

Everybody's

**TELEVISION
and
RADIO
HANDBOOK**



Everybody's

**TELEVISION
and
RADIO
HANDBOOK**

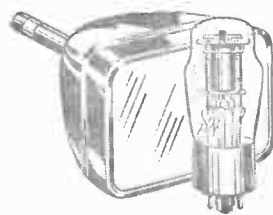

POPULAR SCIENCE PUBLISHING CO., INC.
353 Fourth Avenue · New York 10, N.Y.

COPYRIGHT, 1951
POPULAR SCIENCE PUBLISHING COMPANY, INC.

ALL RIGHTS RESERVED

PRINTED IN THE UNITED STATES OF AMERICA

TABLE
of
CONTENTS

CONTENTS

Why Call a Television Serviceman?..... 9	This Booster Is a Specialist..... 63
<i>Here's how to fix the thing yourself—with care!</i>	<i>A couple of evenings and a few dollars are all it takes</i>
Mike Made from Phono Cartridge..... 14	External Speaker Adds to Auto Radio.... 68
<i>And it has an output higher than most commercial jobs</i>	New Antennas Chase "Ghosts"..... 68
These Parts Put the World at Your	16-Inch Tube Modernizes 10-Inch Set.... 69
Finger Tips..... 15	<i>Changing 1 resistor may be all you need to do</i>
<i>Two coils, switch and condenser add short wave</i>	Servicing Intermittent Radios..... 73
From Triode to Pentagrid..... 18	Socket Pre-mounts Radio Parts..... 73
<i>How three-element tubes work—and what they're for</i>	Warmer Fits Toaster..... 73
Cabinet for Small Set Combined	DC from Your AC Lines..... 74
with Shelf..... 22	<i>Make this low-cost, easily assembled electrolytic rectifier</i>
Pepped-Up Output from B-Supply..... 22	Induction Demonstrated..... 78
Replacing Broken-Off Grid Caps..... 22	Transformer Voltage Ratio..... 78
How to Make Electric Candles..... 23	Homemade DC Motor..... 79
Flashlight Tests TV Lead..... 23	Electric Generators..... 79
What's Inside a TV Doghouse..... 24	Magic with Neon Glow Lamps..... 80
<i>You won't get bitten if you know how to look for trouble</i>	<i>Any radio-supply shop gives you this "genie under glass"</i>
Music Without Knobs..... 27	Pocket Tester from Old Fuse..... 84
<i>Child's phonograph runs itself, can't play too loud</i>	Infra-Red Flatteners for Warped Records 85
High-Gain A.F. Amplifier..... 31	Tube Prongs Make Phone Jacks..... 85
<i>Big volume from resistance-coupled, 2-pentode hookup</i>	Knots Identify Leads..... 85
Rotary Rectifier..... 32	Hanger for Radio Test Leads..... 85
<i>Supplies DC for charging storage batteries</i>	Preheat Chassis for Soldering..... 85
Would a Booster Help Your TV Set?.... 36	Shield for Metal Tube Grids..... 86
<i>How to find out—easily and painlessly</i>	Paint Improves TV View..... 86
"Grasshopper" Spies on Enemy..... 39	Solder "Pencil" Is Easy to Use..... 86
Small Towns to Get TV on Small Waves 40	What You Should Know About TV
News Timer for Your Radio..... 41	Antennas 87
600-Watt Resistance Element Makes	<i>Where you live determines which is best for you</i>
Electric Drier..... 42	Buzzer Wired to Alarm Clock..... 91
File Makes Insulation Scraper..... 42	Clothes on Aerial Turns Rain..... 91
Can Protects Switch..... 42	Handle for Booster Batteries..... 91
Play All Three on Your Old Phonograph 43	Relay Put on Radio-Tube Base..... 91
<i>Convert any record player to all three speeds</i>	Midget Switches with a Hair Trigger.... 92
Make TV Pictures Sound Better..... 46	<i>Get acquainted with these versatile and precise tools</i>
<i>Make push-pull stage that hooks into any receiver</i>	Radio-Phono Bedside Combination..... 96
Radio Makes Group Code Set..... 48	<i>Doubles as a night table besides bringing you music</i>
Shunt Makes Temporary Repair..... 48	Homemade Booster Improves TV
Matchstick Needles Cut Record Noise.... 48	Pictures 97
Shim Helps Repair Thin Wires..... 48	<i>Amplifying distant signals gives you close-by reception</i>
Turntable Simplifies Servicing..... 48	Radio Combination in Wall Bookcase...100
Replacing Worn Volume Control..... 49	<i>Radio and record-player unit fits compactly</i>
Adding Extra Speaker..... 49	Tips for TV Cabinet Builders.....102
Frequency-Test Recordings..... 49	<i>Eight pointers for beauty, efficiency and safety</i>
Replacing Broken Dial Cords..... 49	Your Pocket Can House a Four-Tube
Make Things Obey Your Voice..... 50	Radio103
<i>Voice-operated switches serve many functions</i>	<i>Homemade midget superhet brings in everything</i>
What Ails Your Old Phonograph?..... 56	What Color Does to TV.....106
<i>How to bring that wind-up portable back to shape</i>	<i>It provides pleasure for the audience, problems for producers</i>
Short Pin Improves Portable Lid Hinge 58	Amplifier Circuits and How They Work 110
Fiber Tool Adjusts Condensers..... 58	<i>Basic electronics lore shows workings of complex rigs</i>
Oil Solution Cleans Crackle..... 58	High-Gain Amplifier Makes
Tire Pump Dusts Radio Chassis..... 58	Two-Way Communicator.....113
Diagram on Set Speeds Repairs..... 58	<i>Resistance-coupled audio amplifier steps up output</i>
Are You Using Chassis Punches?..... 59	
<i>They make big holes, any shape, out of little ones</i>	
Radio Builder's Crystal Kit..... 60	
<i>Make this kit for your favorite small-fry radio ham</i>	

Channels in antenna inches - 137

How to Splice TV Lead-in Lines.....	114	Turntable Swings Small Radio to Peak Signal.....	160
Penholder Makes Radio Tool.....	114	<i>Finger-tip screwing action gives directional effect</i>	
Jot Service Notes on Diagram.....	114	Save Money—Make Your Own TV Cabinet.....	161
Tweezers Make Fine-Wire Stripper.....	115	<i>How to economize, whether you're buying or converting</i>	
Pipe-Plug Reaches Out-of-the-Way Outlet.....	115	Power Unit Plugs into Chassis Socket.....	162
Underwriters' Knot.....	115	Remote-Control Tractor.....	162
Pipe Cleaner Separates Wires.....	115	Lightning vs. Television.....	163
Keeping Chips Out of Radio Chassis.....	116	<i>Does the antenna mean danger? Here's what to do about it</i>	
Deep Cabinet Made of Narrow Lumber	116	Spark Coil.....	164
Brighten the TV Tuning Knob.....	116	Fluorescent Works on "Open" Circuit.....	164
Marks Make Readjusting Less Risky.....	116	Electronic Smoke-Precipitator.....	165
TV Color "Sampler" Costs Only \$8.....	117	Sparks Perforate Paper.....	165
<i>This simple rig uses only parts from the scrap-box</i>		Voice-Operated Fluorescent Light.....	165
Color Unit for Small Set.....	119	Electric Bell Rouses Sound Sleepers.....	166
Combination Cabinet Houses Radio and Clock.....	120	Flush-Tank Guide Makes Handy Ground Connection.....	166
Glow of "Candle" Keeps Time to Music.....	120	Wire Fished with Folding Rule.....	166
Your Body Is Part of Test Circuit.....	121	Is Foreign Radio Equal to Ours?.....	167
Phono Record Calls Radio Ham.....	121	Servicing Your Radio.....	169
Photo Meter Checks Circuits.....	121	<i>How to use color-coding to simplify your job</i>	
Quarter-Round Conceals Wires.....	121	Automatic Tune Switch Has Scores of Uses.....	170
Better Tone from Table Radios.....	122	<i>Clock-driven drum controls anything electrical</i>	
<i>How a discarded console speaker helps portable</i>		How to Double Your Radio's Usefulness	172
Best Ways to Mount TV Antennas.....	123	<i>Inexpensive, self-controlled extension gives extra uses</i>	
<i>How long you get a good picture depends on the antenna</i>		Replacing Line-Cord Resistors.....	174
Pine Washstand Holds Phono-Radio.....	127	Walkie-Talkies.....	174
<i>Make this set to harmonize with pine furnishings</i>		Midget Condensers.....	174
How to Photograph Fights via Television	128	New Tuner Adds Radio to TV.....	175
<i>Double your TV enjoyment by capturing it on film</i>		<i>This tuner lets you hear FM on TV—and helps the TV, too</i>	
Learn to Shoot with Light.....	132	Portable Interphones.....	177
<i>Electronic gun makes plaything for the youngsters</i>		Quick Wire-Splicing.....	177
Midget Neon Bulbs Make Pilot Lights.....	135	Open-Blade, Snap-Action Switch.....	177
Power Pack from Discarded Tubes.....	135	Coreless Fluxed Solder.....	177
Toughening Thread for Dial Cables.....	135	Sensitive High-Temperature Thermostat	178
Sealed Relays.....	135	<i>Controls temperature within close limits</i>	
How to Fish for More TV Stations.....	136	Giving Radio Its Voice.....	180
<i>How to make rabbit-ears, lead-in wires, etc.</i>		<i>How sounds are impressed on radio-frequency waves</i>	
Seats Built into TV Set.....	138	Oscillators—Tuning Forks of Electronics	184
<i>Homemade cabinet holds table model, offers storage space</i>		<i>How tubes generate high-frequency currents</i>	
Simple Rig Picks Up Phone Conversations.....	144	Amplifiers—Magic Levers of Electronics	188
Gripper Keeps Tubes in Place.....	144	<i>Circuits that respond to all frequency ranges</i>	
Extension Leads for Radio Batteries.....	144	How to Hush Your TV Set.....	190
How to Improvise a Signal Generator.....	145	<i>How to get away from the kids' noise as well as pictures</i>	
<i>Align circuits with record-player and another set</i>		Glow Shows TV Misalignment.....	192
Workshopper's Tricks Tickle TV Audiences.....	147	"Ham" TV Station.....	193
<i>Behind the scenes on workshop-TV show</i>		<i>War-surplus parts make simple TV transmitter</i>	
Starter Repair for Induction Motor.....	150	Old Phonograph Plays a Different Tune	197
Nail Clippers Strip Wire.....	150	<i>Convert that old hand-me-down into a useful record-player</i>	
Pump Motor.....	150	Cigar-Box Tesla Coil.....	198
Feed-Through Cord Switches.....	150	<i>Make this simple rig for high-frequency work</i>	
Summer-Winter Radio.....	151	TV Set "Sees" Color Pictures.....	203
<i>Changing case makes indoor table model, outdoor portable</i>		<i>\$4 worth of parts make this color-TV unscrambler</i>	
Hidden Fuses Protect TV Sets.....	153	Heat Restores Weak Radio Tubes.....	206
How to Stop TV Interference.....	154	Substitutes for Spaghetti Tubing.....	206
Hide a Radio in a Skillet.....	156	Heater "Unfreezes" Stuck Turntable.....	206
<i>Miniature parts make this 5-tube kitchen superhet</i>		Snarl-Proofing Your Dial Cord.....	206
		Guard Fingers Against Tube Heat.....	206

"Printing" Radio Sets.....	207	Compact Soldering Transformer.....	235
<i>Stenciled circuits work space-saving wonders</i>		<i>Salvaged wire from junked parts make this handy tool</i>	
Inside the Color TV Sets.....	210	Simple TV Lightning Arrester.....	238
<i>How the color receivers do their job</i>		Phone Jacks Made of Tubing.....	238
New Trap May Brighten TV Pictures.....	212	Enlarging Your TV Pictures.....	238
TV Cabinet Conceals Bar.....	212	Nontip Base for Small Torch.....	239
Make Lightweight Plastic Record-Pickup Arm.....	213	Solder Chips Mixed with Flux.....	239
Grooving Rig for Home Recorders.....	213	Test Outlet Protects Fuses.....	239
No Harids, No License Needed!.....	214	Suction Clip Makes Small-Parts Vise.....	239
<i>Radio controller operates anything, needs no license</i>		Shaver Operates Off Car Radio.....	239
Curing Noisy Volume Control.....	219	Recharger Peps Up Flashlight Cells.....	240
Locating High-Voltage Leaks.....	219	<i>Scrap parts make this simple dry-cell charger</i>	
Test Uses for Resistor Bridges.....	219	Filters Cut Fluorescent Static.....	242
Radio Question Bee.....	220	Floating Arm Adapted to Mike.....	242
<i>Can you name these familiar radio parts?</i>		Clamps Hold Radio to Bench.....	242
How to Light a Room for Television.....	222	Tape Shields Tube Numbers.....	242
<i>Your giant screen may be wasted if room lighting's wrong</i>		Tiny Resistors Are Accurate.....	242
Boost Radio Batteries on Home-made Charger.....	224	Coil Form Is Easily Tapped.....	242
<i>Simple charger operates on house current</i>		Transformer Regulates Motors.....	243
8 Tips on Choosing a TV Set.....	225	Commutator Seats Brushes.....	243
<i>These easy-to-make tests let you get your money's worth</i>		Tube Supports Soldering Iron.....	243
Graph Adds Parallel Resistors.....	229	Hams Are Radio's Vanguard.....	244
Inlay Decorates Radio Panel.....	229	<i>Amateurs still improve the industry they created</i>	
Switches Act as Door Lock.....	229	Wireless Wiring for Radios.....	249
Radio-Frequency Power.....	230	<i>Stamped circuits replace wiring mazes</i>	
<i>Radio's heavy-duty job offers challenge</i>		Contact Mike Boosts Music.....	250
One-Tube Radio Can Be Mailed.....	234	Automatic Volume Control.....	251
<i>Subminiature tubes make this flat novelty receiver</i>		<i>Duplex-diode unit modernizes old superhets</i>	

NOTICE TO THE READER

The editors have endeavored in this book to present the latest, most up-to-date, useful radio and television projects and ideas. All material and directions have been checked and rechecked for accuracy and ease of application.

Nevertheless, success and safety in radio and television construction or repair depend to a great extent upon individual accuracy, skill and caution. For this reason, the publisher is not able to guarantee the results of any project contained in this book, nor to be responsible for any damages to property or injury to persons occasioned through their production. Persons constructing these projects do so entirely at their own risk.

Everybody's

TELEVISION

and

RADIO

HANDBOOK



Protect yourself by wearing gloves and covering your eyes when you handle a picture tube. Hertzberg wears same goggles he uses when he sharpens tools on a power grinder.

Why Call a Television Serviceman?

Your chances of fixing the thing yourself may be much better than you think — but don't wreck it!

By Robert Hertzberg

“WHAT? Fix something with all those tubes in it? Not me!” That's what a lot of TV-set owners think. So television servicemen make thousands of trips that aren't really necessary.

A television set is complicated. But so's your auto. And that doesn't stop you from cleaning spark plugs. If you were equally familiar with your TV set, you could save other men's time (and your money) in similar ways.

Trouble outside of the cabinet is often responsible for a set's antics. Servicemen frequently collect a fee for simply shoving a line plug

Don't guess! Study the manufacturer's service data carefully, and be sure what you are doing before you poke around in a TV set. Note, too, how the author keeps picture tube covered.



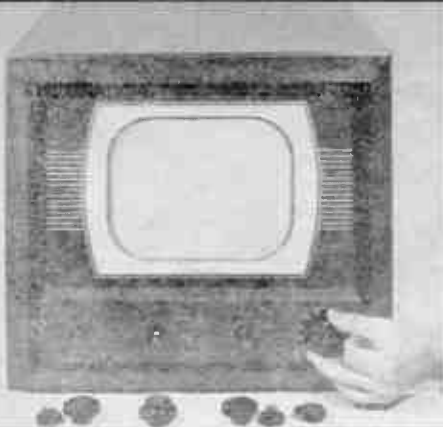

1. First step in taking a chassis out of set of this type is to pull off front knobs.

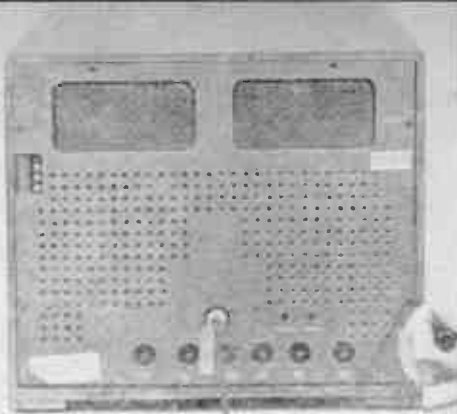

2. Safety cover on back is then unscrewed. Power plug (center) comes out with back.

Removing the chassis from a set like this is easy...

3. Bottom bolts that hold the chassis in the cabinet then are removed to release it.

4. Thus freed from woodwork, chassis can be slid out without disturbing anything on it.

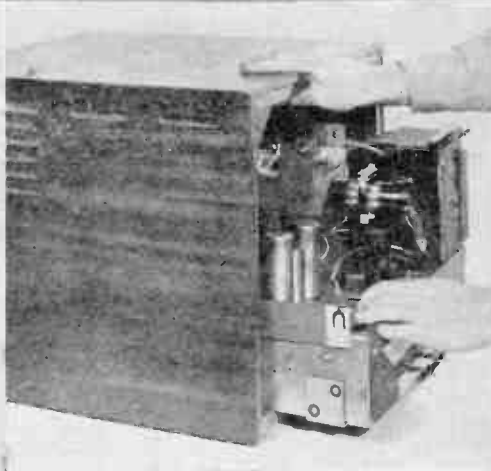

back into a wall receptacle. Moving a set around to change the viewing angle may loosen its plug without anyone's suspecting it. This also may loosen the lead-in from the antenna.

Anyone who can fix a doorbell can find and fix breakdowns outside of a set. First, be sure that the power line is okay. Then see if the lead-in still is firmly attached both to the set and the antenna arms. Note, too, whether the antenna is still the way it was before you had trouble—that's often the trouble. Then see if the lead in has been bruised. Though tough, its thin wires can be fractured—and you may only need a new piece of lead-in.

Trouble inside the set calls for some knowledge of what's there. The best time to find out is before the trouble occurs, and

the best way is to study the manufacturer's service data for your particular set. If you can't get a copy from the manufacturer, try any of several book publishers who put out radio-TV service manuals. No one should tinker with his set without these service notes.

Tube failures occur more often than any other kind of breakdown. Tubes can be changed without disturbing the wiring or adjustments. Simply switching tubes of the same type will sometimes make a set work better. And a fresh tube sometimes will compensate for minor trouble in some other part of a circuit. The service notes can be used to locate both the tubes and circuits responsible for various kinds of trouble.

Many servicemen do not even take a tube tester with them when called to fix a



1. This cabinet supports front of picture tube and must first be opened from the top.



2. Safety mask, fastened from inside, then can be removed to make tube accessible.

... But disassembling a set like this is tricky.

3. Tube socket and ion-trap magnet must come off—and be put back in same position.

4. High-voltage lead from "doghouse" must be pulled off flared side of big tube.



set that has suddenly balked. They simply take a few hand tools and a carton of tubes, check the external details, then yank the chassis out, and look at the tubes.

Removing the chassis from most of the newer sets is quite simple. The picture tube is supported by a ring or frame attached to the chassis, the loudspeaker is simply plugged in, and the power line is run through the perforated safety cover on the back of the set in such a way that removing the cover disconnects the power. Loosening a few bolts enables you to slide the chassis out.

Sometimes, however, the picture tube is mounted in a basketlike frame that is structurally independent of the chassis. The chassis of such a set can be freed without removing the tube.

And in some older receivers the neck of the tube is supported by the chassis and the picture end by the cabinet. So the cabinet must be opened carefully and the tube removed before the chassis can be taken out. This is a pretty tricky job for a novice.

It's dangerous to rush into any set without first taking precautions. Get the children out of the room, because the big picture tube is susceptible to *implosion* from atmospheric pressure if its surface is nicked or hit sharply. Modern tubes are made of well-tempered glass and there have been few accidents with them. But they are not playthings.

If the picture-tube supports are part of the chassis, keep the tube covered with a bath towel. If the tube is supported by a



Heater testing can be done with any earphones and dry cell. If you hear a loud click when you touch correct base pins (consult a tube chart or the circuit diagram), the filament inside is okay. Otherwise, tube is burned out.

separate basket, leave it in the cabinet. If it's the kind that must be removed, place it face down on a soft cloth in a safe spot.

You will probably be tempted to twiddle some of the dozens of little adjusting screws that stud the chassis. But don't touch them unless you are sure you know what you are doing. Concentrate instead on the tubes, their markings, positions, and functions.

To simplify troubleshooting, the large diagrams in service notes usually are sectionalized. By studying the set and the

diagrams, the trouble usually can be localized. It is also helpful to have your tube sockets identified on your chassis. You can mark them with a grease crayon or adhesive-tape labels. Use the same symbols shown in the wiring diagram, and add the tube type number and function. For instance: V-5, TYPE 6AU6, 1st VIDEO AMP.

Nearly all of the tubes now used in TV receivers slide straight in and out of flat wafer sockets. Do not twist or turn them. Some are held by springs that grip the base and these springs must be pressed down to free the tubes. The larger tubes, of the "loktal" and "octal" types, have keyed bases; the miniatures have no bases at all, but the pin spacing orients them in their sockets.

It helps to know whether tubes are wired in parallel or series. A tube in a parallel circuit can burn out without affecting the others, but if one goes dead in a series circuit the whole string stops working. Both kinds of circuits are frequently found in TV sets.

Study the schematic diagram in your service notes that shows the actual connections of components and look especially for the wiring of the heaters, or filaments, of the tubes.

To light up the tubes while the chassis is out, servicemen connect it to a wall receptacle with a separate cord called a "cheater." If you use one, don't touch anything while the power is on.

Note how the glass tubes glow when the

TV TROUBLESHOOTING

If sound is okay but picture:

Look first for a defect in the:

Disappears and a bright horizontal line appears.

Vertical sweep circuit.

Disappears and a bright vertical line appears.

Horizontal sweep circuit.

Bobs up and down.

Vertical synchronizing or sweep circuits.

Darts from side to side.

Horizontal synchronizing or sweep circuits.

Folds over horizontally.

Damper tube.

Background is unstable.

DC restorer tube.

Grows larger and loses focus.

High-voltage rectifier tube.

FOR YOUR POPULAR SCIENCE INFORMATION FILE

set is working normally, and you will often be able to spot defective tubes simply by looking at them. Metal tubes must be felt. Turn off the switch and disconnect the cheater after the set has warmed up, and then see if these tubes are warm. This is not always a reliable test, as some tubes run on the cool side, but it's better than no test.

The high voltages that scare many people are seldom lethal (because the amperage is low), but must be treated with respect. The high-voltage compartment is known as the "doghouse." It delivers between 5,000 and 15,000 volts to the picture tube through a fastener on the flared part of the tube. *Never put your hand into the doghouse with the power on!*

A tube with a burned-out filament should be discarded. This heater circuit can be tested quickly by touching the heater pins on the removed tube with prods that are in series with earphones and a dry cell. You'll get a loud click if the filament is good. If your service notes do not identify the base-pin connections, get a tube chart.

Even though the heater is perfectly good, a tube may not work properly or work at all in a particular spot. Try another tube of the same type and see what happens. If you don't want to buy a new tube until you're sure, perhaps you can borrow one.

The shortest-lived tubes are usually the rectifiers in the power supply. They carry a lot of current, are subject to high voltages, and run pretty hot. Deterioration

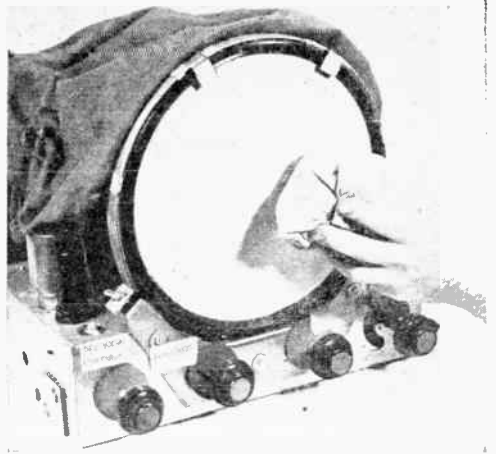

Cleaning the face of a picture tube often brightens pictures. Warmth and voltage attract dust and soot to the tube. Hertzberg cleans his every 60 days. Both sides of safety glass often need cleaning, too.

shows up most quickly in the tubes used in the synchronization and sweep circuits. The most critical circuit position is that of the oscillator in the tuner section. A tube that doesn't produce any results at all there may work fine in an amplifier stage.

The picture tube usually outlasts the small ones, but its fluorescent coating may burn out before its heater does.

If your set still won't work, or works poorly, after you've checked the power line, the antenna, the lead-in and the small tubes, you need not feel apologetic about calling in a serviceman. **END**

TV TROUBLESHOOTING

When sound is gone and screen is dark, look for trouble in low-voltage power.

When sound is gone and picture is okay, examine the audio circuits.

When sound and picture are gone, but the screen is bright, check the antenna, RF tuner, and intercarrier IF.

When sound is okay, but picture acts up, trouble may be in high-voltage power, synchronizing circuits, low-voltage power, or dual-channel video IF.

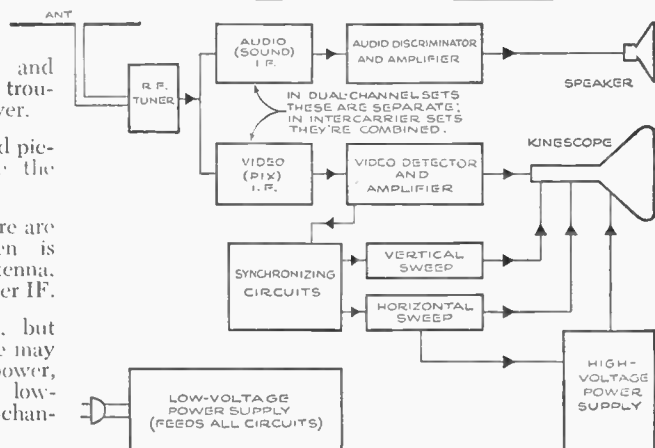

FOR YOUR POPULAR SCIENCE INFORMATION FILE

Mike Made From Phono Cartridge

OLD phonograph cartridges contain the makings of pretty good microphones, as I discovered when I needed a mike for testing an amplifier and recorder.

The Rochelle-salt crystal units of both mikes and pickups do the same job of converting vibrations into volts. To make a discarded cartridge responsive to sound waves I proceeded in this way:

I drilled out the rivets holding the cartridge shell together, carefully separated the halves, removed the crystal unit, and sawed off the tops of both shell halves. To one of the fingerlike projections on the crystal unit I cemented a wire lever.

For the microphone case I used a small solder container, cutting an opening along the bottom edge to pass the connecting wires. The diaphragm is a disk of cigarette-package tin foil with the paper soaked off. It is pressed over the projecting wire lever, and cemented around the edges of the can. At the point where the lever pierces the foil I added another drop of cement. To let sound reach the diaphragm, I cut away most of the can lid and cemented a piece of loud-speaker grille cloth around the opening.

A shielded single-conductor wire connects the mike to the input of an amplifier. The center wire goes to one lug on the cartridge and the shield to the other. I also soldered a connection from the shield to a bare spot on the can. As a final touch I coated the outside metal with black lacquer.

Output of this microphone is somewhat higher than most commercial jobs. I haven't tested it for sensitivity or frequency range, but on several amplifiers and recorders it passed the ear test with flying colors.—*Norman J. Pederson, Seattle, Wash.*

Cartridge is mounted in a solder can. The foil diaphragm is cemented to lever at point of contact and pressed down around edges of can.

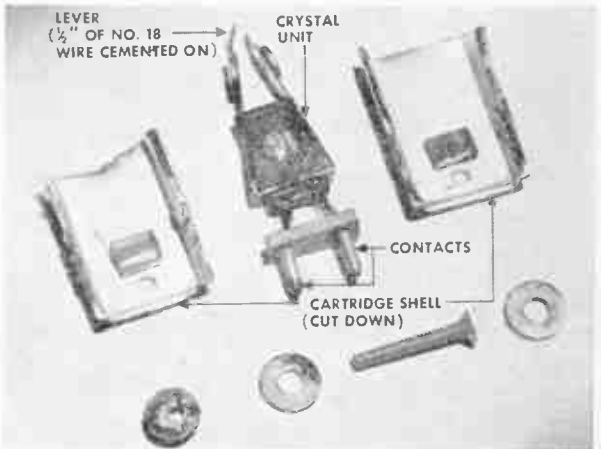

Drilling out rivets permits shell and crystal to be disassembled. The shell is cut down and a wire lever is cemented to the crystal.

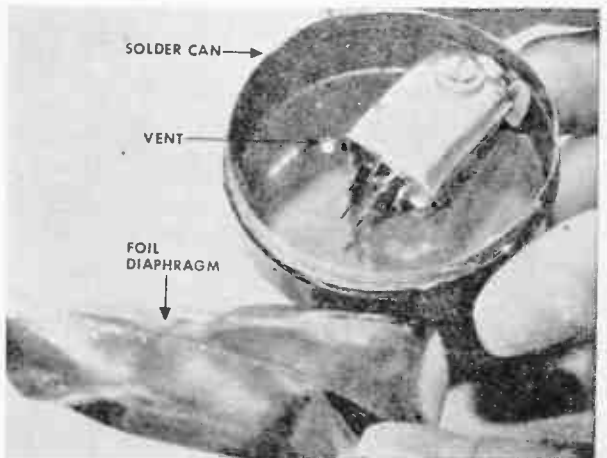



Two homemade coils, a band switch, and a condenser can add short waves to many postwar radios.

These Parts Put the World at Your Finger Tips

WOULD it be worth \$2 to you to hear Europe, Africa, China, and other distant points on your radio?

That's all it costs to add a short-wave band to most postwar AC-DC receivers. And you can do it without affecting the normal working of the set in any way. There are no new tubes to buy and no complicated circuit changes. The only parts you need are a two-band switch, a condenser, and a couple of easily made coils.

First thing to determine is whether your set can be converted easily. It can if it uses the conventional AC-DC circuit employed

in most small receivers built since 1942. These sets have a loop antenna and five tubes, one of which is a 6SA7, 12SA7, or 12BE6. The last is a 7-pin miniature used in very compact models.

Other tubes in the line-up are usually a 6SK7 or 12SK7, a 6SQ7 or 12SQ7, a 50L6, and a 35Z5. In the miniature line they will probably be 12BA6, 12AT6, 50B5, and 35W4. You may run into some variations in these tubes, depending chiefly on the date of the set. For example, the 6AV6 or 12AV6, the 35B5 or 35C5, and the 50C5 are alternatives in the miniature sets. ▶

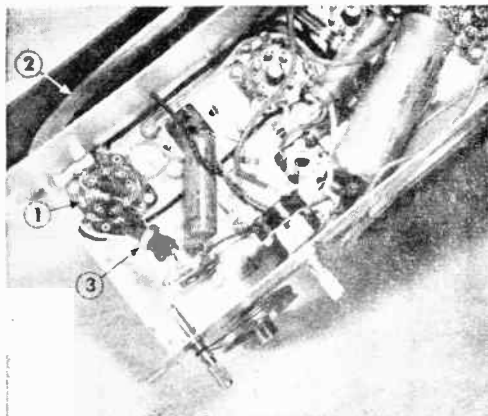

Remove the radio from the cabinet and locate the parts you will have to deal with. These are the oscillator-tube socket (1), loop antenna (2), oscillator coil (3) and the tuning condenser, which is on top of the chassis. The condenser has two sections, or gangs, and in most cases one will have larger plates than the other. The smaller gang tunes the oscillator section; the larger is the antenna-tuning condenser. Oscillator coils come in many different shapes so you may not recognize yours immediately. If you're in doubt, check the wiring. The coil has three wired terminals. One goes to ground (on some sets it's the chassis; on others a heavy bus wire is used as a floating ground). A second lug is connected to the oscillator-tuning condenser. The third is wired to the cathode of the oscillator-mixer tube (pin 6 on the 6SA7 or 12SA7; pin 2 on the 12BE6).



Before you commence the wiring, install the band switch. This is a 4-pole, double-throw unit. (Actually you need only three poles, but these are harder to get than the 4-pole type.) The conventional ones will be too large for most receivers, so shop around for the smallest switch you can find. The smaller one of the pair at left measures about 1 1/2" across the base. It is handy to bring the switch out the front of the chassis (which requires drilling a new hole in the cabinet), but if space doesn't allow, you can place the switch toward the side or back.

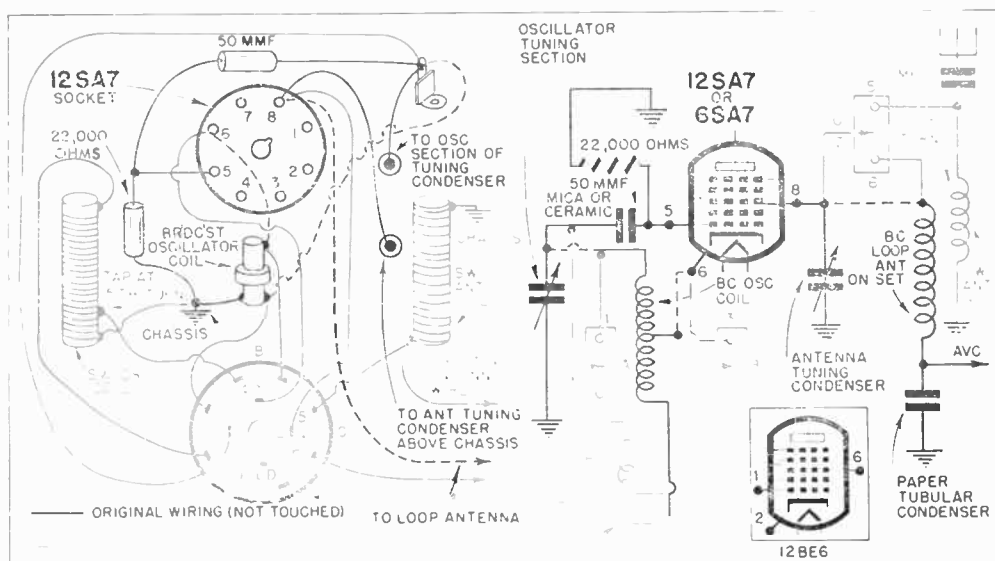

When the switch is mounted you're ready to start the wiring. One of these diagrams is pictorial, the other schematic, but both show the same things. Broken lines in both diagrams show connections that have to be removed. First cut or unsolder the wire that goes from the oscillator coil to the cathode terminal of the tube socket. Also break the connection between

the coil and the oscillator-tuning condenser. The third lead that has to be cut goes from the loop antenna to grid No. 3 of the tube. The next step is to restore all these connections exactly as they were except that they now go through the switch. You should be able to plug the set in and play it the same as before if the switch is turned to the correct position.

Now start on the short-wave coils. To make them you need a couple of inches of $\frac{3}{8}$ " plastic or similar tubing and some No. 18 enameled wire. Drill small holes through the tube walls to bring the wire ends through. For the antenna coil wind 17 turns on a $1\frac{1}{2}$ "- to 2"-length of tubing. The oscillator coil takes 21 turns on a similar length. At the fifth turn scrape a bare spot through the enamel and solder on a piece of wire as a tap.

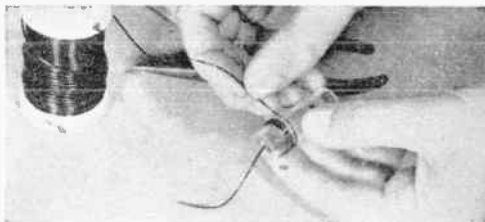

Fit the coils in under the chassis. They are light enough to be supported by their own wires. Ground one side of each coil. Either end will do on the antenna coil but on the oscillator it must be the one nearer the tap. Connect the remaining terminals to the switch as in the diagrams. In one switch position you have regular broadcast reception; in the other, short-wave reception. Connect a 25' hank of wire for a short-wave antenna, inserting a protective .01-mfd. paper condenser in series with it.

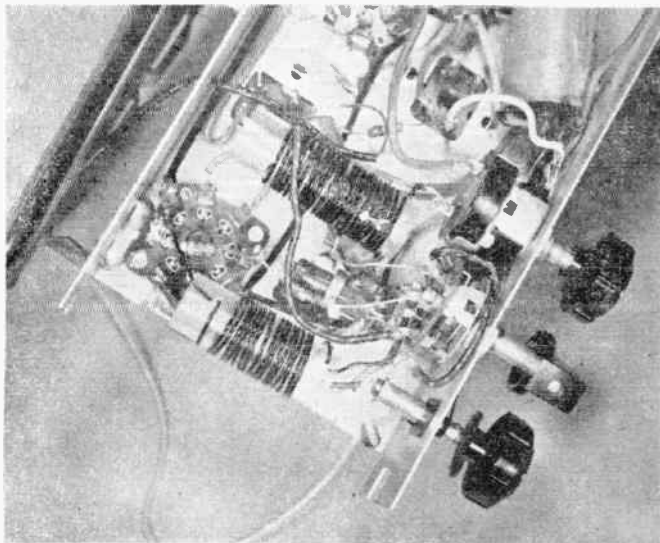

Here's the front panel of the finished set, now a two-band receiver. Often only half the dial is used for broadcast-band calibration, so you can use the other half for short-wave markings. In this case a piece of cardboard was pasted over the lower half of the dial and calibrated in both meters and megacycles. A signal generator could be used for scale marking, or you can listen for station and frequency identification. The set covers 17. to 40 meters.

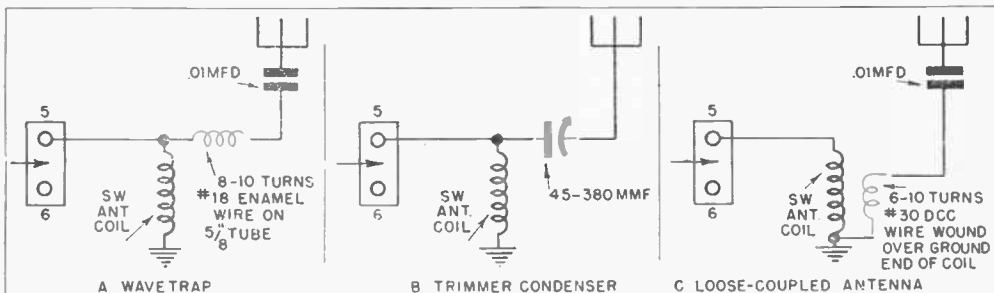
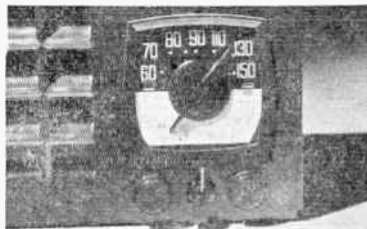

If you live very close to a regular broadcast transmitter, you may be troubled by "break-through," that is, hearing the nearby station on your short-wave receiver. If so, you can increase selectivity by the methods above. Shield-

ing the coils may also help. Slip the cardboard sleeve from a flashlight cell over a coil and wrap tin foil around it. Solder a ground connection to the foil, and then wrap it with insulating tape to prevent accidental shorts.

From Triode

HOW THREE-ELEMENT TUBES

tor, if this is an earlier stage in a resistance-coupled amplifier) must be connected in the plate circuit so that the plate current will flow through and activate it. Let us imagine that 1 milliamperere is flowing through the tube and this load resistance, whatever its nature. In other words, the power-supply voltage of 250 volts is sufficient to force 1 milliamperere through the total resistance of the plate circuit at this moment. Part of this resistance is the tube itself; the other part is the load.

Part of the potential of 250 volts is therefore expended in overcoming the resistance of the load; the remainder is applied to driving the current through the tube. The voltage necessary to force a given current through a resistance is called the voltage drop; it represents a loss in potential across that resistance and can be found by multiplying the current in amperes by the resistance in ohms, the product being expressed in volts.

Assuming a reasonable value of 100,000 ohms for the load in this circuit, and a current of 1 milliamperere, the voltage drop across this resistance is 100 volts. Therefore the potential applied to the plate is actually this much less than the 250 volts supplied.

FIRST STEPS IN ELECTRONICS



Limited only by cost and circuit complications, a pentode, such as the one shown at left, is almost always used when the amplification required is great

Amplification in a tetrode, like the one at right, is also great, but the pentode is now largely taking its place.

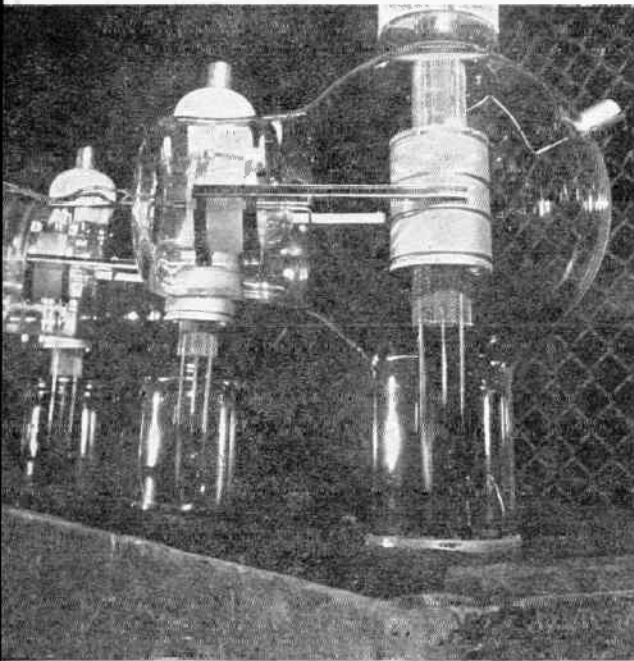

Courtesy Westinghouse

High-frequency transmission tubes like these keep the Navy's land stations in touch with our fighting ships

ADDING a grid to the diode gave electronics the triode, a tube of such sensitivity and usefulness that any further development might at first thought seem superfluous. Yet modern electronic devices, including the home radio, make use of four, five, and even seven-element tubes. Are these extra electrodes added merely to make tubes more complicated, or are they truly improvements on the simple but practical triode?

The answer lies in the fact that the triode is mechanically simple but extremely complicated from an electrodynamic viewpoint. It has, for example, two grave faults that limit its usefulness as an amplifier.

We have seen that the current passed by a triode varies with three things: the heater temperature that governs cathode emission, the plate voltage that attracts the emitted electrons, and the charge on the grid. But ideally only one of these should affect the tube current—the grid potential. We can maintain the heater temperature within close limits, so it offers no trouble. The grid potential necessarily varies with the incoming signal. We can also supply a fairly constant plate current. A typical amplifier circuit with these elements is shown in Fig. 1 of the drawings.

The loudspeaker (or the plate resis-

to Pentagrid

WORK . . . AND WHY SOME IN YOUR RADIO HAVE SEVERAL GRIDS

If, now, the grid of the tube becomes less negative in response to the signal, more electrons and therefore more plate current will flow. Suppose that this is now 2 milliamperes. Immediately the voltage drop across the load is 200 volts instead of 100, and only 50 volts is applied to the tube. This lower plate potential means that fewer electrons will be drawn from the cathode, and the plate current will promptly decrease. The result is that we do not obtain the amplification that would be justified by the original change in grid potential; the tube does not respond faithfully to signal variations because changes in plate voltage tend to cancel out changes in grid voltage.

This takes place, of course, at a certain critical point below which the tube performs well. Nevertheless, this inherent characteristic limits the amplification that can be obtained from a triode.

It is limited also by the second fault. Small as they are, the grid and the plate form the two plates of a tiny condenser, with a minute but quite measurable capacitance. If the grid is charged with electrons, these will repel a like number of electrons from the plate, as surely as in the case of any other condenser. Similarly, a charge on the plate induces a charge on the grid, and

changes in the plate potential will induce changes in the grid charge. But a change of charge on the grid during normal operation will change the plate-current flowing across the tube and, therefore, the plate voltage.

Consider what happens if a slight accidental disturbance of the plate current lowers its voltage by .1 volt and this causes a change of only .001 volt in the grid potential. If the tube amplifies 200 times, that change in grid voltage immediately changes the plate voltage 200 times .001 volt, just as any other voltage of that magnitude applied to the grid would. But that means a change of .2 volts in the plate potential, twice as much as the original accidental change. In turn, this induces a .002-volt change in the grid charge, which causes a .4-volt change in the plate. But this again induces a .004-volt grid change, and so forth, until the tube goes into oscillation, bouncing those self-induced charges back and forth at a rate dependent on the values of resistance, inductance, and capacitance in the circuit, and becomes useless for anything else.

Of course, so long as the amplification factor of the tube is less than 100—that is, less than the capacitance, or the coupling ratio between grid and plate—it won't oscil-

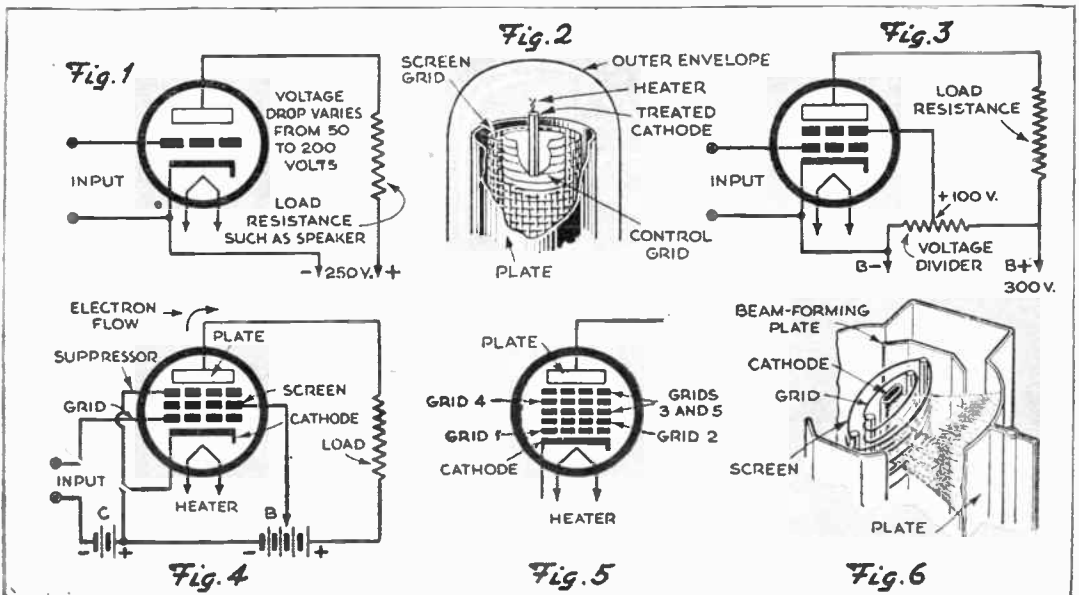

late. Or, if that coupling effect is reduced so that a 1-volt plate change causes only, say, a 1/1,000-volt grid change, an amplification factor of 1,000 times is possible.

The addition of a screen grid between the control grid and the plate overcomes both these faults of the triode in a very large measure. The tetrode tube has that screen as its fourth electrode, as shown in Fig. 2.

Figure 3 shows a typical tetrode amplifier circuit. The screen separating the control grid and the plate practically eliminates the condenser effect between them; fluctuations of plate voltage have far less effect on the grid, and much greater amplification is possible without having the tube go into self-excited oscillation.

Furthermore, the screen cuts off the plate's attraction for electrons near the cathode; the plate can no longer have much effect on the electrons emitted, and hence no great effect on the strength of the electron current, which now depends on the potentials of the screen and control grids almost exclusively. But although electrons are accelerated from the cathode to the screen by the positive voltage applied to the latter, they are not stopped by the screen. Almost all flow through it and reach the plate.

Since the screen is connected directly to a source of potential, there is no voltage drop, and the charge on the screen does not vary greatly with the plate current. True, there is a condenser effect between control grid and screen grid now, instead of between grid and plate, but there is no amplification of induced potential changes, which are therefore very small. The result is that, whereas triodes are limited to an amplification gain of about 100 times, tetrodes can amplify several hundred times.

But the tetrode has one drawback. Ideally, changes in plate voltage should effect no changes whatever in the plate current; grid voltage alone should do that. What makes the tetrode fall short in this respect is secondary electron emission.

It was previously shown that one way to get electrons out of metal is to blast them out by bombardment with other electrons. If an electron, accelerated to tens of thousands of miles per second by 100 volts of potential, crashes into metal, it may knock from two to 10 secondary electrons out of the metal atoms like chips of broken rock flying up at the impact of a high-velocity bullet.

If the screen of a tetrode is at 100 volts, and the plate of the tube is also at 100 volts with respect to the

cathode, electrons drawn across the tube will, for the most part, miss the fine wires of the screen and hit the plate. The impact will knock out secondary electrons with considerable violence. If the screen and plate are at the same voltage, some of these secondary electrons will be collected by the screen instead of falling back to the plate. Since that constitutes a flow of current from plate to screen, it diminishes the total plate current available outside the tube. If the screen is at 100 volts, and the plate falls to 80 volts, nearly all the secondary electrons will go to the screen, causing a marked drop in plate current. The effect is decidedly annoying except in certain special applications. Luckily it can be eliminated.

If a third or suppressor grid is placed between the screen and the plate, we have the modern pentode amplifier, shown in Fig. 4. It is so satisfactory that the tetrode has been almost entirely abandoned; the triode continues in use because of the simplicity of its circuits in low-frequency amplifiers and because of special advantageous properties at extremely high frequencies. The suppressor is simply another fine-wire structure which in some pentode tubes is connected within the tube directly to the cathode, and in others is supplied with a base pin which permits it to be so connected externally or used in some other way for special applications. Being strongly negative with respect to the

LOW-AMPLIFICATION TRIODE CURVES

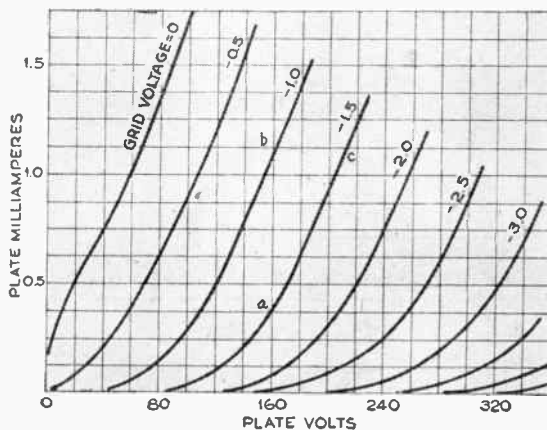

To increase plate current from a to b with the plate at 160 volts, a .5-volt change in grid voltage is needed, while to obtain the same plate current at the original -1.5-volt grid potential, as at c, plate voltage must be increased to 210 volts. Since a .5-volt grid change increases plate current the same as a 50-volt change in plate potential, the tube amplification factor is 100

plate, the suppressor promptly drives any secondary electrons back to the plate. One of the graphs shown here indicates how nearly independent of plate voltage the plate current is. Compare this with the triode and tetrode curves.

Pentagrid mixers and converters are actually tetrodes with a triode element inserted in the electron stream. In Fig. 5, a schematic arrangement of a pentagrid type is shown. Grids 1 and 2 constitute the grid and plate of a triode, which can be connected in a regular triode oscillator circuit. This will impress on the electron stream flowing through the tube an oscillation, but grid 4 can be used to control this electron stream further. Grids 3 and 5 act as shielding grids to prevent the voltage applied to grids 1 and 2, or the plate-voltage variations, from affecting grid 4. This tube can be used to mix two different frequencies, or it can serve as a combined oscillator mixer. If radio-frequency oscillation is applied to grid 1 and an audio-frequency voltage is applied to grid 4, an audio-frequency-modulated, radio-frequency plate current results.

One more important tube type is the beam-power tube, a type of power-output tetrode that, because of mechanical design and shaping of the electrodes, is a "virtual pentode" in which the suppressor grid is replaced by space-charge effects.

Figure 6 shows the typical beam-power

tube structure. The wires of the control grid and the wires of the screen grid are carefully arranged in such a fashion that the spaces between them, through which the electron streams must flow, are aligned. Each screen-grid wire is directly behind a control-grid wire. The result is that the electrons flow across the tube in sheets or beams like sunlight falling through a barred window. Since most beam-power tubes are designed to handle comparatively heavy currents, these beams consist of trillions of electrons; the space-charge effect they produce is quite intense and is equivalent to that of a regular grid charged to a strong negative potential. The result is that secondary electrons emitted by the plate are hurled back.

A typical beam-power tube, the 6L6-G, can handle as much as 300 milliamperes at 100 volts; two used in push-pull are frequently used for small radio transmitters, for high-power audio-frequency amplifiers, or in small induction-heating devices, since they can develop about 50 watts of power at any frequency from 10 to 10,000,000 cycles.

Many single tubes contain nine, 10, or even more electrodes, but generally they are simply combinations of two or more tubes in one envelope. Thus a 6SQ7, listed as a "duplex-diode hi-mu triode" is simply an ordinary triode amplifier in the same envelope with two small diode rectifiers, all using the same cathode.

PERFORMANCE OF THE TETRODE

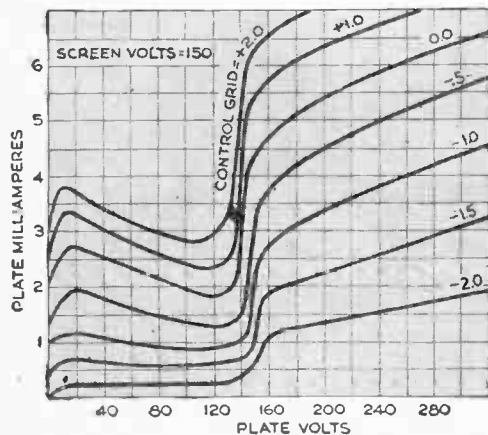

So long as plate voltage is higher than screen-grid voltage, a tetrode has a high amplification factor, but, with a heavy plate current, voltage drop may reduce the plate potential to that of the screen grid, at which point the output is distorted, as shown by sharp slopes on the graph. This is due to secondary electrons the screen draws from the plate

PENTODE CHARACTERISTICS

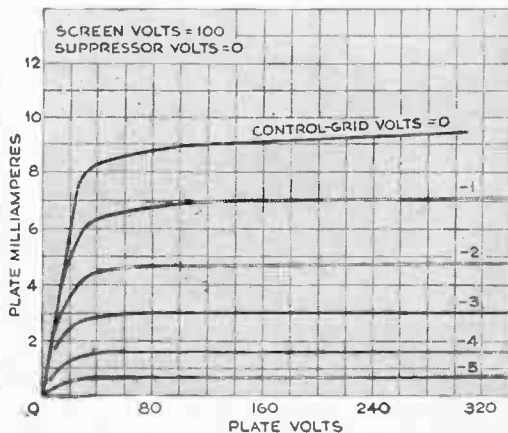

Pentode curves are smooth and almost flat and parallel. A 100-volt change in plate potential produces only about the same increase in plate current as a .1-volt grid change would cause. The amplification is therefore on the order of 1,000, as indicated by the almost imperceptible slope on this graph of a 6SJ7 voltage amplifier



Cabinet for Small Set Combined with Shelf

TO KEEP the kitchen radio out of harm's way, a combination cabinet and hanging shelf like this will not only prove its worth but will hold the electric clock, flowers, and a few knickknacks. It is made of six plywood panels sawed as indicated in the drawing.

Top, bottom, and sides are slotted, as shown, for interlocking, and the back is screwed and glued to the assembly, although glue may not be necessary if the set

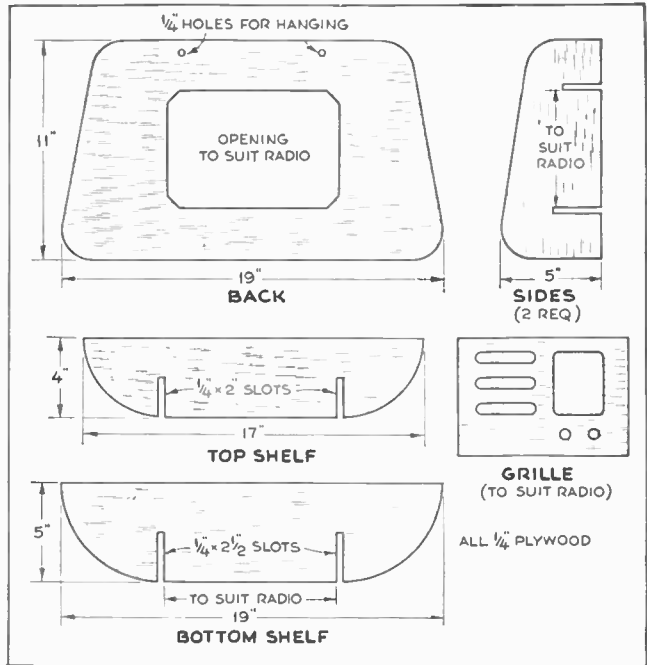

to be housed is light. Cut the grille to suit the radio and fasten it with brads.

Only outside dimensions are given since the others will, of course, have to accommodate the radio used.

PEPPED-UP OUTPUT can often be obtained from a B-voltage power supply of the choke-input type with the condenser shown dotted (C) at right. This 2 to 16-mfd. condenser across the rectifier-tube output drains heavier current through the tube during conducting periods. If the transformer secondary does not have a few hundred ohms D.C. resistance, place a 1 to 5-watt, 100-ohm resistor in series with the center tap of the high-voltage winding to avoid any possible overloading.—G. R. SONBERGHI.

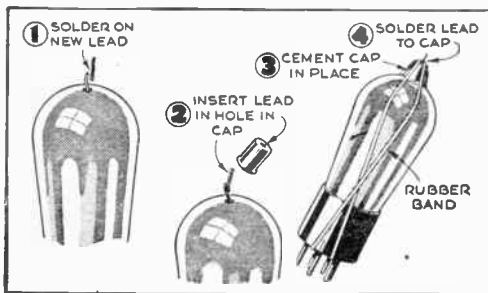
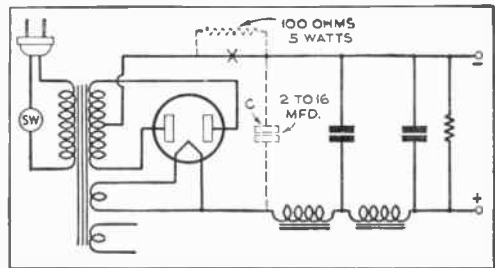

BROKEN-OFF GRID CAPS can be replaced on glass tubes without impairment of service by the four steps illustrated at left. First, scrape clean the short wire lead protruding from the top of the tube and solder another short wire to it. Then insert the wire through a hole drilled in the cap. Next, cement the cap on, holding it until the cement dries with rubber bands slipped over the cap and through the prongs. And finally, solder the end of the wire lead to the grid cap. Solder quickly to keep from weakening the cement.

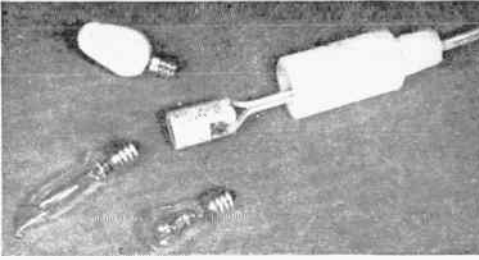

These parts, plus the bottle, make an attractive candle lamp. You have a choice of bulbs, including the candle-flame type, center. All are low wattage, suitable for night lights.



To add to the realistic appearance of your candle lamp, drip some wax from another candle down the neck and onto the bottle. Seal the candle to the mouth of the bottle with soft wax.



How to Make Electric Candles

FOR soft, quiet light, there's nothing like a candle—except an electric candle. This one is ideal for use as a subdued TV lamp.

You can make a candle lamp out of any attractive bottle, a plumber's candle, and a small bulb and socket. First step is to select the bottle—preferably one made of deep-toned glass. Next drill a small hole near the base to allow the lamp cord to enter.

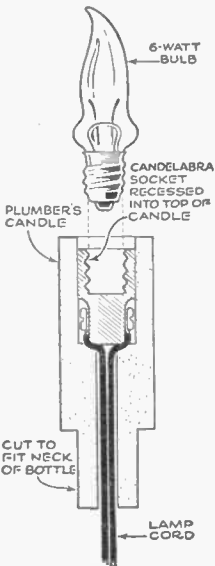

Drilling glass is a tricky job. If you don't feel confident of your own ability, you can play it safe and let the local glazier do it for you.

Drill a $\frac{1}{4}$ " hole lengthwise through the center of a plumber's candle, and carve a shoulder at one end to fit snugly into the mouth of the bottle. At the other end of the candle widen the center hole enough to take a small, cardboard-sheathed candelabra socket. ("Candelabra" means a lamp base slightly larger

than either the miniature flashlight or Christmas-tree lamp size.)

Bring the lamp cord through the bottle, wire the socket, and your lamp is practically finished. For extra realism, you can melt some wax drippings around the candle neck and down the sides of the bottle.

Flashlight Tests TV Lead

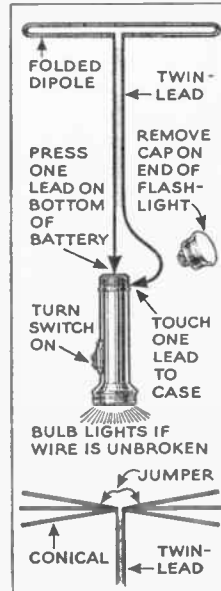

THE twin-lead ribbon that connects your television antenna to the set takes a beating from the wind and rain. If you suspect a break in the down lead, disconnect both wires from the set and find out for sure with the simple flashlight test shown.

If you have a folded-dipole antenna, you can make the test without going out of the house. If not, connect a jumper across the arms to complete the circuit. — Arthur Trauffer, McClelland, Iowa.

What's Inside a TV Doghouse

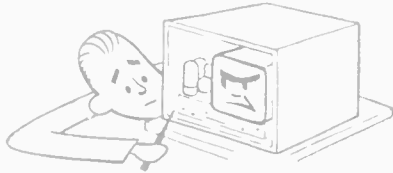

Take a look and see. You won't get bitten if you know how—and it's where you're most likely to spot set trouble.

By Robert Hertzberg

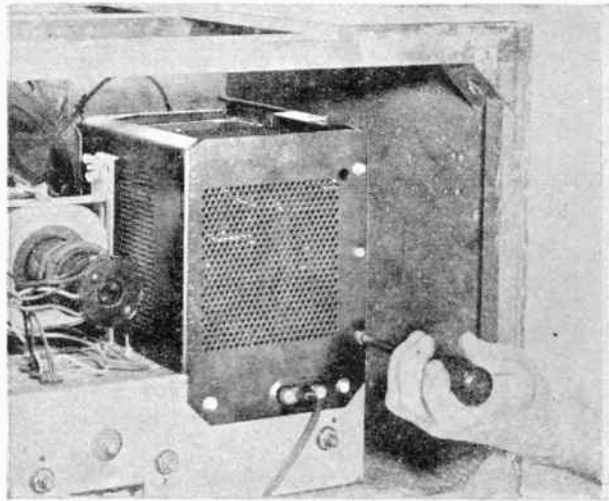

To get inside doghouse on the common 630-type chassis, use a small socket wrench to remove screws in back. Line cord is disconnected.

ALREADY TV sets are sprouting their own folklore. One notion kicking around is that anyone who isn't an electronic expert should never go near the "doghouse"—that little steel box on the chassis where the high voltage lives.

Don't you believe it. The doghouse need not be dangerous. And the amateur repairman who avoids it may be missing a bet, because the tubes in it are among the most vulnerable in the entire receiver.

If the other tubes are working all right (see PS, April '51, p. 209), and if the sound is coming through, a dark picture tube can be traced directly to the doghouse in 99 cases out of 100. As a matter of fact, you *ought* to be familiar with the doghouse in your set. Otherwise, something like this may happen:

One day the picture tube goes blank. You check the line cord and antenna; all okay there. So you pull the chassis and check the tubes outside the doghouse; all okay there. "Oh-oh," you say, already feeling pain in the pocketbook. "the picture tube's blown." Then you call the serviceman. He replaces a bad tube in the doghouse and the set works fine. It leaves you with a why-didn't-I-do-that feeling.

Safety Rules. Nobody wants to scuffle with 15,000 volts. So make it a rule not to plug in the set with the doghouse open. There's one exception to this—when you

want to see if the doghouse tube filaments light up—so be particularly careful to keep your hands out then.

The second rule is to discharge the high-voltage condensers in the picture-tube circuit after you turn the receiver off. Locate the single well insulated wire from the doghouse to the side of the picture tube and pull it free where it joins the tube. Allow the fastener at the end to touch the chassis, thus discharging the high-voltage condensers. You may see small sparks jumping to the chassis. Be sure to put the cap back before you turn the set on.

What you need. A few common hand tools, the manufacturer's service notes for the set, and possibly a "cheater" are all that's necessary for troubleshooting in the doghouse. The service notes are important, as is a tube manual that lists the tube heater pins, allowing you to make a simple series check of the filaments. A cheater is a length of 115-volt wire with a plug on one end and fittings to match the set's power-supply connection at the other.

Doghouse construction varies considerably. In some receivers the compartment has a simple cover that yields readily to a screwdriver or pair of pliers. In others, you may have to remove eight or ten screws from the sides and edges. Some newer sets compartmentalize the doghouse in an area under the chassis. In most sets the power

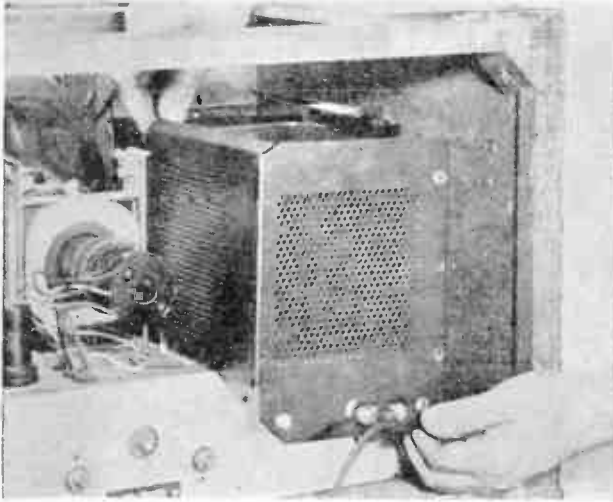

Back and top now slide free. Line cord comes off, too. If you don't have "cheater," drill out rivets connecting plug to the cover.

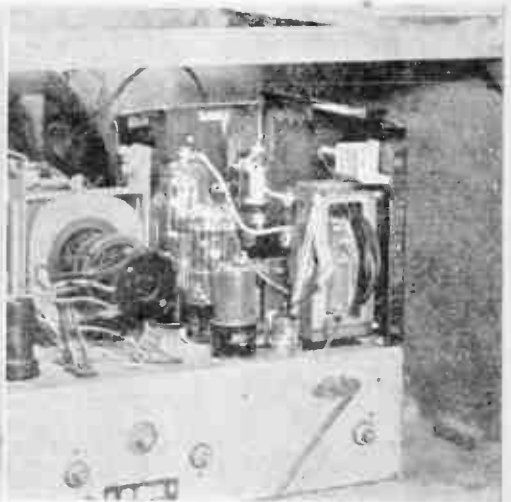

Parts inside are now exposed. Freed plug now acts as "cheater." **Keep hands off with power on.** Replace rivets with screws on reassembly.

cord comes off with the rear chassis guard or the doghouse cover.

Dust it out. The first thing you'll notice is the thick coat of dust inside the doghouse, attracted by the heat and high voltage. Clean out the box with a soft paintbrush, but don't wield it too vigorously. Now plug in the set, turn it on, keep your hands well clear, and take a good look at the tubes.

You can pretty well expect that the high-voltage rectifier, which you can identify from the service notes, will be dark. In many sets this is a 1B3GT. Remove it and make a continuity check of the filament (a

series link-up of a single dry cell, a pair of carphones, and the filament pins is one easy way). If its filament tests "open," the tube is simply burned out and a new one is needed.

Circuit oddity. It is entirely possible, however, for the tube to be in good shape. Then a brand-new 1B3GT put in the same socket will likewise fail to light. This is due to an oddity of many TV circuits.

In most sets, all tubes except the high-voltage rectifier receive their filament current from the low-voltage windings on the regular power transformer. The rectifier gets its filament current from a special transformer associated with a tube marked

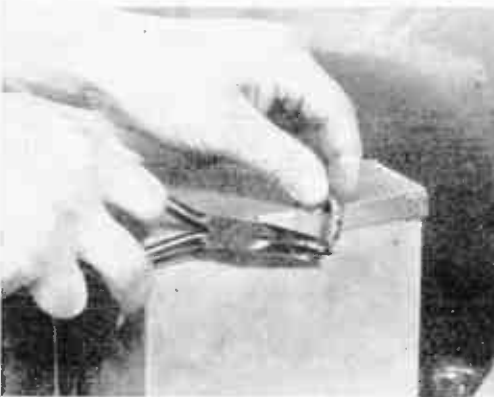

Can-type doghouse is opened by removing ball chain and gently prying off lid. Be sure juice



is off, condensers discharged. Take care not to bang lid or tools against picture tube.

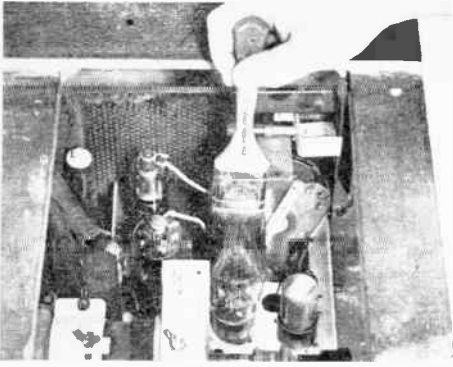

Brush out dust with soft paintbrush, but don't injure fragile leads. Leave wires in same position you found them. If a tube has a spring socket, press collar on base to release it.

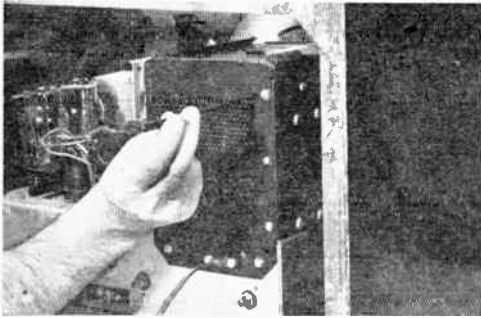

Slender plastic screwdriver is used to adjust width or linearity control in doghouse. This is done with doghouse reassembled and power on. Never use a metal tool for this job.

either "high-voltage oscillator" or "horizontal sweep output." If this tube goes bad, the rectifier gets no filament juice and fails to deliver high voltage to the picture tube.

Tube failure means more than just a burned-out filament or heater. It is common in TV servicing to encounter tubes that light normally and yet simply refuse to work in certain critical positions. Among these are the oscillator and horizontal output stages, the usual tenants of TV doghouses. It isn't uncommon to find an oscillator tube that decides to stop oscillating after a year or so, although it does fine if switched to the sound end of the receiver.

After replacing doghouse tubes, be sure you remember to replace the high-voltage lead to the picture tube that you pulled to ground the condensers.

In most TV sets, replacement of the doghouse tubes won't require readjustment of the various picture controls. At most, slight readjustment of the focus control may be needed. In some sets a control marked "linearity" or "width" is inside the doghouse, and is accessible through a small hole in the case. After you have the set buttoned up again, tune in a test pattern and, using an all-plastic screwdriver, carefully adjust this control. As with other picture controls, it's smart to mark the adjusting screw's original position before you change it. EXP

VACUUM CLEANER

If it will not pick up (upright type), the cleaner bag may be filled or badly clogged. The rotating brush may be worn or improperly adjusted so that it does not brush the surface being cleaned. The brush drive belt may be loose or broken. The nozzle may not be adjusted to suit the floor being cleaned. Adjustment is correct when a half dollar can be slipped under the nozzle edge between the nozzle and the rug. Low motor speed will reduce cleaning efficiency. If the motor runs slowly, it could be because of bad bearings, worn motor brushes or poor motor connections.

If it will not pick up (tank type), the cleaner bag or filter may be clogged. The wrong cleaning tool for the job may have been selected. The cleaning tool may be improperly used. Light pressure and slow, steady strokes do the job better than heavy pressure and rapid strokes. Low motor speed will reduce cleaning efficiency of this type too.

If it will not run, there may be an open circuit to the cleaner motor. First make sure the house circuit itself is not at fault. The break may be in the plug, the cord, the switch or the motor. In the motor, an open circuit could result from a broken wire, loose connections, worn brushes, worn or dirty commutator or open field.

If it is noisy, the bearings may be dry, tight or worn. The motor armature shaft may be bent so that the armature is rubbing on the pole shoes. A loose, bent or broken fan will cause excessive noise. On the tank type of cleaner with two fans, noise may result if the fans are out of balance. They can be balanced by loosening the fan nut and turning the outside fan one-eighth turn, then tightening the nut again. Repeat until the cleaner runs quietly.

(From *Electrical Appliance Servicing*, by William H. Crouse.)

FOR YOUR POPULAR SCIENCE INFORMATION FILE

Music Without Knobs

This child's phonograph runs itself and is never too loud—because dad sets the volume.

By Norman L. Chalfin

*Executive Secretary
of Associated Radio-Television
Servicemen of N. Y.*

EVERY father and mother—and child—who saw this phonograph being built and photographed wanted one like it.

It plays all sizes of standard 78-r.p.m. records. Lifting up the pickup arm to place it on a record starts the motor and amplifier; returning the arm to its rest shuts everything off. The volume cannot get out of hand, because you preset it, and the kids can't change it.

There is nothing comparable in New York City stores at any price—and the parts required to build this machine cost only \$25.

Amplifier is simple. The amplifier has so few parts it's a cinch to assemble and wire. It uses one tube—a battery or filament type—and a selenium rectifier. Together

To change volume, this rear panel must be removed. The notches in it are for ventilation.

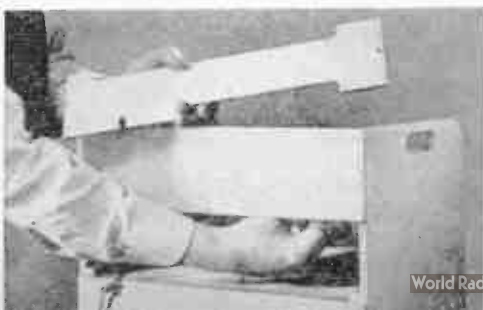

Lifting the arm off its rest starts the machine.

they give instant warm-up, so there's no waiting between turn-on and play. Parts aren't crowded even on a 4" by 5" chassis. There are only seven resistors besides the volume control, and the wiring is simple.

All specifications given here are for the 3V4 tube. The filter condensers C1, C2, and C3 may be in a single can, or two units as shown, or three separate parts. Instead of the 3V4 tube, you could use a 3LF4 (lock-in base), 3Q4, or 3S4. But if you use another tube, be sure to check the socket connections and also the load resistance of the tube, so that you can buy an output transformer to match. Some condenser and resistor values might also have to be changed.

A high-output pickup is important. Make sure the cartridge you buy has an output of

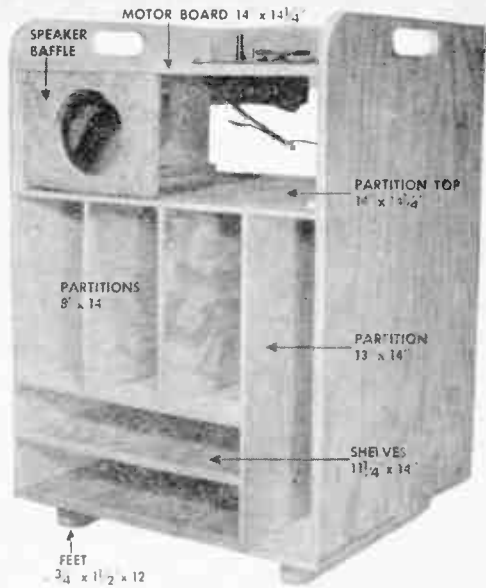
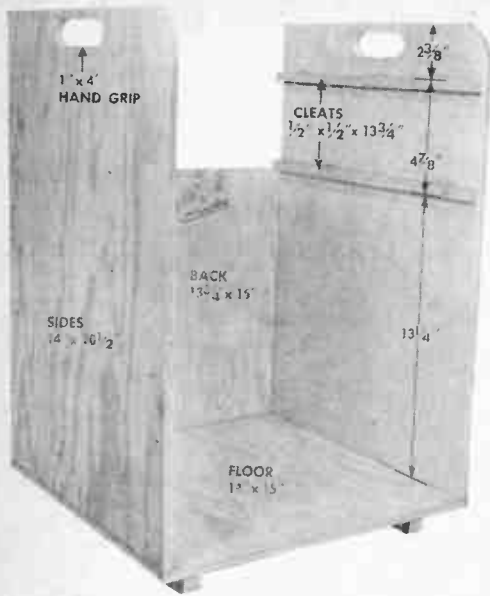

Secure the cabinet back with glue and wood screws after squaring sides with bottom. Bevel the edges of the back with sandpaper. Countersink all screws and set nail heads.

Use glue and 1" nails to assemble and hold in record partitions. Triangular glue blocks may be fitted under the shelves. Motor board carrying working parts lies on upper cleats.

at least 3.5 volts. The midget snap switch must have a light-pressure leaf or lever, so that it can be actuated by the weight of the pickup, and it should be the normally closed type. If the spring leaf works too stiffly, you may be able to file it thinner, or to pivot the leaf instead. An even simpler switch might be made from an old phone jack or relay contact leaves, as shown in the drawing.

Too low a filament voltage will cause dis-

tortion. If your line voltage is low, experiment with a slightly higher value for R4, or a slightly lower value for R6.

Cabinet is butt-joint job. You needn't be a whiz to build the cabinet. As always, power tools will save you time, but basically this is a hammer, saw, and screwdriver job, with not a mortise or tenon in a carload. The hardest part is cutting the pieces to size.

Although $\frac{3}{8}$ " plywood was used for the carcass and $\frac{1}{8}$ " plywood for the shelves in the cabinet shown, it's easier to use the $\frac{3}{8}$ " thickness throughout.

By using a fine-toothed saw and taking care not to splinter the edges, you can save yourself some patching and filling. The handgrips in the sides can be omitted, but are handy when the cabinet has to be moved.

First attach the two feet to the floor of the cabinet with glue and nails. Then drive a couple of screws through into each foot. Turn the floor upside down and scribe a line $3 \frac{1}{16}$ " from the two side edges. Drill countersunk holes along these lines for thin wood screws to go into the sides. Use plenty of glue on the end grain, locate the sides on top of the floor and flush with the edges, and secure with nails. Then drive the screws.

The back is the same width as the floor, and overlaps the sides, strengthening the whole structure. Drill countersunk holes

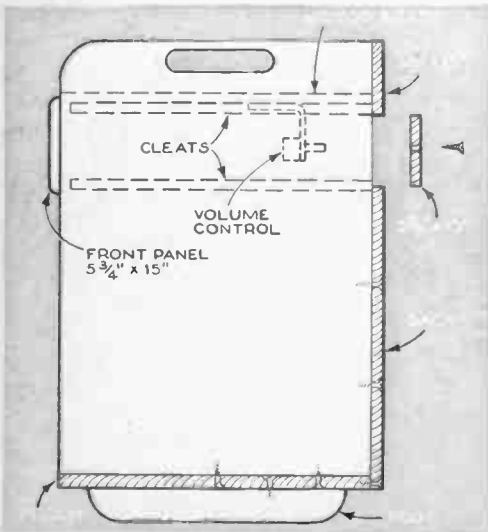

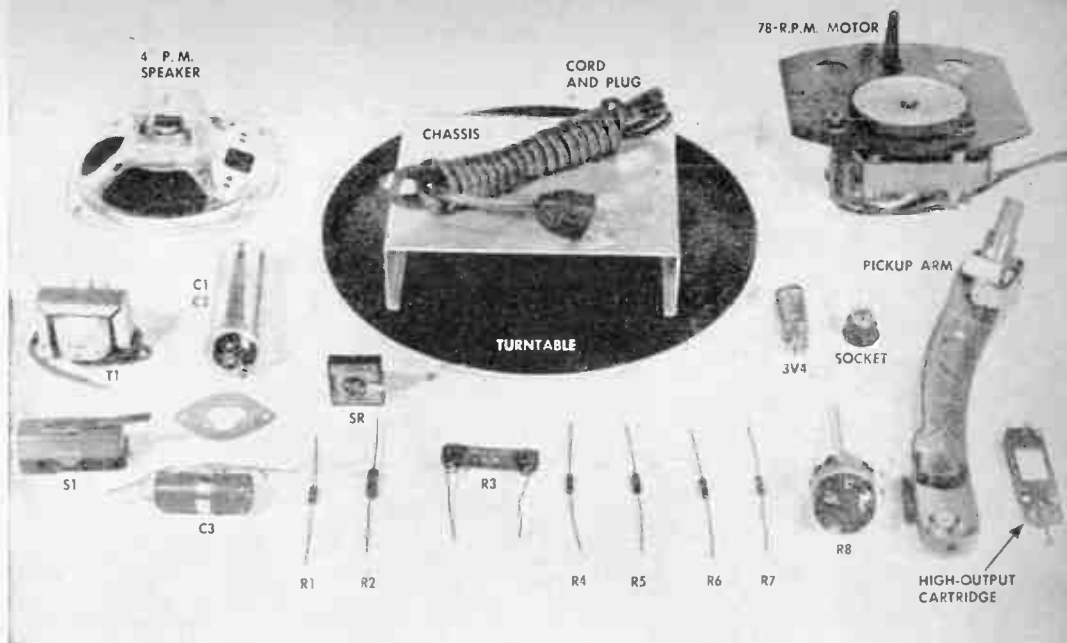

LIST OF PARTS

- | | | |
|--------------------------------------|---|---|
| R1: 27 ohms, $\frac{1}{2}$ watt. | C2: 40-mfd., 150-volt electrolytic. | 3V4 tube, 7-pin miniature socket. |
| R2: 150 ohms, 1 watt. | C3: 100-mfd., 25-volt electrolytic. | 3.5-volt crystal cartridge and pickup arm, 4" PM speaker with 3-4 ohm voice coil, 78-r.p.m. motor and turntable, small chassis, line cord and plug, terminal strips, mounting bolts and nuts, hookup wire, $\frac{1}{4}$ " bushing and nut, $\frac{1}{8}$ " shafting. |
| R3: 2,250 ohms, 10 watts. | T1: Output transformer; 10,000-ohm plate to 3-4 ohm voice coil. | |
| R4: 250 ohms, $\frac{1}{2}$ watt. | SR: 65-ma. selenium rectifier. | |
| R5: 150 ohms, $\frac{1}{2}$ watt. | S1: Normally-on midget snap switch. | |
| R6: 68 ohms, $\frac{1}{2}$ watt. | | |
| R7: 25,000 ohms, $\frac{1}{2}$ watt. | | |
| R8: 500,000-ohm volume control. | | |
| C1: 80-mfd., 150-volt electrolytic. | | |

along two sides and the bottom of the back. Apply glue, and nail the piece lightly in place. Use a steel square, or measure the

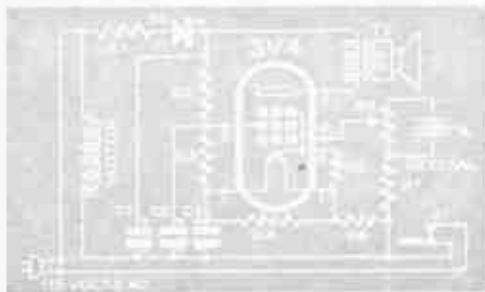

diagonals (which should be equal) to make sure the sides are square with the bottom. Then drive more nails and the wood screws.

Glue and nail in four cleats at the heights specified in the photos. The top of the record case fits under the lower cleats. Glue alone will hold it, as it is supported by the partitions. Mark center nailing lines on the bottom, the case top, and the left-hand side where partitions are to go. Glue and nail together the two shelves and three partitions. Apply glue to the exposed ends, place the assembly in the cabinet, and nail it fast.

Record player is a unit. The phonograph motor, pickup, loudspeaker, chassis,

Small chassis is uncrowded. Speaker goes on baffle fastened to motor board, and volume control on angle bracket or small wooden panel.

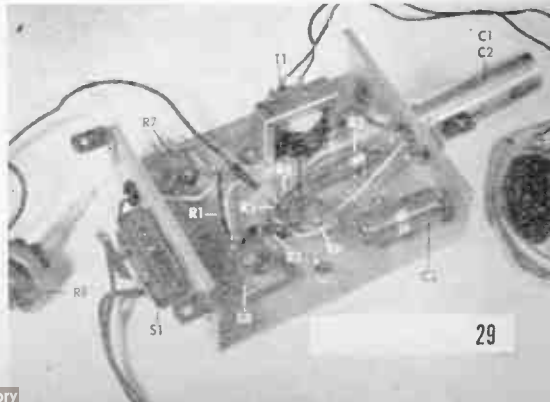

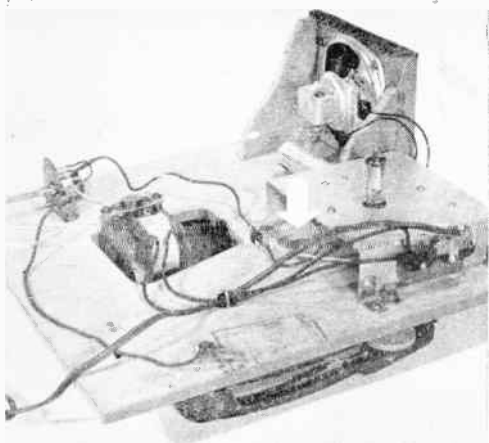

All sound equipment goes on one panel, here shown upside down. Volume control is toward the back. Cut a ventilating hole (arrow) above the chassis where it will be covered by the turntable. Tack screening over the hole.

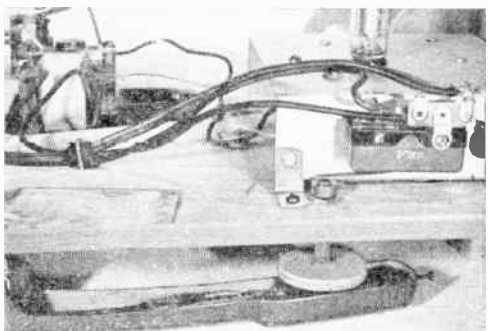
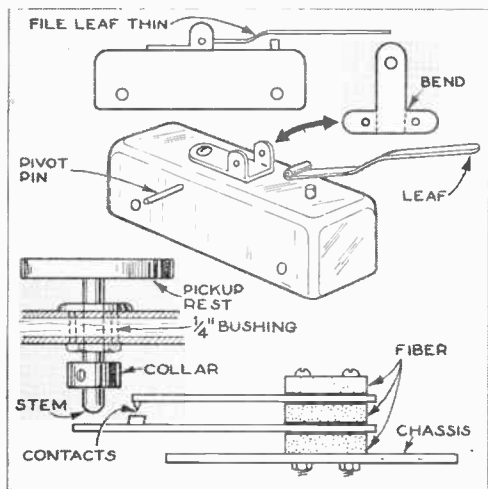

This upside-down closeup of the pickup rest and snap switch shows how they work. A collar fastened on the stem under the panel keeps the pickup rest from being pulled out.

and controls all go on the $\frac{3}{8}$ " motor board, which should be made an easy drop fit between the sides to rest on the upper cleats. It's held by two wood screws in each cleat. Thus it can be lifted out as a unit if repairs are necessary.

It's safest to cut a piece of cardboard the size of the motor board and make a trial fitting of the parts on this to determine the proper spacing. Tiy a 12" record on the turntable to be sure it clears the sides.

Locate the chassis so that the end of the snap-switch lever comes about $1\frac{1}{2}$ " behind the end of the pickup head, and at least 1" inside the edge of the board. The chassis is mounted upside down with angle brackets as shown, the tube hanging down. Mount the volume control toward the back where you can reach in from the rear of the cabinet to set it after the player is mounted.

The speaker baffle can be soft fiberboard or plywood, mounted with two plywood brackets held on by wood screws.

Cut a hole in the plywood front panel directly in front of the speaker. Nail this panel on with glue along the side and bottom, but not to the motor board.

Pickup triggers power. When not in playing position, the pickup lies on a round rest affixed to a stem that works on the switch lever. Cut a small disk out of plywood, centerdrill it just under $\frac{1}{2}$ ", and drive in a bit of $\frac{3}{8}$ " radio shafting or plastic rod. Mount a threaded $\frac{3}{8}$ " bushing (obtainable at radio stores) on the panel. Glue a soft eraser alongside the turntable for the pickup to drop on if it's pushed off the rest.

Bear in mind that the chassis is electrically hot. Therefore don't let it touch the pickup arm or the motor under the panel, and be sure to mount it with short wood screws that do not project above the panel.

Final touches. Sand the cabinet well, particularly along the edges, first filling any core holes, as well as splintered areas and nail and screw holes. Follow with your own favorite finishing schedule for plywood or those given elsewhere in this volume for radio-TV cabinets. The cabinet shown was sprayed with lacquer. A trim color was applied to the turntable compartment and to all edges.

Tack a bit of screening in front of the baffle to keep the youngsters from poking anything into the speaker cone, and glue a piece of cloth over the screen. Fasten the motor board in place. Then watch the children take over.

END

HIGH-GAIN A. F. AMPLIFIER

Resistance-Coupled Hookup with Two Pentodes Gives Big Volume

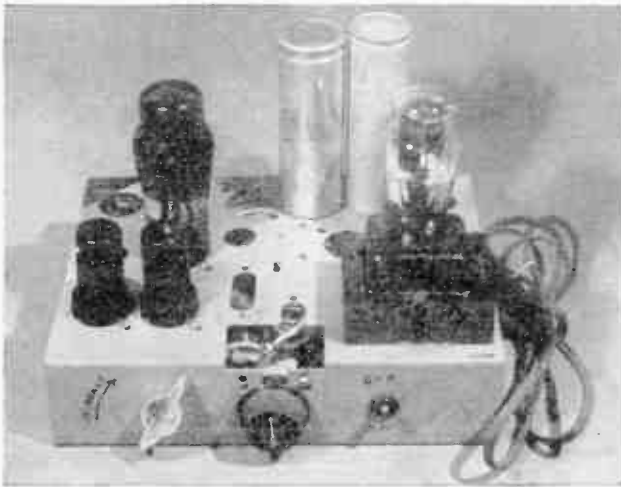

If a power pack is built in, as above, keep it as far from the amplifier wiring as possible. A type-80 rectifier was used here

SO MUCH gain can be had from this two-pentode hookup that for ordinary purposes the full output will rarely be needed. The amplifier will step up the output of a crystal-detector receiver to full loud-speaker volume. A phonograph pickup or vacuum-tube detector should be connected at the second A.F. input terminals.

As a trick demonstration of electronics, you can even make audible the movement of molecules in an iron bar that is being magnetized. Hook the primary of an old audio transformer or a choke coil across the input terminals and place a big nail or a bolt within the coil. If a small permanent magnet is now brought near the nail, a rushing sound will be heard from the speaker. As the molecules in the bar are pulled into alignment by the magnet, each in flopping over generates an electrical im-

pulse in the coil. This, amplified many thousand times, actuates the loudspeaker.

The amplifier is hard to build in proportion to its great sensitivity, and all the precautions suggested in a previous article must be carefully observed. Shielded input leads consisting of a wire enclosed in a braided metal sheath are a "must." The sheath is grounded and serves as one lead, eliminating stray-current pickup. Use an old radio chassis or a tin cigar box enamelled black; the chassis must be metal.

Values of the various parts are shown for the 6SJ7 and 6V6, but use whatever tubes you have. Tetrodos will serve in place of the pentodes. Consult the tables of amplifier values in standard tube manuals for data

applicable to your tubes. In doing so, remember that the second volume control constitutes part of the circuit of the first tube, not of the second. The setting of this control determines what part of the output of the first stage is fed to the second grid.

If 60-cycle hum is present, connect two 50-ohm resistors in series across the heater wires, and their midpoint connection to a 12-volt tap on a 200,000-ohm voltage divider hooked across the high-voltage plate supply. This will give the heaters a positive potential with respect to the cathodes, eliminating electron emission from the heaters to the cathodes, a phenomenon that is sometimes the cause of persistent hum.

It is essential to keep all heater wires as far from the grid leads as possible. Twist them tightly and lay them along a corner of the chassis.

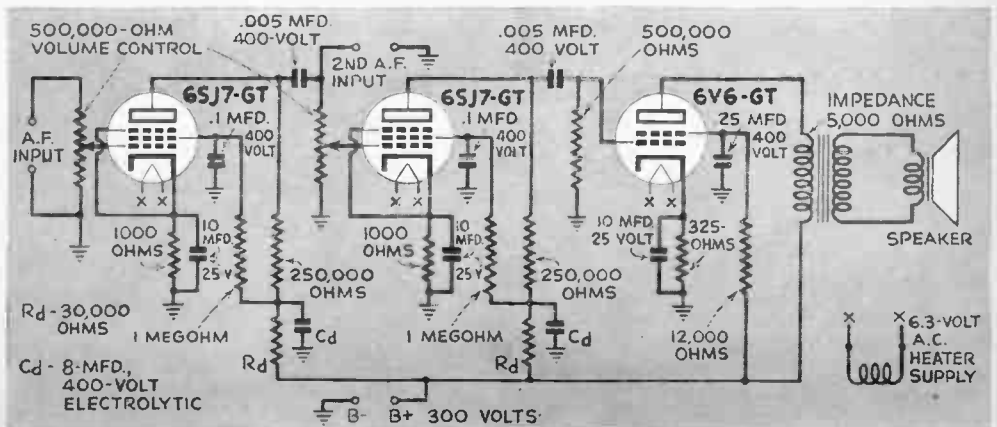

ROTARY RECTIFIER

Supplies Direct Current for Charging Storage Batteries

FINDING your auto battery discharged is a nuisance at any time—and one that is likely to occur oftener now under our reduced driving program. This is a particular hardship on owners of some recent cars, who may find hand-cranking difficult. It is no

wonder, then, that home battery chargers have commanded increasing interest.

Many drivers are familiar with the dry-disk, chemical, and mercury-arc rectifiers used, but here is a simple apparatus utilizing a fractional-horsepower motor that changes A.C. into D.C. and will charge an auto battery in a few hours. A 1/40 to 1/25-hp. synchronous motor is preferable, but a small split-phase induction motor can be converted for the job if it is rated at 1,725 to 1,750 r.p.m. Also needed are a heavy-duty transformer that will deliver 15 volts at 8 to 10 amp. from the A.C. line, an auto cutout, an ammeter, a 1 3/4" diameter bar commutator 7/8" wide, parts to make brush holders, some resistor wire, and a porcelain tube.

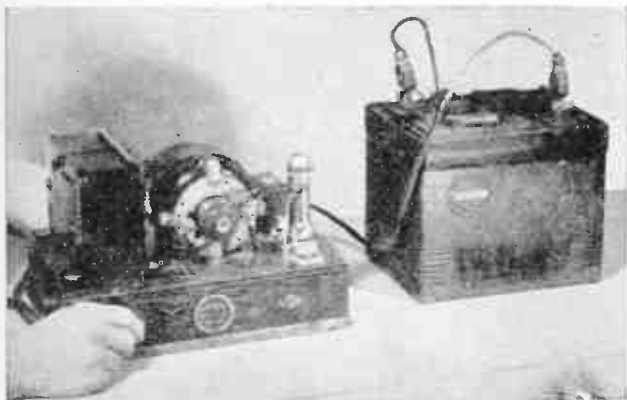

Current for charging a bat-

Connected to a house A.C. line, the homemade charger restores a battery at a rate up to 10 amp.

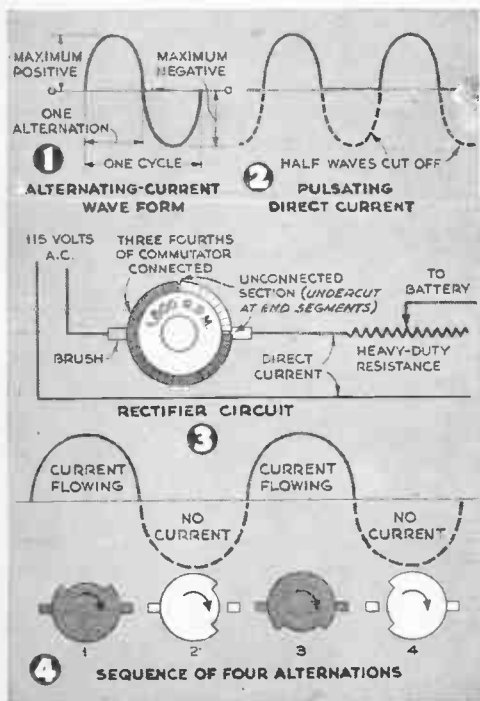

Four flats are filled across the induction-motor rotor in making the unit synchronous. Distance between each two opposite flats must be the same

Wound on a wooden form, the transformer coil is provided with loops in the wire to serve as taps

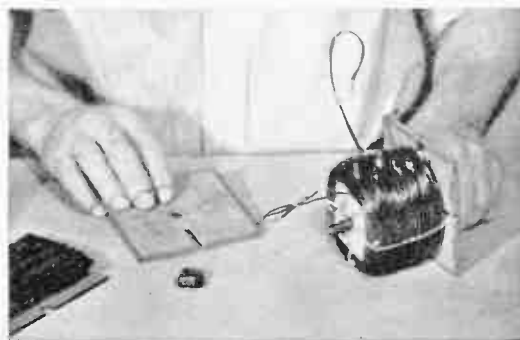

tery must flow in only one direction. A.C. is converted into such unidirectional current by cutting off alternate half waves (Figs. 1 and 2). With the rotary rectifier, A.C. is converted to pulsating D.C. by a commutator having three fourths of its segments joined with a band of hard solder or brazing metal and the remaining quarter unconnected, as in Fig. 3. The commutator may have 32, 36, or 40 bars, or any number divisible by four.

Join the segments at the risers or the back edge, and undercut the mica deeply between the end segments of the joined sections and those left unconnected. On the shaft of a motor running at synchronous speed of 1,800 r.p.m., the commutator will interrupt A.C., connected with the brushes in series on one side of the line, every time its unconnected segments pass one of the brushes. The result will be pulsating D.C., as shown in the wave diagram in Fig. 4.

If a synchronous motor is unavailable, a split-phase induction motor of about the same horsepower can be adapted by making some simple changes in the rotor. After removing the rotor, file four flats across its laminations at exactly 90-deg. points, as in Fig. 5, being careful to lay them out correctly and being sure *not* to file the copper end rings. The width of the flats depends upon the individual rotor, but generally it should be about half that of an unfiled space. Check the balance after assembly and make

corrections on the position of the flats, if necessary, for if they are not spaced exactly, the motor will run out of balance.

The theory in changing the rotor is that the flats crowd the flux into the spaces between them, thus making definite poles that cause the rotor to pull into synchronism. Test the motor with a tachometer after assembly. The speed must be exactly 1,800 r.p.m. and should remain constant under moderate load.

Figure 6 shows how the brushes are mounted. The plastic, fiber, or hard-rubber brush ring is adjustable, being held between clips bent from 1/8" flat copper or steel stock that are attached to the motor housing. Two old brush holders from an auto starter or generator can be used to hold the carbon brushes, but they must be installed in perfect alignment.

If operating cost because of current loss is no object, the transformer can be left out of the circuit and a heavy-duty resistor, capable of carrying about 10 amp., connected in series with one side of the line to the battery to limit current (Fig. 3). But if the saving of current is important, a transformer should be used. This reduces the current draw to 3 or 4 amp. for a 10-amp. charging rate. An autotransformer, connected in the ground side of the line as in Fig. 7, is simplest to use. It will reduce the 115-volt A.C. to 15 volts, and the small resistor (Fig. 9)

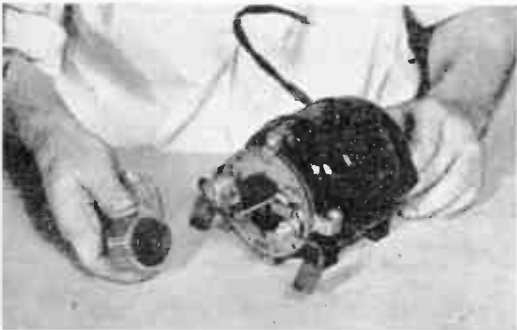

Three fourths of the bars of the commutator are joined with hard solder and the remaining part is left free. This cuts off half of the A.C. wave

After leads are soldered on, the coil is taped, and the E-section laminations are put in place

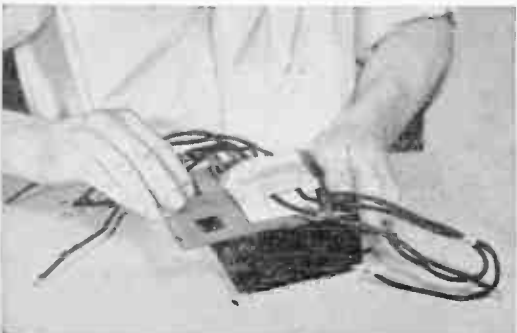

Both brushes must be in perfect alignment on the motor. Their position can be adjusted by loosening two machine screws and then moving the plastic ring

Here is the completed unit as seen from the rear. Wiring connections are concealed in a boxlike base

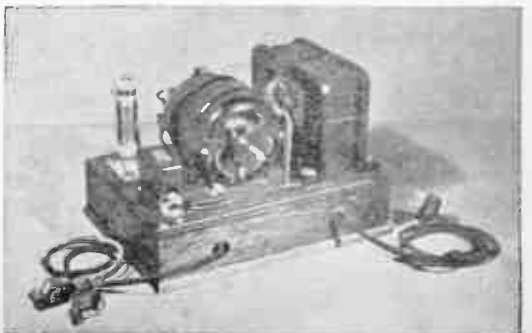

in the battery circuit will be large enough for further regulation.

A suitable autotransformer may be built from materials in the junk box if a serviceable one of the required capacity is not at hand. Start with the core of an old radio power transformer or any with a cross section of about $3\frac{1}{4}$ sq. in. Remove the coil. The core shown in the photographs had a center-leg measurement of $1\frac{5}{8}$ " by 2", so a wooden form was made this size, and a new coil consisting of two No. 16 enameled magnet wires wound in parallel was wound on the form in the lathe at slow speed. A total of 180 turns will be needed on a core of these dimensions, and a tap at the 24th turn should give 15 volts (Fig. 8). It is well to bring out taps or loops at the 22nd and 25th turns also so the one nearest the required voltage can be used. Taps provided at the 30th, 45th, 70th, 90th, and 125th turns will make the transformer useful for other purposes.

Use a piece of sleeving over each loop as the winding progresses, to insulate it from adjacent turns, and keep all taps as near as possible to the same side of the coil. When completed, solder No. 16 flexible leads to the taps and at the start and finish of the coil. Then be sure to identify them with paint or other suitable means.

In figuring the voltage, consider the 115 volts impressed across the coil of 180 turns as an average value. Dividing the volts by the turns gives a value of approximately .64 volts per turn. It is easy then to determine how many turns will be needed for a tap to put out the voltage desired.

Laminations should be placed carefully so as to alternate the E-sections and single pieces in successive layers, and when all have been placed, they should be tapped lightly into line with a wooden block and clamped tightly. One method of clamping is to use two iron frames bent out on one side to provide feet and held together with bolts, as indicated in the photos. A wrapping of cotton tape is advisable after the coil has been dipped in insulating varnish, but be sure the soldered joints under the tape are well insulated.

In the battery line in Fig. 7 is an automobile cutout relay that will close only when the direction of the current is correct and will remain open and vibrate when the current is reversed. In addition, when the line switch is opened, the cutout will also open and prevent discharge of the battery through the rectifier and transformer. With chargers of this type, a reversal in the polarity of the battery leads takes place if the current is interrupted and then restored with the motor pulling in on the reverse D.C. half wave. Opening and closing the

line switch a few times will make it pull in again on the desired half wave. For this reason it is not a good idea to leave the charger unattended, or working overnight, since the warning buzz might not be heard.

Those who wish to make the charger fully automatic may purchase or make a reverse-current relay that will cut in the battery line to operate on the reverse current. However, it is usually possible to charge most batteries during a time when someone will always be within earshot.

In either case, the charger should be sup-

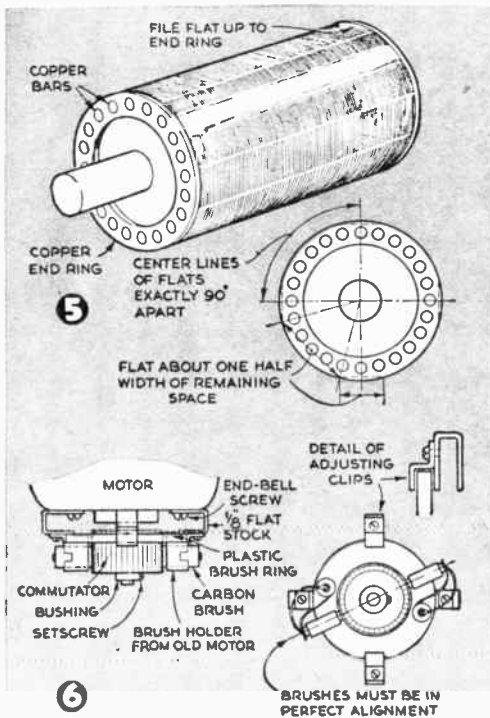

plied through a fuse in the live side of the line. One with a low rating such as 6 amp. will do, but better yet is a 4-amp. time-lag fuse. Both provide protection against short circuits and overloads.

An inverted wooden box, rather flat, will serve satisfactorily as a base that will house and conceal the wiring as well as provide a panel for an ammeter and toggle switches. Almost any light stock—plywood, if you have it on hand—may be used. It may be stained and varnished as desired. Mount the transformer first on one side, as indicated in the photos, and take the leads through drilled holes to the inside of the box. Next, mount the motor at the center, and take the input and brush wires through similar holes into the box. The small resistor and cutout

are mounted on the other side of the motor, their wires also going into the box, while the ammeter and toggle switches are set in the front panel. Connections, as shown in Fig. 7, are then made inside the base.

Test the transformer first by connecting it temporarily in the line and using a low-reading A.C. voltmeter to check voltage from the start of the coil and from the 24th tap or the one most nearly giving 15 volts. Then connect this tap to one brush. Let the tracer-marked wire in the line cord be the grounded side of the line direct to the battery in order to avoid shocks when touching the battery clips. The line switch cuts in on the live side of the line. Be sure to use a polarity plug and A.C. socket that can be plugged together in only one way. Solder all joints and tape them well; then board up the bottom of the base.

Now, close the line switch to start the motor, leaving the load switch open and the battery unconnected, and allow a little time for the brushes to wear to a good fit, using a commutator stone on them if one is available. With the battery still out of the circuit, immerse the battery clips on the wires in a tumbler containing water and a teaspoonful of salt, and then close the load switch. The cutout armature will vibrate loudly and, therefore, should be held down firmly with one hand.

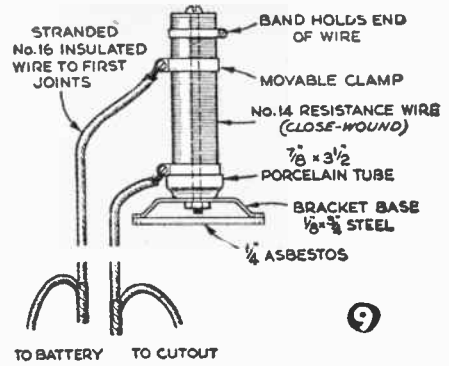

Bubbles will collect around one clip in the salt water, indicating the negative side. Touch the clips together for an instant to see which way the ammeter reads. If this is up the scale toward charge, mark the clips for positive and negative. Should the ammeter read down scale toward discharge, open and close the line switch quickly a few times to make the motor pull in on the other half of the wave. After marking the clips, always connect the positive side to the positive battery terminal.

Cutout buzzing should stop when the battery is connected; but if some buzzing continues, bend the spring slightly to change tension and perfect the adjustment. Should the brushes spark under load when first started, correct their adjustment until the tendency is halted. Keep the commutator in good condition by an occasional cleaning with fine sandpaper while it is rotating, and inspect and clean the cutout points occasionally. The cutout can be checked with the cover off by opening and closing the line switch, which should open and close the points.

Adjustment can be made in the charging rate to the battery by moving the clip on the resistor. The nearer it is moved to the base, the less the resistance and the higher the rate of charge. With the apparatus described here, it is not advisable to exceed a 10-amp. charge, and it is better to keep it between 6 and 8 amp. However, the rectifying commutator itself is only limited in load by what the brushes and commutator will carry. It is possible to build heavier regulating equipment and use a heavier transformer and wiring, and then to supply considerably heavier current. By increasing the voltage of this setup with a higher transformer tap, you would be able to charge at one time several batteries connected in series. The smaller job, however, is ample for recharging most automobile batteries that have run down because of infrequent use.

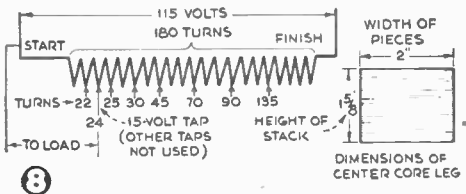
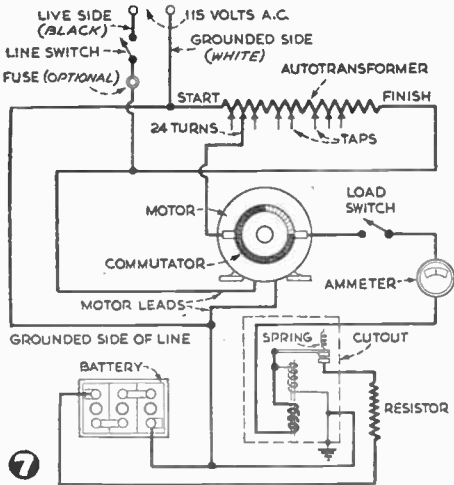

Would a Booster Help Your TV Set?



You have to try one to tell. But that can be done easily, and the results are sometimes really worth the effort.

By Robert Hertzberg

IF YOU are somewhat beyond the “normal” TV range and your pictures are weak . . .

If one station that you especially want comes in poorly . . .

If you are near a transmitter but can't have a roof-top antenna . . .

. . . You should try a television booster.

It may strengthen the faint signals plucked out of the air by your antenna. A booster can be attached to your set in a jiffy. The only tool you need is a screwdriver.

If the booster decidedly improves your

pictures, you are in luck. If the images are still pale and snowy, you're not entirely out of luck; you can try boosters of other makes and possibly find a better one.

There is no way to be sure that a booster will help—except to try one with *your* receiver in *your* home. Recognizing this, many dealers will let you have one on trial. The best boosters cost only about \$30, and a satisfactory one may prove much cheaper than a new set or an elaborate antenna.

Boosters may be roughly classified according to the number of controls that have to be operated. Tunable models require the most adjustment, semi-tunable boosters need somewhat less attention, and the non-tunable need no attention at all. Most non-tunable ones and some of the others have

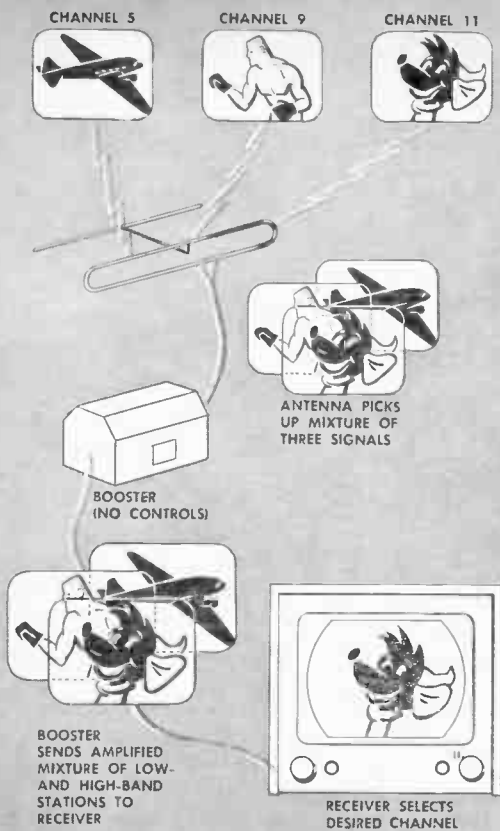

What a NON-TUNABLE Booster Does

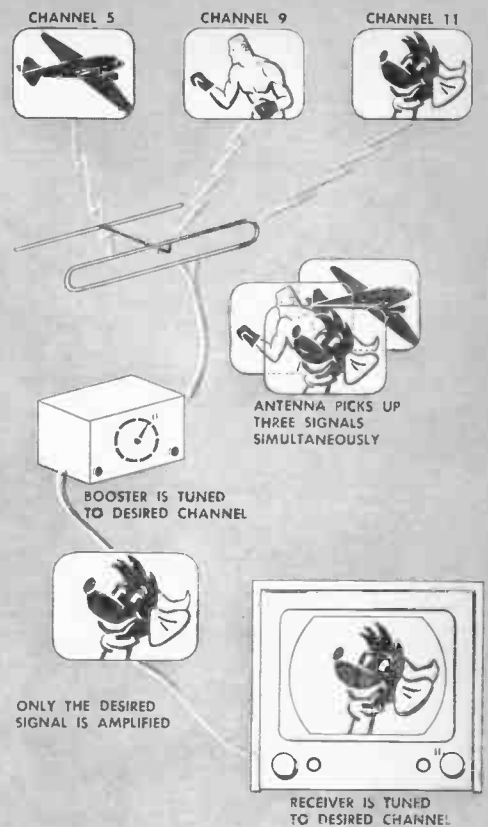

What a TUNABLE Booster Does

automatic switches that turn them on or off when the receiver is operated. In most of the automatic models the regular on-off switch is linked with an aerial change-over device that cuts the lead-in directly over to the receiver when the booster is turned off.

Generally speaking, the tunable boosters

are the best. They not only give the most amplification, tube for tube, but under some circumstances they make the receiver slightly more selective. The semi-tunable type runs second, and the non-tunable third. Among all three types, there is considerable variation in the uniformity of amplification. Most

Simplest kind of booster uses only one miniature tube. Others have up to four tubes. Larger models usually contain two separate amplifiers, one for low and one for high band.

Booster is hooked up by removing antenna leads from set and connecting them to booster's "in" terminals. The "out" terminals are linked to receiver by short piece of lead-in wire.

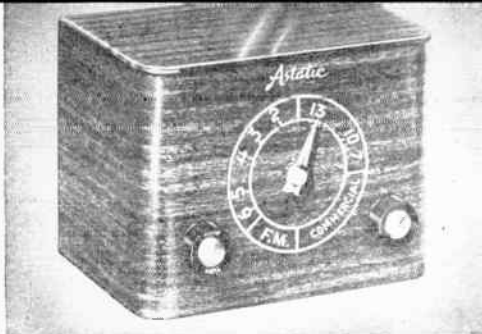

Tunable boosters like this generally give most amplification but must be tuned to match set.



Semi-tunable type has switch for high or low band operation plus a fine-tuning adjustment.

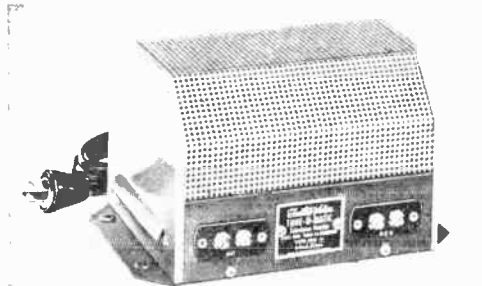

Non-tunable booster requires no adjustment. Automatic switch makes it easiest type to use.

Color Need a Boost?

If you need a booster now, you'll need one at least as much to receive colorcasts. In the CBS method, the illusion of color is created by means of a revolving disk composed of red, blue, and green filters. These filters hold back part of the light, so the image on the picture tube has to be pretty bright before the filters are brought into play. A booster may make the difference between gloomy shades and bright color.

boosters are better on the low bands than on the high. The same is true, for that matter, of TV receivers.

A booster also may improve your neighbor's reception by eliminating interference that is generated in your set and radiated by your aerial. A booster, connected between an offending receiver and its antenna, acts as a buffer and prevents the energy from getting out to bother others.

A factor that limits the amount of useful amplification you can squeeze out of boosters is "noise" due to electronic agitation in tubes and to other obscure sources. This shows up on the screen as irregular splotches and may spoil the "boosted" picture.

One non-tunable booster is unusual in that it is designed for mounting on the roof, close to the aerial itself. It is being used even in strong-signal areas where the down lead from the antenna unavoidably passes close to electrical devices that cause interference.

If a booster is placed near the receiver, it amplifies both the video signals and interference. But when placed between the top of the lead-in and the antenna, it amplifies the video signals but not the interference picked up by the lead-in.

The "best" booster is the one that gives results with your set.

If one booster amplifies signals to a certain degree, will two boosters in tandem work twice as well? A man in Pennsylvania is using this unorthodox combination with a classy antenna atop a 75-foot mast. He enjoys fairly regular reception on ten channels, including five stations that are more than 1,000 miles away!

END

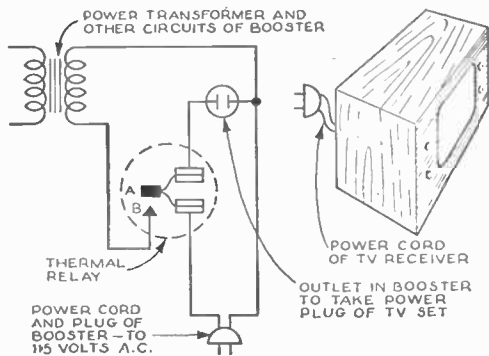

Typical automatic switch uses thermal relay. Contact arm, normally at A, allows current to reach receiver. When set is on, contact heats up, snaps over to B, and turns on the booster.

“Grasshopper” Spies on Enemy

ELECTRONIC spies that uncover the enemy's weather secrets have been developed by the United States. They are robot radio stations named Grasshoppers. Parachuted behind enemy lines, they could measure and transmit strategic weather data automatically. They might also send guiding signals to lead bombers to a target.

This weird robot really looks and acts the part. When it hits the ground, an explosive charge goes off. That disconnects the parachute, which is conspicuous and which might otherwise drag the unit. Later—after a preset “dormant” interval, if desired—there's another explosion. This one unlocks spring-loaded legs, and Grasshopper stands up. Explosion number three shoots up a whip antenna. Then it's ready to send whenever the built-in clock turns the transmitter on. The batteries last 15 days if it reports every three hours.

The standard model, developed during World War II by the National Bureau of Standards for the Navy, measures temperature, humidity, and barometric pressure. Its pulses tell which Grasshopper is reporting in, and signal when the batteries are fading. END

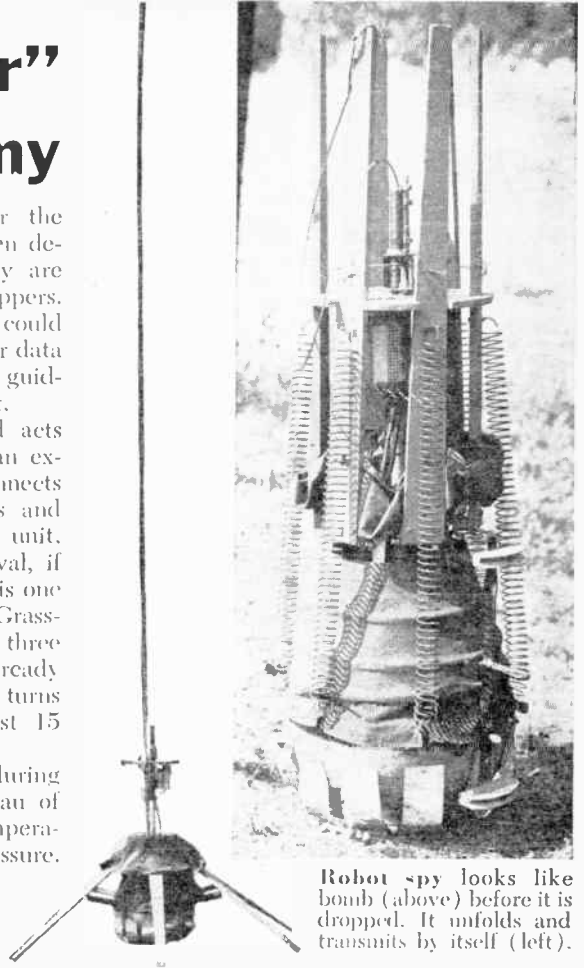

Robot spy looks like bomb (above) before it is dropped. It unfolds and transmits by itself (left).

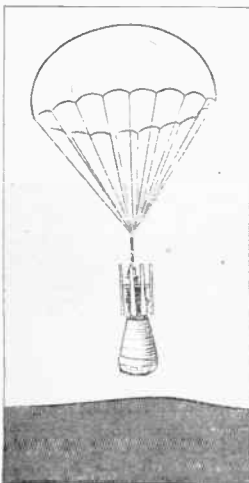

1 Parachute floats automatic spy unit to ground.



2 Explosion disconnects chute so unit won't be dragged.

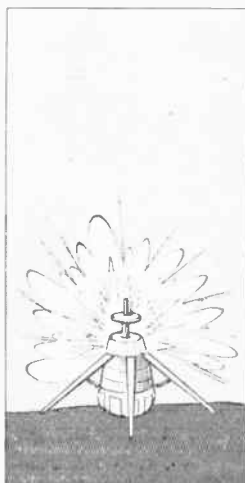

3 Explosion-released legs can right spy if it lands on side.

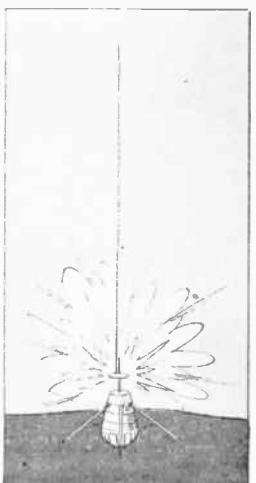

4 The last explosion sends antenna up, and unit is ready.

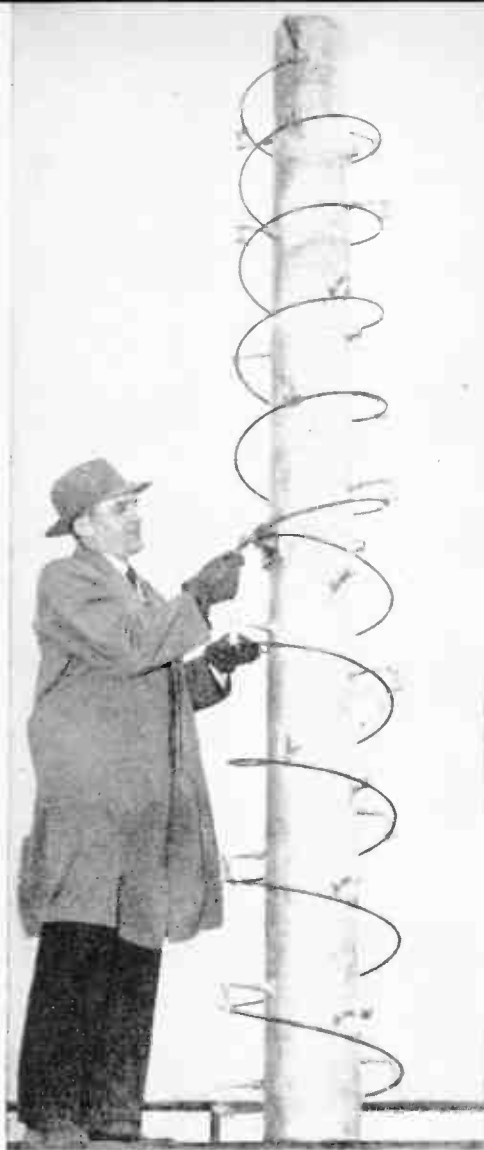

Corkscrew antenna helps make GE's new ultra-high-frequency transmitter the world's most powerful. Four sections like one above boost output of special five-kilowatt tube 20 times.

Small Towns to Get TV on Small Waves

YOU may be watching television in small towns now off the TV map very soon now. Tiny waves way up in the ultra-high frequencies near radar make this possible. These frequencies have now been tentatively assigned by the Federal Communications Commission to 1,357 stations. And TV manufacturers are already working on trans-



New converter for bringing UHF telecasts into present sets looks like small radio (above). Made for Crosley receivers, it needs only to be connected to antenna terminals (right).

mitters to broadcast them and receiver attachments to pick them up.

Today's television operates in the very-high-frequency range, which has room for only 484 stations (107 are already on the air). More stations than that would interfere with each other. Thus, only the roomier UHF band can provide new stations for areas that now get poor video or none at all.

Present TV sets are VHF and cannot receive UHF at all. But most manufacturers are developing converters that will let them get both types of telecasts.

Crosley has a converter for its receivers that looks like a table-model radio. It is simply connected to the antenna terminals of the regular set. RCA, GE, and Zenith have also tested such attachments.

Transmitters are a problem, too, since comparatively high power is needed to cover sizable areas with these very short waves. General Electric has developed the most powerful station yet. It can produce 100 kilowatts. Westinghouse is trying out a war-time radar-jamming tube for UHF.

While UHF television has been tested experimentally for some time—in Bridgeport, Conn., for example—commercial operation is not expected immediately. Some delay is likely before the FCC gives its final approval. And manufacturers are so busy that transmitters may be held up.

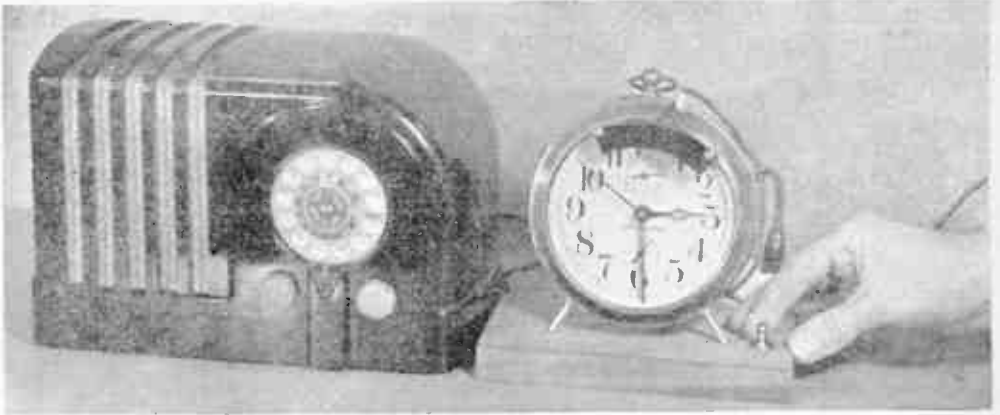

With the switch on, regular bulletins are tuned in automatically; off, the radio operates as usual

NEWS TIMER FOR YOUR RADIO

YOUR radio can be turned on automatically hourly to catch regular news bulletins with this timer built around a clock, preferably an electric one for accuracy. Two strips of springy brass or bronze, attached to the face as shown, provide a circuit that closes when the minute hand makes contact and breaks to shut off the receiver when the hand has passed. The arched strip can be adjusted for contact to the made about 30 seconds before the hour and to end six minutes later, covering fully the time of most hourly news broadcasts. A second-switching unit can be made to catch the half-hour bulletin periods. The only alterations of the clock required are removal of the glass and soldering of nuts to the face rim.

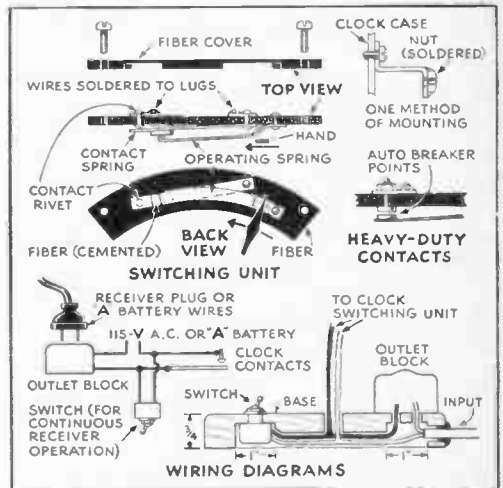

Wiring diagram and parts used in the timer. The heavy-duty contacts are best for large receivers



Nuts are soldered to the case as above or in the diagram, and the timer attached with 6-32 screws

Two curved pieces of thin fiber or plastic encase the switching control, one as a support for the contacts and operating spring, the other to cover the wire ends

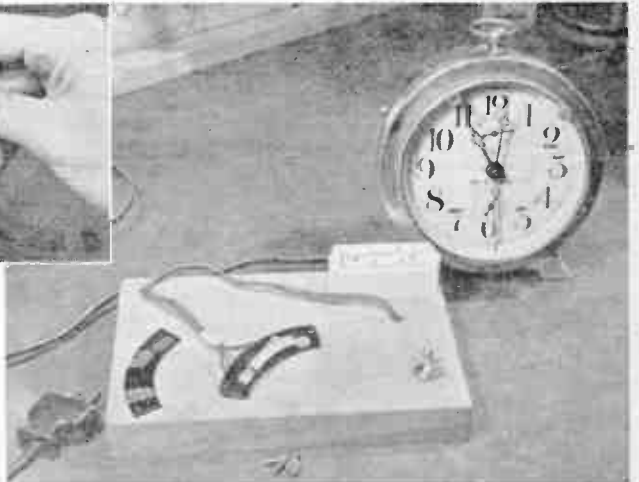

Homemade Electrical Device Dries Dishes and Glasses Speedily

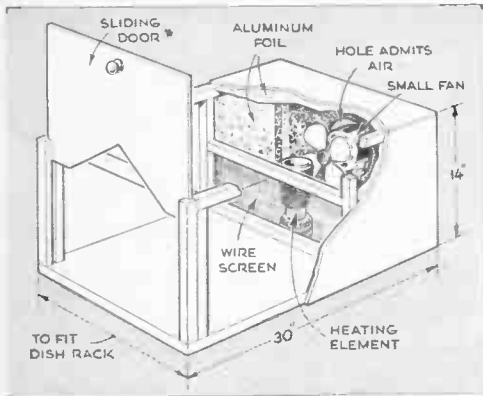

HEATED air from a 600-watt resistance element is blown over wet dishes in this device, which practically eliminates the need for a dish towel in the kitchen. In tests, dishes and glassware rinsed in water at 115 deg., which normally required up to 45 min. for air-drying, were completely dried in about 7 min.

The dryer consists of a box of hard composition board with pine framing, proportioned to take a standard dish rack. A circular hole in the rear and a notch in the sliding front permit the passage of air. The heating element and small fan are wired in parallel and controlled by a switch. Alumi-

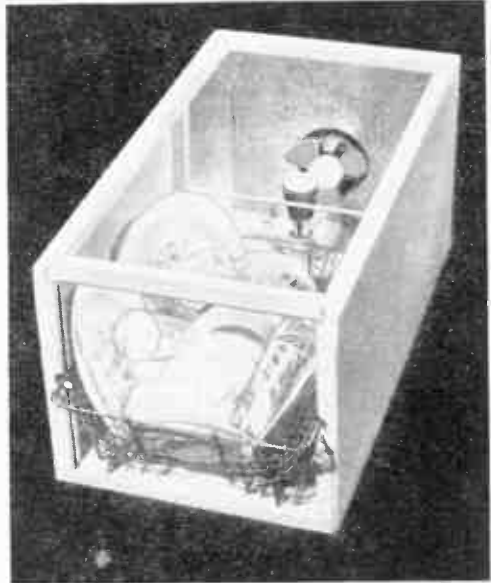

num foil is placed on the interior near the resistance unit, and a wire screen acts as a stop for the dish rack. Take every precaution to guard against shock: use only rubber-covered wire, and tape securely or otherwise protect all connections. Don't use a switch, but control the device by plugging in a heavy-duty plug.—G. S. GARDNER.

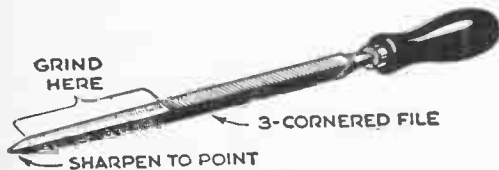

File Makes Insulation Scraper

A HANDY insulation scraper for the radio and electrical worker's bench may be made from a worn triangular file. Grind off all teeth from the three sides for a distance of about 3", holding it against the wheel in such a way as to leave a slightly concave face on each side. The edges produced will be quite sharp but may be whetted on a small handstone for still greater keenness. If in addition the tip is ground to a tapering point, the tool will be useful for starting wood screws and for enlarging and burring small holes that have been drilled or punched in sheet metal.—HERBERT SPOHN.

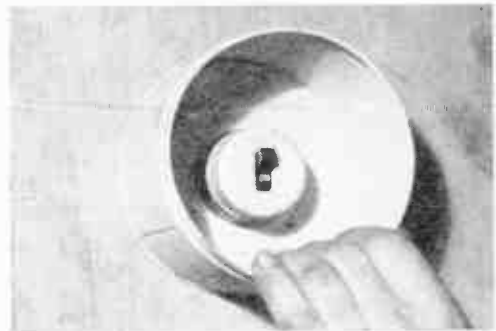

Can Protects Outdoor Switch

GARAGE and outbuilding switches that are directly exposed to the weather or are on porches or similar locations that rain may reach can be protected with old coffee cans. Use the kind with a screw-on lid, and paint well to prevent rusting. The switch is mounted and wired through holes punched in the can bottom.—IVAN GROSVENOR.

Play All Three On Your Old Phonograph

By J. Raymond Schneider

YOUR old record player may not be as out-dated as you think it is. If your record collecting has been slowed down because your phonograph can't handle the new slow-speed records, here's a way to bring that platter-turner up to date: an all-electronic system that turns any 78-r.p.m. synchronous motor at 33 $\frac{1}{3}$ and 45 r.p.m.

Fundamentally this unit consists of a variable-frequency generator. Since synchronous motors turn at a speed that is governed by the frequency of the house current (usually 50 or 60 cycles) it is only necessary to vary the frequency to vary the speed.

The generator shown here uses standard radio parts and requires few tools. It is important that the components be of heavy-duty construction in order to achieve the necessary power-handling capacity.

An audio-oscillator circuit using two 6L6 pentodes in push-pull does the main work of frequency changing. Power is supplied by a voltage doubler consisting of four dry-disk selenium rectifiers and two filter condensers. Output of the oscillator goes to a push-pull output transformer, T2. Condensers C3, C4, and C5 are connected across the primary of this transformer to produce a resonant circuit. It is important to use the particular output transformer (T2) specified in the parts list. The 5,000-ohm primary of this unit has two leads for the plate and one for B-plus. On the secondary side you use only the black and yellow leads (the 500-ohm tap).

Note that two condensers (C3 and C4) ▶

Change speeds electronically to play 33 $\frac{1}{3}$ - and 45-r.p.m. records on your old turntable.



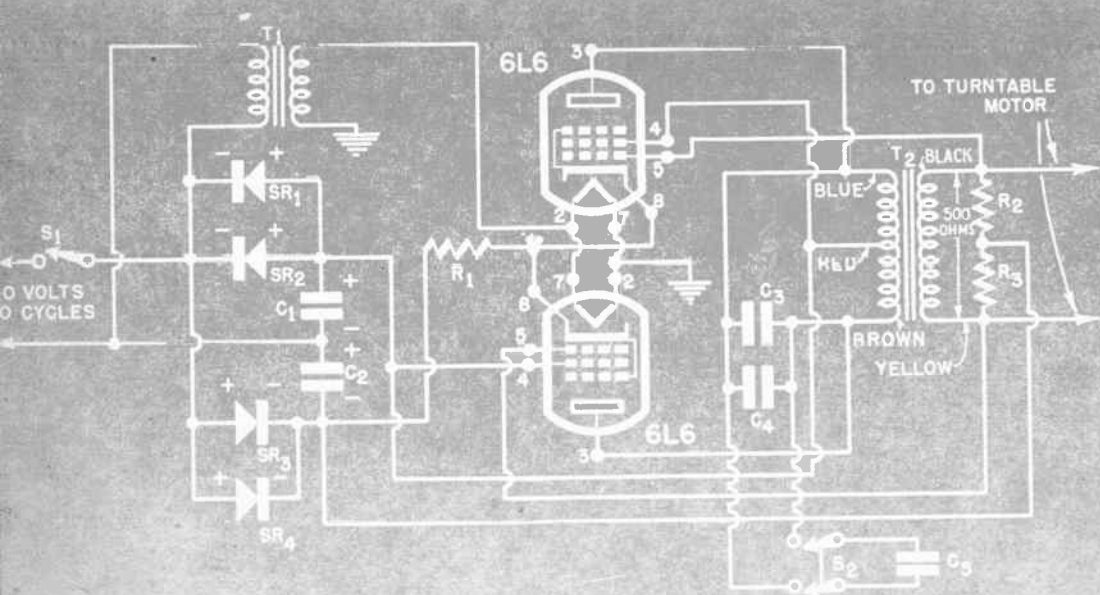

This oscillator, using standard radio parts, changes the frequency of the line current.

LIST OF PARTS

C1, C2: 30-mfd., 450-volt electrolytic.
 C3: 1-mfd. 450-volt paper or bathtub-type.
 C4: 25-mfd. 450-volt
 C5: 5-mfd. 450-volt
 R1: 100-ohm 10-watt wire-wound.

R2, R3: 30 000-ohm 1/2-watt carbon.
 SR1, SR2, SR3, SR4: 100-ma dry-disk selenium rectifiers
 T1: 6.3-volt 2.5-amp filament trans.
 T2: Push-pull output transformer

(Stancor. A-3800: 5 000-ohm primary)
 S1: SPST toggle
 S2: DPST toggle
 Two 6L6's line cord and plug, female outlet receptacle.

are permanently connected across the primary of output transformer T2. This combination should cause the turntable to run at 45 r.p.m. A third condenser, C5, is connected in parallel with the other two by means of switch S2. The effect of adding this condenser is to lower the resonant frequency of the circuit, cutting speed to 33%.

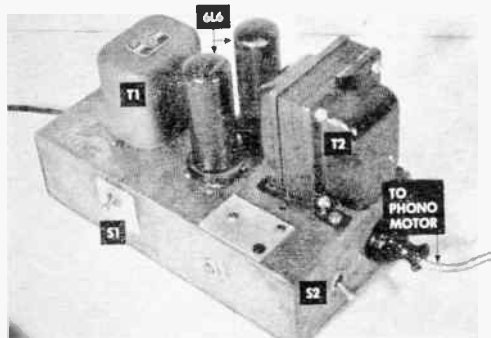

The converter is connected to the house line and the phono motor plugged into the flush-mounted receptacle on the edge of the chassis.

There are many variations in phono motors. Use a stroboscopic disk to find the exact speed yours delivers when powered through the frequency changer. You may discover that it is turning a few revolutions faster than you want. Should this happen, add an extra 450-volt condenser in parallel with C3 and C4. First try a .1-mfd. unit. If the speed is still too high, add another.

If the 45-r.p.m. position is correct but the 33% slightly high, add the .1-mfd. capacitor in parallel with C5. Conversely, if the motor is too slow, replace C3, C4, or C5 with slightly smaller capacitors. A small amount of experimentation should put the turntable speed right on the nose.

A second basic change in the new records is a narrower groove that requires both a sharper stylus and lighter pickup pressure.

The simplest solution to this end of the problem is to add a lightweight arm with a narrow-groove stylus at some convenient place on the motor-mounting board. The photo on page 43 shows this additional tone arm. The shielded lead from this arm is wired in parallel with the other one.

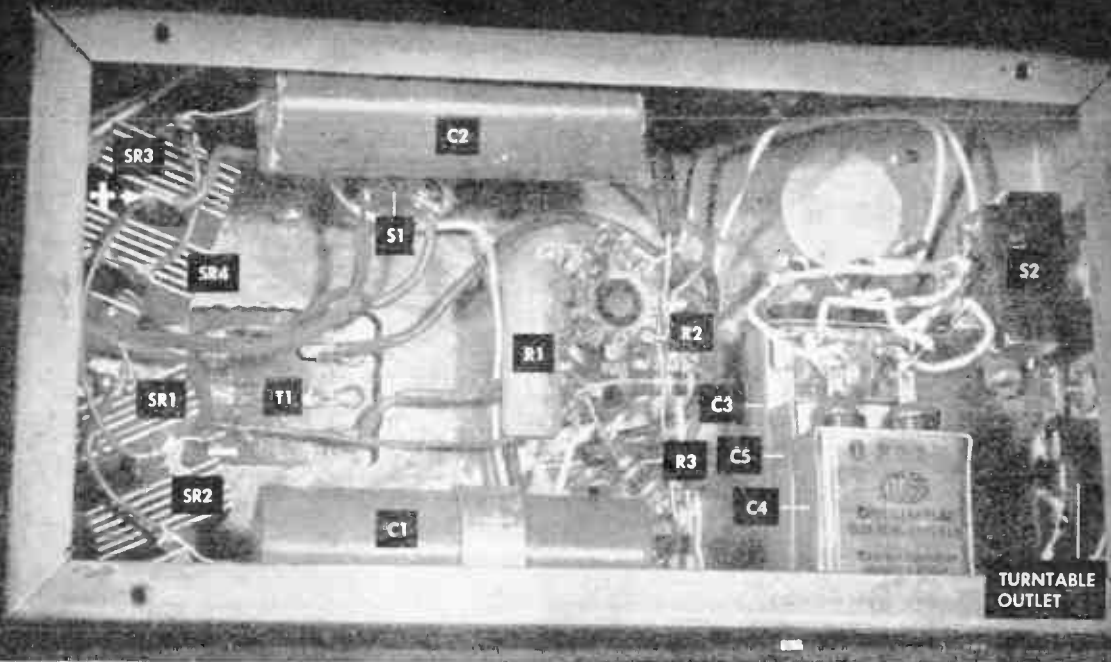

The position of most components can be seen here. Note the polarity of the dry-disk rectifiers.

To operate the frequency changer, plug the line cord into a 115-volt AC outlet. The power leads from the 78-r.p.m. motor are plugged into the receptacle provided on this unit. Allow the tubes a few seconds warmup, turn the switch to either the 33 $\frac{1}{2}$ or 45 position, and play your new records.

This converter has enough power to handle the phonograph motor *but not the amplifier*. If your phonograph has a single plug for both the motor and amplifier, it is necessary to separate the wires. Plug only the phono motor into the converter; the amplifier and radio go to the house line.

Depending upon your own particular cab-

inet arrangement, you may wish to connect the switches through extension cords. This will allow you to hide the converter while bringing the controls to the front. In this event it may also be desirable to add a DPDT switch between converter and motor. Wire it with the motor leads running to the blade contacts, house current to one side, and converter output to the other. This gives a choice of the slow speeds or a feed-through arrangement that will connect the phono motor directly to the 115-volt, 60-cycle line. The latter position will be used when you want to play your phonograph at its original speed of 78 r.p.m. END

Hot Iron Rests on Typewriter Spool

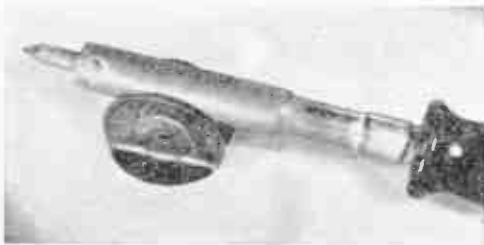

A HANDY stand for a soldering iron can be made by bending a metal typewriter-ribbon spool as above to form a base. Also flare the upper edges to receive the iron.—*John J. Rea, Urbana, Ill.*

Paper Tray Keeps Parts in Order

It's often easier to take things apart than to put them together. Next time you have to handle small parts, arrange them as shown here in a tray made by pleating paper. The folds keep all the bits and pieces in sight, prevent them from rolling around and show you the order in which they should be replaced.—*Albert Griffin, The Bronx, N. Y.*





Make TV Pictures Sound Better

This push-pull stage can be hooked to any receiver. It by-passes the tiny speaker, takes advantage of set's FM sound.

PULLING pictures out of the air seems to have dulled the ears of many Americans to the sound accompanying those pictures. If you look inside a table-model teleset, you'll probably see a 3- to 5-inch loudspeaker fed by a single output tube—just about what you'd get in a cheap AC-DC radio.

But TV sound *can* be first-rate. It is broadcast by FM and the receiving circuits usually are well designed.

You can make better use of the sound potential of your TV set by building yourself the 9-watt push-pull output unit pictured above. It can be attached to any receiver without tampering with the wiring. To obtain the best results, however, you should use it with a 10- or 12-inch speaker in a separate baffle.

Keeping the unit compact makes it easier to mount in or near the video cabinet. It takes some squeezing, but as you can see from the photos, all the parts will fit a chassis 5" square and 1½" high.

Though only two tubes are visible, the circuit is actually a three-tube plus two-rectifier affair. There is one 6F6 and one 6AD7-G. The latter is a dual tube containing the equivalent of a 6F6 pentode plus a triode phase inverter. Two dry-disk selenium rectifiers in a voltage-doubler arrangement supply nearly 250 volts for the plates of the amplifier tubes.

To minimize tampering with the television receiver, the sound signal is picked up at the secondary (voice-coil) winding of the teleset's output transformer. This means that only two wires have to be disconnected at the set. It also means that a shielded intercom transformer is needed to match the low-impedance output of the set to the input of the push-pull unit. Both primary terminals of T1 must be insulated from the chassis.

In wiring, watch the grid and plate leads. Make them as short as possible. If they must stretch over an inch, use shielded wire and ground the braid to the chassis. Work on the heater connections first, and then do the remaining tube-socket wiring. Rectifier and line circuits can be put in last.

Speaker of set is disconnected at voice coil. The two wires are brought to the output stage.

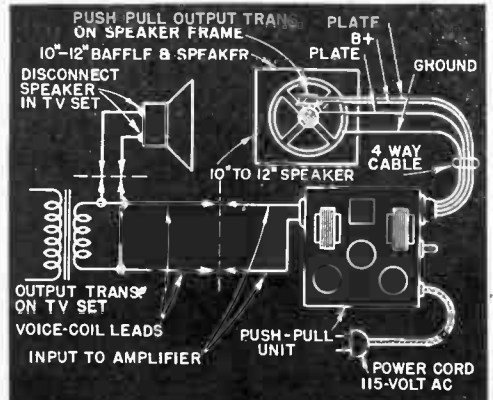

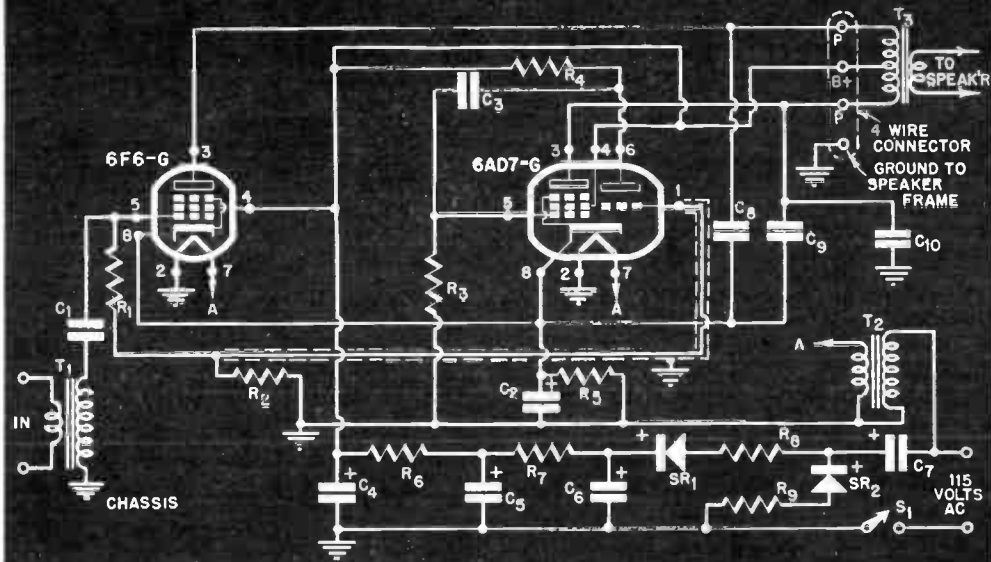

LIST OF PARTS

R1: 330,000-ohm, $\frac{1}{2}$ -watt carbon.
 R2: 100,000-ohm, 1-watt carbon.
 R3: 470,000-ohm, $\frac{1}{2}$ -watt carbon.
 R4: 33,000-ohm, 1-watt carbon.
 R5: 600-ohm, 2-watt carbon.
 R6: 500-ohm, 10-watt wire-wound.
 R7: 1,000-ohm, 10-watt wire-wound.
 R8, R9: 47-ohm, 1-watt carbon.
 C1: .01-mfd., 400-volt paper.

C2: 10-mfd., 50-volt electrolytic.
 C3: .005-mfd., 400-volt paper.
 C4, C5: 10-mfd., C6: 20-mfd., Triple unit, 150-volt elect., or single units.
 C7: 30-mfd., 150-volt elect.
 C8, C9, C10: .01-mfd., 400-volt paper.
 T1: Shielded intercom transformer, 4-ohm pri. to 25,000-ohm sec.

T2: 6.3-volt, 1.2-amp. filament transformer.
 T3: 10-watt universal push-pull output trans.
 S1: SPST toggle.
 SR1, SR2: 100-ma. dry rectifiers. Shielded jack or terminals (for input), 4-prong socket and plug (for output), tubes and sockets, 10" to 12" speaker and baffle, misc. hardware.

To eliminate the high-pitched, frequently scratchy tones you often hear on the sound tracks of old TV movies, condensers C8, C9, and C10 have been used to "mellow" the tone. You may find that they cut too much of the treble for your taste. If so, disconnect C10 or reduce the value of C8 and C9 from the .01 mfd. specified to about .005 mfd.

A 4-prong socket is flush-mounted at one end of the chassis and a matching plug and length of 4-wire cable are used to make

connection with the primary of the output transformer. The transformer can be mounted directly on the frame of the new speaker. A universal type is recommended because it provides a choice of impedances that simplifies proper matching. There are several taps on the secondary. Connect the speaker voice coil to any two of these, and then try all combinations till you find the two taps that give best results. Solder the voice-coil leads to these taps. **END**

Compact chassis requires careful arrangement of parts. The dry disks, placed one above the other, are held to chassis with a 2" machine screw.

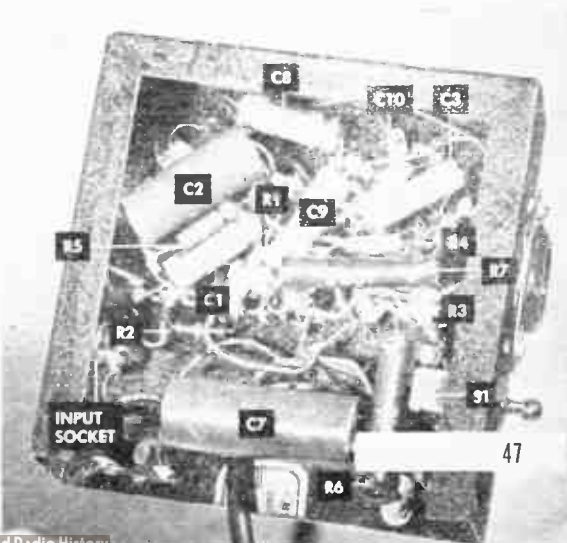
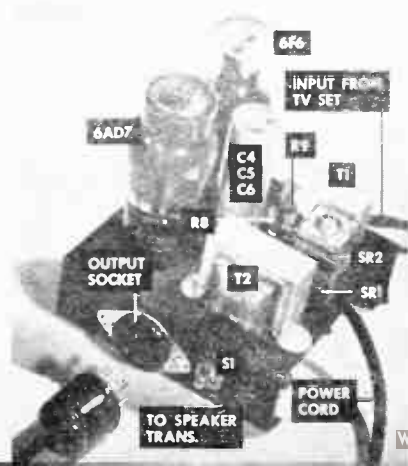

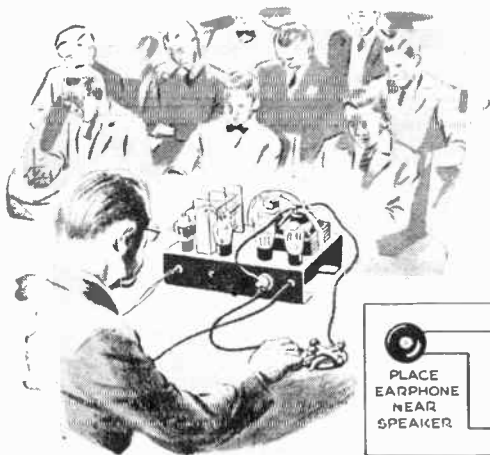

Radio Used for Group Code Work

ANY radio equipped with a phonograph jack can be quickly converted to a group code-practice set with a few extra parts. Connect an earphone, phono plug, and telegraph key as shown in the diagram. Ordinary line cord is suitable. When placed behind the radio loudspeaker near the voice coil, the earphone, which acts as a microphone, will make a feedback circuit providing a tone loud enough for a small group. Experiment with the earphone location until instantaneous feedback is obtained.

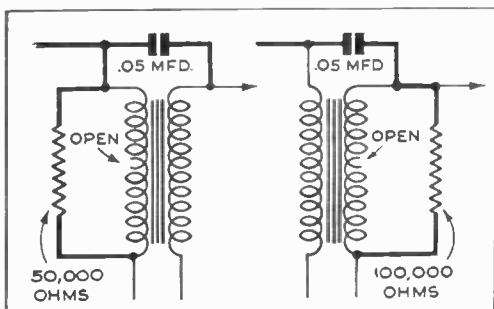
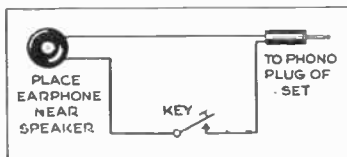

Shunt Makes Temporary Repair

IF THE CAUSE of radio trouble has been identified as an open audio transformer and no replacement is available, a quick temporary repair with a resistor-condenser combination will put the set back in service immediately. Simply shunt the open side of the transformer with a resistor and couple with a condenser (see sketch).

Matchstick Needles Cut Noise

PHONOGRAPH needles made from ordinary kitchen matches will reduce the pickup noise usually heard with open-type record players, while providing good reproduction with little loss at high frequencies.

Shorten a dry, soft-wood matchstick to about $\frac{3}{8}$ " and whittle it to a diameter that will fit the pickup. Then make a perfectly pointed sharp tip. A cactus needle sharpener may be used, or the matchstick can be rotated in the chuck of a hand drill against sandpaper. Resharpen after each record for best results.

Shim Helps Repair Thin Wires

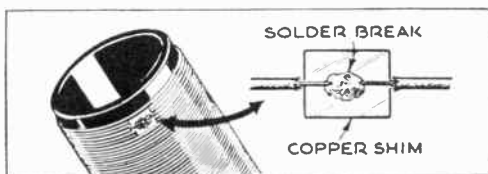

A SMALL piece of copper shim stock will help to solder thin wires when repairing radio coils and leads. Place a tinned shim under the broken ends of the wire and solder the ends on the shim. To prevent the iron from picking up the shim, hold it down with a toothpick. A few drops of tar, fingernail polish, or shellac will serve as insulation when the job is done.

Turntable Simplifies Servicing

RADIO servicing, which usually requires turning the set around many times, can be speeded up by using a turntable. Mount the turntable directly on the workbench, using a metal rod and wooden support arranged as shown in the sketch so that the turntable and rod can be removed when you don't need them.

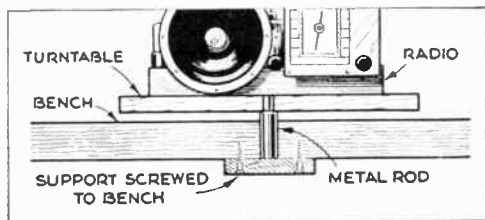

WHEN THE VOLUME CONTROL of a small A.C.-D.C. receiver becomes inoperative, it may be found difficult to obtain a replacement with a built-in switch. If so, an ordinary volume control may be installed and the broken side of the supply line inside the set soldered together and taped.

To provide a way to shut off the receiver, the conventional plug may be removed and the two cord leads soldered, as shown below, to the interior socket contacts of a plug-in night light equipped with a switch. The covering over the insulation should be taped down neatly, after which sealing wax may be poured into the socket. Such a switch control is convenient only when it can be plugged into a waist-high receptacle. Its current-carrying capacity limits it to small table sets and the like.

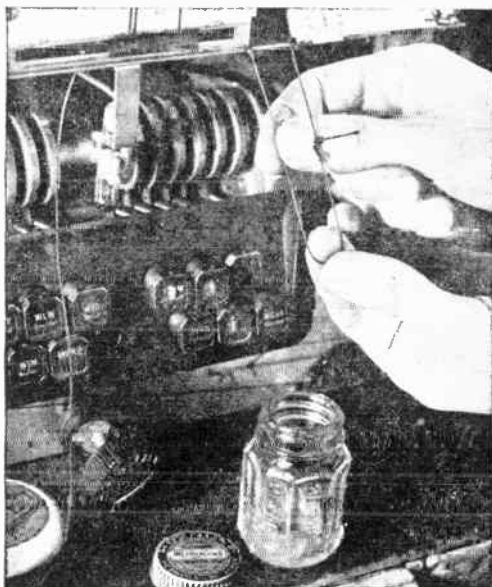
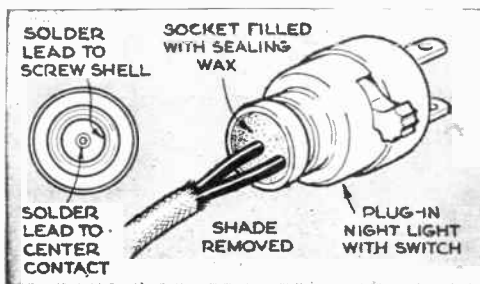

BROKEN DIAL CORDS and those on pointers can be replaced with heavy fishing line, such as 18-lb. test line, as shown above. The new cord may be kept pliable, and made to last considerably longer, by lubricating it with petroleum jelly at points where it passes through grommets or rubs against another part of the receiver.

AN ADDITIONAL SPEAKER of the permanent-magnet type for use in a kitchen, bedroom, or basement shop may be connected to your present receiver, as shown at the right, by placing a single-pole double-throw switch near or on the set. The switch may be a telephone-switchboard key or one of a similar type that provides good contact, or it can be a double-pole double-throw switch with only one side used. A jack for headphones may be installed similarly.

The operating switch cuts off one speaker and turns on the other. If possible, use a switch that cannot leave both circuits open.

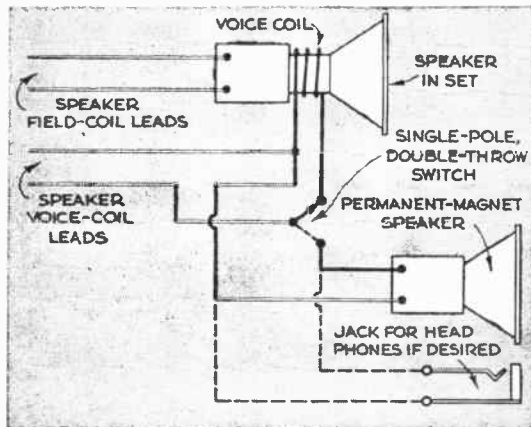

FREQUENCY-TEST RECORDINGS are available for spotting circuit and apparatus resonant peaks in a phonograph and showing up defective pickup units. They are 12" records for use on standard equipment.

One firm has one that sweeps slowly from 10,000 to 40 cycles with signal clicks to mark even thousands and hundreds. An-

other has several recordings of single-tone frequencies. One gives even thousands, hundreds, and tens from 10,000 to 50 cycles. On another, vocal announcements identify frequency. A third has a fast sweep from 10,000 to 40 cycles, then noise spectrums of all simultaneously from 40 to 14,000 followed by limited-range spectrums.

Make Things Obey

By building voice switches, you can cause all sorts of things to happen when you say the word.

By Karl Greif

THERE'S power in your voice. Like your hands and feet, it can be used to make many kinds of apparatus heed your wishes.

This simple one-tube unit is all it takes to run a model train.

THIS one-tube voice switch will make standard remote-control locomotives of the type used in many model-train sets do what you tell them. These engines have sequence selectors that make the cars stop, start, or back up when a switch is pushed.

The switch momentarily breaks the flow

of current to the track. Each interruption moves the selector one notch. If the train is going forward, the first interruption brings it to a halt, the next sends it into reverse, then stop, forward, stop, and so on. Since the locomotive is built to do this, the control mechanism only has to meter your speech and change sounds into pulses. Each pulse closes a relay and interrupts the current flow.

The sketch at the right shows you what happens. The microphone converts sound

into electrical impulses that open and close relays. The result is the same as if you reached out and turned switches.

Parts for this control unit were selected for economy and simplicity. The carbon microphone, for example, is a war surplus item still available at a low price. The 117L7 is a good tube choice because it operates directly off the line and needs no filament transformer. It also contains its own rectifier diode.

You may have to experiment a bit to find the proper connections to the output transformer, T2. This can be done after the wiring is completed and the unit is in operation. If you have a voltmeter, clip the prods across the relay coil and whistle a steady note into the microphone. Note the voltage, reverse the leads to the transformer secondary, and repeat the test. Make the final connections to whichever taps give the highest output.

Two penlight cells in series provide the mike voltage. If the relay tends to stick, adjust the spring or put a piece of paper over the pole.

If the relay picks up when you press the talk switch on the mike, remove the switch spring and lubricate the slide with petroleum jelly.



A child can learn to operate this voice controller. It is connected by four wires between the train transformer and the track.

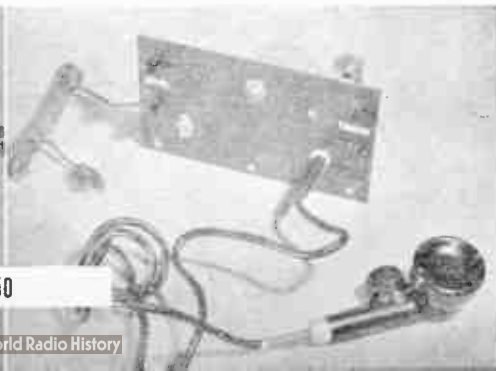
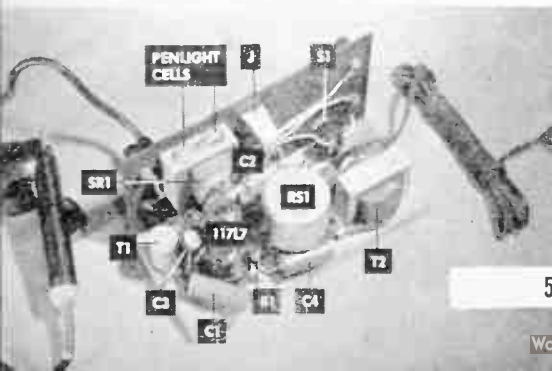

Your Voice

into alternating current. An amplifier puts muscle into this AC signal. It then is rectified and filtered into separate pulses of direct current that are fed to a relay.

What kind of sound do you need to make a pulse? That depends on the filtering. By choosing the right components you can mold the action of the relay to respond to long or short words or syllables.

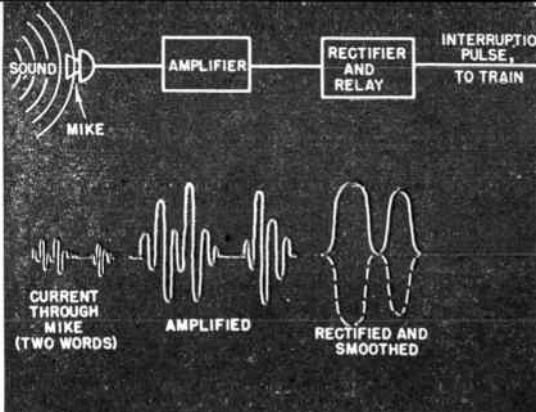

You don't have to make any changes in the train equipment. While the relay is in the up (normal) position, current flows from the train transformer to the track just as if the voice switch weren't there. But when a sound energizes the relay, the contact arm falls and interrupts the circuit.

Give yourself a practice workout with the

train controller before putting it on display. By spacing such words and phrases as "Stop," "Forward," "Now go back," and the like, you can advance the selector relay one, two, three, or more steps at a time. The trains will respond to *any* sound pulse. You have to pick the right number of words to make them do as you tell them.

LIST OF PARTS

- R1: 150-ohm, 1-watt carbon.
- R2: 30-ohm, 1-watt carbon.
- R3: 5,000-ohm, 1-watt carbon.
- C1: 10-mfd., 25-volt electrolytic
- C2: 40-mfd., 150-volt elect.
- C3: 20-mfd., 150-volt elect.
- C4: 4-mfd., 50-volt elect.

- T1: Single-button microphone transformer, approx. 200-ohm pri. to 80,000-ohm sec.
- T2: Output trans., 10,000-ohm pri. to 2,500-ohm sec.
- RS1: 2,500-ohm SPDT plate-circuit relay.

- SR1: 50-ma. dry-disk rectifier.
- S1: DPST toggle.
- J: Single-button microphone jack. Indicator lamp (same voltage as train set), breadboard chassis, panel, dial-light assembly, carbon mike (T-17 or other).

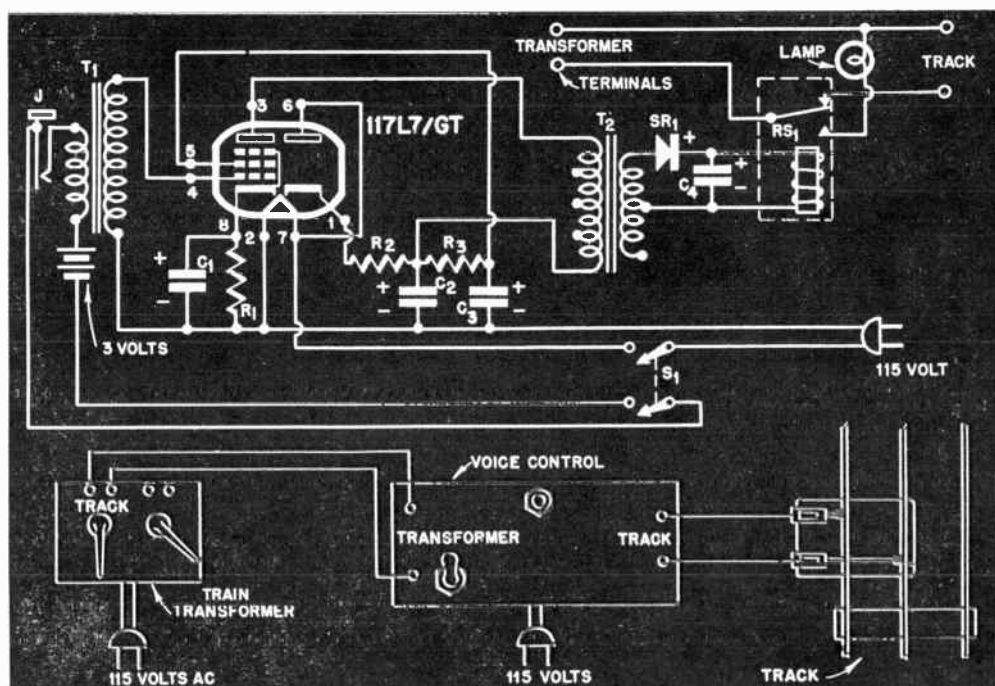

Here's a robot that will turn off radio commercials for you.

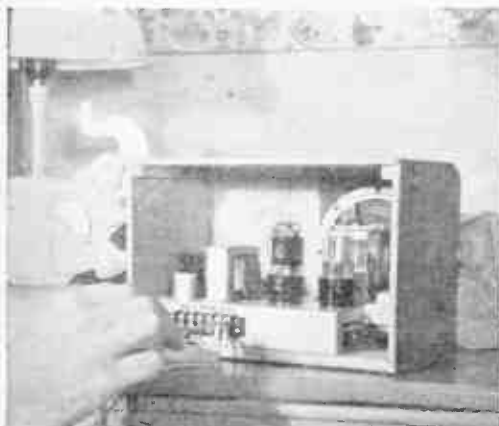

Connected to a bell and placed beside the baby's crib, this sound switch will set off a remote alarm whenever the baby cries.



Connected to a radio, this box silences commercials on your spoken command. The radio will come on again after a period of quiet.

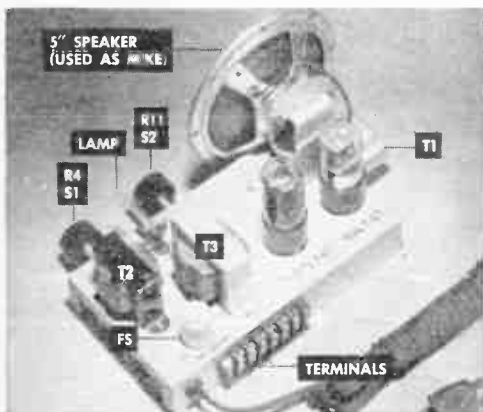

When using the timer circuit, turn on S2 before setting the sensitivity control. Otherwise the click of the switch might trip the relay.

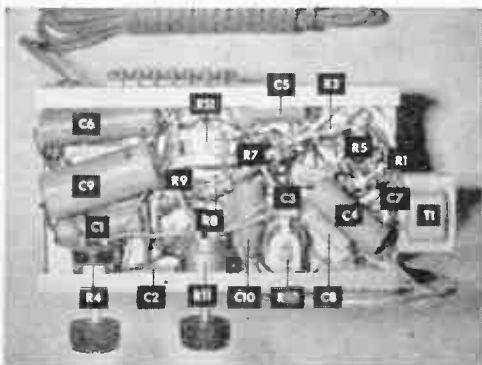

If you want the momentary contacts on RS1 to stay closed longer after the trigger sound stops, use a larger condenser in place of C10.

ADDITIONAL two circuits to the basic voice switch described on the previous pages will make it more versatile. With the electronic package pictured above, you can turn off the radio during commercials without going near it. All you do is call "Quiet!" or even "Shaddup!" and the radio will be mute for about 45 seconds. A second use of the same device warns you in a distant part of the house whenever the baby cries.

One of the additional circuits is a timer that stretches out the switch action; the other is a preamplifier that increases sensitivity. The completed unit looks like a small radio, but in this case the speaker is used as a microphone.

The labeled photo at the left shows how the major parts are arranged. The high gain of the circuit makes their position rather critical. Note particularly that the shielded input transformer, T1, is placed at right angles to the output transformer, T3.

Two sets of terminals are attached to the rear edge of the chassis. One set provides momentary switching action, the other prolongs the action for a controlled period after the triggering sound impulse stops.

The time-delay circuit works like this: a sound picked up by the microphone loud-speaker is turned into an electric pulse that energizes relay RS1. This relay remains picked up just long enough to close a second circuit and allow current to reach the coil of relay RS2, a 115-volt AC relay. This is wired in parallel with a fluorescent-lamp starter (FS) so any voltage that appears

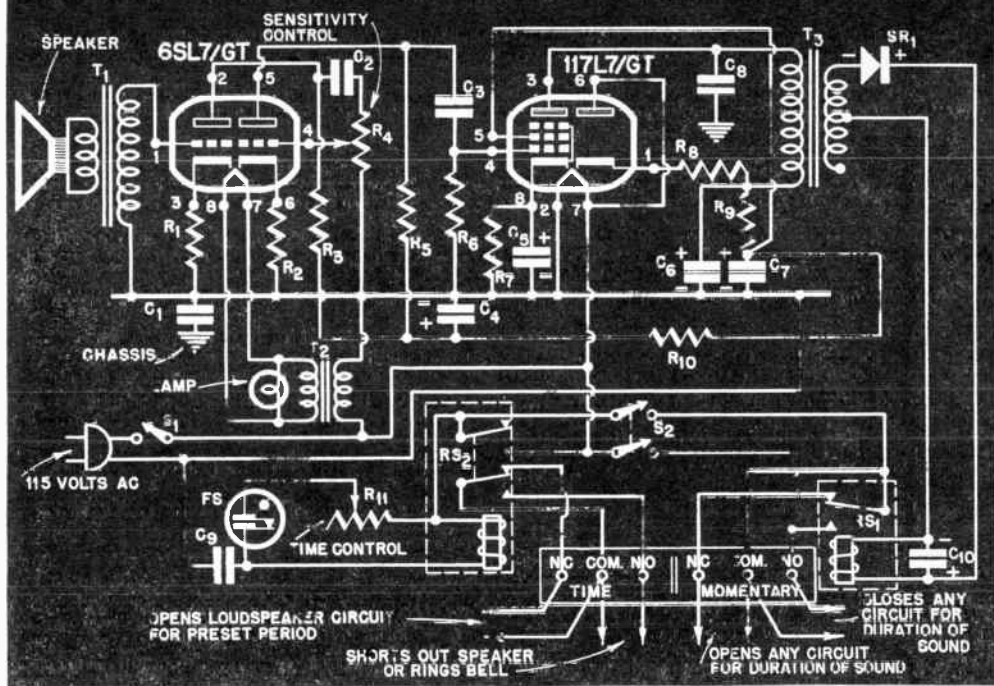

LIST OF PARTS

R1: 3,000-ohm, 1-watt carbon.
 R2: 2,500-ohm, 1-watt carbon.
 R3: 200,000-ohm, 1-watt carbon.
 R4: 500,000-ohm potentiometer.
 R5: 100,000-ohm, 1-watt carbon.
 R6: 500,000-ohm, 1-watt carbon.
 R7: 150-ohm, 1-watt carbon.
 R8: 15-ohm, 1-watt carbon.
 R9: 5,000-ohm, 1-watt carbon.
 R10: 3,000-ohm, 1-watt carbon.
 R11: 500-ohm A.C. wiper pot. or rheostat.
 C1: .1 mfd., 600-volt paper.

C2: .001 mfd., 100-volt paper.
 C3: .003 mfd., 100-volt paper.
 C4: 20-mfd., 150-volt electrolytic.
 C5: 10 mfd., 25-volt elect.
 C6: 10 mfd., 150-volt elect.
 C7: 20 mfd., 150-volt elect.
 C8: .002-mfd., 600-volt paper.
 C9: 1 mfd., 600-volt paper.
 C10: 1 mfd., 50-volt elect.
 T1: 6.3-volt filament transformer, approx. 25,000 ohms primary to match 5 to 6-ohm voice coil.

T2: 6.3-volt filament.
 T3: Output trans., approx. 10,000-ohm pri. to 2,500-ohm sec.
 RS1: 2,500-ohm SPDT plate-circuit relay.
 RS2: 115-volt DPDT AC relay.
 SR1: 50-ma. disc rectifier.
 S1: SPST switch on R4.
 S2: DPST switch on R11.
 FS: 15-20 watt neon-tube pilot-light starter.
 FS: 6.3-volt pilot lamp, 5" PM speaker, 1 1/2" by 1 1/2" by 8" chassis.

across the relay coil also appears across the starter. When current flows through the starter, it heats the bimetal contacts and bends them till they finally touch. This lowers the voltage in the relay and ends the timing cycle. The time-control rheostat, R11, regulates the current through the starter and therefore the delay.

To use this unit as a radio silencer, connect either the normally-open (NO) time terminals across the voice coil of the radio's speaker or the normally-closed (NC) pair in series with one speaker lead. Turn on the time switch (S2) and set the time control to maximum. Then, while the radio is operating at normal volume, adjust the sensitivity control, R4. It should be below the point where the radio's sound can trigger the relay. A word or handclap will then silence the radio for about 15 seconds. It will come back on automatically.

The higher the sensitivity control is set,

the easier it will be to set off the device, but if the setting is too high it may respond to loud music, or an auto horn in the street, or even vigorous conversation. Sometimes the unit may have to be mounted on sponge rubber to keep it from reacting to vibrations other than a loud voice aimed directly at it.

To use this unit as a baby tender, connect the normally-open contacts either on "time," or "momentary" (depending on whether you want a long or short alarm) to a bell. Juice for the bell can be tapped off the 6-volt pilot-light terminals. Place the control box close to the crib, and place the alarm bell wherever you wish. Now when the baby cries, his voice will make the alarm bell ring.

This device also can be used as a night watchman, to make lights turn on, to trip a camera shutter, or to start or stop household appliances. For some of these purposes, however, relays capable of handling larger loads may be needed. ▶

Continuous-duty switch uses little power, keeps its ear cocked.

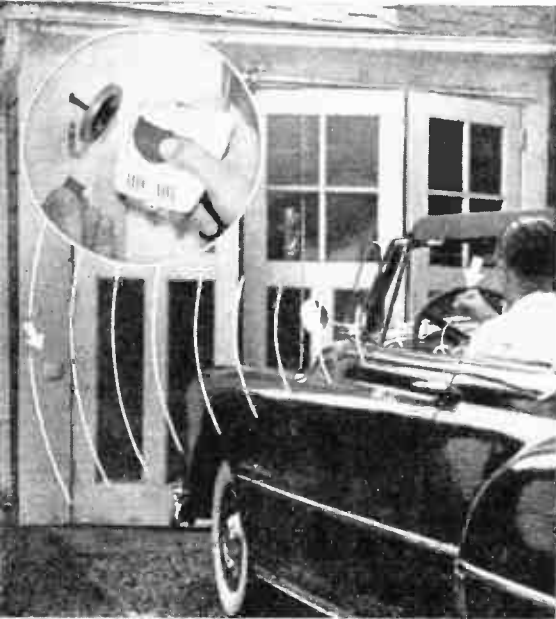

Automatic garage doors can be honked open with this sound-operated switch. Mike is cushioned on rubber, enclosed in a watertight hood.

THERE are a lot of applications in which voice switches have to be left on for long periods of time. In such cases it's important that the power consumption be held to a minimum. Here's a circuit that will do it. It is built around a gas-discharge tube known as a thyatron.

The special advantage of a thyatron is that it needs no DC and draws plate current only when triggered. In other words, the only power used in stand by operation is the small amount needed for the filament and for the carbon microphone supply.

When a signal hits the mike, it is stepped up through transformer T1 and impressed upon the grid of the tube. Voltage on the grid makes the tube "fire." You know it's firing when you see a blue-violet glow inside the bulb. What happens, actually, is that the tube becomes conductive and starts drawing pulses of current from the AC line. The pulses energize the relay. The higher the value of the pulse-smoothing condenser, C3, the longer the relay will remain picked up after the firing in the tube stops. Higher values of R6 will also increase the time lag.

LIST OF PARTS

R1: 1,000-ohm potentiometer.
R2: 50-ohm, 1-watt carbon.
R3: 5-meg., 1/2-watt carbon.
R4: 500-ohm, 1-watt carbon.
R5: 25,000-ohm, 1-watt carbon.
R6: 5,000-ohm, 1-watt carbon.
C1: 100-mfd., 15-volt electrolytic.

C2: .02-mfd., 600-volt paper.
C3: 40-mfd., 150-volt elect. (8- to 100-mfd. can be used to vary closed-time of relay).
T1: Single-button mike trans. approx. 200-ohm pri. to 80,000-ohm sec.

T2: 6.3-volt filament trans.
RS1: 2,500-ohm SPST plate-circuit relay.
SR1: 50-ma. dry-disk rectifier.
S1: DPST toggle.
S2: SPST toggle.
Carbon mike, chassis, tube.

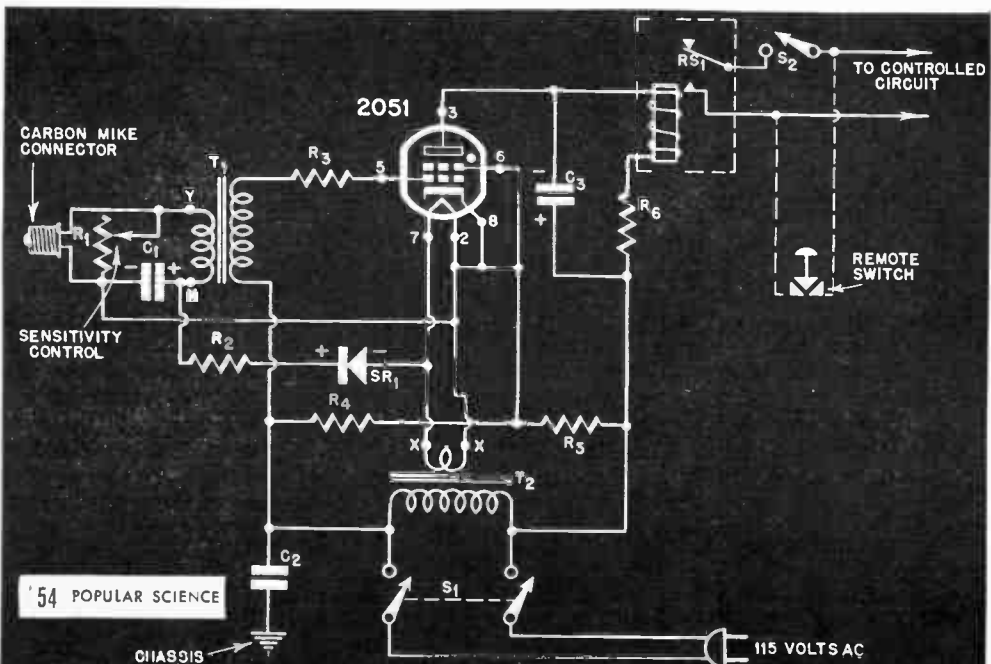

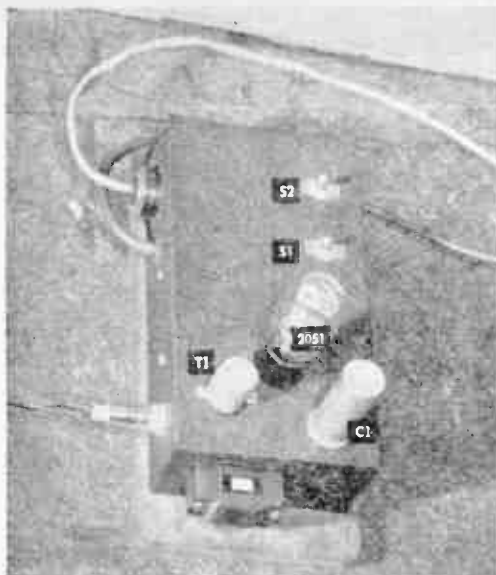

The wooden board on which the chassis rests can be screwed to a wall. The oversize chassis insures ample ventilation in tight quarters.

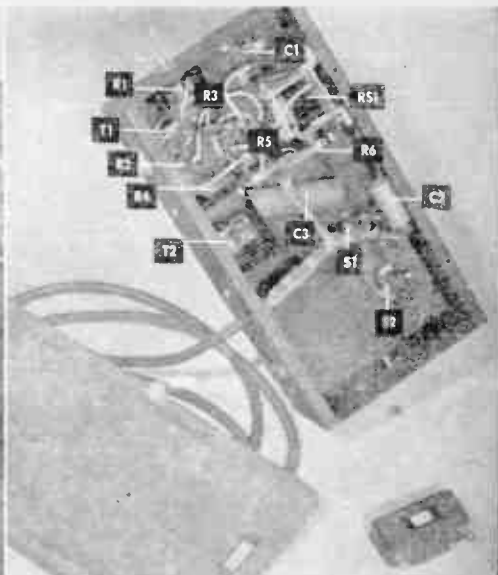

If the thyatron tends to fire too easily, increase the value of the bias resistor, R4; if it doesn't fire, try a smaller resistor.

The entire unit is built on a 3" by 5" by 10" chassis. The only critical part of the wiring is that referred to by the letters "x-x" and "y-y" in the diagram. The position of these leads controls the phasing of hum voltage in the mike circuit. If the tube is uncontrollable or tends to pulse erratically, reverse the connections at x-x or y-y.

The single-button carbon mike shown in the photos was removed from a surplus telephone handset. For most applications it is important to mount the microphone on sponge rubber. A water-inlet hood from a washing machine was used as a protective housing for the mike.

Relay contacts are connected to the circuit to be controlled. In this case it happened to be an automatic garage-door opener. Dotted lines in the diagram show how

the original control switch was connected into this circuit.

In use, the sensitivity control (R1) must be set at a fairly low point so that it will respond to an auto horn sounded four or five feet away but ignore other noises.

Another application for this control is to turn on runway and landing lights at a private or unattended airport. The mike could be mounted on a sounding-board panel and located near the runway. When a pilot "buzzed" the airport, the roar of the motor would trigger the thyatron and turn on the field lights through a heavy-duty latching relay. An automatic timing circuit would have to be added to turn the lights off after a suitable interval. Automatic turnoff is important since the circuit is necessarily subject to chance noises.

END

Jumping Tests Your Shocks

THE function of automobile shock absorbers is to dampen, or slow down, the up and down movement permitted by the springs. You can test whether yours are doing their job by standing on the front bumper and bouncing the chassis up and down. If it continues to bounce excessively after you get off, the front shock absorbers need attention, perhaps replacement. Jump on the rear bumper for a similar test of the shock absorbers at that end.

Gluing Wood Controls Warping

Why is the top of a workbench usually made of several strips of wood glued together, rather than a solid piece?

There's a sound reason. Under changing climatic conditions, any wood tends to warp and split. But if the wood is sawed into strips, rearranged, and then glued together, the tendency of one part to twist out of line is counteracted by the forces exerted by the others joined to it. This is a good point to remember in any woodworking job.

What Ails Your Old Phonograph?



NOW is the time to bring that portable wind-up phonograph down from the attic and put it in shape for summer. Rattles, shrills, wows, and the other awful sounds that phonographs may give out often come from easily correctible troubles. These photos show some of the common flaws and what to do about them.

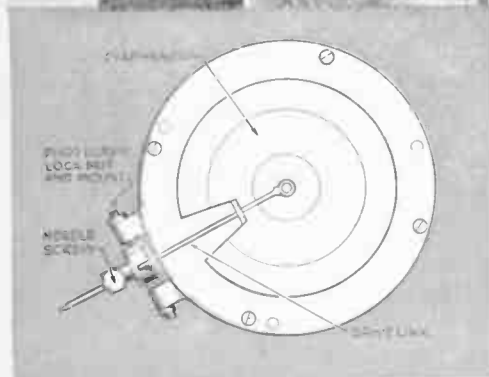

Is the pickup head okay? If not, it will either bottleneck the sound or bring it out sour. A damaged diaphragm causes distortion and loss of volume. Small dents may be pressed out.

A needle holder that's too loose causes rattles; one that's tight reproduces records shrilly. Test the holder with your finger. It should have the tiniest amount of play. If necessary, adjust the pivot screws. Don't bother fixing bent or broken parts, for new heads are inexpensive. The new one needn't be identical with the old as long as it fits the arm.



Does the needle track? If it tends to jump the groove, inspect the side-to-side and up-and-down movement of the arm. It should be free in both directions. Polish arm joints with fine sandpaper. If the joint has a slot, make sure it is clean. Apply a dry lubricant such as graphite before reassembling the parts.



Does the table wobble? If so, it may bounce the needle out of its track and will probably put "wows" in the music. A piece of chalk tells the story. Hold the chalk firmly, rest your hand on a solid surface, and bring the chalk down till it just touches the felt. If the table is level, it should mark the rim evenly all around. Wobble

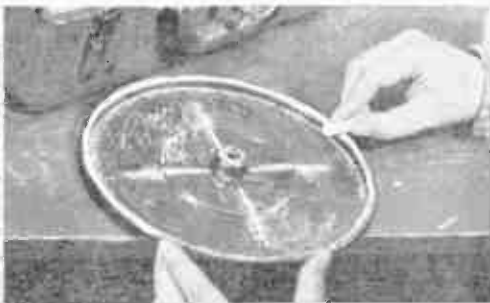

may be caused by loose or missing mounting bolts or a bent spindle.

If you suspect that the bottom of the turntable is rubbing against the stop lever, speed regulator, or mounting board, chalk the lower edge of the rim liberally. The powder will rub off on obstructions or high points.



Is the speed right? Poor speed regulation can make records sound as if the musicians were being paid by the beat. Or it can turn a fox trot into a funeral march. Adjusting the speed-regulator arm should bring the speed to a fairly constant 78 r.p.m. This can be checked with a stroboscopic disk. Seen under an electric light, one row of lines seems to stand still when the speed is right. The disk shown at the left



above has rows for all three phono speeds for both 50- and 60-cycle lights.

Another way to check turntable speed is to count revolutions, as shown at right. Slip a piece of paper under a record so that part of it projects. Start the motor and count the number of times the paper passes a point in a given time. Adjust the speed regulator until it counts 78 turns a minute.

Does the regulator regulate? If not, lift off the turntable and take a look at the linkage to the brake lever. Sometimes the collar that connects the regulator arm and lever comes loose. The collar bolt should be tightened. If the collar is tight, the governor itself may be faulty. You'll have to check that next.

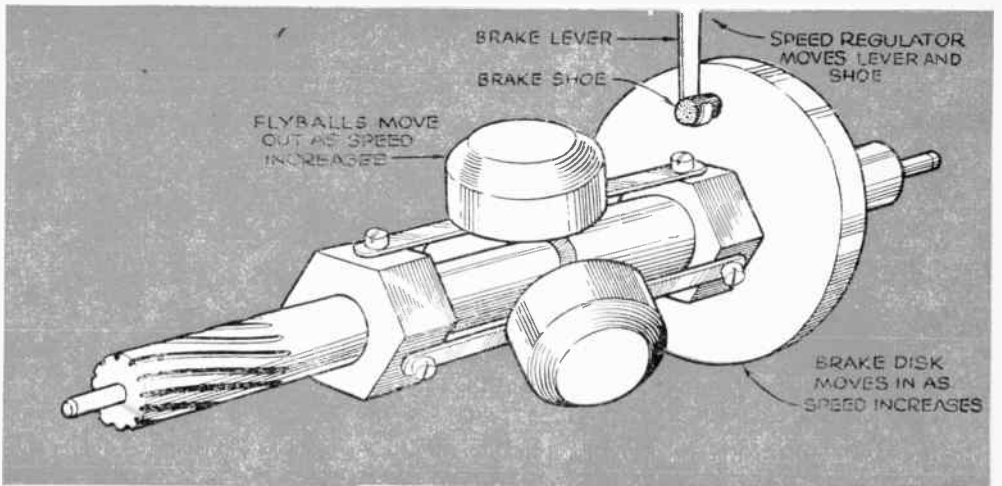
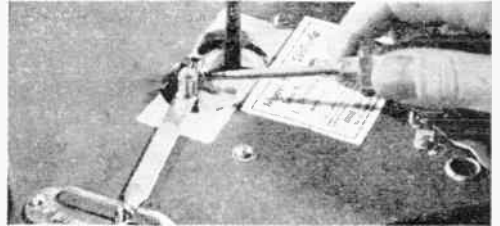

Is the governor sticking? The photo at right shows the parts of the speed-control mechanism. Three weighted balls or disks are spring-fastened to two collars on the shaft. One collar—which is attached to a brake disk—is free to slide on the shaft. As speed increases, the balls fly outward and pull the sliding disk against the brake shoe. The three balls must be of equal weight and their springs of equal tension. If movement seems sluggish, the shaft should be polished and lightly oiled. Replace the brake shoe if it is worn or broken.

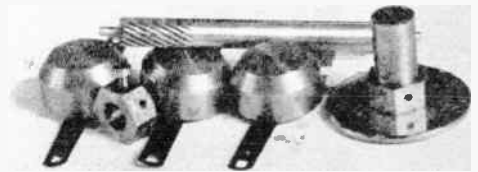

Short Pin Improves Lid Hinge

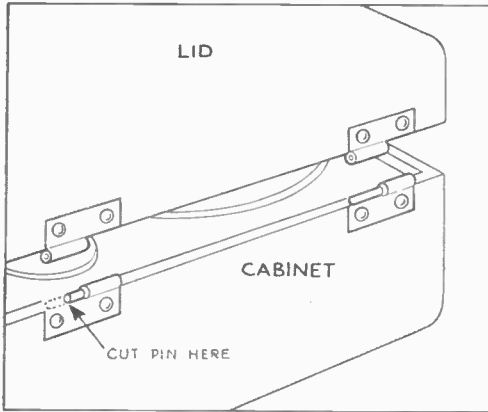

FOR easier replacement of the detachable lids on some portable radios, phonographs, and typewriters, cut about $\frac{1}{8}$ " off one of the hinge pins. Then both pins need not be lined up simultaneously. To attach the lid, engage the longer hinge pin first, sliding it into the hole far enough to serve as a pivot while the shortened pin is being aligned with its hole.—W. E. B.

Fiber Tool Adjusts Condensers



FIBER SCREW DRIVER

BLOWN tubes and painful jolts often result from the careless use of metal screwdrivers in adjusting trimmer condensers. For safety, and to eliminate the adjustment errors that cause capacity effects, cut a tool from $\frac{1}{8}$ " fiber or other stiff insulating material. File the blade to screwdriver shape.—A. M. LINDNER, JR.

Oil Solution Cleans Crackle

DUST-COLLECTING crackle finishes used on radio equipment can be cleaned with carbon tetrachloride and a few drops of oil. About 10 drops of household oil to one ounce of the tetrachloride will prevent the surfaces from drying a lusterless gray. Apply with absorbent cotton and wipe with a soft cloth.—G. F. BATES.

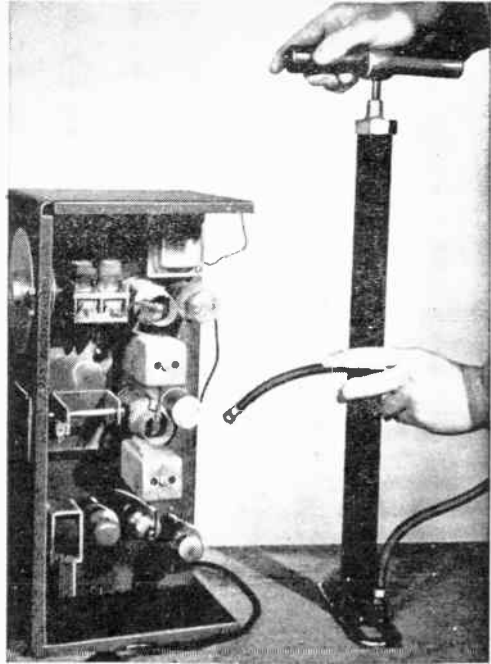

Tire Pump Dusts Radio Chassis

AN AUTOMOBILE tire pump cleans radio chassis effectively. Tubes, shields, condenser plates, and other often inaccessible parts that require occasional dusting can be reached by the air stream from the flexible pump hose.

Diagram on Set Speeds Repairs

FUTURE repairs on homemade electronic equipment will be made more intelligently and quickly if the circuit diagram is cut out and glued to the chassis or panel when the wiring is done. Water glass or household cement will hold it on crackle-finish panels.

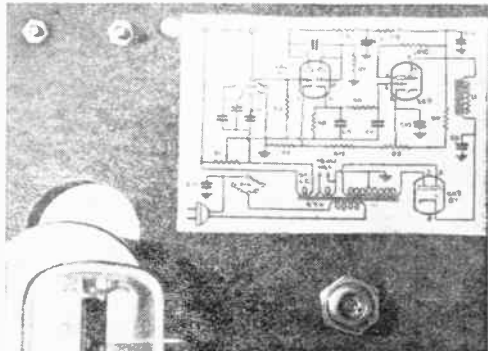

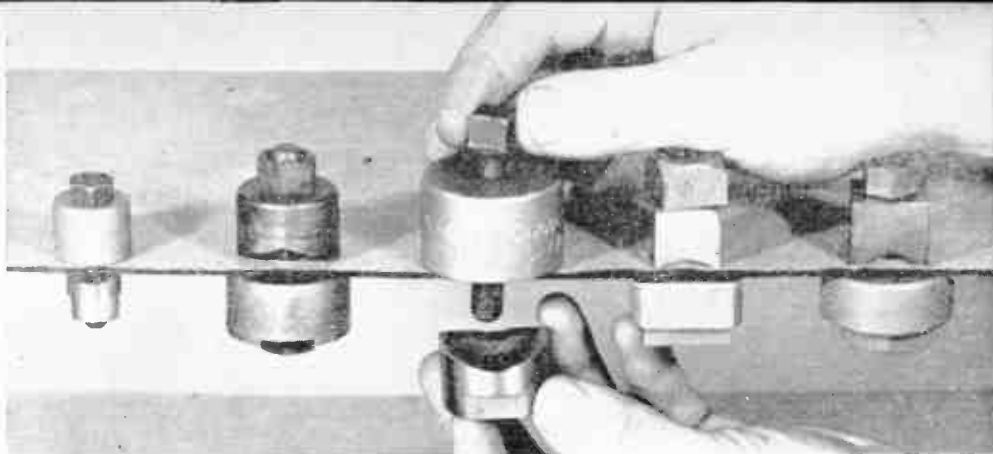

Drawing up on the bolt pulls the hardened cutter into the die, produces a cleanly cut hole.

Are You Using Chassis Punches?

They make big holes—round or rectangular—out of little ones.

ONCE you graduate from the breadboard stage of radio building you sometimes run into metal-working problems that are tougher and more time-consuming than the wiring itself. The job of cutting holes in a chassis to take tube sockets, filter condensers, transformers, meters and the like can be a poser if your shop lacks an important yet simple piece of radio-making equipment.

Chassis punches have long been common in radio shops but many radio enthusiasts whose "workbench" is the kitchen table after the dishes are cleared away have tried to struggle along without them. Using other tools you can make big holes in metal in a variety of ways. You can drill a circle of small holes and chisel out the remaining metal, or you can chew it away with a jeweler's saw or file. Another method is to bore your largest twist-drill size and file out the rest. A hole cutter used in a drill press will also do a fair job. But as often as not the hole made by these methods will not be a smooth circle.

Chassis punches do the job better and in a fraction of the time. These tools consist of a cutting die, a socket, and a bolt that draws the die and socket together. The three steps involved in punching a perfect hole consist of drilling a single pilot hole (ranging from $\frac{1}{8}$ " to $\frac{1}{2}$ ", depending on the punch), assembling the die and socket on top and bottom of the opening, and drawing up on the bolt with a small wrench.

Aluminum and steel up to $\frac{1}{8}$ " thick give way like cardboard to these cutters. They are available in about two dozen sizes ranging from $\frac{1}{2}$ " to $3\frac{1}{2}$ " round and $\frac{3}{8}$ " to 1" square. For radio work the 1 $\frac{3}{16}$ " round punch is a good all-around size.

The usefulness of the devices, however, isn't limited to radio. They can be valuable and timesaving in all sheet metal work, and there are many interesting and still unexplored possibilities in craft projects in brass and copper.—R. Hertzberg, Queens, N. Y.

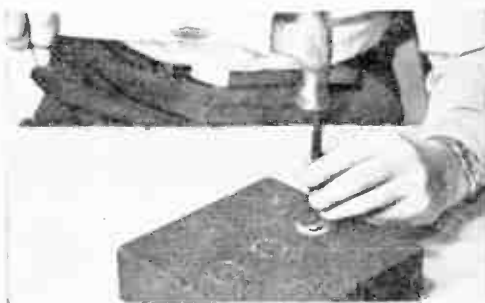

One method of making a tube-socket opening is to drill a circle of small holes and chisel out the metal between. But punches do it better.

Large square or rectangular openings of any size can be sheared out with square cutters. Just overlap several bites as needed.



Radio Builder's



Crystal Kit

Remember the sets you built when you were a kid?

You can encourage your boy to build one with these parts.

NEXT time you're looking around for a gift for a small boy, hop down to the radio store and pick up the inexpensive components shown in the picture at the top of the next page. Put them together in a gift box. Paste an attractive cover on it (like the heading above). Enclose a sheet of directions such as you'll find on page 62. Then let the youngster have the fun of assembling his own radio.

The set shown here is an up-to-date version of those with coils wound on oatmeal boxes that you probably made as a boy. It has a permeability tuner that changes stations by sliding a powdered-iron core in and out of a coil.

If you select units that look like those in the photo, it will be easy for a boy to identify them. Lay all of the parts out on the baseboard and punch starting

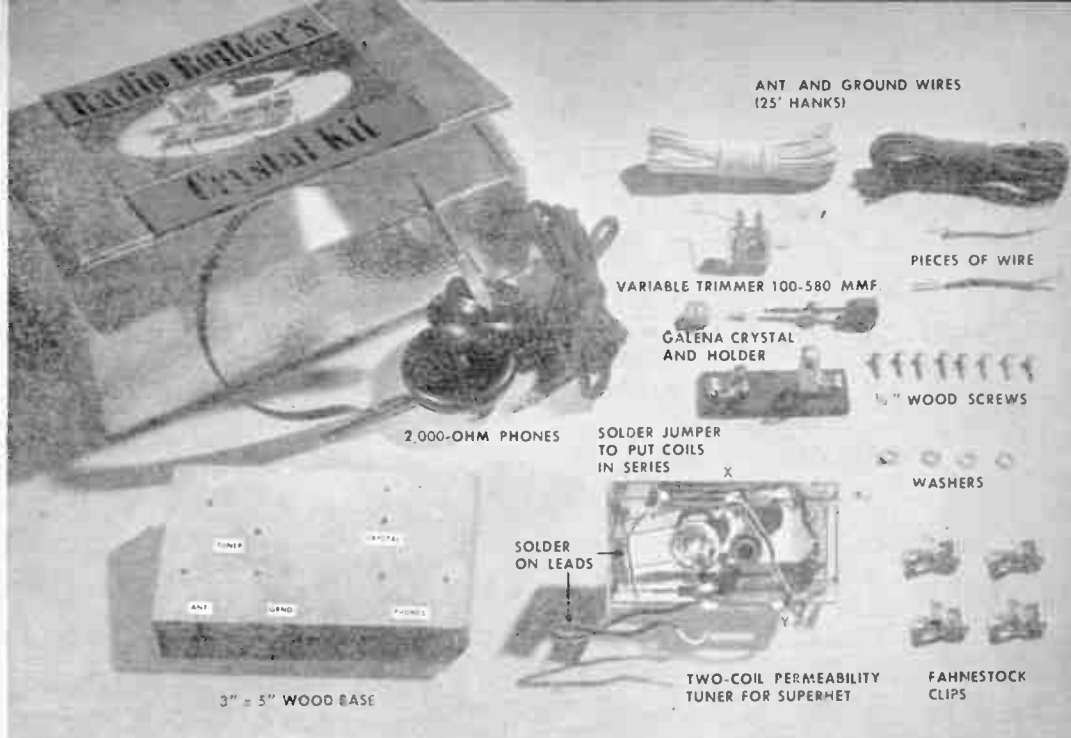

These parts can be used by a boy of 10 to build the radio shown in the photo on the dressed-up

cigar-box lid. The instructions for assembling the set can be pasted inside the box (below).

holes for the screws. Then print or paste labels to the board to mark each item.

The tuner is made for superhets, so you'll have to put the two coils in series. Solder a connection between X and Y, taking care not to disturb the delicate leads from the coils to the soldering lugs. Any permeability tuner of the kind shown will serve when the coils are connected in series. The one pictured is manufacturer's surplus and cost \$1.

To eliminate all soldering operations for the junior builder, you'll probably want to attach wires to lugs A and B. Leave these long enough to reach the antenna and phone clips. While the iron is hot, you can also connect short wires to the trimmer-condenser terminals.

For the connections in the set, solid push-back wire is probably the best. The antenna and ground wires should be stranded. You can make it a little easier for the builder by tinning the tips so the wires won't come unstranded.

It'll also help if you caution him not to touch the fine leads in the tuner, and not to finger the galena crystal. (A crystal dirtied by handling can be cleaned with carbon tetrachloride.) If you're far enough away from



a transmitter to need an outdoor antenna (say 15 miles or more) and if you don't already have one, you'd better add some antenna insulators and a lead-in strip to the kit.

Decorate a cigar box in a way that will appeal to a boy, paste on a sheet of instructions, and wrap the parts. The box shown was covered with heavy gift paper held on with rubber cement. ▶

Labels such as those printed below can be pasted on the base to make assembling easy for him.

TUNER CRYSTAL ANT. GRND. PHONES

How to Assemble Your Crystal Radio

1. Fasten the part marked TUNER to the board with one or two screws.
2. Place one of the four loose clips on the board at the point marked ANT (antenna). Connect the wire from point A under the screw that holds this clip. Loop the wire around the screw and under a washer as shown in the sketch. Whenever you make a connection, remember to cut off a small amount of insulation so that the contact is made on clean, bare wire.
3. Place the trimmer condenser loosely on the board at the place shown. Make a loop in one of the wires soldered to it. Place the GRND (ground) clip in position and screw it in place, fastening the trimmer wire under the screw as you do so.
4. Fasten the crystal holder to the board with two screws. Your holder may look a little different, but it will work the same.
5. Take one of the short pieces of loose wire in the box and slip one end under the crystal-holder clip C. You may have to bend the clip in order to get the crystal into the socket in front of this clip.
6. The other end of this wire goes under the screw and washer holding phone clip E. The wire from the other end of the trimmer is attached to the same screw.
7. Slip another loose wire under crystal clip D, and connect the other end to phone clip F. The wire that comes from the point on the tuner marked B is attached to the same screw. The wiring of the set is now complete.

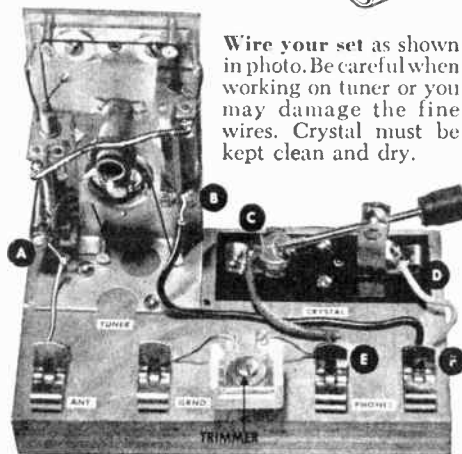
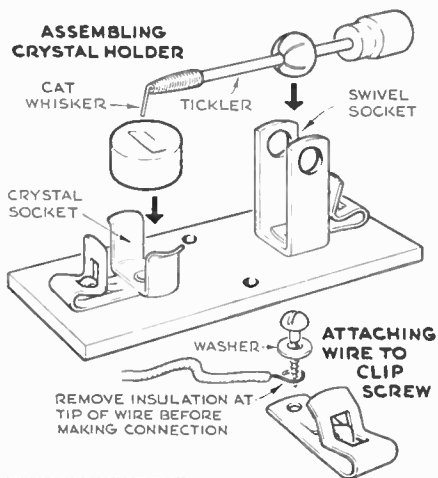

Wire your set as shown in photo. Be careful when working on tuner or you may damage the fine wires. Crystal must be kept clean and dry.

To operate your crystal receiver, assemble the parts of the crystal holder. The galena crystal provided with this kit is embedded in a small disk. Press it down between the two upright arms at C, taking care not to touch the galena itself with your fingers. A rotating arm on a ball-and-swivel goes between the uprights at D. These, too, may have to be bent to make them hold the swivel ball tightly. A tiny spring slips over the tip of the rod. This is the "cat whisker." You use it to find a "hot" spot on the face of the crystal. Move the tickler arm by the knob in order to get the cat whisker to touch the crystal. You may have to try several spots before you find the best one.

Connect the headphones by inserting the jacks in clips E and F. Unwind one of the long hanks of wire and connect one end under the ANT clip. Drop the other end out a window or connect it to a bed spring. Use the other hank of wire to make a connection between the GRND clip and a water pipe or radiator. Scrape a clean, bare spot on the pipe so the wire will make good contact.

Tune the set slowly by turning the knob on the front of the tuner. If you don't hear anything, jiggle the cat whisker to see if you can find a more sensitive spot on the crystal. With a screwdriver, carefully and slowly turn the trimmer screw. Move it about a half turn at a time and repeat the tuning operation. Once the trimmer is set for best results, you don't have to touch it again.

This Booster Is a Specialist

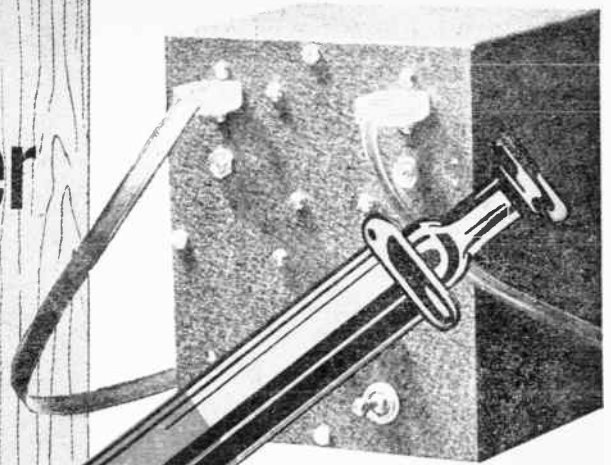

Booster is connected to set and antenna by twin-lead plugs and 300-ohm lead. To disconnect booster, simply pull plugs and join them together. This connects set directly to antenna.

It will give any weak channel a shot in the arm, and you can build it in a couple of evenings for a few dollars.

By Howard G. McEntee

HERE'S a TV booster that you can tailor to your particular needs. It is designed to be adjusted to strengthen signals from one station, and then left alone. It is simple and efficient. Its tube and circuits were chosen to provide moderate amplification with a minimum of noise.

It is tunable over either the high or low band, depending on which set of coils you make. Frequency adjustments are made by movable iron cores in its two tuning coils. You have to wind these coils yourself. Bandswitching is not provided for in these plans because it would add to the complexity and cost and reduce the booster's efficiency.

Laying out the chassis. I built this booster on the steel cover of a 4" by 5" by 6" box. The box supports and protects this chassis-cover. I left the back off to permit air to circulate. Use the kind with the removable 5" by 6" panels; the type with the removable 4" by 6" sides is not suitable.

Dimensions given on the drawings and photos show the location of critical parts. Drill all the marked holes as specified, stand the remaining parts on the chassis and shift them until they clear the sides of the box, and then mark and drill the rest of the mounting holes.

Making the coils. The coil forms that I used are made by the Cambridge Thermi-

EVERYONE WHO HAS TRIED THIS BOOSTER LIKES IT

ARE you annoyed because one television station you get doesn't come in quite strongly enough for comfortable viewing?

Rotating the antenna helps. But most of the time the pictures on that channel are faint, snowy, and taunting.

The author of this article designed and built a booster to improve his reception of telecasts on Channel 13—and succeeded. Friends tried his prescription on other channels and on several makes of receivers—and were delighted. Maybe it will help you, too.

YOU BUY THESE PARTS



POWER TRANSFORMER
PRIMARY 115 VOLTS AC
SECONDARY 117 VOLTS AND
6.3 VOLTS

LINE CORD
AND PLUG



6.3-V PILOT LIGHT
AND ASSEMBLY



5-PIN
TOGGLE SWITCH



75-MA SELENIUM
RECTIFIER



2-MMF CERAMIC
CONDENSER



40-MFD., 150-VOLT
ELECTROLYTIC CONDENSER

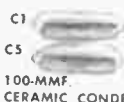

C1
C5
.100-MMF.
CERAMIC CONDENSERS

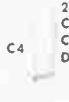

7-PIN
MINIATURE
WAFER
SOCKET



NO. 18
INSULATED

NO. 22
INSULATED



NO. 18
BARE



NO. 28
ENAMELED

NO. 12 BARE

WIRE

2 PAIRS
300-OHM
POLARIZED
TWIN-LEAD
PLUGS

COIL FORMS
CTC. TYPE LS-3
(SEE TEXT)

BRACKETS,
GROMMETS,
SPACERS

RESISTORS

RED VIOLET YELLOW
270,000-OHM, 1/2-WATT

BROWN BLACK BROWN
100-OHM, 1/2-WATT

RED RED BLACK
22-OHM, 1/2-WATT

TERMINAL
STRIPS

7-PIN
MINIATURE
WAFER
SOCKET

...AND MAKE THESE



AND EITHER THESE



HIGH-BAND COILS

OR THESE



LOW-BAND COILS

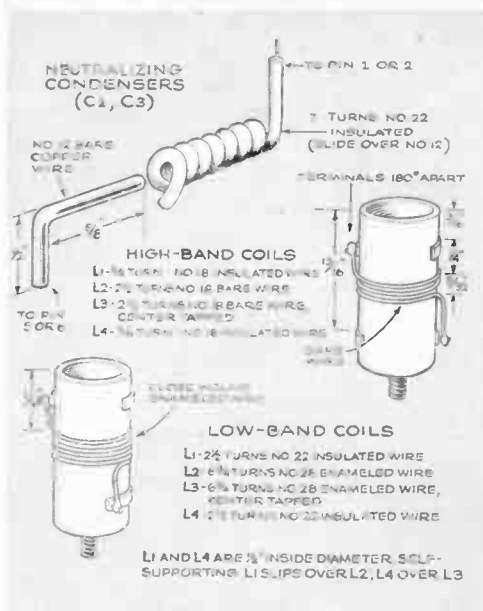

Follow these specifications exactly in making the coils and neutralizing condensers.

onic Corp. (CTC) and sold by many radio supply houses. Specify type LS-3 form with a No. 200630 high-inductance iron core. If you can't get that, obtain type LS-3 60-megacycle coil and remove the original windings.

Follow the coil dimensions and wire sizes shown above, place the windings exactly as illustrated, and wind all coils in the same direction. Make the turns as specified, then experiment if necessary.

To keep the wire taut while winding the coils, solder one end of the wire to one of the clips on the form. Then clamp the other

These parts cost me \$11.77 at standard retail prices. I had to shop around for some of them. If you have some items on hand, your booster may cost you less.

AND MOUNT PARTS ON PANEL THIS WAY

To make mounting holes for the 300-ohm antenna-lead plugs, drill two $5/16"$ holes side by side for each and file them out to get rectangular slots. File off corners of plugs and fasten them with wire saddles as shown below.

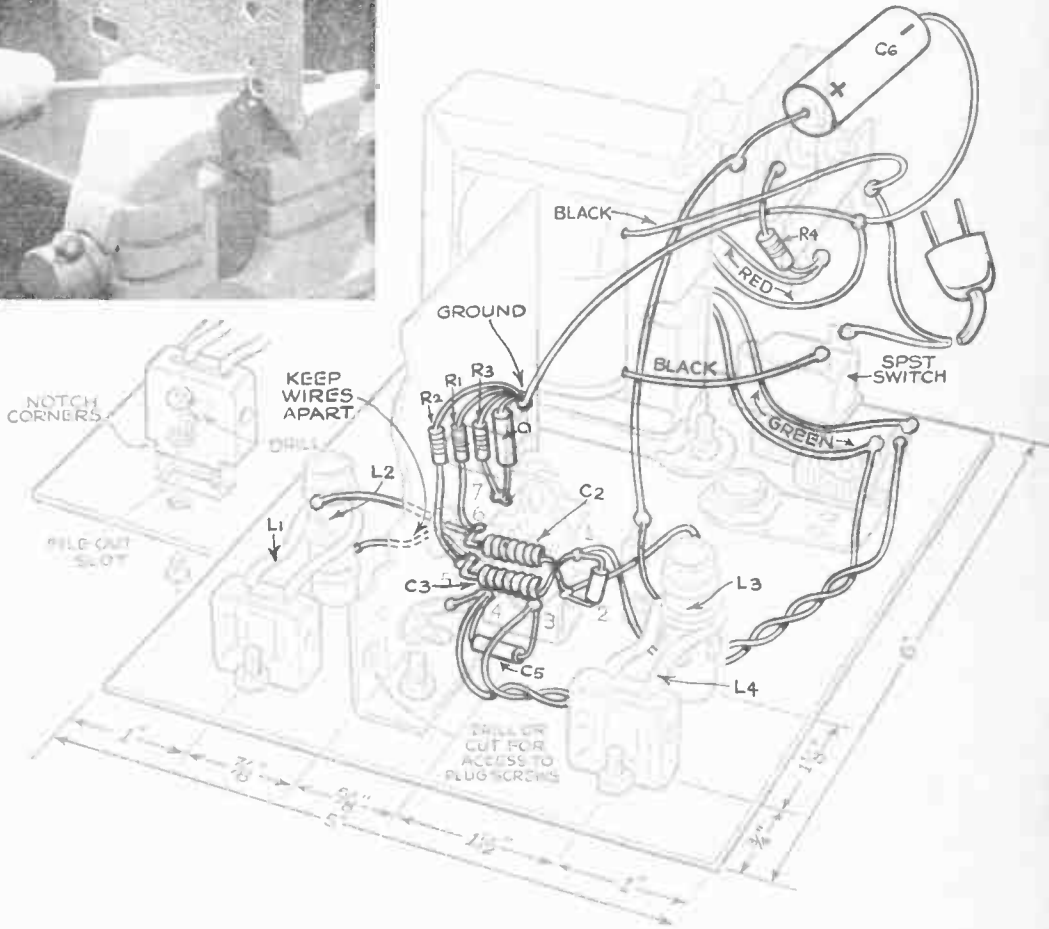

In laying out the parts, follow dimensions wherever they are given. You can wire the booster from this sketch or use the schematic diagram on the following page.

end of the wire in a vise and wind the coil toward it. After you have the required number of turns, solder the wire to the second clip and cut off the excess wire. Apply a bit of coil dope or cellulose cement to keep the turns in place.

To make the low-frequency plate coil (for channels 2 to 6), wind just under $3\frac{1}{2}$ turns, make a $\frac{1}{2}"$ loop in the wire for a tap, twist it a few times, then continue with the other half of the winding.

To make high-band coils (for channels 7 to 13), place the connection clips 180° apart, then wind $2\frac{1}{2}$ turns. The plate coil

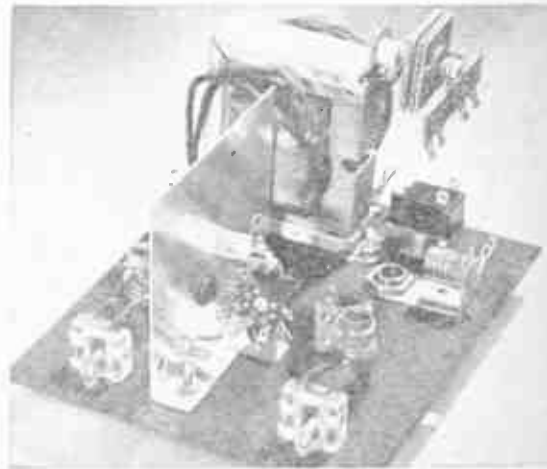

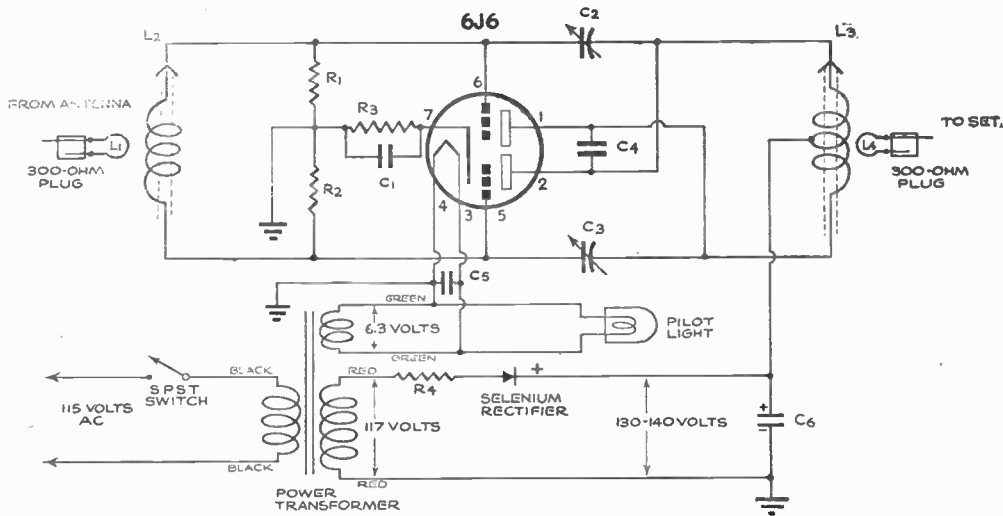

YOU WIRE THE PARTS THIS WAY

Even if you work from the pictorial diagram on the preceding page you should check the

connections in your booster against the schematic before you plug it into an AC outlet.

for the high band uses heavier wire and fewer turns, so you should be able to wind the entire coil in one operation and solder the tap exactly in the middle. No tap is needed in the grid coil for either band.

The coupling coils are self-supporting and are held by the screws in the twin-lead connectors.

Buying the parts: The transformer is a type that has only recently become popular. I used a Merit type P-3045. Other manufacturers make very similar units.

I tried to buy a 50-milliampere selenium rectifier but couldn't, so I settled for a larger 75-ma. unit. In some localities you may be able to purchase a 2.2-mmf. ceramic capacitor (C4) more easily than the 2-mmf. condenser shown. You can use either one. The same is true of 250,000-ohm as against 270,000-ohm resistors (R1 and R2).

Mounting the parts: The coil forms have threaded necks that fit into $\frac{1}{8}$ " holes in the chassis and are fastened by lock screws on the outside. The tube socket is held by a couple of metal brackets, one attached to the chassis and the other to the aluminum shield that cuts the chassis in half.

Most of the other parts are fastened with short 6-32 machine screws and nuts.

Wiring the booster: Start by wiring the transformer, switch, rectifier, and power supply. Go next to the pilot light and tube

filament, and then proceed with the remaining tube-socket connections. Leave the neutralizing condensers for the last.

Keep all leads as short as possible. If a wire can't be kept short, lead it near the chassis and keep it away from the edge. Check all bare wires carefully to make sure they aren't touching other parts or the chassis in the wrong places.

I collected most of the ground connections at two points. One is a lug on the 4-terminal strip bolted to the rectifier, the other a solder lug on the aluminum shield. I then wired the two lugs together.

Adjusting the booster: When you have double-checked every connection, plug in the booster. Before you turn it on, tune your receiver to a weak channel. Switch on the unit and connect the input side to your antenna and the output to the set. Label these on the box.

The four adjustment points are the two neutralizing condensers and the movable slugs in the tuning coils. Set the coil cores so they both project about $\frac{1}{2}$ " on the panel. Examine the screen for odd, wavy patterns and listen for a hissing sound in the speaker. They indicate oscillation. The neutralizing condensers must be adjusted to cancel it out.

To adjust the condensers, use a plastic "neutralizing tool" or a sliver of dry wood.

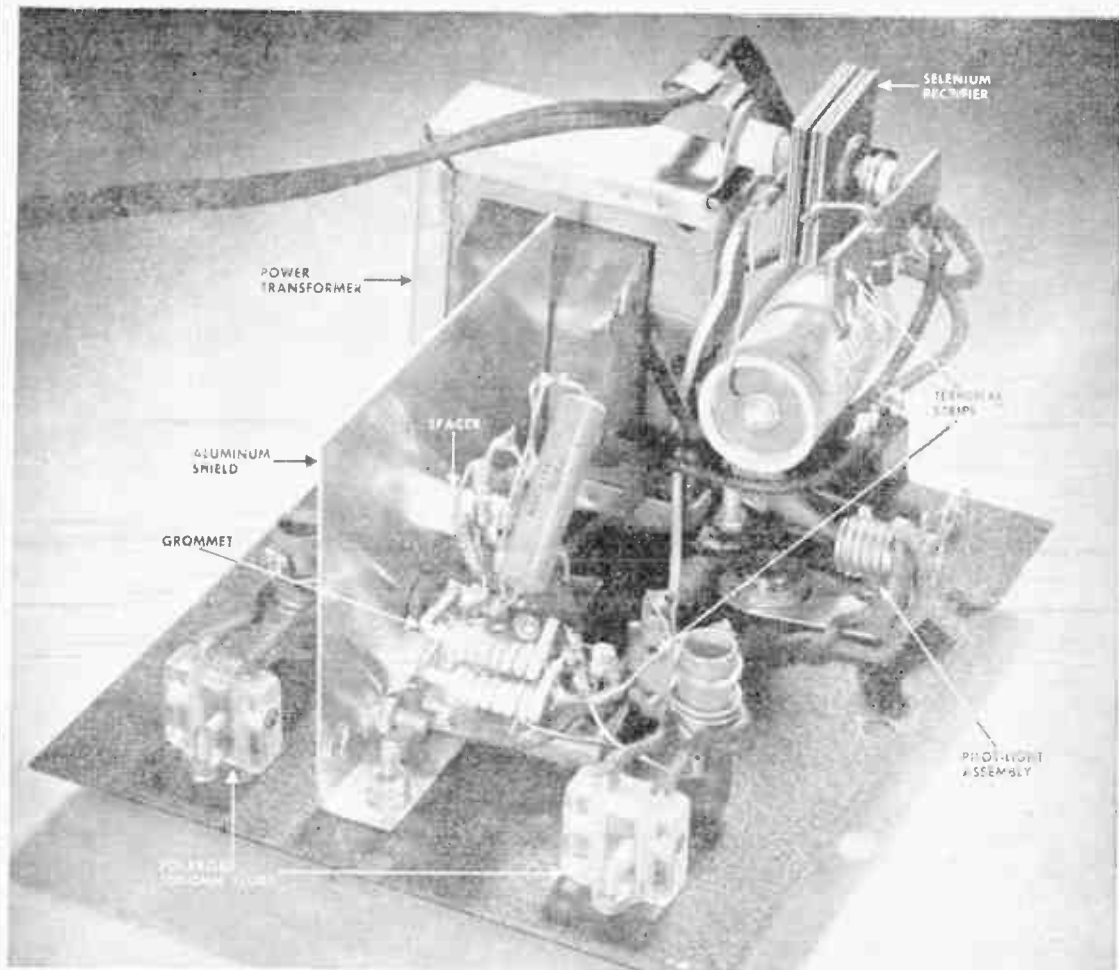

Finished booster. Yours should match critical RF stage, foreground, but may vary elsewhere.

Don't use a pencil or ordinary screwdriver. Move the outer windings in or out on the bent piece of No. 12 wire (see drawing) until the oscillation stops. The best position will probably be where the outer coil is more than half off the inner wire. The coiled wire on both condensers should be in about the same position. Once the circuit is properly neutralized it should need no further adjustment. But adjusting it may take quite a while. Move the tuning slugs in or out till the signal comes in strongest. The two slugs should be out about the same distance when properly adjusted for any station.

Modifying your coils slightly may increase the boosting action. Experiment by squeezing the windings a little closer together or spreading them a little farther apart.

END



Oscillation in the booster will show up as odd, wavy patterns on the TV screen. To cancel it out, adjust the neutralizing condensers by sliding the coils along the inner wires.

External Speaker Adds Uses to Your Auto Radio

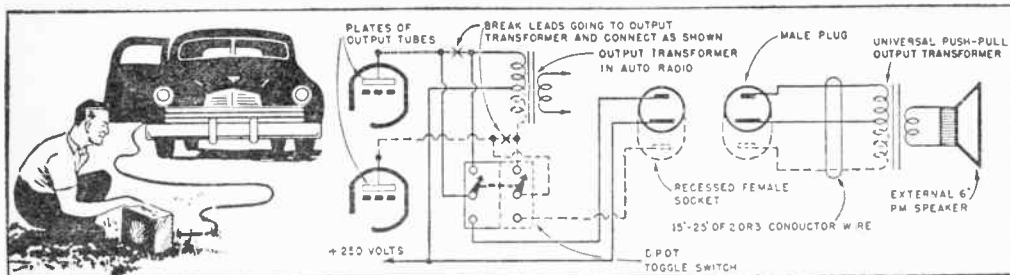

Give a loudspeaker enough cord and you can hang it on a nearby limb or simply place it on the ground beside you when you get out of an auto to loll in the shade. For those many times when you are just far enough away from a car for its radio to be of no use, this external speaker is the perfect answer.

The toggle switch makes it possible to change instantly from the internal to external sound. Just plug in the connector,

flick the switch, and carry the boxed speaker anywhere within the 15' to 25' range of the extension wire. The solid lines in the diagram show what must be done if the radio has a single output tube; for push-pull output make the changes shown by the broken lines as well. With single-tube output you'll need only a SPDT switch. A two- or three-way polarized plug and socket and two- or three-conductor wire make the connection.

New Antennas Chase "Ghosts"

TELEVISION and FM frequencies, with their interference problems from terrain or buildings, are bringing a crop of new antennas. A roof antenna for automobile communication systems, made by L. S. Braeh Mfg. Corp., Newark, is shown in Fig. 1. It covers the 152 to 162 mc. band. Blanket coverage from 44 to 216 mc.—including old and new FM and all television channels—is claimed by Interstate Mfg. Corp., also of Newark, who make the receptor pictured in Fig. 2. The indoor television antenna (Fig. 3) can be shifted and tuned for clearest reception. Burnett Service Co., New York, sells the unit. The S-shaped, folded dipole (Fig. 4) is nondirectional and serves both FM and television. Technical Appliance Corp., Sherborne, N.Y., is the maker. It also makes the mast, Fig. 5, with separate orientation for high and low-band TV.

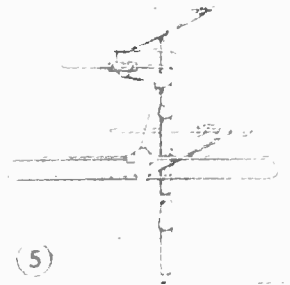
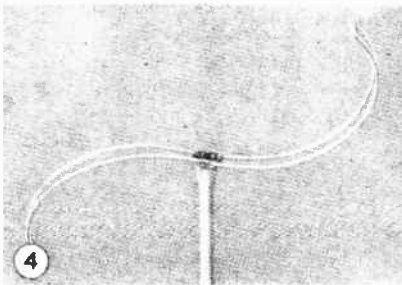
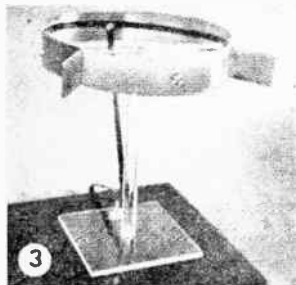
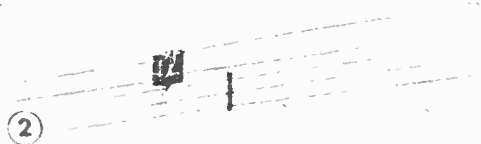
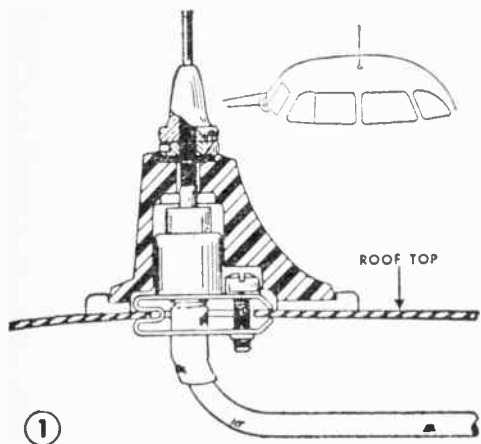

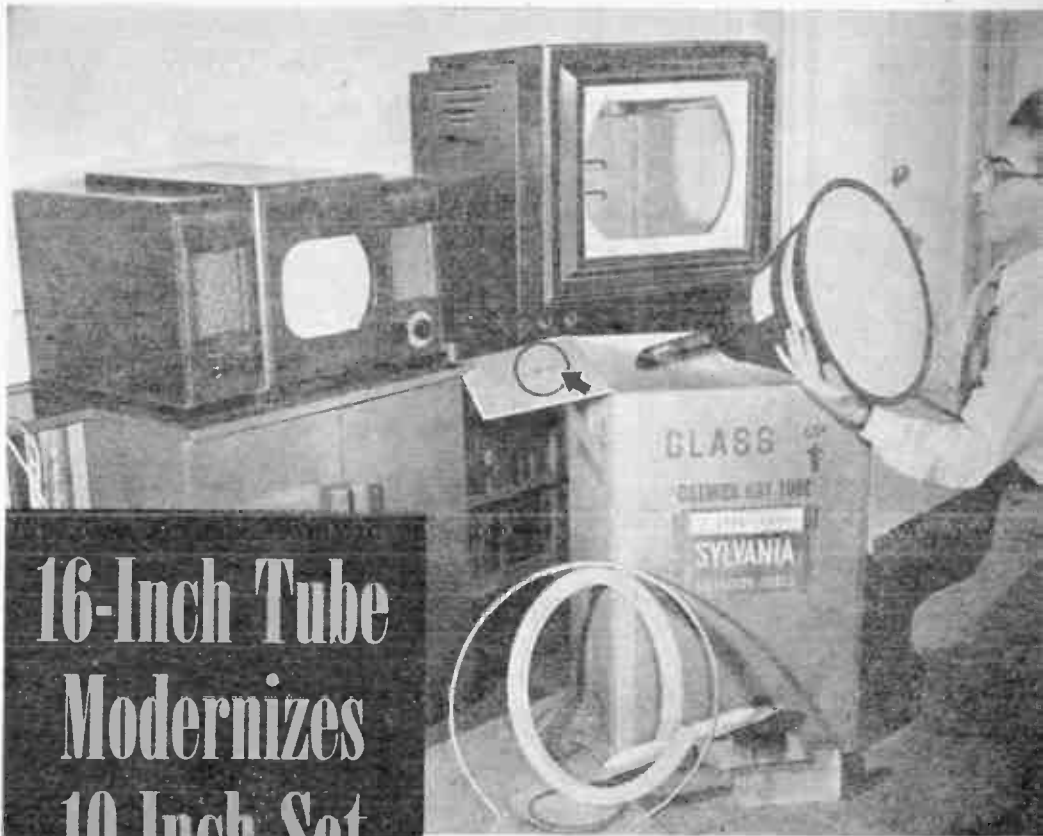

16-Inch Tube Modernizes 10-Inch Set

Here are the raw materials of big-screen TV: An old 630-type 10-inch receiver, a larger cabinet, a 16AP4 metal or 15DP4 glass kinescope, mounting hardware, and a 27,000-ohm resistor (arrow).

Changing one resistor in a small chassis may enable you to enjoy TV pictures that are 2½ times larger.

By Robert Gorman

PS photos by W. W. Morris

SEVERAL hundred thousand 10-inch television sets now in use have enough power built into them to drive 16-inch picture tubes. Yours may be one.

It is if it uses the RCA 630-type circuit. Sets of this design were widely distributed from 1946 to 1948 and later. They first appeared under the RCA label and then under a score of other well-known brands. The "6" stands for 1946 and "30" is the number of tubes including rectifiers and kinescope.

I had one of these sets—built from a kit as described in a previous TV article. Following the present trend to king-size pic-

tures, I decided to convert my small set for big-screen operation.

But how?

I found the answer in a leading TV lab. Engineers who wouldn't have been afraid to tackle big wiring jobs were making the change I wanted simply *by adding one resistor*.

Electronically it's as simple as that. The resulting performance matches the quality of any 16-inch receiver.

Making the change, however, involves a few fussy mechanical problems that stem from variations in tube size, mounting hardware, and cabinet dimensions.

Tubes: Among the picture tubes that can be used are the 16AP4 (metal shell), 15DP4 (glass type) and 12LP4 (12-inch, ▶



1 I began by taking the old cabinet apart. In most cases the top lifts off or unscrews. Then the front mask and safety glass can be unscrewed from the inside.



2 The second-anode connector—the high-voltage cap that plugs into the glass near the bulb end of the picture tube—lifts out. Stored juice is discharged by grounding it.



3 I slipped the ion trap off the neck of the big tube after removing the tube socket. This trap is of the permanent-magnet type. Some traps are wired into the circuit.

glass). They all have the same socket arrangement as the original 10BP4. Their cost ranges from about \$30 to \$75.

Brackets: These are available in different styles in both wood and metal. A set consists of a cradle or ring support for the tube face and a platform for raising the yokes that fit around the neck of the tube.

Cabinets: Since mounting hardware isn't uniform it's important to see that the cabinet matches the modified chassis. The height of the tube face must correspond with the picture window. The speaker also has to be moved from its original place. Make sure that the speaker opening isn't in the way of the tube holder.

Another approach is to build a cabinet from scratch. You'll not only get what you want but also save money. The following article gives details on constructing a table-model cabinet to suit your TV chassis.

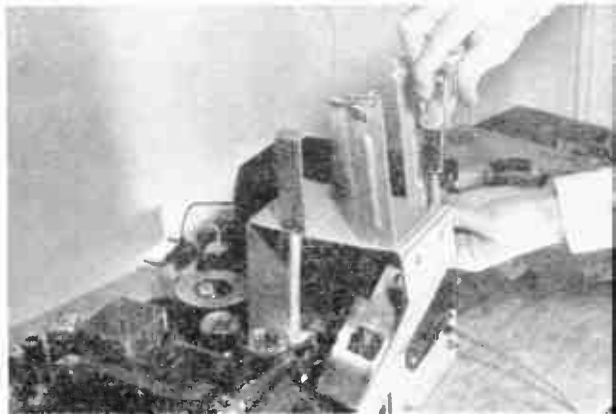

7 I attached an elevated platform to the chassis and mounted the coil brackets on top of the platform. It's part of the mounting hardware I bought for my conversion.

Watch Out!

Beware of high voltage and picture-tube breakage.

Pull the power plug before you look inside the cabinet. Also be sure to discharge the capacitors by grounding the second-anode button to the chassis. If you have to extend the second-anode lead, use wire with at least 15,000-volt insulation. For other extensions, use 2,000-volt insulation.

Handle picture tubes by the bulb only, and treat them with respect.



10 The new resistor is soldered to pin 8 of the 6BC6-G. This is the horizontal sweep output tube and is located inside the high-voltage compartment. Diagram helps to locate tube.



4 Next, I slipped out the tube and put it away carefully. I then pulled off the knobs, loosened the chassis bolts under the cabinet, and pulled out the chassis.



5 The focus coil is supported in a metal bracket. The coil is removed from the bracket; then the supporting frame is unbolted from the chassis with a socket wrench.



6 The deflection yoke also has to come off so its bracket can be removed. Loosening three wing nuts frees the yoke from its frame. Wires have to be lengthened.

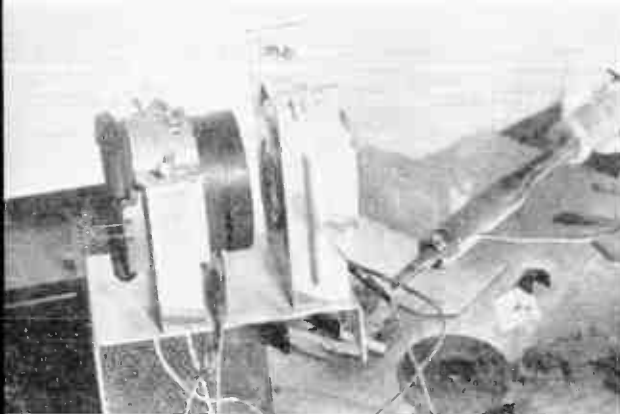

8 After determining the position of the platform, I removed the rear leg to reach the deflection- and focus-coil wires. These have to be extended to reach the new coil locations.

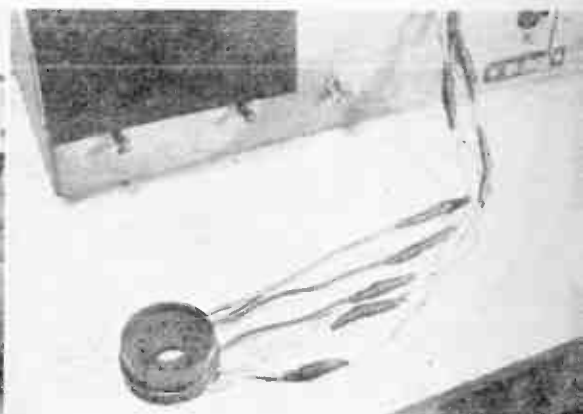

9 Leads for tube socket also had to be extended. I cut the five wires in staggered steps for increased safety. Even if the tape slips off, the splices aren't likely to short.

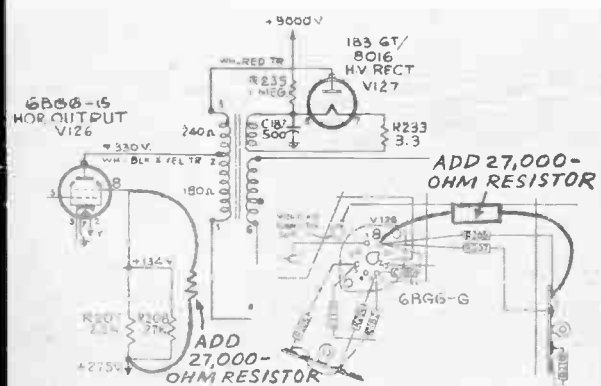

11 These diagrams of related socket connections are adapted from the RCA service manual. Resistors 207 and 208 are already in parallel. The new one shunts them both.



12 Pencil points to 27,000-ohm, 2-watt resistor added to circuit. Its effect is to decrease screen resistance and increase voltage on primary of high-voltage transformer.



13 The entire metal shell of the 16AP4 is "hot," so it's wise to cover it with a plastic insulating hood and ring. The brackets I bought had a metal ring support.



14 The chassis crossbar that holds the tube mount was drilled for the legs of the supporting ring, but the holes were in the wrong places. I redrilled them to fit.

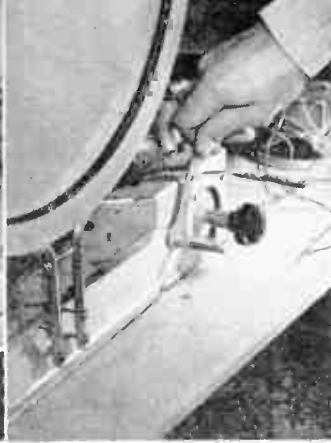

15 The right way to mount the crossbar is with the flat side to the front. However this made the tube sit too far back, so I reversed the bar. It's held by control nuts.

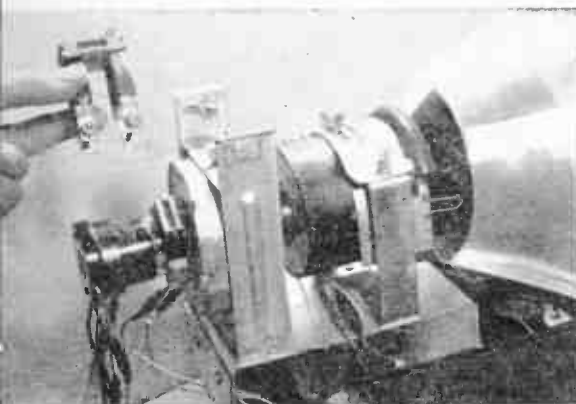

16 Another change I didn't expect to make concerned the ion trap. The neck of the 16-inch tube is about 1 inch shorter than the old 10 incher, so I substituted a narrower trap.



17 Tuning the set consists of resetting the six rear controls as well as adjusting the ion trap, and focus and deflection coils. I wore gloves while I was working near tube neck.

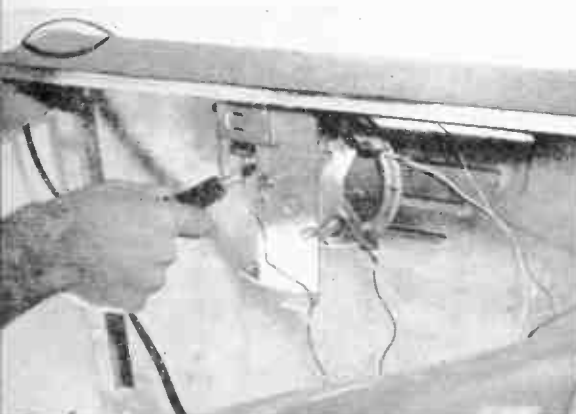

18 After set was pushed into cabinet I re-mounted the speaker in its new location, frame and all. Leads have to be extended, and it's essential to ground speaker frame to chassis.

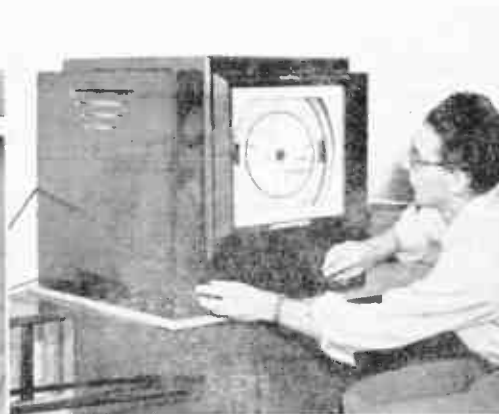

19 Here's my new TV receiver, up-to-date again. When I got my 10 incher, big tubes were scarce, but they're not any more, and the current trend is in the direction of larger screens.

Servicing Intermittent Radios

If you've ever tried repairing radios you know what a headache an "intermittent" can be. Some sets have elusive troubles that come and go by themselves. They almost always seem to happen when you're listening to a good program but disappear as soon as you drag out your voltmeter.

Rather than waste time waiting for them, you can hustle these troubles into the open by creating tough operating conditions. The three that show up intermittents most quickly are overheating and boosted or lowered voltage.

Quick heating can be achieved as shown in the photo at the right. Connect a 100- or 150-watt bulb, place it next to the chassis, and cover both with a cardboard carton. The locked-in heat will give the effect of an hour or two of playing in a few minutes.

A couple of old filament transformers or windings can be used to tamper with the line voltage. Rigged as shown in the sketch, the 2.5- and 7.5-volt transformers are bucking each other. Their combined output is tied to the 6.3-volt winding of the third unit and results in a total output of about 95 volts. Low line voltage often causes a defective oscillator to stop operating.

Reversing the leads on the 2.5-volt transformer puts it in series with the 7.5-volt winding and boosts the line to about 130 volts. High voltage gives a fine imitation of trouble-causing line surges.

Socket Premounts Radio Parts

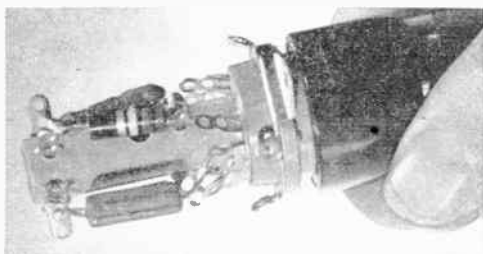

RADIO and electronic circuits can be assembled in stages with the aid of a new tube socket made by Vector Electronic Co., Los Angeles. The socket itself is the same as conventional types but a plastic turret is bonded to the lower part. Lugs on the turret permit mounting of associated parts. This arrangement makes it possible to do much of the wiring outside the chassis, increases the usable depth of the chassis, and reduces lead length. Sockets come in all common types.

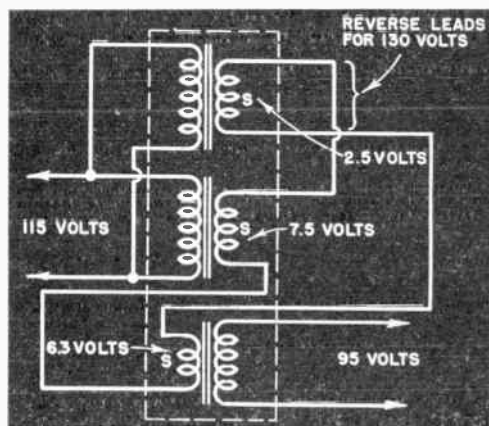
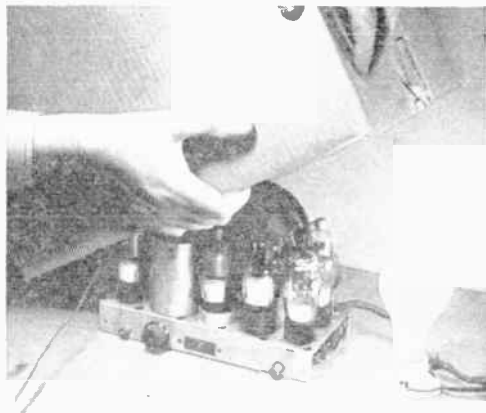

Butter Warmer Fits Toaster

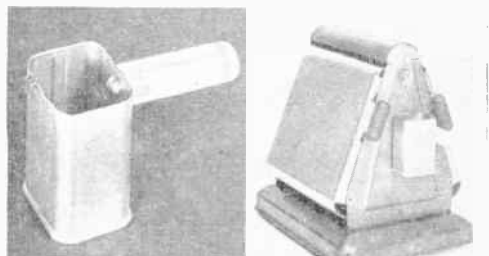

COLD butter is not only hard to spread but also tends to cool your toast too rapidly. This warmer gives you easy-spreading butter along with your toast, for it hooks right on the toaster and takes heat from it.

Almost any small can (except the lacquer-lined type) can be used. Check it first with water to be sure it's leakproof, and then cut it to size, leaving a little tab on the front. Attach a wooden or plastic handle with a wood screw. Drill a $\frac{1}{4}$ " hole in the side of the toaster and hook the can on.—Arthur Trauffer, Council Bluffs, Iowa.



D. C. from Your A. C. Lines

NEED DIRECT CURRENT?
IT'S YOURS WITH A LOW-
COST, EASILY ASSEMBLED
ELECTROLYTIC RECTIFIER.

By Harold P. Strand

CRUDE as it may seem to engineers and the fortunate few who do their experimenting in well-equipped laboratories, the electrolytic rectifier can boast of advantages over its more efficient rivals. It is cheaper and easier to build than vacuum-tube, dry-disk, or motor-generator rectifiers, yet it is a reliable source of low-voltage D.C., useful for electroplating, charging batteries, and operating model railroads.

Practically all the needed materials will be found around the house or in the scrap box. Chief items are a resistance or transformer to drop the line voltage, a 1-gal. stoneware crock or jar, two small sheets of $\frac{1}{8}$ " aluminum, one of $\frac{1}{16}$ " or 1/16" lead, and a panel of bakelite or similar material large enough to span the mouth of the crock. Any one of several chemical solutions will serve as the electrolyte.

In the photo on the facing page, the rectifier is shown in operation as a battery charger. Maximum efficiency is obtained when a transformer with a centertapped secondary is used as shown in Fig. 1. The charging rate as indicated on the D.C. meter is 6 to 8 amp.; current draw from the line is 3.7 to 4 amp. Output can be varied by altering either the spacing of the plates or the input voltage. A transformer that can deliver 20 volts from either side to the center tap and 10 to 12 amp. without overheating is required. The wire marked with the "plus" sign goes to the corresponding battery terminal or to the anode (plating metal) in an electroplating bath.

For half-wave operation, either a series resistance (Fig. 2) or a transformer (Fig. 3) will serve to reduce the line voltage. In the first case, to get an equivalent charging rate

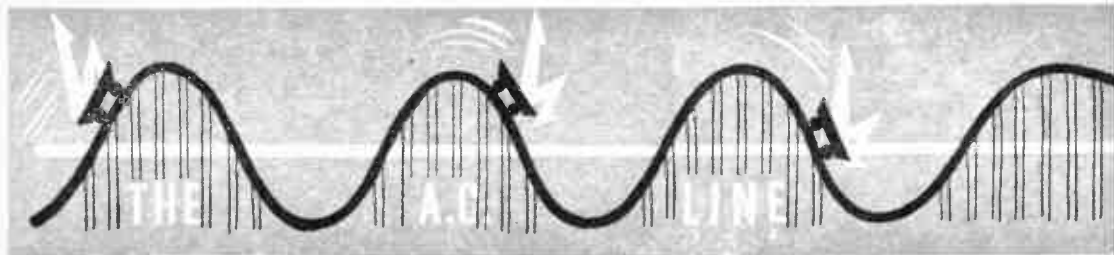

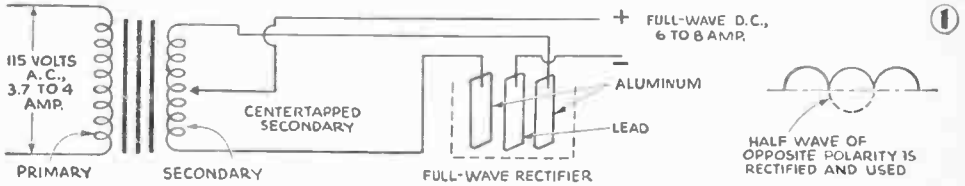
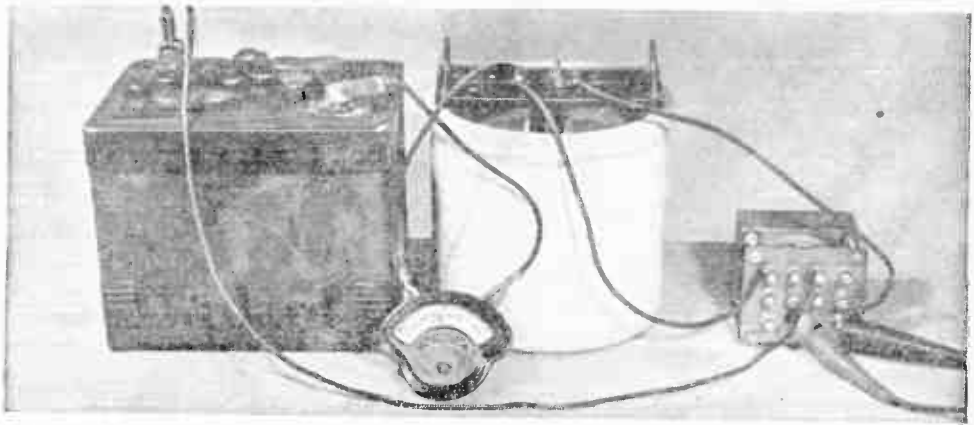

of 8 amp. would impose a line draw of 15 to 20 amp. because of heat losses in the resistance.

With a heating-unit resistance, shown in the photo at the top of page 76, a charging rate of 1.5 to 2 amp. is obtained at a line-current cost of 4 amp. Substituting a lower resistance will increase the output but it will also cause a sharp rise in the input.

A more flexible half-wave rectifier is made with a transformer capable of delivering 18 volts at 11 to 12 amp. Using the connections shown in Fig. 3, it is possible to obtain the relatively efficient charging rate of 5 to 6 amp. with only 2.6 to 3 amp. being drawn by the line.

To build the electrolytic unit, cut one lead and two aluminum plates as shown in Fig. 4, notching the two adjacent ends of one pair so that the plates can be brought close

together without making electrical contact. A strip of bakelite or other insulating plastic is attached to each side of the lead plate as additional insurance against touching.

Assembly of the pieces presents no difficulties. The lead plate is attached to the panel with two 8-32 brass machine screws, and a knurled thumb nut is placed over one of the hold-down nuts to act as a terminal post for the negative lead. Use an extra thumb nut on the screw holding each of the aluminum plates.

Sodium phosphate, obtainable at any drug store, makes a suitable electrolyte. Ammonium phosphate and household borax are two of the other readily available chemicals that can be used. First prepare a saturated water solution—that is, add the phosphate or other chemical until no more can be absorbed by the water and it begins to settle out to the

RECTIFIER

THE D.O. LINE

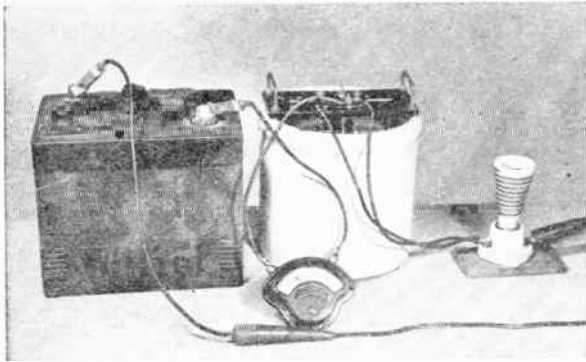

When efficiency is not a factor, the use of the series resistance shown at the left is satisfactory. Wiring connections are given in Fig. 2, below.

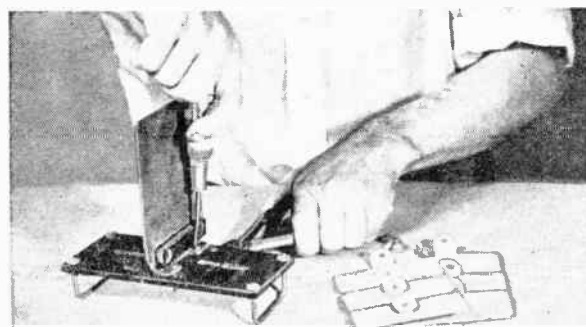
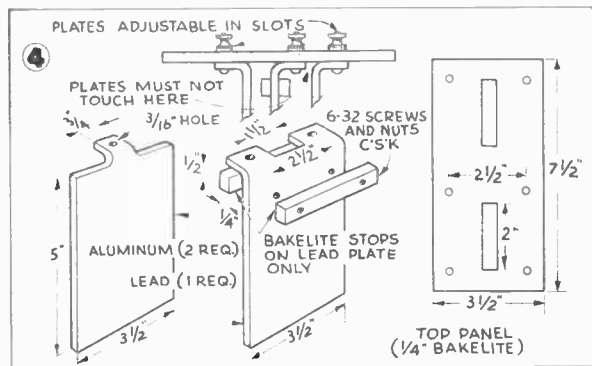
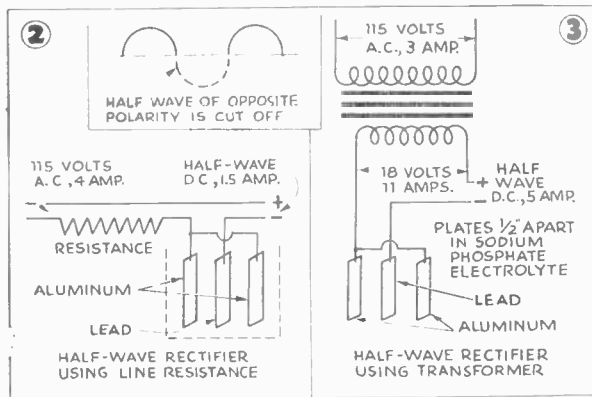

bottom. Stir the solution thoroughly and wait for it to clear; then pour it off into the crock.

With the plates submerged in the liquid, connect a wire to the binding post atop each plate. Join the outer pair at one terminal of a porcelain socket as seen in the upper righthand photo on page 77. One side of the power line goes to the other socket terminal, while the other side of the line and the wire from the lead, or center, plate constitute the output or charging lines.

Add a teaspoonful of table salt to a glass of water and place the bared ends of the output wires in this solution. When the power is turned on, tiny bubbles will be seen to form around the wire coming from the lead or negative plate. Touch the wires together and bubbles will begin to form around the aluminum plates. Hold the connection for about 20 minutes to permit a film of aluminum hydroxide to form on the positive plates. This film, acting as a rectifying agent, offers extremely high resistance to the flow of current in one direction and a low resistance in the other.

To measure output voltage, set up a complete circuit so that current will flow; this can be done by connecting a resistance across the rectifier and measuring the voltage across this load. An ammeter in series will tell the current in the circuit.

Servicing boils down chiefly to the problem of offsetting the effects of chemical action. Connections are liable to corrode, especially where screw heads make contact with the plates; the aluminum plates may also wear out

At left, attaching the lead plate with brass machine screws. Note the handles on which the panel rests; simple knobs can be used in place of the handles.



Mix the chemical and water in a saturated solution, stir it well, allow the liquid to clear, and pour it off into the crock.

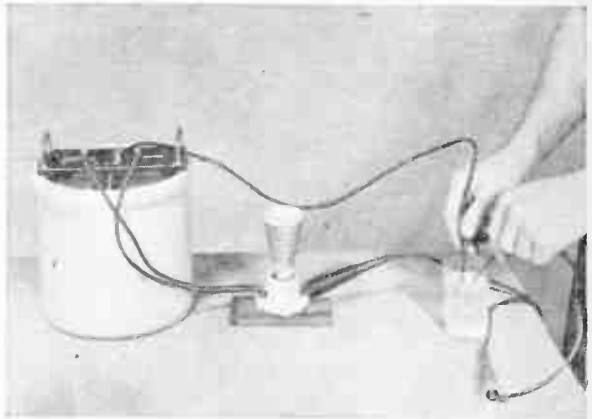

When both leads are submerged in a salt solution, bubbles will form around the negative wire. Short-circuit the wires to permit a hydroxide film to form on the aluminum plates.

and have to be replaced. Clean the plates from time to time and repeat the forming process to allow the hydroxide film to form again. When the solution shows signs of persistent overheating, and the charging rate cannot be brought up to scratch, it is time to throw out the old liquid and prepare a new batch.

In continuous operation the solution will gradually rise in temperature. If it becomes too hot, or if a heavy current is being drawn, place the crock in a larger vessel and allow a stream of water to run in the space between.

For experimental use, where low-voltage, short-duration D.C. is needed, a simple electrolytic rectifier is illustrated in Fig. 5 and the photo below. Two plates provide half-

wave rectification; the container is an empty fruit jar of about 1-qt. capacity. One lead and one aluminum plate, spaced about $\frac{1}{4}$ " apart and supported by 8-32 screws and nuts, constitute the vital parts. The same electrolyte may be used in this outfit as in the larger one.

Since the output of the smaller unit is low at best, it should be used only with a transformer. A heavy-duty toy train transformer able to deliver about 30 volts in the secondary should serve nicely. With the latter input, an output of about 1 amp. at 6 to 6.5 volts can be obtained. The output can be raised somewhat by using a higher input voltage, but if more service is required of the rectifier, it would probably be better to build the larger one described above.

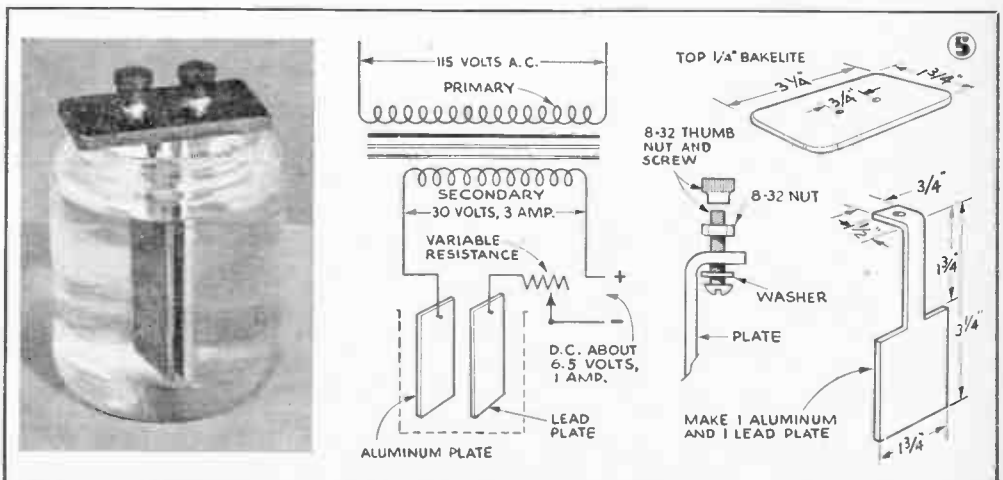

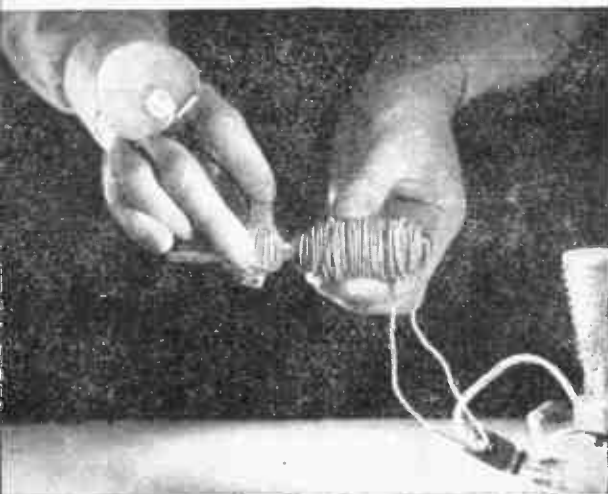
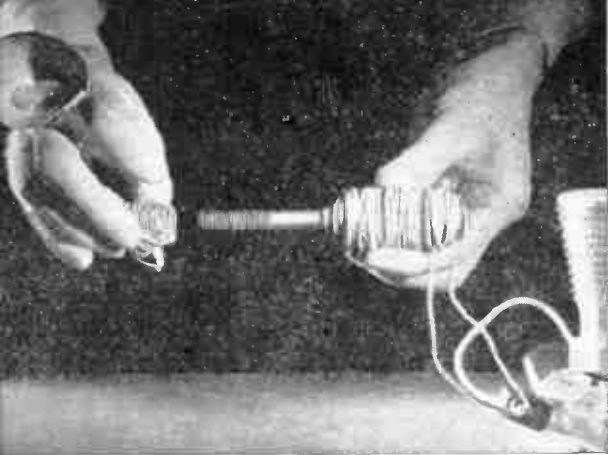

THE PRINCIPLE OF INDUCTION,

which causes electric current to be transferred from one circuit to another with which it has no metallic connection, can be demonstrated with the simple equipment at the left. First, bring to a red heat an iron bolt about 5" long, and allow it to cool slowly. Then wind about 100 turns of bell wire around half the bolt nearest the head. Wind a second coil of about 200 turns of finer, insulated wire around a thick pencil or dowel of such a size that when it is removed the coil will fit loosely over the bolt. Connect a flashlight bulb and socket to the ends of this second coil, and then connect the ends of the coil on the bolt in series with a resistance such as a heater unit and to a source of 110-volt alternating current.

Now slide the second coil onto the bolt, and the bulb will light, increasing in brightness as the coils are brought closer together. Transformers and spark coils operate on the same principle, except that the efficiency of commercial equipment is increased by precise design of core and windings.

IN A TRANSFORMER the voltage ratio between the two coils is almost exactly equal to the difference in the number of turns in the coils. With 100 turns on the primary, or input coil, and 10 turns on the secondary, or output coil, the voltage from the secondary will be one tenth of that impressed on the primary. A transformer in which the secondary voltage is less than the primary voltage is called a step-down transformer. Bells and toy trains are operated with transformers of this type. With such a transformer in a 110-volt A.C. line, a low-voltage bulb may be lit safely.

That the voltage ratio is reversible can be proved by impressing low voltage interrupted current on the secondary and obtaining high voltage from the primary. Connect dry cells in series with the sec-

ondary, connect a small, 110-volt argon lamp to the primary, and interrupt the current by drawing one of the wires lightly over a file connected in the circuit, as illustrated. The lamp will glow brilliantly, although only one pole will light up. This is due to the fact that direct current is employed. If you reverse the leads, you will find the opposite pole will light when the intermittent current is supplied.



A HOMEMADE D.C. MOTOR that will really run can be constructed quickly by duplicating the apparatus at the right. Two bolts about 2" long should be annealed by heating, as in the first experiment, and then wound with a continuous length of bell wire. Wind 50 turns clockwise on one bolt, leave 4" straight, then wind 50 turns counterclockwise on the other. The direction of winding must in both cases be considered from the bolthead end. Mount the bolts about 2" apart with head facing head. Then, when connected with one or two dry cells, they will become the field magnets of your motor.

For an armature, or rotor, wind a slightly smaller bolt with about 50 turns of finer wire and mount the unit on a shaft contrived by thrusting a length of stiff wire through the coils of the winding. Crude bearings and a commutator are now all that are needed to complete the motor.

The bearings are strips of notched tin. A cork will make a good commutator when fitted with two strips of thin sheet metal. Press the cork onto the rotor shaft, as indicated, and glue the two strips of sheet metal to its sides. The strips should be just wide enough to go around the cork except for slight separations between them. Solder the two ends of the rotor windings to these improvised commutator segments; then arrange a terminal wire from one of the field magnets so that it presses lightly against the underside of the cork, and connect the other wire from the field poles to one terminal of several dry cells in series.

Hold the other terminal wire from the dry cells lightly against the cork, as shown,

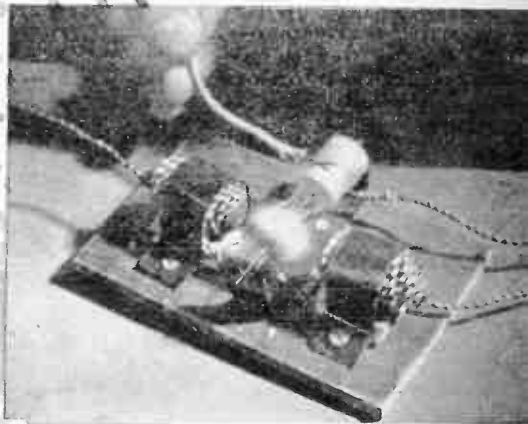

and the motor will spin rapidly. The function of a commutator is to reverse the direction of current flow through the armature twice in every revolution so that each pole is first attracted and then repelled by the adjacent pole of the field magnet.

ELECTRIC GENERATORS produce their current by rotating wire coils between the poles of powerful magnets so that they cut magnetic lines of force. This principle of an electric alternator may be demonstrated by means of the equipment used above, minus the commutator, but with a galvanometer added to the circuit as shown below.

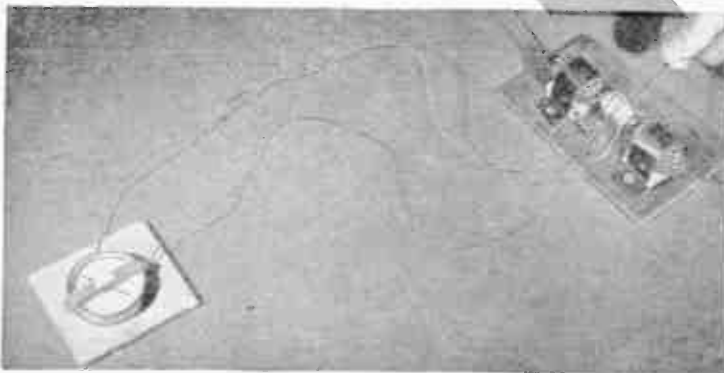

For the galvanometer, use a toy compass wound around the center with 50 turns of fine, insulated wire. Connect this current-detecting device with the two ends of the armature winding, and station it far enough from the magnets so that the needle will not be influenced by stray magnetism. If you now twist the rotor shaft while current

flows through the field coils, you will discover that the compass needle is deflected first in one direction and then in the other as the rotor passes through each half of a full turn. In a regular alternator, brushes would collect alternating current from rings fitted around the rotor shaft and connected with the windings which are built into the rotor.

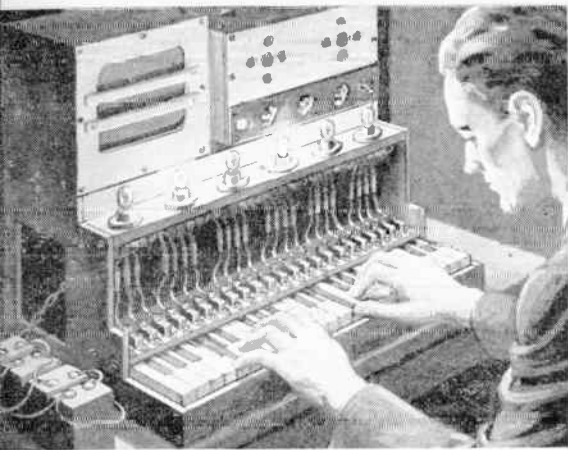

Electric organ could be based on glow-lamp oscillator circuits feeding an audio amplifier.

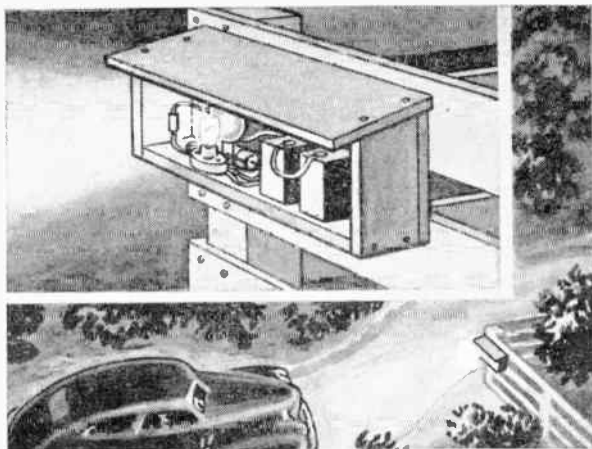

Night hazards can be marked with blinkers that will operate months on the same battery.

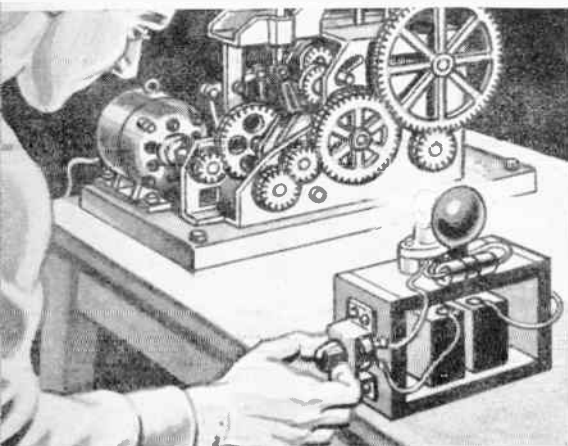

Motion is stopped by a synchronized glow-lamp stroboscope. The room lights must be out.

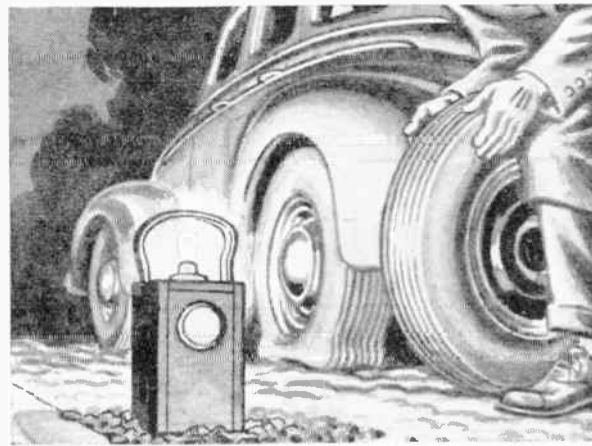

Portable blinkers warn of danger. Similar units guided columns of tanks during wartime action.

Magic with Neon Glow Lamps

By Walter E. Burton

ALADDIN had his lamp, but you can buy a modern substitute at any radio-supply shop. Glow lamps are practically little genii under glass. Once you know their secrets, they stand ready to do all sorts of chores—from playing Aloha electrically to “stopping” a machine in full motion so you can see what makes the wheels go ‘round.

A glow lamp consists of two electrodes—wires or plates—surrounded by inert neon

gas. When the electrodes are connected to a sufficiently high voltage, light is produced at the negative one. On AC, of course, the electrodes take turns at being the negative one, changing polarity so rapidly that the eye sees both glowing steadily.

Glow lamps consume very little current, the smallest drawing 1/25 watt and the largest about 3. The tiniest have the longest life—about 25,000 hours. Bigger ones are good for 3,000 hours. Even then a glow lamp doesn't burn out; it merely gets dim-

mer gradually. This makes the lamps ideal as indicator or pilot lights, for they can't quit suddenly and so fail to give warning. They produce no appreciable heat and are not sensitive to shock or vibration.

Glow Lamps Trigger Current

The curious thing about glow lamps is that they don't—and then again they do—conduct electricity. Connect a glow lamp to half a dozen dry cells, and nothing happens. Increase the voltage to a certain critical point, and in a millisecond several things happen. The inert gas is ionized, becoming a conductor. Current passes, light is generated, and if you haven't put a resistance in the circuit, the lamp will quickly "run away," or pass so much current as to destroy itself. This instantaneous trigger effect is constant, tireless, and useful in several ways, as will be shown farther on.

To limit current to a safe value, a resistance must be connected in series with each lamp as in Fig. 1. Lamps with screw bases have a built-in resistance and require no external one on ordinary 115-volt house current, but extra resistance should be added if they are connected to higher potentials. When several lamps are connected to one power line, each lamp must have its own resistor as shown in Fig. 2. They cannot be operated in series.

Lamps as Electrical Tools

Everybody, from the radio service man to the householder who just blew a fuse, will find use for a gadget that shows whether the juice is there. Just connect a 1/25-watt lamp with a resistor, some flexible insulated wire, and a pair of phone tips as in Fig. 1. It's a good idea to house the lamp in a glass or plastic tube. The gadget will also indicate DC polarity once the leads are identified. Touch them to a radio B battery of 90 volts or more, mark the lead touching the negative terminal, and mark the lamp base or housing to indicate the lighted electrode.

If you add a common radio potentiometer to the tester circuit as in Fig. 4, and calibrate the potentiometer dial, you'll have a handy tool-kit voltmeter. It works on the principle that the ionizing or starting (break-down) voltage of a lamp is always the same—about 90 volts DC and 65 volts AC for 1/25-watt lamps such as the NE 2 or NE-51—and that on falling voltage the lamp will suddenly cease glowing at an equally definite point. On DC, this maintaining voltage

is about 15 volts less than the starting voltage, but on AC it's about the same.

If you connect the circuit in Fig. 4 to 120 volts DC and turn the potentiometer up, at some point the voltage across the lamp will top 90 and the lamp will suddenly glow. If you now move the potentiometer back slowly, you'll find a point at which the lamp goes out. Mark this point 120 volts DC on the dial. Repeat the calibration on other known voltages of AC and DC. On an unknown voltage, simply turn the knob until the lamp lights, and then back to where it goes out, and read the circuit voltage off your dial. [Turn the page.]

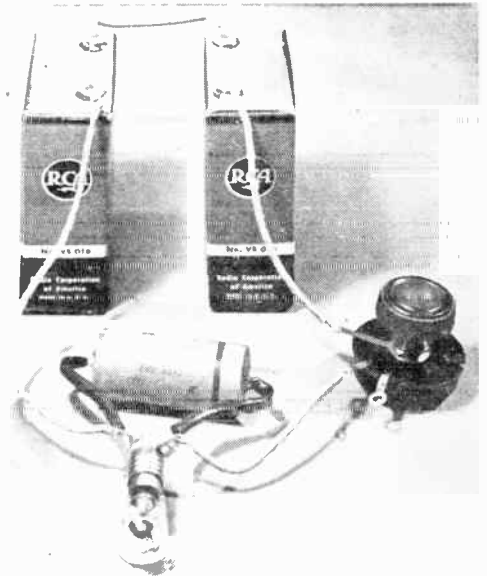

Batteries charge the condenser to ionizing voltage, and it then discharges through the lamp.

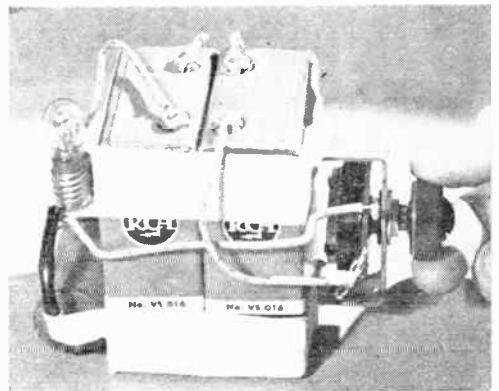

High resistance such as 10 megohms gives slow flashing. The unit makes a compact package.

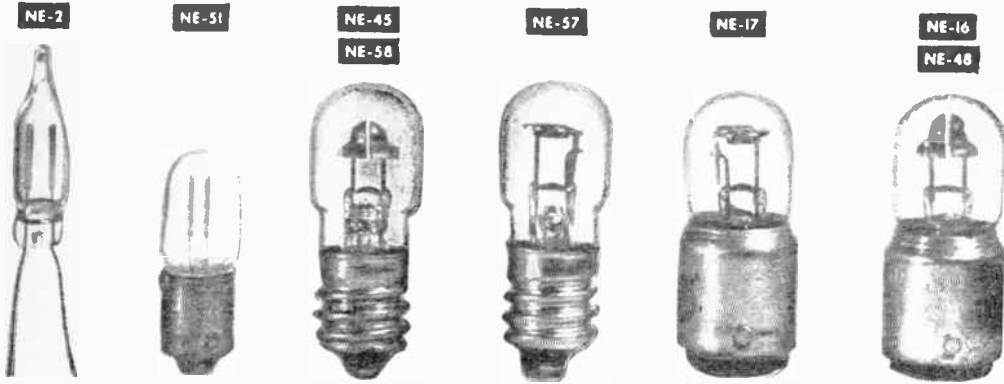

Lamps with wire leads or bayonet bases need external resistors. Screw bases have them inside.

A similar circuit can be used as a sound monitor for use with a microphone and a home recorder or other instrument. With the potentiometer left at the critical point as determined by test, the lamp will flash whenever sound output is too great.

You can also, just for fun, hook the circuit in Fig. 4 to the plate side of the output transformer in a radio. Converting sound to light, it'll show you visually what's coming out of the loudspeaker.

Lamps That Wink at You

If you walk into the Nela Park office of H. M. Ferrec, a General Electric engineer, you'll soon become aware of a contraption on one of the filing cabinets, for it winks at you—a reddish neon wink—every five sec-

onds. It consists of a pair of 67½-volt B batteries, a radio condenser, a potentiometer, and a glow lamp. This particular setup has been winking for six months and is expected to keep it up on the same batteries for 18 more. Similar blinkers kept tank columns together in night movements during the war.

The blinker circuit is shown in Fig. 3. For visibility, a ¼-watt glow lamp with circular electrodes, such as the tiny NE-17 or NE-57, is recommended (use an outside resistor with the NE-17). Connect the disk to the negative side; then you can focus the light with a lens or mirror.

Potentiometer resistance in Fig. 3 should be about 10 megohms for one flash per second. Reducing this increases flash frequency, so by turning the potentiometer you can

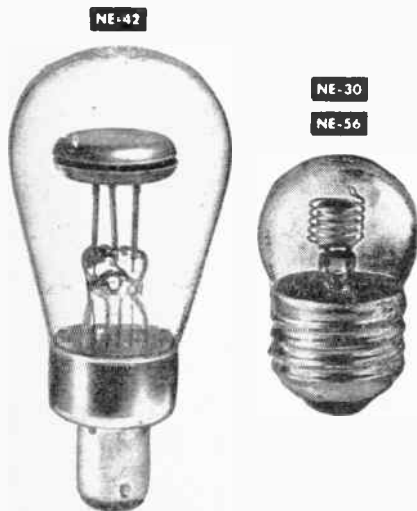

Twin disks glow in the 3-watt lamp at left. The 1-watt lamp at right fits standard light sockets.



Circuit tester is a 1/25-watt lamp housed in a glass or plastic tube, a resistor, and two leads.

vary the interval. What happens is that the battery charges the condenser quickly or slowly as the resistance permits. The instant the condenser charge reaches the starting voltage of the lamp, the latter "fires," discharging the condenser, which then starts to recharge.

One use for such a blinker setup is as a darkroom timer. Count flashes for timing enlargements or other short-duration processes. Similarly, it might serve as a visible metronome for music students.

Another Nela Park engineer had a roadside mailbox vulnerable to night-time motorists. After rebuilding it once or twice, he installed a neon blinker. The mailbox hasn't been hit since.

Within a limited range such a light might be useful as a dock marker to enable boatmen to find their way back to shore. You could use one to identify your house by night, or by prearrangement as a signal that you are or aren't at home. If you have to leave your car in a hazardous location at night, a blinker may save you smashed fenders or worse. The gadgets might also be used to mark hazardous locations such as cliffs and culverts, and to guide others following in the dark.

Music from a Lamp

Vary condenser capacity and the series resistance, and you "tune" blinker frequency right into the audio range. Such a circuit appears on page 84. A heavy pencil line on the baseboard forms the variable resist-

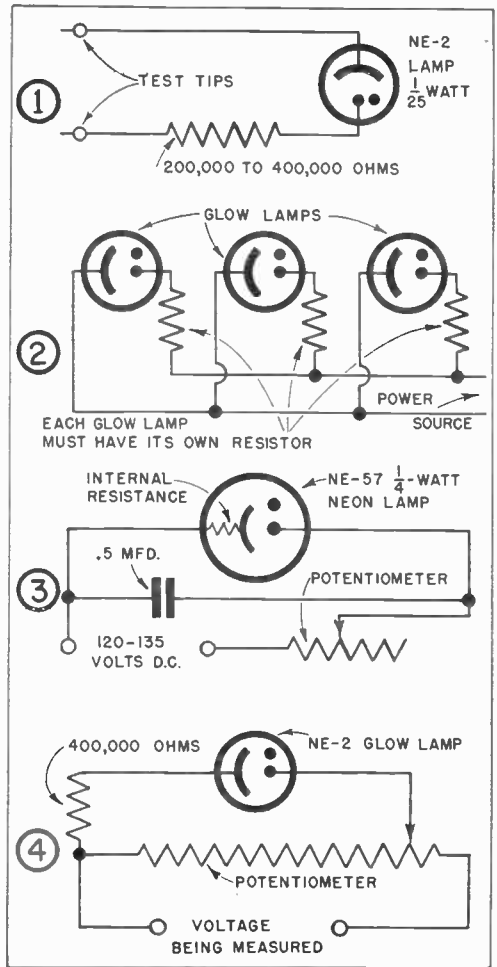

NEON GLOW LAMPS

[ELECTRICITY]

Lamp No.	NE-2 ^o	NE-15 ^o	NE-18 ^o	NE-30	NE-32	NE-34	NE-36	NE-40	NE-42
Watts, Nominal	1 25	1 4	1/4	1	1	2	2	3	3
Base	Wires	Candelabra screw	D.C. bay cand.	Medium screw	D.C. bay cand.	Medium screw	Sk. d.c. bay cand.	Medium screw	Sk. d.c. bay cand.
Starting voltage, approx. AC DC	65 90	65 90	65 90	60 85	60 85	60 85	60 85	60 85	60 85
Series resistance, ohms, for									
105 to 125 v.	200 000	30 000 [†]	30 600	4 800 [†]	4 800	3 500 [†]	3 500	2 200 [†]	2 200
250 to 300 v.	750 000	82 000	110 000	13 000	18 000	9 100	11 000	6 200	8 200
300 to 375 v.	1 000 000	120 000	150 000	18 000	24 000	13 000	16 000	8 200	11 000
375 to 450 v.	1 200 000	150 000	180 000	24 000	30 000	16 000	20 000	11 000	13 000
450 to 600 v.	1 600 000	200 000	240 000	33 000	39 000	22 000	27 000	16 000	18 000

^oNE-51 same as NE-2 but has single-contact bayonet miniature base.

^oNE-57 same as NE-45 except starting voltages are 55 AC, 70 DC, and electrodes are different.

^oNE-17 same as NE-48 except starting voltages are 55 AC, 70 DC, and electrodes are different.

Base abbreviations: D.C. bay. cand.; Double-contact bayonet candelabra. Sk. d.c. bay. cand.; Skirted

double-contact bayonet candelabra.

[†] Internal resistance in base

POPULAR SCIENCE MONTHLY SHOP DATA

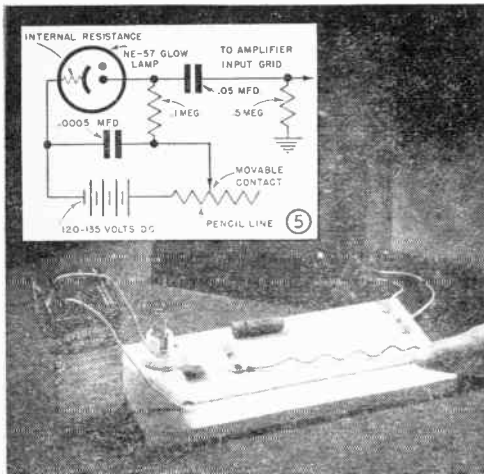

A blinker tuned to the audio range creates music notes, "played" by varying the resistance.

ance, with which a thumbtack makes contact. Slide the flexible lead along the pencil line with the fingers. The tone is something like that of a flute. If the range isn't great enough, experiment with different values of condensers and resistors. You may prefer a series of fixed resistors and switches instead of a sliding contact. Couple the circuit to a standard amplifier through a small condenser as shown. A .5-megohm resistor from input to amplifier ground creates the necessary voltage drop on the grid of the input tube in the amplifier.

A lamp connected across the terminals of an open switch will glow if the rest of the circuit is complete and go out when the switch is closed, serving both to show whether it's open or not, and to locate it in the dark. A glow lamp shunting a fuse

won't glow unless the fuse blows; then it signals the dead one instantly.

Twelve tiny glow lamps spaced around a circle make a distinctive illuminated clock dial, yet consume all together about 1/2 watt. If the clock face is made of transparent plastic, the glow will be diffused enough to silhouette the hands and show them plainly.

Since glow lamps have no thermal lag, but wink out the instant current is cut off, they have useful stroboscopic characteristics. For instance, you can check the speed of a camera shutter by photographing a lamp burning on 60-cycle AC. Use fast panchromatic film, and *move* the camera or the lamp during exposure. Thus a series of images is obtained. Since there are 120 flashes per second, you have only to count the images to learn how long the shutter was open. For instance, 12 flashes show the shutter speed was 1/10 second.

Stroboscopic disks commonly used for checking the speed of motion-picture projectors and phonograph turntables are used with neon glow lamps. Naturally no other light must shine on the moving disk. When the machine runs at the correct speed, the disk appears to stand still, while any deviation makes it seem to run backward or forward at a rate proportional to the difference.

Machinery, springs, anything in repetitive motion, can be studied stroboscopically by neon lamps. Use a blinker circuit with a frequency comparable to that of the action. Turn out all other light, and synchronize the lamp with the device by using a potentiometer control. You can stop action completely or, by going just a little "out of phase," get the effect of a slow-motion camera. END



Pocket Tester from Old Fuse

A HANDY tester can be made from a burned-out multiple fuse of the kind that glows as each fuse link is blown. Pry off the cap, being careful not to damage the fine leads going to the lamp and the tiny resistor. Bore a hole in a short plastic rod to hold the lamp. Solder on two insulated test leads, tape all joints, and pack the bulb and wires in securely with plastic composition wood. The gadget will tell if a circuit is alive, identify the "hot" side, and track down shorts, opens, and grounds.



Infra-Red Lamp Rays Flatten Warped Phonograph Records

THE EVEN heat of an infra-red lamp can be used to straighten warped phonograph records. Place the disk on a turntable or a felt-covered level surface and let the beam play over it for about five minutes. When warm the record will usually level out by itself, but it may be helped by gentle pressure. Guard against uneven or excessive heating that may damage records.

Serviceable Phone Jacks Made from Prongs of Radio Tubes

METAL prongs from discarded tubes can be converted into phone jacks for experimental and repair jobs that arise when you've run out of the regular cord tips. Break away the plastic that adheres to the

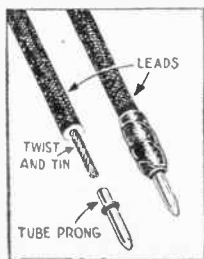

prong, and unsolder the old wires. Heat and tin the apparatus lead, insert it in the prong, and flow in enough solder to hold the wire. Rubber tape wrapped around the upper part of the pin acts as a grip.—A. M. LINDNER, JR.

Knots Tied in Wires Identify Leads Detached from Speaker

SCREW-LUG connections to loudspeakers usually have to be disconnected when the set is removed from the cabinet for servicing. To make sure that the wires are replaced properly, tie loose knots in the cord ends. The wire with one knot goes to the first terminal, that with two to the second, and so on for all the wires.—H. LEEPER.

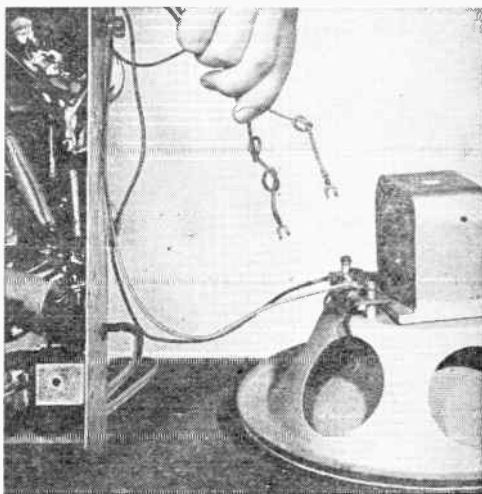

Hanger for Radio Test Leads

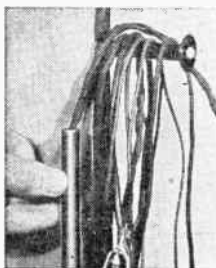

EMPTY film spools, mounted alongside the shop bench as shown at the left, may be used for hanging test leads and other short wires. The rounded body can't cut the insulation or kink the test-lead wires.

Preheat Chassis for Soldering

WHEN the seams of a chassis need to be soldered and your small iron can't work up enough heat, preheating may be the answer. Clean and clamp the joints, apply a good flux, and place the unit in an oven or over a burner. Warm metal steals heat from a soldering iron less rapidly than cold metal.—A. J. SHARENBERGER.

Shield for Metal-Tube Grids

GRID shields are often used in radio and amplifier circuits to reduce noise pickup.

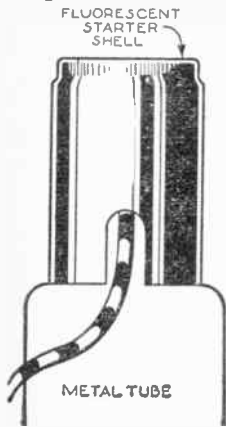

You can make an effective shield for the type of metal tube that has an exposed grid cap on top by using the shell of a discarded fluorescent starter. The aluminum shell fits snugly on top of the tube; all you have to do is bend up the tabs that hold the shell to the base and cut out a small opening for the grid lead wire.—*H. L. Davidson, Ft. Dodge, Iowa.*

Paint Improves TV View

IF YOUR TV set has a metal border around the face of the screen, you may improve your viewing by painting the metal border a flat black. The black will prevent the reflection of light from the metal that sometimes weakens the TV picture.

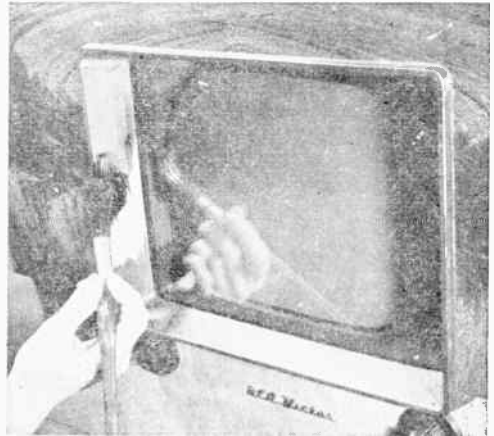

Tubing Form Pivots Up Out of Way



A PIECE of 4" pipe about three feet long mounted as shown can be used to form tubing from sheet metal. The hinge lets you swing it up out of the way when not in use. A block under the pipe adds rigidity.—*Ralph S. Wilkes, Keuka Park, N. Y.*

Solder "Pencil" Is Easy to Use

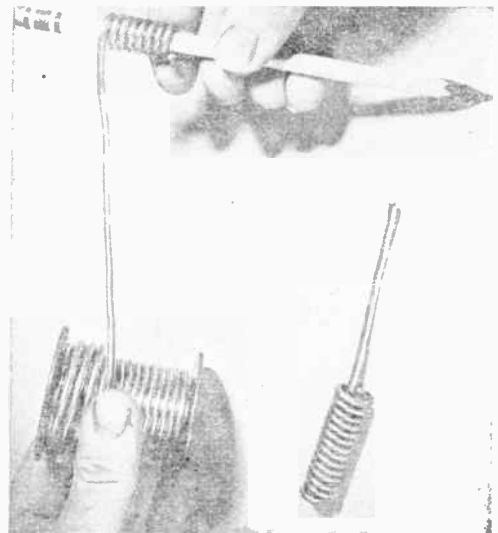

WIRE solder can be put into a convenient form by wrapping turns around a pencil. Then slip the coil off the pencil and pull one end through the coil. In use, the solder is pulled through the coil as needed.—*David Findlay, Brooklyn, N. Y.*

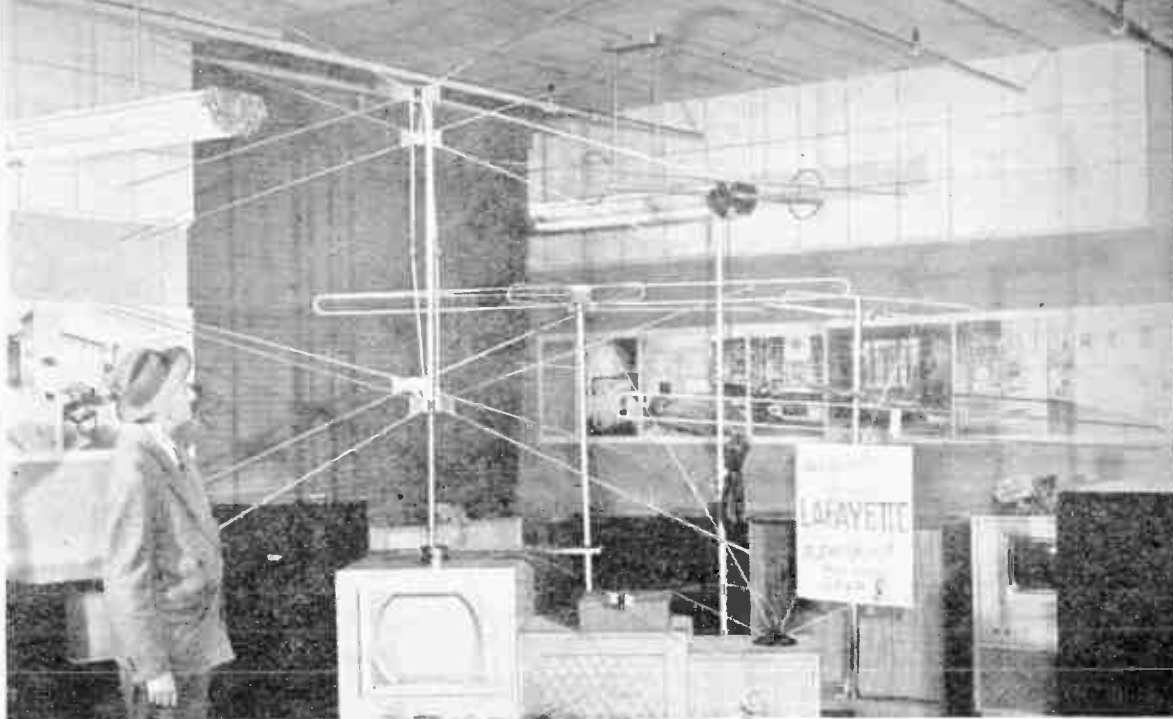

What You Should Know About TV Antennas

There are as many ways of catching signals as there are to skin a cat . . . Which is best where you live?

By **Robert Hertzberg**

DRAWINGS BY RAY PICH

WHETHER your receiver cost \$49.50 or \$499.50, it has to catch TV signals to produce bright, sharp pictures. Your signal-catcher is your antenna. Luckily, it is something that you often can experiment with profitably, even though you don't know a

ELECTRICAL SHADOWS AND REFLECTIONS

A steel-frame building or other large structure may block off signals, making a receiver in the shadow area useless. This effect is particularly marked on the high-frequency channels.

Behaving like light waves, TV impulses under fortunate conditions are sometimes reflected from buildings into receiving aerials in shadow areas. Satisfactory pictures are thus obtained.

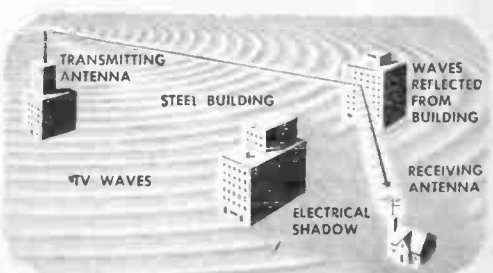
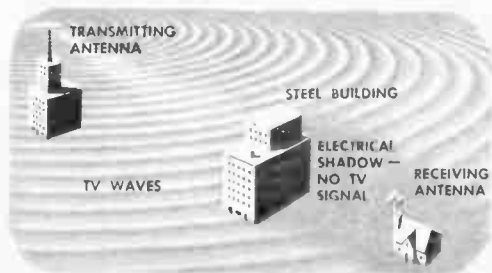

DIRECTIONAL PATTERNS

Basic folded dipole (1) receives equally well front and back, poorly off its ends. Reflector added to dipole (2) reduces signals and interference from back, but increases pickup from front. Multi-element antenna (3), with director rods in front of dipole and reflector behind, is called a "Yagi." It is sharply directional in forward plane, has practically no response to side and back, and responds with very high efficiency to signals of single frequency that corresponds to length and spacing of elements.

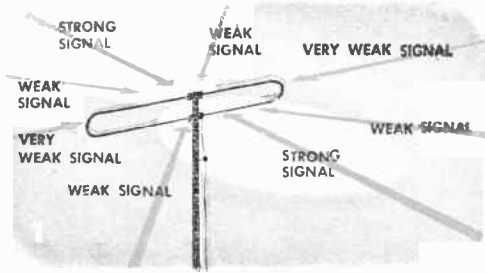

thing about the complicated innards of a video receiver.

You don't need a single meter or other piece of special equipment. Poles, rods, and wires can be re-arranged with common hand tools. And you may not even have to do any fancy climbing—trial set-ups in the attic may show what can be done where you live with various kinds of antennas. But it helps to know a little about the way TV pictures fly through the air.

Electronic lighthouse. Think of a television transmitter as an electronic lighthouse that shoots out flat circles of invisible waves. These waves respond to focusing, but peter out rapidly as they advance, and can be blocked or reflected by obstacles such as hills and good-sized buildings.

In the U. S., the waves are polarized horizontally. In England, they are polarized vertically, and receiving antennas there look like fishing poles. But our experts chose horizontal polarization, because much of the interference from electrical machinery is vertically polarized, and antennas in this country work better when they are horizontal.

The earth's curvature, height of the transmitting aerial, and the height and position of your own antenna limit the distance at which signals can be caught consistently. This distance is not likely to be more than

75 miles, although many cases of successful reception at greater distances have been reported.

Where are you? If you live out in the wide open spaces, your freedom from interference and ability to place your antenna wherever you please may help you catch TV shows.

All sorts of things can happen in cities. A woman in a New York apartment enjoyed excellent reception with a simple indoor antenna until she lowered her blinds. Then the screen went blank because the aluminum slats formed a perfect shield.

A building between your antenna and the transmitting aerial may cast an electrical shadow within which reception is poor or hopeless. Another building may reflect the signals *into* such a dead spot, and make good reception possible. Or several buildings may act as mirrors and shine several signals into an antenna, producing that multiplicity of images commonly known as ghosts.

How dipoles are made. The simplest type of signal catcher is a single dipole—a straight rod, tube, or wire about half as long as the waves from the transmitter. It is cut in half, the inside ends are pulled apart a half inch or so, and the two conductors of the lead-in wire are attached to these two halves.

DEVELOPMENT OF CONICAL DIPOLE

Electronically, a dipole consisting of two enclosed metal cones (1) makes an effective broadband antenna, but mechanically it is impractical. Desirable characteristics remain when cones are replaced by basket-weave arrangement of wires (2), or by rods forming V-shaped legs (3). This modified conical, with reflector to give directional pattern similar to that of folded dipole with reflector, is popular because it is easy to erect and pulls strong signals from stations up to about 25 miles away.

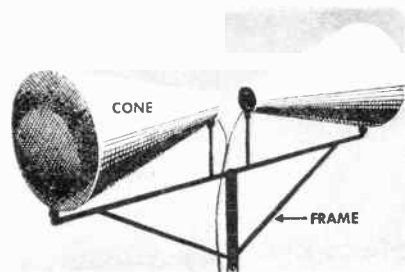

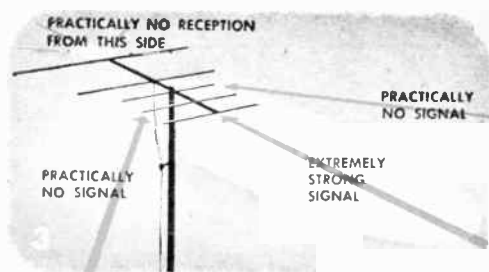
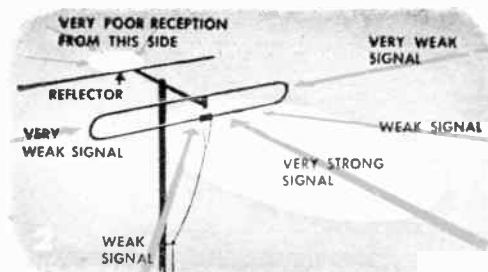

The overall length of a single dipole cut to receive Channel 4 is 80 inches. For Channel 13, by mere coincidence, each arm should be only about 13 inches long. See other antenna stories. Inexpensive aluminum tubing, about $\frac{3}{8}$ " or $\frac{1}{2}$ " in diameter, is usually used because it is self supporting and easy to mount. Copper or brass tubing would serve just as well.

Such a dipole receives best from the directions at right angles to the rod. You may not notice any difference if the rod is swung 15° to 20° to either side of the true compass bearing of the source of the signal you want to catch. Nevertheless, this directional effect is often useful in eliminating ghosts.

Folding the dipole. Unfortunately, a simple dipole, cut to the proper length to catch the signals from one station, may not bring in stations on other channels equally well. This difference in the response to different stations can be reduced, however, by "doubling" the dipole. This is done by folding a rod twice as long as would be needed for a simple dipole into a trombone shape.

A folded dipole has the same directional characteristics as a single dipole. But a double dipole cut to the proper length for Channel 4 will usually work better on Channels 3 and 5, and 2 and 6, than a single dipole of the same length.

These channels, 2 to 6 inclusive, constitute the low band of TV frequencies. The other channels, 7 to 13 inclusive, are the high band, and to receive them, a separate, shorter dipole is often added to an antenna.

Adding a reflector. There also are other ways of improving a dipole's performance. A separate, slightly longer rod, for example, can be fastened to a crossarm on the mast so that it will be in a horizontal plane behind the dipole and serve as a reflector. No wires are attached to this extra rod—but its spacing in relation to the dipole is somewhat critical.

Its distance behind the dipole should be between a tenth and a quarter of the length of the desired incoming waves. When this distance is right, the extra rod picks up energy from the station toward which the dipole has been faced and bounces this additional energy back into the dipole. And at the same time it serves as a shield against waves coming from the rear that might interfere with the reception of the desired signals.

Adding a director. An unconnected rod can also be placed in front of a dipole. It then becomes a director if it is made a trifle shorter than the dipole, and spaced so that energy is re-radiated from it to the dipole to strengthen the signal received.

When a director is used, the spacing is

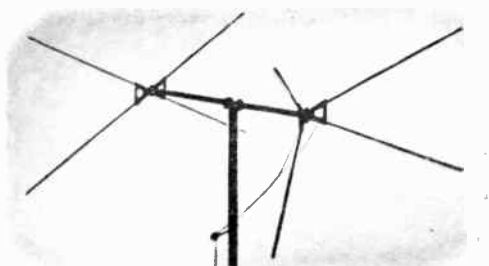
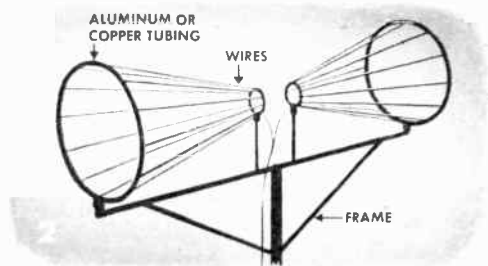

extremely important. It is roughly a tenth of a wavelength (one fifth the length of the dipole), but should be adjusted on the spot for best results. If this spacing is wrong, the secondary signals that the director shoves into the dipole will tend to cancel out the signal that the dipole picked up on its own hook, and the result will be a poor picture or no picture.

The more reflectors and directors that you add to an antenna, the more heartily it can feed signals into your receiving set—but

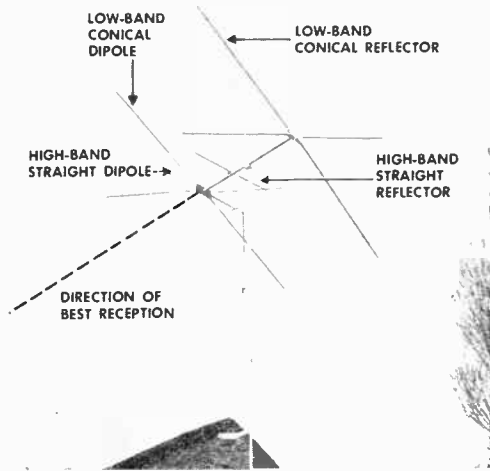

Typical modified conical antenna, with additional high-band dipole and reflector to give extra gain on channels 7 to 13, is shown above. Direction of best reception is to left.

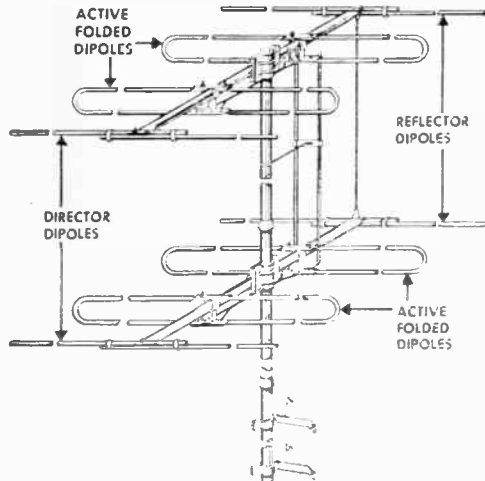

Special stacked twin-driven "Yagi" antenna, for use on a single channel in fringe areas or other difficult locations. Directional effect is very sharp; spacing of elements is critical.

at the same time the directional or beam effect of the antenna becomes narrower. Hence, such an antenna is most likely to be desirable where you only hope to receive the signals from one station or from stations that are geographically aligned.

A particularly useful type of antenna has five elements and is called a Yagi after a Japanese engineer who worked out its tricky spacing. A Yagi has three director rods, a dipole, and one reflector. Pointing one of these things is almost like shooting with a rifle.

Stacking 'em up. It is also feasible to mount several ordinary two-element beam antennas, one over the other, on a common pole, with a common lead-in. Such an arrangement is called a "stacked array."

Its advantage over the Yagi is that it retains the relatively broad-band frequency coverage of the basic dipole. But a stacked array can become clumsy. A stacked array having four two-element beams, for example, may require a reinforced tower of some kind.

Conical frames. Probably the best general-purpose TV aerial, electronically, would be a dipole with the elements in the form of closed metal cones. As a mechanical body it is impractical. Its desirable broad-band characteristics can be largely retained, however, by replacing the cones with a basket-like arrangement of wires. And experimenters who kept removing a few wires at a time discovered that such an antenna still worked well with only two rods on each side, fanned out to form a wide V.

This modified "conical" can be backed up with reflectors and stacked in the form of arrays, and is proving successful where the available stations are distributed over both low and high bands.

But the directional property of beam antennas is not an unmixed blessing. Suppose you live between two stations. If you aim your antenna at one, you may not get a glimmer out of the other station. But there are two ways to overcome this trouble: Use two antennas and switch from one to the other, or make your antenna rotate so that it can be aimed at either station.

Tricks such as these are enabling the kids to enjoy Hopalong Cassidy where satisfactory reception would be impossible otherwise.

END

Buzzer Wired to Alarm Clock

SOMETIMES it is desirable to make a clock provide an alarm in a distant room. This can be done by wiring it in a buzzer circuit, provided the alarm bell is or can be insulated from the clockwork. Bend the hammer so that it remains on the bell and so closes the circuit when the alarm mechanism is tripped. The alarm spring need not be wound. Add a switch to shut off the buzzer after it has done its work.—BERT LARUE.

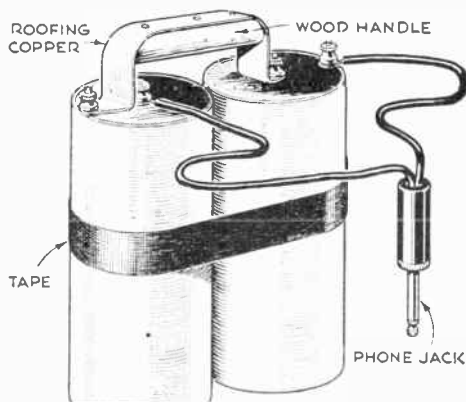
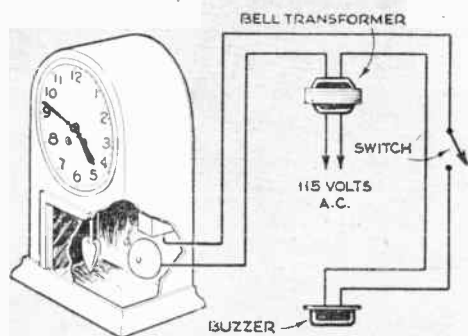

Handle for Booster Batteries

PORTABLE booster batteries for starting model gas planes are easier to carry if the two dry cells are connected with a handle of sheet copper or aluminum. Join one end to the negative terminal of one cell and the other to the positive terminal of the other cell; then fit in a rounded piece of wood to serve as a grip. Friction tape will hold the two cells together.—GEORGE MCGINNIS.

Clothespin on Wire Turns Rain

AERIAL lead-in wires that go directly into a house without a loop sometimes carry in rain water. A clothespin snapped on such a wire a few inches from the house is effective in preventing this. The water will run against it and drip off harmlessly before it can reach the wall.—FRED CORNELIUS.

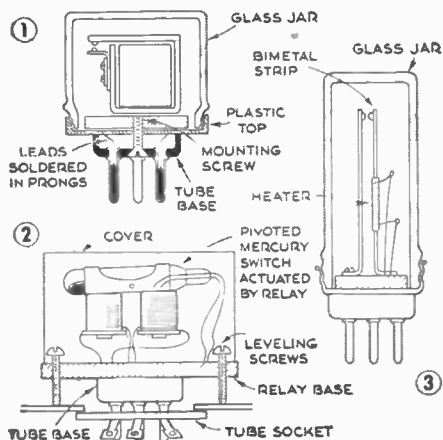
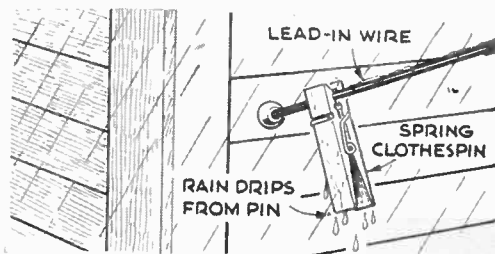

Relay Put on Radio-Tube Base

MOUNTING a relay on a radio-tube base has several advantages. Wiring is simplified, relays become interchangeable, and adjustments or repairs can be made to a relay without unsoldering connections.

Cut the tube base short and bolt a piece of $\frac{1}{4}$ " bakelite or fiber to it as shown in Fig. 1. Drill holes in this piece for the leads, soldering them into the tube-base prongs. Relays and thermostatic elements can be protected from dust by clamping the lid of a wide-mouth jar between the fiber and the base and screwing the glass jar in place as a cover (Figs. 1 and 3).

If the relay must be leveled, tap the fiber for leveling screws as in Fig. 2.—D. H. M.

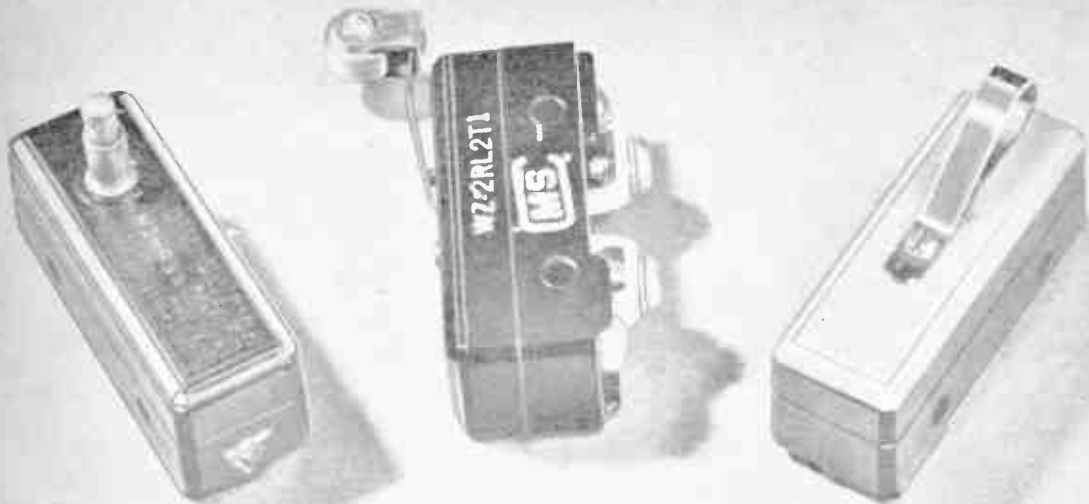

Various actuating devices (here a button, roller, and leaf) come on similar basic switches.

Midget Switches with a Hair Trigger

Say good-by to knife switches and get acquainted with these versatile and precise electrical handy men.



YOU CAN put one of these midget switches in your watch pocket, or hold a couple in your closed hand. Yet at 115 volts, one of them will easily handle 10

amp.—ample to run a ½-hp. shop motor. What's more, it'll do it with an operating pressure of a few ounces, and with a plunger travel of less than .005". Better yet, it'll

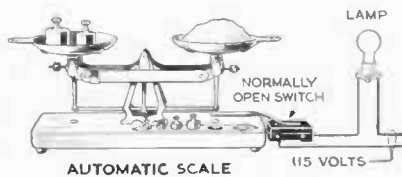
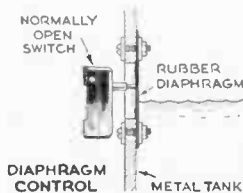
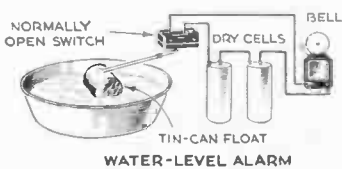
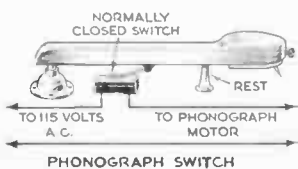
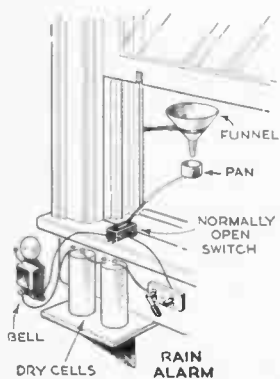

Countless applications in the home and shop will be found for these switches. Here are a few.

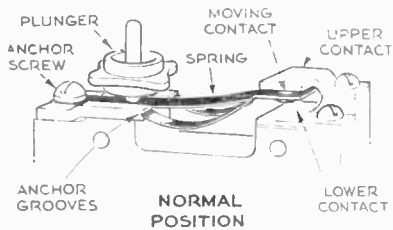

NORMAL POSITION

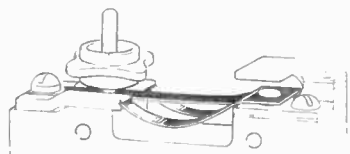

OPERATED POSITION



SPRING AND CONTACT

How it works is shown in this Micro Switch[®] phantom view. At rest the bowed spring arm hold the moving contact against the upper one; depressing the plunger snaps the spring down.

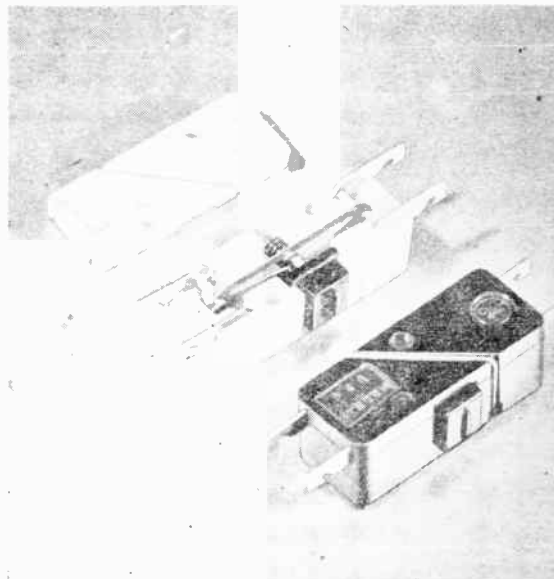

Lighter and smaller, this GE Switchette[®] is designed for light-duty service. The upper one has its cover off to show spring action. It can be either normally open or normally closed.

do its job in a matter of a few milliseconds, and will repeat the same task precisely and reliably for upwards of 1,500,000 times.

What this means for the workshoper (or the householder with a yen to put more electrical servants to work for him) is considerable. Up until recently, having chiefly knife and toggle switches at his disposal, he has been handicapped by their mechanical limitations and by the often laborious job of installation. With snap switches, the sky (and his own ingenuity) are the limit.

Though small enclosed switches of this

type began to appear in industry about 15 years ago, it wasn't until shortly before the war that they became common. With great volumes of them now available in war-surplus stores, and with new ones obtainable at electrical and radio-parts stores as well as mail-order houses, the craftsman who wishes to use them in his home or shop can choose from a variety of makes and styles.

While the operating details vary from make to make, such switches generally employ a curved arm of copper that's alloyed

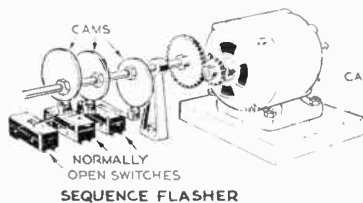

SEQUENCE FLASHER

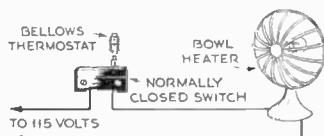

HEAT CONTROL

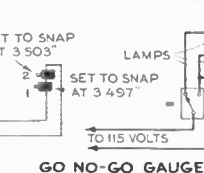
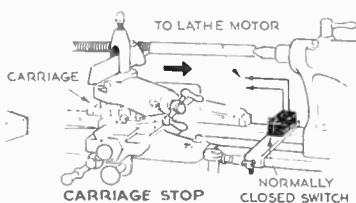

GO NO-GO GAUGE

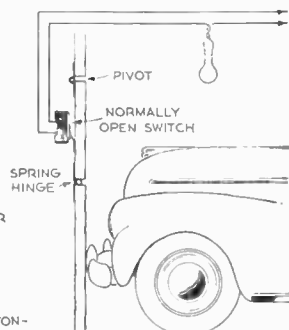

GARAGE WARNING

Sensitivity, shortness of travel, fast action, and repeat accuracy are switch characteristics.

with beryllium for springiness and resistance to fatigue. This arm, carrying movable contacts at its free end or ends, is mounted in a plastic case in such a way that short movement of a plunger will cause the contact arm to snap down to a second position. The instant pressure is released, the arm snaps back. Both make and break are clean and sharp; there's no in-between position.

Most snap switches are of three types: normally open, normally closed, or single-pole double-throw. The "normally" designation describes the switch when no pressure is applied to its actuator—not necessarily the position in which the switch is usually left. To clear up the point, consider for a moment the switch controlling the light inside a refrigerator, which is a normally closed type, being held open when the door is shut. Note that in this application as in some others, a normally closed switch is habitually held in an open position.

If you aren't sure of the uses to which you are going to put the switches, it's smart to get the SPDT type. This is because they can be used as either normally open or normally closed ones, depending on which

of the terminals you connect. One kind, shown at top right on page 93, can be connected to open and close two entirely separate circuits, or (with the lugs at one end connected together) employed as a SPDT switch.

Actuating levers to press the plunger on the switch are made in a variety of styles, including simple and compound levers, springy leaves, and cam-following rollers. Since forcible overtravel of the plunger may damage the switch, be sure to use a lever that'll protect the switch in cases where the applied pressure may be large. Suppose you use a normally closed switch on the bed of a screw-cutting lathe, wiring it in series with the motor so that it will cut power at the end of the carriage travel. The momentum of the motor, jackshaft, and gears may be enough, however, to move the carriage a substantial fraction of an inch *after* the juice has been cut. Your remedy, naturally, is to use a switch having either a telescoping button over the plunger or a springy leaf.

Just a few of the ways these handy gadgets can be used are illustrated on these pages. Almost all of the applications can be adapted to suit your needs. For instance, the water-level alarm would serve as shown as a reminder to dump the pan beneath the icebox, or to shut off the windmill or pump filling a tank. If the switch were changed to a normally closed type, the setup could serve as a warning that the stock watering trough or cistern was running low.

If occasion warrants it, a good deal of elaboration of these ideas is also possible. The automatic scale, for example, is handy for measuring a large number of identical quantities, and it signals when the specified weight has been poured on the scale. (Be sure to include the switch-tripping pressure in setting it to produce a particular amount.) As

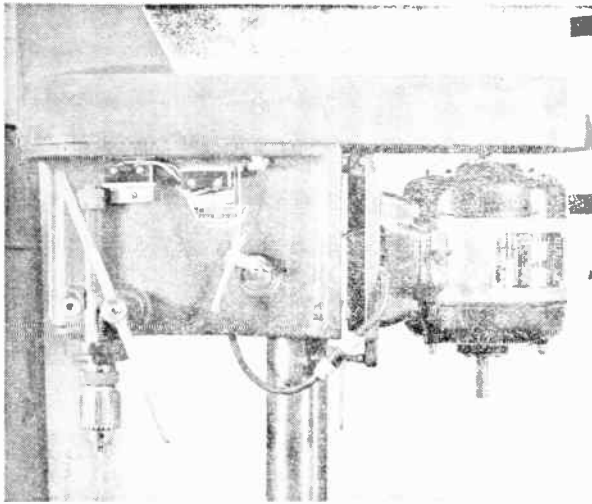

For convenience and safety, H. L. Phillips, of Watertown, Mass., rigged a drill press this way. Moving the feed lever starts the motor—but only if the chuck key is hung up.

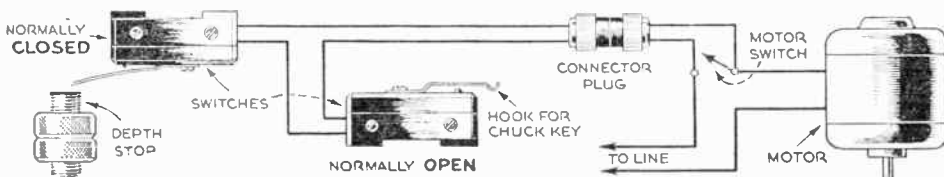

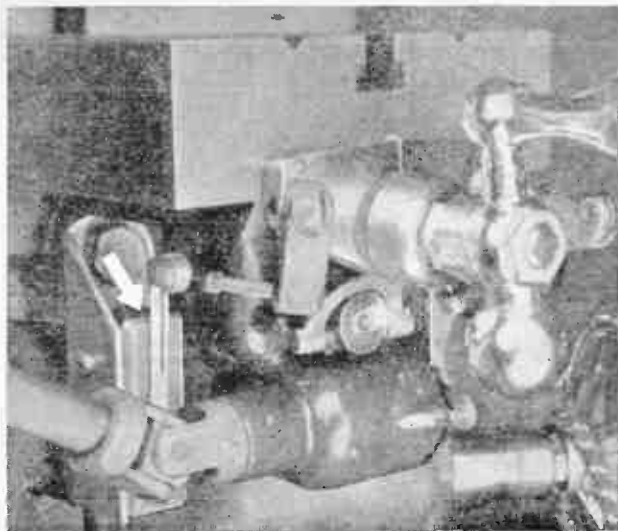

Damage to power tools having automatic feeds is made less likely with these switches. Here a normally closed switch is used on a bench mill to cut power at the end of table travel.

shown, the rig signals when a specified amount *or more* has been added; but it wouldn't be difficult to add a second switch and signal to show when the weight went above a second, upper limit.

The extreme precision and repeat reliability of snap switches were used in some war plants to make the electrical gauges shown schematically on page 93. A pair of switches checked each dimension, and several different dimensions were tested simultaneously. With an actuating movement of little more than .001", the gauges were accurate enough for many jobs.

One agreeable thing about the switches is that they're tailormade for duties that you want performed automatically. Consider for example the drill-press application shown here. If you've ever inadvertently left the chuck key in the chuck when the motor was switched on, you know that it can be slung out with dismaying violence. In this setup that *can't* happen; the motor just won't start until the key is hung up where it belongs. The other switch is more of a convenience than a safety measure, but starting the motor just by pulling down the feed lever will be appreciated by anyone who has groped for an awkwardly placed drill-press switch.

Many applications of snap switches will be suggested by your own activities. Thus the radio ham will use them on transmitter-

cabinet doors to cut the primary of high-voltage transformers when the cabinet is opened. Or the truck operator will put them under the springs to signal overloads or on side or rear gates to tell if they aren't shut.

The photographer will find them particularly handy. With a few scraps of wood and a hinge, a snap switch becomes a foot switch that will make enlarging easier. A light in a hall outside the darkroom door won't fog valuable film, no matter who walks in inopportunately, if it's fed through a switch held shut by the darkroom door. A normally open switch attached to the paper storage box and connected to the white room light will protect photo paper.

For the householder, they'll come in handy for an automatic closet light, using a normally closed type. Or for burglar-alarm systems, using normally closed switches that are held open by acceptable window or door positions, or by taut trip threads. Or for gate or mailbox signal devices. Or for home fire-alarm systems (normally closed switches held open by bits of low-melting-point wax might do the trick). Or for position indicators if you have to get a big car in a small garage. **END**



A push-to-talk control for an inexpensive microphone can be easily installed. Since it requires only very slight pressure, it can be kept shut for a long time without discomfort.

Radio-Phono Combination Doubles as Bedside Table



Finished cabinet has veneer strips on all exposed edges. Radio panel is piece of plastic.

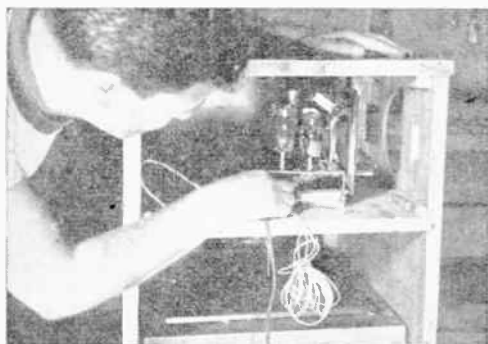

Radio is fitted into side of cabinet routed out for it. Wooden blocks hold the radio in position.

YOU can use this radio-phono combination beside a bed, where it'll double as a night table, or you can place it in the living room beside an easy chair. Radio, changer, and record storage are compactly arranged.

No dimensions are given here since the size of the cabinet is controlled by the size of the radio and changer. I built the cabinet of $\frac{3}{4}$ " mahogany-veneer plywood except for the two shelves. Because these do not show, $\frac{3}{8}$ " fir plywood was used.

First step is to measure the radio and changer. Then you can determine the cabinet dimensions. Leave an extra space over the radio for ventilation. When you lay out the side panels, allow for the thickness of the two shelves—for the radio and for the record-changer drawer. The album storage space, too, should be high enough to permit easy removal of a 12" album.

The side panel that will house the controls must be routed out to $\frac{3}{8}$ " over an area the size of the radio's front. This will permit the control shafts to reach through the plywood. To slide the changer drawer, you can use channel iron and small ball-bearing wheels, or a pair of the commercial slides made for this purpose. Finish the cabinet with a mahogany oil stain and clear lacquer. —Walter Fischman, Philadelphia, Pa.



Here are the works. The box in the foreground contains the radio-phono connection and switch.

The \$8 unit at the right "melts" the snow that flakes through weak signals, sharpens and brightens images.

Homemade Booster Improves TV Pictures

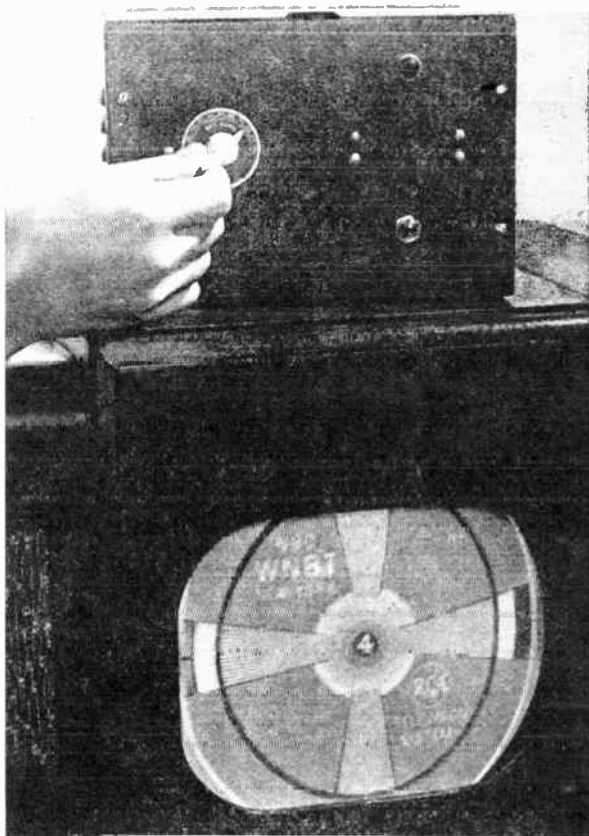

Amplifying distant signals may give you grandstand reception in the bleachers.

ARE your TV pictures as good as they ought to be? If not, you may be able to help yourself to greater video enjoyment with a booster that will strengthen weak signals on the low channels.

"Snow" in a picture is a sure sign of weakness. Not only can a booster cure this condition but it can also sharpen image outlines and improve contrast and clarity.

The unit shown above can be built for about \$8. You can use it with either an indoor or outdoor antenna, but it won't take the place of either. It improves a signal, but doesn't create any where none exists. If you live in a fringe area you will still need your roof-top rig. But whatever your antenna, if you are now getting pictures that are under par, a booster will help.

Though the range of this booster covers only the first five channels, it is so designed as to cause no interference with high-band stations. You can leave it connected even

when you're looking at channels 7 to 13.

Two lengths of 300-ohm flat-ribbon lead-in are wired directly to the coils. One of these (marked "IN" in the diagram on page 99) goes directly to the 300-ohm lead from the antenna. The other goes to the antenna terminals on the receiver. Placed ahead of the receiver input, the booster acts to amplify signals coming in from the antenna. The unit has its own power supply and must be plugged into an AC outlet.

To put the booster in operation, first tune in the station on the set, then tune the booster by varying the tuning condenser. This is the amplifier's only control. For channel 2, set the pointer knob so that the plates are fully in mesh. Find the best setting for each channel and mark the dial accordingly. For high channels set the pointer so that the plates are out of mesh.

Want one? Turn the page for building instructions. ▶

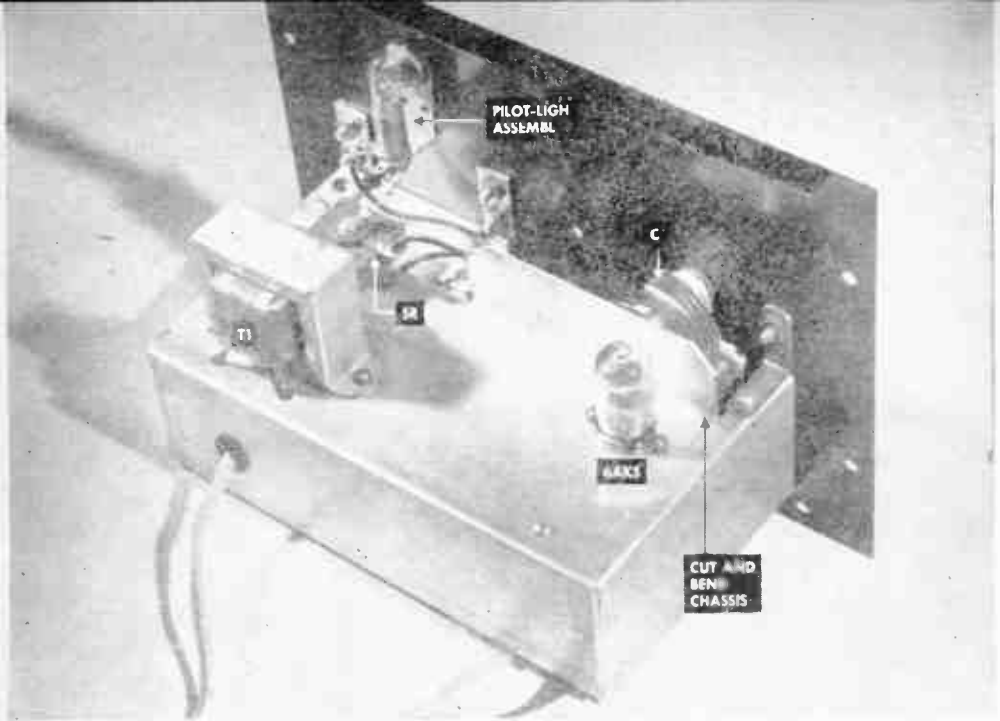

You can use almost any chassis and cabinet for this unit. The transformer, selenium rectifier, and the single tube are on top of the chassis, which is bolted to the front panel with angles.

The switch, pilot-light assembly, and the 50-mmf variable condenser are on the panel. The tube is directly behind the condenser, but note the 1" ledge bent up on the chassis as a screen.

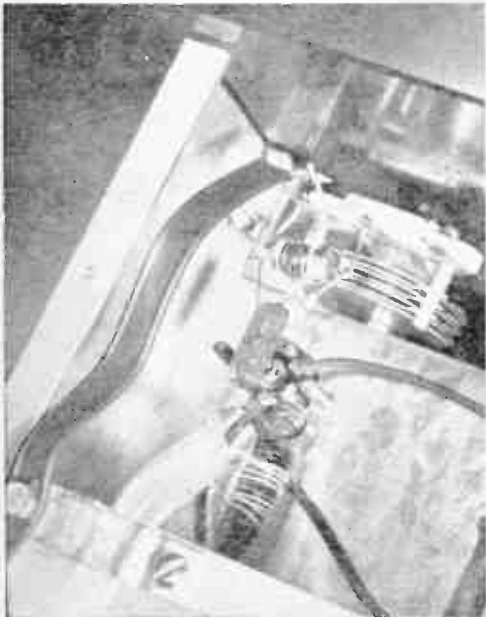

To keep RF losses to a minimum—which is important at television frequencies—make wiring compact. This close-up shows a 7-pin miniature ceramic tube socket with all related parts clustered in a tight huddle around it. Leads are soldered directly to socket-pin lugs. All ground connections are gathered at one point on the chassis near the tube socket.

COIL-WINDING DATA

- (Wind L1 on R1 and L2 on R2)
- L1A: 6 turns No. 18 enamel (close wound)
- L1B: 8 turns No. 30 D.C.C. (wound over L1A)
- L2A: 19 turns No. 18 enamel (close wound)
- L2B: 8 turns No. 30 D.C.C. (wound over L2A)

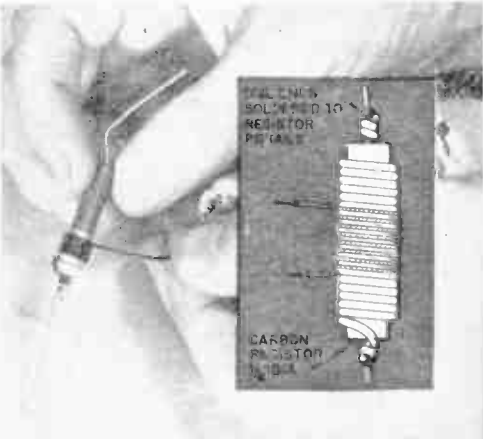

Another dodge for compacting parts is to use resistors R1 and R2 as forms for winding coils L1 and L2. To do this, you should purchase 1-watt resistors with diameters of 1/4". The table specifies the number of turns for each winding, but don't take that for gospel. Your booster may show better results with fewer or more turns. Experiment with both 8-turn windings.

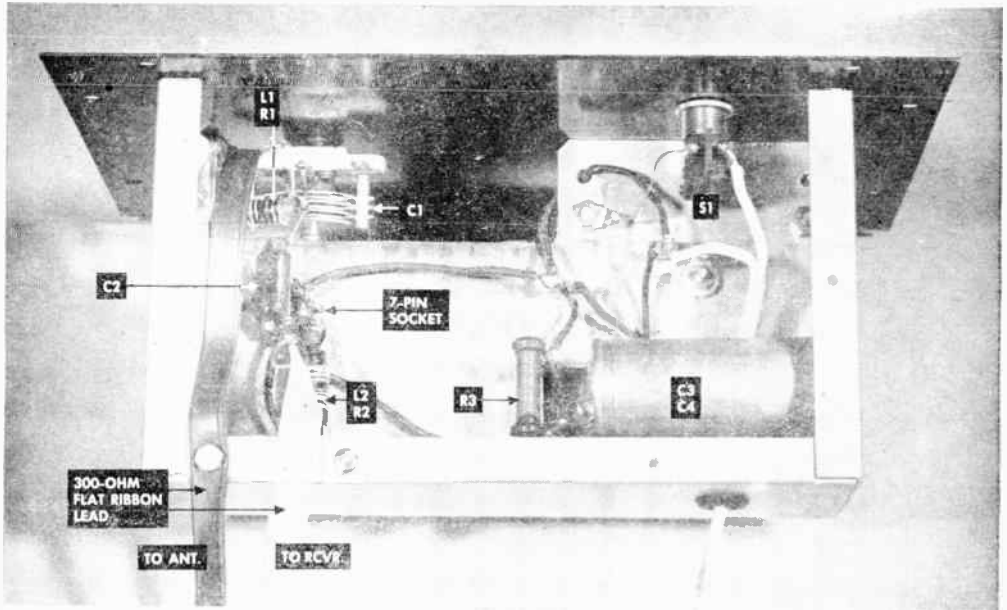

The dotted line dividing the diagram below and the space in the middle of the photo above separate the booster circuit into its two parts. Wiring to the right of the line requires no

special precautions. But all leads to the left with the exception of the 300-ohm ribbon lead must be kept as short as possible. A close-up of this portion is shown on the facing page.

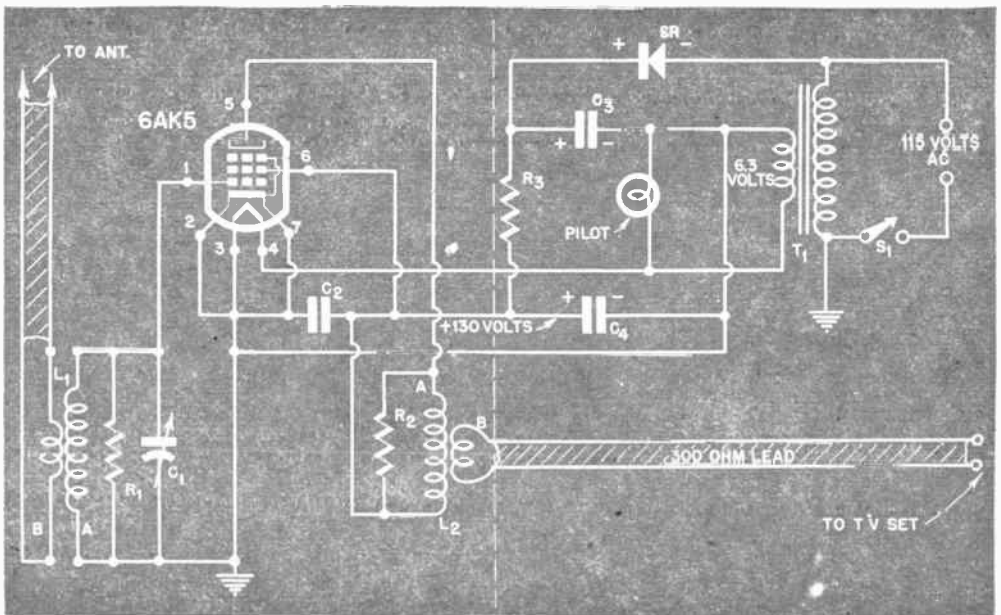

- R1:** 5,000-ohm, 1-watt carbon, approx. $\frac{1}{4}$ " dia. (Use as form for L1)
R2: 2,000-ohm, 1-watt carbon, approx. $\frac{1}{4}$ " dia. (Use as form for L2)
R3: 1,000-ohm, 1-watt carbon
C1: 5- to 50-mmf. variable

LIST OF PARTS

- condens.
C2: 150-mmf. mica.
C3: 40-mfd., 150-volt electrolyt.
C4: 20-mfd., 150-volt elect.
 (May be dual unit with C3).
S1: SPST toggle.
SR: 75-ma. dry-disk selenium rect.

- Pilot-light assembly with 6.3-volt brown-head bulb, chassis, cabinet, 7-pin miniature ceramic socket, 6AK5 pentode, 300-ohm flat-ribbon lead, set of coils (see text and table), misc. hardware.
T1: 115 to 6.3-volt Filament transformer.

RADIO COMBINATION in a Wall Bookcase

By RICHARD B. LEWIS

SOME record-player and radio combinations outlive the usefulness of their cabinets. If you have one that has become an eyesore or is so bulky that it takes up needed space in the living room, it can easily be converted into a built-in job. This is especially effective if you have a recess for bookshelves, although the unit could be installed as well in a deep wall bookcase.

In the project illustrated, the living room had a recess that already contained a built-in bookcase consisting of a cabinet topped by two drawers and four shelves, as shown in the photo at left below. A panel was provided for the lowest shelf and jigsawed to take the radio dial and speaker.

Tucked neatly away in a recessed bookcase, an old radio-phonograph combination is readily accessible and a modern piece. At left below, the bookcase before conversion; at right, after installation.

changer and turntable unit was installed in one of the drawers. A power receptacle was wired into the wall behind the radio, and antenna and ground connections were also made there. Records are stored in the cabinet and on the shelves.

Because the record changer needed more depth than the drawer originally provided,



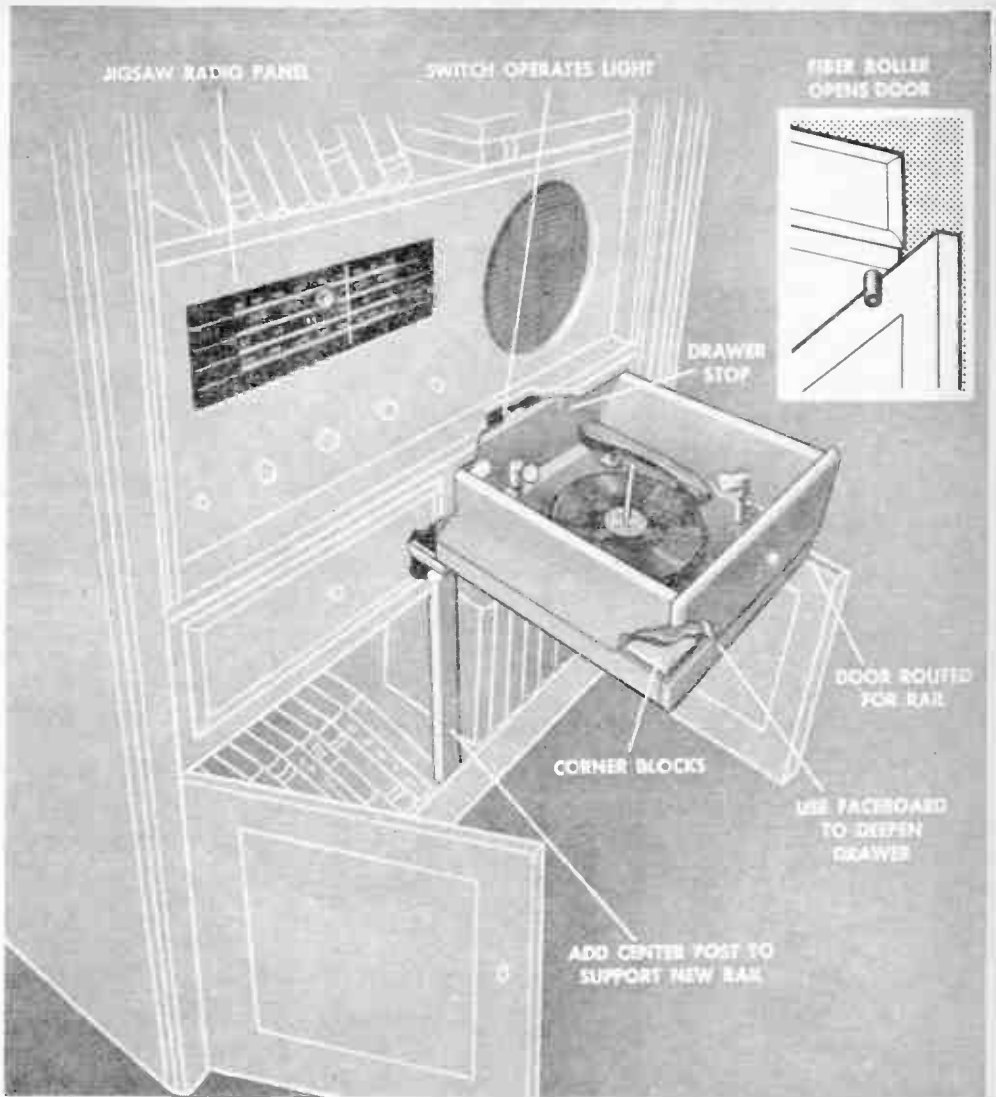

When records are to be put on the changer unit, the drawer is pulled open. It rides on a rail on one door.

the bottom of the drawer was lowered the necessary amount. Part of the old drawer rail was used as the extension in front to preserve a symmetrical appearance. A center post was added to support the drawer at the side away from the hinge jamb, and a stop was attached at the back of the drawer to keep it from being pulled out too far. The record changer was then mounted on corner blocks on the bottom of the drawer.

A steel rail of the type used in showcases was fastened in a groove routed in the top edge of the door that helps support the

drawer, and the bottom edge of the drawer was well waxed so it would ride smoothly. This door is opened by a roller as the record changer is pulled out. A spring closes it.

To accommodate the radio chassis, a board was attached behind the panel with shelf brackets. This made a movable mount that could be pulled out from the bookcase for servicing the set. Wires for the radio and record changer were, of course, kept long enough to provide slack. Ventilation was cared for by a 3" by 18" slot at the back of the shelf just above the radio.

Tips for TV Cabinet Builders

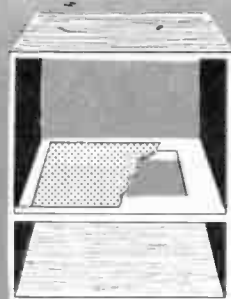
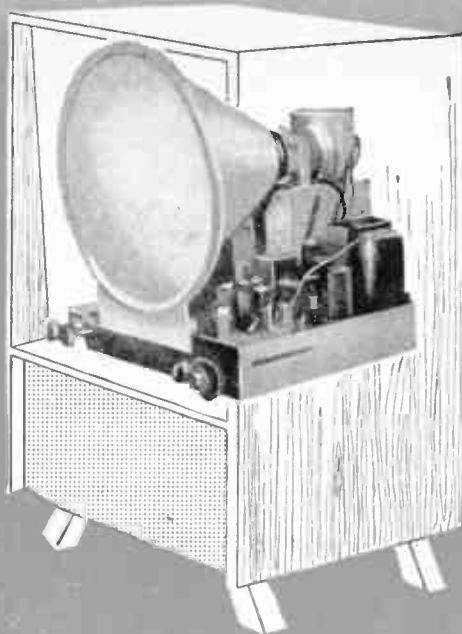

Allow for ventilation. Be sure there's air space below the shelf on which set rests. Drill holes in mesh, or, better, cut a large opening and cover it with heavy metal mesh.

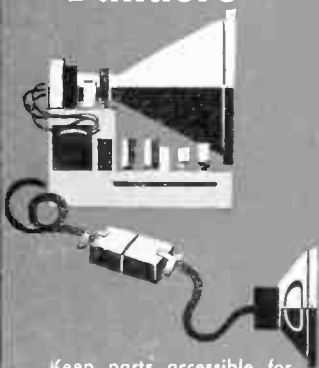

Keep parts accessible for servicing. Each unit should be removable without disturbing others. Connect units with polarized plugs and sockets.



Minimize glare on picture. Tilting the chassis forward about 4° and letting cabinet overhang the picture tube at top will help to cut light reflection.

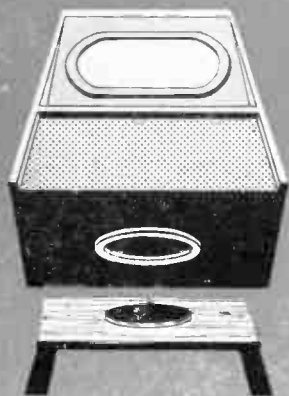

Consider viewing angles. If set won't be convenient to move, rotate screen. The set, use a rotating base. You can buy a commercial wheel or make a ring and disk as shown.

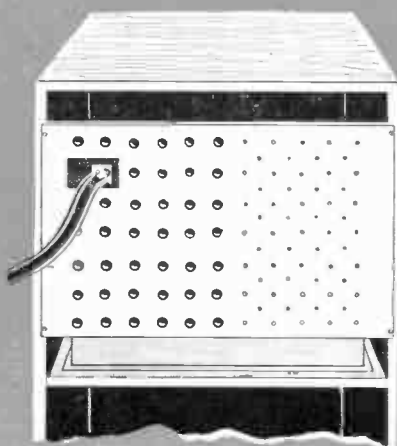

Install protective cover on back. It must combine safety with maximum ventilation. 1/2" holes will stop most flying glass. Heat high-voltage coils, make holes 3/16"



Guard against voltage leaks that may make front of set "hot." Use neoprene, not rubber, for metal tube supports.

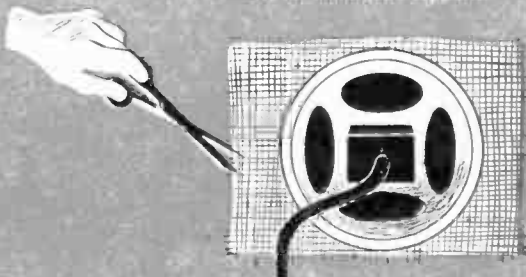

Trim speaker grille cloth. Most speaker slots have metal flares. If loose threads snaggle into coils with high voltage, your set may become dangerous to touch.

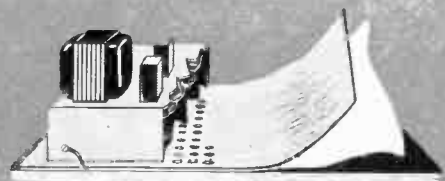

Shield the bottom of the set to reduce noise pickup. Easiest way is to line chassis shell with aluminum foil and cover top with cardboard. Connect chassis to foil. Punch vent holes through all layers.

Your Pocket Can House a 4-tube Radio

Homemade midget superhet will bring in everything on the dial.

By Albert Rowley

YOU don't have to carry your portable radio this summer—you can wear it. Here's a homemade receiver that is just about the last word in midgets. It's so small you can slip it into your shirt or trouser pocket and hardly know you have it with you.

You might think that so tiny a set has to be a slipshod, one-tube imitation of a real radio. Not this one. It is a four-tube superheterodyne that will pick up everything on the dial. Headphones reproduce the sound with good tone, fidelity, and volume. Inch for inch and ounce for ounce, this is a good bet in portables.

If you've had a little practice in radio building, you can make yourself a midget receiver just like it. The job does present some rigid space limitations, so it is important that you work carefully and systematically. The first step is to collect all the parts, including the cabinet. Then plan the complete arrangement, and drill all mounting and trimmer-adjustment holes before you solder a single wire.



It's light as well as small. Complete with batteries, the set weighs less than 14 ounces.

Cabinet: Since the cabinet may determine the arrangement, let's talk about it first. The one shown was made from a plastic dressing-table tray that came from the dime store. It's the kind women use to keep make-up articles separated. Compartments are molded right into the plastic. One three-section strip was sawed off and left-over pieces were used for a cover and mounting strip.

The three tray compartments are perfectly suited to the three-part construction of the receiver. Even if you decide to modify the cabinet you will find it easier to build this set if you work on it by sections.

Section 1—Controls: The top compartment contains the parts that tune and

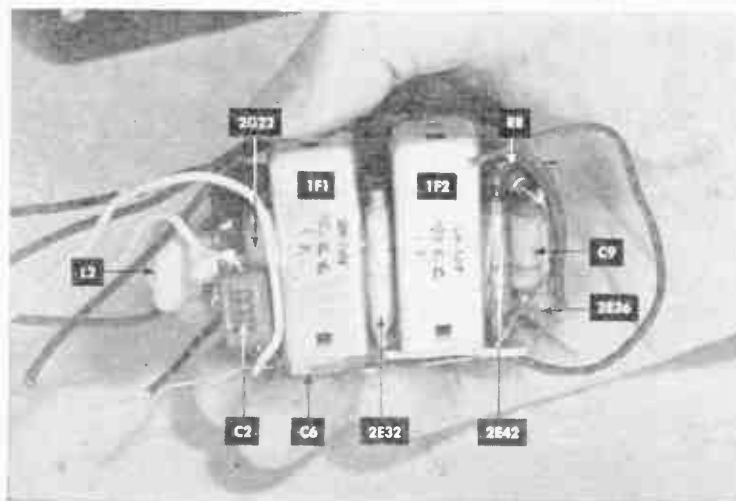

Tubes are attached to the IF transformers with cellulose tape. Make sure that the prongs clear the sides of the cans. Transformer shield cans must be grounded.

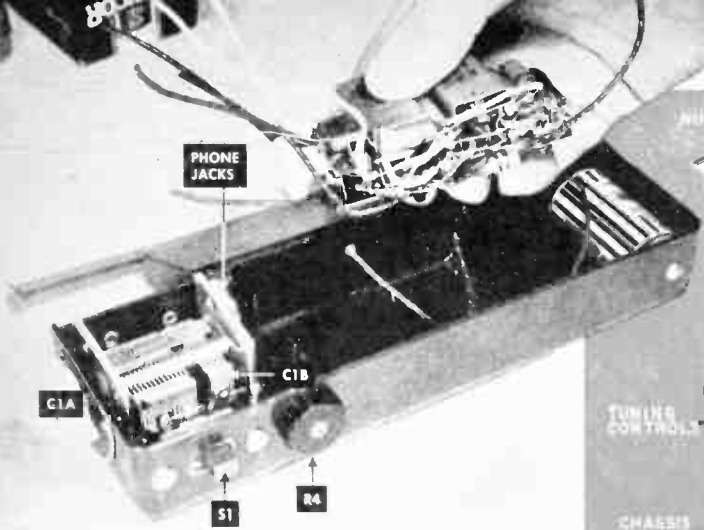

The oscillator coil, at the end of the chassis strip, extends into the top compartment. The wall between is cut away to make room for it.

adjust the receiver. They are shown by solid color lines in the diagram. A two-gang variable condenser (C1) is placed so that its tuning shaft protrudes through the top of the cabinet. When the plates are in mesh, the unit fits nicely in the 1 1/2" cabinet depth. To make room for the plates to swing through the entire tuning range, however, it was necessary to cut away one corner of the cover as shown in the cabinet drawing.

Other parts located in the tuning section are the on-off slide switch, two phone jacks, volume control (R4), and the homemade antenna coil (L1). The volume control is an extremely compact unit made for hearing aids. Its variable-resistor element is enclosed in the knob, so only the three connecting lugs actually go inside the box.

The antenna coil is the only non-standard part in the receiver. To get one small enough, you may have to make it yourself. For the core, use the powdered-iron slug from a standard iron-core antenna coil. Examine any burned-out coils you may have in your junk box, and try to find a slug of the dimensions shown in the sketch.

Wind 125 turns of No. 34 D.C.C. wire around this core. Fit the finished coil between the slide switch and the variable condenser.

Section 2—Chassis Strip: All the tubes and most of the small parts are assembled on a plastic strip that fits into the center compartment. The IF transformers, attached to the strip with self-tapping screws, serve as anchors for the peanut tubes. The 2G22 and 2E32 are taped to the

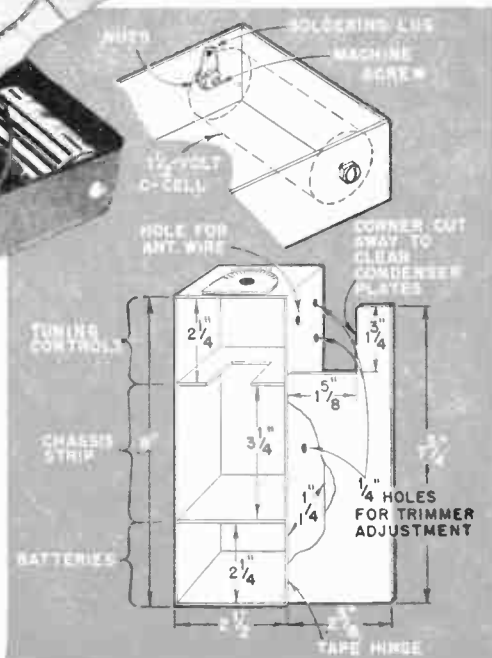

left and right, respectively, of 1F1. The 2E42 goes on the right side of 1F2.

The two other major parts of the chassis strip, the 2E36 output tube and the unshielded oscillator coil, L2, are mounted directly to the plastic.

A small, pencil-size soldering iron will be a big help in wiring the tighter corners. If you don't have one, use a sharp tip in your regular iron. Take it easy with the solder. Some of the connections—especially to tube prongs—are so closely spaced that even a small solder blob may short them out.

Wire all necessary parts and leads to the 2E42, and then go on to the 2E36, the

Wind the antenna coil on a powdered-iron core. Make the windings flat, and seal the coil with dope, nail polish, or cellulose tape.

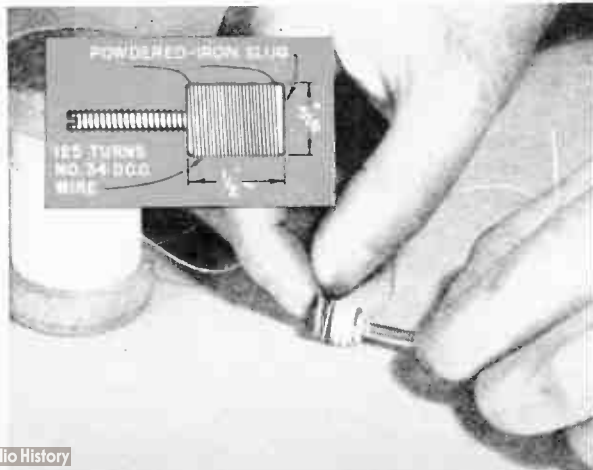

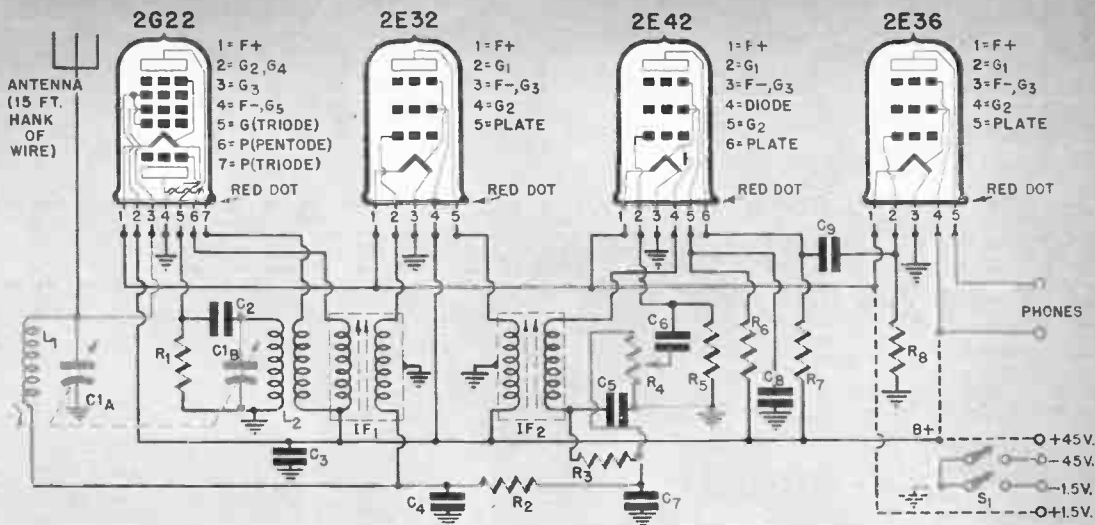

LIST OF PARTS

All fixed resistors $\frac{1}{4}$ -watt carbon.
 R1: 220,000 ohms.
 R2, R7: 1 meg.
 R3: 47,000 ohms.
 R4: 500,000-ohm hearing-aid-type volume control.
 R5: 10 meg.
 R6: 3.3 meg.

R8: 4.7 meg.
 C1A, B: Two-gang, cut-plate tuning condenser, midget type.
 C2, C5: .0001-mfd. mica.
 C3, C4, C6, C8, C9: .01-mfd., 200-volt midget paper tubular.
 C7: 50-mfd. mica.
 IF1, IF2: Iron-core intermediate-

frequency transformers for 455 kc. Midget (spec.)
 L1: Antenna coil (see text).
 L2: Unshielded air-core osc. coil, 455 kc.
 S1: DPST midget slide switch.
 Subminiature tubes, 2,000 to 4,000-ohm headphones.

2E32, and 2G22 in that order. Remember that you don't have a metal chassis to act as a common ground, so you'll have to interconnect all grounds just as carefully as you do the B-plus or filament lines.

Section 3—Batteries: You will know you're reaching the home stretch when you come to the battery compartment. This contains two 22½-volt miniature B batteries connected in series and a C-size flashlight cell. Since the small cell has to be changed fairly often, it should be clipped in, rather than soldered. Good clip contacts can be made by driving two ¼" machine screws through opposite sides of the cabinet. Bat-

tery connections are indicated by the broken black lines.

Connecting the sections: The final stage of the wiring consists of running leads between the compartments. Don't forget to link the common points.

You can use any pair of high-impedance earphones to pipe the sound from the radio to your ear. The very compact, single ear-piece shown on the opening page is a Telex Earset of 2,000 ohms impedance. If you get one of these, be sure to purchase it with a matching crimped-tip cord for use with phone tips; the plug-tipped cord isn't suitable. END

Remove the IF transformers from their cans by pushing back the retaining clips. Drill a small hole in the side of each can and a correspond-

ing hole in the plastic strip. Attach transformers with self-tapping screws. Screw heads and solder lugs can be seen in the photo below.

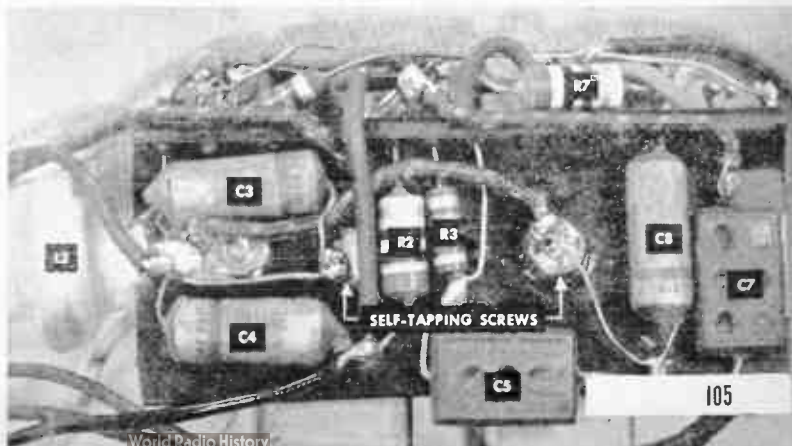
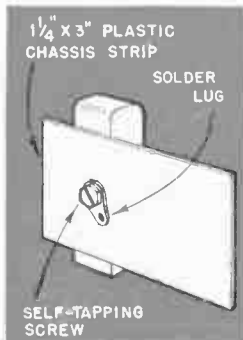

What *COLOR* Does to TV



THE STUDIO More lights, placed lower, is major change on CBS color set where Director Frances Buss (left), Ed Sullivan, Patty Painter discuss script.

Everyday color television is on the air, adding pleasure for the audience—and some problems for producers.

By Kendall W. Goodwyn

YOU'LL see more on your TV screen, whether it's big or small, when you've converted to color. But putting the color into the pictures poses new problems that producers and engineers are busy solving now.

Shows already being telecast and others being planned prove what color does to television. What it does is good. More than simply adding beauty and realism to a gray picture, it makes possible scenes and whole shows that black-and-white would miss.

Take the impressive program that inaugurated commercial color TV this summer. In one sequence of a ballet, the dancer relinquished her bouquet of red roses for one of black roses, signifying death. In black-and-white, the whole scene would have been meaningless.

And the regular, everyday programs that followed the big "Premiere" hour on the Columbia Broadcasting System, while not so lavish with high-priced talent, have also demonstrated what color can do. Naturalist Ivan T. Sanderson shows you the brilliant feathers of exotic birds or explains why Nature gave unusual tropical plants their strange shapes.

Color Helps You Identify Objects

This fall there will be plays, children's programs, football games. Outdoor sports events come through very effectively in color. And you can always tell which team is which just by the colors of the uniforms.

Science demonstrations are another natural subject for color television. Already one series is being prepared with the cooperation of Kenneth M. Swezey, well known to *POPULAR SCIENCE* readers for his regular home-experiment articles.

Working independently of CBS with science expert Dr. Gerald Wendt and two young producers, Harvey Cort and Milton Subotsky, Swezey is providing the material for short movies that explain the everyday applications of science.

Color Films Can Be Used

Color television can reproduce 16-mm. color film, such as Cort and Subotsky use, or 35-mm. films. The shows now being



THE CONTROLS An extra panel (extreme right in photo above) adjusts the color-wheel motor and color balance in each camera. The technician's hand is on the knob that sets the amount of red in the picture. Adjacent knobs control blue, green.

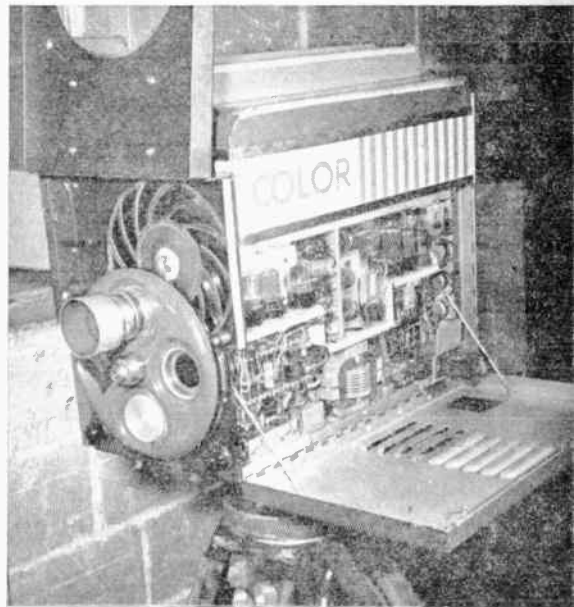

THE CAMERA Only when covers are opened can alterations that convert camera to color be seen. Twelve-segment filter disk (above lens turret) spins on long shaft running through camera to motor in rear. Viewfinder shows black-and-white picture.



Scene from "How an Airplane Flies"—one of science films being made for color TV—shows how air blown between apples creates low-pressure area that sucks apples together. Color in such shows heightens interest, lets you actually see chemical changes, wildlife beauty.

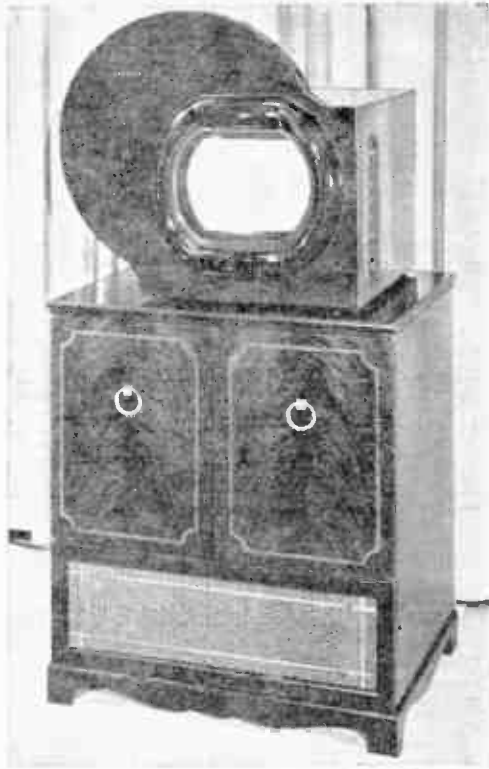

Color slave unit developed by Crosley for its receivers can be attached to current models by making two simple connections. Slave shows 12½-inch color picture magnified from its own 10-inch tube. It also has separate controls for brightness, focus, hold and contrast.

telecast by CBS, however, are not films, but "live."

Are they harder to put on than black-and-white? "We've adapted ourselves to color very quickly," says Frances Buss, the comely young woman who directs the Ivan Sander-son show. "Stage settings are hardly different from the black-and-white ones. Those are normally colored anyway, you know. Costuming may be easier—we only have to consider how colors blend, not how they re-produce as shades of gray."

Four Times as Much Light Needed

Another TV showman who expects color programs to be easier to handle is Worthing-ton Miner, producer of such well known black-and-white presentations as "Studio One." He suggests, "An entire chorus of a song, for example, may be carried on a single setup in color without a sense of monotony . . . Camera setups might be re-duced 25 to 30 percent . . ."

Studio engineers, too, find the change to color simple. Ted Lawrence, color-quality supervisor for CBS, points out, "The camera is basically a standard model. We've made some electronic changes and added a color disk and a small electric motor to turn it. The camera disk has 12 filter segments, in-stead of the six segments used in receivers; so that we can use a slower motor.

"We have to use about four times as much illumination because the red, green and blue filters on the camera absorb light," Lawrence adds. "Many lights are placed low, in order to keep the illumination—and the color—even. We usually have several re-flectors at head height.

"Fluorescents? Sure, we can use them. Their uneven color spectrum doesn't bother color television the way it does color pho-tography. Partly that's because the shad-ers can adjust the mixing controls to make, in effect, almost any type color 'emulsion' we need."



RCA COLOR Despite Government decision setting up CBS method as only regular color TV system, RCA began tests of its rival technique last summer. RCA color has advantage of "compatibility"—existing receivers require no modification to pick up

colorcast in black-and-white. New Yorkers who have thus received monochrome views of RCA's colorcasts have found the quality excellent. Newspapermen who witnessed demonstrations of RCA color receivers last summer also praised the color tube's performance.

The "shaders" are technicians who keep the picture quality in adjustment. For color work, they have three extra knobs marked red, green and blue that vary the strength of the primary colors to maintain true-to-life colors in the final picture.

Transmitted Like Black-and-White

Once the colorvision signal gets past the studio control room, it is handled in the same way as black-and-white. Telephone wires carry it to CBS "master control," which pipes it to the local transmitter and may also feed it to the coaxial cable or microwave relay for networking. The ride on the coaxial cable doesn't harm it.

While the people who produce TV shows oh and ah over color, the people who produce TV receivers moan and groan. Now that CBS color is here, they say, the public has stopped buying their sets, which cannot receive CBS color without internal changes.

The big manufacturers have bitterly

fought Columbia's color system. But now one major company, Crosley, has announced a color slave—a separate cabinet with picture tube, color wheel and circuits that can be plugged into Crosley receivers. However, the unit is not yet in production.

Color TV Is Here to Stay

Other manufacturers, hints industry gossip, are about to include built-in adapters in sets in production. These will enable the receivers to get color programs in black-and-white and will simplify later conversion to full color.

CBS, through its recently purchased set-manufacturing subsidiary, led everyone else in getting color receivers into stores. Dozens of smaller electronics firms are scrambling to get on the band-wagon. So there's sure to be equipment to bring to the public the beautiful full-color television that, after many years of false starts, is finally on the air.

END

Amplifier Circuits and

FIRST STEPS IN ELECTRONICS

A SINGLE pentode can readily amplify a feeble input signal 350 times, but what if we require an output strength 350,000 or 3,500,000 times that of the original impulse? An example of this is the home radio. A distant station may generate in the antenna a signal to be measured only in millionths of a volt, whereas the loud-speaker may require several volts. Here an amplification of several million is needed. It is obtained by using tubes in cascade.

If the output of one tube is fed into the grid of the next, the amplification of the two tubes is not the sum of their single amplification factors (a value called the *mu* of the tube) but the product. Thus if a high-*mu* triode amplifies 50 times, two in cascade will amplify 50 times 50, or 2,500 times.

But when we begin to feed the plate current of one tube into the grid circuit of another, we run into trouble. Figure 1, for example, shows a simple hookup of two triodes. This won't work at all. The second grid, being connected directly to the first plate, is at about the same potential as its own plate, which is connected to the same plate supply. The result is that the second tube won't react to small changes in grid voltage and will not amplify at all. In fact, the high grid voltage will attract so many electrons toward the plate that the tube will probably burn out.

As shown in Fig. 2a, this fault can be overcome by inserting a grid bias battery of about the same voltage as the plate supply. The grid is at approximately the same potential as the cathode, and the tube will

react to small voltage variations produced on this grid by the output of the first tube.

A similar result is achieved in Fig. 2b by using a separate plate supply for each tube, and in Fig. 2c by dividing the potential of a single large plate-voltage supply across a resistor.

These two circuits are frequently used as so-called D.C. (direct-current) amplifiers. They will amplify a variation in D.C. or the voltage of D.C., and will faithfully reproduce the wave form of a signal. Medical research makes use of such amplifiers. Figure 3 shows some of the odd wave forms they will follow and reproduce.

But for other purposes, including radio, these hookups are unsatisfactory. One reason is that each tube requires its own plate supply (or two tubes require a single one twice as large, if a voltage divider is used as in Fig. 2c.) If screen grids and suppressors are to be connected, still more power supplies may be needed.

Even more serious is the fact that these circuits amplify the total input current as well as any variation in it. Suppose the average input is 1 milliamperere and varies .001 milliamperere. To read that variation on a meter, we may wish to amplify it to one of 10 milliampere, or 10,000 times. But a D.C. amplifier, in stepping up the variation to this extent, must also amplify the 1-milliamperere input current, which will become 10,000 milliampere, or 10 ampere—a current only heavy-duty transmission tubes could handle. Figure 4 illustrates this.

The answer is, of course, to amplify only the variations and not the D.C. component. Figure 5 shows how this can be done with transformer coupling. A transformer can-

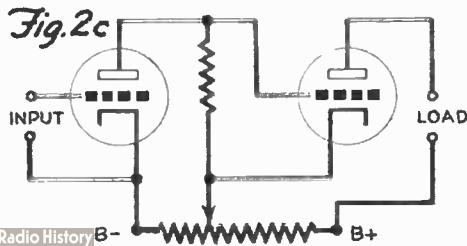
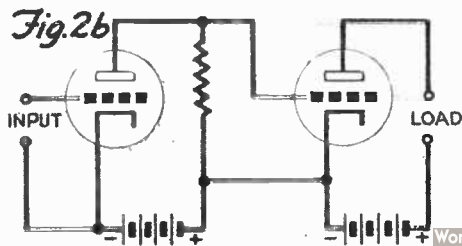
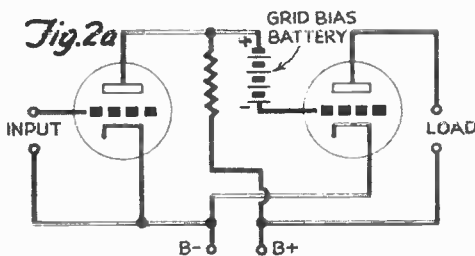
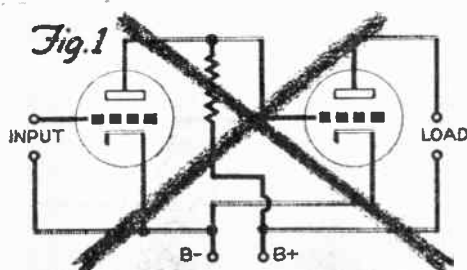

How They Work

not pass direct current; its secondary responds only to *changes* in the primary current. The D.C. component flows through the primary from the plate to the B supply. Only *variations* in the plate current (caused by the input signal on the first grid) are impressed on the secondary and so carried on to the second grid.

A second way of passing only current variations on to the second grid is shown in Fig. 6. Several previously neglected features have been included. A variable resistor or potentiometer R1 is included as a volume control; the whole input voltage is impressed across this and the desired fraction applied to the first grid by adjusting the sliding contact. The plate current flows through the plate resistor R5, and coupling is through the blocking condenser C3. This blocks the D.C. plate supply from the grid of the second tube, but passes the varying component freely, because a condenser in effect "conducts" A.C. In an audio-frequency amplifier, this condenser would be one of .004 to .01-mfd. capacity.

Since it is desirable to have the grid negative to the cathode, we can either add a grid bias battery or make the cathode slightly positive to the ground. The latter effect is achieved by adding the bias resistors R2 and R3. The plate current flowing through them causes a voltage drop across each of these resistors, so that

the cathode has a few less electrons on it—is slightly more positive—that if it were connected directly to ground. The grid, grounded through R1 in the first tube and through R4 in the second, is therefore negative with respect to the cathode.

However, to get the full voltage of the signal on the cathode, we don't want it to fight its way through R2 and R3. We provide an alternative way for it through the by-pass condensers C1 and C2. Being A.C., the signal passes these freely. For audio frequencies, these condensers are from 1 to 10 mfd, and 25-volt electrolytic condensers are often used. ➤

Microphone impulses are amplified by this unit before entering the transmitting tubes of international short-wave station WGEO
Photo courtesy of General Electric

Fig. 3

D.C. AMPLIFIERS CAN HANDLE SUCH ODD WAVE FORMS AS THESE

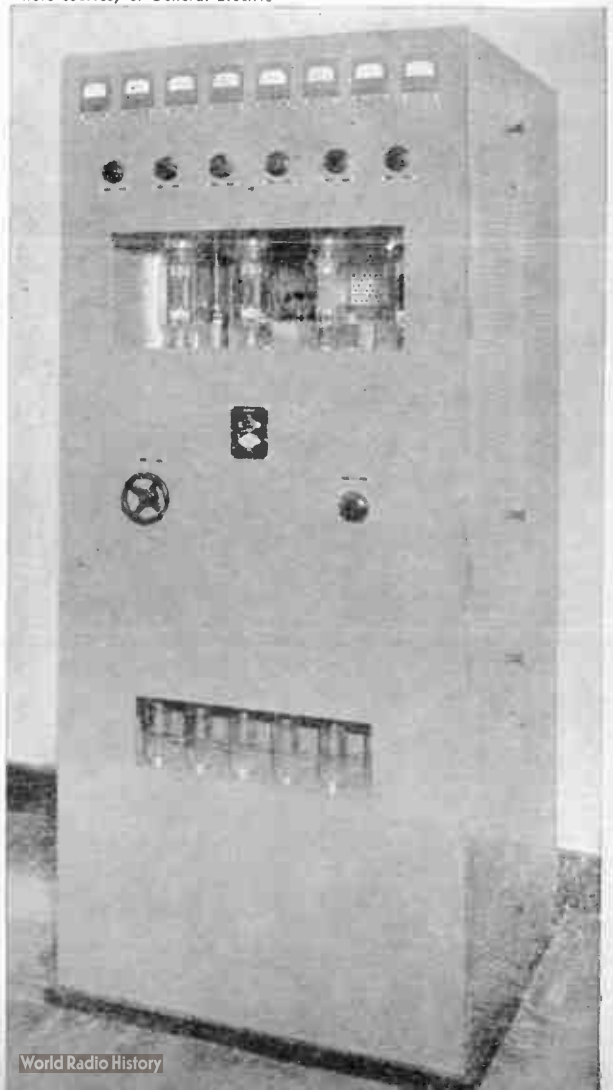
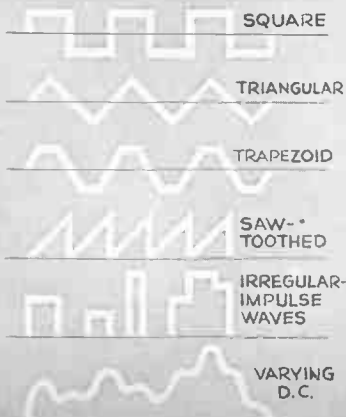

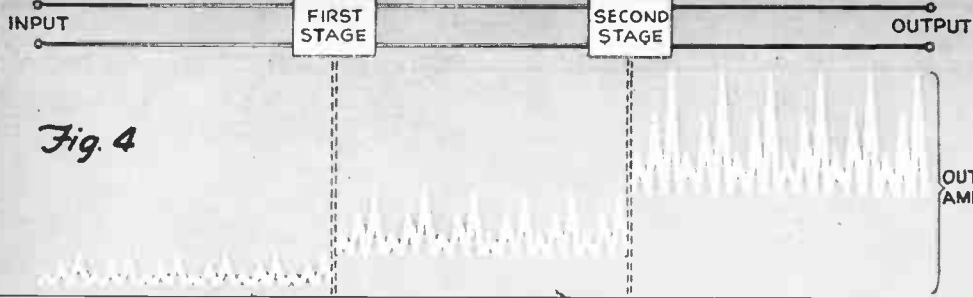

A D.C. AMPLIFIER AMPLIFIES BOTH THE ORIGINAL CURRENT AND THE CURRENT VARIATIONS

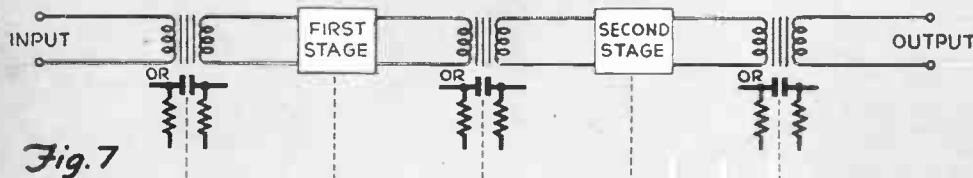
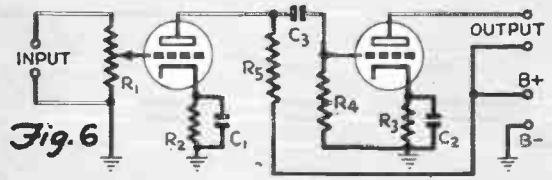
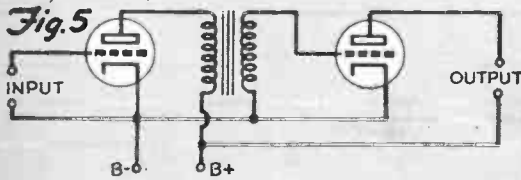

IN AN A.C. AMPLIFIER, TRANSFORMER OR RESISTANCE COUPLING PASSES ON ONLY THE VARYING COMPONENT

We need the resistor R4 because, as the condenser C3 cannot pass D.C., the grid would be insulated from ground without it. Stray electrons from the cathode would soon charge the grid so strongly negative as to block the tube completely.

Still another way of connecting tubes in cascade is by impedance coupling. A choke coil (an inductance) is substituted for the load resistor R5 in Fig. 6. This passes a constant plate current unhindered, but variations generated in it by the signal impressed on the grid will be resisted by the inductance and will result in an A.C. voltage across it, which in turn will be impressed upon the coupling condenser C3. This coupling method finds little application in A.F. amplifiers, because a small resistor can do the same work as a larger, more expensive choke coil. At radio frequencies, choke coils are very small and offer advantages over resistors.

The decoupling resistors and condensers (Rd and Cd) in the amplifier circuit on the facing page keep plate-current fluctuations of the output tube from feeding back into the plate circuit of the first tube

through the common plate-supply connection. Were they to reach this tube, they would cause fluctuations in the first blocking condenser and so affect the grid of the second tube. This tube, after amplifying them, would pass them to the third tube, from which they would return further amplified to the first one—and how the amplifier would squeal!

Instead, they go to ground through the condensers Cd, which to them represent a closed circuit, while the D.C. plate current is impressed on the plates through the resistors. For audio frequencies, Cd is usually an electrolytic condenser rated at 250 to 400 volts and having a capacity of 4 to 8 mfd.

In building an amplifier, remember that audio-frequency currents can pass, by induction, from one wire to another. That includes 60-cycle current. Keep heater leads away from grid leads, preferably twisted together in a corner channel of a metal chassis. Don't let plate-circuit leads pass near the grid leads of a preceding tube. It's wise to mount plate resistors right on the tube sockets, and to attach the decoupling

condensers to them there, cutting the leads off to $\frac{3}{4}$ " or less.

The result of jamming parts together may look anything but neat, but the real problem is one of electrical neatness. Keep every lead as short as you can—short leads mean smaller "aerials" from which currents can jump by induction. Keep input and output leads as far apart as the chassis will permit. A straight-line layout is good. So is building the power pack in a separate unit.

If despite all these precautions your amplifier still hums or whistles, hitch insulated test leads to a .5-mfd or larger paper con-

denser and touch it across the various by-pass condensers. Keep your fingers out—use long, stiff, well-insulated wire probes. If no improvement is apparent, try hooking an 8-mfd, high-voltage electrolytic condenser across the decoupling and cathode by-pass circuits. In testing, be sure that you always connect such an electrolytic condenser with due respect for polarity.

Since these tests must be made with power on, extreme caution is indicated. Remember that the high-voltage current present is capable of delivering a serious shock. Take care to avoid contact with live wires.

High-Gain Amplifier Can Be Used As Two-Way Communicator

THIS resistance-coupled audio amplifier will readily step up the output of a radio detector stage or phonograph pickup to loudspeaker volume. With two identical permanent-magnet speakers, it can be used as a room-to-room communicator, the speakers acting alternately as microphones. Water or steam pipes will serve as one lead to the remote speaker. The switch is of the ganged double-pole, double-throw type and

is located at the amplifier. It switches the input to either speaker. A miniature D.P.D.T. switch cannot be used, however, as the input and output leads cannot be brought so close together. The outfit will howl if both speakers are in the same room, as when testing, because of acoustic coupling between them.

A 6SJ7 pentode, 6F5 triode, and 6V6 beam

power tube were used in the original. Triodes alone, or other tubes of the same types, may be used, but other values of condensers and resistors may be needed. The following are right for the tubes specified:

R_{vc}, 500,000-ohm potentiometer; R₁, 1,060 ohms; R₂, 1,000,000 ohms; R₃, 250,000 ohms; R₄, 500,000 ohms; R₅, 4,000 ohms; R₆, 250,000 ohms; R₇, 500,000 ohms; R₈, 325 ohms; C₁, C₄, C₆, 8 to 10-mfd, 25-volt electrolytics; C₂, .1 mfd., 400 volts; C₃, .005 mfd.; C₅, .006 mfd.; Cd, 8-mfd., 250-volt electrolytic; Rd, 30,000 ohms.

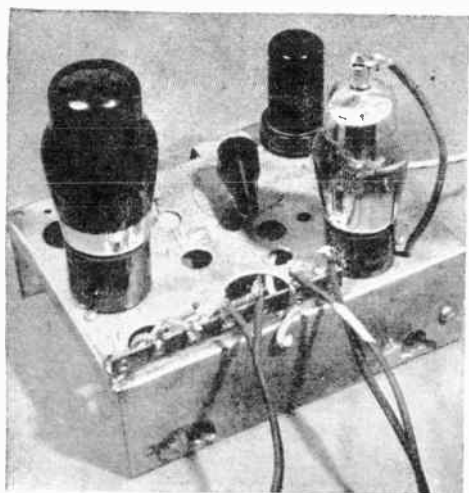

"Supper in five minutes," can be announced by the lady of the house to her husband downstairs without a skip of the beater. At left, the amplifier unit

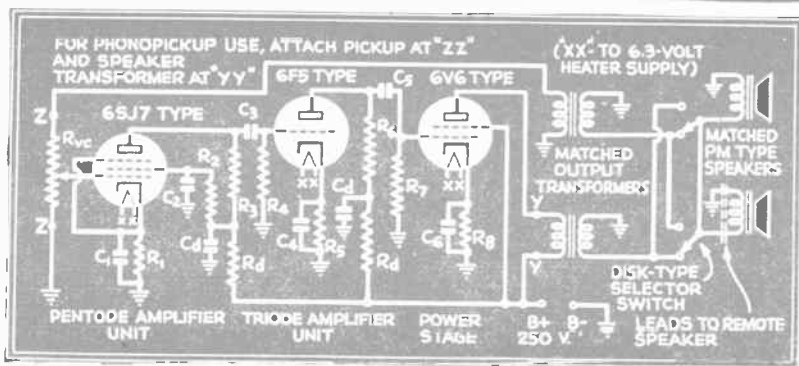

"Coming right up!" is his answer. A switch reverses the connections



How to Splice TV Lead-In Lines

THAT flat ribbon that connects a television set to its antenna is an important factor in the reception of TV shows. When it is spliced, the spacing between the two conducting wires should be kept the same.

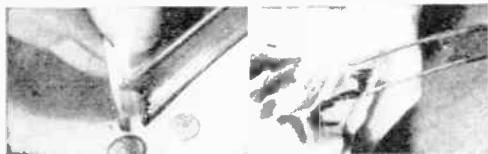

Removing the insulation: Most flat-ribbon leads are insulated with polyethylene plastic. It can be stripped off by melting it over a lighted match. Another easy way is to place it on the barrel of a hot soldering iron until an inch or two of the insulation is soft. The hot goo then can be wiped off with a cloth, and the bared leads scraped clean.



Short splices can be made this way. Bare the ends of the two pieces, hold them evenly back to back and twist the leads together. Soldering both joints will make them stronger. Straighten the joined pieces, dress the twisted leads flat, and tape them down.

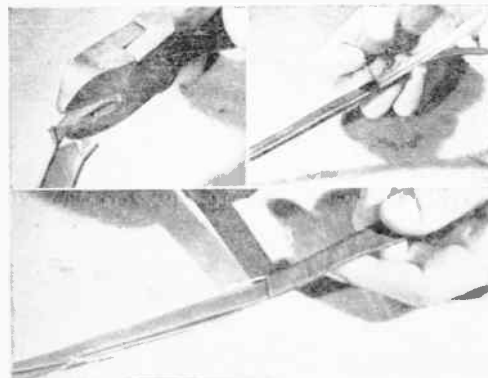

Long splices are better. Notch the insulating ridge of each ribbon as shown, then pull one wire out about three inches and the other wire out about six inches. Then lap the ends of the two pieces so that the long wire on one meets the short wire on the other. Twist these pairs together, solder the joints, dress them neatly and tape the lap. Mechanically this splice is strong and durable; electrically, it's as good as new.

Penholder Used as Radio Tool

A PLASTIC OR wooden penholder is a handy addition to a radio tool kit. The insulated shaft is good for probing around the innards of a chassis. Or you can hold it by the tapered handle and use the cork or rubber finger grip as a tube tapper.—Arthur Trauffer, McClelland, Iowa.



Jot Service Notes on Diagram

WHEN you service a radio or TV set—particularly if you make a circuit change—mark what you have done on the diagram or set. It will help you or any other serviceman who has to trace the same circuit at a later time. If it is not your own equipment, tape a memo on or near the new part.

Wrapped Tape Makes Doughnut Tires

HERE'S an easy way to make small doughnut tires for models and toys. Wrap electrician's rubber tape (not friction tape) in overlapping spirals around a cardboard cylinder, or wood dowel, and then roll the tape back over itself and off the cylinder. Don't stretch the tape too tightly.

I use a cylinder about two and a half times the diameter of the wheel for which the tire is intended, and make a spiral wrapping about ten times longer than the width of tire wall desired. But a little experimenting may be necessary. If the tape is tacky, dust the tire with talcum or paint with sidewall paint.—A. M. Campbell, Seneca, Mo.



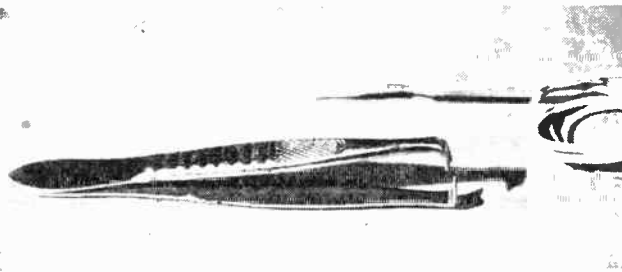

BEVEL ONE JAW
INSIDE, ONE
OUTSIDE

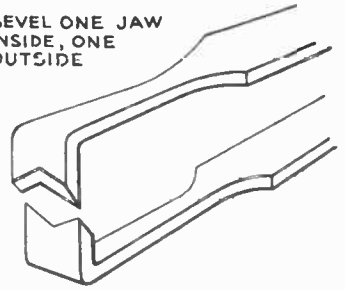

Fine-Wire Insulation Stripper Made from Dime-Store Tweezers

PARTICULARLY useful for light electrical work, this handy insulation stripper can be made from a pair of blunt-end tweezers. First file the tips as shown above and bend

them inwards at right angles so that the jaws just overlap. To use, press the cutting edges on the wire, twist to cut the insulation, and then pull.

Pipe Fastened in Plug Neck Reaches Inaccessible Outlet

IF AN electric cord must frequently be plugged into an out-of-the-way outlet on the ceiling or behind furniture, a reach plug can make life a bit easier. Into a long-neck rubber plug (the type designed to give ample finger grip) screw a suitable length of $\frac{1}{8}$ " pipe threaded at the end. A few turns will join the plug and pipe firmly. Tape the joint for extra strength, and bush the other end of the pipe with a short piece of windshield-wiper tubing to protect the cord from fraying at this point.

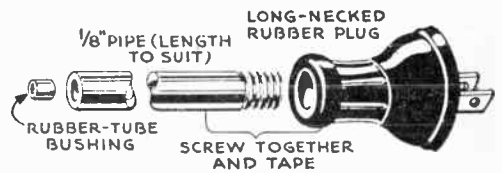

Pipe Cleaner Separates Wires

CIRCUIT wires grouped and bound together simplify servicing and repairs. Pipe cleaners will hold the wires neatly and can be color-coded with nail polish or enamel.

UNDERWRITER'S KNOT

[ELECTRICAL]

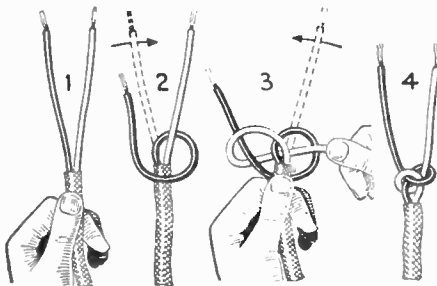

INSULATION
RIGHT UP TO
SCREW HEAD

Electrical wiring is not considered safe unless it has a margin of safety great enough to protect it against unforeseen and excessive strains. Thus, while it is not good practice to pull a plug out of a socket by yanking the cord, some method for taking up such strains should be provided at the time the wiring is done. One recommended procedure is the so-called underwriters' knot illustrated at the left. Before wires are connected to the terminal screws of a plug, socket, or other fixture, knot them as shown to keep sudden pulls from being transferred directly to the terminals. An alternative or supplementary method for taking up strain on plug wires is pictured at the lower left. It consists of leading the wires around the prongs as shown before attaching.

POPULAR SCIENCE MONTHLY SHOP DATA

Keeping Chips Out of Radio Chassis

WHEN you drill holes in a wired radio or electrical chassis, don't let metal chips or cuttings fall into the maze of wires, sockets, and connections. A small envelope taped to the chassis just below the hole will catch chips carried through on the drill.—*Walter E. Burton, Akron, Ohio.*



Brighten the TV Tuning Knob

INDICATOR knobs on TV sets often have white dots or lines by which they can be indexed on the channel selector dial. If the dot or line on your set becomes indistinct, you can sharpen it up and make it more visible in dim light with a little white touch-up paint. Apply it with a brush, pen, or orange stick.—*H. Leeper, Canton, Ohio.*



Deep Cabinet Made of Narrow Lumber

I NEEDED a small record cabinet but didn't want to buy a costly 4' by 8' plywood panel to make it out of. So I built two identical units from cheap 1" by 8" lumber as shown. Then I doweled and glued them edge-to-edge as shown below to get the necessary depth.—*George Warren, New York City.*

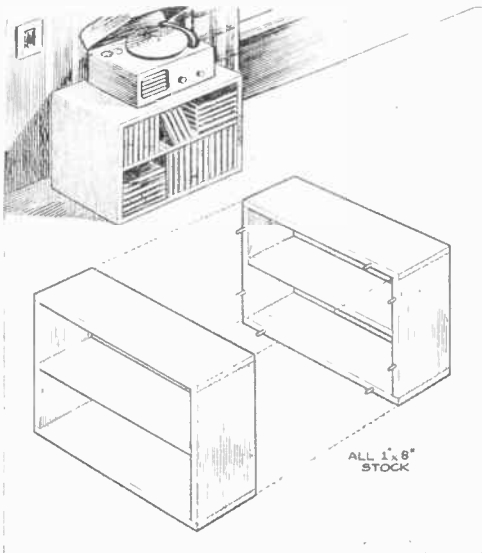

Marks Make Readjusting a TV Receiver Less Risky

VIBRATION, age, and other factors may whittle away the quality of your TV picture. In many cases, however, you can restore top performance by careful readjustment of the back-of-the-set controls. Changing their setting, however, may also throw a receiver completely out of adjustment. If you'd like to try sharpening your reception but are

afraid of the consequences of a bad job, mark the position of each control before you start. You can then be sure of being able to restore it to its original position if the new setting doesn't help. Pencil an index line on the control shaft and a corresponding line on the chassis. To locate the ion-trap magnet, use nail polish or a grease pencil.

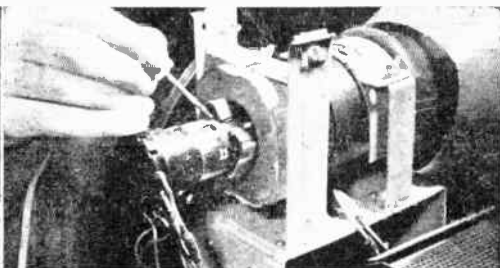
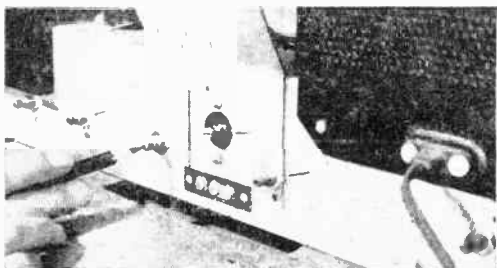

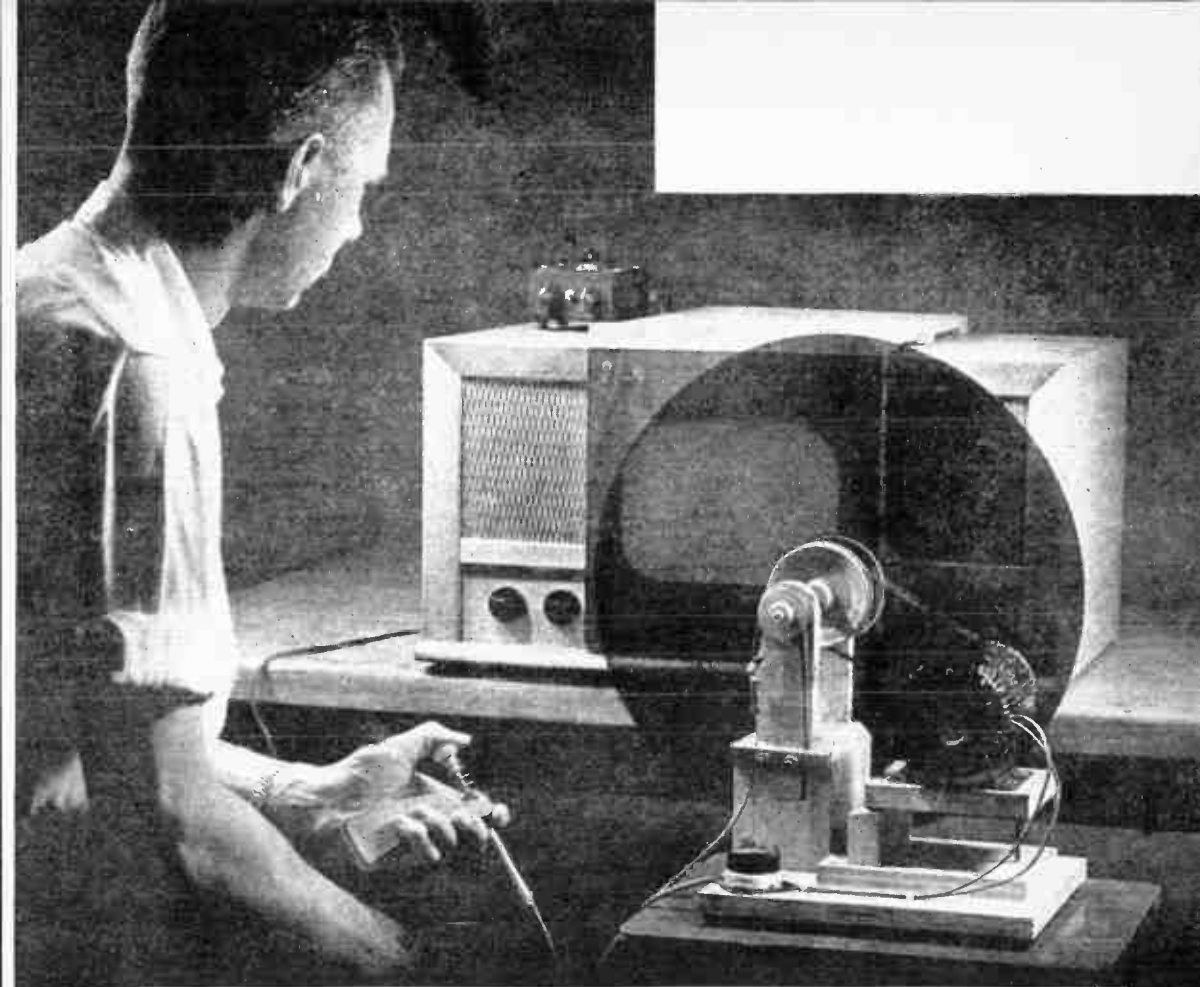

TV Color 'Sampler' Costs Only \$8

Until I'd seen TV color, I didn't know how good it can be. This simple rig—using only scrap-box parts—brings color to a TV set.

By Herbert Pfister

WE'RE already enjoying the color shows at my house, and I've only spent \$8 for these previews of the future.

I'll want a better color TV set some day, but this rig has the great merit of simplicity. It's strictly mechanical, be-

cause I'm in the kindergarten when it comes to electronics.

So POPULAR SCIENCE's editors asked me to tell you how to build one like it.

Your wife will probably object to having the setup in your living room permanently, but she'll be as delighted as you are with the color pictures.

The synchronism isn't automatic—



Making the wheel. I started with a 21" square of Lucite 1/16" thick. After sawing it to a rough circle, I centered it on the threaded shaft, clamping it between washers and nuts. Then I cut it to a true circle by holding a chisel to the edge while it ran. Cut-outs of colored cellophane, taped to the plastic, completed the wheel.

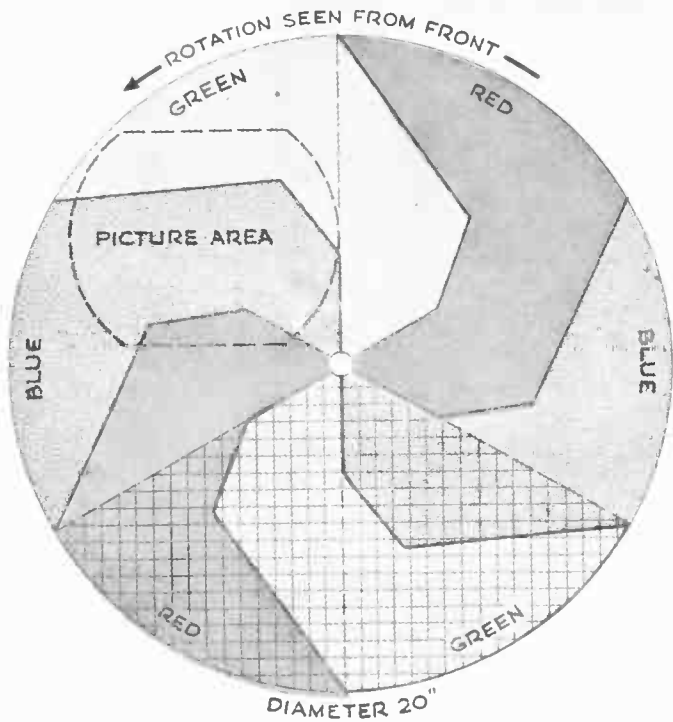

you hold a flexible-cable speed control, touching it whenever the picture is about to drift out of "sync." This isn't hard; with the wheel speed set right initially, it will stay on the nose for many seconds, and a touch of the hand control brings it back.

Building an automatically synchronized wheel is tougher. That calls for a tone gen-

Adjusting speed. You can bring the ratio between motor pulley and shaft pulley to just about the right speed by padding the pulleys with strips of masking tape. Building up the motor pulley turns the wheel faster. Adding to the shaft pulley slows down the wheel.

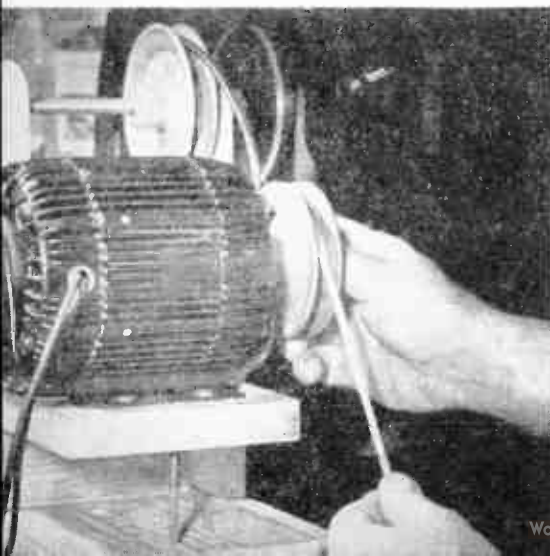

erator, a fistful of tubes, a saturable reactor and some special circuitry.

What you need. First off, your receiver must be color-adapted—modified so you can switch to the special scanning rates used in color broadcasts (see page 117). You'll also need a constant-speed motor, a home-made or commercial color wheel, and some pulleys, shafing, belts and scrap-box findings.

Wheel. Factory-made 20" color wheels (suitable for use with a 10" receiver) are currently available for about \$18. I made my own, taping colored cellophane to a 1/16" clear-plastic disk. The drawing shows the hook shape and color sequence required for present transmitting standards. I laid out a cardboard cutting pattern to help me trim uniform, properly shaped color segments. If you have trouble finding cellophane sheets of the right hue and saturation, theatrical floodlight filters or photographic filters are okay. Or you can buy filters made expressly for color TV by Eastman Kodak.

Motor. Profit by my experience and steer clear of AC-DC motors—brush sparking will make your picture go blooey. Use a split-phase or repulsion-induction motor, preferably 1/10-hp. or better because the belt, pulleys and big disk soak up plenty of

power. A ¼-h.p., 1,750-r.p.m. shop motor will do, though it's a bit big.

Mounting. This will depend on your TV set. With the color sequence and rotation shown, the viewing area is the upper left quadrant as seen from the front. I put the wheel support and motor on a separate platform out front, but they could be located above or under the set.

The wheel shaft turns in ball bearings that are a light press fit in counterbored holes of wooden arms. One end of the shaft is threaded for clamping nuts that hold the wheel between two plastic washers. The wheel must turn freely and run dead true.

Speed. Color fields are transmitted at the rate of 144 per second. Multiplied by 60 seconds and divided by 6—the number of segments in the wheel—this gives you 1,440 r.p.m. as the necessary wheel speed. Choose motor and shaft pulleys to drive the disk at this speed. (Pulley diameters should have the same ratio to each other as exists between motor speed and 1,440 r.p.m.).

The motor I used ran at 1,550. Standard V-belt pulleys don't come in the right sizes to belt this speed down to exactly 1,440. I used an approximate ratio, a 3½" pulley on the motor and a 4" one on the shaft, and then adjusted it by adding strips of masking tape in the pulley grooves.

I use an endless sewing-machine belt of

Braking the wheel. Adjust the spring-loaded brake so it applies just a little more pressure than you need. Then only a little thumb pressure is required to make the wheel run at the right speed. The brake cable is an auto choke cable fitted with a wooden pistol grip.



round cross section, having found that even a small V belt added too much extra load. A round rubber vacuum-cleaner belt is another possibility.

Brake. I get best results by belting the wheel to turn a bit over 1,440 r.p.m. and then applying light brake pressure to pull it down to "sync." A loop of leather riding in an extra pulley on the wheel shaft is tightened by an auto choke cable fitted with a wooden pistol grip. The cable is spring-loaded to apply more braking pressure than you need, so that a light touch of your thumb holds the wheel in "sync."

Adjust the pulleys with tape to run the wheel a little fast, and adjust the brake to drag the wheel down a little too slow in the hand's-off condition.

With some practice you'll find it isn't hard to hold the synchronism and color phasing pretty reliably. END

Color Unit Can Be Bolted to Housing of Small Set

MY LITTLE girl was so delighted with color TV in our living room that she wanted more of the same on the 7" set in her room. The one I built for her is like the big unit, except the brake is a little different. This brake is hinged at one end.

A piece of leather is cemented to the other end. The leather rides against a wooden disk mounted on the shaft behind the wheel. A piece of cord with a spring on one end provides wheel-speed control.—Herbert Pfister, New York City.

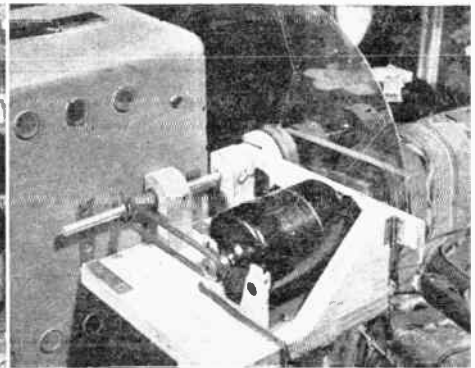

COMBINATION CABINET HOUSES BOTH A RADIO CHASSIS AND CLOCK

HAVING a good but unhoused radio chassis and an electric clock with a badly damaged case, we constructed a combination cabinet for both units along the lines shown here.

Clock, speaker, and shaft positions were first marked off on a composition panel, which was then drilled and jigsawed. A square of cloth is glued behind the loudspeaker grille. To extend the clock-setting knob, we soldered to it a stiff wire extension, and between the clock and radio we placed a metal shield grounded to the radio chassis.

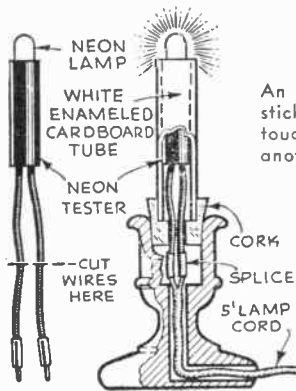
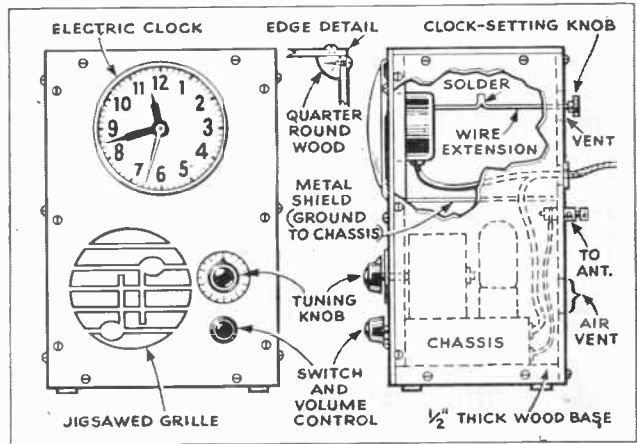

GLOW OF RADIO "CANDLE" KEEPS TIME TO MUSIC

An old wooden candlestick adds a realistic touch to the lamp, but another base would do.

A LITTLE light that seems to flicker and flare in time with the voice or music reproduced by your radio can be made of a neon tester of the kind used to check circuits.

Substitute a 5' length of lamp cord for the test leads and enclose the shaft in a 4" tube of white enameled cardboard to simulate a candle. Mount the tester in a wood or cork base and connect the wires across the primary of the output transformer of your radio.

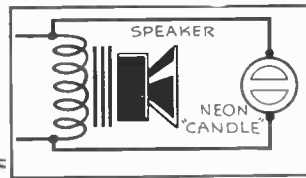

SHOP ANTENNA FOR AUTO RADIOS MADE OF COPPER TUBING

TESTING auto radios in a shop sometimes fails to give an accurate picture of performance because the long outside antenna tends to overload the set under test. Auto radios are designed for high-sensitivity reception since they are expected to operate with short aerials. If you often have occasion to service these sets, use a copper tube about 5' long, installed above your workbench by means of stand-off insulators, as shown at the right.

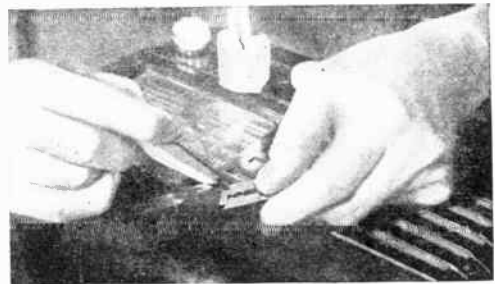
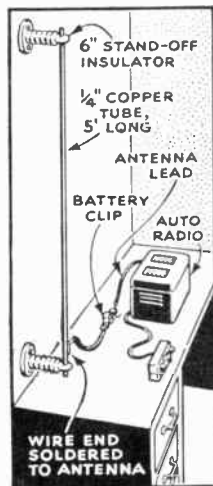

SEALING WAX FILLS SCRATCHES IN PLASTIC CABINETS

SMALL nicks and scratches on plastic radio cabinets can be neatly repaired with ordinary sealing wax. To prevent the sealing wax from hardening too quickly while it is being worked, warm the cabinet by removing the chassis and replacing it with a large lamp bulb.

Drop a tiny blob of wax where needed and smooth with a razor blade.

Your Body Is Part of Test Circuit

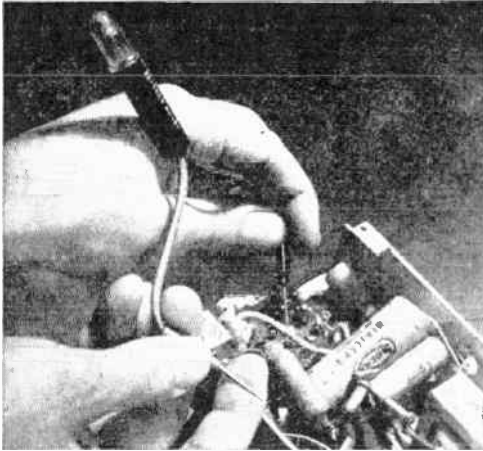

You don't have to hunt for an outside ground when you check the "hot" side of an AC line with a neon tester. Just touch one lead to the hot line and hold the other. Your body will act as a partial ground and make the neon bulb glow feebly. The resistance of the neon tester is so high there's no danger of a shock, but don't try it with anything else. Some servicemen use this trick to locate burned-out tubes in series, to polarize line plugs, and to find breaks.

Phono Record Calls Radio Hams



WHEN a radio amateur wants to talk to anyone who happens to hear him, he broadcasts a "CQ" or general-inquiry call in which he repeats his own call letters several times and tells what frequencies he will be listening on for a reply. If he gets no answer, he repeats the whole business. Paul Ford, W9KQJ, of Terre Haute, Ind., saves his voice by using a recorded CQ for each band he works. The record does the repeating until he gets an answer. Then he switches to a microphone and takes up from there.

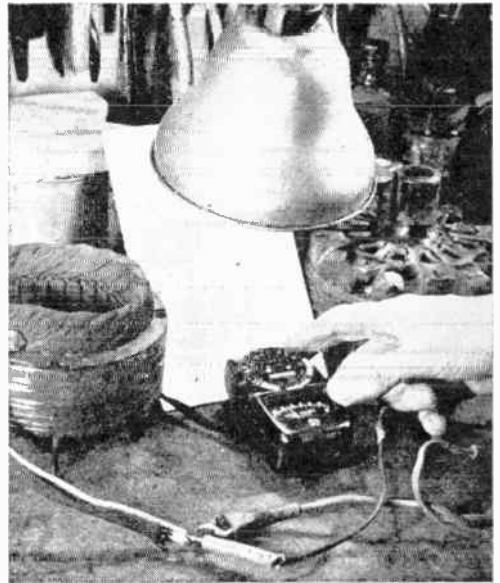
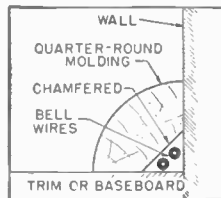

Photo Meter Checks Circuits

PHOTO-ELECTRIC exposure meters may be used to make rough comparison tests of electrical circuits. In the above photo, the meter is being used to check the relative resistance in the windings of a fan motor. The winding is connected to a 115-volt outlet through a 60-watt lamp. A light-colored card reflects light from the lamp to the meter. With the motor coils shorted out, the distance between the lamp and reflector is adjusted until the meter hand reaches the center of the scale. Then the coils are cut into the circuit one at a time and the position of the meter hand noted. By comparing the various readings, an idea of the motor coil resistances can be obtained. A shorted winding will produce a reading near that of the lamp at full brilliancy. The meter should not be moved between readings.—Walter E. Burton, Akron, Ohio.

Quarter-Round Conceals Wires



AS SHOWN in the sketch at left, low-voltage bell wires may be concealed behind quarter-round molding. The back of the molding must be chamfered to make room for the wires. Then the molding is nailed or even glued in place. At corners, the molding can be mitered.

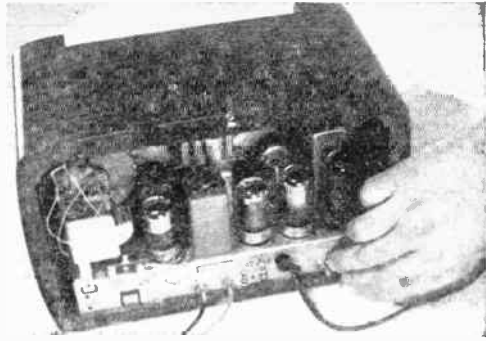
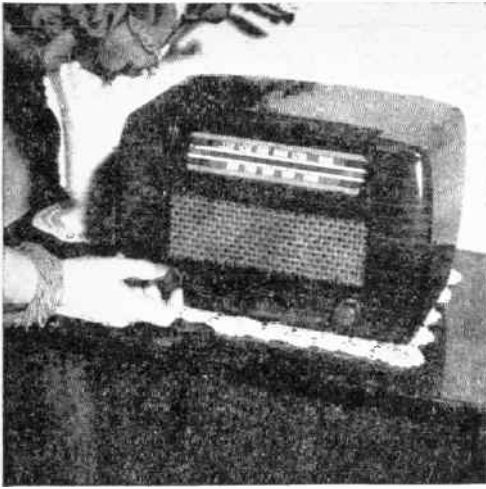

Two jacks and a toggle switch, installed on the chassis of a table radio as shown above, permit the small set to be connected to the speaker of a console model by wires leading from the jacks

Better TONE from Table Radios

HOW A DISCARDED CONSOLE SPEAKER CAN BE CONNECTED TO ANY PORTABLE RECEIVER

HAVING smaller speakers with less baffle area, popular table radios are likely to have tones inferior to those of console models with large speakers. Such old console models may be found still preserved but long since disused in many homes. It is not difficult to connect their large speakers to small radios for use either permanently or only during programs for which good tonal quality is desired.

At the rear of the chassis of the small receiver mount a toggle switch and two insulated jacks—three jacks if the set has push-pull output. This switch connects either of the two speakers to the output circuit of the small radio. Two wires leading from the jacks are connected to the voice coil of the large speaker through an output transformer that will match it to the output circuit of the small radio. If this speaker is already equipped with an output transformer, disconnect its original voice-coil leads and solder the leads from the new transformer to the lugs on the voice coil (Fig. 1). Connect the switch and jacks inside the small set as in Fig. 2.

If the console speaker is the dynamic type, its field coil must be energized by a simple rectifier like that in Fig. 3. This is not necessary with a magnetic speaker.

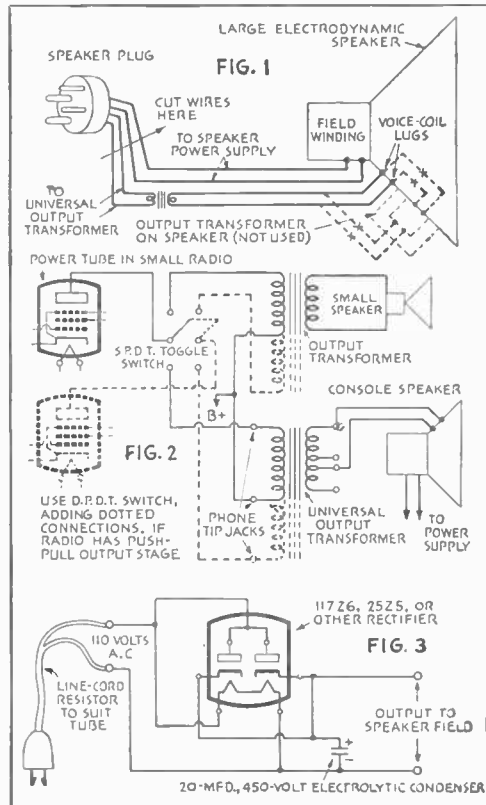

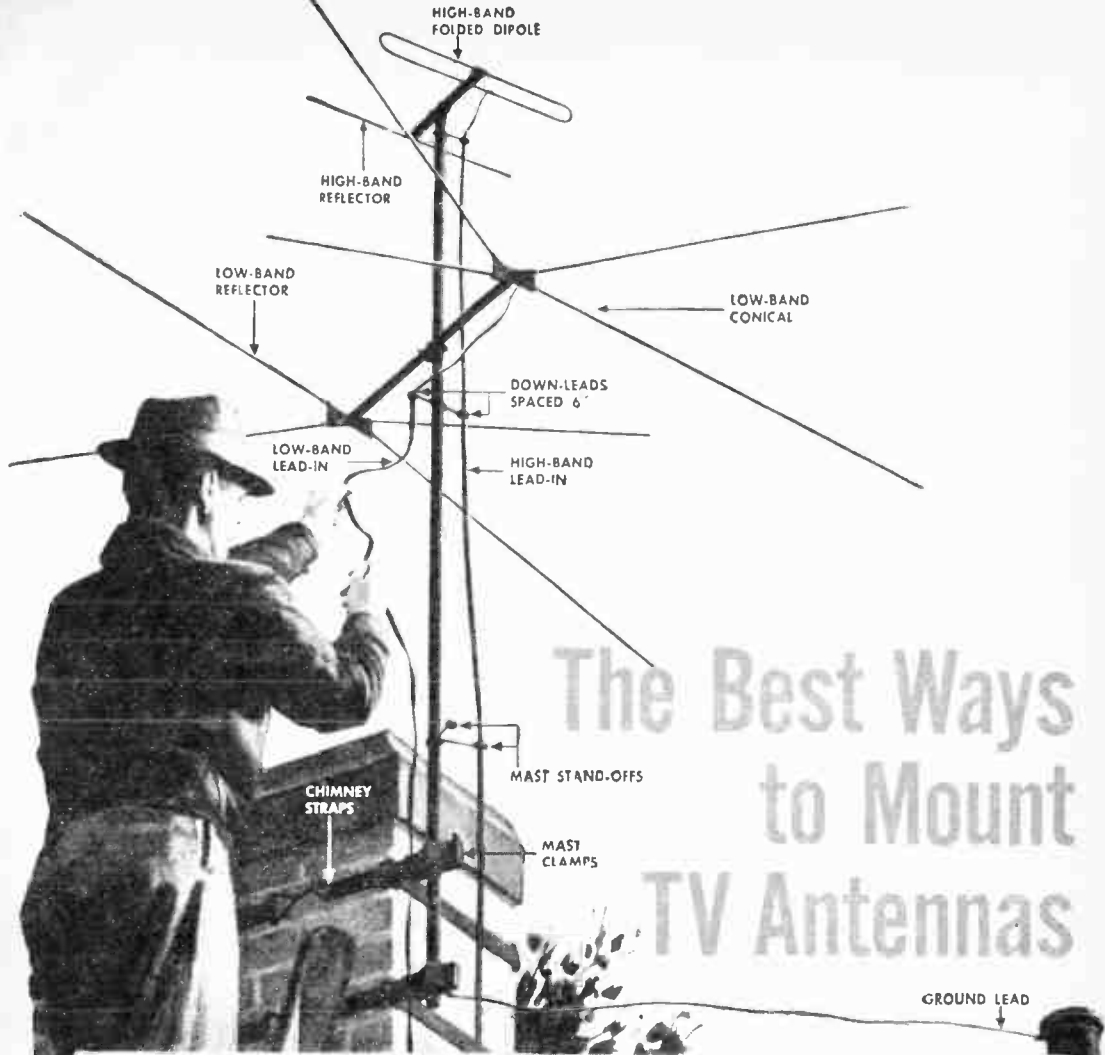

The Best Ways to Mount TV Antennas

How long you keep getting a good picture depends on how you put up that aluminum signal catcher.

By Norman L. Chalfin

DRAWINGS BY RAY PIOCH

DRIVE down any street in old television territory, and you're likely to see antennas that look like dead trees. Some lean wearily and dangerously, some have bent or broken arms, and many swing and sway in ways that make clear reception almost miraculous. Passersby have been imperiled, architecture has been marred, and the eyes of TV viewers have been strained—for

no reason other than poor installation.

TV antennas are not so very heavy or difficult to mount properly. Brackets galore are available for attaching them firmly to flat or sloping roofs, walls, or chimneys. Properly used, these attachments should hold a mast vertical for many years. Guy wires and lead-in ribbons can easily be kept from dangling like forgotten clotheslines. In fact, anybody able to make roof and gutter repairs can also put up a television antenna securely.

Wind and ice are the saboteurs that have wrecked many antennas. If a TV assembly sways even slightly in the breeze, the picture is affected: if a gale

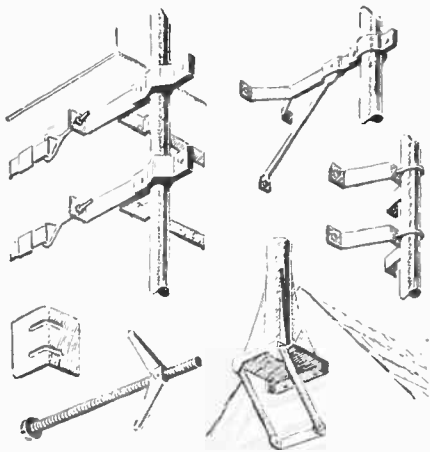

BRACKETS. There's a size and style for every roof or wall. Corner guards under chimney straps protect brick and mortar. Toggle bolts hold best in wood, stucco, or similar walls.

twists the rods around, the picture may fade out completely. Ice collecting on the rods increases the surface that must withstand the wind's assaults and thus makes the antenna more vulnerable. A 50-m.p.h. wind applies 10 lb. of pressure per square foot, and when the wind rises to 100 m.p.h. the pressure per square foot soars to 40 lb. An ice formation that doubles the diameter of a rod may also increase the weight of a solid rod 150 percent and a hollow rod as much as 1,000 percent. Hence, the weather that you can expect where you live is one of the most important factors to consider when you put up a television antenna.

Why Make Your Own?

You can usually buy an antenna system as cheaply as you can make your own. If put where the TV signals can reach them, these antennas will generally do what the manufacturers say they will do. But they will not *stay* there unless they are supported adequately. And before you tackle the job, it's a good plan to check on local legal requirements from a building inspector and the fire department (which is sometimes concerned with guy-wire obstructions as well as lightning hazards).

The commonly used antenna systems are available in knockdown form, and only a few tools are needed to assemble them. Most of these kits include a 5' or 8' mast, usually a hollow aluminum or dural rod. Such a tube will withstand considerable

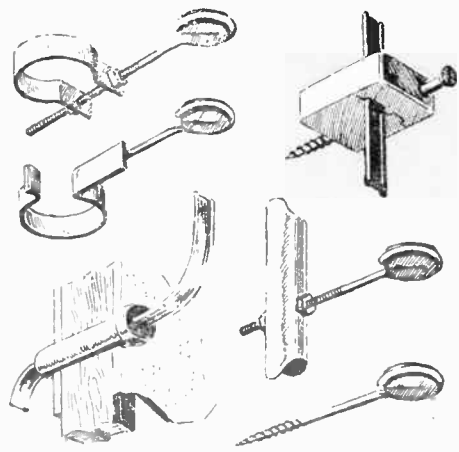

STAND-OFFS. They keep down-lead spaced off masts and walls, hold it taut, bend it smoothly around corners. To bring lead into house, use porcelain feed-throughs (above, lower left).

bad weather if its walls are at least .040" thick and it is 1 1/2" in diameter. If more height is needed, 5' extension lengths can be purchased.

Wall Clamps and Brackets

Antennas having only a few arms on a short mast often can be attached to brick walls or roof parapets with U clamps or stand-off brackets. But these should be screwed to the wall. Holes can be made in the bricks—the mortar bond should not be relied on, because rain may loosen it—with a star drill, lead anchors inserted, and screws threaded into these. There should be at least two such brackets in every case and one every 3' if the mast extends down the wall more than 3'.

Similar brackets can be used to hold a small antenna to the face of a gable end of a wood-sheathed house. This is often simpler than mounting the rig on the roof. But the brackets should be placed close to the pinnacle and attached firmly to the wood. Lag screws rather than ordinary wood screws can be used but expansion or toggle bolts are better.

Don't Wreck Your Chimney!

Chimneys are convenient things to put antennas on. But if the mortar is cracked or bricks are loose, a chimney should not be used unless it is first made solid enough to withstand the additional stresses that an antenna will place on it. Punching holes in

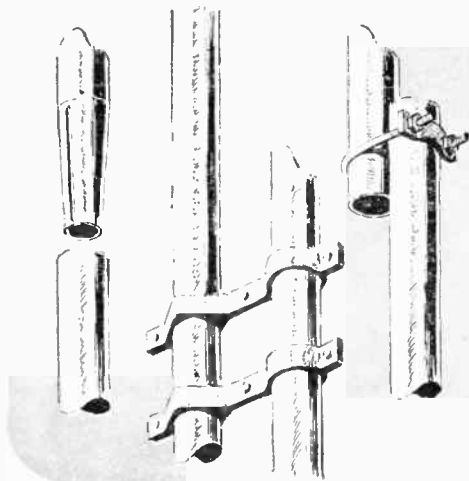

MAST CLAMPS. To gain height you can stack mast sections one above the other. Some types have nesting ends; others may be joined by clamps made to fit standard mast diameters.

a chimney, moreover, is likely to damage it. Straps with pipe clamps attached can be used, but the strap must be chosen and put on carefully. One that is too narrow may cut into the mortar, damage the chimney, and leave the antenna wobbly. A strap that is too thin may snap and let the mast fall on someone's noggin. Galvanized steel straps about 1" wide have proved satisfactory in many cases—but inadequate, improvised straps have caused much trouble.

Never support an antenna by strapping its mast to another post or pipe structure with whatever you happen to have handy. Straps have a tendency to rust and stretch—and then slip. A pipe-clamp type of mounting unit in which the pressure is maintained by screw threads will usually hold heavy metal parts together much more securely.

Flat and Sloping Roofs

Flat roofs such as you find on apartment houses usually consist of several layers of material through which it is difficult to drive bolts, nails, or screws without letting water seep in. Setting the mast on a heavy wooden or metal base and guying it carefully may reduce the number of holes needed. Packing roofing compound around every screw that goes into a roof or frame wall will help to keep leaks from starting.

Several types of mast mountings are now available for installations on sloped roofs. Choose one that you know you can put up without damaging your roof or impairing

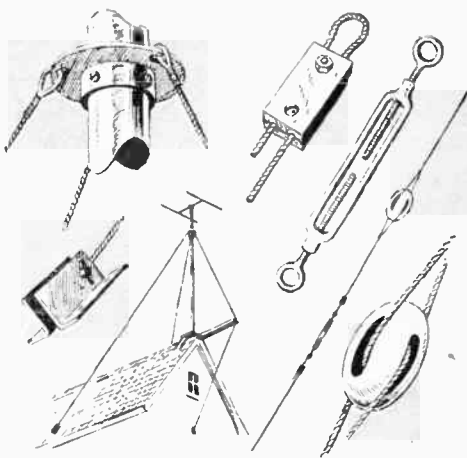

GUYS. Support high antennas with three or four equally spaced, firmly anchored guy wires. Build out extra anchor point on roof if needed. Use strain insulators to break long wires.

the appearance of your home, if you must place your antenna on such a roof. Then guy it in at least three directions, even if this means that you must put an outrigger support at one end of the roof for a guy wire.

No mast should be anywhere near a power line. The minimum distance between an antenna and a power line should be at least eight feet more than the height of the mast. Every mast should also be grounded. Number 6 or 8 wire securely connected from the mast to a water pipe will serve. This does not eliminate the need for a lightning arrester in the lead-in itself.

How to Guy Antennas

Every antenna more than 8' or 10' high should be guyed. The guy wires should be non-corrosive and of 300-lb. test strength, run if possible in four directions at right angles to each other, and be at an angle of about 30° from the mast. They should be attached to the upright pole with guy rings, and turnbuckles should be placed near the base ends. The tension then can be adjusted if the changes in the weather make this necessary. Too much tension may buckle a mast, so this must be done carefully.

On a tall, base-supported pole there should be a set of guy rings 5' from the bottom and another set for every 8' or 10' of mast above. Ball-bearing rotatable guy rings are available for rotating masts.

When the guy wires are longer than the

DO



... Keep high- and low-band lead-ins 6" apart and on opposite sides of pole.

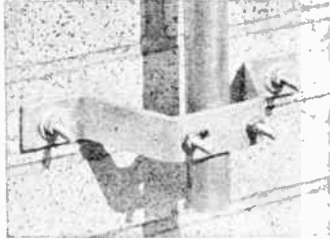

... Attach your mast mount to brick, not mortar. Use lead anchors in holes in bricks.



... Use porcelain tubes to bring lead-in through wall. And keep it short.

DON'T



... Fasten a lead-in tightly to a mast this way. Use stand-offs.



... Place guy wires where children — or firemen — might run into them.



... Leave loops or coils like this in the lead-in near insulators.

Length of the antenna arms from tip to tip, strain insulators should be inserted. None of the lengths between these insulators should equal the over-all length of dipoles cut for the channels you wish to receive (PS, Sept. '50, p. 237) or multiples of those lengths. Guy wires of such lengths become parasitic and reduce an antenna's efficiency.

Attaching the Lead-In

Antenna assemblies often include 60 feet or so of 300-ohm lead-in ribbon. This is the type most commonly used, although a shielded type is better if you live in a "noisy" area—that is, one where considerable electrical disturbance is encountered. When the 300-ohm ribbon must be spliced, care should be taken to preserve the distance between the wires.

The best way to attach these wires to your antenna is to solder U- or ring-type lugs to the ends and bolt them to the terminals, using lock washers. Keeping the lead-in at least 3" away from the mast that supports the antenna will reduce the danger of losing signal strength. This can be done quite easily with cheap stand-off insulators.

The lead-in should be kept as short and straight as possible. Loops and coils in the ribbon can weaken your picture and put

ghosts in it. When the ribbon is brought around corners, it should be done with stand-off brackets. And when it runs for any considerable distance it should be anchored often enough to prevent it from flapping in the wind, fluttering the picture.

TV receivers, like people, work best when they are well fed—and how well your set is fed depends to a large extent on how well your antenna is put up and connected to it. Doing the job right will improve the looks of both the pictures on your screen and the exterior of your home. END

How to Make Your Own Rubber Stamps

LARGE block letters, numerals, or symbols for stamping signs and placards may be easily made from a discarded inner tube. Draw or trace the letters on pieces of the tubing and cut them out with a sharp razor blade, using a ruler as a guide. Cement the letters to a wood block in reverse order and face down, as shown, and ink with a stamp pad.





Cabinet doors and hinged drawer front reveal—or conceal—the radio and slide-out changer.

Pine Washstand Holds Phono-Radio

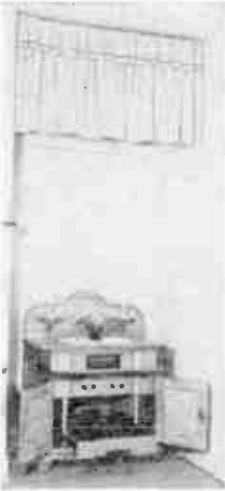

A RADIO and phono-graph console that harmonizes with pine furnishings isn't easy to find in the music shops, but its parts can be assembled without great difficulty. This unit was put together at a fraction of what the complete set would cost, and it has become the showpiece of the room.

Better-than-average radio equipment was bought new; the cabinet is a colonial washstand that was picked up at a bargain because it needed refinishing. The photos above show two views of the completed set, and at the lower right you can see the cabinet with the works removed. All parts are accessible for repair.

The face of the drawer above the doors was hinged at the bottom; it drops flat to expose the dial. A supporting frame was built for the record changer, and

the unit mounted on slides so that it can be withdrawn for loading and unloading. The ball-bearing slides for this purpose may be purchased at a hardware or radio-parts store.

Although there is ample room for a speaker inside the stand, the existence of a very suitable alcove made possible the arrangement pictured at the left. A shelf was built across the upper part of the recess in which the console stands; the speaker was baffled into this space, and a short drape hung in front of it. The extra room in the cabinet is utilized for record storage.—JACK MCGHEE.



THESE PHOTOS WERE
SHOT AT RINGSIDE



Press photographer, Matty Zimmerman, AP cameraman, leans under the ropes to picture Janiro-Graziano fight, below.

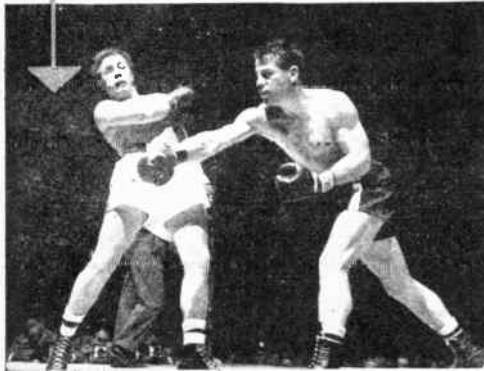

How You Can the Fights

Like a ringside cameraman, you must anticipate the action. For best results, shoot at 1/50 sec.—and overdevelop.

By R. P. Stevenson

NEXT time you watch a prize fight on TV, keep one eye on the edge of the ring, and you'll occasionally see a newspaper photographer push his camera under the ropes to snap a picture.

What these men do at ringside, you now can try at home—on TV. The pictures you get may not have all the zing of ringside shots but they'll be surprisingly good.

Shooting fights is a little more tricky than other types of TV photography. For one thing, you must try to beat the fighters to the punch with your shutter finger—just as news photographers do.

Listen to an expert's opinion: "You can't wait until you see a fighter land a blow," says Mathew Zimmerman, an Associated Press photographer who has shot many standout photos during his dozen years as a ringside specialist. "You've got to outfigure the fighter. You must shoot your pictures in that split second when the action is in the windup stage, so you'll record it when it happens."

You may have seen Matty during fights telecast from Madison Square Garden. At



Photograph Via Television



THESE WERE
SHOT ON A
TV SCREEN

ringside he always has the same position—the left corner opposite the TV camera.

"The experienced photographer knows his fighters, and their style of fighting," Zimmerman adds. "He knows pretty well when to expect the jabs, hooks, crosses, and uppercuts. He *has* to know if he is to get good action pictures."

At ringside, a press photographer shoots with overhead speed lights focused on the ring. When he trips the shutter, these throw a brilliant flash lasting only about 1/5,000 of a second. It is this flash, and not the shutter, that "freezes" the action of the fast-moving fighters.

TV requires slow speeds. As you sit before your TV set, with your camera rigidly supported on a tripod, you can't, of course, resort to such superspeeds. The nature of the television image itself limits your shutter speeds to the lower brackets. But to stop the action, you obviously want to shoot as fast as possible.

Ever since television came along, photographers have been advised not to shoot faster than 1/25 second. The reason? It takes 1/30 second for each image to develop fully. Hence, at any shutter speed faster than 1/30 second your photo would show an image that lacks some scanning lines.

But shooting at 1/25 second did not satisfy Bill Morris, chief photographer of

TV photographer. Bill Morris, of POPULAR SCIENCE, shows you how. His photos below are of same fight shown opposite.

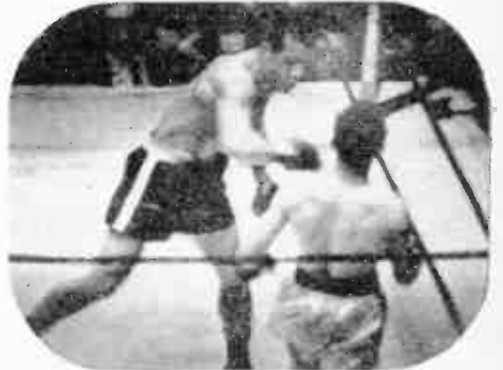

How images are produced on your television set.



Each 1/60 second the scanning beam, a pinpoint of light, moves in slanting zigzag lines from top to bottom of tube. This produces a "field." As it moves, the beam momentarily records an image made up of tones ranging from black to white. In a single field, your eye could see a recognizable image, but with spaces between lines picture would be incomplete.



A second scanning, also taking 1/60 second, is needed to give a full image. This is called the "interlace." Scanning beam moves back and forth over spaces not covered first time. Consequently, the interlace lets you see parts of image you didn't see in first field. Sketches are exaggerated. Actually, there are at least 250 scanning lines in one field.



Complete TV image consists of two fields, one interlaced with the other. This is called a "frame." A new one is produced each 1/30 second. A succession of frames, one following the other without measurable delay, creates action you see. In effect, each frame is a still picture. Actually, there may be slight movement of image from one field to next.

POPULAR SCIENCE. At that speed he found it next to impossible to get satisfactory TV photos of fights, dancing, and other fast action. So he set out to experiment with faster speeds—specifically 1/50 and 1/100 second.

And here are the results. Eventually he found that 1/50 second at $f/3.5$ gave him what he wanted—a good image with little or no movement. To compensate for the underexposure that results at these settings, even with Super XX and other film of equal speed, he overdevelops all his shots. Using D-76 developer, he gives his film 45 or 60 minutes of development instead of the customary 15. This formula causes no chemical fog in prolonged development, and in moderate enlargements his 2 1/4" by 2 1/4" negatives give no trouble from grain.

Turn brightness above normal. For all his TV shots Bill uses a 2 1/4" by 2 1/4" reflex fitted with a portrait attachment and moved in close to a 10" screen. While shooting, he turns the brightness a little above normal—but not enough to wash detail out of the highlights. He shoots with the lens open wide at $f/3.5$.

If your camera has an $f/4.5$ lens, you still can probably get good fight photos by developing your film longer, say to 75 or 90 minutes. Should you be using sheet film, you can of course buy film that is far faster than the Super XX type. This will not require such long development.

Sketches show what happens. Why 1/50 second shutter speed is the most practical for stopping TV action is shown in the accompanying sketches. First, study how a TV image is formed. Then see what happens at different shutter speeds.

(This explanation refers only to between-the-lens shutters. Focal-plane shutters are sometimes used for TV shooting, but most photographers do not favor them because of their different action—a slit sweeping across the film.)

Even though some scanning lines are missing at 1/50 second, this makes very little difference. In moderate blow-ups, you'll never notice they aren't there. Best of all, the one scanning field and part of another enables you to get many shots without the blurs that come from fast action.

What about 1/30 second? In theory, a shutter opening of 1/30 second might be considered ideal, especially if the shutter could be synchronized to open and close with the beginning and completion of in-

dividual TV frames. But modern between-the-lens shutters, except for one or two unreliable ones, don't offer 1/30 second.

Actually, if you had that choice you still would be better off shooting at 1/50. At the

slower speed, your shutter opening could very easily straddle parts of three different TV fields—in each of which the subject may have moved slightly. At 1/50, you stay within two fields. **END**

What happens when you shoot at different speeds.

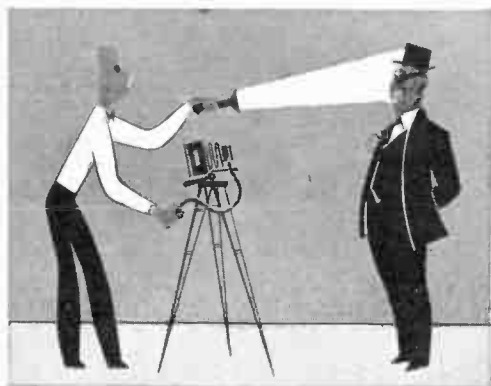

First point to remember is that it's a moving pin point of light, the scanning beam, that produces an image on film in your camera. Because of the rapidity with which the beam moves you may tend to think of a TV image as similar to your Uncle George—always there. But it's not. It just seems to be. Photographing a TV image is like opening the shutter of your camera in an absolutely dark room and then moving the beam of a spotlight back and forth across stock-still Uncle George, starting at his head. There's one difference, however. With Uncle G., you'd get a complete photo in one spotlight scanning from head to toe. On TV it takes two trips to fill in the picture.

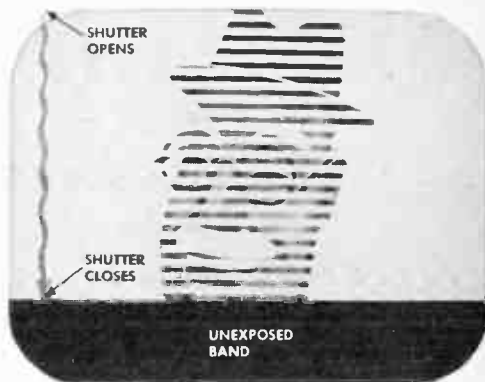

At 1/100 second your camera shutter doesn't give the TV scanning beam time to form even a single 1/60 second field. Consequently, an unexposed strip shows up across negative. Where strip falls depends on what point scanning beam had reached when shutter opens. The same unexposed strip would result while you are spot scanning Uncle George if you closed shutter as the beam reached his knees. You'd get no photo of his feet because they were not yet illuminated. In a 1/100-second TV photo, unexposed strip may show some detail because the scanning beams continue to glow for about 1/1,000 second after beam has passed. If there's no strip, your shutter is probably slow.

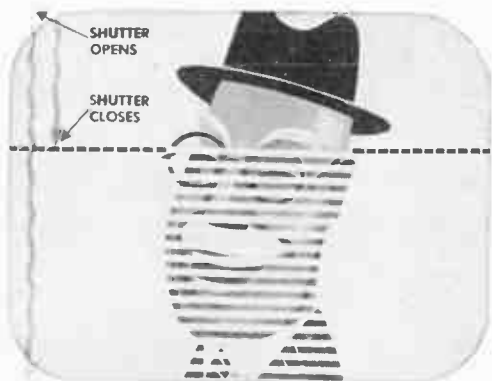

At 1/50 second you have the best chance of taking action TV photos without blurring. At this speed you give scanning beam time to produce a complete field and a good part of another. The amount you get of the second will depend on how accurately your shutter is working. If it is actually slower than 1/50 second, as many shutters are, you'll get just that much more of the second field.



At 1/10 second you must catch your subject absolutely still to get a shot without movement. During that interval, the TV scene has been scanned six times. This means you have a combination picture of six different fields, in each of which subject may have moved slightly. You'll probably have blurred result above. At 1/25 second, or better still 1/50, you reduce chance of motion.



Learn to Shoot

Nobody can hurt himself with this gun—which makes it a fine Christmas gift for a budding young marksman.

THIS gun shoots nothing but light. Any child can use it safely, yet it will test any man's marksmanship.

The target is a photoelectric device with a small bull's-eye window, above which a cardboard duck is poised. A straight shot topples the duck and rings a bell.

This target can be used up to 50 feet away from the light gun. It will also respond to a flashlight's beam, but sweeping the target with a steady beam wouldn't test your aim.

What the gun does: The gun (shown below) emits a quick flash of light when fired. The battery in it charges a condenser. Pulling the trigger lets the condenser discharge through the bulb. The 45-volt radio B battery lasts for months.

What the target does: The target responds to very small changes in the light striking it. The light's energy is converted into electricity and amplified a million times by a photomultiplier tube. This hefty charge is then fed to an OA4G trigger tube. When the charge on this tube reaches a prede-

termined level, the tube "fires" and energizes a relay. The relay, in turn, makes the target sound off.

Making the gun: To make my light gun look real, I used the stock and action of a toy rifle and combined it with a barrel made from a 16" length of $\frac{3}{4}$ " aluminum tubing. The toy gun's trigger works the lever of a rigidly mounted SPDT midget snap switch. When not triggered, this switch keeps the battery-condenser circuit closed so a charge can build up in the condenser. When triggered, it opens the battery circuit and puts the lamp across the condenser.

Any inexpensive lens can be used to focus the light. My lens is cemented to a cardboard tube that slides inside the gun barrel, and I focus the beam by moving the tube in and out.

The bulb must be a 6-8-volt, .15-amp., brown-bead pilot lamp; no other type will do. A standard radio-pilot-light assembly holds it partly below and partly inside the barrel, a few inches from the end of the muzzle, with its filament at right angles to the lens. Before drilling the bulb opening in the barrel, I determined the proper spacing by connecting the bulb to a 6-volt battery



Gun contains an instant-acting light circuit that fires one bright, brief flash. The parts in-

clude a 45-volt battery, a snap switch, a condenser, and a radio pilot lamp.



With Light

By J. Raymond Schneider

PS PHOTOS BY HUBERT LUCKETT

(to provide a steady glow) and moving the lens in front of it until the spot was focused on a wall 10 feet away.

Making the target: To get good results from the phototube in the target, you need about 1,000 volts. An ordinary 1,000-volt power transformer is pretty expensive, but a photoflash transformer will suffice. It will usually put out much more than the required voltage, however, so a dropping resistor (R1) must be used. R1 is a 2,000-ohm, 20-watt adjustable resistor. Connect it in series with the primary, as shown, and hook a high-range AC voltmeter across the transformer secondary. Adjust the tap on R1 until the meter reads 1,000 volts. If the full 2,000-ohm resistance still does not bring the voltage low enough, another resistor can be added in series.

Other transformers with 10-to-1 or higher step-up ratios will also work. I used a Ken-

yon type T-2 microphone-to-grid transformer. If you use an audio transformer, however, be sure it is a heavy duty unit that can handle fairly heavy currents in the primary.

Both tubes used in this circuit are the cold-cathode type. They do not have heaters, require no filament current, and give

Bell mechanism can be scavenged from an old doorbell. When magnet coil is energized, hammer strikes bell. As clapper moves, pivot wire slips loose and duck topples down.

Gun construction and wiring are shown below. Toy-gun trigger trips switch lever. Be sure switch is rigidly mounted. Lamp filament should be at right angles to sliding lens.

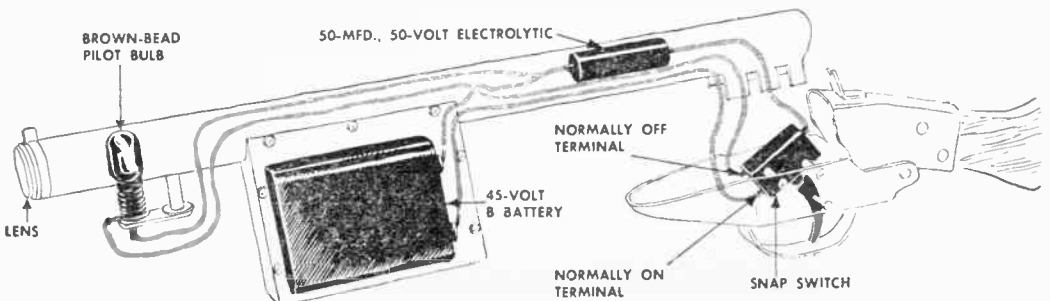

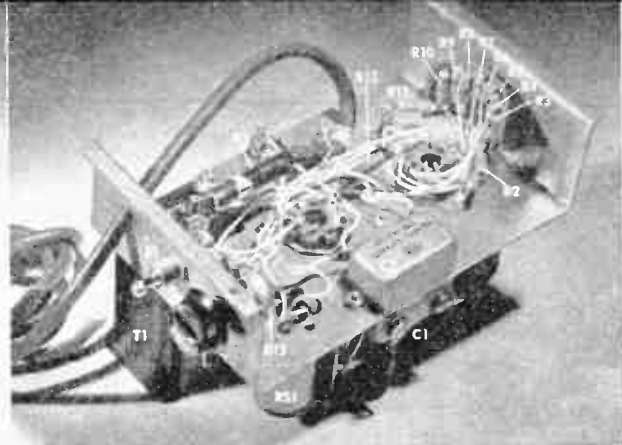
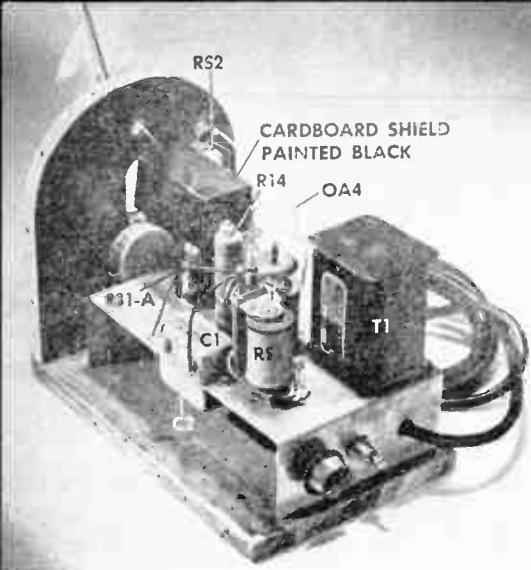

Wiring isn't critical, and wide range of parts may be used. Scrap-box or bargain-counter components can save you money, but be sure their characteristics approximate those specified. Entire unit must be hooded against light.

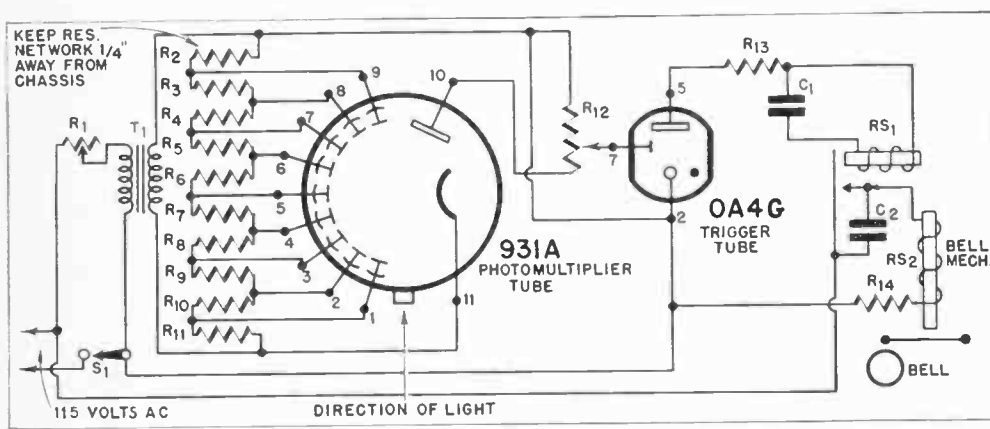

LIST OF PARTS

- R1: 2,000-ohm, 20-watt adjustable wire-wound.
- R2 through R11: 39,000-ohm, 1/2-watt carbon.
- R12: 200,000-ohm potentiometer.
- R13: 1,000-ohm, 1/2-watt carbon.
- R14: 50-ohm, 25-watt wire-wound.
- C1: 1-mfd., 400-volt paper or bathtub.
- C2: Same as C1, but .05 mfd.
- S1: SPST toggle.
- T1: Step-up trans. (see construction information).
- RS1: 5,000-ohm, SPDT plate-circuit relay.
- RS2: electromagnet from doorbell buzzer.
- 931-A photomultiplier tube and 11-prong socket.
- OA4 cold-cathode trigger tube and octal socket.

long, trouble-free service. The resistor network, which breaks down the high voltage from the transformer into 100-volt steps, must be kept away from the chassis. The complete network is assembled on a plastic strip and mounted in 1/4" spacers.

My bell-ringer was made from an old 6-volt doorbell buzzer. Dropping resistor R14 was used because the buzzer had a 6-volt coil. A 115-volt bell would do just as well and no resistor would be needed.

The duck was clipped from a magazine and pasted on cardboard. I covered my target with a sheet of metal to keep out light and placed a cardboard shield over the

phototube (shown in the photo) to minimize the effects of stray light.

Final adjustments: To operate the unit, the bull's-eye window must be turned away from bright-light sources, and the sensitivity control, R12, adjusted until the trigger tube receives just enough current to cause the bell to ring. The control is then backed off until the bell stops. This leaves the circuit balanced on a fine edge so that it will go off when any extra light hits it. A flash from the light gun is plenty—provided your aim is true.

Is it? Why don't you build a shooting gallery and find out? END

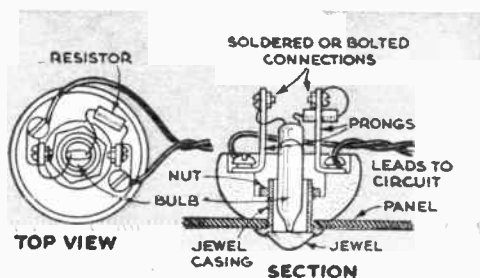

MIDGET NEON BULBS of the baseless, resistor type make desirable pilot and indicator lights where high visibility is not required, since their small current consumption contributes to their long life. Ordinary appliance plugs can be used as panel mounts for these bulbs if the cord hole is reamed out to fit over the threaded casing of a pilot-light jewel so that the assembly can be secured on the panel, as illustrated above. The tip end of the bulb is inserted in the casing, and the leads from it and its resistor are connected to the ends of the plug prongs. Short leads and a drop of sealing wax hold the bulb in position. Binding screws on the plug are used to connect the device into the circuit.

A POWER PACK for furnishing plate current to a radio or amplifier, or for experimental purposes, can be built from four discarded 35Z5 rectifier tubes. These have a double filament, one side of which serves as a resistor for the pilot light, and this usually burns out first.

As shown in the diagram below, the unit is essentially a voltage doubler, and no transformer is needed. The filter block has two 8-mfd. condensers and one of 16-mfd. capacity across the output terminals. This should have a rating of at least 250 volts; one of 450 volts would provide a better safety factor. The field coil of a small dynamic loudspeaker with a resistance not exceeding 450 ohms may be used as a filter choke.

A voltage doubler such as this must never be used with grounded apparatus,

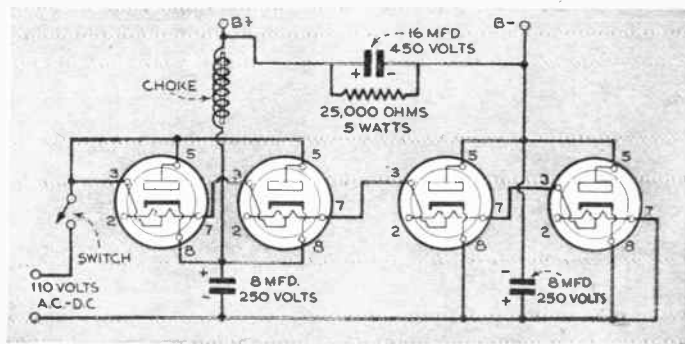

BROKEN DIAL CABLES can be replaced with a good quality of stout thread that has been given a simple toughening treatment. First soak the thread in alcohol and then, while it is still wet, draw it back and forth across a piece of rosin until the rosin has been thoroughly worked into every fiber. Greatly increasing the strength of the string and giving it surprising durability, the process also imparts tractive power sufficient to keep it from slipping on the pulleys of the ordinary set. The string should be allowed to dry thoroughly before installation.

SEALED RELAYS like that at the right will fit any standard octal socket, providing delays of one to 100 seconds when installed in transmitters as automatic cutoff or cutin devices. They are compensated for ambient changes of -40 to $+100$ deg. F. This type of relay is available as a single-pole device with either normally open or normally closed contacts. It is capable of handling up to 12-amp., 115-volt A.C. or D.C. The contacts are hermetically sealed in inert gas to prevent oxidation.

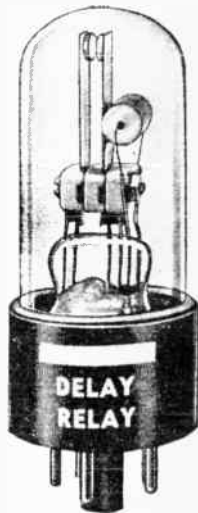

as for example a radio, unless the equipment is grounded through a 100,000-ohm resistor with a .1-mfd. paper condenser in parallel. Should touching the set cause a mild shock, try reversing the wall plug.

Two tubes instead of four would deliver enough current for small radios, but the two tube heaters cannot be connected across the 110-volt line without also using a suitable line-cord resistor.



You can adjust the arms of this curtain-rod room antenna in direction, angle, and length.

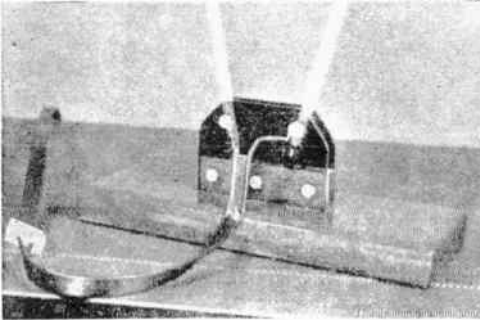

Use machine screws to clamp the rods between the plastic sides. Draw up on the nuts until the plastic grips the rods lightly.

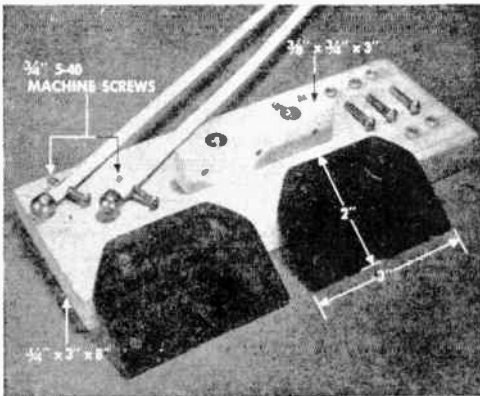

Holes in the rods should be big enough to clear 5-40 screws. If they aren't, use smaller screws; enlarging holes may weaken rods.

How to Fish For More TV Stations

Curtain rods and lead-in wire can help you overcome antenna troubles.

HAVING TV trouble? It often can be ended for 30 cents. Simple homemade dipoles sometimes lick ghosts, snow, noise, or weak signals.

For all-around service an indoor aerial is rarely equal to a good rooftop rig, but in strong-signal areas it may be adequate. Moreover, it may be just what you need to supplement another antenna. An indoor antenna can be quickly tuned and oriented to the station you want. If you are having trouble with your present setup, here are three inexpensive rigs that are easy to try.

Curtain-rod rabbit ears. You can make a fully adjustable antenna like the one pictured at the left from dime-store curtain rods and scraps of wood and plastic. This one's base is a 3/4" by 3" by 8" piece of plywood, and the photos show how it was assembled and connected to a 300-ohm lead-in wire.

This antenna can be rotated until a clear picture is received. Start with the rods in V formation and try moving the arms up and down, and in and out. A little experimenting will show you the best adjustment for each station.

Lead-in wire antenna. If you now

To switch from one antenna to another use the arrangement shown at the right. Connect a length of 300-ohm line from the input terminals on receiver to the center contacts of a DPDT switch. Bring the two antennas to the outer switch terminals. Use an old-fashioned knife switch for best results.

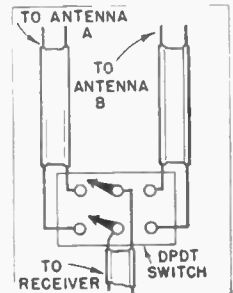



This one-channel antenna may actually surpass a roof antenna. Turn it to face the station.

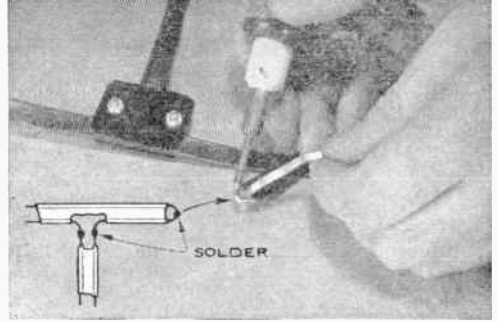

Soldering the tips of the wire together turns a piece of 300-ohm lead-in into a folded dipole. Try various locations until you find a good one. It may be under a rug (as at right) or behind some furniture.



receive all but one of your local stations, an extra antenna may help you pull in the elusive channel. You can make a tuned dipole from a couple of feet of 300-ohm flat ribbon wire.

The table at the right gives the length suggested for each channel or combination of channels. If, for example, you are trying to improve reception on channel 7, cut a piece of 300-ohm ribbon about 31" long. Bare the ends of the wire and solder the tips together as shown in the photo. Find the exact center, snip one of the two parallel conductors, and solder another piece of 300-ohm lead-in to the severed leads. To give the assembly extra strength, clamp a couple of pieces of plastic at the point where the lead-in joins the antenna.

Connect the lead-in to the set and move the antenna around until you find the best location. You may also want to try extending the lead line and carrying the antenna to an upper floor or into a closet.

Curtain-rod trombones. Another type of curtain-rod antenna (below) was built

CHANNEL OR BAND	FREQUENCY (MC)	TOTAL LENGTH OF ARMS (INCHES)
2	54-60	98
3	60-66	88
4	66-72	80
5	76-82	70
6	82-88	65
7	174-180	31
8	180-186	30
9	186-192	29
10	192-198	28
11	198-204	27
12	204-210	26
13	210-216	25
low band (channels 2-6)	54-88	78
high band (channels 7-13)	174-216	28
all band (channels 2-13)	54-216	60 to 65
FM	88-102	56

by Edward R. Maki, of Worcester, Mass. He uses it in his attic to pick up Boston stations 40 miles away. Four rods fitted together in the shape of a folded dipole make up the high-band antenna; the low-band unit uses four rods plus an extension strip. The reflector—which is slightly longer than the low-channel dipole—consists of two extension strips fitted together.

The elements shown are tied to a 6' strip of lumber, pivoted on top of a lamp stand. Separate lead lines connect the antennas to the receiver through a switch. The reflector is of course not connected.

The arms of the low-band attic dipole are somewhat less than the full length suggested in the table. You can find the best length by experimentation.

END

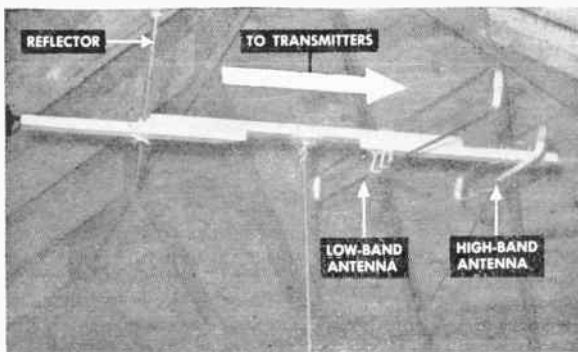

Attic antenna is protected from wind and rain, so the dipoles and reflector are simply tied to wooden mount.



Before the author went to work, his 16-inch television set looked best in a dim light.

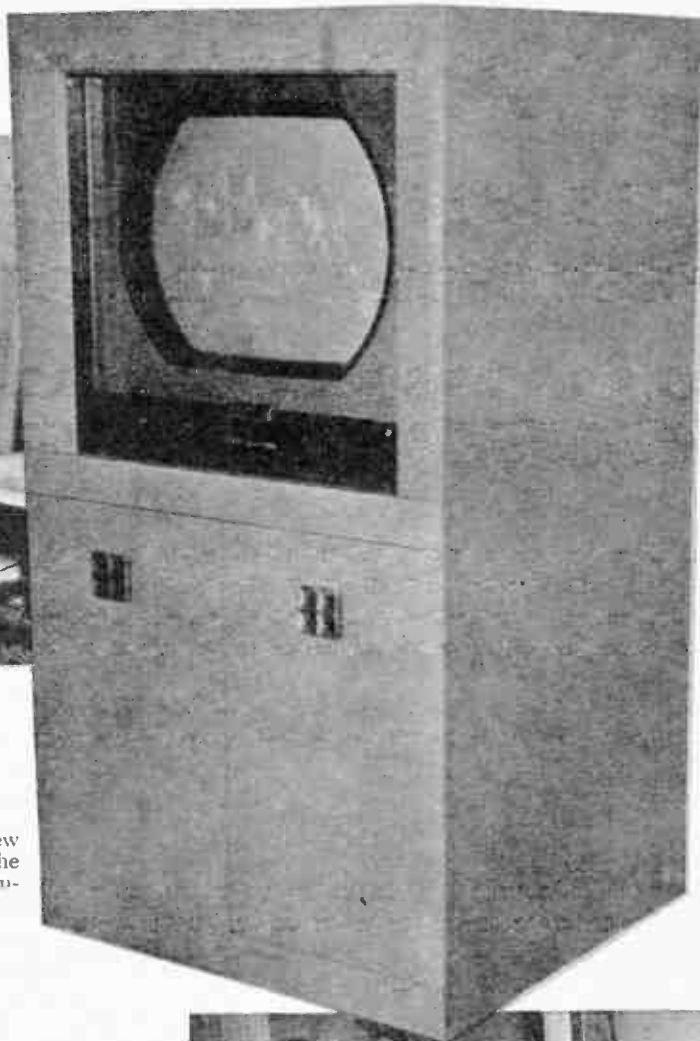

After he put it in a new cabinet, he was glad he had bought an inexpensive table model.

Seats Built Into TV Set

Extra chairs can be stowed in this homemade cabinet for a table model.

By Herbert Pfister

PS PHOTOS BY W. W. MORRIS

138



Someone coming? Two extra chairs can be pulled right out of this modern TV cabinet.

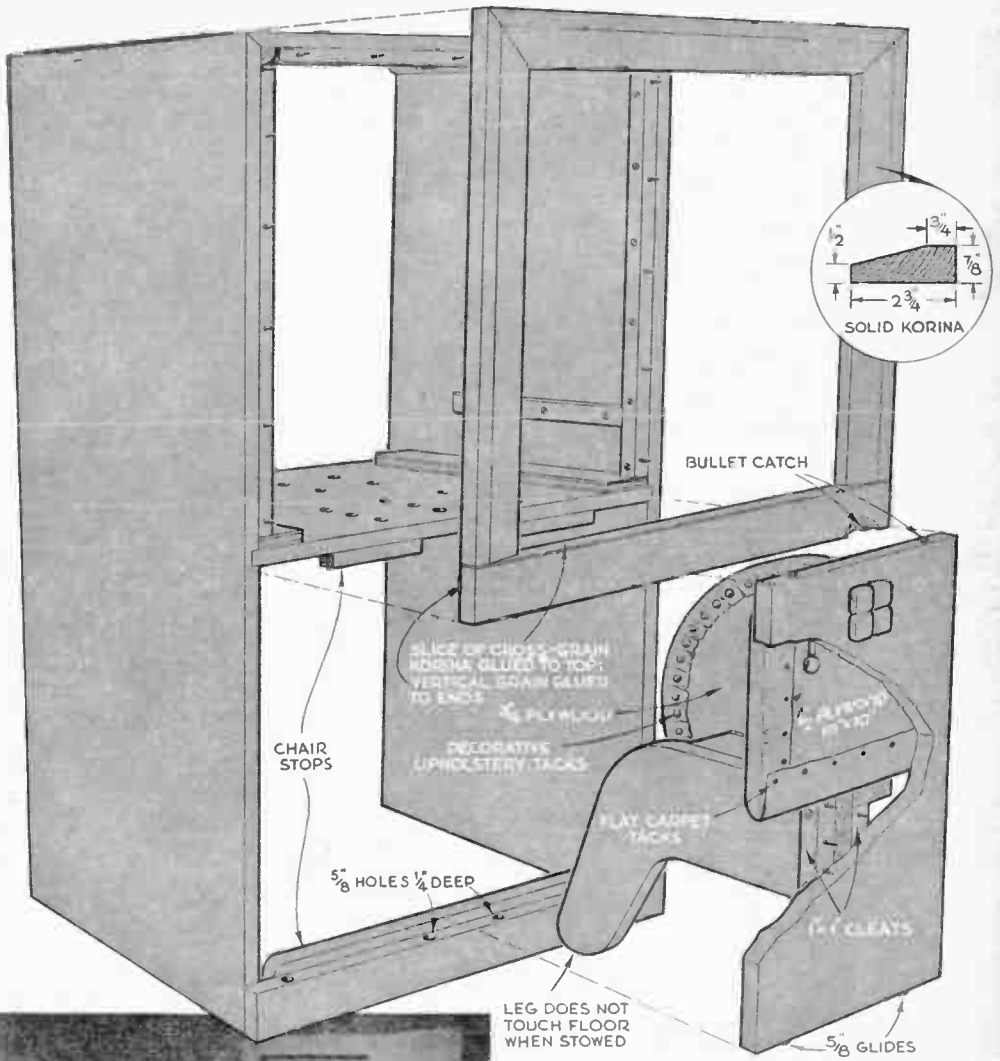

TV for two more. The cabinet doors are the backs of the two upholstered folding chairs.

THE designers of television cabinets must think that everyone lives in a palace. They've not produced a suitable model yet for a home like mine, where every inch counts. So I bought the simplest table model that I could find and built my own cabinet—with hideaway seats.

Now we never have to run upstairs for another chair when the neighbors' children drop in. We have two guest chairs right in the cabinet. And when our guests depart, we simply shove the chairs back into the set.

It's a console that anyone the least bit handy with tools can build. It looks as trim as a factory-built job. And you can slide a table model into it without doing anything whatever to the original set.

My set was a 16-inch RCA, 21" high,

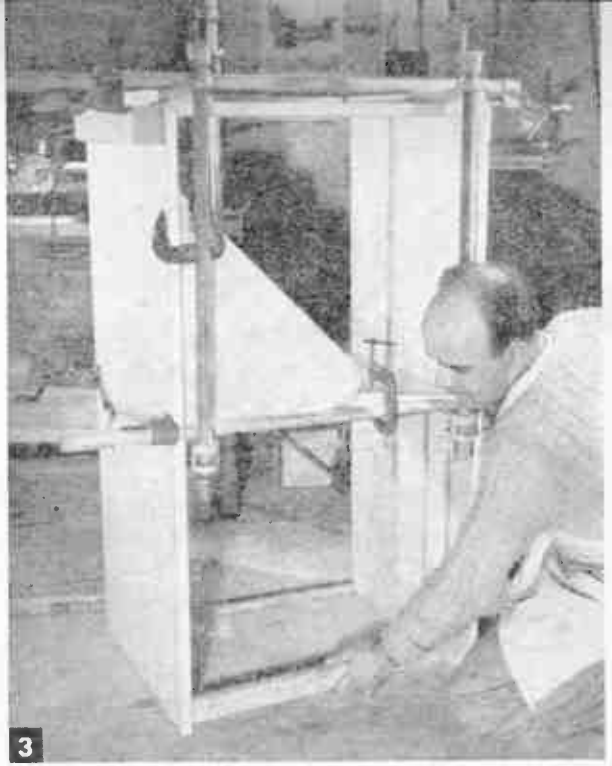

21½" wide and 20" deep. But I made the recess into which it slides slightly larger, leaving an extra ¼" at the sides and above and below the set, and an inch of additional depth.

Cabinet details: After examining various cabinets in the stores I concluded that the shelf on which the TV set rests should be 24" from the floor. I then worked out my plans so as to get all my large pieces from one 4' by 8' panel of ¾" korina-veneered stock.

I did this to keep the cost down, but found it also enabled me to be sure the grain would run in the right direction in all of the

pieces. By going about the job in a similar way, you can have the big panel cut to manageable size before you trundle it home from the lumberyard. But yard cuts are not always true or smooth, so allow an inch for trimming.

Figure 1 (above) shows how I mitered the tops of the large sidepieces. Near one end of each piece I scribed a miter line square with the edge of the stock. Then I set the saw for a 45° cut and measured the distance from my saw blade to the side of the saw table. Exactly the same distance in from the miter line I clamped a guide strip to the work. This strip bore against the side of the table as I fed the work through the cutter.

I put the sides and top together and trimmed the center shelf to fit. Then I dadoed the shelf into the sides as shown in Fig. 2. But before gluing the shelf in, I drilled a liberal number of vent holes in it.

I glued and clamped the pieces with great care (Fig. 3), and when the glue had set,

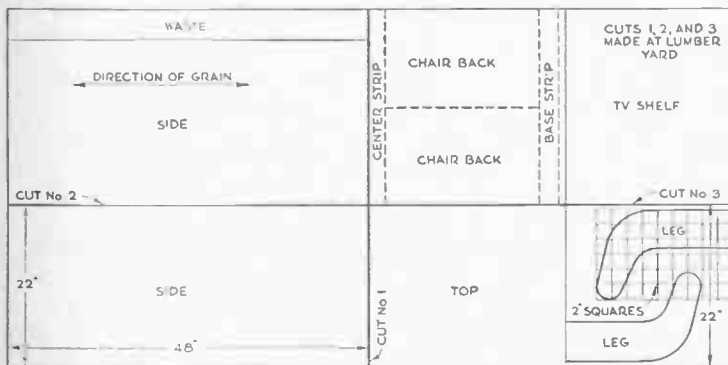

Here's how the necessary pieces were obtained from a 4' by 8' panel.

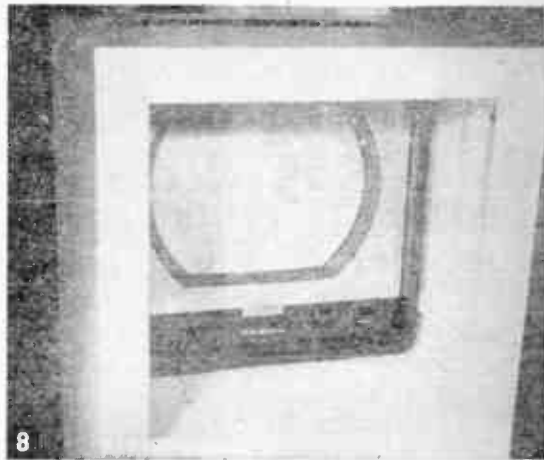
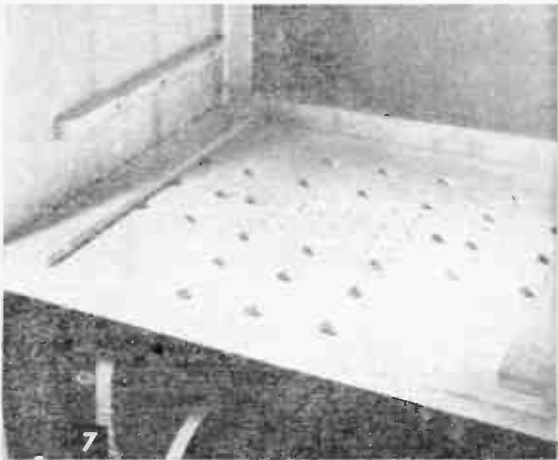
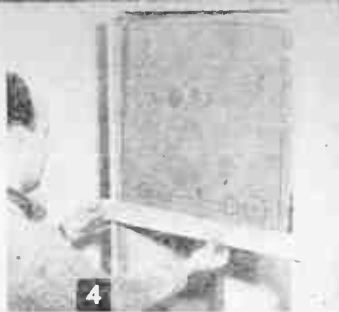

I reinforced the joints by gluing a strip of quarter-round in each corner.

If you don't have enough large clamps you can still get a pretty clean joint by screwing a long, square cleat in each corner. Drill pilot holes through the cleats, sides, and top. Brush on the glue and screw the cleats in place to pull the corners together.

Make a template. To avoid having to lift the set repeatedly to fit it into the cabinet properly, I cut a cardboard template and accurately marked the picture mask outline and knob positions on it (Fig. 4). This helped me determine the correct position for the center cross strip. Once this was established, the location of the door panels and bottom strip followed simply (Fig. 5).

You can use a ready-made picture frame for the cabinet mask, or build one as I did. My frame is three-sided and has mitered corners at the top (Fig. 6). It butts against the center cross strip and is flush with it on the inside but chamfered on the outside.

To get the chamfer effect, I had to use solid korina for the top and sides of the frame. Then I cleated it to the cabinet from the inside.

The loudspeaker is on the top of my set, so I sawed out an appropriate speaker opening in the top of the cabinet. I made a simple wooden frame to fit the opening, tacked

a piece of radio grille cloth over the frame, and bradded the frame into the opening and flush with the top.

Figures 7 and 8 show additional details of the completed TV shelf. The $\frac{1}{2}$ " slide rails in the two lower corners hold the set level (I didn't think the rubber cabinet bumpers were stable enough). For side-to-side alignment, I used $\frac{3}{8}$ " side rails, rounding the corners, sanding the rails smooth, and countersinking the screws. These make it possible to slide the set out for servicing and be sure it will go back in exactly the same position.

The chairs: A finished chair frame—the right-hand one—is shown in Fig. 9. Note that the door panel and the curved center leg are so joined as to tip the chair back a couple of degrees. This puts most of the weight on the squared rear support and makes the chair more stable.

The door panels were cut to fit the lower opening and are held in place by furniture glides and bullet catches as shown in the construction drawing.

I made each seat from a 15" square of $\frac{3}{8}$ " plywood, rounding the front corners so the seat would clear the cabinet when tipped in and out. I cut a pad of 1" foam rubber and a sheet of upholstery plastic, and assembled the layers as in Fig. 10. The covering plastic tends to stretch, so you have to

draw it taut as you tack it to the underside of the seat (Fig. 11). Flat carpet tacks should be used on the part that lies against the hinge board.

Each seat is hinged to its frame parallel with but 2" away from the back panel (Fig. 12). A cabinet catch keeps the seat upright when stowed. And a screen-door hook keeps

it from tipping accidentally while it's in use.

Backs for the chairs were made from 10" squares of $\frac{1}{2}$ " plywood. Two keyhole slots (Fig. 13) were drilled and sawed in each back so that it could be hung on two round-head screws.

The finished chairs, neatly stowed in the cabinet, are shown in Fig. 14. END

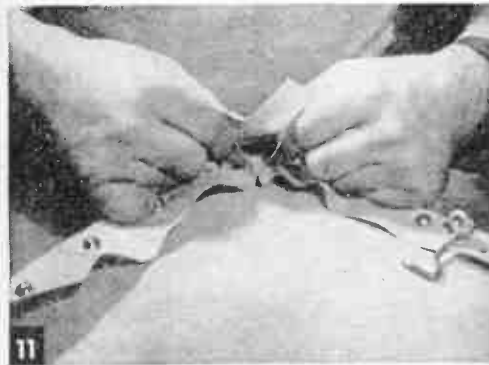
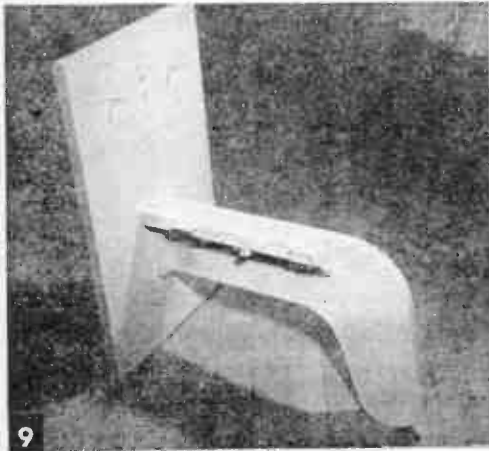

There's Also Room for a Record Player and Albums

AFTER building his TV cabinet, as described on the preceding pages, the author found that there was room enough not only for chairs but also for a 45-r.p.m. phonograph and albums. Here's how he tucked them out of sight. He cut a two-shelf ladder arrangement out of $\frac{1}{2}$ " stock and made a large opening in one side so that he could reach the wheel-type on-off switch. The player is connected to the phono jack.

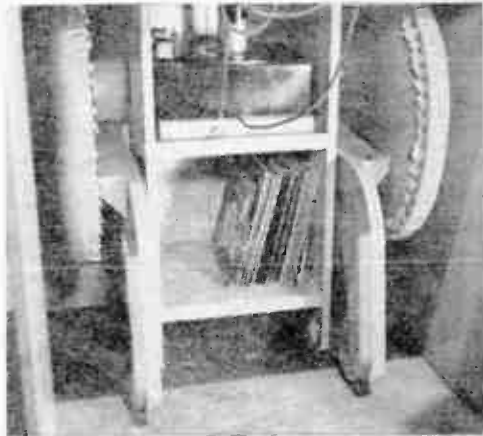

Rolls-Royce of Press Cameras Sports New Optical Finder

AT THE turn of a knob, the viewing field of the new optical view finder on the camera shown below shrinks or expands to suit lenses of various focal length from 90 mm. to 360 mm. It's made for the Linhof Super Technika, a de luxe German camera.

Another knob corrects parallax. The finder's front-lens mount turns to match the rectangular field to the revolving camera

back. In action shots, you can see the subject about to enter the picture field.

A longer-base range finder on the redesigned Technika assures utmost accuracy in focusing. Interchangeable coupling cams, now made in America, synchronize the finder to as many lenses as desired. Kling Photo Supply Corp., New York, distributes the camera and its accessories.

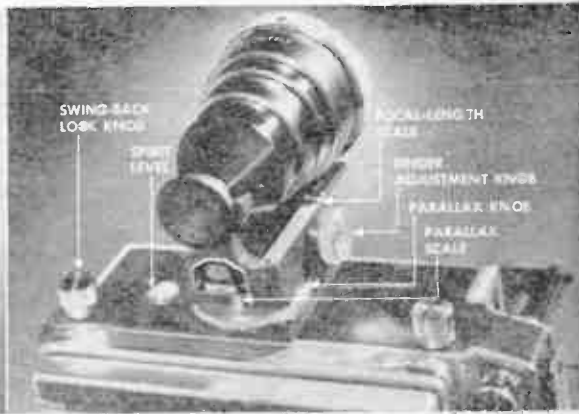

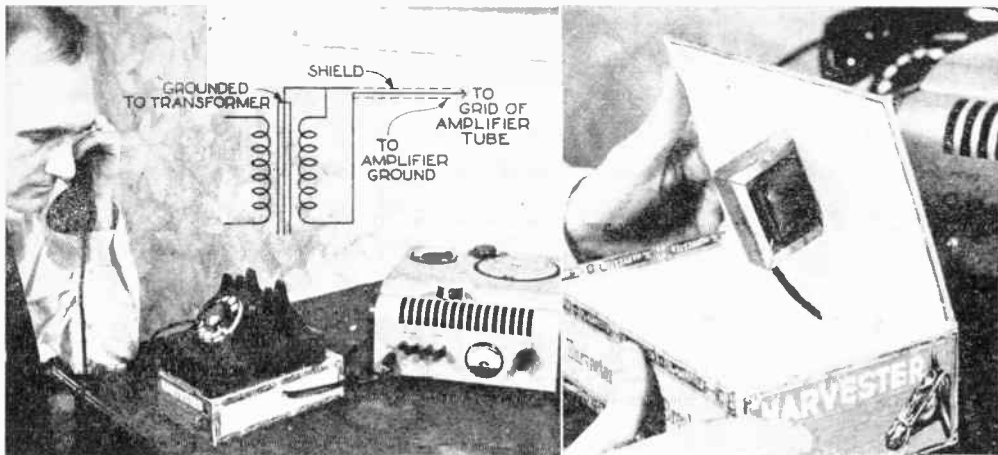

Simple Rig Picks Up Phone Conversation

AN AUDIO or output transformer with a high-impedance winding, a cigar box, and a piece of shielded wire can be made into an inexpensive magnetic telephone pickup. With it and a wire, tape, or disk recorder, you can record both sides of a phone conversation. (Be sure to let the other party know his words are being taken down, for there are strict laws about unauthorized wire tapping.) You can also hook the pickup to a radio or audio amplifier so several people can listen. The device won't make the phone company unhappy, either, because you don't

have to tamper with their instrument, which is also illegal.

Mount the transformer inside the box and connect the shielded wire as shown. Try different transformer windings till you find the best one. One side is connected to the transformer frame and the shield—which acts as the ground conductor; the other side of the winding goes to the amplifier grid. Call up a friend. While he's talking, move the phone over the box until you locate the loudest signal, and mark the position.—*J. A. Rademacher, Fargo, N. D.*

Paint Car Tools to Stop Rust

JACK handles, lug wrenches, and other emergency tools that lie unused in the car for long periods won't be rusty and messy to handle if they are given a coat of paint occasionally.—*C. E. Wilkinson, Peru, Neb.*

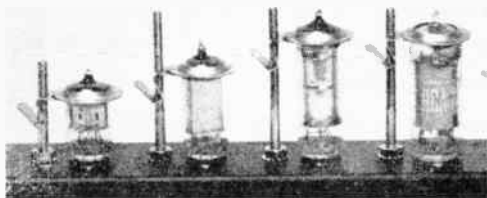

Gripper Keeps Tubes in Place

THE danger of tubes or other plug-in parts shaking loose from portable radio equipment is largely eliminated by the Top Hat® retainer pictured above. Made in a variety of sizes, the retainer fastens to the chassis and grips and holds the top of the tube or other component.

Extension Leads for Radio Batteries

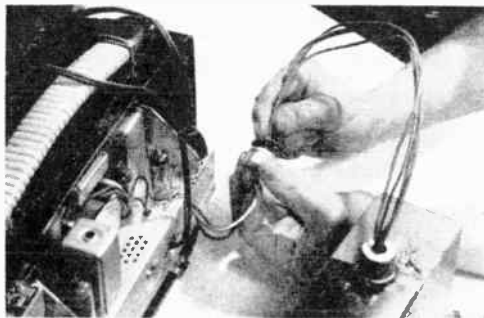

EXTENSION leads that enable you to separate the chassis from the battery of your portable, as above, give easier access to the receiver for servicing. You can buy matching plugs and sockets at many radio-parts stores, or you can use connectors salvaged from worn-out batteries.

How to Improvise a Signal Generator

You can align radio circuits with a record player and another radio set.

WHEN you build or service a superhet receiver, you often run into the problem of aligning its circuits so that they will work together properly. Professionals do this with a signal generator, but it can be done if necessary by simply "borrowing" the right frequencies from a working set and using them to adjust the ailing one correctly.

Audio test. To be sure the trouble is not in the audio part of the set you are working on, you need a source of audio signals. Although these can be tapped off a "healthy" set, it's easier to get them from a record player, which supplies a clean audio signal of the right impedance and voltage. The leads from the record player that ordinarily are connected to an amplifier are used. If your player has a phonograph plug, you can separate the two leads by soldering short wires to the contacts of a matching jack.

Connect one of these leads to the chassis of the radio you wish to test and start the record player. Then connect your other lead to the grid of the output tube (point A in diagram on next page). If you're not sure which tube-base pin goes to the grid, check it in a tube manual. If you hear the record through the radio's speaker, the output stage, speaker, and power supply are functioning. Checking similarly at the grid of any other audio tube in your receiver (such as point B) will tell you whether that part is working properly.

I.F. alignment: You can then proceed to align the intermediate-frequency stages with another radio. It should operate at the same I.F. frequency as the set you wish to align. Nearly all superhets now have standardized 455-465 kilocycle I.F. circuits.

If both sets are AC-DC types, you should be sure that their power plugs are polarized the same way to avoid shorts. Plug in and turn on both sets, and connect a neon tester across the two chassis or grounds. If the tester lights up, reverse one of the line plugs. Then see what happens when you connect the tester between one chassis and a water pipe. If the neon bulb lights, reverse the power plugs of both radio sets.

After plugging the sets in properly, tune in a strong station on the one that's operating. Don't bother tuning the other one, but connect the two chassis with a test lead in which a .01 mfd. 400-volt condenser has been inserted. Put a similar condenser in a second test lead and connect one

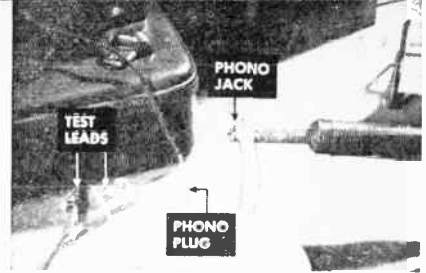

Making the test leads

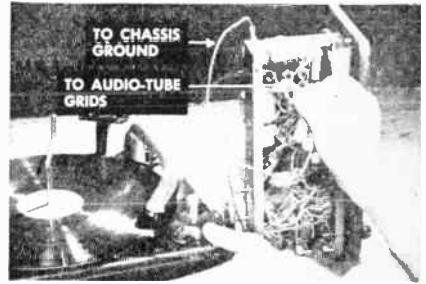

Checking the audio circuits

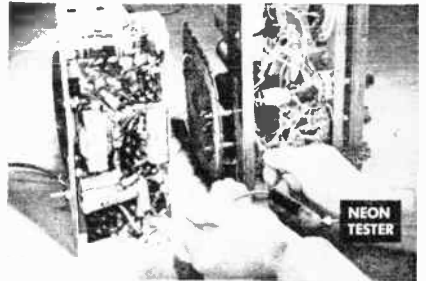

Using the neon tester

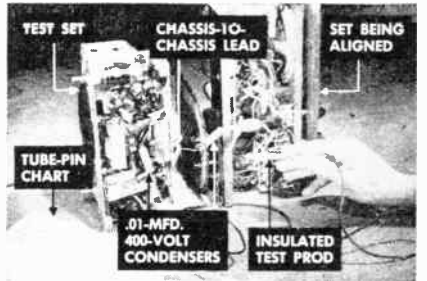

Feeding an I.F. signal

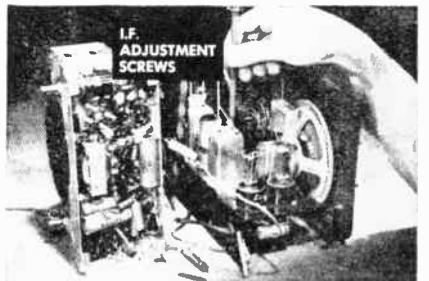

Adjusting the I.F. trimmers

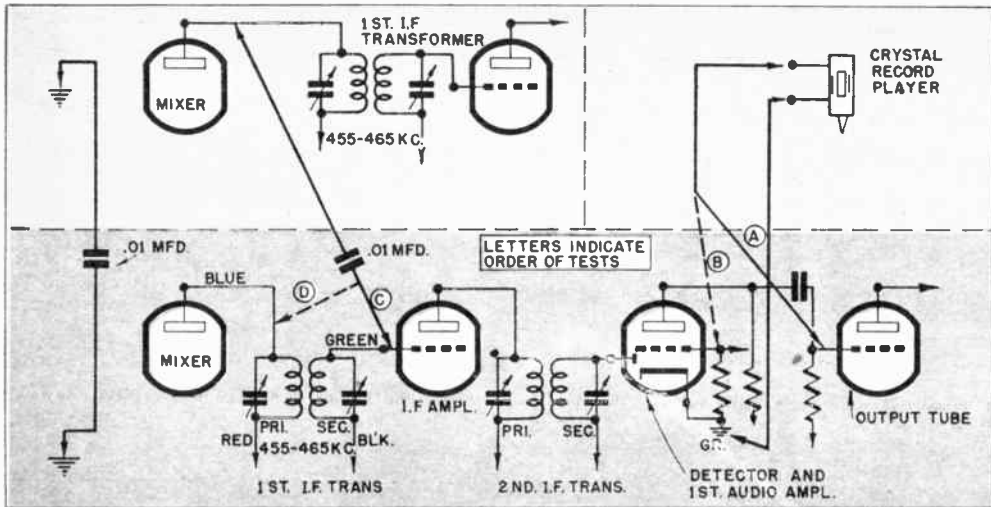

end of the lead to the plate of the mixer tube in the operating receiver. Insulate the other end of the lead and touch the grid of the last I.F. amplifier tube (point C) in the set you wish to align with it.

With a small screwdriver or neutralizing tool (a non-metallic screwdriver), adjust the trimmer screws on the following I.F. transformer. Work first on the secondary trimmer, then on the primary. This changes the frequency of the transformer and, at some point, should allow sound to come through to the speaker of the set being aligned. Adjust trimmers for peak volume.

Move the test prod to the plate of the mixer tube (test point D) and adjust the trimmers on the first I.F. transformer. If the set you're aligning has two I.F. stages, (two tubes and three transformers) you have to align the extra transformer by repeating Step C on the middle stage.

Once you have adjusted the I.F. transformers for maximum response by this method, you can put aside your improvised signal generator and do the rest of the job by ear. (For further steps in tracking and aligning a superhet, see index for additional material.

DEGREE TABLE

The index head or bull gear on a lathe, used with this table, makes it easy to lay out degrees or divisions of circles. For instance, if you want six equally spaced divisions, and have a 72-hole index plate, the table shows that counting 12 holes each time gives you the proper location. The table can also be used with a gear having 72, 60, or 48 teeth.

72 HOLE CIRCLE		60 HOLE CIRCLE		48 HOLE CIRCLE					
No. of Holes	Div.	No. of Holes	Div.	No. of Holes	Div.				
1	5	72	1	6	60	1	7.5	48	1
2	10	36	2	18	30	2	15	24	2
3	15	24	3	12	20	3	22.5	16	3
4	20	18	4	15	15	4	30	12	4
5	25	14.4	5	20	12	5	37.5	8	5
6	30	12	6	26	10	6	45	6	6
7	25.14	10.29	7	42	7	7	52.5	5	7
8	40	9	8	48	6	8	60	4	8
9	45	8	9	54	6	9	67.5	4	9
10	50	7.2	10	60	6	10	75	4	10
11	55	6.55	11	55	6	11	82.5	4	11
12	60	6	12	60	6	12	90	4	12
13	60	5.54	13	72	5	13	97.5	4	13
14	70	5.14	14	84	4	14	105	3	14
15	75	4.8	15	90	4	15	112.5	3	15
16	80	4.5	16	96	4	16	120	3	16
17	85	4.24	17	102	4	17	127.5	3	17
18	90	4	18	108	4	18	135	3	18
19	95	3.78	19	114	3	19	142.5	3	19
20	100	3.6	20	120	3	20	150	3	20
21	105	3.43	21	126	3	21	157.5	3	21
22	110	3.27	22	132	3	22	165	3	22
23	115	3.13	23	138	3	23	172.5	3	23
24	120	3	24	144	3	24	180	3	24
25	125	2.88	25	150	3	25	187.5	3	25
26	130	2.77	26	156	3	26	195	3	26
27	135	2.67	27	162	3	27	202.5	3	27
28	140	2.57	28	168	3	28	210	3	28
29	145	2.48	29	174	3	29	217.5	3	29
30	150	2.4	30	180	3	30	225	3	30
31	155	2.32	31	186	3	31	232.5	3	31
32	160	2.25	32	192	3	32	240	3	32
33	165	2.18	33	198	3	33	247.5	3	33
34	170	2.12	34	204	3	34	255	3	34
35	175	2.06	35	210	3	35	262.5	3	35
36	180	2	36	216	3	36	270	3	36

FOR YOUR POPULAR SCIENCE INFORMATION FILE



Workshoppers' Tricks Tickle TV Audience

By Andrew R. Boone

Scenery as well as tricks comes from the Arquette and Willock workshops. Below, Arquette jigsaws part of an arch for a living-room set.



WHEN Cliff Arquette and Dave Willock build a television set in their home workshops, the only picture it shows is a test pattern—painted on. But it does things no normal receiver can. On cue (as shown in the picture above), it explodes, shooting the works out of the cabinet and blowing up the screen like a rubber balloon.

For this set is a prop, one of the many trick gimmicks that get the laughs on the

television show Arquette and Willock stage on Hollywood's station KNBH. The two actors dream up and make all the gadgets, and the scenery, besides. There's a clock that explodes, waving an American flag; a floating "hand" that fires a gun; a plate that cracks when the gun shoots; and an iron that burns its way through the pants being pressed and then through the ironing board.

The story of the show centers around a mythical newspaper, the *Mt. Ida Ledger* (net circulation, one copy), which Arquette and Willock also produce. The masthead is routed out of linoleum block on a drill press, while other parts of the paper are printed from regular type they keep on hand.

Both Arquette and Willock are veteran actors—and workshoppers. Arquette, a regular on the Fibber McGee and Molly radio show, among others, pursues dozens of craft hobbies of which the show uses only a few. Willock has conducted a TV show based entirely on amateur wood working—he would build a complete project during the half-hour program.



The moose head played a big part in a hunting sequence one week. Arquette, touching up one eye in photo above, made it from paper and fur.



Audience thought iron burned through pants and ironing board. Actually, wires lowered it through holes as Willock (right) blew smoke.



In sharpshooting scene, floating gun (on wires) fired at plate, cracking it. "Cracks" were zigzag paper strips, tripped by Arquette.

The *Mt. Ida Ledger*, mythical newspaper used on the show, is also homemade. The masthead is a linoleum block, cut with a $\frac{1}{4}$ -inch router in

a drill press (left) and finished with a hand gouge. After inking (center), the single copy is printed with a roller and peeled off (below).

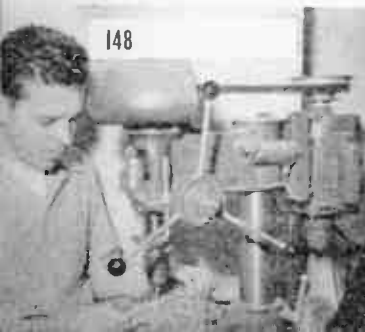



The script calls for the walls to shake and the pictures to tilt whenever a train goes by (left, above). Willock tilts the pictures easily with



wires offstage (right). Weight keeps the picture tilted so that Willock can let go of the wire and get back into the scene.



Prize example of craftwork produced for this program is a plywood replica of an old-fashioned stove, shown at left above before finishing



and at right in realistic black. The range can't burn anything, but it makes a handy place to store props between shows.



Starter Repair for Induction Motor

INDUCTION motors equipped with throw-out mechanisms of the type shown at the left will not start themselves when the two semicircular sliding plates become so badly worn that they no longer make contact with the split ring mounted on the end plate. Irregular starting may also show that the plates are worn.

This can be remedied by removing the sliding plates and filing the bolt slots longer at the outer ends, as shown at the left below. It may be necessary also to file a little from the tips. In some cases, turning the plates over to utilize the unworn edges is desirable.

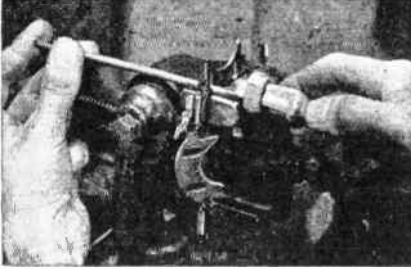

Nail Clippers Used in Stripping Wire

SMALL semicircular notches filed or ground in the jaws will convert a pair of discarded nail clippers into a handy tool for stripping insulated or enameled wire. Vary the size of the notches for wires of different gauge. Use care to avoid nicking the wire.

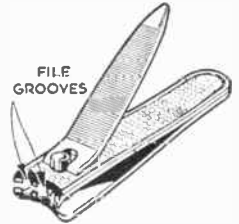

Pump Motor Adapted for Shop Use

Motors of about 1/3 hp., designed to run on 115 or 230-volt single-phase A.C., can often be purchased from dealers in used gasoline-pump equipment. These motors are well built, but they require some simple conversion for shop use.

Start by taking such a motor apart and cleaning out all grease and dirt. Then drill several 3/8" holes in each end cap for ventilation. Repack ball bearings in fresh grease. For continuous operation, it is advisable to install an internal fan. Replace any badly worn wiring. A terminal box may be built from sheet metal. Solder and tape all joints in the box. A base that can be attached to a bench can be fashioned from heavy angle-iron stock.

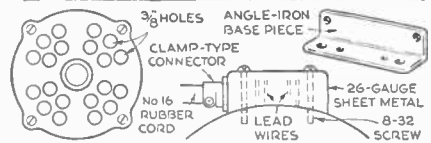
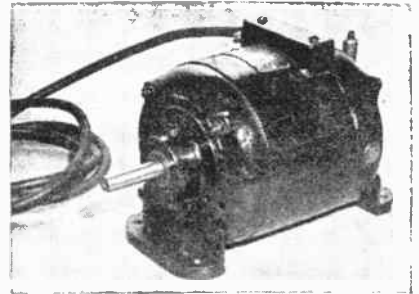

FEED-THROUGH CORD SWITCHES

[ELECTRICAL]

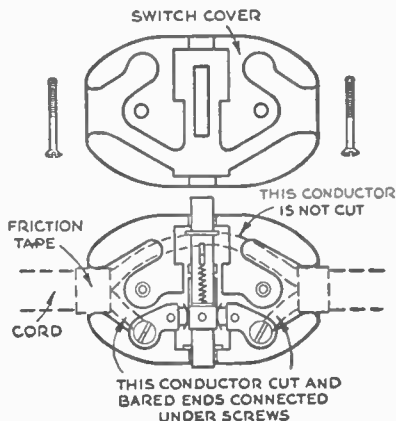

If an appliance is not equipped with a built-in control switch, a feed-through switch on the cord may be found convenient. Switches rated at 3 to 6 amp. are suitable for use on lamps and light-duty appliances, but for heavier motors, large flood lamps, and the like, the switch must be at least equal in rating to the current draw.

To install a switch of this type, first select a point in the cord at a convenient distance from the appliance. On heating pads, toasters, and similar appliances, 18" to 24" from the unit will be most convenient, while on some other equipment greater distances may be preferred.

Carefully cut through the outer braid of the cord at the point selected, and push back or cut away this covering for a space a little less than the length of the switch. Cut apart one conductor only at the middle of this part, braid the two ends, twist the strands tightly together, and attach the ends under the switch-terminal screws. Remember to wind the wires under the screws toward the right, or tightening direction, on the screw shank.

Bind the braid with narrow strips of adhesive tape at each end of the switch, lay the wires in the grooves in the switch housing, and fasten the other half of the housing in place with the screws provided.

POPULAR SCIENCE MONTHLY SHOP DATA



SUMMER- WINTER RADIO



One radio takes the place of two. The polished walnut table model works on house current. Placed in a sport case, it becomes a battery-powered portable

CARRIED outdoors, the compact four-tube superheterodyne receiver shown at the top of the page is a sporty, summertime portable radio, finished in striped airplane-luggage canvas, and powered by batteries. But it takes a second look at the highly polished walnut table-model radio in the lower picture to be convinced that it is the same set, stripped of its sport clothes and formally dressed for wintertime use in your living room. As a table model, it is powered by house current, either alternating or direct.

The secret behind this all-season radio lies in the construction of a canvas-covered

outer wooden cabinet, with a carrying handle and space for a battery pack, into which the walnut-finished main cabinet can be slipped. A handy plug connector simplifies attaching the batteries, replacing the power cord used for house-current operation. Dimensions for making the cabinets are given in the accompanying drawings.

The set's circuit uses a 1A7GT tube which serves as the combined second detector, automatic volume control, and first audio tube. It is necessary to use a 1A56T which

feeds into a five-inch permanent-magnet speaker through a universal output transformer. As the reader follows the circuit diagram, he will see a fifth tube—the 117Z6GT—which serves as a rectifier, when the set is using A.C. house current, to supply the necessary direct current. The "A" current flows through a 2,500-ohm, 10-watt resistor and a 60-milliamperere pilot bulb, which serves as a fuse to protect the filaments of the tubes, and does not light when the batteries are in use. Plate current is supplied through a 3,500-ohm, 1-watt resis-

tor and two electrolytic condensers of 24 and 40 microfarads, respectively, and 150 volts each.

The two iron-core, intermediate-frequency transformers are peaked at 455 kilocycles and measure only 1¼" by 3¼". At the back of the 1-megohm volume control is a D.P., S.T. switch for turning off either battery or house current.

The 5" by 8" loop antenna behind the cabinet is held in place by three small screws. Notice that the speaker is attached directly to the front of the cabinet and that its frame is grounded to the chassis.

Hidden Fuses Protect TV Sets

One bad part can damage others. Fuses turn off the juice before this happens.

FUSES and circuit breakers are used in many TV sets to protect expensive parts, keep house fuses from blowing when something goes wrong, and prevent overheating that may cause fires. Not all sets have fuses, however, and those that do may use them differently.

In a few models they are put where you can check them quickly. In many others they are hidden on or under the chassis. These can mislead you and turn what should be a five-minute service job into a costly repair-shop trip.

Check your set before calling in a professional, and try to find out whether it has fuses, where they are and what they do. The best way to do this is to study the manufacturer's service notes. Any time you have the chassis out, mark fuse locations. It is easy to recognize the slender glass tubes that are clipped in black spring holders, but don't overlook the ones with soldered-in pig-tails that may be hidden under other parts.

Power circuits in some sets have slow-blowing fuses that can withstand surges in line voltage and momentary high currents occurring during warm-up. They should be replaced with fuses of the same type.

High-voltage circuits are often fused independently. The fuse is rated at a fraction of an ampere. When it opens, the picture tube goes completely dark but sound is not affected.

A blown fuse or a tripped circuit breaker is a sign of trouble. Oddly enough, it may not reappear when the fuse is replaced or the breaker is reset. Therefore allow yourself one new fuse or one push on the breaker. If it kicks out again, call in your

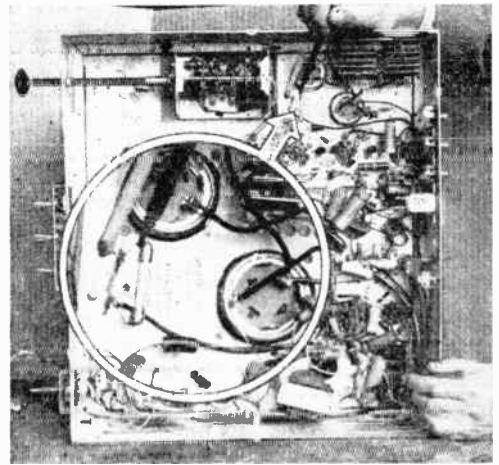

FUSED PLUG (left) and two types of outlet adapters can be used to protect unfused sets. Top: fuses are often soldered under chassis.

serviceman; the set needs expert attention.

You can fuse the power circuit of your set if it has no built-in protection. Fused plugs and outlet adapters like those above cost less than a dollar. The plug replaces the one on the receiver's line cord; the adapter just plugs in between the set and wall outlet. They use auto-type fuses; the five-ampere size is fine for any set. In case of trouble it will blow before the 15-ampere house fuse even gets warm.—Robert Hertzberg, Jackson Heights, N. Y.

Homemade gadgets, made of scrap parts, can trap or filter out the flying hash that messes up many video screens.

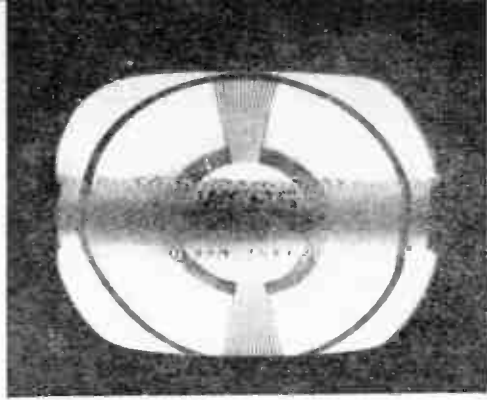

How to Stop TV Interference

By Howard G. McEntee

IS STATIC interfering with your enjoyment of the pictures on your TV screen?

A pair of wave traps, or a filter that you can make for less than a buck, will sometimes eliminate the herringbone patterns, Venetian-blind slats, torn-up images, or shooting streaks that result from interference in television signals.

You cannot always tell in advance which of these noise-catchers will work best for you. But since they are simple to make, you can try out several of them without expending much time or money.

Traps tune out noise. Wave traps are particularly useful against the type of interference that comes from a single source and is uniform in frequency. A nearby police or ham-radio transmitter, FM station, or

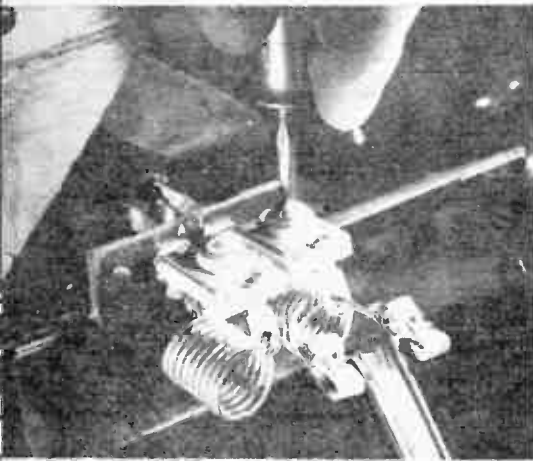

Install traps close to the antenna terminals. Use two identical traps and adjust one, then the other, until interference is at a minimum.

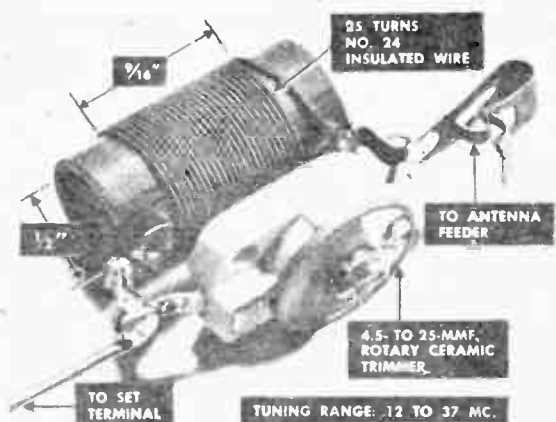
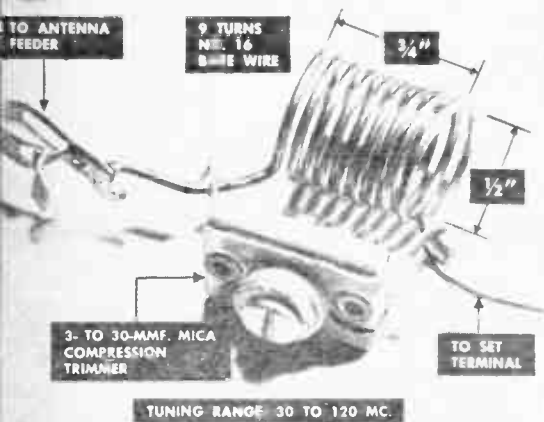

Wide-range trap uses 25-cent trimmer, a coil and a clip. You have to make two exactly alike.

A different combination of coil and condenser lowers the frequency range of this trap.

diathermy machine may be "breaking through" the tuned circuits of your receiver. Traps—which are additional tuned circuits—short-circuit the interference and help block out these unwanted signals.

First try the broad-band trap shown at bottom left of preceding page, which uses a postage-stamp trimmer. Make two identical units and insert one in each antenna feeder. Watch the screen and tune the trimmers until the interfering signal disappears. If the first pair doesn't clean up your picture, experiment with one or both of the other types shown. Since these traps cover specified frequency ranges, they may be more effective against the interference causing your trouble.

Interference sometimes sneaks into a television through the power cord rather than the antenna. Traps in both legs of the power line will close off this point of entry. But be sure to mount them in an insulated box.

Filters are catchalls. Hit-and-run interference occurs even more often than the fixed-frequency kind. You can't tune it out with a trap because it skips around from one frequency to another. To get rid of it you have to block off the whole frequency band in which it appears. That's a job for a filter. The one shown at right below absorbs all signals below 40 megacycles. A lot of diathermy, police-radio, and car-ignition static falls in this range.

Arrange the coils and condensers on a plastic strip at least 4" long. (Squeezing the parts onto a shorter strip might cause the coils to interact.) Place the coils at right angles to each other. Connect the filter be-

Weak Signals Invite Interference

A strong signal is usually a good signal. If "hash" is getting into your picture, check your antenna and lead-in. Clean the antenna terminals. Make sure the lead-in is connected securely, and that both conductors are making good contact all the way down. Rotating the antenna may also help strengthen your signal.

The lead itself sometimes picks up "noise," especially from car-ignition systems. If you live near a busy highway, install the lead as far from the road as possible.

tween the lead-in and the set terminals and clip the ground lead to the receiver chassis. This filter isn't tunable—you just install it and leave it alone. If it weakens interference but doesn't quite kill it all, enclose the unit in a metal box and ground the box to the chassis. END

Filters block out hit-and-run noise below the TV band. If interference source is close and strong, shield the unit in a metal box.

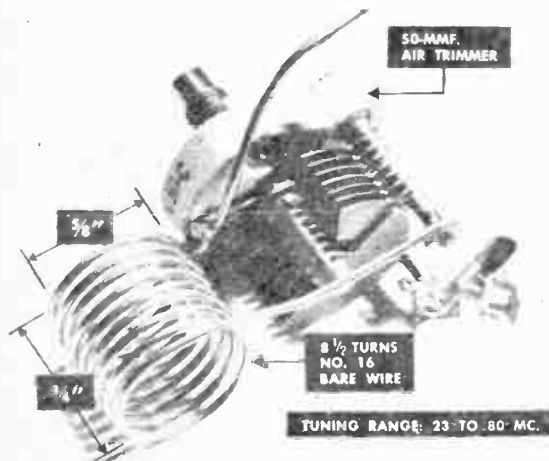
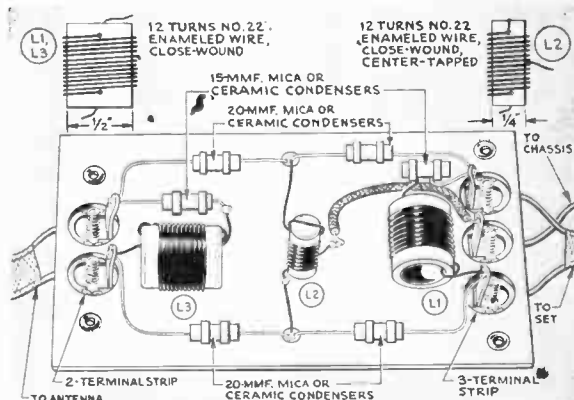

This trap tunes very sharply and is most effective against some types of strong, local noise.

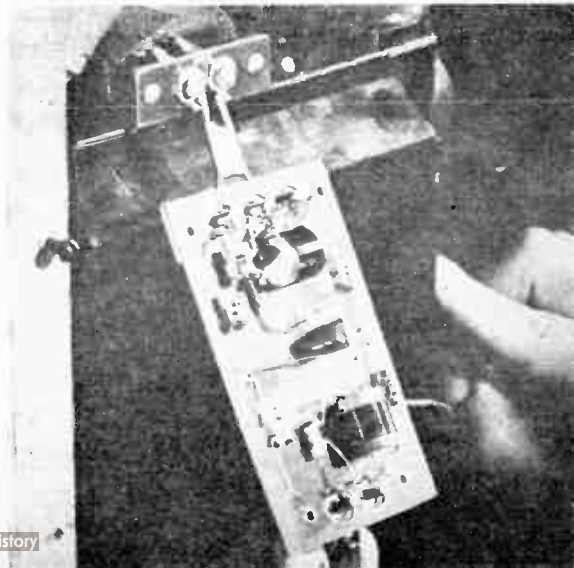

Hide a Radio in a Skillet

You can use miniature parts to produce this attractive 5-tube superhet job for kitchen entertainment.

By Edward Blanton

YOU can brighten up your wife's home workshop—the kitchen—with a little frying-pan art of your own. This radio in a skillet can be hung among other pots and pans as a decorative addition to her kitchen that will supply music, news, and soap operas—and sometimes remind her that it's later than she thinks.

Decide first, if possible, where the pan will be hung. If it goes against a metal cabinet, the loop antenna may not work well, but an antenna coil can be substituted for the loop as shown in the diagram on page 157. Should you hang the set on a plaster wall or the side of a wooden cabinet or spice shelf, the loop will give good service.

The circuit is a standard five-tube superhet design, which assures plenty of pickup and volume. The layout shown is for a 10" skillet; a smaller one may cause a little trouble. The pan can be old or new, aluminum, cast iron, or copper.

Making the Templates

After choosing your skillet, cut a cardboard template for the chassis. Determine its size by a cut-and-try process, but make one edge flat and the other semicircular. Bend a shelf for the tubes along the flat edge. The skillet shown is 2½" deep, so the ledge was made 2" wide. On the semicircular edge, cut and bend two 1½" by 1¾" mounting brackets for the tuning condenser (C1) and volume control (R7). Place them so that the shafts will protrude slightly through clearance holes that are drilled for them along the lower side of the pan.

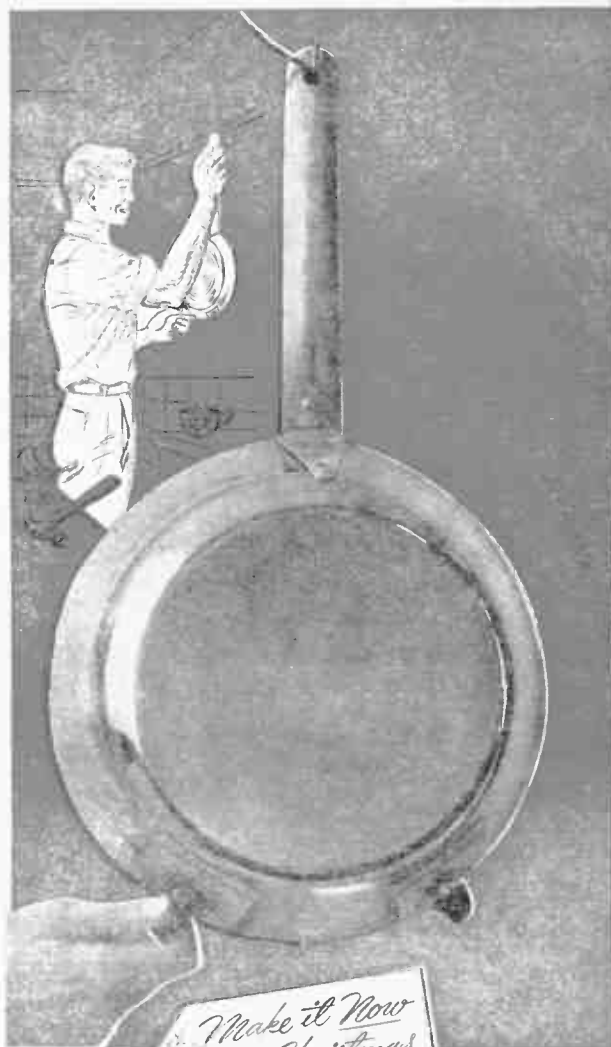

*Make it Now
for Christmas*

Snip out a second cardboard template for the speaker mounting board and clip it to the back of the chassis template. Spread your parts out on the cardboard then to make sure you have room for all of them (if you're not careful the speaker and the tubes may get in each other's way).

When you have the chassis and major parts arranged to fit, trace off the templates. The chassis can be cut from a 6" by 9" sheet of aluminum; the speaker board from a 6" by 10" piece of plywood, plastic, or composition board. Mounting holes are needed for the miniature tube sockets, IF transformers, tuning condenser, volume control, and other large parts.



Parts layout must be planned before work begins if the set is to fit snugly in a skillet.

A common characteristic of AC-DC receivers is a "hot" chassis, since one side of the power line is connected directly to ground. When the wall plug is inserted one way, there is a potential of 115 volts between the chassis and an external ground such as a water faucet or pipe. This could be dangerous, so it's essential that you isolate the chassis from ground.

Note in the diagram that a common wire lead is used as a "floating" ground. This ground point is connected to the chassis at a few places through condensers and a resistor; it must never touch the chassis directly. Some additional circuit stability is obtained by connecting the ground and chassis to-

gether in this fashion, and the voltages that reach the chassis are too low to be dangerous.

For additional protection, line the skillet with tape at any place where the chassis may touch it directly. Make sure, also, that the control shafts don't rub against the edge of the pan.

Two Controls Do the Job

Only two controls are needed. The SPST power switch, S1, is mounted on the back of the volume control, R7. The other control belongs to the midget two-gang tuning condenser, C1. One section of this condenser tunes the antenna coil or loop, the other the oscillator. The oscillator section of the con-

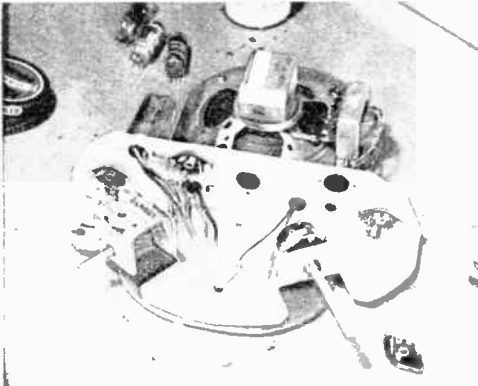

Cut and drill the chassis and assemble the major parts before wiring. Note flaps in the lower edge for volume and tuning controls.

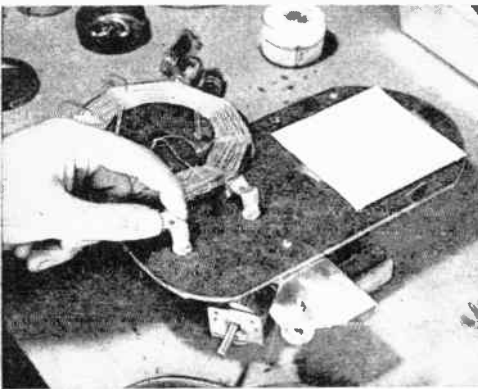

Set the loop antenna away from the back of speaker board to space the speaker off the wall and let the sound come out clearly.



To hold the set in the pan, use a flat bracket at top and a right-angle bracket at bottom. Chassis should not touch the pan.

denser has fewer and smaller plates than the antenna half. Try to buy a condenser with built-in trimmers for final adjustment.

The signal picked up by the antenna is tuned and amplified by the 12BE6 oscillator-mixer tube. The oscillator coil mounted next to the tuning condenser must be clear of the skillet when the set is assembled. When you buy the coil, be sure to specify the type with a single winding and center-tap. You don't want a coil that has two separate windings and four connections.

Choose Miniature Parts

Use miniature parts as much as possible. The paper condensers in this set are the new midget tubulars; resistors, too, are being made smaller than they used to be. Should you have trouble locating a .2-mfd., 400-volt condenser (C3), you can use two .1-mfd. capacitors in parallel. That was done in this set. Hence, the label C3 points to two units in the photo on page 243.

Any frequency that is tuned in is converted by the oscillator-mixer to a fixed frequency of 455 kc. This is amplified again by the 12BA6 IF amplifier and fed to the diode portion of the 12AT6 detector-first audio tube. There it is changed into an audio-frequency signal and amplified some more. It then goes to the 50B5 output tube where it is built up to loudspeaker volume.

A transformer in the plate circuit of the output tube matches the impedance of the tube (about 2,500 ohms) to the voice coil of the speaker (3 to 8 ohms, depending on the make). To be sure of getting a good match, you can use a universal output transformer that has several taps from which you can choose the best combination.

To cut out shrill tones, a by-pass condenser (C11) is wired between the plate and screen grid of the 50B5. If it makes the wiring easier you can connect this condenser from plate to ground instead.

Controls at an Angle

In the construction shown, the control shafts go outward at an angle. Hence, the holes in the skillet are oversized; they should be, anyhow, to prevent electrical contact between the shaft and the metal of the pan. The holes are covered on the outside by dial plates.

The speaker and output transformer are attached to the insulating panel that is bolted to the chassis. Use the back of the same panel for mounting the loop antenna. Space

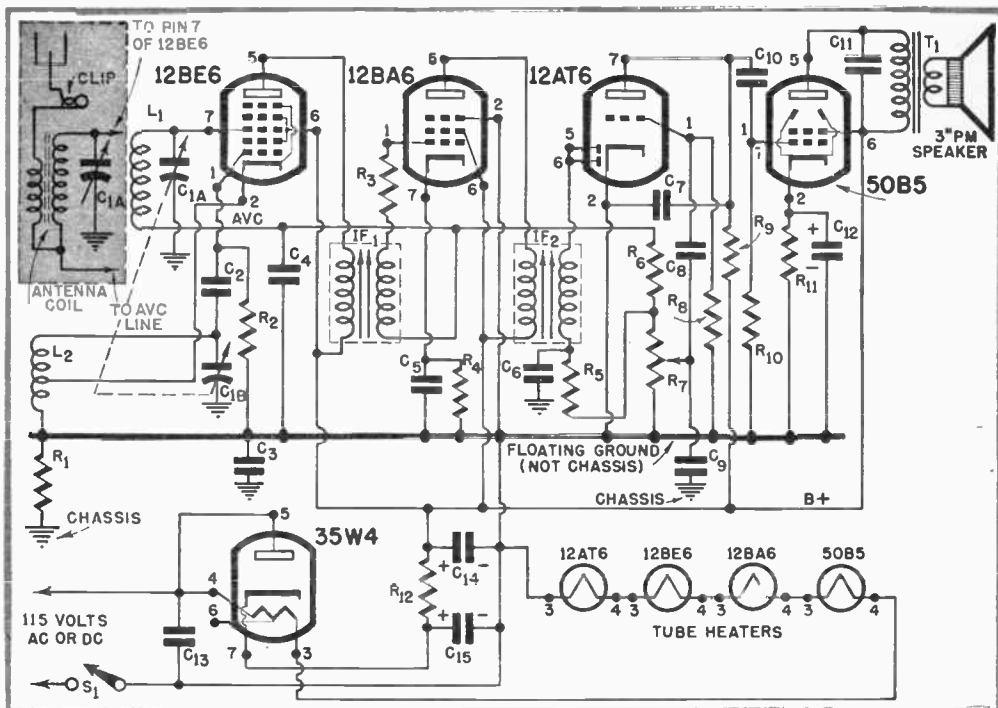

LIST OF PARTS

All resistors $\frac{1}{2}$ -watt carbon unless otherwise specified.

R1: 1.2, R5: 22,000 ohms.

R3: 1,500 ohms.

R4: 4.0 ohms.

R6: 2.2 meg.

R7: 500,000-ohm pot. with sw. tch.

R5: 3.3 mer

R9: 220,000 ohms.

R10: 470,000 ohms.

R11: 150-ohm, 1-watt carbon.

R12: 1,200-ohm, 2-watt carbon.

C1A, B: Two-gang mid-gat tuning condenser with cut-plate oscillator

C2: 50-mmf. mica.

C3: .2-mfd., 400-volt paper

(see text).

C4, C5, C13: .05-mfd., 400-volt

paper.

C6, C9: 300-mmf. mica.

C7: 220-mmf. mica.

C8: .006-mfd. mica.

C10, C11: .01-mfd., 400-volt

paper.

C12: 10-mfd., 25-volt electrolytic.

C14, C15: 50-mfd., 150-volt

electrolytic.

L1: Loop antenna or auxiliary coil

for broadcast band (see text).

L2: Center-tapped oscillator coil

for 455 kc. IF.

IF1, IF2: Mid-gat iron-core inter-

mediate-frequency trans.

T1: Universal output transformer,

3" PM speaker, misc. hardware.

the loop off the panel with metal clips as shown in the photos.

Tube heaters are wired in series and are detailed separately in the lower right-hand part of the diagram. Since the rating of all tubes together is something over 121 volts, no dropping resistor is needed to operate them directly off the line. Wire them in the sequence shown.

Final Adjustments

When the wiring is complete, you may have to sharpen the alignment a trifle. Tune in a strong local station. Adjust the trimmers on the IF transformers to obtain the greatest volume possible. If the set gets too loud, turn down the volume control. Next, touch up the trimmer across the oscillator section of the tuning condenser. Tune in a station at the high end of the broadcast band

(with the plates out of the mesh) and adjust the oscillator trimmer until the station comes in at the correct dial setting. Finally, adjust the trimmer on the antenna section of C1 until stations are received at maximum signal strength.

P.S. How about giving your wife a new pan and using her old one for this project?

END

The Weight of Light

THE weight or mass of light has been shown by Dr. Einstein in his studies of other forms of energy. It is based on the fact that light coming from a distant star is pulled inward as it passes close to the sun. Calculations show that, during every second, the total mass of light and other radiation from the sun amounts to 4,620,000 tons. One percent of this amount will be used up in 150,000,000,000 years.

Turntable Swings Small Radio for Peaking Signal

TWO real advantages are yours with this turntable for midget radios. Placed on it, the radio will swivel at the touch of a finger for tuning from either side of a table. If the set has a built-in loop antenna, another touch swings it to favor the station to which the dial is set. This can often make the difference between good and bad reception.

Dimensions may have to be changed slightly to suit the cabinet. A piece of $\frac{3}{8}$ " composition board cut to fit the bottom of



the receiver is held in place by the chassis screws. Make a plywood base slightly smaller than the radio bottom. Space the pivot and stop pins and three furniture glides to suit. A bolt and nut may be substituted for the pivot pin, but take care that it does not come into contact with the chassis.—*Glenn A. Wagner, Delmar, N. Y.*

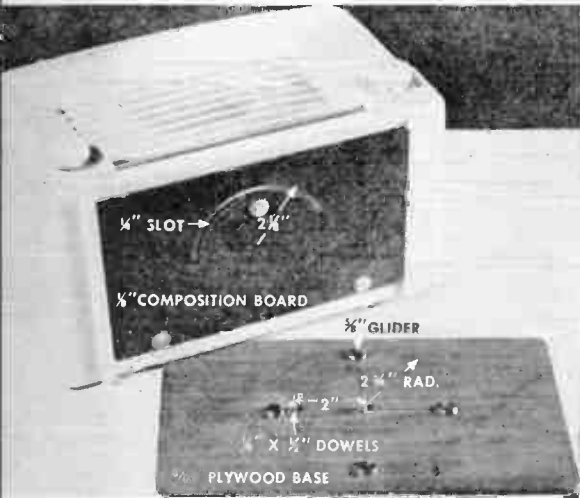

The composition-board plate is fastened to the receiver by the chassis screws. If desired, felt may be glued to the bottom of the base.

The arc slot for the stop pin can be scroll-sawed, or routed as above. A dowel is set in a board clamped beneath to act as a pivot.

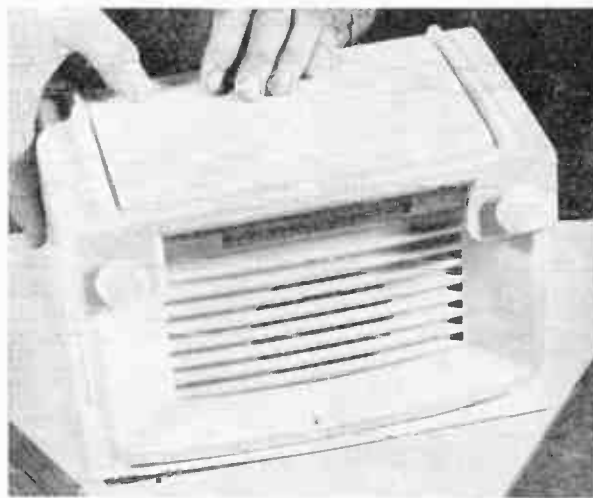

To locate the screw centers, cut a piece of paper the size of the plate, press it down, and transfer the imprinted marks for drilling.

Sand and finish the base before hammering in the $\frac{3}{8}$ " furniture glides. The $\frac{1}{4}$ " by $\frac{3}{8}$ " dowel pins should be glued into holes in the base.

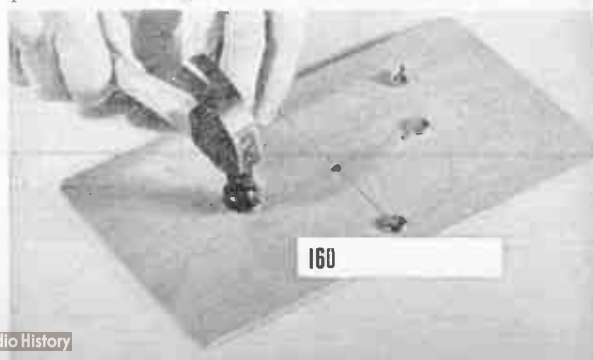
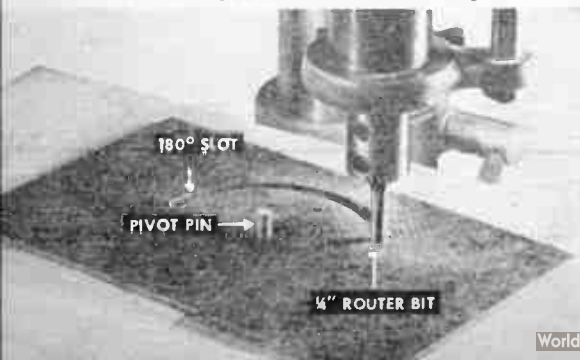

Save Money by Making Your Own Television Cabinet

Cabinets add a chunk to TV prices. Here's how you can economize, whether you're buying or converting.



IF YOU put a larger tube in your TV receiver, as described earlier (pages 69-72), you can make your own cabinet to the right dimensions for far less than a ready-built one would cost.

And if you're still shopping for a TV set, you can save money by buying a kit or wired chassis and putting it in a home-made cabinet. The dimensions given in the drawing below are for an RCA type 630 chassis, but by changing dimensions the same construction can be used for any set.

Checking the Dimensions: Place your set's chassis with mounted picture tube on a flat table. Measure the distance from the table to the highest point on the tube. This plus $2\frac{1}{2}$ " is the inside height of the cabinet. For the height of the front panel add 1" for overlapping the base and an extra $\frac{1}{4}$ " for the top rabbet. To get the outside width of the front panel, measure the chassis at its widest point and add 4". Overall length of the chassis, plus 3" or 4" gives the depth.

Marking the Panel: On most chassis the picture tube is placed in the center, so the front panel has to be marked off symmetrically. Cut a sheet of cardboard to the height and width of the panel and draw a center line from top to bottom. Hold the cardboard against the front of the set with the line bisecting the tube face and press it against the control shafts to mark their position. Without moving the sheet, mark the points where the top and bottom of the tube face cross the center line. These two points represent the top and bottom of the rectangular picture-frame opening.

Constructing the Cabinet: When you have settled on the dimensions, cut out stock to suit. For the base, make a rectangular frame. Use $\frac{3}{4}$ " by $1\frac{1}{2}$ " stock for front and sides. For the rear member use a piece $\frac{1}{2}$ " thick to allow some ventilation from below. Cover the frame with $\frac{1}{4}$ " plywood.

Mount the $\frac{3}{4}$ " by $\frac{3}{4}$ " uprights on the base with long screws and glue. Do the same with the top crosspieces. Then cover it with gum plywood or other veneered stock, and give it a stained or rubbed-lacquer finish.—Bernard Gladstone, Hempstead, N. Y.

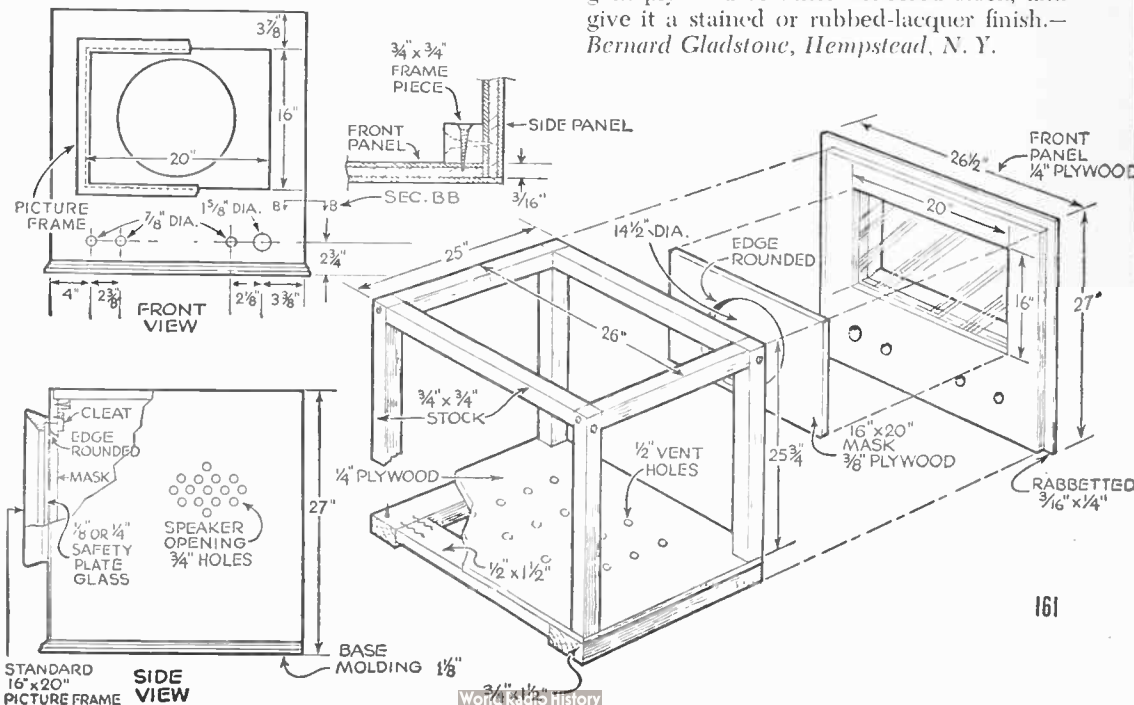

Complete Power Unit Plugs Into Socket on Chassis

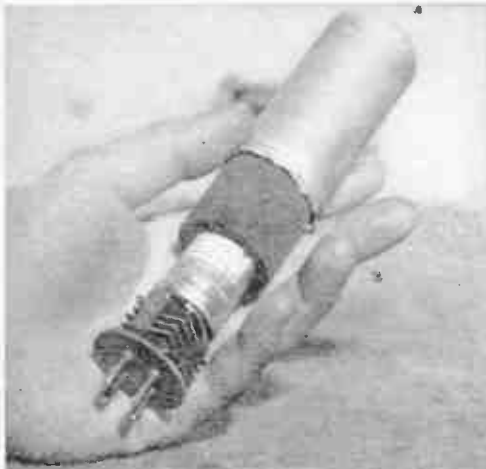

This plug-in power supply can save you space or time or both in your radio-building work. If there isn't room for the parts of a rectifier under a small chassis, you can use this unit to stack them upright on top. It will save you time, too, on experimental work, for you can build one power supply and switch it from chassis to chassis with very little trouble.

The rectifier unit consists of a selenium rectifier, dual electrolytic condensers, and two resistors, mounted inside a discarded vibrator can. The photo shows the arrangement of the selenium disk and condenser. A terminal strip is attached at the point where the two units meet. One lug of the strip is used to anchor the 1,800-ohm resistor; another lug serves as a common ground. The whole unit is wrapped in insulating material before being inserted in the can.

To use the power unit with a small receiver, mount a 4-prong socket on the receiver chassis. Connect pin 2 to the "hot" side of the AC line through a switch, and wire pin 1 to the chassis or other common ground. You can then tap your filtered B-plus voltage (about 110 volts) off pin 4. Should you want a higher, less-filtered voltage for the plate of an output tube, use pin 3. There should be about 140 volts available at this point.—Homer L. Davidson, Ft. Dodge, Iowa.

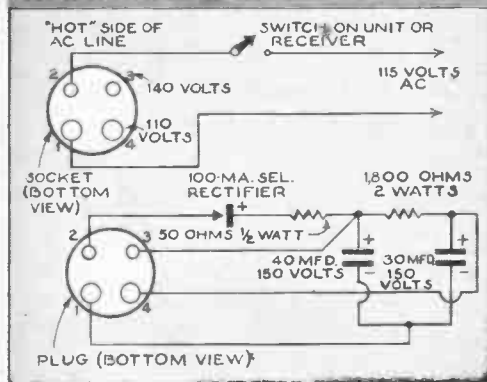

Remote-Control Tractor Runs in Any Direction

A SINGLE lever controls forward, backward, and steering movements in this remote control for toy vehicles. The control and the tractor were built by P. J. Durham, of Kew Gardens, N. Y. The tractor treads are geared to two small universal motors, each having three leads. One is the common

return and the other two connect to opposing field windings and govern direction of rotation. The motors are linked to a home-made switch at the end of the control cable that actuates the appropriate motor windings. The switch, at right below, automatically returns to neutral when released.



Lightning vs. Television

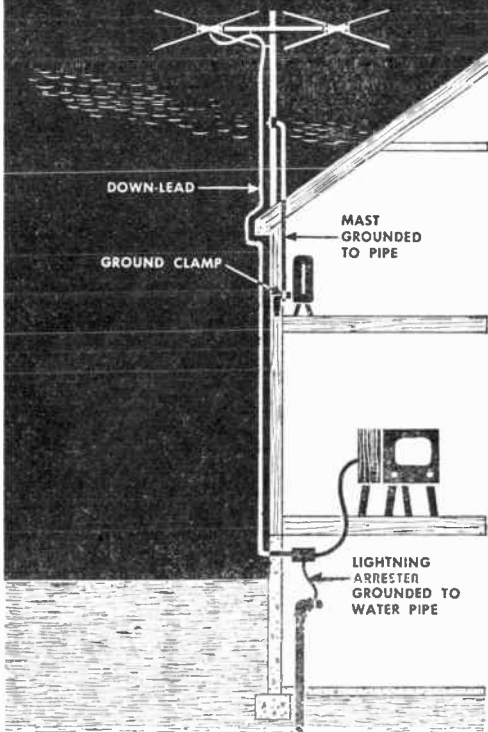

**Does the antenna endanger your home?
Can you install adequate protection?**

MANY POPULAR SCIENCE readers have worried about lightning since putting television antennas on the roofs of their homes. Here are their questions—and the answers:

Should lightning protection be provided when an antenna is put up?

Yes. It costs little, and is required by electrical codes in most communities.

Have many homes been damaged because of a lack of such protection?

No, possibly because TV antennas have been concentrated in cities where tall buildings act as lightning rods. Only fairly recently have TV antennas begun to appear in areas where the lightning hazard is great.

It is difficult, moreover, to determine whether a TV antenna is responsible when lightning does strike.

Should an arrester be used on an antenna mast?

No. The mast should be well connected to a good ground. A water pipe is best.

What about the lead-in?

A lightning arrester should be used with an unshielded ribbon lead-in. When a coaxial cable or shielded down-lead is used, the arrester can be omitted and the shield grounded.

Where should the arrester be put?

At the point where the down-lead enters the house. It may be either inside or outside but should not be near any combustible material. An arrester connected at the mast end of the lead offers no protection against induced charges that hit the wire below.

What kind of arrester should I use?

A double arrester that protects both leads. If you can only get the single type, use one in each lead. Underwriters Laboratories test arresters for safety and proper performance. Look for the UL label.

Can I install an arrester myself?

Yes. Most approved TV arresters are made to fit ribbon lead-in. Just slide the wire in and tighten the screws or nuts as directed. With most types, you do not have to cut the wire or even strip the insulation. The center lead or clamp must be grounded.

Is a vent or soil pipe a good ground?

No. Neither is a fire escape. (Non-conductors are often used at the joints.) But the metal frame of a building, electrical conduit, or any underground piping system is a good ground. If necessary, you can bury metal rods or plates deep in the earth.

What size wire should be used for the ground connection?

Electrical codes specify sizes from No. 14 to No. 4. The heat generated by a lightning bolt will melt almost any wire, but the wire will do its job before it falls apart. Number 14 is adequate. It should be clamped—not looped or soldered—to the ground.

Does an arrester affect a set's operation?

Some arresters may weaken the signal in some cases. Reverse the receiver's AC power plug if this happens.

Should a set be turned off during a storm?

Not unless you're the nervous type. Turning it off may reduce the chances that your set will be damaged, but does not affect an antenna's vulnerability to lightning. **END**

HOME EXPERIMENTS

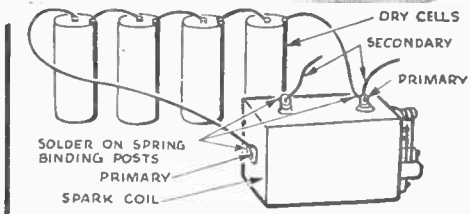
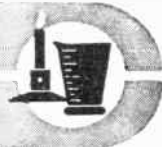

FOUR DRY CELLS connected in series with a spark coil of the type used in the Model T Ford will enable you to perform the experiments on these pages. For convenience, solder a spring-type binding post to each of the three terminals of the coil. As shown at left, one lead of both the primary and secondary goes to the side terminal near the vibrator end.

High-Voltage Fun with a Spark Coil

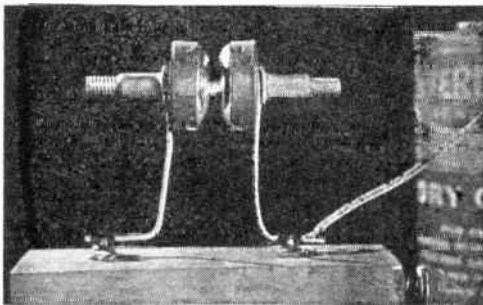

ELECTRIC LIGHTS normally require a closed, or complete, circuit. Yet stand a fluorescent tube on the lone secondary terminal of your coil, supporting it with insulating material; close the primary circuit, and the tube lights dimly even though the secondary is "open". Balance a pie pan on the tube, and it lights still more strongly. Why? In the first case, the charge in the air about the secondary excites the gas in the tube. In the second, the pan intensifies the electrical flow by acting as the plate of a condenser, accumulating a larger charge than the terminal of the tube alone.

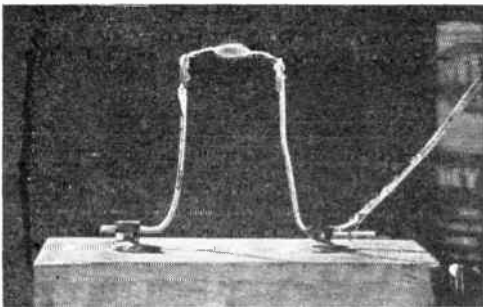

PRODUCTION OF SPARKS is the function of a spark coil. It can do this because, although the input potential is only a few volts, the output of the secondary may be from 10,000 to 15,000 volts, this high voltage permitting the secondary current to jump at least $\frac{1}{2}$ ". The spark length, however, depends on the terminals, as you can show. First improvise a spark gap with sharp points, drawing them apart (with the current off!) until you get the longest possible spark. Substitute metal silence domes for furniture (as above), and the spark will jump only a fraction as far. The reason? In the case of the points, the charge is concentrated right at these points. When the surface is large, the pressure density is less.

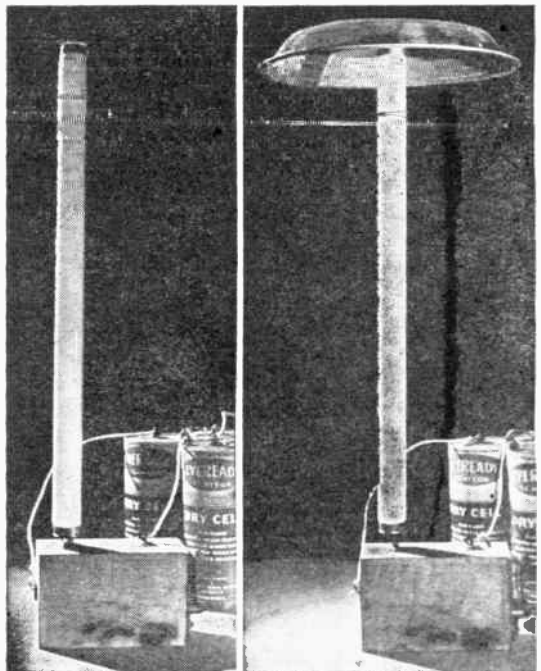

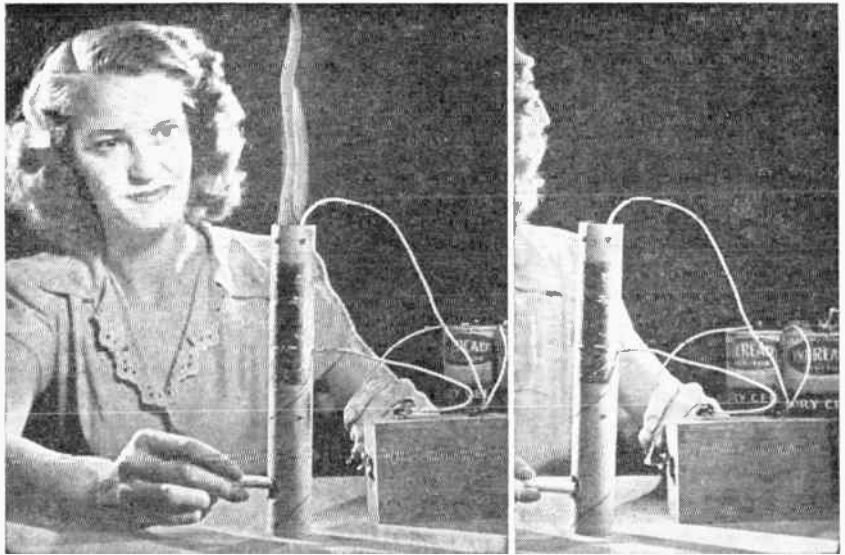
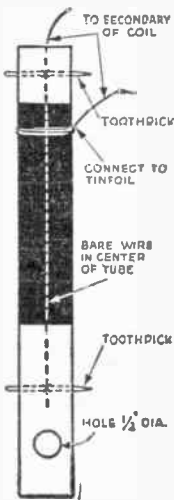

SMOKE IS REDUCED in many cities through use of Cottrell precipitators in industrial plants. The diagram above indicates how you can rig up a working model of such a precipitator with a mailing tube and a piece of tin foil. When the setup is ready, thrust a lighted cigarette or incense stick into the

hole in the tube. Smoke will pour from the top. Connect the primary circuit of your spark coil, as at the right, and the smoke will stop. Although nothing visible happens within the tube, the high-voltage electrical field set up inside causes the smoke particles to clump together and fall to the bottom.



PRACTICAL JOKERS might try this idea. Over the single secondary terminal of the spark coil invert a metal ash tray with tin foil underneath to make an electrical connection. Place a cigarette paper on the tray and, with the current on, move a wire from the other secondary terminal back and forth above the paper, not quite touching it. Invisible sparks will perforate the paper with hundreds of microscopic holes. Try to smoke a cigarette made of it. You'll find it impossible.

HERE'S A TRICK to mystify your friends. Place a fluorescent tube on a table covered with a cloth. At your command, the tube will light or go out—as often as you wish. Before your performance, however, set the stage by placing two strips of tin foil under the cloth and connecting them to the secondary terminals of your spark coil, concealed under the table. Operate the coil with a concealed push-button switch. The tube must be placed with the terminals over the tin foil as shown in the drawing below.



Electric Bell Provides Steady Alarm to Rouse Sound Sleepers

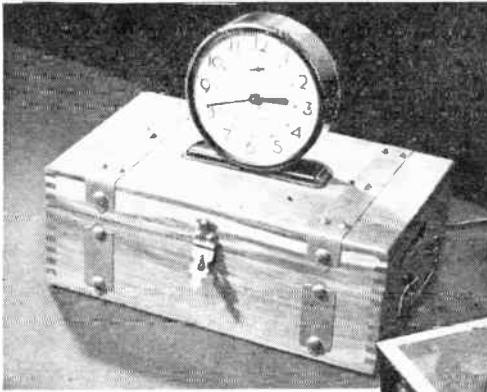

If your wind-up alarm clock runs through its short tinkle without disturbing your slumber, try using this electric bell that will keep on ringing until you disconnect it. It employs a door-bell transformer and bell, housed in any decorative box that blends with the bedroom furniture.

Drill the alarm-wind key for a string tied to a small rod. A spring mounted along one edge of the box acts as the moving contact, while the other connection is carried to a screw head placed beneath the free end of the spring. Bend the last turn of spring wire flat and fill

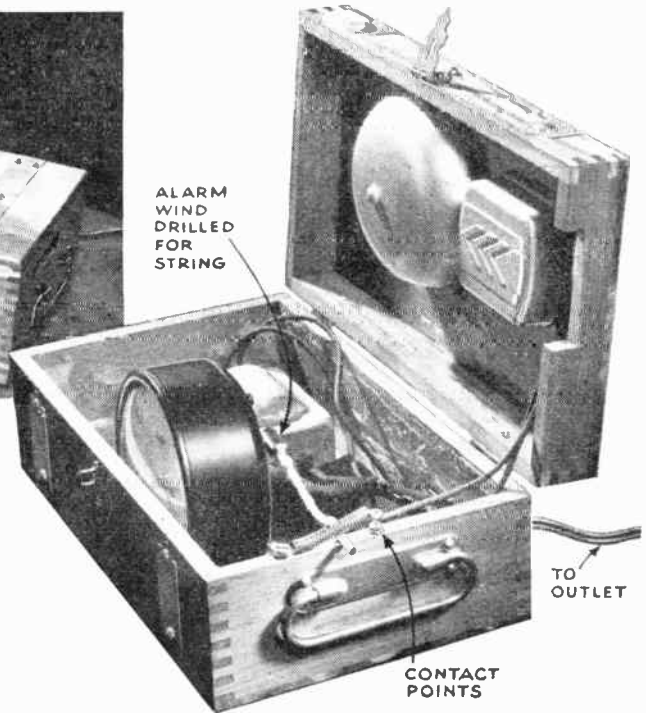

it with solder. When the clock goes off, the unwinding key pulls the rod from under the spring and starts the bell jangling. The contacts can be placed on a ledge inside the box if you'd rather not notch the edge.

Flush-Tank Guide Forms Handy Detachable Ground Connection

WHEN it is desirable to install a pipe ground clamp from which the wire can be readily detached, a rod guide of the type used in toilet flush tanks may be made to serve. To install it, clamp the body of the guide to the pipe, and solder the ground wire into the detachable arm as shown. The arm is then inserted in the guide socket and locked in place with the set-screw. This arrangement will be found particularly convenient in hard-to-reach places when the wire must be removable.

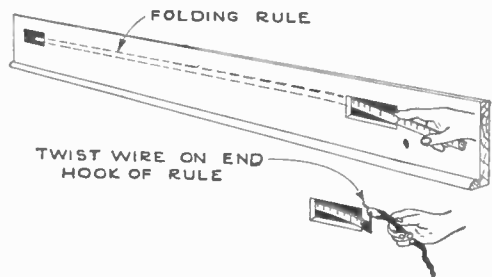
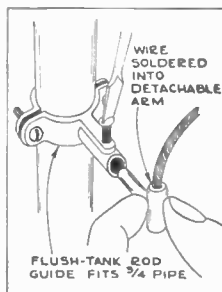

Wire Fished with Folding Rule

SHORT wire-fishing jobs encountered when installing horizontal wiring in studless partitions and behind built-in cabinets can be done with a folding carpenter's rule, as shown above. Rigid enough to support itself horizontally, yet flexible enough to snake around obstructions, a rule often proves more controllable than conventional fishing wire or ordinary cable.—J. MODROCH.

Is Foreign Radio Equal to Ours?

CAPTURED GERMAN SETS, THOUGH GOOD, ARE BEHIND OURS, WHILE JAP EQUIPMENT DATES BACK FARTHER

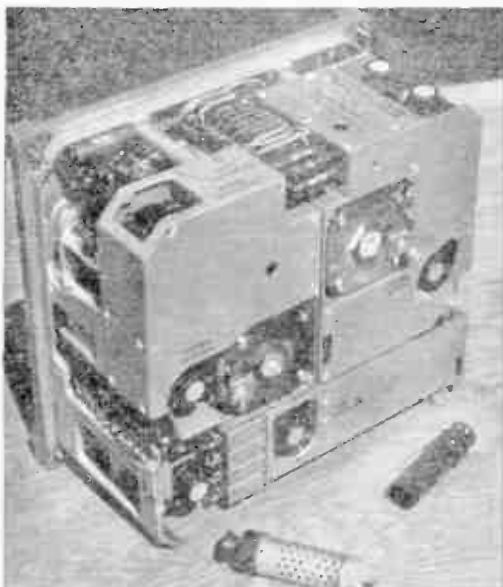

Above is a German superheterodyne tank receiver. It has a range of 27.2 to 33.4 megacycles, and uses a dynamotor that draws 4 amps. from a 12-volt battery

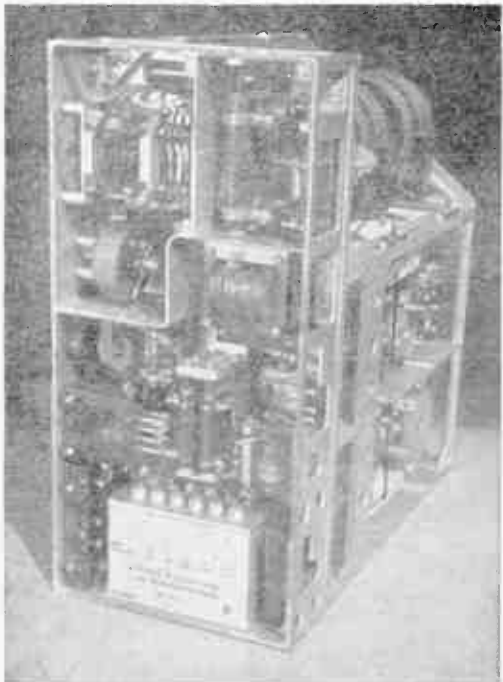

U. S. ARMY Signal Corps representatives have had the opportunity to study and test a wealth of captured German and Japanese radior equipment. The results of their investigations are of real interest to all radio listeners and especially to hams.

In general, they have found German sets to be five years behind our own and Japanese design and construction to be nearly 15 years old when judged by our own standards.

The German sets are well built, but lack waterproofing and dustproofing. They suffer from obviously critical shortages of steel, copper, zinc, mica, quartz, and phenolic resin. Copper and copper alloys are used solely for contact springs, terminals, and other pieces in which low resistance is a prime requisite. When mica is used, it is usually brown and definitely of an inferior grade.

Despite the shortage of quartz, it is employed in an interesting manner in one German transmitter. This set has a frequency-calibration checking device that consists of a tiny bar of quartz in a gas-filled glass container. When the crystal is excited at its resonant frequency, the gas lights up. If this glow does not appear at a pre-established reference point,

German 5-watt tank transmitter. A self-excited oscillator with a single-tube final amplifier, operating on 12 volts with a drain of 7.2 amp.

Below, the German dynamotor that supplies power to the tank transmitter. It turns at 3,000 r.p.m.



the trimming condensers are manipulated until it does.

The shortage of phenolic resin is most apparent when laminated-plastic resistor and condenser mounting strips are used. Because the bond applied between the laminations is not waterproof, as is phenolic resin, the laminations separate when damp.

Aluminum and magnesium alloys, nickel, and tin are used extensively. Plywood and hard fiberboard, covered on both sides with thin sheets of metal, usually aluminum, are utilized for panels, side walls, and covers.

Instead of mica in ordinary condensers, a resin-impregnated paper is used; in compression-type trimming condensers, a silvered ceramic material is employed.

Tube shields are made of various materials. The best of them are constructed of extruded aluminum or hot-worked magnesium. Others consist of a molded substance on which a thin layer of metal has been sprayed. The worst-protected tubes have shields that are simply layers of metal sprayed directly on the tubes themselves.

All the parts are marked with terminal numbers to facilitate replacement. The wiring is small and neatly cabled. Dials are well machined and accurate. There is little backlash. All the sets are designed for mass production.

Many of the parts used in Japanese sets are copies of equipment sold on the American distress markets back in 1930. Their nonwatertight cabinets have frames made of wood. The coil frames are also wood, or molded mud, even in equipment operating up to 90 megacycles. Most of the transformers are unpotted. Crystals, however, are usually well designed. They are accurately ground and are set in carefully molded holders. Nameplates are often made of sheet ivory with the lettering cut and blackened in the conventional manner.

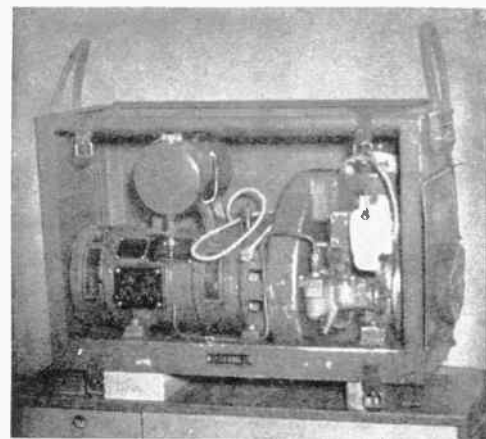
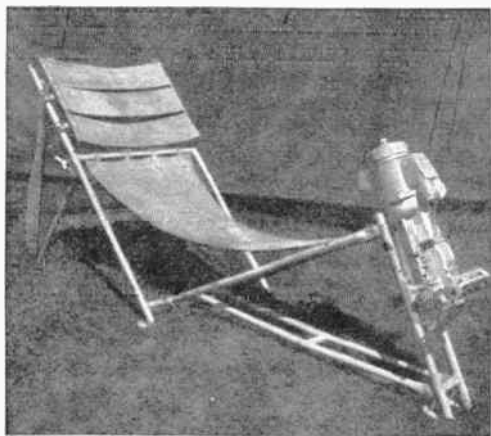

Jap portable gasoline-engine power-supply unit. An exception to the usually poor Jap equipment, it weighs only 103 pounds and delivers 914 watts

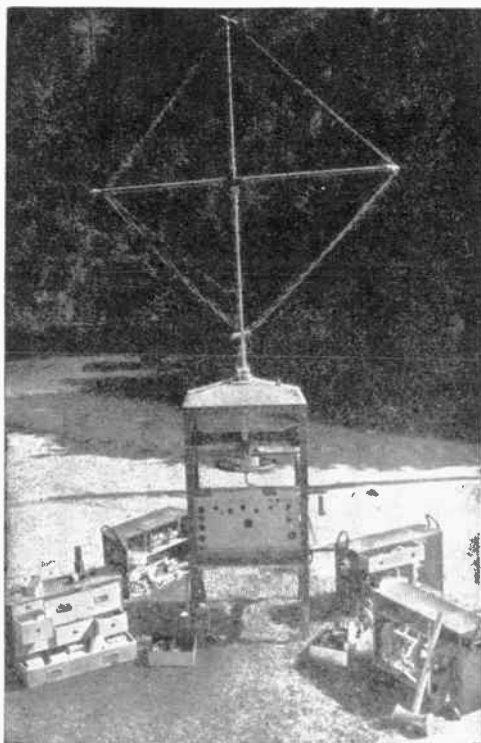

Jap direction finder and intercept receiver. Range: 100 to 2,000 kc. Employing a heterodyne detector, three stages of R.F. amplification, and two stages of audio amplification, it is comparable to the American sets of the 1925 to 1930 period. The loop antenna consists of six unshielded turns and has approximately 16 sq. ft. of projected surface area

Italian pedal generator, called Lawn Chair Mark I by Americans. It is driven by two bicycle pedals while the operator reclines in the canvas chair

Servicing Your Radio

COLOR coding is being employed increasingly by manufacturers of a variety of radio parts as a help to both the professional and the home serviceman in distinguishing the various values of equipment. Dial lamps, battery cables, line cords, and condensers are some of the accessories that are being so identified.

Several types of dial lamps are manufactured to meet the filament-voltage requirements of different sets. In color-coded bulbs, the beads on which the filament is mounted now come in four hues—brown, blue, pink, and white. A dial lamp with a brown bead is rated at 6.3 volts and 0.15 amp., and is employed in sets having tubes of similar rating, such as the 12SQ7-GT/G diode triode. A blue bead indicates that the filament voltage of the dial lamp is 6.3 volts and 0.25 amp. for use in sets having 6.3-volt, 0.3-amp. tubes. White is used for lamps of 2.5 volts and 0.5 amp., while a pink bead identifies lamps of 2 volts and 0.6 amp. for battery sets.

Many battery and three-way portable sets have a color-coded battery cable that will tell the serviceman immediately what wire should be connected to which battery in case instructions are lost or a battery plug is broken. The red wire is usually A+; the black wire, A-; the blue wire, B+ maximum; the yellow one, B-; the white, B+ intermediate (22½ or 45 volts); the brown, C+; and the green, C-. They leave no need for guesswork.

There is a special color code employed for identifying the resistance value in line cords used in A.C.-D.C. receivers. As a rule, these line-cord resistors have three wires, one red and one black, and a third wire that is the color-coded resistor wire. In this code yellow means 135 ohms; blue, 160 ohms; white, 180 ohms; green, 200 ohms; light brown, 220 ohms; orange, 260 ohms; grey, 290 ohms; maroon, 315 ohms; and dark brown, 360 ohms. However, if the value is stamped on the plug, the color code does not apply.

Some manufacturers use voltage-coded paper tubular condensers in their sets. A colored band denoting working voltage is placed around one end of such condensers. For example, a brown band denotes a D.C.-voltage rating of 100 volts. Other ratings are represented as follows: red, 200 volts; orange, 300 volts; yellow, 400 volts; green, 500 volts; and blue, 600 volts. No matter which way a condenser may be turned in a

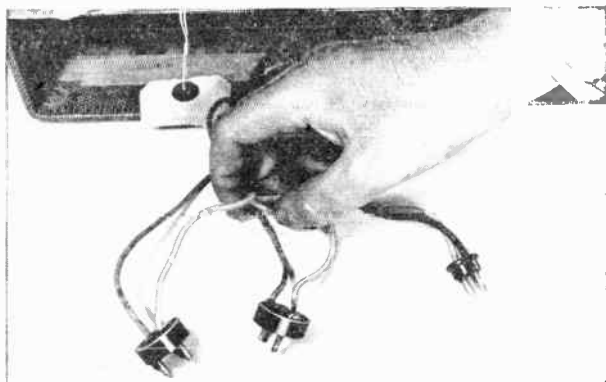

Color reveals the right connections for these battery cables

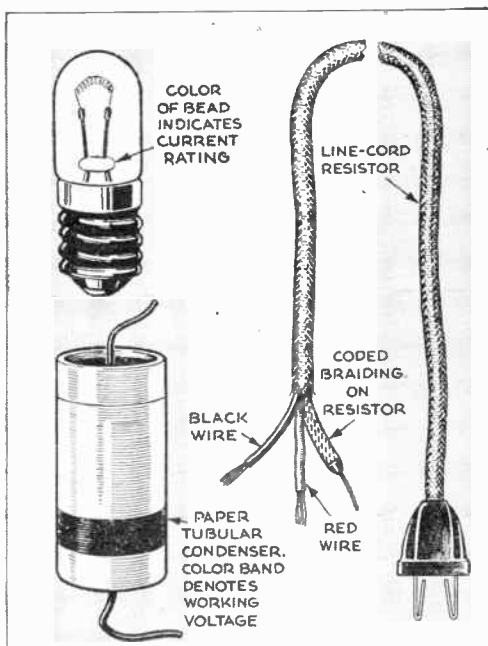

The voltage of the dial lamp is shown by the color of its bead, and color also tells the value of the resistor wire in the cord. Bands mark condensers

receiver, this method of coding with a colored band provides instant identification of its D.C.-voltage rating.

A color code is also used by several manufacturers of phonograph motors to designate the A.C. cycle for which they were designed. If, for instance, a motor is built for use on 25 cycles, the manufacturer usually places a white spot somewhere on the frame. The frame of a motor built for 50 cycles is marked with a green spot. No marking is used on 60-cycle phonograph motors.

Automatic Time Switch

CLOCK-DRIVEN DRUM CAN BE SET TO CONTROL ALMOST

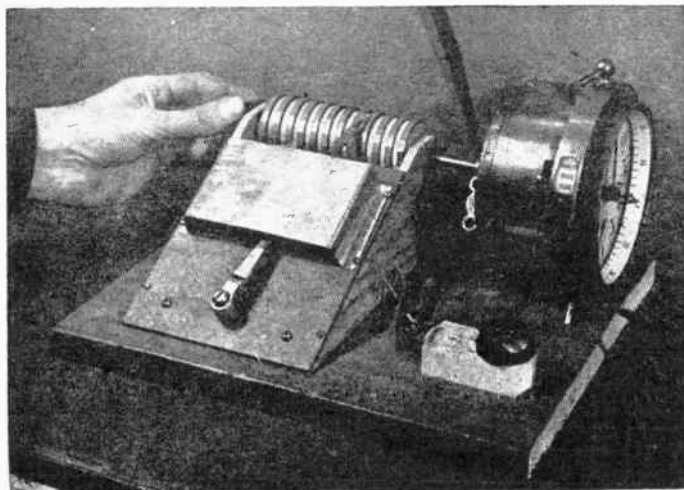

two layers thick, are glued around the drum in a spiral, as in Fig. 1. For 12-hour operation, they should be $3/32$ " or $1/8$ " wide for a drum of this size, and the groove between them should be the same width. A better job can be done in a lathe with wood, metal, or plastic by cutting coarse-pitch square or V threads. It is possible in this way to make a highly accurate drum that will operate 24 hours or more.

Mount the drum and clock on a base, as shown in the photos, with the time-setting knob and drum shaft in line. A simple coupling,

made as shown in the drawing and in Fig. 2, joins the knob to the shaft. Be sure the drum turns without much resistance, or the clock will stall.

A windshield-wiper arm having a built-in pressure spring makes an ideal lever, or one may be fashioned from a strip of metal or even wood. Arrange some kind of spring so the free end will be forced down against the drum. At this end rivet a short pin that will slide easily along the drum groove without too much side play (Fig. 2).

The contact brush is a piece of thin, springy brass or bronze bent once around the lever, insulated from it by a layer of mica or other nonconductor, and projecting $3/4$ ", as show in Fig. 3 and in the drawing.

Strips wound side by side on the drum will make a perfect spiral groove if one is glued on and the other is used as a spacer. Glue another strip on top for double thickness and finish with lacquer

FROM an alarm clock, a small drum, the arm of a discarded windshield wiper, and a few other odds and ends, you can construct a time switch for turning on and off a radio, poultry-house lights, a feed release for poultry or household pets, garage or barn lights, a window ventilator, an electric cooker, an electric sign, store-window lamps, or shop machinery. It will also operate relays to control heavy currents and high voltages.

The switch mechanism consists essentially of a grooved drum rotated, at one revolution per hour, by the time-setting knob of an ordinary alarm clock. Riding on the drum is a pin on the end of an automobile windshield-wiper arm or a similar lever about $6\frac{1}{2}$ " long. Attached to the lever is a spring-metal brush that moves across electrical contacts mounted on a composition-board panel with the lever. Two or more sets of contacts may be used, controlling in sequence more than one operation or circuit. Thus the device could be arranged to open the furnace draft at 6:00 A.M., turn on the coffee percolator at 6:30, and at 6:45 switch on the radio to awaken you!

A cylindrical wooden box $1\frac{3}{4}$ " to 2" in diameter and 4" to 5" long will make an adequate drum. Glue the lid on and drill it and the bottom in the exact center to receive a $1/4$ " by 7" rod that forms the shaft. A staple, run through a hole in the shaft and driven into the drum, serves to connect the two together. Strips of thin cardboard,

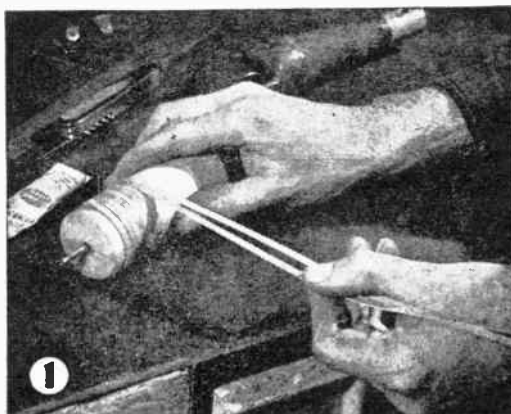

Has Scores of Uses

ANYTHING ELECTRICAL IN THE HOME OR ON THE FARM

This projection is split for $\frac{1}{2}$ " to form two fingers that can be bent to press firmly against the panel. The brush is held to the lever by a C-shaped clamp made from sheet metal.

Cut the contacts from thin brass, bronze, or tin-can stock, and bolt them to the panel. Figure 3 shows only one set, but you can mount several pairs to control additional circuits, and you can also fasten more than one brush to the lever for handling still more circuits. The contacts in Fig. 3 are slotted so they can be shifted to vary the timing. By moving the lower contact to the left, the turn-on time is put ahead; by moving the top contact to the right, the turn-off time is set back. The wiring diagram for the circuit is given in the drawing.

A removable shield installed over the panel will prevent accidental touching of the live parts of the mechanism. One made of wire screening will allow you to see the contacts and brush.

To put the timer into operation, set the clock minute hand to the fraction of the hour the circuit is to be closed; then place the lever pin in a groove far enough from the end to permit sufficient "on" time after the circuit is closed, and adjust the contacts so the brush will just touch them at this point. For exact timing, loosen one

of the setscrews in the coupling and, with a lamp plugged into the convenience outlet, turn the drum until the lamp lights; then tighten the setscrew. After these adjustments, the clock is set for the correct time and allowed to run normally. Then to set the timer so it will close the circuit after a definite interval, say five hours, move the lever pin five spaces (grooves) from the clock toward the starting end of the revolving drum.

When the current draw is heavy, such as that for an electric roaster or a large motor, the switch circuit should not be connected directly. It is much safer to have it control a low-voltage relay that in turn handles the heavy-current circuit.

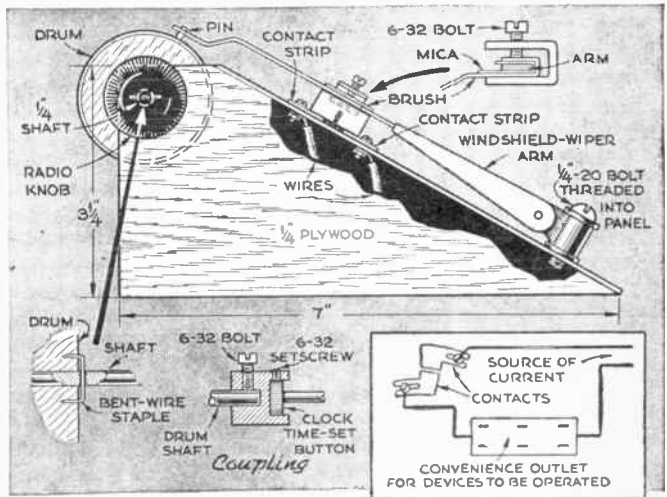

Joined to a shaft by a simple coupling, the time-setting knob turns the drum at one revolution per hour. As a pin slides in the groove, a lever to which it is attached is in turn moved slowly across the face of the contact panel

Here are the contacts on the time-switch panel. The brush on the lever arm closes the circuit when it touches both contacts and opens it again when contact is broken

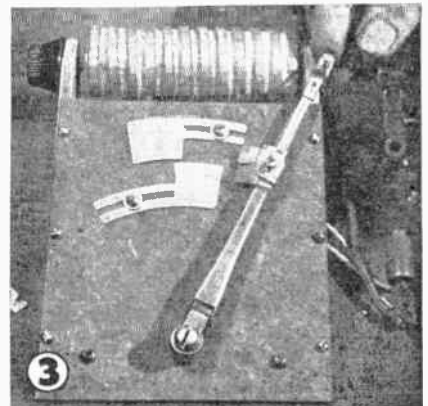
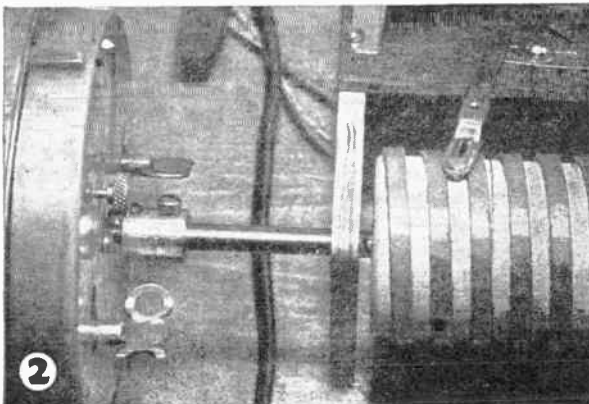



This loudspeaker takes the place of a kitchen radio. You can build it yourself for a lot less than the cost of a separate receiver.

How to Double the Usefulness of Your Radio

Listen to records or your favorite programs while you work. And if your shop gets noisy, just turn the volume up.

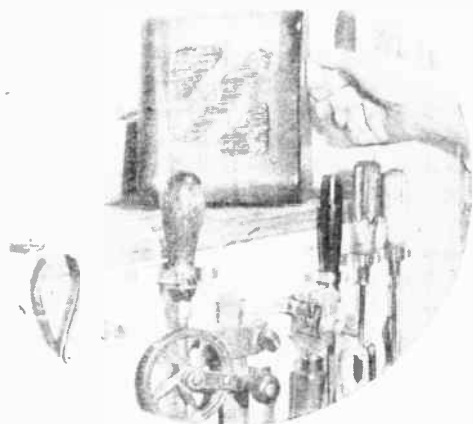

An inexpensive extension speaker with its own volume control will make one set serve as two.

By Henry C. Martin

WOULD you like an extra radio for your workshop, kitchen, den, basement, bedroom, or attic? Here's an easy, inexpensive device to make your present receiver work in two places at once.

It's an extension speaker with a built-in amplifier that allows you to control volume independently of the master set. If your shop is noisy, you can turn this speaker up without boosting volume at the radio.

You're not limited to radio programs, either, for you can put a stack of records on your upstairs phonograph and let the extension unit play them to you in the basement. The remote amplifier is connected to the main set by low-voltage, two-conductor wire and can be as much as 150 feet away.

Small Space Required

The simple one-tube amplifier fits easily on a flat sheet of aluminum measuring $3\frac{1}{2}$ " by $5\frac{1}{2}$ ". You can bolt the chassis to the frame of the speaker and mount the entire unit in a small speaker cabinet.

Tapped off the voice coil of the master set, the signal is fed to an intercom transformer. One with a 4-ohm primary winding is specified in the parts list because this impedance provides a fairly close match for the voice-coil impedance of most radio speakers. In wiring the transformer, make sure that both the primary lead and input terminals are well insulated from the chassis.

A volume control across the transformer secondary effectively regulates the signal voltage reaching the grid of the 117N7 pentode. The signal is amplified by the tube and then piped to an output transformer that matches it to a small loudspeaker.

Consider the Cost

Note the term "small loudspeaker." This amplifier has about the same tone and volume as an AC-DC radio, which means that it's good but not in the high-fidelity class.

There's no point, therefore, in using an expensive speaker. When you go shopping for one, look closely at the price tag. You should be able to buy a unit like the one in the pictures here for \$2 or less, complete with output transformer. Pick a transformer that has a 2,500 to 3,000-ohm primary.

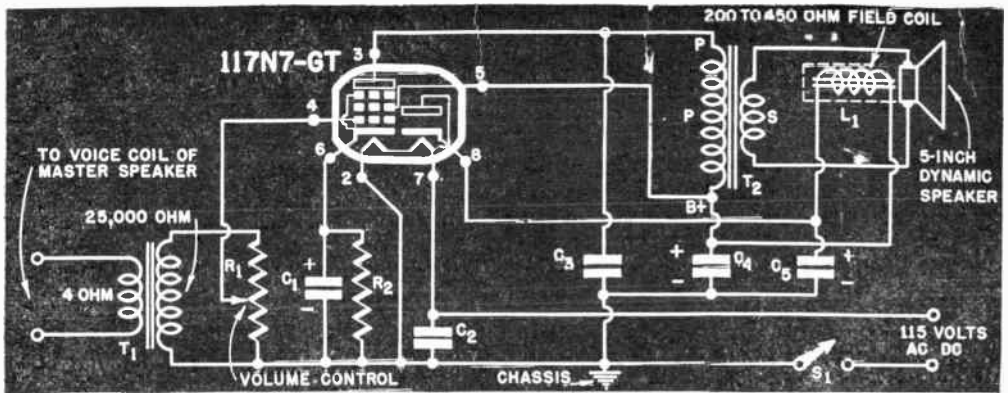

LIST OF PARTS

R1: 500,000-ohm volume control,
 R2: 270-ohm, 1/2-watt carbon,
 C1: 10-mfd., 25-volt electrolytic,
 C2: .01-mfd., 100-volt paper,
 C3: .006-mfd., 100-volt paper.

C4, C5: 20-20-mfd., 150-volt
 dual electrolytic.
 T1: Intercom transformer, 4-ohm
 primary, 25,000-ohm secondary,
 T2: Output trans. to match 3,000-

ohm load to speaker voice coil.
 L1: 450-ohm field coil on dy-
 namic speaker.
 S1: SPST switch on R1
 Speaker, 117N7, and socket.

Also, try to get an electrodynamic speaker with a field coil rated at about 450 ohms. A field-coil speaker saves you a little extra money since the coil doubles as a filter choke. If you already have a speaker of the permanent-magnet type in your scrap box, use it by all means. But don't forget to wire in a separate choke coil in place of L1.

The use of the 117N7 in this amplifier is another economy step. Because it has a 117-volt heater, the tube operates right off the power line and needs no filament transformer. It contains a rectifier diode in addition to the amplifier pentode.

You should find it an easy job to wire up the dozen parts that go into this amplifier speaker. Once you have it assembled, you

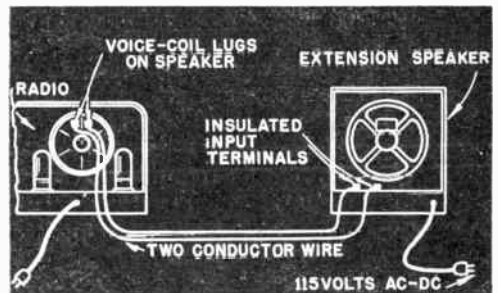

are ready to connect it to a radio—any radio. Tune in the radio and set the volume at any point from a whisper to full throttle. You can then adjust listening volume at a remote speaker to any level you like. **END**

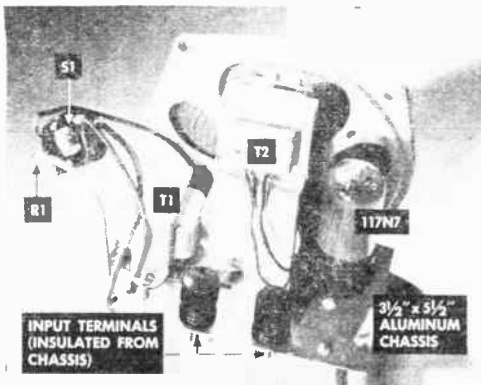

Most speakers have suitable holes, so the small chassis can be screwed directly to the frame. The complete unit fits in a speaker cabinet.

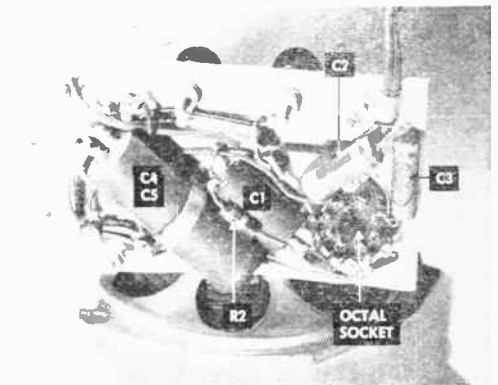

Bottom view shows simple, flat arrangement of the parts. Even a beginner should find it easy to wire this one-tube circuit.



F. M. WALKIE-TALKIES developed by the U. S. Army Signal Corps triple the range of the Army's older man-packed radios and have the clarity of tone and static-free transmission and reception associated with frequency modulation. Improved superheterodyne operation facilitates use of two or more sets on the same frequency for intercommunication, while miniature tubes add to compactness and increase battery life.

Both a headset and handset are used with the F.M. walkie-talkie so two can listen in. There are also two types of antennas

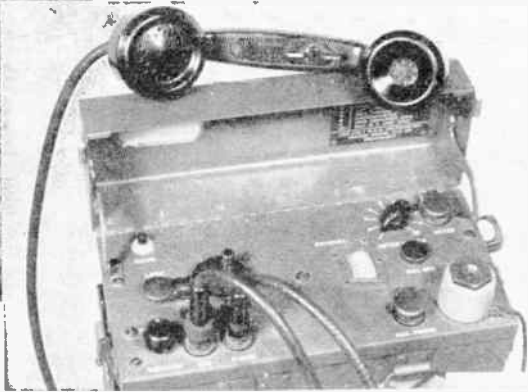

LINE-CORD RESISTORS can be replaced by standard plug-in ballast tubes with the use of a new resistance-cord adapter now on the market. The adapter, shown below, is mounted either inside or outside the cabinet, and its leads, color-coded the same as those of the old cord, are soldered to the connections of those being removed. A ballast tube of the proper voltage drop is then plugged in. Four types of adapters will replace all the resistance power cords now in use.

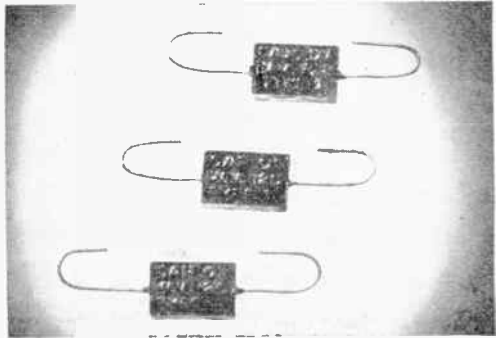

MIDGET PAPER CONDENSERS now come in a new and smaller size for use with modern compact battery equipment or in other circuits where D.C. does not exceed 120 volts. These tiny condensers, shown about half size above, are available in the customary capacities up to .01 mmfd. They are made of paper and aluminum foil, impregnated with transformer oil, then molded in a casing, normalized, heat treated, and vacuum-impregnated at high temperature.



Only visible change in TV set to which the new DuMont tuner has been added is replacement of dial above by one at right. Its outer band is used for TV and its inner band for FM.

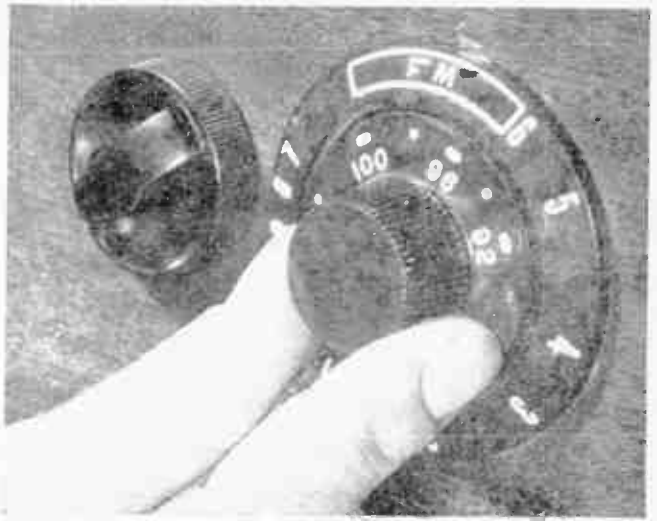

New Tuner Adds Radio To TV

You can put in this tuner and hear FM broadcasts on a video receiver. And pictures will come in better, too.

By Robert Gorman

A MILLION or more of the TV receivers now in American homes can be converted so that they can be also used as FM radio receivers. The original tuners in many of these sets are becoming worn. They can be replaced with newly available "front ends" that both bring in FM broadcasts and improve the reception of TV pictures.

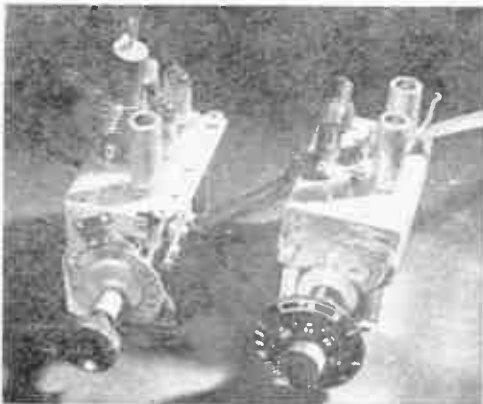

Switch-type tuner (left) used in many TV sets and the new Inputuner (right) are both physically and electrically interchangeable.

These units, the latest in the line of DuMont Inputuners, can be substituted for the switch-type tuners in most of the RCA 630-TS circuits found in about 20 different makes of sets. They can also be put into many other TV receivers that have separate intermediate-frequency circuits for pictures and sound. But they aren't recommended for sets that have "single channel," sometimes called "intercarrier," sound systems.

How about your set? To see whether the new tuner could be used in your set, first compare its dimensions (given on the next page) with those of your present tuner. Then consult the manufacturer's service manual. If your receiver has an intercarrier sound system, you will not find more than one sound IF stage on the diagram, but if it is a dual-channel receiver the diagram will show two, three, or more tubes labeled "sound" or "audio" IF.

Another important item is the sound IF frequency. Various ones have been used in different sets. Replacement Inputuners are made for two of the most common IF sound frequencies: 21.25 and 21.75 mc.

How it's installed. Installation of a new tuner is not difficult. Remove the chassis and loosen the screws that hold the old tuner in place. Snip off the flat ribbon lead-in wire that runs to the tuner from the antenna-input terminals.

Turn the chassis over and trace, with the

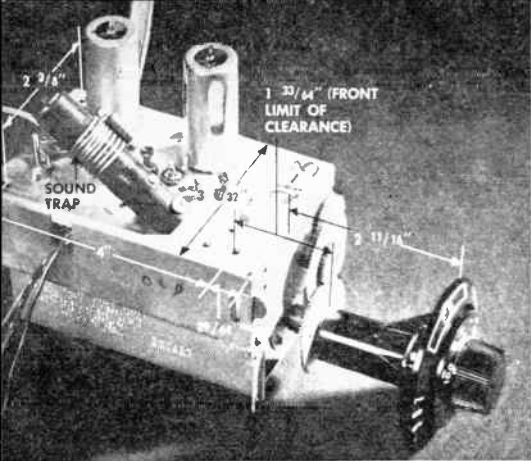

Check these dimensions against corresponding ones on your present set and tuner. Some models of the new unit do not have sound take-off trap.

help of your diagram, the five leads that connect the tuner to the other circuits. Note where each wire ends and then unsolder the lead. If you can't reach it with a soldering iron, snip the lead, leaving an inch or so of wire. You'll then be able to splice a new wire to the old one.

One lead goes to B-plus, another feeds the 6.3-volt heaters, and a third connects to the grid of the first sound IF amplifier. A

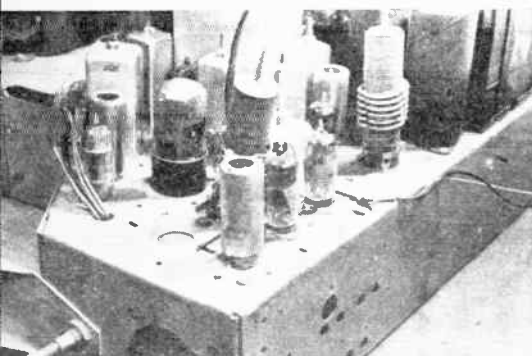

Tuner sub-chassis is bolted to cut-out in main chassis. Before removing unit, identify wires coming from it with aid of circuit diagram.

Slight adjustment must be made to peak the video and sound. Adjustment points are grid coil, shown, and movable slug in sound trap.



bare wire coming through the back of the tuner goes to the grid of the first video IF tube. It must be kept short. A fifth wire is supposed to feed into the AGC (automatic gain control) circuit. Some sets, including the original versions of the 630, do not have AGC. The procedure, however, is the same; just substitute this lead for the fifth connection of the original tuner. In the 630 it goes to the diode plates of the first audio amplifier, a 6AT6.

When you've restored the twin-lead connections to the antenna terminals, you are ready to tune in your new TV-FM combination. Replace and connect the picture tube and adjust the ion-trap magnet for the brightest raster (scanning lines at an unoccupied channel). Make sure that there are no shadows at the corners of the raster.

Final adjustments. You should get good picture and sound immediately, but a couple of touch-up adjustments may sharpen them both. The alignment points are the grid-coil adjustment (see photo) and the slug in the sound trap. Undoubtedly the best way is to align them with a signal generator and a vacuum-tube voltmeter, but it should be possible to peak them pretty well by turning the adjustment screws and looking and listening very carefully. Don't touch any of the other slugs.

And don't be satisfied with pictures that are only just as good as before. This tuner has about twice the gain—especially on the high channels—of the models it replaces. It also should do a better job of rejecting unwanted signals. END

Shoptalk

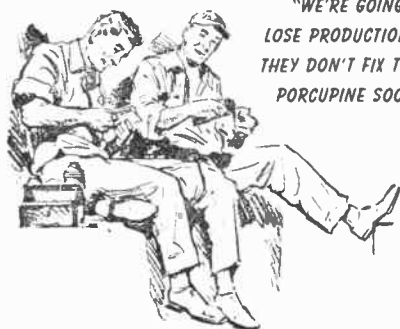

What are they talking about?

Where do they work? Answer below.

They're steel workers. A porcupine is a revolving cylindrical rack for cooling and inspecting galvanized sheet steel.

PORTABLE INTERPHONES are being used to speed installations, riveting, and assembly in plane, ship, and other vital construction. These instruments, provided with either conventional or throat-type microphones, enable a mechanic working in one part of a plane to communicate with members of his crew in other compartments to coordinate the installation and testing of equipment. A bucker and riveter on opposite sides of a huge fuselage or wing skin can exchange information without hammer signals that might endanger the fabric. The phones were originally developed for flight training.

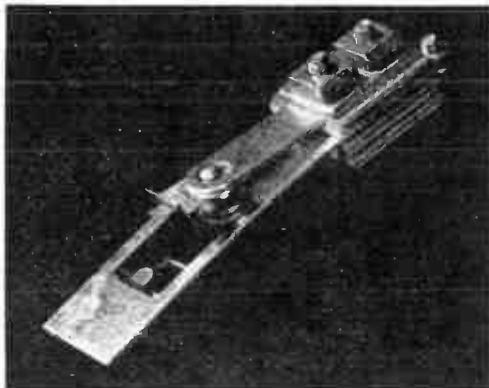

SPEEDY CONTACT with light operating pressure is obtained with the new open-blade snap-action switch shown at left. It is designed for machine-tool control devices, aircraft landing-gear controls, and other applications, including relays and contactors. Positive snap action is produced by a fast rolling spring that minimizes contact burning. The switch is rated at 15 amp. on 125-volt A.C. Types are single pole, single and double throw, and set and return.

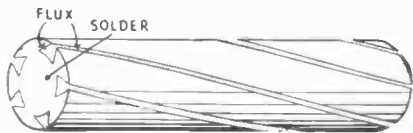

NEW TYPE OF WIRE SOLDER WITH FLUX IN GROOVES

FLUXED WIRE SOLDER containing flux in longitudinal grooves instead of in the core is now on the market. Being on the outside, the flux liquefies and flows onto the work before the solder itself melts, thus, according to the manufacturers, insuring a thorough fluxing of the work for a strong joint. The inconvenience of breaks in the flux is avoided since there are several lines of flux, and a gap in one would be offset by the others. Diameters are standard.

WIRES CAN BE SPLICED quickly and neatly without the use of solder by joining the two terminals shown in the photos at the right. The two parts are identical. A crimped end slips over and grips the end of the wire; then the coupling itself is made with a knife-switch wiping action, as shown, providing contact at four points. The joint can then be protected by an insulation sleeve slipped on readily. Now used in plane installations, the product has many other important uses.

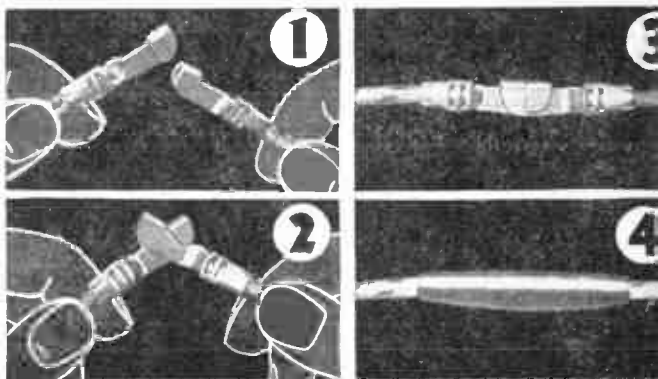

SENSITIVE HIGH-TEMPERATURE

WILL CONTROL AN ELECTRIC TEMPERING FURNACE

A **HOMEMADE** thermostat that is able to hold an electrical tempering furnace within a few degrees of a selected temperature may be readily built from old auto parts and other scrap. The key part of the device is a bimetallic strip cut from a junked car thermostat. Mounted at the lower end of a pipe projecting into the furnace, this strip actuates a rod running through the pipe, opening or closing the heating circuit by moving an automobile breaker-point arm. The device is adapted for use in a resistance furnace, up to about 1,000 deg.

The thermostatic spiral spring, obtainable in most junk yards, should be of the kind used in manifold dampers or automatic choke controls rather than in cooling systems. Snip off a piece about 3½" long and bend in a U shape with one arm longer than the other; then insert the piece for a moment in a gas flame to make certain that it has been bent in such a way that heat causes the arms to move together. Rivet or bolt the shorter arm to a large washer that is mounted between two nuts at the end of a ¼" brass or iron pipe. The free end of the bimetallic strip should center under the pipe opening. A sheet-metal shield may be placed

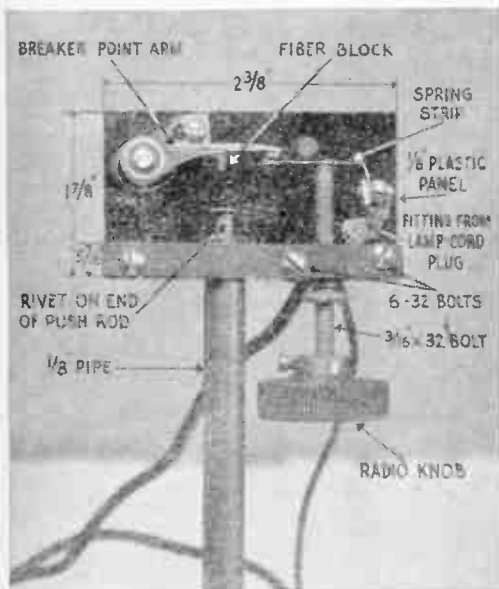

The bimetallic strip, cut from a thermostatic manifold control in a junked car, is pictured above, while the photo below shows the way it is mounted. At the left below, the operation of the device is indicated schematically. Directly at left is the circuit-breaking mechanism

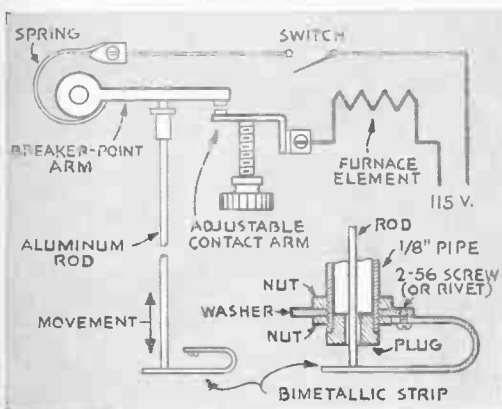

THERMOSTAT

WITHIN CLOSE LIMITS

around the strip to protect it from bumps.

The circuit-breaking unit, which is mounted at the upper end of the pipe, consists of a small plastic panel fitted with an adjustable contact and a breaker arm taken from an auto distributor. The arm is attached so that its fiber bearing surface is directly over the pipe center and its contact point over the adjustable contact. Along the lower edge of the panel, bolt on a plastic strip that is tapped to take the adjustment screw. Equip this screw with an old radio knob, and insulate it from the spring-brass contact by means of either an insulating cap or a piece of fiber taped to the arm it bears against. Cover the exposed side of the panel with a piece of mica or plastic.

The push rod running through the pipe should be as light as possible. The one shown is an aluminum welding rod with its upper end forced into a hollow-shank rivet. Metal plugs are driven into both ends of the pipe and holes drilled in them that are large enough to take the push rod without binding.

Connect the thermostat in series with the furnace and turn the adjustment knob until the points are in firm contact. Use a pyrometer or thermometer for calibration; when it indicates the temperature at which you wish the circuit broken, turn the control knob back until the points just separate. If you find that there is more than a 5-deg. variation above or below the selected temperature, inspect the push rod for binding

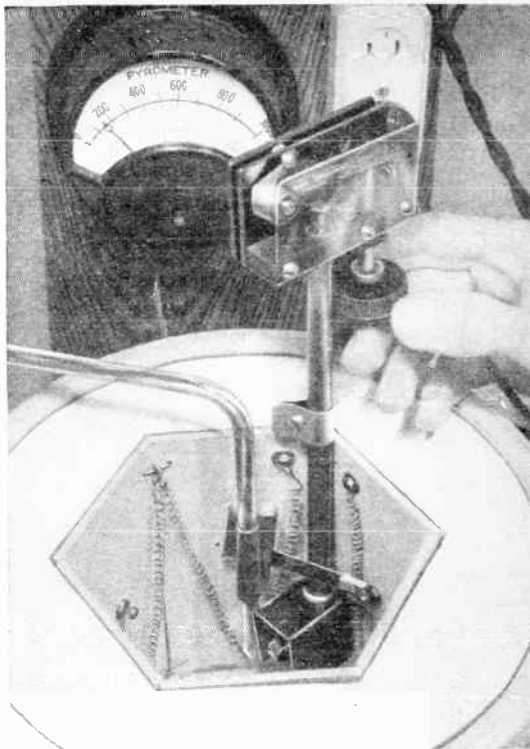

Use a pyrometer or a thermometer to set and check the accuracy and working cycle of the thermostat

and if possible use a lighter rod. The thermostat usually works best when it is mounted vertically, but it may be mounted horizontally if the breaker-arm spring is strong enough to move the push rod back when the bimetallic strip relaxes pressure. If the furnace used draws over 5 amp., more rugged contact points of the kind made for heavy-duty trucks will have a longer life.

LOAD ON LIGHTING CIRCUITS

[ELECTRICITY]

The latest National Electrical Code, new edition, in its specifications for a 15-amp. branch circuit, does not mention the number of connecting outlets it may contain, the only restriction of this nature being that the load shall not exceed 15 amp. at any time. However, the wiring must be done with No. 14 wire in an approved manner, and the fuses should not exceed 15 amp. Although the outlets can have permanently connected lamp holders (sockets) and receptacles rated at not more than 15 amp., it is of the utmost importance that appliances should not have an individual rating of over 12 amp. And incidentally, but little extra could be used with such an appliance without blowing the fuse.

If the circuit also supplies lamps and other portable appliances and the appliances are of fixed construction, their rating cannot exceed 6 amp. If it is exclusively for motor-operated appliances, however, the rating can be as high as 12 amp. Should the circuit supply only fixed appliances other than motor-operated types, a 15-amp. fixed appliance can be connected.

POPULAR SCIENCE MONTHLY SHOP DATA

GIVING

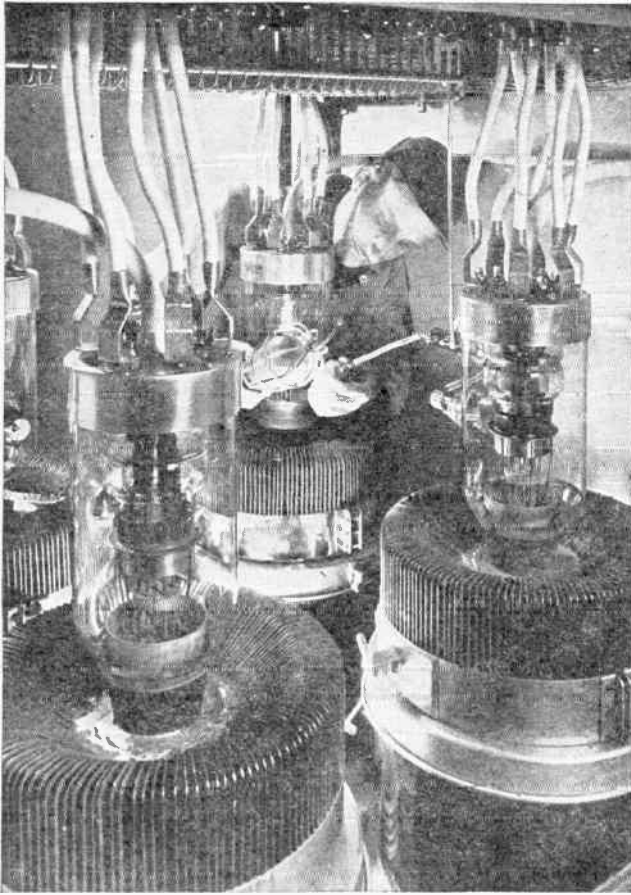

Each of these air-cooled modulator tubes has a 50,000-watt output

How Sounds Picked Up by the Microphone Are Impressed Upon the Space-Spanning Carrier Waves That Made Radio Possible

WITHOUT modulation—the process of impressing meaningful variations on a carrier wave—we might still be in the days of wireless telegraphy. High-frequency radiations have the peculiar property of spanning space without conventional electrical conductors. By themselves, however, they have only a limited communications value; they can send a signal by what might be called the turn-it-on, turn-it-off method, that is, by code. Even this, as shown in the drawing on the facing page, is an elementary form of modulation.

To give radio a real voice, engineers have ingeniously combined two forms of electric-

ity into a hybrid. Since the early days of the telephone, it has been possible to translate sounds into varying electrical currents, send them along wires, and then retranslate these currents into sounds. What modulation does is to superimpose on the space-spanning R. F. waves the complex patterns of sound-giving A.F. waves. One kind of wave travels without wires but of itself carries no meaning, the other reproduces sounds but ordinarily requires wires—and together they make radio possible.

The current passing through a microphone, though constantly varying in strength, is not discontinuous. The R.F. carrier wave therefore can't be interrupted; instead it must be varied in exact accordance with the A.F. impulses that represent speech and music. Fig. 1 shows how this is done by amplitude modulation. The carrier wave has a constant frequency, but its amplitude is varied from instant to instant by the A.F. signal. What appears as the outline of the wave form is an accurate representation of the impressed audio frequency. Another method, frequency modulation, is shown diagrammatically in Fig. 2. Here there is no variation in the amplitude (strength) of the carrier wave; instead, the message-carrying changes

are in the frequency of the R.F. signal.

In a vacuum tube a small change in grid voltage causes a great change in plate output, so that modulating a transmitter might seem to be a simple matter. All that would apparently be necessary would be to feed A.F. signals from the microphone to the grid of an R.F. amplifier tube. Actually, this would be an extremely inefficient way to design a transmitter. To understand why this is so, it is necessary to examine for a moment the kinds of transmitter amplifiers commonly used, and their special characteristics.

Vacuum-tube amplifiers may be of several

RADIO ITS VOICE

different types, of which the commonest are designated Classes A, B and C. Figure 4 shows the sine wave and circuit of Class A amplification, as achieved by two tubes arranged in push-pull.

The latter term, incidentally, describes a method of pairing tubes to produce approximately twice the maximum plate-current swing that either could produce by itself. Push-pull is a useful arrangement—frequently it is the *swing* of plate current, not its amount, which is valuable—and it is often employed in Class A, and always in Classes B and C.

Returning to Fig. 4, it can be seen that there are several important characteristics of Class A amplification. One is that the grid draws no actual current from preceding stages; it requires only a potential, or voltage. The second is that the grid signal may not exceed the grid bias without causing distortion. And the third characteristic is that a substantial plate current passes even when no signal is impressed on the grid.

Because of this last fact, Class A does not afford the maximum swing of which the

tube or tubes are capable. A greater range between the no-signal current and the maximum-signal current can be obtained by applying so much grid bias that the tube passes almost no current when no signal is present, and by permitting the signal to exceed the grid bias. The result is Class B amplification (Fig. 5).

In Class B the grid draws current when the signal voltage exceeds the bias, and one or the other of the tubes (Class B is used only in push-pull) is always conducting. The circuit is so arranged that the signal voltage is inverted before reaching one of the tubes; after one tube follows its half of the signal and then cuts off, the other begins conducting. Class B uses tubes far more efficiently than Class A: a pair of 6L6's, for instance, will yield about 55 watts of audio power in Class B, compared to about 30 watts in Class A.

Class C amplification (Fig. 6) carries the same idea a step farther. Here the grid bias is made nearly twice the value necessary to cut off the plate current, and a grid signal which is twice *that* value is applied. The

Fig. 1

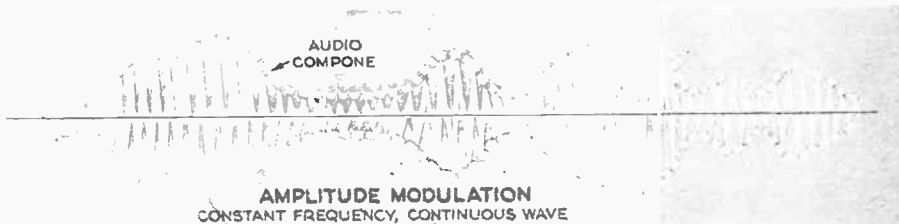

Fig. 2

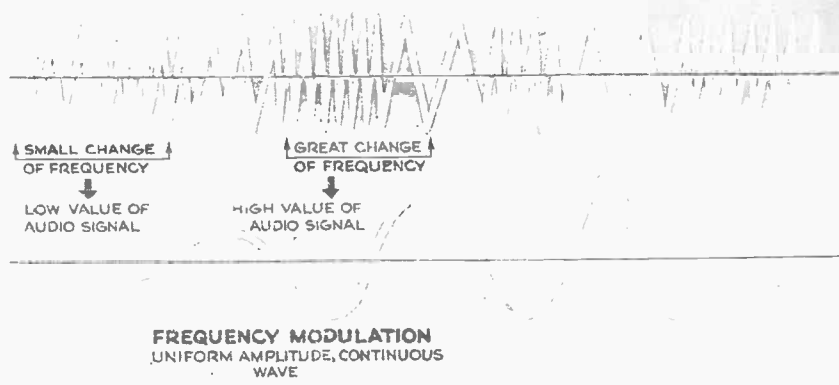
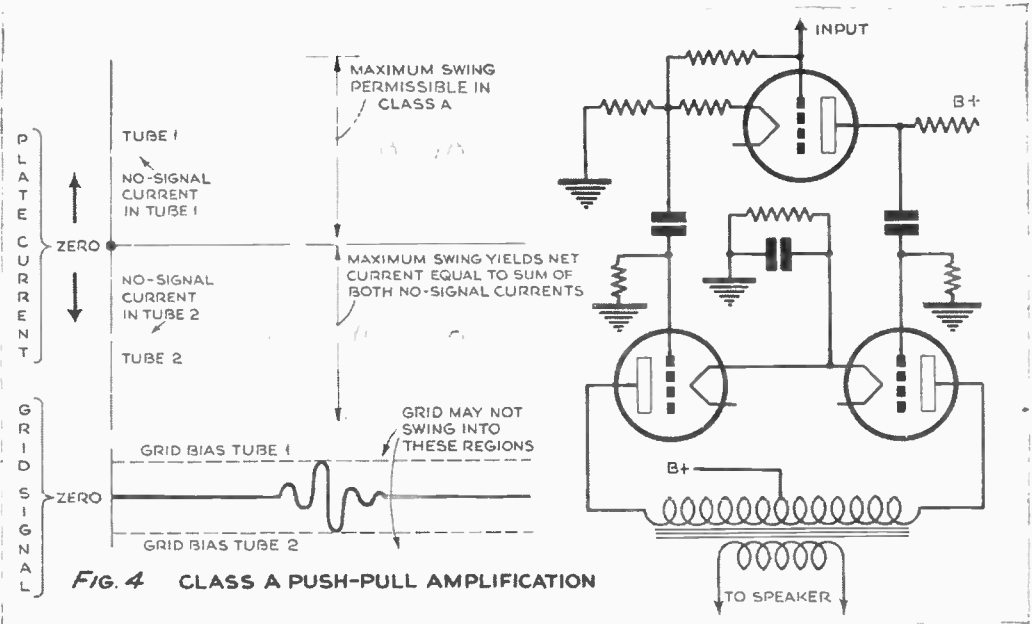

Fig. 3





grid is driven so far positive that every electron the cathode can release is sucked across the tube. In fact, at the peak of the signal, plate current is actually decreased for an instant because the highly positive grid absorbs a respectable fraction of the electrons emitted by the cathode.

Class C amplifiers produce a very ragged output because of this dip in plate current, and because, due to the high grid bias, the plate current is wholly cut off in both tubes during an appreciable part of the cycle. Although Class C is the most efficient method of power amplification in use—the pair of 6L6's already mentioned would give over 90

watts of R.F. output—its raggedness limits it to R.F. amplifiers in transmitters, where the resonant tank circuit, like the flywheel of a one-cylinder gas engine, helps smooth out the periodic surges of energy.

Earlier, it was mentioned that the most obvious way to modulate a transmitter would seem to be to apply the signal to the grid of an R.F. amplifier tube. The reason why this isn't done is now apparent: the output of Class C is so rough that the transmitted signal would be badly distorted. Yet a transmitter in which modulation could be applied at the grid isn't the answer, since it would require for undistorted output the use

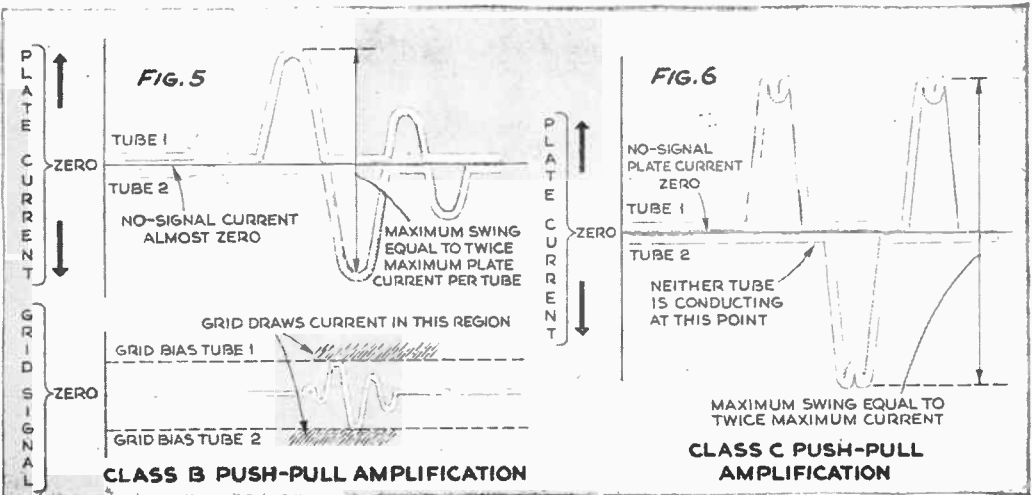

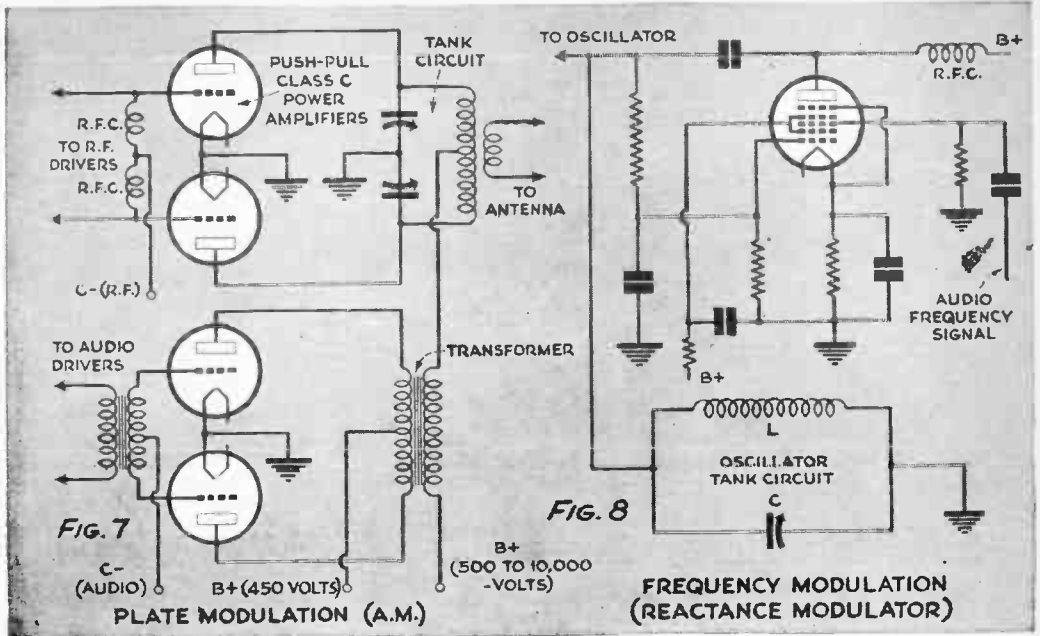

of Class A or at best Class B amplifiers in R.F. stages—an uneconomical way to obtain a powerful carrier wave.

Fortunately, the output of a tube can be varied by controlling any of the electrode voltages—grid, cathode, or plate. In most amplitude-modulation transmitters, accordingly, the A.F. is impressed on the plate of the final Class C amplifier. It is not affected by the tank circuit employed to smooth out the Class C output, since A.F. is unchanged in a circuit resonant at radio frequencies. From the viewpoint of power required, modulation at the plate is a far cry from grid control. It takes about half as much as the actual output itself to modulate a transmitter in this manner—say, 25,000 watts of A.F. energy to modulate a 50,000-watt R.F. output. The extra power required for modulation at the plate is not wasted, since in actual practice it adds to the strength of the carrier wave.

Frequency modulation is a different and in some ways a simpler matter. The A.F. impulses are applied to the original oscillator that generates the radio frequency, and only a small amount of power is required. (The reason A.F. can be applied at this point, rather than on the plate of the final Class C amplifier, is that the amplitude does not have to be changed, but only the frequency.)

Two principles are ingeniously used in achieving frequency modulation. In a resonant circuit, the current in the inductance lags the voltage by 90 deg., and a vacuum tube coupled to the circuit is also capable of

producing a current that lags the voltage by 90 deg. The tube can therefore act in the tuned circuit exactly as an inductance would. In practice, a polygrid tube is used, with the lagging current established by the first grid and the amplitude of the current controlled by the second. Thus if A.F. is fed to the second grid, the amount of lagging current varies with the audio signal. Since the effect in the tuned circuit is as though the inductance were being varied, the oscillator frequency will faithfully follow the audio signal.

In big transmitters the modulating unit is highly important to signal quality. Below, an air-cooled modulator tube of new design is installed



Oscillators—Tuning Forks

HOW TUBES GENERATE HIGH-FREQUENCY CURRENTS THAT

ALMOST everyone knows how the electricity of dry cells and household power lines behaves. But the same electrons comprising these currents can, under different circumstances, move in baffling ways. They will be transmitted through insulators and will be insulated by metal wrappings. They will follow a fairly direct path, but if the conductor loops or winds about, they will balk, die out, or escape and wander off through space. A hollow tube will prove a better conductor than a solid rod, for the electrons won't go through metal at all, but instead will race across the surface.

The current that acts so strangely is high-frequency A.C., a form of electricity that only electron tubes can generate and handle efficiently. Our familiar 60-cycle household current obeys much the same laws as does D.C. At 6,000 and even 60,000 cycles, A.C. is still reasonably akin to D.C. But at 600,-

000 cycles it begins to behave peculiarly in conductors.

For example, a plain copper wire will conduct it more efficiently than the same wire with a thin plating of tin, even though the tin plating increases the cross section of the conductor. The reason? The electrons constituting the current, like all moving electrons, set up magnetic fields in and around the wire. At 600,000 cycles the oscillations are so rapid and the fields therefore so strong that they force the electrons apart, toward the outside surface of the conductors. If this surface is tin, a poorer conductor than copper, the resistance will be greater than that of an unplated wire.

At 50,000,000 cycles, or 50 megacycles, two loops in a conductor become an inductance. So does an ordinary paper condenser made of strips of tin foil and paper rolled into a spiral. The inductance effect is so

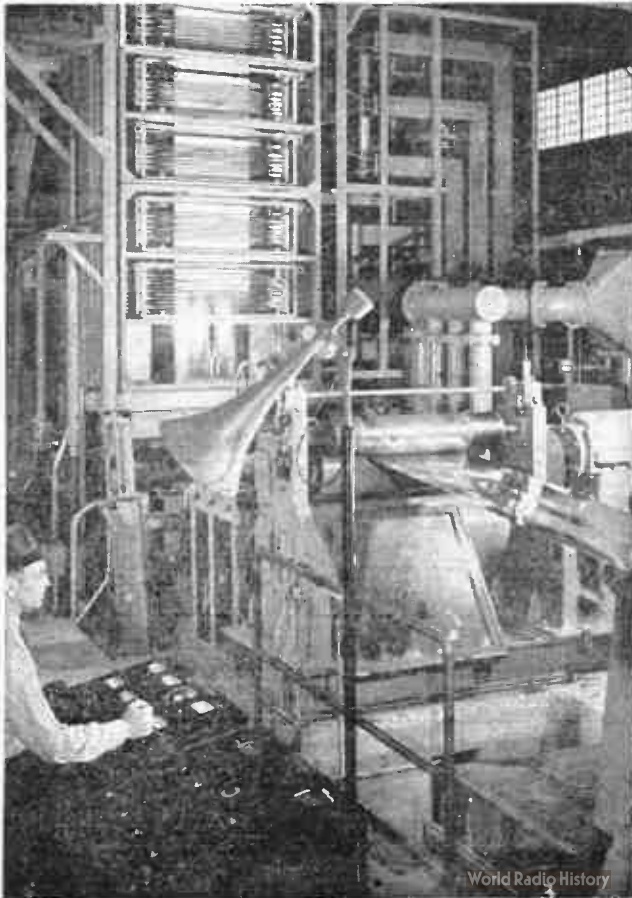

Radio-frequency induction heaters now permit a saving of two thirds of the virgin tin until recently needed for the production of tin plate. Note in the installation at the left, which is in a steel-manufacturing plant, the change in reflectivity when the tin fuses in passing the last of the coils

In the model tin fusing mill that is pictured below, an electrical engineer reads the temperature of the plated steel strip as it runs past the inductance. A water tank cools off the heated, tin-coated strip before it is wound up again



of Electronics



SPAN SPACE, HEAT WITHOUT FLAME, AND SMASH ATOMS

great that the condenser acts as a choke coil—a high inductive resistance.

Nor will an ordinary dielectric like paper do for condensers used at these frequencies. When a condenser is charged, an electrostatic stress is applied to the molecules of the dielectric between the plates. These molecules are thus "stretched" out of their normal position, and so store potential energy which is released when the condenser is discharged. But when the condenser is charged and discharged 50,000,000 times a second, the molecules cannot respond quickly enough. The electrostatic energy, instead of being stored and released, is expended in trying to move these sluggish molecules and is dissipated in the dielectric as heat. This renders wood, glass, rubber, waxes, and oils unsuitable for use as dielectrics in high-frequency work. Mica serves fairly well. Special plastics and ceramics are also used.

For the same reason that dielectrics must be carefully chosen, any nonconductor in the vicinity of a radio-frequency (R.F.) circuit will absorb some of the energy and so affect the electric characteristics. Conductors do the same thing, but for another reason. The field of energy surrounding a R.F. inductance will induce currents in any metal near by. Because these circle about within the metal itself, they are termed eddy currents. The R.F. energy that is absorbed and generates these is again manifested as heat.

Since both conductors and nonconductors cause adverse effects, no ordinary dynamo, with its iron cores, wire coils, and insulation, can generate high-frequency current efficiently, and this becomes a function of the electron tube.

In building an amplifier, we must guard against stray feed-backs—currents from the plate circuit that by inductive or capacitive effects are fed back into the grid of a preceding tube. Any feed-back is amplified, and the amplified fraction of it that is again fed back is further amplified, and so on, until the amplifier tube goes into oscillation, generating A.C. of a frequency that depends upon the values of the inductance and capacitance in the circuit.

Undesirable as this is in amplifiers, it enables a tube to function as an oscillator, or generator of high-frequency currents. An oscillator usually includes a condenser, a coil, and an amplifying tube so connected that some considerable portion of the output power is fed back to the grid. This feed-back energy must always be more than the loss in the grid circuit.

Many of the largest broadcasting transmitters and R.F. induction furnaces are controlled by the oscillations of a small tube such as a 6SK7 or 6J5. Frequently a 6L6 is used as the first power amplifier, followed by larger tubes, the last of which may be a bank of huge, water-cooled, 100,000-watt tri-

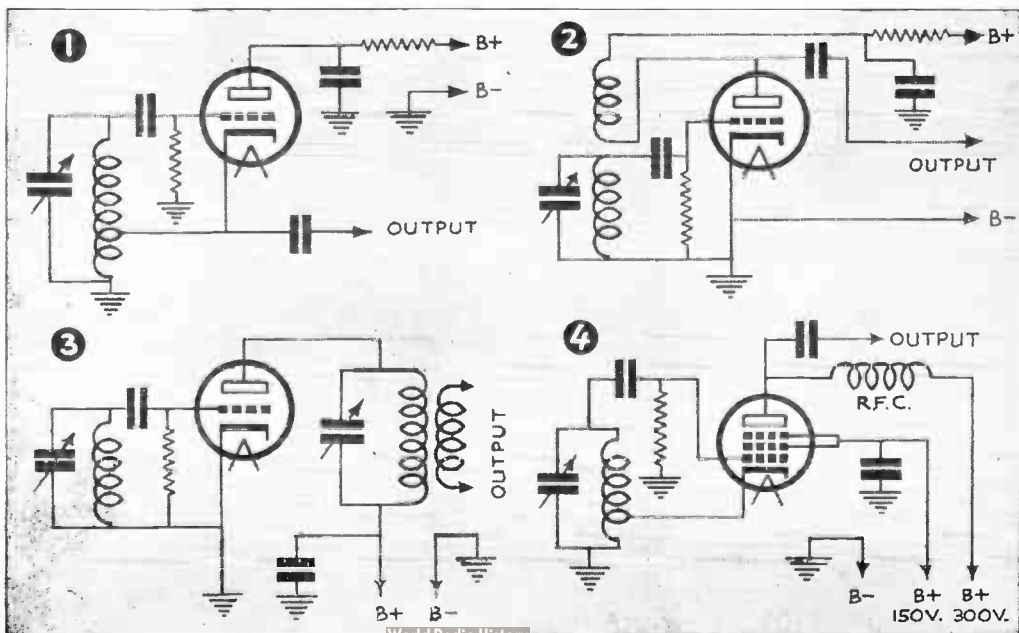

odes. But whether the final output is to power a cyclotron "atom smasher" or a precision electric clock, the oscillator circuit is essentially the same.

In some oscillators, such as those used in broadcasting and in frequency standards, the output frequency must be mathematically exact, but one intended for an R.F. induction furnace must deliver a heavy output current, and the frequency is of little importance. An audio-frequency oscillator designed for testing A.F. amplifiers must be capable of generating pure single-frequency tones up to 15,000 cycles per second. When tuned to 1,000 cycles, it must generate only that frequency, and not the second, third, or fourth harmonics at 2,000, 3,000, or 4,000 cycles.

Superheterodyne receivers, by means of a mixer tube, impress the incoming signal on one generated by an oscillator in the set itself, and the resultant "beat signal" is then amplified. This calls for an oscillator that will generate a reasonable amount of power, that can be tuned to any of a wide range of frequencies, and that will remain at any frequency it is tuned to.

A common oscillator is the Hartley circuit, shown in Fig. 1. The feed-back energy is obtained by inductive coupling in the coil, through the lower part of which the cathode current, and therefore the plate current, flows. The coil acts as an autotransformer,

and part of the energy appears in the upper portion of it, which is connected to the grid. Another standard oscillator is the tickler circuit (Fig. 2). Here the transformer effect between the tickler coil and the grid coil supplies the feed-back.

In the tuned-plate, tuned-grid circuit (Fig. 3) there is no apparent way for feed-back to reach the grid, but feed-back results, nevertheless, from the capacitance effect between the plate and the grid. This factor is always present in any vacuum-tube circuit, and is often alone sufficient to cause unwanted oscillation in high-gain amplifiers. Triodes oscillate readily in this circuit.

An oscillator with extremely good stability, and one that is not detuned by a change in the load on the output circuit, is the electron-coupled circuit shown in Fig. 4. The oscillator is the triode formed by the cathode, control grid, and screen grid, the latter acting as the plate. The plate proper merely collects spurts of electrons passing through the screen and suppressor grids, and therefore shows an oscillating voltage. The radio-frequency choke (R.F.C.) permits application of a positive potential to the plate, but blocks the return of R.F. current. A 6SK7 is excellent for this circuit.

Precision oscillators invariably depend upon quartz crystals. These are, in effect, supersonic tuning forks: they vibrate mechanically at a frequency determined by

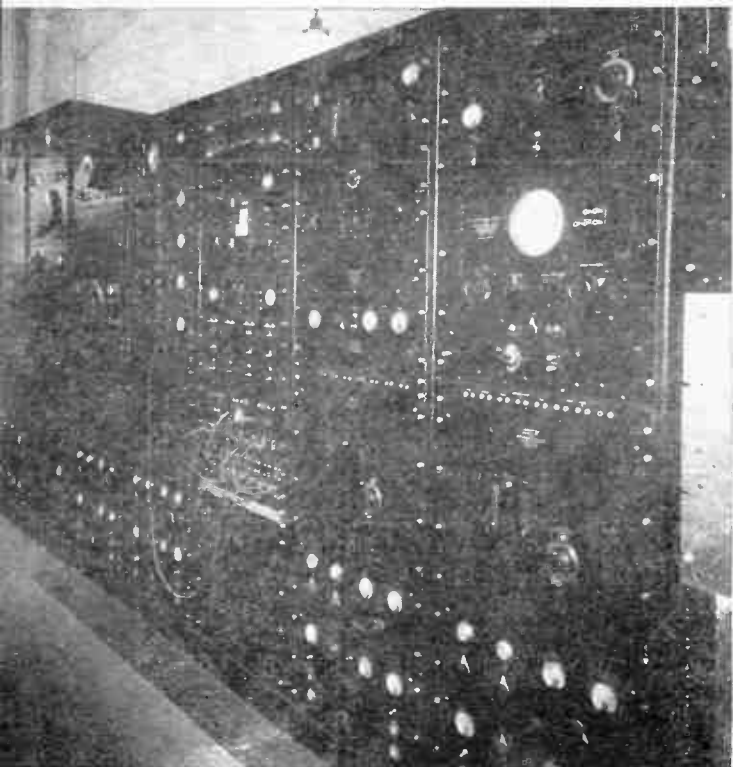
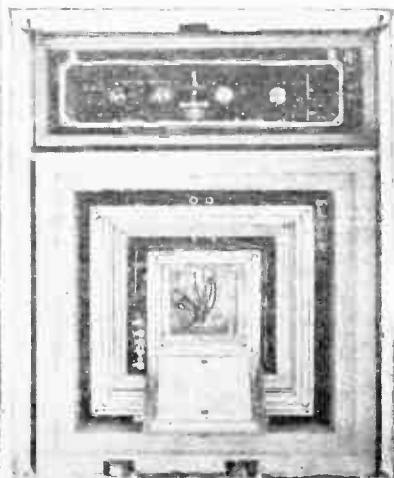

Photo courtesy of General Radio Company

Signals from a radio station are generated by such apparatus as this. Their frequency is counted by a synchronous electric clock that keeps step with every cycle and is regularly checked against time signals from the Naval Observatory

The crystal that controls the initial oscillation is in the insulated compartment below. Its temperature is kept within close limits by thermostats



their thickness and other physical characteristics. Put between metal plates, such a crystal changes shape to a microscopic degree when an electric charge is applied to the plates. Conversely, if it is set vibrating, it will itself generate an oscillating potential on its two surfaces. If an applied potential is of the crystal's own frequency, the entire system oscillates in harmony, but if the applied oscillation is out of step, it meets the counter potential generated by the crystal itself, and oscillation ceases. So the crystal oscillator circuit (Fig. 5) can generate only a signal of the frequency of the crystal.

The U. S. Bureau of Standards maintains radio station WWV, from which only signals of certain standard frequencies emanate at definite time intervals. Their accuracy of about one part in ten million is made possible by the multivibrator oscillator (Fig. 6). Its frequency is governed by the time required for a charge to drain off a condenser through a resistance. This interval may be from a billionth of a second to a minute.

Unlike the other oscillators shown, this one readily generates the harmonics, or multiples, of any frequency to which it is tuned, and it easily falls into step with any outside frequency near its own that is fed into it. A precision crystal-controlled oscillator generates the original signal at 1,000,000 cycles per second. By means of multivibrator units meshed with it, this signal is

stepped up to as much as 15,000,000 c.p.s. and down to an audio frequency of 440 c.p.s.

One multivibrator unit locked in with the other produces a 1,000-cycle note, which is amplified to drive a synchronous electric clock. This clock is compared daily with time signals from the Arlington Naval Observatory, and by its dial the engineers of WWV can accurately count the number of cycles of any signal they transmit.

Figure 7 shows a beat-frequency oscillator commonly used to generate audio frequencies. To generate low frequencies with an ordinary oscillator would require big, clumsy inductances and condensers. This circuit can be tuned over the whole range of audio frequencies by the tuning condenser C.

There are two circuits, one tuned to a fixed frequency of, say, 100,000 cycles, which signal is fed into coil L_1 . The other can be tuned by C, to from 100,000 to 120,000 cycles. If it is tuned at 100,030 cycles, this signal fed into coil L_2 will be out of phase with that in L_1 most of the time, but 30 times a second the two will be in phase and reinforce one another. This beat frequency, fed to the mixer tube, will produce a 30-cycle note in the output. The same principle applied to radio frequencies makes possible the superheterodyne receiver, the beat frequency (in this case called the intermediate frequency) usually being 456 kilocycles.

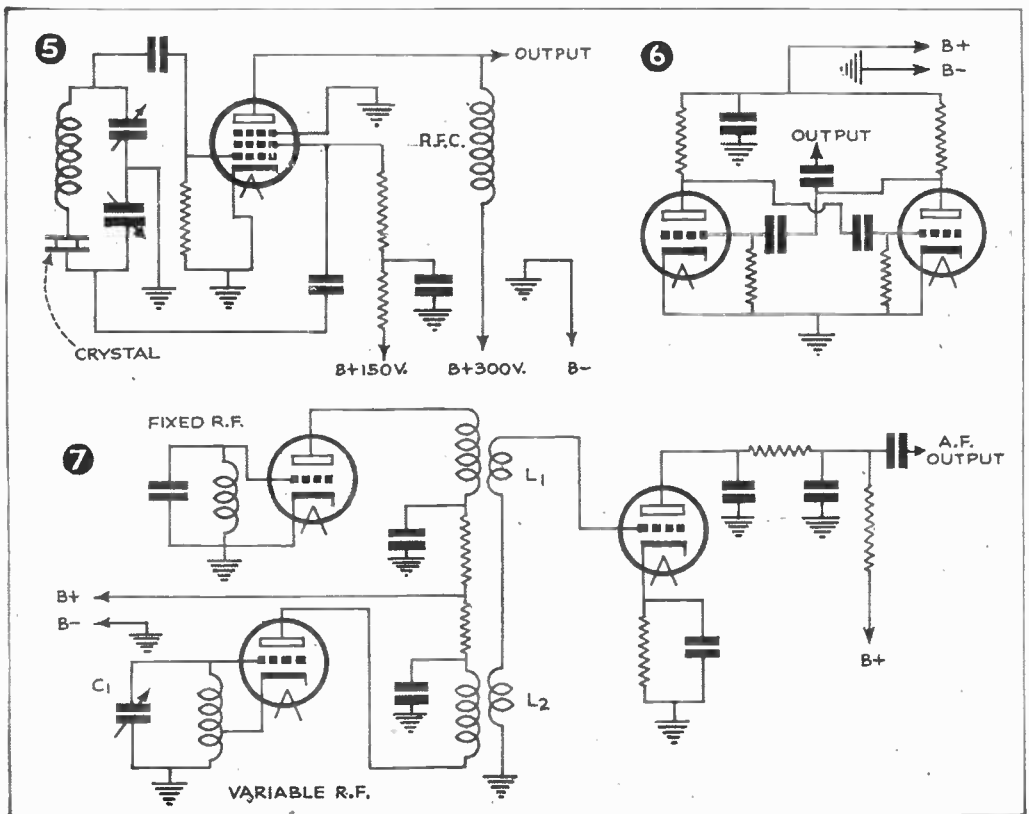

AMPLIFIERS... Magic

HOW CIRCUITS ARE DESIGNED TO RESPOND TO FREQUENCIES RANGING FROM A FEW TO MILLIONS OF CYCLES PER SECOND

IN THE days when loudspeakers resembled Grandpa's ear trumpet, audio-frequency amplifiers, proudly wired with right-angled bus bars, were built around what looked like miniature power-line transformers. Today, amplifiers are almost all resistance-coupled. What happened to the transformers?

Theoretically, transformer coupling has many advantages over resistance-capacitance coupling. But theory involves the use of an ideal transformer—without core losses, winding losses, or resonance peaks—which remains nonexistent because there is no such thing as a pure inductance.

Because the magnetic field surrounding each turn of wire in a coil sets up a counter E.M.F. in adjacent turns, an impressed A.C. voltage results in a voltage difference between any two turns as well as across the entire winding. At extremely high radio frequencies, this may amount to hundreds

of volts. But two adjacent conductors at different potentials constitute a condenser, so our inductance coil is also a capacitance. The wire winding, like other conductors, also has a certain resistance.

In electronics, these factors weigh heavily and were largely responsible for the abandonment of transformer coupling, for in audio-frequency transformers, the inevitable capacitance effects act with the inductance of the windings to produce resonance peaks within or near the audio-frequency range of between 15 and 15,000 cycles per second. By careful design, these resonance peaks can be shifted out of this range, but the linear-response transformers so built are high-priced precision instruments.

Another reason for discarding transformers is more complex. The maximum gain is obtained from a given tube when the load resistance is about the same as the plate resistance of the tube. Modern pentodes have a plate resistance of several hundred thousand to a million ohms or more. While it is impractical to make a million-ohm transformer winding, a million-ohm resistance is easy to make and correspondingly cheap.

Another advantage is that a complete resistance-capacitance coupling takes less space than even the mounting bracket for a transformer. Furthermore, resistors and condensers are unaffected by near-by power transformers, which may cause hums in audio coupling transformers.

For all these reasons the iron-core transformer is limited to push-pull driver circuits and the output

Metals are checked, evaluated, and even sorted by the cyclograph pictured. Instruments like this usually employ broad-band-pass amplifiers which, if used in a radio, would amplify all frequencies at the same time

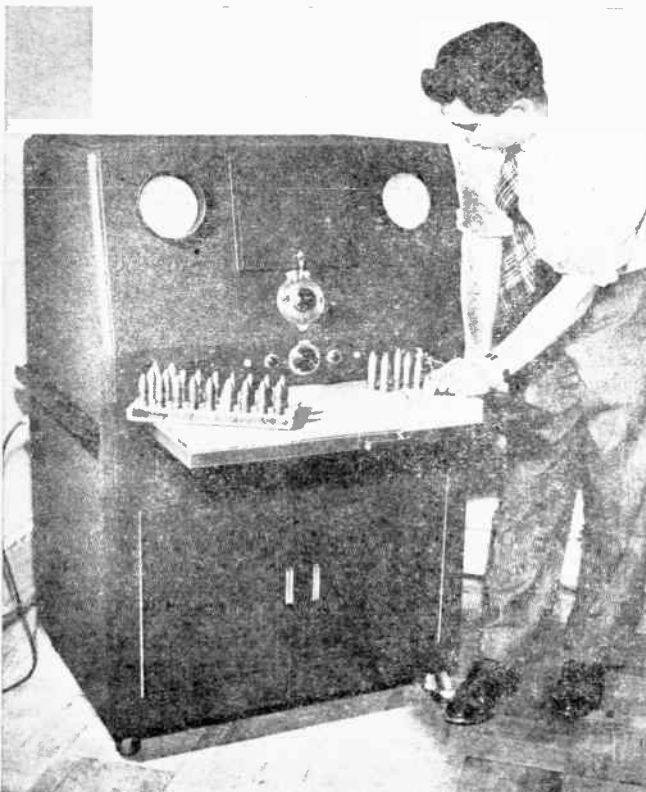

Levers of Electronics

circuit of resistance-coupled amplifiers. Radio-frequency amplifiers, however, make good use of another kind of transformer—the air-core type—by taking advantage of its tendency to tune to certain resonance frequencies. Figure 1 shows a standard radio-frequency circuit. A single such unit may feed a superheterodyne circuit, or three may be combined into a tuned-radio-frequency (T.R.F.) set.

Only the secondaries of the transformers are tuned. The adjustable condensers are usually both on the same shaft, or ganged. They are shown in the diagram by a symbol with a curved arrow representing the movable plates.

Transformers with both a tuned primary and secondary are more selective and give greater gain. Figure 2 shows how they are used in a superheterodyne hookup. An incoming signal is first converted to a predetermined intermediate-frequency (I.F.) signal, and the I.F. transformers are tuned once to this frequency when the set is assembled. The tuning condensers (trimming condensers) are represented by the conventional condenser symbol with an arrow through it. In practice, they are usually built into the metal housing or shield surrounding the transformer, with only the heads of the adjusting screws accessible, and are tuned with a screwdriver. If left unshielded, such transformers would pick up hum from a power transformer, or one coil could affect another.

The response range of transformer-coupled amplifiers is thus governed by resonance effects due to inductance and capacitance, and it is these that enable us to tune R.F. circuits so that they will respond only to the frequency of the signal desired. With A.F. amplifiers, the problem is just the opposite. Voice and music frequencies

range from 15 to 10,000 cycles. If an audio-frequency amplifier responded only to frequencies of 200 to 2,000 cycles, both low and high notes would be lost. Then what governs the response range of a standard resistance-coupled circuit such as that shown in Fig. 3?

Since D.C. will not pass through the coupling condenser C₂, it is plain that the circuit will not amplify D.C. By definition, one cycle per second is A.C., but the circuit will not pass that either. There is a lower limit to the frequency C₂ will pass, and this depends upon its value and that of the

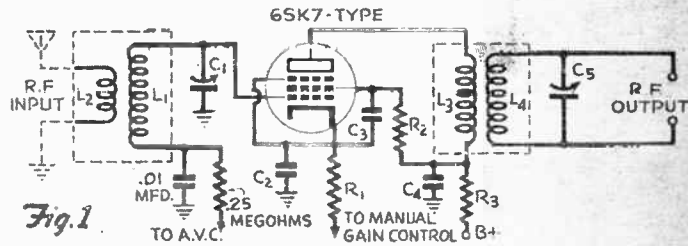

Fig. 1

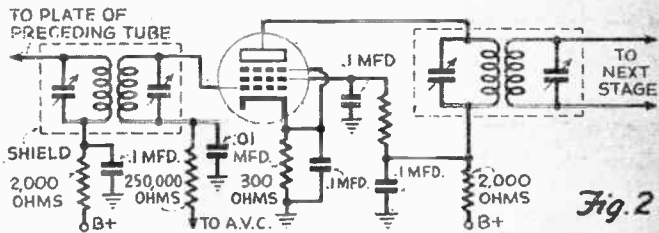

Fig. 2

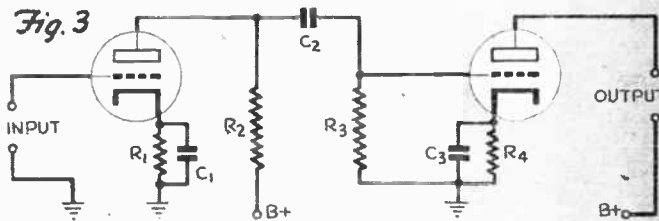

Fig. 3

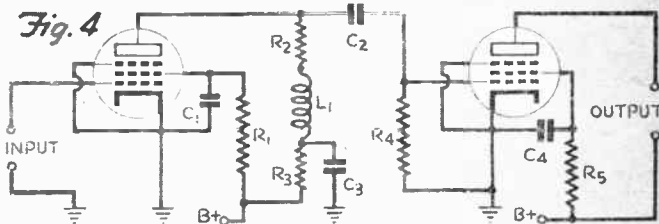

Fig. 4

resistor R3. If R3 drains the charge off C2 as fast as, or faster than, it accumulates, no signal will pass to the grid of the second tube. For frequencies down to 100 cycles, with a 500,000-ohm value for R3, C2 may be .01 mfd. For a high-fidelity amplifier sensitive to frequencies as low as 15 cycles, C2 would have to be of .1-mfd. capacity or more.

Response to high frequencies is limited by another factor—losses from wiring and tube capacitance. The tube sockets, resistances, and condensers are mounted on a metal chassis. But any two conductors separated by insulation constitute a condenser. Thus there is capacitance between the wiring of the amplifier and the chassis. Since this is only about 30 mmfd., it is negligible at low frequencies. But a condenser offers less resistance to A.C. as the frequency of the current increases. At 1,000,000 cycles, capacitance losses can be appreciable.

In radios this effect is nullified by using this wiring capacitance as part of the tuning capacitance of the tuned-transformer coupling. One side of each secondary and tuning condenser is grounded to the chassis. The trick can't be used with a television video (picture-image) amplifier, which must faithfully amplify all frequencies from 30 to 4,000,000 cycles. This problem is solved by the hookup shown in Fig. 4.

The load resistance, instead of being a resistor, consists of a resistor and an inductance in series. To A.C., such a combination offers ordinary resistance plus inductive reactance, the sum of these being termed impedance. A resistor of low value is used for R2, greatly impairing the amplification at low frequencies, since, as was stated earlier, maximum gain is obtained when load impedance is equal to plate impedance.

The inductance L1, however, will offer more and more resistance as the frequency increases, and at very high frequencies, the impedance will be great enough to outweigh the resistance of R2 and thus greatly increase the amplification gain.

Because at medium or low frequencies the load impedance is too low to match that of the tube, the gain is held down to the same level as that obtained at high frequencies after capacitance losses have taken their toll. Thus these losses, although they cannot be eliminated, can be compensated for. The coupling described provides just the proper adjustment automatically.

Resistance R3 and condenser C3 in this circuit are not merely the usual decoupling circuit; they help improve low-frequency response. At frequencies to which C2 offers little impedance, C3 similarly offers little or none. But at lower frequencies to which C2 offers series impedance, so does C3. While C3 passes the A.C. signals freely to the ground, resistor R3 is to all purposes not in the circuit. But when at low frequencies C3 offers appreciable impedance, R3 becomes effective, increasing the total load resistance and thus the gain. With rightly proportioned values of R2, R3, L1, C2, and C3, an amplifier could uniformly amplify all frequencies from 50 to 5,000,000 cycles.

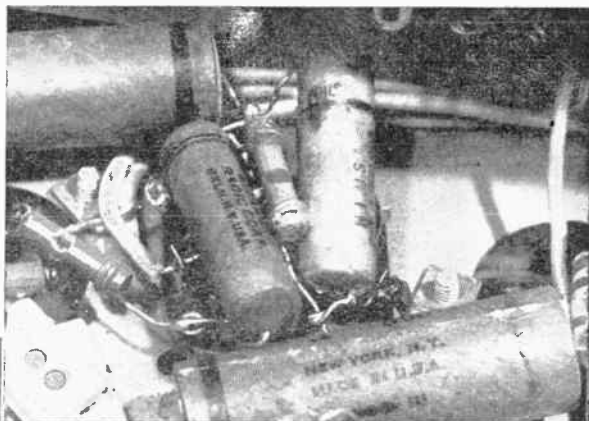

Wiring under the chassis of a receiver is a studied jumble. The close-up view above is that part shown within the square at left



The plate-load resistor is mounted on the tube socket and a decoupling resistor is attached there. Howl results if a plate lead passes too close to a grid lead of a preceding stage

How to Hush Your TV Set

You can escape the kids' pictures by leaving the room. Don't let the sound follow you.

PEACE in a television home is easily restored—if you provide earphones. Gun-shy parents then can enjoy their newspapers while the children watch the cowboys and Indians. And the kids can sleep undisturbed while father catches a late wrestling match or prize fight.

An "earphone attachment" is simply a 2" by 4" strip of plywood or composition board on which a standard phone jack and a single pole, double throw toggle switch have been mounted. It can be attached to the back edge of the cabinet or screwed to any convenient ledge near the receiver.

The hardest part of the job is getting at the loudspeaker. Many cabinets are put together in sections, and the top or front panel can be unscrewed for ready access. But in other cases the chassis may have to be taken out. To do this, pull off the knobs and loosen the bottom bolts. Then make sure that the front of the picture tube is firmly sup-

Tired of having heavy bombers roar down at you out of the TV skies? Let others listen through earphones without disturbing you.



ported when you slide the assembly out.

To add earphones you have to cut only one wire in the receiver. Between the speaker and the output transformer—which is usually bolted on the speaker frame—there are two stiff-wire voice-coil leads. Snip either one of these leads. Solder extensions to the cut ends and bring them to the toggle switch. When the switch is in one position, the set will operate exactly as before. Solder another wire to the other side of the

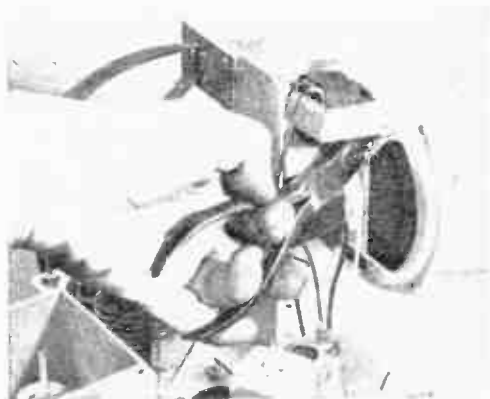

Cutting either of two voice-coil leads is only change needed in receiver. Snipped ends go to toggle switch. Make sure picture tube is supported if you remove chassis from cabinet.

Small panel for phone jack and toggle switch may be mounted at back of cabinet or near set. Condensers are on other side of strip. Surplus Army phones come equipped with plug.



speaker voice coil and connect an earphone jack and two condensers, as in the drawing.

There is no danger from shock, as the earphones are isolated from the high-voltage portions of the circuit by the output transformer and additionally protected by the condensers in series with the speaker leads. These condensers may be of any capacity from .05 to .25 mfd.; rated working voltage should be 300 volts or more.

The earphones may be either the low- or high-impedance type. Signal Corps surplus phones are fine. As many as a dozen pairs can be used simultaneously if extra jacks are connected in parallel. Kids love to wear phones: they give 'em that Captain Video appearance.

P. S. You can use exactly the same rig on any radio if you want to protect yourself against old-fashioned ear-busters. END

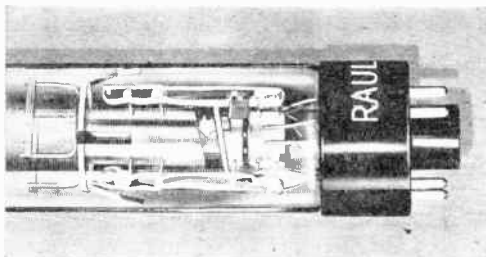
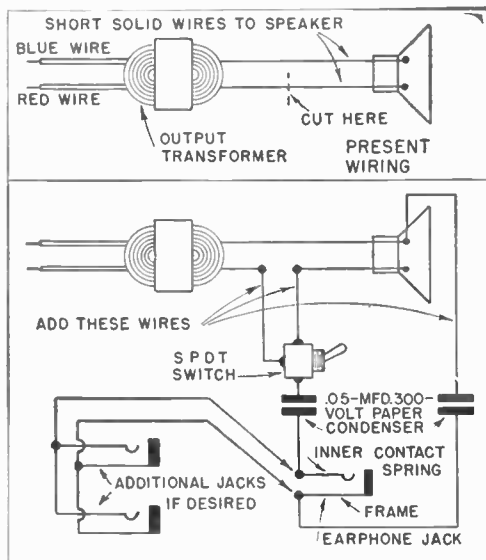

Glow Shows TV Misalignment

EVERYONE who has serviced or adjusted TV receivers knows the importance—and the difficulty—of aligning the ion-trap magnet. Misalignment cuts down picture brightness, fuzzes the focus, shortens picture-tube life.

The ion-trap magnet, which fits around the neck of the tube, bends the electron beam so that it can pass through a small aperture in a metal disk (see arrow). With ordinary tubes it is difficult to know when the magnet is properly adjusted. Now a new indicator ion trap, used in tubes made by the Rauland Corporation, Chicago, gives positive indication of alignment. A fluorescent coating on the disk does the job. When the electron beam is improperly adjusted, it hits the coating and causes it to glow. The ion trap is adjusted by moving the magnet until the glow disappears.

Synthetic Beef

A new food, made from dried skim milk and yeast, has been developed by researchers at the University of Arkansas. Golden brown in color, it has taste and texture similar to beef but costs one third less.

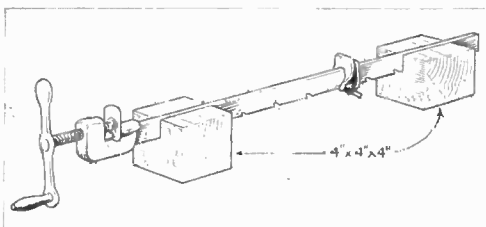

Blocks Support Bar Clamps

GLUING up lumber is easy—if you have four hands. But if you have only the normal number you've probably had trouble trying to manage the work and the clamps at the same time. One way of simplifying the job is by making supporting blocks for your bar clamps. For each clamp slot a pair of 4" hardwood cubes as shown. They will hold the clamps steady while you line up the work before tightening up on the screws. —C. R. Schlegel, Jenkintown, Pa.

Shop Use for Old Calendars

Don't throw away your old wall calendars. Shop bins, drawers, and jars containing nails or screws, bolts or nuts, and other small parts can be neatly marked for size with the numbers cut from a few old calendars. Glue the numbers to the face of the container and coat with clear varnish. Calendars showing the current month in big figures and the past and coming months in small figures are fine where fractional and whole numbers are used together. You also can use cutout letter to form word labels. —Warren W. Howe, Longview, Wash.

Radio 'Ham' Builds TV Station

California amateur sends voice and picture over transmitter made from \$500 worth of war-surplus parts.

By Andrew R. Boone

PULSING through the California skies from a weather-beaten back-yard shack, the image of a beautiful brunette flows into television receivers around San Francisco Bay. The boys who have seen her call the vision Gwendolyn.

Reproduced by a collection of second-hand tubes and war-surplus video equipment, Gwendolyn represents the first standard TV image broadcast successfully and repeatedly by an amateur. Soon, from the same station, W6JDI-TV, radio ham Clarence Wolfe, Jr. hopes to televise live images.

For over a year the 35-year-old amateur has been broadcasting Gwendolyn's picture from Burlingame, Calif., to demonstrate that

Gwendolyn, a picture of a beautiful brunette, is Clarence Wolfe's TV trade-mark. It's the only image he can now send over his homemade transmitter. Later he hopes to send live images and movies. At right, W6JDI's three rotating antennas.

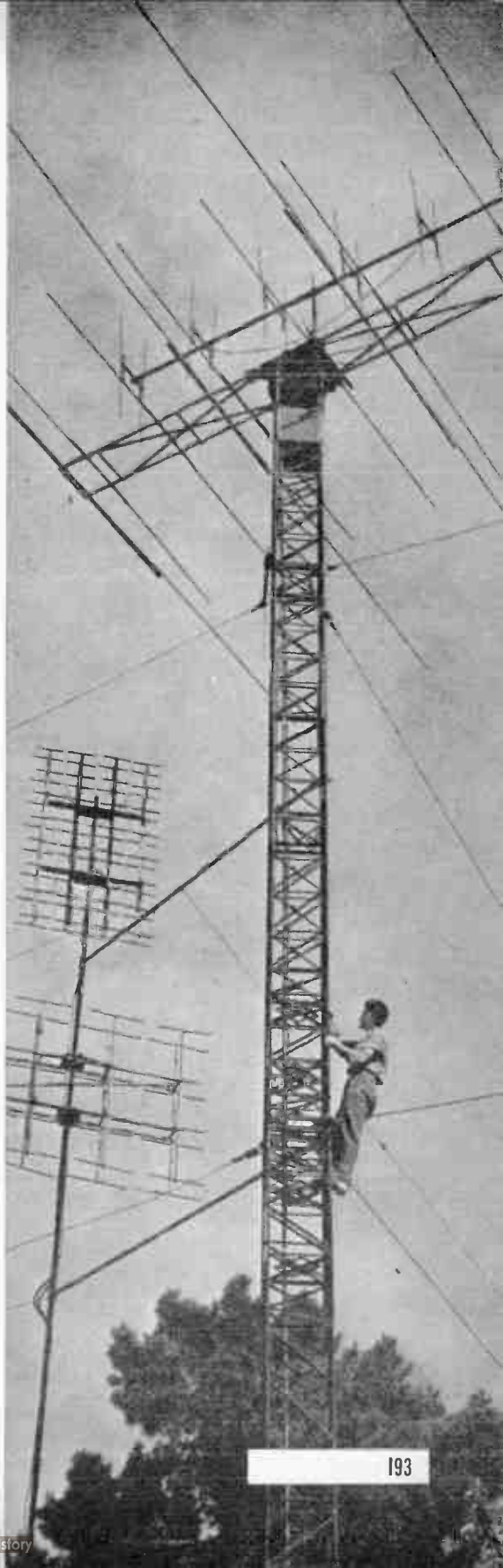

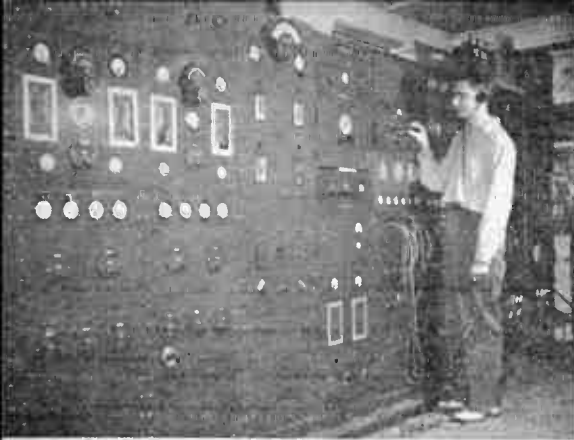

Control panels for radio and TV fill one room of radio shack in Wolfe's back yard. Most of his equipment was built from scratch.

his homemade \$500 TV outfit can compete with commercial stations. His R.M.A. signal—meaning a standard TV image that meets rigid standards laid down by the Radio Manufacturers Association—was flying into the winds six months before the first commercial telecaster went on the air in nearby San Francisco.

Not many have seen Gwendolyn yet. She is an image of 525 interlaced lines per picture and 30 pictures a second. The thing that keeps her audience down to a select few is that she travels around in the 429-mc. band, reserved by the Federal Communications Commission for amateur experimental work. Standard home receivers, tuned for the commercial bands between 50 and 200 mc., must use converters to receive ham TV. To hams that's only a minor problem. There

From 14 tubes and a wartime chassis, Wolfe built this 50-watt, crystal-controlled transmitter. It is the final link to the antenna.

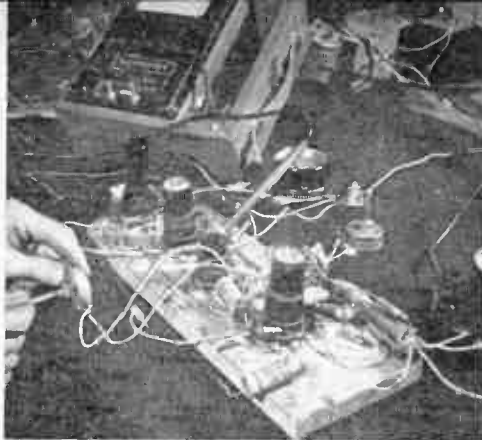

Real laboratory of W6JDI-TV is this board. On it each circuit was set up and tested. The best were later incorporated in the TV system.

are a number of war-surplus radio altimeters that will step down the frequency properly.

Gwendolyn is the chief store-bought item in Wolfe's setup. She is a photograph of an unknown girl pasted inside a monoscope—a tube built to send a single image. Unlike the iconoscope or camera tube which scans any picture or scene, a monoscope sees only the photo bottled within it.

Two years were spent building the transmitter, but before that Wolfe spent 22 years building the experience that went into it. He became a radio bug in 1925 when he was 11 years old. In the following years he started a one-man radio service and repair shop in his home town, won his ham license (1932), and began seriously to study radio. Soon after he built the Burlingame police department's first two-way radio system.

Experimental camera for live broadcasts and movies consists of an iconoscope or picture tube, three coffee cans, and a lens.

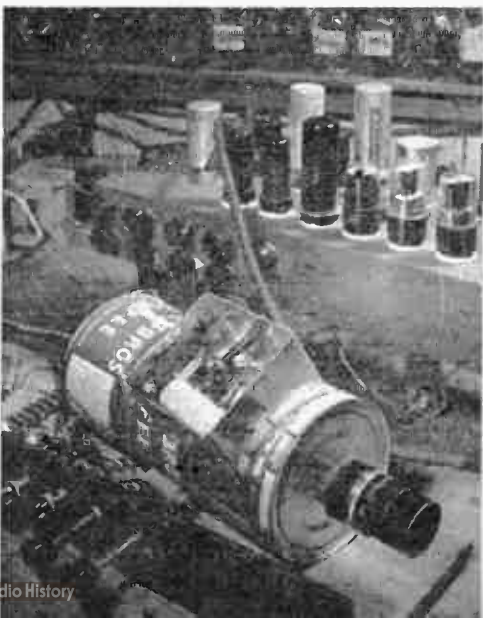

During the war he taught radio and radar, and later installed delicate fire-control apparatus. On returning to his store after the war he started learning the ways of television, and decided to become the first ham on the air with a standard TV picture. Unable to buy expensive commercial equipment, he set about building and adapting what he had or what he could get cheaply. For help he turned to a ham friend, Leslie Seabold, an airline radio engineer.

No well-equipped laboratory awaited his experiments. He had a few pieces of test equipment and a shop-full of odd and spare parts. To make a test panel, he screwed a few sockets to a board. With Seabold, Wolfe worked out the circuits on paper. Then he tried them out in practice. Literally hundreds were tested; only the efficient survived, and these were incorporated in the final sending apparatus.

He tackled the timer first. Twenty modifications came and went before he was satisfied with the neat unit that does the job today. After that came the control assembly, an intricate array of 120 tubes.

To get Gwendolyn's picture out with a big push, Wolfe settled on the antenna array shown in these pages—64 short lengths of aluminum tubing 1" in diameter. Half carry power, the other half serve as reflectors. In the favored direction, field strength is equivalent to 5,000 watts from a dipole. What's surprising about this figure is that the signal comes from the transmitter with only 50 watts of muscle behind it.

When field tests showed that he had what he wanted, Wolfe started his transmitter humming. "This is W6JDI-TV, broadcasting image of a girl on 429 mc.," he said into the microphone suspended above his battered desk. "Do you see her?" For several months he received no response. Except for the hams who picked up the pictureless voice, no one knew an amateur was putting out a TV picture. Then a few, eager to share in the adventure, hooked up radio altimeters to their television receivers. Six months after Wolfe went on the air, Bob Melvin, of Berkeley, answered: "Gwendolyn coming in clear and beautiful."

The name stuck. Confirmations came from Oakland, Vallejo, San Francisco, San Jose.

Incidentally, Melvin caught the bug shortly afterward and built a transmitter of his own in the family garage.

Wolfe now is trying to perfect a camera to replace his single-image monoscope. His



Lovely Gwendolyn reposes in lightproof tube made from candy container. On top is a monitor scope; in the foreground is the timing unit.



Control assembly started as a single oscillator. It develops three sets of synchronized signals that form the composite signal or picture.

Voice accompanies the picture. This is the control console of W6JDI-TV; it serves also for regular transmissions on other ham bands.





Experimental monitor tube in this portable viewer permits Wolfe to see from anywhere in his shop the quality of the outgoing signal.

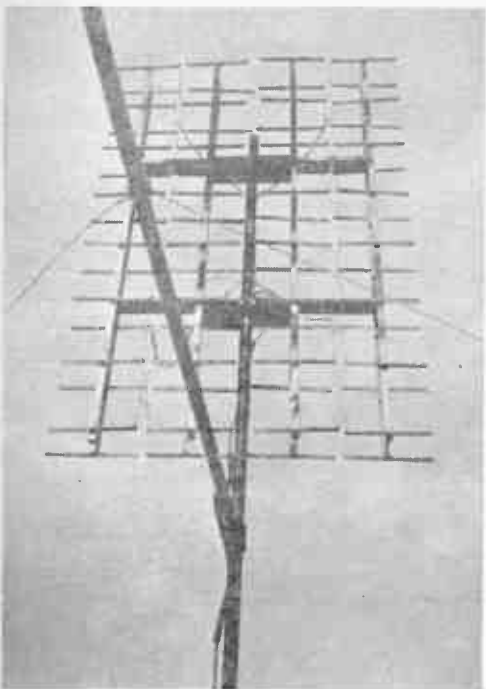

Broad-band TV antenna consists of 64 elements; half are driven, the rest reflectors. Antenna covers a band 4.5 mc. wide.

Radio altimeter is used to convert a standard receiver to pick up the 429-mc. experimental band on which the broadcasts go out.

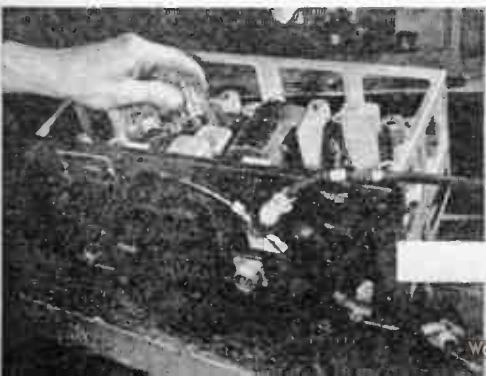

fifth model is a simple device—three 1-lb. coffee cans enclosing an iconoscope that receives images through a 2" f/1.5 lens taken from an old 16-mm. movie camera. With it he hopes to transmit live images and also motion pictures. But broadcasting movies will require a projector. That's in the works, too. From a standard projector he plans to remove the intermittent mechanism and run the film through continuously. By pulsing a light source 30 times a second and projecting the illuminated images onto the iconoscope he will change the frame speed from the 24 per second used in films to the 30 needed in video.

Movies present a special problem for the ham televiser since one of the FCC rules governing ham operation is a restriction on broadcasting entertainment. Wolfe thinks that a good deal of the movie fare used on commercial TV stations runs no risk of entertaining anybody, but a legal definition of what a ham can televise is still to come.

What does the future hold for amateur TV? Wolfe doesn't expect many hams to follow his lead, at least for the present. Cost won't be the big factor. The \$500 that this rig cost is a lot less than many hams put into voice equipment, but a lot of know-how and work is needed too.

Then, too, there are a lot of technical limitations that have to be overcome before TV can be reshaped into the ham tradition. First step will be simplification of the circuits and some method of getting more stations into the limited space in the airwaves. Perhaps ham ingenuity will also conquer the distance barrier that now makes television a short-range affair.

These are questions for the future. Radio once posed similar problems, and hams played a big part in solving them. Will they do the same for television? Wolfe has proved that video has a place for hams. He's given the wheel the first spin, and you never know where it will stop. —END

This standard image of Gwendolyn has been picked up at points 35 miles away. She's proof that \$500 and ingenuity can put TV on the air.





BEFORE



AFTER

Old Phonograph Plays a Different Tune

CONVERSION of an old-fashioned phonograph cabinet into a handsome low-boy record player of convenient armchair height is a project that requires few tools and little skill. The turntable, pickup arm, motor, and amplifier from a small electric phonograph were installed in place of the hand-winding mechanism of the old phonograph to modernize its operation. A new and larger speaker was also obtained and mounted on a baffle in what had been the record-storage compartment.

The doors and record racks were removed from the cabinet shown, and the legs were cut short. A plywood panel was substituted for the speaker opening in the upper third of the front, the cabinet was lined with insulation board, and the speaker and baffle, which was also cut from insulation board, were mounted in the lower two thirds as indicated. The opening was then covered with burlap. Molding strips tacked across the front helped the appearance. A series of $1\frac{1}{2}$ " holes bored through both the insulation and back board near the bottom will improve the tone.

The mechanism from the portable was mounted on plywood cut to fit inside the cabinet; it rests on cleats about 4" below the top. A new plywood top edged with beveled molding was attached.

An antique finish was applied and stenciled decorations were added. The burlap was given a coat of thinned shellac before painting.

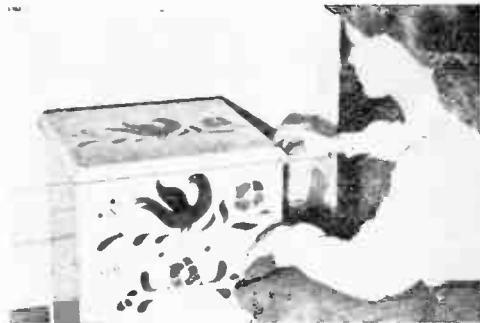

With the old cabinet as a base, construction is held to a minimum. A new and larger loudspeaker is housed in what once was the record compartment.

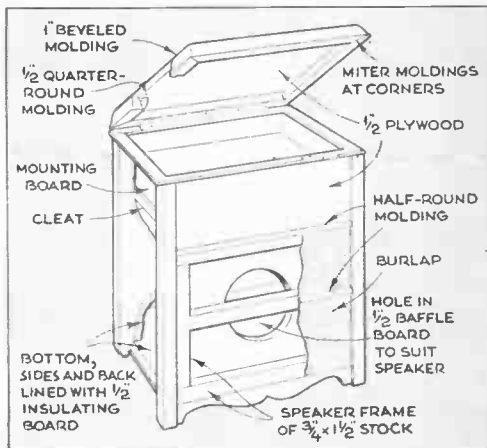



Radiant power is only part of the wonder of a Tesla coil. When brought within the field of the energized coil, an ordinary bulb glows with a strange violet light as rosy streamers shoot out from the filament.



Is this the lighting of the future? The young lady's reading light consists of a fluorescent tube without wired connections. The Tesla coil that powers the tube is located in another room, but plain walls are no obstacle to its energy.

Wires of small diameter can't confine the high-frequency currents generated by the Tesla coil. Current leaps out of the wire sandwiched between the glass plates, making it glow in the dark.

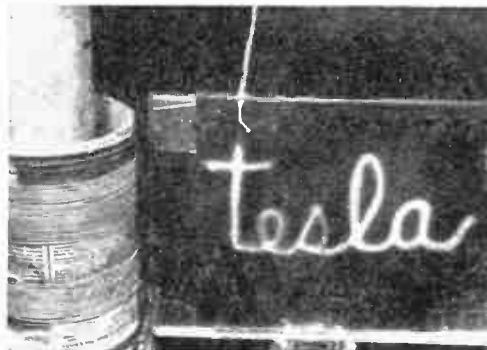

Cigar-Box Tesla Coil

WORKS WEIRD WONDERS

By Tracy Diers

"IS THERE, I ask, can there be a more interesting study than that of alternating currents?"

With this question, put to a group of outstanding engineers and scholars more than half a century ago, Nikola Tesla opened an address and an epoch. These words ushered the leading scientists of two continents into a veritable fairyland of crackling brush discharges, indescribably beautiful gaseous glows, and space-spanning energy that wires could not confine.

On that historic night, young Tesla brought into public view the wonders of high-frequency, high-voltage alternating current (H.F.H.V.A.C.). Its source was the now famous Tesla coil.

A Tesla coil is a transformer used for stepping up medium-high voltage, H.F.A.C., to fantastically high voltages. By following the instructions given on the next page, you will be able to construct a coil capable of producing all the effects described in this article. When your coil is complete, close the filament switch. Ten seconds later, close the high-voltage switch. Immediately a $2\frac{1}{2}$ " arc will leap from the high-voltage terminal into the surrounding air. If it doesn't, the primary coils are probably bucking, and either one should have its connections reversed.

The things that this corona can and will do are legion. Two of them are illustrated by the four photos on page 193. For experiment No. 1, your equipment consists of a stiff horizontal wire supported on a free-moving metal spinner. If the wire is coated with shellac along its entire length so that the corona can discharge only at the tips, then when the H.F.A.C. rushes into the wire, it will drive it merrily—and luminously—around.

Experiment No. 2 demonstrates the ineffectiveness of glass to resist the hot electrical energy that bursts forth from the Tesla coil. One of the two metal rods of the spark gap goes to the high-voltage outlet; the other returns to ground. Both are shielded from any mid-point contacts. When the gap operates smoothly, insert a sheet of $\frac{1}{4}$ "

High voltages don't like to be fenced in. It's a serious problem for engineers, but for Tesla-coil experimenters the corona, right, is a welcome sign.

plate glass—and watch the spark continue right through.

Notwithstanding these facts and its terrifying appearance, the corona is quite harmless. If you hold a copper rod in your hand and bring its free end close to the discharge, the current will jump to the rod, and race via your body back to ground. But you won't even feel it!

Not enough current? Don't kid yourself! While it is true that the power output of this coil is not very high, 50,000 volts at the current you have here would normally ferry you into another world. Safety lies in the frequency of the current, which is well above a million cycles a second. All high-frequency currents travel on the surface of conductors; when you are the conductor, your skin carries the current and your internal organs aren't affected.

A much more strikingly visual proof of this phenomena is shown at bottom right on the facing page. Since H.F.A.C. insists on traveling only on the surface of conductors, these conductors may be hollow pipes instead of wires, but they must have

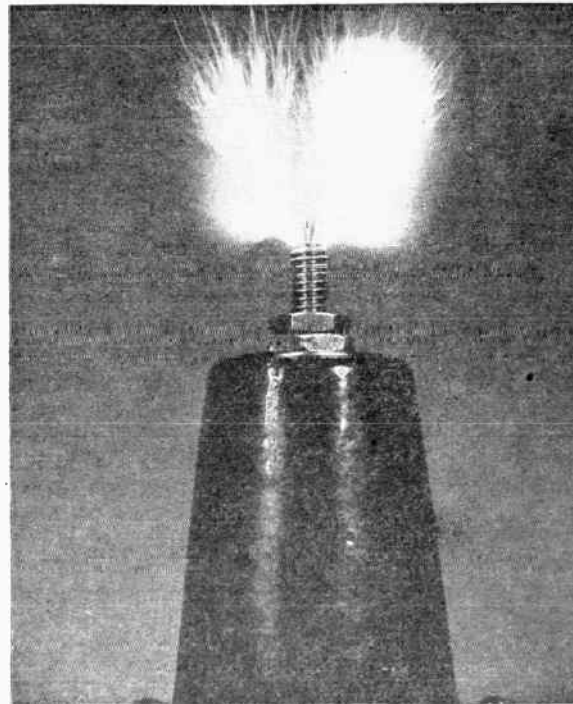

surface area—lots of it. If you try to conduct high-frequency currents through fine wires without enough surface area, the current will leap clear into the surrounding air, causing the inadequate wire to glow with a ghostly light. If you spell out a word with a continuous piece of 30- or 32-gauge bare copper wire, connect one end to the high-voltage terminal, and sandwich it between glass, the word will light up.

One of Tesla's great dreams concerned the transmission of power without wires. He didn't quite make the idea practicable, but he came close enough to enable you to amaze your friends and amuse yourself with these stunts based on wireless power transmission. Connect a metal plate to the high-tension terminal. This power transmission plate must be well insulated from the ground. A short distance away, arrange another in-

Induction Coil Replaced by Vacuum Tubes in Cigar-Box Tesla Coil

WITH a Tesla coil built from a few familiar radio parts you can try for yourself the fascinating experiments described in this article.

The coils are wound on ordinary cardboard tubes. A core $2\frac{1}{2}$ " in diameter by 26" long is used for the high-voltage secondary. Coat the outside of the tube with hot paraffin, and, when dry, wind a 21" coil of 30-gauge D.C.C. wire evenly and smoothly, starting 1" from the bottom. The end of this wire is brought up inside the tube through a wood block and insulator. Drill a $\frac{3}{4}$ " hole in the round block, boil it in paraffin, and glue it into the top of the block. Screw the insulator directly to the block.

For the other coils, cut an oatmeal box down to 6" in length and use 16-gauge D.C.C. wire for both windings. L_1 can start 1" from the bottom and extend for 15 turns. Leave another 1" space and wind 20 turns for L_2 . Cover all the coils with a good shellac.

When dry, attach the secondary coil to the cigar box with small metal brackets. Bring the ground lead inside the box, making sure that it does not come near the primary. Then slip the larger form over the other and attach it in the same way. Carry the leads into the box through four small holes and fill the holes with shellac.

Connect the high-voltage side of a power transformer—500 volts or more—to the input of the Tesla coil through a single-pole, single-throw switch, and use a separate switch for the filament leads.

A pair of four-prong sockets is needed for the type-10 tubes; other parts shown in the wiring diagram are: R_1, R_2 : 2,700 ohms, 10-watt wire-wound resistors; R_3 : 40 ohms, centertapped; R_4 : 5,000 ohms, 10 watt; C_1 : .001 mfd., 1,000-volt mica; C_2, C_3 : .0005 mfd., 1,000-volt mica condensers.

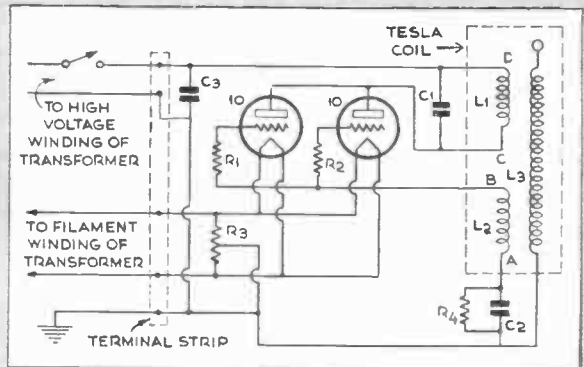
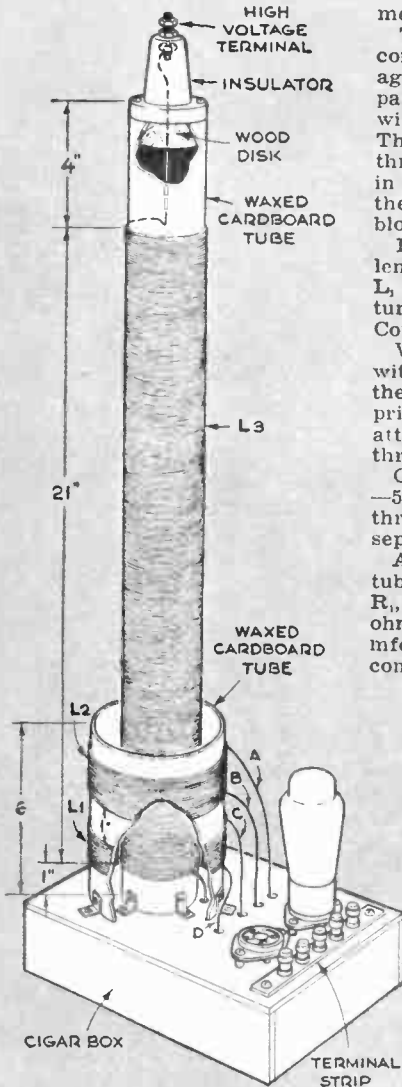

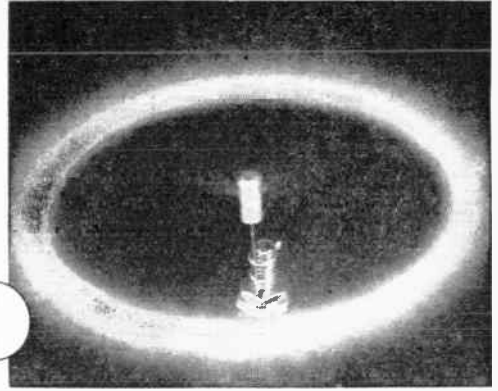
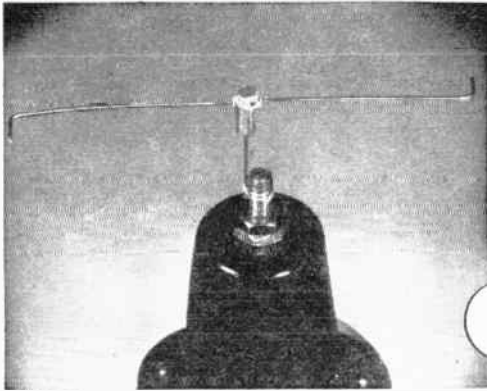

1

The spinner used in this experiment can be made of any light wire. Drill a small hole so that the metal will pivot on a pin attached to the high-voltage terminal. Shellac all but the tips of the horizontal wire.

If you've always had high respect for glass as an insulator, make the test shown below. The spark seems to jump the gap despite the 1/4" glass plate. You may have to shorten the gap a bit after inserting the glass.

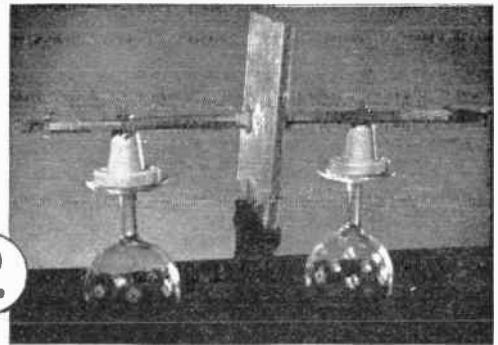
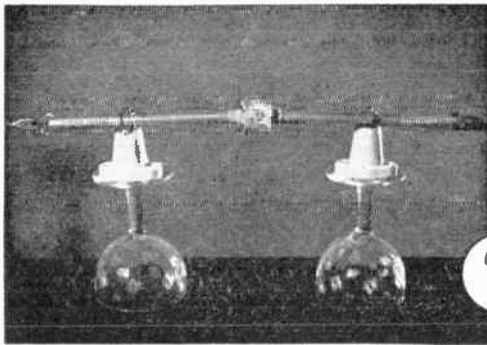

2

insulated plate so that its face is parallel with that of the first. If you touch this power-receiving plate with a screwdriver, you will draw sparks from it even though it has no wired connection with any source of electrical energy. At still greater distances—say 8' to 10'—you should be able to light a neon tube by bringing it close to the receiving plate. Small nails scattered on the table between the two plates will also throw sparks at your screwdriver.

Now for the public part of your demonstration. Place the Tesla coil in one room and locate the power-transmitting plate close to a wall that connects with another room. Draw a chair up to the adjoining wall in the second room—preferably darkened—and begin to read a book. Do you need light? Easiest thing in the world! Just pick up a 20- or 30-watt fluorescent tube. As long as you keep your hand on the tube, it will stay lit. This works well as far as 12'. Perhaps it even presages the day when we will carry our lamps from room to room without wires.

Are you tempted to do just that with

your homemade Tesla coil? Well, don't! In the first place the system would prove relatively inefficient. Even more important, it will reduce your neighbors to a state of frenzied hair pulling. This is a point well worth bearing in mind when conducting your experiments. All high-voltage devices generate some static, causing interference with radio and other electrical equipment in the vicinity. Out of consideration for your neighbors, you should avoid using your Tesla coil at those hours when you know that most people are listening to their radios.

Clearly, a good deal of electrical energy is popping out of your Tesla coil. As you might expect, it packs a lot of heat. Hold the end of a cigar or cigarette close to the output tap, and it will readily light up. If you pass the cigarette through the corona, a large number of tiny holes will appear in the paper. An alcohol-soaked cloth will also burst into flames on being brought into contact with the corona.

Fine metal wire, such as steel wool, provides a fine fireworks display. Arrange a



The stiff wire shown at the right carries the high voltage from the coil output to a wad of steel wool spread out on the loop. Can the steel wool take it? See above.

stiff wire structure, as shown at right, so one end will make contact with the terminal and the rest is well insulated from ground. Spread some steel wool across the wire loop and close the Tesla-coil switch. The steel wool will carry the current for a moment only—then it becomes white hot and disintegrates. That's a picture of what's left of the stuff right above.



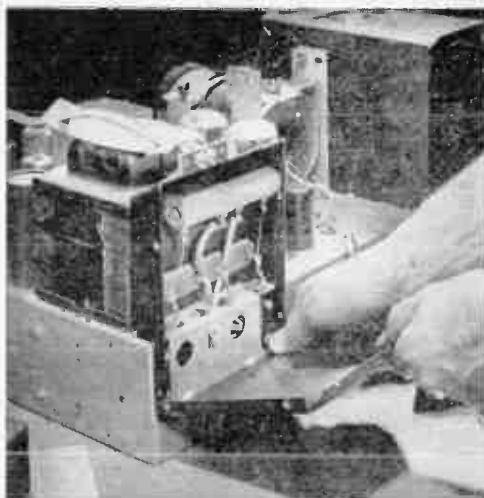

A black metal plate at the left rear of the 630 chassis covers a large resistor and two $\frac{3}{8}$ " holes. All leads from adapter can be fed to the chassis through the left-hand hole.

My TV Set 'Sees' Color Pictures

This \$4 adapter made a dual-purpose televiser out of a 630-type receiver. Here's how I built and wired it.

THOSE streaks and bars you may have seen on your screen lately are color television. They don't look like much on present sets, but with a few dollars' worth of parts you can turn them into good black-and-white images. I recently did just that on a set using the popular, widely licensed RCA 630 circuit. It doesn't hurt the set a bit—a flip of a switch and I'm back to regular reception. And later on I can simply add a motor-driven color wheel and get the pictures in full color.

The fast-moving electron beam that paints a TV picture is guided by two oscillator circuits that whip it back and forth and up and down the tube face. To adapt a set you have to increase the speed of both the horizontal and vertical oscillators.

In a 630-type receiver this means changing three condensers. For convenience in adjusting the color picture, it is also desirable to add new controls for color focus, height, and vertical linearity. All the circuit changes—and the parts I used—are shown on the next two pages.

It is almost impossible to find condensers of exactly the right capacity, so I used an

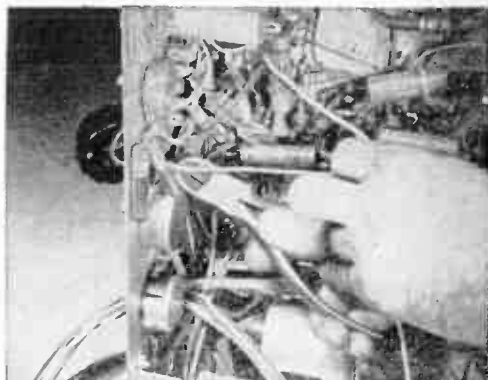

Three connections to rear-apron controls have to be cut so new leads can be installed. I cut the wires right at the control terminals.



Three condensers have to be removed. They can be used in the adapter box. In some 630 models, four condensers are affected.



This 4,700-mmf. mica condenser is taken out of the vertical oscillator circuit—(left, above)



and installed in adapter box (right) between shielded lead *d* and switch contact 10.

adjustable trimmer and a fixed capacitor in parallel in three of the circuits that I altered.

I mounted a two-deck, 8-pole, double-throw wafer switch in a 2" by 4" by 4" steel box and connected all the parts on and around the switch. Only six circuits are affected, so I left two of the eight switch poles unconnected. I put the horizontal and vertical connections on separate wafers.

To keep from getting wires and contacts mixed up, I worked out the code shown in the diagrams. I numbered the switch contacts from 1 to 18 and taped corresponding numbers on the wires connected to the contacts. I taped the letters *a* to *f* on the leads that go to other points in the box.

In my receiver I found a single .015-mfd. capacitor connected between terminal A on the horizontal-discriminator transformer and pin 5 of the 6AC7 control tube. In many 630s there is an additional .0012-mfd. capacitor—shown by dotted lines in the diagrams—in parallel with it. Where two are used, they should both be removed and installed in the adapter as C4.

When I finished, I taped the splices and insulated the shielded cables. Then I reassembled the receiver and adjusted the black-and-white image as it was before. Next, I tuned in a color broadcast, switched the adapter to "color," and adjusted the new controls.

—Norman L. Chalfin, Culver City, Calif.

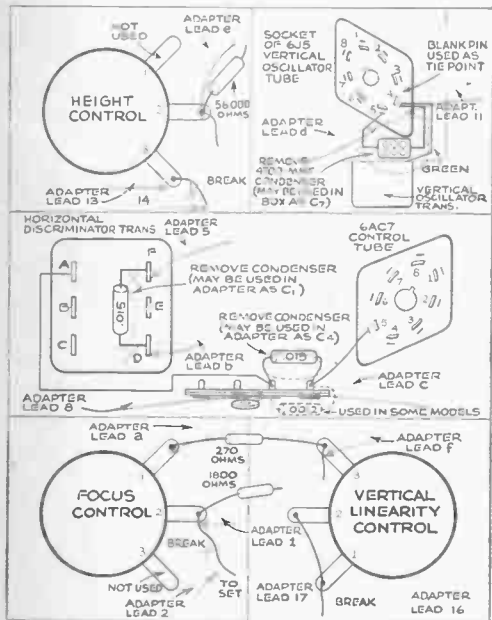

This is the completed installation. Labels show places where wiring changes were made.

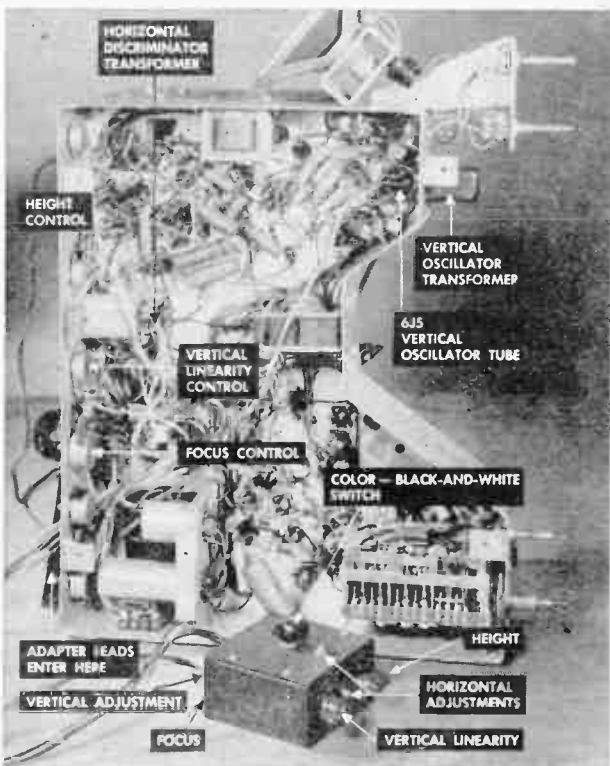

PARTS FOR ADAPTER BOX				SWITCH CONTACT NUMBERS	LEADS TO ADAPTER BOX
CIRCUIT	KEY	PARTS USED	WHAT IT DOES		
Color Focus	R1	1,500-ohm wire-wound potentiometer	Adjusts focus of color picture	1, 2, 3	1, 2, a
Color Phase	C2, C3	.0035-mfd., 400-volt paper cond. (C2) in parallel with .001-mfd. trimmer (C3)*	Allows horizontal "lock-in" circuit to operate at color-scanning rate	4, 5, 6	Two-conductor shielded cable containing wires 5 and b. Shield grounded at set and adapter
Black-and-White (B&W) Phase	C1	.015-mfd., 400-volt paper cond. (may be taken from set)	Restores orig. circuit for B&W reception		
Color Frequency (Horizontal)	C5, C6	.0035-mfd., 400-volt paper cond. (C5) in parallel with .001-mfd. trimmer (C6)*	Raises horizontal scanning frequency to 29,160 cycles for color reception	7, 8, 9	Two-conductor shielded cable containing wires 8 and c. Shield grounded at set and adapter
B&W Frequency (Horizontal)	C4	.015-mfd., 400-volt paper cond. (or .015 and .0012 in parallel. See text. May be taken from set)	Restores horizontal frequency to 15,750 cycles for B&W reception		
Color Frequency (Vertical)	C8, C9	.002-mfd., 400-volt paper cond. (C8) in parallel with .0005-mfd. trimmer (C9)*	Raises vertical scanning frequency to 144 cycles for color reception	10, 11, 12	Two-conductor shielded cable containing wires 11 and d. Shield grounded at set and adapter
B&W Frequency (Vertical)	C7	4,700-mmf. mica (May be taken from set)	Restores vertical frequency to 60 cycles for B&W reception		
Color Height	R2	2.5-megohm potentiometer	Adjusts height of color picture	13, 14, 15	e, 13, 14
Color Vertical Linearity	R3	5,000-ohm potentiometer	Adjusts vertical linearity of color picture	16, 17, 18	16, 17, f

OTHER PARTS: Two-deck, 8-pole, double-throw wafer switch (two poles not used)
 Adapter box, 2" by 4" by 4" or larger steel cabinet
 Three 60" lengths two-conductor shielded cable
 Nine 60" lengths No. 18 stranded hook-up wire (color-coded for identification)
 *All trimmers are compression-type mica

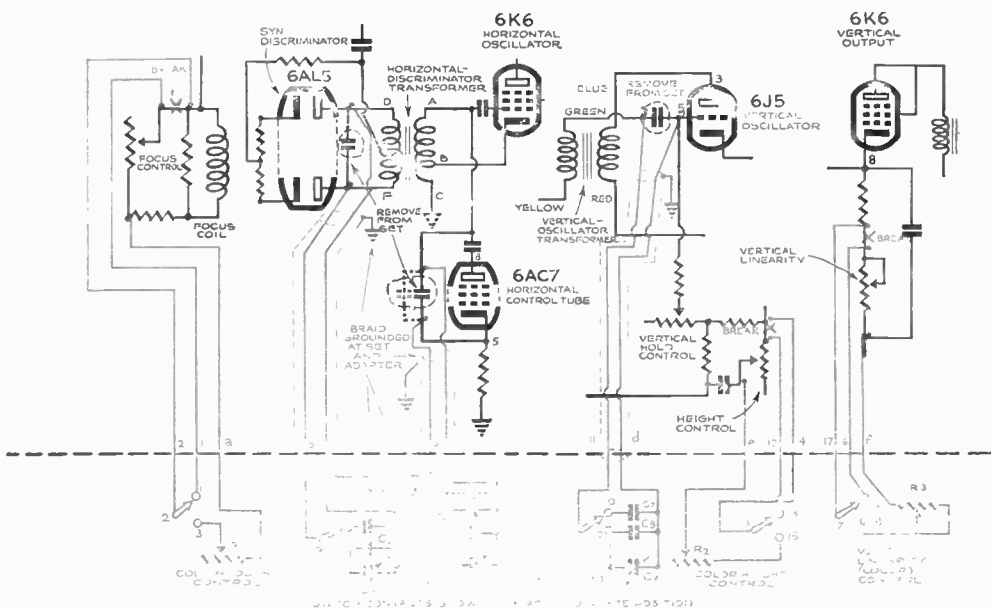

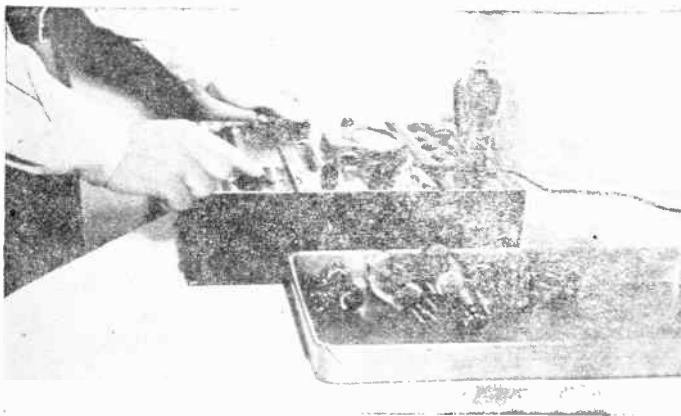

WEAK RADIO TUBES often show new signs of life when subjected to the healing effects of heat. You may have noticed that tubes that were relegated to the spare-parts shelf for a "rest" worked perfectly a year or so later. Heat merely speeds up this self-healing process. To reactivate tubes having no defects other than low electron emission, place them in a tray or shallow pan and bake them for four to five hours in an oven that is kept between 350 and 400 deg. F. Allow the tubes to cool in the oven, and test them after they are cool. Some tubes will show no improvement until they have been in operation for a few hours. The process is usable only on tubes with oxide-coated cathodes, but this class embraces practically all modern receiving tubes. No tube can be successfully reactivated more than once, so those so treated should be plainly marked.

SPAGHETTI with nail-polish "sauce" doesn't make a very appetizing dish, but your radio won't be able to tell the difference. If you have trouble obtaining spaghetti tubing, use ordinary soda-pop straws. After fitting the straw around the wire, cover it with nail polish or shellac. Be sure to apply the latter generously around the ends to prevent slipping.

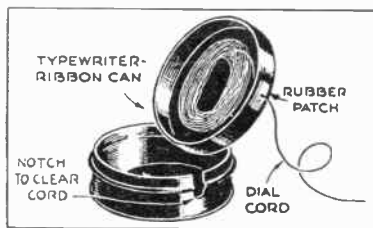
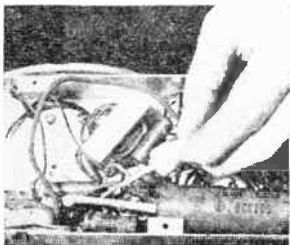

DIAL CORD won't snarl up in a serviceman's kit if it is carried in a dispenser such as that shown above. Drill a hole about $\frac{1}{8}$ " diameter in the upper part of a typewriter-ribbon can and cut a corresponding notch in the lower piece. Cement a small rubber patch over the hole, and when the cement has dried, punch a pinhole and draw the cord through. The patch acts to prevent the cord from slipping back inside.

FROZEN MUSIC used to be a constant cold-weather problem because our automatic phonograph, located next to an outside wall, refused to warm up.

We gave our sluggish turntable a boost by mounting a 5,000-ohm resistor in a space between the motor and record-changer mechanism. A separate cord and plug assembly, which can be removed in the spring, connects with the 115-volt line. The heat dissipated by the resistor keeps the phonograph at operating temperature. Power consumption, even under continuous operation, is less than two kilowatt-hours a month.



BURNED FINGERS sometimes result when tubes that have become uncomfortably hot are removed or switched around. Rectifiers, power-output tubes, and high-current television amplifiers such as the 6AC7 shown often dissipate enough watts to become painful to the touch. A pair of rubber finger-tips of the sort used by many bank tellers will protect your fingers against heat, and will provide a safe and sure grip on the tube as well.



Tiny Circuits of Silver 'Ink' Baked on Ceramic Base Plates

By HARTLEY E. HOWE

TECHNIQUES borrowed from the graphic arts now "print" whole radio circuits. The maze of wiring is replaced by a pattern of silver "ink" on a ceramic base as hard as a gem. Resistors are sprayed on. Condensers are paper-thin disks. Tubes are the size of flashlight bulbs. The result is a circuit that is not only extremely compact, but



rugged, simple to check and repair, and easy to manufacture quickly and precisely.

Once again one industry has borrowed a process from another, as in the adaptation of paper-making techniques to tin-plate manufacture. In this case, it is the familiar silk-screen process used in printing labels, posters, and textile designs. With it, a master circuit can be reproduced simply and exactly from a pattern almost as easily as a calling card is printed.

Behind the new application of this old process lies a wartime search to perfect one of our most potent secret weapons, the proximity fuse used in artillery. This deadly gadget enabled an anti-aircraft gun to knock down a hostile plane without a direct hit, by an elaborate electrical hookup that exploded the shell as it neared the target. The fuse, no longer than an ordinary radio tube, carried a completely self-contained turbogenerator, control circuits, safety devices, and an entire radio transmitter-receiver.

The space problem was tough enough, but a worse one was the terrific impact that the fuse had to sustain at the moment of firing

Methods developed to build an entire radio transmitter-receiver into the deadly proximity fuse, here compared in size to a standard radio tube, are used in printing radio circuits for commercial purposes.



Inside this rotary mixer, talc, clays, and water are whirled into a smooth mass, from which base plates of calling-card size are made for tiniest radio sets.

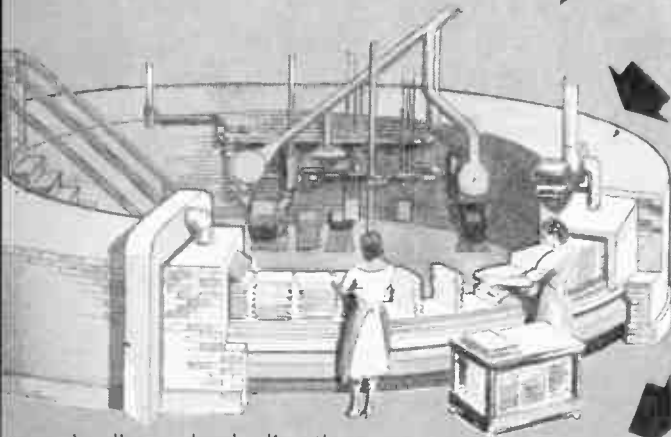

Loading and unloading the rotary kiln where the molded plates are fired. This process takes about 24 hours.

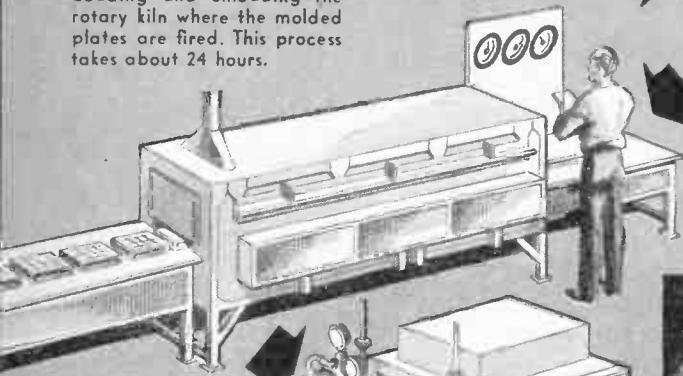

Circuits of silver paste are baked firmly to their bases in the furnace above.

Resistors of a carbon mixture are sprayed onto base plates through a stencil, then baked into position.

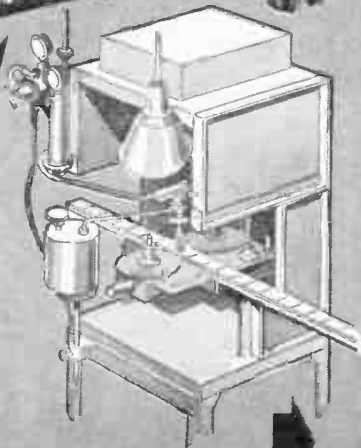

Rig double-acting hydraulic presses mold base plates under pressure up to 10 tons per square inch.

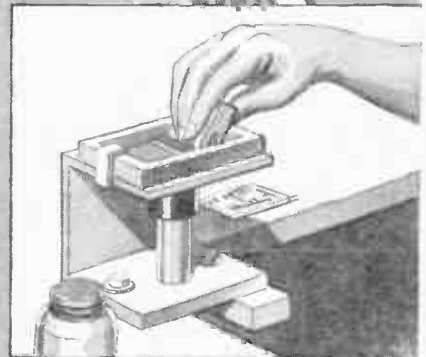
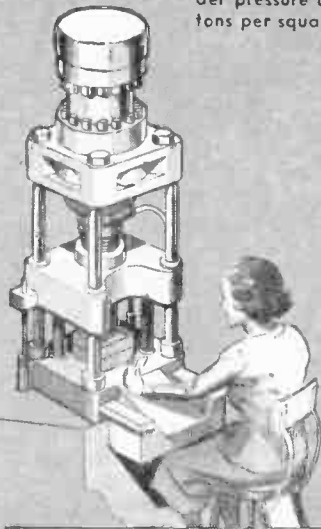

Printing a radio circuit on its base by forcing silver paste through stencilled silk screen with neoprene bar.

A small penlike soldering iron is used to fasten the miniature tube leads to the ceramic base plate.



—equal to a blow 10,000 times its own weight. Conventional wired circuits just couldn't take it.

The whole problem was turned over to the National Bureau of Standards, working with the Centralab Division of Globe Union, Inc. Centralab had a lead toward a solution. Before the war its researchers had worked on a way to build capacitors and resistors by bonding silver to ceramics. Now they applied the principle to whole circuits—wiring, capacitors, and resistors all on one ceramic base. It worked; the proximity fuse began smelling out and destroying enemy planes in upper space—and today's printed circuits are available for peacetime uses.

First step in printing a circuit is to make a pattern, which is photographed and printed on a silk screen coated with sensitive emulsion. The portions masked by the pattern are water-soluble and can be washed away, leaving the exposed emulsion on the silk in a stencil pattern of the circuit.

The "ink" is finely divided metallic silver or silver oxide mixed with binders and solvents to form a paste. This is spread on the screen, which is placed on the ceramic base plate. A neoprene bar is then pulled along the screen, forcing the silver through the stencil onto the surface of the plate to print the circuit. The silk mesh makes the deposit uniform throughout. It is fixed in place by baking it at a temperature between 1,300 and 1,500 degrees. The heat removes the solvents and binders and leaves the pure silver bonded to the plate with a tensile strength of about 3,000 pounds to the square inch.

The circuit completed, the next step is to add the resistors. These are also "ink," but a different compound: a conducting material such as finely divided carbon, an inert filler, a binder and a solvent. By combining proper proportions of these elements, and making variations in the dimensions of the resistor, exact resistances can be made

ranging from 3 ohms to 200 megohms.

The carbon mixture is sprayed on the base plate through a stencil, and after air drying the plates are again baked, this time at the much lower temperature of 300 degrees. After being coated with resin the resistors are highly stable under heavy loads or high humidity.

The capacitors or condensers are the third element to be added to the circuit. These are also of a novel type: paper-thin ceramic disks, silvered on both sides and from $\frac{1}{8}$ to $\frac{3}{8}$ of an inch in diameter. Attaching these tiny capacitors to the base plate is a delicate job. A low-temperature bismuth solder must be used because the heat of normal soldering would crack the thin condenser plates. In addition, two percent silver must be added to the solder to prevent it from absorbing the silver from the base plate.

Since ordinary solder would soak up the circuit, silver solder is also used in the final step, adding the tubes. The new tiny tubes developed during the war, highly efficient rugged, and with an extremely low filament drain, are used to keep the unit compact.

The plates on which the circuits are printed are made of a ceramic called steatite. When molded, under great pressure, the plates are chalklike. To shrink and harden them, they are dipped in glass-forming materials and fired in kilns at around 2,400 degrees Fahrenheit. When they come out they are hard enough to cut glass. Steatite will not absorb water, solvents or acids ever when completely submerged—extremely important for electrical use.

Centralab does not plan to produce complete radio sets itself but rather component parts, including amplifiers, filters, control circuits and small subassemblies, for other manufacturers. Subcircuits printed on plates plugged into the main chassis are as easy to change as a tube. This is particularly important in the export trade: radio repairmen are few in remote areas and a plugged-in circuit that can be bought as a unit, like any spare part, will enable the owner to make his own repairs.

Vest-pocket radio telephones to be carried by individuals still lie in the future but there are many immediate uses for the tiny circuits. Hearing aids can be made far smaller and more compact. Meteorological instruments can be lighter and stronger. Electronic controls of all sorts, in fact, will benefit from the ruggedness and simplicity of the silver circuits, and from the small amount of space they occupy.

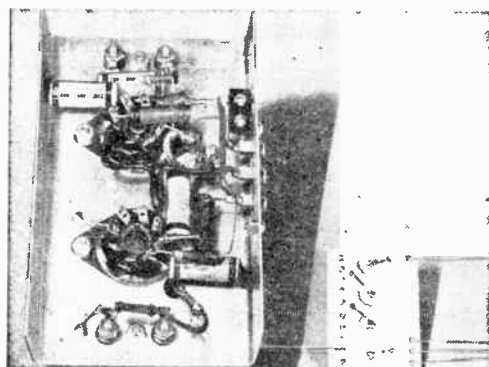

The bottom of a regular radio chassis, with its clutter of wires and parts, contrasts strikingly with the compact base plate of a printed radio circuit, shown at a comparable stage of assembly.



First color receiver, CBS-Columbia console, left, will also catch black-and-white telecasts.

Here Is What You'll Find

Inside the New Color TV Sets

By Robert Gorman

"COLOR receivers are simple and should be within the economic reach of the great mass of the purchasing public," declared the Federal Communications Commission when it okayed the Columbia Broadcasting System's proposals for color television.

One way to make a color receiver is to

build onto a present black-and-white set. CBS colorcasts can be received in black-and-white on any set if an *adapter* is added to it. Colors can be seen by adding a *converter* with color wheel to an adapted set. Or a *slave unit* consisting of a separate picture tube and color wheel can be connected up to an ordinary TV set to bring in color pictures.

But manufacturers are rushing now to

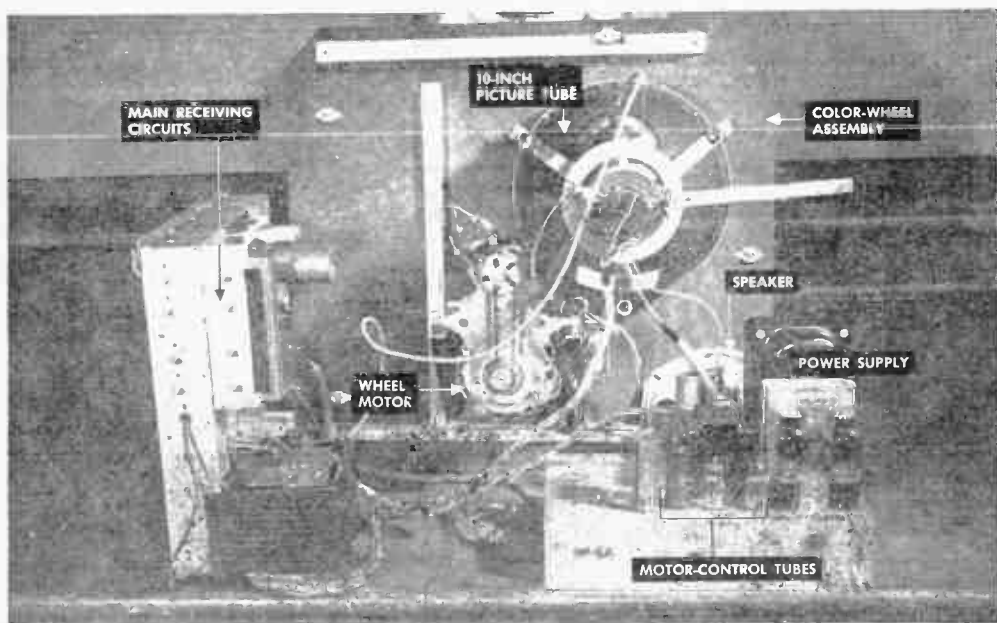

Pilot model of the works inside the console at top of page. Chassis is little different from

present receivers, but has added circuit to keep color wheel synchronized with transmitter.

produce *combination sets* that will receive either colorcasts or black-and-white on the same screen. One of the first of these to be disclosed is the CBS-Columbia console (in some places also trade-named "Air King"), shown on this and the facing page. It is made by a subsidiary of the color-championing Columbia Broadcasting System.

How it works. When a color picture is televised in the studio, filters at the camera separate the picture's red, blue and green components. These individual color "fields" are transmitted as a rapid succession of black-and-white images. They are sent out at a rate of 144 a second.

To put this picture together in the receiver, a spinning color wheel passes over these black-and-white pictures at exactly the same rate. In Air King receivers, the wheel is driven by a motor that's linked to the wheel shaft with a toothed belt.

This specially designed induction motor can hold to a fairly constant speed. By itself, though, it probably wouldn't stay for long in exact step with the transmitter. To keep it locked in, the receiver uses an ingenious comparison circuit that gets its timing orders from the incoming pictures.

Wheel-speed control. A small segmented disk called an alternator is attached to the color-wheel shaft. As it turns, it cuts through the magnetic field of a tone generator. It interrupts the field at about 144 times a second.

This, together with the incoming picture pulses, gives two sets of 144-cycle tones. Both are fed to a control circuit and electronically compared. So long as they are the same, nothing happens. But any difference between them results in a voltage that is fed to a special transformer called a saturable reactor. The reactor immediately responds by modifying the power that drives the motor, speeding or slowing the wheel until it keeps exact pace with the incoming picture.

Wheel-phase control. Like a rookie who marches at the same pace as his squad but out of step, the color disk in a receiver can still be wrong. It can spot the green segment in front of the picture tube when the red one should be there. When you turn the set on, the wheel may join the parade at the right speed—but out of phase.

The answer to this is comparatively simple. When a green-haired singer shows up, you just touch the phasing switch on the control panel. This causes the color

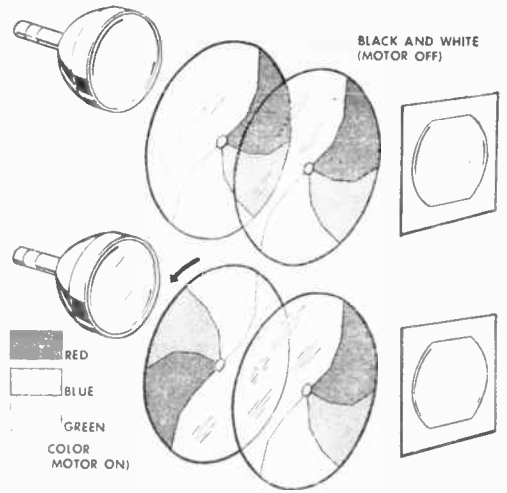

Clear segments of wheels line up before panel window when motor is off (top above). When wheels spin for colorcasts, one lags half a turn behind other, giving full color wheel (bottom).

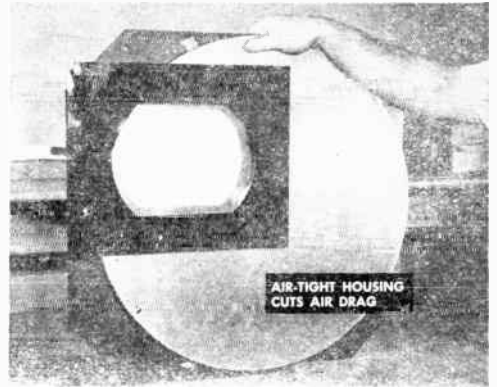

Twin wheels make it possible to see black-and-white shows without moving them aside (above). The 10-in. screen magnified to 12½-in. is as big as can be used easily with disks.

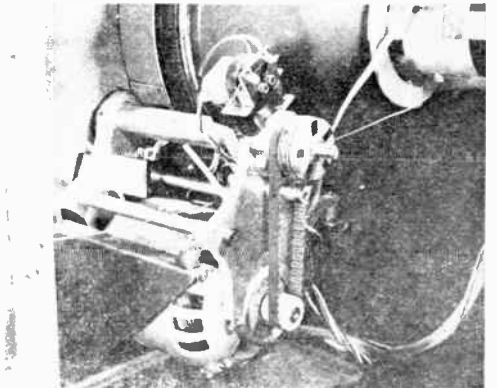

Wheel motor, its speed precisely governed by transmitter pulses, turns color-wheel shaft by a toothed belt. This gives a positive, nonslip drive like a car's timing chain.

drive to skip a beat, bringing the right color segment into place at the right moment. (Since there are three colors involved, the singer may look even queerer the first time you touch the switch. But just keep at it and she'll turn the right color).

Two wheels used. Having succeeded in coloring the picture, the designers of the combination receiver were faced with a poser: what do you do with the color wheel when you want to watch a regular black-and-white program? Pivoting mounts to swing the whole rig out of the way would be bulky and cumbersome.

They licked this problem by using two

wheels. Half of each one is clear plastic. The other half is divided into color segments. Each wheel turns on the same shaft, secured to it by hubs that use a clever centrifugal locking device. When the wheels spin, they are locked 180 degrees apart so the colored part of one masks the clear part of the other. In this state they amount to a single, complete color wheel. But when they stop, the centrifugal hubs and a brake bring the wheels to rest with the clear sections lined up in front of the tube face for black-and-white viewing.

This combination receiver uses a 10-inch tube, magnified by a built-in lens to 12½ inches.

TV Wire Replaces Handle Strap

WHEN the handle strap on my camera case wore out, I replaced it with a strip of ribbon-type television twin-lead wire. I doubled both ends of the wire and riveted them to the case.—H. Holsten, *The Bronx, N. Y.*

New Trap May Brighten TV Picture

REPLACING an old ion-trap magnet with a new or more efficient one often will brighten a TV picture. Traps are available in single- and double-magnet types. Make sure the new one matches the original. Rotate and slide the magnet on the tube neck until you get the brightest image. Then readjust the focus coil slightly if necessary to make the picture fit the frame.



TV Cabinet Conceals Bar



WHEN closed, this bar looks like an ordinary TV set. Elliot Nouas, left, built it into a chassis-less Du Mont cabinet for a friend. The whole front of the cabinet pivots at the center.

Shellac Reduces Plywood Splintering

You can get cleaner cuts when jigsawing designs in plywood if you coat the underside with shellac. Mix equal parts of shellac and alcohol. Let it dry before sawing.

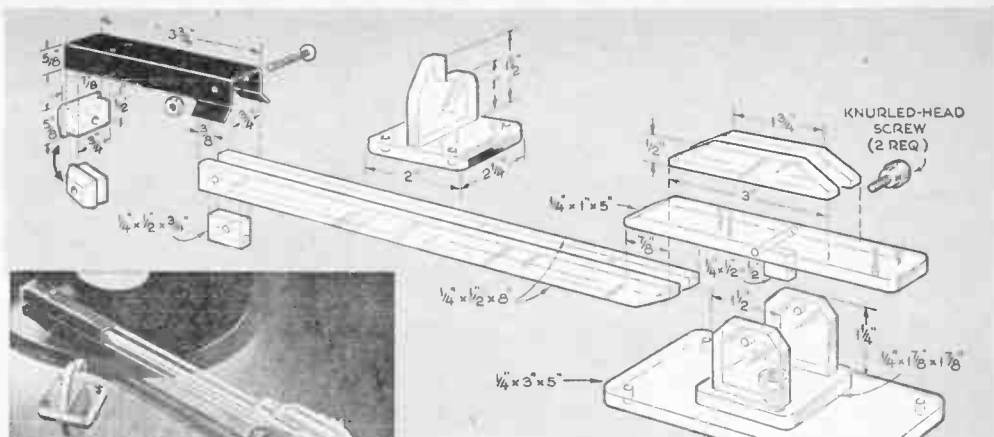

Phonograph Pickup Arm of Plastic Is Handsome and Light in Weight

HIGH-QUALITY reproduction and modern design are combined in this pickup made from a light-pressure crystal replacement cartridge and a few pieces of $\frac{1}{4}$ " clear plastic, which may be scraps.

The pieces were cut as shown, the edges sanded to a smooth, frosty finish, and joined with plastic cement. Thin aluminum was

shaped as shown for the cartridge housing, and a shielded wire run back along the channel of the arm through a length of $\frac{1}{4}$ " pipe nipple at the base. The nipple is a tight fit in the base and a free fit in the swivel bracket, while the knurled screws are a snug fit in the bracket and a free one in the arm for easy action

Recording-Disk Grooving Rig Uses Electric-Clock Motor



WITH pregrooved recording disks hard to find, many home-recording enthusiasts have been forced to use expensive cutting heads in order to make impressions on ungrooved blanks.

Having assembled all the equipment except the cutter, however, I found that the rig shown at the left gave excellent service as a pregroover. The only unusual piece of equipment involved is a 1-r.p.m. electric-clock motor. Mounting the motor inside the cabinet, I fitted the vertically projecting shaft with a small section of $\frac{1}{2}$ " bolt. The bolt acts as a winding drum for a length of No. 30 wire fastened to the recording arm about two thirds of the way from the pivot. As the clock motor turns, the needle is pulled across the record. A light coil spring placed around the pivot, as shown at the lower left, provides the slight tension needed to keep the wire tight between pickup and drum.

For proper operation, the drum must rotate at a constant speed and be completely free of wobble. Spacing of the grooves can be varied to some extent by shifting the connecting wire closer to, or further from, the recording-arm pivot. Using this setup, I get about 75 lines per inch. The smaller the drum, the more lines.



Look, Pa...

No Hands, No License

This radio can open garage doors,
run a lawn mower, or steer a boat.
And you need no license to use it.

By Howard G. McEntee

LET'S dream a little. You lie in a hammock on a warm day with a cool drink in one hand. With the other you jiggle a switch on a small box by your side. And fifty feet away, a power mower trims your lawn, aboutfacing at the end of each swath. When the chore is done, it rolls into the tool shed, and the engine dies.

Or you're a modelmaker with a new power boat. You put it in the water, and a finger on a control panel starts it up. You maneuver it out, race it between floats, bring it back alongside the slip. Invisibly, your hands are on the tiller all the way.

Radio control does things like that. But Uncle Sam says you have to have a ham license to work a short-wave control rig. Does that leave you pausing behind a mower, or running your boat in circles?

It needn't, because there is a radio-control system you may use without a license. Called RF induction, it's widely used for "wireless" phonographs, garage-door openers, and campus broadcasting stations.

Keep it legal. The Federal Communications Commission permits transmission of this kind—provided it does not interfere with other radio services or exceed a certain signal strength at a given distance from the antenna. The transmitter pictured on the facing page stays well within the legal limits, yet packs enough sock for a host of radio-control applications.

So far, I'm still dreaming of my robot lawn mower, garage-door opener, and maybe a miniature Army tank. But I have actually put radio control to work in a model

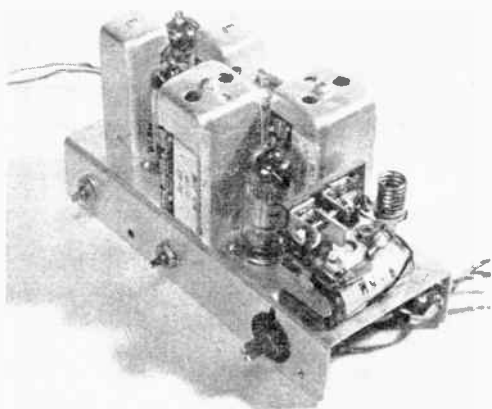

cruiser. I can guide the craft within an 80' radius (or a 160' circle if I take the transmitter out in a rowboat), and I can boost this range by using a larger loop antenna on the receiver.

The transmitter. You don't need a fancy transmitter. The photos show how simple mine is, and I built in a couple of operating frills that aren't essential.

I housed the whole broadcasting station—batteries and all—in a 5" by 6" by 9" steel box. A strip of brass on the bottom of the case was drilled and tapped $\frac{1}{4}$ "-20 to fit a tripod screw. A similar arrangement on top fastens the loop antenna.

Parts layout isn't critical, and a few items shown in the diagram can even be omitted. Among these are the meter and thermocouple, which I salvaged from a two-dollar, war-surplus antenna unit from a BC-442 transmitter. The meter provides a handy check on transmitter operation, but if you can't get one cheaply, leave it out and join

Transmitter at right is steering boat at left. Antennas are flat to avoid directional effects.



the two wires that go to the terminals marked "line."

On the front panel under the meter I mounted two jacks. The regular phone jack is for the transmitter "key," which can be a simple on-off switch or a control mechanism such as is shown on page 206. The second jack—also optional—furnishes 1.5 volts to operate the control motor.

The receiver. The other end of the radio control resembles an ordinary superhet receiver. To conserve space I bent up my own chassis out of sheet aluminum. The size of the coils, tubes, and relay limit the amount of squeezing you can do; the remaining parts have room to spare under the chassis.

I wound the antenna loop on a 1½" by 3¾" by 6¾" plastic box. If you don't have one like it, cut a block of *dry* wood to the same dimensions. A larger loop would make the receiver more sensitive; if you make it larger, however, you'll have to use fewer turns and a smaller capacity for C4. If you redesign the antenna or build it into a model, keep it away from metal.

Testing the units. I normally operate the transmitter on a 90-volt B battery, but when I want to stretch the range a little—as when my boat sails out of control—I switch in an extra 45 volts. I haven't gone beyond 135 volts because it would be illegal—and would also damage the 1S4 tube.

The scale on the antenna meter is marked arbitrarily from 1 to 10. It should read about 4 when the transmitter is operated at 90

volts and 7 at 135 volts. The pointer should not go over 8.

If you have omitted the meter you can check the transmitter by plugging an ordinary 0- to 25-milliamperere DC meter into the key jack. It should read about 10 ma. at 90 volts.

It is fairly simple to tune up the receiver, but you will save time if you can lay hands on a signal generator and a 0-to-1 milliammeter.

Connect the meter to the receiver test jack. When no signal is being picked up it should read about .6 ma. If you have a signal generator, set the dial to 150 kc. and connect the output leads across the outside terminals of the transmitter loop. Rotate the screws on the three receiver trimmer condensers until the meter shows its lowest reading. Then adjust the tuning screws on the transformer cans and see if you can lower the meter needle.

If you don't have and can't borrow a signal generator, proceed as follows:

1. Check the meter reading in the "no signal" condition, as above.

2. Turn on the transmitter and dial its tuning condenser while you watch the meter at the receiver.

3. If the meter doesn't change, adjust receiver trimmer C3 about a quarter turn and repeat step 2 until the receiver meter dips.

4. Touch up the receiver trimmers and transformer screws till you get the lowest

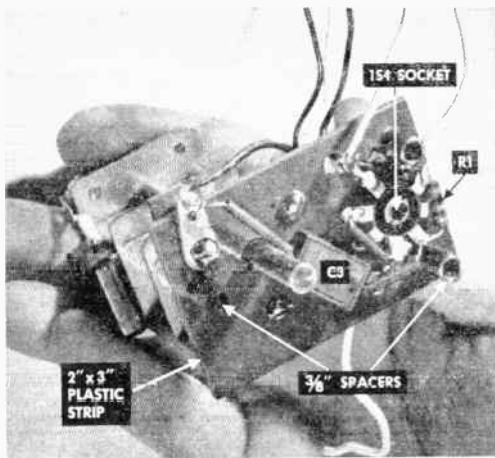
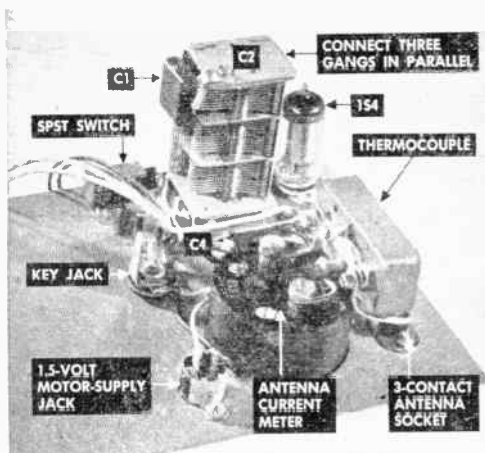

Transmitter chassis is panel of steel box. Tuning condenser must be insulated from case; I mounted it and tube socket on plastic (right).

Shaft goes through oversized hole in panel. Circuit below should be used with antenna shown or signal strength may exceed legal limit.

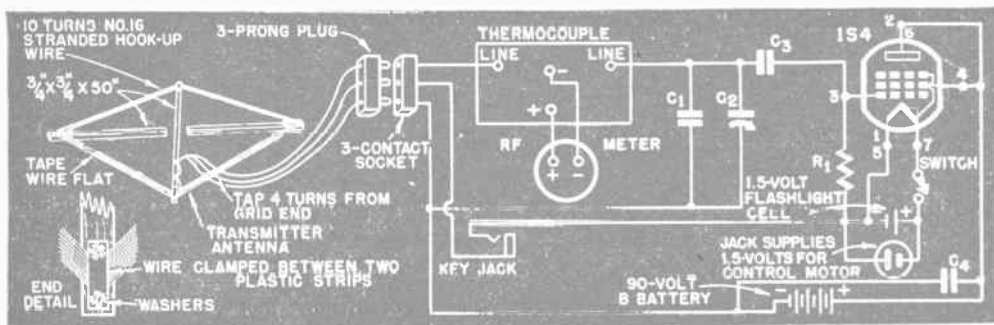

LIST OF PARTS FOR TRANSMITTER

C1: .003-mfd. mica.

C2: midget 3-gang tuning condenser, 365-mmf. each section (J. W. Miller Co. No. 2113 or equivalent).

C3: .001-mfd. mica.

C4: .005-mfd. mica.

R1: 22,000-ohm, 1/2-watt carbon.

3-prong plug and socket for antenna connection; 125 ft. No. 16 stranded hook-up wire for antenna (see sketch); meter and thermocouple from surplus BC-412 antenna unit (optional,

see text); SPST toggle switch; dial plate and knob; phone jack; two-contact socket; 1S4 tube and 7-pin miniature socket; 5" by 6" by 9" case; 1.5-volt A battery, 90- or 135-volt B battery.

reading. If the needle goes to zero, move the receiver further from the transmitter.

When you have both units in operation, but before you remove the receiver test meter, set the relay contacts. The relay should operate at .5 ma. and open at .4. The contact adjustment screws regulate its response. You can change the current that reaches it by detuning the transmitter or signal generator. If you order your relay from the factory, ask them to preset it at these values.

Control system. A model boat hull 27" long with an 8½" beam just comfortably holds the receiver, steering unit, and an electric drive unit. You could get more speed, of course, with a gas engine, but you

wouldn't be able to start it up again by remote control once you stopped it.

Minimum control calls for right or left rudder in any desired degree, plus full ahead or stop. This sounds like a lot to wangle out of a single control channel, but you can do it by pulsing the transmitter.

A small permanent-magnet motor is connected to the rudders through a gear train that moves them from one extreme to the other in about six seconds. Two single flashlight cells are so connected across the relay points that when there is no signal, one cell turns the motor to give right rudder. Reception of a transmitter signal flips the relay, closing the other cell circuit and reversing motor polarity to give left rudder.

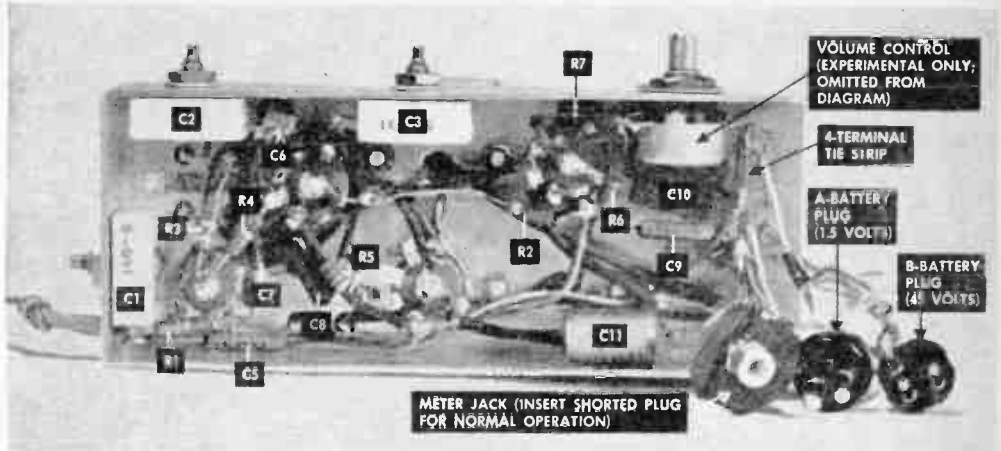

Volume control (shown in photo above) and pilot light are omitted from diagram (below) because they play no part in actual operation.

Contacts on RF and oscillator coils, T1 and T2, are numbered on cans. Follow diagram numbers even if different from manufacturer's data.

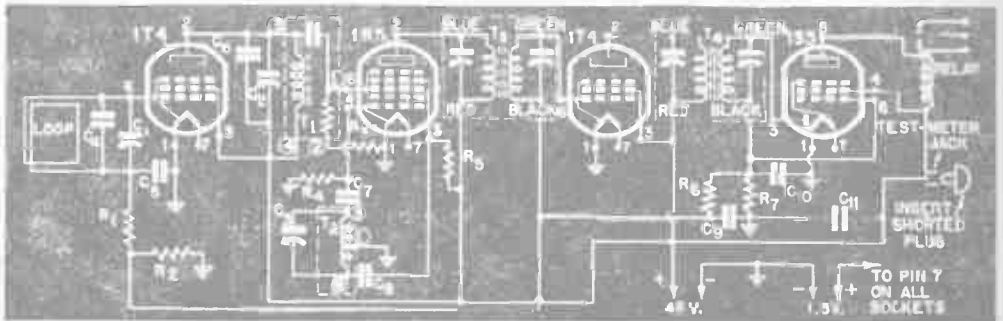

LIST OF PARTS FOR RECEIVER

C1, C2, C3: 50-400-mmfd. mica compression trimmers (Miller[®] 160-B or equivalent).
 C4: .00125-mfd. mica (.001 and .00025 may be used in parallel).
 C5: .002-mfd., 150-volt midget paper.
 C6: 100-mfd. mica.
 C7: 150-mfd. mica.
 C8: 500-mfd. mica.
 C9: .001-mfd., 150-volt midget paper.
 C10: 250-mfd. mica.
 C11: .25-mfd., 100-volt paper.
 R1: 47,000-ohm, $\frac{1}{4}$ -watt carbon.

R2: 2.2-megohm, $\frac{1}{4}$ -watt carbon.
 R3: 270,000-ohm, $\frac{1}{4}$ -watt carbon.
 R4: 22,000-ohm, $\frac{1}{4}$ -watt carbon.
 R5: 27,000-ohm, $\frac{1}{4}$ -watt carbon.
 R6: 1-megohm, $\frac{1}{4}$ -watt carbon.
 R7: 2.2-megohm, $\frac{1}{4}$ -watt carbon.
 T1: 140-125 kc. miniature RF coil (Miller[®] X-121-RF or equiv.).
 T2: Miniature oscillator coil (Miller[®] X-121-C or equiv.).
 T3: 127-137 kc. input IF trans., iron core (Miller[®] 012-M1 or equiv.).
 T4: 127-137 kc. output IF trans., iron core (Miller[®] 012-M4 or

equiv.).
 Relay, 10,000-ohm SPDT plate-circuit (Sigma Instruments, South Braintree, Mass., Model 5F, or 8,000-ohm model 4F, or equivalent).
 Tubes: 1T4 (2), 1R5, 1S5 and 7-pin miniature sockets (4); aluminum for chassis; 4-bag terminal strip; phono jack (for meter) and shorted plug; 1" by 3" by 6" plastic box and $\frac{1}{8}$ lb. No. 28 D.C.C. wire for antenna (see photo); 45-volt B battery, 1.5-volt A battery. *J. W. Miller Co., Los Angeles.

The loop antenna is wound flat on a plastic box as shown. The Sigma 5F relay seen in photo is excellent but expensive; alternate, less costly unit in parts list also works fine.

This sounds as if you have to keep going from one rudder position to the other. But if an on-off pulse signal is transmitted, the relay flips up and down, making the steering motor turn just a few revolutions back and forth continuously. The rudders jiggle but don't move enough to have any effect. So whenever you want to make the boat



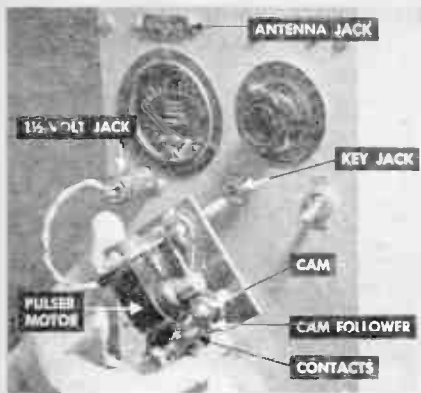

Transmitter is housed in metal cabinet. A plate in the bottom is tapped 5"-20 for a camera tripod; the antenna mount, tapped the same way, is bolted to the top. A phone jack connects pulser into circuit, and a two-contact socket feeds juice from the A batt'ry to the pulser's motor.



Control is installed in an Elco 35 cruiser from a kit made by Marine Model Co., of Halesite, N. Y. An oversize hatch was fitted to the forward deck to accommodate the receiver. The cabin roof was made removable and the loop fixed to it. A 12-volt motor drives the craft. Motor batteries and steering gear are in the stern.

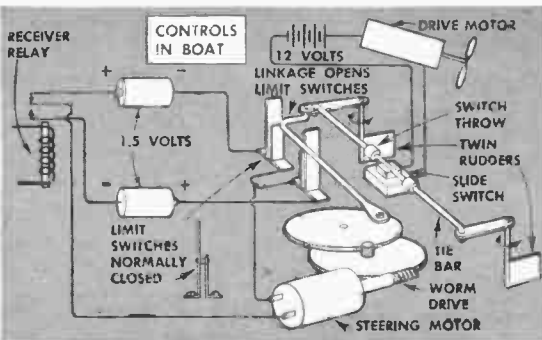
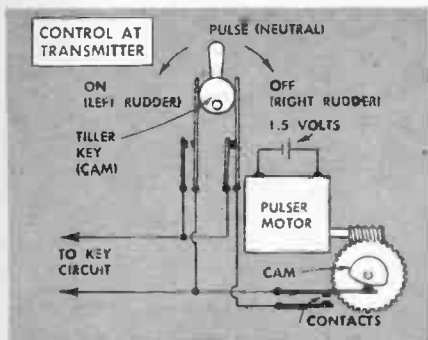

go straight or keep turning in the same direction, you just send a pulsed signal at the point you want the rudders to stop.

The pulser. To time the pulse for on and off periods of the same length, I use a small battery motor with a 30-to-1 worm gear that turns at about 100 r.p.m. A brass cam on the gear is filed to a shape that will close a set of spring contacts during half its rotation. This gives an on-off pulse about 100 times a minute.

Control key. A telephone-switchboard type of key switch with right, left, and center positions makes it easy to visualize rudder movement. But two single-throw spring switches, one normally on and one normally off, will do. The switches are connected across the pulser so that in one position they short the pulser contacts (steady signal, left rudder) while in the other they break the pulser circuit (no signal, right rudder). Untouched, they let the pulser send its rhythmic on-off signal.

The steering linkage works between two limit switches, each a pair of normally closed spring contacts. At each extreme of travel, the linkage touches one contact leaf, opening the circuit through which the motor is being powered. It can't then be energized again except through the reverse circuit.

Drive control. To turn the driving motor on and off, a slide-type switch is mounted between two adjustable throws on the rudder tie bar. When the rudder reaches extreme left, the switch goes off. To turn the motor on again, the rudder must be swung over to the extreme right.

If the boat gets out of range (no signal), the relay throws to right rudder, leaving the motor on to bring the ship in a circle back toward the transmitter.

For partial rudder, the tiller key is held to one side, then centered. The rudder will stay on that side.

ENB

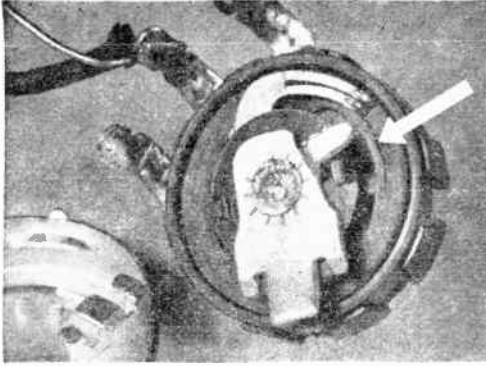

NOISY OR ERRATIC performance may result if there is pitting in the resistance element of a carbon-strip potentiometer, above, often used as a volume or tone control. The pitting, which develops after use or where the unit must carry appreciable current, occurs directly under the curved path of the movable contact finger. A satisfactory repair can be effected by bending the movable contact radially, either in or out, so that it travels along a fresh track on the carbon strip. Controls having two or more contact fingers will work for a time with only one, so if a new path cannot be obtained, remove the finger that rides along the pitted path.

HIGH-VOLTAGE LEAKS within a condenser can be quickly located with just an ohmmeter or voltmeter and a B-battery. The same method will measure unknown high resistances on the order of 10,000 megohms.

To test the resistance of a condenser, connect it as at A, close the circuit for an instant, and then open it. The meter will kick. If the condenser were perfect, remaking the circuit would not cause the meter to budge. In practice, a .02-mfd mica condenser in good shape won't show a second meter kick after a delay of a minute, though a good paper condenser may lose its charge in a few seconds. Comparative tests with similar condensers known to be good will tell whether a specific condenser is good, fair, or poor.

RESISTOR BRIDGES, or chains of fixed carbon resistors, have numerous test uses. Below is shown how five 1-megohm resistors were connected to measure a 10,000-volt power supply with a 5,000-volt voltmeter. They were connected across the power supply to simulate its normal load and the voltmeter was then connected across one of the resistors. The true voltage was somewhat more than five times the reading because of the voltmeter draw, but this factor can be neglected with most testing meters.

Another use for this improvised voltage divider is for securing accurate low A.C. test voltages sometimes required as a signal input. To obtain .1 volt, for example, use 10 resistors of equal value across a 1-volt 60-cycle source.

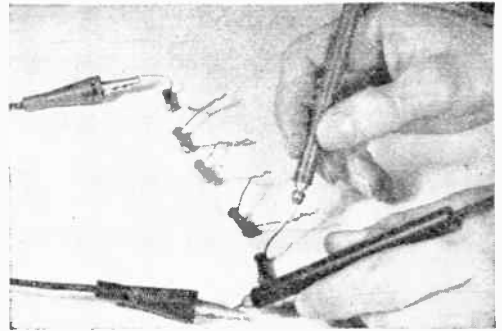

Approximate values of resistors can be determined as at B. By comparing the meter deflection after a timed wait when the condenser is shunted across an unknown resistor with that obtained from a known one, you can gauge the unknown value.

Insulation resistance can be checked by the method illustrated at C. A 1 or 2-mfd. oil-filled condenser may show a substantial charge after eight hours if in good condition. Give one of this type a charge of several hundred volts from a B power supply, and connect it across the insulation to be checked. If the condenser alone gives a healthy meter kick after eight hours, but in the circuit loses its charge in five minutes, the insulation leaks badly.

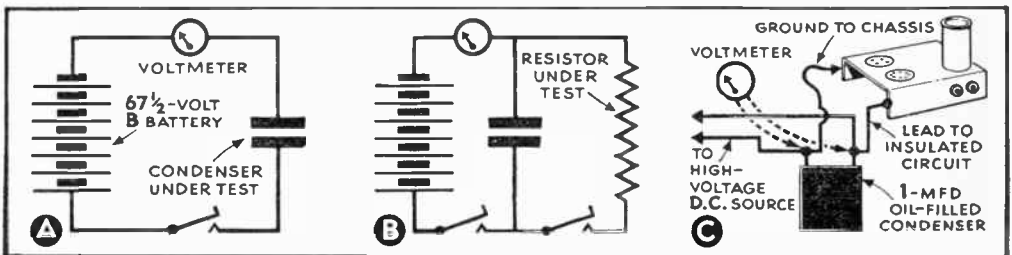

ANSWERS

1. Universal output transformers.
2. C bias cell, a "perpetual" battery that maintains a 1½-volt potential for an indefinite time.
3. Intermediate-frequency (456 kc.) transformer.
4. Radio-frequency chokes.
5. Straight-line frequency short-wave tuning condenser.
6. Short-wave receiver plug-in coils.
7. Paper bypass condensers.
8. Mounting or terminal strips.

8

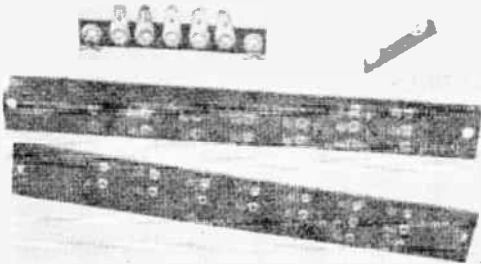

7



9

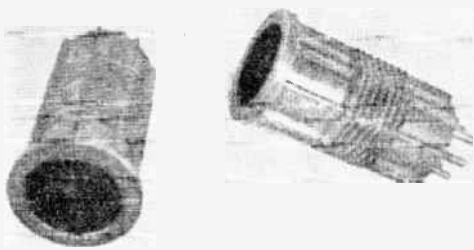

5

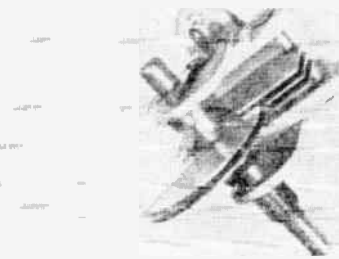

4



3

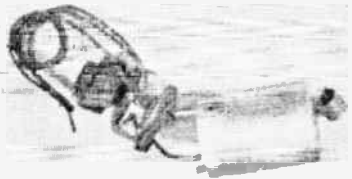

2



1

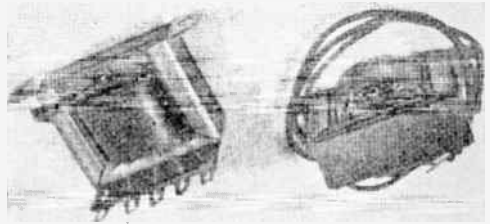

Question Bee

ANSWERS

1. Various types of sockets.
2. Potentiometers.
3. Loudspeaker voice coil removed from the cone.
4. Electrolytic filter condensers — dry and wet can types and a dry cardboard type.
5. Carbon resistors.
6. Three-gang tuning condenser for a superheterodyne.
7. Wire-wound, heavy-duty bleeder and voltage-divider resistors.

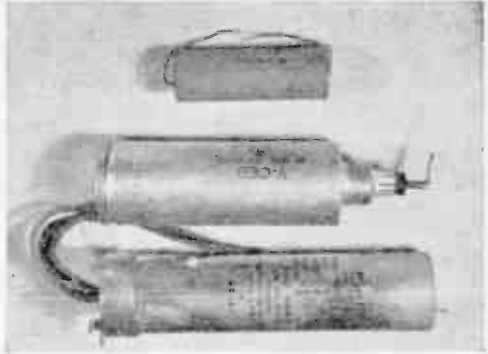

4

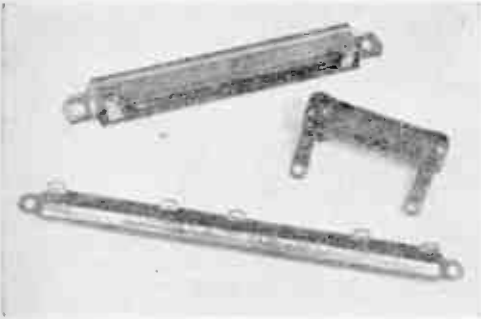

3

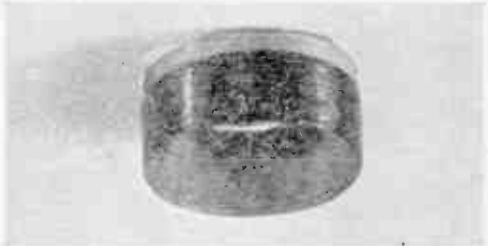

2

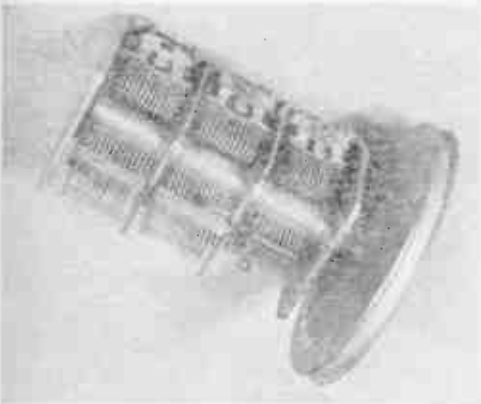

1



5

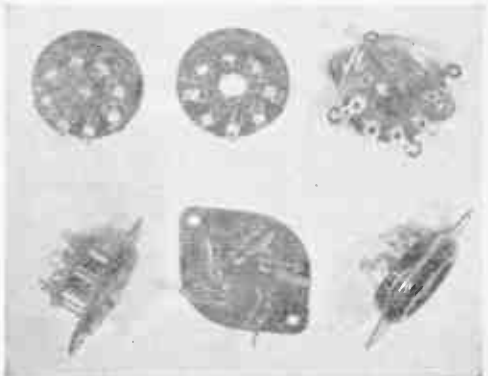

Can you name these familiar radio parts?

How to Light a Room for Television

Badly placed lights, or not enough, can strain your viewing fun—and your eyes.

TELEVISION lighting isn't entirely up to the technicians in the studio. You, the viewer, can increase your enjoyment of the show if you light your TV theater right.

The first thing most people did when they turned on their brand-new sets was to turn off the room lights. After all, don't you watch

movies in the dark? This, say the experts, couldn't be more wrong. Movie theaters are dark to balance their very large, very dim screens. TV screens are small and surprisingly bright. To avoid discomfort—and possible eyestrain—they should be balanced with fairly bright lighting.

The expert's formula is a very even, reasonably high level of illumination throughout the room. The wall behind the set should be especially carefully lit—smoothly, quite brightly, but with no areas much brighter than the screen itself. This lets your eyes move around without encountering sharp contrasts, which are very annoying. Ideally, none of this light should fall directly on the TV screen. But most important, no bright spots—lampshades or lighted bulbs—should be reflected back to your eyes by the screen.

Here are some tips for your TV room:

Don't use ceiling lights except totally indirect ones or the modern, flush types that project light straight down. Ordinary ceiling fixtures may cause bad reflections.

Do use floor and table lamps. Indirect floor lamps, set at low or medium brightness, work very well. If translucent lampshades are reflected in the TV screen, you might replace them with opaque shades. If the bright inside rim of a lampshade is picked up by the screen, try covering the rim with a band of dark material.

Don't put lamps near the set so you see them when looking at the screen. Even though the light may not disturb your eyes, the bright area will tend to distract your attention from the picture.

Experiment with a small light fastened to the back of the set itself. This is a very effective way of lighting the viewing wall, for the cabinet hides the bulb and the bright area immediately around it.

Check for reflected bright spots in the TV screen. One quick way is to hold a small hand mirror against the safety glass and move it around. If reflections show up, you may be able to eliminate them simply by moving something—the lamp, the set, or the chair you normally watch from.



Most annoying lighting trouble is reflection of bright lamps in the viewing screen. An easy test for this is to turn on the lamps and move a hand mirror around on the safety glass.

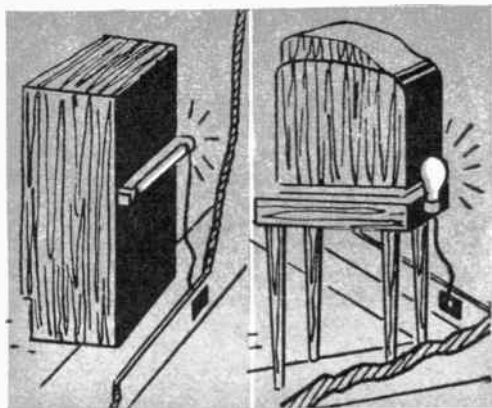

Rigging a light directly to the set is a good way of illuminating the important background area. If set rests flat against wall, use 8-watt fluorescent or 30-watt Lumiline type of incandescent. Ordinary round incandescent (25 or 40 watts) can be used if set is in a corner.



WRONG This looks like fun, but is almost sure to lead to eye fatigue. The junior cowpokes are too close to the screen in a room that is much too dark. Bright screen sur-

rounded by darkness "locks" eyes, tiring them. Areas near set should be bright, so that the children's eyes can move around without making adjustments to sharp changes in illumination.



RIGHT The room is now correctly lit for comfortable viewing—and safe walking. High light level will not wash out picture on modern "black" tubes. Notice placement of

floor lamp. It is out of children's view, does not spill direct light on screen and is not reflected in the screen. Another light fastened to back of set helps illuminate background walls. END

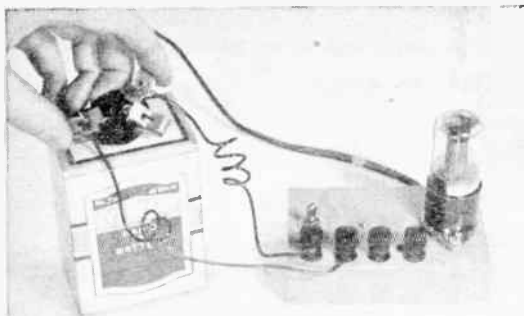

Charging a "B" battery from house current, left. "A" batteries are connected to the other two posts on the charger for similar rejuvenation. Only one battery should be recharged at a time

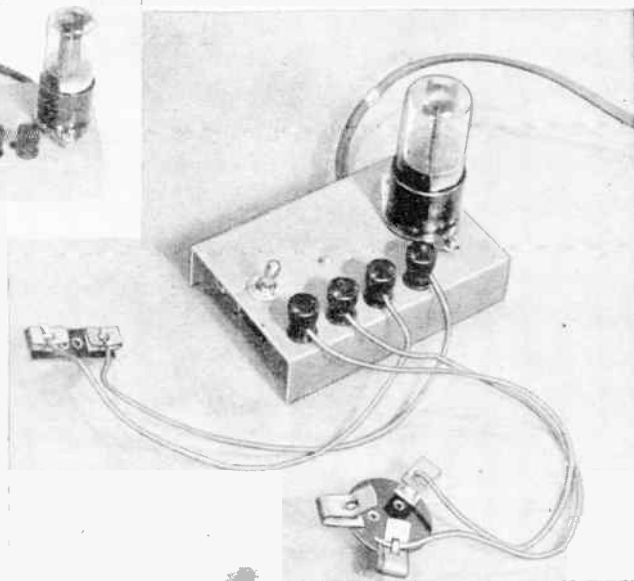

LIST OF PARTS

Metal chassis, 1 1/4" by 3 1/2" by 4 1/2".
 Octal wafer socket,
 Half-wave rectifier tube,
 117Z6-GT.
 Carbon resistor, 2 watts,
 50 ohms.
 Wire-wound resistors (3):
 10 watts, 30 ohms; 10
 watts, 7,000 ohms; 25
 watts, 2,000 ohms.
 Electrolytic condenser.
 Toggle switch, S.P.S.T.
 Binding posts (4).
 Rubber line cord and plug.

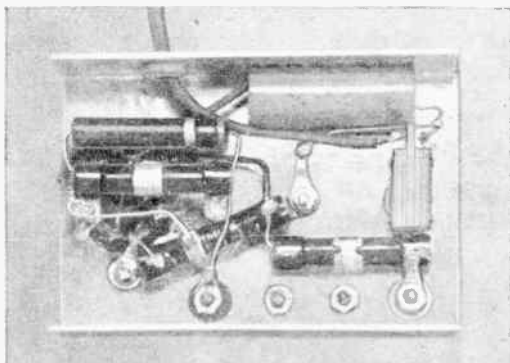

Four resistors and an electrolytic condenser are installed under the chassis, as shown above, with connections made as in the wiring diagram below

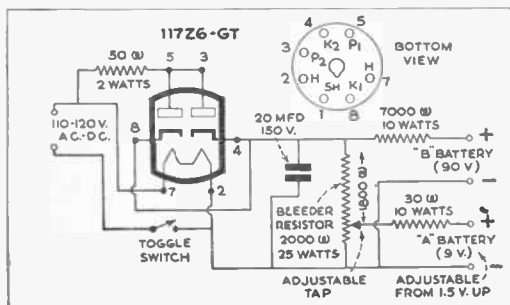

Radio Batteries Boosted on Homemade Charger

BATTERY life can be lengthened with this home-built charger consisting of a special resistor network and a 117-volt half-wave rectifier tube. Operation is on ordinary household current, A.C. or D.C., 110-120 volts. The circuit is arranged to provide a charging rate equal to about one third of the discharge rate of the average portable receiver having three to five tubes—a ratio found to give best results.

Batteries should be placed on charge immediately after each use, and the charging period should be at least twice the length of time they were operated. This may have to be extended even more as they age. Charging every few weeks, even when the receiver has not been used, is advisable. Be sure the battery terminals are connected to the proper posts to avoid damage.

Wiring connections are made as shown in the diagram at left, with the resistors and condenser placed under the small chassis. The carbon resistor in the plate circuit of the rectifier tube protects the tube and condenser from line surges, which may sometimes go as high as 300 volts if the unit happens to be turned off on a particular part of the cycle.



This couple is testing a TV set in a store. He is trying one of eight POPULAR SCIENCE tips—wrapping the antenna lead-in around an electric shaver to test the sync circuit. Good sets show no interference, or only fine black streaks (left). On poor sets, the picture “tears” (right).



8 Tips on Judging a TV Set

These simple tests that anyone can make will help you get your money's worth.

ASK the television “experts” and they say, “Test a TV set? Uh-uh! Only a specialist can do that. Play safe and buy a name brand from a dealer you know.”

Naturally, it's a good idea to stick to reputable manufacturers and honest retailers. But even the best factory can turn out a lemon. And relying wholly on this advice might lead you to pass up a really good buy in a make you had never heard of before.

The truth is, you *can* test a TV set without being an electronics engineer, without knowing a cathode-ray tube from a transformer, without even looking at the works. You wouldn't spend your money on a new kind of car until you checked the specifications and road-tested it. You don't need an engineering degree or a lab full of apparatus for that. Well, the same thing applies to

television. You can find out a lot about a TV set's quality with just your eyes and ears.

If you want to know more than picture size and cabinet appearance when you lay down \$150 or more for parlor fun, here's what to do. Follow these eight tips for intelligent TV shopping.

Interference: black or white? Automobiles and gadgets like electric shavers sometimes interfere with the TV picture. In a good set this interference—if it shows at all—will appear as horizontal streaks of black dots. But if the manufacturer has cut too many corners in the circuit, the black dots will have white tails, and the whole picture may “go out of sync”—start flipping down the screen. A good way to check this point is to take an electric shaver with you while shopping. Just plug it in, twist the set's an-

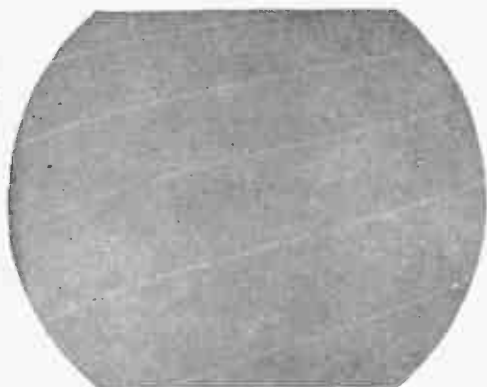

You want all stations. Sets with enough power usually can make "noise" show as pattern of

dancing specks (above) when contrast is up on vacant channel. Weak set gives picture at left.

tenna lead-in around it, and watch what happens to the picture.

Gain enough? Well-designed sets usually have enough gain—amplification power—to make the circuit's inherent noise (natural random movement of electrons) visible. There's an easy way to check this (see the photos above). Turn the station selector to a vacant channel, and then twist the contrast knob all the way up (be sure it's the contrast, not the brightness, that you turn up). If the screen is covered all over with dancing black and white specks, okay. (The dancing specks are noise.) If the screen is just a smooth gray crossed by diagonal white lines, beware. Lack of gain isn't serious if you live in the city near the transmitters, but if you're a country dweller far from the stations, it's very important.

Can you see the lines? Television pictures don't *have* to be fuzzy. Make sure yours aren't by checking the set's *resolving power*, as shown at bottom of this page.

Tune in a test pattern and look at the wedge of converging lines that points down from the top of the picture. You should be able to distinguish the individual lines in the wedge nearly all the way down to the white circles in the center of the test pattern. (All test patterns aren't alike, so try this test with several stations, or use the same test pattern to compare two sets.) Even inexpensive sets should meet this test. Don't try to judge resolving power from the sharpness of station call letters—use the converging lines.

You don't want twins! By cheapening the vertical synchronizing circuit, some manufacturers introduce a defect that—to the uncritical eye—seems to improve the sharpness of the picture. Actually, it leaves out half the detail that should be there. As you know, a video picture is made up of 525 horizontal lines. The electron gun "paints" half of these during one "trace," then goes back and "interlaces" the other half. On a good set, the interlaced lines will

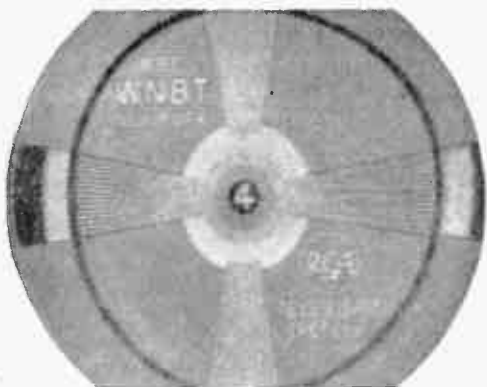

You want sharp pictures. Think the one at left is good? Wrong. Lines in vertical wedges blur, 226

indicating poor resolution. Set above is a good one, gives sharp lines, but has poor antenna.



You want proper contrast. No question here about which picture is better. So check the sets



you shop by looking at facial tones, or better, at the shaded circles on a test pattern.

be exactly midway between the lines of the first trace. On a poor set, they may vary from this midway position, "twinning" (also called "pairing") with the first-trace lines. Sometimes they will even merge with the first-trace lines, disappearing completely. You can check for twinning by tuning in a station, turning the contrast down and the brightness up, and moving the vertical-hold knob back and forth a little. But you'll have to look closely, for the lines are very fine.

Tattletale gray? Insist on pictures that are really black and white, not just muddy shades of gray. Note the difference in the pictures at the top of this page. The faces in "live" shows should look natural, but don't expect this in most telecast movies. For a better check, examine the test pattern. It has a set of concentric circles that should range from solid black to pure white, with sharply different shades of gray in between. A "black" picture tube (the glass face is tinted gray) helps tone rendition a lot.

Circles or eggs? Watching many a TV set, you'd think all video actors were short and fat. 'Tain't so. And they don't have to look that way on your set if you choose it carefully. Look at the big circles on a test pattern. These should be real circles, not eggs or other out-of-round shapes. To some extent, out-of-roundness may only be poor adjustment of the height and width controls, but don't count on it. Anyway, you should expect a good new set to be properly adjusted at the factory.

High voltage high? Ask the salesman how much voltage is supplied the picture tube. It should be somewhere close (in kilovolts, or thousands of volts) to the diagonal dimension of the screen. Thus a 10-inch set should have eight to 10 kilovolts, a 12-incher around nine to 12 kilovolts, and so on. Don't expect big sets—16 inchers or above—to have more than 14 kilovolts, which is the maximum considered safe in home receivers. But watch out for cheap, under-

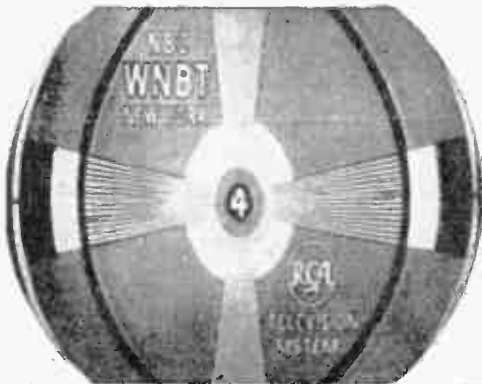

You want normal proportions. The big circles on a test pattern should be circles, as at right,

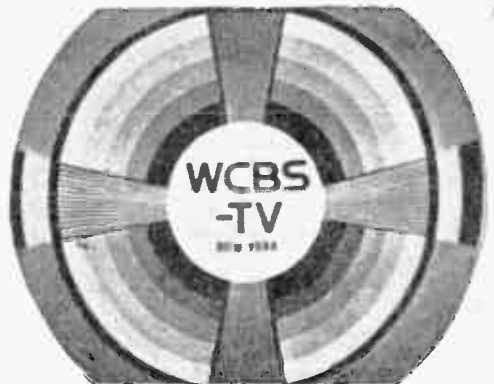

and not eggs or other odd shapes, as at left. Maybe this fault can be fixed easily, maybe not.

powered sets; the picture will be dim and the highlights may blur.

How's the sound sound? Try it out by listening to music from a "live" show originating in the station you pick up. Few inexpensive TV sets have really good audio systems, but some are better than others.

These eight tips do not make up an exhaustive performance test for a TV set, but they will help you pick the best from a selection of three or four. Ideally, they should be tried in your home. Television sets usually work better at home than in the store (because of better antenna, less interference), so this point isn't too serious.

Among the many other things to consider when buying TV, don't forget the obvious ones:

- the cabinet—it'll be the center of all eyes in most living rooms;
- and the screen size—a small screen restricts the audience and usually requires shifting of furniture for comfortable viewing (but a big screen doesn't necessarily mean high quality).

Rectangular picture tubes are being offered in many of the new sets. They don't work any better—or worse—than the round ones, but they are easier to fit inside cabinets, reducing the retail price. They also show all the picture, which round tubes seldom do (although they can).

The Famous 630 Chassis

You'll hear a lot about the "630 chassis"—a 1946 30-tube circuit designed by RCA and used by many manufacturers. Servicemen, particularly, will often tell you it's the only one to buy. The 630 was a good set, but RCA is the first to say it is now outmoded. Today's circuits are simpler, cost less, yet do a better job. Servicemen, always suspicious of new tricks, like the 630 because it is the type they're familiar with.

Another phrase the "experts" toss around glibly is "intercarrier sound." This refers to a method of using the same amplifying system for both picture and sound, instead of separate amplifiers, which costs more. Half the experts maintain intercarrier sound is terrible. The other half say it's excellent when designed properly. The best advice for the ordinary TV shopper seems to be buy the set that performs well, and don't worry about how the designer made it perform that way. END

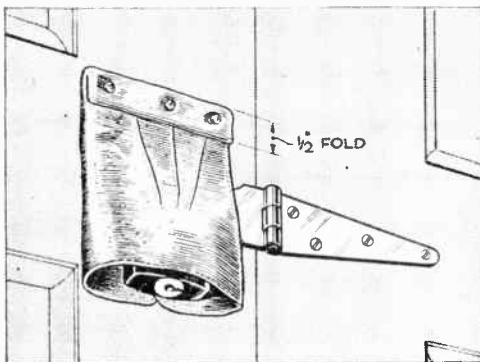

Glove Shields Lock from Frost

FROZEN padlocks on garage and barn doors used to cause me a lot of trouble. I licked this chronic winter problem by turning a couple of old snap-fastener gloves into lock protectors. I shield a lock from rain, sleet, and frost by cutting the fingers off a glove and nailing the leather above the padlock hasp. To get at the lock, I just un-snap the button and lift the glove.—Anson R. Durant, *Contoocook, N.H.*

My Most Uningenious Solution



Wrestling with a heavy roll of linoleum is no fun. I know from past experience. So last month when I laid new linoleum on our kitchen floor, I tried a trick that let me easily unroll the linoleum as I needed it. What did I use?

I took my kids' roller skates, turned them upside down on the floor, and placed the roll of linoleum on the skate wheels. Then I was able to unroll easily as much or as little linoleum as I needed for cutting and fitting, the heavy roll riding on the skate wheels.—F. W. McIntyre, *Milan, Ohio.*

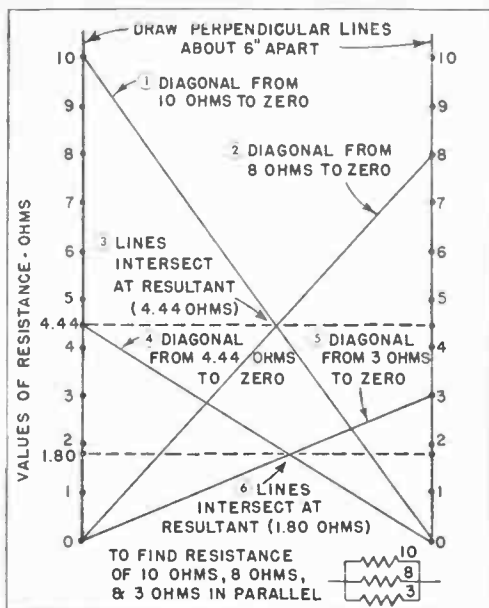

Graph Adds Parallel Resistors

ONE of the more tedious jobs in electrical work is calculating the combined resistance of resistors in parallel. The classical method is to add reciprocals, but if the range of values is not too great, there is a simpler way that is accurate enough for most practical purposes.

On some ruled paper, draw perpendicular lines about 6" apart. From the horizontal line representing the highest resistor—10 in the sample above—draw a diagonal to zero. Do the same on the opposite side with the next highest. Extend the point of intersection to the margin (4.44 ohms) and repeat for this and the third resistance. The resultant is found where the lines intersect. You can continue for any number of resistances; when the page becomes crowded, transfer the last figure and continue on a new sheet.—JOHN W. LA LONDE.

Inlay Decorates Radio Panel

FOR craftsmen who like to work in wood, a custom-made auto-radio panel is a satisfying project. The one at the right is made of curly maple with mahogany inlay. Richer in appearance than the chrome escutcheon it replaced, it also harmonizes with the car's interior. The back of the panel is routed for the metal retaining plate, and curved to fit flush against the rounded contour of the dash. GLENN A. WAGNER.

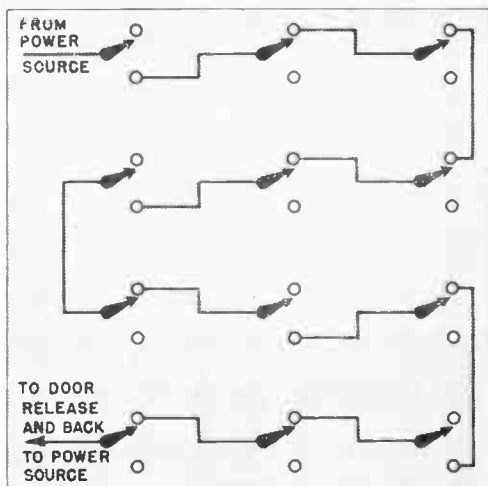

Switches Act as Door Lock

AN ELECTRIC combination lock is extremely handy on a frequently used door such as that of a workshop. No key is needed, and the combination can be changed at will. A sliding bolt withdrawn by a magnet or solenoid may form the lock, or if you want a key lock in addition, a magnetic strike such as is installed on apartment-house doors can be used.



The combination consists of from six to 12 SPDT switches, either flush mounting or the toggle type, wired so that they must be thrown in a definite pattern for a continuous circuit to open the lock. With 12, thousands of combinations are possible. All wiring must be concealed and inaccessible from outside.—CHAMBERLAIN FERRY.

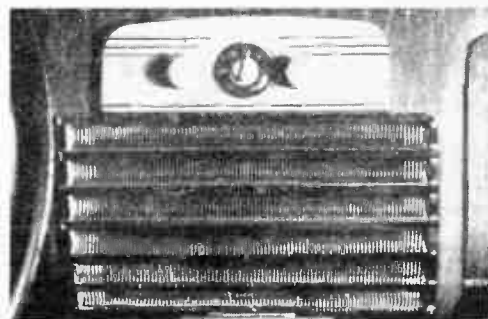

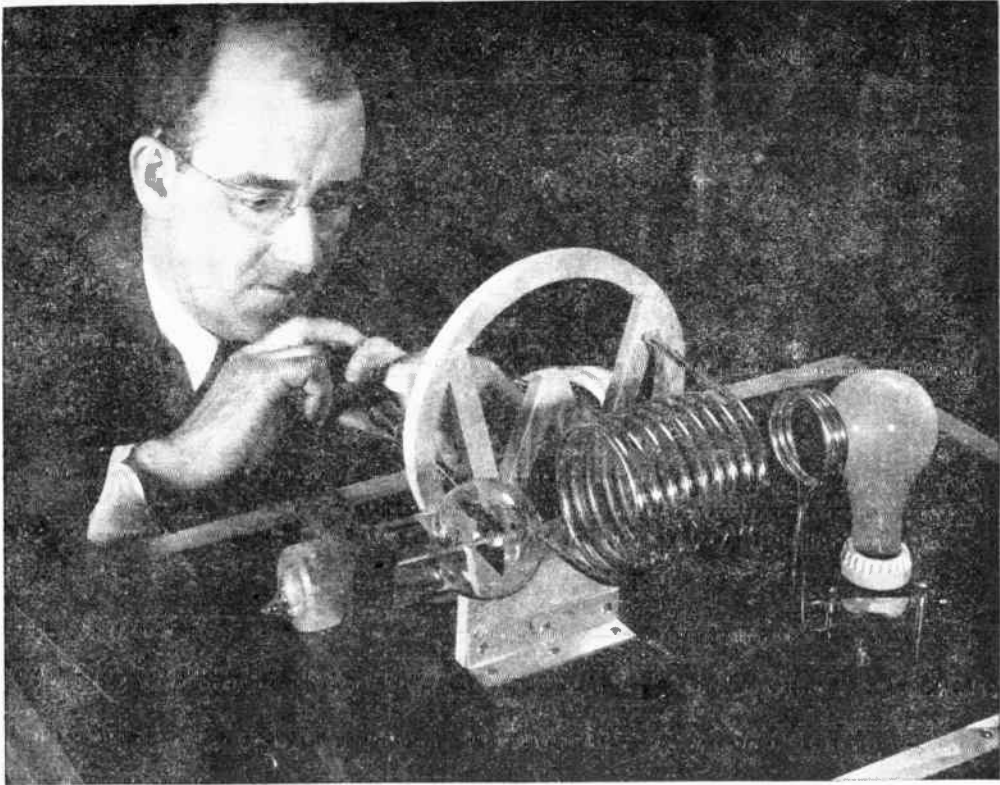

R. F. power lights this unconnected bulb, and also makes a metal disk in the glass tube become red hot

RADIO-FREQUENCY POWER

Already Vital to Many Industries, This Versatile Form of Energy Specializes in Performing the Impossible



THE equipment and techniques that we now have for generating radio-frequency current are largely the product of research conducted for radio communications. Nevertheless, R. F. power—something vastly different from the simple sending of a signal—has become the fast-growing beneficiary of this same research.

Broadcast transmitters are limited by law to a maximum of 50,000 watts, which is plenty for communications but small change in terms of power. Long ago power engineers stopped thinking in terms of watts and began using kilowatts as units. Now electronic engineers are talking kilowatts, and R. F. power is going to work—soldering, brazing, welding, and tempering metal; firing explosive rivets; drying spooled rayon; baking plywood, treating diseases, cooking foods. Installations of more than 10,000

kilowatts have been made which, in a single application—tin-plate processing—use over 200 times the maximum current allowed a broadcast transmitter.

Yet R. F. power is costly. Generating it calls for huge power-amplifier tubes, with a complicated battery of auxiliary apparatus to feed them. Required are such accessory devices as oscillators, power-amplifier drivers, heavy-duty rectifiers, tank circuits, control circuits, and grid-supply circuits—all involving substantial engineering and construction costs. Then, too, many kilowatts are wasted in generating R. F. current; high-power tubes, cooled by air blast or water, throw away large amounts of the energy fed to them.

With these handicaps, why is more and more R. F. heating being specified by cost-minded industrial engineers? The answer lies in its almost magical selectivity. With high-frequency heating, it is possible to fuse

iron held in an asbestos crucible in a man's hand without heating the hand. It is also possible to heat the hand without warming the iron. A piece of metal inside an evacuated glass tube can be heated without softening the glass; or the glass can be heated without softening low-melting-point alloys sealed inside.

Often it's desirable to manufacture a sort of "soft-boiled" steel—steel that is hard on the outside but relatively soft (and hence tough instead of brittle) on the inside. A soft-boiled egg gets that way because outer layers are heated to coagulation before enough heat reaches the center to harden the yolk; boiling water carries heat to the egg faster than the egg can distribute heat inside. With steel, furnaces can't achieve enough difference between inner and surface temperatures so that quenching will harden the outside and leave the inside soft.

Ordinary power-line current would heat the steel, but would be little help because it heats uniformly. R. F. current, though, behaves very differently. High-frequency currents have a "skin effect"; they flow only very near to the surface, because of the magnetic fields involved. Consequently, R. F. heating will produce "soft-boiled" steel—a metal that is of a glass hardness at the surface but is still elastic and tough within, just right for certain kinds of armor plate, crank bearings, and other special applications.

In manufacturing electron tubes, the elements are assembled within a glass or metal envelope which is then pumped out to a high-grade vacuum. One difficulty comes from the fact that the metal elements themselves are saturated with gases, and in a vacuum, these ordinarily absorbed gases start coming out. Somehow the metal parts must be heated sufficiently to drive out the gases. Since the elements are in a vacuum, heat cannot be applied directly, and not enough ordinary current can be supplied to the plate and other electrodes to heat them. But if the entire tube is placed in the magnetic field of an R. F. coil, heavy currents will be induced in the tube elements, heating them and driving out the absorbed gases. The glass envelope, which would

soften and perhaps collapse under atmospheric pressure if it were heated, isn't even warmed.

In other applications, heat is wanted in a nonconductor and not in nearby metal parts. To achieve this, the work may be placed between the plates of a condenser to which high-frequency power is supplied. The non-conducting material then acts as a dielectric in the electrostatic field of the condenser. Dielectric losses are normally the bane of the radio engineer, but this time he puts them to work. The losses within the non-conductor heat it, though they do not affect any metallic conductor near by.

Moreover, it's possible to heat one non-conductor without heating another non-conducting material in the immediate vicinity, and then later heat the second without affecting the first. This remarkable blow-hot-blow-cold trick is worked by using different frequencies. Many materials have comparatively low dielectric losses at all but certain frequencies, when their molecules go into a sort of resonance. Thus the first material in the example suggested above might have a heavy dielectric loss at 4.75 megacycles, while the second material might have low losses at this level but might heat readily at 5.32 megacycles.

R. F. power is peculiarly well suited to the manufacture of plywood bonded with heat-setting adhesives. Steam plywood

The alternator pictured below with its inventor represented an early attempt at mechanical R. F. generation. Only moderately efficient, it made use of a principle resembling that of an outmoded car magneto

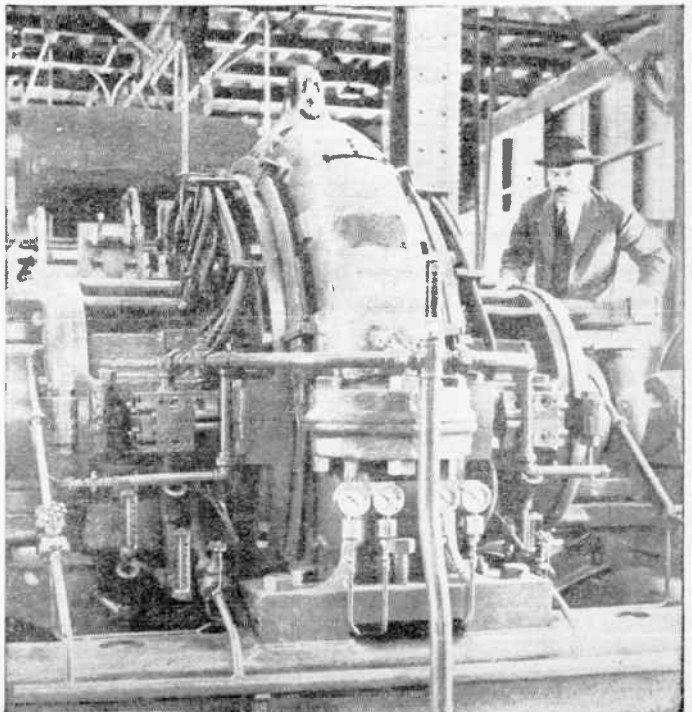

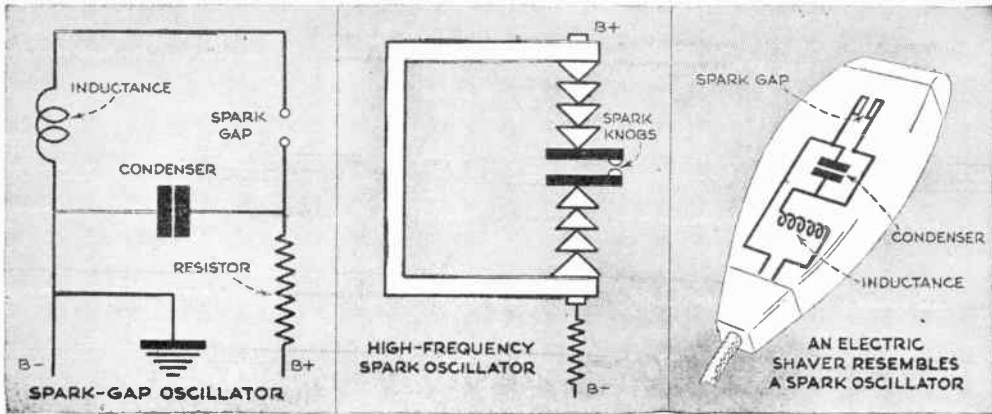

Above, a basic type of spark-gap oscillator; at the center, one producing ultrahigh frequencies. Note that the spark knobs are on the condenser plates themselves

presses are not completely satisfactory for work more than 1" thick, since to get enough heat to penetrate the inner layers, almost destructively high temperatures must be developed in the outer zones—or else prolonged medium temperatures must be used. With high-frequency heating, an even, controlled heat can be quickly generated inside the plywood, and thickness makes no difference whatever.

Food preparation is another field for high-frequency heating. Because of the time saved, this method may in the future even be able to compete on a cost basis. At present, roasts, for instance, are cooked for hours solely because a low oven temperature must be used to keep the outer layers from burning, and because heat is only slowly transferred within. The same job can be done in seconds with R. F. current. Restaurants of the future may offer everything on a cooked-while-you-wait basis; perhaps a waiter may put a raw potato between two metal plates, press a button, and in a few seconds serve you a steaming, perfectly baked potato.

Physicians, too, make extensive use of "short-wave diathermy," which is nothing more than R. F. heating under a different guise. The characteristic of readily controllable internal warming of bone and tissue adapts the technique for treating arthritis and rheumatism, hitherto often

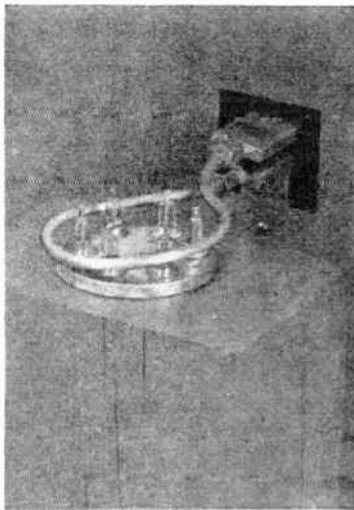

Multiple soldering jobs can be done simultaneously with a "radiothermic" soldering iron—merely an R. F. coil

friction and inertia in the mechanical parts of the controls, prevent them from holding temperature to exact levels. But since R. F. heating is virtually instantaneous, lightning-fast electronic controls are useful.

In R. F. equipment for melting tin plate, a strip of steel coated with tin is pulled past an induction coil at speeds approaching 1,000' per minute. A photoelectric cell "watches" the melted tin surface as it races past. To this tube, there is ample time to observe the melted surface, react, and adjust the heat as needed—all while any single point on the speeding strip has advanced but a fraction of an inch.

Other uses than heating have been and are being developed for this astonishing form of electricity. The atom-smashing cyclotron is made possible by R. F. power. A wholly different field is suggested by the

An electric razor, as any radio testifies, has all the elements of a true spark-gap oscillator: a condenser, a coil, and a pair of points that function as a gap

treated by external baking. Another use has been to induce an artificial fever as a means to fight some diseases; the intensity of the fever is carefully held at levels which, without harming the patient, will kill or weaken the organisms causing the disease.

High-frequency current is not only extremely selective in the composition and position of the substance which it heats, but it is also remarkably quick and flexible. Ordinary furnaces controlled by thermostatic devices don't have fast reflexes; thermal lag, even

fact that fluorescent lamps can be lighted readily by these radiations. They require neither metallic electrodes nor a heater within the tubes—thus by-passing most present problems of gas-discharge lamps. In one decorative display a small R. F. generator is placed at the base of a Christmas tree, with a wire "aerial" leading up the trunk. The tree is decorated with globes and tubes of different shapes, filled with argon, neon, or helium gas, and mercury or sodium vapor. No connection to the bulbs is necessary to make each lamp glow colorfully.

High-frequency radiations can be directed into fairly narrow beams, making the radio transmission of power theoretically possible. However, there are no signs at present that we can develop planes or cars driven by high-frequency radiations, because only the minute fraction of the power broadcast which hits the receiving antenna could be of use, assuming that we had a reasonably efficient way to use it. Wireless transmission of power might be valuable, though, where physical barriers rather than distance intervene between power source and motor. A sealed stirring motor, for instance, could be run inside a sealed chemical vat without introducing any contaminating leads.

The only satisfactory way of generating

R. F. power is with a vacuum-tube oscillator; mechanical generators are impracticable for modern demands. Historically, the first source of R. F. current which was of experimental value was the spark-gap oscillator, used by Hertz to produce microwaves to test Clerk-Maxwell's electromagnetic theories.

The basic spark-gap circuit, similar to the one devised by Hertz, is shown at the top of the facing page. A potential is built up in the condenser until the voltage reaches a point where the air gap breaks down and becomes conductive. The spark, once started, carries a heavy surge of current that oscillates in the resonant circuit until the energy stored in the condenser is dissipated; then the arc can no longer maintain itself, the condenser is recharged, and the cycle repeats. To the eye and ear, the cycle is so rapid as to appear a continuous discharge.

The inherent simplicity and reliability of a spark-gap oscillator is in a sense its most serious drawback. A doorbell buzzer, spark plug, electric motor with sparking brushes, electric shaver, static discharges from clouds, even people walking across rugs can act as a spark-gap oscillator. Since the tuning is broad and there are many harmonics, the radiations are received as static practically everywhere on the radio spectrum.

In this press, laminated wooden airplane spars, coated with a heat-setting adhesive, are in effect the dielectric of a R. F. condenser. The resultant internal heat quickly bonds the single pieces together

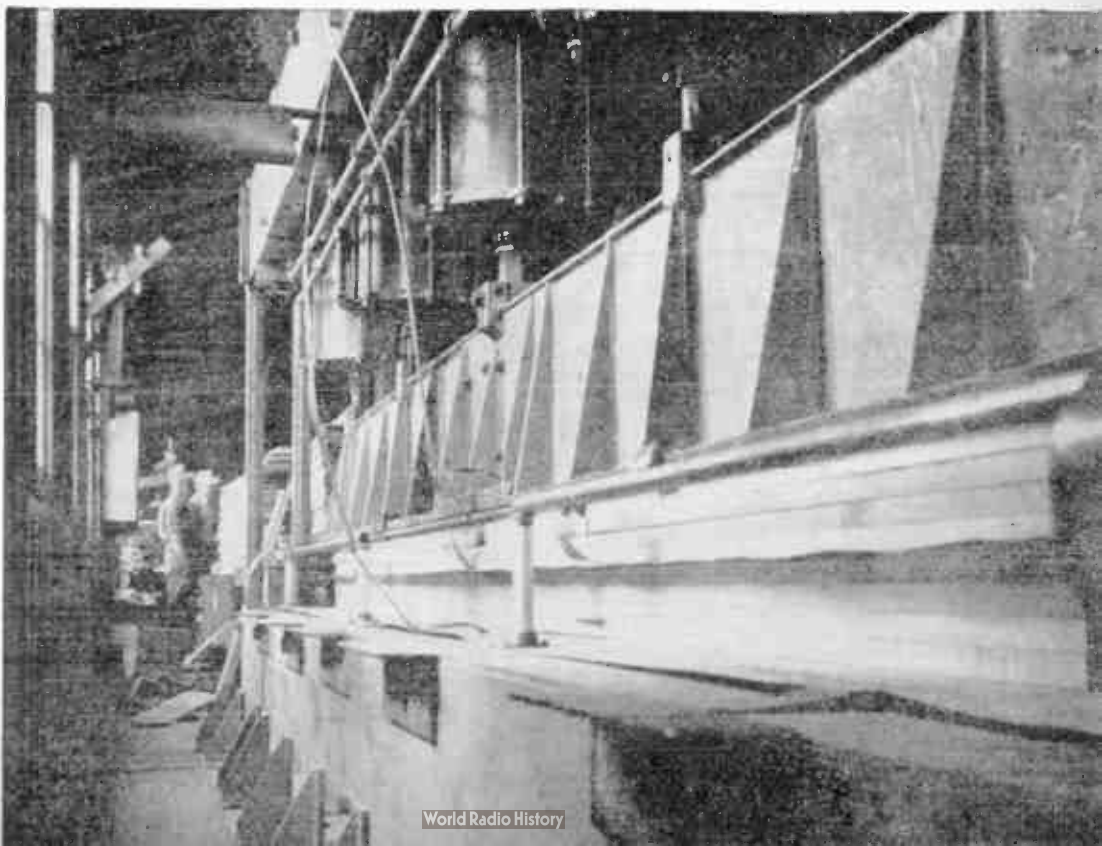

One-Tube Radio Can Be Mailed

SUBMINIATURE tubes measuring less than $\frac{1}{8}$ " in diameter will make it possible to redesign radio circuits to almost any shape and size. This novelty receiver is as flat as the tube itself and can therefore be inserted in a 6" by 9" envelope and sent through the mails as a letter. The two pieces of $\frac{1}{8}$ " cardboard that form the chassis are held together by the same nuts and bolts that hold the phone, battery, antenna and ground terminals in place. Slots are cut in the cardboard to clear the components.

The tiny 2E32 tube is a shielded pentode and operates with a plate voltage of $22\frac{1}{2}$ and a filament voltage of $1\frac{1}{4}$. For the latter, a small flashlight cell will give several hours of useful life. One of the miniature $22\frac{1}{2}$ - or 30-volt batteries will supply both the plate and the screen.

To keep the receiver flat, the coil is wound on a cardboard disk 4" in diameter. Cut 13 slots at intervals of approximately 1" as shown in the sketch below; then interlace the form with 92 turns of No. 30 enameled wire. At every twelfth turn, make a tap by scraping the enamel and letting a drop of solder adhere to the spot.

Although the circuit doesn't employ regeneration, it has sufficient power to pull in local stations. By selecting the right antenna and ground taps and adjusting the trimmer in the antenna lead, it should be possible to cover the entire broadcast band. The trimmer specified in the drawing is intended for use with a short indoor antenna; if used with a long antenna, a trimmer of lower capacity—say 125 to 350 mmf.—should be substituted.—ALBERT ROWLEY.

Fitting parts into slots in the cardboard chassis makes the set flat and also guards the components.

Small crocodile clips soldered to the various detachable leads permit quick and easy connection.

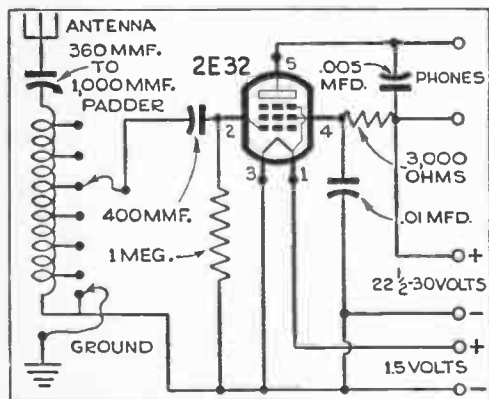

Resistors are $\frac{1}{4}$ watt, and the tubular condensers 200 volts; phone impedance should be 2,000 ohms.

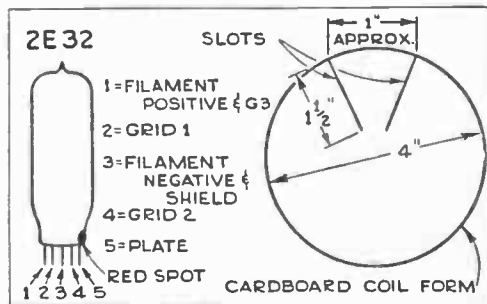

Tube leads may be identified by the position of the red spot. The coil is wound on a cardboard circle.

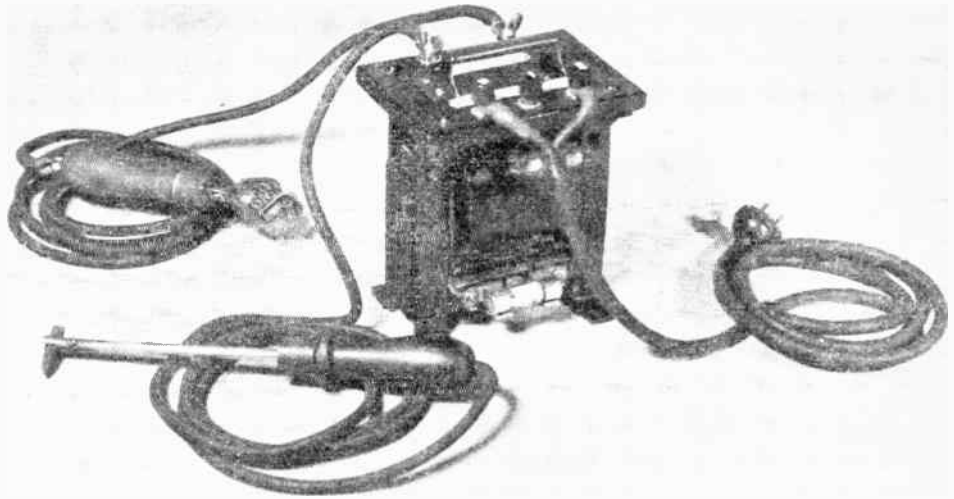

SALVAGED WIRE SERVES IN BUILDING THIS COMPACT Soldering Transformer

CAPABLE of many heavy soldering jobs, this small but efficient transformer delivers up to 110 amp. at about 5 volts for short periods. The heavy current raises a carbon electrode to white heat when it is held against the grounded work. No electric arc is formed as in welding, but the heat transferred is ample for soldering.

The materials used in making the transformer require priorities if purchased new, but most home workshop mechanics can probably salvage what is needed from junked parts. The No. 16 wire for the primary can often be found in old motor fields, magnets, or solenoids. If one continuous length cannot be found to make up the 270 turns required, wind to the end of a layer and bring out a tap or splice which can be soldered and taped. The heavy flat wire for the secondary can be obtained from old automobile starting motors. If the wire is not as large in cross section as that specified, .321" by .1", lay two lengths together and wind them on in parallel, joining the ends in soldered lugs.

If no heavy flat wire can be obtained, an electrical shop or building salvage yard may be able to supply some old No. 8 rubber-covered wire such as is used for service conductors, submains, or motor wiring. Two pieces about 8' long will be required. Burn off all insulation, wind the clean wires with

a layer of friction tape, and apply a coat of varnish. When this conductor is wound on over the primary much the same as the specified flat wire, it will serve about as well.

To get high efficiency from the small core cross section, the core material should be silicon transformer steel. Strips cut from the laminations of burned-out lighting transformers can be used. Other necessary items can generally be found here and there with little effort.

The first step is to cut the sheet metal into strips 1 $\frac{1}{4}$ " wide. Altogether, about 7 $\frac{1}{2}$ lb. of steel will be required. Cut half the strips into 2 $\frac{5}{8}$ " lengths, and half into 4 $\frac{1}{2}$ " lengths, as in Fig. 1, and make two piles of strips of each length. Cut enough strips so that when they are piled and tightly compressed, each of the four piles will be 1 $\frac{1}{2}$ " high. Make all cuts perfectly square.

A wooden form is now needed to stack the core, as shown in Fig. 2. Wooden blocks nailed to the baseboard provide a slot in which a C-clamp is later fitted to hold the laminations. Start by placing two of the long strips and two of the short strips in the form as shown, butting the edges tightly together. In the next set, strips are laid in alternate positions so that they will cover the joints of the first. This procedure is followed throughout the stacking. When all



The white-hot carbon heats work enough to melt solder freely

the strips are in place, compress them tightly with a C-clamp so that the unit can be lifted out of the form.

After applying a layer of friction tape to the two sides of the core to pull them together as much as possible, the next step is to make four side irons, as in Fig. 3. Clamp two of them with 3/16" stove bolts to the end of the core opposite the C-clamp. Release the clamp and then carefully remove the laminations from this end. Lay aside the core, which should now look as it does in Fig. 3, and start work on the coil.

Another wooden form, shown in Fig. 4, will facilitate hand winding of the coil. Wrap three layers of varnished cambric, or a layer of thin fiber, around the form and secure it with cellulose tape. Insert the No. 16 wire through the hole in the side of the form and wind a layer with turns close together. A layer of brown paper is next wrapped around, a second layer of wire wound on, and the process continued until five layers have been applied. As No. 16 wire will wind about 45 turns to the 3" winding space, the winding so far will include 225 turns. At this point bring out a loop or tap, and wind on a sixth layer, making 270 turns in all.

Good insulation is required over the last layer. Several turns of varnished cambric will serve the purpose, or a layer of rubber tape followed by cellulose tape will do. Over this insulation, the heavy secondary winding is applied. Put on 12 turns, which may be in the form of six turns in each of two layers, depending on the width of the wire available. Bring the two ends to within 1/2" of each other, pulling them almost together

with heavy cord, but being sure that they do not touch. Now take the form apart and remove the coil, which should look as it does in Fig. 5. Dip it in insulating varnish and allow it to dry very thoroughly in a hot place.

Place the coil on the open leg of the core and weave in the remaining laminations. Strips of fiber wedged between the coil and the core will keep the former tightly in place, and prevent a ground or short circuit. This fiber is best inserted just before the attachment of the last two side irons.

Next, measure the length required for the ends of the secondary winding to reach the wingnut terminals. If the wire strip is wide enough, holes can be drilled in the ends for the terminal screws, but otherwise soldered copper lugs should be used. Before the final tightening of the side

irons, drive all joints of the laminations solidly together and true up the core.

In Fig. 6 is shown the plan of the top panel, for which 3/8" plywood or a piece of

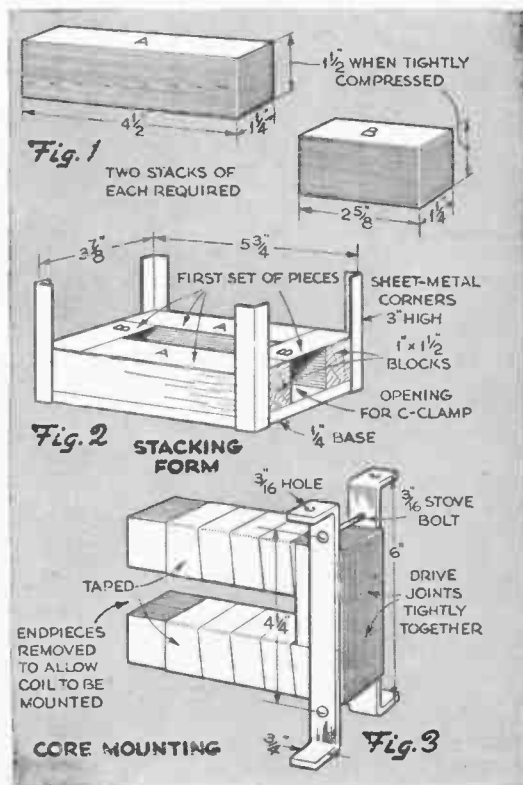

radio panel can be used. The two wing nuts are the low-voltage output, and the three insulated terminals are the 115-volt input. Four 3/16" machine screws hold the panel to the top ends of the side irons.

The plan of the wiring is shown in Fig. 8. To prevent overloading, a fuse should be connected in one side of the line. The holder for the fuse can be made by removing two of the clips from a 30-amp., 250-volt cartridge-type cutout. These are mounted on a 3/4" strip of plastic with a thin piece of fiber under it to prevent grounding to the core, and the fuse block is secured with a single machine screw. The carbon holder and ground-clamp details are given in Fig. 7.

Using the input terminals plus-minus and No. 1, the output will be close to 5 volts; by changing the second wire to the No. 2 terminal, about 5.6 volts will result with an increase in amperage adequate for the heaviest work. Never connect the line to the No. 1 and No. 2 terminals. This might damage the winding and would probably blow the line fuses. The amount of heat can be regulated to some extent by the length of the carbon in the holder. Long carbons increase resistance and reduce heat.

In soldering, the carbon should be held

behind or at the side of the work. This will help protect the eyes from the intense light, and will also keep the carbon from blackening the cleaned area. It takes only a few seconds for the work to heat up to a point where solder will flow. Small parts can be placed on a piece of sheet metal to which the ground clamp is attached, thus avoiding the grounding of each individual part. For such work, use the plus-minus and No. 1 posts, since this gives a smaller output than if the leads are attached to the plus-minus and No. 2 posts.

Keep the carbon in contact with the work during the soldering operation. The end of the carbon turns first to a red and then to an intensely white heat. As its heat increases, the electrical resistance of carbon becomes less, which is a characteristic opposite to that of most metallic conductors. A short carbon is best for heavy work, since it will pass the maximum current when fully heated.

Parts to be soldered should be thoroughly cleaned of all corrosion and dirt. Brass and copper are about the easiest of the common metals to solder. Whatever the metal, bulky and awkward jobs can be done more efficiently this way than with an iron.

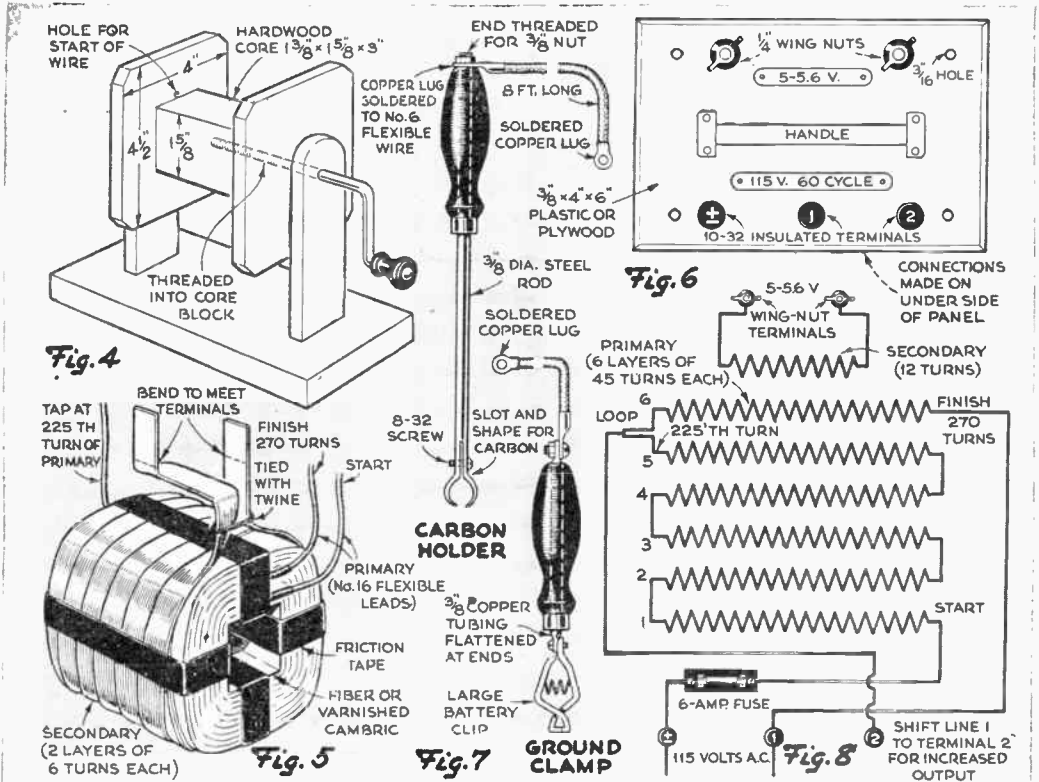

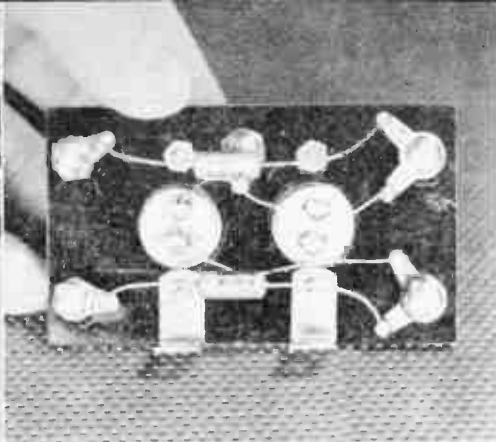

Lightning Arrester for TV

TELEVISION antennas sprouting from housetops have brought back some of the

lightning hazard that existed in the early, long-aerial days of radio. A lightning arrester that will protect you from the worst dangers of the bolts can be made from a couple of neon bulbs and two ceramic condensers. Mount the parts on a small insulating strip as shown. Connect one terminal to a pipe or other good earth ground and pair the four remaining lugs to antenna and receiver. Should any large charge accumulate on the roof antenna, it will flash over to ground instead of going to the set.

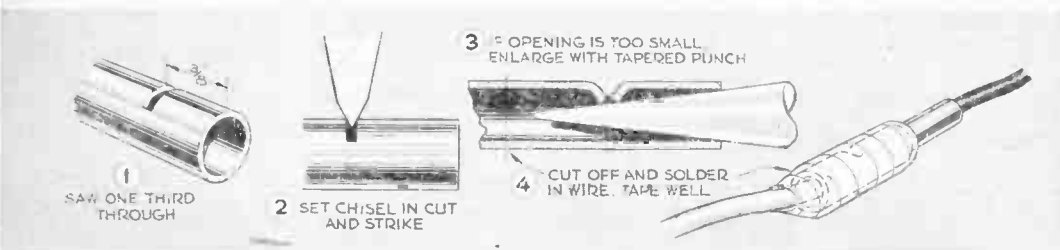
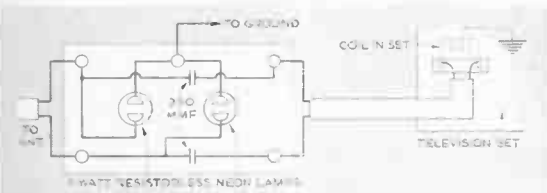

Phone Jacks Made of Tubing

DETACHABLE jack connectors for phone tips and similar small plugs are handy for breadboard circuits, photoflash equipment, and model work. You can make good sub-

stitutes for ready-made jacks from hard brass tubing as shown above. Hacksaw a slot near one end and strike a chisel held in the cut. If the opening is too tight, enlarge it with a punch. Cut the tube off to a convenient length.

Enlarging Your TV Pictures

IF YOUR TV receiver is an early postwar model, it is probably adjusted to receive pictures in the standard 3-by-4 "aspect ratio." By sacrificing the corners of the rectangle, however, you can enlarge the

central portion of the scene about 50 percent and utilize more of the tube face.

All you have to do is readjust the "fixed" width and height controls on the back of the chassis. Set the controls while a test pattern is on the screen. Keep the circular part of the pattern centered and as round as possible. Part of the wedge lines will spread off the tube face.

To take full advantage of the spread-out picture, make a new picture mask or cut away the corners of the old one. Be sure to replace the plastic or safety-glass shield.

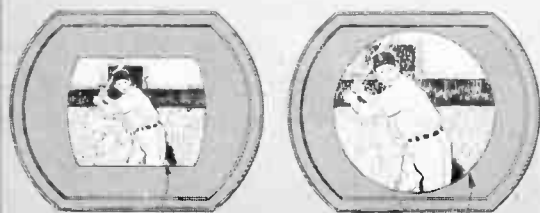

OLD PICTURE AND MASK

MASK CUT AWAY TO PERMIT GREATER VIEWING AREA

Nontip Base for Small Torch

ALCOHOL torches, being narrow and inclined to tip over easily, can be dangerous to the person handling them and a fire hazard as well. A base to prevent tipping can be made from sheet metal and fitted with upright clips of spring brass that fit around the twin barrels of this type of torch. Cut the base as a 2" by 3" oval; then solder the clips in place, giving them enough spring tension so that they grip the torch firmly but can be removed when desired.

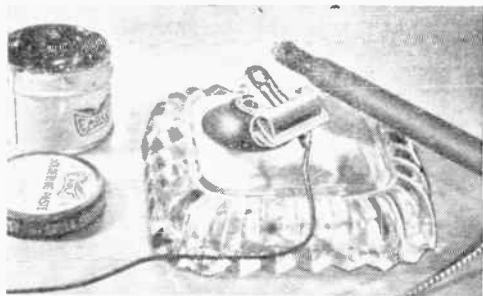

Suction Clip Is Used as Vise

A TRAVELER who has occasion to do light soldering while away from home uses a spring type paper clip affixed to a suction cup as a light-day vise. The cup is attached to the bottom of a glass ash tray, and screws, eyelets, terminals, and the like are held in the clip when other parts are to be soldered to them. Dripping solder is caught on the ash tray, which also provides a rest for the hot iron.—GEORGE WALTON.

Solder Chips Mixed with Flux

SMALL shavings scraped off a strip of solder and mixed directly in the can of flux will be found useful for small soldering jobs, eliminating the sloppy runs and oversoldered joints that often result when the solder strip is applied to the work. Enough shavings should be cut from a strip at one time to load the paste in the can completely. Such a mixture can then be kept on hand for instant use whenever a job that requires just a bit of solder arises.

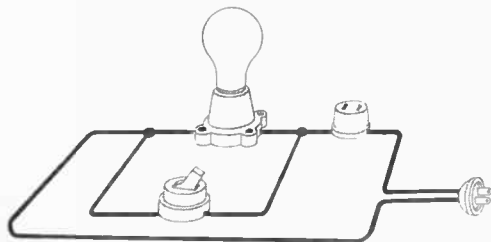

Test Outlet Protects Fuses

LEST the first trial of homemade radio or electrical equipment result in blowing fuses because of improper wiring, connect a 100-watt bulb in series with a test outlet as above. Plug the apparatus into this. No light at all indicates an open circuit, and a bright light usually means it is safe to switch on full line voltage to the equipment under test.—GEORGE O. SMITH.

Shaver Operates off Car Radio

TOURISTS, salesmen, and campers can do their electric shaving on the road by using the B supply of their auto radios. A normally-closed phone jack, mounted on any free area of the radio case, is connected to the B-plus (cathode) lead from the rectifier. The phone plug is connected to a dropping resistor and a receptacle which is mounted, for convenience, on the edge of the dashboard.

Inserting the plug in the jack opens the B-plus supply to the radio and diverts it, through the resistor, to the receptacle into which the shaver is plugged. Removing the plug from the jack restores normal radio operation.—H. C. MARHOFF.

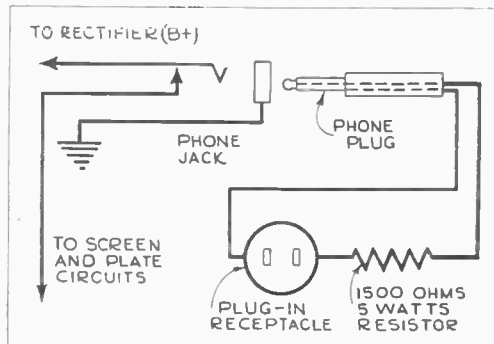

Recharger Peps Up Flashlight Cells



New life can be pumped into weak cells an average of fifteen times before they are worn out.

CAN you really recharge dry cells? And does it pay? The answers are, respectively, an emphatic yes and a temperate maybe.

To take the second point first, it would plainly not be sensible to lay out the \$9 or \$10 for the parts of this charger if you only use a handful of 10-cent cells a year. But if your home keeps three or four flashlights in use, or if your portable radio or bike lights show a hungry appetite for dry cells, this charger may indeed be worth while. Heavy users of batteries—press photogra-

phers, theater managers, repairmen, persons using hearing aids—may find that a charger can pay for itself fast.

In figuring the economics of it, don't be put off by the cost figure quoted. The device shown was built entirely from store-bought parts, and assembled with an eye to looks. If you have a fair-sized scrap box, and if you can dispense with a slope-front cabinet, you can probably halve the cost at least.

The charger pictured works off a 115-volt AC line and handles any size dry cell, flashlight cell, and radio A or C battery up to 6 volts. It is *not* designed for multiple-cell B batteries of comparatively high voltage.

For a transformer I used a standard universal output transformer (a Stancor A-3852). It's considerably cheaper than a 10-volt filament transformer and serves just as well, delivering 9.5 volts between the Nos. 3 and 4 lugs on the secondary or voice-coil winding. The primary is centertapped, and the input is between either lead and the center-tap, the other lead being cut back and taped.

Many other transformers will do, of course, but don't try to use one of the smaller door-bell types. The chances are that the voltage after rectification will be insufficient.

The rest of the components are also commonplace. A small 100-ma. selenium rectifier of the kind found in many new AC-DC radios is used, and costs less than a dollar. With 9.5 volts input, the rectified output is about 6 volts without load.

Adjustment of the charging rate, which must be varied according to the size of the cell, is accomplished through the 750-ohm wire-wound potentiometer. A cheap milliammeter, costing about \$1.50, can be considered a must to allow this adjustment. Less essential but still highly convenient is a low-reading DC voltmeter to measure cells before and after charging.

Assemble the circuit in any convenient chassis, cabinet, or box, being careful to follow polarity of the leads. In the charger shown I punched two large holes in the top and rigged up a mounting to take two D-size cells at once, using a pair of grid caps as clips for the positive leads. A set of jacks and plugs permits running wires to other dry cells to be charged.

Considerable experimenting with recharging dry cells stands back of the following rules: Don't try to recharge cells with bulged or corroded cases. Don't try to recharge any that have been out of use for a year or more. Don't try to recharge cells that have

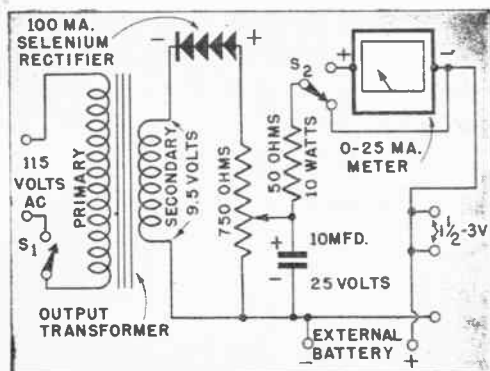

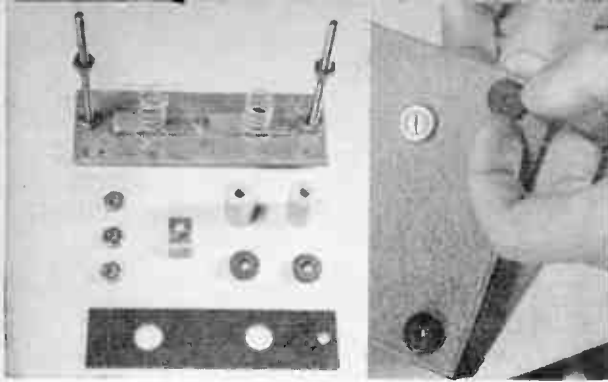

Stiff fiber strips, left, are spaced out on two long 8-32 screws to hold D-size cells that are charged. Right, cushioned feet hold the cabinet.

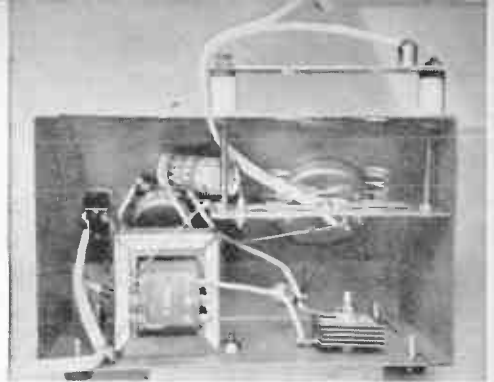

Rear view shows simplicity of construction. An inexpensive output transformer supplies power to the small selenium rectifier shown at right.

dropped below about two thirds of their original voltage. Don't put a recharged cell into immediate use, but let it rest for a day first to lose any temporary overvoltage.

Unlike storage batteries, dry cells seem to have a more or less fixed charging time—around 22 hours. After approximately this period on charge the current flow goes up sharply and the cell should be removed. Here is the preferred charging rate for different cells:

SIZE OF CELL	CURRENT IN MA.
No. 6 dry cell	15-25
D cell	10-15
C cell	7-15
AA cell (penlite)	5-10

One rule to keep in mind is to hold the current down so that the cells never feel warm to the touch.

You'll find a considerable variation from cell to cell. Some will come up nicely; others of the same make, age, and previous condition of servitude will be reluctant performers. Occasionally one will respond poorly the first few times it's charged but will later behave better, taking repeated charges. A cell in good condition can generally be recharged fifteen times or more.

If you're interested in theory, it has been found experimentally that discharged cells contain manganese oxide in the depolarizer. Since this substance is originally manganese dioxide, it seems likely that one result of discharging is to convert this dioxide into monoxide. The process is reversible; recharging seems to convert it back to dioxide, thus revitalizing the cell.—Arthur C. Miller, Manhattan, N. Y.



Hearing-Aid B's Recharged

USERS of this device for recharging hearing-aid B batteries charge one battery while using the other. Each morning the batteries are exchanged. Made by the Shelby Instrument Co., of Long Beach, Calif., the charger retails for \$10. The maker claims it gives up to 75 percent longer battery life, and uses about 5 cents worth of electricity a month.

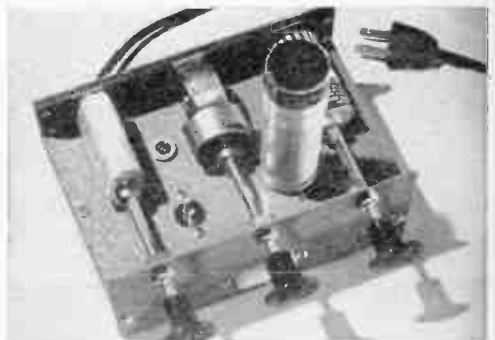

Hearing-Aid A's Recharged

ABLE to handle any type of A batteries used in hearing aids, this charger is said to cut A battery costs from \$5 to 50 cents a month. Made by Mecon Products, Inc., of Los Angeles, and selling for \$12.95, it draws about 3 cents worth of current a month. Given proper care, each battery can be charged 10 times or more, the maker asserts.

Quickly Installed Filters Cut Fluorescent-Light Static

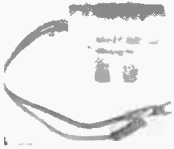

THE cool, efficient illumination that you get from fluorescent lights is almost matched on the debit side by the static they cause in radio and television receivers. If you have installed any of these new lights you can do yourself and your

neighbors a favor by adding line filters. Many condenser manufacturers produce filters that keep the high-frequency disturbances out of the electrical wiring system by by-passing them to ground.

A typical unit—the smaller one in the photo above—consists of two capacitors connected in series with the center part grounded to the case. When the leads are wired across the line and the mounting bracket is bolted to the lamp reflector, both conducted and radiated interference are sharply reduced. A separate filter should be used on each fixture, and for multiple units a larger filter (top) is recommended; it is connected in series with the 115-volt line. It is advisable to use the larger-capacity type if a television set is in operation since it protects the video as well as the broadcast frequencies.



Clamps Steady Radio on Bench

COILS or tubes are sometimes damaged when a radio chassis is placed on the workbench for servicing. To keep weight off these parts and lessen the chance of breakage, attach one or two C-clamps as shown to support and steady the set.—H. LEEPER.

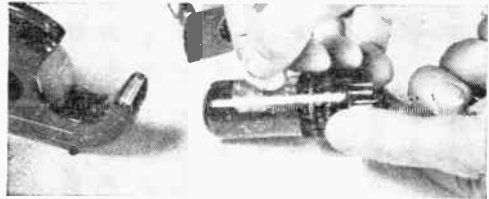

Tape Shields Tube Numbers

EXPERIMENTERS who keep a supply of tubes on hand often find it impossible to identify some because the type numbers have been worn away through handling. This won't happen if you put clear cellulose tape over the number when the tube is new.



Floating Arm Adapted to Mike

GETTING a microphone into the desired position quickly is no problem with this completely flexible arm that moves in any direction and stays exactly where you put it. Long in use on desk lamps, it is now made available with mike fittings by Dazor Manufacturing Corp., St. Louis.

Tiny Resistors Are Accurate

MINIATURE precision resistors, built to a standard tolerance of 1 percent, have been announced by the Shallcross Manufacturing Company, Collingdale, Pa. The smallest single unit is 15/32" long. Other types with two to four sections have also been produced.

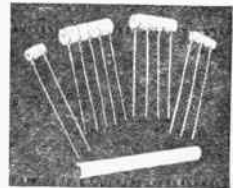

Form Is Easily Tapped

A FLUTED coil form made by Henry L. Crowley & Co., Inc., West Orange, N. J., eliminates the need for special holes and will take a tap from any part of a winding. Matching terminal clips and bases are available.

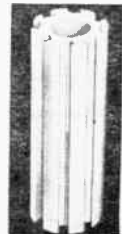

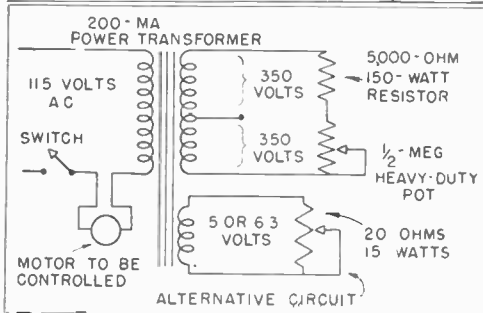
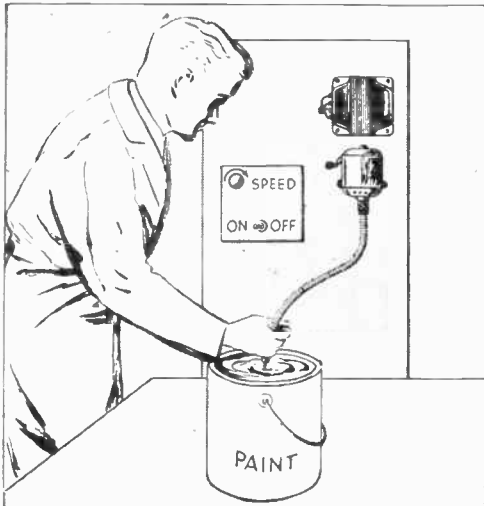

Transformer Regulates Motors

OLD motors taken from discarded vacuum cleaners, hair dryers, kitchen mixers, and the like can be put to good use in the shop. But an effective speed control is often indispensable. One solution that can be applied to small universal AC-DC motors and even the 24-volt DC type is shown above.

When there is no load on the secondary of a transformer, practically no current flows in the primary. Thus, by connecting the motor in series with the 115-volt line and the primary, you can regulate its speed by means of a variable resistor across the secondary. This may enable you to use a rheostat or potentiometer that you couldn't connect directly in the motor circuit itself (it must of course be of a rating to carry the secondary current).

Depending upon the size and current drain of the motor (it must not exceed the safe capacity of the primary winding) either a high- or low-voltage secondary may be employed. If the transformer has both, as shown, the unused portion must be left open. —Alva A. Queen, Ft. Lauderdale, Fla.

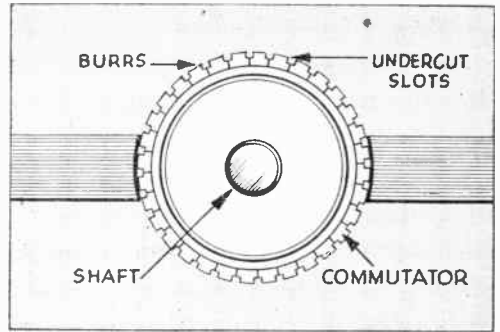

Commutator Seats Brushes

AFTER undercutting a motor commutator, it is necessary to reseat the brushes. This is often done by pulling sandpaper around the commutator, but you'll save yourself some work by letting the burrs on the slots do the job. Insert the brushes and rotate the armature a dozen turns or so. The fine edges left on the bars will shave the brush faces to a perfect fit. With the armature still rotating, hold 00 sandpaper against the commutator to smooth it off. —Roy C. Bradley, San Bernardino, Calif.

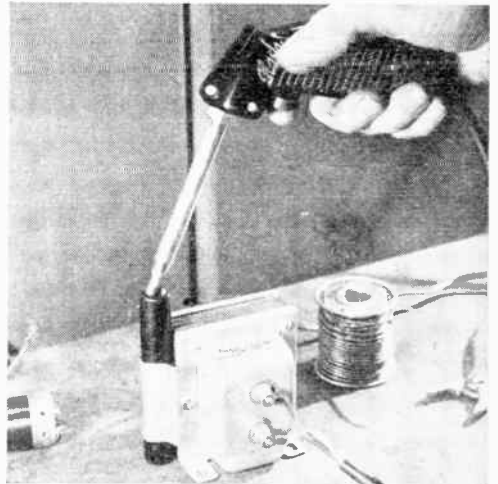

Tube Supports Soldering Iron

A HANDY holster for an electric soldering iron of the transformer-operated type is made by attaching a tube to the transformer. It should be slightly longer and about 1/8" more in diameter than the iron. The hard-rubber tube shown is secured by a strip of aluminum and a bolt. A metal tube would serve as well, but plastic that might soften under heat should be avoided. —Walter E. Burton, Akron, Ohio.

Hams Are Radio's Vanguard

The amateurs, a rapidly growing clan, are still cooking up improvements for the industry they helped to create.

By George H. Waltz, Jr.

PSM Photos by Hubert Luckett

THE headlines that remind you of America's 80,000 radio hams are deceptive. You have seen them: "RADIO AMATEUR SENDS HELP TO FLOOD AREAS" is one, and "HAM SAVES PLANE CREW ON ICE FLOE" is another.

These news items, of course, are true, but saving the lives of stranded, desperate people is only part of the tremendous service for which everyone is indebted to the radio amateurs. They are the unsung explorers and conquerors of the electronic world, and the developers of its tremendously useful industries.

Such achievements have not been so spectacularly publicized. Yet even Marconi proudly spoke of himself as an amateur, and from the dots and dashes and tinkering of such "hams" as Lee DeForest, FM's Major Armstrong, and RCA's David Sarnoff, and

the thousands of hams who have followed them, have come our present-day high-fidelity broadcasting systems and our super-de-luxe, multiple-tube home receivers.

Without the hams, Fred Allen's voice would still be in a theater rather than in your parlor, and we would not know what rockets encounter in the far reaches of the atmosphere. The radio amateur, moreover, is still pioneering, still contributing, not only to radio and communications techniques, but also to the creation of a truly international fraternal understanding.

Who is the average ham? What is he like? What makes him spend a good portion of his spare time in his "shack," which may be anything from a corner of his crowded attic to an outbuilding in his back yard? How does he earn a living?

According to the latest cross-sectional portrait made by the American Radio Relay League—the hams' father confessor, guiding hand, and fraternal lodge—the ham is just a typical science-minded American. He is married, about 31 years old, and in what statisticians call "the middle-income bracket." Mentally, he leans toward mechanics and electricity. Socially, he is fairly gregarious. He likes people and he likes to talk—particularly to people in out-of-the-

How the Hams Talk

Amateur radio jargon is unintelligible to the average layman but many of its terms are only a sort of telegraphic shorthand. For instance, a ham message might go something like this:

"W9YMV de W1PEK R ge om tnx fr el. That ant bkn fr eld CQ 3 times wid nd. Ur sigs RST 599 hr Hrtfd Conn. Wx elr es eld. Xmtr hr pp 5514s in fnl wid abt 400 wts. Rvtr hr SX28A; ant is 3.5 mc folded dipole. Use xtal mstli but nw hv VFO. QTH? Hw? ar W9YMV de W1PEK K."

Freely translated, this would run as follows:

"W9YMV from W1PEK, your last transmission received OK. Good evening. Old Man; thanks for call. I thought my antenna

had broken, for I called the general inquiry call, CQ, three times without results. Your signals were perfectly readable, extremely strong and had purest direct-current note as received here at Hartford, Conn. The weather is clear and cold. The transmitter here is push-pull type 5514 vacuum tubes in the radio frequency final amplifier stage with about 400 watts input. The receiver here is a manufacturer's type SX28A; the antenna is a folded dipole dimensioned to resonate at 3.5 megacycles. I use crystal frequency control mostly but now have a variable frequency oscillator. What is the location of your station? How are you receiving my signals? End of message. W9YMV from W1PEK. Go ahead with your answer."



Like many hams, Russell Valentine finds it hard to tell where business stops and hobby begins. Chief engineer of New York's WQXR, which he

has built and rebuilt more than 10 times, he has no trouble in giving his ham rig, W2GX, a professional look—as its control panel testifies.

way places. His wife is at least mildly tolerant of his pastime; many wives become so enthusiastic that they, too, acquire amateur licenses.

Significantly, the ham is a tinkerer, an experimenter. His station represents an investment of about \$400, and he spends about \$150 a year to keep it operating and up-to-date. His receiver is probably factory-made, but his transmitter is apt to be pretty much a product of his own know-how.

He averages about 96 minutes a day on the air. Of this total, 38 minutes go for normal "over-the-back-fence" gossip with other hams ("ragchewing," he calls it); 26 minutes are spent contacting stations that are a long distance away (DX); 20 minutes go for trying out new experimental rigs and equipment; and 13 minutes are taken up with "traffic," or relaying messages from one corner of the globe to another.

If the radio ham has a second hobby, it is likely to be photography. The Morse code and camera-toting seem to go together. Nobody knows why.

The ham's job is likely to be in some branch of the electrical or communications industries. At last count, a check of executive positions in the radio industry showed that 45 presidents, 16 vice-presidents, 5 general managers, 69 managers, 37 owners, 324 engineers, 19 announcers, and 11 directors had started out in their own ham stations. In one of the largest broadcasting stations, nearly all of the operators and engineers are licensed amateurs. About nine-tenths of all the broadcasting engineers and operators in the country are, or have been, amateurs. In radio manufacturing, the figures are similar.

To those of us whose main interest in radio is twisting a dial or pushing a button to hear a comedian, a ball game or a newscast, this wedding of full-time business and spare-time hobby is important. It is a union that has brought, and will continue to bring, many advances in radio and electronics. Because the ham is a born experimenter, and generally not hampered by the pre-conceived ideas of the experts, he often

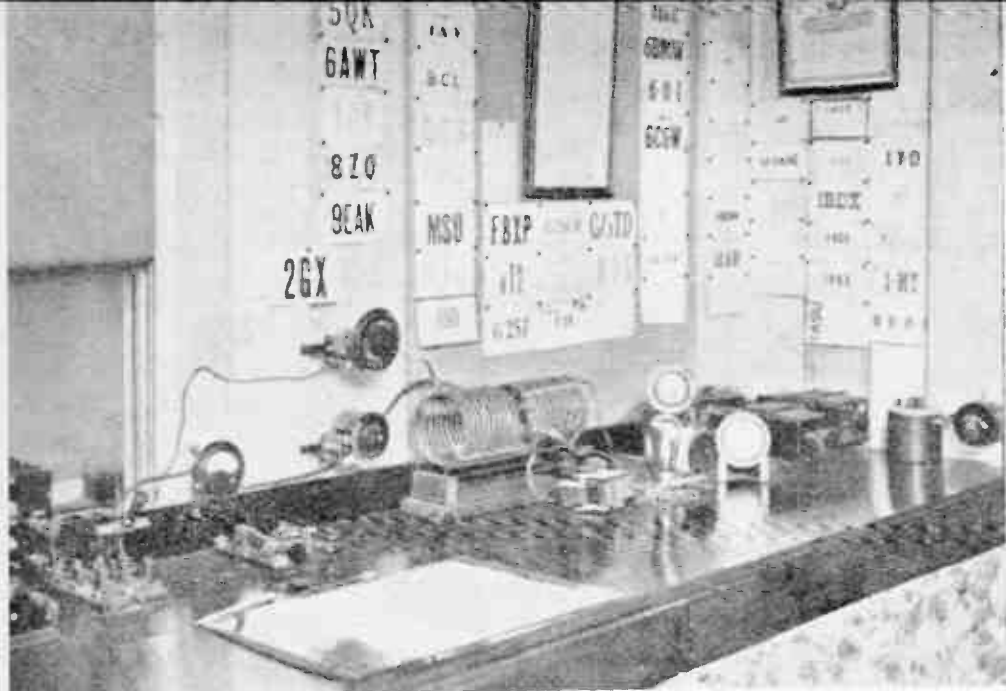

Back in 1923, Valentine's "shack" looked like this. The array of QSL cards, acknowledgments

from stations with which he had communicated, typifies DX efforts by amateurs, then and now.

attacks problems that far more learned men have thought unsolvable. Sometimes he solves them.

Nothing illustrates this better than the early history of amateur radio itself. In 1912 there was a great clamor among the commercial operators to limit the upstarts who called themselves amateurs to specified frequencies. On Aug. 17, President Taft signed the Alexander Bill, which provided for the licensing of all ham stations and operators, limited them to 1,000 watts of power (a ruling still in effect), and confined them to a wave band of 200 meters. The 200-meter band and any of the shorter wave lengths then were considered worthless for communications.

The amateurs, however, not only found a way to make good use of the "worthless" 200-meter band, but also helped to pioneer the way into the shorter and shorter wave lengths—the ultra ultra-short waves. In 1912, head-wagging theorists thought that a radio wave that measured as little as 200 meters (a little over a tenth of a mile) from crest to crest was useless, but radio amateurs today are playing successfully with tiny wavelets about .06 of an inch long.

Relegated from the beginning to the shorter waves and the higher frequencies, the radio ham has made the most of them—a

fact that opened the relatively new and valuable fields of radar and microwaves. The future of the microwaves—the shorter and still shorter wave lengths—should be watched, and you can bet your radio-phonograph combination that the amateur is watching—and what's more, experimenting. Microwaves provide a region for communication far wider than that of all the other wave lengths combined.

There's a Ham Behind It

Find some new radio development and you will find at least one ham or ex-ham mixed up in the maze of wires and tubes. Not long ago, for example, the Army announced that it had bounced a radar beam off the moon. Four out of the five experts operating the Army's equipment in that test were hams. The lieutenant colonel in charge of the project had attempted a similar experiment with homemade equipment in his own ham station down in Tennessee some years before!

It is seldom that a single radio amateur's name is attached to a new radio development. There have been exceptions, of course, such as the perfection of the radio noise eliminator by James Lamb, a ham who later did a great deal toward developing the television guided bomb. On the whole,

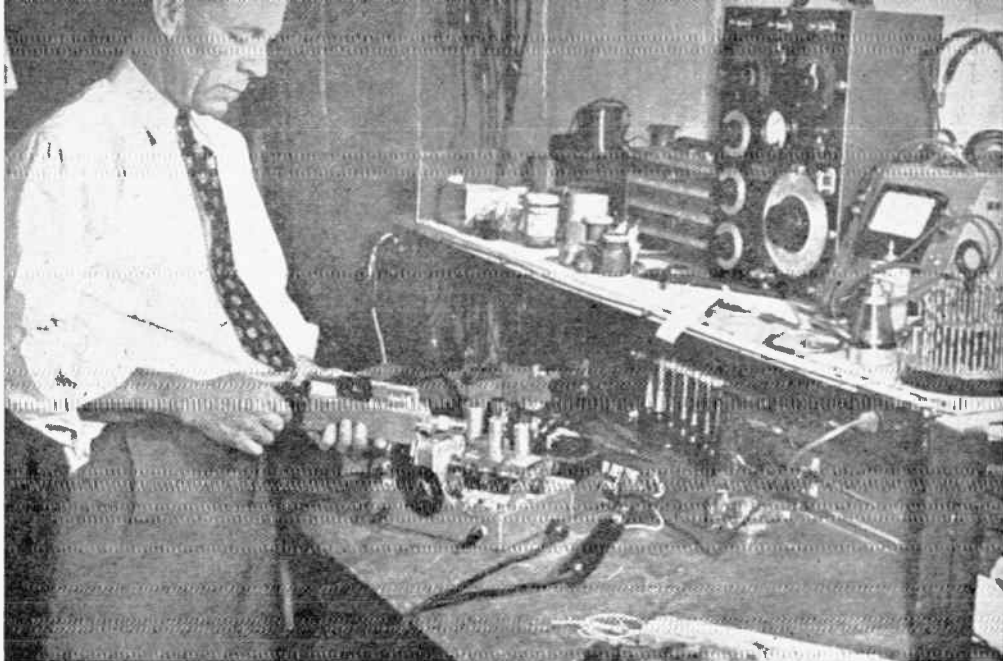

Hams are a creative bunch. Valentine holds "grid dipper" made by W. M. Scherer (W2AEF)

to measure resonant frequencies. Black cabinet on shelf is a hand-made impedance bridge.

however, the ham's contribution to radio is made on a teamwork basis. A good portion of that 38 minutes a day that the average ham spends in chewing the rag on the airwaves is spent talking to other hams about what he found out during his daily average of 20 minutes of experimenting. In this way, no ham's idea is every completely his own; it's a group achievement.

The National Bureau of Standards in Washington makes good use of this tendency whenever it has a broad radio-testing project. By mustering amateur observers, the Bureau has a large reservoir of first-rate, widely scattered monitoring stations to help study what happens to radio reception during solar eclipses, or investigate the skip effect in short-wave transmissions. Each participating amateur spends specified hours listening in on assigned frequencies and forwards his reports to Washington. How else, except for the amateurs, could such large-scale, nation-wide research be carried on? Not even the largest commercial research organization could afford the cost if the thousands of monitoring stations had to be built and manned by salaried employees.

During the war years—from December 8, 1941, to August 21, 1945, to be exact—the ham, as such, was off the air. His "shack" was closed and his frequencies were taken

over by the War Department. He wasn't silenced, though. About 26,500 U.S. hams served with the Armed Forces (17,700), the Merchant Marine (900), Civil Service (3,600), and in industry (4,300). And along with the hams went many of their cherished receivers and transmitters.

Reconnaissance — with Cash

War caught the Signal Corps without much in the way of modern communications equipment. Many of its transmitters had seen service in World War I. Where could a supply of modern rigs be obtained quickly? The radio manufacturers could not meet the demand immediately. The one answer was the amateur. With the aid of the American Radio Relay League, caravans of Signal Corps trucks, each carrying an officer armed with a pocketful of money, spread out across the country. Pulling up in front of a ham's house, the officer would pay off in cold cash and stow another up-to-date transmitter or receiver in his truck.

The story is told about one amateur who sold his receiver to the government in this way and not long afterward was drafted and assigned to the Signal Corps. When he reported to his field station in North Africa, he took one look at the equipment and gulped. There stood his own receiver, with

his amateur call letters painted across it!

Since the war ended, the ranks of the hams have grown considerably, and the rate of growth is increasing. According to the latest figures available, some 1,000 new licenses are being issued every month. At the war's beginning, there were approximately 60,000 amateurs in the U.S. Today's count shows upwards of 80,000, and 250,000 are forecast in five years.

That should be a good omen for radio. With three times as many amateurs, there are sure to be a larger number of new developments. But it goes farther than that. With 250,000 American hams chewing the rag with about 25,000 foreign hams, there should be a better meeting of minds on a good many subjects besides radio. You can't call a man OM (ham language for "old man") and end up with 73s ("best regards") without feeling pretty friendly. National and military barriers are harder to overcome than geographical ones—contact with Russian amateurs still is a rarity, and there aren't many hams in an occupied zone—but the gregarious, information-sharing ham is on the right track. END



Mounted in a tree over his Bayside, N. Y., home, Valentine's directional antenna can be rotated by a switch on the control panel to aid signals.

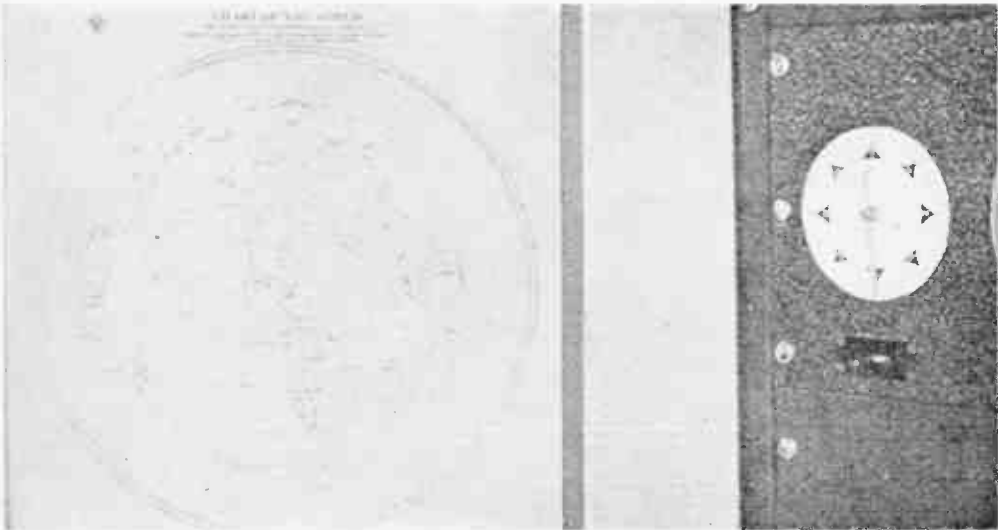

Long-distance work is more than luck. A world map and a compass rose, above the antenna

direction switch, help Valentine find the most favorable radio path to any point on the earth.

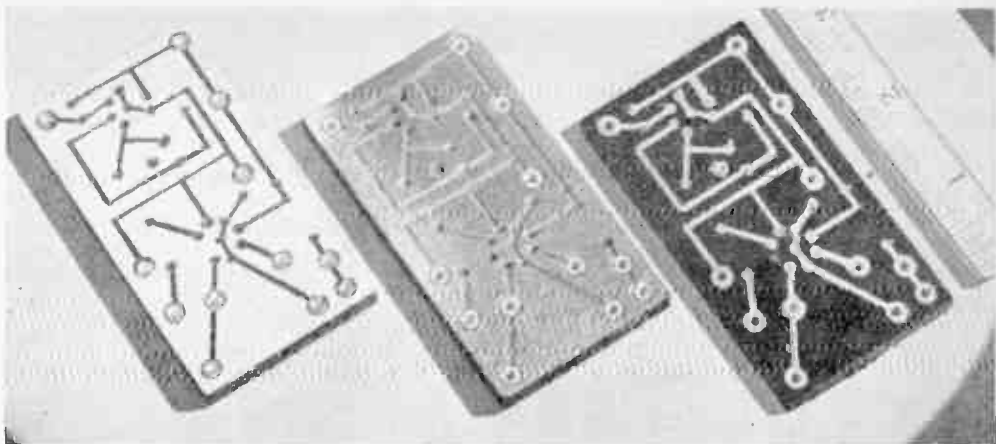

Progress of sprayed circuit. Left to right, plastic base with stencil in place; base with grooves sandblasted in; base with grooves filled with sprayed metal, completing the circuit.

Wireless Wiring for Radios

THAT repairman's headache, the jumble of wires on the bottom of a radio, may join crystal sets in the museum. Two new processes mass-produce neat circuits, easy to check for trouble. They promise to do for average radios what printed circuits are doing for miniatures.

In a system invented by A. M. Hathaway and developed by Spraywire Labs. of Minneapolis, a plastic panel is covered by a

Scotch-tape stencil of the circuit. Through this, grooves are sandblasted, then spray-gunned full of atomized metal. Two guns can spray more than 1,000 units an hour.

Another method uses two copper sheets on opposite sides of an insulating panel. All horizontal parts of the circuit are stamped out in strips on one side; vertical on the other. The two are connected by metal eyelets punched through the panel.

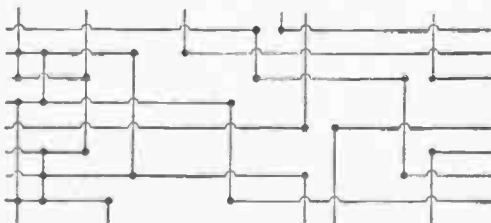

Conventional circuit diagram (above) as drawn by an engineer is duplicated by the stamped circuit below, developed by A. W. Franklin Mfg. Corp., of Long Island City, N. Y.

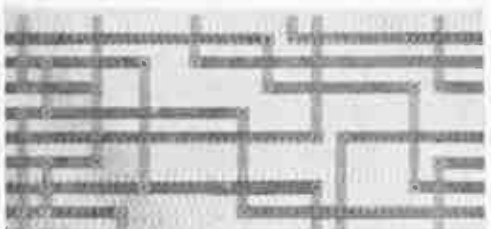

In **phantom drawing** of stamped circuit, heavy lines represent metal strips on top of base; light lines, strips beneath. Eyelets connect them.

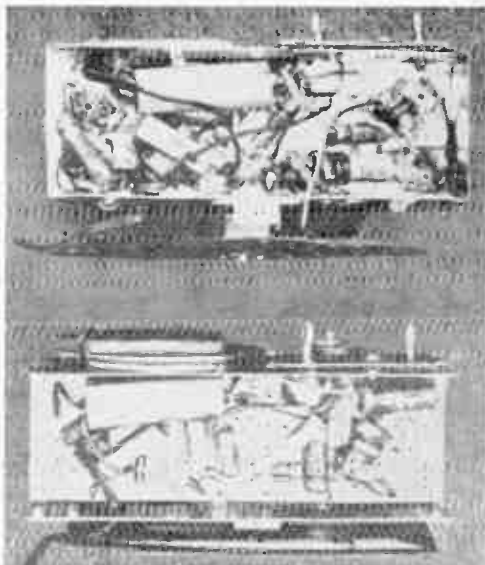

Usual rat's-nest wiring of conventional radio is at top; below, the same thing using neat, easy-to-maintain circuit produced by stamping.

Contact Mike Boosts Music

PRACTICALLY any radio can be used as an electronic booster for your violin, guitar, piano, or similar instrument. A contact microphone feeds the music into the amplifier section of the radio. If the set has a high-gain audio system, the electrical connections may be made directly; a typical installation is shown in the drawing at the lower right.

Radios that don't give all the amplification you want can be pepped up with another audio stage as shown in the diagram below. Tube V1 is the detector-amplifier already in the receiver—probably a 6SQ7, 12SQ7, 6SR7, or the like. Break the grid circuit at the point marked X, and wire in a switching jack as shown. For AC-DC sets using 150 ma. tubes such as 12SA7, 12SK7, 50L6, or 35Z5, the extra tube and associated parts values are given in column A below. Other AC-DC sets with 300 ma. tubes (6SA7, etc.) take the values in column B. Column C applies to straight AC sets with such tubes as the 6SJ7, 6SA7, and 6SK7.

For sets of the last type, connect the heater of V2 in parallel with those already in the circuit; in the case of all AC-DC sets, wire it in series with the other tubes at the ground side of the line.—WILLARD MOODY.

TABLE OF VALUES

	A	B	C
R1:	.5 meg.	.5 meg.	.5 meg.
R2:	2.4 meg.	2.4 meg.	2.5 meg.
R3:	2,400 ohms.	2,400 ohms.	1,500 ohms.
C1:	.0015 mfd.	.0015 mfd.	.0015 mfd.
C2:	.5 mfd., 25 v.	.5 mfd., 25 v.	10 mfd., 25 v.
C3:	.05 mfd.	.05 mfd.	.05 mfd.
V2:	12SJ7	6SJ7	6SJ7

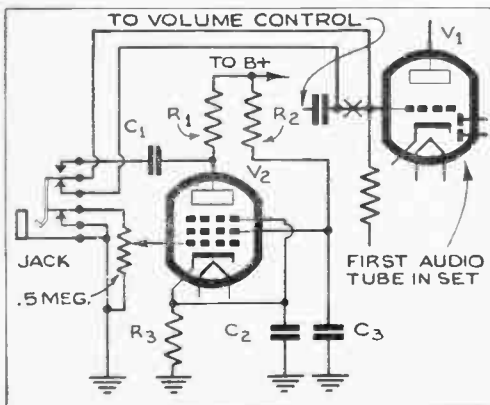

A little rubber cement was used to attach the contact microphone to this flat-top guitar. You can find the best place for the mike by actual trial.



Contact microphones come in a variety of styles, with hand and foot controls. The two models shown above are made by Amperite Company, of New York.

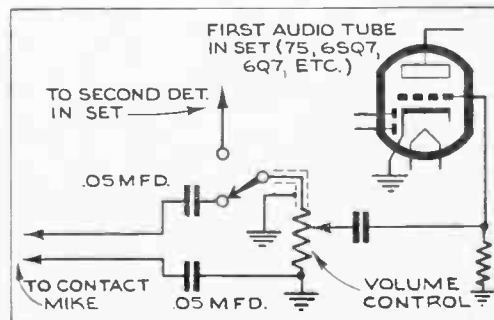

The diagram above shows a simple installation between the detector-audio stages; at left, a more elaborate method, using an extra amplifier tube.

AUTOMATIC VOLUME CONTROL

Duplex-Diode Unit Modernizes Old Superhets

"Servicing Your Radio"



Top and bottom views of the panel of the A. V. C. unit show the set connections and wiring. The 2" high base is sawed from a small card-index cabinet

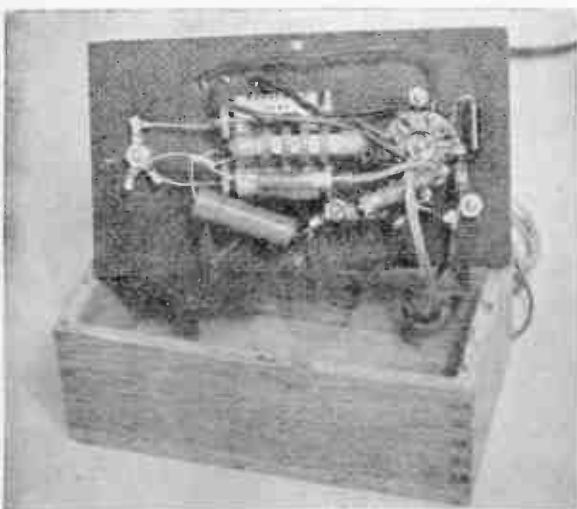

Changes necessary in the old radio set to permit its use with the duplex-diode unit are simple to make and are shown fully in the diagram below. A wiring diagram of the unit itself is at the right

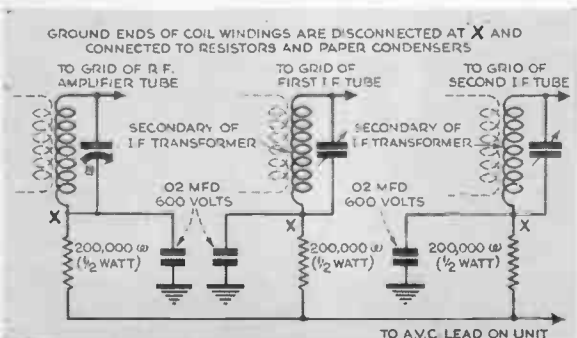

MANY console and midget superheterodyne radios have no automatic volume control. Most of them are 10 to 15 years old and were designed before duplex-diode detector tubes made A.V.C. possible even in inexpensive sets.

A.V.C. helps to keep a receiver from fading continually and also helps to avoid "blasting" from powerful local stations. Best results will be obtained if the receiver to which this unit is attached has one R.F. stage and one or two I.F. stages.

Duplex-diode detector tubes contain two diodes and a triode or pentode amplifier. One diode is usually used as the detector, the other for the A.V.C. circuit, and the triode or pentode as the first audio-amplifier tube. The unit shown was designed for a 7E7 tube, but any duplex-diode pentode type will do provided a transformer affording the correct heater voltage is selected.

The tube socket and filament transformer are mounted on a wood or composition panel set over half of a card-index box. All condensers and resistors are mounted underneath. Shielding is needed only on the grid lead to the set.

In operation the unit acts as a resistance-coupled I.F. amplifier generating its own A.V.C. current. If used with an A.C. receiver having a power transformer with a 6.3-volt heater tap, the filament transformer can be dispensed with and the heater current for the extra tube tapped directly from the set. The unit will operate only on A.C.

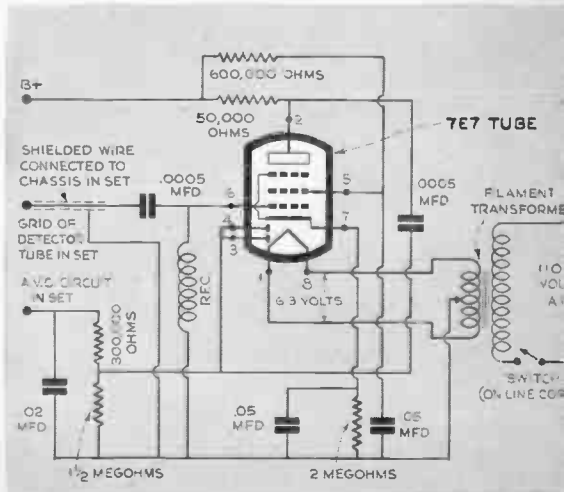

INDEX

- A**dapter box, color 202
 Alarm clock buzzer 91
 Alternating current 199
 Amplifier 188
 Amplifier, high-gain 31
 Amplifier circuits 110
 Antennas, interference-eliminating 68
 Arm, floating 242
 Auto radio, extra speaker for 68
- B**ar in TV Cabinet 212
 Base, nontip 239
 Battery charger, homemade 224
 Battery lead, extension 144
 Bookcase radio combination 100
 Booster 36
 Booster, homemade 63, 97
 Booster, non-tunable 37
 Booster, tunable 37
 Booster battery handle 91
 Brushes, reseating 243
 Built-in TV seats 138
 Butter warmer 73
- C**abinet 116
 Cabinet, shelf 22
 Candle, electric 23
 Candle, musical 120
 Carrier waves 180
 Charger, flashlight cell 240
 Chassis, dusting 58
 Chassis, keeping clean 116
 Chassis, preheating 85
 Chassis, removing 10
 Chassis punches 59
 Circuit checking 121
 Circuit load 179
 Circuits, mass-produced 249
 Circuits, printed 207
 Clamps, bench 242
 Code-practice set 48
 Coils, homemade 15
 Coil form, fluted 242
 Color coding 169
 Color television 106
 Color television adaptation 203
 Color television sampler 117
 Color unit, small 119
 Commercial control 52
 Communicator, two-way 113
 Commutator, undercutting 243
 Condenser, locating leaks in 219
 Condenser, midjet paper 174
 Condenser, 2 to 16 mfd. 22
 Condenser adjusting tool 58
 Contact microphone 250
 Continuous-duty switch 54
 Crackle finish, cleaning 58
 Crystal kit 60
 Crystal radio, assembling 62
- D**. C. motor, homemade 79
 Degree table 146
 Diagram, notes on 114
 Dial cables, broken 135
 Dial cords, broken 49
 Dial cord dispenser 206
 Dipole antennas 87
 Dish drier, electrical 42
 Duplex-diode unit 251
- E**lectric bell alarm clock 166
 Electrician's tape 114
- Electronic booster, radio as 250
- F**ilters, static 242
 Flashlight cells, recharging 240
 F. M. walkie-talkie 174
 Frequency-test recordings 49
- G**enerator 79
 Glow lamps, neon 80
 Grid caps, replacing 22
 Grid shield 86
 Grooving rig 213
 Ground connection, detachable 166
- H**ams 244
 Hams' identification record 121
 Hanger, test-lead 85
 Hearing aid A's, recharging 241
 Hearing aid B's, recharging 241
- I**ndicator lights, neon 135
 Induction, demonstrating 78
 Induction motor repair 150
 Insulation scraper 42
 Insulation stripper, fine wire 115
 Intermittent radios, servicing 73
 Interphones, portable 177
 Ion-trap magnet 192, 212
- L**ead-in wires 91
 Lead-in wires, splicing 114
 Leads, identifying 85
 Leaks, condenser 219
 Lid hinge 58
 Lighting, TV room 222
 Lightning arrester, TV 238
 Lightning protection 163
 Line-cord resistors, replacing 174
 Load on lighting circuits 179
- M**icrophone, floating arm for 242
 Microphone, phono-cartridge 14
 Model train control 50
 Motor regulator 243
- N**eon glow lamps 80, 83
 News timer 41
- O**pen audio transformer, repairing 48
 Oscillators 184
 Outdoor switch, protecting 42
 Outlets, inaccessible 115
- P**arallel resistor graph 229
 Peaking signal, locating 160
 Penholder tool 114
 Phone jacks 85
 Phone jacks, homemade 238
 Phonograph, child's 27
 Phonograph, cold 206
 Phonograph, converting 189
- Phonograph, 3-speed conversion 43
 Phonograph, wind-up 56
 Phonograph needles, matchstick 48
 Phonograph pickup, plastic 213
 Phonograph records, warped 85
 Phono-radio in washstand 127
 Photoelectric target gun 132
 Picture tube, cleaning 13
 Picture tube, replacing 69
 Pilot lights, neon 135
 Pocket radio, 4-tube 103
 Potentiometer, carbon-strip 219
 Power pack 135
 Power supply, choke-input 22
 Power supply, plug-in 162
 Pump motor, adapting 150
 Push-pull receiver stage 46
- Q**uestion bee 220
- R**adio, foreign 167
 Radio, 4-tube pocket 103
 Radio, 4-tube superhet 151
 Radio, kitchen 156
 Radio, one-tube 234
 Radio-clock 120
 Radio-frequency induction 214
 Radio-frequency power 230
 Radio-phonos, bedside 96
 Radio-phonos, bookcase 100
 Radio panel, custom-made 229
 Readjusting marks 116
 Recording-disk grooving rig 213
 Record player in TV set 143
 Rectifier, electrolytic 74
 Rectifier, rotary 32
 Relay, mounting 91
 Relay, sealed 135
 Remote-control toy 162
 Resistance-cord adaptor 174
 Resistors, miniature 242
 Resistors, bridges 219
 Robot radio spy 39
- S**creen border, painting 85
 Sealed relays 135
 Shaver, car-radio 239
 Short-wave band, inexpensive 15
 Signal generator, improvised 145
 Small-town TV 40
 Socket, premounting 73
 Solder, fluxed wire 177
 Solder chips 239
 Solder pencil 86
 Soldering iron support 243
 Soldering thin wires 48
 Soldering transformer 235
 Spark coil 164
 Speaker, additional 49
 Speaker, extension 172
 Speaker, extra auto radio 68
 Speed control, motor 243
 Starter repair 150
 Static, fluorescent light 242
 Storage battery, charging 32
 Switches, door-locking 229
 Switches, feed-through 150
 Switches, midjet 92
 Switches, snap-action 177
 Switches, voice 50

T elephone pickup	144	Turntable, servicing	48	TV sound, improving	46
Tesla coil	199	TV, photographing	128	TV station, "ham"	193
Test circuit	121	TV antennas	87	TV troubleshooting	12, 13
Test outlet	239	TV antennas, lightning		TV tuner replacement	175
Test pattern	226	protection	163	TV workshoppers' tricks	147
Tester, pocket	84	TV antennas, mounting	123		
Thermostat,		TV antenna troubles,		U nderwriters' knot	115
high-temperature	178	overcoming	136		
Time switch, automatic	170	TV cabinets, building	102	V acuum tubes	200
Tone, improving		TV cabinets, homemade	161	Vise, suction clip as	239
table radio	122	TV color sets	210	Voice switches	50
Transformer	78	TV doghouse	24	Volume control, automatic	251
Transformer, soldering	235	TV earphone attachment	191	Volume control, replacing	49
Transmitter, unlicensed	214	TV fuses	153		
Triode tubes	18	TV interference	154	W ires, concealing	121
Tubes, hot	206	TV lead, testing	23	Wires, separating	115
Tubes, three-element	18	TV lightning arrester	238	Wires, soldering	48
Tubes, weak	206	TV misalignment	192	Wires, splicing	177
Tube characteristics	20, 21	TV picture, enlarging	238	Wire fishing	166
Tube gripper	144	TV repairing	9	Wire strippers	150
Tube numbers, shielding	242	TV set, disassembling	11	Wiring diagram, handy	58
Tubing, spaghetti	206	TV set, judging	225		
Tuning knob, brightening	116	TV set, modernizing	69		
Turntable, peaking signal	160	TV set with built-in seats	138		

Everybody's

**TELEVISION
and
RADIO
HANDBOOK**

