



ORDER FROM YOUR
RCA PARTS DISTRIBUTOR

Note that RCA Radio Tubes, RCA DeForest Amateur Tubes, RCA Victor P. A. System PG-62-D, RCA Victor Record Players, Store Recorders, Needles and Records are handled only by those RCA Parts Distributors who are also Authorized Distributors for the products named.



RADIO PARTS
C A T A L O G U E

**SPECIALTIES FOR THE
RADIO SERVICE ENGINEER**

☆☆☆ **RCA** ☆☆☆

RADIO SERVICE NEWS

PUBLISHED IN THE INTEREST OF RADIO SERVICE SALES ENGINEERS

APRIL 5, 1935

CAMDEN, NEW JERSEY

Vol. 1, No. 6

OSCILLOGRAPH AIDS ARE READY

ANNOUNCE TWO AUDIO OUTPUT TRANSFORMERS

Universal Output Transformer Used With All Tubes and Speakers

Two new oscillograph transformers, designed to meet the needs of the radio service engineer, are announced by RCA. The first is a universal output transformer, which is designed to be used with all tubes and speakers. The second is a speaker transformer, which is designed to be used with all speakers. Both transformers are designed to be used with all tubes and speakers.



The RCA transformer, designed to meet the needs of the radio service engineer.

The RCA transformer, designed to meet the needs of the radio service engineer, is a universal output transformer, which is designed to be used with all tubes and speakers. It is designed to be used with all tubes and speakers.

PENCIL OFFER EXPIRES

Bring On Television!



SILK PURSES, SOWS' EARS, AND LICENSES
An Editorial by F. R. Ostman

Service Manager, RCA Victor Division

Continuing radio service engineering

The radio service engineer is a professional, and as such, he should be treated as such. He should be given the same respect and consideration as any other professional.

It is the duty of the radio service engineer to provide the best service possible to his customers. He should be given the same respect and consideration as any other professional.

It is the duty of the radio service engineer to provide the best service possible to his customers. He should be given the same respect and consideration as any other professional.

It is the duty of the radio service engineer to provide the best service possible to his customers. He should be given the same respect and consideration as any other professional.

It is the duty of the radio service engineer to provide the best service possible to his customers. He should be given the same respect and consideration as any other professional.

It is the duty of the radio service engineer to provide the best service possible to his customers. He should be given the same respect and consideration as any other professional.

It is the duty of the radio service engineer to provide the best service possible to his customers. He should be given the same respect and consideration as any other professional.

It is the duty of the radio service engineer to provide the best service possible to his customers. He should be given the same respect and consideration as any other professional.

It is the duty of the radio service engineer to provide the best service possible to his customers. He should be given the same respect and consideration as any other professional.

It is the duty of the radio service engineer to provide the best service possible to his customers. He should be given the same respect and consideration as any other professional.

NEW \$34.50 OSCILLATOR HAS FEATURES OF SIGNAL GENERATOR

Frequency Modulator and New Test Oscillator Are Designed for Use With RCA Oscillograph

A new oscillator, designed to meet the needs of the radio service engineer, is announced by RCA. This oscillator has the features of a signal generator and is designed to be used with the RCA oscillograph. It is designed to be used with the RCA oscillograph.

The new oscillator, designed to meet the needs of the radio service engineer, is announced by RCA. This oscillator has the features of a signal generator and is designed to be used with the RCA oscillograph. It is designed to be used with the RCA oscillograph.

LOW PRICE ON HIGH QUALITY SOUND SYSTEM

New PA Equipment Offers Hope for Price Market to Service Engineers

The new PA equipment, designed to meet the needs of the radio service engineer, is announced by RCA. This equipment has the features of a sound system and is designed to be used with the RCA oscillograph. It is designed to be used with the RCA oscillograph.

GET ON THE MAILING LIST FOR RCA RADIO SERVICE NEWS . . .

"It's a corker," says Michael Dolgas of Passaic, N. J.

"It's the cat's whiskers," says Ansel Searles, Searles Radio Service, Boscobel, Wis.

They were talking about RCA Radio Service News, the paper that is "published in the interests of radio service engineers." Whether you think it's a corker or the cat's whiskers, you'll agree that it is so good you won't want to miss a single issue. Each issue has technical articles especially written for the radio service profession, articles on the use of new developments such as the cathode ray oscillograph, dozens of practical service tips contributed by readers, and interesting announcements of new products of the RCA Parts Division and the doings of service engineers throughout the country.

Ask us to have your name put on the mailing list, or write direct to RCA Radio Service News, Camden, N. J.

A Booklet on Phonograph Modernization

This twenty-four page booklet explains how to connect electric pickups to radio sets and gives diagrams to help those who are cashing in on the "1935 Opportunity for Service Engineers." Limited quantity still available free on request while they last. See us or write to RCA Parts Division, Advertising Department, Camden, N. J.

STAMPED AND IMPRINTED POSTCARDS, \$1 per 100

Order these business-builders from us or send your order direct to RCA Parts Division, Camden, New Jersey, with your remittance. Order by number and give specific imprinting instructions.



Your Radio Can Take It

It takes all the noise and interference and passes them on to you unless it is equipped with a scientific antenna system. For short-wave reception especially, you must have an efficient antenna. We specialize in antenna installations and recommend the noise-reducing RCA World-Wide Antenna System . . . a remarkable "double-doublet" system that reduces noise and brings in stations you never get before. Let us make a **Certified Installation** . . . Phone us today.

YOUR IMPRINT HERE
PRICE \$1.00 PER HUNDRED
(Government Stamped)

EM 7



CARUSO, RUDY VALLEE or a SYMPHONY . . . whenever you want them

That old phonograph of yours—for a few dollars we can connect it to your radio so that you can hear your favorite artists through your radio whenever you wish. No springs to wind, and you get the same modern tone quality that you get on radio reception . . . or with an RCA Victor Record Player you can play records through your radio without ever leaving your easy chair . . . And it's inexpensive . . . Phone us today . . . Let us tell you more about it.

YOUR IMPRINT HERE
PRICE \$1.00 PER HUNDRED
(Government Stamped)

EM 10



You Never Realize

how good your all-wave radio set can be until you install a special short-wave antenna system. Let us make a **Certified Installation** of the noise-reducing RCA World-Wide Antenna System. You'll be surprised at the new stations you can get . . . without noise and interference.

YOUR IMPRINT HERE
PRICE \$1.00 PER HUNDRED
(Government Stamped)

EM 8



HAVE YOU OLD RECORDS . . . AN OLD PHONOGRAPH ?

When you can't get what you want on the radio, why not listen to your old favorites on your phonograph—played through your radio?

It costs very little to install an electric motor and pickup on your old phonograph and connect it to your radio . . . then you can have the music you want when you want it, without even bothering to wind a spring. Phone us; we'll be glad to tell you more about it.

YOUR IMPRINT HERE
PRICE \$1.00 PER HUNDRED
(Government Stamped)

EM 9



de Forest AMATEUR RADIO TUBES

PRICE LIST

Type	Amateur's Net Price	DESCRIPTION	Elec-trodes	Max. Plate Dissipation Watts	Cathode Type	Cath-ode Volts
203-A	\$17.50	R-F Power Amplifier, Oscillator, Class B Modulator	3	100	Filament	10.0
204-A	97.50	Oscillator, R-F Power Amplifier, Class B Modulator	3	250	Filament	11.0
211	17.50	R-F Power Amplifier, Oscillator, A-F Power Amplifier, Modulator	3	100	Filament	10.0
800	10.00	R-F Power Amplifier, Oscillator, Class B Modulator	3	35	Filament	7.5
801	4.50	R-F and A-F Power Amplifier, Oscillator, Modulator	3	20	Filament Heater	7.5 6.3
802	3.90	R-F Power Amplifier Pentode	5	10	Filament	11.0
831	265.00	Oscillator, R-F Power Amplifier	3	400	Filament	2.0
840	6.00	R-F Pentode	5	—	Filament	2.0
841	3.25	R-F Power Amplifier, Oscillator, A-F Voltage Amplifier	3	15	Filament	7.5
842	3.25	A-F Power Amplifier, Modulator	3	15	Filament	7.5
843	12.50	Power Amplifier, Oscillator	3	15	Heater	2.5
844	18.00	Screen Grid R-F Power Amplifier	4	15	Heater	2.5
845	20.00	Modulator, A-F Power Amplifier	3	75	Filament	10.0
849	160.00	Modulator, A-F and R-F Power Amplifier, Oscillator	3	400	Filament	11.0
850	37.50	Screen Grid R-F Power Amplifier	4	100	Filament	10.0
851	350.00	Modulator, A-F and R-F Power Amplifier, Oscillator	3	750	Filament	11.0
852	23.80	Oscillator, R-F Power Amplifier	3	100	Filament	10.0
860	35.00	Screen Grid R-F Power Amplifier	4	100	Filament	10.0
861	295.00	Screen Grid R-F Power Amplifier	4	400	Filament	11.0
864	1.60	Amplifier (Low Microphonic Design)	3	—	Filament	1.1
865	12.75	Screen Grid R-F Power Amplifier	4	15	Filament	7.5
868	6.00	Phototube	2	—	—	—
918	6.00	Phototube (High Sensitivity)	2	—	—	—
955	3.75	Amplifier, Detector, Oscillator (Acorn Type)	3	—	Heater	6.3

Type	Amateur's Net Price	RECTIFIERS	Elec-trodes	Max. Peak Inverse Volts	Cathode Type	Cath-ode Volts
217-A	\$20.00	Half-Wave, High-Vacuum	2	3,500	Filament	10.0
217-C	20.00	Half-Wave, High-Vacuum	2	7,500	Filament	10.0
866	4.50	Half-Wave, Mercury-Vapor	2	7,500	Filament	2.5
866-A	5.00	Half-Wave, Mercury-Vapor	2	10,000	Filament	2.5
872	16.50	Half-Wave, Mercury-Vapor	2	7,500	Filament	5.0
872-A	18.50	Half-Wave, Mercury-Vapor	2	10,000	Filament	5.0
878	11.00	Half-Wave, High-Vacuum for Cathode-Ray Tubes	2	20,000	Filament	2.5
879	3.00	Half-Wave, High-Vacuum for Cathode-Ray Tubes	2	7,500	Filament	2.5
885	2.00	Gas-Triode for Cathode-Ray Sweep-Circuit Control	3	300	Heater	2.5

Type	Amateur's Net Price	CATHODE-RAY TUBES	Elec-trodes	Max. Anode No. 2 Volts	Cathode Type	Cath-ode Volts
904	\$52.50	5 in., Electrostatic-Magnetic Deflection, High-Vacuum	5	4,600	Heater	2.5
905	45.00	5 in., Electrostatic Deflection, High-Vacuum	4	2,000	Heater	2.5
906	18.00	3 in., Electrostatic Deflection, High-Vacuum	4	1,200	Heater	2.5
907	48.75	5 in., Electrostatic Deflection, High-Vacuum, Short Persistence Screen	4	2,000	Heater	2.5
908	21.00	3 in., Electrostatic Deflection, High-Vacuum, Short Persistence Screen	4	1,200	Heater	2.5

Effective April 1, 1935—Prices subject to change without notice



RCA-906



RCA-800



RCA-955



RCA-802



RCA-8



GENUINE RCA

MICRO-SENSITIVE RADIO TUBES

with

- QUICKER START
- QUIETER OPERATION
- UNIFORM PERFORMANCE
- UNIFORM VOLUME, and
- SEALED CARTON PROTECTION

Carry a 5-1 public preference over their nearest competitor—now priced to appeal to a price-conscious public.

As distributors of RCA Radio Tubes we are in a position to give recognized dealers and service men special quotations. Write for attractive discounts.

TYPE	VOLTS	LIST PRICE	TYPE	VOLTS	LIST PRICE	TYPE	VOLTS	LIST PRICE
00A	5.0	\$1.25	42	6.3	\$0.99	83V	5.0	\$1.50
01A	5.0	.59	43	25.0	.99	84	6.3	1.25
1	6.3	1.25	45	2.5	.69	85	6.3	.99
1-v	6.3	.89	46	2.5	.99	89	6.3	.99
10	7.5	2.00	47	2.5	.89	V99	3.3	.99
11	1.1	1.25	48	30.0	2.50	X99	3.3	.99
12	1.1	1.25	49	2.0	.99	1A6	2.0	1.25
112A	5.0	.69	50	7.5	2.50	2A3	2.5	1.25
19	2.0	.99	53	2.5	1.25	2A5	2.5	.99
20	3.3	.99	55	2.5	.99	2A6	2.5	.99
22	3.3	1.25	56	2.5	.69	2A7	2.5	1.25
24A	2.5	.89	57	2.5	.89	6A4	6.3	1.25
26	1.5	.59	58	2.5	.89	6A6	6.3	1.25
27	2.5	.69	59	2.5	1.25	6A7	6.3	1.25
30	2.0	.69	71A	5.0	.69	2B7	2.5	1.25
31	2.0	.69	75	6.3	.99	6B7	6.3	1.25
32	2.0	1.25	76	6.3	.69	1C6	2.0	1.50
33	2.0	.99	77	6.3	.99	6C6	6.3	.99
34	2.0	1.25	78	6.3	.99	6D6	6.3	.89
35	2.5	.89	79	6.3	1.25	6F7	6.3	1.50
36	6.3	.89	80	5.0	.59	5Z3	5.0	.89
37	6.3	.69	81	7.5	2.00	12Z3	12.6	.99
38	6.3	.89	82	2.5	.89	25Z5	25.0	.99
39-44	6.3	.89	83	5.0	.89	874	...	4.90
40	5.0	.69				876	...	6.70
41	6.3	.89				886	...	6.75

RCA RADIO TUBE SALES AIDS

... will help you make more money!

Whether it's technical data, business-building forms, or sales aids, for the service man or dealer . . . we have it. In ordering, be sure to print the imprint desired. All orders should be accompanied by cash, check or money order.

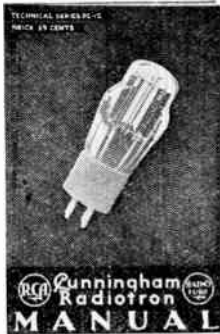

LETTERHEADS: Your own stationery as you would want it. Imprinted 500 for \$2.75, 1,000 for \$4.50, including envelopes.

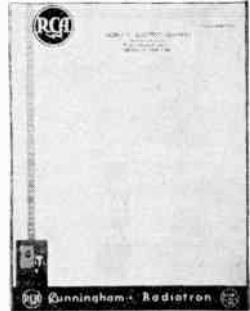

RC-12 MANUAL: Technical data on all receiving type tubes. Single copies free. Additional copies 25 cents each.



NOT-AT-HOME CARDS: Remove all doubt of your having called. Imprinted for 25c per 100.



CALLING CARDS: Your own business card printed in two colors for almost less than the price of the blank card. \$1.00 for 500.

TUBE TEST STICKERS: Bring your name to mind when tubes have to be replaced. 2,000 imprinted reminders for \$1.00.



SERVICE ORDER FORM: Systematize all orders. Form recognized as the best obtainable. Imprinted 50 sets of triplicate forms to a pad, costing \$1.25 for 3 pads.

BILLHEADS: Use business-like billheads in all your dealings. Available imprinted for the small amount of \$1.00 for 500.



DE LUXE LOG: Lists all local and foreign stations. Specify whether merchandise or service copy is desired for back cover. "S" means service copy. Price imprinted \$3.00 per 100. In lots of 1,000, \$2.75 per 100; in lots of 2,500, \$2.50 per 100.

RADIO TOUR MAPS: Maps showing radio stations of United States, Canada and Mexico, and principal short-wave stations of world by location, call letters and kilocycles. With your imprint: \$2.00 per 100; in lots of 500, \$1.75 per 100; in lots of 1,000, \$1.50 per 100.



PRICE LIST CARDS: For store and reference use —reverse side of card gives interchangeable types. Free on request.



Look Neat ...it Pays!

1. Test all tubes. Label O.K. tubes and destroy defective tubes in the presence of your customer.
2. Check and compare all voltages with manufacturers service instructions. It helps isolate the trouble. Good test equipment adds prestige to your work.
3. Replace defective parts with genuine RCA Parts. The RCA trademark needs no explanation. RCA quality insures satisfied customers.
4. Don't let a mis-aligned receiver reflect on the job you have done. Align all receivers, even though you only

Tips FOR PROFITABLE SERVICING

change a tube. Every set, regardless of its type or age, can be improved by realigning.

5. Be neat. Clean up all dirt and polish the cabinet. It only takes a minute and pays large returns.
6. If trouble is not obvious, take the chassis to your shop. It creates a better impression and you'll do a better job.
7. Do a good job and ask a fair price. Good work commands a good price. Don't throw away your heritage.
8. Keep a card file and follow up every call. Let your customers know you're interested in their radio problems.
9. Keep up-to-date. Modern service equipment helps you do better work in less time. Increasingly complex circuits require increased knowledge.
10. Professional service requires professional appearance. See that your car, your equipment and your appearance measure up to the high standard of the service profession. Good showmanship pays big returns.

Ready-Made Ads and Stamped Postcards Help Sales

The ready-made ad and the Government stamped postcard imprinted with your name are great helps for aggressive Service Engineers. Their cost is low, and the results high. Use them to build your business. Postcards with your imprint, \$1.00 per 100, prepaid. Ready-made ads free.

ORDER THESE FREE AD MATS FROM US OR DIRECT FROM RCA PARTS DIVISION, Camden, N. J.



Foreign Stations Like Locals

That's what you'll say when your new all-wave receiver is connected to an RCA World-Wide Antenna. PRICE \$6.00

Ask us about a Certified Installation

YOUR NAME AND ADDRESS

EM-20



Stations Weak?

You'll get stronger stations and less noise with an RCA World-Wide Antenna. PRICE \$6.00

Ask us about a Certified Installation.

YOUR NAME AND ADDRESS

EM-21



More FOREIGN STATIONS with LESS NOISE

When Your Short Wave Radio is connected to an RCA WORLD-WIDE ANTENNA

You don't have to wait until the short waves are "hot." If your set is connected to an RCA World-Wide Antenna Eliminates noise from electrical devices and automobiles. RCA Antennas are designed by the same engineers who maintain communication with 46 foreign countries 24 hours daily. Price \$6.00. Certified installation by our antenna specialists extra.

Your Name and Address

EM-22



IMPROVE YOUR SHORT WAVE Radio Reception with the WORLD-WIDE ANTENNA

Regardless of the make, type or age of your short wave receiver, reception will be improved with the RCA World-Wide Antenna. Greater signal pick-up and reduction of noise from electrical devices and automobiles gives better reception in all locations. The RCA World-Wide Antenna is designed by the same engineers who maintain communication with 46 foreign countries 24 hours daily. Price \$6.00. Certified installation by our trained specialists extra.

Your Name and Address

EM-23



STATIONS NOISY? SIGNALS WEAK?



Stronger stations and less noise are secured by connecting your set to an RCA World-Wide Antenna. PRICE \$6.00

Installation Extra

Your Name and Address

EM-24



Radio Noisy?

Modern radios must have a scientific antenna for quiet reception. Let us show you how much more you'll enjoy your radio with an RCA World-Wide Antenna. PRICE \$6.00

Installation Extra

YOUR NAME AND ADDRESS

EM-25



More Stations with Less Noise

When you connect your all-wave radio to an RCA WORLD-WIDE ANTENNA

PRICE \$6.00

Installation Extra

YOUR NAME AND ADDRESS

EM-26

Government Stamped Postcards, Imprinted \$1.00 per 100 : Order any of these postcards imprinted with your name from your RCA Parts Distributor or from RCA Parts Division, Camden, New Jersey, enclosing remittance. . . .



This Week's SPECIAL!

Our Trained Engineers Will Come to Your Home and—

- Align all circuits in your receiver (adjusts on alignment)
- Check and label all tubes
- Clean exposed volume control
- Remove corrosion from antenna terminals
- Clean and polish radio cabinet
- Estimate cost of any needed repairs

ALL FOR \$2.00

YOUR IMPRINT HERE

Street Address Phone Number
City and State or Slopes here

EM-16 A PROVEN BUSINESS-BOOSTER

EM-16



RADIO WEAK?

We can see as well as hear exactly what is wrong with your radio on our RCA Cathode Ray Oscilloscope. Drop into our Service Department and see this remarkable instrument.

We recommend and install the RCA World-Wide Antenna System. A necessity for noise-free short-wave reception.

YOUR IMPRINT HERE

Street Address Phone Number
City and State or Slopes Here

EM-17 CASH-IN ON YOUR OSCILLOGRAPH

EM-17



HOW'S YOUR ANTENNA?

Do you know a poor antenna causes more noisy and unsatisfactory reception than any other factor? The new RCA World-Wide Antenna guarantees more stations with less noise. Phone us; we'll be glad to tell you more about it.

We use the latest RCA factory-type service equipment.

YOUR IMPRINT HERE

Street Address Phone Number
City and State or Slopes Here

EM-18 HELPS ANTENNA SALES

EM-18



PROGRAMS NOISY?

YOU'LL never recognize your old set after one of our antenna, tube and alignment checks. We guarantee more signals, less noise and better tone quality. Latest RCA test equipment used.

AN RCA WORLD-WIDE ANTENNA SYSTEM is a Necessity for Noise-Free Short-Wave Reception. Let us install One

YOUR IMPRINT HERE

Street Address Phone Number
City and State or Slopes here

EM-19 A SURE REMINDER

EM-19

« RCA »

THE LEADER

As prominently as the RCA Building stands out on New York's sky line, so do the achievements of RCA engineers stand out in the field of radio research.

Service engineers, who have studied radio, know that to chronicle the contributions of RCA to the radio art is to write much of the history of radio. RCA can also contribute much to the radio service profession.

When you offer your customers, in connection with your professional services, the RCA products listed in this catalog, you are associating *your* name with the greatest name in radio—RCA.

When you use RCA Test Equipment or RCA Parts you are using products backed by the only organization that is an active leader in every phase of radio.

We invite you to let the famous RCA monogram be one of the assets of your business.



PRESIDENT, RCA MANUFACTURING COMPANY, INC.

OTHER RCA UNITS . . . RCA Communications, Inc. . . . Radiomarine Corporation of America . . . National Broadcasting Co., Inc. . . . RCA Institutes

RCA Building, Radio City, New York. Headquarters of Radio Corporation of America and The National Broadcasting Company, an RCA subsidiary.



Shake, Radio Service Engineer



You are interested in servicing every kind of radio apparatus; RCA makes all kinds of radio apparatus and is interested in having it properly serviced. § You are interested in the stabilization of the radio service business. So is RCA. Everything that benefits radio in any of its branches benefits RCA. § Between you and RCA there is a natural partnership. You can depend on RCA to see things from your point of view. § You can depend on RCA, as your partner, to support you in anything that benefits the radio service business in particular and the radio industry and the public in general. § You can depend on RCA to produce accurate Test Instruments designed for your needs and priced for your pocketbook. § You can depend on RCA for Replacement Parts for RCA Victor sets that are built with the same precision as the original parts. § You can depend on RCA to furnish you with complete technical information on its products. § You can depend on the RCA trademark making it easier for you to obtain customers and easier to keep them satisfied.

A stylized, handwritten signature in black ink, likely belonging to the Sales Manager mentioned in the text below.

SALES MANAGER, RCA PARTS DIVISION



INDEX

	Page		Page
A			
ADAPTER—Oscillator	16	Cones—For Loudspeakers	71
ADDRESS—Public Address Equipment	32, 90	Controls, Tone	70, 71
Adapter, Split Cathode	38	Controls, Volume	70, 71
Aerials—See Antennas		Control Unit—Instrument Panel Control Unit for Autos	28
Alignment Tools	16	CROSS INDEX to G. E., Westinghouse and Graybar Receivers and Guide to Replacement Parts	74, 83
All-wave Coils	24, 53	D	
ANTENNA—Auto Roof Antenna	28	Detector Coils	24, 57
Coils	24, 53	DRAWINGS—Antenna Coils	52, 54
Di-Pole Noise Reducing Auto Antenna	29	Pickup	35, 36
Standard Shielded	20	R. F. Coils	55, 56, 57
World-Wide	17, 18, 19	R. F. System of All-Wave Receiver	57
Anvil—Off-Set Riveting Anvil	16	DI-POLE Auto Antenna	29
Arms, Pickup	40	Drive Gears	43
Audio Transformers	65	E	
AUTO Antennas—Di-Pole	29	Electrolytic Capacitors	47, 48
Capacitors	27	Escutcheons—For Pickup Arms	40
Radio Lock	28	F	
Roof Antennas	20, 28	Filter Reactors	67
Suppressors	27	Flexible Resistors	62
Automatic Record Changer	39	FREQUENCY Modulator	13
B			
Balls—Steel	43	G	
Bolt—Motor Mounting Bolt Assembly	37	Gears—Drive	43
Bound Volume Service Notes	31	Gears—Intermediate	43
Boxes—Needle	43	I	
Brake—Turntable Automatic Eccentric Brake	37	INDICATOR—Output	14
By-Pass Auto Capacitors	27	Instrument Control Unit	28
C			
CABINET Refinishing Kit	30	Intermediate Frequency Coils	25, 63, 64, 65
CAPACITORS—Packs—Electrolytic	48	Intermediate Gears	43
Packs—RCA Victor Replacement	50, 51	K	
By-Pass for Autos	27	KIT—Cabinet Refinishing Kit	30
Electrolytic Dry—Aluminum Containers	47	KIT—Oscillator Modernization	12
Electrolytic Dry—Paper Containers	47	KITS—Phonograph Modernization Kits	37, 38
Electrolytic Wet—Aluminum Containers	47	Knurled Nut Wrench	16
Electrolytic Wet—Copper Containers	47	L	
Paper Flat	46	Lever—Turntable Speed Shift Lever	37
Paper Tubular	46	Lock—Auto Radio	28
Toothpick Mica	45	Loudspeaker Cones	73
Tuning	49	Loudspeakers	72
Tuning Capacitors for Magic Brain Receivers	25	M	
Carbon Resistors	37, 58, 59, 60	MAGIC Brain Parts	24, 25
Cathode Adaptor	38	Magnetic Pickup	41
CATHODE RAY OSCILLOGRAPH	8, 9	Mica Capacitors	45
COILS—All-Wave	53	MODERNIZATION—Phonograph	33
Antenna	53	MODULATOR—Frequency	13
Antenna for Magic Brain Receivers	24		
Detector—For Magic Brain Receivers	24		
Intermediate Frequency—For Magic Brain Receivers	25		
Oscillator—For Magic Brain Receivers	24		

LIST PRICES Are Shown For All Re-Sale Items

INDEX

	Page		Page
MOTORS—Board Layouts	34	Riveting Punch	16
Board Spring Assembly	37	Riveting Anvil	16
Mounting Assembly	37, 38		
Phonograph	37	S	
Small Phonograph	38, 41	Screwdriver—Off-Set	16
Turntable Drive Replacement Motors	44	Selector Switch	25
		SERVICE NOTES—Bound Volumes of RCA	
N		Service Notes	31
Needle Boxes	43	Shielded Antenna System	20
		Shields—For Magic Brain R. F. and I. F. Coils	25
O		Sound Box—Orthophonic	42
Off-Set Anvil	16	Spring Assembly—Motor Board	37
Off-Set Screwdrivers	16	Steel Balls	43
Orthophonic Sound Boxes	42	Suppressors—Auto	27
OSCILLATOR Adapter	16	Switch—Radio—Record	37
Coils	24, 57	Switches—Selector Switches for Magic Brain	
Modernization Kit	12	Receivers	25
Phonograph	32		
Test—TMV-97-C	10, 11	T	
OSCILLOGRAPH—Cathode Ray	8, 9	Technical Purpose Records	39
OUTPUT Indicator	14	TEST Oscillator	10, 11
Transformers	21, 66	Tone Controls	70, 71
		Tools—Miscellaneous	16
P		Toothpick Capacitors	45
Paper Capacitors	46	TRANSFORMERS—Audio	65
PHONOGRAPH—Modernization		Power Auto	27
33, 34, 35, 36, 37, 38, 39		Intermediate Frequency	63, 64, 65
Modernization Kits	37, 38	Output	66
Motors	37, 38, 41, 44	Power	68, 69
Oscillator	32	Universal Output	21
Pickup and Arm—Small	41	Universal Power	22, 23
Pickup Arm Escutcheons	40	Tuning Capacitors	25, 49
Pickup Arms	40	TUNING Wand	16
Pickup—Magnetic	41	Turntable Brake	37
Porcelain Resistors	61	Turntables	42
Power Transformers	22, 23, 27, 68, 69	Turntable Speed Shift Lever	37
Powertrons—Vibrators for Auto Radio	28	Turntable—Two-Speed	37, 42
Power Unit—Regulated—TMV-118-B	15	Two-Speed Turntables	37, 42
PUBLIC Address Equipment	32, 90		
Punch—Riveting	16	U	
		UNIVERSAL Transformers	21, 22, 23
R			
Radio—Record Switch	37	V	
Reactors—Filter	67	Vibrators—Auto	26, 28
RECORD CHANGER—Automatic	39	Vibrators	26
Records—Technical Purpose	39	Victor Alignment Tool	16
REGULATED Power Unit	15	Volume Controls	70, 71
Replacement Capacitor Packs	50, 51		
RESISTORS—Carbon 25,000 Ohm	37	W	
Carbon—1/4 Watt	58	Wand, Tuning	16
Carbon—1/2 Watt	59	Wirewound Resistors	42
Carbon—1 Watt	60	WORLD-WIDE Antenna	17, 18, 19
Carbon—3 Watt	60	Wrench—Knurled Nut	16
Flexible Wirewound	62	Wrench—Victor Alignment	16
Porcelain—Tapped	61		
Wirewound—Flat	62		

Prices Shown Are Subject to Change Without Notice



CATHODE RAY OSCILLOGRAPH

STOCK NO. 9545

\$84⁵⁰

NET PRICE

With RCA tubes, including
RCA-906 Cathode Ray Tube



• **COMPLETE . . .**

The RCA Cathode Ray Oscillograph, Type TMV-122-B, is complete in every essential requirement for immediate use. It includes two power supplies (one for the Cathode Ray Tube and one for the amplifier), vertical and horizontal amplifiers, saw-tooth timing frequency generator and six tubes, including the RCA-906 Cathode Ray Tube (3-inch).

• **2 VOLTS PER INCH . . .**

Through the use of two wide-frequency-range high-gain amplifiers, the sensitivity is guaranteed at 2 volts d-c per inch for both vertical and horizontal deflection. The amplifiers have flat frequency characteristics between 20 and 90,000 cycles \pm 10 per cent. The amplifier gain is approximately 40.

• **20-15,000 CYCLES . . .**

A linear saw-tooth timing frequency oscillator with a special synchronizing circuit is an integral part of the RCA Oscillograph. The frequency range extends from 20 to 15,000 cycles and permits the examination of a single cycle up to 15,000 cycles or the examination of six cycles up to the limit of the amplifier—90,000 cycles.

• **FREQUENCY MODULATOR . . .**

The RCA Frequency Modulator, price \$27.50, and the RCA Test Oscillator, Type TMV-97-C, price \$34.50, are auxiliary instruments for aligning radio circuits with the RCA Oscillograph. The Frequency Modulator is a combined motor-driven capacitor and a-c generator. The Test Oscillator has a range from 90 to 25,000 K.C. These instruments are described on pages 10, 11 and 13.

HIGH BRILLIANCE . . . COMPLETE CONTROLS . . . LOW COST

The X-RAY of RADIO SERVICE

● For Service Engineers

Visual alignment of tuned circuits, "flat-topping" I. F. circuits, measuring hum and checking distortion in audio amplifiers are but few of the problems which are easily solved through the use of the RCA Cathode Ray Oscillograph. A visual presentation of practically all alternating current circuit functions may be quickly and easily made.

● For Amateurs and Experimenters

The RCA Cathode Ray Oscillograph enables the amateur to monitor percentage modulation, to check modulated waveform for distortion and examine the phase shift in audio amplifiers. Through its use the experimenter may easily and quickly arrive at the solution of the most difficult problem.

● For High Schools and Universities

Now every high school and uni-

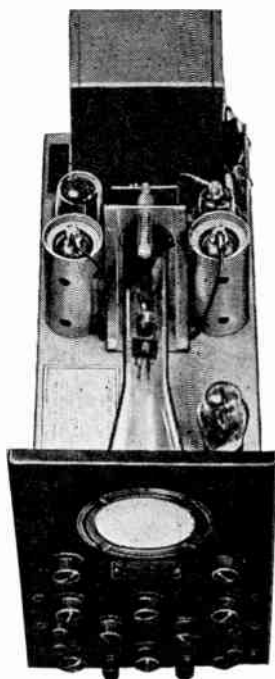

versity may easily give students the benefit of visual presentation of alternating current phenomena through the use of an oscillograph. Studies of alternating current wave shapes and demonstrations of the effects of changing constants in circuits may be quickly and easily made.

● For Radio Dealers

The RCA Cathode Ray Oscillograph gives the Radio Dealer an instrument for comparison of receiver characteristics and for making extremely effective window displays. Selling-up from a low-priced instrument to a higher-priced one is much easier when the eye as well as the ear can note the difference in performance.

● For Manufacturers

The RCA Cathode Ray Oscillograph is a valuable instrument either for receiver development or production testing. Better engineering and quicker and better tests are a direct result of its use in the manufacturing field.

SPECIFICATIONS

Focusing

A special circuit with adjustable control on the front panel provides a means of accurately focusing the light beam on the screen.

Illumination

The light intensity is such that photographs may be easily made with ordinary commercial equipment. No hood is required.

Sensitivity

20 to 100,000,000 CPS: 27.0 Volts RMS for 1 inch deflection, 74.0 Volts RMS for full screen image; 20 to 90,000 CPS: 0.7 Volts RMS for 1 inch deflection, 1.9 Volts RMS for full screen deflection.

Sweep Circuit

A linear saw-tooth oscillator, adjustable from 20 to 15,000 cycles, is provided. A special circuit provides a positive means for synchronizing this oscillator with the voltage under test. Binding posts are provided so that an external synchronizing voltage source also may be used.

Amplifiers

Two wide frequency range amplifiers are provided, one for horizontal and one for vertical deflection. The amplifiers are linear from 20 cycles to 90 kilocycles $\pm 10\%$. The gain is approximately 40.

Centering Adjustments

Two screw driver adjustments are provided at the rear of the case for both vertical and horizontal beam centering adjustment.

Radiotrons Used

1 RCA-906, 1 RCA-879, 1 RCA-885, 1 RCA-80, 2 RCA-57; Total 6.

Power Supply

Complete a-c operation from 110-120-volt lines. Power consumption 50 watts.

Size

Height $12\frac{1}{4}$ inches (less handle), width $7\frac{1}{4}$ inches, length $17\frac{3}{4}$ inches.

Weight

39 pounds

PORTABLE . . . COMPLETE . . . A. C. OPERATED



TEST OSCILLATOR TMV-97-C

NET PRICE

\$34.50

STOCK NO. 9595



No longer must service engineers content themselves with a Test Oscillator having high leakage, poor calibration, unsymmetrical modulation or any of the usual undesirable features of most oscillators. A new RCA Test Oscillator, priced at only \$34.50 net to service engineers, overcomes these and all other features heretofore considered unavoidable in instruments of this type. While this new instrument retains the general appearance of its predecessors, its performance and flexibility have been improved to the point where it definitely gives laboratory type performance.

Copper-Shielded Coil Unit

A newly-developed copper-shielded coil assembly gives an output which may be adjusted from less than 1 microvolt to over 0.2 volts over the frequency range from 90 to 1500 K.C. At higher frequencies the maximum output is slightly less while the minimum is somewhat higher. At 25,000 K.C., the leakage is less than 40 microvolts. Provision for oscillograph operation, external modulation, and operation as a heterodyne frequency meter are but few of the many new features of this remarkable instrument.

Again RCA has placed in the hands of service engineers an instrument that permits them to offer factory type service to the most involved and complicated receiver.

DIRECT READING DIAL - WIDE RANGE - OSCILLOGRAPH OPERATION

FREQUENCY RANGE

The output frequency range extends from 90 K.C. to 25,000 K.C. by means of eight overlapping bands. This range covers all radio frequency and intermediate frequency line-up points of all receivers. The frequency range is covered entirely by the fundamental frequency of the oscillator, no harmonics being used.

MODULATION

A separate modulator tube is provided which modulates the radio frequency output with a 400 cycle sine-wave voltage. There is a panel switch provided for operating the oscillator either with or without modulation. Also a panel jack permits applying an external modulating frequency voltage such as a beat frequency oscillator or phonograph output to the r-f signal.

OSCILLOGRAPH OPERATION

Convenient operation with the RCA Oscillograph and RCA Frequency Modulator is accomplished by a sweep circuit jack and operation without modulation. This is a very important feature because of the increasing popularity of the oscillograph method of circuit alignment.

HETERODYNE FREQUENCY METER

By plugging in a pair of headphones in the modulation jack, and placing the modulation switch at the unmodulated position, the modulator tube operates as a detector and the zero beat method of frequency checking may be used. This is very useful to amateur operators for checking the frequency of unknown transmitting stations.

CALIBRATION

The direct reading dial is guaranteed accurate $\pm 3\%$. However, a blank card and frame on the back of the oscillator permits individual calibration when desired. Individual factory calibration is available at an additional charge of \$5.00.

R. F. OUTPUT VOLTAGES

A two-position toggle switch combined with a new variable attenuator circuit provides two ranges of output r-f voltages. The switch gives approximately a 100:1 ratio of voltage change. The minimum range of the high position overlaps the maximum range of the low position, thereby giving a continuous variation over the entire range.

COMPARE THESE R. F. OUTPUT VOLTAGES

Range, K.C.	Switch at Low Position		Switch at High Position, Maximum Volts
	Minimum Less Than	Maximum	
90- 200	1 Micro-Volt	2 Milli-Volts	0.2
200- 400	"	2 "	0.2
400- 800	"	2 "	0.2
800- 1500	"	2 "	0.2
1500- 3100	5 Micro-Volts	1 Milli-Volt	0.1
3100- 6800	10 "	1 "	0.1
6800-14000	20 "	1 "	0.1
14000-25000	40 "	1 "	0.1



**EQUAL TO
MANY
SIGNAL
GENERATORS**

LOW LEAKAGE . . . COPPER SHIELDING . . . HIGH OUTPUT

MODERNIZATION KIT

FOR RCA OSCILLATORS

Modernize Your RCA Test Oscillator

GREATER OUTPUT · EXTREMELY
LOW LEAKAGE · NEW FEATURES



\$4⁷⁵

NET PRICE

STOCK NO. 9559

Extremely low leakage and high output are two new features that any service engineer can now add to his RCA Test Oscillator, either Type TMV-97-A or TMV-97-B, by means of a Modernization Kit. The Kit is offered for only \$4.75, little more than manufacturing cost, so that owners of either of the older type RCA Oscillators can have equipment of the very latest type at minimum expense.

MATERIAL INCLUDED IN KIT

- 1 Shielded Coil Assembly with mounting unit.
- 1 Range Switch Escutcheon.
- 1 High-Low Output Switch.
- 1 High-Low Output Switch Escutcheon.
- 1 200,000-Ohm Resistor.
- 1 2000-Ohm Resistor.
- 1 Modulation Switch.
- 1 Modulation Switch Escutcheon.
- 1 Dial Scale.
- 1 Sweep Capacitor Jack.
- 1 Instruction Book complete with Drilling Template.

90 K. C.—25,000 K. C.

The frequency range of the modernized oscillator is from 90 K.C. to 25,000 K.C. by means of eight individual over-lapping ranges. The entire range is covered by the fundamental frequency of the oscillator, no harmonics being used. The eight-position range switch and the tuning dial are marked directly in kilocycles. Thus accurate dial and switch settings for a given frequency are easily and quickly made. The accuracy of dial calibration is guaranteed $\pm 3\%$.

MODULATION CONTROL

A separate tube is included in all RCA Test Oscillators for providing a 400-cycle modulation frequency. Certain applications, notably those with the RCA Cathode Ray Oscillograph, require an unmodulated output. To provide for this contingency, a two-position toggle switch, mounted on the panel, permits operation either with or without modulation.

SWEEP CIRCUIT JACK

When using a test oscillator for aligning r-f or i-f stages in conjunction with the RCA Cathode Ray Oscillograph, it is necessary to parallel a sweep capacitor across the tank capacitor of the test oscillator. To facilitate this connection, a jack is provided for mounting on the front panel, thus permitting use of the low-capacity cable furnished with the RCA Frequency Modulator for this application.

MINIATURE MAGIC BRAIN

The heart of the improved test oscillator kit is the shielded coil and switch assembly, similar to the famous RCA Victor MAGIC BRAIN. This unit includes eight coils and an eight-position rotary switch, all compactly mounted in a drawn copper container. High efficiency and low leakage give an output r-f voltage adjustable over a wide range.

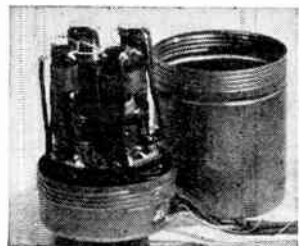

Frequency Modulator

FOR ALIGNING
RECEIVERS WITH
YOUR RCA
OSCILLOGRAPH

Net Price

\$2750

Stock No. 9558



SPECIFICATIONS

TUNING CAPACITOR—Two sections—each 35 mmfd. Panel switch for connection of either one or both to output. Variable sweep range 22.5 mmfd. or 45 mmfd.

CONNECTING CABLE—14-inch low-capacity connecting cable with plugs.

GENERATOR FREQUENCY—Two cycles per revolution permit positive synchronizing for double-sweep alignment.

GENERATOR VOLTAGE—1.5 volts minimum.

MOTOR—Repulsion induction type—1550 R.P.M.

PANEL CONTROLS—“Hi-Lo” capacity switch, “On-Off” switch, output binding posts and single-circuit jack.

SIZE—Height 8½ inches (including raised handle), case alone 6½ inches, width 9¼ inches, depth 4½ inches.

WEIGHT—5¼ pounds.

CURRENT CONSUMPTION—25 watts.



ALIGN your circuits visually with this new RCA Frequency Modulator and the RCA Cathode Ray Oscillograph. Sweeps the r-f voltage of your test oscillator over the resonant frequency of the circuit under test and generates an a-c synchronizing voltage simultaneously. Quick, accurate alignment, just like factory production, is quickly done, eliminating all possibility of error. Motor-driven, balanced tuning capacitor of two ranges and a-c generator driven from same shaft, thereby eliminating screen flicker.

FEATURES

TWO PURPOSES—The RCA Frequency Modulator functions both as a sweep capacitor and as an a-c impulse synchronizing generator.

25 SWEEPS PER SECOND—25 sweeps per second in each direction eliminate all possibility of screen flicker of the projected curve.

PEAKED WAVE-FORM—The output of the impulse generator has a very peaked wave-form instead of the usual sine wave of a-c generators. Such a wave-form gives a very positive means of synchronizing the horizontal “saw-tooth” oscillator of the cathode ray oscillograph with the output of the receiver under test.



OUTPUT INDICATOR

\$4.00

NET PRICE

SPECIFICATIONS

Dimensions, 5³/₈" x 2⁷/₈" x 2³/₈".

Weight, 13 Ounces.

Case, Die-cast moulded bakelite.

Lamp Rating, 50-60 volts breakdown.

Transformer Ratio, 80:1 (maximum).

Input Impedances, O to H, 4 ohms. O to L, 1¹/₂ ohms. H to L, .6 ohm.

Potentiometer Resistance, 100,000 ohms.



STOCK NO. 4317

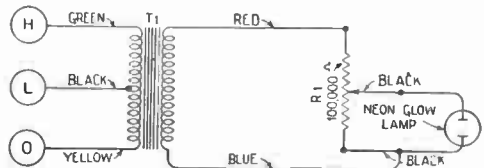

See your output with this visual output indicator. It can't burn out; overload does not hurt it. Impresses your customers and gives a quick, accurate indication of the proper alignment point. Works from any dynamic loudspeaker.

The RCA Output Indicator is designed for use with an oscillator when aligning radio receivers. The instrument consists of a tapped step-up transformer, a potentiometer, a glow tube and three binding posts for connecting the output of the receiver to the transformer. The glow of this lamp is very sensitive, following variations in frequency and intensity. This gives a very sensitive indicator for adjusting trimmer capacitors to their optimum position. Stock No. 4317 — Net Price \$4.00.

SEE YOUR OUTPUT



REGULATED POWER UNIT TMV-118-B



NET PRICE
\$39⁵⁰

WITH TUBES

STOCK NO.
9560

A Constant Source of "B" Voltage for Designers, Development Laboratories, Electrical Laboratories, Experimenters, Engineers, Manufacturing Tests, Production Inspection, Physical Laboratories, School Demonstration Rooms, Scientific Service Organizations, Universities, etc.

"Better than B Batteries" sounds impossible, but accurately describes the new RCA Regulated Power Unit. Operating from the 110-volt A.C. lines, it provides a wide range of hum-free direct current voltages that are constant regardless of line voltage or load current variations.

SPECIFICATIONS

The RCA Regulated Power Unit will deliver voltages between 135 volts and 180 volts D.C. at a current drain between 10 m.a. and 80 m.a. with line voltages of 110 volts $\pm 10\%$ or 120 volts $\pm 10\%$ with a load voltage variation of not over 2%. Higher voltages may be obtained at reduced current drains.

In addition, the RCA Regulated Power Unit will deliver both 90 volts and 135 volts for operation of

equipment which requires both of these voltages. The 90-volt tap will deliver up to 20 m.a. at 90 volts, while the output from the main section is 40 m.a. at 135 volts.

TUBES—RCA 80, Rectifier; RCA 2A3, Voltage Regulator; RCA 57, D.C.-A.C. Amplifier; RCA 874, Voltage Standard; RCA 874, Regulator for 90-volt tap.

Power Unit from top with hinged cover removed to show compact design and sturdy construction

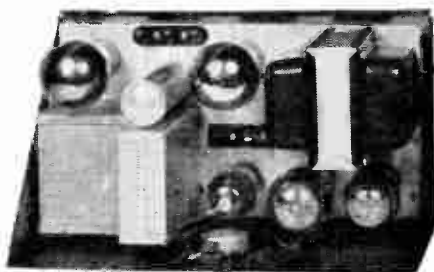

A QUALITY PRODUCT FROM THE RCA PARTS DIVISION



SERVICE ENGINEERS TOOLS

RCA Tools and Accessories are designed for definite service needs and are applicable to a wide variety of uses. Their practicability is first demonstrated in the manufacturing department of the RCA Manufacturing Company and only those tools that meet the exacting requirements of factory production are offered to service engineers.

ALIGNMENT TOOL



The Stock No. 4160 Alignment Tool is a bakelite shaft combination screw driver and socket wrench. The metal screw driver bit is so shaped that the increase in capacity caused by its touching a trimmer screw is offset by the reduction in inductance caused by its shape. This is very important when making adjustments on all-wave receivers where the screw driver must be inserted through the end of the coil. The socket end fits the main tuning capacitor trimmer adjustment screws used on numerous RCA Victor Receivers. The bakelite shaft is $\frac{1}{4}$ " in diameter, which gives entrance to $\frac{1}{4}$ " holes, used on older model Radiola receivers.

Stock No. 4160

Net Price \$0.60

OSCILLATOR ADAPTER



The Stock No. 4316 Oscillator Adapter is a desirable accessory for use with the TMV-97-A or B Test Oscillator. The adapter is for inserting in the modulator tube socket when operation without modulation is desired.

Stock No. 4316

Net Price \$0.45

RIVETING PUNCH



The Stock No. 10987 Riveting Punch is a special metal punch for use with a riveting anvil. The punch may be used with the rivets usually used on radio receivers and permits the service man to make a factory type repair, instead of using machine screws to replace rivets. The punch is $\frac{1}{8}$ " in diameter and $5\frac{1}{2}$ " long.

Stock No. 10987

Net Price \$0.50

KNURLED NUT WRENCH



The Stock No. 10982 Knurled Nut Wrench is a special wrench designed for tightening or removing the knurled nuts such as are used with toggle type switches. These nuts are ordinarily impossible to remove or tighten without marring. The wrench will hold a nut from $\frac{3}{8}$ " to $\frac{1}{2}$ " diameter. The overall length is $8\frac{1}{2}$ ".

Stock No. 10982

Net Price \$1.20

OFF-SET RIVETING ANVIL

The Stock No. 10988 Off-Set Riveting Anvil is a special anvil that permits riveting in places ordinarily inaccessible. It is to be used in conjunction with a riveting punch such as Stock No. 10987. The anvil is $\frac{1}{8}$ " in diameter and $3\frac{1}{2}$ " long.

Stock No. 10988

Net Price \$0.70

OFF-SET SCREW DRIVERS



The Stock Nos. 3064 and 2930 Off-Set Screw Drivers are useful for making adjustments to remote control units and other small screws that are inaccessible with an ordinary screw driver. The No. 3064 screw driver is $2\frac{1}{2}$ " long, while No. 2930 has an overall length of $4\frac{3}{8}$ ".

Stock No. 3064

Stock No. 2930

Net Price \$0.50

Net Price \$0.50

TUNING WAND



The Stock No. 6679 Tuning Wand is a special alignment tool which makes possible the checking of alignment in all-wave receivers without disturbing the adjustment of the trimmer capacitors. The tool consists of a bakelite rod having a brass cylinder at one end and a special finely divided iron core at the other end. Inserting the brass cylinder into a coil lowers its inductance, while inserting the iron increases the inductance. From this it is evident that before adjusting trimmers, the adjustment may be checked by inserting each end of the wand into the coil. Proper adjustment is evidenced by a reduction in output with either end of the wand inserted into the coil.

Stock No. 6679

Net Price \$1.10

VICTOR ALIGNMENT WRENCH



The Stock No. 10983 Socket Wrench is a special flexible end socket wrench designed for adjusting the alignment screws of the 1929 and 1930 Victor Receivers. Models R-32, R-35, etc. The overall length is $8\frac{1}{2}$ ".

Stock No. 10983

Net Price \$1.80

The FAMOUS RCA WORLD-WIDE ANTENNA SYSTEMS

NOISE FREE RADIO RECEPTION



Assembled at factory—all joints now soldered for you

Stronger signals with less man-made noise

Exclusive RCA double-doublet; all-band coverage

An installation for every location

A model for every requirement

Scientific length of antenna and transmission line

Scientifically designed—not a compromise

Easy to sell because nationally advertised

Designed by the world's most famous antenna engineers, RCA Antennas give exceptionally fine performance on all wave bands. Through the use of a unique double-doublet antenna and a transposed lead-in, complete coverage of all short wave bands is accomplished and noise pickup greatly reduced.

On the higher wave-length bands, such as the police and broadcast band, the action of the antenna changes to that of an efficient double T-Type, giving excellent pickup.

Many thousands of installations of this antenna in all parts of the world have proven its efficiency under all conditions. Recommend it to your customers. You'll never apologize for its performance.

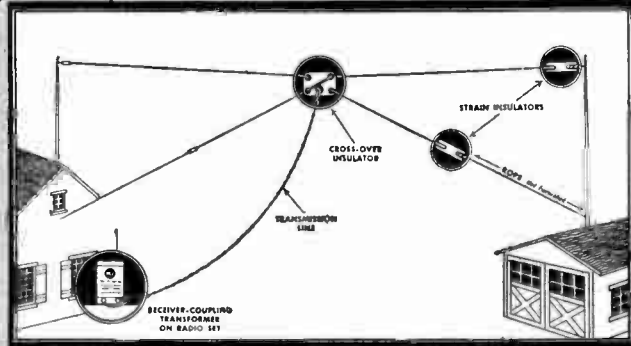

THE DE LUXE SYSTEM REDUCES NOISE ON ALL BANDS

THE STANDARD SYSTEM FOR LESS NOISE ON S-W BANDS

SEE NEXT THREE PAGES FOR DESCRIPTION OF KITS



Antenna Systems

THE RCA WORLD-WIDE ANTENNA SYSTEM



STOCK NO. 9500-A—LIST PRICE, \$6.00

The RCA World-Wide Antenna System has brought new reliability and freedom from noise to short-wave reception. Uses the famous RCA double-doublet antenna with a weather-proof transmission line and a receiver-coupling transformer. A special feature is the electrostatic shield in the receiver-coupling transformer which prevents power line noises from entering the receiver via the lead-in system. Functions as an efficient "T" type antenna on the broadcast band without noise-reducing properties.

Contents of Kit

- 2 Nail-on Knobs
- 1 Roll Transmission Line (80 feet)
- 1 Receiver-Coupling Transformer
- 1 Crossover Insulator
- 4 Strain Insulators

- 2 Rolls Stranded Antenna Wire (each 46½ feet long)
- 1 Entrance-tube Insulator
- 1 Ground Clamp
- 2 Links (for attaching coupling transformer)
- 1 Instruction Sheet

RCA WORLD-WIDE ANTENNA SYSTEM KIT OF ESSENTIAL PARTS

For dealers, service engineers, or experimenters, who may prefer to buy standard parts locally, the Kit of Essential Parts of the RCA World-Wide Antenna System is provided. All the advantages of the standard Kit (Stock No. 9500-A) may be obtained by the use of this Kit plus antenna wire, insulators, etc., purchased locally. A special instruction sheet discusses results obtained with different lengths of antenna wire and different types of installations.

Amateurs who desire to experiment with the RCA "double-doublet," and dealers and service engineers who buy wire, insulators, etc., in bulk, can get the required special parts for the RCA World-Wide Antenna System in this Kit.

The receiver-coupling transformer included is the improved type, having no switch. It automatically gives the advantages of the "double-doublet" on short waves and of a "T" type antenna on standard broadcast.



STOCK NO. 9550—LIST PRICE, \$5.00

Contents of Kit

- 1 Roll Transmission Line (80 feet)
- 1 Receiver-Coupling Transformer
- 1 Crossover Insulator



Antenna Systems

THE RCA DE LUXE WORLD-WIDE ANTENNA SYSTEM

This new RCA De Luxe World-Wide Antenna System is similar to the regular RCA World-Wide Antenna System with the important improvement of noise reduction on the broadcast band. This is accomplished through the use of a coupling transformer at the antenna end of the transmission line, as well as the receiver end.

Contents of Kit

- 2 Rolls Stranded Antenna Wire (each 46½ feet)
- 1 Roll Transmission Line (80 feet)
- 1 Antenna Transformer
- 1 Receiver-Coupling Transformer
- 1 Crossover Insulator
- 4 Strain Insulators
- 2 Nail-on Knobs
- 1 Entrance-tube Insulator
- 1 Ground Clamp
- 2 Links (for attaching coupling transformer)
- 1 Instruction Sheet



STOCK NO. 9555—LIST PRICE, \$7.75

RCA WORLD-WIDE DEALER DEMONSTRATION ANTENNA SYSTEMS

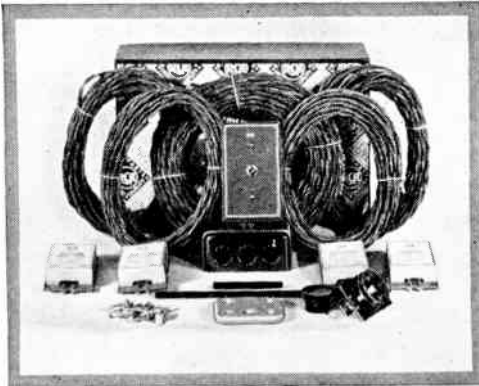

STOCK NO. 9504-A—NET PRICE \$9.85

World-Wide Antenna System except that it handles four sets which may be placed at convenient points in the store.

Think what it will mean to be able to make convincing demonstrations of short-wave or standard broadcast reception from radio sets on the floor of your store, when your prospect's interest is high. With the noise-reducing RCA World-Wide Dealer Demonstration Antenna System you no longer need to apologize for the poor reception conditions in your location.

Higher unit sales will result, because you can connect four sets to the RCA World-Wide Dealer Demonstration Antenna System and switch from one set to another instantly, thereby demonstrating the superior performance of higher-priced units.

The RCA Dealer Demonstration Antenna System is the same as the standard RCA

Contents of Kit

- 1 Transmission Line (53 feet)
- 4 Secondary Transmission Lines (27 feet)
- 4 Receiver-Coupling Transformers
- 1 Crossover Insulator
- 1 Four-position Switch complete with switch box and flush plate
- 8 Links for attaching transformer
- 1 Instruction Sheet

RCA ANTENNA ACCESSORIES

LOADING COILS—Loading coils may be used with any RCA World-Wide Antenna System where space does not permit the use of the standard lengths of the “double-doublet” antenna. They compensate for the decreased inductance lost by cutting the longer doublet. The over-all loss when using loading coils is not appreciable. Not furnished with the kits.

Each loading coil consists of the proper number of turns of enameled wire wound on a high-grade porcelain tube; entire assembly dipped in weather-proof compound. Tinned soldering lugs are provided for easy connection. Size of each coil $2\frac{1}{8}$ inches long and $\frac{1}{8}$ inches in diameter.

Stock No. 6958—List Price, per pair, 60 cents

EXTRA TRANSMISSION LINE (For RCA World-Wide Antenna Kits)—Each kit contains 80 feet of transmission line. When less than 80 feet is required, the excess line provided in kit should be coiled behind the receiver. When more than 80 feet, and less than 160 feet, of transmission line is required, a second 80-foot length should be purchased and spliced and taped to the first length and excess coiled behind receiver. Above 160 feet, transmission line may be cut to exact length required. Only this special transmission line should be used in order to secure proper impedance matching between the “double-doublet” antenna and the receiver-coupling transformer.

Stock No. 4738—1 Roll Transmission Line (80 Feet) List Price, \$3.48

EXTRA TRANSMISSION LINE (For RCA Shielded Antenna System)—Additional transmission line may be added to either the Stock No. 7717 or 7718 Kit up to approximately 500 feet without greatly impaired results. Additional transmission line is available and may be had in any length.

Stock No. 4095—100 feet—List Price, \$2.00

RCA AUTO ROOF ANTENNAS—For use in cars which have no built-in antenna or when the factory-installed antenna does not give satisfaction. Makes a neat job at a small expense. Easily installed, being simply pinned to the inside fabric of the car roof with six safety-pin type fasteners that come with the antenna. Size 11 inches by 32 inches. Composed of No. 23 gauge cotton-covered soft copper wire wound on heavy flat cardboard, then covered with attractive book-cover paper.

Stock No. 7622 (Gray Cover)—List Price, \$1.50

Stock No. 7621 (Tan Cover)—List Price, \$1.50

RCA SHIELDED ANTENNA SYSTEM

(For Standard Broadcast Reception Only)

RCA Standard Shielded Antenna Systems bring startlingly improved performance to the radio listener accustomed to an ordinary makeshift antenna. An antenna transformer matches the antenna impedance to the shielded transmission-line impedance. A receiver-coupling transformer matches the receiver input impedance to the shielded transmission line. This permits having a shielded transmission line of a low impedance value. Having a low impedance value insures little or no electrical noise pickup in the lead-in. The system functions on all antennas of any type and length.

Contents of Kit

1 Antenna Transformer 1 Lightning Arrester
1 Receiver-Coupling Transformer 1 Instruction Sheet
1 Roll of Shielded Transmission Line (100 feet)

For use with all standard broadcast receivers. Not recommended for all-wave or short-wave receivers.

Stock No. 7718 (Illustrated)—List Price, \$5.00

RCA Victor Model 280, and other receivers having a similar antenna input transformer, do not require the receiver-coupling transformer of the above kit. For such receivers use Stock No. 7717 Kit (same as Stock No. 7718, less the receiver-coupling transformer).

Stock No. 7717 (Not Illustrated)—List Price, \$3.50

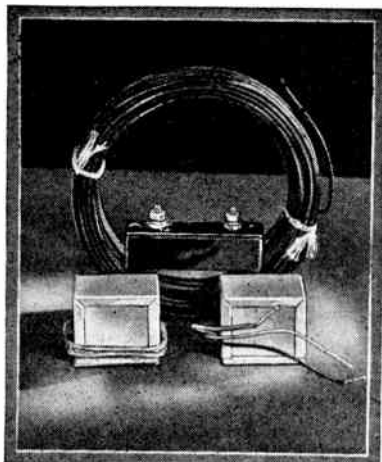



SPECIFICATIONS

Size — Standard Model
— 2 3/4" x 2 1/4" x 2".
Cased Model — 2 3/4"
x 2 3/8" x 3".

Voice Coil Impedances
— 1 to 15 Ohms.

Primary Load Impedances—1,000 to 20,000
Ohms.

Maximum Working Potential—500 Volts.

Maximum Plate Current
(each tube)—55 Mil-
liamperes.

Frequency Range—30
to 10,000 Cycles.

UNIVERSAL OUTPUT TRANSFORMER

STOCK \$195 LIST
No. 7852 PRICE

- One transformer for exact matching of all output tubes (either single or push-pull) to all dynamic loudspeakers. (Covers voice-coil impedances from 1 ohm to 15 ohms.)
- Universal mechanically as well as electrically. Angle bracket with slots for easy mounting on either chassis or loudspeaker frame.
- Wide frequency range—30 to 10,000 cycles. No distortion caused by mis-match of tubes or speaker.
- Silicon steel core eliminates possibility of damage from mechanical shock or from temporary electrical overload.
- Tinned soldering terminals for quickly attaching tube and speaker leads.
- Baked varnish impregnation gives protection against normal climatic conditions.
- Low net price insures adequate profit with minimum investment.

SPECIAL IMPREGNATED MODEL

For those extreme tropical conditions of high temperature and humidity, RCA has provided a special cased model of the Universal Output Transformer, having vacuum wax impregnated windings and complete potting in an asphalt compound for protection. The case is cadmium plated and fitted with a bakelite terminal board.

Stock No. 7853—List Price, \$2.42

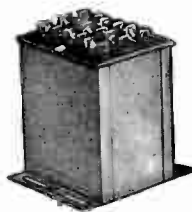

FITS ALL TUBES TO ALL SPEAKERS

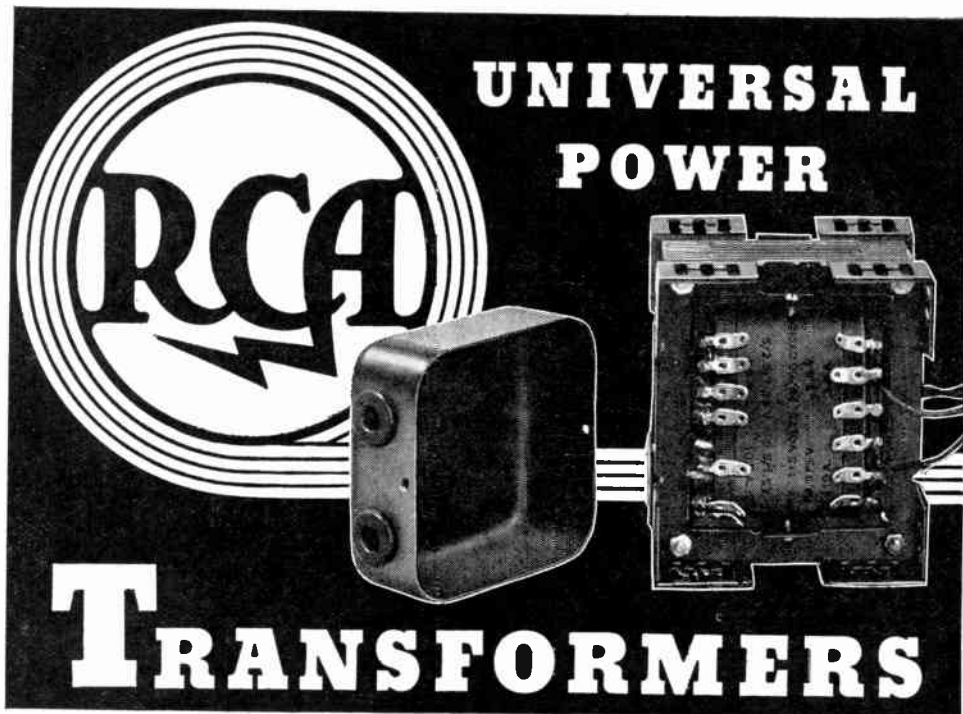

UNIVERSAL POWER

TRANSFORMERS

Now service engineers can install true RCA quality in replacement power transformers for any make or model of a-c set manufactured to date and do so from a stock of only four transformers. The new line of four types of RCA Universal Power Transformers is priced surprisingly low, yet has really universal mounting brackets, removable end-bells, wide range of windings and taps, and is truly universal both electrically and mechanically.

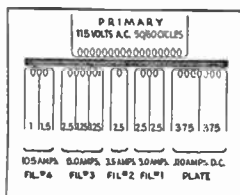
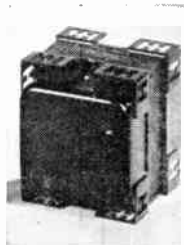

STOCK NO. 9551
LIST PRICE \$6.00

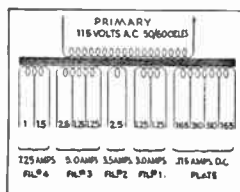
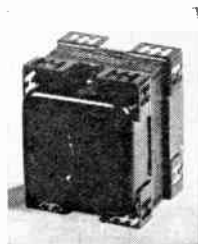

STOCK NO. 9552
LIST PRICE \$6.50

FOR 10-12-TUBE SETS

A heavy-duty transformer capable of handling the largest of standard receivers. Heavy core, high voltage plate winding, removable end-bells and rugged construction make this a transformer capable of meeting the most severe requirements.

FOR CLASS B SETS

Exceptionally high (475/475) voltage plate winding and high current carrying capacity make this a transformer suitable for Class "B" output amplifiers. Good regulation and the usual RCA features make this an exceptional value.

FOR 1.5, 2.5, 5, and 6.3 VOLT TUBES

- Universal Mounting Brackets
- Removable End Bells
- Grommets for Leads
- Voltages Marked on Terminal Board
- Approved by Underwriters
- Adequate Filament Windings

*Compare Prices
and Quality*

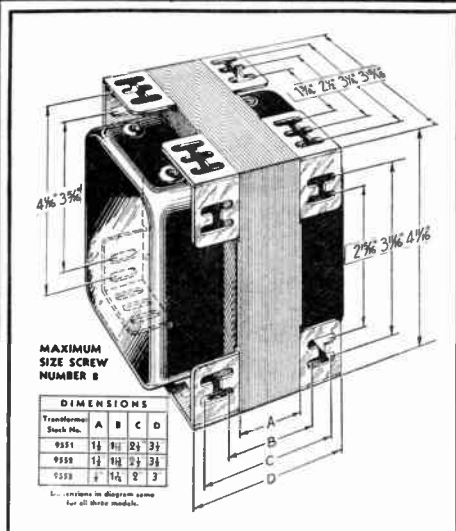

• SPECIFICATIONS •

The transformers have been divided into four classes, for ten- or twelve-tube receivers, for class "B" receivers, for five- to nine-tube receivers, and also for four-tube receivers. Sufficient windings and taps have been brought out to cover any of the receivers that have been manufactured under the particular tube designation indicated. Mechanically, these transformers have mounting slots which permit a wide variety of mounting arrangements. An exclusive feature is the removable end bell, which permits all connections to be made and the bell replaced, thus assuring a workmanlike job. The voltages at each tap are clearly marked on the terminal board. Each transformer includes an insulation sheet to place over the connections to prevent short-circuiting or grounding after replacing the end bell. The end bell permits the transformers to be passed by the underwriters, a feature not usually found in replacement transformers.

FOR 5-9-TUBE SETS

The most popular of the RCA Universal Transformers because it fits the greatest number of receivers. A quality transformer you can use on receivers of many types and manufacture.

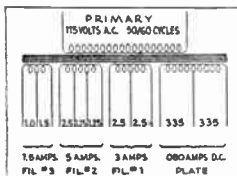

STOCK NO. 9553
LIST PRICE \$4.75



FOR 4-TUBE SETS

A high quality small transformer for midget four-tube receivers. Incorporates the high quality features needed for a transformer of this type.

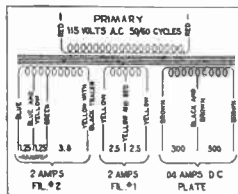

STOCK NO. 9556
LIST PRICE \$2.06



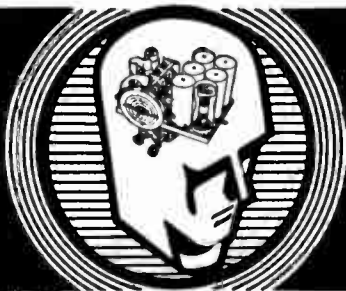

RCA VICTOR MAGIC BRAIN RECEIVER

THE sensational performance of the famous RCA Victor Magic Brain Receivers is due to the advanced engineering of the circuits and the precision construction of the parts. Now you can use these fine parts for replacement or experimental use. In proper circuits, these parts bring "Magic Brain" type performance.

RADIO FREQUENCY COILS

The radio frequency coils listed are suitable for use on 1935 models of the RCA Victor Magic Brain receivers or experimental circuits of all types and description. The tuning range given is that obtained when a tuning capacitor having a range of 11-450 mmfd. is used. Trimmer capacitors are included for all windings.



7810

ANTENNA COILS

TUNING RANGE K.C.	STOCK NO.	LIST PRICE
140-410 and 1720-5400	7810	\$2.10
540-1720 and 5400-18,000	*7803	1.82
18,000-36,000	4410	.70



4410

FIRST DETECTOR COILS

TUNING RANGE, K.C.	STOCK NO.	LIST PRICE
140-410 and 1720-5400	*7808	\$2.05
540-1720 and 5400-18,000	*7805	2.15
18,000-36,000	†4421	.70

OSCILLATOR COILS

TUNING RANGE, K.C.	STOCK NO.	LIST PRICE
140-410 and 1720-5400	*7809	\$1.70
540-1720 and 5400-18,000	*7807	1.62

No oscillator coil is furnished for 18,000-36,000 K.C. range.

In RCA Victor receivers the second harmonic of the 5400-18,000 K.C. band coil is used.

* Similar to Stock No. 7810

† Similar to Stock No. 4410

REPLACEMENT PARTS



INTERMEDIATE FREQUENCY TRANSFORMERS



4431

The intermediate frequency transformers used in RCA Victor Magic Brain receivers are efficient, include trimmer capacitors and tune to 460 K.C. A single stage i-f amplifier with two transformers gives a highly selective, high gain intermediate frequency amplifier suitable for many applications.

The following transformers are used in the five-, six-, eight- and ten-tube RCA Victor Magic Brain receivers:

STOCK NO.	STAGE	LIST PRICE
4431	First	\$2.28
4433	Second	2.15

The transformers listed below are used in the twelve-tube RCA Victor Magic Brain receivers which have a two-stage i-f amplifier and an additional A.V.C. intermediate frequency stage.

STOCK NO.	STAGE	LIST PRICE	STOCK NO.	STAGE	LIST PRICE
7794	A.V.C.	\$0.82	7792	Second	\$2.22
7791	First	2.35	7793	Third	2.50

SELECTOR SWITCHES

Band changing in all-wave receivers is accomplished through the use of a multi-position gang selector switch. The following switches are suitable for many applications of this type.

NO. OF GANGS	NO. OF POSITIONS	STOCK NO.	LIST PRICE
10	3	4728	\$4.32
11	4	4617	3.32
11	5	7836	3.05
12	5	7802	4.05



4728

TUNING CAPACITORS

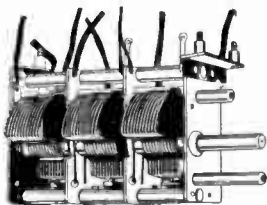

7801

The RCA Victor Magic Brain Tuning Capacitors listed have a wide tuning range and are of rugged mechanical construction. They are held to very exact matching limits and do *not* include trimmer capacitors.

STOCK NO.	NO. OF GANGS	RANGE	LIST PRICE
6603	4	16-335	\$3.80
7801	3	11-450	4.42
4504	2	11-450	2.78

SHIELDS

The r-f and i-f transformers listed do not include the shields necessary for their use in chassis assemblies. The following shields are easily mounted by means of two self-tapping screws.

STOCK NO.	FOR	LIST PRICE
4521	Antenna, Oscillator or First Detector Coils	\$0.42
7800	I.F.	.45



4521

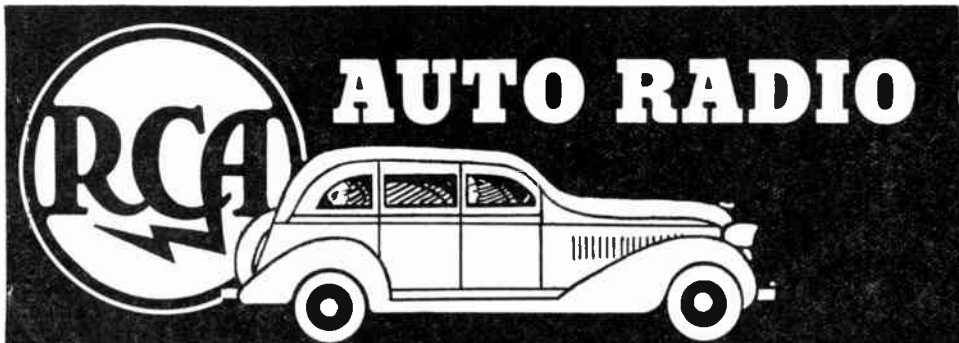

AUTO RADIO

ACCESSORIES

RCA Automobile Radio Receivers are as sensational in the automotive field as RCA Magic Brain receivers are in the home. Excellent performance, rugged construction and latest design features are a built-in quality of the following parts and accessories. While these parts have been designed primarily for use with RCA Automobile Receivers, they are nevertheless suitable for use with other receivers.

RCA VIBRATORS AND INVERTER-RECTIFIERS

The Vibrator or Inverter-Rectifier is the heart of the high voltage power supply system in practically all automobile receivers. Each type has its advantages. The straight vibrator, which merely interrupts the direct current to the primary of the transformer, requires a rectifying tube for converting the resultant A.C. into direct current. The inverter-rectifier type vibrator functions also as a mechanical rectifier, thus eliminating the necessity for a rectifier tube. It, however, has more parts and is somewhat higher in cost. RCA Auto Receivers use both types, which are available for general use.

VIBRATOR INVERTER-RECTIFIER WITH SCREW MOUNTING BASE

(Complete with buffer capacitors in base)



Stock No.
7604

STOCK NO.	USED IN	LIST PRICE
7604	M-34	\$6.00
7689	M-105	7.20
7694	M-116	7.20

VIBRATOR INVERTER-RECTIFIER WITH PLUG-IN BASE

(Complete with buffer capacitors)



Stock No.
7757

STOCK NO.	USED IN	LIST PRICE
7757	M-123	\$8.50
4278	Base for above vibrator	.26



4278

VIBRATOR INVERTER

(For use with rectifier tube)



Stock No.
7780

STOCK NO.	USED IN	LIST PRICE
7780	M-107	\$4.96
6980	Base for above vibrator	.20



MAGIC BRAIN

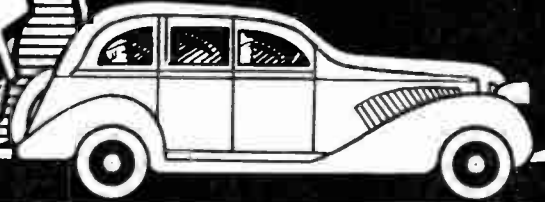

POWER TRANSFORMERS

RCA Auto Radio Power Transformers are conservatively built and will withstand a wide range of input voltages. They should be used with the vibrators listed on the preceding page for the same receivers.



7759



9457

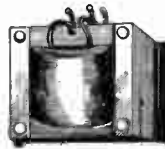

9049



7775

STOCK NO.	USED IN	LIST PRICE	STOCK NO.	USED IN	LIST PRICE
7759	M-123	\$3.95	9430	M-34	\$3.60
9049	M-105	3.75	*9457	M-116	4.78
7775	M-107	3.78			

*Battery operation transformer

SUPPRESSORS—25,000 OHMS

RCA Spark Plug and Distributor Suppressors are built to high standards, are suitable for all cars and have long and carefree life. They are used to reduce the effects of ignition interference when objectionable on certain types of receivers. The suppressors listed are of 25,000 ohms resistance.



6151



6152



6175



6670

STOCK NO.	TYPE	LIST PRICE	STOCK NO.	TYPE	LIST PRICE
6151	Spark Plug	\$0.56	6175	Splice-in	\$0.56
6152	Distributor	.56	6670	Elbow-type for spark plugs	.56

BY-PASS CAPACITORS

The usual auto radio installation requires a capacitor to be connected across the output of the generator and from one side of the ammeter to ground. The capacitors listed are suitable for each of these applications.



6494

THE RCA DI-POLE ANTENNA REDUCES IGNITION NOISE.

See Page 29



6495

STOCK NO.	TYPE	VALUE	LIST PRICE
6494	Ammeter	0.5 mfd.	\$0.46
6495	Generator	0.5 mfd.	.72

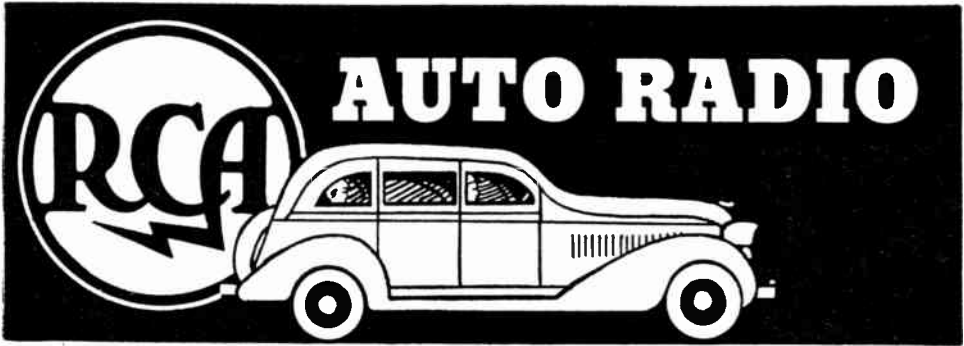

AUTO RADIO

ACCESSORIES

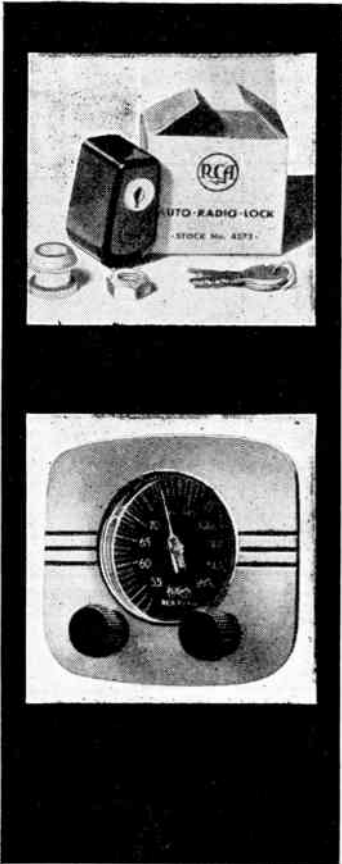

RCA AUTO RADIO LOCK

Auto Radio Receivers are easy to install—but also easy to steal—unless protected by an RCA Auto Radio Lock. Just remove the old nut from the bulk-head bolt, slip on the special bushing and nut, and the lock slips over the nut and bushing like a spare tire lock. The lock barrel is made by Yale. The RCA Auto Lock fits all makes of auto radio receivers.

Stock No. 4575—List price, \$1.35.

INSTRUMENT PANEL CONTROL UNIT

(For RCA Models M-123 and M-107)

The RCA Instrument Control Unit replaces the steering column control supplied with RCA Victor Models M-107 and M-123. It is designed to be fitted into the instrument control panel of the 1933 and 1934 Ford cars and may be used with a number of others that have suitable panel space. It also may be adapted to other receivers having double shaft controls. Mounts flush with instrument panel. Chromium finish with black enamel stripes.

This control unit makes a neat job that will increase your sales of RCA Victor Auto receivers.

Stock No. 4476—List price, \$2.75.

POWERTRONS FOR 1935 RCA VICTOR MAGIC BRAIN AUTO RECEIVERS

The RCA Victor 1935 Magic Brain Auto Receivers use the newly developed Powertron, which is an advanced development of the vibrator. Long trouble-free life and ease of replacement (all have plug-in bases) are features not found in the usual vibrator.



7857

STOCK NO.	TYPE	USED IN	LIST PRICE
5067	Pri. Interrupters	M-109	\$3.66
7857	Full Wave	M-104 and M-108	5.64

RCA AUTO ROOF ANTENNAE

For use in cars which have no built-in antenna or when the factory-installed antenna does not give satisfaction. Makes a neat job at small expense. Easily installed, being simply pinned to the inside fabric of the car roof with six safety-pin type fasteners that come with the antenna. Size 11 inches by 32 inches. Composed of No. 23 gauge cotton-covered soft copper wire wound on heavy flat cardboard, then covered with attractive book-cover paper.

Stock No. 7622 (Gray cover)—List price, \$1.50. Stock No. 7621 (Tan cover)—List price, \$1.50.

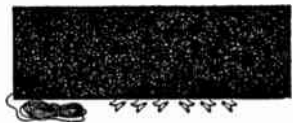



DI-POLE AUTO ANTENNA

LIST PRICE

\$2.60

STOCK NO. 9605

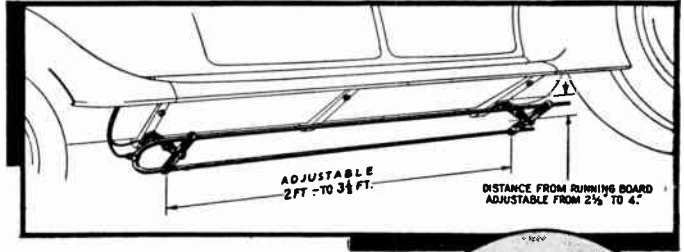

A "Set-up" for the Service Engineer

Steel top autos plus this new noise - reducing running board antenna mean profits for you

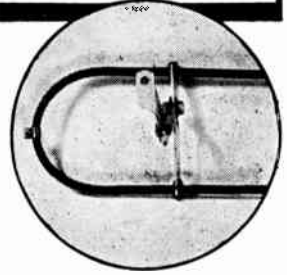

Cash in on the new steel-top automobiles without antennas. Install the new RCA Noise-Reducer Di-Pole Antenna on any car and guarantee improved results. As sensational in the automotive field as the famous RCA World-Wide Antenna is in the home field.

The new RCA Noise-Reducer Auto Antenna is an entirely new development in automobile antenna design. It's easily and quickly installed on any car, gives efficient pickup from stations and eliminates all ignition noise pickup by the antenna. Its low price insures a ready sale to any automobile radio purchaser. Works with any set.

SPECIFICATIONS

CONNECTIONS

A machine screw at the center of the bend in the rod is provided for attaching the shielded antenna lead from the receiver.

MOUNTING

Two universal type brackets are provided for attaching to the running board by means of the bolts normally used on the car. The height of the

antenna may be quickly adjusted by the brackets to insure road clearance.

OPERATING PRINCIPLE

Signals are picked up by the antenna acting as a counterpoise and the car acting as an antenna. Decreasing the distance from the antenna to the road increases signal pickup. Noise from nearby sources such as ignition interference is eliminated by cancellation effects caused by the shape of the antenna.

RCA CABINET REFINISHING KIT.



NET PRICE
\$2.90

Stock No.
9546

PRICE
\$2.90

YOU won't call in the cabinet refinisher nearly so often after you get the RCA Cabinet Refinishing Kit. Of course, you can't do every refinishing job with it, but you can do most of them—saving time and money on every job. It's the little touch-up jobs that occur most often anyhow. Someone in the shop lays a hammer on the cabinet; a button on the truck driver's coat scratches it in delivery; or perhaps it has been marred in home demonstrations or while on display in the dealer's store. But whatever the cause, you have the remedy at hand when you have this kit.

The RCA Cabinet Refinishing Kit does not contain all the material you will need for every job. For example, it does not contain lacquer, or a lamp for heating the spatula. But things like that are obtainable anywhere. Only the hard-to-obtain things have been included; the items you would have to run all over town to get, if obtainable at all.

Packed in a durable leatherette case, measuring $9\frac{1}{2}''$ x $4\frac{1}{2}''$ x $2\frac{1}{4}''$, it opens like a purse. Stock No. 9546. Net to Service Engineers, \$2.90.

- 1 Can Refco Oil
- 1 Can Valvoline
- 1 Can Tripoli
- 1 Assortment Sand Paper
- 1 Assortment Stick Shellac
- 2 Pkgs. Aniline Stain Powders
- 1 Touch-up Brush
- 1 Spatula
- 1 Rubbing Block
- 1 Instruction Sheet

YOU SAVE TIME AND MONEY

All RCA Victor Service Notes ... Now in Five Bound Volumes

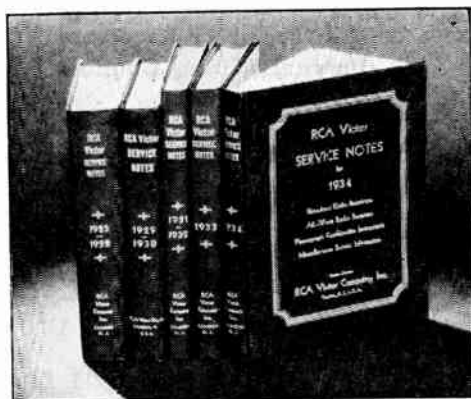

This library contains complete service information, drawings and price lists 1923-1935

The five bound volumes of Service Notes cover all RCA or Victor models produced from 1923 to 1935 except old Victrola instruments that did *not* contain a radio receiver. Complete replacement parts lists are provided for all models issued since 1929.

Service Engineers who use the volumes regard them as their "Business Bible," not alone for the diagrams and drawings, but for the time-saving service information, conveniently arranged for every RCA Victor receiver. Schematic drawings can be obtained elsewhere, but the technical information is not so readily found.

In addition, each volume contains other valuable information, such as impedance, inductance and capacity charts, and other data peculiar to the receivers described therein.

NET PRICE \$100 PER VOLUME

F. O. B. CAMDEN, N. J.



PHONOGRAPH OSCILLATOR

A Miniature Broadcasting Station for Attaching Pickups or Microphones to All Types of Receivers Without Making Internal Wiring Changes.



STOCK No. 9554

\$ 7⁷⁵

LIST PRICE
(WITHOUT TUBE)

NO longer is it necessary to worry about difficult pickup connections to receivers not having pickup terminal boards . . . If the receiver can receive a broadcasting station, it will work perfectly with the RCA Phonograph Oscillator . . . Includes radio-record switch and connectors for all connections.

SPECIFICATIONS

Tuning Range . 1400 K. C.-1700 K. C.

Type of Modulation
Suppressor Grid Modulation

Input Voltage for Optimum Modulation 0.3 Volts

Output Impedance 30 Ohms

Type of Tube Required
RCA-2A7 or RCA-6A7

Heater Current
1.0 Ampere (2A7)—0.3 Amperes (6A7)

Plate Current
2.0 Milliamperes at 250 Volts

MAKE AN INEXPENSIVE P. A. SYSTEM

with the RCA Phonograph Oscillator and any radio receiver. The connections and additional parts required are shown in the diagram. Cash in on this large field and make your share of the profits.

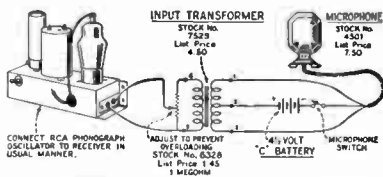

Makes Phonograph Modernization Easy

PHONOGRAPH MODERNIZATION

★ ★ ★

THE 1935 OPPORTUNITY FOR SERVICE ENGINEERS!

ALTHOUGH radio maintains its place as the chief source of home entertainment, the public is showing a growing desire for recorded music, for phonographs and phonograph records.

Those who can afford it are buying radio-phonograph combinations—glorious instruments that bring to their owners a choice of all that the world affords in radio or recorded music. But what of those who cannot now afford a combination instrument? What of these millions who have radio receivers that are in every way satisfactory, but who long also to hear their old and new favorites whenever they wish, as only the phonograph can bring them? Here is the 1935 Opportunity for Service Engineers: Phonograph Modernization.

New Kits Simplify Work

Every phonograph modernization job is more or less a “custom-built” job. Yet the work is so simple that any competent service engineer can handle it without difficulty. RCA Phonograph Modernization Kits make it easy to use scientifically matched parts, parts that are used in the finest RCA Victor radio-phonograph combination instruments.

The Phonograph Oscillator for Easier Installations

The RCA Phonograph Oscillator has been introduced to make the installation of phonograph equipment as easy as possible. If a survey of the receiver to be used discloses that no pickup terminal boards or jacks are available, every effort should be made to sell the RCA Phonograph Oscillator with all kits. This greatly reduces your installation difficulties and insures the best possible results with the minimum time and effort on your part, since all circuit alterations are eliminated.

If, however, a Phonograph Oscillator cannot be sold, and there are no phonograph terminal boards available on the chassis, then internal connections to the chassis must be made. In conjunction with this, you will find that practically all receivers fall into three general classes. These are as follows:

- 1. Receivers having power detectors and low-gain audio stages.** In these receivers, it is necessary to connect the secondary of the input transformer in series with the grid of the second detector. The leads from the transformer to the receiver should be thoroughly shielded and grounded to avoid picking up hum.
- 2. Receivers having high-gain audio stages.** These receivers usually make it necessary to connect the secondary of the phonograph input transformer in series with the first audio stage.
- 3. Receivers using either 2B7 or 6B7 second detector.** Practically all receivers merchandised during 1933 and 1934 use second detectors of this type. In these receivers it is but necessary to place the secondary of the phonograph input transformer in series with the grid cap connections to the 2B7 and 6B7 tubes. Usually this can be done without removing the chassis from the cabinet.

The diagrams on the following pages show the proper connections to be made for receivers of all classes.

MOTOR BOARD LAYOUTS

FOR RCA VICTOR PHONOGRAPH PARTS

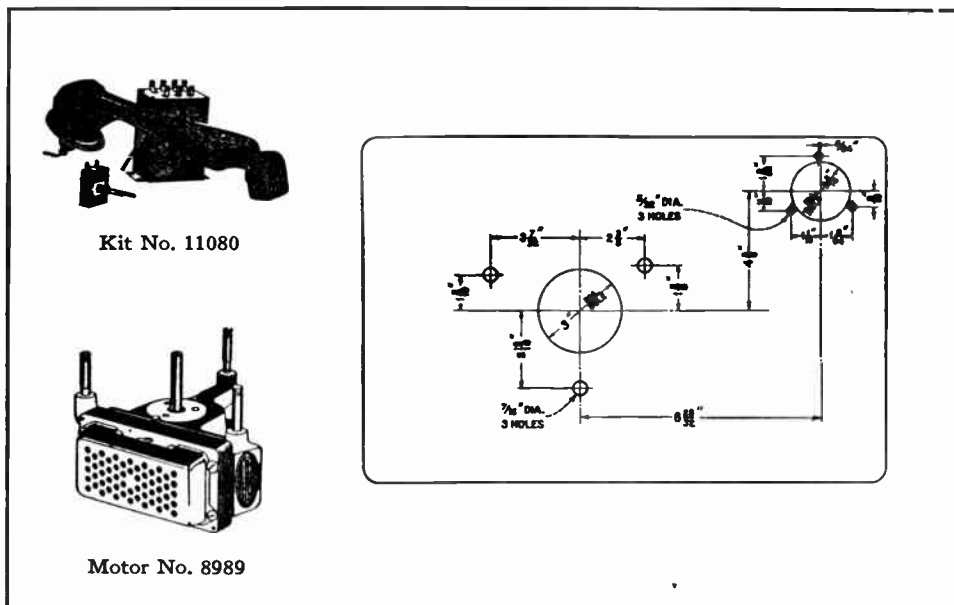

FIGURE 1—Motor Board Layout showing dimensions and location of all holes required for mounting Stock No. 11080 Kit and Stock No. 8989 Motor.

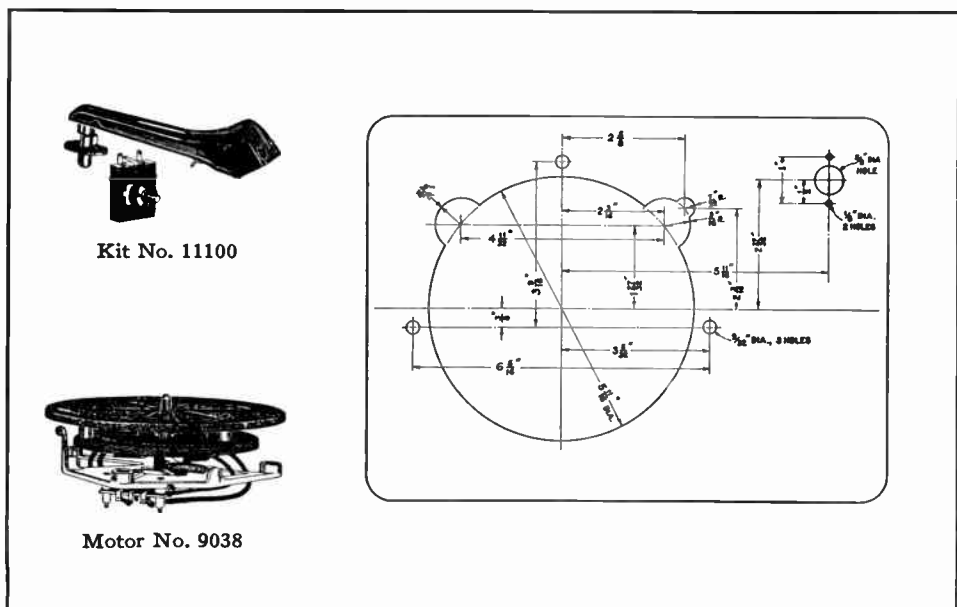

FIGURE 2—Motor Board Layout showing dimensions and location of all holes required for mounting Stock No. 11100 Kit and Stock No. 9038 Motor.

HOOK-UPS USING KIT NO. 11080

(The Standard Installation)

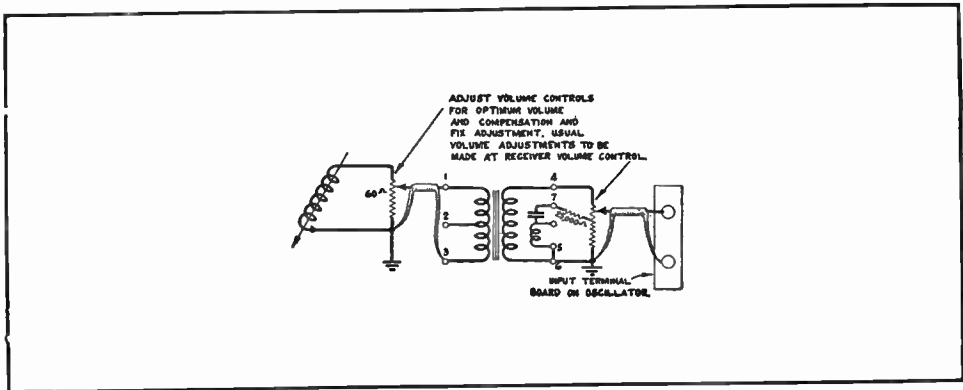

FIGURE 3—Schematic Circuit of Connections of Stock No. 11080 Kit and the RK-24 Phonograph Oscillator.

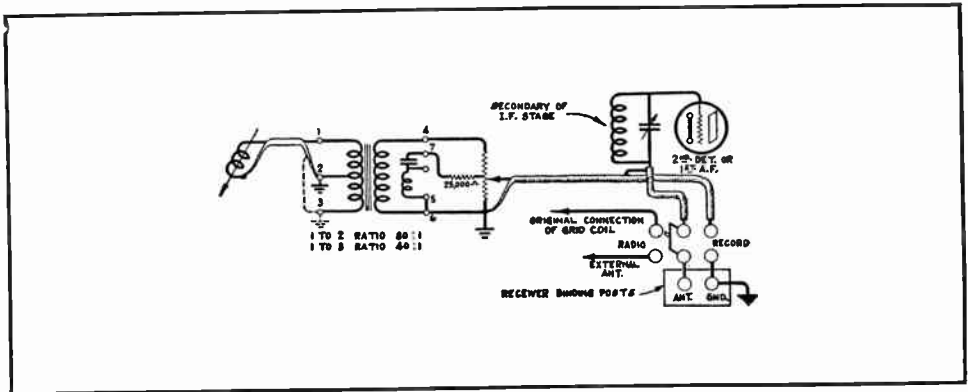

FIGURE 4—Schematic Circuit of Connections of Stock No. 11080 Kit and a typical superheterodyne receiver. In receivers having power detectors and one audio stage the pickup should be connected from terminals 1 to 2 of the input transformer. On receivers having high-gain audio systems, the pick-up connected from terminals 1 to 3 will give the best results.

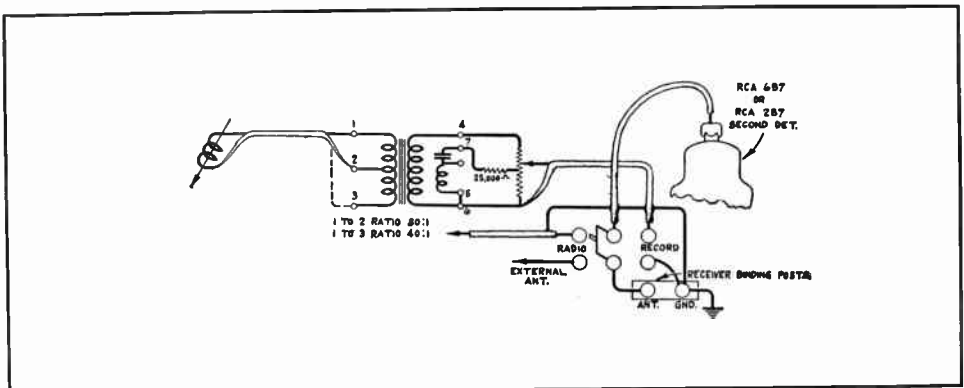

FIGURE 5—Schematic Circuit of Connections of Stock No. 11080 Kit and Receivers using RCA-6B7 or 2B7 Second Detectors. Proper shielding of leads indicated is very important.

HOOK-UPS USING KIT NO. 11100

(The Inexpensive Installation)

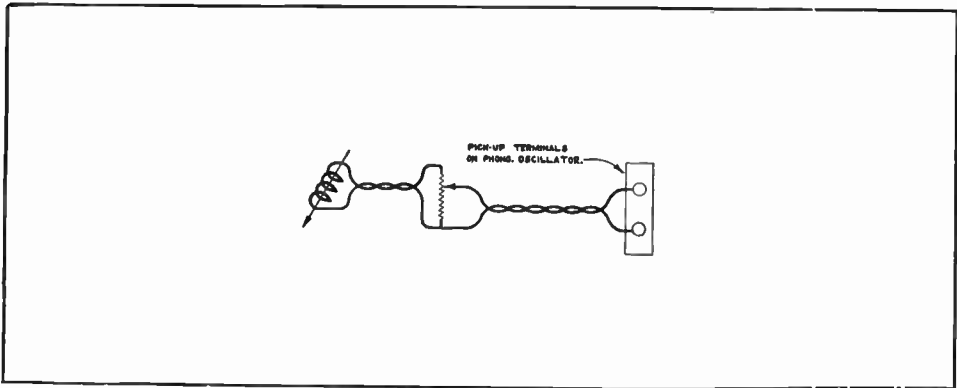

FIGURE 6—Schematic Circuit of Connections of Stock No. 11100 Kit and RK-24 Phonograph Oscillator.

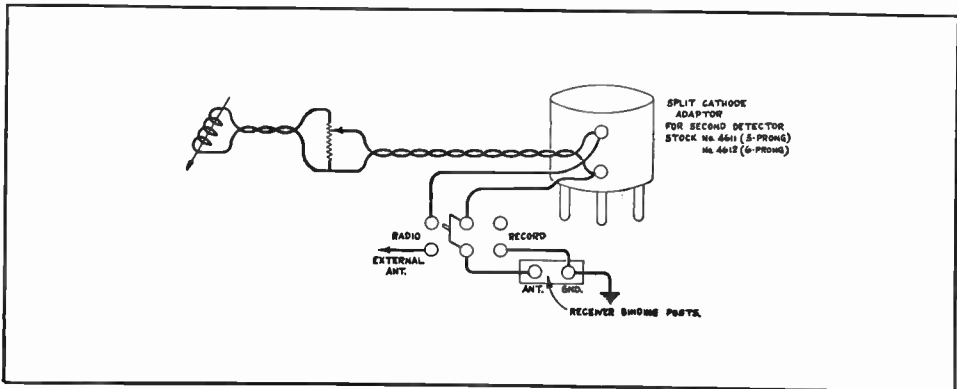

FIGURE 7—Schematic Circuit of Connections of Stock No. 11100 Kit and Stock No. 4611 or 4612 Adaptor. These connections to be used on receivers not having phonograph terminal boards and having high gain audio system. The adaptor is to be placed in the second detector socket.

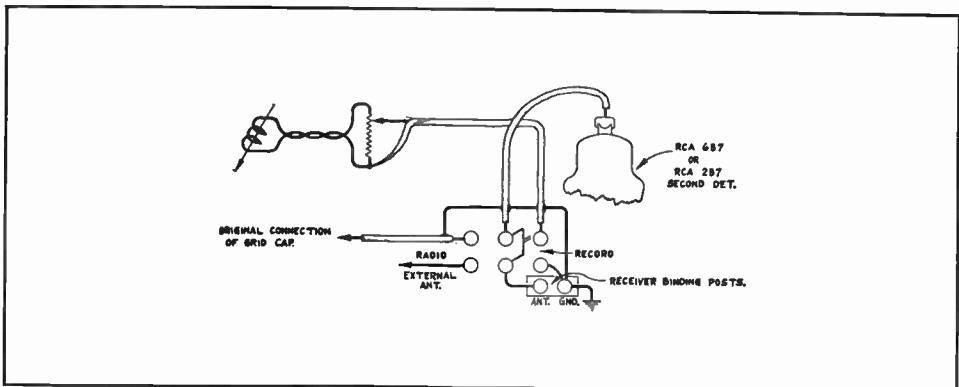
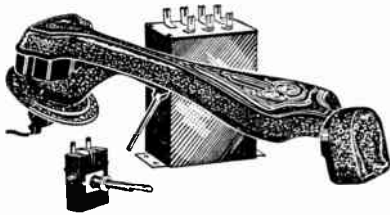

FIGURE 8—Schematic Circuit of Connections of Stock No. 11100 Kit and Receivers using RCA-6B7 or 2B7 Second Detectors. Proper shielding of leads indicated is very important.

FOR THE STANDARD INSTALLATION



RCA VICTOR
Phonograph Modernization Kit
Stock No. 11080

Contents: 7-ohm Pickup, Inertia Type Pickup Arm, 20,000-ohm Volume Control, and Input Transformer. Same type pickup as is used on de luxe RCA Victor instruments. Has Viscaloid damper which gives smoother and wider frequency range. Transformer and volume control include compensation circuit for improved low-volume reproduction. Pickup counter-balanced for two-speed ($33\frac{1}{2}$ or 73 R.P.M.) operation. List price, \$13.10.

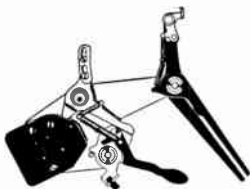

Stock No. 6896

AUTOMATIC ECCENTRIC BRAKE to stop turntable at end of record having an eccentric groove. To be used with Kits Nos. 11080 and 11076 (Pickup arms of the inertia type). List price, \$2.50.



Stock No. 11106

The **SHIFT LEVER** used to change the speed of the turntable (8948) from standard to long playing. Not included with 8948. List price, \$0.98.



DPDT RADIO-RECORD SWITCH, rotary type, for changing circuit from radio to record reproduction. Used on all modernization installations. Not needed when RCA Phonograph Oscillator is used in installation.

Stock No. 4460 Switch. List price, \$0.40.

Stock No. 3829 Knob for above Switch. List price, \$0.22.

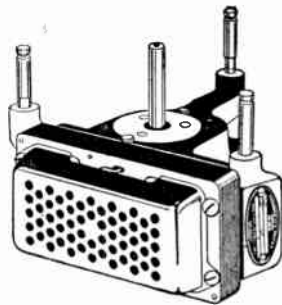

Stock No. 8989

MOTOR complete, for 60 cycles, 115 volts. This is the same sturdy motor used in the highest quality of phonographs and combinations made by RCA Victor. List price, \$18.52.

Stock No. 3599

MOTOR MOUNTING ASSEMBLY (not illustrated), comprising one screw, one washer and one lock washer. This unit contains the three sets necessary for mounting the Stock No. 8989 Motor on the motor board. List price, \$0.30.

Stock No. 3391

MOTOR BOARD SUSPENSION SPRING ASSEMBLY (not illustrated), comprising 1 bolt, 1 top spring, 1 bottom spring, 2 cap washers, 1 C washer and 1 nut. Recommended for mounting a motor board for Stock No. 8989 in a cabinet. Specially tuned springs prevent vibration being transmitted mechanically to the pickup and spoiling reproduction. Four sets required. List price, 4 sets, \$2.00.

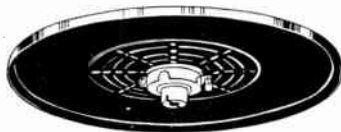

Stock No. 8948

TWO-SPEED TURNTABLE. Fits shaft of Stock No. 8989 Motor. This turntable adds distinction to your work and gives it the stamp of modern workmanship. It is the same turntable used in RCA Victor Combinations to play both standard (78 R.P.M.) and long-playing ($33\frac{1}{2}$ R.P.M.) recordings. List price, \$5.50.

RESISTOR—25,000 ohms—carbon type— $\frac{1}{2}$ watt. (Not illustrated.) Used in phonograph compensation circuits. See Figures 3, 4 and 5. Stock No. 3264. List price, \$0.20.

FOR THE INEXPENSIVE INSTALLATION

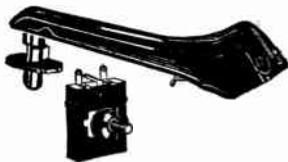

RCA VICTOR
Phonograph Modernization Kit
Stock No. 11100

Contents: A 2450-ohm Midget Pickup and 5000-ohm Volume Control. For inexpensive installations where space is limited. Usually used with Stock No. 9038 Motor, shown at right. Single speed (78 R.P.M.) only. List price, \$5.85.

DPDT RADIO RECORD SWITCH, see opposite page. Not needed when RCA Phonograph Oscillator is used in installation. Stock No. 4460 Switch. List price, \$0.40. Stock No. 3829 Knob for above switch. List price, \$0.22.

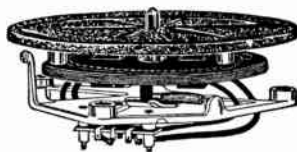

Stock No. 9038

SYNCHRONOUS TYPE MOTOR WITH TURNTABLE—115 volts, 60 cycles. Although this motor is not self-starting, it serves the purpose admirably where cost is a factor. Where space is limited this unit fits in easily. Plays either 10- or 12-inch records at standard speed. List price, \$8.00.

Stock No. 3813

MOTOR MOUNTING ASSEMBLY (not illustrated), comprising one metal bushing, two rubber bushings, one flat washer, one lock washer and one nut. Three sets required to mount Stock No. 9038 Motor (above). List price, 3 sets, \$1.68.

MISCELLANEOUS

The parts shown above and on the previous page will handle the great majority of all phonograph modernization jobs. For certain applications the Kits shown below may be preferred. The RCA Parts Division can supply RCA Victor phonograph parts for any requirements.

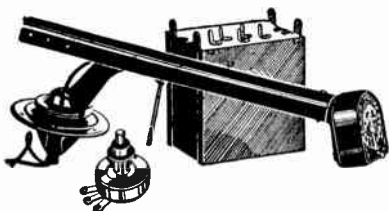

KITS WITH STRAIGHT ARM PICKUPS. May be used for single-speed (78 R.P.M.) operation only. Usually used as exact replacements on old instruments.

RCA VICTOR
Phonograph Modernization Kit
Stock No. 11099

Contents: 200-ohm Pickup, Straight Type Pickup Arm, 500-ohm Volume Control and Input Transformer. This Kit, minus the transformer, can be connected to 1929 Victor models without internal circuit changes. List price, \$12.10.

RCA VICTOR
Phonograph Modernization Kit
Stock No. 11075

Not illustrated: similar to Kit No. 11099. Contents: 20-ohm Pickup, Straight Type Pickup Arm, 60-ohm Volume Control, and Input Transformer. List price, \$10.80.



RCA VICTOR
Phonograph Modernization Kit
Stock No. 11076

Contents: 700-ohm Pickup, Inertia Type Pickup Arm, 5000-ohm Volume Control. Due to high impedance of pickup, no input transformer is included. Pickup counter-balanced for two-speed operation. Limited frequency range, no viscaloid damper. Uncompensated volume control. This kit should not be used with low-gain audio systems. List price, \$10.50.

SPLIT-CATHODE ADAPTOR (not illustrated), for cathode type phonograph connection. See Figure No. 7.

Stock No. 4611—5-Prong. List price, \$1.00.
Stock No. 4612—6-Prong. List price, \$1.00.



VICTOR TECHNICAL PURPOSE RECORDS

a valuable aid to
ALL SERVICE ENGINEERS

The increasing popularity of the RCA Victor Cathode-Ray Oscillograph and other service equipment that is rapidly raising the standards of the servicing profession has brought new interest in some little-known records produced by RCA Victor. While originally made for engineering laboratories, many service shops are ordering them after hearing them in use at RCA Victor Service Meetings.

The Records are various and diversified, including constant frequency discs, varying fre-

quency discs, constant volume discs, aural test records, wireless telegraphy records, and others. The wireless telegraph discs are six in number, and comprise a comprehensive course in Morse telegraphy. They sell for \$5.00 a set, complete with handbook. All other Technical Purpose Records sell at 75 cents each for the 10-inch size, and \$1.25 for the 12-inch size. A few of them follow (the complete list may be procured by writing directly to the RCA Manufacturing Company, Camden, N. J.):

<i>Catalog No.</i>	<i>Size</i>	<i>Description</i>
*XL-101	12-inch	Variable frequency of approximate-constant amplitude from 30 to 10,000 cycles.
*83001	10-inch	15-second periods of 46, 50, 58, 68, and 75 cycles per second.
84519-B	12-inch	15-second periods of 84, 125, 150, 175, 200, 225, 250, 275, and 300 cycles per second.
84519-A	12-inch	15-second periods of 350, 400, 450, 500, 550, 600, 650, 700, and 750 cycles per second.
84518-B	12-inch	15-second periods of 800, 850, 900, 950, 1000, 1100, 1200, and 1300 cycles per second.
84518-A	12-inch	15-second periods of 1400, 1500, 1600, 1700, 1800, 1900, 2100, and 2200 cycles per second.
84517-B	12-inch	15-second periods of 2300, 2400, 2500, 2600, 2700, 2800, 2900, 3000, and 3200 cycles per second.
84517-A	12-inch	15-second periods of 3400, 3600, 3800, 4000, 4200, 4400, 4600, 4800, and 5000 cycles per second.

*Single-face. All others double-face.



AUTOMATIC RECORD CHANGER

LIST PRICE

\$72.50

STOCK NO. 9501

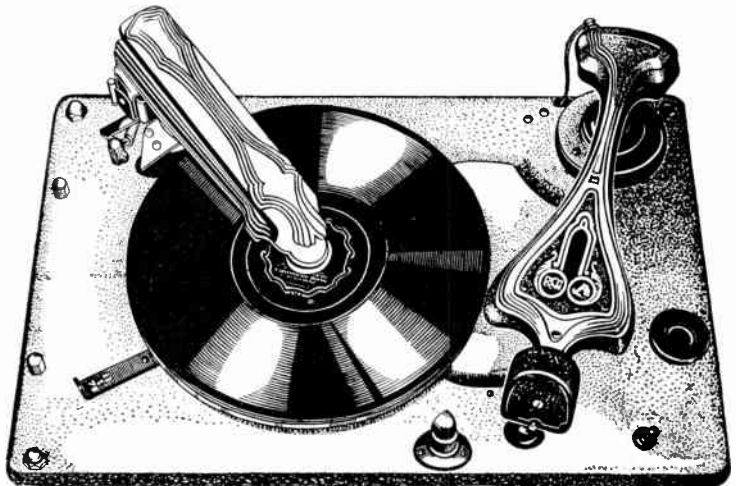

Uninterrupted record reproduction for as long as an hour and a half (if long-playing records are used) without attention. Automatically changes and plays either eight 10-inch or seven 12-inch records at either 78 or 33 $\frac{1}{3}$ R.P.M. Uses extended frequency range Vis-

caloid pickup and inertia type tone arm.

Overall dimensions of unit: 18 $\frac{1}{8}$ inches long, 12 $\frac{5}{8}$ inches wide and 8 $\frac{3}{8}$ inches high, including parts below the motor board. Requires also space at left of motor board 7 $\frac{1}{4}$ x 15 $\frac{1}{4}$ inches and 11 inches deep for record well. Stock No. 9501. List price, \$72.50.

RCA VICTOR PHONOGRAPH EQUIPMENT

RCA Victor Phonograph Reproducing Equipment is recognized throughout the world as the ultimate in record reproducing equipment. Advanced mechanical and electrical design, coordination with record development and adaptability for use with modern radio receivers are but few of the many features of this equipment.

PICKUP SUSPENSION ARMS (INERTIA TYPE)

List Price \$4.00



INERTIA TYPE
PICKUP ARM

STOCK NO.	FOR MODELS	USED WITH PICKUP NO.
6543*	331	6542
7530*	RE-81, CRD-9AC, CRD-9DC	6335
7538*	RAE-84	6335
7579*	RE-80	6335
8643	RAE-68	7085
8675	RE-16, RE-16-A	7412
8732	RE-73	7307
8757	RAE-59, RAE-26, RAE-79	7325
8796	RE-18	7394
8874	RE-19	6217
8880*	RE-20, RE-18-A	6222

* Supplied less escutcheon. See bottom of page for proper escutcheon.

PICKUP SUSPENSION ARMS (STRAIGHT TYPE)

List Price \$4.00

STOCK NO.	FOR MODELS	USED WITH PICKUP NO.
8520	R-67, R-47	2601 or 6064
8858	PT-33	7394
8906	CE-29	7475



STRAIGHT TYPE
PICKUP ARM

ESCUTCHEONS FOR INERTIA TYPE PICKUP ARMS

(Includes Mounting Rivets)



ESCUTCHEON

STOCK NO.	USED WITH ARM NO.	LIST PRICE
3779	6543	\$0.46
3390	7530, 7579, 7538	.46
3351	8880	.46

RCA VICTOR MAGNETIC PICKUPS



RCA Victor Magnetic Pickups are of rugged mechanical construction and have frequency ranges comparable with modern records and reproducing equipment. We recommend the use of compensated input systems as shown on page 71 with these pickups.

STOCK NO.	COIL IMPEDANCE	LIST PRICE	USED WITH ARM NO.
2601	12 ohms	\$4.00	8520
6064	11 "	4.00	8520
6217	12.7 "	4.00	8874
6222	7 "	4.00	8880
6335	7 "	4.00	7530, 7538, 7579
6542	28 "	4.15	6543
7085	20 "	4.00	8643
7307	12.7 "	4.00	8675
7325	20 "	4.00	8757
7394	7 "	4.00	8796, 8858
7412	48.5 "	4.00	8675
7475	7 "	4.00	8906

LOW PRICED TURNTABLE EQUIPMENT

For 10" or 12" Records

RCA Stock No. 9038 Turntable and motor, together with RCA Stock No. 6592 Pickup Arm, provide low cost phonograph operation with excellent reproduction characteristics. Operation is confined to single speed 78 r.p.m. records only. The small physical size of these units render them particularly suitable for modernization work with old style phonographs.

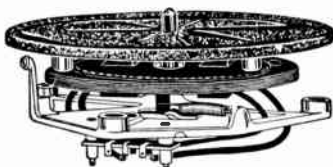

Stock No. 9038

MOTOR SPECIFICATIONS

Voltage—105-125 volts

Frequency—60 cycles (can be supplied for 50 cycles)

Diameter—7 inches

List Price—\$8.00



Stock No. 6592

PICKUP AND ARM SPECIFICATIONS

Coil Impedance—2450 ohms

Overall Length—7 inches

List Price—\$5.00

RCA VICTOR ORTHOPHONIC SOUND BOXES

List Price \$4.50

RCA Victor Orthophonic Sound Boxes are the ultimate in the mechanical reproducing sound box. Stock No. 6927 is a universal box complete with the necessary bushings to permit use with many earlier type Victor mechanical phonographs fitted with similar type sound boxes.



STOCK NO.	FINISH	USED IN
6915	Gold Bronze	7-11, 2-55G
6917	Gold	8-9
6926	Polished Brass	2-65
6927	Oxidized Bronze	Universal
6930	Gold Bronze	2-25
6932	Polished Brass	2-25

RCA VICTOR TURNTABLES

All RCA Turntables have a felt cover for contact with the record. They are suitable for use with the motors listed on page 44 for same model numbers. The two-speed turntable uses the ball-race speed reducer, which ensures smooth operation at either 33 $\frac{1}{3}$ r.p.m. or 78 r.p.m.



TWO-SPEED



SINGLE-SPEED

STOCK NO.	USED IN	LIST PRICE	TYPE
7627	2-25	\$1.64	Single-speed
8582	R-86, E-135, RE-17, RE-57, T-5, RE-16, RE-16A	2.00	Single-speed
8642	RAE-68	2.40	Single-speed
8660	2-65 (Blue)	2.00	Single-speed
8667	2-65 (Red)	2.00	Single-speed
8733	RE-73, RE-18, 2-speed M.B., PT-33	3.04	2-speed
8759	RAE-59, RAE-26	3.90	2-speed
8783	RAE-79	4.50	2-speed
8877	RE-19, RE-18A, RE-20	3.00	2-speed
8909	CE-29	5.25	Single-speed
8936	SR-1, SR-3	5.50	2-speed
8937	SR-2	5.50	2-speed
8948	RE-81, RE-80, RE-40, RE-40P, 310, 330	5.50	2-speed
8950	RAE-84	6.50	2-speed
8968	CRD-9AC, CRD-9DC	2.58	2-speed
9010	331	5.50	2-speed

NEEDLE BOXES



STOCK NO.	USED IN	LIST PRICE
2759	1-90, 4-40, 7-26, 8-35, 9-56, CE-66, 8-36, 9-16, 12-15, T-90, V-30, E-152, E-35, RE-45, E-135, RE-17, RE-57, RE-154, RE-73, RE-156, RE-75, T-5, RE-16, RE-18, R-86, RE-16-A	\$0.30
3189	RAE-59, RAE-26, RAE-79, RE-19	.35
3304	CE-29	.35
3416	RAE-84	.50
3430	RE-81, RE-80, RE-40, 310, 330, RE-40-P	.45
6232	RE-20, RE-18-A	.35
10241	331	.30
10308	4-40, 4-20, 7-10, 8-12	.30
10325	7-25, 7-30, 8-12, 9-25, 9-55	.30
10560	8-8	.35

STEEL BALLS

List Price \$0.25 per package of 20

STOCK NO.	DIAMETER	STOCK NO.	DIAMETER
10129	$\frac{3}{16}$ "	10705	$\frac{5}{32}$ "
10194	$\frac{1}{4}$ "	10941	$\frac{1}{8}$ "
10278	$\frac{3}{32}$ "		



INTERMEDIATE GEARS



STOCK NO.	SET USED IN	LIST PRICE
8657	2-65	\$0.70
10158	2-30, 2-60, T-90	.55
10200	2-35, 2-55	.55
10499	9-54, 9-56, 10-35	.60
10718	9-55X, 10-50	1.00
10762	V-30	1.00

SPRING BARREL DRIVE GEARS

STOCK NO.	SET USED IN	LIST PRICE
10698	T-90	\$0.40
10759	V-30	.50
10959	2-55	.40



RCA VICTOR TURN- TABLE DRIVE MOTORS

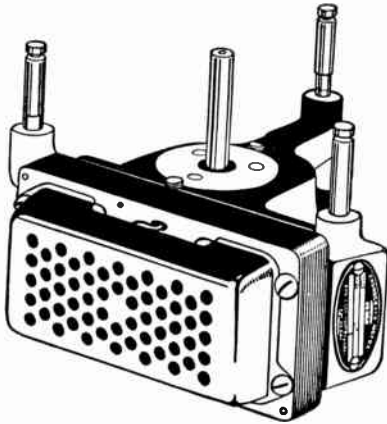

RCA Victor Phonograph Motors are of strong foolproof construction, have ample power and are free from variations in speed which cause "wows" in phonograph reproduction. The motor spindles are suitable for use with the two-speed turntables listed

on page 42.

STOCK NO.	SPECIFICATIONS	USED IN	LIST PRICE
8648	110 volts—60 cycles	RAE-68	\$32.50
8649	105-125 volts (50 cycles)	RAE-68	32.80
8752	110 volts—25 cycles	RAE-59, RAE-26, RAE-79	38.40
8753	110 volts—30 cycles	RAE-59, RAE-26, RAE-79	38.40
8754	110 volts—50 cycles	RAE-59, RAE-26, RAE-79	35.28
8755	110 volts—60 cycles	RAE-59, RAE-26, RAE-79, CE-29	29.20
8776	110 volts—25 cycles	RAE-68	39.92
8795	110 volts—60 cycles	RE-18, RE-18A, PT-33, RE-19, RE-20, 2-speed M.B.	16.00
8800	110 volts—25 cycles	RE-18, RE-19, RE-20, RE-18A, PT-33, 2-speed M.B.	23.88
8801	110 volts—30 cycles	RE-18, RE-19, RE-18A, PT-33	23.88
8804	110 volts—30 cycles	RAE-68	37.50
8856	110 volts—50 cycles	RE-18, RE-19, RE-18A, RE-20, PT-33, 2-speed M.B.	16.00
8887	220 volts—60 cycles	RE-20, RE-18, RE-19, RE-18A	18.68
8888	220 volts—50 cycles	RE-20, RE-18, RE-19, RE-18A	18.68
8939	105-125 volts—60 cycles	RE-81, RE-80	15.92
8940	105-125 volts—50 cycles	RE-81, RE-80	20.20
8941	105-125 volts—25 cycles	RE-81, RE-80	24.64
8952	105-125 volts—60 cycles	RAE-84	35.40
8953	105-125 volts—25 cycles	RAE-84	41.16
8954	105-125 volts—50 cycles	RAE-84	37.50
8966	105-125 volts—60 cycles	CRD-9AC	18.26
8970	110 volts D.C.	CRD-9DC	34.40
8989	110-125 volts—60 cycles	RE-40, RE-40P, 330, 310	18.52
8990	110-125 volts—50 cycles	RE-40, RE-40P, 330, 310	18.52
8991	110-125 volts—40 cycles	RE-40, RE-40P, 330, 310	23.36
8992	110-125 volts—25 cycles	RE-40, RE-40P, 330, 310	23.36
9011	105-125 volts—60 cycles	331	19.72
9012	105-125 volts—25 cycles	331	24.16
9013	105-125 volts—40 cycles	331	24.16
9014	105-125 volts—50 cycles	331	19.72

RCA TOOTH-PICK MICA CAPACITORS

RCA Tooth-Pick Mica Capacitors are well known for their high quality and universal application. From this large assortment you can order a suitable value for any purpose on any receiver.

- Conservatively rated at 500 volts D.C.
- Close tolerances— $\pm 5\%$ —assures exact value.
- Extremely small size—fit anywhere.
- RCA quality at low cost.

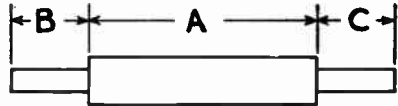
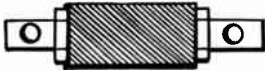

CAPACITY	DIMENSIONS			LIST PRICE	STOCK NO.	CODE MARKING
	A	B	C			
9 Mmfd.	1 1/2	13/16	13/16	\$0.25	3024	A-J
10 "	1 1/2	13/16	13/16	.25	10842	A-E
12 "	1 1/2	1 1/32	1 1/32	.44	3775	D-C
15 "	1 1/2	13/16	13/16	.36	3747	X-J
20 "	1 1/2	1 1/32	1 1/32	.34	4033	K-A
40 "	7/8	5/16	5/16	.22	3696	E-X
45 "	7/8	5/16	5/16	.30	3931	J-L
50 "	7/8	5/16	5/16	.30	3849	H-A
60 "	1 1/2	13/16	13/16	.36	3596	X-S
80 "	7/8	5/16	5/16	.40	3711	F-D
100 "	1 1/2	1 1/32	1 1/32	.30	3794	D-J
150 "	1 1/2	13/16	13/16	.32	3546	B-W
160 "	7/8	5/16	5/16	.30	3865	H-C
190 "	1 1/2	13/16	13/16	.30	3890	H-V
200 "	1 1/2	1 1/32	1 1/32	.30	4013	F-J
280 "	1 1/2	13/16	13/16	.40	3232	R
300 "	7/8	5/16	5/16	.34	3616	E-W
320 "	1 1/2	13/16	13/16	.30	2981	J
375 "	1 3/8	7/16	7/16	.30	3378	E-F
390 "	7/8	5/16	5/16	.34	4032	K-B
400 "	1 1/2	5/8	5/8	.30	3604	E-U
600 "	1 1/2	1 1/32	1 1/32	.30	3793	D-T
630 "	1 1/2	9/32	9/32	.30	3384	E-J
650 "	1 1/2	9/32	9/32	.30	6312	E-C
670 "	1 1/2	9/32	9/32	.30	6320	C-U
700 "	1 1/2	13/16	13/16	.48	3513	M
720 "	1 1/2	5/16	5/16	.40	3699	F-E
745 "	1 1/2	13/16	13/16	.30	2734	X-O
770 "	1 1/2	13/16	13/16	.30	3605	B-H
800 "	7/8	5/16	5/16	.34	3746	E-V
820 "	7/8	5/16	5/16	.36	3894	H-S
900 "	7/8	5/16	5/16	.30	3784	F-W
950 "	7/8	5/16	5/16	.40	3895	H-T
1000 "	1 1/2	13/16	13/16	.34	3973	A-G
1200 "	1 7/16	13/16	13/16	.30	3460	A-D
1500 "	1 1/2	13/16	13/16	.30	3873	B-V
2250 "	1 1/2	13/16	13/16	.50	3846	H-H
2340 "	1 1/2	13/16	13/16	.50	3845	H-J
2400 "	1 1/2	13/16	13/16	.35	2749	X-X
2700 "	1 1/2	13/16	13/16	.50	4031	K-C

RCA TUBULAR PAPER CAPACITORS

RCA Tubular Paper Capacitors are ideal for the usual low-value by-passing requirements of radio receivers. Small size and self-mounting bus leads permit quick installation with minimum space requirements.

*Famous
For*

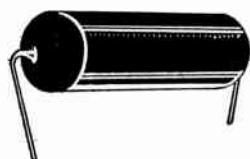

*Their
Dependability*

CAPACITY	D.C. WORKING VOLTAGE	LIST PRICE	STOCK NO.
.0024 Mfd.	600	\$0.30	3932
.005 "	800	.25	3643
.008 "	400	.25	3642
.01 "	300	.30	3701
.02 "	200	.25	3639
.025 "	200	.34	3765
.05 "	200	.25	3640
.1 "	200	.35	3641
.25 "	125	.36	3750
.5 "	125	.40	3751

RCA FLAT TYPE PAPER CAPACITORS

RCA Flat Type Paper Capacitors are similar to the tubular type except they are constructed to require less depth for mounting. Often this type of capacitor is suitable for locations that preclude the use of other types.

CAPACITY	D.C. WORKING VOLTAGE	LIST PRICE	STOCK NO.
.005 Mfd.	600	\$0.38	3617
.006 "	400	.42	3562
.007 "	800	.45	3723
.008 "	800	.35	3098
.01 "	800	.44	3455
.01 "	300	.38	3578
.015 "	400	.35	3433
.02 "	300	.35	3370
.025 "	300	.48	2756
.025 "	400	.35	7362
.05 "	150	.34	3556
.05 "	300	.40	6317
.1 "	300	.35	3042
.2 "	300	.46	3450
.25 "	300	.40	3597
.5 "	150	.32	3772

*The Flat
Shape*



*Helps In
Crowded
Chassis*

RCA ELECTROLYTIC CAPACITORS

RCA Electrolytic Capacitors are supplied in four types, as listed below. Thorough testing, low leakage and conservative voltage ratings make these units suitable for all replacement or experimental use. The wet types are recommended for filter requirements. The dry type are suitable for low voltage filter circuits and by-passing applications.

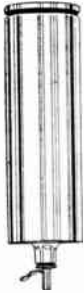

WET TYPE—ALUMINUM CONTAINER

CAPAC- ITY	D.C. VOLTAGES		MOUNTING	LIST PRICE	STOCK NO.
	PEAK	WORKING			
10 Mfd.	475	425	Stud and nut	\$1.50	6443
10 "	450	425	Stud and nut	1.20	6571
10 "	450	425	Clamp	1.40	7590
18 "	300	270	Stud and nut	1.10	6609

WET TYPE—COPPER CONTAINER

CAPAC- ITY	D.C. VOLTAGES		MOUNTING	LIST PRICE	STOCK NO.
	PEAK	WORKING			
4 Mfd.	450	430	Stud and nut	\$1.40	3057
10 "	450	430	Stud and nut	1.75	2957



DRY TYPE—SMALL TUBULAR

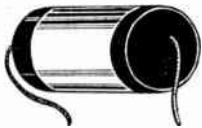

CAPACITY	D.C. RATED PEAK VOLTAGE	LIST PRICE	STOCK NO.
4 Mfd.	25	\$0.60	3796
4 "	300	.86	7641
8 "	175	.95	6548

DRY TYPE—ALUMINUM CONTAINER

STOCK NO.	CAPACITY	WORKING VOLTS D. C.	LIST PRICE
4934	{ 4 4 4	{ 10 50 100	\$1.36
4933	{ 4 4	{ 100 200	1.02
4961	8	450	1.28



RCA ELECTROLYTIC CAPACITOR PACKS

RCA Electrolytic Capacitor packs consist of from two to four capacitors manufactured as an integral unit. The tabulation shows the capacities, voltages and

internal connections of the various packs. Low voltage filter circuits and high value by-passing requirements are the usual applications for capacitor packs of this type.

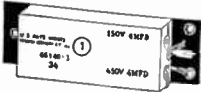

STYLE A

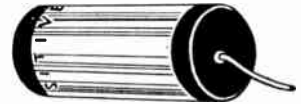

STYLE B

ELECTRICAL SPECIFICATIONS		MOUNTING	INTERNAL CONNECTIONS	DIMENSIONS	STOCK NO.	LIST PRICE
Capacity MFD.	Voltage					
4	175	B-Leads	Negative Common	3 1/8" x 1 5/8" dia.	3538	\$1.18
4	175					
5	175	B-Leads	4-175 Blue Negative—Red Positive—4-225 Bus Negative—Yellow Positive	3 3/8" x 1" dia.	6535	1.25
5	225					
4	200	B-Leads	Negative Common	3 1/8" x 1 5/8" dia.	6845	1.18
4	200					
4	150	A-Lugs	Negative Common	5" x 1 9/16" x 1"	7589	1.64
4	450					
4	150	A-Lugs	Negative Common	5" x 1 9/16" x 1"	6555	1.64
10	300					
5	35	B-Leads	Negative Common	2 1/2" x 2 3/4" dia.	6513	1.00
5	35					
5	50	B-Leads	Negative Common	2 1/2" x 2 3/4" dia.	6844	1.10
5	50					
8	175	A-Leads	Negative Common—175 Yellow—250 Red	4 3/16" x 1 1/2" x 1 1/8"	6518	1.58
8	250					
10	150	A-Leads	Negative Common Black—150 Green—420 Red	5 3/8" x 1 3/4" x 1"	6574	1.80
10	420					
4	150	A-Leads	Negative Common Black—4-150 Green, 4-300 Blue, 8-350 Red	4 7/16" x 1 9/16" x 1 5/8"	6703	2.46
4	300					
8	350					
4	175	A-Leads	4 Black Negative—Yellow Positive, 8 Green Negative—Red Positive, 10 Black Negative—Green Positive	4 3/16" x 1 3/16" x 1 1/8"	6511	1.49
8	175					
10	25					
4	150	A-Leads	Negative Common Black—4 Yellow, 10 Brown	3 1/2" x 3" x 1 3/8"	6626	1.86
10	25					
10	25					
4	25	A-Leads	Negative Common Lug—4-25 Blue, 4-300 Lug, 4-300 Red, 10-150 Yellow	5" x 1 9/16" x 1 5/8"	6487	2.90
4	300					
4	300					
10	150	A-Leads	Negative Common Black, 4-150 Green, 4-300 Blue, 8-350 Red, 12-25 Yellow	5" x 1 9/16" x 1 5/8"	6691	2.16
4	150					
4	300					
8	350					
12	25					
4	175	A-Leads	4-175 Blue Negative, Maroon Positive, 8-175 Green Negative, Brown Positive, 8-300 Black Negative, Red Positive, 10-25 Blue Negative, Green Positive	4 3/16" x 2 3/4" x 1 3/8"	6728	2.94
8	175					
8	300					
10	25					
5	50	A-Leads	5 mfd. Negative Common Green, Positive Yellow, 8 mfd. Negative Common Black, Positive Red and Blue	4 5/8" x 1 7/8" x 1 3/4"	6661	2.70
5	50					
8	450					
8	450					

RCA TUNING CAPACITORS

Exact matching throughout the tuning range, modified straight line frequency curve, inclusion of trimmer capacitors and strong mechanical construction made the RCA Tuning Capacitors suitable for many replacement or experimental uses. A wide selection of styles, values and number of gangs permits choice of the proper capacitor for all purposes.

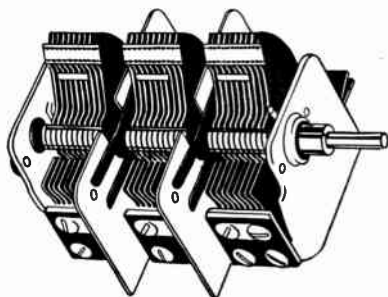

STOCK NO.	DESCRIPTION		USED IN	LIST PRICE
	NO. OF GANGS	CAPACITOR EACH GANG MMFD.		
6451	2	12-365	R-17M, R-18W, R-27	\$2.04
6506	3	18-405	R-22, 114	3.24
6533	3	18-380	R-51B, R-53B	5.55
6536	3	14-325	260, 280	5.00
6585	2	14-405	300	2.20
6593	3	15-335	330	3.25
6598	3	15-335	120, 210, 310	3.00
6603	4	16-335	140, 141, 240, AVR-1	3.80
6624	3	15-335	110, 111, 115	3.50
6660	2	18-410	100, 101	2.78
6680	3	18-405	220, 222	3.80
6694	3	16-405	121, 122	3.75
6717	3	18-365	142B, 241B	3.50
6723	3	18-405	112	4.15
6786	3	14-325	R-90P	7.12
7581	3	14-325	R-90	5.00
7588	3	15-335	R-28, RE-40, 331	2.85
7597	3	15-335	R-37, R-37P, R-38, R-38P	2.85
7601	3	16-325	M-34, M-105	2.84
7241	3	18-325	R-7A, R-43, R-11, R-7LW, R-10, RE-18, RAE-26, RE-16A, R-4, R-6, R-8, R-10	4.00
7438	3	18-325	R-12, RE-18A, RE-19, R-21, R-78, RAE-84	4.40
7548	3	16-325	M-32	3.50
7501	3	18-325	R-70, R-71, R-72, R-73, R-74, R-76, R-77, RE-80	4.20
8700	4	18-330	R-80, R-82, R-86, RAE-68	10.48
8708	4	18-330	RE-20, R-50, R-55, RAE-59	9.50

RCA VICTOR CAPACITOR PACKS

For direct replacement in RCA Victor Receivers

The Capacitor Packs listed in the following tabulation are usually used as replacements in the RCA Victor models listed. They consist of both paper and dry electrolytic type capacitors and may be used in applications where the values are suitable.

STOCK NO.	CAPACITIES (MFD.)	SETS USED IN	LIST PRICE
2241	.5-.5-.5-.5-2.0	R-18, Rad-51	\$3.30
2954	.1-.1-.1	R-5, R-5X, R-5DC	.75
3606	.005-.025	R-28P, RE-40, 100, 101	.40
3722	.05-.05	R-18W	.70
3755	.1-.1-.25	112, 114	.60
6002	.25-.75	R-44, R-46, R-47	2.25
6003	.1-.1-.1	Rad-21, R-22, R-44, R-46, R-47	1.95
6414	.1-.1-.75-.75-1.0	R-3B	2.36
6422	.05-.1-.25-4.0-4.0-0.5-0.5	R-25DC	4.04
6429	.11-.7	R-90, R-90P, 260	.98
6430	.025-.1-.25-.5-4.0-4.0	R-90, R-90P, 260	3.78
6492	1.0-3.6	M-34, M-105	1.08
6567	.17-.7	280	.95
6587	4.0-4.0-4.0-4.0-4.0-15.0	300	2.42
6620	.005-.035	110, 111, 115, 120, 121, 122, 210, 220	.50
6621	.05-.1	112, 114	.46
6787	.005-.017	100	.30
7058	.1-.1-.1-.5-1.0	RAE-68, R-80, R-82, R-86	2.00
7106	.27-.75	R-14, R-15, RE-17, R-42, R-48	1.15
7107	1.0-1.0	R-14, R-15, RE-17, R-42, R-48	.70
7108	.1-.1-.1	R-14, R-15, RE-17, R-42, R-48	.80
7231	.05-.25-.25-2.0	R-5, R-5X	2.50
7238	.1-.5-.5-.5-.5-1.0	R-7, R-7LW, R-9, R-10DC	2.75
7251	.025-.25-.1-.5-1.0	R-5DC	2.70
7256	.005-.1-.5-.5-.5-.5-1.0	R-7A, RE-16A	2.65
7264	.1-.1-.1-.25-.25-.25-.5-.75	R-43	2.50
7269	.05-.05-.1-.1-.1-.1-.5-.5-.5-.5-8.0-8.0	R-11, RE-18, RE-18A, R-21, RAE-26	5.40
7285	.1-.1-.5-1.0	RE-20, R-50, R-55, RAE-59, RAE-79	2.10
7286	.1-.1-.1-.5-1.0	RE-20, R-50, R-55, RAE-59, RAE-79	2.50
7342	.1-.1-.1-.1-.05-.05-.5-.5-.5-.5-4.0-4.0-10.0	R-8, R-10, R-12, RE-19, RQ-23	6.75

RCA VICTOR CAPACITOR PACKS (Continued)

STOCK NO.	CAPACITIES (MFD.)	SETS USED IN	LIST PRICE
7421	.018-.018-.1-.1-.1-.25-.25-.5-.5-4.0	M-30	\$4.25
7477	.1-.1-.1-.1-.1-1.0-1.0	R-78, RAE-84	2.25
7478	.02-.1-.5-.5-.5-.5	R-78, RAE-84	2.20
7502	.1-.1-.1-.1-.1-.3-.5-.5-1.0-4.0-8.0-10.0	SW-3, R-24, R-71, R-72	6.40
7513	.1-.1-.1-.1-.1-.3-.5-.5-1.0-7.0-10.0-10.0-10.0-10.0	R-74, R-76, R-77, RE-81	8.60
7525	.005-.005-.025-.05-.1-.25-.5-.75-8.0	R-71B	4.50
7539	.1-.1-.1-.1-.1-.3-.5-.5-4.0-4.0-8.0-10.0	R-71, R-72	8.80
7546	.005-.05-.05-.1-.25-.25-.08-.75-4.0	M-32	3.58
7550	.1-.1-.1-.3-.5-8.0-10.0-10.0-1.0-1.0	R-73, R-75, RE-80	7.40
7559	.05-.1-.1-.1-.3-.5-1.0-8.0-10.0	R-70	6.70
7564	.1-.1-.1-.3-.5-4.0-8.0-8.0-10.0-10.0	R-73, R-75, RE-80	7.24
7578	.05-.05	RAE-84	1.04
7582	.1-.1-.1-1.0-1.0-8.0-10.0-10.0	R-73, R-75	8.06
7583	4.0-8.0-8.0-10.0-10.0	R-73, R-75	10.00
8384	.1-.1-4.0	R-62	5.88
8498	1.0-1.0-1.0-1.5-1.5-2.0	R-67	9.75
8553	.05-2.0-3.0-3.0	RAE-68, R-80, R-82, R-86	8.64
8712	.1-.2-.3-.5-.5	RE-20, R-50, R-55, RAE-59	4.60
8751	.01-.5-.5-4.0-4.0	RE-20, R-50, R-55, RAE-59, RAE-79	4.60
8839	.01-.05-.1-.1-.5-.5-4.0-8.0-10.0	R-4	7.70
8846	.01-.05-.1-.1-.5-.5-4.0-8.0-10.0	R-6	7.75
8890	.005-.005-.05-.05-.1-.1-.1-.25-.75-4.0	P-31	4.55
8902	.01-.5-.5-2.0-4.0-10.0-10.0	CE-29	7.55
8910	10.0-10.0	R-78, RAE-84	4.10
8982	1.0-1.0	R-90, R-90P, 260	1.44
10400	.1-.1-.55	R-32, RE-45, R-52, RE-75	2.40
10404	.1-.1-.125	R-32, RE-45, R-52, RE-75	2.40
10818	.25-.75	R-34, R-35, R-39, RE-57, RE-73	1.25
10819	.1-1.0	R-34, R-35, R-39, RE-57, RE-73	1.20
10837	.1-.1-.1	R-34, R-35, R-39, RE-57, RE-73	.75
10993	.25-.25-.25	R-32, RE-45, R-52, RE-75	1.75

TYPICAL SCHEMATIC DIAGRAMS FOR RCA ANTENNA COILS

STOCK N^o 6470 and 6527

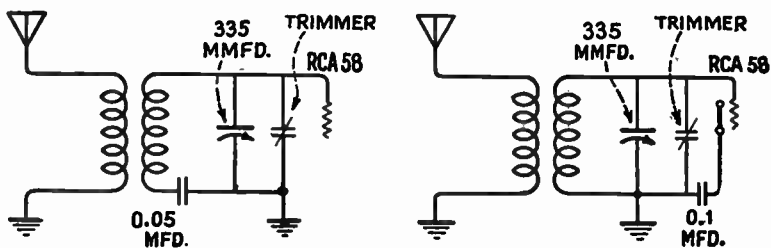

STOCK N^o 6489 and 6731

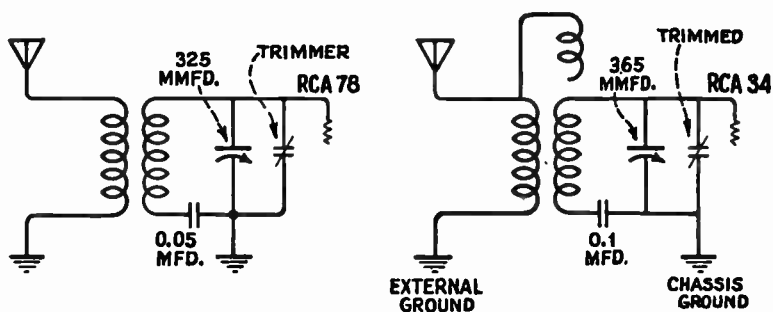

STOCK N^o 6519

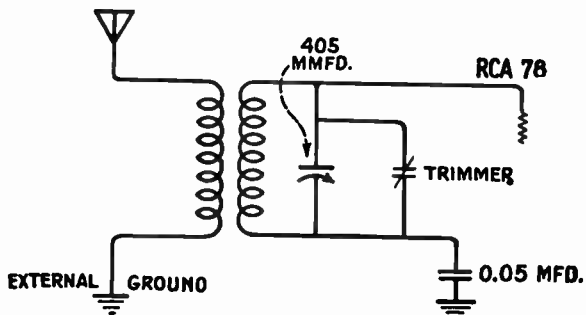

ANTENNA COILS

RCA Antenna Coils are of efficient design and simple construction. For improved performance, use these coils for general replacement use in circuits similar to those shown on opposite page.

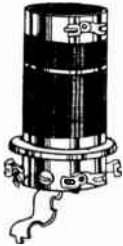

TYPICAL RCA
ANTENNA COIL

STOCK NO.	USED IN	LIST PRICE
6470	R-28BW, R-37, R-38, RE-40, R-28, R-37P	\$1.08
6519	R-22, 112, 114	.88
6527	R-28P, R-37P, R-38P, RE-40P, 110, 111, 115, 120, 210, 330, 310, 331	1.08
6538	R-90P, 260	1.80
6544	R-51B, R-53B	.85
6561	280	1.65
6666	100, 101	1.08
6683	220, 222	1.38
6701	121, 122	2.64
6731	M-105	.88

ALL-WAVE COILS AND TRIMMER CAPACITORS

All-Wave Coils complete with an associated tuning capacitor are necessary for modern receivers and experimental designs. The coils listed are suitable for many applications and cover the frequency range given when used with tuning capacitors having a range of 16-335 MMFD.

STOCK NO.	FUNCTION	FREQUENCY—K.C.	LIST PRICE
6628	Antenna	8000-18000	\$1.50
6631	Antenna	150-410	2.16
6632	RF	150-410	2.10
6633	Oscillator	150-410	1.40
6634	Antenna	540-1500	1.86
6635	RF	540-1500	2.00
6636	Oscillator	540-1500	1.40
6637	Antenna	1500-4000	1.56
6638	RF	1500-4000	1.66
6639	Oscillator	1500-4000	1.40
6640	Antenna	4000-10000	1.54
6641	RF	4000-10000	1.60
6642	Oscillator	4000-10000	1.34
6643	RF	8000-18000	1.52
6644	Oscillator	8000-18000	1.54

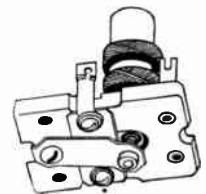

ALL-WAVE COIL
WITH TRIMMER
CAPACITOR

TYPICAL SCHEMATIC DIAGRAMS FOR RCA ANTENNA COILS

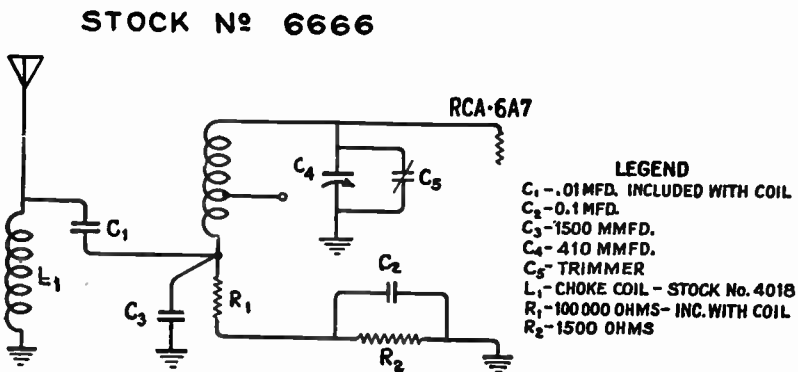
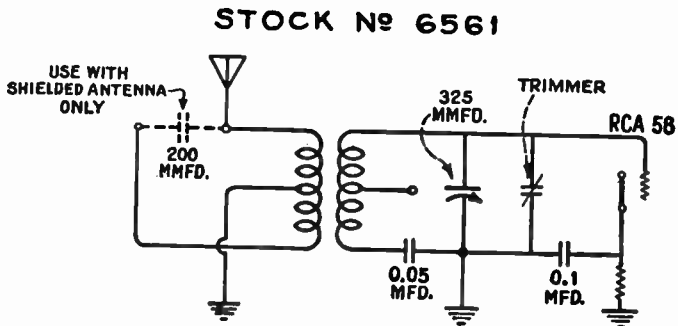
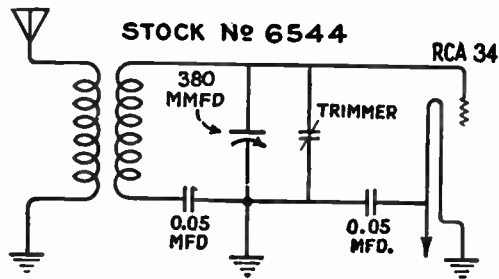

TYPICAL SCHEMATIC DIAGRAMS FOR RCA R. F. COILS

STOCK N^o 6308 OR 6433

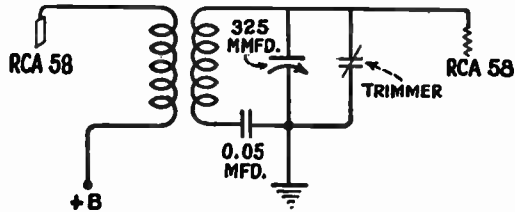

STOCK N^o 6373 OR 6454

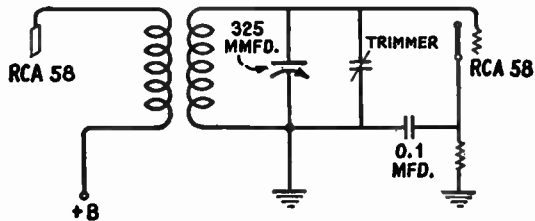

STOCK N^o 6419

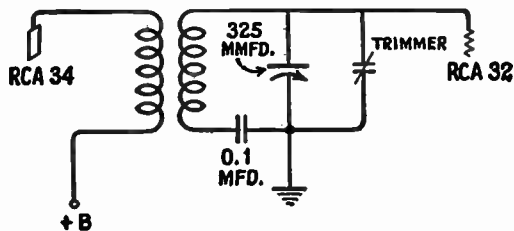

TYPICAL SCHEMATIC DIAGRAMS FOR RCA R. F. COILS

STOCK N^o 3540 COIL

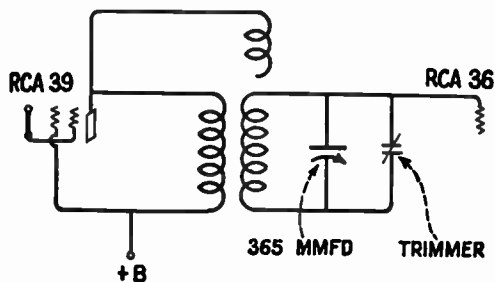

STOCK N^o 6137 COIL

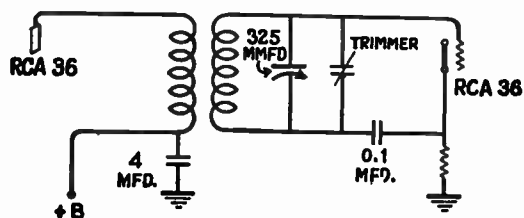

STOCK N^o 6366 OR 6426

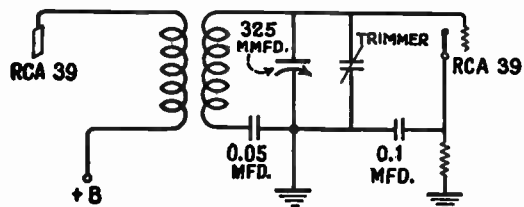

RADIO FREQUENCY COILS

RCA Radio Frequency Coils are suitable for the first detector circuit of many receivers. While designed for the receivers listed, they are also suitable for applications shown on pages 55 and 56.

See Diagrams
Pages 55 and 56
for
Typical Circuits

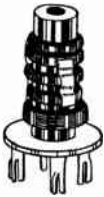

Using These
Precision Coils

STOCK NO.	USED IN	LIST PRICE
2738	R-80, R-82, R-86, RAE-68	\$0.42
2997	R-7A, R-7LW, R-10DC, RE-16A, R-7, R-9, R-4, R-6	
3540	R-27	1.60
6137	M-30	1.08
6366	M-32	.90
6373	R-70	1.32
6411	R-24A, SWA-3	1.06
6419	R-3B	1.54
6426	R-25DC	1.04
6433	R-90	.95
6454	R-73, R-75	1.80
6520	R-22, 112, 114	.90
6528	R-28P, R-38P, RE-40P, 110, 111, 115, 120, 210, 330, 310, 331, R-38	.94
6540	M-34, M-105	.94
6588	300	.70
6699	121, 122	2.44
6719	142B, 241B	.90
7261	R-43	1.25
7278	R-50, R-55, RAE-59, RAE-79, RE-20	1.60
7493	R-8 (220 V)	1.25

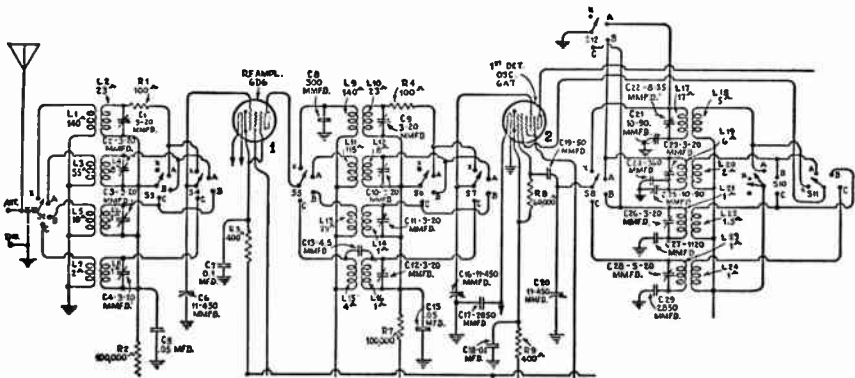

TYPICAL R. F. SYSTEM OF AN ALL-WAVE RECEIVER

RCA CARBON TYPE RESISTORS

Rigid inspection, close tolerances and conservative ratings are inherent characteristics of RCA Carbon Resistors. Color coded in accordance with RMA standards, they are suitable for all replacement and experimental purposes. A wide assortment of values permits selection of the proper value and wattage rating.

RCA CARBON RESISTORS— $\frac{1}{4}$ WATT LIST PRICE 20 CENTS EACH

● CLOSE LIMITS $\pm 10\%$

● CONSERVATIVE RATING



● RMA COLOR CODED

● 100% FACTORY TESTED

RESISTANCE OHMS	STOCK NO.	RESISTANCE OHMS	STOCK NO.	RESISTANCE OHMS	STOCK NO.
80	4091	1800	3706	100000	3118
100	3442	3000	4242	140000	6241
140	3443	5000	2871	200000	3116
150	3059	6000	6243	250000	3744
270	6135	10000	3381	300000	3922
400	3704	15000	3998	400000	3619
550	6246	30000	3152	500000	6186
600	3708	40000	6143	700000	6244
700	4240	50000	3114	1000000	3033
750	4020	60000	3602	1500000	4241
850	6247	65000	6245	2000000	6242
1700	3703	80000	3357		



RCA Victor Model Shop where all new designs are tested prior to production

RCA CARBON RESISTORS— $\frac{1}{2}$ WATT

LIST PRICE 20 CENTS EACH

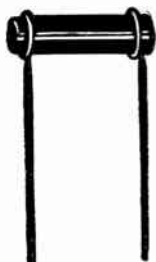

● LONG PIGTAILS

● QUIET OPERATION

● AMPLE OVERLOAD RATING

● NON-INDUCTIVE

$\frac{1}{2}$ watt

RESISTANCE OHMS	STOCK NO.	RESISTANCE OHMS	STOCK NO.	RESISTANCE OHMS	STOCK NO.
50	3614	2600	3900	60000	6282
63	3579	2800	3458	70000	3464
100	4170	3000	3358	80000	3297
150	3049	3500	3939	90000	3912
170	6304	4000	6250	100000	3252
200	3581	4500	3440	110000	3295
220	6313	5000	3413	150000	3360
250	3435	6000	6142	160000	3080
300	3792	8000	6183	170000	3869
400	3863	10000	3078	190000	3046
500	3383	11000	2832	200000	6228
600	3892	15000	6279	230000	3946
700	3798	16000	3452	250000	3514
750	3382	17000	3522	300000	6187
800	3868	18000	3219	350000	3948
850	3631	19000	6240	390000	3947
1000	2816	20000	6303	400000	6280
1100	6281	24000	3453	450000	3700
1200	3554	25000	3264	500000	3048
1500	3047	30000	3077	600000	3439
1600	3560	31000	3559	750000	6278
1700	3436	40000	3079	1000000	3076
1800	3515	45000	6315	2000000	6188
2000	3526	50000	3594	5000000	3051
2500	6316				



Read RCA Radio Service News. It's the liveliest and timeliest paper in the service industry. To have your name placed on the mailing list, address a request to RCA Radio Service News, Camden, N. J., U. S. A.

RCA CARBON RESISTORS—1 WATT

LIST PRICE 22 CENTS EACH

● SOLID CARBON

● STRONG MECHANICALLY



● EASILY MOUNTED

● ALL SIZES AVAILABLE

1 watt

RESISTANCE OHMS	STOCK NO.	RESISTANCE OHMS	STOCK NO.	RESISTANCE OHMS	STOCK NO.
130	10839	5000	3891	50000	2969
170	2736	6000	2563	60000	2724
400	3897	6500	3470	70000	2880
450	6040	8000	2963	80000	6104
500	3632	9000	3155	100000	3058
600	2965	10000	2731	110000	2732
650	3037	12000	3066	180000	3034
800	6103	13000	2964	200000	2798
1000	3738	14000	6306	250000	2549
1200	6134	15000	2545	270000	3039
1300	3035	16000	2796	280000	2971
1500	3153	17000	2797	350000	3038
2000	2547	18000	2730	430000	2799
2500	3469	20000	6114	500000	2970
2800	10840	28000	2966	1000000	2546
3000	3607	29000	3036	1500000	10841
3200	2794	30000	2240	2500000	2367
3500	6136	40000	3045	4000000	2011
4000	3044	45000	2967	6000000	2814
4500	2990				

RCA CARBON RESISTORS—3 WATT

LIST PRICE 25 CENTS EACH

RESISTANCE OHMS	STOCK NO.	RESISTANCE OHMS	STOCK NO.
700	3145	14000	3050
3000	4239	16000	3081
8500	3771	20000	5817
9000	10838	25000	3889
10000	3630	40000	6105
12000	2795		

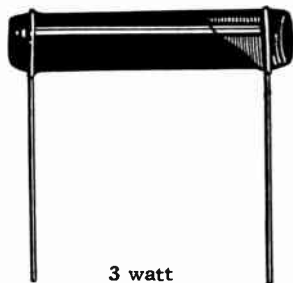

3 watt

RCA WIRE-WOUND RESISTORS—PORCELAIN TYPE

RCA Porcelain Type Resistors are necessary for applications where resistors must dissipate several watts. A large selection fills all requirements for resistors of this type. Rugged mechanical strength, high overload rating and convenient taps make these resistors adaptable to many experimental applications.

*A Heavy
Duty Resistor*



*For High
Current Uses*

TOTAL RESISTANCE OHMS	TAPPED SECTIONS OHMS	OVERALL LENGTH INCHES	OUTSIDE DIAMETER INCHES	INSIDE DIAMETER INCHES	STOCK NO.	LIST PRICE
.62		2	$\frac{7}{16}$	$\frac{1}{4}$	6737	\$0.56
1.9		$1\frac{1}{2}$	$\frac{1}{2}$	$\frac{5}{16}$	3001	.60
15		2	$\frac{7}{16}$	$\frac{1}{4}$	3414	.88
20		2	$\frac{1}{2}$	$\frac{5}{16}$	3002	.60
34		2	$\frac{7}{16}$	$\frac{1}{4}$	6295	.60
36		$4\frac{1}{8}$	$\frac{3}{4}$	$\frac{7}{16}$	2827	1.30
48	16-16-16	$4\frac{1}{2}$	$\frac{1}{2}$	$\frac{1}{4}$	2572	1.00
50		2	$\frac{7}{16}$	$\frac{1}{4}$	3770	.34
180	17-163	$8\frac{1}{2}$	$1\frac{1}{8}$	$\frac{3}{4}$	3004	1.48
180		$5\frac{1}{2}$	$\frac{9}{16}$	$\frac{5}{16}$	6507	.60
200		$1\frac{3}{4}$	$\frac{5}{16}$	$\frac{3}{16}$	3552	.80
250		$7\frac{1}{8}$	$\frac{9}{16}$	$\frac{5}{16}$	3720	1.00
254	12.5-12.5-12.5-216.5	$6\frac{1}{8}$	$1\frac{1}{4}$	$\frac{27}{32}$	3478	1.86
315		$7\frac{1}{8}$	$\frac{9}{16}$	$\frac{5}{16}$	3806	.40
320		5	$\frac{3}{4}$	$\frac{1}{2}$	3915	.88
380		5	$\frac{15}{16}$	$\frac{5}{8}$	2145	1.60
584	80-504	$3\frac{3}{16}$	1	$\frac{5}{8}$	2571	1.80
636	80-556	$3\frac{1}{8}$	1	$\frac{5}{8}$	2372	1.48
2005	425-1580	5	$\frac{3}{4}$	$\frac{1}{2}$	6296	.80
3040	160-130-250-1000-1500	$6\frac{1}{2}$	1	$\frac{5}{8}$	2343	2.00
3665	365-3300	2	$\frac{7}{16}$	$\frac{1}{4}$	3457	.78
4500		2	$\frac{7}{16}$	$\frac{1}{4}$	3369	.85
7400	3800-500-3100	4	$\frac{7}{16}$	$\frac{1}{4}$	3774	.80
7800	3635-3600-565	4	$\frac{9}{16}$	$\frac{3}{8}$	6283	1.00
8000		$1\frac{3}{4}$	$\frac{5}{16}$	$\frac{3}{16}$	3553	.80
10000		2	$\frac{7}{16}$	$\frac{1}{4}$	3991	.60

RCA FLAT WIRE-WOUND RESISTORS

RCA Flat Wire-Wound Resistors are suitable for many purposes where resistors of higher current carrying capacity are required. The 55 ohm and 60 ohm value are particularly suited for center-tap filament requirements.

*High Quality
Resistor*



*For Biasing
Output Tube*

RESISTANCE	TAPPED SECTIONS	STOCK NO.	LIST PRICE
5	No Taps	2013	\$0.50
15	No Taps	3397	.52
17	No Taps	3275	.40
20	10, 10	10434	.25
55	27.5, 27.5	2722	.50
60	30, 30	6025	.60
440	60, 70, 120, 90	7458	.50
715	No Taps	7053	.50
800	No Taps	2007	.40
1000	No Taps	2028	.40
3940	.600, 1900, 440	2242	.80

RCA FLEXIBLE WIRE-WOUND RESISTORS

RCA Flexible Wire-Wound Resistors are suitable for a wide variety of replacement purposes because of their adaptability to various mounting requirements. They are rated at 1 watt per inch for the $\frac{3}{16}$ " diameter resistors and $\frac{1}{2}$ watt per inch for the $\frac{1}{8}$ " diameter resistors. They are color coded in accordance with RMA standards.



*A Resistor
That Also
Serves As a
Connection
Wire*

RESISTANCE, OHMS	STOCK NO.	LIST PRICE
.5	3743	\$0.20
.7	4356	.15
1.5	6249	.20
2.3	3576	.24
4	6144	.20
15	3220	.20
100	4418	.15
120	3359	.20
300	3468	.20
370	3550	.16
2500	4208	.15

RCA INTERMEDIATE FREQUENCY TRANSFORMER

The modern superheterodyne radio receiver is the direct result of intensive research and resultant refinements carried on by RCA since the first introduction to the industry of the inherent advantages of this type of circuit. Because of this basic background RCA intermediate frequency transformers are today conceded to be the most efficient for this very important feature of the superheterodyne radio receiver. Every research and manufacturing facility commanded by RCA has been combined in the creating of an intermediate frequency transformer of excellent construction.



"A" MOUNTING

*Transformer
and
Two Trimmers
in
One Case*

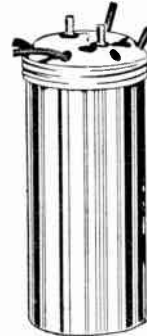

"B" MOUNTING

FIRST STAGE

STOCK NO.	MOUNTING	FREQUENCY K.C.	USED IN	LIST PRICE
2991	A	175	R-7A, R-4, R-6, RAE-16A	\$2.04
3636	A	175	M-34, M-105	1.74
6309	A	175	R-24, R-71, R-72	2.50
6326	A	175	R-71B	2.05
6360	A	175	M-32	2.14
6367	A	175	R-73, R-75, RE-80	2.14
6376	A	175	R-70	2.12
6416	A	175	R-3B	2.18
6423	A	175	R-25DC	2.84
6435	A	175	R-90, R-90P, 260	2.54
6483	A	175	R-37, R-38, 120	1.84
6524	A	175	R-51B, R-53B	2.28
6553	A	175	330, 331	1.56
6564	A	175	280	2.30
6610	A	445	140, 141, 240	1.55
6662	B	460	100, 101	2.34
6686	A	175	220, 222	1.80
6697	B	370	121, 122	1.80
6712	A	175	142B, 241B	1.70
7262	A	175	R-43	2.00
7266	A	175	R-11, RE-18, RE-18A, R-21, RAE-26	2.20

FIRST STAGE—(Continued)

STOCK NO.	MOUNTING	FREQUENCY K.C.	USED IN	LIST PRICE
7281	A	175	RE-20, R-50, R-55, RAE-59, RAE-79	\$2.00
7340	A	175	R-8, R-10, R-12, RE-19, RO-23	2.00
7422	A	175	M-30	2.00
7480	A	175	R-78, RAE-84	2.15
7514	A	175	R-74, R-76, R-77, RE-81	2.04
8567	A	175	R-80, R-82, R-86, RAE-68	2.10

SECOND STAGE

STOCK NO.	MOUNTING	FREQUENCY K.C.	USED IN	LIST PRICE
2992	A	175	R-7, R-7A, R-9, R-10DC, RE-16A	\$2.20
3637	A	175	M-34, M-105	1.65
6310	A	175	R-24, R-71, R-72	2.50
6327	A	175	R-71B	2.85
6353	A	175	R-78A, RAE-84	2.35
6361	A	175	M-32	2.28
6368	A	175	R-73, R-75, RE-80	2.14
6375	A	175	R-70	1.88
6417	A	175	R-3B	2.02
6424	A	175	R-25DC	2.20
6440	A	175	R-90, R-90P, 260	1.94
6464	A	175	R-28, R-28P, R-28BW, RE-40, RE-40P, R-22, 110, 111, 114, 115, 210, 310	1.88
6484	A	175	R-37, R-38, R-37P, R-38P, 120	1.70
6525	A	175	R-51B, R-53B	2.25
6554	A	175	330, 331	1.64
6565	A	175	280	2.10
6611	A	445	140, 141, 240	1.62
6663	B	460	100, 101	1.06
6687	A	175	220, 222	1.78
6698	B	370	121, 122	1.78
6713	A	175	142B, 241B	1.92
6727	A	175	112	1.68
7263	A	175	R-43	2.00
7267	A	175	R-11, RE-18, RE-18A, R-21, RAE-26	2.00
7282	A	175	RE-20, R-50, R-55, RAE-59	2.40
7341	A	175	R-8, R-10, R-12, RE-19, RO-23	2.00
7365	A	175	RAE-79	2.50
7423	A	175	M-30	2.00
7499	A	175	R-78	2.15
7515	A	175	R-74, R-76, R-77, RE-81	2.00
8565	A	175	R-80, R-82, R-86, RAE-68	2.10
8841	A	175	R-4, R-6	1.80

THIRD STAGE

STOCK NO.	MOUNTING	FREQUENCY K.C.	USED IN	LIST PRICE
6352	A	175	R-78A, RAE-84	\$2.35
6441	A	175	R-90, R-90P, 260	1.76
6566	A	175	280	1.72
7283	A	175	RE-20, R-50, R-55, RAE-59, RAE-79	3.25
7492	A	175	R-78	1.80
8566	A	175	R-80, R-82, R-86, RAE-68	2.10

RCA AUDIO TRANSFORMERS

Use RCA-quality Audio Transformers replacements in all sets. Consult "turn ratio," "primary impedance," and "tube" column for the transformer you need.

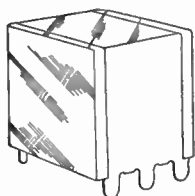

"A" MOUNTING



"B" MOUNTING

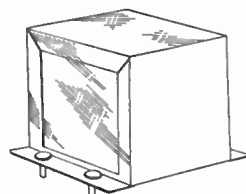

"C" MOUNTING

STOCK NO.	TURN RATIO	PRIMARY IMPEDANCE AT 60 CYCLES A.C.	COUPLES TUBES	MOUNTING	LIST PRICE
6432	1-3	88000 ohms	56 and PP-2A5	A	\$3.69
6488	1-1	12500 "	6B7 and 89	A	1.30
6551	2-1	5300 "	56 and 53*	B	1.48
6562	3-1	35000 "	PP-56 and PP-59*	A	3.04
6568	1-2	95000 "	55 and PP-56	A	3.10
6608	2.6-1	7500 "	56 and 53*	C	2.04
6710	1-1.5	7500 "	30 and PP-30*	B	2.22
6732	1-2	4000 "	6B7 and 41	B	2.00
7271	1-2	40000 "	27 and PP-47	C	2.20
7425	1-1	8750 "	37 and PP-112A*	A	1.60
7479	1-4	75000 "	56 and PP-56	A	3.25
7519	3-1	12000 "	56 and PP-46*	C	2.35
7549	1-3	51000 "	55 and PP-2A5	A	2.48
7558	1-2	95000 "	56 and 47	A	2.48

*Class "B" Amplifier.

OUTPUT TRANSFORMERS

RCA Victor Audio and Output Transformers are built to the exacting standards required of all component parts used in RCA Victor receivers and amplifiers. Electrically they are designed to have a flat frequency response throughout the audio frequency spectrum, thus assuring distortionless reproduction.

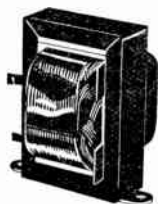

"A" MOUNTING

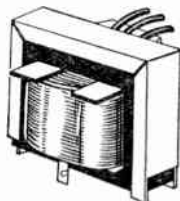

"B" MOUNTING



"C" MOUNTING

STOCK NO.	TURN RATIO	PRIMARY IMPEDANCE AT 3 VOLTS-60 CYCLES A.C.	USED WITH TUBES	MOUNTING	LIST PRICE
3688	39.4-1	2400 ohms	Single 89	A	\$1.50
6254	58.6-1	7500 "	Push-Pull 30	B	1.80
6325	47-1	10000 "	Push-Pull 46*	B	2.00
6334	25.9-1	22000 "	Push-Pull 46*	A	2.80
6364	44.9-1	3000 "	Single 89	B	2.00
6371	55.2-1	11500 "	Push-Pull 47	B	1.90
6378	39.2-1	2350 "	Single 47	B	1.94
6455	55.2-1	9500 "	Push-Pull 2A5	B	1.95
6467	39.4-1	2400 "	Single 2A5	A	1.44
6476	39.4-1	2400 "	Single 2A5	A	1.44
6477	107.8-1	2500 "	Single 38	A	1.32
6509	30.6-1	2100 "	Single 43	A	1.34
6526	64.1-1	11300 "	Push-Pull 30*	B	1.80
6556	50.5-1	10000 "	Single 53	A	1.50
6569	46.25-1	22000 "	Push-Pull 59	A	1.95
6591	58.4-1	3100 "	Single 38	A	1.22
6605	50.5-1	10000 "	Single 53	A	1.48
6659	44.2-1	3400 "	Single 38	A	1.60
6690	39.4-1	2400 "	Single 2A5	A	1.46
6709	59.2-1	10000 "	Push-Pull 30*	A	2.18
6730	30.6-1	2100 "	Single 43	A	1.52
6770	39.7-1	2400 "	Single 2A5	A	2.00
6788	42-1	3100 "	Single 41	A	1.60
7104	44.8-1	8500 "	Push-Pull 45	C	2.50
7234	38.7-1	1100 "	Single 47	B	1.20
7258	64.5-1	6000 "	Push-Pull 47	B	1.20
7276	55.2-1	6600 "	Push-Pull 38	B	1.00
7424	58.5-1	3350 "	Push-Pull 112A*	A	1.20

*Class "B" Amplifier.

RCA FILTER REACTORS

RCA Victor Filter Reactors are constructed of the finest materials under the strict specifications necessary in this type of equipment. In common with audio and power transformers they are subjected to high potential insulation tests and vacuum impregnated to insure against failure due to extreme humidity conditions. They are available in the three physical types illustrated and in a wide range of electrical values. The d-c resistance specification is given at a temperature of 25° Centigrade.

High quality reactors for reducing hum, for impedance coupling of tubes, and for use in amateur transmitters.

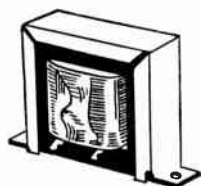

"A" MOUNTING

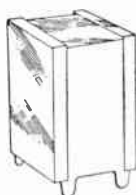

"B" MOUNTING

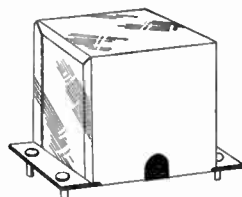

"C" MOUNTING

SPECIFICATIONS		INDUC- TANCE HENRIES	DIRECT CURRENT MILLI- AMPERES	MOUNT- ING	STOCK NO.	LIST PRICE
D-C RESIST- ANCE OHMS	A-C IMPEDANCE					
59	4700 ohms at 60 cycles	12.0	50	B	8911	\$3.15
157	2500 ohms at 60 cycles	6.5	50	B	7518	2.30
450	3600 ohms at 60 cycles	10.0	30	A	3724	1.10
450	2600 ohms at 60 cycles	7.0	55	A	6505	1.06
500	4500 ohms at 60 cycles	12.0	15	A	3537	1.10
770	6000 ohms at 60 cycles	16.0	43	C	6606	1.66
1000	5800 ohms at 60 cycles	15.0	45	A	6552	1.04
1300	11500 ohms at 60 cycles	30.0	30	B	6431	1.92
2300	52000 ohms at 60 cycles	75.0	0.75	A	6301	1.40

RCA POWER TRANSFORMERS

Stock No.	Typical Tube Combinations	SECONDARY VOLTAGES						LEAD COLORS—See Diagram Opposite Page											Mounting	List Price
		D-E		F-H		J-L		A	B	C	D	E	F	G	H	J	K	L		
		Voltage	Current	Voltage	Current RMS	Voltage	Current													
7560	3-58, 2-56, 1-47, 1-80	5.0	2.0	750	.075	2.5	7.25	Red	...	Red	Yellow	Yellow	Brown	{ Black Brown	Brown	Blue	{ Blue Yellow	Blue	A	\$6.14
7584	3-58, 1-56, 1-55, 2-2A5, 1-80	5.0	2.0	750	.097	2.5	9.0	Red	...	Red	Yellow	Yellow	Brown	{ Black Brown	Brown	Blue	{ Blue Yellow	Blue	A	5.72
8556	4-24A, 2-27, 2-45, 1-80	5.0	2.0	760	.093	2.5	13.55	{ Black Red T	{ Black Red	Black	{ Brown Green	{ Brown Green	{ Black Blue	{ Yellow Red	{ Black Blue	Brown	...	Brown	B	9.52
8669	2-24A, 1-27, 1-80	5.0	2.0	650	.055	2.5	7.0	Red	...	{ Black Red	Yellow	Yellow	Brown	{ Black Brown	Brown	Blue	{ Blue Yellow	Blue	A	5.20
8679	2-35, 1-24A, 2-27, 2-47, 1-80	5.2	2.0	750	.084	2.6	12.0	Red	...	{ Black Red	Yellow	Yellow	Brown	{ Black Brown	Brown	Blue	{ Black Blue	Blue	A	7.50
8842	2-35, 1-24A, 2-27, 1-47, 1-80	5.2	2.0	740	.065	2.6	10.9	Red	...	Red	Yellow	Yellow	Brown	{ Black Brown	Brown	Blue	{ Blue Yellow	Blue	A	5.20
8900	1-30, 2-47, 1-80	5.2	2.0	780	.080	2.6	3.0	Red	...	Red	Yellow	Yellow	Brown	{ Black Brown	Brown	Green	{ Green Yellow	Green	A	5.60
8978	4-58, 3-56, 2-2A5, 1-80	5.0	2.0	775	.118	2.5	12.5	Red	...	Red	Yellow	Yellow	Brown	{ Black Brown	Brown	Blue	{ Blue Yellow	Blue	C	8.50
8985	1-2A5, 1-58, 1-57, 1-2A7, 1-80	5.0	2.0	750	.076	2.5	5.2	Red	...	Red	Yellow	Yellow	Brown	{ Black Brown	Brown	Blue	{ Blue Yellow	Blue	C	4.26
9005	2-58, 1-2A7, 1-2B7, 1-2A5, 1-80	5.0	2.0	750	.078	2.5	6.2	Red	...	Red	Yellow	Yellow	Brown	{ Black Brown	Brown	Blue	{ Blue Yellow	Blue	C	4.80
9026	2-58, 1-2A7, 1-55, 1-56, 1-80, 1-53	5.0	2.0	615	.100	2.5	7.4	Red	...	Red	Yellow	Yellow	Brown	{ Black Brown	Brown	Blue	{ Blue Yellow	Blue	C	4.80
9028	4-56, 4-58, 1-55, 2-59, 1-5Z3	5.0	3.0	990	.09	2.5	15.25	{ Black Red T	{ Red Black	Red	Yellow	Yellow	Brown	{ Black Brown	Brown	Blue	{ Blue Yellow	Blue	C	7.75
9042	3-58, 1-2A7, 1-2B7, 1-56, 1-53, 1-80	5.0	2.0	640	.133	2.5	8.44	Red	...	{ Black Red	Yellow	Yellow	Brown	{ Black Brown	Brown	Blue	{ Blue Yellow	Blue	B	6.84
9441	2-58, 1-2A7, 1-2B7, 1-2A5, 1-80	5.0	2.0	750	.087	2.5	6.2	Red	...	Red	Yellow	Yellow	Brown	{ Black Brown	Brown	Blue	{ Blue Yellow	Blue	C	4.92
9446	2-58, 1-2A7, 1-2B7, 1-2A5, 1-80	5.0	2.0	750	.087	2.5	6.2	{ Red Black	{ Red Black	Red	Yellow	Yellow	Brown	{ Black Brown	Brown	Blue	{ Blue Yellow	Blue	C	5.40
9464	1-6A7, 1-6F7, 1-41, 1-1V	6.3	.828	330	.105	19.0	.38	Red	...	Red	Blue	...	Brown	Green	...	Black	C	3.20
9505	2-6D8, 1-6A7, 4-76, 242, 1-5Z3	5.0	3.0	775	.113	6.3	4.5	Red	{ Red Black	{ Black Red T	Yellow	Yellow	Brown	{ Black Brown	Brown	Blue	...	Blue	C	6.35
9511	2-6D8, 1-6A7, 1-6B7, 1-41, 1-80	5.0	2.0	700	.076	6.3	1.6	Red	...	Red	Yellow	Yellow	Brown	{ Black Brown	Brown	Blue	...	Blue	C	4.78

Also available in 25-40 cycles at slightly higher price.

RCA POWER TRANSFORMERS

Of rugged construction, the power transformers listed have been designed for continuous operation under extreme conditions of temperature and humidity. Each transformer is subjected to high potential tests, which must be withstood for a definite period, between the given winding and all other windings and from each winding to the case. The three different types of mountings provide a unit for many requirements. The typical tube combinations column represents the tubes used in the RCA Victor receivers using the particular power transformer, but, of course, any combination of tubes of the proper voltage and current ratings can be used.

See Opposite Page for Specifications and Prices



"A" MOUNTING



"B" MOUNTING



"C" MOUNTING

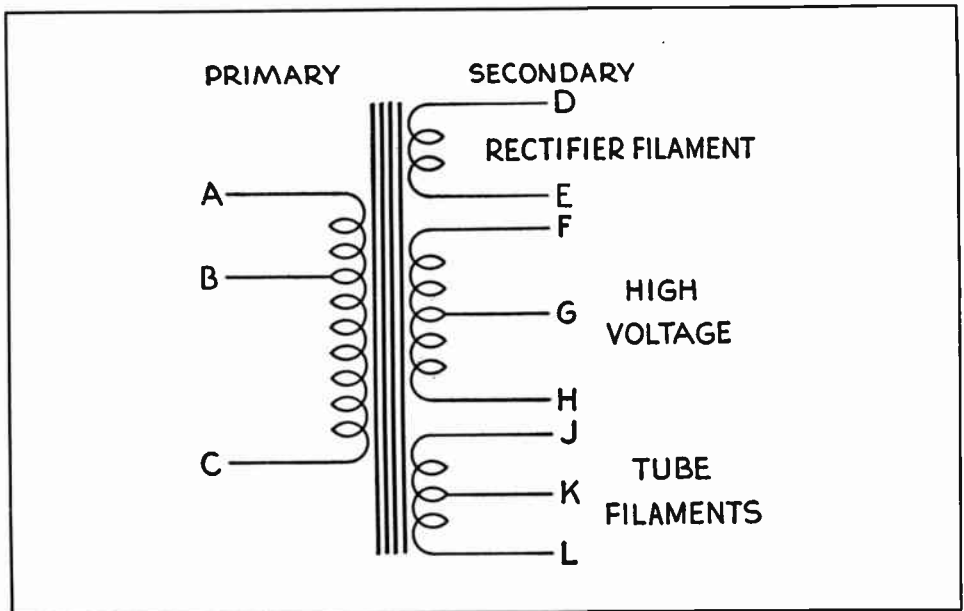

Key Diagram to Transformers Listed on Opposite Page

RCA VOLUME AND TONE CONTROLS

RCA Volume and Tone Control Potentiometers are manufactured from the finest materials primarily for use in RCA Victor radio receivers. A large selection of resistance values and physical characteristics supply the proper unit for all requirements. They are supplied in both the wire-wound and carbon-type, as indicated in the associated table, and have a standardized $\frac{3}{8}$ " x 32" thread for which a mounting nut is supplied. They are quiet in operation and give excellent service.

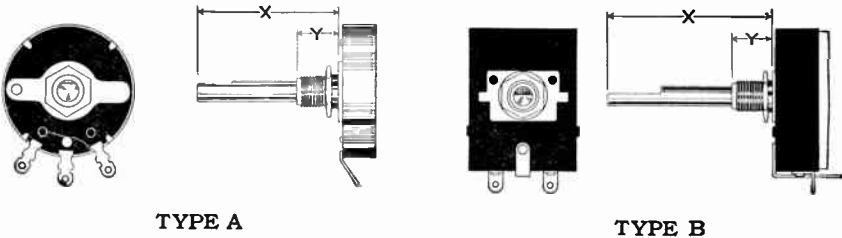

TYPE A TYPE B

A Unit For Any Requirement

ELECTRICAL SPECIFICATIONS				MECHANICAL SPECIFICATIONS			Switch	STOCK NO.	LIST PRICE
RESISTANCE AT PERCENTAGE SHAFT ROTATION				TYPE	X INCHES	Y INCHES			
25%	50%	75%	100%						
15	30	45	60	A-Wire	1 $\frac{3}{8}$	$\frac{3}{4}$	No	7078	\$1.25
15	30	45	60	A-Wire	1 $\frac{7}{16}$	$\frac{13}{16}$	No	3164	1.50
750	1500	2250	3000	A-Wire	1 $\frac{19}{32}$	$\frac{1}{4}$	Yes	6465	1.22
750	1500	2250	3000	A-Wire	1 $\frac{1}{32}$	$\frac{1}{4}$	Yes	6599	1.25
900	1800	2700	3600	A-Wire	1 $\frac{5}{16}$	$\frac{7}{16}$	Yes	7061	1.20
1125	2250	3375	4500	A-Wire	1 $\frac{3}{16}$	$\frac{3}{8}$	Yes	6508	1.36
1125	2250	3375	4500	A-Wire	1 $\frac{15}{16}$	$\frac{7}{16}$	No	2995	1.20
30	150	900	5000	B-Carbon	1 $\frac{1}{32}$	$\frac{3}{8}$	No	6590	1.20
90	8000	19000	20000	A-Carbon	1 $\frac{11}{64}$	$\frac{1}{2}$	No	2959	1.15
400	400	400	0	A-Wire	2	$\frac{3}{8}$	No	6275	2.50
4000	8000	14000	25000	B-Carbon			No		
12500	25000	37500	50000	A-Carbon	1 $\frac{1}{16}$	$\frac{13}{64}$	No	6157	1.25
4000	8300	13800	30000	B-Carbon	2	$\frac{3}{8}$	No	6355	1.45
4000	12500	33500	50000	A-Carbon	1 $\frac{19}{32}$	$\frac{3}{8}$	No	6714	1.20
3500	12500	29000	50000	A-Carbon	1 $\frac{5}{16}$	$\frac{3}{8}$	No	3142	1.25
8500	17000	25000	50000	B-Carbon	2	$\frac{3}{8}$	No	6322	1.25
5000	11000	30000	50000	B-Carbon	1 $\frac{15}{16}$	$\frac{3}{8}$	No	3234	1.50
5000	11000	30000	50000	B-Carbon	2	$\frac{5}{32}$	No	6307	1.60
3000	10000	40000	100000	B-Carbon	2	$\frac{5}{32}$	No	6324	1.30

RCA VOLUME AND TONE CONTROLS (Continued)

ELECTRICAL SPECIFICATIONS				MECHANICAL SPECIFICATIONS			Switch	STOCK NO.	LIST PRICE
RESISTANCE AT PERCENTAGE SHAFT ROTATION				TYPE	X INS.	Y INS.			
25%	50%	75%	100%						
4000	7500	42000	100000	A-Carbon	1 1/32	3/8	No	6623	\$1.25
4000	7500	42000	100000	A-Carbon	1 19/32	3/8	Yes	6619	1.44
4000	7500	42000	100000	A-Carbon	1 19/32	3/8	No	6645	1.20
4000	7500	42000	100000	A-Carbon	2 19/32	3/8	Yes	6705	1.20
4000	7500	42000	100000	A-Carbon	2 15/16	3/8	Yes	6681	1.25
19000	38000	116000	190000	A-Carbon	3/8	3/8	Yes	6499	1.36
70000	175000	192000	200000	B-Carbon	2	3/8	No	6448	1.04
18000	42000	120000	200000	B-Carbon	1 15/16	3/8	Yes	3093	1.35
1450	25000	130000	250000	A-Carbon	1 17/32	3/8	No	6612	1.20
2500	13000	55000	500000	B-Carbon	1 19/32	3/8	Yes	6486	1.10
25000	85000	415000	500000	B-Carbon	2	3/8	No	6276	1.40
2750	50000	250000	500000	A-Carbon	1 19/32	3/8	No	6485	1.20
25000	85000	400000	500000	B-Carbon	1 5/16	3/8	No	3143	1.20
2500	13000	55000	500000	B-Carbon	1 25/32	3/8	No	6559	1.60
2500	13000	55000	500000	B-Carbon	1 29/32	3/8	No	6595	1.46
40000	200000	370000	1000000	B-Carbon	2	3/8	No	6328	1.45
50000	200000	500000	1000000	B-Carbon	1 1/2	3/8	No	6363	1.38
120000	500000	620000	1000000	B-Carbon	1 1/32	3/8	Yes	6560	1.60
120000	500000	620000	1000000	B-Carbon	1 19/32	3/8	Yes	6590	1.20
95000	700000	825000	2000000	B-Carbon	2	3/8	No	3707	1.40
2800	80000	360000	2000000	B-Carbon	2	3/8	Yes	6370	1.34
7000	270000	1000000	4000000	B-Carbon	2	3/8	No	6449	1.06

TAPPED VOLUME CONTROLS

STOCK NO.	TOTAL RESIST.	TAPPED AT	LIST PRICE
6275	30,000Ω	6,000Ω	\$2.50
6447	44,000Ω	{ 7,000Ω 14,000Ω }	1.92

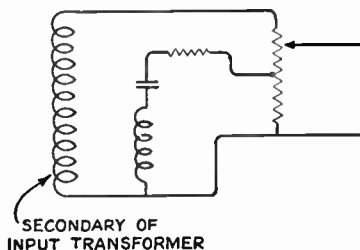

TYPICAL CIRCUIT OF COMPENSATED VOLUME CONTROL OF ELECTRIC PHONOGRAPH

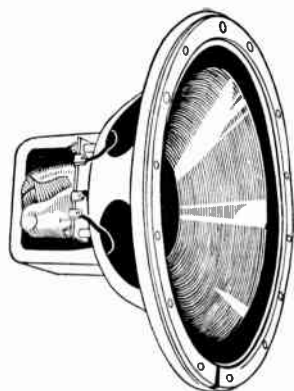

RCA LOUDSPEAKERS

A complete line of dynamic loudspeakers offering a wide choice of both physical and electrical characteristics are included in this list of RCA loudspeakers. The finest materials and workmanship are combined in the production of these units. Excellent fidelity of reproduction is an inherent characteristic of all the loudspeakers listed.

STOCK NO.	PHYSICAL SPECIFICATIONS		ELECTRICAL SPECIFICATIONS		FIELD COIL CURRENT AM-PERES	LIST PRICE
	DIAMETER INCHES	DEPTH INCHES	VOICE COIL IMPEDANCE OHMS	FIELD COIL RESISTANCE OHMS		
7818	8 $\frac{7}{32}$	3 $\frac{3}{4}$	2.1	1290		\$6.58
7819	10 $\frac{3}{8}$	5 $\frac{9}{16}$	4.5	P.M.		12.18
7824	10 $\frac{3}{8}$	6 $\frac{3}{8}$	4.5	40	.4	8.00
7847	6 $\frac{1}{2}$	4 $\frac{3}{32}$	4.2	1350	.060	6.30
9043	6 $\frac{1}{2}$	4 $\frac{3}{32}$	4.2	1360	.063	5.50
9044	6 $\frac{1}{2}$	4 $\frac{3}{32}$	4.2	5900	.029	5.00
9429	5	2 $\frac{13}{32}$	2.2	P.M.		4.85
9435	5	3 $\frac{13}{32}$	4.2	1360	.063	4.75
9436	5	3 $\frac{13}{32}$	4.2	1800	.050	5.30
9438	10 $\frac{3}{8}$	6 $\frac{3}{8}$	4.5	6950	.035	6.88
9440	6 $\frac{5}{16}$	4 $\frac{3}{32}$	4.2	1060	.078	4.75
9445	10 $\frac{3}{8}$	6 $\frac{3}{8}$	4.2	1300		7.14
9447	6 $\frac{1}{2}$	4 $\frac{3}{32}$	4.2	1200		5.25
9449	6 $\frac{1}{2}$	4 $\frac{3}{32}$	4.2	1290	.075	5.20
9453	6 $\frac{9}{16}$	2 $\frac{3}{4}$	4.2	P.M.		5.58
9455	10 $\frac{1}{4}$	5 $\frac{3}{32}$	4.2	P.M.		10.00
9458	5	4	4.2	1500	.050	5.20
9461	10 $\frac{3}{8}$	6 $\frac{3}{8}$	4.2	1300	.085	8.50
9462	5	4	4.2	5900	.029	5.14
9463	10 $\frac{3}{8}$	6 $\frac{3}{8}$	4.2	750	.110	9.42
9467	5	3 $\frac{13}{16}$	4.2	1800	.050	5.15
9472	10 $\frac{3}{8}$	6 $\frac{3}{8}$	4.2	2950	.060	8.50
9473	10 $\frac{3}{8}$	6 $\frac{3}{8}$	4.2	1300	.085	8.00
9474	10 $\frac{3}{8}$	6 $\frac{3}{8}$	4.5	100	.276	7.10
9480	10 $\frac{1}{4}$	7 $\frac{5}{8}$	7.0	2950	.060	15.44
9491	6 $\frac{1}{2}$	4 $\frac{3}{32}$	4.2	4	1.73	4.16
9494	6 $\frac{1}{2}$	4 $\frac{3}{32}$	4.2	4	1.73	5.65
9497	6 $\frac{1}{2}$	4 $\frac{3}{32}$	4.2	40	.4	6.75
9502	6 $\frac{5}{8}$	2 $\frac{3}{4}$	4.2	P.M.		8.40
9508	10 $\frac{3}{8}$	7 $\frac{7}{8}$	7.0	2060	.070	17.40
9514	6 $\frac{1}{2}$	4 $\frac{3}{32}$	4.5	1290	.068	6.00
9527	10 $\frac{3}{8}$	6 $\frac{3}{8}$	4.5	1290	.068	8.00
9532	8 $\frac{7}{32}$	3 $\frac{3}{4}$	2.2	1070	.110	7.50
9536	10 $\frac{3}{8}$	6 $\frac{3}{8}$	4.5	1070	.110	8.40
9538	7 $\frac{5}{8}$	4	4.5	P.M.		7.65
9541	10 $\frac{3}{8}$	7 $\frac{7}{8}$	7.0	2060	.070	17.32
9543	10 $\frac{3}{8}$	6 $\frac{3}{8}$	4.2	1975	.067	10.36

RCA LOUDSPEAKER CONES

While RCA Loudspeaker Cones are designed primarily for replacement use in RCA Loudspeakers, they nevertheless may be used with all speakers provided the mechanical and electrical characteristics are correct. The larger sizes have the corrugated type of construction which eliminates any possibility of paper rattles or cone distortion. The frequency characteristics of RCA Cones when properly used are remarkably free from peals in the useful reproducing range.

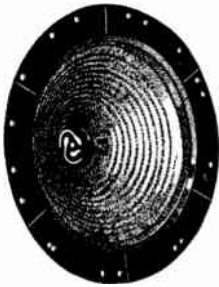

PHYSICAL SPECIFICATIONS			VOICE COIL IMPEDANCE OHMS	STOCK NO.	LIST PRICE
OUTSIDE DIAMETER INCHES	DEPTH INCHES	VOICE COIL DIAMETER INCHES			
5	1 1/2	1 1/8	4.2	8987	\$1.00
5	1 7/32	1 1/16	2.2	7598	.87
5	1 1/2	1 1/8	4.2	9023	1.00
6 1/4	1 3/4	1	4.2	9492	.74
6 3/8	1 13/16	1	4.2	9428	1.00
6 3/8	1 13/16	1	4.2	9499	1.22
7 5/8	2	1 1/16	4.2	8962	1.12
7 5/8	2	1 1/16	4.2	8984	1.25
7 5/8	2	1 1/16	4.5	9539	.86
10 1/4	3 1/4	1 11/32	1.0	8935	1.05
10 1/4	3	1 5/8	13	8558	2.00
10 1/4	3 3/32	1 1/2	3.0	8601	1.50
10 1/4	3 1/4	1 19/32	7.0	8916	1.65



ASSEMBLING RCA VICTOR CONES AT RADIO HEADQUARTERS

REPLACEMENT PARTS GUIDE AND CROSS-INDEX FOR

RCA VICTOR, GENERAL ELECTRIC, WESTINGHOUSE AND GRAYBAR RECEIVERS

The following list gives the Stock Number and List Price of the important parts for the receivers listed. The cross-index shows the model numbers of the receivers that have identical chassis sold by the companies indicated. RCA Victor parts are exact replacements for the General Electric, Westinghouse and Graybar receivers listed. Use this guide for quickly finding the part you need.

RCA Victor	G.E.	Westinghouse Int.	Graybar Electric	Antenna Coil		Detector Oscillator Coil		1st I. F. Trans.		2nd I. F. Trans.		A. F. Trans.		Output Trans. * Combined With A. F. Transformer		Cone		Volume Control		Tone Control		Power Trans.		Filter Pack or High Voltage Capacitor	
				Stock No.	List Price	Stock No.	List Price	Stock No.	List Price	Stock No.	List Price	Stock No.	List Price	Stock No.	List Price	Stock No.	List Price	Stock No.	List Price	Stock No.	List Price	Stock No.	List Price	Stock No.	List Price
R-4	J-70	WR-17	GT-7	2997	\$1.60	7436	\$2.20	2991	\$2.04	8841	\$1.80	8840	\$3.60	*	*	7442	\$1.00	2995	\$1.20	3234	\$1.50	8842	\$5.20	8839	\$7.70
R-5	T-12	WR-14	GB-4	2955	1.20	2956	1.40	2991	2.04	8841	1.80	8840	3.60	7234	1.20	7236	1.00	2959	1.15	2957	1.75	8669	5.20	8839	7.70
R-5-DC	T-12-D	3022	1.30	2956	1.40	2nd R.F.	7252	2.25	7276	1.00	7236	1.00	2959	1.15	7251	2.70
R-5-X	T-12-E	WR-14-CR	...	2955	1.20	2956	1.40	2nd R.F.	2.04	8841	1.80	7343	3.50	7234	1.20	7236	1.00	2959	1.15	3234	1.50	8669	5.20	2957	1.75
R-6	J-75	...	GC-13	2997	1.60	7436	2.20																		
R-7	S-22 and S-22-X	WR-10	GB-8	2997	1.60	2998	2.15	2991	2.04	2992	2.20	7239	4.00	*	*	8601	1.50	2995	1.20	2996	1.20	8679	7.50	2957	1.75
R-7A	S-22 (2)	WR-10-A	GB-8-A	2997	1.60	2998	2.15	2991	2.04	2992	2.20	7255	3.50	*	*	8601	1.50	2995	1.20	3093	1.35	8679	7.50	2957	1.75
R-7-DC & R-9-DC	2997	1.60	2998	2.15	2991	2.04	2992	2.20	7239	4.00	*	*	8601	1.50	2995	1.20	2996	1.20
R-7 LW	2997	1.60	3226	1.05	7336	2.50	7337	2.50	7239	4.00	*	*	8601	1.50	3231	1.25	8769	10.92	2957	1.75
R-8	J-80	WR-18	GT-8	3095	1.25	3235	1.90	7340	2.00	7341	2.00	7343	3.50	*	*	8601	1.50	3092	1.25	3234	1.50	7344	6.90	7342	6.75
R-8-DC (220 volt)	7493	1.25	7494	2.55	2991	2.04	2992	2.20	7239	4.00	*	*	8601	1.50	2995	1.20	2996	1.20	7238	2.75
R-9	S-42	WR-12	...	2997	1.60	2998	2.15	2991	2.04	2992	2.20	7239	4.00	*	*	8601	1.50	2995	1.20	2996	1.20	8679	7.50	2957	1.75
R-10	S-132	WR-15-A	GB-989	3035	1.25	3235	1.90	7340	2.00	7341	2.00	7343	3.50	*	*	8601	1.50	3092	1.25	3234	1.50	7344	6.90	7342	6.75
R-10-DC	2997	1.60	2998	2.15	2991	2.04	2992	2.20	7239	4.00	*	*	8601	1.50	2995	1.20	2996	1.20	7238	2.75
R-11	K-62	WR-15	GB-9	3095	1.25	3096	2.25	7266	2.20	7267	2.00	7271	2.20	7258	1.20	8601	1.50	3092	1.25	3093	1.35	7272	8.00	7269	5.40
R-12	J-85	WR-13	GC-14	3095	1.25	3235	1.90	7340	2.00	7341	2.00	7343	3.50	*	*	8601	1.50	3092	1.25	3234	1.50	7344	6.90	7342	6.75
RE-16	SZ-42-P	WR-13	...	2997	1.60	2998	2.15	2991	2.04	2992	2.20	7239	4.00	*	*	8601	1.50	2995	1.20	2996	1.20	8679	7.50	2957	1.75
RE-16-A	...	WR-13-A	...	2997	1.60	2998	2.15	2991	2.04	2992	2.20	7255	3.50	7258	1.20	8601	1.50	2995	1.20	3093	1.35	8679	7.50	2957	1.75
R-17-M	BX or K-41	WR-26-M	...	3715	1.08	3714	.98	7594	1.00	3542	1.18	3538	1.18
RE-18 and RE-18A	KZ-62-P	3095	1.25	3096	2.25	7266	2.20	7267	2.00	7271	2.20	7258	1.20	8601	1.50	3092	1.25	3093	1.35	7272	8.00	7269	5.40
R-18-W	K-40-A	3715	1.08	3714	.98	8477	1.32	7598	.87	3542	1.18	3538	1.18
Rad. 18	GB-310	8318	4.80	(R.F. Coll Ass.)	1.90	7340	2.00	7341	2.00	5667	6.75	5901	1.85	8335	9.60	8333	7.40
RE-19	3095	1.25	3235	1.90	7340	2.00	7341	2.00	7343	3.50	*	*	8601	1.50	3092	1.25	3234	1.50	7344	6.90	7342	6.75

RE-20	7278	\$1.60	3138	\$2.65	7281	\$2.00	7282 (2d) 7283 (3d)	\$2.40 3.25	8711	\$4.25	*	*	8558	\$2.00	3142	\$1.25	3143	\$1.20	8710	\$9.52	8751	\$4.60
R-21 Rad. 21 and Rad. 22	B-1 and B-2	3095 8535 8536 7026 8534	1.25 2.25 1.75 2.55 6.40	3096 1st R. F. 2d R. F. 3d R. F. (Export)	2.25	7266	2.20	7267	2.00	7271	2.20	7258	\$1.20	8601	1.50	3092	1.25	3093	1.35	7272	8.00	7269	5.40
R-22-S	L-50	(Exp.) 6519	.88	6520 (Det.) 6521 (Osc.)	.94 .60	6464	1.88	6509	1.34	8987	1.00	6508	1.36	6510	1.00
R-22-W	L-51	6519	.88	6520 (Det.) 6521 (Osc.)	.94 .60	6464	1.88	6509	1.34	8987	1.00	6508	1.36	6510	1.00
RO-23 R-24 R-24-A (47) R-24-A (2A5)	JZ-835 JZ-822 JZ-822-A	WR-16 WR-24 WR-24	...	3095 6308 6308 6454	1.25 1.36 1.36 .90	3235 7504 7481 7481	1.90 2.25 2.20 2.20	7340 6309 6367 6367	2.00 2.50 2.14 2.14	7341 6310 6368 6368	2.00 2.50 2.14 2.14	7343 8917 7549 7549	3.50 3.42 2.48 2.48	*	*	8601 8921 8935 8969	1.50 1.20 1.05 1.27	3092 6322 6369 6452	1.25 1.25 1.16 1.40	3234 6307 6370 6370	1.50 1.80 1.34 1.34	7344 8918 7551 7584	6.90 5.40 6.40 5.72	7342 7502 7550 7582	6.75 6.40 7.40 8.06
R-25-DC RAE-26	6426 3095	.95 1.25	6425 3096	2.65 2.25	6423 7266	2.84 2.20	6424 7267	2.20 2.00	6421 7271	3.68 2.20	*	*	7442 8601	1.00 1.50	6468 3092	1.25 1.25	3093	1.35	7272	8.00	6422 7269	4.04 5.40
R-27	K-40	WR-26	...	3540 (E'ly) 3715 (Late)	1.08 1.08	3714	.98	7258 Early Product. (Dyn.) 6477 (Late Product.)	1.20 1.32	7598 (Mag.) 7594	.87 1.00	3542	1.18	3538	1.18
R-28	K-50	6470	1.08	6471 (Osc.) 6540 (Det.)	.74 .94	6464	1.88	6467	1.44	8987	1.00	6465	1.22	6466	.45	8985	4.26	7589	1.64
R-28-P	K-50-P	6527	1.08	6471 (Osc.) 6528 (Det.)	.74 .94	6464	1.88	6467	1.44	8987	1.00	6465	1.22	6466	.45	8985	4.26	7589	1.64
R-28-P (A to G)	K-51-P	WR-27	...	6527	1.08	6471 (Osc.) 6528 (Det.)	.74 .94	6464	1.88	6467	1.44	8987	1.00	6465	1.22	6466	.45	8985	4.26	7589	1.64
M-30 P-31	A-90 A-81	6137 8894	.90 1.25	6138 6138	2.00 2.00	7422 8891	2.00 2.00	7423 8892	2.00 1.85	7425 7425 (1st) 8889 (2nd) 7545	1.60 1.60 1.50	7424 6254	1.20 1.80	8829 8829	1.05 1.05	6157 6239	1.25 1.05	7421 8890	4.25 4.55
M-32	A-60	6366	1.32	6365	2.32	6360	2.14	6361	2.28	6364	2.00	8962	1.12	6363	1.38	7554	4.50
Victor R-32, RE-45, R- 52, RE-75	10448 (1st, 3rd or 4th)	1.00	10447 (2nd)	1.25	10414	4.68	10418	10.00	10801	2.00	10450	2.04	10408	1.25	10415	11.48	10417	3.50
Rad. 33 (A, C.) M-34	.. B-40	...	GB-311	8463 6489	5.40 .86	(R. F. Coil Assm.) 6471 (Osc.) 6540 (Det.)	.. .74 .94	.. 3636	.. 1.74	.. 3637	.. 1.65	5667 6488	6.75 1.30	8333 3688	7.40 1.50	.. 9023	.. 1.00	5901 6499	1.95 1.36	.. 6490	.. .35	8335 9430	9.60 3.60	.. 7600	.. 4.06
Victor R-35, R-39, RE- 57, RE-73	10828 (Ant. R. F.)	1.40; 1.50;	10829 (1st 3rd R. F.)	R. F.) 1.60;	1.50; 10817	10830 (2nd Link)	1.10	8554	7.86	*	*	8558	2.00	10826	2.40	10813	1.25	10917	14.00	10909	7.65	

REPLACEMENT PARTS GUIDE AND CROSS-INDEX (Continued)

RCA Victor	G.E.	Westinghouse Int.	Graybar Electric	Antenna Coil		Detector Oscillator		1st I. F. Trans.		2nd I. F. Trans.		A. F. Trans.		Output Trans. *Combined With A. F. Transformer		Cone		Volume Control		Tone Control		Power Trans.		Filter Pack or High Voltage Capacitor			
				Stock No.	List Price	Stock No.	List Price	Stock No.	List Price	Stock No.	List Price	Stock No.	List Price	Stock No.	List Price	Stock No.	List Price	Stock No.	List Price	Stock No.	List Price	Stock No.	List Price	Stock No.	List Price	Stock No.	List Price
R-37	K-80	6470	\$1.08	6471 (Osc.) 6540 (Det.)	\$.74 .94	6483	\$1.84	6484	\$1.70	6476	\$1.44	9428	\$1.00	6485	\$1.20	6486	\$1.10	9005	\$4.80	6487	\$2.90		
R-37-P	K-60-P	WR-28	...	6527	1.08	6471 (Osc.) 6528 (Det.)	.74 .94	6483	1.84	6484	1.70	6476	1.44	9428	1.00	6485	1.20	6486	1.10	9005	4.80	6487	2.90		
R-38	K-65	6470	1.08	6471 (Osc.) 6540 (Det.)	.74 .94	6483	1.84	6484	1.70	6476	1.44	9428	1.00	6485	1.20	6486	1.10	9005	4.80	6487	2.90		
R-38-P	K-65-P	6527	1.08	6471 (Osc.) 6528 (Det.)	.74 .94	6483	1.84	6484	1.70	6476	1.44	9428	1.00	6485	1.20	6486	1.10	9005	4.80	6487	2.90		
RE-40	K-54	6470	1.08	6471 (Osc.) 6540 (Det.)	.74 .94	6464	1.88	6467	1.44	8987	1.00	6465	1.22	6466	.45	8985	4.26	7589	1.64		
RE-40-P	K-54-P	WR-29	...	6527	1.08	6471 (Osc.) 6528 (Det.)	.74 .94	6464	1.88	6467	1.44	8987	1.00	6465	1.22	6466	.45	8985	4.26	7589	1.64		
R-43 Rad. 44	S-42-B	GB-500	7261 8469 (1st R.F.)	1.25 2.25	2998 8470 (2nd or 3rd R.F.)	2.15 1.75	7262	2.00	7263	2.00	7265 6004	2.75 3.75	* ..	* ..	8601	1.50	7260 6005	1.20 1.44	7260	1.20	8472	12.90	2957 8476	1.75 16.00
Rad. 46	GB-550	8469 (1st R.F.)	2.25	8470 (2nd or 3rd R.F.)	1.75	6004	3.75	6019	5.85	8558	2.00	6005	1.44	8472	12.90	8476	16.00		
Rad. 48	T-41	WR-4	GB-678	7112 (1st R.F.)	1.50	7113 (2nd, 3rd or 4th R.F.)	1.50	*	*	7104	2.50	8601	1.50	7129	2.30	8609	9.92	8608	8.00	
R-50	H-32	7278	1.60	3139	2.65	7281	2.00	7282 (2nd) 7283 (3rd)	2.40 3.25	8711	4.25	* *	* *	8558	2.00	3142	1.25	3143	1.20	8710	9.52	8751	4.60		
Rad. 51	GB-320	8318	4.80	(R. F. Coil) Assembly	5667	6.75	* *	* *	8359	1.40	5901	1.95	8335	9.60	8333	7.40		
R-51-B, R-53-B R-55	GB-103	6544 7278	.85 1.60	6545 3139	2.44 2.65	6524 7281	2.28 2.00	6525 7282	2.25 2.40	6523 8711	5.24 4.25	6526 *	1.80 *	9432 8558	1.88 2.00	3707 3142	1.40 1.25	6449 3143	1.06 1.20	8710	9.52	8751	4.60		
RAE-59	H-72	7278	1.60	3139	2.65	7281	2.00	(2nd) 7283 (3rd)	3.25	8711	4.25	* *	* *	8558	2.00	3142	1.25	3143	1.20	8710	9.52	8751	4.60		
Rad. 60	GB-330	8341	6.00	(R. F. and Det. Coil Assembly)	..	8342	3.80	Use 8342 in all stages	..	5805	4.80	* *	* *	5811	1.90	8344	12.90	8346	16.24		

Rad. 62	GB-340	8341	\$6.00	(R. F. and Det. Coil Assembly)	8342	\$3.60	Use 8342 in all stages	5805	\$4.80	8383	\$10.00	8558	\$2.00	5811	\$1.90	8344	\$12.90	8382	\$16.50
Rad. 64	8341	6.00	(R. F. and Det. Coil Assembly)	8342	3.60	Use 8342 in all stages	5869	9.90	5868	7.75	8558	2.00	2336 2334 (Sen.)	1.75 1.90	8373	20.28	8368	15.00
Rad. 66	GB-600	8480	10.00	(R. F. and Det. Coil Assembly)	8481	3.90	8482 (1st or 2nd)	6021	18.75	6019	5.85	8558	2.00	6027	1.44	8483	12.90	8487	14.25
Rad. 67	8480	10.00	(R. F. and Det. Coil Assembly)	8481 (1st or 2nd)	3.90	8482 (3rd)	8506	9.75	8505	22.20	8558	2.00	2336 (Rad.) 2602 (Ph.)	1.75 1.95	2603	\$1.95	8501	27.00	8504	28.20
RAE-68	8563	1.60	8564	2.40	8567 (1st) 2.10; 8565 (2nd) 2.10; 8566 (3rd) 2.10	8554	7.86	*	*	8558	2.00	7156	3.00	7074	1.25	8556	9.52	8553	8.64	
R-70 and R-70-N R-71	J-72 J-82	WR-21 WR-19	...	6373 6308	1.06 1.36	6374 7504	2.14 2.25	6376 2.12 6309 2.50	6375 1.88 6310 2.50	7558 2.48 8917 3.42	6378 *	1.94 *	8935 1.05 8921 1.20	6372 1.34 6322 1.25	7522 1.30 6307 1.60	7560 6.14 8918 5.40	7559 6.70 7502 6.40						
R-71-B	6308	1.36	7524	2.30	6326 2.05	6327 2.85	7526 2.50	7527 (Inc. Input) *	3.25	8921 1.20	6328 1.45	6329 1.25	7525	4.50				
R-72 R-73 (47)	J-86 J-83	WR-22	...	6308 6308	1.36 1.36	7504 7481	2.25 2.20	6309 2.50 6367 2.14	6310 2.50 6368 2.14	8917 3.42 7549 2.48	6371	1.90	8969 1.27 8935 1.05	6322 1.25 6369 1.16	6307 1.60 6370 1.34	8918 5.40 7551 6.40	7502 6.40 7550 7.40						
R-73 (2A5) R-74 R-75 (47)	J-83-A J-100 J-87	WR-20	...	6454 6308 6308	.90 1.36 1.36	7481 7504 7481	2.20 2.25 2.20	6367 2.14 7514 2.04	6368 2.14 7515 2.00	7549 2.48 7519 2.35 7549 2.48	6455 1.95 6325 2.00 6371 1.90	8969 1.27 8935 1.05 8935 1.05	6452 1.40 6322 1.25 6369 1.16	6370 1.34 6324 1.30 6370 1.34	7584 5.72 8932 7.70 7551 6.40	7582 8.06 7513 8.60 7550 7.40							
R-75 (2A5) R-76 R-77	J-87-A J-105 J-107	6454 6308 6308	.90 1.36 1.36	7481 7504 7504	2.20 2.25 2.25	6367 2.14 7514 2.04	6368 2.14 7515 2.00	7549 2.48 7519 2.35 7519 2.35	6455 1.95 6325 2.00 6325 2.00	8969 1.27 8935 1.05 8935 1.05	6452 1.40 6322 1.25 6322 1.25	6370 1.34 7522 1.30 7522 1.30	7584 5.72 8932 7.70 8932 7.70	7582 8.06 7513 8.60 7513 8.60							
R-78	J-125	6308	1.36	7481	2.20	7480 (1st) 2.15; 7499 (2nd) 2.15; 7492 (3rd) 1.80	7479	3.25	8912 (Inc. Input)	4.36	8916 1.65	6275 2.50	6276 1.40	8913 8.65	8910 4.10						
R-78 Noise Suppressor	J-125-A	6308	1.36	7504	2.25	7480 (1st) 2.15; 6353 (2nd) 2.35; 6352 (3rd) 2.35	7479	3.25	8912 (Inc. Input)	4.36	8916 1.65	6275 2.50 6354 1.30 (Sup.)	6276 1.40	8913 8.65	8910 4.10						
RAE-79	7278	1.60	3139	2.65	7281 (1st) 2.00; 7365 (2nd) 2.50; 7283 (3rd) 3.25	8711	4.25	*	*	8558 2.00	7398 3.00	3143 1.20	8749 15.56	8751 4.60						
RE-80	..	WR-23	...	6308	1.36	7481	2.20	6367 2.14	6368 2.14	7549 2.48	6371	1.90	8935 1.05	6369 (Rad.) 6385 (Ph.) 7061	1.16 2.02 1.20	6370 1.34	7551 6.40	7550 7.40					
Rad. 80, 82, 86	H-31, 51, 71	WR-5, 6, 7	GB-700, 770, 900	8563	1.60	8564	2.40	8567 (1st) 2.10; 8565 (2nd) 2.10; 8566 (3rd) 2.10	8554	7.86	*	*	8558 2.00	7061 1.20	7074 1.25	8556 9.52	8553 8.64						
RE-80-SW	..	WR-25	...	6308	1.36	7481	2.20	6367 2.14	6368 2.14	7549 2.48	6371	1.90	8935 1.05	6369 (Rad.) 6385 (Ph.)	1.16 2.02	6370 1.34	7551 6.40	7550 7.40					

REPLACEMENT PARTS GUIDE AND CROSS-INDEX (Continued)

RCA Victor	G.E.	Westinghouse Int.	Graybar Electric	Antenna Coil		Detector Oscillator Coil		1st I. F. Trans.		2nd I. F. Trans.		A. F. Trans.		Output Trans. * Combined With A. F. Transformer		Cone		Volume Control		Tone Control		Power Trans.		Filter Pack or High Voltage Capacitor	
				Stock No.	List Price	Stock No.	List Price	Stock No.	List Price	Stock No.	List Price	Stock No.	List Price	Stock No.	List Price	Stock No.	List Price	Stock No.	List Price	Stock No.	List Price	Stock No.	List Price	Stock No.	List Price
RE-81	6308	\$1.36	7504	\$2.25	7514	\$2.04	7515	\$2.00	7519	\$2.35	6325	\$2.00	8935	\$1.05	6322 (Rad.) 6337 (Ph.) 7156	\$1.25 1.60 3.00	7522	\$1.30	8932	\$7.70	7513	\$8.60
Rad. 82-R and 86-R RAE-84	H-51-R and 71-R	WR-6-R and 7-R	...	8563	1.60	8564	2.40	8567 (1st) 2.10; 8565 (2nd) 2.10; 8566 (3rd) 2.10		8554		7.86	*	*	8558	2.00	*	*	7074	1.25	8556	9.52	8553	8.64	
				6308	1.36	7504	2.25	7480 (1st) 2.15; 6353 (2nd) 2.35; 6352 (3rd) 2.35		7479		3.25	8912 (Inc. Input)	4.36	8916	1.65	6275 (Sup.) 6354 (Sup.)	2.50 1.30	6276	1.40	8913	8.65	8910	4.10	
R-90	K-106	6433	1.80	6437 (Osc.) 6438 (Det.)	1.24 1.44	6435 (1st) 2.54; 6440 (2nd) 1.94; 6441 (3rd) 1.76		6432		3.69	6455	1.95	8969	1.27	6447 (Sup.) 6450 (Sup.)	1.92 1.24	6448 (Low) 6449 (High)	1.04 1.06	8978	8.50	6430	3.78	
R-90-P	K-106-P	6538	1.80	6437 (Osc.) 6539 (Det.)	1.24 1.44	6435 (1st) 2.54; 6440 (2nd) 1.94; 6441 (3rd) 1.76		6432		3.69	6455	1.95	8969	1.27	6447 (Sup.) 6450 (Sup.)	1.92 1.24	6448 (Low) 6449 (High)	1.04 1.06	8978	8.50	6430	3.78	
91-B	C-30	6820	.86	6821 (2nd R.F.)	.96	9471	.70	6829	1.05	6831 (C-8, C-12)	.94
100	K-43	WR-32	...	6666	1.08	6664	.94	6662	2.34	6663	1.06	6659 (38) 6788 (41) 4957	1.60 1.60 1.18	8987 8987 9602	1.00 1.00 .75	6667 6667 5018	1.58 1.58 1.00	6669 666950 .50 ...	9045 9464 7859	4.84 3.20 2.02	6661 6661 4958	2.70 2.70 1.34
101	M-41	6666	1.08	6664	.94	6662	2.34	6663	1.06
M-101	D-50	4950	.74	6967 (Osc.) 6966 (Det.)	.52 .80	4951	1.26	4952	1.76	9602	.75	5018	1.00	7859	2.02	4958	1.34
102	M-40	6820	.86	6821 (2nd R.F.)	.96	9471	.70	3542	1.18	6823	1.14
103	M-42	6666	1.08	6664 (Osc.) 6967 (Osc.) 6966 (Det.)	.94 .52 .80	4951	1.26	4952	1.76	4803 4957	1.45 1.18	9588 9602	.71 .75	6667 5018	1.58 1.00	6669 5001	.50 .66	9464 7859	3.20 2.02	6661 4958	2.70 1.34
M-104	D-51	4950	.74	6967 (Osc.) 6966 (Det.)	.52 .80	4951	1.26	4952	1.76	9602	.75	5018	1.00	5001	.66	7859	2.02	4958	1.34
M-105	C-41	WR-41	...	6731	.88	6471 (Osc.) 6540 (Det.) 6967 (Osc.) 6966 (Det.)	.74 .94 .52 .80	3636	1.74	3637	1.65	6732	2.00	3688	1.50	9023	1.00	6499	1.36	6490	.35	9049	3.75	7600	4.06
M-107	C-60	6965	.70	6967 (Osc.) 6966 (Det.)	.52 .80	6960	1.80	6962	1.85	6982	1.35	9492	.74	6978	1.20	6669	.50	7775	3.78	7776	1.90
M-108	D-52	4950	.74	6967 (Osc.) 6966 (Det.)	.52 .80	4951	1.26	4952	1.76	4957	1.18	9602	.75	5018	1.00	5001	.66	7859	2.02	4958	1.34
M-109	D-72	4950	.74	6967 (Osc.) 6966 (Det.)	.52 .80	5055	1.32	5056	1.42	5057	1.00	5090	2.62	9598	.78	5018	1.00	5072	.82	5065	2.48	5069	1.78
110	K-52	6527	1.08	6471 (Osc.) 6528 (Det.)	.74 .94	6464	1.88	6467	1.44	8987	1.00	6465	1.22	6623	1.25	8985	4.26	7589	1.64
111	K-53	WR-35	...	6527	1.08	6471 (Osc.) 6528 (Det.)	.74 .94	6464	1.88	6467	1.44	8987	1.00	6465	1.22	6623	1.25	8985	4.26	7589	1.64

112	L-52	WR-34	...	6519	.88	6521 (Osc.) 6520 (Det.)	.60 .94	6727	1.68	6730	1.52	9428	1.00	6724	1.20	6728	2.94
112-A	6519	.88	6521 (Osc.) 6520 (Det.)	.60 .94	6727	1.68	7846	1.65	9492	.74	4702	1.30	6728	2.94
114	L-53	6519	.88	6521 (Osc.) 6520 (Det.)	.60 .94	6464	1.88	6509	1.34	8987	1.00	6508	1.36	6783	4.38
115	K-53-M	6527	1.08	6471 (Osc.) 6528 (Det.)	.74 .94	6464	1.88	6467	1.44	8987	1.00	6465	1.22	6623	1.25	8985	4.26	7589	1.64
M-116	B-52	WR-42	...	6742	.88	6745 (Osc.) 6743 (Det.)	.62 .98	6740	2.16	6741	1.78	6759	2.55	6764	1.42	8987	1.00	6746	1.20	6747	1.20	9456 (A.C.) 9457 (Bat.)	4.00 4.78	6738	1.54
117	M-50	4903 (Ant. Det.)	1.58	4902 (Osc.)	1.22	4900	2.25	4901	1.50	4893	1.48	9533	3.50	4429	1.40	5052	.30	4897	3.98	7790	1.05
118	M-51, M-51-A	WR-48, WR-48-A	...	4430 (Ant. Det.)	1.92	4432 (Osc.)	1.65	4431	2.28	4433	2.15	4505	1.55	9492	.74	4429	1.40	4426	.35	9511	4.78	7790	1.05
119	M-52	5051 (Ant. Det.)	1.28	5050 (Osc.)	.56	4900	2.25	4901	1.50	4893	1.48	9588	.71	4429	1.40	4905	.30	4897	3.98	7790	1.05
120	K-63	WR-36	...	6527	1.08	6471 (Osc.) 6528 (Det.)	.74 .94	6483	1.84	6484	1.70	6476	1.44	9428	1.00	6485	1.20	6619	1.44	9005	4.80	6487	2.90
121, 122	K-64	WR-37	...	6701	2.64	6700 (Osc.) 6699 (Det.)	2.30 2.44	6697	1.80	6698	1.78	6476	1.44	9428	1.00	6695	1.20	6705	1.20	9446	5.40	6571	1.20
M-123	C-61	5965	.70	6967 (Osc.) 6966 (Det.)	.52 .80	6960	1.80	6962	1.85	6969	1.50	6970	1.52	9492	.74	6964 6972 (Sup.)	1.20 .90	6971	.90	7759	3.95	7758	6.00
124	M-63	6527	1.08	6471 (Osc.) 6528 (Det.)	.74 .94	6483	1.84	6484	1.70	6476	1.44	9428	1.00	6485	1.20	6619	1.44	9005	4.80	6487	2.90
125	M-62	WR-53	...	5087 (Ant. Det.) 6992 (Ant. Det.)	1.86 .98	5089 (Osc.) 6664 (Osc.)	1.90 .94	5102 (1st) 1.98 5105	1.80	8 5103 (2nd) 1.65	4893	1.48	9588	.71	4429	1.40	5052	.30	9511	4.78	7790	1.05
126-B	C-62	6992 (Ant. Det.) 6983	.98 2.68	6664 (Osc.) 6700 (Osc.) 6699 (Det.)	.94 2.30 2.44	6993	2.10	6994	1.05	*	*	6996	1.68	9428	1.00	6995	1.10	6669	.50	4349	3.95
127	K-64-D	6983	2.68	6700 (Osc.) 6699 (Det.)	2.30 2.44	6697	1.80	6698	1.78	6987	4.50	6988	1.60	9499	1.22	6695	1.20	6705	1.20	6985	1.50

RCA Victor	G.E.	Westing-house Int.	Graybar Electric	Antenna Coil		Detector Coil		Oscillator Coil		1st I. F. Trans.		2nd I. F. Trans.		A. F. Trans.		Output Trans.		Cone		Volume Control		Tone Control		Power Trans.		Filter Pack or High Voltage Capacitor			
				Stock No.	List Price	Stock No.	List Price	Stock No.	List Price	Stock No.	List Price	Stock No.	List Price	Stock No.	List Price	Stock No.	List Price	Stock No.	List Price	Stock No.	List Price	Stock No.	List Price	Stock No.	List Price	Stock No.	List Price	Stock No.	List Price
128	M-61	WR-46	...	4516(B) 7803 (A & C)	\$1.65 1.82	4514(B) 7805 (A & C)	\$1.65 2.15	4511(B) 7807 (A & C)	\$1.52 1.62	4431	\$2.28	4433	\$2.15	4818	\$2.15	9533	\$3.50	4519	\$1.25	4517	\$0.90	9511	\$4.78	7790	\$1.05
128-E	..	WR-50	...	4734(A) 7803 (B & C)	3.05 1.82	4751(A) 7805 (B & C)	2.38 2.15	4733(A) 7807 (B & C)	3.05 1.62	4431	2.28	4433	2.15	4818	2.15	9533	3.50	4519	1.25	4517	.90	9511	4.78	7790	1.05

REPLACEMENT PARTS GUIDE AND CROSS-INDEX (Continued)

RCA Victor	G.E.	Westinghouse Int.	Graybar Electric	Antenna Coil		Detector Coil		Oscillator Coil		1st I. F. Trans.		2nd I. F. Trans.		A. F. Trans.		Output Trans.		Cone		Volume Control		Tone Control		Power Trans.		Filter Pack or High Voltage Capacitor	
				Stock No.	List Price	Stock No.	List Price	Stock No.	List Price	Stock No.	List Price	Stock No.	List Price	Stock No.	List Price	Stock No.	List Price	Stock No.	List Price	Stock No.	List Price	Stock No.	List Price	Stock No.	List Price	Stock No.	List Price
135-B	C-70	WR-47	..	4430	\$1.92	Comb. 4430	with ..	4432	\$1.65	4431	\$2.28	7840 (2nd) 4538 (3rd)	\$2.35 2.15	4533	\$3.98	Comb. 4533	with ..	9539	\$0.86	4535	\$1.40	4536	\$0.95
ACR-136 140 and 140-E	K-80	WR-30	..	4516(B) 7803 (A & C)	1.65 1.82	4514(B) 7805 (A & C)	1.65 2.15	4511(B) 7807 (A & C)	1.52 1.62	4431	2.28	4433	2.15	4505	\$1.55	9492	.74	4519	1.25	4517	.90	9511	\$4.78	7790	\$1.05
141 and 141-E	K-80-X	WR-31	..	6634(A) 6637(B) 6640(C) 6628 (D-1st) 6643 (D-2nd)	1.86 1.56 1.54 1.50 1.52	6635(A) 6638(B) 6641(C) 6643(D)	2.00 1.66 1.60 1.52	6636(A) 6639(B) 6642(C) 6644(D)	1.40 1.40 1.34 1.54	6610	1.55	6611	1.62	6608	2.04	6605	1.48	8969	1.27	6612	1.20	6627	1.44	9042	6.84	6571	1.20
140 and 140-E (External I.F.) 141 and 141-E (External I.F.) 142-B	K-80 K-80-X B-81	WR-30 WR-31	See Model 140 See Model 141 646986	See Model 140 See Model 141 671990	See Model 140 See Model 141 672078	6890	2.40	6891	2.40	6608	2.04	6605	1.48	8969	1.27	6612	1.20	6892	1.50	9042	6.84	6889	1.55
143	M-81	WR-45, WR-45-A	..	7810 (X & B) 7803 (A & C)	2.10 1.82	7808 (X & B) 7805 (A & C)	2.05 2.15	7809 (X & B) 7807 (A & C)	1.70 1.62	4431	2.28	4433	2.15	4620	2.98	9535	1.50	9533	3.50	4519 4618 (Sen.)	1.25 1.25	4616	1.28	9505	6.35	7790	1.05
210	K-55	6527	1.08	6528	.94	6471	.74	6464	1.88	6770	2.00	8935	1.05	8599	1.25	6860	1.15	8985	4.26	7589	1.64
211	M-56	4430	1.92	Comb. 4430	with ..	4432	1.85	4431	2.28	4433	2.15	4472	1.40	8935	1.05	4429	1.40	4426	.35	9511	4.78	7790	1.05

214	M-55	4903	1.58	4902	1.22	4900	2.25	4901	1.50	4818	2.15	9533	3.50	4429	1.40	5052	.30	4897	3.98	7589	1.64
220	K-66	6683	1.38	6684	1.10	6685	1.05	6686	1.80	6687	1.78	6690	1.46	8969	1.27	6682	1.25	6681	1.25	9441	4.92	6691	2.18
221	M-65	6701	2.64	6699	2.44	6700	2.30	6697	1.80	6698	1.78	6770	2.00	8935	1.05	6695	1.20	6705	1.20	9446	5.40	6703	2.46
222	K-66-M	6683	1.38	6684	1.10	6685	1.05	6686	1.80	6687	1.78	6690	1.46	8969	1.27	6682	1.25	6681	1.25	9441	4.92	6691	2.18
223	C-67	6527	1.08	6528	.94	6471	.74	6483	1.84	6484	1.70	6861	1.36	8935	1.05	6485	1.20	6860	1.15	7734	3.60	6862	3.34
224	M-67	4516(B) 7803 (A & C)	1.65 1.82	4514(B) 7805 (A & C)	1.65 2.15	4511(B) 7807 (A & C)	1.52 1.62	4431	2.28	4433	2.15	4472	1.40	8935	1.05	4519	1.25	4517	.90	9511	4.78	7790	1.05
224-E		4734(A) 7803 (B & C)	3.05 1.82	4751(A) 7805 (B & C)	2.38 2.15	4733(A) 7807 (B & C)	3.05 1.62	4431	2.28	4433	2.15	4472	1.40	8935	1.05	4519	1.25	4517	.90	9511	4.78	7790	1.05
225	M-655	5087	1.86	5089	1.90	5102	1.98	5103	1.98	4892	1.30	8935	1.05	4429	1.40	5052	.30	9511	4.78	5101	2.14
226	M-66	WR-46-A	..	4809(B) 7803 (A & C)	1.92 1.82	4815(B) 7805 (A & C)	1.80 2.15	4807(B) 7807 (A & C)	1.85 1.62	4431	2.28	4433	2.15	4892	1.30	8935	1.05	4519	1.25	4517	.90	9511	4.78	7790	1.05
235-B	C-75	4430	1.92	Comb. 4430	with ..	4432	1.65	4431	2.28	7840 (2nd) 4538 (3rd)	2.35 2.15	4533	3.98	Comb. 4533	with ..	9432	1.88	4535	1.40	4536	.95
236-B		4796	2.30	Comb. 4796	with ..	4800	1.90	4431	2.28	7840 (2nd) 4538 (3rd)	2.35 2.15	4533	3.98	Comb. 4533	with	4535	1.40	4799	.62
240	K-85	6634 (A) 6637 (B) 6640 (C) 6628 (D-1st) 6643 (D-2nd)	1.86 1.56 1.54 1.50 1.52	6635 (A) 6638 (B) 6641 (C) 6643 (D)	2.00 1.66 1.60 1.52	6636 (A) 6639 (B) 6642 (C) 6644 (D)	1.40 1.40 1.34 1.54	6810	1.55	6611	1.62	6608	2.04	6605	1.48	8969	1.27	6612	1.20	6627	1.44	9042	6.84	6571	1.20
241-B	B-86	6489	.86	6719	.90	6720	.78	6712	1.70	6713	1.92	6710	2.22	6709	2.18	9428	1.00	6714	1.20	6716	.38
242	M-86	7810 (X & B) 7803 (A & C)	2.10 1.82	7808 (X & B) 7805 (A & C)	2.05 2.15	7809 (X & B) 7807 (A & C)	1.70 1.62	4431	2.28	4433	2.15	4620	2.98	4599	1.34	8969	1.27	4519 4618 (Sen.)	1.25 1.25	4616	1.28	9505	6.35	7790	1.05
260	K-107	6538	1.80	6539	1.44	6437	1.24	6435	2.54	6440 (2nd) 6441 (3rd)	1.94 1.76	6432	3.69	6455	1.95	8969	1.27	6447	1.92	6448 (Low) 6449 (High)	1.04 1.06	8978	8.50	6443	1.50
261	K-105	6538	1.80	6539	1.44	6437	1.24	6435	2.54	6440 (2nd) 6441 (3rd)	1.94 1.76	6432	3.69	6455	1.95	8969	1.27	6447	1.92	6448 (Low) 6449 (High)	1.04 1.06	8978	8.50	6443	1.50
262	M-106	7810 (X & B) 7803 (A & C) 4410(D)	2.10 1.82 .70	7808 (X & B) 7805 (A & C) 4421(D)	2.05 2.15 .70	7809 (X & B) 7807 (A & C)	1.70 1.62	4431	2.28	4433	2.15	7841 7832 (T-3)	4.05 2.85	7834	3.75	8969	1.27	4832 7804 (Sen.)	1.25 1.30	4829 4830 (High)	1.00 1.00	9505	6.35	7790	1.05

REPLACEMENT PARTS GUIDE AND CROSS-INDEX (Continued)

RCA Victor	G.E.	Westing- house Int.	Graybar Electric	Antenna Coil		Detector Coil		Oscillator Coil		1st I. F. Trans.		2nd I. F. Trans.		A. F. Trans.		Output Trans.		Cone		Volume Control		Tone Control		Power Trans.		Filter Pack or High Voltage Capacitor	
				Stock No.	List Price	Stock No.	List Price	Stock No.	List Price	Stock No.	List Price	Stock No.	List Price	Stock No.	List Price	Stock No.	List Price	Stock No.	List Price	Stock No.	List Price	Stock No.	List Price	Stock No.	List Price	Stock No.	List Price
263	M-107	7810 (X & B) 7803 (A & C) 4410(D)	\$2.10 1.82 .70	7808 (X & B) 7805 (A & C) 4421(D)	\$2.05 2.15 .70	7809 (X & B) 7807 (A & C)	\$1.70 1.62	4431	\$2.28	4433	\$2.15	7841	\$4.05	5080	\$1.60	8969	\$1.27	4832 7804 (Sen.)	\$1.25 1.30	4829 (Low) 4830 (High)	\$1.00 1.00	9505	\$6.35	7790	\$1.05
280	K-126	6561	1.65	6539	1.44	6437	1.24	6564	2.30	6565 (AVC) 6568 (2nd) 7792	2.10 1.72	6562 (Driv.) 6568 (Inter.) 7785 (Driv.) 7786 (Inter.) 7794 (AVC)	3.04 3.10	6569	1.95	8969	1.27	6447	1.92	6448 (Low) 6449 (High) 4829 (Low) 7797 (High)	1.04 1.06	8028	7.75	6571	1.20
281	M-125	7810 (X & B) 7803 (A & C) 4410(D)	2.10 1.82 .70	7808 (X & B) 7805 (A & C) 4421(D)	2.05 2.15 .70	7809 (X & B) 7807 (A & C)	1.70 1.62	7791	2.35	7792 (2nd) 7783 (3rd) 7794 (AVC)	2.22 2.50 .82	7785 (Driv.) 7786 (Inter.)	2.40 4.25	4506	2.85	7000	1.89	6450 (Sup.) 7798 7804 (Sen.)	1.24 2.05 1.30	4829 (Low) 7797 (High)	1.00 1.35	9505	6.35	7790	1.05
300	K-48	6588	.70	6589	.80	(Tuned R.F.)	6591	1.22	8987	1.00	6586 6590 (Phono.)	1.20 1.20	6587	2.42	
301	M-49	6666	1.08	6664	.94	6662	2.34	6663	1.06	6788	1.60	8987	1.00	6667 6827 (Phono.) 6599 6475 (Phono.) 6695 6757 (Phono.)	1.58 1.46 1.25 1.25 1.20 2.70	6669	.50	9464	3.20	6661	2.70
310	K-58	6527	1.08	6528	.94	6471	.74	6464	1.88	6467	1.44	9428	1.00	6680	1.15	8985	4.26	7589	1.64		
320	6701	2.64	6699	2.44	6700	2.30	6697	1.80	6698	1.78	6476	1.44	9428	1.00	6705	1.20	9446	5.40	6571	1.20		
321	M-68	6701	2.64	6699	2.44	6700	2.30	6697	1.80	6698	1.78	6770	2.00	8969	1.27	6895 6766 (Phono.) 4519 6766 (Phono.) 4519 6766 (Phono.)	1.20 2.28 1.25 2.28 1.25 2.28	6705	1.20	9446	5.40	6571	1.20
322	M-89	WR-49	..	4518(B) 7803 (A & C) 4734(A) 7803 (B & C)	1.85 1.82 3.05 1.82	4514(B) 7805 (A & C) 4751(A) 7805 (B & C)	1.85 2.15 2.38 2.15	4511(B) 7807 (A & C) 4733(A) 7807 (B & C)	1.52 1.62 3.05 1.62	4431	2.28	4433	2.15	4472	1.40	8935	1.05	4517	1.25	4517	.90	9511	4.78	7790	1.05
322-E	4734(A) 7803 (B & C)	3.05 1.82	4751(A) 7805 (B & C)	2.38 2.15	4733(A) 7807 (B & C)	3.05 1.62	4431	2.28	4433	2.15	4472	1.40	8935	1.05	4519 6766 (Phono.)	1.25 2.28	4517	.90	9511	4.78	7790	1.05
327	6983	2.68	6699	2.44	6700	2.30	6697	1.80	6698	1.78	6987	4.50	4599	1.34	8969	1.27	6895 4590 (Phono.) 6594 6804 (Phono.)	1.20 2.18 1.40 1.60	6705	1.20	..	6986	1.60	
330	K-78	6527	1.08	6528	.94	6471	.74	6553	1.58	6554	1.64	6551	1.48	6556	1.50	8969	1.27	6595	1.46	8026	4.80	7590	1.40		

331	K-79	6527	1.08	6528	.94	6471	.74	6553	1.56	6554	1.64	6551	1.48	6556	1.50	8969	1.27	6485 6560 (Phono.)	1.20 1.60	6595	1.46	9026	4.80	7590	1.40
340	K-88	WR-38	..	6634(A) 6637(B) 6640(C) 6628 (D-1st) 6643 (D-2nd)	1.88 1.56 1.54 1.50 1.52	6635(A) 6638(B) 6641(C) 6643(D)	2.00 1.66 1.80 1.52	6636(A) 6639(B) 6642(C) 6644(D)	1.40 1.40 1.34 1.54	6610	1.55	6611	1.62	6608	2.04	6605	1.48	8969	1.27	6612 6766 (Phono.)	1.20 2.28	6627	1.44	9042	6.84	6571	1.20
340-E	K-88-X	WR-39	..	6631(X) 6634(A) 6637(B) 6640(C) 6628 (D-1st) 6643 (D-2nd)	2.16 1.86 1.56 1.54 1.50 1.52	6632(X) 6635(A) 6638(B) 6641(C) 6643(D)	2.10 2.00 1.66 1.80 1.52	6633(X) 6636(A) 6639(B) 6642(C) 6644(D)	1.40 1.40 1.40 1.34 1.54	6610	1.55	6611	1.62	6608	2.04	6605	1.48	8969	1.27	6612 6766 (Phono.)	1.20 2.28	6627	1.44	9042	6.84	6571	1.20
340 (External I.F)	K-88	WR-38	..	6634(A) 6637(B) 6640(C) 6628 (D-1st) 6643 (D-2nd)	1.86 1.56 1.54 1.50 1.52	6635(A) 6638(B) 6641(C) 6643(D)	2.00 1.66 1.80 1.52	6636(A) 6639(B) 6642(C) 6644(D)	1.40 1.40 1.34 1.54	6890	2.40	6891	2.40	6608	2.04	6605	1.48	8969	1.27	6612 6766 (Phono.)	1.20 2.28	6892	1.50	9042	6.84	6889	1.55
340-E (External I.F.)	K-88-X	WR-39	..	6631(X) 6634(A) 6637(B) 6640(C) 6628 (D-1st) 6643 (D-2nd)	2.16 1.86 1.56 1.54 1.50 1.52	6632(X) 6635(A) 6638(B) 6641(C) 6643(D)	2.10 2.00 1.66 1.80 1.52	6633(X) 6636(A) 6639(B) 6642(C) 6644(D)	1.40 1.40 1.40 1.34 ..	6890	2.40	6891	2.40	6608	2.04	6605	1.48	8969	1.27	6612 6766 (Phono.)	1.20 2.28	6892	1.50	9042	6.84	6889	1.55
341	M-89	7810 (X & B) 7803 (A & C)	2.10 1.82	7808 (X & B) 7805 (A & C)	2.05 2.15	7809 (X & B) 7807 (A & C)	1.70 1.62	4431	2.28	4433	2.15	4620	2.98	4599	1.34	8969	1.27	4519 4618 (Sen.) 6766 (Phono.)	1.25 1.25 2.28	4616	1.28	9505	6.35	7790	1.05
380	M-128	6561	1.65	6539	1.44	6437	1.24	6564	2.30	6565 (AVC) 6566 (2nd)	2.10 1.72	6562 (Driv.) 6568 (Inter.)	3.04 3.10	6569	1.95	8969	1.27	6447 6450 (Sup.) 6799 (Phono.)	1.92 1.24 3.00	6448 (Low) 6449 (High)	1.04 1.06	9028	7.75	6571	1.20
380-IHR	M-128-R	6561	1.65	6539	1.44	6437	1.24	6564	2.30	6565 (AVC) 6566 (2nd)	2.10 1.72	6562 (Driv.) 6568 (Inter.)	3.04 3.10	6569	1.95	8969	1.27	6447 6450 (Sup.) 6799 (Phono.)	1.92 1.24 3.00	6448 (Low) 6449 (High)	1.04 1.06	9028	7.75	6571	1.20
381	M-129	7810 (X & B) 7803 (A & C) 4410(D)	2.10 1.82 .70	7808 (X & B) 7805 (A & C) 4421(D)	2.05 2.15 .70	7809 (X & B) 7807 (A & C)	1.70 1.62	7791	2.35	7792 (2nd) 7793 (3rd) 7784 (AVC)	2.22 2.50 .82	7785 (Driv.) 7786 (Inter.)	2.40 4.25	4506	2.85	7000	1.89	7798 7804 (Sen.)	2.05 1.30	4829 (Low) 7797 (High)	1.00 1.35	9505	6.35	7790	1.05



RCA RADIO TUBE CHART



TYPE	NAME	BASE	SOCKET CONNECTIONS	DIMENSIONS MAXIMUM OVERALL LENGTH X DIAMETER	CATHODE TYPE #	RATING				USE Values to right give operating conditions and characteristics for indicated typical use	PLATE SUP- PLY VOLTS	GRID VOLTS #	SCREEN VOLTS	SCREEN MILL- AMP.	PLATE MILLI- AMP.	A-C PLATE RESIST- ANCE OHMS	MUTUAL CON- DUCT- ANCE MICRO- MHOS	VOLT- AGE AMPLI- FICATION FACTOR	LOAD FOR STATED POWER OUTPUT OHMS	POWER OUT- PUT WATTS	TYPE		
						FILAMENT OR HEATER		PLATE	SCREEN														
						VOLTS	AMPERES															MAX. VOLTS	MAX. VOLTS
1A6	PENTAGRID CONVERTER #	SMALL 6-PIN	FIG. 28	4 1/2" x 1 1/8"	D-C FILAMENT	2.0	0.06	180	67.5	CONVERTER	180	{ - 3.0 min. }	67.5	2.4	1.3	500000	Anode-Grid (# 2) 135 max. volts, 2.3 ma. Oscillator Grid (# 1) Resistor, 50000 ohms. Conversion conductance, 300 micromhos.				1A6		
1C6	PENTAGRID CONVERTER #	SMALL 6-PIN	FIG. 28	4 1/2" x 1 1/8"	D-C FILAMENT	2.0	0.12	180	67.5	CONVERTER	180	{ - 3.0 min. }	67.5	2.0	1.5	750000	Anode Grid (# 2) 135 max. volts, 3.3 ma. Oscillator Grid (# 1) Resistor, 50000 ohms. Conversion conductance, 325 micromhos.				1C6		
2A3	POWER AMPLIFIER TRIODE	MEDIUM 6-PIN	FIG. 1	5 1/2" x 2 1/4"	FILAMENT	2.5	2.5	250 300	—	CLASS A AMPLIFIER PUSH-PULL AMPLIFIER	250 300	-45 -62	— Self-bias Fixed-bias	— 40.0 40.0	800	5250	4.2	2500	3.5	2A3			
2A5	POWER AMPLIFIER PENTODE	MEDIUM 6-PIN	FIG. 15A	4 1/2" x 1 1/2"	HEATER	2.5	1.75	250	250	CLASS A AMPLIFIER	250	-16.5	250	6.5	34.0	100000	Power Output is for 2 tubes at stated load, plate-to-plate	5000	10.0	3000	15.0	2A5	
2A6	DUPEX-DIODE HIGH-MU TRIODE	SMALL 6-PIN	FIG. 13	4 1/2" x 1 1/8"	HEATER	2.5	0.8	250	—	TRIODE UNIT AS CLASS A AMPLIFIER	250	- 1.35	—	—	0.4	—	Gain per stage = 50-60	2200	220	7600	3.0	2A6	
2A7	PENTAGRID CONVERTER #	SMALL 7-PIN	FIG. 20	4 1/2" x 1 1/8"	HEATER	2.5	0.8	250	100	CONVERTER	250	{ - 3.0 min. }	100	2.2	3.5	360000	Anode Grid (# 2) 200 max. volts, 4.0 ma. Oscillator Grid (# 1) Resistor, 50000 ohms. Conversion conductance, 520 micromhos.				2A7		
2B7	DUPEX-DIODE PENTODE	SMALL 7-PIN	FIG. 21	4 1/2" x 1 1/8"	HEATER	2.5	0.8	250	125	PENTODE UNIT AS R-F AMPLIFIER PENTODE UNIT AS A-F AMPLIFIER	100 250 250	- 3.0 - 3.0 - 4.5	100 125 50	1.7 2.3 —	5.8 9.0 0.65	300000 650000	950 1125	285 730	— —	— —	— —	2B7	
6A4 <small>also 2A</small>	POWER AMPLIFIER PENTODE	MEDIUM 6-PIN	FIG. 6	4 1/2" x 1 1/2"	FILAMENT	6.3	0.3	180	180	CLASS A AMPLIFIER	100 180	- 6.5 - 12.0	100 180	1.6 3.9	9.0 45500	83250 2200	1200 100	100 8000	11000 8000	0.31 1.40	6A4 <small>also 2A</small>		
6A8	TWIN-TRIODE AMPLIFIER	MEDIUM 7-PIN #	FIG. 24	4 1/2" x 1 1/2"	HEATER	6.3	0.8	300	—	CLASS B AMPLIFIER	250 300	0 —	—	—	—	—	Power output value is for one tube at stated load, plate-to-plate.	8000	8.0	10000	10.0	6A8	
6A7	PENTAGRID CONVERTER #	SMALL 7-PIN	FIG. 20	4 1/2" x 1 1/8"	HEATER	6.3	0.3	250	100	CONVERTER	250	{ - 3.0 min. }	100	2.2	3.5	360000	Anode Grid (# 2) 200 max. volts, 4.0 ma. Oscillator Grid (# 1) Resistor, 50000 ohms. Conversion conductance, 520 micromhos.				6A7		
6B7	DUPEX-DIODE PENTODE	SMALL 7-PIN	FIG. 21	4 1/2" x 1 1/8"	HEATER	6.3	0.3	250	125	PENTODE UNIT AS R-F AMPLIFIER PENTODE UNIT AS A-F AMPLIFIER	100 250 250	- 3.0 - 3.0 - 4.5	100 125 50	1.7 2.3 —	5.8 9.0 0.65	300000 650000	950 1125	285 730	— —	— —	— —	6B7	
6C6	TRIPLE-GRID DETECTOR AMPLIFIER	SMALL 6-PIN	FIG. 11	4 1/2" x 1 1/8"	HEATER	6.3	0.3	250	100	SCREEN GRID R-F AMPLIFIER BIAS DETECTOR	250	- 3.0	100	0.5	2.0	—	exceeds 1.5 meg.	1225	exceeds 1500	—	—	—	6C6
6D6	TRIPLE-GRID SUPER-CONTROL AMPLIFIER	SMALL 6-PIN	FIG. 11	4 1/2" x 1 1/8"	HEATER	6.3	0.3	250	100	SCREEN GRID R-F AMPLIFIER MIXER IN SUPERHETERODYNE	250	{ - 3.0 min. }	100	2.0	8.2	800000	1600	1280	—	—	—	—	6D6
# Grids # 3 and # 5 are screen. Grid # 4 is signal-input control-grid. * Requires different socket from small 7-pin.											* Applied through plate coupling resistor of 20000 ohms. ** Applied through plate coupling resistor of 250000 ohms.												
6F7	TRIODE- PENTODE	SMALL 7-PIN	FIG. 27	4 1/2" x 1 1/8"	HEATER	6.3	0.3	100	—	TRIODE UNIT AS AMPLIFIER	100	- 3.0	—	—	3.5	17800	450	8	—	—	—	6F7	
								250	100	PENTODE UNIT AS AMPLIFIER	250	{ - 3.0 min. }	100	1.5	6.5	850000	1100	900	—	—	—		
								250	100	PENTODE UNIT AS MIXER	250	-10.0	100	0.6	2.8	—	—	—	—	—	—		—

'00-A	DETECTOR TRIODE	MEDIUM 4-PIN	FIG. 1	$4\frac{1}{2}'' \times 1\frac{1}{2}''$	D-C FILAMENT	5.0	0.25	45	---	GRID LEAK DETECTOR	-45	Grid Return to (-) Filament	1.5	30000	666	20	---	---	'00-A			
01-A	DETECTOR* AMPLIFIER	MEDIUM 4-PIN	FIG. 1	$4\frac{1}{2}'' \times 1\frac{1}{2}''$	D-C FILAMENT	5.0	0.25	135	---	CLASS A AMPLIFIER	90 135	- 4.5 - 9.0	---	---	2.5 3.0	11000 10000	725 800	8.0 8.0	---	---	01-A	
10	POWER AMPLIFIER TRIODE	MEDIUM 4-PIN	FIG. 1	$5\frac{1}{2}'' \times 2\frac{1}{4}''$	FILAMENT	7.5	1.25	425	---	CLASS A AMPLIFIER	350 425	-31.0 -39.0	---	---	16.0 18.0	5150 5000	1550 1600	8.0 8.0	11000 10200	0.9 1.6	10	
11	DETECTOR* AMPLIFIER TRIODE	WD 4-PIN	FIG. 12	$4\frac{1}{2}'' \times 1\frac{1}{2}''$	D-C FILAMENT	1.1	0.25	135	---	CLASS A AMPLIFIER	90 135	- 4.5 - 10.5	---	---	2.5 3.0	15500 15000	425 440	6.6 6.6	---	---	11	
12	DETECTOR* AMPLIFIER TRIODE	MEDIUM 4-PIN	FIG. 1	$4\frac{1}{2}'' \times 1\frac{1}{2}''$	D-C FILAMENT	1.1	0.25	135	---	CLASS A AMPLIFIER	90 135	- 4.5 - 10.5	---	---	2.5 3.0	15500 15000	425 440	6.6 6.6	---	---	12	
19	TWIN TRIODE AMPLIFIER	SMALL 6-PIN	FIG. 25	$4\frac{1}{2}'' \times 1\frac{1}{8}''$	D-C FILAMENT	2.0	0.26	135	---	CLASS B AMPLIFIER	135 135	0 - 3.0	---	---	Power output value is for one tube at stated load, plate-to-plate.				10000 10000	2.1 1.9	19	
'20	POWER AMPLIFIER TRIODE	SMALL 4-PIN	FIG. 1	$4\frac{1}{2}'' \times 1\frac{1}{8}''$	D-C FILAMENT	3.3	0.132	195	---	CLASS A AMPLIFIER	90 135	-16.5 -22.5	---	---	3.0 6.5	8000 6300	415 525	3.3 3.3	9600 6500	0.045 0.110	'20	
22	R-F AMPLIFIER TETRODE	MEDIUM 4-PIN	FIG. 4	$5\frac{1}{2}'' \times 1\frac{1}{2}''$	D-C FILAMENT	3.3	0.132	135	67.5	SCREEN GRID R-F AMPLIFIER	135 135	- 1.5 - 1.5	45 67.5	0.6* 1.3*	1.7 3.7	725000 325000	375 500	270 160	---	---	22	
24-A	R-F AMPLIFIER TETRODE	MEDIUM 5-PIN	FIG. 9	$5\frac{1}{2}'' \times 1\frac{1}{8}''$	HEATER	2.5	1.75	275	90	SCREEN GRID R-F AMPLIFIER	180 250	- 3.0 - 3.0	90	1.7* 1.7*	4.0 4.0	460000 600000	1000 1050	400 630	---	---	24-A	
26	AMPLIFIER TRIODE	MEDIUM 4-PIN	FIG. 1	$4\frac{1}{2}'' \times 1\frac{1}{8}''$	FILAMENT	1.5	1.05	180	---	CLASS A AMPLIFIER	90 180	- 7.0 - 14.5	---	---	2.9 6.2	8900 7300	935 1150	8.3 8.3	---	---	26	
27	DETECTOR* AMPLIFIER TRIODE	MEDIUM 5-PIN	FIG. 8	$4\frac{1}{2}'' \times 1\frac{1}{8}''$	HEATER	2.5	1.75	275	---	CLASS A AMPLIFIER	135 250	- 9.0 - 21.0	---	---	4.5 5.2	9000 9250	1000 975	9.0 9.0	---	---	27	
30	DETECTOR* AMPLIFIER TRIODE	SMALL 4-PIN	FIG. 1	$4\frac{1}{2}'' \times 1\frac{1}{8}''$	D-C FILAMENT	2.0	0.06	180	---	CLASS A AMPLIFIER	90 135 180	- 4.5 - 9.0 - 13.5	---	---	2.5 3.0 3.1	11000 10300 10300	850 900 900	9.3 9.3 9.3	---	---	30	
★For Grid-leak Detection—plate volts 45, grid return to + filament or to cathode. ●Applied through plate coupling resistor of 250000 ohms or 500-henry choke shunted by 0.25 megohm resistor. *Maximum.																						
31	POWER AMPLIFIER TRIODE	SMALL 4-PIN	FIG. 1	$4\frac{1}{2}'' \times 1\frac{1}{8}''$	D-C FILAMENT	2.0	0.13	180	---	CLASS A AMPLIFIER	135 180	-22.5 -30.0	---	---	8.0 12.3	4100 3600	925 1050	3.8 3.8	7000 5700	0.185 0.375	31	
32	R-F AMPLIFIER TETRODE	MEDIUM 4-PIN	FIG. 4	$5\frac{1}{2}'' \times 1\frac{1}{8}''$	D-C FILAMENT	2.0	0.06	180	67.5	SCREEN GRID R-F AMPLIFIER	135 180	- 3.0 - 3.0	67.5 67.5	0.4* 0.4*	1.7 1.7	950000 1200000	640 650	610 780	---	---	32	
33	POWER AMPLIFIER PENTODE	MEDIUM 5-PIN	FIG. 6	$4\frac{1}{2}'' \times 1\frac{1}{8}''$	D-C FILAMENT	2.0	0.26	180	180	BIAS DETECTOR	180	- 6.0	---	---	Plate current to be adjusted to 0.2 milliamperes with no signal.				---	---	33	
34	SUPER-CONTROL R-F AMPLIFIER PENTODE	MEDIUM 4-PIN	FIG. 4A	$5\frac{1}{2}'' \times 1\frac{1}{8}''$	D-C FILAMENT	2.0	0.06	180	67.5	CLASS A AMPLIFIER	180	-18.0	180	5.0	22.0	55000	1700	90	6000	1.4	33	
35	SUPER-CONTROL R-F AMPLIFIER TETRODE	MEDIUM 5-PIN	FIG. 9	$5\frac{1}{2}'' \times 1\frac{1}{8}''$	HEATER	2.5	1.75	275	90	SCREEN GRID R-F AMPLIFIER	135 180	- 3.0 - 3.0	67.5 67.5	1.0 1.0	2.8 2.8	600000 1000000	600 620	360 620	---	---	34	
36	R-F AMPLIFIER TETRODE	SMALL 5-PIN	FIG. 9	$4\frac{1}{2}'' \times 1\frac{1}{8}''$	HEATER	6.3	0.3	250	90	SCREEN GRID R-F AMPLIFIER	180 250	- 3.0 - 3.0	90 90	2.5* 2.5*	6.3 6.5	300000 400000	1020 1050	305 420	---	---	35	
37	DETECTOR* AMPLIFIER TRIODE	SMALL 5-PIN	FIG. 8	$4\frac{1}{2}'' \times 1\frac{1}{8}''$	HEATER	6.3	0.3	250	---	SCREEN GRID R-F AMPLIFIER	100 180 250	- 1.5 - 3.0 - 3.0	55 90 90	---	1.8 3.1 3.2	550000 500000 550000	850 1050 1080	470 525 595	---	---	36	
38	POWER AMPLIFIER PENTODE	SMALL 5-PIN	FIG. 9A	$4\frac{1}{2}'' \times 1\frac{1}{8}''$	HEATER	6.3	0.3	250	250	BIAS DETECTOR	100 250	- 5.0 - 8.0	55 90	---	Plate current to be adjusted to 0.1 milliamperes with no signal.				---	---	37	
39-44	SUPER-CONTROL R-F AMPLIFIER PENTODE	SMALL 5-PIN	FIG. 9A	$4\frac{1}{2}'' \times 1\frac{1}{8}''$	HEATER	6.3	0.3	250	90	CLASS A AMPLIFIER	90 180 250	- 6.0 - 13.5 - 18.0	---	---	2.5 4.3 7.5	11500 10200 800	800 900 1100	9.2 9.2 9.2	---	---	38	
39-44	SUPER-CONTROL R-F AMPLIFIER PENTODE	SMALL 5-PIN	FIG. 9A	$4\frac{1}{2}'' \times 1\frac{1}{8}''$	HEATER	6.3	0.3	250	90	BIAS DETECTOR	90 250	- 10.0 - 28.0	---	---	Plate current to be adjusted to 0.2 milliamperes with no signal.				---	---	37	
39-44	SUPER-CONTROL R-F AMPLIFIER PENTODE	SMALL 5-PIN	FIG. 9A	$4\frac{1}{2}'' \times 1\frac{1}{8}''$	HEATER	6.3	0.3	250	90	CLASS A AMPLIFIER	100 180 250	- 9.0 - 18.0 - 25.0	100 180 250	1.2 2.4 3.8	7.0 14.0 22.0	140000 115000 100000	875 1050 1200	15000 12000 10000	0.27 1.00 2.50	---	---	38
39-44	SUPER-CONTROL R-F AMPLIFIER PENTODE	SMALL 5-PIN	FIG. 9A	$4\frac{1}{2}'' \times 1\frac{1}{8}''$	HEATER	6.3	0.3	250	90	SCREEN GRID R-F AMPLIFIER	90 180 250	- 3.0 - 3.0 - 3.0	90 90 90	1.6 1.4 1.4	5.6 5.8 5.8	375000 750000 1000000	960 1000 1050	360 750 1050	---	---	39-44	
★For Grid-leak Detection—plate volts 45, grid return to + filament or to cathode. ●Applied through plate coupling resistor of 250000 ohms or 500-henry choke shunted by 0.25 megohm resistor. *Maximum.																						
■Either A. C. or D. C. may be used on filament or heater, except as specifically noted. For use of D. C. on A-C filament types, decrease stated grid volts by 1/2 (approx.) of filament voltage. ♥Applied through plate coupling resistor of 100000 ohms.																						

TYPE	NAME	BASE	SOCKET CONNECTIONS	DIMENSIONS MAXIMUM OVERALL LENGTH X DIAMETER	CATHODE TYPE #	RATING			USE Values to right give operating conditions and characteristics for indicated typical use	PLATE SUPPLY VOLTS	GRID VOLTS	SCREEN VOLTS	SCREEN MILLI-AMP.	PLATE MILLI-AMP.	A-C PLATE RESISTANCE OHMS	MUTUAL CONDUCTANCE MICRO-MHOS	VOLTAGE AMPLIFICATION FACTOR	LOAD FOR STATED POWER OUTPUT OHMS	POWER OUTPUT WATTS	TYPE	
						FILAMENT OR HEATER		SCREEN													
						VOLTS	AMPERES	MAX. VOLTS													MAX. VOLTS
40	VOLTAGE AMPLIFIER TRIODE	MEDIUM 4-PIN	FIG. 1	4 1/8" x 1 1/8"	D-C FILAMENT	5.0	0.25	180	—	CLASS A AMPLIFIER	135 X 180 X	- 1.5 - 3.0	—	—	0.2 0.2	150000 150000	200 200	30 30	—	—	40
41	POWER AMPLIFIER PENTODE	SMALL 8-PIN	FIG. 15A	4 1/2" x 1 1/8"	HEATER	6.3	0.4	250	250	CLASS A AMPLIFIER	100 180 250	- 7.0 - 13.5 - 18.0	100 180 250	1.6 3.0 5.5	9.0 18.5 32.0	103500 81000 63000	1450 1850 2100	150 150 150	12000 9000 7600	0.33 1.50 3.40	41
42	POWER AMPLIFIER PENTODE	MEDIUM 6-PIN	FIG. 15A	4 1/8" x 1 1/8"	HEATER	6.3	0.7	250	250	CLASS A AMPLIFIER	250	- 16.5	250	6.5	34.0	100000	2200	220	7000	3.00	42
43	POWER AMPLIFIER PENTODE	MEDIUM 6-PIN	FIG. 15A	4 1/8" x 1 1/8"	HEATER	25.0	0.3	135	135	CLASS A AMPLIFIER	95 135	- 15.0 - 20.0	95 135	4.0 7.0	34.0	45000 35000	2600 2300	90 80	4500 4000	0.90 2.00	43
45	POWER AMPLIFIER TRIODE	MEDIUM 4-PIN	FIG. 1	4 1/8" x 1 1/8"	FILAMENT	2.5	1.5	275	—	CLASS A AMPLIFIER	180 250	- 31.5 - 56.0	—	—	31.0 36.0	1650 1700	2125 2050	3.5 3.5	2700 4600	0.82 1.60 2.90	45
46	DUAL-GRID POWER AMPLIFIER	MEDIUM 5-PIN	FIG. 7	5 1/8" x 2 1/8"	FILAMENT	2.5	1.75	250	—	CLASS A AMPLIFIER	250	- 33.0	—	—	22.0	2380	2350	5.6	6400	1.25	46
47	POWER AMPLIFIER PENTODE	MEDIUM 5-PIN	FIG. 8	5 1/2" x 2 1/8"	FILAMENT	2.5	1.75	250	250	CLASS A AMPLIFIER	300 400	0 0	—	—	—	Power output values are for 2 tubes at indicated plate-to-plate load.			5200 5800	16.0 20.0	47
48	POWER AMPLIFIER TETRODE	MEDIUM 6-PIN	FIG. 15	5 1/2" x 2 1/8"	D-C HEATER	30.0	0.4	125	100	CLASS A AMPLIFIER	96 125	- 19.0 - 20.0	96 100	9.0 9.5	52.0 56.0	— 3900	3800	—	1500	2.5 2.0	48
49	DUAL-GRID POWER AMPLIFIER	MEDIUM 6-PIN	FIG. 7	4 1/8" x 1 1/8"	D-C FILAMENT	2.0	0.12	180	—	CLASS A AMPLIFIER	135 180	- 20.0	—	—	6.0	4175	1125	4.7	11000	0.17	49
50	POWER AMPLIFIER TRIODE	MEDIUM 4-PIN	FIG. 1	6 1/8" x 2 1/8"	FILAMENT	7.5	1.25	450	—	CLASS A AMPLIFIER	300 400 450	- 54.0 - 70.0 - 84.0	—	—	35.0 55.0	2000 1800 1800	1900 2100 3.8	3.8 3.8	4600 3670 4350	1.6 3.4 4.6	50
53	TWIN-TRIODE AMPLIFIER	MEDIUM 7-PIN	FIG. 24	4 1/8" x 1 1/8"	HEATER	2.5	2.0	300	—	CLASS B AMPLIFIER	250 300	0 0	—	—	—	Power output value is for one tube at stated load, plate-to-plate.			8000 10000	8.0 10.0	53
55	DUPLEX-DIODE TRIODE	SMALL 8-PIN	FIG. 13	4 1/2" x 1 1/8"	HEATER	2.5	1.0	250	—	TRIODE UNIT AS CLASS A AMPLIFIER	135 180 250	- 10.5 - 13.5 - 20.0	—	—	3.7 6.0 8.0	11000 8500 7500	750 975 1100	8.3 8.3	25000 20000	0.075 0.160 0.350	55
56	SUPER-TRIODE AMPLIFIER DETECTOR	SMALL 8-PIN	FIG. 8	4 1/8" x 1 1/8"	HEATER	2.5	1.0	250	—	CLASS A AMPLIFIER	250	- 13.5	—	—	5.0	9500	1450	13.8	—	—	56
57	TRIPLE-GRID DETECTOR AMPLIFIER	SMALL 8-PIN	FIG. 11	4 1/8" x 1 1/8"	HEATER	2.5	1.0	250	100	BIAS DETECTOR	250	- 20.0 (approx.)	—	—	—	Plate current to be adjusted to 0.2 milliamperes with no signal.			—	—	57
										SCREEN GRID R.F. AMPLIFIER	250	- 3.0	100	0.5	2.0	exceeds 1.5 meg.	1225	exceeds 1500	—	—	57
										BIAS DETECTOR	250	- 1.95	50	Cathode current 0.65 ma		Plate coupling resistor 250000 ohms. Grid coupling resistor 250000 ohms**.			—	—	57

*For Grid-leak Detection—plate volts 45, grid return to + filament or to cathode.
#Requires different socket from small 7-pin.

□Grid next to plate tied to plate. †Two grids tied together **For grid of following tube.
#Applied through plate coupling resistor of 250000 ohms.

58	TRIPLE-GRID SUPER-CONTROL AMPLIFIER	SMALL 8-PIN	FIG. 11	4 1/8" x 1 1/8"	HEATER	2.5	1.0	250	100	SCREEN GRID R.F. AMPLIFIER	250	- 3.0 (min.)	100	2.0	8.2	800000	1600	1280	—	—	58
										MIXER IN SUPERHETERODYNE	250	- 10.0	100	—	—	Oscillator peak volts = 7.0.			—	—	58
59	TRIPLE-GRID POWER AMPLIFIER	MEDIUM 7-PIN	FIG. 18	5 1/8" x 2 1/8"	HEATER	2.5	2.0	250	250	AS TRIODE † CLASS A AMPLIFIER	250	- 28.0	—	—	26.0	2300	2600	6.0	5000	1.25	59
										AS PENTODE ** CLASS A AMPLIFIER	250	- 18.0	250	9.0	35.0	40000	2500	100	6000	3.00	59
										AS TRIODE † CLASS B AMPLIFIER	300 400	0 0	—	—	—	Power output values are for 2 tubes at indicated plate-to-plate load.			4600 6000	15.0 20.0	59

71-A	POWER AMPLIFIER TRIODE	MEDIUM 4-PIN	FIG. 1	$4\frac{1}{2}'' \times 1\frac{1}{8}''$	FILAMENT	5.0	0.25	180	—	CLASS A AMPLIFIER	90 180	-19.0 -43.0	—	—	10.0 20.0	2170 1750	1400 1700	3.0 3.0	3000 4800	0.125 0.790	71-A		
75	DUPEX-DIODE HIGH-MU TRIODE	SMALL 6-PIN	FIG. 13	$4\frac{1}{2}'' \times 1\frac{1}{8}''$	HEATER	6.3	0.3	250	—	TRIODE UNIT AS CLASS A AMPLIFIER	250	-1.35	—	—	0.4	—	—	—	—	Gain per stage = 50-60	75		
76	SUPER-TRIODE AMPLIFIER DETECTOR*	SMALL 6-PIN	FIG. 8	$4\frac{1}{2}'' \times 1\frac{1}{8}''$	HEATER	6.3	0.3	250	—	CLASS A AMPLIFIER	250	-13.5	—	—	5.0	9500	1450	13.8	—	—	76		
										BIAS DETECTOR	250	-20.0	—	—	—	—	—	—	—	Plate current to be adjusted to 0.2 milliamperes with no signal.			
77	TRIPLE-GRID DETECTOR AMPLIFIER	SMALL 6-PIN	FIG. 11	$4\frac{1}{2}'' \times 1\frac{1}{8}''$	HEATER	6.3	0.3	250	100	SCREEN GRID R.F. AMPLIFIER	100 250	-1.5 -3.0	60 100	0.4 0.5	1.7 2.3	65000 150000	1100 1250	715 1500	—	—	77		
										BIAS DETECTOR	250	-1.95	50	—	—	—	—	—	—	Plate coupling resistor 250000 ohms. Grid coupling resistor 250000 ohms**.			
78	TRIPLE-GRID SUPER-CONTROL AMPLIFIER	SMALL 6-PIN	FIG. 11	$4\frac{1}{2}'' \times 1\frac{1}{8}''$	HEATER	6.3	0.3	250	125	SCREEN GRID R.F. AMPLIFIER	90 180 250	{ - 3.0; min. }	90 75 100 125	1.3 1.0 1.7 2.6	5.4 4.0 7.0 10.5	31500 100000 80000 60000	1275 1100 1450 1600	400 1100 1160 990	—	—	78		
79	TWIN-TRIODE AMPLIFIER	SMALL 6-PIN	FIG. 19	$4\frac{1}{2}'' \times 1\frac{1}{8}''$	HEATER	6.3	0.6	250	—	CLASS B AMPLIFIER	180 250	0 0	—	—	—	—	—	—	Power output value is for one tube at stated load, plate-to-plate.	7000 14000	5.5 8.0	79	
85	DUPEX-DIODE TRIODE	SMALL 6-PIN	FIG. 13	$4\frac{1}{2}'' \times 1\frac{1}{8}''$	HEATER	6.3	0.3	250	—	TRIODE UNIT AS CLASS A AMPLIFIER	135 180 250	-10.5 -13.5 -20.0	—	—	—	3.7 6.0 8.0	11000 8500 7500	750 975 1100	8.3 8.3 8.3	25000 20000 20000	0.075 0.160 0.350	85	
										AS TRIODE & CLASS A AMPLIFIER	160 180 250	-20.0 -22.5 -31.0	—	—	—	17.0 20.0 32.0	3300 3000 2600	1425 1550 1800	4.7 4.7 4.7	7000 6500 5900	0.320 0.400 0.900		
										AS PENTODE && CLASS A AMPLIFIER	100 180 250	-10.0 -18.0 -25.0	100 100 250	1.6 3.0 5.5	9.5 20.0 32.0	104000 80000 70000	1200 1550 1800	125 125 125	10700 8000 6750	0.33 1.50 3.40			
										AS TRIODE & CLASS B AMPLIFIER	180	0	—	—	—	—	—	—	—	Power output values are for 2 tubes at indicated plate-to-plate load.	13600 9600	2.50 3.50	89
V99 X99	DETECTOR* AMPLIFIER TRIODE	SMALL 4-NUB SMALL 4-PIN	FIG. 10 FIG. 1	$3\frac{1}{2}'' \times 1\frac{1}{8}''$ $4\frac{1}{2}'' \times 1\frac{1}{8}''$	D-C FILAMENT	3.3	0.063	90	—	CLASS A AMPLIFIER	90	-4.5	—	—	2.5	15500	425	6.6	—	—	V99 X99		
112-A	DETECTOR* AMPLIFIER TRIODE	MEDIUM 4-PIN	FIG. 1	$4\frac{1}{2}'' \times 1\frac{1}{8}''$	D-C FILAMENT	5.0	0.25	180	—	CLASS A AMPLIFIER	90 180	-4.5 -13.5	—	—	5.0 7.7	5400 4700	1575 1800	8.5 8.5	—	—	112-A		

*For Grid-leak Detection—plate volts 45, grid return to + filament or to cathode.
 †Either A. C. or D. C. may be used on filament or heater, except as specifically noted. For use of D. C. on A-C filament types, decrease stated grid volts by 1/2 (approx.) of filament voltage.
 ‡Requires different socket from small 7-pin.

**Grid #1 is control grid. Grid #2 is screen. Grid #3 tied to cathode.
 ††Grid #1 is control grid. Grids #2 and #3 tied to plate. †††Applied through plate coupling resistor of 250000 ohms
 ‡‡Grids #1 and #2 connected together. Grid #3 tied to plate. ‡‡‡For grid of following tube.

RECTIFIERS

523	FULL-WAVE RECTIFIER	MEDIUM 4-PIN	FIG. 2	$5\frac{1}{2}'' \times 2\frac{1}{8}''$	FILAMENT	5.0	3.0	—	—	Maximum A-C Voltage per Plate.....	500 Volts, RMS	—	—	—	—	—	—	—	—	Maximum D-C Output Current.....	250 Milliamperes	523
1223	HALF-WAVE RECTIFIER	SMALL 4-PIN	FIG. 22	$4\frac{1}{2}'' \times 1\frac{1}{8}''$	HEATER	12.6	0.3	—	—	Maximum A-C Plate Voltage.....	250 Volts, RMS	—	—	—	—	—	—	—	—	Maximum D-C Output Current.....	60 Milliamperes	1223
2525	RECTIFIER-DOUBLER	SMALL 6-PIN	FIG. 5	$4\frac{1}{2}'' \times 1\frac{1}{8}''$	HEATER	25.0	0.3	—	—	Maximum A-C Voltage per Plate.....	125 Volts, RMS	—	—	—	—	—	—	—	—	Maximum D-C Output Current.....	100 Milliamperes	2525
1-V ^o	HALF-WAVE RECTIFIER	SMALL 4-PIN	FIG. 22	$4\frac{1}{2}'' \times 1\frac{1}{8}''$	HEATER	6.3	0.3	—	—	Maximum A-C Plate Voltage.....	350 Volts, RMS	—	—	—	—	—	—	—	—	Maximum D-C Output Current.....	50 Milliamperes	1-V ^o
80	FULL-WAVE RECTIFIER	MEDIUM 4-PIN	FIG. 2	$4\frac{1}{2}'' \times 1\frac{1}{8}''$	FILAMENT	5.0	2.0	—	—	A-C Voltage per Plate (Volts RMS).....	350 400 550	—	—	—	—	—	—	—	The 550 volt rating applies to filter circuits having an input choke of at least 20 henries.	125 110 135	80	
'81	HALF-WAVE RECTIFIER	MEDIUM 4-PIN	FIG. 3	$6\frac{1}{2}'' \times 2\frac{1}{8}''$	FILAMENT	7.5	1.25	—	—	Maximum A-C Plate Voltage.....	700 Volts, RMS	—	—	—	—	—	—	—	—	Maximum D-C Output Current.....	85 Milliamperes	'81
82	FULL-WAVE RECTIFIER	MEDIUM 4-PIN	FIG. 2	$4\frac{1}{2}'' \times 1\frac{1}{8}''$	FILAMENT	2.5	3.0	—	—	Maximum A-C Voltage per Plate.....	500 Volts, RMS	—	—	—	—	—	—	—	—	Maximum Peak Inverse Voltage.....	1400 Volts	82
83	FULL-WAVE RECTIFIER	MEDIUM 4-PIN	FIG. 2	$5\frac{1}{2}'' \times 2\frac{1}{8}''$	FILAMENT	5.0	3.0	—	—	Maximum D-C Output Current.....	125 Milliamperes	—	—	—	—	—	—	—	—	Maximum Peak Plate Current.....	400 Milliamperes	83
83-V	FULL-WAVE RECTIFIER	MEDIUM 4-PIN	FIG. 2	$4\frac{1}{2}'' \times 1\frac{1}{8}''$	HEATER	5.0	2.0	—	—	Maximum A-C Voltage per Plate.....	500 Volts, RMS	—	—	—	—	—	—	—	—	Maximum Peak Inverse Voltage.....	1400 Volts	83-V
										Maximum D-C Output Current.....	250 Milliamperes	—	—	—	—	—	—	—	—	Maximum Peak Plate Current.....	800 Milliamperes	
84	FULL-WAVE RECTIFIER	SMALL 6-PIN	FIG. 23	$4\frac{1}{2}'' \times 1\frac{1}{8}''$	HEATER	6.3	0.5	—	—	Maximum A-C Plate Voltage per Plate.....	400 Volts, RMS	—	—	—	—	—	—	—	—	Maximum D-C Output Current.....	200 Milliamperes	84
also 62d										Maximum A-C Voltage per Plate.....	350 Volts, RMS	—	—	—	—	—	—	—	—	Maximum D-C Output Current.....	50 Milliamperes	also 62d

‡Mercury Vapor Type. * Interchangeable with Type 1. † Cathode connected to No. 4 base pin.

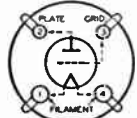

FIG. 1

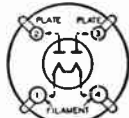

FIG. 2

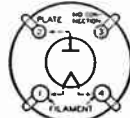

FIG. 3

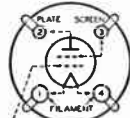

FIG. 4

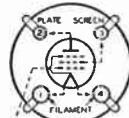

FIG. 4A

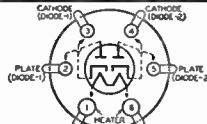

FIG. 5

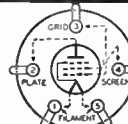

FIG. 6

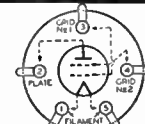

FIG. 7

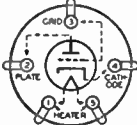

FIG. 8

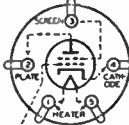

FIG. 9

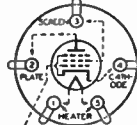

FIG. 9A

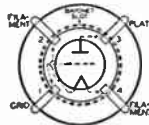

FIG. 10

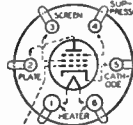

FIG. 11

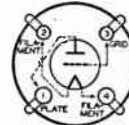

FIG. 12

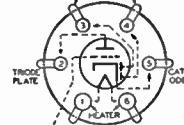

FIG. 13

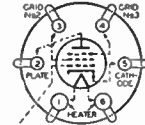

FIG. 14

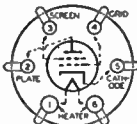

FIG. 15

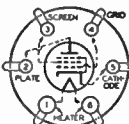

FIG. 15A

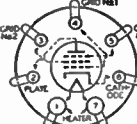

FIG. 18

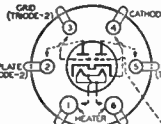

FIG. 19

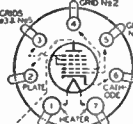

FIG. 20

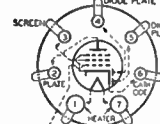

FIG. 21

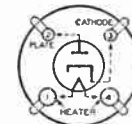

FIG. 22

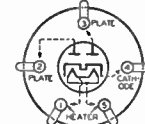

FIG. 23

TUBE SYMBOLS AND BOTTOM VIEWS OF SOCKET CONNECTIONS

Pin Numbers on Socket Diagrams are shown according to the new system recently standardized by the Radio Manufacturers Association.

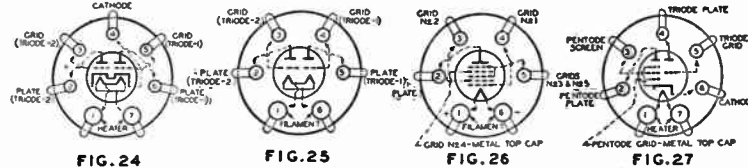

FIG. 24

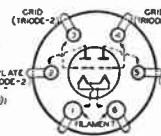

FIG. 25

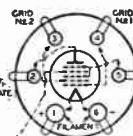

FIG. 26

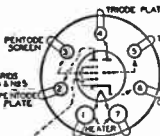
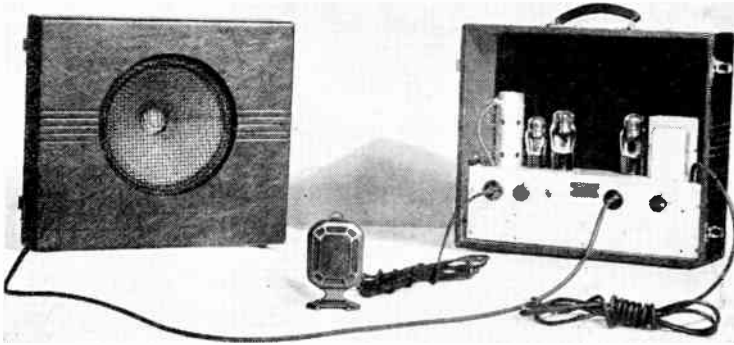

FIG. 27

INDEX OF TYPES BY USE AND BY CATHODE VOLTAGE

CATHODE VOLTS	POWER AMPLIFIERS	VOLTAGE AMPLIFIERS Including Duplex-Diode Types	CONVERTERS IN SUPERHETERODYNES	DETECTORS	MIXER TUBES IN SUPERHETERODYNES	RECTIFIERS	CATHODE VOLTS
1.1	—	11, 12	—	11, 12	—	—	1.1
1.5	—	26	—	—	—	—	1.5
2.0	19, 31, 33, 49	30, 32, 34	1A6, 1C6	30, 32	1A6, 1C6, 34	—	2.0
2.5	2A3, 2A5, 45, 46, 47, 53, 59	2A6, 2B7, 24-A, 27, 35, 55, 56, 57, 58	2A7	2A6, 2B7, 24-A, 27, 55, 56, 57	2A7, 24-A, 35, 57, 58	82	2.5
3.3	*20	22, 99	—	99	—	—	3.3
5.0	112-A, 71-A	01-A, 40, 112-A	—	00-A, 01-A, 40, 112-A	—	523, 80, 83, 83-V	5.0
6.3	6A4, 6A6, 38, 41, 42, 79, 89	6B7, 6C6, 6D6, 6P7, 36, 37, 39-44, 75, 76, 77, 78, 85	6A7, 6P7	6B7, 6C6, 6P7, 36, 37, 75, 76, 77, 85	6A7, 6C6, 6D6, 6P7, 36, 39-44, 77, 78	1-V, 84	6.3
7.5	10, 50	—	—	—	—	'81	7.5
12.6	—	—	—	—	—	1223	12.6
25.0	43	—	—	—	—	2325	25.0
30.0	48	—	—	—	—	—	30.0



MODEL PG-63B: Double-button Carbon Microphone; 6-watt Amplifier, 3 stage. 75 db. gain, 50-60 cycles, A. C. 105-125 volts; 10" electro-dynamic Speaker, Phonograph Jack, Tone Control, RCA Radio Tubes: 1RCA-57, 1RCA-56, 1RCA-53, 1RCA-80. Self-contained in handsome carrying case, finished in dark Spanish blue fabrikoid. Dimensions: 8 $\frac{1}{8}$ " deep, 16 $\frac{3}{8}$ " wide, 16" high. Weight: 28 $\frac{1}{2}$ pounds. List price, complete, \$79.50 f. o. b. Camden, N. J.

RCA VICTOR PORTABLE PUBLIC ADDRESS SYSTEM

Model PG-63B (Cat. No. MI-4701A)

The RCA Victor portable Public Address System *Model PG-63B* is admirably suited for moderate-sized auditoriums; also for such diversified applications as bus terminals, carnivals, restaurants, stores and gymnasiums.

Exceptional tone quality and ease of operation make the new PG-63B the outstanding Portable P. A. system in the low-price field. Matched loudspeaker and amplifier insure faithful reproduction of voice or record. The dynamic speaker will handle the maximum output of the 6-watt amplifier without distortion. The equipment and controls are simple, convenient and foolproof. To set it in opera-

Right: Double Button Carbon Type Microphone, improved model; gives remarkably efficient results.



tion, connect the power cable with any 110 volt, 50-60 cycle alternating current supply, and plug the microphone and speaker cables into the amplifier. The speaker section of the carrying case may be suspended from a hook provided for that purpose, anywhere within the 25-foot radius of the speaker cable. A 12-foot cable is attached to the microphone, so that the complete unit meets all ordinary operating requirements, without any additional wiring.

By means of separate portable phonograph attachments, records may be used for musical programs or to furnish music background for voice announcements.

**Complete System
LIST PRICE
\$79.50**
f. o. b. Camden

RCA Victor Portable Public Address System

Model PG-62D

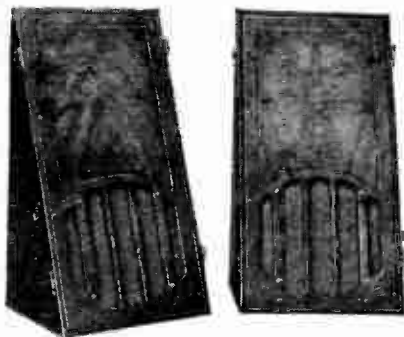

20 Watts Output . . .
Velocity Mike . . . Two
Speakers . . . All in
Two Compact Cases.

LIST PRICE
f. o. b. Camden

\$395



MODEL PG-62D Includes: Velocity microphone; announcer type Stand with extension arm; 20-watt amplifier, 5 stage, 108 db. gain, 50-60 cycles, a-c, 105-125 volts; 2 electro-dynamic speakers, finished wood baffle; RCA Radio Tubes: 1RCA-57, 2RCA-56, 3RCA-59, 1RCA-83. Amplifier, microphone and cables assembled in reinforced carrying case which is 15" high, 22" long, 9" deep.

Loudspeakers fit together, forming a compact portable case which is 12 3/4" high, 23 3/4" long, 10" deep. List price complete. \$395.00 f.o.b. Camden, N. J.

MODEL PG-62D, because of its marvelous sensitivity, due to the famous RCA Victor Velocity Microphone and high fidelity loudspeakers, is the finest portable public address system of its kind on the market. Auditoriums, banquet halls, dance halls, restaurants, night clubs, hotels and a host of other places find this model perfectly adaptable for their use. It can be used to amplify speeches in large auditoriums or orchestral music in large restaurants or dance halls, without distortion. Will provide ample volume for audiences of 2500.

. . .

Below: This amplifier case allows space to hold the microphone as well as the amplifier. It is reinforced and is covered with black leatherette; 22" long, 15" high, 9" deep.

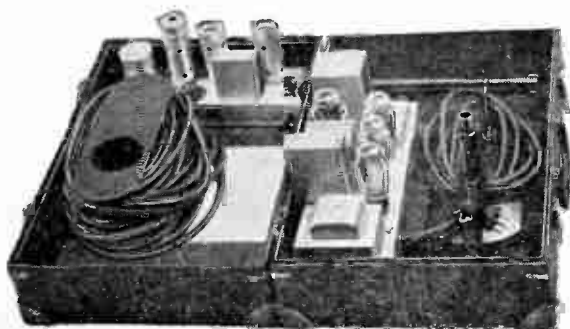

Complete Sound Systems

RCA Victor Commercial Sound Systems, with their great flexibility, cover practically the whole field of electrical sound control, reproduction and distribution. The applications range from simple announcing systems to the most elaborate indoor or outdoor installations. *Standardized, matched units* insure satisfactory performance and contribute greatly to ease and economy of installation.

We are prepared to give you technical assistance and detailed specifications on any type of sound reinforcing system, or on Photophone sound picture equipment for non-theatrical installations.

Write or call us for complete information on RCA Victor Commercial Sound Systems.

Portable P. A. Systems

Centralized Radio

Photophone
Sound Picture Equipment

Announcing
and Paging Systems

Antenaplex

Sound Reinforcement

The RCA VICTOR RECORD PLAYER

Attaches to Any Radio . . . Transforms it into a Convenient Combination

ONE of the most justly popular and fast-selling radio accessories of the year is RCA Victor's new Record Player, which, for the first time, makes it possible to hear phonograph records through the tubes and loudspeaker of an ordinary radio. The instrument is a combination of synchronous motor, electric pick-up and turntable, capable of playing either 10-inch or 12-inch records at standard speed. It is portable, extremely compact, and may be operated remotely from the radio without jumping up and down to change records. Installed with RCA Phonograph Oscillator (See page 32), the Record Player may be quickly attached to any radio.



RCA Victor Record Player. Weighs only 8½ pounds. Housed in an attractive walnut-finished cabinet only 10⅞" long, 8" wide, 5" high. List price, complete with volume control, needle cup and power cord, only \$16.50 (slightly higher in Far West)

The RCA Victor Store Recorder

A four-tube recording device built especially for dealer use with the object of increasing store traffic and of providing additional profits on recording blanks. Operates on 60 cycle a-c current. Sold complete with two-button microphone, hand-operated pick-up lift, two-speed turntable, volume control, visual neon "modulation" indicator. 14" x 18½" x 14" walnut-finished table cabinet is provided with air vents, removable lid and special compartment for storing microphone.

Record Needles

Type	Half Tone	Full Tone	Extra Loud	Price
STEEL	75 needles to Package 100 Packages to Carton	100 needles to Package 100 Packages to Carton	100 needles to Package 100 Packages to Carton	\$10.00 per Carton
TUNGSTONE	None made	8 needles to Container 50 Containers to Carton	8 needles to Container 50 Containers to Carton	\$12.50 per Carton
SHADOW-GRAPH	5,000 needles to Carton	10,000 needles to Carton	None made	\$3.25 per Thousand
HOME RECORDING	8 needles to Container. 50 Containers to Carton			\$12.50 per Carton
CHROMIUM (Green or Orange Shank)	6 needles to Container. 50 Containers to Carton			\$12.50 per Carton

Standard Victor Records

Red Seal—Covering music exclusively of the classical or semi-classical type. List price range: from \$1.00 per Record to \$3.50 per Record.

Black Label—Incorporating chiefly the music of popular dance bands and radio vocal artists. List price range: 75 cents per ten-inch Record. Twelve-inch, \$1.25.

Blue Bird Records—Containing old familiar tunes, race numbers and popular dance melodies. All ten-inch size. List price, 35 cents per Record.

Special Victor Records

Home Recording Blanks—Made especially for recording selections on Home Recording units. List prices: Six-inch Blanks (kit of 4), 95 cents; Ten-inch Blanks (kit of 2), 95 cents; Twelve-inch Blanks (kit of 2), \$1.75.

Technical Purpose—See page 39.

Wireless Telegraph—A set of six records comprising a comprehensive course in Morse telegraphy. List price, complete with handbook, \$5.00 per set.

For Extra Profits . . . Extra Store Traffic . . .

The RCA VICTOR STORE RECORDER

Here is an instrument that's *not* made for public sale. But, for scores of dealers, it has proved an extremely effective sales *maker*. It's a four-tube device capable of an extraordinarily high quality of recording, and it was manufactured especially to increase store traffic and to provide additional profits on recording blanks. The Store Recorder is equipped with a two-button microphone, hand-operated pick-up lift, two-speed turntable, volume control and visual neon "modulation" indicator—everything, in short, that is necessary to the making of unusually good "amateur" recordings. It operates on 60 cycle a-c current. Enclosed in a handsome walnut-finished table cabinet provided with air vents, removable lid and special compartment for storing the microphone, the Store Re-

recorder is at once convenient, portable, and marvelously efficient. No other device of comparable price and purpose can remotely approximate its effectiveness.



The handsome walnut-finished cabinet of the RCA Victor Store Recorder measures 14" high, 18½" wide, 14" deep. It is shipped from the factory with a special six-piece advertising campaign to promote the sale of recorded blanks.

VICTOR RECORDS

Red Seal—Covering music exclusively of the classical or semi-classical type. List price range: from \$1.00 per Record to \$3.50 per Record.

Black Label—Incorporating chiefly the music of popular dance bands and radio vocal artists. List price range: 75 cents per ten-inch Record. Twelve-inch, \$1.25.

Blue Bird Records—Containing old familiar tunes, race numbers and popular dance melodies. All ten-inch size. List price, 35 cents per Record.

United States-Foreign—Designed to reach alien residents in the United States. Recorded in 30 different languages. Price range same as Black Label Records.

Educational Records—Offer selections for school, college and university study. Include

both Red Seal and Black Label Records, and cover the list price range of these two groups.

Home Recording Blanks—Grooved discs of semi-soft material made especially for recording selections on Home Recording units. List prices: Six-inch Blanks (kit of 4) 95 cents; Ten-inch Blanks (kit of 2) 95 cents; Twelve-inch Blanks (kit of 2) \$1.75.

Technical Purpose—Special Records for research, service and development uses, including constant frequency discs, varying frequency discs, constant volume discs, aural test records and others. List prices: Ten-inch Record, 75 cents each. Twelve-inch Record, \$1.25 each. See page 39 for description and list.

Wireless Telegraph—A group of six records comprising a comprehensive course in Morse telegraphy. List price, complete with handbook, \$5.00 per set.



AMATEUR COMMUNICATIONS RECEIVER

ACR-136



**AMATEUR'S
NET PRICE**

\$69⁵⁰

F. O. B. FACTORY

THE RCA Amateur Communications Receiver, Model ACR-136, presents a combination of attractive features not usually found even in receivers selling at a considerably higher price. The design of the ACR-136 has been determined by a desire to produce a receiver of superior sensitivity, selectivity and operating characteristics at a price which would make it an outstanding value.

• SPECIFICATIONS •

CABINET: Metal, black ripple finish, cabinet size 22" long x 10½" high x 11½" deep.

CIRCUIT: 7-Tube Superheterodyne, 460 K. C. Intermediate Frequency.

TUBES: 6D6 r-f amplifier; 6A7 oscillator and mixer; 6D6 i-f amplifier; 6B7 second detector, automatic volume control, a-f amplifier; 6D6 beat-frequency oscillator; 4Z4 a-f output; 80 rectifier.

FREQUENCY RANGE: 540 to 18,000 kilocycles, continuous in three bands.

DIAL: Calibrated in kilocycles and megacycles, with vernier pointer for positive logging of received stations. Vernier pointer makes over 9 complete revolutions while main pointer covers one band.

BAND CHANGING: By switch from front of panel. Each band employs a separate set of antenna, r-f and oscillator coils. No tapped coils.

POWER SUPPLY: Built-in. An integral part of receiver.

POWER CONSUMPTION: 85 watts.

SPEAKER: Five-inch, full electro-dynamic, built-in.

CONTROLS: (1) Stand-by Switch; (2) Combined Power Switch and Sensitivity Control; (3) High-Frequency Tone Control; (4) Beat-Frequency Oscillator "On-Off" Switch; (5) Dual-Ratio Vernier Tuning Control; (6) Band Switch; (7) Audio Volume Control; (8) Automatic Volume Control "On-Off" Switch. The Beat-Frequency Oscillator Adjustment Handle is readily accessible by raising lid.

ACCESSORIES: The ACR-136 is supplied complete with coils, tubes, power supply, and speaker. There is nothing else to buy. Connect it to antenna and plug in the power supply and your phones. It is ready to operate.

THE GREATEST VALUE IN AMATEUR RECEIVERS

RCA PARTS for the AMATEUR

Operators of amateur radio stations, and experimenters, will appreciate the high quality and low cost of the many RCA Parts that are suitable for their use. The conservative engineering and high overload rating of RCA Parts insure long life in many experimental applications. The extreme flexibility of RCA Test Equipment makes it desirable for many amateur applications. Several RCA products suitable for amateur use are described below. Others can be found by referring to the index.

THE RCA CATHODE RAY OSCILLOGRAPH

offers the most direct method of checking every phase of transmitter performance. Checking of percentage modulation, of distortion in audio amplifiers, and of many other transmitter characteristics is easily and quickly done with the Cathode Ray Oscillograph. It also may be used to monitor modulation either direct or remotely. A linear horizontal sweep frequency gives a true picture of the modulation envelope, no interpretation being necessary. Vertical and horizontal amplifiers permit examination of low voltages.



STOCK NO. 9545
NET PRICE \$84.50



STOCK NO. 9595
NET PRICE \$34.50

THE RCA TEST OSCILLATOR has many applications for the amateur, such as aligning experimental circuits, frequency monitoring and frequency checking. By providing a source of r-f over a wide frequency range, the efficiency of experimental circuits, both receiving and transmitting, may be quickly determined. A phone jack permits operation as a heterodyne frequency meter, thereby permitting an accurate frequency check of any source of r-f voltage. Frequency range—90 K. C.—25000 K. C.

RCA ANTENNA SYSTEMS are famous for their scientific design and satisfactory performance. The Stock No. 9550 Kit contains the essentials for making a highly satisfactory receiving or medium-powered transmitting antenna. Use of the double-doublet arrangement for transmitting permits high efficiency at any two frequencies plus noise-reduction while receiving. Instruction sheet tells how to compute antenna lengths for all frequencies.



STOCK NO. 9550
NET PRICE \$2.85

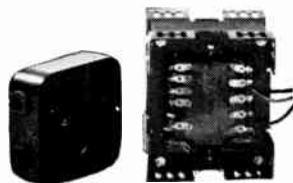

STOCK NO. 9552
LIST PRICE \$6.50

RCA POWER TRANSFORMERS are ruggedly constructed and conservatively rated. The Stock No. 9552 Transformer shown has sufficient windings for all requirements of a medium-powered power supply. 475/475 (115 M. A.)—1.25/1.25 (3.0 A)—2.5 (3.5 A)—2.5/1.25/1.25 (5.0 A)—1/1.5 (7.25 A) Primary 115 volts.

- Output Transformers, p. 21
- Tuning Wands, p. 16
- Power Units, p. 15

- Phonograph Equipment, p. 38
- Audio Transformers, p. 65
- Power Transformers, p. 22

- Mica Capacitors, p. 45
- L. F. Transformers, p. 63
- Filter Capacitors, p. 47

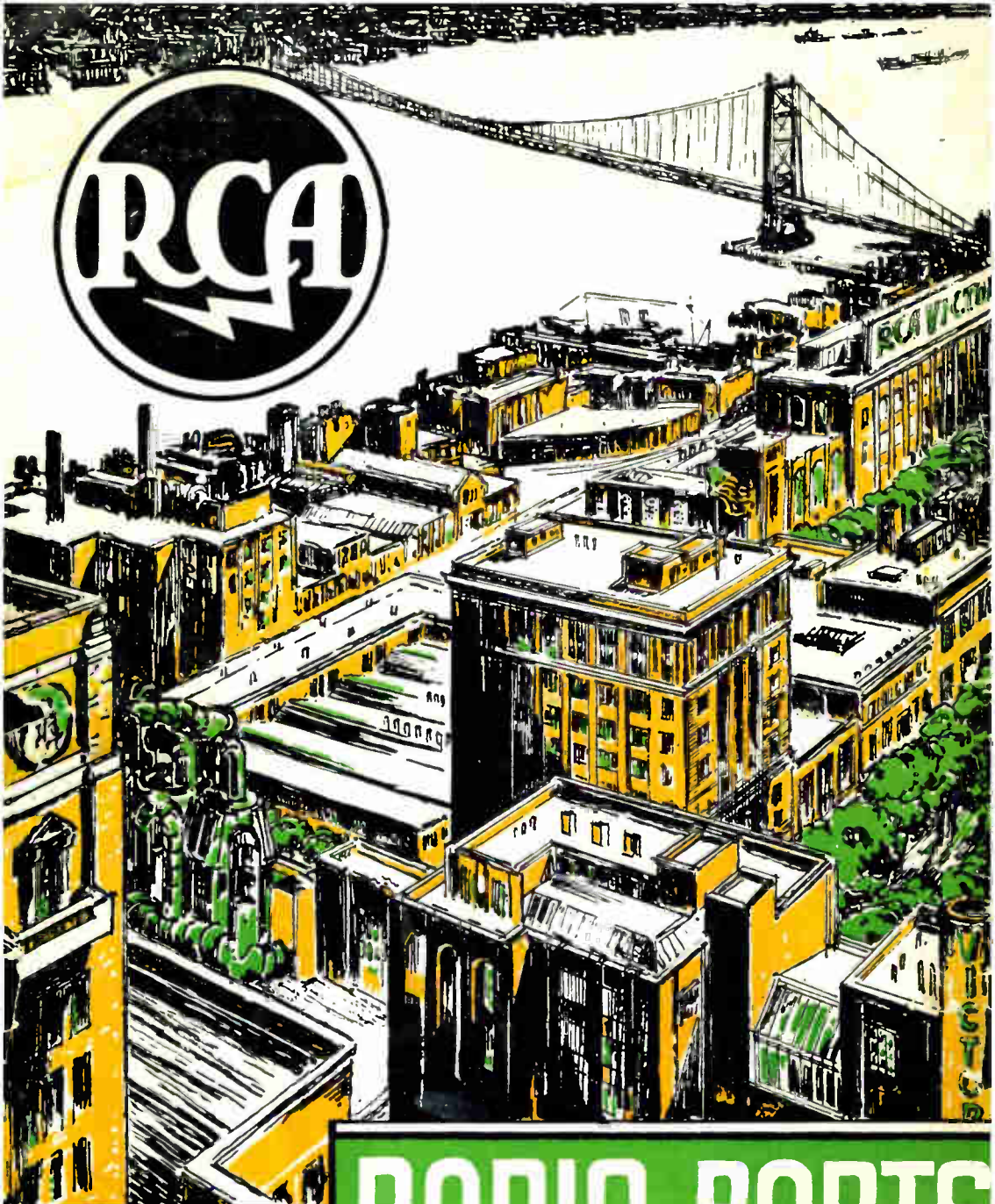

RADIO PARTS

C A T A L O G U E

**SPECIALTIES FOR THE
RADIO SERVICE ENGINEER**