

Engineer's Mini-Notebook

Magnet and
Magnet Sensor
Projects

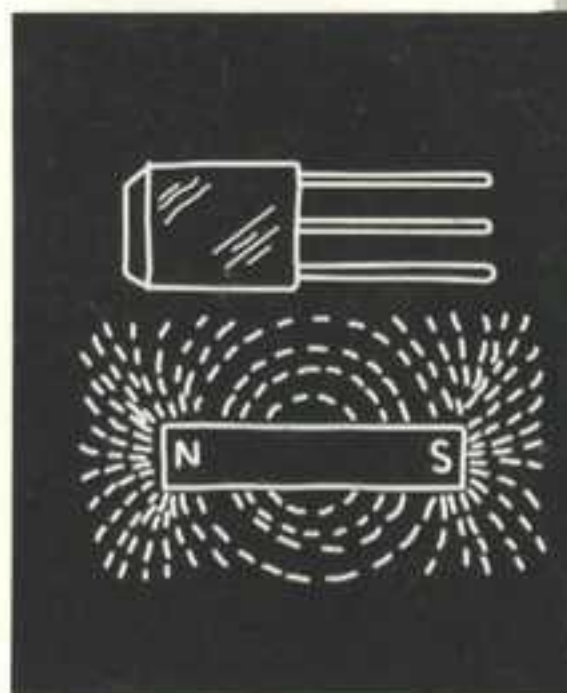
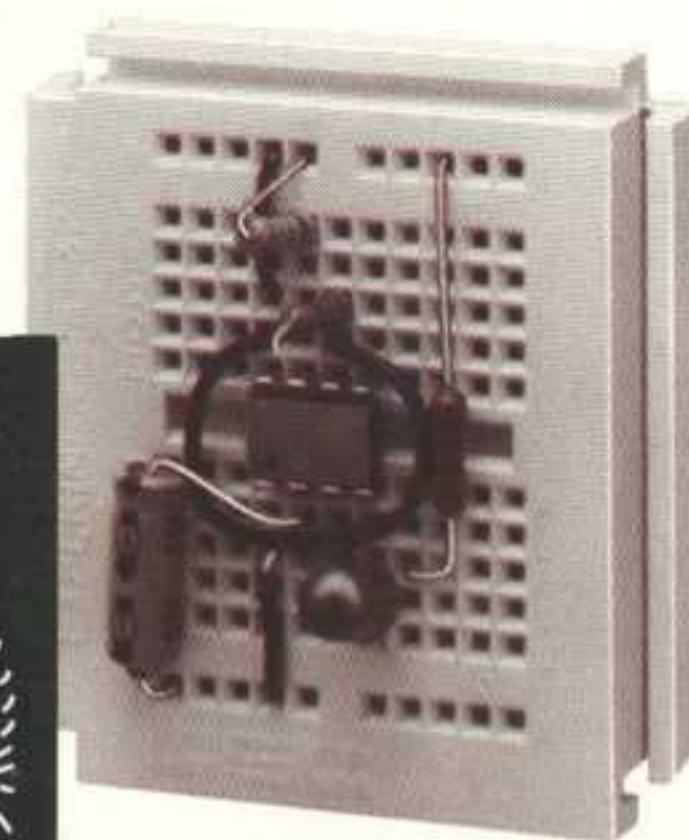

Forrest M. Mims III

R RadioShack

A Division of Tandy Corporation
Fort Worth, TX 76102

PRINTED IN U.S.A.

620-5020



0 40293 14316 9

CIRCUIT SYMBOLS

FIXED RESISTOR	VARIABLE RESISTOR	FIXED CAPACITOR	POLARIZED CAPACITOR
RECTIFIER/ DIODE	ZENER DIODE	PNP TRANSISTOR	NPN TRANSISTOR
LED	SOLAR CELL	PHOTO-RESISTOR	PHOTO-TRANSISTOR
CONNECTED WIRES	UNCONNECTED WIRES	POSITIVE SUPPLY	GROUND
SPST SWITCH	SPDT SWITCH	NORMALLY OPEN PUSHBUTTON	NORMALLY CLOSED PUSHBUTTON
RELAY	TRANSFORMER	SPEAKER	PIEZO-SPEAKER
METER	LAMP	BATTERY	OP-AMP

ENGINEER'S MINI-NOTEBOOK

MAGNET AND MAGNET SENSOR PROJECTS

BY
FORREST M. MIMS III

FIRST PRINTING - 1998

A SILICONCEPTS™ BOOK

COPYRIGHT © 1998 BY FORREST M. MIMS III
ALL RIGHTS RESERVED

PRINTED IN THE UNITED STATES OF AMERICA

THIS BOOK INCLUDES STANDARD APPLICATION CIRCUITS AND CIRCUITS DESIGNED BY THE AUTHOR. EACH CIRCUIT WAS ASSEMBLED AND TESTED BY THE AUTHOR AS THE BOOK WAS DEVELOPED. AFTER THE BOOK WAS COMPLETED, THE AUTHOR REASSEMBLED EACH CIRCUIT TO CHECK FOR ERRORS. WHILE REASONABLE CARE WAS EXERCISED IN THE PREPARATION OF THIS BOOK, VARIATIONS IN COMPONENT TOLERANCES AND CONSTRUCTION METHODS MAY CAUSE THE RESULTS YOU OBTAIN TO DIFFER FROM THOSE GIVEN HERE. THEREFORE THE AUTHOR AND RADIO SHACK ASSUME NO RESPONSIBILITY FOR THE SUITABILITY OF THIS BOOK'S CONTENTS FOR ANY APPLICATION. SINCE WE HAVE NO CONTROL OVER THE USE TO WHICH THE INFORMATION IN THIS BOOK IS PUT, WE ASSUME NO LIABILITY FOR ANY DAMAGES RESULTING FROM ITS USE. OF COURSE IT IS YOUR RESPONSIBILITY TO DETERMINE IF COMMERCIAL USE, SALE OR MANUFACTURE OF ANY DEVICE THAT INCORPORATES INFORMATION IN THIS BOOK INFRINGES ANY PATENTS, COPYRIGHTS OR OTHER RIGHTS.

DUE TO THE MANY INQUIRIES RECEIVED BY RADIO SHACK AND THE AUTHOR, IT IS NOT POSSIBLE TO PROVIDE PERSONAL RESPONSES TO REQUESTS FOR ADDITIONAL INFORMATION (CUSTOM CIRCUIT DESIGN, TECHNICAL ADVICE, TROUBLESHOOTING ADVICE, ETC.). IF YOU WISH TO LEARN MORE ABOUT ELECTRONICS, SEE OTHER BOOKS IN THIS SERIES AND RADIO SHACK'S "GETTING STARTED IN ELECTRONICS." ALSO, READ MAGAZINES LIKE MODERN ELECTRONICS AND RADIO-ELECTRONICS. THE AUTHOR WRITES A MONTHLY COLUMN, "ELECTRONICS NOTEBOOK," FOR MODERN ELECTRONICS.

CONTENTS

THE FIRST MAGNETS	5
MAGNETIC FIELDS	6
MAGNETIC POLES	6
MAGNETIC FIELD INTENSITY	7
EARTH'S MAGNETIC FIELD	7
EARTH'S GEOGRAPHIC POLES	8
EARTH'S MAGNETIC POLES	8
LIVING MAGNETS	9
MAGNETIC BACTERIA	9
APPLICATIONS FOR MAGNETS	10
MAGNET CONFIGURATIONS	11
TEMPORARY MAGNETS	12
PERMANENT MAGNETS	12
USING AND CARING FOR MAGNETS	13
THE COMPASS	14
MAPPING A MAGNETIC FIELD	15
ELECTROMAGNET	16
SOLENOID	16
ELECTROMAGNETIC RELAY	17
RELAY DRIVER	17
MAGNET SWITCHES	18
MAGNETIC SWITCH INTERFACE	19
MAGNETIC-ACTUATED TONE	19
THE HALL EFFECT	20
APPLICATIONS FOR HALL SENSORS	21
HALL SENSOR BASICS	22
BASIC HALL SENSOR	22
BASIC HALL SENSOR CIRCUIT	22
HALL SENSOR OUTPUT VOLTAGE	23
HALL SENSOR + LOGIC CIRCUIT	24

INTEGRATED DIGITAL HALL SENSOR	24
HALL SENSOR + AMPLIFIER	25
INTEGRATED LINEAR HALL SENSOR	25
HALL SENSOR SPECIFICATIONS	26
BASIC GAUSS METER	26
POWER HALL SENSOR	27
HALL LAMP DRIVER	27
HALL SENSOR OPERATING TIPS	28
HALL SENSOR MAGNET SEPARATION	29
FLUX CONCENTRATORS	29
BEST MAGNET ARRANGEMENTS	30
HEAD-ON OPERATION	30
SLIDE-BY OPERATION	30
PUSH-PUSH OPERATION	31
PUSH-PULL OPERATION	31
INTERFACING DIGITAL SENSORS	32
LED INTERFACE	32
TRANSISTOR INTERFACE	32
TTL LOGIC INTERFACE	33
CMOS LOGIC INTERFACE	33
APPLICATION CIRCUITS	
FERROUS METAL INDICATOR	34
HALL SENSOR RELAY	35
LEVEL INDICATOR	36
MAGNET POSITION DETECTOR	37
DUAL-OUTPUT HALL SENSORS	38
FIELD STRENGTH BARGRAPH	39
HALL SENSOR DIRECTION INDICATOR	40
ULTRA-SENSITIVE MAGNET SWITCH	41
MAGNET MUSIC	42
MUSICAL PENDULUM	43
DAMPED OSCILLATING TONE	43
PRESSURE-SENSITIVE TONE	43
SUPER-SENSITIVE FIELD SENSOR	44
SUPER-SENSITIVE FIELD SWITCH	45
GIANT COMPASS MAGNETOMETER	46
HALL SENSOR NORTH COMPASS	47
SPECIALIZED HALL SENSORS	48
A3421 DIRECTION SENSOR	48
AT5610 GEAR TOOTH SENSOR	48

THE FIRST MAGNETS

AS FAR BACK AS 800 B.C., THE GREEKS WROTE ABOUT THE STRANGE PROPERTIES OF A DARK GRAY OR BLACK MINERAL THAT CAN ATTRACT AND HOLD BITS OF IRON. THIS MINERAL IS THE IRON OXIDE (Fe_3O_4) NOW KNOWN AS MAGNETITE. PIECES OF THIS MINERAL ARE NATURAL MAGNETS. HERE IS A SKETCH OF A PIECE OF MAGNETITE ON MY DESK AS I WRITE:

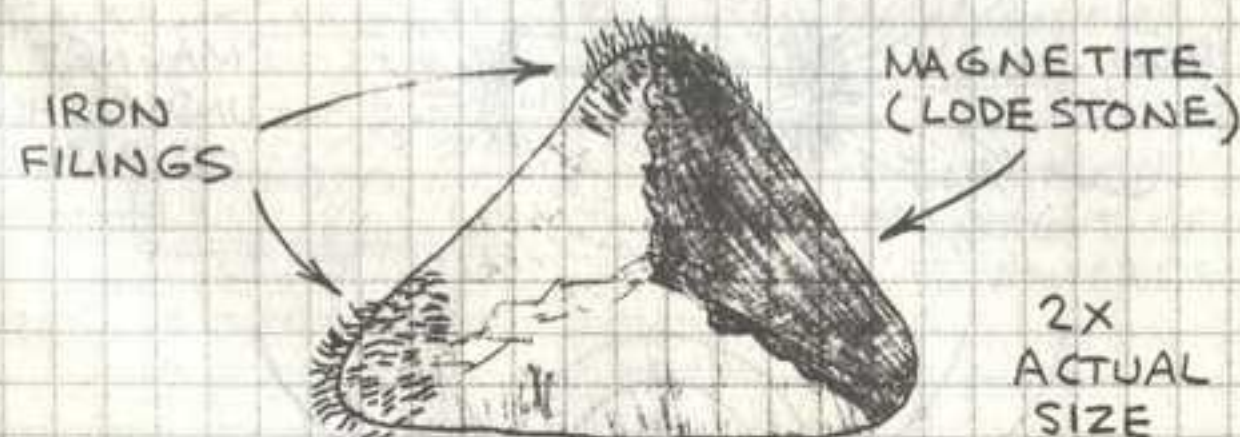

NATURAL MAGNETS ARE CALLED LODESTONES. THIS NAME COMES FROM "LEADING STONE," WHICH REFERS TO THE FACT THE SAME SIDE OF A LODESTONE SUSPENDED FROM A STRING ALWAYS POINTS NORTH. THIS DISCOVERY LED TO THE INVENTION OF THE COMPASS, THE FIRST WIDESPREAD APPLICATION FOR NATURAL MAGNETS. THE COMPASS GAVE SAILORS AND EXPLORERS A VITALLY IMPORTANT NAVIGATIONAL TOOL.

THERE ARE AT LEAST TWO STORIES ABOUT THE ORIGIN OF THE WORD "MAGNET." ACCORDING TO THE ROMAN WRITER LUCRETIUS,¹ THE WORD COMES FROM MAGNESIA, THE GREEK PROVINCE WHERE LODESTONES WERE FOUND. PLINY THE ELDER² WROTE THAT THE NAME CAME FROM MAGNES, A GREEK SHEPHERD. THE NAILS IN HIS SHOES AND THE IRON TIP OF HIS STAFF WERE ATTRACTED TO A FIELD OF MAGNETITE AS HE WALKED.

¹ 96 TO 55 B.C. ² A.D. 23 TO 79

MAGNETIC FIELDS

THE REGION AROUND A MAGNET THAT INFLUENCES EXTERNAL OBJECTS IS THE MAGNETIC FIELD OF THE MAGNET. THE MAGNETIC FIELD AROUND A MAGNET FORMS AN ORGANIZED PATTERN. THIS PATTERN CAN BE MADE VISIBLE BY SPRINKLING IRON FILINGS ON A SHEET OF WHITE PAPER LYING ON A BAR MAGNET.

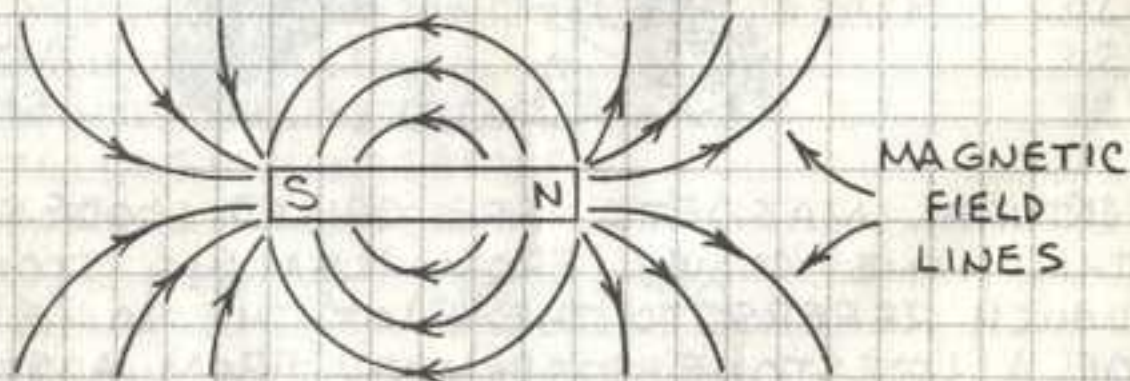
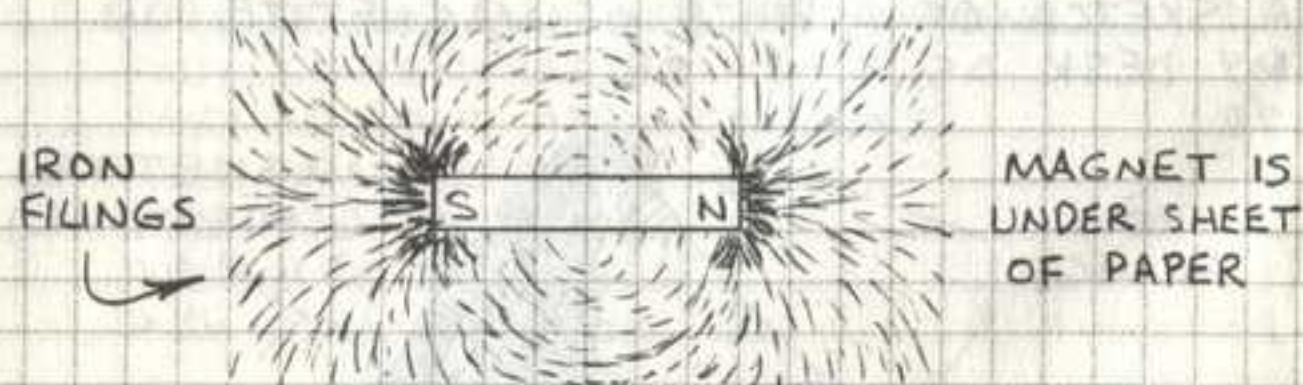

MAGNETIC FIELD LINES ARE MAPPED WITH A COMPASS.

MAGNETIC POLES

A MAGNET'S FORCE IS CONCENTRATED AT POINTS CALLED POLES. IF A BAR MAGNET IS HUNG FROM A STRING, ONE END WILL EVENTUALLY POINT NORTH. THIS END IS THE MAGNET'S NORTH POLE. THE END OF THE MAGNET THAT POINTS SOUTH IS THE SOUTH POLE.

THE OPPOSITE POLES OF TWO MAGNETS ATTRACT ONE ANOTHER. LIKE POLES REPEL.

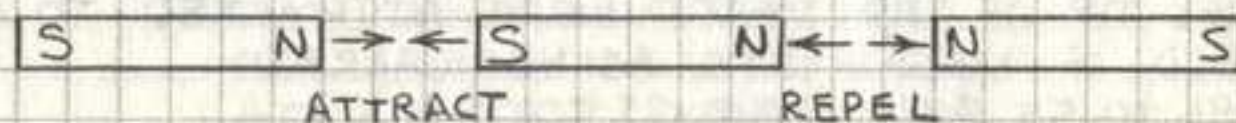

MAGNETIC FIELD INTENSITY

THE INTENSITY OF A MAGNETIC FIELD IS MEASURED IN GAUSS. THE MAGNETIC FIELD 1 CENTIMETER FROM A STRAIGHT LENGTH OF WIRE THROUGH WHICH A CURRENT OF 5 AMPERES IS FLOWING IS 1 GAUSS. THE MAGNETIC FIELD OF VARIOUS MAGNETS CAN BE HUNDREDS OR EVEN THOUSANDS OF GAUSS.

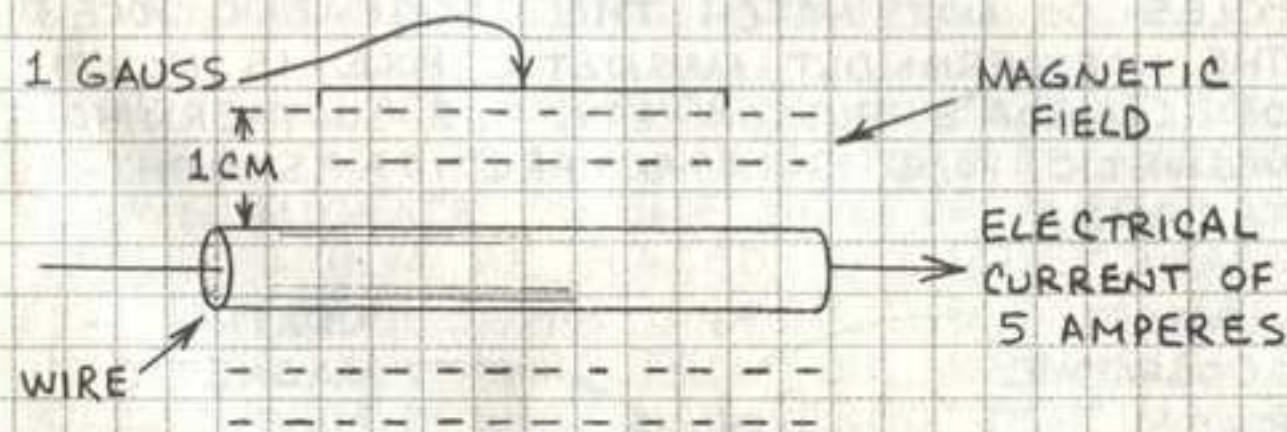

THE TERM GAUSS HONORS CARL FRIEDRICH GAUSS (1777 TO 1855), THE GREAT MATHEMATICIAN.

IS THE EARTH A MAGNET?

EARTH HAS A MAGNETIC FIELD, BUT EARTH IS NOT A MAGNET. THE EARTH'S CORE IS BELIEVED TO BE MOLTEN METAL THAT IS MUCH TOO HOT TO BE MAGNETIC. THE MOST POPULAR THEORY IS THAT EARTH'S MAGNETIC FIELD IS CAUSED BY ELECTRICAL CURRENTS GENERATED BY ROTATION OF THE LIQUID CORE.

EARTH'S MAGNETIC FIELD

THE FORCE OF EARTH'S MAGNETIC FIELD IS ABOUT 0.3 GAUSS NEAR THE EQUATOR AND ABOUT 0.7 GAUSS NEAR THE POLES. THOUGH VERY WEAK, THE FIELD IS EASILY DETECTED BY A COMPASS.

EARTH'S GEOGRAPHIC POLES

EARTH ROTATES ABOUT AN IMAGINARY AXIS. THE POINTS WHERE THE AXIS MEETS EARTH'S SURFACE ARE THE NORTH AND SOUTH POLES.

EARTH'S MAGNETIC POLES

EARTH ALSO HAS MAGNETIC POLES. THE MAGNETIC POLES DO NOT MATCH THE GEOGRAPHIC POLES. THE NORTHERNMOST MAGNETIC POLE IS NORTH OF CANADA'S HUDSON BAY. THE SOUTHERNMOST MAGNETIC POLE IS IN ANTARCTICA SOUTH OF TASMANIA.

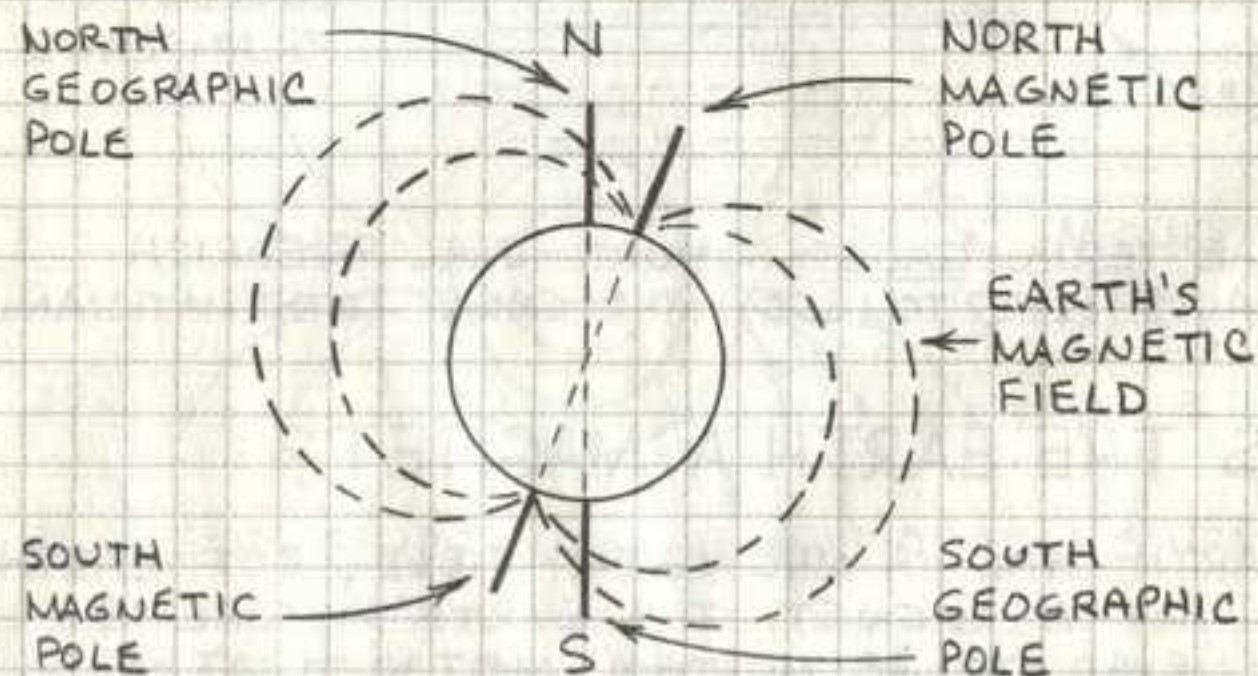

EARTH'S CHANGING FIELD

THE FORCE OF EARTH'S MAGNETIC FIELD FLUCTUATES ON A DAILY BASIS. THE CHANGE NEAR THE EQUATOR IS ABOUT 0.0002 GAUSS EACH DAY. AT THE POLES THE CHANGE IS 0.0005 GAUSS EACH DAY. THE CHANGE IS SOMETIMES GREATER THAN THIS WHEN THE SUN IS VERY ACTIVE.

LIVING MAGNETS

THE BODIES OF MANY ANIMALS INCLUDE BITS OF MAGNETITE. RECENT DISCOVERIES HAVE SHOWN THAT MAGNETITE MAY ACT AS A KIND OF COMPASS THAT ASSISTS THE NAVIGATION OF VARIOUS BIRDS, INSECTS, FISH AND EVEN BACTERIA.

MAGNETIC BACTERIA

IN 1975 RICHARD BLACKMORE NOTICED THAT SOME BACTERIA FROM THE MUDDY BOTTOMS OF MARSHES ALWAYS MIGRATE TO ONE SIDE OF A DROP OF WATER. WHEN HE PLACED A MAGNET NEARBY, THE BACTERIA SWAM TOWARD THE SOUTH-SEEKING POLE AND AWAY FROM THE NORTH-SEEKING POLE. LATER IT WAS DISCOVERED THAT MAGNETIC BACTERIA ALIGN THEMSELVES WITH A MAGNETIC FIELD EVEN WHEN THEY ARE DEAD. MORE THAN A DOZEN KINDS OF MAGNETIC BACTERIA HAVE BEEN DISCOVERED. MOST LIVE IN MUD OR SILT UNDER BODIES OF WATER, AND SOME LIVE IN SOIL. THEY ARE COLLECTIVELY KNOWN AS MAGNETOTAXIC BACTERIA. THEY INCLUDE A STRING OF MICROSCOPIC MAGNETS CALLED MAGNETOSOMES.

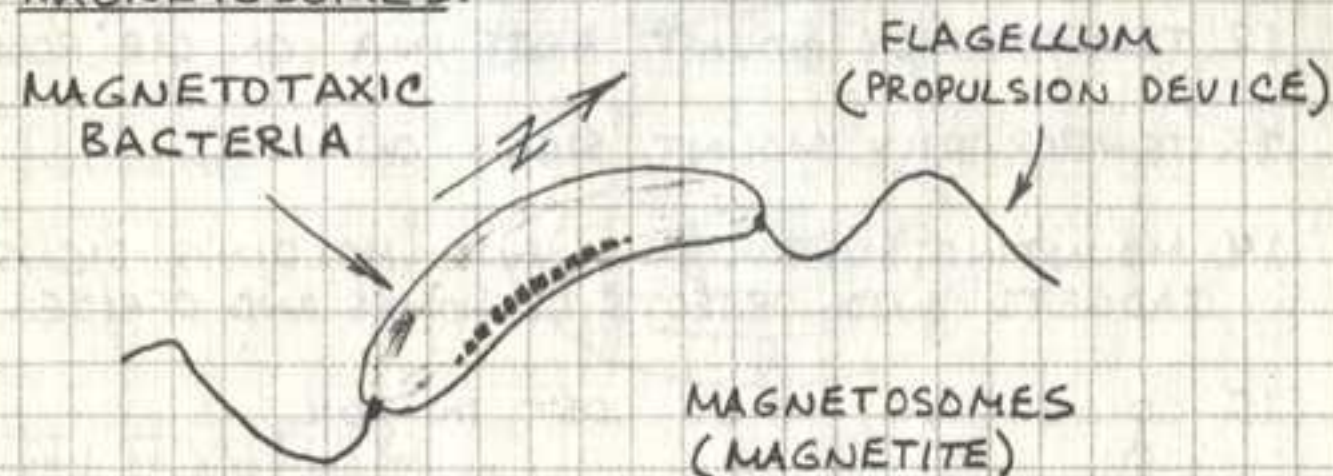

MAGNETOTAXIC BACTERIA IN THE NORTHERN HEMISPHERE SWIM NORTH. THOSE IN THE SOUTHERN HEMISPHERE SWIM SOUTH. THOSE NEAR THE EQUATOR SWIM IN EITHER DIRECTION.

APPLICATIONS FOR MAGNETS

1. DIRECT CURRENT (DC) MOTORS
2. ELECTRICAL GENERATORS
3. AUDIO SPEAKERS
4. AUDIO EAR AND HEAD PHONES
5. SEPARATING IRON AND STEEL SCRAP FROM NON-MAGNETIC MATERIALS
6. RETRIEVE IRON AND STEEL OBJECTS LOST IN BODIES OF WATER
7. RETRIEVE BROKEN DRILL HEADS FROM OIL AND GAS WELLS
8. COLLECT FILING CHIPS FROM DRILLED HOLES
9. TRAP BITS OF METAL IN STOMACHS OF COWS ("COW MAGNETS")
10. ERASE DATA STORED ON MAGNETIC TAPE
11. CABINET LATCHES
12. TEMPORARILY MOUNT ANTENNA ON CAR ROOF
13. TEMPORARILY MOUNT SIGNS ON CARS
14. MOUNTING, SUPPORTING AND HOLDING SIGNS, GADGETS AND OBJECTS IN HOMES AND OFFICES
15. COLLECTING NAILS LOST IN SOIL
16. PAPER CLIP HOLDER
17. SCIENTIFIC RESEARCH AND DEVELOPMENT
18. I'VE USED A MAGNET TO FIND BITS OF IRON METEORITE INSIDE A LARGE METEOR CRATER

MAGNET CONFIGURATIONS

AMONG THE MANY MAGNET CONFIGURATIONS ARE THESE:

BAR

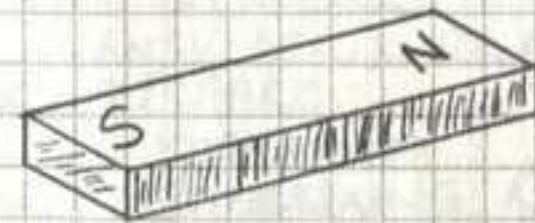

DISK



HORSE SHOE

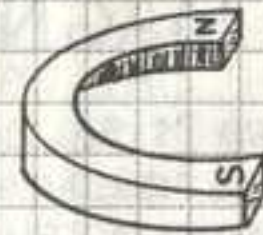

CYLINDER

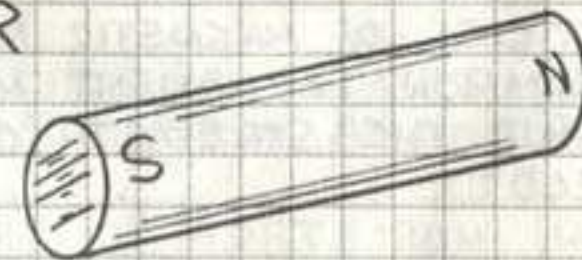

RING



FLEXIBLE

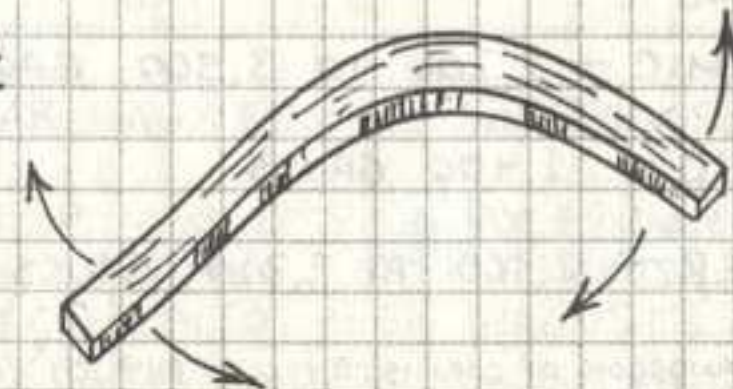

TEMPORARY MAGNETS

SOFT IRON AND STEEL CAN BE MAGNETIZED, BUT DO NOT NECESSARILY STAY MAGNETIZED.

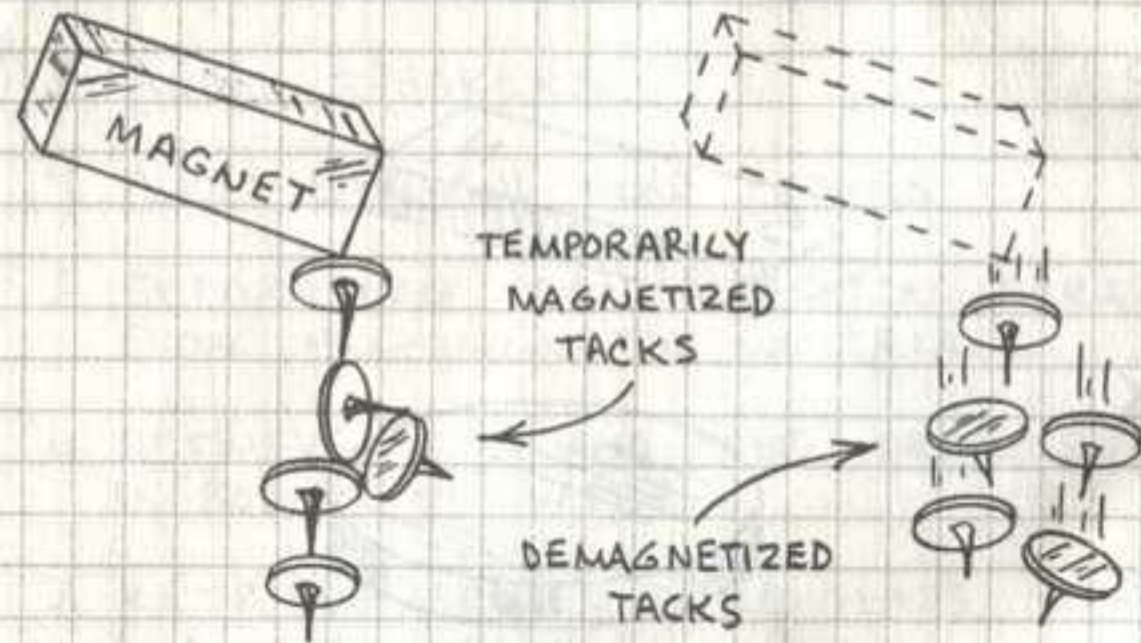

PERMANENT MAGNETS

HARDENED IRON AND STEEL AND CERTAIN METAL ALLOYS STAY MAGNETIZED INDEFINITELY. CERAMIC MAGNETS AND MAGNETIC RUBBER AND PLASTIC CONTAIN PARTICLES OF MAGNETIC MATERIAL. HERE ARE SOME COMMON PERMANENT MAGNET MATERIALS AND THE STRENGTH OF THEIR MAGNETIC FIELD:

ALNICO (VARIOUS ALLOYS OF ALUMINUM, NICKEL AND COBALT) — 5,500 TO 13,100 GAUSS

CHROMIUM STEEL — 9,700 GAUSS

RARE EARTH COBALT — 8,100 GAUSS

CERAMIC — 2,200 TO 3,500 GAUSS

PLASTIC — 1,400 GAUSS

RUBBER — 1,300 TO 2,300 GAUSS

DATA: "HANDBOOK OF CHEMISTRY AND PHYSICS" (CRC PRESS).

USING AND CARING FOR MAGNETS

1. THE ABILITY OF A MAGNET TO LIFT A LOAD IS REDUCED BY SOIL, DUST, PAINT AND RUST ON THE MAGNET OR LOAD.
2. LIFTING ABILITY IS REDUCED WHEN THE LOAD IS VERY THIN (CANS, ETC.) OR HAS A ROUGH OR IRREGULAR SURFACE.
3. AVOID DROPPING OR STRIKING A MAGNET. IT MIGHT BREAK OR BECOME DEMAGNETIZED.
4. FORCING THE SAME POLES OF TWO MAGNETS TOGETHER CAN PARTIALLY DEMAGNETIZE BOTH MAGNETS.
5. ALWAYS SEPARATE TWO MAGNETS BY PULLING THEM AWAY FROM ONE ANOTHER. DO NOT SLIDE ONE MAGNET AGAINST ANOTHER TO SEPARATE THEM AS THIS MIGHT SHARPLY DEMAGNETIZE ONE OR BOTH MAGNETS. TRY TO KEEP SEPARATED MAGNETS FROM SLAMMING BACK TOGETHER.
6. AVOID PLACING A MAGNET NEAR A STRONG MAGNETIC FIELD FROM A MOTOR.
7. A "KEEPER" OF SOFT IRON WILL EXTEND THE LIFE OF A MAGNET.

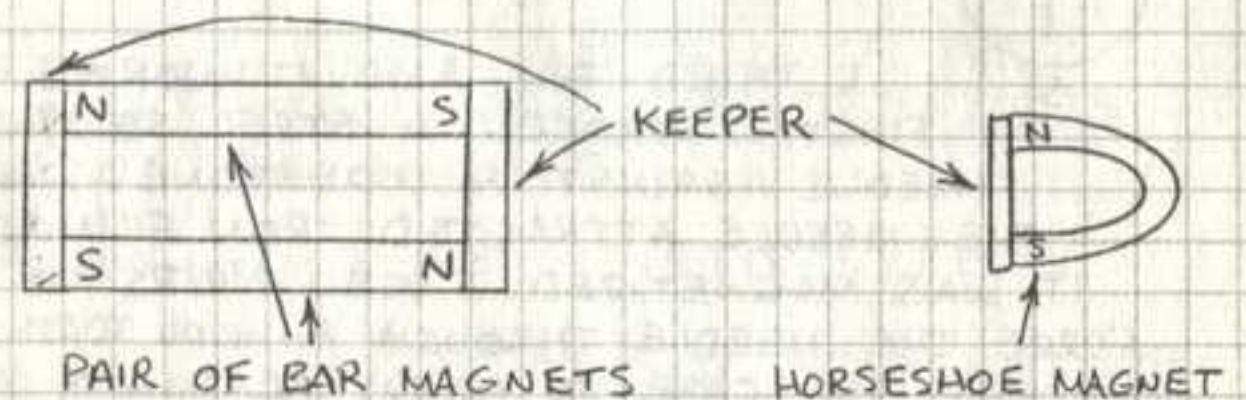

8. CAUTION! KEEP MAGNETS AWAY FROM MAGNETIC MEDIA (COMPUTER DISKS, CREDIT CARDS, RECORDING TAPE, ETC.)! ALSO KEEP MAGNETS AWAY FROM MECHANICAL WATCHES.

THE COMPASS

THE SIMPLEST COMPASS IS A MAGNETIZED IRON NEEDLE OR POINTER FREE TO ROTATE ABOUT A PIVOT. THE NEEDLE WILL ALIGN ITSELF ALONG THE EARTH'S MAGNETIC FIELD. SOME HISTORIANS BELIEVE THE FIRST COMPASS WAS A LODESTONE ATOP A SMALL PIECE OF WOOD FLOATING IN A BOWL OF WATER. I TRIED THIS BY PLACING A LODESTONE ON A SMALL SQUARE OF WOOD FLOATING ON WATER IN A PLASTIC BOX. BUT THIS "COMPASS" WORKS ONLY WHEN THE WATER IS STILL. IT MIGHT WORK ON LAND, BUT IT WOULD NOT WORK WELL IN A BOAT. THE FIRST PRACTICAL COMPASSES ARE BELIEVED TO HAVE BEEN MAGNETIZED NEEDLES INSERTED CROSSWAYS THROUGH A FLOATING REED OR SPLINTER. THE NEEDLE WAS MAGNETIZED BY STROKING IT AGAINST A LODESTONE.

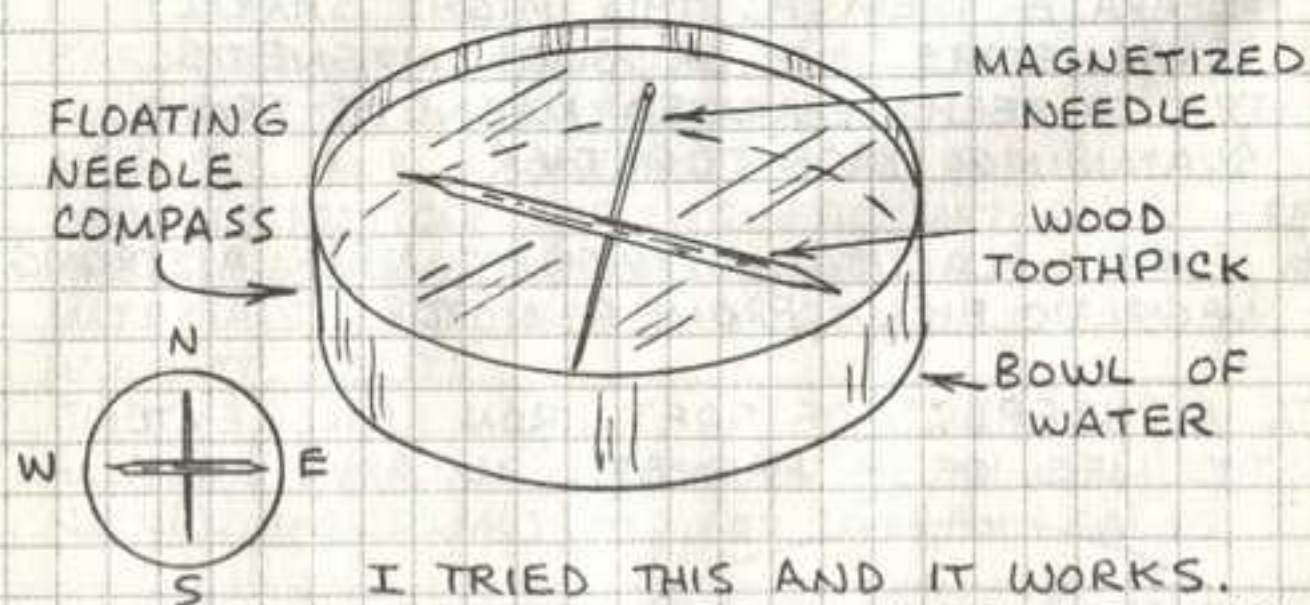

I TRIED THIS AND IT WORKS. FIRST I STROKED A STEEL SEWING NEEDLE AGAINST A LODESTONE. SINCE THE NEEDLE ATTRACTED IRON FILINGS, IT WAS MAGNETIZED. I USED PLIERS TO FORCE THE NEEDLE THROUGH A WOOD TOOTHPICK. CAUTION: USE CARE TO AVOID BREAKING THE NEEDLE OR PRESSING IT INTO A FINGER! WHEN FLOATED ON WATER, THE NEEDLE AND TOOTHPICK ARRANGEMENT WILL SLOWLY ROTATE UNTIL THE NEEDLE POINTS NORTH AND SOUTH AND THE TOOTHPICK EAST AND WEST.

MAPPING A MAGNETIC FIELD

A COMPASS CAN BE USED TO MAP A MAGNET'S FIELD. THIS IS OFTEN MORE PRACTICAL THAN USING IRON FILINGS.

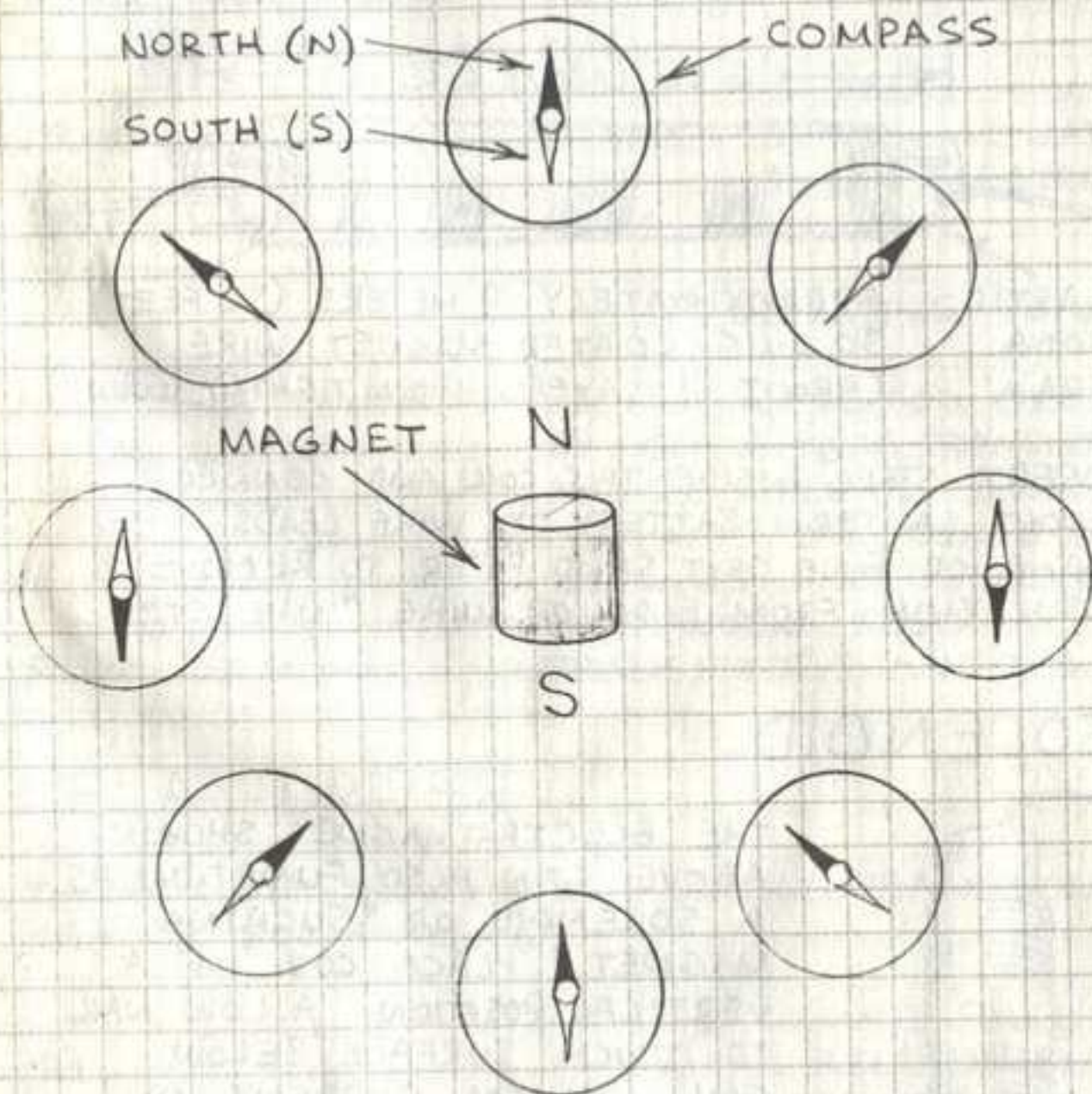

NOTICE HOW THE NORTH END OF THE COMPASS NEEDLE POINTS TO THE SOUTH POLE OF THE MAGNET.

TIP: OPPOSITES ATTRACT, UNLIKES REPEL.

A COMPASS WILL RESPOND TO A MAGNET UP TO 30 CENTIMETERS (ABOUT 1 FOOT) AWAY.

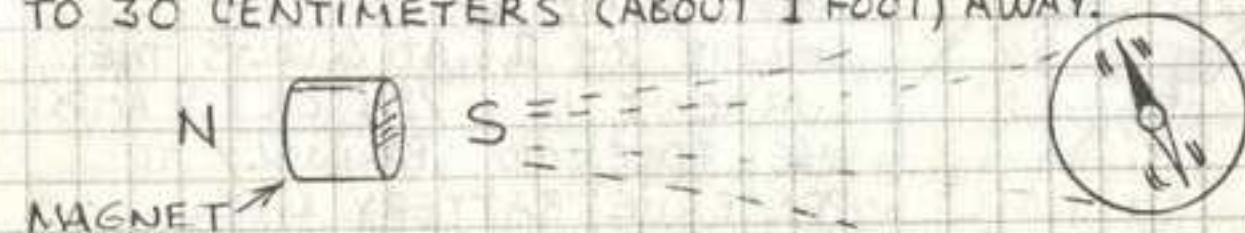

ELECTROMAGNET

AN ELECTRICAL CURRENT FLOWING THROUGH A LOOP OF WIRE CREATES A MAGNETIC FIELD. THE WEAK FIELD OF A SINGLE LOOP CAN BE GREATLY INCREASED BY WINDING A COIL OF MANY LOOPS.

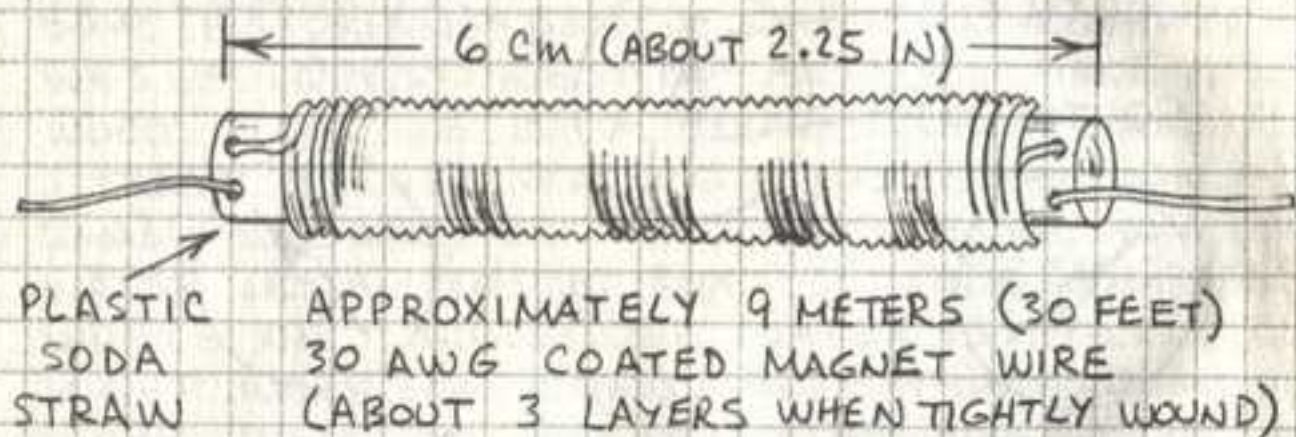

INSERT STEEL* INSIDE THIS COIL AND CONNECT A 6-VOLT LANTERN BATTERY TO WIRE LEADS. USE FLAME OR FINE GRIT SAND PAPER TO REMOVE INSULATION FROM ENDS OF WIRE. *NAIL, ETC.

SOLENOID

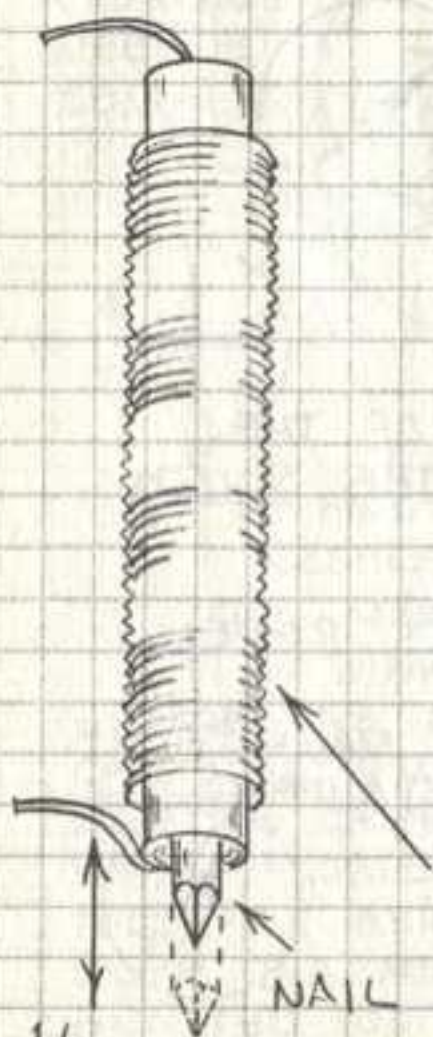

THE ELECTROMAGNET SHOWN ABOVE CAN ALSO FUNCTION AS A SOLENOID OR "SUCTION MAGNET." PLACE COIL IN A VERTICAL POSITION. ALLOW NAIL TO TOUCH SURFACE BELOW COIL. WHEN CURRENT IS APPLIED TO THE COIL, THE NAIL WILL BE RAPIDLY PULLED UP INTO THE COIL BY THE COIL'S MAGNETIC FIELD. SOLENOIDS RELEASE LATCHES, CLOSE VALVES, LOCK DOORS, ETC.

RESISTANCE OF PROTOTYPE COIL IS 3.1Ω . AT 6 VOLTS THE CURRENT IS $6/3.1$ OR 1.9 AMPS. USE SOLENOID SPARINGLY TO PRESERVE BATTERY LIFE.

ELECTROMAGNETIC RELAY

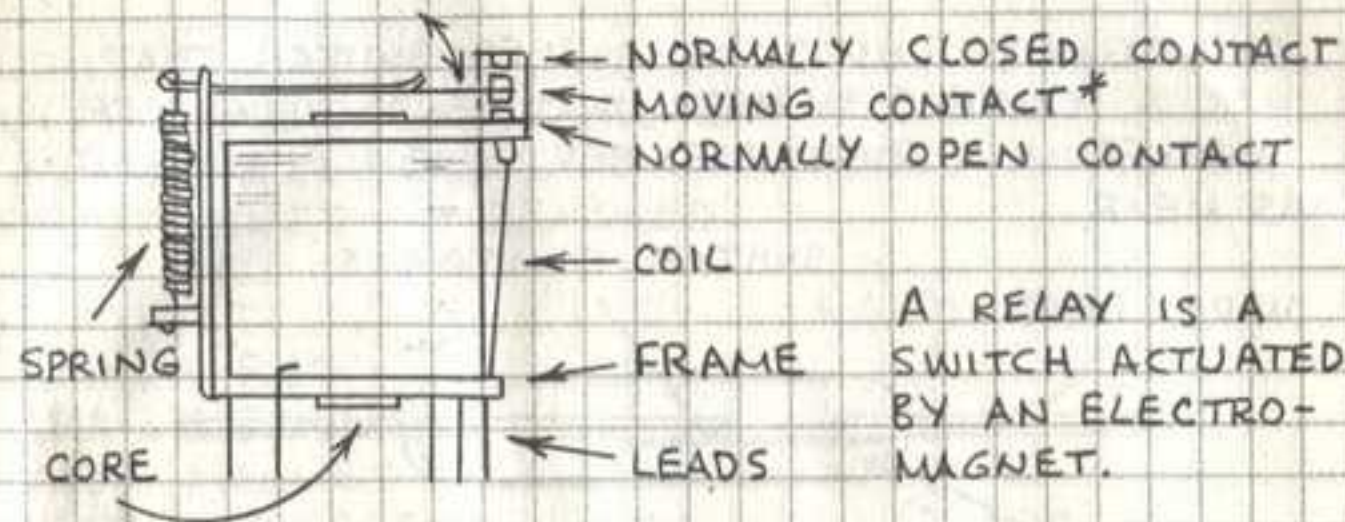

A RELAY IS A SWITCH ACTUATED BY AN ELECTROMAGNET.

* OPERATING POINT

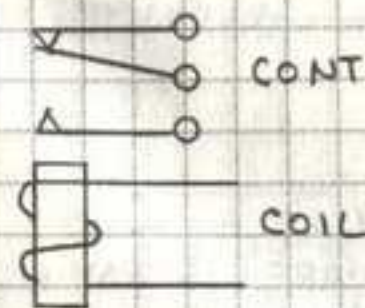

RELAY DIAGRAM

RELAYS CAN BE ACTUATED BY LOW-VOLTAGE TRANSISTOR AND IC CIRCUITS. THEIR CONTACTS CAN CONTROL VOLTAGES AND CURRENTS THAT WOULD DESTROY TRANSISTORS AND ICs.

RELAY DRIVER

THIS CIRCUIT SHOWS HOW A SINGLE TRANSISTOR CAN CONTROL A RELAY.

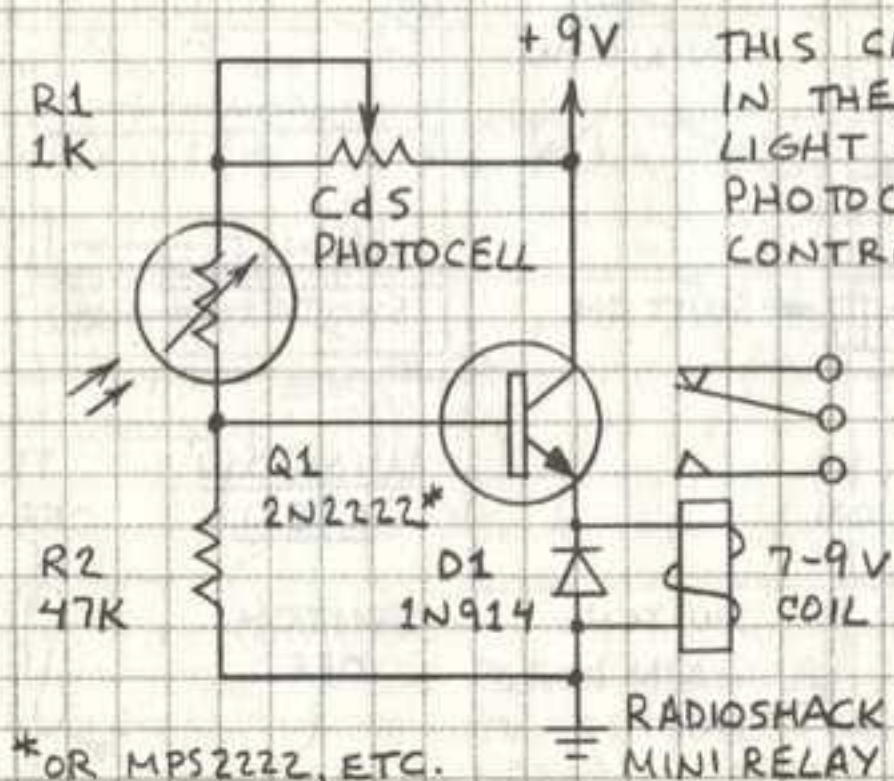

THIS CIRCUIT PULLS IN THE RELAY WHEN LIGHT STRIKES THE PHOTOCELL. R1 CONTROLS SENSITIVITY.

D1 PROTECTS Q1 FROM HIGH VOLTAGE SPIKE THAT OCCURS WHEN RELAY IS SWITCHED OFF.

*OR MPS2222, ETC.

MAGNET SWITCHES

A MAGNET SWITCH IS A REED SWITCH THAT HAS A FLEXIBLE MEMBER THAT BENDS TOWARD OR AWAY FROM A RIGID MEMBER WHEN A MAGNET IS NEAR.

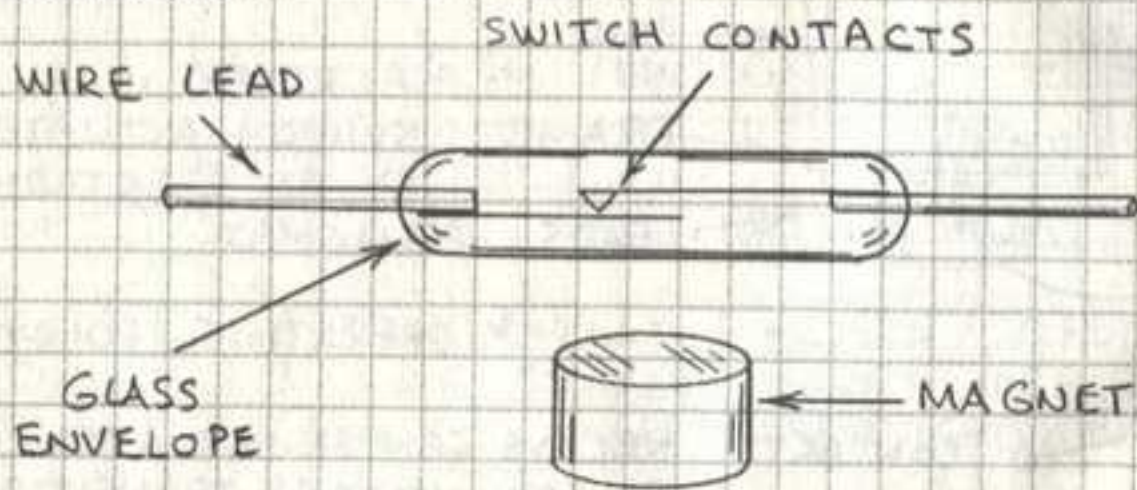

MAGNET SWITCHES ARE VERY RELIABLE AND REQUIRE NO POWER SUPPLY. THEY ARE OFTEN USED TO DETECT OPEN DOORS AND WINDOWS IN SECURITY ALARM SYSTEMS. FOR THESE USES THE SWITCH IS USUALLY INSTALLED IN A PLASTIC HOUSING WITH EXTERNAL WIRE LEADS OR SCREW TERMINALS. THE ACTUATING MAGNET IS INSTALLED IN A SIMILAR HOUSING.

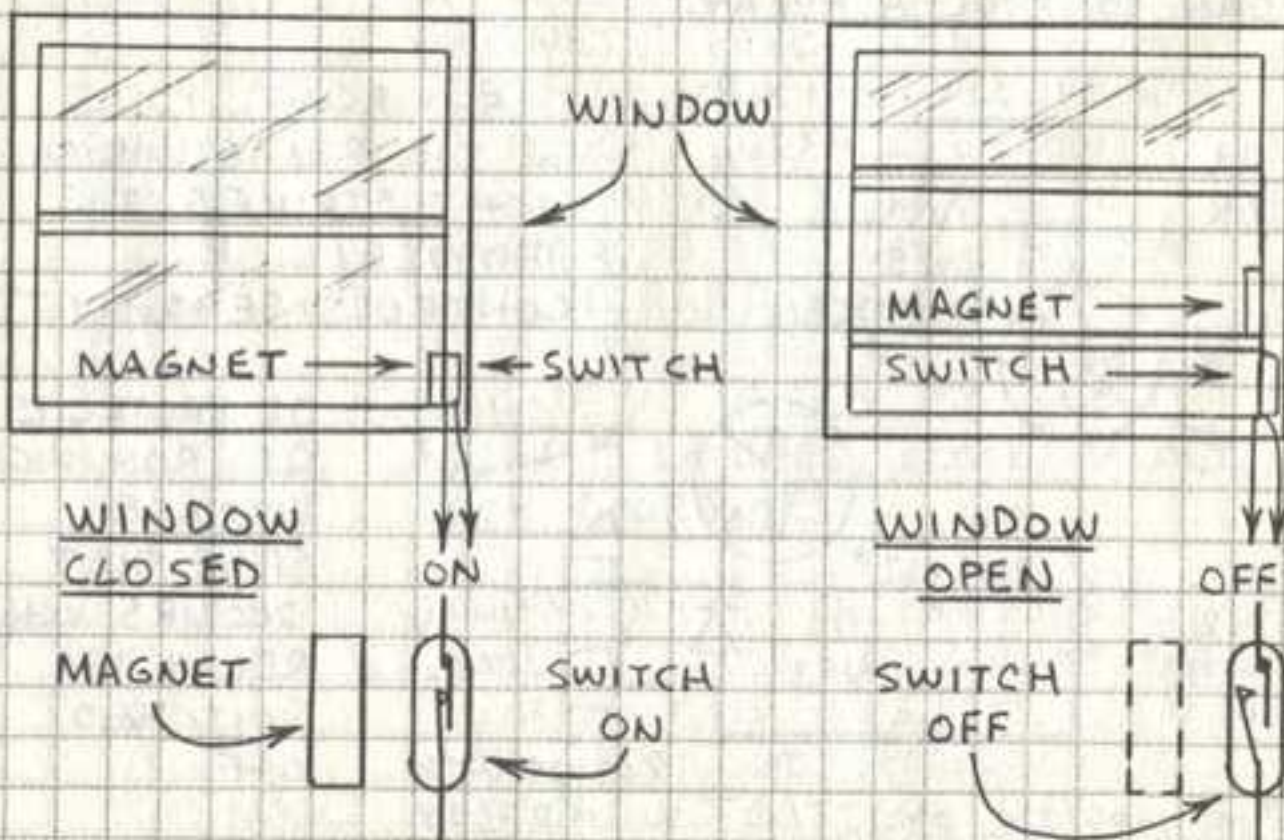

MAGNET SWITCH INTERFACE

THIS SIMPLE TRANSISTOR CIRCUIT WILL SWITCH ON LED 2 WHEN A MAGNET IS NEAR SW1. LED 1 IS SWITCHED ON WHEN THE MAGNET IS REMOVED.

TIP: LET
LED 1 = RED
LED 2 = GREEN.
THEN MAGNET
PRESENT = GREEN
AND MAGNET
ABSENT = RED.

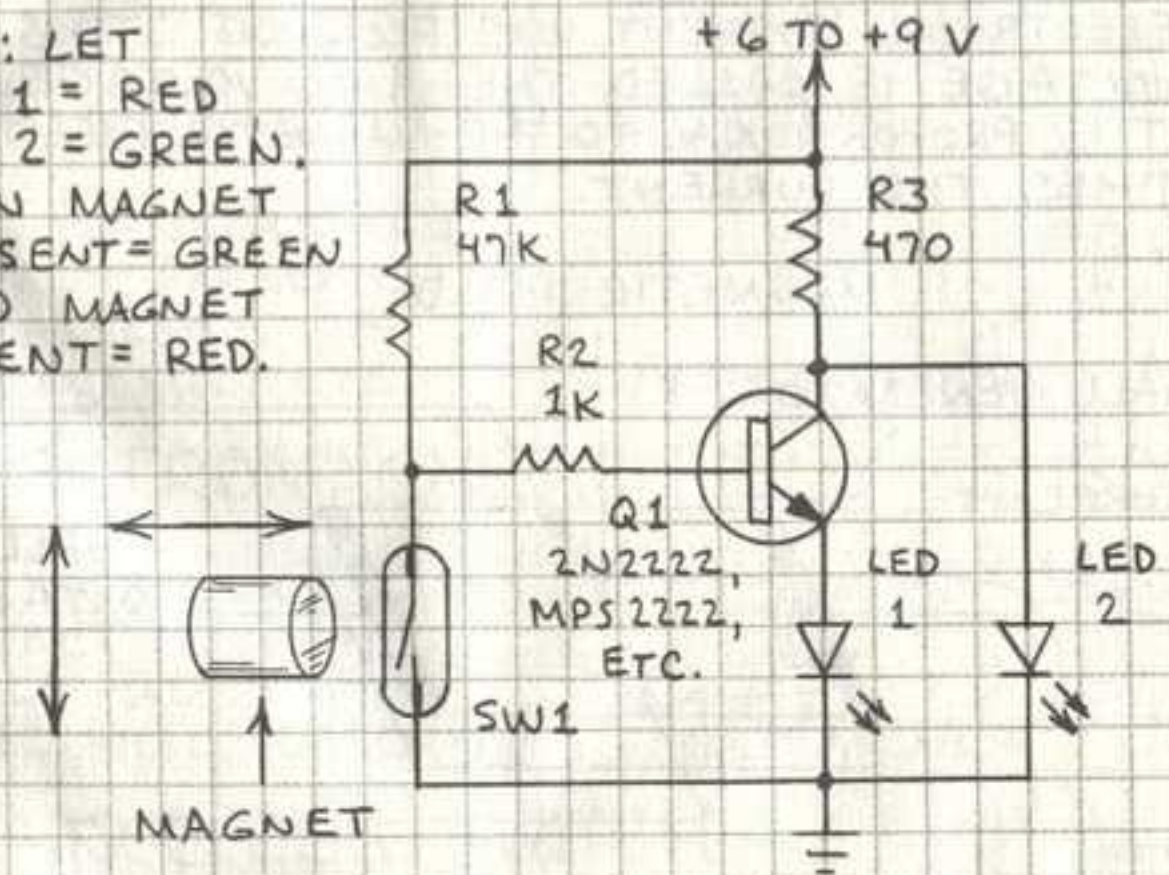

MAGNET	LED 1	LED 2
YES	OFF	ON
NO	ON	OFF

SWITCH WILL RESPOND TO EITHER NORTH OR SOUTH POLE OF MAGNET.

MAGNET ACTUATED TONE

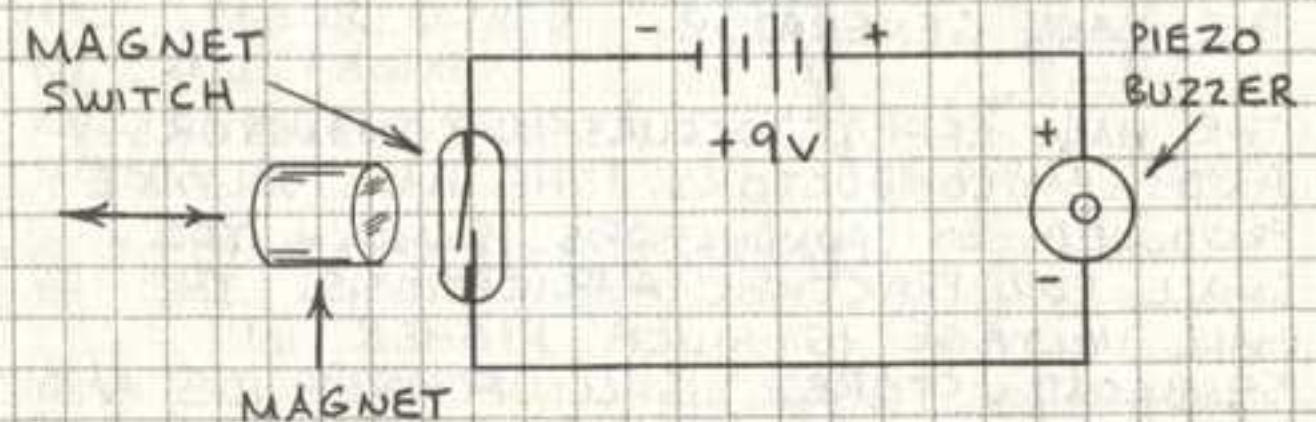

PLACE MAGNET NEAR SWITCH TO ACTIVATE TONE. OK TO USE LAMP INSTEAD OF BUZZER.

THE HALL EFFECT

IN OCTOBER 1879, THE PHYSICIST EDWARD HALL DISCOVERED THE EFFECT THAT BEARS HIS NAME. HALL FOUND THAT A STRONG MAGNETIC FIELD CAUSED A VOLTAGE TO APPEAR ACROSS A THIN FILM OF GOLD THROUGH WHICH AN ELECTRICAL CURRENT WAS FLOWING. THIS VOLTAGE IS CALLED THE HALL VOLTAGE. IT IS PROPORTIONAL TO THE MAGNETIC FIELD TIMES THE CURRENT.

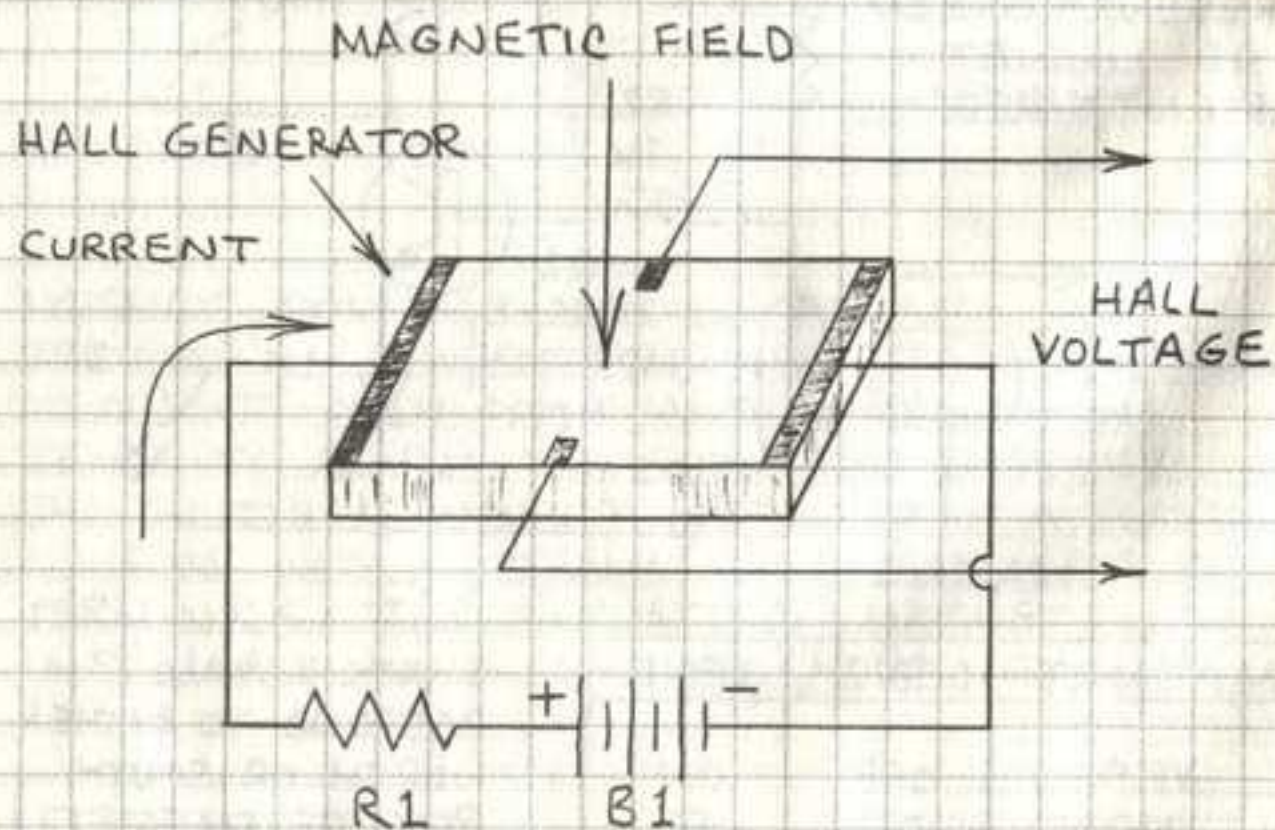

RESISTOR R1 LIMITS (RESTRICTS) THE CURRENT FROM BATTERY B1 TO A SAFE VALUE. TOO MUCH CURRENT WILL OVERHEAT AND DAMAGE THE HALL GENERATOR.

THE HALL EFFECT OCCURS IN CONDUCTORS AND SEMICONDUCTORS. THE HALL VOLTAGE PRODUCED BY CONDUCTORS IS MUCH TOO SMALL FOR PRACTICAL APPLICATIONS. THE HALL VOLTAGE IS MUCH HIGHER IN SEMICONDUCTORS. GALLIUM ARSENIDE AND OTHER SEMICONDUCTORS PRODUCE THE MOST VOLTAGE. BUT SILICON IS PREFERRED SINCE IT IS STURDIER AND EASIER TO MANUFACTURE.

APPLICATIONS FOR HALL SENSORS

HALL SENSORS HAVE MANY APPLICATIONS IN ELECTRONICS AND SENSING. THEY CAN BE USED INSTEAD OF LIGHT SENSORS IN APPLICATIONS WHERE THE SENSOR MIGHT BECOME DIRTY OR EXPOSED TO BRIGHT LIGHT. HERE ARE SOME OF THE MOST COMMON APPLICATIONS:

MAGNETIC FIELD SENSOR

HALL SENSORS CAN DETECT PRESENCE OR ABSENCE OF SMALL MAGNETS.

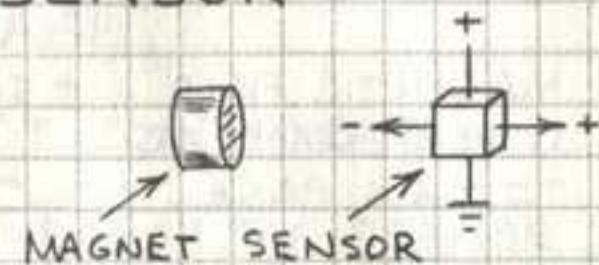

ELECTROMAGNETIC FIELD SENSOR

HALL SENSORS CAN DETECT MAGNETIC FIELD CAUSED BY ELECTRICAL CURRENT.

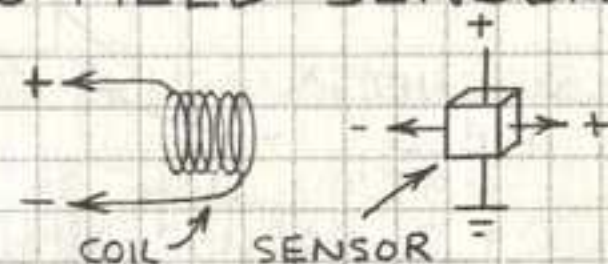

BOUNCELESS SWITCH

SWITCH MADE WITH HALL SENSOR DOES NOT HAVE MECHANICAL "BOUNCE" OF CONVENTIONAL SWITCH.

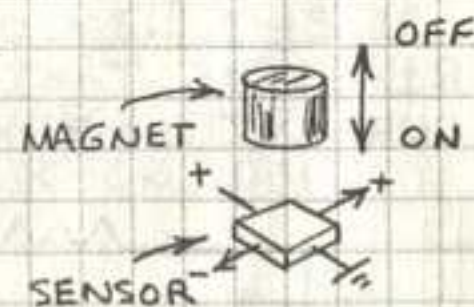

FERROUS METAL DETECTOR

HALL SENSOR BACKED BY SMALL MAGNET WILL DETECT FERROUS METAL.

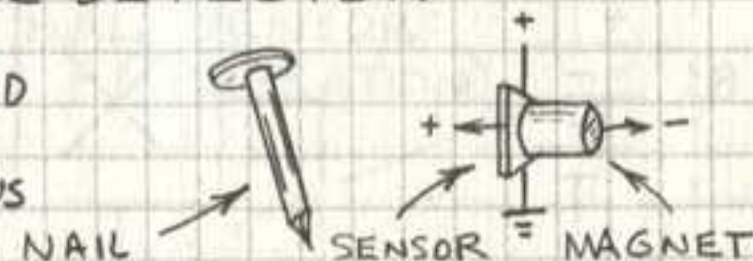

GEAR TOOTH SENSOR

HALL SENSOR BACKED BY SMALL MAGNET WILL DETECT TEETH ON A GEAR.

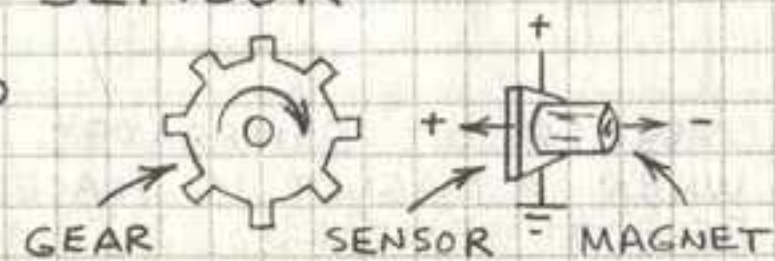

HALL SENSOR BASICS

MOST HALL SENSORS ARE MANUFACTURED WITH A BUILT-IN AMPLIFIER OR LOGIC CIRCUIT TO MAKE THEM EASIER TO USE. IT'S HELPFUL TO UNDERSTAND HOW THE SENSOR IS CONNECTED TO THESE INTERFACE CIRCUITS.

BASIC HALL SENSOR

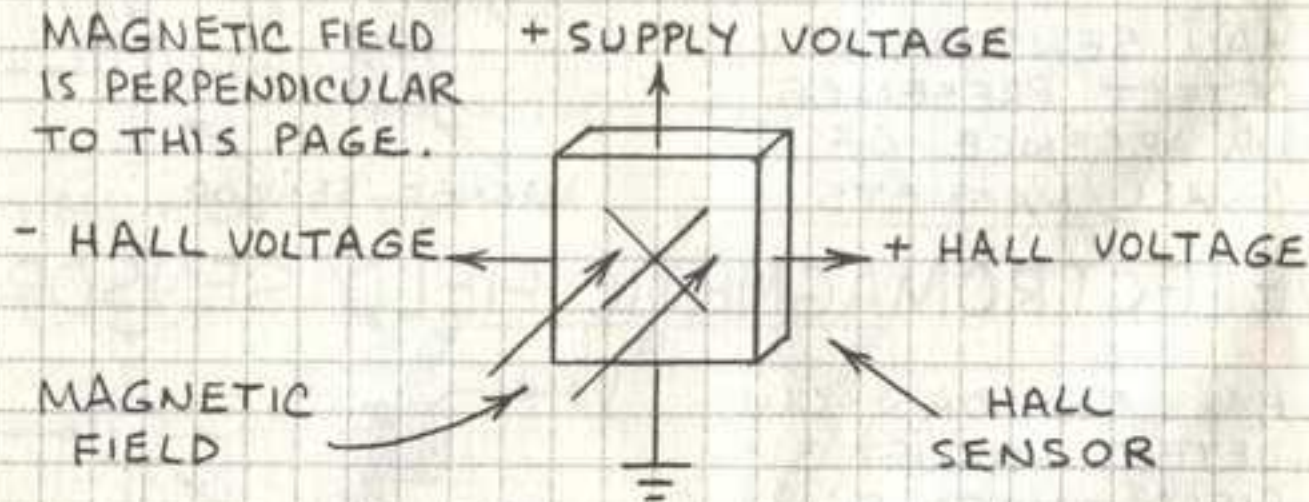

BASIC HALL SENSOR CIRCUIT

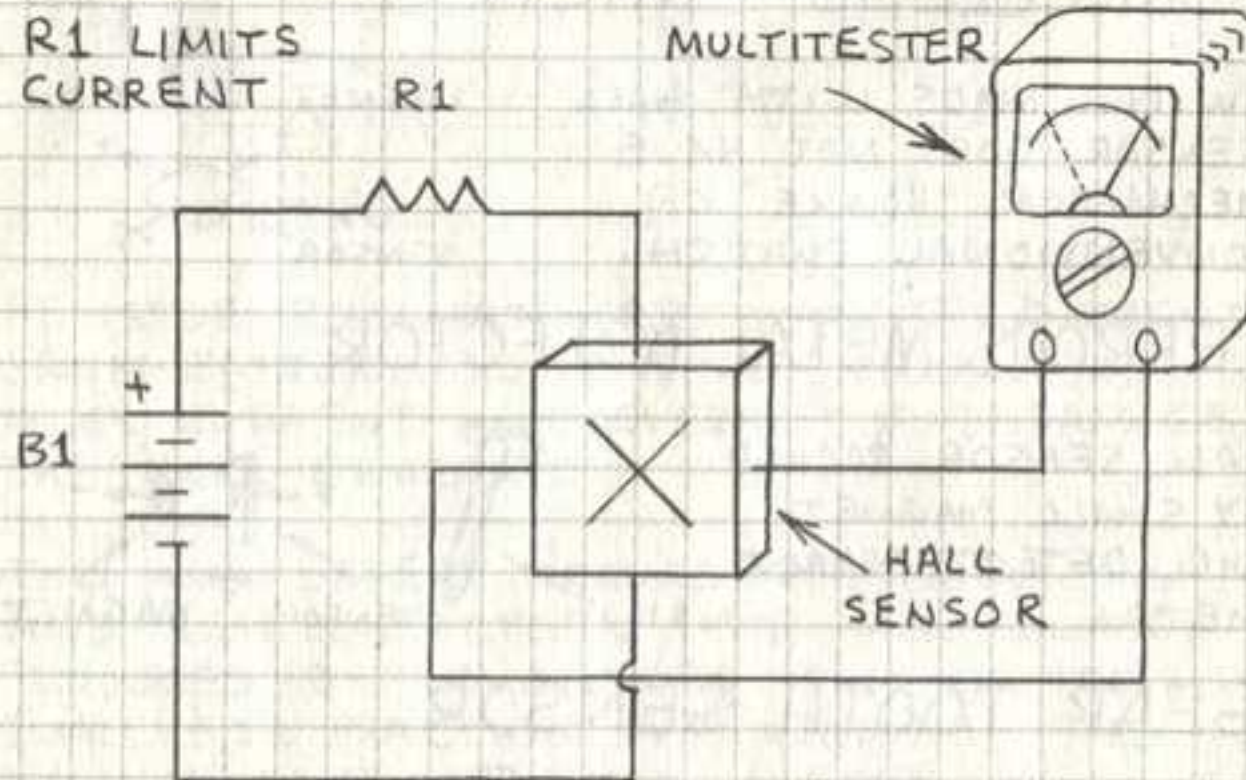

THIS CIRCUIT GENERATES AN OUTPUT VOLTAGE WHEN A MAGNET IS PLACED NEAR THE HALL EFFECT SENSOR.

HALL SENSOR OUTPUT VOLTAGE

THE HALL VOLTAGE IS PROPORTIONAL TO THE APPLIED MAGNETIC FIELD ACCORDING TO:

$$V_H = R_H \times \left(\frac{I}{t} \times B \right)$$

WHERE,

V_H IS THE HALL VOLTAGE,

R_H IS THE HALL EFFECT COEFFICIENT,

I IS THE CURRENT THROUGH THE SENSOR,

t IS THE THICKNESS OF THE SENSOR, AND

B IS THE PERPENDICULAR MAGNETIC FIELD.

IN PRACTICAL TERMS, THE HALL VOLTAGE IN A TYPICAL SILICON HALL SENSOR IS ABOUT 18 MICROVOLTS (0.000018 VOLT) PER GAUSS WHEN THE SUPPLY IS 3 VOLTS. THIS IS SUCH A SMALL VOLTAGE THAT HALL SENSORS ARE USUALLY MANUFACTURED WITH A BUILT-IN AMPLIFIER OR LOGIC CIRCUIT.

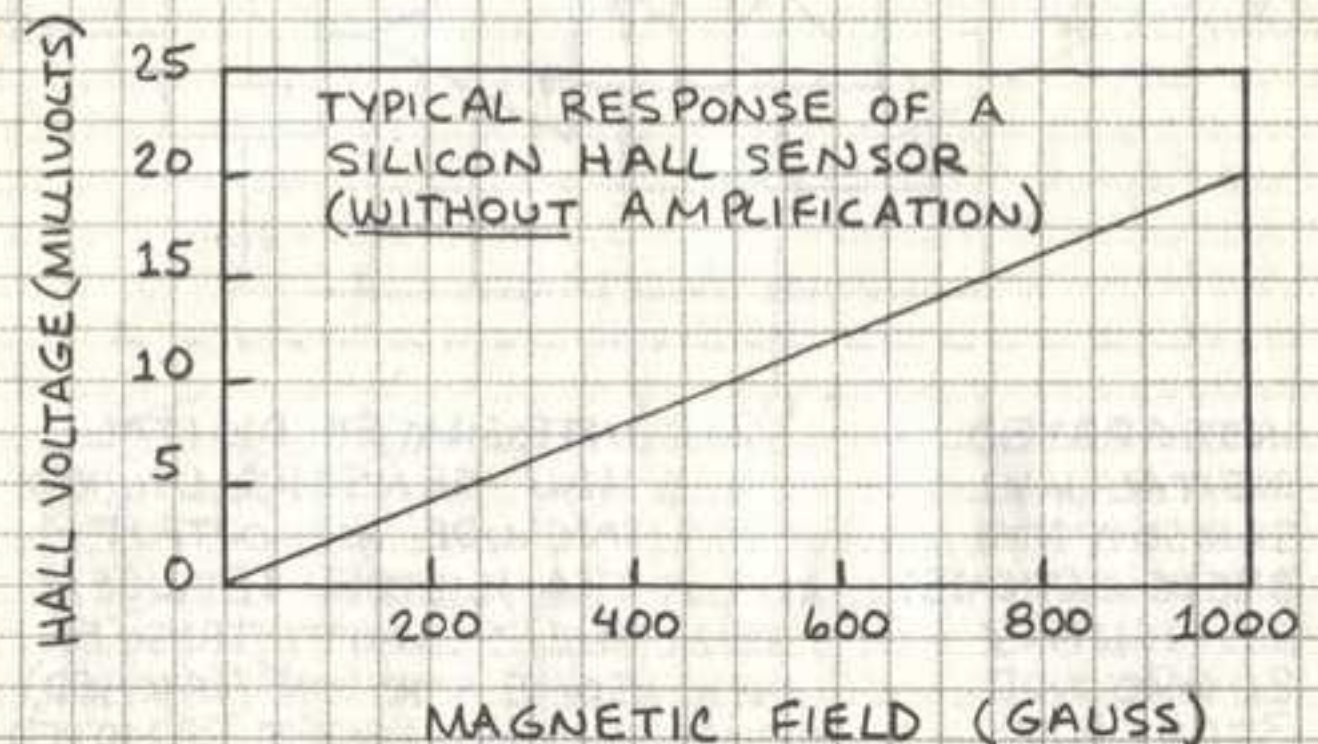

HALL SENSOR + LOGIC CIRCUIT

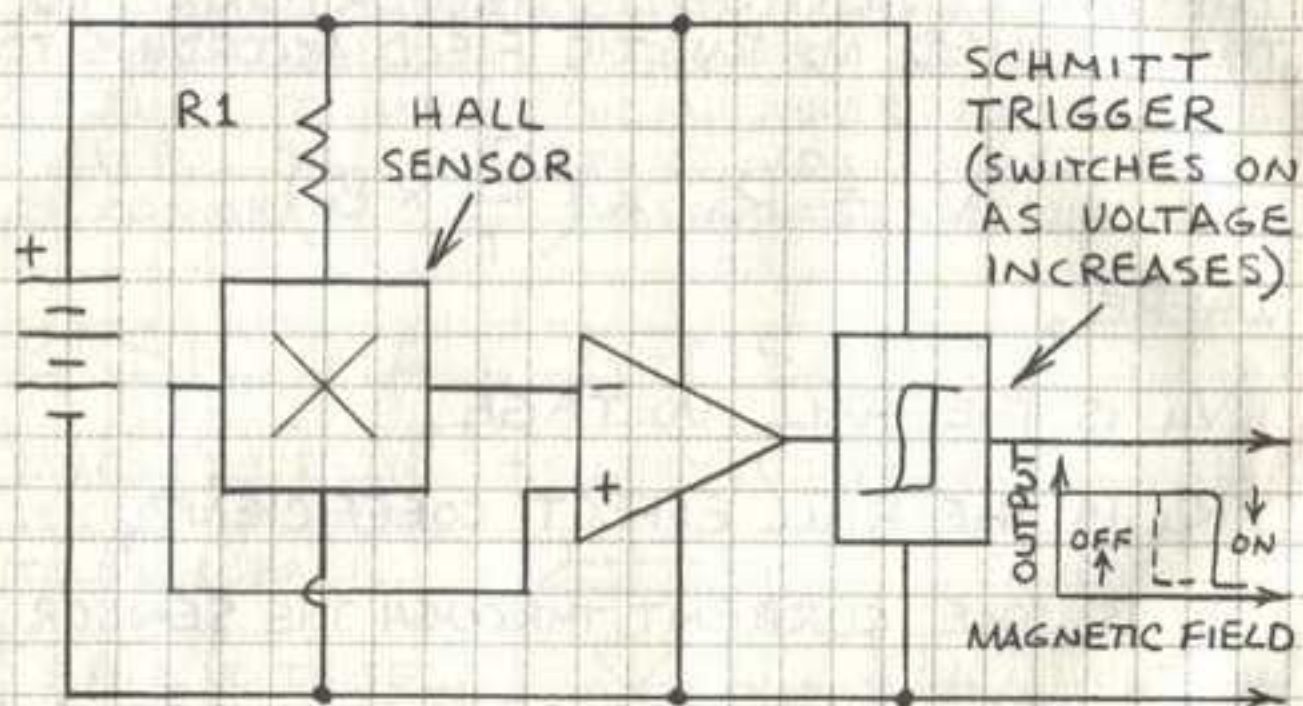

HALL SENSOR + AMPLIFIER

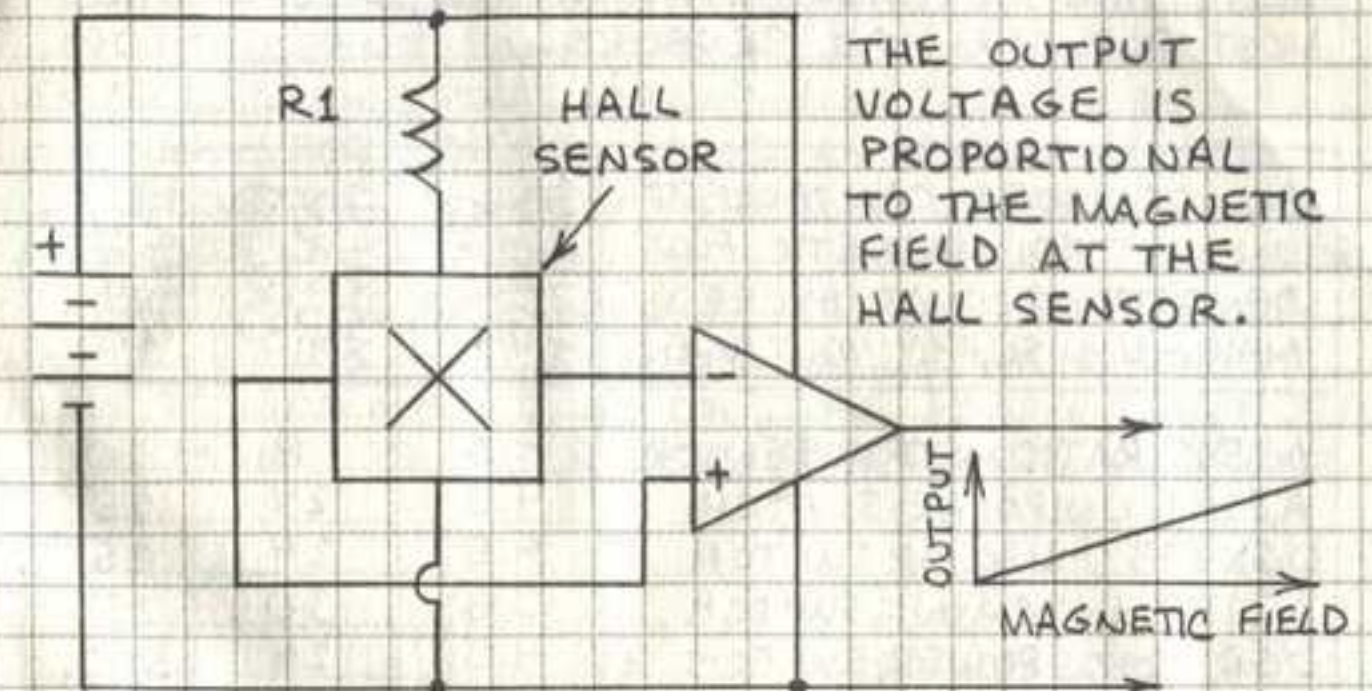

INTEGRATED DIGITAL HALL SENSOR

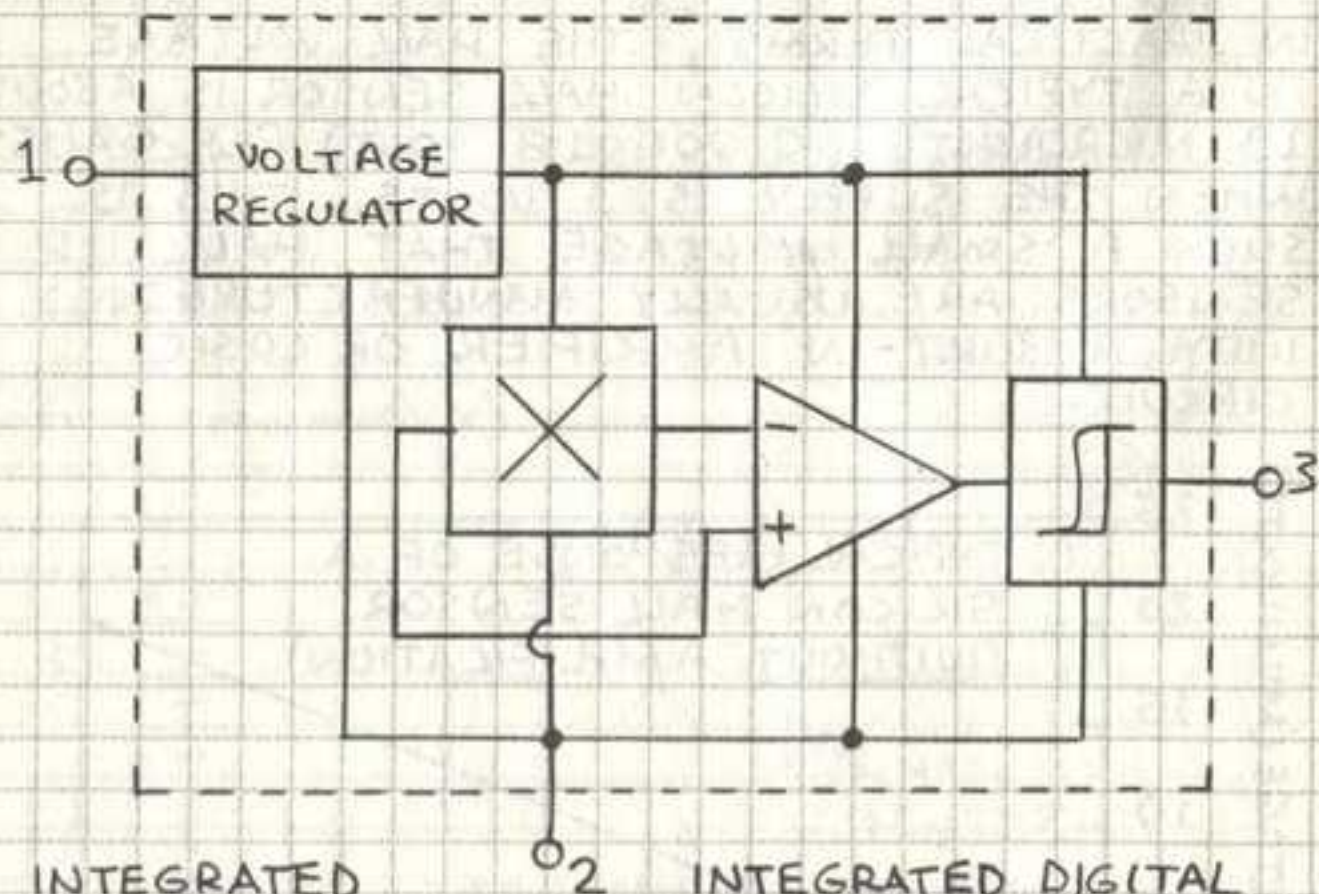

INTEGRATED DIGITAL HALL SENSOR PIN DESIGNATIONS:
 1. + SUPPLY
 2. GROUND
 3. OUTPUT

INTEGRATED DIGITAL HALL SENSORS USUALLY INCLUDE AN OUTPUT TRANSISTOR BETWEEN THE SCHMITT TRIGGER. SOME STAY "ON" (LATCHED) WHEN MAGNET REMOVED.

INTEGRATED LINEAR HALL SENSOR

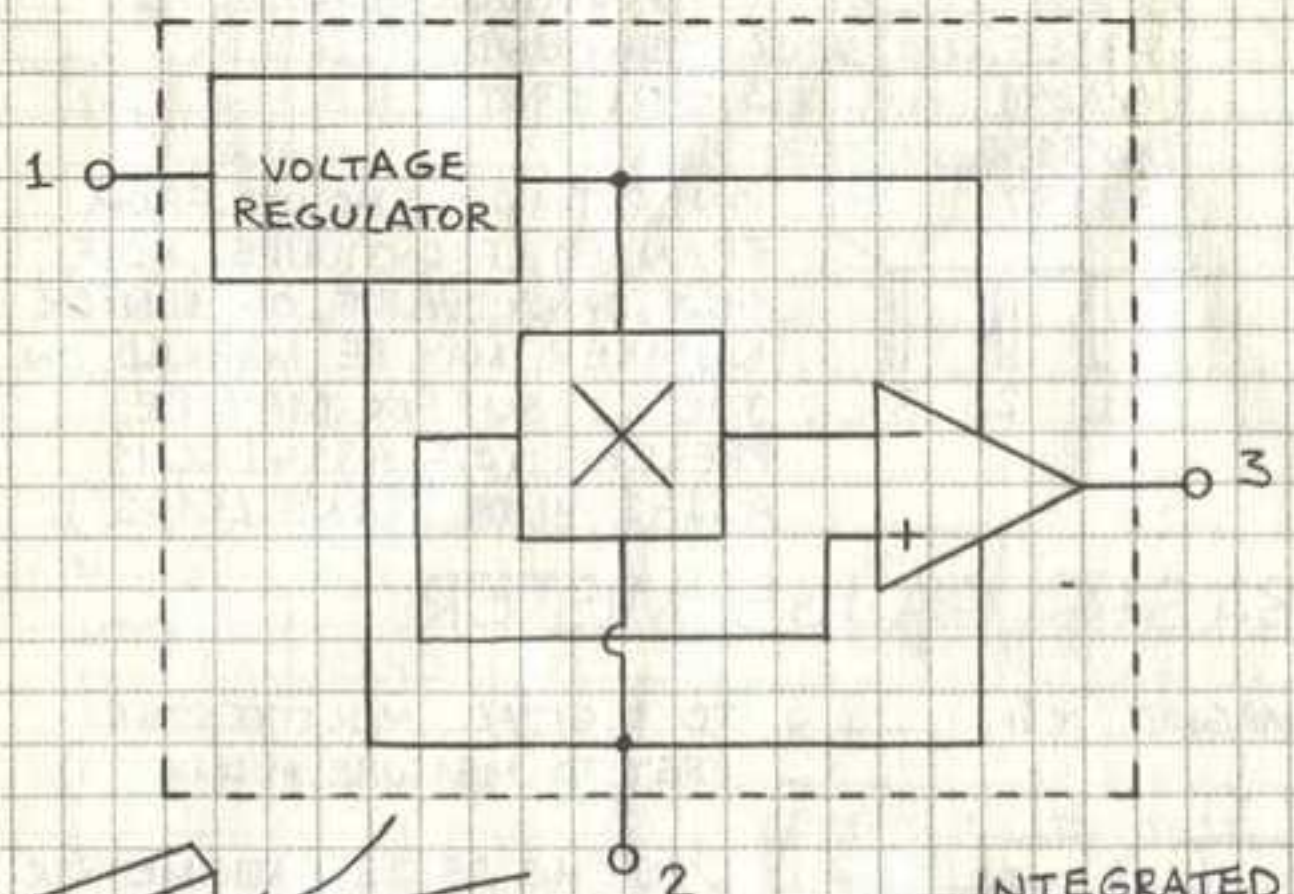

INTEGRATED LINEAR HALL SENSOR PIN DESIGNATIONS:
 1. + SUPPLY
 2. GROUND
 3. OUTPUT

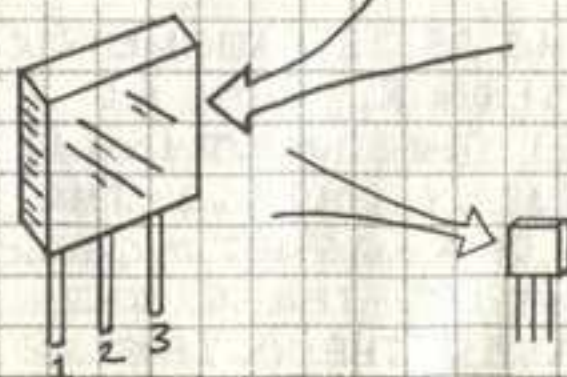

HALL SENSOR SPECIFICATIONS

HERE ARE KEY SPECIFICATIONS FOR SOME OF THE MOST POPULAR HALL SENSORS.

ALL SENSORS CAN ACCEPT UNLIMITED MAGNETIC FLUX DENSITY. DO NOT EXCEED MAXIMUM SUPPLY VOLTAGE.	MINIMUM SUPPLY (VOLTS)	MAXIMUM SUPPLY (VOLTS)	OUTPUT CURRENT (mA)
A3515 RATIOMETRIC SENSOR	4.5	8	10
A3141 UNIPOLAR SWITCH	4.5	24	25
UGX3132 BIPOLAR SWITCH	4.5	24	25
A3187 LATCHING SWITCH	3.8	30	25
UGQ5140 POWER SWITCH	4.5	24	300
A3422 DIRECTION SENSOR	4.5	18	30
ATS610 GEAR TOOTH SENSOR	4.5	16	25

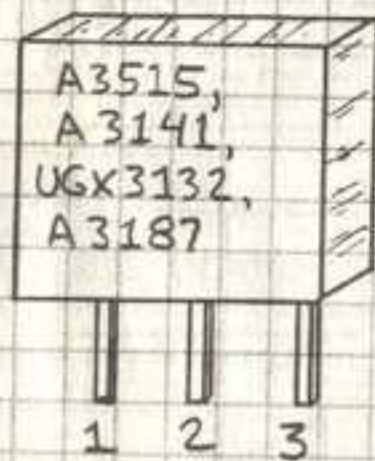

- 1 - POSITIVE (+) SUPPLY
- 2 - GROUND
- 3 - OUTPUT

PIN OUTLINE SHOWN FROM BRANDED (FRONT) SIDE. NOTE THAT ONLY PART OF SENSOR NUMBER MAY BE MARKED ON THE IC. SUFFIX MAY BE PRESENT (e.g. A3141LL IS A3141 WITH "LONG LEADS").

BASIC GAUSS METER

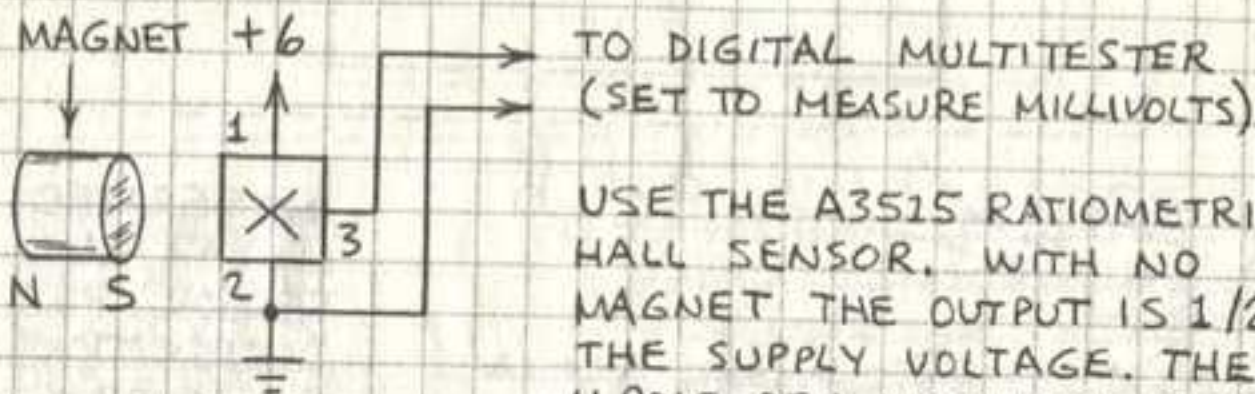

OUTPUT CHANGES 25 MILLIVOLTS PER GAUSS.

USE THE A3515 RATIOMETRIC HALL SENSOR. WITH NO MAGNET THE OUTPUT IS 1/2 THE SUPPLY VOLTAGE. THE N POLE OF A MAGNET INCREASES THE OUTPUT. THE S POLE DECREASES THE OUTPUT.

POWER HALL SENSOR

MOST HALL SENSORS CANNOT DIRECTLY DRIVE AN INCANDESCENT LAMP, RELAY, SMALL MOTOR OR OTHER DEVICE THAT DRAWS MORE THAN 10 TO 25 mA. FOR THESE LOADS AN EXTERNAL DRIVE TRANSISTOR IS REQUIRED. THE UGQ5140 HALL SENSOR INCLUDES A BUILT-IN DRIVE TRANSISTOR THAT CAN CONTINUOUSLY SINK UP TO 300 mA. THIS POWER HALL SENSOR WILL BRIEFLY SINK UP TO 900 mA TO ALLOW TIME FOR A LAMP TO WARM UP TO ITS RATED OPERATING CURRENT.



- PIN 1 - SUPPLY (+4.5 TO 28V)
- PIN 2 - OUTPUT (300 mA MAXIMUM)
- PIN 3 - DIODE *
- PIN 4 - GROUND

* THE DIODE PIN CAN BE USED FOR AN OPTIONAL LAMP TEST FUNCTION.

HALL LAMP DRIVER

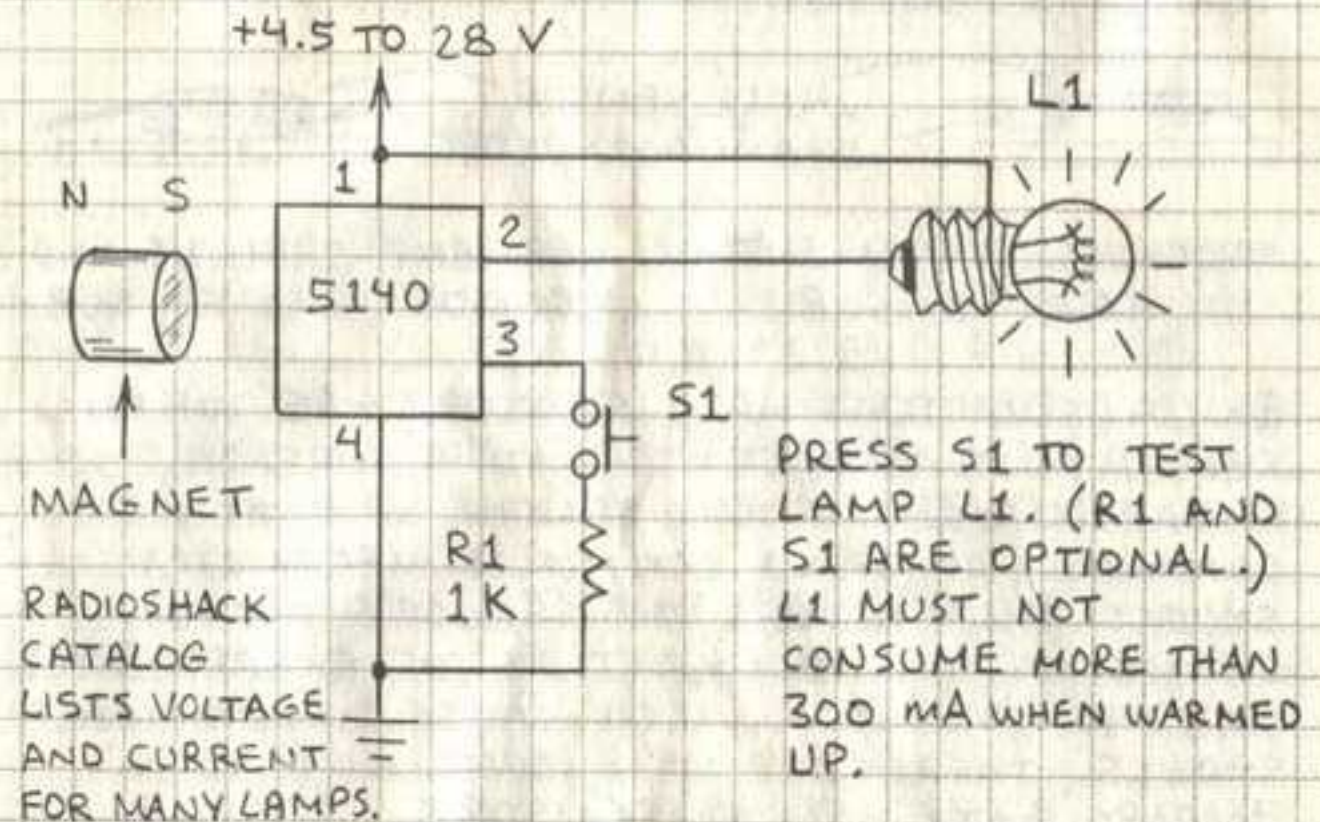

PRESS S1 TO TEST LAMP L1. (R1 AND S1 ARE OPTIONAL.) L1 MUST NOT CONSUME MORE THAN 300 mA WHEN WARMED UP.

RADIO SHACK CATALOG LISTS VOLTAGE AND CURRENT FOR MANY LAMPS.

HALL SENSOR OPERATING TIPS

HALL SENSORS ARE VERY EASY TO USE. THEY ARE UNAFFECTED BY DIRT AND GREASE THAT CAN DISABLE OPTOELECTRONIC SENSORS. THEY WORK OVER A VERY WIDE TEMPERATURE RANGE (TYPICALLY -40°C TO $+85^{\circ}\text{C}$). EXTREMELY HIGH MAGNETIC FIELD INTENSITIES WILL NOT HARM HALL SENSORS.

HALL SENSORS ARE VERY SENSITIVE TO MECHANICAL STRESS AND EXCESS SUPPLY VOLTAGE. THEREFORE IT'S VERY IMPORTANT TO OBSERVE THE FOLLOWING GUIDELINES WHEN INSTALLING AND USING HALL SENSORS:

POWER SUPPLY—IT'S BEST TO POWER HALL SENSORS AT THE LOWEST ALLOWABLE VOLTAGE. NEVER EXCEED THE MAXIMUM ALLOWABLE!

MOUNTING HALL SENSORS—HALL SENSORS ARE OFTEN ATTACHED TO A SURFACE WITH ADHESIVE. FOR BEST RESULTS, USE A FILLED EPOXY. NEVER USE CYANOACRYLATE GLUE! THIS GLUE SHRINKS AND CAN EASILY CAUSE ENOUGH MECHANICAL STRAIN TO CHANGE THE HALL SENSOR'S OUTPUT.

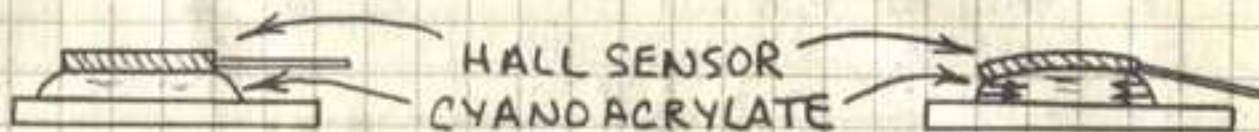

ORIGINAL PLACEMENT OF HALL SENSOR

CEMENT SHRINKS AND BENDS HALL SENSOR

ENCAPSULATING HALL SENSORS—AS WHEN CEMENTING HALL SENSORS TO A SURFACE, ENCAPSULATING A HALL SENSOR IN POTTING COMPOUND OR EPOXY CAN CAUSE MECHANICAL STRESS THAT ALTERS THE SENSOR'S OUTPUT. CHANGING THE TEMPERATURE OF ENCAPSULATED HALL SENSORS CAN ALSO CAUSE MECHANICAL STRESS. THEREFORE IT'S BEST NOT TO ENCAPSULATE HALL SENSORS.

HALL SENSOR—MAGNET SEPARATION

IDEALLY, THE STRENGTH OF A MAGNETIC FIELD IS INVERSELY PROPORTIONAL TO THE SQUARE OF THE DISTANCE FROM THE MAGNET. AT 3 CM THE STRENGTH OF THE FIELD SHOULD BE ABOUT $1/3^2$ OR $1/9$ THE VALUE AT 1 CM. AS THIS GRAPH SHOWS, IN THE "REAL WORLD" THIS RELATIONSHIP IS NOT SO IDEAL—OR AT LEAST NOT EASILY MEASURED.

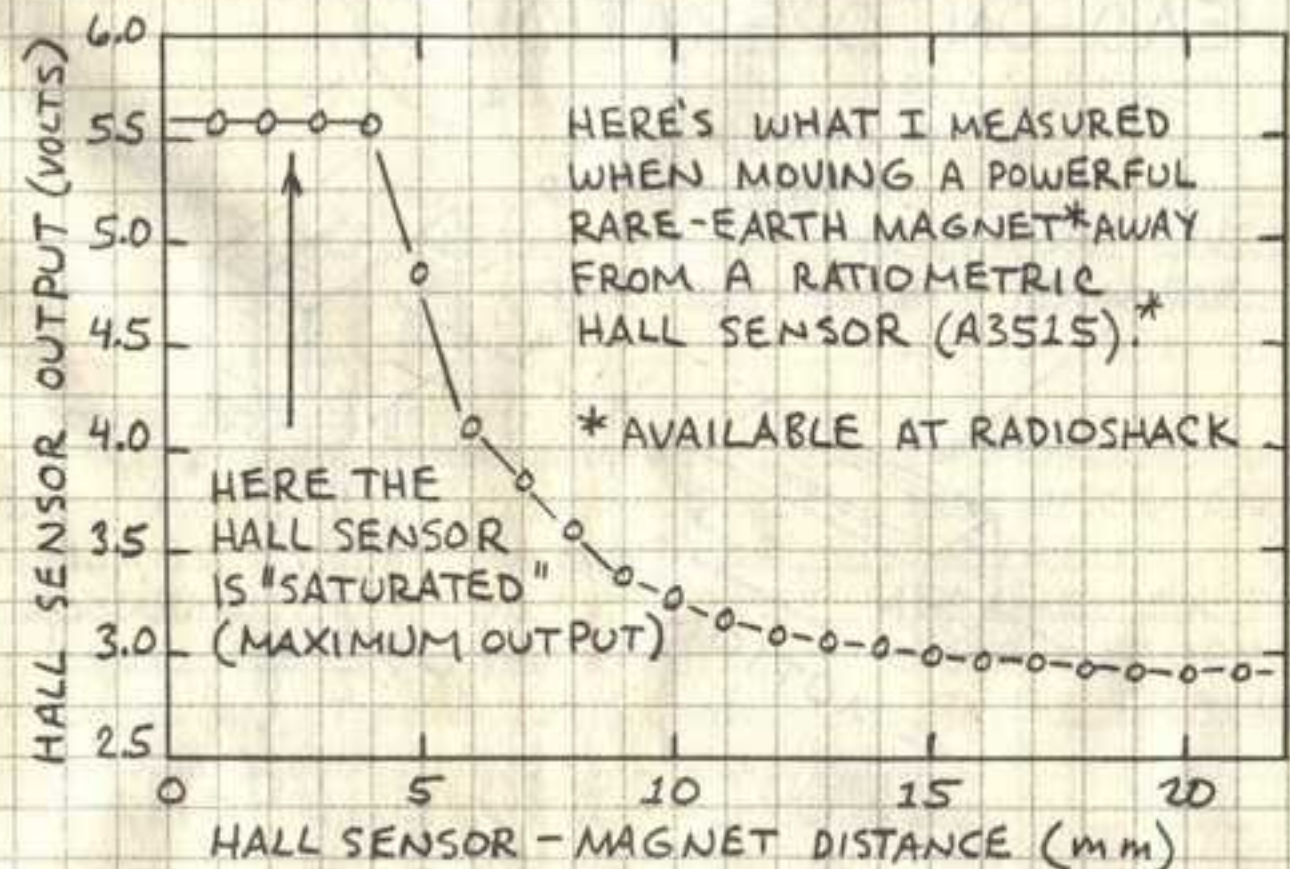

FLUX CONCENTRATORS

FLUX CONCENTRATORS, MADE FROM LOW-CARBON STEEL GUIDE, OR CONCENTRATE A MAGNETIC FIELD. STEEL NAILS CAN BE USED AS EXPERIMENTAL FLUX CONCENTRATORS. FOR BEST RESULTS, THE DIAMETER OF THE CONSTRICTED END OF A FLUX CONCENTRATOR SHOULD APPROXIMATE THAT OF THE HALL SENSOR CHIP.

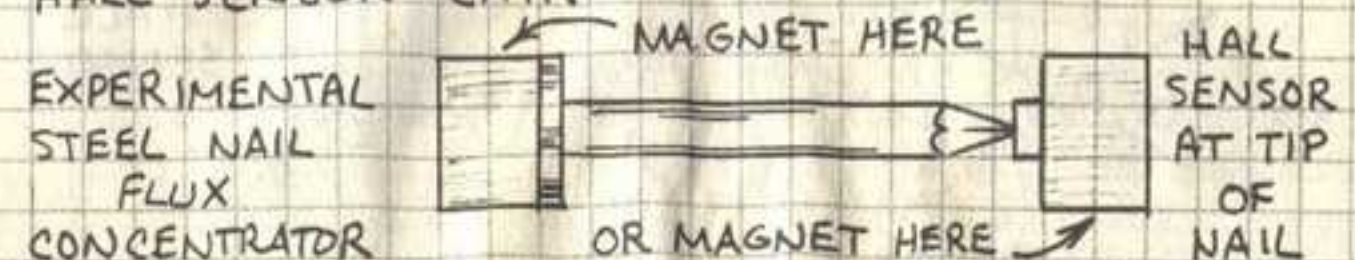

BEST MAGNET ARRANGEMENTS

IT'S IMPORTANT TO PLAN AHEAD WHEN DESIGNING HALL EFFECT CIRCUITS. IT'S USUALLY BEST TO MAKE A TEST CIRCUIT BEFORE BUILDING YOUR FINAL DESIGN. THIS WILL ALLOW YOU TO TEST THE CIRCUIT'S RESPONSE TO VARIOUS MAGNETS AND MAGNETIC FIELDS.

HEAD-ON OPERATION

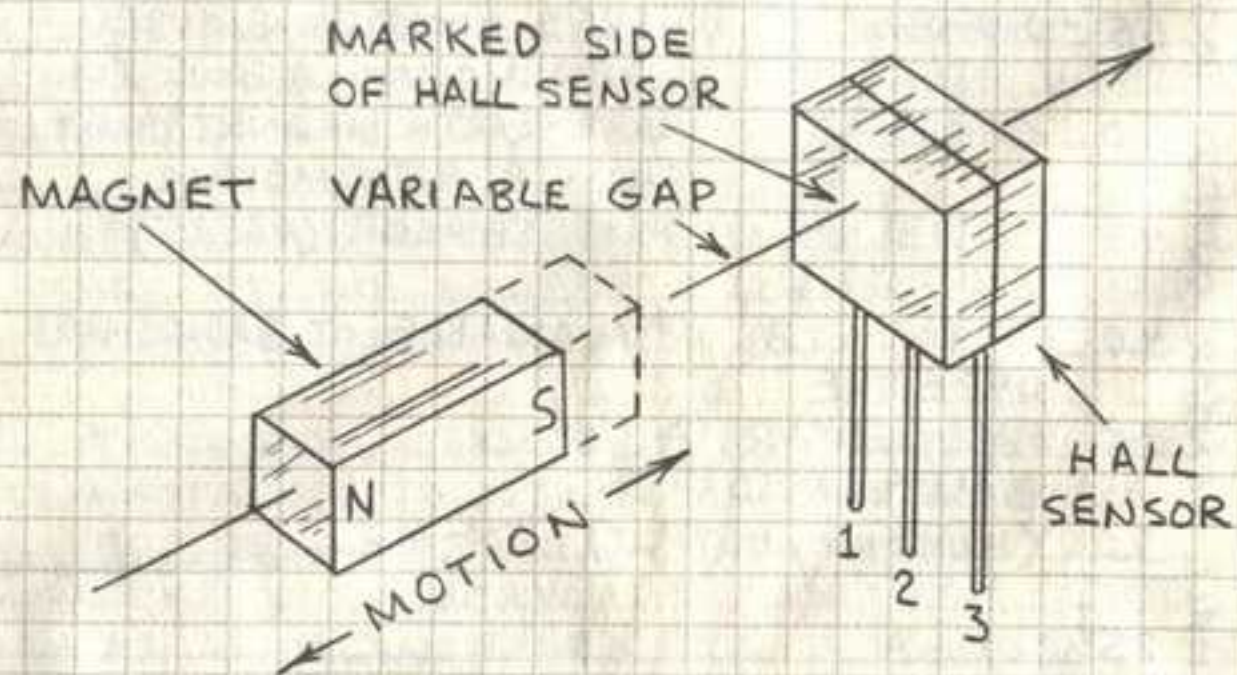

SLIDE-BY OPERATION

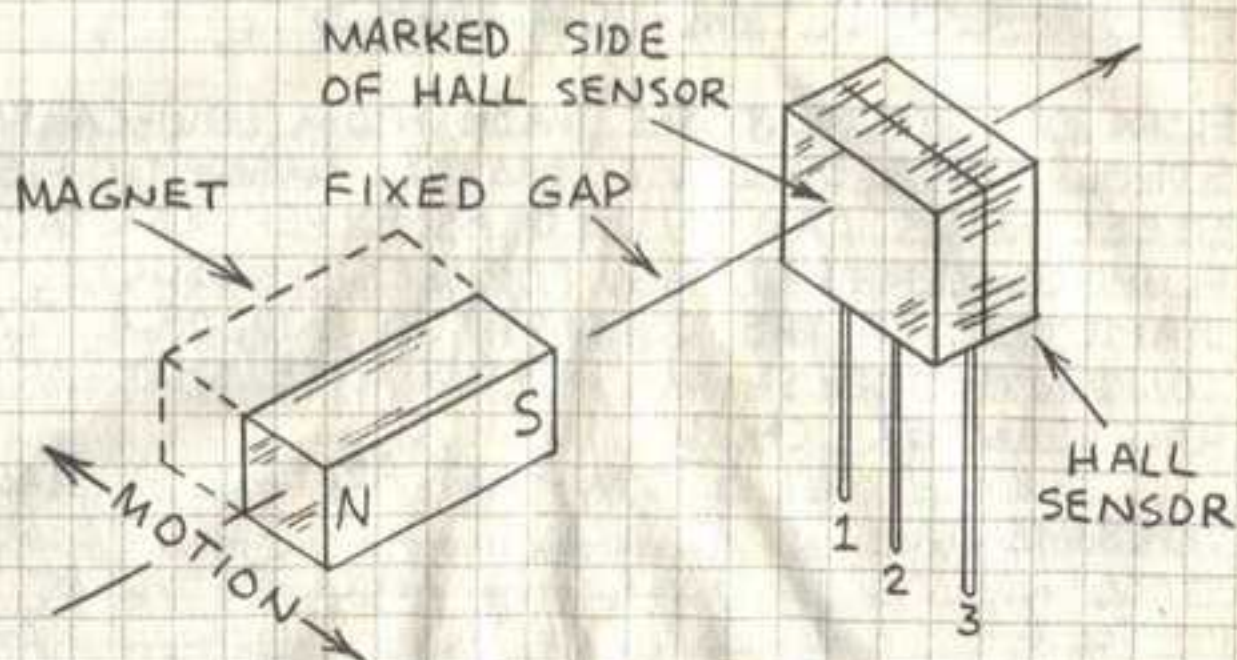

PUSH-PUSH OPERATION

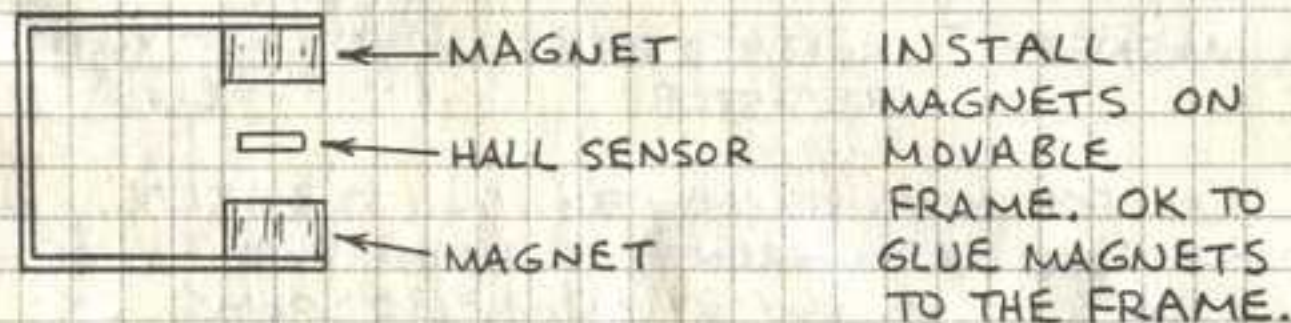
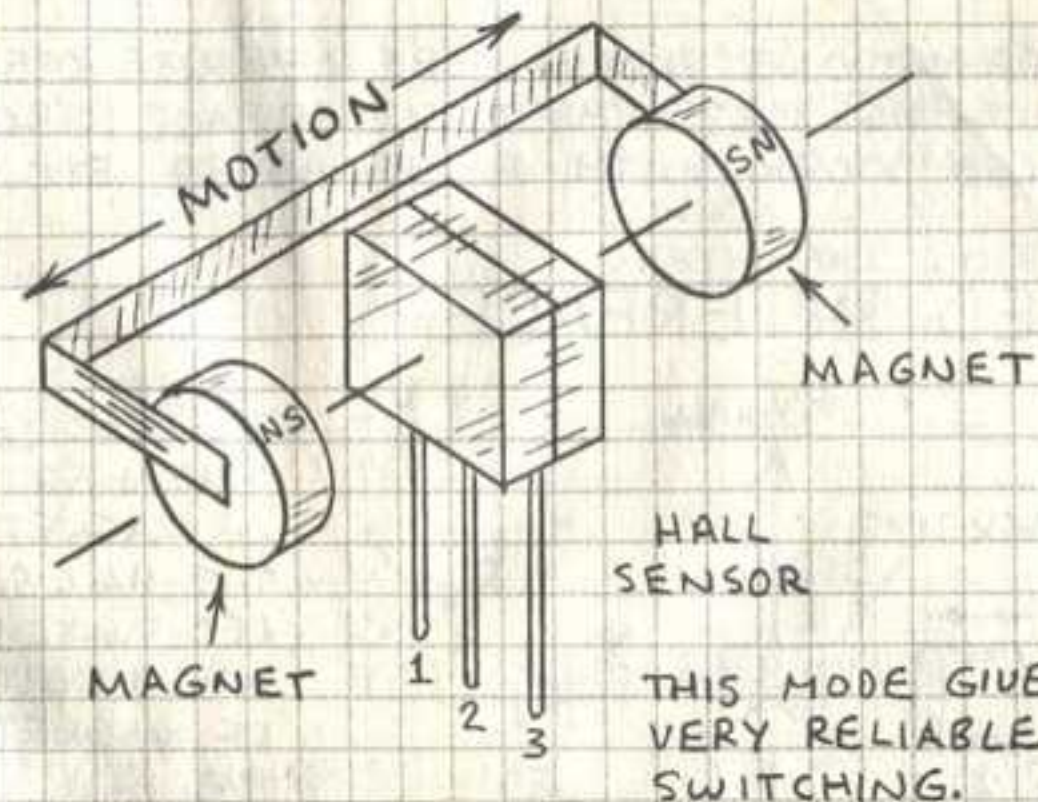

PUSH-PULL OPERATION

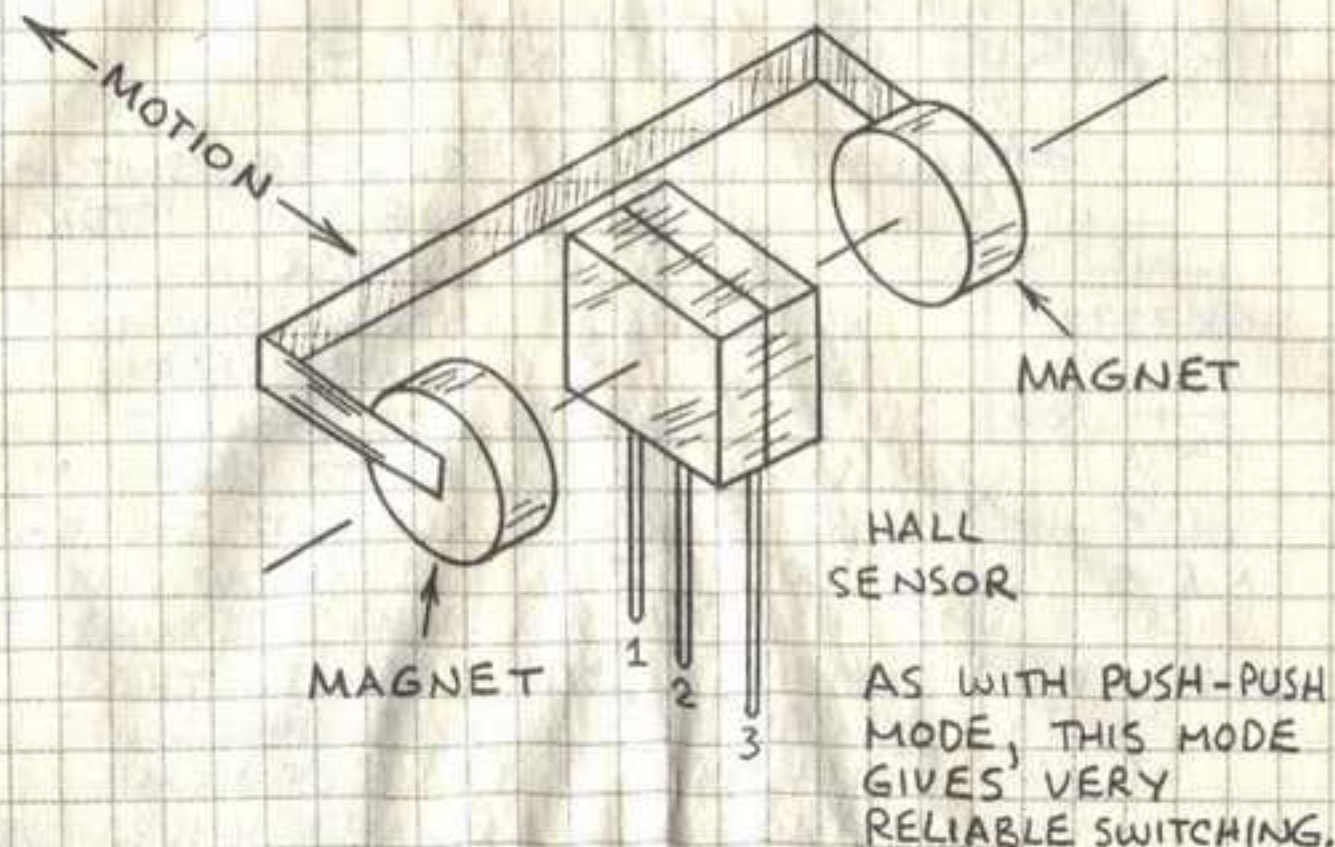

INTERFACING DIGITAL HALL SENSORS

APPLICATIONS SHOWN HERE DESCRIBE OPERATION WITH UGX3132. THESE INTERFACE CIRCUITS ALSO WORK WITH A3141, A3187, ETC.

LED INTERFACE

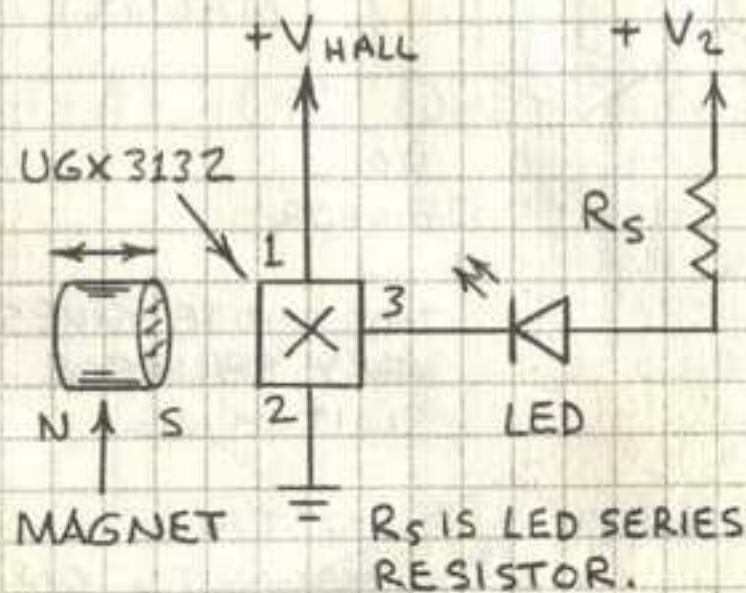

THE LED GLOWS WHEN SOUTH POLE OF MAGNET IS NEAR THE HALL SENSOR. LED SWITCHES OFF WHEN NORTH POLE OF MAGNET IS NEAR THE HALL SENSOR.

$$R_S = \frac{V_2 - V_{LED}}{I_{LED}}$$

V_{LED} FOR MOST VISIBLE LEDs IS 2 TO 3 VOLTS. FOR I_{LED} (LED CURRENT) OF 10 mA AND V_2 OF 6 VOLTS, $R_S = (6V - 3V) / 0.01 = 300$ OHMS. OK TO USE 270 TO 330 OHMS IN MOST APPLICATIONS.

TRANSISTOR INTERFACE

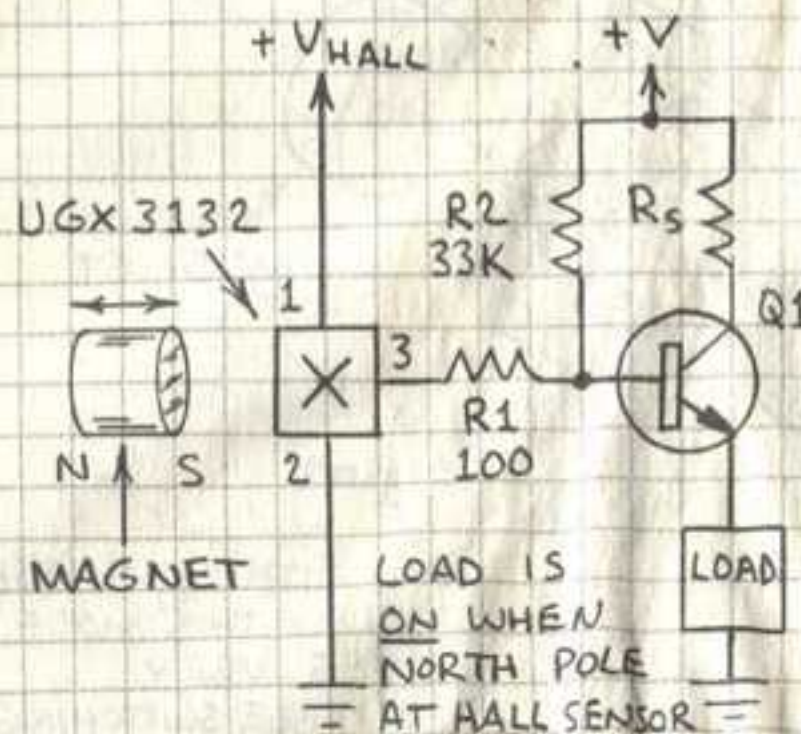

Q1 IS NPN SWITCHING TRANSISTOR (2N2222, MPS2222, ETC.). LOAD IS LAMP, RELAY, ETC. SELECT R_S TO KEEP CURRENT THROUGH Q1 BELOW MAXIMUM ALLOWABLE. LOAD SWITCHES OFF WHEN SOUTH POLE OF MAGNET IS NEAR HALL SENSOR.

TTL LOGIC INTERFACE

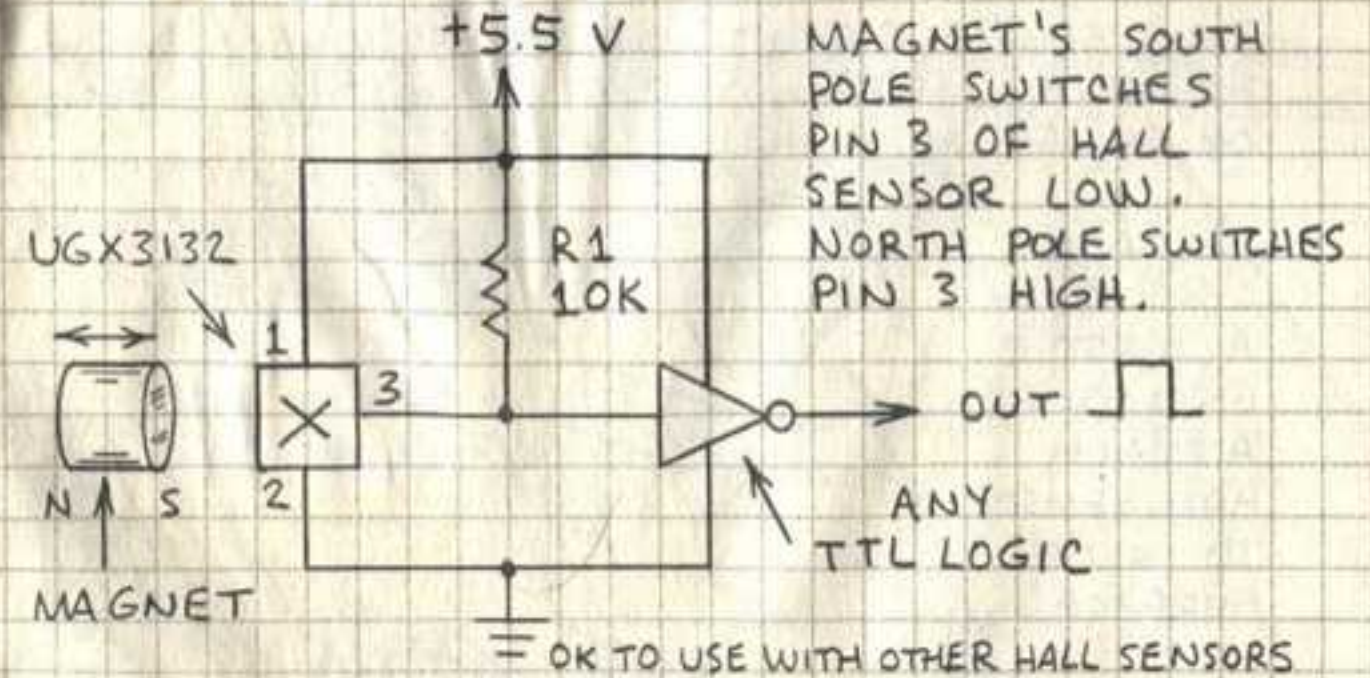

THIS CIRCUIT WORKS WITH OLDER TTL AND NEWER LOW-POWER TTL LOGIC. THE HALL SUPPLY VOLTAGE SHOULD MATCH THE TTL SUPPLY VOLTAGE.

CMOS LOGIC INTERFACE

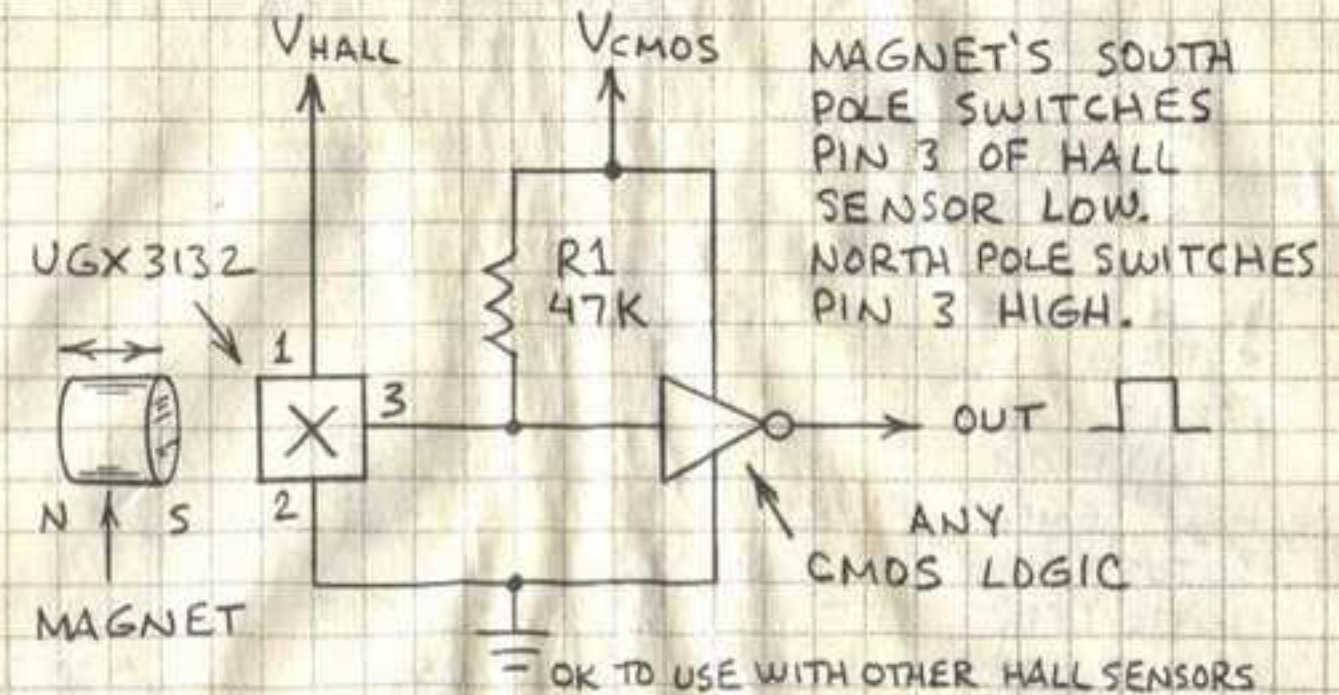

BEST TO POWER HALL SENSOR AND CMOS LOGIC FROM SAME SUPPLY WHEN POSSIBLE. IF NOT, KEEP HALL SUPPLY VOLTAGE AT OR BELOW CMOS SUPPLY VOLTAGE. BE SURE TO FOLLOW CMOS HANDLING PRECAUTIONS.

FERROUS METAL INDICATOR

THIS SIMPLE CIRCUIT INDICATES WHEN A FERROUS METAL OBJECT IS WITHIN 1 CM OR SO FROM A HALL SENSOR.

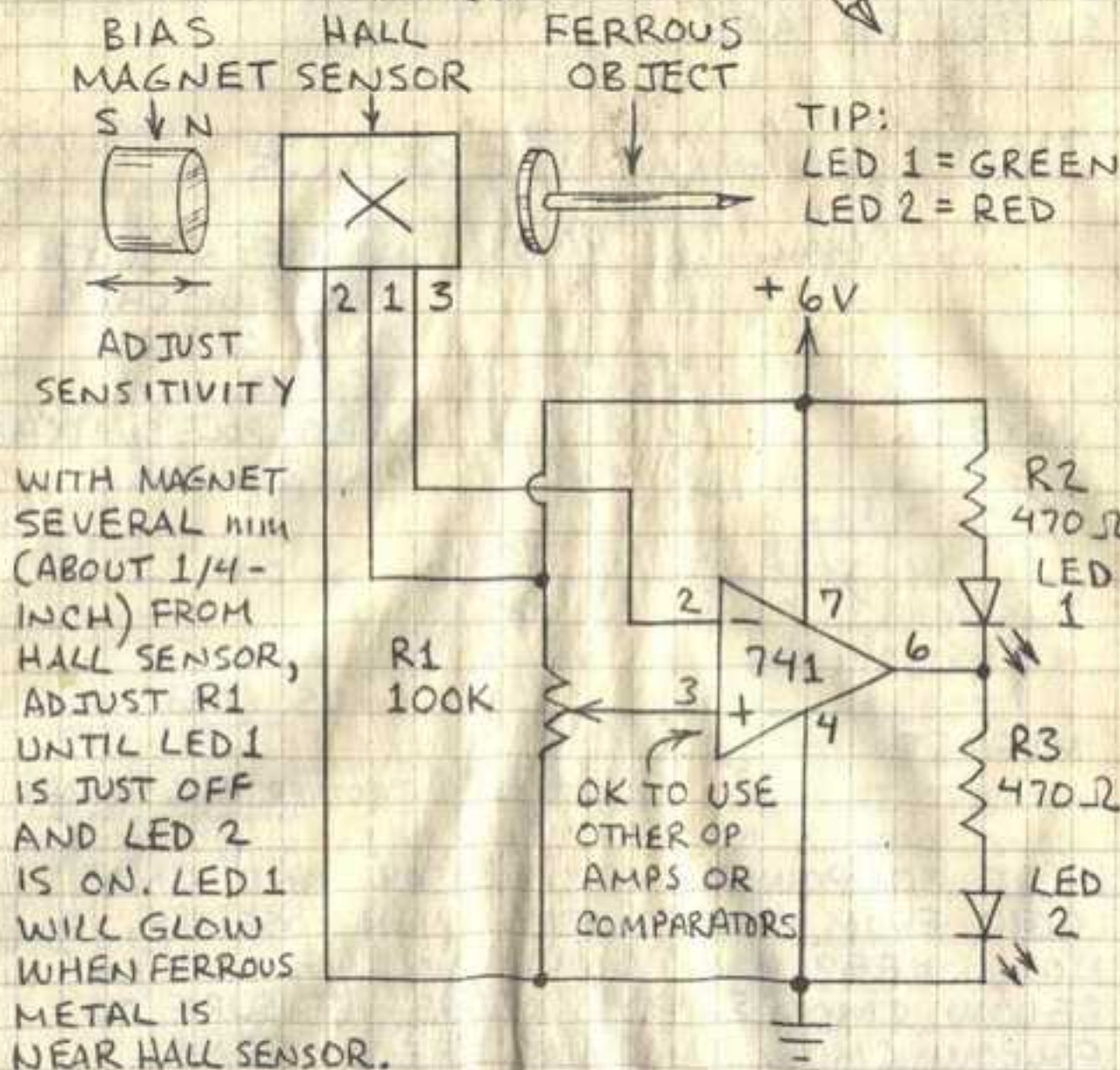
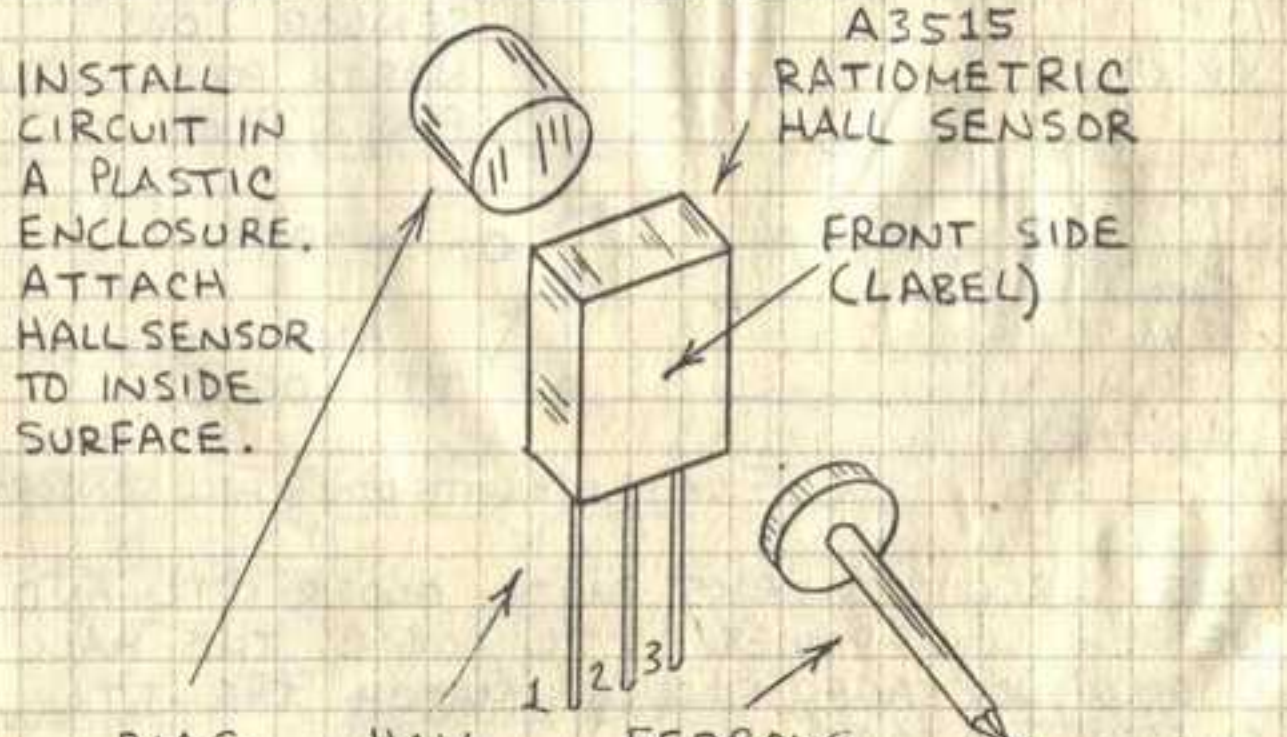

INSTALL CIRCUIT IN A PLASTIC ENCLOSURE. ATTACH HALL SENSOR TO INSIDE SURFACE.

BIAS MAGNET

HALL SENSOR

FERROUS OBJECT

TIP: LED 1 = GREEN
LED 2 = RED

ADJUST SENSITIVITY

WITH MAGNET SEVERAL mm (ABOUT 1/4-INCH) FROM HALL SENSOR, ADJUST R1 UNTIL LED 1 IS JUST OFF AND LED 2 IS ON. LED 1 WILL GLOW WHEN FERROUS METAL IS NEAR HALL SENSOR.

HALL SENSOR RELAY

THE MOVING CONTACT OF AN ELECTROMAGNETIC RELAY PRODUCES A SOMETIMES UNWANTED CLICKING SOUND AND CAN EVENTUALLY WEAR OUT OR BE CONTAMINATED WITH GREASE OR DUST. A HALL SENSOR CAN REPLACE A RELAY'S CONTACTS IN SOME APPLICATIONS.

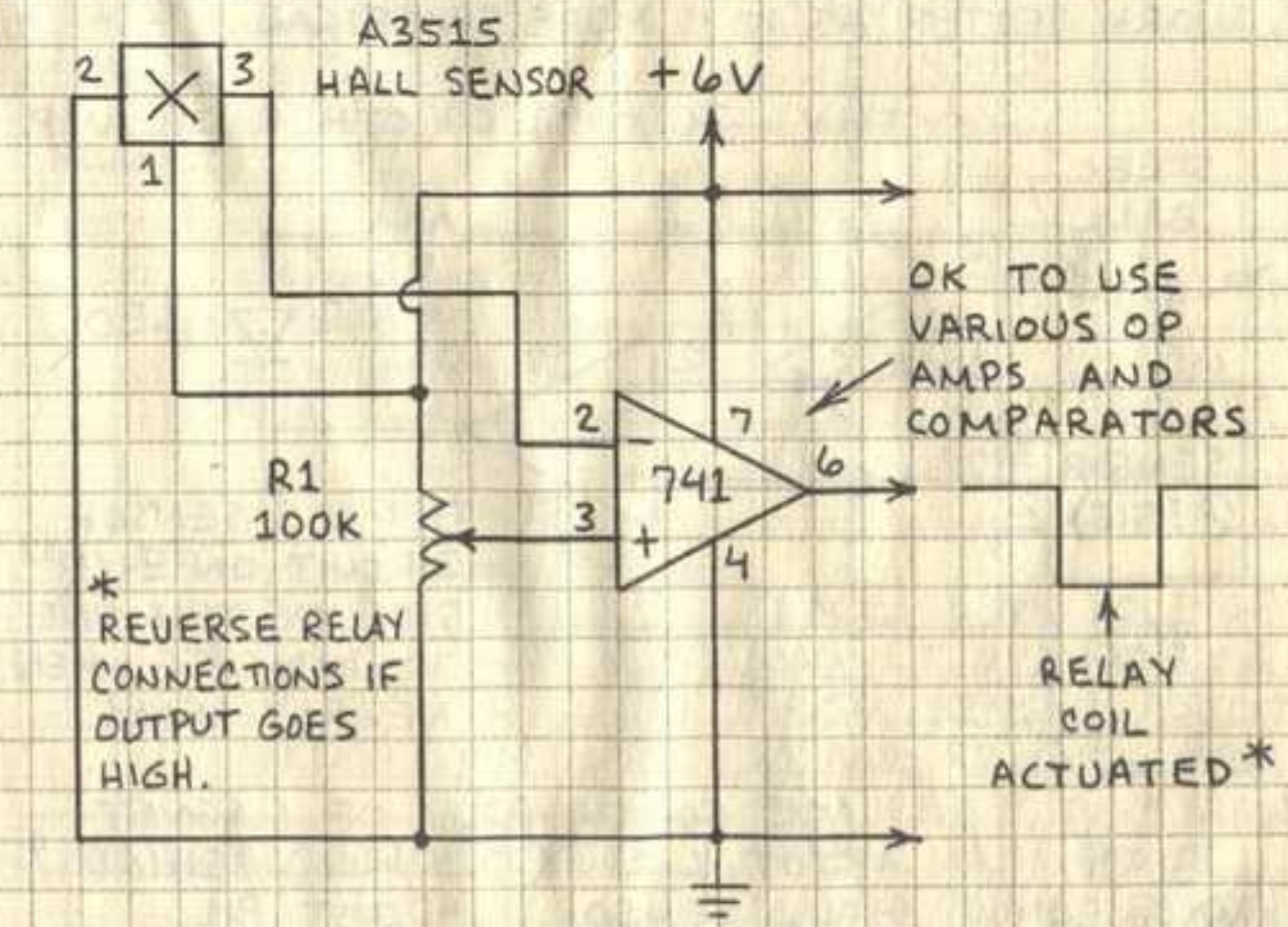
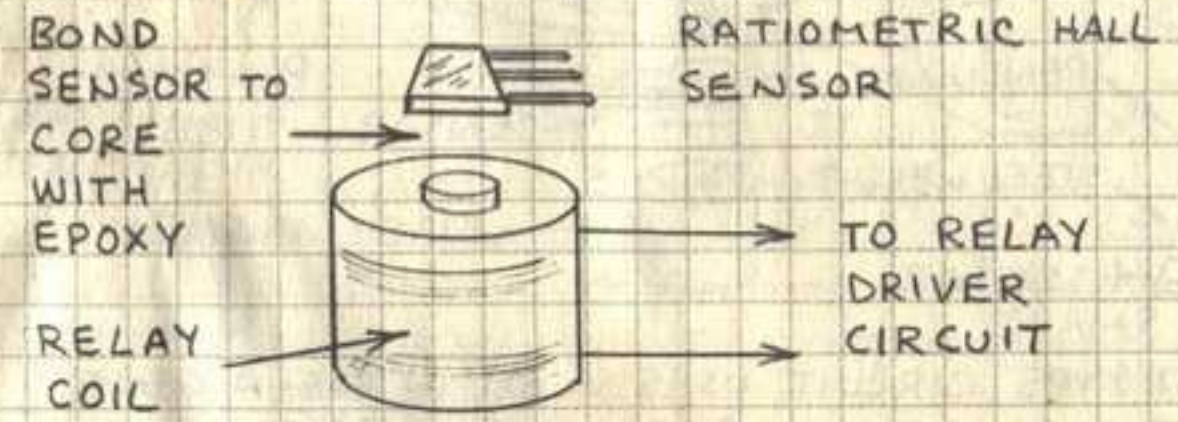

ADJUST R1 UNTIL PIN 6 JUST GOES HIGH. WHEN RELAY COIL IS ENERGIZED, PIN 6 WILL GO LOW. CHANGES IN RESIDUAL MAGNETISM OF THE RELAY'S STEEL CORE MAY NECESSITATE OCCASIONAL ADJUSTMENTS OF R1.

LEVEL INDICATOR

THIS CIRCUIT IS AN ELECTRONIC LEVEL INDICATOR THAT SENSES WHEN A ROLLING STEEL BALL IS AT REST.

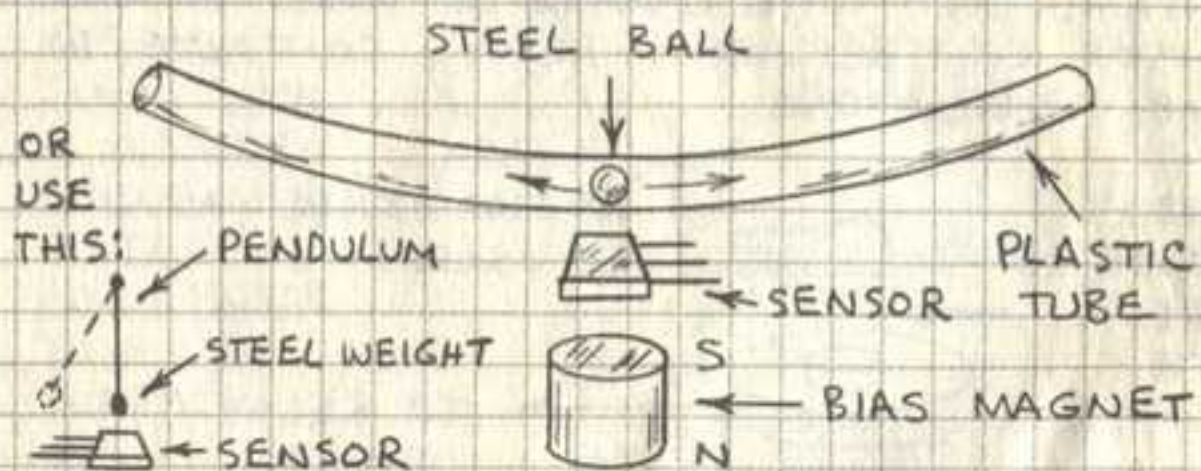

PROTOTYPE CIRCUIT USES A BB INSIDE A GENTLY BENT SODA STRAW. A SMALL BALL BEARING WILL WORK BETTER AS IT IS MORE SPHERICAL.

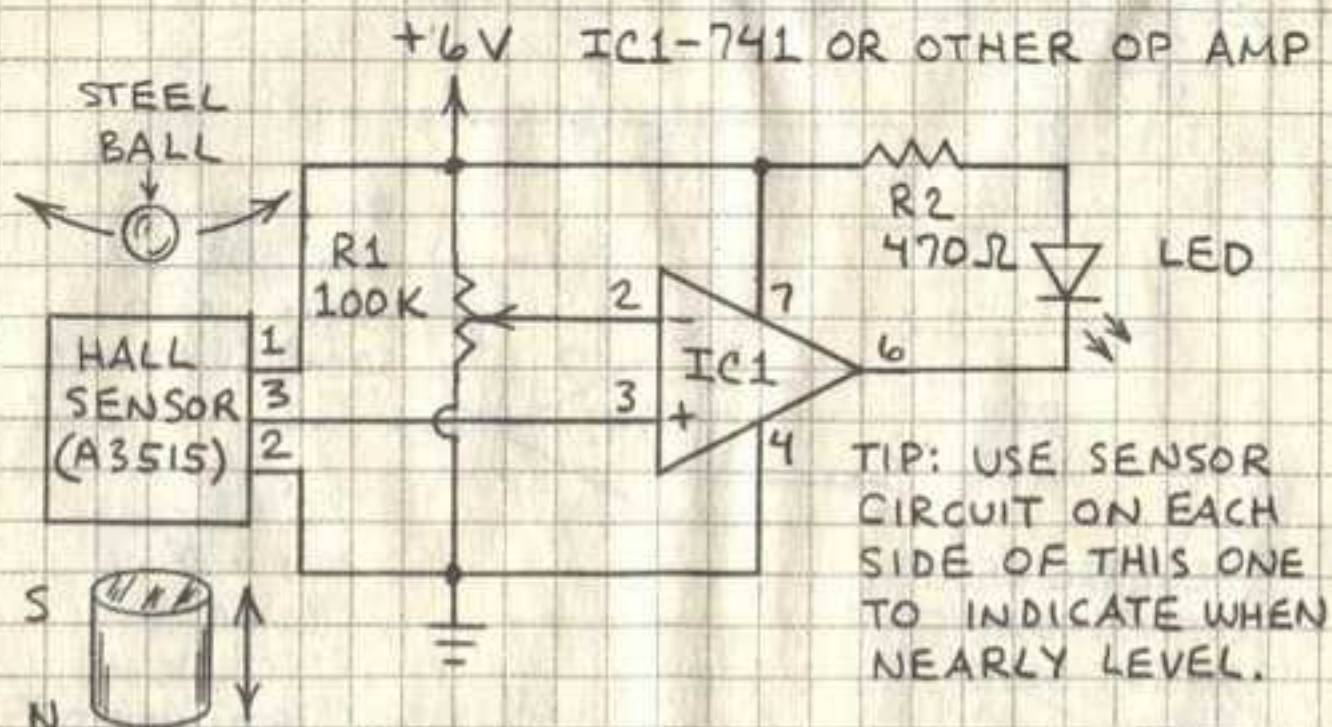

PLACE SOUTH POLE OF MAGNET ABOUT 1 CM (0.4 INCH) BEHIND HALL SENSOR. ADJUST R1 UNTIL LED JUST STOPS GLOWING. THE LED SHOULD NOW GLOW WHEN STEEL BALL APPROACHES THE HALL SENSOR. EXPERIMENT WITH POSITION OF MAGNET FOR BEST RESULTS.

BIAS MAGNET (S, N)

(ADJUST POSITION AS REQUIRED)

MAGNET POSITION DETECTOR

THIS CIRCUIT INDICATES WHEN A MAGNET IS AT A PRESET, ADJUSTABLE DISTANCE FROM A RATIOMETRIC HALL SENSOR.

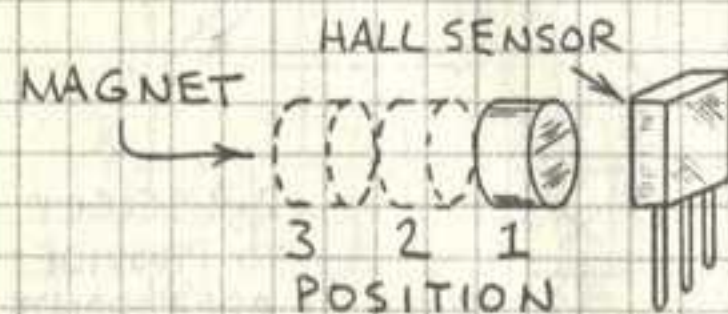
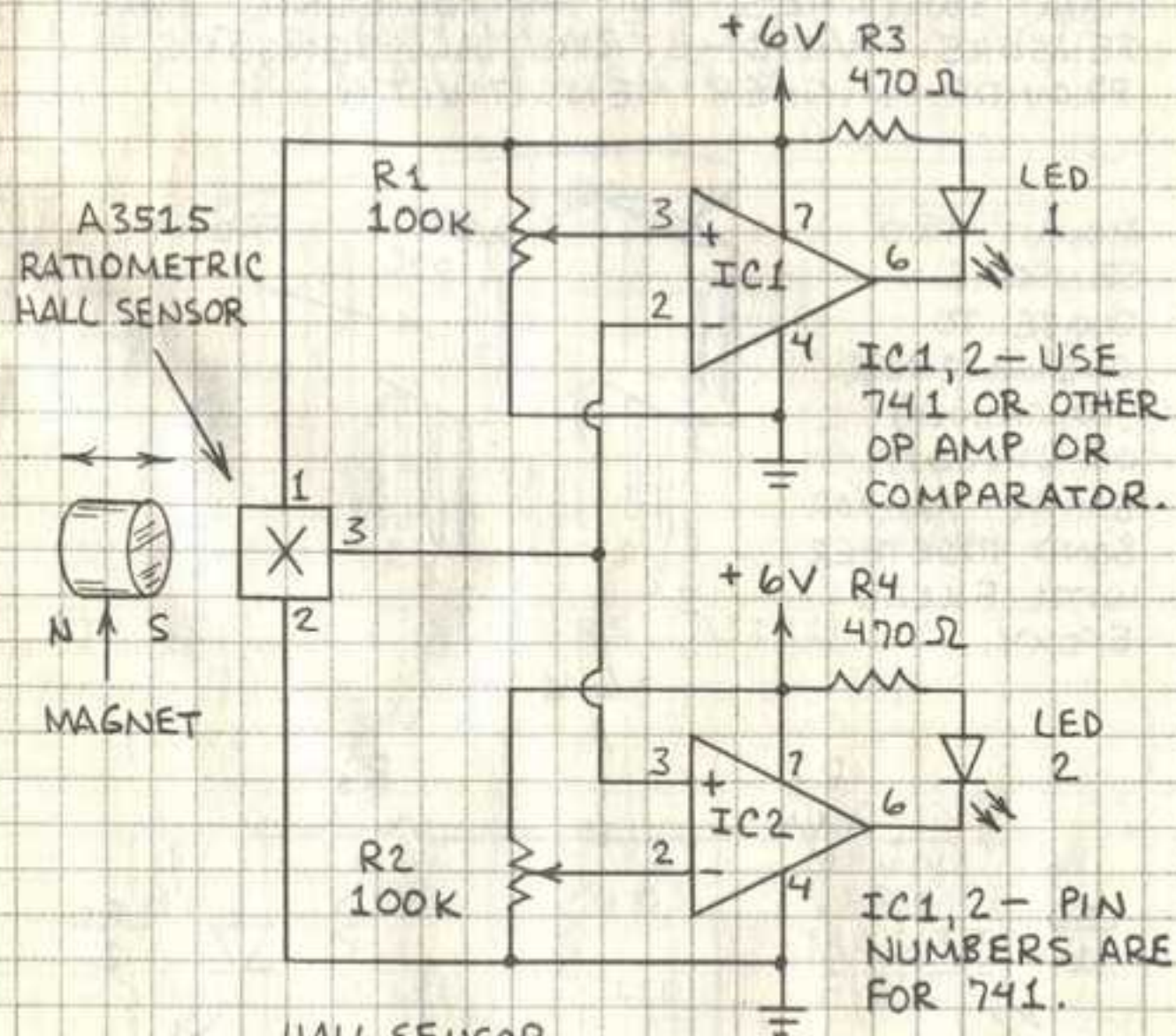

POSITION	LED 1	LED 2
SOUTH 1	ON	OFF
SOUTH 2	ON	ON
SOUTH 3	OFF	ON
NORTH 1	OFF	ON
NORTH 2	ON	ON
NORTH 3	ON	OFF

PLACE SOUTH POLE OF MAGNET UP TO 1-2 CM FROM SENSOR. ADJUST R1 AND R2 UNTIL LED 1 AND LED 2 JUST GLOW. WHEN MAGNET IS MOVED TOWARD SENSOR, LED 2 SWITCHES OFF. WHEN MAGNET IS MOVED AWAY, LED 1 SWITCHES OFF. USE NORTH POLE OF MAGNET TO REVERSE OPERATION.

DUAL-OUTPUT HALL SENSORS

A PAIR OF BACK-TO-BACK HALL SENSORS PROVIDES A DUAL-OUTPUT MAGNET SENSOR. THIS METHOD WORKS WITH BOTH DIGITAL HALL SWITCHES AND RATIOMETRIC HALL SENSORS. RATIOMETRIC HALL SENSORS PROVIDE HIGHER SENSITIVITY.

MOUNT TWO SENSORS CLOSE TO ONE ANOTHER (TOUCHING) ON CIRCUIT BOARD AND/OR BOND TOGETHER WITH FILLED EPOXY.

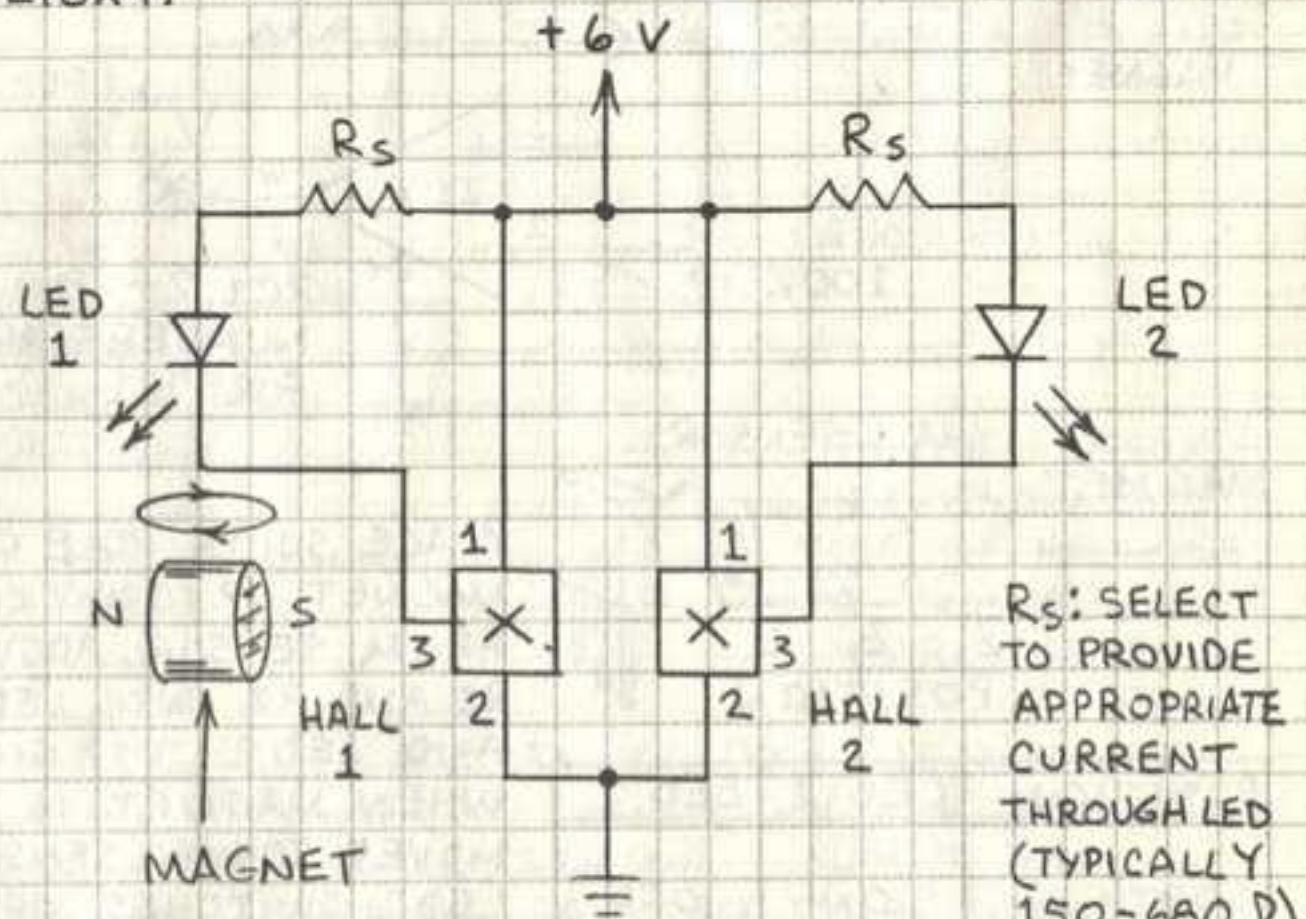
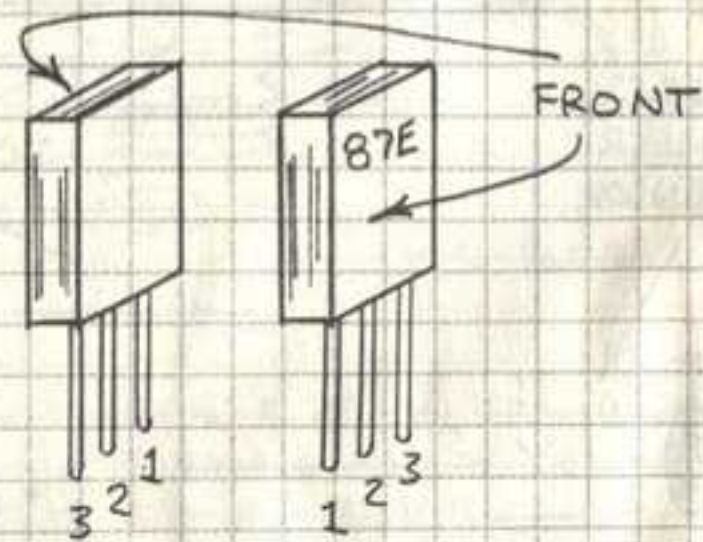

R_s : SELECT TO PROVIDE APPROPRIATE CURRENT THROUGH LED (TYPICALLY 150-680 Ω).

POLE AT HALL 1	DIGITAL		RATIOMETRIC	
	LED 1	LED 2	LED 1	LED 2
N	OFF	ON	ON	OFF
S	ON	OFF	OFF	ON

HALL 1, 2:
A3141,
A3515

FIELD STRENGTH BARGRAPH

A LINEAR OR RATIOMETRIC HALL SENSOR CAN MEASURE THE STRENGTH OF A MAGNETIC FIELD. THIS CIRCUIT SHOWS HOW TO USE A STACK OF DIGITAL HALL SENSORS (THREE OR MORE) TO DISPLAY MAGNETIC FIELD STRENGTH ON A BARGRAPH LED DISPLAY.

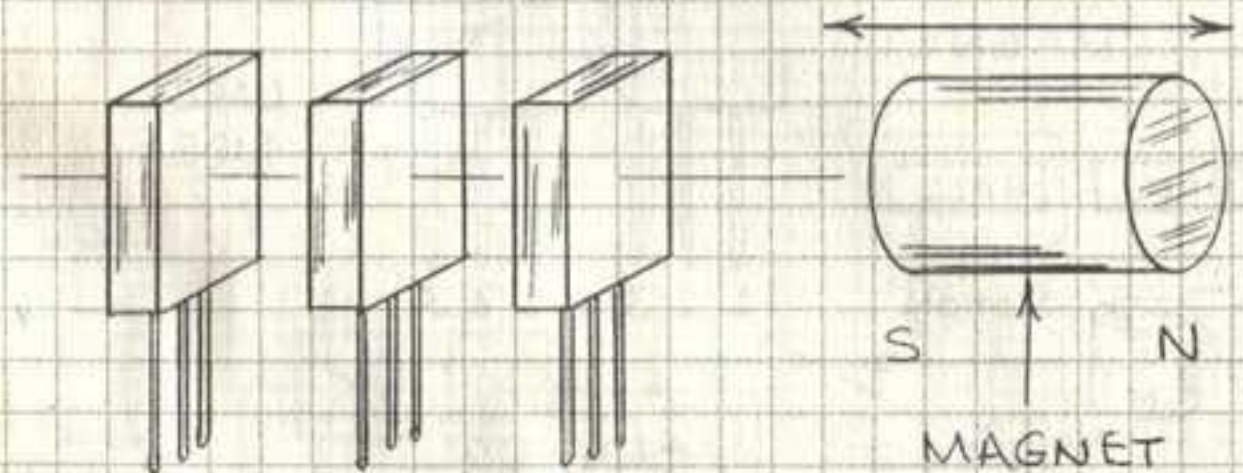

STACKED HALL SENSORS (A3141)

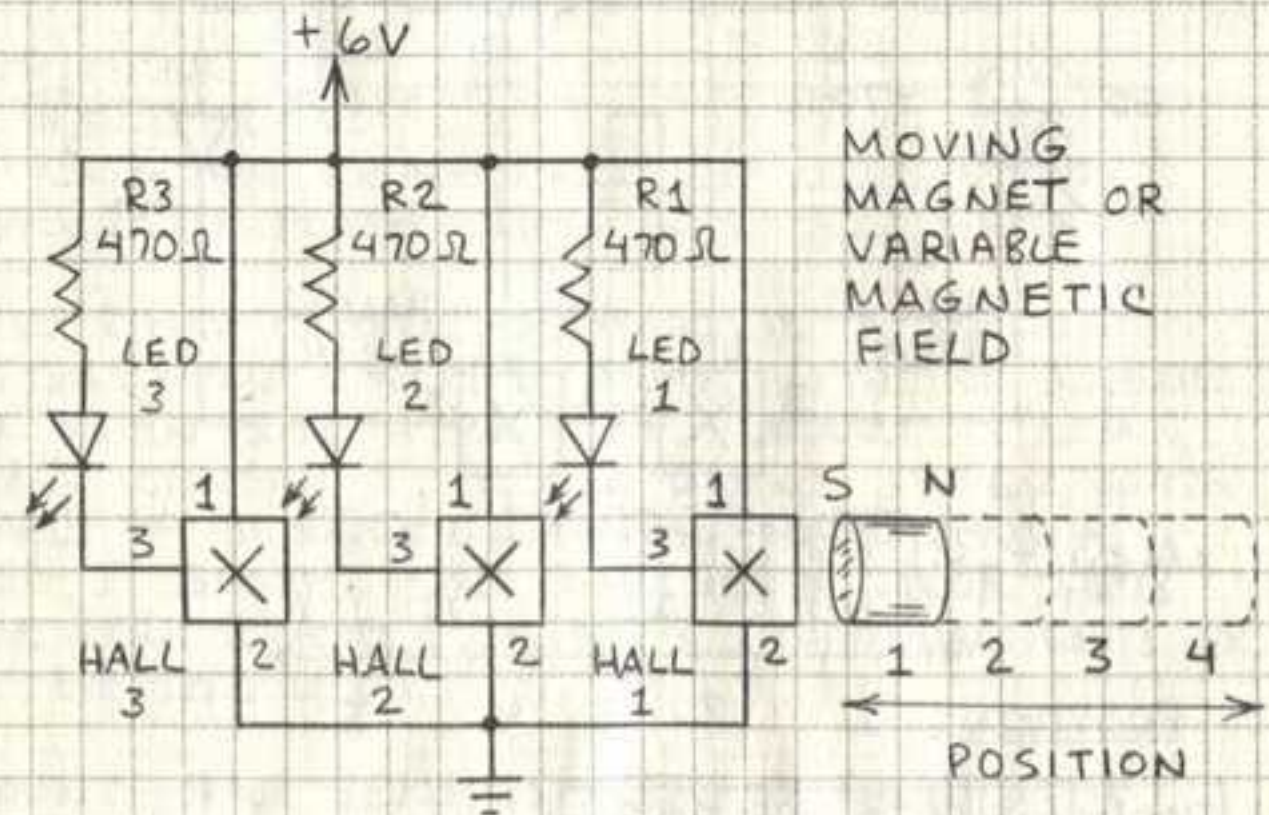

MOVING MAGNET OR VARIABLE MAGNETIC FIELD

POSITION	LED 1	LED 2	LED 3
1	ON	ON	ON
2	ON	ON	OFF
3	ON	OFF	OFF
4	OFF	OFF	OFF

OK TO USE ANY COLOR LEDs. I USED RED, GREEN AND BLUE.

HALL SENSOR DIRECTION INDICATOR

TWO OR MORE HALL SENSORS ARRANGED SIDE-BY-SIDE CAN INDICATE THE DIRECTIONAL MOVEMENT OF A NEARBY MAGNET.

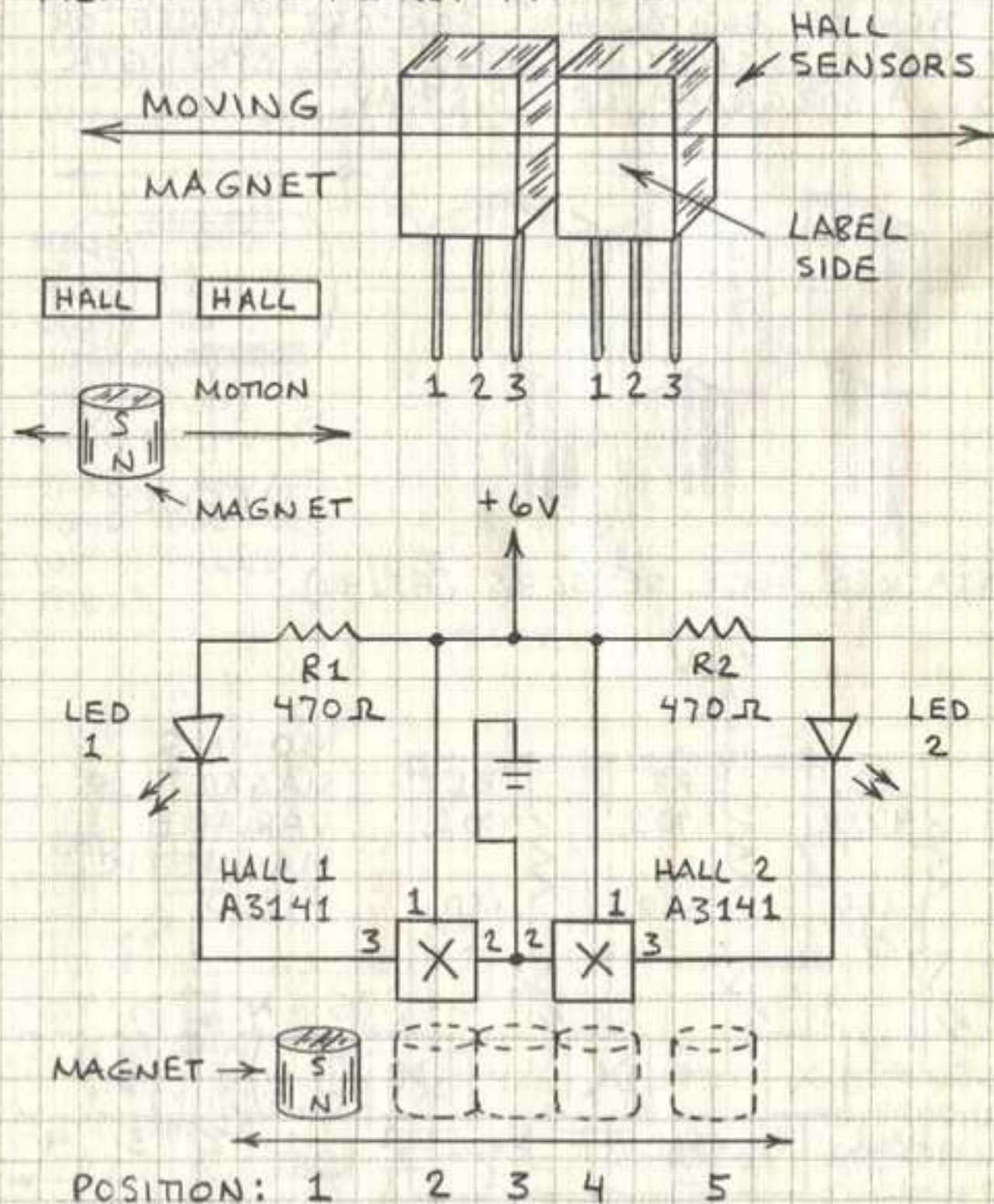

POSITION	LED 1	LED 2
1	OFF	OFF
2	ON	OFF
3	ON	ON
4	OFF	ON
5	OFF	OFF

THIS CIRCUIT DRIVES LEDs, BUT IT WILL ALSO DRIVE EXTERNAL LOGIC CIRCUITS.

ULTRA-SENSITIVE MAGNET SWITCH

A VERY SENSITIVE MAGNET SWITCH CAN BE MADE BY CONNECTING A PAIR OF BACK-TO-BACK HALL SENSORS TO AN OP AMP OR COMPARATOR.

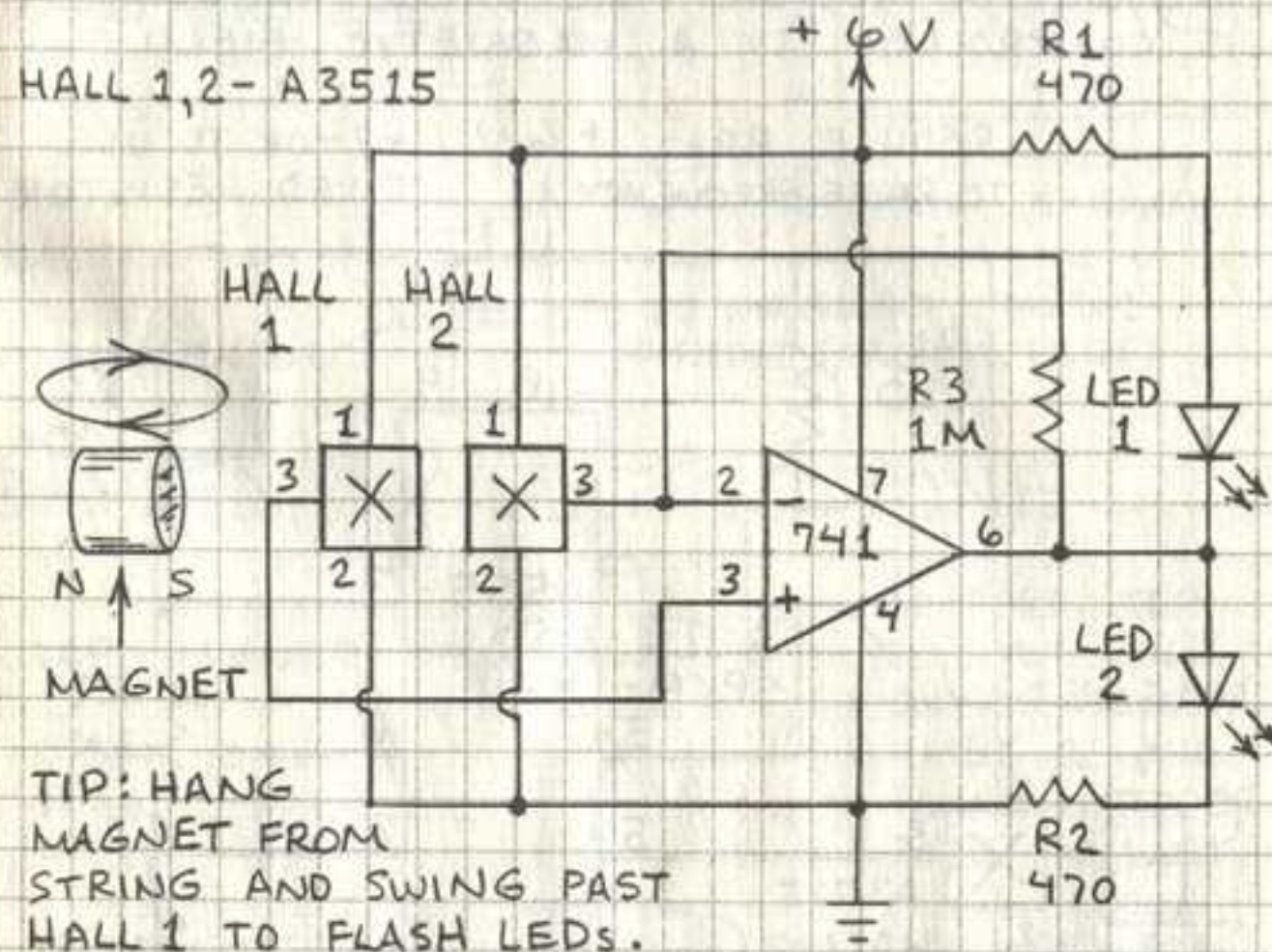

THIS CIRCUIT WILL RESPOND TO A MAGNET 15 CM (ABOUT 6 INCHES) AWAY. WITH NO MAGNET OR WHEN SOUTH POLE OF MAGNET IS NEAR HALL SENSOR 1, LED 2 GLOWS. WHEN NORTH POLE OF MAGNET IS NEAR HALL SENSOR 1, LED 1 GLOWS. USE DIFFERENT COLOR LEDs FOR LEDs 1 AND 2, EITHER INDIVIDUAL LEDs OR A BICOLOR LED.

MOUNT HALL SENSORS BACK-TO-BACK WITH FRONT SIDE OF HALL SENSOR 1 (SIDE WITH NUMBERS) CLOSEST TO WHERE MAGNET WILL BE PLACED.

THOUGH THIS CIRCUIT DRIVES LEDs, IT CAN ALSO POWER MANY OTHER DEVICES. USE APPROPRIATE INTERFACE CIRCUITRY.

MAGNET MUSIC

THE OUTPUT VOLTAGE FROM A RATIOMETRIC (LINEAR) HALL SENSOR CAN CONTROL A VOLTAGE-TO-FREQUENCY CONVERTER. THIS PROVIDES A MUSICAL TONE WHOSE FREQUENCY IS CONTROLLED BY A MAGNETIC FIELD.

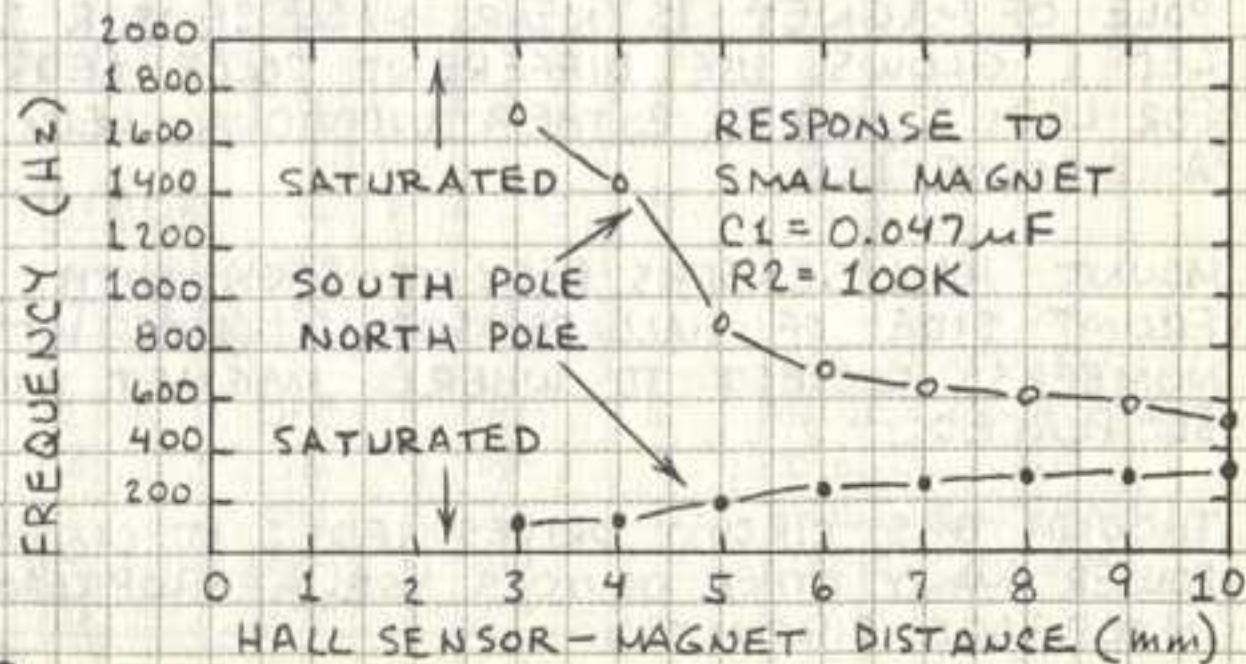
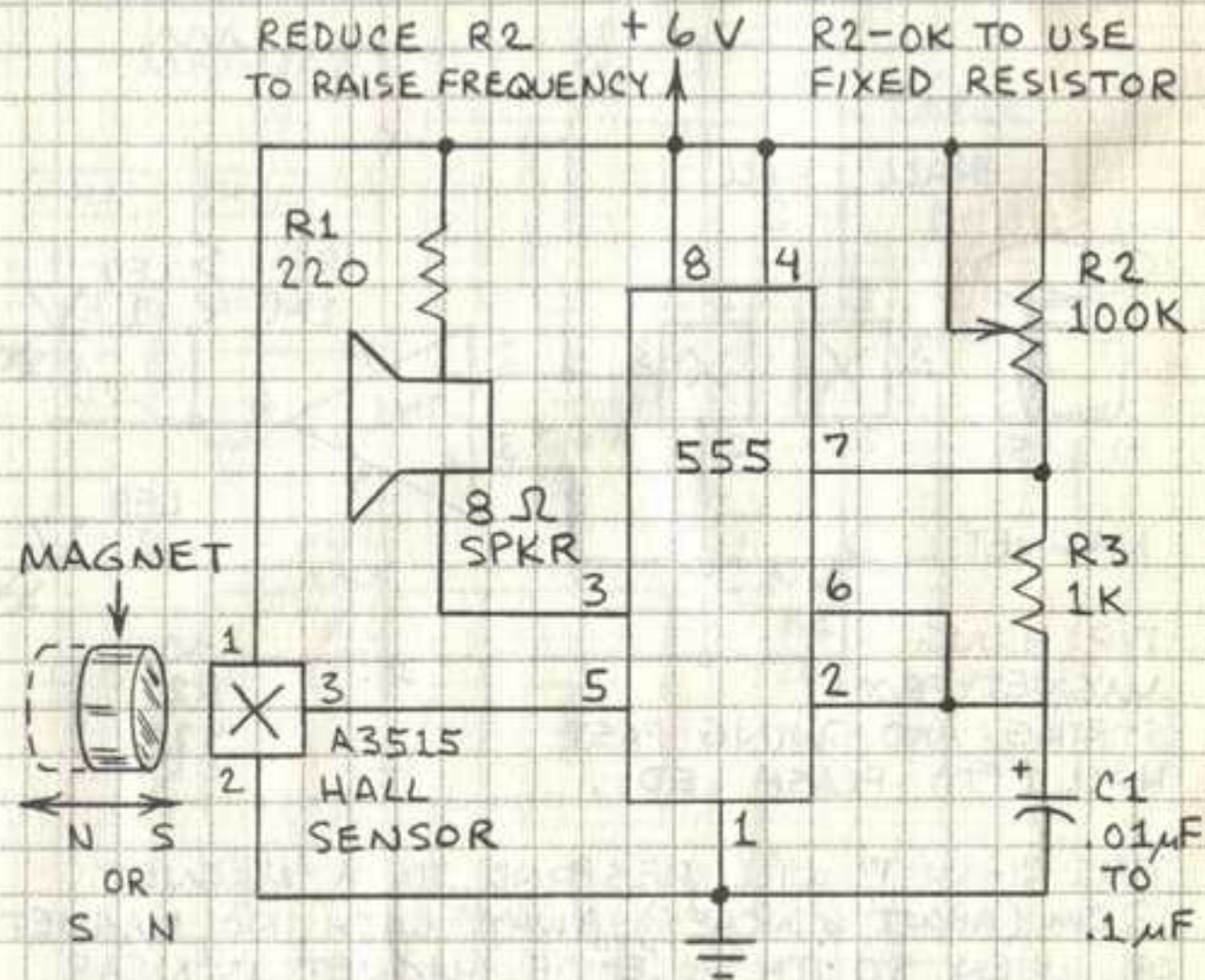

MUSICAL PENDULUM

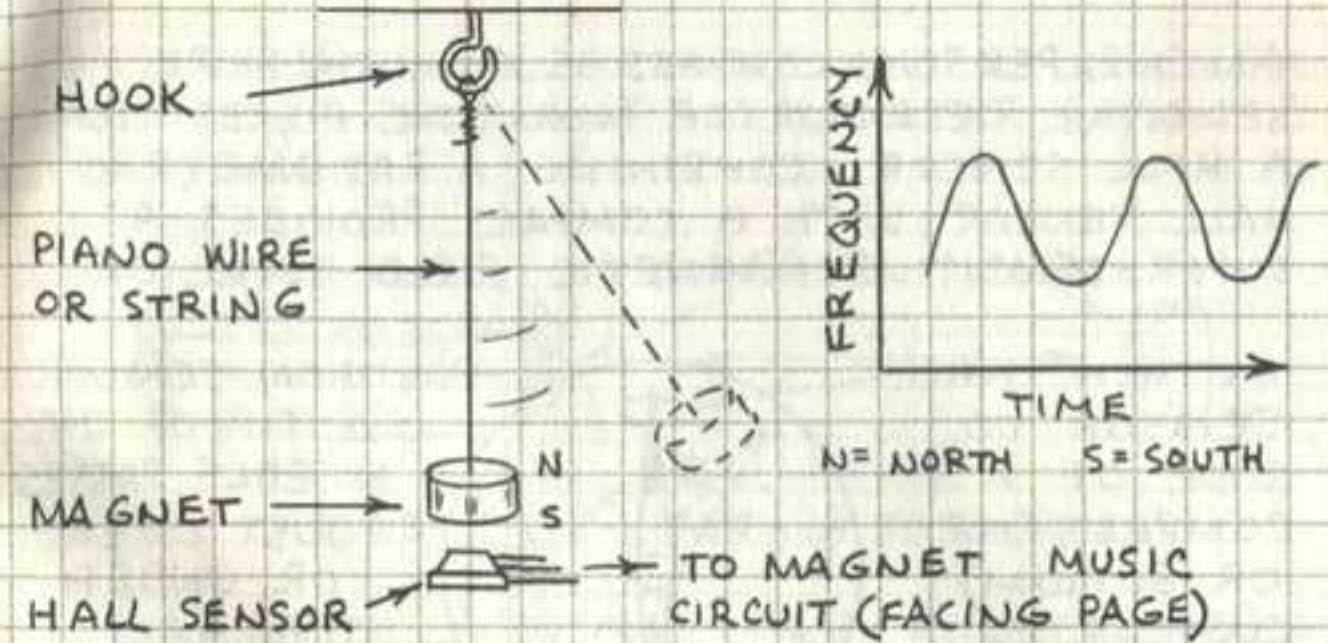

DAMPED OSCILLATING TONE

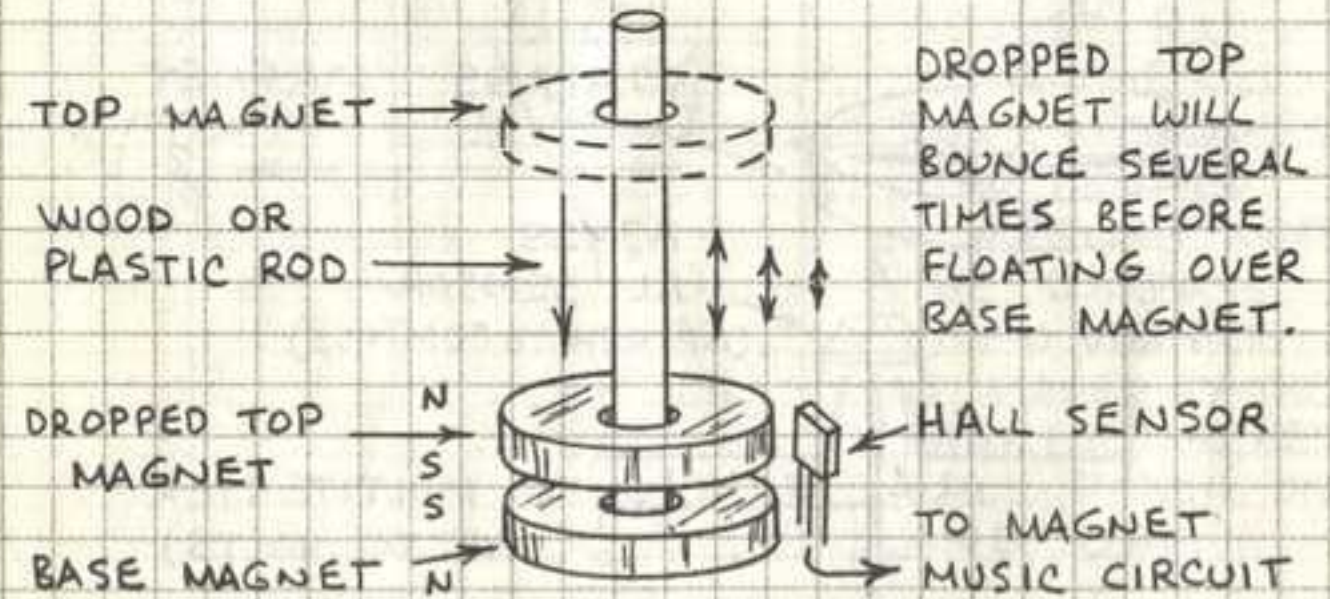

PRESSURE-SENSITIVE TONE

PRESS AND RELEASE FLOATING MAGNET (SHOWN ABOVE) OR MOUNT A MAGNET ON A FLEXIBLE BEAM AS SHOWN HERE:

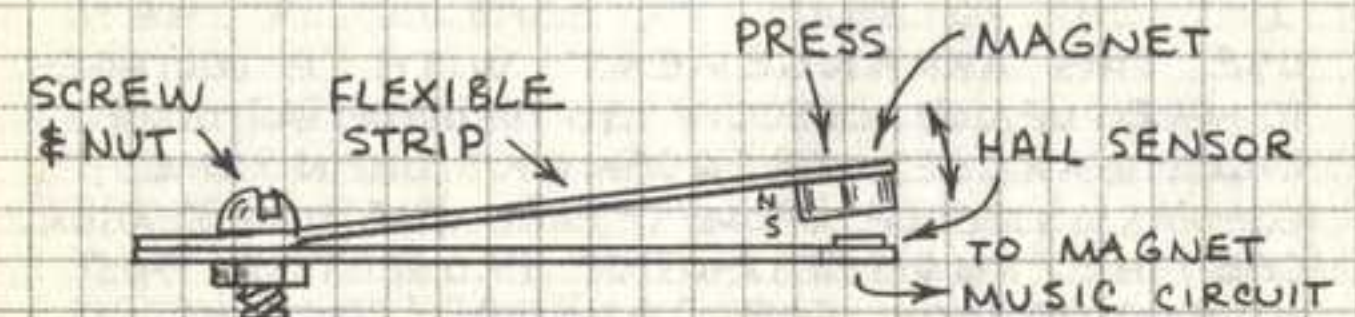

SUPER-SENSITIVE FIELD SENSOR

AN INEXPENSIVE COMPASS IS A MUCH MORE SENSITIVE DETECTOR OF MAGNETIC FIELDS THAN A HALL SENSOR. COMBINING A RATIO-METRIC HALL SENSOR WITH A COMPASS PROVIDES A SUPER-SENSITIVE MAGNETIC FIELD DETECTOR.

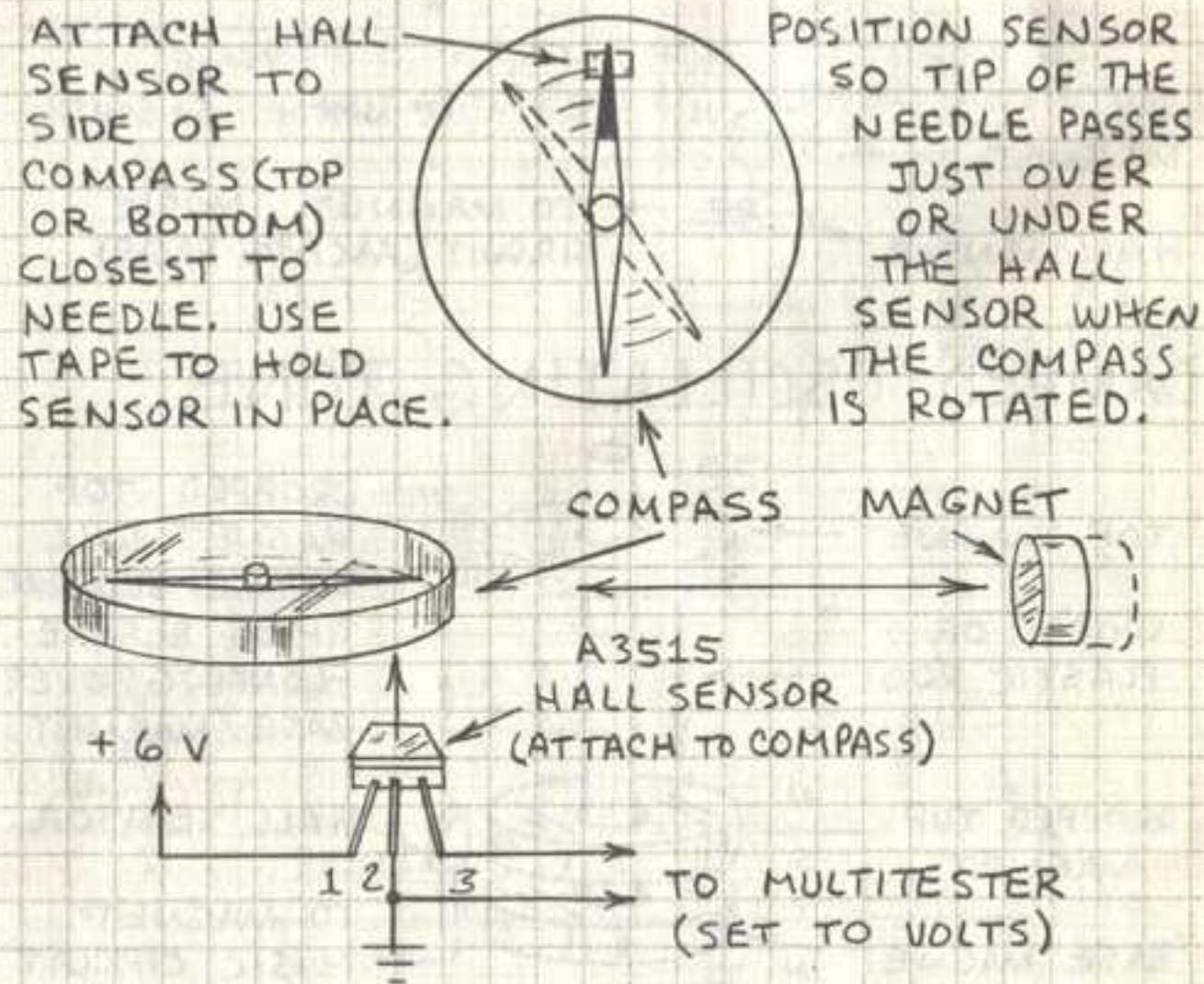

THIS ARRANGEMENT WILL DETECT MOVEMENTS OF A STRONG MAGNET MORE THAN 1 METER (ABOUT 3 FEET) AWAY FROM COMPASS. THE VOLTAGE CHANGE MAY BE ONLY ABOUT 10 MILLIVOLTS (0.010 VOLT) OR SO. SO IT'S BEST TO USE A DIGITAL MULTITESTER.

USE THIS ARRANGEMENT WITH A VOLTAGE-TO-FREQUENCY CIRCUIT TO PROVIDE A TONE THAT CHANGES FREQUENCY WHEN THE COMPASS NEEDLE MOVES PAST THE HALL SENSOR. SEE THE "MAGNET MUSIC" PROJECT IN THIS MINI-NOTEBOOK FOR DETAILS (PAGE 42).

SUPER-SENSITIVE FIELD SWITCH

THIS CIRCUIT WILL ACTIVATE AN LED WHEN A MAGNET IS PLACED UP TO 1 METER (ABOUT 3 FEET) AWAY.

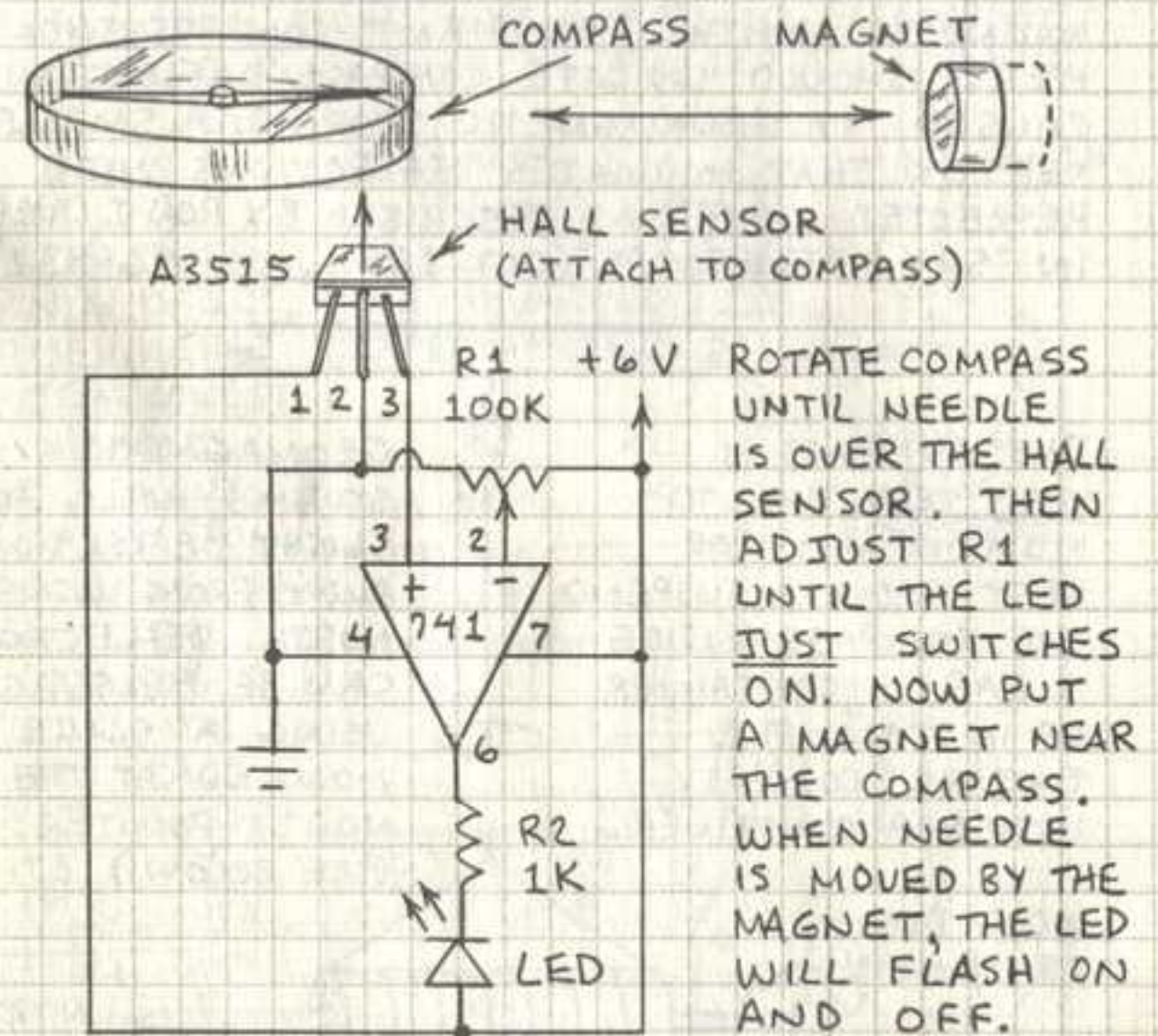

ABOUT THIS CIRCUIT: THE 741 IS A LOW-COST OPERATIONAL AMPLIFIER (OP AMP) CONNECTED AS A COMPARATOR. THE OUTPUT OF A COMPARATOR IS EITHER LOW OR HIGH. IN THIS CIRCUIT, THE OUTPUT SWITCHES FROM LOW TO HIGH WHEN THE HALL SENSOR OUTPUT VOLTAGE IS ABOUT 0.01 VOLT HIGHER THAN THE VOLTAGE AT PIN 2 OF THE 741.

MANY DIFFERENT OP AMPS WILL WORK IN THIS CIRCUIT. JUST BE SURE TO CONNECT THE PROPER PINS. R2 CAN BE REDUCED TO 470Ω. THE LED CAN BE REPLACED BY A LOW-VOLTAGE PIEZO TONE GENERATOR.

GIANT COMPASS MAGNETOMETER

GEOMAGNETIC STORMS CAUSED BY SOLAR ACTIVITY CAN CAUSE MAJOR POWER BLACKOUTS AND AURORAS. THEY ALTER EARTH'S MAGNETIC FIELD SO THAT COMPASS NEEDLES DEVIATE FROM MAGNETIC NORTH. THE GIANT COMPASS SHOWN HERE SHOULD INDICATE COMPASS DEFLECTIONS CAUSED BY GEOMAGNETIC STORMS. A SMALLER VERSION THAT INDICATES DEFLECTIONS WITH REFLECTED LIGHT WAS DESCRIBED BY RON J. LIVESEY IN "SKY & TELESCOPE" (OCT. 1989, pp. 426-432).

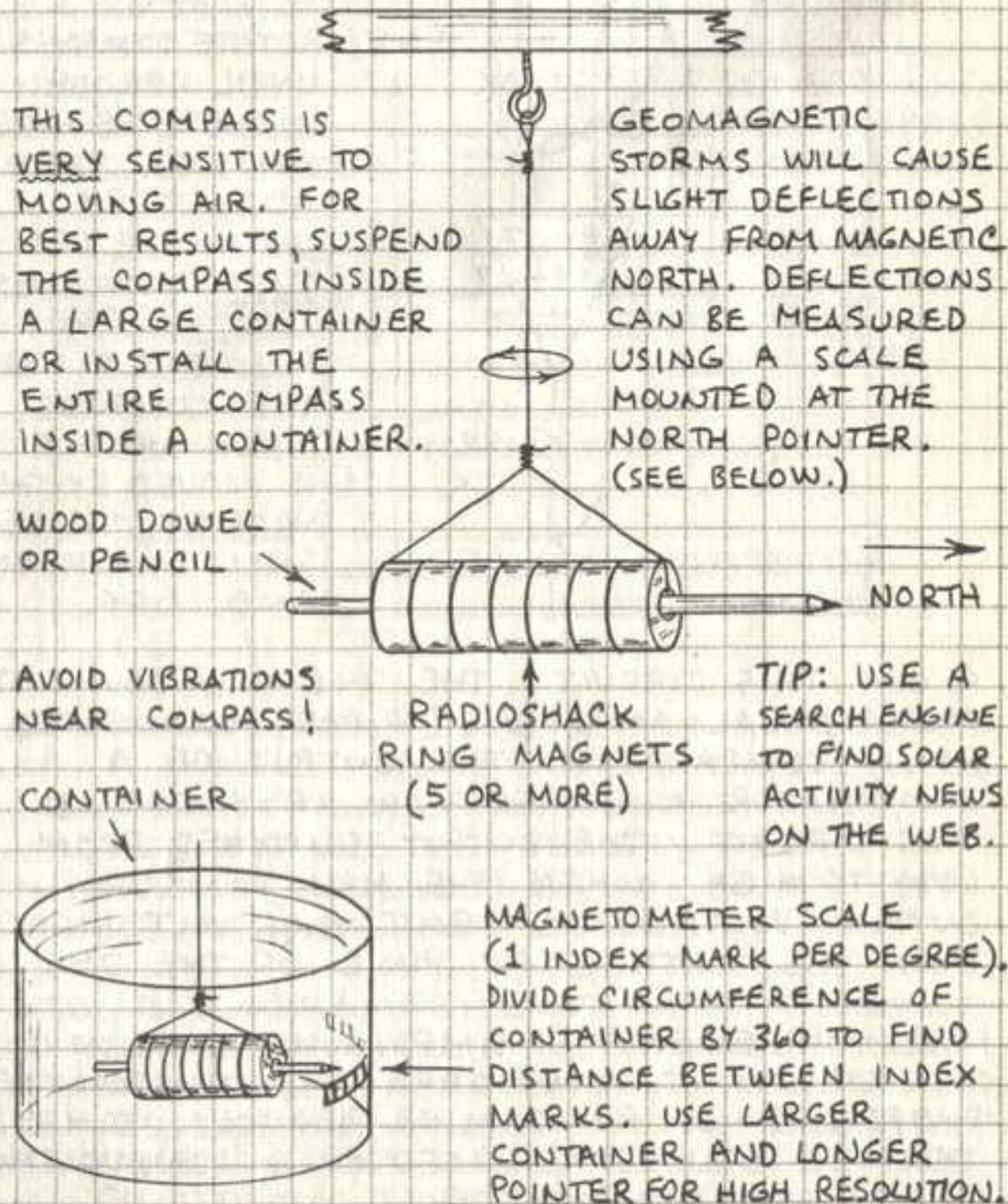

HALL SENSOR NORTH COMPASS

A RATIO-METRIC HALL SENSOR CAN DETECT MAGNETIC NORTH. AT MY LOCATION IN CENTRAL TEXAS THE OUTPUT FROM A RATIO-METRIC HALL SENSOR IS A FEW MILLIVOLTS HIGHER WHEN THE SENSOR POINTS NORTH THAN WHEN IT POINTS ELSEWHERE. THIS VOLTAGE IS ENOUGH TO TRIGGER THIS CIRCUIT.

ADJUST R1 UNTIL VOLTAGE AT PIN 6 OF IC1 IS SOMEWHERE BETWEEN LOWEST AND HIGHEST VALUE. GO OUTDOORS AWAY FROM POWER LINES AND LARGE METAL OBJECTS. ROTATE CIRCUIT UNTIL PRINTED FACE OF HALL SENSOR POINTS NORTH. ADJUST R4 UNTIL LED 1 JUST TURNS ON AND LED 2 JUST TURNS OFF. ROTATE CIRCUIT BOARD TOWARD EAST OR WEST AND LED 1 WILL TURN OFF AND LED 2 WILL TURN ON.

TIP: INCREASE SENSITIVITY BY USING A NAIL AS A FLUX CONCENTRATOR (SEE ABOVE).

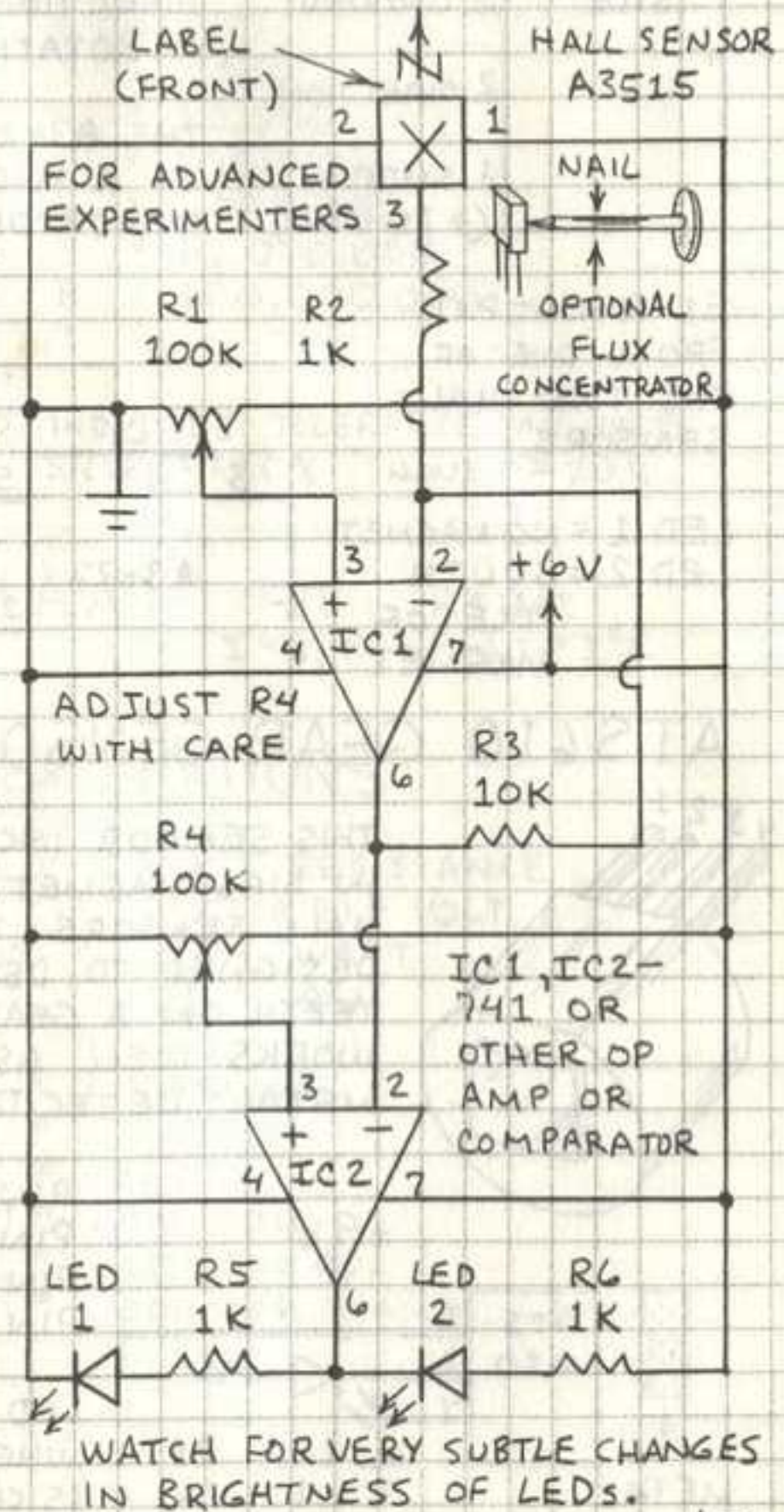

SPECIALIZED HALL SENSORS

A3422 DIRECTION SENSOR

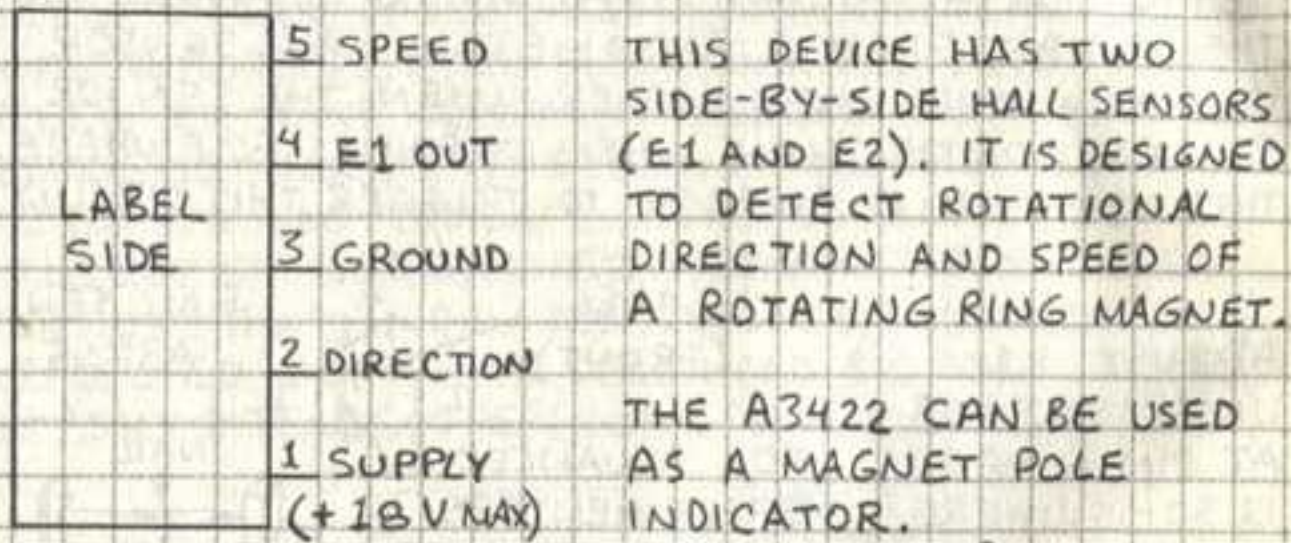

E1 IS OUTPUT FROM ONE OF THE TWO HALL SENSORS.

LED 1 = NO MAGNET
LED 2 = SOUTH POLE OF MAGNET

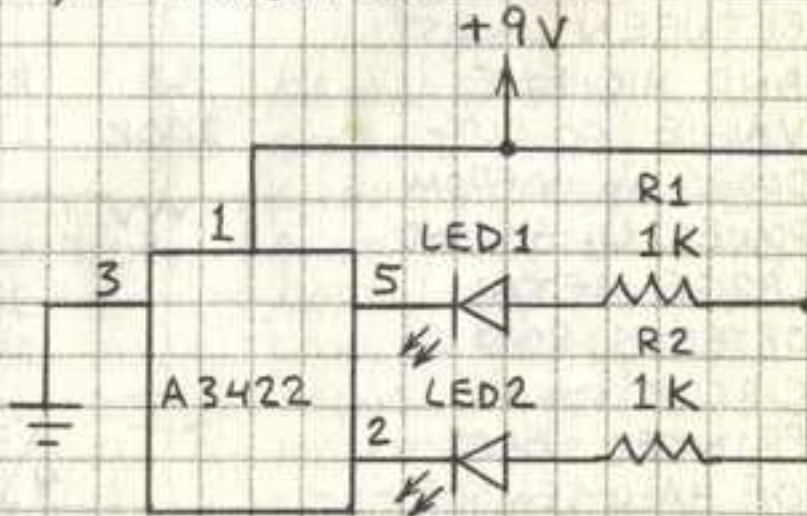

ATS610 GEAR SENSOR

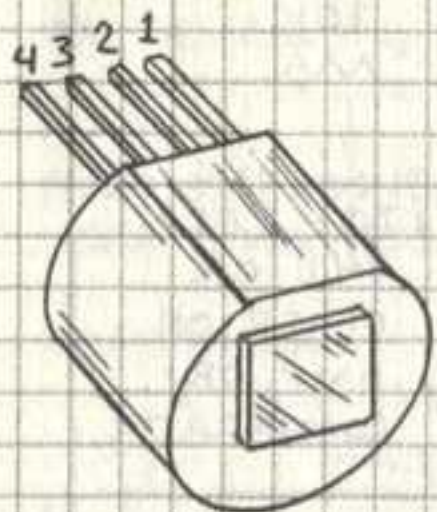

THIS SENSOR INCLUDES A BUILT-IN BIAS MAGNET BEHIND TWO HALL SENSORS. THIS SENSOR IS DESIGNED TO DETECT SMALL TEETH ON A GEAR. IT ALSO WORKS WELL AS A FERROUS METAL DETECTOR.

PIN 1 - SUPPLY (+16V)
PIN 2 - OUTPUT
PIN 3 - CAPACITOR
PIN 4 - GROUND

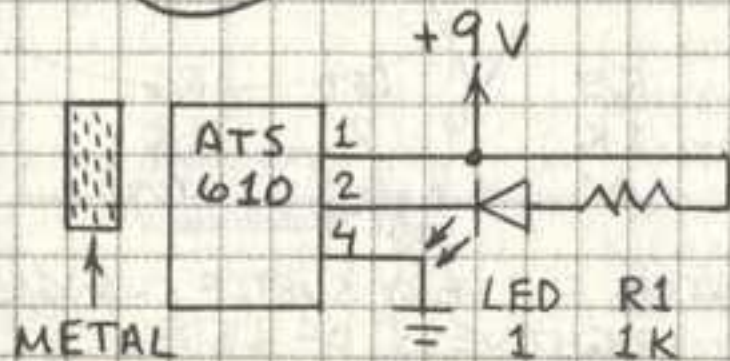

LED 1 STOPS GLOWING WHEN FERROUS METAL IS CLOSE TO SENSOR.

RESISTOR COLOR CODE



BLACK	0	0	x 1
BROWN	1	1	x 10
RED	2	2	x 100
ORANGE	3	3	x 1,000
YELLOW	4	4	x 10,000
GREEN	5	5	x 100,000
BLUE	6	6	x 1,000,000
VIOLET	7	7	x 10,000,000
GRAY	8	8	x 100,000,000
WHITE	9	9	—

FOURTH BAND INDICATES TOLERANCE (ACCURACY):
GOLD = ±5% SILVER = ±10% NONE = ±20%

OHM'S LAW: $V = IR$ $R = V/I$
 $I = V/R$ $P = VI = I^2R$

ABBREVIATIONS

A = AMPERE	R = RESISTANCE
F = FARAD	V (OR E) = VOLT
I = CURRENT	W = WATT
P = POWER	Ω = OHM

M (MEG-)	= x 1,000,000
K (KILO-)	= x 1,000
m (MILLI-)	= .001
μ (MICRO-)	= .000 001
n (NANO-)	= .000 000 001
p (PICO-)	= .000 000 000 001