

ELECTRONIC TECHNOLOGY SERIES

ANTENNAS

a **RIDER** **publication**

\$1.50

ANTENNAS

Edited by
Alexander Schure, Ph.D., Ed.D.

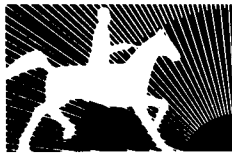

JOHN F. RIDER PUBLISHER, INC.

116 West 14th Street • New York 11, N. Y.

Copyright March 1957 by

JOHN F. RIDER PUBLISHER, INC.

All rights reserved. This book or parts thereof may not be reproduced in any form or in any language without permission of the publisher.

Library of Congress Catalog Card No. 57-7215

Printed in the United States of America

PREFACE

A knowledge of antenna theory and fundamental antenna principles is obviously important to the serious student and practitioner of electronics. An antenna is essentially a device for radiating or intercepting electromagnetic wave energy. It is a conductor (or group of conductors) coupling a transmitter or a receiver unit with the conducting medium, space. An antenna thus constitutes the final link in a transmitting facility and the initial link in the receiver. Serious deficiencies may arise in a communications system due to improper choice of an antenna or lack of understanding as to the design, installation, matching requirements, and properties of an antenna furnished or recommended for use with a given electronics system.

The purpose of this book is to provide the fundamental concepts of antenna theory. A minimum of mathematical treatment has been employed, but the analyses are sufficiently extensive to permit the interested technician, practicing engineer, or advanced student to develop a full comprehension of the pertinent facets of such theory. To ensure this aim, specific attention is given to the fundamental antenna principles; the basic antenna types; input impedance and radiation resistance; ground effects; variations of electrical length by loading; gain and directivity; driven and parasitic arrays; various types of long wire antennas; feeding and matching principles; and several variations on the basic dipole design reflected in current practical antenna types.

Educators agree that a good grounding in fundamental theory is essential for continued growth of the sincere student. The content was selected with this philosophy as a guide and is sufficient for an adequate foundation in both the theory and application of this subject.

Grateful acknowledgment is made to the staff of the New York Institute of Technology for its assistance in the preparation of the manuscript for this book.

New York, N. Y.
March 1957

A.S.

CONTENTS

<i>Chapter</i>		<i>Page</i>
1	Fundamental Antenna Principles	1
2	Gain and Directivity	25
3	Long Wire Antennas	39
4	Feeding and Matching Principles	52
5	Practical Antenna Types	68

Chapter 1

FUNDAMENTAL ANTENNA PRINCIPLES

1. Introduction

An antenna is a device for radiating or intercepting electromagnetic wave energy. Virtually every transmitter and every receiver must have an antenna, and all antennas operate in accordance with certain basic principles, some of which are merely extensions of basic transmission line theory.

Electromagnetic waves are produced whenever there is a radio-frequency current. Wires, r-f coils, capacitors, and other components carrying this type of current are subject to r-f power loss due to radiation. The amount of energy liberated depends upon the amount of current, the size and shape of the conducting materials, and the environment.

In our development of antenna theory, we are assuming that the antenna is being used for transmission purposes. Most characteristics of a transmitting antenna will be found applicable to receiving antennas. This does not mean, however, that *any* antenna used for reception is suitable for transmission with maximum efficiency. Only under certain conditions are the two antennas interchangeable.

2. Review of Transmission Lines

An antenna is analogous in many respects to a section of transmission line. Let us examine Fig. 1A. An r-f generator with sinusoidal output is shown connected to an r-f transmission line that terminates in a matching resistive load. The r-f energy from the generator is assumed to be propagated down the transmission

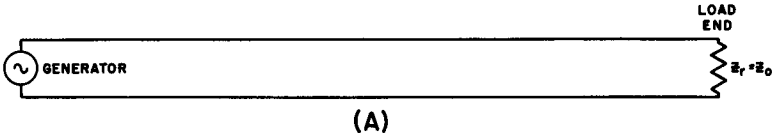

E_i = INCIDENT VOLTAGE WAVE
 E_r = REFLECTED VOLTAGE WAVE
 I_i = INCIDENT CURRENT WAVE
 I_r = REFLECTED CURRENT WAVE

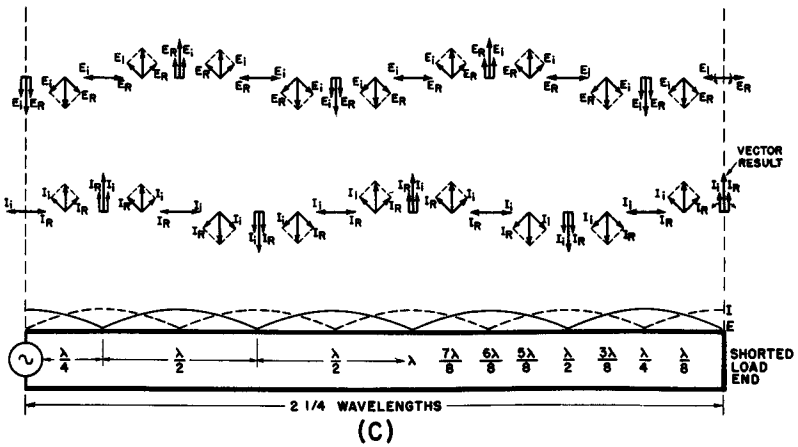
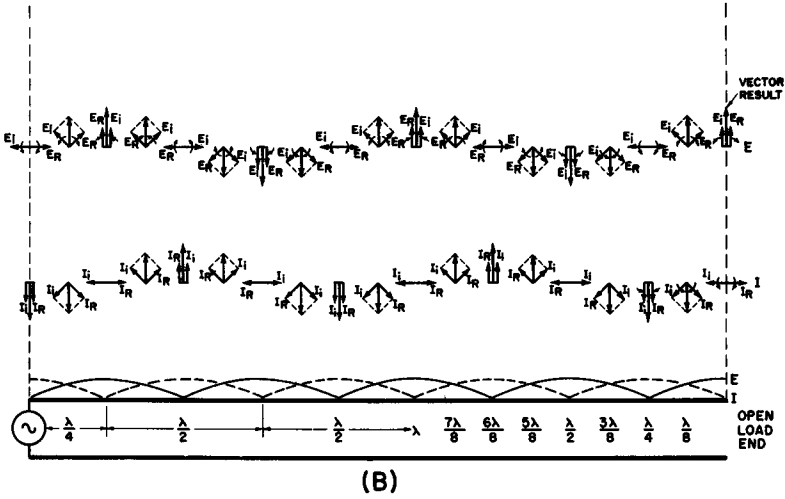

Fig. 1. Vector analysis of standing waves on an open and a shorted transmission line.

line toward the load end, with the voltage and current in phase. The *wavelength* of the line is defined as the distance the wave must travel to complete a phase change of 360 degrees.

If a line were infinitely long, energy would continue to move down it, slowly dissipating (because of losses). It would never return to the source, because the source would not "know" that the line was infinitely long and had no termination. If the load impedance (Z_r) is made equal to the impedance of an infinite extension of the line (i.e., to its characteristic impedance, Z_0) as shown in Fig 1A, all the energy except for dielectric and resistive losses is absorbed in the load. Line and load are *matched*.

When the load is not matched to the impedance of the line, the load does not absorb all of the incident wave energy. The amount not absorbed is changed in phase at the load end and sent back to the source. It is called the *reflected* wave. The ratio of the magnitude of the reflected wave (voltage or current) to the magnitude of the incident wave (voltage or current) is called the *reflection coefficient*.

Figure 1B shows the voltage and current vectors and distribution for a case in which the load is not matched to the line. Assume that the hypothetical line has a characteristic impedance of 100 ohms. The load is an *open circuit* (an *infinite impedance*). Nearly 100 percent of the wave arriving at the load is reversed in phase and reflected back to the source.

Whatever the value of the voltage across this open circuit, no current can flow, and no power is absorbed by the infinite impedance at the load end. In the current vector illustration (Fig. 1B), we show the incident and reflected currents 180 degrees out of phase at the load end, and therefore cancelling each other. However, the reflected voltage is in phase at the load end with the incident voltage; hence, the voltages add directly.

Referring again to Fig. 1B, at progressive distances from the load end, the incident vector rotates in one direction, while the reflected current vector rotates in the other direction, causing different *resultant* currents at different points on the line. If we disregard the polarity of the resultant current, it can be said that the pattern of current variation is *repeated every half-wavelength* and *reversed every quarter-wavelength* from the load end of the line.

With a short-circuited load, the incident and reflected voltage waves cancel, while current waves are in phase and add, as shown in Fig. 1C. The current and voltage vectors rotate in opposite directions, as they do with an open load. However, where there had been (in the open-circuited line) a voltage or current *node* (minimum), there is now a *loop* (maximum).

Standing Waves. At any one frequency and for any one line and load, the physical positions of these current and voltage maxima and minima never change with respect to the load. For this reason, the resulting wave patterns are termed *standing waves*. The ratio of the magnitude of a voltage or current at its maximum point to its magnitude at a minimum point is called the *standing wave ratio* (SWR). The ratio of maximum to minimum *voltage* is called the *voltage standing wave ratio* (VSWR). Even with appreciable losses, the VSWR can be very high with open, shorted, or badly mismatched lines.

Impedance of the Line. The impedance of the line at any point is the impedance that would be "seen" while "looking" toward the load end if the line were cut at that point; this impedance is governed by the ratio of voltage to current at that point.

$$Z = \frac{E}{I} \quad (1)$$

where Z is the impedance in ohms, and E the voltage in volts, and I the current in amperes.

The ratio of voltage to current usually varies along the line. However, if the current and voltage are in phase throughout (no standing waves) the impedance is constant. If the voltage and current are not in phase throughout, the impedance varies along the line and follows approximately the voltage standing wave curve.

The impedance that the generator "sees" when "looking" into the line is largely determined by the kind of load in which the line is terminated. If the load is resistive and equal to the Z_0 of the line, the generator will see the Z_0 since there will be no standing waves. If the line is terminated in something other than a resistive Z_0 , standing waves will be present, and there will be an impedance variation along the line. What the generator will see under these circumstances is largely determined by its distance from the load and by the degree of mismatch. For example, in Fig. 1C, the generator is located $2\frac{1}{4}$ wavelengths from the load. This is at an impedance minimum point, so the generator sees a virtual short circuit — even though the load is an open circuit.

If the load is purely reactive instead of resistive, reflections still take place. The voltage and current distribution vary in the same way as with the open- or short-circuited line previously discussed. The main difference is that a reactive load causes displacement of the current and voltage loops and nodes from the position they would have occupied if the load were a resistive, open, or short circuit — a *mismatch*. If the load is capacitive (equivalent to a capacitor connected across an open circuited line), the voltage

node (current loop) is displaced toward the load end by a distance depending on the value of capacitive reactance. This displacement is equivalent to adding up to a quarter-wavelength to the line.

If the line is terminated in an inductive reactance of the same value, the displacement of the voltage and current waves is the same, except that the line appears to be terminated in a short circuit. As far as the generator is concerned, terminating the line in a pure inductance is equivalent to terminating the line in a short circuit and lengthening the line by some value less than a quarter-wavelength. Terminating the line in a load composed of both resistance and reactance results in a lower SWR than with a shorted or open load. The addition of resistance to a reactive load does not change the direction in which the loops and nodes are shifted.

If the SWR is high, the source can be made to see impedances that vary from near zero to near infinite, depending on the distance between the source and the load. It is this property of transmission line segments that makes them so useful as impedance matching devices, transformers, and even as the basis for development of a waveguide.

Transmission lines do not radiate, even though they carry r-f current and are usually several wavelengths long. Radiation is minimized because the two conductors are close together, and the opposing magnetic fields built up by the currents in the wires cancel each other almost completely. Complete cancellation would result only if the wires were occupying the same space.

3. The Basic Antenna

Now that we have examined some of those transmission line characteristics that are applicable to antennas, let us refer to Fig. 2, where the conductors in a quarter-wavelength open line segment are spread apart. The conductors are no longer parallel and adjacent. The resonant characteristics, impedance, voltage, and current properties are not significantly altered. Note, however, that both magnitude and polarity are shown in this diagram. Since the opposing magnetic fields no longer cancel, radiation is possible. We have "created" an antenna out of a transmission line. This simple antenna is called a *half-wavelength dipole*, or *Hertz antenna*.

The shortest length of dipole capable of resonance is an electrical half-wavelength. The term *resonance* in this instance relates to the total electrical length of *both* rods of the dipole. If each is of the proper length, energy emanating from the generator and

propagated down the rods will arrive back at the generator exactly in phase. There is only one rod length that will make this relationship precise at any one frequency. If the rod is exactly a quarter-wavelength long, the wave takes one quarter of a cycle to travel from the generator to the end of the rod. At this point, an instantaneous reversal of phase takes place. (This is equivalent to a half-cycle delay.) Another quarter-cycle is required for the wave to return to the generator. This is equivalent to a total of a complete cycle. Standing waves exist on this dipole exactly as they did on the open-ended transmission line segment. If the un-

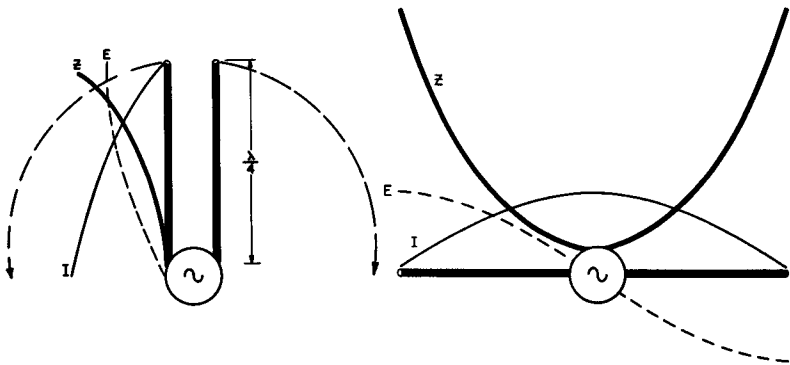

Fig. 2. How a half-wavelength dipole antenna is formed by spreading apart a quarter-wavelength open-circuited transmission line segment.

terminated end of each rod is considered as the load, at a quarter-wavelength back (where the generator of a half-wave dipole is located), there is a reversal of standing wave conditions — i.e., at the open end there is minimum current, maximum voltage, and maximum impedance; at the generator end, a quarter-wavelength away, there is maximum current, minimum voltage, and minimum impedance.

The existence of minimum voltage and maximum current (low impedance) at the generator may be justified by comparing the round trip times of the current and voltage waves. Each wave has a transit time of one half-cycle, but the phase reversal of the current results in its being in phase with the next outgoing current wave. The voltage does not undergo phase reversal and it arrives back at the generator in time to cancel a new outgoing voltage wave. Thus, at the input terminals of a half-wavelength dipole, the generator “sees” a minimum resistive impedance at resonance.

When the generator is shown between the dipole segments, it may represent an r-f source or the end of a line connected to a

transmitter. (If the line is properly matched, the transmitter is effectively placed in this position.) When a generator is supplying r-f power to an antenna, current and voltage fields are set up about that antenna, as shown in Fig. 3. These fields correspond in intensity to the maximum and minimum standing wave points. The field resulting from current is the *electromagnetic* ("magnetic") field. That resulting from voltage is the *electrostatic* ("electric") field. Magnetic and electric fields are always at right angles to each other, as they are in free space. Figure 3A shows only a two-dimensional configuration of the electrostatic lines of force. Actually, they surround the antenna in all planes that include it. The electrostatic lines are most dense at the ends of the antenna, where there is a voltage loop (maximum). Magnetic lines of force surround the antenna in a similar manner (Fig. 3B) and are most intense at the high-current point at the middle.

Because a half-wave antenna acts as a resonant circuit, current is continuously flowing from one end of the antenna to the other

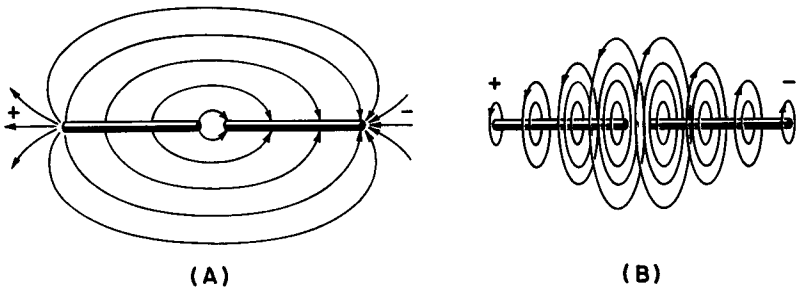

Fig. 3. Electrostatic (A) and magnetic (B) lines of force on a center-fed dipole at one instant.

at the source frequency. The sinusoidal oscillations cause one end of the antenna to become positive and the other negative during one half of the input cycle; during the other half of the cycle, these polarities reverse. It is believed that radiation occurs in the following manner:

As in Fig. 4, electrostatic lines of force surround the antenna during the major part of one half-cycle. As the generator output approaches the zero point of its sine wave, however, the difference in potential between one end of the antenna and the other also decreases to zero. Theoretically, the strength of an electric field is always directly proportional to the causative difference in potential, and the electric field should also decrease to zero, causing the electric lines of force to shrink back to the antenna. Electro-

static lines of force, however, tend to repel one another; consequently, as the voltage approaches zero, some of the outer lines are retarded in their effort to return to the antenna. This retardation is great enough so that when the voltage reaches zero, some of the lines are left in space, where they form closed loops that propagate radially outward.

Simultaneously, magnetic lines of force (not shown) are snapped free of the antenna. (They are always perpendicular to the electrostatic lines.) The continuously varying electric lines are accompanied by a *displacement* current, which gives rise to the changing magnetic field. The magnetic field (with the electric field and its displacement current) exists in the propagated electromagnetic wave, the magnetic field producing the electric field, and the electric field (by virtue of its displacement current) re-establishing the magnetic field. The two fields support each other; a radio wave can never exist with either absent. The electric field orientation in space is always parallel to the antenna, while the magnetic field is always perpendicular to the antenna. Thus, if the dipole is horizontal relative to the earth's surface, it will radiate *horizontally polarized* waves; if it is vertical, it will radiate *vertically polarized* waves. The plane of the electric field component is the determining factor, because the electric field component of the radiated wave is the one that produces the current in the receiving antenna.

4. Input Impedance and Radiation Resistance

As r-f power is fed into the antenna from the transmission line, a certain amount of this power is radiated. The power that is fed into the antenna and is not radiated is dissipated by the resistance effects associated with the antenna itself. This resistance loss is manifested by heat radiation. It is the result of eddy currents in surrounding metallic objects, resistance of the antenna elements, corona discharge, and dielectric losses of imperfect insulators. The two components of the total power used — the power expended in radiation, and the power expended through various losses — may be represented in a common way; i.e., by the insertion at a specified point of a *theoretical* resistance that would consume the same amount of power as that actually dissipated in these two ways. The two resistances are called *radiation resistance* (R_r) and "ohmic" resistance (R_o); the total resistance of any antenna (R_a) is the sum of the two components ($R_a = R_o + R_r$) and represents the total equivalent resistance in which all the power supplied to the antenna by the source is consumed. (As a general rule the "ohmic"

resistance is negligible.) The antenna's resistance may also be represented by the quotient of the total power supplied to the antenna divided by the square of the effective current in the antenna at a specified point of reference, or $R_a = P_a / (I_{eff})^2$.

When operating at its first, or *fundamental* resonant frequency in theoretically free space, a half-wavelength antenna has an input impedance (Z_a) at its center point equal to its resistance (R_a). The impedance at any other point is not purely resistive, but is equal to the ratio of E/I , as it is on a transmission line segment.

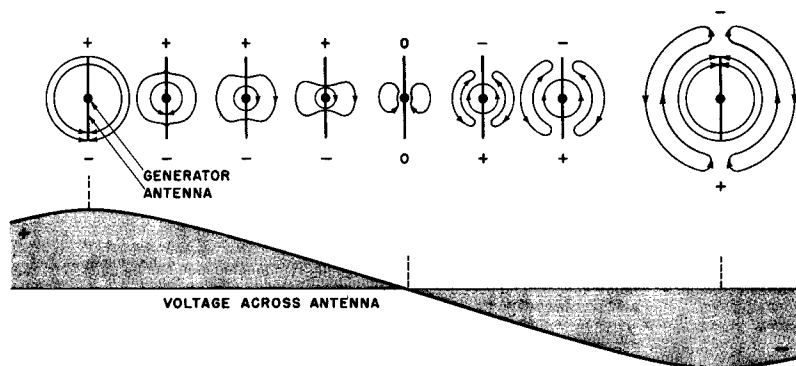

Fig. 4. The phenomenon of radiation during one half-cycle of excitation. Only radiation of electrostatic lines is shown.

In an isolated simple half-wave dipole made of infinitely thin conductor, the impedance at the center is approximately 72 ohms, and increases to as much as several thousand ohms at the ends.

The value of the impedance at any point on an antenna is affected by the antenna's proximity to other objects. The center input impedance may dip rather low when the antenna is close to other objects (as it is when employed as part of a larger antenna system).

When the impedance of an antenna is referred to, it must either be stated in terms of a specific point (i.e., end, middle, etc.) or in terms of the average impedance. The ratio E/I defines the impedance at any point, where both E and I are instantaneous values. In a *matched* transmission line, the ratio E/I does not change along the line, and we can call it the surge (or characteristic) impedance of the line, since its value does not depend on the line length, but rather on the physical construction of the line. In a resonant antenna, however, the E and I both represent a resultant of two waves traveling in opposite directions and possessing different values at different points in the line. A useful

method of giving the surge impedance of an antenna is to express it as an average of the different values existing at different places on the antenna. The average surge impedance of a center-fed dipole is given as:

$$Z_a = 276 \log_{10} \frac{1}{P} \quad (2)$$

where P is the periphery of the rod expressed in wavelengths.

A dipole antenna that is operated slightly off its resonant frequency behaves much as a series resonant circuit would behave under the same conditions. If the input frequency is lower than the antenna's "cut" frequency (antenna cut too short for the given frequency), the generator will see a resistance plus a capacitive reactance. If the generator feeds power to the antenna at a frequency higher than the antenna's resonant frequency (antenna cut too long for given frequency), the input impedance will be composed of a resistance and an inductive reactance.

The amount by which the reactance increases as the antenna's length is varied from resonance is a function of the length/diameter ratio, or the *thickness* of the rods with respect to the wavelength used. Under the assumption that the rods are round, this thickness may be related to the periphery (P) by the *proportionality constant* π . The *thicker* the rod the *lower the rate of reactive change* as the antenna is operated off resonance; the *thinner* the rod the *greater the rate of change*. This is shown in Fig. 5, which shows input resistance and reactance of a center-fed dipole of arbitrary length. The thinner the rod the more radical the change in reactance for a given change from (for example) quarter-wavelength resonance.

In the region of quarter-wavelength resonance, the behavior of the rod at different length/diameter ratios is analogous to the action of a series resonant circuit with different values of Q . A high Q corresponds to a high length/diameter ratio and a high reactive change with a small frequency change. A low Q corresponds to a low length/diameter ratio, and a less rapid change of reactance either side of resonance. This is important in antenna considerations because reactance in a load does not absorb but reflects power. Therefore, if the antenna is to operate at frequencies off resonance, it should have a low Q ; i.e., it should be made of relatively thick rods.

The input resistance is also affected by the length/diameter ratio, as shown in Fig. 5. For an infinitely thin wire it is 73 ohms; for wire with a diameter of $\lambda/1000$ about 64 ohms, varying to about 55 ohms for a diameter of $\lambda/10$. The input impedance of

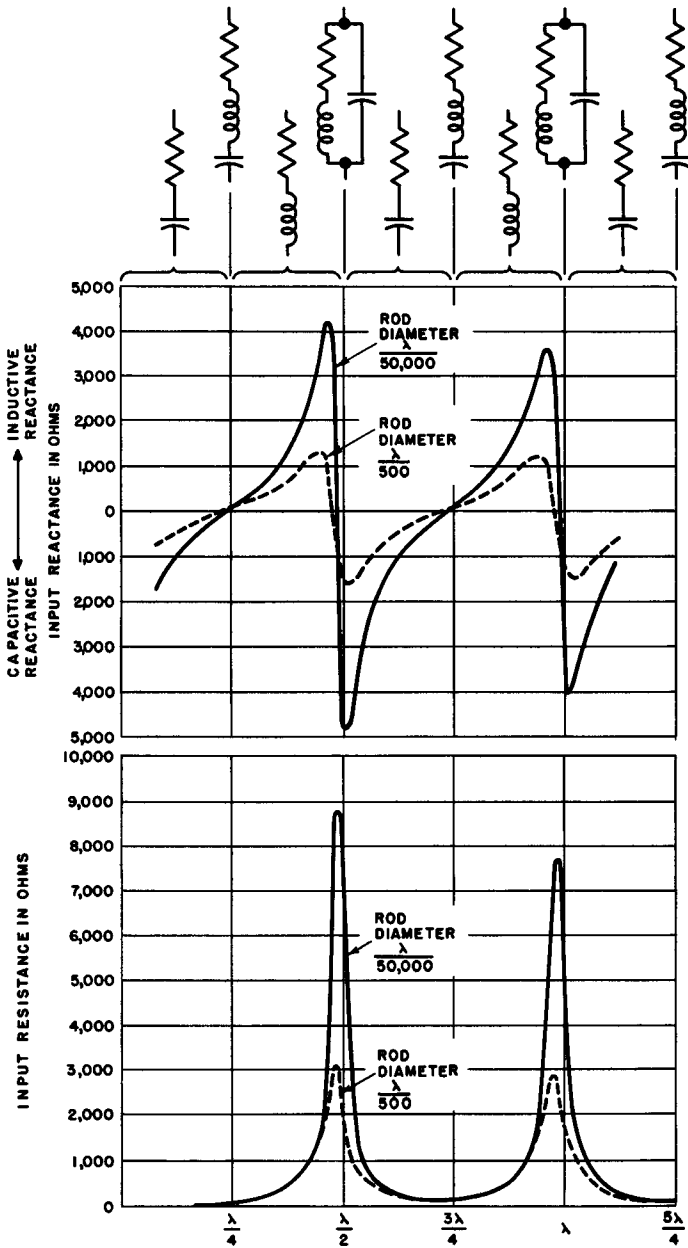

Fig. 5. Input resistance and reactance of center-fed dipole of arbitrary length.

an antenna is the series combination of the reactance and resistance. Taking the two sets of curves together, it can be seen why matching a transmission line to an antenna over a wide frequency range is a difficult proposition when high Q's are involved. Of course, the impedance variations will differ if the antenna is placed in the vicinity of any conducting or semi-conducting objects.

Half-Wavelength Dimensions. The formula for calculating a half-wavelength in theoretical free space at a given frequency is:

$$\begin{aligned} \text{length (feet)} &= \frac{492}{\text{frequency (mc)}} & (3) \\ \text{or length (inches)} &= \frac{5905}{\text{frequency (mc)}} \end{aligned}$$

Example: What is the free-space wavelength at 50 mc?

$$L = \frac{492}{f} = \frac{492}{50} = 9.84 \text{ feet or } L = \frac{5905}{f} = \frac{5905}{50} = 118.1 \text{ inches.}$$

There is a slight deviation from this formula when applying it to a practical antenna. Because a dipole antenna is never infinitely thin and because it is never in free space, there is a perceptible capacitance between it and the surrounding objects. This capacitance is always present to some extent, and has the effect of making the free-space-dimensioned antenna appear too long. To offset this, the antenna must be shortened in physical length. The amount of shortening varies with the type of antenna and the thickness of the antenna wires or the diameter of the elements. A dipole's physical length may be obtained to a close approximation by modifying Formula 3 by 5 percent. Formula 3 is true only for relatively thin conductors.

$$\begin{aligned} \text{length (feet)} &= \frac{(492 \times .95)}{\text{frequency (mc)}} \\ &= \frac{468}{\text{frequency (mc)}} & (4) \\ \text{or length (inches)} &= \frac{5616}{\text{frequency (mc)}} \end{aligned}$$

Example: What is the length of a practical thin dipole resonant at 50 mc?

$$L = \frac{468}{f} = \frac{468}{50} = 9.36 \text{ feet or } L = \frac{5616}{f} = \frac{5616}{50} = 112.32 \text{ inches}$$

Note the difference between these dimensions and those given by Equation 3.

5. Harmonically Operated Dipole

If we employ an antenna a half-wavelength long and increase the operating frequency to some integral multiple of the original value, or increase the antenna length to some integral multiple, keeping the frequency constant, the antenna is said to be operating *harmonically*. Operationally, the antenna will have different current and voltage characteristics, depending upon the harmonic of the fundamental frequency for which the antenna was dimensioned.

The harmonic of operation is denoted by the ratio (N) of the operating frequency to the frequency for which the dipole is a half-wavelength. (This is also the number of half-wavelength current loops on the antenna.) Directivity and gain in the favored direction — whether the antenna is used for transmitting or receiving purposes — are increased when operating on a harmonic. However, this is not always possible practically, because it is dependent upon the *antenna's impedance being correctly matched to the transmission line and the load at the operating frequency*. For this reason, a knowledge of the input impedance, radiation resistance, and antenna resistance of the harmonic antenna is desirable. Figure 6 shows the current distribution on a dipole as it operates on each of a number of harmonics. It will be noted that there is a significant difference in R_a and R_r , depending on whether N is odd or even. If N is *odd*, there is a current *loop* with an *impedance minimum* at the center; if N is *even*, there is a current *node* with an *impedance maximum* at the center.

At odd frequency ratios (N odd):

$$R_a = R_r = 69 \log_{10} 10N \quad (5)$$

at even frequency ratios (N even): (6)

$$R_r = 200 \log_{10} 5N$$

$$R_a = \frac{Z_a^2}{R_r}$$

where Z_a is the average surge impedance of antenna.

The physical shortening effect of conductor thickness and end effect still cause shortening in harmonic operation, but the shortening is not a linear function of the harmonic number. For example, if the antenna length is correctly calculated for its fundamental frequency, it will usually be slightly too short for second harmonic operation. Most of the end effect on a half-wavelength dipole is caused by capacitance between the ends of the antenna

and ground. In a harmonic antenna, the capacitance effect is still at the ends, but now there are a number of half-wavelength sections of wire between the end portions and the center. For these in-between half-wavelength sections, the end effect is much smaller, and the length of a harmonic wire cannot be presumed to be a mere multiple of a half-wavelength antenna's length. The

APPROXIMATE FREQUENCY RATIO (N)		RADIATION RESISTANCE AT CURRENT LOOP	ANTENNA RESISTANCE AT LOAD
1		$R_R = 72$	$R_A = 72$
2		$R_R = 200$	$R_A = \frac{Z_A^2}{R_R} = \frac{Z_A^2}{200}$
3		$R_R = 102$	$R_A = 102$
4		$R_R = 260$	$R_A = \frac{Z_A^2}{260}$
5		$R_R = 117$	$R_A = 117$

Fig. 6. Current standing waves on a dipole operating on different harmonics.

overall end effect will lessen as the number of wavelengths on the wire increases. An empirical formula that works well for determining the physical length of a harmonic antenna is:

$$\text{length (feet)} = \frac{492 (N - 0.05)}{\text{frequency (mc)}} \quad (7)$$

Example: What is the resonant length of a 5 half-wavelength antenna at 30 mc? How does the average length per electrical half-wave compare with the length of a half-wave antenna at the same frequency?

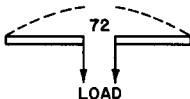
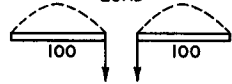
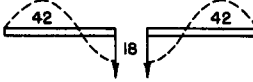
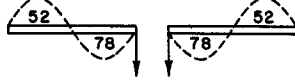
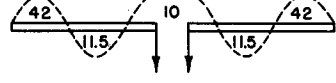
$$\begin{aligned} L &= \frac{492 (5 - 0.05)}{30} = \frac{492 (4.95)}{30} \\ &= \frac{2435.4}{30} = 81.18 \text{ feet} \end{aligned}$$

$$\frac{81.18}{5} = 16.236 \text{ feet per half-wave}$$

Single half-wave at 30 mc:

$$L = \frac{468}{30} = 15.56 \text{ feet}$$

Thus the single half-wave antenna is 0.67 foot shorter than the average length per half-wave of the 5 half-wave antenna.

6. Radiation Patterns

A half-wavelength dipole does not radiate energy with equal intensity in all directions. The radiation intensity is proportional to the square of the rms r-f current, but the antenna has standing waves, and thus does not have the same current in all places. Because of this uneven current distribution, the radiation will be uneven, having maximum intensity where the current is maximum.

The fact that a single-element antenna has a directivity characteristic results from:

(a) The radiation in a direction in line with, or parallel to any current-carrying wire is zero along the line (axis) of the antenna. This is true because the field radiates perpendicular to the antenna and cannot couple with objects at 90 degrees to the plane of radiation.

(b) The current loops (if more than one) along the antenna are radiation sources that differ in location and phase and therefore add or subtract differently in different directions.

Examples are shown in Fig. 7A. The half-wave antenna has only one current loop, which is located in the center. Because there is no other current loop to interfere, radiation falls off only at the ends, because of factor (a) above. The full-wave antenna has two current loops. At point D, or any other point on a line perpendicular to the antenna, equal and opposite fields are received from the two current loops, and there is zero radiation in this direction. However, in a direction at an angle such as Θ , the difference in distance from one field to the distant point and the other field to the same point is such that the fields no longer cancel, but add to make a maximum or "lobe" of radiation.

The directive effects of an antenna are shown by a *radiation pattern*. This is a graph in *polar coordinates* of the radiation intensity. The antenna is assumed to be a point in the center of the graph, and the radiation in any given direction is proportional to the distance between this point and the pattern line along a line in this direction.

The radiation patterns for the two antennas of A are shown in B of Fig. 7.

The radiation pattern of an antenna is actually three-dimensional, although often only the cross-section in the horizontal plane is shown. Figure 7C shows a three-dimensional view of the radiation pattern of a dipole mounted *horizontally* in space. There is

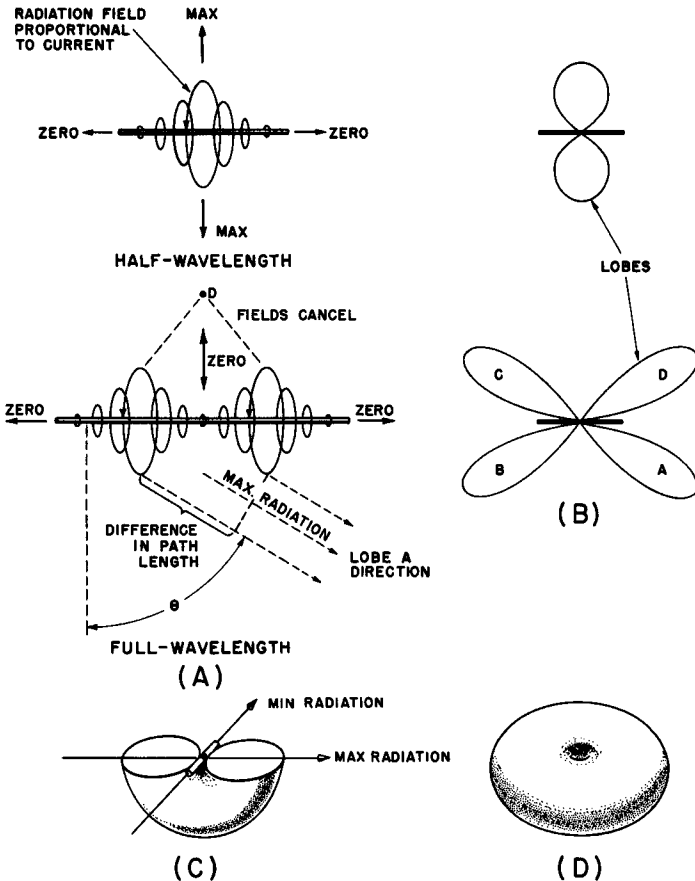

Fig. 7. Nature and evolution of directivity and directivity patterns.

maximum radiation at all points on lines perpendicular to the axis of the antenna. The complete pattern would look like a doughnut (Fig. 7D) if the upper half were shown.

The pattern in the horizontal plane is a cross-section of the "doughnut" as shown in Fig. 8A. This cross-section gives the polar diagram. In practical terms, it indicates the direction of maximum signal radiation or signal pickup for a horizontal transmitting or receiving antenna. The intersection of the "doughnut" with a

vertical plane is shown in Fig. 8B. It shows the relative radiation intensity in a plane perpendicular to the antenna. Note that in this diagram the radiation of the dipole is equal in all directions.

As previously explained, if the dipole length is increased to some integral half-wavelength multiple, the radiation pattern differs materially from that of the half-wavelength dipole. Figure 9 shows typical radiation patterns for harmonically operated dipoles

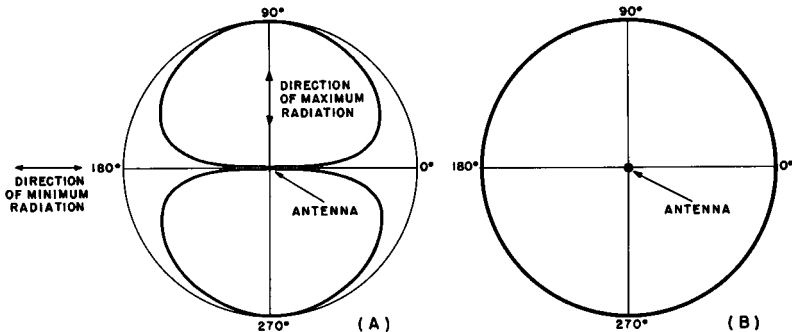

Fig. 8. (A) Free-space horizontal radiation pattern of a horizontal half-wavelength dipole. (B) Free-space vertical radiation pattern of horizontal half-wavelength dipole.

of two wavelengths. They are called clover leaf patterns; lobe 1 is a minor lobe and lobe 2 is a major lobe. As the number of half-wavelengths increases, the number of minor lobes increases and they cluster around (but not on) an axis perpendicular to the antenna, while angle Θ (made by the major lobes with the line of the antenna) decreases. The number of minor lobes depends upon the harmonic of operation.

7. Ground Effects

In all previous discussions of an antenna, it was assumed that the antenna was located in free space. Clearly, except for a few free space applications, an antenna is invariably located relatively close to the ground. Because of this location, a certain portion of the radiated field from the antenna will strike the ground. Some of this energy will be reflected and, together with a different portion of the energy being radiated directly from the antenna, will be propagated to the receiving antenna. These two waves combine vectorially and produce a resultant that depends on the phase difference between the two signals at the instant of arrival.

The ground is at times both an absorber and a reflector of radio waves, and thus tends to modify the radiation pattern of

the antenna. The factors contributing to the type and extent of modification are the conductivity of the ground, the polarization and frequency of the wave, and the height of the antenna in terms of wavelengths above ground. A number of graphs are shown in Fig. 10. They show how the ground modifies the theoretical free-space radiation pattern. They are calibrated in terms of

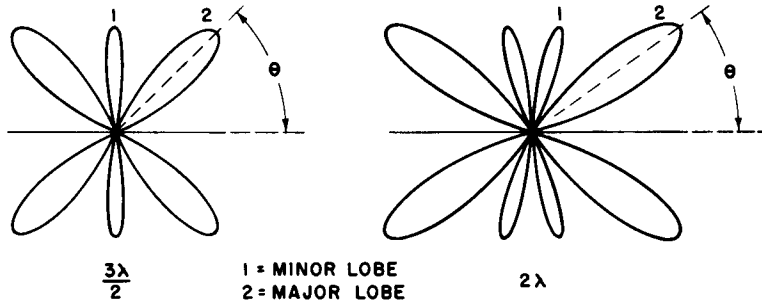
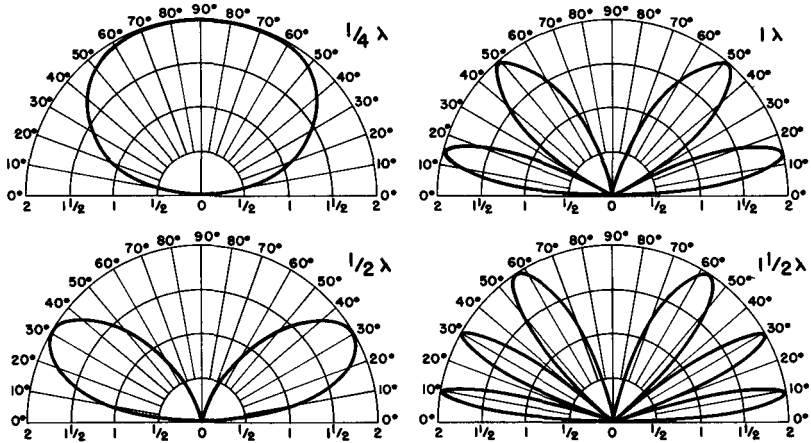

Fig. 9. Typical radiation patterns of harmonically operated dipoles.

reflection factor, which is merely a multiplication factor that tells how much (at a specific angle) the free space diagram is altered by the antenna's proximity to the ground. The charts are based on a perfectly conducting ground. When the known free-space radiation intensity at a certain angle is multiplied by the reflection factor for that angle and for that antenna at a specified height, the resultant radiation intensity is found. It should be stressed that these graphs are *not* radiation patterns, but only *multiplication* factors. They apply equally to antennas of all lengths. The difference between the graphs results from their being plotted for vertical and horizontal polarization.

If the energy leaves the antenna downward at sufficiently large angles from the horizontal, it strikes the ground directly below the antenna, and upon reflection, it is intercepted by the antenna itself. The transmitting antenna then carries two currents — one flowing from the input and the other induced by the reflected wave. These two currents will add vectorially and produce a resultant current that is dependent on the phase difference between them. The phase difference is, in turn, dependent on the height of the antenna above the ground. Since, through all this, the input power to the antenna is remaining constant, while the effective current changes at different antenna heights, the radiation resistance must be changing ($R_r \sim P/I^2$). Figure 11 shows the relationship between a horizontal half-wavelength antenna's height



HORIZONTAL ANTENNA

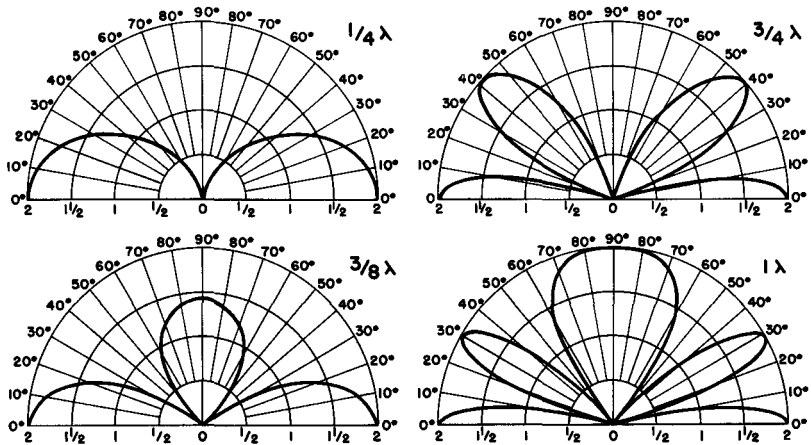

VERTICAL ANTENNA

Fig. 10. How the free-space radiation patterns in the vertical plane are affected by distance between an antenna and ground. Horizontal scales represent factors by which free-space radiation must be multiplied.

above ground and its radiation resistance. Approximate free space conditions are approached (i.e., the ground has no effect on the radiation resistance) at antenna heights greater than three wavelengths. In fact, it can be seen in the graph that the radiation resistance above one wavelength varies by only a relatively small amount, and approaches the free-space radiation resistance of 72 ohms.

In practice, the variations in radiation resistance are not exactly those of Fig. 11, which is based on a *perfectly* reflecting

ground. To simulate these ideal conditions, and thus achieve more closely the desired radiation resistance at a predetermined antenna height, a wire mesh or screen (a *ground plane*) can be placed on or near (sometimes under) the ground below the antenna, and extended (for best results) to a minimum distance of one half-

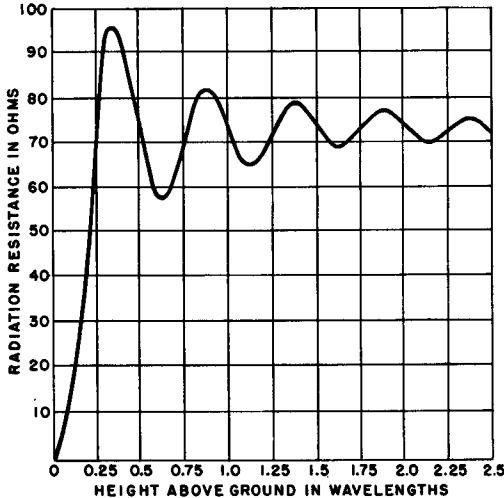

Fig. 11. Graph showing how the radiation resistance of an antenna is modified by its height above the ground. (Curve shown is for half-wave horizontal antenna.)

wavelength in all directions. The height of the antenna is now considered as the height above the wire mesh.

8. The Marconi Antenna

Antennas have evolved from two basic types, the Hertz and the Marconi. The Hertz, or dipole, because it is balanced (i.e., electrically and physically symmetrical with ground) is usually horizontally polarized when operating on frequencies above 7 mc; at lower frequencies, because of its great length and the difficulty of feeding at a current loop, it is not practical for use in a horizontal position.

When vertical polarization and/or a low angle of radiation are desired at low frequencies, the antenna must be made vertical. If we ground one rod of the dipole — either directly, or through the coupling device — to the transmitter, the reflecting qualities of the ground present to the half wave antenna a “mirror image” of itself. (See Fig. 12.) Thus the missing half of the antenna is supplied by the ground. The result is that the grounded Marconi quarter-wavelength antenna can achieve half-wavelength resonance

in much the same manner as the balanced half-wavelength Hertz antenna by virtue of this reflecting quality of the ground.

The grounded Marconi is used mostly for low frequency vehicular, aircraft, and commercial broadcast purposes. However, it is also frequently encountered in the form of "whips" for uhf mobile use. In commercial a-m broadcasting, the ground wave is the important carrier of r-f power, and for this mode of propagation, vertical polarization is essential.¹ In vehicular installations space is important and the reduction in length is a considerable advantage.

9. Varying Electrical Length by Loading

The electrical length of the Marconi antenna may be altered by the insertion of an inductance or capacitance in series with the antenna. Typically, the antenna is made electrically longer by the insertion of an inductance or "loading coil" at the appropriate

Fig. 12. The grounded Marconi antenna.

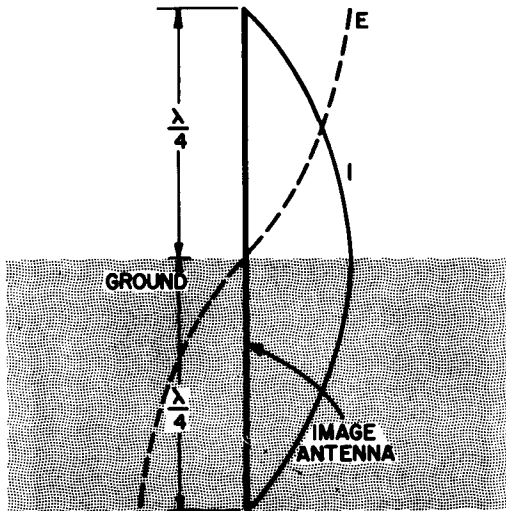

point. The voltage and current variations along a quarter-wavelength antenna are the same as for *one* side of a half-wave dipole, as shown in Fig. 13A. When the antenna is physically shorter than a quarter-wavelength at the operating frequency (as shown in Fig. 13B and C), the input impedance looks, to the grounded end,

¹ See A. Schure (ed.), *Wave Propagation* (New York: John F. Rider Publisher, Inc., 1957).

like a capacitive reactance. If the inserted inductance is of the proper value, it will cancel this capacitive reactance and allow the antenna to become resonant.

If the antenna is longer than a quarter-wavelength at the operating frequency, an inductive reactance is presented to the

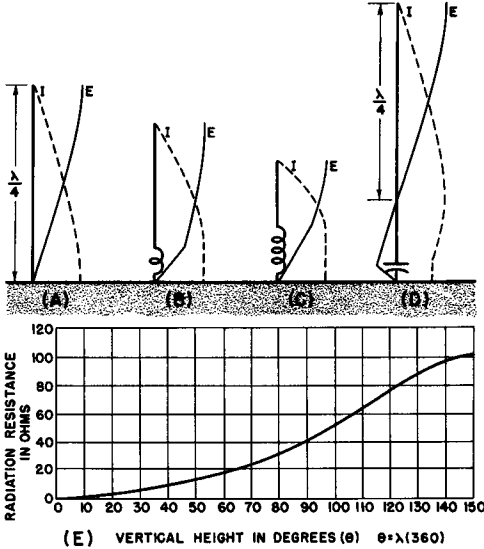

Fig. 13. How inductive and capacitive loading may be used to modify the electrical length of a grounded Marconi antenna.

grounded input end. For this reason, it can be tuned to resonance by the insertion of a capacitance of the proper value. (See Fig. 13D.)

The length of a Marconi antenna is half that of a dipole; i.e.,

$$\text{length (feet)} = \frac{234}{\text{frequency (mc)}} \quad (8)$$

The radiation resistance of the quarter-wavelength Marconi antenna is about 36 ohms, as measured at the point of connection of the base to ground or a coupling device to the transmitter. The radiation resistance varies from several thousand ohms, when the antenna is a half-wavelength long, to a fraction of an ohm when the antenna is less than .1 wavelength long. The radiation resistance of a Marconi antenna expressed as a function of its electrical length is given in Fig. 13E.

The total power dissipated in a Marconi antenna is made up of two components: the useful radiated power dissipated in the radiation resistance, and the power dissipated in the ground resistance.

$$P_a = I^2 (R_r + R_g) \quad (9)$$

where I is the antenna current as measured at the base (feed point) of the antenna, P_a the total power consumed by the antenna, R_r the radiation resistance, and R_g the ground resistance.

Of these two increments of power (I^2R_r and I^2R_g), I^2R_g represents *lost* power. In other words, the effective power radiated (P_r) is the difference between the total power consumed by the antenna and the power lost in the ground.

$$(P_r = P_a - I^2R_g) \quad (10)$$

Because the power loss occurs across the ground resistance, this resistance should be kept as low as possible. A good ground system may be provided in a number of ways; cold water pipes or a number of stakes driven deep in the ground and, if possible, treated with salt make a good low-resistance ground connection. If the earth is either so sandy that its resistance is high or so rocky that stakes cannot be driven, a capacitive grounding device called a *counterpoise* is used.

A counterpoise is a system of wires on or above the ground and extending radially outward from the base of the antenna like the spokes of a large wheel. For best results at least 15 "spokes," each a half-wavelength long, should be used. This will insure the necessarily large capacitance to ground. In vehicular installations, the whip antenna obtains its ground from chassis, which thus acts as a counterpoise. A counterpoise and a ground plane (previously discussed) are functionally the same. Although the distinction between them is not sharp, the term counterpoise usually refers to systems that are both large and supported above the ground, like an auxiliary antenna. Wires laid in the ground are referred to as a "ground plane" or "ground system." In uhf practice, radial rods or screens under antennas are also referred to as "ground planes." (See "Ground Plane Antennas" in Chap. 5.)

Antenna efficiency is a function of the ratio of radiation resistance to ground resistance; therefore it is good practice to make R_r high in addition to making R_g low. Radiation resistance may be increased by increasing the electrical length of the antenna (by inserting an inductance) or increasing the physical length, moving the current loop up the antenna. Increasing the electrical length instead of the physical length of the antenna is often feasible. The action of the inserted inductance for this purpose has been discussed. The current loop may be made to move up (and therefore present something other than a current maximum at the base of the antenna) by the use of *top loading*. This usually takes the

form of small spokes formed of conductors in a horizontal plane and connected to the top of the antenna. This "flat top" causes the current loop to move up the antenna, effectively increasing the impedance and radiation resistance at the base, thus decreasing the power losses at the base.

10. Review Questions

- (1) Why doesn't a half-wavelength antenna radiate from its ends?
- (2) What is the correct length (in feet) for a half-wavelength dipole in free space resonating at a frequency of 14.1 mc?
- (3) How long should antenna in Question 2 be in ordinary practice? (Consider end effect.)
- (4) What is the radiation resistance of a dipole operating on the fifth harmonic?
- (5) If the fundamental frequency of the antenna in Question 4 is 5 mc, how long should it be?
- (6) Why is it that the ratio of radiation resistance to ground resistance should be kept as high as possible in a grounded Marconi antenna?
- (7) What is the purpose of a counterpoise?
- (8) What is the difference in the standing wave configuration between an open transmission line and a shorted transmission line?
- (9) What is the effect of a reactance load on the SWR characteristic?

Chapter 2

GAIN AND DIRECTIVITY

11. Directivity

The major consideration in radio communication is the transmission of r-f energy from the transmitting antenna to the receiving antenna. If the energy from the transmitting antenna is to be sent to a particular receiving antenna in one direction, energy radiated in any other direction is obviously wasted. If, however, a directive transmitting antenna concentrating its radiated power in a particular direction is used, a greater portion of the total energy radiated will be "beamed" to the receiving antenna. In such a case, a low-power transmitter with a directive antenna can do the job of a high-power transmitter with a non-directive antenna.

The same reasoning may be applied to a receiving antenna; i.e., if this directive transmitting antenna is used for receiving purposes and is properly oriented, a greater voltage will be induced in the antenna than would be induced in an antenna that is sensitive to signals arriving from all directions. In addition, a directive receiving antenna discriminates against interfering signals arriving from other directions.

All antennas are directive to some extent. A dipole's bidirectional characteristics were shown in Figs. 7 and 8. Because a half-wave dipole is a basic antenna, it is used as a standard of comparison in judging the capabilities of other types of antennas. If, at a given receiving point, a half-wave dipole and another receiving antenna are compared in their relative performance (while the transmitter power remains fixed), the measured gain of the second antenna over the dipole is defined as the ratio of the signal

power delivered to the receiver input terminals by this antenna to the power delivered to the receiver input terminals by the dipole — assuming that impedances are matched and losses are the same in each case. The “gain” of a directive antenna is usually expressed logarithmically in “decibels” (db). Db of gain are determined from:

$$\text{gain (db)} = 10 \log_{10} \frac{P_1}{P_2} \quad (11)$$

where P_1 and P_2 are any two powers forming the ratio P_1/P_2 .

The decibel measurement is merely ten times the logarithm of the ratio of two powers. It indicates the relation between two power levels. If the absolute value of P_2 is given as a reference, the number of db indicates the absolute value of P_1 . In antenna measurements, the half-wavelength dipole’s radiation under standard conditions is taken as the reference power. The half-wave dipole is therefore a *zero-db antenna*. The ratio of power supplied by two identical dipoles is one-to-one; the log of 1 is zero, hence a dipole has a gain of zero db. Since many antennas have minor and major lobes, it is understood that the power ratio is taken with respect to the maximum power radiation of the major lobe of the given antenna and the maximum of the reference dipole.

In this chapter we deal with a number of terms that will be defined at this point. The *element* of a directive antenna is the half-wavelength dipole. Combinations of such elements constitute a *directional array*, or directional antenna. The elements may be vertical or horizontal; they may be mounted end-to-end (*collinear*) or parallel, or both.

Elements may be either *driven* or *parasitically excited*; i.e., a transmission line may actually deliver power to an element, or the element may get its power from magnetic coupling with one or more driven elements in the vicinity. The latter is called a *parasitic* element. An antenna may have more than one parasitic element.

If the array is one in which each of the elements is driven, the array is called a *driven array*. If one or more of the elements is excited parasitically, the array is a *parasitic array*. There are two major types of arrays, unidirectional and bidirectional. In a unidirectional array, the ratio of the power received or radiated from the front with respect to the rear is called the *front-to-back ratio*. Of the driven element arrays, there are three classifications: the *collinear* array and the *broadside* array, in which the maximum radiation occurs in a line perpendicular to the plane containing the elements, and the *end-fire* array, in which the direction of maximum radiation is in a plane containing the elements and perpendicular to them. (See Fig. 14.)

One of the ways of qualifying the directivity of an antenna is in terms of its *beam width*. The beam width of a directive array is the angle between the two extreme azimuthal directions in which power is radiated. The measuring points on the beam pattern are where the power is one-half the maximum value occurring at the

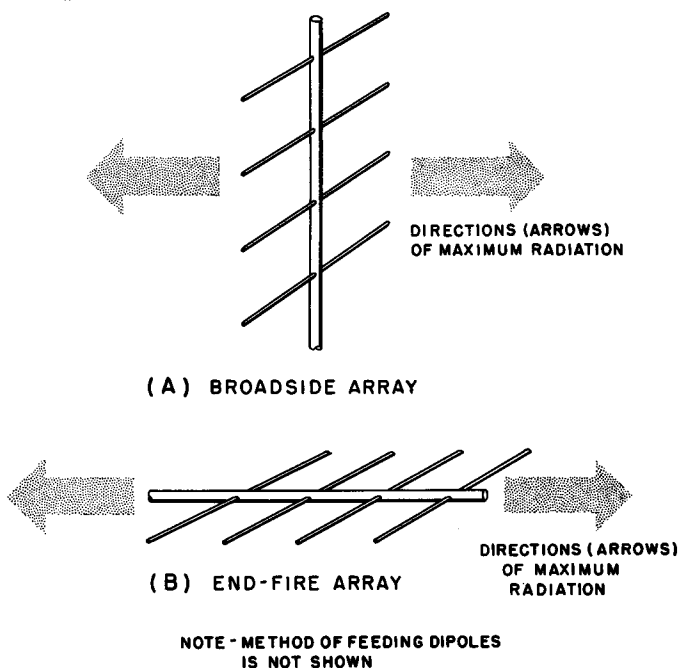

Fig. 14. Directive antennas.

center of the beam. (See Fig. 15.) If the antenna is made more directive, the width of the beam will decrease.

The term *phase* as applied to an antenna refers to the time difference (usually expressed in degrees) between voltages and currents on or in two or more elements of an array. Generally, different elements are either in phase with one another, or 180 degrees out of phase. Phasing is an important item in the operation of any array, since it is often the phase relation between the currents in different elements that determines the directional qualities of the antenna.

12. Driven Arrays

The collinear array. This is an antenna system consisting of a number of half-wavelength antennas placed along the same line, with the current in each element having the same phase. Figure

16A shows a wire one wavelength long. Note that the current and voltage reverse at each half-wavelength. If we want to make a collinear array out of this wire, we have to break it as shown in Fig. 16B and provide some method of switching the phase of current and voltage as the energy progresses from one half-wavelength section to the other. Since the right-hand end of the left element is adjacent to the left-hand end of the right element, these adjacent ends must have voltages of opposite phase if the elements are driven in phase. Such a phase relationship exists in Fig. 16C, where the

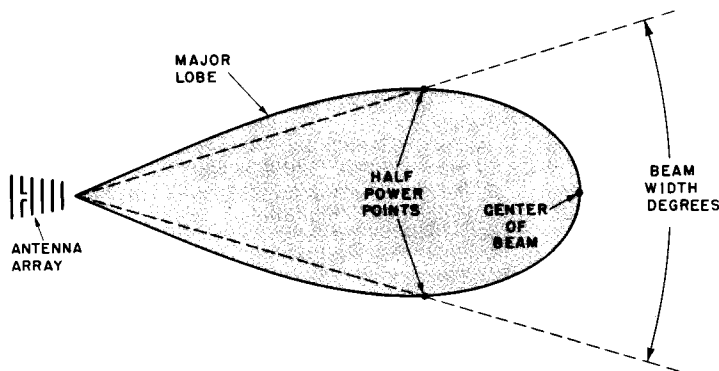

Fig. 15. The half-power point method of specifying an array's beam width.

system is fed from the center. Since the two wires of the transmission line have currents of opposite phase, the line feeds the two half-wave elements in such a way that both will have the same phase conditions. The input impedance at the feed point is rather high, since it is at a voltage loop. Impedances of 1000 to 6000 ohms can be expected, depending on the type of conductors used. Methods of matching this impedance to a transmission line are discussed in Chap. 4. The directive pattern of this two-element collinear array is shown in Fig. 17, superimposed on the pattern of a half-wavelength dipole. The power gain over a dipole is on the order of 2 db.

When greater directivity and gain are desired, more than two collinear elements can be connected together. Now it is necessary to provide some method of switching the phase between elements. A shorted quarter-wavelength transmission line segment, called a *phasing stub*, is used for this purpose. At resonance, the line segment presents the high impedance of a parallel tuned circuit, and in this application acts only as a polarity reverser. Figure 16D shows how these line segments are connected to the ends of the

elements. The impedance at the feed point may be on the order of 1200 ohms or more, and so a matching section (discussed in Chap. 4) must be used when connecting to a relatively low impedance transmission line. One method of overcoming the matching difficulty is to connect the transmission line at a current loop. Figure 16E illustrates the procedure. Here the impedance is about 300 ohms, and therefore matches the impedance of 300-ohm transmission line.

Increasing the number of elements in a collinear array increases the length of the major lobes. Small minor lobes appear with arrays greater than two elements, but they are of little consequence. A three-element collinear array has a gain of about 3 db over a dipole and a beam width of about 35 degrees. It is impor-

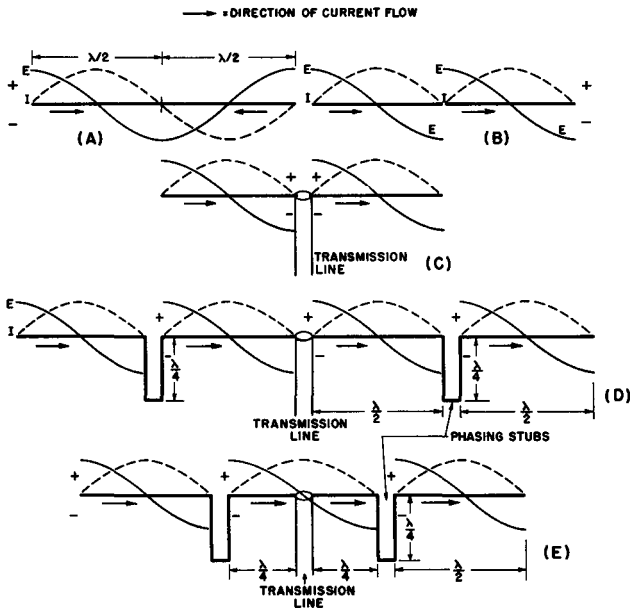

Fig. 16. The collinear array.

tant that the phasing stubs be correctly tuned for the frequency of operation. A collinear array is noted for its low Q . This is tantamount to a wide frequency response curve or operation over a relatively wide band.

End-fire array. An end-fire antenna consists of a number of half-wavelength elements mounted parallel to one another. Spacing and the relative phase relationship between elements are the controlling factors in the determination of gain and directivity.

The parallel elements are always fed *out of phase* and, because of this, maximum response (or radiation) is in a line containing the elements.

To show how this can happen, let us examine Fig. 18. Consider two dipoles, A and B, spaced one half-wavelength apart. Point C represents a transmitter radiating a plane wave in the plane containing the two dipoles. At a given instant, a portion of the wave will cut dipole A and induce a current in it. Since

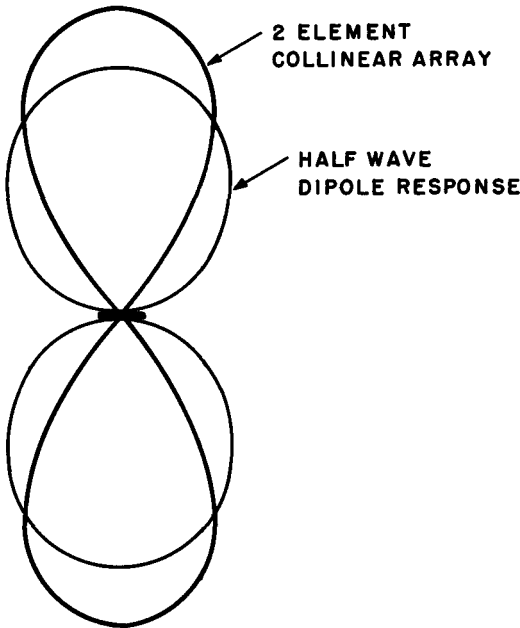

Fig. 17. Free-space response pattern of a two-element collinear array vs. a half-wave dipole.

the two dipoles are one half-wavelength apart, by the time the wave has progressed to dipole B, it has reversed phase and induced a current in dipole B of a polarity opposite to that of dipole A. The object in the end-fire system is to make use of these two oppositely-phased currents in the dipoles. This can be accomplished by collecting the energy in a special way. The current from dipole A flows to point D. The length of the transmission line connecting D to E is one half-wavelength. By the time the wave has traveled down this transmission line from D to E, it has reversed polarity and arrives at E in phase with the other current arriving at this point from dipole B. Thus the two currents add and produce a greater current on the transmission line at this point than could have been obtained from either dipole alone. Maximum response

is always in a direction perpendicular to all the elements, and in a plane containing them.

Now suppose a signal arrives from point G, which is in a line perpendicular to the plane of the elements. Radiation arrives at both dipoles in the same phase. Currents of equal magnitude and phase appear at points D and E. The energy from D, however, must travel an extra half-wavelength, or an extra 180 degrees so that when it arrives at point E, its polarity is opposite to that of the current at point E, and the two currents cancel.

A variety of gain figures and directive patterns can be obtained by varying the spacing and phase relation between the elements. Figure 19 shows examples of two popular phase and spacing relationships. If the half-wavelength elements are spaced a half-wavelength apart and fed 180 degrees out of phase, a bidirectional horizontal pattern with a gain of about 2.2 db is obtained. If the phase difference remains 180 degrees and spacing is reduced to a quarter-wavelength, the gain increases to about 3.8 db. The gain continues to increase as the spacing decreases up to a limit

Fig. 18. End-fire array, showing how directivity is favored toward point C as compared to point G.

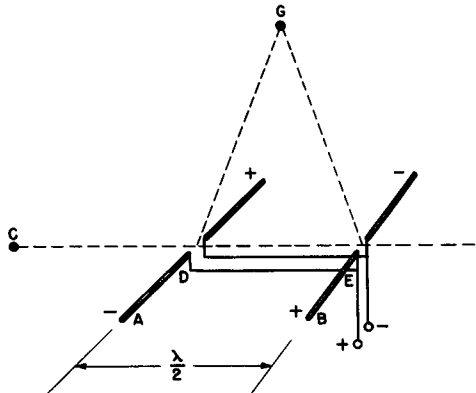

of one eighth-wavelength. If the spacing is decreased much below this, opposite currents in the two elements begin to cancel each other as they do on a transmission line.

In the end-fire array, the length of the elements is not very critical and may be varied up to 5 percent without much change in the performance. A more important design consideration is the element phasing and spacing. The antenna is a low-Q affair and has many applications when broad banding is desirable. Increasing the number of elements of an end-fire array will make the major lobe longer and narrow, resulting in a greater gain. The impedance of this antenna is rather low, depending on the spacing. For quarter-

wavelength spacing, the impedance conductors should be used for the elements to prevent much power dissipation due to ohmic resistance and skin effect.

As the phase difference between the two elements is reduced below 180 degrees and approaches 90 degrees, the antenna assumes unidirectional characteristics. In Fig. 19, an end-fire antenna with

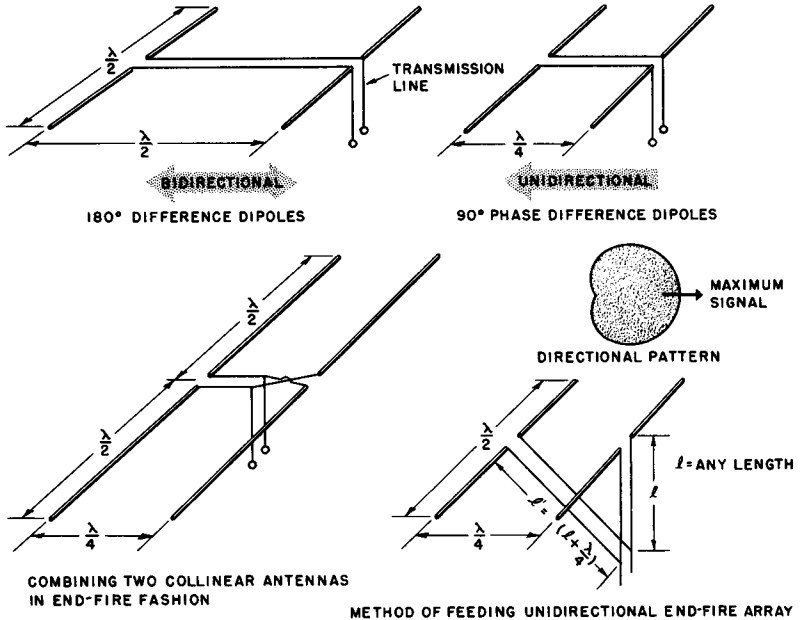

Fig. 19. Examples of end-fire array.

quarter-wavelength spacing and 90-degree phase difference between elements is shown to have the unidirectional (cardioid) pattern. More than two elements may be used in this and in other end-fire arrays as long as the spacing and phasing between elements is observed. For this reason, feeding and matching systems may become quite complicated with some of the bigger multi-element arrays.

Broadside array. If the elements of an end-fire array are fed in phase instead of out of phase with each other, maximum radiation or reception occurs in a line perpendicular to the plane containing the elements. This is a *broadside array*. Figure 20 shows two dipoles receiving radiation from point G. The currents induced in the two dipoles and arriving at points D and E respectively will be of the same phase because of the symmetrical rela-

tionship of G with each dipole. The separation between the dipoles is one half-wavelength. Energy that appears at point D will reverse in phase as it travels the half-wavelength of transmission line to point E , and therefore is opposite in phase to the energy arriving at that point from dipole B . For maximum reception from point G , this reversal of phase must be canceled. It is done by transposing the transmission line's wires, restoring the phase relationship that existed on dipole A . The two currents will now add directly at E and produce a greater overall current. If radiation is received from point C , oppositely phased currents are induced in the two dipoles. Currents from the two dipoles arrive at E in opposite phase and cancel. Therefore, maximum reception is from G and minimum reception from C .

Elements are usually stacked, one above another, to secure horizontal radiation and horizontal polarization. Theoretically, any number of elements may be stacked, but usually space and feeding problems restrict the number to two, except in the uhf region where the elements are less bulky. The gain of the array increases not only as the number of elements increases, but as the spacing between elements increases. Maximum gain is reached

Fig. 20. How response is secured broadside to the line of the elements, in a broadside array.

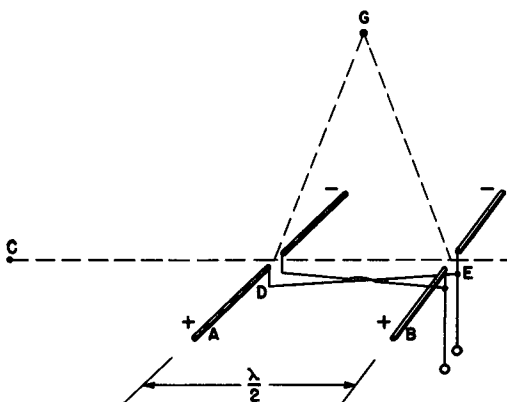

with element spacing on the order of 0.6 to 0.7 wavelength. For a two element half-wavelength spaced antenna, the gain is about 4 db. As the number of elements increases, the impedance of the antenna decreases; even with a two-element array, the impedance is significantly below 100 ohms. For this reason, matching and feeding problems arise when more elements are added.

One of the prime uses of the broadside array is to concentrate most of its energy in a horizontal plane. This eliminates much of

the effect of ground reflections and other interference. Figure 21 shows a broadside array's vertical radiation pattern, as compared to that of a dipole.

13. Parasitic Arrays

The addition of one or more parasitic elements to a dipole is one of the most effective methods of enhancing its limited gain

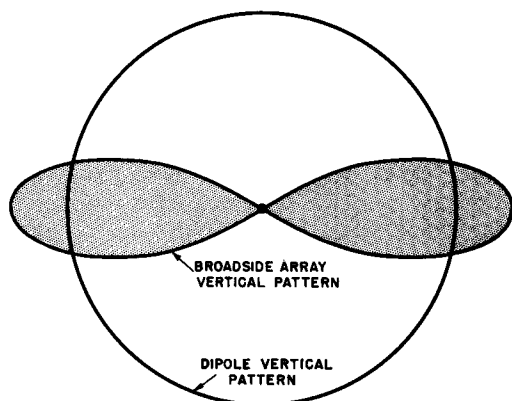

Fig. 21. Comparison of vertical free-space radiation pattern between a broadside array and a half-wave dipole antenna.

and directivity. An antenna with one driven element and one or more electromagnetically excited elements is called a parasitic antenna.

To understand the operation of a parasitic antenna, suppose that a half-wavelength driven dipole is placed in proximity to another resonant dipole that is continuous and unloaded. If the latter dipole is spaced a quarter-wavelength behind the driven dipole, which receives a signal from the front, as shown in Fig. 22A, an interesting phenomenon occurs.

Energy from the wavefront will be intercepted by the front dipole. The front dipole is matched to its load, but in this instance the total power intercepted by the dipole will not be absorbed by this load; the power not absorbed will be re-radiated. It is known that the re-radiated power is one-half the total power intercepted by the antenna, if the load is correctly matched. Thus, if dipole A in Fig. 22 intercepts one milliwatt of power, it will re-radiate one half-milliwatt of power. Re-radiation always occurs one quarter-cycle (90 degrees) later.

The re-radiated wave will travel on and be intercepted by unloaded dipole B, undergoing on the way another 90-degree lagging phase shift because of the quarter-wavelength spacing between

dipoles. Being unloaded, this dipole will re-radiate a quarter-cycle later virtually all the energy it intercepts. A portion of the energy that is re-radiated from the unloaded dipole (B) will travel back in the opposite direction and be intercepted by the loaded dipole (A). Again, because of the spacing, the wave will undergo a fourth 90-degree lagging phase shift. Thus, if the spacing is correct, and the elements lengths properly adjusted, the wave that is returned by dipole B will arrive back at dipole A in phase with the original signal. The signal present at the loaded dipole is greater than it would have been if there were no unloaded dipole (parasitic element) a quarter-wavelength away.

This unique phase relationship discriminates against radiation from the rear. The unloaded dipole, in this case, acts like a *reflector*, and has been given this name.

It can be seen from the above description that spacing is of prime importance in this antenna's design. The greatest forward gain can be achieved by placing the reflector 0.15 wavelength behind the dipole. However, if nothing else is changed the system

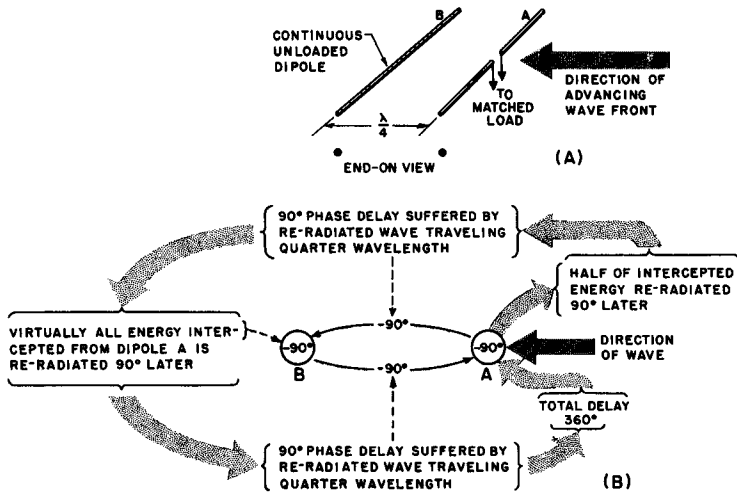

Fig. 22. How a parasitic antenna works.

will be a poor performer, because the quarter-wavelength spacing in the above example was necessary to obtain the proper phase relationship. If the spacing is decreased below a quarter-wavelength and other things remain equal, insufficient delay will be introduced in the returning signal. If the reflector is made slightly longer than a half-wavelength, however, the re-radiation delay can be made sufficiently longer to make up for the loss in delay time

suffered when decreasing the spacing to 0.15 wavelength. Thus, by increasing the reflector length slightly (usually about 5 percent), advantage may be taken of the greater gain at a particular spacing.

In the same manner as above, if an unloaded resonant dipole (B) is placed in front of a loaded resonant dipole (A) at a spacing of 0.1 wavelength, and if the unloaded dipole is shorter than dipole A by about 5 percent, it will act as a lens, concentrating the energy toward the front. It is called a "director" for that reason.

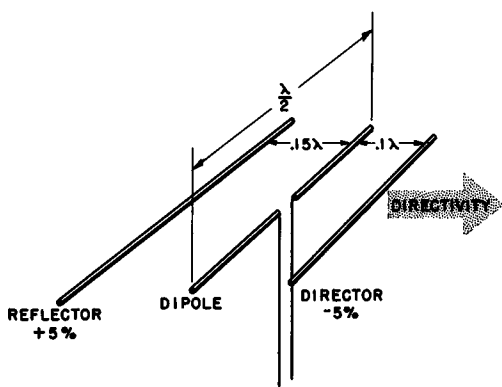

Fig. 23. A three-element parasitic array.

Often a reflector and a director are both used to make a simple and compact array.

Figure 23 shows a three-element array (reflector, dipole, and director). This is a unidirectional array, as can be seen by its horizontal radiation pattern (Fig. 24). A gain of about 1 to 8 db is possible with director spacing of 0.1 wavelength, when the reflector and director are 5 percent longer and shorter respectively than the dipole. In parasitic arrays, some response is always present toward the rear, but it is of little consequence in a properly designed antenna.

The radiation resistance of the loaded dipole of the multiple element antenna is always less than it would be in the absence of the parasitic element or elements, since the current in the loaded dipole is increased by parasitic elements. The smaller the spacing between elements the lower the resistance. (It can be as low as 10 ohms.) Power losses can result in less gain than the theoretical value. This calls for a special transmission line "matching" arrangement.

Power losses in the form of heat can be reduced by using large tubing for the conductors. Large tubing also has the advantage of reducing the Q , thus increasing the bandwidth over which the

antenna will perform properly. Tuning of reflector and directors is quite critical if maximum performance is desired. The tuning necessary for maximum front-to-back ratio, however, is not the same tuning necessary for maximum forward gain. Tuning, as a rule, is done by hand, since small differences of element length make rather large differences in performance.

A four-element parasitic antenna or "beam" is composed of a reflector, a dipole, and two directors. The added director is about 5 percent shorter than the other director. Matching to a transmission line is more difficult because of the low radiation resistance of the beam. Various schemes have been introduced to raise the radiation resistance and at the same time preserve most of the gain.

Stacking one array on top of another and feeding them in broadside fashion is often done to make the vertical pattern narrower and to provide more gain. Stacking two beams will provide

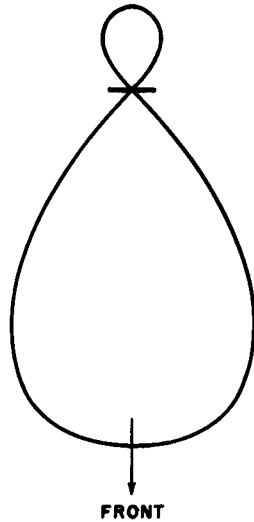

Fig. 24. Horizontal response pattern of a three-element parasitic array.

about a 3-db (double the power) gain over one beam alone. If the frequency is high enough, rather complicated arrays may be constructed without exceeding the physical limits of practicability.

14. Review Questions

- (1) Why must the currents in adjacent collinear elements be in phase with one another?
- (2) What is the decibel gain of an antenna that has a delivered power of 1 microwatt, when under the same circumstances a dipole delivers 0.1 microwatt?
- (3) What is the limiting factor in the stacking of elements (broadside array)?

- (4) Why does a shorted dipole re-radiate almost all of its intercepted energy when a dipole correctly matched to its load re-radiates only half of its intercepted energy?
- (5) What is the main advantage of a parasitic array over a driven array?
- (6) Describe the means by which the different directive characteristics are obtained with an end-fire array.
- (7) Describe the means by which the different directive characteristics are obtained with a broadside array.

Chapter 3

LONG WIRE ANTENNAS

15. General Discussion

Thus far, we have discussed forms of beams or arrays that were, for the most part, rigidly supported and relatively compact. There is, however, a large category of antennas that make use of particular directive characteristics obtained when the length of a conductor exceeds the usual half-wavelength. This comprises the family of *long wire* antennas.

Long wire antennas come in various shapes and sizes. They have in common some properties that long ago established their usefulness in communications. They are broad banded, in the sense that they can handle large frequency deviations with relatively little variation of efficiency. At low frequencies, say 7 mc or less, they are about the most efficient type of radiator. They are rugged, cheap, and simple to construct. They can handle large amounts of power and, when used as receiving antennas, possess a good signal-to-noise ratio.

Their most glaring disadvantage is that they take up so much space, often making their use impractical. They are not readily re-oriented or re-positioned and thus are most useful in point-to-point communication, where the direction of radiation or reception is not likely to change.

16. Long Single Wire Antenna

If a single, unterminated wire is used as an antenna and is over a wavelength long (in multiples of a half-wavelength), the

number of minor lobes appearing in the pattern increases and the four main "clover leaf" lobes tend to move closer to the axis of the antenna. If the wire is an even number of half-wavelengths long, there will be a gap (area of minimum radiation) in the plane of the wire and perpendicular to it. If the wire is an odd number of wavelengths long, there will be a minor lobe at this point. Figure 25 shows the effect upon the free-space radiation pattern of increasing the length of the wire. If the figures are considered as cross-sections of solids of revolution about the wire as an axis,

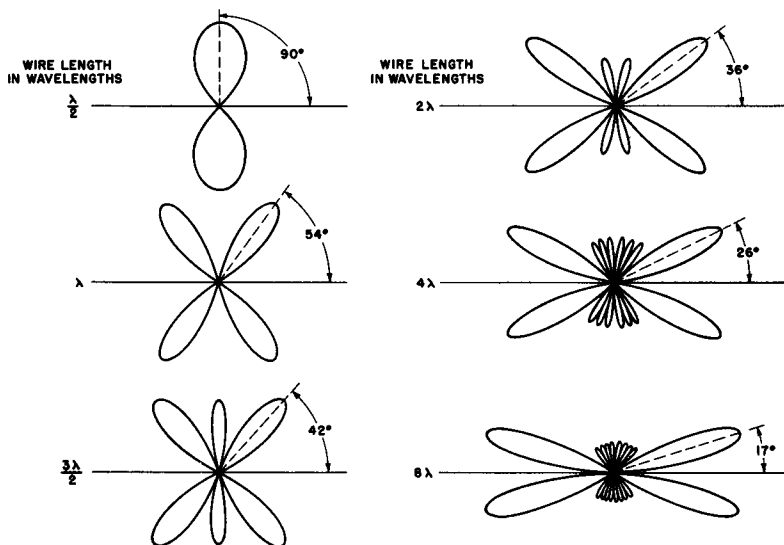

Fig. 25. Radiation patterns of long wires.

the true three-dimensional pattern may be envisioned. As the length of the wire is increased, more and more power is concentrated in the major lobes, which swing toward the axis of the wire. Although minor lobes increase in number, the power contained in them becomes a decreasing percentage of the total power radiated.

There is usually a practical limit to wire length. Beyond about 8 to 10 wavelengths, the major lobe does not significantly move closer to the axis of the wire, but remains at an angle of about 17 degrees. If the major lobe is to coincide with the desired direction of radiation or reception, the wire itself must be placed in the proper position. The exact angle is, of course, a function of the length of the antenna, because the length governs the position of the major lobes with respect to the line of the wire. (See Fig. 26A.) Approximate orientation of the wire can be obtained from:

$$\Theta = \cos^{-1} \left[1 - \left(\frac{0.5}{N} \right) \right] \quad (12)$$

where Θ is the angle that the axis of the antenna makes with the direction of desired transmission or reception, and N is the length of the antenna in wavelengths. The same reasoning may be applied to vertical orientation. At low frequencies (below 30 mc) this is an important consideration in long distance communication, where a low angle of radiation is of paramount importance. Figure 26B shows that, by giving the antenna the proper tilt, bidirectional horizontal radiation at the required vertical angle is obtained. Of course, there is also vertical radiation, and because of the tilt there will be both horizontal and vertical polarization. The actual free-space radiation pattern is modified by the antenna's proximity to the ground, according to the principles set forth in Chap. 1. The lowest end of the wire should be at least a half-wavelength from the ground (computed at the lowest frequency used).

If space is available, it is good to use as long a wire as possible. The length of this antenna is given by Formula 7. As the length

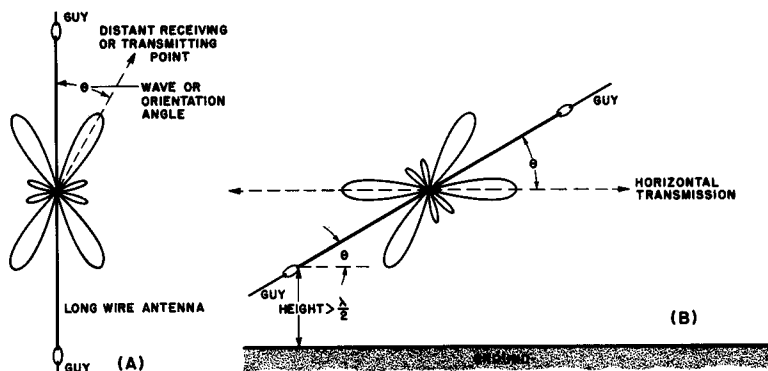

Fig. 26. The resonant long wire antenna.

is increased, the radiation resistance increases as shown in Table 1. This chart gives the power gain, major lobe angle, and radiation resistance as functions of the antenna length.

Feeding long wire antennas is sometimes a problem. Since the desirable directive qualities of the antenna are obtained when r-f currents are out of phase in adjacent half-wavelength sections, it is important not to disturb this relationship with the feeding mechanism. If restricted harmonic operation (i.e., odd or even harmonics of the fundamental frequency of operation) is desired, the wire must be fed from the end, because at any point the im-

pedance conditions would change radically with changes in frequency. Although gain decreases, and there is a certain disruption of the conventional directive characteristics, long wire antennas are often operated well off their resonant frequencies, particularly in receiving applications. If properly oriented, the same long wire antenna might work well at a low amateur frequency (3.5 mc), and still be a good receptor of vhf television stations and all frequencies between.

TABLE 1

<i>Antenna Length (λ)</i>	<i>Gain Over Dipole (db)</i>	<i>Angle of Major Lobe with Wire Θ (Wave Angle in Degrees)</i>	<i>Radiation Resistance (Ohms)</i>
0.5	0	90	72
1	.5	52	95
1.5	.85	43	105
2	1.45	36	110
3	2.25	28	122
4	3.1	25	132
5	4	22	139
6	4.7	20	145
7	5.5	19	150
8	6.3	18	155
9	6.8	17.5	157
10	7.4	17	162

The classical long wire antenna is a resonant structure, as are all the antennas described thus far. They have all the qualities of resonance; their performance is dependent upon the exact frequency of operation. Resonance is, however, not necessary for the proper operation of such an antenna system.

17. The Non-Resonant Long Wire Antenna

Consider the two long wire antennas of Figs. 27 and 28. One of the wires is unterminated, and the other terminates in its *characteristic impedance*. Comparative current distributions for the two wires are shown. On the unterminated wire (Fig. 27)

standing waves exist, and it is classified as a resonant device; standing waves are an integral part of all resonant antenna systems.

There are no standing waves on the other antenna (Fig. 28) because it is correctly terminated in a load resistance equal to its characteristic impedance. In fact, the current in the line hardly

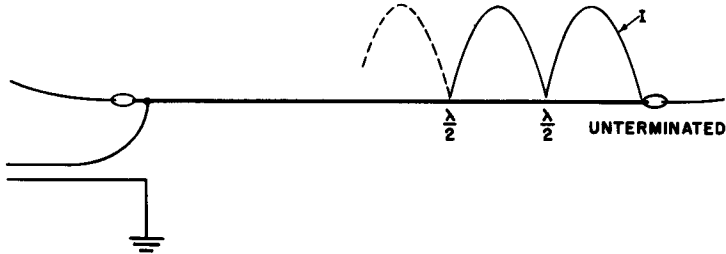

Fig. 27. Standing waves appear on a long wire antenna. The antenna is not terminated.

varies. Virtually all the power reaching the end of the line is absorbed in the load resistance. (The slight exponential decay of current shown is caused by losses.) This terminated wire can be considered a two-conductor transmission line with the conductors spaced a great distance apart. (The line is one conductor, the

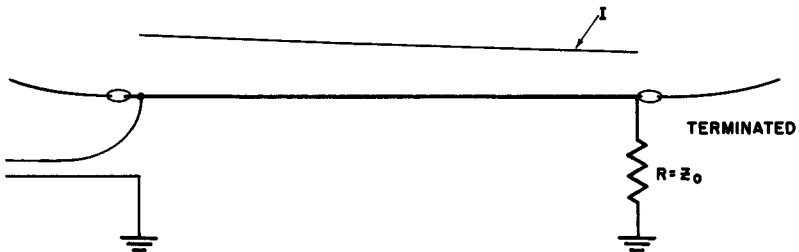

Fig. 28. The elimination of standing waves on a long wire antenna by the act of terminating it in its characteristic impedance.

earth the other.) In fact, the primary electrical difference between this antenna and a transmission line is that here the conductors are so far apart that opposing magnetic fields do not cancel, and radiation and/or reception may take place. Because there are no standing waves on the correctly terminated long wire antenna, it is called a non-resonant antenna.

The difference in radiation patterns between resonant and non-resonant wires is shown in Fig. 29. Note that on the resonant

wire (A) the radiation pattern is symmetrical with both ends of the wire; this was true of all the resonant antennas described thus far. In B and C of Fig. 29, the wires are terminated in their characteristic impedance. The radiation pattern will be, in each instance, approximately one-half the resonant radiation pattern.

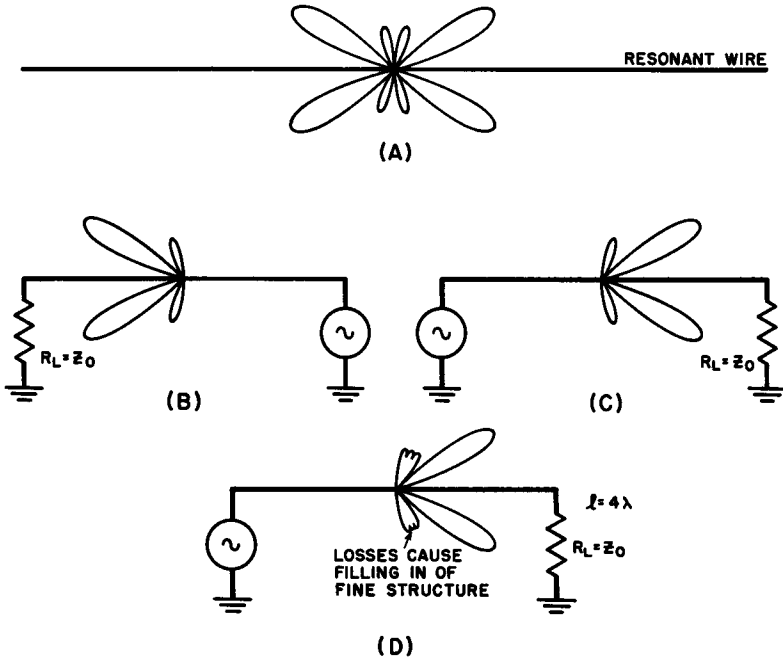

Fig. 29. The radiation pattern of a resonant wire is the combination of the patterns of two non-resonant wires pointed in opposite directions.

The pattern of Fig. 29A may be considered as the vectorial addition of the individual patterns of B and C.

If the current is traveling down the line as in B of Fig. 29, it will cause the main lobe to be pointed approximately in the direction of current travel. The actual radiation pattern of a terminated wire is not always that of the theoretical type shown in A and B. Ohmic and radiation losses tend to modify the pattern here, even if free space conditions are present. Figure 29D shows how excessive losses can distort the major lobe and fill in the fine structure of the minor lobes. Still, with the correct load resistance, this non-resonant wire has become a unidirectional device; this enhances its usefulness in communication work. (Note: it is im-

portant that the termination resistance have no reactive component; i.e., a wirewound resistance cannot be used.)

The angle the major lobe makes with the line of the antenna (wave angle) can be approximately determined from Table 1, even though this table is meant for a resonant wire. The directional characteristics obviously change with frequency, as does the gain. Otherwise, the wire may be used on any frequency with a relatively constant input impedance. As with the resonant wire, the greater the length with respect to the wavelength of operation, the greater the gain.

18. The V Antenna

If two resonant long wire antennas are placed as shown in Fig. 30A with the proper apex angle, and if they are fed 180 degrees out of phase from a common transmission line, major lobes 1, 2, 5, and 6 tend to cancel, while lobes 3, 4, 7, and 8 (shaded areas) add, resulting in a bidirectional pattern (Fig. 30B).

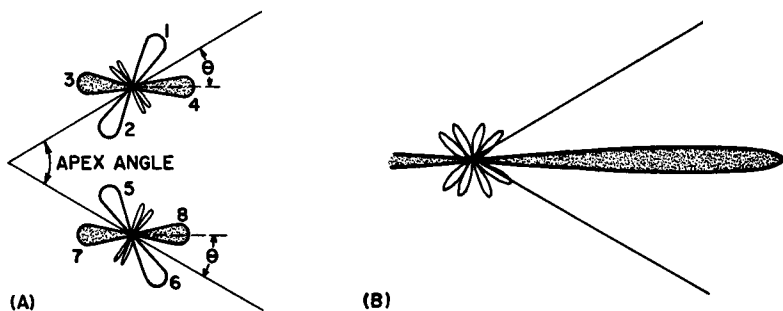

Fig. 30. The V antenna.

There are still minor lobes in the pattern, but if each leg of the antenna is long in terms of wavelength, the minor lobes are small compared to the resultant major lobes. With this combination, more gain and sharper vertical and horizontal patterns are obtained than could have been expected from either long wire individually.

Clearly, the whole principle of operation of the V antenna is dependent upon the apex angle being of the correct value so that certain lobes cancel and others add. The apex angle is, in turn, dependent on the angle θ the major lobes make with the line of each leg, and θ is dependent upon the length of each leg in wavelengths. Figure 31 is a graph of the apex angle and the gain of the

antenna as functions of the length (in terms of wavelength) of each leg. Theoretically, if the frequency is altered to some harmonic of the frequency that was used in computing the apex angle, the gain should decrease and the pattern should break up because of an incorrect apex angle. Because of this difficulty, an antenna that is to be used on both fundamental and harmonic frequencies should be rather long (over 5 wavelengths), as verified in Fig. 31 by the rather small change in gain between 5 and 10 wavelengths.

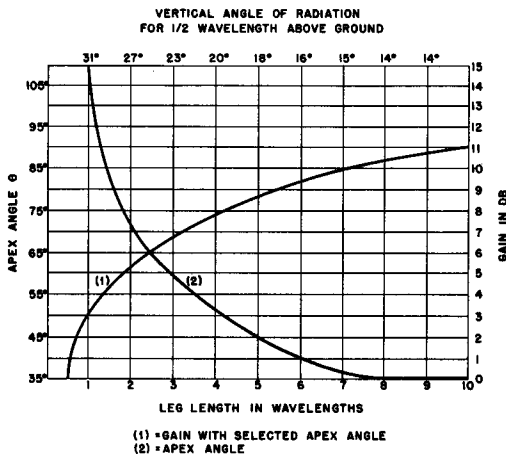

Fig. 31. Design characteristics for a V antenna.

It is important to realize that the beam width decreases as the length of the legs is increased. Orientation, then, becomes an important thing when the legs are long, and even an error of a few degrees in positioning can significantly reduce the gain. If such a mistake in orientation is made, an increase in gain may be obtained by shortening the legs, causing a wider response that includes the receiving or transmitting station "missed" with the narrower beam.

The length of each leg of a V antenna may be calculated from Formula 7. The input impedance of the antenna is on the order of 600 ohms, and a transmission line of this impedance may be used quite satisfactorily.

If unidirectional characteristics are desired, the ends of the V antenna may be terminated in their characteristic impedance, as is done with the non-resonant long wire antenna. Although this is not often done because of practical considerations, it works very well in providing unidirectional characteristics.

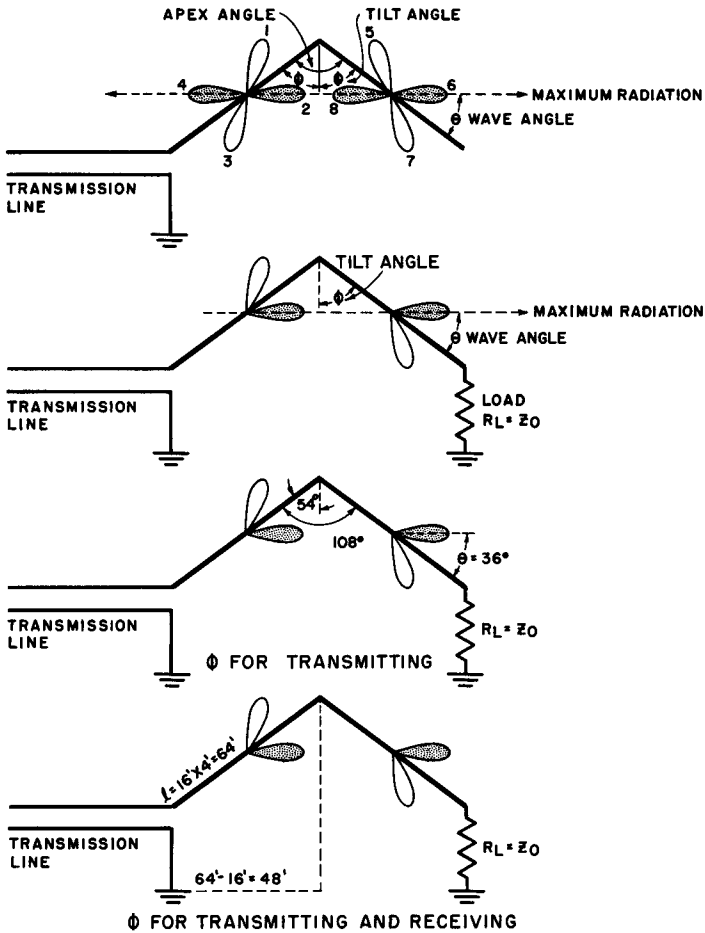

Fig. 32. The unterminated (A) and terminated (B-D) half rhombic antenna.

The distance above the ground with all long wire antennas is important in determining the vertical angle of radiation. The terminating resistance should be non-inductive and capable of dissipating at least one-third of the power fed to the antenna.

19. The Half Rhombic Antenna

Two long wire antennas may be combined by the method indicated in Fig. 32A. This is called a *half rhombic* antenna. In this example the wire is not terminated; it is a resonant antenna.

If the apex angle between the legs is adjusted to the correct value, the vertical radiation represented by lobes 1, 3, 5, and 7 (unshaded areas) will nearly cancel. The resulting radiation is in the horizontal direction, as shown by the arrow. This type of antenna has an advantage over the standard V antenna, in that its beam direction tends to remain more or less stable over a wide frequency range. The antenna is one of the largest in use; often when suspended in a vertical position for low frequency work, the apex is over 500 feet high, and the total length in excess of a quarter of a mile. Balloons and kites are sometimes used to suspend the wires, and orientation and adjustment of the apex angle are often difficult. However, the same antenna can be used with wires strung horizontally. The impedance is on the order of 400 to 500 ohms.

If the half rhombic antenna is terminated in its characteristic impedance and the apex angle properly adjusted, the vertical lobes still partially cancel, resulting in a unidirectional horizontal pattern in the direction of the load resistance (Fig. 32B). When ground resistance is high, a counterpoise that extends to the same length as the antenna is used.

The entire principle of operation of a unidirectional half rhombic antenna is dependent on the value of the apex angle. As with the V antenna, this is a function of the individual wire lengths. The tilt angle (Φ in Fig. 32B) should be chosen so that it is the complement of the wave angle (Θ). For the example shown, the leg is two wavelengths long. The wave angle for this length of wire (obtained from Fig. 27) is 36 degrees. The tilt angle is the complement of 36 degrees or 54 degrees (90 degrees - 36 degrees = 54 degrees). If the antenna is to be used for transmission, the apex angle is twice the tilt angle, or 108 degrees.

The apex angle for a half rhombic antenna used for both transmission and reception is a compromise value. To calculate it, find the tilt angle for transmission. Then determine the physical length of one leg of the antenna as a function of a given number of wavelengths at the lowest frequency used. Derive a second tilt angle so that the vertical projection of this leg on the earth will be one half-wavelength shorter than the length of the leg. Find the average between the two tilt angles. This gives the best overall tilt angle for transmission and reception. Twice this value is the correct apex angle.

Applying this rule, we will now modify the tilt angle previously derived for a transmitting antenna. The length of one leg is given as two wavelengths, and the lowest frequency of operation for this antenna is assumed to be 29.2 mc. The physical length of one half-wavelength is:

$$\text{length} = \frac{468}{29.2} = 16 \text{ feet}$$

There are four half-wavelengths ($16 \times 4 = 64$ feet). The horizontal projection of this is a half-wavelength shorter ($64 - 16 = 48$ feet). As in Fig. 32D, tilt angle (Φ) = $\sin^{-1} 48/64 = 48.5$ degrees. Taking the average of this and the original tilt angle, $(48.5 + 54) / 2 = 51.25$ degrees. This is the compromise tilt angle used for transmitting and receiving applications.

20. The Full Rhombic Antenna

In high-power installations — where a low angle of radiation, high gain, low signal-to-noise ratio, and a wide operating frequency at relatively constant input impedance are desired — the full rhombic antenna is used.

The rhombic can be considered as an extension of the V antenna (or as two half rhombics connected in parallel and lying in a horizontal plane with their ends connected across a common terminating resistance). If the tilt angle (Φ) is adjusted properly,

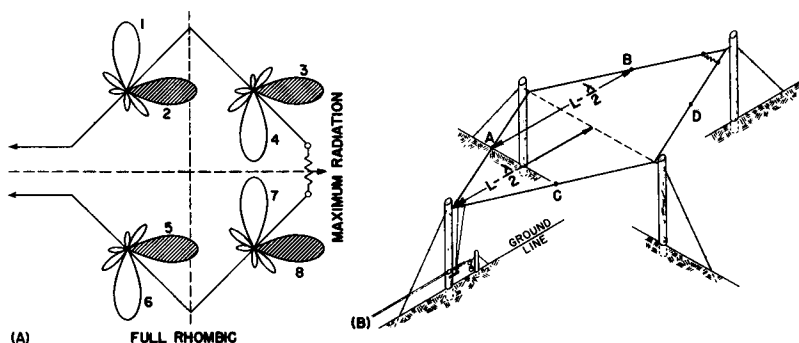

Fig. 33. The full rhombic antenna showing lobes and the direction of maximum radiation.

all major lobes will cancel each other (except those adding to produce maximum radiation in a line parallel with the bisector of the antenna, and in the direction of the terminating resistance). The rhombic may be terminated or left open at the ends.

If the rhombic is to be designed for maximum directivity, and if the proper lobes are to add and cancel, the tilt angle must be determined with the same care employed with the half rhombic. Figure 33A shows that if the tilt angle (Φ) is chosen to be the complement of the wave angle for each leg, lobes 1, 4, 6, and 7

(shaded areas) will cancel, leaving lobes 2, 3, 5, and 8 to add in the forward direction. Again, the final apex angle is double the tilt angle. The tilt angle may also be derived as shown in Fig. 33B. Here it is shown that the tilt angle is adjusted so that the distance from A to B (or C to D) is one half-wavelength less than the length of the leg. The theoretical gain of a rhombic antenna is quite high and, as with all long wire antennas, increases with leg length. There is approximately a 3-db power loss in the terminating resistor. This power loss represents the power that would normally have been radiated in the other direction if the termina-

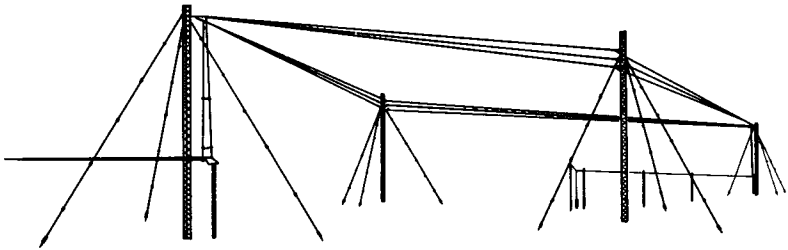

Fig. 34. Stabilizing the input impedance of a full rhombic over a wide frequency range by increasing the number of conductors.

tion were not present, so in a sense it is not really a loss. The terminating resistor should not be inductive and should be capable of dissipating half the power of the transmitter. If the antenna is used exclusively for reception, an ordinary half-watt carbon resistor is quite satisfactory. Considering the terminating loss, the gain of a properly terminated rhombic antenna can be given roughly by:

$$\text{Gain (db)} = \frac{N + 12}{2}$$

where N is the length of a leg in half-wavelengths.

One of the great advantages of a rhombic antenna over others is that a very high front-to-back ratio is obtainable if the terminating resistance is of the correct value. In practice, this termination resistance does not equal the Z_0 of the antenna, but is slightly higher, because the input and output impedances of the antenna are not the same. The impedance of the antenna varies from end to end because of losses that are greatly dependent on the operational frequency. If we shift frequency about 10 mc, the input impedance may vary as much as 100 ohms. Because of this varia-

tion of impedance, ideal unidirectional characteristics (infinite front-to-back ratio) cannot be realized.

The input impedance of a rhombic antenna may be stabilized over a wide frequency range by increasing the number of conductors, as shown in Fig. 34. The use of these additional wires reduces the Z_0 slightly. A typical antenna would have an impedance of 600 ohms – ideal for matching to a standard 600-ohm transmission line.

21. Review Questions

- (1) What is the main factor influencing the angle between the line of a long wire antenna and a major lobe?
- (2) List the main advantages and disadvantages of long wire antennas.
- (3) What effect on the radiation pattern is achieved if a long wire antenna is terminated in its characteristic impedance?
- (4) What is the significance of the apex angle in the design of the V, half rhombic, and full rhombic antennas?
- (5) Name at least one disadvantage of making the leg of a V antenna very long, other than the space it takes up.
- (6) Why are additional wires included in each leg of a rhombic?
- (7) Why does the Z_0 of a rhombic vary from end to end?

Chapter 4

FEEDING AND MATCHING PRINCIPLES

22. Feeding with a Resonant Line

It is a well-known axiom that maximum transfer of power from a source to a load will be accomplished when the impedance of the source matches the impedance of the load. This law applies equally well to the transfer of power between a transmission line and an antenna. When transmitting, the line is considered the source of power, and the antenna the load; when receiving, the antenna is the source and the transmission line the load. In either case, the impedance of the two must be the same if the flow of power from one to the other is to be maximized.

There are two principal methods of feeding an antenna — with a tuned or resonant transmission line, and with a flat or non-resonant line. Whether a line is considered tuned or flat is determined by the SWR. If it is low (1.5:1 or less) the line is considered flat. A higher SWR makes the line's impedance vary along its length, and the line is said to be resonant. There are distinct advantages and disadvantages in both types of feeding systems. Whether a flat line or a tuned line is used to feed an antenna is determined in great measure by the frequency range over which the antenna must operate, and by the extent of antenna impedance variation with a change in frequency.

If an antenna is to operate on a number of harmonics, there will be a large change in the antenna's input impedance. Because of this change, it is almost impossible to prevent standing waves on the transmission line; therefore, a tuned line is used. Here no attempt is made to match the antenna's input impedance to that

of the line. Standing waves will exist on the line, as they do on the antenna. In fact, the line can be considered as an extension of the antenna. Because of this, the line length is rather critical, and provision must be made to make the transmission line the correct length to place either a current loop or a current node at the transmitter end of the line. At these intervals, the line's impedance is purely resistive. With a matching device at the transmitter end, slight deviation from these intervals can be compensated (i.e., any reactance that may be present is "tuned out" by the matching network). The matching device must also couple to the tank circuit of the transmitter.

This is shown in Fig. 35; in A and B the antenna is center-fed. Because there is a current loop at the center of the antenna, it is said to be current-fed. In Fig. 35A the line is a half-wavelength (or an integral multiple of a half-wavelength) long. It acts as a 1:1 impedance matching transformer. The antenna's center impedance is effectively presented to the output of the transmitter.

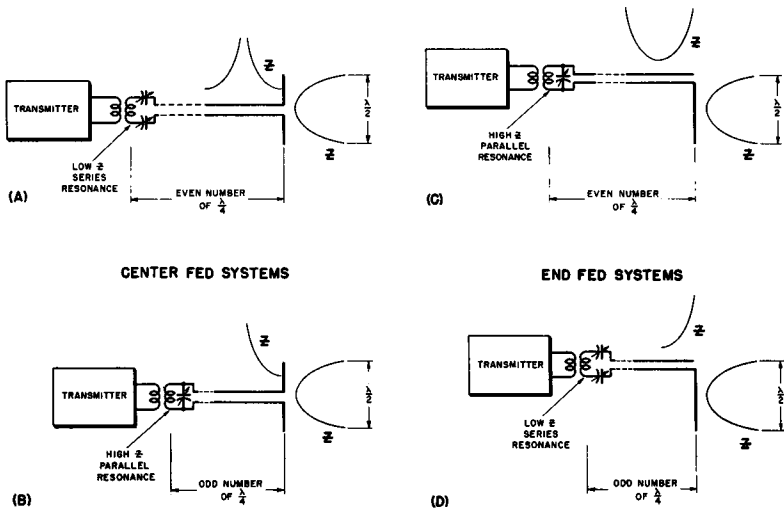

Fig. 35. Two-wire resonant feeder systems.

At this place there is a series resonant circuit that has approximately the same low impedance as the end of the line. Under these conditions, maximum power from the transmitter will flow into the line. Because the impedance curve of the line matches that of the antenna where the two meet (both minimum), maximum power will flow from the line to the antenna.

In Fig. 35B a quarter-wavelength (or odd multiple of a quarter-wavelength) line is used. As can be seen in the illustration, the impedance undergoes an inversion in this quarter-wavelength, and the minimum impedance at the antenna is presented to the coupling circuit at the transmitter as a maximum impedance. This is matched by the maximum impedance of a *parallel* resonant circuit. This antenna is also considered current-fed, although there is a voltage and impedance loop at the transmitter end of the line.

In Fig. 35C the antenna is fed at the end, where a voltage loop exists. Because of this, the antenna is said to be voltage-fed. Even though one end of the transmission line is not connected, power will flow into the antenna. Remember that this is a maximum impedance point, and conditions are almost exactly like those of an open-ended transmission line. In this illustration the line is an integral multiple of a half-wavelength; hence the impedance conditions at the antenna will be repeated at the transmitter. An effective match between the transmitter and the line is achieved by a parallel tuned circuit with its very high impedance. In Fig. 35D the same conditions are present, except that an impedance inversion is desired. With a transmission line an odd multiple of a quarter-wavelength long, a minimum impedance is presented to the transmitter, even though there is a maximum impedance at the antenna.

An intuitive understanding of the operation of resonant feeding systems may be gained by considering the transmission line as only an extension of the antenna proper. Indeed, if the line has been correctly installed, there will be no interruption of the standing waves that exist on the antenna. The reason the line does not radiate, while the antenna does, is that the theoretically equal and opposite currents in the parallel conductors of the line cancel each other's magnetic fields, resulting in little or no radiation. If the currents in adjacent conductors of the line are not equal and opposite (that is, if the line is not electrically balanced), radiation losses cannot be canceled. Care should be taken not to run the line parallel to one side of the antenna, or to anything else that will induce an additional current in one side of the line. If this should happen, radiation losses and noise pickup will increase.

Sometimes, as with the end-fed systems, a slight line unbalance is unavoidable. Correction of this unbalance is provided in A and D of Fig. 35 where the series resonant circuit has a variable capacitor in each conductor of the line. When employing a parallel tuned circuit as in B and C of Fig. 35, it is often necessary to put a small variable capacitor in series with one side of the line to cancel this unbalance.

An antenna may be fed with a single wire feeder. Radiation from this line will not be canceled, since there is no adjustment conductor with an out-of-phase current. The single wire line may be attached at a high impedance point at the end of the antenna as shown in Fig. 36. Efficiency of this system is less than with a two-wire feeder because of the radiation. In addition, there will be a mixture of polarization (vertical from the line, and horizontal from the antenna). Radiation from the line is inefficient because

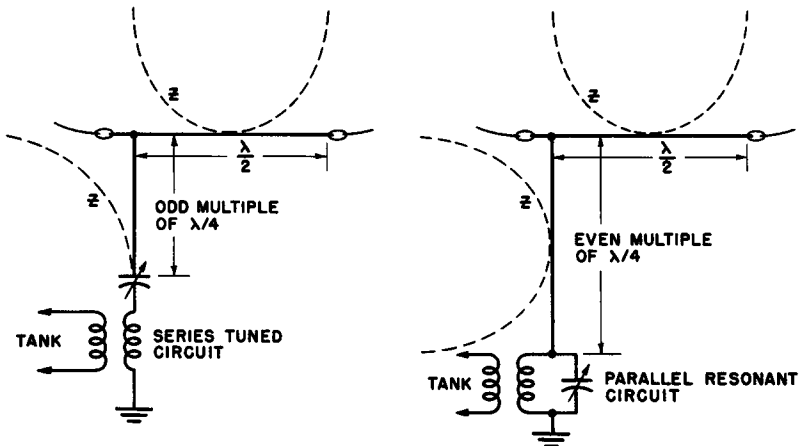

Fig. 36. Single-wire feeder systems.

much of it takes place at heights close to the ground where surrounding metallic objects tend to absorb much of the radiation. The popularity of this type of feeding system is attributed to its simplicity.

23. Feeding with a Non-Resonant Line

Resonant lines, as a class, are not as efficient as non-resonant lines. At low frequencies there is not much difference between the two, but as the frequency enters the vhf region, the presence of standing waves appreciably increases power losses. It is therefore advantageous, when possible, to match the antenna to the characteristic impedance of the line.

The input impedance of an antenna (or antenna system) at its fundamental resonant frequency is a function of many variables. With some antennas it may be a fraction of an ohm, with others thousands of ohms. Non-resonant transmission lines, on the other hand, have come to be standardized in certain popular values of

characteristic impedance: 52, 75, 150, 300, 400, and 600 ohms. There is often a large discrepancy between transmission line and antenna input impedances, and the problem of matching the two cannot be solved by the simple expedient of buying a transmission line of the correct impedance. Of course, a special line with the required impedance might be constructed, but experience has shown that line losses are kept to a minimum when certain construction criteria are adhered to, as they are in the popular impedance values. Impedance matching between antenna and line may be accomplished in one of two ways: by selecting antennas with special

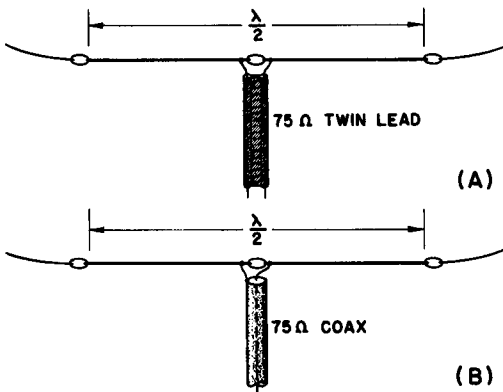

Fig. 37. Direct matching a half-wave dipole to a transmission line.

impedance properties that match those of the line or by using an impedance matching device that converts the antenna's impedance to that of the line. The first method is the simplest, except that there are few antennas that have natural input impedances matching the standard lines. The second approach allows a greater choice of antennas and transmission lines without regard to their impedance properties. It has a disadvantage, in that the matching devices are often complicated and bulky, and require tedious adjustment.

24. Directly Matched Dipoles

The center impedance of a simple thin dipole is in the neighborhood of 72 ohms. This is suitable for a direct match to either a 75-ohm twin-lead parallel conductor transmission line or a 75-ohm coaxial line. These are shown in Fig. 37. Although insulators are used at low frequencies, where the wire length is considerable, rigid conductors are used for both sections of the dipole when operating at frequencies where their length is not excessive. At

frequencies of 14 mc or higher, aluminum tubing is used, supported by a plastic block at the center, where connection terminals are provided for the transmission line. The twin-lead transmission line is balanced to ground, while the coaxial is not balanced. As far as the antenna is concerned, they both present the same impedance, and a match is effected. The center impedance of a simple thin dipole is 72 ohms only at its resonant frequency; at all other frequencies some sort of mismatch will exist. At odd harmonics of its resonant frequency a fair match may be effected, but at other frequencies, the impedance variations are quite high. If the dipole is close to ground, or if it is part of an array, its impedance may drop so low as to make this type of match impractical.

25. Folded Dipole

A useful method of increasing the input impedance is to use a *folded dipole*, as shown in Fig. 38.' The folded dipole affords

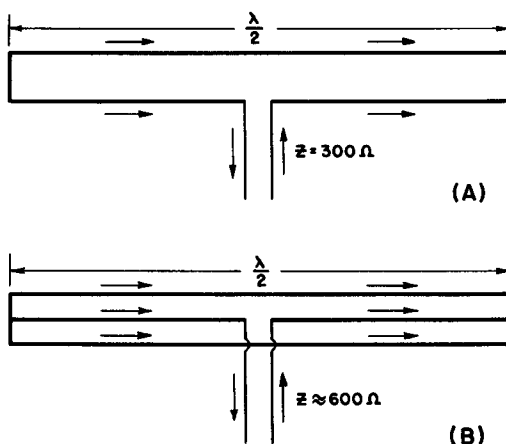

Fig. 38. The folded dipole.

the bidirectional characteristics of a dipole with higher impedance. In A of Fig. 38, the current is divided between the upper and bottom dipoles or conductors. Because the top conductor is "folded" back on the bottom, the currents in the two will be the same. Effectively, the two conductors are in parallel, and the total current of the antenna is equally divided between each conductor. The power fed to the antenna as a whole remains the same as that fed to a simple dipole, and the current in the bottom dipole — where the total power enters — represents one-half of the total current. The impedance presented at the input terminals is four

times as great as that of the simple dipole. (Since $I^2 = P/Z$, $(I/2)^2 = P/4Z$.)

If the spacing between the conductors is small and the diameter of the conductors the same, the input impedance is approximately equal to the input impedance of an ordinary dipole multiplied by the square of the number of conductors. A simple dipole has an impedance of about 72 ohms; therefore, a two-conductor folded dipole has an input impedance of 72×2^2 or about 288 ohms (Fig. 38A). A three conductor folded dipole has an input im-

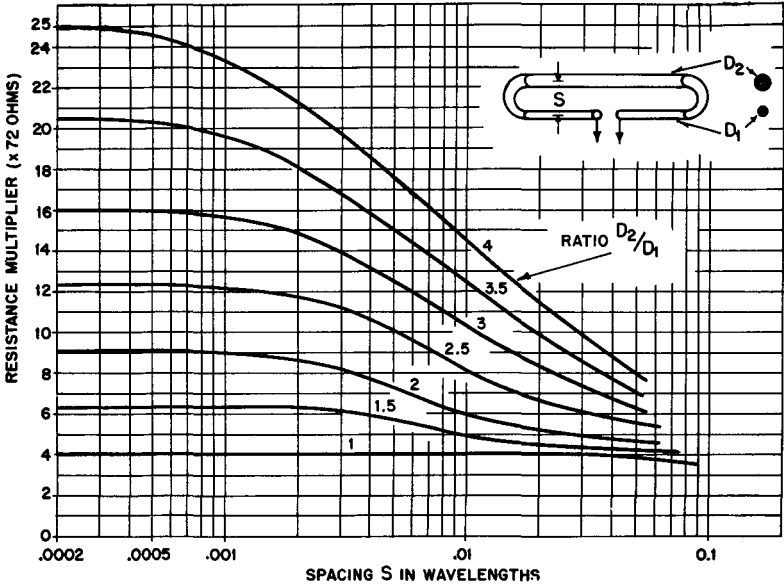

Fig. 39. Design chart for the folded dipole.

pedance of 72×3^2 or about 648 ohms (Fig. 38B). These impedance values are close enough for good matching to a 300-ohm and 600-ohm transmission line, respectively.

Often, in an array, the impedance of the transmission-line-connected element will drop to a low value compared with its free space input impedance. For this reason, it is good practice to start with a high-impedance dipole and rely on the array to bring the impedance down to a level suitable for matching to a lower impedance line. This explains the frequent use of folded dipoles with reflectors and directors in tv antennas.

If a wider choice of impedance values is desired, it may be obtained by varying the size and spacing of the conductors. Figure 39 shows the design characteristics for a two-conductor folded

dipole with variable spacing and conductor sizes. The two-conductor folded dipole has a wider frequency response than a simple dipole. This stems from the fact that the additional conductor acts in parallel with the original. The effect is that of increasing the radiating area and lowering the Q of the system. A lower Q means a greater frequency bandwidth. Consequently, less attention must be paid to cutting the dipole to an exact half-wavelength. This is important in broad band operations, such as television, where an extremely wide frequency response is desirable. Another advantage of a folded dipole is that in its high-frequency version, where it is constructed of tubing, the center of the upper, closed element may be fastened directly to the antenna mast. Since there

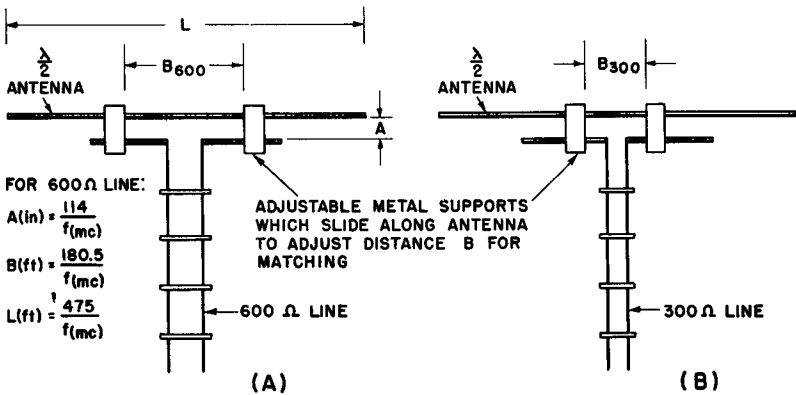

Fig. 40. T matching methods.

is a voltage node at this point, nothing is disturbed in the process. It effectively places both sides of the transmission line at a d-c ground potential. This affords lightning protection.

26. T and Gamma Matching

A T-matched antenna is a combination of a dipole and a two-conductor folded dipole. A and B of Fig. 40 are examples of the T-matched dipole. The principle of operation is analogous to that of a section of transmission line. Each section of the "T" (dimension B) "appears" to the input terminals as a shorted transmission line segment. It acts as an impedance transformer, but because it is less than a quarter-wavelength long, it presents an inductive reactance to the input. Consequently, the antenna is lengthened by the required amount to present sufficient compensating capacitive reactance to counteract this inductive reactance.

The T-matched dipole has several inherent advantages over a folded dipole; it is easier to construct and adjust for the required impedance transformation. It is lighter, simpler, and easier to support. This is important when it is used with an array. If a coaxial transmission line is to be used, only one half of the T match is needed, as shown in Fig. 41. This is known as a "gamma match."

27. The Delta Match

If the center impedance of a dipole is too low to match a given transmission line, the line may be connected at a point on either side of the center, where the impedance is greater. Figure 42 shows

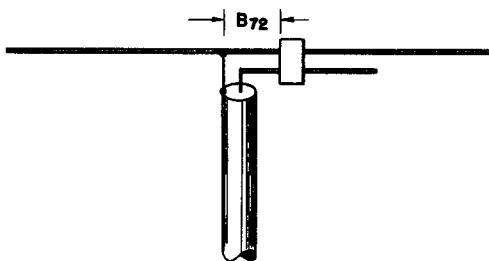

Fig. 41. Diagram of a "gamma match." One half of a T match is used with a coaxial transmission line.

how this may be done. The transmission line is "fanned" outward. This will cause a gradual increase in its characteristic impedance in the fanned section. If the end of the section is connected at the proper points on the antenna, it will match the impedance at the end of the fanned section.

There are so many variables governing the design of this matching system that dimensions are available only for 600-ohm transmission line. These are shown in Fig. 42. There is an inherent disadvantage to this system in that there is always some radiation from the fanned section, even when it is balanced. (Radiation occurs because the conductors are too far apart to cancel each other's magnetic fields.)

28. Quarter-Wave Matching Transformer

During every quarter-wavelength, standing wave conditions reverse on an open or shorted transmission line. A short is transformed to an open a quarter-wavelength away, and a low impedance changes to a high impedance (and vice versa) in accordance with the theory of Chap. 1. The resistive input impedance (R_i)

of a quarter-wavelength line segment is a function of the quotient of the square of its characteristic impedance (Z_s) and its terminating resistance (R_1); that is $R_1 = Z_s^2/R_1$. Expressing this in terms of the *segment characteristic impedance* (Z_s):

$$Z_s = \sqrt{R_1 R_1} \tag{14}$$

where Z_s is the Z_0 of the quarter-wavelength segment, R_1 the load impedance, and R_1 the source or input impedance of the segment.

This expression tells us that if we have two dissimilar impedances that we wish to match, we may insert between them a quarter-wavelength segment of the proper characteristic impedance and, through the impedance transforming properties of this section, effect an impedance match. Wide latitude is allowed by this matching system in the selection of antenna and transmission

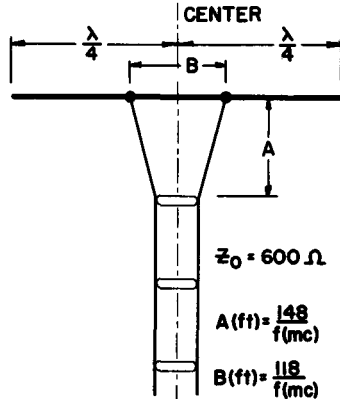

Fig. 42. The delta matched dipole.

line impedances. The only factor governing the extremes of impedances that can be matched is the ability to construct a quarter-wavelength line of the proper impedance. This quarter-wavelength segment is sometimes called a "Q" matching section.

Example: Figure 43A shows a practical matching situation. Here a dipole with a center impedance of 72 ohms must be matched to a 400-ohm open wire transmission line. The value for the segment's characteristic impedance may then be calculated from Formula 14.

$$Z_s = \sqrt{R_1 R_1} = \sqrt{400 \times 72} = \sqrt{28,800} = 170 \text{ ohms}$$

Practically, commercial 150-ohm twin lead would be used because it is close enough to the required impedance.

This type of matching is particularly popular when matching the dipole of a parasitic array to the transmission line. In such an array

(dipole, director, and reflector), the center impedance of the dipole will typically dip as low as 20 ohms (Fig. 43B). The impedance of the matching section required to match this antenna is a 300-ohm twin lead transmission line is:

$$Z_s = \sqrt{20 \times 300} = \sqrt{6000} = 78 \text{ ohms}$$

A commercially available 75-ohm twin lead will serve admirably for this purpose.

29. Matching Stubs

A transmission line that is terminated in other than its characteristic impedance will have reflections of voltage and current (Fig. 44A). The impedance looking into the line is a function of the distance from the load and is composed of a reactance and a

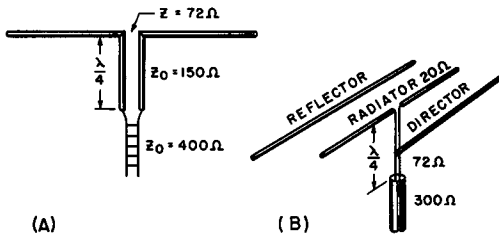

Fig. 43. Matching an antenna to a transmission line with a quarter-wavelength matching transformer.

resistance at every place except at multiples of a quarter-wavelength. Concentrating our attention on the quarter-wavelength section of the line nearest the load, the impedance in this interval will be made up of capacitive reactance and resistance if the load resistance is larger than the characteristic impedance of the line, and inductive reactance and resistance if the load resistance is less than the Z_0 of the line. According to Formula 14, the value of the resistive component of this impedance may assume any value between the load resistance and Z_0^2/R_1 , depending on the location within this quarter-wavelength segment at which the impedance is measured.

Because the resistive component of the reflected impedance may take on almost any value, there must be some place within the quarter-wavelength segment where it equals the Z_0 of the line. At this point, if the reactive component of the impedance is canceled, only the resistance will be left, and as far as the rest of the line is concerned, it will be properly terminated in this resistance. Of course, there will still be standing waves on the section of line between the load and the point of reactive insertion, but this represents a negligible part of the line. If the load resistance is

larger than the Z_0 , a certain value of inductive reactance must be inserted somewhere in this quarter-wavelength interval to cancel the capacitive component of the reflected impedance. If the load resistance is less than the Z_0 of the line, a capacitive reactance of the proper value must be inserted to cancel the inductive reactance. In either case, the point where the opposing reactance is inserted

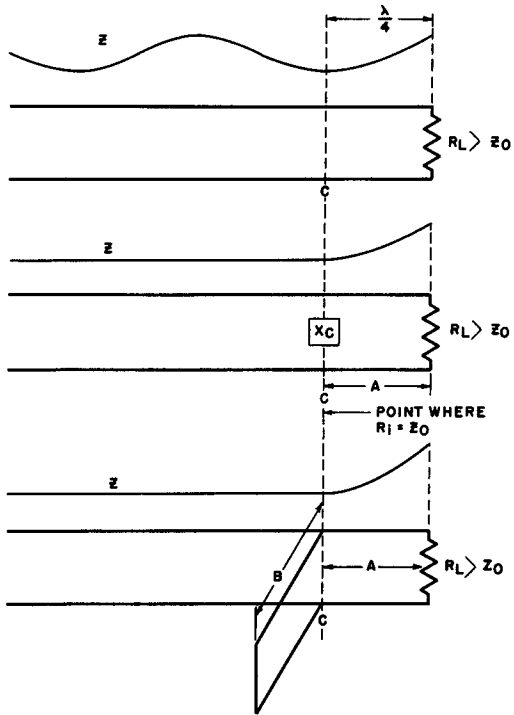

Fig. 44. Action of a matching stub showing change in reflected impedance.

is the point where the resistive component of the reflected impedance is equal to the Z_0 of the line.

Another way of stating the above is to say that the reflected wave produced by the inserted reactance is equal and opposite in phase to the reflected wave that exists on the line at this point by virtue of reflection from the load resistance. The two waves cancel each other and, although there are standing waves over interval A, the rest of the line from A back to the source is flat and free from reflections

An open or shorted section of transmission line of less than a quarter-wavelength serves well as the source for the reactance necessary for insertion at point C. If the section is less than a

quarter-wavelength long and shorted, it presents an inductive reactance at its input terminals; if it is less than a quarter-wavelength long and open at one end, it will reflect a capacitive reactance at the other end. These line segments are called *matching stubs*. The amount of reactance present at the input terminals of the stub is a function of its length with respect to a quarter-wavelength.

The dimensions of the point of connection of the stub (X in Fig. 45) and the length of the stub (Y in Fig. 45) are functions of the Z_o of the stub, the length of the stub, and the SWR of the line. If the stub and line have the same Z_o (as is most convenient), X and Y are dependent only on the SWR of the line. X and Y

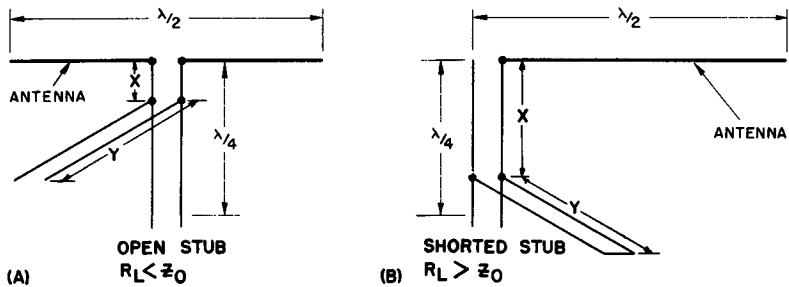

Fig. 45. Applications of a matching stub.

may then be determined without knowing the value of the load resistance if the SWR and point of voltage loop can be found — as they exist on the line before the stub is attached. If the load resistance is less than the Z_o of the line, an open ended stub is connected as shown in Fig. 45A. This is the most typical case when the line current-feeds an antenna. If the antenna is voltage-fed (voltage loop) as in Fig. 45B, a shorted stub is used.

If the load is assumed to be a pure resistance, and if the Z_o of the line and stub are the same, the calculations become simplified. In A and B of Fig. 46 the data have been derived and plotted for dimensions A and B in terms of wavelengths for an open and a shorted stub. It is important to remember that, when converting from wavelength measurement to linear units, the free space length is not usually equal to the physical length; the velocity constant¹ of the transmission line must be taken into account. The conversion formula is:

$$\text{Physical length (feet)} = \frac{984}{f} \times VC \quad (15)$$

¹A chart showing the velocity constant for various transmission lines is given in A. Schure (ed.), *R-F Transmission Lines* (New York: John F. Rider, Publisher, Inc., 1956).

where f is the frequency in mc and VC the velocity constant of the transmission line.

The great advantage of this type of stub matching is that the antenna does not have to be exactly on resonance. Some reactance in the load is quite permissible, since the principle of operation of the system is based on the cancellation of standing waves at the first voltage loop from the load. In fact, this stub matching system can be used to match any load to any transmission line, provided that the load is not a short, an open, or purely reactive in nature.

30. Transmission Line Feed System for Arrays

The purpose of a feeding system for an array is to supply power to, or receive power from each of the driven elements of the array. To do this, an impedance match must exist between

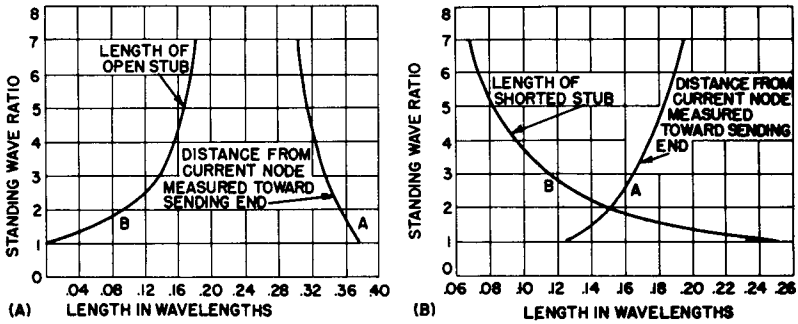

Fig. 46. Matching stub design data. (After *The A.R.R.L. Antenna Book*.)

each of the elements and the common transmission line. In addition, the correct phase relationship between the elements must be retained throughout the feed system. Feeding the driven elements of an array, then, is a problem of impedance matching as well as of phasing.

In Fig. 47, for example, A shows two half-wavelength folded dipoles stacked in a broadside manner and fed in phase. The center impedance of each folded dipole is 300 ohms at resonance, hence a 300-ohm transmission line is connected to each of them. The transmission line that connects at the center — that is, at the junction of the upper (1) and lower (2) 300-ohm lines — will see both sections 1 and 2 of the 300-ohm line in parallel. Thus, at the junction point in the middle, the effective combined impedance of sections 1 and 2 is 150 ohms, and this is the value of transmission line that is needed for proper power transfer. Carrying the idea a bit further to include the identical broadside at B, the same reasoning follows, and a 150-ohm line is also needed to feed

that array. If we choose to combine the two in collinear fashion (indicated by the dotted lines), the junction of the two 150-ohm lines will present a common impedance of 75 ohms. A 75-ohm transmission line is then needed to feed the total array.

Clearly, by applying the impedance matching rules (which we must observe), we have caused the input impedance of the array to decrease in a ratio proportional to the number of folded dipoles

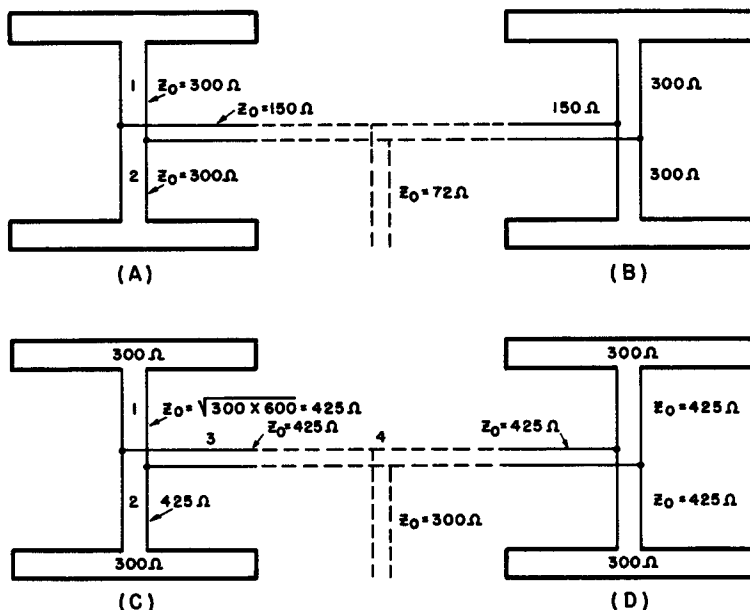

Fig. 47. Transmission line feeding systems for an array.

used. In the same manner, it can be shown that an array of 8 folded dipoles will have a common input impedance of about 35 ohms. If we had used elementary dipoles instead of folded dipoles, the total impedance would have dropped to about 9 ohms. Commercial transmission lines are not available to feed this extremely low impedance. Some sort of matching device is mandatory. Instead of using an external matching network, it has been found feasible to utilize the interconnecting lines themselves as matching devices.

Let us examine C of Fig. 47. Here are the same two folded dipoles, but this time provisions have been made so that interconnecting lines 1 and 2 combine in parallel at the junction point as 300 ohms. The transformation from 300 to 600 ohms is possible because the distance from the junction to each folded dipole is a quarter-wavelength. Selecting this quarter-wavelength segment to

have a characteristic impedance of $\sqrt{600 \times 300} = 425$ ohms, the 300-ohm antenna is made to appear as 600 ohms at the other end of the line segment. The two such segments (1 and 2) combine in parallel at the junction point and present a common impedance of $600 \times 600 / (600 + 600) = 300$ ohms.

A 300-ohm line could very well be matched at this point, but — keeping in mind that we wish to interconnect the entire array, which also includes the broadside at D — we will choose the value of this quarter-wavelength line to be 425 ohms, and at the other end of the segment (at point 4), the line will again appear to have an impedance of 600 ohms. Everything is identical in the broadside at D, so the point at 4 will appear to have two 600-ohm impedances in parallel. This will again combine to form a common impedance of 300 ohms, suitable for connecting to a 300-ohm transmission line.

In designing feed systems of this kind, several precautions should be observed. If the center impedance of the elements is very low (as it would be with a dipole and several parasitics), there is a practical limit to which the impedance may be raised by the quarter-wavelength line segment without incurring too great a power loss in the segment. To keep these losses as low as possible, the ratio of the segment's Z_0 to the element's input resistance should be low. Also, it should be pointed out that each of these segments is a resonant circuit. The presence of too many of them will seriously narrow the frequency response of the antenna as a whole.

31. Review Questions

- (1) Compare and contrast the performance qualities of tuned and flat transmission lines.
- (2) Why is it that conditions on a resonant transmission line are not altered by extending the line a half-wavelength?
- (3) What is the main cause of radiation on both resonant and non-resonant lines?
- (4) Of what importance is the maintenance of a physically symmetrical relationship between the transmission line and the antenna?
- (5) What would be the approximate input impedance of a folded dipole with five elements?
- (6) Could a three-quarter wavelength transmission line segment of the proper Z_0 be used to match two dissimilar impedances? If so, why? If not, why not?
- (7) Why is it that a folded dipole has a wider frequency response than a plain dipole?
- (8) What must be the Z_0 of a quarter-wavelength line segment to match two resistive impedances of 100 and 600 ohms?
- (9) Why are matching sections desirable in the feed system of an array?
- (10) What distinction is made with regard to the SWR between flat and tuned lines?

Chapter 5

PRACTICAL ANTENNA TYPES

There are several variations on the basic dipole design, most of which have been created with a specific purpose in mind. They all make use of the basic antenna principles previously explained.

32. The Conical Antenna and Variations

It is possible to improve greatly the performance of a simple dipole by changing its physical shape. Some examples of such changes are shown in Fig. 48. In all versions the effective diameter of the rods has in some way been expanded. This lowers the inductance and raises the capacitance of the lower rods to provide a lower Q . A lower Q is usually accompanied by a lower gain. The increased area of the conductors, however, intercepts a larger portion of the wave front, so that no decrease is suffered. Such antennas usually have a gain of 1 to 1.5 db over a simple dipole.

In Fig. 48A the size of the rods has been greatly increased. Doing this lowers the resonant (resistive) input impedance to about 40 ohms. The useful frequency bandwidth has been increased to about that of a dipole through this procedure. It is cumbersome and has a higher wind resistance than a dipole. The low center impedance makes it inconvenient for matching directly to a transmission line.

To correct for the disadvantages of large-diameter tubing, the conical antenna (Fig. 48B) was developed. It consists of two right circular cones lying on a common axis of revolution. In the commercial version the cones are made of light sheet metal. The transmission line is attached to the apex of each cone, as indicated. The great advantage of the conical over the thick rod dipole is that

the input impedance is a function of the angle of revolution, Θ . The input impedance at resonance is related rather closely to angle Θ by input impedance (ohms) = $1300 - 70\Theta$.

Example: If the angle of revolution is 10 degrees, what is the input impedance?

$$1300 - 70(10) = 1300 - 700 = 600 \text{ ohms.}$$

By making Θ the correct value, virtually any desired input impedance may be obtained for this antenna.

The element length should be approximately $.365$ wavelengths, as measured along the surface of the cone. This antenna has a useful bandwidth of over 30 percent of its center frequency. Over this range, its input impedance is very nearly constant.

Unfortunately, the conical antenna is large and unwieldy, and has a large wind resistance. If at least 10 equally spaced radial wires (Fig. 48C) are used instead of the sheet metal surface, we can closely approximate the original performance. As the number

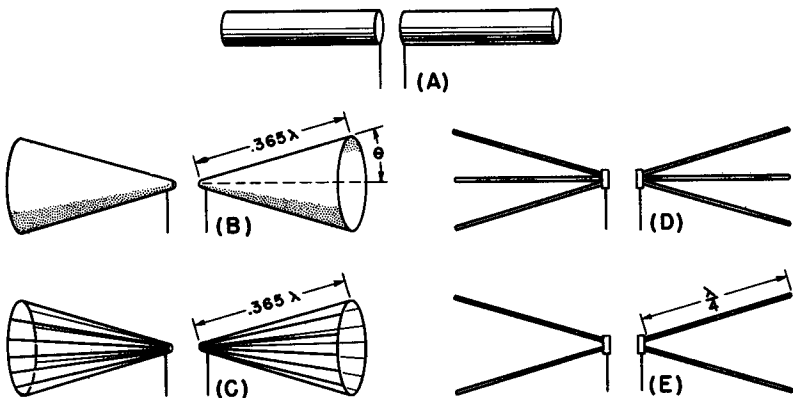

Fig. 48. Variations on the dipole design.

of rods is decreased, the approximation to a pure conical antenna diminishes. D and E are further modifications that have, in varying degrees, the advantages of a conical antenna.

33. The Circular Antenna

By modifying a folded dipole so that it forms a circle, or loop (Fig. 49), greater gain and directivity are obtained than with most other types of dipole modifications. Because the ends are at a current loop, while the voltage loops occur at points of large conductor area, the normal end (shortening) effect is not present. The circumference is essentially a full free-space wavelength.

Because there is a large space between the top and bottom parts of the antenna, it exhibits a definite broadside characteristic, and has a rather low vertical angle of radiation. As a consequence, noise pickup from the ground is reduced when the antenna is used for reception. The circular antenna has considerably less bandwidth than a dipole.

34. Omnidirectional Antennas

There are times when directivity is not the prime object in antenna design, for example, when the receiving site is surrounded

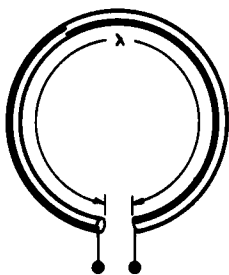

Fig. 49. The circular antenna.

by a number of tv transmitters; under these conditions, it would be desirable to have equal sensitivity to all signals.

Such omnidirectivity may be obtained by bending an ordinary folded dipole around in a circle as shown in Fig. 50. The horizontal directional pattern thus obtained is nearly circular. Of course, since the energy of the antenna (if used in transmitting) is spread out equally in all horizontal directions instead of being concentrated in two lobes, there is a decrease in the radiation strength. This type of antenna has a loss of about 2 to 3 db with respect to a dipole.

The same results may be achieved by mounting two folded dipoles at right angles to each other and connecting them in parallel. Of course, the resulting input impedance is only 150 ohms. Connection to a 300-ohm transmission line with a 2:1 SWR is possible as shown in B of Fig. 50. Plain dipoles could be used but the combined input impedance would then be only 36 ohms.

35. The Vertical "J" Antenna

The vertical "J" antenna is a vertical radiator combined with a quarter-wavelength matching section. This is a higher frequency version of the end-fed antenna of Fig. 35D. The one difference is

that here provision is made for matching to twin-lead transmission line, as shown in Fig. 51A. The input impedance of the antenna is about 50 ohms, so that when coaxial line is used it may be connected directly to the bottom of the antenna (Fig. 51B). Matching to twin lead is accomplished by sliding the lead up and down the matching section until the proper point is reached; this is the point of maximum signal pickup. The bottom shorting bar of the section may be grounded, if desired.

Several disadvantages of the "J" antenna make its application rather limited. Radiation often occurs from the matching section, which combines with the radiation from the main radiator, producing a distorted radiation pattern and a much higher vertical

Fig. 50. Omnidirectional antennas.

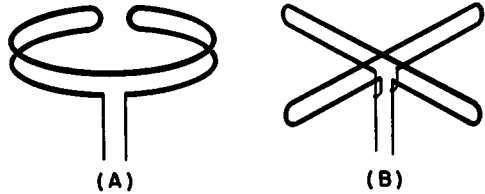

angle of radiation. This happens especially in the vhf and uhf regions, where the spacing between the conductors of the matching section is greater in terms of wavelength.

The vertical radiation characteristics do not hold when operating off resonance. For this and other reasons, the antenna is rather limited in its application. Its gain at resonance is zero db.

36. The Coaxial Antenna

To eliminate matching section and feeder radiation of the "J" antenna, the coaxial antenna shown in Fig. 52A was developed, in an effort to maintain the lowest possible angle of radiation. The center conductor of the 72-ohm coaxial line is connected to the upper portion of the antenna, which serves as a quarter-wavelength radiator. The coaxial line is run through a quarter-wavelength sleeve, as shown in the illustration. The outer (shield) conductor of the line connects to the sleeve at its top. This sleeve acts as the lower half of the dipole. Since the line runs into the antenna at its axial center, it cannot interfere with radiation. The antenna has a very narrow frequency response, inasmuch as the dimensions of the sleeve are governed by the frequency of operation. Small variations from this frequency will result in severe power losses. This antenna also has a gain of zero db.

37. The Ground-Plane Antenna

The ground-plane antenna is basically a vertical quarter-wavelength radiator with a counterpoise included as a physical part of the antenna. A counterpoise, as explained in Chap. 1, provides a good grounding system for the Marconi antenna when soil conditions prohibit any other method of grounding. This is so important that broadcast stations are required by the FCC to have at the base of the grounded Marconi antenna a circular counterpoise composed of at least 120 radially positioned wires at least

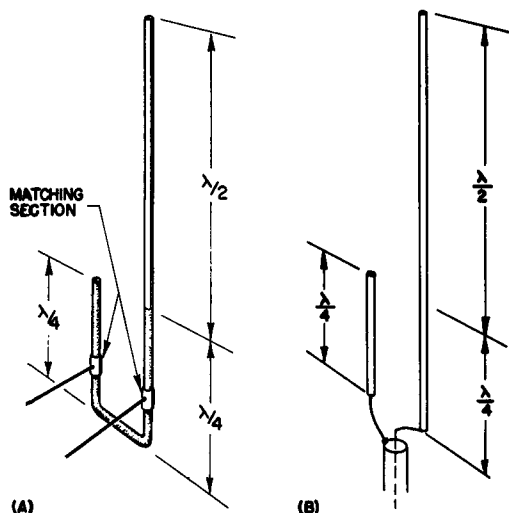

Fig. 51. The vertical "J" antenna.

a quarter-wavelength long. The main reason for this is to insure good radiation at the ground level. Without a good ground system such as this, much of the radiation below a vertical angle of about 5 degrees is absorbed by the ground. Attaching a counterpoise at the base of a small uhf version of a Marconi antenna will insure that low angles of radiation are not lost.

The most perfectly simulated ground that can be installed is a large metal sheet over a quarter-wavelength in radius, as shown in Fig. 52B. The input impedance of this antenna is about 35 ohms. It is an uneconomical and unwieldy affair except at frequencies of 100 mc or higher. A modification of this ground plane antenna is shown in C of Fig. 52. Here little difference is experienced in the performance, except that input impedance has dropped to between 20 and 35 ohms. One disadvantage of this antenna is this very low input impedance, which requires a matching section for connection to any standard coaxial line.

To raise the input impedance, the radial wires may be bent below the horizontal, as shown in Fig. 52D. As the angle (θ) that the radials make with the horizontal increases, the input impedance rises. In this way a satisfactory direct match may be secured with a standard 52-ohm coaxial line. The input impedance may be further increased by bending the radials down in the fashion shown in E of Fig. 52. In this model, a direct match to 75-ohm coax is realized. The gain of all ground-plane antennas described is zero db, and they all have vertical polarization.

The main advantages of all types of ground-plane antennas are low vertical angle of radiation, small cost, simplicity, and small space requirements.

38. The Corner Reflector

At very high frequencies, where the size of an antenna system is small, other more complicated antenna designs are feasible. Representative of the lot is the corner reflector shown in Fig. 53.

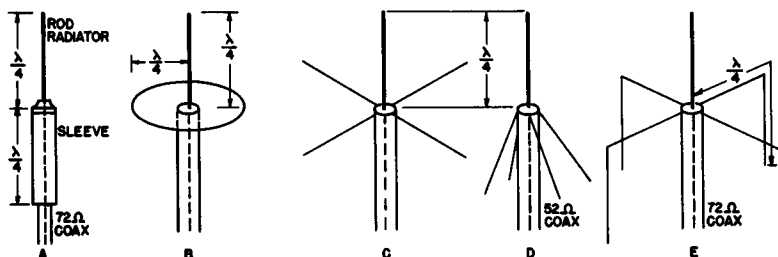

Fig. 52. The coaxial (A) and ground-plane (B-E) antennas.

This is a dipole (or folded dipole) mounted in a line with the apex of the corner formed by two reflecting sheets at a distance of about .5 wavelength. These sheets do not have to be solid, but may be made of chicken wire or rods spaced no more than 0.1 wavelength apart. The reflectors are at least 5 percent longer than the dipole and extend outward for at least a wavelength. Dimensions are not critical in this antenna. The apex angle is often 90 degrees. The impedance of the center-fed dipole under these conditions is about 150 ohms. This antenna is capable of gains up to 10 db, and is noted for its high front-to-back ratio.

39. Multi-frequency Antennas

In communications, it is frequently desirable to have an antenna that operates well at two or more widely-separated frequen-

cies. This allows a change of operation from one of these frequencies to any other without changing the antenna.

If the desired extra frequencies are *odd multiples* of a fundamental, coverage of the extra frequencies is quite easily obtained by use of a half-wavelength dipole cut for the fundamental, as illustrated in Fig. 54. At the fundamental frequency, f , the standard half-wave dipole characteristics apply, and there is a current loop

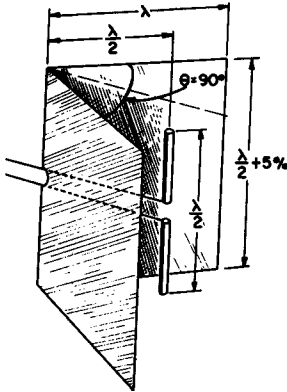

Fig. 53. Corner reflector.

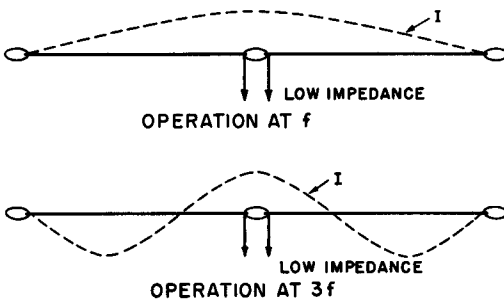

Fig. 54. A simple form of multi-frequency antenna. It is a half-wavelength dipole at f , with low-impedance feed. At $3f$ the center characteristics of the antenna are the same.

at the center feed point. This means that a low-impedance line, such as a coaxial type, can be connected there for a good match. At the third harmonic, or $3f$, there is also a current loop at the center, and the antenna feed point presents a relatively low-impedance and acts as a $3/2$ -wavelength wire. The antenna feed point impedance remains relatively low, but higher than 72 ohms for $5f$, $7f$, and all odd multiples of the fundamental frequency. Of course, directivity changes as frequency increases, as explained earlier.

For even multiples of the fundamental frequency, such as $2f$, $4f$, $6f$, etc., the impedance at the center is high and increases as the

order of "f" increases. To provide coverage at these frequencies, a resonant line must be used.

If the desired extra operating frequencies are not harmonically related, these arrangements cannot be used. In that case, multi-frequency coverage can be obtained by the use of *traps* in what is known as a *multimatch* or *multiband* antenna. The traps isolate

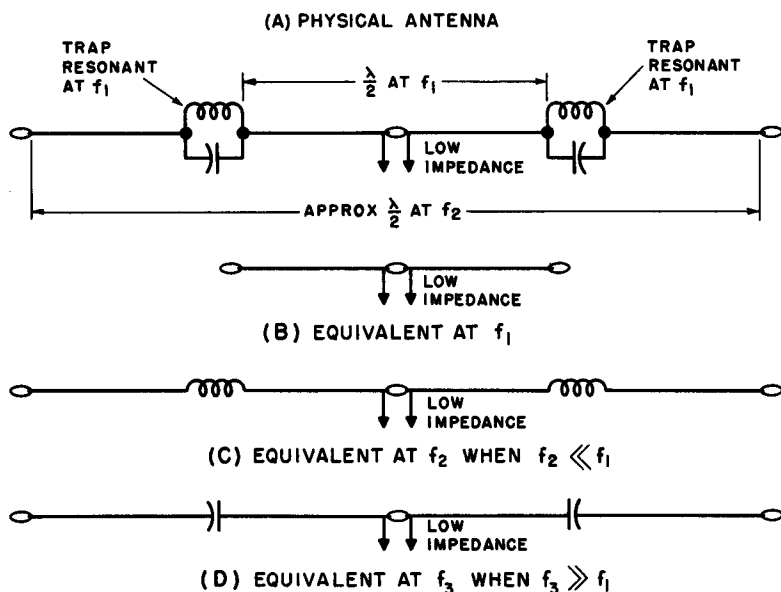

Fig. 55. Typical trap-type multi-frequency antenna, showing its equivalent circuit at several different frequencies.

parts of the antenna at frequencies at which this is desirable. An example of such an antenna is shown in Fig. 55A. Each trap is a parallel-resonant L-C circuit tuned to a given high frequency, f_1 . The center portion is a half-wavelength at f_1 . The whole length of the antenna, including the portions outside the traps, is approximately a half-wavelength at some frequency considerably lower than f_1 . Why it is only approximately a half-wavelength will be apparent in the discussion that follows.

At frequency f_1 , the traps are resonant and act as open circuits, like insulators. Thus the portion of the antenna inside the traps is a half-wavelength dipole at f_1 acting by itself without interference from the remainder of the antenna. The equivalent of the antenna at f_1 is as shown in B of Fig. 55.

Frequency f_2 is substantially below f_1 . The traps, being parallel-resonant circuits, become equivalent to inductances at the

lower frequency. Therefore, the equivalent circuit at f_2 is as shown at C of Fig. 55. The inductance added by the traps "loads" the antenna. For this reason, the antenna's physical length must be made less than that of a simple wire dipole at that frequency.

At other frequencies, higher than f_1 , the traps are equivalent to capacitances, as indicated at D. At any frequency above f_1 the length of the whole antenna can be made approximately an odd number of half-wavelengths long. The feed point in the center will then match a low impedance line. Capacitors in series with an antenna tend to shorten it, so the physical length of the whole antenna must be adjusted to resonate at the desired odd-multiple frequency; it is thus longer than a simple wire similarly resonant.

A typical antenna of this type, popular in amateur radio operation, resonates the center portion and the traps near 7 mc (40-meter band). The whole antenna is equivalent to a half-wavelength near 3.5 mc (80-meter band), and becomes a $3/2$ -wavelength antenna at 14 mc (20-meter band).

40. Review Questions

- (1) Give the advantages of a conical antenna over the basic dipole design.
- (2) Explain the effects of expanding the effective diameter of the rods of a basic dipole on (a) inductance, (b) capacitance of the lower rods, and (c) Q of the antenna.
- (3) List the characteristics of a circular antenna with respect to gain and directivity. Explain the reasons for the characteristics you have listed.
- (4) Define "omnidirectivity." Draw a sketch of an omnidirectional antenna and list its primary features.
- (5) Why is the vertical "J" antenna limited in its applications?
- (6) What antenna type could be utilized to eliminate matching section and feeder? Why?
- (7) What is the purpose of the counterpoise included as a physical part of the ground-plane antenna?
- (8) What are the advantages of the ground-plane antenna?
- (9) Describe the "corner reflector" type of antenna with respect to physical configuration, impedance characteristics, gain capabilities, and front-to-back ratio.
- (10) Describe the action of the L-C traps used in multi-frequency antennas.

INDEX

- Antenna, orientation of, 46
- Antenna characteristics, table of, 42
- Apex angle, 45, 48, 73
- Average surge impedance, 13

- Balanced half-wavelength Hertz, 21
- Basic antenna, 5-8
- Beam, 37
- Beamwidth, 27
- Bi-directional horizontal radiation, 41
- Broadside array, 26, 32-33

- Capacitance effect, 13
- Capacitive load, 4
- Capacitive loading, 76
- Cardioid pattern, 32
- Center impedance, 56
- Center-fed antenna, 53
- Center-fed dipole, 10
- Characteristic impedance, 9, 42, 44, 56
- Circular antenna, 69-70
- Clover leaf lobes, 40
- Clover leaf patterns, 17
- Coaxial antenna, 71
- Coaxial line, 57
- Collinear, definition of, 26
- Collinear array, 27-29
- Combined impedance, 65
- Conductor spacing, 58

- Conical antenna, 68-69
- Conical antenna, variations of, 68-69
- Corner reflector, 73
- Corona discharge, 8
- Counterpoise, 23, 72
- Current node, 3
- Cut frequency, 10

- Decibels, 26
- Delta matching, 59-60
- Dielectric losses, 8
- Dipole antenna, 10
- Directional array, 26
- Directive antenna elements, 26
- Directive antenna gain, 26
- Directive array, 27
- Directivity, 13, 25-27
- Directly matched dipoles, 56-57
- Displacement current, 8
- Doughnut, 16
- Driven arrays, 26-34
- Driven elements, 26

- Effective radiated power, 23
- Effective rod diameter, 68
- Electric field, 7
- Electrical length, 5
- Electrical length variation, 21-24
- Electromagnetic field, 7

- Electrostatic field, 7
- Electrostatic lines of force, 8
- Element length, conical antenna, 69
- End effect, 14
- End-fed systems, 54
- End-fire antenna, 32
- End-fire array, 26, 29-31

- FCC requirements, Marconi antenna, 72
- Feed point, 23
- Feed system for arrays, 65-67
- Folded dipole, 57-59
- Four-element parasitic antenna, 37
- Free-space conditions, 19
- Free-space radiation pattern, 18, 41
- Full rhombic antenna, 49-51
- Full-wave antenna, 15

- Gain, 13
- Gamma matching, 59-60
- Ground conductivity, 18
- Ground effects, 17
- Ground plane, 20, 23
- Ground-plane antenna, 72-73
- Ground resistance, 23
- Ground system, 23
- Grounded Marconi, 20-21

- Half rhombic antenna, 47-49
- Half-wave antenna, 7, 9, 15
- Half-wave dipole, 5, 21
- Half-wavelength dimensions, 12
- Harmonic antenna, 13-14
- Harmonic of operation, 13
- Harmonically operated dipole, 13-14, 17
- Heat radiation, 8
- Hertz antenna, 5, 20
- Horizontal half-wave antenna, 18
- Horizontal polarization, 41
- Horizontally polarized waves, 8

- Impedance matching, 13, 56
- Impedance variation, 4
- Incident wave energy, 3
- Infinite impedance, 3
- Input impedance, conical antenna, 69

- Length/diameter ratios, 10
- Lightning protection, 59
- Line impedance, 4
- Line termination, 5
- Line wavelength, 3
- Loaded resonant dipole, 36
- Loading coil, 21
- Long single wire antenna, 39-45

- Magnetic field, 8
- Marconi antenna, 20-21, 72
- Matching devices, 5, 53, 66
- Matching section, 29
- Matching stubs, 62-64
- Maximum transfer of power, 52
- Minimum resistive impedance, 6
- Mismatch, 4
- Multi-band antenna, 75
- Multi-frequency antennas, 73-76
- Multi-frequency antennas, fundamental frequencies of, 74
- Multi-match antenna, 75
- Multiplication factors, 18

- Non-resonant line, 52
- Non-resonant line feeding, 55-56
- Non-resonant long wire antenna, 42

- Ohmic resistance, 8
- Omnidirectional antenna, 70
- Open circuit load, 3
- Orientation, formula for, 40-41

- Parallel resonant circuit, 54
- Parasitic arrays, 34-37
- Parasitically excited elements, 26
- Phase relation between elements, 31
- Phasing, 27
- Phasing stub, 28
- Physical shorting effect, 13
- Polar coordinates, 15
- Proportionality constant, 10

- Q, 10, 12, 29, 36, 59
- Q matching section, 61
- Quarter-wave matching transformer, 60-62

- Radiated power, 25
- Radiation, 7-8
- Radiation pattern, 15, 16, 17, 44, 71
- Radiation
 - resistance, 8-12, 18-19, 22-24, 36
- Reference power, 26
- Reflected impedance, 62
- Reflected wave, 3, 35
- Reflection coefficient, 3, 4
- Reflection factor, 18
- Reflector length, 35
- Re-radiated power, 34
- Re-radiated wave, 34
- Re-radiation delay, 35
- Resonant line feeding, 52-54
- Restricted harmonic operation, 41
- Rod periphery, 10

- Segment characteristic impedance, 61
- Signal-to-noise-ratio, 39
- Simple dipole, 57
- Simulated ground, 72
- Single element antenna, 15
- Single wire feeder, 55
- Stacked elements, 33
- Standing wave ratio, 4, 5, 52, 64
- Standing waves, 4, 6, 15, 43, 52-53, 55
- Surge impedance, 9-10
- SWR, 4, 5, 52, 64

- T matching, 59-60
- Terminating resistor, 50
- Three-element array, 36
- Tilt angle, 48-50
- Top loading, 23-24
- Transmission line matching, 12
- Transmission line segments, 5-6
- Transmission lines, review of, 2-5
- Traps, 75-76
- Tuned transmission line, 52, 54
- Twin lead transmission lines, 57
- Two-conductor folded dipole, 58-59
- Two-element antenna, 33

- Unidirectional array, 36
- Unidirectional characteristics, 51
- Untuned transmission line, 55-56

- V antenna, 45-47, 49
- Velocity constant, 65
- Vertical "J" antennas, 70-71
- Vertical polarization, 20, 41
- Vertical radiation, 41
- Vertically polarized waves, 8
- Voltage node, 3, 5
- Voltage standing wave ratio, 4
- VSWR, 4

- Whips, 21