

No. 170-1

basic electronics

by **VAN VALKENBURGH,
NOOGER & NEVILLE, INC.**

VOL. 1

INTRODUCTION TO ELECTRONICS
DIODE VACUUM TUBES,
DRY METAL RECTIFIERS
WHAT A POWER SUPPLY IS
FILTERS, VOLTAGE REGULATORS

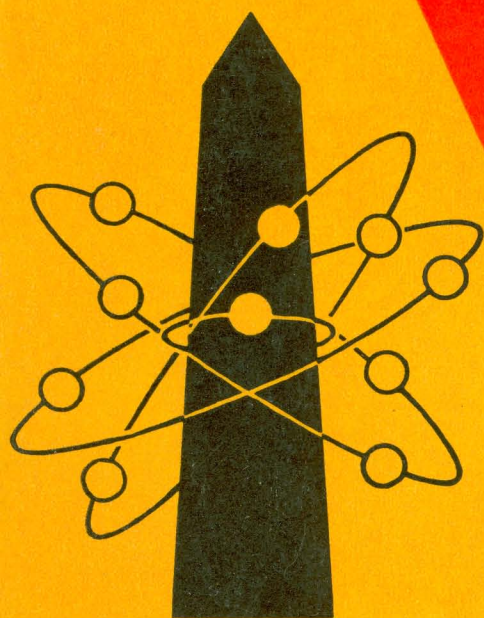

A. STICH

a **RIDER** publication

\$2.25

basic electronics

**by VAN VALKENBURGH,
NOOGER & NEVILLE, INC.**

VOL. I



JOHN F. RIDER PUBLISHER, INC.
116 West 14th Street • New York 11, N. Y.

First Edition

Copyright 1955 by

VAN VALKENBURGH, NOOGER AND NEVILLE, INC.

All Rights Reserved under International and Pan American Conventions. This book or parts thereof may not be reproduced in any form or in any language without permission of the copyright owner.

Library of Congress Catalog Card No. 55-6984

Printed in the United States of America

PREFACE

The texts of the entire Basic Electricity and Basic Electronics courses, as currently taught at Navy specialty schools, have now been released by the Navy for civilian use. This educational program has been an unqualified success. Since April, 1953, when it was first installed, over 25,000 Navy trainees have benefited by this instruction and the results have been outstanding.

The unique simplification of an ordinarily complex subject, the exceptional clarity of illustrations and text, and the plan of presenting one basic concept at a time, without involving complicated mathematics, all combine in making this course a better and quicker way to teach and learn basic electricity and electronics.

In releasing this material to the general public, the Navy hopes to provide the means for creating a nation-wide pool of pre-trained technicians, upon whom the Armed Forces could call in time of national emergency, without the need for precious weeks and months of schooling.

Perhaps of greater importance is the Navy's hope that through the release of this course, a direct contribution will be made toward increasing the technical knowledge of men and women throughout the country, as a step in making and keeping America strong.

Van Valkenburgh, Nooger and Neville, Inc.

New York, N. Y.

February, 1955

TABLE OF CONTENTS

VOL. 1 — BASIC ELECTRONICS

Introduction to Electronics	1-1
What a Power Supply Is	1-7
Half-Wave Rectifiers — Dry Metal Type	1-17
Half-Wave Rectifiers — Vacuum Tube Type	1-23
Half-Wave Rectifiers — Transformer Type	1-39
The Full-Wave Rectifier Circuit	1-45
Filter Circuits	1-52
Voltage Regulator Circuits	1-81
Other Types of Power Supply Circuits	1-92
Characteristics of Diode Vacuum Tubes	1-109

introduction to

ELECTRONICS

What You Are Going To Do Now

You now have a good solid foundation in the field of electricity. You know how electricity is generated, how electron current flows through a circuit, the nature and uses of magnetism, the proper use and care of meters, the characteristics of DC and AC and how various types of electrical motors and other electrical devices operate.

Now you have all the fundamental knowledge that you need to begin your study of a new and fascinating subject—electronics.

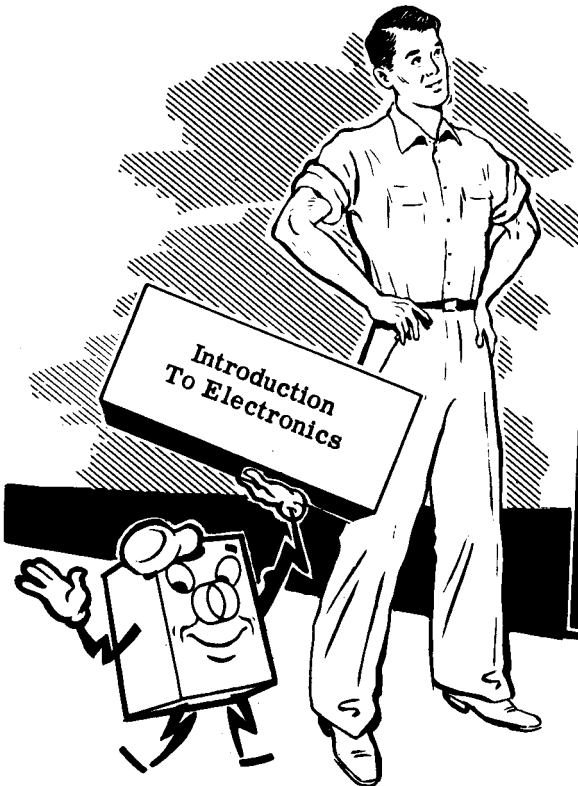

BASIC ELECTRICITY

Vol. 5
DC & AC
Machinery

Vol. 4
AC Circuits

Vol. 3
Alternating
Current

Vol. 2
DC Circuits

Vol. 1
Introduction to
Electricity

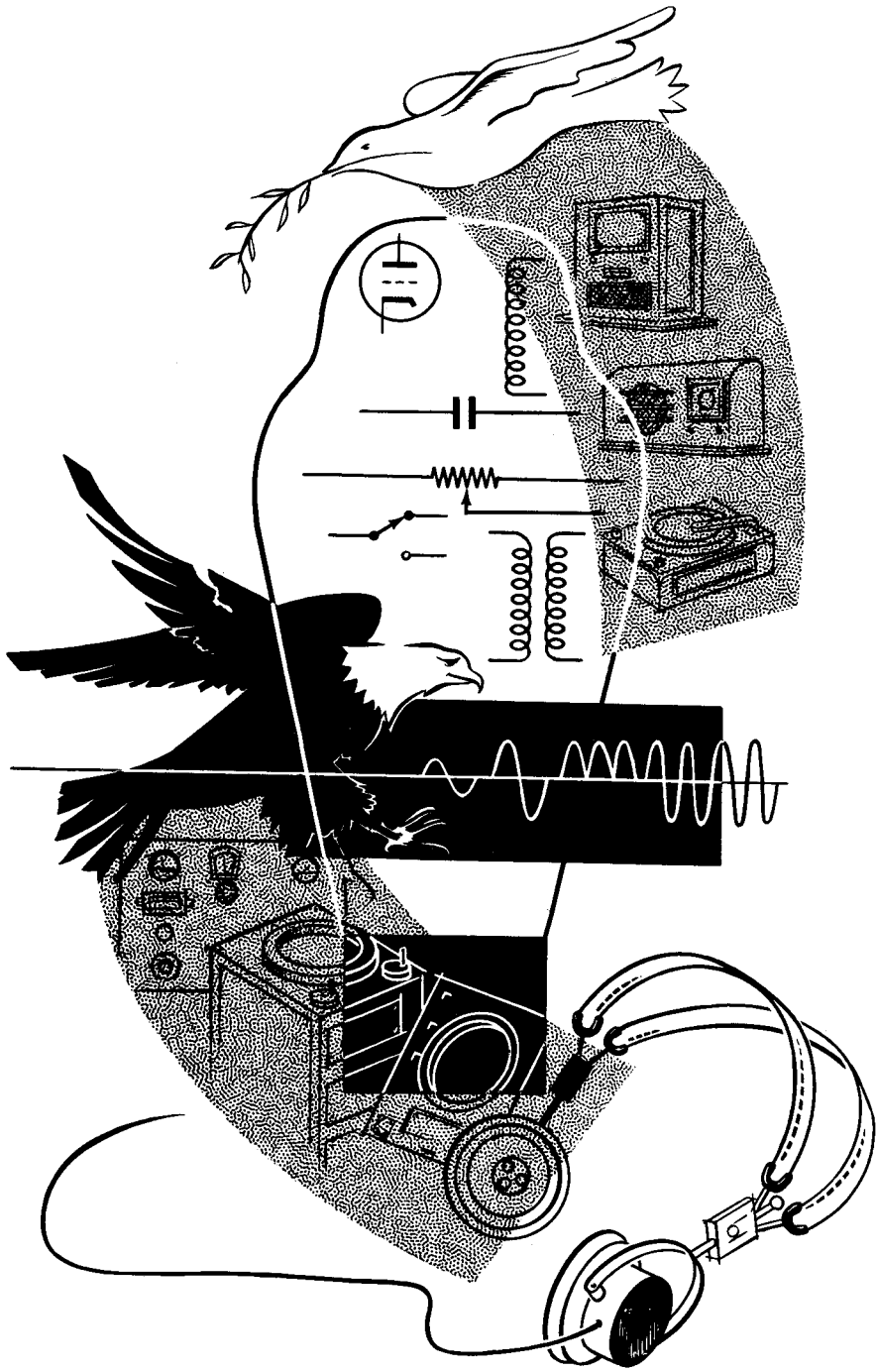

Introduction to electronics

INTRODUCTION TO ELECTRONICS

The Meaning of "Electronics"

You have heard the word "electronics" many times in the past. Electronics means the science of the electron. Since the study of electricity and electronics both involve the use of the concept of electron flow, you may wonder where electricity ends and electronics begins. For your purposes it is easy enough to make the distinction that electronics is the science which is concerned with the flow of electrons through vacuum or gas-filled tubes sometimes called "electron tubes." Thus, electronics includes the study of any equipment that contains "tubes."

You are already acquainted with quite a few types of electronic equipment. Radio—"talkie" motion pictures—record players—public address systems—television—"electric eye" door openers—all of these make use of "tubes" and are correctly termed electronic equipment. Of course they also make use of various types of DC and AC circuits, of meters, transformers, capacitors, and all the other components which you have learned about in Basic Electricity. That is why you needed a course in fundamentals before going on with the electronics phase of your study.

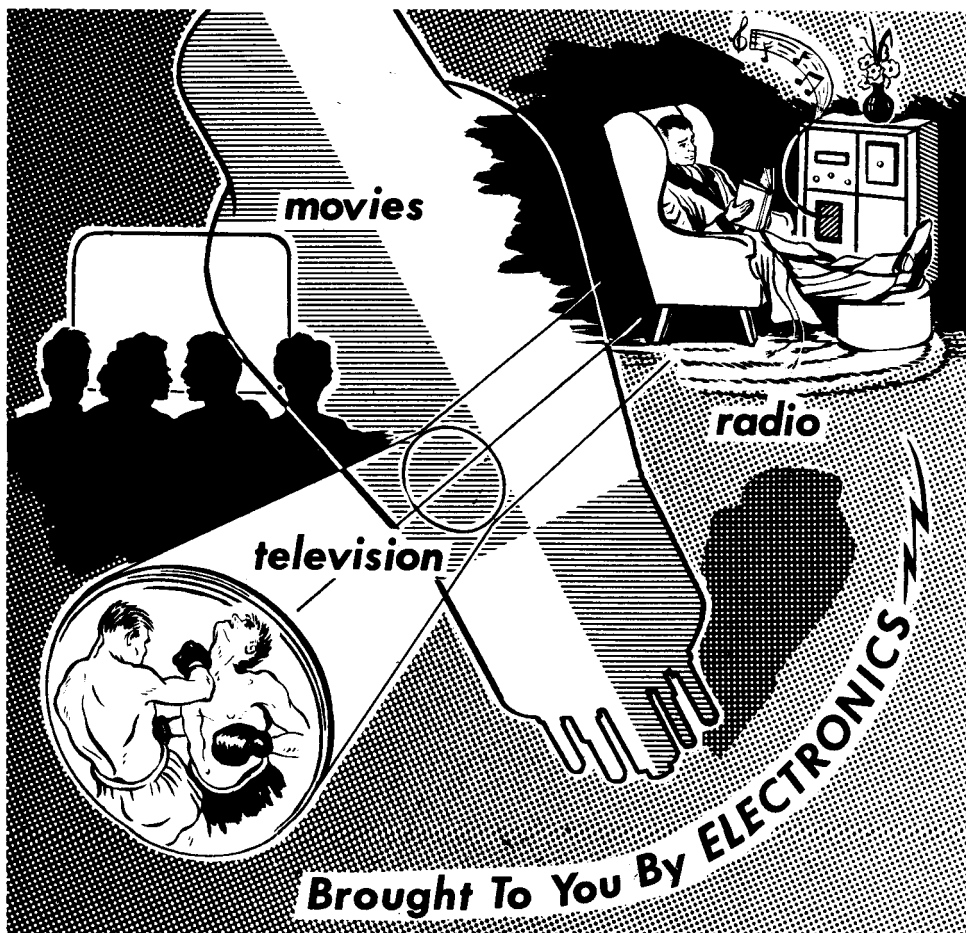

INTRODUCTION TO ELECTRONICS

Electronic Equipment

All electronic equipment is made up of only a few basic circuits. Just how many basic types of circuit are there? Three! Are there any other types you will ever have to know? There are additional types of special circuits you will have to learn when you begin to study equipment, but these special circuits are nothing but variations of the three basic electronic circuits.

The three basic electronic circuits are rectifier circuits, amplifier circuits and oscillator circuits.

Rectifier circuits change AC to DC. Their most common use is in electronic equipment power supplies which take AC from the power line and transform it to DC which is required to operate electron tubes.

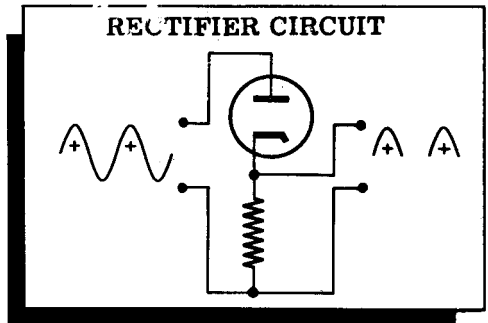

Amplifier circuits take small voltage changes and enlarge or amplify them into large voltage changes. Amplifier circuits are by far the most commonly used circuits in electronic equipment. They take very weak signals that are barely detectable and amplify them into strong signals that can drive a pair of earphones, a loudspeaker or an oscilloscope.

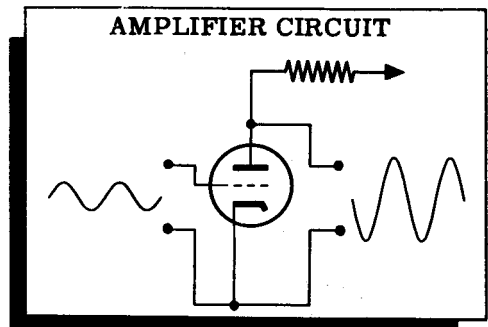

Oscillator circuits generate AC voltages at any particular desired frequency. Oscillator circuits are used to generate the AC voltages that carry a radio signal from one place to another. They are also used very extensively for testing other electronic circuits.

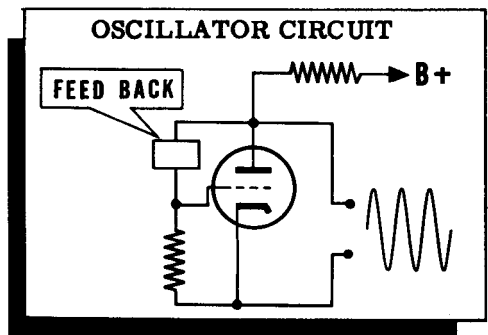

INTRODUCTION TO ELECTRONICS

Parts Used in Electronic Equipment

Now that you have found out that there are only three basic types of electronic circuits (rectifiers, amplifiers and oscillators) that you have to be concerned with, you probably would like to know about the parts used in those circuits. Actually there are only six commonly used types of parts in electronic circuits. Five of these parts you already know—resistors, capacitors, coils, transformers and switches. There is one additional type of part that you will learn about very soon—"vacuum tubes."

You see that by understanding three basic types of electronic circuits and the use of six types of parts in those circuits, you will understand all you need to know about electronics for the present.

*From such as these
are circuits made*

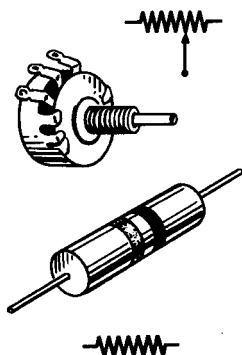

RESISTOR

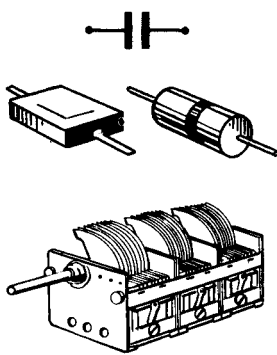

CAPACITOR

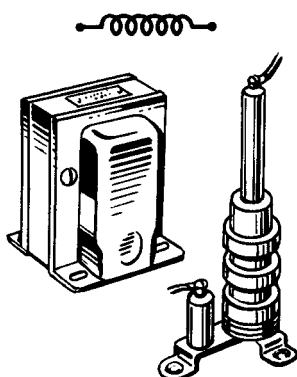

COIL OR
INDUCTANCE

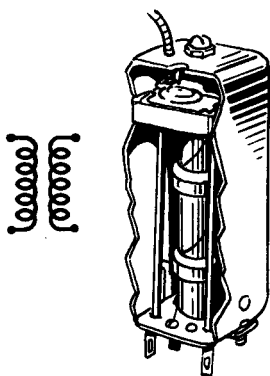

TRANSFORMER

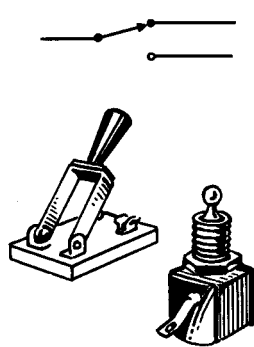

SWITCH

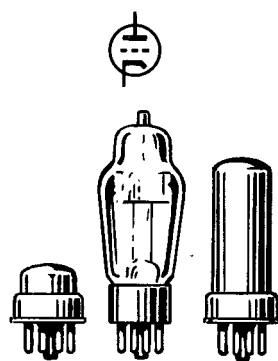

VACUUM TUBE

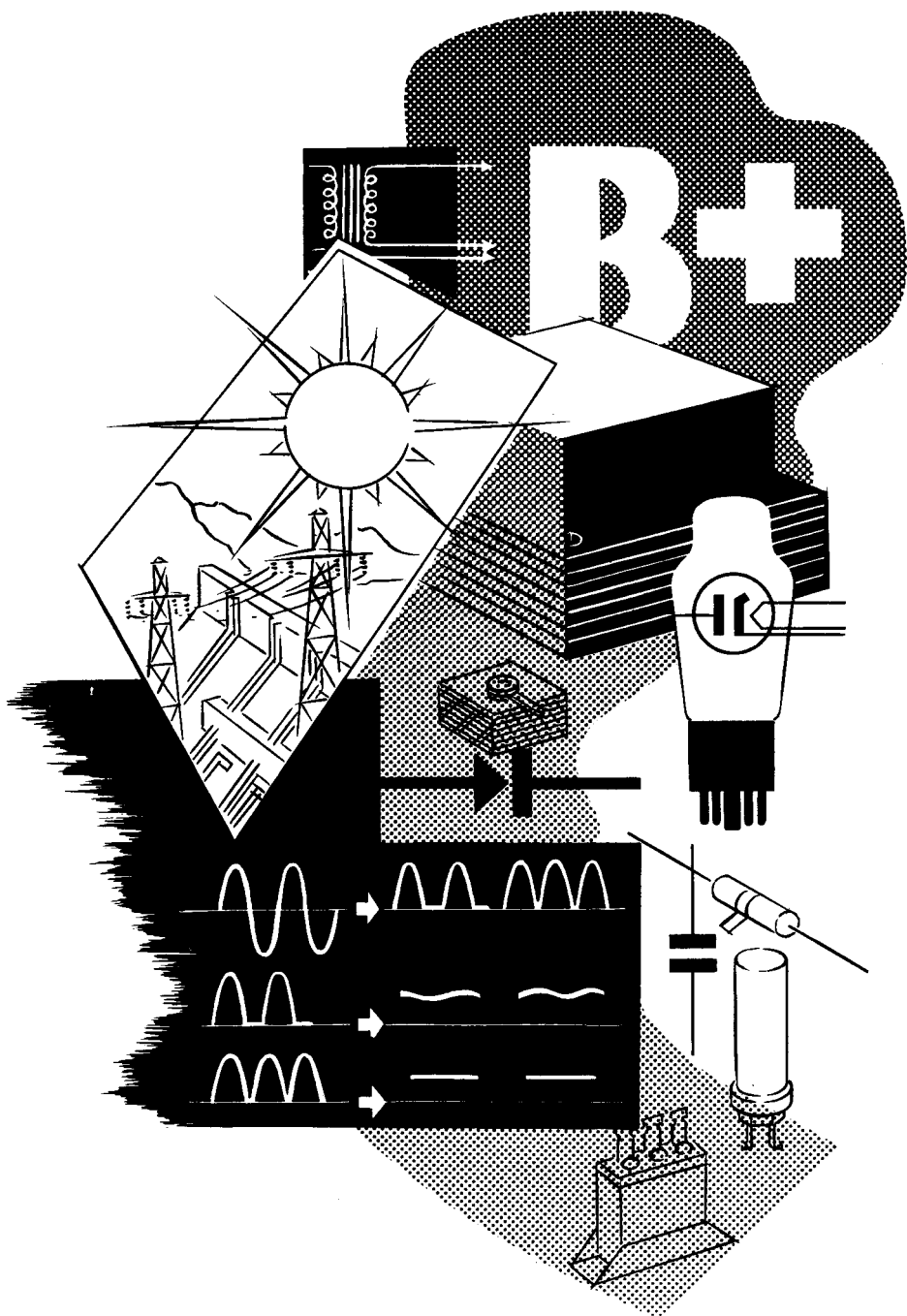

Power Supplies

WHAT A POWER SUPPLY IS

Importance of Power Supplies

Everything that lives or does work must have a source of power or a "power supply." The sun supplies power that enables plants to manufacture food, and food in turn supplies the power that makes you live and move, - speak, run, and think. In the realm of non-living mechanisms, the motor in the old Model "T" supplied power to move the car as surely as the huge turbines at Boulder Dam supply power today to drive electric generators.

It is obvious that the same kind of power is not used in the same way in these different cases. Each thing—large or small, living or non-living—must take its power from a primary source such as the sun, falling water, or an electric light socket and change it into the specific kind of power needed. In electronics, then, a "power supply" is a circuit or device that changes the primary electric power into the kind and amount of AC or DC needed by different types of electronic circuits.

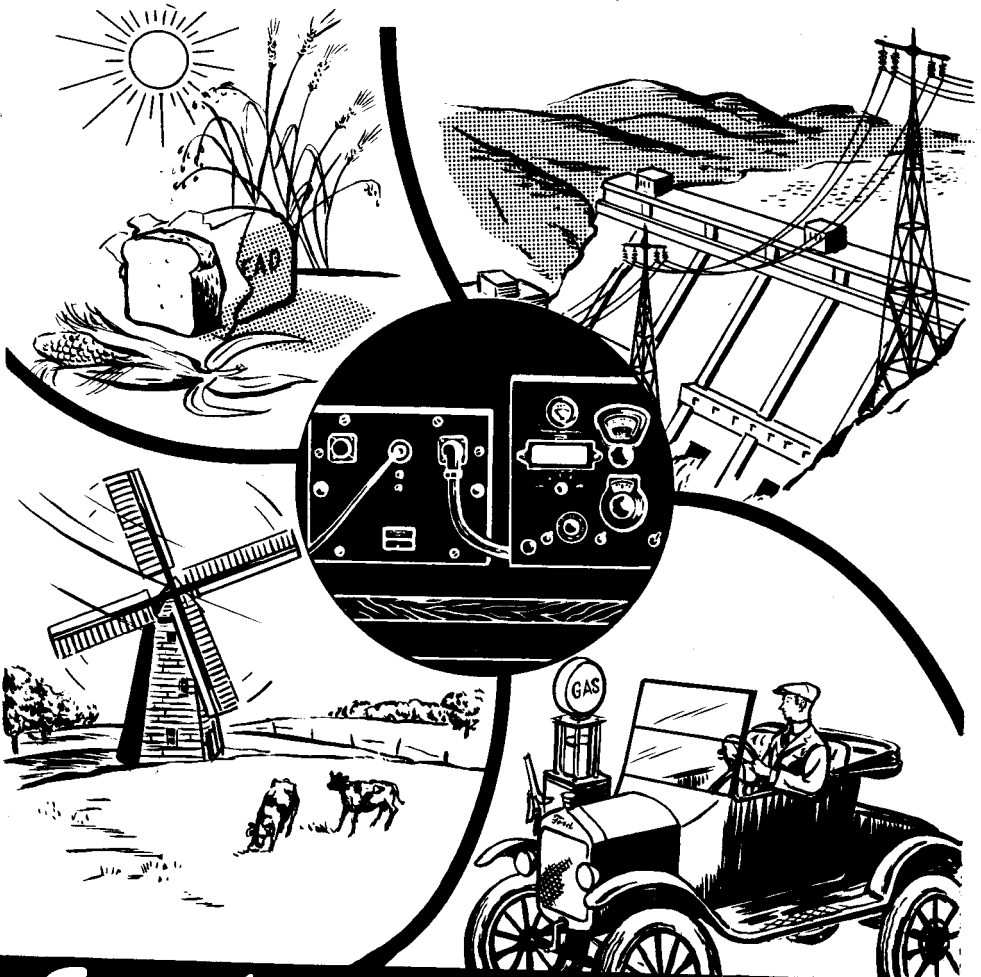

Everything needs its **POWER SUPPLY**

WHAT A POWER SUPPLY IS

What Power Supplies Do

Let's get down to cases and find out just what a power supply is supposed to do. Different types of electronic equipment—amplifiers, oscillators, transmitters and receivers—contain different types of vacuum tube circuits which must have certain AC and DC voltages supplied to them before they can operate. While there are exceptions, in general these various vacuum tube circuits require approximately 350 volts DC and 6.3 volts AC. Just why these two voltages are required is something you will learn when you come to study these circuits. For the present it is enough for you to know that the usual power supply must put out these voltages.

When you plug any piece of electronic equipment into an electric outlet, that outlet puts out 117 volts AC. That is not what you want—the vacuum tube circuits usually must have 350 volts DC and 6.3 volts AC. How a power supply changes the available line voltage into the high DC voltage (called "B+" voltage in all electronics work) and low AC voltage is the major subject of this section.

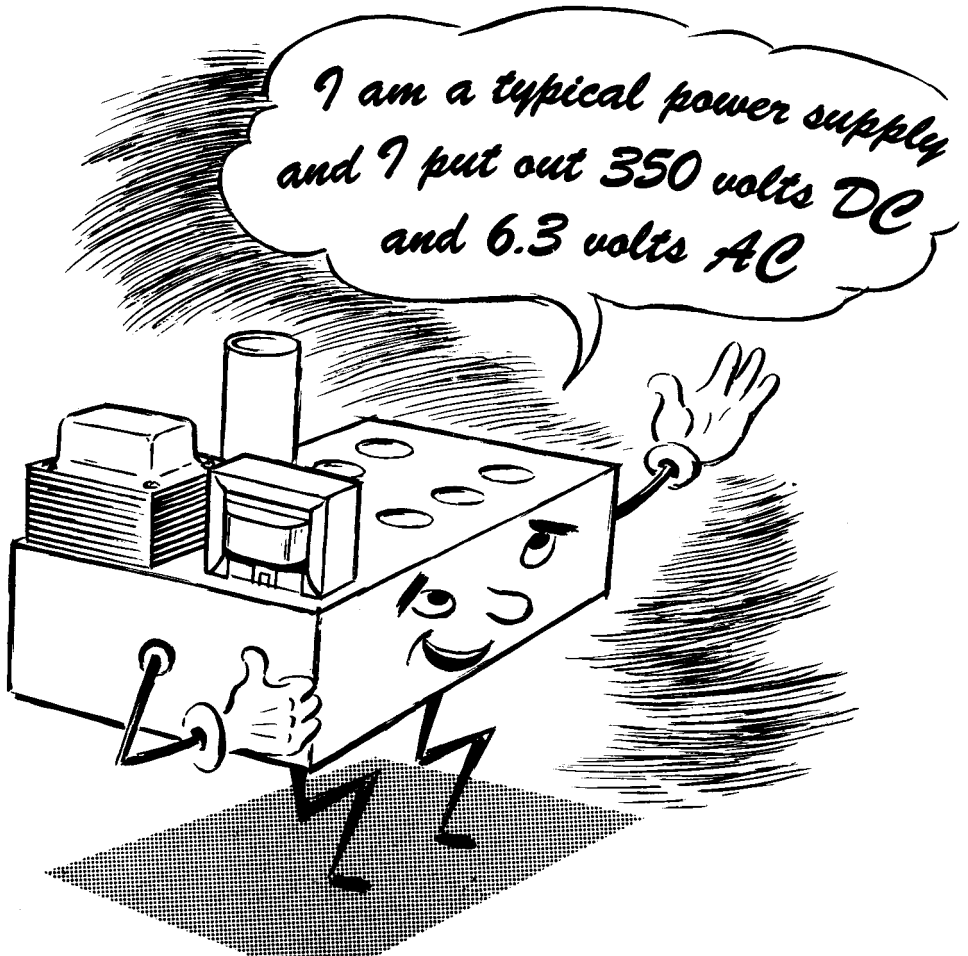

WHAT A POWER SUPPLY IS

How a Power Supply Works—The Transformer

A typical power supply consists of three major components—a transformer, a rectifier and a filter.

You already know about transformers from your work in basic electricity. A transformer is a device made up of two or more coils of wire wound on an iron core. Transformers can take an AC voltage and increase it or decrease it depending upon the number of turns of wire in the various windings. Here are a few examples of transformers that you will find in electronic equipment power supplies.

TYPICAL POWER TRANSFORMERS

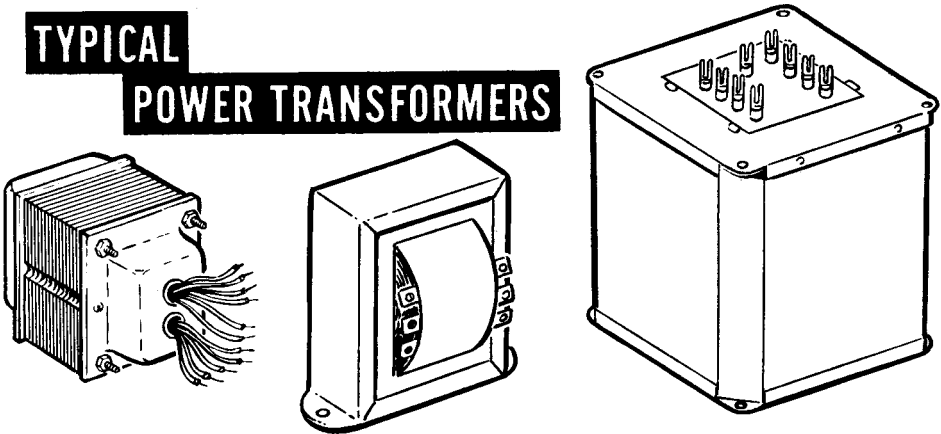

In a typical power supply the transformer is connected to the 117-volt AC power line through a suitable fuse and switch. The transformer puts out three AC voltages—a voltage somewhat higher than 350 volts AC, 5 volts AC and 6.3 volts AC. The 6.3 volt AC output is connected directly to the vacuum tube circuits. The other two voltages are connected to the rectifier circuit where the high voltage AC is changed to approximately 350 volts DC. More than 350 volts AC are required to get 350 volts DC because of losses that occur in the process of changing AC to DC, so you must begin with a higher voltage than you want to take out.

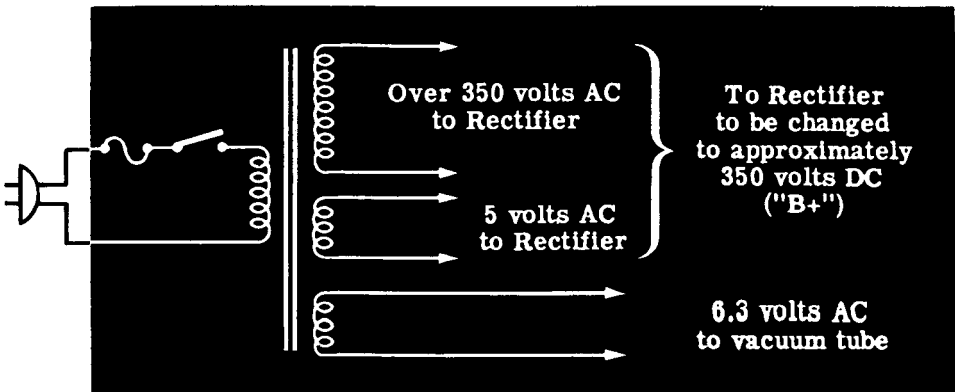

WHAT A POWER SUPPLY IS

How a Power Supply Works—The Rectifier

Up to now you have learned that the job of a typical power supply is to take 117 volts AC from the power line and to put out approximately 350 volts DC and 6.3 volts AC. You have learned that the major components of a power supply are a transformer, a rectifier and a filter circuit; and you have found out about the job of the transformer.

The job of the rectifier is to change the high voltage AC coming out of the transformer into high voltage DC. The 5-volt AC voltage coming out of the transformer is used to heat the rectifier tube, when such a type of rectifier is used. The 5-volt AC winding is eliminated from the transformer when it is not required for the operation of the rectifier.

The job of changing high voltage AC into high voltage DC is a difficult one. All the rectifier can do is to change the AC into pulsating DC like this:

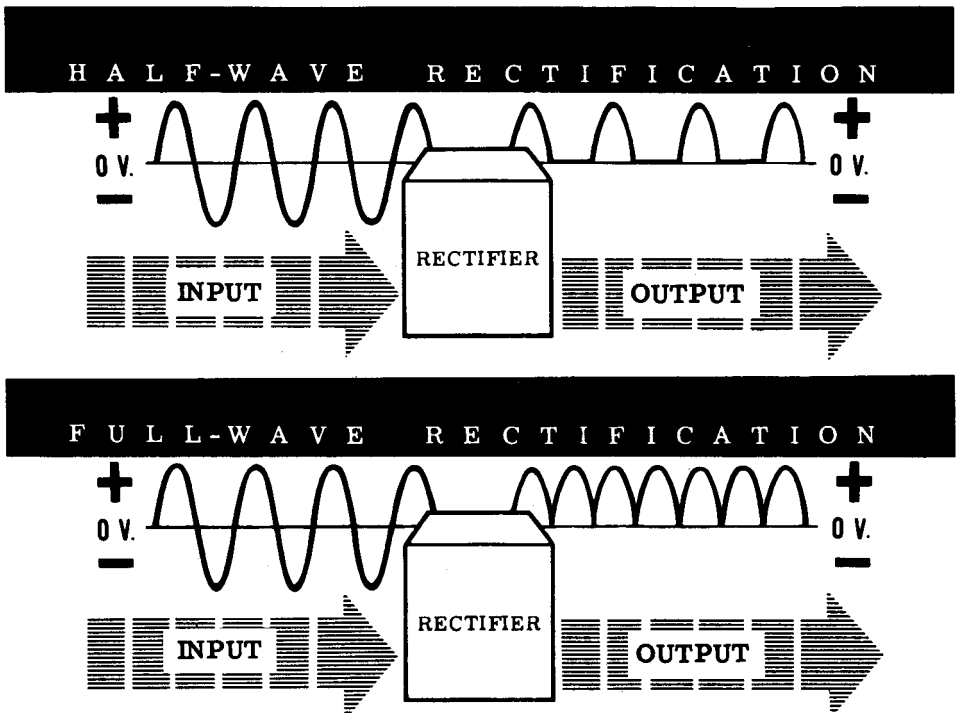

Notice that the DC output is not a constant voltage but rises and falls in time with the AC voltage input. When only the positive half cycles of the input voltage are allowed to pass through the rectifier and the negative half cycles cannot pass through at all, the process is called "half-wave rectification."

When the positive half cycle of the input voltage is allowed to pass through the rectifier and the negative half cycles are changed to positive half cycles, the process is called "full-wave rectification."

WHAT A POWER SUPPLY IS

How a Power Supply Works—The Rectifier (continued)

The rectifiers you will work with in this section will be dry metal or vacuum tube rectifiers. Either of these rectifiers come in half-wave or full-wave types. Vacuum tube rectifiers require that the transformer have a low voltage AC winding which supplies the rectifier tube with heater voltage. Dry metal rectifiers do not require this winding.

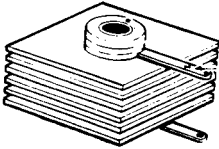

RECTIFIERS

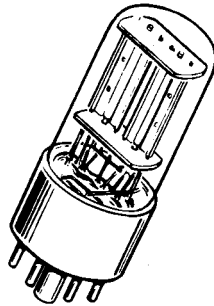
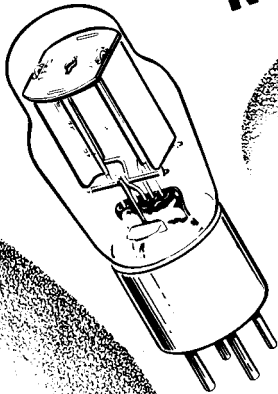

HALF-WAVE RECTIFICATION

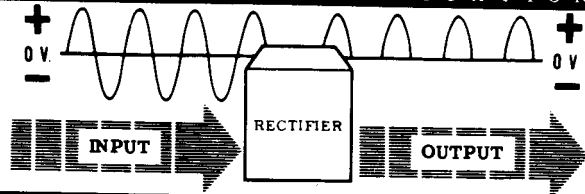

FULL-WAVE RECTIFICATION

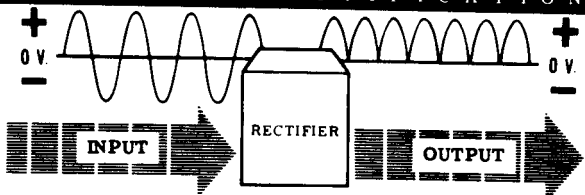

WHAT A POWER SUPPLY IS

How a Power Supply Works—The Filter

So far you have learned that the job of a typical power supply is to take 117 volts AC from the power line and to deliver approximately 350 volts DC and 6.3 volts AC. You have learned that the major components of a power supply are a transformer, a rectifier and a filter circuit. You have learned the purpose of the transformer and the rectifier, and now you are ready to learn about the filter.

You know that the output of the rectifier is a pulsating DC voltage. What you want is a steady DC voltage of +350 volts with as little pulsation as possible.

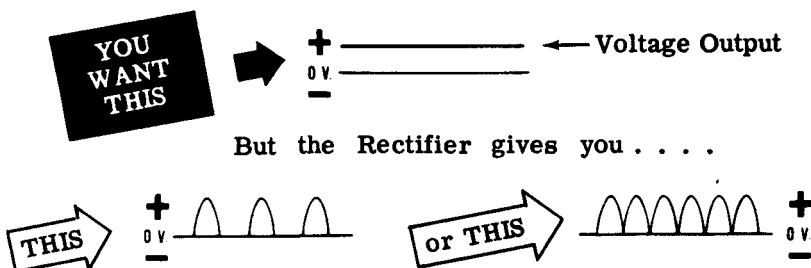

The job of the filter circuit is to smooth out the pulsations in the rectifier output and give you a steady voltage with little or no ripple. Filter circuits come in various forms, but all filter circuits are made up of various combinations of inductances and capacitors or resistances and capacitors. You will learn how these filter circuits work to smooth out the pulsations in the rectifier output as soon as you have done some work with various rectifier circuits.

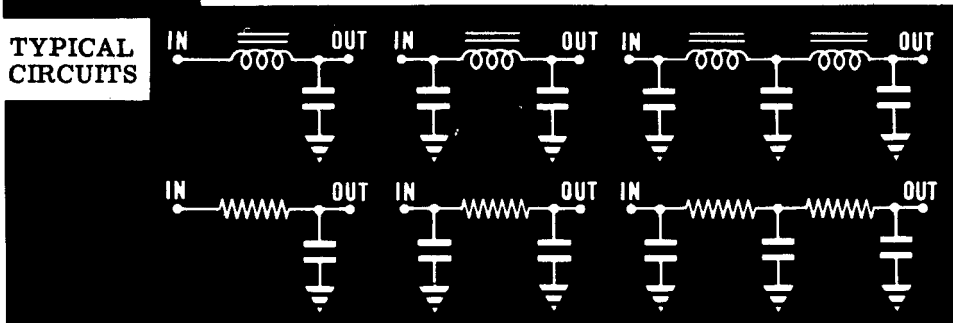
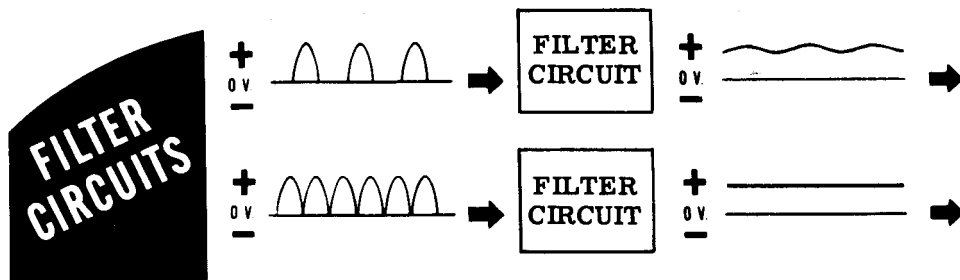

WHAT A POWER SUPPLY IS

Voltage Regulators

A typical power supply is made up of a transformer, a rectifier and a filter circuit. This is all that is required to give you the high voltage DC and the low voltage AC required to operate various types of electronic circuits. However, when current is drawn out of the high voltage DC terminal of a power supply, the voltage drops. This is due to the internal resistance of the power supply. It is not unusual for the 350-volt DC output to drop to 300 volts when the current drawn out increases from 0.05 amp to 0.100 amp.

This voltage drop is not serious for many types of electronic circuits, and they will go right on working in the proper manner. However, there are some types of electronic circuits that cannot operate properly if the voltage varies more than two or three volts. These types of circuits require that the power supply have a voltage regulator circuit added to it. When a power supply has a voltage regulator circuit, only those circuits that require a constant voltage are connected to the voltage regulator—other circuits are usually connected directly to the unregulated high voltage DC terminal.

The basic part of all voltage regulator circuits is the voltage regulator tube, commonly known as the "VR" tube. These tubes are made so that they will hold the DC voltage at a particular point in spite of current variations. VR tubes are made so that they will hold the voltage at 59, 75, 90, 108, and 153 volts DC. By using various combinations of these tubes, you can get a constant voltage of almost any value that is required.

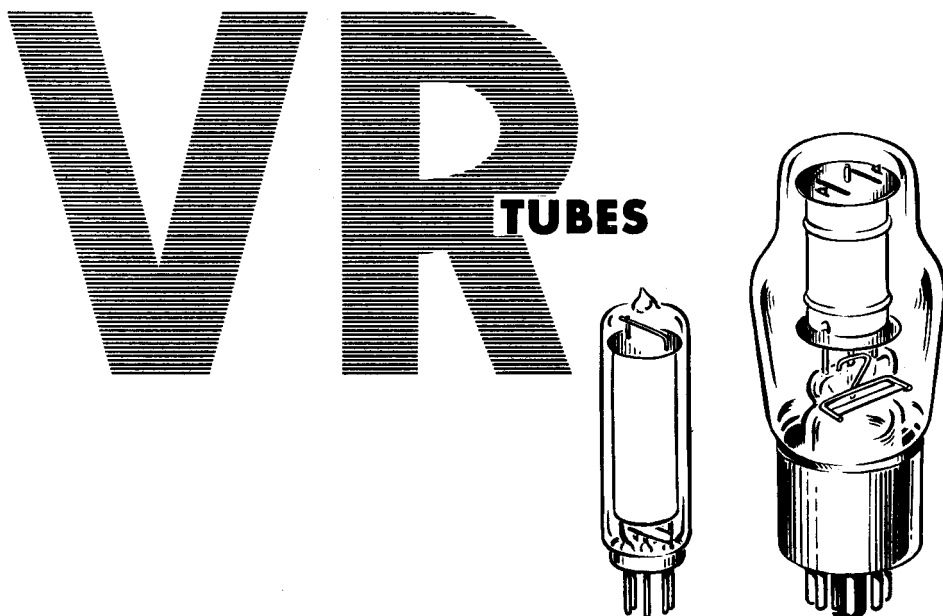

WHAT A POWER SUPPLY IS

Why There are Different Types of Power Supplies

You know that most power supplies are made up of transformers, rectifiers, filter circuits and sometimes voltage regulators. You can get almost any kind of power supply by putting these components together in various ways. Of course, sometimes you will have to use large rectifier tubes and large transformers; sometimes you will have to use sub-miniature parts; but, large or small, all the circuits will contain the same components.

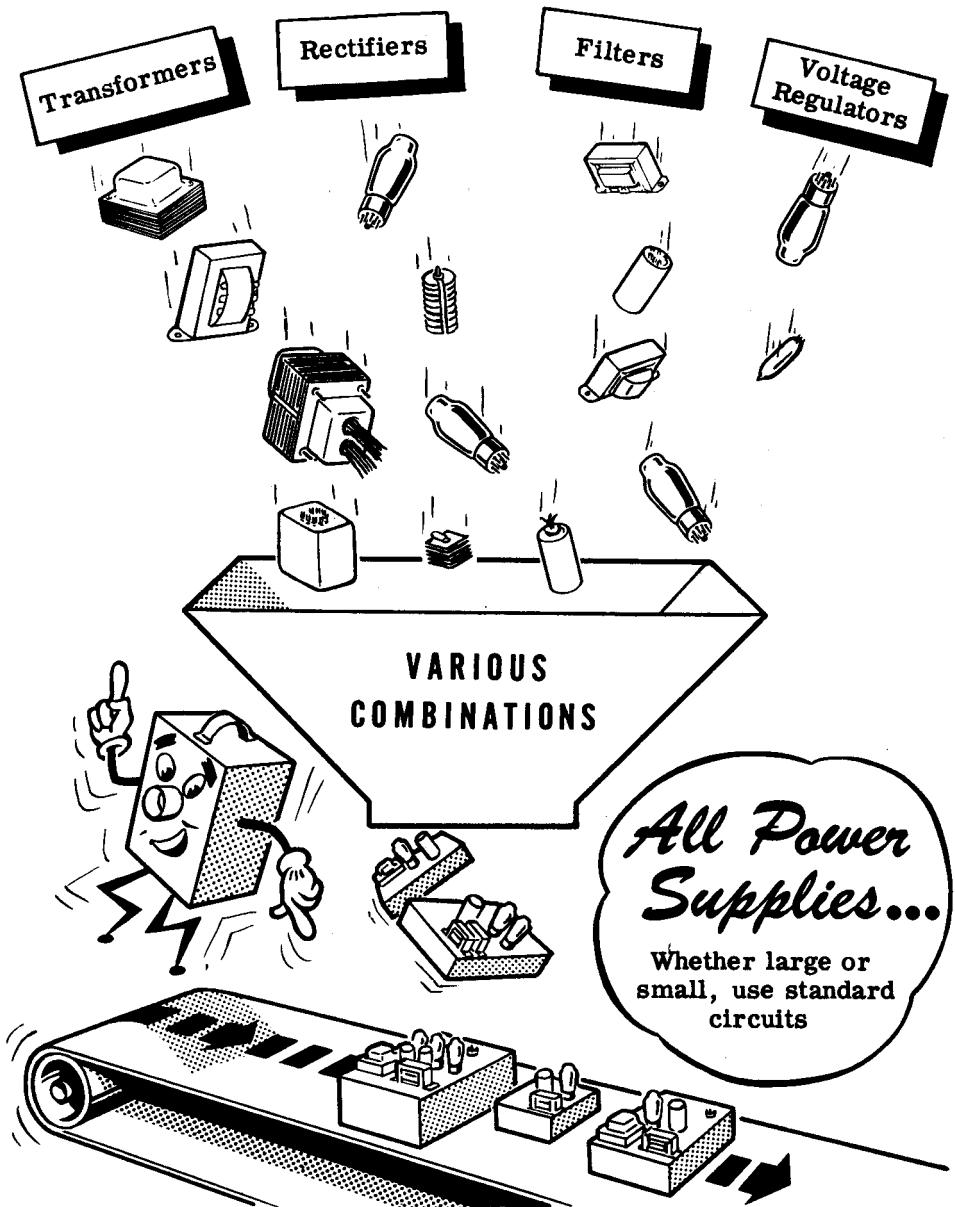

WHAT A POWER SUPPLY IS

Why There are Different Types of Power Supplies (continued)

Now you will want to know why there are different types of power supplies used in various types of equipment. After all, the major job they do is nothing more than changing AC into DC.

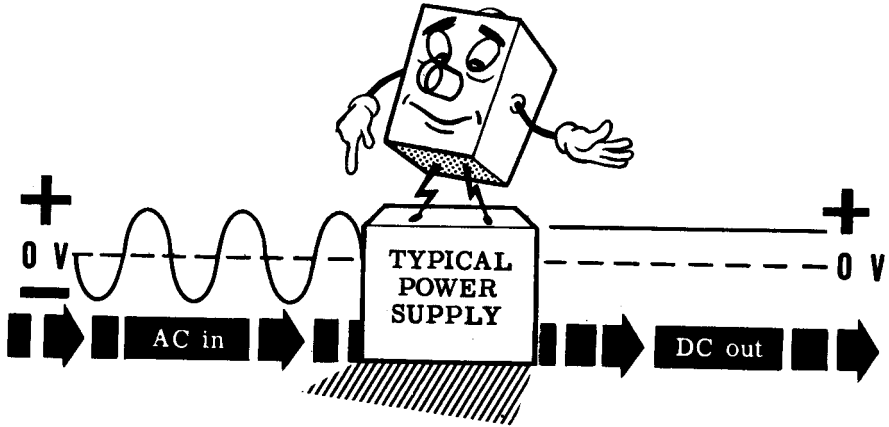

The reason why different types of power supplies are required is simple. One power supply you may build would go up in smoke if you drew much more than 150 ma. of current from the high DC voltage supply. Certain types of transmitters require as much as 5,000 or 10,000 ma. from their power supplies. Certain special oscilloscope circuits may require a DC output of 10,000 volts or more.

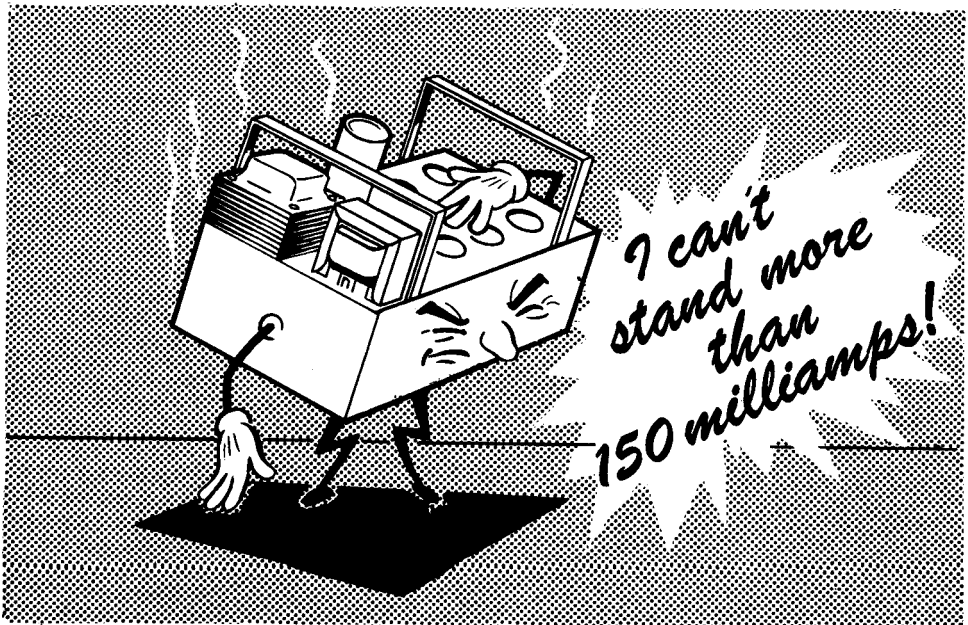

WHAT A POWER SUPPLY IS

Why There are Different Types of Power Supplies (continued)

Some special radar circuits require power supplies with especially good voltage regulation. This means that the DC voltage put out by the power supply must not change more than one or two volts when the current is varying.

Sometimes power supplies are needed that will put out negative DC voltages rather than positive DC voltages. Sometimes power supplies are needed that will put out several positive and several negative DC voltages. Sometimes a super-low ripple is required, etc. etc.

From this, you can see that there are many jobs for power supplies.

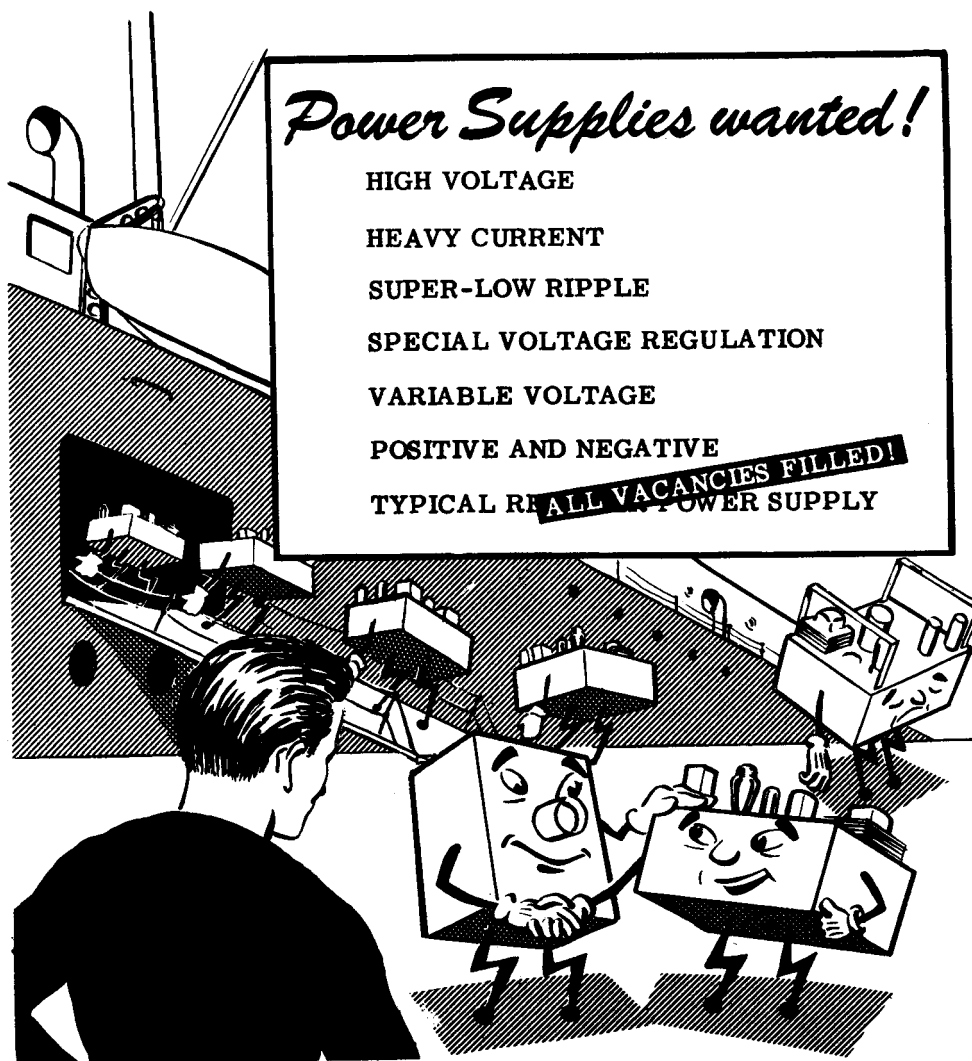

HALF-WAVE RECTIFIERS—DRY METAL TYPE

Changing AC to DC

Most electric power is distributed by AC power lines and most electronic equipments contain power supplies which change the AC power line voltage to those DC and AC voltages required by the equipment. To change the AC power line voltage to other AC voltages is relatively simple. A transformer is used to either step up or step down the line voltage, to obtain the required AC voltages.

POWER SUPPLY TRANSFORMERS STEP UP OR STEP DOWN VOLTAGES AS REQUIRED

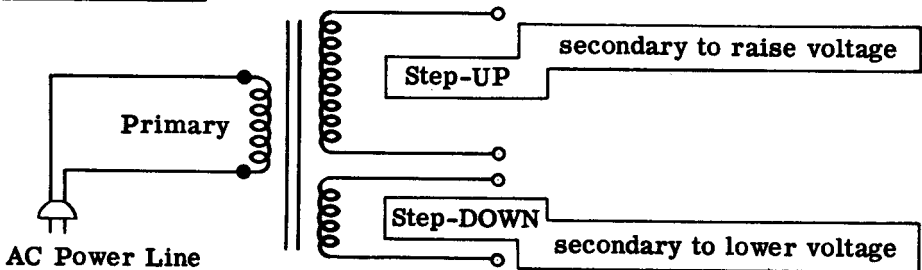

To obtain the required DC voltages, the AC line voltage must be changed to DC. This changing of AC to DC is called "rectification." Devices which change AC to DC are called "rectifiers" and circuits used to change AC to DC are called "rectifier circuits."

Rectifiers are devices which allow current to flow through them in one direction only, acting as a conductor for current flow in one direction and as an insulator for current flow in the other direction. Thus when a rectifier is placed in an AC circuit every other half-cycle of the AC voltage causes current flow in the circuit in that direction for which the rectifier is a conductor. Since the alternate half-cycles are trying to force current through the circuit in a direction for which the rectifier acts as an insulator, no current flows during these alternate half-cycles. As a result, the current flow in a simple rectifier circuit is pulsating DC (alternate half-cycles of AC) rather than a steady DC current flow.

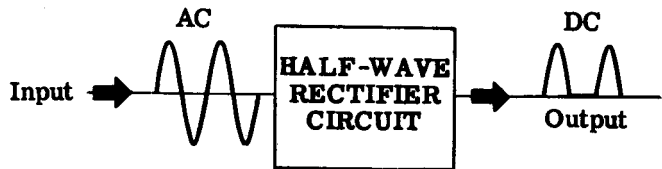
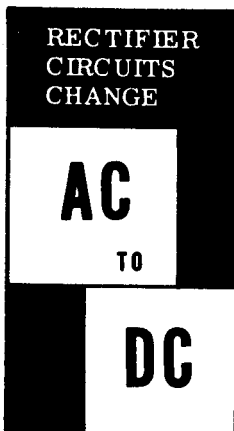

A RECTIFIER

conducts in one direction.

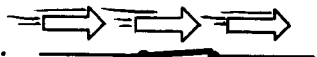

insulates in the other..



HALF-WAVE RECTIFIERS—DRY METAL TYPE

Dry Metal Rectifiers

When certain metallic materials are pressed together to form a junction, the combination acts as a rectifier having a low resistance to current flow in one direction and a very high resistance to current flow in the opposite direction. This action is due to the chemical properties of the combined materials. The combinations usually used as rectifiers are copper and copper-oxide, or iron and selenium. Dry metal rectifiers are constructed of disks ranging in size from less than a half inch to more than six inches in diameter. Copper-oxide rectifiers consist of disks of copper coated on one side with a layer of copper oxide while selenium rectifiers are constructed of iron disks coated on one side with selenium.

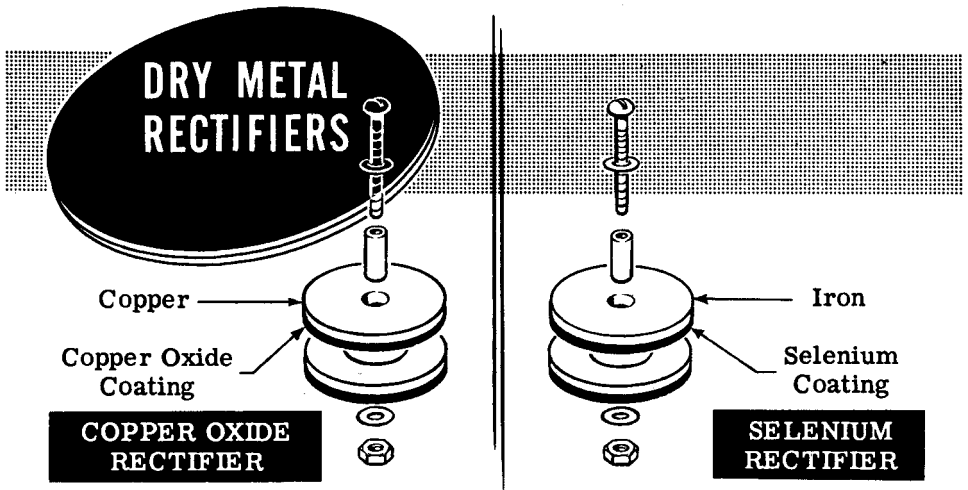

Dry metal rectifier elements (an element is a single disk) are generally made in the form of washers which are assembled on a mounting bolt in any desired series or parallel combination to form a rectifier unit. The symbol shown below is used to represent a dry metal rectifier of any type. Since these rectifiers were made before the electron theory was used to determine the direction of current flow, the arrow points in the direction of conventional current flow but in the direction opposite to the electron flow. Thus the arrow points in opposite direction to that of the current flow as used in electronics.

DRY METAL RECTIFIER SYMBOL

ELECTRON current flow
opposite direction from symbol arrow

Dry Metal Rectifiers (continued)

Each dry metal rectifier element will stand only a few volts across its terminals but by stacking several elements in series the voltage rating is increased. Similarly each element can pass only a limited amount of current. When greater current is desired several series stacks are connected in parallel to provide the desired amount of current.

series stacking increases the
VOLTAGE RATING of a dry metal rectifier

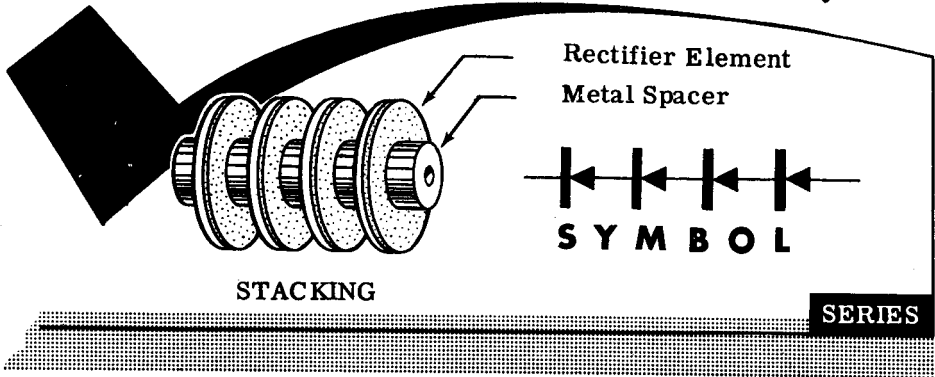

parallel connection increases the
CURRENT RATING.

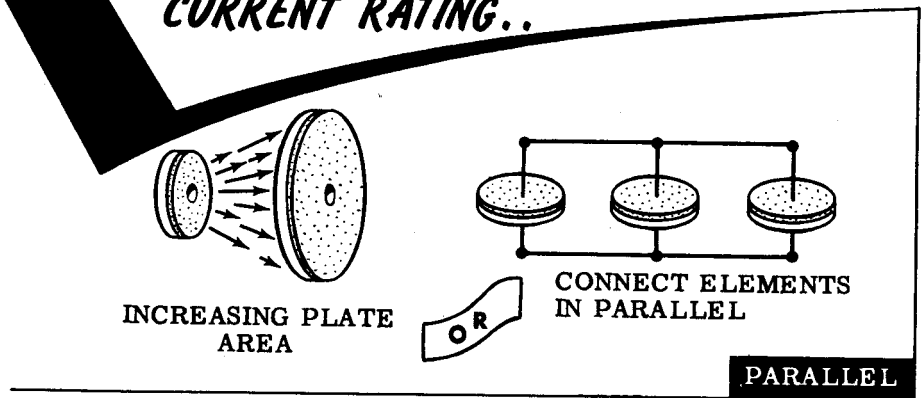

Dry metal rectifiers are very rugged and have an almost unlimited life if not abused. Because of the low voltage rating of individual units they are normally used for low voltages (130 volts or less) since it becomes impractical to connect too many elements in series. By paralleling stacks or increasing the diameter of the disks, the current rating can be increased to several amperes so that they are often used for low voltage-high current applications. Very small units are used to measure AC voltage on a DC voltmeter. Larger units are used in battery chargers and various types of power supplies for electronic equipment.

Dry Metal Rectifiers (continued)

Selenium rectifiers are used in power supplies while copper oxide rectifiers are used in special applications such as meter rectifiers. A typical selenium rectifier of the type used in practical power supplies is illustrated below. It is rated at 130 volts AC and can furnish a maximum of 100 ma. of DC current. The + terminal marking indicates the polarity of the rectifier and is used for identification of leads when connecting the rectifier in a circuit. The positive terminal is sometimes identified by a red dot and the negative terminal by a yellow dot.

TYPICAL SELENIUM RECTIFIER

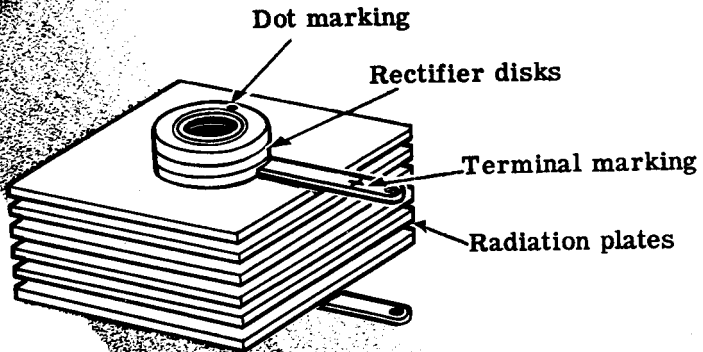

USED IN POWER SUPPLIES

A perfect rectifier would offer no resistance to current flow in one direction and infinite resistance in the opposite direction, but such a rectifier is only theoretical. Practical rectifiers used in power supplies actually have low resistance in one direction and very high resistance in the opposite direction. For dry metal rectifiers these resistances can be measured with an ohmmeter.

To test a selenium rectifier the resistance across the terminals is measured in one direction, and then the ohmmeter leads are reversed to measure the resistance in the opposite direction. If the high reading is 10 or more times as large as the low reading, the rectifier is in good condition.

HALF-WAVE RECTIFIERS—DRY METAL TYPE

A Half-Wave Rectifier Circuit

A basic half-wave rectifier circuit consists of a rectifier connected in series between the AC voltage source and the circuit load resistance. The rectifier permits current to flow only during the positive half cycles of the applied AC voltage and the circuit current then is pulsating DC. In the circuit illustrated, the applied line voltage is 117 volts, 60 cycles AC and current flows only for one half of each cycle. Thus the current flow through the circuit is in pulses at the rate of 60 pulses per second. Actually there is a slight current flow in the opposite direction during the negative half cycles but it is so small that it is considered to be zero.

This simple circuit illustrated is the basic circuit used to change AC to DC. When connected as shown, the DC voltage across the load resistor is positive at the end which connects to the rectifier and negative at the other end. The negative terminal of the load resistor is normally grounded to the chassis in a power supply.

HALF-WAVE RECTIFIER CIRCUIT

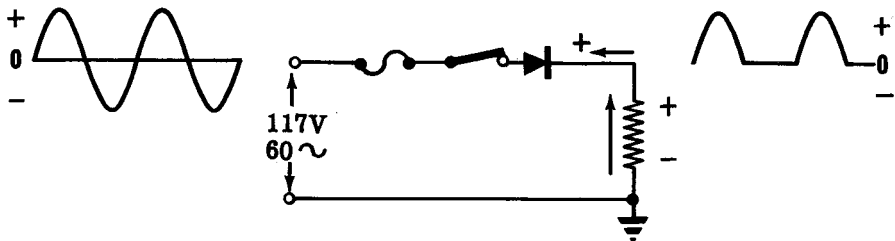

To reverse the polarity of the DC voltage obtained, the rectifier is reversed. This allows current to flow only on the opposite half cycles as compared to the previous circuit. This circuit is used to obtain a negative DC voltage with respect to ground. The grounded end of the load resistor is positive.

REVERSING THE POLARITY OF OUTPUT VOLTAGE

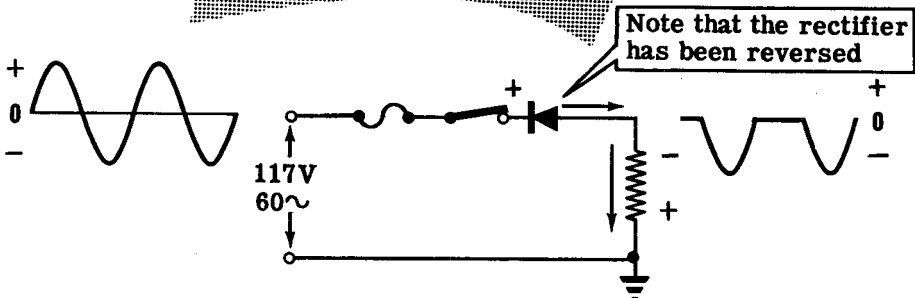

HALF-WAVE RECTIFIERS—DRY METAL TYPE

Review

RECTIFICATION — When a device called a rectifier is placed in series with an AC circuit, it permits current to flow only in one direction, changing the applied AC voltage to pulsating DC. Rectification is the changing of AC to DC.

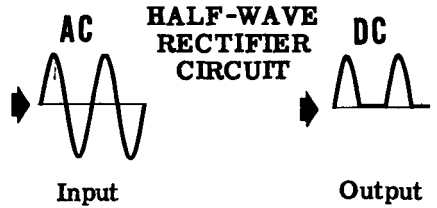

DRY METAL RECTIFIERS — A rectifier consisting of two unlike metallic substances pressed together, which allows current flow in one direction only. Copper-oxide and iron-selenium combinations are usually used to construct dry metal rectifiers.

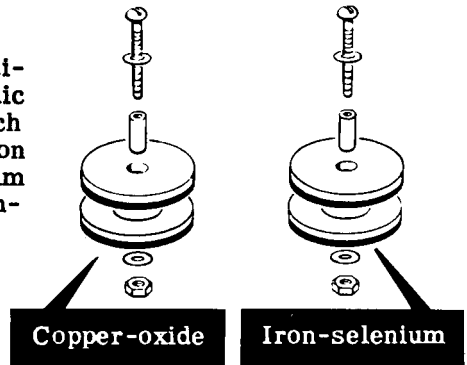

HALF-WAVE RECTIFIER CIRCUIT — A rectifier connected in series between an AC voltage source and the circuit load resistance. The rectifier changes the applied AC to a DC output voltage across the load resistance.

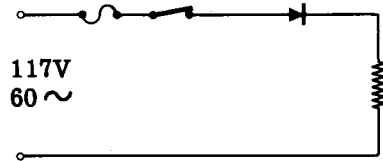

RECTIFIER CIRCUIT WAVEFORMS — If the applied voltage is an AC sine wave, the output waveform consists of half cycles of the applied AC voltage. This output waveform is a pulsating DC voltage.

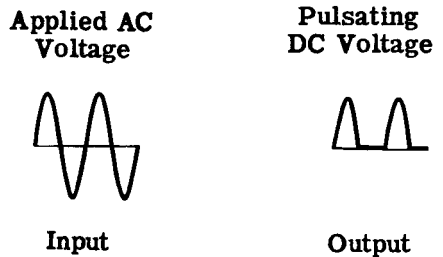

HALF-WAVE RECTIFIERS—VACUUM TUBE TYPE

Vacuum Tubes

Dry metal rectifiers are used in many power supplies to change AC to DC but they are limited as to voltage and current rating. They are not normally rated at voltages greater than 130 volts AC. Low voltage units rated at 10 volts or less have a high current capacity, greater than 1 ampere, while the current capacity of higher voltage units is much less than 1 ampere.

Because of the voltage and current limitations of dry metal rectifiers, another type of rectifier, the diode vacuum tube, is often used in power supplies. As a rectifier, the diode vacuum tube operates in the same way as a dry metal rectifier, acting as a good conductor of current in one direction and as an insulator in the other direction. The diode vacuum tube also has many other uses in electronics which you will find out about later.

**VACUUM TUBES ARE USED AS
RECTIFIERS**

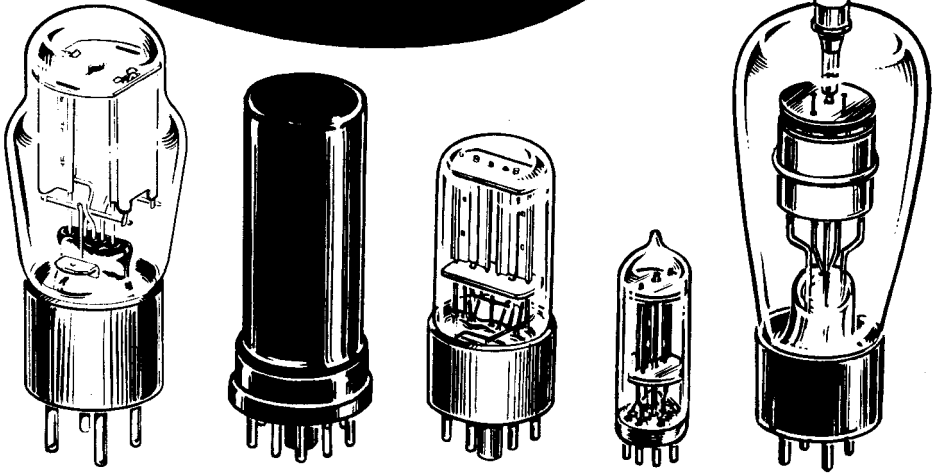

**VACUUM TUBE RECTIFIERS
DO THE SAME JOB AS
DRY METAL RECTIFIERS**

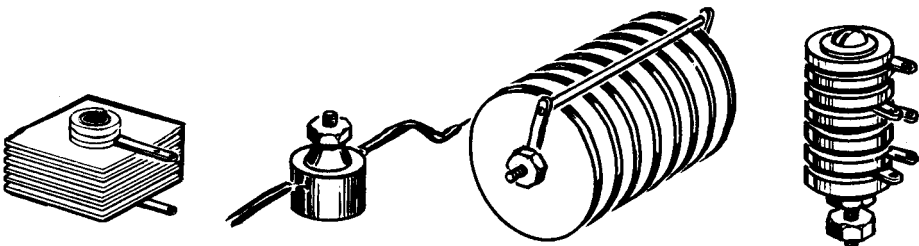

HALF-WAVE RECTIFIERS—VACUUM TUBE TYPE

The Discovery of the Diode

The principle on which a diode is based was discovered some 70 years ago—before anything was known about electrons.

Thomas Edison was working on an experiment with his incandescent lamps in which a carbon filament was used. The filaments which he used broke too easily as they were constructed of thin threads or filaments of carbon.

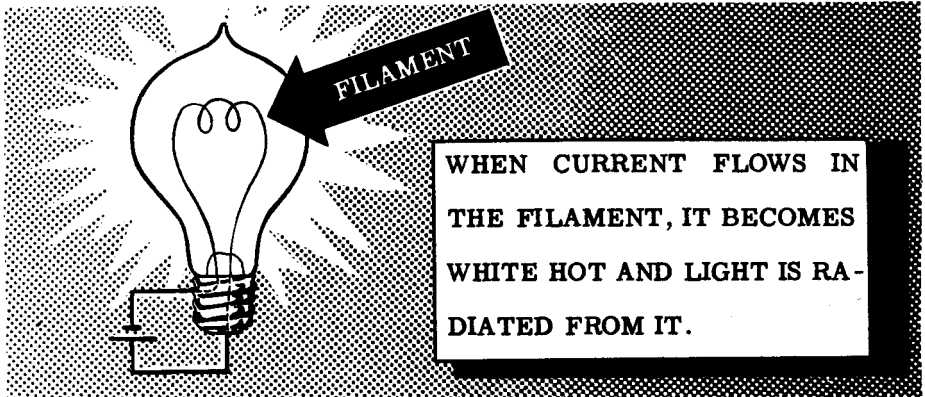

In an effort to lengthen the life of his light bulbs, Edison constructed a metal support which he connected to the fragile filament by insulated sections. For some unknown reason, he connected the metal support to the positive side of a battery and the filament to the negative side. To his surprise, he noticed that a current was flowing.

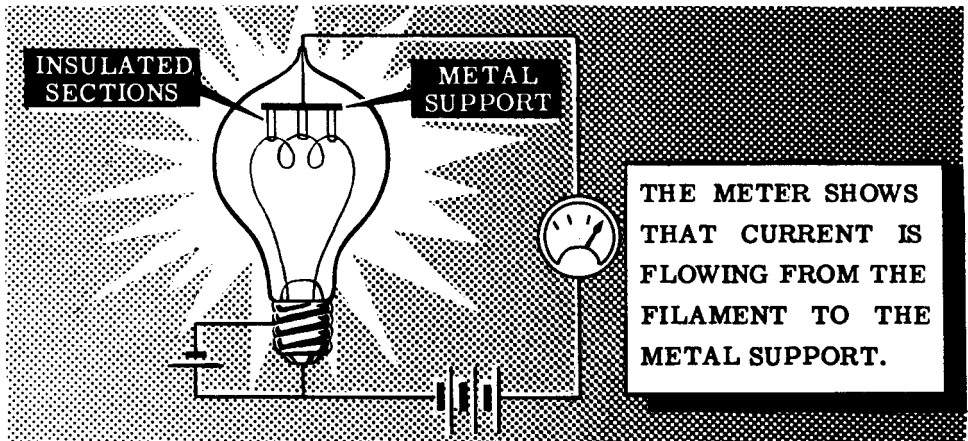

Since nothing was known about electrons, Edison could not understand or see any importance in his discovery and it took 21 years before Fleming, a British scientist learned the significance of this flow of electrons. Because he observed that current could flow only in one direction, Fleming called his vacuum tube a "valve." In fact, vacuum tubes are still called "valves" by the British.

HALF-WAVE RECTIFIERS—VACUUM TUBE TYPE

How a Diode Tube Works

The diode vacuum tube is like a game of baseball in which control is the important thing. An understanding of how a diode vacuum tube controls the flow of current is required to understand how a diode tube works as a rectifier.

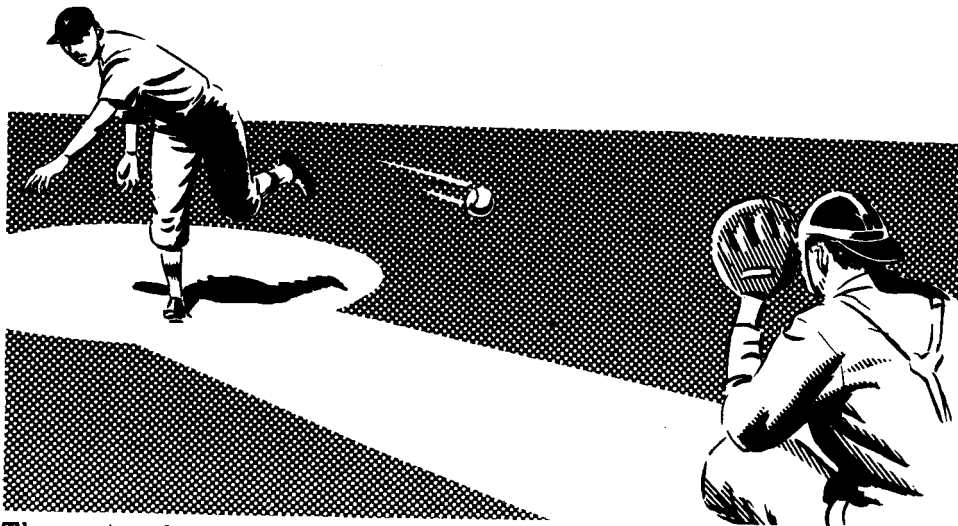

The parts of a vacuum tube which directly control the flow of current are called elements. A heated element which gives up electrons is called the cathode. The plate is a cylindrical element surrounding the cathode which attracts electrons when it is positively charged. The cathode is heated by a filament of resistance wire called a heater, which is not considered to be an element since it does not directly control the amount of current flow from cathode to plate. A vacuum tube of the type illustrated is called a diode because it has only two elements, a cathode and plate.

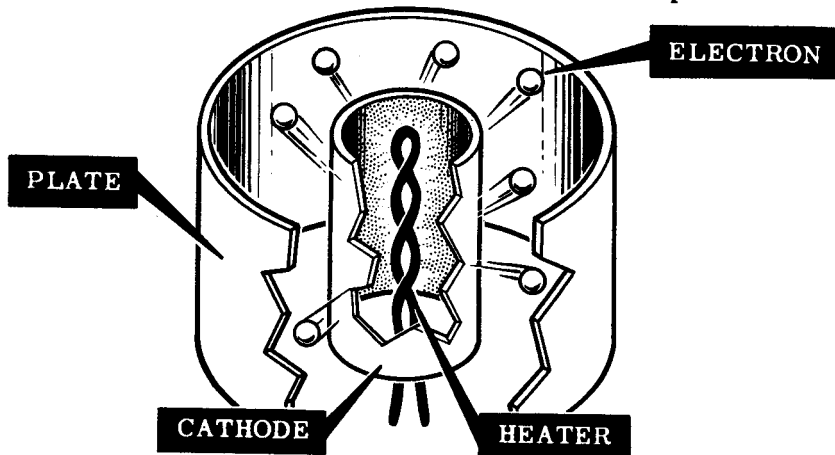

In addition to preventing the filament from burning, removing the air from the tube prevents the air molecules from interfering with the flow of electrons from cathode to plate. Sometimes the air is replaced by an inert gas which aids rather than opposes the electron flow.

HALF-WAVE RECTIFIERS—VACUUM TUBE TYPE

Electron Emission

The basic requirement of a diode vacuum tube is that there has to be a source of freely moving electrons which can be used to give us current flow. Of course, electrons are found in every atom of every substance but we still need a method of driving them out of the substance to make them freely moving.

In Edison's set-up, the intense heat of the filament did the trick, and heat is used to do it in practically all the vacuum tubes you will see. Driving electrons out of a substance by heat is known as "thermionic emission."

In the illustration, you will notice that the cathode is a cylinder or "sleeve" which surrounds, but does not touch, the filament. The filament is heated by the current flowing in it and the cathode is heated because it is so close to the filament. This arrangement of parts is known as an indirectly heated cathode.

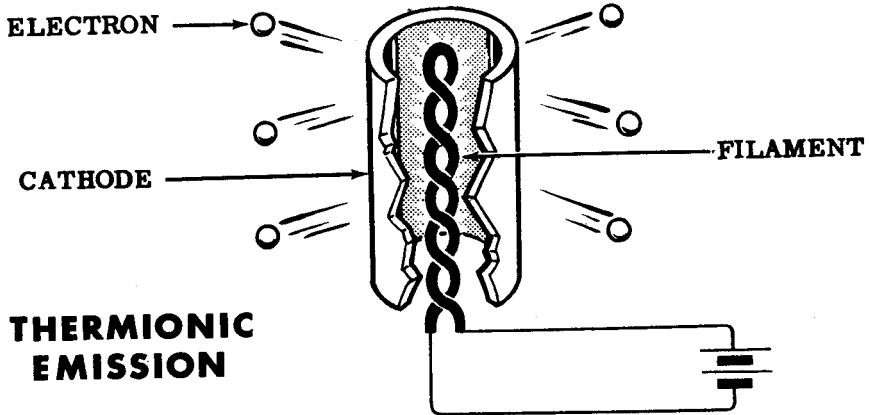

Some tubes such as the Fleming's Valve or the type 80 rectifier tube have what is known as directly heated cathodes, which means that there is no sleeve around the filament and the filament is itself the electron emitter.

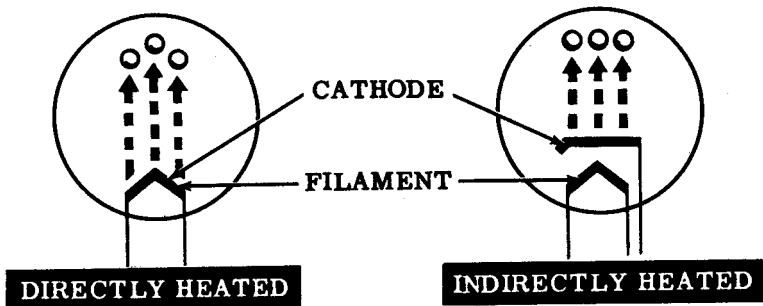

Because they can emit many more electrons than the indirectly heated type, directly heated cathodes are used in vacuum tubes designed for power supplies which supply high currents. Indirectly heated cathodes are more frequently used in low-current power supplies. Having the heater (filament) and the electron emitter (cathode) separate in an indirectly heated tube allows for the separation of the filament's and the cathode's electrical circuits.

HALF-WAVE RECTIFIERS—VACUUM TUBE TYPE

Electron Emission (continued)

If the cathode and filament were alone in the glass tube, the emitted electrons would form a cloud called "space charge" around the cathode. Like the electrons in it, the space charge is negatively charged and therefore tends to repel other electrons and to keep more electrons from being emitted by the cathode. After a while, a balance would be reached between the tendency of the cathode to emit electrons and that of the space charge to repel them.

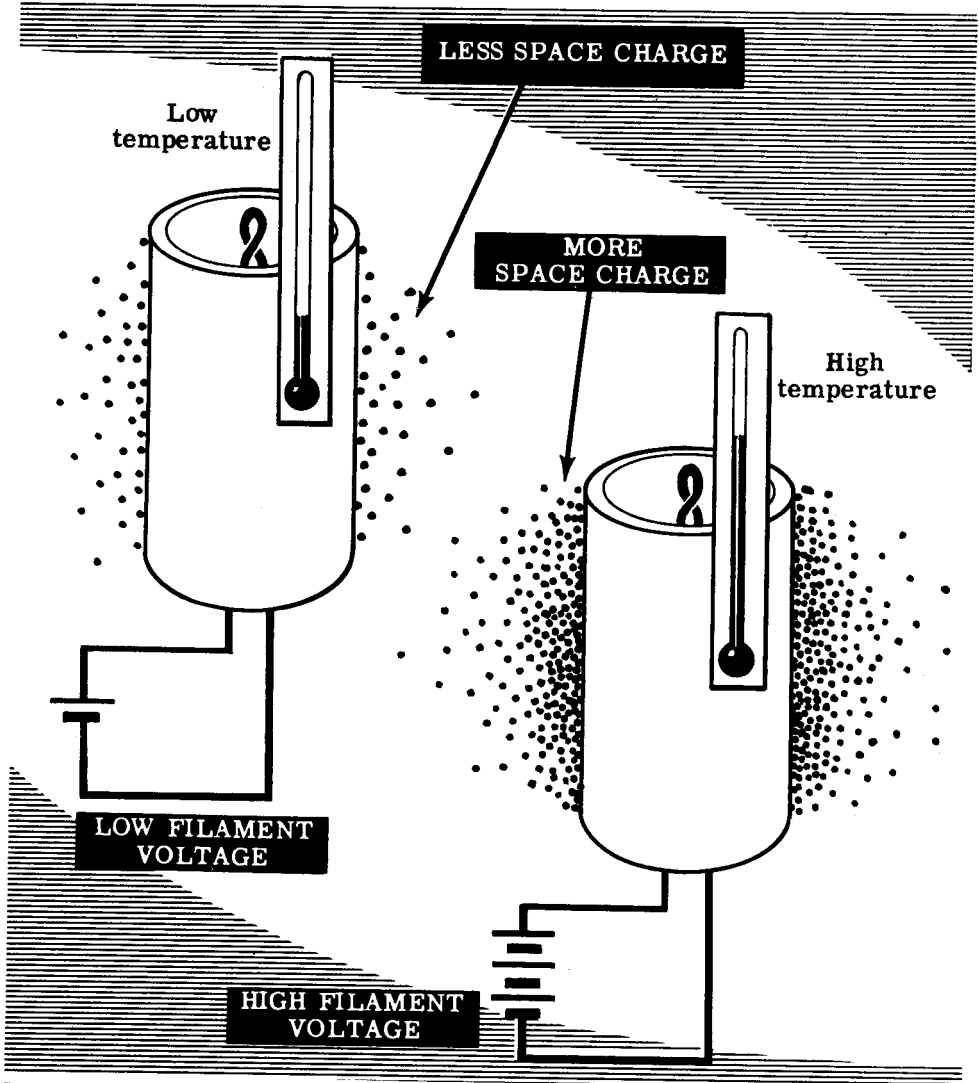

To increase the emission of electrons, you would have to raise the cathode's temperature by increasing the filament current. If, on the other hand, the cathode's temperature is lowered, the space charge will force some of its electrons to re-enter the cathode, resulting in decreased emission. The heater voltage for a tube is usually fixed. Various types of tubes operate with AC or DC heater voltages in the range from 1.25 to 117 volts.

HALF-WAVE RECTIFIERS—VACUUM TUBE TYPE

How Current Flows in a Diode

When a positively charged plate is placed around the cathode, the electrons are attracted from the space charge. The number of electrons which flows to the plate depends on the plate voltage with respect to the cathode.

When the plate is more negative with respect to the cathode, no current flows from cathode to plate because the negative plate repels the electrons. Current cannot flow from the plate to the cathode, since the plate does not emit electrons.

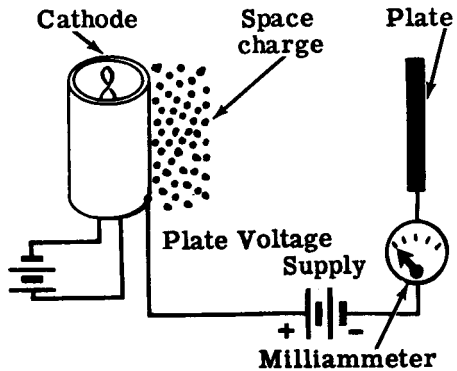

When the plate and cathode are at the same potential, the plate neither attracts nor repels electrons — the current is still zero.

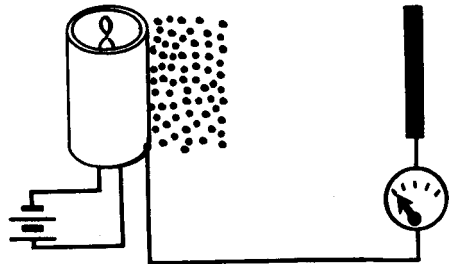

As soon as the plate becomes positive with respect to the cathode, current will flow from the space charge.

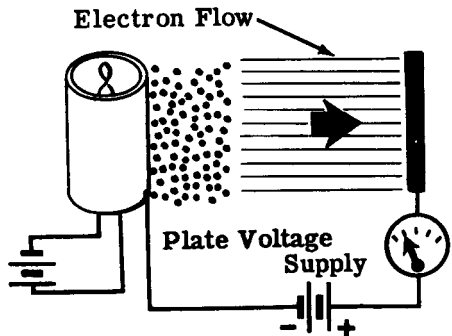

If this plate voltage is doubled, the current which flows is also doubled. This is the normal way for a diode to work: as long as the plate is positive with respect to the cathode, every change in plate voltage causes a corresponding change in plate current.

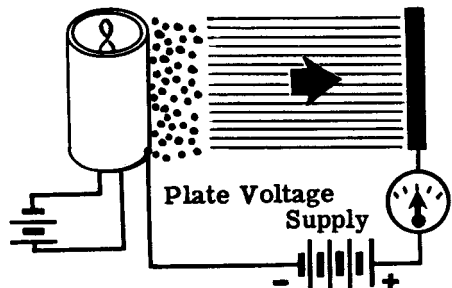

HALF-WAVE RECTIFIERS—VACUUM TUBE TYPE

How Current Flows in a Diode (continued)

Now that the plate is very positive with respect to the cathode, the milliammeter indicates that a very large current is flowing. The plate is attracting the electrons as fast as the cathode can emit them.

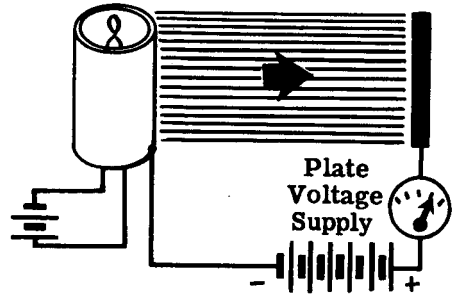

At this point, a further increase in plate voltage does not result in any additional current. The current does not increase because the cathode is emitting all the electrons it can. It is NOT normal to operate a diode at such a high plate voltage that changes in plate voltage do not produce changes in plate current.

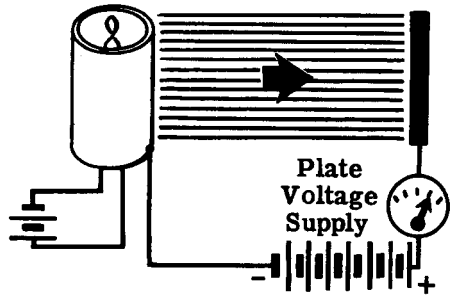

If we now increase the filament voltage above its normal value, we enable the cathode to emit more electrons and, with the same plate voltage as before, we observe that a larger plate current is flowing.

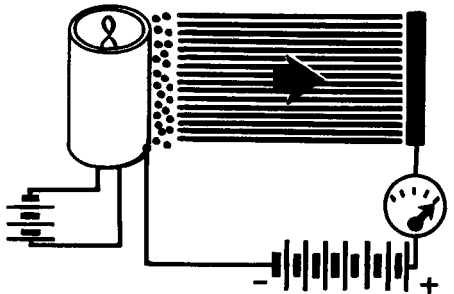

If we had reduced the filament voltage, the current would have decreased because the cathode could not emit as many electrons as before. In practice, the filament voltage is not varied. Changes in plate current are achieved by varying the plate voltage as already described. However, after a tube has been used for some time, the cathode's emission decreases and the result is the same as if the filament voltage were decreased.

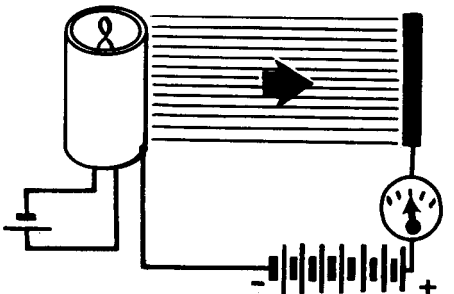

HALF-WAVE RECTIFIERS—VACUUM TUBE TYPE

The Rectifier Tube

The process of changing AC into DC is called "rectification." To change AC to DC a device must be used which will permit current flow in one direction only. A diode vacuum tube is such a device, permitting current to flow only from the cathode to the plate. Current does not flow from the plate to the cathode because the plate is not heated and therefore does not emit electrons. Since the plate will not emit electrons but will, when positive, attract electrons from the cathode space charge, the diode is a conductor only from cathode to plate and not from plate to cathode.

Any diode will rectify AC into DC but some are especially designed for use in power supplies and these are referred to as rectifier tubes. A typical rectifier tube with its schematic symbol is illustrated below. It is a twin diode (two diode tubes in the same glass envelope) and has a directly heated cathode. A filament which also acts as the cathode is suspended inside each metal plate and the two filaments are internally connected in series.

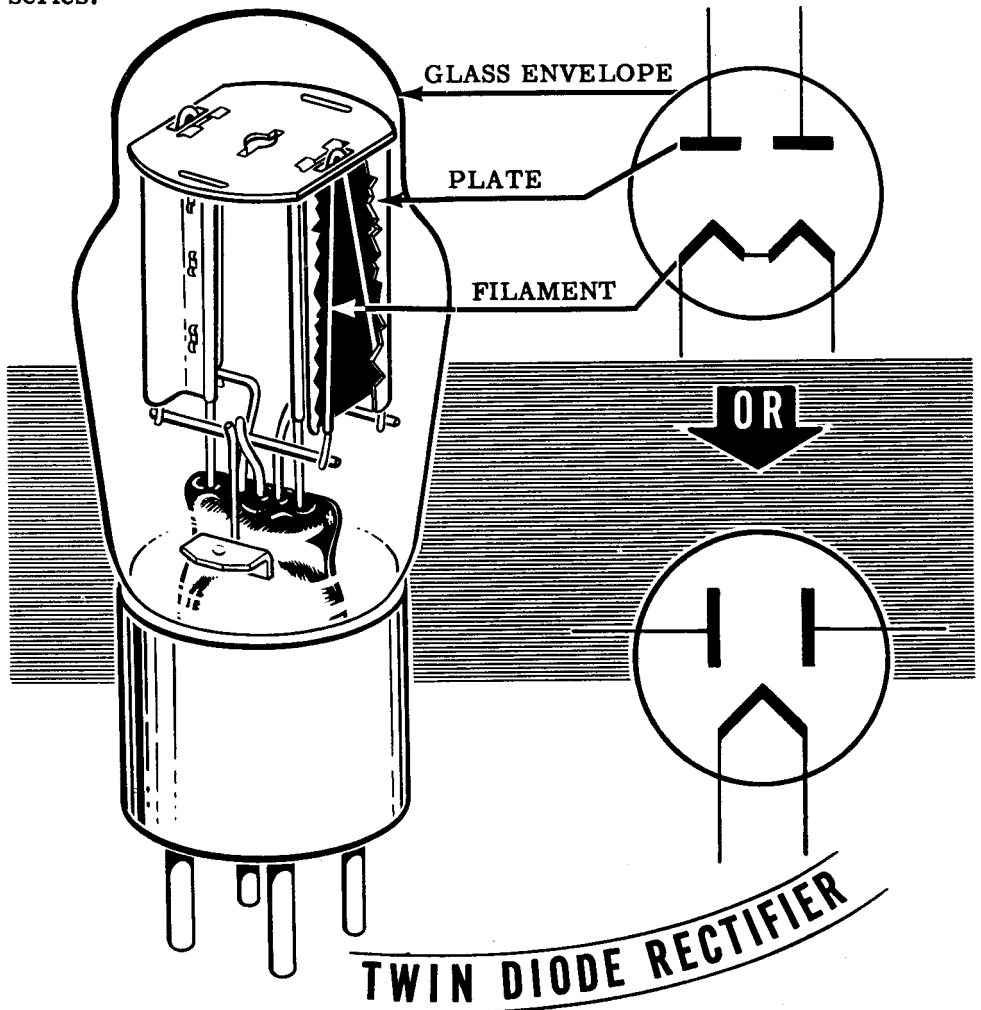

HALF-WAVE RECTIFIERS—VACUUM TUBE TYPE

The Rectifier Tube (continued)

Some rectifier tubes have indirectly heated cathodes. A typical tube of this type is illustrated below. Vacuum tubes of all types are identified by number and the numbering system, which you will find out about later, indicates certain characteristics of the tube. The rectifier illustrated on the preceding sheet is a type 80 tube and the one illustrated below is a 117Z6-GT.

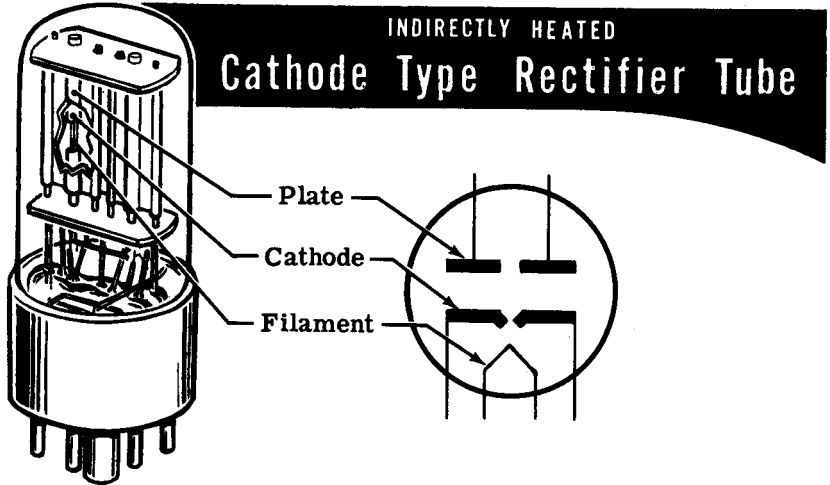

Vacuum tubes are constructed with a plug-in base which fits into a socket. The socket is permanently wired into the circuit and the tube is removable and easily replaced. Vacuum tubes have a relatively short life as compared to other components used in electronic equipment and a method of easy replacement is required.

Although many special types of sockets are used, most of the vacuum tubes used in electronics require one of the eight sockets illustrated below. One method of classifying tubes is according to the socket required. The pin numbering system is also illustrated and refers to the bottom side of the socket since the circuit wiring is done on that side.

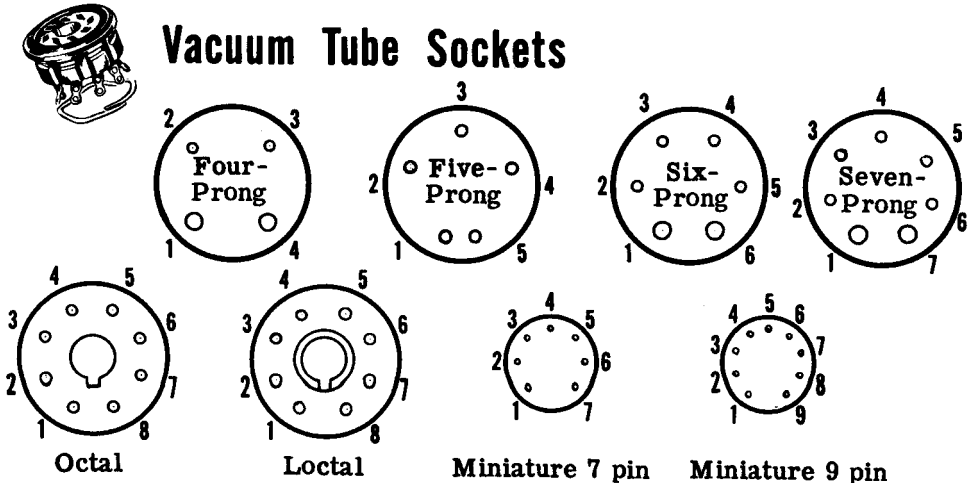

HALF-WAVE RECTIFIERS—VACUUM TUBE TYPE

The Rectifier Tube (continued)

In an indirectly heated tube, the cathode and filament are separate structures and are connected to separate circuits. In a directly heated tube, the filament replaces the two structures, and is connected to two circuits. The filament wires are connected across a low voltage of about 5 volts which heats the filament and causes thermionic emission. In addition, one of the filament wires is connected to the circuit to which a cathode would be connected if the tube were indirectly heated.

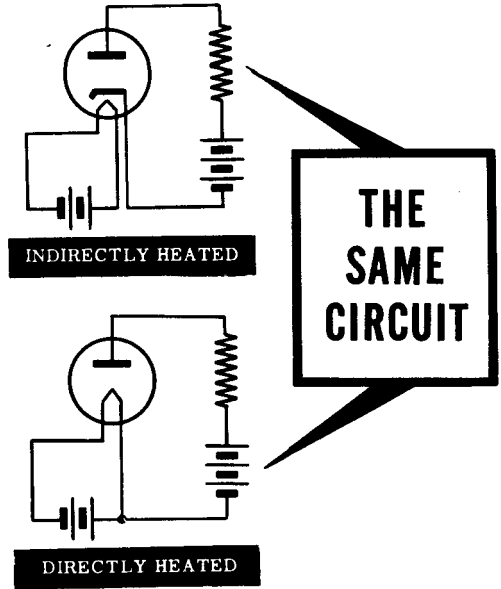

There are two different ways of using a rectifier tube which has two plates and one filament. If both plates are connected together, the tube is acting the same as one diode because, in effect, you have only increased the plate area.

The other way is to connect the plates separately to different parts of the circuit. In this way the plates will not be at the same voltage and the effect is the same as using two separate diodes with the cathodes (or filaments) connected together. No matter how the connections are made, each plate will draw current only when it is positive with respect to the filament.

TWO PLATES CONNECTED TOGETHER

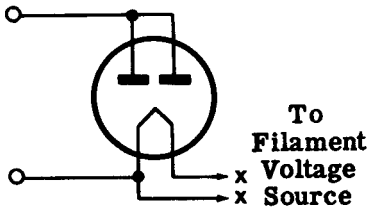

ACT LIKE . . .

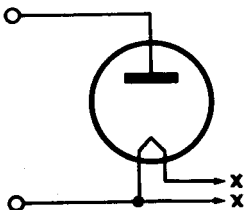

TWO PLATES CONNECTED SEPARATELY

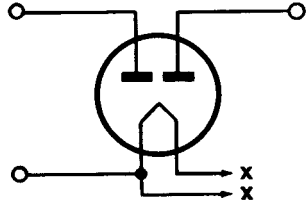

ACT LIKE . . .

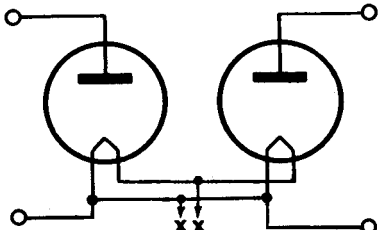

HALF-WAVE RECTIFIERS—VACUUM TUBE TYPE

A Half-Wave Vacuum Tube Rectifier Circuit

A diode rectifier tube may be used in the half-wave rectifier circuit in place of a selenium rectifier if there is a voltage source available to supply the filament current required by the rectifier tube. The basic rectifier circuit using a vacuum tube rectifier is illustrated below. If the plate and cathode connections are reversed the polarity of the DC output voltage is reversed.

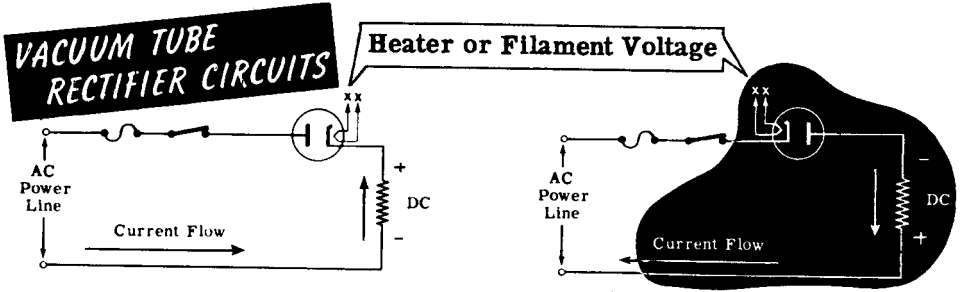

The rectifier tube filament circuit requires an additional source of filament voltage not required by the selenium rectifier—otherwise the operation of the circuit is identical to that of the basic dry metal rectifier circuit. Rectifier tube filaments are rated in volts and amperes so that the filament must be connected to a voltage source of the rated voltage and current. Filament or heater voltages are normally obtained from a step-down transformer or by using a series resistor to drop the line voltage to the correct value. Tubes having heaters rated at the same current are sometimes connected in series across the AC power line. Some rectifier tube heaters are rated at 117 volts and may be connected directly across the AC power line.

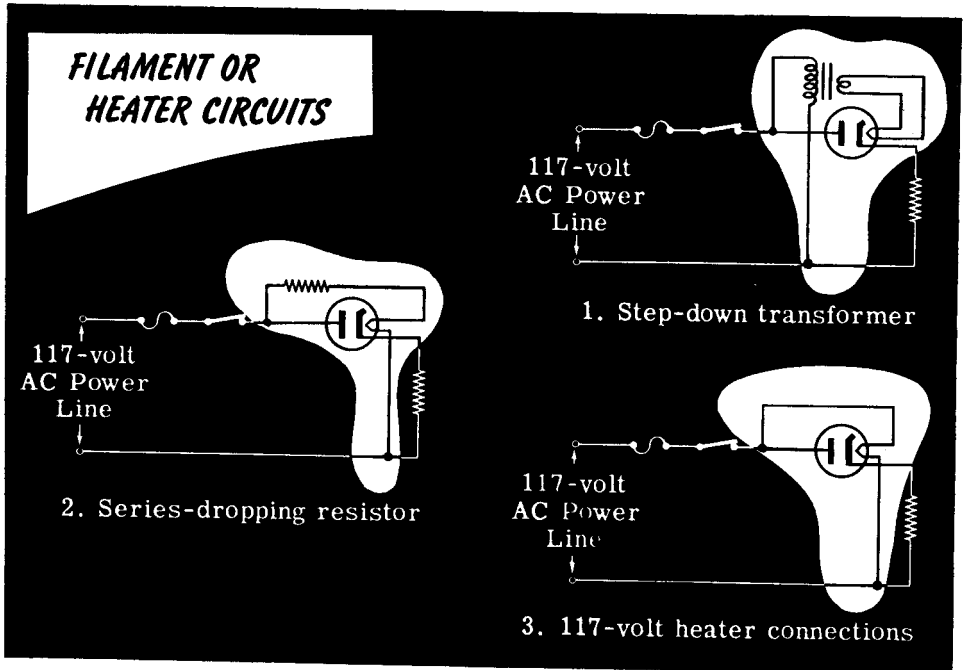

HALF-WAVE RECTIFIERS—VACUUM TUBE TYPE

Vacuum Tube Circuit Wiring

In electronic circuit diagrams, vacuum tubes like other parts are represented by symbol. Usually the symbol shows only the connection of the tube elements to various parts of the circuit. To wire the socket, it is necessary to refer to a tube manual which shows the pin numbers of each tube element. In the illustration below a 117Z6-GT is shown in the circuit diagram with the plates and cathodes connected together to form a single diode. The tube base diagram of the type found in a tube manual and the actual wiring connections for the socket are shown below.

WIRING A 117Z6-GT TUBE SOCKET

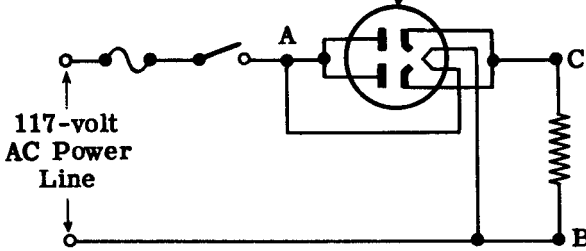

Base diagram from tube manual

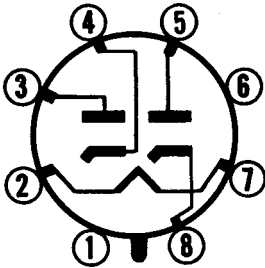

Actual socket wiring

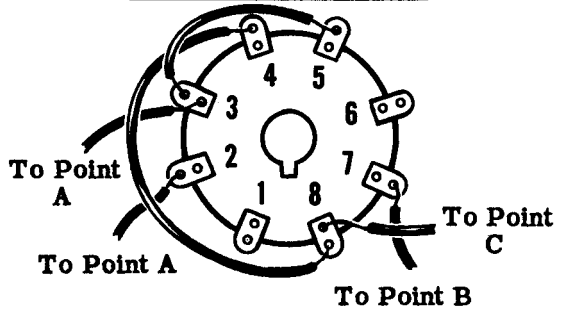

There is a wide variation in the method of representing a vacuum tube in a circuit diagram and tube pins as well as elements are sometimes indicated.

SOME METHODS USED TO SHOW VACUUM TUBES IN CIRCUITS

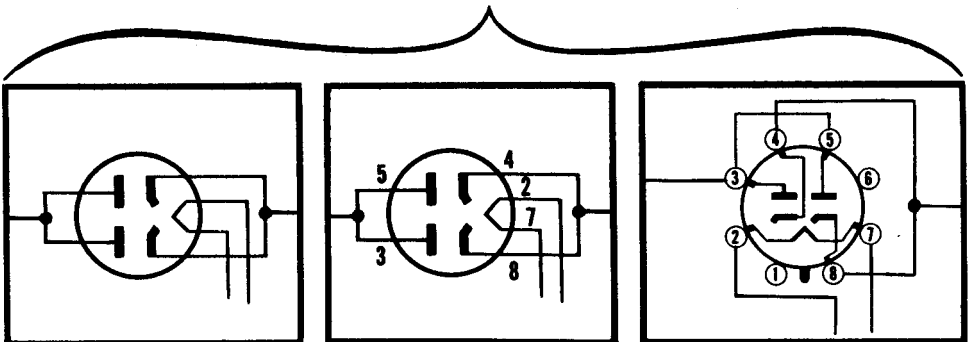

HALF-WAVE RECTIFIERS—VACUUM TUBE TYPE

The Gas-Filled Diode

You have already learned about two types of rectifying devices—the high vacuum diode and the dry metal rectifier. You have been told that the dry metal type could be used in the same circuit as the diode and the circuit would work the same way. Now you are going to find out about a third type of rectifying device which is used in similar circuits and works in very much the same way.

Not all diodes are vacuum tubes. In some, all the air is removed from the tube and, before the tube is sealed, a small amount of chemically-inactive gas is placed in it. Then, instead of a high vacuum, the diode would have a low pressure gas in it. One common gas tube has a small quantity of mercury placed in it and, because of the low pressure around it, the mercury vaporizes. The mercury vapor acts the same way as an inert gas such as neon or argon.

The symbol for a gas tube or mercury vapor tube differs from the symbol of a high vacuum tube only by the round dot which indicates the presence of the gas. Any time you see that dot on a tube symbol, you know that the tube is of the gas-filled type.

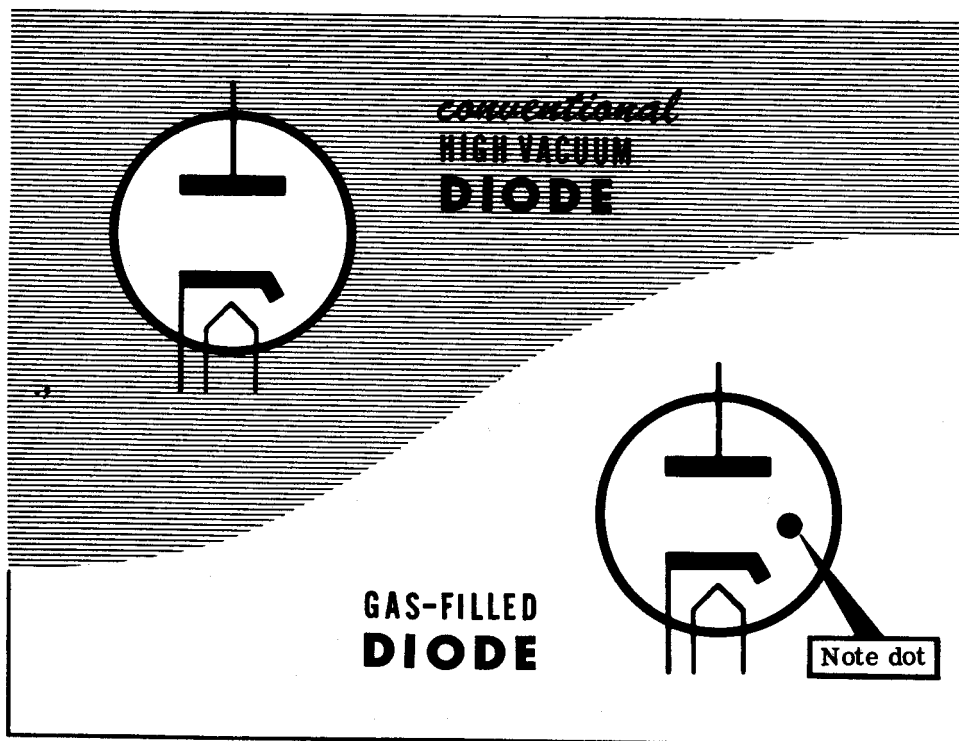

As you can see in the illustration, a gas tube has the same basic type of heater and cathode arrangement as the conventional diode. Many gas tubes have directly heated cathodes similar to the one in the type 80 high vacuum rectifier diode. Furthermore, the purpose of the cathode is the same in both types of tubes—to emit electrons.

HALF-WAVE RECTIFIERS—VACUUM TUBE TYPE

The Gas-Filled Diode (continued)

A diode acts just like an ordinary resistor when the tube is conducting. This is its disadvantage. Let's see why.

When you draw only a little current from a power supply which has a high vacuum rectifier, there is only a small voltage drop across the diode. As a result, the B+ voltage is very high. On the other hand, when a large current is taken from the power supply, the drop across the tube becomes very large and the B+ voltage drops way down. For this reason, a power supply using a high vacuum diode does not have good regulation. Regulation, is a measure of how well a power supply can maintain a constant output voltage as the load current varies from zero up to rated current. Because of its poor regulation, high vacuum rectifiers, aren't in power supplies which must deliver large load currents.

WHEN THE
LOAD
CURRENT
GOES UP

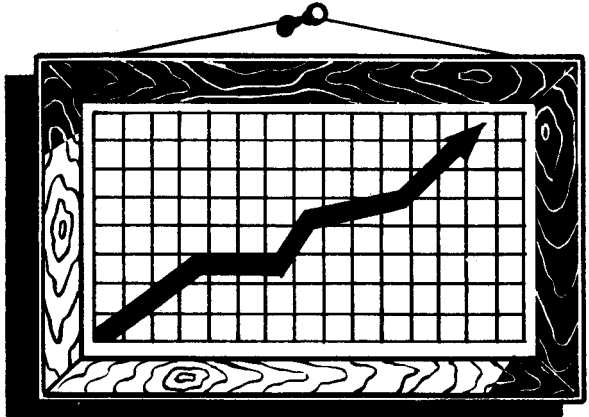

THE
OUTPUT
VOLTAGE
(B+)
GOES DOWN

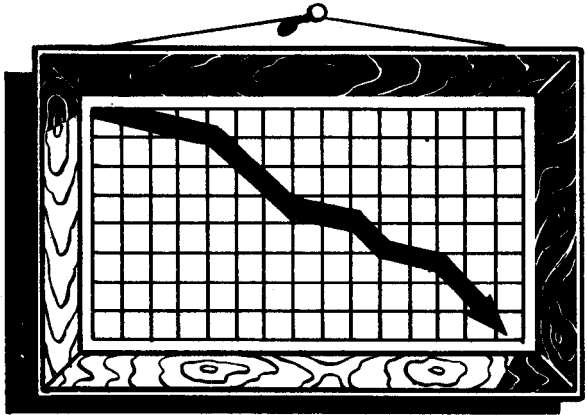

A POWER SUPPLY USING A
HIGH VACUUM DIODE
HAS Poor Regulation

HALF-WAVE RECTIFIERS—VACUUM TUBE TYPE

The Gas-Filled Diode (continued)

In a gas diode, electrons flow from the cathode to the plate just as in any diode. These electrons passing through the gas at fairly high speeds, knock one or more electrons out of the gas atom, leaving the atom with a + charge, and the gas is said to be ionized. The positive ions (the atoms which have had electrons knocked out of them) drift over to the cathode and pick up the electrons they lack. Some time later, another fast moving electron will knock some electrons out of the neutral atom, thus ionizing it again. In this way the gas always contains some ionized atoms.

Ionized gas has an amazing property. When a little current flows through the tube, there is a voltage drop across the tube of about 15 volts. When a lot of current passes through the tube, the voltage drop across the tube is still about 15 volts. There is an extremely small change in this voltage drop as the tube current varies over a wide range.

You can see that if the voltage across the gas tube is constant at different load currents, the B+ voltage will not change as much as it did in a power supply using a high vacuum tube. For this reason, the gas tube causes the power supply to have a better regulated output voltage than did the high vacuum tube.

You will find gas rectifiers used on any power supply which must deliver large load currents. Because of the low drop across the gas rectifier, the power supply will be much more efficient than if a high vacuum tube had been used.

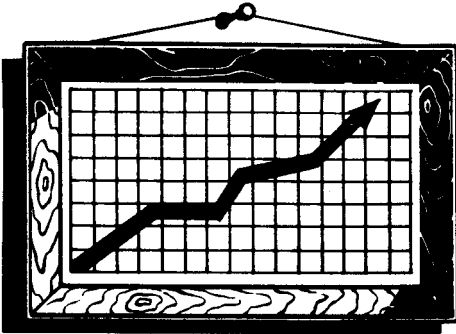

WHEN THE
LOAD
CURRENT
GOES UP

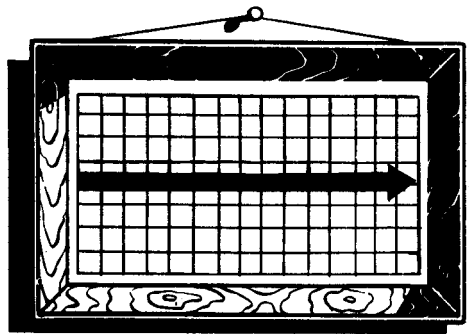

THE
OUTPUT
VOLTAGE (B+)
REMAINS CONSTANT



A POWER SUPPLY USING A
GAS-FILLED DIODE
HAS Good Regulation

HALF-WAVE RECTIFIERS—VACUUM TUBE TYPE

Review of Vacuum Tube Rectifiers

DIODE VACUUM TUBE — A two element vacuum tube consisting of a heated cathode and a metal plate enclosed in a glass envelope or tube from which the air has been removed.

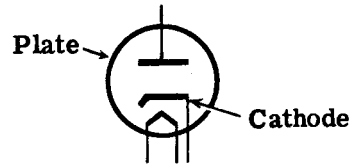

ELECTRON EMISSION — The action of the cathode in giving up electrons when the cathode is heated.

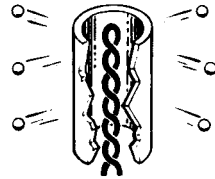

SPACE CHARGE — The negative charge in the area surrounding the cathode caused by the emission of electrons from the cathode.

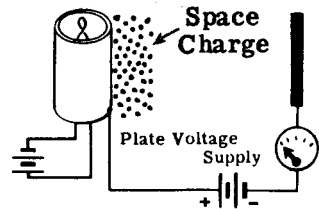

RECTIFIER TUBE — A vacuum tube made especially for use as a rectifier.

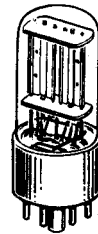

FILAMENTS — Fine wire heater used to heat the cathode in a vacuum tube. In directly heated cathode tubes, the filament and cathode are the same wire while in indirectly heated cathode tubes, the filament is called a heater and is used only to heat the cathode.

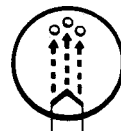

Directly Heated

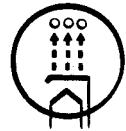

Indirectly Heated

BASIC VACUUM TUBE RECTIFIER CIRCUIT — A diode vacuum tube connected in series with an AC voltage source to change AC to DC.

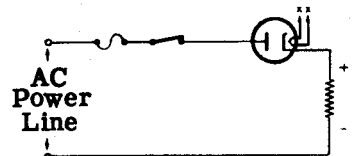

HALF-WAVE RECTIFIERS—TRANSFORMER TYPE

Transformer Type Power Supplies

The two basic rectifier circuits which have been discussed are used to change the 117 volt AC line voltage to DC. These rectifier circuits are often used for inexpensive power supplies when it is not necessary to isolate the rectifier circuit from the AC power line or to obtain DC voltages greater than 120 volts.

By adding a transformer to the circuit between the power line and the rectifier, the AC voltage can be increased or decreased resulting in a corresponding rise or fall of the DC output voltage. Also the output of the rectifier circuit will be completely isolated from the power line, and various filament voltages may be obtained by using additional secondary windings on the transformer. Because of the different voltages required and the need for isolating circuits in electronic equipment, most power supplies are of the transformer type. Several typical power supplies of this type are shown below.

Transformer Type Power Supplies

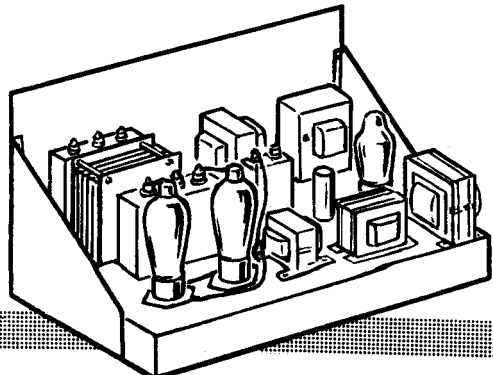
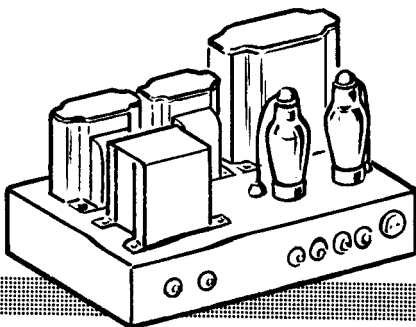
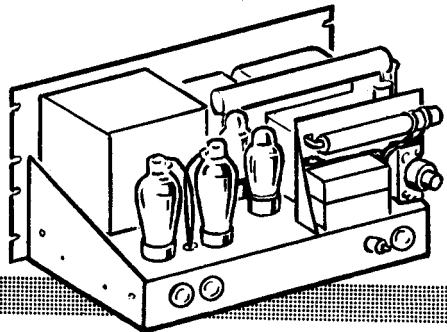
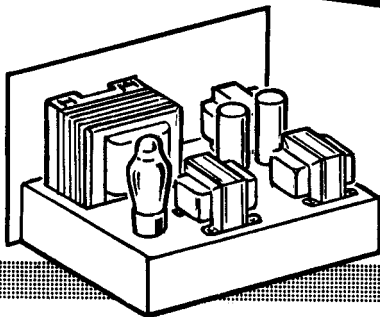
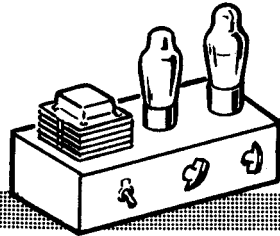

HALF-WAVE RECTIFIERS—TRANSFORMER TYPE

The Diode in a Transformer Type Circuit

All rectifiers, including the half-wave rectifier, change an AC voltage into a pulsating DC voltage. Each rectifier accomplishes this by allowing current to flow in the circuit in only one direction, and only slight differences exist in different rectifier circuits. You are going to see how the half-wave transformer type rectifier circuit makes the change from AC to pulsating DC.

The rectifying action of this circuit depends on the operation of a diode, the rectifier tube. The theory of operation of the diode has already been covered but, in order to understand the operation of the diode in the transformer type circuit, you should review these two facts.

1. The diode allows electrons to pass through it only when its plate is positive with respect to its cathode.

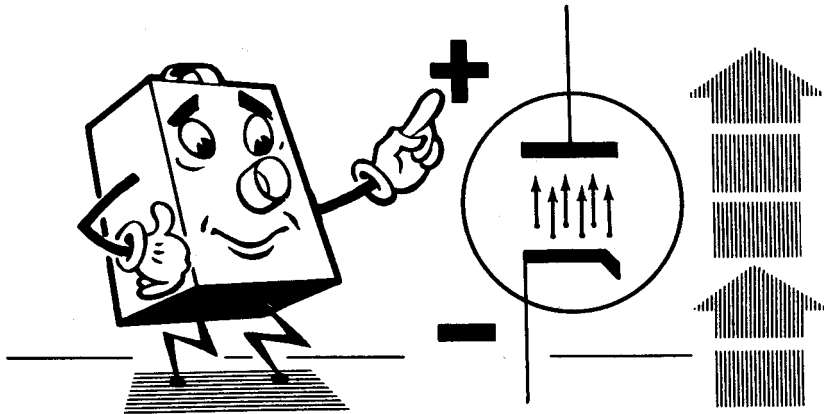

2. The diode does not allow electrons to flow through it when the plate is negative with respect to the cathode.

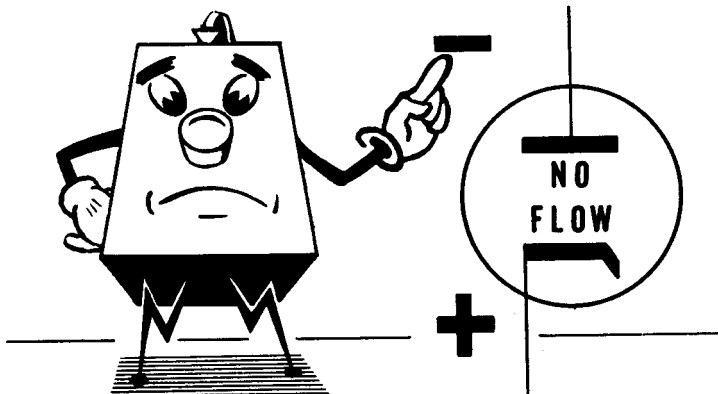

You know from your previous experiment with a diode that when the tube is connected across the 60 cycle power line the diode plate becomes positive 60 times per second and negative 60 times per second. Connecting the diode to the high voltage winding of a transformer keeps the situation exactly the same except that the voltage put on the plate is much higher, and the resulting pulsating DC is at a correspondingly higher voltage.

HALF-WAVE RECTIFIERS—TRANSFORMER TYPE

The Diode in a Transformer Type Circuit (continued)

Suppose you put the diode into a simple half-wave circuit with a transformer and see how it changes AC into DC.

When the transformer voltage makes the rectifier tube plate positive, electrons flow, and a voltage appears across the load.

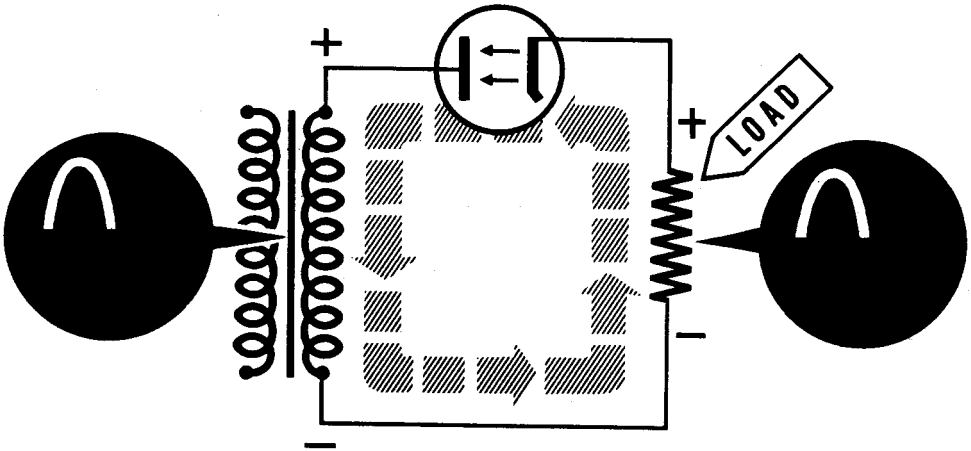

When the transformer voltage makes the rectifier tube plate negative, electrons cannot flow and, of course, no voltage can appear across the load.

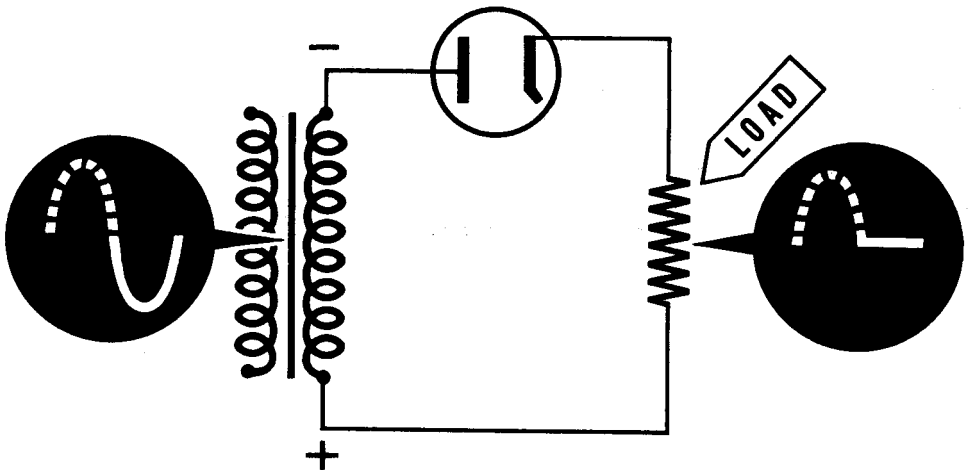

The diode rectifier tube, by allowing electrons to flow through it in only one direction (from cathode to plate), causes pulses of current to flow through the load and, therefore, causes a pulsating DC voltage to appear across the load. The AC voltage input from the transformer appears as a pulsating DC voltage across the load. Notice that the half-wave rectifier has used only the positive half of the AC input. The negative half is not used at all.

HALF-WAVE RECTIFIERS—TRANSFORMER TYPE

Circuit Diagram of a Transformer Type Circuit

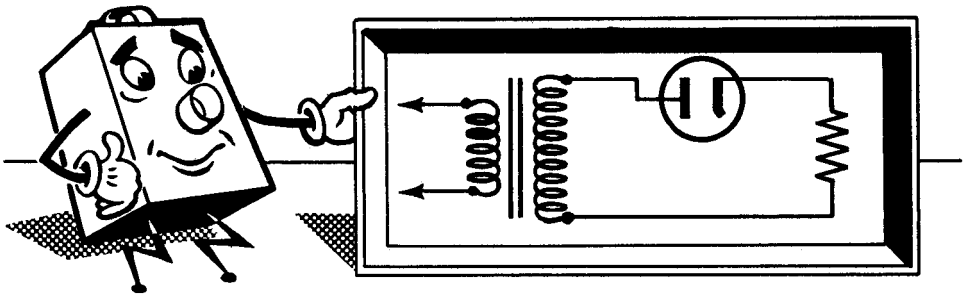

Compare the above schematic of the half-wave rectifier to the one below.

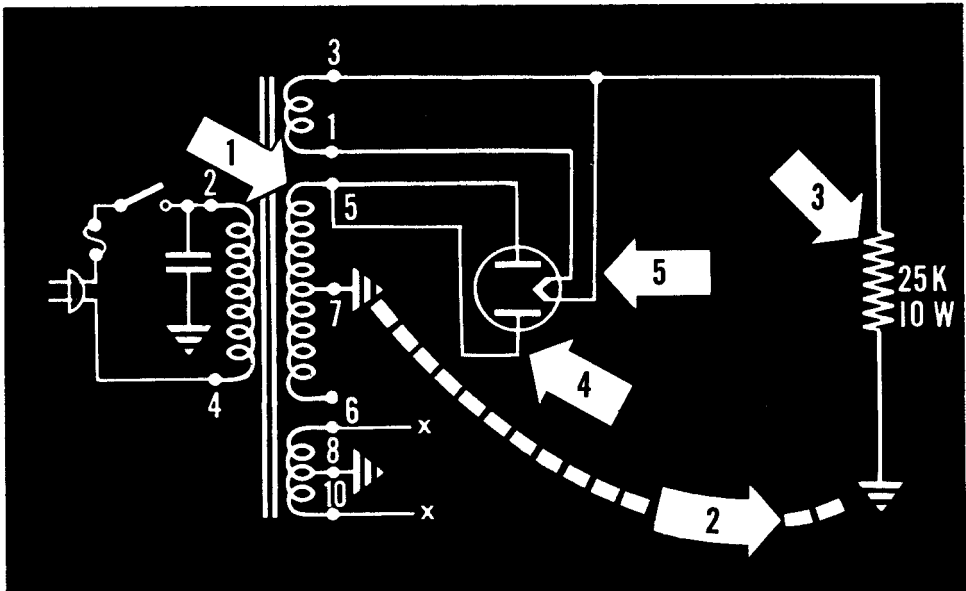

Notice the similarity between the two circuits. You can see that:

1. Only one-half of the transformer high voltage winding is used—the half from terminal 5 to terminal 7. This supplies the rectifier tube plate voltage.
2. The current path from the transformer to the load will be through the chassis (ground).
3. The load will be represented by the 25K resistor.
4. The two plates of the rectifier tube have been wired together so that the tube acts like a single diode.
5. The tube has a directly heated cathode. Therefore, the cathode is connected to the transformer filament winding—terminal 1 and terminal 3—as well as the load.

HALF-WAVE RECTIFIERS—TRANSFORMER TYPE

Operation of the Transformer Type Circuit

The basic operation of the half-wave rectifier circuit just shown has been described previously. In the circuit diagram illustrated the flow of current through the circuit is indicated by arrows. The + and - signs show the reversal in polarity of the transformer secondary voltage for alternate half cycles. The rectifier tube will only conduct from cathode (filament) to plate, and only when the plate is positive with respect to the cathode.

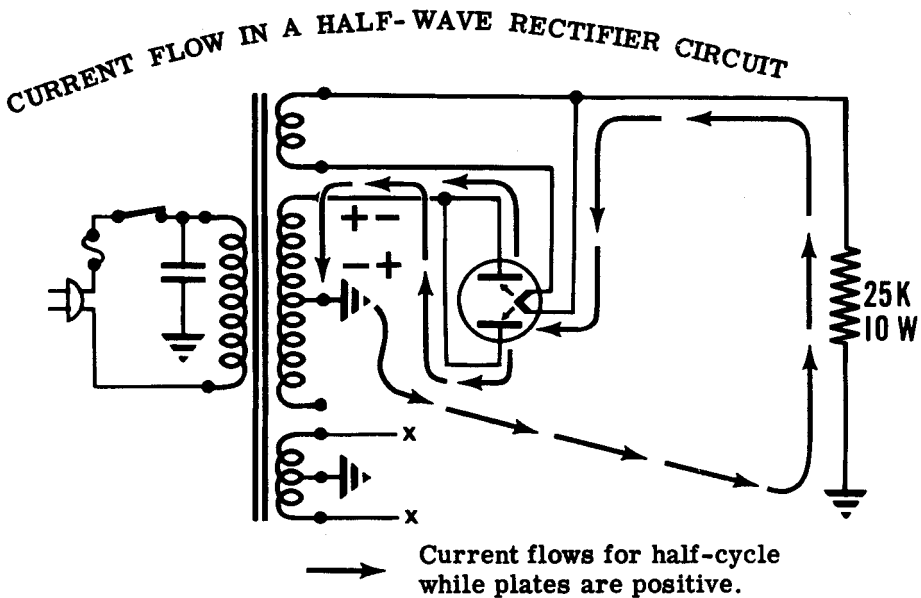

The .001 mfd. capacitor used does not effect the circuits basic operation as a half-wave rectifier. This condenser is connected between one side of the AC power line and ground to reduce electrical interference and prevent such interference from passing through the rectifier circuit. Capacitors used for this purpose may be connected in any of the ways illustrated below.

POWER LINE FILTER CONDENSER CIRCUITS

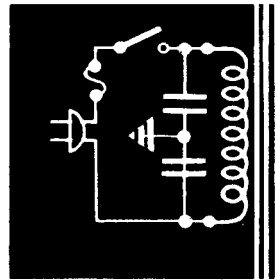
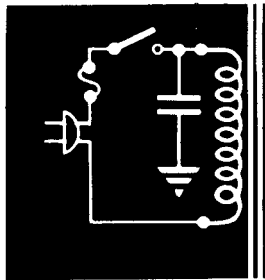
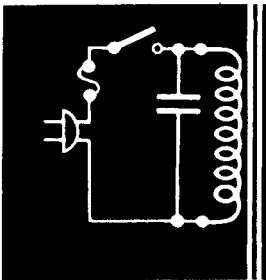

HALF-WAVE RECTIFIERS—TRANSFORMER TYPE

Review of the Half-Wave Rectifier Circuit

TRANSFORMER TYPE POWER SUPPLY — A power supply which uses a transformer to either raise or lower the AC power line voltage to obtain a desired value of DC output voltage.

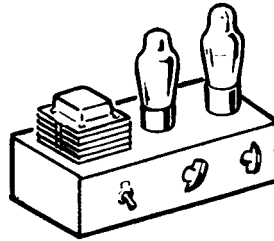

HALF-WAVE RECTIFIER CIRCUIT — A rectifier circuit using a single rectifier unit which changes AC to DC by allowing current to flow only in one direction. Alternate half-cycles of the AC power wave are utilized to provide a pulsating DC output. The circuit sometimes uses a transformer to increase or decrease the output voltage.

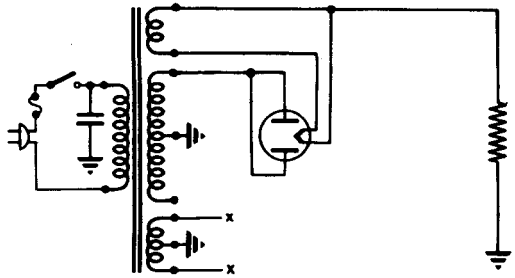

CURRENT FLOW IN A HALF-WAVE RECTIFIER CIRCUIT — AC is applied to the rectifier plate and current flows only during those half-cycles which are positive on the plate side of the circuit input.

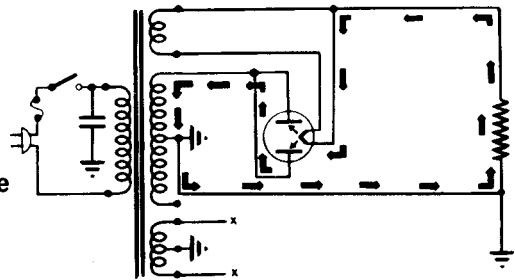

HIGH VOLTAGE MEASUREMENT — Always use only one hand in measuring voltages or testing circuits where high voltage is present. Use a test prod which is insulated and rated for working with high voltages.

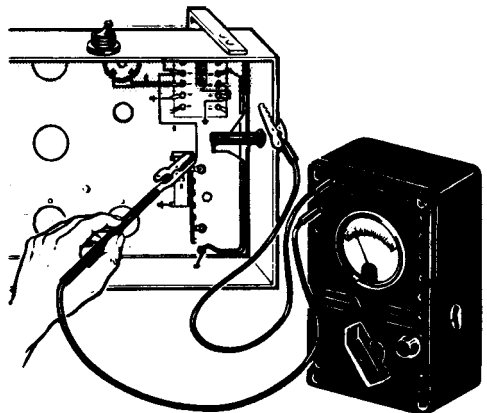

THE FULL-WAVE RECTIFIER CIRCUIT

Full-Wave Rectifiers

You have seen how the half-wave rectifier works. Now, in the following sheets you will see how the full-wave rectifier does the same job in a slightly different way.

You must know the full-wave rectifier because it is used in nine out of ten pieces of electronic equipment. It may be supplying any voltage from 100 volts to 5,000 volts. On any ship, any station, anywhere where electronic equipment is used, you'll find full-wave rectifiers supplying most of the power.

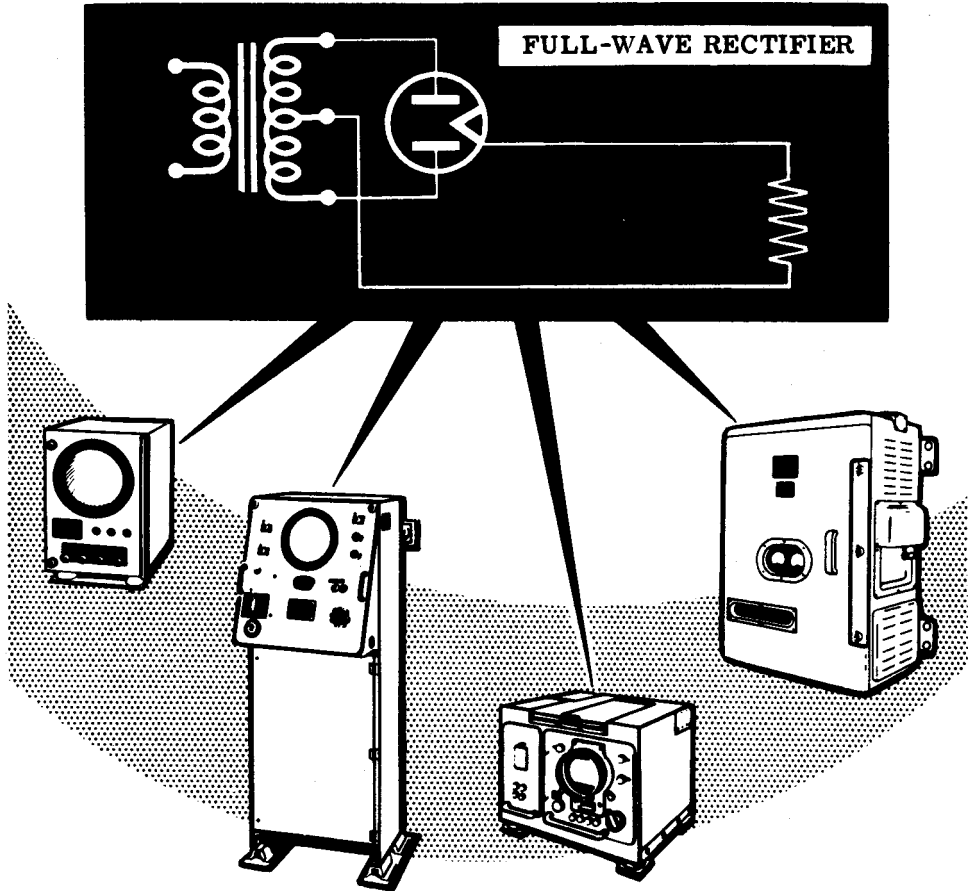

THE FULL-WAVE RECTIFIER CIRCUIT

How the Full-wave Rectifier Works

In a full-wave rectifier circuit a diode rectifier tube is placed in series with each half of the transformer secondary and the load. Effectively, you have two half-wave rectifiers working into the same load.

On the first half-cycle the transformer's AC voltage makes the upper diode rectifier plate positive so that it conducts and, as a result, current flows through the load causing a pulse of voltage across the load. Notice that, while the upper diode conducts, the lower diode plate is negative with respect to its cathode so that it does not conduct.

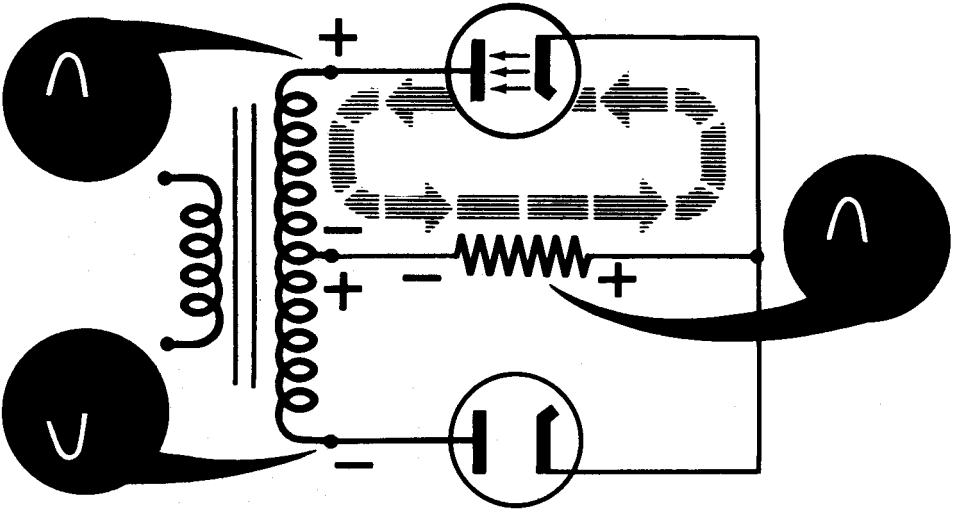

On the second half-cycle the plate of the upper diode is negative so that it cannot conduct, whereas the plate of the lower diode is positive so that current flows through it and through the load. Since both pulses of current through the load are in the same direction, a pulsating DC voltage now appears across the load. The full-wave rectifier has changed both halves of the AC input into a pulsating DC output.

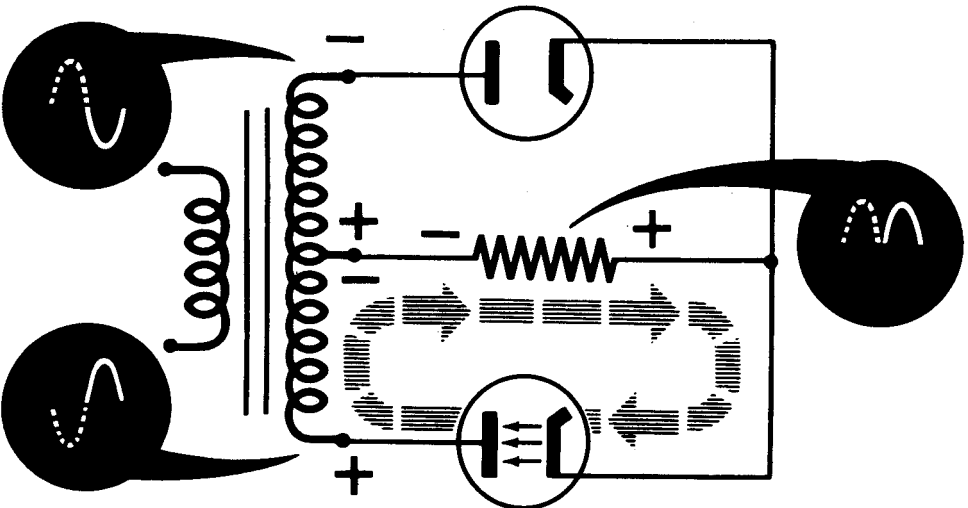

THE FULL-WAVE RECTIFIER CIRCUIT

The Full-wave Rectifier Tube

The diagram on the previous sheet shows two separate rectifier tubes being used in the full-wave rectifier circuit. Sometimes you may find this circuit used in power supplies but more frequently just one tube is used in the full-wave rectifier. If you will refer back to the diagram on the previous sheet, you will see that the filaments of the two tubes are connected together.

Since this is so, two separate rectifier tubes can be put together into one envelope so that the two plates share a common filament. The full-wave rectifier tube therefore contains two plates but only one filament. Such a tube is the 80 rectifier tube.

When a full-wave rectifier is used in a full-wave rectifier circuit, the circuit is most commonly drawn like this.

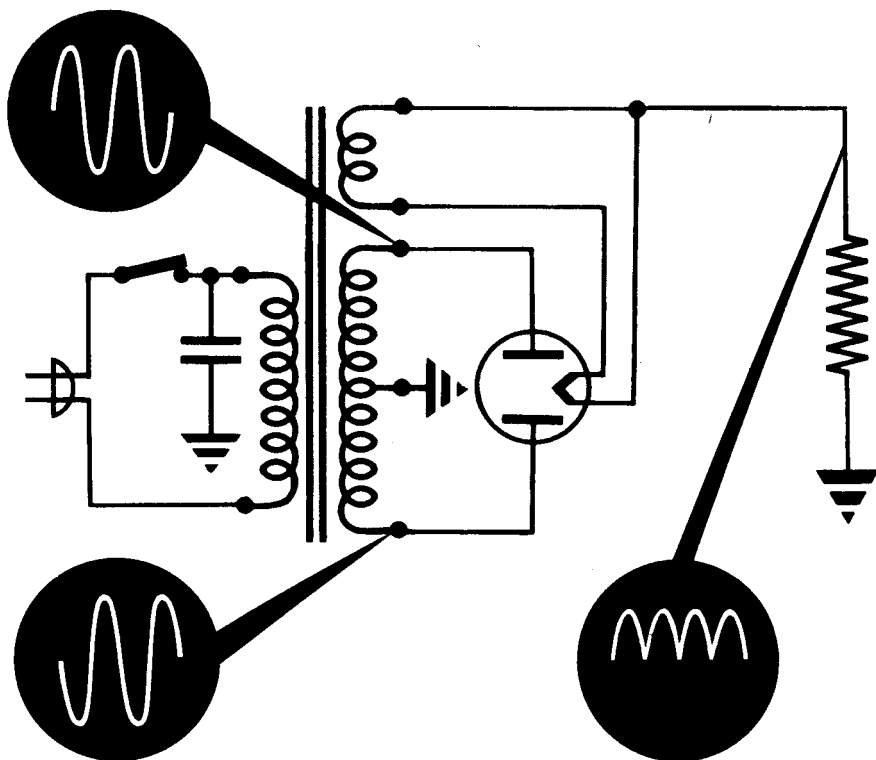

Notice that in this tube there is only one filament which supplies electrons to both plates. During one-half of the AC input cycle, one plate draws electrons from the filament and, during the other half of the cycle, the other plate draws the electrons. As in any diode, the direction of current flow inside this tube is always from the filament and this current flows first to one plate and then to the other. The load, which is in series with the filament, therefore has pulsating DC current flowing through it.

THE FULL-WAVE RECTIFIER CIRCUIT

Current Flow in the Full-wave Rectifier Circuits

The illustration below compares the operation of the full-wave rectifier circuit to that of a basic full-wave rectifier.

In the basic circuit illustrated, plates 1 and 2 of the rectifier tube are connected to opposite ends of the transformer winding so that there is always a 180 degree phase difference between the voltages applied to the two plates. Current flows only to that plate which is positive so that current flows from a common cathode to each plate on alternate half cycles. Since the load resistor is connected between the cathode and the transformer secondary winding centertap, the current flow in the load resistor is in the same direction for both half cycles.

In the basic full-wave rectifier circuit two cathodes are used but since they are connected together a single common cathode can be used instead in a typical circuit. Also in the basic circuit one end of the load resistor connects directly to the transformer secondary winding centertap and no ground connection is used. This connection can be made by grounding the centertap and one end of the load resistor to different points on the chassis.

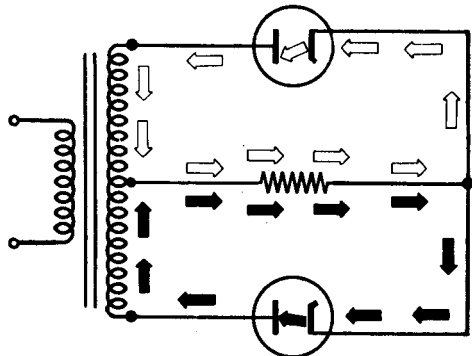

BASIC FULL-WAVE RECTIFIER CIRCUIT

TYPICAL COMPLETE FULL-WAVE RECTIFIER CIRCUIT

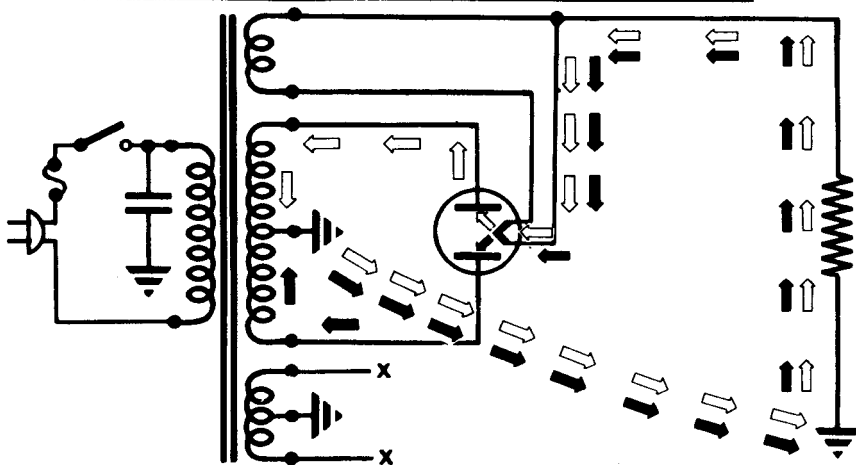

THE FULL-WAVE RECTIFIER CIRCUIT

The Bridge Rectifier Circuit

The bridge rectifier, just like the other rectifiers you have studied, changes AC voltage to DC voltage. Here's how it does it!

Four dry metal rectifiers are hooked together with the AC input and the load as shown. As the AC voltage input swings positive, current flows from one side of the input through one dry metal rectifier, through the load, and then through another dry metal rectifier back to the other side of the input.

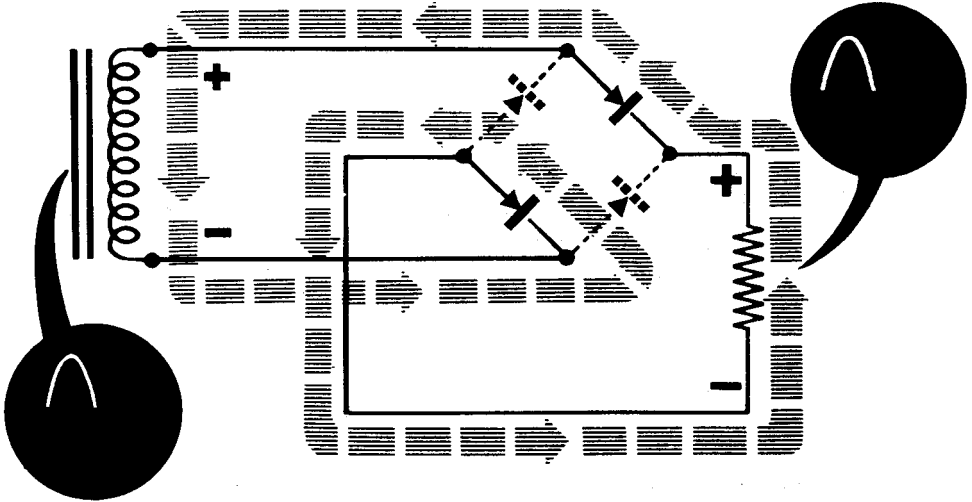

Then, when the AC voltage input swings negative, current flows through the other pair of dry metal rectifiers and the load. Notice that the current flow through the load is in the same direction during both half-cycles of the input wave. Therefore, the voltage developed across the load is pulsating DC which can, of course, be filtered just as any other pulsating DC output from a rectifier circuit.

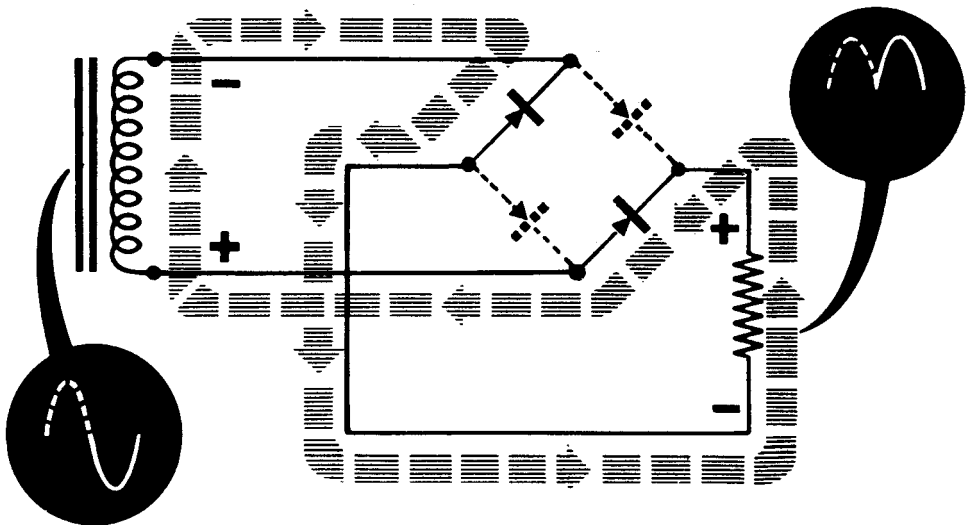

THE FULL-WAVE RECTIFIER CIRCUIT

The Bridge Rectifier Circuit (continued)

In actual practice the four dry metal rectifier units used in the bridge rectifier circuit are joined together in one physical unit and are connected externally into the bridge rectifier circuit.

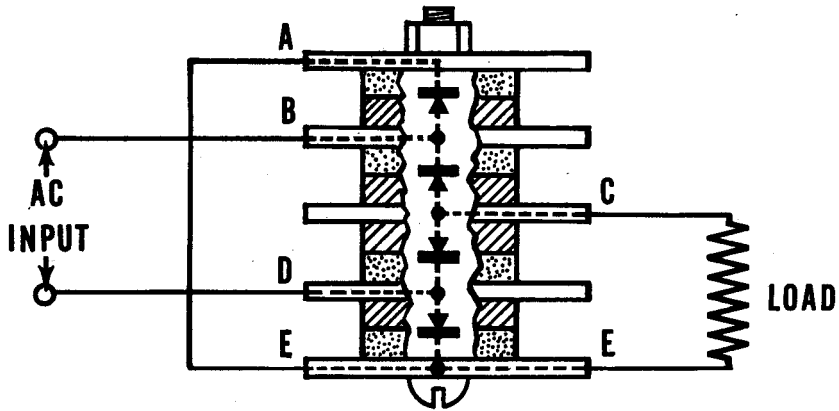

To get from the pictorial to the schematic diagram, just imagine the two end units being rotated around as shown below. Before you continue, make sure you understand the relationship between the physical unit and the schematic.

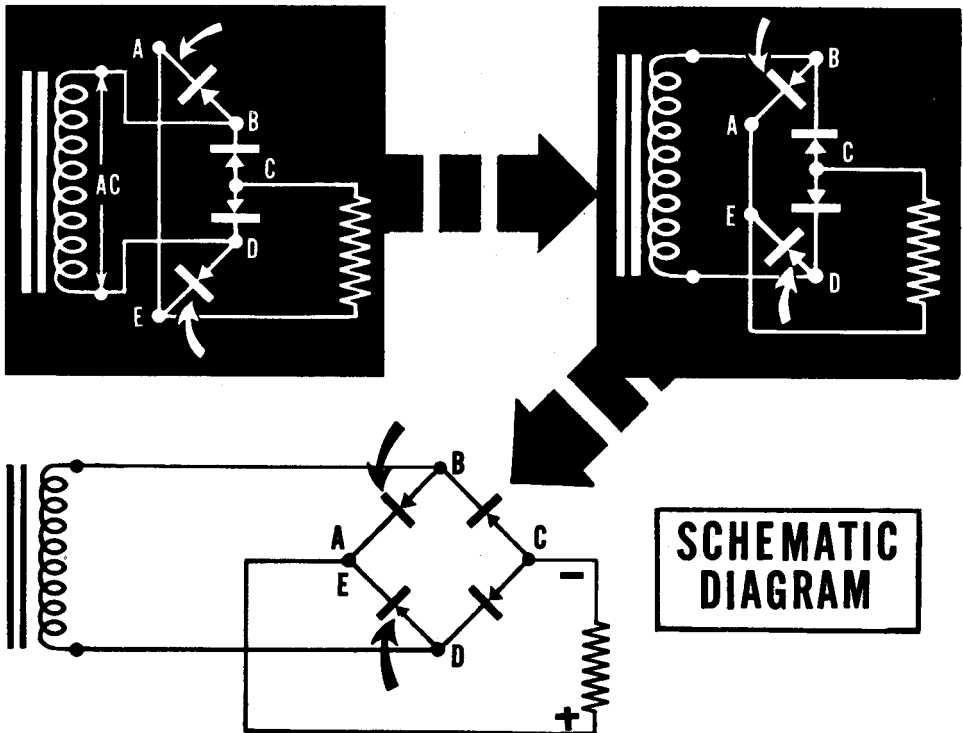

THE FULL-WAVE RECTIFIER CIRCUIT

Review of the Full-Wave Rectifier Circuit

FULL-WAVE RECTIFIER CIRCUIT -

A rectifier circuit which utilizes both cycles of the applied AC voltage to obtain pulsating DC. A center-tapped transformer secondary winding is used with two diodes rectifying alternate half cycles of the voltage, causing pulses of current to flow in the same direction through a load resistor for each half cycle of applied AC.

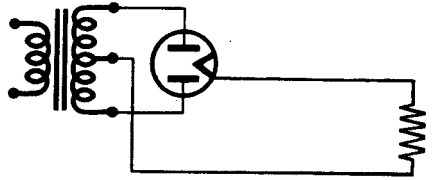

FULL-WAVE RECTIFIER TUBE - A

vacuum tube consisting of two specially designed diodes and a common cathode in the same glass envelope. Both direct and indirectly heated cathodes are used depending on the requirements of the rectifier circuit.

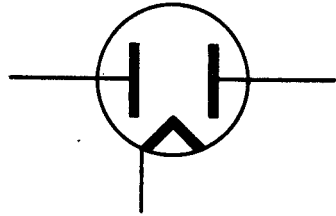

CURRENT FLOW IN THE FULL-WAVE RECTIFIER CIRCUIT -

Current flows from the rectifier tube cathode to whichever plate is positive, then through one half of the secondary winding to the chassis ground. From the ground point it flows through the chassis to one end of the load resistor then through the load resistor back to the rectifier tube cathode.

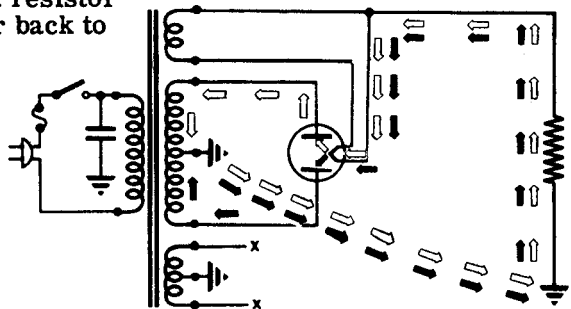

FILTER CIRCUITS

What You Have to Know about Power Supplies

Learning all about the various power supplies is going to be a simple job. Why? Because you can open up any power supply and find that it contains only two major circuits—the rectifier circuit and the filter circuit.

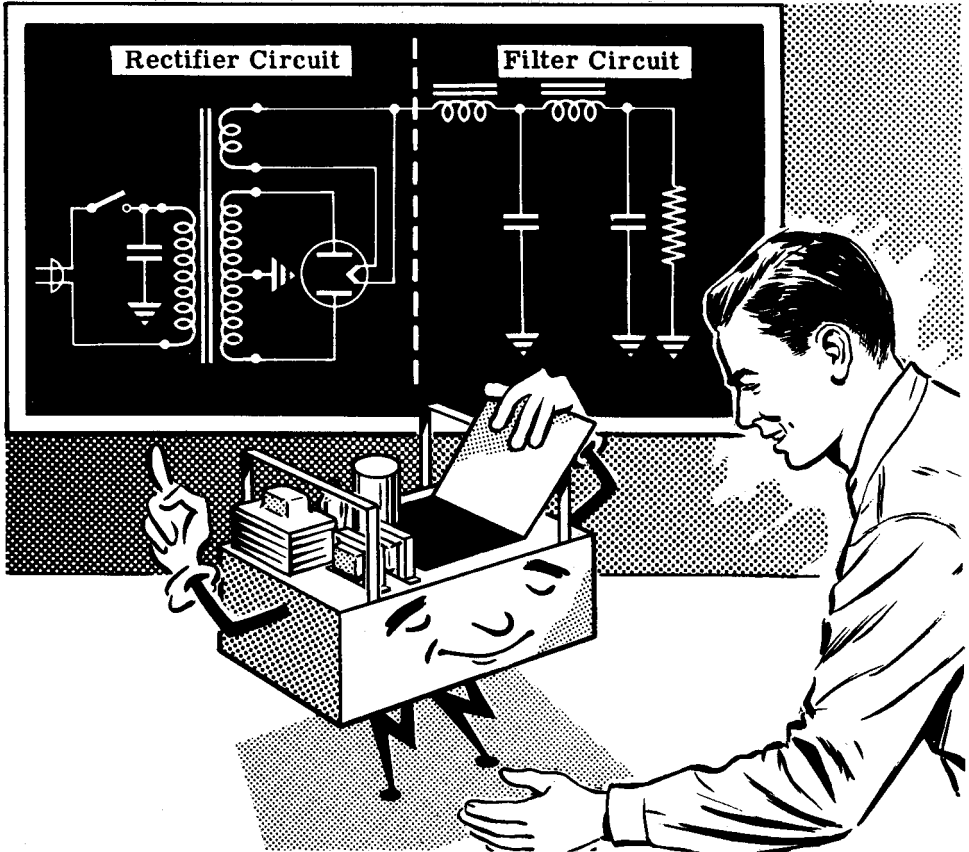

You already know that there are only two types of rectifier circuits in general use—the full-wave and the half-wave rectifiers—and they both perform the same job of changing AC into pulsating DC. There are only three types of filter circuits that are in general use. These filter circuits all have one thing in common—they remove the ripple from the pulsating DC output of the rectifier.

In addition, there is only one basic type of voltage regulator tube which is used with power supplies. As its name implies, this tube maintains the output voltage of a power supply at a required value in spite of line voltage fluctuations or variations of load current.

Know these power supply circuits and you know almost all you will ever have to know about power supplies. This is true because nearly every power supply that exists consists of various combinations of basic rectifier circuits, basic filter circuits, and voltage regulator tubes.

The three most common types of filter circuits used are shown on the next sheet.

FILTER CIRCUITS

Power Supply Filter Circuits

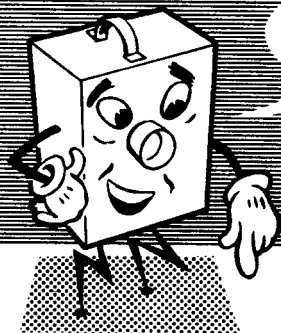

Here are THE THREE FILTER CIRCUITS YOU WILL LEARN NOW

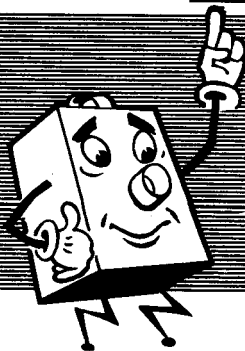
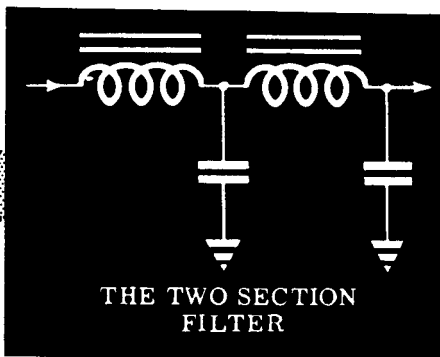
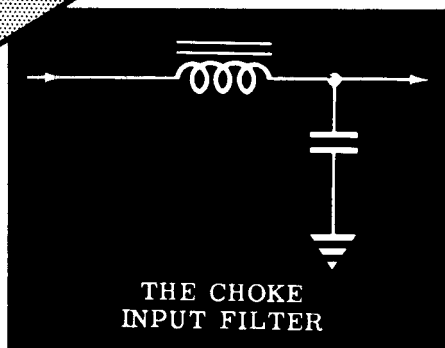
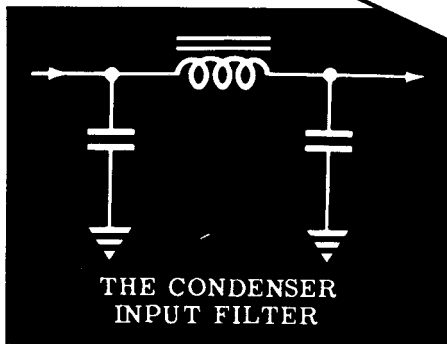
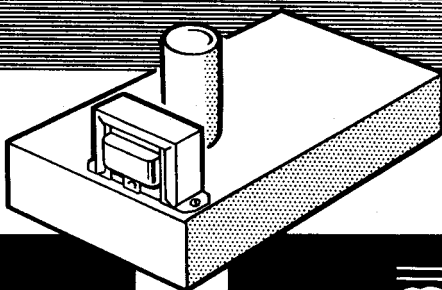

THESE ARE THE FILTERS YOU WILL SEE IN YOUR POWER SUPPLY CIRCUITS

FILTER CIRCUITS

Characteristics of the Rectifier Output

You have been told that electronic circuits in general require a source of about +350 volts DC and a source of 6.3 volts AC in order to operate. The power supply transformer supplies the 6.3 volts AC directly to the heaters of the tubes requiring it. The transformer feeds high voltage AC into the rectifier and rectifier puts out pulsating DC that looks like this:

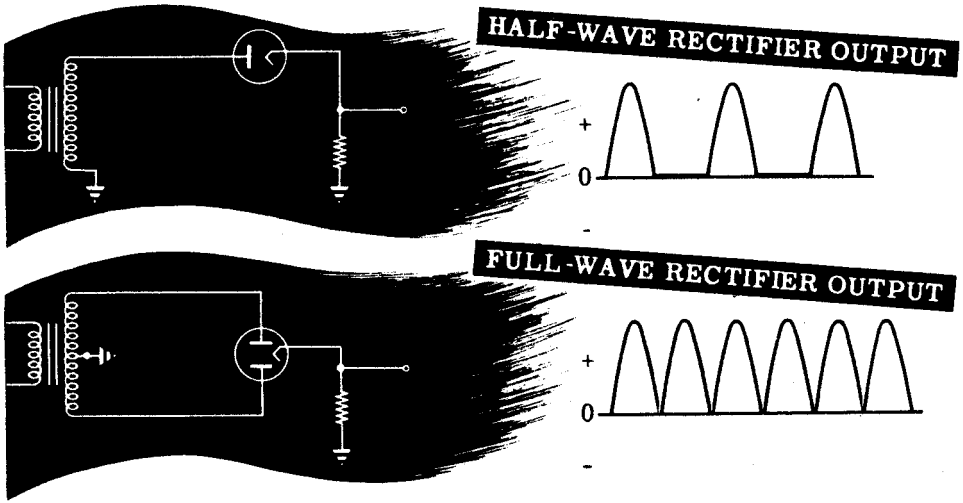

The electronic circuits which are connected to the power supply output cannot use a pulsating voltage of this sort. What these circuits require is a steady DC voltage with as little pulsation as possible. The purpose of the filter circuit is to remove the pulsations from the rectifier output and deliver a steady DC voltage.

The output of a rectifier tube consists of pulses of current which always flow in the same direction through the load resistor. The current rises from zero to a maximum and then falls to zero, repeating this cycle over and over again. At no time does the electron current through the load resistor change its direction and flow from the filament to ground. The voltage resulting from this flow of electrons through the load resistor is a voltage that rises from zero to a maximum and then falls back to zero, repeating this cycle over and over again. This voltage takes on the shape of half sine waves. In the case of a half-wave rectifier the average DC voltage is 31.8 percent of the peak value. In the case of a full-wave rectifier the average DC is 63.6 percent of the peak value.

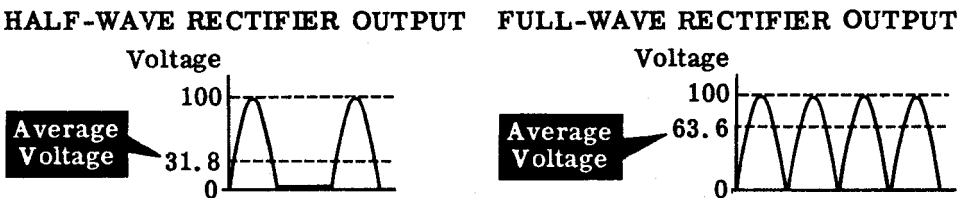

FILTER CIRCUITS

AC and DC Components

If you connect a DC voltmeter across the rectifier output you will get a reading. If you connect an AC voltmeter across the rectifier output, you will also get a reading. This AC reading is a result of the output voltage variation. Therefore, the output of the rectifier can be considered as a DC voltage with an AC voltage superimposed upon it. You can look upon the job of a filter circuit as the job of removing the AC portion (or AC component) of the rectifier output and allowing only the DC component to get to the power supply output terminals. If the filter succeeds in removing all of the AC from the rectifier output, only pure DC will be left.

You may now ask the question "How can a pulsating DC voltage have an AC component if the voltage rises from zero to a high positive value and falls back to zero, but never becomes negative?" You have always thought of an AC voltage as one which alternates above and below a zero voltage, first becoming positive, then zero and then negative. If the voltage never becomes negative, how can there be any AC in it?

Any wave that varies in a regular manner has an AC component. Suppose you examine an example in which an AC voltage is combined with a DC voltage and the result is a voltage wave which never becomes negative. Suppose you have a voltage of +50 volts DC and you combine it with an AC voltage which varies from +20 volts through zero to -20 volts.

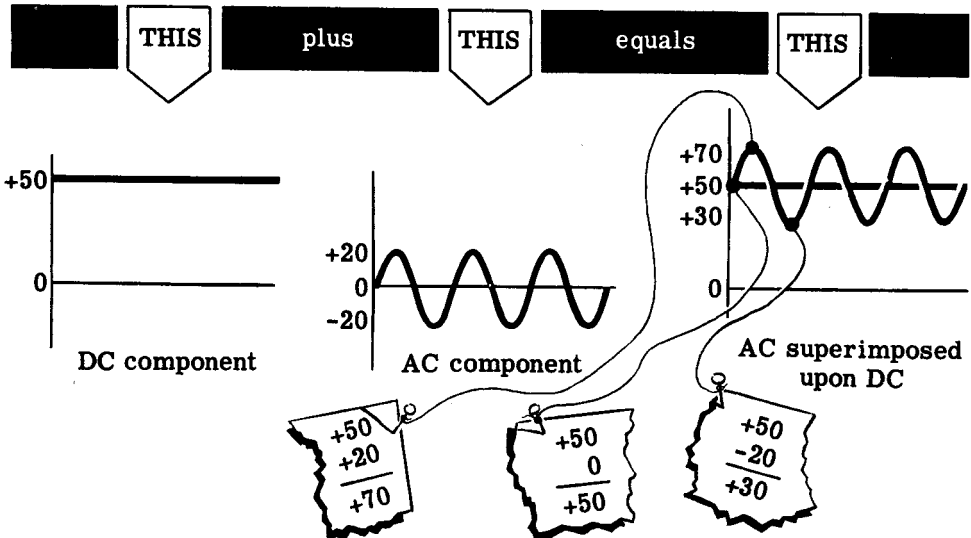

When the +20 volt AC peak is added to the +50 volts DC, the result is +70 volts. When the 0 volt point on the AC wave is added to the +50 volts DC, the result is +50 volts. When the -20 volts AC peak is added to the +50 volts, the result is +30 volts. The total result is a DC voltage which varies from +50 volts—up to +70 volts and down to +30 volts. The voltage of the resulting wave never becomes negative and yet it consists of an AC component and a DC component.

FILTER CIRCUITS

AC and DC Components (continued)

You have seen how a DC voltage and an AC voltage can be added together to give a voltage wave which never becomes negative. Here are a few more examples:

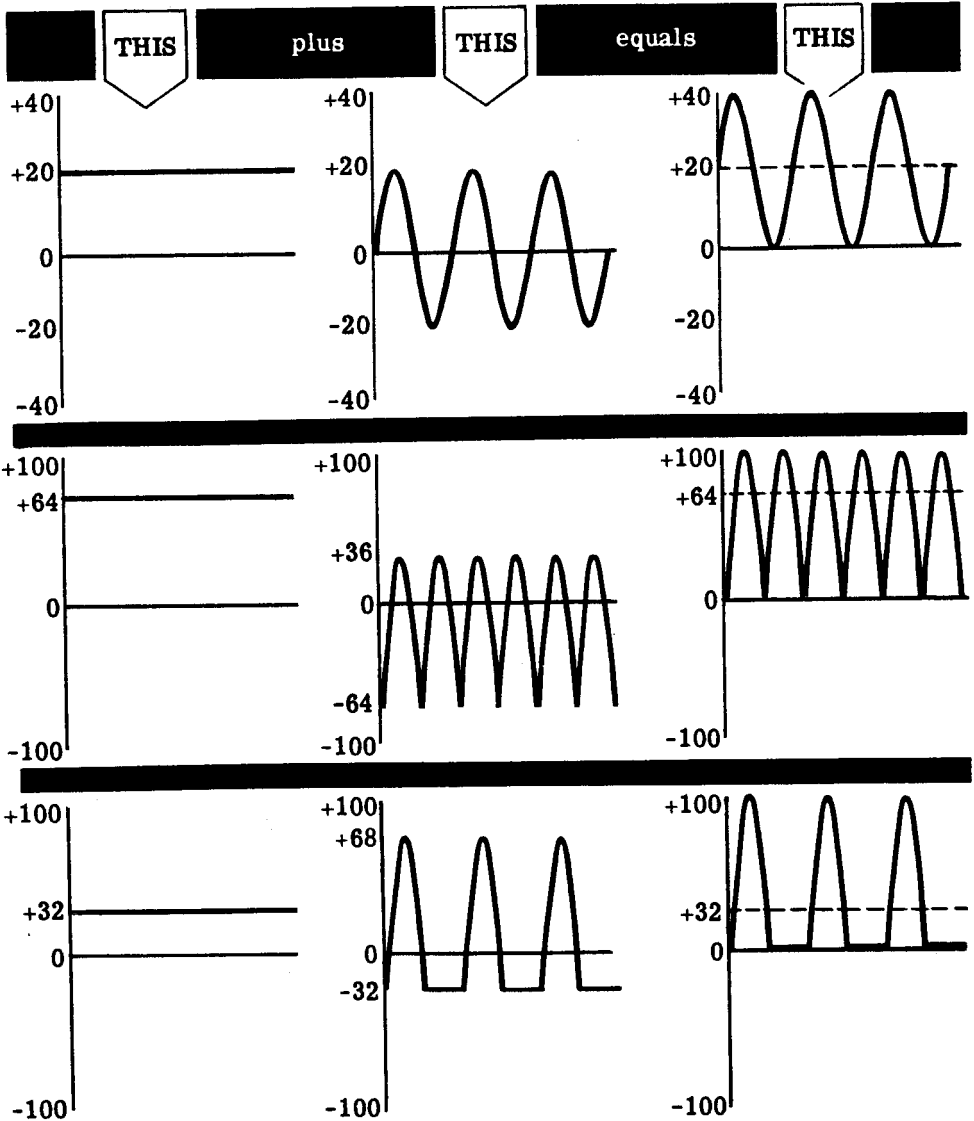

You can see that as long as a voltage varies in any regular manner, it can be broken up into a DC component and an AC component. The output of a rectifier contains both a DC component and an AC component. It is the job of the filter to remove as much of the AC voltage as is possible (and economical!) before the resulting high voltage DC is fed to the electronic circuits which require it.

FILTER CIRCUITS

The Condenser in the Filter Circuit

If you remove the load resistor from the output of the rectifier and replace the resistor with a large condenser, pure DC will appear across the condenser. When you find out why this takes place, you will see how this effect can be used in filter circuits.

You know that, when a condenser is placed across a battery, it charges up to the battery voltage if it is given enough time.

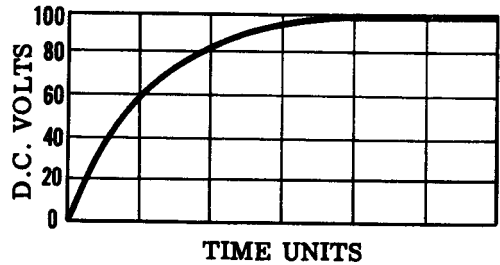
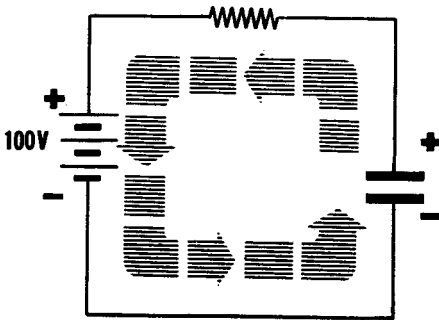

The same is true when a condenser is placed across the output of a rectifier. The rectifier starts charging up the condenser every time it conducts. If the condenser does not have time to charge up to the peak of the pulsating DC wave on the first half-cycle, it will do so during the next few half-cycles. After a few cycles have passed, there will be pure DC across the condenser. Because current can flow in only one direction through the rectifier, the condenser will not discharge between the peaks of the pulsating DC voltage. What has been the effect of placing the condenser across the output of the rectifier? By charging up, the condenser has filtered out the ripple in the pulsating DC, leaving pure DC.

Action of the Filter Condenser...

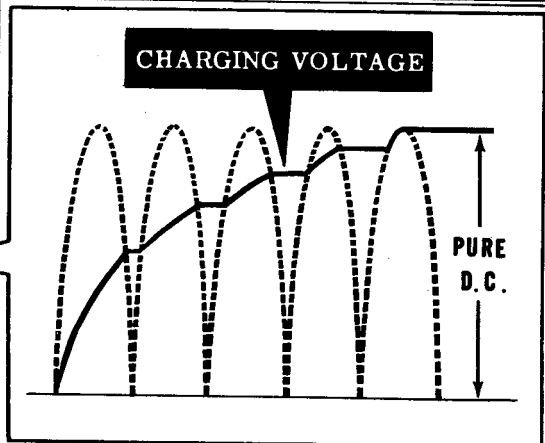
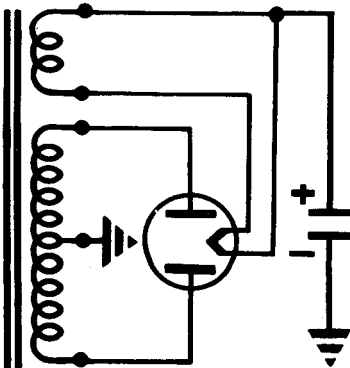

FILTER CIRCUITS

The Condenser in the Filter Circuit (continued)

If a power supply did not have to supply current to other circuits, pure DC voltage could be obtained simply by connecting a condenser from the rectifier filament to ground. However, the various electronic circuits do draw a certain amount of current. The current drawn by these electronic circuits is called the load current, and the effect of this load current can be duplicated by connecting a load resistor across the rectifier output and ground.

You know from your study of RC circuits in Basic Electricity that when a resistor is placed across a charged condenser, the condenser will discharge through the resistor. The speed of the discharge will depend upon the size of the resistor. The lower the resistance the more current will be drawn from the condenser, and the faster will be the discharge.

As soon as the resistor is connected across the condenser of the rectifier circuit, that condenser will begin to discharge and the voltage will drop. The voltage, however, will not drop to zero because a new voltage peak appears at the rectifier filament 60 times a second for a half-wave rectifier and 120 times a second for a full-wave rectifier. This voltage peak will recharge the condenser, and then the condenser will proceed to discharge through the resistor until the next voltage peak comes along. The result will be a pulsating DC output. Notice that the pulsations are much smaller than you would get with no condenser.

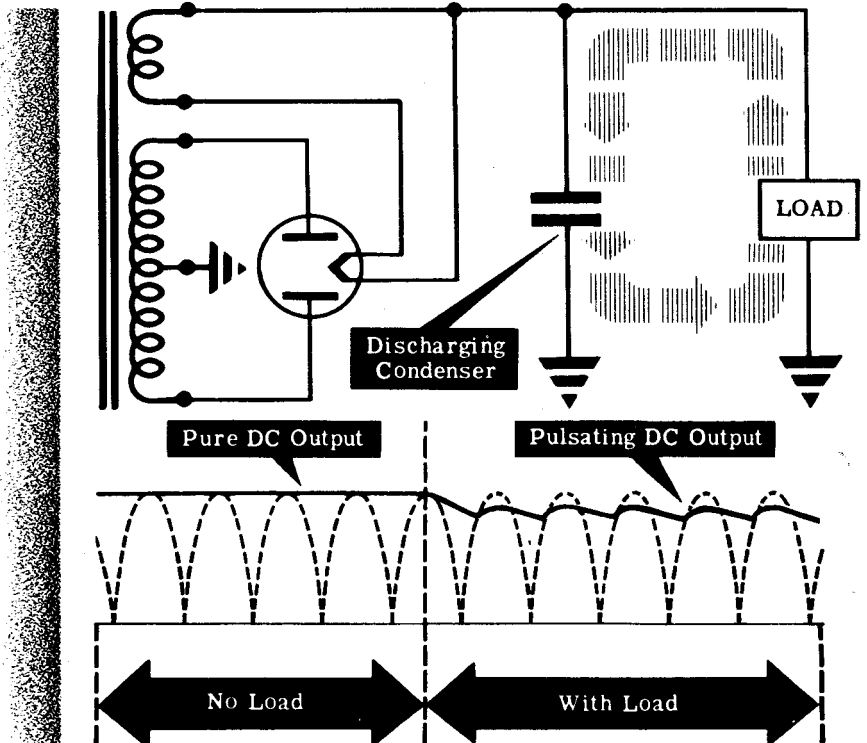

FILTER CIRCUITS

The Condenser in the Filter Circuit (continued)

The result of placing a load on the single filter condenser is that the output of the rectifier is no longer pure DC—it is DC upon which is superimposed an AC component. This AC component is called "ripple." It is because of this AC component or ripple that a condenser, by itself, does not constitute a satisfactory filter. Additional filtering components have to be added to remove the ripple and make the final B+ output as close to pure DC as is possible and economical. Just why ripple in the B+ output is so undesirable is something you will learn when you come to the study of amplifiers.

The amount of ripple resulting from a load placed across a single filter condenser depends upon the size of the load, the size of the condenser and the type of rectifier. The larger the condenser the more electrons it can accumulate on its plates, and it will discharge a smaller amount when a load is put across it. The larger the load current drawn out of the condenser the larger will be the voltage drop, and the larger will be the ripple. Since half-wave rectifiers will charge the condenser 60 times per second, there will be more time for the condenser to discharge through the load than with a full-wave rectifier which charges the condenser 120 times per second. Thus the ripple will be greater for a half-wave rectifier than for a full-wave rectifier because the voltage will drop a greater amount during pulses.

The larger the load the greater the ripple

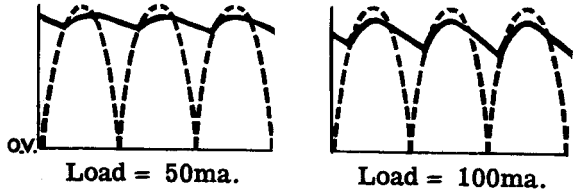

The smaller the capacity of the condenser the greater the ripple

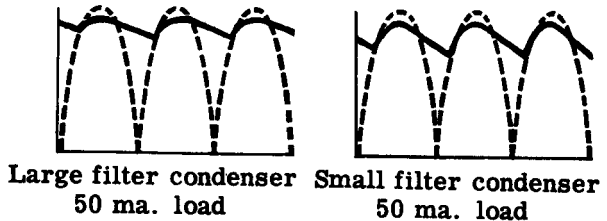

Same load, same filter condenser

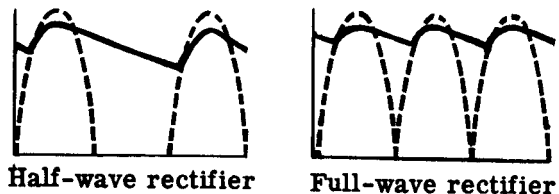

FILTER CIRCUITS

Filter Condensers

Filter condensers (capacitors) used in power supplies are of two types: (1) paper dielectric condensers and (2) electrolytic condensers.

Paper condensers are constructed of alternate layers of metal foil and waxed paper rolled together. The waxed paper is the dielectric with the metal foil being used as plates. Paper condensers smaller than 1 mfd. are used throughout most electronic equipment and larger values are sometimes used as filter condensers in power supplies.

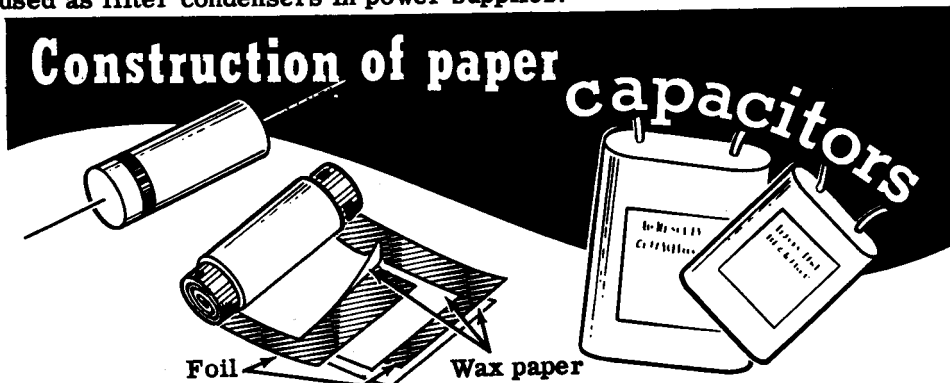

Paper condensers are not polarized and when operated within their voltage rating they last much longer than electrolytic condensers. However, large sizes of paper condensers are bulky and relatively expensive. They are normally not made larger than 16 mfd.

High voltage power supplies use paper filter condensers which are oil impregnated and will withstand greater peak voltages than those impregnated with wax. Condensers are rated according to direct current working voltage (DCWV) and also in peak voltage. The DCWV is the maximum voltage the condenser is designed to operate at continuously. The peak voltage is the voltage above which the condenser dielectric will break down and act as a conductor.

HIGH VOLTAGE PAPER FILTER CAPACITORS

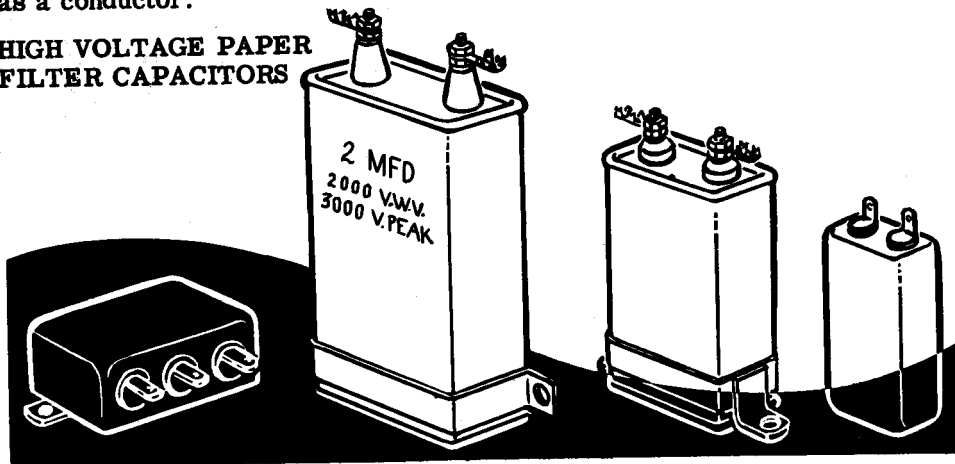

FILTER CIRCUITS

Filter Condensers (continued)

Electrolytic condensers are usually used as power supply filter condensers because they can be made in very large sizes at low cost and are much smaller physically than paper condensers of the same capacity. Electrolytic condensers are made in larger sizes than paper condensers with the usual values being between 2 mfd and 1000 mfd.

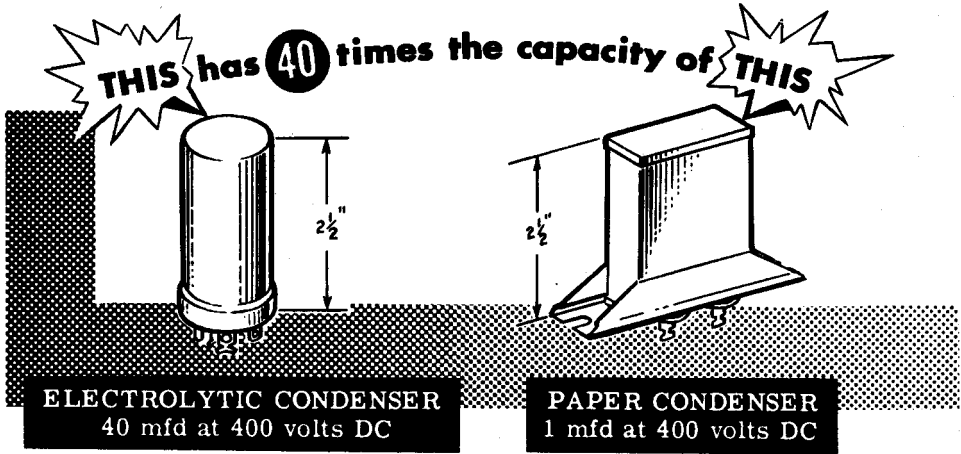

Power supplies rated at 600 volts or less usually use electrolytic filter condensers but when a higher voltage rating is required paper condensers are used. Electrolytics are polarized and failure to observe the correct polarity will not only permanently damage the condenser but may also cause it to break open and damage other parts.

While paper condensers have no leakage current (flow of direct current across the condenser dielectric) electrolytic condenser dielectrics are not perfect insulators and a leakage current flows even during normal operation. The leakage current is greater in the wet electrolytic than in the dry types. If the voltage rating of an electrolytic condenser is exceeded the leakage current increases and may damage the dielectric.

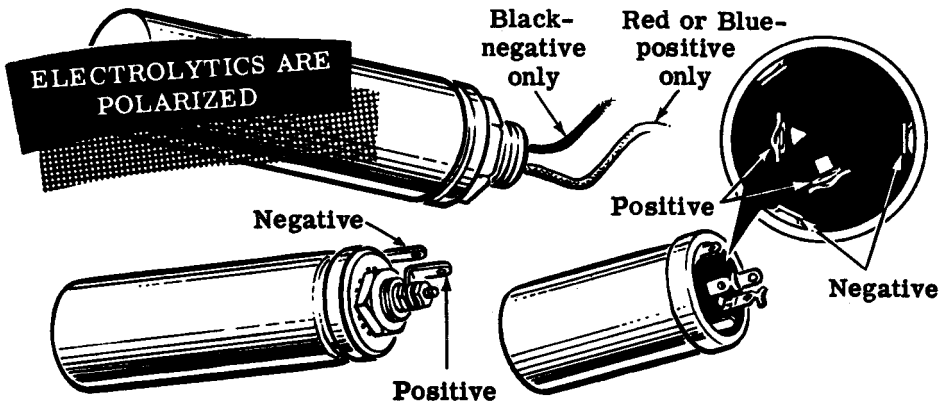

FILTER CIRCUITS

Filter Condensers (continued)

Electrolytic condensers are of two types: (1) wet and (2) dry.

A wet electrolytic condenser consists of an aluminum electrode immersed in a solution called an electrolyte. When the electrode is connected to the positive terminal of a DC voltage source and the electrolyte container is connected to the negative terminal, current flows through the electrolyte. This current flow results in chemical action which causes a film to form on the electrode surface. This film acts as a dielectric, insulating the electrode from the electrolyte. These two elements then act as plates in a condenser—the electrode becoming a + terminal, and the electrolyte a - terminal. The connection to the electrolyte is made through the container.

Reversing the polarity of the voltage applied to the condenser breaks down the dielectric completely. A momentary overload in the correct polarity punctures the dielectric but application of the rated voltage reforms the dielectric so that wet electrolytics are said to be self-healing.

The capacitance of an electrolytic condenser is greater than that of a paper condenser of equivalent physical size because the dielectric film is very thin, enabling close spacing between the condenser plates. The positive plate surface is roughened and the liquid electrolyte negative plate follows the rough surface of the positive plate resulting in greater plate area in a given space.

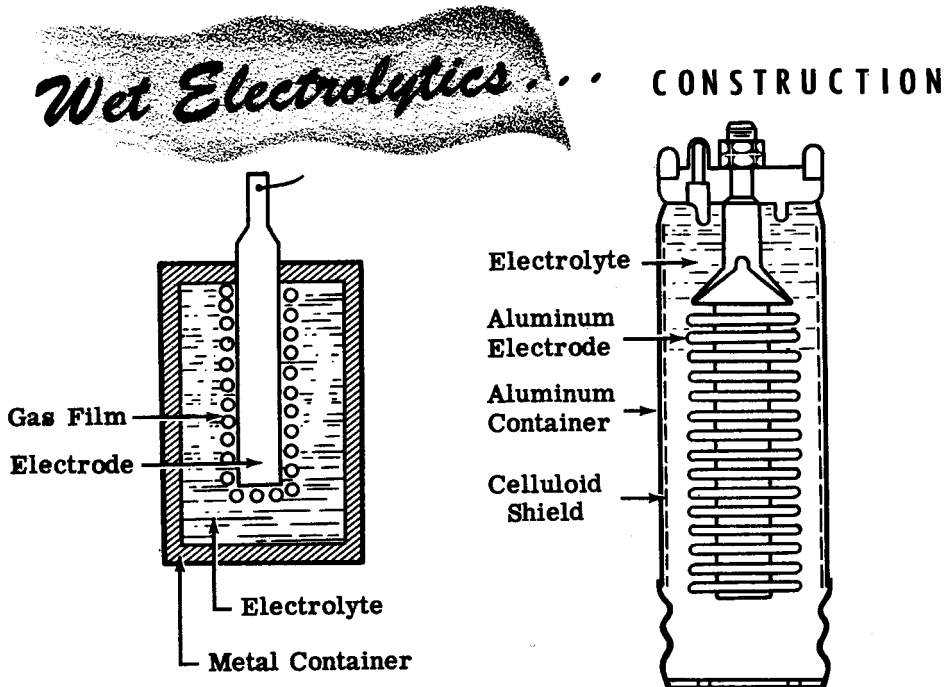

FILTER CIRCUITS

Filter Condensers (continued)

Dry electrolytic condensers use an electrolyte in the form of paste. A cloth impregnated with the electrolytic paste is rolled between alternate layers of aluminum foil in the same manner as that used to make paper condensers. One layer of metal foil is used as a positive plate of the electrolytic condenser and the other layer of metal foil is used to contact the negative plate (electrolyte) of the condenser.

A dry electrolytic condenser operates in the same way as a wet electrolytic except that it is not self-healing when the dielectric has been punctured. Both types of electrolytic condensers have a relatively short life due to the drying up of the electrolyte. Of the two, dry electrolytics generally last longer. Wet electrolytics are not often used since they dry out rapidly and must be mounted upright to prevent leaking of the liquid electrolyte. Several types of dry electrolytic condensers are illustrated below.

DRY

Electrolytic Capacitor

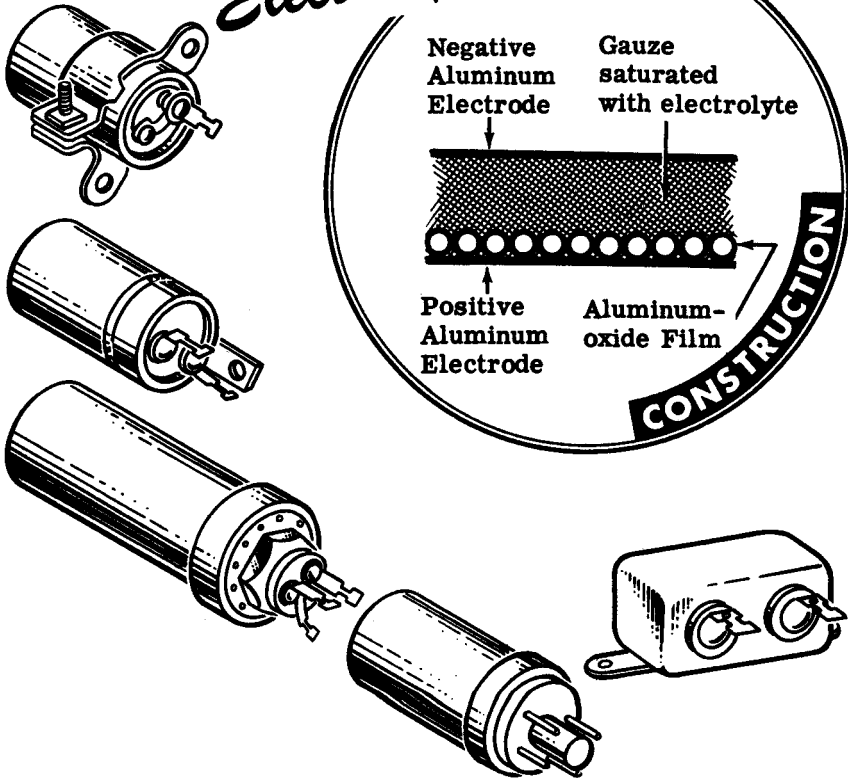

FILTER CIRCUITS

Improving the Operation of the Filter

You saw on a preceding sheet that the larger you make the filter condenser, the lower will be the AC component or ripple in the output. Filter condensers can be made very large in capacity and small in size, as you will see shortly, but there are size limitations that cannot be exceeded. A filter condenser of practical size might reduce the AC component to about 25 volts AC, but this is not good enough. Many electronic circuits require a B+ voltage that cannot have more than 3 or 4 volts of AC present in a DC output of 350 volts—the AC component must be less than 2 percent or even less than 1 percent of the total output voltage. No filter condenser of practical size can do this job alone—other filtering components must be added.

Suppose you set up a circuit consisting of a 500 ohm resistor connected in series with a 16 mfd condenser as shown in the illustration. If you connect this circuit to the rectifier and the single filter condenser previously used, you will be putting into this new filter circuit 350 volts DC upon which is superimposed about 25 volts of AC. To understand how this circuit removes the AC ripple voltage you will have to find out something about voltage dividers.

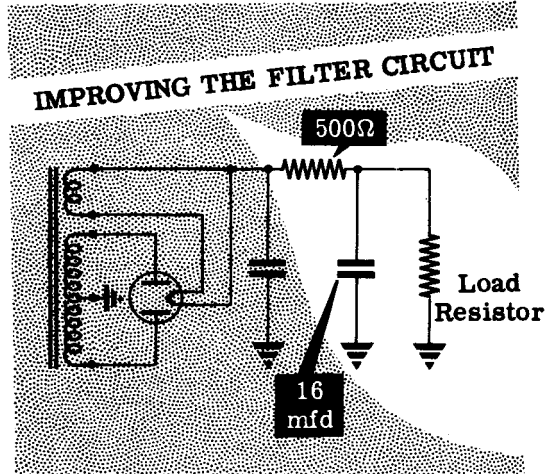

You know from your work with DC series circuits in Basic Electricity that when you place a DC voltage across three equal resistors, one third of the total voltage appears across each of the resistors. From this it can be seen that if you have two resistors and one is twice the resistance of the other, 1/3 of the voltage will appear across the small resistor, and 2/3 of the voltage will appear across the larger resistor. Similarly if one resistor contains 1/10 of the total resistance and the other resistor contains 9/10 of the total resistance; 1/10 of the total voltage appears across the small resistor and 9/10 of the total voltage appears across the large resistor. From this you can see that a DC voltage divides itself across two resistors in direct proportion to the size of the resistors.

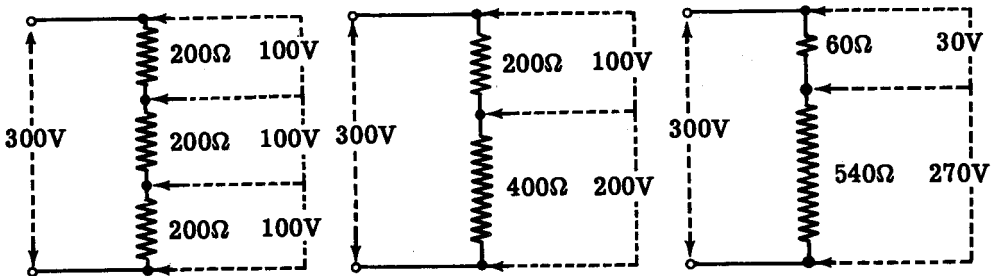

FILTER CIRCUITS

Improving the Operation of the Filter (continued)

When the 25 volts ripple from the input filter condenser appears across the resistor and output capacitor, as shown below, the resistor presents 500 ohms resistance and the condenser presents only 80 ohms reactance to 120 cycle AC ripple. This means that the AC ripple voltage is divided across a total of 580 ohms. About 1/7 of the AC voltage will appear across the condenser and 6/7 of the AC voltage will appear across the resistor. The AC voltage across the condenser and therefore between B+ and ground will be 1/7 of 25 volts, or about 3.5 volts AC.

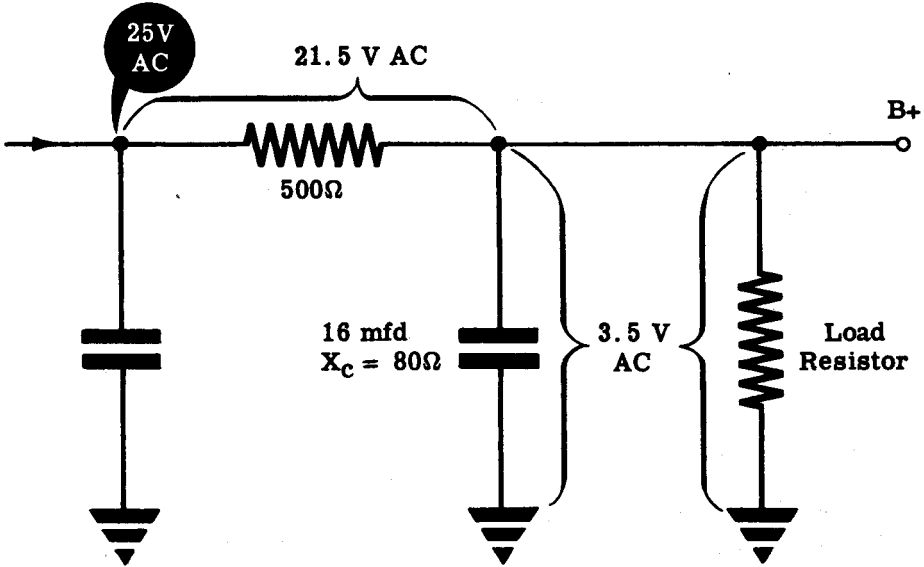

You see that the simple addition of a 500 ohm resistor and another filter condenser has succeeded in reducing the ripple voltage down to 3.5 volts which is about 1 percent of the total DC output. This amount of filtering is satisfactory for most applications in electronics.

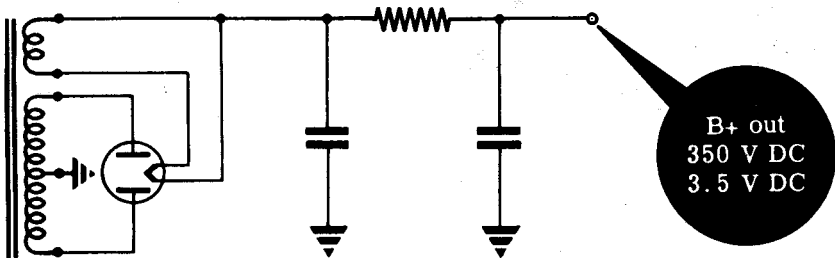

FILTER CIRCUITS

The Faults of RC Filters

The filter circuit you now have consists of two condensers and one resistor making up an RC filter network. This filter is compact in size, low in cost and is used in many small commercial radios.

There are two reasons why this RC filter cannot be used in most other power supplies—it is difficult to get a high B+ voltage when a large load current is required; and there is a large change in B+ voltage whenever the load current changes.

Suppose you consider the first fault—the difficulty of getting a high B+ voltage when a large load current is required. Many electronic equipments require that the power supply deliver 100 to 200 milliamps of current at a B+ voltage of 350 volts. All of this current must flow through the 500 ohm filter resistor and will, according to Ohm's law, cause a drop in voltage across that resistor. This means that if 200 milliamps flow through 500 ohms, the voltage drop across the resistor will be—

$$E = IR = 0.200 \text{ amp} \times 500 \text{ ohms} = 100 \text{ volts}$$

Instead of getting 350 volts out of the filter, you will get only 250 volts (350 - 100 = 250V). In order to get 350 volts out of the filter, the transformer will have to be made so that it will feed a much higher voltage into the rectifier to make up for the loss of voltage across the resistor. Increasing the voltage output of the transformer makes it larger, heavier and more expensive—three very undesirable qualities.

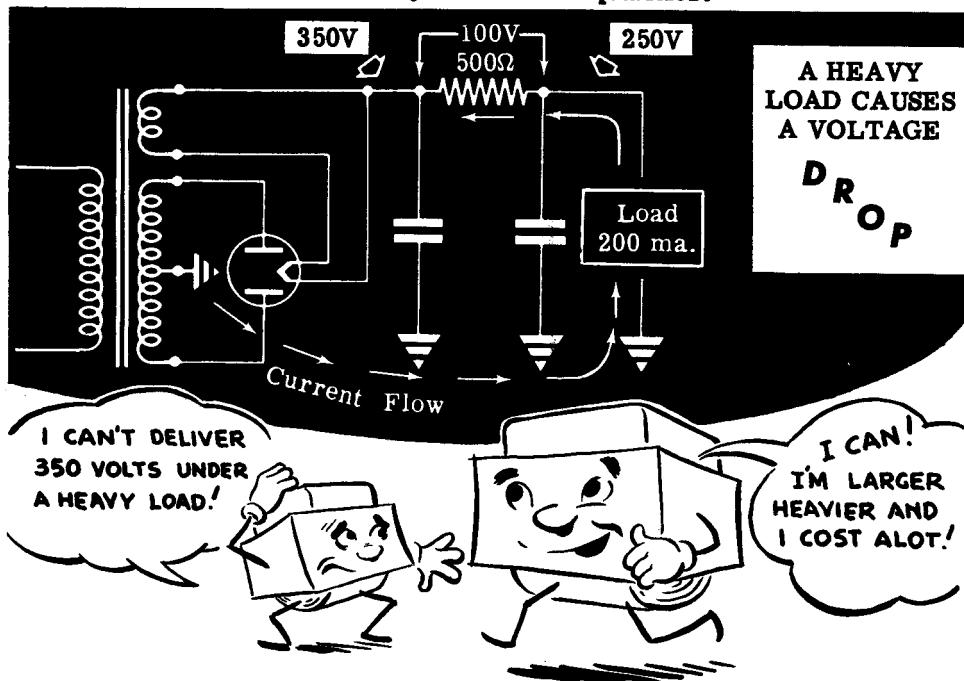

FILTER CIRCUITS

The Faults of RC Filters (continued)

You have seen that one fault of the RC filter is that it causes a large voltage drop across the filter resistor which means that the transformer must put out a higher AC voltage in order to compensate for this loss. The second fault of RC filters is even more serious—a small change in the load current causes the B+ output to vary by many volts.

You have read in the introduction to this section that it is important for the B+ voltage output to remain fairly stable in spite of changes in load current. Many types of electronic equipment draw varying amounts of load current from the B+ voltage supply, but the voltage change must remain small in spite of this.

As an example, suppose that you have a unit of electronic equipment that draws 50 ma. from the B+ supply under one set of conditions, and then the conditions change so that 100 ma. are drawn from the B+ supply. First you have 50 ma. flowing through the 500 ohm filter resistor and then you have 100 ma. flowing through that same resistor. Suppose that the voltage coming out of the filter is 350 volts and 50 ma. are being drawn by the load. The voltage drop across the 500 ohms resistor will be $E = IR = .050 \times 500 = 25V$. Suddenly an additional 50 ma. are drawn through the 500 ohm load resistor (making a total of 100 ma.). The result is an increased voltage drop across the 500 ohm resistor.

$$E = IR = 0.100 \times 500 = 50V$$

Since the voltage drop has increased 25V, the output voltage must decrease by the same amount.

The output voltage will decrease from 350V to 325V when the load current increases from 50 to 100 ma.

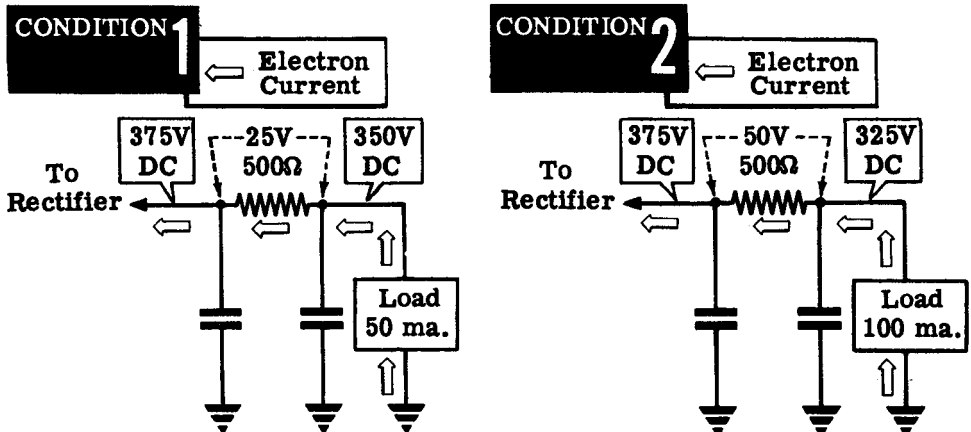

Similarly a change of 100 ma. in the load current will cause the B+ voltage to drop 50 volts. Such a rise and fall in output voltage is very undesirable in electronic equipment. Voltage regulator circuits might be added to compensate for this voltage change due to the filter resistor, but it would require a large and expensive circuit to compensate for changes such as are indicated here.

FILTER CIRCUITS

Using a Choke Instead of a Resistor

A resistor can do a fairly good job of filtering because its resistance to AC is higher than the reactance of a filter condenser to AC. When the ripple voltage is placed across this circuit, the AC voltage divides so that only a small part of this ripple voltage appears across the filter condenser and at B+. The DC voltage divides across this circuit so that most of the DC voltage appears across the filter condenser and at B+.

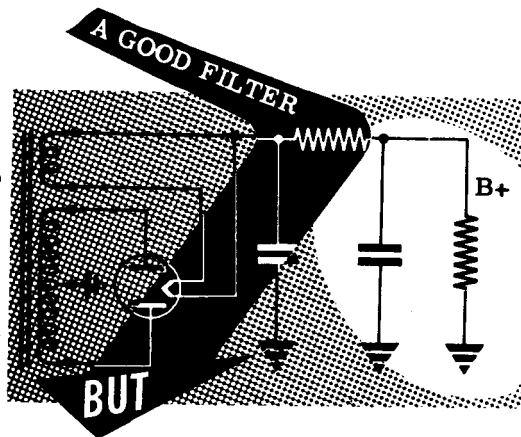

What the filter circuit requires is that the resistor have a high resistance for AC and a low resistance to DC. A resistor presents exactly the same resistance to both AC and DC and cannot meet this requirement. When a filter resistor is used, its size must be a compromise between these two opposing requirements.

There is, however, a certain type of component that will meet this requirement—the filter choke. From your study of AC circuits in Basic Electricity you know that a choke opposes any change of current flowing through it. In other words the inductance of a choke presents a high reactance to AC. Because a choke is made up of many turns of copper wire wound around a core, it also presents a low resistance to DC. A choke has the very qualities that are required to replace the resistor in a filter circuit.

Inductors or chokes, as used in electronic power supplies, are called "filter chokes" because they are used to "choke" out the AC. A 10-henry choke is fairly small in size and will present a reactance of about 7500 ohms to 120 cycle ripple and will have a DC resistance of about 200 ohms. Such a choke has 15 times more reactance to AC than a 500 ohm resistor, and also has less than half its DC resistance. Because of these excellent qualities you will find that chokes are used in the filter circuits of most electronic power supplies. Before you learn about the various combinations of chokes and condensers that are used in filter circuits, suppose you find out about the construction of these components.

A 10-henry FILTER CHOKE

IS 15 TIMES BETTER THAN

A 500-ohm RESISTOR

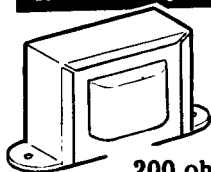

200 ohms

For Filtering AC

AND HAS LESS THAN HALF
THE DC RESISTANCE



500 ohms

FILTER CIRCUITS

Filter Chokes

The purpose of a filter choke is to furnish a high impedance to AC ripple voltage and a low resistance to DC current. A choke consists of many turns of copper wire wound around a laminated iron core. The total impedance of the choke depends upon the number of turns of wire and the size, shape and material of the core. The DC resistance of the choke depends upon the total length of wire used and the diameter of the wire.

By increasing the number of turns of wire and by increasing the size of the core, you can raise the impedance; but this also increases the size and the weight of the choke. In addition, the increased length of wire through which the current must flow causes the DC resistance to increase. The only way to decrease DC resistance is either to decrease the number of turns (which lowers the impedance) or to increase the diameter of the wire (which increases the weight).

Every type of choke manufactured is a compromise of size, weight, AC impedance and DC resistance requirements. Because requirements differ according to the equipment, many different sizes of chokes are made. Chokes are rated by the amount of inductance, the DC resistance and the maximum amount of current flow.

Typical FILTER CHOKES

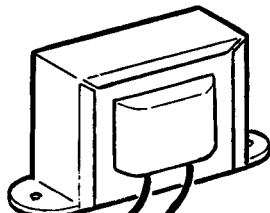

7 henries
200 ohms
150 ma.
2 lbs.

For amplifiers
and small
transmitters

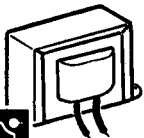

7 henries
550 ohms
50 ma.
1/2 lb.

For small radio receivers

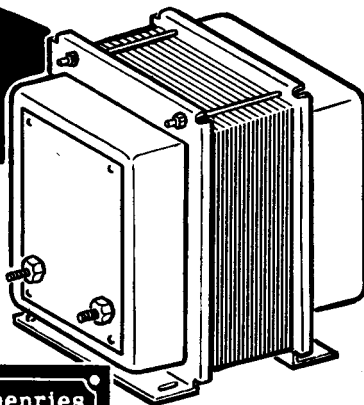

6 henries
75 ohms
500 ma.
24 lbs.

For
high voltage
high load
power supplies

FILTER CIRCUITS

The Single-Section Choke and Condenser Input Filters

The single-section choke input filter consists of a filter choke in series with the power supply load and a filter condenser across the load. The DC component of the rectifier output appears across the load. Most of the AC component appears across the high inductive reactance of the choke. Only a small amount of AC appears across the output filter condenser because of its low reactance. Since the load is in parallel with the output filter condenser, very little ripple appears across the load.

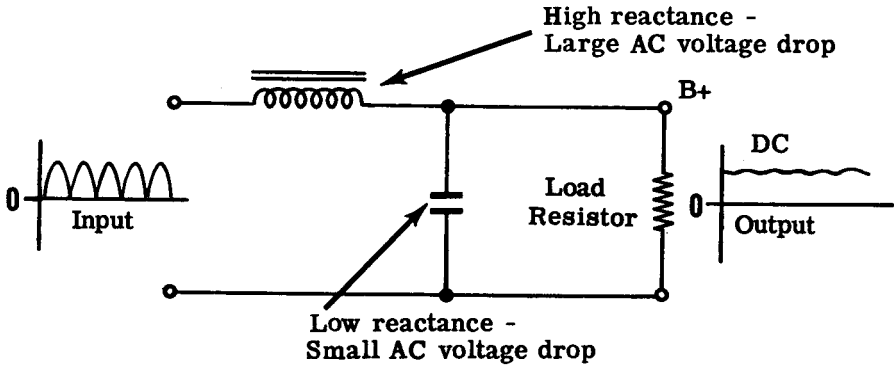

SINGLE SECTION CHOKE INPUT FILTER CIRCUITS

A single-section condenser input filter consists of a filter condenser connected across the input terminals of a single-section choke input filter. Because of the shape of the circuit diagram, filter circuits of this type are sometimes called π type filters.

Large values of inductance and capacitance are used in condenser input filters so that they are often called "brute-force" filters. Inductance values of from 10 to 30 henries and capacitance values of from 2 to 16 microfarads are commonly used.

SINGLE-SECTION CONDENSER INPUT

*Filter.....
Circuit*

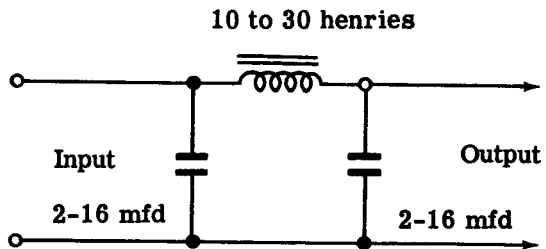

FILTER CIRCUITS

The Single-Section Choke Input Filter

You will see that the single-section choke input filter does just a little better job of filtering than the condenser alone. The voltage output of the choke input filter is lower than the voltage output of the condenser alone. This is because the choke builds up a back emf which cancels a part of the voltage coming out of the rectifier. An important feature of the choke input filter is that it limits the peak current flowing through the rectifier tube and, as a result, there is less strain on the tube. The choke input filter also has the characteristic of holding the output voltage quite constant despite load variations. Because of these last two characteristics, choke input filters are used most commonly in power supplies which are subjected to heavy or varying loads. The results of using this type of filter for such loads are a more stable output voltage from the power supply and longer life of the rectifier tube.

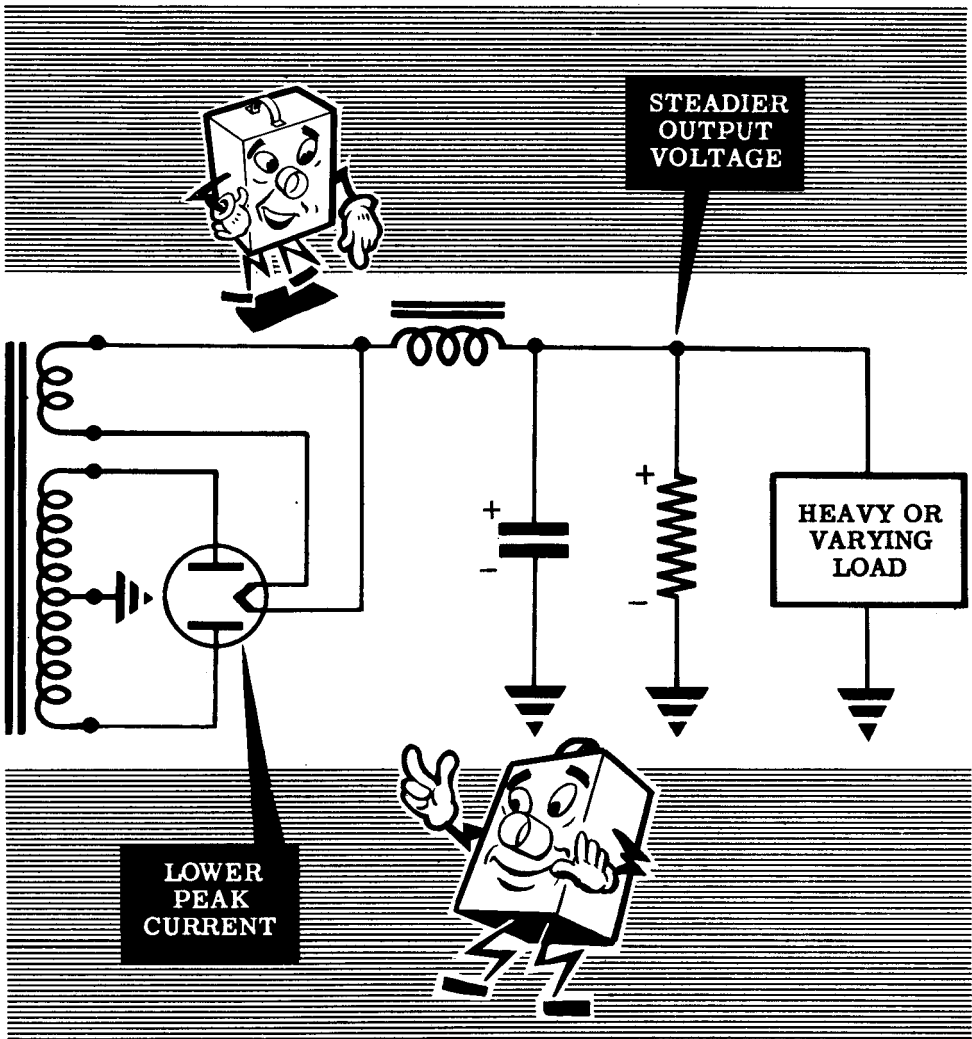

FILTER CIRCUITS

The Condenser Input Filter

By comparing these wave forms and voltages with those of the preceding filter circuits, you can see that the condenser input filter does a better job of filtering than any of the others. The voltage output of this filter is larger than it was for the choke input filter because of the charging and discharging action of the input condenser.

However, unlike the choke input filter, this circuit draws large peaks of current from the rectifier tube. The voltage regulation is not as good as it is for a choke input filter. The condenser input filter, very often called a "brute-force" filter, is the most widely used filter circuit for applications where the required amount of DC power is small.

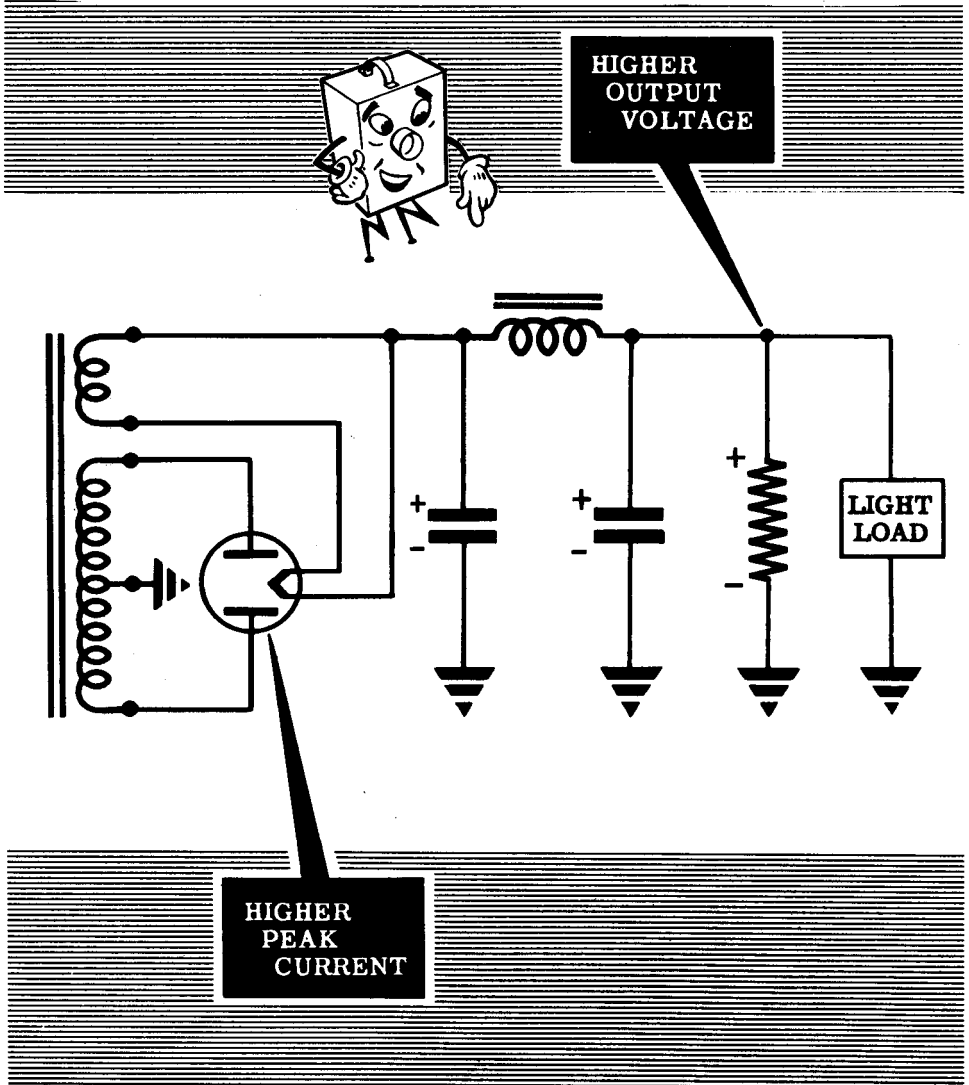

FILTER CIRCUITS

The Two-Section Filter

A two-section choke input filter circuit consists of two single-section choke input filters connected in series. Adding another condenser across the filter input terminals changes the choke input circuit into a two-section condenser input filter. Both types of two-section filters reduce the output voltage ripple to a negligible value.

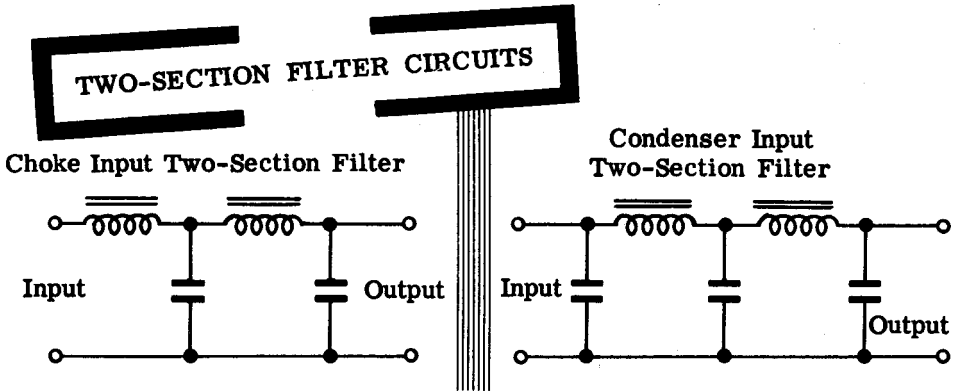

Resonant filter circuits may be used in power supplies although they are usually used in other types of electronic circuits. A series-resonant filter consists of a choke and condenser connected in series across the output terminals of the rectifier circuit. You learned in Basic Electricity (series-resonant circuits) that when a choke and condenser in series are resonant, their inductive and capacitive reactance cancel each other and their total impedance is zero. Therefore, if the components used are resonant at the ripple frequency of the power supply, they will act as a short circuit across the load for that particular frequency.

A parallel-resonant combination of L and C can be used in series with one output terminal of the power supply to provide additional filtering at the ripple frequency. The parallel-resonant circuit offers high impedance to the ripple frequency.

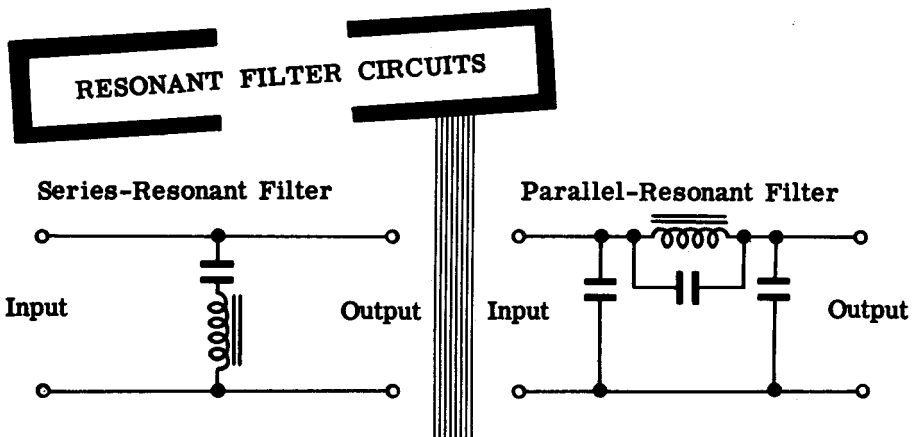

FILTER CIRCUITS

Filter Condenser Considerations

When a condenser input filter is used the instantaneous peak current of the rectifier may be much higher than the maximum current delivered to the load. The input condenser across the load circuit acts like a short circuit when a voltage is first applied to it. The initial charging current may exceed the rectifier rating. Series resistors are sometimes used with selenium rectifiers in order to limit the initial charging current of the input filter condenser.

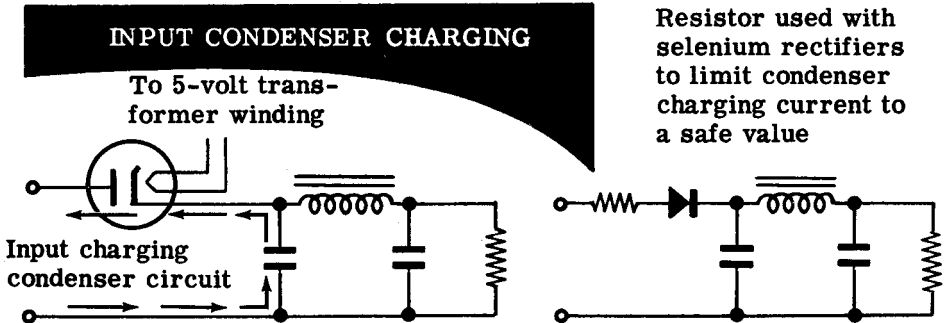

Because of the time lapse between pulses of direct current, the output of a half-wave rectifier requires more filtering than that of a full-wave rectifier and the filtered output voltage will be lower. Filter condensers used in half-wave power supplies are usually from 2 to 4 times as large as those used in full-wave power supplies. Increasing the size of the filter condensers provides additional filtering.

Filtering HALF- AND FULL-WAVE RECTIFIER OUTPUT

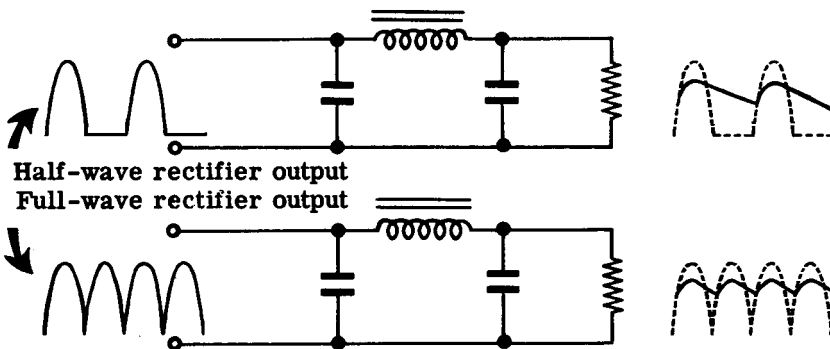

The higher the frequency of the AC input voltage to a power supply the lower the value of the filter condensers required. The time between pulses is shorter at higher frequencies and the inductive action of the choke is greater at higher frequencies.

FILTER CIRCUITS

Bleeder Resistors

If the load is entirely removed from a power supply the voltage rises to a value much higher than normal. With no load current there is no DC voltage drop in the circuit and no discharge path for the filter condensers, resulting in a build-up in voltage across the filter condensers to a value approximately equal to the peak AC voltage applied to the rectifier tube.

To prevent soaring of the voltage at no load, resistors are often connected across the output terminals of power supplies. These resistors called "bleeder resistors" provide a discharge path for the filter condensers and also serve as a fixed load to bleed off a constant value of current. The bleeder resistor usually draws about 10 percent of the total rated current output of the power supply.

Since a bleeder resistor prevents sharp increases in voltage output under light or no load conditions it improves the power supply voltage regulation and tends to maintain the output voltage at a constant value regardless of load. This method of voltage regulation is sufficient for most power supply applications but in many cases better voltage regulation is required.

Bleeder resistors dissipate a relatively large amount of power as heat and should be mounted in a well-ventilated position. The resistance value and power rating of the bleeder resistor depend on the maximum voltage and current ratings of the power supply. For example, if a power supply is rated at 300 volts and can supply 100 milliamperes the bleeder current should be about 10 milliamperes and the voltage across the bleeder 300 volts. The bleeder resistance (30,000 ohms) is found by dividing the voltage (300 volts) by the bleeder current (.010 ampere). The power dissipated is equal to the voltage multiplied by the bleeder current. ($300 \times .01 = 3$ watts). The wattage rating of a resistor should be higher than the power dissipated so that a 30K, 10-watt resistor is used as a bleeder.

BLEEDER RESISTORS Improve Voltage Regulation

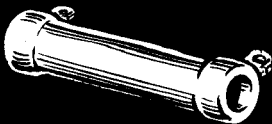
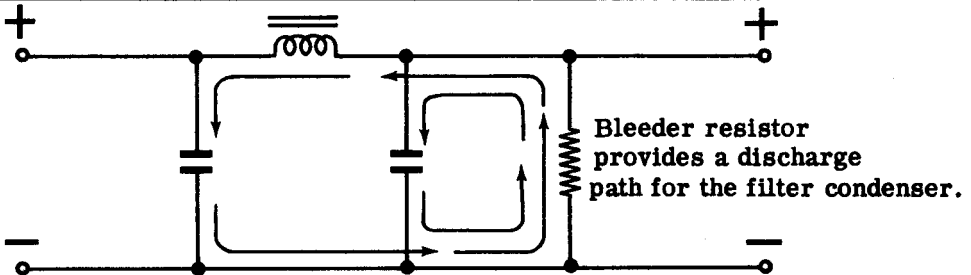

Bleeder resistors provide a continuous load for the power supply.

FILTER CIRCUITS

Bleeder Resistors (continued)

Bleeder resistors are sometimes tapped to provide one or more voltages lower than the maximum voltage of the power supply. The bleeder may consist of several resistors connected in series across a source of voltage with various voltages available at the resistor junctions.

When a bleeder is connected directly across the power supply output, the voltage at various points along the bleeder is exactly proportional to the resistance at that point, provided no current is drawn from any of the taps. For example, if a 30,000-ohm resistor tapped at 7,500-ohms, 15,000 ohms and 22,500 ohms is connected across the output of a 300 volt power supply the voltage divides proportionately. At the 15,000-ohm tap the voltage is one half of the total or 150 volts, at the 7,500-ohm tap it is one fourth of the total or 75 volts and at the 22,500-ohm tap it is three fourths of the total or 225 volts. The bleeder current through the resistor is 10 milliamperes.

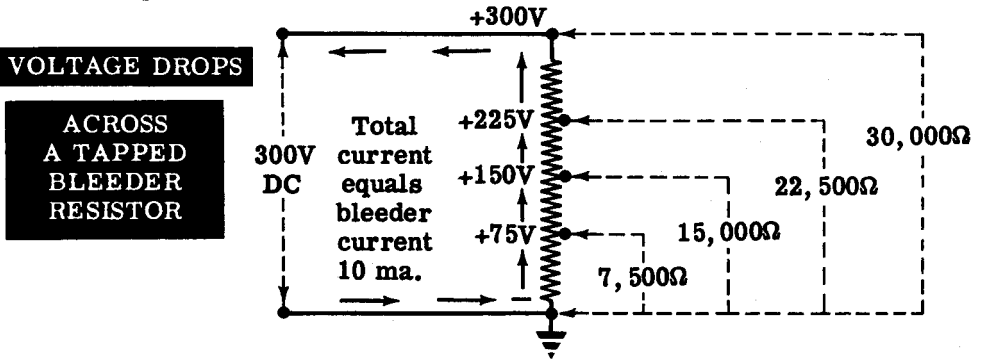

The voltages available at the voltage divider taps depend on the current drawn from each tap and are affected by changes in current supplied by any of the voltage taps. When a load is connected to any of the taps its resistance is in parallel with a portion of the voltage divider. This forms a series-parallel circuit and reduces the total resistance across the circuit resulting in an increase in current drawn from the power supply. The voltage drop in the series part of the voltage divider circuit increases due to the increased current, and the voltage drop and bleeder current for the parallel part of the voltage divider are decreased.

TAPPED BLEEDER RESISTOR WITH A LOAD CONNECTED

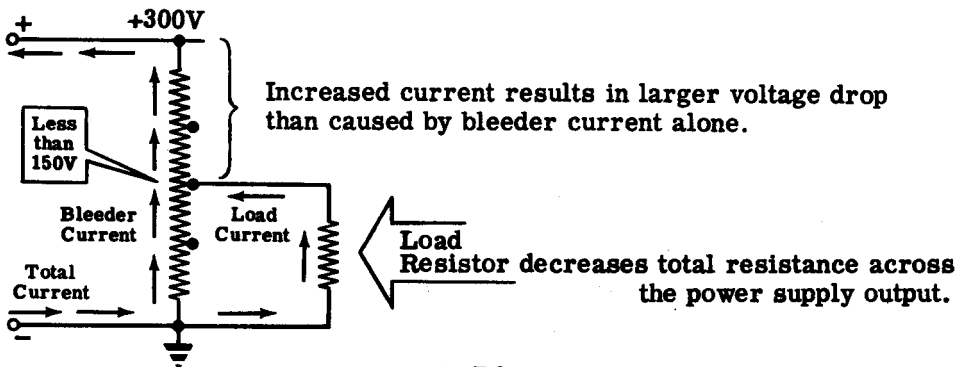

FILTER CIRCUITS

Bleeder Resistors (continued)

A typical voltage divider for a 300 volt, 100 milliamperere power supply might provide for a bleeder current of 10 milliamperes, a tap at 200 volts to supply 40 milliamperes and a tap at 150 volts to supply 50 milliamperes. To find the resistance values for each part of such a voltage divider circuit the voltage drop and current through each resistor must be found. In the illustration, points A, B, C and D provide the desired voltage taps and the resistance values of R_1 , R_2 , and R_3 are found as follows:

R_1 The voltage drop across R_1 (between points C and D) is 150 volts. The current flow through R_1 is only the bleeder current or 10 ma. then

$$R_1 = \frac{150}{.01} = \underline{15,000 \text{ ohms.}}$$

R_2 The voltage drop across R_2 (between points B and C) is 50 volts (150V to 200V). The current flow through R_2 is bleeder current, 10 ma.,

plus the load current, 50 ma., or 60 ma. then $R_2 = \frac{50}{.06} = \underline{833 \text{ ohms.}}$

R_3 The voltage drop across R_3 (between points A and B) is 100 volts (200V to 300V). The current flow through R_3 is the sum of the bleeder current and the current through each load— $10 + 50 + 40 = 100$ ma. then

$$R_3 = \frac{100}{.1} = \underline{1000 \text{ ohms.}}$$

The wattage dissipation of each resistor is found by multiplying the current through the resistor by the voltage drop across it:

$$150 \times .01 = 1.5 \text{ watts for } R_1$$

$$50 \times .06 = 3 \text{ watts for } R_2$$

$$100 \times .1 = 10 \text{ watts for } R_3$$

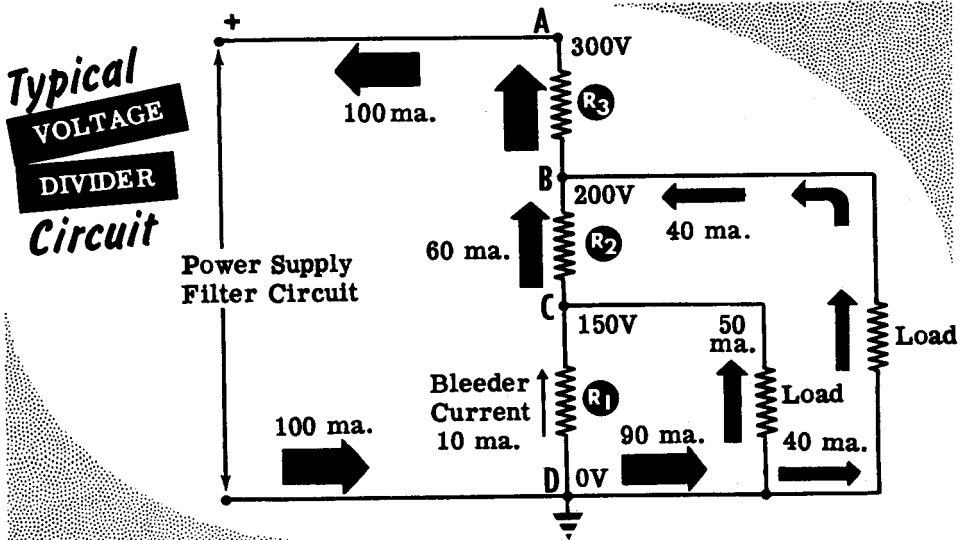

FILTER CIRCUITS

Review of Filter Circuits

FILTER CAPACITORS — Capacitors used in power supplies to change the pulsating DC output of rectifiers into DC having a relatively slight variation in value. The condenser charges through the rectifier circuit and discharges through the load circuit to help maintain voltage applied to the load at a steady value.

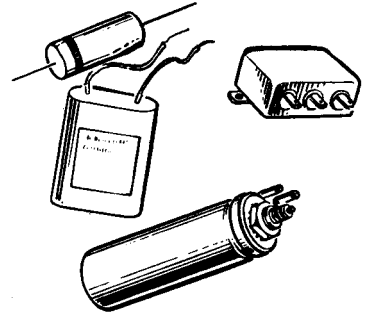

PAPER FILTER CAPACITORS — Paper filter condensers are bulky and their value is usually limited to less than 10 mfd. They are not polarized and can be made to withstand very high voltages. There is no appreciable leakage across a paper filter condenser. Oil-impregnated paper condensers are used in high voltage filter circuits.

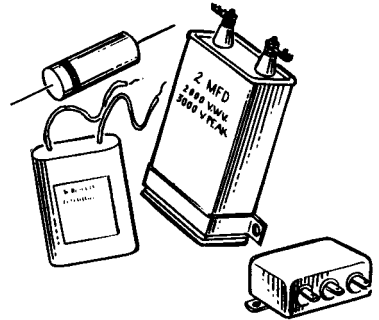

ELECTROLYTIC FILTER CAPACITORS — Electrolytics have a high value of capacitance as compared to a paper condenser of the same physical size. They are polarized and are normally constructed to operate at less than 600 volts. There is appreciable leakage across an electrolytic condenser but this effect is usually offset by their large values of capacitance. Electrolytics range in value from 1 to 1000 mfd.

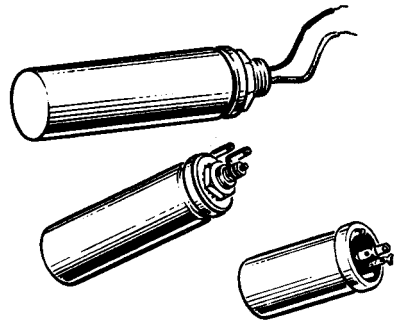

WET ELECTROLYTIC CAPACITOR — A condenser consisting of a metal electrode immersed in an electrolytic solution. The electrode and solution are the two condenser plates while an oxide film formed on the electrode is the dielectric. The dielectric film is formed by current flow from the electrolyte to the electrode.

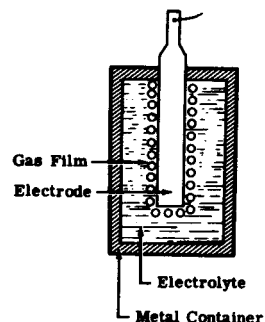

FILTER CIRCUITS

Review of Filter Circuits (continued)

DRY ELECTROLYTIC CONDENSERS

— In a dry electrolytic condenser the electrolyte is a paste. Cloth which is impregnated with the paste is rolled between layers of metal foil which act as the condenser terminals. One metal foil is the positive plate and a film formed on its surface is the dielectric. The electrolyte paste is the negative condenser plate and its terminal connection is made through a layer of metal foil.

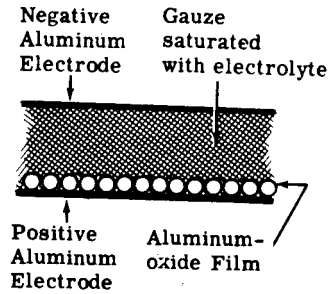

FILTER CHOKE — An iron-core inductance placed in series with the rectifier output. It opposes any change in current flow and reduces the amount of change in the pulsating DC output of the rectifier circuit.

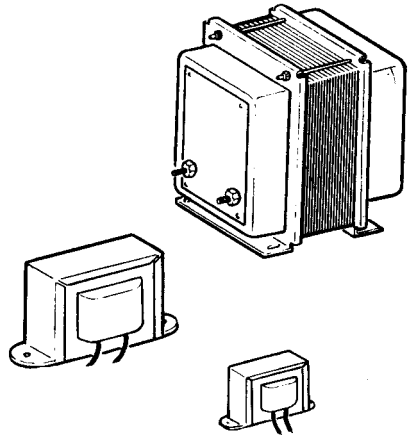

CHOKeless POWER SUPPLY FILTER

— A low current power supply filter circuit in which resistors are used in place of filter chokes. Resistors are used to save weight, space and cost.

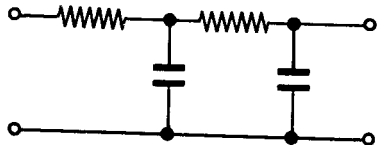

FILTER CIRCUITS

Review of Filter Circuits (continued)

SINGLE-SECTION CHOKE INPUT FILTER

FILTER — A filter circuit consisting of a filter choke connected in series with the rectifier output and a filter condenser connected across the output terminals. The output voltage ripple is between 3 and 10 percent of the DC output voltage.

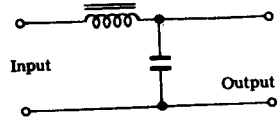

SINGLE-SECTION CONDENSER INPUT FILTER

FILTER — A filter circuit consisting of a filter choke connected in series with the rectifier output and two filter condensers, one connected across the filter input and the other across the filter output terminals. The output voltage ripple is less than that of a single-section choke input filter and the voltage output is higher than that of a choke input filter.

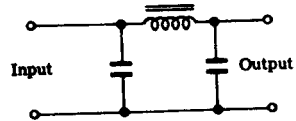

TWO-SECTION CHOKE INPUT FILTER

— A filter circuit consisting of two single-section choke input filters connected in series. The output ripple is a negligible value for most power supply applications.

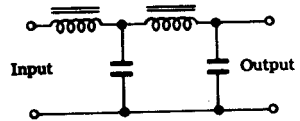

TWO-SECTION CONDENSER INPUT FILTER

FILTER — A two-section choke input filter with an additional filter condenser connected across the filter input terminals. The voltage output is increased as compared to a choke input filter and the ripple is reduced.

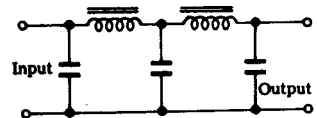

VOLTAGE REGULATOR CIRCUITS

Voltage Regulation

By this time you understand the theory of operation of rectifier circuits and filter circuits. You appreciate the importance of maintaining the power supply in good working order so that the complete electronic equipment may be able to do its job.

Now you are going to study voltage regulated power supply circuits which are required to do specialized jobs that the ordinary general purpose power supply cannot do. Like other circuits you will use, voltage regulator circuits range from very simple circuits using only one or two parts to very complex circuits requiring many components. However, all of these circuits operate in the same way as the basic regulator circuits.

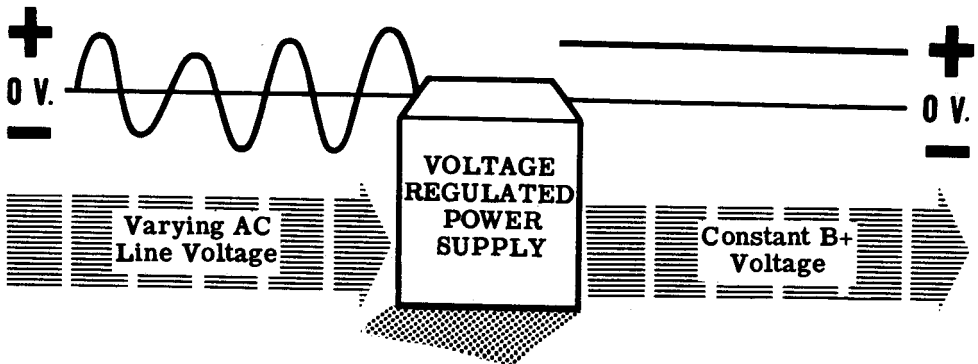
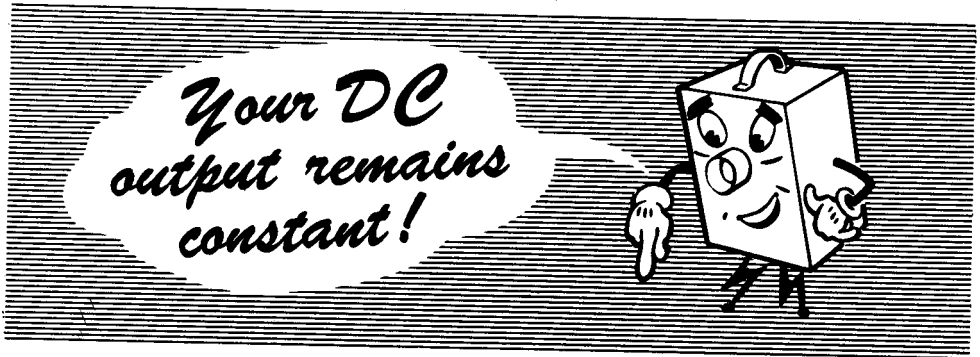

VOLTAGE REGULATOR CIRCUITS

Voltage Regulation (continued)

You already know the two most important factors which affect the B+ voltage output in a conventional power supply. When the AC line voltage goes up, the B+ output voltage goes up; and, when the AC line voltage goes down, the B+ output voltage goes down. Also, when there is a small current drain out of the B+ terminal, the B+ voltage is higher than when there is a large current drain. What you want to know now is how the voltage regulator circuit overcomes both these problems.

If you connect a potentiometer across B+ and ground in any conventional power supply, you have a perfect hand-operated voltage regulator.

Assume that you have a 1000-ohm potentiometer and a power supply with a B+ of 100 volts. Also assume that you want a steady output voltage of 50 volts. You first adjust your potentiometer so that the center tap is right at the middle of the potentiometer resistance. If the B+ voltage rises momentarily due to an increase in AC line voltage or a decrease in B+ current drain, all you do is move the tap closer to ground (decrease the resistance between tap and ground) until you get 50 volts again. If the B+ voltage falls due to a decrease in the AC line voltage or an increase in B+ current drain, all you do is move the tap away from ground (increase the resistance between tap and ground) until you get 50 volts again.

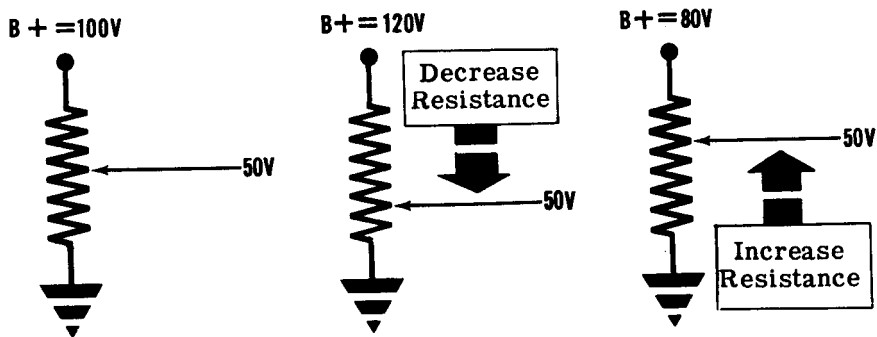

You can see that the hand-operated voltage regulator works very well. You increase or decrease the resistance between ground and the output voltage tap to increase or decrease the output voltage back to the desired value whenever the B+ supply voltage falls or rises for any reason.

The main fault with this method is that it is too slow. First, the output voltage must change. Then you must notice that it has changed, and then you must increase or decrease the resistance between the voltage tap and ground to get back the desired voltage output. When you consider that there are many electronic circuits in a radar system which must have a steady voltage, you can see that many men would be needed to keep them all regulated.

The voltage regulator circuit solves all your problems! The voltage regulator tube automatically increases or decreases its internal resistance as the B+ supply voltage falls and rises, so as to maintain a constant voltage across itself.

VOLTAGE REGULATOR CIRCUITS

The Voltage Regulator Tube

The voltage regulator tube consists of a plate and a cathode placed in an envelope containing a gas at low pressure. There is no filament and, therefore, the tube is known as a cold cathode type tube. The radio symbol for the tube is as illustrated. The dot inside the envelope indicates the presence of a gas.

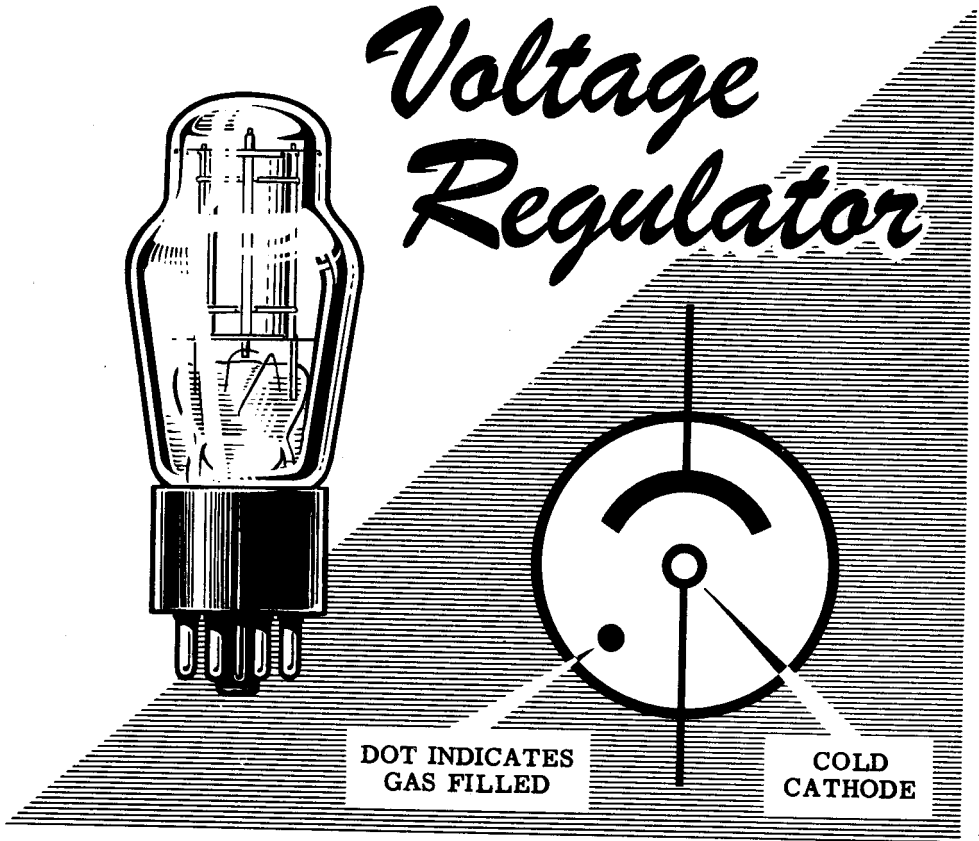

When a large enough potential is applied between the cathode and the plate, the gas in the tube conducts and electrons flow from cathode to plate. Conduction is characterized by a bluish glow inside the tube—the heavier the conduction the brighter the glow.

The numbering system used for voltage regulator tubes has been changed in recent years. The VR-150/30, the VR-90/30 and the VR-75/30 are old numbers no longer used. The term "VR" meant voltage regulator; the first number, "150" etc., stood for the operating voltage of the tube—the voltage at which it regulated. The last number represented the maximum rated current that could pass through the tube without damaging it. In all regulator tubes there is also a minimum operating current of about 5 ma. The tube will stop conducting if the current through it drops below this value. A wide range of regulated voltages can be had by using any of the voltage regulator tubes singly or in series combinations.

VOLTAGE REGULATOR CIRCUITS

The Voltage Regulator Tube (continued)

The new numbering system for VR tubes is as follows:

Tube Type	DC Operating Voltage	Current Range Ma.
OA2	151	5 to 30
OA3	75	5 to 40
OB2	108	5 to 30
OC3	108	5 to 40
OD3	153	5 to 40
874	90	10 to 50
991	59	0.4 to 2.0

VR TUBE DIAGRAMS

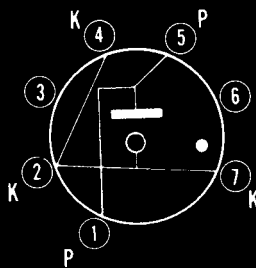

OA2
OB2

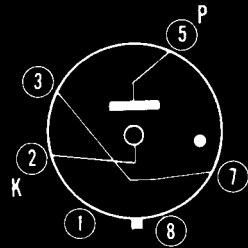

OA3
OC3
OD3

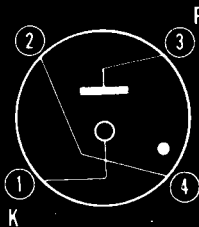

874

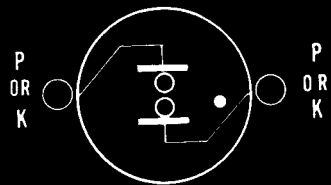

991

K = Cathode

P = Plate

Under this new system there are available a larger variety of DC operating voltages and current ranges.

The VR tube is a diode which consists of a thin vertical rod held in position inside of a thin metal cylinder. The air is removed from the tube envelope and is replaced by a small quantity of neon or helium gas mixed with a small quantity of argon gas. As long as the current flow through the tube is kept within the listed limits the plate voltage of the tube will change very little.

If operating voltages higher than those listed above are required, two or more VR tubes may be connected in series. In this case the operating voltage will become the sum of all the operating voltages of the tubes connected in series. Parallel operation is used when a larger current is required.

VOLTAGE REGULATOR CIRCUITS

A Simple VR Tube Circuit

Here is an example of how a VR tube is used in a typical circuit. Suppose that you have a power supply with an output voltage of 340 volts DC. You need to supply voltage to a special circuit that needs 150 volts DC with a current variation of from 10 to 30 milliamps. This circuit requires that the 150 volts DC be kept constant in spite of the current change.

Since you want a constant voltage of 150 volts DC with a maximum current drain of 30 milliamps, an OD3 (VR-150) will meet your requirements. Here are the operating characteristics of the OD3 (VR-150) as listed by the manufacturer - note that they meet your requirements:

- DC power supply voltage 185 volts min.
- DC starting voltage 160 volts
- DC operating voltage 153 volts
- DC operating current5 to 40 ma.

For a current variation of from 5 to 30 ma. the voltage will change 2 volts.

For a current variation of from 5 to 40 ma. the voltage will change 4 volts.

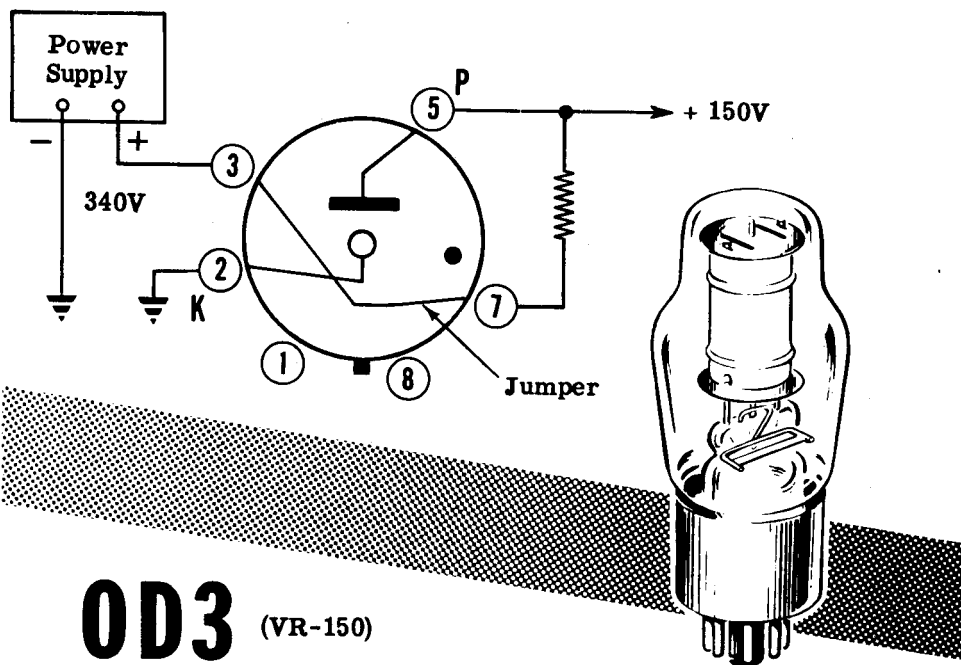

OD3 (VR-150)

Notice that there is a "jumper connection" between pins 3 and 7 inside the tube. If pins 3 and 7 are wired in series with the circuit, this jumper will act as a switch. When the VR tube is pulled out, the circuit requiring the 150 volts will be disconnected from the power supply. If this jumper were not connected as a switch and the VR tube were pulled out, the 150 volt circuit would receive more than 150 volts—resulting in damage to its components or in improper operation.

VOLTAGE REGULATOR CIRCUITS

A Simple VR Tube Circuit (continued)

In order to illustrate the circuit described on the previous sheet, the VR tube is connected to the power supply like this:

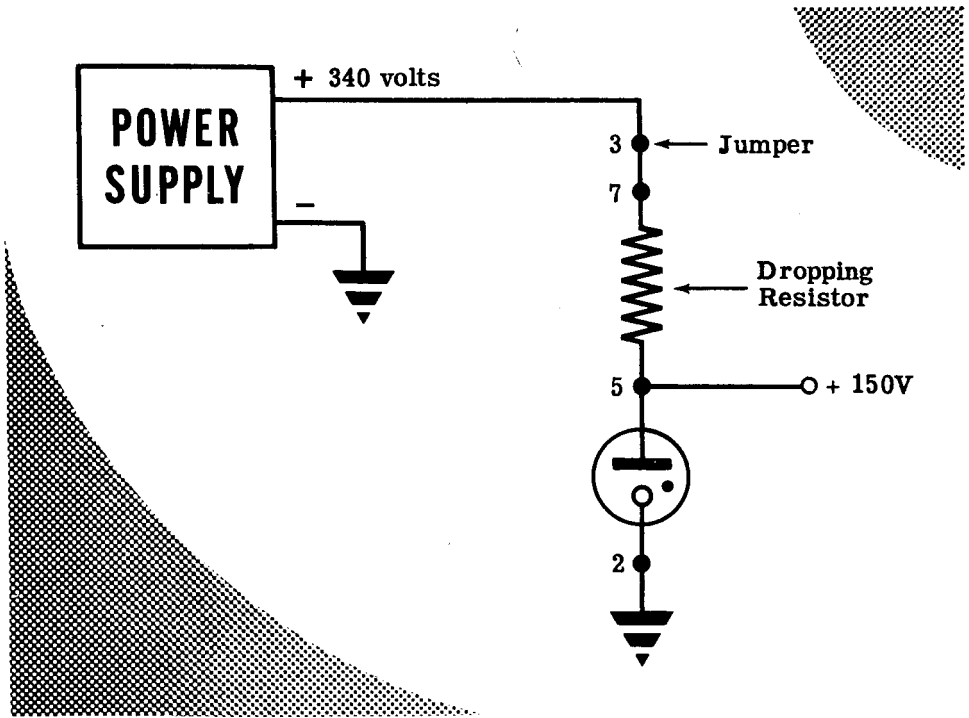

Note that the 150 volt point is disconnected from the power supply if the VR tube is pulled out.

In order to determine the size of the dropping resistor, you must begin with a condition when no load is connected to the 150 volt output terminal. You must then adjust the size of the dropping resistor so that the maximum current (40 ma.) will flow through the VR tube. You already know that the output of the power supply is 340 volts, so the voltage across the resistor will have to be 340 - 150 or 190 volts. For these current and voltage conditions the size of the resistor is calculated from Ohm's law:

$$R = \frac{E}{I} = \frac{190V}{0.04A} = 4750 \text{ ohms}$$

The wattage of the resistor is found from the power formula
 $W = EI = 190V \times 0.04A = 7.6 \text{ watts.}$

The resistance you want according to the above results is a resistor of 4750 ohms rated at 7.6 watts. Such a resistor is not available except on special order. The nearest standard value of wire wound resistance available is 5000 ohms. This resistor would allow 38 ma. to flow through the tube, which is suitable for your purposes. A 10 watt resistor could be used but a 25 watt resistor would probably be best since the size and cost are not much more and the danger of burnouts would be reduced.

VOLTAGE REGULATOR CIRCUITS

Voltage Regulation When Load Current Varies

Now that you have the details of a VR tube circuit worked out, suppose you find out how it operates to keep the output voltage stable at 150 volts in spite of a change in output current. In order to do this, the VR tube increases and decreases its resistance to adjust to changes in load and supply voltage.

When no load is attached to the 150 volt output, 38 ma. will flow through the tube. Since the current flowing through the tube is within the rated value, the VR tube adjusts its internal resistance so that the voltage at the plate is 150 volts.

A SIMPLE VR TUBE CIRCUIT WITH NO LOAD

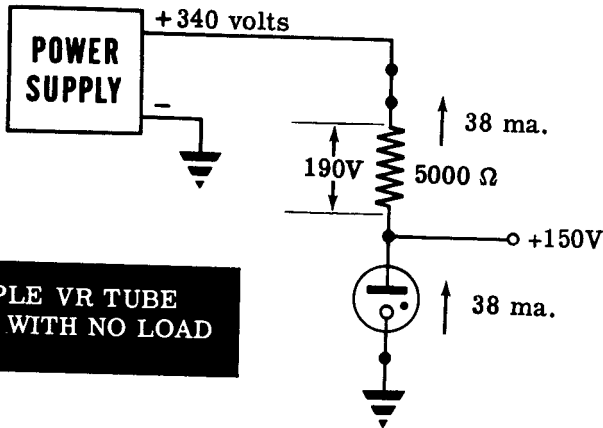

Suppose you attach an 8 ma. load to the 150 volt terminal. Of the 38 ma. flowing through the dropping resistor, 8 ma. flows through the load and 30 ma. flows through the VR tube. Since the VR tube current is yet within the rated range of 5 to 40 ma., the VR tube adjusts its internal resistance so that the plate voltage remains at 150 volts.

**8 ma. LOAD
VOLTAGE OUTPUT
REMAINS THE SAME**

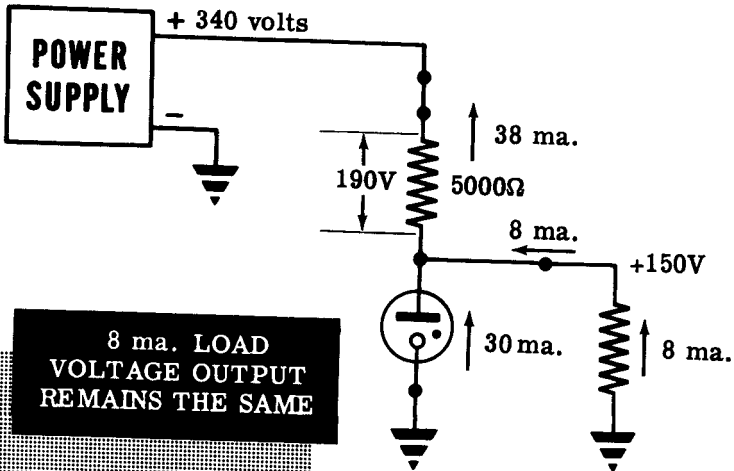

VOLTAGE REGULATOR CIRCUITS

Voltage Regulation When Load Current Varies (continued)

If you now increase the load on the 150 volt terminal to 18 ma., 20 ma. will flow through the VR tube, and the output voltage will remain at 150 volts. As long as the current flowing through the VR tube is within the range of 5 to 40 ma., the tube is able to adjust its internal resistance so as to keep the plate voltage essentially at 150 volts.

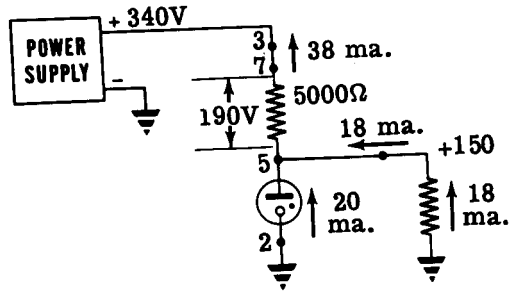

You may increase the load on the 150 volt output terminal until the current through the load reaches 33 ma. At this load, only 5 ma. will flow through the VR tube—this is the minimum current that may flow through the VR tube and still keep the output terminal at 150 volts. Any further increase in load current will cause less than 5 ma. to flow through the tube and it will "go out" or cease glowing. From this point on the VR tube will have no effect on the output voltage, and the output voltage will be determined only by Ohm's Law.

For a load of 38 ma. on the output terminal the voltage drop across the dropping resistor will be:

$$E = IR = .038 \times 5000 = 190 \text{ volts}$$

Subtracting the voltage drop across the resistor from the voltage of the power supply gives you the following voltage at the plate of the tube:

$$340 - 190 \text{ volts} = 150 \text{ volts}$$

For a load of 40 ma. on the output terminal the voltage drop across the dropping resistor will be:

$$E = IR = .040 \times 5000 = 200 \text{ volts}$$

And the voltage at the plate of the tube will be:

$$340 \text{ volts} - 200 \text{ volts} = 140$$

Similarly the following loads on the output terminal will result in the following voltages at the output terminal.

Load Current	42 ma.	44 ma.	46 ma.	48 ma.
Output Voltage	130V.	120V.	110V.	100V.

You see, therefore, that as long as the voltage regulator tube conducts its rated current the voltage remains constant. The voltage remains essentially at 150V in spite of a change in load of from 0 to 33 ma. Once the current through the VR tube becomes less than the minimum required, the tube goes out of action and Ohm's law determines the output voltage. Once Ohm's law determines the output voltage, a change in load of only 2 ma. will cause a voltage change of 10V at the output terminal.

VOLTAGE REGULATOR CIRCUITS

Voltage Regulation When Power Supply Voltage Varies



There is another aspect of voltage regulator circuits that has not been considered so far—how the voltage regulator circuit maintains a constant voltage output when the power supply voltage changes. The power supply B+ voltage will rise when the line voltage rises, and it will fall when the line voltage falls. In addition there usually are other circuits connected to the power supply B+ output voltage, in addition to the voltage regulation circuit. When these other circuits draw more current from B+, the voltage drops; and when these other circuits draw less current from B+, the voltage rises. The voltage regulator circuit must put out a constant voltage output at the plate of the VR tube in spite of these changes in B+ voltage.

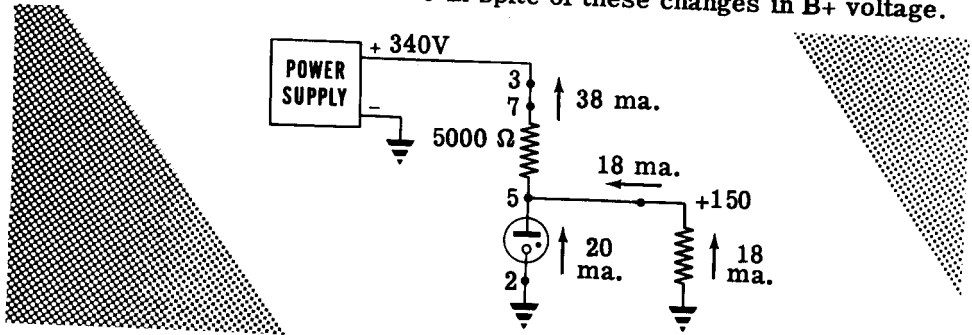

Under the operating conditions shown, 38 ma. flow through the dropping resistor, 20 ma. flow through the VR tube, and 18 ma. flow through the load. If the B+ voltage were to rise to +360 volts, the VR tube would have to adjust its internal resistance so that its plate voltage remained at 150 volts. Let's see if the VR tube is able to make this adjustment.

Under these conditions the top of the dropping resistor would be at +360 volts and the bottom would be at +150 volts. This means that there will be 210 volts across the resistor and the current flow through that resistor will be determined by Ohm's law as follows

$$I = \frac{E}{R} = \frac{210}{5000} = .042 \text{ amps} = 42 \text{ ma.}$$

Since the load draws 18 ma. at 150 volts, the remainder of the current (42 ma. - 18 ma. = 24 ma.) must flow through the VR tube. The VR tube is designed to do its job of regulating if the current flow through it remains between 5 and 40 ma. The VR tube can adjust for this B+ voltage change and still maintain the voltage at its plate at 150 volts.

In order for the circuit to fail in its job, the B+ voltage would have to go up to over 440 volts. At this point there would be 290 volts across the dropping resistor and 58 ma. total current through this resistor. The load current would be 18 ma. and the VR tube current would be 40 ma. Any further increase in B+ voltage would cause over 40 ma. to flow through the VR tube and it would be damaged by the excessive current.

VOLTAGE REGULATOR CIRCUITS

Voltage Regulation When Power Supply Voltage Varies (continued)

Now that you have examined what happens when there is a rise in the B+ voltage supplied to the voltage regulator circuit, suppose you find out what happens when this B+ voltage falls.

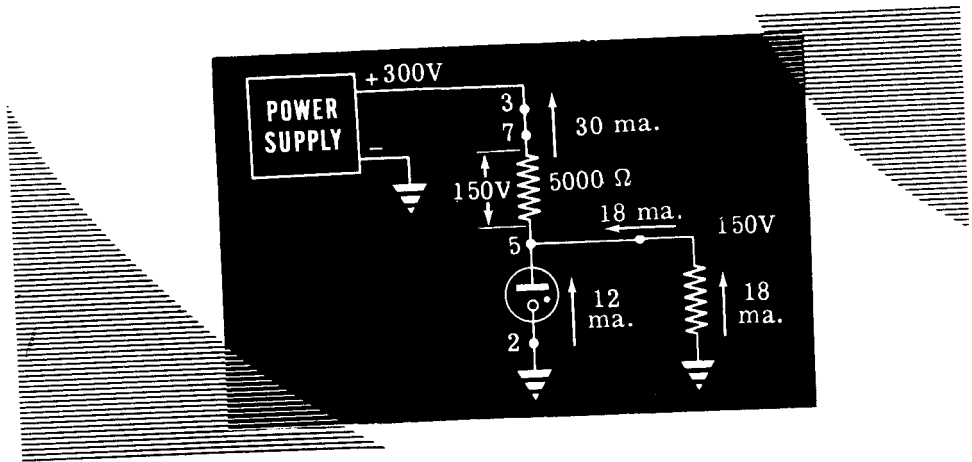

If the B+ voltage were to fall to 300 volts, the VR tube would have to adjust its internal resistance so that the plate voltage remains at 150V. Let's see if the tube can make this adjustment. The voltage across the dropping resistor is 300 volts - 150 volts = 150 volts. The current through the dropping resistor is:

$$I = \frac{E}{R} = \frac{150}{5000} = .030 \text{ amps} = 30 \text{ ma.}$$

The load draws 18 ma. and the remainder of the current (30 ma. - 18 ma. = 12 ma.) flows through the VR tube. The VR tube will do its job as long as the current flow through it remains between 5 and 40 ma. The VR tube can adjust for the drop in B+ voltage and still maintain 150 volts at its plate.

In order for the circuit to fail in its job the B+ voltage would have to drop below 265. At this point there will be 115 volts across the dropping resistor and 23 ma. total current through this resistor. The load current would be 18 ma. and the VR tube current would be 5 ma. Any further drop in B+ voltage will cause less than 5 ma. to flow through the VR tube, and it will stop functioning. The voltage at the plate will then be determined only by Ohm's law as applied to the B+ voltage and the resistance of the dropping resistor.

You have examined the principles behind the operation of the voltage regulator circuit. You have seen that the voltage on the VR tube plate will remain essentially constant as long as the current limitations of this tube are not exceeded. By using a voltage regulator circuit of this type you can get a constant voltage output in spite of fairly large changes in power supply voltage and in spite of sizeable changes in current drain from the regulated source.

VOLTAGE REGULATOR CIRCUITS

Review

VOLTAGE REGULATION — Voltage regulation is a term used to express how well a power supply maintains a constant voltage output in spite of changes in line voltage and load current. There are certain types of electronic circuits that will not operate properly if the supplied voltage varies more than a few volts. The voltage supply to these circuits requires the addition of a voltage regulator circuit which will maintain an essentially constant voltage regardless of line voltage and load current changes.

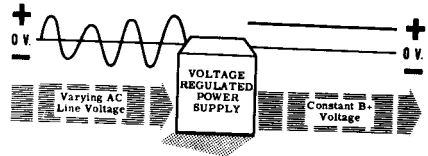

VOLTAGE REGULATOR TUBE —

The voltage regulator (VR) tube contains a plate and a cathode with no filament—both enclosed in a glass envelope containing a gas at low pressure. When a large enough voltage is applied across the tube, a current is conducted through the tube. As long as the current flowing through the tube remains within the limits listed by the manufacturer, the voltage at the plate will remain essentially constant.

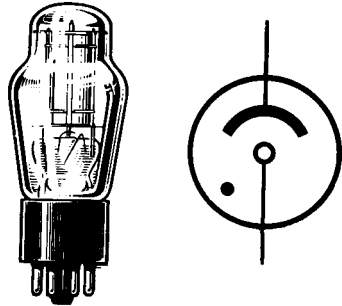

VR TUBE CIRCUIT -- The simplest (and very widely used) voltage regulator circuit consists of a voltage dropping resistor and a VR tube placed in series across the power supply output and ground. The regulated voltage is taken from the plate of the VR tube. The load current and the VR tube current both flow through the dropping resistor, and the VR tube current changes along with the load current so as to keep the dropping resistor current constant.

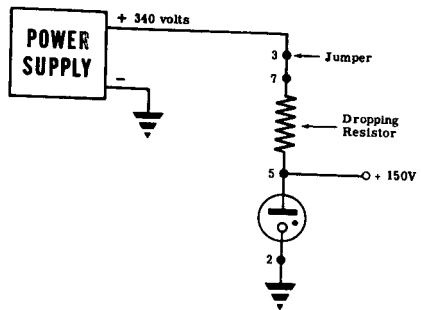

VR TUBE JUMPER — The purpose of the jumper in a VR tube is to prevent unregulated voltage from reaching a special electronic circuit if the VR tube is pulled out. Without the jumper, unregulated voltage would reach the circuit, causing improper operation and possible damage. Pulling out the VR tube removes the jumper and disconnects the voltage from the special circuit.

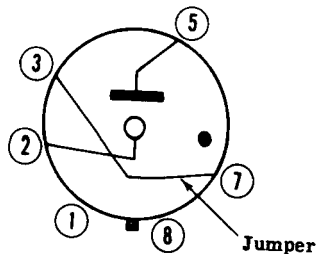

OTHER TYPES OF POWER SUPPLY CIRCUITS

Why the Need for Other Types of Power Supplies

Nearly every power supply you will find in electronic equipment will consist of a half- or full-wave rectifier with a choke or a condenser input filter.

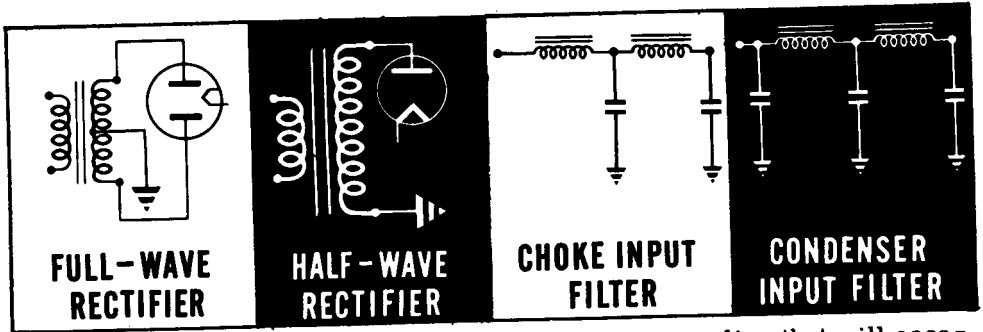

However, there are certain other types of power supplies that will occasionally be found in special types of electronic equipment. These special types of power supplies will be found in equipment upon which are placed size or weight limitations, or limitations as to the type of voltage available from the power line—if a power line is available at all.

Size or weight limitations may require that no transformers or chokes be used in the power supply. In certain cases it may be necessary to eliminate the bulky rectifier tube. There will be cases where AC voltage is not available—requiring the use of a 110 DC line. At some time or another you may even find that 110 DC voltage is not available and only a low voltage DC line or low voltage batteries are available.

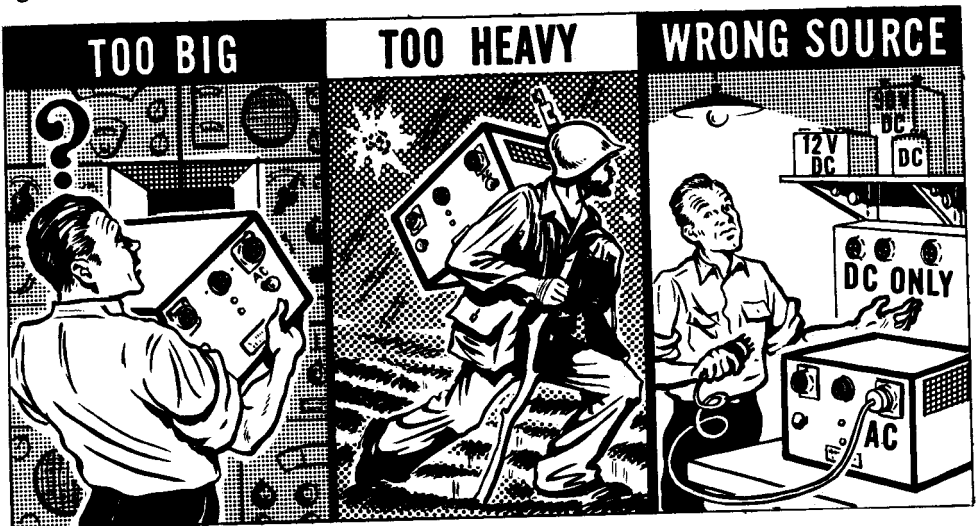

The purpose of this portion of the Power Supply Section is to show you how high voltage DC may be supplied to vacuum tubes under these various restrictions. Even though these power supplies are not common, you should know how they work because you are sure to come across at least several of them in the near future. Learn them now and save yourself future headaches.

OTHER TYPES OF POWER SUPPLY CIRCUITS

General Types

The special types of power supplies you will learn about in the remainder of this topic are divided into two main groups:

1. Power supplies which are included in equipment upon which there are size and weight limitations.

In this group are included:

- a. Transformerless power supplies
- b. Transformerless and chokeless power supplies

.... SIZE AND WEIGHT LIMITATIONS

**TRANSFORMERLESS
POWER SUPPLIES**

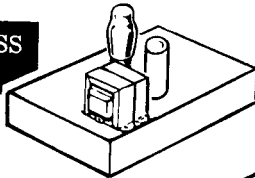

**TRANSFORMERLESS AND
CHOKELESS POWER SUPPLIES**

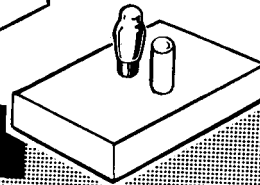

2. Power supplies which are designed for equipment which will have only DC voltage available either from a DC line or from battery sources.

- a. Vibrator power supplies
- b. Motor generators, dynamotors and rotary converters

.... ONLY DC VOLTAGE AVAILABLE

AVAILABLE

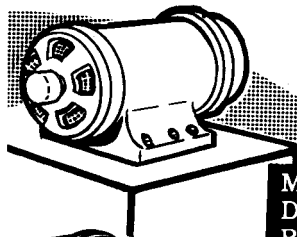

**MOTOR — GENERATORS,
DYNAMOTORS, AND
ROTARY CONVERTERS**

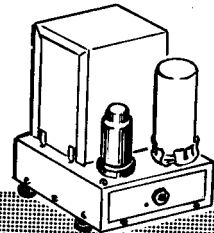

VIBRATOR POWER SUPPLIES

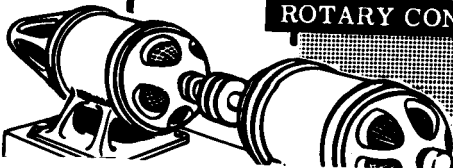

OTHER TYPES OF POWER SUPPLY CIRCUITS

Transformerless Power Supplies

Transformerless power supplies are sometimes used in some electronic equipment to save the weight and space of the power transformer. In commercial radios, transformerless power supplies are very often used to save the cost of the transformer as well as to save the space and weight. Nearly any portable radio that you may look into will have a transformerless power supply, and many "console" model radios are made that way too. There are three types of transformerless power supplies in general use—the AC-DC half-wave rectifier, the voltage doubler and the dry metal rectifier power supplies.

The AC-DC Half-Wave Rectifier Power Supply

The AC-DC half-wave rectifier power supply is useful only in circuits where the tubes will operate at about 100 volts B+ and with tubes that have high voltage filaments. This circuit will supply about 100 volts B+ and will operate either on AC or DC. The circuit itself is a simple half-wave rectifier circuit usually followed by a condenser input filter—you are acquainted with the operation of both these circuits.

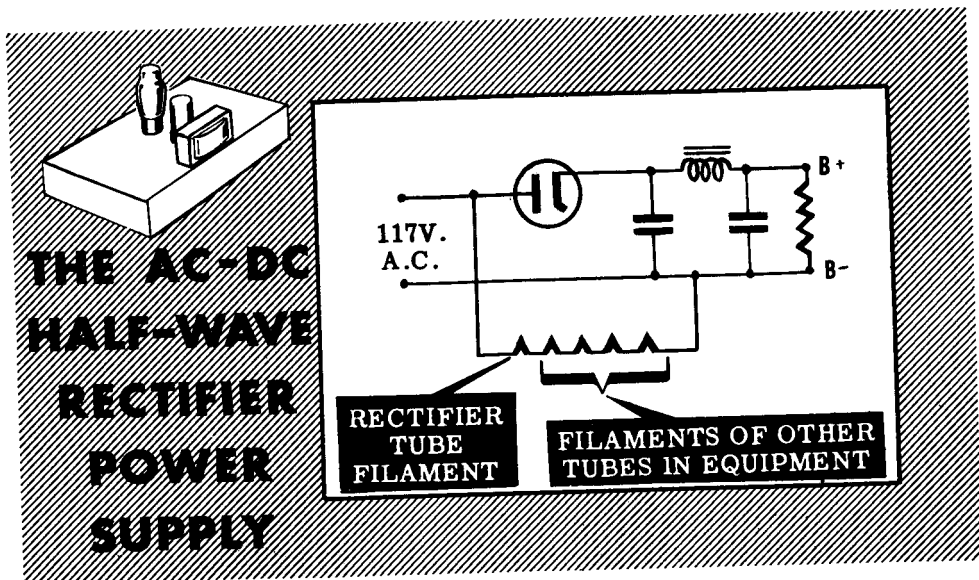

Notice that the filaments of the rectifier tube and the other tubes in the circuit are all connected in series across the power line. As long as all the tubes have the same filament current requirement and as long as the filament voltages add up to approximately the line voltage, the circuit will operate properly. A typical 5-tube portable radio would use a 35Z5 rectifier tube; a 12SA7 first detector, a 12SK7 IF amplifier, a 12SQ7 second detector and a 50L6 audio amplifier. The filament voltages required by these tubes add up to 121 volts ($35 + 12 + 12 + 12 + 50 = 121$) which is close enough to the line voltage.

OTHER TYPES OF POWER SUPPLY CIRCUITS

Transformerless Power Supplies (continued)

The AC-DC Half-Wave Rectifier Power Supply (continued)

One special thing about this power supply is that it will operate on either AC or DC. If a transformer were included in the circuit, the transformer would burn out (or a protecting fuse would blow) in the event that it was connected to a DC line. In the AC-DC half-wave power supply there is no transformer. When the plate of the rectifier tube is connected to the positive side of a DC line and when the cathode is connected to the negative side of the DC line through the load, the circuit will supply B+ voltage. The rectifier plate will always be positive with respect to the cathode, and a steady stream of electrons will be attracted to the plate—a B+ voltage with very little ripple will appear at the cathode.

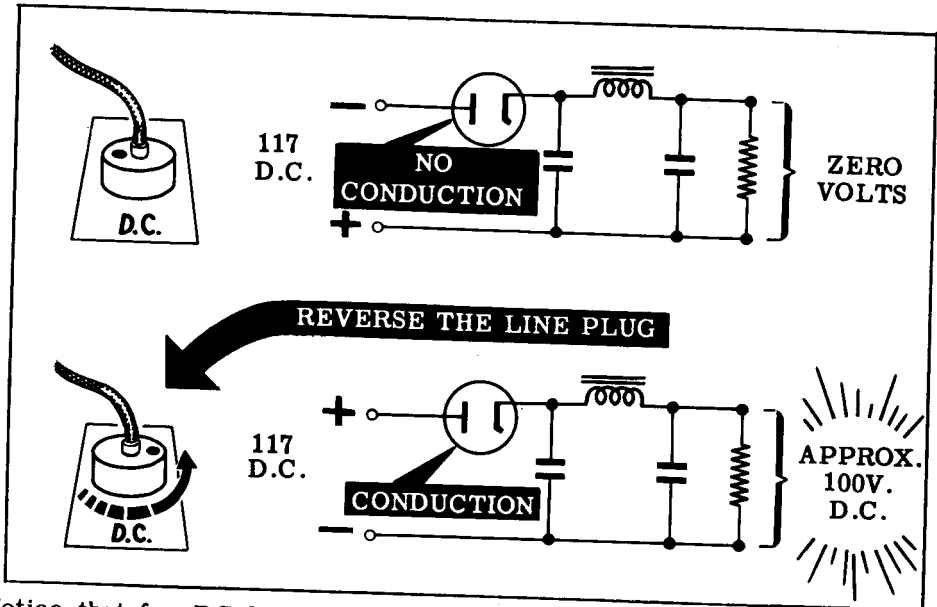

Notice that for DC line operation the plate must always be connected to the positive side of the line and the cathode must always be connected through the load to the negative side of the line. If these connections should be reversed accidentally (because of the use of a non-polarized line plug), the plate of the rectifier will be negative and will attract no electrons from the cathode. The circuit will not work. Whenever a power supply of this type does not operate on a DC line, one of your first checks should be to pull out the line plug and turn it so as to reverse the rectifier tube connections to the line. The use of a polarized line and line plug prevents this trouble.

If an AC line is used, this power supply will operate no matter how the line plug is connected to the line. However, one side of the AC line is usually grounded and one side is "hot." If the rectifier is plugged in so that the cathode is connected to the "hot" side of the line through the load, there will be more AC hum in the circuit attached to the power supply. Whenever you notice excessive hum in equipment using a power supply of this type, try reversing the line plug. The use of a polarized line and line plug will prevent this trouble.

OTHER TYPES OF POWER SUPPLY CIRCUITS

Transformerless Power Supplies (continued)

The Voltage Doubler Power Supply

A transformerless type of power supply which is sometimes used in electronic equipment is the voltage doubler. The disadvantage of the AC-DC half-wave power supply is that it will furnish only about 100 volts B+ which places great restrictions upon the type of circuits which may use this power supply. Voltage doublers do away with this problem by supplying approximately 300 volts B+ when connected to a 110-volt AC line.

THE VOLTAGE DOUBLER

D C OUTPUT
= TWICE
PEAK A C
INPUT

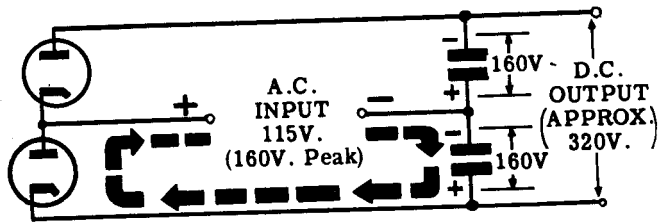
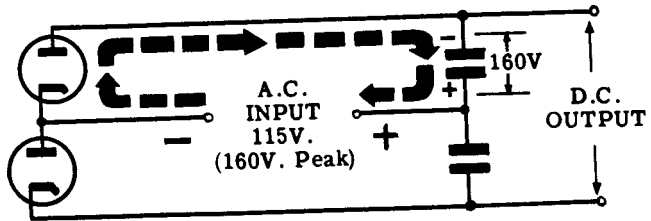

The operation of a voltage doubler circuit is very simple and is shown in the illustration. This circuit uses a rectifier containing two plates and two cathodes—giving you two half-wave rectifier circuits. Each of the two half-wave rectifiers operates off the same AC input. When the right-hand AC input terminal is positive, the upper rectifier in the diagram conducts electron current and the upper condenser charges up to peak line voltage. When the left-hand AC input terminal is positive, the lower rectifier in the diagram conducts electron current and the lower condenser charges up to peak line voltage. Each condenser is now charged and both are in series with respect to the DC output terminals. The sum of these two peak voltages is now available as a DC output which is equal to twice the peak voltage of the AC input.

In circuits of this type the heaters of the rectifier tube and the other tubes in the circuit are all connected in series in the same way as with the AC-DC half-wave rectifier. The voltage doubler will operate only when connected to an AC line since the doubling effect is due to the reversal in line voltage. The voltage doubler circuit sometimes has a transformer between the line and the AC input terminals of the doubler circuit. The transformer is used either to isolate the circuit from the ground of the AC line or to put a higher AC voltage into the circuit so as to get a very high voltage DC output.

OTHER TYPES OF POWER SUPPLY CIRCUITS

Transformerless Power Supplies (continued)

Dry Metal Rectifier Power Supplies

Earlier you learned how dry metal rectifier circuits worked. Dry metal rectifiers allow you to eliminate the transformer in an electronic power supply. Dry metal rectifiers have the advantage of being rugged, long-lived, small in size and capable of large current output. They are quite adaptable to being hooked up in half-wave, full-wave and voltage doubler circuits. They also can be hooked up to give either a positive or negative voltage output.

Dry metal rectifiers are used to some extent in radar, sonar and communications equipment. In addition they are also used as the rectifier in AC voltmeters. A few common circuits that contain dry metal rectifiers are shown below. Since you are already acquainted with both the dry metal rectifier and the circuits themselves, you should be able to understand how these circuits work without further explanation.

When power is first applied, a high current will flow to charge the input condenser. You will notice that a resistor (R) is inserted in series with each half-wave rectifier element. This resistor is put in as a current limiting device to prevent too much current from flowing through the rectifier.

BRIDGE TYPE RECTIFIER

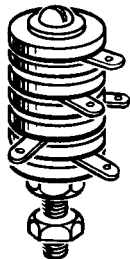

HALF-WAVE DRY METAL RECTIFIER CIRCUIT

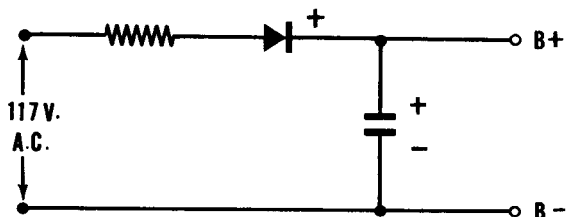

VOLTAGE DOUBLER CIRCUIT

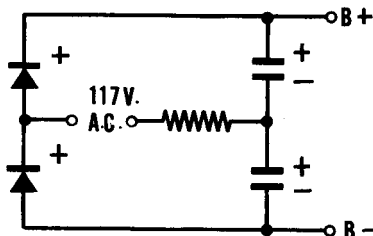

BRIDGE RECTIFIER

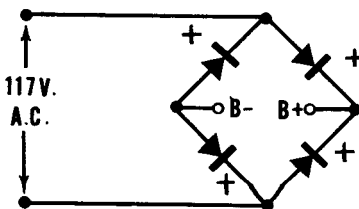

OTHER TYPES OF POWER SUPPLY CIRCUITS

Transformerless and Chokeless Power Supplies

Eliminating the choke as well as the transformer from the power supply results in the savings of weight, space and cost. The choke may be eliminated from the filter circuit by replacing it with a resistor. The result is a resistance-capacitor (RC) filter as shown in the illustration. RC filters are economical and work very well whenever the load current drawn from the filter circuit is small. RC filters are used extensively in oscilloscopes, vacuum tube voltmeters and other equipment that require very little B+ current drain.

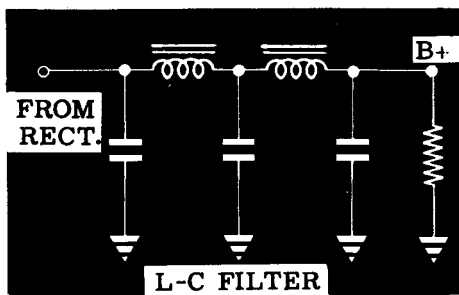

PARTS USED:

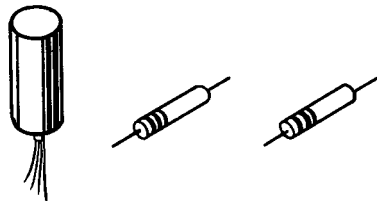
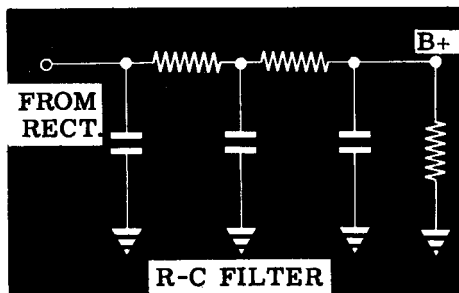
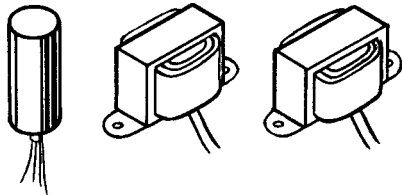

The advantage of the RC filter is its savings in weight, space and cost. The disadvantage is that the filtering action is effective only with small B+ current drain. As you recall, a choke presents a high impedance to the AC ripple coming out of the rectifier and the condenser presents a low impedance. As a result, most of the ripple will appear across the choke and very little will appear across the condenser and the load. The DC voltage, however, is not presented with any impedance by the choke other than the resistance of the winding which is very low.

The RC filter offers the same resistance to both the AC ripple and the DC current. As a result there is a drop in DC voltage caused by the DC current flow through the filter resistor. If the value of the resistor is made low to decrease the DC voltage drop, ripple voltage will get through the filter. If the value of the resistance is increased to stop the AC ripple, the drop in DC voltage will be too great. The only way to make this type of filter operate efficiently is to use a large value of resistance to draw very little DC current from B+. Very little DC current flowing through the high value of resistance means that there will be a very small DC voltage drop across the resistor and the filter will operate efficiently.

OTHER TYPES OF POWER SUPPLY CIRCUITS

Power Supplies for DC Voltage Sources

Now that you know something about power supplies that are specially designed to save weight and space (and cost in commercial applications), you are ready to find out something about power supplies that are designed to operate electronic equipment when only DC voltage is available.

In order to operate electronic equipment properly, a fairly high DC voltage is required for the various vacuum tubes in the equipment. When an AC line is available, it is a simple matter to step up the available AC voltage by means of a transformer and rectify the resulting high voltage AC into high voltage DC. You have seen that when space and weight restrictions are important, power supplies may eliminate the transformer and put out a DC voltage of approximately 100 volts B+. You have also seen low-voltage doubler circuits can give you a B+ voltage twice the peak value of the AC line without the use of a transformer.

You are now ready to find out how high voltage DC can be supplied to electronic circuits when the only source of voltage is DC at 110 volts or lower voltage sources such as batteries. The general solution to this problem is to change the DC to AC, which can then be stepped up in voltage and then rectified into high voltage DC. This is done by means of vibrators, motor generators, dynamotors and rotary converters. When DC voltage at approximately 110 volts is available and if a B+ voltage output of 100 volts is satisfactory, the AC-DC half-wave rectifier power supply already described may be used.

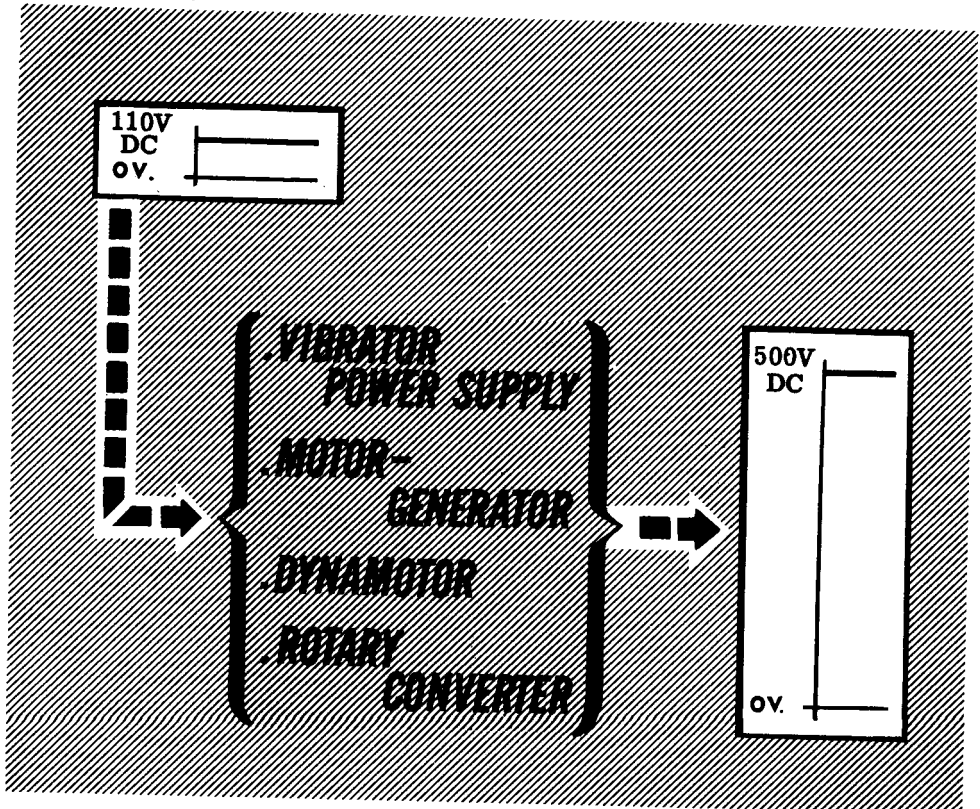

OTHER TYPES OF POWER SUPPLY CIRCUITS

Vibrators

The vibrator type power supply changes low voltage DC from batteries or a DC line into high voltage DC by means of three operations:

1. The low voltage DC is changed into AC of the same voltage.
2. The low voltage AC is put into a transformer and comes out as high voltage AC.
3. The high voltage AC is rectified and filtered into high voltage DC.

The vibrator is the means by which the first operation is accomplished. Operation 2 is accomplished by means of a transformer. Operation 3 is done by means of either the vibrator or one of the conventional vacuum tube rectifier and filter circuits with which you are already familiar.

The construction of a simple vibrator is shown below. A heavy strip of metal serves as a frame to hold a small electromagnet, a spring metal "reed" and two electrical contacts in place. A soft-iron tip is mounted on the free end of the reed, near the electromagnet. The electromagnet is mounted slightly off-center so that it can move the reed whenever current flows in the coil of the electromagnet. This vibrator mechanism is inserted in a metal cover which is often lined with a vibration absorbing material such as soft rubber.

What goes on inside the VIBRATOR !

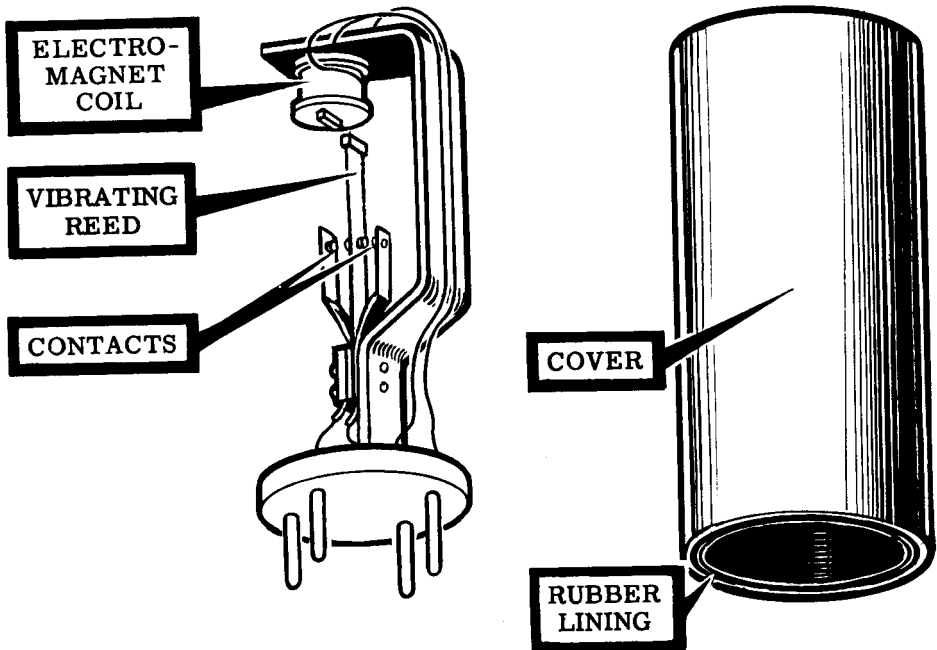

OTHER TYPES OF POWER SUPPLY CIRCUITS

Vibrators (continued)

The vibrator you saw on the last sheet is connected to the primary winding of a transformer as shown in the illustrations on this sheet. For the moment ignore the transformer secondary circuit and just consider what takes place in the primary circuit. Before the DC source—here shown as a battery—is connected into the circuit, the reed remains between the two contacts. When the battery is put into the circuit, the following things happen:

1. A small DC current flows from the battery through the electromagnet, through the lower half of the transformer primary and back into the battery.
2. The electromagnet builds up a magnetic field and attracts the reed towards the lower contact.
3. The reed strikes the lower contact and a large DC electron current flows from the battery through the reed, through the lower contact, through the lower half of the transformer primary and back into the battery.

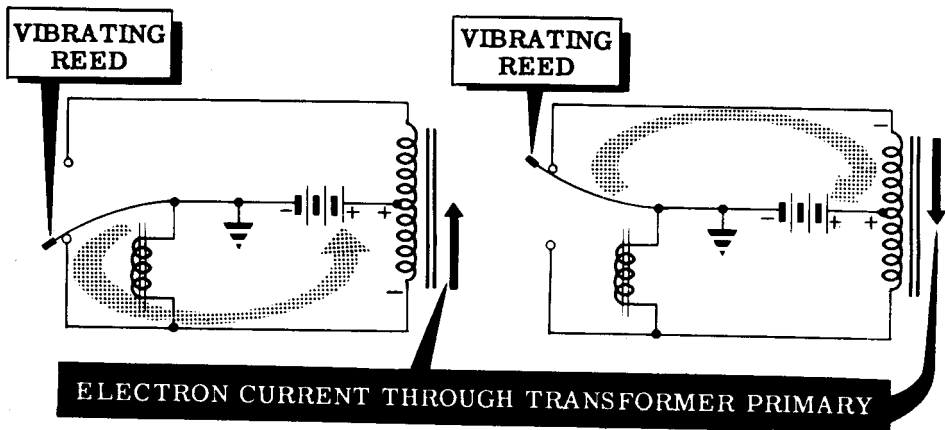

When the vibrator reed hits the lower contact, it puts a direct short across the electromagnet coil. This causes the magnetic field to collapse. Since the electromagnet can no longer hold the reed against the lower contact, the reed springs back past the center position and strikes the upper contact. When the reed strikes the upper contact, the following things happen.

4. A large DC electron current flows from the battery through the reed, through the upper contact, through the upper half of the transformer primary and back into the battery.
5. Since the electromagnet is no longer shorted out by the reed, it builds up a magnet field and pulls the reed back towards the lower contact.

The entire cycle is repeated again and again. Vibrations take place at approximately 100 times per second.

OTHER TYPES OF POWER SUPPLY CIRCUITS

Vibrators (continued)

The net result is an AC current that flows through the primary of the transformer, first in one direction and then in the opposite direction. This reversal of current, induces high voltage in the transformer secondary. This high voltage is rectified by a vacuum tube rectifier circuit and becomes high voltage DC. The fact that this high voltage DC has square topped peaks instead of the usual sine wave shape does not matter—the filter circuit changes it into a smooth B+ voltage.

The type of vibrator used in this circuit is known as a "non-synchronous" vibrator.

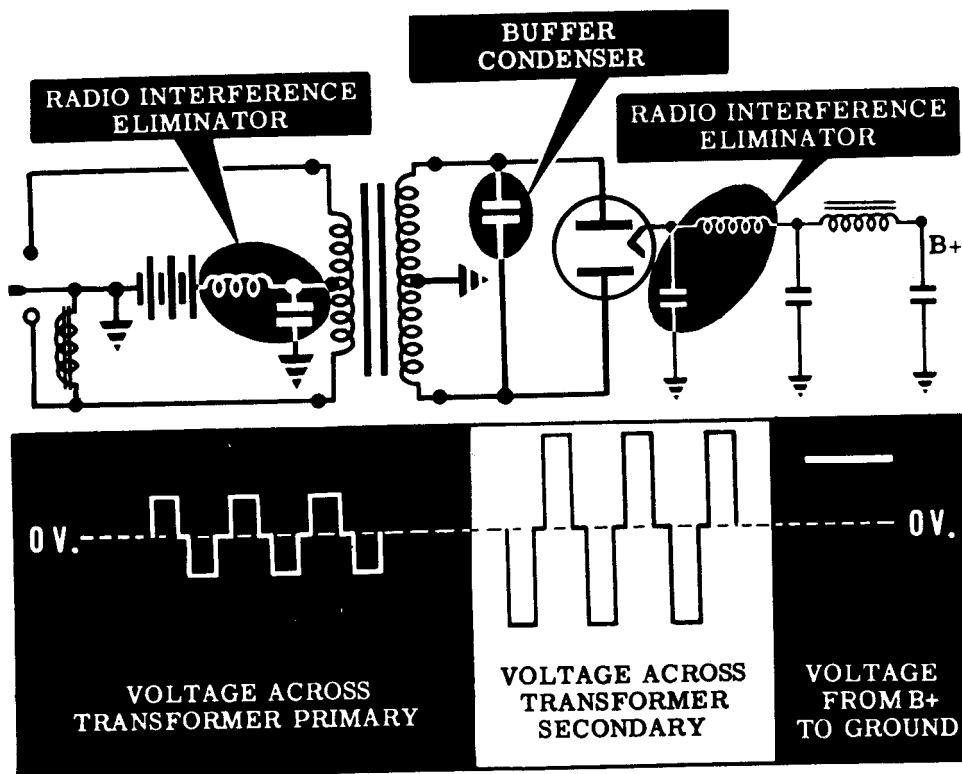

Because of the very sharp voltage surges occurring in the vibrator power supply circuit, various difficulties are experienced with this type of circuit. One annoying trouble is sparking at the vibrator contacts due to the very high voltage induced in the secondary at the instant the reed separates from the contacts. This sparking shortens the life of the vibrator, but it may be eliminated to a large extent by inserting a buffer condenser across the secondary to short out the sharp voltage pulses. This condenser has a fairly critical value, usually in the range of from 0.0005 to 0.05 microfarads. The buffer condenser reduces sparking so that the life of the vibrator contacts will not be shortened; however, any remaining sparking may cause radio interference. This radio interference is eliminated by the addition of RF chokes and condensers in the transformer primary center tap and in the rectifier output.

OTHER TYPES OF POWER SUPPLY CIRCUITS

Vibrators (continued)

Another type of vibrator circuit is one that makes use of the vibrating reed to rectify the high voltage AC from the transformer secondary into pulsating DC without the use of a separate rectifier. This circuit is known as the "synchronous" vibrator circuit. The portion of the circuit in the transformer primary works exactly the same as in the non-synchronous vibrator circuit. The transformer secondary is connected back to the vibrator reed by means of an extra pair of contacts as shown in the diagram.

THE Synchronous Vibrator

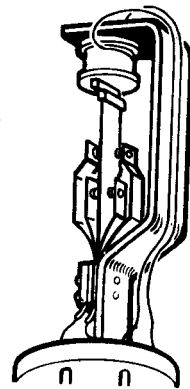
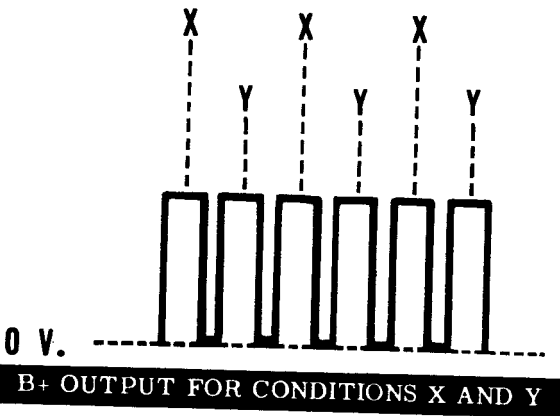
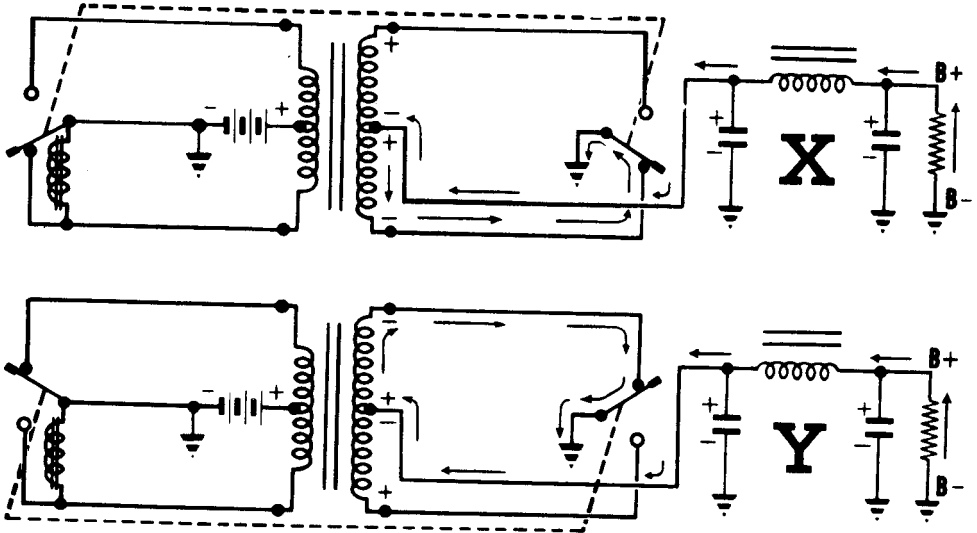

The two vibrating reeds shown connected together by the dotted line in the diagram are actually one reed placed between two pairs of contacts. The action of the reed between the transformer secondary contacts produces the same results as a full-wave rectifier. RF chokes and buffer condensers are used in this vibrator circuit in the same manner as in the non-synchronous vibrator to eliminate contact sparking and radio interference.

OTHER TYPES OF POWER SUPPLY CIRCUITS

Motor Generators, Dynamotors and Rotary Converters

Motor generators, dynamotors and rotary converters are sometimes used to operate AC electronic equipment when only a DC source of voltage is available. A motor generator consists of a motor and a generator mechanically connected together. For the application being considered a DC motor would be used to drive an AC generator which would be designed to give a 60-cycle output at line voltage. Equipment designed to operate from 60-cycle AC at line voltage could then be operated from a DC source by means of this type of motor generator. This type of motor generator could be used as an emergency unit by having the equipment operate off the AC line under normal conditions, and the equipment could operate from a battery source by means of the motor generator in the event of an AC line failure.

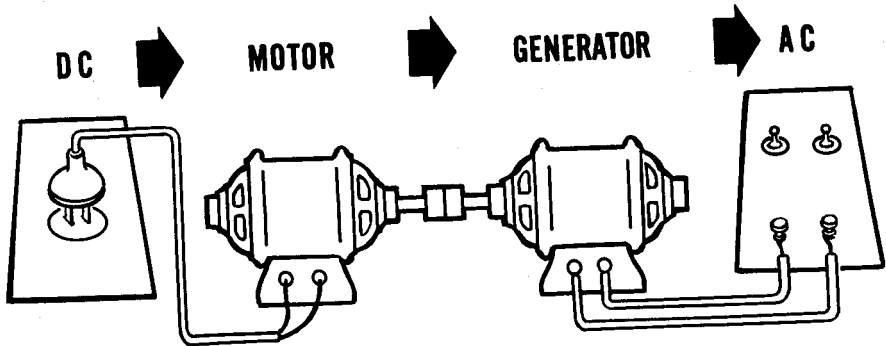

A dynamotor is a rotating DC machine that operates from a low voltage DC source and puts out one or several high voltage DC outputs. It is basically a DC motor and a DC generator built onto one armature and having two or more windings and two or more commutators. Dynamotors are usually operated from 6-, 12-, 24- or 32-volt storage batteries and deliver from 250 to over a thousand volts DC at various current ratings.

DYNAMOTOR PRINCIPLE

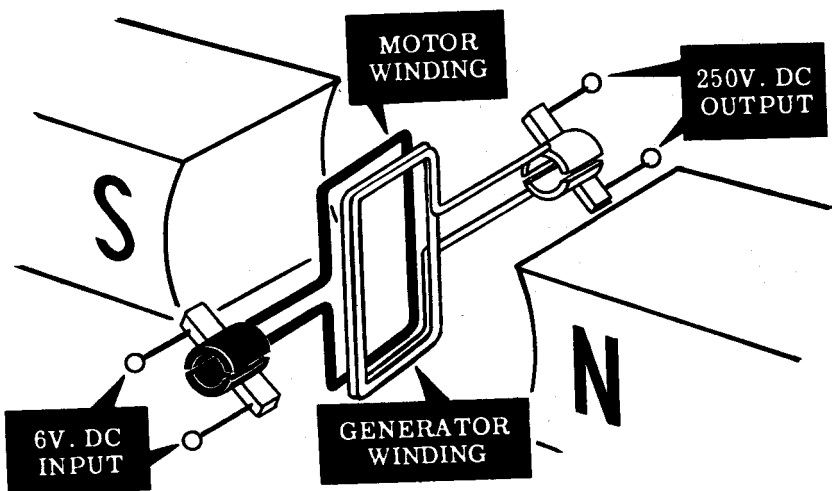

OTHER TYPES OF POWER SUPPLY CIRCUITS

Motor Generators, Dynamotors and Rotary Converters (continued)

Rotary converters are commonly used to change AC to DC, but they may be used to operate off storage batteries and give an output of 60 cycles AC at line voltage. When used to operate from DC sources and give AC outputs, they are known as inverters. The construction of a rotary converter is similar to a DC generator except that two slip rings are used which are connected to commutator segments 180 degrees apart.

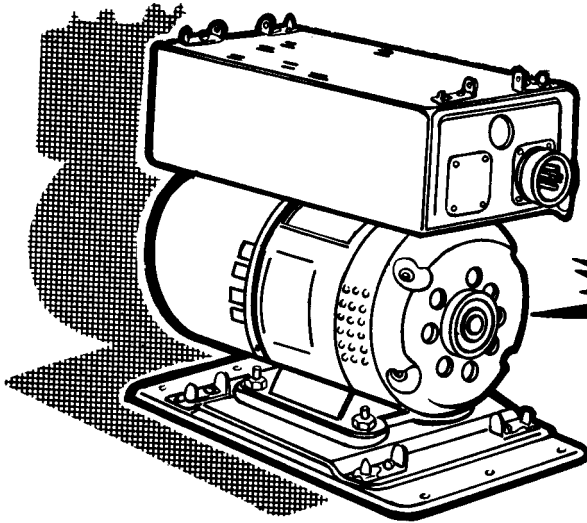
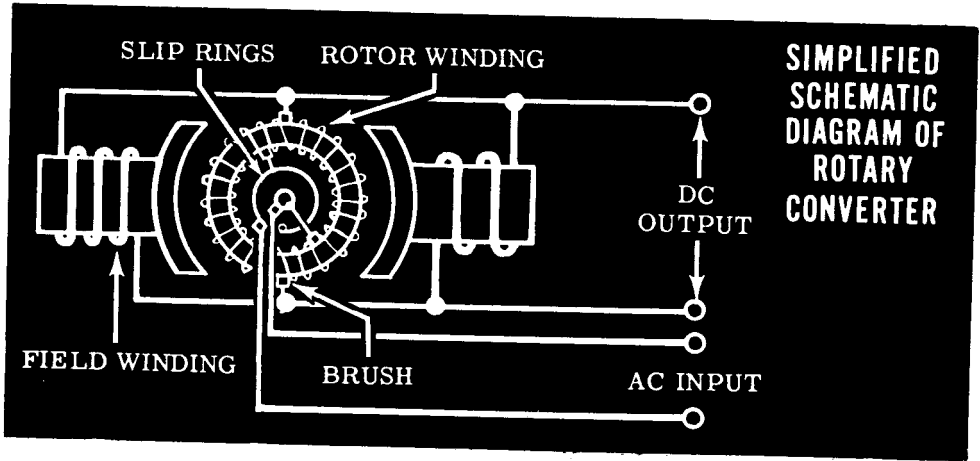

TYPICAL
INVERTER UNIT

When the peak AC voltage output desired is no higher than the average DC voltage input, one winding may be used on the armature. If a greater voltage is desired, two windings are used on the same armature. The use of one armature and one field for both the AC and DC sections results in instability of operation. In order to increase stability the AC and DC sections are often wound on two armatures using separate fields. The two armatures are coupled together and the whole unit functions as a motor and a generator built into one unit.

OTHER TYPES OF POWER SUPPLY CIRCUITS

Review of Transformerless Power Supplies

AC-DC HALF-WAVE RECTIFIER

POWER SUPPLY — This circuit will supply about 100 volts B+ and will operate from either in AC or DC power line. The circuit is a simple half-wave rectifier circuit usually followed by a condenser input filter. The filaments of the rectifier tube and the other tubes in the circuit are all connected in series across the power line.

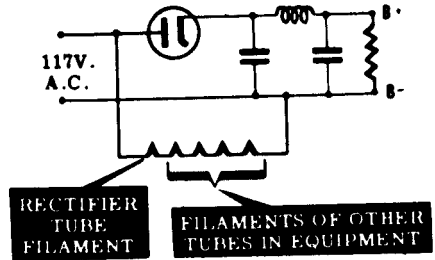

VOLTAGE DOUBLER POWER SUPPLY

-- This circuit will supply up to 320 volts B+ from a 117-volt AC power line without the use of a transformer. The circuit consists of two half-wave rectifiers and two capacitors. The capacitors are connected in series and each is charged up to peak line voltage resulting in the voltage doubling effect. The filaments of the rectifier tube and the other tubes in the circuit are all connected in series across the power line.

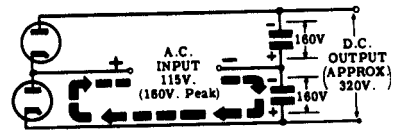

DRY METAL RECTIFIER POWER

SUPPLY — Dry metal rectifiers may be used instead of vacuum tube rectifiers. Dry metal rectifiers are rugged, long-lived, small in size and capable of large current output. They can be hooked up in half-wave, full-wave and voltage doubler circuits.

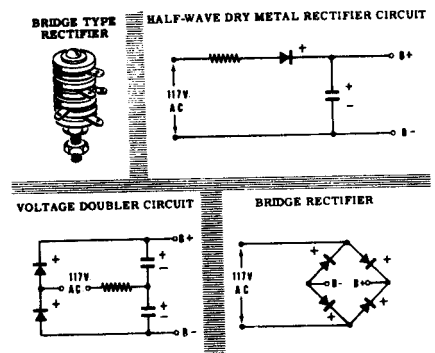

OTHER TYPES OF POWER SUPPLY CIRCUITS

Review of Transformerless and Chokeless Power Supplies

CHOKeless POWER SUPPLIES — Any of the transformerless rectifier circuits listed on the previous sheet may be used with standard choke and capacitor filter circuits. However, an additional savings may be made in space, weight and cost if the filter choke is replaced with a resistor. This type of RC filter is effective only when a very small B+ current drain is required and a fairly large resistor can be used.

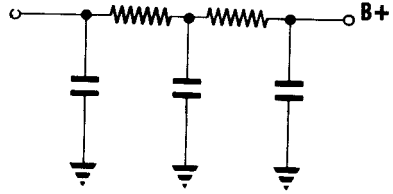

Review of Power Supplies for DC Voltage Sources

VIBRATORS — A vibrator is a mechanical device which changes DC into AC. A simple vibrator is essentially a single pole double throw switch with a vibrating switch arm. When the vibrator is connected to a transformer with a center tapped primary as shown, the action of the vibrating switch arm causes current to flow first in one direction and then in the other direction through the transformer primary. The transformer puts out an alternating high voltage which can be rectified and filtered into a high voltage DC.

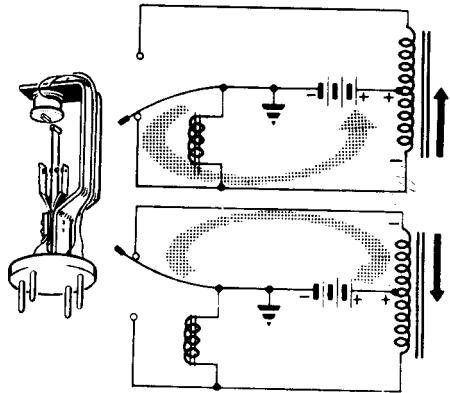

SYNCHRONOUS VIBRATORS — The non-synchronous vibrator changes DC into high voltage AC which must then be rectified by means of a vacuum tube rectifier. A synchronous vibrator does away with the need for a separate rectifier. The portion of the vibrator in the transformer primary works exactly as in the non-synchronous vibrator circuit. The transformer secondary winding is connected back to the vibrator reed by means of an extra pair of contacts as shown. The action of the vibrating reed between the transformer secondary contacts produces results the same as if a full-wave rectifier were placed there.

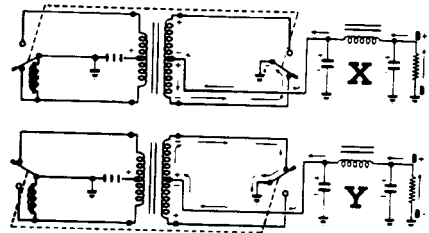

OTHER TYPES OF POWER SUPPLY CIRCUITS

Review of Power Supplies for DC Voltage Sources (continued)

MOTOR GENERATOR — A motor and a generator mechanically coupled together. Equipment designed to operate from an AC power source may be made to operate from the DC line if a motor generator is used. The DC motor is connected to the DC line, and the DC motor spins the rotor of the AC generator which puts out 117 volts AC.

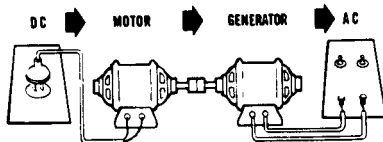

DYNAMOTOR — A rotating DC machine that operates from a low voltage DC source and puts out one or more high DC voltages. A dynamotor is basically a DC motor and a DC generator built onto one armature and having two or more commutators.

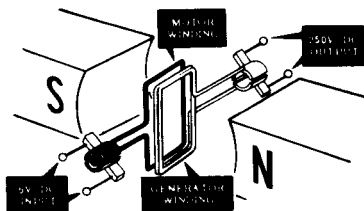

ROTARY CONVERTER — Rotary converters are commonly used to change AC to DC, but they may be used to operate from storage batteries to give an output of 117 volts AC and are then known as inverters. The construction of a rotary converter is similar to a DC generator except that two slip rings are used which are connected to commutator segments 180 degrees apart.

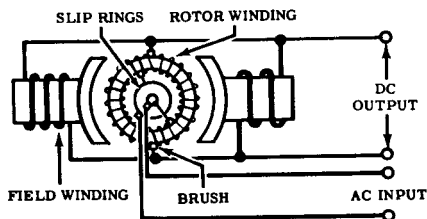

CHARACTERISTICS OF DIODE VACUUM TUBES

The Jobs of a Vacuum Tube

Up to this time you have been working with vacuum tubes used as rectifiers in power supply circuits. Your knowledge of diode tubes has been sufficient for an understanding of power supplies. However, from now on you are going to do a great deal of work with vacuum tubes in many types of circuits, and now is the time to begin finding out about vacuum tubes.

The subject of vacuum tubes is really a simple one because—and you will be glad to know this—vacuum tubes do only two types of jobs.

A vacuum tube can change an AC voltage into a pulsating DC voltage. This is called **RECTIFICATION**. This job is accomplished by the diode.

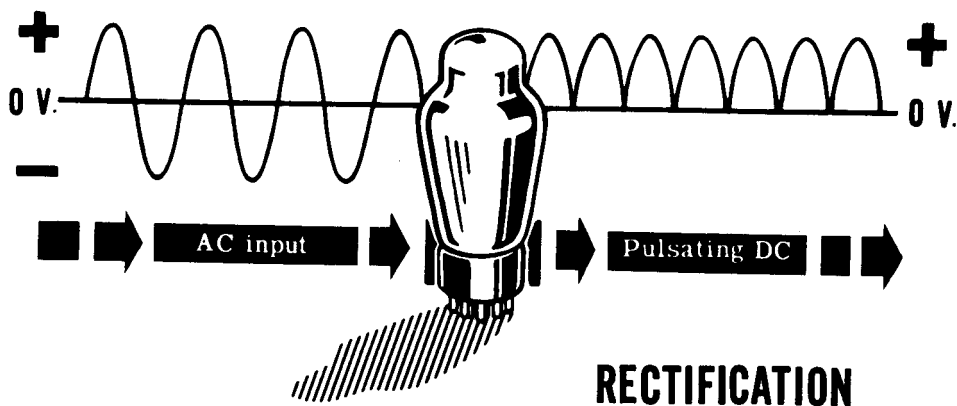

A vacuum tube can change a small AC voltage into a large AC voltage. This is called **AMPLIFICATION**. This job is done by the triode, the tetrode or the pentode.

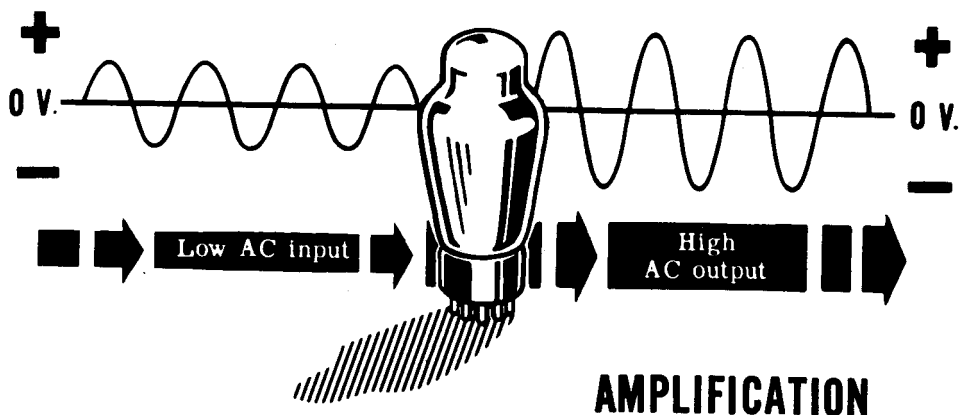

You have been concerned with the vacuum tubes that take care of rectification. Later, in the amplifier section, you will learn about the other types of vacuum tubes.

CHARACTERISTICS OF DIODE VACUUM TUBES

Factors Common to All Vacuum Tubes

The diode is one of the four basic types of vacuum tubes. There are many things which are common to all vacuum tubes and you won't have to learn all about these common characteristics each time you study another type of tube. You will learn about these things in your study of the diode.

As previously stated, all vacuum tubes need a source of free electrons and you will find that each type of tube obtains them in the same way as the diode—by thermionic emission. Furthermore, the cathode and filament structure does not differ very much from one type of tube to the next. You will study the effects of the filament on cathode emission only during your diode experiment—remember, it's the same for the other tubes you will study.

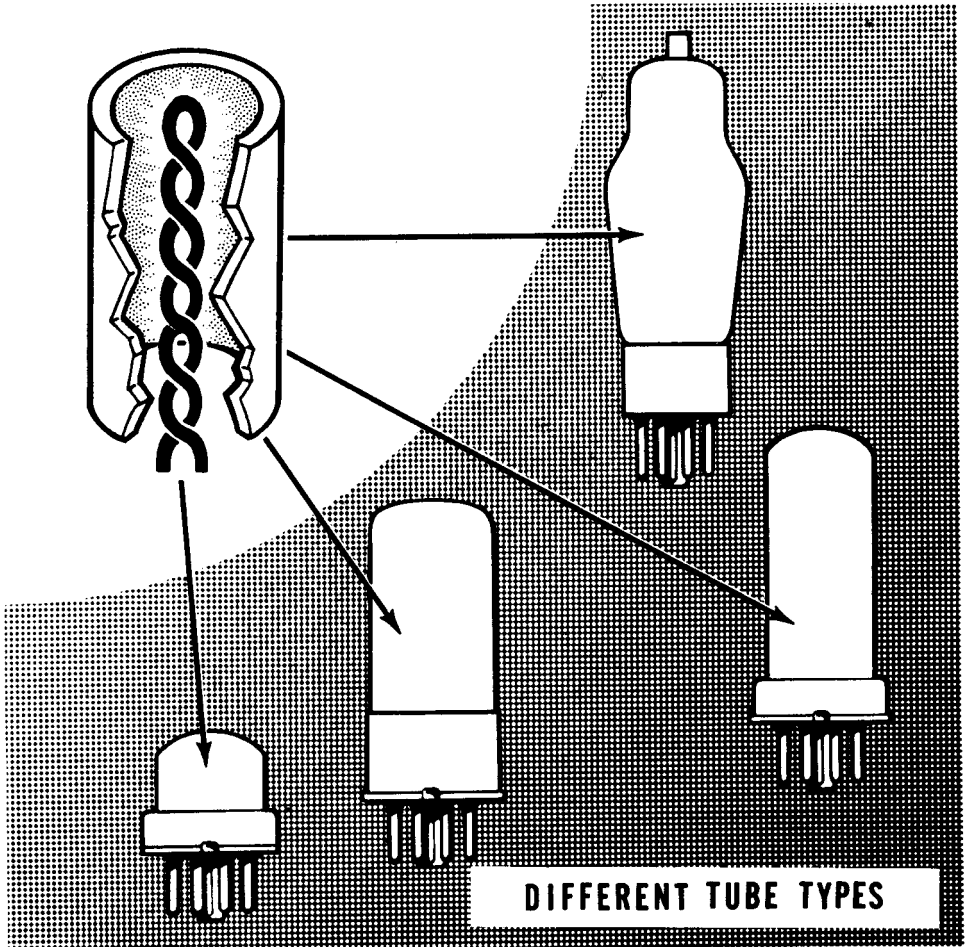

The differences between the diode and the other vacuum tubes lead to their different uses. The diode is used to change an AC voltage into a pulsating DC voltage; the other tubes are used to change a small AC voltage into a large AC voltage

CHARACTERISTICS OF DIODE VACUUM TUBES

Review of Diode Characteristics

Diodes are used as rectifiers in power supplies, and as detectors, noise limiters and automatic volume control tubes in radio receivers. Whatever their application is, however, diodes are used because they allow current to flow in only one direction.

From the time the plate becomes just slightly positive with respect to the cathode until the time saturation is reached, the current in the diode is proportional to the plate voltage. Between these limits, then, the tube acts the same as an ordinary resistor. Of course, when the plate voltage rises above the saturation point, the current does not respond to voltage changes and therefore, in this region, the tube loses its resemblance to the resistor.

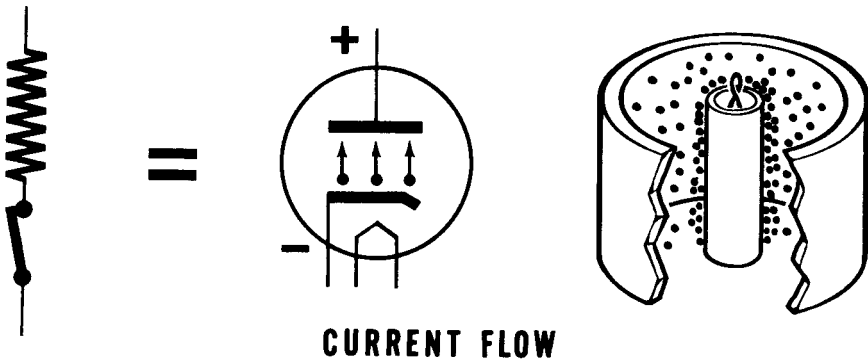

When the plate becomes the least bit negative with respect to the cathode, no electrons will flow from the cathode to the plate. The tube acts as if it were a resistor in series with a switch and the switch were opened up.

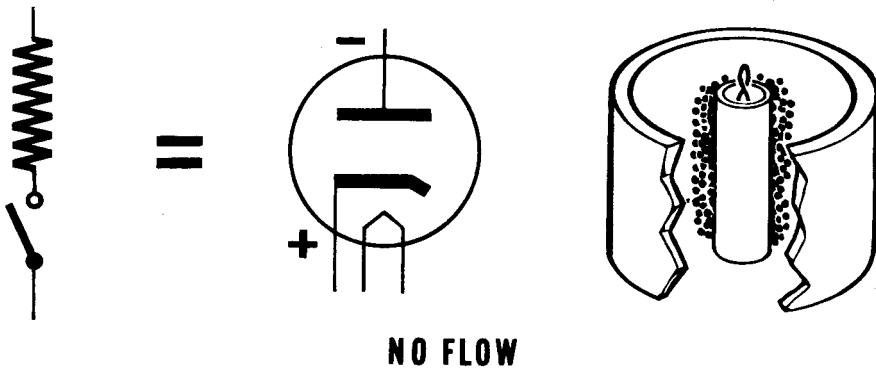

CHARACTERISTICS OF DIODE VACUUM TUBES

How Current Is Controlled in a Diode

A simple way to show how a diode will respond to changes of voltage is with a graph. A graph picturing how a typical diode's current is affected by its plate-to-cathode voltage (at two different values of filament voltage) is shown below.

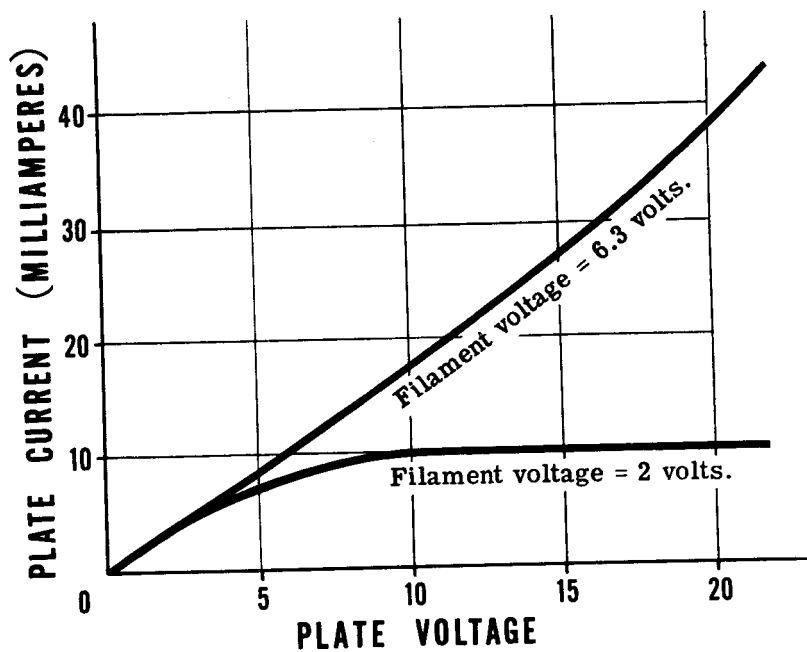

From a quick look at the graph you can tell that:

1. At normal filament voltage (6.3 volts), the plate current increases steadily as the plate voltage is increased from zero to 20 volts.
2. At the lower value of filament voltage (simulating the effect of an old tube), the plate current increases as the plate voltage is raised to about 8 volts, and any further increase of plate voltage does not bring about increased plate current. This shows us that at 8 volts the plate is drawing all the electrons the cathode can emit.

This undesirable restriction on the plate current which is due to limited cathode emission is called "saturation." Even in a fairly new tube working at rated filament voltage (6.3 volts), saturation would occur, but at a higher value of plate voltage. This would appear on the curve of 6.3 filament volts if higher values of plate voltage had been used.

POWER SUPPLIES

Review of Power Supplies

Before you leave the study of power supplies and go on to learn about amplifiers, suppose you review some of the important things you've found out about power supplies and their components.

RECTIFICATION — A diode vacuum tube allows electron current to flow in only one direction—from the cathode to the plate. This effect permits AC voltage to be "rectified" into a pulsating DC voltage.

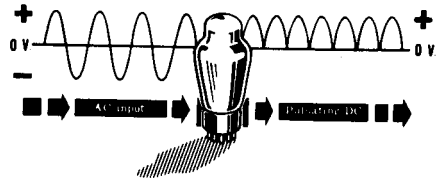

SATURATION — Plate current increases regularly as plate voltage is increased. When all of the electrons that can be emitted by the cathode are attracted to the plate, a further increase in plate voltage cannot attract any more electrons than are flowing already. When an increase of plate voltage fails to cause a rise in plate current, the tube is said to be "saturated."

SATURATION AND FILAMENT VOLTAGE

— Increasing the filament voltage increases the filament temperature—resulting in a hotter cathode. The more heat the cathode gets, the more electrons will be emitted from its surface. When the cathode emits more electrons, the saturation point will not occur until the plate voltage reaches a much higher value.

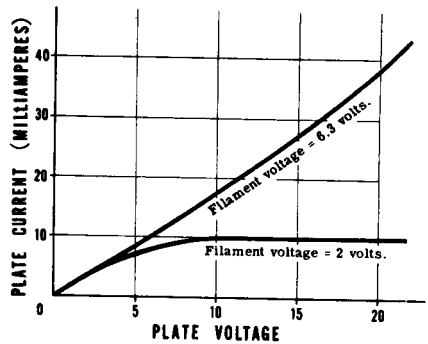

HALF-WAVE RECTIFICATION — Changing the positive cycles of an AC voltage to pulsating DC by allowing current to flow through a circuit in one direction only.

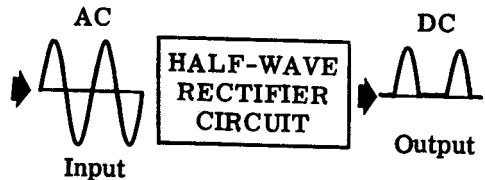

FULL-WAVE RECTIFICATION — Changing both cycles of AC to pulsating DC.

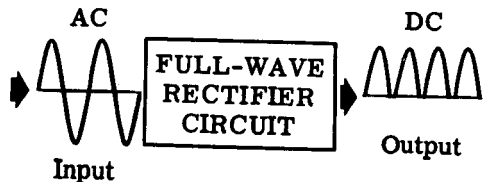

POWER SUPPLIES

Review of Power Supplies (continued)

DRY METAL HALF-WAVE RECTIFIER — A circuit which produces half-wave rectification by using a device consisting of two metallic plates which conduct current flow in only one direction.

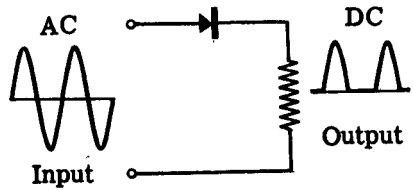

RECTIFIER TUBE — A vacuum tube diode consisting of plate and cathode which allow electron flow only from cathode to plate and thus acts as a rectifier.

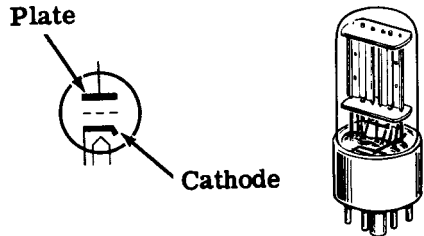

VACUUM-TUBE RECTIFIER CIRCUIT — A diode vacuum tube connected in series with an AC voltage source to change AC to DC.

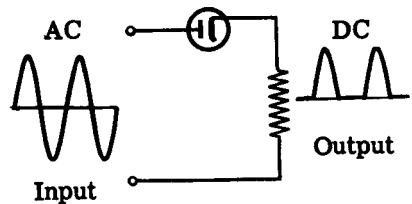

TRANSFORMER TYPE HALF-WAVE RECTIFIER — A circuit which uses a transformer to supply high-voltage AC to a vacuum tube rectifier, which then rectifies it to pulsating high-voltage DC.

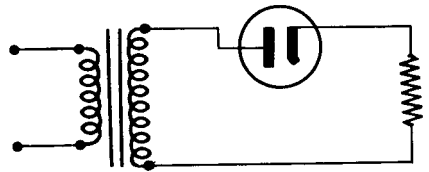

FULL-WAVE RECTIFIER CIRCUIT — A circuit which uses a transformer and a full-wave rectifier diode to produce full-wave rectified pulsating DC from an AC input.

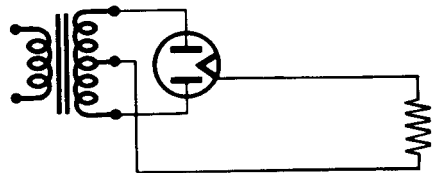

POWER SUPPLIES

Review of Power Supplies (continued)

FILTER CIRCUITS — Circuits consisting of inductors and capacitors used to change pulsating DC output of a rectifier to pure DC.

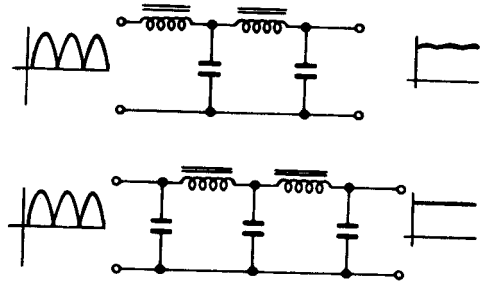

COMPLETE POWER SUPPLY — The complete circuit consisting of full-wave rectifier and filter circuits, used to supply high DC voltage to other circuits.

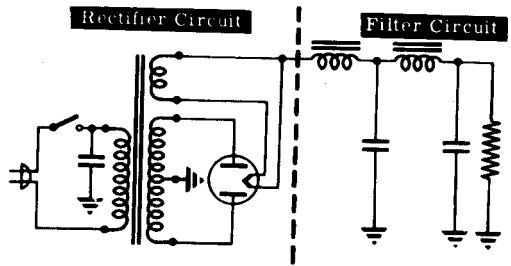

VOLTAGE REGULATOR CIRCUIT — A circuit which uses a gas-filled diode to maintain constant output voltage. The voltage across tube terminals remains constant over a large range of source voltage or load current changes.

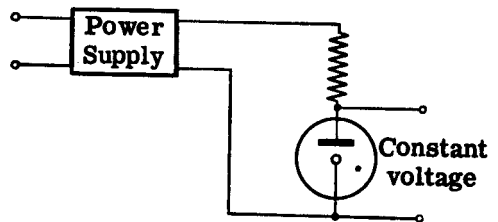

OTHER POWER SUPPLIES — Transformerless and chokeless power supplies, vibrators, motor-generators, dynamotors and rotary converters are other types of power supplies used to fill special requirements as to size, weight, power source available and load requirements.

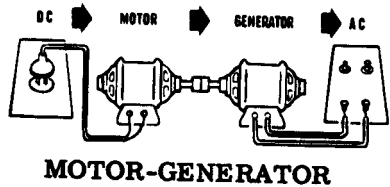
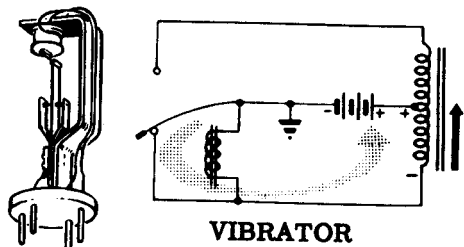

INDEX TO VOL. 1

(Note: A cumulative index covering all five volumes in this series will be found at the end of Volume 5.)

- AC-DC half-wave rectifier, in power supplies, 1-94, 1-95
- Bridge rectifier circuits, 1-49, 1-50
- Current flow, in half-wave rectifier circuit, 1-43
in full-wave rectifier circuit, 1-48
- Diodes, characteristics of, 1-109 to 1-112
 - current flow in, 1-28, 1-29
 - gas-filled, 1-35, 1-37
 - how current is controlled in, 1-112
 - how they work, 1-25
 - in transformer type circuits, 1-40, 1-41
 - vacuum-filled, 1-36
- Dynamotors, 1-104
- Electronics, meaning of, 1-1
- Electronic equipment, 1-2
 - parts used in, 1-3
- Filters, improving operation of, 1-64, 1-65
 - in power supplies, 1-12
- Filter capacitors (condensers), 1-60 to 1-63
 - dry electrolytic, 1-63
 - electrolytic, 1-61 to 1-63
 - paper construction of, 1-60
 - paper high voltage, 1-60
 - wet electrolytic, 1-62
- Filter chokes, 1-69
- Filter circuits, 1-52 to 1-80
 - capacitors in, 1-57 to 1-59
 - capacitor input, single-section, 1-70, 1-72
 - choke input, single-section, 1-70, 1-71
 - in power supplies, 1-53
 - parallel-resonant, 1-73
 - RC faults of, 1-66, 1-67
 - series-resonant, 1-73
 - two-section, 1-73
 - using choke instead of resistor, 1-68
- Input filter capacitor, charging, 1-74
- Inverters, 1-105
- Motor generators, 1-104
- Power line filter capacitor circuits, 1-43
- Power supplies, circuits in, 1-52
 - dry metal rectifier, 1-97
 - for DC voltage sources, 1-99
 - general types, 1-93
 - importance of, 1-7
 - need for other types, 1-92
 - transformer type, 1-39
 - transformerless, 1-94 to 1-98
 - transformerless and chokeless, 1-98
 - voltage doubler, 1-96
 - what they do, 1-8
 - why there are different types, 1-14 to 1-16
- Rectifiers, changing AC to DC
 - in half-wave
 - dry metal type, 1-17
 - circuits in dry metal half-wave type, 1-21
 - copper oxide, 1-18
 - description of half-wave dry metal type, 1-18 to 1-20
 - dry metal half-wave, 1-17 to 1-22
 - full-wave, 1-45 to 1-151
 - gas-filled diodes, 1-35 to 1-37
 - how the full-wave type works, 1-46
 - parallel connection of elements
 - in dry metal type, 1-19
 - power supplies, 1-10, 1-11

INDEX TO VOL. 1

- selenium, 1-18, 1-20
- series stacking of elements in dry
 - metal type, 1-19
 - transformer type half-wave, 1-39 to 1-44
 - vacuum tubes, 1-23
 - vacuum tube half-wave type, 1-23 to 1-38
- Rectifier circuits, half-wave vacuum tube, 1-33
- Rectifier output, AC and DC components in, 1-55, 1-56
 - characteristics of, 1-54
 - filtering half- and full-wave, 1-74
- Rectifier tubes, 1-30, 1-31
 - cathode type, 1-31
 - diodes, 1-30, 1-31
 - directly heated, 1-32
 - full-wave, 1-47
 - indirectly heated, 1-32
 - plates connected together, 1-32
 - plates connected separately, 1-32
- Resistors, bleeder, 1-75 to 1-77
- Review, Characteristics of Diode Vacuum Tubes, 1-111
 - Filter Circuits, 1-78 to 1-80
 - Full-Wave Rectifier Circuit, 1-51
 - Half-Wave Rectifiers — Dry Metal Type, 1-22
 - Half-Wave Rectifiers—Transformer Type, 1-44
 - Half-Wave Rectifiers — Vacuum Tube Type, 1-38
 - Other Types of Power Supply Circuits, 1-106 to 1-108
 - Power Supplies, 1-113 to 1-115
 - Voltage Regulator Circuits, 1-91
- Rotary converters, 1-105
- Transformers, power supplies, 1-9
- Transformer type circuit, diagram of, 1-42
 - operation of, 1-43
- Vacuum tube, circuit wiring, 1-34
 - discovery of diode, 1-24
 - electron emission, 1-26, 1-27
 - factors common to all, 1-110
 - jobs of, 1-109
 - methods of representation in diagrams, 1-34
 - sockets, 1-31
- Vibrators, 1-100 to 1-103
 - synchronous, 1-103
- Voltage regulation, 1-81, 1-82
 - when load current varies, 1-87, 1-88
 - when power supply voltage varies, 1-89, 1-90
- Voltage regulators, power supplies, 1-13
- Voltage regulator circuits, 1-81 to 1-91
- Voltage regulator tube, 1-83, 1-84
- Voltage regulator tube circuit, 1-85, 1-86

HOW THIS OUTSTANDING COURSE WAS DEVELOPED:

In the Spring of 1951, the Chief of Naval Personnel, seeking a streamlined, more efficient method of presenting Basic Electricity and Basic Electronics to the thousands of students in Navy speciality schools, called on the graphiological engineering firm of Van Valkenburgh, Nooger & Neville, Inc., to prepare such a course. This organization, specialists in the production of complete "packaged training programs," had broad experience serving industrial organizations requiring mass-training techniques.

These were the aims of the proposed project, which came to be known as the Common-Core program: to make Basic Electricity and Basic Electronics completely understandable to every Navy student, regardless of previous education; to enable the Navy to turn out trained technicians at a faster rate (cutting the *cost* of training as well as the time required) without sacrificing subject matter.

The firm met with electronics experts, educators, officers-in-charge of various Navy schools and, with the Chief of Naval Personnel, created a dynamic new training course . . . completely up-to-date . . . with heavy emphasis on the visual approach.

First established in selected Navy schools in April, 1953, the training course comprising Basic Electricity and Basic Electronics was such a tremendous success that it is now the *backbone* of the Navy's *current* electricity and electronics training program!*

The course presents one fundamental topic at a time, taken up in the order of need, rendered absolutely understandable, and hammered home by the use of clear, cartoon-type illustrations. These illustrations are the most effective ever presented. *Every page has at least one such illustration—every page covers one complete idea!* An imaginary instructor stands figuratively at the reader's elbow, doing demonstrations that make it easier to understand each subject presented in the course.

Now, for the first time, Basic Electricity and Basic Electronics have been released by the Navy for civilian use. While the course was *originally* designed for the Navy, the concepts are so broad, the presentation so clear—*without* reference to specific Navy equipment—that it is ideal for use by schools, industrial training programs, or home study. *There is no finer training material!*

"Basic Electronics" consists of *five* volumes, as follows: *Vol. 1*—Introduction to Electronics, Diode Vacuum Tubes, Dry Metal Rectifiers, What a Power Supply Is, Filters, Voltage Regulators. *Vol. 2*—Introduction to Amplifiers, The Triode Tube, Tetrodes & Pentodes, Audio Voltage & Power Amplifiers. *Vol. 3*—Video Amplifiers, RF Amplifiers, Oscillators. *Vol. 4*—Transmitters, Transmission Lines & Antennas, CW Transmission & Amplitude Modulation. *Vol. 5*—Receiver Antennas, Detectors & Mixers, TRF Receivers, Superheterodyne Receivers.

*"Basic Electricity," the first portion of this course, is available as a separate series of volumes.

JOHN F. RIDER PUBLISHER, INC., 116 WEST 14th ST., N. Y. 11, N. Y.