

1967

A HOWARD W. SAMS PUBLICATION

RON NOTT

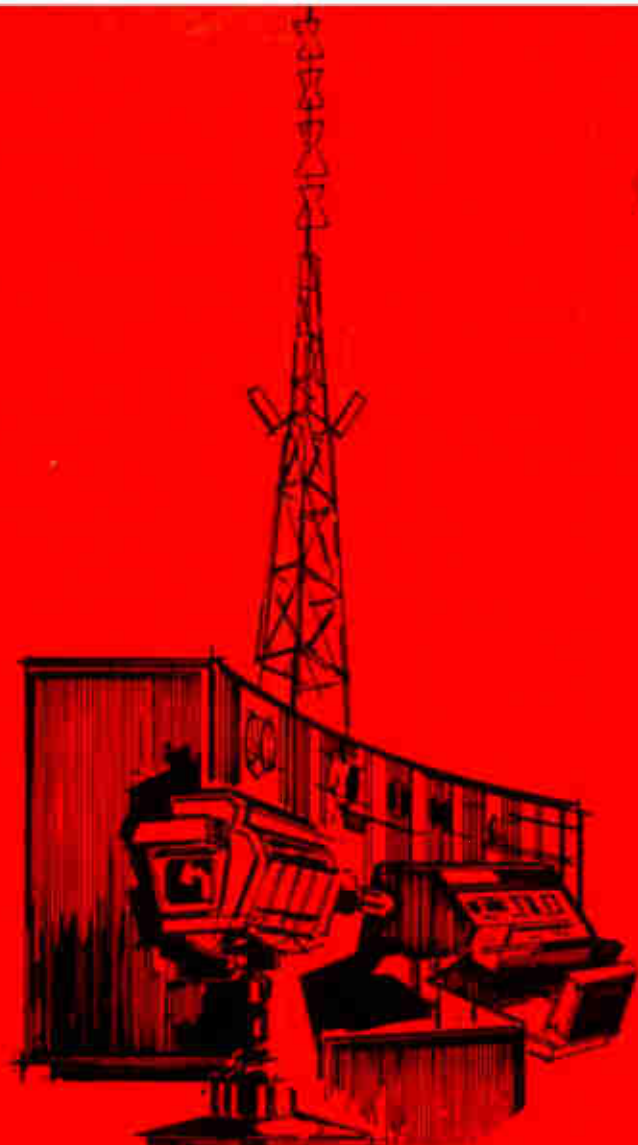

# The Broadcast Industry

# BUYERS GUIDE

A comprehensive directory of products and services for the broadcast-communications industry . . . containing: complete alphabetical product and service listing, manufacturer listing with products and services, and addresses of manufacturers and their representatives.

\$1.50

Prepared by the staff of  
**Broadcast Engineering\***

World Radio History

**RIKER IS**

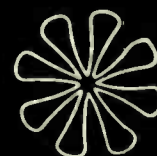

# VIDEOMNIFEROUS



**VID'-I-OM-NIF'-ĒRƏS**

The omnipotent ability to produce all varieties and forms of Video Terminal, Studio and Test Equipment for TV Broadcasting.

**RIKER MAKES THEM ALL:  
VIDEO SWITCHING EQUIPMENT •  
SYNC EQUIPMENT • DISTRIBUTION  
EQUIPMENT • VIDEO PROCESSING  
AMPLIFIERS • SPECIAL EFFECTS •  
AUTOMATED PROGRAMMING SYS-  
TEMS FOR SWITCHERS • VIDEO  
TEST EQUIPMENT • VIDEOTAPE  
DROPOUT COMPENSATORS**



Riker Video Industries, Inc., 100 Parkway Drive So.,  
Hauppauge, N.Y. 11787. Phone: 516-543-5200.

Atlanta • Los Angeles • Detroit • Washington, D.C. • Dallas

**WITH TOTAL**

# VIDEOCOLORABILITY

**PARTIAL LISTING OF  
AVAILABLE EQUIPMENT:**



- ENCODED COLOR BAR GENERATOR
- COLOR BAR GENERATOR
- COLOR SYNC GENERATOR  
With burst flag
- SUBCARRIER REGENERATOR  
For precise color locking to remote color signals
- BAR & DOT GENERATOR
- COLOR VIDEO SWITCHING SYSTEMS
- ADDITIVE/NON-ADDITIVE MIXER  
For finest color and monochrome inserts
- BLACK BURST GENERATOR  
Provides color burst while in black
- BURST FLAG GENERATOR
- COLOR SPECIAL EFFECTS GENERATOR
- TEST SIGNAL GENERATORS  
Test all your color facilities
- COLORIZER  
Colors a monochrome camera output. Range from a single color to complete traversing spectrum. Use with special effects to attain unlimited number of multi-color combinations or produce a color picture from a monochrome source.
- 3.58 MC PHASE SHIFTER
- PLUS MANY OTHERS



Riker Video Industries, Inc., 100 Parkway Drive So.,  
Hauppauge, N.Y. 11787. Phone: 516-543-5200.

Atlanta · Los Angeles · Detroit · Washington, D.C. · Dallas

Look carefully at  
every issue of  
**Time,**  
**Life,**  
**Newsweek,** and  
**U.S. News & World Report.**  
**For a year.**

**Count the microphones  
you see in every picture.**

You'll find more E-V microphones than all other U.S. brands combined.

You'll find more E-V microphones than all foreign brands combined.

You'll find E-V microphones shown 3.77 times more often than any other brand.

When the chips are down, professional sound engineers for radio, TV, motion pictures, and critical sound reinforcement choose Electro-Voice.

What's new about that?

Nothing.

It's been going on for years!



**ELECTRO-VOICE, INC.**  
Dept. 171VG, 639 Cecil Street  
Buchanan, Michigan 49107

**Electro-Voice®**  
SETTING NEW STANDARDS IN SOUND



Prepared by the staff of  
**Broadcast Engineering®**

STOLEN BY A RAT FINK FROM  
 RON NOTT

# the broadcast industry

# BUYERS GUIDE

## CONTENTS

|                          |     |
|--------------------------|-----|
| ❖ product directory      | 9   |
| ❖ guide to manufacturers | 41  |
| ❖ representatives        | 67  |
| ❖ engineering data       | 129 |
| ❖ consulting engineers   | 157 |
| ❖ index to advertisers   | 162 |

**publisher**  
 Howard W. Sams

**general manager**  
 Donald W. Bradley

**editor**  
 William E. Burke

**managing editor**  
 James M. Moore

**associate editor**  
 Harold E. Hale

**research librarian**  
 Bonny Howland

**production**  
 Esther M. Rainey, *Manager*

**circulation**  
 Pat Osborne, *Manager*

**advertising sales offices**  
 Hugh Wallace, *Sales Manager*

**central and midwestern**  
 Roy Henry  
 Howard W. Sams & Co., Inc.  
 4300 West 62nd St.  
 Indianapolis, Ind. 46206  
 291-3100

**eastern**  
 Gregory C. Masefield  
 Howard W. Sams & Co., Inc.  
 3 West 57th St.  
 New York 19, New York  
 MU 8-6350

**southwestern**  
 C. H. (Jake) Stockwell  
 C. H. Stockwell Co., 4916 West 64th St.  
 Mission, Kansas, RA 2-4417

**western**  
 LOS ANGELES OFFICE  
 G. R. (Jerry) Holtz  
 The Maurice A. Kimball Co., Inc.  
 2008 West Carson St., Suites 203-204  
 Torrance, California, 90501  
 320-2204

**SAN FRANCISCO OFFICE**  
 The Maurice A. Kimball Co., Inc.  
 580 Market St., Room 400  
 San Francisco 4, California  
 EX 2-3365

**foreign**  
 LONDON W.C. 2, ENGLAND  
 John Ashcraft, Leicester Square  
 Whitehall 0525

Copyright © 1967  
 by Howard W. Sams & Co., Inc.

The Broadcast Industry BUYERS GUIDE is published by Howard W. Sams & Co., Inc. Editorial, Circulation, and Advertising headquarters: 4300 West 62nd Street, Indianapolis, Indiana 46206.

This Guide has been compiled from listing form as completed by the manufacturers and submitted to us by an editorial deadline date. The publisher is not responsible for errors or omissions in editorial content.

Advertisers and advertising agencies assume liability for all content (including text, representation, and illustrations) of advertisements printed and also assume responsibility for any claims arising therefrom made against the publisher.

Reproduction or use, without express permission, of editorial or pictorial content, in any manner, is prohibited. No patent liability is assumed with respect to the use of the information contained herein.



# EIMAC POWER GRID TUBES and Accessories

**(24 hour factory delivery on most distributor orders)**

At EIMAC you'll find the most complete line of power grid tubes available today: triodes, tetrodes, pulse modulators, diodes, zero-bias tubes, ceramic tubes, glass tubes, air cooled, water cooled and vapor cooled tubes. And there are more to come! Continuing EIMAC projects are ever increasing the scope of power grid tube capabilities.

| Tube Type        | User Price | Socket Type  | Socket Price | Chimney Type | Chimney Price | Tube Type        | User Price | Socket Type                       | Socket Price | Chimney Type | Chimney Price |
|------------------|------------|--------------|--------------|--------------|---------------|------------------|------------|-----------------------------------|--------------|--------------|---------------|
| 2-01C            | \$ 18.00   | None         | \$ ....      | None         | \$ ....       | 3CX20,000A3      | 580.00     | SK-1300                           | 78.50        | None         | ....          |
| 2C39A            | 20.75      | Jettron      | ....         | None         | ....          | 3CX20,000H3      | 580.00     | None                              | ....         | None         | ....          |
| 3CPN10A5/7815    | 30.75      | No. 76-020   | ....         | None         | ....          | 3W5000A1/8240    | 280.00     | (See Note 1)                      | ....         | None         | ....          |
| 3CPX100A5/7815R  | 30.75      | Jettron      | ....         | None         | ....          | 3W5000A3/8242    | 245.00     | (See Note 1)                      | ....         | None         | ....          |
| 3CV30,000A1      | 710.00     | No. 76-020   | ....         | None         | ....          | 3W5000F1/8241    | 260.00     | None                              | ....         | None         | ....          |
| 3CV30,000A3      | 590.00     | SK-1300      | 78.50        | None         | ....          | 3W5000F3/8243    | 250.00     | None                              | ....         | None         | ....          |
| 3CW5000A1        | 280.00     | SK-1300      | 78.50        | None         | ....          | 3X3000A1/8238    | 210.00     | (See Note 1)                      | ....         | None         | ....          |
| 3CW5000A3        | 245.00     | (See Note 1) | ....         | None         | ....          | 3X3000A7         | 255.00     | (See Note 1)                      | ....         | None         | ....          |
| 3CW5000F1        | 260.00     | (See Note 1) | ....         | None         | ....          | 3X3000F1/8239    | 220.00     | None                              | ....         | None         | ....          |
| 3CW5000F3        | 250.00     | None         | ....         | None         | ....          | 3X3000F7/8162    | 260.00     | None                              | ....         | None         | ....          |
| 3CW5000H3        | 240.00     | None         | ....         | None         | ....          | 3-400Z/8163      | 34.00      | SK-410                            | 6.50         | SK-416       | 6.50          |
| 3CW10,000H3      | 356.00     | None         | ....         | None         | ....          | 3-1000Z/8164     | 78.00      | SK-510                            | 6.50         | SK-516       | 12.00         |
| 3CW20,000A1      | 560.00     | SK-1300      | 78.50        | None         | ....          | 4-65A/8165       | 27.00      | E. F. Johnson                     | ....         | None         | ....          |
| 3CW20,000A3      | 455.00     | SK-1300      | 78.50        | None         | ....          | No. 122-101      |            | SK-400                            | 17.50        | SK-406       | 6.50          |
| 3CW20,000A7      | 710.00     | SK-1300      | 78.50        | None         | ....          | 4-125A           | 36.00      | SK-410                            | 6.50         | SK-406       | 6.50          |
| 3CW20,000H3      | 455.00     | None         | ....         | None         | ....          | 4-250A           | 46.50      | SK-400                            | 17.50        | SK-406       | 6.50          |
| 3CW25,000A3      | 480.00     | SK-1300      | 78.50        | None         | ....          | 4-400A/8438      | 48.00      | SK-410                            | 6.50         | SK-406       | 6.50          |
| 3CW30,000H3      | 510.00     | None         | ....         | None         | ....          | 4-1000A/8166     | 131.50     | SK-400                            | 17.50        | SK-406       | 6.50          |
| 3CW40,000H3      | 620.00     | None         | ....         | None         | ....          | 4CPX250K         | 68.50      | SK-410                            | 6.50         | SK-406       | 6.50          |
| 3CW100,000H3     | 2,320.00   | None         | ....         | None         | ....          | 4CS250H          | 69.50      | SK-500                            | 24.30        | SK-506       | 12.00         |
| 3CX100A5/7289    | 26.50      | Jettron      | ....         | None         | ....          | 4CV20,000A       | 470.00     | SK-510                            | 6.50         | SK-506       | 12.00         |
| 3CX100F5/8250    | 34.00      | No. 76-020   | ....         | None         | ....          | 4CV35,000A       | 825.00     | SK-740                            | 10.70        | None         | ....          |
| 3CX1000A7/8283   | 250.00     | Jettron      | ....         | None         | ....          | 4CV100,000C/8351 | 2,350.00   | (See Note 2)                      | ....         | None         | ....          |
| 3CX2500A3        | 200.00     | No. 76-020   | ....         | None         | ....          | 4CW800A          | 331.00     | SK-800B                           | 54.00        | SK-806       | 8.50          |
| 3CX2500F3        | 205.00     | SK-860       | 38.00        | SK-816       | 7.00          | 4CW2000A/8244    | 220.00     | SK-810B                           | 56.00        | SK-806       | 8.50          |
| 3CX2500H3        | 240.00     | SK-870       | 40.00        | SK-816       | 7.00          | 4CW10,000A       | 610.00     | SK-890B                           | 65.00        | SK-806       | 8.50          |
| 3CX3000A1        | 210.00     | (See Note 1) | ....         | None         | ....          | 4CW25,000A       | 825.00     | SK-300                            | 103.00       | SK-306       | 6.50          |
| 3CX3000A7        | 255.00     | (See Note 1) | ....         | None         | ....          | 4CW50,000C/8350  | 2,100.00   | SK-300A                           | 103.00       | SK-316       | 9.65          |
| 3CX3000F1        | 220.00     | (See Note 1) | ....         | None         | ....          | 4CW100,000D      | 2,100.00   | SK-300                            | 103.00       | SK-306       | 6.50          |
| 3CX3000F7        | 260.00     | None         | ....         | None         | ....          | 4CX250B/7203     | 35.60      | SK-300A                           | 103.00       | SK-316       | 9.65          |
| 3CX5000A3        | 356.00     | SK-1300      | 78.50        | None         | ....          | 4CX250F/7204     | 38.00      | SK-1500                           | 220.00       | None         | ....          |
| 3CX5000H3        | 356.00     | None         | ....         | None         | ....          | 4CX250K/8245     | 64.00      | SK-1500                           | 220.00       | None         | ....          |
| 3CX10,000A1/8158 | 490.00     | None         | ....         | None         | ....          | 4CX250R/7580W    | 44.50      | SK-1510                           | 250.00       | None         | ....          |
| 3CX10,000A3/8159 | 490.00     | SK-1300      | 78.50        | SK-1306      | 6.50          | 4CX300A/8167     | 54.00      | *See SK-600 Series Socket Listing | ....         | None         | ....          |
| 3CX10,000A7/8160 | 530.00     | SK-1300      | 78.50        | SK-1306      | 6.50          | 4CX300Y          | 105.00     | *See SK-600 Series Socket Listing | ....         | None         | ....          |
| 3CX10,000H3      | 455.00     | None         | ....         | None         | ....          | 4CX350A/8321     | 48.50      | *See 4CX125C Socket Listing       | ....         | None         | ....          |
| 3CX15,000A3      | 510.00     | SK-1300      | 78.50        | None         | ....          | 4CX350F/8322     | 51.50      | *See SK-600 Series Socket Listing | ....         | None         | ....          |
| 3CX15,000H3      | 510.00     | None         | ....         | None         | ....          | 4CX600A          | 319.00     | *See SK-600 Series Socket Listing | ....         | None         | ....          |
|                  |            |              |              |              |               | 4CX1000A/8168    | 181.00     | SK-800B                           | 54.00        | SK-806       | 8.50          |
|                  |            |              |              |              |               | 4CX1000K/8352    | 193.00     | SK-810B                           | 56.00        | SK-806       | 8.50          |
|                  |            |              |              |              |               |                  |            | SK-890B                           | 65.00        | SK-806       | 8.50          |
|                  |            |              |              |              |               |                  |            | SK-820                            | 140.00       | SK-806       | 8.50          |
|                  |            |              |              |              |               |                  |            | SK-830                            | 178.00       | SK-806       | 8.50          |

Note (1): None, but the following colls are available from EIMAC: 149575 (innerline filament collet); 149576 (outer line filament collet)  
 Note (2): None, but the following colls are available from EIMAC: 008290 (heater pin connection); 008291 (cathode collet); 008292 (control grid collet); 008294 (anode collet); 882931 (screen grid collet)

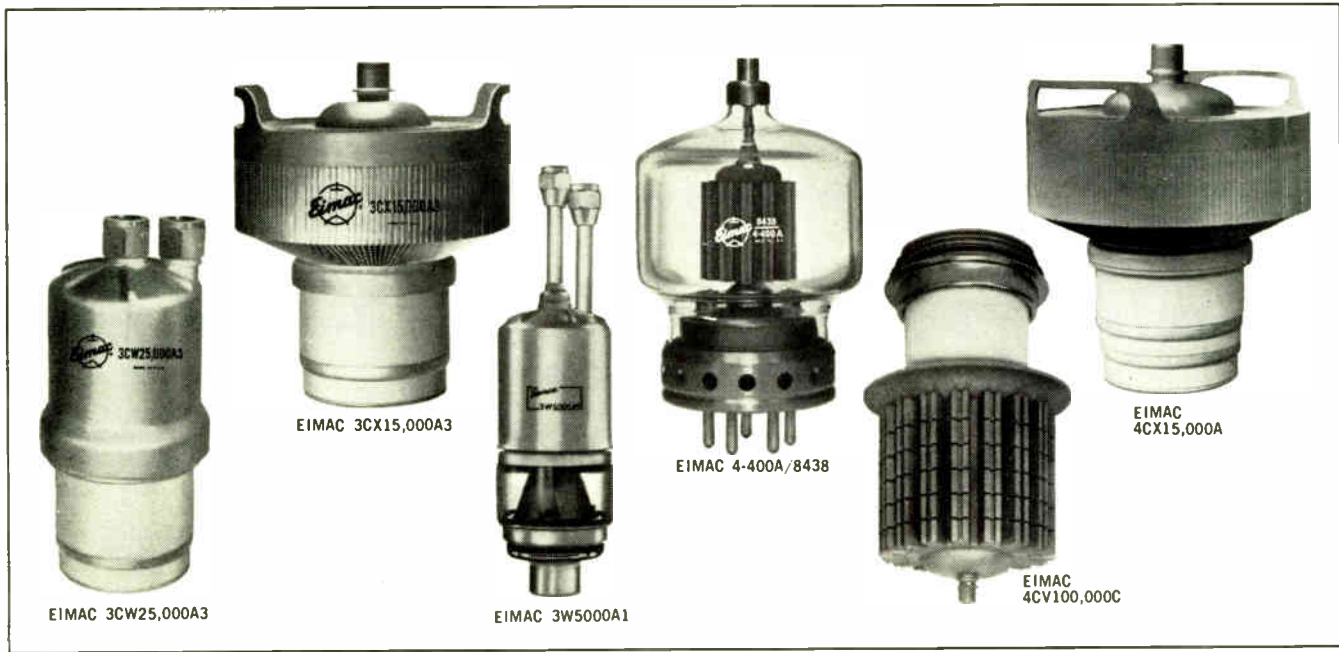

| Tube Type        | User Price | Socket Type                         | Socket Price | Chimney Type | Chimney Price | Tube Type                     | User Price  | Socket Type                        | Socket Price        | Chimney Type         | Chimney Price |       |
|------------------|------------|-------------------------------------|--------------|--------------|---------------|-------------------------------|---|------------------------------------|---------------------|----------------------|---------------|-------|
| 4CX1500B/8660    | 205.00     | *See 4CX1000A Series Socket Listing |              |              |               |                               | 8166/4-1000A  | 131.50                             | SK-500              | 24.30                | SK-506        | 12.00 |
| 4CX3000A/8169    | 420.00     | SK-1400A                            | 107.00       | SK-1406      | 6.50          |                               |   | SK-510                             | 6.50                | SK-506               | 12.00         |       |
|                  |            | SK-1470A                            | 107.00       | SK-1406      | 6.50          | 8167/4CX300A                  | 54.00   | *See 4CX125C Series Socket Listing |                     |                      |               |       |
| 4CX5000A/8170    | 495.00     | SK-300                              | 103.00       | SK-306       | 6.50          | 8168/4CX1000A                 | 181.00  | SK-800B                            | 54.00               | SK-806               | 8.50          |       |
|                  |            | SK-300A                             | 103.00       | SK-316       | 9.65          |                               |   | SK-810B                            | 56.00               | SK-806               | 8.50          |       |
| 4CX5000R/8170W   | 705.00     | SK-300                              | 103.00       | SK-306       | 6.50          |                               |   | SK-890B                            | 65.00               | SK-806               | 8.50          |       |
|                  |            | SK-300A                             | 103.00       | SK-316       | 9.65          | 8169/4CX3000A                 | 420.00  | SK-1400A                           | 107.00              | SK-1406              | 6.50          |       |
| 4CX10,000D/8171  | 550.00     | SK-300                              | 103.00       | SK-306       | 6.50          |                               |   | SK-1470A                           | 107.00              | SK-1406              | 6.50          |       |
|                  |            | SK-300A                             | 103.00       | SK-316       | 9.65          | 8170W/4CX5000R                | 705.00  | SK-300                             | 103.00              | SK-306               | 6.50          |       |
| 4CX15,000A/8281  | 695.00     | SK-300                              | 103.00       | SK-306       | 6.50          |                               |   |                                    |                     | SK-316               | 9.65          |       |
|                  |            | SK-300A                             | 103.00       | SK-316       | 9.65          | 8171/4CX10,000D               | 550.00  | SK-300                             | 103.00              | SK-306               | 6.50          |       |
|                  |            |                                     |              | SK-1306      | 6.50          |                               |   |                                    |                     | SK-316               | 9.65          |       |
| 4CX35,000C/8349  | 1,765.00   | SK-1500                             | 220.00       | None         | .....         | 8172/4X150G                   | 58.00   | None                               | .....               | None                 | .....         |       |
|                  |            | SK-1510                             | 250.00       | None         | .....         | 8173/4W20,000A                | 2,030.00  | None                               | .....               | None                 | .....         |       |
| 4E27A/5-125B     | 45.00      | E. F. Johnson                       | .....        | None         | .....         | 8238/3X3000A1                 | 210.00  | None                               | .....               | None                 | .....         |       |
|                  |            | No. 122-237                         | .....        | None         | .....         | 8239/3X3000F1                 | 220.00  | None                               | .....               | None                 | .....         |       |
| 4W20,000A/8173   | 2,030.00   | None                                | .....        | None         | .....         | 8240/3W5000A1                 | 280.00  | None                               | .....               | None                 | .....         |       |
| 4X150A/7034      | 23.15      | *See SK-600 Series Socket Listing   |              |              |               |                               | 8241/3W5000F1   | 260.00                             | None                | .....                | None          | ..... |
| 4X150D/7035      | 29.00      | *See SK-600 Series Socket Listing   |              |              |               |                               | 8242/3W5000A3   | 245.00                             | None                | .....                | None          | ..... |
| 4X150G/8172      | 58.00      | None                                | .....        | None         | .....         | 8243/3W5000F3                 | 250.00  | None                               | .....               | None                 | .....         |       |
| 4X250B           | 35.60      | *See SK-600 Series Socket Listing   |              |              |               |                               | 8244/4CW2000A   | 220.00                             | SK-800B             | 54.00                | None          | ..... |
| 4X250F           | 35.60      | *See SK-600 Series Socket Listing   |              |              |               |                               |   |                                    | SK-810B             | 56.00                | None          | ..... |
| 4X500A           | 127.50     | SK-900                              | 68.50        | SK-906       | 15.00         | 8245/4CX250K                  | 64.00   | SK-890B                            | 65.00               | None                 | .....         |       |
| 5-500A           | 58.50      | SK-400                              | 17.50        | None         | .....         | 8250/3CX100F5                 | 34.00   | None                               | .....               | None                 | .....         |       |
|                  |            | SK-410                              | 6.50         | None         | .....         |                               |   | Jettron                            | .....               | None                 | .....         |       |
| 5CX1500A         | 218.00     | SK-840                              | 61.25        | SK-806       | 8.50          | 8281/4CX15,000A               | 695.00  | No. 76-020                         | .....               | SK-306               | 6.50          |       |
| 5CX3000A         | 437.00     | Y-386                               | 114.00       | None         | .....         |                               |   | SK-300A                            | 103.00              | SK-316               | 9.65          |       |
| 304TH            | 83.00      | E. F. Johnson                       | .....        | None         | .....         |                               |   |                                    |                     | SK-1306              | 6.50          |       |
|                  |            | No. 124-213                         | .....        | None         | .....         | 8283/3CX1000A7                | 250.00  | SK-860                             | 38.00               | SK-816               | 7.00          |       |
| 304TL            | 83.00      | E. F. Johnson                       | .....        | None         | .....         |                               |   | SK-870                             | 40.00               | SK-816               | 7.00          |       |
|                  |            | No. 124-213                         | .....        | None         | .....         | 8321/4CX350A                  | 48.50   | *See SK-600 Series Socket Listing  |                     |                      |               |       |
| 450TH            | 85.00      | E. F. Johnson                       | .....        | None         | .....         | 8322/4CX350F                  | 51.50   | *See SK-600 Series Socket Listing  |                     |                      |               |       |
|                  |            | No. 123-211                         | .....        | None         | .....         | 8349/4CX35,000C               | 1,765.00  | SK-1500                            | 220.00              | None                 | .....         |       |
| 450TL            | 85.00      | E. F. Johnson                       | .....        | None         | .....         | 8350/4CW50,000C               | 2,100.00  | SK-1500                            | 220.00              | None                 | .....         |       |
|                  |            | No. 123-211                         | .....        | None         | .....         | 8351/4CX100,000C              | 2,350.00  | SK-1510                            | 250.00              | None                 | .....         |       |
| 575A             | 20.15      | E. F. Johnson                       | .....        | None         | .....         | 8352/4CX1000K                 | 193.00  | SK-820                             | 140.00              | SK-806               | 8.50          |       |
|                  |            | No. 123-211                         | .....        | None         | .....         |                               |   | SK-830                             | 178.00              | SK-806               | 8.50          |       |
| 592/3-200A3      | 55.00      | None                                | .....        | None         | .....         | 8438/4-400A                   | 48.00   | SK-400                             | 17.50               | SK-406               | 6.50          |       |
| 673              | 20.15      | E. F. Johnson                       | .....        | None         | .....         |                               |   | SK-410                             | 6.50                | SK-406               | 6.50          |       |
|                  |            | No. 123-206                         | .....        | None         | .....         | 8561/4CX300Y                  | 105.00  | SK-711A                            | 25.70               | SK-606               | 0.75          |       |
| 750TL            | 224.00     | E. F. Johnson                       | .....        | None         | .....         |                               |   | SK-760                             | 10.70               | None                 | .....         |       |
|                  |            | No. 124-214                         | .....        | None         | .....         | 8660/4CX1500B                 | 205.00  | SK-770                             | 10.70               | None                 | .....         |       |
| 869B             | 138.00     | None                                | .....        | None         | .....         |                               |   | SK-800B                            | 54.00               | SK-806               | 8.50          |       |
| 869B/L           | 138.00     | None                                | .....        | None         | .....         |                               |   | SK-810B                            | 56.00               | SK-806               | 8.50          |       |
| 5867A            | 30.60      | SK-410                              | 6.50         | SK-406       | 6.50          | KY21A                         | 33.80   | E. F. Johnson                      | .....               | None                 | .....         |       |
| 6155             | 36.00      | SK-410                              | 6.50         | SK-406       | 6.50          |                               |   | No. 122-225                        | .....               | None                 | .....         |       |
| 6156             | 42.00      | SK-410                              | 6.50         | SK-406       | 6.50          | RX21A                         | 32.80   | E. F. Johnson                      | .....               | None                 | .....         |       |
| 6696A            | 1,105.00   | None                                | .....        | None         | .....         |                               |   | No. 122-225                        | .....               | None                 | .....         |       |
| 6697A            | 1,330.00   | None                                | .....        | None         | .....         | *SK-600 Series Socket Listing |   |                                    |                     |                      |               |       |
| 7034/4X150A      | 23.15      | *See SK-600 Series Socket Listing   |              |              |               |                               | For the following tubes, use the socket and chimney schedule shown below: |                                    |                     |                      |               |       |
| 7035/4X150D      | 29.00      | *See SK-600 Series Socket Listing   |              |              |               |                               |   |                                    |                     |                      |               |       |
| 7203/4CX250B     | 35.60      | *See SK-600 Series Socket Listing   |              |              |               |                               |   |                                    |                     |                      |               |       |
| 7204/4CX250F     | 35.60      | *See SK-600 Series Socket Listing   |              |              |               |                               |   |                                    |                     |                      |               |       |
| 7211             | 88.50      | Jettron                             | .....        | None         | .....         |                               |   |                                    |                     |                      |               |       |
|                  |            | No. 76-020                          | .....        | None         | .....         | <b>Tubes</b>                  | <b>Socket Type</b>  | <b>Socket Price</b>                | <b>Chimney Type</b> | <b>Chimney Price</b> |               |       |
| 7257             | 45.00      | SK-410                              | 6.50         | None         | .....         | 4X150A/7034                   |   |                                    |                     |                      |               |       |
| 7289/3CX100A5    | 26.50      | Jettron                             | .....        | None         | .....         | 4X150D/7035                   |   |                                    |                     |                      |               |       |
|                  |            | No. 76-020                          | .....        | None         | .....         | 4X250B                        | SK-600  | 11.25                              | SK-606              | 0.75                 |               |       |
| 7480             | 1,590.00   | None                                | .....        | None         | .....         | 4X250F                        | SK-600A   | 11.25                              | SK-606              | 0.75                 |               |       |
| 7580W/4CX250R    | 44.50      | *See SK-600 Series Socket Listing   |              |              |               |                               | 4CX250B/7203  | SK-610                             | 11.25               | SK-606               | 0.75          |       |
| 7698             | 88.50      | Jettron                             | .....        | None         | .....         | 4CX250F/7204                  | SK-620  | 12.00                              | SK-606              | 0.75                 |               |       |
|                  |            | No. 76-020                          | .....        | None         | .....         | 4CX250R/7580W                 |   |                                    |                     |                      |               |       |
| 7815/3CPN10A5    | 30.75      | Jettron                             | .....        | None         | .....         | 4CX350A/8321                  | SK-620A   | 15.00                              | SK-636B             | 11.00                |               |       |
| 7815R/3CPX100A5  | 30.75      | Jettron                             | .....        | None         | .....         | 4CX350F/8322                  |   |                                    | SK-626              | 0.75                 |               |       |
|                  |            | No. 76-020                          | .....        | None         | .....         | 7203/4CX250B                  |   |                                    | SK-636B             | 11.00                |               |       |
| 7843             | 51.00      | None                                | .....        | None         | .....         | 7204/4CX250F                  | SK-630A   | 15.00                              | SK-626              | 0.75                 |               |       |
| 8158/3CX10,000A1 | 490.00     | SK-1300                             | 78.50        | SK-1306      | 6.50          | 7580W/4CX250R                 |   |                                    | SK-636B             | 11.00                |               |       |
| 8159/3CX10,000A3 | 490.00     | SK-1300                             | 78.50        | SK-1306      | 6.50          | 8321/4CX350A                  | SK-640  | 6.90                               | SK-606              | 0.75                 |               |       |
| 8160/3CX10,000A7 | 530.00     | SK-1300                             | 78.50        | SK-1306      | 6.50          | 8322/4CX350F                  | SK-650  | 8.50                               | None                | .....                |               |       |
| 8163/3-400Z      | 34.00      | SK-410                              | 6.50         | SK-416       | 6.50          | 7034/4X150A                   |   |                                    |                     |                      |               |       |
| 8164/3-1000Z     | 78.00      | SK-510                              | 6.50         | SK-516       | 12.00         | 7035/4X150D                   |   |                                    |                     |                      |               |       |
| 8165/4-65A       | 27.00      | E. F. Johnson                       | .....        | None         | .....         |                               |   |                                    |                     |                      |               |       |
|                  |            | No. 122-101                         | .....        | None         | .....         |                               |   |                                    |                     |                      |               |       |

Prices subject to change without notice. Write for complete specifications on any tube to Power Grid Tube Marketing.



**EIMAC**  
Division of Varian  
San Carlos, California 94070



# MEMO

TO: General Manager  
FROM: Director of Engineering

Like for you to look over this Computer-Programmer. I've been checking into what's available and this looks like the one for us, for several reasons:

1. It's a pretty sophisticated system. We could integrate our entire studio operation—master control switching, studio switching, audio functions, machine controls—the whole works.

2. All the peripheral equipment—machine control interfaces, video and audio switching gear, etc.—comes with it.

3. Most important—it works! It's made by Sarkes Tarzian, Inc. in Bloomington, Ind. They're the only ones I've found with actual computer experience in broadcasting—in both large and small stations. This 4th generation model of theirs has all the bugs worked out. Looks like they meet our basic criteria: they've got the experience, the equipment, and they've applied both.

What do you think?



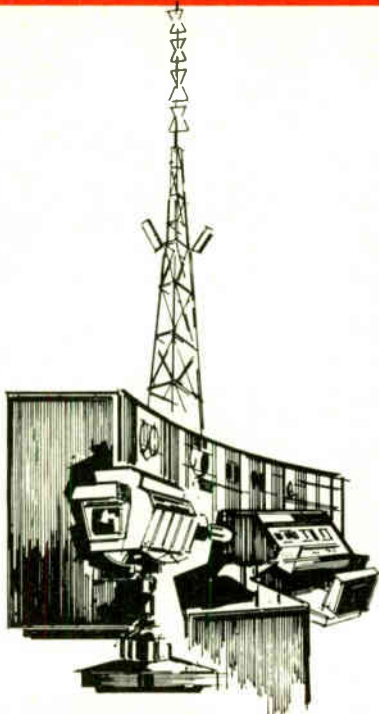

# PRODUCT DIRECTORY

The listings in this section have been compiled from questionnaires completed by manufacturers and service organizations across the nation. It contains over 650 major product classifications. For a specific manufacturer, see Guide to Manufacturers.

## ACOUSTIC MATERIALS

ATLAS SOUND  
HARTLEY PRODUCTS  
ROBINS INDUSTRIES CORP.  
SINGER PRODUCTS CO.

## ADAPTERS, CONNECTOR

AMECO, INC.  
AMERICAN CABLE ELECTRONICS  
AMPHENOL DISTRIBUTOR DIVISION  
APPLIED ELECTRO-MECHANICS  
ATLAS SOUND  
BIRNS & SAWYER  
BLONDRÉ-TONGUE LABORATORIES  
G C ELECTRONICS COMPANY  
GENERAL RADIO CO  
HEWLETT-PACKARD CO.  
IMPEX ELECTRONICS CORP  
JERROLD ELECTRONICS CORP  
MICROWAVE ASSOCIATES, INC.  
PRODELIN, INCORPORATED  
ROBINS INDUSTRIES CORP.  
SWITCHCRAFT, INC.  
THE TECHNICAL MATERIAL CORP  
TROMPETER ELECTRONICS

## ADAPTERS, FM STEREO

CALBEST ELECTRONICS  
G C ELECTRONICS COMPANY  
HEATH CO  
IMPEX ELECTRONICS CORP  
KARG LABORATORIES  
MCMARTIN INDUSTRIES  
SINGER PRODUCTS CO

## ADAPTERS, TEST

AMECO, INC.  
RIRNBACH CO  
DELTA ELECTRONICS, INC.  
G C ELECTRONICS COMPANY  
HEWLETT-PACKARD CO.  
JERROLD ELECTRONICS CORP  
MICROLAB / FXR

## ADAPTERS, TUBE

EIMAC DIVISION OF VARIAN

## ALARM, FAULT

BIOTIC INSTRUMENTS, INC.  
BIRD ELECTRONIC CORPORATION  
HOUSTON ELECTRONICS CO.  
HUGHES & PHILLIPS  
JERROLD ELECTRONICS CORP  
MALLORY DISTRIBUTOR PRODUCTS  
MOSELEY ASSOCIATES, INC.  
SINGER PRODUCTS CO.  
SPENCER-KENNEDY LABORATORIES  
TREPAC CORPORATION OF AMERICA

## ALARM, INTRUDER

BIOTIC INSTRUMENTS, INC.  
ELECTRONICS ESSENTIALS OF CCC  
THE JAMES FLOYD FORD CO

HOUSTON ELECTRONICS CO.

## ALARM, SIGNAL

BIOTIC INSTRUMENTS, INC.  
DELTA ELECTRONICS, INC.  
THE JAMES FLOYD FORD CO  
MINNESOTA MINING - 3 M  
SINGER PRODUCTS CO.  
TREPAC CORPORATION OF AMERICA

## AMMETERS, AC

ALLIED ELECTRONICS CORP  
API INSTRUMENTS CO.  
COLUMBIA ELECTRIC MFG CO  
G E INDUSTRIAL SALES OPERATION  
GENERAL ELECTRIC CO  
HEWLETT-PACKARD CO.  
HICKOK ELECTRICAL INSTRUMENT  
INSTRUMENT LABORATORIES CORP  
THE SINGER CO - METRICS DIV  
TRIPLETT ELECTRICAL INSTRUMENT  
YOKOGAWA ELECTRIC WORKS

## AMMETERS, AC, THERMOCOUPLE

API INSTRUMENTS CO.  
G E INDUSTRIAL SALES OPERATION  
THE SINGER CO - METRICS DIV  
TRIPLETT ELECTRICAL INSTRUMENT  
YOKOGAWA ELECTRIC WORKS

## AMMETERS, DC

ALLIED ELECTRONICS CHRP  
API INSTRUMENTS CO.  
COMU ELECTRONICS  
COLUMBIA ELECTRIC MFG CO  
G E INDUSTRIAL SALES OPERATION  
GENERAL ELECTRIC CO  
HEWLETT-PACKARD CO.  
HICKOK ELECTRICAL INSTRUMENT  
INSTRUMENT LABORATORIES CORP  
THE SINGER CO - METRICS DIV  
TRIPLETT ELECTRICAL INSTRUMENT  
YOKOGAWA ELECTRIC WORKS

## AMMETERS, RF

G E INDUSTRIAL SALES OPERATION  
HEWLETT-PACKARD CO.  
THE SINGER CO - METRICS DIV  
TELESIS CORPORATION  
TELETRONIX  
TRIPLETT ELECTRICAL INSTRUMENT  
YOKOGAWA ELECTRIC WORKS

## AMPLIFIER, AF, AGC

ALTEC LANSING  
AMECO, INC.  
AMPLIFIER CORP OF AMERICA  
BAUER ELECTRONICS CORPORATION  
CCA ELECTRONICS CORPORATION  
CENTRAL DYNAMICS CORPORATION  
ELECTRONIC SYSTEM ENGINEERING  
GATES RADIO COMPANY  
MARTI ELECTRONICS

MELCOR ELECTRONICS  
RCA BROADCAST PRODS.  
ROUND HILL ASSOCIATES  
SINGER PRODUCTS CO.  
STEPHENS ELECTRONICS  
TELETRONIX  
VISUAL ELECTRONICS CORP  
WARD ELECTRONIC INDUSTRIES  
WILKINSON ELECTRONICS, INC

## AMPLIFIER, AF, COMPRESSING

ALTEC LANSING  
AMPLIFIER CORP OF AMERICA  
BAUER ELECTRONICS CORPORATION  
C R S LABORATORIES  
CCA ELECTRONICS CORPORATION  
CENTRAL DYNAMICS CORPORATION  
COLLINS RADIO COMPANY  
ELECTRONIC SYSTEM ENGINEERING  
GATES RADIO COMPANY  
MARTI ELECTRONICS  
MELCOR ELECTRONICS  
ORBIT RADIO  
RCA BROADCAST PRODS.  
ROUND HILL ASSOCIATES  
SINGER PRODUCTS CO.  
SOUTHWESTERN COMMUNICATIONS  
STANCIŁ-HOFFMAN CORPORATION  
STEPHENS ELECTRONICS  
TELETRONIX  
TREPAC CORPORATION OF AMERICA  
VEGA ELECTRONICS CORPORATION  
VISUAL ELECTRONICS CORP  
WARD ELECTRONIC INDUSTRIES

## AMPLIFIER, AF, GENERAL PURPOSE

ALMA ENGINEERING INC  
ALTEC LANSING  
AMPLIFIER CORP OF AMERICA  
BAUER ELECTRONICS CORPORATION  
CCA ELECTRONICS CORPORATION  
CENTRAL DYNAMICS CORPORATION  
CENTURY PROJECTOR CORPORATION  
CROWN INTERNATIONAL  
DAYTON ELECTRONIC PRODUCTS CO  
DELTA ELECTRONICS, INC.  
ELECTRO-VOICE INC  
ELECTRONICS ESSENTIALS OF CCC  
FAIRCHILD RECORDING EQUIPMENT  
FISHER BERKELEY CORPORATION  
GATES RADIO COMPANY  
G F VISUAL COMMUNICATION, PROD  
GENERAL RADIO CO  
INTERNATIONAL GOOD MUSIC  
LANG ELECTRONICS, INC  
LANGVIN  
MARANTZ COMPANY  
MARTI ELECTRONICS  
MCMARTIN INDUSTRIES  
MELCOR ELECTRONICS  
MID AMERICA ELECTRONICS CORP

MULTRONICS  
NORTH AMERICAN PHILIPS CO  
ORBIT RADIO  
PERMOFLUX CORPORATION  
RCA BROADCAST PRODS.  
ROUND HILL ASSOCIATES  
H. H. SCOTT, INCORPORATED  
SCULLY RECORDING INSTRUMENTS  
SOUNDRAFT INDUSTRIES  
SOUTHWESTERN COMMUNICATIONS  
STANCIŁ-HOFFMAN CORPORATION  
STEPHENS ELECTRONICS  
TELETRONIX  
TREPAC CORPORATION OF AMERICA  
VISUAL ELECTRONICS CORP  
WARD ELECTRONIC INDUSTRIES

## AMPLIFIER, AF, MONAURAL

ALMA ENGINEERING INC  
ALTEC LANSING  
BAUER ELECTRONICS CORPORATION  
BROWNING LABORATORIES, INC.  
CCA ELECTRONICS CORPORATION  
CENTRAL DYNAMICS CORPORATION  
CROWN INTERNATIONAL  
DAYTON ELECTRONIC PRODUCTS CO  
ELECTRO-SOUND ACOUSTICS  
ELECTRONICS ESSENTIALS OF CCC  
GATES RADIO COMPANY  
G F VISUAL COMMUNICATIONS PROD  
GREGORY AMPLIFIER CORP  
JERROLD INDUSTRIES, INC.  
JOHNSON ELECTRONICS, INC.  
LANGVIN  
MAGNECOR  
MARANTZ COMPANY  
MCMARTIN INDUSTRIES  
MELCOR ELECTRONICS  
ORBIT RADIO  
PERMOFLUX CORPORATION  
RCA BROADCAST PRODS.  
RECORDING EQUIPMENT COMPANY  
ROUND HILL ASSOCIATES  
RUSSCO ELECTRONICS MFG.  
H. H. SCOTT, INCORPORATED  
SCULLY RECORDING INSTRUMENTS  
SOUTHWESTERN COMMUNICATIONS  
STANCIŁ-HOFFMAN CORPORATION  
STEPHENS ELECTRONICS  
TELETRONIX  
VIKING OF MINNEAPOLIS  
VISUAL ELECTRONICS CORP  
WILKINSON ELECTRONICS, INC

## AMPLIFIER, AF, PEAK LIMITING, AM

ALTEC LANSING  
BAUER ELECTRONICS CORPORATION  
C R S LABORATORIES  
CCA ELECTRONICS CORPORATION  
COLLINS RADIO COMPANY  
FAIRCHILD RECORDING EQUIPMENT

# We'll do a m for you free!

Great solid-state profit-boosters! They let you realize the full potential of your transmitter. And any one or all will work for 30 days free! If they haven't proved their worth by then, ship them back. We'll even pay the freight.

30 day trial offer limited to U.S.A. only.

Audimax is an automatic level control guaranteed to outperform ordinary compressors, limiters or AGCs. It can increase effective program power up to 4:1.

Volumax is an automatic peak controller that overcomes the inherent limitations of peak limiters. Its microsecond regulation virtually doubles the efficiency of Audimax. Result: a combined increase in effective program power of up to 8:1.

The FM Volumax is a totally new concept in automatic peak control that solves FM overmodulation problems created by pre-emphasized audio signals. It offers positive prevention of FM overmodulation and SCA crosstalk without distortion.

**Audimax thinks smart.** Its solid state logic circuitry monitors incoming signal and compares it with its memory of average program content over a preceding period of time. This gives

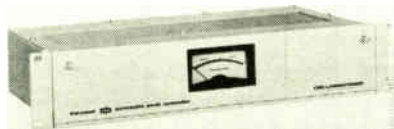

Audimax the ability to adapt to changing program gain situations and react in the same way a human engineer would.

Its remarkable Gated Gain Stabilizer enables Audimax to maintain constant gain during prolonged program pauses. It eliminates the fade-out of background effects or "swish-up" of background noise.

A special Return-to-Zero function

operates when standby conditions occur. Audimax waits about 10 seconds, keeping gain steady at the last correct setting.

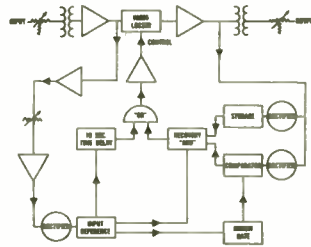

When its memory is convinced that the program has ended, it slowly returns to normal gain. Background effects are held at natural levels, and proper level is assured upon resumption of program.

Audimax boosts overall average levels while automating control functions. Average modulation can be increased by 6 dB, which represents a 300% increase in radiated program power. Specifications: Audimax III, Mod. 444, \$665. Frequency Response, flat within 1 dB, from 50 to 15,000 cps; Harmonic Distortion, less than 1% from 50 to 15,000 cps at +16 dBm output; Noise Level, below -60 dBm at normal gain; Control Characteristic,  $\pm 10$  dB of gain control; Gated Gain Stabilizer, threshold adjustable from -24 dB to normal output; Return-to-Zero Function, returns gain to normal during pauses greater than 10 seconds; Maximum Gain, 50 dB; Input and Output Impedance, 600 ohms, balanced or unbalanced (150 ohms optional); Normal Output Level, +11 VU; Maximum Output, +25 dBm; Minimum Input Level, -30 VU; Physical Dimensions, standard 19" rack mounting, 3 1/2" high, 9 3/8" deep; Power Requirements, 15 watts at 115/230 volts AC, 50/60 cps; Shipping Weight, 17 lbs.; Audimax III S,

Model 445, specially coupled for Stereophonic Operation, \$1390.

**Volumax makes each watt work harder.** The only similarity between Volumax and conventional peak limiters is that it also prevents overmodulation by instantaneous program peaks. But with conventional limiters, program level must be reduced so that limiting of peaks won't cause drastic distortion and "pumping". Conventional limiters usually moderate pumping by using long recovery times. Thus, in intervals immediately following high peaks, valuable modulation capability is wasted as limiter recovers from reduced gain.



Volumax, however, analyzes all program material, automatically chooses the most appropriate regulation speed and limiting action is gentle or micro-second fast, depending on the nature of the program waveform. Result: a more even, pleasant sound that can be safely transmitted at twice the program power usually expected with conventional limiters.

While Audimax controls average program levels, Volumax precisely controls transmitter modulation. Used together, they can raise effective program power by factor of nearly 8:1.

Bonus for AM Broadcasters: Since Volumax can be operated asymmetrically at the user's option, limiting levels for negative peaks may be kept below the 100% modulation level, while positive peaks may be allowed to exceed 100%, thus boosting effective coverage still further.

# onth's work

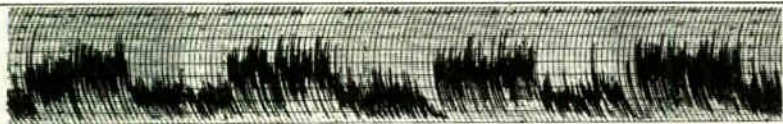

Under carefully controlled test conditions, the performance of a Valumax was compared with a popular conventional peak limiter by a non-CBS affiliated broadcasting network. Both devices were adjusted for comparable limiting and peak output resulting in 100% modulation. At five-minute intervals the two units were alternately switched into the transmission circuit and the off-the-air demodulated signals were compared in a monitoring receiver. The above chart of a recording VU meter shows the results. Valumax provided nearly twice the modulation level of the conventional limiter.

**Specifications: Valumax, Mod. 400, \$665.** Input and Output Impedance, 600 ohms, balanced or unbalanced; Input Level, -24 to +8 dBm; Maximum Output Level, controlled peaks +21 dBm; noncontrolled peaks +25 dBm; Maximum Gain, 50 dB; Noise Level, below -70 dB re +21 dBm output; Frequency Response, flat within 1 dB, 50 to 15,000 cps throughout normal control range; Attack Time, less than 1 microsecond or 2 milliseconds, depending on program waveform; Recovery Time, 140 milliseconds; Maximum Operating Temperature, 55° C; Power Requirements, 15 watts at 115/230 volts AC, 50/60 cps; Physical Dimensions, fits standard 19" rack, 3½" high, 9⅝" deep; Shipping Weight, 17 lbs.

**FM Volumax now solves the classic FM pre-emphasis dilemma.** Musical effects such as cymbal crashes can easily cause overmodulation up to 300%.

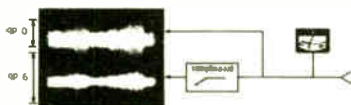

(Diagram and oscilloscope photos show audio peak levels of cymbal crash with and without pre-emphasis.) To transmit such a signal safely, an FM broadcaster would have to reduce his low frequency

modulation level to approximately 35% and operate with less than ⅛ of his authorized maximum program power. Various methods of control have been tried from time to time. Limiting before pre-emphasis, controls low frequencies but doesn't permit much increase in program levels. Limiting after pre-emphasis, controls overmodulation, but often means severe pumping and sudden losses in level. Clipping after pre-emphasis, removes only offending peaks, and creates new problems of serious distortion.



**Solution:** the new FM Volumax works like a recording-session engineer who moves certain instruments away from the microphones and requires others to play softer. It uses time-varying functions to control low and high frequency amplitudes separately, and instantaneous final limiting to prevent overmodulation. A new method of dynamic frequency compensation adjusts high frequency levels and processes all frequencies at reference level, without distortion.

Amplitude response of FM Volumax. At low levels, frequency response is flat over

entire range. At maximum levels, response is the inverse of the pre-emphasis slope. Thus, maximum output is always precisely equal to the 100% modulation level, after transmitter pre-emphasis.

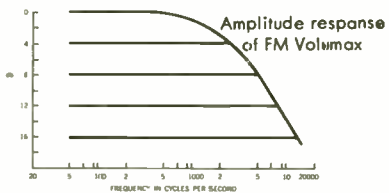

**Specifications: FM Volumax, Mod. 410, \$695.** Input and Output Impedance, 600 ohms, balanced or unbalanced (150 ohms optional); Input Level, -24 to +8 dBm; Maximum Peak Output Level, +21 dBm; Maximum Gain, 50 dB; Noise Level, below -70 dB re +21 dBm output; Frequency Response, flat within 1 dB, 50 to 15,000 cps, 20 dB below maximum level; 75 microsecond slope at maximum; 50 microsecond or other contours possible with simple field modification; Harmonic Distortion, less than 1% from 50 to 15,000 cps throughout entire control range; Attack Time, less than one microsecond or 2 milliseconds depending on program waveform; Recovery Time, 140 milliseconds (low frequencies), 10 milliseconds (high frequencies); Maximum Operating Temperature, 55° C; Power Requirements, 15 watts, at 115/230 Volts AC, 50/60 cps; Physical Dimensions, standard 19" rack, 3½" high, 9⅝" deep; Shipping Weight, 18 lbs.; **FM Volumax, Model 411, specially coupled for Stereophonic Operation, \$1390.**

All prices F.O.B. Stamford, Connecticut.

**CBS LABORATORIES**  
Stamford, Connecticut. A Division of  
Columbia Broadcasting System, Inc.

GATES RADIO COMPANY  
G E VISUAL COMMUNICATIONS PROO  
KAHN RESEARCH LABORATORIES  
RCA BROADCAST PROOS.  
ROUND HILL ASSOCIATES  
SINGER PRODUCTS CO.  
SOUTHWESTERN COMMUNICATIONS  
TELETRONIX  
VISUAL ELECTRONICS CORP  
WARD ELECTRONIC INDUSTRIES  
WILKINSON ELECTRONICS, INC

AMPLIFIER, AF,

PEAK LIMITING, FM  
PEAK LIMITING, FM  
BAUER ELECTRONICS CORPORATION  
C B S LABORATORIES  
CCA ELECTRONICS CORPORATION  
COLLINS RADIO COMPANY  
FAIRCHILD RECORDING EQUIPMENT  
GATES RADIO COMPANY  
G E VISUAL COMMUNICATIONS PROO  
ROUND HILL ASSOCIATES  
SINGER PRODUCTS CO.  
SOUTHWESTERN COMMUNICATIONS  
TELETRONIX  
VISUAL ELECTRONICS CORP  
WILKINSON ELECTRONICS, INC

AMPLIFIER, AF, REMOTE

ALMA ENGINEERING INC  
ALTEC LANSING  
CCA ELECTRONICS CORPORATION  
ELECTRONIC SYSTEM ENGINEERING  
GATES RADIO COMPANY  
G E VISUAL COMMUNICATIONS PROO  
LANGEVIN  
ORBIT RADIO  
PERMOFLUX CORPORATION  
RCA BROADCAST PROOS.  
ROUND HILL ASSOCIATES  
H. H. SCOTT, INCORPORATED  
SINGER PRODUCTS CO.  
SOUTHWESTERN COMMUNICATIONS  
STANCILO-HOFFMAN CORPORATION  
STEPHENS ELECTRONICS  
TAPECASTER ELECTRONICS  
TELETRONIX  
TREPAC CORPORATION OF AMERICA  
VISUAL ELECTRONICS CORP  
WARD ELECTRONIC INDUSTRIES

AMPLIFIER, AF, REVERBERATION

AMPLIFIER CORP OF AMERICA  
AUDIO INSTRUMENT CO  
BAUER ELECTRONICS CORPORATION  
CALIFONE/ROBERTS  
GREGORY AMPLIFIER CORP  
NORTH AMERICAN PHILIPS CO  
ORBIT RADIO  
ROUND HILL ASSOCIATES  
SINGER PRODUCTS CO  
SOUTHWESTERN COMMUNICATIONS  
STEPHENS ELECTRONICS  
VISUAL ELECTRONICS CORP

AMPLIFIER, AF, STEREO

ALLIED ELECTRONICS CORP  
ALMA ENGINEERING INC  
ALTEC LANSING  
BAUER ELECTRONICS CORPORATION  
ALBEST ELECTRONICS  
CENTRAL DYNAMICS CORPORATION  
CROWN INTERNATIONAL  
ELECTRO-SOUND ACOUSTICS  
ELECTRO-VOICE INC  
ELECTRONICS ESSENTIALS OF CCC  
GATES RADIO COMPANY  
G E VISUAL COMMUNICATIONS PROO  
HEATH CO  
JETRONIC INDUSTRIES, INC.  
KARG LABORATORIES  
KOSS ELECTRONICS, INC.  
JAMES B LANSING SOUND CO  
MAGNECORD  
MARANTZ COMPANY  
MELCOR ELECTRONICS  
ORBIT RADIO  
PERMOFLUX CORPORATION  
RCA BROADCAST PROOS.  
ROUND HILL ASSOCIATES  
RUSSCO ELECTRONICS MFG.  
H. H. SCOTT, INCORPORATED  
SCULLY RECORDING INSTRUMENTS  
SETCHELL CARLSON INCORPORATED  
SONY CORPORATION OF AMERICA  
SOUTHWESTERN COMMUNICATIONS  
STEPHENS ELECTRONICS  
TELETRON INDUSTRIES CORP  
VIKING OF MINNEAPOLIS

AMPLIFIER, BRIDGING

ALMA ENGINEERING INC  
ALTEC LANSING  
AMECO, INC.  
AMPLIVISION CORPORATION  
ANACONDA ASTRODATA CO  
BAUER ELECTRONICS CORPORATION  
C-COR ELECTRONICS  
DELTA ELECTRONICS, INC.  
GATES RADIO COMPANY  
INTERNATIONAL NUCLEAR CORP.  
JERROLO ELECTRONICS CORP  
LANGEVIN  
LINDSAY SPECIALTY PRODUCTS  
ORBIT RADIO  
RCA BROADCAST PROOS.  
ROUND HILL ASSOCIATES  
H. H. SCOTT, INCORPORATED  
SINGER PRODUCTS CO.  
SOUNDCRAFT INDUSTRIES  
SOUTHWESTERN COMMUNICATIONS  
SPENCER-KENNEY LABORATORIES

STANCILO-HOFFMAN CORPORATION  
STEPHENS ELECTRONICS  
THE TECHNICAL MATERIEL CORP  
WARD ELECTRONIC INDUSTRIES

AMPLIFIER, CATV

AMECO, INC.  
AMERICAN ELECTRONIC LABS  
AMPLIVISION CORPORATION  
ANACONDA ASTRODATA CO  
KEITH ANDERSON CO  
RALL BROTHERS RESEARCH  
BENCO TELEVISION ASSOCIATES  
BLONDER-TONGUE LABORATORIES  
C-COR ELECTRONICS  
CRAFTSMAN ELECTRONICS PRODUCTS  
ENTRON INC  
GBC AMERICA CORPORATION  
JERROLO ELECTRONICS CORP  
KAISER-COX  
LINDSAY SPECIALTY PRODUCTS  
MICROMEGA  
ROUND HILL ASSOCIATES  
SPENCER-KENNEY LABORATORIES  
TELESIS CORPORATION

AMPLIFIER, CLAMPING

RAYTHEON CO EQUIPMENT DIVISION

AMPLIFIER, OC

ALTEC LANSING  
BAUER ELECTRONICS CORPORATION  
BIRNS & SAWYER  
C-COR ELECTRONICS  
COMU ELECTRONICS  
GENERAL RADIO CO  
MELCOR ELECTRONICS  
MILES REPRODUCER CO  
MOSELEY ASSOCIATES INC.  
VIDEON CORPORATION

AMPLIFIER, DISTRIBUTION

ALMA ENGINEERING INC  
ALTEC LANSING  
AMECO, INC.  
AMPLIVISION CORPORATION  
ANACONDA ASTRODATA CO  
APPLIFO ELECTRO-MECHANICS  
ASCO SONOCRAFT CORP  
BALL BROTHERS RESEARCH  
BLONDER-TONGUE LABORATORIES  
BROADCAST ELECTRONICS, INC  
CCA ELECTRONICS CORPORATION  
C-COR ELECTRONICS  
CENTRAL DYNAMICS CORPORATION  
COMU ELECTRONICS  
COOKE ENGINEERING COMPANY  
FLTA ELECTRONICS, INC.  
OYNAIR ELECTRONICS, INC.  
INTERNATIONAL NUCLEAR CORP.  
JERROLO ELECTRONICS CORP  
LINDSAY SPECIALTY PRODUCTS  
MARCONI DIVISION  
MCMARTIN INDUSTRIES  
MELCOR ELECTRONICS  
NORTH AMERICAN PHILIPS CO  
ORBIT RADIO  
RCA BROADCAST PROOS.  
RIKER VIDEO INDUSTRIES  
ROUND HILL ASSOCIATES  
SARKES-TARZIAN  
SPENCER-KENNEY LABORATORIES  
SYLVANIA-COMM. ELECTRONICS DIV  
TELEMET COMPANY  
TELEQUIP CORPORATION  
TELEVISION UTILITIES CORP  
VIDEON CORPORATION  
VISUAL ELECTRONICS CORP  
VITAL INDUSTRIES  
WARD ELECTRONIC INDUSTRIES

AMPLIFIER, KEYING

RCA BROADCAST PROOS.  
RIKER VIDEO INDUSTRIES  
TELEMET COMPANY

AMPLIFIER, MASKING

C B S LABORATORIES  
RCA BROADCAST PROOS.  
RIKER VIDEO INDUSTRIES

AMPLIFIER, PULSE

ALMA ENGINEERING INC  
ALTEC LANSING  
APPLIED ELECTRO-MECHANICS  
C-COR ELECTRONICS  
CENTRAL DYNAMICS CORPORATION  
COMU ELECTRONICS  
OYNAIR ELECTRONICS, INC.  
GENERAL RADIO CO  
INTERNATIONAL NUCLEAR CORP.  
MARCONI DIVISION  
MICROWAVE ASSOCIATES, INC.  
RCA BROADCAST PROOS.  
RIKER VIDEO INDUSTRIES  
SARKES-TARZIAN  
STEPHENS ELECTRONICS  
SYLVANIA-COMM. ELECTRONICS DIV  
TELEMET COMPANY  
TELEQUIP CORPORATION  
VISUAL ELECTRONICS CORP  
WARD ELECTRONIC INDUSTRIES

AMPLIFIER, RF, GENERAL PURPOSE

AMECO, INC.  
AMPLIVISION CORPORATION  
KEITH ANDERSON CO  
BLONDER-TONGUE LABORATORIES  
CCA ELECTRONICS CORPORATION  
C-COR ELECTRONICS  
GATES RADIO COMPANY  
GENERAL RADIO CO  
JERROLO ELECTRONICS CORP  
MCMARTIN INDUSTRIES  
MICROMEGA  
MULTRONICS

RCA BROADCAST PROOS.  
RHG ELECTRONICS LABORATORY  
SINGER PRODUCTS CO.  
STANDARO ELECTRONICS CORP

AMPLIFIER, RF, PEAK LIMITING

BEAR ELECTRONICS LABORATORY  
CCA ELECTRONICS CORPORATION  
MCMARTIN INDUSTRIES  
MICROWAVE ASSOCIATES, INC.  
RCA BROADCAST PROOS.  
ROHDE & SCHWARZ SALES CO. -USA  
SINGER PRODUCTS CO.

AMPLIFIER, RF, POWER

AMERICAN ELECTRONIC LABS  
KEITH ANDERSON CO  
BAUER ELECTRONICS CORPORATION  
CCA ELECTRONICS CORPORATION  
C-COR ELECTRONICS  
CONTINENTAL ELECTRONICS MFG  
COURIER COMMUNICATIONS  
EIMAC DIVISION OF VARIAN  
GATES RADIO COMPANY  
G E VISUAL COMMUNICATIONS PROO  
GENERAL RADIO CO  
E F JOHNSON COMPANY  
MCMARTIN INDUSTRIES  
MICROWAVE ASSOCIATES, INC.  
MILES REPRODUCER CO  
MULTRONICS  
RCA BROADCAST PROOS.  
RHG ELECTRONICS LABORATORY  
SINGER PRODUCTS CO.  
THE TECHNICAL MATERIEL CORP  
TELETRONIX

AMPLIFIER, SENSING

APPLIED ELECTRO-MECHANICS  
BROADCAST PRODUCTS COMPANY  
HOUSTON ELECTRONICS CO.  
INTERNATIONAL GOOD MUSIC  
RIKER VIDEO INDUSTRIES  
SCHAFER ELECTRONICS  
WARD ELECTRONIC INDUSTRIES

AMPLIFIER, STABILIZING

RALL BROTHERS RESEARCH  
CENTRAL DYNAMICS CORPORATION  
INTERNATIONAL NUCLEAR CORP.  
MARCONI DIVISION  
RCA BROADCAST PROOS.  
RIKER VIDEO INDUSTRIES  
SYLVANIA-COMM. ELECTRONICS DIV  
TELEMET COMPANY  
TELEQUIP CORPORATION  
VISUAL ELECTRONICS CORP  
VITAL INDUSTRIES  
WARD ELECTRONIC INDUSTRIES

AMPLIFIER, TV, BOOSTER

AMECO, INC.  
AMPLIVISION CORPORATION  
ANACONDA ASTRODATA CO  
BENCO TELEVISION ASSOCIATES  
BLONDER-TONGUE LABORATORIES  
C-COR ELECTRONICS  
CRAFTSMAN ELECTRONICS PRODUCTS  
THE FINNEY CO  
JERROLO ELECTRONICS CORP  
LINDSAY SPECIALTY PRODUCTS  
MICROWAVE ASSOCIATES, INC.  
RCA BROADCAST PROOS.  
TELEMET COMPANY

AMPLIFIER, TV, VIDEO

ALMA ENGINEERING INC  
AMPLIVISION CORPORATION  
APPLIED ELECTRO-MECHANICS  
BALL BROTHERS RESEARCH  
BLONDER-TONGUE LABORATORIES  
CATEL COMPANY  
C-COR ELECTRONICS  
CENTRAL DYNAMICS CORPORATION  
COMU ELECTRONICS  
OYNAIR ELECTRONICS, INC.  
GBC AMERICA CORPORATION  
G E VISUAL COMMUNICATIONS PROO  
INTERNATIONAL NUCLEAR CORP.  
MARCONI DIVISION  
RAYTHEON CO EQUIPMENT DIVISION  
RCA BROADCAST PROOS.  
RIKER VIDEO INDUSTRIES  
SARKES-TARZIAN  
STANDARO ELECTRONICS CORP  
TELEMATION, INC.  
TELEMET COMPANY  
TELEQUIP CORPORATION  
VIDEON CORPORATION  
VISUAL ELECTRONICS CORP  
VITAL INDUSTRIES  
WARD ELECTRONIC INDUSTRIES

AMPLIFIER, VIDEO, SWEEP

ALMA ENGINEERING INC  
AMPLIVISION CORPORATION  
BLONDER-TONGUE LABORATORIES  
HEWLETT-PACKARD CO.  
RCA BROADCAST PROOS.  
ROHDE & SCHWARZ SALES CO. -USA  
VISUAL ELECTRONICS CORP

ANALYZERS, DISTORTION

AUDIO INSTRUMENT CO  
BARKER & WILLIAMSON  
GENERAL RADIO CO  
HEWLETT-PACKARD CO.  
MARCONI INSTRUMENTS  
NORTHEAST ELECTRONICS CORP  
ROHDE & SCHWARZ SALES CO. -USA  
THE SINGER CO - METRICS DIV  
WAVEFORMS, INCORPORATED

ANALYZERS, HARMONIC

BARKER & WILLIAMSON

GENERAL RADIO CO  
HEWLETT-PACKARD CO.  
MARCONI INSTRUMENTS  
ROHDE & SCHWARZ SALES CO. -USA  
THE SINGER CO - METRICS DIV

ANALYZERS, INTERMOULATION

AUDIO INSTRUMENT CO  
THE SINGER CO - METRICS DIV

ANALYZERS, NOISE

GENERAL MICROWAVE CORPORATION  
GENERAL RADIO CO  
HEWLETT-PACKARD CO.  
NORTHEAST ELECTRONICS CORP  
ROHDE & SCHWARZ SALES CO. -USA  
H. H. SCOTT, INCORPORATED  
THE SINGER CO - METRICS DIV

ANALYZERS, SIOERANO

OYNAIR ELECTRONICS, INC.  
RCA BROADCAST PROOS.  
ROHDE & SCHWARZ SALES CO. -USA  
THE SINGER CO - METRICS DIV  
THE TECHNICAL MATERIEL CORP  
WARD ELECTRONIC INDUSTRIES

ANALYZERS, SPECTRUM

TEKTRONIX INC

ANALYZERS, VIDEO

COLORADO VIDEO  
HEWLETT-PACKARD CO.  
KRS INSTRUMENTS DIVISION  
ROHDE & SCHWARZ SALES CO. -USA  
THE SINGER CO - METRICS DIV  
VIDEON CORPORATION

ANCHORS, GUY

ADVANCE INDUSTRIES  
AMECO, INC.  
AIRNRACH CO  
G C ELECTRONICS COMPANY  
LIBERTY TOWER MFG. CO  
LITTLE JOE ENTERPRISES

ANTENNAS, AM

ADVANCE INDUSTRIES  
ANTENNA PRODUCTS COMPANY  
CCA ELECTRONICS CORPORATION  
GATES RADIO COMPANY  
JAMPRO ANTENNA COMPANY  
JERROLO ELECTRONICS CORP  
RCA BROADCAST PROOS.  
SCALA RADIO CORPORATION  
SINGER PRODUCTS CO.  
STAINLESS, INC.  
SWAGER TOWER CORPORATION  
TELETRONIX  
TRYLON INCORPORATED  
VISUAL ELECTRONICS CORP

ANTENNAS, FM

ALFORD MANUFACTURING COMPANY  
ALLIED ELECTRONICS CORP  
AMECO, INC.  
ANTENNA PRODUCTS COMPANY  
APPARATUS DEVELOPMENT CO  
BLONDER-TONGUE LABORATORIES  
BROWNING LABORATORIES, INC.  
CCA ELECTRONICS CORPORATION  
COLLINS RADIO COMPANY  
THE FINNEY CO  
GATES RADIO COMPANY  
G C ELECTRONICS COMPANY  
JAMPRO ANTENNA COMPANY  
JERROLO ELECTRONICS CORP  
LINDSAY SPECIALTY PRODUCTS  
MARTI ELECTRONICS  
MCMARTIN INDUSTRIES  
RCA BROADCAST PROOS.  
ROBINS INDUSTRIES CORP.  
SCALA RADIO CORPORATION  
SINGER PRODUCTS CO  
SITCO ANTENNA CO.  
TECHNICAL APPLIANCE CORP  
TELETRONIX  
THOMSON ELECTRIC CO  
VISUAL ELECTRONICS CORP

ANTENNAS, LF

MULTRONICS

ANTENNAS, MF

MULTRONICS

ANTENNAS, MICROWAVE

ADVANCE INDUSTRIES  
AMECO, INC.  
AMERICAN ELECTRONIC LABS  
ANDREW CORPORATION  
DEMORNAV - BONAROI DIVISION  
FORT WORTH TOWER CO., INC.  
JERROLO ELECTRONICS CORP  
LITTON EDUCATIONAL TELE DIV  
MICRO-LINK SYSTEMS/VARIAN ASSO  
MOTOROLA COMMUNICATIONS  
NARDA MICROWAVE CORPORATION  
PRODELIN, INCORPORATED  
RAYTHEON CO EQUIPMENT DIVISION

# for TOP PERFORMANCE in TV ANTENNAS

## VHF SUPER TURNSTILE

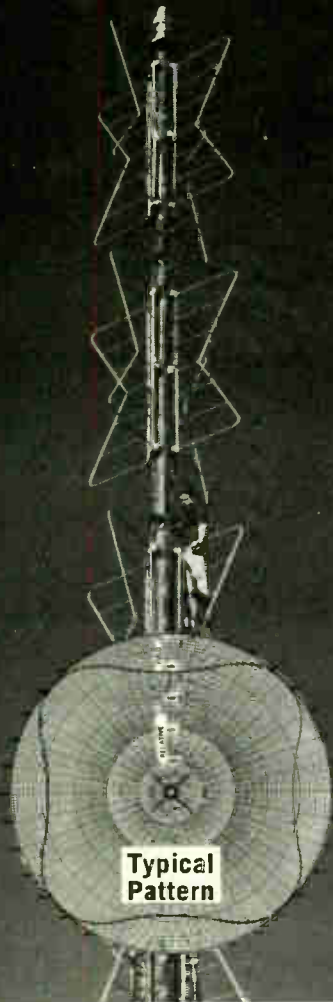

Typical  
Pattern

**DESCRIPTION**  
Improved mechanical construction  
Wide variety of Gains  
Power rating to 50 kw  
Beam tilting and null fill available at no increase in cost

## UHF ZIG ZAG

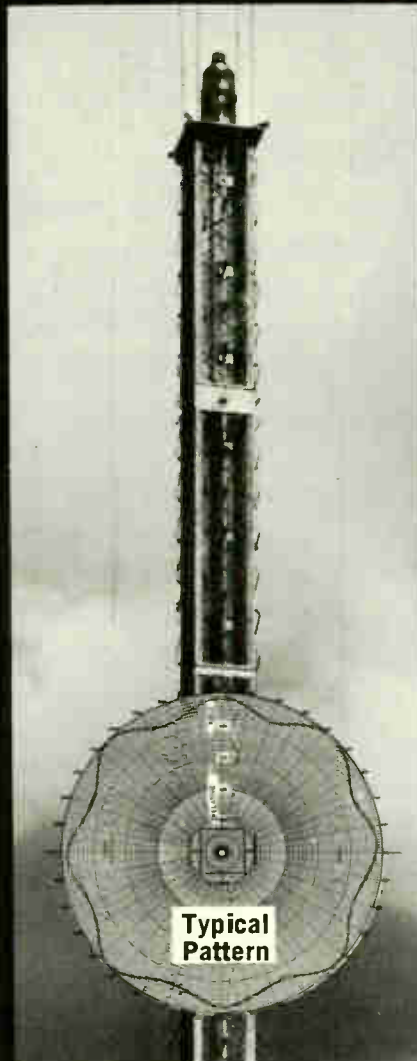

Typical  
Pattern

**DESCRIPTION**  
Simple panel construction  
All copper elements  
All Teflon insulated  
Low VSWR  
Inputs to 60 kw  
Gain of about 30 per panel

## CORNER REFLECTORS

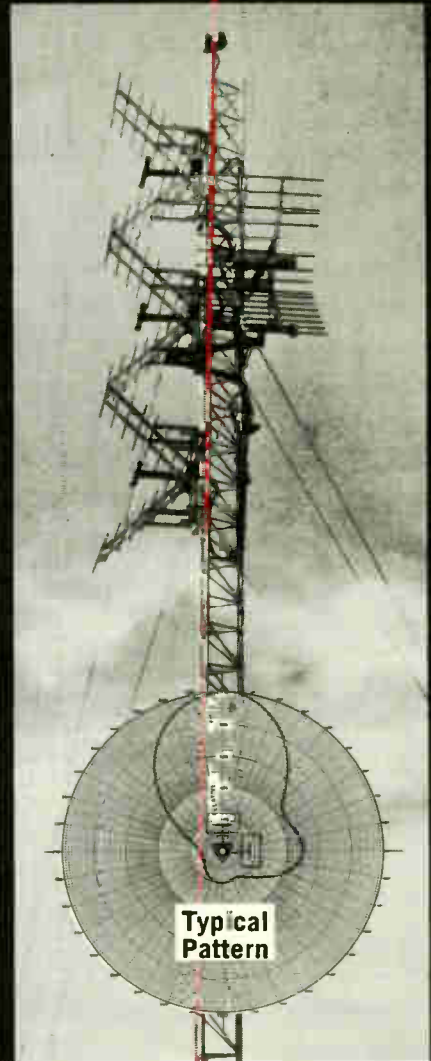

Typical  
Pattern

**DESCRIPTION**  
Wide variety of frequencies from Channel 2 through 83  
Low VSWR  
Versatile for fill in or directionals  
Gains of generally around 10 per corner

# J A M P R O

- TV Antennas
- Coax Switches
- Notch Diplexers
- FM Antennas
- Harmonic Filters
- ETV Antennas

**ANTENNA COMPANY**  
6939 POWER INN ROAD  
SACRAMENTO, CALIFORNIA

RCA BROADCAST PRODS.  
 ROMDE & SCHWARZ SALES CO. -USA  
 SCIENTIFIC-ATLANTA  
 SINGER PRODUCTS CO  
 STAINLESS, INC.  
 TECHNICAL APPLIANCE CORP  
 VISUAL ELECTRONICS CORP

ANTENNAS, MOBILE  
 ANDREW CORPORATION  
 F & M SYSTEMS COMPANY  
 GATES RADIO COMPANY  
 G C ELECTRONICS COMPANY  
 HY-GAIN ELECTRONICS  
 JERROLD ELECTRONICS CORP  
 HFRB KRECKMAN CO  
 LINDSAY SPECIALTY PRODUCTS  
 MARTI ELECTRONICS  
 MOTOROLA COMMUNICATIONS  
 PRODELIN, INCORPORATED  
 RCA BROADCAST PRODS.  
 SINGER PRODUCTS CO  
 TECHNICAL APPLIANCE CORP  
 UTICA CORPORATION  
 WATERS MANUFACTURING

ANTENNAS, REMOTE PICKUP  
 HERB KRECKMAN CO

ANTENNAS, TV  
 ALFORD MANUFACTURING COMPANY  
 ALLIED ELECTRONICS CORP  
 BLONDER-TONGUE LABORATORIES  
 FMCEE  
 THE FINNEY CO  
 GATES RADIO COMPANY  
 G C ELECTRONICS COMPANY  
 G E VISUAL COMMUNICATIONS PROO  
 JAMPRO ANTENNA COMPANY  
 JERROLD ELECTRONICS CORP  
 LINDSAY SPECIALTY PRODUCTS  
 MARCONI DIVISION  
 PACIFIC TOWER CO  
 RCA BROADCAST PRODS.  
 SCALA RADIO CORPORATION  
 SINGER PRODUCTS CO.  
 TECHNICAL APPLIANCE CORP  
 THOMSON ELECTRIC CO  
 VISUAL ELECTRONICS CORP

ANTENNAS, TV, MASTER-COMMUNITY  
 AMECO, INC.  
 AMPLIVISION CORPORATION  
 ANTENNA PRODUCTS COMPANY  
 BENCO TELEVISION ASSOCIATES  
 BLONDER-TONGUE LABORATORIES  
 CUSH CRAFT  
 THE FINNEY CO  
 JERROLD ELECTRONICS CORP  
 LINDSAY SPECIALTY PRODUCTS  
 SCALA RADIO CORPORATION  
 SCIENTIFIC-ATLANTA  
 SITCO ANTENNA CO.  
 STAINLESS, INC  
 TECHNICAL APPLIANCE CORP

ANTENNAS, 2500 MHZ  
 ALFORD MANUFACTURING COMPANY  
 AMERICAN ELECTRONIC LABS  
 ANDREW CORPORATION  
 JAMPRO ANTENNA COMPANY  
 JERROLD ELECTRONICS CORP  
 LITTON EDUCATIONAL TELE DIV  
 NAROA MICROWAVE CORPORATION  
 PRODELIN, INCORPORATED  
 RAYTHEON CO EQUIPMENT DIVISION  
 RCA BROADCAST PRODS.  
 SCIENTIFIC-ATLANTA  
 TECHNICAL APPLIANCE CORP

ANTENNAS, SYSTEMS, HF  
 DELTA ELECTRONICS INC

ARMS, PHONOGRAPH -  
SEE ARMS, TONE

ARMS, TONE  
 THE ASIATIC CORPORATION  
 EUPHONICS MARKETING  
 GATES RADIO COMPANY  
 GOTHAM AUDIO CORPORATION  
 GRAY RESEARCH & DEVELOPMENT CO  
 KOSS ELECTRONICS, INC.  
 RCA BROADCAST PRODS.  
 SHURE BROTHERS, INC.  
 SINGER PRODUCTS CO  
 SONY CORPORATION OF AMERICA

ATTENUATORS, AUDIO  
 ALTEC LANSING  
 AMECO, INC.  
 CENTRALAB  
 FAIRCHILD RECORDING EQUIPMENT  
 GENERAL RADIO CO  
 HEWLETT-PACKARD CO.  
 JORDAN ELECTRIC COMPANY  
 LANGEVIN  
 MALLORY DISTRIBUTOR PRODUCTS  
 MICROLAB / FXR  
 PAINTON INCORPORATED  
 ROMDE & SCHWARZ SALES CO. -USA  
 SOUNOCRAFT INDUSTRIES  
 SOUTHWESTERN COMMUNICATIONS  
 STEPHENS ELECTRONICS  
 TELONIC INDUSTRIES  
 TROMPETER ELECTRONICS

ATTENUATORS, FIXED  
 ALTEC LANSING  
 BIRD ELECTRONIC CORPORATION  
 GENERAL MICROWAVE CORPORATION  
 GENERAL RADIO CO  
 GOTHAM AUDIO CORPORATION  
 HEWLETT-PACKARD CO.  
 HOLLAND ELECTRONICS INC  
 JERROLD ELECTRONICS CORP  
 JORDAN ELECTRIC COMPANY

ATTENUATORS, MICROWAVE  
 AMECO, INC.  
 DEMORNAY - BONARDI DIVISION  
 GENERAL MICROWAVE CORPORATION  
 GENERAL RADIO CO  
 HEWLETT-PACKARD CO.  
 JERROLD ELECTRONICS CORP  
 MICROLAB / FXR  
 MICROWAVE ASSOCIATES, INC.  
 NAROA MICROWAVE CORPORATION  
 OHMITE MANUFACTURING COMPANY  
 PAINTON INCORPORATED  
 ROMDE & SCHWARZ SALES CO. -USA  
 SOUTHWESTERN COMMUNICATIONS  
 TROMPETER ELECTRONICS

ATTENUATORS, VIDEO  
 AMECO, INC.  
 CENTRAL DYNAMICS CORPORATION  
 HOLLAND ELECTRONICS INC  
 NAROA MICROWAVE CORPORATION  
 PAINTON INCORPORATED  
 ROMDE & SCHWARZ SALES CO. -USA  
 SARKES-TARZIAN  
 SCIENTIFIC-ATLANTA  
 TELONIC INDUSTRIES  
 TROMPETER ELECTRONICS  
 WATERS MANUFACTURING

AUTOMATION, EQUIPMENT  
 ATTKEN COMMUNICATIONS  
 AMECO, INC.  
 BROADCAST ELECTRONICS, INC  
 BROADCAST PRODUCTS COMPANY  
 CCA ELECTRONICS CORPORATION  
 CENTRAL DYNAMICS CORPORATION  
 CHRONO-LOG CORPORATION  
 CONTINENTAL ELECTRONICS MFG  
 DELTA ELECTRONICS, INC.  
 F & M SYSTEMS COMPANY  
 GATES RADIO COMPANY  
 HANCOCK TELECONTROL  
 INTERNATIONAL GOOD MUSIC  
 KRS INSTRUMENTS DIVISION  
 MACARTA INC.  
 MACKENZIE LABORATORIES  
 MID AMERICA ELECTRONICS CORP  
 ORBIT RADIO  
 RCA BROADCAST PRODS.  
 RIKER VIDEO INDUSTRIES  
 SARKES-TARZIAN  
 SCHAFFER ELECTRONICS  
 SCULLY RECORDING INSTRUMENTS  
 SINGER PRODUCTS CO  
 S. STERLING COMPANY  
 TAPEMASTER ELECTRONICS  
 TELESIS CORPORATION  
 TREPAC CORPORATION OF AMERICA  
 TROMPETER ELECTRONICS  
 VISUAL ELECTRONICS CORP  
 WARD ELECTRONIC INDUSTRIES

BACKGROUND MUSIC SERVICE  
 AMECO, INC.  
 ASCO SONOCRAFT CORP  
 BROWNING LABORATORIES, INC.  
 CCA ELECTRONICS CORPORATION  
 CINE SONIC SOUND  
 THE JAMES FLOYD FORD CO  
 INTERNATIONAL GOOD MUSIC  
 MAGNETRONICS, INC.  
 MCMARTIN INDUSTRIES  
 MINNESOTA MINING - 3 M  
 MOTOROLA COMMUNICATIONS  
 ORBIT RADIO  
 SCHAFFER ELECTRONICS

ATTENUATORS, IMPEDANCE MATCHING  
 ALTEC LANSING  
 AMECO, INC.  
 HOLLAND ELECTRONICS INC  
 JERROLD ELECTRONICS CORP  
 MICROLAB / FXR  
 MICROWAVE ASSOCIATES, INC.  
 NAROA MICROWAVE CORPORATION  
 OHMITE MANUFACTURING COMPANY  
 PAINTON INCORPORATED  
 ROMDE & SCHWARZ SALES CO. -USA  
 SOUTHWESTERN COMMUNICATIONS  
 TROMPETER ELECTRONICS

ATTENUATORS, MICROWAVE  
 AMECO, INC.  
 DEMORNAY - BONARDI DIVISION  
 GENERAL MICROWAVE CORPORATION  
 GENERAL RADIO CO  
 HEWLETT-PACKARD CO.  
 JERROLD ELECTRONICS CORP  
 MICROLAB / FXR  
 MICROWAVE ASSOCIATES, INC.  
 NAROA MICROWAVE CORPORATION  
 PRODELIN, INCORPORATED  
 ROMDE & SCHWARZ SALES CO. -USA  
 SCIENTIFIC-ATLANTA  
 THE SINGER CO - METRICS DIV  
 TELONIC INDUSTRIES

ATTENUATORS, RF  
 AMECO, INC.  
 BENCO TELEVISION ASSOCIATES  
 BIRD ELECTRONIC CORPORATION  
 BLONDER-TONGUE LABORATORIES  
 GENERAL MICROWAVE CORPORATION  
 GENERAL RADIO CO  
 HEWLETT-PACKARD CO.  
 HOLLAND ELECTRONICS INC  
 JERROLD ELECTRONICS CORP  
 MARCONI INSTRUMENTS  
 MICROLAB / FXR  
 MICROWAVE ASSOCIATES, INC.  
 NAROA MICROWAVE CORPORATION  
 PAINTON INCORPORATED  
 ROMDE & SCHWARZ SALES CO. -USA  
 SCIENTIFIC-ATLANTA  
 THE SINGER CO - METRICS DIV  
 TELONIC INDUSTRIES

ATTENUATORS, VIDEO  
 AMECO, INC.  
 CENTRAL DYNAMICS CORPORATION  
 HOLLAND ELECTRONICS INC  
 NAROA MICROWAVE CORPORATION  
 PAINTON INCORPORATED  
 ROMDE & SCHWARZ SALES CO. -USA  
 SARKES-TARZIAN  
 SCIENTIFIC-ATLANTA  
 TELONIC INDUSTRIES  
 TROMPETER ELECTRONICS

AUTOMATION, EQUIPMENT  
 ATTKEN COMMUNICATIONS  
 AMECO, INC.  
 BROADCAST ELECTRONICS, INC  
 BROADCAST PRODUCTS COMPANY  
 CCA ELECTRONICS CORPORATION  
 CENTRAL DYNAMICS CORPORATION  
 CHRONO-LOG CORPORATION  
 CONTINENTAL ELECTRONICS MFG  
 DELTA ELECTRONICS, INC.  
 F & M SYSTEMS COMPANY  
 GATES RADIO COMPANY  
 HANCOCK TELECONTROL  
 INTERNATIONAL GOOD MUSIC  
 KRS INSTRUMENTS DIVISION  
 MACARTA INC.  
 MACKENZIE LABORATORIES  
 MID AMERICA ELECTRONICS CORP  
 ORBIT RADIO  
 RCA BROADCAST PRODS.  
 RIKER VIDEO INDUSTRIES  
 SARKES-TARZIAN  
 SCHAFFER ELECTRONICS  
 SCULLY RECORDING INSTRUMENTS  
 SINGER PRODUCTS CO  
 S. STERLING COMPANY  
 TAPEMASTER ELECTRONICS  
 TELESIS CORPORATION  
 TREPAC CORPORATION OF AMERICA  
 TROMPETER ELECTRONICS  
 VISUAL ELECTRONICS CORP  
 WARD ELECTRONIC INDUSTRIES

BACKGROUND MUSIC SERVICE  
 AMECO, INC.  
 ASCO SONOCRAFT CORP  
 BROWNING LABORATORIES, INC.  
 CCA ELECTRONICS CORPORATION  
 CINE SONIC SOUND  
 THE JAMES FLOYD FORD CO  
 INTERNATIONAL GOOD MUSIC  
 MAGNETRONICS, INC.  
 MCMARTIN INDUSTRIES  
 MINNESOTA MINING - 3 M  
 MOTOROLA COMMUNICATIONS  
 ORBIT RADIO  
 SCHAFFER ELECTRONICS

BASE STATIONS  
 GATES RADIO COMPANY  
 MARTI ELECTRONICS  
 RCA BROADCAST PRODS.  
 SINGER PRODUCTS CO  
 UTICA CORPORATION

BATTERIES, DRY CELL  
 BURGESS BATTERY COMPANY  
 RCA ELECTRONIC COMPONENTS

BATTERIES, LEAD ACID  
 IMPEX ELECTRONICS CORP  
 SINGER PRODUCTS CO

BATTERIES, NICKEL CADMIUM  
 BERKEY TECHNICAL CORP  
 BIRNS & SAWYER  
 COLORTRAN INDUSTRIES - BERKEY  
 G E CAPACITOR DEPARTMENT  
 GENERAL ELECTRIC CO  
 IMPEX ELECTRONICS CORP  
 SINGER PRODUCTS CO.

BATTERIES, OTHER  
 GENERAL ELECTRIC CO

BLOWERS AND FANS  
 AMECO, INC.  
 BUO RADIO, INC  
 DYANCOOL MANUFACTURING CO  
 ENCLOSURE CORP  
 RCA BROADCAST PRODS.  
 ROTRON MANUFACTURING COMPANY  
 SIGMA INDUSTRIES  
 SINGER PRODUCTS CO.

BOXES, DECADE, CAPACITOR  
 AERVOX CORP.  
 GENERAL RADIO CO  
 HEATH CO

BOXES, DECADE, INDUCTOR  
 AERVOX CORP.  
 GENERAL RADIO CO  
 UNITED TRANSFORMER COMPANY

BOXES, DECADE, RESISTOR  
 AERVOX CORP.  
 GENERAL RADIO CO  
 HEATH CO  
 JORDAN ELECTRIC COMPANY  
 OHMITE MANUFACTURING COMPANY

BRIGDES  
 ALFORD MANUFACTURING COMPANY  
 ALTEC LANSING  
 AMECO, INC.  
 BLONDER-TONGUE LABORATORIES  
 DELTA ELECTRONICS INC  
 GENERAL ELECTRIC CO  
 GENERAL MICROWAVE CORPORATION  
 GENERAL RADIO CO  
 HEATH CO  
 HEWLETT-PACKARD CO.  
 HICKOK ELECTRICAL INSTRUMENT  
 JERROLD ELECTRONICS CORP  
 MARCONI INSTRUMENTS  
 ROMDE & SCHWARZ SALES CO. -USA  
 YOKOGAWA ELECTRIC WORKS

BROADCAST PROGRAMMING SERVICE  
 AMECO, INC.  
 ASCO SONOCRAFT CORP  
 BISCAYNE AUDIO COMPANY  
 THE JAMES FLOYD FORD CO  
 HOUSTON ELECTRONICS CO.  
 INTERNATIONAL GOOD MUSIC  
 ORBIT RADIO  
 SCHAFFER ELECTRONICS  
 ALBERT SCHULTZ, INC  
 TELEVISION, INC.

BUILDINGS, PREFABRICATED -  
SEE PREFABRICATED BUILDINGS

CABINETS, METAL  
 ACME VISIBLE RECORDS  
 ALLIED ELECTRONICS CORP  
 AMECO, INC.  
 BUO RADIO, INC  
 BURKE & JAMES  
 CCA ELECTRONICS CORPORATION  
 COOK ELECTRIC COMPANY  
 DATA INSTRUMENT DIVISION  
 ENCLOSURE CORP  
 GATES RADIO COMPANY

CABINETS, PLASTIC  
 RCA BROADCAST PRODS.

CABINETS, STORAGE, DISC  
 ACME VISIBLE RECORDS  
 GATES RADIO COMPANY  
 GRINNAN FUTURE COMPANY  
 HARWALD COMPANY  
 NEUMAQUE PRODUCTS CORPORATION  
 WALLACH & ASSOCIATES

CABINETS, STORAGE, FILM  
 ACME VISIBLE RECORDS  
 GRINNAN FUTURE COMPANY  
 HARWALD COMPANY  
 MINNESOTA MINING - 3 M  
 NEUMAQUE PRODUCTS CORPORATION  
 RCA BROADCAST PRODS.  
 WALLACH & ASSOCIATES

CABINETS, STORAGE  
 MAGNETIC TAPE  
 ACME VISIBLE RECORDS  
 BROADCAST ELECTRONICS, INC  
 BURKE & JAMES  
 COOK ELECTRIC COMPANY  
 GRINNAN FUTURE COMPANY  
 MINNESOTA MINING - 3 M  
 NEUMAQUE PRODUCTS CORPORATION  
 RCA BROADCAST PRODS.  
 SINGER PRODUCTS CO  
 WALLACH & ASSOCIATES

CABINETS, STORAGE,  
MAGNETIC TAPE, CARTRIDGE  
 BROADCAST ELECTRONICS, INC  
 BROADCAST PRODUCTS COMPANY  
 SPARTA ELECTRONIC CORPORATION

CABINETS, STORAGE, SLIDE  
 WALLACH & ASSOCIATES

CABINETS, WOOD  
 BROADCAST PRODUCTS COMPANY  
 BURKE & JAMES  
 GATES RADIO COMPANY  
 GRINNAN FUTURE COMPANY  
 LANG ELECTRONICS, INC  
 LITTLE JOE ENTERPRISES  
 MARANTZ COMPANY  
 SETCHELL CARLSON INCORPORATED

CABLE, ARMORED  
 ALLIED ELECTRONICS CORP  
 ALPHA WIRE  
 AMPHENOL DISTRIBUTOR DIVISION  
 BIRNBACH CO  
 BOSTON INSULATED WIRE & CABLE  
 PHELPS DODGE  
 SUPERIOR CABLE CORPORATION

CABLE, ASSEMBLIES  
 ALPHA WIRE  
 AMECO, INC.  
 AMPHENOL DISTRIBUTOR DIVISION  
 ANDREW CORPORATION  
 BOSTON INSULATED WIRE & CABLE  
 COMU ELECTRONICS  
 D & B ELECTRONICS COMPANY  
 G C ELECTRONICS COMPANY  
 GENERAL RADIO CO  
 GIBBS MFG. AND RESEARCH CORP.  
 ITT CANNON ELECTRIC  
 JERROLD ELECTRONICS CORP  
 PHELPS DODGE  
 ROBINS INDUSTRIES CORP.  
 ROME CABLE DIV OF ALCOA  
 SAXTON PRODUCTS  
 SINGER PRODUCTS CO.  
 SOUTHWESTERN COMMUNICATIONS  
 SUPERIOR CABLE CORPORATION  
 SYLVANIA-COMM. ELECTRONICS DIV  
 TELEQUIP CORPORATION  
 TIMES WIRE AND CABLE  
 TROMPETER ELECTRONICS  
 WECKESSER COMPANY, INC.

CABLE, CAMERA  
 BOSTON INSULATED WIRE & CABLE

CABLE, CATV, HARDWARE  
 AMECO, INC.  
 AMPHENOL DISTRIBUTOR DIVISION  
 AMPLIVISION CORPORATION  
 ANACONDA ASTRODATA CO  
 ANDREW CORPORATION  
 COPPERWELD STEEL COMPANY  
 CRAFTSMAN ELECTRONICS PRODUCTS  
 DIAMOND EXPANSION BOLT CO INC  
 JERROLD ELECTRONICS CORP  
 KAISER-COX  
 PHELPS DODGE  
 PRODELIN, INCORPORATED  
 SIGMA INDUSTRIES  
 SPENCER-KENNEDY LABORATORIES  
 SUPERIOR CABLE CORPORATION  
 TELEMET COMPANY  
 TELEQUIP CORPORATION  
 TIMES WIRE AND CABLE

CABLE, COAXIAL, FLEXIBLE  
 ALPHA WIRE

# Why is Belden specified by most broadcast engineers?

Belden designs and manufactures a complete line of audio, camera, and control cables to meet every TV and radio broadcasting, recording studio, and remote control need.

Many Belden Audio and Broadcast Cables feature Beldfoil\* shielding. This superior cable shield provides 100% protection against crosstalk . . . increases electrical reliability . . . reduces cable diameter and weight . . . is easier to terminate . . . usually lower in cost.

Here is just a part of this complete line, available from stock. Ask your Belden Electronics Distributor for complete information. Request also a copy of the latest Belden Electronics Catalog.

\*Belden U.S. Pat. 3,032,604  
Belden Trademark—Reg. U.S. Pat. Off.

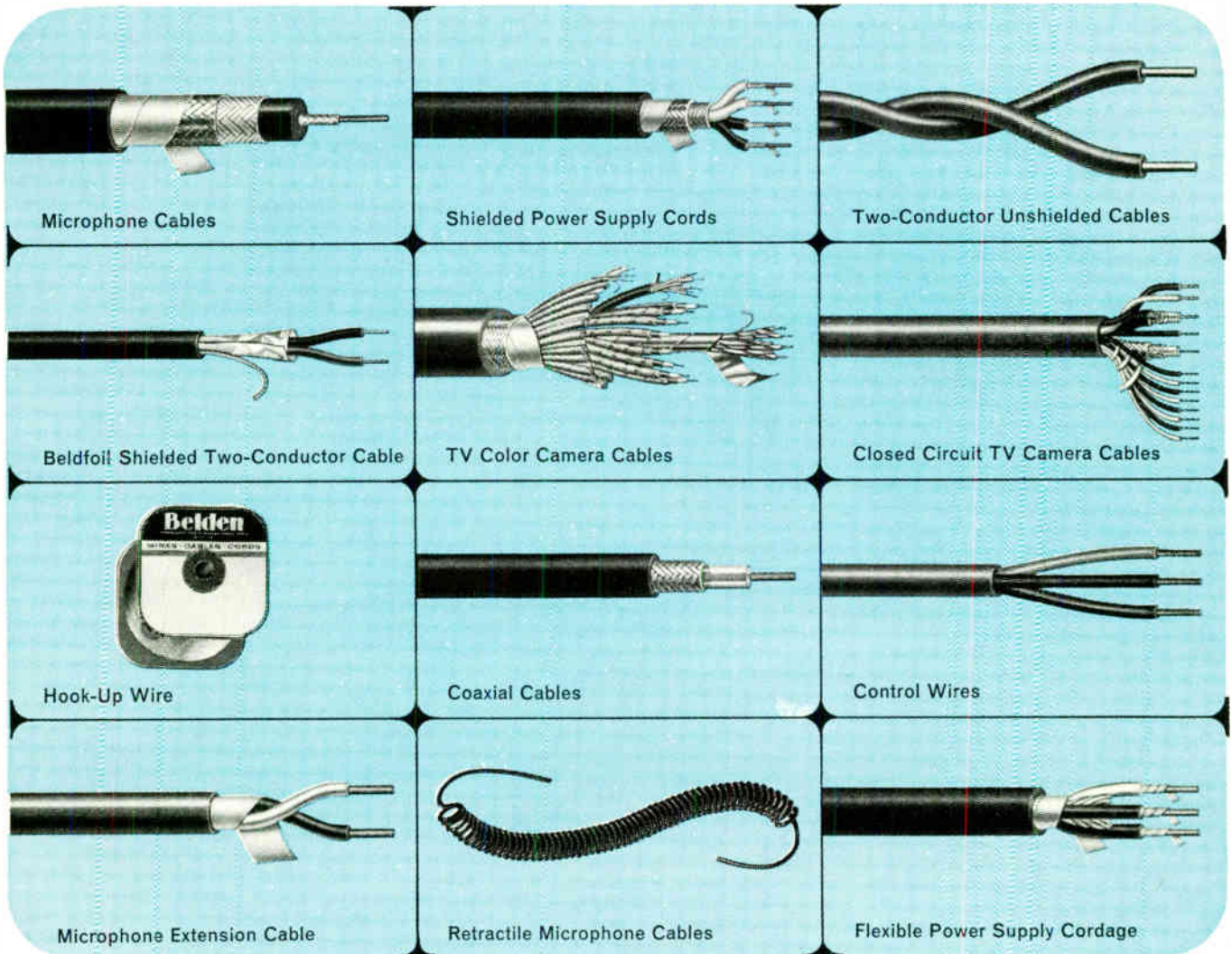

8-5-6

see your Belden Electronics Distributor



electronic wire and cable

BELDEN MANUFACTURING COMPANY • P.O. Box 5070-A • Chicago, Illinois 60680

**Two of the three major networks use  
Norelco cameras for their prime-time color shows.**

**If that doesn't convince you to buy a  
Norelco 3-tube Plumbicon\* color camera,  
take a trip on us.**

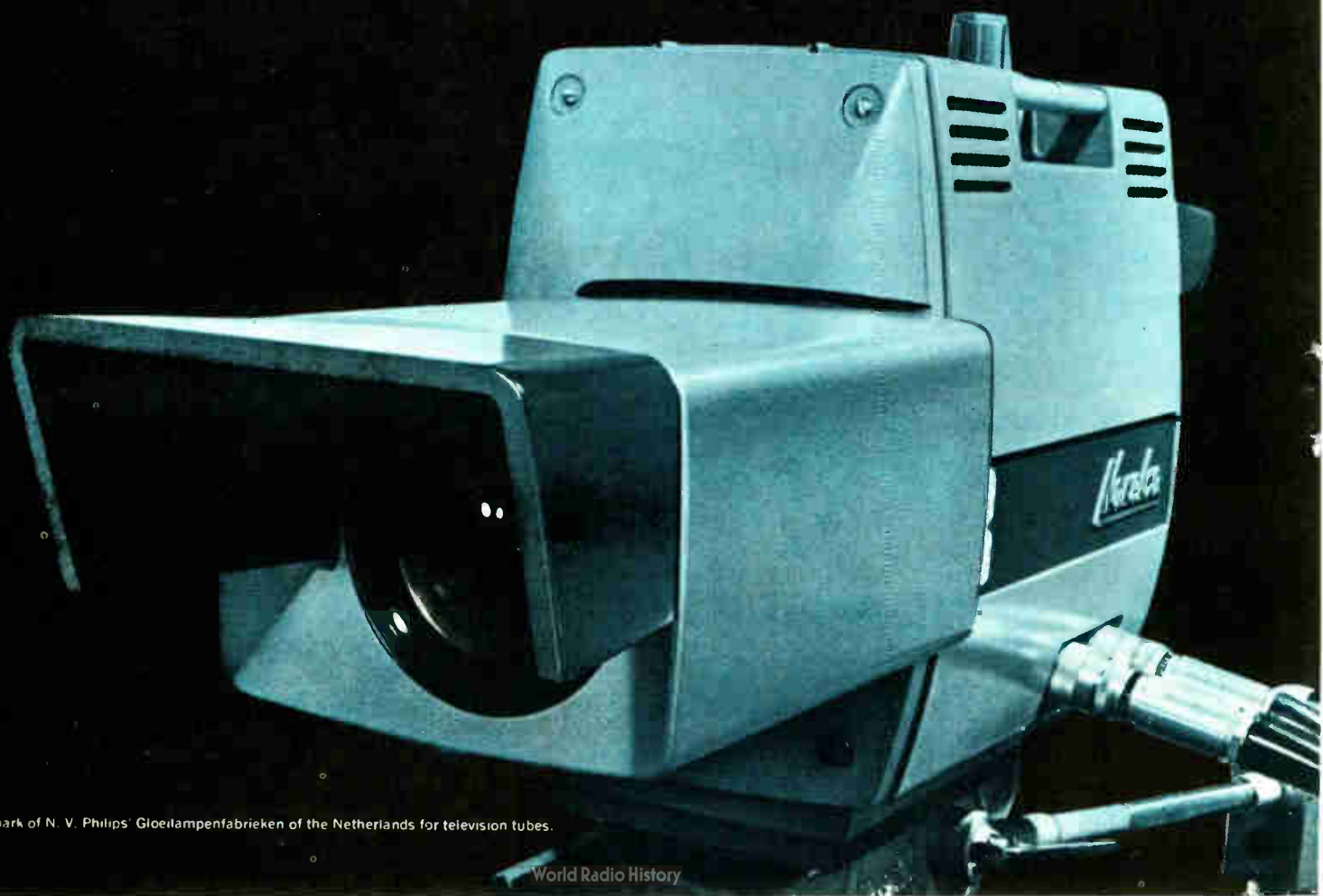

Trademark of N. V. Philips' Gloeilampenfabrieken of the Netherlands for television tubes.

World Radio History



This is an invitation to discover—at our expense—the practical, everyday reasons why you should now be using the new Norelco 3-tube Plumbicon rather than any other color TV camera on the market. Do this. Call, or write us direct. We'll schedule and pay for a trip to a station now using the Norelco 3-tube Plumbicon TV camera—subject to the availability of the station's time and technical personnel. They'll tell you and show you why they chose the new Norelco. You'll see it in program action. You'll learn for yourself—at no cost to yourself—why the Norelco Plumbicon TV camera is used for more programming than all other new generation makes.

**Here's a partial list of stations now using the new Norelco**

| EAST                |                         |
|---------------------|-------------------------|
| STATION             | LOCATION                |
| WNHC-TV             | New Haven, Connecticut  |
| WNEW-TV             | New York                |
| REEVES SOUND STUDIO | New York                |
| SOUTH               |                         |
| WAGA-TV             | Atlanta, Georgia        |
| WJBF-TV             | Augusta, Georgia        |
| WCYB-TV             | Bristol, Virginia/Tenn. |
| WKRG-TV             | Mobile, Alabama         |
| WSPA-TV             | Spartanburg, S.C.       |
| MIDWEST             |                         |
| WFIE-TV             | Evansville, Indiana     |
| WFRV-TV             | Green Bay, Wisconsin    |
| WISH-TV             | Indianapolis, Indiana   |
| WEST                |                         |
| KABC-TV             | Los Angeles, California |
| KTTV                | Los Angeles, California |
| KXTV                | Sacramento, California  |

When you visit one of these stations you'll be able to separate the facts from the fiction regarding color TV cameras. Facts and fiction like this:

**FICTION:** A 4-tube camera produces a sharper picture than a 3-tube color camera.

**FACT:** This concept is as obsolete as the 12-cylinder car. The Norelco 3-tube PC-70 Plumbicon Color Camera produces a sharper color and monochrome picture than any 4-tube camera. Reason: the first practical application of the unique "contours-out-of-green" principle provides both horizontal and vertical aperture correction. The contour signal produced from the green channel, is simply fed to all three channels.

**RESULT:** A startling increase in color and monochrome sharpness — on the home receiver—plus the same tolerance to misregistration that a fourth tube provides. All with one less tube, less maintenance, minimum operational make-ready time and trouble-free color matching.

**FICTION:** "Contours-out-of-green" creates an excessive noise problem.

**FACT:** Absolutely not. But some 4-tube cameras do have a noise problem. Check the "specs." You'll discover that these 4-tube models recommend a fixed gamma of 0.5. We provide continuously variable gamma and recommend an 0.45 operating point. This stretches blacks and gives you more detail in dark areas and shadows. A gamma of 0.5 hides noise by compressing blacks. Result: the 4-tube camera loses dark area detail and literally demands the use of flat lighting.

**FICTION:** By this time next year Norelco will be selling a

four tube camera.

**FACT:** Definitely not. We made the best possible 4-tube camera but decided not to sell it. While using it to compare 3-tube vs. 4-tube, we discovered what every 4-tube manufacturer has since learned: 4-tube resolution is inherently less than 3-tube; that extra light split to the Y channel reduces the light to the RGB channels, causing noticeable lag. (Try moving a light object against a dark background with a camera using 4 photo conductor pick-up tubes. You'll see what we mean.)

**FICTION:** The Norelco PC-70 is made in Holland and won't be in full production for years.

**FACT:** The PC-70 camera is made by Norelco in Mt. Vernon, N. Y., where existing and constantly expanding facilities are meeting the demand for the most economical, easiest to use and maintain, color TV camera available today.

**Other reasons to choose the Norelco PC-70:**

A simple but remarkable 3-way beam split prism that eliminates the need for shading controls. (Because of their complicated beam split, many 4-tube models require as many as 16 shading controls.)

No magenta cast, a problem even some of the newest 4-tube cameras haven't solved.

Lens interchangeability.

No set-up operating controls in the camera head except for tube-focus and back-focus positions. Eliminates the need for a two-man set-up and for hectic on-the-set adjustments.

Now get all the reasons to choose the Norelco PC-70. Get them from the men behind the camera. Today, call our sales representative, Visual Electronics, or call us directly.



NORTH AMERICAN PHILIPS COMPANY, INC.  
900 South Columbus Avenue, Mount Vernon, New York 10550

**AMFCO, INC.**  
AMPHENOL DISTRIBUTOR DIVISION  
ANACONDA ASTRODATA CO  
ANDREW CORPORATION  
ANSONIA WIRE AND CABLE CO  
RELDEN MANUFACTURING CO  
BOSTON INSULATED WIRE & CABLE  
GENERAL RADIO CO  
GOTHAM AUDIO CORPORATION  
ITT WIRE & CABLE DIVISION  
JAMPRO ANTENNA COMPANY  
JERROLD ELECTRONICS CORP  
PHELPS DODGE  
PRODELIN, INCORPORATED  
RCA BROADCAST PRODS.  
ROME CABLE DIV OF ALCOA  
SAXTON PRODUCTS  
SINGER PRODUCTS CO.  
SPENCER-KENNEDY LABORATORIES  
SUPERIOR CABLE CORPORATION  
TELEQUIP CORPORATION  
TENSOLITE INSULATED WIRE CO.  
TIMES WIRE AND CABLE  
VISUAL ELECTRONICS CORP

**CABLE, COAXIAL, RIGID**

ALPHA WIRE  
AMPHENOL DISTRIBUTOR DIVISION  
ANDREW CORPORATION  
ANTENNA PRODUCTS COMPANY  
ITT WIRE & CABLE DIVISION  
JAMPRO ANTENNA COMPANY  
JERROLD ELECTRONICS CORP  
PHELPS DODGE  
PRODELIN, INCORPORATED  
RCA BROADCAST PRODS.  
SAXTON PRODUCTS  
SINGER PRODUCTS CO.  
SUPERIOR CABLE CORPORATION  
TECHNICAL APPLIANCE CORP  
TELEQUIP CORPORATION  
TIMES WIRE AND CABLE  
VISUAL ELECTRONICS CORP

**CABLE, DIRECT-BURIAL**

ALPHA WIRE  
AMFCO, INC.  
AMPHENOL DISTRIBUTOR DIVISION  
ANACONDA ASTRODATA CO  
ANDREW CORPORATION  
BELDEN MANUFACTURING CO  
BIRNBACH CO  
ITT WIRE & CABLE DIVISION  
JERROLD ELECTRONICS CORP  
PHELPS DODGE  
ROME CABLE DIV OF ALCOA  
SAXTON PRODUCTS  
SUPERIOR CABLE CORPORATION  
TELEQUIP CORPORATION  
TIMES WIRE AND CABLE

**CABLE, SHIELDED, AUDIO**

ALLIED ELECTRONICS CORP  
ALPHA WIRE  
AMPHENOL DISTRIBUTOR DIVISION  
BELDEN MANUFACTURING CO  
BIRNBACH CO  
BOSTON INSULATED WIRE & CABLE  
G E ELECTRONICS COMPANY  
G E VISUAL COMMUNICATIONS PROD  
GOTHAM AUDIO CORPORATION  
LENZ ELECTRIC MANUFACTURING CO  
RCA BROADCAST PRODS.  
ROHNS INDUSTRIES CORP.  
ROME CABLE DIV OF ALCOA  
SAXTON PRODUCTS  
SINGER PRODUCTS CO.  
SUPERIOR CABLE CORPORATION  
TELEQUIP CORPORATION  
TENSOLITE INSULATED WIRE CO.

**CABLE, TELEPHONE**

ALPHA WIRE  
AMFCO, INC.  
ANSONIA WIRE AND CABLE CO  
BELDEN MANUFACTURING CO  
BIRNBACH CO  
FISHER BERKELEY CORPORATION  
ITT WIRE & CABLE DIVISION  
LENZ ELECTRIC MANUFACTURING CO  
ROME CABLE DIV OF ALCOA  
SAXTON PRODUCTS  
SUPERIOR CABLE CORPORATION

**CALIBRATION SERVICE, FREQUENCY**

**EDISON ELECTRONIC COMPANY**  
ELECTRONICS ESSENTIALS OF CCC  
F & M SYSTEMS COMPANY  
HERB FITZGERALD COMMUNICATIONS  
AND ELECTRONICS  
HEWLETT-PACKARD CO.  
RADIO AIDS  
S. STERLING COMPANY

**CALIBRATION SERVICE, INSTRUMENT**

DATA INSTRUMENT DIVISION  
EDISON ELECTRONIC COMPANY  
ELECTRONICS ESSENTIALS OF CCC  
THE JAMES FLOYD FORD CO  
HEWLETT-PACKARD CO.  
INSTRUMENT LABORATORIES CORP  
S. STERLING COMPANY

**CALORIMETERS**

BIRD ELECTRONIC CORPORATION  
THE ENGLISH ELECTRIC CORP.  
MARCONI INSTRUMENTS  
NARDA MICROWAVE CORPORATION  
RCA BROADCAST PRODS.

**CAMERA, MOUNTING EQUIPMENT**

AMFCO, INC.  
F J DAUGHMAN CO  
BERKEY TECHNICAL CORP  
BIRNS & SAWYER  
RURKE & JAMES

COMU ELECTRONICS  
COLORTRON INDUSTRIES - BERKEY  
HOUSTON FEARLESS CORPORATION  
MOTOROLA COMMUNICATIONS  
POWER-OPTICS INCORPORATED  
RCA BROADCAST PRODS.  
SYLVANIA-COMM. ELECTRONICS DIV  
TELEQUIP CORPORATION  
TELEVISION UTILITIES CORP  
TRAID CORPORATION  
UP-RIGHT SCAFFOLDS  
VISUAL ELECTRONICS CORP

**CAMERA, REMOTE**

CONTROL EQUIPMENT  
AMFCO, INC.  
AMPLIVISION CORPORATION  
COMU ELECTRONICS  
DELTA ELECTRONICS, INC.  
MOTOROLA COMMUNICATIONS  
POWER-OPTICS INCORPORATED  
SYLVANIA-COMM. ELECTRONICS DIV  
TELEQUIP CORPORATION  
TELEVISION UTILITIES CORP  
VISUAL ELECTRONICS CORP

**CAMERAS, FILM, CINE**

AMFCO, INC.  
ARRIFLEX CORP OF AMERICA  
BECKMAN & WHITLEY  
BIRNS & SAWYER  
BLONDER-TONGUE LABORATORIES  
RURKE & JAMES  
EASTMAN KODAK COMPANY  
D. B. MILLIKEN COMPANY  
MINNESOTA MINING - 3 M  
NORTH AMERICAN PHILIPS CO  
PRECISION LABORATORIES  
RCA BROADCAST PRODS.  
TELEVISION UTILITIES CORP  
TRAID CORPORATION  
VISUAL ELECTRONICS CORP

**CAMERAS, FILM, STILL**

BIRNS & SAWYER  
BLONDER-TONGUE LABORATORIES  
RURKE & JAMES  
EASTMAN KODAK COMPANY  
MINNESOTA MINING - 3 M  
NORTH AMERICAN PHILIPS CO  
PRECISION LABORATORIES

**CAMERAS, OSCILLOSCOPE**

AMFCO, INC.  
BENLUS  
HEWLETT-PACKARD CO.  
D. B. MILLIKEN COMPANY  
THE SINGER CO - METRICS DIV  
TEKTRONIX INC  
TRAID CORPORATION

**CAMERAS, TV, COLOR**

AMFCO, INC.  
AMPEX CORPORATION  
AMPLIVISION CORPORATION  
ASCO SONOCRAFT CORP  
BLONDER-TONGUE LABORATORIES  
COMU ELECTRONICS  
G E VISUAL COMMUNICATIONS PROD  
MARCONI DIVISION  
NORTH AMERICAN PHILIPS CO  
RCA BROADCAST PRODS.  
SARKES-TARZIAN  
VISUAL ELECTRONICS CORP

**CAMERAS, TV, MONOCHROME**

AMFCO, INC.  
AMPEX CORPORATION  
AMPLIVISION CORPORATION  
BLONDER-TONGUE LABORATORIES  
COMU ELECTRONICS  
COLORADO VIDEO  
DAGE BELL CORPORATION  
DIAMOND ELECTRONICS  
DIECRAFT, INC.  
G E VISUAL COMMUNICATIONS PROD  
MARCONI DIVISION  
MARYLAND TELECOMMUNICATIONS  
MOTOROLA COMMUNICATIONS  
NORTH AMERICAN PHILIPS CO  
RCA BROADCAST PRODS.  
SARKES-TARZIAN  
SONY CORPORATION OF AMERICA  
SYLVANIA-COMM. ELECTRONICS DIV  
TELEMATON, INC.  
TELEVISION UTILITIES CORP  
THOMSON ELECTRIC CO  
VISUAL ELECTRONICS CORP

**CAPACITORS, FIXED, GENERAL**

BUD RADIO, INC  
AERVOX CORP.  
AMERICAN ELITE  
CENTRALAB  
CORNELL-DUBILIER ELECTRONICS  
G E CAPACITOR DEPARTMENT  
JENNINGS RADIO MANUFACTURING  
MALLORY DISTRIBUTOR PRODUCTS  
MINNESOTA MINING - 3 M  
SINGER PRODUCTS CO.  
TRW ELECTRONICS

**CAPACITORS, FIXED, CERAMIC**

AERVOX CORP.  
AMERICAN ELITE  
CENTRALAB  
CORNELL-DUBILIER ELECTRONICS  
G E CAPACITOR DEPARTMENT  
JENNINGS RADIO MANUFACTURING  
MALLORY DISTRIBUTOR PRODUCTS  
MINNESOTA MINING - 3 M  
SINGER PRODUCTS CO.  
TRW ELECTRONICS

**CAPACITORS, FIXED, ELECTROLYTIC**

AERVOX CORP.  
AMERICAN ELITE  
AMPEREX ELECTRONIC CORP  
CORNELL-DUBILIER ELECTRONICS  
GENERAL ELECTRIC CO  
MALLORY DISTRIBUTOR PRODUCTS

DHMITTE MANUFACTURING COMPANY  
SINGER PRODUCTS CO.

**CAPACITORS, FIXED, FILM**

AERVOX CORP.  
AMERICAN ELITE  
AMPEREX ELECTRONIC CORP  
CORNELL-DUBILIER ELECTRONICS  
DEARBORN ELECTRONICS INC  
GENERAL ELECTRIC CO  
MALLORY DISTRIBUTOR PRODUCTS  
THE NOVA COMPANY  
SINGER PRODUCTS CO.  
TEXAS INSTRUMENTS  
TRW ELECTRONICS

**CAPACITORS, FIXED, METALLIZED**

AERVOX CORP.  
ALTEC LANSING  
CENTRALAB  
CORNELL-DUBILIER ELECTRONICS  
DEARBORN ELECTRONICS INC  
THE NOVA COMPANY  
TRW ELECTRONICS

**CAPACITORS, FIXED, MICA**

AERVOX CORP.  
ALTEC LANSING  
CORNELL-DUBILIER ELECTRONICS  
G E CAPACITOR DEPARTMENT  
GENERAL RADIO CO  
MINNESOTA MINING - 3 M  
SINGER PRODUCTS CO.

**CAPACITORS, FIXED, OIL-FILLED**

AERVOX CORP.  
ALTEC LANSING  
DEARBORN ELECTRONICS INC  
ENGINEERING ASSOCIATES  
G E CAPACITOR DEPARTMENT  
GENERAL ELECTRIC CO  
SINGER PRODUCTS CO.

**CAPACITORS, FIXED, PAPER**

AERVOX CORP.  
ALTEC LANSING  
CORNELL-DUBILIER ELECTRONICS  
DEARBORN ELECTRONICS INC  
GENERAL ELECTRIC CO  
SINGER PRODUCTS CO.

**CAPACITORS, FIXED, OTHER**

AERVOX CORP.  
ALTEC LANSING  
AMPEREX ELECTRONIC CORP  
COOK ELECTRIC COMPANY  
CORNELL-DUBILIER ELECTRONICS  
DEARBORN ELECTRONICS INC  
G E CAPACITOR DEPARTMENT  
GENERAL ELECTRIC CO  
JENNINGS RADIO MANUFACTURING  
MALLORY DISTRIBUTOR PRODUCTS

**CAPACITORS, VARIABLE**

ALTEC LANSING  
AMERICAN ELITE  
BUD RADIO, INC  
CARDWELL CONDENSER CORP  
CENTRALAB  
GENERAL RADIO CO  
JENNINGS RADIO MANUFACTURING  
E F JOHNSON COMPANY  
ROANWELL CORPORATION  
SARKES-TARZIAN  
SINGER PRODUCTS CO.  
SOLITRON DEVICES  
TRW ELECTRONICS

**CARRIER CURRENT EQUIPMENT**

BAUER ELECTRONICS CORPORATION  
LOW POWER  
ORBIT RADIO

**CARTRIDGES, MAGNETIC TAPE**

AMERLINE CORPORATION  
AUDIO DEVICES  
BROADCAST ELECTRONICS, INC  
CINE SONIC SOUND  
DISPLAY TECHNOLOGIES INC  
GATES RADIO COMPANY  
INTERNATIONAL GOOD MUSIC  
JOA CARTRIDGE SERVICE  
KRS INSTRUMENTS DIVISION  
MACARTA INC.  
MACKENZIE LABORATORIES  
MAGNETIC MEDIA CORPORATION  
MARATHON PRODUCTS CORP.  
MILES REPRODUCER CO  
MINNESOTA MINING - 3 M  
RCA BROADCAST PRODS.  
REVEES SOUNDCAST  
SHURE BROTHERS, INC.  
SINGER PRODUCTS CO.  
SPARTA ELECTRONIC CORPORATION  
TAPECASTER ELECTRONICS  
VIKING OF MINNEAPOLIS  
VISUAL ELECTRONICS CORP

**CARTRIDGES, PHONO**

THE ASTATIC CORPORATION  
BENJAMIN ELECTRONIC SOUND CORP  
ELECTRO-VOICE INC  
EUPHONICS MARKETING  
FAIRCHILD RECORDING EQUIPMENT  
G E DISTRIBUTOR SALES FORCE  
GOTHAM AUDIO CORPORATION  
GRADD LABORATORIES, INC  
RCA BROADCAST PRODS.  
SHURE BROTHERS, INC.  
SINGER PRODUCTS CO.  
SONY CORPORATION OF AMERICA  
SPARTA ELECTRONIC CORPORATION

CARTRIDGES, TAPE,  
~~RECORDING TAPE~~  
AMPEX CORPORATION  
CINE SONIC SOUND  
MARATHON PRODUCTS CORP.  
ORBIT RADIO

**CASES, PORTABLE**

**ELECTRONIC EQUIPMENT**  
ENCLOSURE CORP  
HEWLETT-PACKARD CO.

**CATV EQUIPMENT & COMPONENTS -**

**ALSO SEE OTHER CATEGORIES**  
AMFCO, INC.  
AMERICAN CABLE ELECTRONICS  
AMERICAN ELECTRONIC LABS  
AMPLIVISION CORPORATION  
ANACONDA ASTRODATA CO  
BALL BROTHERS RESEARCH  
BENCO TELEVISION ASSOCIATES  
BLONDER-TONGUE LABORATORIES  
C-COR ELECTRONICS  
COMU ELECTRONICS  
ELECTROLINE TV EQUIPMENT INC.  
ENTRON INC  
JERROLD ELECTRONICS CORP  
KAISER-COX  
PRUZAN COMPANY  
SIGMA INDUSTRIES  
SPENCER-KENNEDY LABORATORIES  
TAPE-ATHON CORPORATION  
TELEMATON, INC.  
TELEQUIP CORPORATION  
TELEVISION UTILITIES CORP  
TRW ELECTRONICS  
UTILITY TOWER CO.

**CATV, CABLE TERMINALS**

AMFCO, INC.  
AMERICAN PAMCOR, INC  
ANACONDA ASTRODATA CO  
BENCO TELEVISION ASSOCIATES  
ENTRON INC  
JERROLD ELECTRONICS CORP  
KAISER-COX  
SIGMA INDUSTRIES  
SUPERIOR CABLE CORPORATION  
TELEMET COMPANY  
TELEQUIP CORPORATION  
UTILITY PRODUCTS CO.

**CATV, CHANNEL AMPLIFIERS**

AMFCO, INC.  
AMERICAN ELECTRONIC LABS  
AMPLIVISION CORPORATION  
ANACONDA ASTRODATA CO  
KEITH ANDERSON CO  
BENCO TELEVISION ASSOCIATES  
BLONDER-TONGUE LABORATORIES  
C-COR ELECTRONICS  
ENTRON INC  
JERROLD ELECTRONICS CORP  
KAISER-COX  
SPENCER-KENNEDY LABORATORIES  
TELESIS CORPORATION

**CATV, HEAD-END EQUIPMENT**

AMFCO, INC.  
AMERICAN ELECTRONIC LABS  
AMPLIVISION CORPORATION  
ANACONDA ASTRODATA CO  
KEITH ANDERSON CO  
BENCO TELEVISION ASSOCIATES  
BLONDER-TONGUE LABORATORIES  
C-COR ELECTRONICS  
DYNAIR ELECTRONICS, INC.  
ENTRON INC  
INTERNATIONAL GOOD MUSIC  
JERROLD ELECTRONICS CORP  
KAISER-COX  
ROHN MANUFACTURING CO.  
SPENCER-KENNEDY LABORATORIES  
TELEMET COMPANY  
TELESIS CORPORATION  
TELEVISION UTILITIES CORP

**CATV, ORIENTATION EQUIPMENT**

AMFCO, INC.  
AMERICAN CABLE ELECTRONICS  
AMERICAN ELECTRONIC LABS  
AMPEX CORPORATION  
AMPLIVISION CORPORATION  
BLONDER-TONGUE LABORATORIES  
CATEL COMPANY  
CENTRAL DYNAMICS CORPORATION  
COMU ELECTRONICS  
JERROLD ELECTRONICS CORP  
KAISER-COX  
TELEMATON, INC.  
TELEQUIP CORPORATION  
TELESIS CORPORATION  
TELEVISION UTILITIES CORP

**CAVITIES, MICROWAVE**

AMPEREX ELECTRONIC CORP  
DEMORNAY - RONARDI DIVISION  
MICROLAR / FXR  
MICRO-LINK SYSTEMS/VARIAN ASSO  
MICROWAVE ASSOCIATES, INC.  
NARDA MICROWAVE CORPORATION  
RCA ELECTRONIC COMPONENTS

**CHARGERS, BATTERY**

AMPHENOL DISTRIBUTOR DIVISION  
BIRNS & SAWYER  
COLORTRON INDUSTRIES - BERKEY  
G E ELECTRONICS COMPANY  
GENERAL ELECTRIC CO  
IMPEX ELECTRONICS CORP  
ONAN DIVISION  
SINGER PRODUCTS CO

**CHASSIS - SEE HARDWARE**

**CHOKES, WAVEGUIDE**

DEMORNAY - BONARDI DIVISION  
MICRO-LINK SYSTEMS/VARIAN ASSO  
MICROWAVE ASSOCIATES, INC.  
NARDA MICROWAVE CORPORATION  
PAINTON INCORPORATED

**CHOPPERS**

OAK MANUFACTURING CO  
TOWNSEND ASSOCIATES

**CIRCUIT BREAKERS**

CCA ELECTRONICS CORPORATION  
G C ELECTRONICS COMPANY  
G E INDUSTRIAL SALES OPERATION  
GENERAL ELECTRIC CO  
HOUSTON ELECTRONICS CO.  
LITTLELUSE, INC.  
MALLORY DISTRIBUTOR PRODUCTS

**CIRCUITS, PRINTED**

AMECO, INC.  
SINGER PRODUCTS CO.  
SOLITRON DEVICES  
TOWNSEND ASSOCIATES  
TREPAC CORPORATION OF AMERICA  
VITRO ELECTRONICS

**CLAMPS, CABLE**

AMECO, INC.  
ANDREW CORPORATION  
BIRNBACH CO  
DIAMOND EXPANSION BOLT CO INC  
G C ELECTRONICS COMPANY  
SUPERIOR CABLE CORPORATION  
THE THOMAS & BETTS CO  
WECKERSSER COMPANY, INC.

**CLAMPS, COMPONENT**

ELECTROVERT, INCORPORATED  
TELEMET COMPANY  
THE THOMAS & BETTS CO

**CLAMPS, GROUND**

AMECO, INC.  
THE THOMAS & BETTS CO

**CLAMPS, TUBE**

THE THOMAS & BETTS CO

**CLEANERS, CHEMICAL -**

ALSO SEE SOLVENTS  
BROADCAST ELECTRONICS, INC  
G C ELECTRONICS COMPANY  
J W GIBSON CO, INC

**CLEANERS, LENS**

DUOTONE COMPANY INC  
THE TEXWIPE COMPANY

**CLEANERS, OTHER -**

ALSO SEE SOLVENTS  
DUOTONE COMPANY INC  
G C ELECTRONICS COMPANY  
NEUMADE PRODUCTS CORPORATION  
THE TEXWIPE COMPANY

**CLIPS, TEST**

BIRNBACH CO  
ELECTRONICS ESSENTIALS OF CCC  
G C ELECTRONICS COMPANY  
HEWLETT-PACKARD CO.  
INDUSTRIAL DEVICES, INC.

**CLOCKS & CHRONOGRAPHS**

CCA ELECTRONICS CORPORATION  
CENTRAL DYNAMICS CORPORATION  
CHRONO-LOG CORPORATION  
G E SUPPLY COMPANY  
GENERAL RADIO CO  
GIBBS MFG. AND RESEARCH CORP.  
RCA BROADCAST PRODS.  
RIKER VIDEO INDUSTRIES  
TEXAS ELECTRONICS

**COILS - ALSO SEE INDUCTANCES**

**COILS, ANTENNA LOADING**

BARKER & WILLIAMSON  
CCA ELECTRONICS CORPORATION  
COLLINS RADIO COMPANY  
DELTA ELECTRONICS INC  
GATES RADIO COMPANY  
MULTRONICS  
PRODELIN, INCORPORATED  
RCA BROADCAST PRODS.  
TRW ELECTRONICS

**COILS, CHOKE, AF**

ADC PRODUCTS  
ALTEC LANSING  
PERMOFLUX CORPORATION  
TRW ELECTRONICS  
UNITED TRANSFORMER COMPANY

**COILS, CHOKE, RF**

ALTEC LANSING  
BARKER & WILLIAMSON  
CALBEST ELECTRONICS  
CCA ELECTRONICS CORPORATION  
O & B ELECTRONICS COMPANY  
GATES RADIO COMPANY  
E F JOHNSON COMPANY  
TRW ELECTRONICS

**COILS, DEFLECTION AND FOCUSING**

AMERICAN ELITE  
CLEVELAND ELECTRONICS  
DEFLECTION COMPONENTS OIV  
CONRAC  
LAKE ELECTRONICS, INC.  
SINGER PRODUCTS CO.  
TELEQUIP CORPORATION  
TRW ELECTRONICS

**COILS, DEGAUSSING**

G C ELECTRONICS COMPANY

**COILS, HYBRID**

ADC PRODUCTS  
ALTEC LANSING  
RCA BROADCAST PRODS.  
UNITED TRANSFORMER COMPANY

**COILS, TELEPHONE**

ADC PRODUCTS  
ALTEC LANSING  
RCA BROADCAST PRODS.  
SINGER PRODUCTS CO.  
UNITED TRANSFORMER COMPANY

**COMMUNICATIONS SYSTEMS, CB**

ALTEC LANSING  
AMPENCL DISTRIBUTOR DIVISION  
BROWNING LABORATORIES, INC.  
COURIER COMMUNICATIONS  
F & M SYSTEMS COMPANY  
HEATH CO  
F F JOHNSON COMPANY  
MILES REPRODUCER CO  
MOSELEY ASSOCIATES INC.  
THE NOVA COMPANY  
PRODELIN, INCORPORATED  
RCA ELECTRONIC COMPONENTS  
SINGER PRODUCTS CO.  
UTICA CORPORATION

**COMMUNICATIONS SYSTEMS,**

**INTERCOM, WIRED**  
ALTEC LANSING  
AMERICAN ELITE  
AMERICAN GELOSO ELECTRONICS  
ASCO SONOCRAFT CORP  
ATLAS SOUND  
CALBEST ELECTRONICS  
CENTRAL DYNAMICS CORPORATION  
DELTA ELECTRONICS, INC.  
F & M SYSTEMS COMPANY  
FISHER BERKELEY CORPORATION  
THE JAMES FLOYD FORD CO  
HEATH CO  
ITT TELECOMMUNICATIONS  
MCMARTIN INDUSTRIES  
MILES REPRODUCER CO  
RCA BROADCAST PRODS.  
SOUTHWESTERN COMMUNICATIONS  
ULTRA AUDIO PRODUCTS  
VISUAL ELECTRONICS CORP  
WARD ELECTRONIC INDUSTRIES

**COMMUNICATIONS SYSTEMS,**

**INTERCOM, WIRELESS**  
ASCO SONOCRAFT CORP  
DELTA ELECTRONICS, INC.  
F & M SYSTEMS COMPANY  
FISHER BERKELEY CORPORATION  
THE JAMES FLOYD FORD CO  
HEATH CO  
E F JOHNSON COMPANY  
MILES REPRODUCER CO  
ROUND HILL ASSOCIATES  
SOUTHWESTERN COMMUNICATIONS  
UTICA CORPORATION

**COMMUNICATIONS SYSTEMS,**

**LAND MOBILE**  
ALTEC LANSING  
AMERICAN ELITE  
AMPEX CORPORATION  
ATLAS SOUND  
CCA ELECTRONICS CORPORATION  
F & M SYSTEMS COMPANY  
THE JAMES FLOYD FORD CO  
J M ELECTRONICS COMPANY  
E F JOHNSON COMPANY  
MARTI ELECTRONICS  
MILES REPRODUCER CO  
MOSELEY ASSOCIATES INC.  
MULTRONICS  
THE NOVA COMPANY  
PRODELIN, INCORPORATED  
RCA BROADCAST PRODS.  
SINGER PRODUCTS CO  
SOUTH SHORE RADIO TELEPHONE  
UTICA CORPORATION

**COMMUNICATIONS SYSTEMS,**

**MICROWAVE**  
ALTEC LANSING  
AMERICAN ELECTRONIC LABS  
AMERICAN ELITE  
AMPLIVISION CORPORATION  
F & M SYSTEMS COMPANY  
ITT TELECOMMUNICATIONS  
JERROLD ELECTRONICS CORP  
LENKURT ELECTRIC CO., INC.  
MARTI ELECTRONICS  
MICROLAB / FXR  
MICRO-LINK SYSTEMS/VARIAN ASS  
MICROWAVE ASSOCIATES, INC.  
MOSELEY ASSOCIATES INC.  
PRODELIN, INCORPORATED  
RCA BROADCAST PRODS.  
RHG ELECTRONICS LABORATORY  
SARKES-TARZIAN  
STAINLESS, INC.

**COMMUNICATIONS SYSTEMS,**

**MULTIPLY**  
AMERICAN ELITE  
BELAR ELECTRONICS LABORATORY  
BROWNING LABORATORIES, INC.  
F & M SYSTEMS COMPANY  
ITT TELECOMMUNICATIONS  
LENKURT ELECTRIC CO., INC.  
MCMARTIN INDUSTRIES  
MOSELEY ASSOCIATES INC.  
RCA BROADCAST PRODS.  
RHG ELECTRONICS LABORATORY  
SINGER PRODUCTS CO.  
TOWNSEND ASSOCIATES

# FULL COLOR FIDELITY WITH **COLORVUE** SOLID-STATE CATV TRUNK-LINE AMPLIFIERS

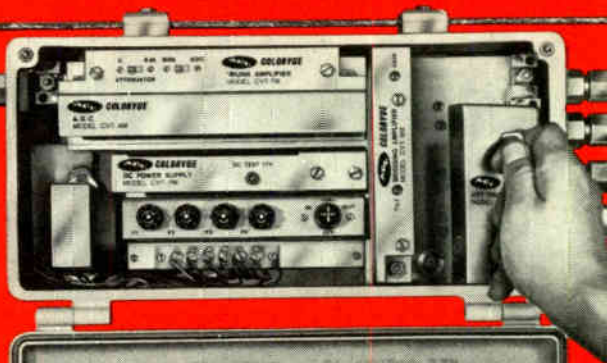

**HIGH OUTPUT • HIGH GAIN  
LOW NOISE • FLAT RESPONSE  
TRUE PLUG-IN MODULARITY**

Looking for high grade color distribution, plus easy field maintenance and low inventory costs?

Then see COLORVUE... the solid-state amplifier with the 48dbmV output and 26db operating gain over all 12 channels, low noise figure and VSWR, ±0.25db response flatness and 50 to 220MHz bandwidth.

And it's truly modular! Just one basic housing and five individual units that plug in—in the field—in seconds, and with 1 to 4 feeder lines.



Basic housing with Trunk Amplifier / DC Power Supply (2 modules).



Basic housing with Trunk Amplifier / AGC / DC Power Supply (3 modules).



Basic housing with Trunk Amplifier/Bridging Amplifier/ Off-Trunk Splitter / DC Power Supply (4 modules).



Basic housing with Trunk Amplifier / AGC / Bridging Amplifier / Off-Trunk Splitter / DC Power Supply (5 modules).

Yes, COLORVUE is great... the result of AEL's exceptional capabilities. Want to know more? Drop us a line or call us at 215/822-2929.



**American Electronic Laboratories, Inc.**

RICHARDSON ROAD, COLMAR, PA.  
215/822-2929 • TWX: 510/661-4974

Correspondence: P.O. Box 552, Lansdale, Pennsylvania 19446

**COMMUNICATIONS SYSTEMS:**

**TELEPRINTER**  
 F & M SYSTEMS COMPANY  
 SINGER PRODUCTS CO  
 TREPAC CORPORATION OF AMERICA

**COMPUTER EQUIPMENT**

**AMPEX CORPORATION**  
 CHRONO-LOG CORPORATION  
 OISPLAY TECHNOLOGIES INC  
 GENERAL ELECTRIC CO  
 HANCOCK TELECONTROL  
 HARVEY RADIO CO. INC.  
 HEALTH CO  
 MINNESOTA MINING - 3 M  
 SARKES-TARZIAN  
 S. STERLING COMPANY

**COMPUTER SERVICES**

ACME VISIBLE RECORDS  
 THE JAMES FLOYD FORD CO  
 S. STERLING COMPANY

**CONNECTORS, AF & MICROPHONE**

AMPHENOL DISTRIBUTOR DIVISION  
 DIALIGHT CORPORATION  
 ELECTRONICS ESSENTIALS OF CCC  
 G C ELECTRONICS COMPANY  
 GENERAL RADIO CO  
 GOTHAM AUDIO CORPORATION  
 ITT CANNON ELECTRIC  
 RCA BROADCAST PRODS.  
 SWITCHCRAFT, INC.  
 TROMPFETER ELECTRONICS

**CONNECTORS, ANTENNA**

AMECO, INC.  
 AMERICAN PAMCOR, INC  
 AMPHENOL DISTRIBUTOR DIVISION  
 AMPLIVISION CORPORATION  
 BLONDER-TONGUE LABORATORIES  
 G C ELECTRONICS COMPANY  
 ITT CANNON ELECTRIC  
 JERROLD ELECTRONICS CORP  
 PHELPS DODGE  
 PRODELIN, INCORPORATED  
 ROMDE & SCHWARZ SALES CO. -USA  
 THE TECHNICAL MATERIEL CORP  
 TROMPFETER ELECTRONICS

**CONNECTORS, COAXIAL CABLE**

**AMECO, INC.**  
 AMERICAN CABLE ELECTRONICS  
 AMERICAN PAMCOR, INC  
 AMPHENOL DISTRIBUTOR DIVISION  
 AMPLIVISION CORPORATION  
 ANACONDA ASTRODATA CO  
 ANOREW CORPORATION  
 BENCO TELEVISION ASSOCIATES  
 BLONDER-TONGUE LABORATORIES  
 COOKE ENGINEERING COMPANY  
 CRAFTSMAN ELECTRONICS PRODUCTS  
 ENGINEERING ASSOCIATES  
 ENTRON INC  
 G C ELECTRONICS COMPANY  
 GENERAL RADIO CO  
 ITT CANNON ELECTRIC  
 JERROLD ELECTRONICS CORP  
 KAISER-COX  
 NARDA MICROWAVE CORPORATION  
 PHELPS DODGE  
 PRODELIN, INCORPORATED  
 RCA BROADCAST PRODS.  
 ROMDE & SCHWARZ SALES CO. -USA  
 SIGMA INDUSTRIES  
 SINGER PRODUCTS CO.  
 SPENCER-KENNEDY LABORATORIES  
 SUPERIOR CABLE CORPORATION  
 THE TECHNICAL MATERIEL CORP  
 TELETRONIX  
 THE THOMAS & BETTS CO  
 TIMES WIRE AND CABLE  
 TROMPFETER ELECTRONICS  
 VISUAL ELECTRONICS CORP  
 VITRO ELECTRONICS

**CONNECTORS, POWER**

AMECO, INC.  
 AMERICAN PAMCOR, INC  
 AMPHENOL DISTRIBUTOR DIVISION  
 AMPLIVISION CORPORATION  
 ANDREW CORPORATION  
 BIRD ELECTRONIC CORPORATION  
 CRAFTSMAN ELECTRONICS PRODUCTS  
 ENGINEERING ASSOCIATES  
 ENTRON INC  
 GENERAL RADIO CO  
 ITT CANNON ELECTRIC  
 JERROLD ELECTRONICS CORP  
 MICROWAVE ASSOCIATES, INC.  
 NARDA MICROWAVE CORPORATION  
 PHELPS DODGE  
 PRODELIN, INCORPORATED  
 ROMDE & SCHWARZ SALES CO. -USA  
 SUPERIOR CABLE CORPORATION  
 SWITCHCRAFT, INC.  
 THE TECHNICAL MATERIEL CORP  
 THE THOMAS & BETTS CO  
 TIMES WIRE AND CABLE  
 TROMPFETER ELECTRONICS  
 VITRO ELECTRONICS

**CONNECTORS, RF**

**AMECO, INC.**  
 AMERICAN PAMCOR, INC  
 AMPHENOL DISTRIBUTOR DIVISION  
 AMPLIVISION CORPORATION  
 ANDREW CORPORATION  
 BIRD ELECTRONIC CORPORATION  
 CRAFTSMAN ELECTRONICS PRODUCTS  
 ENGINEERING ASSOCIATES  
 ENTRON INC  
 GENERAL RADIO CO  
 ITT CANNON ELECTRIC  
 JERROLD ELECTRONICS CORP  
 MICROWAVE ASSOCIATES, INC.  
 NARDA MICROWAVE CORPORATION  
 PHELPS DODGE  
 PRODELIN, INCORPORATED  
 ROMDE & SCHWARZ SALES CO. -USA  
 SUPERIOR CABLE CORPORATION  
 SWITCHCRAFT, INC.  
 THE TECHNICAL MATERIEL CORP  
 THE THOMAS & BETTS CO  
 TIMES WIRE AND CABLE  
 TROMPFETER ELECTRONICS  
 VITRO ELECTRONICS

**CONSOLE, AUDIO, AM**

ALMA ENGINEERING INC  
 AMPEX CORPORATION  
 BAUER ELECTRONICS CORPORATION  
 CCA ELECTRONICS CORPORATION

COLLINS RADIO COMPANY  
 CROWN INTERNATIONAL  
 FAIRCHILD RECORDING EQUIPMENT  
 G E VISUAL COMMUNICATIONS PROD  
 GOTHAM AUDIO CORPORATION  
 HOUSTON ELECTRONICS CO.  
 IMPEX ELECTRONICS CORP  
 MIO AMERICA ELECTRONICS CORP  
 RCA BROADCAST PRODS.  
 SINGER PRODUCTS CO  
 SPARTA ELECTRONIC CORPORATION  
 STEPHENS ELECTRONICS  
 TELETRONIX  
 UNITED RADIO SUPPLY, INC  
 VISUAL ELECTRONICS CORP  
 WILKINSON ELECTRONICS, INC

**CONSOLE, AUDIO, FM**

ALMA ENGINEERING INC  
 ALTEC LANSING  
 AMPEX CORPORATION  
 ANCHA ELECTRONICS  
 BAUER ELECTRONICS CORPORATION  
 CCA ELECTRONICS CORPORATION  
 COLLINS RADIO COMPANY  
 FAIRCHILD RECORDING EQUIPMENT  
 GATES RADIO COMPANY  
 GOTHAM AUDIO CORPORATION  
 HARVEY RADIO CO. INC.  
 HOUSTON ELECTRONICS CO.  
 IMPEX ELECTRONICS CORP  
 LITTLE JOE ENTERPRISES  
 MID AMERICA ELECTRONICS CORP  
 ORBIT RADIO  
 RCA BROADCAST PRODS.  
 SINGER PRODUCTS CO  
 SOUTHWESTERN COMMUNICATIONS  
 SPARTA ELECTRONIC CORPORATION  
 STANDARD ELECTRONICS CORP.  
 STEPHENS ELECTRONICS  
 TELETRONIX  
 ULTRA AUDIO PRODUCTS  
 VISUAL ELECTRONICS CORP  
 WARD ELECTRONIC INDUSTRIES  
 WILKINSON ELECTRONICS, INC

**CONSOLE, AUDIO, PORTABLE**

ALMA ENGINEERING INC  
 ALTEC LANSING  
 AMPEX CORPORATION  
 BAUER ELECTRONICS CORPORATION  
 CCA ELECTRONICS CORPORATION  
 DATA INSTRUMENT DIVISION  
 DELTA ELECTRONICS, INC.  
 GATES RADIO COMPANY  
 G E VISUAL COMMUNICATIONS PROD  
 GOTHAM AUDIO CORPORATION  
 HARVEY RADIO CO. INC.  
 HOUSTON ELECTRONICS CO.  
 IMPEX ELECTRONICS CORP  
 LANG ELECTRONICS, INC  
 LITTLE JOE ENTERPRISES  
 MIO AMERICA ELECTRONICS CORP  
 NORTH AMERICAN PHILIPS CO  
 ORBIT RADIO  
 RCA BROADCAST PRODS.  
 SINGER PRODUCTS CO  
 SOUTHWESTERN COMMUNICATIONS  
 SPARTA ELECTRONIC CORPORATION  
 STEPHENS ELECTRONICS  
 STEPHENS ELECTRONICS  
 TELETRONIX  
 ULTRA AUDIO PRODUCTS  
 VISUAL ELECTRONICS CORP  
 WARD ELECTRONIC INDUSTRIES

**CONSOLE, AUDIO, RECORDING**

ALMA ENGINEERING INC  
 ALTEC LANSING  
 AMERICAN ELITE  
 AMPEX CORPORATION  
 ANCHA ELECTRONICS  
 ASCO SONOCRAFT CORP  
 BAUER ELECTRONICS CORPORATION  
 CCA ELECTRONICS CORPORATION  
 DATA INSTRUMENT DIVISION  
 FAIRCHILD RECORDING EQUIPMENT  
 GATES RADIO COMPANY  
 G E VISUAL COMMUNICATIONS PROD  
 GOTHAM AUDIO CORPORATION  
 HARVEY RADIO CO. INC.  
 HOUSTON ELECTRONICS CO.  
 IMPEX ELECTRONICS CORP  
 LANG ELECTRONICS, INC  
 LITTLE JOE ENTERPRISES  
 MID AMERICA ELECTRONICS CORP  
 NORTH AMERICAN PHILIPS CO  
 ORBIT RADIO  
 RCA BROADCAST PRODS.  
 SINGER PRODUCTS CO  
 SOUTHWESTERN COMMUNICATIONS  
 SPARTA ELECTRONIC CORPORATION  
 STEPHENS ELECTRONICS  
 TELETRONIX  
 ULTRA AUDIO PRODUCTS  
 UNITED RADIO SUPPLY, INC  
 VISUAL ELECTRONICS CORP  
 WARD ELECTRONIC INDUSTRIES  
 WILKINSON ELECTRONICS, INC

**CONSOLE, AUDIO, TV**

ALMA ENGINEERING INC  
 ALTEC LANSING  
 AMPEX CORPORATION  
 ANCHA ELECTRONICS  
 BAUER ELECTRONICS CORPORATION  
 BLONDER-TONGUE LABORATORIES  
 CCA ELECTRONICS CORPORATION  
 CENTRAL DYNAMICS CORPORATION  
 COLLINS RADIO COMPANY  
 DATA INSTRUMENT DIVISION  
 FAIRCHILD RECORDING EQUIPMENT  
 GATES RADIO COMPANY  
 G E VISUAL COMMUNICATIONS PROD

GOTHAM AUDIO CORPORATION  
 HOUSTON ELECTRONICS CO.  
 INTERNATIONAL NUCLEAR CORP.  
 LAKE ELECTRONICS, INC.  
 LITTLE JOE ENTERPRISES  
 MARYLAND TELECOMMUNICATIONS  
 MID AMERICA ELECTRONICS CORP  
 ORBIT RADIO  
 RCA BROADCAST PRODS.  
 SARKES-TARZIAN  
 SINGER PRODUCTS CO.  
 SOUTHWESTERN COMMUNICATIONS  
 SPARTA ELECTRONIC CORPORATION  
 STANDARD ELECTRONICS CORP  
 STEPHENS ELECTRONICS  
 S. STERLING COMPANY  
 SYLVANIA-COMM. ELECTRONICS DIV  
 TELETRONIX  
 ULTRA AUDIO PRODUCTS  
 VISUAL ELECTRONICS CORP  
 WARD ELECTRONIC INDUSTRIES  
 WILKINSON ELECTRONICS, INC

**CONSOLE, CAPINETS AND HARDWARE**

ALTEC LANSING  
 ASCO SONOCRAFT CORP  
 BAUER ELECTRONICS CORPORATION  
 BUD RADIO, INC  
 DATA INSTRUMENT DIVISION  
 ENCLOSURE CORP  
 GATES RADIO COMPANY  
 GRINNAN FIXTURE COMPANY  
 LANG ELECTRONICS, INC  
 LITTLE JOE ENTERPRISES  
 RCA BROADCAST PRODS.  
 SINGER PRODUCTS CO.  
 SPARTA ELECTRONIC CORPORATION  
 TELEQUIP CORPORATION  
 TELEVISION UTILITIES CORP  
 VENT-RAK INCORPORATED

**CONSOLE, KITS**

AMPEX CORPORATION  
 BAUER ELECTRONICS CORPORATION  
 DATA INSTRUMENT DIVISION  
 FAIRCHILD RECORDING EQUIPMENT  
 GOTHAM AUDIO CORPORATION  
 TELEQUIP CORPORATION  
 TELEVISION UTILITIES CORP

**CONSOLE, VIDEO, PORTABLE**

ALMA ENGINEERING INC  
 AMPEX CORPORATION  
 AMPLIVISION CORPORATION  
 CENTRAL DYNAMICS CORPORATION  
 DATA INSTRUMENT DIVISION  
 RIKFR VIDEO INDUSTRIES  
 SARKES-TARZIAN  
 SONY CORPORATION OF AMERICA  
 S. STERLING COMPANY  
 SYLVANIA-COMM. ELECTRONICS DIV  
 TELEQUIP CORPORATION  
 TELEVISION UTILITIES CORP  
 WARD ELECTRONIC INDUSTRIES

**CONSOLE, VIDEO, STUDIO**

ALMA ENGINEERING INC  
 AMPEX CORPORATION  
 AMPLIVISION CORPORATION  
 CENTRAL DYNAMICS CORPORATION  
 DATA INSTRUMENT DIVISION  
 MARYLAND TELECOMMUNICATIONS  
 MID AMERICA ELECTRONICS CORP  
 RCA BROADCAST PRODS.  
 RIKFR VIDEO INDUSTRIES  
 SARKES-TARZIAN  
 SONY CORPORATION OF AMERICA  
 STANDARD ELECTRONICS CORP  
 S. STERLING COMPANY  
 SYLVANIA-COMM. ELECTRONICS DIV  
 TELEQUIP CORPORATION  
 TELEVISION UTILITIES CORP  
 VISUAL ELECTRONICS CORP  
 WARD ELECTRONIC INDUSTRIES

**CONVERTERS**

ALTEC LANSING  
 AMECO, INC.  
 AMPLIVISION CORPORATION  
 KEITH ANDERSON CO  
 F W BELL, INC  
 BENCO TELEVISION ASSOCIATES  
 BIRNS & SAWYER  
 BLONDER-TONGUE LABORATORIES  
 GENERAL ELECTRIC CO  
 GIRRS MFG. AND RESEARCH CORP.  
 JERROLD ELECTRONICS CORP  
 KAHN RESEARCH LABORATORIES  
 MICROWAVE ASSOCIATES, INC.  
 MINNESOTA MINING - 3 M  
 THE SINGER CO - METRICS DIV  
 STANDARD KOLLSMAN INDUSTRIES  
 THE TECHNICAL MATERIEL CORP

**COOLING UNITS, TUBE**

EIMAC DIVISION OF VARIAN

**COPYING EQUIPMENT**

MINNESOTA MINING - 3 M

**CORDS, DIAL**

BIRNBACH CO  
 G C ELECTRONICS COMPANY  
 SINGER PRODUCTS CO.  
 UNITED STATES PLASTIC ROPE

**CORDS, LACING**

BIRNBACH CO  
 G C ELECTRONICS COMPANY

**CORDS, PATCH**

ADC PRODUCTS  
 APPLIED ELECTRO-MECHANICS

AUDIO ACCESSORIES  
 BIRNBACH CO  
 CCA ELECTRONICS CORPORATION  
 CENTRAL DYNAMICS CORPORATION  
 COLORTAN INDUSTRIES - BERKEY  
 COOKE ENGINEERING COMPANY  
 D & B ELECTRONICS COMPANY  
 ELECTRONICS ESSENTIALS OF CCC  
 HOLLAND ELECTRONICS INC  
 RCA BROADCAST PRODS.  
 ROBINS INDUSTRIES CORP.  
 SARKES-TARZIAN  
 SINGER PRODUCTS CO.  
 SWITCHCRAFT, INC.  
 THE TECHNICAL MATERIEL CORP  
 TROMPFETER ELECTRONICS  
 VITRO ELECTRONICS

**CORDS, SET**

RELFON MANUFACTURING CO  
 BIRNBACH CO  
 D & B ELECTRONICS COMPANY  
 ITT WIRE & CABLE DIVISION  
 SINGER PRODUCTS CO.  
 WABER ELECTRONICS, INC.

**CORES, TRANSFORMER AND COIL**

SINGER PRODUCTS CO.

**COUNTERS, FREQUENCY**

ENGINEERING ASSOCIATES  
 GENERAL RADIO CO  
 HEWLETT-PACKARD CO.  
 HICKOK ELECTRICAL INSTRUMENT

**COUPLERS**

AMECO, INC.  
 BIRD ELECTRONIC CORPORATION  
 CONTINENTAL ELECTRONICS MFG  
 CRAFTSMAN ELECTRONICS PRODUCTS  
 DEMORNAVY - BONARDI DIVISION  
 G C ELECTRONICS COMPANY  
 E F JOHNSON COMPANY  
 MICROLAR / FXR  
 MICROWAVE ASSOCIATES, INC.  
 MULTIRONICS  
 NARDA MICROWAVE CORPORATION  
 RCA BROADCAST PRODS.  
 ROMDE & SCHWARZ SALES CO. -USA  
 SINGER PRODUCTS CO.  
 STANDARD ELECTRONICS CORP  
 WABER ELECTRONICS, INC.

**CRYSTALS, PIEZOELECTRIC**

ELBSON ELECTRONIC COMPANY  
 ELECTRONIC RESEARCH COMPANY  
 G E DISTRIBUTOR SALES FORCE  
 MINNESOTA MINING - 3 M  
 PIEZO CRYSTAL COMPANY  
 PRECISION PIEZO SERVICE  
 RCA BROADCAST PRODS.  
 TRW ELECTRONICS

**CUTTERS, DISC - SEE LATHES****DECALCOMANIAS**

W H BRADY CO  
 G C ELECTRONICS COMPANY  
 MINNESOTA MINING - 3 M

**DEHUMIDIFIERS**

PALL TRINITY MICRO CORP

**DELAY DEVICES, AF**

AUDIO INSTRUMENT CO  
 BAUER ELECTRONICS CORPORATION  
 S. HIMMELSTEIN AND CO.  
 SINGER PRODUCTS CO.  
 TAPECASTER ELECTRONICS  
 TREPAC CORPORATION OF AMERICA  
 UNITED TRANSFORMER COMPANY

**DELAY LINES**

ANDREW CORPORATION  
 AUDIO INSTRUMENT CO  
 CENTRAL DYNAMICS CORPORATION  
 GENERAL RADIO CO  
 JERROLD ELECTRONICS CORP  
 KAPPA NETWORKS, INC  
 MICROWAVE ASSOCIATES, INC.  
 PHELPS DODGE  
 RCA BROADCAST PRODS.  
 ROMDE & SCHWARZ SALES CO. -USA  
 UNITED TRANSFORMER COMPANY

**DEMAGNETIZERS, BULK TAPE**

DEROVEX CORP.  
 AMPEX CORPORATION  
 AMPLIFIER CORP OF AMERICA  
 BROADCAST ELECTRONICS, INC  
 G C ELECTRONICS COMPANY  
 HEWLETT-PACKARD CO.  
 JOA CARTRIDGE SERVICE  
 RCA BROADCAST PRODS.  
 ROBINS INDUSTRIES CORP.  
 SINGER PRODUCTS CO.  
 THE SOUND SCRIBER CORP.  
 SPARTA ELECTRONIC CORPORATION

**DEMAGNETIZERS, HEAD**

AMPEX CORPORATION  
 AMPLIFIER CORP OF AMERICA  
 AUDIO DEVICES  
 BROADCAST ELECTRONICS, INC  
 G C ELECTRONICS COMPANY  
 JOA CARTRIDGE SERVICE  
 RCA BROADCAST PRODS.  
 ROBINS INDUSTRIES CORP.  
 SPARTA ELECTRONIC CORPORATION

**DEMODULATORS**

AMECO, INC.  
 BELAR ELECTRONICS LABORATORY  
 DYNAIR ELECTRONICS, INC.  
 G E VISUAL COMMUNICATIONS PROD

# RAYTHEON

## THE BEST VALUE IN STUDIO EQUIPMENT

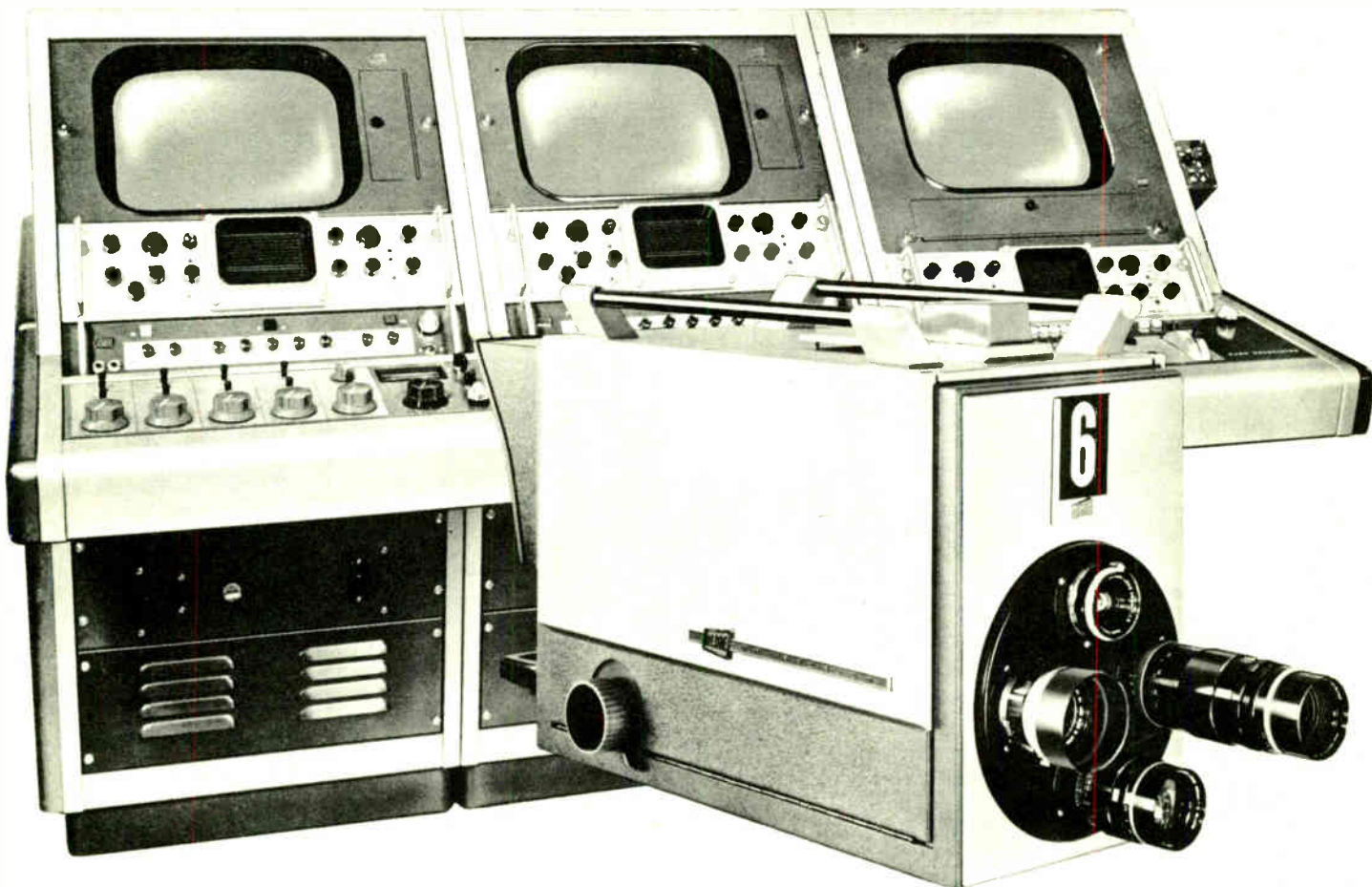

Whatever your requirements—commercial or educational broadcasting, CATV, closed circuit television, or 2500 mHz ITV, Raytheon offers the best value in television studio equipment. Whether you need a single component or a complete studio, Raytheon's years of experience in building television equipment for the broadcast industry, schools and the military, assures you of the ultimate in quality and years of satisfactory service.

Raytheon's experienced television consultants are at your service... why not discuss your needs with one of them today? There's no obligation, of course.

## RAYTHEON TELEVISION SYSTEMS

**RAYTHEON**

DAGE-BELL CORPORATION

A SUBSIDIARY OF RAYTHEON COMPANY

455 Sheridan Avenue, Michigan City, Indiana 46360

JERROLD ELECTRONICS CORP  
RCA BROADCAST PRODS.  
ROHDF & SCHWARZ SALES CO. -USA  
STANDARD ELECTRONICS CORP  
WARD ELECTRONIC INDUSTRIES

**DESICCANTS**  
G C ELECTRONICS COMPANY  
PALL TRINITY MICRO CORP

**DESIGNATION CARDS & STRIPS**  
ACME VISIBLE RECORDS

**DETECTORS, MICROWAVE**  
DEMORNAY - BONARDI DIVISION  
GENERAL ELECTRIC CO  
HEWLETT-PACKARD CO.  
JERROLD ELECTRONICS CORP  
MICROLAB / FXR  
MICRO-LINK SYSTEMS/VARIAN ASSO  
MICROWAVE ASSOCIATES, INC.  
NARDA MICROWAVE CORPORATION  
ROHDE & SCHWARZ SALES CO. -USA  
SYLVANIA-SEMICONDUCTOR DIV.

**DETECTORS, STANDING WAVE**  
BIRD ELECTRONIC CORPORATION  
BLONDER-TONGUE LABORATORIES  
DEMORNAY - BONARDI DIVISION  
GENERAL RADIO CO  
HEWLETT-PACKARD CO.  
MICROLAB / FXR  
MICRO-LINK SYSTEMS/VARIAN ASSO  
NARDA MICROWAVE CORPORATION  
ROHDE & SCHWARZ SALES CO. -USA

**DIAL POINTERS - SEE HARDWARE**

**DIALS, INSTRUMENT**  
AMPHENOL DISTRIBUTOR DIVISION  
G C ELECTRONICS COMPANY  
GENERAL RADIO CO  
MALLORY DISTRIBUTOR PRODUCTS  
TEXAS ELECTRONICS

**DIALS, TELEPHONE**  
ITT TELECOMMUNICATIONS

**DIODES - SEE SEMICONDUCTORS**

**DIPLEXERS**  
ALFORD MANUFACTURING COMPANY  
G E VISUAL COMMUNICATIONS PROD  
JAMPRO ANTENNA COMPANY  
MICROLAB / FXR  
MICROWAVE ASSOCIATES, INC.  
PHELPS ODGE  
PRODELIN, INCORPORATED  
RCA BROADCAST PRODS.  
STANDARD ELECTRONICS CORP  
VISUAL ELECTRONICS CORP  
BLONDER-TONGUE LABORATORIES

**DISPLAY EQUIPMENT, TV**  
BLONDER-TONGUE LABORATORIES  
C B S LABORATORIES  
CENTRAL DYNAMICS CORPORATION  
COMU ELECTRONICS  
COLORADO VIDEO  
CONRAC  
DISPLAY TECHNOLOGIES INC  
GRINMAN FIXTURE COMPANY  
ITI ELECTRONICS, INC.  
MARCONI DIVISION  
MARYLAND TELECOMMUNICATIONS  
MICRO-LINK SYSTEMS/VARIAN ASSO  
MIRATEL ELECTRONICS, INC.  
Q-TV SALES & DISTRIBUTING CORP  
SYLVANIA-COMM. ELECTRONICS DIV  
TELEQUIP CORPORATION  
TELEVISION UTILITIES CORP

**DIVIDERS, FREQUENCY**  
DEMORNAY - BONARDI DIVISION  
GENERAL ELECTRIC CO  
GENERAL RADIO CO  
MICROWAVE ASSOCIATES, INC.  
ROHDE & SCHWARZ SALES CO. -USA  
TV CABLE SUPPLY CO  
VICON CORPORATION

**DIVIDERS, POWER**  
ALFORD MANUFACTURING COMPANY  
CONTINENTAL ELECTRONICS MFG  
DEMORNAY - BONARDI DIVISION  
FMCEE  
GATES RADIO COMPANY  
MICROLAB / FXR  
NARDA MICROWAVE CORPORATION  
PRODELIN, INCORPORATED  
SCIENTIFIC-ATLANTA  
STANDARD ELECTRONICS CORP

**DIVIDERS, VOLTAGE**  
ENGINEERING ASSOCIATES  
GENERAL ELECTRIC CO  
GENERAL RADIO CO  
IRC, INC.  
JENNINGS RADIO MANUFACTURING  
THE SINGER CO - METRICS DIV

**DOLLIES, CAMERA**  
BIRNS & SAWYER  
BLONDER-TONGUE LABORATORIES  
COLORTRON INDUSTRIES - BERKEY  
HOUSTON FEARLESS CORPORATION  
RCA BROADCAST PRODS.  
SYLVANIA-COMM. ELECTRONICS DIV  
TELEQUIP CORPORATION  
TELEVISION UTILITIES CORP  
THOMSON ELECTRIC CO  
VISUAL ELECTRONICS CORP  
WABER ELECTRONICS, INC.

**DOLLIES, TEST EQUIPMENT**  
RCA BROADCAST PRODS.  
THE SINGER CO - METRICS DIV  
TEKTRONIX INC  
TELEQUIP CORPORATION  
WABER ELECTRONICS, INC.

**DRAFTING EQUIPMENT**  
VALUE INCORPORATED

**ORPOUT COMPENSATOR, VIDEO TAPE**  
AMPX CORPORATION  
MINNESOTA MINING - 3 M  
RCA BROADCAST PRODS.  
RIKER VIDEO INDUSTRIES  
VISUAL ELECTRONICS CORP

**OUTS, VENTILATION**  
BURKE & JAMES

**DUCTS, WIRING**  
WABER ELECTRONICS, INC.

**DUMMY LOAD**  
AMERICAN ELECTRONIC LABS  
BARKER & WILLIAMSON  
BIRD ELECTRONIC CORPORATION  
CCA ELECTRONICS CORPORATION  
CONTINENTAL ELECTRONICS MFG  
D & B ELECTRONICS COMPANY  
DFMORNAY - BONARDI DIVISION  
GATES RADIO COMPANY  
JAMPRO ANTENNA COMPANY  
LITTLE JOE ENTERPRISES  
MICROLAB / FXR  
PRODELIN, INCORPORATED  
RCA BROADCAST PRODS.  
ROHDE & SCHWARZ SALES CO. -USA  
STANDARD ELECTRONICS CORP.  
THE TECHNICAL MATERIEL CORP  
WATERS MANUFACTURING

**EARPHONES, HEADPHONES**  
AMPX CORPORATION  
ASCO SONOCRAFT CORP  
THE ASTATIC CORPORATION  
G C ELECTRONICS COMPANY  
GOTHAM AUDIO CORPORATION  
HEATH CO  
JENSEN MANUFACTURING  
KOSS ELECTRONICS, INC.  
NORTH AMERICAN PHILIPS CO  
PERMOLUX CORPORATION  
RCA BROADCAST PRODS.  
ROANWELL CORPORATION  
SINGER PRODUCTS CO

**ECHO DEVICES - SEE AMPLIFIERS  
REGENERATION DEVICES**

**EDITORS, AUDIO TAPE**  
AMPX CORPORATION  
ASCO SONOCRAFT CORP  
BIRNS & SAWYER  
ORBIT RADIO  
ROBINS INDUSTRIES CORP.  
SCULLY RECORDING INSTRUMENTS

**EDITORS, FILM**  
BIRNS & SAWYER  
BURKE & JAMES  
HARWALD COMPANY  
THE KALART COMPANY  
MINNESOTA MINING - 3 M  
NEUMAQUE PRODUCTS CORPORATION  
PRECISION LABORATORIES  
RCA BROADCAST PRODS.

**EDITORS, VIDEO TAPE**  
AMPX CORPORATION  
BIRNS & SAWYER  
GOTHAM AUDIO CORPORATION  
PRECISION LABORATORIES  
RCA BROADCAST PRODS.  
VISUAL ELECTRONICS CORP

**EDUCATION FACILITIES, PUBLISHERS**  
HAYDEN BOOK COMPANY  
JENSEN MANUFACTURING  
NORTH AMERICAN PHILIPS CO  
HOWARD W SAMS & CO INC

**EDUCATION FACILITIES, EQUIPMENT**  
ASCO SONOCRAFT CORP  
AUDIO INSTRUMENT CO  
CENTRAL DYNAMICS CORPORATION  
CROWN INTERNATIONAL  
DELTA ELECTRONICS, INC.  
HARWALD COMPANY  
JENSEN MANUFACTURING  
KRS INSTRUMENTS DIVISION  
NORTH AMERICAN PHILIPS CO  
TELEMATON, INC.

**EDUCATION FACILITIES, SCHOOLS**  
HOWARD W SAMS & CO INC  
GRANTHAM SCHOOLS, INC

**ELECTRIC MOTORS - SEE HARDWARE**

**ENCLOSURES, SPEAKER**  
ALTEC LANSING  
ASCO SONOCRAFT CORP  
ELECTRO-SOUND ACOUSTICS  
ELECTRO-VOICE INC  
HARTLEY PRODUCTS  
NORTH AMERICAN PHILIPS CO  
RCA BROADCAST PRODS.  
TRUSONIC

**ENHANCERS, TV IMAGE**  
C B S LABORATORIES  
COLORADO VIDEO  
DYNASCENCES CORPORATION  
G C ELECTRONICS COMPANY

MARCONI DIVISION  
SARKES-TARZIAN

**EQUALIZERS, AUDIO EMPHASIS**  
ALTEC LANSING  
CCA ELECTRONICS CORPORATION  
G E VISUAL COMMUNICATIONS PROD  
GOTHAM AUDIO CORPORATION  
GRAY RESEARCH & DEVELOPMENT CO  
LANGEVIN  
MELCOR ELECTRONICS  
MILES REPRODUCER CO  
PULSE TECHNIQUES, INC.  
RCA BROADCAST PRODS.  
SOUTHWESTERN COMMUNICATIONS

**ERASERS, MAGNETIC - SEE HEADS  
AND DEMAGNETIZERS**

**EXCITERS, FM**  
AMERICAN ELECTRONIC LABS  
BELAR ELECTRONICS LABORATORY  
CCA ELECTRONICS CORPORATION  
COLLINS RADIO COMPANY  
GATES RADIO COMPANY  
KAHN RESEARCH LABORATORIES  
MARCONI DIVISION  
MARTI ELECTRONICS  
MOSELEY ASSOCIATES INC.  
RCA BROADCAST PRODS.  
RNG ELECTRONICS LABORATORY  
SINGER PRODUCTS CO  
STANDARD ELECTRONICS CORP  
TELETRONIX  
TOWNSEND ASSOCIATES  
VISUAL ELECTRONICS CORP  
WILKINSON ELECTRONICS, INC

**EXPOSURE METER -  
SEE METERS, LIGHT**

**FACSIMILE EQUIPMENT**  
SINGER PRODUCTS CO

**FILM, PHOTOGRAPHIC**  
EASTMAN KODAK COMPANY  
MINNESOTA MINING - 3 M  
NEUMAQUE PRODUCTS CORPORATION

**FILM, PROCESSING SERVICE**  
AWE FILM & VIDEOTAPE LABS  
EASTMAN KODAK COMPANY

**FILTERS, ANTENNA**  
AMCO, INC.  
BENCO TELEVISION ASSOCIATES  
BIRD ELECTRONIC CORPORATION  
BLONDER-TONGUE LABORATORIES  
CCA ELECTRONICS CORPORATION  
GATES RADIO COMPANY  
JAMPRO ANTENNA COMPANY  
JERROLD ELECTRONICS CORP  
PRODELIN, INCORPORATED  
TELETRONIX

**FILTERS, AUDIO**  
AOC PRODUCTS  
AEROVOX CORP.  
ALTEC LANSING  
G E VISUAL COMMUNICATIONS PROD  
GENERAL RADIO CO  
LANGEVIN  
ORBIT RADIO  
RCA BROADCAST PRODS.  
RECORDING EQUIPMENT COMPANY  
ROHDE & SCHWARZ SALES CO. -USA  
STEPHENS ELECTRONICS  
TREPAC CORPORATION OF AMERICA  
TRW ELECTRONICS  
T T ELECTRONICS  
UNITED TRANSFORMER COMPANY

**FILTERS, RF**  
FILTERS, RF  
ADC PRODUCTS  
AEROVOX CORP.  
AMCO, INC.  
AMERICAN ELECTRONIC LABS  
BIRD ELECTRONIC CORPORATION  
BLONDER-TONGUE LABORATORIES  
CCA ELECTRONICS CORPORATION  
CONTINENTAL ELECTRONICS MFG  
CORNELL-OBILIER ELECTRONICS MFG  
DELTA ELECTRONICS INC  
GATES RADIO COMPANY  
G E VISUAL COMMUNICATIONS PROD  
GENERAL RADIO CO  
HOLLAND ELECTRONICS INC  
ITT CANNON ELECTRIC  
JAMPRO ANTENNA COMPANY  
JERROLD ELECTRONICS CORP  
KAPPA NETWORKS, INC  
MICROLAB / FXR  
MICROWAVE ASSOCIATES, INC.  
NARDA MICROWAVE CORPORATION  
PRODELIN, INCORPORATED  
RECORDING EQUIPMENT COMPANY  
ROHDE & SCHWARZ SALES CO. -USA  
STANDARD ELECTRONICS CORP  
TELETRONIX  
T T ELECTRONICS  
FILTERS, OTHER  
ALTEC LANSING  
BURKE & JAMES  
COLORTRON INDUSTRIES - BERKEY  
CORNELL-OBILIER ELECTRONICS  
ELECTRONIC RESEARCH COMPANY  
ENTRON INC  
JAMPRO ANTENNA COMPANY  
PALL TRINITY MICRO CORP  
PIEZO CRYSTAL COMPANY  
RCA BROADCAST PRODS.  
STANDARD ELECTRONICS CORP  
TELEMET COMPANY  
TRW ELECTRONICS

T T ELECTRONICS  
UNITED TRANSFORMER COMPANY  
WATERS MANUFACTURING

**FIXTURES - SEE HARDWARE**

**FLASHERS, TOWER**  
ELECTRONIC LIGHTS, INC.  
GATES RADIO COMPANY  
HOUSTON ELECTRONICS CO.  
HUGHEY & PHILLIPS  
RCA BROADCAST PRODS.  
SWAGER TOWER CORPORATION

**FRAMES, MOUNTING**  
MINNESOTA MINING - 3 M

**FREQUENCY-MEASUREMENT SERVICES  
SEE CALIBRATION SERVICE,  
FREQUENCY**

**FUSES**  
G C ELECTRONICS COMPANY  
GENERAL ELECTRIC CO  
ITT WIRE & CABLE DIVISION  
LITTLELUSE, INC.  
SINGER PRODUCTS CO.

**GAUSSMETER  
F W BELL, INC**

**GENERATORS, FM, STEREO**  
GENERATORS, FM, STEREO  
AMERICAN ELECTRONIC LABS  
BELAR ELECTRONICS LABORATORY  
CATEL COMPANY  
CCA ELECTRONICS CORPORATION  
GATES RADIO COMPANY  
HEATH CO  
HEWLETT-PACKARD CO.  
HICKOK ELECTRICAL INSTRUMENT  
KARG LABORATORIES  
MARCONI INSTRUMENTS  
MOSELEY ASSOCIATES, INC.  
RCA BROADCAST PRODS.  
RCA ELECTRONIC COMPONENTS  
ROHDE & SCHWARZ SALES CO. -USA  
H. H. SCOTT, INCORPORATED  
SINGER PRODUCTS CO  
STANDARD ELECTRONICS CORP  
WILKINSON ELECTRONICS, INC

**GENERATORS, FM, SUBCARRIER**  
AMERICAN ELECTRONIC LABS  
AMPLIVISION CORPORATION  
CCA ELECTRONICS CORPORATION  
GATES RADIO COMPANY  
GIBBS MFG. AND RESEARCH CORP.  
MARTI ELECTRONICS  
MOSELEY ASSOCIATES INC.  
RCA BROADCAST PRODS.  
H. H. SCOTT, INCORPORATED  
SINGER PRODUCTS CO  
TELETRONIX  
WILKINSON ELECTRONICS, INC

**GENERATORS, POWER,  
ELECTRIC MOTOR**  
COLUMBIA ELECTRIC MFG CO  
GENERAL ELECTRIC CO

**GENERATORS, POWER,  
GASOLINE ENGINE**  
ONAN DIVISION

**GENERATORS, POWER,  
WIND & THERMOELECTRIC**  
KEITH ANDERSON CO

**GENERATORS, SIGNAL, AF**  
BARKER & WILLIAMSON  
CCA ELECTRONICS CORPORATION  
DELTA ELECTRONICS, INC.  
ENGINEERING ASSOCIATES  
GENERAL RADIO CO  
GIBBS MFG. AND RESEARCH CORP.  
HEATH CO  
HICKOK ELECTRICAL INSTRUMENT  
INSTRUMENT LABORATORIES CORP  
INTERNATIONAL GOOD MUSIC  
JERROLD ELECTRONICS CORP  
MARCONI INSTRUMENTS  
NORTHEAST ELECTRONICS CORP  
RCA BROADCAST PRODS.  
RCA ELECTRONIC COMPONENTS  
ROHDE & SCHWARZ SALES CO. -USA  
THE SINGER CO - METRICS DIV  
STEPHENS ELECTRONICS  
TREPAC CORPORATION OF AMERICA  
WAVEFORMS, INCORPORATED

**GENERATORS, SIGNAL, COLOR BAR**  
AMPHENOL DISTRIBUTOR DIVISION  
HEATH CO  
HICKOK ELECTRICAL INSTRUMENT  
MARCONI DIVISION  
RCA BROADCAST PRODS.  
RCA ELECTRONIC COMPONENTS  
RIKER VIDEO INDUSTRIES  
TELEMET COMPANY  
TELEQUIP CORPORATION  
VICON CORPORATION  
VISUAL ELECTRONICS CORP

**GENERATORS, SIGNAL, DOT BAR**  
COMU ELECTRONICS  
HEATH CO  
HICKOK ELECTRICAL INSTRUMENT  
LAKE ELECTRONICS, INC.  
MARCONI DIVISION  
RCA BROADCAST PRODS.  
RCA ELECTRONIC COMPONENTS  
RIKER VIDEO INDUSTRIES  
TELEMET COMPANY  
TELEQUIP CORPORATION  
VICON CORPORATION  
VISUAL ELECTRONICS CORP

only  
**3M**  
 gives  
 you  
 true  
 Color ○  
 Dropout ○  
 Restoration ●

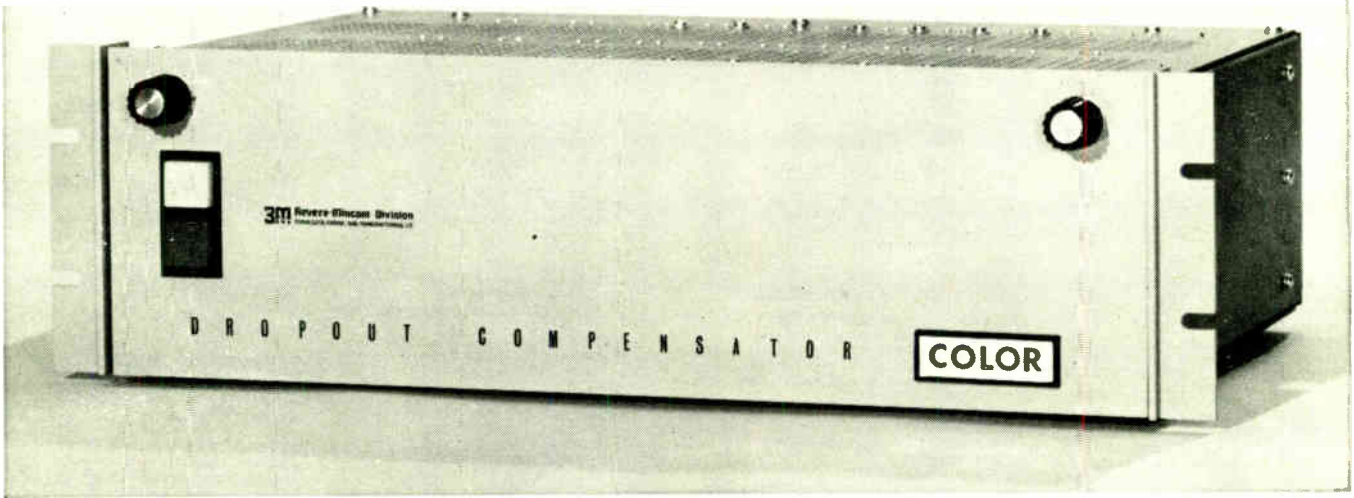

*Revere-Mincom conquers the Color Dropout Problem*

When color VTR is subjected to ordinary dropout compensation techniques, some improvement may result. Often, however, these primitive techniques generate effects more distracting than the dropout itself. Two examples: 1. Switching transients due to FM substitution. 2. Color phase inversion caused by one-line information delay.

Revere-Mincom's Color Dropout Compensator solves the problem of keeping the Danube blue, Hornets green, and signals in the pink. It's compatible with all time correction units, Hi-Band, Low Band, Color and Monochrome.

For more information about color dropouts and Revere-Mincom's Color DOC, write for this booklet:



**Revere-Mincom Division** **3M** COMPANY  
 300 SOUTH LEWIS ROAD • CAMARILLO CALIFORNIA 93010

Please send me a copy of the booklet,  
 "Compensating for Dropouts in Color Television Recording."

Name \_\_\_\_\_ Position: \_\_\_\_\_  
 Company \_\_\_\_\_  
 Address \_\_\_\_\_  
 City \_\_\_\_\_ State \_\_\_\_\_ Zip \_\_\_\_\_

#### GENERATORS, SIGNAL, MARKER

BLONDER-TONGUE LABORATORIES  
GIBBS MFG. AND RESEARCH CORP.  
HICKOK ELECTRICAL INSTRUMENT  
JERROLD ELECTRONICS CORP  
LAKE ELECTRONICS, INC.  
RCA ELECTRONIC COMPONENTS  
TEKTRONIX INC  
VIDEON CORPORATION  
VISUAL ELECTRONICS CORP

#### GENERATORS, SIGNAL, PULSE

DATAPULSE DIVISION  
GIBBS MFG. AND RESEARCH CORP.  
HEWLETT-PACKARD CO.  
HICKOK ELECTRICAL INSTRUMENT  
LAKE ELECTRONICS, INC.  
NARDA MICROWAVE CORPORATION  
RIKER VIDEO INDUSTRIES  
SPENCER-KENNEDY LABORATORIES  
TEKTRONIX INC  
TELEQUIP CORPORATION  
TRAID CORPORATION  
VIDEON CORPORATION  
VISUAL ELECTRONICS CORP

#### GENERATORS, SIGNAL, RF

AMECO, INC.  
AMPHENOL DISTRIBUTOR DIVISION  
BLONDER-TONGUE LABORATORIES  
CCA ELECTRONICS CORPORATION  
ENGINEERING ASSOCIATES  
GENERAL RADIO CO  
GIBBS MFG. AND RESEARCH CORP.  
HEATH CO  
HEWLETT-PACKARD CO.  
HICKOK ELECTRICAL INSTRUMENT  
JERROLD ELECTRONICS CORP  
MARCONI INSTRUMENTS  
MICROWAVE ASSOCIATES, INC.  
NARDA MICROWAVE CORPORATION  
RCA ELECTRONIC COMPONENTS  
ROHDE & SCHWARZ SALES CO., -USA  
THE SINGER CO - METRICS DIV  
THE TECHNICAL MATERIEL CORP  
TELEQUIP CORPORATION  
TELONIC INDUSTRIES  
TRIPLETT ELECTRICAL INSTRUMENT  
WILKINSON ELECTRONICS, INC

#### GENERATORS, SIGNAL, SPECIAL EFFECT

ALMA ENGINEERING INC  
APPLIED ELECTRO-MECHANICS  
BALL BROTHERS RESEARCH  
CENTRAL DYNAMICS CORPORATION  
COLORADO VIDEO  
RCA BROADCAST PRODS.  
RIKER VIDEO INDUSTRIES  
H. H. SCOTT, INCORPORATED  
TELEQUIP CORPORATION  
VIDEON CORPORATION  
VISUAL ELECTRONICS CORP

#### GENERATORS, SIGNAL, SQUARE WAVE

DATAPULSE DIVISION  
ENGINEERING ASSOCIATES  
GENERAL RADIO CO  
GIBBS MFG. AND RESEARCH CORP.  
HEATH CO  
JERROLD ELECTRONICS CORP  
LAKE ELECTRONICS, INC.  
TEKTRONIX INC  
TELEQUIP CORPORATION  
VIDEON CORPORATION  
VISUAL ELECTRONICS CORP  
WAVEFORMS, INCORPORATED  
TELEQUIP CORPORATION

#### GENERATORS, SIGNAL, TV SYNCHRONIZING

BLONDER-TONGUE LABORATORIES  
CENTRAL DYNAMICS CORPORATION  
COMU ELECTRONICS  
COLORADO VIDEO  
DAGE BELL CORPORATION  
G E VISUAL COMMUNICATIONS PROD  
LAKE ELECTRONICS, INC.  
MARCONI DIVISION  
MARYLAND TELECOMMUNICATIONS  
RCA BROADCAST PRODS.  
RIKER VIDEO INDUSTRIES  
SARKES-TARZIAN  
SYLVANIA-COMM. ELECTRONICS DIV  
TELEMAT, INC.  
TELEMET COMPANY  
TELEQUIP CORPORATION  
VIDEON CORPORATION  
VISUAL ELECTRONICS CORP

#### GENERATORS, SIGNAL, VITS

CENTRAL DYNAMICS CORPORATION  
RIKER VIDEO INDUSTRIES  
TELEMET COMPANY  
TELEQUIP CORPORATION  
VIDEON CORPORATION  
VISUAL ELECTRONICS CORP

#### GROMMETS - SEE HARDWARE

#### HARDWARE, CHASSIS

BUD RADIO, INC  
D & B ELECTRONICS COMPANY  
ELECTRONICS ESSENTIALS OF CCC  
G C ELECTRONICS COMPANY  
TELEQUIP CORPORATION  
VENT-RAK INCORPORATED

#### HARDWARE, DIAL POINTERS

G C ELECTRONICS COMPANY  
TELEQUIP CORPORATION

#### HARDWARE, FIXTURES, HOLDING

BUD RADIO, INC  
TELEQUIP CORPORATION

#### HARDWARE, GENERAL

AMECO, INC.  
BIRNBACH CO  
ELECTROVERT, INCORPORATED  
ELECTRONICS ESSENTIALS OF CCC  
G C ELECTRONICS COMPANY  
ROBINS INDUSTRIES CORP.  
SWITCHCRAFT, INC.  
TELEQUIP CORPORATION

#### HARDWARE, GROMMETS

BIRNBACH CO  
ELECTROVERT, INCORPORATED  
ELECTRONICS ESSENTIALS OF CCC  
G C ELECTRONICS COMPANY

#### HARDWARE, LOUVERS, VENTILATING

BUD RADIO, INC

#### HARDWARE, MOUNTS

ADVANCE INDUSTRIES  
BUD RADIO, INC  
ELECTRONICS ESSENTIALS OF CCC  
ROBINS INDUSTRIES CORP.  
TELEQUIP CORPORATION  
H. WILSON CORPORATION

#### HARDWARE, PANEL

BUD RADIO, INC  
COOK ELECTRIC COMPANY  
E F JOHNSON COMPANY  
TELEQUIP CORPORATION  
VITRO ELECTRONICS

#### HARDWARE, RACK

BIRNBACH CO  
BUD RADIO, INC  
COOK ELECTRIC COMPANY  
ELECTRONICS ESSENTIALS OF CCC  
GATES RADIO COMPANY  
G C ELECTRONICS COMPANY  
MCMARTIN INDUSTRIES  
SARKES-TARZIAN  
TELEQUIP CORPORATION  
VITRO ELECTRONICS

#### HARDWARE, RETAINING RINGS

CRAFTSMAN ELECTRONICS PRODUCTS

#### HARDWARE, TOOLS - SEE TOOLS

AMECO, INC.  
ELECTRONICS ESSENTIALS OF CCC  
G C ELECTRONICS COMPANY  
H. K. PORTER, INC.  
SINGER PRODUCTS CO.  
THE THOMAS & BETTS CO  
UPSON BROS.  
XCELITE INCORPORATED

#### HARDWARE, TUBING, METAL

ELECTRONICS ESSENTIALS OF CCC

#### HARDWARE, TUBING, PLASTIC

BIRNBACH CO  
ELECTRONICS ESSENTIALS OF CCC  
G C ELECTRONICS COMPANY  
MINNESOTA MINING - 3 M  
SIGMA INDUSTRIES

#### HEAD-END EQUIPMENT

##### SEE CATV HEAD-END EQUIPMENT

AMECO, INC.  
AMERICAN ELECTRONIC LABS  
AMPLIVISION CORPORATION  
ANACONDA ASTRODATA CO  
BENCO TELEVISION ASSOCIATES  
BLONDER-TONGUE LABORATORIES  
C-COR ELECTRONICS  
DYNAIR ELECTRONICS, INC.  
ENTRON INC  
JERROLD ELECTRONICS CORP  
KAISER-COX  
ROHN MANUFACTURING CO.  
SPENCER-KENNEDY LABORATORIES

#### HEADS, DISC RECORDING

AUDIO DEVICES  
FAIRCHILD RECORDING EQUIPMENT  
GOTHAM AUDIO CORPORATION  
KOSS ELECTRONICS, INC.  
LIPPS, INC.  
SCULLY RECORDING INSTRUMENTS  
SINGER PRODUCTS CO.

#### HEADS, ERASE, MAGNETIC

AMPX CORPORATION  
BROADCAST ELECTRONICS, INC  
FAIRCHILD RECORDING EQUIPMENT  
JOA CARTRIDGE SERVICE  
LIPPS, INC.  
MAGNA-TECH CORPORATION  
NORTRONICS COMPANY, INC  
RCA BROADCAST PRODS.  
ROBINS INDUSTRIES CORP.  
SCULLY RECORDING INSTRUMENTS  
SINGER PRODUCTS CO.  
SONY CORPORATION OF AMERICA  
TELECTRO INDUSTRIES CORP  
MINNEAPOLIS MAGNETICS

#### HEADS, RECORDING, MAGNETIC

AMPX CORPORATION  
BROADCAST ELECTRONICS, INC  
FAIRCHILD RECORDING EQUIPMENT  
JOA CARTRIDGE SERVICE  
LIPPS, INC.  
MAGNA-TECH CORPORATION  
MINNEAPOLIS MAGNETICS  
MINNESOTA MINING - 3 M  
NORTRONICS COMPANY, INC  
PRECISION LABORATORIES  
RCA BROADCAST PRODS.  
ROBINS INDUSTRIES CORP.  
SCULLY RECORDING INSTRUMENTS  
SINGER PRODUCTS CO  
SONY CORPORATION OF AMERICA

SPARTA ELECTRONIC CORPORATION  
TAPECASTER ELECTRONICS  
TELETRON INDUSTRIES CORP

#### HEAT SINKS

BIRNBACH CO  
DELCO RADIO DIV  
EIMAC DIVISION OF VARIAN  
G C ELECTRONICS COMPANY  
INTERNATIONAL RECTIFIER  
SOLITRON DEVICES

#### HEATING ELEMENTS

GENERAL ELECTRIC CO

#### HOLDERS, CRYSTAL

E F JOHNSON COMPANY  
MICROLAB / FXR  
MICROWAVE ASSOCIATES, INC.

#### HOLDERS, FUSE

G C ELECTRONICS COMPANY  
LITTLE FUSE, INC.  
SINGER PRODUCTS CO.

#### HOUSINGS, ANTENNA

BENCO TELEVISION ASSOCIATES  
CCA ELECTRONICS CORPORATION  
GATES RADIO COMPANY

#### IMAGE MOTION

STABILIZATION SYSTEM  
DYNASCENCES CORPORATION

#### INDUCTANCES - ALSO SEE COILS

#### INDUCTANCES, FIXED

ADC PRODUCTS  
CCA ELECTRONICS CORPORATION  
GENERAL RADIO CO  
HEWLETT-PACKARD CO.  
E F JOHNSON COMPANY  
KAPPA NETWORKS, INC  
LAKE ELECTRONICS, INC.  
J. W. MILLER CO.  
MULTRONICS  
UNITED TRANSFORMER COMPANY

#### INDUCTANCES, VARIABLE

CCA ELECTRONICS CORPORATION  
DELTA ELECTRONICS INC  
GENERAL RADIO CO  
E F JOHNSON COMPANY  
KAPPA NETWORKS, INC  
J. W. MILLER CO.  
MULTRONICS  
UNITED TRANSFORMER COMPANY

#### INDUSTRIAL TV - ALSO SEE

##### TV, CLOSED CIRCUIT

AMPX CORPORATION  
ANACONDA ASTRODATA CO  
BALL BROTHERS RESEARCH  
BIDNIC INSTRUMENTS, INC.  
BLONDER-TONGUE LABORATORIES  
CENTRAL DYNAMICS CORPORATION  
COMU ELECTRONICS  
COLORADO VIDEO  
DAGE BELL CORPORATION  
DYNAIR ELECTRONICS, INC.  
GBC AMERICA CORPORATION  
G E VISUAL COMMUNICATIONS PROD  
GENERAL ELECTRIC CO  
ITI ELECTRONICS, INC.  
JERROLD ELECTRONICS CORP  
LAKE ELECTRONICS, INC.  
MARCONI DIVISION  
MARYLAND TELECOMMUNICATIONS  
MIRATEL ELECTRONICS, INC  
POWER-OPTICS INCORPORATED  
RCA BROADCAST PRODS.  
RIKER VIDEO INDUSTRIES  
SETCHELL CARLSON INCORPORATED  
SONY CORPORATION OF AMERICA  
S. STERLING COMPANY  
SYLVANIA-COMM. ELECTRONICS DIV  
TELEMET COMPANY  
TELEQUIP CORPORATION  
TELEVISION UTILITIES CORP

#### INSULATORS, ANTENNA

ANTENNA PRODUCTS COMPANY  
BIRNBACH CO  
CENTRALAB  
G C ELECTRONICS COMPANY  
L F JOHNSON COMPANY  
UNITED STATES PLASTIC ROPE

#### INSULATORS, FEED THROUGH

BIRNBACH CO  
CENTRALAB  
G C ELECTRONICS COMPANY  
E F JOHNSON COMPANY

#### INSULATORS, STAND-OFF

ANTENNA PRODUCTS COMPANY  
BIRNBACH CO  
CENTRALAB  
G C ELECTRONICS COMPANY  
E F JOHNSON COMPANY

#### INSULATORS, OTHER

BIRNBACH CO  
BUCHANAN ELECTRICAL CORP  
CENTRALAB  
G C ELECTRONICS COMPANY  
E F JOHNSON COMPANY  
UTILITY TOWER CO.

#### INTEGRATED CIRCUITS

AEROVOX CORP  
AMERICAN ELITE  
CENTRALAB  
GENERAL ELECTRIC CO  
ITT CANNON ELECTRIC

MICROWAVE ASSOCIATES, INC.  
MOTOROLA SEMICONDUCTOR  
RCA ELECTRONIC COMPONENTS  
TEXAS INSTRUMENTS  
VITRO ELECTRONICS

#### INVERTERS, DC TO AC, CHOPPER

ALTEC LANSING  
GIBBS MFG. AND RESEARCH CORP.

#### INVERTERS, DC TO AC, SOLID STATE

ALTEC LANSING  
ELECTRO PRODUCTS LABORATORIES  
ITI ELECTRONICS, INC.  
POWER SOURCES  
SINGER PRODUCTS CO  
TEXAS ELECTRONICS  
TOPAZ INCORPORATED  
TREPAC CORPORATION OF AMERICA

#### INVERTERS, DC TO AC, VIBRATORS

ALTEC LANSING  
BIRNS & SAWYER  
CORNELL-DUBILIER ELECTRONICS  
SONY CORPORATION OF AMERICA

#### JACK PANEL ASSEMBLIES

ADC PRODUCTS  
AUDIO ACCESSORIES  
CENTRAL DYNAMICS CORPORATION  
COOKE ENGINEERING COMPANY  
D & B ELECTRONICS COMPANY  
ELECTRONICS ESSENTIALS OF CCC  
HOLLAND ELECTRONICS INC  
PHELPS DODGE  
RCA BROADCAST PRODS.  
SARKES-TARZIAN  
SINGER PRODUCTS CO.  
SOUTHWESTERN COMMUNICATIONS  
S. STERLING COMPANY  
SWITCHCRAFT, INC.  
THE TECHNICAL MATERIEL CORP  
TREPAC CORPORATION OF AMERICA  
TROMPETER ELECTRONICS  
VISUAL ELECTRONICS CORP  
VITRO ELECTRONICS

#### JACKS

ADC PRODUCTS  
AUDIO ACCESSORIES  
BIRNBACH CO  
CENTRAL DYNAMICS CORPORATION  
COOKE ENGINEERING COMPANY  
ELECTRONICS ESSENTIALS OF CCC  
G C ELECTRONICS COMPANY  
GENERAL RADIO CO  
E F JOHNSON COMPANY  
MALLORY DISTRIBUTOR PRODUCTS  
PHELPS DODGE  
ROBINS INDUSTRIES CORP.  
SINGER PRODUCTS CO.  
SWITCHCRAFT, INC.  
THE TECHNICAL MATERIEL CORP  
THOMSON ELECTRIC CO  
TROMPETER ELECTRONICS  
VISUAL ELECTRONICS CORP  
VITRO ELECTRONICS

#### JOINTS, ROTARY, COAXIAL

ANDREW CORPORATION  
GENERAL RADIO CO  
MICRO-LINK SYSTEMS/VARIAN ASSO  
SCIENTIFIC-ATLANTA

#### JOINTS, ROTARY, WAVEGUIDE

ANDREW CORPORATION  
DEMORNY - BONARDI DIVISION  
MICRO-LINK SYSTEMS/VARIAN ASSO  
MICROWAVE ASSOCIATES, INC.

#### KITS

AEROVOX CORP.  
ALLIED ELECTRONICS CORP  
HEATH CO  
UPSON BROS.  
WABER ELECTRONICS, INC.

#### KNOBS

BIRNBACH CO  
G C ELECTRONICS COMPANY  
GENERAL RADIO CO  
MALLORY DISTRIBUTOR PRODUCTS  
OHMITE MANUFACTURING COMPANY  
PAINONT INCORPORATED  
SINGER PRODUCTS CO.  
TELEQUIP CORPORATION  
TELETRONIX

#### LAMP ASSEMBLIES

ATLAS SOUND  
D & B ELECTRONICS COMPANY  
DIALIGHT CORPORATION  
ELECTRONICS ESSENTIALS OF CCC  
HARWOOD MFG. CO.  
HUGHEY & PHILLIPS  
INDUSTRIAL DEVICES, INC.  
ROBINS INDUSTRIES CORP.  
VENT-RAK INCORPORATED

#### LAMPS, ARC

ENGINEERING ASSOCIATES  
MOLE-RICHARDSON CO.

#### LAMPS, EXCITER

G E DISTRIBUTOR SALES FORCE

#### LAMPS, GLOW

DIALIGHT CORPORATION  
G E DISTRIBUTOR SALES FORCE  
INDUSTRIAL DEVICES, INC.  
MOLE-RICHARDSON CO.

#### LAMPS, PANEL

ADC PRODUCTS  
AUDIO ACCESSORIES





**FOR PROFESSIONAL REEL-TO-REEL MACHINES**

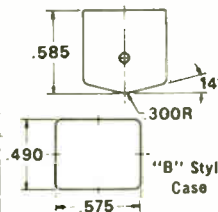
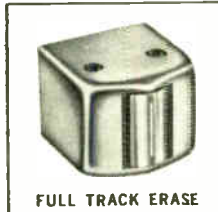
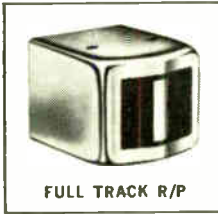

**Head Mounting Brackets for Professional Machines**



**QK-76 with Nortronics Head original Ampex equipment... Net Each \$12.00**

QK-76 contains all hardware and illustrated instructions necessary to adapt a Nortronics head to the shield cup of an Ampex head nest. Includes: precision cast aluminum block; spacers; screws; connector plug—all other parts necessary are utilized from the

**QK-35** is a special base-mount bracket kit for adapting Nortronics no-mount heads for replacement of Brush heads, or in any application requiring a large base-mounting stud. (Stud is 1/4" - 28 x 3/8")... Net Each **\$2.00**

**FOR CARTRIDGE MACHINES**

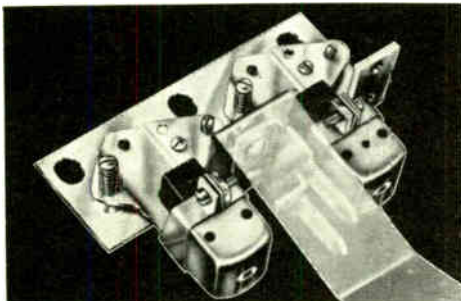

**YOUR LOCAL DISTRIBUTOR STOCKS THE FULL LINE OF NORTRONICS TAPE HEADS AND ACCESSORIES**

**QUICK-KITS** (Head Mounting Assemblies)—Tape Guides—Alignment Tape—Connector Assemblies—Bias Oscillator Transformers—Replacement Heads for over 1500 models... Consult your distributor for full information.

| Manufacturer and Model Numbers   | Original Function                          | Nortronics Head + Quik-Kit           | Net,† Less Quik-Kit |       |
|--|--|--------------------------------------|---------------------|-------|
| <b>AMPEX</b><br>300, 350, 354, 400 Series<br><br>NOTE: On PR-10, 600, 900 and 1200 Series, use QK-66 instead of QK-76. | Record, Full Track                         | 8001 + 76                            | \$36.00             |       |
|  | Play, Full Track                           | 8000 + 76                            | 36.00               |       |
|  | Erase, Full Track (for all but 300 series) | 8109 + 76                            | 30.00               |       |
|  | Erase, Full Track (for 300 series only)    | 8106 + 76                            | 30.00               |       |
|  | Record Mono, 2-Track                       | 8401 + 76                            | 22.00               |       |
|  | Play Mono, 2-Track                         | 8400 + 76                            | 22.00               |       |
|  | Erase Mono, 2-Track                        | 8504 + 76                            | 18.00               |       |
|  | Record Stereo, 2-Track                     | 8201 + 76                            | 32.00               |       |
|  | Play Stereo, 2-Track                       | 8200 + 76                            | 32.00               |       |
|  | Erase Stereo, 2-Track                      | 8304 + 76                            | 26.00               |       |
|  | Record Stereo, 4-Track                     | 8604 + 76                            | 30.00               |       |
|  | Play Stereo, 4-Track                       | 8600 + 76                            | 30.00               |       |
|  | Erase Stereo, 4-Track                      | 8701 + 76                            | 26.00               |       |
|  | 3200                                       | Record, Full Track                   | 8004 + 76           | 40.00 |
|  |  | Play, Full Track                     | 8008 + 76           | 36.00 |
| Record Stereo, 2-Track   |  | 8214 + 76                            | 32.00               |       |
| Play Stereo, 2-Track   |  | 8210 + 76                            | 32.00               |       |
| Record Stereo, 4-Track   |  | 8614 + 76                            | 30.00               |       |
| Play Stereo, 4-Track   |  | 8610 + 76                            | 30.00               |       |
| Record Mono, 2-Track   |  | 8414 + 76                            | 22.00               |       |
| Play Mono, 2-Track   |  | 8402 + 76                            | 22.00               |       |
| <b>CROWN</b><br>701, 801, BX801, 1001, 1401  |  | Play only or Record/Play, Full Track | 8006 + 35           | 36.00 |
|  |  | Record, Full Track                   | 8001 + 35           | 36.00 |
|  | Erase, Full Track                          | 8102 + 35                            | 30.00               |       |
| 712, 822, BX822, 1022, 1422/8  | Play only or Record/Play Stereo, 2-Track   | 8209 + 35                            | 32.00               |       |
| Record Stereo, 2-Track   | 8201 + 35                                  | 32.00                                |                     |       |
| Erase Stereo, 2-Track  | 8304 + 38                                  | 26.00                                |                     |       |
| 702, 802, BX802, 1002, 1402/8  | Play only or Record/Play Mono, 2-Track     | 8403 + 35                            | 22.00               |       |
|  | Record Mono, 2-Track                       | 8404 + 35                            | 22.00               |       |
|  | Erase Mono, 2-Track                        | 8504 + 38                            | 18.00               |       |
| A51, A314  | Play only Mono, 2-Track                    | 8406 + 66                            | 22.00               |       |
| A54, A324  | Play only Stereo, 4-Track                  | 8608 + 66                            | 30.00               |       |
| 714C, 824, BX824, 1024, 1424   | Play only or Record/Play Stereo, 4-Track   | 8608 + 66                            | 30.00               |       |
|  | Record Stereo, 4-Track                     | 8608 + 66                            | 30.00               |       |
|  | Erase Stereo, 4-Track                      | 8701 + 38                            | 26.00               |       |
| <b>MAGNECORD</b><br>1021<br>*No QK required  | Record, Full Track                         | 8005 *                               | 40.00               |       |
|  | Play Mono, 2-Track                         | 8408 *                               | 22.00               |       |
|  | Erase, Full Track                          | 8102 *                               | 30.00               |       |
|  | Play, Full Track (Optional)                | 8006 *                               | 36.00               |       |
| 1022<br>*No QK required  | Record Stereo, 2-Track                     | 8203 *                               | 35.00               |       |
|  | Play Stereo, 2-Track                       | 8202 *                               | 35.00               |       |
|  | Erase Stereo, 2-Track                      | 8302 *                               | 26.00               |       |
| 1024<br>*No QK required  | Record Stereo, 4-Track                     | 8602 *                               | 30.00               |       |
|  | Play Stereo, 4-Track                       | 8607 *                               | 30.00               |       |
|  | Erase Stereo, 4-Track                      | 8702 *                               | 26.00               |       |
| P60, P75, M90<br>*No QK required   | Record, Full Track                         | 8001 + 35                            | 36.00               |       |
|  | Play, Full Track                           | 8000 + 35                            | 36.00               |       |
|  | Erase, Full Track                          | 8105 + 35                            | 30.00               |       |
| <b>R.C.A.</b><br>RT21<br>*No QK required   | Record, Full Track                         | 8002 *                               | 68.00               |       |
|  | Play, Full Track                           | 8003 *                               | 54.00               |       |
|  | Erase, Full Track                          | 8110 *                               | 68.00               |       |
|  | Record Stereo, 2-Track                     | 8206 *                               | 42.00               |       |
|  | Play Stereo, 2-Track                       | 8205 *                               | 54.00               |       |
|  | Erase Stereo, 2-Track                      | 8307 *                               | 48.00               |       |

**NO-MOUNT and REAR-MOUNT HEADS FOR ATC, Collins, Gates, KRS, Macarta, RCA, Sparta, Tapecaster**

FOR REPLACEMENT OR NAB CONVERSION. FULL LISTINGS IN NORTRONICS BULLETIN 7230A. SEND FOR YOUR COPY.

**No-Mount Head Bracket Assembly for Cartridge Machines**

**QK-114** installs two no-mount dual channel heads for monophonic use, or two no-mount three channel heads for stereo operation. Left head is for recording; right head for playback. Requires heads similar to 2000 Series. Completely assembled and semi-aligned... Net Each **\$13.60**

**QK-115** installs two no-mount monophonic 2-track heads (see monitor conversion information below). Requires heads similar to 3000 Series. Completely assembled and semi-aligned... Net Each **\$13.60**

BOTH QK-114 AND QK-115 FURNISHED WITH CARTRIDGE HOLD-DOWN SPRING AND CARTRIDGE GUIDE RAIL.

**NAB CONVERSION TO MONITOR**—As all professional users of tape equipment know, superior results can be achieved by using a special record-only head plus a separate playback head. Professionals also appreciate the ability to be able to monitor a tape as it is being recorded. Nortronics offers a conversion to monitor operation to update cartridge machines.

**NORTRONICS COMPANY, INC.**

8101 Tenth Avenue North • Minneapolis, Minnesota 55427 • Phone: (612) 545-0401

DIALIGHT CORPORATION  
ELECTRONICS ESSENTIALS OF CCC  
G E DISTRIBUTOR SALES FORCE  
INDUSTRIAL DEVICES, INC.  
J. G. MCALISTER  
MOLE-RICHARDSON CO.  
SINGER PRODUCTS CO.

LAMPS, PROJECTION  
G E DISTRIBUTOR SALES FORCE  
MOLE-RICHARDSON CO.  
H. WILSON CORPORATION

LATHE, DISC RECORDING  
FAIRCHILD RECORDING EQUIPMENT  
GOTHAM AUDIO CORPORATION  
KOSSE ELECTRONICS, INC.  
SCULLY RECORDING INSTRUMENTS  
SINGER PRODUCTS CO  
SOUTHWESTERN COMMUNICATIONS

LEADER, FILM  
PRD-TEX REEL BAND COMPANY

LEADS, TEST  
ELECTRONICS ESSENTIALS OF CCC  
E-2-HOOK TEST PRODUCTS  
G C ELECTRONICS COMPANY

LENSES, OPTICAL, FIXED  
ALBION OPTICAL COMPANY  
AMECO, INC.  
AMPEX CORPORATION  
BIRNS & SAWYER  
BURKE & JAMES  
COMU ELECTRONICS  
GRAY RESEARCH & DEVELOPMENT CO  
MINNESOTA MINING - 3 M  
POWER-OPTICS INCORPORATED  
RCA BROADCAST PRODS.  
SYLVANIA-COMM. ELECTRONICS DIV  
TELEQUIP CORPORATION  
TELEVISION UTILITIES CORP  
TRAIT CORPORATION  
VISUAL ELECTRONICS CORP  
ZOOMATICS CORPORATION  
ZOOMAR, INC.

LENSES, OPTICAL, ZOOM  
ALBION OPTICAL COMPANY  
AMECO, INC.  
AMPEX CORPORATION  
BIRNS & SAWYER  
BURKE & JAMES  
COMU ELECTRONICS  
LAKE ELECTRONICS, INC.  
MINNESOTA MINING - 3 M  
POWER-OPTICS INCORPORATED  
RCA BROADCAST PRODS.  
SYLVANIA-COMM. ELECTRONICS DIV  
TELEMATIION, INC.  
TELEQUIP CORPORATION  
TELEVISION UTILITIES CORP  
TELEVISION ZOOMAR  
TRAIT CORPORATION  
VISUAL ELECTRONICS CORP  
ZOOMATICS CORPORATION  
ZOOMAR, INC.

LETTERS AND NUMBERS,  
PRESSURE SENSITIVE  
W H BRADY CO.

LIFTS, AERIAL, TRUCK MOUNTED  
HUNT-PIERCE CORP  
TELSTA CORPORATION

LIGHTING, TV, COMPONENTS  
BIRNS & SAWYER  
BURKE & JAMES  
CENTURY LIGHTING, INC.  
COLORTRAN INDUSTRIES - BERKEY  
HARWOOD MFG. CO.  
LIGHTING & ELECTRONICS, INC.  
J. G. MCALISTER  
METROPOLITAN ELECTRIC MFG CO  
MOLE-RICHARDSON CO.  
PACIFIC TOWER CO  
RCA BROADCAST PRODS.  
TELEQUIP CORPORATION  
TELEVISION UTILITIES CORP  
VISUAL ELECTRONICS CORP

LIGHTING, TV, CONTROLS  
CENTURY LIGHTING, INC.  
COLORTRAN INDUSTRIES - BERKEY  
HOUSTON ELECTRONICS CO.  
LIGHTING & ELECTRONICS, INC.  
METROPOLITAN ELECTRIC MFG CO  
MOLE-RICHARDSON CO.  
RCA BROADCAST PRODS.  
TELEQUIP CORPORATION  
TELEVISION UTILITIES CORP  
VISUAL ELECTRONICS CORP

LIGHTING, TV, SYSTEMS  
CENTURY LIGHTING, INC.  
COLORTRAN INDUSTRIES - BERKEY  
ELECTRONIC LIGHTS, INC.  
LIGHTING & ELECTRONICS, INC.  
J. G. MCALISTER  
METROPOLITAN ELECTRIC MFG CO  
MOLE-RICHARDSON CO.  
PACIFIC TOWER CO  
RCA BROADCAST PRODS.  
SYLVANIA-COMM. ELECTRONICS DIV  
TELEQUIP CORPORATION  
TELEVISION UTILITIES CORP  
VISUAL ELECTRONICS CORP

LIGHTNING ARRESTERS  
AMECO, INC.  
BIRNBACH CO  
CONTINENTAL ELECTRONICS MFG  
G C ELECTRONICS COMPANY  
GENERAL ELECTRIC CO

MOLE-RICHARDSON CO.  
TELEVISION UTILITIES CORP  
UP-RIGHT SCAFFOLDS

LIGHTS, TOWER, OBSTRUCTION  
ROHN MANUFACTURING CO.

LIMITERS - SEE AMPLIFIERS

LOG BOOKS OR SHEETS  
ACME VISIBLE RECORDS  
ROBINS INDUSTRIES CORP.

LOUVRES, VENTILATING -  
SEE HARDWARE

LUBRICANTS  
G C ELECTRONICS COMPANY

MAINTENANCE SERVICES, AM  
AMERICAN ELECTRONIC LABS  
AMPEX CORPORATION  
ASCO SONOCRAFT CORP  
CCA ELECTRONICS CORPORATION  
DRESSER CRANE HOIST & TOWER  
EITEL ELECTRONICS  
LIBERTY TOWER MFG. CO  
LITTLE JOE ENTERPRISES  
ORBIT RADIO  
RCA SERVICE COMPANY  
SOUTHWESTERN COMMUNICATIONS

MAINTENANCE SERVICES,  
CARTRIDGE TAPE  
JOA CARTRIDGE SERVICE

MAINTENANCE SERVICES, FM  
AMERICAN ELECTRONIC LABS  
AMPEX CORPORATION  
ASCO SONOCRAFT CORP  
CCA ELECTRONICS CORPORATION  
DRESSER CRANE HOIST & TOWER  
EITEL ELECTRONICS  
LIBERTY TOWER MFG. CO  
LITTLE JOE ENTERPRISES  
ORBIT RADIO  
RCA SERVICE COMPANY  
SOUTHWESTERN COMMUNICATIONS  
STANDARO ELECTRONICS CORP.

MAINTENANCE SERVICES, MICROWAVE  
AMECO, INC.  
AMERICAN ELECTRONIC LABS  
EITEL ELECTRONICS  
LIBERTY TOWER MFG. CO  
RCA SERVICE COMPANY

MAINTENANCE SERVICES,  
STEEPLE JACK  
LIBERTY TOWER MFG. CO  
LITTLE JOE ENTERPRISES  
RCA SERVICE COMPANY  
SWAGER TOWER CORPORATION  
TRYLON INCORPORATED  
UTILITY TOWER CO.

MAINTENANCE SERVICES, TV  
AMPEX CORPORATION  
CENTRAL DYNAMICS CORPORATION  
DRESSER CRANE HOIST & TOWER  
EITEL ELECTRONICS  
THE JAMES FLOYD FORD CO  
RCA SERVICE COMPANY  
SARKES-TARZIAN  
STANDARD ELECTRONICS CORP  
TELEVISION UTILITIES CORP  
TOWNSEND ASSOCIATES

METERS, DB AND VU  
ALTEC LANSING  
API INSTRUMENTS CO.  
C B S LABORATORIES  
G E INDUSTRIAL SALES OPERATION  
GOTHAM AUDIO CORPORATION  
MCMARTIN INDUSTRIES  
NORTHEAST ELECTRONICS CORP  
RCA BROADCAST PRODS.  
RDBINS INDUSTRIES CORP.  
TRIPLETT ELECTRICAL INSTRUMENT  
YOKOGAWA ELECTRIC WORKS

METERS, DB AND VU, WIDE RANGE  
ALTEC LANSING  
C B S LABORATORIES  
G E INDUSTRIAL SALES OPERATION  
H. H. SCOTT, INCORPORATED  
YOKOGAWA ELECTRIC WORKS

METERS, FIELD STRENGTH  
AMPHENOL DISTRIBUTOR DIVISION  
ANCONDA ASTRODATA CO  
BENCO TELEVISION ASSOCIATES  
BLONDER-TONGUE LABORATORIES  
ENGINEERING ASSOCIATES  
JERROLD ELECTRONICS CORP  
MCMARTIN INDUSTRIES  
RCA BROADCAST PRODS.  
ROHDE & SCHWARZ SALES CO. -USA  
THE SINGER CO - METRICS DIV  
TV CABLE SUPPLY CO  
VITRO ELECTRONICS  
WILKINSON ELECTRONICS, INC  
YOKOGAWA ELECTRIC WORKS

METERS, FLUTTER & WOW  
ALBION OPTICAL COMPANY  
AMPLIFIER CORP OF AMERICA  
GOTHAM AUDIO CORPORATION  
MCOM, INC

METERS, FREQUENCY  
BELAR ELECTRONICS LABORATORY  
BLONDER-TONGUE LABORATORIES  
ENGINEERING ASSOCIATES  
GENERAL RADIO CO  
HEWLETT-PACKARD CO.

HICKOK ELECTRICAL INSTRUMENT  
LAMPKIN LABORATORIES INC  
MCMARTIN INDUSTRIES  
MICROLAB / FXR  
NARDA MICROWAVE CORPORATION  
RCA BROADCAST PRODS.  
ROHDE & SCHWARZ SALES CO. -USA  
THE SINGER CO - METRICS DIV  
WATERS MANUFACTURING  
WAVEFORMS, INCORPORATED  
YOKOGAWA ELECTRIC WORKS

METERS, FREQUENCY CALIBRATING  
ENGINEERING ASSOCIATES  
GENERAL RADIO CO  
HEWLETT-PACKARD CO.  
MICROLAB / FXR  
NARDA MICROWAVE CORPORATION  
ROHDE & SCHWARZ SALES CO. -USA  
TV CABLE SUPPLY CO

METERS, LIGHT  
BURKE & JAMES  
ELECTRONIC SYSTEM ENGINEERING  
GAMMA SCIENTIFIC, INC.  
G E SUPPLY COMPANY  
YOKOGAWA ELECTRIC WORKS  
ZOOMAR, INC.

METERS, PHASE ANGLE  
ENGINEERING ASSOCIATES  
GENERAL ELECTRIC CO  
HEWLETT-PACKARD CO.  
HICKOK ELECTRICAL INSTRUMENT  
ROHDE & SCHWARZ SALES CO. -USA  
THE SINGER CO - METRICS DIV  
YOKOGAWA ELECTRIC WORKS

METERS, POWER  
BIRD ELECTRONIC CORPORATION  
CCA ELECTRONICS CORPORATION  
ENGINEERING ASSOCIATES  
GENERAL MICROWAVE CORPORATION  
HEWLETT-PACKARD CO.  
MARCONI INSTRUMENTS  
NARDA MICROWAVE CORPORATION  
ROHDE & SCHWARZ SALES CO. -USA  
THE SINGER CO - METRICS DIV  
YOKOGAWA ELECTRIC WORKS

METERS, STANDING WAVE  
BIRD ELECTRONIC CORPORATION  
DELTA ELECTRONICS INC  
DEMORNAY - BONARDI DIVISION  
ENGINEERING ASSOCIATES  
GENERAL MICROWAVE CORPORATION  
HEWLETT-PACKARD CO.  
NARDA MICROWAVE CORPORATION  
ROHDE & SCHWARZ SALES CO. -USA  
STANDARO ELECTRONICS CORP.  
THE TECHNICAL MATERIEL CORP

METERS - SEE SPECIFIC TYPE  
API INSTRUMENTS CO.  
COMU ELECTRONICS  
HEWLETT-PACKARD CO.  
HICKOK ELECTRICAL INSTRUMENT  
LAMPKIN LABORATORIES INC  
MCMARTIN INDUSTRIES  
THE SINGER CO - METRICS DIV

MICROPHONE HARDWARE  
ALTEC LANSING  
AMECO, INC.  
AMERICAN GELDSO ELECTRONICS  
ELECTRONICS ESSENTIALS OF CCC  
G C ELECTRONICS COMPANY  
GOTHAM AUDIO CORPORATION  
NORTH AMERICAN PHILIPS CO  
RCA BROADCAST PRODS.  
RCA ELECTRONIC COMPONENTS  
ROBINS INDUSTRIES CORP.  
SHURE BROTHERS, INC.  
SYLVANIA-COMM. ELECTRONICS DIV  
TRUSONIC  
TURNER MICROPHONE CO  
VISUAL ELECTRONICS CORP

MICROPHONE STANDS & BOOMS  
ALTEC LANSING  
AMERICAN GELSO ELECTRONICS  
THE ASTATIC CORPORATION  
E J BAUGHMAN CO  
CENTURY LIGHTING, INC.  
G C ELECTRONICS COMPANY  
GOTHAM AUDIO CORPORATION  
HOUSTON FEARLESS CORPORATION  
MOLE-RICHARDSON CO.  
NORTH AMERICAN PHILIPS CO  
RCA BROADCAST PRODS.  
RCA ELECTRONIC COMPONENTS  
SHURE BROTHERS, INC.  
SINGER PRODUCTS CO.  
SYLVANIA-COMM. ELECTRONICS DIV  
TELEVISION UTILITIES CORP  
TURNER MICROPHONE CO  
VISUAL ELECTRONICS CORP

MICROPHONES, CONDENSER  
ALTEC LANSING  
AMERICAN ELITE  
GOTHAM AUDIO CORPORATION  
NORTH AMERICAN PHILIPS CO  
RCA ELECTRONIC COMPONENTS  
SINGER PRODUCTS CO.  
SONY CORPORATION OF AMERICA  
SPARTA ELECTRONIC CORPORATION  
SYNCRON CORPORATION  
TRUSONIC  
VEGA ELECTRONICS CORPORATION  
VISUAL ELECTRONICS CORP

MICROPHONES, DYNAMIC  
ALTEC LANSING  
AMERICAN ELITE  
AMERICAN GELSO ELECTRONICS

AMPEX CORPORATION  
THE ASTATIC CORPORATION  
CALIFONE/ROBERTS  
ELECTRO-VOICE INC  
GATES RADIO COMPANY  
G C ELECTRONICS COMPANY  
MCMARTIN INDUSTRIES  
MILES REPRODUCER CO  
NORTH AMERICAN PHILIPS CO  
PERMOFLUX CORPORATION  
RCA BROADCAST PRODS.  
RCA ELECTRONIC COMPONENTS  
ROBINS INDUSTRIES CORP.  
SHURE BROTHERS, INC.  
SINGER PRODUCTS CO.  
SONY CORPORATION OF AMERICA  
SPARTA ELECTRONIC CORPORATION  
SYLVANIA-COMM. ELECTRONICS DIV  
TURNER MICROPHONE CO  
VISUAL ELECTRONICS CORP

MICROPHONES, VELOCITY  
RCA BROADCAST PRODS.  
RCA ELECTRONIC COMPONENTS  
SINGER PRODUCTS CO.  
VISUAL ELECTRONICS CORP

MICROPHONES, WIRELESS  
AMERICAN GELSO ELECTRONICS  
MILES REPRODUCER CO  
SINGER PRODUCTS CO  
SONY CORPORATION OF AMERICA  
SPARTA ELECTRONIC CORPORATION  
TRUSONIC  
VEGA ELECTRONICS CORPORATION  
VISUAL ELECTRONICS CORP

MICROWAVE COMPONENTS  
ALFORD MANUFACTURING COMPANY  
AMECO, INC.  
AMERICAN ELITE  
AMPEX ELECTRONIC CORP  
ANDREW CORPORATION  
BIRD ELECTRONIC CORPORATION  
CARDWELL CONDENSER CORP  
DEMORNAY - BONARDI DIVISION  
EIMAC DIVISION OF VARIAN  
ENGINEERING ASSOCIATES  
ELECTRONICS ESSENTIALS OF CCC  
GENERAL ELECTRIC CO  
GENERAL RADIO CO  
HEWLETT-PACKARD CO.  
JERROLD ELECTRONICS CORP  
LITTON EDUCATIONAL TELE DIV  
MICROLAB / FXR  
MICRO-LINK SYSTEMS/VARIAN ASSO  
MICROWAVE ASSOCIATES, INC.  
MOTOROLA SEMICONDUCTOR  
NARDA MICROWAVE CORPORATION  
PHELPS DODGE  
PRODELIN, INCORPORATED  
RAYTHEON CO EQUIPMENT DIVISION  
RCA BROADCAST PRODS.  
RMG ELECTRONICS LABORATORY  
ROHDE & SCHWARZ SALES CO. -USA  
SCIENTIFIC-ATLANTA  
SOLITRON DEVICES  
SYLVANIA-SEMICONDUCTOR DIV.  
TEXAS INSTRUMENTS

MICROWAVE SYSTEMS, STL  
AMECO, INC.  
COLLINS RADIO COMPANY  
DEMORNAY - BONARDI DIVISION  
F & M SYSTEMS COMPANY  
JERROLD ELECTRONICS CORP  
LENKURT ELECTRIC CO., INC.  
LITTON EDUCATIONAL TELE DIV  
MARTI ELECTRONICS  
MICROLAB / FXR  
MICRO-LINK SYSTEMS/VARIAN ASSO  
MICROWAVE ASSOCIATES, INC.  
MOSELEY ASSOCIATES, INC.  
PRODELIN, INCORPORATED  
RAYTHEON CO EQUIPMENT DIVISION  
RCA BROADCAST PRODS.  
RMG ELECTRONICS LABORATORY  
SARKES-TARZIAN  
SINGER PRODUCTS CO  
TELETRONIX  
VISUAL ELECTRONICS CORP

MICROWAVE SYSTEMS, 2500 MHZ  
AMERICAN ELITE  
DEMORNAY - BONARDI DIVISION  
EMCEE  
F & M SYSTEMS COMPANY  
ITT TELECOMMUNICATIONS  
JERROLD ELECTRONICS CORP  
LITTON EDUCATIONAL TELE DIV  
MICROLAB / FXR  
MICRO-LINK SYSTEMS/VARIAN ASSO  
PRODELIN, INCORPORATED  
RAYTHEON CO EQUIPMENT DIVISION  
RCA BROADCAST PRODS.  
RMG ELECTRONICS LABORATORY

MICROWAVE SYSTEMS, OTHER  
CARDWELL CONDENSER CORP  
EMCEE  
F & M SYSTEMS COMPANY  
JERROLD ELECTRONICS CORP  
MICROLAB / FXR  
MICRO-LINK SYSTEMS/VARIAN ASSO  
MICROWAVE ASSOCIATES, INC.  
NARDA MICROWAVE CORPORATION  
RAYTHEON CO EQUIPMENT DIVISION  
RCA BROADCAST PRODS.  
RMG ELECTRONICS LABORATORY  
MIXERS - ALSO SEE CONSOLES  
AMERICAN GELSO ELECTRONICS  
BAUER ELECTRONICS CORPORATION  
BIRNS & SAWYER  
BLONDER-TONGUE LABORATORIES  
CENTRAL DYNAMICS CORPORATION

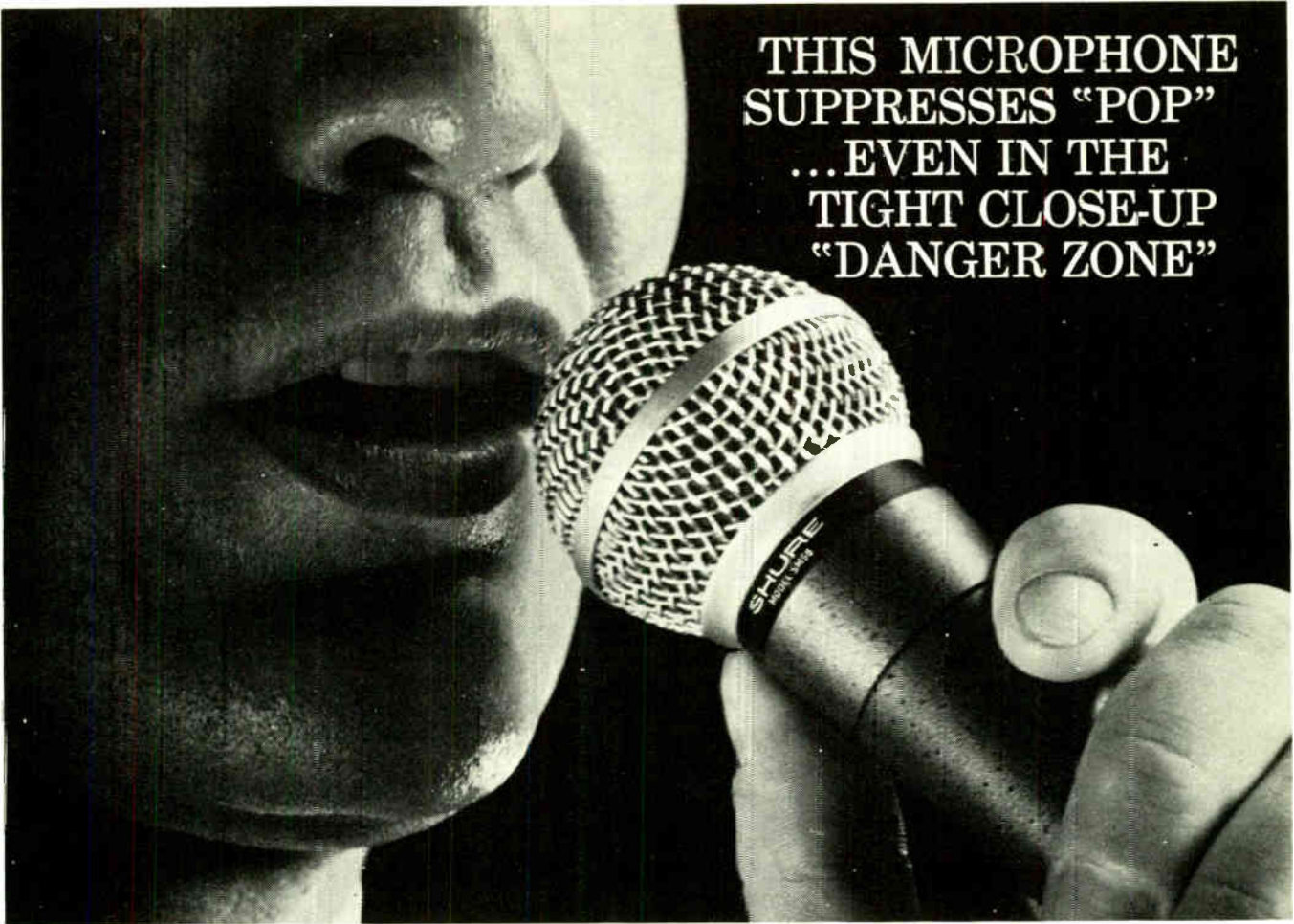

**THIS MICROPHONE  
SUPPRESSES "POP"  
...EVEN IN THE  
TIGHT CLOSE-UP  
"DANGER ZONE"**

The Shure SM58 self-windscreened unidirectional microphone is ideal for broadcast uses such as remote news, sports, interview and vocal recordings because it eliminates or minimizes the irritating "pop" caused by explosive breath sounds. With the SM58 you will have the peace-of-mind assurance that you're delivering the quality audio that goes with pop-free pickup. It's great for studio announcing, too—or wherever the announcer or vocalist has the audio-degrading habit of "mouthing" the microphone. Of course, the same filters that eliminate pop also do away with the necessity for an add-on windscreen in outdoor uses.

On the other hand, the unusually effective unidirectional cardioid pickup pattern (uniform at all frequencies, in all planes) means that it is a real problem-solver where background noise is high or where the microphone must be operated at some distance from the performer. Incidentally,

but very important, the SM58 tends to control the low frequency "boominess" that is usually accented by close-up microphones.

All in all, close up or at a distance, the Shure SM58 solves the kind of ever-present perplexing problems the audio engineer may have felt were necessary evils. The SM58 might well be the finest all-purpose hand-held microphone in manufacture today. And, all things considered, it is moderate in cost.

Other features: the complete pop-proof filter assembly is instantly replaceable in the field, without tools. Filters can be easily cleaned, too. Stand or hand operation. Detachable cable. Rubber-mounted cartridge minimizes handling noise. Special TV-tested non-glare finish.

For additional information, write directly to Mr. Robert Carr, Manager of Professional Products Division, Shure Brothers, Inc., 222 Hartrey Ave., Evanston, Illinois 60204.

## SHURE SM58

SELF-WINDSCREENED UNIDIRECTIONAL DYNAMIC MICROPHONE

OTHER SHURE PROFESSIONAL MICROPHONES... FOR SUPERIOR AUDIO

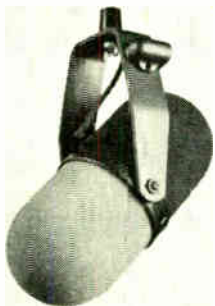

**MODEL SM5  
CARDIOID BOOM DYNAMIC**

Because its cardioid directional pattern is uniquely uniform with frequency and symmetrical about its axis, the SM5 is singularly independent of the effects of environment. Even in extreme shooting situations (such as with tight sets, low ceilings, hard walls, low microphone angles, traffic or air-conditioner noise and rumble and changing distance) the SM5 minimizes sound coloration and ambient noise pickup.



**MODEL SM76  
3/4" OMNIDIRECTIONAL  
DYNAMIC**

Ideal for interviews and audience participation, yet unusually smooth wide range response (40-20 KC) for critical music reproduction. Instantly detachable from stand. Steel case with Cannon connector.



**MODEL SM50  
OMNIDIRECTIONAL  
DYNAMIC**

Self-windscreened and pop-free for news, sports, remotes, and interviews. Also ideal for many studio and control room applications. Comfortably balanced for hand or stand use. Natural response.

FAIRCHILD RECORDING EQUIPMENT  
GOTHAM AUDIO CORPORATION  
HARVEY RADIO CO. INC.  
HOUSTON ELECTRONICS CO.  
LANG ELECTRONICS, INC.  
MICROLAB / FXR  
NORTH AMERICAN PHILIPS CO  
ORBIT RADIO  
RCA BROADCAST PRODS.  
SHURE BROTHERS, INC.  
SINGER PRODUCTS CO  
SOUNDCRAFT INDUSTRIES  
SOUTHWESTERN COMMUNICATIONS  
SPARTA ELECTRONIC CORPORATION

MOBILE EQUIPMENT

AMERICAN ELITE  
AMERICAN GELOSIO ELECTRONICS  
AMPEX CORPORATION  
ANDREW CORPORATION  
ATLAS SOUND  
CENTRAL DYNAMICS CORPORATION  
COURIER COMMUNICATIONS  
F & M SYSTEMS COMPANY  
GATES RADIO COMPANY  
G E COMMUNICATION PRODUCTS  
J M ELECTRONICS COMPANY  
E F JOHNSON COMPANY  
MARTI ELECTRONICS  
MICROWAVE ASSOCIATES, INC.  
MOSELEY ASSOCIATES INC.  
THE NOVA COMPANY  
RCA BROADCAST PRODS.  
SINGER PRODUCTS CO  
SYLVANIA-COMM. ELECTRONICS DIV  
UTICA CORPORATION  
H. WILSON CORPORATION

MOBILE EQUIPMENT, TV

ELECTRONIC MOBILE UNITS  
TELE - DEVICES CO.

MODULATORS, TV

AMECO, INC.  
BLONDER-TONGUE LABORATORIES  
CATEL COMPANY  
DYNATR ELECTRONICS, INC.  
EMCEE  
INTERNATIONAL NUCLEAR CORP.  
JERROLD ELECTRONICS CORP  
MARCONI DIVISION  
ROHDE & SCHWARZ SALES CO. -USA  
STANDARD ELECTRONICS CORP.  
SYLVANIA-COMM. ELECTRONICS DIV  
TELEQUIP CORPORATION  
TOWNSEND ASSOCIATES

MONITORS, AM SYSTEMS

ALTEC LANSING  
BELAR ELECTRONICS LABORATORY  
CCA ELECTRONICS CORPORATION  
COLLINS RADIO COMPANY  
GATES RADIO COMPANY  
G E VISUAL COMMUNICATIONS PROO  
MELCOR ELECTRONICS  
RCA BROADCAST PRODS.  
SINGER PRODUCTS CO  
SOUTHWESTERN COMMUNICATIONS  
TREPAC CORPORATION OF AMERICA  
VISUAL ELECTRONICS CORP  
VITRO ELECTRONICS  
WILKINSON ELECTRONICS, INC

MONITORS, FM SYSTEMS, MONO

ALTEC LANSING  
AMECO, INC.  
BELAR ELECTRONICS LABORATORY  
BROWNING LABORATORIES, INC.  
CCA ELECTRONICS CORPORATION  
COLLINS RADIO COMPANY  
GATES RADIO COMPANY  
HEWLETT-PACKARD CO.  
KARG LABORATORIES  
MCMARTIN INDUSTRIES  
MELCOR ELECTRONICS  
RCA BROADCAST PRODS.  
SINGER PRODUCTS CO.  
SOUTHWESTERN COMMUNICATIONS  
UTICA CORPORATION  
VISUAL ELECTRONICS CORP  
VITRO ELECTRONICS

MONITORS, FM SYSTEMS, SCA

BELAR ELECTRONICS LABORATORY  
CCA ELECTRONICS CORPORATION  
COLLINS RADIO COMPANY  
GATES RADIO COMPANY  
MCMARTIN INDUSTRIES  
RCA BROADCAST PRODS.  
SINGER PRODUCTS CO  
VISUAL ELECTRONICS CORP

MONITORS, FM SYSTEMS, STEREO

AMECO, INC.  
BELAR ELECTRONICS LABORATORY  
CCA ELECTRONICS CORPORATION  
COLLINS RADIO COMPANY  
GATES RADIO COMPANY  
GOTHAM AUDIO CORPORATION  
KARG LABORATORIES  
MCMARTIN INDUSTRIES  
MELCOR ELECTRONICS  
RCA BROADCAST PRODS.  
SINGER PRODUCTS CO.  
VISUAL ELECTRONICS CORP

MONITORS, FREQUENCY

AMECO, INC.  
BELAR ELECTRONICS LABORATORY  
CCA ELECTRONICS CORPORATION  
COLLINS RADIO COMPANY  
GATES RADIO COMPANY  
G E VISUAL COMMUNICATIONS PROO  
HEWLETT-PACKARD CO.  
LAMPKIN LABORATORIES INC  
MCMARTIN INDUSTRIES

MICROLAB / FXR  
RCA BROADCAST PRODS.  
THE SINGER CO - METRICS DIV  
SINGER PRODUCTS CO  
TELETRONIX  
VISUAL ELECTRONICS CORP  
WILKINSON ELECTRONICS, INC

MONITORS, MODULATION

LAMPKIN LABORATORIES INC

MONITORS, PHASE

GATES RADIO COMPANY  
MICROLAB / FXR  
MULTRONICS  
RCA BROADCAST PRODS.  
VISUAL ELECTRONICS CORP  
VITRO ELECTRONICS

MONITORS, POWER

F W BELL, INC  
BIRD ELECTRONIC CORPORATION

MONITORS, VIDEO

AMECO, INC.  
AMPEX CORPORATION  
AMPLIVISION CORPORATION  
BLONDER-TONGUE LABORATORIES  
COMU ELECTRONICS  
CONRAC  
DIAMOND ELECTRONICS  
GBC AMERICA CORPORATION  
G E VISUAL COMMUNICATIONS PROO  
LAKE ELECTRONICS, INC.  
LAVIOLETTE ELECTRONICS  
MARCONI DIVISION  
MARYLAND TELECOMMUNICATIONS  
MIRATEL ELECTRONICS, INC  
RCA BROADCAST PRODS.  
SARKES-TARZIAN  
SETCHELL CARLSON INCORPORATED  
THE SINGER CO - METRICS DIV  
SONY CORPORATION OF AMERICA  
SYLVANIA-COMM. ELECTRONICS DIV  
TELEMET COMPANY  
TELEQUIP CORPORATION  
TELEVISION UTILITIES CORP  
VISUAL ELECTRONICS CORP

MONITORS, WAVEFORM

COLORADO VIDEO  
HEWLETT-PACKARD CO.  
MARCONI DIVISION  
RCA BROADCAST PRODS.  
THE SINGER CO - METRICS DIV  
SONY CORPORATION OF AMERICA  
SYLVANIA-COMM. ELECTRONICS DIV  
TEKTRONIX INC  
VISUAL ELECTRONICS CORP

MOTORS, ELECTRIC - SEE HARDWARE

TOWNSEND ASSOCIATES

MOUNTS, ANTENNA, FIXED

AMECO, INC.  
ANDREW CORPORATION  
GATES RADIO COMPANY  
G C ELECTRONICS COMPANY  
JERROLD ELECTRONICS CORP  
LIBERTY TOWER MFG. CO  
PRODELIN, INCORPORATED  
RAYTHEON CO EQUIPMENT DIVISION  
RCA BROADCAST PRODS.  
ROHN MANUFACTURING CO.  
SCIENTIFIC-ATLANTA  
TECHNICAL APPLIANCE CORP  
TELEQUIP CORPORATION

MOUNTS, ANTENNA, MOBILE

GATES RADIO COMPANY  
G C ELECTRONICS COMPANY  
PRODELIN, INCORPORATED  
RAYTHEON CO EQUIPMENT DIVISION  
RCA BROADCAST PRODS.  
TECHNICAL APPLIANCE CORP  
TELEQUIP CORPORATION  
UTICA CORPORATION  
WATERS MANUFACTURING

MOUNTS, INSTRUMENT

ATLAS SOUND  
BIRNS & SAWYER  
TELEQUIP CORPORATION  
UTICA CORPORATION

MOUNTS, VIBRATION AND SHOCK

ELECTROVERT, INCORPORATED  
MINNESOTA MINING - 3 M

MULTIPLXERS

DAGE BELL CORPORATION  
RCA BROADCAST PRODS.  
SYLVANIA-COMM. ELECTRONICS DIV  
TELEPHATION, INC.  
VIDEON CORPORATION

NAMEPLATES

D & B ELECTRONICS COMPANY  
MINNESOTA MINING - 3 M

NARROW BAND FM EQUIPMENT

AMECO, INC.  
AMPLIVISION CORPORATION  
COURIER COMMUNICATIONS  
MARTI ELECTRONICS  
MOSELEY ASSOCIATES INC.  
SINGER PRODUCTS CO  
STANDARD ELECTRONICS CORP  
TOWNSEND ASSOCIATES  
UTICA CORPORATION

NEEDLES, CUTTING - SEE STYLI

NEEDLES, PLAYBACK - SEE STYLI

NETWORKS, MATCHING, AUDIO

ALTEC LANSING

GATES RADIO COMPANY  
HARTLEY PRODUCTS  
LANGVIN  
SOUTHWESTERN COMMUNICATIONS  
STEPHENS ELECTRONICS

NETWORKS, MATCHING, RF

ALFORD MANUFACTURING COMPANY  
AMECO, INC.  
AMPLIVISION CORPORATION  
CCA ELECTRONICS CORPORATION  
NARDA MICROWAVE CORPORATION  
TELEVIC INDUSTRIES

NETWORKS, PHASING

AMERICAN ELECTRONIC LABS  
AMPLIVISION CORPORATION  
CCA ELECTRONICS CORPORATION  
COLLINS RADIO COMPANY  
GATES RADIO COMPANY  
JERROLD ELECTRONICS CORP  
MULTRONICS  
RCA BROADCAST PRODS.  
SINGER PRODUCTS CO.  
SOUTHWESTERN COMMUNICATIONS  
WARD ELECTRONIC INDUSTRIES

OHMMETERS

COMU ELECTRONICS  
ENGINEERING ASSOCIATES  
GOTHAM AUDIO CORPORATION  
HEATH CO  
HEWLETT-PACKARD CO.  
HICKOK ELECTRICAL INSTRUMENT  
INSTRUMENT LABORATORIES CORP  
RCA ELECTRONIC COMPONENTS  
TRIPLETT ELECTRICAL INSTRUMENT  
YOKOGAWA ELECTRIC WORKS

OSCILLATORS, AF AND RF

ALSO SEE GENERATORS

BENRUS  
CCA ELECTRONICS CORPORATION  
ENGINEERING ASSOCIATES  
GENERAL RADIO CO  
GIBBS MFG. AND RESEARCH CORP.  
HEATH CO  
HEWLETT-PACKARD CO.  
MARCONI INSTRUMENTS  
MICROLAB / FXR  
NARDA MICROWAVE CORPORATION  
RCA BROADCAST PRODS.  
ROHDE & SCHWARZ SALES CO. -USA  
SCIENTIFIC-ATLANTA  
SOUNDCRAFT INDUSTRIES  
TREPAC CORPORATION OF AMERICA  
WAVEFORMS, INCORPORATED

OSCILLATORS, AM

CCA ELECTRONICS CORPORATION  
ELECTRONIC RESEARCH COMPANY  
ENGINEERING ASSOCIATES  
GATES RADIO COMPANY  
GENERAL RADIO CO  
GIBBS MFG. AND RESEARCH CORP.  
HEATH CO  
HICKOK ELECTRICAL INSTRUMENT  
MARCONI INSTRUMENTS  
ROHDE & SCHWARZ SALES CO. -USA  
SOUTHWESTERN COMMUNICATIONS

OSCILLATORS, FM

BELAR ELECTRONICS LABORATORY  
CCA ELECTRONICS CORPORATION  
ELECTRONIC RESEARCH COMPANY  
GATES RADIO COMPANY  
GIBBS MFG. AND RESEARCH CORP.  
HEATH CO  
HICKOK ELECTRICAL INSTRUMENT  
MARCONI INSTRUMENTS  
ROHDE & SCHWARZ SALES CO. -USA  
SOUTHWESTERN COMMUNICATIONS  
STANDARD ELECTRONICS CORP.  
  
OSCILLATORS, TV  
GATES RADIO COMPANY  
GIBBS MFG. AND RESEARCH CORP.  
HEATH CO  
HICKOK ELECTRICAL INSTRUMENT  
RIVER VIDEO INDUSTRIES  
ROHDE & SCHWARZ SALES CO. -USA  
STANDARD ELECTRONICS CORP  
TELEMET COMPANY  
VIDEON CORPORATION

OSCILLATORS, OTHER

ETIMAC DIVISION OF VARIAN  
ELECTRONIC RESEARCH COMPANY  
ENGINEERING ASSOCIATES  
GIBBS MFG. AND RESEARCH CORP.  
MARCONI INSTRUMENTS  
NARDA MICROWAVE CORPORATION  
ROHDE & SCHWARZ SALES CO. -USA  
TELEVIC INDUSTRIES  
WAVEFORMS, INCORPORATED

OSCILLOSCOPES

ALLIED ELECTRONICS CORP  
BENRUS  
COLORADO VIDEO  
DATA INSTRUMENT DIVISION  
ENGINEERING ASSOCIATES  
HEATH CO  
HEWLETT-PACKARD CO.  
HICKOK ELECTRICAL INSTRUMENT  
ITI ELECTRONICS, INC.  
RCA BROADCAST PRODS.  
RCA ELECTRONIC COMPONENTS  
TEKTRONIX INC  
TELEQUIP CORPORATION

OVENS, CRYSTAL

ELECTRONIC RESEARCH COMPANY  
SINGER PRODUCTS CO.  
TRW ELECTRONICS

PANELS - SEE HARDWARE

PANELS, INSTRUMENT

FOR RACK MOUNTING -

ALSO SEE HARDWARE

BUD RADIO, INC  
COLORTAN INDUSTRIES - BERKEY  
GENERAL ELECTRIC CO  
SOUTHWESTERN COMMUNICATIONS  
TELEQUIP CORPORATION  
VENT-RAK INCORPORATED  
YOKOGAWA ELECTRIC WORKS

PAPER, CHART AND GRAPH

ENGINEERING ASSOCIATES  
MINNESOTA MINING - 3 M  
SCIENTIFIC-ATLANTA

PHASING UNITS - SEE

NETWORKS, PHASING

PHONOGRAPH TURNTABLES -

SEE TURNTABLES

PICKUP, MUSICAL INSTRUMENTS

CUSTOM CRAFT DESIGNS

PLOWS, CABLE LAYING

F. B. RYAN MFG. COMPANY, INC.

PLUGS, COAXIAL

ADC PRODUCTS  
AMECO, INC.  
AMERICAN PAMCOR, INC  
AMPHENOL DISTRIBUTOR DIVISION  
ENGINEERING ASSOCIATES  
ELECTRONICS ESSENTIALS OF CCC  
GENERAL RADIO CO  
JAMPRO ANTENNA COMPANY  
PHELPS DODGE  
RCA BROADCAST PRODS.  
ROBINS INDUSTRIES CORP.  
SINGER PRODUCTS CO.  
THE TECHNICAL MATERIEL CORP  
TROMPETER ELECTRONICS

PLUGS, PHONE

ADC PRODUCTS  
AMPHENOL DISTRIBUTOR DIVISION  
AUDIO ACCESSORIES  
BIRNBACH CO  
ELECTRONICS ESSENTIALS OF CCC  
G C ELECTRONICS COMPANY  
HALLORY DISTRIBUTOR PRODUCTS  
RCA BROADCAST PRODS.  
ROBINS INDUSTRIES CORP.  
SINGER PRODUCTS CO.  
SWITCHCRAFT, INC.

POLE CLIMBING EQUIPMENT

AMECO, INC.  
PRUZAN COMPANY

POTENTIOMETERS, CARBON

AMERICAN ELITE  
AMPHENOL DISTRIBUTOR DIVISION  
CENTRALAB  
GOTHAM AUDIO CORPORATION  
IRC, INC.  
OHMITE MANUFACTURING COMPANY  
SINGER PRODUCTS CO.

POTENTIOMETERS, WIREWOUND

ALTEC LANSING  
AMPHENOL DISTRIBUTOR DIVISION  
CENTRALAB  
ENGINEERING ASSOCIATES  
GENERAL RADIO CO  
IRC, INC.  
OHMITE MANUFACTURING COMPANY  
PAINTON INCORPORATED  
SINGER PRODUCTS CO.  
WATERS MANUFACTURING

POWER SUPPLIES, AC

ADC PRODUCTS  
ALTEC LANSING  
AMECO, INC.  
ANACONDA ASTRODATA CO  
BIRNS & SAWYER  
BLONDER-TONGUE LABORATORIES  
COMU ELECTRONICS  
CORNELL-DOBILIER ELECTRONICS  
D & B ELECTRONICS COMPANY  
ENGINEERING ASSOCIATES  
FAIRCHILD RECORDING EQUIPMENT  
GATES RADIO COMPANY  
GENERAL ELECTRIC CO  
GENERAL RADIO CO  
GIBBS MFG. AND RESEARCH CORP.  
GREGORY AMPLIFIER CORP  
HEATH CO  
JERROLD ELECTRONICS CORP  
POWER SOURCES  
THE SINGER CO - METRICS DIV  
SOLA ELECTRIC  
SORENSEN OPERATION-RAYTHEON CO  
STACO, INC.  
STANDARD ELECTRONICS CORP  
TELEQUIP CORPORATION  
TREPAC CORPORATION OF AMERICA

POWER SUPPLIES, DC

ADC PRODUCTS  
ALMA ENGINEERING INC  
ALTEC LANSING  
AMECO, INC.  
BIRNS & SAWYER  
BLONDER-TONGUE LABORATORIES  
CENTURY PROJECTOR CORPORATION  
COMU ELECTRONICS  
CORNELL-DOBILIER ELECTRONICS  
DELTA ELECTRONICS, INC.  
ELECTRO PRODUCTS LABORATORIES  
ENGINEERING ASSOCIATES

# Tektronix Television Instruments

## Type 526 Vectorscope for Chroma-Signal Displays

- color encoder adjustments
- differential phase measurements
- differential gain measurements
- vertical-interval-test-signal (VITS) displays
- video tape-recorder setup



Measuring amplitude changes and phase shifts can be done accurately, conveniently, and independently with the Vectorscope. The Vectorscope presents relative phase and amplitude displays (of chrominance information in the N.T.S.C. color signal). Dual-trace capability permits simultaneous display of two color signals for precise matching of phase and amplitude. In addition to the vector display, the Vectorscope can present the chroma signal demodulated along any phase-angle with respect to time.

Type 526 Vectorscope . . . . . \$1665  
Size is 8 3/4" high, 19" wide, and 18" deep. Weight is ~ 45 pounds. Designed for rack mounting.

## Type 529/RM529 for Waveform Monitoring

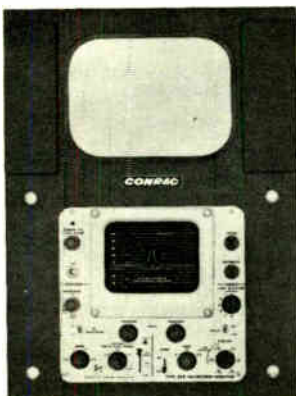
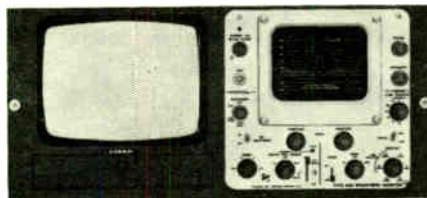
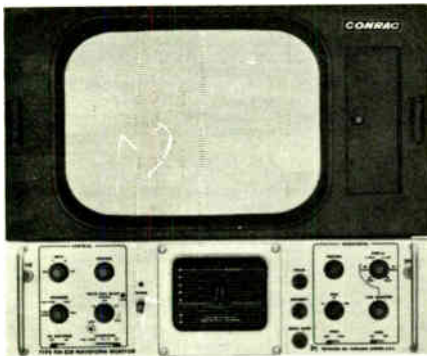

- vertical-interval-test-signal (VITS) displays
- sine-squared pulse and bar testing
- transmitter modulation monitoring
- YRBG or RBG displays (with color-processing amplifiers)
- video signal-level monitoring
- bandwidth measurements
- differential-gain measurements

In waveform-monitoring applications, the Type 529 and RM529 offer 2 LINE and 2 FIELD displays plus calibrated sweep rates of 0.25 H/cm, 0.125 H/cm, 0.025 H/cm with X5 Magnifier, and 0.005 H/cm with X25 Magnifier. They provide 4 response characteristics necessary to monitor VITS—FLAT to 8 MHz (which assures excellent waveform fidelity for sine-squared testing with 2T, T, and 1/2T pulses), HIGH PASS 3.58 MHz, center frequency, LOW PASS—18 dB at 500 kHz, and IEEE 1958 STD 23-S-1. Other characteristics include a backporch type DC restorer, a positive-going field selector, and a full-field line-selector including digital VIT line selection.

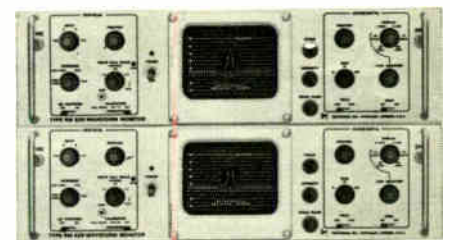
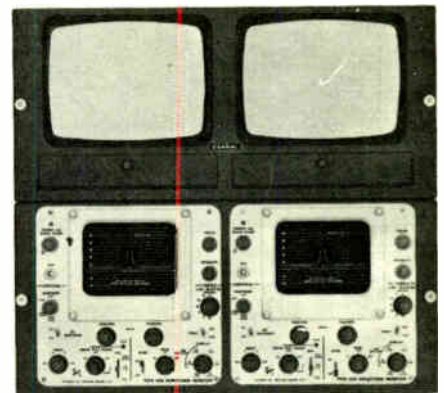

Type 529 Waveform Monitor . . . . . \$1050  
(8 1/4" high, 8 1/2" wide, 19" deep, weighs 24 pounds.)

Rack Mount Type RM529 . . . . . \$1100  
(5 1/4" high, 19" wide, 20" deep, weighs 27 pounds.)

Power consumption of each model is ~ 80 watts — no fan used.

U.S. Sales Prices, f.o.b. Beaverton, Oregon

**Tektronix, Inc.**



For complete information, contact your nearby Tektronix field engineer or write: Tektronix, Inc., P.O. Box 500, Beaverton, Oregon 97005

ENTRON INC  
FAIRCHILD RECORDING EQUIPMENT  
FISHER BERKELEY CORPORATION  
GATES RADIO COMPANY  
G E VISUAL COMMUNICATIONS PROD  
GENERAL ELECTRIC CO  
GENERAL RADIO CO  
HEATH CO  
HEWLETT-PACKARD CO.  
INTERNATIONAL NUCLEAR CORP.  
LANGVIN  
MELCOR ELECTRONICS  
POWER SOURCES  
RCA BROADCAST PRODS.  
SOLA ELECTRIC  
SORENSEN OPERATION-RAYTHEON CO  
SOUNDCRAFT INDUSTRIES  
SOUTHWESTERN COMMUNICATIONS  
STACO, INC.  
STANDARD ELECTRONICS CORP.  
STEPHENS ELECTRONICS  
SYLVANIA-COMM. ELECTRONICS DIV  
TELEQUIP CORPORATION  
TOWNSEND ASSOCIATES  
TREPAC CORPORATION OF AMERICA  
VIDEON CORPORATION

POWER SUPPLIES, PRECISION  
ALTEC LANSING  
COHU ELECTRONICS  
ENGINEERING ASSOCIATES  
GIBBS MFG. AND RESEARCH CORP.  
HEATH CO  
HEWLETT-PACKARD CO.  
SOLA ELECTRIC  
TELEQUIP CORPORATION  
TRW ELECTRONICS  
VIDEON CORPORATION

PREAMPLIFIERS, AUDIO  
AITKEN COMMUNICATIONS  
ALMA ENGINEERING INC  
ALTEC LANSING  
AMECO, INC.  
AUDIO INSTRUMENT CO  
BAUER ELECTRONICS CORPORATION  
CCA ELECTRONICS CORPORATION  
CENTRAL DYNAMICS CORPORATION  
CENTURY PROJECTOR CORPORATION  
CROWN INTERNATIONAL  
DELTA ELECTRONICS, INC.  
FAIRCHILD RECORDING EQUIPMENT  
G E VISUAL COMMUNICATIONS PROD  
GENERAL RADIO CO  
GREGORY AMPLIFIER CORP  
KOSS ELECTRONICS, INC.  
LANGVIN  
MARANTZ COMPANY  
MARTI ELECTRONICS  
MCMARTIN INDUSTRIES  
MELCOR ELECTRONICS  
MICROWAVE ASSOCIATES, INC.  
MILES REPRODUCER CO  
NORTH AMERICAN PHILIPS CO  
ORBIT RADIO  
PERMFLUX CORPORATION  
Q R K ELECTRONIC PRODUCTS  
RCA BROADCAST PRODS.  
RECORDING EQUIPMENT COMPANY  
RUSSCO ELECTRONICS MFG.  
SCHAFFER ELECTRONIC  
H. H. SCOTT, INCORPORATED  
SCULLY RECORDING INSTRUMENTS  
SHURE BROTHERS, INC.  
SONY CORPORATION OF AMERICA  
SOUNDCRAFT INDUSTRIES  
SOUTHWESTERN COMMUNICATIONS  
SPARTA ELECTRONIC CORPORATION  
STANCILOFF-HOFFMAN CORPORATION  
STEPHENS ELECTRONICS  
TREPAC CORPORATION OF AMERICA  
UTICA CORPORATION  
WARD ELECTRONIC INDUSTRIES

PREAMPLIFIERS, VIDEO  
AMECO, INC.  
BLONDER-TOMAU LABORATORIES  
CENTRAL DYNAMICS CORPORATION  
GATES RADIO COMPANY  
INTERNATIONAL NUCLEAR CORP.  
JERROLD ELECTRONICS CORP  
TELEQUIP CORPORATION  
VIDEON CORPORATION  
WARD ELECTRONIC INDUSTRIES

PREFABRICATED BUILDINGS  
FORT WORTH TOWER CO., INC.  
UTILITY TOWER CO.

PRESSURIZATION EQUIPMENT, TRANSMISSION LINE  
ANDREW CORPORATION  
GATES RADIO COMPANY  
THE MCINTIRE COMPANY  
RCA BROADCAST PRODS.  
SIGMA INDUSTRIES

PRINTERS, TELETYPE  
SINGER PRODUCTS CO  
TREPAC CORPORATION OF AMERICA

PROBS, OSCILLOSCOPE  
DATA INSTRUMENT DIVISION  
ELECTRONICS ESSENTIALS OF CCC  
G C ELECTRONICS COMPANY  
HEWLETT-PACKARD CO.  
RCA ELECTRONIC COMPONENTS  
TEKTRONIX INC  
TELEMET COMPANY

PROBS, TEST LEAD  
F W BELL, INC  
ELECTRONICS ESSENTIALS OF CCC  
E-Z-HOOK TEST PRODUCTS  
G C ELECTRONICS COMPANY  
HEWLETT-PACKARD CO.

E F JOHNSON COMPANY  
RCA ELECTRONIC COMPONENTS

PROCESSORS, FILM, B & W  
BURKE & JAMES  
THE JAMES FLOYD FORD CO  
HOUSTON FEARLESS CORPORATION  
MICRO RECORD CORP.  
RCA BROADCAST PRODS.

PROCESSORS, FILM, COLOR  
BURKE & JAMES  
HOUSTON FEARLESS CORPORATION  
MICRO RECORD CORP.  
RCA BROADCAST PRODS.  
TELEVISION ZOOMAR

PROJECTORS, FILM  
ARRIFLEX-SIEMENS  
BIRNS & SAWYER  
BURKE & JAMES  
CENTURY PROJECTOR CORPORATION  
EASTMAN KODAK COMPANY  
THE KALART COMPANY  
MARCONI DIVISION  
PRECISION LABORATORIES  
RCA BROADCAST PRODS.  
SINGER PRODUCTS CO.  
SYLVANIA-COMM. ELECTRONICS DIV  
TELEVISION UTILITIES CORP  
TRAIT CORPORATION  
VISUAL ELECTRONICS CORP

PROJECTORS, FILM, REAR  
ROBINS INDUSTRIES CORP.

PROJECTORS, SLIDE  
AMPLIFIER CORP OF AMERICA  
BURKE & JAMES  
DISPLAY TECHNOLOGIES INC  
EASTMAN KODAK COMPANY  
GRAY RESEARCH & DEVELOPMENT CO  
HARWALD COMPANY  
THE KALART COMPANY  
PRECISION LABORATORIES  
RCA BROADCAST PRODS.  
SINGER PRODUCTS CO.  
SYLVANIA-COMM. ELECTRONICS DIV  
VISUAL ELECTRONICS CORP  
ZOLOMATICS CORPORATION

PROJECTORS, TV, LARGE SCREEN  
GENERAL TELEVISION NETWORK

BACKS, MOUNTING - ALSO SEE HARDWARE  
AMECO, INC.  
RUD RADIO, INC  
CENTURY PROJECTOR CORPORATION  
COOK ELECTRIC COMPANY  
DATA INSTRUMENT DIVISION  
FAIRCHILD RECORDING EQUIPMENT  
GATES RADIO COMPANY  
G E VISUAL COMMUNICATIONS PROD  
MICROWAVE ASSOCIATES, INC.  
NEUMADE PRODUCTS CORPORATION  
RAYTHEON CO EQUIPMENT DIVISION  
RCA BROADCAST PRODS.  
SCHAFFER ELECTRONICS  
WABER ELECTRONICS, INC.

RADAR, WEATHER  
RCA BROADCAST PRODS.

RADOMES  
ANDREW CORPORATION  
FORT WORTH TOWER CO., INC.  
JERROLD ELECTRONICS CORP  
PROELIN, INCORPORATED  
SCIENTIFIC-ATLANTA  
TECHNICAL APPLIANCE CORP

RECEIVERS, AM  
ALLIED ELECTRONICS CORP  
AMERICAN ELITE  
BENJAMIN ELECTRONIC SOUND CORP  
CALBEST ELECTRONICS  
CCA ELECTRONICS CORPORATION  
DELCO RADIO DIV  
ELECTRO-VOICE INC  
G F SUPPLY COMPANY  
HEATH CO  
KAHN RESEARCH LABORATORIES  
MARCONI INSTRUMENTS  
NORTH AMERICAN PHILIPS CO  
RHODE & SCHWARZ SALES CO. -USA  
SETCHELL CARLSON INCORPORATED  
SINGER PRODUCTS CO  
TELECTRO INDUSTRIES CORP  
UTICA CORPORATION  
VITRO ELECTRONICS

RECEIVERS, FM  
ALLIED ELECTRONICS CORP  
ALTEC LANSING  
AMECO, INC.  
AMERICAN ELITE  
RELAR ELECTRONICS LABORATORY  
BENJAMIN ELECTRONIC SOUND CORP  
CALBEST ELECTRONICS  
CCA ELECTRONICS CORPORATION  
DAYTON ELECTRONIC PRODUCTS CO  
DELCO RADIO DIV  
ELECTRO-VOICE INC  
GATES RADIO COMPANY  
HEATH CO  
JOHNSON ELECTRONICS, INC.  
KARG LABORATORIES  
MARANTZ COMPANY  
MARCONI INSTRUMENTS  
MARTI ELECTRONICS  
MCMARTIN INDUSTRIES  
MILES REPRODUCER CO  
NORTH AMERICAN PHILIPS CO  
RHG ELECTRONICS LABORATORY  
RHODE & SCHWARZ SALES CO. -USA

H. H. SCOTT, INCORPORATED  
SETCHELL CARLSON INCORPORATED  
SINGER PRODUCTS CO  
SONY CORPORATION OF AMERICA  
TELECTRO INDUSTRIES CORP  
UTICA CORPORATION  
VEGA ELECTRONICS CORPORATION  
VITRO ELECTRONICS

RECEIVERS, HF  
AMERICAN ELECTRONIC LABS  
AMERICAN ELITE  
BENJAMIN ELECTRONIC SOUND CORP  
JOHNSON ELECTRONICS, INC.  
KAHN RESEARCH LABORATORIES  
MARCONI DIVISION  
MARCONI INSTRUMENTS  
NARDA MICROWAVE CORPORATION  
RHG ELECTRONICS LABORATORY  
RHODE & SCHWARZ SALES CO. -USA  
SCIENTIFIC-ATLANTA  
SINGER PRODUCTS CO  
THE TECHNICAL MATERIEL CORP  
TELECTRO INDUSTRIES CORP  
VITRO ELECTRONICS

RECEIVERS, MULTIPLEX  
BELAR ELECTRONICS LABORATORY  
BROWNING LABORATORIES, INC.  
CCA ELECTRONICS CORPORATION  
CONRAC  
ELECTRO-VOICE INC  
HEATH CO  
JOHNSON ELECTRONICS, INC.  
JOHNSON ELECTRONICS, INC.  
KARG LABORATORIES  
MARANTZ COMPANY  
MCMARTIN INDUSTRIES  
H. H. SCOTT, INCORPORATED  
SINGER PRODUCTS CO  
TELECTRO INDUSTRIES CORP  
VITRO ELECTRONICS

RECEIVERS, RCA  
BELAR ELECTRONICS LABORATORY  
BROWNING LABORATORIES, INC.  
CALBEST ELECTRONICS  
CCA ELECTRONICS CORPORATION  
DAYTON ELECTRONIC PRODUCTS CO  
KARG LABORATORIES  
MARTI ELECTRONICS  
MCMARTIN INDUSTRIES  
SINGER PRODUCTS CO

RECEIVERS, TV, COLOR  
AMECO, INC.  
CONRAC  
G F SALES AND DISTRIBUTION  
HEATH CO  
SETCHELL CARLSON INCORPORATED

RECEIVERS, TV, MONOCHROME  
AMECO, INC.  
CONRAC  
G F SALES AND DISTRIBUTION  
HEATH CO  
SETCHELL CARLSON INCORPORATED  
SONY CORPORATION OF AMERICA  
SYLVANIA-COMM. ELECTRONICS DIV

RECORDERS, DISC, MAGNETIC  
AMPX CORPORATION  
COLORADO VIDEO  
FAIRCHILD RECORDING EQUIPMENT  
MILES REPRODUCER CO  
MVR CORPORATION

RECORDERS, FILM, LIGHT  
MINNESOTA MINING - 3 M  
TELEVISION UTILITIES CORP

RECORDERS, FILM, MAGNETIC  
CENTURY PROJECTOR CORPORATION  
MINNESOTA MINING - 3 M  
STANCILOFF-HOFFMAN CORPORATION  
TELEVISION UTILITIES CORP

RECORDERS, MAGNETIC TAPE, AUDIO  
ALLIED ELECTRONICS CORP  
AMERICAN ELITE  
AMERICAN GELOSO ELECTRONICS  
AMPX CORPORATION  
AMPLIFIER CORP OF AMERICA  
AUDIO INSTRUMENT CO  
BROADCAST ELECTRONICS, INC  
CALIFONE/ROBERTS  
COMPUTRON INC  
CROWN INTERNATIONAL  
FAIRCHILD RECORDING EQUIPMENT  
GENERAL RADIO CO  
GOTHAM AUDIO CORPORATION  
HEATH CO  
IMPX ELECTRONICS CORP  
INTERNATIONAL GOOD MUSIC  
JETRONIC INDUSTRIES, INC.  
JOA CARTRIDGE SERVICE  
KRS INSTRUMENTS DIVISION  
MACARTA INC.  
MACKENZIE LABORATORIES  
MAGNA-TECH CORPORATION  
MAGNECORD  
METROTECH INCORPORATED  
MILES REPRODUCER CO  
MINNESOTA MINING - 3 M  
NORTH AMERICAN PHILIPS CO  
RCA BROADCAST PRODS.  
SCHAFFER ELECTRONICS  
SCULLY RECORDING INSTRUMENTS  
SONY CORPORATION OF AMERICA  
THE SOUND SCRIBER CORP.  
STANCILOFF-HOFFMAN CORPORATION  
STEPHENS ELECTRONICS  
MATTHEW STUART & CO, INC  
TAPECASTER ELECTRONICS  
TAPE-ATHON CORPORATION

TELECTRO INDUSTRIES CORP  
VIKING OF MINNEAPOLIS  
VISUAL ELECTRONICS CORP

RECORDERS, MAGNETIC TAPE, AUDIO, CARTRIDGE  
BROADCAST ELECTRONICS, INC  
COLLINS RADIO COMPANY  
GATES RADIO COMPANY  
KRS INSTRUMENTS DIVISION  
LACROSSE ELECTRONICS, INC.  
MACKENZIE LABORATORIES  
RCA BROADCAST PRODS.  
SPARTA ELECTRONIC CORPORATION  
TAPECASTER ELECTRONICS  
VIKING OF MINNEAPOLIS

RECORDERS, MAGNETIC TAPE, LOGGING  
AMPX CORPORATION  
CROWN INTERNATIONAL  
KRS INSTRUMENTS DIVISION  
MAGNECORD  
METROTECH INCORPORATED  
MILES REPRODUCER CO  
MINNESOTA MINING - 3 M  
SCHAFFER ELECTRONICS  
THE SOUND SCRIBER CORP.  
STANCILOFF-HOFFMAN CORPORATION  
TAPE-ATHON CORPORATION  
TELECTRO INDUSTRIES CORP  
VIKING OF MINNEAPOLIS

RECORDERS, MAGNETIC TAPE, VIDEO  
AMPX CORPORATION  
AMPLIVISION CORPORATION  
MINNESOTA MINING - 3 M  
MVR CORPORATION  
NORTH AMERICAN PHILIPS CO  
RCA BROADCAST PRODS.  
SONY CORPORATION OF AMERICA  
TELECTRO INDUSTRIES CORP  
VISUAL ELECTRONICS CORP

RECORDERS, PAPER LOGGING AND GRAPHIC  
API INSTRUMENTS CO.  
BAUER ELECTRONICS CORPORATION  
ENGINEERING ASSOCIATES  
GENERAL ELECTRIC CO  
GENERAL RADIO CO  
HEATH CO  
HEWLETT-PACKARD CO.  
NESCO INSTRUMENTS DIV.  
RHODE & SCHWARZ SALES CO. -USA  
SCIENTIFIC-ATLANTA  
YOKOGAWA ELECTRIC WORKS

RECORDERS, VIDEO, KINESCOPE  
VUE-TRONICS INC.

RECORDING SERVICE, AUDIO, TAPE  
THE JAMES FLOYD FORD CO

RECORD PLAYERS - SEE TURNTABLES

RECORDS, BLANK, ACETATE, FOR RECORDING  
ASCO SONOCRAFT CORP  
DUDTONE COMPANY INC  
SINGER PRODUCTS CO.  
TRANSCO PRODUCTS, INTL

RECORDS, BLANK, LACQUER, FOR RECORDING  
AUDIO DEVICES  
REEVES SONOCRAFT  
SINGER PRODUCTS CO.  
TRANSCO PRODUCTS, INTL

RECORDS, SOUND EFFECT SPEEDY-0 ENTERPRISES

RECORDS, TEST  
C B S LABORATORIES

RECTIFIERS - ALSO SEE SEMICONDUCTORS  
CCA ELECTRONICS CORPORATION  
EIMAC DIVISION OF VARIAN  
GENERAL ELECTRIC CO  
HEINTZ & KAUFMAN, LTD  
INTERNATIONAL RECTIFIER  
MOTOROLA SEMICONDUCTOR  
SARKES-TARZIAN  
SILTRON DEVICES  
STANOARD ELECTRONICS CORP.  
TEXAS INSTRUMENTS  
WILKINSON ELECTRONICS, INC

RECTIFIERS, SELENIUM  
AMERICAN ELITE  
GENERAL ELECTRIC CO  
INTERNATIONAL RECTIFIER  
IRC, INC.  
SARKES-TARZIAN  
SINGER PRODUCTS CO.

REFLS, CABLE, AUTOMATIC INDUSTRIAL DEVICES, INC.  
INDUSTRIAL ELECTRIC REFLS  
VENT-RAK INCORPORATED

REFLS, FILM  
AMERLINE CORPORATION  
BIRNS & SAWYER  
BURKE & JAMES  
HARWALD COMPANY  
NEUMADE PRODUCTS CORPORATION  
STANCILOFF-HOFFMAN CORPORATION

REFLS, TAPE  
AMERLINE CORPORATION  
AUDIO DEVICES

# SPARTA-MATIC<sup>®</sup> TAPE CARTRIDGE SYSTEMS\*



**800C SERIES**  
Space saving, compact, table-top convenience • Transistorized modular electronics • Super-silent operation • Hinged lid for easy internal access

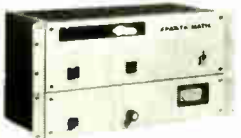

**300C SERIES**  
Rack, table-top or cabinet mounting • Transistorized plug-in modules • 2nd and 3rd tone cue option • Separate record amplifier • Full remote operation

## NEW SPARTA ENGINEERED CH-5 TAPE CARTRIDGE TRANSPORT



Direct motor capstan drive eliminates belt driven assembly • Hysteresis synchronous motor with lifetime lubricated ball bearings • Exclusive super-silent solenoid system • Precision crafted for years of maintenance free service



## BP-211C BRIEFCASE CARTRIDGE PLAYBACK

Provides quick and convenient tape cartridge auditioning • Excellent sales aid unit • Rechargeable battery and A/C operation • Extension speaker • Cartridge storage • Samsonite attache case with business paper portfolio

## MC-104

### MULTI-CARTRIDGE PLAYBACK

Provides four independent plug-in CH-5 tape cartridge transports • Compact design for table-top (illustrated) or rack mount installation • Individual transistorized electronics • Manual or sequential operation • Multi tone and audio switcher options



### CD-15 TIME DELAY & REVERB UNIT

Time delay of 3 seconds to 31 minutes • Provides "before-air" censorship of conversational programing • Selective reverberation effects.



\*  
ALL SPARTAMATIC  
SYSTEMS EXCEED NAB  
STANDARDS

†  
ALL SPARTA CONSOLES  
EXCEED FCC PROOF OF PERFORMANCE  
SPECIFICATIONS

# SPARTA AUDIO EQUIPMENT AND ACCESSORIES †



**AS-30  
STEREO AUDIO CONSOLE**  
Five stereo mixer channels • 14 stereo audio inputs • Monitor, cueing & muting terminal facilities provided • All transistorized modular electronics • Selectable stereo/mono mode control

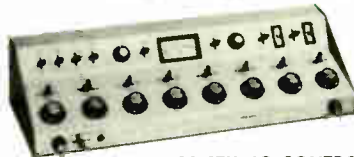

**A-20 STUDIO CONTROL CONSOLE**  
Full facility audio control center • All transistorized • Eight mixers • Twenty-two inputs • Self-contained power supply • .5 watt monitor and .5 watt cue amplifier • Accommodates eight preamps (three supplied) • Individual electronic modules • Studio talkback provisions • Functional, space-saving compactness • All inputs and output are transformer balanced



**A-15 AUDIO CONSOLE**  
14 audio inputs • Five mixing channels • Built in monitor, cueing & muting systems • All transistorized modular electronics • Three line outputs plus P.A., head-phone & external speaker output • Accommodates up to four preamps



**RA-5 REMOTE MIXER**  
Two mixers • 3 audio inputs • Line test oscillator • P.A. output • 30 hour battery operation • Shoulder strap carrying case included



## AC-155 STUDIO/REMOTE UNIT

Recording studio • Remote broadcast • Main studio control • Full broadcast facility • Monitor & cue system • Muting • P. A. output • Solid state removable console • Two 3-speed custom turntable systems • Six low-level and eight high-level inputs •



## SHOWCASE CABINERY

Console Desk • Dual & Single turntable Returns • Utility Returns with Cartridge Hutch • Mix'n Match for a Custom Look



**FIDELIPAC  
TAPE  
CARTRIDGES**  
All sizes and standard lengths in stock • Cartridge reconditioning and reloading service.



**CE-2  
CARTRIDGE  
ERASER**  
Faster and total erasing of cartridges and reels up to 10 1/2"



# SPARTA ELECTRONIC CORPORATION

5851 FLORIN-PERKINS ROAD, SACRAMENTO, CALIFORNIA 95828  
(916) 383-5353

EXPORT SALES: SPARTA INTERNATIONAL CORPORATION  
95 BROAD STREET, NEW YORK, N.Y. 10004



## TC-12 CUSTOM TURNTABLE

Instant acceleration • Heavy-duty professional quality • Positive 3-speed lever control • Plays 45's without adapter • Trouble free performance

All prices subject to change

BIRNS & SAWYER  
BROADCAST ELECTRONICS, INC.  
EASTMAN KODAK COMPANY  
MAGNECORD  
MINNESOTA MINING - 3 M  
REEVES SOUNDRAFT  
ROBINS INDUSTRIES CORP.  
SONY CORPORATION OF AMERICA  
STANDARD RECORD MFG. CO.  
WIDE RESPONSE

REFLECTORS, PASSIVE  
ADVANCE INDUSTRIES  
FORT WORTH TOWER CO., INC.  
MASTER TOWER CO.  
MICROFLECT COMPANY INC.  
RCA BROADCAST PRODS.  
ROHN MANUFACTURING CO.  
STAINLESS, INC.  
UTILITY TOWER CO.

REGULATORS, CURRENT  
G E SUPPLY COMPANY  
GENERAL ELECTRIC CO  
SOLA ELECTRIC

REGULATORS, VOLTAGE  
ALTEC LANSING  
CCA ELECTRONICS CORPORATION  
G E SUPPLY COMPANY  
GENERAL ELECTRIC CO  
GENERAL RADIO CO  
SOLA ELECTRIC  
STACO, INC.

RELAYS, ANTENNA  
COOK ELECTRIC COMPANY  
E F JOHNSON COMPANY

RELAYS, BREAK IN  
ESSEX WIRE CORPORATION

RELAYS, COAXIAL  
ENGINEERING ASSOCIATES  
JENNINGS RADIO MANUFACTURING  
STRUTHERS-DUNN  
TROMPETER ELECTRONICS  
VISUAL ELECTRONICS CORP

RELAYS, GENERAL PURPOSE  
ALLIED ELECTRONICS CORP  
COOK ELECTRIC COMPANY  
CORNELL-DUBILIER ELECTRONICS  
ESSEX WIRE CORPORATION  
GENERAL ELECTRIC CO  
JENNINGS RADIO MANUFACTURING  
OHMITE MANUFACTURING COMPANY  
RHM CONTROLS  
SIGMA INSTRUMENTS INC.  
STRUTHERS-DUNN

RELAYS, LATCHING  
AMERICAN ELITE  
CORNELL-DUBILIER ELECTRONICS  
GENERAL ELECTRIC CO  
JENNINGS RADIO MANUFACTURING  
OHMITE MANUFACTURING COMPANY  
RHM CONTROLS  
SIGMA INSTRUMENTS INC.  
STRUTHERS-DUNN

RELAYS, LIGHT INDICATING  
HUGHEY & PHILLIPS  
OHMITE MANUFACTURING COMPANY

RELAYS, OVERLOAD  
APT INSTRUMENTS CO.  
CORNELL-DUBILIER ELECTRONICS  
ENGINEERING ASSOCIATES  
ESSEX WIRE CORPORATION  
GENERAL ELECTRIC CO  
G-V CONTROLS INC.  
JENNINGS RADIO MANUFACTURING  
OHMITE MANUFACTURING COMPANY  
SIGMA INSTRUMENTS INC.  
STRUTHERS-DUNN

RELAYS, PHOTOELECTRIC  
CORNELL-DUBILIER ELECTRONICS  
GENERAL ELECTRIC CO  
HOUSTON ELECTRONICS CO.  
HUGHEY & PHILLIPS  
SIGMA INSTRUMENTS INC.  
STEPHENS ELECTRONICS

RELAYS, PLUG IN  
CORNELL-DUBILIER ELECTRONICS  
ESSEX WIRE CORPORATION  
RHM CONTROLS  
SIGMA INSTRUMENTS INC.  
STEPHENS ELECTRONICS  
STRUTHERS-DUNN  
TREPAC CORPORATION OF AMERICA

RELAYS, POWER  
CORNELL-DUBILIER ELECTRONICS  
ENGINEERING ASSOCIATES  
ESSEX WIRE CORPORATION  
GENERAL ELECTRIC CO  
JENNINGS RADIO MANUFACTURING  
OHMITE MANUFACTURING COMPANY  
RHM CONTROLS  
SIGMA INSTRUMENTS INC.  
STRUTHERS-DUNN

RELAYS, SEQUENCING  
CORNELL-DUBILIER ELECTRONICS  
ESSEX WIRE CORPORATION  
SIGMA INSTRUMENTS INC.  
STRUTHERS-DUNN  
TREPAC CORPORATION OF AMERICA  
TROMPETER ELECTRONICS

RELAYS, STEPPING  
CORNELL-DUBILIER ELECTRONICS

ENGINEERING ASSOCIATES  
JENNINGS RADIO MANUFACTURING  
STRUTHERS-DUNN  
TROMPETER ELECTRONICS

RELAYS, TELEPHONE  
COOK ELECTRIC COMPANY  
CORNELL-DUBILIER ELECTRONICS  
ENGINEERING ASSOCIATES  
ESSEX WIRE CORPORATION  
ITT TELECOMMUNICATIONS  
RHM CONTROLS  
SIGMA INSTRUMENTS INC.

RELAYS, THERMAL  
BLONDFR-TONGUE LABORATORIES  
OIALIGHT CORPORATION  
ESSEX WIRE CORPORATION  
GENERAL ELECTRIC CO  
G-V CONTROLS INC.

RELAYS, TIME DELAY  
AMPERITE CO  
CORNELL-DUBILIER ELECTRONICS  
DIALIGHT CORPORATION  
ENGINEERING ASSOCIATES  
ESSEX WIRE CORPORATION  
GENERAL ELECTRIC CO  
HOUSTON ELECTRONICS CO.  
OHMITE MANUFACTURING COMPANY  
RHM CONTROLS  
STRUTHERS-DUNN  
TREPAC CORPORATION OF AMERICA  
G-V CONTROLS INC.  
MOLE-RICHARDSON CO.

REMOTE CONTROL SYSTEMS  
ALBION OPTICAL COMPANY  
BAUER ELECTRONICS CORPORATION  
ANDREW CORPORATION  
BIONIC INSTRUMENTS, INC.  
CENTRAL DYNAMICS CORPORATION  
CONTINENTAL ELECTRONICS MFG  
DELTA ELECTRONICS, INC.  
ENGINEERING ASSOCIATES  
F & M SYSTEMS COMPANY  
GATES RADIO COMPANY  
GENERAL ELECTRIC CO  
HANCOCK TELECONTROL  
MARTI ELECTRONICS  
MOSELEY ASSOCIATES INC.  
ORBIT RADIO  
SCHAFER ELECTRONICS  
SINGER PRODUCTS CO.  
SOUTHWESTERN COMMUNICATIONS  
TELETRONIX  
VISUAL ELECTRONICS CORP  
TREPAC CORPORATION OF AMERICA

RESISTORS, FIXED, CARBON  
AEROVOX CORP.  
AMERICAN ELITE  
AMPEREX ELECTRONIC CORP  
G C ELECTRONICS COMPANY  
IRC, INC.  
OHMITE MANUFACTURING COMPANY  
PAINTON INCORPORATED  
SINGER PRODUCTS CO.  
TEXAS INSTRUMENTS

RESISTORS, FIXED, NONINDUCTIVE  
GENERAL RADIO CO  
IRC, INC.  
OHMITE MANUFACTURING COMPANY  
VISHAY RESISTOR PRODUCTS DIV

RESISTORS, FIXED, PRECISION  
AEROVOX CORP.  
AMPHENOL DISTRIBUTOR DIVISION  
GENERAL RADIO CO  
IRC, INC.  
JORDAN ELECTRIC COMPANY  
MALLORY DISTRIBUTOR PRODUCTS  
OHMITE MANUFACTURING COMPANY  
PAINTON INCORPORATED  
TEXAS INSTRUMENTS  
VISHAY RESISTOR PRODUCTS DIV

RESISTORS, FIXED, WIREWOUND  
AMPHENOL DISTRIBUTOR DIVISION  
GENERAL ELECTRIC CO  
GENERAL RADIO CO  
HAMILTON HALL RESISTOR CORP.  
IRC, INC.  
JORDAN ELECTRIC COMPANY  
MALLORY DISTRIBUTOR PRODUCTS  
OHMITE MANUFACTURING COMPANY  
PAINTON INCORPORATED  
SINGER PRODUCTS CO.

RESISTORS, FIXED, OTHER  
AEROVOX CORP.  
AMPEREX ELECTRONIC CORP  
GENERAL ELECTRIC CO  
IRC, INC.  
OHMITE MANUFACTURING COMPANY  
PAINTON INCORPORATED

RESISTORS, VARIABLE, CARBON  
AMPHENOL DISTRIBUTOR DIVISION  
MALLORY DISTRIBUTOR PRODUCTS  
OHMITE MANUFACTURING COMPANY  
SINGER PRODUCTS CO.

RESISTORS, VARIABLE, WIREWOUND  
AMPHENOL DISTRIBUTOR DIVISION  
ENGINEERING ASSOCIATES  
G C ELECTRONICS COMPANY  
GENERAL RADIO CO  
IRC, INC.  
MALLORY DISTRIBUTOR PRODUCTS  
OHMITE MANUFACTURING COMPANY  
PAINTON INCORPORATED  
WATERS MANUFACTURING

REVERBERATION DEVICES -  
ALSO SEE AMPLIFIERS  
AMPLIFIER CORP OF AMERICA  
BAUER ELECTRONICS CORPORATION  
CLEVELAND ELECTRONICS  
SPEAKER DIVISION  
FAIRCHILD RECORDING EQUIPMENT  
GOTHAM AUDIO CORPORATION  
GREGORY AMPLIFIER CORP  
LITTLE JOE ENTERPRISES  
ORBIT RADIO  
SINGER PRODUCTS CO  
STEPHENS ELECTRONICS  
VISUAL ELECTRONICS CORP

REWINDERS, FILM  
BURKE & JAMES  
CENTURY PROJECTOR CORPORATION  
HARWALD COMPANY  
NEUMADE PRODUCTS CORPORATION  
RCA BROADCAST PRODS.

REWINDERS, TAPE  
HARVEY RADIO CO, INC.

RHEOSTATS  
ENGINEERING ASSOCIATES  
GENERAL ELECTRIC CO  
GENERAL RADIO CO  
MALLORY DISTRIBUTOR PRODUCTS  
NEUMADE PRODUCTS CORPORATION  
OHMITE MANUFACTURING COMPANY

RINGS, RETAINING - SEE HARDWARE

RODS, GROUND  
AMPLIVISION CORPORATION

SAFETY DEVICES, CLIMBING  
AIR SPACE DEVICES  
PRUZAN COMPANY

SCHOOLS, FACILITIES & EQUIPMENT  
SEE EDUCATION FACILITIES

SCRAMBLERS, SPEECH  
SINGER PRODUCTS CO  
TREPAC CORPORATION OF AMERICA

SCREENS, PROJECTION, FRONT  
ASCO SONOCRAFT CORP  
BIRNS & SAWYER  
BURKE & JAMES  
RAVEN SCREEN CORPORATION  
VISUAL ELECTRONICS CORP

SCREENS, PROJECTION, REAR  
BURKE & JAMES  
DISPLAY TECHNOLOGIES INC  
RAVEN SCREEN CORPORATION  
VISUAL ELECTRONICS CORP  
H. WILSON CORPORATION

SEMICONDUCTOR DIODES  
AMERICAN ELECTRONIC LABS  
AMERICAN ELITE  
AMPEREX ELECTRONIC CORP  
G E DISTRIBUTOR SALES FORCE  
GENERAL ELECTRIC CO  
HEWLETT-PACKARD CO.  
INTERNATIONAL RECTIFIER  
IRC, INC.  
MICROLAB / FXR  
MICROWAVE ASSOCIATES, INC.  
MOTOROLA SEMICONDUCTOR  
OHMITE MANUFACTURING COMPANY  
RCA ELECTRONIC COMPONENTS  
SARKES-TARZIAN  
SINGER PRODUCTS CO.  
SOLITRON DEVICES  
SYLVANIA-SEMICONDUCTOR DIV.  
TEXAS INSTRUMENTS  
THOR ELECTRONICS  
TRW ELECTRONICS

SEMICONDUCTOR RECTIFIERS,  
GENERAL  
CENTURY PROJECTOR CORPORATION  
G E DISTRIBUTOR SALES FORCE  
GENERAL ELECTRIC CO  
INTERNATIONAL RECTIFIER  
IRC, INC.  
MALLORY DISTRIBUTOR PRODUCTS  
MOTOROLA SEMICONDUCTOR  
RCA ELECTRONIC COMPONENTS  
SARKES-TARZIAN  
SINGER PRODUCTS CO.  
SOLITRON DEVICES  
SYLVANIA-SEMICONDUCTOR DIV.  
TEXAS INSTRUMENTS  
THOR ELECTRONICS  
WILKINSON ELECTRONICS, INC

SEMICONDUCTOR RECTIFIERS,  
HIGH VOLTAGE  
G E DISTRIBUTOR SALES FORCE  
INTERNATIONAL RECTIFIER  
MOTOROLA SEMICONDUCTOR  
RCA ELECTRONIC COMPONENTS  
SARKES-TARZIAN  
SINGER PRODUCTS CO.  
SOLITRON DEVICES  
TEXAS INSTRUMENTS  
THOR ELECTRONICS  
TRW ELECTRONICS  
WILKINSON ELECTRONICS, INC

SEMICONDUCTOR RECTIFIERS,  
POWER  
G E DISTRIBUTOR SALES FORCE  
GENERAL ELECTRIC CO  
INTERNATIONAL RECTIFIER  
MALLORY DISTRIBUTOR PRODUCTS  
MOTOROLA SEMICONDUCTOR

RCA ELECTRONIC COMPONENTS  
SARKES-TARZIAN  
SINGER PRODUCTS CO.  
SOLITRON DEVICES  
SYLVANIA-SEMICONDUCTOR DIV.  
TEXAS INSTRUMENTS  
THOR ELECTRONICS  
WILKINSON ELECTRONICS, INC

SEMICONDUCTOR RECTIFIERS,  
SILICON CONTROLLED - SCR  
AMPEREX ELECTRONIC CORP  
DELCO RADIO DIV  
G E DISTRIBUTOR SALES FORCE  
GENERAL ELECTRIC CO  
INTERNATIONAL RECTIFIER  
IRC, INC.  
MOTOROLA SEMICONDUCTOR  
RCA ELECTRONIC COMPONENTS  
SARKES-TARZIAN  
TEXAS INSTRUMENTS  
THOR ELECTRONICS

SEMICONDUCTORS, THYRISTORS  
AMPEREX ELECTRONIC CORP  
G E DISTRIBUTOR SALES FORCE  
INTERNATIONAL RECTIFIER  
IRC, INC.  
MOTOROLA SEMICONDUCTOR  
RCA ELECTRONIC COMPONENTS  
TEXAS INSTRUMENTS  
THOR ELECTRONICS

SEMICONDUCTORS, TRANSISTORS, AF  
AMERICAN ELITE  
AMPEREX ELECTRONIC CORP  
DELCO RADIO DIV  
G E DISTRIBUTOR SALES FORCE  
INTERNATIONAL RECTIFIER  
LAKE ELECTRONICS, INC.  
MOTOROLA SEMICONDUCTOR  
RCA ELECTRONIC COMPONENTS  
SINGER PRODUCTS CO.  
SOLITRON DEVICES  
SYLVANIA-SEMICONDUCTOR DIV.  
TEXAS INSTRUMENTS  
THOR ELECTRONICS

SEMICONDUCTORS, TRANSISTORS, FE  
AMPEREX ELECTRONIC CORP  
G E DISTRIBUTOR SALES FORCE  
MOTOROLA SEMICONDUCTOR  
RCA ELECTRONIC COMPONENTS  
TEXAS INSTRUMENTS  
THOR ELECTRONICS

SEMICONDUCTORS, TRANSISTORS,  
GENERAL  
AMPEREX ELECTRONIC CORP  
DELCO RADIO DIV  
G E DISTRIBUTOR SALES FORCE  
GENERAL ELECTRIC CO  
INTERNATIONAL RECTIFIER  
LAKE ELECTRONICS, INC.  
MOTOROLA SEMICONDUCTOR  
RCA ELECTRONIC COMPONENTS  
SINGER PRODUCTS CO.  
SOLITRON DEVICES  
SYLVANIA-SEMICONDUCTOR DIV.  
TEXAS INSTRUMENTS  
THOR ELECTRONICS  
TRW ELECTRONICS

SEMICONDUCTORS, TRANSISTORS, RF  
AMERICAN ELITE  
AMPEREX ELECTRONIC CORP  
G E DISTRIBUTOR SALES FORCE  
INTERNATIONAL RECTIFIER  
MOTOROLA SEMICONDUCTOR  
RCA ELECTRONIC COMPONENTS  
SOLITRON DEVICES  
SYLVANIA-SEMICONDUCTOR DIV.  
TEXAS INSTRUMENTS  
THOR ELECTRONICS  
TRW ELECTRONICS

SERVICES, FREQUENCY-MEASUREMENT  
SEE CALIBRATION SERVICES,  
FREQUENCY

SERVICES, INSTALLATION  
GRINMAN FICTURE COMPANY  
GULF ELECTRO-SALES INC

SERVICES, MAINTENANCE -  
SEE MAINTENANCE SERVICES

SHIELDINGS, TUBE  
ELECTRONICS ESSENTIALS OF CCC

SHIFTERS, PHASE, MICROWAVE  
DEMORNY - BONARDI DIVISION  
MICROWAVE ASSOCIATES, INC.  
NARDA MICROWAVE CORPORATION  
PRODELIN, INCORPORATED

SHUNTS, METER  
ENGINEERING ASSOCIATES  
G E INDUSTRIAL SALES OPERATION  
GENERAL ELECTRIC CO  
THE SINGER CO - METRICS DIV  
TRIPLETT ELECTRICAL INSTRUMENT

SLIDES, CHASSIS  
BUD RADIO, INC  
CHASSIS TRAK  
ELECTRONICS ESSENTIALS OF CCC  
ROBINS INDUSTRIES CORP.  
VENT-RAK INCORPORATED

SLOTTED SECTIONS  
ALFORD MANUFACTURING COMPANY  
DEMORNY - BONARDI DIVISION  
MICROLAB / FXR  
MICRO-LINK SYSTEMS/VARIAN ASSO



NARDA MICROWAVE CORPORATION  
PHELPS DODGE  
PRODELIN, INCORPORATED  
ROMBE & SCHWARZ SALFS. CO. -USA

SOCKETS, CRYSTAL

E F JOHNSON COMPANY

SOCKETS, LAMP

AUDIO ACCESSORIES  
DIALIGHT CORPORATION  
ELECTRONICS ESSENTIALS OF CCC  
E F JOHNSON COMPANY

SOCKETS, TUBE

AERVOX CORP.  
EIMAC DIVISION OF VARIAN  
ELECTRONICS ESSENTIALS OF CCC  
G C ELECTRONICS COMPANY  
E F JOHNSON COMPANY

SOLDER

G C ELECTRONICS COMPANY  
SINGER PRODUCTS CO.

SOLVENTS AND CLEANERS

G C ELECTRONICS COMPANY  
HARWALD COMPANY  
NEUMADE PRODUCTS CORPORATION  
RDRINS INDUSTRIES CORP.

SOUND SYSTEMS, OUTDOOR

ALTEC LANSING  
AMERICAN GELOSO ELECTRONICS  
AMPEX CORPORATION  
APPLIED ELECTRO-MECHANICS  
ATLAS SOUND  
AUDIO INSTRUMENT CO  
GREGORY AMPLIFIER CORP  
HARVEY RADIO CO. INC.  
HOUSTON ELECTRONICS CO.  
JENSEN MANUFACTURING  
JAMES B LANSING SOUND CO  
MCMARTIN INDUSTRIES  
NORTH AMERICAN PHILIPS CO  
RCA BROADCAST PRODS.  
SOUTHWESTERN COMMUNICATIONS  
TRUSONIC

SOUND SYSTEMS, PORTABLE

ALTEC LANSING  
AMERICAN GELOSO ELECTRONICS  
AMPEX CORPORATION  
APPLIED ELECTRO-MECHANICS  
CALIFONE/ROBERTS  
CENTURY PROJECTOR CORPORATION  
GREGORY AMPLIFIER CORP  
HARVEY RADIO CO. INC.  
HOUSTON ELECTRONICS CO.  
JENSEN MANUFACTURING  
MCMARTIN INDUSTRIES  
NORTH AMERICAN PHILIPS CO  
ORBIT RADIO  
RCA BROADCAST PRODS.  
SINGER PRODUCTS CO.  
SONY CORPORATION OF AMERICA  
SOUTHWESTERN COMMUNICATIONS  
TRUSONIC

SOUND SYSTEMS, THEATER

ALTEC LANSING  
AMPEX CORPORATION  
ATLAS SOUND  
AUDIO INSTRUMENT CO  
CENTURY PROJECTOR CORPORATION  
GREGORY AMPLIFIER CORP  
HARVEY RADIO CO. INC.  
HOUSTON ELECTRONICS CO.  
JENSEN MANUFACTURING  
JAMES B LANSING SOUND CO  
MCMARTIN INDUSTRIES  
MID AMERICA ELECTRONICS CORP  
NORTH AMERICAN PHILIPS CO  
RCA BROADCAST PRODS.  
TRUSONIC

SPEAKER COMPONENTS

ALTEC LANSING  
AMERICAN GELOSO ELECTRONICS  
ATLAS SOUND  
CALBEST ELECTRONICS  
ELECTRO-VOICE INC  
ELECTRONICS ESSENTIALS OF CCC  
JENSEN MANUFACTURING  
JAMES B LANSING SOUND CO  
NORTH AMERICAN PHILIPS CO  
PERMOFLUX CORPORATION  
RCA BROADCAST PRODS.  
SINGER PRODUCTS CO  
SONY CORPORATION OF AMERICA  
TRUSONIC

SPEAKERS

ALTEC LANSING  
AMERICAN ELITE  
AMERICAN GELOSO ELECTRONICS  
AMPEX CORPORATION  
ATLAS SOUND  
CALIFONE/ROBERTS  
CCA ELECTRONICS CORPORATION  
CENTURY PROJECTOR CORPORATION  
CLEVELAND ELECTRONICS  
SPEAKER DIVISION  
ELECTRO-SOUND ACOUSTICS  
ELECTRO-VOICE INC  
GATES RADIO COMPANY  
GREGORY AMPLIFIER CORP  
HARTLEY PRODUCTS  
JENSEN MANUFACTURING  
KOSS ELECTRONICS, INC.  
LAKE ELECTRONICS, INC.  
JAMES B LANSING SOUND CO  
MCMARTIN INDUSTRIES  
NORTH AMERICAN PHILIPS CO  
OAKTRON INDUSTRIES, INC.  
PERMOFLUX CORPORATION  
RCA BROADCAST PRODS.

SEYCHELL CARLSON INCORPORATED  
SINGER PRODUCTS CO  
SONY CORPORATION OF AMERICA  
TRUSONIC  
TRW ELECTRONICS

SPLICERS, MAGNETIC TAPE & FILM

BIRNS & SAWYER  
BROADCAST ELECTRONICS, INC  
BURKE & JAMES  
G C ELECTRONICS COMPANY  
HARWALD COMPANY  
THE KALART COMPANY  
MINNESOTA MINING - 3 M  
MINUMADE PRODUCTS CORPORATION  
PRECISION LABORATORIES  
RCA BROADCAST PRODS.  
ROBINS INDUSTRIES CORP.  
SPARTA ELECTRONIC CORPORATION

STANDS, TELEVISION MONITOR

GENERAL TELEVISION NETWORK

STL EQUIPMENT

ANDREW CORPORATION  
CCA ELECTRONICS CORPORATION  
COLLINS RADIO COMPANY  
JERROLD ELECTRONICS CORP  
MARTI ELECTRONICS  
MCMARTIN INDUSTRIES  
MICRO-LINK SYSTEMS/VARIAN ASSO  
MOSLEY ASSOCIATES INC.  
RCA BROADCAST PRODS.  
RMG ELECTRONICS LABORATORY  
SARKES-TARZIAN  
SINGER PRODUCTS CO  
TELEMET COMPANY  
TELETRONIX  
TREPAC CORPORATION OF AMERICA  
VISUAL ELECTRONICS CORP

STROBE, DISC

G C ELECTRONICS COMPANY  
GENERAL RADIO CO  
LANG ELECTRONICS, INC  
ROBINS INDUSTRIES CORP.

STROBE, LIGHT

BERKEY TECHNICAL CORP  
ELECTRONIC LIGHTS, INC.  
G C ELECTRONICS COMPANY  
GENERAL RADIO CO  
ROBINS INDUSTRIES CORP.

STYLI, CUTTING

THE ASTATIC CORPORATION  
DUOTONE COMPANY INC  
SINGER PRODUCTS CO.  
TRANSCO PRODUCTS, INTL

STYLI, PLAYBACK

THE ASTATIC CORPORATION  
DUOTONE COMPANY INC  
SHURE BROTHERS, INC.  
TRANSCO PRODUCTS, INTL

SWITCHERS

ALMA ENGINEERING INC  
AMECO, INC.  
AMERICAN PAMCOR, INC  
BLONDER-TONGUE LABORATORIES  
CENTRAL DYNAMICS CORPORATION  
COMU ELECTRONICS  
DYNAIR ELECTRONICS, INC.  
G E VISUAL COMMUNICATIONS PROD  
INTERNATIONAL GOOD MUSIC  
INTERNATIONAL NUCLEAR CORP.  
JENNINGS RADIO MANUFACTURING  
RCA BROADCAST PRODS.  
RIKER VIDEO INDUSTRIES  
SCHAFFER ELECTRONICS  
SOUTHWESTERN COMMUNICATIONS  
SYLVANIA-COMM. ELECTRONICS DIV  
TELEMATION, INC.  
TREPAC CORPORATION OF AMERICA  
VISION CORPORATION  
VISUAL ELECTRONICS CORP  
WARD ELECTRONIC INDUSTRIES

SWITCHES, COAXIAL

ALFORD MANUFACTURING COMPANY  
AMERICAN ELECTRONIC LABS  
ANDREW CORPORATION  
BARKER & WILLIAMSON  
BIRD ELECTRONIC CORPORATION  
BLONDER-TONGUE LABORATORIES  
ENGINEERING ASSOCIATES  
JAMPRO ANTENNA COMPANY  
JENNINGS RADIO MANUFACTURING  
JERROLD ELECTRONICS CORP  
MICROLAB / FR  
MICROWAVE ASSOCIATES, INC.  
NARDA MICROWAVE CORPORATION  
PRODELIN, INCORPORATED  
SINGER PRODUCTS CO.  
THE TECHNICAL MATERIEL CORP  
TROMPETER ELECTRONICS  
WATERS MANUFACTURING

SWITCHES, CROSSBAR

CENTRAL DYNAMICS CORPORATION  
INTERNATIONAL NUCLEAR CORP.  
ITT TELECOMMUNICATIONS  
JENNINGS RADIO MANUFACTURING  
TROMPETER ELECTRONICS

SWITCHES, FOOT

ATLAS SOUND  
GENERAL ELECTRIC CO

SWITCHES, ILLUMINATED

DIALIGHT CORPORATION  
DONALD P. MOSSMAN, INC.  
OAK MANUFACTURING CO  
ROBINS INDUSTRIES CORP.



**SAF-T-CLIMB  
SAVES A LIFE!**

Saf-T-Climb — the only 100% positive safe climbing device — prevents falls from any vertical structure, above or below ground.

And, Saf-T-Climb is simplest to install, simplest to use — even on convex and concave structures. Galvanized, aluminum or stainless Saf-T-Notch Rail attaches rigidly to structure.

Worker wears belt snapped to manganese bronze Saf-T-Lok Sleeve with patented locking pawl that limits falls to 6-inch maximum. Widely approved; proven in use for over 12 years.



For informative  
brochure write:

**AIR SPACE DEVICES, INC.** 

Safety Tower Ladder Division  
Dept. 8G67, P.O. Box 338,  
Paramount, Calif., 90723.  
Phone: (213) 774-4905.

STEPHENS ELECTRONICS SWITCHCRAFT, INC.

**SWITCHES, INTERLOCK**  
GENERAL ELECTRIC CO  
DONALD P. MOSSMAN, INC.  
DAK MANUFACTURING CO  
SWITCHCRAFT, INC.

**SWITCHES, KNIFE**  
BIRNBACH CO  
ENGINEERING ASSOCIATES  
G C ELECTRONICS COMPANY  
E F JOHNSON COMPANY  
METRODOLITAN ELECTRIC MFG CO

**SWITCHES, LEVER**  
CENTRALAB  
GENERAL ELECTRIC CO  
MALLORY DISTRIBUTOR PRODUCTS  
DONALD P. MOSSMAN, INC.  
DAK MANUFACTURING CO  
SWITCHCRAFT, INC.

**SWITCHES, MECHANICALLY ACTUATED**  
ENGINEERING ASSOCIATES  
GENERAL ELECTRIC CO  
JENNINGS RADIO MANUFACTURING  
DAK MANUFACTURING CO  
DHMITE MANUFACTURING COMPANY  
WABER ELECTRONICS, INC.

**SWITCHES, MULTICONTACT**  
ALTEC LANSING  
CENTRALAB  
HICKOK ELECTRICAL INSTRUMENT  
LANGEVIN  
DONALD P. MOSSMAN, INC.  
DAK MANUFACTURING CO  
PAINTON INCORPORATED  
SWITCHCRAFT, INC.

**SWITCHES, PUSHBUTTON**  
AMERICAN ELITE  
BIRNBACH CO  
CENTRALAB  
G C ELECTRONICS COMPANY  
GENFRAL ELECTRIC CO  
MALLORY DISTRIBUTOR PRODUCTS  
DONALD P. MOSSMAN, INC.  
OAK MANUFACTURING CO  
PAINTON INCORPORATED  
SWITCHCRAFT, INC.

**SWITCHES, ROTARY**  
ALTEC LANSING  
AMERICAN ELITE  
CENTRALAB  
ENGINEERING ASSOCIATES  
G C ELECTRONICS COMPANY  
GENERAL ELECTRIC CO  
INDUSTRIAL DEVICES, INC.  
JENNINGS RADIO MANUFACTURING  
JERROLD ELECTRONICS CORP  
LANGEVIN  
MALLORY DISTRIBUTOR PRODUCTS  
DAK MANUFACTURING CO  
DHMITE MANUFACTURING COMPANY  
PAINTON INCORPORATED  
SINGER PRODUCTS CO.

**SWITCHES, SLIDE**  
AMERICAN ELITE  
BIRNBACH CO  
CENTRALAB  
ELECTRONICS ESSENTIALS OF CCC  
G C ELECTRONICS COMPANY  
DAK MANUFACTURING CO  
SINGER PRODUCTS CO.  
SWITCHCRAFT, INC.

**SWITCHES, SNAP**  
ELECTRONIC RESEARCH COMPANY  
ELECTRONICS ESSENTIALS OF CCC  
GENERAL ELECTRIC CO  
E F JOHNSON COMPANY  
DAK MANUFACTURING CO  
ROBINS INDUSTRIES CORP.  
SINGER PRODUCTS CO.

**SWITCHES, TELEPHONE TYPE**  
ITT TELECOMMUNICATIONS  
DONALD P. MOSSMAN, INC.  
SWITCHCRAFT, INC.

**SWITCHES, THERMAL**  
ELECTRONIC RESEARCH COMPANY  
GENERAL ELECTRIC CO  
G-V CONTROLS INC.

**SWITCHES, TOGGLE**  
AMERICAN ELITE  
BIRNBACH CO  
ELECTRONICS ESSENTIALS OF CCC  
G C ELECTRONICS COMPANY  
GENERAL ELECTRIC CO  
PAINTON INCORPORATED  
ROBINS INDUSTRIES CORP.  
SINGER PRODUCTS CO.

**SWITCHES, WAVEGUIDE**  
AMERICAN ELECTRONIC LABS  
ANDREW CORPORATION  
DEMORNAV - BONARDI DIVISION  
MICROLAB / FXR  
MICROWAVE ASSOCIATES, INC.

**SWITCHING MATRICES**  
ALMA ENGINEERING INC  
AMERICAN PAMCOR, INC  
ANDREW CORPORATION  
CENTRAL DYNAMICS CORPORATION  
COHU ELECTRONICS  
DELTA ELECTRONICS INC  
INTERNATIONAL NUCLEAR CORP.  
JENNINGS RADIO MANUFACTURING

MULTRONICS  
SARKES-TARZIAN  
SCHAFFER ELECTRONICS  
S. STERLING COMPANY  
SWITCHCRAFT, INC.  
TELEMET COMPANY  
TREPETER ELECTRONICS  
WARD ELECTRONIC INDUSTRIES

**SWITCHING SYSTEMS**  
ALMA ENGINEERING INC  
AMERICAN PAMCOR, INC  
ANDREW CORPORATION  
CENTRAL DYNAMICS CORPORATION  
COHU ELECTRONICS  
DYNAIR ELECTRONICS, INC.  
F & M SYSTEMS COMPANY  
GATES RADIO COMPANY  
HANDCOCK TELECONTROL  
INTERNATIONAL GOOD MUSIC  
INTERNATIONAL NUCLEAR CORP.  
ITT TELECOMMUNICATIONS  
JENNINGS RADIO MANUFACTURING  
RCA BROADCAST PRODS.  
RIKER VIDEO INDUSTRIES  
SARKES-TARZIAN  
STEPHENS ELECTRONICS  
S. STERLING COMPANY  
SWITCHCRAFT, INC.  
TELEQUIP CORPORATION  
TREPAC CORPORATION OF AMERICA  
TROMPETER ELECTRONICS  
VIDEON CORPORATION  
VISUAL ELECTRONICS CORP  
VITAL INDUSTRIES  
WARD ELECTRONIC INDUSTRIES

**TAPE DECKS, MAGNETIC**  
AMPFX CORPORATION  
AMPLIVISION CORPORATION  
ASCO SONOCRAFT CORP  
AUDIO INSTRUMENT CO  
BROADCAST ELECTRONICS, INC  
CONTINENTAL ELECTRONICS MFG  
CROWN INTERNATIONAL  
DISPLAY TECHNOLOGIES INC  
GATES RADIO COMPANY  
IMPEX ELECTRONICS CORP  
INTERNATIONAL GOOD MUSIC  
JETRONIC INDUSTRIES, INC.  
KRS INSTRUMENTS DIVISION  
MACKENZIE LABORATORIES  
MAGNA-TECH CORPORATION  
MAGNECORD  
MINNESOTA MINING - 3 M  
RCA BROADCAST PRODS.  
SCHAFFER ELECTRONICS  
SINGER PRODUCTS CO  
STAC, INC.  
STANCLIFF-HOFFMAN CORPORATION  
TELECTRO INDUSTRIES CORP  
VIKING OF MINNEAPOLIS  
VISUAL ELECTRONICS CORP

**TAPE DUPLICATORS**  
AMPX CORPORATION  
ASCO SONOCRAFT CORP  
BIONIC INSTRUMENTS, INC.  
CROWN INTERNATIONAL  
HARVEY RADIO CO, INC.  
LANG ELECTRONICS, INC  
MAGNA-TECH CORPORATION  
MAGNECORD  
MINNESOTA MINING - 3 M  
SINGER PRODUCTS CO  
TELECTRO INDUSTRIES CORP  
VIKING OF MINNEAPOLIS  
VISUAL ELECTRONICS CORP

**TAPE, MAGNETIC RECORDING, AUDIO**  
ALLIED ELECTRONICS CORP  
AMERICAN GELOSD ELECTRONICS  
AMPX CORPORATION  
ASCO SONOCRAFT CORP  
THE ASTATIC CORPORATION  
AUDIO DEVICES  
BIRNS & SAWYER  
BROADCAST ELECTRONICS, INC  
BURGESS BATTERY COMPANY  
COMPUTRON INC  
DUOTONE COMPANY INC  
EASTMAN KODAK COMPANY  
IMPEX ELECTRONICS CORP  
JDA CARTRIDGE SERVICE  
MACARTA INC.  
MAGNETIC MEDIA CORPORATION  
MINNESOTA MINING - 3 M  
RCA BROADCAST PRODS.  
REEVES SOUNDRAFT  
ROBINS INDUSTRIES CORP.  
SARKES-TARZIAN  
SINGER PRODUCTS CO  
TAPECASTER ELECTRONICS  
WIDE RESPONSE

**TAPE, MAGNETIC RECORDING, AUDIO, CARTRIDGE**  
AUDIO DEVICES  
BROADCAST ELECTRONICS, INC  
MINNESOTA MINING - 3 M  
SPARTA ELECTRONIC CORPORATION

**TAPE, MAGNETIC RECORDING, COMPUTER**  
AMPX CORPORATION  
AUDIO DEVICES  
COMPUTRON INC  
MAGNETIC MEDIA CORPORATION  
MEMOREX CORPORATION  
MINNESOTA MINING - 3 M  
REEVES SOUNDRAFT

**TAPE, MAGNETIC RECORDING, TEST**  
AMPX CORPORATION  
AUDIO DEVICES  
COMPUTRON INC

GATES RADIO COMPANY  
MINNEAPOLIS MAGNETICS  
MINNESOTA MINING - 3 M  
NDRTRONICS COMPANY, INC  
ORBIT RADIO

**TAPE, MAGNETIC RECORDING, VIDEO**  
AMECO, INC.  
AMPX CORPORATION  
AMPLIVISION CORPORATION  
ASCO SONOCRAFT CORP  
COMPUTRON INC  
MAGNETIC MEDIA CORPORATION  
MEMOREX CORPORATION  
MINNESOTA MINING - 3 M  
RCA BROADCAST PRODS.  
REEVES SOUNDRAFT  
SONY CORPORATION OF AMERICA  
TELEVISION UTILITIES CORP

**TAPE, MAGNETIC, GRAPHIC**  
KRS INSTRUMENTS DIVISION  
MINNESOTA MINING - 3 M

**TELEPHONE EQUIPMENT**  
ALTEC LANSING  
AMERICAN ELITE  
AUDIO INSTRUMENT CO  
BROADCAST ELECTRONICS, INC  
COOK ELECTRIC COMPANY  
ELECTRONICS ESSENTIALS OF CCC  
THE JAMES FLOYD FORD CO  
HEWLETT-PACKARD CO.  
ITT TELECOMMUNICATIONS  
RDANWELL CORPORATION  
TELEMET COMPANY

**TERMINAL BLOCKS**  
ADC PRODUCTS  
AMERICAN PAMCOR, INC  
BUCHANAN ELECTRICAL PRODS CORP  
COOK ELECTRIC COMPANY  
ELECTRONICS ESSENTIALS OF CCC  
GENERAL ELECTRIC CO  
RCA BROADCAST PRODS.  
SINGER PRODUCTS CO.  
THE THOMAS & BETTS CO

**TERMINAL BOARDS**  
ADC PRODUCTS  
BUCHANAN ELECTRICAL PRODS CORP  
D & B ELECTRONICS COMPANY  
ELECTRONICS ESSENTIALS OF CCC  
GENERAL ELECTRIC CO  
RCA BROADCAST PRODS.  
SINGER PRODUCTS CO.  
THE THOMAS & BETTS CO  
UTILITY PRODUCTS CO.

**TERMINAL CARDS**  
ACME VISIBLE RECORDS  
BUCHANAN ELECTRICAL PRODS CORP  
D & B ELECTRONICS COMPANY

**TERMINAL STRIPS**  
ADC PRODUCTS  
BIRNBACH CO  
BUCHANAN ELECTRICAL PRODS CORP  
D & B ELECTRONICS COMPANY  
ELECTRONICS ESSENTIALS OF CCC  
RCA BROADCAST PRODS.  
SINGER PRODUCTS CO.  
VITRO ELECTRONICS

**TERMINALS, BARRIER**  
BUCHANAN ELECTRICAL PRODS CORP  
ELECTRONICS ESSENTIALS OF CCC  
RCA BROADCAST PRODS.  
THE THOMAS & BETTS CO

**TERMINALS, HIGH VOLTAGE**  
AMERICAN PAMCOR, INC  
ELECTRONICS ESSENTIALS OF CCC  
PHELPS DODGE

**TERMINALS, LUG**  
AMERICAN PAMCOR, INC  
BIRNBACH CO  
BUCHANAN ELECTRICAL PRODS CORP  
ELECTRONICS ESSENTIALS OF CCC  
G C ELECTRONICS COMPANY  
HOLLINGSWORTH SOLDERLESS  
TERMINAL CO  
SINGER PRODUCTS CO.  
THE THOMAS & BETTS CO

**TERMINALS, SOLDER**  
BIRNBACH CO  
BUCHANAN ELECTRICAL PRODS CORP  
ELECTRONICS ESSENTIALS OF CCC  
G C ELECTRONICS COMPANY  
SINGER PRODUCTS CO.

**TERMINALS, SOLDERLESS**  
AEROVIX CORP.  
AMERICAN PAMCOR, INC  
BIRNBACH CO  
BUCHANAN ELECTRICAL PRODS CORP  
ELECTRONICS ESSENTIALS OF CCC  
G C ELECTRONICS COMPANY  
HOLLINGSWORTH SOLDERLESS  
TERMINAL CO  
SINGER PRODUCTS CO.  
THE THOMAS & BETTS CO

**TESTERS, BATTERY**  
GENERAL ELECTRIC CO  
GOTHAM AUDIO CORPORATION  
HICKOK ELECTRICAL INSTRUMENT  
MALLORY DISTRIBUTOR PRODUCTS  
SINGER PRODUCTS CO.

**TESTERS, CAPACITOR**  
CORNELL-DUBILIER ELECTRONICS  
GENERAL RADIO CO  
HICKOK ELECTRICAL INSTRUMENT  
RHODE & SCHWARZ SALES CO. -USA

**TESTERS, INSULATION**  
ENGINEERING ASSOCIATES  
GENERAL ELECTRIC CO  
GENERAL RADIO CO  
GOTHAM AUDIO CORPORATION  
RHODE & SCHWARZ SALES CO. -USA  
SINGER PRODUCTS CO  
TELEMET COMPANY  
YOKOGAWA ELECTRIC WORKS

**TESTERS, SEMICONDUCTOR**  
AMERICAN ELECTRONIC LABS  
DELTA ELECTRONICS, INC.  
HICKOK ELECTRICAL INSTRUMENT  
RHODE & SCHWARZ SALES CO. -USA  
SOLITRON DEVICES  
TEKTRONIX INC  
TRIPLETT ELECTRICAL INSTRUMENT

**TESTERS, VACUUM TUBE**  
ALLIED ELECTRONICS CORP  
ENGINEERING ASSOCIATES  
HICKOK ELECTRICAL INSTRUMENT  
RCA ELECTRONIC COMPONENTS  
TEKTRONIX INC  
TRIPLETT ELECTRICAL INSTRUMENT

**THYRISTORS - SEE SEMICONDUCTORS**

**TIMERS, ELECTRIC**  
BIONIC INSTRUMENTS, INC.  
BURKE & JAMES  
CURTIS INSTRUMENTS  
ENGINEERING ASSOCIATES  
GENERAL ELECTRIC CO  
GIBBS MFG. AND RESEARCH CORP.  
G-V CONTROLS INC.  
HICKOK ELECTRICAL INSTRUMENT  
MALLORY DISTRIBUTOR PRODUCTS  
SELA ELECTRONICS CO.

**TIMERS, MANUAL**  
THE ELMOR COMPANY  
JULES RACINE CO INC

**TOOLS, CLAMPS**  
AMECO, INC.

**TOOLS, CRIMPERS**  
AEROVIX CORP.  
AMECO, INC.  
AMERICAN PAMCOR, INC  
BLONDRF-TONGUE LABORATORIES  
BUCHANAN ELECTRICAL PRODS CORP  
HOLLINGSWORTH SOLDERLESS  
TERMINAL CO  
MATHIAS KLEIN & SONS  
MINNESOTA MINING - 3 M  
H. K. PORTER INC.  
THE THOMAS & BETTS CO

**TOOLS, CUTTERS**  
MATHIAS KLEIN & SONS  
H. K. PORTER INC.  
THE THOMAS & BETTS CO  
XCELITE INCORPORATED

**TOOLS, HAND**  
ELECTRONICS ESSENTIALS OF CCC  
HOLLINGSWORTH SOLDERLESS  
TERMINAL CO  
MATHIAS KLEIN & SONS  
H. K. PORTER INC.  
SINGER PRODUCTS CO.  
THE THOMAS & BETTS CO  
UPSON BROS.  
XCELITE INCORPORATED

**TOOLS, PLIERS**  
MATHIAS KLEIN & SONS  
SINGER PRODUCTS CO.  
XCELITE INCORPORATED

**TOOLS, PUNCH, CHASSIS**  
GREENLEE TOOL COMPANY

**TOOLS, SCREWDRIVERS**  
ELECTRONICS ESSENTIALS OF CCC  
G C ELECTRONICS COMPANY  
MATHIAS KLEIN & SONS  
SINGER PRODUCTS CO.  
UPSON BROS.  
XCELITE INCORPORATED

**TOOLS, SOLDERING IRONS, GUN**  
SINGER PRODUCTS CO.

**TOOLS, SOLDERING IRONS, INDUSTRIAL**  
SINGER PRODUCTS CO.  
UNGAR ELECTRIC TOOLS

**TOOLS, WRENCHES**  
ELECTRONICS ESSENTIALS OF CCC  
MATHIAS KLEIN & SONS  
XCELITE INCORPORATED

**TOWERS, ANTENNA, CATV, HEAD-END**  
ADVANCE INDUSTRIES  
AMECO, INC.  
AMPLIVISION CORPORATION  
ANTENNA PRODUCTS COMPANY  
BLAW-KNOX COMPANY  
DRESSER CRANE HOIST & TOWER  
FORT WORTH TOWER CO., INC.  
HY-GAIN ELECTRONICS  
JERROLD ELECTRONICS CORP  
KLINE IRON & STEEL COMPANY  
LIBERTY TOWER MFG. CO

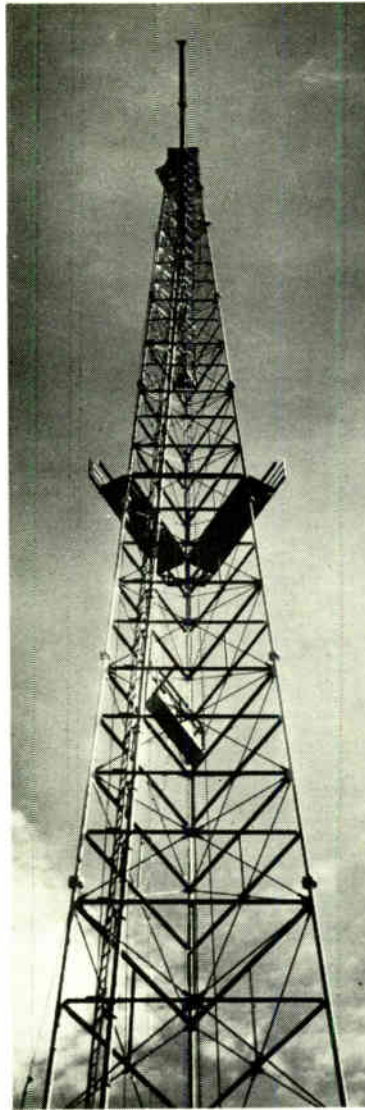

*At Rochester, N. Y., this self-supporting tower gives the WOKR antenna 306.5' elevation above the ground.*

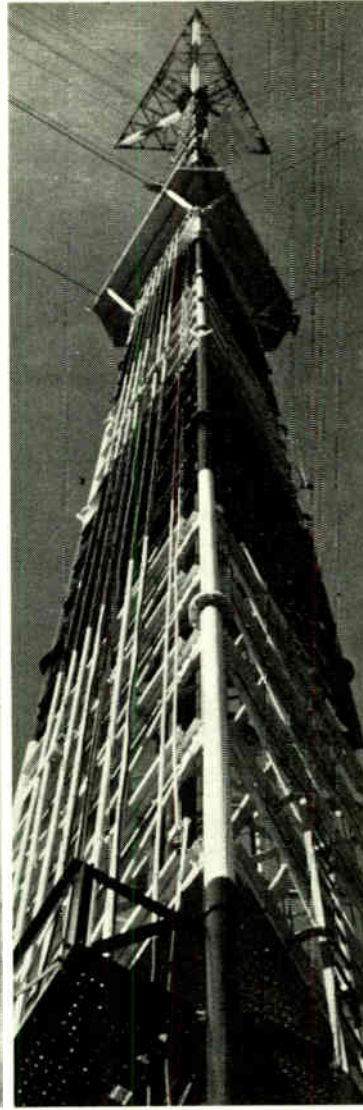

*Candelabra® tower carries 3 antenna as high as 1549' above ground for KCRA-TV, KOVR, KXTV.*

## TOWERS BY DRESSER FOR TV, RADIO, MICROWAVE, RADAR

**TV AND RADIO BROADCAST ANTENNA TOWERS**—*Types:* guyed or self-supporting. Can be insulated. Guyed available with fixed or pivoted base. *Heights:* available in any height. *Wind Loads:* 20 lb. through 90 lb. available as standard. Heavier loads available when required. *Antenna Loads:* designs available for any single TV or radio antenna, or any combination of antennas in stacked, side-mounted, or Candelabra (R) arrangements.

**MICROWAVE TOWERS**—*Types:* guyed or self-supporting. *Heights:* 50' through 300' available as standard. Greater heights available when required. *Wind Loads:* 30 lb. and 40 lb. loads standard. Heavier loads available when required. *Antenna Loads:* design available to support any combination of microwave equipment.

**RADAR TOWERS**—Types, heights and loads custom-designed to meet any requirement for support of radar equipment. Extensive experience in the design of radar structures for the Government.

**SPECIAL DESIGNS**—Large, experienced engineering staff and well-equipped fabricating plant capable of creating and fabricating towers of any kind, height or type for any requirement.

**TOWER ELEVATORS**—All steel elevator for TV and radio towers, rated for 750 lb. load, radio controlled, completely equipped with automatic safeties.

**TOWER ERECTION AND INSPECTION**—Complete tower erection and inspection service under supervision of graduate engineers.

**DRESSER**

**CRANE, HOIST & TOWER DIVISION**

one of the Dresser Industries  
(formerly Dresser-Idaco Co.)

885 Michigan Ave., Columbus, Ohio 43215  
Phone area 614, 299-2123 • TWX 614-759-0672  
Branch: 2314 Redondo Beach Blvd., Gardena, Calif. 90247

LITTLE JOE ENTERPRISES  
MASTER TOWER CO  
MICROFLECT COMPANY INC.  
PACIFIC TOWER CO  
ROHM MANUFACTURING CO.  
STAINLESS, INC.  
SWAGER TOWER CORPORATION  
UNITED STATES TOWERS  
UP-RIGHT SCAFFOLDS  
UTILITY TOWER CO.

TOWERS, ANTENNA, RECEIVING

ADVANCE INDUSTRIES  
AMECO, INC.  
ANTENNA PRODUCTS COMPANY  
DRESSER CRANE HOIST & TOWER  
FORT WORTH TOWER CO., INC.  
FLINE IRON & STEEL COMPANY  
LIBERTY TOWER MFG. CO  
LITTLE JOE ENTERPRISES  
MASTER TOWER CO  
MICROFLECT COMPANY INC.  
PACIFIC TOWER CO  
ROHM MANUFACTURING CO.  
SINGER PRODUCTS CO  
STAINLESS, INC.  
SWAGER TOWER CORPORATION  
TRYLON INCORPORATED  
UNITED STATES TOWERS  
UP-RIGHT SCAFFOLDS  
UTILITY TOWER CO.

TOWERS, ANTENNA, TRANSMITTING, AM

ADVANCE INDUSTRIES  
ANTENNA PRODUCTS COMPANY  
BLAW-KNOX COMPANY  
CCA ELECTRONICS CORPORATION  
DRESSER CRANE HOIST & TOWER  
FORT WORTH TOWER CO., INC.  
GATES RADIO COMPANY  
JAMPRO ANTENNA COMPANY  
KLINE IRON & STEEL COMPANY  
LIBERTY TOWER MFG. CO  
LITTLE JOE ENTERPRISES  
MASTER TOWER CO  
MICROFLECT COMPANY INC.  
GUNNAR A OLSEN CORP  
PACIFIC TOWER CO  
RCA BROADCAST PRODS.  
ROHM MANUFACTURING CO.  
SINGER PRODUCTS CO  
STAINLESS, INC.  
SWAGER TOWER CORPORATION  
TRYLON INCORPORATED  
UNITED STATES TOWERS  
UP-RIGHT SCAFFOLDS  
UTILITY TOWER CO.  
VISUAL ELECTRONICS CORP

TOWERS, ANTENNA, TRANSMITTING, FM

ADVANCE INDUSTRIES  
ANTENNA PRODUCTS COMPANY  
BLAW-KNOX COMPANY  
CCA ELECTRONICS CORPORATION  
DRESSER CRANE HOIST & TOWER  
FORT WORTH TOWER CO., INC.  
GATES RADIO COMPANY  
JAMPRO ANTENNA COMPANY  
KLINE IRON & STEEL COMPANY  
LIBERTY TOWER MFG. CO  
LITTLE JOE ENTERPRISES  
MASTER TOWER CO  
MICROFLECT COMPANY INC.  
GUNNAR A OLSEN CORP  
PACIFIC TOWER CO  
RCA BROADCAST PRODS.  
ROHM MANUFACTURING CO.  
SINGER PRODUCTS CO  
STAINLESS, INC.  
SWAGER TOWER CORPORATION  
TRYLON INCORPORATED  
UNITED STATES TOWERS  
UP-RIGHT SCAFFOLDS  
UTILITY TOWER CO.  
VISUAL ELECTRONICS CORP

TOWERS, ANTENNA, TRANSMITTING, TV

ADVANCE INDUSTRIES  
ANTENNA PRODUCTS COMPANY  
BLAW-KNOX COMPANY  
DRESSER CRANE HOIST & TOWER  
FORT WORTH TOWER CO., INC.  
GATES RADIO COMPANY  
JAMPRO ANTENNA COMPANY  
KLINE IRON & STEEL COMPANY  
LIBERTY TOWER MFG. CO  
MASTER TOWER CO  
MICROFLECT COMPANY INC.  
GUNNAR A OLSEN CORP  
PACIFIC TOWER CO  
RCA BROADCAST PRODS.  
ROHM MANUFACTURING CO.  
SINGER PRODUCTS CO.  
STAINLESS, INC.  
SWAGER TOWER CORPORATION  
TRYLON INCORPORATED  
UNITED STATES TOWERS  
UP-RIGHT SCAFFOLDS  
UTILITY TOWER CO.  
VISUAL ELECTRONICS CORP

TRANSFORMERS, AUDIO, ISOLATION

ADC PRODUCTS  
ALLIED ELECTRONICS CORP  
ALTEC LANSING  
ESSEX WIRE CORPORATION  
GOTHAM AUDIO CORPORATION  
LAFAYETTE RADIO ELECTRONICS  
PERMOFLUX CORPORATION  
RCA BROADCAST PRODS.  
ROHDE & SCHWARZ SALES CO. -USA  
STACO, INC.

TRW ELECTRONICS  
UNITED TRANSFORMER COMPANY

TRANSFORMERS, AUDIO, MATCHING

ADC PRODUCTS  
ALLIED ELECTRONICS CORP  
ALTEC LANSING  
ATLAS SOUND  
ESSEX WIRE CORPORATION  
GENERAL RADIO CO  
GOTHAM AUDIO CORPORATION  
LAFAYETTE RADIO ELECTRONICS  
LAKE ELECTRONICS, INC.  
PERMOFLUX CORPORATION  
RCA BROADCAST PRODS.  
ROHDE & SCHWARZ SALES CO. -USA  
STACO, INC.  
TRW ELECTRONICS  
TV CARLE SUPPLY CO  
UNITED TRANSFORMER COMPANY

TRANSFORMERS, AUDIO, POWER OUTPUT

ADC PRODUCTS  
ALLIED ELECTRONICS CORP  
ALTEC LANSING  
ESSEX WIRE CORPORATION  
LAFAYETTE RADIO ELECTRONICS  
LAKE ELECTRONICS, INC.  
MILF'S REPRODUCER CO  
PERMOFLUX CORPORATION  
STACO, INC.  
TRW ELECTRONICS  
UNITED TRANSFORMER COMPANY

TRANSFORMERS, AUTO

ADC PRODUCTS  
ALLIED ELECTRONICS CORP  
ALTEC LANSING  
CRAFTSMAN ELECTRONICS PRODUCTS  
ESSEX WIRE CORPORATION  
GENERAL ELECTRIC CO  
GENERAL RADIO CO  
HUGHEY & PHILLIPS  
LAFAYETTE RADIO ELECTRONICS  
PERMOFLUX CORPORATION  
SINGER PRODUCTS CO.  
SOLA ELECTRIC  
STACO, INC.  
TRW ELECTRONICS  
UNITED TRANSFORMER COMPANY

TRANSFORMERS, COUPLING

ADC PRODUCTS  
ALTEC LANSING  
ESSEX WIRE CORPORATION  
PERMOFLUX CORPORATION  
TRW ELECTRONICS  
UNITED TRANSFORMER COMPANY

TRANSFORMERS, FILAMENT

ADC PRODUCTS  
ALLIED ELECTRONICS CORP  
ALTEC LANSING  
ENGINEERING ASSOCIATES  
ESSEX WIRE CORPORATION  
GENERAL ELECTRIC CO  
LAFAYETTE RADIO ELECTRONICS  
LAKE ELECTRONICS, INC.  
PERMOFLUX CORPORATION  
SOLA ELECTRIC  
STACO, INC.  
TRW ELECTRONICS  
UNITED TRANSFORMER COMPANY

TRANSFORMERS, GENERAL

ADC PRODUCTS  
ALLIED ELECTRONICS CORP  
ALTEC LANSING  
ANACONDA ASTRODATA CO  
ESSEX WIRE CORPORATION  
G E INDUSTRIAL SALES OPERATION  
GENERAL ELECTRIC CO  
LAFAYETTE RADIO ELECTRONICS  
LAKE ELECTRONICS, INC.  
PERMOFLUX CORPORATION  
SINGER PRODUCTS CO.  
SOLA ELECTRIC  
STACO, INC.  
TRW ELECTRONICS  
TV CARLE SUPPLY CO  
UNITED TRANSFORMER COMPANY

TRANSFORMERS, PLATE

ADC PRODUCTS  
ALLIED ELECTRONICS CORP  
ALTEC LANSING  
ESSEX WIRE CORPORATION  
LAKE ELECTRONICS, INC.  
PERMOFLUX CORPORATION  
SOLA ELECTRIC  
STACO, INC.  
TRW ELECTRONICS  
UNITED TRANSFORMER COMPANY

TRANSFORMERS, POWER

ADC PRODUCTS  
ALLIED ELECTRONICS CORP  
ALTEC LANSING  
ENGINEERING ASSOCIATES  
ESSEX WIRE CORPORATION  
GENERAL ELECTRIC CO  
HUGHEY & PHILLIPS  
LAFAYETTE RADIO ELECTRONICS  
LAKE ELECTRONICS, INC.  
PERMOFLUX CORPORATION  
SOLA ELECTRIC  
STACO, INC.  
TRW ELECTRONICS  
UNITED TRANSFORMER COMPANY

TRANSFORMERS, RF

ADC PRODUCTS  
ALLIED ELECTRONICS CORP  
AMERICAN CABLE ELECTRONICS  
ANTENNA PRODUCTS COMPANY

BARKER & WILLIAMSON  
BLONDER-TONGUE LABORATORIES  
CRAFTSMAN ELECTRONICS PRODUCTS  
D & B ELECTRONICS COMPANY  
ESSEX WIRE CORPORATION  
KAPPA NETWORKS, INC.  
LAKE ELECTRONICS, INC.  
MICROLAB / FXR  
J. W. MILLER CO.  
THE TECHNICAL MATERIEL CORP

TRANSFORMERS, TRANSISTOR

ADC PRODUCTS  
ALLIED ELECTRONICS CORP  
ESSEX WIRE CORPORATION  
GOTHAM AUDIO CORPORATION  
LAFAYETTE RADIO ELECTRONICS  
LAKE ELECTRONICS, INC.  
STACO, INC.  
TRW ELECTRONICS  
UNITED TRANSFORMER COMPANY

TRANSFORMERS, VARIABLE

ALLIED ELECTRONICS CORP  
ENGINEERING ASSOCIATES  
ESSEX WIRE CORPORATION  
GENERAL ELECTRIC CO  
LAKE ELECTRONICS, INC.  
OHMITZ MANUFACTURING COMPANY  
STACO, INC.  
TRW ELECTRONICS  
UNITED TRANSFORMER COMPANY

TRANSISTORS - SFE SEMICONDUCTORS

AMPLIVISION CORPORATION  
KEITH ANDERSON CO  
RFCO TELEVISION ASSOCIATES  
CATEL COMPANY  
EMCEE  
F & M SYSTEMS COMPANY  
LITTON EDUCATIONAL TELE DIV  
TOWNSEND ASSOCIATES

TRANSMISSION LINES

AMECO, INC.  
ANDREW CORPORATION  
ANTENNA PRODUCTS COMPANY  
COPPERWELD STEEL COMPANY  
GATES RADIO COMPANY  
JAMPRO ANTENNA COMPANY  
JERROLD ELECTRONICS CORP  
MICROWAVE ASSOCIATES, INC.  
NARDA MICROWAVE CORPORATION  
PHELPS DODGE  
RCA BROADCAST PRODS.  
TRYLON INCORPORATED  
VISUAL ELECTRONICS CORP

TRANSMISSION TEST SETS

NARDA MICROWAVE CORPORATION  
PHELPS DODGE  
RCA BROADCAST PRODS.  
RIKER VIDEO INDUSTRIES  
VISUAL ELECTRONICS CORP  
WAVEFORMS, INCORPORATED

TRANSMITTER KITS

ALLIED ELECTRONICS CORP  
BAUER ELECTRONICS CORPORATION  
CCA ELECTRONICS CORPORATION  
GATES RADIO COMPANY  
E F JOHNSON COMPANY  
MILES REPRODUCER CO  
SINGER PRODUCTS CO

TRANSMITTERS, AM, LOW POWER

BAUER ELECTRONICS CORPORATION  
LOW POWER

TRANSMITTERS, AM, 250 WATT

AMERICAN ELECTRONIC LABS  
BAUER ELECTRONICS CORPORATION  
CCA ELECTRONICS CORPORATION  
COLLINS RADIO COMPANY  
GATES RADIO COMPANY  
E F JOHNSON COMPANY  
SINGER PRODUCTS CO  
TELETRONIX

TRANSMITTERS, AM, 1KW

AMERICAN ELECTRONIC LABS  
BAUER ELECTRONICS CORPORATION  
CCA ELECTRONICS CORPORATION  
COLLINS RADIO COMPANY  
GATES RADIO COMPANY  
E F JOHNSON COMPANY  
MARCONI DIVISION  
RCA BROADCAST PRODS.  
SINGER PRODUCTS CO  
TELETRONIX  
VISUAL ELECTRONICS CORP  
WILKINSON ELECTRONICS, INC

TRANSMITTERS, AM, 5KW

AMERICAN ELECTRONIC LABS  
BAUER ELECTRONICS CORPORATION  
CCA ELECTRONICS CORPORATION  
COLLINS RADIO COMPANY  
GATES RADIO COMPANY  
RCA BROADCAST PRODS.  
ROHDE & SCHWARZ SALES CO. -USA  
SINGER PRODUCTS CO  
TELETRONIX  
VISUAL ELECTRONICS CORP  
WILKINSON ELECTRONICS, INC

TRANSMITTERS, AM, 10KW

AMERICAN ELECTRONIC LABS  
AMERICAN ELITE  
BAUER ELECTRONICS CORPORATION

CCA ELECTRONICS CORPORATION  
COLLINS RADIO COMPANY  
CONTINENTAL ELECTRONICS MFG  
GATES RADIO COMPANY  
MARCONI DIVISION  
RCA BROADCAST PRODS.  
ROHDE & SCHWARZ SALES CO. -USA  
SINGER PRODUCTS CO  
TELETRONIX  
VISUAL ELECTRONICS CORP  
WILKINSON ELECTRONICS, INC

TRANSMITTERS, AM, 25 KW

AMERICAN ELECTRONIC LABS  
BAUER ELECTRONICS CORPORATION  
CCA ELECTRONICS CORPORATION  
CONTINENTAL ELECTRONICS MFG  
GATES RADIO COMPANY  
RCA BROADCAST PRODS.  
SINGER PRODUCTS CO  
VISUAL ELECTRONICS CORP

TRANSMITTERS, AM, 50 KW

AMERICAN ELECTRONIC LABS  
AMERICAN ELITE  
BAUER ELECTRONICS CORPORATION  
CCA ELECTRONICS CORPORATION  
CONTINENTAL ELECTRONICS MFG  
GATES RADIO COMPANY  
MARCONI DIVISION  
RCA BROADCAST PRODS.  
SINGER PRODUCTS CO  
TELETRONIX  
VISUAL ELECTRONICS CORP

TRANSMITTERS, AM, OVER 50 KW

AMERICAN ELITE  
CCA ELECTRONICS CORPORATION  
CONTINENTAL ELECTRONICS MFG  
GATES RADIO COMPANY  
MARCONI DIVISION  
SINGER PRODUCTS CO

TRANSMITTERS, AM, TO ORDER

EITEL ELECTRONICS

TRANSMITTERS, FM

MILES REPRODUCER CO  
ROHDE & SCHWARZ SALES CO. -USA  
THOMSON ELECTRIC CO

TRANSMITTERS, FM, 10 WATTS

AMERICAN ELECTRONIC LABS  
CCA ELECTRONICS CORPORATION  
GATES RADIO COMPANY  
MARTI ELECTRONICS  
MOSELEY ASSOCIATES INC.  
SINGER PRODUCTS CO

TRANSMITTERS, FM, 50 WATTS

GATES RADIO COMPANY

TRANSMITTERS, FM, 100 WATTS

CCA ELECTRONICS CORPORATION  
MARTI ELECTRONICS  
RMG ELECTRONICS LABORATORY  
SINGER PRODUCTS CO

TRANSMITTERS, FM, 250 WATTS

AMERICAN ELECTRONIC LABS  
CCA ELECTRONICS CORPORATION  
GATES RADIO COMPANY  
SINGER PRODUCTS CO  
STANDARD ELECTRONICS CORP.  
TELETRONIX

TRANSMITTERS, FM, 1 KW

AMERICAN ELECTRONIC LABS  
BAUER ELECTRONICS CORPORATION  
CCA ELECTRONICS CORPORATION  
COLLINS RADIO COMPANY  
GATES RADIO COMPANY  
MARCONI DIVISION  
RCA BROADCAST PRODS.  
RMG ELECTRONICS LABORATORY  
SINGER PRODUCTS CO  
STANDARD ELECTRONICS CORP.  
TELETRONIX  
WILKINSON ELECTRONICS, INC

TRANSMITTERS, FM, 3 KW

BAUER ELECTRONICS CORPORATION  
CCA ELECTRONICS CORPORATION  
GATES RADIO COMPANY  
TELETRONIX  
VISUAL ELECTRONICS CORP

TRANSMITTERS, FM, 5 KW

AMERICAN ELECTRONIC LABS  
AMERICAN ELITE  
CCA ELECTRONICS CORPORATION  
COLLINS RADIO COMPANY  
GATES RADIO COMPANY  
MARCONI DIVISION  
RCA BROADCAST PRODS  
SINGER PRODUCTS CO  
STANDARD ELECTRONICS CORP.  
TELETRONIX  
VISUAL ELECTRONICS CORP  
WILKINSON ELECTRONICS, INC

TRANSMITTERS, FM, 7.5 KW

AMERICAN ELECTRONIC LABS  
BAUER ELECTRONICS CORPORATION  
GATES RADIO COMPANY  
WILKINSON ELECTRONICS, INC

TRANSMITTERS, FM, 10 KW

AMERICAN ELECTRONIC LABS  
AMERICAN ELITE  
BAUER ELECTRONICS CORPORATION  
CCA ELECTRONICS CORPORATION  
COLLINS RADIO COMPANY  
GATES RADIO COMPANY  
RCA BROADCAST PRODS

# CONTINENTAL'S TYPE 317C\_\_\_\_\_

Within 18 months following its introduction, Continental had sold 13 Type 317C transmitters. Here's why:

**OVERALL EFFICIENCY:**

62% or better

**PLATE EFFICIENCY:**

80% or better

**POWER CONSUMPTION:**

82 kw @ 0 modulation

92 kw @ 30% modulation

120 kw @ 100% modulation

**SELF-CONTAINED:** compact design assures minimum installation cost. The 317C uses only 62 sq. ft. of total floor space. Blower is contained within transmitter cabinet. One neat package for the world's most efficient 50 kw AM broadcast transmitter.

THE WORLD'S MOST EFFICIENT 50KW  
AM BROADCAST TRANSMITTER!

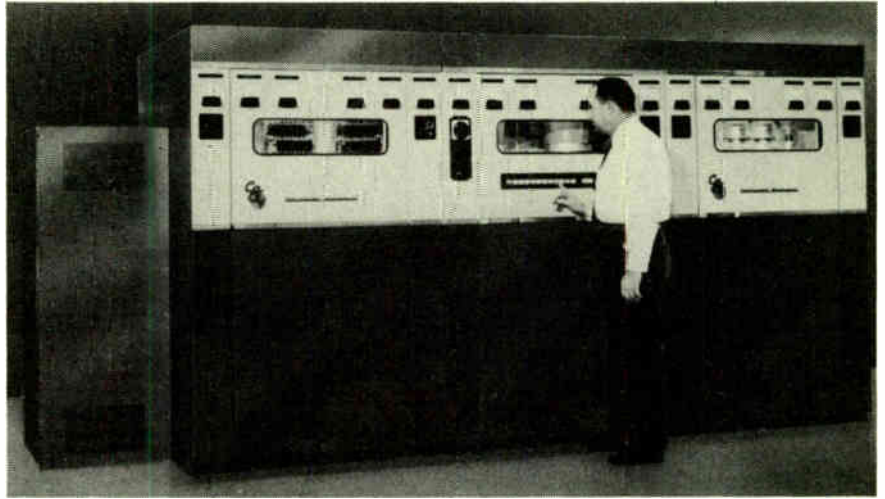

OTHER CONTINENTAL BROADCAST TRANSMITTERS range in power from 5,000 watts to 1,000,000 watts.

## CONTINENTAL'S PROLOG-AUTOMATIC PROGRAMMING & LOGGING AS EASY AS TYPING UP YOUR STATION LOG!

Prolog uses your station log to provide any degree or combination of unattended, automatic or manual-live operation desired. Your log can be prepared on any standard electric typewriter, or you can use any of the auto-typing, IBM punch-card and similar equipment in use today. PROLOG uses your established programming format; nothing changes unless you want to change it. That's PROLOG: simple and flexible!

For additional information on Continental transmitters or PROLOG Systems, write Commercial Sales Dept; Continental Electronics Mfg. Co.; Box 17040, Dallas, Texas 75217

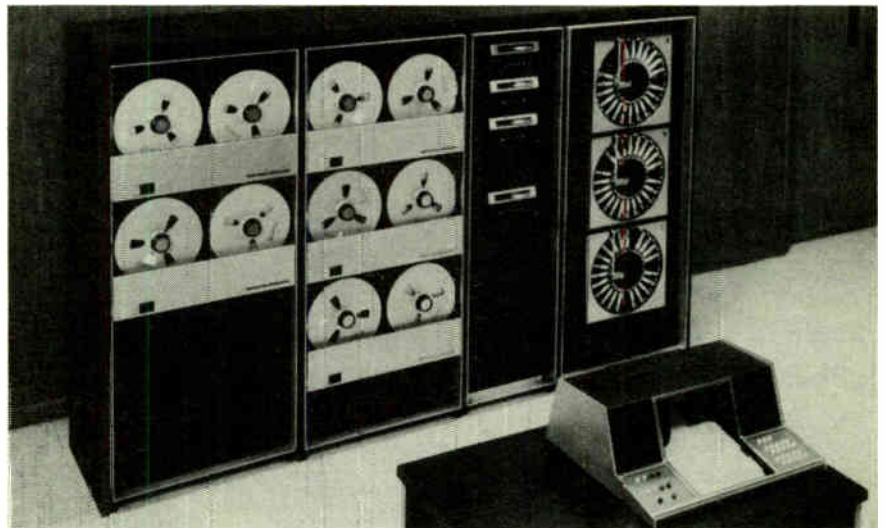

*Continental Electronics*   
A SUBSIDIARY OF **LTV** ELECTROSYSTEMS, INC.

RHG ELECTRONICS LABORATORY  
STANDARD ELECTRONICS CORP.  
TELETRONIX  
VISUAL ELECTRONICS CORP  
WILKINSON ELECTRONICS, INC

TRANSMITTERS, FM, 15 KW  
CCA ELECTRONICS CORPORATION  
GATES RADIO COMPANY

TRANSMITTERS, FM, 20 KW  
AMERICAN ELECTRONIC LABS  
BAUER ELECTRONICS CORPORATION  
CCA ELECTRONICS CORPORATION  
COLLINS RADIO COMPANY  
GATES RADIO COMPANY  
RCA BROADCAST PRODS  
SINGER PRODUCTS CO  
STANDARD ELECTRONICS CORP.  
VISUAL ELECTRONICS CORP  
WILKINSON ELECTRONICS, INC

TRANSMITTERS, FM, 40 KW  
CCA ELECTRONICS CORPORATION  
GATES RADIO COMPANY  
RCA BROADCAST PRODS

TRANSMITTERS, FM, 50 KW  
AMERICAN ELITE

TRANSMITTERS, FM, 100 KW  
AMERICAN ELITE

TRANSMITTERS, FM, TO ORDER  
EITEL ELECTRONICS

TRANSMITTERS, TV  
ROHDE & SCHWARZ SALES CO. -USA  
THOMSON ELECTRIC CO

TRANSMITTERS, TV, 1 WATT  
KEITH ANDERSON CO  
EMCEE

TRANSMITTERS, TV, 10 WATTS  
KEITH ANDERSON CO

TRANSMITTERS, TV, 20 WATTS  
EMCEE

TRANSMITTERS, TV, 60 WATTS  
UTICA CORPORATION

TRANSMITTERS, TV, 100 WATTS  
EMCEE  
GATES RADIO COMPANY

TRANSMITTERS, TV, 500 WATTS  
GATES RADIO COMPANY  
STANDARD ELECTRONICS CORP

TRANSMITTERS, TV, 1 KW  
MARCONE DIVISION  
EMCEE  
SARKES-TARZIAN

TRANSMITTERS, TV, 2 KW  
RCA BROADCAST PRODS

TRANSMITTERS, TV, 3 KW  
TOWNSEND ASSOCIATES

TRANSMITTERS, TV, 5 KW  
GATES RADIO COMPANY  
MARCONE DIVISION  
RCA BROADCAST PRODS  
STANDARD ELECTRONICS CORP.

TRANSMITTERS, TV, 6 KW  
RCA BROADCAST PRODS

TRANSMITTERS, TV, 10 KW  
G E VISUAL COMMUNICATIONS PROD  
MARCONE DIVISION  
STANDARD ELECTRONICS CORP.

TRANSMITTERS, TV, 11.5W  
RCA BROADCAST PRODS

TRANSMITTERS, TV, 12 KW  
RCA BROADCAST PRODS

TRANSMITTERS, TV, 15 KW  
TOWNSEND ASSOCIATES  
VISUAL ELECTRONICS CORP

TRANSMITTERS, TV, 25 KW  
MARCONE DIVISION  
RCA BROADCAST PRODS  
STANDARD ELECTRONICS CORP.

TRANSMITTERS, TV, 30 KW  
G E VISUAL COMMUNICATIONS PROD  
RCA BROADCAST PRODS  
TOWNSEND ASSOCIATES  
VISUAL ELECTRONICS CORP

TRANSMITTERS, TV, 35 KW  
STANDARD ELECTRONICS CORP.

TRANSMITTERS, TV, 50 KW  
G E VISUAL COMMUNICATIONS PROD  
RCA BROADCAST PRODS  
STANDARD ELECTRONICS CORP.

TRANSMITTERS, TV, 55 KW  
TOWNSEND ASSOCIATES  
VISUAL ELECTRONICS CORP

TRANSMITTERS, TV, 70 KW  
STANDARD ELECTRONICS CORP.

TRANSMITTERS, TV, 100 KW  
G E VISUAL COMMUNICATIONS PROD  
TOWNSEND ASSOCIATES

TRANSMITTERS, TV, 150 KW  
RCA BROADCAST PRODS

TRANSMITTERS, TV, TO ORDER  
EITEL ELECTRONICS

TUNING - SEE HARDWARE

TURNABLES, PHONOGRAPH  
BENJAMIN ELECTRONIC SOUND CORP  
DISPLAY TECHNOLOGIES INC  
FAIRCHILD RECORDING EQUIPMENT  
GOTHAM AUDIO CORPORATION  
GRAY RESEARCH & DEVELOPMENT CO  
KOSS ELECTRONICS, INC.  
MARANTZ COMPANY  
Q R K ELECTRONIC PRODUCTS  
RCA BROADCAST PRODS.  
RUSSCO ELECTRONICS MFG.  
SINGER PRODUCTS CO  
SONY CORPORATION OF AMERICA  
SPARTA ELECTRONIC CORPORATION  
TELECTRO INDUSTRIES CORP  
VISUAL ELECTRONICS CORP  
THE SINGER CO - METRICS DIV

TV SYSTEMS, CLOSED CIRCUIT  
AMECO, INC.  
AMERICAN CABLE ELECTRONICS  
AMPEX CORPORATION  
AMPLIVISION CORPORATION  
ANACONDA ASTRODATA CO  
RALL PROTHERS RESEARCH  
BIONIC INSTRUMENTS, INC.  
BLONDER-TONGUE LABORATORIES  
CENTRAL DYNAMICS CORPORATION  
COHU ELECTRONICS  
COLORADO VIDEO  
DAGE RELL CORPORATION  
DIAMOND ELECTRONICS  
DIACRAFT, INC  
F & M SYSTEMS COMPANY  
THE JAMES FLOYD FORD CO  
GRC AMERICA CORPORATION  
G E VISUAL COMMUNICATIONS PROD  
GENERAL ELECTRIC CO  
JERROLD ELECTRONICS CORP  
J M ELECTRONICS COMPANY  
KAISER-COX  
THE KALART COMPANY  
LITTON EDUCATIONAL TELE DIV  
MARCONE DIVISION  
MARYLAND TELECOMMUNICATIONS  
MICRO-LINK SYSTEMS/VARIAN ASSO  
MIRATFL ELECTRONICS, INC  
MVR CORPORATION  
RCA BROADCAST PRODS.  
RIKER VIDEO INDUSTRIES  
SARKES-TARZIAN  
SETCHELL CARLSON INCORPORATED  
SIGMA INDUSTRIES  
SONY CORPORATION OF AMERICA  
SPFNCR-KENNEDY LABORATORIES  
STANDARD ELECTRONICS CORP.  
S. STERLING COMPANY  
SYLVANIA-COMM. ELECTRONICS DIV  
TELEMATION, INC.  
TELEMET COMPANY  
TELEQUIP CORPORATION  
TELEVISION UTILITIES CORP  
TELTRON, INC  
THOMSON ELECTRIC CO

VACUUM TUBES, BALLAST  
AMPERITE CO  
LEWIS AND KAUFMAN, LTD.  
THOR ELECTRONICS

VACUUM TUBES, CAMERA,  
IMAGE-ORTHICON  
AMPEREX ELECTRONIC CORP  
THE ENGLISH ELECTRIC CORP.  
G E PICKUP TUBE OPERATION  
RCA ELECTRONIC COMPONENTS  
TELEQUIP CORPORATION  
TELTRON, INC  
THOR ELECTRONICS  
VISUAL ELECTRONICS CORP  
WESTINGHOUSE ELECTRIC CORP

VACUUM TUBES, CAMERA, PLUMBICON  
AMPEREX ELECTRONIC CORP  
NORTH AMERICAN PHILIPS CO  
VISUAL ELECTRONICS CORP

VACUUM TUBES, CAMERA, VIDICON  
AMPEREX ELECTRONIC CORP  
THE ENGLISH ELECTRIC CORP.  
GBC AMERICA CORPORATION  
G E PICKUP TUBE OPERATION  
LEWIS AND KAUFMAN, LTD.  
NORTH AMERICAN PHILIPS CO  
RCA ELECTRONIC COMPONENTS  
TELEQUIP CORPORATION  
TELEVISION UTILITIES CORP  
THOR ELECTRONICS  
VISUAL ELECTRONICS CORP  
WESTINGHOUSE ELECTRIC CORP

VACUUM TUBES, CATHODE RAY,  
OSCILLOSCOPE  
TEKTRONIX INC

VACUUM TUBES, CATHODE RAY,  
TV, COLOR  
G E DISTRIBUTOR SALES FORCE  
RCA ELECTRONIC COMPONENTS  
SINGER PRODUCTS CO.  
THOR ELECTRONICS  
WESTINGHOUSE ELECTRIC CORP

VACUUM TUBES, CATHODE RAY,  
TV, MONOCHROME  
AMERICAN ELITE  
CONRAC  
G E DISTRIBUTOR SALES FORCE

LEWIS AND KAUFMAN, LTD.  
RCA ELECTRONIC COMPONENTS  
SINGER PRODUCTS CO.  
THOR ELECTRONICS  
WESTINGHOUSE ELECTRIC CORP

VACUUM TUBES, RECEIVING  
AMERICAN ELITE  
AMPEREX ELECTRONIC CORP  
CALVERT ELECTRONICS  
G E DISTRIBUTOR SALES FORCE  
HEINITZ & KAUFMAN, LTD  
LEWIS AND KAUFMAN, LTD.  
MICROWAVE ASSOCIATES, INC.  
RCA ELECTRONIC COMPONENTS  
SINGER PRODUCTS CO.  
TELEQUIP CORPORATION  
THOR ELECTRONICS  
WESTINGHOUSE ELECTRIC CORP

VACUUM TUBES, TRANSMITTING  
AMECO, INC.  
AMERICAN ELITE  
AMPEREX ELECTRONIC CORP  
CALVERT ELECTRONICS  
CCA ELECTRONICS CORPORATION  
EIMAC DIVISION OF VARIAN  
THE ENGLISH ELECTRIC CORP.  
G E DISTRIBUTOR SALES FORCE  
HEINITZ & KAUFMAN, LTD  
JOA CARTRIDGE SERVICE  
LEWIS AND KAUFMAN, LTD.  
THE MACHLETT LABORATORIES  
MICROWAVE ASSOCIATES, INC.  
RCA ELECTRONIC COMPONENTS  
THOR ELECTRONICS  
WESTINGHOUSE ELECTRIC CORP

VESTIGIAL SIDEBAND FILTERS  
ALFORD MANUFACTURING COMPANY  
G E VISUAL COMMUNICATIONS PROD  
JAMPRO ANTENNA COMPANY  
VISUAL ELECTRONICS CORP

VOLTMETERS, AC  
ALLIED ELECTRONICS CORP  
API INSTRUMENTS CO.  
COHU ELECTRONICS  
COLUMBIA ELECTRIC MFG CO  
DATA INSTRUMENT DIVISION  
ENGINEERING ASSOCIATES  
G E INDUSTRIAL SALES OPERATION  
GENERAL ELECTRIC CO  
GENTRAL RADIO CO  
GOTHAM AUDIO CORPORATION  
HEATH CO  
HEWLETT-PACKARD CO.  
HICKOK ELECTRICAL INSTRUMENT  
INSTRUMENT LABORATORIES CORP  
MOTOROLA COMMUNICATIONS  
RCA ELECTRONIC COMPONENTS  
ROHDE & SCHWARZ SALES CO. -USA  
THE SINGER CO - METRICS DIV  
TEXAS ELECTRONICS  
TRIPLETT ELECTRICAL INSTRUMENT  
WABER ELECTRONICS, INC.  
WAVEFORMS, INCORPORATED  
YOKOGAWA ELECTRIC WORKS

VOLTMETERS, DC  
ALLIED ELECTRONICS CORP  
API INSTRUMENTS CO.  
COHU ELECTRONICS  
COLUMBIA ELECTRIC MFG CO  
DATA INSTRUMENT DIVISION  
ENGINEERING ASSOCIATES  
G E INDUSTRIAL SALES OPERATION  
GENERAL ELECTRIC CO  
GENERAL RADIO CO  
HEATH CO  
HEWLETT-PACKARD CO.  
HICKOK ELECTRICAL INSTRUMENT  
MOTOROLA COMMUNICATIONS  
RCA ELECTRONIC COMPONENTS  
ROHDE & SCHWARZ SALES CO. -USA  
THE SINGER CO - METRICS DIV  
TEXAS ELECTRONICS  
TRIPLETT ELECTRICAL INSTRUMENT  
YOKOGAWA ELECTRIC WORKS

VOLTMETERS, VACUUM TUBE  
COHU ELECTRONICS  
ENGINEERING ASSOCIATES  
GENERAL RADIO CO  
HEATH CO  
HEWLETT-PACKARD CO.  
HICKOK ELECTRICAL INSTRUMENT  
INSTRUMENT LABORATORIES CORP  
RCA ELECTRONIC COMPONENTS  
ROHDE & SCHWARZ SALES CO. -USA  
TRIPLETT ELECTRICAL INSTRUMENT  
WAVEFORMS, INCORPORATED  
BENRUS

WATTMETERS  
F W BELL, INC  
BIRD ELECTRONIC CORPORATION  
ENGINEERING ASSOCIATES  
G E INDUSTRIAL SALES OPERATION  
GENERAL ELECTRIC CO  
GENERAL MICROWAVE CORPORATION  
MOTOROLA COMMUNICATIONS  
RCA BROADCAST PRODS.  
ROHDE & SCHWARZ SALES CO. -USA  
THE SINGER CO - METRICS DIV  
STANDARD ELECTRONICS CORP.  
TRIPLETT ELECTRICAL INSTRUMENT  
WATERS MANUFACTURING  
YOKOGAWA ELECTRIC WORKS

WAVEGUIDE AND ASSOCIATED  
COMPONENTS  
ANDREW CORPORATION  
CARDWELL CONDENSER CORP  
COOK ELECTRIC COMPANY

D & B ELECTRONICS COMPANY  
DEMORNAY - BDNARDI DIVISION  
GENERAL MICROWAVE CORPORATION  
HEWLETT-PACKARD CO.  
JERROLD ELECTRONICS CORP  
MICROLAB / FXR  
MICRO-LINK SYSTEMS/VARIAN ASSO  
MICROWAVE ASSOCIATES, INC.  
PHELPS DODGE  
RCA BROADCAST PRODS.  
SCIENTIFIC-ATLANTA  
TECHNICAL APPLIANCE CORP

WEATHER INSTRUMENTS  
AMECO, INC.  
BECKMAN & WHITLEY  
BLONDER-TONGUE LABORATORIES  
TELSIS CORPORATION  
TEXAS ELECTRONICS

WINDERS, CARTRIDGE  
BROADCAST ELECTRONICS, INC

WIRE, BARE, COPPER  
ALLIED ELECTRONICS CORP  
ALPHA WIRE  
AMECO, INC.  
BELDEN MANUFACTURING CO  
BIRNBACH CO  
CCA ELECTRONICS CORPORATION  
JAMPRO ANTENNA COMPANY  
PACIFIC TOWER CO  
RCA BROADCAST PRODS.  
ROBINS INDUSTRIES CORP.  
SAXTON PRODUCTS  
SWAGER TOWER CORPORATION  
UTILITY TOWER CO.

WIRE, BARE, COPPER STRAP  
ALPHA WIRE  
CCA ELECTRONICS CORPORATION  
JAMPRO ANTENNA COMPANY  
RCA BROADCAST PRODS.  
SAXTON PRODUCTS  
SWAGER TOWER CORPORATION  
UTILITY TOWER CO.

WIRE, BARE, STEEL  
COPPERWELD STEEL COMPANY  
SAXTON PRODUCTS

WIRE, INSULATED, HIGH VOLTAGE  
ALPHA WIRE  
BELDEN MANUFACTURING CO  
BIRNBACH CO  
BOSTON INSULATED WIRE & CABLE  
ITT WIRE & CABLE DIVISION  
LENZ ELECTRIC MANUFACTURING CO  
SAXTON PRODUCTS  
SINGER PRODUCTS CO.  
TENSOLITE INSULATED WIRE CO.

WIRE, INSULATED, HOOKUP  
ALLIED ELECTRONICS CORP  
ALPHA WIRE  
BELDEN MANUFACTURING CO  
BIRNBACH CO  
ITT WIRE & CABLE DIVISION  
LENZ ELECTRIC MANUFACTURING CO  
ROBINS INDUSTRIES CORP.  
SAXTON PRODUCTS  
SUPERIOR CABLE CORPORATION  
TENSOLITE INSULATED WIRE CO.

WIRE, SHIELDED  
ALLIED ELECTRONICS CORP  
ALPHA WIRE  
BELDEN MANUFACTURING CO  
BIRNBACH CO  
BOSTON INSULATED WIRE & CABLE  
ITT WIRE & CABLE DIVISION  
LENZ ELECTRIC MANUFACTURING CO  
RCA BROADCAST PRODS.  
ROBINS INDUSTRIES CORP.  
SAXTON PRODUCTS  
SINGER PRODUCTS CO.  
TELEQUIP CORPORATION  
TENSOLITE INSULATED WIRE CO.

WIRING & CABLING SERVICES  
ALPHA WIRE  
AMECO, INC.  
APPLIED ELECTRO-MECHANICS  
AUDIO ACCESSORIES  
BOSTON INSULATED WIRE & CABLE  
D & B ELECTRONICS COMPANY  
IAT CANNON ELECTRIC  
PALL TRINITY MICRO CORP  
SAXTON PRODUCTS  
TENSOLITE INSULATED WIRE CO.  
VITRO ELECTRONICS

YOKES, DEFLECTION  
AMERICAN ELITE  
LAKE ELECTRONICS, INC.  
SINGER PRODUCTS CO.  
TELEQUIP CORPORATION

**NEW** FROM **EMCEE**

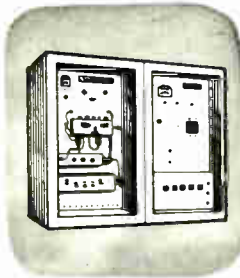

**1KW  
TRANSLATOR**  
UHF

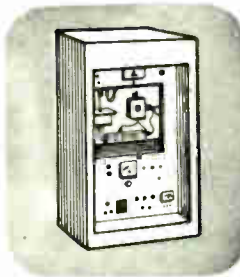

**1KW  
TRANSMITTER**  
UHF

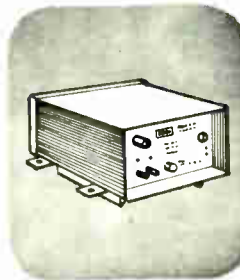

**1 WATT  
TRANSISTORIZED  
TRANSLATOR**  
VHF ONLY

Send for full details . . . now



**Electronics Missiles and Communications Inc.**

160 EAST THIRD STREET, MT. VERNON, NEW YORK 10550

TELEPHONE: (914) 668-3012

# Collins could sell FM transmitters for 20% less



## BUT then they wouldn't be the best in the world

All Collins transmitters could be sold for less.

- Corners could be cut on transformers (narrowing safety margins for continuous operation).
- Less shielding could be used against spurious radiation (sacrificing some degree of stability).
- Standards on components, wiring, cabling and switches could be lowered.
- Collins' rigid testing could be bypassed.
- Meeting proper load conditions could be left to luck.
- Money devoted to research and development could be saved.
- Collins' 2-year warranty could be cut to the 1-year period of other manufacturers.

All these compromises could lower the price—as well as the *quality, performance* and *reliability* of the product—about 20%. But then Collins transmitters wouldn't be known for their careful engineering, conservatively-rated components, and precision manufacturing techniques.

Collins gives the broadcaster a discount in the form of quality and service. And that's worth a lot more than 20%.

For technical information on any FM transmitter ranging from 250w to 20kw, contact Collins Radio Company, Broadcast Communication Division, Dallas, Texas. Area Code 214, AD 5-9511.

COMMUNICATION / COMPUTATION / CONTROL



COLLINS RADIO COMPANY / DALLAS, TEXAS • CEDAR RAPIDS, IOWA • NEWPORT BEACH, CALIFORNIA • TORONTO, ONTARIO  
Bangkok • Beirut • Frankfurt • Hong Kong • Kuala Lumpur • Los Angeles • London • Melbourne • Mexico City • New York • Paris • Rome • Washington • Wellington





# GUIDE TO MANUFACTURERS

A listing of over 450 manufacturers active in the broadcast industry.  
For a specific product, see Product Directory.

**ACME FILM & VIDEOTAPE LABS.**  
FILM, PROCESSING SERVICE

**ACME VISIBLE RECORDS**  
CABINETS, METAL  
CABINETS, STORAGE, DISC  
CABINETS, STORAGE, FILM  
CABINETS, STORAGE,  
MAGNETIC TAPE  
COMPUTER SERVICES  
DESIGNATION CARDS & STRIPS  
LOG BOOKS OF SHEETS  
TERMINAL CARDS

**ADC PRODUCTS**  
COILS, CHOKES, AF  
COILS, HYBRID  
COILS, TELEPHONE  
COROS, PATCH  
FILTERS, AUDIO  
FILTERS, RF

INDUCTANCES, FIXED  
JACK PANEL ASSEMBLIES  
JACKS  
LAMP, PANEL  
PLUGS, COAXIAL  
PLUGS, PHONE  
POWER SUPPLIES, AC  
POWER SUPPLIES, DC  
TERMINAL BLOCKS  
TERMINAL BOARDS  
TERMINAL STRIPS  
TRANSFORMERS, AUDIO,  
ISOLATION  
TRANSFORMERS, AUDIO, MATCHING  
TRANSFORMERS, AUDIO,  
POWER OUTPUT  
TRANSFORMERS, AUTO  
TRANSFORMERS, COUPLING  
TRANSFORMERS, FILAMENT  
TRANSFORMERS, GENERAL  
TRANSFORMERS, PLATE  
TRANSFORMERS, POWER  
TRANSFORMERS, RF  
TRANSFORMERS, TRANSISTOR

**AIR SPACE DEVICES, INC.**  
SAFETY DEVICES, CLIMBING

**ADVANCE INDUSTRIES**  
ANCHORS, GUY  
ANTENNAS, AM  
ANTENNAS, CATV  
ANTENNAS, MICROWAVE  
HARDWARE, MOUNTS  
REFLECTORS, PASSIVE  
TOWERS, ANTENNA,  
CATV, HEAD-END  
TOWERS, ANTENNA, RECEIVING  
TOWERS, ANTENNA,  
TRANSMITTING, AM  
TOWERS, ANTENNA,  
TRANSMITTING, FM

TOWERS, ANTENNA,  
TRANSMITTING, TV

**AEROVOX CORP.**  
BOXES, DECADE, CAPACITOR  
BOXES, DECADE, INDUCTOR  
BOXES, DECADE, RESISTOR  
CAPACITORS, FIXED, CERAMIC  
CAPACITORS, FIXED,  
ELECTROLYTIC  
CAPACITORS, FIXED, FILM  
CAPACITORS, FIXED, METALLIZED  
CAPACITORS, FIXED, MICA  
CAPACITORS, FIXED, OIL-FILLED  
CAPACITORS, FIXED, PAPER  
CAPACITORS, FIXED, OTHER  
DEMAGNETIZERS, BULK TAPE  
FILTERS, AUDIO  
FILTERS, RF  
INTEGRATED CIRCUITS  
KITS  
RESISTORS, FIXED, CARBON  
RESISTORS, FIXED, PRECISION  
RESISTORS, FIXED, OTHER  
SOCKETS, TUBE  
TERMINALS, SOLDERLESS  
TOOLS, CRIMPERS

**AITKEN COMMUNICATIONS**  
AUTOMATION EQUIPMENT  
PREAMPLIFIERS, AUDIO

**ALBION OPTICAL COMPANY**  
LENSES, OPTICAL, FIXED  
LENSES, OPTICAL, ZOOM  
METERS, FLUTTER & WOW  
REMOTE CONTROL SYSTEMS

**ALFORD MANUFACTURING COMPANY**  
ANTENNAS, FM  
ANTENNAS, TV  
ANTENNAS, 2500 MHZ  
BRIDGES  
DIPLEXERS  
DIVIDERS, POWER  
MICROWAVE COMPONENTS  
NETWORKS, MATCHING, RF  
SLOTTED SECTIONS  
SWITCHES, COAXIAL  
VEGETIGIAL SIDEBAND FILTERS

**ALLIED ELECTRONICS CORP.**  
AMMETERS, AC  
AMMETERS, DC  
AMPLIFIER, AF, STEREO  
ANTENNAS, FM  
ANTENNAS, TV  
CABINETS, METAL  
CABLE, ARMORED  
CABLE, SHIELDED, AUDIO  
KITS  
OSCILLOSCOPES  
RECEIVERS, AM

RECEIVERS, FM  
RECORDERS, MAGNETIC TAPE,  
AUDIO  
RELAYS, GENERAL PURPOSE  
TAPE, MAGNETIC RECORDING,  
AUDIO  
TESTERS, VACUUM TUBE  
TRANSFORMERS, AUDIO,  
ISOLATION  
TRANSFORMERS, AUDIO, MATCHING  
TRANSFORMERS, AUDIO,  
POWER OUTPUT  
TRANSFORMERS, AUTO  
TRANSFORMERS, FILAMENT  
TRANSFORMERS, GENERAL  
TRANSFORMERS, PLATE  
TRANSFORMERS, POWER  
TRANSFORMERS, RF  
TRANSFORMERS, TRANSISTOR  
TRANSFORMERS, VARIABLE  
TRANSMITTER KITS  
VOLTMETERS, AC  
VOLTMETERS, DC  
WIRE, BARE, COPPER  
WIRE, INSULATED, HOOKUP  
WIRE, SHIELDED

**ALMA ENGINEERING**

AMPLIFIER, AF,  
GENERAL PURPOSE  
AMPLIFIER, AF, MONAURAL  
AMPLIFIER, AF, REMOTE  
AMPLIFIER, AF, STEREO  
AMPLIFIER, BRIDGING  
AMPLIFIER, DISTRIBUTION  
AMPLIFIER, PULSE  
AMPLIFIER, TV, VIDEO  
AMPLIFIER, VIDEO, SWEEP  
CONSOLE, AUDIO, AM  
CONSOLE, AUDIO, FM  
CONSOLE, AUDIO, PORTABLE  
CONSOLE, AUDIO, RECORDING  
CONSOLE, AUDIO, TV  
CONSOLE, VIDEO, PORTABLE  
CONSOLE, VIDEO, STUDIO  
GENERATORS, SIGNAL,  
SPECIAL EFFECTS  
POWER SUPPLIES, DC  
PREAMPLIFIERS, AUDIO  
SWITCHES  
SWITCHING MATRIXES  
SWITCHING SYSTEMS

**ALPHA WIRE**

CABLE, ARMORED  
CABLE, ASSEMBLIES  
CABLE, COAXIAL, FLEXIBLE  
CABLE, COAXIAL, RIGID  
CABLE, DIRECT-BURIAL  
CABLE, SHIELDED, AUDIO  
CABLE, TELEPHONE  
WIRE, BARE, COPPER  
WIRE, BARE, COPPER STRAP

WIRE, INSULATED, HIGH VOLTAGE  
WIRE, INSULATED, HOOKUP  
WIRE, SHIELDED  
WIRING AND CABLING SERVICES

**ALTEC LANSING**

AMPLIFIER, AF, AGC  
AMPLIFIER, AF, COMPRESSING  
AMPLIFIER, AF,  
GENERAL PURPOSE  
AMPLIFIER, AF, MONAURAL  
AMPLIFIER, AF, PEAK LIMITING, AM  
AMPLIFIER, AF, REMOTE  
AMPLIFIER, AF, STEREO  
AMPLIFIER, BRIDGING  
AMPLIFIER, DC  
AMPLIFIER, DISTRIBUTION  
AMPLIFIER, PULSE  
ATTENUATORS, AUDIO  
ATTENUATORS, FIXED  
ATTENUATORS,  
IMPEDANCE MATCHING  
BRIDGES  
CAPACITORS, FIXED, METALLIZED  
CAPACITORS, FIXED, MICA  
CAPACITORS, FIXED, OIL-FILLED  
CAPACITORS, FIXED, PAPER  
CAPACITORS, FIXED, OTHER  
CAPACITORS, VARIABLE  
COILS, CHOKES, AF  
COILS, CHOKES, RF  
COILS, HYBRID  
COILS, TELEPHONE  
COMMUNICATIONS SYSTEMS, CB  
COMMUNICATIONS SYSTEMS,  
INTERCOM, WIRED  
COMMUNICATIONS SYSTEMS,  
LAND MOBILE  
COMMUNICATIONS SYSTEMS,  
MICROWAVE  
CONSOLE, AUDIO, FM  
CONSOLE, AUDIO, PORTABLE  
CONSOLE, AUDIO, RECORDING  
CONSOLE, AUDIO, TV  
CONSOLE, CABINETS  
AND HARDWARE  
CONSOLE, AUDIO, AM  
CONVERTERS  
ENCLOSURES, SPEAKER  
EQUALIZERS, AUDIO EMPHASIS  
FILTERS, AUDIO  
FILTERS, OTHER  
INVERTERS, DC TO AC, CHOPPER  
INVERTERS, DC TO AC,  
SOLID STATE  
INVERTERS, DC TO AC,  
VIBRATORS  
METERS, DB AND VU  
METERS, DB AND VU, WIDE RANGE  
MICROPHONE HARDWARE  
MICROPHONE STANDS & BOOMS  
MICROPHONES, CONDENSER

MICROPHONES, DYNAMIC  
 MONITORS, AM SYSTEMS  
 MONITORS, FM SYSTEMS, MONO  
 NETWORKS, MATCHING, AUDIO  
 POTENTIOMETERS, WIREWOUND  
 POWER SUPPLIES, AC  
 POWER SUPPLIES, DC  
 POWER SUPPLIES, PRECISION  
 PREAMPLIFIERS, AUDIO  
 RECEIVERS, FM  
 REGULATORS, VOLTAGE  
 SOUND SYSTEMS, OUTDOOR  
 SOUND SYSTEMS, PORTABLE  
 SOUND SYSTEMS, THEATER  
 SPEAKER COMPONENTS  
 SPEAKERS  
 SWITCHES, MULTICONTACT  
 SWITCHES, ROTARY  
 TELEPHONE EQUIPMENT  
 TRANSFORMERS, AUDIO,  
 ISOLATION  
 TRANSFORMERS, AUDIO, MATCHING  
 TRANSFORMERS, AUDIO,  
 POWER OUTPUT  
 TRANSFORMERS, AUTO  
 TRANSFORMERS, COUPLING  
 TRANSFORMERS, FILAMENT  
 TRANSFORMERS, GENERAL  
 TRANSFORMERS, PLATE  
 TRANSFORMERS, POWER

**AMECO, INC.**

ADAPTERS, CONNECTOR  
 ADAPTERS, TEST  
 AMPLIFIER, AF, AGC  
 AMPLIFIER, BRIDGING  
 AMPLIFIER, CATV  
 AMPLIFIER, DISTRIBUTION  
 AMPLIFIER, RF,  
 GENERAL PURPOSE  
 AMPLIFIER, TV, BOOSTER  
 ANCHORS, GUY  
 ANTENNAS, CATV  
 ANTENNAS, FM  
 ANTENNAS, MICROWAVE  
 ANTENNAS, TV,  
 MASTER-COMMUNITY  
 ATTENUATORS, AUDIO  
 ATTENUATORS,  
 IMPEDANCE MATCHING  
 ATTENUATORS, MICROWAVE  
 ATTENUATORS, RF  
 ATTENUATORS, VIDEO  
 AUTOMATION EQUIPMENT  
 BACKGROUND MUSIC SERVICE  
 BALUNS  
 BLOWERS AND FANS  
 BRIDGES  
 BROADCAST PROGRAMMING SERVICE  
 CABINETS, METAL  
 CABLE, ASSEMBLIES  
 CABLE, CATV, HARDWARE  
 CABLE, COAXIAL, FLEXIBLE  
 CABLE, DIRECT-BURIAL  
 CABLE, TELEPHONE  
 CAMERA, MOUNTING EQUIPMENT  
 CAMERA, REMOTE  
 CONTROL EQUIPMENT  
 CAMERAS, FILM, CINE  
 CAMERAS, OSCILLOSCOPE  
 CAMERAS, TV, COLOR  
 CAMERAS, TV, MONOCHROME  
 CATV EQUIPMENT - ALSO SEE  
 OTHER CATEGORIES  
 CATV, CABLE TERMINALS  
 CATV, CHANNEL AMPLIFIERS  
 CATV, HEAD-END EQUIPMENT  
 CATV, ORIGINATION EQUIPMENT  
 CIRCUITS, PRINTED  
 CLAMPS, CABLE  
 CLAMPS, GROUND  
 CONNECTORS, ANTENNA  
 CONNECTORS, COAXIAL CABLE  
 CONNECTORS, POWER  
 CONNECTORS, RF  
 CONVERTERS  
 COUPLERS  
 DEMODULATORS  
 FILTERS, ANTENNA  
 FILTERS, RF  
 GENERATORS, SIGNAL, RF  
 HARDWARE, GENERAL  
 HARDWARE, TOOLS  
 HEAD-END EQUIPMENT,  
 SEE CATV HEAD-END EQUIPMENT  
 LENSES, OPTICAL, FIXED  
 LENSES, OPTICAL, ZOOM  
 LIGHTNING ARRESTERS  
 MAINTENANCE SERVICES,  
 MICROWAVE  
 MICROPHONE HARDWARE  
 MICROWAVE COMPONENTS  
 MICROWAVE SYSTEMS, STL  
 MODULATORS, TV  
 MONITORS, FM SYSTEMS, MONO  
 MONITORS, FM SYSTEMS, STEREO  
 MONITORS, FREQUENCY  
 MONITORS, VIDEO  
 MOUNTS, ANTENNA, FIXED  
 NARROW-BAND FM EQUIPMENT  
 NETWORKS, MATCHING, RF  
 PLUGS, COAXIAL  
 POLE CLIMBING EQUIPMENT  
 POWER SUPPLIES, AC  
 POWER SUPPLIES, DC  
 PREAMPLIFIERS, AUDIO  
 PREAMPLIFIERS, VIDEO  
 RACKS, MOUNTING  
 RECEIVERS, FM  
 RECEIVERS, TV, COLOR  
 RECEIVERS, TV, MONOCHROME  
 SWITCHERS  
 TAPE, MAGNETIC RECORDING,  
 VIDEO  
 TOOLS, CLAMPS  
 TOOLS, CRIMPERS

TOWERS, ANTENNA,  
 CATV, HEAD-END  
 TOWERS, ANTENNA, RECEIVING  
 TRANSMISSION LINES  
 TV SYSTEMS, CLOSED CIRCUIT  
 VACUUM TUBES, TRANSMITTING  
 WEATHER INSTRUMENTS  
 WIRE, BARE, COPPER  
 WIRING AND CABLING SERVICES

**AMERICAN CABLE ELECTRONICS**

ADAPTERS, CONNECTOR  
 CATV EQUIPMENT - ALSO SEE  
 OTHER CATEGORIES  
 CATV, ORIGINATION EQUIPMENT  
 CONNECTORS, COAXIAL CABLE  
 TRANSFORMERS, RF  
 TV SYSTEMS, CLOSED CIRCUIT

**AMERICAN ELECTRONIC LABS**

AMPLIFIER, CATV  
 AMPLIFIER, RF, POWER  
 ANTENNAS, MICROWAVE  
 ANTENNAS, 2500 MHZ  
 BALUNS  
 CATV EQUIPMENT - ALSO SEE  
 OTHER CATEGORIES  
 CATV, CHANNEL AMPLIFIERS  
 CATV, HEAD-END EQUIPMENT  
 CATV, ORIGINATION EQUIPMENT  
 COMMUNICATIONS SYSTEMS,  
 MICROWAVE  
 DUMMY LOAD  
 EXCITERS, FM  
 GENERATORS, FM, STEREO  
 FILTERS, RF  
 GENERATORS, FM, SUBCARRIER  
 HEAD-END EQUIPMENT,  
 SEE CATV HEAD-END EQUIPMENT  
 MAINTENANCE SERVICES, AM  
 MAINTENANCE SERVICES, FM  
 MAINTENANCE SERVICES,  
 MICROWAVE  
 NETWORKS, PHASING  
 RECEIVERS, HF  
 SEMICONDUCTOR DIODES  
 SWITCHES, COAXIAL  
 SWITCHES, WAVEGUIDE  
 TESTERS, SEMICONDUCTOR  
 TRANSMITTERS, AM, 250 WATT  
 TRANSMITTERS, AM, 1 KW  
 TRANSMITTERS, AM, 5 KW  
 TRANSMITTERS, AM, 10 KW  
 TRANSMITTERS, AM, 25 KW  
 TRANSMITTERS, AM, 50 KW  
 TRANSMITTERS, FM, 10 WATTS  
 TRANSMITTERS, FM, 250 WATTS  
 TRANSMITTERS, FM, 1 KW  
 TRANSMITTERS, FM, 5 KW  
 TRANSMITTERS, FM, 7.5 KW  
 TRANSMITTERS, FM, 10 KW  
 TRANSMITTERS, FM, 20 KW

**AMERICAN ELITE**

CAPACITORS, FIXED, CERAMIC  
 CAPACITORS, FIXED,  
 ELECTROLYTIC  
 CAPACITORS, FIXED, FILM  
 CAPACITORS, VARIABLE  
 COILS, DEFLECTION  
 AND FOCUSING  
 COMMUNICATIONS SYSTEMS,  
 INTERCOM, WIRED  
 COMMUNICATIONS SYSTEMS,  
 LAND MOBILE  
 COMMUNICATIONS SYSTEMS,  
 MICROWAVE  
 COMMUNICATIONS SYSTEMS,  
 MULTIPLEX  
 CONSOLE, AUDIO, RECORDING  
 INTEGRATED CIRCUITS  
 MICROPHONES, CONDENSER  
 MICROPHONES, DYNAMIC  
 MICROWAVE COMPONENTS  
 MICROWAVE SYSTEMS, 2500 MHZ  
 MOBILE EQUIPMENT  
 POTENTIOMETERS, CARBON  
 RECEIVERS, AM  
 RECEIVERS, FM  
 RECEIVERS, HF  
 RECORDERS, MAGNETIC TAPE,  
 AUDIO  
 RECTIFIERS, SELENIUM  
 RELAYS, LATCHING  
 RESISTORS, FIXED, CARBON  
 SEMICONDUCTOR DIODES  
 SEMICONDUCTORS,  
 TRANSISTORS, AF  
 SEMICONDUCTORS,  
 TRANSISTORS, RF  
 SPEAKERS  
 SWITCHES, PUSHBUTTON,  
 NONILLUMINATED  
 SWITCHES, ROTARY  
 SWITCHES, SLIDE  
 SWITCHES, TOGGLE  
 TELEPHONE EQUIPMENT  
 TRANSMITTERS, AM, 10 KW  
 TRANSMITTERS, AM, 50 KW  
 TRANSMITTERS, AM, OVER 50 KW  
 TRANSMITTERS, FM, 5 KW  
 TRANSMITTERS, FM, 10 KW  
 TRANSMITTERS, FM, 50 KW  
 TRANSMITTERS, FM, 100 KW  
 VACUUM TUBES, CATHODE RAY  
 TV, MONOCHROME  
 VACUUM TUBES, RECEIVING  
 VACUUM TUBES, TRANSMITTING  
 YOKES, DEFECTION

**AMERICAN GELOSO ELECTRONICS**

COMMUNICATIONS SYSTEMS,  
 INTERCOM, WIRED  
 MICROPHONE HARDWARE  
 MICROPHONE STANDS & BOOMS  
 MICROPHONES, DYNAMIC

MICROPHONES, WIRELESS  
 MIXERS - ALSO SEE CONSOLES  
 MOBILE EQUIPMENT  
 RECORDERS, MAGNETIC TAPE,  
 AUDIO  
 SOUND SYSTEMS, OUTDOOR  
 SOUND SYSTEMS, PORTABLE  
 SPEAKER COMPONENTS  
 SPEAKERS  
 TAPE, MAGNETIC RECORDING,  
 AUDIO

**AMERICAN PAMCOR, INC.**

CATV, CABLE TERMINALS  
 CONNECTORS, ANTENNA  
 CONNECTORS, COAXIAL CABLE  
 CONNECTORS, POWER  
 CONNECTORS, RF  
 PLUGS, COAXIAL  
 SWITCHERS  
 SWITCHING MATRIXES  
 SWITCHING SYSTEMS  
 TERMINAL BLOCKS  
 TERMINALS, HIGH VOLTAGE  
 TERMINALS, LUG  
 TERMINALS, SOLDERLESS  
 TOOLS, CRIMPERS

**AMERLINE CORPORATION**

CARTRIDGES, MAGNETIC TAPE  
 REELS, FILM  
 REELS, TAPE

**AMPEREX ELECTRONIC CORP.**

CAPACITORS, FIXED,  
 ELECTROLYTIC  
 CAPACITORS, FIXED, FILM  
 CAPACITORS, FIXED, OTHER  
 CAVITIES, MICROWAVE  
 MICROWAVE COMPONENTS  
 RESISTORS, FIXED, CARBON  
 RESISTORS, FIXED, OTHER  
 SEMICONDUCTOR DIODES  
 SEMICONDUCTOR RECTIFIERS,  
 SILICON CONTROLLED - SCR  
 SEMICONDUCTORS, THYRISTORS  
 SEMICONDUCTORS,  
 TRANSISTORS, AF  
 SEMICONDUCTORS,  
 TRANSISTORS, FE  
 SEMICONDUCTORS, TRANSISTORS,  
 GENERAL  
 SEMICONDUCTORS,  
 TRANSISTORS, RF  
 VACUUM TUBES, CAMERA,  
 IMAGE-ORTHICON  
 VACUUM TUBES, CAMERA,  
 PLUMBICON R  
 VACUUM TUBES, CAMERA, VIDICON  
 VACUUM TUBES, RECEIVING  
 VACUUM TUBES, TRANSMITTING

**AMPERITE CO.**

RELAYS, TIME DELAY  
 VACUUM TUBES, BALLAST

**AMPEX CORPORATION**

CAMERAS, TV, COLOR  
 CAMERAS, TV, MONOCHROME  
 CARTRIDGES, TAPE,  
 RECORDING SERVICE  
 CATV, ORIGINATION EQUIPMENT  
 COMMUNICATIONS SYSTEMS,  
 LAND MOBILE  
 COMPUTER EQUIPMENT  
 CONSOLE, AUDIO, AM  
 CONSOLE, AUDIO, FM  
 CONSOLE, AUDIO, PORTABLE  
 CONSOLE, AUDIO, RECORDING  
 CONSOLE, AUDIO, TV  
 CONSOLE, KIITS  
 CONSOLE, VIDEO, PORTABLE  
 CONSOLE, VIDEO, STUDIO  
 DEMAGNETIZERS, BULK TAPE  
 DEMAGNETIZERS, HEAD  
 DROPOUT COMPENSATOR,  
 VIDEO TAPE  
 EARPHONES, HEADPHONES  
 EDITORS, AUDIO TAPE  
 EDITORS, VIDEO TAPE  
 HEADS, ERASE, MAGNETIC  
 HEADS, RECORDING, MAGNETIC  
 INDUSTRIAL TV  
 LENSES, OPTICAL, FIXED  
 LENSES, OPTICAL, ZOOM  
 MAINTENANCE SERVICES, AM  
 MAINTENANCE SERVICES, FM  
 MAINTENANCE SERVICES, TV  
 MICROPHONES, DYNAMIC  
 MOBILE EQUIPMENT  
 MONITORS, VIDEO  
 RECORDERS, DISC, MAGNETIC  
 RECORDERS, MAGNETIC TAPE,  
 AUDIO  
 RECORDERS, MAGNETIC TAPE,  
 LOGGING  
 RECORDERS, MAGNETIC TAPE,  
 VIDEO  
 SOUND SYSTEMS, OUTDOOR  
 SOUND SYSTEMS, PORTABLE  
 SOUND SYSTEMS, THEATER  
 SPEAKERS  
 TAPE DECKS, MAGNETIC  
 TAPE DUPLICATORS  
 TAPE, MAGNETIC RECORDING,  
 AUDIO  
 TAPE, MAGNETIC RECORDING,  
 COMPUTER  
 TAPE, MAGNETIC RECORDING,  
 TEST  
 TAPE, MAGNETIC RECORDING,  
 VIDEO  
 TV SYSTEMS, CLOSED CIRCUIT

**ANACONDA ASTRODATA CO.**

AMPLIFIER, BRIDGING  
 AMPLIFIER, CATV  
 AMPLIFIER, DISTRIBUTION  
 AMPLIFIER, TV, BOOSTER  
 CABLE, CATV, HARDWARE  
 CABLE, COAXIAL, FLEXIBLE  
 CABLE, DIRECT-BURIAL  
 CATV EQUIPMENT - ALSO SEE  
 OTHER CATEGORIES  
 CATV, CABLE TERMINALS  
 CATV, CHANNEL AMPLIFIERS  
 CATV, HEAD-END EQUIPMENT  
 CONNECTORS, COAXIAL CABLE  
 HEAD-END EQUIPMENT,  
 SEE CATV HEAD-END EQUIPMENT  
 INDUSTRIAL TV  
 METERS, FIELD STRENGTH  
 POWER SUPPLIES, AC  
 TRANSFORMERS, GENERAL  
 TV SYSTEMS, CLOSED CIRCUIT

CABLE, ARMORED  
 CABLE, ASSEMBLIES  
 CABLE, CATV, HARDWARE  
 CABLE, COAXIAL, FLEXIBLE  
 CABLE, COAXIAL, RIGID  
 CABLE, DIRECT-BURIAL  
 CABLE, SHIELDED, AUDIO  
 CHARGERS, BATTERY  
 COMMUNICATIONS SYSTEMS, CB  
 CONNECTORS, AF & MICROPHONE  
 CONNECTORS, ANTENNA  
 CONNECTORS, COAXIAL CABLE  
 CONNECTORS, POWER  
 CONNECTORS, RF  
 DIALS, INSTRUMENT  
 GENERATORS, SIGNAL, COLOR BAR  
 GENERATORS, SIGNAL, RF  
 METERS, FIELD STRENGTH  
 PLUGS, COAXIAL  
 PLUGS, PHONE  
 POTENTIOMETERS, CARBON  
 POTENTIOMETERS, WIREWOUND  
 RESISTORS, FIXED, PRECISION  
 RESISTORS, FIXED, WIREWOUND  
 RESISTORS, VARIABLE, CARBON  
 RESISTORS, VARIABLE,  
 WIREWOUND

**AMPLIFIER CORP. OF AMERICA**

AMPLIFIER, AF, AGC  
 AMPLIFIER, AF, COMPRESSING  
 AMPLIFIER, AF,  
 GENERAL PURPOSE  
 AMPLIFIER, AF, REVERBERATION  
 DEMAGNETIZERS, BULK TAPE  
 DEMAGNETIZERS, HEAD  
 METERS, FLUTTER & WOW  
 PROJECTORS, SLIDE  
 RECORDERS, MAGNETIC TAPE,  
 AUDIO  
 REVERBERATION DEVICES

**AMPLIVISION CORPORATION**

AMPLIFIER, BRIDGING  
 AMPLIFIER, CATV  
 AMPLIFIER, DISTRIBUTION  
 AMPLIFIER, RF,  
 GENERAL PURPOSE  
 AMPLIFIER, TV, BOOSTER  
 AMPLIFIER, TV, VIDEO  
 AMPLIFIER, VIDEO, SWEET  
 ANTENNAS, TV,  
 MASTER-COMMUNITY  
 CABLE, CATV, HARDWARE  
 CAMERA, REMOTE  
 CONTROL EQUIPMENT  
 CAMERAS, TV, COLOR  
 CAMERAS, TV, MONOCHROME  
 CATV EQUIPMENT - ALSO SEE  
 OTHER CATEGORIES  
 CATV, CHANNEL AMPLIFIERS  
 CATV, HEAD-END EQUIPMENT  
 CATV, ORIGINATION EQUIPMENT  
 COMMUNICATIONS SYSTEMS,  
 MICROWAVE  
 CONNECTORS, ANTENNA  
 CONNECTORS, COAXIAL CABLE  
 CONNECTORS, RF  
 CONSOLE, VIDEO, PORTABLE  
 CONSOLE, VIDEO, STUDIO  
 CONVERTERS  
 GENERATORS, FM, SUBCARRIER  
 HEAD-END EQUIPMENT,  
 SEE CATV HEAD-END EQUIPMENT  
 MONITORS, VIDEO  
 NARROW-BAND FM EQUIPMENT  
 NETWORKS, MATCHING, RF  
 NETWORKS, PHASING  
 RECORDERS, MAGNETIC TAPE,  
 VIDEO  
 RODS, GROUND  
 TAPE DECKS, MAGNETIC  
 TAPE, MAGNETIC RECORDING,  
 VIDEO  
 TOWERS, ANTENNA,  
 CATV, HEAD-END  
 TRANSLATOR SYSTEMS  
 TV SYSTEMS, CLOSED CIRCUIT

**ANACONDA ASTRODATA CO.**

AMPLIFIER, BRIDGING  
 AMPLIFIER, CATV  
 AMPLIFIER, DISTRIBUTION  
 AMPLIFIER, TV, BOOSTER  
 CABLE, CATV, HARDWARE  
 CABLE, COAXIAL, FLEXIBLE  
 CABLE, DIRECT-BURIAL  
 CATV EQUIPMENT - ALSO SEE  
 OTHER CATEGORIES  
 CATV, CABLE TERMINALS  
 CATV, CHANNEL AMPLIFIERS  
 CATV, HEAD-END EQUIPMENT  
 CONNECTORS, COAXIAL CABLE  
 HEAD-END EQUIPMENT,  
 SEE CATV HEAD-END EQUIPMENT  
 INDUSTRIAL TV  
 METERS, FIELD STRENGTH  
 POWER SUPPLIES, AC  
 TRANSFORMERS, GENERAL  
 TV SYSTEMS, CLOSED CIRCUIT

**ANCHA ELECTRONICS**

CONSOLE, AUDIO, FM  
 CONSOLE, AUDIO, RECORDING  
 CONSOLE, AUDIO, TV  
 CONSOLE, AUDIO, AM

**KEITH ANDERSON CO.**

AMPLIFIER, CATV  
 AMPLIFIER, RF,  
 GENERAL PURPOSE  
 AMPLIFIER, RF, POWER  
 BALUNS  
 CATV, CHANNEL AMPLIFIERS  
 CATV, HEAD-END EQUIPMENT  
 CONVERTERS

GENERATORS, POWER,  
WIND AND THERMOELECTRIC  
TRANSLATOR SYSTEMS  
TRANSMITTERS, TV, 1 WATT  
TRANSMITTERS, TV, 10 WATTS

**ANDREW CORPORATION**

ANTENNAS, MICROWAVE  
ANTENNAS, MOBILE  
ANTENNAS, 2500 MHZ  
CABLE, ASSEMBLIES  
CABLE, CATV, HARDWARE  
CABLE, COAXIAL, FLEXIBLE  
CABLE, COAXIAL, RIGID  
CABLE, DIRECT-BURIAL  
CLAMPS, CABLE  
CONNECTORS, COAXIAL CABLE  
CONNECTORS, RF  
DELAY LINES  
JOINTS, ROTARY, COAXIAL  
JOINTS, ROTARY, WAVEGUIDE  
MICROWAVE COMPONENTS  
MOBILE EQUIPMENT  
MOUNTS, ANTENNA, FIXED  
PRESSURIZATION EQUIPMENT,  
TRANSMISSION LINE  
RADOMES  
REMOTE CONTROL SYSTEMS  
STL EQUIPMENT  
SWITCHES, COAXIAL  
SWITCHES, WAVEGUIDE  
SWITCHING MATRICES  
SWITCHING SYSTEMS  
TRANSMISSION LINES  
WAVEGUIDE AND  
ASSOCIATED COMPONENTS

**ANSONIA WIRE AND CABLE CO.**

CABLE, COAXIAL, FLEXIBLE  
CABLE, TELEPHONE

**ANTENNA PRODUCTS COMPANY**

ANTENNAS, AM  
ANTENNAS, CATV  
ANTENNAS, FM  
ANTENNAS, TV,  
MASTER-COMMUNITY  
BALUNS  
CABLE, COAXIAL, RIGID  
INSULATORS, ANTENNA  
INSULATORS, STAND-OFF  
TOWERS, ANTENNA,  
CATV HEAD-END  
TOWERS, ANTENNA, RECEIVING  
TOWERS, ANTENNA,  
TRANSMITTING, AM  
TOWERS, ANTENNA,  
TRANSMITTING, FM  
TOWERS, ANTENNA,  
TRANSMITTING, TV  
TRANSFORMERS, RF  
TRANSMISSION LINES

**API INSTRUMENTS CO.**

AMMETERS, AC  
AMMETERS, AC, THERMOCOUPLE  
AMMETERS, DC  
METERS, DB AND VU  
METERS - SEE SPECIFIC TYPES  
RECORDERS, PAPER,  
LOGGING AND GRAPHIC  
RELAYS, OVERLOAD  
VOLTMETERS, AC  
VOLTMETERS, DC

**APPARATUS DEVELOPMENT CO.**

ANTENNAS, FM  
BALUNS

**APPLIED ELECTRO-MECHANICS**

ADAPTERS, CONNECTOR  
AMPLIFIER, DISTRIBUTION  
AMPLIFIER, PULSE  
AMPLIFIER, SENSING  
AMPLIFIER, TV, VIDEO  
CORDS, PATCH  
GENERATORS, SIGNAL,  
SPECIAL EFFECT  
SOUND SYSTEMS, OUTDOOR  
SOUND SYSTEMS, PORTABLE  
WIRING AND CABLING SERVICES

**ARRIFLEX CORP. OF AMERICA**

CAMERAS, FILM, CINE  
PROJECTORS, FILM

**ASCO SONOCRAFT CORP.**

AMPLIFIER, DISTRIBUTION  
BACKGROUND MUSIC SERVICE  
BROADCAST PROGRAMMING SERVICE  
CAMERAS, TV, COLOR  
COMMUNICATIONS SYSTEMS,  
INTERCOM, WIRED  
COMMUNICATIONS SYSTEMS,  
INTERCOM, WIRELESS  
CONSOLE, AUDIO, RECORDING  
CONSOLE, CABINETS  
AND HARDWARE  
EARPHONES, HEADPHONES  
EDITORS, AUDIO TAPE  
EDUCATION FACILITIES, EQPT  
ENCLOSURES, SPEAKER  
MAINTENANCE SERVICES, AM  
MAINTENANCE SERVICES, FM  
RECORDS, BLANK, ACETATE,  
FOR RECORDING  
SCREENS, PROJECTION, FRONT  
TAPE DECKS, MAGNETIC  
TAPE DUPLICATORS  
TAPE, MAGNETIC RECORDING,  
AUDIO  
TAPE, MAGNETIC RECORDING,  
VIDEO

**THE ASTATIC CORPORATION**

ARMS, TONE

CARTRIDGES, PHONO  
EARPHONES, HEADPHONES  
MICROPHONE STANDS & BOOMS  
MICROPHONES, DYNAMIC  
STYLUS, CUTTING  
STYLUS, PLAYBACK  
TAPE, MAGNETIC RECORDING,  
AUDIO

**ATLAS SOUND**

ACOUSTIC MATERIALS  
ADAPTERS, CONNECTOR  
COMMUNICATIONS SYSTEMS,  
INTERCOM, WIRED  
COMMUNICATIONS SYSTEMS,  
LAND MOBILE  
LAMP ASSEMBLIES  
MOBILE EQUIPMENT  
MOUNTS, INSTRUMENT  
SOUND SYSTEMS, OUTDOOR  
SOUND SYSTEMS, THEATER  
SPEAKER COMPONENTS  
SPEAKERS  
SWITCHES, FOOT  
TRANSFORMERS, AUDIO, MATCHING

**AUDIO ACCESSORIES**

CORDS, PATCH  
JACK PANEL ASSEMBLIES  
JACKS  
LAMPS, PANEL  
PLUGS, PHONE  
SOCKETS, LAMP  
WIRING AND CABLING SERVICES

**AUDIO DEVICES**

CARTRIDGES, MAGNETIC TAPE  
DEMAGNETIZERS, HEAD  
HEADS, DISC RECORDING  
RECORDS, BLANK, LACQUER,  
FOR RECORDING  
REELS, TAPE  
TAPE, MAGNETIC RECORDING,  
AUDIO  
TAPE, MAGNETIC RECORDING,  
AUDIO, CARTRIDGE  
TAPE, MAGNETIC RECORDING,  
COMPUTER  
TAPE, MAGNETIC RECORDING,  
TEST

**AUDIO INSTRUMENT CO.**

AMPLIFIER, AF, REVERBERATION  
ANALYZERS, DISTORTION  
ANALYZERS, INTERMODULATION  
DELAY DEVICES, AF  
DELAY LINES  
EDUCATION FACILITIES, EQPT  
PREAMPLIFIERS, AUDIO  
RECORDERS, MAGNETIC TAPE,  
AUDIO  
SOUND SYSTEMS, OUTDOOR  
SOUND SYSTEMS, THEATER  
TAPE DECKS, MAGNETIC  
TELEPHONE EQUIPMENT

**BALL BROTHERS RESEARCH**

AMPLIFIER, CATV  
AMPLIFIER, DISTRIBUTION  
AMPLIFIER, STABILIZING  
AMPLIFIER, TV, VIDEO  
CATV EQUIPMENT - ALSO SEE  
OTHER CATEGORIES  
GENERATORS, SIGNAL,  
SPECIAL EFFECT  
INDUSTRIAL TV  
TV SYSTEMS, CLOSED CIRCUIT

**BARKER & WILLIAMSON**

ANALYZERS, DISTORTION  
ANALYZERS, HARMONIC  
COLLS, ANTENNA LOADING  
COLLS, CHOKER, RF  
DUMMY LOAD  
GENERATORS, SIGNAL, AF  
SWITCHES, COAXIAL  
TRANSFORMERS, RF

**BAUER ELECTRONICS CORPORATION**

AMPLIFIER, AF, AGC  
AMPLIFIER, AF, COMPRESSING  
AMPLIFIER, AF,  
GENERAL PURPOSE  
AMPLIFIER, AF, MONAURAL  
AMPLIFIER, AF,  
PEAK LIMITING, AM  
AMPLIFIER, AF,  
PEAK LIMITING, FM  
AMPLIFIER, AF, REVERBERATION  
AMPLIFIER, AF, STEREO  
AMPLIFIER, BRIDGING  
AMPLIFIER, DC  
AMPLIFIER, RF, POWER  
CARRIER-CURRENT EQUIPMENT  
CONSOLE, AUDIO, AM  
CONSOLE, AUDIO, FM  
CONSOLE, AUDIO, PORTABLE  
CONSOLE, AUDIO, RECORDING  
CONSOLE, AUDIO, TV  
CONSOLE, CABINETS  
AND HARDWARE  
CONSOLE, KITS  
DELAY DEVICES, AF  
MIXERS - ALSO SEE CONSOLES  
PREAMPLIFIERS, AUDIO  
RECORDERS, PAPER,  
LOGGING AND GRAPHIC  
REMOTE CONTROL SYSTEMS  
REVERBERATION DEVICES  
TRANSMITTER KITS  
TRANSMITTERS, AM, LOW POWER  
TRANSMITTERS, AM, 250 WATT  
TRANSMITTERS, AM, 1 KW  
TRANSMITTERS, AM, 5 KW  
TRANSMITTERS, AM, 10 KW

## Color Problems?

# AEM HAS THREE NEW ANSWERS



**LAP AMPLIFIERS**—Here's the new LDA-series of lap-dissolve amplifiers that AEM developed especially for color. Photo-electric cells, remotely controlled by DC circuitry, assure a velvety transition between two inputs. All solid state (silicon semiconductors exclusively), the LDA provides the signal handling characteristics of a high performance distribution amplifier. Differential phase and gain do not change even during the lap interval. Embarrassing color shifts and level changes become a thing of the past. And the price is just as attractive as the performance: LDA-1, \$555.00; LDA-2 (sync adding), \$585.00.

**COLOR SENSORS**—We are introducing a Color Sensor attachment to the LDA amplifiers which samples both incoming channels and then closes a relay when *either* input has color burst . . . gives your switching system the information it needs to react properly. LDA-1 with Color Sensor, \$595.00; LDA-2 with Color Sensor, \$625.00.

**BURST GENERATOR**—Our new black Burst Generator with CONTROLLED chroma background will allow you to control color fades to black or any hue. The variable chroma feature also acts as a source for coloring backgrounds of monochrome slides and movies. Color Burst Generator, just \$595.00; standard black Burst Generator, \$545.00.

Call or write for more information about AEM video equipment. Feature for feature, there is nothing comparable on today's market!

## APPLIED ELECTRO MECHANICS, INC.

2350 Duke Street, Alexandria, Virginia 22314  
PHONE: (703) 548-2166



TRANSMITTERS, AM, 25 KW  
TRANSMITTERS, AM, 50 KW  
TRANSMITTERS, FM, 1 KW  
TRANSMITTERS, FM, 3 KW  
TRANSMITTERS, FM, 7.5 KW  
TRANSMITTERS, FM, 10 KW  
TRANSMITTERS, FM, 20 KW

**E. J. BAUGHMAN CO.**

CAMERA, MOUNTING EQUIPMENT  
MICROPHONE STANDS & BOOMS

**BECKMAN & WHITLEY**

CAMERAS, FILM, CINE  
WEATHER INSTRUMENTS

**BELAR ELECTRONICS LABORATORY**

AMPLIFIER, RF, PEAK LIMITING  
COMMUNICATIONS SYSTEMS,  
MULTIPLY  
DEMODULATORS  
EXCITERS, FM  
GENERATORS, FM, STEREO  
METERS, FREQUENCY  
MONITORS, AM SYSTEMS  
MONITORS, FM SYSTEMS, MONO  
MONITORS, FM SYSTEMS, SCA  
MONITORS, FM SYSTEMS, STEREO  
MONITORS, FREQUENCY  
OSCILLATORS, FM  
RECEIVERS, FM  
RECEIVERS, MULTIPLEX  
RECEIVERS, SCA

**BELDEN MANUFACTURING CO.**

CABLE, COAXIAL, FLEXIBLE  
CABLE, DIRECT-BURIAL  
CABLE, SHIELDED, AUDIO  
CABLE, TELEPHONE  
CORDS, SET  
WIRE, BARE, COPPER  
WIRE, INSULATED, HIGH VOLTAGE  
WIRE, INSULATED, HOOKUP  
WIRE, SHIELDED

**F. W. BELL, INC.**

CONVERTERS  
GAUSS METER  
MONITORS, POWER  
PROBES, TEST LEAD  
WATTMETERS

**BENCO TELEVISION ASSOCIATES**

AMPLIFIER, CATV  
AMPLIFIER, TV, BOOSTER  
ANTENNAS, TV,  
MASTER-COMMUNITY  
ATTENUATORS, RF  
CATV EQUIPMENT - ALSO SEE  
OTHER CATEGORIES  
CATV, CABLE TERMINALS  
CATV, CHANNEL AMPLIFIERS  
CATV, HEAD-END EQUIPMENT  
CONNECTORS, COAXIAL CABLE  
CONVERTERS  
FILTERS, ANTENNA  
HEAD-END EQUIPMENT,  
SEE CATV HEAD-END EQUIPMENT  
HOUSINGS, ANTENNA  
METERS, FIELD STRENGTH  
TRANSLATOR SYSTEMS

**BENJAMIN ELECTRONIC SOUND CORP**

CARTRIDGES, PHONO  
RECEIVERS, AM  
RECEIVERS, FM  
RECEIVERS, HF  
TURNTABLES, PHONOGRAPH

**BENRUS TECHNICAL PRODUCTS**

CAMERAS, OSCILLOSCOPE  
OSCILLATORS, AF AND RF,  
SEE GENERATORS  
OSCILLOSCOPES  
VOLTMETERS, TRANSISTORIZED

**BERKEY TECHNICAL CORP.**

BATTERIES, NICKEL CADMIUM  
CAMERA, MOUNTING EQUIPMENT  
STROBE, LIGHTS

**BIONIC INSTRUMENTS, INC.**

ALARM, FAULT  
ALARM, INTRUDER  
ALARM, SIGNAL  
INDUSTRIAL TV  
REMOTE CONTROL SYSTEMS  
TAPE DUPLICATORS  
TIMERS, ELECTRIC  
TV SYSTEMS, CLOSED CIRCUIT

**BIRD ELECTRONIC CORPORATION**

ALARM, FAULT  
ATTENUATORS, FIXED  
ATTENUATORS, RF  
CALORIMETERS  
CONNECTORS, RF  
COUPLERS  
DETECTORS, STANDING WAVE  
DUMMY LOAD  
FILTERS, ANTENNA  
FILTERS, RF  
METERS, POWER  
METERS, STANDING WAVE  
MICROWAVE COMPONENTS  
MONITORS, POWER  
SWITCHES, COAXIAL  
WATTMETERS

**BIRNBACH CO.**

ADAPTERS, TEST  
ANCHORS, GUY  
CABLE, ARMORED  
CABLE, DIRECT-BURIAL  
CABLE, SHIELDED, AUDIO  
CABLE, TELEPHONE

CLAMPS, CABLE  
CLIPS, TEST  
CORDS, DIAL  
CORDS, LACING  
CORDS, PATCH  
CORDS, SET  
HARDWARE, GENERAL  
HARDWARE, GROMMETS  
HARDWARE, RACK  
HARDWARE, TUBING, PLASTIC  
HEAT SINKS  
INSULATORS, ANTENNA  
INSULATORS, FEED THROUGH  
INSULATORS, STAND-OFF  
INSULATORS, OTHER  
JACKS  
KNOBS  
LIGHTNING ARRESTERS  
PLUGS, PHONE  
SWITCHES, KNIFE  
SWITCHES, PUSHBUTTON,  
NONILLUMINATED  
SWITCHES, SLIDE  
SWITCHES, TOGGLE  
TERMINAL STRIPS  
TERMINALS, LUG  
TERMINALS, SOLDER  
TERMINALS, SOLDERLESS  
WIRE, BARE, COPPER  
WIRE, INSULATED, HIGH VOLTAGE  
WIRE, INSULATED, HOOKUP  
WIRE, SHIELDED

**BIRNS & SAWYER**

ADAPTERS, CONNECTOR  
AMPLIFIER, DC  
BATTERIES, NICKEL CADMIUM  
CAMERA, MOUNTING EQUIPMENT  
CAMERAS, FILM, CINE  
CAMERAS, FILM, STILL  
CHARGERS, BATTERY  
CONVERTERS  
DOLLIES, CAMERA  
EDITORS, AUDIO TAPE  
EDITORS, FILM  
EDITORS, VIDEO TAPE  
INVERTERS, DC TO AC,  
VIBRATORS  
LENSES, OPTICAL, FIXED  
LENSES, OPTICAL, ZOOM  
LIGHTING, TV, COMPONENTS  
MIXERS - ALSO SEE CONSOLES  
MOUNTS, INSTRUMENT  
POWER SUPPLIES, AC  
POWER SUPPLIES, DC  
PROJECTORS, FILM  
REELS, FILM  
REELS, TAPE  
SCREENS, PROJECTION, FRONT  
SPLICERS, MAGNETIC TAPE  
AND FILM  
TAPE, MAGNETIC RECORDING,  
AUDIO

**BISCAYNE AUDIO COMPANY**

BROADCAST PROGRAMMING SERVICE

**BLAW-KNOX COMPANY**

TOWERS, ANTENNA,  
CATV, HEAD-END  
TOWERS, ANTENNA,  
TRANSMITTING, AM  
TOWERS, ANTENNA,  
TRANSMITTING, FM  
TOWERS, ANTENNA,  
TRANSMITTING, TV

**BLONDER-TONGUE LABORATORIES**

ADAPTERS, CONNECTOR  
AMPLIFIER, CATV  
AMPLIFIER, DISTRIBUTION  
AMPLIFIER, RF,  
GENERAL PURPOSE  
AMPLIFIER, TV, BOOSTER  
AMPLIFIER, TV, VIDEO  
AMPLIFIER, VIDEO, SWEEP  
ANTENNAS, CATV  
ANTENNAS, FM  
ANTENNAS, TV  
ANTENNAS, TV,  
MASTER-COMMUNITY  
ATTENUATORS, RF  
BALUNS  
BRIDGES  
CAMERAS, FILM, CINE  
CAMERAS, FILM, STILL  
CAMERAS, TV, COLOR  
CAMERAS, TV, MONOCHROME  
CATV EQUIPMENT - ALSO SEE  
OTHER CATEGORIES  
CATV, CHANNEL AMPLIFIERS  
CATV, HEAD-END EQUIPMENT  
CATV, ORIENTATION EQUIPMENT  
CONNECTORS, ANTENNA  
CONNECTORS, COAXIAL CABLE  
CONSOLE, AUDIO, TV  
CONVERTERS  
DETECTORS, STANDING WAVE  
DIPLEXERS  
DISPLAY EQUIPMENT, TV  
DOLLIES, CAMERA  
FILTERS, ANTENNA  
FILTERS, RF  
GENERATORS, SIGNAL, MARKER  
GENERATORS, SIGNAL, RF  
GENERATORS, SIGNAL,  
TV SYNCHRONIZING  
HEAD-END EQUIPMENT,  
SEE CATV HEAD-END EQUIPMENT  
INDUSTRIAL TV  
METERS, FIELD STRENGTH  
METERS, FREQUENCY  
MIXERS - ALSO SEE CONSOLES  
MODULATORS, TV  
MONITORS, VIDEO  
POWER SUPPLIES, AC

POWER SUPPLIES, DC  
PREAMPLIFIERS, VIDEO  
RELAYS, THERMAL  
SWITCHES  
SWITCHES, COAXIAL  
TOOLS, CRIMPERS  
TRANSFORMERS, RF  
TV SYSTEMS, CLOSED CIRCUIT  
WEATHER INSTRUMENTS

**BOSTON INSULATED WIRE & CABLE**

CABLE, ARMORED  
CABLE, ASSEMBLIES  
CABLE, CAMERA  
CABLE, COAXIAL, FLEXIBLE  
CABLE, SHIELDED, AUDIO  
WIRE, INSULATED, HIGH VOLTAGE  
WIRE, SHIELDED  
WIRING AND CABLING SERVICES

**W. M. BRADY CO.**

DECALCOMANIAS  
LETTERS AND NUMBERS,  
PRESSURE SENSITIVE

**BROADCAST ELECTRONICS, INC.**

AMPLIFIER, DISTRIBUTION  
AUTOMATION EQUIPMENT  
CABINETS, STORAGE,  
MAGNETIC TAPE  
CABINETS, STORAGE,  
MAGNETIC TAPE, CARTRIDGE  
CARTRIDGES, MAGNETIC TAPE  
CLEANERS, CHEMICAL  
DEMAGNETIZERS, BULK TAPE  
DEMAGNETIZERS, HEAD  
HEADS, ERASE, MAGNETIC  
HEADS, RECORDING, MAGNETIC  
RECORDERS, MAGNETIC TAPE,  
AUDIO  
RECORDERS, MAGNETIC TAPE,  
AUDIO, CARTRIDGE  
REELS, TAPE  
SPLICERS, MAGNETIC TAPE  
AND FILM  
TAPE DECKS, MAGNETIC  
TAPE, MAGNETIC RECORDING,  
AUDIO  
TAPE, MAGNETIC RECORDING  
AUDIO, CARTRIDGE  
TELEPHONE EQUIPMENT  
WINDERS, CARTRIDGE

**BROADCAST PRODUCTS COMPANY**

AMPLIFIER, SENSING  
AUTOMATION EQUIPMENT  
CABINETS, STORAGE,  
MAGNETIC TAPE, CARTRIDGE  
CABINETS, WOOD

**BROWNING LABORATORIES**

AMPLIFIER, AF, MONAURAL  
ANTENNAS, FM  
BACKGROUND MUSIC SERVICE  
COMMUNICATIONS SYSTEMS, CB  
COMMUNICATIONS SYSTEMS,  
MULTIPLEX, FM  
MONITORS, FM SYSTEMS, MONO  
RECEIVERS, MULTIPLEX  
RECEIVERS, SCA

**BUCHANAN ELECTRICAL PROD CORP**

INSULATORS, OTHER  
TERMINAL BLOCKS  
TERMINAL BOARDS  
TERMINAL CARDS  
TERMINAL STRIPS  
TERMINALS, BARRIER  
TERMINALS, LUG  
TERMINALS, SOLDER  
TERMINALS, SOLDERLESS  
TOOLS, CRIMPERS

**BUD RADIO, INC**

BLOWERS AND FANS  
CABINETS, METAL  
CAPACITORS, FIXED, GENERAL  
CAPACITORS, VARIABLE  
CONSOLE, CABINETS  
AND HARDWARE  
HARDWARE, CHASSIS  
HARDWARE, FIXTURES, HOLDING  
HARDWARE, LOUVERS,  
VENTILATING  
HARDWARE, MOUNTS  
HARDWARE, PANEL  
HARDWARE, RACK  
PANELS, INSTRUMENT,  
FOR RACK MOUNTING  
RACKS, MOUNTING  
SLIDES, CHASSIS

**BURGESS BATTERY COMPANY**

BATTERIES, DRY CELL  
TAPE, MAGNETIC RECORDING,  
AUDIO

**BURKE & JAMES**

CABINETS, METAL  
CABINETS, STORAGE,  
MAGNETIC TAPE  
CABINETS, WOOD  
CAMERA, MOUNTING EQUIPMENT  
CAMERAS, FILM, CINE  
CAMERAS, FILM, STILL  
DUCTS, VENTILATION  
EDITORS, FILM  
FILTERS, OTHER  
LENSES, OPTICAL, FIXED  
LENSES, OPTICAL, ZOOM  
LIGHTING, TV, COMPONENTS  
METERS, LIGHT  
PROCESSORS, FILM, B-W  
PROCESSORS, FILM, COLOR  
PROJECTORS, FILM  
PROJECTORS, SLIDE

REELS, FILM  
REWINDERS, FILM  
SCREENS, PROJECTION, FRONT  
SCREENS, PROJECTION, REAR  
SPLICERS, MAGNETIC TAPE  
AND FILM  
TIMERS, ELECTRIC

**CALBEST ELECTRONICS**

ADAPTERS, FM STEREO  
AMPLIFIER, AF, STEREO  
COILS, CHOKE, RF  
COMMUNICATIONS SYSTEMS,  
INTERCOM, WIRE  
RECEIVERS, AM  
RECEIVERS, FM  
RECEIVERS, SCA  
SPEAKER COMPONENTS

**CALIFONE-ROBERTS**

AMPLIFIER, AF, REVERBERATION  
MICROPHONES, DYNAMIC  
RECORDERS, MAGNETIC TAPE,  
AUDIO  
SOUND SYSTEMS, PORTABLE  
SPEAKERS

**CALVERT ELECTRONICS**

VACUUM TUBES, RECEIVING  
VACUUM TUBES, TRANSMITTING

**CARDWELL CONDENSER CORP**

CAPACITORS, VARIABLE  
MICROWAVE COMPONENTS  
MICROWAVE SYSTEMS, OTHER  
WAVEGUIDE AND  
ASSOCIATED COMPONENTS

**CATEL COMPANY**

AMPLIFIER, TV, VIDEO  
CATV, ORIENTATION EQUIPMENT  
GENERATORS, FM, STEREO  
MODULATORS, TV  
TRANSLATOR SYSTEMS, FM

**CBS LABORATORIES**

AMPLIFIER, AF, COMPRESSING  
AMPLIFIER, AF,  
PEAK LIMITING, AM  
AMPLIFIER, AF,  
PEAK LIMITING, FM  
AMPLIFIER, MASKING  
DISPLAY EQUIPMENT, TV  
ENHANCERS, TV IMAGE  
METERS, DB AND VU  
METERS, DB AND VU, WIDE RANGE  
RECORDS, TEST

**CCA ELECTRONICS CORPORATION**

AMPLIFIER, AF, AGC  
AMPLIFIER, AF, COMPRESSING  
AMPLIFIER, AF,  
GENERAL PURPOSE  
AMPLIFIER, AF, MONAURAL  
AMPLIFIER, AF,  
PEAK LIMITING, AM  
AMPLIFIER, AF,  
PEAK LIMITING, FM  
AMPLIFIER, AF, REMOTE  
AMPLIFIER, DISTRIBUTION  
AMPLIFIER, RF,  
GENERAL PURPOSE  
AMPLIFIER, RF, PEAK LIMITING  
AMPLIFIER, RF, POWER  
ANTENNAS, AM  
ANTENNAS, FM  
AUTOMATION EQUIPMENT  
BACKGROUND MUSIC SERVICE  
CABINETS, METAL  
CIRCUIT BREAKERS  
CLOCKS  
COILS, ANTENNA LOADING  
COILS, CHOKE, RF  
COMMUNICATIONS SYSTEMS,  
LAND MOBILE  
CONSOLE, AUDIO, AM  
CONSOLE, AUDIO, FM  
CONSOLE, AUDIO, PORTABLE  
CONSOLE, AUDIO, RECORDING  
CONSOLE, AUDIO, TV  
CORDS, PATCH  
DUMMY LOAD  
EQUALIZERS, AUDIO EMPHASIS  
EXCITERS, FM  
FILTERS, ANTENNA  
FILTERS, RF  
GENERATORS, FM, STEREO  
GENERATORS, FM, SUBCARRIER  
GENERATORS, SIGNAL, AF  
GENERATORS, SIGNAL, RF  
HOUSINGS, ANTENNA  
INDUCTANCES, FIXED  
INDUCTANCES, VARIABLE  
MAINTENANCE SERVICES, AM  
MAINTENANCE SERVICES, FM  
METERS, POWER  
MONITORS, AM SYSTEMS  
MONITORS, FM SYSTEMS, MONO  
MONITORS, FM SYSTEMS, SCA  
MONITORS, FM SYSTEMS, STEREO  
MONITORS, FREQUENCY  
NETWORKS, MATCHING, RF  
NETWORKS, PHASING  
OSCILLATORS, AF AND RF,  
SEE GENERATORS  
OSCILLATORS, AM  
OSCILLATORS, FM  
PREAMPLIFIERS, AUDIO  
RECEIVERS, AM  
RECEIVERS, FM  
RECEIVERS, MULTIPLEX  
RECEIVERS, SCA  
RECTIFIERS - ALSO SEE SEMI-  
CONDUCTORS & VACUUM TUBES  
REGULATORS, VOLTAGE  
SPEAKERS

STL EQUIPMENT  
TOWERS, ANTENNA,  
TRANSMITTING, AM  
TOWERS, ANTENNA,  
TRANSMITTING, FM  
TRANSMITTER KITS  
TRANSMITTERS, AM, 250 WATT  
TRANSMITTERS, AM, 1 KW  
TRANSMITTERS, AM, 5 KW  
TRANSMITTERS, AM, 10 KW  
TRANSMITTERS, AM, 25 KW  
TRANSMITTERS, AM, 50 KW  
TRANSMITTERS, AM, OVER 50 KW  
TRANSMITTERS, FM, 10 WATTS  
TRANSMITTERS, FM, 100 WATTS  
TRANSMITTERS, FM, 250 WATTS  
TRANSMITTERS, FM, 1 KW  
TRANSMITTERS, FM, 3 KW  
TRANSMITTERS, FM, 5 KW  
TRANSMITTERS, FM, 10 KW  
TRANSMITTERS, FM, 15 KW  
TRANSMITTERS, FM, 20 KW  
TRANSMITTERS, FM, 40 KW  
VACUUM TUBES, TRANSMITTING  
WIRE, BARE, COPPER  
WIRE, BARE, COPPER STRAP

**C-COR ELECTRONICS**

AMPLIFIER, BRIDGING  
AMPLIFIER, CATV  
AMPLIFIER, DC  
AMPLIFIER, DISTRIBUTION  
AMPLIFIER, PULSE  
AMPLIFIER, RF,  
GENERAL PURPOSE  
AMPLIFIER, RF, POWER  
AMPLIFIER, TV, BOOSTER  
AMPLIFIER, TV, VIDEO  
CATV EQUIPMENT - ALSO SEE  
OTHER CATEGORIES  
CATV, CHANNEL AMPLIFIERS  
CATV, HEAD-END EQUIPMENT  
HEAD-END EQUIPMENT  
SEE CATV HEAD-END EQUIPMENT

**CENTRALAB**

ATTENUATORS, AUDIO  
CAPACITORS, FIXED, CERAMIC  
CAPACITORS, FIXED, METALLIZED  
CAPACITORS, VARIABLE  
INSULATORS, ANTENNA  
INSULATORS, FEED THROUGH  
INSULATORS, STAND-OFF  
INSULATORS, OTHER  
INTEGRATED CIRCUITS  
POTENTIOMETERS, CARBON  
POTENTIOMETERS, WIREWOUND  
SWITCHES, LEVER  
SWITCHES, MULTICONTACT  
SWITCHES, PUSHBUTTON,  
NONILLUMINATED  
SWITCHES, ROTARY  
SWITCHES, SLIDE

**CENTRAL DYNAMICS CORP.**

AMPLIFIER, AF, AGC  
AMPLIFIER, AF, COMPRESSING  
AMPLIFIER, FM,  
GENERAL PURPOSE  
AMPLIFIER, AF, MONAURAL  
AMPLIFIER, AF, STEREO  
AMPLIFIER, DISTRIBUTION  
AMPLIFIER, PULSE  
AMPLIFIER, STABILIZING  
AMPLIFIER, TV, VIDEO  
ATTENUATORS, VIDEO  
AUTOMATION EQUIPMENT  
CATV, ORIGINATION EQUIPMENT  
CLOCKS  
COMMUNICATIONS SYSTEMS,  
INTERCOM, WIRED  
CONSOLE, AUDIO, TV  
CONSOLE, VIDEO, PORTABLE  
CONSOLE, VIDEO, STUDIO  
CORDS, PATCH  
DELAY LINES  
DISPLAY EQUIPMENT, TV  
EDUCATION FACILITIES, EOPT  
GENERATORS, SIGNAL,  
SPECIAL EFFECT  
GENERATORS, SIGNAL,  
TV SYNCHRONIZING  
GENERATORS, SIGNAL, VITS  
INDUSTRIAL TV  
JACK PANEL ASSEMBLIES  
JACKS  
MAINTENANCE SERVICES, TV  
MIXERS - ALSO SEE CONSOLES  
MOBILE EQUIPMENT  
PREAMPLIFIERS, AUDIO  
PREAMPLIFIERS, VIDEO  
REMOTE CONTROL SYSTEMS  
SWITCHERS  
SWITCHES, CROSSBAR  
SWITCHING MATRIXES  
SWITCHING SYSTEMS  
TV SYSTEMS, CLOSED CIRCUIT

**CENTURY LIGHTING INC.**

LIGHTING, TV, COMPONENTS  
LIGHTING, TV, CONTROLS  
LIGHTING, TV, SYSTEMS  
MICROPHONE STANDS & BOOMS

**CENTURY PROJECTOR CORPORATION**

AMPLIFIER, AF,  
GENERAL PURPOSE  
POWER SUPPLIES, DC  
PREAMPLIFIERS, AUDIO  
PROJECTORS, FILM  
RACKS, MOUNTING  
RECORDERS, FILM, MAGRETI  
REWINDERS, FILM  
SEMICONDUCTOR RECTIFIERS,  
GENERAL

SOUND SYSTEMS, PORTABLE  
SOUND SYSTEMS, THEATER  
SPEAKERS

**CHASSIS TRAK  
SLIDES, CHASSIS**

**CHRONO-LOG CORPORATION**

AUTOMATION EQUIPMENT  
CLOCKS  
COMPUTER EQUIPMENT

**CINE SONIC SOUND**

BACKGROUND MUSIC SERVICE  
CARTRIDGES, MAGNETIC TAPE  
CARTRIDGES, TAPE,  
RECORDING SERVICE

**CLEVELAND ELECTRONICS**

COILS, DEFLECTION  
AND FOCUSING

**CLEVELAND ELECTRONICS**

SPEAKER DIVISION  
REVERBERATION DEVICES  
SPEAKERS

**COMU ELECTRONICS**

AMMETERS, DC  
AMPLIFIER, DC  
AMPLIFIER, DISTRIBUTION  
AMPLIFIER, PULSE  
AMPLIFIER, TV, VIDEO  
CABLE, ASSEMBLIES  
CAMERA, MOUNTING EQUIPMENT  
CAMERA, REMOTE  
CONTROL EQUIPMENT  
CAMERAS, TV, COLOR  
CAMERAS, TV, MONOCHROME  
CATV EQUIPMENT - ALSO SEE  
OTHER CATEGORIES  
CATV, ORIGINATION EQUIPMENT  
DISPLAY EQUIPMENT, TV  
GENERATORS, SIGNAL, DOT BAR  
GENERATORS, SIGNAL,  
TV SYNCHRONIZING  
INDUSTRIAL TV  
LENSES, OPTICAL, FIXED  
LENSES, OPTICAL, ZOOM  
METERS - SEE SPECIFIC TYPES  
MONITORS, VIDEO  
OHMMETERS  
POWER SUPPLIES, AC  
POWER SUPPLIES, DC  
POWER SUPPLIES, PRECISION  
SWITCHES  
SWITCHING MATRIXES  
SWITCHING SYSTEMS  
TV SYSTEMS, CLOSED CIRCUIT  
VOLTMETERS, AC  
VOLTMETERS, DC  
VOLTMETERS, VACUUM TUBE

**COLLINS RADIO COMPANY**

AMPLIFIER, AF, COMPRESSING  
AMPLIFIER, AF,  
PEAK LIMITING, AM  
AMPLIFIER, AF,  
PEAK LIMITING, FM  
ANTENNAS, FM  
COILS, ANTENNA LOADING  
CONSOLE, AUDIO, AM  
CONSOLE, AUDIO, FM  
CONSOLE, AUDIO, TV  
EXCITERS, FM  
MICROWAVE SYSTEMS, STL  
MONITORS, AM SYSTEMS  
MONITORS, FM SYSTEMS, MONO  
MONITORS, FM SYSTEMS, SCA  
MONITORS, FM SYSTEMS, STEREO  
MONITORS, FREQUENCY  
NETWORKS, PHASING  
RECORDERS, MAGNETIC TAPE,  
AUDIO, CARTRIDGE  
STL EQUIPMENT  
TRANSMITTERS, AM, 250 WATT  
TRANSMITTERS, AM, 1 KW  
TRANSMITTERS, AM, 5 KW  
TRANSMITTERS, AM, 10 KW  
TRANSMITTERS, FM, 1 KW  
TRANSMITTERS, FM, 5 KW  
TRANSMITTERS, FM, 10 KW  
TRANSMITTERS, FM, 20 KW

**COLORADO VIDEO**

ANALYZERS, VIDEO  
CAMERAS, TV, MONOCHROME  
DISPLAY EQUIPMENT, TV  
ENHANCERS, TV IMAGE  
GENERATORS, SIGNAL,  
SPECIAL EFFECT  
GENERATORS, SIGNAL,  
TV SYNCHRONIZING  
INDUSTRIAL TV  
MONITORS, WAVEFORM  
OSCILLOSCOPES  
RECORDERS, DISC, MAGNETIC  
TV SYSTEMS, CLOSED CIRCUIT

**COLORTRAN INDUSTRIES, INC.**

BATTERIES, NICKEL CADMIUM  
CAMERA, MOUNTING EQUIPMENT  
CHARGERS, BATTERY  
CORDS, PATCH  
DOLLIES, CAMERA  
FILTERS, OTHER  
LIGHTING, TV, COMPONENTS  
LIGHTING, TV, CONTROLS  
LIGHTING, TV, SYSTEMS  
PANELS, INSTRUMENT,  
FOR RACK MOUNTING

**COLUMBIA ELECTRIC MFG. CO.**

AMMETERS, AC  
AMMETERS, DC

# BIRD RF POWER 50Ω Quality Instruments

New 50kW, 25 kW, 15 kW  
RF COAXIAL  
LOAD RESISTORS



TERMALINE®  
Series 8700

Units weigh  
only 13 lbs  
and mount  
directly on  
1-5/8", 3-1/8"

or 6-1/8" line for low VSWR termination  
to 800 MHz. Also ideal for accurate  
power measurement with Series 6010  
Calorimeters (2% typical).



FOR BIRD CATALOG, CONTACT

**BIRD ELECTRONIC  
CORPORATION**

30303 AURORA RD. • CLEVELAND (SOLON) OHIO 44139  
Phone 216-248-1200 • Cable BIRDELEC

## FREE BULLETIN (BI-MONTHLY) HOW TO MEASURE TERMINATE ATTENUATE FILTER or SWITCH RF POWER\*



Thruline®  
Directional Wattmeter

Catalog, included with first  
issue of 'Watt's New From  
Bird', covers:

Absorption & Directional Watt-  
meters, Attenuators & Load  
Resistors, Coaxial RF Filters,  
Selector Switches.

\*From 2 to 2200 MC and from 25  
milliwatts to 250 kilowatts in  
50-ohm coaxial line systems.



Use Reader Service  
Card or Contact

**BIRD ELECTRONIC  
CORPORATION**

CLEVELAND (SOLON) OHIO 44139  
30303 AURORA RD., Phone 216-248-1200

GENERATORS, POWER, ELECTRIC MOTOR  
VOLTMETERS, AC  
VOLTMETERS, DC

**COMPUTRON INC.**  
RECORDERS, MAGNETIC TAPE, AUDIO  
TAPE, MAGNETIC RECORDING, AUDIO  
TAPE, MAGNETIC RECORDING, COMPUTER  
TAPE, MAGNETIC RECORDING, TEST  
TAPE, MAGNETIC RECORDING, VIDEO

**COMRAC**  
COILS, DEFLECTION AND FOCUSING  
DISPLAY EQUIPMENT, TV  
MONITORS, VIDEO  
RECEIVERS, MULTIPLEX  
RECEIVERS, TV, COLOR  
RECEIVERS, TV, MONOCHROME  
VACUUM TUBES, CATHODE RAY, TV, MONOCHROME

**CONTINENTAL ELECTRONICS MFG.**  
AMPLIFIER, RF, POWER  
AUTOMATION EQUIPMENT  
COUPLERS  
DIVIDERS, POWER  
DUMMY LOAD  
FILTERS, RF  
LIGHTNING ARRESTERS  
REMOTE CONTROL SYSTEMS  
TAPE DECKS, MAGNETIC  
TRANSMITTERS, AM, 5 KW  
TRANSMITTERS, AM, 10 KW  
TRANSMITTERS, AM, 25 KW  
TRANSMITTERS, AM, 50 KW  
TRANSMITTERS, AM, OVER 50 KW

**COOK ELECTRIC COMPANY**  
CABINETS, METAL  
CABINETS, STORAGE, MAGNETIC TAPE  
CAPACITORS, FIXED, OTHER  
HARDWARE, PANEL  
HARDWARE, RACK  
RACKS, MOUNTING  
RELAYS, ANTENNA  
RELAYS, GENERAL PURPOSE  
RELAYS, TELEPHONE  
TELEPHONE EQUIPMENT  
TERMINAL BLOCKS  
WAVEGUIDE AND ASSOCIATED COMPONENTS

**COOKE ENGINEERING COMPANY**  
AMPLIFIER, DISTRIBUTION  
CONNECTORS, COAXIAL CABLE  
CORDS, PATCH  
JACK PANEL ASSEMBLIES  
JACKS

**COURIER COMMUNICATIONS**  
AMPLIFIER, RF, POWER  
COMMUNICATIONS SYSTEMS, CB  
MOBILE EQUIPMENT  
NARROW-BAND FM EQUIPMENT

**COPPERWELD STEEL CO.**  
CABLE, CATV, HARDWARE  
TRANSMISSION LINES  
WIRE, BARE, STEEL

**CORNELL-DUBILIER ELECTRONICS**  
CAPACITORS, FIXED, CERAMIC  
CAPACITORS, FIXED, ELECTROLYTIC  
CAPACITORS, FIXED, FILM  
CAPACITORS, FIXED, METALLIZED  
CAPACITORS, FIXED, MICA  
CAPACITORS, FIXED, PAPER  
CAPACITORS, FIXED, OTHER  
FILTERS, RF  
FILTERS, OTHER  
INVERTERS, DC TO AC, VIBRATORS  
POWER SUPPLIES, AC  
POWER SUPPLIES, DC  
RELAYS, GENERAL PURPOSE  
RELAYS, LATCHING  
RELAYS, OVERLOAD  
RELAYS, PHOTOELECTRIC  
RELAYS, PLUG-IN  
RELAYS, POWER  
RELAYS, SEQUENCING  
RELAYS, STEPPING  
RELAYS, TELEPHONE  
RELAYS, TIME DELAY  
TESTERS, CAPACITOR

**CRAFTSMAN ELECTRONIC PRODUCTS**  
AMPLIFIER, CATV  
AMPLIFIER, TV, BOOSTER  
CABLE, CATV, HARDWARE  
CONNECTORS, COAXIAL CABLE  
CONNECTORS, RF  
COUPLERS  
HARDWARE, RETAINING RINGS  
TRANSFORMERS, AUTO  
TRANSFORMERS, RF

**CROWN INTERNATIONAL**  
AMPLIFIER, AF, GENERAL PURPOSE  
AMPLIFIER, AF, MONAURAL  
AMPLIFIER, AF, STEREO  
CONSOLE, AUDIO, AM  
EDUCATION FACILITIES, EQPT  
PREAMPLIFIERS, AUDIO  
RECORDERS, MAGNETIC TAPE, AUDIO

RECORDERS, MAGNETIC TAPE, LOGGING  
TAPE DECKS, MAGNETIC  
TAPE DUPLICATORS

**CURTIS INSTRUMENTS**  
TIMERS, ELECTRIC

**CUSH CRAFT**  
ANTENNAS, CATV  
ANTENNAS, TV,  
MASTER-COMMUNITY

**CUSTOM CRAFT DESIGNS**  
PICKUP, MUSICAL INSTRUMENT

**DAGE BELL CORPORATION**  
CAMERAS, TV, MONOCHROME  
GENERATORS, SIGNAL, TV SYNCHRONIZING  
INDUSTRIAL TV  
MULTIPLEXERS  
TV SYSTEMS, CLOSED CIRCUIT

**DATA INSTRUMENT DIV.**  
CABINETS, METAL  
CALIBRATION SERVICE, INSTRUMENT  
CONSOLE, AUDIO, PORTABLE  
CONSOLE, AUDIO, RECORDING  
CONSOLE, AUDIO, TV  
CONSOLE, CABINETS AND HARDWARE  
CONSOLE, KITS  
CONSOLE, AUDIO, AM  
CONSOLE, AUDIO, FM  
CONSOLE, VIDEO, PORTABLE  
CONSOLE, VIDEO, STUDIO  
OSCILLOSCOPES  
PROBES, OSCILLOSCOPE  
RACKS, MOUNTING  
VOLTMETERS, AC  
VOLTMETERS, DC

**DATAPULSE DIVISION**  
GENERATORS, SIGNAL, PULSE  
GENERATORS, SIGNAL, SQUARE WAVE

**DAYTON ELECTRONIC PRODUCTS CO.**  
AMPLIFIER, AF, GENERAL PURPOSE  
AMPLIFIER, AF, MONAURAL  
RECEIVERS, FM  
RECEIVERS, SCA

**D & B ELECTRONICS CO.**  
CABLE, ASSEMBLIES  
COILS, CHOKE, RF  
CORDS, PATCH  
CORDS, SET  
DUMMY LOAD  
HARDWARE, CHASSIS  
JACK PANEL ASSEMBLIES  
LAMP ASSEMBLIES  
MANIFOLDS  
POWER SUPPLIES, AC  
TERMINAL BOARDS  
TERMINAL CARDS  
TERMINAL STRIPS  
TRANSFORMERS, RF  
WAVEGUIDE AND ASSOCIATED COMPONENTS  
WIRING AND CABLING SERVICES

**DEARBORN ELECTRONICS, INC.**  
CAPACITORS, FIXED, FILM  
CAPACITORS, FIXED, METALLIZED  
CAPACITORS, FIXED, OIL-FILLED  
CAPACITORS, FIXED, PAPER  
CAPACITORS, FIXED, OTHER

**DELCO RADIO DIV.**  
HEAT SINKS  
RECEIVERS, AM  
RECEIVERS, FM  
SEMICONDUCTOR RECTIFIERS  
SILICON CONTROLLED - SCR  
SEMICONDUCTORS,  
TRANSISTORS, AF  
SEMICONDUCTORS, TRANSISTORS, GENERAL

**DELTA ELECTRONICS, INC. - N.C.**  
ADAPTERS, TEST  
ALARM, SIGNAL  
AMPLIFIER, AF, GENERAL PURPOSE  
AMPLIFIER, BRIDGING  
AMPLIFIER, DISTRIBUTION  
AUTOMATION EQUIPMENT  
CAMERA, REMOTE CONTROL EQUIPMENT  
COMMUNICATIONS SYSTEMS, INTERCOM, WIRED  
COMMUNICATIONS SYSTEMS, INTERCOM, WIRELESS  
CONSOLE, AUDIO, PORTABLE  
EDUCATION FACILITIES, EQPT  
GENERATORS, SIGNAL, AF  
POWER SUPPLIES, DC  
PREAMPLIFIERS, AUDIO  
REMOTE CONTROL SYSTEMS  
TESTERS, SEMICONDUCTOR

**DELTA ELECTRONICS INC - V A**  
ANTENNA SYSTEMS, HF  
BRIDGES  
COILS, ANTENNA LOADING  
FILTERS, RF  
INDUCTANCES, VARIABLE  
METERS, STANDING WAVE  
SWITCHING MATRIXES, ANTENNA

**DEMORNAY-BONARDI DIVISION**  
ANTENNAS, MICROWAVE

ATTENUATORS, MICROWAVE  
CAVITIES, MICROWAVE  
CHOKES, WAVEGUIDE  
COUPLERS, MICROWAVE  
DETECTORS, MICROWAVE  
DETECTORS, STANDING WAVE  
DIVIDERS, FREQUENCY  
DIVIDERS, POWER  
DUMMY LOAD  
JOINTS, ROTARY, WAVEGUIDE  
METERS, STANDING WAVE  
MICROWAVE COMPONENTS  
MICROWAVE SYSTEMS, STL  
MICROWAVE SYSTEMS, 2500 MHZ  
SHIFTERS, PHASE, MICROWAVE  
SLOTTED SECTIONS  
SWITCHES, WAVEGUIDE  
WAVEGUIDE AND ASSOCIATED COMPONENTS

**DIALIGHT CORPORATION**  
CONNECTORS, AF & MICROPHONE  
LAMP ASSEMBLIES  
LAMPS, GLOW  
LAMPS, PANEL  
RELAYS, THERMAL  
RELAYS, TIME DELAY  
SOCKETS, LAMP  
SWITCHES, ILLUMINATED

**DIAMOND ELECTRONICS**  
CAMERAS, TV, MONOCHROME  
MONITORS, VIDEO  
TV SYSTEMS, CLOSED CIRCUIT

**DIAMOND EXPANSION BOLT CO. INC.**  
CABLE, CATV, HARDWARE  
CLAMPS, CABLE

**DIECRAFT, INC.**  
CAMERAS, TV, MONOCHROME  
TV SYSTEMS, CLOSED CIRCUIT

**DISPLAY TECHNOLOGIES**  
CARTRIDGES, MAGNETIC TAPE  
COMPUTER EQUIPMENT  
DISPLAY EQUIPMENT, TV  
PROJECTORS, SLIDE  
SCREENS, PROJECTION, REAR  
TAPE DECKS, MAGNETIC  
TURNTABLES, PHONOGRAPH

**DRESSER CRANE HOIST & TOWER**  
MAINTENANCE SERVICES, AM  
MAINTENANCE SERVICES, FM  
MAINTENANCE SERVICES, TV  
TOWERS, ANTENNA,  
CATV, HEAD-END  
TOWERS, ANTENNA, RECEIVING  
TOWERS, ANTENNA,  
TRANSMITTING, AM  
TOWERS, ANTENNA,  
TRANSMITTING, FM  
TOWERS, ANTENNA,  
TRANSMITTING, TV

**DUOTONE COMPANY, INC.**  
CLEANERS, LENS  
CLEANERS, OTHER  
RECORDS, BLANK, ACETATE,  
FOR RECORDING  
STYLI, CUTTING  
STYLI, PLAYBACK  
TAPE, MAGNETIC RECORDING,  
AUDIO

**DYANCOOL MANUFACTURING CO.**  
BLOWERS AND FANS

**DYNAIR ELECTRONICS, INC.**  
AMPLIFIER, DISTRIBUTION  
AMPLIFIER, PULSE  
AMPLIFIER, TV, VIDEO  
ANALYZERS, SIDEBAND  
CATV, HEAD-END EQUIPMENT  
DEMODULATORS  
HEAD-END EQUIPMENT,  
SEE CATV HEAD-END EQUIPMENT  
INDUSTRIAL TV  
MODULATORS, TV  
SWITCHERS  
SWITCHING SYSTEMS

**DYNASCENCES CORPORATION**  
ENHANCERS, TV IMAGE  
IMAGE MOTION  
STABILIZATION SYSTEM

**EASTMAN KODAK COMPANY**  
CAMERAS, FILM, CINE  
CAMERAS, FILM, STILL  
FILM, PHOTOGRAPHIC  
AND CHEMICALS  
FILM, PROCESSING SERVICE  
PROJECTORS, FILM  
PROJECTORS, SLIDE,  
NOT FOR VIDEO SYSTEMS  
REELS, TAPE  
TAPE, MAGNETIC RECORDING,  
AUDIO

**EIDSON ELECTRONIC COMPANY**  
CALIBRATION SERVICE,  
FREQUENCY  
CALIBRATION SERVICE,  
INSTRUMENT  
CRYSTALS, PIEZOELECTRIC  
MONITORS, FREQUENCY

**EIMAC DIV OF VARIAN**  
ADAPTERS, TUBE  
AMPLIFIER, RF, POWER  
COOLING UNITS, TUBE  
HEAT SINKS  
MICROWAVE COMPONENTS,  
KLYSTRONS  
OSCILLATORS, OTHER, RF

RECTIFIERS - VACUUM TUBES  
SOCKETS, TUBE  
VACUUM TUBES, TRANSMITTING

**EITEL ELECTRONICS**  
MAINTENANCE SERVICES, AM  
MAINTENANCE SERVICES, FM  
MAINTENANCE SERVICES, MICROWAVE  
MAINTENANCE SERVICES, TV  
TRANSMITTERS, AM, TO ORDER  
TRANSMITTERS, FM, TO ORDER  
TRANSMITTERS, TV, TO ORDER

**ELECTROLINE TV EQUIP INC.**  
CATV EQUIPMENT - ALSO SEE OTHER CATEGORIES

**ELECTRONIC LIGHTS, INC.**  
FLASHERS, TOWER  
LIGHTING, TV, SYSTEMS  
STROBE, LIGHTS

**ELECTRONIC MOBILE UNITS**  
MOBILE EQUIPMENT, TV

**ELECTRONIC RESEARCH COMPANY**  
CRYSTALS, PIEZOELECTRIC  
FILTERS, OTHER  
OSCILLATORS, FM  
OSCILLATORS, OTHER  
OVENS, CRYSTAL  
SWITCHES, SNAP  
SWITCHES, THERMAL

**ELECTRONICS ESSENTIALS OF CCC**  
ALARM, INTRUDER  
AMPLIFIER, AF, GENERAL PURPOSE  
AMPLIFIER, AF, MONAURAL  
AMPLIFIER, AF, STEREO  
CALIBRATION SERVICE,  
FREQUENCY  
CALIBRATION SERVICE,  
INSTRUMENT  
CLIPS, TEST  
CONNECTORS, AF & MICROPHONE  
CORDS, PATCH  
HARDWARE, CHASSIS  
HARDWARE, GENERAL  
HARDWARE, GROMMETS  
HARDWARE, MOUNTS  
HARDWARE, RACK  
HARDWARE, TOOLS  
HARDWARE, TUBING, METAL  
HARDWARE, TUBING, PLASTIC  
JACK PANEL ASSEMBLIES  
JACKS  
LAMP ASSEMBLIES  
LAMPS, PANEL  
LEADS, TEST  
MICROPHONE HARDWARE  
MICROWAVE COMPONENTS  
PLUGS, COAXIAL  
PLUGS, PHONE  
PROBES, OSCILLOSCOPE  
PROBES, TEST LEAD  
SHIELDINGS, TUBE  
SLIDES, CHASSIS  
SOCKETS, LAMP  
SOCKETS, TUBE  
SPEAKER COMPONENTS  
SWITCHES, SLIDE  
SWITCHES, SNAP  
SWITCHES, TOGGLE  
TELEPHONE EQUIPMENT  
TERMINAL BLOCKS  
TERMINAL BOARDS  
TERMINAL STRIPS  
TERMINALS, BARRIER  
TERMINALS, HIGH VOLTAGE  
TERMINALS, LUG  
TERMINALS, SOLDER  
TERMINALS, SOLDERLESS  
TOOLS, HAND  
TOOLS, SCREWDRIVERS  
TOOLS, WRENCHES

**EMCEE**  
ANTENNAS, TV  
DIVIDERS, POWER  
MICROWAVE SYSTEMS, 2500 MHZ  
MICROWAVE SYSTEMS, OTHER  
MODULATORS, TV  
TRANSLATOR SYSTEMS  
TRANSMITTERS, TV, 1 WATT  
TRANSMITTERS, TV, 20 WATTS  
TRANSMITTERS, TV, 100 WATTS  
TRANSMITTERS, TV, 1 KW

**ELECTRONIC SYSTEM ENGINEERING**  
AMPLIFIER, AF, AGC  
AMPLIFIER, AF, COMPRESSING  
AMPLIFIER, AF, REMOTE  
METERS, LIGHT

**ELECTRO PRODUCTS LABORATORIES**  
INVERTERS, DC TO AC,  
SOLID STATE  
POWER SUPPLIES, DC

**ELECTRO-SOUND ACOUSTICS**  
AMPLIFIER, AF, MONAURAL  
AMPLIFIER, AF, STEREO  
ENCLOSURES, SPEAKER  
SPEAKERS

**ELECTROVERT, INCORPORATED**  
CLAMPS, COMPONENT  
HARDWARE, GENERAL  
HARDWARE, GROMMETS  
MOUNTS, VIBRATION AND SHOCK

**ELECTRO-VOICE, INC.**  
AMPLIFIER, AF,  
GENERAL PURPOSE

# Depco's

# S/6

*... means Solid State SCA Multiplex Equipment*

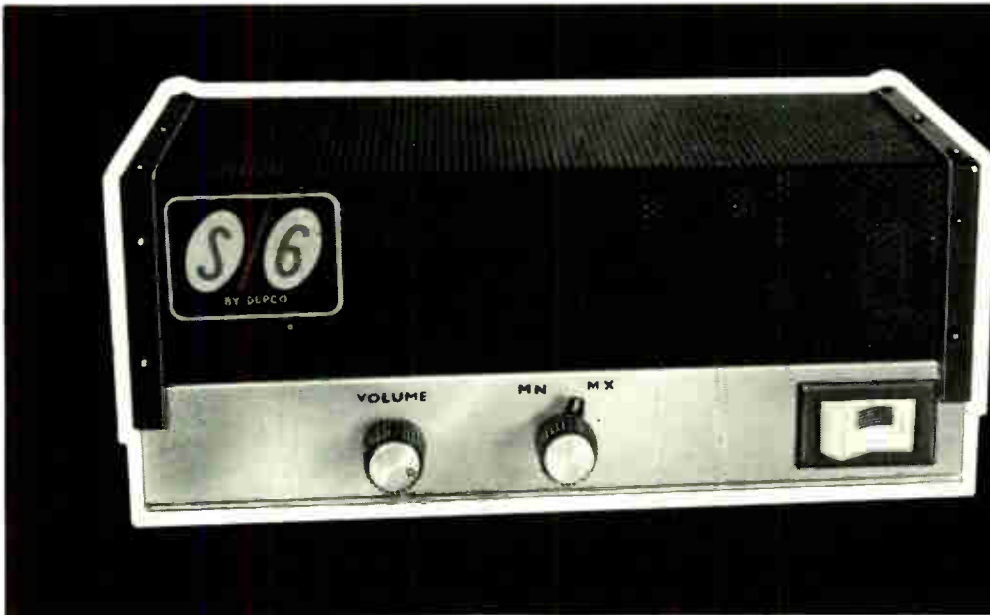

**S/6... New and Better Background Music. First with "FET Front End" in multiplex receivers. 3 new modular models and now a separate tuner. Whatever your needs — distance, selectivity, difficult terrain or big city interference — Depco's S-6 guarantees quality reception. Depco also has available solid state external 20 and 70 watt amplifiers — general purpose.**

## *Other Products by Depco*



**TMG-1 Time Mark Generator... Portable, accurate, self-contained frequency source... 100 KHz, 1 MHz, 10 MHz... Also available, 455 KHz, 10.7 MHz, 30 MHz other frequencies upon request.**



**SA-2 Solid State Signal Analyzer, produced for U.S.A.F. — custom electronic equipment designed and produced to your specifications.**



**AN/TRC-68A U.H.F. Transceiver... Presently being produced for U.S. Army Signal Corps.**

# Depco®

**DAYTON ELECTRONIC PRODUCTS COMPANY**  
117 E. Helena Street • Dayton, Ohio 45404 • 513/461-4951

AMPLIFIER, AF, STEREO  
CARTRIDGES, PHONO  
ENCLOSURES, SPEAKER  
MICROPHONES, DYNAMIC  
RECEIVERS, AM  
RECEIVERS, FM  
RECEIVERS, MULTIPLEX  
SPEAKER COMPONENTS  
SPEAKERS

THE ELMOR COMPANY  
TIMERS, MANUAL-CHRONOGRAPH

ENCLOSURE CORP.  
BLOWERS AND FANS  
CABINETS, METAL  
CASES, PORTABLE,  
ELECTRONIC EQUIPMENT  
CONSOLE, CABINETS  
AND HARDWARE

ENGINEERING ASSOCIATES

CAPACITORS, FIXED, OIL-FILLED  
CONNECTORS, COAXIAL CABLE  
CONNECTORS, RF  
COUNTERS, FREQUENCY  
DIVIDERS, VOLTAGE  
GENERATORS, SIGNAL, AF  
GENERATORS, SIGNAL, RF  
GENERATORS, SIGNAL,  
SQUARE WAVE  
LAMPS, ARC  
METERS, FIELD STRENGTH  
METERS, FREQUENCY  
METERS, FREQUENCY CALIBRATING  
METERS, PHASE ANGLE  
METERS, POWER  
METERS, STANDING WAVE  
MICROWAVE COMPONENTS  
OHMMETERS  
OSCILLATORS, AF AND RF,  
SEE GENERATORS  
OSCILLATORS, AM  
OSCILLATORS, OTHER  
OSCILLOSCOPES  
PAPER, CHART AND GRAPH  
PLUGS, COAXIAL  
POTENTIOMETERS, WIREWOUND  
POWER SUPPLIES, AC  
POWER SUPPLIES, DC  
POWER SUPPLIES, PRECISION  
RECORDERS, PAPER,  
LOGGING AND GRAPHIC  
RELAYS, COAXIAL  
RELAYS, OVERLOAD  
RELAYS, POWER  
RELAYS, STEPPING  
RELAYS, TELEPHONE  
RELAYS, TIME DELAY  
REMOTE CONTROL SYSTEMS  
RESISTORS, VARIABLE,  
WIREWOUND  
RHEOSTATS  
SHUNTS, METER  
SWITCHES, COAXIAL  
SWITCHES, KNIFE  
SWITCHES, MECHANICALLY  
ACTUATED  
SWITCHES, ROTARY  
TESTERS, INSULATION  
TESTERS, VACUUM TUBE  
TIMERS, ELECTRIC  
TRANSFORMERS, FILAMENT  
TRANSFORMERS, POWER  
TRANSFORMERS, VARIABLE  
VOLTMETERS, AC  
VOLTMETERS, DC  
VOLTMETERS, VACUUM TUBE  
WATTMETERS

THE ENGLISH ELECTRIC CORP.  
CALORIMETERS  
VACUUM TUBES, CAMERA,  
IMAGE-ORTHICON  
VACUUM TUBES, CAMERA, VIDICON  
VACUUM TUBES, TRANSMITTING

ENTRON, INC.  
AMPLIFIER, CATV  
CATV EQUIPMENT - ALSO SEE  
OTHER CATEGORIES  
CATV, CABLE TERMINALS  
CATV, CHANNEL AMPLIFIERS  
CATV, HEAD-END EQUIPMENT  
CONNECTORS, COAXIAL CABLE  
CONNECTORS, RF  
FILTERS, OTHER  
HEAD-END EQUIPMENT,  
SEE CATV HEAD-END EQUIPMENT  
POWER SUPPLIES, DC

ESSEX WIRE CORPORATION  
RELAYS, BREAK-IN  
RELAYS, GENERAL PURPOSE  
RELAYS, OVERLOAD  
RELAYS, PLUG-IN  
RELAYS, POWER  
RELAYS, SEQUENCING  
RELAYS, TELEPHONE  
RELAYS, THERMAL  
RELAYS, TIME DELAY  
TRANSFORMERS, AUDIO,  
ISOLATION  
TRANSFORMERS, AUDIO, MATCHING  
TRANSFORMERS, AUDIO,  
POWER OUTPUT  
TRANSFORMERS, AUTO  
TRANSFORMERS, COUPLING  
TRANSFORMERS, FILAMENT  
TRANSFORMERS, GENERAL  
TRANSFORMERS, PLATE  
TRANSFORMERS, POWER  
TRANSFORMERS, RF  
TRANSFORMERS, TRANSISTOR  
TRANSFORMERS, VARIABLE

EUPHONICS MARKETING  
ARMS, TONE  
CARTRIDGES, PHONO

E-Z-HOOK TEST PRODUCTS  
LEADS, TEST  
PROBES, TEST LEAD

FAIRCHILD RECORDING EQUIPMENT

AMPLIFIER, AF,  
GENERAL PURPOSE  
AMPLIFIER, AF,  
PEAK LIMITING, AM  
AMPLIFIER, AF,  
PEAK LIMITING, FM  
ATTENUATORS, AUDIO  
CARTRIDGES, PHONO  
CONSOLE, AUDIO, AM  
CONSOLE, AUDIO, FM  
CONSOLE, AUDIO, RECORDING  
CONSOLE, AUDIO, TV  
CONSOLE, KITS  
HEADS, DISC RECORDING  
HEADS, ERASE, MAGNETIC  
HEADS, RECORDING, MAGNETIC  
LATHE, DISC RECORDING  
MIXERS - ALSO SEE CONSOLES  
POWER SUPPLIES, AC  
POWER SUPPLIES, DC  
PREAMPLIFIERS, AUDIO  
RACKS, MOUNTING  
RECORDERS, DISC, MAGNETIC  
RECORDERS, MAGNETIC TAPE,  
AUDIO  
REVERBERATION DEVICES  
TURNTABLES, PHONOGRAPH

THE FINNEY CO.  
AMPLIFIER, TV, BOOSTER  
ANTENNAS, FM  
ANTENNAS, TV  
ANTENNAS, TV,  
MASTER-COMMUNITY  
BALUNS

F & M SYSTEMS COMPANY  
ANTENNAS, MOBILE  
AUTOMATION EQUIPMENT  
CALIBRATION SERVICE,  
FREQUENCY  
COMMUNICATIONS SYSTEMS, CB  
COMMUNICATIONS SYSTEMS,  
INTERCOM, WIRED  
COMMUNICATIONS SYSTEMS,  
INTERCOM, WIRELESS  
COMMUNICATIONS SYSTEMS,  
LAND MOBILE  
COMMUNICATIONS SYSTEMS,  
MICROWAVE  
COMMUNICATIONS SYSTEMS,  
MULTIPLEX  
COMMUNICATIONS SYSTEMS,  
TELEPRINTER  
MICROWAVE SYSTEMS, STL  
MICROWAVE SYSTEMS, 250D-MHZ  
MICROWAVE SYSTEMS, OTHER  
MOBILE EQUIPMENT  
REMOTE CONTROL SYSTEMS  
SWITCHING SYSTEMS  
TRANSLATOR SYSTEMS  
TV SYSTEMS, CLOSED CIRCUIT

FISHER BERKELEY CORPORATION  
AMPLIFIER, AF,  
GENERAL PURPOSE  
CABLE, TELEPHONE  
COMMUNICATIONS SYSTEMS,  
INTERCOM, WIRED  
COMMUNICATIONS SYSTEMS,  
INTERCOM, WIRELESS  
POWER SUPPLIES, DC

HERB FITZGERALD COMMUNICATIONS  
AND ELECTRONICS  
CALIBRATION SERVICE,  
FREQUENCY

THE JAMES FLOYD FORD COMPANY  
ALARM, INTRUDER  
ALARM, SIGNAL  
BACKGROUND MUSIC SERVICE  
BROADCAST PROGRAMMING SERVICE  
CALIBRATION SERVICE,  
INSTRUMENT  
COMMUNICATIONS SYSTEMS,  
INTERCOM, WIRED  
COMMUNICATIONS SYSTEMS,  
INTERCOM, WIRELESS  
COMMUNICATIONS SYSTEMS,  
LAND MOBILE  
COMPUTER SERVICES  
MAINTENANCE SERVICES, TV  
PROCESSORS, FILM, B-W  
RECORDING SERVICE, AUDIO,  
TAPE  
TELEPHONE EQUIPMENT  
TV SYSTEMS, CLOSED CIRCUIT

FORT WORTH TOWER CO.  
ANTENNAS, MICROWAVE  
PREFABRICATED BUILDINGS  
RADOMES  
REFLECTORS, PASSIVE  
TOWERS, ANTENNA,  
CATV, HEAD-END  
TOWERS, ANTENNA, RECEIVING  
TOWERS, ANTENNA,  
TRANSMITTING, AM  
TOWERS, ANTENNA,  
TRANSMITTING, FM  
TOWERS, ANTENNA,  
TRANSMITTING, TV

GAMMA SCIENTIFIC, INC.  
METERS, LIGHT

GATES RADIO COMPANY  
AMPLIFIER, AF, AGC  
AMPLIFIER, AF, COMPRESSING  
AMPLIFIER, AF,  
GENERAL PURPOSE  
AMPLIFIER, AF, MONAURAL  
AMPLIFIER, AF,  
PEAK LIMITING, AM  
AMPLIFIER, AF,  
PEAK LIMITING, FM  
AMPLIFIER, AF, REMOTE  
AMPLIFIER, AF, STEREO  
AMPLIFIER, BRIDGING  
AMPLIFIER, RF,  
GENERAL PURPOSE  
AMPLIFIER, RF, POWER  
ANTENNAS, AM  
ANTENNAS, FM  
ANTENNAS, MOBILE  
ANTENNAS, TV  
ARMS, TONE  
AUTOMATION EQUIPMENT  
BASE STATIONS  
CABINETS, METAL  
CABINETS, STORAGE, DISC  
CABINETS, WOOD  
CARTRIDGES, MAGNETIC TAPE  
COILS, ANTENNA LOADING  
COILS, CHOKE, RF  
CONSOLE, AUDIO, FM  
CONSOLE, AUDIO, PORTABLE  
CONSOLE, AUDIO, RECORDING  
CONSOLE, AUDIO, TV  
CONSOLE, CABINETS  
AND HARDWARE  
CONSOLE, AUDIO, AM  
DIVIDERS, POWER  
DUMMY LOAD  
EXCITERS, FM  
FILTERS, ANTENNA  
FILTERS, RF  
FLASHERS, TOWER  
GENERATORS, FM, STEREO  
GENERATORS, FM, SUBCARRIER  
HARDWARE, RACK  
HOUSINGS, ANTENNA  
MICROPHONES, DYNAMIC  
MOBILE EQUIPMENT  
MONITORS, AM SYSTEMS  
MONITORS, FM SYSTEMS, MONO  
MONITORS, FM SYSTEMS, SCA  
MONITORS, FM SYSTEMS, STEREO  
MONITORS, FREQUENCY  
MONITORS, PHASE  
MOUNTS, ANTENNA, FIXED  
MOUNTS, ANTENNA, MOBILE  
NETWORKS, MATCHING, AUDIO  
NETWORKS, PHASING  
OSCILLATORS, AM  
OSCILLATORS, FM  
OSCILLATORS, TV  
POWER SUPPLIES, AC  
POWER SUPPLIES, DC  
PREAMPLIFIERS, VIDEO  
PRESSURIZATION EQUIPMENT,  
TRANSMISSION LINE  
RACKS, MOUNTING  
RECEIVERS, FM  
RECORDERS, MAGNETIC TAPE,  
AUDIO, CARTRIDGE  
REMOTE CONTROL SYSTEMS  
SPEAKERS  
SWITCHING SYSTEMS  
TAPE DECKS, MAGNETIC  
TAPE, MAGNETIC RECORDING,  
TEST  
TOWERS, ANTENNA,  
TRANSMITTING, AM  
TOWERS, ANTENNA,  
TRANSMITTING, FM  
TOWERS, ANTENNA,  
TRANSMITTING, TV  
TRANSMISSION LINES  
TRANSMITTER KITS  
TRANSMITTERS, AM, 250 WATT  
TRANSMITTERS, AM, 1 KW  
TRANSMITTERS, AM, 5 KW  
TRANSMITTERS, AM, 10 KW  
TRANSMITTERS, AM, 25 KW  
TRANSMITTERS, AM, 50 KW  
TRANSMITTERS, AM, OVER 50 KW  
TRANSMITTERS, FM, 10 WATTS  
TRANSMITTERS, FM, 50 WATTS  
TRANSMITTERS, FM, 250 WATTS  
TRANSMITTERS, FM, 1 KW  
TRANSMITTERS, FM, 3 KW  
TRANSMITTERS, FM, 5 KW  
TRANSMITTERS, FM, 7.5 KW  
TRANSMITTERS, FM, 10 KW  
TRANSMITTERS, FM, 15 KW  
TRANSMITTERS, FM, 20 KW  
TRANSMITTERS, FM, 40 KW  
TRANSMITTERS, TV, 100 WATTS  
TRANSMITTERS, TV, 500 WATTS  
TRANSMITTERS, TV, 5 KW

GBC AMERICA CORP.  
AMPLIFIER, CATV  
AMPLIFIER, TV, VIDEO  
INDUSTRIAL TV  
MONITORS, VIDEO  
TV SYSTEMS, CLOSED CIRCUIT  
VACUUM TUBES, CAMERA, VIDICON

GBC ELECTRONICS COMPANY  
ADAPTERS, CONNECTOR  
ADAPTERS, FM STEREO  
ADAPTERS, TEST  
ANCHORS, GUY  
ANTENNAS, FM  
ANTENNAS, MOBILE  
ANTENNAS, TV  
CABLE, ASSEMBLIES  
CABLE, SHIELDED, AUDIO  
CHARGERS, BATTERY  
CIRCUIT BREAKERS

CLAMPS, CABLE  
CLEANERS, CHEMICAL  
CLEANERS, OTHER  
CLIPS, TEST  
COILS, DEGAUSSING  
CONNECTORS, AF & MICROPHONE  
CONNECTORS, ANTENNA  
CONNECTORS, COAXIAL CABLE  
CORDS, DIAL  
CORDS, LACING  
COUPLERS  
DECALCOMANIAS  
DEMAGNETIZERS, BULK TAPE  
DEMAGNETIZERS, HEAD  
DESICCANTS  
DIALS, INSTRUMENT  
EARPHONES, HEADPHONES  
ENHANCERS, TV IMAGE  
FUSES  
HARDWARE, CHASSIS  
HARDWARE, DIAL POINTERS  
HARDWARE, GENERAL  
HARDWARE, GROMMETS  
HARDWARE, RACK  
HARDWARE, TOOLS  
HARDWARE, TUBING, PLASTIC  
HEAT SINKS  
HOLDERS, FUSE  
INSULATORS, ANTENNA  
INSULATORS, FEED THROUGH  
INSULATORS, STAND-OFF  
INSULATORS, OTHER  
JACKS  
KNOBS  
LEADS, TEST  
LIGHTNING ARRESTERS  
LUBRICANTS  
MICROPHONE HARDWARE  
MICROPHONE STANDS & BOOMS  
MICROPHONES, DYNAMIC  
MOUNTS, ANTENNA, FIXED  
MOUNTS, ANTENNA, MOBILE  
PLUGS, PHONE  
PROBES, OSCILLOSCOPE  
PROBES, TEST LEAD  
RESISTORS, FIXED, CARBON  
RESISTORS, VARIABLE,  
WIREWOUND  
SOCKETS, TUBE  
SOLDER  
SOLVENTS AND CLEANERS  
SPLICERS, MAGNETIC TAPE  
AND FILM  
STROBE, DISCS  
STROBE, LIGHTS  
SWITCHES, KNIFE  
SWITCHES, PUSHBUTTON,  
NONILLUMINATED  
SWITCHES, ROTARY  
SWITCHES, SLIDE  
SWITCHES, TOGGLE  
TERMINALS, LUG  
TERMINALS, SOLDER  
TERMINALS, SOLDERLESS  
TOOLS, SCREWDRIERS

G E VISUAL COMMUNICATIONS PROD

AMPLIFIER, AF,  
GENERAL PURPOSE  
AMPLIFIER, AF, MONAURAL  
AMPLIFIER, AF,  
PEAK LIMITING, AM  
AMPLIFIER, AF,  
PEAK LIMITING, FM  
AMPLIFIER, AF, REMOTE  
AMPLIFIER, AF, STEREO  
AMPLIFIER, RF, POWER  
AMPLIFIER, TV, VIDEO  
ANTENNAS, TV  
CABINETS, METAL  
CABLE, SHIELDED, AUDIO  
CAMERAS, TV, COLOR  
CAMERAS, TV, MONOCHROME  
CONSOLE, AUDIO, AM  
CONSOLE, AUDIO, PORTABLE  
CONSOLE, AUDIO, RECORDING  
CONSOLE, AUDIO, TV  
CONSOLE, AUDIO, FM  
DEMODULATORS  
DIPLAXERS  
EQUALIZERS, AUDIO EMPHASIS  
FILTERS, AUDIO  
FILTERS, RF  
GENERATORS, SIGNAL,  
TV SYNCHRONIZING  
INDUSTRIAL TV  
MONITORS, AM SYSTEMS  
MONITORS, FREQUENCY  
MONITORS, VIDEO  
POWER SUPPLIES, DC  
PREAMPLIFIERS, AUDIO  
RACKS, MOUNTING  
SWITCHERS  
TRANSMITTERS, TV, 1D KW  
TRANSMITTERS, TV, 30 KW  
TRANSMITTERS, TV, 50 KW  
TRANSMITTERS, TV, 100 KW  
TV SYSTEMS, CLOSED CIRCUIT  
VESTIGIAL SIDEBAND FILTERS

G E DISTRIBUTOR SALES FORCE

VACUUM TUBES  
CARTRIDGES, PHONO  
CRYSTALS, PIEZOELECTRIC  
LAMPS, GLDW  
LAMPS, EXCITER  
LAMPS, PANEL  
LAMPS, PROJECTION  
SEMICONDUCTOR DIODES  
SEMICONDUCTOR RECTIFIERS,  
GENERAL  
SEMICONDUCTOR RECTIFIERS,  
HIGH VOLTAGE  
SEMICONDUCTOR RECTIFIERS,  
POWER



# SUPER SOUNDS

start  
with

# FAIRCHILD

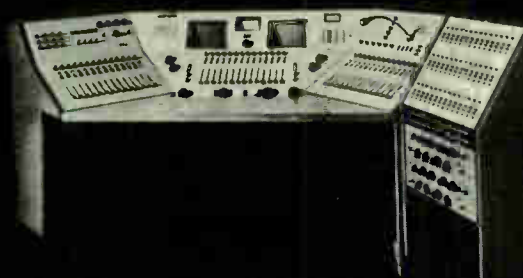

New FAIRCHILD 42 input TV Network Mixer.



## FAIRCHILD MASTER TAPE IMPROVEMENT SYSTEM

FAIRCHILD MTIS with "focused-gap" head design reduces bias-induced noise to a point where it is no greater than 2 db than the noise of virgin or bulk-erased tape. FAIRCHILD MTIS has an S/N ratio of 72 db on one track of a 4-track 1/2" tape. FAIRCHILD MTIS increases the recording level by 4 db over present standards, with the lowest harmonic, intermodulation, and cross-modulation distortion of only .5%. Only the FAIRCHILD MTIS comes in a compatible, convertible package allowing you to update your present tape transports to the highest quality "state-of-the-art" recording standards.



## FAIRCHILD CONAX

The world-accepted standard to control high frequency spillovers due to pre-emphasis. Maintain high levels even with brass and crashing cymbals in FM and recording.

## THE REVERBERTRON

The new compact reverberation system which gives your station that real big voice. With the Reverbertron you can have that Carnegie Hall effect as close as the gain control on the Reverbertron. And there's the added plus of an increase in apparent loudness of your station sound due to reverberation, as originally described by Dr. Maxfield.



## FAIRCHILD COMPACT COMPRESSOR MODEL 663

Allows creation of those up tight levels that contribute materially to presence and loudness combined with overload protection. The FAIRCHILD Model 663 Compact Compressor produces no distortion despite the amount of compression used... no thumps, no noise. The 663 provides adjustable release time and up to 20 db of compression. Model 663 NL comes with unity gain and additional gain if needed with +18 dbm output.



## FAIRCHILD PROGRAM EQUALIZER MODEL 664NL

An ideal no loss equalizer for broadcast and recording. The FAIRCHILD Model 664NL allows the production of the "hot, solid commercial" sound standard with major recording studios; transforms any conventional console into 'Big Board sound'. 1 1/2" x 5 1/4" high unit provides equalization up to 10 db at 4, 6, 8, 10, or 15 KHZ and low end equalization up to 10 db. Rolloffs also provided. The Model 664NLB has equalization at 2, 3, 4, 5, and 7.5 KHZ for motion picture demands. The FAIRCHILD Program Equalizer contains equalization plus 18 dbm amplifier output. Put life into your sound with the FAIRCHILD Equalizer.



## FAIRCHILD LIMITER MODEL 670

Fast attack Stereo Limiter (50 microseconds) with low distortion and absence of thumps. Sum and difference limiting position eliminates floating stereo image. Includes regular channel A and B limiting. Dual controls, dual meters provided. Used throughout the world. Flexible release times make it indispensable in stereo recording and broadcasting.

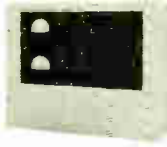

## Why are 6 FAIRCHILD CONAX'S on top of the EMPIRE STATE BUILDING?



Several New York FM and TV stations, including WNEW-TV, WPIX-FM, WPIX-TV, WOR-FM, WOR-TV, and WQXR-FM, value their transmission location on top of the Empire State Building and they also value their audience. The FAIRCHILD CONAX allows these stations to maintain high average listening levels without danger of over-modulation caused by high frequency spikes and thereby increasing fringe area coverage. The super-fast attack and release times of the FAIRCHILD CONAX makes this instantaneous control inaudible to the listener's ear. The FAIRCHILD CONAX does not "muddy-up" the top in an effort to control it. Easily integrated into existing systems, the FAIRCHILD CONAX does not obsolete conventional compressors or limiters — it actually improves their performance. Only the FAIRCHILD CONAX is the world accepted solution for high frequency pre-emphasis problems. Join the "1000 Club"... the satisfied users of the FAIRCHILD CONAX in recording and broadcasting throughout the world. Write to FAIRCHILD — the pacemaker in professional audio products — for complete details.

Write to FAIRCHILD — the pacemaker in professional audio products — for complete details.

# FAIRCHILD

RECORDING EQUIPMENT CORPORATION  
10-40 45th Ave., Long Island City 1, N. Y.

# FAIRCHILD

RECORDING EQUIPMENT CORPORATION  
10-40 45th Ave., Long Island City 1, N. Y.

SEMICONDUCTOR RECTIFIERS, SILICON CONTROLLED - SCR  
SEMICONDUCTORS, THYRISTORS  
SEMICONDUCTORS, TRANSISTORS, AF  
SEMICONDUCTORS, TRANSISTORS, FE  
SEMICONDUCTORS, TRANSISTORS, GENERAL  
SEMICONDUCTORS, TRANSISTORS, RF  
VACUUM TUBES, CATHODE RAY, TV, COLOR  
VACUUM TUBES, CATHODE RAY, TV, MONOCHROME  
VACUUM TUBES, RECEIVING  
VACUUM TUBES, TRANSMITTING

G E INDUSTRIAL SALES OPERATION

AMMETERS, AC  
AMMETERS, AC, THERMOCOUPLE  
AMMETERS, DC  
AMMETERS, RF  
CIRCUIT BREAKERS  
METERS, DB AND VU  
METERS, DB AND VU, WIDE RANGE  
SHUNTS, METER  
TRANSFORMERS, GENERAL  
VOLTMETERS, AC  
VOLTMETERS, DC  
WATTMETERS

G E CAPACITOR DEPARTMENT

BATTERIES, NICKEL CADMIUM  
CAPACITORS, FIXED, AIR  
CAPACITORS, FIXED, CERAMIC  
CAPACITORS, FIXED, MICA  
CAPACITORS, FIXED, OIL-FILLED  
CAPACITORS, FIXED, OTHER

G E SUPPLY COMPANY

CLOCKS  
METERS, LIGHT  
RECEIVERS, AM  
REGULATORS, CURRENT  
REGULATORS, VOLTAGE

G E SALES AND DISTRIBUTION

RECEIVERS, TV, COLOR  
RECEIVERS, TV, MONOCHROME

G E COMMUNICATION PRODUCTS

MOBILE EQUIPMENT

G E PICKUP TUBE OPERATION

VACUUM TUBES, CAMERA, IMAGE-ORTHICON  
VACUUM TUBES, CAMERA, VIDICON

GENERAL ELECTRIC COMPANY

AMMETERS, AC  
AMMETERS, DC  
BALLASTS, LAMP  
BATTERIES, NICKEL CADMIUM  
BATTERIES, OTHER  
BRIDGES  
CAPACITORS, FIXED, ELECTROLYTIC  
CAPACITORS, FIXED, FILM  
CAPACITORS, FIXED, OIL-FILLED  
CAPACITORS, FIXED, PAPER  
CAPACITORS, FIXED, OTHER  
CHARGERS, BATTERY  
CIRCUIT BREAKERS  
COMPUTER EQUIPMENT  
CONVERTERS  
DETECTORS, MICROWAVE  
DIVIDERS, FREQUENCY  
DIVIDERS, VOLTAGE  
FUSES  
GENERATORS, POWER, ELECTRIC MOTOR  
HEATING ELEMENTS  
INDUSTRIAL TV  
INTEGRATED CIRCUITS  
LIGHTNING ARRESTERS  
METERS, PHASE ANGLE  
MICROWAVE COMPONENTS  
PANELS, INSTRUMENT, FOR RACK MOUNTING  
POWER SUPPLIES, AC  
POWER SUPPLIES, DC  
RECORDERS, PAPER, LOGGING AND GRAPHIC  
RECTIFIERS - ALSO SEE SEMI-CONDUCTORS & VACUUM TUBES  
RECTIFIERS, SELENIUM  
REGULATORS, CURRENT  
REGULATORS, VOLTAGE  
RELAYS, GENERAL PURPOSE  
RELAYS, LATCHING  
RELAYS, OVERLOAD  
RELAYS, PHOTOELECTRIC  
RELAYS, THERMAL  
RELAYS, TIME DELAY  
REMOTE CONTROL SYSTEMS  
RESISTORS, FIXED, WIREWOUND  
RESISTORS, FIXED, OTHER  
RHEOSTATS  
SEMICONDUCTOR DIODES  
SEMICONDUCTOR RECTIFIERS, GENERAL  
SEMICONDUCTOR RECTIFIERS, POWER  
SEMICONDUCTOR RECTIFIERS, SILICON CONTROLLED - SCR  
SEMICONDUCTORS, TRANSISTORS, GENERAL  
SHUNTS, METER  
SWITCHES, FOOT  
SWITCHES, INTERLOCK  
SWITCHES, LEVER  
SWITCHES, MECHANICALLY ACTUATED

SWITCHES, PUSHBUTTON, NONILLUMINATED  
SWITCHES, ROTARY  
SWITCHES, THERMAL  
SWITCHES, TOGGLE  
TERMINAL BLOCKS  
TERMINAL BOARDS  
TESTERS, BATTERY  
TESTERS, INSULATION  
TIMERS, ELECTRIC  
TRANSFORMERS, AUTO  
TRANSFORMERS, FILAMENT  
TRANSFORMERS, GENERAL  
TRANSFORMERS, POWER  
TRANSFORMERS, VARIABLE  
TV SYSTEMS, CLOSED CIRCUIT  
VOLTMETERS, AC  
VOLTMETERS, DC  
WATTMETERS

GENERAL MICROWAVE CORPORATION

ANALYZERS, NOISE  
ATTENUATORS, FIXED  
ATTENUATORS, MICROWAVE  
ATTENUATORS, RF  
BRIDGES  
METERS, POWER  
METERS, STANDING WAVE  
WATTMETERS  
WAVEGUIDE AND ASSOCIATED COMPONENTS

GENERAL RADIO COMPANY

ADAPTERS, CONNECTOR  
AMPLIFIER, AF, GENERAL PURPOSE  
AMPLIFIER, DC  
AMPLIFIER, PULSE  
AMPLIFIER, RF, GENERAL PURPOSE  
AMPLIFIER, RF, POWER  
ANALYZERS, DISTORTION  
ANALYZERS, HARMONIC  
ANALYZERS, NOISE  
ATTENUATORS, AUDIO  
ATTENUATORS, FIXED  
ATTENUATORS, MICROWAVE  
ATTENUATORS, RF  
BALUNS  
BOXES, DECADE, CAPACITOR  
BOXES, DECADE, INDUCTOR  
BOXES, DECADE, RESISTOR  
BRIDGES  
CABLE, ASSEMBLIES  
CABLE, COAXIAL, FLEXIBLE  
CAPACITORS, FIXED, AIR  
CAPACITORS, FIXED, MICA  
CAPACITORS, FIXED, OTHER  
CAPACITORS, VARIABLE  
CLOCKS  
CONNECTORS, AF & MICROPHONE  
CONNECTORS, COAXIAL CABLE  
CONNECTORS, RF  
COUNTERS, FREQUENCY  
DELAY LINES  
DETECTORS, MICROWAVE  
DETECTORS, STANDING WAVE  
DIALS, INSTRUMENT  
DIVIDERS, FREQUENCY  
DIVIDERS, VOLTAGE  
FILTERS, AUDIO  
FILTERS, RF  
GENERATORS, SIGNAL, AF  
GENERATORS, SIGNAL, RF  
GENERATORS, SIGNAL, SQUARE WAVE  
INDUCTANCES, FIXED  
INDUCTANCES, VARIABLE  
JACKS  
JOINTS, ROTARY, COAXIAL  
KNOBS  
METERS, FREQUENCY  
METERS, FREQUENCY CALIBRATING  
MICROWAVE COMPONENTS  
OSCILLATORS, AF AND RF, SEE GENERATORS  
OSCILLATORS, AM  
PLUGS, COAXIAL  
POTENTIOMETERS, WIREWOUND  
POWER SUPPLIES, AC  
POWER SUPPLIES, DC  
PREAMPLIFIERS, AUDIO  
RECORDERS, MAGNETIC TAPE, AUDIO  
RECORDERS, PAPER, LOGGING AND GRAPHIC  
REGULATORS, VOLTAGE  
RESISTORS, FIXED, NONINDUCTIVE  
RESISTORS, FIXED, PRECISION  
RESISTORS, FIXED, WIREWOUND  
RESISTORS, VARIABLE, WIREWOUND  
RHEOSTATS  
STROBE, DISCS  
STROBE, LIGHTS  
TESTERS, CAPACITOR  
TESTERS, INSULATION  
TRANSFORMERS, AUDIO, MATCHING  
TRANSFORMERS, AUTO  
TRANSFORMERS, VARIABLE  
VOLTMETERS, AC  
VOLTMETERS, DC  
VOLTMETERS, VACUUM TUBE

GENERAL TELEVISION NETWORK

PROJECTORS, TV, LARGE SCREEN  
STANDS, TELEVISION MONITOR

GIBBS MFG. & RESEARCH CORP.

CABLE, ASSEMBLIES  
CLOCKS  
CONVERTERS  
GENERATORS, FM, SUBCARRIER  
GENERATORS, SIGNAL, AF

GENERATORS, SIGNAL, MARKER  
GENERATORS, SIGNAL, PULSE  
GENERATORS, SIGNAL, RF  
GENERATORS, SIGNAL, SQUARE WAVE  
INVERTERS, DC TO AC, CHOPPER  
OSCILLATORS, AF AND RF, SEE GENERATORS  
OSCILLATORS, AM  
OSCILLATORS, FM  
OSCILLATORS, TV  
OSCILLATORS, OTHER  
POWER SUPPLIES, AC  
POWER SUPPLIES, PRECISION  
TIMERS, ELECTRIC

J W GIBSON CO., INC.

CLEANERS, CHEMICAL

GOTHAM AUDIO CORPORATION

ARMS, TONE  
ATTENUATORS, FIXED  
CABLE, COAXIAL, FLEXIBLE  
CABLE, SHIELDED, AUDIO  
CARTRIDGES, PHONO  
CONNECTORS, AF & MICROPHONE  
CONSOLE, AUDIO, AM  
CONSOLE, AUDIO, FM  
CONSOLE, AUDIO, PORTABLE  
CONSOLE, AUDIO, RECORDING  
CONSOLE, AUDIO, TV  
CONSOLE, KITS  
EARPHONES, HEADPHONES  
EDITORS, VIDEO TAPE  
EQUALIZERS, AUDIO EMPHASIS  
HEADS, DISC RECORDING  
LATHE, DISC RECORDING  
METERS, DB AND VU  
METERS, FLUTTER & WOW  
MICROPHONE HARDWARE  
MICROPHONE STANDS & BOOMS  
MICROPHONES, CONDENSER  
MIXERS - ALSO SEE CONSOLES  
MONITORS, FM SYSTEMS, STEREO  
OHMMETERS  
POTENTIOMETERS, CARBON  
RECORDERS, MAGNETIC TAPE, AUDIO  
REVERBERATION DEVICES  
TESTERS, BATTERY  
TESTERS, INSULATION  
TRANSFORMERS, AUDIO, ISOLATION  
TRANSFORMERS, AUDIO, MATCHING  
TRANSFORMERS, TRANSISTOR  
TURNTABLES, PHONOGRAPH  
VOLTMETERS, AC

HOUSTON FEARLESS CORP.

CAMERA, MOUNTING EQUIPMENT  
DOLLIES, CAMERA  
MICROPHONE STANDS & BOOMS  
PROCESSORS, FILM, B-W  
PROCESSORS, FILM, COLOR

GRADO LABORATORIES, INC.

CARTRIDGES, PHONO

GRANTHAM SCHOOLS

EDUCATION FACILITIES, SCHOOLS

GRAY RESEARCH & DEVELOPMENT CO

ARMS, TONE  
EQUALIZERS, AUDIO EMPHASIS  
LENSES, OPTICAL, FIXED  
PROJECTORS, SLIDE  
TURNTABLES, PHONOGRAPH

GREENLEE TOOL COMPANY

TOOLS, PUNCH, CHASSIS

GREGORY AMPLIFIER CORP

AMPLIFIER, AF, MONAURAL  
AMPLIFIER, AF, REVERBERATION  
POWER SUPPLIES, AC  
PREAMPLIFIERS, AUDIO  
REVERBERATION DEVICES  
SOUND SYSTEMS, OUTDOOR  
SOUND SYSTEMS, PORTABLE  
SOUND SYSTEMS, THEATER  
SPEAKERS

GRINNAN FIXTURE COMPANY

CABINETS, STORAGE, DISC  
CABINETS, STORAGE, FILM  
CABINETS, STORAGE, MAGNETIC TAPE  
CABINETS, WOOD  
CONSOLE, CABINETS AND HARDWARE  
DISPLAY EQUIPMENT, TV  
SERVICES, INSTALLATION

GULF ELECTRO-SALES, INC.

SERVICES, INSTALLATION

G-V CONTROLS INC.

RELAYS, OVERLOAD  
RELAYS, THERMAL  
RELAYS, TIME DELAY  
SWITCHES, THERMAL  
TIMERS, ELECTRIC

HAMILTON HALL RESISTOR CORP.

RESISTORS, FIXED, WIREWOUND

HANCOCK TELECONTROL

AUTOMATION EQUIPMENT  
COMPUTER EQUIPMENT  
REMOTE CONTROL SYSTEMS  
SWITCHING SYSTEMS

HARTLEY PRODUCTS

ACOUSTIC MATERIALS  
ENCLOSURES, SPEAKER  
NETWORKS, MATCHING, AUDIO

SPEAKERS

HARVEY RADIO CO., INC.

COMPUTER EQUIPMENT  
CONSOLE, AUDIO, FM  
CONSOLE, AUDIO, PORTABLE  
CONSOLE, AUDIO, RECORDING  
CONSOLE, AUDIO, AM  
MIXERS - ALSO SEE CONSOLES  
REWINDERS, TAPE  
SOUND SYSTEMS, OUTDOOR  
SOUND SYSTEMS, PORTABLE  
SOUND SYSTEMS, THEATER  
TAPE DUPLICATORS

HARWALO COMPANY

CABINETS, STORAGE, DISC  
CABINETS, STORAGE, FILM  
EDITORS, FILM  
EDUCATION FACILITIES, EQPT  
PROJECTORS, SLIDE  
REELS, FILM  
REWINDERS, FILM  
SOLVENTS AND CLEANERS  
SPLICERS, MAGNETIC TAPE  
AND FILM

HARWOOD MFG. CO.

CABINETS, METAL  
LAMP ASSEMBLIES  
LIGHTING, TV, COMPONENTS

HAYDEN BOOK COMPANY

EDUCATION FACILITIES, PUBLISHERS

HEATH COMPANY

ADAPTERS, FM STEREO  
AMPLIFIER, AF, STEREO  
BOXES, DECADE, CAPACITOR  
BOXES, DECADE, RESISTOR  
BRIDGES  
COMMUNICATIONS SYSTEMS, CB  
COMMUNICATIONS SYSTEMS, INTERCOM, WIRED  
COMMUNICATIONS SYSTEMS, INTERCOM, WIRELESS  
COMPUTER EQUIPMENT  
EARPHONES, HEADPHONES  
GENERATORS, FM, STEREO  
GENERATORS, SIGNAL, AF  
GENERATORS, SIGNAL, COLOR BAR  
GENERATORS, SIGNAL, DOT BAR  
GENERATORS, SIGNAL, RF  
GENERATORS, SIGNAL, SQUARE WAVE  
KITS  
OHMMETERS  
OSCILLATORS, AF AND RF, SEE GENERATORS  
OSCILLATORS, AM  
OSCILLATORS, FM  
OSCILLATORS, TV  
OSCILLOSCOPES  
POWER SUPPLIES, AC  
POWER SUPPLIES, DC  
POWER SUPPLIES, PRECISION  
RECEIVERS, AM  
RECEIVERS, FM  
RECEIVERS, MULTIPLEX  
RECEIVERS, TV, COLOR  
RECEIVERS, TV, MONOCHROME  
RECORDERS, MAGNETIC TAPE, AUDIO  
RECORDERS, PAPER, LOGGING AND GRAPHIC  
VOLTMETERS, AC  
VOLTMETERS, DC  
VOLTMETERS, VACUUM TUBE

HEINTZ & KAUFMAN, LTD

RECTIFIERS - VACUUM TUBES  
VACUUM TUBES, RECEIVING  
VACUUM TUBES, TRANSMITTING

HEWLETT - PACKARD CO.

ADAPTERS, CONNECTOR  
ADAPTERS, TEST  
AMMETERS, AC  
AMMETERS, DC  
AMMETERS, RF  
AMPLIFIER, VIDEO, SWEEP  
ANALYZERS, DISTORTION  
ANALYZERS, HARMONIC  
ANALYZERS, NOISE  
ANALYZERS, VIDEO  
ATTENUATORS, AUDIO  
ATTENUATORS, FIXED  
ATTENUATORS, MICROWAVE  
ATTENUATORS, RF  
BRIDGES  
CALIBRATION SERVICE, FREQUENCY  
CALIBRATION SERVICE, INSTRUMENT  
CAMERAS, OSCILLOSCOPE  
CASES, PORTABLE, ELECTRONIC EQUIPMENT  
CLIPS, TEST  
COUNTERS, FREQUENCY  
DEGAMNETIZERS, BULK TAPE  
DETECTORS, MICROWAVE  
DETECTORS, STANDING WAVE  
GENERATORS, FM, STEREO  
GENERATORS, SIGNAL, PULSE  
GENERATORS, SIGNAL, RF  
INDUCTANCES, FIXED  
METERS, FREQUENCY  
METERS, FREQUENCY CALIBRATING  
METERS, PHASE ANGLE  
METERS, POWER  
METERS, STANDING WAVE  
METERS - SEE SPECIFIC TYPES  
MICROWAVE COMPONENTS  
MONITORS, FM SYSTEMS, MONO  
MONITORS, FREQUENCY

get complete coverage  
and combination rates  
in your Domestic  
and Foreign Markets

Look at the facts below to see how BROADCAST ENGINEERING and RADIO y TELEVISION give you complete coverage, both domestic and foreign, of the ever-expanding broadcast-communications market. And this complete coverage—almost 30,000 total circulation\*—is now available with money-saving combination rates in both magazines.

To sell more at a lower cost, include these two influential publications, along with THE BROADCAST INDUSTRY BUYERS GUIDE, in your advertising program.

\*November figures are projected totals based on business before adjustments. Any variation on the December 31st statement will be minimal.

## CIRCULATION FACTS

### Broadcast Engineering

November, 1966

123% INCREASE SINCE 1963—Circulation has increased almost 12,000 since 1963, giving you the most complete coverage of management and technical personnel of AM, FM, CATV and TV broadcast stations.

| BUSINESS AND INDUSTRY   |           | NOV    |
|---|-----------|--------|
| RADIO & TV STATIONS and NETWORKS:   |           |        |
| Classification by Title   |           |        |
| Owners, Presidents, Vice Presidents, general managers, and station managers |           | 5,418  |
| Chief engineers, engineers, supervisors and technicians                     |           | 9,202  |
| Company and other copies  |           | 624    |
|   | SUB TOTAL | 15,244 |
| CONSULTING ENGINEERS  |           | 817    |
| RECORDING STUDIOS   |           | 688    |
| MANUFACTURERS & DISTRIBUTORS of Electronic & other Broadcasting Equipment   |           | 1,914  |
| GOVERNMENT AGENCIES, LIBRARIES & SCHOOLS                                    |           | 1,075  |
| STUDENTS  |           | 194    |
| CLOSED CIRCUIT TV   |           | 21     |
| COMMUNITY ANTENNA & TELEVISION SYSTEMS                                      |           | 1,547  |
|   | TOTAL     | 21,500 |

### Radio y Television

November, 1966

Circulation is controlled with 8120 going to owners, management and technical personnel at all AM, FM and TV stations in Latin American countries, Spain and other Spanish and Portuguese-speaking areas of the world. In addition, RADIO y TELEVISION goes to wholesalers, agents, distributors and manufacturers of broadcast-related electronic equipment in all these countries . . . plus radio and television stations in the United States with Spanish and Portuguese programming.

|                    |      |                        |      |
|--------------------|------|------------------------|------|
| Argentina          | 598  | Nicaragua              | 105  |
| Bolivia            | 168  | Panama                 | 200  |
| Brazil             | 1081 | Paraguay               | 79   |
| Colombia           | 477  | Peru                   | 471  |
| Costa Rica         | 143  | Philippines            | 46   |
| Chile              | 363  | Portugal               | 176  |
| Dominican Republic | 175  | Puerto Rico            | 238  |
| Ecuador            | 342  | Spain                  | 490  |
| El Salvador        | 120  | Uruguay                | 216  |
| Guatemala          | 188  | USA (Spanish Stations) | 687  |
| Honduras           | 161  | Venezuela              | 400  |
| Mexico             | 1048 |                        |      |
| Miscellaneous      | 148  | TOTAL                  | 8120 |

Reach this  
Combined  
Circulation  
of 29,620  
at Lower Cost  
with  
Combination  
Rates

Combination rates with BROADCAST ENGINEERING and RADIO y TELEVISION are available on request. EXAMPLE: 12 insertions in each publication earn the 24-time rate in both, or 6 insertions in each earn the 12-time rate in both.

MONITORS, WAVEFORM  
OHMMETERS  
OSCILLATORS, AF AND RF,  
SEE GENERATORS  
OSCILLOSCOPES  
POWER SUPPLIES, OC  
POWER SUPPLIES, PRECISION  
PROBES, OSCILLOSCOPE  
PROBES, TEST LEAD  
RECORDERS, PAPER,  
LOGGING AND GRAPHIC  
SEMICONDUCTOR OIODES  
TELEPHONE EQUIPMENT\*  
VOLT METERS, AC  
VOLT METERS, DC  
VOLT METERS, VACUUM TUBE  
WAVEGUIDE AND  
ASSOCIATED COMPONENTS

#### HICKOK ELECTRICAL INSTRUMENTS

AMMETERS, AC  
AMMETERS, DC  
BRIGES  
COUNTERS, FREQUENCY  
GENERATORS, FM, STEREO  
GENERATORS, SIGNAL, AF  
GENERATORS, SIGNAL, COLOR BAR  
GENERATORS, SIGNAL, DOT BAR  
GENERATORS, SIGNAL, MARKER  
GENERATORS, SIGNAL, PULSE  
GENERATORS, SIGNAL, RF  
METERS, FREQUENCY  
METERS, PHASE ANGLE  
METERS - SEE SPECIFIC TYPES  
OHMMETERS  
OSCILLATORS, AM  
OSCILLATORS, FM  
OSCILLATORS, TV  
OSCILLOSCOPES  
SWITCHES, MULTICONTACT  
TESTERS, BATTERY  
TESTERS, CAPACITOR  
TESTERS, SEMICONDUCTOR  
TESTERS, VACUUM TUBE  
TIMERS, ELECTRIC  
VOLT METERS, AC  
VOLT METERS, OC  
VOLT METERS, VACUUM TUBE

#### S. HIMMELSTEIN AND COMPANY

DELAY DEVICES, AF

#### HOLLAND ELECTRONICS INC.

ATTENUATORS, FIXED  
ATTENUATORS,  
IMPEDANCE MATCHING  
ATTENUATORS, RF  
ATTENUATORS, VIDEO  
CORDS, PATCH  
FILTERS, RF  
JACK PANEL ASSEMBLIES

#### HOLLINGSWORTH SOLDERLESS

TERMINAL COMPANY  
TERMINALS, LUG  
TERMINALS, SOLDERLESS  
TOOLS, CRIMPERS  
TOOLS, HAND

#### HOUSTON ELECTRONICS CO.

ALARM, FAULT  
ALARM, INTRUDER  
AMPLIFIER, SENSING  
BROADCAST PROGRAMMING SERVICE  
CIRCUIT BREAKERS  
CONSOLE, AUDIO, AM  
CONSOLE, AUDIO, FM  
CONSOLE, AUDIO, PORTABLE  
CONSOLE, AUDIO, RECORDING  
CONSOLE, AUDIO, TV  
FLASHERS, TOWER  
LIGHTING, TV, CONTROLS  
MIXERS - ALSO SEE CONSOLES  
RELAYS, PHOTOELECTRIC  
RELAYS, TIME DELAY  
SOUND SYSTEMS, OUTDOOR  
SOUND SYSTEMS, PORTABLE  
SOUND SYSTEMS, THEATER

#### HUGHES & PHILLIPS

ALARM, FAULT  
FLASHERS, TOWER  
LAMP ASSEMBLIES  
RELAYS, LIGHT-INDICATING  
RELAYS, PHOTOELECTRIC  
TRANSFORMERS, AUTO  
TRANSFORMERS, POWER

#### HUNT-PIERCE CORP

LIFTS, AERIAL, TRUCK-MOUNTED

#### HY-GAIN ELECTRONICS

ANTENNAS, CATV  
ANTENNAS, MOBILE  
TOWERS, ANTENNA,  
CATV, HEAD-END

#### IMPEX ELECTRONICS

ADAPTERS, CONNECTOR  
ADAPTERS, FM STEREO  
BATTERIES, LEAD ACID  
BATTERIES, NICKEL CADMIUM  
CHARGERS, BATTERY  
CONSOLE, AUDIO, AM  
CONSOLE, AUDIO, FM  
CONSOLE, AUDIO, PORTABLE  
CONSOLE, AUDIO, RECORDING  
RECORDERS, MAGNETIC TAPE,  
AUDIO  
TAPE DECKS, MAGNETIC  
TAPE, MAGNETIC RECORDING,  
AUDIO

#### INDUSTRIAL DEVICES

CLIPS, TEST  
LAMP ASSEMBLIES

LAMPS, GLOW  
LAMPS, PANEL  
REELS, CABLE, AUTOMATIC  
SWITCHES, ROTARY

#### INDUSTRIAL ELECTRIC REELS

REELS, CABLE, AUTOMATIC

#### INSTRUMENT LABORATORIES CORP.

AMMETERS, AC  
AMMETERS, DC  
CALIBRATION SERVICE,  
INSTRUMENT  
GENERATORS, SIGNAL, AF  
OHMMETERS  
VOLT METERS, AC  
VOLT METERS, VACUUM TUBE

#### INTERNATIONAL GOOD MUSIC

AMPLIFIER, AF,  
GENERAL PURPOSE  
AMPLIFIER, SENSING  
AUTOMATION EQUIPMENT  
BACKGROUND MUSIC SERVICE  
BROADCAST PROGRAMMING SERVICE  
CARTRIDGES, MAGNETIC TAPE  
CATV, HEAD-END EQUIPMENT  
GENERATORS, SIGNAL, AF  
RECORDERS, MAGNETIC TAPE,  
AUDIO  
SWITCHES  
SWITCHING SYSTEMS  
TAPE DECKS, MAGNETIC

#### INTERNATIONAL NUCLEAR CORP

AMPLIFIER, BRIDGING  
AMPLIFIER, DISTRIBUTION  
AMPLIFIER, PULSE  
AMPLIFIER, STABILIZING  
AMPLIFIER, TV, VIDEO  
CONSOLE, AUDIO, TV  
MODULATORS, TV  
POWER SUPPLIES, OC  
SWITCHES  
SWITCHES, CROSSBAR  
SWITCHING MATRIXES  
SWITCHING SYSTEMS

#### INTERNATIONAL RECTIFIER

HEAT SINKS  
RECTIFIERS - ALSO  
SEE SEMICONDUCTORS  
RECTIFIERS, SELENIUM  
SEMICONDUCTOR OIODES  
SEMICONDUCTOR RECTIFIERS,  
GENERAL  
SEMICONDUCTOR RECTIFIERS,  
HIGH VOLTAGE  
SEMICONDUCTOR RECTIFIERS,  
POWER  
SEMICONDUCTOR RECTIFIERS,  
SILICON CONTROLLED - SCR

SEMICONDUCTORS, THYRISTORS  
SEMICONDUCTORS,  
TRANSISTORS, AF  
SEMICONDUCTORS, TRANSISTORS,  
GENERAL  
SEMICONDUCTORS,  
TRANSISTORS, RF

#### IRC, INC.

DIVIDERS, VOLTAGE  
POTENTIOMETERS, CARBON  
POTENTIOMETERS, WIREWOUND  
RECTIFIERS, SELENIUM  
RESISTORS, FIXED, CARBON  
RESISTORS, FIXED,  
NONINDUCTIVE  
RESISTORS, FIXED, PRECISION  
RESISTORS, FIXED, WIREWOUND  
RESISTORS, FIXED, OTHER  
RESISTORS, VARIABLE,  
WIREWOUND  
SEMICONDUCTOR DIODES  
SEMICONDUCTOR RECTIFIERS,  
GENERAL  
SEMICONDUCTOR RECTIFIERS,  
SILICON CONTROLLED - SCR  
SEMICONDUCTORS, THYRISTORS

#### ITI ELECTRONICS

DISPLAY EQUIPMENT, TV  
INDUSTRIAL TV  
INVERTERS, DC TO AC,  
SOLID STATE  
OSCILLOSCOPES

#### ITT CANNON ELECTRIC

DECK, ASSEMBLIES  
CONNECTORS, AF & MICROPHONE  
CONNECTORS, ANTENNA  
CONNECTORS, COAXIAL CABLE  
CONNECTORS, POWER  
CONNECTORS, RF  
FILTERS, RF  
INTEGRATED CIRCUITS  
WIRING AND CABLING SERVICES

#### ITT TELECOMMUNICATIONS

COMMUNICATIONS SYSTEMS,  
INTERCOM, WIRED  
COMMUNICATIONS SYSTEMS,  
MICROWAVE  
COMMUNICATIONS SYSTEMS,  
MULTIPLEX  
OIALS, TELEPHONE  
MICROWAVE SYSTEMS, 2500 MHZ  
RELAYS, TELEPHONE  
SWITCHES, CROSSBAR  
SWITCHES, TELEPHONE TYPE  
SWITCHING SYSTEMS, TELEPHONE  
TELEPHONE EQUIPMENT

#### ITT WIRE & CABLE DIV

CABLE, COAXIAL, FLEXIBLE

CABLE, COAXIAL, RIGID  
CABLE, DIRECT-BURIAL  
CABLE, TELEPHONE  
CORDS, SET  
FUSES  
WIRE, INSULATED, HIGH VOLTAGE  
WIRE, INSULATED, HOOKUP  
WIRE, SHIELDED

#### JAMPRO ANTENNA COMPANY

ANTENNAS, AM  
ANTENNAS, CATV  
ANTENNAS, FM  
ANTENNAS, TV  
ANTENNAS, 2500 MHZ  
CABLE, COAXIAL, FLEXIBLE  
CABLE, COAXIAL, RIGID  
DIPLEXERS  
DUMMY LOAD  
FILTERS, ANTENNA  
FILTERS, RF  
FILTERS, HYBRID  
PLUGS, COAXIAL  
SWITCHES, COAXIAL  
TOWERS, ANTENNA,  
TRANSMITTING, AM  
TOWERS, ANTENNA,  
TRANSMITTING, FM  
TOWERS, ANTENNA,  
TRANSMITTING, TV  
TRANSMISSION LINES  
VESTIGIAL SIDEBAND FILTERS  
WIRE, BARE, COPPER  
WIRE, BARE, COPPER STRAP

#### JENNINGS RADIO

CAPACITORS, FIXED, CERAMIC  
CAPACITORS, FIXED, OTHER  
CAPACITORS, VARIABLE  
DIVIDERS, VOLTAGE  
RELAYS, COAXIAL  
RELAYS, GENERAL PURPOSE  
RELAYS, LATCHING  
RELAYS, OVERLOAD  
RELAYS, POWER  
RELAYS, STEPPING  
SWITCHES  
SWITCHES, COAXIAL  
SWITCHES, CROSSBAR  
SWITCHES, MECHANICALLY  
ACTUATED  
SWITCHES, ROTARY  
SWITCHING MATRIXES  
SWITCHING SYSTEMS

#### JENSEN MANUFACTURING DIVISION

EARPHONES, HEADPHONES  
EDUCATION FACILITIES,  
PUBLISHERS  
EDUCATION FACILITIES, EOPT  
SOUND SYSTEMS, OUTDOOR  
SOUND SYSTEMS, PORTABLE  
SOUND SYSTEMS, THEATER  
SPEAKER COMPONENTS  
SPEAKERS

#### JERROLD ELECTRONICS

ADAPTERS, CONNECTOR  
ADAPTERS, TEST  
ALARM, FAULT  
AMPLIFIER, BRIDGING  
AMPLIFIER, CATV  
AMPLIFIER, DISTRIBUTION  
AMPLIFIER, RF,  
GENERAL PURPOSE  
AMPLIFIER, TV, BOOSTER  
ANTENNAS, AM  
ANTENNAS, CATV  
ANTENNAS, FM  
ANTENNAS, MICROWAVE  
ANTENNAS, MOBILE  
ANTENNAS, TV  
ANTENNAS, TV,  
MASTER-COMMUNITY  
ANTENNAS, 2500 MHZ  
ATTENUATORS, FIXED  
ATTENUATORS,  
IMPEDANCE MATCHING  
ATTENUATORS, MICROWAVE  
ATTENUATORS, RF  
BALUNS  
BRIDGES  
CABINETS, METAL  
CABLE, ASSEMBLIES  
CABLE, CATV, HARDWARE  
CABLE, COAXIAL, FLEXIBLE  
CABLE, COAXIAL, RIGID  
CABLE, DIRECT-BURIAL  
CATV EQUIPMENT - ALSO SEE  
OTHER CATEGORIES  
CATV, CABLE TERMINALS  
CATV, CHANNEL AMPLIFIERS  
CATV, HEAD-END EQUIPMENT  
CATV, ORIGINATION EQUIPMENT  
COMMUNICATIONS SYSTEMS,  
MICROWAVE  
CONNECTORS, ANTENNA  
CONNECTORS, COAXIAL CABLE  
CONNECTORS, RF  
CONVERTERS  
DELAY LINES  
DEMODULATORS  
DETECTORS, MICROWAVE  
FILTERS, ANTENNA  
FILTERS, RF  
GENERATORS, SIGNAL, AF  
GENERATORS, SIGNAL, MARKER  
GENERATORS, SIGNAL, RF  
GENERATORS, SIGNAL,  
SQUARE WAVE  
HEAD-END EQUIPMENT,  
SEE CATV HEAD-END EQUIPMENT  
INDUSTRIAL TV  
METERS, FIELD STRENGTH  
MICROWAVE COMPONENTS  
MICROWAVE SYSTEMS, STL

MICROWAVE SYSTEMS, 2500 MHZ  
MICROWAVE SYSTEMS, OTHER  
MODULATORS, TV  
MOUNTS, ANTENNA, FIXED  
NETWORKS, PHASING  
POWER SUPPLIES, AC  
PREAMPLIFIERS, VIDEO  
RADOMES  
STL EQUIPMENT  
SWITCHES, COAXIAL  
SWITCHES, ROTARY  
TOWERS, ANTENNA,  
CATV, HEAD-END  
TRANSMISSION LINES  
TV SYSTEMS, CLOSED CIRCUIT  
WAVEGUIDE AND  
ASSOCIATED COMPONENTS

#### JETRONIC INDUSTRIES

AMPLIFIER, AF, MONAURAL  
AMPLIFIER, AF, STEREO  
RECORDERS, MAGNETIC TAPE,  
AUDIO  
TAPE DECKS, MAGNETIC

#### J. M. ELECTRONICS CO.

COMMUNICATIONS SYSTEMS,  
LAND MOBILE  
MOBILE EQUIPMENT  
TV SYSTEMS, CLOSED CIRCUIT

#### JOA CARTRIDGE SERVICE

CARTRIDGES, MAGNETIC TAPE  
DEMAGNETIZERS, BULK TAPE  
DEMAGNETIZERS, HEAD  
HEADS, ERASE, MAGNETIC  
HEADS, RECORDING, MAGNETIC  
MAINTENANCE SERVICES,  
CARTRIDGE, TAPE  
RECORDERS, MAGNETIC TAPE,  
AUDIO  
TAPE, MAGNETIC RECORDING,  
AUDIO  
VACUUM TUBES, TRANSMITTING

#### E. F. JOHNSON COMPANY

AMPLIFIER, RF, POWER  
CAPACITORS, VARIABLE  
COILS, CHOKE, RF  
COMMUNICATIONS SYSTEMS, CB  
COMMUNICATIONS SYSTEMS,  
INTERCOM, WIRELESS  
COMMUNICATIONS SYSTEMS,  
LAND MOBILE  
COUPLERS  
HARDWARE, PANEL  
HOLDERS, CRYSTAL  
INDUCTANCES, FIXED  
INDUCTANCES, VARIABLE  
INSULATORS, ANTENNA  
INSULATORS, FEED THROUGH  
INSULATORS, STAND-OFF  
INSULATORS, OTHER  
JACKS  
MOBILE EQUIPMENT  
PROBES, TEST LEAD  
RELAYS, ANTENNA  
SOCKETS, CRYSTAL  
SOCKETS, LAMP  
SOCKETS, TUBE  
SWITCHES, KNIFE  
SWITCHES, SNAP  
TRANSMITTER KITS  
TRANSMITTERS, AM, 250 WATT  
TRANSMITTERS, AM, 1 KW

#### JOHNSON ELECTRONICS, INC.

AMPLIFIER, AF, MONAURAL  
RECEIVERS, FM  
RECEIVERS, HF  
RECEIVERS, MULTIPLEX  
RECEIVERS, MULTIPLEX

#### JORDAN ELECTRIC COMPANY

ATTENUATORS, AUDIO  
ATTENUATORS, FIXED  
BOXES, DECADE, RESISTOR  
RESISTORS, FIXED, PRECISION  
RESISTORS, FIXED, WIREWOUND

#### KAHN RESEARCH LABORATORIES

AMPLIFIER, AF,  
PEAK LIMITING, AM  
CONVERTERS  
EXCITERS, FM  
RECEIVERS, AM  
RECEIVERS, HF

#### KAISER-COX

AMPLIFIER, CATV  
ANTENNAS, CATV  
CABLE, CATV, HARDWARE  
CATV EQUIPMENT - ALSO SEE  
OTHER CATEGORIES  
CATV, CABLE TERMINALS  
CATV, CHANNEL AMPLIFIERS  
CATV, HEAD-END EQUIPMENT  
CATV, ORIGINATION EQUIPMENT  
CONNECTORS, COAXIAL CABLE  
HEAD-END EQUIPMENT,  
SEE CATV HEAD-END EQUIPMENT  
TV SYSTEMS, CLOSED CIRCUIT

#### THE KALART COMPANY

EDITORS, FILM  
PROJECTORS, FILM  
PROJECTORS, SLIDE  
SPLICERS, MAGNETIC TAPE  
AND FILM  
TV SYSTEMS, CLOSED CIRCUIT,  
PROJECTORS

#### KAPPA NETWORKS, INC.

DELAY LINES  
FILTERS, RF  
INDUCTANCES, FIXED

INDUCTANCES, VARIABLE  
TRANSFORMERS, RF

#### KARG LABORATORIES

ADAPTERS, FM STEREO  
AMPLIFIER, AF, STEREO  
GENERATORS, FM, STEREO  
MONITORS, FM SYSTEMS, MONO  
MONITORS, FM SYSTEMS, STEREO  
RECEIVERS, FM  
RECEIVERS, MULTIPLEX  
RECEIVERS, SCA

#### MATHIAS KLEIN & SONS

TOOLS, CRIMPERS  
TOOLS, CUTTERS  
TOOLS, HAND  
TOOLS, PLIERS  
TOOLS, SCREWDRIVERS  
TOOLS, WRENCHES

#### KLINE IRON & STEEL COMPANY

TOWERS, ANTENNA,  
CATV, HEAD-END  
TOWERS, ANTENNA, RECEIVING  
TOWERS, ANTENNA,  
TRANSMITTING, AM  
TOWERS, ANTENNA,  
TRANSMITTING, FM  
TOWERS, ANTENNA,  
TRANSMITTING, TV

#### KOSS ELECTRONICS

AMPLIFIER, AF, STEREO  
ARMS, TONE  
EARPHONES, HEADPHONES  
HEADS, DISC RECORDING  
LATHE, DISC RECORDING  
PREAMPLIFIERS, AUDIO  
SPEAKERS  
TURNTABLES, PHONOGRAPH

#### HERB KRECKMAN CO

ANTENNAS, MOBILE  
ANTENNAS, REMOTE PICKUP

#### KRS INSTRUMENTS DIVISION

ANALYZERS, VIDEO  
AUTOMATION EQUIPMENT  
CARTRIDGES, MAGNETIC TAPE  
EDUCATION FACILITIES, EOPT  
RECORDERS, MAGNETIC TAPE,  
AUDIO  
RECORDERS, MAGNETIC TAPE,  
AUDIO, CARTRIDGE  
RECORDERS, MAGNETIC TAPE,  
LOGGING  
TAPE DECKS, MAGNETIC  
TAPE, RECORDING, GRAPHIC

#### LACROSSE ELECTRONICS

RECORDERS, MAGNETIC TAPE,  
AUDIO, CARTRIDGE

#### LAFAYETTE RADIO ELECTRONICS

TRANSFORMERS, AUDIO,  
ISOLATION  
TRANSFORMERS, AUDIO, MATCHING  
TRANSFORMERS, AUDIO,  
POWER OUTPUT  
TRANSFORMERS, AUTO  
TRANSFORMERS, FILAMENT  
TRANSFORMERS, GENERAL  
TRANSFORMERS, POWER  
TRANSFORMERS, TRANSISTOR

#### LAKE ELECTRONICS, INC.

COILS, DEFLECTION  
AND FOCUSING  
CONSOLE, AUDIO, TV  
GENERATORS, SIGNAL, DOT BAR  
GENERATORS, SIGNAL, MARKER  
GENERATORS, SIGNAL, PULSE  
GENERATORS, SIGNAL,  
SQUARE WAVE  
GENERATORS, SIGNAL,  
TV, SYNCHRONIZING  
INDUCTANCES, FIXED  
INDUSTRIAL TV  
LENSES, OPTICAL, ZOOM  
MONITORS, VIDEO  
SEMICONDUCTORS,  
TRANSISTORS, AF  
SEMICONDUCTORS, TRANSISTERS,  
GENERAL  
SPEAKERS  
TRANSFORMERS, AUDIO, MATCHING  
TRANSFORMERS, AUDIO,  
POWER OUTPUT  
TRANSFORMERS, FILAMENT  
TRANSFORMERS, GENERAL  
TRANSFORMERS, PLATE  
TRANSFORMERS, POWER  
TRANSFORMERS, RF  
TRANSFORMERS, TRANSISTOR  
TRANSFORMERS, VARIABLE  
YOKES, DEFLECTION

#### LAMPKIN LABORATORIES

METERS, FREQUENCY  
METERS - SEE SPECIFIC TYPES  
MONITORS, FREQUENCY  
MONITORS, MODULATION

#### LANG ELECTRONICS, INC.

AMPLIFIER, AF,  
GENERAL PURPOSE  
CABINETS, METAL  
CABINETS, WOOD  
CONSOLE, AUDIO, PORTABLE  
CONSOLE, AUDIO, RECORDING  
CONSOLE, CABINETS  
AND HARDWARE  
MIXERS - ALSO SEE CONSOLES  
STROBE, DISCS  
TAPE DUPLICATORS

#### LANGEVIN

AMPLIFIER, AF,  
GENERAL PURPOSE  
AMPLIFIER, AF, MONAURAL  
AMPLIFIER, AF, REMOTE  
AMPLIFIER, BRIDGING  
ATTENUATORS, AUDIO  
ATTENUATORS, FIXED  
EQUALIZERS, AUDIO EMPHASIS  
FILTERS, AUDIO  
NETWORKS, MATCHING, AUDIO  
POWER SUPPLIES, DC  
PREAMPLIFIERS, AUDIO  
SWITCHES, MULTICONTACT  
SWITCHES, ROTARY

#### JAMES B. LANSING SOUND CO.

AMPLIFIER, AF, STEREO  
SOUND SYSTEMS, OUTDOOR  
SOUND SYSTEMS, THEATER  
SPEAKER COMPONENTS  
SPEAKERS

#### LAVIOLETTE ELECTRONICS

MONITORS, VIDEO

#### LENKVURT ELECTRIC CO.

COMMUNICATIONS SYSTEMS,  
MICROWAVE  
COMMUNICATIONS SYSTEMS,  
MULTIPLEX  
MICROWAVE SYSTEMS, STL

#### LENZ ELECTRIC MFG. COMPANY

CABLE, SHIELDED, AUDIO  
CABLE, TELEPHONE  
WIRE, INSULATED, HIGH VOLTAGE  
WIRE, INSULATED, HOOKUP  
WIRE, SHIELDED

#### LEWIS AND KAUFMAN LTD.

VACUUM TUBES, BALLAST  
VACUUM TUBES, CAMERA, VIDICON  
VACUUM TUBES, CATHODE RAY,  
TV, MONOCHROME  
VACUUM TUBES, RECEIVING  
VACUUM TUBES, TRANSMITTING

#### LIBERTY TOWER MFG. CO.

ANCHORS, GUY  
MAINTENANCE SERVICES, AM  
MAINTENANCE SERVICES, FM  
MAINTENANCE SERVICES,  
MICROWAVE  
MAINTENANCE SERVICES,  
STEEPLEJACK  
MOUNTS, ANTENNA, FIXED  
TOWERS, ANTENNA,  
CATV, HEAD-END  
TOWERS, ANTENNA, RECEIVING  
TOWERS, ANTENNA,  
TRANSMITTING, AM  
TOWERS, ANTENNA,  
TRANSMITTING, FM  
TOWERS, ANTENNA,  
TRANSMITTING, TV

#### LIGHTING & ELECTRONICS

LIGHTING, TV, COMPONENTS  
LIGHTING, TV, CONTROLS  
LIGHTING, TV, SYSTEMS

#### LINDSAY SPECIALTY PRODUCTS LTD.

AMPLIFIER, BRIDGING  
AMPLIFIER, CATV  
AMPLIFIER, DISTRIBUTION  
AMPLIFIER, TV, BOOSTER  
ANTENNAS, CATV  
ANTENNAS, FM  
ANTENNAS, MOBILE  
ANTENNAS, TV  
ANTENNAS, TV,  
MASTER-COMMUNITY

#### LIPPS, INC.

HEADS, DISC RECORDING  
HEADS, ERASE, MAGNETIC  
HEADS, RECORDING, MAGNETIC

#### LITTELFUSE

CIRCUIT BREAKERS  
FUSES  
HOLDERS, FUSE

#### LITTLE JOE ENTERPRISES

ANCHORS, GUY  
CABINETS, WOOD  
CONSOLE, AUDIO, FM  
CONSOLE, AUDIO, PORTABLE  
CONSOLE, AUDIO, RECORDING  
CONSOLE, AUDIO, TV  
CONSOLE, CABINETS  
AND HARDWARE  
CONSOLE, AUDIO, AM  
DUMMY LOAD  
MAINTENANCE SERVICES, AM  
MAINTENANCE SERVICES, FM  
MAINTENANCE SERVICES,  
STEEPLEJACK  
REVERBERATION DEVICES  
TOWERS, ANTENNA,  
CATV, HEAD-END  
TOWERS, ANTENNA, RECEIVING  
TOWERS, ANTENNA,  
TRANSMITTING, AM  
TOWERS, ANTENNA,  
TRANSMITTING, FM

#### LITTEN EDUCATIONAL TELEVISION

ANTENNAS, MICROWAVE  
ANTENNAS, 2500 MHZ  
MICROWAVE COMPONENTS  
MICROWAVE SYSTEMS, STL  
MICROWAVE SYSTEMS, 2500 MHZ  
TRANSLATOR SYSTEMS  
TV SYSTEMS, CLOSED CIRCUIT

# for TOP PERFORMANCE in FM ANTENNAS

## DUAL POLARIZED



### DESCRIPTION

Any combination of elements  
Any power split from 50-50 to 30-70  
Can be mounted, interlace,  
stacked or back to back  
Mounting hardware furnished for  
your tower.

## DIRECTIONALIZED

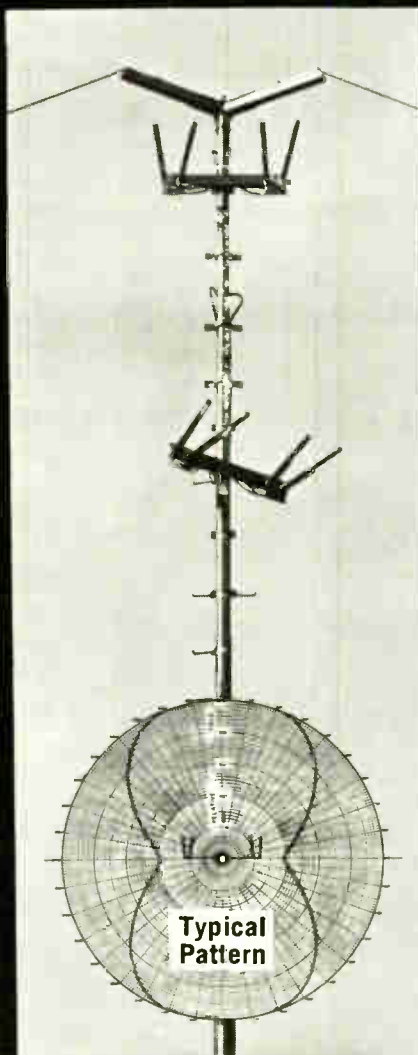

### DESCRIPTION

Phased directional (shown)  
Parasitic Directional  
Can be made for pole or tower  
mount.  
Complete filing information  
furnished along with  
certified pattern

## HORIZONTAL

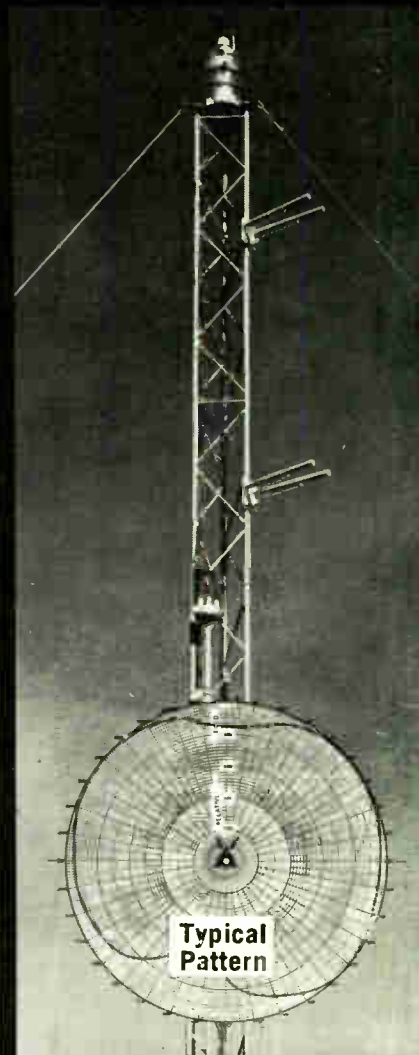

### DESCRIPTION

Basic Jampro design with  
in phase signal over full  
modulation swing by use of  
power divider feed system.  
Input power up to 50 kw  
Complete with  
all hardware

# J A M P R O

- TV Antennas
- Coax Switches
- Notch Diplexers
- FM Antennas
- Harmonic Filters
- ETV Antennas

**ANTENNA**  
6939 POWER INN ROAD

**COMPANY**  
SACRAMENTO CALIFORNIA

PHONE  
AREA CODE 916  
**422-1177**

LOW POWER BROADCAST EQUIP CO  
CARRIER-CURRENT EQUIPMENT  
TRANSMITTERS, AM, LOW POWER

MACARTA INC

AUTOMATION EQUIPMENT  
CARTRIDGES, MAGNETIC TAPE  
RECORDERS, MAGNETIC TAPE,  
AUDIO  
TAPE, MAGNETIC RECORDING,  
AUDIO

THE MACHLETT LABORATORIES  
VACUUM TUBES, TRANSMITTING

MACKENZIE LABORATORIES

AUTOMATION EQUIPMENT  
CARTRIDGES, MAGNETIC TAPE  
RECORDERS, MAGNETIC TAPE,  
AUDIO  
RECORDERS, MAGNETIC TAPE,  
AUDIO, CARTRIDGE  
TAPE DECKS, MAGNETIC

MAGNA-TECH CORPORATION  
HEADS, ERASE, MAGNETIC  
HEADS, RECORDING, MAGNETIC  
RECORDERS, MAGNETIC TAPE,  
AUDIO  
TAPE DECKS, MAGNETIC  
TAPE DUPLICATORS

MAGNECORD

AMPLIFIER, AF, MONAURAL  
AMPLIFIER, AF, STEREO  
RECORDERS, MAGNETIC TAPE,  
AUDIO  
RECORDERS, MAGNETIC TAPE,  
LOGGING  
REELS, TAPE  
TAPE DECKS, MAGNETIC  
TAPE DUPLICATORS

MAGNETIC MEDIA CORPORATION  
CARTRIDGES, MAGNETIC TAPE  
TAPE, MAGNETIC RECORDING,  
AUDIO  
TAPE, MAGNETIC RECORDING,  
COMPUTER  
TAPE, MAGNETIC RECORDING,  
VIDEO

MAGNE-TRONICS, INC.  
BACKGROUND MUSIC SERVICE

MALLODY DISTRIBUTOR PRODUCTS

ALARM, FAULT  
ATTENUATORS, AUDIO  
CAPACITORS, FIXED, CERAMIC  
CAPACITORS, FIXED,  
ELECTROLYTIC  
CAPACITORS, FIXED, FILM  
CAPACITORS, FIXED, OTHER  
CIRCUIT BREAKERS  
DIALS, INSTRUMENT  
JACKS  
KNOBS  
PLUGS, PHONE  
RESISTORS, FIXED, PRECISION  
RESISTORS, FIXED, WIREWOUND  
RESISTORS, VARIABLE, CARBON  
RESISTORS, VARIABLE,  
WIREWOUND  
RHEOSTATS  
SEMICONDUCTOR RECTIFIERS,  
GENERAL  
SEMICONDUCTOR RECTIFIERS,  
POWER  
SWITCHES, LEVER  
SWITCHES, PUSHBUTTON,  
NONILLUMINATED  
SWITCHES, ROTARY  
TESTERS, BATTERY  
TIMERS, ELECTRIC

MARANTZ COMPANY

AMPLIFIER, AF,  
GENERAL PURPOSE  
AMPLIFIER, AF, MONAURAL  
AMPLIFIER, AF, STEREO  
CABINETS, WOOD  
PREAMPLIFIERS, AUDIO  
RECEIVERS, FM  
RECEIVERS, MULTIPLEX  
TURNTABLES, PHONOGRAPH

MARATHON PRODUCTS CORP.

CARTRIDGES, MAGNETIC TAPE  
CARTRIDGES, TAPE,  
RECORDING SERVICE

MARCONI DIVISION

AMPLIFIER, DISTRIBUTION  
AMPLIFIER, PULSE  
AMPLIFIER, STABILIZING  
AMPLIFIER, TV, VIDEO  
ANTENNAS, TV  
CAMERAS, TV, COLOR  
CAMERAS, TV, MONOCHROME  
DISPLAY EQUIPMENT, TV  
ENHANCERS, TV IMAGE  
EXCITERS, FM  
GENERATORS, SIGNAL, COLOR BAR  
GENERATORS, SIGNAL, DOT BAR  
GENERATORS, SIGNAL,  
TV SYNCHRONIZING  
INDUSTRIAL TV  
MODULATORS, TV  
MONITORS, VIDEO  
MONITORS, WAVEFORM  
PROJECTORS, FILM  
RECEIVERS, HF  
RECEIVERS, AM, 1 KW  
TRANSMITTERS, AM, 10 KW  
TRANSMITTERS, AM, 50 KW

TRANSMITTERS, AM, OVER 50 KW  
TRANSMITTERS, FM, 1 KW  
TRANSMITTERS, FM, 5 KW  
TRANSMITTERS, TV, 1 KW  
TRANSMITTERS, TV, 5 KW  
TRANSMITTERS, TV, 10 KW  
TRANSMITTERS, TV, 25 KW  
TV SYSTEMS, CLOSED CIRCUIT

MARCONI INSTRUMENTS

ANALYZERS, DISTORTION  
ANALYZERS, HARMONIC  
ATTENUATORS, RF  
BRIDGES  
CALDRIMETERS  
GENERATORS, FM, STEREO  
GENERATORS, SIGNAL, AF  
GENERATORS, SIGNAL, RF  
METERS, POWER  
OSCILLATORS, AF AND RF,  
SEE GENERATORS  
OSCILLATORS, AM  
OSCILLATORS, FM  
OSCILLATORS, OTHER  
RECEIVERS, AM  
RECEIVERS, FM  
RECEIVERS, HF

MARTI ELECTRONICS

AMPLIFIER, AF, AGC  
AMPLIFIER, AF, COMPRESSING  
AMPLIFIER, AF,  
GENERAL PURPOSE  
ANTENNAS, FM  
ANTENNAS, MOBILE  
BASE STATIONS  
COMMUNICATIONS SYSTEMS,  
LAND MOBILE  
COMMUNICATIONS SYSTEMS,  
MICROWAVE  
EXCITERS, FM  
GENERATORS, FM, SUBCARRIER  
MICROWAVE SYSTEMS, STL  
MOBILE EQUIPMENT  
NARROW-BAND FM EQUIPMENT  
PREAMPLIFIERS, AUDIO  
RECEIVERS, FM  
RECEIVERS, SCA  
REMOTE CONTROL SYSTEMS  
STL EQUIPMENT  
TRANSMITTERS, FM, 10 WATTS  
TRANSMITTERS, FM, 100 WATTS

MARYLAND TELECOMMUNICATIONS

CAMERAS, TV, MONOCHROME  
CONSOLE, AUDIO, TV  
CONSOLE, VIDEO, STUDIO  
DISPLAY EQUIPMENT, TV  
GENERATORS, SIGNAL,  
TV SYNCHRONIZING  
INDUSTRIAL TV  
MONITORS, VIDEO  
TV SYSTEMS, CLOSED CIRCUIT

MASTER TOWER CO

REFLECTORS, PASSIVE  
TOWERS, ANTENNA,  
CATV, HEAD-END  
TOWERS, ANTENNA, RECEIVING  
TOWERS, ANTENNA,  
TRANSMITTING, AM  
TOWERS, ANTENNA,  
TRANSMITTING, FM  
TOWERS, ANTENNA,  
TRANSMITTING, TV

J. G. MCALISTER

LAMPS, PANEL  
LIGHTING, TV, COMPONENTS  
LIGHTING, TV, SYSTEMS

THE MCINTIRE COMPANY

PRESSURIZATION EQUIPMENT,  
TRANSMISSION LINE

MCARTIN INDUSTRIES

ADAPTERS, FM STEREO  
AMPLIFIER, AF,  
GENERAL PURPOSE  
AMPLIFIER, AF, MONAURAL  
AMPLIFIER, DISTRIBUTION  
AMPLIFIER, RF,  
GENERAL PURPOSE  
AMPLIFIER, RF, PEAK LIMITING  
AMPLIFIER, RF, POWER  
ANTENNAS, FM  
BACKGROUND MUSIC SERVICE  
CABINETS, METAL  
COMMUNICATIONS SYSTEMS,  
INTERCOM, WIRED  
COMMUNICATIONS SYSTEMS,  
MULTIPLEX  
HARDWARE, RACK  
METERS, DB AND VU  
METERS, FIELD STRENGTH  
METERS, FREQUENCY  
METERS - SEE SPECIFIC TYPES  
MICROPHONES, DYNAMIC  
MONITORS, FM SYSTEMS, MONO  
MONITORS, FM SYSTEMS, SCA  
MONITORS, FM SYSTEMS, STEREO  
MONITORS, FREQUENCY  
PREAMPLIFIERS, AUDIO  
RECEIVERS, FM  
RECEIVERS, MULTIPLEX  
RECEIVERS, SCA  
SOUND SYSTEMS, OUTDOOR  
SOUND SYSTEMS, PORTABLE  
SOUND SYSTEMS, THEATER  
SPEAKERS  
STL EQUIPMENT

MELCOR ELECTRONICS

AMPLIFIER, AF, AGC  
AMPLIFIER, AF, COMPRESSING

AMPLIFIER, AF,  
GENERAL PURPOSE  
AMPLIFIER, AF, MONAURAL  
AMPLIFIER, AF, STEREO  
AMPLIFIER, DC  
AMPLIFIER, DISTRIBUTION  
EQUALIZERS, AUDIO EMPHASIS  
MONITORS, AM SYSTEMS  
MONITORS, FM SYSTEMS, MONO  
MONITORS, FM SYSTEMS, STEREO  
POWER SUPPLIES, DC  
PREAMPLIFIERS, AUDIO

MEMOREX CORPORATION

TAPE, MAGNETIC RECORDING,  
COMPUTER  
TAPE, MAGNETIC RECORDING,  
VIDEO

METROPOLITAN ELECTRIC MFG. CO.

CABINETS, METAL  
LIGHTING, TV, COMPONENTS  
LIGHTING, TV, CONTROLS  
LIGHTING, TV, SYSTEMS  
SWITCHES, KNIFE

METROTECH INCORPORATED

RECORDERS, MAGNETIC TAPE,  
AUDIO  
RECORDERS, MAGNETIC TAPE,  
LOGGING

MICOM, INC

METERS, FLUTTER & WOW

MICROFLECT CO., INC.

REFLECTORS, PASSIVE  
TOWERS, ANTENNA,  
CATV, HEAD-END  
TOWERS, ANTENNA, RECEIVING  
TOWERS, ANTENNA,  
TRANSMITTING, AM  
TOWERS, ANTENNA,  
TRANSMITTING, FM  
TOWERS, ANTENNA,  
TRANSMITTING, TV

MICROLAB/FXR

ADAPTERS, TEST  
ATTENUATORS, AUDIO  
ATTENUATORS, FIXED  
ATTENUATORS,  
IMPEDANCE MATCHING  
ATTENUATORS, MICROWAVE  
ATTENUATORS, RF  
CAVITIES, MICROWAVE  
COMMUNICATIONS SYSTEMS,  
MICROWAVE  
COUPLERS  
DETECTORS, MICROWAVE  
DETECTORS, STANDING WAVE  
DIPLEXERS  
DIVIDERS, POWER  
DUMMY LOAD  
FILTERS, RF  
HOLDERS, CRYSTAL  
METERS, FREQUENCY  
METERS, FREQUENCY CALIBRATING  
MICROWAVE COMPONENTS  
MICROWAVE SYSTEMS, STL  
MICROWAVE SYSTEMS, 2500 MHZ  
MICROWAVE SYSTEMS, OTHER  
METERS - ALSO SEE CONSOLES  
MONITORS, FREQUENCY  
MONITORS, PHASE  
OSCILLATORS, AF AND RF,  
SEE GENERATORS  
SEMICONDUCTOR DIODES  
SLOTTED SECTIONS  
SWITCHES, COAXIAL  
SWITCHES, WAVEGUIDE  
TRANSFORMERS, RF  
WAVEGUIDE AND  
ASSOCIATED COMPONENTS

MICRO-LINK SYSTEMS

ANTENNAS, MICROWAVE  
CAVITIES, MICROWAVE  
CHOKES, WAVEGUIDE  
COMMUNICATIONS SYSTEMS,  
MICROWAVE  
DETECTORS, MICROWAVE  
DETECTORS, STANDING WAVE  
DISPLAY EQUIPMENT, TV  
JOINTS, ROTARY, COAXIAL  
JOINTS, ROTARY, WAVEGUIDE  
MICROWAVE COMPONENTS  
MICROWAVE SYSTEMS, STL  
MICROWAVE SYSTEMS, 2500 MHZ  
MICROWAVE SYSTEMS, OTHER  
SLOTTED SECTIONS  
STL EQUIPMENT  
TV SYSTEMS, CLOSED CIRCUIT  
WAVEGUIDE AND  
ASSOCIATED COMPONENTS

MICROMEGA

AMPLIFIER, CATV  
AMPLIFIER, RF,  
GENERAL PURPOSE

MICRO RECORD CORP.

PROCESSORS, FILM, B-W  
PROCESSORS, FILM, COLOR

MICROWAVE ASSOCIATES, INC.

ADAPTERS, CONNECTOR  
AMPLIFIER, PULSE  
AMPLIFIER, RF, PEAK LIMITING  
AMPLIFIER, RF, POWER  
AMPLIFIER, TV, BOOSTER  
ATTENUATORS, FIXED  
ATTENUATORS,  
IMPEDANCE MATCHING  
ATTENUATORS, MICROWAVE  
ATTENUATORS, RF

CAVITIES, MICROWAVE  
CHOKES, WAVEGUIDE  
COMMUNICATIONS SYSTEMS,  
MICROWAVE  
CONNECTORS, RF  
CONVERTERS  
COUPLERS  
DELAY LINES  
DETECTORS, MICROWAVE  
DIPLEXERS  
DIVIDERS, FREQUENCY  
FILTERS, RF  
GENERATORS, SIGNAL, RF  
HOLDERS, CRYSTAL  
INTEGRATED CIRCUITS,  
MICROWAVE  
JOINTS, ROTARY, WAVEGUIDE  
MICROWAVE COMPONENTS  
MICROWAVE SYSTEMS, STL  
MICROWAVE SYSTEMS, OTHER  
MOBILE EQUIPMENT  
PREAMPLIFIERS, AUDIO  
RACKS, MOUNTING  
SEMICONDUCTOR DIODES  
SHIFTERS, PHASE, MICROWAVE  
SWITCHES, COAXIAL  
SWITCHES, WAVEGUIDE  
TRANSMISSION LINES  
VACUUM TUBES, RECEIVING  
VACUUM TUBES, TRANSMITTING  
WAVEGUIDE AND  
ASSOCIATED COMPONENTS

MID AMERICA ELECTRONICS CORP

AMPLIFIER, AF,  
GENERAL PURPOSE  
AUTOMATION EQUIPMENT  
CONSOLE, AUDIO, AM  
CONSOLE, AUDIO, FM  
CONSOLE, AUDIO, PORTABLE  
CONSOLE, AUDIO, RECORDING  
CONSOLE, AUDIO, TV  
CONSOLE, VIDEO, STUDIO  
SOUND SYSTEMS, THEATER

MILES REPRODUCER CO

AMPLIFIER, DC  
AMPLIFIER, RF, POWER  
CARTRIDGES, MAGNETIC TAPE  
COMMUNICATIONS SYSTEMS, CB  
COMMUNICATIONS SYSTEMS,  
INTERCOM, WIRED  
COMMUNICATIONS SYSTEMS,  
INTERCOM, WIRELESS  
COMMUNICATIONS SYSTEMS,  
LAND MOBILE  
EQUALIZERS, AUDIO EMPHASIS  
MICROPHONES, DYNAMIC  
MICROPHONES, WIRELESS  
PREAMPLIFIERS, AUDIO  
RECEIVERS, FM  
RECORDERS, DISC, MAGNETIC  
RECORDERS, MAGNETIC TAPE,  
AUDIO  
RECORDERS, MAGNETIC TAPE,  
LOGGING  
TRANSFORMERS, AUDIO,  
POWER OUTPUT  
TRANSMITTER KITS  
TRANSMITTERS, FM,  
UP TO 1 WATT

J. W. MILLER COMPANY

INDUCTANCES, FIXED  
INDUCTANCES, VARIABLE  
TRANSFORMERS, RF

D. B. MILLIKEN COMPANY

CAMERAS, FILM, CINE  
CAMERAS, OSCILLOSCOPE

MINNEAPOLIS MAGNETICS

HEADS, ERASE, MAGNETIC  
HEADS, RECORDING, MAGNETIC  
TAPE, MAGNETIC RECORDING,  
TEST

MINNESOTA MINING & MFG. CO.

ALARM, SIGNAL  
BACKGROUND MUSIC SERVICE  
CABINETS, STORAGE, FILM  
CABINETS, STORAGE,  
MAGNETIC TAPE  
CAMERAS, FILM, CINE  
CAMERAS, FILM, STILL  
CAPACITORS, FIXED, CERAMIC  
CAPACITORS, FIXED, MICA  
CARTRIDGES, MAGNETIC TAPE  
COMPUTER EQUIPMENT  
CONVERTERS  
COPYING EQUIPMENT  
CRYSTALS, PIEZOELECTRIC  
DECALCOMANIAS  
DROPOUT COMPENSATOR,  
VIDEOTAPE  
EDITORS, FILM  
FILM, PHOTOGRAPHIC  
FRAMES, MOUNTING  
HARDWARE, TUBING, PLASTIC  
HEADS, RECORDING, MAGNETIC  
LENSES, OPTICAL, FIXED  
LENSES, OPTICAL, ZOOM  
MOUNTS, VIBRATION AND SHOCK  
NAMEPLATES  
PAPER, CHART AND GRAPH  
RECORDERS, FILM, LIGHT  
RECORDERS, FILM, MAGNETIC  
RECORDERS, MAGNETIC TAPE,  
AUDIO  
RECORDERS, MAGNETIC TAPE,  
LOGGING  
RECORDERS, MAGNETIC TAPE,  
VIDEO  
REELS, TAPE  
SPLITTERS, MAGNETIC TAPE  
AND FILM

# Renting Your Program Lines . . . ?

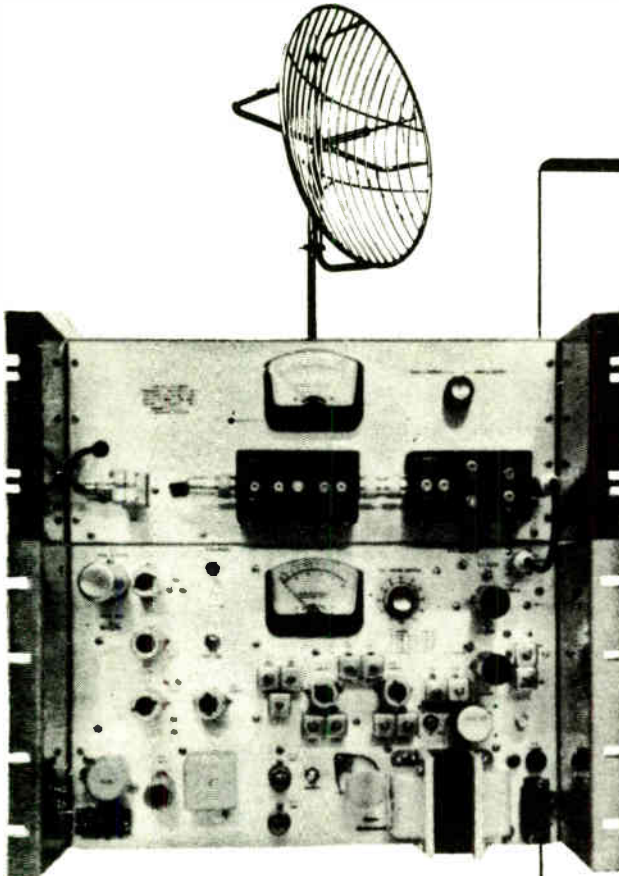

STUDIO-TRANSMITTER LINK  
& INTER CITY RELAY 950 MHz

Marti STL and RPU equipment is specifically designed, engineered, and manufactured to provide two basic advantages for you, the Broadcaster. First, the equipment is unique because it reduces your monthly line charges while increasing the revenue derived from greater flexibility in your remote programming. Secondly, it provides program quality and reliability at least equal to, and usually better than, its land counterpart.

The wide and varied uses of this STL and RPU equipment, adds up to one big advantage at the end of your fiscal year—**MORE NET PROFIT!** Write us for more profitable information concerning this equipment.

**MARTI**  
**NOT** *Only*  
**MANUFACTURES**  
**STL's & RPU's**

*We  
Perfect  
them...!*



RADIO REMOTE PICK-UP  
26-150-450 MHz

**MARTI HAS ALSO  
PERFECTED THESE  
ACCESSORIES . . .**

- Radio Remote Control Systems
- Telemetry Systems
- Sub-Carrier Generator & Receiver
- RPU & STL Antennas
- Automatic Relay Systems
- Communication Transmitters & Receivers
- FM Rebroadcast Receivers
- Transmission Line & Fittings
- Microphones
- Transcription Arms & Stylus
- Turntable & Microphone Preamps

**MANUFACTURED BY A BROADCASTER FOR THE BROADCASTER**

**MARTI** *Electronics* / P. O. BOX 661 • 817 MI 5-4091  
CLEBURNE, TEXAS 76031

World Radio History

TAPE DECKS, MAGNETIC  
TAPE DUPLICATORS  
TAPE, MAGNETIC RECORDING,  
AUDIO  
TAPE, MAGNETIC RECORDING,  
AUDIO, CARTRIDGE  
TAPE, MAGNETIC RECORDING,  
COMPUTER  
TAPE, MAGNETIC RECORDING,  
TEST  
TAPE, MAGNETIC RECORDING,  
VIDEO  
TAPE, RECORDING, GRAPHIC  
TOOLS, CRIMPERS

MIRATEL ELECTRONICS, INC.  
DISPLAY EQUIPMENT, TV  
INDUSTRIAL TV  
MONITORS, VIDEO  
TV SYSTEMS, CLOSED CIRCUIT

MOLE-RICHARDSON CO.  
LAMPS, ARC  
LAMPS, GLOW  
LAMPS, PANEL  
LAMPS, PROJECTION  
LIGHTING, TV, COMPONENTS  
LIGHTING, TV, CONTROLS  
LIGHTING, TV, SYSTEMS  
LIGHTNING ARRESTERS  
MICROPHONE STANDS & BOOMS  
RELAYS, TIME DELAY

MOSELEY ASSOCIATES INC.  
ALARM, FAULT  
AMPLIFIER, DC  
COMMUNICATIONS SYSTEMS, CB  
COMMUNICATIONS SYSTEMS,  
LAND MOBILE  
COMMUNICATIONS SYSTEMS,  
MICROWAVE  
COMMUNICATIONS SYSTEMS,  
MULTIPLEX  
EXCITERS, FM  
GENERATORS, FM, STEREO  
GENERATORS, FM, SUBCARRIER  
MICROWAVE SYSTEMS, STL  
MOBILE EQUIPMENT  
NARROW-BAND FM EQUIPMENT  
REMOTE CONTROL SYSTEMS  
STL EQUIPMENT  
TRANSMITTERS, FM, 10 WATTS

DONALD P. MOSSMAN, INC.  
SWITCHES, ILLUMINATED  
SWITCHES, INTERLOCK  
SWITCHES, LEVER  
SWITCHES, MULTICONTACT  
SWITCHES, PUSHBUTTON,  
NONILLUMINATED  
SWITCHES, TELEPHONE TYPE

MOTOROLA COMMUNICATIONS  
ANTENNAS, MICROWAVE  
ANTENNAS, MOBILE  
BACKGROUND MUSIC SERVICE  
CAMERA, MOUNTING EQUIPMENT  
CAMERA, REMOTE  
CONTROL EQUIPMENT  
CAMERAS, TV, MONOCHROME  
VOLTMETERS, AC  
VOLTMETERS, DC  
WATTMETERS

MOTOROLA SEMICONDUCTOR  
PRODUCTS, INC.  
INTEGRATED CIRCUITS  
MICROWAVE COMPONENTS  
RECTIFIERS - ALSO  
SEE SEMICONDUCTORS  
SEMICONDUCTOR DIODES  
SEMICONDUCTOR RECTIFIERS,  
GENERAL  
SEMICONDUCTOR RECTIFIERS,  
HIGH VOLTAGE  
SEMICONDUCTOR RECTIFIERS,  
POWER  
SEMICONDUCTOR RECTIFIERS,  
SILICON CONTROLLED - SCR  
SEMICONDUCTORS, THYRISTORS  
SEMICONDUCTORS,  
TRANSISTORS, AF  
SEMICONDUCTORS,  
TRANSISTORS, FE  
SEMICONDUCTORS, TRANSISTORS,  
GENERAL  
SEMICONDUCTORS,  
TRANSISTORS, RF

MULTRONICS, INC.  
AMPLIFIER, AF,  
GENERAL PURPOSE  
AMPLIFIER, RF,  
GENERAL PURPOSE  
AMPLIFIER, RF, POWER  
ANTENNAS, LF  
ANTENNAS, MF  
COILS, ANTENNA LOADING  
COMMUNICATIONS SYSTEMS,  
LAND MOBILE  
COUPLERS  
INDUCTANCES, FIXED  
INDUCTANCES, VARIABLE  
MONITORS, PHASE  
NETWORKS, PHASING  
SWITCHING MATRIXES

MVR CORPORATION  
RECORDERS, DISC, MAGNETIC  
RECORDERS, MAGNETIC TAPE,  
VIDEO  
TV SYSTEMS, CLOSED CIRCUIT

NARDA MICROWAVE  
ANTENNAS, MICROWAVE  
ANTENNAS, 2500 MHZ

ATTENUATORS, FIXED  
ATTENUATORS,  
IMPEDANCE MATCHING  
ATTENUATORS, MICROWAVE  
ATTENUATORS, RF  
ATTENUATORS, VIDEO  
CALORIMETERS  
CAVITIES, MICROWAVE  
CHOKES, WAVEGUIDE  
CONNECTORS, COAXIAL CABLE  
CONNECTORS, RF  
COUPLERS  
DETECTORS, MICROWAVE  
DETECTORS, STANDING WAVE  
DIVIDERS, POWER  
FILTERS, RF  
GENERATORS, SIGNAL, PULSE  
GENERATORS, SIGNAL, RF  
METERS, FREQUENCY  
METERS, FREQUENCY CALIBRATING  
METERS, POWER  
METERS, STANDING WAVE  
MICROWAVE COMPONENTS  
MICROWAVE SYSTEMS, OTHER  
NETWORKS, MATCHING, RF  
OSCILLATORS, AF AND RF,  
SEE GENERATORS  
OSCILLATORS, OTHER  
RECEIVERS, HF  
SHIFTERS, PHASE, MICROWAVE  
SLOTTED SECTIONS  
SWITCHES, COAXIAL  
TRANSMISSION LINES  
TRANSMISSION TEST SETS

NESCO INSTRUMENTS DIVISION  
RECORDERS, PAPER,  
LOGGING AND GRAPHIC

NEUMADE PRODUCTS  
CABINETS, METAL  
CABINETS, STORAGE, DISC  
CABINETS, STORAGE, FILM  
CABINETS, STORAGE,  
MAGNETIC TAPE  
CLEANERS, OTHER  
EDITORS, FILM  
FILM, PHOTOGRAPHIC  
RACKS, MOUNTING  
REELS, FILM  
REWINDERS, FILM  
RHEOSTATS  
SOLVENTS AND CLEANERS  
SPLICERS, MAGNETIC TAPE  
AND FILM

NORTHEAST ELECTRONICS  
ANALYZERS, DISTORTION  
ANALYZERS, NOISE  
GENERATORS, SIGNAL, AF  
METERS, DB AND VU

NORTH AMERICAN PHILIPS COMPANY  
AMPLIFIER, AF,  
GENERAL PURPOSE  
AMPLIFIER, AF, REVERBERATION  
AMPLIFIER, DISTRIBUTION  
CAMERAS, FILM, CINE  
CAMERAS, FILM, STILL  
CAMERAS, TV, COLOR  
CAMERAS, TV, MONOCHROME  
CONSOLE, AUDIO, PORTABLE  
CONSOLE, AUDIO, RECORDING  
EARPHONES, HEADPHONES  
EDUCATION FACILITIES,  
PUBLISHERS  
EDUCATION FACILITIES, EQPT  
ENCLOSURES, SPEAKER  
MICROPHONE HARDWARE  
MICROPHONE STANDS & BOOMS  
MICROPHONES, CONDENSER  
MICROPHONES, DYNAMIC  
MIXERS - ALSO SEE CONSOLES  
PREAMPLIFIERS, AUDIO  
RECEIVERS, AM  
RECEIVERS, FM  
RECORDERS, MAGNETIC TAPE,  
AUDIO  
RECORDERS, MAGNETIC TAPE,  
VIDEO  
SOUND SYSTEMS, OUTDOOR  
SOUND SYSTEMS, PORTABLE  
SOUND SYSTEMS, THEATER  
SPEAKER COMPONENTS  
SPEAKERS  
VACUUM TUBES, CAMERA,  
PLUMBICON R  
VACUUM TUBES, CAMERA, VIOTICON

NORTONICS COMPANY, INC.  
HEADS, ERASE, MAGNETIC  
HEADS, RECORDING, MAGNETIC  
TAPE, MAGNETIC RECORDING,  
TEST

THE NOVA CORPORATION  
CAPACITORS, FIXED, FILM  
CAPACITORS, FIXED, METALLIZED  
COMMUNICATIONS SYSTEMS, CB  
COMMUNICATIONS SYSTEMS,  
LAND MOBILE  
MOBILE EQUIPMENT

OAK MANUFACTURING CO.  
CHOPPERS  
SWITCHES, ILLUMINATED  
SWITCHES, INTERLOCK  
SWITCHES, LEVER  
SWITCHES, MECHANICALLY  
ACTUATED  
SWITCHES, MULTICONTACT  
SWITCHES, PUSHBUTTON,  
NONILLUMINATED  
SWITCHES, ROTARY  
SWITCHES, SLIDE  
SWITCHES, SNAP

OKTRON INDUSTRIES  
SPEAKERS

OHMITE MANUFACTURING COMPANY  
ATTENUATORS,  
IMPEDANCE MATCHING  
BOXES, DECADE, RESISTOR  
CAPACITORS, FIXED,  
ELECTROLYTIC  
KNOBS  
POTENTIOMETERS, CARBON  
POTENTIOMETERS, WIREWOUND  
RELAYS, GENERAL PURPOSE  
RELAYS, LATCHING  
RELAYS, LIGHT-INDICATING  
RELAYS, OVERLOAD  
RELAYS, POWER  
RELAYS, TIME DELAY  
RESISTORS, FIXED, CARBON  
RESISTORS, FIXED,  
NONINDUCTIVE  
RESISTORS, FIXED, PRECISION  
RESISTORS, FIXED, WIREWOUND  
RESISTORS, FIXED, OTHER  
RESISTORS, VARIABLE, CARBON  
RESISTORS, VARIABLE,  
WIREWOUND  
RHEOSTATS  
SEMICONDUCTOR DIODES  
SWITCHES, MECHANICALLY  
ACTUATED  
SWITCHES, ROTARY  
TRANSFORMERS, VARIABLE

GUNNAR A. OLSEN CORP.  
TOWERS, ANTENNA,  
TRANSMITTING, AM  
TOWERS, ANTENNA,  
TRANSMITTING, FM  
TOWERS, ANTENNA,  
TRANSMITTING, TV

ONAN DIVISION  
CHARGERS, BATTERY  
GENERATORS, POWER,  
GASOLINE ENGINE

ORBIT RADIO  
AMPLIFIER, AF, COMPRESSING  
AMPLIFIER, AF,  
GENERAL PURPOSE  
AMPLIFIER, AF, MONAURAL  
AMPLIFIER, AF, REMOTE  
AMPLIFIER, AF, REVERBERATION  
AMPLIFIER, AF, STEREO  
AMPLIFIER, BRIDGING  
AMPLIFIER, DISTRIBUTION  
AUTOMATION EQUIPMENT  
BACKGROUND MUSIC SERVICE  
BROADCAST PROGRAMMING SERVICE  
CARRIER-CURRENT EQUIPMENT  
CARTRIDGES, TAPE,  
RECORDING SERVICE  
CONSOLE, AUDIO, FM  
CONSOLE, AUDIO, PORTABLE  
CONSOLE, AUDIO, RECORDING  
CONSOLE, AUDIO, TV  
CONSOLE, AUDIO, AM  
EDITORS, AUDIO TAPE  
FILTERS, AUDIO  
MAINTENANCE SERVICES, AM  
MAINTENANCE SERVICES, FM  
MIXERS - ALSO SEE CONSOLES  
PREAMPLIFIERS, AUDIO  
REMOTE CONTROL SYSTEMS  
REVERBERATION DEVICES  
SOUND SYSTEMS, PORTABLE  
TAPE, MAGNETIC RECORDING,  
TEST

PACIFIC TOWER CO.  
ANTENNAS, TV  
LIGHTING, TV, COMPONENTS  
LIGHTING, TV, SYSTEMS  
TOWERS, ANTENNA,  
CATV, HEAD-END  
TOWERS, ANTENNA, RECEIVING  
TOWERS, ANTENNA,  
TRANSMITTING, AM  
TOWERS, ANTENNA,  
TRANSMITTING, FM  
TOWERS, ANTENNA,  
TRANSMITTING, TV  
WIRE, BARE, COPPER

PAINTON INCORPORATED  
ATTENUATORS, AUDIO  
ATTENUATORS, FIXED  
ATTENUATORS,  
IMPEDANCE MATCHING  
ATTENUATORS, RF  
ATTENUATORS, VIDEO  
CHOKES, WAVEGUIDE  
KNOBS  
POTENTIOMETERS, WIREWOUND  
RESISTORS, FIXED, CARBON  
RESISTORS, FIXED, PRECISION  
RESISTORS, FIXED, WIREWOUND  
RESISTORS, FIXED, OTHER  
RESISTORS, VARIABLE,  
WIREWOUND  
SWITCHES, MULTICONTACT  
SWITCHES, PUSHBUTTON,  
NONILLUMINATED  
SWITCHES, ROTARY  
SWITCHES, TOGGLE

PALL TRINITY MICRO CORP.  
DEHUMIDIFIERS  
DESICCANTS  
FILTERS, OTHER  
WIRING AND CABLING SERVICES

PERMOFLUX CORPORATION  
AMPLIFIER, AF,  
GENERAL PURPOSE

AMPLIFIER, AF, MONAURAL  
AMPLIFIER, AF, REMOTE  
AMPLIFIER, AF, STEREO  
COILS, CHOKE, AF  
EARPHONES, HEADPHONES  
MICROPHONES, DYNAMIC  
PREAMPLIFIERS, AUDIO  
SPEAKER COMPONENTS  
SPEAKERS  
TRANSFORMERS, AUDIO,  
ISOLATION  
TRANSFORMERS, AUDIO, MATCHING  
TRANSFORMERS, AUDIO,  
POWER OUTPUT  
TRANSFORMERS, AUTO  
TRANSFORMERS, COUPLING  
TRANSFORMERS, FILAMENT  
TRANSFORMERS, GENERAL  
TRANSFORMERS, PLATE  
TRANSFORMERS, POWER

PHELPS DODGE  
CABLE, ARMORED  
CABLE, ASSEMBLIES  
CABLE, CATV, HARDWARE  
CABLE, COAXIAL, FLEXIBLE  
CABLE, COAXIAL, RIGID  
CABLE, DIRECT-BURIAL  
CONNECTORS, ANTENNA  
CONNECTORS, COAXIAL CABLE  
CONNECTORS, RF  
DELAY LINES  
DIPLEXERS  
JACK PANEL ASSEMBLIES  
JACKS  
MICROWAVE COMPONENTS  
PLUGS, COAXIAL  
SLOTTED SECTIONS  
TERMINALS, HIGH VOLTAGE  
TRANSMISSION LINES  
TRANSMISSION TEST SETS  
ASSOCIATED COMPONENTS  
WAVEGUIDE AND

PIEZO CRYSTAL CO.  
CRYSTALS, PIEZOELECTRIC  
FILTERS, OTHER

H K PORTER INC  
HARDWARE, TOOLS  
TOOLS, CRIMPERS  
TOOLS, CUTTERS  
TOOLS, HAND

POWER-OPTICS INCORPORATED  
CAMERA, MOUNTING EQUIPMENT  
CAMERA, REMOTE  
CONTROL EQUIPMENT  
INDUSTRIAL TV  
LENSES, OPTICAL, FIXED  
LENSES, OPTICAL, ZOOM

POWER SOURCES  
INVERTERS, DC TO AC,  
SOLID STATE  
POWER SUPPLIES, AC  
POWER SUPPLIES, DC

PRECISION LABORATORIES  
CAMERAS, FILM, CINE  
CAMERAS, FILM, STILL  
EDITORS, FILM  
EDITORS, VIDEO TAPE  
HEADS, RECORDING, MAGNETIC  
PROJECTORS, FILM  
PROJECTORS, SLIDE  
SPLICERS, MAGNETIC TAPE  
AND FILM

PRECISION PIEZO SERVICE  
CRYSTALS, PIEZOELECTRIC

PRODELIN, INCORPORATED  
ADAPTERS, CONNECTOR  
ANTENNAS, MICROWAVE  
ANTENNAS, MOBILE  
ANTENNAS, 2500 MHZ  
ATTENUATORS, MICROWAVE  
ATTENUATORS, RF  
CABLE, CATV, HARDWARE  
CABLE, COAXIAL, FLEXIBLE  
CABLE, COAXIAL, RIGID  
COILS, ANTENNA LOADING  
COMMUNICATIONS SYSTEMS, CB  
COMMUNICATIONS SYSTEMS,  
LAND MOBILE  
COMMUNICATIONS SYSTEMS,  
MICROWAVE  
CONNECTORS, ANTENNA  
CONNECTORS, COAXIAL CABLE  
CONNECTORS, RF  
DIPLEXERS  
DIVIDERS, POWER  
DUMMY LOAD  
FILTERS, ANTENNA  
FILTERS, RF  
MICROWAVE COMPONENTS  
MICROWAVE SYSTEMS, STL  
MICROWAVE SYSTEMS, 2500 MHZ  
MOUNTS, ANTENNA, FIXED  
MOUNTS, ANTENNA, MOBILE  
RADOMES  
SHIFTERS, PHASE, MICROWAVE  
SLOTTED SECTIONS  
SWITCHES, COAXIAL

PRO-TEX REEL BAND COMPANY  
LEADER, FILM

PRUZAN COMPANY  
CATV, HARDWARE  
POLE CLIMBING EQUIPMENT  
SAFETY DEVICES, CLIMBING



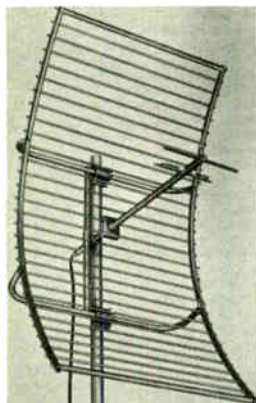
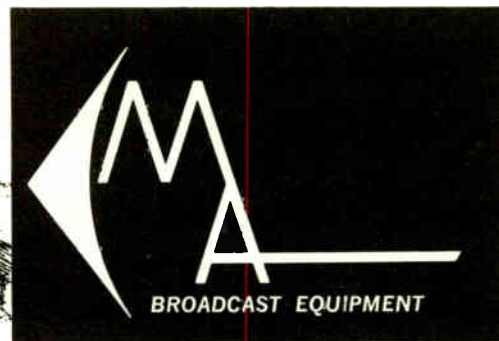

Scala PR-450 Antenna

## AURAL STUDIO-TRANSMITTER LINKS

FOR FM · AM · TV · INTERCITY RELAY

Six years of continuous operation in broadcast service and 150 units in the field have established the Moseley STL as the accepted industry standard.

**Model PCL-2B** Low distortion, wide frequency response, and exceptionally good transient response. Designed for continuous duty, the PCL-2B is rated at 8 watts maximum output. For FM stereo use DUAL MODEL PCL-2B, a concept pioneered by Moseley Associates, Inc.

## SOLID-STATE REMOTE CONTROL SYSTEMS

RADIO and WIRE

**Model PBR-21** All transistorized 21 channel deluxe control system can be operated over single wire line or radio circuit. DC line continuity not required. A complete line of control subcarrier generators and detectors is available to adapt the PBR-21 to STL systems for radio control. All FM radio remote control systems compatible with stereophonic and SCA program operation. (Write for Technical Bulletin 213). PBR-21 Studio Control Unit illustrated at right.

**Model WRC-10T** Designed to operate over a SINGLE DC wire pair, this 10 channel all solid-state control system is dependable, accurate, and economical. 4" rectangular meter provided for easy readout.

**Model SCS-1 Status/Control System** Employing plug-in modules, this solid-state 8 channel system can be used as status indicator, fault reporting, or one-way control system. Will operate over single telephone line or narrow band radio channel.

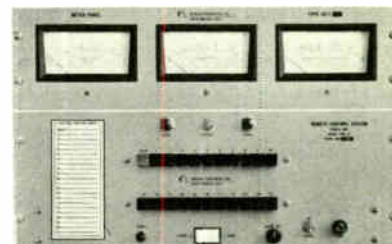

Model PBR-21

## FM TRANSMISSION EQUIPMENT

LPE-10 SCG-3 SCG-4T

The **Model SCG-4T SCA Subcarrier Generator** illustrated is the newest FM product of Moseley Associates. Of all solid-state design, the Model SCG-4T contains a peak reading deviation meter calibrated directly in KHz. Muting circuitry is all electronic (no relays) for maximum reliability.

The **Model LPE-10 direct FM 10 watt Exciter** is FCC Type Accepted for stereo and SCA service as well as an educational transmitter (LPT-10). It is ideal as replacement exciter when updating old style FM transmitters. **Model SCG-3 FM Stereo Generator** connects directly into exciter. Wideband input capability of LPE-10 assures maximum transmission linearity of composite stereo waveform from SCG-3.



Model SCG-4T



Model RPL-1T

## BROADCAST REMOTE PICKUP SYSTEMS

**Model RPL-1** Designed for continuous duty, 30 watt high quality broadcast remote pickup transmitter provides studio sound away from home. Operating in the 148-174 MHz band, the RPL-1 Remote Pickup System has low distortion and wide frequency response, making it an excellent choice for FM stations.

**450 MHz Solid-state Remote Pickup System** Newly designed, this all solid-state system provides the broadcaster with a modern, high quality remote pickup unit for use on any of the 20 channels in Group N. Only JEDEC-registered silicon semiconductors used.

# MOSELEY ASSOCIATES, INC.

135 NOGAL DRIVE, SANTA BARBARA, CALIFORNIA 93105  
TELEPHONE 805-967-0424

**PULSE TECHNIQUES**

EQUALIZERS, AUDIO EMPHASIS

**O R K ELECTRONIC PRODUCTS**

PREAMPLIFIERS, AUDIO  
TURNABLES, PHONOGRAPH

**Q-TV SALES & DISTRIBUTING**

DISPLAY EQUIPMENT, TV

**JULES RACINE CO., INC.**

TIMERS, MANUAL

**RADIO AIDS**

CALIBRATION SERVICE,  
FREQUENCY

**RAVEN SCREEN CORPORATION**

SCREENS, PROJECTION, FRONT  
SCREENS, PROJECTION, REAR

**RAYTHEON CO., EQUIPMENT DIV.**

AMPLIFIER, CLAMPING  
AMPLIFIER, TV, VIDEO  
ANTENNAS, MICROWAVE  
ANTENNAS, 2500 MHZ  
MICROWAVE COMPONENTS  
MICROWAVE SYSTEMS, STL  
MICROWAVE SYSTEMS, 2500 MHZ  
MICROWAVE SYSTEMS, OTHER  
MOUNTS, ANTENNA, FIXED  
MOUNTS, ANTENNA, MOBILE  
RACKS, MOUNTING

**RBM CONTROLS**

RELAYS, GENERAL PURPOSE  
RELAYS, LATCHING  
RELAYS, PLUG-IN  
RELAYS, POWER  
RELAYS, TELEPHONE  
RELAYS, TIME DELAY

**RCA BROADCAST PRODS.**

AMPLIFIER, AF, AGC  
AMPLIFIER, AF, COMPRESSING  
AMPLIFIER, AF,  
GENERAL PURPOSE  
AMPLIFIER, AF, MONAURAL  
AMPLIFIER, AF,  
PEAK LIMITING, AM  
AMPLIFIER, AF, REMOTE  
AMPLIFIER, AF, STEREO  
AMPLIFIER, BRIDGING  
AMPLIFIER, DISTRIBUTION  
AMPLIFIER, KEYING  
AMPLIFIER, MASKING  
AMPLIFIER, PULSE  
AMPLIFIER, RF,  
GENERAL PURPOSE  
AMPLIFIER, RF, PEAK LIMITING  
AMPLIFIER, RF, POWER  
AMPLIFIER, STABILIZING  
AMPLIFIER, TV, BOOSTER  
AMPLIFIER, TV, VIDEO  
AMPLIFIER, VIDEO, SWEEP  
ANALYZERS, SIDEBAND  
ANTENNAS, AM  
ANTENNAS, FM  
ANTENNAS, MICROWAVE  
ANTENNAS, MOBILE  
ANTENNAS, TV  
ANTENNAS, 2500 MHZ  
ARMS, TONE  
ATTENUATORS, FIXED  
AUTOMATION EQUIPMENT  
BASE STATIONS  
BLOWERS AND FANS  
CABINETS, METAL  
CABINETS, PLASTIC  
CABINETS, STORAGE, FILM  
CABINETS, STORAGE,  
MAGNETIC TAPE  
CABLE, COAXIAL, FLEXIBLE  
CABLE, COAXIAL, RIGID  
CABLE, SHIELDED, AUDIO  
CALORIMETERS  
CAMERA, MOUNTING EQUIPMENT  
CAMERAS, FILM, CINE  
CAMERAS, TV, COLOR  
CAMERAS, TV, MONOCHROME  
CARTRIDGES, MAGNETIC TAPE  
CARTRIDGES, PHONO  
CLOCKS  
COILS, ANTENNA LOADING  
COILS, HYBRID  
COILS, TELEPHONE  
COMMUNICATIONS SYSTEMS,  
INTERCOM, WIRED  
COMMUNICATIONS SYSTEMS,  
LAND MOBILE  
COMMUNICATIONS SYSTEMS,  
MICROWAVE  
COMMUNICATIONS SYSTEMS,  
MULTIPLY  
CONNECTORS, AF & MICROPHONE  
CONNECTORS, COAXIAL CABLE  
CONSOLE, AUDIO, AM  
CONSOLE, AUDIO, FM  
CONSOLE, AUDIO, PORTABLE  
CONSOLE, AUDIO, RECORDING  
CONSOLE, AUDIO, TV  
CONSOLE, CABINETS  
AND HARDWARE  
CONSOLE, VIDEO, STUDIO  
CORDS, PATCH  
COUPLERS  
CRYSTALS, PIEZOELECTRIC  
DELAY LINES  
DEMAGNETIZERS, BULK TAPE  
DEMAGNETIZERS, HEAD  
DEMODULATORS  
DIPLEXERS  
DOLLIES, CAMERA  
DOLLIES, TEST EQUIPMENT  
DROPOUT COMPENSATOR,  
VIDEO TAPE

DUMMY LOAD  
EARPHONES, HEADPHONES  
EDITORS, FILM  
EDITORS, VIDEO TAPE  
ENCLOSURES, SPEAKER  
EQUALIZERS, AUDIO EMPHASIS  
EXCITERS, FM  
FILTERS, AUDIO  
FLASHERS, OTHER  
FLASHERS, TOWER  
GENERATORS, FM, STEREO  
GENERATORS, FM, SUBCARRIER  
GENERATORS, SIGNAL, AF  
GENERATORS, SIGNAL, COLD BAR  
GENERATORS, SIGNAL, DOT BAR  
GENERATORS, SIGNAL,  
SPECIAL EFFECT  
GENERATORS, SIGNAL,  
TV SYNCHRONIZING  
HEADS, ERASE, MAGNETIC  
HEADS, RECORDING, MAGNETIC  
INDUSTRIAL TV  
JACK PANEL ASSEMBLIES  
LENSES, OPTICAL, FIXED  
LENSES, OPTICAL, ZOOM  
LIGHTING, TV, COMPONENTS  
LIGHTING, TV, CONTROLS  
LIGHTING, TV, SYSTEMS  
METERS, DB AND VU  
METERS, FIELD STRENGTH  
METERS, FREQUENCY  
MICROPHONE HARDWARE  
MICROPHONE STANDS & BOOMS  
MICROPHONES, DYNAMIC  
MICROPHONES, VELOCITY  
MICROWAVE COMPONENTS  
MICROWAVE SYSTEMS, STL  
MICROWAVE SYSTEMS, 2500 MHZ  
MICROWAVE SYSTEMS, OTHER  
MIXERS - ALSO SEE CONSOLES  
MOBILE EQUIPMENT  
MONITORS, AM SYSTEMS  
MONITORS, FM SYSTEMS, MONO  
MONITORS, FM SYSTEMS, SCA  
MONITORS, FM SYSTEMS, STEREO  
MONITORS, FREQUENCY  
MONITORS, PHASE  
MONITORS, VIDEO  
MONITORS, WAVEFORM  
MOUNTS, ANTENNA, FIXED  
MOUNTS, ANTENNA, MOBILE  
MULTIPLEXERS  
NETWORKS, PHASING  
OSCILLATORS, AF AND RF,  
SEE GENERATORS  
OSCILLOSCOPES  
PLUGS, COAXIAL  
PLUGS, PHONE  
POWER SUPPLIES, DC  
PREAMPLIFIERS, AUDIO  
PRESSURIZATION EQUIPMENT,  
TRANSMISSION LINE  
PROCESSORS, FILM, B-W  
PROCESSORS, FILM, COLOR  
PROJECTORS, FILM  
PROJECTORS, SLIDE  
RACKS, MOUNTING  
RADAR, WEATHER  
RECORDERS, MAGNETIC TAPE,  
AUDIO  
RECORDERS, MAGNETIC TAPE,  
AUDIO, CARTRIDGE  
RECORDERS, MAGNETIC TAPE,  
VIDEO  
REFLECTORS, PASSIVE  
REWINDERS, FILM  
SOUND SYSTEMS, OUTDOOR  
SOUND SYSTEMS, PORTABLE  
SOUND SYSTEMS, THEATER  
SPEAKER COMPONENTS  
SPEAKERS  
SPLICERS, MAGNETIC TAPE  
AND FILM  
STL EQUIPMENT  
SWITCHERS  
SWITCHING SYSTEMS  
TAPE DECKS, MAGNETIC  
TAPE, MAGNETIC RECORDING,  
AUDIO  
TAPE, MAGNETIC RECORDING,  
VIDEO  
TERMINAL BLOCKS  
TERMINAL BOARDS  
TERMINAL STRIPS  
TERMINALS, BARRIER  
TOWERS, ANTENNA,  
TRANSMITTING, AM  
TOWERS, ANTENNA,  
TRANSMITTING, FM  
TOWERS, ANTENNA,  
TRANSMITTING, TV  
TRANSFORMERS, AUDIO,  
ISOLATION  
TRANSFORMERS, AUDIO, MATCHING  
TRANSMISSION LINES  
TRANSMISSION TEST SETS  
TRANSMITTERS, AM, 1 KW  
TRANSMITTERS, AM, 5 KW  
TRANSMITTERS, AM, 10 KW  
TRANSMITTERS, AM, 25 KW  
TRANSMITTERS, AM, 50 KW  
TRANSMITTERS, FM, 1 KW  
TRANSMITTERS, FM, 5 KW  
TRANSMITTERS, FM, 10 KW  
TRANSMITTERS, FM, 20 KW  
TRANSMITTERS, FM, 40 KW  
TRANSMITTERS, TV, 2 KW  
TRANSMITTERS, TV, 5 KW  
TRANSMITTERS, TV, 6 KW  
TRANSMITTERS, TV, 11 KW  
TRANSMITTERS, TV, 12 KW  
TRANSMITTERS, TV, 25 KW  
TRANSMITTERS, TV, 30 KW  
TRANSMITTERS, TV, 50 KW  
TRANSMITTERS, TV, 150 KW  
TURNABLES, PHONOGRAPH

TV SYSTEMS, CLOSED CIRCUIT  
WATTMETERS  
WAVEGUIDE AND  
ASSOCIATED COMPONENTS  
WIRE, BARE, COPPER  
WIRE, BARE, COPPER STRAP  
WIRE, SHIELDED

**RCA ELECTRONIC COMPONENTS**

BATTERIES, DRY CELL  
CAVITIES, MICROWAVE  
COMMUNICATIONS SYSTEMS, CB  
GENERATORS, FM, STEREO  
GENERATORS, SIGNAL, AF  
GENERATORS, SIGNAL, COLOR BAR  
GENERATORS, SIGNAL, DOT BAR  
GENERATORS, SIGNAL, MARKER  
GENERATORS, SIGNAL, RF  
INTEGRATED CIRCUITS  
MICROPHONE HARDWARE  
MICROPHONE STANDS & BOOMS  
MICROPHONES, CONDENSER  
MICROPHONES, DYNAMIC  
MICROPHONES, VELOCITY  
DMMETERS  
OSCILLOSCOPES  
PROBES, OSCILLOSCOPE  
PROBES, TEST LEAD  
SEMICONDUCTOR DIODES  
SEMICONDUCTOR RECTIFIERS,  
GENERAL  
SEMICONDUCTOR RECTIFIERS,  
HIGH VOLTAGE  
SEMICONDUCTOR RECTIFIERS,  
POWER  
SEMICONDUCTOR RECTIFIERS,  
SILICON CONTROLLED - SCR  
SEMICONDUCTORS, THYRISTORS  
SEMICONDUCTORS,  
TRANSISTORS, AF  
SEMICONDUCTORS,  
TRANSISTORS, FE  
SEMICONDUCTORS, TRANSISTORS,  
GENERAL  
SEMICONDUCTORS,  
TRANSISTORS, RF  
TESTERS, VACUUM TUBE  
VACUUM TUBES, CAMERA,  
IMAGE-ORTHICON  
VACUUM TUBES, CAMERA, VIDICON  
VACUUM TUBES, CATHODE RAY,  
TV, COLOR  
VACUUM TUBES, CATHODE RAY,  
TV, MONOCHROME  
VACUUM TUBES, RECEIVING  
VACUUM TUBES, TRANSMITTING  
VOLTMETERS, AC  
VOLTMETERS, DC  
VOLTMETERS, VACUUM TUBE

**RCA SERVICE COMPANY**

MAINTENANCE SERVICES, AM  
MAINTENANCE SERVICES, FM  
MAINTENANCE SERVICES,  
MICROWAVE  
MAINTENANCE SERVICES,  
STEREO  
MAINTENANCE SERVICES, TV

**RECORDING EQUIPMENT COMPANY**

AMPLIFIER, AF, MONAURAL  
FILTERS, AUDIO  
FILTERS, RF  
PREAMPLIFIERS, AUDIO

**REEVES SOUNDRAFT**

CARTRIDGES, MAGNETIC TAPE  
RECORDS, BLANK, LACQUER,  
FOR RECORDING  
REELS, TAPE  
TAPE, MAGNETIC RECORDING,  
AUDIO  
TAPE, MAGNETIC RECORDING,  
COMPUTER  
TAPE, MAGNETIC RECORDING,  
VIDEO

**RHG ELECTRONICS LABORATORY**

AMPLIFIER, RF,  
GENERAL PURPOSE  
AMPLIFIER, RF, POWER  
COMMUNICATIONS SYSTEMS,  
MICROWAVE  
COMMUNICATIONS SYSTEMS,  
MULTIPLY  
EXCITERS, FM  
MICROWAVE COMPONENTS  
MICROWAVE SYSTEMS, STL  
MICROWAVE SYSTEMS, 2500 MHZ  
MICROWAVE SYSTEMS, OTHER  
RECEIVERS, FM  
RECEIVERS, HF  
STL EQUIPMENT  
TRANSMITTERS, FM, 100 WATTS  
TRANSMITTERS, FM, 1 KW  
TRANSMITTERS, FM, 10 KW

**RIKER VIDEO INDUSTRIES**

AMPLIFIER, DISTRIBUTION  
AMPLIFIER, KEYING  
AMPLIFIER, MASKING  
AMPLIFIER, PULSE  
AMPLIFIER, SENSING  
AMPLIFIER, STABILIZING  
AMPLIFIER, TV, VIDEO  
AUTOMATION EQUIPMENT  
BALUNS  
CLOCKS  
CONSOLE, VIDEO, PORTABLE  
CONSOLE, VIDEO, STUDIO  
DROPOUT COMPENSATOR,  
VIDEO TAPE  
GENERATORS, SIGNAL, COLOR BAR  
GENERATORS, SIGNAL, DOT BAR  
GENERATORS, SIGNAL, PULSE

GENERATORS, SIGNAL,  
SPECIAL EFFECT  
GENERATORS, SIGNAL,  
TV, SYNCHRONIZING  
GENERATORS, SIGNAL, VITS  
INDUSTRIAL TV  
OSCILLATORS, TV  
SWITCHERS  
SWITCHING SYSTEMS  
TRANSMISSION TEST SETS  
TV SYSTEMS, CLOSED CIRCUIT

**ROANWELL CORPORATION**

CAPACITORS, VARIABLE  
EARPHONES, HEADPHONES  
TELEPHONE EQUIPMENT

**ROBINS INDUSTRIES CORP**

ACOUSTIC MATERIALS  
ADAPTERS, CONNECTOR  
ANTENNAS, FM  
CABLE, ASSEMBLIES  
CABLE, SHIELDED, AUDIO  
CORDS, PATCH  
DEMAGNETIZERS, BULK TAPE  
DEMAGNETIZERS, HEAD  
EDITORS, AUDIO TAPE  
HARDWARE, GENERAL  
HARDWARE, MOUNTS  
HEADS, ERASE, MAGNETIC  
HEADS, RECORDING, MAGNETIC  
JACKS  
LAMP ASSEMBLIES  
LOG BOOKS OR SHEETS  
METERS, DB AND VU  
MICROPHONE HARDWARE  
MICROPHONES, DYNAMIC  
PLUGS, COAXIAL  
PROJECTORS, FILM, REAR  
REELS, TAPE  
SLIDES, CHASSIS  
SOLVENTS AND CLEANERS  
SPLICERS, MAGNETIC TAPE  
AND FILM  
STROBE, DISCS  
STROBE, LIGHTS  
SWITCHES, ILLUMINATED  
SWITCHES, SNAP  
SWITCHES, TOGGLE  
TAPE, MAGNETIC RECORDING,  
AUDIO  
WIRE, BARE, COPPER  
WIRE, INSULATED, HOOKUP  
WIRE, SHIELDED

**ROHDE & SCHWARZ SALES CO-USA**

AMPLIFIER, RF, PEAK LIMITING  
AMPLIFIER, VIDEO, SWEEP  
ANALYZERS, DISTORTION  
ANALYZERS, HARMONIC  
ANALYZERS, NOISE  
ANALYZERS, SIDEBAND  
ANALYZERS, VIDEO  
ANTENNAS, MICROWAVE  
ATTENUATORS, AUDIO  
ATTENUATORS, FIXED  
ATTENUATORS,  
IMPEDANCE MATCHING  
ATTENUATORS, MICROWAVE  
ATTENUATORS, RF  
ATTENUATORS, VIDEO  
BALUNS  
BRIDGES  
CONNECTORS, ANTENNA  
CONNECTORS, COAXIAL CABLE  
CONNECTORS, POWER  
CONNECTORS, RF  
COUPLERS  
DELAY LINES  
DEMODULATORS  
DETECTORS, MICROWAVE  
DETECTORS, STANDING WAVE  
DIVIDERS, FREQUENCY  
DUMMY LOAD  
FILTERS, AUDIO  
FILTERS, RF  
GENERATORS, FM, STEREO  
GENERATORS, SIGNAL, AF  
GENERATORS, SIGNAL, RF  
METERS, FIELD STRENGTH  
METERS, FREQUENCY  
METERS, FREQUENCY CALIBRATING  
METERS, PHASE ANGLE  
METERS, POWER  
METERS, STANDING WAVE  
MICROWAVE COMPONENTS  
MODULATORS, TV  
OSCILLATORS, AF AND RF,  
SEE GENERATORS  
OSCILLATORS, AM  
OSCILLATORS, FM  
OSCILLATORS, TV  
OSCILLATORS, OTHER  
RECEIVERS, AM  
RECEIVERS, FM  
RECEIVERS, HF  
RECORDERS, PAPER,  
LOGGING AND GRAPHIC  
SLOTTED SECTIONS  
TESTERS, CAPACITOR  
TESTERS, INSULATION  
TESTERS, SEMICONDUCTOR  
TRANSFORMERS, AUDIO,  
ISOLATION  
TRANSFORMERS, AUDIO, MATCHING  
TRANSMITTERS, AM, 5 KW  
TRANSMITTERS, AM, 10 KW  
TRANSMITTERS, FM  
TRANSMITTERS, TV  
VOLTMETERS, AC  
VOLTMETERS, DC  
VOLTMETERS, VACUUM TUBE  
WATTMETERS

ROMN MANUFACTURING COMPANY  
CATV, HEAD-END EQUIPMENT  
HEAD-END EQUIPMENT,  
SEE CATV HEAD-END EQUIPMENT  
LIGHTS, TOWER, OBSTRUCTION  
MOUNTS, ANTENNA, FIXED  
REFLECTORS, PASSIVE  
TOWERS, ANTENNA,  
CATV, HEAD-END  
TOWERS, ANTENNA, RECEIVING  
TOWERS, ANTENNA,  
TRANSMITTING, AM  
TOWERS, ANTENNA,  
TRANSMITTING, FM  
TOWERS, ANTENNA,  
TRANSMITTING, TV

RDME CABLE DIV. OF ALCOA  
CABLE, ASSEMBLIES  
CABLE, COAXIAL, FLEXIBLE  
CABLE, DIRECT-BURIAL  
CABLE, SHIELDED, AUDIO  
CABLE, TELEPHONE

ROTRON MANUFACTURING COMPANY  
BLOWERS AND FANS

ROUND HILL ASSOCIATES

AMPLIFIER, AF, AGC  
AMPLIFIER, AF, COMPRESSING  
AMPLIFIER, AF,  
GENERAL PURPOSE  
AMPLIFIER, AF, MONAURAL  
AMPLIFIER, AF,  
PEAK LIMITING, AM  
AMPLIFIER, AF,  
PEAK LIMITING, FM  
AMPLIFIER, AF, REMOTE  
AMPLIFIER, AF, REVERBERATION  
AMPLIFIER, AF, STEREO  
AMPLIFIER, BRIDGING  
AMPLIFIER, CATV  
AMPLIFIER, DISTRIBUTION  
COMMUNICATIONS SYSTEMS,  
INTERCOM, WIRELESS

RUSSCO ELECTRONICS MFG.  
AMPLIFIER, AF, MONAURAL  
AMPLIFIER, AF, STEREO  
PREAMPLIFIERS, AUDIO  
TURNTABLES, PHONOGRAPH

F. B. RYAN MFG. CO.  
PLOWS, CABLE LAYING

HOWARD W. SAMS & CO. INC.  
EDUCATION FACILITIES,  
PUBLISHERS  
EDUCATION FACILITIES, SCHOOLS

SARKES-TARZIAN  
AMPLIFIER, DISTRIBUTION  
AMPLIFIER, PULSE  
AMPLIFIER, TV, VIDEO  
ATTENUATORS, VIDEO  
AUTOMATION EQUIPMENT  
CAMERAS, TV, COLOR  
CAMERAS, TV, MONOCHROME  
CAPACITORS, VARIABLE  
COMMUNICATIONS SYSTEMS,  
MICROWAVE  
COMPUTER EQUIPMENT  
CONSOLE, AUDIO, TV  
CONSOLE, AUDIO, AM  
CONSOLE, VIDEO, PORTABLE  
CONSOLE, VIDEO, STUDIO  
CORDS, PATCH  
DISPLAY EQUIPMENT, TV  
ENHANCERS, TV IMAGE  
GENERATORS, SIGNAL,  
TV SYNCHRONIZING  
HARDWARE, RACK  
JACK PANEL ASSEMBLIES  
MAINTENANCE SERVICES, TV  
MICROWAVE SYSTEMS, STL  
MONITORS, VIDEO

RECTIFIERS - ALSO SEE SEMI-  
CONDUCTORS & VACUUM TUBES  
RECTIFIERS, SELENIUM  
SEMICONDUCTOR DIODES  
SEMICONDUCTOR RECTIFIERS,  
GENERAL  
SEMICONDUCTOR RECTIFIERS,  
HIGH VOLTAGE  
SEMICONDUCTOR RECTIFIERS,  
POWER  
SEMICONDUCTOR RECTIFIERS,  
SILICON CONTROLLED - SCR  
STL EQUIPMENT  
SWITCHING MATRIXES  
SWITCHING SYSTEMS  
TAPE, MAGNETIC RECORDING,  
AUDIO  
TRANSMITTERS, TV, 1 KW  
TV SYSTEMS, CLOSED CIRCUIT

SAXTON PRODUCTS INC.  
CABLE, ASSEMBLIES  
CABLE, COAXIAL, FLEXIBLE  
CABLE, COAXIAL, RIGID  
CABLE, DIRECT-BURIAL  
CABLE, SHIELDED, AUDIO  
CABLE, TELEPHONE  
WIRE, BARE, COPPER  
WIRE, BARE, COPPER STRAP  
WIRE, BARE, STEEL  
WIRE, INSULATED, HIGH VOLTAGE  
WIRE, INSULATED, HOOKUP  
WIRE, SHIELDED  
WIRING AND CABLING SERVICES

SCALE RADIO CORPORATION  
ANTENNAS, AM  
ANTENNAS, CATV  
ANTENNAS, FM  
ANTENNAS, TV

ANTENNAS, TV,  
MASTER-COMMUNITY  
BALUNS

SCHAFFER ELECTRONICS  
AMPLIFIER, SENSING  
AUTOMATION EQUIPMENT  
BACKGROUND MUSIC SERVICE  
BROADCAST PROGRAMMING SERVICE  
CABINETS, METAL  
PREAMPLIFIERS, AUDIO  
RACKS, MOUNTING  
RECORDERS, MAGNETIC TAPE,  
AUDIO  
RECORDERS, MAGNETIC TAPE,  
LOGGING  
REMOTE CONTROL SYSTEMS  
SWITCHERS  
SWITCHING MATRIXES  
TAPE DECKS, MAGNETIC

ALBERT SCHULTZ, INC.  
BACKGROUND MUSIC SERVICE  
BROADCAST PROGRAMMING SERVICE

SCIENTIFIC-ATLANTA

ANTENNAS, CATV  
ANTENNAS, MICROWAVE  
ANTENNAS, TV,  
MASTER-COMMUNITY  
ANTENNAS, 2500 MHZ  
ATTENUATORS, MICROWAVE  
ATTENUATORS, RF  
ATTENUATORS, VIDEO  
CABINETS, METAL  
CONSOLE, CABINETS  
AND HARDWARE  
DIVIDERS, POWER  
JOINTS, ROTARY, COAXIAL  
MICROWAVE COMPONENTS  
MOUNTS, ANTENNA, FIXED  
OSCILLATORS, AF AND RF,  
SEE GENERATORS  
PAPER, CHART AND GRAPH  
RADOMES  
RECEIVERS, HF  
RECORDERS, PAPER,  
LOGGING AND GRAPHIC  
WAVEGUIDE AND  
ASSOCIATED COMPONENTS

H. H. SCOTT, INC.

AMPLIFIER, AF,  
GENERAL PURPOSE  
AMPLIFIER, AF, MONAURAL  
AMPLIFIER, AF, REMOTE  
AMPLIFIER, AF, STEREO  
AMPLIFIER, BRIDGING  
ANALYZERS, NOISE  
GENERATORS, FM, STEREO  
GENERATORS, FM, SUBCARRIER  
GENERATORS, SIGNAL,  
SPECIAL EFFECT, NOISE  
METERS, DB AND VU, WIDE RANGE  
PREAMPLIFIERS, AUDIO  
RECEIVERS, FM  
RECEIVERS, MULTIPLEX

SCULLY RECORDING INSTRUMENTS

AMPLIFIER, AF,  
GENERAL PURPOSE  
AMPLIFIER, AF, MONAURAL  
AMPLIFIER, AF, STEREO  
AUTOMATION EQUIPMENT  
EDITORS, AUDIO TAPE  
HEADS, DISC RECORDING  
HEADS, ERASE, MAGNETIC  
HEADS, RECORDING, MAGNETIC  
LATHE, DISC RECORDING  
PREAMPLIFIERS, AUDIO  
RECORDERS, MAGNETIC TAPE,  
AUDIO

SELA ELECTRONICS CO.  
TIMERS, ELECTRIC

SETCHELL CARLSON, INC.  
AMPLIFIER, AF, STEREO  
CABINETS, WOOD  
INDUSTRIAL TV  
MONITORS, VIDEO  
RECEIVERS, AM  
RECEIVERS, FM  
RECEIVERS, TV, COLOR  
RECEIVERS, TV, MONOCHROME  
SPEAKERS  
TV SYSTEMS, CLOSED CIRCUIT

SHURE BROTHERS

ARMS, TONE  
CARTRIDGES, MAGNETIC TAPE  
CARTRIDGES, PHONO  
MICROPHONE HARDWARE  
MICROPHONE STANDS & BOOMS  
MICROPHONES, DYNAMIC  
MIXERS - ALSO SEE CONSOLES  
PREAMPLIFIERS, AUDIO  
STYLUS, PLAYBACK

SIGMA INDUSTRIES

BLOWERS AND FANS  
CABLE, CATV, HARDWARE  
CATV EQUIPMENT - ALSO SEE  
OTHER CATEGORIES  
CATV, CABLE TERMINALS  
CONNECTORS, COAXIAL CABLE  
HARDWARE, TUBING, PLASTIC  
PRESSURIZATION EQUIPMENT,  
TRANSMISSION LINE  
TV SYSTEMS, CLOSED CIRCUIT

SIGMA INSTRUMENTS INC.  
RELAYS, GENERAL PURPOSE  
RELAYS, LATCHING  
RELAYS, OVERLOAD  
RELAYS, PHOTOELECTRIC

RELAYS, PLUG-IN  
RELAYS, POWER  
RELAYS, SEQUENCING  
RELAYS, TELEPHONE

THE SINGER CO - METRICS DIV.

AMMETERS, AC  
AMMETERS, AC, THERMOCOUPLE  
AMMETERS, DC  
AMMETERS, RF  
ANALYZERS, DISTORTION  
ANALYZERS, HARMONIC  
ANALYZERS, INTERMODULATION  
ANALYZERS, NOISE  
ANALYZERS, SIDEBAND  
ANALYZERS, VIDEO  
ATTENUATORS, FIXED  
ATTENUATORS, MICROWAVE  
ATTENUATORS, RF  
CAMERAS, OSCILLOSCOPE  
CONVERTERS  
DIVIDERS, VOLTAGE  
DOLLIES, TEST EQUIPMENT  
GENERATORS, SIGNAL, AF  
GENERATORS, SIGNAL, RF  
METER, FIELD STRENGTH  
METERS, FREQUENCY  
METERS, PHASE ANGLE  
METERS, POWER  
METERS - SEE SPECIFIC TYPES  
MONITORS, FREQUENCY  
MONITORS, VIDEO  
MONITORS, WAVEFORM  
POWER SUPPLIES, AC  
SHUNTS, METER  
TURNTABLES, PHONOGRAPH  
VOLTMETERS, AC  
VOLTMETERS, DC  
WATTMETERS

SINGER PRODUCTS CO.

ACOUSTIC MATERIALS  
ADAPTERS, FM STEREO  
ALARM, FAULT  
ALARM, SIGNAL  
AMPLIFIER, AF, AGC  
AMPLIFIER, AF, COMPRESSING  
AMPLIFIER, AF,  
PEAK LIMITING, AM  
AMPLIFIER, AF,  
PEAK LIMITING, FM  
AMPLIFIER, AF, REMOTE  
AMPLIFIER, AF, REVERBERATION  
AMPLIFIER, BRIDGING  
AMPLIFIER, RF,  
GENERAL PURPOSE  
AMPLIFIER, RF, PEAK LIMITING  
AMPLIFIER, RF, POWER  
ANTENNAS, AM  
ANTENNAS, FM  
ANTENNAS, MICROWAVE  
ANTENNAS, MOBILE  
ANTENNAS, TV  
ARMS, TONE  
ATTENUATORS, RF  
AUTOMATION EQUIPMENT  
BACKGROUND MUSIC SERVICE  
BALUNS  
BASE STATIONS  
BATTERIES, LEAD ACID  
BATTERIES, NICKEL CADMIUM  
BLOWERS AND FANS  
CABINETS, STORAGE,  
MAGNETIC TAPE  
CABLE, ASSEMBLIES  
CABLE, COAXIAL, FLEXIBLE  
CABLE, COAXIAL, RIGID  
CABLE, SHIELDED, AUDIO  
CAPACITORS, FIXED, CERAMIC  
CAPACITORS, FIXED,  
ELECTROLYTIC  
CAPACITORS, FIXED, FILM  
CAPACITORS, FIXED, MICA  
CAPACITORS, FIXED, OIL-FILLED  
CAPACITORS, FIXED, PAPER  
CAPACITORS, VARIABLE  
CARTRIDGES, MAGNETIC TAPE  
CARTRIDGES, PHONO  
CHARGERS, BATTERY  
CIRCUITS, PRINTED  
COILS, DEFLECTION  
AND FOCUSING  
COILS, TELEPHONE  
COMMUNICATIONS SYSTEMS, CB  
COMMUNICATIONS SYSTEMS,  
LAND MOBILE  
COMMUNICATIONS SYSTEMS,  
MULTIPLEX  
COMMUNICATIONS SYSTEMS,  
TELEPRINTER  
CONNECTORS, COAXIAL CABLE  
CONSOLE, AUDIO, AM  
CONSOLE, AUDIO, FM  
CONSOLE, AUDIO, PORTABLE  
CONSOLE, AUDIO, RECORDING  
CONSOLE, AUDIO, TV  
CONSOLE, CABINETS  
AND HARDWARE  
CORDS, DIAL  
CORDS, PATCH  
CORDS, SET  
CORES, TRANSFORMER AND COIL  
COUPLERS  
DELAY DEVICES, AF  
DEAMAGNETIZERS, BULK TAPE  
EARPHONES, HEADPHONES  
EXCITERS, FM  
FACSIMILE EQUIPMENT  
FUSES  
GENERATORS, FM, STEREO  
GENERATORS, FM, SUBCARRIER  
HARDWARE, TOOLS  
HEADS, DISC RECORDING  
HEADS, ERASE, MAGNETIC  
HEADS, RECORDING, MAGNETIC  
HOLDERS, FUSE

INVERTERS, DC TO AC,  
SOLID STATE  
JACK PANEL ASSEMBLIES  
JACKS  
KNDSB  
LAMPS, PANEL  
LATHE, DISC RECORDING  
MICROPHONE STANDS & BOOMS  
MICROPHONES, CONDENSER  
MICROPHONES, DYNAMIC  
MICROPHONES, VELOCITY  
MICROPHONES, WIRELESS  
MICROWAVE SYSTEMS, STL  
MIXERS - ALSO SEE CONSOLES  
MOBILE EQUIPMENT  
MONITORS, AM SYSTEMS  
MONITORS, FM SYSTEMS, MONO  
MONITORS, FM SYSTEMS, SCA  
MONITORS, FM SYSTEMS, STEREO  
MONITORS, FREQUENCY  
NARROW-BAND FM EQUIPMENT  
NETWORKS, PHASING  
OVENS, CRYSTAL  
PLUGS, COAXIAL  
PLUGS, PHDNE  
POTENTIOMETERS, CARBON  
POTENTIOMETERS, WIREWOUND  
PRINTERS, TELETYPE  
PROJECTORS, FILM  
PROJECTORS, SLIDE  
RECEIVERS, AM  
RECEIVERS, FM  
RECEIVERS, HF  
RECEIVERS, MULTIPLEX  
RECEIVERS, SCA  
RECORDS, BLANK, ACETATE,  
FOR RECORDING  
RECORDS, BLANK, LACQUER,  
FOR RECORDING  
RECTIFIERS, SELENIUM  
REMOTE CONTROL SYSTEMS  
RESISTORS, FIXED, CARBON  
RESISTORS, FIXED, WIREWOUND  
RESISTORS, VARIABLE, CARBON  
REVERBERATION DEVICES  
SCRAMBLERS, SPEECH  
SEMICONDUCTOR DIODES  
SEMICONDUCTOR RECTIFIERS,  
GENERAL  
SEMICONDUCTOR RECTIFIERS,  
HIGH VOLTAGE  
SEMICONDUCTOR RECTIFIERS,  
POWER  
SEMICONDUCTORS,  
TRANSISTORS, AF  
SEMICONDUCTORS, TRANSISTORS,  
GENERAL  
SOLDER  
SOUND SYSTEMS, PORTABLE  
SPEAKER COMPONENTS  
SPEAKERS  
STL EQUIPMENT  
STYLUS, CUTTING  
SWITCHES, COAXIAL  
SWITCHES, ROTARY  
SWITCHES, SLIDE  
SWITCHES, SNAP  
SWITCHES, TOGGLE  
TAPE DECKS, MAGNETIC  
TAPE DUPLICATORS  
TAPE, MAGNETIC RECORDING,  
AUDIO  
TERMINAL BLOCKS  
TERMINAL BOARDS  
TERMINAL STRIPS  
TERMINALS, LUG  
TERMINALS, SOLDER  
TERMINALS, SOLDERLESS  
TESTERS, BATTERY  
TESTERS, INSULATION  
TOOLS, HAND  
TOOLS, PLIERS  
TOOLS, SCREWDRIVERS  
TOOLS, SOLDERING IRONS, GUN  
TOOLS, SOLDERING IRONS,  
INDUSTRIAL  
TOWERS, ANTENNA, RECEIVING  
TOWERS, ANTENNA,  
TRANSMITTING, AM  
TOWERS, ANTENNA,  
TRANSMITTING, FM  
TOWERS, ANTENNA,  
TRANSMITTING, TV  
TRANSFORMERS, AUTO  
TRANSFORMERS, GENERAL  
TRANSMITTER KITS  
TRANSMITTERS, AM, 250 WATT  
TRANSMITTERS, AM, 1 KW  
TRANSMITTERS, AM, 5 KW  
TRANSMITTERS, AM, 10 KW  
TRANSMITTERS, AM, 25 KW  
TRANSMITTERS, AM, 50 KW  
TRANSMITTERS, AM, OVER 50 KW  
TRANSMITTERS, FM, 10 WATTS  
TRANSMITTERS, FM, 100 WATTS  
TRANSMITTERS, FM, 250 WATTS  
TRANSMITTERS, FM, 1 KW  
TRANSMITTERS, FM, 5 KW  
TRANSMITTERS, FM, 20 KW  
TURNTABLES, PHONOGRAPH  
VACUUM TUBES, CATHODE RAY,  
TV, COLOR  
VACUUM TUBES, CATHODE RAY,  
TV, MONOCHROME  
VACUUM TUBES, RECEIVING  
WIRE, INSULATED, HIGH VOLTAGE  
WIRE, SHIELDED  
YOKES, DEFLECTION

SITCO ANTENNA COMPANY

ANTENNAS, CATV  
ANTENNAS, FM  
ANTENNAS, TV,  
MASTER-COMMUNITY  
BALUNS

**SOLA ELECTRIC**

BALLASTS, LAMP  
POWER SUPPLIES, AC  
POWER SUPPLIES, DC  
POWER SUPPLIES, PRECISION  
REGULATORS, CURRENT  
REGULATORS, VOLTAGE  
TRANSFORMERS, AUTO  
TRANSFORMERS, FILAMENT  
TRANSFORMERS, GENERAL  
TRANSFORMERS, PLATE  
TRANSFORMERS, POWER

**SOLITRON DEVICES**

CAPACITORS, VARIABLE  
CIRCUITS, PRINTED  
HEAT SINKS  
MICROWAVE COMPONENTS  
RECTIFIERS - ALSO SEE SEMI-  
CONDUCTORS & VACUUM TUBES  
SEMICONDUCTOR DIODES  
SEMICONDUCTOR RECTIFIERS,  
GENERAL  
SEMICONDUCTOR RECTIFIERS,  
HIGH VOLTAGE  
SEMICONDUCTOR RECTIFIERS,  
POWER  
SEMICONDUCTORS,  
TRANSISTORS, AF  
SEMICONDUCTORS, TRANSISTORS,  
GENERAL  
SEMICONDUCTORS,  
TRANSISTORS, RF  
TESTERS, SEMICONDUCTOR

**SONY CORPORATION OF AMERICA**

AMPLIFIER, AF, STEREO  
ARMS, TONE  
CAMERAS, TV, MONOCHROME  
CARTRIDGES, PHONO  
CONSOLE, VIDEO, PORTABLE  
CONSOLE, VIDEO, STUDIO  
HEADS, ERASE, MAGNETIC  
HEADS, RECORDING, MAGNETIC  
INDUSTRIAL TV  
INVERTERS, DC TO AC,  
VIBRATORS  
MICROPHONES, CONDENSER  
MICROPHONES, DYNAMIC  
MICROPHONES, WIRELESS  
MONITORS, VIDEO  
MONITORS, WAVEFORM  
PREAMPLIFIERS, AUDIO  
RECEIVERS, FM  
RECEIVERS, TV, MONOCHROME  
RECORDERS, MAGNETIC TAPE,  
AUDIO  
RECORDERS, MAGNETIC TAPE,  
VIDEO  
REELS, TAPE  
SOUND SYSTEMS, PORTABLE  
SPEAKER COMPONENTS  
SPEAKERS  
TAPE, MAGNETIC RECORDING,  
VIDEO  
TURNTABLES, PHONOGRAPH  
TV SYSTEMS, CLOSED CIRCUIT

**SORENSEN OPERATION**

POWER SUPPLIES, AC  
POWER SUPPLIES, DC

**SOUNDSCRAFT INDUSTRIES**

AMPLIFIER, AF,  
GENERAL PURPOSE  
AMPLIFIER, BRIDGING  
ATTENUATORS, AUDIO  
MIXERS - ALSO SEE CONSOLES  
OSCILLATORS, AF AND RF,  
SEE GENERATORS  
POWER SUPPLIES, DC  
PREAMPLIFIERS, AUDIO

**THE SOUNDSCRIBER CORPORATION**

DEMAGNETIZERS, BULK TAPE  
RECORDERS, MAGNETIC TAPE,  
AUDIO  
RECORDERS, MAGNETIC TAPE,  
LOGGING

**SOUTH SHORE RADIO-TELEPHONE**

COMMUNICATIONS SYSTEMS,  
LAND MOBILE

**SOUTHWESTERN COMMUNICATIONS**

AMPLIFIER, AF, COMPRESSING  
AMPLIFIER, AF,  
GENERAL PURPOSE  
AMPLIFIER, AF, MONAURAL  
AMPLIFIER, AF,  
PEAK LIMITING, AM  
AMPLIFIER, AF,  
PEAK LIMITING, FM  
AMPLIFIER, AF, REMOTE  
AMPLIFIER, AF, REVERBERATION  
AMPLIFIER, AF, STEREO  
AMPLIFIER, BRIDGING  
ATTENUATORS, AUDIO  
ATTENUATORS, FIXED  
ATTENUATORS,  
IMPEDANCE MATCHING  
BACKGROUND MUSIC SERVICE  
CABLE, ASSEMBLIES  
COMMUNICATIONS SYSTEMS,  
INTERCOM, WIRED  
COMMUNICATIONS SYSTEMS,  
INTERCOM, WIRELESS  
CONSOLE, AUDIO, FM  
CONSOLE, AUDIO, PORTABLE  
CONSOLE, AUDIO, RECORDING  
CONSOLE, AUDIO, TV  
CONSOLE, AUDIO, AM  
EQUALIZERS, AUDIO EMPHASIS  
JACK PANEL ASSEMBLIES  
LATHE, DISC RECORDING  
MAINTENANCE SERVICES, AM

MAINTENANCE SERVICES, FM  
MIXERS - ALSO SEE CONSOLES  
MONITORS, AM SYSTEMS  
MONITORS, FM SYSTEMS, MONO  
NETWORKS, MATCHING, AUDIO  
NETWORKS, PHASING  
OSCILLATORS, AM  
OSCILLATORS, FM  
PANELS, INSTRUMENT,  
FOR RACK MOUNTING  
POWER SUPPLIES, DC  
PREAMPLIFIERS, AUDIO  
REMOTE CONTROL SYSTEMS  
SOUND SYSTEMS, OUTDOOR  
SOUND SYSTEMS, PORTABLE  
SWITCHERS

**SPARTA ELECTRONIC CORPORATION**

CABINETS, STORAGE,  
MAGNETIC TAPE, CARTRIDGE  
CARTRIDGES, MAGNETIC TAPE  
CARTRIDGES, PHONO  
CONSOLE, AUDIO, AM  
CONSOLE, AUDIO, FM  
CONSOLE, AUDIO, PORTABLE  
CONSOLE, AUDIO, RECORDING  
CONSOLE, AUDIO, TV  
CONSOLE, CABINETS  
AND HARDWARE  
DEMAGNETIZERS, BULK TAPE  
DEMAGNETIZERS, HEAD  
HEADS, RECORDING, MAGNETIC  
MICROPHONES, CONDENSER  
MICROPHONES, DYNAMIC  
MICROPHONES, WIRELESS  
MIXERS - ALSO SEE CONSOLES  
PREAMPLIFIERS, AUDIO  
RECORDERS, MAGNETIC TAPE,  
AUDIO CARTRIDGE  
SPLICERS, MAGNETIC TAPE  
AND FILM  
TAPE, MAGNETIC RECORDING,  
AUDIO, CARTRIDGE  
TURNTABLES, PHONOGRAPH

**SPEEDY-Q ENTERPRISES**

RECORDS, SOUND EFFECT

**SPENCER-KENNEY LABORATORIES**

ALARM, FAULT  
AMPLIFIER, BRIDGING  
AMPLIFIER, CATV  
AMPLIFIER, DISTRIBUTION  
CABINETS, METAL  
CABLE, CATV, HARDWARE  
CABLE, COAXIAL, FLEXIBLE  
CATV EQUIPMENT - ALSO SEE  
OTHER CATEGORIES  
CATV, CHANNEL AMPLIFIERS  
CATV, HEAD-END EQUIPMENT  
CONNECTORS, COAXIAL CABLE  
GENERATORS, SIGNAL, PULSE  
HEAD-END EQUIPMENT,  
SEE CATV HEAD-END EQUIPMENT  
TV SYSTEMS, CLOSED CIRCUIT

**STACO, INC.**

POWER SUPPLIES, AC  
POWER SUPPLIES, DC  
REGULATORS, VOLTAGE  
TAPE DECKS, MAGNETIC  
TRANSFORMERS, AUDIO,  
ISOLATION  
TRANSFORMERS, AUDIO, MATCHING  
TRANSFORMERS, AUDIO,  
POWER OUTPUT  
TRANSFORMERS, AUTO  
TRANSFORMERS, FILAMENT  
TRANSFORMERS, GENERAL  
TRANSFORMERS, PLATE  
TRANSFORMERS, POWER  
TRANSFORMERS, TRANSISTOR  
TRANSFORMERS, VARIABLE

**STAINLESS, INC.**

ANTENNAS, AM  
ANTENNAS, MICROWAVE  
ANTENNAS, TV,  
MASTER-COMMUNITY  
COMMUNICATIONS SYSTEMS,  
MICROWAVE  
REFLECTORS, PASSIVE  
TOWERS, ANTENNA,  
CATV, HEAD-END  
TOWERS, ANTENNA, RECEIVING  
TOWERS, ANTENNA,  
TRANSMITTING, AM  
TOWERS, ANTENNA,  
TRANSMITTING, FM  
TOWERS, ANTENNA,  
TRANSMITTING, TV

**STANCLIFF-HOFFMAN CORPORATION**

AMPLIFIER, AF, COMPRESSING  
AMPLIFIER, AF,  
GENERAL PURPOSE  
AMPLIFIER, AF, MONAURAL  
AMPLIFIER, AF, REMOTE  
AMPLIFIER, BRIDGING  
PREAMPLIFIERS, AUDIO  
RECORDERS, FILM, MAGNETIC  
RECORDERS, MAGNETIC TAPE,  
AUDIO  
RECORDERS, MAGNETIC TAPE,  
LOGGING  
REELS, FILM  
TAPE DECKS, MAGNETIC

**STANDARD ELECTRONICS CORP**

AMPLIFIER, RF,  
GENERAL PURPOSE  
AMPLIFIER, TV, VIDEO  
BALUNS  
CONSOLE, AUDIO, FM  
CONSOLE, AUDIO, TV  
CONSOLE, VIDEO, STUDIO

**COUPLERS**

DEMODULATORS  
DIPLEXERS  
DIVIDERS, POWER  
DUMMY LOAD  
EXCITERS, FM  
FILTERS, RF  
FILTERS, OTHER  
GENERATORS, FM, STEREO  
MAINTENANCE SERVICES, FM  
MAINTENANCE SERVICES, TV  
METERS, STANDING WAVE  
MODULATORS, TV  
NARROW-BAND FM EQUIPMENT  
OSCILLATORS, FM  
OSCILLATORS, TV  
POWER SUPPLIES, AC  
RECTIFIERS - ALSO SEE SEMI-  
CONDUCTORS & VACUUM TUBES  
TRANSMITTERS, FM, 250 WATTS  
TRANSMITTERS, FM, 1 KW  
TRANSMITTERS, FM, 5 KW  
TRANSMITTERS, FM, 10 KW  
TRANSMITTERS, FM, 20 KW  
TRANSMITTERS, TV, 500 WATTS  
TRANSMITTERS, TV, 5 KW  
TRANSMITTERS, TV, 10 KW  
TRANSMITTERS, TV, 25 KW  
TRANSMITTERS, TV, 35 KW  
TRANSMITTERS, TV, 50 KW  
TRANSMITTERS, TV, 70 KW  
TV SYSTEMS, CLOSED CIRCUIT  
WATTMETERS

**STANDARD KOLLSMAN INDUSTRIES**

CONVERTERS

**STANDARD RECORD MFG. CO.**

REELS, TAPE

**STEPHENS ELECTRONICS**

AMPLIFIER, AF, AGC  
AMPLIFIER, AF, COMPRESSING  
AMPLIFIER, AF,  
GENERAL PURPOSE  
AMPLIFIER, AF, MONAURAL  
AMPLIFIER, AF, REMOTE  
AMPLIFIER, AF, REVERBERATION  
AMPLIFIER, AF, STEREO  
AMPLIFIER, BRIDGING  
AMPLIFIER, PULSE  
ATTENUATORS, AUDIO  
CONSOLE, AUDIO, AM  
CONSOLE, AUDIO, FM  
CONSOLE, AUDIO, PORTABLE  
CONSOLE, AUDIO, PORTABLE  
CONSOLE, AUDIO, RECORDING  
CONSOLE, AUDIO, TV  
FILTERS, AUDIO  
GENERATORS, SIGNAL, AF  
NETWORKS, MATCHING, AUDIO  
POWER SUPPLIES, DC  
PREAMPLIFIERS, AUDIO  
RECORDERS, MAGNETIC TAPE,  
AUDIO  
RELAYS, PHOTOELECTRIC  
RELAYS, PLUG-IN  
REVERBERATION DEVICES  
SWITCHES, ILLUMINATED  
SWITCHING SYSTEMS

**S. STERLING CO.**

AUTOMATION EQUIPMENT  
CALIBRATION SERVICE,  
FREQUENCY  
CALIBRATION SERVICE,  
INSTRUMENT  
COMPUTER EQUIPMENT  
COMPUTER SERVICES  
CONSOLE, AUDIO, TV  
CONSOLE, VIDEO, PORTABLE  
CONSOLE, VIDEO, STUDIO  
INDUSTRIAL TV  
JACK PANEL ASSEMBLIES  
SWITCHING MATRIXES  
SWITCHING SYSTEMS  
TV SYSTEMS, CLOSED CIRCUIT

**STRUTHERS-DUNN**

RELAYS, COAXIAL  
RELAYS, GENERAL PURPOSE  
RELAYS, LATCHING  
RELAYS, OVERLOAD  
RELAYS, PLUG-IN  
RELAYS, POWER  
RELAYS, SEQUENCING  
RELAYS, STEPPING  
RELAYS, TIME DELAY

**MATTHEW STUART & CO.**

RECORDERS, MAGNETIC TAPE,  
AUDIO

**SUPERIOR CABLE CORPORATION**

CABLE, ARMORED  
CABLE, ASSEMBLIES  
CABLE, CATV, HARDWARE  
CABLE, COAXIAL, FLEXIBLE  
CABLE, COAXIAL, RIGID  
CABLE, DIRECT-BURIAL  
CABLE, SHIELDED, AUDIO  
CABLE, TELEPHONE  
CATV, CABLE TERMINALS  
CLAMPS, CABLE  
CONNECTORS, COAXIAL CABLE  
CONNECTORS, RF  
WIRE, INSULATED, HOOKUP

**SWAGER TOWER CORPORATION**

ANTENNAS, AM  
FLASHERS, TOWER  
MAINTENANCE SERVICES,  
STEPLEJACK  
TOWERS, ANTENNA,  
CATV, HEAD-END

TOWERS, ANTENNA, RECEIVING  
TOWERS, ANTENNA,  
TRANSMITTING, AM  
TOWERS, ANTENNA,  
TRANSMITTING, FM  
TOWERS, ANTENNA,  
TRANSMITTING, TV  
WIRE, BARE, COPPER  
WIRE, BARE, COPPER STRAP

**SWITCHCRAFT, INC.**

ADAPTERS, CONNECTOR  
CONNECTORS, AF & MICROPHONE  
CONNECTORS, RF  
CORDS, PATCH  
HARDWARE, GENERAL  
JACK PANEL ASSEMBLIES  
JACKS  
PLUGS, PHONE  
SWITCHES, ILLUMINATED  
SWITCHES, INTERLOCK  
SWITCHES, LEVER  
SWITCHES, MULTICONTACT  
SWITCHES, PUSHBUTTON,  
NON ILLUMINATED  
SWITCHES, SLIDE  
SWITCHES, TELEPHONE TYPE  
SWITCHING MATRIXES  
SWITCHING SYSTEMS

**SYLVANIA-COMM. ELECTRONICS DIV**

AMPLIFIER, DISTRIBUTION  
AMPLIFIER, PULSE  
AMPLIFIER, STABILIZING  
CABLE, ASSEMBLIES  
CAMERA, MOUNTING EQUIPMENT  
CAMERA, REMOTE CONTROL  
EQUIPMENT  
CAMERAS, TV, MONOCHROME  
CONSOLE, AUDIO, TV  
CONSOLE, VIDEO, PORTABLE  
CONSOLE, VIDEO, STUDIO  
DISPLAY EQUIPMENT, TV  
DOLLIES, CAMERA  
GENERATORS, SIGNAL,  
TV SYNCHRONIZING  
INDUSTRIAL TV  
LENSES, OPTICAL, FIXED  
LENSES, OPTICAL, ZOOM  
LIGHTING, TV, SYSTEMS  
MICROPHONE HARDWARE  
MICROPHONE STANDS & BOOMS  
MICROPHONES, DYNAMIC  
MOBILE EQUIPMENT  
MODULATORS, TV  
MONITORS, VIDEO  
MONITORS, WAVEFORM  
MULTIPLEXERS  
POWER SUPPLIES, DC  
PROJECTORS, FILM  
PROJECTORS, SLIDE  
RECEIVERS, TV, MONOCHROME  
SWITCHERS  
TV SYSTEMS, CLOSED CIRCUIT

**SYLVANIA-SEMICONDUCTOR DIV.**

DETECTORS, MICROWAVE  
MICROWAVE COMPONENTS  
SEMICONDUCTOR DIODES  
SEMICONDUCTOR RECTIFIERS,  
GENERAL  
SEMICONDUCTOR RECTIFIERS,  
POWER  
SEMICONDUCTORS,  
TRANSISTORS, AF  
SEMICONDUCTORS, TRANSISTORS,  
GENERAL  
SEMICONDUCTORS,  
TRANSISTORS, RF

**SYNCRON CORPORATION**

MICROPHONES, CONDENSER

**TAPE-ATHON CORP.**

CATV EQUIPMENT - ALSO SEE  
OTHER CATEGORIES  
RECORDERS, MAGNETIC TAPE,  
AUDIO  
RECORDERS, MAGNETIC TAPE,  
LOGGING

**TAPECASTER ELECTRONICS**

AMPLIFIER, AF, REMOTE  
AUTOMATION EQUIPMENT  
CARTRIDGES, MAGNETIC TAPE  
DELAY DEVICES, AF  
HEADS, RECORDING, MAGNETIC  
RECORDERS, MAGNETIC TAPE,  
AUDIO  
RECORDERS, MAGNETIC TAPE,  
AUDIO, CARTRIDGE  
TAPE, MAGNETIC RECORDING,  
AUDIO

**TECHNICAL APPLIANCE CORP**

ANTENNAS, CATV  
ANTENNAS, FM  
ANTENNAS, MICROWAVE  
ANTENNAS, MOBILE  
ANTENNAS, TV  
ANTENNAS, TV,  
MASTER-COMMUNITY  
ANTENNAS, 2500 MHZ  
CABLE, COAXIAL, RIGID  
MOUNTS, ANTENNA, FIXED  
MOUNTS, ANTENNA, MOBILE  
RADOMES  
WAVEGUIDE AND  
ASSOCIATED COMPONENTS

**THE TECHNICAL MATERIEL CORP**

ADAPTERS, CONNECTOR  
AMPLIFIER, BRIDGING  
AMPLIFIER, RF, POWER  
ANALYZERS, SIDEBAND  
BALUNS

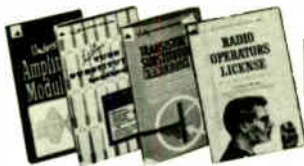

# Howard W. Sams Books FOR THE BROADCAST FIELD

## Broadcast Engineering Notebooks

by *Harold E. Ennes*. An invaluable reference series for the use of broadcast station personnel. Provides the latest data required by engineers, technicians, operators, and students.

- Vol. 1. Television Tape Fundamentals. BEN-1
  - Vol. 2. AM-FM Broadcast Operations. BEN-2
  - Vol. 3. AM-FM Broadcast Maintenance. BEN-3
  - Vol. 4. Television Systems Maintenance. BEN-4
- Each volume..... \$595

## Design & Operation of Regulated Power Supplies

by *Irving M. Gottlieb*. Latest edition provides a full understanding of the design and operation of these increasingly important power supplies. Includes full design and circuitry data. 144 pages. RPS-2..... \$325

## Understanding Amplitude Modulation

by *Irving M. Gottlieb*. Explains the principles used in the amplitude modulation of a carrier signal, and describes the various types of systems (tube and transistor), used to accomplish it. 160 pages. AMG-1..... \$325

## Tube Substitution Handbook, 10th Ed.

Lists over 12,000 direct substitutions; includes hundreds of new substitutions. Covers substitutions for receiving, picture tubes, subminiature, industrial, and communications types. TUB-10..... \$175

## Transistor Substitution Handbook, 6th Ed.

Lists thousands of direct substitutions; includes basing diagrams and polarity indications. Covers all types of transistors, both U.S. and foreign (including Japanese). SSH-6..... \$150

## First-Class Radiotelephone License Handbook

by *Edward M. Noll*. Newest edition updated to cover the latest revision of the FCC Commercial Examination Element IV. Invaluable preparation for the exam as well as a thorough textbook for broadcast engineering training. 400 pages. BON-2..... \$525

## Second-Class Radiotelephone License Handbook

by *Edward M. Noll*. New 3rd edition; complete study course for Elements I, II and III of the latest FCC exams. 336 pages. QAN-2..... \$475

## Radio Operators License Handbook

by *Edward M. Noll*. Latest edition. This guide fully explains the laws, rules, regulations, and accepted operating procedures for those who operate radio equipment. 136 pages. RON-1..... \$325

## Frequency Changers

by *Irving M. Gottlieb*. A one-source handbook covering basic principles; includes chapters on modulators, frequency multipliers, translators, and dividers; also covers commercial circuits. 224 pages. FCG-1..... \$495

## Closed-Circuit TV Handbook

by *Leon A. Wortman*. The most comprehensive book on the subject. Describes systems and applications; invaluable for anyone planning, installing, operating, or maintaining CCTV. 288 pages. CLC-1..... \$750

## Electronic Tests & Measurements

by *Robert G. Middleton*. A practical reference guide on how to measure such diverse properties as inductance, capacitance, resistance, frequency, distortion, impedance, transistor characteristics, zener point and many others. 288 pages. MET-1..... \$695

## North American Radio-TV Station Guide

by *Vane A. Jones*. New 3rd edition. Lists frequencies, call letters, locations, power, etc., for all AM, FM, and TV stations (including UHF) in the U.S., Canada, Cuba, Mexico and West Indies. 128 pages. R5G-3..... \$195

## Dictionary of Electronics Communications Terms

Complete and up-to-date definitions of terms used in broadcasting, microwave, 2-way radio, amateur, and CB radio systems. Includes over 2500 entries. COM-1..... \$395



**HOWARD W. SAMS & CO., INC.**

4300 WEST 62nd ST. • INDIANAPOLIS, INDIANA 46206

CONNECTORS, ANTENNA  
CONNECTORS, COAXIAL CABLE  
CONNECTORS, RF  
CONVERTERS, FSK  
CORDS, PATCH  
DUMMY LOAD  
GENERATORS, SIGNAL, RF  
JACK PANEL ASSEMBLIES  
JACKS  
METERS, STANDING WAVE  
PLUGS, COAXIAL  
RECEIVERS, HF  
SWITCHES, COAXIAL  
TRANSFORMERS, RF

### TEKTRONIX INC

ANALYZERS, SPECTRUM  
CAMERAS, OSCILLOSCOPE  
DOLLIES, TEST EQUIPMENT  
GENERATORS, SIGNAL, MARKER  
GENERATORS, SIGNAL, PULSE  
GENERATORS, SIGNAL, SQUARE WAVE  
MONITORS, WAVEFORM  
OSCILLOSCOPES  
PROBES, OSCILLOSCOPE  
TESTERS, SEMICONDUCTOR  
GENERATORS, SIGNAL, DOT BAR  
GENERATORS, SIGNAL, TV SYNCHRONIZING  
GENERATORS, SIGNAL, VITS  
INDUSTRIAL TV  
MONITORS, VIDEO  
OSCILLATORS, TV  
PROBES, OSCILLOSCOPE  
STL EQUIPMENT  
SWITCHING MATRICES  
TELEPHONE EQUIPMENT  
TESTERS, INSULATION  
TV SYSTEMS, CLOSED CIRCUIT

### TELEQUIP CORPORATION

AMPLIFIER, DISTRIBUTION  
AMPLIFIER, PULSE  
AMPLIFIER, STABILIZING  
AMPLIFIER, TV, VIDEO  
CABLE, ASSEMBLIES  
CABLE, CATV, HARDWARE  
CABLE, COAXIAL, FLEXIBLE  
CABLE, COAXIAL, RIGID  
CABLE, DIRECT-BURIAL  
CABLE, SHIELDED, AUDIO  
CAMERA, MOUNTING EQUIPMENT  
CAMERA, REMOTE  
CONTROL EQUIPMENT  
CATV EQUIPMENT - ALSO SEE OTHER CATEGORIES  
CATV, CABLE TERMINALS  
CATV, ORIENTATION EQUIPMENT  
COILS, DEFLECTION  
AND FOCUSING  
CONSOLE, CABINETS  
AND HARDWARE

CONSOLE, KITS  
CONSOLE, VIDEO, PORTABLE  
CONSOLE, VIDEO, STUDIO  
DISPLAY EQUIPMENT, TV  
DOLLIES, CAMERA  
DOLLIES, TEST EQUIPMENT  
GENERATORS, SIGNAL, COLOR BAR  
GENERATORS, SIGNAL, OOT BAR  
GENERATORS, SIGNAL, PULSE  
GENERATORS, SIGNAL, RF  
GENERATORS, SIGNAL, SPECIAL EFFECT  
GENERATORS, SIGNAL, SQUARE WAVE  
GENERATORS, SIGNAL, TV SYNCHRONIZING  
GENERATORS, SIGNAL, VITS  
TESTERS, VACUUM TUBE  
VACUUM TUBE, CATHODE RAY, OSCILLOSCOPE

### TELECTRO INDUSTRIES INC

AMPLIFIER, AF, STEREO  
HEADS, ERASE, MAGNETIC  
HEADS, RECORDING, MAGNETIC  
RECEIVERS, AM  
RECEIVERS, FM  
RECEIVERS, HF  
RECEIVERS, MULTIPLEX  
RECORDERS, MAGNETIC TAPE, AUDIO  
RECORDERS, MAGNETIC TAPE, LOGGING  
RECORDERS, MAGNETIC TAPE, VIDEO  
TAPE DECKS, MAGNETIC  
TAPE DUPLICATORS  
TURNTABLES, PHONOGRAPH

### TELE-DEVICES CO

MOBILE EQUIPMENT, TV

### TELEMATION, INC.

AMPLIFIER, TV, VIDEO  
BROADCAST PROGRAMMING SERVICE  
CAMERAS, TV, MONOCHROME  
CATV EQUIPMENT - ALSO SEE OTHER CATEGORIES  
CATV, ORIENTATION EQUIPMENT  
EDUCATION FACILITIES, EOPT  
GENERATORS, SIGNAL, TV SYNCHRONIZING  
LENSES, OPTICAL, ZOOM  
MULTIPLEXERS  
SWITCHERS  
TV SYSTEMS, CLOSED CIRCUIT

### TELEMET COMPANY

AMPLIFIER, DISTRIBUTION  
AMPLIFIER, KEYING  
AMPLIFIER, PULSE  
AMPLIFIER, STABILIZING  
AMPLIFIER, TV, BOOSTER

AMPLIFIER, TV, VIDEO  
CABLE, CATV, HARDWARE  
CATV, CABLE TERMINALS  
CATV, HEAD-END EQUIPMENT  
CLAMPS, COMPONENT  
FILTERS, OTHER  
GENERATORS, SIGNAL, COLOR BAR  
HARDWARE, CHASSIS  
HARDWARE, DIAL POINTERS  
HARDWARE, FIXTURES, HOLDING  
HARDWARE, GENERAL  
HARDWARE, MOUNTS  
HARDWARE, PANEL  
HARDWARE, RACK  
INDUSTRIAL TV  
KNOBS  
LENSES, OPTICAL, FIXED  
LENSES, OPTICAL, ZOOM  
LIGHTING, TV, COMPONENTS  
LIGHTING, TV, CONTROLS  
LIGHTING, TV, SYSTEMS  
MODULATORS, TV  
MONITORS, VIDEO  
MOUNTS, ANTENNA, FIXED  
MOUNTS, ANTENNA, MOBILE  
MOUNTS, INSTRUMENT  
OSCILLOSCOPES  
PANELS, INSTRUMENT, FOR RACK MOUNTING  
POWER SUPPLIES, AC  
POWER SUPPLIES, DC  
PREAMPLIFIERS, VIDEO  
SWITCHING SYSTEMS  
TV SYSTEMS, CLOSED CIRCUIT  
VACUUM TUBES, CAMERA, IMAGE-ORTHICON  
VACUUM TUBES, CAMERA, VIDICON  
VACUUM TUBES, RECEIVING  
WIRE, SHIELDED  
YOKES, DEFLECTION

### TELESIS CORPORATION

AMMETERS, RF  
AMPLIFIER, CATV  
AUTOMATION EQUIPMENT  
CATV, CHANNEL AMPLIFIERS  
CATV, HEAD-END EQUIPMENT  
CATV, ORIENTATION EQUIPMENT  
WEATHER INSTRUMENTS

### TELETRONIX DIVISION

AMMETERS, RF  
AMPLIFIER, AF, AGC  
AMPLIFIER, AF, COMPRESSING  
AMPLIFIER, AF, GENERAL PURPOSE  
AMPLIFIER, AF, MONAURAL  
AMPLIFIER, AF, PEAK LIMITING, AM  
AMPLIFIER, AF, PEAK LIMITING, FM  
AMPLIFIER, AF, REMOTE

AMPLIFIER, RF, POWER  
ANTENNAS, AM  
ANTENNAS, FM  
CONNECTORS, COAXIAL CABLE  
CONSOLE, AUDIO, AM  
CONSOLE, AUDIO, FM  
CONSOLE, AUDIO, PORTABLE  
CONSOLE, AUDIO, RECORDING  
CONSOLE, AUDIO, TV  
EXCITERS, FM  
FILTERS, ANTENNA  
FILTERS, RF  
GENERATORS, FM, SUBCARRIER  
KNOBS  
MICROWAVE SYSTEMS, STL  
MONITORS, FREQUENCY  
REMOTE CONTROL SYSTEMS  
STL EQUIPMENT  
TRANSMITTERS, AM, 250 WATT  
TRANSMITTERS, AM, 1 KW  
TRANSMITTERS, AM, 5 KW  
TRANSMITTERS, AM, 10 KW  
TRANSMITTERS, AM, 50 KW  
TRANSMITTERS, FM, 250 WATTS  
TRANSMITTERS, FM, 1 KW  
TRANSMITTERS, FM, 3 KW  
TRANSMITTERS, FM, 5 KW  
TRANSMITTERS, FM, 10 KW

### TELEVISION UTILITIES CORP.

AMPLIFIER, DISTRIBUTION  
CAMERA, MOUNTING EQUIPMENT  
CAMERA, REMOTE  
CONTROL EQUIPMENT  
CAMERAS, FILM, CINE  
CAMERAS, TV, MONOCHROME  
CATV EQUIPMENT - ALSO SEE OTHER CATEGORIES  
CATV, HEAD-END EQUIPMENT  
CATV, ORIENTATION EQUIPMENT  
CONSOLE, CABINETS  
AND HARDWARE  
CONSOLE, KITS  
CONSOLE, VIDEO, PORTABLE  
CONSOLE, VIDEO, STUDIO  
DISPLAY EQUIPMENT, TV  
DOLLIES, CAMERA  
INDUSTRIAL TV  
LENSES, OPTICAL, FIXED  
LENSES, OPTICAL, ZOOM  
LIGHTING, TV, COMPONENTS  
LIGHTING, TV, CONTROLS  
LIGHTING, TV, SYSTEMS  
LIGHTNING ARRESTERS  
MAINTENANCE SERVICES, TV  
MICROPHONE STANDS & BOOMS  
MONITORS, VIDEO  
PROJECTORS, FILM  
RECORDERS, FILM, LIGHT  
RECORDERS, FILM, MAGNETIC  
TAPE, MAGNETIC RECORDING, VIDEO

TV SYSTEMS, CLOSED CIRCUIT  
VACUUM TUBES, CAMERA, VIDICON

TELEVISION ZOOMAR COMPANY  
LENSES, OPTICAL, ZOOM  
PROCESSORS, FILM, COLOR

TELECOM INDUSTRIES

ATTENUATORS, AUDIO  
ATTENUATORS, MICROWAVE  
ATTENUATORS, RF  
ATTENUATORS, VIDEO  
BALUNS  
GENERATORS, SIGNAL, RF  
NETWORKS, MATCHING, RF  
OSCILLATORS, OTHER

TELSTA CORPORATION

LIFTS, AERIAL, TRUCK-MOUNTED

TELTRON, INC.

TV SYSTEMS, CLOSED CIRCUIT  
VACUUM TUBES, CAMERA,  
IMAGE-ORTHICON

TENSOLITE INSULATED WIRE CO.

CABLE, COAXIAL, FLEXIBLE  
CABLE, SHIELDED, AUDIO  
WIRE, INSULATED, HIGH VOLTAGE  
WIRE, INSULATED, HOOKUP  
WIRE, SHIELDED  
WIRING AND CABLING SERVICES

TEXAS ELECTRONICS

CLOCKS  
DIALS, INSTRUMENT  
INVERTERS, DC TO AC,  
SOLID STATE  
VOLTMETERS, AC  
VOLTMETERS, DC  
WEATHER INSTRUMENTS

TEXAS INSTRUMENTS

CAPACITORS, FIXED, FILM  
INTEGRATED CIRCUITS  
MICROWAVE COMPONENTS  
RECTIFIERS - ALSO  
SEE SEMICONDUCTORS  
RESISTORS, FIXED, CARBON  
RESISTORS, FIXED, PRECISION  
SEMICONDUCTOR DIODES  
SEMICONDUCTOR RECTIFIERS,  
GENERAL  
SEMICONDUCTOR RECTIFIERS,  
HIGH VOLTAGE  
SEMICONDUCTOR RECTIFIERS,  
POWER  
SEMICONDUCTOR RECTIFIERS  
SILICON CONTROLLED - SCR  
SEMICONDUCTORS, THYRISTORS  
SEMICONDUCTORS,  
TRANSISTORS, AF  
SEMICONDUCTORS,  
TRANSISTORS, FE  
SEMICONDUCTORS, TRANSISTORS,  
GENERAL  
SEMICONDUCTORS,  
TRANSISTORS, RF

THE TEXWIP COMPANY

CLEANERS, LENS  
CLEANERS, OTHER

THE THOMAS & BETTS CO.

CLAMPS, CABLE  
CLAMPS, COMPONENT  
CLAMPS, GROUND  
CLAMPS, TUBE  
CONNECTORS, COAXIAL CABLE  
CONNECTORS, POWER  
CONNECTORS, RF  
HARDWARE, TOOLS  
TERMINAL BLOCKS  
TERMINAL BOARDS  
TERMINALS, BARRIER  
TERMINALS, LUG  
TERMINALS, SOLDERLESS  
TOOLS, CRIMPERS  
TOOLS, CUTTERS  
TOOLS, HAND

THOMSON ELECTRIC CO.

ANTENNAS, FM  
ANTENNAS, TV  
CAMERAS, TV, MONOCHROME  
DOLLIES, CAMERA  
JACKS  
TRANSMITTERS, FM  
TRANSMITTERS, TV  
TV SYSTEMS, CLOSED CIRCUIT

THOR ELECTRONICS

SEMICONDUCTOR DIODES  
SEMICONDUCTOR RECTIFIERS,  
GENERAL  
SEMICONDUCTOR RECTIFIERS,  
HIGH VOLTAGE  
SEMICONDUCTOR RECTIFIERS,  
POWER  
SEMICONDUCTOR RECTIFIERS,  
SILICON CONTROLLED - SCR  
SEMICONDUCTORS, THYRISTORS  
SEMICONDUCTORS,  
TRANSISTORS, AF  
SEMICONDUCTORS,  
TRANSISTORS, FE  
SEMICONDUCTORS, TRANSISTORS,  
GENERAL  
SEMICONDUCTORS,  
TRANSISTORS, RF  
VACUUM TUBES, BALLAST  
VACUUM TUBES, CAMERA,  
IMAGE-ORTHICON  
VACUUM TUBES, CAMERA, VIDICON

VACUUM TUBES, CATHODE RAY,  
TV, COLOR

VACUUM TUBES, CATHODE RAY,  
TV, MONOCHROME  
VACUUM TUBES, RECEIVING  
VACUUM TUBES, TRANSMITTING

TIMES WIRE AND CABLE

CABLE, ASSEMBLIES  
CABLE, CATV, HARDWARE  
CABLE, COAXIAL, FLEXIBLE  
CABLE, COAXIAL, RIGID  
CABLE, DIRECT-BURIAL  
CONNECTORS, COAXIAL CABLE  
CONNECTORS, RF

TOPAZ, INCORPORATED

INVERTERS, DC TO AC,  
SOLID STATE

TOWNSEND ASSOCIATES

ATTENUATORS, RF  
CHOPPERS - VERTICAL INTERVAL  
CIRCUITS, PRINTED  
COMMUNICATIONS SYSTEMS,  
MULTIPLX  
EXCITERS, FM  
MAINTENANCE SERVICES, TV  
MODULATORS, TV  
NARROW-BAND FM EQUIPMENT  
POWER SUPPLIES, DC,  
HIGH VOLTAGE  
HIGH VOLTAGE  
TRANSLATOR SYSTEMS  
TRANSMITTERS, TV, 3 KW  
TRANSMITTERS, TV, 15 KW  
TRANSMITTERS, TV, 30 KW  
TRANSMITTERS, TV, 55 KW  
TRANSMITTERS, TV, 100 KW

TRAID CORP.

CAMERA, MOUNTING EQUIPMENT  
CAMERAS, FILM, CINE  
CAMERAS, OSCILLOSCOPE  
GENERATORS, SIGNAL, PULSE  
LENSES, OPTICAL, FIXED  
LENSES, OPTICAL, ZOOM  
PROJECTORS, FILM

TRANSCO PRODUCTS, INTL.

RECORDS, BLANK, ACETATE,  
FOR RECORDING  
RECORDS, BLANK, LACQUER,  
FOR RECORDING  
STYLI, CUTTING  
STYLI, PLAYBACK

TREPAC CORPORATION OF AMERICA

ALARM, FAULT  
ALARM, SIGNAL  
AMPLIFIER, AF, COMPRESSING  
AMPLIFIER, AF,  
GENERAL PURPOSE  
AMPLIFIER, AF, REMOTE  
AUTOMATION EQUIPMENT  
CIRCUITS, PRINTED  
COMMUNICATIONS SYSTEMS,  
TELEPRINTER  
DELAY DEVICES, AF  
FILTERS, AUDIO  
GENERATORS, SIGNAL, AF  
INVERTERS, DC TO AC,  
SOLID STATE  
JACK PANEL ASSEMBLIES  
MONITORS, AM SYSTEMS  
OSCILLATORS, AF AND RF,  
SEE GENERATORS  
POWER SUPPLIES, AC  
POWER SUPPLIES, DC  
PREAMPLIFIERS, AUDIO  
PRINTERS, TELETYPE  
RELAYS, PLUG IN  
RELAYS, SEQUENCING  
RELAYS, TIME DELAY  
REMOTE CONTROL SYSTEMS  
SCRAMBLERS, SPEECH  
STL EQUIPMENT  
SWITCHERS  
SWITCHING SYSTEMS

TRIPLETT ELECTRICAL INSTR. CO.

AMMETERS, AC  
AMMETERS, AC, THERMOCOUPLE  
AMMETERS, DC  
AMMETERS, RF  
GENERATORS, SIGNAL, RF  
METERS, DB AND VU  
OHMMETERS  
SHUNTS, METER  
TESTERS, SEMICONDUCTOR  
TESTERS, VACUUM TUBE  
VOLTMETERS, AC  
VOLTMETERS, DC  
VOLTMETERS, VACUUM TUBE  
WATTMETERS

TROMPETER ELECTRONICS

ADAPTERS, CONNECTOR  
ATTENUATORS, AUDIO  
ATTENUATORS, FIXED  
ATTENUATORS,  
IMPEDANCE MATCHING  
ATTENUATORS, RF  
ATTENUATORS, VIDEO  
AUTOMATION EQUIPMENT  
CABLE, ASSEMBLIES  
CONNECTORS, AF & MICROPHONE  
CONNECTORS, ANTENNA  
CONNECTORS, COAXIAL CABLE  
CONNECTORS, RF  
COROS, PATCH  
JACK PANEL ASSEMBLIES  
JACKS  
PLUGS, COAXIAL  
RELAYS, COAXIAL

RELAYS, SEQUENCING  
RELAYS, STEPPING  
SWITCHES, COAXIAL  
SWITCHES, CROSSBAR  
SWITCHING MATRICES  
SWITCHING SYSTEMS

TRUSONIC

ENCLOSURES, SPEAKER  
MICROPHONE HARDWARE  
MICROPHONES, CONDENSER  
MICROPHONES, WIRELESS  
SOUND SYSTEMS, OUTDOOR  
SOUND SYSTEMS, PORTABLE  
SOUND SYSTEMS, THEATER  
SPEAKER COMPONENTS  
SPEAKERS

TRW ELECTRONICS

CAPACITORS, FIXED, AIR  
CAPACITORS, FIXED, CERAMIC  
CAPACITORS, FIXED, FILM  
CAPACITORS, FIXED, METALLIZED  
CAPACITORS, VARIABLE  
CATV EQUIPMENT - ALSO SEE  
OTHER CATEGORIES  
COILS, ANTENNA LOADING  
COILS, CHOKE, AF  
COILS, CHOKE, RF  
COILS, DEFLECTION  
AND FOCUSING  
CRYSTALS, PIEZOELECTRIC  
FILTERS, AUDIO  
FILTERS, OTHER  
OVENS, CRYSTAL  
POWER SUPPLIES, PRECISION  
SEMICONDUCTOR DIODES  
SEMICONDUCTOR RECTIFIERS,  
GENERAL  
SEMICONDUCTOR RECTIFIERS,  
HIGH VOLTAGE  
SEMICONDUCTORS, TRANSISTORS,  
GENERAL  
SEMICONDUCTORS,  
TRANSISTORS, RF  
SPEAKERS  
TRANSFORMERS, AUDIO,  
ISOLATION  
TRANSFORMERS, AUDIO, MATCHING  
TRANSFORMERS, AUDIO,  
POWER OUTPUT  
TRANSFORMERS, AUTO  
TRANSFORMERS, COUPLING  
TRANSFORMERS, FILAMENT  
TRANSFORMERS, GENERAL  
TRANSFORMERS, PLATE  
TRANSFORMERS, POWER  
TRANSFORMERS, TRANSISTOR  
TRANSFORMERS, VARIABLE

TRYLON INCORPORATED

ANTENNAS, AM  
BALUNS  
MAINTENANCE SERVICES,  
STEEPLEJACK  
TOWERS, ANTENNA, RECEIVING  
TOWERS, ANTENNA,  
TRANSMITTING, AM  
TOWERS, ANTENNA,  
TRANSMITTING, FM  
TOWERS, ANTENNA,  
TRANSMITTING, TV  
TRANSMISSION LINES, OPEN WIRE

T T ELECTRONICS

FILTERS, AUDIO  
FILTERS, RF  
FILTERS, OTHER

TURNER MICROPHONE CO.

MICROPHONE HARDWARE  
MICROPHONE STANOS & BOOMS  
MICROPHONES, DYNAMIC

TV CABLE SUPPLY CO.

DIVIDERS, FREQUENCY  
METERS, FIELD STRENGTH  
METERS, FREQUENCY CALIBRATING  
TRANSFORMERS, AUDIO, MATCHING  
TRANSFORMERS, GENERAL

ULTRA AUDIO PRODUCTS

COMMUNICATIONS SYSTEMS,  
INTERCOM, WIRED  
CONSOLE, AUDIO, FM  
CONSOLE, AUDIO, PORTABLE  
CONSOLE, AUDIO, RECORDING  
CONSOLE, AUDIO, TV  
CONSOLE, AUDIO, AM

UNGAR ELECTRIC TOOLS

TOOLS, SOLDERING IRONS,  
INDUSTRIAL

UNITED RADIO SUPPLY, INC.

CONSOLE, AUDIO, AM  
CONSOLE, AUDIO, RECORDING

UNITED STATES PLASTIC ROPE

COROS, DIAL  
INSULATORS, ANTENNA

UNITED STATES TOWERS

TOWERS, ANTENNA,  
CATV, HEAD-END  
TOWERS, ANTENNA, RECEIVING  
TOWERS, ANTENNA,  
TRANSMITTING, AM  
TOWERS, ANTENNA,  
TRANSMITTING, FM  
TOWERS, ANTENNA,  
TRANSMITTING, TV

UNITED TRANSFORMER COMPANY

BOXES, DECADE, INDUCTOR  
COILS, CHOKE, AF

CDLS, HYBRID  
COILS, TELEPHONE  
DELAY DEVICES, AF  
DELAY LINES  
FILTERS, AUDIO  
FILTERS, OTHER  
INDUCTANCES, FIXED  
INDUCTANCES, VARIABLE  
TRANSFORMERS, AUDIO,  
ISOLATION  
TRANSFORMERS, AUDIO, MATCHING  
TRANSFORMERS, AUDIO,  
POWER OUTPUT  
TRANSFORMERS, AUTO  
TRANSFORMERS, COUPLING  
TRANSFORMERS, FILAMENT  
TRANSFORMERS, GENERAL  
TRANSFORMERS, PLATE  
TRANSFORMERS, POWER  
TRANSFORMERS, TRANSISTOR  
TRANSFORMERS, VARIABLE

UP-RIGHT SCAFFOLDS

CAMERA, MOUNTING EQUIPMENT  
LIGHTNING ARRESTERS  
TOWERS, ANTENNA,  
CATV, HEAD-END  
TOWERS, ANTENNA, RECEIVING  
TOWERS, ANTENNA,  
TRANSMITTING, AM  
TOWERS, ANTENNA,  
TRANSMITTING, FM  
TOWERS, ANTENNA,  
TRANSMITTING, TV

UPSON BROS.

HARDWARE, TOOLS  
KITS  
TOOLS, HAND  
TOOLS, SCREWDRIVERS

UTICA CORP.

ANTENNAS, MOBILE  
BASE STATIONS  
COMMUNICATIONS SYSTEMS, CB  
COMMUNICATIONS SYSTEMS,  
INTERCOM, WIRELESS  
COMMUNICATIONS SYSTEMS,  
LAND MOBILE  
MOBILE EQUIPMENT  
MONITORS, FM SYSTEMS, MONO  
MOUNTS, ANTENNA, MOBILE  
MOUNTS, INSTRUMENT  
NARROW-BAND FM EQUIPMENT  
PREAMPLIFIERS, AUDIO  
RECEIVERS, AM  
RECEIVERS, FM  
TRANSMITTERS, TV, 60 WATTS

UTILITY PRODUCTS CO.

CATV, CABLE TERMINALS  
TERMINAL BOARDS

UTILITY TOWER CO.

CATV EQUIPMENT - ALSO SEE  
OTHER CATEGORIES  
INSULATORS, TOWER BASE  
MAINTENANCE SERVICES,  
STEEPLEJACK  
PREFABRICATED BUILDINGS  
REFLECTORS, PASSIVE  
TOWERS, ANTENNA,  
CATV, HEAD-END  
TOWERS, ANTENNA, RECEIVING  
TOWERS, ANTENNA,  
TRANSMITTING, AM  
TOWERS, ANTENNA,  
TRANSMITTING, FM  
TOWERS, ANTENNA,  
TRANSMITTING, TV  
WIRE, BARE, COPPER  
WIRE, BARE, COPPER STRAP

VALUE INCORPORATED

DRAFTING EQUIPMENT

VEGA ELECTRONICS CORP.

AMPLIFIER, AF, COMPRESSING  
MICROPHONES, CONDENSER  
MICROPHONES, WIRELESS  
RECEIVERS, FM

VENT-RAK INCORPORATED

CABINETS, METAL  
CONSOLE, CABINETS  
AND HARDWARE  
HARDWARE, CHASSIS  
LAMP ASSEMBLIES  
PANELS, INSTRUMENT,  
FOR RACK MOUNTING  
REELS, CABLE, AUTOMATIC  
SLIDES, CHASSIS

VIDEON CORPORATION

AMPLIFIER, DC  
AMPLIFIER, DISTRIBUTION  
AMPLIFIER, TV, VIDEO  
ANALYZERS, VIDEO  
DIVIDERS, FREQUENCY  
GENERATORS, SIGNAL, COLOR BAR  
GENERATORS, SIGNAL, DOT BAR  
GENERATORS, SIGNAL, MARKER  
GENERATORS, SIGNAL, PULSE  
GENERATORS, SIGNAL,  
SPECIAL EFFECT  
GENERATORS, SIGNAL,  
SQUARE WAVE  
GENERATORS, SIGNAL,  
TV SYNCHRONIZING  
GENERATORS, SIGNAL, VITS  
MULTIPLXERS  
OSCILLATORS, TV  
POWER SUPPLIES, DC  
POWER SUPPLIES, PRECISION  
PREAMPLIFIERS, VIDEO

SWITCHERS  
SWITCHING SYSTEMS

VIKING OF MINNEAPOLIS

AMPLIFIER, AF, MONAURAL  
AMPLIFIER, AF, STEREO  
CARTRIDGES, MAGNETIC TAPE  
RECORDERS, MAGNETIC TAPE,  
RECORDERS, MAGNETIC TAPE,  
AUOJO  
AUDIO, CARTRIDGE  
RECORDERS, MAGNETIC TAPE,  
TAPE DECKS, MAGNETIC  
TAPE DUPLICATORS

VISHAY RESISTOR PRODUCTS

RESISTORS, FIXEO,  
NONINDUCTIVE  
RESISTORS, FIXEO, PRECISION

VISUAL ELECTRONICS CORP

AMPLIFIER, AF, AGC  
AMPLIFIER, AF, COMPRESSING  
AMPLIFIER, AF,  
GENERAL PURPOSE  
AMPLIFIER, AF, MONAURAL  
AMPLIFIER, AF,  
PEAK LIMITING, AM  
AMPLIFIER, AF,  
PEAK LIMITING, FM  
AMPLIFIER, AF, REMOTE  
AMPLIFIER, AF, REVERBERATION  
AMPLIFIER, DISTRIBUTION  
AMPLIFIER, PULSE  
AMPLIFIER, STABILIZING  
AMPLIFIER, TV, VIDEO  
AMPLIFIER, VIDEO, SWEEP  
ANTENNAS, AM  
ANTENNAS, FM  
ANTENNAS, MICROWAVE  
ANTENNAS, TV  
AUTOMATION EQUIPMENT  
CABLE, COAXIAL, FLEXIBLE  
CABLE, COAXIAL, RIGID  
CAMERA, MOUNTING EQUIPMENT  
CAMERA, REMOTE  
CONTROL EQUIPMENT  
CAMERAS, FILM, CINE  
CAMERAS, TV, COLOR  
CAMERAS, TV, MONOCHROME  
CARTRIDGES, MAGNETIC TAPE  
COMMUNICATIONS SYSTEMS,  
INTERCOM, WIREO  
CONNECTORS, COAXIAL CABLE  
CONSOLE, AUDIO, AM  
CONSOLE, AUDIO, FM  
CONSOLE, AUDIO, PORTABLE  
CONSOLE, AUDIO, RECORDING  
CONSOLE, AUDIO, TV  
CONSOLE, VIDEO, STUDIO  
OIPLEXERS  
DOLLIES, CAMERA  
DROPOUT COMPENSATOR,  
VIDEO TAPE  
EDITORS, VIDEO TAPE  
EXCITERS, FM  
GENERATORS, SIGNAL, COLOR BAR  
GENERATORS, SIGNAL, DOT BAR  
GENERATORS, SIGNAL, MARKER  
GENERATORS, SIGNAL, PULSE  
GENERATORS, SIGNAL, SPECIAL EFFECT  
GENERATORS, SIGNAL,  
SQUARE WAVE  
GENERATORS, SIGNAL,  
TV SYNCHRONIZING  
GENERATORS, SIGNAL, VITS  
JACK PANEL ASSEMBLIES  
JACKS  
LENSES, OPTICAL, FIXED  
LENSES, OPTICAL, ZOOM  
LIGHTING, TV, COMPONENTS  
LIGHTING, TV, CONTROLS  
LIGHTING, TV, SYSTEMS  
MICROPHONE HARDWARE  
MICROPHONE STANDS & BOOMS  
MICROPHONES, CONDENSER  
MICROPHONES, DYNAMIC  
MICROPHONES, VELOCITY

MICROPHONES, WIRELESS  
MICROWAVE SYSTEMS, STL  
MONITORS, AM SYSTEMS  
MONITORS, FM SYSTEMS, MONO  
MONITORS, FM SYSTEMS, SCA  
MONITORS, FM SYSTEMS, STEREO  
MONITORS, FREQUENCY  
MONITORS, PHASE  
MONITORS, VIDEO  
MONITORS, WAVEFORM  
PROJECTORS, FILM  
PROJECTORS, SLIDE  
RECORDERS, MAGNETIC TAPE,  
AUDIO  
RECORDERS, MAGNETIC TAPE,  
VIDEO  
RELAYS, COAXIAL  
REMOTE CONTROL SYSTEMS  
REVERBERATION DEVICES  
SCREENS, PROJECTION, FRONT  
SCREENS, PROJECTION, REAR  
STL EQUIPMENT  
SWITCHERS  
SWITCHING SYSTEMS  
TAPE DECKS, MAGNETIC  
TAPE DUPLICATORS  
TOWERS, ANTENNA,  
TRANSMITTING, AM  
TOWERS, ANTENNA,  
TRANSMITTING, FM  
TOWERS, ANTENNA,  
TRANSMITTING, TV  
TRANSMISSION LINES  
TRANSMISSION TEST SETS  
TRANSMITTERS, AM, 1 KW  
TRANSMITTERS, AM, 5 KW  
TRANSMITTERS, AM, 10 KW  
TRANSMITTERS, AM, 25 KW  
TRANSMITTERS, AM, 50 KW  
TRANSMITTERS, FM, 3 KW  
TRANSMITTERS, FM, 5 KW  
TRANSMITTERS, FM, 10 KW  
TRANSMITTERS, FM, 20 KW  
TRANSMITTERS, TV, 15 KW  
TRANSMITTERS, TV, 30 KW  
TRANSMITTERS, TV, 55 KW  
TURNTABLES, PHONOGRAPH  
VACUUM TUBES, CAMERA,  
IMAGE-ORTHICON  
VACUUM TUBES, CAMERA,  
PLUMBICON R  
VACUUM TUBES, CAMERA, VIDICON  
VESTIGIAL SIOEBAND FILTERS

VITAL INDUSTRIES

AMPLIFIER, DISTRIBUTION  
AMPLIFIER, STABILIZING  
AMPLIFIER, TV, VIDEO  
SWITCHING SYSTEMS

VITRO ELECTRONICS

CIRCUITS, PRINTED  
CONNECTORS, COAXIAL CABLE  
CONNECTORS, RF  
CORDS, PATCH  
HARDWARE, PANEL  
HARDWARE, RACK  
INTEGRATEO CIRCUITS  
JACK PANEL ASSEMBLIES  
JACKS  
METERS, FIELD STRENGTH  
MONITORS, AM SYSTEMS  
MONITORS, FM SYSTEMS, MONO  
MONITORS, PHASE  
RECEIVERS, AM  
RECEIVERS, FM  
RECEIVERS, HF  
RECEIVERS, MULTIPLEX  
TERMINAL STRIPS  
WIRING AND CABLING SERVICES

VUE-TRONICS INC.

RECORDERS, VIDEO,  
FILM, KINESCOPE

WABER ELECTRONICS INC.

CABINETS, METAL  
CONNECTORS, POWER  
CORDS, SET

COUPLERS  
DOLLIES, CAMERA  
DOLLIES, TEST EQUIPMENT  
DUCTS, WIRING  
KITS

RACKS, MOUNTING  
SWITCHES, MECHANICALLY  
ACTUATED  
VOLTMETERS, AC

WALLACH & ASSOCIATES

CABINETS, STORAGE, OISC  
CABINETS, STORAGE, FILM  
CABINETS, STORAGE,  
MAGNETIC TAPE  
CABINETS, STORAGE, SLIDE

WARD ELECTRONIC INDUSTRIES

AMPLIFIER, AF, AGC  
AMPLIFIER, AF, COMPRESSING  
AMPLIFIER, AF,  
GENERAL PURPOSE  
AMPLIFIER, AF,  
PEAK LIMITING, AM  
AMPLIFIER, AF, REMOTE  
AMPLIFIER, BRIDGING  
AMPLIFIER, DISTRIBUTION  
AMPLIFIER, PULSE  
AMPLIFIER, SENSING  
AMPLIFIER, STABILIZING  
AMPLIFIER, TV, VIDEO  
ANALYZERS, SIDEBAND  
AUTOMATION EQUIPMENT  
COMMUNICATIONS SYSTEMS,  
INTERCOM, WIRED  
CONSOLE, AUDIO, FM  
CONSOLE, AUDIO, PORTABLE  
CONSOLE, AUDIO, RECORDING  
CONSOLE, AUDIO, TV  
CONSOLE, AUDIO, AM  
CONSOLE, VIDEO, PORTABLE  
CONSOLE, VIDEO, STUDIO  
DEMODULATORS  
NETWORKS, PHASING  
PREAMPLIFIERS, AUDIO  
PREAMPLIFIERS, VIDEO  
SWITCHERS  
SWITCHING MATRICES  
SWITCHING SYSTEMS

WATERS MANUFACTURING

ANTENNAS, MOBILE  
ATTENUATORS, RF  
DUMMY LOAD  
FILTERS, OTHER  
METERS, FREQUENCY  
MOUNTS, ANTENNA, MOBILE  
POTENTIOMETERS, WIREWOUND  
RESISTORS, VARIABLE,  
WIREWOUND  
SWITCHES, COAXIAL  
WATTMETERS

WAVEFORMS, INCORPORATED

ANALYZERS, DISTORTION  
GENERATORS, SIGNAL, AF  
GENERATORS, SIGNAL,  
SQUARE WAVE  
METERS, FREQUENCY  
OSCILLATORS, AF AND RF,  
SEE GENERATORS  
OSCILLATORS, OTHER  
TRANSMISSION TEST SETS  
VOLTMETERS, AC  
VOLTMETERS, VACUUM TUBE

WECKESSER COMPANY

CABLE, ASSEMBLIES  
CLAMPS, CABLE

WESTINGHOUSE ELECTRIC CORP.

VACUUM TUBES, CAMERA,  
IMAGE-ORTHICON  
VACUUM TUBES, CAMERA, VIOICON  
VACUUM TUBES, CATHODE RAY,  
TV, COLOR  
VACUUM TUBES, CATHODE RAY,  
TV, MONOCHROME  
VACUUM TUBES, RECEIVING  
VACUUM TUBES, TRANSMITTING

WIDE RESPONSE

REELS, TAPE  
TAPE, MAGNETIC RECORDING,  
AUDIO

WILKINSON ELECTRONICS, INC

AMPLIFIER, AF, AGC  
AMPLIFIER, AF, MONAURAL  
AMPLIFIER, AF,  
PEAK LIMITING, AM  
AMPLIFIER, AF,  
PEAK LIMITING, FM  
CONSOLE, AUDIO, AM  
CONSOLE, AUDIO, FM  
CONSOLE, AUDIO, RECORDING  
CONSOLE, AUDIO, TV  
EXCITERS, FM  
GENERATORS, FM, STEREO  
GENERATORS, FM, SUBCARRIER  
GENERATORS, SIGNAL, RF  
METERS, FIELD STRENGTH  
MONITORS, AM SYSTEMS  
MONITORS, FREQUENCY  
RECTIFIERS - ALSO SEE  
SEMICONDUCTORS  
SEMICONDUCTOR RECTIFIERS,  
GENERAL  
SEMICONDUCTOR RECTIFIERS,  
HIGH VOLTAGE  
SEMICONDUCTOR RECTIFIERS,  
POWER  
TRANSMITTERS, AM, 1 KW  
TRANSMITTERS, AM, 5 KW  
TRANSMITTERS, AM, 10 KW  
TRANSMITTERS, FM, 1 KW  
TRANSMITTERS, FM, 5 KW  
TRANSMITTERS, FM, 7.5 KW  
TRANSMITTERS, FM, 10 KW  
TRANSMITTERS, FM, 20 KW

W. WILSON CORPORATION

HARWARE, MOUNTS  
LAMPS, PROJECTION  
MOBILE EQUIPMENT  
SCREENS, PROJECTION, REAR

XCELITE INCORPORATED

HARWARE, TOOLS  
TOOLS, CUTTERS  
TOOLS, HAND  
TOOLS, PLIERS  
TOOLS, SCREWDRIVERS  
TOOLS, WRENCHES

YOKOGAWA ELECTRIC WORKS

AMMETERS, AC  
AMMETERS, AC, THERMOCOUPLE  
AMMETERS, DC  
AMMETERS, RF  
BRIDGES  
METERS, DB AND VU  
METERS, DB AND VU, WIDE RANGE  
METERS, FIELD STRENGTH  
METERS, FREQUENCY  
METERS, LIGHT  
METERS, PHASE ANGLE  
METERS, POWER  
OHMMETERS  
PANELS, INSTRUMENT,  
FOR RACK MOUNTING  
RECORDERS, PAPER,  
LOGGING AND GRAPHIC  
TESTERS, INSULATION  
VOLTMETERS, AC  
VOLTMETERS, DC  
WATTMETERS

ZOLOMATIC CORPORATION

LENSES, OPTICAL, FIXED  
LENSES, OPTICAL, ZOOM  
PROJECTORS, SLIDE

ZOOMAR, INC.

LENSES, OPTICAL, FIXED  
LENSES, OPTICAL, ZOOM  
METERS, LIGHT

# Here's one way to kill a Teltron tube



Teltron image orthicons have long life characteristics. You'll grow old trying to wear them out. These tubes offer performance features surpassing the finest image orthicon's manufactured (monochrome or color applications) at a savings of 35% to 65% (computed on average hourly cost basis). Teltron tubes are guaranteed as long or longer than any competitors product, (for just about everything but smashing them with a hammer). Join the list of satisfied Teltron users. You'll agree that Teltron is the "Answer to a need".

## Teltron tubes are die-hards.



**teltron**  
INCORPORATED

7 BALA AVENUE, BALA CYNWYD, PA. 19004 Telephone 215-664-6672



# When leading broadcast engineers insist on genuine EEV camera tubes, they must have good reasons.

## They do. Plenty of them, in fact.

Television broadcasters the world over have come to rely almost exclusively on the unique combination of tube quality and long-life economy that only English Electric Valve — the world's foremost camera tube manufacturer — can provide.

Typical of this foremost camera tube line are . . .

### ELCON-Target Image Orthicons

- Long life — 3 to 4 times longer
- Stable, non-stick target
- Uniform sensitivity and gamma throughout extended tube life
- No burn-in



#### ELCON Color-Matched Tubes

Matched color sets of ELCON Image Orthicon tubes are selected on the basis of camera control operating parameters, as well as tube sensitivities and signal current outputs. And, in most cases, the need for trimming with neutral density filters is completely eliminated . . . orbiting is not required . . . and sensitivity is improved.

| Type            | Description                                     |
|-----------------|---|
| 4415E/<br>4416E | 3" tube—field mesh; matched set of three tubes. |



#### ELCON 3" Image Orthicon

Non-field mesh and field mesh tubes with effective operational life of 3,000 to 5,000 hours. Full target warranty of 1,200 hours.

| Type    | Description   |
|---------|---|
| 5820A/E | 3" tube—non-field mesh                                |
| 7293B   | 3" tube—field mesh                                    |
| 8093A/E | 3" tube—field mesh; with close target-to-mesh spacing |



#### ELCON 4 1/2" Image Orthicon

ELCON Target — JEDEC-designated; 3,000-5,000/hour operational life; 1,200/hour target warranty.

| Type  | Description  |
|-------|--|
| 7295C | 4 1/2" tube — field mesh.                                    |
| 7389C | 4 1/2" tube — field mesh; with close mesh-to-target spacing. |

### 1-inch Vidicons



#### 1-inch Vidicons, Integral Mesh

| Type  | Description   |
|-------|---|
| P860  | Utilizes new photosurface (similar to 8625, 8626) for high sensitivity, minimum lag; film or studio applications; monochrome or color |
| 7038  | Monochrome or color film camera applications; 600 ma filament   |
| 7735A | For studio and remote cameras; high sensitivity; 600 ma filament  |

#### 1-inch Vidicons, Separate Mesh

- Highest quality pictures with minimal shading
- Low lag; reduced long-term sticking.
- Lower light level operation
- Photo-surface of 8625 and 8626 vidicons combine high "blue" sensitivity and reduced "red" sensitivity for correct panchromatic response to standard tungsten lighting
- Resolution exceeds 1,000 lines
- Beam landing errors minimized for improved signal output

| Type | Description  |
|------|--|
| 8625 | High sensitivity photosurface; preferred spectral response of 7038 type; 600 ma filament |
| 8626 | Equivalent to 8625, with 95 ma filament for transistorized cameras                       |
| 8507 | Low lag, high sensitivity characteristics; 600 ma filament                               |
| 8541 | Equivalent to 8507, with 95 ma filament for transistorized cameras                       |
| 8572 | Low lag characteristics for film application, monochrome or color; 600 ma filament       |



Other tubes available for specific applications. World-wide patents applied for.

For complete information and prices on the Blue Ribbon quality EEV camera tube line, contact

### VISUAL ELECTRONICS CORPORATION

356 west 40th street • new york, n.y. 10018 • (212) 736-5840

FIRST BY ANY STANDARD

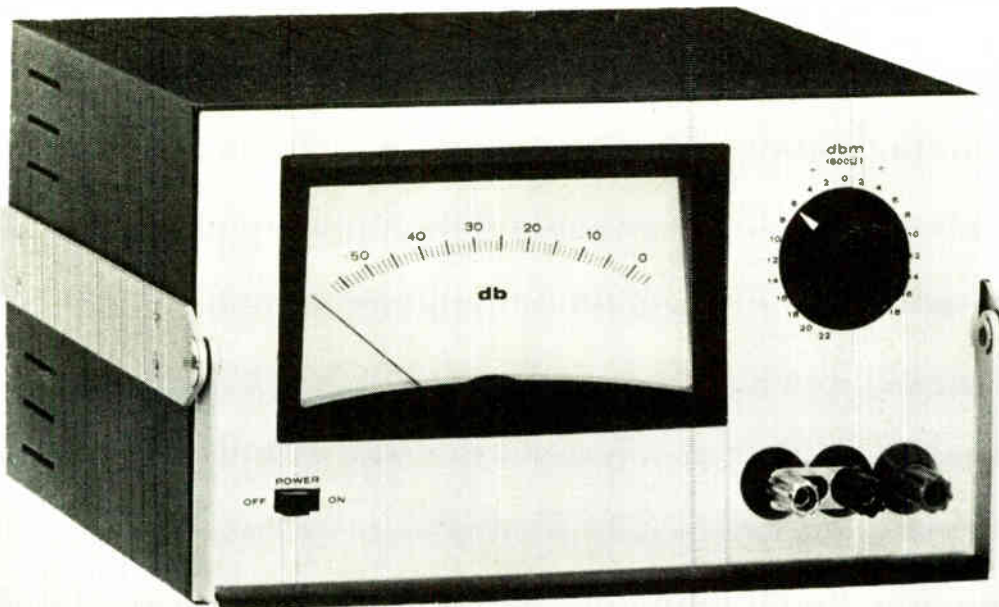

## A new way to keep your signal clean.

CBS Laboratories presents its new Model 600 Wide Range Program Monitor.

This remarkable instrument can't censor "blue" comics, but it can keep you from transmitting cross-talk, studio noise and other sounds that may clutter your signal.

In fact, it's the first monitor to combine the latest developments in audio technology with the reliability of solid-state design for accurate audio measurement and analysis on a single 60 dB-wide scale.

Where the standard Volume Indicator measures only the top 23 dB of signal level logarithmically, this new Program Monitor displays information from +3 to -57 dB on a single linear, decibel scale, thus permitting accurate reading of low level audio material as well as line noise during program pauses. The 0 dB reference settings are adjustable from +18 to -22 dBm.

The 600 is also equipped with a separate DC output for graphic logging over the full 60 dB range or to drive a second meter for remote monitoring. It is also available in a standard 19-inch mounting rack from which it can be easily removed for portable use.

While not intended as a replacement for the standard Volume Indicator, the 600's meter ballistics are such that its readings are compatible with VU indications. It's a practical studio monitor as well as a valuable measuring tool.

### SPECIFICATIONS:

Model 600 Wide Range Program Monitor, \$345. As shown above, without standard 19-inch mounting enclosure, \$305.

|                               |   |
|-------------------------------|---|
| Reference Deflection (0 dB)   | Adjustable from +18 to -22 dBm  |
| Internal Noise Level          | At least 15 dB below the -57 dB reading   |
| Total Measurable Range        | -79 to +21 dBm  |
| Scale                         | Linear 60 dB-wide scale from -57 to +3 dB   |
| DC Output                     | Linear volts dB output is 6 volts maximum at 5500 ohms impedance. Calibrated to provide remote monitoring |
| Frequency Range               | 50 to 15,000 cps  |
| Linearity                     | ± 1 dB  |
| Input Impedance               | 15,000 ohms, bridging, balanced or unbalanced   |
| Maximum Operating Temperature | 55° C   |
| Dimensions                    | In enclosure: 19" wide, 7" high, 10" deep<br>Out of enclosure: 9" wide, 5" high, 10" deep                 |
| Power Requirements            | 12 watts, 115/230 volts AC  |
| Shipping Weight               | With enclosure: 14 lbs.<br>Without enclosure: 9 lbs.  |

## Technical series Professional Test records

Unique, high-precision tools designed to help audio and quality control engineers and test and service technicians to evaluate audio components, equipment and systems.

Each record has a complete series of tests. These eliminate the need for certain equipment, save hours of time, and make the record a productive tool in the laboratory, on the production line, and in field testing.

### BTR 150 BROADCAST TEST RECORD

Developed especially to meet needs of broadcast engineers seeking a convenient signal source for testing and adjusting all audio equipment. It contains Volume Indicator ballistic calibration signals and is an essential tool for measuring phonographic pickup response. In providing complex waveforms for special tests, it replaces elaborate instrumentation generally unavailable in broadcast stations. Can be used to advantage by all AM, FM, TV and FM-Stereo broadcasters. BTR 150, Net Ea. \$10.00

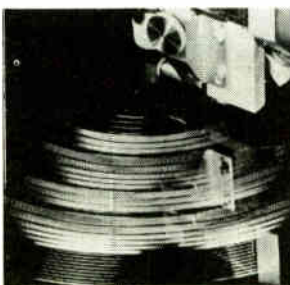

### STR 130 RIAA FREQUENCY RESPONSE TEST RECORD

Designed for calibration of professional recording equipment and for testing response of professional and consumer record reproduction equipment. Rapid, accurate procedures replace lengthy and tedious adjustments. Time for production testing and quality control is reduced to a fraction of time required with conventional methods. Suitable for use with automatic curve tracer to provide permanent, visible records for precise evaluation. Instruction for use without automatic curve tracing included. STR 130, Net Ea. \$10.00

### STR 100 STEREOPHONIC FREQUENCY TEST RECORD

Designed for evaluation of pickups and systems, it was recorded with a constant amplitude characteristic below 500 cps and a constant velocity characteristic above 500 cps. Tests include: Sweep Frequency (with the sweep rate synchronized with the General Radio Type 1521 A Recorder); Spot Frequency (with voice announcements); Channel Separation; Wavelength Loss and Stylus Wear (to pinpoint oversize or worn-out styli, and excessive pickup tracking force); Compliance; Phasing; Vertical and Lateral Tracking Tone Arm Resonance (to check system performance at low and sub-audible frequencies and thus reveal undamped resonances which may cause equipment over-loading). STR 100, Net Ea. \$8.50

**CBS LABORATORIES**  
Stamford, Connecticut. A Division of  
Columbia Broadcasting System, Inc.

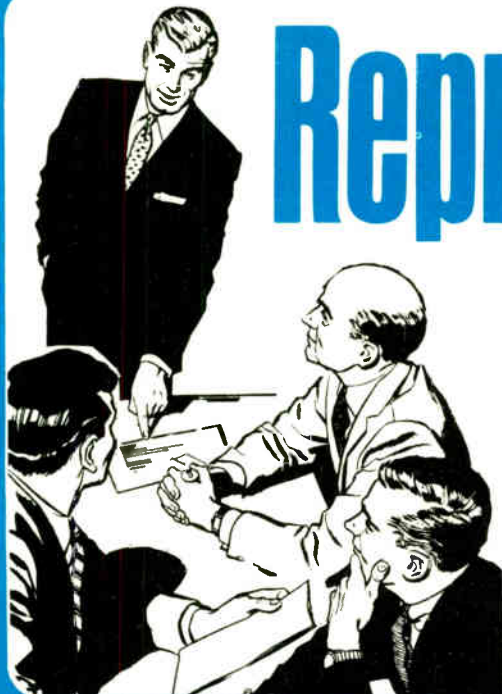

# Representatives

This listing is arranged alphabetically by manufacturer and contains the company name, address, telephone number, and TWX number; sales manager or other executives; brand names; and company representatives arranged alphabetically by states and countries.

## ACME FILM & VIDEOTAPE

**LABORATORIES**  
GENERAL MANAGER  
MEL SAWELSON  
COMPANY ADDRESS  
1161 NORTH HIGHLAND AVE  
LOS ANGELES, CALIF. 90038  
COMPANY REPRESENTATIVES  
BOB TROUP, VP EASTERN SALES  
400 MADISON AVENUE  
NEW YORK, N. Y.  
212 421-3400

## ACME VISIBLE RECORDS, INC.

SALES MANAGER  
J. B. HINCH  
BRAND NAMES  
FLEXOLINE  
ELECTROFILE  
ORDA-FLO  
VERI-VISIBLE  
CENTRAC  
ASTROMATIC  
SUPER-VISIBLE  
COMPANY ADDRESS  
CROZET, VIRGINIA 22932  
COMPANY REPRESENTATIVES  
W. B. SMEA, R. MGR.  
1111 CRENSHAW BLVD.  
LOS ANGELES, CALIF. 90019  
213-933-8595  
B. E. SMITH, R. MGR.  
675 CALIFORNIA STREET  
SAN FRANCISCO, CALIF. 94108  
415-781-5253  
R. B. EVANS, R. MGR.  
934 BANK OF GEORGIA BLDG.  
ATLANTA, GA. 30303  
404-521-0195  
R. O. SHEALOR, R. MGR.  
405 PARK AVENUE  
NEW YORK, N.Y. 10022  
212-PL9-3330  
W. H. BRENT, R. MGR.  
3121 EUCLID AVENUE  
CLEVELAND, OHIO 44115  
216-881-6660  
O. D. SAGGESE, R. MGR.  
BARCLAY BLDG.  
BALA-CYNWYD, PA. 19004  
215-TE9-6020  
R. E. WEBB  
REGIONAL MANAGER  
7701 STEMMONS FREEWAY STE 131  
DALLAS, TEXAS 75247  
214-ME7-1330  
REPS. IN OTHER COUNTRIES  
R. B. MCARDLELL, SALES MGR.  
ACME SEELEY BUSINESS  
SYSTEMS LTD.  
32 MENDOTA ROAD  
TORONTO 18, ONTARIO  
416 259-8435

## ADC PRODUCTS

SALES MANAGER  
W. J. HOLMBECK  
COMPANY ADDRESS  
6405 CAMBRIDGE STREET  
MINNEAPOLIS, MINN 55426  
COMPANY REPRESENTATIVES  
ADC SOUTHWESTERN SALES OFFICE  
99 EAST MAGNOLIA BLVD.  
SUITE 303  
BURBANK, CALIFORNIA 91502  
213-849-5821  
ALLEN I. WILLIAMS COMPANY  
4971 JACKSON STREET  
DENVER, COLORADO 80222  
303-388-4391  
CES ASSOCIATES  
P.O. BOX 1152  
MELBOURNE, FLORIDA 32902  
305-AL4-2183  
JAY C. ANGEL & COMPANY  
2743 PETERSON AVE., WEST  
CHICAGO, ILLINOIS  
312 UP B-0653  
V. J. HUNTOON & ASSOCIATES  
908 BELMONT AVENUE  
SPRINGFIELD, B MASS  
413-ST8-8916  
V. J. HUNTOON & ASSOCIATES  
272 CENTRE STREET  
NEWTON, MASS. 02158  
617-244-2278  
R. G. RAGON, INC.  
1136 WEST LARPENTOUR AVENUE  
ST. PAUL, MINNESOTA 55113  
612-488-6634  
R. R. BURTON SALES CO., INC.  
7546 TROOST AVENUE, RM. 2D  
P.O. BOX 5324  
KANSAS CITY, MISSOURI 64131  
816 JA 3-7865  
R. R. BURTON SALES CO., INC.  
SUITE 201, WOODSON PARK BLDG  
2050 WOODSON ROAD  
ST. LOUIS, MISSOURI 63114  
314-JA6-2226  
ALLEN I. WILLIAMS COMPANY  
3221 SILVER AVENUE, SE  
ALBUQUERQUE, NEW MEXICO 87106  
505-ALS-9632  
E. R. A., INCORPORATED  
330 GREAT NECK ROAD  
GREAT NECK, NEW YORK 11021  
516-HU2-9320  
T. FERGUSON SALES, INC.  
228 WINTON ROAD NORTH  
P.O. BOX 3893  
ROCHESTER, NEW YORK 14610  
716-482-7757  
J. F. WULFETANGE DIVISION  
P.O. BOX 293  
4314 EAST GENESEE STREET  
DEWITT, NEW YORK 13214

315-446-3330

K. O. BRDWN & COMPANY  
P.O. BOX 1791  
GREENSBORO, N.C. 27402  
919-BR3-5973  
JAMES W. MURRAY & ASSOCIATES  
P.O. BOX 11028  
BEL RUE CREST CENTER  
CINCINNATI, OHIO 45211  
513-MO2-1616  
C. A. ROBINSON COMPANY, INC.  
P.O. BOX 51  
4225 MAYFIELD ROAD  
CLEVELAND, OHIO 44121  
216-EV1-9049  
T. J. RAY & COMPANY  
P.O. BOX 5417  
TULSA, OKLAHOMA 74104  
918-MA7-1515  
DANCO CORPORATION  
GERMANTOWN PIKE AND  
QUARRY HALL ROAD  
FAIRVIEW VILLAGE, PA.  
215-BR5-2600  
JOHN A. GREEN COMPANY  
7118 ENVOY COURT  
DALLAS, TEXAS 75247  
214 ME 1-7450  
JOHN A. GREEN COMPANY  
P.O. BOX 66506  
ROOM 110, 3400 MONTROSE  
HOUSTON, TEXAS 77006  
713-JA6-2959  
ALLEN I. WILLIAMS COMPANY  
2461 SOUTH MAIN STREET  
SALT LAKE CITY, UTAH 84115  
801-466-8709  
JON B. JOLLY  
69 MARION STREET  
SEATTLE, WASHINGTON 98104  
MA3-7060  
REPS. IN OTHER COUNTRIES  
WILLER ENGINEERING & SALES CO  
1800 AVENUE ROAD  
TORONTO 12, ONTARIO  
416-783-3373

## ADVANCE INDUSTRIES

SALES MANAGER  
G. S. CHESEN  
COMPANY ADDRESS  
705 DOUGLAS ST.  
STOUC CITY, IOWA 51101  
712-252-4475

## AEROVOX CORP.

SALES MANAGER  
MATT SIMON  
BRAND NAMES  
AEROCUP  
AEROFILM  
AEROGLAZE  
AEROLENE

AEROMET  
AUTOPASS  
CERAFIL  
CERALAM  
POLYCAP  
CEROL  
OURAMIC  
81-ELECTRIC  
COMPANY ADDRESS  
740 BELLEVILLE AVE.  
NEW BEDFORD, MASS. 02741  
COMPANY REPRESENTATIVES  
STANLEY K. WALLACE ASSOCIATES  
3040 WHISPERING PINES CIRCLE  
BIRMINGHAM, 16 ALABAMA  
205-822-2196  
MEYER, ROSS & FLEMING  
113 TENTH STREET  
SAN FRANCISCO 3, CALIF.  
ME 1-0652  
AL J. RISSI SALES  
1017 E. LAS TUNAS DRIVE  
SAN GABRIEL, CALIF. 91776  
CU 3-7614 OR AT 6-1476  
COMMONS, INC.  
2241 STACY DRIVE  
DENVER, COLORADO 80221  
303-428-1575  
GERBER SALES COMPANY  
31 BROADWAY  
NEW HAVEN, CONN. 06515  
777-6279  
STANLEY K. WALLACE ASSOCIATES  
3761 EAST 8TH AVENUE  
HIALEAH, FLORIDA  
OX 1-1654  
STANLEY K. WALLACE ASSOCIATES  
P.O. BOX 67  
LUTZ, FLORIDA  
949-1817  
STANLEY K. WALLACE ASSOCIATES  
715 FLAMINGO DRIVE, S.W.  
ATLANTA 11, GEORGIA  
PL 3-8463  
DOUGHERTY ENTERPRISES  
P.O. BOX 3497  
1164 WAIMANU ST  
HONOLULU, HAWAII 96811  
510-281 & 504-987  
ELLINGER SALES CORP.  
6580 NORTHWEST HIGHWAY  
CHICAGO, ILLINOIS 60631  
312 763-1570  
ELLINGER SALES CORP.  
5214 FOREST AVENUE  
FORT WAYNE, INDIANA  
749-9955  
ELLINGER SALES CORP.  
309 FOURTH AVE., S.E.  
CLARION, IOWA  
515-532-3278  
EARL K. MOORE COMPANY  
5864 LOUISVILLE STREET

NEW ORLEANS, LOUISIANA 70124  
 HU 8-2407  
 GERBER SALES COMPANY  
 48 PEARL STREET  
 BROOKLINE, MASS. 02147  
 BE 2-2425  
 GERBER SALES COMPANY  
 26 MAPLE COURT  
 EAST LONGMEADOW, MASS. 01028  
 413-525-3059  
 ROBERT MILSK COMPANY  
 19375 JAMES COUZENS HIGHWAY  
 DETROIT, MICHIGAN 48235  
 313-342-6660-1-2-3  
 FRED B. HILL COMPANY  
 6110 EXCELSIOR BLVD.  
 MINNEAPOLIS, MINNESOTA 55416  
 929-1783  
 ELLINGER SALES CORP.  
 4969 BANCROFT  
 ST. LOUIS, MISSOURI 63109  
 314-352-2027  
 SIMBERKOFF SALES, INC.  
 175 OAKWOOD AVE.  
 ORANGE, NEW JERSEY  
 201 674-4100  
 SIMBERKOFF SALES, INC.  
 176 STATE STREET  
 ALBANY, NEW YORK  
 518-465-1248  
 SIMBERKOFF SALES, INC.  
 14 JUNIOR AVENUE  
 BUFFALO, NEW YORK  
 716-823-8399  
 STANLEY K. WALLACE ASSOCIATES  
 RTE. 1 BOX 423  
 MATTHEWS, NORTH CAROLINA  
 708-847-9262  
 C. H. DOLFUSS, JR. & COMPANY  
 EAST 21ST AND PAYNE AVE.  
 CLEVELAND 14, OHIO  
 771-1270-1  
 GENE S. ROOT & COMPANY  
 809 WAINWRIGHT DRIVE  
 PITTSBURGH, PA. 15228  
 412-961-4125  
 SIMBERKOFF SALES, INC.  
 1021 LEVICK STREET  
 PHILADELPHIA, PA.  
 215-743-2512  
 STANLEY K. WALLACE ASSOCIATES  
 638 ROCHELLE DRIVE  
 NASHVILLE 4, TENN.  
 VE 2-0794  
 THE TEXPORT COMPANY  
 510A CAPEH  
 MEMPHIS, TENNESSEE  
 363-4160  
 THE TEXPORT COMPANY  
 2411 FARRINGTON STREET  
 DALLAS, TEXAS 75207  
 631-6270  
 THE TEXPORT COMPANY  
 8811 GAYLORD  
 HOUSTON, TEXAS 77024  
 465-3031  
 SIMBERKOFF SALES, INC.  
 724 W-ARLINGTON TOWERS  
 ARLINGTON, VIRGINIA  
 703-525-5898  
 DON SMITH SALES COMPANY  
 2320 NORTH 45TH STREET  
 SEATTLE, WASHINGTON  
 ME 3-3160  
 DON SMITH SALES COMPANY  
 2404 WEST DALTON  
 SPOKANE 13, WASHINGTON  
 FA 5-4022

**AIR SPACE DEVICES, INC.**  
 SALES MANAGER  
 HAROLD A. LANE  
 BRAND NAMES  
 SAF-T-CLIMB  
 COMPANY ADDRESS  
 P.O. BOX 405  
 NORTH HOLLYWOOD, CALIF. 91603

**AITKEN COMMUNICATIONS, INC.**  
 PRESIDENT  
 KENNETH AITKEN  
 COMPANY ADDRESS  
 301 S. LINCOLN ST.  
 TAFT, CALIF. 93268  
 805-765-5403

**ALBION OPTICAL COMPANY INC.**  
 SALES MANAGER  
 ROY M. LEAVESLEY  
 BRAND NAMES  
 DUOPANCHRO  
 KINETAL  
 ORTAL  
 SENTAL  
 SPEEO PANCHRO  
 TELEPANCHRO  
 VARDITAL  
 VIDITAL  
 COMPANY ADDRESS  
 260 NORTH ROUTE 303  
 WEST NYACK, NEW YORK 10994

**ALFORD MANUFACTURING COMPANY**  
 SALES MANAGER  
 HAROLD M. LEACH  
 BRAND NAMES  
 HYBRIDGE  
 COMPANY ADDRESS  
 299 ATLANTIC AVENUE  
 BOSTON, MASS. 02110

**ALLIED ELECTRONICS CORP.**  
 SUBSID. OF ALLIED RADIO CORP.  
 SALES MANAGER  
 R. G. PETERSON

BRAND NAMES  
 KNIGHT-KIT  
 KNIGHT  
 COMPANY ADDRESS  
 100 N. WESTERN AVE.  
 CHICAGO, ILL. 60680  
 COMPANY REPRESENTATIVES  
 K. HILL  
 960 N. SAN ANTONIO RD.  
 LOS ALTOS, CALIF. 94022  
 415-941-0524  
 J. KLIMEC  
 ALLIED RADIO OF CALIF  
 2085 E. FOOTHILL BLVD.  
 PASADENA, CALIF.  
 213-684-0730  
 P. WHILE  
 6767 E. 39TH AVENUE  
 DENVER, COLO. 80207  
 303-399-2250  
 M. SIMMS  
 600 KENNEDY STREET  
 WASHINGTON, O. C. 20011  
 202-291-5000  
 C. SMITH  
 4605 J. F. KENNEDY BLVD.  
 TAMPA, FLA. 33609  
 813-877-6791  
 D. LAEMONT  
 13831 FENKELL AVENUE  
 DETROIT, MICH.  
 313-836-0007  
 J. LOVETANG  
 4330 HIGHWAY 7  
 MINNEAPOLIS, MINN. 55416  
 612-920-5800  
 M. SADOW  
 255 NORTH GOODMAN ST.  
 ROCHESTER, N.Y. 14602  
 716-244-8750  
 R. OFRIEL  
 2975 FAR HILLS AVE.  
 DAYTON, OHIO 45401  
 513-298-9831  
 J. WINTERMUTE  
 3592 LEE ROAD  
 CLEVELAND, OHIO 44120  
 216-752-3290  
 C. HOFFMAN, DIST. MGR.  
 9622 DYER STREET  
 DALLAS, TEXAS 75206  
 214-369-2341  
 M. KEENAN  
 1020 FOURTH AVE., S.  
 SEATTLE, WASHINGTON 98134  
 206-MU2-8026  
 M. MITCHELL  
 3709 FOND DU LAC  
 MILWAUKEE, WISC. 53216  
 414-444-2840

**ALMA ENGINEERING INC.**  
 SALES MANAGER  
 WILLIAM A ROSE  
 BRAND NAMES  
 ALMA  
 COMPANY ADDRESS  
 8090 ENGINEER ROAD  
 SAN DIEGO, CALIF. 92111  
 COMPANY REPRESENTATIVES  
 S. S. KRINSKY & ASSOC.  
 6311 YUCCA STREET  
 HOLLYWOOD 28, CALIF.  
 213-462-1133

**ALPHA WIRE**  
 SALES MANAGER  
 JOHN E. MYERS  
 COMPANY ADDRESS  
 711 LIDGERWOOD AVE.  
 ELIZABETH, NEW JERSEY 07207  
 201 925-8000  
 COMPANY REPRESENTATIVES  
 SHEFLER KAHN COMPANY  
 PHOENIX, ARIZONA  
 602-258-7893  
 F. W. MOULTHROP ASSOC.  
 OAKLAND, CALIFORNIA  
 415-261-7676  
 ALPHA WIRE  
 TORRANCE, CALIFORNIA  
 213-775-6871  
 HYDE ELECTRONIC CO.  
 DENVER, COLORADO  
 303-936-3456  
 GERBER SALES  
 NEW HAVEN, CONN.  
 203-777-6279  
 MILLAR-HUTTO ASSOC.  
 WINTER PARK, FLA.  
 305-647-7407  
 MILLAR-HUTTO ASSOC.  
 ATLANTA, GA.  
 404-876-0919  
 BILL KOLANS COMPANY  
 HONOLULU, HAWAII  
 811-628  
 RUSS GAMME & ASSOC.  
 CHICAGO, ILL.  
 312-775-5381  
 ALPHA WIRE  
 CHICAGO, ILL.  
 312-965-8300  
 THOMAS & SISKUP  
 INDIANAPOLIS, IND.  
 317-251-4574  
 FLORENCE & MEYER  
 WICHITA, KANSAS  
 316-264-2893  
 GERBER SALES COMPANY  
 EAST LONGMEADOW, MASS.  
 413-525-3059  
 GERBER SALES COMPANY  
 WALTHAM, MASS.  
 617-891-8040

SHALCO, INC.  
 FERNDALE, MICH.  
 616 243-7607  
 SHALCO, INC.  
 GRAND RAPIDS, MICH.  
 616-243-7607  
 CLARK R. GIBB CO.  
 MINNEAPOLIS, MINN.  
 612-377-1200  
 FLORENCE & MEYER  
 KANSAS CITY, MO.  
 816-561-7282  
 FLORENCE & MEYER  
 BERKLY, MO.  
 315-521-6800  
 HYDE ELECTRONICS CO.  
 ALBUQUERQUE, N.M.  
 505-265-8895  
 MARSEY SALES  
 ROCHESTER, N.Y.  
 716-442-9700  
 NEAL BEAR CORP.  
 DAYTON, OHIO  
 513-299-3566  
 NEAL BEAR CORP.  
 WEST RICHFIELD, OHIO  
 216-659-3331  
 BEIL & WHITAKER INC.  
 READING, PA.  
 215-779-2610  
 NEBCO ASSOC.  
 MONROEVILLE, PA.  
 412-824-2111  
 THE TEXPORT COMPANY  
 DALLAS, TEXAS  
 214-631-6270  
 THE TEXPORT COMPANY  
 HOUSTON, TEX.  
 713-465-3031  
 HYDE ELECTRONICS INC.  
 SALT LAKE CITY, UTAH  
 801-278-4465  
 DON MILLER & ASSOC.  
 RICHMOND, VA.  
 703-353-5324  
 DAVE MILLER SALES CO.  
 SEATTLE, WASH.  
 206-632-7070  
 RUSS GAMME & ASSOC.  
 MILWAUKEE, WISC.  
 414-354-4889  
 REPS. IN OTHER COUNTRIES  
 FRANK EAKIN, LTD.  
 WESTON, ONTARIO  
 416-741-7485

**ALTEC LANSING, A DIVISION OF**  
 LTV LING ALTEC, INC.  
 VICE PRES. MARKETING  
 H. S. MORRIS  
 BRAND NAMES

PEERLESS ELECTRICAL PRODUCTS  
 GONSET, INC.  
 SEOUR  
 REVOCON  
 MOALA  
 GIANT VOICE  
 COMPANY ADDRESS  
 1515 S. MANCHESTER AVE.  
 ANAHEIM, CALIF. 92803  
 COMPANY REPRESENTATIVES  
 JOHN G. HUMBLE  
 237 ELM STREET  
 SAN MATEO, CALIF. 94401  
 415-343-1477  
 ROGER J. FAUST  
 22211 VAN OWEN STREET  
 CANOGA PARK, CALIF. 91303  
 213 01 6-6285  
 STAN CLUPHF & ASSOC.  
 1268 WEST NEVADA PLACE  
 DENVER, COLORADO 80223  
 303-744-6329  
 NORMAN R. SCHNEIDER  
 3777 MONTFORD DRIVE  
 CHAMBLEE, GEORGIA 30005  
 404-261-8930  
 SHELDON SCHAK & ASSOC.  
 6229 NORTH CALIFORNIA AVE.  
 CHICAGO, ILLINOIS 60645  
 312-338-7730  
 JOE CLANCY & CO., INC.  
 P.O. BOX 269  
 ANGOLA, INDIANA 46703  
 219-665-2561  
 ROBERT J. PATYER  
 8805 BENSON DRIVE  
 OVERLAND PARK, KANSAS 66212  
 913-DU1-2699  
 CHARLES L. RANGE, JR.  
 9131 HOLLYOAK DRIVE  
 BETHESDA, MARYLAND 20034  
 301-365-1699  
 JACK LIZARS  
 P.O. BOX 64  
 FRAMINGHAM, MASS. 01702  
 617-879-2300  
 CHUCK BERUBE  
 P.O. BOX 177  
 WESTFIELD, MASS. 01085  
 413-562-6690  
 BURCAW-COWAN & COMPANY  
 18236 WEST MCNICHOLS ROAD  
 DETROIT, MICHIGAN 48219  
 313-KE3-7700  
 CARMINE A. VIGNOLA ASSOC.  
 P.O. BOX 569  
 21 SCHELLRIDGE ROAD  
 JEFFERSON CITY, MO. 65102  
 314-635-1023  
 BARTON W. FLOYD, JR.  
 22 WAVERTON DRIVE  
 ST. LOUIS, MO. 63124  
 314-MY4-0390  
 HAROLD A. MOYER COMPANY  
 P.O. BOX 14

220 HADDON AVENUE  
 HADDONFIELD, N.J. 08033  
 609-MH9-7792  
 JERRY GREENBERG & ASSOC.  
 100 NORTH VILLAGE AVENUE  
 ROCKVILLE CENTRE  
 LONG ISLAND, N.Y. 11570  
 516-OR8-3668  
 J. W. LEMMER COMPANY  
 367 BRYNHILD ROAD  
 COLUMBUS, OHIO 43202  
 614-268-5260  
 RICHARD N. VAN DERVORT  
 1308 BEACH AVENUE  
 LAKEWOOD, OHIO 44107  
 216-221-4004  
 JACK LEHNER, JR.  
 1783 - 18TH STREET  
 CUYAHOGA FALLS, OHIO 44223  
 216-928-7630  
 AVCO SALES COMPANY  
 P.O. BOX 30153  
 2339 FARRINGTON  
 DALLAS, TEXAS 75217  
 214-363-5925  
 W. K. WOOD, INC.  
 P.O. BOX 46046  
 10233 MARINE VIEW DRIVE, S.W.  
 SEATTLE, WASHINGTON 98146  
 206-935-9400  
 RAYMOND P. KROGH  
 2212 ST. CLAIR STREET  
 RACINE, WISCONSIN 53402  
 414-634-7467

**AMECO, INC.**  
 SALES MANAGER  
 R. DUANE HALL  
 BRAND NAMES  
 AMECOAX  
 PACESETTER  
 REMCOR  
 COMPANY ADDRESS  
 2949 W. OSBORN ROAD  
 PHOENIX, ARIZONA 85017  
 COMPANY REPRESENTATIVES  
 FRANK HAMILTON  
 627 SOUTH 45TH STREET  
 BIRMINGHAM, ALABAMA  
 404-261-1951  
 MASON HAMILTON  
 DICK OLD  
 JOHN WESTFIELD  
 PHOENIX, ARIZONA  
 262-5500  
 RUSH MENOENHALL  
 566 VIA MANZANAS#3  
 SAN LORENZO, CALIF  
 415-775-4566  
 JAMES CUNNINGHAM  
 380 S. SIERRA MADRE BLVD  
 APT. D  
 PASADENA, CALIF.  
 213 254-9832  
 FRANK HAMILTON  
 233 LAFAYETTE CIRCLE  
 TALLAHASSEE, FLA.  
 454-2623  
 CHARLES AUER  
 P.O. BOX 13441 STA. K  
 ATLANTA, GA.  
 261-1951  
 CHARLES AUER  
 106 HEATHER LANE  
 COLLEGE PARK, GA.  
 404-261-1951  
 JON WESTFIELD  
 1300 C AVENUE N. W.  
 GREAT FALLS, MONTANA 59401  
 406-454-2623  
 LEO BORIN  
 119 SOUTH 19TH STREET  
 OMAHA, NEBRASKA 68102  
 402-558-0323  
 PHIL COLOME, JR.  
 P.O. BOX 48  
 ONEONTA, NEW YORK 13820  
 518-434-9758  
 THOMAS UMBREIT  
 P. O. BOX 1335  
 CINCINNATI, OHIO 45201  
 513-321-8060  
 THOMAS GOODALL  
 905 NORTH 36TH STREET  
 CORVALLIS, OREGON  
 503-232-7051  
 DEAUARO SWINDLER  
 3443 S. E. 31 ST.  
 PORTLAND, ORE.  
 232-7051  
 JAMES LOKER  
 5 JEFFERY ROAD -M. R.  
 MECHANICSBURG, PENN 17055  
 717-737-3792  
 CARL RICHARD  
 ROBERT MC CANN  
 P. O. BOX 3343  
 HARRISBURG, PA.  
 737-3792  
 JOE D. MARLOWE  
 P. O. BOX 102  
 REEDSVILLE, PENN  
 717-737-3792  
 GEORGE MARTIN  
 1120 STANLEY AVENUE  
 CHAMBERSBURG, PENN 17201  
 717-737-3792  
 DEAN SCOTT  
 EDWARD ABBOTT  
 1334 MOTOR CIRCLE  
 DALLAS, TEXAS 75207  
 214 631-5516  
 REPS. IN OTHER COUNTRIES  
 RAY N. BENNETT  
 624-736 GRANVILLE STREET  
 VANCOUVER, B. C.

604-685-4723  
PAUL LEWIS-WATTS  
ALBERT DE BOER  
3685 WESTON ROAD  
WESTON, ONTARIO  
416 248-1551

**AMERICAN CABLE ELECTRONICS**  
EXECUTIVE VICE PRESIDENT  
WM. J. BRESNAN  
BRAND NAMES  
WEATHER DATA  
EMERG-ALERT  
AMERICAN CABLE ELECTRONICS  
JACK KENT COOKE, INC  
COMPANY ADDRESS  
9808 WILSHIRE BLVD.  
BEVERLY HILLS, CALIF.  
COMPANY REPRESENTATIVES  
TED SWANSON  
J. FRED WEBER  
BEVERLY HILLS, CALIF.  
213 273-4450

**AMERICAN ELECTRONIC**  
LABORATORIES, INC.  
SALES MANAGER  
IRVIN A FAYE  
BRAND NAMES  
COLORVUE  
COMPANY ADDRESS  
P. O. BOX 552  
LANSDALE, PA. 19446  
COMPANY REPRESENTATIVES  
MELVIN LUCAS  
TELE-GUARD CORP  
P O BOX 493  
WEST SACRAMENTO, CALIF  
916 482 8816  
FRED CLARE  
778 LOWER COLONIAL DRIVE  
ST PAUL, MINNESOTA  
RICHARD WITKOVSKI  
WITKO ELECTRONIC CORP  
435 BRANIFF BUILDING  
DALLAS, TEXAS  
214 RI 1 5225

**AMERICAN ELITE, INC.**  
SALES MANAGER & VICE. PRES.  
BEN JACOBS  
BRAND NAMES  
TELEFUNKEN  
AEG  
COMPANY ADDRESS  
48-50 34TH STREET  
LONG ISLAND CITY, N. Y. 11101

**AMERICAN GELOSO**  
ELECTRONICS, INC.  
SALES MANAGER  
ROBERT A. COHEN  
BRAND NAMES  
GELOSO  
STEMOTAPE  
AMPLIVOICE  
ULTRVOX  
AMPLIBOX  
COMPANY ADDRESS  
251 PARK AVENUE SOUTH  
NEW YORK, NEW YORK 10010  
COMPANY REPRESENTATIVES  
SHEPPARD, WINTERS & STERN CO.  
P.O. BOX 1218  
MAGNOLIA PARK STA.  
BURBANK, CALIF.  
ELVEY PROCTOR CO.  
P. O. BOX 1205  
1650 LAUREL AVE  
SAN CARLOS, CALIF. 94071  
415-593-1121  
A. J. NELSON CO., INC.  
1294 SOUTH BANNOCK STREET  
DENVER, COLO. 80223  
303-733-5528  
GEORGE B. SMITH  
193 QUAKER LANE SOUTH  
WEST HARTFORD, CONN.  
203-523-0512  
GEORGE FENTON  
P.O. BOX 7387  
ORLANDO, FLORIDA  
305-423-5720  
H. K. DEWEES CO., INC.  
3133 MAPLE DRIVE, N.E.  
ATLANTA, GEORGIA 30305  
404-261-7362  
WILLIAM PILLER  
515 HIBBARD ROAD  
WILMETTE, ILL.  
312-AL1-7681  
ROBERT SMITH CO.  
59 VERNDAL STREET  
BROOKLINE 46, MASS.  
617-277-0017  
G. TUGMAN & ASSOC.  
6346 WEST MCNICHOLS  
DETROIT, MICH. 48221  
UN2-6867  
JAMES LEE CO.  
4241 TOLEDO AVENUE SOUTH  
MINNEAPOLIS, MINN.  
612-920-1525  
CLAASEN CO.  
308 NORTH MAIN STREET  
FREMONT, NEBRASKA 68025  
SID MENELY CO.  
P.O. BOX 9802  
OKLAHOMA CITY 18, OKLA.  
405-JOS-5084  
H. D. LEWIS CO.  
1801 J. F. KENNEDY BLVD.  
PHILADELPHIA, PA.  
215-L07-2068  
CRUSOL, INC.

BOX 98  
URBANIZACION HNAS, DAVILA.  
BAYAMON, PUERTO RICO  
785-3531  
DON SMITH SALES CO.  
2320 NORTH 45TH STREET  
SEATTLE, WASH. 98103  
206-ME3-3160  
REPS. IN OTHER COUNTRIES  
CANADIAN GELOSO ELECTRONICS  
700 WESTON ROAD  
TORONTO 9, ONTARIO

**AMERICAN PAMCOR, INC**  
SALES MANAGER  
DONALD F. MIERSCH  
BRAND NAMES  
COAXICLAMP  
TERMI-BLOK  
SOLISTRAND  
PLASTI-GRIP  
AMPPOWER  
PIDG  
COMPANY ADDRESS  
P. O. BOX 1776  
PAOLI, PA. 19301  
215 647-1000  
COMPANY REPRESENTATIVES  
AMERICAN PAMCOR INC  
3138 W EL SEGUNDO BLVD  
HAWTHORNE, CALIF 90250  
213 SP 2-2251  
AMERICAN PAMCOR INC  
512 S AIRPORT BLVD  
5 SAN FRANCISCO, CALIF 94080  
415 589-7722  
AMERICAN PAMCOR INC  
2970 PEACHTREE ROAD NW  
SUITE 550  
ATLANTA, GA 30305  
404 261-8712  
AMERICAN PAMCOR INC  
1145 BISHOP ST RM 206  
HONOLULU, HAWAII  
583-774  
AMERICAN PAMCOR INC  
5555 NORTHWEST HWY  
CHICAGO, ILL 60630  
312 RO 3-0882  
AMERICAN PAMCOR INC  
BEAR HILL OFF TOWER  
60 HICKORY DRIVE  
WALTHAM, MASS 02154  
617 893-0137  
AMERICAN PAMCOR INC  
15800 WEST MCNICHOLAS  
DETROIT, MICH 48235  
313 835-1210  
AMERICAN PAMCOR INC  
COMMERCE TOWER BLDG RM 2006  
KANSAS CITY, MO 64105  
816 HA 1-6141  
AMERICAN PAMCOR INC  
SUITE 214  
2510 BRENTWOOD BLVD  
BRENTWOOD, MO 63144  
314 962-9090  
AMERICAN PAMCOR INC  
80 WEST STREET  
ENGLEWOOD, N J 07631  
201 LO 9-0626  
AMERICAN PAMCOR INC  
CARROUSEL TOWERS  
8075 READING ROAD  
CINCINNATI, OHIO 45237  
513 821-6651  
AMERICAN PAMCOR INC  
20950 CENTER RIDGE ROAD  
CLEVELAND, OHIO 44116  
216 333-0307  
AMERICAN PAMCOR INC  
6509 N INTERSTATE  
PORTLAND, OREGON 97217  
503 285-9841  
AMERICAN PAMCOR INC  
771 LANCASTER AVE  
VILLANOVA, PA 19085  
215 LA 5-5825  
AMERICAN PAMCOR INC  
MANOR OAK OFF BLDG  
1910 COCHRAN RD  
PITTSBURG, PA 15220  
412 563-0803  
PAMCOR INC  
C/O R J CUEBAS  
P O BOX 813  
RID PIEDRAS, P R 00928  
AMERICAN PAMCOR INC  
2247 VANTAGE ST  
DALLAS, TEXAS 75207  
214 ME 1-0850  
AMERICAN PAMCOR INC  
3130 S W FREEWAY RM 207  
HOUSTON, TEXAS 77006  
713 522-1043

**AMERLINE CORPORATION**  
SUBSID THE REVLON CORP  
SALES MANAGER  
F. O. GLAUBITZ  
BRAND NAMES  
AMERLINE  
COMPANY ADDRESS  
1800 W. FULLERTON AVE.  
CHICAGO, ILL. 60614  
COMPANY REPRESENTATIVES  
STICKEL - MCALLISTER CO.  
4357 MELROSE  
LOS ANGELES, CALIF.  
665-6621  
JOHN F. THOMPSON  
322 RIVERSIDE DRIVE  
ORMOND BEACH, FLA.  
677-2298

# BROADCAST TRANSMITTERS

from

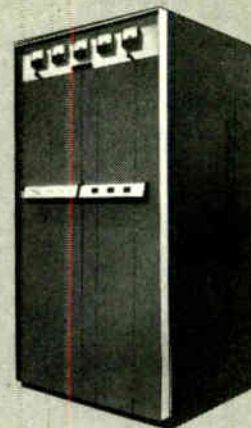

AEL's line of type accepted AM and FM Broadcast Transmitters features the following: ■ Designed for remote control — no kits necessary ■ Factory pretested at customer frequency ■ Running-time meter ■ One-button operation ■ Self-protecting circuit breakers ■ High-speed overload relays ■ Solid state power supplies ■ Automatic recycling ■ Attractive modern cabinets ■ Minimum size.

## AM BROADCAST TRANSMITTERS (powers available up to 100 KW)

- AM-1KA . . . . . 1000 watts
- AM-5KA . . . . . 5000 watts
- AM-10KA . . . . . 10,000 watts

## FM BROADCAST TRANSMITTERS (powers available up to 40 KW)

- FM-1DA . . . . . 10 watts
- FM-2.5HA . . . . . 250 watts
- FM-1KA . . . . . 1000 watts
- FM-5/7.5KA . . . . . 5000/7500 watts
- FM-10KA . . . . . 10,000 watts

Completely solid state stereophonic equipment will be in actual operation at the 1967 NAB Convention.

Write for complete details on AEL AM and FM Broadcast Transmitters



**AMERICAN ELECTRONIC LABORATORIES, INC.**  
P. O. BOX 552, LANSDALE, PA. 19446 • (215) 822-2929

K & M SALES  
1627 MAIN STREET  
KANSAS CITY, MO.  
GR1-1355  
ROBERT CMESHIRE  
271 MADISON AVENUE  
NEW YORK, N.Y.  
MUS-1890

**AMPEREX ELECTRONIC CORP.**  
SALES MANAGER  
TUBE DIVISION  
JOHN MESSERSCHMITT  
SEMICONDUCTOR DIVISION  
ED MEAGHER  
COMPANY ADDRESS  
TUBE DIVISION  
HICKSVILLE, N. Y. 11802  
SEMICONDUCTOR DIVISION  
SLATERSVILLE, R. I. 02876  
COMPANY REPRESENTATIVES  
A. B. ANDREWS  
1308 S. 28TH ST., APT. 206  
BIRMINGHAM, ALABAMA  
205-251-4540  
AMPEREX ELECTRONIC CORP.  
801 E. CHARLES ROAD  
PALO ALTO, CALIF. 94303  
415 327 0461  
W. J. BARRON COMPANY  
1406 S. GRAND AVENUE  
LOS ANGELES, CALIF. 90015  
213 748 6191  
SHEPARD WINTERS STERN, INC.  
4109 BURBANK BLVD.  
BURBANK, CALIF. 91505  
213 849 6671  
TWX 910 498 2208  
R. W. THOMPSON ASSOCIATES  
4135 EL CAMINO WAY  
PALO ALTO, CALIF.  
415 321 6383  
TWX 415 192 9308  
R. W. THOMPSON ASSOCIATES  
17071 VENTURA BLVD.  
ENCINO, CALIF. 91316  
213-783-4480  
WILLIAM J. PURDY AGENTS  
312 SEVENTH STREET  
SAN FRANCISCO, CALIF. 94103  
415-UN 3-3300  
WILLIAM J. PURDY AGENTS  
6527 WESTBROOK DRIVE  
CITRUS HEIGHTS, CALIF. 95610  
916-725-4065  
MEL PEARSON & COMPANY  
1860 SO. ACOMA STREET  
DENVER, COLO. 80223  
303-777-7878 & 777-8646  
GERBER SALES COMPANY, INC.  
P.O. BOX 2917, 31 BROADWAY  
NEW HAVEN, CONN. 06515  
203-577-6279

VECTOR SALES  
662 BRIDGEPORT AVE.  
MILFORD, CONN.  
203-TR4-2112

MECHTRONICS SALES, INC.  
7600 GEORGE AVE., NW RM. 208  
WASHINGTON, D.C. 20012  
202-291-6004  
A. B. ANDREWS  
BOX 124, ROUTE 5  
ORLANDO, FLORIDA  
305-PA3-8333

MILLAR HUTTO ASSOC., INC.  
P.O. BOX 1603  
WINTER PARK, FLA. 32790  
305-MI 7-7407

MILLAR HUTTO ASSOC., INC.  
P.O. BOX 7116, STATION C.  
1036 PEACHTREE STREET N.E.  
ATLANTA, GA. 30309  
404-876-0919 OR 872-6212

AMPEREX ELECTRONIC CORP.  
360 EAST NORTH AVENUE  
NORTHLAKE, ILL. 60164  
312-562-1060, 61

DWIGHT SMITH ASSOCIATES, INC.  
32 S. RIVER STREET  
AURORA, ILL. 60504  
312-TW 6-0828

THOMAS & SUKUP, INC.  
2060 E. 54TH STREET  
INDIANAPOLIS, IND. 46220  
317-CL 1-4574-5  
TWX 317-633-8075

CARTWRIGHT & BEAN  
182 BULLARD AVE.  
METAIRIE, LA.  
504-887-0482

BROTHERS & CONNEEN ASSOCIATES  
6302 LINCOLN AVENUE  
BALTIMORE, MD. 21209  
301-764-7189

BROTHERS & CONNEEN ASSOCIATES  
1808 GLEN RIDGE ROAD  
BALTIMORE 34, MD.  
301-764-7189

MECHTRONICS SALES, INC.  
1123 MEADOWLARK DRIVE  
BALTIMORE, MD.  
301-242-4123

SCIENTIFIC SYSTEMS SALES CORP  
8138 15TH AVENUE  
HYATTSVILLE, MD. 20783  
301-445-1130

GERBER SALES COMPANY, INC.  
176 SECOND AVENUE  
WALTHAM, MASS. 02154  
617-891-8040

GERBER SALES COMPANY, INC.  
P.O. BOX 447, 26 MAPLE COURT  
E. LONGMEADOW, MASS. 01028  
413-LA 5-3059

VECTDR SALES  
774 PLEASANT STREET  
BELMONT, MASS. 02178  
617-489-1400  
JACK M. THORPE CO.  
640 HIDDEN LANE  
DETROIT, MICH. 48236  
313-884-4360

AMPEREX ELECTRONIC CORP.  
8053 BLOOMINGTON FREEWAY  
MINNEAPOLIS, MINN. 55420  
612-888-4681  
CLARK R. GIBB CO.  
2400 MENNEPIN AVE.  
MINNEAPOLIS, MINN. 55405  
612-377-1200  
TWX 612-321-1460

DIPRO, INC.  
P.O. BOX 1427  
HARVLANO HEIGHTS, MO. 63042  
314-432-3444  
R. W. FARRIS CO., INC.  
1715 BALTIMORE AVE.  
KANSAS CITY, MO. 64108  
816-NA 1-1757  
TWX 314-872-8396

BROTHERS & CONNEEN ASSOCIATES  
813 FORDHAM STREET  
RIVERSIDE, N.J.  
215-KI 3-8641  
MICHAEL PAGE & ASSOCIATES  
209 SAN PABLO, S.E.  
ALBUQUERQUE, N.M. 87108  
505-265-8526

KANGAM SALES CORPORATION  
1261 BROADWAY  
NEW YORK, N.Y. 10001  
212-MU 4-7772-3-4-5-6-7  
TWX 710-581-2729

PASTON-HUNTER CO., INC.  
3307 ERIE BLVD. E  
P. O. BOX 129  
DEWITT STATION  
SYRACUSE, N. Y. 13214  
315-446-2180  
R. W. MITSCHER CO., INC.  
496 ELLICOTT SQ. BLDG.  
BUFFALO, NEW YORK 14203  
716-854-2517  
TWX 716-858-1144  
R. W. MITSCHER CO., INC.  
606 FOREST DRIVE  
N. SYRACUSE, N. Y.  
315 458-1321

SCIENTIFIC SYSTEMS SALES CORP  
376 GREAT NECK ROAD  
GREAT NECK, L. I., N.Y.  
516 466-0053  
TWX 516 466-0962  
R. W. MITSCHER CO., INC.  
16 LIMETREE LANE  
LIVERPOOL, NEW YORK  
315-652-7190  
R. W. MITSCHER CO., INC.  
ROUTE 82-A  
SALT POINT, N.Y.  
914-266-5976  
R. W. MITSCHER CO., INC.  
51 ELY DRIVE  
FAYETTEVILLE, N.Y. 13066  
315-446-4540  
A. B. ANDREWS  
P.O. BOX 2627, BRANCH  
BANKING & TRUST CO. BLDG.  
RALEIGH, N.C. 27602  
919 833-5565

MILLAR HUTTO ASSOC., INC.  
P.O. BOX 17566  
4023 ARBOR WAY  
CHARLOTTE, N.C. 28211  
704-EM 6-2061

MULLIGAN & MATHIAS COMPANY  
2011 RIVERSIDE DRIVE  
COLUMBUS, OHIO 43221  
614-486-2267

RICHARD LEGG COMPANY  
P.O. BOX 25327  
PORTLAND, OREGON 97225  
503-292-8824  
TWX 503-224-1060

BEIL & WHITAKER, INC.  
3623 JACKSONWALD AVE.  
READING, PA. 19606  
215-779-2610

PARAGON SALES COMPANY  
111 SOUTH 22ND STREET  
PHILADELPHIA, PENN. 19103  
215-LO 3-7060

BROTHERS & CONNEEN ASSOCIATES  
131 WARNED ROAD  
SPRINGFIELD, DELAWARE CO, PA.  
215 KI 3-8641  
BEIL & WHITAKER, INC.  
BOX 384, R.D. #2  
DOVER, PA. 17315  
717-292-4071

BEIL & WHITAKER, INC.  
1303 N. TRDXELL STREET  
ALLENTOWN, PA. 18103  
215-434-5220

CARTWRIGHT & BEAN  
560 SOUTH COOPER ST.  
MEMPHIS, TENN. 38104  
901-276-4442

DUNBAR ASSOCIATES  
417 MEADOWS BLDG.  
DALLAS, TEXAS 75206  
214 363-2536  
TWX 214 899-9172

LUND & COMPANY  
2215 N. OLIVE STREET  
DALLAS, TEXAS 75201  
214-748-8839

MICHAEL PAGE & ASSOCIATES  
5122 BURNET ROAD  
P.O. BOX 9402

AUSTIN, TEXAS 78756  
512-452-9503

LUND & COMPANY  
P.O. BOX 36256  
HOUSTON, TEXAS 77036  
713-523-6756

MICHAEL PAGE & ASSOCIATES  
BRANIFF BLDG., SUITE 435  
EXCHANGE PARK  
DALLAS, TEXAS 75235  
214-351-4795

MEL PEARSON & COMPANY  
288 CANYON ROAD  
SALT CITY, UTAH 84103  
801-364-7524

**AMPERITE COMPANY**  
SALES MANAGER  
T. WHALEN  
COMPANY ADDRESS  
600 PALISADE AVE.  
UNION CITY, NEW JERSEY 07087

**AMPEX CORPORATION**  
VP GEN MGR MARKETING DIVISION  
ROBERT R. DWEN  
SALES MANAGER  
THOMAS W. HARLEMAN

BRAND NAMES  
AMPEX  
MARCONI  
COMPANY ADDRESS  
401 BROADWAY  
REDWOOD CITY, CALIF 94063  
415 367-2011

COMPANY REPRESENTATIVES  
DISTRICT OFFICE  
3322 S MEMORIAL PARKWAY  
HOLIDAY OFF CTR., SUITE 27  
MUNTSVILLE, ALA 35801  
205 881 4271  
TWX 205 533-2820

A A SROKA  
WESTERN AREA MKTG MGR  
8467 BEVERLY BLVD  
LOS ANGELES, CALIF 90048  
213 OL 3 1610  
TWX 213 655-6535

K THOMPSON  
SAN FRANCISCO REG MGR  
2220 BAY ROAD  
REDWOOD CITY, CALIF 94063  
415 367 3861  
TWX 415 364-9034

W BRUSS  
LOS ANGELES REG MGR,  
COMMERCIAL & GOV. PRODUCTS  
8467 BEVERLY BLVD  
LOS ANGELES, CALIF 90048  
213 OL 3 1610  
TWX 213 655-6535

K HERRING  
LOS ANGELES REG MGR  
8467 BEVERLY BLVD  
LOS ANGELES, CALIF 90048  
213 OL 3 1610  
TWX 213 655-6535

L JORDAN  
FLORIDA REG MGR  
1980 NORTH ATLANTIC AVE  
COCOA BEACH, FLA 32931  
305 783 1811  
TWX 305 783-1738

G SUDDUTH  
ATLANTA REG MGR  
3376 PEACHTREE RD  
N E ATLANTA, GA  
404 231 3480  
TWX 404 231-1637

L HASE  
CHICAGO REG MGR  
10 KING ST  
ELK GROVE VILLAGE, ILL 60007  
312 439 4600  
TWX 910 222-2864

N. SCHMIDT  
BOSTON REG. MGR.  
235 BEAR HILL RD.  
WALTHAM, MASS. 02154  
617 899-2040  
TWX 710 324-0364

E WENDT  
MINNEAPOLIS REG MGR  
4010 W 65TH ST  
MINNEAPOLIS, MINN 55424  
612 WA 7 5638  
TWX 910 576-2806

WILLIAM SLOVER  
EASTERN AREA MKTG MGR  
75 COMMERCE WAY  
WACKESACK, N J 07661  
201 489 7400  
TWX 201 488-6715

R SIRINSKY  
NEW YORK REG MGR  
75 COMMERCE WAY  
WACKESACK, N J 07661  
201 489 7400  
TWX 201 488-6715

R BEENE  
ALBUQUERQUE REG MGR  
414 SAN MATEO BLVD. NE  
ALBUQUERQUE, N.M. 35801  
505 265 8507  
TWX 910 989-1639

D CRESWELL  
DAYTON REG MGR  
333 W 51 ST, SUITE 338  
DAYTON, OHIO 45402  
513 BA B 5117  
TWX 810 459-1714

G SULLIVAN  
PHILADELPHIA REG MGR  
947 YDRK ROAD  
ABINGTON, PA 19001  
215 TU 7 7650

TWX 215 884-2822

W HEYWOOD  
DALLAS REG MGR  
2626 W MOCKINGBIRD LANE  
SUITE 290  
DALLAS, TEXAS 75235  
214 FL 7 0481  
TWX 214 899-9001

DISTRICT OFFICE  
6001 GULF FREEWAY, ST C-134  
HOUSTON, TEXAS 77023  
713 WA 8 3741  
TWX 713 571-1494

W CRAIG  
WASHINGTON, D C REG MGR  
3620 S 27TH ST  
ARLINGTON, VA 22206  
703 671 4000  
TWX 710 955-9832

J HOPKINS  
SEATTLE REG MGR  
8434 RAINIER AVE  
S SEATTLE, WASH 98118  
206 PA 3 3170  
TWX 206 998-9014

**AMPHENDL DISTRIBUTOR DIVISION**  
SALES MANAGER  
W. T. ADAMS  
COMPANY ADDRESS  
2875 SOUTH 25TH AVE.  
BROADVIEW, ILL. 60153  
COMPANY REPRESENTATIVES  
DDN DE BASID  
401 EAST INDIAN SCHOOL ROAD  
SUITE 209  
PHOENIX, ARIZONA  
602-264-9397-98

RICHARD COLT  
17000 VENTURA, SUITE 306  
ENCINO, CALIF.  
213-788-8560

JAMES V. CLARIZIO  
DISTRICT SALES OFFICE  
1826 INDUSTRIAL WAY, SUITE 8  
REDWOOD CITY, CALIF.  
415-369-2981

RALPH NOFFKE  
DISTRICT SALES OFFICE  
709 W. LITTLETON BLVD.,  
SUITE 200A  
LITTLETON, COLO.  
303-794-6269

EDMUND LEHMANN  
DISTRICT SALES OFFICE  
7600 GEORGIA AVENUE, N.W.  
WASHINGTON, O.C.  
202-829-9000

CHARLES W. KUCCERA  
DISTRICT SALES OFFICE  
601 N. NEW YORK AVENUE,  
SUITE 5  
WINTER PARK, FLORIDA  
305-647-5504

DISTRICT SALES OFFICE  
3224 PEACHTREE RD., N.E.  
ATLANTA, GEORGIA  
404-233-1569

EARL ASSOCIATES  
P.O. BOX 2845, 1638 KONA ST.  
HONOLULU, HAWAII  
808-996-953

JOHN N. KOYS  
2801 S. 25TH AVENUE  
BROADVIEW, ILLINOIS  
312-261-2000

LESLIE M. DEVDE CO.  
4010 WASHINGTON BLVD.  
INDIANAPOLIS, INDIANA  
317-283-1395

RICHARD PURINTON, INC.  
11 MUZZEY STREET  
LEXINGTON, MA, MASS.  
617-862-8300

ALLEN P. NEMETZ  
DISTRICT SALES OFFICE  
960 E. MAPLE RD., SUITE 116  
BIRMINGHAM, MICHIGAN  
313-646-1262

ROGER JENNE  
7701 NORMANDALE ROAD  
MINNEAPOLIS, MINN.  
612-927-6589

JOSEPH B. SVEMLA  
DISTRICT SALES OFFICE  
47 VILLAGE SQUARE  
HAZELWOOD, MO  
314-838-6996

ROBERT MEADE  
DISTRICT SALES OFFICE  
6525 S. CRESCENT BLVD.  
SUITE 212  
PENNSAUKEN, N. J.  
609-665-2870

RICHARD J. PARISSIDI  
DISTRICT SALES OFFICE  
2 LAGRANGE AVENUE  
POUGHKEEPSIE, N. Y.  
914-452-4220

STEPHEN R. KELLEHER  
DISTRICT SALES OFFICE  
310 NORTHERN BLVD.  
GREAT NECK, L. I., N. Y.  
516-482-4700

EDWARD B. SMITH  
DISTRICT SALES OFFICE  
6443 RIDINGS ROAD  
SYRACUSE, N.Y.  
315-437-2689

JOHN J. CARSELLLO  
DISTRICT SALES OFFICE  
20545 CENTER RIDGE ROAD  
SUITE 242  
CLEVELAND, OHIO  
216-331-9100

JOHN E. JANSEN

DISTRICT SALES OFFICE  
811 S. CENTRAL EXPRESSWAY,  
SUITE 295  
RICHARDSON, TEXAS  
214-235-8318  
DONALD C. PERCELL  
DISTRICT SALES OFFICE  
14444 SUNSET HIGHWAY & CO  
P O BOX 726  
BELLEVUE, WASHINGTON  
206 746-5363  
REPS. IN OTHER COUNTRIES  
OAI ICHI DENSHI KOGYO, KK#20,  
3 CHOME, YODOSHI, SHIBUYA-KU  
TOKYO, JAPAN  
UMD - USINE METALLURGIQUE  
DOLOISE, S.A.  
17 AVENUE NIEL 75  
PARIS, FRANCE  
UMD - USINE METALLURGIQUE  
DOLOISE, S.A.  
92 A98 AVENUE DE GRAY 39  
OOLE, FRANCE  
AMPHENOL-BORG ELECTRONICSGMBH  
8024 DEISENHOFEN  
BEI MUNICH, W. GERMANY  
AMPHENOL LIMITED, THANET WAY  
WHITSTABLE, KENT, ENGLAND  
AMPHENOL CANADA LIMITED  
44 METROPOLITAN ROAD  
SCARBOROUGH, ONT.  
AMPHENOL CANADA LIMITED  
42 AYLNER AVENUE  
OTTAWA, ONTARIO  
AMPHENOL CANADA LIMITED  
3285 CAVENISH BLVD. RM 160  
MONTREAL, QUEBEC  
AMPHENOL, S.A. DE C.V.  
CALLE DE PUENTE NO. 6  
MEXICO 22, O.F., MEXICO

AMPLIFIER CORP OF AMERICA

SALES MANAGER  
A. J. GILLETTE  
BRAND NAMES  
MAGNERASE  
MAGNERASER JR  
MAGNETIC PROJECTOR  
COMPANY ADDRESS  
75 FROST STREET  
WESTBURY, L. I., N. Y. 11590  
SALES REPRESENTATIVES  
ARTRONICS  
650 CLEVELAND, AVE  
RIVER VALE, N. J.

AMPLIVISION CORPORATION

SALES MANAGER  
GEORGE BROWNSTEIN  
BRAND NAMES  
AMPLI-VISION  
BENCO  
GILBER  
SONY  
COMPANY ADDRESS  
2000 STONER  
LOS ANGELES, CALIF. 90025  
GR 8-7751  
COMPANY REPRESENTATIVES  
WM LASKY  
2000 STONER  
LOS ANGELES, CALIF. 90025  
GR 8-7751  
LEANORO COMEN  
C/O AMPLIVISION  
PARAMOUNT BLOG SUITE 1300  
1501 BROADWAY  
NEW YORK, NEW YORK  
BR 9-8700

ANACONDA ASTRODATA CO

VP SALES & MKTG  
A. L. GINTY  
MKTG MGR, CATV  
R.A. BROOKS  
SALES MGR CATV SYSTEMS  
O. P. ROBERTS  
MGR, DISTRIBUTION SALES, CATV  
P. LAZANICH  
BRAND NAMES  
XDR  
COMPANY ADDRESS  
1430 SOUTH ANAHEIM BLVD.  
P. O. BOX 3772  
ANAHEIM, CALIF. 92803  
714-635-0150  
COMPANY REPRESENTATIVES  
C. R. MANN  
SALES MGR WESTERN REGION  
1419 BONNIE DOONE TERRACE  
CORONA DEL MAR, CALIF  
714 675 1015  
R. O. OYLYE  
SALES MGR S. E. REGION  
400 PINETREE STREET  
FOREST PARK, GA.  
404-366-7576  
P. K. JOE  
SALES MGR CENTRAL REGION  
RFO NO. 3  
FORT DODGE, IOWA  
515-576-1313  
C. C. MOODY  
SALES MGR. N. CENTRAL REGION  
13808 STEBENS ROAD  
BURNSVILLE, MINN  
612 890-2017  
O. WATERS  
SALES MGR. N. E. REGION  
P. O. BOX 629  
THOUSAND ISLAND PARK, N. Y.  
315 482-9396  
L. FELTS  
SALES MGR. S. CENTRAL REGION  
7839 CLAREMONT DRIVE  
DALLAS, TEXAS

ANCHA ELECTRONICS INC

PRESIDENT  
ROBERT F. ANCHA  
COMPANY ADDRESS  
7011 WEST HIGGINS AVE.  
CHICAGO, ILL. 60656

KEITH ANDERSON CO

SALES MANAGER  
KEITH ANDERSON  
COMPANY ADDRESS  
P. O. BOX 18  
BLACK HAWK, S. OAKOTA 57718  
COMPANY REPRESENTATIVES  
JUAN M. ORTIZ  
BOX 532  
GUAYAMA, PUERTO RICO  
REPS. IN OTHER COUNTRIES  
JOHN NANCE  
SKEENA BROADCASTERS  
BOX 1540  
TERRACE, B. C.  
L. D. STEWART  
WESTERN TELONICS  
110 BAYS WATER ROAD  
RUSHCUTTERS BAY  
N. S. W., AUSTRALIA  
31 64 34

ANDREW CORPORATION

SALES MANAGER  
ROBERT C. BICKEL  
BRAND NAMES  
HELIX  
HUBLOC  
UNIPOLE  
COMPANY ADDRESS  
P.O. BOX 807  
CHICAGO, ILL. 60642  
COMPANY REPRESENTATIVES  
ANDREW CALIFORNIA CORPORAT:ON  
941 E. MARYLIND  
CLAREMONT, CALIF.  
714-626-3505  
ANDREW CALIFORNIA CORPORATION  
701 WELCH ROAD  
PALO ALTO, CALIF.  
415-323-3139  
ANDREW CORPORATION  
P.O. BOX 5897  
WASHINGTON, D.C.  
202-654-2540  
ANDREW INTERNATIONAL CORP.  
P.O. BOX 787  
CHICAGO, ILL.  
312-349-3300  
ANDREW CORPORATION  
P.O. BOX 416  
RIDGWOOD, N. J.  
201-445-2500  
ANDREW CORPORATION  
P.O. BOX 30506  
DALLAS, TEXAS  
214-735-1279  
REPS. IN OTHER COUNTRIES  
ANDREW ANTENNA SYSTEMS  
LOCHGELLY, FIFE, G.B.  
LOCHGELLY 561  
ANDREW ANTENNA COMPANY, LTD.  
608 GATENSURBY STREET  
COQUITLAM, NEW WESTMINSTER,  
BRITISH COLUMBIA  
604-936-6421  
ANDREW ANTENNA COMPANY, LTD.  
P.O. BOX 177  
WHITBY, ONTARIO  
416-668-3348  
ANDREW ANTENNA COMPANY, LTD.  
55 LITTLE ROCK AVENUE  
POINTE CLAIRE  
LACHINE, QUEBEC  
514 695-5365  
ANDREW ANTENNAS PTY., LTD.  
437 ST KILDA RD, MELBOURNE  
VICTORIA, AUSTRALIA  
26-2824

ANSONIA WIRE & CABLE CO

SALES MANAGER  
OON W. HOFFMAN  
BRAND NAMES  
ANKOSEAL  
ANKOBOND  
COMPANY ADDRESS  
111 MARTIN STREET  
ASHTON, R. I. 02864  
401-724-6400

ANTENNA PRODUCTS COMPANY

DIVISION OF ALL PRODUCTS CO  
SALES MANAGER  
GRAY W. HAVENER  
COMPANY ADDRESS  
P.O. BOX 520  
MINERAL WELLS, TEXAS 76067  
COMPANY REPRESENTATIVES  
WALTER A. LAUKAITIS  
618 ELLSWORTH DR.  
SILVER SPRING, MO.  
301 JU 5-3931  
ASSOCIATED ELECTRONICS, INC.  
119 THE GREAT RD.  
BEFORD, MASS.  
617 275-9020  
TELESCO INTERNATIONAL CORP.  
171 MADISON AVENUE  
NEW YORK, N.Y.  
212 MU 3-9420  
M. J. FEIN & CO.  
HARWOOD BLDG.  
SCARSDALE, N.Y.  
914 GR 2-1100  
EAC ASSOCIATES  
53-11 90TH STREET  
ELMHURST, N.Y. 11373  
212 OE 5-0606

API INSTRUMENTS CO

SALES MANAGER  
ROBERT H. PUGSLEY  
COMPANY ADDRESS  
7100 WILSON MILLS ROAD  
CHESTERLAND, OHIO 44026  
216 423-3131  
COMPANY REPRESENTATIVES  
API INSTRUMENTS CO  
175 W WIEUCA RD N E  
ATLANTA, GA  
404 252-2445  
API INSTRUMENTS CO  
1008 E NORTHWEST HWY  
MT PROSPECT, ILL 60057  
312 392-5770  
THUNDERBIRD ENG CO  
4014 A WEST 95TH ST  
PRAIRIE VILLAGE, KANSAS  
913 642-7220  
THUNDERBIRD ENG CO  
6405 E KELLOGG  
WICHITA, KANSAS  
316 684-3941  
SAUL COHEN  
611 TRAPELO RD  
BOSTON, MASS  
617 894-6921  
API INSTRUMENTS CO  
15042 FENKELL AVE  
DETROIT, MICH  
313 273-6078  
ROBERT W. MARSHALL CO  
6106 EXCELSIOR BLVD  
MINNEAPOLIS, MINN  
612 929-0457  
THUNDERBIRD ENG CO  
P O BOX 6156  
ST. LOUIS, MO.  
314 838-6688  
API INSTRUMENTS CO  
162 RT 208 BOX 123  
OKLAHOMA, N J  
201 337-6163  
TECHNICAL SALES INC  
P O BOX 182  
PULASKI, N Y  
315 298-5103  
API INSTRUMENTS CO  
3545 W CHESTER PIKE  
NEWTOWN SQUARE, PA  
215 353-0772  
CAREY-WOLF CO  
P O BOX 12425  
FT WORTH, TEXAS  
817 738-1702  
CAREY-WOLF CO  
P O BOX 60338 4031 BROADWAY  
SUITE 103  
HOUSTON, TEXAS  
713 643-2114

APPARATUS DEVELOPMENT CO INC

BRAND NAMES  
FM/O  
COMPANY ADDRESS  
ORAWER 153  
WETHERSFIELD, CONN, 06109  
COMPANY REPRESENTATIVES  
KOESSLER SALES  
818 N. FAIRFAX,  
LOS ANGELES, CAL.  
JAS. PIPER ASSOCIATES  
10 HAVEN,  
DOVER, MASS.  
L. D. RODOEY SALES  
4242 WATERBURY DR.  
CHARLOTTE, N. C.  
CHAS LUCAS SALES  
BOX 8506  
DALLAS, TEX  
VECTOR CORP  
307 WALL ST.  
SEATTLE, WASH

ATLAS SOUND DIVISION

AMERICAN TRADING & PRODUCTION CORP  
SALES MANAGER  
JEROME W. HELLER  
BRAND NAMES  
ATLAS  
COMPANY ADDRESS  
10 POMEROY ROAD  
PARSIPPANY, N. J. 07054  
COMPANY REPRESENTATIVES  
BASSETT & MOORE  
12045 MAGNOLIA BLVD.  
N. HOLLYWOOD, CAL.  
213-766-2117  
F. W. MOULTHROP & ASSOCIATES  
1530 E. 12TH ST.  
OAKLAND, CAL.  
261-7676  
GORDON MOSS ELECTRONICS  
P.O. BOX J  
GREELEY, COLORADO 80632  
353-1452  
CARTWRIGHT & BEAN  
20100 NE 25TH COURT  
N. MIAMI BEACH, FLA.  
945-2962  
CARTWRIGHT & BEAN  
395 TRITON RD.  
ORMOND BEACH, FLA.  
OR 7-3480  
CARTWRIGHT & BEAN  
2505 NANCY STREET  
ORLANDO, FLA.  
GA 5-8284  
CARTWRIGHT & BEAN  
3223 CAINS HILL PLACE NW  
ATLANTA, GA.  
237-2273  
BRUCE CUMMING & ASSOCIATES  
6029 W. BELMONT AVENUE,  
CHICAGO, ILL.  
312 ME 7-3770  
THOMAS & SUKUP  
2060 EAST 54TH ST.  
INDIANAPOLIS, INO.  
CL 1-4574  
KOENIG-MYERS ASSOCIATES  
7603 DENNIS DRIVE  
DES MOINES, IOWA  
515 276-3777  
KOENIG-MYERS ASSOCIATES

APPLIED ELECTRO MECHANICS INC

SALES MANAGER  
COL. GEORGE GLEN  
BRAND NAMES  
AEM  
COMPANY ADDRESS  
2350 DUKE STREET  
ALEXANDRIA, VA. 22314  
703 548-2166  
COMPANY REPRESENTATIVES  
W. S. FLOGAUS  
6631 WAKEFIELD DRIVE  
ALEXANDRIA, VA. 22307  
703-768-4964

ARRIFLEX CORPORATION OF AMERICA

SALES MANAGER  
VICTOR JAMES  
BRAND NAMES  
ARRIFLEX  
SIEMENS  
COMPANY ADDRESS  
25-20 BRKLYN-QUEENS EXPWY W  
WOODSIDE, NEW YORK 11377

ASCO SONOCRAFT CORP

SALES MANAGER  
FRED LISSER  
BRAND NAMES  
ASCO  
ASCO/SONOCRAFT  
COMPANY ADDRESS  
115 W. 45TH ST  
NEW YORK, N. Y. 10016  
JU 2-1750

THE ASTATIC CORPORATION

COMPANY ADDRESS  
BOX 120  
CONNEAUT, OHIO 44030

COMPANY REPRESENTATIVES  
BASSETT & MOORE  
12045 MAGNOLIA BLVD.  
NORTH HOLLYWOOD, CALIF. 91607  
877-7129  
WILLIAM J. PURDY CO.  
312 SEVENTH ST.  
SAN FRANCISCO, CALIF. 94103  
415-863-3300  
CONNORS, INC.  
2241 STACY DR.  
DENVER, COLORADO 80221  
428-1575  
HOLLINGSWORTH & STILL  
3098 PIEDMONT RD. N. E.  
ROOM 100  
ATLANTA, GA. 30305  
OUGHERTY ENTERPRISES  
P. O. BOX 3497,  
1164 WAIMANU ST.  
HONOLULU, HAWAII 96811  
MARKAL SALES CORP.  
5787 N. LINCOLN AVE.  
CHICAGO, ILLINOIS 60645  
LONGBEACH 1-7290  
EDWIN A. SCHULZ CO.  
BOX 40305, 721 SHERWOOD DR.  
INDIANAPOLIS, INDIANA 46240  
ANDERSON SALES CO.  
177 STATE ST.  
BOSTON, MASS. 02109  
617 CAPITOL 72980  
ROBERT MILSK CO.  
19375 JAMES COUZENS HWY.  
DETROIT, MICHIGAN 48235  
313 342-6660  
MEL E. FOSTER CO, INC.  
228 S. CEDAR LAKE RD.  
MINNEAPOLIS, MINN. 55405  
MAURY E. BETTIS CO.  
3706 BROADWAY  
KANSAS CITY, MISSOURI  
417 LOGAN 1-0772  
JERRY KRISHBAUM & CO.  
1533 PENINSULA BLVD.  
HEWLETT, L. I. N. Y.  
FRANKLIN 4-0111  
PASTON-HUNTER CO, INC.  
2002 TEAL AVE.  
SYRACUSE, N. Y. 13206  
315 437-2992  
MIKE ROTH SALES CO.  
678 SO. GREEN RD.  
CLEVELAND, OHIO 44121  
EV 2-9090  
DALE G. WEBER CO.  
WEATHERLY BLDG, SUITE 306  
PORTLAND, OREGON 97214  
503 234-0686  
LOWERY ASSOC. CO.  
2801 W. CHESTER PIKE  
BROOMALL, PA. 19008  
EL 6-5300  
CARTWRIGHT & BEAN  
CROSSTOWN STA. BOX 760,  
560 S. COOPER ST.  
MEMPHIS, TENN.  
J. Y. SCHOONMAKER CO, INC.  
5328 REDFIELD  
P. O. BOX 35266  
DALLAS, TEXAS 75235  
214 ME1-8480

P. O. BOX, 374  
SHAWNEE MISSION, KAN. 66201  
ME 2-8300  
CARTWRIGHT & BEAN  
1812 BULLARD AVE  
METAIRIE, LA.  
504-887-0482  
LOWERY ASSOCIATES  
6200 ANNAPOLIS RD.  
MYATTSVILLE, MD  
773-4977  
ROBERT MILSK CO.  
19375 JAMES COUZENS HWY.  
DETROIT, MICH  
342-6660  
JIM PIPER ASSOCIATES  
BOX 21  
SOUTH DUXBURY, MASS.  
WE 4-2498  
JIM PIPER ASSOCIATES  
10 HAVEN ST  
DOVER, MASS  
449-1144  
CLARK R. GIBB COMPANY  
1311 W. 25TH STREET  
MINNEAPOLIS, MINN.  
612-377-1200  
KOENIG-MYERS ASSOCIATES  
2721 BELOIT DRIVE  
BRIDGEOTON, MO.  
PE 9-1655  
GORDON MOSS ELECTRONICS  
2418 BARCELONA DRIVE SW  
ALBUQUERQUE, NEW MEXICO  
IRV BROWN CO.  
401 KINGSTON BLVD.  
BROOKLYN, N. Y.  
HY 3-1379  
PASTON-HUNTER CO. INC.  
2002 TEALL AVENUE  
SYRACUSE, N. Y.  
315-437-2992  
F. A. DAUGHERTY  
6025 MAYFIELD RD.  
CLEVELAND, OHIO  
449-1122  
MARSHALL JAMES  
3950 SOUTH ELMRAN  
LAKE OSWEGO, ORE.  
636-5777  
COOPER-DAUGHERTY SALES CO.  
112 OAKWOOD RD.  
MCURRAY, PA. 15317  
941-6473  
LOWERY ASSOCIATES  
2801 WEST CHESTER PIKE  
BROOMALL, PA.  
EL 6-5300  
LOWERY ASSOCIATES  
1501 ALLISON STREET  
HARRISBURG, PA.  
233-0917  
CARTWRIGHT & BEAN  
560 S. COOPER ST.  
MEMPHIS, TENN.  
BR 6-4442  
J. Y. SCHOONMAKER CO.  
5328 REDFIELD AVE.  
DALLAS, TEX.  
WE 1-8480  
J. Y. SCHOONMAKER CO.  
107 WINNTEKA,  
SAN ANTONIO, TEXAS  
DIAMOND-2-0251  
NORTHWESTERN AGENCIES  
4130 FIRST AVE.  
SEATTLE, WASH  
MA 3-8882  
BRUCE CUMMING & ASSOCIATES  
5537 N. ARGYLE AVE.  
MILWAUKEE, WIS.  
372-7650  
REPS. IN OTHER COUNTRIES  
ATLAS RADIO CORPORATION  
50 WINGOLD AVENUE  
TORONTO, ONTARIO  
416-RU 1-6174

**AUDIO ACCESSORIES, INC.**

**BRAND NAMES**  
AUDIO-LINE  
COMPANY ADDRESS  
GILSUM, N. H. 03448  
COMPANY REPRESENTATIVES  
KOESSLER SALES, CO.  
818 NORTH FAIRFAX AVE  
LOS ANGELES, CAL. 90046  
213 653-1605  
KOESSLER SALES, CO.  
1485 BAYSHORE  
SAN FRANCISCO, CAL. 94124  
415 584-1818  
S. GLASSMAN ASSOCIATES, INC.  
28 PRESTWICK TERRACE  
GLEN COVE N. Y. 11542  
516 676-1039  
DETI SALES  
601 LODI, ST.  
RIO PIEORAS, P R 00924  
765-8080

**AUDIO DEVICES, INC.**

**SALES MANAGER**  
RICHARD VAUGHAN  
**BRAND NAMES**  
AUDIOTAPE  
AUDIOPAK & ASSOCIATES  
AUDIOFILM  
AUDIODISCS  
AUDIOPOINTS  
AUDEV  
COMPANY ADDRESS  
235 EAST 42ND STREET  
NEW YORK, NEW YORK 10017  
COMPANY REPRESENTATIVES  
AUDIO DEVICES, INC.

1426 FLOWER ST.  
GLENDALE, CALIF  
213 245-6587  
AUDIO DEVICES, INC.  
16466 WOODACRES RD.  
LOS GATOS, CALIF.  
408 245-6802  
KOESSLER SALES CO.  
318 NO. FARIFAX AVE.  
LOS ANGELES 46, CALIF.  
213-853-1605  
MEYER, ROSS & FLEMING  
113 TENTH ST.  
SAN FRANCISCO, CALIF. 94103  
415-431-0652  
R. G. BOWEN CO. INC.  
721 SO. BROADWAY  
DENVER 9, COLORADO  
303-722-4641  
AUDIO DEVICES, INC.  
254 E. PACES FERRY RD N. E.  
ATLANTA, GA.  
404 237-0686  
MOLLINGSWORTH & STILL  
3098 PIEDMONT RD.  
ATLANTA GA.  
404-261-5838  
AUDIO DEVICES, INC.  
7321 NORTH HAMLIN AVE.  
SKOKIE, ILL  
312 583-4161  
FITZSIMMONS ASSOC.  
6774 NORTHWEST HIGHWAY  
CHICAGO, ILL  
312-775-6990  
AUDIO DEVICES, INC.  
8605 CAMERON ST  
SILVER SPRINGS, MD.  
301 585-4845  
A. G. RADAR  
5 SCOTT OR.  
FRAMINGHAM, MASS  
617-449-0724  
BURCAW-COWAN & CO.  
18236 W. MCNICOLS RD.  
DETROIT, MICH. 48219  
313-KE3-7700  
THE HEIMANN CO.  
5603 LYNOALE AVE SO  
MINNEAPOLIS, MINN.  
612-827-0157  
ALVIN THOMAS & CO.  
1828 WALNUT ST.  
KANSAS CITY, MO.  
815-471-6750  
C. T. CARLBERG & ASSOC.  
P. O. BOX 3177 STATION D  
ALBUQUERQUE, NEW MEXICO  
505-265-1579  
ROCKE INTERNATIONAL CORP.  
13 E. 40TH STREET  
NEW YORK, N. Y.  
212 689-0200  
WAXMAN CURRENT SALES, INC.  
990 KENMORE, AVE.  
BUFFALO 23, N. Y.  
716-873-0442  
NEAL BEAR CORP.  
3435 STREETSBORO RD.  
WEST RICHFIELD, OHIO  
216-659-3331  
INDEL SUPPLY CO.  
6749 EAST 12TH ST.  
TULSA, OKLA.  
NEBCO ASSOC.  
1974 GREGORY AVE.  
MONROEVILLE, PENN 15146  
412-824-2111  
CARTWRIGHT & BEAN  
560 SO. COOPER ST.  
CROSSTOWN STA.  
MEMPHIS 4, TENN  
901-276-4442  
AUDIO DEVICES, INC.  
8282 PARK PLACE BLVD, B-3  
HOUSTON, TEX.  
713 649-7182  
RON MERRITT CO.  
1320 PROSPECT ST.  
SEATTLE, WASH. 98109  
206 682-7337  
REPS. IN OTHER COUNTRIES  
ELECTRO-TEC MARKETERS, INC.  
1624 WEST 3RD ST.  
VANCOUVER, B. C.  
736-6377  
ALEX L. CLARK LTO.  
3751 BLOOR ST.  
ISLINGTON, ONTARIO  
416-231-3203

**AUDIO INSTRUMENT COMPANY INC.**

**SALES MANAGER**  
A. T. ADAMS  
COMPANY ADDRESS  
311 MOUNTAIN ROAD  
UNION CITY, N. J. 07087  
COMPANY REPRESENTATIVES  
AUDIO INDUSTRIES CORP.  
1419 N. LA BREA AVE.  
HOLLYWOOD, CALIF.  
HO-5-4111  
LOREN F. GREEN & ASSOCIATES  
5218 WEST OIVERSEY AVE  
CHICAGO, ILL.  
312-286-6824  
SLOAN & ASSOCIATES  
452 HIGHLAND AVE.  
MALDEN 48, MASS.  
617 322-1153  
ROCKE INTERNATIONAL CORP.  
13 EAST 40TH ST.  
NEW YORK, N. Y.  
MU9-0200  
LANG ELECTRONICS, INC.  
507 FIFTH AVE.

NEW YORK, N. Y.  
212-MU2-7147  
AUDIO-ELECTRO CO.  
1 LIMEKILN PIKE  
GLENSIDE PA.  
TU-7-5210  
M. K. WIDOEKIND & CO.  
815 WEST EWING ST.  
SEATTLE, WASH.  
206-284-8020  
REPS. IN OTHER COUNTRIES  
ALEX L. CLARK LTO.  
3751 BLOOR ST.  
WEST ISLINGTON, TORONTO,  
ONTARIO  
416 BE 1-3303

**BALL BROTHERS RESEARCH CORP.**

**SALES MANAGER**  
W. A. DOUGLASS  
COMPANY ADDRESS  
P.O. BOX 1062  
BOULDER, INDUSTRIAL PARK.  
COLORADO 80302  
COMPANY REPRESENTATIVES  
ELSCO, ARIZONA  
SCOTTSDALE, ARIZONA  
REVES ELECTRONICS  
LOS ANGELES, CALIFORNIA  
213 876-3300  
REVES ELECTRONICS  
VALTO ALTO, CALIFORNIA  
415 326-0663  
ELSCO, COLORADO  
DENVER, COLORADO  
303 433-2991  
VIDEO ENGINEERING CO.  
WASHINGTON, O. C.  
202 882-6131  
SOUTHEAST ELECTRONICS  
JACKSONVILLE, FLORIDA  
305 356-3007  
ELECTRONIC EQUIPMENT, INC.  
ATLANTA, GEORGIA  
404 872-5622  
VIDEO SYSTEMS, INC.  
CHICAGO, ILLINOIS  
312 677-9000  
GENERAL TELEVISION NETWORK  
DETROIT, MICHIGAN  
313 548-2500  
K & M ELECTRONICS  
MINNEAPOLIS, MINNESOTA  
612 927-6545  
VIDEO SYSTEMS, INC.  
ST. LOUIS, MISSOURI  
314 772-3295  
TELE-MEASUREMENTS  
CLIFTON, NEW JERSEY  
201 473-8822  
SOUTHERN ENGINEERING &  
SALES, INC.  
TULSA, OKLAHOMA  
918 622-1007  
PETRCE PHELPS, INC.  
PHILADELPHIA, PENNSYLVANIA  
215 477-9000  
BLUFF CITY DISTRIBUTING CO.  
MEMPHIS, TENNESSEE  
901 276-4501  
UNIVERSAL MAGNETICS INC.  
DALLAS, TEXAS  
214 631-4730  
UNIVERSAL MAGNETICS INC.  
HOUSTON, TEXAS  
713 529-3105  
ELECTRONIC SALES CORP  
SALT LAKE CITY, UTAH  
801 466-8631  
MUTUAL ELECTRONIC SUPPLY  
SEATTLE, WASHINGTON  
206 632-2791

**BARKER & WILLIAMSON, INC.**

**SALES MANAGER**  
ELMER BUSH  
COMPANY ADDRESS  
CANAL STREET  
BRISTOL, PENN. 19007

**BAUER ELECTRONICS CORPORATION**

**SALES MANAGER**  
PAUL GREGG  
**BRAND NAMES**  
LOG-ALARM  
PEAKMASTER  
COMPANY ADDRESS  
1663 INDUSTRIAL ROAD  
SAN CARLOS, CALIF. 94070  
COMPANY REPRESENTATIVES  
JESS SWICEGOOD  
P. O. BOX 1828  
DOTHAN, ALA.  
205 794-6339  
EUGENE D. BRADLEY  
1328 W. FLOWER  
PHOENIX 13, ARIZ.  
602 266-2292  
R. W. PLATT  
2317 SO. 25TH STREET  
FORT SMITH, ARK. 72901  
501 783-8492  
RICHARD R. BROOKS  
3706 W. 225TH STREET  
TORRANCE, CALIF. 90505  
213 373-2309  
HENRY S. BROUGHALL  
600 MARBLE STREET  
BROOMFIELD, COLO. 80020  
303 466-3851  
ROBERT H. PEARSON  
99-117 CHESTER WAY  
AIEA, HAWAII 96701  
GLENN E. WEBSTER  
823 S. GREENWOOD AVE.

PARK RIDGE, ILL. 60068  
312 823-8206  
HERBERT L. ARMS  
P. O. BOX 327  
CORYDON, IND.  
812 738-5752  
WILFRED FISHER  
VANCLEVE, KY. 41385  
606 666-5006  
GEORGE WILSON  
P. O. BOX 592  
FERRIDAY, LA.  
318 7200  
HOWARD B. HAYES  
18510 MUNCASTER ROAD  
DERWOOD, MD. 20752  
301 948-5863  
J. GORDON KEYWORTH  
BERKSHIRE DRIVE  
WILLIAMSTOWN, MASS.  
413 458-6538  
AUBREY FELDER  
P O BOX 546  
BROOKHAVEN, MISS.  
601 1298  
OLIVER J. COBURN  
P. O. BOX 636  
LIBBY, MONTANA 59923  
RICHARD W. BURDEN  
342 LEXINGTON AVE.  
MT. KISCO, N. Y. 10549  
914 666-3730  
HENRY A. BOGUSLAWSKI  
TELE-PROJECTS, INC.  
30 EAST 42ND STREET  
NEW YORK, N. Y. 10017  
212 687-1255  
JOHN O. BROOKS  
200 STONEWALL STREET  
ALBEMARLE, N. CAR.  
704 982-5667  
WILLIAM F. BAKER, JR.  
WBKR BROADCAST SERVICE  
1169 SYLVANIA ROAD  
CLEVELAND HTS. OHIO 44121  
382-0900  
WILLIAM M. BRADLEY  
200 COUNTRY CLUB ROAD  
SAND SPRINGS, OKLA. 74063  
918 245-5603  
A. C. MCMILLIAN  
16679 S. W. MAPLE CIRCLE  
LAKE OSWEGO, OREGON 97034  
503 636 6257  
KENNETH B. ANDERSON  
44 MCCracken ROAD  
GREENVILLE, PA. 16125  
412 588-4320  
JAMES CALDERON  
AM-13 VILLA RICA  
BAYAMON, PUERTO RICO  
SAMUEL FIELDS  
1009 SILVER STREET  
RAPID CITY, S. DAK.  
605 342-4372  
CHESTER J. DAVIS  
HARTSVILLE, TENN. 37074  
374-2422  
CHESTER FAISON  
P O BOX 4727  
DALLAS 6, TEXAS  
214 826-1044

**E. J. BAUGHMAN COMPANY**

**SALES MANAGER**  
E. C. BAUGHMAN  
COMPANY ADDRESS  
1914 N. COGSWELL RD.  
SOUTH EL MONTE, CALIF 91733

**BECKMAN & WHITLEY, INC.**

**MARKETING MGR.**  
DONALD L. TUCKER  
COMPANY ADDRESS  
441 WHISMAN ROAD  
MOUNTAIN VIEW, CALIF. 94040  
COMPANY REPRESENTATIVES  
HENRY GROSSMAN ASSOC.  
519 S. 5TH AVENUE  
MT. VERNON, NEW YORK 10550  
914 664-5393

**BELAR ELECTRONICS LABORATORY**

**COMPANY ADDRESS**  
8329 DELAWARE AVENUE  
UPPER DARBY, PENN. 19028

**BELDEN MANUFACTURING COMPANY**

**SALES MANAGER**  
CHARLES O. ATWATER  
**BRAND NAMES**  
BELOSOL  
BELDFOL  
CELENAMEL  
CELLULINE  
PERMOMME  
POLY THERMALEGE  
WELDDOWN  
98 PACKET  
COMPANY ADDRESS  
415 S. KILPATRICK AVE.  
CHICAGO, ILLINOIS 60644

**F. W. BELL, INC.**

**SALES MANAGER**  
RICHARD J. MACKESSY  
**BRAND NAMES**  
HALL-PAK  
COMPANY ADDRESS  
1356 NORTON AVENUE  
COLUMBUS, OHIO 43212  
614 294 4906  
TUX 434 789 0193  
COMPANY REPRESENTATIVES  
PHYSIMETRICS  
2105 DOGWOOD LANE  
HUNTSVILLE, ALA. 35810



**BBRC** provides versatile, economical equipment to commercial stations—and also enhances the capabilities of educational TV stations, university workshops and closed circuit systems. All equipment is simple to install, easy to operate, and features the long-term stability and low maintenance of solid-state circuitry.

**THE MARK VI** Special Effects Generator is a moderately priced, self-contained unit designed to meet commercial black and white television broadcast standards. Two models are available: a standard rack-mounted Mark VI-A, and a remote-controlled Mark VI-AR (SHOWN BELOW). Both provide three basic wipes, external video keying, and independent selective matting of background information in any value of gray from black to white. The Mark VI can serve as an ideal standby generator, an auxiliary unit for a second studio, or can be used in mobile van operations. Prices start from \$1375.00.

**THE MARK VII** is an advanced Color Special Effects Generator designed for the most critical studio applications. The Mark VII is capable of color inserts (color matting). The output video of the unit can be the combination of background video and artificially-generated color inserts—with any color within the NTSC spectrum generated by manual control settings. A non-additive mixing technique, insensitive to variations in video brightness levels, is incorporated for new effects with lap dissolves. The basic system accepts a variety of monochrome or color signals in either composite or non-composite format at the inputs. In addition to keying effects, as many as fourteen wipes can be provided. Prices from \$1810.00. Write for additional information.

# DEPENDABLE BROADCAST TELEVISION EQUIPMENT

FROM BALL BROTHERS  
RESEARCH CORPORATION

**THE MARK VIII** Automatic Gain Control (AGC) Video Amplifier was developed to provide continuous monitoring of video signals from a variety of originating equipment. It is available in two models: one for use in studios where local drives can be supplied, and the other where drive pulses are derived from composite video signals originating outside the studio, or from VTR's. Both have full color capabilities, and are designed to compensate for both video and set-up levels over a  $\pm 6$ db range. It is ideally suited to follow film chains and live cameras, or network originations. It is also used ahead of video tape recorders and standard transmission lines where signals are limited to precise levels to prevent distortion. Prices from \$3340.00.

**THE MARK IX** Video and Pulse Distribution Amplifiers were developed specifically for color studio operations. Up to ten video or pulse amplifiers (or any combination of both) can be plugged into the Mark IX chassis to provide as many as 40 isolated signal outputs at one central distribution point. The Mark IX Video Amplifier requires no high frequency adjustment because of its wideband frequency response characteristics. Differential gain and phase measurements are shown for all input signal conditions at 0.25 percent and 0.25 degrees, respectively. The Pulse Amplifier has highly isolated signal outputs with an impedance of 75 ohms terminated at the sending end. Each amplifier has bridging or looping input drive signal provisions. The active circuitry maintains constant pulse rise times of less than 50 nanoseconds and is compensated for possible component replacement. Pulse delay of less than 50 nanoseconds is measured at the output. Prices: Video Pulse Amplifier, \$295.00 each; Electronic Housing, \$275.00.

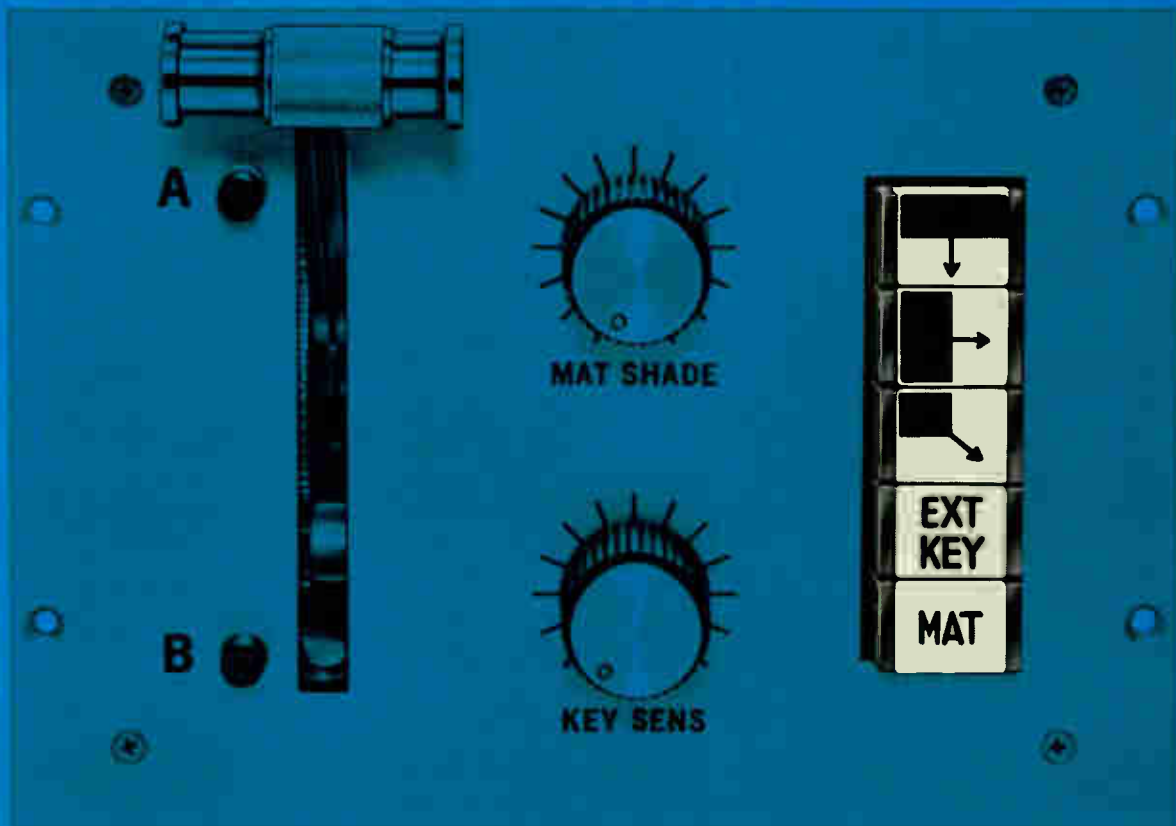

205 539-3274  
PAUL NURCHES COMPANY  
2396 E. FOOTHILL BLVD.  
PASADENA, CALIF. 91107  
213 796 5844  
STRAUBE ASSOCIATES  
483 WILLOW ROAD  
MENLO PARK, CALIF. 94025  
415 323-2476  
TWX 415-492-9266  
STRAUBE ASSOCIATES  
2888 TELEGRAPH AVE.  
BERKELEY, CALIF. 94705  
415 841-4450  
GORDON MOSS ELECTRONICS, INC.  
BOX J  
GREELEY, COLORADO 80632  
303 353-1452  
PHYSIMETRICS  
P.O. BOX 536, 502 SELKIRK DR  
WINTER PARK, FLA. 32789  
305 647-5722  
PHYSIMETRICS  
SUITE 518-PENTHOUSE,  
3376 PEACHTREE RD., N.E.  
ATLANTA, GA. 30326  
404 237-8278  
R. EDWARD STEMME, INC.  
5681 W. LAKE STREET  
CHICAGO, ILL. 60644  
312-379-2700  
TWX 312-265-1344  
ELECTRONIC COMPONENTS AND  
SERVICES  
611 TRAPELO RD  
WALTHAM, MASS 02154  
617 894 6921  
TWX 617 894 9857  
WKM ASSOCIATES, INC.  
1474 EAST OUTER DRIVE  
DETROIT, MICH. 48234  
313 892-2500  
R. EDWARD STEMME, INC.  
2713 LYNDALE AVE., S.  
MINNEAPOLIS, MINN. 55408  
612 827-8406  
LABTRONICS, INC.  
161 PICKARD BLDG.  
SYRACUSE, N.Y. 13211  
315 454-9314  
CANE TECHNICAL SALES, INC.  
555 E. BOSTON POST RD.  
HAMARONEK, N.Y. 10543  
914 698-4411  
JOSEPH PLASENCIA, INC.  
EXPORT ONLY  
521 FIFTH AVENUE  
NEW YORK, N.Y. 10017  
212 867 8084  
WKM ASSOCIATES, INC.  
6741 RIDGE RD.  
CLEVELAND, OHIO 44129  
216 885-5616  
TWX 216-845-2304  
WKM ASSOCIATES, INC.  
6085 FAR HILLS AVE.  
DAYTON, OHIO 45459  
513 298-7203  
TWX 513-944-0280  
F. W. BELL, INC.  
1356 NORTON AVENUE  
COLUMBUS, OHIO 43212  
614 294-4906  
TWX 614 759-0193  
DALE G. WEBER COMPANY  
SUITE 306 WEATHERLY BLDG.  
PORTLAND, OREGON 97214  
503 234-7671  
TYLER GRIFFIN COMPANY  
46 DARBY RD.  
PAOLI, PA. 19301  
215 647-1550  
WKM ASSOCIATES, INC.  
90 CLAIRTON BLVD.  
PITTSBURGH, PA. 15227  
412 892-2953  
TWX 412-525-2356  
CAREY-WOLF COMPANY  
BOX 12425, 3327 WINTHROP AVE  
FORT WORTH, TEXAS 76116  
817 738-1702  
TWX 817 891 8203  
CAREY-WOLF COMPANY  
BOX 60398  
HOUSTON, TEXAS 77060  
713 643-2114  
TWX 713-571-1123  
GORDON MOSS ELECTRONICS, INC.  
BOX 8022 FOOTHILLS SECTION  
1502 PRESTON STREET  
SALT LAKE CITY, UTAH 84108  
801 485 2870  
DALE G. WEBER COMPANY  
325 MARITIME BLDG.  
SEATTLE, WASH. 98104  
206 623-5990  
REPS. IN OTHER COUNTRIES  
MEGATRONIX LIMITED  
1800 AVENUE ROAD  
TORONTO 12, ONTARIO  
416 783-3329  
TWX 610 491-1713

BENCO TELEVISION ASSOCIATES  
SALES MANAGER - CANADA  
C. J. EVANS  
SALES MANAGER - US  
HARRY D. GRAY  
SUBSIDIARY  
BENCO TELEVISION CORP  
P O BOX 10068  
JACKSONVILLE, FLA. 32207  
904 398 6907  
COMPANY ADDRESS  
27 TABER ROAD  
REXDALE, ONTARIO, CANADA

BENJAMIN ELECTRONIC SOUND CORP.  
SALES MANAGER  
JAY MENDUKE  
BRAND NAMES  
ELAC  
MIRACORD  
BENJAMIN  
COMPANY ADDRESS  
40 SMITH STREET  
FARMINGDALE, N.Y. 11735  
COMPANY REPRESENTATIVES  
ALASKA ELECTRONICS SUPPLY CO  
201 E. 4TH AVE., BOX 4-669  
ANCHORAGE, ALASKA  
BERNARD L. CAHN CO.  
420 MARKET STREET  
SAN FRANCISCO, CALIF.  
415 781-7981  
ELLARD STRASSNER CO.  
3121 LOS FELIZ BLVD.  
LOS ANGELES, CALIF. 90039  
213 666-1511  
HYDE ELECTRONICS CO.  
888 S. LIPIAN  
DENVER, COLORADO  
303 936-3456  
MATLAND K. SMITH CO.  
31 16TH STREET, N.W.  
ATLANTA, GA.  
404 875-8031  
DOUGHERTY ENTERPRISES  
P.O. BOX 3497  
HONOLULU, HAWAII  
MARKEL SALES CORP.  
5787 N. LINCOLN AVENUE  
CHICAGO, ILL.  
312 561-7290  
FRANK MCSWEENEY & ASSOC  
4123 N. KEYSTONE AVENUE  
INDIANAPOLIS, IND.  
317 547-2112  
ART GAINES CO  
1151 VIERS MILL RD  
WHEATON, MD  
301 933 2550  
ANDERSON SALES CO.  
177 STATE STREET  
BOSTON, MASS.  
617 227-2980  
ROBERT MILSK CO.  
19375 JAMES COUZENS HWY.  
DETROIT, MICH.  
313 342-6660  
PAT AYLWARD & CO.  
3807 GRAND AVENUE  
MINNEAPOLIS, MINN.  
612 824-6266  
CARMINE VIGNOLA & ASSOC  
21 SCHELLRIDGE RD  
JEFFERSON CITY, MO  
314 635 1023  
ARNOLD KRAMERSON  
73 HICKS LANE  
GREAT NECK, N.Y.  
516 482-1589  
METROPOLITAN SALES CO.  
110 JERICHO TPKE.  
FLORAL PARK, N.Y.  
516 328-0120  
LES MORROW CO.  
3123 W. 117TH STREET  
CLEVELAND, OHIO  
216 291-5700  
FRANK FARUSI  
312 ROCKFIELD RD.  
PITTSBURGH, PA.  
412 221-4676  
MARTIN WEINBERG & ASSOC.  
1122 E CLIVEDEN STREET  
PHILADELPHIA, PA.  
215 549-1122  
TECH-TRONIC SALES CO  
2920 WESLAYAN  
HOUSTON, TEXAS  
713 667-5003  
DAVID CHAMPLIN CO.  
12347 BOTHELL WAY, N.E.  
SEATTLE, WASH.  
206 362-0401

BENRUS-TECHNICAL PRODUCTS DIV.  
SALES MANAGER  
LOUIS A. RICCIO  
COMPANY ADDRESS  
30 CHERRY AVENUE  
WATERBURY, CONNECTICUT 06720  
COMPANY REPRESENTATIVES  
DIETRICH-MEFFNER ASSOC.  
2202 W. MAGNOLIA BLVD.  
BURBANK, CALIF.  
213 849-6871  
TWX 213 846-7801  
TECHNICAL ASSOC. INC.  
2319 EAST SOUTH STREET  
ORLANDO, FLORIDA 32803  
305 424-9681  
BARD ASSOCIATES, INC.  
LAGRANGE INDUSTRIAL PK.  
LAGRANGE, ILLINOIS  
312 354-0660  
TWX 312 352-7782  
LEEMARK ASSOCIATES  
P. O. BOX 6175  
LEAWOOD, KANSAS  
913 648-0124  
INSTRUMENT ASSOCIATES INC.  
30 PARK AVENUE  
ARLINGTON, MASS. 02174  
617 648-2922  
S. STERLING, CD.  
21250 10 - 1/2 MILE RD.  
SOUTHFIELD, MICHIGAN  
313 357-3700  
TWX 313 357-4615  
INSTRUMENTATION SALES CO.  
P. O. BOX 403

RIDGEWOOD, N. J.  
615-5210  
TWX 444-2988  
AZTEC ENTERPRISES  
5206-B CONSTITUTION AVE.  
ALBUQUERQUE, NEW MEXICO  
505 268-6421  
FRATHON COMPANY  
202 W. 46TH ST.  
NEW YORK, N. Y. 10017  
212 687-9390  
J. D. RYERSON ASSOC. INC.  
425 MANOR DRIVE  
EAST SYRACUSE, N. Y.  
315 656-7419  
TWX 315 477-1132  
KASTLE ASSOCIATES  
354 NORTH MAIN ST.  
DOYLESTOWN, PENNA.  
215 348-4466  
NOAKES ENGINEERING  
2338 MACARTHUR BLVD.  
IRVING, TEXAS.  
214 BL 5-0441  
THE JAC COMPANY  
2914 ANNANDALE ROAD  
FALLS CHURCH, VA. 22042  
703 534-7800  
ASSOCIATED INDUSTRIES  
3711 S. HUDSON STREET  
SEATTLE, WASHINGTON 98118  
206 PA 2-3347  
TWX 206 998-1202  
REPS IN OTHER COUNTRIES  
BRH ASSOCIATES LTD.  
6338 VICTORIA AVE.  
MONTREAL 26, QUEBEC  
514 733-5331

BERKEY TECHNICAL CORP  
VP SALES  
HERBERT HOLLANDER  
BRAND NAMES  
ASCOR  
CAESAR-SALTZMAN  
ASCORLIGHT  
COMPANY ADDRESS  
25-15 50TH STREET  
NEW YORK CITY, N.Y. 11377  
COMPANY REPRESENTATIVES  
BERKEY TECHNICAL OF CALIF.  
CALORTRAN  
1015 CHESTNUT ST  
BURBANK, CALIF.  
ASCOR ELECTRONICS CORP.  
2035 NE 151ST STREET  
N. MIAMI BEACH, FLORIDA  
BERKEY TECHNICAL CORP  
3701 M VERNON AVE  
ALEXANDRIA, VA.  
REPS IN OTHER COUNTRIES  
BERKEY OF CANADA, LTD.  
3320 ELMBANK RD.  
MALTON, ONTARIO

BIONIC INSTRUMENTS, INC.  
SALES MANAGER  
BROADCAST EQUIPMENT  
D RIDGELY BOLGIANO  
SALES MANAGER  
HOSPITAL CCTV  
J MALVERN BENJAMIN  
COMPANY ADDRESS  
221 ROCK HILL ROAD  
BALA-CYNWYD, PA 19004

BIRD ELECTRONIC CORPORATION  
VICE. PRES.-SALES  
M. A. RICKMAN  
BRAND NAMES  
THRULINE  
COAXWITCH  
SENTRILINE  
TERMALINE  
WATCHER  
TENULINE  
COMPANY ADDRESS  
30303 AURORA ROAD  
SOLON, OHIO 44139  
216 248 1200  
TWX 216 248 6458  
COMPANY REPRESENTATIVES  
ALLGOOD ASSOCIATES, INC.  
3388 WEST 8TH STREET  
LOS ANGELES, CALIF. 90005  
213 383-4443  
TWX 213 380-8761  
O H BROWN CO.  
P O BOX 128  
PALO ALTO, CALIF. 94302  
415 321-8867  
TWX 415 492-9396  
BIRD ELECTRONIC CORP.  
235 BEAR HILL ROAD  
WALTHAM, MASSACHUSETTS 02154  
617 899-4162  
MAXWELL A. BROWN ASSOCIATES  
308 SECOND AVE.  
BRADLEY BEACH, N. J.  
201 775-7829  
REPS IN OTHER COUNTRIES  
LEIGH & HURWITZ PTY LTD.  
P. O. BOX 3236  
JOHANNESBURG, SOUTH AFRICA  
HANS BUCH & CO. A/S  
SVANEVEJ 6  
P. O. BOX 975  
COPENHAGEN NV, DENMARK  
OY ASEKO AB  
VUORIKATU 22  
HELSINKI 10, FINLAND  
TECHNIQUE ET PRODUITS  
63 BIS RUE O AGUESSEAU  
BOULOGNE S/SEINE,  
SEINE, FRANCE  
WACKER GMBH

STETTENSTRASSE 9  
6 FRANKFURT AM MAIN  
W. GERMANY  
LIVINGSTON LABORATORIES, LTD.  
GREYCAINES ESTATE  
BUSHEY HILL LANE  
N. WATFORD, HERTS, ENGLAND  
DOTT, ING. MARIO VIANELLO  
VIA L. ANELLI 13  
MILAN, ITALY  
VIA S. CROSE IN  
GERUSALEMME 97  
ROME, ITALY  
MORGENSTIERNE & CO A/S  
WESSELS GATE 6  
OSLO, NORWAY  
ATAID INGENIERDS  
ENRIQUE LARRETA 12  
MADRID 16, SPAIN  
ERIK FERNER AB  
P. O. BOX 56  
BROMMA, SWEDEN  
MEGEX-ZURICH, GMBH  
BADENERSTRASSE 582  
8048 ZURICH, SWITZERLAND  
WARBURTON FRANK LIMITED  
307 KENT STREET  
SYDNEY, AUSTRALIA

BIRNBACH CO. INC.  
SALES MANAGER  
GERDGE ORTIZ  
BRAND NAMES  
BIRNBACH  
COMPANY ADDRESS  
435 HUDSON ST  
NEW YORK, NEW YORK 10014  
COMPANY REPRESENTATIVES  
BIRNBACH RADIO  
427 S HINDRY ST.  
INGLEWOOD, CALIF.  
213 673-2900  
ELECTRONIC MFG. CONS. INC  
226 E. VERM. SD  
COLORADO SPRINGS, COLO.  
R A CHOLMER CO.  
349 PEACHTREE HILLS AVE NE  
ATLANTA, GA.  
404 233-3208  
DELTA SALES  
1407 N. ILLINOIS STREET  
INDIANAPOLIS, IND.  
317 ME 1-4136  
ORC CO.  
1643 BEACON STREET  
WABAN, MASS.  
617 332-9600  
CARMINE A. VIGNOLA & ASSOC.  
21 SCHELLRIDGE RD.  
JEFFERSON CITY, MO.  
314 635-1023  
JULES S BRESSLER, INC  
4808 BERGENLINE AVE.  
UNION CITY, N.J.  
201 864-9577  
CALLAHAN-FERGUSON CO.  
107 GREENHEDGE DR.  
CAMILLUS, N.Y.  
315 488-5518  
THOMAS SHELBY CO  
17 SD. WALNUT STREET  
NEW BREMEN, OHIO  
619 629-6511  
LOWERY ASSOCIATES CO.  
2801 WESTCHESTER PIKE  
BROOMAL, PA.  
215 JA 8 5170

BIRNS & SAWYER INC  
SALES MANAGER  
CLIFFORD SAWYER  
BRAND NAMES  
AUREFLEX  
AURIBELL  
E-Z-SEE  
OMNITAR  
OMNIPPON  
COMPANY ADDRESS  
6424 SANTA MONICA BLVD.  
LOS ANGELES, CALIF 90038

BISCAYNE AUDIO COMPANY-  
BROADCAST EQUIPMENT DIV  
COMPANY ADDRESS  
P.O. BOX 543  
DETROIT, MICHIGAN 48232

BLAW-KNOX COMPANY  
BLAW-KNOX EQUIPMENT DIVISION  
SALES MANAGER  
ADVANCECO PRODUCTS DEPT  
E S MILLER  
COMPANY ADDRESS  
P.O. BOX 1198  
PITTSBURGH, PA. 15230  
COMPANY REPRESENTATIVES  
THE THORSON COMPANY  
6824 MELROSE AVENUE  
LOS ANGELES, CALIF.  
MURRAY SOCLOF  
2013 BEDFORD STREET  
ROME, NEW YORK

BLOUNDER-TONGUE LABORATORIES, INC  
SALES MANAGER  
RICHARD B. HELMOSKI  
BRAND NAMES  
BLONDER-TONGUE  
COMPANY ADDRESS  
9 ALLING STREET  
NEWARK, NEW JERSEY 07102  
COMPANY REPRESENTATIVES  
GRAHAM SISSON  
BOX 5357  
SAN JOSE, CALIF. 95129  
408 257-3302

MOULTHROP & HUNTER  
165 ELEVENTH STREET  
SAN FRANCISCO, CALIF.  
415 UN 3-7880  
MIKE STOBIN COMPANY  
14663 ARMINA STREET  
VAN NUYS, CALIF.  
213 ST 2-9421  
HYDE ELECTRONICS COMPANY  
888 SOUTH LIPAN STREET  
DENVER, COLORADO  
303 936-3455  
W. F. HEMMING COMPANY, INC.  
P.O. BOX 6008  
SARASOTA, FLORIDA  
813 625-6000  
ERNEST C. SISSON  
3057 RANLD DRIVE  
DORAVILLE, GEORGIA  
404 938-7085  
BILL KOLANS COMPANY  
P.O. BOX 2098  
HONOLULU, HAWAII  
C. HENRY LIRD  
23 W. 031 HACKBERRY DRIVE  
GLEN ELLYN, ILLINOIS  
312 HD 9-7193  
GEDRGE PETITT COMPANY  
349 NORTH ASHLAND AVENUE  
RIVER FOREST, ILLINOIS  
312 CO 1-0342  
HOEMIG SALES COMPANY  
3405 BUTLER COURT  
FORT WAYNE, INDIANA  
219 483-6913  
FORRISTAL-YOUNG SALES  
5550 BUENA VISTA  
MISSION, KANSAS  
913 432-1420  
W. A. HENDRICKSON COMPANY  
29 FIRST PARISH RD.  
SCITUATE, MASS.  
617 LI 5-0652  
J. MALCOLM FLORA, INC.  
165 W. LIBERTY  
PLYMOUTH, MICH.  
313 GL 3-4296  
MEL FOSTER COMPANY  
228 S. CEDAR LAKE ROAD  
MINNEAPOLIS, MINN.  
612 374-2612  
FORRISTAL-YOUNG SALES  
7110 DAKLAND STREET  
ST. LOUIS, MO.  
314 MI 5-2360  
L-C-A SALES, INC.  
75 MAIN STREET  
TUCKAHOE, N.Y.  
914 WD 1-4700  
LSM ASSOCIATES  
ORCHARD PARK, PHELPS, N.Y.  
315 548-4891  
ATCHESON & ADAMS  
P.O. BOX 9085  
GREENSBORO, N.C.  
919 272-6838  
WELLER ELECTRONIC SALES, INC.  
P.O. BOX 212  
WORTHINGTON, OHIO  
614 TU 5-7819  
JACK F. MCKINNEY SALES CO.  
1303 CHEMICAL STREET  
DALLAS, TEXAS  
214 ME 1-9450  
M. K. WIDDEKIND COMPANY  
815 W. EWING STREET  
SEATTLE, WASH.  
206 AT 4-8020  
REPS IN OTHER COUNTRIES  
R. J. BUCKLAND COMPANY  
P.O. BOX 367 STATION B  
LONDON, ONTARIO

**BOSTON INSULATED**  
**WIRE & CABLE COMPANY**  
SALES MANAGER  
ROBERT COWEN  
BRAND NAMES  
B I W  
ELAC  
COMPANY ADDRESS  
65 BAY STREET  
DORCHESTER, MASS. 02125  
COMPANY REPRESENTATIVES  
W. E. ANDERSON  
2825 HIGHLAND AVE. B-4  
BIRMINGHAM, ALA.  
205 323-2870  
BIW, ELAC DIV.  
141 NEVADA ST.  
EL SEGUNDO, CALIF.  
213 DR 8-6141  
D. R. BUGBEE  
11 PARKER FARMS RD.  
WALLINGFORD, CONN.  
203 265-1067  
T. R. RUSSELL  
4068 WESTERN AVE.  
WESTERN SPRINGS, ILL.  
312 246 2570  
J. D. ALLEN  
1438 LANGFORD ROAD  
BALTIMORE, MD.  
301 RI 7-3404  
R. S. WILLIAMSON  
34 BACON ST.  
NATICK, MASS.  
617 OL 3-8756  
F. K. GUNTHER  
56 MAPLE ST.  
CHAGRIN FALLS, OHIO  
216 247-6117  
REPS IN OTHER COUNTRIES  
81W, LTD.  
118 SHAW STREET  
HAMILTON, ONTARIO  
416 JA 9-7151

**W. H. BRADY CO.**  
ADVERTISING MANAGER  
J A PESCHECK  
BRAND NAMES  
PERMA-CODE  
SIGNATURE PLATES  
QUIK-LABEL  
BRADY  
COMPANY ADDRESS  
727 W. GLENDALE AVE.  
MILWAUKEE, WIS. 53209  
**BROADCAST ELECTRONICS, INC.**  
VICE. PRES. FOR SALES  
JOHN L. NEFF  
BRAND NAMES  
SPDMASTER  
PDRAPAK  
FIDELIPAC  
COMPANY ADDRESS  
8810 BROOKVILLE ROAD  
SILVER SPRING, MARYLAND 20910  
301 588 4983  
COMPANY REPRESENTATIVES  
WISE RADIO & TV SUPPLY INC  
1001 TOWSON AVENUE  
FORT SMITH, ARKANSAS  
501 783-8925  
WESTERN RADIO & TV SUPPLY CO  
1415 INDIA STREET  
SAN DIEGO 1 CALIFORNIA  
714 239-0361  
UNIVERSAL TAPEDEX  
7660 GLORIA AVENUE  
VAN NUYS, CALIFORNIA 91406  
213 989-3370  
BAUER ELECTRONICS CORP  
1663 INDUSTRIAL ROAD  
SAN CARLOS, CALIF.  
FUJI-YA  
1662 POST STREET  
SAN FRANCISCO, CALIF 94115  
415 346-7173  
FIRST STATE ELECTRONICS INC  
801 NORTH UNION ST  
WILMINGTON, DELAWARE  
CONTINENTAL ELECTRONICS WHL5  
457 WEST 28TH STREET  
HIALEAH, FLORIDA  
305 888-3511  
FLAGLER RADIO CO INC  
1068 WEST FLAGLER STREET  
MIAMI, FLORIDA  
305 373-1425  
ACME SALES COMPANY  
31 16TH STREET, N W  
ATLANTA, GEORGIA  
404 355-9267  
WEBSTER ENGINEERING CO  
823 SOUTH GREENWOOD AVENUE  
PARK RIDGE, ILLINDIS  
312 823-8206  
MOTOROLA, INC  
COMMUNICATIONS PRODUCTS DIV  
4501 W AUGUSTA BLVD  
CHICAGO, ILLINOIS  
SARKES TARZIAN  
EAST HILLSIDE DRIVE  
BLOOMINGTON, INDIANA  
812 332-7251  
WILFRED FISHER  
VANCLEVE, KENTUCKY  
606 666-5006  
B & R INC  
15312 SANTA ROSA  
DETROIT, MICHIGAN 48238  
313 341-7990  
FELDER ELECTRONIC  
P O BOX 546  
BROOKHAVEN, MISS.  
601 833-6911  
GENERAL SOUND AND VISUAL  
62 CONGRESS STREET  
PDRTSMOUTH, NEW HAMPSHIRE  
603 436-8963  
VISUAL ELECTRONICS CORP.  
356 WEST 40TH STREET  
NEW YORK, NEW YORK  
212 736 5840  
GENERAL ELECTRIC  
VISUAL COMMUNICATION PRODS.  
BUILDING 7, ROOM G164,  
ELECTRONICS PARK  
SYRACUSE, NEW YORK  
315 456-2869  
ELECTRONICS MISSILES &  
COMMUNICATIONS, INC.  
160 EAST THIRD STREET  
MOUNT VERNON, NEW YORK 10550  
914 668-3012  
LANG ELECTRONICS, INC  
507 FIFTH AVE  
NEW YORK, NEW YORK  
212 682-7147  
LEE-JEFFERIES INC  
535 MADISON AVE  
NEW YORK, NEW YORK  
212 759-7220  
ATWOOD RICHARDS, INC  
625 MADISON AVE  
NEW YORK, NEW YORK  
WARREN RADIO COMPANY  
1002 ADAMS STREET  
TOLEDO 1, OHIO  
GALLAGHER SERVICES  
P O BOX 98  
WHITE HAVEN, PENNSYLVANIA  
717 443-9850  
WILKINSON ELECTRONICS INC  
1936 MACDADE BLVD  
WOODLYN, PENN 19094  
215 874-5256  
ORTIZ ELECTRONICS CORP  
MCKINLEY 210 DESTA  
APARTADO 731  
MAYAGUEZ, PUERTO RICO  
JOSE ARTURO FERNANDEZ

**KEEP TOMORROW'S  
NEEDS IN MIND  
TODAY WITH BELAR**

**ADD-ON  
MONITOR  
SYSTEM**



The Belar ADD-ON MONITORING SYSTEM allows the broadcaster to fulfill his monitoring requirements as the needs arise. The basic unit is the FMM-1 Frequency and Modulation Monitor for monaural use, and when requirements call for SCA, add the plug in SCAM-1 SCA unit. And for stereo the FMS-1 Stereo unit completes the system.

Today's monitoring requirements make this system a must.

**BELAR ELECTRONICS LAB.**  
Delaware & Montrose Avenues  
Upper Darby, Pa. 19082

**THE  
ADD-ON  
IS  
COMPLETE**

Pilot Frequency  
38 KC Suppression  
L-R Crosstalk  
L-R Crosstalk  
AM Noise or Inc. AM

The FMS-1 monitors and measures:

Total Modulation  
L-R Modulation  
L-R Modulation  
Pilot Amplitude  
Left or Right Channel

FCC TYPE APPROVED

A stereo station must—the Belar FMS-1 monitors the 19 KC pilot frequency as well as all the modulation characteristics of FM stereo. The advanced solid-state circuitry guarantees that all FCC performance requirements for stereo monitors are exceeded so that precise, accurate proof-of-performance measurements can be made for the finest in stereo broadcasting.

P O BOX 5124  
PUERTE DE TIERRA STA.  
SAN JUAN, PUERTO RICO 00906  
DIXIE RADIO SUPPLY CO  
1900 BARNWELL STREET  
COLUMBIA, SOUTH CAROLINA  
803 253-5333  
PEPPER SOUND STUDIOS INC  
47 SOUTH FLORENCE STREET  
MEMPHIS, TENNESSEE  
901 274-6674  
BLUFF CITY DISTRIBUTING CD  
234 EAST STREET  
MEMPHIS, TENN  
555 1212  
BROADCAST EQUIP & SUPPLY CO  
P O BOX 3141  
BRISTOL, TENN 37623  
615 764-8032  
HOWELL COMPANY  
2873 PERSHING DRIVE  
EL PASO, TEXAS 79903  
915 566-3968  
WITKO ELECTRONICS INC  
435 BRANIFF BLDG  
DALLAS, TEXAS  
214 741-5225  
R & R ELECTRONIC SUPPLY CO  
1607 AVENUE G  
LUBBOCK, TEXAS 79408  
806 765-8089  
R & R ELECTRONIC SUPPLY CO  
914 WEST SEVENTH ST  
AMARILLO, TEXAS  
806 374-2869  
ELSCO  
2275 SW TEMPLE  
SALT LAKE CITY, UTAH 84115  
801 466-8631  
REPS IN OTHER COUNTRIES  
AMALAGAMATED WIRELESS  
40, JALAN AMPANG  
KUALA LUMPUR, MALAYSIA  
SUNSHINE COMPANY LTD  
P O BOX 1462  
BANGKOK, THAILAND  
HERMAN ALLAN PAOGETT  
GERENTE GENERAL  
APO. 48  
COMAYAGUELA, D.C. HONDURAS  
MR. FRANZ KUBECKA  
UNTERE KIRCHGASSE 20  
8710 KITZINGEN, W. GERMANY  
DIRECT TV REPLACEMENTS LTD  
126 HAMILTON ROAD  
WEST NORWOOD  
LONDON SE 27, ENGLAND  
ATLANTIDA, S. A.  
9-11, RUE DU CLOS  
CASE EAUX-VIVES 103  
1211, GENEVE 6, SWITZERLAND  
NORTHERN ELECTRIC CO. LTD.  
590 BERRY STREET  
ST. JAMES WINNIPEG 21,  
MANITOBA  
NORTHERN ELECTRIC CO LTD  
250 SIDNEY STREET  
BELLEVILLE, ONTARIO  
NORTHERN ELECTRIC CO LTD  
143 LAKE SHORES BOULEVARD E  
TORONTO 2, ONTARIO  
NORTHERN ELECTRIC CO LTD  
1000 GUY STREET  
MONTREAL 25, QUEBEC  
I M E X  
IMPORTADORA MEXICANA  
APARTADO M-2910  
MEXICO, D.F., MEXICO  
SIMON GRAY PTY LTD  
28 ELIZABETH ST  
MELBOURNE, C 1, AUSTRALIA  
EQUIPOS E IMPLEMENTOS  
ELECTRONICOS  
LEON VALARDE 1080  
CASILLA 4087  
LIMA, PERU  
GENERAL ELECTRIC  
DE VENEZUELA, S A  
APARTADO 1666  
CARACAS, VENEZUELA

**BROADCAST PRODUCTS COMPANY**  
SALES MANAGER  
JAMES C. WOODWORTH  
BRAND NAMES  
AUTOCUE  
COMPANY ADDRESS  
1880A WOODWAY DRIVE  
DERWOOD, MARYLAND 20855  
301-942-1224

**BROWNING LABORATORIES, INC**  
SALES MANAGER  
WILLIAM E. FOX  
COMPANY ADDRESS  
1269 UNION AVE  
LACONIA, NEW HAMPSHIRE 03246

**BUCHANAN ELECTRICAL PRODUCTS CORPORATION**  
VICE PRESIDENT, SALES  
PAUL VANCE  
COMPANY ADDRESS  
1065 FLORAL AVE  
UNION, NEW JERSEY 07083  
COMPANY REPRESENTATIVES  
JAMES E. HEUSSER  
62D SUNDALD DR.  
BIRMINGHAM, ALA. 33235  
205 836-3896  
NORMAN F. ROSS  
P.O. BOX 187  
SCOTTSDALE, ARIZONA 85252  
602 WH 5-7262  
PETER W. JASIN  
3506 SKYLARK DRIVE

CONCORD, CALIF. 94520  
415 686-0905  
H. C. VAN YSSELDYK  
412 SEATON STREET  
LOS ANGELES, CALIF. 90013  
213 MA 9-3855  
FRED A. PEASE CO.  
P O BOX 646, AURORA BRANCH  
DENVER, COLORADO 80010  
303 364-9391  
BELCHER AND ASSOC. INC.  
8751 ATLANTIC BLVD.  
JACKSONVILLE, FLA. 32211  
305 RA 4-7811  
BELCHER & ASSOC. INC  
61 NORTHEAST 2ND STREET  
MIAMI, FLORIDA 33132  
305 FR 1 1700  
BELCHER & ASSOC. INC  
1900 FIRST AVENUE, NORTH  
ST PETERSBURG, FLORIDA 33713  
813 862 7575  
JACK H. ANTRY  
34 PEACHTREE STREET, NW  
ATLANTA, GA. 30303  
404 525-4221  
WILLIAM E. NIVEN  
1168 WAIMANU STREET  
HONOLULU, HAWAII 96814  
512 644  
DONALD E. ANDERSON  
600 WEST JACKSON BLVD.  
CHICAGO, ILL. 60606  
312 AN 3-7020  
WILLIAM E. JOBS  
3902 1/2 N. COLLEGE AVE.  
INDIANAPOLIS, IND. 46223  
317 WA 4-2560  
STRICKLAND ASSOCIATES  
P O BOX 19622  
NEW ORLEANS, LA 70119  
504 729 6586  
A D WILSON  
508 ST. PAUL STREET  
BALTIMORE, MD. 21202  
301 SA 7-1424  
HAROLD STANDISH  
3 WILSON DRIVE  
FRAMINGHAM, MASS. 01701  
617 879-1220  
MORTON ELECTRIC SALES CO  
24801 FIVE MILE ROAD  
DETROIT, MICH 48329  
313 534 2070  
MCCULLOCH-LEE CO.  
531 SOUTH 7TH STREET  
MINNEAPOLIS, MINNESOTA 55415  
612 FE 2-3644  
STRICKLAND ASSOCIATES  
152 CHIPPEWA CIRCLE  
JACKSON, MISS 39211  
601 366 6195  
THE RAY MARTIN CO.  
136 W. ADAMS  
KIRKWOOD, MO. 63122  
314 YO 6-8659  
CHARLES L. AREHART  
6621 STERLING  
RAYTOWN, MO. 64133  
816 FL 6-3488  
ED TABER & SONS  
3240 SOUTH 31ST STREET  
LINCOLN, NEBRASKA 68502  
402 423-4420  
WALDRON SALES ENGINEERING CO  
15 POND HILL ROAD  
MORRISTOWN, N J 07960  
201 538 5607  
TOM DESKIN  
317 COMMERCIAL, NE  
P O BOX 808  
ALBUQUERQUE, N.M. 87103  
505 242-3581  
A C SCHULTZ CO.  
BOX 2661 - AMHERST BRANCH  
2095 KENSINGTON AVENUE  
BUFFALO, N.Y. 14226  
716 839-1010  
A C SCHULTZ CO  
7240 ROSEWOOD CIRCLE  
SYRACUSE, N Y  
315 458 6927  
KEN TODD  
949 PALMER ROAD  
BRONXVILLE, N.Y. 10708  
212 FA 4-5466  
MARK SALES AGENCY  
2947 BAYVIEW AVE  
WANTAGH, L I, N Y  
212 PL 7 6454  
C. CARROLL NIEDRINGHAUS  
BOX 424, ROUTE #1  
MATTHEWS, N.C.  
704 847-9288  
POGUE C. SHERRILL  
1117 LANETTE  
CINCINNATI, OHIO 45230  
513 231-9794  
VAUGHN O NEILL  
1090 HOMELAND DRIVE  
CLEVELAND, OHIO 44116  
216 331-4273  
AARON E GREENLEE  
200 SOUTH CLASSEN AVE.  
P O BOX 165  
MOORE, OKLA. 73060  
405 SW 4-2157  
MARTIN GERRARD  
523 N W EVERETT STREET  
PORTLAND, OREGON 97209  
503 CA 7-9591  
MYLES F. SMITH  
761 LINDSAY ROAD  
CARNEGIE, PA. 15106  
412 787-5363  
WILLIAM J. CUSICK

1114 EASTON ROAD  
ROSLYN, PA.  
215 885-3633  
HAL BEARD  
2160 YORK AVENUE  
MEMPHIS, TENN. 38104  
901 274-1744  
J. E. MORTON  
3500 MARTIN STREET  
FORT WORTH, TEXAS 76119  
817 JE 6-5290  
MC IVER & SLAVIN CO  
3200 AUDLEY STREET  
HOUSTON, TEXAS 77006  
713 JA 4-1155  
TAL AGENCIES, INC.  
1043 SIXTH AVE., S.  
SEATTLE, WASH. 98134  
206 MA 4-3355  
ANDERSEN ELEC. SALES  
8526 W VILLARD  
MILWAUKEE, WISC  
414 463 2072  
REPS. IN OTHER COUNTRIES  
MCKAY-MORTON WESTERN LTD  
P O BOX 157, STATION A  
CALGARY, ALBERTA  
CH 3 1664, 3 3534  
MCKAY-MORTON-WESTERN LTD  
11015 102ND STREET  
EDMONTON, ALBERTA  
GA 4 5211, 2 6664  
HARRY H. BROWN  
1533 NORTH PENDER STREET  
WEST VANCOUVER, B. C.  
WA 2-8963  
TED WESTON  
2515 PORTAGE AVENUE  
ST. JAMES, MANITOBA  
943-9165  
LLOYD G. DYKEMAN  
P O BOX 29  
ROTHESAY, NEW BRUNSWICK  
847-8390  
ESNA LIMITED  
271 PROGRESS AVENUE  
SCARBOROUGH, ONTARIO  
293-2431  
JOHN J. BYRON  
404 - 76TH AVENUE  
LA SALLE, QUEBEC  
748-8109

**BUD RADIO, INC**  
COMPANY ADDRESS  
WILLOUGHBY, OHIO 44094  
COMPANY REPRESENTATIVES  
CARTWRIGHT AND BEAN  
2506 ASPEN AVE  
HUNTSVILLE, ALABAMA 35810  
852-4911  
JACK BERMAN CO., INC.  
5800 NORTH 19TH AVENUE  
PHOENIX 15, ARIZONA  
764-6578  
JACK BERMAN CO., INC.  
1751 SO. LA CIENEGA BLVD  
LOS ANGELES, CALIF. 90035  
UP 0-4711  
DAVID H ROSS COMPANY  
534 EL CAMINO REAL  
SAN CARLOS, CALIFORNIA  
591-4411  
R G BOWEN CO., INC.  
721 SOUTH BROADWAY  
DENVER, COLORADO 80209  
722-4641  
CARTWRIGHT & BEAN  
2505 NANCY STREET  
ORLANDO, FLA. 32806  
GA 5-8284  
CARTWRIGHT AND BEAN  
INDUSTRIALS ONLY  
20100 N E 25TH COURT  
NO MIAMI BEACH, FLA 33160  
945 2962  
CARTWRIGHT AND BEAN  
395 TRITON ROAD  
ORMOND BEACH, FLA 32074  
OR 7-3480  
CARTWRIGHT AND BEAN  
3223 CAINS HILL PLACE N. W.  
ATLANTA, GEORGIA 30305  
237-2273  
BRUCE CUMMING & ASSOCIATES  
6029 WEST BELMONT AVENUE  
CHICAGO, ILLINOIS 60634  
ME 7-3770  
SOUTHERN SALES CO.  
LAKE SHORE DRIVE BOX 105  
ANGOLA, INDIANA 46703  
665-3961  
SOUTHERN SALES CO.  
6216 CARROLLTON AVE  
INDIANAPOLIS, INDIANA 46220  
253-3359  
SOUTHERN SALES CO.  
212 REPUBLIC BUILDING  
LOUISVILLE, KENTUCKY 40202  
583-6902  
CARTWRIGHT & BEAN  
1812 BULLARD AVENUE  
METAIRIE, LOUISIANA 70003  
834-8312  
HENRY P. SEGEL CO, INC.  
386 WASHINGTON STREET  
BROOKLINE 46, MASS  
232-7525  
JACK M. THORPE  
64D HIDDEN LANE  
DETROIT, MICHIGAN 48236  
884-4360  
THE CLARK R. GIBB CO  
24DD HENNEPIN AVENUE  
MINNEAPOLIS, MINN 55405  
FR 7-1200

DIPRO INCORPORATED  
7811 CARONDELET AVE  
ST. LOUIS, MISSOURI 63105  
PA 6-4770  
R. W. FARRIS CO INC  
1715 BALTIMORE AVE  
KANSAS CITY, MO. 64108  
421-1751  
HAROLD A. MOYER CO  
P. O. BOX 14  
220 HADDON AVE  
HADDONFIELD, N. J.  
429-7792  
C T CARLBERG & ASSOCIATES  
P O BOX 3177, STATION D  
2611 QUINCY, NE  
ALBUQUERQUE, N M 87110  
265 1579  
MARSEY SALES, INC.  
179 WINTON ROAD, N.Y.  
ROCHESTER, NEW YORK 14610  
482-4133  
WILLGOLD ELECTRONIC SALES CO  
P. O. BOX 27  
100 NORTH VILLAGE AVENUE  
ROCKVILLE CENTRE, N Y 11571  
RO 4-4022  
CARTWRIGHT AND BEAN  
625 HARWYN DRIVE  
CHARLOTTE, N. C. 28205  
333-6457  
MIKE ROTH SALES CO  
678 SO. GREEN ROAD  
CLEVELAND, OHIO 44121  
382-9090  
DON H. BURCHAM CO.  
510 N.W. 19TH STREET  
PORTLAND 9, OREGON  
CA 7-3830  
CARTWRIGHT & BEAN  
560 SOUTH COOPER  
P O BOX 4760  
MEMPHIS, TENN. 38104  
276-4442  
LUND & COMPANY  
2216 NORTH OLIVE STREET  
DALLAS 1, TEXAS  
RI 8-8839  
R G BOWEN CO., INC.  
31 SO. 3RD STREET, EAST  
SALT LAKE CITY, UTAH 84111  
467-5128  
DON H. BURCHAM CO.  
422 FIRST AVENUE, W.  
SEATTLE, WASH. 98199  
AT 4-1121  
BRUCE CUMMING & ASSOCIATES  
4852 NORTH 24TH STREET  
MILWAUKEE 9, WISCONSIN  
UP 3-1381  
REPS IN OTHER COUNTRIES  
FRANK EAKIN, LTD  
9 MILVAN DR  
WESTON, ONTARIO  
741 7485

**BURGESS BATTERY COMPANY**  
DIV. OF SERVEL, INC.  
VP GEN SALES MGR  
C. E. BALZ  
BRAND NAMES  
BURGESS  
COMPANY ADDRESS  
FREEPORT, ILL. 61032

**BURKE & JAMES**  
BRAND NAMES  
BURKE & JAMES  
WATSON  
CARL MEYER  
COMPANY ADDRESS  
333 W. LAKE ST.  
CHICAGO, ILL 60606

**CALBEST ELECTRONICS**  
SALES MANAGER  
I. DUBIN  
BRAND NAMES  
MUSI-PLEX  
COMPANY ADDRESS  
4801 EXPOSITION BLVD.  
LOS ANGELES, CALIF. 90016  
RE1-7291

**CALIFONE/ROBERTS ELECTRONICS**  
DIV. OF RHEEM MFG. CO.  
SALES MANAGER  
MILT PHILIPSON  
COMPANY ADDRESS  
5922 BOWCROFT STREET  
LOS ANGELES, CALIF. 90016  
COMPANY REPRESENTATIVES  
HARRY BARTON SALES CO  
1255 POST STREET, SUITE 605  
SAN FRANCISCO, CALIF. 94109  
MR. JERRY FREED  
149 SO. ROXBURY DRIVE  
BEVERLY HILLS, CALIF  
PACIFIC AUDIO SALES  
1933 SOUTH BROADWAY  
LOS ANGELES, CALIFORNIA  
747 7314  
RON BOWEN & ASSOC.  
721 SO. BROADWAY  
DENVER, COLORADO  
FINE SALES CORPORATION  
1051 EAST 14TH STREET  
HIALEAH, FLORIDA 33010  
MR. N. KENNON CO.  
77 CAMDEN ROAD, N. E.  
ATLANTA, GEORGIA  
PACIFIC ENTERPRISES  
1217 HOPAKA STREET  
HONOLULU, HAWAII

# Fit Every Budget....including yours!

**Video DA**  
**#VA-1B**  
**\$175.00**



**TV Modulator**  
**#TM-2200**  
**\$550.00**

**Aural/Visual**  
**Seperator**  
**#VA-100**  
**\$125.00**



**FM Modulator**  
**#FMX-2000A**  
**\$179.00**

**All Silicon Transistorized, Meets All Color Specifications.**

## CATEL Company

1375 Laurel Street  
 San Carlos, California 94070  
 415 — 592-3776

J. E. PAUL, INC.  
 5701 SHERIDAN ROAD  
 CHICAGO, ILLINOIS 60626  
 THE SAMPSON COMPANY  
 2244 SOUTH WESTERN AVENUE  
 CHICAGO, ILLINOIS  
 JOE CLANCY & CO., INC.  
 P. O. BOX 269  
 ANGOLA, INDIANA  
 FORRISTAL-YOUNG SALES CO.  
 5900 BUENA VISTA - SUITE 101  
 MISSION, KANSAS  
 JACK BLACK SALES CO.  
 11254 TRIANGLE LANE  
 WHEATON, MARYLAND  
 ARBETTER SALES  
 23 HARVARD STREET  
 BROOKLINE, MASS.  
 JOHN CULVER  
 28087 EAST RIVER ROAD  
 GROSSE ILE, MICHIGAN  
 D. NEUMAIER & ASSOC.  
 27610 SCHOOLCRAFT  
 LIVONIA, MICHIGAN  
 LOGAN YOUNG  
 FORRISTAL-YOUNG SALES CO  
 7110 OAKLAND STREET  
 ST. LOUIS, MISSOURI  
 BARON-THAL ASSOC.  
 411 THORNDEN STREET  
 SOUTH ORANGE, NEW JERSEY  
 MR. PHILIP WELCH  
 EASTERN DISTRIBUTION CENTER  
 1808 ROWLAND STREET  
 RIVERTON, N.J.  
 CARL T. CARLBERG & ASSOC.  
 2611 QUINCY STREET  
 P. O. BOX 3177 - STATION D  
 ALBUQUERQUE, NEW MEXICO  
 J. H. THAL ASSOCIATES  
 200 FIFTH AVE - SUITE 1305  
 NEW YORK, N.Y.  
 JOE CORN COMPANY  
 3235 EASTBURN ROAD  
 CHARLOTTE, N.C.  
 ROBERT W. PETERS  
 29000 EUCLID AVE.  
 CLEVELAND, OHIO 44117  
 JAMES H. POOLNY CO.  
 5912 PENN AVENUE  
 PITTSBURGH, PA.  
 SOUTHWEST SALES  
 112 MEYERLAND PLAZA MALL # 9  
 P. O. BOX 35536  
 HOUSTON 35, TEXAS  
 RICHARD WILKES ASSOCIATION  
 4509 140TH AVE. S. E.  
 BELLEVUE, WASHINGTON  
 TAYLOR ELECTRIC COMPANY  
 4080 N. POST WASHINGTON RD.  
 MILWAUKEE 12, WISCONSIN

REPS IN OTHER COUNTRIES  
 J. M. NELSON  
 1224 EAST PENDER STREET  
 VANCOUVER, B C

**CALVERT ELECTRONICS INC.**  
 SALES MANAGER  
 LARRY LEMASTERS  
 BRAND NAMES  
 CALVERTRON  
 GOLD MONARCH  
 COMPANY ADDRESS  
 220 EAST 23RD STREET  
 NEW YORK, NEW YORK 10010

**CARDWELL CONDENSER CORPORATION**  
 COMPANY ADDRESS  
 80 E. MONTAUK HIGHWAY  
 LINDENHURST, N.Y. 11757

**CATEL COMPANY**  
 COMPANY ADDRESS  
 1375 LAUREL STREET  
 SAN CARLOS, CALIF. 94070  
 COMPANY REPRESENTATIVES  
 AIRTRONICS  
 1338 MISSION STREET  
 SAN FRANCISCO, CALIF.  
 MA 1 9500

**CBS LABORATORIES, A DIVISION OF**  
**COLUMBIA BROADCASTING SYSTEMS**  
 MARKETING MANAGER  
 PROFESSIONAL PRODUCTS  
 ALEXANDER J. AUTDTE  
 BRAND NAMES  
 AUDIMAX  
 CHROMAX  
 VISIMAX  
 VOLUMAX  
 COMPANY ADDRESS  
 227 HIGH RIDGE ROAD  
 STAMFORD, CONNECTICUT  
 203 325 4321

**CCA ELECTRONICS CORPORATION**  
 SALES MANAGER  
 BERNARD WISE  
 COMPANY ADDRESS  
 716 JERSEY AVENUE  
 GLOUCESTER CITY, N. J. 08030  
 COMPANY REPRESENTATIVES  
 H A KAZANJIAN  
 1447 BAYSHORE  
 PALO ALTO, CALIF  
 415 322-1803  
 ROBERT SIDWELL  
 P O BOX 40  
 PORT ST JOE, FLA  
 904 229-3866  
 STOKES GRESHAM, JR

7525 GYPSY HILL RD  
 INDIANAPOLIS, IND  
 317 251-2677  
 RICHARD V FLANAGAN  
 PIPER ASSOCIATES, INC  
 TEN HAVEN ST  
 DOVER, MASS  
 617 449-1144  
 C G CUNNINGHAM  
 RTE 1 BOX 51  
 TABS, N MEXICO  
 905 758-2688  
 GERALD LAINER  
 TELESCO INTERNATIONAL CORP  
 171 MADISON AVE  
 NEW YORK 16, N.Y.  
 GEORGE A WASLO  
 10860 GOSLIN RD  
 CINCINNATI, OHIO  
 513 931-1801  
 CLAUDE HILL  
 5139 S UTICA ST  
 TULSA, OKLAHOMA  
 918 WE 2-3523  
 HAROLD RAINEY  
 P D BOX 19126  
 OKLAHOMA CITY, OKLA  
 405 MU 5-7358  
 FRED CHASSEY  
 8612 GERMANTOWN AVE  
 PHILADELPHIA, PA  
 215 248-1380  
 BILL FRIEDMAN  
 SUITE 641 WESTERN SVGS BLDG  
 BROAD & CHESTNUT STS  
 PHILADELPHIA, PA  
 215 KI 6-4121  
 WILLIAM O BARRY  
 P O BOX 221  
 LEBANON, TENN  
 615 444-0305  
 JOHN MCCLAMROCK  
 143 SW 153RD ST  
 SEATTLE, WASH  
 206 CH 4-9391

**C-COR ELECTRONICS, INC.**  
 SALES MANAGER  
 ROBERT K. ARBOGAST  
 BRAND NAMES  
 C-COR  
 NOVACOR  
 COMPANY ADDRESS  
 60 DECIBEL ROAD  
 STATE COLLEGE, PA. 16801  
 COMPANY REPRESENTATIVES  
 ASTROEL, INC.  
 349 FIRST STREET  
 LOS ALTOS, CALIF. 94023  
 415 948-3636  
 RF ASSOCIATES, INC.

1621 PONTIUS AVENUE  
 LOS ANGELES, CALIF. 90025  
 213 478-1586  
 D. E. BOND ASSOC.  
 2149 S. CLERMONT STREET  
 DENVER, COLO. 80222  
 303 756-1234  
 GRA-MAR INC.  
 999 WOODCOCK ROAD, RM. 102  
 ORLANDO, FLORIDA 32802  
 305 841-2330  
 COMMUNICATIONS ENGINEERS  
 7100 N. WESTERN AVE.  
 CHICAGO, ILL. 60645  
 312 761-0548  
 COMMUNICATIONS ENGINEERS  
 2920 SHELBY  
 INDIANAPOLIS, INDIANA 46203  
 317 787-2241  
 EASTERN INSTRUMENTATION INC.  
 1002 INGLESIDE AVE  
 BALTIMORE, MD, 21228  
 301 744-3675  
 ADELCO CORP.  
 56 PICKERING STREET  
 NEEDHAM, MASS. 02192  
 617 444-4754  
 COMMUNICATIONS ENGINEERS  
 7710 COMPUTER AVE.  
 MINNEAPOLIS, MINN. 55424  
 612 927-8465  
 F & F ASSOCIATES  
 58 ARCADIA ROAD  
 WOODCLIFF LAKE, N. J. 07680  
 201 778-6767  
 D. E. BOND ASSOC.  
 P. O. BOX 11331  
 ALBUQUERQUE, N. M. 87112  
 505 247-3442  
 F & F ASSOCIATES  
 461 OLD COUNTRY ROAD  
 WESTBURY, L. I., N. Y. 11590  
 516 334-1160  
 SYLVAN GIMSBURY LTD.  
 72 WEST 45TH STREET  
 NEW YORK, N. Y. 10036  
 212 687-3213  
 TESCO ASSOCIATES  
 114 MILES AVENUE  
 SYRACUSE, N. Y. 13210  
 315 474-1586  
 REP/CORP.  
 2077 EMBURY PARK ROAD  
 DAYTON, OHIO 45414  
 513 275-5885  
 EASTERN INSTRUMENTATION INC.  
 613 CHELTENHAM AVE.  
 PHILA., PA., 19126  
 215 927-6269  
 D. E. BOND ASSOC.  
 P. O. BOX 12293

EL PASO, TEXAS 79912  
915 532-4048  
VIDAL ELECTRONICS CD.  
3403 HIGH BLUFF DRIVE  
DALLAS, TEXAS 75234  
214 247-4252  
PARATECH  
9210 28TH N. W.  
SEATTLE, WASHINGTON 98107  
206 784-6447  
REPS IN OTHER COUNTRIES  
ELECTRONETIC SYSTEMS LTD.  
62 ALMESH STREET  
DOWNSVIEW, ONTARIO  
416 636-3673  
ELECTRONETIC SYSTEMS LTD.  
6420 VICTORIA, AVE, SUITE 17  
MONTREAL 26, QUEBEC

CENTRALAB, THE ELECTRONICS  
DIVISION OF GLOBE-UNION INC  
MANAGER DISTRIBUTOR PRODUCTS  
GEORGE MENA  
COMPANY ADDRESS  
P O BOX 591  
MILWAUKEE, WISCONSIN 53201  
COMPANY REPRESENTATIVES  
LOGAN SALES COMPANY  
P O BOX 1219  
REDWOOD CITY, CALIF 94063  
369 6726  
R L STONE SALES CO  
3600 MOTOR AVE  
LOS ANGELES, CALIF 90034  
UP 0 5973  
MCLOUD & RAYMOND CO  
2151 S GRAPE ST  
P O BOX 22044  
DENVER, COLO 80222  
SK 6 1589  
S. K. MACDONALD INC.  
217 RIGGS BANK BLDG.  
14TH ST. AND PARK RD., NW  
WASHINGTON, D.C. 20010  
CD 5-3938  
FRANK C NICKERSON  
2727 ALOMA AVE  
WINTER PARK, FLA 32789  
HI 7 4697  
FRANK C NICKERSON CO  
626 MEDLOCK RD  
P O BOX 1185  
DECATUR, GA 30033  
ME 6 2752  
BILL KOLANS & CO  
P O BOX 2098  
HONOLULU, HAWAII 96805  
811 628  
EARL T CHAMPIDM  
4828 MAIN ST  
SKOKIE, ILL 60091  
583 3960  
LES M DEVOE CO  
4010 WASHINGTON BLVD  
INDIANAPOLIS, IND 46205  
AT 3 1395  
JERRY VRBIK  
2818 A AVENUE N E  
CEDAR RAPIDS, IOWA 52402  
365 0461  
THE KANGAS-PENZNER CO  
P O BOX 7505  
7505 W 80TH ST  
OVERLAND PARK, KANSAS  
NI 8 4965  
S K MACDONALD, INC  
2016 WINFORD RD  
BALTIMORE, MD 21214  
1D 5 1760  
STANLEY A. HARRIS CO., INC.  
60 DEDHAM AVE.  
NEEDHAM, MASS. 02192  
444-4780  
R. C. MERCHANT & CO., INC.  
18411 W. MCNICOLS RD.  
DETROIT, MICH. 48219  
KE 5-6000  
THE MEL FOSTER CO., INC.  
228 S. CEDAR LAKE RD.  
MINNEAPOLIS, MD. 55405  
274-2612  
NEWHOPE CORPORATION  
6 E. 39TH STREET  
NEW YORK CITY, N.Y. 10016  
LE 2-7327  
LEROY & MCGUIRE, INC.  
RD. NO. 1  
PHELPS, NEW YORK  
KI 8-4891  
LEROY & MCGUIRE, INC.  
RD. NO. 4  
AMSTERDAM, N.Y. 14532  
VI 2-9779  
MIKE ROTH SALES CO.  
678 S. GREEN ROAD  
CLEVELAND, OHIO 44121  
EV 2-9D9D  
ROBERT E. NESBITT CO  
1324 E. 17TH PLACE  
TULSA, OKLA.  
LU 5-1234  
S. K. MACDONALD INC.  
1531 SPRUCE STREET  
PHILADELPHIA, PA. 19102  
KI 5-1205  
S. K. MACDONALD INC.  
10519 FRANKSTOWN RD.  
PITTSBURGH, PA.  
CH 1-7025  
AL S. ENGELMAN CO.  
3205 CRUMP AVE.  
MEMPHIS, TENN. 38112  
458-6263  
ROBERT E. NESBITT CO.  
1925 CEDAR SPRINGS  
DALLAS, TEXAS 75201

899-8375  
ROBERT E. NESBITT CO.  
4810 HAZARD  
HOUSTON, TEXAS 77006  
JA 8-3811  
MCLDUD & RAYMOND CD.  
BDX 16146, 4407 EBONY AVE.  
SALT LAKE CITY, UTAH  
AM 6 5002  
JAMES J. BACKER CD.  
221 W. GALER ST.  
P O BDX 9077  
SEATTLE, WASH 98119  
AT 3 6470

CENTRAL DYNAMICS CORPORATION  
SALES MANAGER  
PETER MACFARLANE  
BRAND NAMES  
CD  
COMPANY ADDRESS  
903 MAIN STREET  
CAMBRIDGE, MASS 02139

CENTURY LIGHTING INC.  
VICE PRESIDENT - SALES  
RDLO GILLESPIE WILLIAMS  
BRAND NAMES  
INSTALITE R  
LEKDLITE R  
EDKOTRON R  
MOBIL RAIL  
C-CARD  
THEATRON  
C-1  
CCR  
FRESNELITE  
COMPANY ADDRESS  
3 ENTIN ROAD  
CLIFTON, NEW JERSEY 07014  
COMPANY REPRESENTATIVES  
E. B. RICHEY  
WHITMAN ASSOCIATES  
823 CITY FEDERAL BLDG.  
BIRMINGHAM, ALA.  
AL 2-8079  
TOM ED PEARCE  
WHITMAN ASSOCIATES  
208 PAYNE ROAD  
WARRINGTON, FLORIDA  
GL 5-8689  
CENTURY LIGHTING, INC.  
5432 W. 102ND ST.  
LOS ANGELES, CALIF.  
776-4600  
E. J. JOHNSON CO.  
P. O. BOX 5291  
PHOENIX, ARIZONA  
CENTURY LIGHTING, INC.  
5432 W. 102ND ST.  
LOS ANGELES, CALIF.  
776-4600  
CENTURY LIGHTING, INC.  
2443 ASH STREET  
PALO ATLO, CALIF.  
327-3262  
JACK BARTON  
3858 12TH ST.  
SACRAMENTO, CALIF.  
HI 6-2394  
N. L. ROUP AGENCY  
1842 S. FAIRFAX STREET  
DENVER 22, COLORADO  
756-2711  
VORLANDER LIGHTING, INC.  
C/O R. H. BROWN  
P. O. BOX 525  
AVON, CONN.  
ORCHARD 7-2311  
DAVID BUTT  
WHITMAN ASSOCIATES  
3646 MAIN HIGHWAY  
COCUNUT GROVE, MIAMI  
HI 8-6770  
MARSHALL LOCHRIDGE  
WHITMAN ASSOC.  
3709 BARCELONA  
TAMPA, FLA  
836-6361  
ROBERT S. MCGARITY  
WHITMAN ASSOC.  
1357 W. BEAVER STREET  
JACKSONVILLE, FLA.  
354-5985  
E. D. JOHNSON  
GEORGE GARDNER  
WHITMAN ASSOCIATES  
313 BONA ALLEN BLDG.  
ATLANTA, GEORGIA  
JA 1-0977  
ROBERT S. MCGARITY  
WHITMAN ASSOC.  
415 SOUTH MAIN STREET  
MOUTRIE, GEORGIA  
YU 5-1568  
HAWAIIAN AIRE, INC.  
45-552 KAM HIGHWAY  
KANEONE, HAWAII  
EARL KOEHLER  
RM. 1505D  
MERCHANDISE MART  
CHICAGO, ILLINOIS 60654  
644-5567  
PAUL ANGRICK  
5119 MOONLIGHT DR.  
INDIANAPOLIS, IND.  
LIBERTY 6-4231  
W. D. FAUST  
1405 S. BROAD STREET  
NEW ORLEANS, LA.  
504-822-0571  
EDWARD RUBIN  
P. O. BOX 2667  
BALTIMORE, MD.  
BELMONT 5-4161  
VORLANDER LIGHTING, INC.

80 BOYLSTON ST  
BOSTON, MASS.  
HANCOCK 6-6927  
E. BURTON WOLF ASSOC.  
1230 W. FORREST AVE.  
DETROIT, MICHIGAN  
831-6190  
WARREN ANDERSON  
110 GLENWOOD AVE  
MINNEAPOLIS 3, MINN.  
338-0533  
FELLMER BEAN  
P. O. BOX 9064  
JACKSDN, MISS.  
266-2558  
VINCE DAWSDN  
P. 3, BOX 11056  
KANSAS CITY, MO.  
GL 3-6888  
MANUFACTURERS SALES AGENCY  
939 N. 24TH STREET  
DUMA, NEBRASKA  
342-5757  
D. J. SALES CD.  
C/O J. L. BIRD  
2600 E. OAKY BLVD.  
LAS VEGAS, NEVADA  
737-2929  
SANFORD PEKELNEY  
3-35 30TH STREET  
FAIRLAWN, N. J.  
SW 7-9261  
JAMES P. SWANN  
ELECTRIC LOCATOR & SALES CO.  
P. O. BOX 425  
3921 DELAMAR, N. E.  
ALBUQUERQUE, N. M.  
MARTIN M. GOLDMAN  
SUDAN ASSOCIATES  
79 ROBIN HILL  
WILLIAMSVILLE, N. Y. 14221  
716-632-1042  
NORMAN FINDAL  
WHITMAN ASSOCIATES  
126 BUILVERS BLDG.  
CHARLOTTE, N.C.  
ED 4-9168  
ERNEST W. WHITE, JR.  
P. O. BOX 14166  
KING CHARLES STATION  
RALEIGH, N. C.  
919-828-8116  
GARY ROOF ASSOC.  
1145 THIRD NATIONAL BLDG  
DAYTON, 2 OHIO  
BALDWIN 4-9813  
GORDON F. STOFER BROS.  
P. D. BOX 2991  
CLEVELAND 16, OHIO  
333-0733  
ROBERT NOTT CD.  
2532 E. ADMIRAL BLVD.  
TULSA 10, OKLA.  
WE 4-4549  
HARRY L. STEARNS  
523 N. W. EVERETT ST.  
PORTLAND, 9 OREGON  
CA 7-0593  
PAUL KYACK, INC.  
P. O. BOX 220  
PLYMOUTH MEETING, PA.  
242-2112  
MARK H. WAINWRIGHT  
211 NELBON AVE  
PITTSBURGH 35, PA.  
CHURCHILL 2-3262  
LUMI-PAR INC.  
ELEANOR ROOSEVELT, 233  
P. O. BOX 1376  
MATO REY, P. R.  
GEORGE W. GREENE  
WHITMAN ASSOC.  
P. O. BOX 416  
2246 SUMTER ST  
COLUMBIA, S. C.  
AL 3-7451 AL 2-3032  
GEORGE W. GREENE  
WHITMAN ASSOC.  
C/O ROY B. MCLEAN  
P. O. BOX 9092  
HANAHAN, S. C.  
803 593-4054  
J. E. MOORE  
WHITMAN ASSOCIATES  
P. O. BOX 5454  
KNOXVILLE, TENN.  
687-3578  
BILLY COOK  
CLDSE COOK ASSOCIATES  
OF DALLAS  
P. O. BOX 20591  
DALLAS, TEXAS 75220  
FL 1-5519  
WAYNE D. CLOSE  
CLOSE-COOK ASSOC.  
P. O. BOX 12106  
7245 SANTA FE DRIVE  
HOUSTON, TEXAS  
MISSION 3-2554  
THOMAS P. HARRIS  
WHITMAN ASSOC.  
6037 BONNEAU ROAD  
RICHMOND, VIRGINIA  
CO 6-3185  
A. WYNN MEREDITH  
WHITMAN ASSOC.  
3329B S. STAFFORD ST.  
ARLINGTON, VA.  
703-549-8513  
A. CARL MUSTED JR.  
404 27TH ST  
VIRGINIA BEACH, VA.  
703-428-8717  
JACK MERRITT  
1016 1ST AVE. SOUTH  
SEATTLE, 4 WASHINGTON

MA 2-7975  
GORDON PEARSON  
STATEWIDE LIGHTING & EQUIP  
3050 S. AMOR DRIVE  
NEW BERLIN, WISCONSIN 53151  
542-2184  
REPS. IN OTHER COUNTRIES  
ARNON ADAR  
33 HASHOFTIM ST  
TEL AVIV, ISRAEL  
CENTURY LIGHTING DF  
CANADA LIMITED  
P. O. BOX 185  
REXDALE, ONTARIO  
249-3355  
SABINO ESCOBEDO GAMEROS  
CIA MEXICANA DE  
ILLUMINACION S. A.  
MANUEL MA. CONTRERAS 96-501  
MEXICO 4, D. F.  
COL. SAN RAFAEL  
JOHN B. STALEY  
APARTADD 9294 CANDELARIA  
CARACAS, VENEZUELA

CENTURY PROJECTDR CORP  
BRAND NAMES  
CENTURY  
CINE-FDCUS  
COMPANY ADDRESS  
729-7TH AVE.  
NEW YDRK, NEW YORK 10019

CHASSIS TRAK INC  
SALES MANAGER  
LAWRENCE M. VAUGHN  
BRAND NAMES  
CHASSIS-TRAK  
COMPANY ADDRESS  
525 S. WEBSTER AVENUE  
INDIANAPOLIS, INDIANA 46219  
COMPANY REPRESENTATIVES  
DYNAMICA ASSOCIATES  
1011 INDUSTRIAL WAY  
EAST BURLINGAME, CAL. 94010  
415 344-2521  
WILLIAMS ASSOCIATES INC.  
4971 JACKSON STREET  
DENVER, COLORADO 80216  
303 388-4391  
YDUNG & LAWRENCE ASSOC. INC.  
601 NORTH NEW YORK AVE  
WINTER PARK FLA. 32789  
305 647-2528  
RINGLAND M. KRUEGER CD.  
5755 W. IRVING PARK RD.  
CHICAGO, ILL. 60634  
312 282-8444  
THOMAS & SUKUP CO.  
2060 EAST 54TH STREET  
INDIANAPOLIS, INDIANA 46220  
317 251-4574  
GENE ROSEN & ASSOC. INC.  
9501 WADSWORTH DRIVE  
BETHESDA, MARYLAND 20034  
301 365-5113  
COAKLEY, BOYD & ABBETT  
BOX 248  
NEEDHAM, MASS. 02192  
617 444-5470  
MARTIN VOGT CO.  
2817 BAMLET ROAD  
RDYAL OAK, MICHIGAN 48073  
313 549-3355  
HASSE ASSOCIATES  
3825 YORK AVE. N  
MINNEAPOLIS, MINN. 55422  
612 588-0551  
ENGINEERING SERVICES CO.  
6717 VERNON AVENUE  
ST. LOUIS, MISSOURI 63130  
314 PA 6-2233  
ROBERT L. RINGER CO.  
P. O. BOX 114  
GLEN ROCK, NEW JERSEY 07452  
201 444-1434  
MISSILETRONIC INC.  
1321 EAST MOREHEAD STREET  
CHARLOTTE, N. CAR. 28204  
704 377-1922  
COMPONENTS ENGINEERING CO.  
7461 N. LINDEN LANE  
CLEVELAND, OHIO 44130  
216 843-2737  
T. J. RAY CO.  
8514 EAST 31ST PLACE  
TULSA, OKLA. 74145  
918 627 1515  
RODGER MARTIN ASSOC.  
P. O. BOX 1002  
BELLAIRES, TEXAS 77401  
713 MO 8-3877  
ELECTRONIC SALES CORP.  
P. O. BOX 6535  
SEATTLE, WASH. 98116  
206 WE 2-0330  
REPS IN OTHER COUNTRIES  
ELECTRONIC MARKETING  
OF CANADA, LTD.  
3600 BRADCLAY AVE.  
MONTREAL, QUEBEC  
514 739-8052

CHRONO-LOG CORPORATION  
SALES MANAGER  
ARTHUR FREILICH  
COMPANY ADDRESS  
2583 W. CHESTER PIKE  
BROOMALL, PA. 19008  
COMPANY REPRESENTATIVES  
S. S. KRINSKY & ASSOC.  
6311 YUCCA ST  
HOLLYWOOD, CALIF.  
213 NO 2-1133  
RIKER VIDEO INDUSTRIES

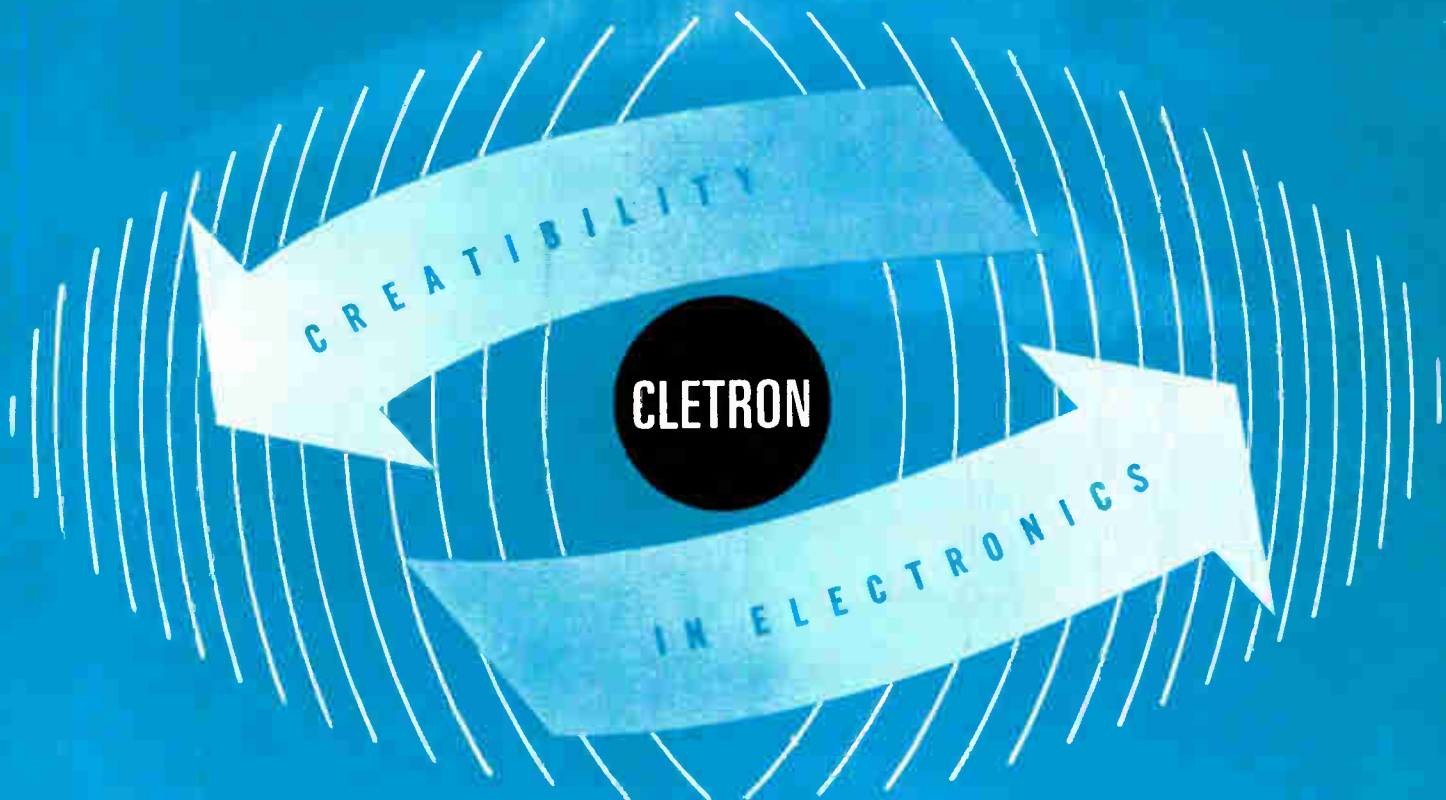

## LEADERS IN TV CAMERA DEFLECTION COMPONENTS VIDICON / PLUMBICON / IMAGE ORTHICON

Cletron, manufacturer of Orthicon and Vidicon Deflection Components for Commercial and Military applications offers you quality-engineered products and services that have been incorporated as standards in the country's leading manufacturing companies of Television Camera Equipment.

Quality products by Cletron . . . Manufacturers of Deflection Components, Custom Transformers, and Sound Reproducing Devices . . .

Write today for additional technical literature, drawings, and engineering specifications on the complete line of Cletron Deflection Components.



**CLEVELAND ELECTRONICS, INC.**

Deflection Components Division

**2000 Highland Road • Twinsburg, Ohio 44087 - U.S.A.**

1336 MISSOURI AVE  
WASHINGTON, D. C.  
202 291-3923  
RIKER VIDEOD INDUSTRIES  
146 DAKDALE DRIVE  
FOREST PARK, GEORGIA  
404 361-4118  
WEBSTER ENGINEERING CO.  
823 S. GREENWOOD AVE  
PARK RIDGE, ILLINOIS  
312 823-8206  
RIKER VIDEOD INDUSTRIES  
33479 CINDY LANE  
LIVONIA, MICHIGAN  
313 427 3674  
RIKER VIDEOD INDUSTRIES  
NORDEN LANE  
HUNTINGTON STATION, N. Y.  
516 MA 1-3568

CINE SONIC SOUND INC

SALES MANAGER  
JEROME SOLOMON  
BRAND NAMES  
CINE SONIC  
EDDLITE  
COMPANY ADDRESS  
485-8TH AVE.  
NEW YORK, NEW YORK 10001  
LD-3-0540  
COMPANY REPRESENTATIVES  
H. SOLOMON  
3710 THIRD  
DETROIT, MICH  
313- TE 2-1498

CLEVELAND ELECTRONICS, INC.

DEFLECTION COMPONENTS DIV.  
SALES MANAGER  
A. J. RINI  
BRAND NAMES  
CLETRON  
COMPANY ADDRESS  
200 HIGHLAND ROAD  
TWINSBURG, OHIO 44087  
COMPANY REPRESENTATIVES  
CORCORAN ASSOCIATES  
P.O. BOX 45897  
LOS ANGELES, CALIF.  
213 398-2675  
LOGAN SALES COMPANY  
P.O. BOX 1112  
REDWOOD CITY, CALIF.  
415 369-1023  
HYDE ELECTRONICS  
888 SOUTH LIPAN STREET  
DENVER 23, COLORADO  
936-3456  
V. AVIS MCCORVEY  
2469 NDRTH DECATUR ROAD  
DECATUR, GEORGIA  
404 636-2502  
W. G. BROUILLETTE & ASSOC.  
1558 NEWCASTLE AVE.  
WESTCHESTER, ILL.  
312 345-6500  
R. D. WHITESELL & ASSOC.  
6620 E. WASHINGTON ST.  
INDIANAPOLIS, INDIANA  
317 359-5374  
TED WHITTAKER  
58 CLIFFE AVENUE  
LEXINGTON, MASS. 02173  
KAY SALES  
4010 WASHINGTON ST.  
KANSAS CITY, MO.  
816 531-2014  
IRV BROWN CO.  
1500 CARROLL STREET  
BROOKLYN 13, N.Y.  
212 493-1379  
DONALD HEVNER  
1528 SPRING MILL ROAD  
GLADWYNE, PA.  
215 525-9727  
ACE ASSOCIATES  
143 S.W. 153RD STREET  
SEATTLE, WASHINGTON  
206 CH 4-9391  
MASSEY ASSOCIATES  
1 THOMAS CIRCLE  
WASHINGTON, D. C.  
202 628-1023

REPS. IN OTHER COUNTRIES

TRANCHANT ELECTRONIQUE S.A.  
19-21 RUE MADAME SANZILLON  
CLINCHY -SEINE-, FRANCE  
T. J. SAS & SON  
VICTORIA HOUSE  
VERNON PLACE, HOLBORN  
LONDON, W.C. 1, ENGLAND  
SILVERSTAR LTD.  
20 VIA DEI GRACCHI  
MILANO, ITALIA  
CALDWELL A/V EQUIP. CO., LTD.  
135 MIDWEST ROAD  
SCARBOROUGH, ONTARIO  
ANGEL BARRANCO  
AV. LIBERTADOR  
RES. EL DARQUE APTO 14  
CARACAS, VENEZUALA

CLEVELAND ELECTRONICS INC

SPEAKER DIVISION  
SALES MANAGER  
DEWAYNE L. MARTIN  
BRAND NAMES  
CLETRON  
COMPANY ADDRESS  
1974 E. 61ST STREET  
CLEVELAND, OHIO 44103  
COMPANY REPRESENTATIVES  
CORCORAN ASSOCIATES  
BOX 45897  
LOS ANGELES, CALIF  
213 398-2675

LOGAN SALES CO  
463 BREWSTER AVE  
REDWOOD CITY, CALIF  
415 369-3726  
HYDE ELECTRONIC CO  
888 SD LIPAN ST  
DENVER, COLO  
303 936-3456  
MASSEY ASSOC  
ND 1 THOMAS CIRCLE  
WASHINGTON, D. C.  
202 628-1023  
V AVIS MCCORVEY  
2187 BRIARCLIFF RD N E  
ATLANTA, GA  
404 636 2502  
W G BROUILLETTE & ASSOC  
1558 NEWCASTLE AVE  
WESTCHESTER, ILL  
312 345 6600  
R D WHITESELL & ASSOC  
6620 E WASHINGTON ST  
INDIANAPOLIS, IND  
317 FL 9 5374  
NEAR INC  
99 HIGHLAND AVENUE  
SOMERVILLE, MASS  
617 PR6-2262  
KAY SALES CO  
4010 WASHINGTON ST  
KANSAS CITY, MO  
816 JE1-2014  
HENRY G RICHTER INC  
1376 U S HIGHWAY ND 22  
MOUNTAINSIDE, N J  
201 AD3-4615  
GEDRGE J GAY INC  
P D BOX 214  
BRCKPORT, NEW YORK  
716 ME7-3776  
IRV BROWN CO  
1500 CARROLL ST  
BROOKLYN 13, NEW YORK  
212 493 1379  
DONALD S HEVNER  
1528 SPRING MILL RD  
GLADWYNE, PA  
215 LA5-9727  
J EARL SMITH  
1353 CHEMICAL STREET  
DALLAS, TEXAS  
214 ME1-1727  
A C E ASSOCIATES  
143 S W 153 ST  
SEATTLE, WASH  
206 CH4-9391

REPS IN OTHER COUNTRIES

TRANCHANT ELECTRONIQUE  
19-21 RUE MADAME  
DE SANZILLON  
CLINCHY, SEINE FRANCE  
T J SAS & SON LTD  
VICTORIA HOUSE, VERNON PLACE  
HOLBORN, LONDON, ENGLAND

CDHU ELECTRONICS, INC

VP MARKETING  
E. T. CLARE  
TV PROD., LINE MGR.  
R. H. BOULID  
BRAND NAMES  
CDHU  
COMPANY ADDRESS  
BOX 623  
SAN DIEGO, CALIF. 92112  
COMPANY REPRESENTATIVES  
BCS ASSOCIATES, INC.  
BOX 1273  
HUNTSVILLE, ALA.  
205 534-1648  
CDHU ELECTRONICS, INC.  
292 LACIENEGA BLVD., SO.  
BEVERLY HILLS, CALIF.  
213 655-5200  
CDHU ELECTRONICS, INC.  
406 CHANNING AVE.  
PALO ALTO, CALIF.  
415 327-3911  
WILLIAMS ASSOCIATES  
4971 JACKSON STREET  
DENVER, COLORADO 80216  
303 388-4391  
TECHNICAL INSTRUMENTS, INC.  
575 BROAD STREET  
BRIDGEPORT, CONN.  
203 368-4582  
BCS ASSOCIATES, INC.  
BOX 6578  
ORLANDO, FLA. 32803  
305 841-3208  
HUGH MARSLAND & CO.  
6699 LINCOLN AVE.  
CHICAGO, ILLINOIS 60645  
312 676-1100  
HUGH MARSLAND & COMPANY  
6730 E. 19TH STREET  
INDIANAPOLIS, IND.  
317 356-4249  
BARTLETT ASSOCIATES, INC.  
7979 OLD GEORGETOWN ROAD  
BETHESDA, MD.  
301 656-3061  
TECHNICAL INSTRUMENTS, INC.  
122 WEST STREET  
WILMINGTON, MASS. 01887  
617 944-3930  
S. STERLING CO.  
21250-10-1/2 MILE ROAD  
SOUTHFIELD, MICH. 48075  
313 442-5656  
HUGH MARSLAND & COMPANY  
231 N. EDGEWOOD AVE.  
MINNEAPOLIS, MINN.  
612 545-4481  
S. STERLING COMPANY  
7849 NORTH LINDBERGH

HAZELWOOD, MO.  
314 837-1221  
FRIEDMAN ASSOCIATES  
32 NORTH DAY STREET  
DRANGE, NEW JERSEY 07052  
201 679-2500  
WILLIAMS ASSOCIATES  
3221 SILVER AVE., S.E.  
ALBUQUERQUE, N.M.  
505 254-1638  
CDHU ELECTRONICS, INC.  
325 MANVILLE RD.  
PLEASANTVILLE, N.Y.  
914 769-0111  
J. A. REAGAN CO., INC.  
41 WOODBURY RD.  
NEW HARTFORD, N.Y.  
315 732-3775  
J. A. REAGAN CO., INC.  
236 ERIE BLVD., EAST  
SYRACUSE, N.Y.  
315 471-7274  
J. A. REAGAN CO., INC.  
327 WESTMORELAND RD.  
BUFFALO, N.Y.  
716 632-2727  
J. A. REAGAN CO., INC.  
528 CRESTMONT RD.  
BINGHAMTON, N.Y.  
607 723-9661  
J. A. REAGAN COMPANY, INC.  
419 CENTRAL AVE.  
ALBANY, NEW YORK 12206  
518 436-9649  
BCS ASSOCIATES, INC.  
BOX 6426  
GREENSBORO, N.C.  
919 273-1918  
S. STERLING COMPANY  
5827 MAYFIELD RD.  
CLEVELAND, OHIO  
216 442-8080  
S. STERLING COMPANY  
3300 S. DIXIE DRIVE  
DAYTON, OHIO  
513 298-7573  
ARNOLD BARNES COMPANY  
3510 MOCKINGBIRD LANE  
MIDWEST CITY, OKLA.  
405 737-4556  
S. STERLING COMPANY  
4232 BROWNVILLE ROAD  
PITTSBURGH, PA.  
412 884-5515  
BARTLETT ASSOCS, INC  
BOX 72  
WAYNE, PA 19087  
215 688 7325  
ARNOLD BARNES CO  
BOX 709  
RICHARDSON, TEXAS 75080  
214 235-4541  
ARNOLD BARNES COMPANY  
3230 MERCER ST.  
HOUSTON, TEXAS  
713 622-3620  
ARNOLD BARNES COMPANY  
BOX 13069  
SAN ANTONIO, TEXAS  
512 342-7311

REPS IN OTHER COUNTRIES

WHITTAKER ELECTRONICS LTD.  
1144 MILLSTREAM RD.  
WEST VANCOUVER, B.C.  
WHITTAKER ELECTRONICS LTD.  
42 HOWDEN AVE.  
OTTAWA 5, ONTARIO  
613 224-1221  
WHITTAKER ELECTRONICS LTD.  
1885 WILSON AVENUE  
WESTON, ONTARIO  
416 247-7454  
WHITTAKER ELECTRONICS LTD.  
BOX 216  
ROXBORO, QUEBEC  
514 684-3000

COLLINS RADIO COMPANY

ASST DIR BRDADCAST COMM DIV  
THEIL SHARPE  
COLLINS RADIO COMPANY  
820 EAST ARAPAH0  
RICHARDSON, TEXAS 75080  
BRAND NAMES  
COLLINS  
COMPANY ADDRESS  
DALLAS, TEXAS 75207  
COMPANY REPRESENTATIVES  
K. A. BLAKE  
P. O. BOX 57087,  
LOS ANGELES, CALIF. 90057  
DU 5-6421  
A. P. WALKER  
UNIVERSAL BUILDING,  
WASHINGTON, D.C.  
C. W. WALTERS  
3658 COLEBROOK DRIVE,  
JACKSONVILLE, FLORIDA 32210  
SP 1-2978  
R. O. LOOPER  
P. O. BOX 207,  
CLINTON, ILLINOIS 61727  
935-5502  
R. J. HENRY  
ROUTE 2  
RDAN0KE, INDIANA  
672-2906  
J. L. LITTLEJOHN  
12708 MYRTLE CIRCLE,  
HOPKINS, MINNESOTA 55343  
935-7011  
R. C. EVANS  
P. O. BOX 8026,  
JACKSON, MISSISSIPPI 39204  
939-4220  
L. H. LEGGETT

1271 AVE. OF THE AMERICAS,  
NEW YORK, NEW YORK  
JU 6-5678  
J. F. STANBERY  
P. O. BOX 748,  
GATLINBURG, TENNESSEE 37738  
436-5497  
J. H. SPECK  
COLLINS RADIO COMPANY  
DALLAS, TEXAS  
AD 5-9511  
J. L. HUMPHREYS  
11514 MAPLE RIDGE ROAD,  
RESTON, VIRGINIA 22070  
471-7449  
W. J. MONRDE  
2826 EMPIRE WAY SOUTH,  
SEATTLE, WASHINGTON 98144  
725-3385

COLORADO VIDEO, INC

SALES MANAGER  
GLEN SOUTHWORTH  
COMPANY ADDRESS  
BOX 928  
BDULDER, COLORADO 80302  
COMPANY REPRESENTATIVES  
EDUCATIONAL ELECTRONICS  
OF CALIFORNIA  
NORTHIDGE, CALIF.  
213 349-1166  
E-A, INC.  
BALTIMORE, MARYLAND  
301 825-2385  
ADELCO CORPORATIDN  
NEEDHAM, MASS.  
617 444-4754  
A. L. S. ELECTRONICS  
ALBUQUERQUE, NEW MEXICO  
505 298-2575  
TELEPROJECTS, INC.  
NEW YORK, N.Y.  
212 687-1255  
ACRDHATIX ASSOC., INC.  
FAIRVIEW VILLAGE, PENNA.  
215 279-0377

COLDRTRON INDUSTRIES, A BERKEY

PHOTO COMPANY  
SALES MANAGER  
JACK HORNE  
BRAND NAMES  
COLDRTRON  
COLDRDYNE  
COMPANY ADDRESS  
1015 CHESTNUT ST  
BURBANK, CALIF. 91502  
213-843-1200  
COMPANY REPRESENTATIVES  
N R VDN DWINGELO  
164 OLD KINGS HIGHWAY  
ND DARIEEN, CONN 06820  
203 655 3290  
CHARLES S SMITH, JR., & CO.  
4275 WENDELL DR SW  
ATLANTA, GA  
404 349 0900  
BILL GLEAVES  
7427 SO CRANDON AVE  
CHICAGO, ILL 60649  
312 RE 4-5776  
CARL J BOKMULLER  
29804 ELMGRDVE  
ST. CLAIR, MICH. 48082  
313 294-3720  
JOE TAWIL  
EASTERN MARKETING MGR  
25-15 50TH ST  
WOODSIDE, N Y 11377  
212 932-4040  
R F DICKENS SALES CO  
SOUTHWEST REP  
2025 FARRINGTON  
DALLAS, TEXAS 75027  
214 RI 7-2555  
LEE CHAMNESS  
3701 MT VERNON AVE  
ALEXANDRIA, VA  
702 836-0705  
REPS IN OTHER COUNTRIES  
GERRY LEE  
BERKEY PHOTO LTD  
3320 ELMBANK RD  
MALTON, ONTARIO  
416 677-3381

COLUMBIA ELECTRIC MFG. CO

SALES MANAGER GENERATORS  
H. W. SUSSHAM  
SALES MANAGER INSTRUMENTS  
L. E. GLEUECK  
BRAND NAMES  
COLUMBIA  
TONG TEST  
COMPANY ADDRESS  
4519 HAMILTON AVE.  
CLEVELAND, OHIO 44114

COMPUTRON INC.

SALES MANAGER  
THOMAS J. DEMPSEY  
BRAND NAMES  
BASF  
COMPANY ADDRESS  
122 CALVARY STREET  
WALTHAM, MASS. 02154  
COMPANY REPRESENTATIVES  
DIMENSION MARKETING AND  
HARRY BARTON SALES  
SUITE 605, 1255 POST STREET  
SAN FRANCISCO, CALIF.  
415 776-5122  
PACIFIC AUDIO SALES INC  
1933 S BROADWAY  
LOS ANGELES, CALIFORNIA  
213 747-7314



DOUGHERTY ENTERPRISES  
1164 WAIMANU ST  
HONOLULU, HAWAII  
510 281 & 504 987  
WILLIAM J DOYLE CD  
7426 N WESTERN AVE  
CHICAGO, ILL  
312 274-6683  
BLIND & ASSOCIATES  
1635 N GENT AVE  
INDIANAPOLIS, INDIANA  
317 635-6291  
ALBERT N REINHERZ  
59 HAMILTON ROAD  
BELMONT 78, MASS  
614 484-7784  
BUTCHART- RATHSBURG  
16637 E WARREN AVENUE  
DETROIT, MICHIGAN  
313 882-1717  
DIPRO INC  
P O BOX 1427  
MARYLAND HEIGHTS, MO  
314 432 3444  
DIPRO INC  
7811 CARONDELET  
CLAYTON 5, MO  
314 726-4770  
R W FARRIS CO INC  
1715 BALTIMORE  
KANSAS CITY, MISSOURI  
816 421-1751  
WILLIAM TAUBER COMPANY  
151 FAYETTE BLVD  
SYRACUSE, NEW YORK  
446-7094  
L-C-A SALES  
76 MAIN STREET  
TUCKAHOE, NEW YORK  
914 961-4700  
C L PUGH COMPANY  
2144 RIVERSIDE DRIVE  
COLUMBUS, OHIO  
614 486-9678  
A H HOFFMAN  
6115 DENTON DRIVE AND  
100 EXCHANGE PARK NORTH  
DALLAS, TEXAS

**CONRAC DIVISION.**  
**GIANNINI CONTROLS CORP**  
SALES MANAGER  
A. W. SEVERDIA  
BRAND NAMES  
CONRAC  
COMPANY ADDRESS  
600 N. RIMSDALE  
COVINA, CALIF. 91722  
COMPANY REPRESENTATIVES  
PHILLIP R HURLBUT  
C/O ELSCO  
4533 N SCOTTSDALE RD  
SCOTTSDALE, ARIZ.  
ALFRED H KALLMAN  
VISUAL ELECTRONICS CORP  
1617 EL CENTRO AVE  
HOLLYWOOD 28, CALIF.  
ROBERT KUHL  
VISUAL ELECTRONICS CORP  
1208 POPLAR AVENUE  
SUNNYVALE, CALIF.  
RICHARD WHITE  
ELSCO COLORADO, INC  
2785 N SPEER BLVD  
DENVER, COLO. 80211  
LEWIS C RADFORD  
VISUAL ELECTRONICS CORP  
3202 LANIER DR  
ATLANTA 19, GA.  
LINTON D HARGREAVES  
VISUAL ELECTRONICS CORP  
409 S KENTUCKY  
MASON CITY, IOWA  
EDWARD S CLAMMER  
VISUAL ELECTRONICS CORP  
5940 AVON DRIVE  
BETHESDA 14, MARYLAND  
CHARLES R RICH  
VISUAL ELECTRONICS CORP  
2 LEONARD ST  
ANNISQUAM, MASS.  
JESSICA C RASKY AND  
MORRIS A MAYERS  
VISUAL ELECTRONICS CORP  
356 W 40TH ST  
NEW YORK, N Y 10018  
JAMES HOWARD  
VISUAL ELECTRONICS CORP  
411 PRICE ST  
THOMASVILLE, N.C.  
P D THOMPSON  
VISUAL ELECTRONICS CORP  
2550 WEYMOUTH ROAD  
WINSTON-SALEM, N.C.  
A W GRESON  
VISUAL ELECTRONICS CORP  
219 HOMEWOOD AVE  
GREENSBORO, N.C.  
FELIX D BONVOULDIR  
VISUAL ELECTRONICS CORP  
1310 GREENVIEW DR  
MIAMISBURG, OHIO  
JOHN P GALLAGHER  
VISUAL ELECTRONICS CORP  
P O BOX 98  
WHITE HAVEN, PA.  
CHET SIEGRIST  
VISUAL ELECTRONICS CORP  
1107 CATHEDRAL ST  
LEBANON, PA.  
WAYNE MARCY  
VISUAL ELECTRONICS CORP  
4007 BELLAIRE  
HOUSTON, TEXAS  
ROBERT C BACON  
VISUAL ELECTRONICS CORP

C/O ELSCO, BOX 15068  
SALT LAKE CITY, UTAH  
LYLE O KEYS  
C/O ELSCO  
P D BOX 15068  
SALT LAKE CITY, UTAH 84115  
SAM W KICHAS  
C/O ELSCO  
P O BOX 15068  
SALT LAKE CITY, UTAH 84115

**CONTINENTAL ELECTRONICS MFG. CO**

SALES MANAGER  
THOMAS B. MOSELEY  
BRAND NAMES  
MAGNIPHASE  
PROLOG  
COMPANY ADDRESS  
P.O. BOX 17040  
DALLAS, TEXAS 75217  
COMPANY REPRESENTATIVES  
DON W. CLARK  
701 WELCH RD.  
PALO ALTO, CALIF. 94304  
415 321-5200  
R. DENNIS MCGUIRE  
701 N. MICHIGAN APT 1924  
CHICAGO, ILL. 60611  
312 787-4200  
WILLIAM C. MIMS  
925 LDNGVIEW OR  
ELLCIDTT CITY, MD. 21043  
301 465-0452  
THOMAS S. BUTLER  
P. O. BOX 145  
RICHARDSON, TEX. 75080  
214 325-1291

**COOK ELECTRIC COMPANY**

SALES MANAGER TELEPHONE PROD.  
GERARD L. MEYER  
COMPANY ADDRESS  
2700 SOUTHPORT AVENUE  
CHICAGO, ILLINOIS 60614  
COMPANY REPRESENTATIVES  
JAMES H. TATUM  
3300 LOS PRADOS,  
SAN MATEO, CALIF. 94403  
415 349-1818  
KENNETH J. PAUL  
P. O. BOX 448  
TALLAHASSEE, FLA. 32302  
904 224-3526  
ALBERT G. ULRICH  
P. O. BOX 51  
CARTHAGE, ILLINOIS 62321  
217 222-6522  
O. WM. LINDBERG  
2 TALL ACRES DRIVE  
PITTSFORD, N Y 14534  
716 586-4900  
JAMES A. CRANE  
P. O. BOX 126  
CARRBORO, N. C. 27510  
919 929-1967  
S. ALLEN SNYDER  
645 PORTLAND WAY SOUTH  
GALION, OHIO 44833  
419 468-3313  
CHARLES C. BROWNE  
1023 SOUTH 11TH ST  
KINGFISHER, OKLA. 73750  
405 375-3789

**COOKE ENGINEERING COMPANY**

SALES MANAGER  
DAVID L. LATHAM  
BRAND NAMES  
COJAX  
COTERM  
COMPANY ADDRESS  
735 NORTH SAINT ASAPH ST  
ALEXANDRIA, VIRGINIA 22314  
COMPANY REPRESENTATIVES  
EDWARD T. BUXTON  
7 BOW STREET  
CDNCORD, MASS  
617-EM9-2807

**COPPERWELD STEEL COMPANY**

**WIRE AND CABLE DIVISION**  
SALES MANAGER  
GEORGE HAMBURGER  
BRAND NAMES  
ALUMOWELD  
COPPERWELD  
AWAC  
COMPANY ADDRESS  
1000 MONONGAHELA AVE  
GLASSPORT, PA 15045  
412 461 4020  
COMPANY REPRESENTATIVES  
A. B. LEACH  
WESTERN SALES MANAGER  
736 WELLS FARGO BLDG  
SAN FRANCISCO, CALIF 94104  
415 433 3587  
A. W. CONRAD  
610 S. BROADWAY  
LOS ANGELES, CALIF. 90014  
213 625-8847  
G. O. SEWICK  
4214 EAST COLFAX AVENUE  
DENVER, COLORADO 80220  
303 388-0571  
J. J. CAMPBELL, JR.  
MANAGER GOVERNMENT SALES  
1875 CONNECTICUT AVE NW  
WASHINGTON, D C 20009  
202 387 1890  
F. W. KNORR  
11628 CARROLLWOOD DRIVE  
TAMPA, FLORIDA 33618  
813 935-8820  
R. R. BALORIGE  
2030 PEACHTREE ROAD, NE

# NOW... THE IDEAL COAXIAL PATCH FIELD for TV STATIONS consists of :

## COTERM

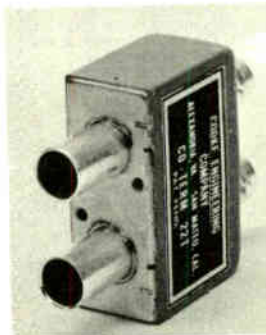

Normal thru coaxial circuits  
without use of patchcords.

Source automatically termi-  
nated in proper impedance when  
load side is patched.

Permits testing of active circuit  
without interruption of signal.

Extremely high density (22  
jacks on 19" x 1-3/4" panel).

## COJAX



COJAX has all features of  
COTERM except self-termina-  
tion of source when load side  
is patched. Accepts same patch-  
cord as COTERM.

## QUICK DISCONNECT CONNECTOR



Unique snap locking feature  
permits easy insertion and  
removal even in extremely high  
density patch fields.

Easy to install using standard  
tools and available for wide  
range of coaxial cables.

# COOKE ENGINEERING COMPANY

735 N. Saint Asaph Street, Alexandria, Va.  
Telephone: 703-548-3889

ATLANTA, GA. 30309  
404 355-7447  
R. C. RAASCH  
MIDWESTERN SALES MANAGER  
140 S DEARBORN STREET  
CHICAGO, ILL 60603  
312 726 2070  
W. H. FRICK AND  
G W BLANCHARD  
140 S DEARBORN ST  
CHICAGO, ILL 60603  
312 726 2070  
R. M. HEIL  
MINNEAPOLIS, MINN  
612 646 4911  
D. R. PETTET  
300 EAST ARMOUR BLVD.  
KANSAS CITY, MO. 64111  
916 LO 1-6400  
W. P. RIECHMAN  
340 PIERRE LACLEDE BLDG  
ST LOUIS, MO 63105  
314 863 5121  
M. E. BROWN  
EASTERN SALES MANAGER  
100 CHURCH STREET  
NEW YORK, N Y 10007  
212 BE 3 5600  
H. J. YOUNG  
100 CHURCH STREET  
NEW YORK, N Y 10007  
212 BE 3 5600  
R. E. TAYLOR  
1229 W. THIRD AVENUE  
COLUMBUS, OHIO 43212  
614 291-9929  
R. C. MITINGER  
1000 MONONGAHELA AVE  
GLASSPORT, PA 15045  
412 461 4020  
L. E. MCGUIRE  
1403 STERICK BLDG  
MEMPHIS, TENN 38103  
901 JA 5 0565  
A. W. HARDER  
520 AQUA DRIVE  
DALLAS, TEXAS 75218  
214 RI 7-1470  
R. CRAIG  
DISTRICT MANAGER  
P O BOX 866  
BELLEVUE, WASH. 98004  
206 GL 4-1233

**CORNELL-DUBILIER ELECTRONICS**  
**DIV. FED. PACIFIC ELECTRIC CO**  
**SALES MANAGER**

JOHN GLYNN  
CORNELL-DUBILIER ELECTRONICS  
921 PROVIDENCE HWY  
NORWOOD, MASS  
COMPANY ADDRESS  
50 PARIS STREET  
NEWARK, NEW JERSEY 07101  
COMPANY REPRESENTATIVES  
DICK BELLEW CO  
1005 WEST 4TH STREET  
EL DORADO, ARKANSAS  
501-UN3-8352  
MOULTHROP & HUNTER  
165 11TH STREET  
SAN FRANCISCO, CALIF.  
415 UN3-7880  
HERB BECKER CO.  
1140 CRENSHAW BLVD  
LOS ANGELES, CALIF.  
213-931-1257  
J. H. FEDER, JR.  
FOR HAWAII  
4144 GLENCOE AVENUE  
VENICE, CALIF.  
213 UP 0-6681  
R. G. BOWEN CO, INC.  
721 SOUTH BROADWAY  
DENVER, COLORADO  
303-722-4641  
MILLAR-HUTTO ASSOC, INC.  
P. O. BOX 1603  
WINTER PARK, FLORIDA  
305-MI7-7407  
MILLAR-HUTTO ASSOCIATES  
1036 PEACHTREE ST N. E.  
P. O. BOX 7116 STATION C  
ATLANTA, GEORGIA  
404-TR6-0919  
MARKAL SALES CORP.  
5787 LINCOLN AVE  
CHICAGO, ILLINOIS  
312-LO1-7290  
KNAGGS, COLLINS,  
HAVERCAMP, HEMPE, INC.  
NO. 6 BANK SQUARE  
EAST ST, LOUIS, ILLINOIS  
EXT-2398  
MACNABB, SCHRÖEDER & LOOMIS  
810 EAST 64TH ST  
INDIANAPOLIS, INDIANA  
317-CL1-4571  
STINSON ASSOCIATES  
12303 STARLIGHT LANE,  
BOWIE, MARYLAND  
HEA-4126  
W. A. HENDRICKSON CO.  
291 FIRST PARIS ROAD  
SCITUATE, MASS.  
617-545-0692  
BUTCHART-RATHSBURG & ASSOC.  
16637 E. WARREN AVE  
DETROIT, MICHIGAN  
882-1717  
STAN OLSEN & ASSOC.  
4201 WOODDALE AVE  
MINNEAPOLIS, MINN.  
612-926-4158  
KNAGGS, COLLINS,  
HAVERCAMP, HEMPE, INC.

5818 NORTH OAK TRAFFICWAY  
KANSAS CITY, MO.  
GL3-3202  
TMC SALES CORP.  
2465 LEMOINE AVENUE  
FORT LEE, NEW JERSEY  
201-944-8340  
ALBUQUERQUE ELECTRONICS  
2318 WISCONSIN, N. E.  
ALBUQUERQUE, N. M.  
505-298-2628  
MESSINA ELECTRONICS  
25 GREENHILL TERR.  
WEST SENECA, NEW YORK  
NR4-7445  
MILLAR-HUTTO ASSOCIATES  
P. O. BOX 17566  
CHARLOTTE, N. C.  
EM6-2061  
BAEHR, GREENLEAF & ASSOC, INC  
14700 DETROIT AVENUE  
CLEVELAND, OHIO  
216-221-9030  
STINSON ASSOCIATES  
227 HAVERFORD AVE  
NARBERTH, PENN.  
MO4-5511  
COVERT-NEWMAN CO.  
300 MT. LEBANON BLVD.  
PITTSBURGH, PA.  
412 563-0303  
PARVIN SALES CO.  
P. O. BOX 307  
ADDISON, TEXAS  
214 EM3-8596  
R. G. BOWEN CO, INC.  
31 SO. 3RD. E.  
SALT LAKE CITY, UTAH  
801-364-4632  
NORTHWESTERN AGENCIES  
4130 FIRST AVE SO.  
SEATTLE, WASHINGTON  
206 MA3-8882  
REPS IN OTHER COUNTRIES  
ELECTRO TEC MARKETERS LTD.  
1624 WEST THIRD AVE  
VANCOUVER 9, B.C.  
604-04-8711  
RUTHERFORD AGENCIES  
2705 BATES ROAD  
MONTREAL 26, QUEBEC  
731-7696

**COURIER COMMUNICATIONS, INC.**

A SUBSIDIARY OF  
**F.C.I. ELECTRONICS**  
**COMMUNICATIONS, INC.**  
SALES MANAGER  
S. O. KAPPEL  
COMPANY ADDRESS  
56 HAMILTON AVE.  
WHITE PLAINS, NEW YORK 10601

**CRAFTSMAN ELECTRONIC**  
**PRODUCTS, INC.**

SALES MANAGER  
JOSEPH H. GIBBS  
115 KESSLER LANE  
FAYETTEVILLE, N Y 13066  
BRAND NAMES  
CRAFTSMAN  
COMPANY ADDRESS  
133 W. SENECA ST.  
MANLIUS, NEW YORK 13104  
COMPANY REPRESENTATIVES  
A-E-5  
1559 CHESTER ST  
AURORA, COLO  
303 366-0208  
GETTLEMAN & LITTEKEN CO  
3736 DEWPSTER ST  
SKOKIE, ILL  
312 588-0030  
NEAR, INC  
99 HIGHLAND ST  
SOMERVILLE, MASS  
617 776-2262  
JOHN E M ANDERSON  
5231 HUMBOLDT AVE  
MINNEAPOLIS, MINN  
612 823-6459  
CARMINE A VIGNOLA  
21 SCHELLRIDGE RD  
JEFFERSON CITY, MO  
314 838-1023  
STEVE FISHER  
121 CEDAR LANE  
TEANECK, N J  
201 836-6661  
WILLIAM TAUBER  
151 FAYETTE BLVD  
SYRACUSE, N Y  
315 446-7094  
SHAMROCK ELECTRONICS  
1755 W MARKET ST  
AKRON, OHIO  
216 864-3090  
JOHN MUSTICO  
206 BEWLEY RD  
HAVERTOWN, PA  
215 446-1961  
ERNEST S WILKS  
BOX 14466  
DALLAS, TEXAS  
214 642-8321  
FLECHART & SULLIVAN, INC  
321 N E 45TH ST  
SEATTLE, WASH  
206 633-4979

**CROWN INTERNATIONAL**

SALES MANAGER  
CLYDE W. MOORE  
BRAND NAMES  
CROWN  
COMPANY ADDRESS

1718 W. MISHAWAKA ROAD  
ELKHART, INDIANA 46514  
COMPANY REPRESENTATIVES  
DOBBS - STANFORD CO  
569 LAUREL ST - P.O. BOX 266  
SAN CARLOS, CALIF  
415 591-0339  
MARSHANK SALES CO  
7422 MELROSE AVE  
LOS ANGELES 46, CALIF  
213 938-2591  
DOW FITZGERALD  
6231 S. CHURCH  
TAMPA, FLA.  
SAM LITTLE CO  
2396 CONALLY DR  
P O BOX 308  
EAST POINT, GA  
404 761-5353  
JOHN GILL  
1043 E 95TH ST  
CHICAGO, ILL 60619  
312 731-4404  
CENTRAL ELECTRONICS SALES CO  
P O BOX 591  
INDIANAPOLIS, INO  
317 923-2932  
TECHREP ASSOCIATES  
P O BOX 161  
TOSNFIELD, MASS  
617 887-8671  
BUTCHART - RATHSBURG & ASSOC  
16637 E WARREN AVE  
DETROIT, MICH  
313 882-1717  
CENTRAL ELECTRONICS SALES CO  
19217 FAIRPORT  
DETROIT 5, MICH  
313 526-5841  
ELIAS ELECTRONICS  
P O BOX 128 N E STATION  
LIVONIA, MICH  
313 476-1520  
ROBERT SHAW  
7800 KENRIDGE LANE  
ST LOUIS, MO  
314 962-7429  
ELDISERCO  
52 MEADOWBROOK DR  
S SOMERVILLE, N J  
201 359-6492  
METROREP  
P O BOX 782  
FREEHOLD, N J  
212 462 1221  
NILES CHRISTENSEN - EXPORT  
SPRINGFIELD, N J  
201 273-3822  
TELESCO INTL - EXPORT  
171 MADISON AVE  
NEW YORK 16, N Y  
212 683-9420  
ROBERT WHITE  
P O BOX 9408  
OLON, OHIO  
216 248-1317  
A C MCMILLAN  
16679 S W MAPLE CIRCLE  
LAKE OSWEGO, ORE  
503 636-6257  
DON MULL  
P O BOX 313  
FREDRICKSBURG, TEXAS  
512 997-5388  
REPS IN OTHER COUNTRIES  
CALDWELL A/V EOPT CO  
135 MIDWEST RD  
SCARBOROUGH, ONTARIO

**CURTIS INSTRUMENTS, INC**

SALES MANAGER  
EDWARD M. HOWELL  
COMPANY ADDRESS  
351 LEXINGTON AVE.  
MOUNT KISCO, NEW YORK 10549  
COMPANY REPRESENTATIVES  
LEE ASSOCIATES  
2400 W CLINTON  
HUNTSVILLE, ALA  
205 539-0761  
CAIRNS ENGINEERING SALES  
900 N SAN ANTONIO RD  
LDS ALTOS, CALIF  
415 941-3226  
CAIRNS ENGINEERING SALES  
6191 W CENTURY BLVD  
LOS ANGELES, CALIF  
213 670-1700  
AZTEC ENTERPRISES  
3385 S BANNOCK  
ENGLEWOOD, COLO  
303 761-0101  
LEE ASSOCIATES  
200 E MARKS  
ORLANDO, FLA  
305 241-4445  
MIDWEST ELECTRONIC SALES  
5707 W DIVISION ST  
CHICAGO, ILL  
312 626-0030  
BARCOCK-BOHAKER-STIDDARD  
880 BONIFANT  
SILVER SPRING, MO  
301 588-4047  
HARMON ASSOCIATES  
251 HARVARD ST  
BROOKLINE, MASS  
617 232-6687  
E C ELECTRONIC SALES  
10108 ABBOT SOUTH  
MINNEAPOLIS, MINN  
612 888-0102  
AZTEC ENTERPRISES  
5206-B CONSTITUTION  
ALBUQUERQUE, N M  
505 268-6421

B AARDN & CO  
P D BOX 186  
ROSLYN, L I, N Y  
516 621-0630  
REP TECH, INC  
P O BOX 98  
PICKARD BLDG  
SYRACUSE, N Y  
315 454-0761  
BEDELE EQUIPMENT  
6900 SILVERTON  
CINCINNATI, OHIO  
513 793-0140  
BARCOCK-BOHAKER-STIDDARD  
130 W LANCASTER  
WAYNE, PA  
215 MU 8-8288  
LEE ASSOCIATES  
432 WEST END  
WINSTON-SALEM, S C  
919 724-2406

**CUSH CRAFT**

SALES MANAGER  
ROBERT W. CUSHMAN  
COMPANY ADDRESS  
621 HAYWARD STREET  
MANCHESTER, NEW HAMP. 03103  
COMPANY REPRESENTATIVES  
BRADDOCK ASSOCIATES  
P. O. BOX 305  
HADDONFIELD, N.J. 08033  
OHIO ASSOCIATES  
P. O. BOX 728  
LIMA, OHIO  
CHESTER DREXLER CO.  
3 LEE DRIVE  
SO. FARMINGDALE, L.I.,  
NEW YORK 11737  
IVAN HARRISON CO.  
P. O. BOX 30241  
DALLAS, TEXAS 75230  
LOWELL, KINGAS & ASSOCIATES  
P. O. BOX 4116  
OVERLAND PARK, KANSAS 66204  
SAM LITTLE COMPANY  
BOX 308  
EAST POINT, GEORGIA 30044  
LOWELL, KINGAS & ASSOCIATES  
P.O. BOX 26, CREVE COEUR STA  
ST. LOUIS, MO. 63141  
ELVEY-PROCTOR COMPANY  
1650 LAUREL AVENUE  
SAN CARLOS, CALIF.  
JACK SPROCH SALES COMPANY  
3520 W. BROWARD BLVD.  
FT. LAUDERDALE, FLA. 33312  
R. G. THOMPSON COMPANY  
5836 PITTSBURY AVE., SOUTH  
MINNEAPOLIS, MINN. 55419  
WALLACE & WALLACE  
1206 MAPLE AVENUE  
LOS ANGELES, CALIF. 90015  
WILLIAM K. WOOD CO., INC.  
P.O. BOX 46046  
SEATTLE, WASH.  
EMEC, INC.  
160 TERMINAL DRIVE  
PLAINVIEW, L.I., N.Y. 11803

**CUSTOM CRAFT DESIGNS**

SALES MANAGER  
J E LICHTENSTEIN  
COMPANY ADDRESS  
2135 DREXEL ST  
WEST HYATTSVILLE, MO 20783  
301 422 7684

**DAGE-BELL CORPORATION**

SUBSID THE RAYTHEON COMPANY  
SALES MANAGER  
DALE SCHONMEYER  
BRAND NAMES  
DAGE  
COMPANY ADDRESS  
455 SHERIDAN AVENUE  
MICHIGAN CITY, INDIANA 46403  
COMPANY REPRESENTATIVES  
HANK GREENSPAN  
REGIONAL MANAGER  
936 W FLORENCE AVE  
INGLEWOOD, CALIF 90301  
213 678 9231  
MERTON KNOLO  
REGIONAL MANAGER  
670 MIAMI CIRCLE, NE  
ATLANTA, GEORGIA 30324  
404 233 3383  
ORAL EVANS  
REGIONAL MANAGER  
455 SHERIDAN AVENUE  
MICHIGAN CITY, INDIANA 46360  
219 874 3251

**DATA INSTRUMENT DIV**

**INDUSTRIAL ELECTRONIC HOWE CO**  
SALES MANAGER  
FRANK BRIDGES  
BRAND NAMES  
TELEQUIPMENT  
WIDNEY DORLEC  
COMPANY ADDRESS  
7300 CRESCENT BLVD.  
PENNSAUKEN, NEW JERSEY 08110  
COMPANY REPRESENTATIVES  
W K GEIST CO  
1205 AIRWAY AVENUE  
GLENDALE, CALIF  
213 245 9501  
CRANE ASSOC  
15419 KESWICK STREET  
VAN NUYS, CALIF  
213 ST O 7972

REYNOLDS & ASSOC  
PO BOX 1032  
EAU GALLIE, FLORIDA  
305 354 0520  
KENNETH W MEYERS CO  
7256 DUMY AVENUE  
CHICAGO, ILLINOIS  
312 SP 4 6440  
MALONE ENG ASSOC  
7640 W NORTH AVENUE  
ELMHWOOD PARK, ILLINOIS  
312 456 4031  
INDUSTRIAL SALES CO  
415 E HERRY STREET  
FT WAYNE, INDIANA  
219 742 7009  
BROGER INST SALES INC  
176 2ND STREET  
WALTHAM, MASS  
617 TW 1 8045  
JAMES LEE CO  
4241 TOLEDD AVENUE  
MINNEAPOLIS, MINN  
612 920 1525  
LEEMARK ASSOC  
2001 BIG BEN BLVD  
ST LOUIS, MISSOURI  
314 MI 5 1470  
L & M ASSOC  
511 VICTOR STREET  
SADDLE BROOK, NEW JERSEY  
201 843 8700  
FRANK TYLINSKI CO  
338 NORTHERN BLVD  
GREAT NECK, NEW YORK  
516 466 9070  
M FRIEDMAN ASSOC  
7 HEATHER ROAD  
BALA CYNWYD, PENNSYLVANIA  
215 TE 9 3450  
WEISS INST  
6 BARTON DRIVE  
PITTSBURGH, PENNA  
412 371 3020  
DATRONICS INC  
7800 WEST GLEN DRIVE  
HOUSTON, TEXAS  
713 SD 2 9851  
ARVA INC  
1320 PROSPECT STREET  
SEATTLE, WASH  
206 MA 2 0177

DATAPULSE DIVISION  
OF DATAPULSE, INC.  
SALES MANAGER  
M. B. COX, JR.  
COMPANY ADDRESS  
509 HINDRY AVE.  
INGLEWOOD, CALIF. 90306  
213 671-4334  
TWX 910 328-6109  
COMPANY REPRESENTATIVES  
BCS ASSOCIATES, INC  
2317 BOB WALLACE AVE., S W  
HUNTSVILLE, ALA., 35805  
HYTRONIC MEASUREMENTS  
1017 NORTH THIRD STREET  
PHOENIX, ARIZONA 85004  
JOHN DHALLORAN & ASSOCIATES  
3268 ROSECANS BLVD  
SAN DIEGO, CALIF. 92110  
JOHN DHALLORAN & ASSOCIATES  
3921 E BAYSHORE BLVD  
PALO ALTO, CALIF. 94303  
JOHN DHALLORAN & ASSOCIATES  
10700 VENTURA BLVD  
N. HOLLYWOOD, CALIF. 91604  
HYTRONIC MEASUREMENTS, INC.  
1295 SOUTH BANNOCK STREET  
DENVER, COLORADO 80223  
INSTRUMENT CONSULTANTS, INC  
2381 WHITNEY AVENUE  
HAMDEN, CONN. 06518  
BCS ASSOCIATES, INC  
940 FERN DRIVE  
ORLANDO, FLORIDA 32803  
RIDGWAY ASSOCIATES, INC  
3759 N HARLEM AVENUE  
CHICAGO, ILLINOIS 60634  
LEEMARK ASSOCIATES, INC  
4518 W 89TH STREET  
PRAIRIE VILLAGE, KAN. 66207  
LEEMARK ASSOCIATES  
P O BOX 6145  
LEAWOOD, KANSAS  
BRIMBERG ASSOCIATES, INC  
110 E PENNSYLVANIA AVENUE  
TOWSON, MARYLAND 21204  
BRIMBERG ASSOCIATES, INC  
814 THAYER AVENUE  
SILVER SPRINGS, MD. 20910  
INSTRUMENT CONSULTANTS, INC  
P O BOX 25  
WABAN, MASS. 02168  
RIDGWAY ASSOCIATES, INC  
7720 MDRGAN AVENUE, SOUTH  
MINNEAPOLIS, MINN. 55423  
LEEMARK ASSOCIATES, INC  
2001 BIG BEND BLVD  
ST. LOUIS, MO. 63117  
G CURTIS ENGEL & ASSOCIATES  
210 S BROAD STREET  
RIDGWOOD, NEW JERSEY 07451  
HYTRONIC MEASUREMENTS, INC  
205 SAN PABLO, S E  
ALBUQUERQUE, N. M. 87108  
J D RYERSON ASSOCIATES, INC.  
P O BOX 1400  
SYRACUSE, NEW YORK 13201  
BCS ASSOCIATES, INC  
1039 E WENDOVER AVENUE  
GREENSBORO, N. C.  
RIDGWAY ASSOCIATES, INC  
22811 LORAIN ROAD  
FAIRVIEW PARK, OHIO 44126

RIDGWAY ASSOCIATES, INC  
2400 E DOROTHY LANE  
DAYTON, OHIO 45420  
AIREP ELECTRONICS, INC  
8119 BELLAIRE BLVD  
HOUSTON, TEXAS 77036  
AIREP ELECTRONICS, INC  
P O BOX 9555  
DALLAS, TEXAS 75214  
HYTRONIC MEASUREMENTS, INC  
2022 S MAIN STREET  
SALT LAKE CITY, UTAH 84115  
HARRY LEVINSKY  
1211 E DENNY WAY  
SEATTLE, WASH. 98122  
REPS. IN OTHER COUNTRIES  
TOSHNIWAL BROS PRV LTD  
198 JAMSHEDJI TATA RD  
BOMBAY 1, INDIA  
TAIYO SHUJI COMPANY, INC.  
16, 5 CHOME, SHIBA-SHIMBASHI  
MINATO-KU, TOKYO, JAPAN  
SELRAM ELECTRONICS  
83, AVENUE DES MIMOSAS  
BRUSSELS, BELGIUM  
DLTRONIX A/S  
MALTTEGAARDEVEJ 18  
GENTOFTE, DENMARK  
OY FINDIP  
MANNERHEIMINTIE 29.C  
HELSINKI 25, FINLAND  
TECHNIQUE ET PRODUITS  
63, BIS RUE D AGUESSEAU  
BOULOGNE-S/-SEINE, FRANCE  
NEUMULLER & CO CMBH  
SCHRAUDDLPSTRASSE 2A  
MUNICH 13, WEST GERMANY  
DYNAMCO INSTRUMENTS, LTD  
25 SALISBURY GROVE  
MYTCHETT, CAMBERLEY  
SURREY, ENGLAND  
SPECIAL-IND  
VIA D. MANIN 33  
MILAN, ITALY  
ELOFYSCIA N-V-AMSTEROAM  
WFERINGSCHANS 120  
AMSTERDAM-C, HOLLAND  
DATAMATIK  
GRONLANDESLEIRET 31  
OSLO, NORWAY  
UNITRONICS  
TOREE DE MADRID  
PISO 12-OFICINA 9  
PLAZA DE ESPANA  
MADRID 13, SPAIN  
SCANTELF AB  
TENGAHLGATAN 24  
STOCKHOLM, SWEDEN  
RAFRLOCHER AG  
FDERRLRUCKSTRASSE 110  
ZURICH 8021, SWITZERLAND  
EASTRONICS LTD  
22 MAZE STREET  
TEL AVIV, ISRAEL 22867  
ATLAS INSTRUMENTS CORP  
DIV OF ATLAS ELECTRONICS LTD  
50 WINGLOD AVENUE  
TORONTO, ONTARIO  
ATLAS INSTRUMENTS CORP  
DIV OF ATLAS ELECTRONICS LTD  
342 1/2 ELGIN STREET  
OTTAWA, ONTARIO  
ATLAS INSTRUMENTS CORP  
333 CAVENDISH BLVD.  
SUITE 390  
MONTREAL, QUEBEC  
SAMPLE ELECTRONICS PTY LTD  
4 GRDSE STREET GLEBE  
SYDNEY, N.S.W., AUSTRALIA  
SAMPLE ELECTRONICS PTY LTD  
9/11 CREMORNE STREET  
RICHMOND E, T.  
VICTORIA, AUSTRALIA

DAYTON ELECTRONIC PRODUCTS CO  
COMMERCIAL SALES MANAGER  
HANK JOSEFCZYK  
COMPANY ADDRESS  
117 E. HELENA ST.  
DAYTON, OHIO 45404  
513 461 4951

D & B ELECTRONICS CO  
SALES MANAGER  
VICTOR BRUNO  
COMPANY ADDRESS  
3611 ESSEX LANE  
PHILADELPHIA, PA. 19114  
215-NE7-2786

DEARBORN ELECTRONICS, INC.  
SUBSIDIARY SPRAGUE ELECTRIC CO  
MARKETING MANAGER  
CHARLES T. LITTLE  
COMPANY ADDRESS  
P.O. BOX 530  
ORLANDO, FLORIDA 32802  
COMPANY REPRESENTATIVES  
SPRAGUE ELECTRIC CO  
3550 N CENTRAL AVENUE  
PHOENIX, ARIZONA 85012  
602 279 5435  
WM J PURDY OF CALIF  
312 7TH STREET  
SAN FRANCISCO, CALIF 94103  
415 863 3300  
SPRAGUE ELECTRIC CO  
12870 PANAMA STREET  
LOS ANGELES, CALIF 90066  
213 870 D161  
SPRAGUE ELECTRIC CO  
5670 E EVANS AVENUE  
DENVER, COLO 80222  
303 756 3611  
SPRAGUE ELECTRIC CO  
3900 WISCONSIN AVE NW

WASHINGTON, D. C. 20016  
202 244 6006  
W BEN WIMBERLY CO  
532 S FORT HARRISON  
CLEARWATER, FLORIDA 33516  
813 446 7072  
W BEN WIMBERLY CO  
500 S DSCEDLA STREET  
ORLANDO, FLORIDA 32801  
305 425 3083  
SPRAGUE ELECTRIC CO  
5942 W MONTRDSE AVENUE  
CHICAGO, ILLINOIS 60634  
312 685 6400  
SPRAGUE ELECTRIC CO  
2511 E 46TH STREET  
INDIANAPOLIS, INDIANA 46205  
317 546 4911  
ROTENHEBER & CO., INC.  
14211 CHESTERFIELD RDAO  
ROCKVILLE, MO 20853  
301 929 3388  
TOM CRAWFORD AND SON  
PO BOX 264  
NORWOOD, MASS 02062  
617 762 6914  
SPRAGUE ELECTRIC CO  
NORTH ADAMS, MASS 01248  
313 664 4411  
SPRAGUE ELECTRIC CO  
259 COLLINGWOOD  
ANN ARBOR, MICH 48103  
313 761 4080  
DAYTON ENG SALES  
1820 FAIRFIELD RDAO S  
MINNETONKA, MINN 55343  
612 545 2221  
SPRAGUE ELECTRIC CO  
3910 LINDELL BLVD  
ST LOUIS, MO 63108  
314 535 7239  
CLARFIELD-STOLLMAK ASSDC  
175 WESTWOOD AVENUE  
WESTWOOD, N J 07675  
201 666 8989  
C T CARLBERG & ASSOC  
PO BOX 3177, STA D  
ALBUQUERQUE, N M 87110  
505 265 1579  
JOSEPH F RIZZO CO - EXPDRT  
ROOM 5710  
EMPIRE STATE BLDG  
NEW YORK, N Y 10001  
212 736 0398  
SPRAGUE ELECTRIC CO  
928 BURKE STREET  
WINSTON-SALEM, N.C. 27101  
919 722 5151  
SPRAGUE ELECTRIC CO  
24 N MAIN STREET  
CHAGRIN FALLS, OHIO 44022  
216 247 6488  
SPRAGUE ELECTRIC CO  
224 LED STREET  
DAYTON, OHIO 45404  
513 223 9187  
ROTENHEBER & CO., INC.  
53 CRICKET AVENUE  
ARMORE, PENNA 19003  
215 642 6911  
DELZELL & EVANS ASSDC  
PO BOX 35093  
DALLAS, TEXAS 75235  
214 351-1839  
SPRAGUE ELECTRIC CO  
4601 AURORA AVENUE NDRTH  
SEATTLE, WASH 98103  
206 632 7761  
REPS. IN OTHER COUNTRIES  
A DESKIN SALES CORP  
1565 LOUVAIN STREET W  
MONTREAL 11, QUEBEC  
514 384 1420

DELCO RADIO DIV.  
GENERAL MOTORS CORP  
SALES MANAGER  
P A SANDBERG  
COMPANY ADDRESS  
700 E FIRMIN ST  
KOKOMO, IND 46901  
457 8461  
BRANCH OFFICES  
726 SANTA MONICA BLVD  
SANTA MONICA, CALIF 90401  
393 1465  
5151 N HARLEM AVENUE  
CHICAGO, ILL 60656  
775 5411  
57 HARPER STREET  
DETROIT, MICH 48202  
873 6560  
324 CHESTNUT STREET  
UNION, N J 07083  
687 3770  
1054 JAMES STREET  
SYRACUSE, N Y 13203  
474 6255

DELTA ELECTRONICS, INC  
SALES MANAGER  
LARRY HANCOCK  
COMPANY ADDRESS  
145 FAYETTE ST  
WINSTON-SALEM, N.C. 27101  
COMPANY REPRESENTATIVES  
LONG ENGINEERING CO  
961 BURKE STREET  
WINSTON-SALEM, N.C. 27101  
725-2306

DELTA ELECTRONICS INC  
SALES MANAGER  
ROBERT H FOLEY  
COMPANY ADDRESS  
4206 WHEELER AVENUE

ALEXANDRIA, VA 22304  
COMPANY REPRESENTATIVES  
REYNOLDS & ASSOC INC  
P O BOX 1043  
EAU GALLIE, FLA  
305 254 0520  
M J FEIN & CO  
HARWOOD BLDG P O BOX 28  
SCARSDALE, NEW YDRK  
914 GR 2 1100  
ROCKE INTERNATIONAL CORP  
13 EAST 40TH ST  
NEW YORK, NEW YORK  
MU 9 0200  
ASHBY ASSOCIATES INC  
CLAYPOOL BLDG SUITE 155  
4130 LINDEN AVE  
DAYTON, OHIO  
513 224-0561

DEMORNAY-BONARDI  
DIV. OF DATAPULSE, INC.  
SALES MANAGER  
PAUL A. LIST  
COMPANY ADDRESS  
1313 N. LINCOLN AVE.  
PASADENA, CALIF. 91103  
213 681-7416  
TWX 910 588-3282  
COMPANY REPRESENTATIVES  
W A BROWN & ASSOCIATES, INC  
1314 BUFORD STREET, N W  
HUNTSVILLE, ALA. 35801  
R F ASSOCIATES, INC.  
1621 PONTIUS AVENUE  
LOS ANGELES, CALIF. 90025  
RF ASSOCIATES, INC  
800 SAN ANTONIO ROAD  
PALO ALTO, CALIF. 94303  
KELLEY ENTERPRISES  
336 E 4TH STREET  
LOVELAND, COLORADO 80537  
W A BROWN & ASSOCIATES, INC  
222 WEBER AVENUE  
ORLANDO, FLA. 32803  
W A BROWN & ASSOCIATES, INC  
3039 N E 32ND AVENUE  
FT. LAUDERDALE, FLA. 33308  
RIDGWAY ASSOCIATES, INC  
3759 N HARLEM AVENUE  
CHICAGO, ILLINOIS 60634  
PENNZER ASSOCIATES, INC  
P O BOX 4362  
OVERLAND PARK, KANSAS 66204  
CONNAUGHTON & COMPANY  
18 BOWHELL ROAD  
BRIGHTON, MASS. 02135  
RIDGWAY ASSOCIATES, INC  
7720 MORGAN AVENUE SOUTH  
MINNEAPOLIS, MINNESOTA 55423  
PENNZER ASSOCIATES, INC  
BOX 26, CREVE COEUR STATION  
ST. LOUIS, MO. 63141  
CENTRAL ASSOCIATES, INC  
44 N DEAN STREET  
ENGLEWOOD, N.J. 07631  
CENTRAL ASSOCIATES, INC  
111 COMMERCIAL STREET  
PLAINVILLE, L.I., N.Y., 11803  
J D RYERSON ASSOCIATES INC  
P O BOX 1400  
SYRACUSE, NEW YORK 13201  
W A BROWN & ASSOCIATES, INC  
440 WEST-END BLVD  
WINSTON-SALEM, N.C. 27101  
RIDGWAY ASSOCIATES  
2400 E DOROTHY LANE  
DAYTON, OHIO 45420  
RIDGWAY ASSOCIATES, INC  
22811 LORAIN ROAD  
FAIRVIEW PARK, OHIO 44126  
R K P ASSOCIATES  
107 FORREST AVENUE  
HARBERTH, PA. 19072  
MITCHELL SPEARS COMPANY  
4944 JAMES AVENUE  
FORT WORTH, TEXAS 76115  
MITCHELL SPEARS COMPANY  
HOUSTON OFFICE CENTER  
ROOM 109C  
HOUSTON, TEXAS 77023  
W A BROWN & ASSOCIATES, INC  
325 FIRST STREET  
ALEXANDRIA, VIRGINIA 22314  
RAY JOHNSTON COMPANY, INC  
1011 NORTHEAST 69TH STREET  
SEATTLE, WASH. 98115  
REPS. IN OTHER COUNTRIES  
TOSHNIWAL BROS PRV LTD  
198, JAMSHEDJI TATA RD  
BOMBAY-1, INDIA  
P O BOX NIBONBASHI  
173 TOKYO JAPAN  
WEN CHANG HONG  
IMPORTERS & EXPORTERS  
ND 23, CHUNG-CHENG ROAD  
TAINAN, TAIWAN  
SHOSHIN SHOJI KAISHA, LTD  
P O BOX NIBONBASHI  
173, TOKYO, JAPAN  
DANIEL DELGAY S A  
BOITE PDSTATE 919  
58A CHAUSSEE DE CHARLERDL  
BRUSSELS, BELGIUM  
OLTRONIX A/S  
MALTTEGAARDEVEJ 18  
GENTOFTE, DENMARK  
MEGEX  
105 QUAI BRANLEY  
PARIS 15E, FRANCE  
TELCO-GESELLSCHAFT FUR MESS  
UND FUNKTECHNIK  
FRANZ - PRUELLTERSTRASSE 15  
MUNICH 8, WEST GERMANY  
C T LONDON LIMITED  
27 ASHLEY PLACE



617 891-4560  
TXW 617-894-8594  
2005 ROUTE 22  
CORNER FAIRWAY DRIVE  
UNION, N.J. 07083  
201 688-8800  
TXW 201 687-9514  
1500 KINGS HIGHWAY  
CHERRY HILL, N.J. 08034  
609 428-6800  
TXW 609 429-4105  
847 JAMES STREET  
SYRACUSE, N.Y. 13203  
315 472-7051  
TXW 315 477-1240  
SOUTHMOOR BUILDING  
10 SOUTHMOOR CIRCLE  
DAYTON, OHIO 45429  
513 298-7318  
TXW 513 944-0546  
FIRST BANK & TRUST BLDG.  
P O BOX 689  
RICHARDSON, TEXAS 75081  
214 235-2385  
TXW 214 231-1403  
1678 SOUTH PIONEER ROAD  
SALT LAKE CITY, UTAH  
801 487 7561  
714 CHURCH STREET  
ALEXANDRIA, VIRGINIA 22314  
703 549-8205  
TXW 703 931-4210

#### EITEL ELECTRONICS

SALES MANAGER  
GEORGE E. EITEL  
BRAND NAMES  
EITELCO  
COMPANY ADDRESS  
P O BOX 830  
211 E SHELTON  
PRESCOTT, ARIZONA 86301  
602 445 0691

#### ELECTROLINE TELEVISION

EQUIPMENT INC.  
PRESIDENT  
MAURICE OLFMAN  
980 NE 170 ST  
N MIAMI BEACH, FLA 33161  
305 949 0933  
COMPANY ADDRESS  
BOX 324  
ULETA, FLA 33164  
COMPANY REPRESENTATIVES  
JEROME GUARDINO  
16 EAST 23RD STREET  
NEW YORK, N.Y. 10010  
212 OR 3-5670  
REPS. IN OTHER COUNTRIES  
HENRY PALL  
DOMINION SQUARE BLDG.  
MONTREAL, QUEBEC  
514 878-9489

#### ELECTRONIC LIGHTS, INC.

SALES MANAGER  
JAMES V. DANIELS  
BRAND NAMES  
SURGELITE  
STROBELITE  
COMPANY ADDRESS  
1713 NORTH ASHLAND AVE  
CHICAGO, ILL 60622

#### ELECTRONIC MOBILE UNITS

COMPANY ADDRESS  
788 PATERSON AVE  
EAST RUTHERFORD, N J  
201 933 3555

#### ELECTRONIC RESEARCH COMPANY

SALES MANAGER  
H. M. DANZIG  
COMPANY ADDRESS  
10000 WEST 75TH STREET  
OVERLAND PARK, KANSAS 66204  
COMPANY REPRESENTATIVES  
WM J PURDY CO  
312 SEVENTH ST  
SAN FRANCISCO, CALIF  
415 863 3300  
SHEPARD WINTERS CO  
4109 BURBANK BLVD  
BURBANK, CALIF  
213 849 6671  
STAN PIERCE, INC  
115 BALD HILL ROAD  
NEW CANAAN, CONN  
203 966 4630  
ORBE, INC  
300 31ST ST N, SUITE 439  
ST PETERSBURG, FLA  
813 894 0687  
ORBE, INC  
1020 GREGORY DR  
MAITLAND, FLA  
305 424 0978  
ORBE, INC  
476 LORIDANS DR, NE  
ATLANTA, GA  
404 233 6453  
WHITMORE ASSOCIATES, INC  
4750 W MILWAUKEE  
CHICAGO, ILL  
312 286 2442  
FLORENCE & MEYER, INC  
2900 WOODLAND  
WICHITA, KANSAS  
316 TE B 7226  
HARRY J WHITE CO  
320 HILLEN RD  
TOWSON, MD 21204  
301 VA 8 6373  
STAN PIERCE, INC

24 LINDEN ST  
NORWOOD, MASS 02062  
617 762 3164  
FLORENCE & MEYER, INC  
406 W 34TH ST  
KANSAS CITY, MO  
816 LO 1 7282  
FLORENCE & MEYER, INC  
BOX 5806  
BERKLEY, MO 63134  
314 JA 1 6800  
COMP TECH SALES  
BOX 50  
RIVERDALE, N J 07457  
201 835 0332  
INTERNATIONAL ELECTRO-COMP CO7  
BOX 353  
PINE BROOK, N J 07058  
201 335 1822  
HARRY J WHITE CO  
801 W MARLTON PIKE  
CHERRY HILL, N J  
609 428 2304  
COMP TECH SALES  
BOX 384  
LYNBROOK, N Y 11563  
516 593 2628  
LAWRENCE SALES CO  
BOX 1038  
RICHARDSON, TEXAS  
214 AD 5 5504  
REPS IN OTHER COUNTRIES  
ELECTRODESIGN, LTD  
9124 ST LAWRENCE BLVD  
MONTREAL, QUEBEC  
514 389 5914

#### ELECTRONICS ESSENTIALS

OF CCC, INC.  
PRESIDENT  
JOSEPH V MITCHELL  
BRAND NAMES  
VERAVOX  
ARMCO  
COMPANY ADDRESS  
4424 FURMAN AVE  
BRONX, N Y 10466

#### EMCEE -

ELECTRONICS, MISSILES,  
COMMUNICATIONS, INC.  
SALES MANAGER  
GARR JOHNSON  
BRAND NAMES  
EMCEE  
COMPANY ADDRESS  
160-E-3 STREET  
MT. VERNON, NEW YORK

#### ELECTRONIC SYSTEM ENGINEERING

SALES MANAGER  
A. A. KAMINSHINE  
BRAND NAMES  
LIMPANDER  
SPEEDMASTER  
COMPANY ADDRESS  
120 1/2 N CLEVELAND  
CUSHING, OKLAHOMA 74023

#### ELECTRO PRODUCTS

LABORATORIES, INC.  
SALES MANAGER  
R. H. NOVIC  
BRAND NAMES  
ELECTRO  
COMPANY ADDRESS  
6125 W. HOWARD  
CHICAGO, ILLINOIS 60648  
COMPANY REPRESENTATIVES  
HYDE ELECTRONICS CO, INC  
4710 N 16TH ST, SUITE 109  
PHOENIX, ARIZ  
602 264 5609  
CARTER & ROSSNEY ASSOC  
2600 W OLIVE AVE  
BURBANK, CALIF  
213 843 3292  
LOGAN SALES CO  
463 BREWSTER AVE  
REDWOOD CITY, CALIF  
415 369 6726  
HYDE ELECTRONICS CO, INC  
888 S LIPAN ST  
DENVER, COLO  
303 936 3456  
COAKLEY, BOYD & ABBETT, INC  
6 GAYWOOD DR  
WATERBURY, CONN  
203 756 8766  
MURPHY & COTA  
712 W VASSAR AVE  
ORLANDO, FLA  
305 424 2167  
MURPHY & COTA  
586 ARMOUR CIRCLE, N E  
ATLANTA, GA  
404 875 2525  
GETTLEMAN & LITTEKEN CO  
3736 DEMPSTER ST  
SKOKIE, ILL  
312 588 0030  
FISHMAN ASSOCIATES  
2060 E 54TH ST UNIT # 1  
INDIANAPOLIS, INO  
317 251 2401  
COAKLEY, BOYD & ABBETT, INC  
1424 HIGHLAND AVE  
NEEDHAM, MASS  
617 444 5470  
DAVID MILSK CO  
20110 OLYMPIA AVE  
DETROIT, MICH  
313 535 4012  
A J WARNER CO  
5022 29TH AVENUE S

MINNEAPOLIS, MINN  
612 729 7371  
PAUL G SCHOLZ CO  
7309 E 109 TERRACE  
KANSAS CITY, MO  
816 761 6522  
HYDE ELECTRONICS CO, INC  
5206 CONSTITUTION AVE N E  
ALBUQUERQUE, N M  
505 265 8895  
CALLAHAN-FERGUSON CO  
107 GREENHEDGE DR  
CAMILLUS, N Y  
315 488 2518  
MURPHY & COTA  
P O BOX 6365  
GREENSBORO, N C  
919 273 6288  
LES A MORROW CO  
3123 W 117TH ST  
CLEVELAND, OHIO  
216 251 5700  
JOHN MUSTICO CO  
312 BEWLEY ROAD  
HAVERTOWN, PA  
215 446 1961  
JAMES H PODOLNY CO  
5912 PENN AVE  
PITTSBURGH, PA  
412 441 0800  
THE TEXPORT CO  
5104 CAPEEN ST  
MEMPHIS, TENN  
901 682 4777  
THE TEXPORT CO  
2411 FARRINGTON ST  
DALLAS, TEXAS  
214 631 6270  
THE TEXPORT CO  
8811 GAYLOR ROOM 206  
HOUSTON, TEXAS  
713 464 3031  
HYDE ELECTRONICS CO, INC  
3081 DELSA DR  
SALT LAKE CITY, UTAH  
801 278 4465  
DOM SMITH SALES CO  
2320 N 45TH ST  
SEATTLE, WASH  
206 633 3160  
STEVE FISHER SALES CO  
121 CEDAR LANE  
TEANECK, NEW JERSEY  
201 836 6661

#### ELECTRO-SOUND ACOUSTICS,

DIVISION OF RAYCO SOUND CO.  
SALES MANAGER & PRESIDENT  
RAYMOND L. IHMORIS  
BRAND NAMES  
ESA  
PRO-CLASSIC  
FUSISTANCE  
ELECTRO-SOUND ACOUSTICS  
COMPANY ADDRESS  
128 WHITMOOR TERRACE  
SILVER SPRING, MARYLAND 20901  
301 593 6455  
COMPANY REPRESENTATIVES  
BETTER ELECTRONICS CO  
7114 WOODLAND AVE  
TAKOMA PARK, MD 20012  
301 589 8610

#### ELECTROVERT INC

SALES MANAGER  
F. J. FARRELL  
BRAND NAMES  
CRADLECLIP  
SPIROBANO  
GROMMET STRIP  
COMPANY ADDRESS  
86 HARTFORD AVE  
MT. VERNON, NEW YORK 10553  
COMPANY REPRESENTATIVES  
CONSTRUCTION SPECIALTIES  
10 EAST SECOND STREET  
SCOTTSDALE, ARIZONA  
CLIFFORD L WOOLSEY  
1029 N BRIGHTON ST  
BURBANK, CALIF 91506  
213 849 5341  
J A WAUGHMAN ASSOC INC  
2785 NORTH SPEER  
DENVER, COLO 80211  
303 292 3926  
H R GROSS & CO  
314 SOUTH MISSOURI AVE  
P O BOX 1427  
CLEARWATER, FLA 33517  
813 446 6649  
LOUIS E BRUNS CO  
2210 NORTH 50TH TERRACE  
KANSAS CITY, KANSAS  
913 289 5242  
ANSELL ENGINEERING CO  
816 THAYER AVE  
SILVER SPRING, MD  
301 588 4222  
CONTACT ASSOCIATES  
7 CYPRESS DRIVE  
BURLINGTON, MASS  
617 272 5051-2-3  
MURRAY A PERCIVAL CO  
22511 SOUTHFIELD ROAD  
SOUTHFIELD, MICH 48075  
313 356 5710  
WOOD CLEMONS CO  
6701 PENNSYLVANIA AVE SO.  
MINNEAPOLIS 23, MINN  
612 866 3401  
LOUIS E BRUNS CO  
514 PARKWOOD AVE  
KIRKWOOD, MISSOURI  
J P DEARIE CO  
P O BOX 66

MOUNTAIN LAKES, N J  
201 334 4848  
J B CLOUGH CO  
4614 PROSPECT AVE  
CLEVELAND, OHIO  
216 431 2700  
J B CLOUGH CO  
3035 PORTSMOUTH AVE  
CINCINNATI, OHIO  
513 321 0478  
HILLIARD ASSOCIATES  
766 OLD YORK ROAD  
JENKINTOWN, PENN  
215 884 6100  
WALTER N LASKA  
530 SIXTH AVE  
PITTSBURGH, PENN  
412 471 0490  
MORRIS SALISS  
P O BOX 464  
ROOSEVELT, PUERTO RICO  
PHIL J SCANLON CO  
P O BOX 70  
RICHARDSON, TEXAS 75081  
214 231 4661  
DWIGHT SMITH ASSOC  
32 SOUTH RIVER STREET  
AURORA, ILL 60504  
313 896 0828  
BILL WADDELL CO  
10211 N.E. 31ST PLACE  
BELLEVUE, WASH  
206 822 3660

#### ELECTRO-VOICE, INC

VP SALES  
LAWRENCE LEKASHMAN  
BRAND NAMES  
ARISTOCRAT R  
CARDLINE R  
ACOUSTIFOAM  
ACOUSTALLOY R  
CDP R  
SONOCASTER  
CV-D  
STEREON R  
FEATHERIDE R  
LINE RADIATOR  
SONOPHASE  
SOUND SPOT R  
MICHIGAN  
MUSICASTER  
RADAX  
PATRICIAN R  
POWER POINT  
SENTRY  
SUPER-SONAX  
VARIABLE-D R  
WOLVERINE R  
COMPANY ADDRESS  
638 CECIL STREET  
BUCHANAN, MICHIGAN 49107  
616 695 6831  
COMPANY REPRESENTATIVES  
EDWARD CAIN  
3258 CAHABA HEIGHTS ROAD  
BIRMINGHAM, ALABAMA 35243  
205 967 3080  
DICK BELLEW SALES COMPANY  
1005 WEST 4TH STREET  
EL OORADO, ARKANSAS  
501 UN 3 8325  
JACK CARTER  
DICK SCHNEPP  
2600 W OLIVE  
BURBANK, CALIFORNIA 91505  
213 843 3292  
MEYER, ROSS & FLEMING  
113 TENTH STREET  
SAN FRANCISCO, CALIFORNIA  
415 HE 1 0652  
MC LDUD & RAYMOND  
2151 S GRAPE STREET  
P O BOX 22044  
DENVER, COLORADO  
303 756 1589  
JOSEPH F HELLAUER, JR  
46 ROCKEFER AVENUE  
WEST HAVEN, CONNECTICUT 06516  
203 923 0261  
JACK SPROCH  
3520 W BROWARD BOULEVARD  
FT LAUDERDALE, FLA 33312  
305 587 3792  
MAITLAND K SMITH COMPANY  
31 16TH STREET, NW  
ATLANTA, GEORGIA 30309  
404 875 8031  
BILL KOLANS & COMPANY  
P O BOX 2098, 158 NOKAUEA  
HONOLULU, HAWAII  
811 628  
J D BOSWELL SALES  
25 PINE TRAIL  
CASEVILLE, ILLINOIS 62232  
314 GE 6 2042  
GENE CLEARS  
20200 ASHLAND AVE  
CHICAGO HEIGHTS, ILL  
312 755 0055  
HARRISON BLIND & ASSOCIATES  
1635 GENT STREET NORTH  
INDIANAPOLIS, INDIANA 46202  
317 ME 5 6291  
ELECTRONIC SALES CO  
1310 HERTZ DRIVE, SE  
CEDAR RAPIDS, IOWA 52403  
319 364 4342  
DICK BELLEW, JR  
5042 D ST, ANTHONY AVE  
NEW ORLEANS, LOUISIANA 70122  
504 282 9625  
DAVE BROTHERS  
6302 LINCOLN AVENUE  
BALTIMORE, MARYLAND  
301 RO 4 7189

JOE RADIMAK  
1808 GLEN RIDGE ROAD  
TOWSON, MARYLAND  
301 661 0713  
MICHAEL SCOTT & COMPANY  
336 WASHINGTON  
WELLESLEY HILLS, MASS  
617 CE 5 0102  
RICHARD FLORA  
294 HDNEY CREEK AVENUE  
ADA, MICHIGAN  
616 676 1854  
RILEY & PETCHELL  
ELECTRONIC SALES  
13209 FENKELL  
DETROIT, MICHIGAN  
313 VE 8 9100  
RAY RIPLEY & ASSOC  
6838 PILLSBURY AVE 50  
MINNEAPOLIS, MINNESOTA  
612 UN 6 8682  
CHARLES SMITH  
813 FORDHAM ROAD  
RIVERSIDE, NEW JERSEY  
609 HD 1 4581  
M & S ASSOCIATES - MILITARY  
P D BOX 185  
HADDANFIELD, NEW JERSEY  
609 HA 9 7055  
CARDUNER SALES CORPORATION  
P O BOX 900  
WESTBURY, NEW YORK  
516 333 8170  
GORDON LE ROY  
ORCHARD PARK  
PHELPS, NEW YORK  
315 548 4891  
JAMES SCHNITZER  
109 EASTON AVENUE  
BUFFALO, NEW YORK  
716 892 6551  
DAVID E COOM  
218 EAST LAKE ROAD  
DE RUYTER, NEW YORK  
315 852 3374  
JAMES CLYMER, JR  
1605 CHATHAM AVENUE  
CHARLOTTE, N CAROLINA  
704 FR 6 5951  
C L PUGH COMPANY  
2144 RIVERSIDE DRIVE  
COLUMBUS, OHIO 43221  
614 486 9678  
GEORGE CONNEEN  
131 HARNED ROAD  
SPRINGFIELD, DELAWARE CO, PA  
215 543 8641  
ELECTRO VOICE TENNESSEE  
RANKIN ROAD  
NEWPORT, TENNESSEE  
615 623 2356  
EDWARD MILLER  
SUITE 251, MELSHIRE BLDG  
1450 PRESTON FOREST SQUARE  
DALLAS, TEXAS 75230  
214 AD 9 3789  
HUGH PUTMAN  
914 WATEKAWAY  
RICHARDSON, TEXAS  
214 AD 1 4353  
JIM HANKOCK  
6022 WIGTON  
HOUSTON, TEXAS 77035  
713 PA 9 0824  
WM R LANPHEAR SALES  
4031 STONEYWAY AVE, NORTH  
SEATTLE, WASHINGTON 98103  
206 ME 3 4900  
REPS IN OTHER COUNTRIES  
ELECTRO TEC MARKETERS  
1624 W THIRD STREET  
VANCOUVER, B C  
604 RE 6 6377  
R C KAHNERT  
359 ENFORD ROAD  
RICHMOND HILLS, ONTARIO  
416 884 4574  
AURELE DES JARDINES  
P O BOX 885  
MONTREAL, QUEBEC  
514 677 5033

**THE ELMOR COMPANY**  
SALES MANAGER  
S. WEINER  
BRAND NAMES  
GALLET  
GALCO  
GUINANO  
SECURITY  
COMPANY ADDRESS  
29 E. MADISON ST  
CHICAGO, ILLINOIS

**ENCLOSURE CORP**  
PRESIDENT  
R. O. EOELMAN  
COMPANY ADDRESS  
1701 INDUSTRIAL BLVD.  
PENNSAUKEN, N. J. 08110  
COMPANY REPRESENTATIVES  
LEE ASSOCIATES  
8100 S MEMORIAL PARKWAY  
HUNTSVILLE, ALABAMA  
205 881 0461  
LEE ASSOCIATES  
200 E MARKS STREET  
ORLANDO, FLA  
305 241 4445  
LEE ASSOCIATES  
12250 WILKINS AVENUE  
ROCKVILLE, MARYLAND  
301 949 4800  
MECHANICAL MARKETING ENG  
20 CONGRESS AVENUE  
CHELSEA, MASSACHUSETTS

617 889 2279  
LEE ASSOCIATES  
432 WEST END BOULEVARD  
WINSTON-SALEM, NORTH CAROLINA  
919 724 2406  
C. E. SNOW  
613 CHELTENHAM AVENUE  
PHILADELPHIA, PENNSYLVANIA  
215 CA 4 2626

**ENGINEERING ASSOCIATES**  
COMPANY ADDRESS  
434 PATTERSON ROAD  
DAYTON, OHIO 45419  
OFC AX3-1662 LAB AX 3-1462

**ENGLISH ELECTRIC VALVE DIVISION**  
THE ENGLISH ELECTRIC CORP  
COMPANY ADDRESS  
ONE PARK AVE  
NEW YORK, N Y 10016  
DIRECT ALL INQUIRES  
45 INDICATED  
SOLE U S DISTRIBUTOR FOR  
IMAGE-ORTHICON & VIDICON  
CAMERA TUBES  
VISUAL ELECTRONICS CORP  
356 WEST 40TH ST  
NEW YORK, N Y 10018  
SOLE U S DISTRIBUTOR FOR  
VACUUM TUBES, TRANSMITTING  
CALVERT ELECTRONICS, INC  
220 EAST 23RD STREET  
NEW YORK, N Y 10010

**ENTRON, INC**  
SALES MANAGER  
JOHN RUSSELL  
COMPANY ADDRESS  
2141 INDUSTRIAL PKWY  
SILVER SPRING, MARYLAND 20904  
COMPANY REPRESENTATIVES  
PAUL MC INNISH  
231 B STOKES STREET  
HUNTSVILLE, ALABAMA 35805  
205 536 7259  
WILLIAM JONES  
3706 MONTGOMERY DRIVE  
SANTA ROSA, CALIF 95404  
RAY LA RUE  
ATLANTA, GEORGIA 30319  
404 634 4089  
WILLIAM SAILOR  
4983 HARBOR BOULEVARD  
COLUMBUS, OHIO 43227  
614 837 3259  
ROBERT TAYLOR  
P O BOX 1037  
RICHARDSON, TEXAS 75080  
214 AD 5 7472  
REPS IN OTHER COUNTRIES  
OMER GIRARD  
15 D ST PATRICE STREET  
MAGOG, QUEBEC

**ELECTRONIC MARKETING DIVISION**  
**ESSEX WIRE CORPORATION**  
SALES MANAGER  
DON ABERDEEN  
BRAND NAMES  
STANCOR  
RBM  
COMPANY ADDRESS  
3501 W. MADISON  
CHICAGO, ILLINOIS 60618  
463 7400  
SALES OFFICES  
444 CAMELBACK ROAD WEST  
PHOENIX, ARIZONA 85017  
602 264 3578  
112 GLASGOW AVENUE  
INGLEWOOD, CALIFORNIA 90301  
213 678 4711  
165 ELEVENTH STREET  
SAN FRANCISCO, CALIF 94103  
415 863 7880  
721 SOUTH BROADWAY  
DENVER, COLORADO 80209  
303 722 4641  
3308 14TH STREET, NW  
WASHINGTON, D C 20010  
202 265 3938  
1010 EXECUTIVE CENTER DRIVE  
ORLANDO, FLORIDA 32803  
305 241 5401  
3098 PIEDMONT ROAD, NE  
ATLANTA, GEORGIA 30305  
404 261 5838  
156 MOKAUEA  
HONOLULU, HAWAII 96803  
815 649  
309 AVONDALE DRIVE  
EAST PEORIA, ILLINOIS 61611  
309 699 3301  
349 NORTH ASHLAND AVENUE  
RIVER FOREST, ILLINOIS 60305  
312 261 0342  
1805 K AVENUE, NE  
CEDAR RAPIDS, IOWA 52402  
319 362 7825  
5450 BUENA VISTA DRIVE  
SHAWNEE MISSION, KANS 66205  
913 432 2131  
1812 BULLARD AVENUE  
METAIRIE, LOUISIANA 70003  
504 887 0482  
5500 HARFORD ROAD  
BALTIMORE, MARYLAND 21214  
301 254 3380  
336 WASHINGTON STREET  
WELLESLEY HILLS, MASS 02181  
617 235 0102  
23529 WOODWARD AVENUE  
FERNDALE, MICHIGAN 48220  
313 547 4771  
5364 KIMBALL AVENUE, SE

GRAND RAPIDS, MICHIGAN 49508  
616 243 7606  
3749 WEST BRADWAY  
MINNEAPOLIS, MINNESOTA 55422  
612 588 4663  
47 VILLAGE SQUARE  
HAZELWOOD, MISSOURI 63042  
314 838 6446  
2611 QUINCY STREET, NE  
ALBUQUERQUE, NEW MEX 87110  
505 265 1579  
496 ELLICOTT SQUARE BUILDING  
BUFFALO, NEW YDRK 14203  
716 854 2517  
311 MEACHAM AVENUE  
ELMONT, LI, NEW YORK 11003  
516 437 8150  
431 GREENWICH STREET-EXPORT  
NEW YORK, NEW YORK 10013  
212 966 2130  
6717 WOODSTOCK DRIVE  
CHARLOTTE, NO CAROLINA 28210  
704 523 3327  
150 EAST BROAD STREET  
COLUMBUS, OHIO 43215  
614 221 3363  
510 N W 19TH AVENUE  
P O BOX 2827  
PORTLAND, OREGON 97208  
503 226 4184  
1531 SPRUCE STREET  
PHILADELPHIA, PENN 19102  
215 545 1205  
106 NELBON AVENUE  
PITTSBURGH, PENN 15235  
412 241 7025  
560 S COOPER STREET  
MEMPHIS, TENNESSEE 38104  
901 276 4642  
2930 MERRELL ROAD  
DALLAS, TEXAS 75220  
214 357 4601  
4810 HAZARD  
HOUSTON, TEXAS 77006  
713 529 3811  
31 SOUTH THIRD, EAST  
SALT LAKE CITY, UTAH 84111  
801 364 4632  
422 FIRST AVENUE, WEST  
P O BOX 9285  
SEATTLE, WASHINGTON 98119  
206 284 1121  
928 EAST WISCONSIN AVENUE  
PEWAUKEE, WISCONSIN 53072  
414 691 0622

**EUPHONICS MARKETING**  
SALES MANAGER  
HOWARD SOUTHER  
BRAND NAMES  
MINICONIC  
COMPANY ADDRESS  
173 W. MADISON ST  
CHICAGO, ILLINOIS 60602

**E-Z-HOOK TEST PRODUCTS**  
SALES MANAGER  
ROBERT N YOUNGER  
BRAND NAMES  
E-Z-HOOK  
COMPANY ADDRESS  
1536 WOODBURN AVE  
COVINGTON, KY 41012  
COMPANY REPRESENTATIVES  
ASH M. WOOD CO.  
P O BOX 1158  
ARCADIA, CALIF.  
AT 7-0449 AND CU 3-1201  
ROYAL A. STEMM CO.  
662 IRVING PARK RD.  
CHICAGO, ILL.  
LA 5-8333  
REPS IN OTHER COUNTRIES  
LEN FINKLER LTD.  
2 TYCOS DRIVE  
TORONTO 19, ONTARIO  
416 781-5231

**FAIRCHILD RECORDING EQUIPMENT CORPORATION**  
SALES ADMINISTRATOR  
M. P. MCLAUGHLIN  
BRAND NAMES  
AUTO-TEN  
BALANCE/GARO  
TRANS/GARD  
BASS-X  
COMPATILIZER  
CONAX  
OYNALIZER  
INTEGRA  
LUMITEN  
LUMITE  
MT15  
REVERBERTRON  
COMPANY ADDRESS  
10-40 45TH AVENUE  
LONG ISLAND CITY, N Y 11101  
SALES REPRESENTATIVES  
WORLD WIDE PRODUCTS CO  
BOX 429  
N MIAMI BEACH, FLA  
LOREN GREEN ASSOCIATES  
5218 W OIVERSEY AVE  
CHICAGO, ILLINOIS  
MARTIN VOGT  
2817 BAMLET ROAD  
ROYAL OAK, MICHIGAN  
BEN JOSEPH ASSOCIATES  
BOX 486  
GREAT NECK, LI, NEW YORK  
H W SEAY COMPANY  
3850 FAIRLINGTON DR  
COLUMBUS, OHIO  
ANTLE SMITH SALES CO  
2721 BROOKFIELD AVE

DALLAS, TEXAS  
WILLIAM K WOOD CO  
5908 CALIFORNIA AVE  
SEATTLE, WASHINGTON

**THE FINNEY COMPANY**  
SALES MANAGER  
TOM PFEIFFER  
BRAND NAMES  
FINCO  
COMPANY ADDRESS  
34 W. INTERSTATE ST.  
BEDFORD, OHIO 44014

**F & M SYSTEMS CO, DIVISION OF FISCHBACH & MOORE, INC**  
MARKETING MANAGER  
M. C. BAIRD, JR.  
COMPANY ADDRESS  
2525 WALNUT HILL LANE  
DALLAS, TEXAS 75220  
COMPANY REPRESENTATIVES  
J MORRIS  
646 NORTH BEACHWOOD DRIVE,  
LOS ANGELES, CALIF 90004  
213 466 2151  
J DOUGLAS AND  
H ALSOP  
1019 22ND ST. N W  
WASHINGTON, D.C. 20037  
202 333-0800  
J LUTRELL  
2525 WALNUT HILL LANE  
DALLAS, TEXAS 75220  
214 CH 1 2121

**FISHER BERKELEY CORPORATION**  
SALES MANAGER  
RAPP BRUSH  
BRAND NAMES  
EXTACOM  
COMPANY ADDRESS  
1475 POWELL STREET  
EMERYVILLE, CALIF. 94608  
COMPANY REPRESENTATIVES  
ELLARD E STRASSNER CO  
3121 LOS FELIZ BLVD  
LOS ANGELES, CALIF  
213 666 1511  
JIM PIPER ASSOCIATES  
10 HAVEN ST  
DOVER, MASS  
617 449 1144  
CLARK R GIBB CO  
2400 HENNEPIN AVENUE  
MINNEAPOLIS, MINN  
612 FR 7 1200  
ROBERT FINLAY SALES CO  
45 NORTH BROAD ST  
RIDGWOOD, N J  
201 652 0088  
JOHN O OLSEN CO  
16201 SHAKER BLVD  
CLEVELAND, OHIO  
216 752 5444  
WILLIAM L METCALFE  
116 W FRANKLIN  
CENTERVILLE, OHIO 45459  
513 885 3722  
RICHARD A STONE  
1843 MAYDELL ST  
PITTSBURGH 16, PA  
412 341 8391  
TECHNO ASSOCIATES  
P O BOX 20544  
DALLAS, TEXAS  
214 FL 7 9213

**HERB FITZGERALD COMMUNICATIONS ELECTRONICS**  
SALES MANAGER  
HERB FITZGERALD  
COMPANY ADDRESS  
635 E. 185TH ST.  
CLEVELAND, OHIO 44119

**THE JAMES FLOYD FORD COMPANY**  
GENERAL MANAGER  
COMPANY ADDRESS  
JFFCO BUILDING P.O.DRW 839  
CAPE GIRARDEAU, MO. 63701  
314-334-6308  
COMPANY REPRESENTATIVES  
JAMES FLOYD FORD CO  
BOX 761  
CHICO, CALIFORNIA 95926

**FORT WORTH TOWER CO, INC**  
PRESIDENT  
T. W. MOORE  
COMPANY ADDRESS  
5201 BRIDGE ST PO BOX 8597  
FORT WORTH, TEXAS 76112  
817 536 5676  
COMPANY REPRESENTATIVES  
A C TILTON  
5201 BRIDGE ST  
FORT WORTH, TEXAS  
817 536 5676

**GAMMA SCIENTIFIC, INCORPORATED**  
SALES MANAGER  
HAROLD P. FIELD  
COMPANY ADDRESS  
5841 MISSION GORGE RO.  
SAN DIEGO, CALIF. 92120  
COMPANY REPRESENTATIVES  
GRIT ASSOCIATES  
3002 MIDVALE AVENUE  
LOS ANGELES, CALIF. 90034  
213 474-1587  
GRIT ASSOCIATES  
560 SAN ANTONIO ROAD  
PALO ALTO, CALIF. 94306  
415 327-3996



875 GREENTREE ROAD  
3 PARKWAY CENTER  
PITTSBURGH, PA. 15220  
412 921-8594  
1420 UNION AVENUE, ROOM 202  
MEMPHIS, TENN. 38104  
901 272-9641  
4447 N. CENTRAL EXPRESSWAY  
DALLAS, TEXAS 75205  
214 LA 1-1931  
CARRDILL AVE., P D BDX 4217  
LYNCHBURG, VA. 24501  
703 846-7311  
112 ANDOVER PARK EAST  
P D BDX 6100  
SEATTLE, WASH. 78051  
206 CH 4-7750  
615 EAST MICHIGAN STREET  
MILWAUKEE, WISC. 53202  
414 271-5000

GENERAL MICROWAVE CORPORATION

SALES MANAGER  
MOR WIND  
BRAND NAMES  
TFT  
COMPANY ADDRESS  
155 MARINE STREET  
FARMINGDALE, NEW YORK 11735  
COMPANY REPRESENTATIVES  
R F ASSOCIATES, INC  
1621 PONTIUS AVE  
LOS ANGELES, CALIF 90025  
213 478 1586  
BURLINGAME ASSOCIATES  
7 WELLINGTON ST  
WALTHAM, MASS 02154  
617 894 1955  
PALATINE ENG SALES, INC  
8587 ST CHARLES RDCK RD  
ST LOUIS, MO 63114  
314 126 7055  
BENNFWITZ ASSOCIATES  
8310 CUTLER, NE  
ALBUQUERQUE, N M 87110  
505 299 8651  
BERTRAM D AARDN & CO  
P D BOX 186  
ROSLYN, N Y 11576  
516 621 0630  
DOOLITTLE ELECTRONICS CORP  
P D BOX 97  
FAYETTEVILLE, N Y 13066  
315 637 3222  
SYLVAN GINSBURY, LTD  
72 W 45TH ST  
NEW YORK, N Y 10036  
212 MU 7 3213  
M J McDONALD CD  
ROUTE 1  
PFAFFTOWN, N C 27040  
919 924 2182  
ELECTRO SALES ASSOCIATES  
DABEL STATION, BDX 143  
DAYTON, OHIO 45420  
513 426 5551  
S & S ASSOCIATES  
BORD LINE ROAD  
KING OF PRUSSIA, PA 19406  
215 265 3450  
ARTHUR ENG SALES CO  
11216 W HALLORY AVE  
HALES CORNERS, WISC. 53130  
414 GA 5 5919  
REPS. IN OTHER COUNTRIES  
ELECTRODESIGN, LTD  
9124 ST LAWRENCE BLVD  
MONTREAL 11, QUEBEC  
514 389 5914

GENERAL RADIO COMPANY

SALES MANAGER  
L. J. CHAMBERLAIN  
BRAND NAMES  
DURATRAK-R  
ORTHONULL-R  
STROBOTAC-R  
SYNCRONMETER-R  
VARIAC-R  
COMPANY ADDRESS  
22 BAKER AVENUE  
W. CONCORD, MASS. 01781

GENERAL TELEVISION NETWORK

SALES MANAGER  
R. RANDOLPH HIPPLER  
BRAND NAMES  
GIANTVIEW  
COMPANY ADDRESS  
901 LIVERNOIS  
FERNDALE, MICHIGAN 48220  
COMPANY REPRESENTATIVES  
JAN EDEN RECORDING & SOUND  
1440 N MERIDIAN ST  
INDIANAPOLIS, IND  
638 1337  
OHIO VALLEY SOUND  
20 E CEDAR  
EVANSVILLE, INDIANA  
425 6173  
AMERICAN SOUND SERVICE  
675 WEST THIRD  
COVINGTON, KENTUCKY  
261 9024  
BARNEY MILLERS INC  
232 E MAIN STREET  
LEXINGTON, KENTUCKY  
252 9622  
DOUGLAS TELEVISION CD  
3804 LEXINGTON RD  
LOUISVILLE, KY  
895 3500  
DOUGLAS TELEVISION CO  
11715 MAIN ST  
MIDDLETOWN, KY  
245 4444

AUDIO COMMUNICATIONS CO  
1191 WEINECKE ROAD  
SAGINAW, MICHIGAN  
793 1090  
AUDIO EQUIPMENT COMPANY  
15749 WYDMING AVE  
DETROIT, MICHIGAN  
864 1884  
CLARKE H JDY CD  
P D BDX 9695  
BAY VILLAGE, OHIO  
871 5900

GIBBS MANUFACTURING AND RESEARCH CORPORATION

VP SALES ENG  
R. E. MDWRIS  
PRODUCT SALES MANAGER  
KENNETH D. SCOTT  
COMPANY ADDRESS  
450 NORTH MAIN STREET  
JANESVILLE, WISCONSIN 53545  
COMPANY REPRESENTATIVES  
TECH-SOURCES UNLIMITED  
P O BOX 184  
BURBANK, CALIF  
213 849 6863  
JAMES F HURLBUT CO  
2240 SO ADAMS ST  
DENVER, COLO 80210  
303 756 2046  
JAMES B GUTTRIDGE  
2125 R STREET N W  
WASHINGTON, D C 20008  
202 667 2730  
REYNOLDS & ASSOC INC  
P D BOX 1043  
EAU GALIE, FLA  
305 254-0520  
M O & ASSOCIATES  
6713 N OLIPHANT AVE  
CHICAGO, ILL 60631  
312 774 8844  
EDWARDS ASSDC  
242 ST JOHNS AVE  
NEW MARKET, NEW JERSEY 08854  
201 752 2724  
ALDEN W SMITH  
PENURY PRIDRY  
DDYLESTOWN, PA  
215 348 4651  
R W MUREEN CD  
5523 DYER STREET  
DALLAS, TEXAS 75206  
214 361 0735  
CANE-JESSUP CO INC  
P O BOX 250  
BELLEVUE, WASH  
206 454 0691

J. W. GIBSON CO., INC.

SALES MANAGER  
DON A. OREAR  
BRAND NAMES  
MYSTIC  
DERREASER  
COMPANY ADDRESS  
1255 WINDSOR STREET  
INDIANAPOLIS, INDIANA

GOTHAM AUDIO CORPORATION

VICE PRESIDENT  
HUGH S. ALLEN  
BRAND NAMES  
EMT  
ELTRD  
BEYER  
DANNER  
GOTHAM  
KLEIN AND HUMMEL  
LYREC  
MULLER & WEIGER  
NEUMAN  
PREH  
STUDER  
TUCHEL  
COMPANY ADDRESS  
2 WEST 46TH STREET  
NEW YORK, N. Y. 10036  
212-265-4111  
COMPANY REPRESENTATIVES  
J-MAR ELECTRONICS, LTD  
2 THORNCLIFFE PARK DR  
TORONTO, 17, ONTARIO  
416 421 9080

GRADO LABORATORIES, INC  
COMPANY ADDRESS  
4614 SEVENTH AVENUE  
BROOKLYN, NEW YORK 11220

GRANTHAM SCHOOLS, INC.

PRESIDENT  
DONALD J. GRANTHAM  
COMPANY ADDRESS  
1505 N. WESTERN AVE.  
HOLLYWOOD, CALIF. 90027

GRAY RESEARCH & DEVELOPMENT CO.

SALES MANAGER  
HY LEHRMAN  
BRAND NAMES  
GRAY  
TELEJECTOR  
TELOP  
COMPANY ADDRESS  
P.O. BOX 296  
HARTFORD, CONN. 06101

GREENLEE TOOL COMPANY

SALES MANAGER  
MARTIN J. TUCKETT  
COMPANY ADDRESS  
2136 TWELFTH STREET  
ROCKFORD, ILLINOIS 61101

GREGORY AMPLIFIER CORP

SALES MANAGER  
ROBERT A CDHEN  
BRAND NAMES  
GREGORY  
BRYAN  
HANDI-AMP  
ADD-VERB  
COMPANY ADDRESS  
3650 DYRE AVE  
BRONX, N Y 10466  
COMPANY REPRESENTATIVES  
L H HARRIS  
204 E HILLSDALE BLVD  
SAN MATEO, CALIF  
415 341 2909  
GEO SMITH  
188 BREWSTER RD  
W HARTFORD, CONN  
203 523 0512  
LOREN F GREEN  
5218 W DIVERSEY AVE  
CHICAGO, ILLINOIS  
312 AV 6 6824  
ROBERT SMITH  
59 VERNDALE ST  
BROOKLINE, MASS  
617 277 0017  
KNAGGS-COLLINS-  
HAVERCAMP & HEMPE INC  
5818 N OAK TRAFFICWAY  
BDX 10719  
KANSAS CITY, MO  
816 GL 3 3203  
RDNNY SINGER  
102 SHDRE VIEW DR  
YONKERS, NEW YORK  
914 779 2221  
CARTWRIGHT & BEAN  
560 S COOPER ST  
MEMPHIS, TENN  
901 276 4442

GRINMAN FIXTURE COMPANY

SALES MANAGER  
JOHN F. GRINMAN  
BRAND NAMES  
GRINMAN  
COMPANY ADDRESS  
16041 GEORGETOWN ST. N.E.  
MINERVA, OHIO 44657

GULF ELECTRO-SALES, INC.

COMPANY ADDRESS  
7031 BURKETT STREET  
HOUSTON, TEXAS 77021

G-V CONTROLS INC.

VP-MARKETING  
GEORGE A. COMPTON  
BRAND NAMES  
G-V  
COMPANY ADDRESS  
101 OKNER PARKWAY  
LIVINGSTON, N.J. 07039  
COMPANY REPRESENTATIVES  
A. R. TICE  
13637 EAST BAILEY STREET  
WHITTIER, CALIF.  
213 696-4281  
EDWARD McMULLEN  
101 OKNER PARKWAY  
LIVINGSTON, N.J. 07039  
201 992-6200

HAMILTON HALL RESISTOR CORP

SALES MANAGER  
KENNETH DEGNAN  
BRAND NAMES  
HALL-OHM  
SERV-OHM  
HALL-RITE  
COMPANY ADDRESS  
227 N. WATER STREET  
MILWAUKEE, WISCONSIN 53202  
COMPANY REPRESENTATIVES  
FEATHERSTONE SALES CD  
1355 MARKET ST  
SAN FRANCISCO, CALIF  
KL 2 2311  
HENRY FELDMAN CO  
P D BDX 66367  
LOS ANGELES 66, CALIF  
RT 9 8803  
KOETHER-COX CD  
1325 S INCA ST  
DENVER 23, COLO  
303 292 1466  
KLEM-STEFFEN INC  
417 HARRISON ST  
DAK PARK, ILL 60204  
312 921 1200  
HDEMIG SALES CO  
SUTLER COURT  
FORT WAYNE, IND  
219 483 6913  
KANSAS SALES INC  
BDX 4116  
OVERLAND PARK, KANSAS 66204  
913 888 3200  
W B PRAY SALES  
ELM ST HOTEL 128  
DEDHAM, MASS 02026  
617 326 9220  
DAVE MILSK CO  
20110 OLYMPIA AVE  
DETROIT, MICH 48240  
313 KE 5 4012  
L R MASSEY CD  
BDX 724  
GREENWOOD, MISS  
GL 3 3038  
T B LOWELL & ASSOC  
BOX 26 CREVE COEUR

ST LOUIS, MO  
314 MI 7 1111  
S FISHER ELECTR SALES CDRP  
800 GREENWOOD AVE  
BROOKLYN 18, N Y  
768 2896  
WILLIAM TAUBER  
151 FAYETTE BLVD  
SYRACUSE, N Y 13224  
446 7094  
C M FURMAN CD  
1228 HARDING PLACE  
CHARLOTTE, N C 28204  
375 2332  
H H SEAY CD  
3850 FAIRLINGTON DR  
COLUMBUS 21, OHIO  
614 488 9994  
HERMAN LEWIS CD  
1510 PENN TOWERS  
1801 PENNA BLVD  
PHILADELPHIA, PA 19103  
LD 7 2068  
ANTLE SMITH SALES CO  
P D BOX 20361  
DALLAS, TEXAS  
FL 7 7279  
ELECTRONIC SALES  
P D RDX 6535  
SEATTLE, WASH 98116  
WF 2 0330

HANCOCK TELECONTROL CORP

SALES MANAGER  
WILLIAM E. BACON  
BRAND NAMES  
UNICON  
COMPANY ADDRESS  
143 SOUND BEACH AVENUE  
OLD GREENWICH, CONN. 06830

HARTLEY PRODUCTS CORPORATION

PRESIDENT  
ROBERT SCHMETTERER  
BRAND NAMES  
CAPRI  
CONCERTMASTER  
CONCERTMASTER JR.  
HARTLEY-LUTH  
HOLTON  
HOLTON JR.  
COMPANY ADDRESS  
BARNET PLACE  
MO-HO-KUS, NEW JERSEY 07423  
COMPANY REPRESENTATIVES  
P H POWELL  
3975 WESLIN AVENUE  
SHERMAN OAKS, CALIF  
213 ST 9-4078  
ASSOCIATED ELECTRONICS  
119 THE GREAT ROAD  
BEDFORD, MASS  
275-9020  
C W DREESE & ASSOC  
3710 CANTERBURY PL  
INDEPENDENCE, MO  
816 IN 1-7294  
C C S BUTT  
BOX 18045  
HOUSTON, TEXAS 77023  
JA 6-3101

HARVEY RADIO CO INC

SALES MANAGERS  
ELI PASSIN  
WALTER BACHMAN  
FRANK RENALDI  
COMPANY ADDRESS  
60 CROSSWAYS PARK WEST  
WOODBURY, L. I., NEW YORK  
COMPANY REPRESENTATIVES  
FEDERAL FABRICATORS  
VESTAL PARKWAY  
BINGHAMTON, N.Y.  
607-748-8211  
HARVEY RADIO CO. INC  
2 WEST 45TH STREET  
NEW YORK, N.Y.  
212 JU 2-1500

HARWALD COMPANY

SALES MANAGER  
WILLIAM STELCHER  
BRAND NAMES  
INSPECT-O-FILM  
PROTECT-O-FILM  
CEMENT-O-FILM  
SPlice-O-FILM  
ADMATIC  
COMPANY ADDRESS  
1245 CHICAGO AVE  
EVANSTON, ILLINOIS 60202  
312 328 7070

HARWOOD MFG CO

SALES MANAGER  
J. H. LIPPMAN  
BRAND NAMES  
HARWOOD  
COMPANY ADDRESS  
446 W. SUPERIOR  
CHICAGO, ILLINOIS 60610

HAYDEN BOOK COMPANY INC

SALES MANAGER  
ALLAN E. BONDS  
BRAND NAMES  
HAYDEN BOOKS  
RIDER BOOKS  
JOHN F. RIDER BOOKS  
RIDER PROGRAMDUALS  
COMPANY ADDRESS  
116 W. 14TH STREET  
NEW YORK, NEW YORK 10011  
COMPANY REPRESENTATIVES  
SMOKIE CLENNEY



**GRAY**



A DEFINITE  
SUPERIORITY  
IN BROADCAST  
TONE ARMS



SHOWN: THE NEW 206-S 12" TONE ARM.

STYLING BY PETER QUAY YANG A.S.I.D.

The Gray Research family of quality products . . . The 208-S Tone Arm, The 602-C Broadcast Equalizer, The Telojector and The Telop, proudly announces its newest Member, The Gray 206-S, 12" professional broadcast Tone Arm.

*WRITE or PHONE 203 289-2743*

**GRAY RESEARCH AND DEVELOPMENT COMPANY, DIV.**  
**BOX 296, HARTFORD, CONNECTICUT 06101**

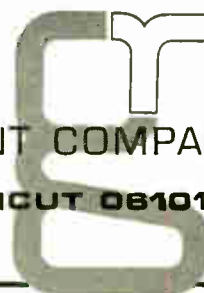

11256 BABBITT AVENUE  
GRAND OAK HILLS, CALIF.  
ROBERT KETZER  
141 MISBRO WAY  
KENWOOD, CALIFORNIA  
PHILIP ALPERT  
7742 SOUTH ESSEX  
CHICAGO, ILLINOIS  
WILLIAM J MARCUS  
147-02 70TH ROAD  
Kew GARDEN HILLS, NEW YORK  
LEWIS HARRITON  
BOX 64  
MINISINK HILLS, PA.  
ROBERT HOUSE  
R. 2, LOT 2 ROUTE 1  
GOODLETTSVILLE, TENNESSEE  
WILLIAM R THOMAS  
7313 DICKENSON STREET  
SPRINGFIELD, VIRGINIA

**HEATH COMPANY**  
DIRECTOR OF MARKETING  
S. L. SHIPMAN  
BRAND NAMES  
HEATHKIT  
COMPANY ADDRESS  
BENTON HARBOR, MICH. 49022  
616-983-3961

**HEINTZ & KAUFMAN, LTD**  
SALES MANAGER  
NATE BECKERMAN  
BRAND NAMES  
HEINTZ & KAUFMAN  
COMPANY ADDRESS  
3650 HAYDEN AVENUE  
CULVER CITY, CALIF 90230

**HEWLETT-PACKARD COMPANY**  
VP MARKETING  
W. NOEL ELDRON  
SALES MANAGER  
JACK PETRAK  
BRAND NAMES  
DATAMEC  
DELCON  
DYMEC  
HARRISON  
HEWLETT-PACKARD  
LP  
MOSELEY  
SANBORN  
COMPANY ADDRESS  
1501 PAGE MILL ROAD  
PALO ALTO, CALIF. 94304  
COMPANY REPRESENTATIVES  
HEWLETT-PACKARD  
SOUTHERN SALES DIVISION  
HOLIDAY OFFICE CTR., SUITE 10  
HUNTSVILLE, ALABAMA 35801  
205 881-4591  
TWX 510 579-2204  
HEWLETT-PACKARD  
NEELY SALES DIVISION  
3009 MO. SCOTTSDALE RD.  
SCOTTSDALE, ARIZONA 85251  
602 945-7601  
TWX 602 949-0111  
HEWLETT-PACKARD  
NEELY SALES DIVISION  
232 SO. TUCSON BLVD.  
TUCSON, ARIZONA 85716  
602 623-2564  
TWX 602 792-2759  
HEWLETT-PACKARD  
NEELY SALES DIVISION  
3939 LANKERSHIM BLVD.  
N. HOLLYWOOD, CALIF. 91604  
213 877-1282 AND 766-3811  
TWX 910-499-2170  
HEWLETT-PACKARD  
NEELY SALES DIVISION  
2591 CARLSBAD AVE.  
SACRAMENTO, CALIF. 95821  
916 482-1463  
TWX 916-444-8683  
HEWLETT-PACKARD  
NEELY SALES DIVISION  
1055 SHAFER STREET  
SAN DIEGO, CALIF. 92106  
714 223-8103  
TWX 714-276-4263  
HEWLETT-PACKARD  
NEELY SALES DIVISION  
1101 EMBARCADERO RD.  
PALO ALTO, CALIF. 94303  
415 327-6500  
TWX 910-373-1280  
HEWLETT-PACKARD  
NEELY SALES DIVISION  
7965 EAST PRENTICE  
ENGLEWOOD, COLORADO 80110  
303 771-3455  
TWX 303-771-3056  
HEWLETT-PACKARD  
YEWELL SALES DIVISION  
589 SAYBROOK RD.  
MIDDLETOWN, CONN. 06458  
203 346-6611  
TWX 710-428-2036  
HEWLETT-PACKARD  
FLORIDA SALES DIVISION  
2907 NORTHWEST 7TH ST.  
MIAMI, FLORIDA 33125  
305 635-6461  
HEWLETT-PACKARD  
FLORIDA SALES DIVISION  
621 COMMONWEALTH AVE.  
ORLANDO, FLORIDA 32803  
305 425-5541  
TWX 305-275-1234  
HEWLETT-PACKARD  
FLORIDA SALES DIVISION  
410-150TH AVE., MADEIRA BEACH

ST. PETERSBURG, FLA. 33708  
813 391-0211  
TWX 813-391-0666  
HEWLETT-PACKARD  
SOUTHERN SALES DIVISION  
3110 MAPLE DRIVE, N.E.  
ATLANTA, GEORGIA 30305  
404 293-1141  
TWX 810-751-3283  
HEWLETT-PACKARD  
CROSSLEY SALES DIVISION  
2501 WEST PETERSON AVE.  
CHICAGO, ILLINOIS 60645  
312 275-1600  
TWX 910-221-0277  
HEWLETT-PACKARD  
CROSSLEY SALES DIVISION  
3919 MEADOWS DR.  
INDIANAPOLIS, IND. 46205  
317 546-4891  
TWX 317-639-4300  
HEWLETT-PACKARD  
SOUTHERN SALES DIVISION  
SUITE 4, 3411 BARDSTOWN RD.  
LOUISVILLE, KY. 40218  
502 459-4140  
TWX 810-535-3128  
HEWLETT-PACKARD  
HORMAN SALES DIVISION  
6660 SECURITY BLVD.  
BALTIMORE, MD. 21207  
301 944-5400  
HEWLETT-PACKARD  
HORMAN SALES DIVISION  
941 ROLLINS AVENUE  
ROCKVILLE, MD. 20852  
301 427-7560  
TWX 710-828-9684  
HEWLETT-PACKARD  
YEWELL SALES DIVISION  
MIDDLESEX TURNPIKE  
BURLINGTON, MASS. 01804  
617 272-9000  
TWX 710-332-0382  
HEWLETT-PACKARD  
CROSSLEY SALES DIVISION  
14425 WEST EIGHT MILE ROAD  
OETROIT, MICH. 48235  
313 342-5700  
TWX 313-342-0702  
HEWLETT-PACKARD  
CROSSLEY SALES DIVISION  
842 RAYMOND AVENUE  
ST. PAUL, MINN. 55114  
612 646-7881  
TWX 910-563-3734  
HARRIS-HANSON COMPANY  
7916 PASEO STREET  
KANSAS CITY, KANSAS 64131  
816 444-9494  
TWX 816-556-2423  
HARRIS-HANSON COMPANY  
2814 S. BRENTWOOD BLVD.  
ST. LOUIS, MO. 63144  
314 647-4350  
TWX 314-962-3933  
HEWLETT-PACKARD  
ROBINSON SALES DIVISION  
SHREWSBURY, NEW JERSEY  
201 747-1060  
HEWLETT-PACKARD  
RMC SALES DIVISION  
391 GRAND AVENUE  
ENGLEWOOD, N.J. 07631  
201 567-3933  
HEWLETT-PACKARD  
NEELY SALES DIVISION  
6501 LOMAS BLVD., N.E.  
ALBUQUERQUE, N.M. 87108  
505 255-5586  
TWX 910-989-1665  
HEWLETT-PACKARD  
NEELY SALES DIVISION  
114 S. WATER STREET  
LAS CRUCES, N.M. 88001  
505 526-2486  
TWX 505-526-2671  
HEWLETT-PACKARD  
RMC SALES DIVISION  
236 EAST 75TH STREET  
NEW YORK, N.Y. 10021  
212 879-2023  
TWX 710-581-4376  
HEWLETT-PACKARD  
SYRACUSE SALES DIVISION  
800 LINDEN AVENUE  
ROCHESTER, N.Y. 14625  
716 381-4120  
TWX 716-221-1514  
HEWLETT-PACKARD  
SYRACUSE SALES DIVISION  
82 WASHINGTON STREET  
POUGHKEEPSIE, N.Y. 12601  
914 454-7330  
TWX 914-452-7425  
HEWLETT-PACKARD  
SYRACUSE SALES DIVISION  
5858 EAST MOLLOY RD.  
SYRACUSE, N.Y. 13211  
315 454-2486  
TWX 710-541-D482  
HEWLETT-PACKARD  
SOUTHERN SALES DIVISION  
1923 N. MAIN STREET  
HIGH POINT, N.C. 27262  
919 882-6873  
TWX 510-926-1516  
HEWLETT-PACKARD  
CROSSLEY SALES DIVISION  
5579 PEARL ROAD  
CLEVELAND, OHIO 44129  
216 886-9209  
TWX 216-888-0715  
HEWLETT-PACKARD  
CROSSLEY SALES DIVISION  
1250 W. DOROTHY LANE

DAYTON, OHIO 45409  
513 299-3594  
TWX 513-944-0090  
HEWLETT-PACKARD  
ROBINSON SALES DIVISION  
CAMP HILL, PA.  
717 737-6791  
HEWLETT-PACKARD  
ROBINSON SALES DIVISION  
144 ELIZABETH STREET  
W. CONSHOHOCKEN, PA. 19428  
215 248-1600 AND 828-6200  
TWX 215-828-3847  
HEWLETT-PACKARD  
CROSSLEY SALES DIVISION  
2545 MOSS SIDE BLVD.  
MONROEVILLE, PA. 15146  
412 271-5227  
TWX 710-797-3650  
HEWLETT-PACKARD  
SOUTHWEST SALES DIVISION  
P.O. BOX 7166, 3605 INWOOD RD  
DALLAS, TEXAS 75209  
214 357-1881 AND 332-6667  
TWX 910 861-4081  
HEWLETT-PACKARD  
SOUTHWEST SALES DIVISION  
P O BOX 22813  
4242 RICHMOND AVE  
HOUSTON, TEXAS 77027  
713 667 2407  
TWX 713 571 1353  
HEWLETT-PACKARD  
NEELY SALES DIVISION  
1482 MAJOR STREET  
SALT LAKE CITY, UTAH 84115  
801 486-8166  
TWX 801-521-2604  
HEWLETT-PACKARD  
SOUTHERN SALES DIVISION  
2112 SPENCER ROAD  
RICHMOND, VIRGINIA 23230  
703 282-5451  
TWX 710-956-0157  
HEWLETT-PACKARD  
NEELY SALES DIVISION  
11656 N.E. 8TH STREET  
BELLEVUE, WASH. 98004  
206 454-3971  
TWX 910-443-2303  
HEWLETT-PACKARD  
CONTRACT MARKETING DIV.  
OLMSTED PLAZA  
MIDDLETOWN, PA. 17057  
717 944-7401  
TWX 717-760-4816  
HEWLETT-PACKARD  
CONTRACT MARKETING DIV.  
144 ELIZABETH STREET  
W. CONSHOHOCKEN, PA. 19428  
215 753-1811  
TWX 215-820-3847  
HEWLETT-PACKARD  
CONTRACT MARKETING DIV.  
225 BILLY MITCHELL ROAD  
SAN ANTONIO, TEXAS 78226  
512 434-4171  
TWX 512-571-0955  
REPS. IN OTHER COUNTRIES  
HEWLETT-PACKARD LTD. - CANADA  
2184 W. BROADWAY  
VANCOUVER, B C  
604 738 7520  
TWX 610 922 5059  
HEWLETT-PACKARD LTD. - CANADA  
8270 MAYRAND STREET  
MONTREAL, QUEBEC  
514 735-2273  
TWX 610-421-3484  
HEWLETT-PACKARD LTD. - CANADA  
1762 CARLING AVENUE  
OTTAWA, ONTARIO  
613 722-4223  
TWX 610-562-1952  
HEWLETT-PACKARD LTD. - CANADA  
1415 LAWRENCE AVENUE WEST  
TORONTO, ONTARIO  
416 249-9196  
TWX 610-492-2382

**THE HICKOK ELECTRICAL INSTRUMENT COMPANY**  
VICE PRES MARKETING  
K F PETERSEN  
COMPANY ADDRESS  
10514 DUPONT AVENUE  
CLEVELAND, OHIO 44108  
COMPANY REPRESENTATIVE  
HICKOK ELECT INST CO  
1124 W MAGNOLIA BLVD  
BURBANK, CALIF 91502  
213 842 2145  
HICKOK ELECT INST CO  
46 TRAYNOR ST  
HAYWARD, CALIF 94544  
415 582 7179  
HUGHES INTERNATIONAL  
BLOG 334, M/S 40,  
CENTINELA & TEALE  
CULVER CITY, CALIF 9023D  
213 391 D711  
GORDON MOSS ELECTRONICS  
BOX 26172  
DENVER, COLORADO 80226  
303 936 4027  
HOLLINGSWORTH & STILL INC  
1010 EXECUTIVE CTR DR  
ORLANDO, FLA 32803  
305 241 5401  
HOLLINGSWORTH & STILL INC  
3098 PIEDMONT RD N E  
ATLANTA, GEORGIA 30305  
404 261 5838  
GENE PIETY FACTORS INC  
16D MOKAUEA ST BOX 29D3  
HONOLULU, HAWAII

810 185  
HICKOK ELECT INST CO  
7416 W BELMONT AVE  
CHICAGO, ILL 60634  
312 237 1373  
LOWELL, KANGAS & ASSOC INC  
BOX 4116  
OVERLAND PARK, KANSAS 66204  
913 888 3200  
MORRIS-CUNNINGHAM ASSOC  
720 E 65TH ST  
INOIANAPOLIS, IND 46220  
317 255 2458  
EARL K MOORE CO  
BOX 24430  
NEW ORLEANS, LA 70124  
504 488 2407  
JOHNSON ASSOCIATES  
81 MERRIMACK ST  
LOWELL, MASS 01852  
617 452 0413  
JOHNSON ASSOCIATES  
471 WASHINGTON ST  
WELLESLEY HILLS, MASS  
617 235 3977  
NICK J LAUB  
3749 BROADWAY WEST  
MINNEAPOLIS, MINN 55422  
612 588 4663  
KELLY-SCHMITZ-WINKLER  
2319 HAMPSTON AVE  
ST LOUIS, MO 63110  
314 781 6111  
HICKOK ELECT INST CO  
117 GERTRUDE AVE  
PARAMUS, N J 07652  
212 947 8016  
GORDON MOSS ELECTRONICS  
2418 BARCELONA DR S W  
ALBUQUERQUE, N M 87105  
505 877 9392  
R W MITTSCHER CO INC  
496 ELLICOTT SQ BLDG  
BUFFALO, N Y 14203  
716 854 2517  
R W MITTSCHER CO INC  
R.F.O. ROUTE 82A  
SALTPPOINT, N Y  
914 266 5875  
R W MITTSCHER CO INC  
606 FOREST DRIVE  
N SYRACUSE, N Y 13212  
315 458 1321  
HOLLINGSWORTH & STILL INC  
6717 WOODSTOCK  
CHARLOTTE, N C 28210  
704 523 3327  
HICKOK ELECT INST CO  
10514 DUPONT AVE  
CLEVELAND, OHIO 44108  
216 541 8060  
HAYS COMPANY  
BOX E  
RICHAROSON, TEXAS  
214 231-1426

**S. HIMMELSTEIN AND COMPANY**  
SALES MANAGER  
S. HIMMELSTEIN  
BRAND NAMES  
IMPELLOR  
COMPANY ADDRESS  
2500 ESTES AVENUE  
ELK GROVE VILLAGE, ILL. 60007  
COMPANY REPRESENTATIVES  
KITTLESON COMPANY  
416 N. LABREA AVE  
LOS ANGELES, CALIF 90036  
213- WE 3-7371  
KITTLESON COMPANY  
809 SAN ANTONIO RD  
PALO ALTO, CALIF.  
415-326-7410  
EQUIPMENT SALES CO, INC.  
P. O. BOX 6098  
NEW HAVEN, CONN. 06517  
203-248-5581  
I B L ENGRING & SALES INC.  
1444 CALHOUN ST  
NEW ORLEANS, LA. 70118  
504-895-4793  
EQUIPMENT SALES CO, INC.  
DANVERS, MASS  
617-774-2400  
ELECTRO SALES ASSOC. INC.  
15324 MACK AVE  
DETROIT, MICHIGAN 48224  
313-886-2280  
ELECTRO SALES ASSOC. INC.  
335 EAST 200TH ST  
CLEVELAND, OHIO 44119  
216-486-1140  
ELECTRO SALES ASSOC. INC.  
OABEL STATION BOX 143  
OAYTON, OHIO 45420  
513-426-5551  
I B L ENGRING & SALES INC.  
5149 EAST 31ST ST  
TULSA, OKLAHOMA 74135  
918 WE 6-6305  
ELECTRO SALES ASSCO. INC.  
201 PENN CENTER BLVD  
PITTSBURGH, PENN 15235  
412-371-9449  
I B L ENGRING & SALES INC.  
219 PRESTON ROYAL CENTER  
SUITE 6  
DALLAS, TEXAS 75230  
214-EM 3-2921  
I B L ENGRING & SALES INC.  
3403 AUOUBON NO. 5  
HOUSTON, TEXAS 77006  
713 JA 3-836D  
I B L ENGRING & SALES INC.  
19D3 WEST 34TH ST

# When you want high efficiency delay lines specify **Kappa Super-η\***



\*SUPER-η LINES embody a new design principle providing the highest efficiency yet obtainable in lumped constant delay lines. Use of network synthesis techniques rather than conventional m-derived methods results in sharply improved delay line efficiency. Compared to ordinary lines of any given delay, KAPPA SUPER-η lines provide linear performance over a much greater band width. In addition these newly developed lines offer such outstanding advantages as: greater inherent reliability, smaller package size, and appreciable cost reduction.

## SUPER-η LINES FOR VIDEO SYSTEMS

**Impedance:** 75 ohms (unless otherwise specified)  
**Amplitude Response:** better than 0.1 db. flatness to 10 MHz or higher  
**Ripple:** within  $\pm .05$  db to 10 MHz or higher  
**Group Delay:** linear within  $\pm 1\%$  or  $\pm$  Insec, whichever is greater.  
**Group Delay Ripple:** within  $\pm 2\frac{1}{2}\%$  to 14 MHz  
**K factor:** better than .25% for T or  $2T \sin^2$  pulse for both American and European systems  
**Cross talk:** less than 46 db.

**UPDATE YOUR VIDEO BROADCAST EQUIPMENT WITH KAPPA SUPER-η DELAY LINES!**

**Specify KAPPA for the most complete line of electro-magnetic delay lines...**

### STANDARD LUMPED CONSTANT DELAY LINES SERIES LC



Delay: 50 Nanoseconds to 1 second  
 Bandwidth: DC to 250 MHz  
 Rise Time: As low as 2 Nanoseconds  
 Impedance: 25 ohms to 50 K ohms

### TRANSPONDER LINES SERIES C



Tap Spacing: 1.45  $\mu$ sec, or as required  
 Tap Tolerance:  $\pm .05$ , or as required  
 Delay-to-Rise-Time Ratio: 100 max.  
 Temperature Stability: 50 ppm  $^{\circ}$ C or less

### LOW DISTORTION LINES SERIES D



Distortion at Output: 2% max.  
 Distortion at Taps: Less than 5% at any tap  
 Distortion Limit: As low as 0.1% if required  
 Delay Range: up to 100 usec.

### PRECISION AUDIO DELAY LINES SERIES A



Delay Range: from 500  $\mu$ sec to 1 sec.  
 Bandwidth: 70 KHZ (max.)  
 Delay Linearity: nominally within  $\pm 0.25\%$  available to within  $\pm 0.05\%$

### PRECISION DECADE DELAY UNITS SERIES DK



Variable delays available between input and output terminals in decade steps. Each decade has eleven (11) switch contacts and ten (10) delay increments so that the dial values overlap.

### ULTRA MINIATURE DELAY LINES SERIES T



Delay Range: to 200nsec.  
 Delay/Rise Time: 10 max.  
 Attenuation: 2 db max.  
 Fully encapsulated

### STANDARD DISTRIBUTED CONSTANT DELAY LINES SERIES DC



Delay Range: to 3  $\mu$ sec.  
 Standard Tolerance:  $\pm 5\%$  on Delay  
 Delay-to-Rise-Time Ratio: 11 max.  
 Distortion:  $\pm 5\%$  (typical),  $\pm 10\%$  max.

### DELAY TRIMMERS: TINY TRIM\* SERIES



Size: 1/4 Cubic Inch

| PART NUMBER | SHIFT RANGE @ 3.58 MHZ DEG. | DELAY (Nano-sec.) | RISE TIME (Nano-sec.) | IMPEDANCE (ohms) |
|-------------|-----------------------------|-------------------|-----------------------|------------------|
|             |                             |                   |                       |                  |
| TT20D       | 25                          | 20                | 5                     | 500              |
| TT30C       | 38                          | 30                | 7.5                   | 390              |
| TT40D       | 50                          | 40                | 10                    | 500              |
| TT50C       | 64                          | 50                | 12.5                  | 390              |
| TT60C       | 75                          | 60                | 15                    | 330              |

Contact us for the name of your nearest representative or consult listing in this directory. Complete new catalog available.

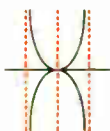

# KAPPA NETWORKS, INC.

Delay Line Specialists • Manufacturing Engineers

165 ROOSEVELT AVENUE • CARTERET, NEW JERSEY 07008 • TEL. (201) 541-4226

D. S. LINZ  
238 SHELWIRE ST  
PHILADELPHIA, PA.  
215-ES 9-0734  
PARVIN SALES CO.  
BOX 307  
ADDISON, TEX.  
214-363-8596  
R. JOHNSTON CO.  
1011 NORTHEAST 69TH ST  
SEATTLE, WASH.  
LA 4-5170  
REPS. IN OTHER COUNTRIES  
E. S. GOULD LTD.  
11 LOUVAIN ST.  
MONTREAL, QUE.  
514-288-5225

**IMPEX ELECTRONICS CORPORATION**  
SALES MANAGER  
M. ROBBINS  
BRAND NAMES  
IMPEX  
COMPANY ADDRESS  
213 SO. ROBERTSON BLVD.  
BEVERLY HILLS, CALIF.

**INDUSTRIAL DEVICES, INC.**

SALES MANAGER  
BERNARD SCHNOLL  
BRAND NAMES  
OMNIT-GLOW  
GLO-DOT  
MINI-SLIDE  
MINI-CATOR  
LINE-O-LITE  
SAFE-T-KLIP  
COMPANY ADDRESS  
EDGEWATER, N.J. 07020

**INDUSTRIAL ELECTRIC REELS, INC.**

SALES MANAGER  
J. C. COSTELLO  
BRAND NAMES  
PORT-O-REELS  
SPRING-O-MATIC  
COLLECTRIC  
COMPANY ADDRESS  
1509 CHICAGO ST  
OMAHA, NEBRASKA 68102  
402 341 4600

**INSTRUMENT LABORATORIES CORP.**

COMPANY ADDRESS  
315 WEST WATSON PLACE  
CHICAGO, ILLINOIS 60610

**INTERNATIONAL GOOD MUSIC INC.**

SALES MANAGER  
ROGAN JONES, JR.  
BRAND NAMES  
IGM  
COMPANY ADDRESS  
BOX 943,  
BELLINGHAM, WASHINGTON 98225  
206-733-4567  
SALES REPRESENTATIVES  
ROBERT POPKE  
322 EUCLID  
HIGHWOOD, ILLINOIS  
312 433 1253  
JOSEPH CURCIO  
155-B GRANDVIEW AVE  
FORDS, NEW JERSEY  
201 442 2301  
JOE TOHER  
7542 MILLBROOK RD  
COLUMBIA, S C  
803 787 2597  
IRVING LAW, JR  
5585 BROADVIEW  
TACOMA, WASH  
206 927 3483

**INTERNATIONAL NUCLEAR CORP**

SALES MANAGER  
GUY SWINDEL  
COMPANY ADDRESS  
608 MORRIS AVENUE  
NASHVILLE, TENN 37204

**INTERNATIONAL RECTIFIER**

SALES MANAGER  
ROBERT J. MUELLER  
COMPANY ADDRESS  
233 KANSAS STREET  
EL SEGUNDO, CALIF. 90245  
EXPORT DIVISION  
INTERNATIONAL RECTIFIER  
P O BOX 227  
FORT LEE, NEW JERSEY  
201 947 3911  
COMPANY REPRESENTATIVES  
SHEFLER-KAHN CO  
2016 N 7TH ST  
PHOENIX, ARIZONA  
602 258-7893  
TWX 602 255 0226  
INTERNATIONAL RECTIFIER  
2158 E MIDOLEFIELD RD  
MOUNTAIN VIEW, CALIF  
415 969 0660  
INTERNATIONAL RECTIFIER  
401 E MANCHESTER  
LOS ANGELES, CALIF  
213 678 2181  
HYTRONIC MEASUREMENTS INC  
1295 S BANNOCK ST  
DENVER, COLO  
303 733 3701  
TWX 303 292 3052  
INTERNATIONAL RECTIFIER  
4230 S W 15TH ST  
MIAMI, FLORIDA  
305 445 5201

LOUIS O COHEN Y CIA  
EXPORT - VENEZUELA  
9323 SW 8TH STREET  
MIAMI, FLORIDA  
444-5111  
INTERNATIONAL RECTIFIER  
6453 LINCOLN AVE  
CHICAGO, ILL  
312 676 4090  
INTERNATIONAL RECTIFIER  
8605 CAMERON ST  
SILVER SPRING, MARYLAND  
301 589 3305  
INTERNATIONAL RECTIFIER  
361 MASSACHUSETTS AVE  
ARLINGTON, MASS  
617 643 7608  
INTERNATIONAL RECTIFIER  
26789 WOODWARD AVE RM 205  
HUNTINGTON WOODS, MICH  
313 548 1144  
INTERNATIONAL RECTIFIER  
5009A EXCELSIOR BLVD  
MINNEAPOLIS, MINN  
612 921 1200  
INTERNATIONAL RECTIFIER  
47 VILLAGE SQUARE  
HAZELWOOD, MO.  
314 838 6333  
INTERNATIONAL RECTIFIER  
1580 LEMOINE AVE  
FORT LEE, N J  
201 947 3311  
SHEFLER-KAHN CO  
408 PENNSYLVANIA ST S E  
ALBUQUERQUE, NEW MEXICO  
505 265 7077  
INTERNATIONAL RECTIFIER  
PAIKIN BLDG 2366 JAMES ST  
SYRACUSE, N Y  
315 437 8495  
INTERNATIONAL RECTIFIER  
1001 LEADER BUILDING  
CLEVELAND, OHIO  
216 771 5562  
INTERNATIONAL RECTIFIER  
3490 S DIXIE DR  
KETTERING, OHIO  
513 299 2635  
INTERNATIONAL RECTIFIER  
SUITE 208 SUBURBAN SQ BLDG  
ARDMORE, PENN  
215 473 3931  
INTERNATIONAL RECTIFIER  
811 S CENTRAL EXPRESSWAY  
SUITE 253  
RICHARDSON, TEXAS  
214 231 2904  
HYTRONIC MEASUREMENTS INC  
2022 S MAIN ST  
SALT LAKE CITY, UTAH  
801 466 4294  
ELECTRONIC SALES INC  
6969 CALIFORNIA AVE SW  
P O BOX 6535  
SEATTLE, WASH  
206 932 0330  
REPS. IN OTHER COUNTRIES  
M I PTY LTD  
JOHANNESBERG TRANSVAAL  
SOUTH AFRICA  
USHA RECTIFIER CORP INDIA LTD  
JEEVAN VIHAR  
3 PARLIAMENT STREET  
NEW DELHI 1, INDIA  
40115  
INTL RECTIFIER CORP JAPAN LTD  
NISHIBA BUILDING  
24, 1-CHROME KANDA SUDA-CHO  
CHIYODA-KU  
TOKYO, JAPAN  
252 8991  
SOLAR ELECTRONIC CENTER  
129-A IBA STREET  
QUEZON, PHILIPPINES  
EL GALLITO COMMERCIAL  
2DA AVENIDA ENTRE  
CALLES 4 Y 6  
SAN JOSE COSTA RICA  
2436/5967/7605  
ELECTRONICA INDUSTRIAL  
SALVADORENA  
19 AVENIDA NORTE 312  
SAN SALVADOR, EL SALVADOR  
5557  
ACCESORIOS ELECTRONICOS  
APARTADO NO 614  
TEGUCIGALPA, HONDURAS,  
2-0656  
SR GUILLERMO A VILORIA  
P O BOX 1324  
PANAMA, REPUBLIC OF PANAMA  
2-3813/3-8374  
ING OTFRIED RIEGER  
10 MARXERGASSE  
VIENNA III, AUSTRIA  
73 46 84  
INTL RECTIFIER EUROPE S A  
38 AV OES ARTS  
BRUSSELS 4, BELGIUM  
11 17 38  
INTERNATIONAL RECTIFIER A/S  
TORDENSKJOLDSGADE 17  
COPENHAGEN, DENMARK  
11 25 77  
OY FLINKENBERG AB & CO  
BULEVARDI 28  
HELSINKI, FINLAND  
63 06 86  
INT RECT CORP FRANCE S A R L  
7 AV GEORGE V  
PARIS 8E, FRANCE  
225 73 82  
INTERNATIONAL RECTIFIER GMBH  
GUILLETSTRASSE 15  
FRANKFURT/MAIN 1, GERMANY

72 92 86  
INTERNATIONAL RECTIFIER CO  
GB LIMITED  
HURST GREEN  
OXTED, SURREY, ENGLAND  
3125  
INTERNATIONAL RECTIFIER CORP  
ITALIANA SPA  
84, STRADA DI LANZO  
BORGARO/TORINESE, ITALY  
57 20 85  
N V DIODE  
EMMASTRAAT 36A  
HILVERSUM, NETHERLANDS  
14 121  
J M FEIRING AS  
LILLETORVET 1  
OSLO 1, NORWAY  
41 43 45  
ELECTROTECNICOS REUNIDOS LDA  
AVENIOA DUGUE DAVILA 65  
LISBON, PORTUGAL  
41161  
M GABARRO S A  
RBLA CATALUNA 80  
BARCELONA-8, SPAIN  
215 19 00  
A B NORDQVIST & BERG  
SMOLSKYVAGEN 8  
STOCKHOLM-K, SWEDEN  
520050  
INTERELECTRONIC E OERTLI  
KIRCHENWEG 5  
ZURICH 32, SWITZERLAND  
34 84 47  
MICHAEL PRUZAN INC  
2 PRAGUE STREET  
TEL-AVIV, ISRAEL  
242756  
DOUGLAS RANDALL OF CANADA LTD  
126 WAINVILLE ROAD  
SCARBOROUGH, ONTARIO  
416 751-7911  
TWX 610-492-1382  
DOUGLAS RANDALL OF CANADA LTD  
1253 MCGILL COLLEGE  
MONTREAL, QUEBEC  
861-0562  
INDUSTRIAS COMERCIALES SA  
MEDELLIN 184  
MEXICO T. O.F., MEXICO  
14-65-58/14-65-66  
WARBURTON FRANKI INDUSTRIES  
SYDNEY PTY LTD  
307-315 KENT STREET  
SYDNEY, AUSTRALIA  
ARNOLO & WRIGHT LTO  
171-173 TARANAKI STREET  
WELLINGTON C3, NEW ZEALAND  
54-078  
RAYO ELECTRONICA SRL  
BUENGRANO 990-60,P.  
BUENOS AIRES, ARGENTINA  
38-1799/37-9476  
PROELEC S A  
CAIXA POSTAL 12863  
VILA MARIANA  
SAO PAULO, BRAZIL  
7-5729/7-7025  
ALBERTO BEUTLER Y BOHMER LTD  
CASILLA 9483  
SANTIAGO, CHILE  
89141  
ELECTROCENTROS LTOA  
APARTADO AEREO 14312  
BOGOTA, D.E., COLOMBIA  
444-443/445-688/445-882  
INTESA SA  
P O BOX 5754  
CORREO CENTRAL  
LIMA, PERU  
36539-PUEBLO LIBRE  
SR HORACIO ASCHERI PETROCELLI  
BOULEVARD GRAL.  
ARTIGAS 635, AP 2  
MONTEVIDEO, URUGUAY  
LOUIS D COHEN Y CIA  
FELIPE ELBERTO LOPEZ  
APARTADO POSTAL 8363  
CARACAS, VENEQUELA

**IRC, INC.**  
VP, SALES & MARKETING  
J. BURTON HENRY  
BRAND NAMES  
AMMO-PAK  
CUBETRIM  
EPIC  
GBT  
GRIP STRIP  
MICROSTAK  
MINEL-R  
PRECISTOR  
RESISTEX  
REVODEX  
SELECTREZ  
COMPANY ADDRESS  
401 N. BROAD STREET  
PHILADELPHIA, PA. 19108  
215 WA 2-8900  
COMPANY REPRESENTATIVES  
CARL HOWER & CO  
P O BOX 1627  
431 N WINFIELD SCOTT PLAZA  
SCOTTSDALE, ARIZ 85252  
602 947 4204  
TWX 610 835 1281  
JACK LOGAN & ASSOCIATES  
801 MAHLER ROAD  
BURLINGAME, CALIF 94010  
415 697 6100  
TWX 910 375 3382  
ELLIOTT RECHT ASSOC  
175 SO SAN ANTONIO ROAD  
LOS ALTOS, CALIF  
415 941 0336

TXW 415 949 7921  
IRC SALES OFFICE  
14827 VENTURA BLVD  
SHERMAN OAKS, CALIF 91403  
213 981 7722  
TWX 213 783 2542  
ELECTRONIC COMPONENT SALES CO  
2340 W MAIN ST  
LITTLETON, COLO 80120  
303 798 8481  
TWX 303 798 8114  
RAY PERRON & CO  
10 BRIARWOOD ROAD  
FARMINGTON, CONN 06032  
203 OR 7 9025  
RAY PERRON & CO  
36 LOUIS ST  
TRUMBULL, CONN 06611  
203 AM 8 9631  
HOLLINGSWORTH & STILL  
1010 EXECUTIVE CENTER DR  
ORLANDO, FLA 32803  
305 241 5401  
TWX 305 841 3357  
HOLLINGSWORTH & STILL  
2098 PIEDMONT RD, NE  
ATLANTA, GA 30305  
404 261 5835  
DOUGHERTY ENTERPRISES  
1164 WAIMANU ST  
P O BOX 3497  
HONOLULU, HAWAII 96811  
504 987  
IRC SALES OFFICE  
6020 DIVERSEY AVE  
CHICAGO, ILL 60639  
312 TU 9 5800  
TWX 312 265 1206  
MACNABB, SCHROEDER & LOOMIS  
820 E 64TH ST  
INDIANAPOLIS, IND 46220  
317 251 4471  
TWX 317 634 8747  
MACNABB, SCHROEDER & LOOMIS  
1123 W WILDWOOD  
FORT WAYNE, IND 46800  
219 745 8609  
HALGIN SALES CO  
5640 BUENA VISTA BOX 1245  
MISSION, KANSAS 66222  
913 RA 2 2441  
TWX 913 552 7300  
JACK F MCKINNEY SALES CO  
2012 CONDON AVE  
METAIRIE, LOUISIANA 70003  
504 833 0976  
RAY PERRON & CO  
1870 CENTRE ST  
ROSTON, MASS 02132  
617 FA 3 1008  
TWX 617 325 8627  
S STERLING CO  
21250 10 1/2 MILE ROAD  
SOUTHFIELD, MICH 48076  
313 357 3700  
TWX 313 357 4615  
THE HEIMANN CO, INC  
5603 LYNDALE AVE, S  
MINNEAPOLIS, MINN 55419  
612 827 5457  
TWX 612 321 1053  
NORTHPORT ENGINEERING, INC  
2027 GRAND AVE  
ST PAUL, MINN 55105  
612 698 3841  
TWX 612 951 0002  
SMITH ENGINEERING ASSOC  
2278 COMO AVENUE  
ST PAUL, MINN 55108  
HALGIN SALES CO  
201 S CENTRAL AVE  
CLAYTON, MO 63837  
314 PA 1 4415  
TWX 314 556 0520  
RAY PERRON AND CO  
19 CARON ROAD  
RFD # 2  
MANCHESTER, N H 03102  
603 472 4091  
EL COM  
P O BOX 3087 STA D  
ALBUQUERQUE, N M 87100  
505 344 8130  
TWX 505 243 8378  
IRC SALES OFFICE  
1967 TURNBULL AVE  
NEW YORK, N Y 10473  
212 597 5500  
TWX 212 824 7980  
HOLLINGSWORTH & STILL  
6717 WOODSTOCK DR  
CHARLOTTE, N C 28200  
704 723 3372  
BAEHR-GREENLEAF ASSOC  
9505 MONTGOMERY RD  
CINCINNATI, OHIO 45242  
513 426 5485  
BAEHR-GREENLEAF ASSOC  
14700 OETROIT AVE  
CLEVELAND, OHIO 44107  
216 AC 1 9030  
BAEHR-GREENLEAF & ASSOC  
3550 MAPLEWOOD OR  
XENIA, OHIO 45385  
513 426 5485  
JACK F MCKINNEY SALES CO  
P O BOX 3958  
TULSA, OKLAHOMA 74101  
918 742 4595  
C K SHANKS & ASSOC  
3104 S W 87TH AVE  
PORTLAND, ORE 97225  
503 292-5656  
IRC SALES OFFICE  
401 N BROAD ST  
PHILADELPHIA, PA 19109

**You'll never  
get a  
blue face  
from us.**



... nor a red one either, because there's no need to worry about your color signal when you use our TSA1 Clamping/Equalizing Video Amplifier. Tip clamping does it. No disturbance of color burst or other chrominance information in or about blanking or back porch levels. Gain ... continuously adjustable from zero output to 6 db with no bounce. 28 db gain also available. Sync stretching or compressing. White stretching and clipping. All solid state. Fits standard rack. Heck man, don't take our word for it ... TAKE 30 DAYS AND TRY IT OUT ... AT OUR EXPENSE!

**PRICE: \$850.00 EACH, F.O.B. NASHVILLE, TENN.**

**28 db gain \$75.00 additional, designated TSA1HG**



*We invite your inquiry . . . please write:*

**INTERNATIONAL NUCLEAR CORPORATION**

*"Transistorizing the Television Industry"*

608 NORRIS AVENUE • NASHVILLE, TENN • PHONE 615-254-3365

215 WA 2 8900  
TWX 215 569 8924  
COVERT & NEWMAN CD  
300 MT LEBANON BLVD  
PITTSBURGH, PA 15234  
412 531 4471  
JACK F MCKINNEY SALES CO  
5458 EDITH ST  
BELLAIRE, TEXAS 77401  
713 665 3653  
JACK F MCKINNEY SALES CO  
1303 CHEMICAL ST  
DALLAS, TEXAS 75207  
214 ME 1 9450  
TWX 214 861 4232  
W T BLACKBURN ASSOC  
SEMICONDUCTORS ONLY  
P O BOX 20073  
DALLAS, TEXAS 75229  
214 FL 1 9991  
TWX 214 899 8518  
ELCOM  
P O BOX 2066  
SALT LAKE CITY, UTAH 84110  
801 262-3700

**ITI ELECTRONICS, INC.**  
SALES MANAGER  
W. FORD  
COMPANY ADDRESS  
369 LEXINGTON AVE.  
CLIFTON, N. J. 07015  
GREGORY 3-09000

**ITT CANNON ELECTRIC.**  
DIV INTERNATIONAL TELEPHONE  
AND TELEGRAPH CORPORATION

VP, DIRECTOR-MARKETING  
V. B. BENFER  
BRAND NAMES  
BOWSPRING  
CANNON R  
CENTI-B  
CENTI-K  
CENTI-LOC  
CENTISTRIP  
CRIMP IMP  
DUAL-SHORE R  
GOLDEN-D  
MICROPIN R  
MICROSOCKET R  
MILLSOCKET  
MORPHO R  
NANO-K  
NANOSTRIP  
POS-ALINE R  
RING-LOC  
ROYAL-D  
50-MIL STRIP  
CAM-RAC  
MILISTRIP  
BUG PLUG  
COMPANY ADDRESS  
3208 HUMBOLDT STREET  
LOS ANGELES, CALIF 90031  
SALES/ENGINEERING OFFICES  
ITT CANNON ELECTRIC  
HOLIDAY OFFICE CENTER  
MEMORIAL PARKWAY  
HUNTSVILLE, ALABAMA 35801  
205 881-4940  
ITT CANNON ELECTRIC  
3625 N. 16TH ST SUITE 121  
PHOENIX, ARIZONA 85016  
602 264-5056  
ITT CANNON ELECTRIC  
1845 S. MANCHESTER AVE  
ANAHEIM, CALIF 92802  
714 638-0770  
ITT CANNON ELECTRIC  
2636 N. FIGUEROA ST  
LOS ANGELES, CALIF 90065  
213 225-1251  
ITT CANNON ELECTRIC  
960 SAN ANTONIO RD RM 13  
PALD ALTO, CALIF 94303  
415 323-9057  
ITT CANNON ELECTRIC  
2420 UNIVERSITY AVE  
SAN DIEGO, CALIF 92104  
714 297-3595  
ITT CANNON ELECTRIC  
300 E. HAMPDEN AVE SUITE 222  
ENGLEWOOD, COLO 80110  
303 761-1474  
ITT CANNON ELECTRIC  
730 HOPMEADOW STREET  
SIMSBURY, CONN 06070  
203 658-4435  
ITT CANNON ELECTRIC  
999 WOODCOCK RD SUITE 3D4  
ORLANDO, FLORIDA 32803  
305 841-4862  
ITT CANNON ELECTRIC  
1447 PEACHTREE ST N E,  
SUITE 10D6  
ATLANTA, GEORGIA 30309  
404 873 2984  
DOUGHERTY ENTERPRISES  
P O BOX 3497  
1164 WAIMANU ST  
HONOLULU, HAWAII  
ITT CANNON ELECTRIC  
5245 N. ELSTON AVE  
CHICAGO, ILLINOIS 60630  
312 282-3410  
ITT CANNON ELECTRIC  
5202 BALTIMORE NATL PIKE  
BALTIMORE, MD 21229  
301 744-5965  
ITT CANNON ELECTRIC  
591 NORTH AVENUE  
WAKEFIELD, MASS 01880  
617 245-3850  
ITT CANNON ELECTRIC  
4725 EXCELSIOR BLVD RM4A

MINNEAPOLIS, MINN 55416  
612 920-2911  
ITT CANNON ELECTRIC  
9369 OLIVE BLVD SUITE 101  
OLIVETTE, MISSOURI 63132  
314 991-1630  
ITT CANNON ELECTRIC  
640 RAHWAY AVENUE  
UNION, NEW JERSEY 07083  
201 687-9500  
ITT CANNON ELECTRIC  
PICKARD BUILDING  
EAST MOLLOY ROAD  
SYRACUSE, NEW YORK 13211  
315 454-9241  
DULA ASSOCIATES INC  
1402 EAST MOREHEAD STREET  
P D BOX 6096  
CHARLOTTE, N. C. 28204  
704 334-7090  
DULA ASSOCIATES INC  
3389 NOTTINGHAM ROAD  
P O BOX 5316  
WINSTON-SALEM, N. C. 27103  
919 723-4205  
ITT CANNON ELECTRIC  
3691 LEE ROAD  
CLEVELAND, OHIO 44120  
216 991-7571  
ITT CANNON ELECTRIC  
3300 SOUTH DIXIE DRIVE  
KETERING, OHIO 45439  
513 298-5258  
ITT CANNON ELECTRIC  
1510 RUSSELL ROAD  
PAOLI, PENNA 19301  
215 647-0212  
ITT CANNON ELECTRIC  
BRANIFF AIRWAYS BUILDING  
SUITE 415 EXCHANGE PARK  
DALLAS, TEXAS 75235  
214 357-8171  
ITT CANNON ELECTRIC  
1730 NASA BLVD SUITE 209  
HOUSTON, TEXAS 77058  
713 488-3110  
ITT CANNON ELECTRIC  
225 108TH AVENUE N E  
BELLEVUE, WASH 98004  
206 454-3903

**ITT TELECOMMUNICATIONS.**  
DIV INTERNATIONAL TELEPHONE  
TELEGRAPH CORP

SALES MANAGER  
S. J. REJNIAK  
COMPANY ADDRESS  
320 PARK AVENUE  
NEW YORK, NEW YORK 10022  
COMPANY REPRESENTATIVE  
A. URSANO, REP MGR  
ITT TELECOMMUNICATIONS  
1801 MURCHIN DR  
BURLINGAME, CALIF. 94011  
415 697-5780  
P. K. COWELL, REG MGR  
ITT TELECOMMUNICATIONS  
10395 W. COLFAX AVENUE  
DENVER, COLO. 80215  
303 238-6361  
H. E. DUNCAN, REG MGR  
ITT TELECOMMUNICATIONS  
NO 4 EXECUTIVE PARK DR  
ATLANTA, GEORGIA 30329  
T. R. SMITH, REG MGR  
ITT TELECOMMUNICATIONS  
3207 D NIMITZ HIGHWAY  
HONOLULU, HAWAII 96819  
812-848  
R. F. SCHUESSLER, REG MGR  
ITT TELECOMMUNICATIONS  
6650 S CICERO AVENUE  
CHICAGO, ILLINDIS 60638  
312 458-6300  
R. E. O'BRIEN, REG MGR  
ITT TELECOMMUNICATIONS  
4010 WEST 65TH STREET  
EDINA, MINNESOTA 55435  
612 927-4636  
JACK T. SHRINER, REG MGR  
ITT TELECOMMUNICATIONS  
1006 GRAND AVENUE  
KANSAS CITY, MISSOURI 64106  
816 471-5433  
JACK H. WILKS, REG MGR  
ITT TELECOMMUNICATIONS  
731 JAMES STREET  
SYRACUSE, NEW YORK 13203  
315 472-8821  
K. H. BENNINGHOVEN, REG MGR  
ITT TELECOMMUNICATIONS  
419 BRANIFF BUILDING  
DALLAS, TEXAS 75235  
214 357-9271

**ITT WIRE & CABLE DIVISION**  
CLINTON OPERATION

SALES MANAGER  
VAUGHN N TANNAHILL  
BRAND NAMES  
ROYAL  
SURPRENANT  
SURCOUR  
COMPANY ADDRESS  
172 STERLING ST  
CLINTON, MASS 01510  
SALES OFFICES  
ITT WIRE & CABLE DIV.  
HOLIDAY OFFICE CENTER  
SUITE 104  
HUNTSVILLE, ALA.  
205 881-4040  
ITT WIRE & CABLE DIV.  
1 WEST ALAMEDA  
BURBANK, CALIF.  
213 843-3220

ITT WIRE & CABLE DIV.  
960 SAN ANTONIO RD.  
PALD ALTO, CALIF.  
415 321-7470  
ITT WIRE & CABLE DIV.  
1545 MINNESOTA STREET  
SAN FRANCISCO, CALIF.  
415 285-4800  
ITT WIRE & CABLE DIV.  
8444 FLOISSANT RD.  
ST. LOUIS, MO.  
314 521-3120  
ITT WIRE & CABLE DIV  
1510 RUSSELL RD.  
PAOLI, PA.  
215 644-1450  
ITT WIRE & CABLE DIV  
5013 BARTON PLACE SOUTH  
SEATTLE, WASH.  
206 723-8152  
COMPANY REPRESENTATIVES  
BRANDEL STEPHENS & CO., INC.  
135 E. COLONIAL DR.  
ORLANDO, FLA.  
305 425-3202  
R. D. CATELLIER INC  
4901 W. FULLERTON AVE.  
CHICAGO, ILL.  
312 237-6460  
BURGIN-KREH ASSOC.  
202 W. PENNSYLVANIA AVE  
TOWSON, MD.  
301 825-3212  
GERALD ROSEN CO.  
563 WORCESTER RD.  
NATICK, MASS.  
617 655-2211  
MULLIGAN-MATHIAS  
2144 RIVERSIDE DR.  
COLUMBUS, OHIO  
614 486-9678  
C. L. PUGH CO.  
2144 RIVERSIDE DR.  
COLUMBUS, OHIO  
614 486-9678  
A-E-PETSCHKE CO.  
807 E. ABRAMS STREET  
ARLINGTON, TEXAS  
817 277-1379

**JAMPRO ANTENNA COMPANY**  
SALES MANAGER  
BILL NEUMANN

BRAND NAMES  
JAMPRO  
ANDREWS  
ROHN  
COMPANY ADDRESS  
6939 POWER INN ROAD  
SACRAMENTO, CALIF. 95828  
916-383-1177  
COMPANY REPRESENTATIVES  
BAUER ELECTRONICS  
1663 INDUSTRIAL ROAD  
SAN CARLOS, CAL  
591-9466  
GATES RADIC COMPANY  
QUINCY, ILLINOIS  
222-8202  
CCA ELECTRONICS CORP  
716 JERSEY AVE  
GLOUCESTER CITY  
CAMDEN CO, N J  
456-1716  
VISUAL ELECTRONICS  
356 WEST 40TH STREET  
NEW YORK, N. Y.  
736-5840  
TELESCO INTERNATIONAL CORP  
171 MADISON AVENUE  
NEW YORK, N.Y.  
COLLINS RADIO COMPANY  
DALLAS 7, TEXAS  
ADAMS 5-9511  
DU-VAL  
GULF STATES BLDG  
DALLAS, TEXAS  
RI 8-7754  
MARTI ELECTRONICS  
105 POINDEXTER  
CLEBURNE, TEXAS  
MI 5-4091  
REPS. IN OTHER COUNTRIES  
THE CROW COMPANY  
79 LONDON STREET  
READING, BERKSHIRE, ENGLAND  
LANAIRSEA, S. A.  
56 GATZAMBIDE  
MADRID, SPAIN

**JENNINGS RADIO**  
MANUFACTURING COMPANY

SALES MANAGER  
ROBERT E. JOHNSTON  
COMPANY ADDRESS  
970 MCLAUGHLIN AVENUE  
SAN JOSE, CALIF. 95108  
COMPANY REPRESENTATIVES  
JOHN J FISKE  
PO BOX 585  
ARCADIA, CALIF 91006  
213 447-7655  
WES SHELLHAMMER  
215 BROOKSIDE AVE  
HOBOKUS, NEW JERSEY  
201 447-0277

**JENSEN MANUFACTURING DIVISION.**  
THE MUTER COMPANY

SALES MANAGER  
FRANK D. LINTERN  
COMPANY ADDRESS  
6601 SOUTH LARAMIE AVE.  
CHICAGO, ILLINOIS 60638

**JERRLD ELECTRONICS CORPORATION**

SALES MANAGER  
CATV DIVISION  
JERRY HASTINGS  
SALES MANAGER  
DISTRIBUTOR SALES DIV.  
TOM SHEA  
SALES MANAGER  
COMMUNICATIONS DIV.  
VROMIN RILEY  
SALES MANAGER  
GOVERNMENT & INDUSTRIAL DIV.  
DOUGLAS VINING  
BRAND NAMES  
STARLINE  
ULTRA-TAP  
J-JACKS  
PARABEAM  
COLDR CAPTAIN  
CHANNEL COMMANDER  
PARALOG  
COMPANY ADDRESS  
401 WALNUT STREET  
PHILADELPHIA, PA. 19105  
COMPANY REPRESENTATIVES  
ROBERT GARNER  
1004 BELLE MEADE DRIVE  
BIRMINGHAM, ALABAMA  
205 836-7457  
JAMES FORGEY  
WESTERN REGIONAL SALES MGR  
1255 VETERANS PLVD  
REDWOOD CITY, CALIF  
415 365-5200  
ROBERT M PESICK  
2186 SO HOLLY AVENUE  
DENVER, COLO  
305 SK 6-6283  
WILLIAM ROBINSON  
S EASTERN REGIONAL SALES MGR  
1927 PIEDMONT CIRCLE, NE  
ATLANTA, GEORGIA 30324  
404 873-5546  
JAMES F SHANLEY  
CENTRAL REGIONAL SALES MGR  
PO BOX 2180  
W LA FAYETTE, IND 47906  
317 743-2055  
ROBERT BYRNE  
104 TUXEEO DRIVE  
SOUTH BEND, IND  
219 234-4458  
MELVIN GRAY  
40 LANTERN LANE  
SHARON, MASS  
617 828-0767  
JOHN DIECKMAN  
MIDWEST REGIONAL SALES MGR  
1334 ATLANTIC  
N KANSAS CITY, MO  
816 842-1130  
JOSEPH CONOWALL  
829 SO MAIN  
HORSEHEADS, NEW YORK  
607 734-2515  
ANTHONY DE LOSS  
297 NO ROCKY FORK DRIVE  
GAENNA, OHIO  
614 471-9243  
J C SPARKMAN  
3612 N E 82ND AVENUE  
PORTLAND, OREGON 97220  
503 255 1048  
HOWARD LOMAX  
N EASTERN REGIONAL SALES MGR  
401 WALNUT STREET  
PHILADELPHIA, PA 19105  
215 WA 5-9870  
JOSEPH CLIFFORD  
310 N 11TH STREET  
SUNBURY, PA  
717 286-2873  
RAY DAVIS  
23 S & T COURT  
YANKTON, SOUTH DAKOTA  
605 665-3072  
W E DART  
S WESTERN REGIONAL SALES MGR  
145 PAYNE STREET  
DALLAS, TEXAS 75207  
214 RI 2-8076

**JETRONICS INDUSTRIES, INC.**  
SALES MANAGER  
R. A. MEYER

COMPANY ADDRESS  
MAIN & COTTON STREETS  
PHILADELPHIA, PA. 19127

**J M ELECTRONICS COMPANY**  
BRAND NAMES  
J M

COMPANY ADDRESS  
29 JOSEPHINE DRIVE  
HAMPTON, N.H. 03842

**JOA CARTRIDGE SERVICE**  
SALES MANAGER  
JOHN H. HENNINGER

BRAND NAMES  
AUTOMATIC TAPE CONTROL  
BROADCAST ELECTRONICS  
EIMAC DIV. OF VARIAN  
MINNESOTA MINING & MFG  
NORTONICS  
TELEPRO INDUSTRIES  
ROBINS INDUSTRIES INC  
MAGNERASER  
COMPANY ADDRESS  
132 HEACOCK LANE  
WYNCOTE, PA. 19095  
TU 6-7993  
AND  
P.O. BOX 3087  
PHILADELPHIA, PA. 19150

AUSTIN, TEXAS 78703  
512-GL 2-2064

**HOLLAND ELECTRONICS, INC.**  
SALES MANAGER  
FRANK MANDARANO  
COMPANY ADDRESS  
772 EAST 53RD STREET  
BROOKLYN, NEW YORK 11203

**HOLLINGSWORTH SOLDERLESS TERMINAL COMPANY**  
SALES MANAGER  
J. C. LUOWICK  
COMPANY ADDRESS  
NUTT & FRENCH CREEK RDS.  
PHOENIXVILLE, PENN. 19460  
COMPANY REPRESENTATIVES  
BRANCH OFFICE  
5557 CAHUENGA BLVD  
N. HOLLYWOOD, CALIF.  
213-887-1555  
YOUNG & LAWRENCE ASSOC.  
70 MOSS LANE  
WINTER PARK, FLORIDA  
305 647 2528  
GENE PIETY FACTORS, INC.  
P. O. BOX 2903  
160 MAHAUEA ST  
HONOLULU-17, HAWAII

BRANCH OFFICE  
819 MANNHEIM ROAD  
WESTNESTER, ILL.  
312-681-3724  
WM S HUEY CO  
8726 OAK ST  
NEW ORLEANS, LA 70114  
504 866 6341  
BRANCH OFFICE  
4 GORDON STREET  
WALTHAM 54, MASS  
617-899-0004  
NORTHERN STATES SALES CO  
1109 W 78 1/2 STREET  
MINNEAPOLIS, MINN 55404  
612 866 3468  
MASTER INDUSTRIAL SUPPLY  
5010 UNION BLVD  
ST LOUIS, MO 63115  
314 EV 5 4431  
SIGMA ASSOCIATES  
315 FRANKLIN PLACE  
SOUTH ORANGE, N J  
201 SO 3 0573  
FRANK W TAYLOR CO  
P O BOX 86  
DEWITT, NEW YORK  
315 446 0422  
M FRANCIS HAGER  
ROUTE 1 BOX 423  
MATTHEWS, N CAROLINA  
704 847 9262  
BRANCH OFFICE  
17705 EUCLID AVENUE  
CLEVELAND 12, OHIO  
216-KE-1-3411  
T J HARRINGTON  
BOX 12471  
MEMPHIS, TENN 38112  
901 452 2606  
JOHN T. ROBBINS  
8005 HAYDEN DRIVE  
KNOXVILLE, TENNESSEE  
615-588-2424  
LUNO & COMPANY  
2215-N OLIVE STREET  
DALLAS 1, TEXAS  
214 RI 8 8839  
WM. R. LANPHEAR  
4031 STONEYWAY AVE NORTH  
SEATTLE WASH 98103  
206-AT-48150

**HOUSTON ELECTRONICS COMPANY**  
SALES MANAGER  
JAMES F. LOCKETT  
COMPANY ADDRESS  
7103 WALKWAY ST.  
HOUSTON, TEXAS 77036  
COMPANY REPRESENTATIVES  
KOCH ENGINEERING & SALES CO.  
13818 KINGSRIDE LANE  
HOUSTON TEXAS  
713-323-7051

**HOUSTON FEARLESS CORPORATION**  
SALES MANAGER  
BERT ROSENBERG  
BRAND NAMES  
LABMASTER  
COMPANY ADDRESS  
11801 W OLYMPIC BLVD.  
LOS ANGELES, CALIF. 90064  
COMPANY REPRESENTATIVES  
RONALD NARGI  
103 CONSTOCK HILL ROAD  
NORWALK, CONN  
847 5225  
JOHN PAYNTER  
SUITE 401 1413 K ST N W  
WASHINGTON, O C  
EX 3 0800  
BREEN LANSFORD  
2126 MOHAWK TRAIL  
MAITLAND, FLA  
305 644 8512  
GORDON TAYLOR  
404 WEST OAK ST  
ROME, NEW YORK  
314 FF 7 4240  
HOWARD INGLE  
125 SHELDON DRIVE  
CENTERVILLE, OHIO  
CL 3 7111

**HUGHEY & PHILLIPS, INC**  
SALES MANAGER  
C. E. STEPHENS  
COMPANY ADDRESS  
3050 NORTH CALIFORNIA ST.  
BURBANK, CALIFORNIA 91503  
COMPANY REPRESENTATIVES  
HENRY J. GEIST  
19 BAYWATER DR.  
DARIEN, CONN. 06820  
203-324-7300  
ROBERT L. LANG  
6733 N. OLMSTEAD AVE  
CHICAGO, ILL. 60631  
312-774-3610  
FAION LOTT  
P. O. BOX 534  
GLEN BURNIE, MARYLAND 21061  
301-944-5155  
WALTER C. WERNER  
313 WOODLAND MANOR  
NEW SHREWSBURY, N. J. 07724  
201-542-0732  
TOM SEARS  
4801 READING STREET  
DALLAS, TEXAS 75247  
214-631-6280

**HUNT-PIERCE CORPORATION**  
SALES MANAGER  
CLAUDE B COPELAND  
BRAND NAMES  
SERVI-LIFT  
SERVI-CLIP  
COMPANY ADDRESS  
230 OLD GATE LANE  
MILFORD, CONN 06460  
COMPANY REPRESENTATIVES  
ARTHUR S. PARKER, JR. AND  
HARRY W. KINGHORN  
230 OLD GATE LANE  
MILFORD, CONN.  
878-7491  
FRANK W. MORRIS  
BOX 16773  
OKLAHOMA CITY, OKLA.  
842-1844  
CARSON C. BITNER  
824 RENEL ROAD  
MORRISTOWN, PA.  
279-2255

**HY-GAIN ELECTRONICS CORPORATION**  
SALES MANAGER  
JACK C. SCHNEIDER  
BRAND NAMES  
HY-GAIN  
COMPANY ADDRESS  
NE HWY. 6 AT STEVENS CREEK  
LINCOLN, NEBRASKA 68501  
COMPANY REPRESENTATIVES  
D BELLEW SALES CO  
1005 W. 4TH ST.  
EL DORADO, ARK.  
501-UM 3-8325  
H. RECKER CO., INC.  
1140 CRENSHAW BLVD  
LOS ANGELES, CAL.  
213-WE 1-1257  
W. J. PURDY CO.  
312 SEVENTH ST.  
SAN FRANCISCO, CAL.  
415-863-3300  
AES, INC.  
1549 CHESTER STREET  
AURORA, COLO.  
366-D208  
V. A. MCCORVEY  
2187 BRIARCILIFF RD. NE  
DECATUR, GA.  
404-636-2502  
W. LINZ & ASSOC.  
4001 W. DEVON  
CHICAGO, ILL  
MU-5-6060  
JACK WEST  
6747 N. OCTAVIA AVE  
CHICAGO, ILL  
313-763-3500  
E. D. MAGNUS & ASSOCIATES  
EXPORT  
5715 NO LINCOLN AVE  
CHICAGO, ILL  
312 334 1503  
FISHMAN ASSOC.  
BOX 4038  
INDIANAPOLIS, IND.  
CL-1-2401  
COAKLEY, BOYO & ABRETT  
1424 HIGHLAND AVE  
NEEDHAM, MASS.  
617-444-5470  
ABM SALES, INC.  
10116 PURITAN  
DETROIT, MICH.  
UN 2-1300  
F. B. HILL CO.  
5110 EXCELSOR BLVD  
MINNEAPOLIS, MINN.  
929-6727  
FLORENCE & MEYER, INC.  
406 WEST 34TH ST.  
KANSAS CITY, MO.  
816-LOI-7282  
M. BETTAN SALES, INC.  
77-15 164TH ST.  
FLUSHING, N. Y.  
OL 7-6659  
PASTON-HUNTER CO., INC.  
2002 TEALL AVE  
SYRACUSE, N. Y.  
437-2992  
F. OHMAN  
BOX 363  
TWINSBURG, OHIO  
216-425-7445

# VIDEO TEST TERMINATIONS



Type PL 259

Type N

Type BNC

HOLLAND ELECTRONICS Precision Test Terminations provide a simple, convenient method for accurately terminating pulse, video and RF coaxial cables. These terminations eliminate undesirable reflections and provide an easily accessible test terminal for checking waveform and level.

The terminating elements are low noise 1% metal film resistors and can be supplied in any value required.

## TEST TERMINATION PLUGS



Tip Jack

Front View

Solder Lug

HOLLAND ELECTRONICS Coaxial Test Termination Plugs are designed for use in Pulse, Video and RF patching systems. These terminations provide a means of properly terminating a line in its characteristic impedance and in addition have access to the center conductor for examination of signal under terminated conditions.

Plugs contain a 1/2W, 1% tolerance low noise resistor. All contact surfaces are heavy gold plated. Choice of test terminal between solder lug or pin tip jack (for 0.080 dia. test probes) color coded, Green 50 ohms, Violet 75 ohms, White 93 ohms. Plugs are compatible with RCA or W.E. patching systems.

## FIXED PAD ATTENUATORS



Type AUHF

Type AN

Type ABNC

HOLLAND ELECTRONICS Fixed Pad Attenuators are precision coaxial assemblies designed for use in pulse, video and RF circuits. Fully enclosed ruggedized metal construction provides shielding and protects the low noise 1% tolerance metal film resistors used in the attenuation networks. Careful design assures good high frequency response to 250 megacycles.

Attenuators are available in any desired db value from 1 through 60 db in 1 db steps. Standard impedances are 50, 75 and 93 ohms. Standard connectors are UHF, N and BNC. Type UHF and BNC attenuators are rated at 1/2 watt; type N at 1 watt. Special units can be supplied with any impedance or attenuation, multiple outputs, different input and output connectors, type TNC and C connectors, test terminals, etc. Impedance matching attenuators are also available.

# HOLLAND ELECTRONICS, INC.

722 EAST 53 STREET • BROOKLYN, NEW YORK 11203 • 212-451-1132

F. F. JOHNSON COMPANY

SALES MANAGER  
C. TRAVIS MARSHALL  
BRAND NAMES  
VIKING  
MESSENGER  
COMPANY ADDRESS  
299 10TH AVENUE, S.W.  
WASECA, MINNESOTA 56093  
507-835-2050  
COMPANY REPRESENTATIVES  
LOGAN SALES COMPANY  
REDWOOD CITY, CALIF  
415 369-6726  
WALLACE & WALLACE  
LOS ANGELES, CALIF  
213 747-0401  
MCLOUD & RAYMOND CO  
DENVER, COLO  
303 756-1589  
MILLAR-HUTTO ASSOC., INC  
ATLANTA, GEORGIA  
404 867-0919  
ELLINGER SALES CORPORATION  
CHICAGO, ILLINOIS  
312 763-1570  
JERRY VRBIC CO  
CEDAR RAPIDS, IOWA  
319 365-0461  
EARL K MOORE CO  
NEW ORLEANS, LA  
504 488-2407  
PAUL R STURGEON, INC  
CHESTNUT HILL, MASS  
617 734-7710  
A B M SALES, INC  
DETROIT, MICHIGAN  
313 862-1300  
H A ROSS & CO  
KANSAS CITY, MISSOURI  
816 221-0866  
R W MITSCHER CO., INC  
BUFFALO, NEW YORK  
716 854-2517  
F EDWIN SCHMITT CO  
ELMONT, L.I., NEW YORK  
516 437-8150  
ROBURN AGENCIES, INC - EXPORT  
NEW YORK, NEW YORK  
212 966 2130-2  
MC FAOEN SALES CO  
COLUMBUS, OHIO  
614 221-3363  
S K MAC DONALD, INC  
PHILADELPHIA, PA  
215 545-1205  
ROBERT E NESBITT CO  
DALLAS, TEXAS  
214 357-4601  
E F JOHNSON CO SEATTLE OFFICE  
MERCER ISLAND, WASHINGTON  
206 232-6242  
REPS. IN OTHER COUNTRIES  
A C SIMMONDS & SONS, LTD.  
TORONTO, ONTARIO  
416 485-9111

JOHNSON ELECTRONICS, INC.

SALES MANAGER  
RALPH L. WEBER  
BRAND NAMES  
JOHNSON-AIR  
COMPANY ADDRESS  
P.O. BOX 7, HWY. 17-92  
CASSELBERRY, FLORIDA 32707  
305 838-2111  
COMPANY REPRESENTATIVES  
MIKE NEWTON  
HYDE ELECTRONICS CO., INC  
4710 N 16TH STREET  
SUITE 109  
PHOENIX, ARIZONA 85015  
602 264-5609  
WAYNE WAINWRIGHT  
TELEPACIFICOM  
PO BOX 926  
LOS GATOS, CALIF  
408 354-1411  
DICK HYDE  
HYDE ELECTRONICS CO., INC  
888 SO LIPAN STREET  
DENVER, COLO 80223  
303 936-3455  
SCOTT ORMSBY  
SCOTT ORMSBY SALES  
230 20TH STREET  
NEW ORLEANS, LA 70124  
504 488-2414  
LEE DAVIS  
HYDE ELECTRONICS CO., INC  
5206 CONSTITUTION AVE., NE  
ALBUQUERQUE, N MEXICO 87110  
505 265-8895  
ERNEST L WILKS  
EL WILCO  
PO BOX 14466  
DALLAS, TEXAS 75234  
214 242-5321  
PAUL POWERS  
HYDE ELECTRONICS CO., INC  
2422 CAMINO WAY  
SALT LAKE CITY, UTAH 84121  
801 278-4465

JORDAN ELECTRIC COMPANY

SALES MANAGER  
BOYO M. BARTON  
COMPANY ADDRESS  
14707 KESWICK STREET  
VAN NUYS, CALIF. 91405

KAHN RESEARCH LABORATORIES INC

BRAND NAMES  
ECHOPLEX

SYMMETRA-PEAK  
VOICEPLEX  
COMPANY ADDRESS  
81 SOUTH BERGEN PLACE  
FREEPORT, NEW YORK 11520

KAISER-COX CORPORATION

SALES MANAGER  
WALT BAXTER  
505 SO WOODBURY RD  
PITMAN, N J 08071  
609 589 0330  
BRAND NAMES  
PHONECIAN  
KASIER-COX  
THUNDERBIRD  
OMPANY ADDRESS  
2216 W. PEORIA AVE. BOX 9728  
PHOENIX, ARIZONA 85022  
COMPANY REPRESENTATIVES  
JAMES TAGLIA  
2292 N PEACHTREE COURT  
CHAMBLEE, GEORGIA 30005  
404 451 0011  
CHARLES LEYRER  
1099 D IRONGATE LANE  
COLUMBUS, OHIO  
GEORGE E BARRY  
14622 CHERRY HILLS DRIVE  
DALLAS, TEXAS 75234  
214 247 4223

THE KALART COMPANY INC

EXEC. VP  
L. QUARTIN  
SALES MANAGER TELE-BEAM DIV  
R. ZEITLER  
BRAND NAMES  
CRAIG  
KALART  
KALART VICTOR  
SOUNDSTRIP  
TELE-BEAM  
VICTOR ANIMATOGRAPH  
VICTOR SOUNDVIEWS  
COMPANY ADDRESS  
PLAINVILLE, CONN. 06062  
COMPANY REPRESENTATIVES  
MORT GOLDBERG  
154 VALLEY ROAD  
COS COB, CONN  
JOHN J HARNETT  
275 E 201ST STREET  
BRONX 58, NEW YORK

KAPPA NETWORKS, INC

SALES MANAGER  
STANLEY L PEARL  
BRAND NAMES  
TINY TRIM  
SUPER-N  
COMPANY ADDRESS  
165 ROOSEVELT AVENUE  
CARTERET, N J 07008  
COMPANY REPRESENTATIVES  
RAYMARG  
P O BOX 515  
SANTA CLARA, CALIF  
248 5199  
WESTERN ELECTRONIC COMPONENTS  
4301 BIRCH ST  
NEWPORT BEACH, CALIF  
631 6110  
BE-MAR ASSOCIATES  
1016 ABINGTON ROAD  
CHERRY HILL, NEW JERSEY  
428 6390  
BERTRAM D AARON & CO  
P O BOX 186  
ROSLYN, L I, NEW YORK  
MA 1 0630  
JOHN O OLSEN CO  
16201 SHAKER BOULEVARD  
CLEVELAND, OHIO  
752 5444  
JOHN O OLSEN CO  
5539 STOKESWOOD COURT  
CINCINNATI, OHIO  
922 2176  
BE-MAR ASSOCIATES  
P O BOX 556  
FALLS CHURCH, VIRGINIA  
534 1004  
REPS IN OTHER COUNTRIES  
UNI-OFFICE, N V  
P O BOX 1122  
ROTTEROAM, HOLLAND

KARG LABORATORIES INC

SALES MANAGER  
J. CURTIS  
COMPANY ADDRESS  
162 ELY AVENUE  
SOUTH NORWALK, CONN. 06856

MATHIAS KLEIN & SONS

SALES MANAGER  
C. F. CASTINO  
COMPANY ADDRESS  
7200 MCCORMICK RD.  
CHICAGO, ILLINOIS 60645

KLINE IRON & STEEL COMPANY

SALES MANAGER  
J. R. TROTTER  
1225 HUGER STREET  
COLUMBIA, S. C. 29202  
AL 4-0301  
BRAND NAMES  
KIMCO  
COMPANY ADDRESS  
P O BOX 1013  
COLUMBIA, S. C. 29202

KOSS ELECTRONICS INC

SALES MANAGER  
GREG CORNEHLS  
BRAND NAMES  
ACOUSTECH  
REK-O-KUT  
KOSS  
COMPANY ADDRESS  
2227 NORTH 31 STREET  
MILWAUKEE, WISCONSIN 53208  
COMPANY REPRESENTATIVES  
F W MOULTHROP & ASSOC  
1930 EAST 12 STREET  
OAKLAND, CALIFORNIA 94606  
415 261 7676  
SHEPARD WINTERS STERN  
4109 BURBANK BLVD  
BURBANK, CALIF 91505  
213 849 6671  
JOHN ROWE & ASSOC  
58 & VALLEY HWY, SUITE 2170  
DENVER, COLO 80216  
303 429 4595  
JOSEPH ANDERSON  
3138 BRINKLEY ROAD, APT 3  
WASHINGTON, D. C. 20031  
202 894-3455  
DOW FITZGERALD  
6231 SOUTH CHURCH  
TAMPA, FLORIDA 33616  
813 834 3981  
R A CHALMERS  
349 PEACHTREE HILLS AVE., NE  
ATLANTA, GEORGIA 30305  
404 253 3208  
MARTIN BORTISM  
139 MAIN STREET  
CAMBRIDGE, MASS 02142  
617 354 3742  
GROSSMAN SALES CO  
339 AUBURN STREET  
AUBURNDALE, MASS 02166  
617 527 7753  
CARMINE A VIGNOLA ASSOC  
21 SCHELLRIDGE ROAD  
JEFFERSON CITY, MO 65101  
314 635 1023  
BACH SALES CORP  
26 MAHAN ROAD  
OLO BETHPAGE, NEW YORK 11804  
212 687 1240  
SCHROEDER SALES CO  
2254 EUCLID AVENUE  
CLEVELAND, OHIO 44115  
216 621 5074  
BRENOAN OHARA  
4952 WYNNFIELD AVENUE  
PHILADELPHIA, PENN 19131  
215 473 3654  
MAYNARD SALES CO  
158 EXPRESS STREET  
DALLAS, TEXAS 75207  
214 742 2384  
VECTOR CORP  
307 WALL STREET  
SEATTLE, WASHINGTON 98121  
206 623 6891  
REPS. IN OTHER COUNTRIES  
KOSS - IMPETUS  
2 VIA BERNA  
LUGANO, SWITZERLAND  
91 38214  
A. C. SIMMONDS & SONS  
100 MERTON STREET  
TORONTO, ONTARIO  
416 485 9111

HERB KRECKMAN CO

SALES MANAGER  
HERB KRECKMAN  
BRAND NAMES  
KRECO ANTENNAS  
COMPANY ADDRESS  
CRESCO, PA. 18326  
COMPANY REPRESENTATIVES  
WAMBLE SALES CO  
3745 MARIE COOK DRIVE  
MONTGOMERY, ALABAMA  
205 272 4600  
HOFFER ENTERPRISES  
129 FIFTH AVE  
ANCHORAGE, ALASKA  
C H MITCHELL CO  
18531 VENTURA BLVD  
TARZANA, CALIF  
881 2626  
JOHN ANDERSON CO., INC  
5231 HUMBOLT AVE  
SO MINNEAPOLIS, MINN  
612 823 6459  
H A ROSS & CO  
260 S CHERRY  
KANSAS CITY, MO  
816 221 0866  
ED BRADDOCK  
BOX 305  
HADDONFIELD, N. J.  
609 429 0087  
CHESTER DREXLER  
3 LEE DRIVE  
SO FARMINGDALE, L.I. N.Y.  
516 249 8206  
OHIO ASSOC  
BOX 728  
LIMA, OHIO  
VAUGHNSVILLE 6500  
WYBORNY SALES CO  
BOX 17070  
DALLAS, TEXAS  
214 381 4645  
DON KOHLER  
11532 4TH AVE NE  
SEATTLE, WASHINGTON  
206 363 1439

KRS INSTRUMENTSDIV OF DATAPIPSE, INC

SALES MANAGER  
JAMES S. JOHNSON  
BRAND NAMES  
STACT  
STACTAPE  
COMPANY ADDRESS  
1313 N. LINCOLN AVE.  
PASADENA, CALIF. 91103  
213 601 7416  
TWX 910 588 3282  
COMPANY REPRESENTATIVES  
W A BROWN & ASSOCIATES, INC  
1314 BUFORD STREET, N W  
HUNTSVILLE, ALABAMA 25801  
HYTRONIC MEASUREMENTS  
1017 N THIRD ST  
PHOENIX, ARIZONA 85004  
THE THORSEN COMPANY  
6824 MELROSE AVENUE  
LOS ANGELES, CALIF. 90038  
HYTRONIC MEASUREMENTS, INC  
1295 SOUTH BANNOCK STREET  
DENVER, COLORADO 80223  
INSTRUMENT CONSULTANTS, INC  
2381 WHITNEY AVENUE  
HAMDEN, CONN 06518  
W A BROWN & ASSOCIATES, INC  
222 WEBER AVENUE  
ORLANDO, FLORIDA 32803  
W A BROWN & ASSOCIATES  
3039 NE 32ND AVE  
FORT LAUDERDALE, FLA 33308  
RIDGWAY ASSOCIATES, INC  
3759 N HARLEM AVENUE  
CHICAGO, ILLINOIS 60634  
LEEMARK ASSOCIATES, INC  
4518 WEST 89TH STREET  
PRAIRIE VILLAGE, KAN. 66207  
WITCO ELECTRONICS  
3919 WILLOW DR  
WICHITA, KANSAS  
BRIMBERG ASSOCIATES, INC  
110 E PENNSYLVANIA AVE  
TOWSON, MD. 21204  
BRIMBERG ASSOCIATES, INC  
814 THAYER AVENUE  
SILVER SPRINGS, MO. 20910  
INSTRUMENT CONSULTANTS, INC  
P O BOX 25  
WABAN, MASS. 02168  
RIDGWAY ASSOCIATES, INC  
7720 MORGAN AVENUE SOUTH  
MINNEAPOLIS, MINN 55423  
LEEMARK ASSOCIATES, INC  
2001 BI BENO BLVD  
ST LOUIS, MO. 63117  
WITKO ELECTRONICS  
P O BOX 125  
FAIRBURY, NEBRASKA  
DATA REP ASSOCIATES  
P O BOX 645  
RIDGWOOD, N J 07451  
HYTRONIC MEASUREMENTS, INC  
205 SAN PABLO, S E  
ALBUQUERQUE, N M 87108  
J D RYERSON ASSOCIATES, INC  
P O BOX 1400  
SYRACUSE, N Y 13201  
DATA REP ASSOCIATES  
BOX 164, HUNTINGTON STATION  
HUNTINGTON, L I, N Y  
W A BROWN ASSOCIATES, INC  
440 WEST-END BLVD  
WINSTON-SALEM, N.C. 27101  
RIDGWAY ASSOCIATES, INC  
22811 LORAIN ROAD  
FAIRVIEW PARK, OHIO  
RIDGWAY ASSOCIATES, INC  
2400 E DOROTHY LANE  
DAYTON, OHIO 45420  
DATA REP ASSOCIATES  
BOX 349  
NORRISTOWN, PENN  
WITKO INC  
435 BRANIFF BUILDING  
DALLAS, TEXAS  
AIREP ELECTRONICS, INC  
P O BOX 36211  
HOUSTON, TEXAS 77036  
AIREP ELECTRONICS, INC  
P O BOX 9555  
DALLAS, TEXAS 75214  
HYTRONIC MEASUREMENTS, INC  
2022 SOUTH MAIN STREET  
SALT LAKE CITY, UTAH 84115  
W A BROWN & ASSOCIATES, INC  
325 FIRST STREET  
ALEXANDRIA, VA 22314  
THE THORSEN COMPANY  
1767 15TH AVENUE SOUTH  
SEATTLE, WASH 98144  
REPS. IN OTHER COUNTRIES  
DELTA EQUIPMENT S A  
28 RUE DE TABELLION  
BRUXELLES 5, BELGIUM  
OMNI RAY GMBH  
NYMPHENBURGER STRASSE 164  
MUNICH 19, WEST GERMANY  
ENVIRONMENTAL EQUIPMENTS, LTO  
STATION YARO  
WOKINGHAM, BERKS, ENGLAND  
GENERAL TEST INSTRUMENTS, LTD  
GLOUCESTER TRADING ESTATE  
HUCKLECOTE, GLOUCESTER, ENG.  
MEL SALES LIMITED  
71 CROCKFORD BLVD  
SCARBOROUGH, ONTARIO  
MEL SALES LIMITED  
P O BOX 1352, POSTAL STA. O  
MONTREAL, QUEBEC  
SIMON GRAY PTY LTO  
28 ELIZABETH STREET  
MELBOURNE, CI, AUSTRALIA



**LACROSSE ELECTRONICS, INC.**  
SALES MANAGER  
KIT VAIL  
COMPANY ADDRESS  
P.O. BOX 102  
LACROSSE, WISCONSIN 54601  
782-6042

**LAFAYETTE RADIO ELECTRONICS**  
SALES MANAGER  
J. RUSSELL  
BRAND NAMES  
ARGONNE-R  
COMPANY ADDRESS  
111 JERICHO TURNPIKE  
SYDSEY, L.I. • N. Y. 11791

**LAKE ELECTRONICS, INC.**  
VICE PRESIDENT-MARKETING  
R. J. TANCZOS  
BRAND NAMES  
LAKE-GERHARD  
COMPANY ADDRESS  
3311 PERKINS AVENUE  
CLEVELAND, OHIO 44114  
216 431 6212

**LAMPKIN LABORATORIES INC.**  
SALES MANAGER  
DAVID A. BOYERS  
COMPANY ADDRESS  
BRADENTON, FLORIDA 33505

**LANG ELECTRONICS, INC.**  
COMPANY ADDRESS  
507 FIFTH AVE  
NEW YORK, NEW YORK 10017

**LANGEVIN, DIVISION SCIENTIFIC INDUSTRIES, INC.**  
SALES MANAGER  
JOHN SWANSON  
BRAND NAMES  
LANGEVIN  
COMPANY ADDRESS  
1801 E. CARNEGIE AVE.  
SANTA ANA, CALIF. 92705  
546-8830  
COMPANY REPRESENTATIVES  
KOESSLER SALES CO  
818 NORTH FAIRFAX AVE  
LOS ANGELES, CALIF  
213 OL 3 1605  
RON BOWEN & ASSOC  
721 SOUTH BROADWAY  
DENVER 9, COLO.  
303 SH 4 2501  
J E JOYNER ASSOCIATES  
P O BOX 10821 STA A  
868 YORK AVE, SW  
ATLANTA, GA 30310  
404 758 7496  
IRVING W. ROSE ASSOC  
4734 N. AUSTIN AVE  
CHICAGO, ILL  
312 AV 2 8835  
GENE ROSEN & ASSOC  
9501 WADSWORTH DRIVE  
BETHESDA, MARYLAND  
301 365 5113  
TECH REP ASSOC  
BOX 161, 17 ANDREW ROAD  
TOPSFIELD, MASS  
617 887 8671  
RILEY & PETCHELL ELECT SALES  
13209 FENKELL  
DETROIT 27, MICH.  
313 VE 8 9100  
SMITH-MEKER ENGINEERING CO  
157 CHAMBERS ST  
NEW YORK, NEW YORK  
212 W 4 5510  
THE M. SIMONS & SON CO., INC  
EXPORT  
150 BROADWAY  
NEW YORK, N. Y.  
212 BA 7-5513  
SCHROEDER SALES CO  
2254 EUCLID AVE  
CLEVELAND, OHIO  
216 MA 1 5075  
HAYS COMPANY  
BOX E, 405 N. BOWSER  
RICHARDSON, TEXAS  
214 AD 1 1426  
WILLIAM R. LANPHEAR CO  
4031 STONEMAN NORTH  
SEATTLE, WASH  
206 ME 3 4900  
REPS. IN OTHER COUNTRIES  
E. J. PIGGOTT ENTERPRISES  
274 CHURCH STREET  
TORONTO, ONTARIO  
416 363 9141

**LANE ELECTRONICS, INC.**  
SALES MANAGER  
DAVID A. BOYERS  
COMPANY ADDRESS  
BRADENTON, FLORIDA 33505

**JAMES B. LANING SOUND CO.**  
BRAND NAMES  
JBL  
COMPANY ADDRESS  
3249 CASITAS AVE.  
LOS ANGELES, CALIF. 90039

**LAVIOLETTE ELECTRONICS**  
SALES MANAGER  
DORIS A. LAVIOLETTE  
COMPANY ADDRESS  
26077 FARMFIELD ROAD  
CALABASAS, CALIF. 91302

**LENKURT ELECTRIC CO INC.**  
SALES MANAGER  
JAY NAUGLE  
BRAND NAMES  
AGAMP  
DATATEL  
LENKURT

**MICROTEL**  
MOBILETEL  
COMPANY ADDRESS  
1105 COUNTY ROAD  
SAN CARLOS, CALIFORNIA 94070  
591 8461  
COMPANY REPRESENTATIVES  
KEN K. HIGGINS  
LENKURT ELECTRIC CO., INC  
845 THIRD AVE 12TH FLOOR  
NEW YORK, N.Y. 10022  
355 1507  
M. C. ROYALTY  
LENKURT ELECTRIC CO., INC  
340 NORTHCREST BLDG  
8609 NORTHWEST PLAZA DR  
DALLAS, TEXAS 75225  
363 0286

**LENZ ELECTRIC MANUFACTURING COMPANY**  
SALES MANAGER  
R. G. ZENDER  
COMPANY ADDRESS  
1751 NORTH WESTERN AVE.  
CHICAGO, ILLINOIS 60647  
COMPANY REPRESENTATIVES  
R. HALES PRIDMORE & ASSOC  
1225 E NORTHVIEW AVE  
PHOENIX, ARIZONA  
944 9631  
PENWARDEN ASSOC, INC  
14547 TITUS ST  
VAN NUYS, CALIF  
ST 2-4920  
WINCO CORP  
257 CASTRO ST  
P O BOX 881  
MOUNTAIN VIEW, CALIF  
961 8510  
MEL FOSTER CO., INC  
228 SO CEDAR LAKE ROAD  
MINNEAPOLIS, MINN  
374 2612  
NORMAN W. KATHRINUS & CO  
2427 BRENTWOOD BLVD  
ST LOUIS, MISSOURI  
WO 2 5627  
MCFADDEN SALES CO  
150 EAST BROAD ST  
COLUMBUS, OHIO  
221 3363  
DANCO CORP  
GERMANTOWN PIKE &  
QUARRY HALL ROAD  
FAIRVIEW VILLAGE, PA  
CH 8 1619  
CAMPION SALES CO  
9002 CHANCELLOR ROW  
DALLAS, TEXAS 75207  
ME 1 3390

**LEWIS AND KAUFMAN LTD.**  
DIRECTOR OF MARKETING  
CHARLES A. TEPPER  
BRAND NAMES  
LEWIS & KAUFMAN  
L & K  
COMPANY ADDRESS  
107 TRUMBULL STREET  
ELIZABETH, NEW JERSEY 07206

**LIBERTY TOWER MFG CO.**  
SALES MANAGER  
B. J. GRIFFITH  
COMPANY ADDRESS  
RT 45 NORTH, BOX 161  
EFFINGHAM, ILLINOIS  
COMPANY REPRESENTATIVES  
GLEN GRIFFITH  
DIETERICH, ILL  
925 3032  
E. A. MARTEN  
EFFINGHAM, ILL  
342 2835  
A. D. GRIFFITH  
EFFINGHAM, ILL  
342 2835  
B. J. GRIFFITH  
EFFINGHAM, ILL.  
342-2835  
BILLY GRIFFITH  
8900 N. E. 51ST  
OKLAHOMA CITY, OKLA  
PR 1 3749  
ART GRIFFITH  
7900 S SHIELDS  
OKLAHOMA CITY, OKLA  
ME 4 8779

**LIGHTING & ELECTRONICS INC.**  
SALES MANAGER  
N. J. SONNENFELD  
COMPANY ADDRESS  
423 SOUTH BROADWAY  
YONKERS, NEW YORK 10705  
COMPANY REPRESENTATIVES  
R C LURIE COMPANY  
4718 N 35TH PARKWAY  
PHOENIX 14, ARIZONA  
602 264 5904  
CALIFORNIA LIGHTING SALES  
3035 WEST 7TH ST  
LOS ANGELES 5, CALIF  
213 388 3176  
DESCO  
6232 EEL COURT  
N HIGHLANDS, CALIF  
916 331 5249  
GREGG N CLOUDS CO  
977 JACKSON ST  
DENVER, COLORADO 80206  
303 355 0660  
WYMAN/YOUNG ASSOC  
6 PRATT STREET  
ROCKY HILL, CONN 06067

203 529 2019  
K. DALE RHODES  
333 N. OCEAN BLVD  
DEERFIELD BEACH, FLORIDA  
305 399 7389  
DON REIMAN & ASSOC  
419 NORTH AVE., N. E.  
ATLANTA, GEORGIA 30305  
404 231 1972  
VERN WINN  
1121 LONGWOOD CIRCLE  
LOUISVILLE, KY 40223  
502 899 9940  
GREGORY-SALISBURY & CO INC  
805 S FRONT STREET  
NEW ORLEANS, LA 70130  
504 524 5207  
GREGORY-SALISBURY & CO INC  
P O BOX 1126  
BATON ROUGE, LA 70003  
504 342 2873  
RICHARD B MURDOCH  
7300 BAYLOR AVE  
COLLEGE PARK, MD 20741  
301 GR 4 5790  
WYMAN/YOUNG ASSOCIATES  
128 ORCHARDVIEW AVE  
WEST SPRINGFIELD, MASS 01089  
413 739 2631  
GERALD FINN  
4892 FULLER AVE S E  
GRAND RAPIDS, MICHIGAN 48211  
616 534 8327  
LIGHTING ASSOCIATES  
1961 E MILWAUKEE AVE  
DETROIT, MICH 48211  
313 875 2757  
GREGORY-SALISBURY CO INC  
350 N MART PLAZA, BOX 9767  
JACKSON, MISS 39026  
601 EM 2 1671  
P M ERWIN ASSOCIATES  
3738 WASHINGTON BLVD  
ST LOUIS 8, MO  
314 JE 5 8651  
TED STUART  
47 DARTMOUTH DRIVE  
DELTRAN, NEW JERSEY  
609 HD 1 6875  
WILLIAM MAY & ASSOCIATES  
57 FIRST STREET  
PEQUANOCK, N J 07440  
201 656 2578  
RUSSELL ERICSSON AGENCY  
1100 ALVARADO DRIVE NE  
ALBUQUERQUE, NEW MEXICO  
505 242 9589  
HEADQUARTERS  
423 SOUTH BROADWAY  
YONKERS, NEW YORK 10705  
914 965 7050  
WARREN A BRENNAN  
15 PIERPORT DRIVE  
WILLIAMSVILLE, N Y 08075  
716 633 8225  
FRANK SWEENEY AGENCY  
225 WIN HILLS DRIVE  
SYRACUSE, N Y 14221  
315 475 0662  
S L BAGBY CO  
322 W MOREHEAD ST  
CHARLOTTE 1, N CAROLINA  
704 334 2821  
WARREN LEHR ASSOC, INC  
1890 NORTHWEST BLVD  
COLUMBUS, OHIO 43212  
614 488 5939  
ROBERT EIMS ASSOC  
224 N E 61ST STREET  
OKLAHOMA CITY, OKLA  
405 VJ 3 0874  
M B MOORE, JR & ASSOC  
BOX 463  
MYRTLE BEACH, S C 29577  
803 449 5881  
GREGORY-SALISBURY & CO INC  
P O BOX 6166  
MEMPHIS, TENN 38106  
901 948 0496  
W J CHILDERS  
5811 MALETTO LANE  
DALLAS, TEXAS 75230  
214 AD 9 3684  
MICHAEL PRICE  
BOX 222  
N SALT LAKE CITY, UTAH 84110  
801 295 3435  
LYNN H MORRIS  
452 HIGH STREET BOX 349  
SALEM, VIRGINIA 24153  
703 389 5798

**LINDSAY SPECIALTY PRODUCTS LTD.**  
BRAND NAMES  
LINDSAY  
COMPANY ADDRESS  
50 MARY ST. W  
LINDSAY, ONTARIO

**LIPPS INC.**  
VICE PRESIDENT - SALES  
BERNARD D. LIPPS  
BRAND NAMES  
LIPPS, INC  
COMPANY ADDRESS  
1630 EUCLID STREET  
SANTA MONICA, CALIF. 90404  
393-0449  
COMPANY REPRESENTATIVES  
WILLIAM F. LANGLEY  
8219 RHEA AVE  
NORTHBRIDGE, CALIF  
349-6694

**LITTELFUSE INC.**  
VICE PRES & SALES MANAGER

WALTER A. CLEMENTS  
BRAND NAMES  
MICROFUSE  
PICDFUSE  
SLD-BLO  
COMPANY ADDRESS  
800 E NORTHWEST HWY  
DESPAINES, ILL 60016  
312 824-1188  
COMPANY REPRESENTATIVES  
HARRY MOORE SALES CO  
4142 N 18TH  
PHOENIX, ARIZONA  
602 274 0060  
WM. J. PURDY CO.  
312 7TH STREET  
SAN FRANCISCO, CALIF.  
415 863 3300  
JACK BERMAN CO., INC.  
1751 S. LA CIENEGA  
LOS ANGELES, CALIF.  
213 870 4711  
MCLOUD & RAYMOND COMPANY  
2151 S. GRAPE  
DENVER, COLORADO  
303 756 1589  
FRANK C. NICKERSON CO  
1244 CLAIRMONT, STE 220  
DECATUR, GEORGIA  
404 636-2752  
RILL KOLANS & COMPANY  
P.O. BOX 2098  
HONOLULU, HAWAII 96805  
811 628  
MARAL SALES CORP  
5787 N LINCOLN  
CHICAGO, ILL 60645  
312 561 7290  
CRESCENT INTERNATIONAL  
540 N. LAKE SHORE  
CHICAGO, ILLINOIS  
312 337 2292  
DEVUE ASSOCIATES  
4010 WASHINGTON BLVD.  
INDIANAPOLIS, IND.  
317 283 1395  
THOMAS-MODRIN ASSOC., INC.  
P.O. BOX 189  
SHAWNEE MISSION, KANSAS  
913 432 2131  
CHARLES SEGAL CO.  
799 WASHINGTON  
NEWTONVILLE, MASS.  
617 969 6900  
R. C. MERCHANT & CO., INC.  
18411 W. MCNICHOLES  
DETROIT, MICH.  
313 535 6000  
NORTHERN STATE SALES CO  
1109 W 78 1/2 ST  
MINNEAPOLIS, MINNESOTA  
612 333-2431  
BRESSLER ASSOCIATES  
4808 BERGENLINE  
UNION CITY, N.J.  
201 864 9577  
R. W. MITSCHEG CO., INC  
496 ELLICOTT SQ BLDG  
BUFFALO, N.Y.  
716 854 2517  
NEAL BEAR CORPORATION  
3435 STREETSBOBO  
WEST RICHFIELD, OHIO  
216 659 3331  
JOSEPH V. BELUSKO CO.  
2355 N.W. QUIMBY  
PORTLAND, OREGON  
503 222 4279  
NEBCO ASSOCIATES  
1974 GREGORY AVENUE  
MONROEVILLE, PA.  
412 824-2111  
SAMUEL W. JEFFRIES, INC.  
105 FORREST  
MARBERTH, PA.  
215 664 8500  
AL ENGELMAN CO.  
P.O. BOX 12091  
MEMPHIS, TENN.  
901 458 6263  
LUND & COMPANY  
2215 N. OLIVE STREET  
DALLAS, TEXAS  
214 748 8839  
REPS. IN OTHER COUNTRIES  
PITT PRODUCTS, LTD.  
87 MINGOLD AVENUE  
TORONTO, ONT.  
416 789 2621

**LITTLE JOE ENTERPRISES**  
SALES MANAGER  
ROBERT D. SIDWELL  
COMPANY ADDRESS  
400 3RD STREET  
PORT ST. JOE, FLORIDA  
COMPANY REPRESENTATIVES  
JAMES H. VICKERS  
P.O. BOX 40  
PORT ST. JOE, FLORIDA  
229 3866

**LITTON EDUCATIONAL TELEVISION DIVISION**  
VICE PRESIDENT  
HENRY SHAPIRO  
COMPANY ADDRESS  
210 WESTCHESTER AVENUE  
WHITE PLAINS, NEW YORK 10604

**LOW POWER BROADCAST EQUIPMENT COMPANY**  
SALES MANAGER  
RICHARD H CROMPTON  
COMPANY ADDRESS

248 SWEDSFORD ROAD  
MALVERN, PA 19355  
215 NI 4-4096

**MACARTA INC.**  
SALES MANAGER  
G. O. ANDREWS  
BRAND NAMES  
CAROUSEL  
ROTA RAK  
MACARTA  
COMPANY ADDRESS  
709 RAILROAD AVE.  
WEST DES MOINES, IOWA 50265

**THE MACHELETT LABORATORIES, INC.**  
A SUBSIDIARY OF RAYTHEON CO.  
SALES MANAGER LG POWER TUBES  
E. H. GILBERT  
COMPANY ADDRESS  
1063 HOPE STREET  
SPRINGDALE, CONN. 06879  
COMPANY REPRESENTATIVES  
K G MORRISON  
120 FL CAMINO REAL  
SAN CARLOS, CALIFORNIA 94070  
415 593 1021  
R A HOFFMAN  
2501 W 7TH STREET  
LOS ANGELES, CALIFORNIA 90057  
213 383 1277  
D S FRANKEL  
BOYCE BUILDING RM 1022  
510 ND DEARBORN STREET  
CHICAGO, ILLINOIS 60610  
312 642 5316

**MACKENZIE LABORATORIES**  
SALES MANAGER  
A. R. TAYLOR  
COMPANY ADDRESS  
1357 N FAIR OAKS AVE  
PASADENA, CALIF 91103  
213 5Y 8 6220

**MAGNA-TECH CORPORATION**  
SALES MANAGER  
RON MATTHEWS  
BRAND NAMES  
MAGNA-TECH  
COMPANY ADDRESS  
2300 AMPEX AVENUE  
OPELIKA, ALA 36801  
205 745 7346

**MAGNECORD**  
DIVISION OF THE TELEX CORP.  
MARKETING MANAGER  
JAMES S ARRINGTON  
BRAND NAMES  
MAGNECORD  
COMPANY ADDRESS  
9600 ALDRICH AVE. SOUTH  
MINNEAPOLIS, MINN. 55420  
COMPANY REPRESENTATIVES  
MAITLAND K. SMITH CO.  
3258 CHABARA RD.  
BIRMINGHAM, ALA. 35243  
205 967-3080  
KOESSLER SALES COMPANY  
4614 NDRTH SEVENTH STREET  
PHOENIX, ARIZONA 85014  
DICK BELLEW SALES CO.  
1005 W 4TH STREET  
EL DORADO, ARKANSAS  
501 863-8325  
KOESSLER SALES CO.  
818 N FAIRFAX AVENUE  
LOS ANGELES, CALIF.  
213 653-1605  
EVANS MARKETING COMPANY  
2803 GENEVA AVENUE  
DALY CITY, CALIF.  
415 584-0818  
JOHN A ROWE & ASSOCIATES  
58TH & WALLEY HWY.  
DENVER, COLO. 80216  
303 623-3030  
MAITLAND K. SMITH CO.  
1850 E DAYTON ST. CIRCLE  
FT. LAUDERDALE, FLA.  
305 587-7378  
MAITLAND K SMITH COMPANY  
31-16TH STREET, N W  
ATLANTA, GA. 30309  
A H PETERSON CO.  
3647 W 62ND ST.  
CHICAGO, ILL.  
312 735-0846  
ZIMMER SALES, INC.  
5620 WOODWARD  
MERRIAM, KANSAS  
913 432-8900  
BROTHERS & CONNEEN ASSOCIATE:  
6302 LINCOLN AVENUE  
BALTIMORE, MD. 21209  
301 RO 4-7189  
HETHERINGTON SALES CO.  
97 BOGEL STREET  
WESTON 93, MASS.  
617 235-5323  
HETHERINGTON SALES CO.  
100 HATHERLY ROAD  
WALTHAM, MASS.  
617 894-4849  
RILEY & PETCHELL ELECTRONIC  
13209 FENKELL AVENUE  
TROY, MICH.  
313 835-0000  
MARTY BETTAN SALES CO.  
77-15 164TH AVENUE  
FLUSHING, N. Y. 11366  
212 657-6659

WAXMAN CURRANT SALES, INC.  
990 KENMORE AVENUE  
BUFFALO, N.Y. 14216  
716 873-0442  
ROCKE INTERNATIONAL CORP.  
EXPORT  
13 E. 40TH STREET  
NEW YORK, N.Y. 10016  
212 MU 9-0200  
MAITLAND K SMITH CO.  
1605 CHATHAM AVE.  
CHARLOTTE, N. C. 28205  
704 376-5951  
C L PUGH CO.  
2144 RIVERSIDE DRIVE  
COLUMBUS 21, OHIO  
614 486-9678  
TWX 614 759-0084  
DALE G WEBER COMPANY  
WEATHERLY BLDG., SUITE 306  
PORTLAND, OREGON 97214  
503 234-0686  
BROTHERS & CONNEEN ASSOCS.  
131 HARNED ROAD  
SPRINGFIELD, DEL. CO., PA.  
215 KI 3-8641  
C L PUGH CO.  
5125 CRESTLINE DR.  
PITTSBURGH34, PA.  
412 531-2731  
J Y SCHOONMAKER CO.  
5328 REDFIELD AVENUE  
DALLAS, TEXAS 75235  
214 631-8480  
TWX 214 631-8962  
J Y SCHOONMAKER CO.  
107 WINNETKA RD.  
SAN ANTONIO, TEXAS 78229  
512 342-0251  
J Y SCHOONMAKER CO.  
2711 BROAD STREET  
HOUSTON, TEXAS  
713 926-9510  
DALE G. WEBER CO.  
325 MARITIME BLDG..  
911 WESTERN AVENUE  
SEATTLE, WASH. 98104  
206 623-5990  
REPS IN OTHER COUNTRIES  
GEORGE BIRLEY  
MAGNECORD CANADA, LTD  
3751 BLOOR STREET, WEST  
ISLINGTON, ONTARIO  
416 BE 1 3303  
A D RUSSELL  
MAGNECORD CANADA, LTD  
2500 BATES ROAD ROOM 102  
MONTREAL 29, QUEBEC  
739 3026  
MAURICE D CHAPMAN  
MAGNECORD AUSTRALASIA PTY  
MACQUARIE PLACE  
SIDNEY, AUSTRALIA

**MAGNETIC MEDIA CORPORATION**

SALES MANAGER  
RICHARD K. PEDERSEN  
BRAND NAMES  
MICRO MEDIA  
COMPANY ADDRESS  
616 FAYETTE AVE.  
MAMARONECK, NEW YORK 10543  
COMPANY REPRESENTATIVES  
CHUCK HARPER  
1933 SO BROADWAY  
LOS ANGELES, CALIFORNIA  
213 R 17 7314  
FRED DOBBS  
569 LAUREL STREET  
P O BOX 266  
SAN CARLOS, CALIF  
415 591 0339  
DICK NORRIS  
915 CHEYENNE BOULEVARD  
COLORADO SPRINGS, COLO  
ROBERT REISS  
70 JESSIE DRIVE  
WEST HAVEN, CONNECTICUT  
203 933 8542  
JACK GEARTNER  
235 LINCOLN ROAD  
MIAMI BEACH, FLORIDA  
305 531 0200  
HEINZ THEILE  
6611 NO CLARKE ST  
CHICAGO, ILLINOIS  
312 465 2622  
CURTIS-MATHEWS SALES CO  
760 N WESTLINK  
WICHITA, KANSAS  
ROD BUTCHART  
BUTCHART RATHSBURG & ASSOC  
16637 E WARREN AVENUE  
DETROIT, MICHIGAN  
313 882 1717  
PAT AYLRARD  
3807 GRAND AVENUE SOUTH  
MINNEAPOLIS, MINNESOTA  
612 824 6266  
WALT LANDOME  
75 PLANDOME  
MANHASSET, NEW YORK  
516 MA 7 6620  
MAURY FARBBER  
220 DELAWARE AVENUE  
BUFFALO, NEW YORK  
716 TL 6 3543  
LUKE RODDEY  
115 EAST BOULEVARD  
CHARLOTTE, N CAROLINA  
WHITE ASSOCIATES  
465 EAST HANLEY ROAD  
MANSFIELD, OHIO  
FRANK YARUSSI  
312 ROCKFIELD ROAD  
PITTSBURGH, PENNSYLVANIA

412 CA 1 4676  
BRENDON O HARA  
4952 WYNNEFIELD AVENUE  
PHILADELPHIA, PENNSYLVANIA  
215 473 3654  
KENNETH WYBORN  
WYBORN ASSOCIATES  
P O BOX 17070  
DALLAS, TEXAS  
214 381 4645  
WILLIAM K WOOD  
P O BOX 46046  
5908 CALIFORNIA AVENUE, SW  
SEATTLE 16, WASH.  
206 WE 5-9400

**MAGNE-TRONICS INC.**  
SALES MANAGER  
A. J. KENDRICK  
COMPANY ADDRESS  
850 THIRD AVENUE  
NEW YORK, N Y 10022

**MALLORY DISTRIBUTOR**  
PRODUCTS CO.  
SALES MANAGER  
FRANK P. VENDELY  
COMPANY ADDRESS  
101 S. PARKER AVE. BOX 1558  
INDIANAPOLIS, IND. 46206

**MARANTZ COMPANY, INC.**  
SALES MANAGER  
RICHARD BRUNELLE  
C/O SUPERSCOPE, INC.  
8150 VINELAND AVE  
SUN VALLEY, CALIF  
BRAND NAMES  
MARANTZ  
COMPANY ADDRESS  
37-04 57TH STREET  
WOODSIDE, NEW YORK 11377  
COMPANY REPRESENTATIVES  
H & K SALES, INC  
3695 HAVEN AVENUE  
MENLO PARK, CALIFORNIA  
415 EM 9 6244  
SUPERSCOPE INCORPORATED  
8150 VINELAND AVENUE  
SUN VALLEY, CALIFORNIA  
213 875 0810  
SATTER SALES COMPANY  
3835 ELM STREET  
DENVER, COLORADO  
303 388 6376  
J & B ASSOCIATES  
380 NE 67TH STREET  
MIAMI, FLORIDA  
305 PL 1 9752  
J & B ASSOCIATES  
1000 PEACHTREE ST N E  
ATLANTA, GEORGIA  
404 241 6537  
GENE PIETY FACTORS  
P O BOX 2903  
MONOLULU, HAWAII  
SUPERSCOPE CHICAGO, INC  
1601 SD WOLF ROAD  
HILLSIDE, ILL  
312 449 7264  
MICHAEL SCOTT CO  
336 WASHINGTON ST  
WELLESLEY HILLS, MASS  
617 CE 5 0102  
SUPERSCOPE DETROIT, INC  
17220 WEST B MILE ROAD  
SOUTHFIELD, MICHIGAN  
313 353 0212  
NORTHERN STATES SALES  
1109 W 78 1/2 STREET  
MINNEAPOLIS, MINNESOTA  
612 866 3468  
CHARLES W DREESE  
3710 CANTERBURY PLACE  
INDEPENDENCE, MISSOURI  
816 IN 1 7294  
HAROLD A MOYER COMPANY  
P O BOX 14  
HADDONFIELD, NEW JERSEY  
609 HA 9 7792  
SUPERSCOPE N Y, INCORPORATED  
56-16 37TH AVENUE  
WOODSIDE, NEW YORK  
212 446 7227  
DELRAMA INTERNATIONAL-EXPORT  
1140 BRDAOWAY  
NEW YORK NEW YORK  
212 MU 3 5440  
SHAMROCK ELECTRIC SALES INC  
1755 WEST MARKET STREET  
AKRON, OHIO  
216 864 3090  
MILLER & ASSOCIATES  
1450 PRESTON FORREST SQUARE  
DALLAS, TEXAS  
214 AD 9 3789  
SUPERSCOPE SEATTLE, INC  
15000 NE 15TH STREET  
BELLEVUE, WASHINGTON  
206 SH 6 1550

**MARATHON PRODUCTS CORP.**

SALES MANAGER  
B. D. BAGDASARIAN  
COMPANY ADDRESS  
370 SO MAIN STREET  
HOLDEN, MASS 01520

**MARCONI DIVISION**

**THE ENGLISH ELECTRIC CORP.**  
COMPANY ADDRESS  
ONE PARK AVE  
NEW YORK, N Y 10016

**MARCONI INSTRUMENTS**  
DIV ENGLISH ELECTRIC CORP

MANAGER/VICE PRESIDENT  
WILLIAM A. BUCK  
BRAND NAMES  
MARCONI  
EDDYSDOME  
COMPANY ADDRESS  
111 CEDAR LANE  
ENGLEWOOD, N J 07631  
201 567 0607  
COMPANY REPRESENTATIVES  
LEE ASSOCIATES INC  
P O BOX 1506  
HUNTSVILLE, ALA  
205 539 0761  
MOXON ELECTRONICS CORP  
2311 PONTIUS AVE  
LOS ANGELES, CALIF  
213 272 9311  
MOXON ELECTRONICS CORP  
15 41ST AVE  
SAN MATEO, CALIF  
415 345 7961  
MOXON ELECTRONICS CORP  
2054 GARNET ST  
SAN DIEGO, CALIF  
714 274 6525  
HYTRONIC MEASUREMENTS INC  
1295 S BANNOCK ST  
DENVER, COLO  
303 733 3701  
VECTOR SALES  
267 W RUTLAND ROAD  
MILFORD, CONN  
203 874 2112  
LEE ASSOCIATES INC  
P O BOX 7896  
ORLANDO, FLORIDA  
305 241 4445  
HAR-KOM HAWAII INC  
2933 KOAPAKA STREET  
HONOLULU, HAWAII  
815 617  
KENNETH W MEYERS CO  
7256 W TOUHY AVE  
CHICAGO, ILL 60648  
312 774 6440  
S & S ASSOCIATES  
4405 EAST-WEST HWY  
BETHESDA, MD  
301 654 2420  
VECTOR SALES  
301 BELMONT ST  
BELMONT, MASS  
617 489 1400  
GAIN ENGINEERING  
20531 MACK AVE  
DETROIT, MICH 48236  
313 TU 1 3532  
PALATINE ENGINEERING SALES  
8587 ST CHARLES ROCK RO  
ST LOUIS, MO 63114  
314 426 7055  
L & M ASSOCIATES  
511 VICTOR ST  
SADDLE BROOK, N J 07663  
201 343 3070  
HYTRONIC MEASUREMENTS INC  
305 WASHINGTON S E  
ALBUQUERQUE, N M  
505 268 3941  
LEE ASSOCIATES INC  
P O BOX 906  
WINSTON-SALEM, N C  
919 724 2406  
GAIN ENGINEERING  
29603 BRUCE DRIVE  
WILLOWICK, OHIO  
216 WH 3 3731  
L & M ASSOCIATES  
P O BOX 4242  
PHILADELPHIA, PA 19144  
215 438 5666  
S & S ASSOCIATES  
BORO LINE ROAD  
KING OF PRUSSIA, PA  
215 265 3450  
GAIN ENGINEERING  
6 BARTON DRIVE  
PITTSBURGH, PA  
412 371 3020  
READING INTL EQUIPMENT INC  
P O BOX 12159  
LOIZA STATION  
SANTURCE, PUERTO RICO  
SAN JUAN 723 5030  
BRADEN ENGINEERING CO  
2646 ANDJON DRIVE  
DALLAS, TEXAS  
214 352 4626  
BRADEN ENGINEERING CO  
3130 SOUTHWEST FREEWAY  
HOUSTON, TEXAS  
713 JA 99881  
HYTRONIC MEASUREMENTS INC  
2022 SO MAIN ST  
SALT LAKE CITY, UTAH  
801 466 4924  
J K DOOLEY CO INC  
4110 STONEYWAY NDRTH  
SEATTLE, WASH 98119  
206 ME 2 1618

**MARTI ELECTRONICS**

SALES AND MARKETING MANAGER  
ROBERT E. RICHARDS  
COMPANY ADDRESS  
105 POINDEXTER, PO BOX 661  
CLEBURNE, TEXAS 76031  
COMPANY REPRESENTATIVES  
GATES RADIO COMPANY  
QUINCY, ILLINOIS  
217 BA 2 8202  
COLLINS RADIO COMPANY  
DALLAS, TEXAS  
214 AD 5 9511

# YOU WON'T FIND A PANIC BUTTON ON A MAGNECORD!



When Magnecord engineered a long list of safety factors into their professional line of tape recorder/reproducers . . . they engineered the emergencies out! A sturdy die-cast mainplate, supporting the transport in every model, insures precise location of internal parts under the roughest operating conditions. Rigid die-cast head mounts eliminate alignment problems. Professional quality hysteresis synchronous

capstan motor and individual reel drive motors are heavy duty models, and the capstan shaft assembly is re-inforced for extra strength and longer life.

While you are taping, safe-guard operating features protect your thinnest tapes. With Magnecord you get top-notch performance and superb fidelity to keep your taping facility operating at maximum capacity, even after years of constant use. Ask a broadcaster who uses one . . . MagneCORDs are built to take it!

Write now for the full story on the complete line of durable quality MagneCORD tape instruments.

*MagneCORD 8+ Reels now available from Audiotape®. See your local dealer.*

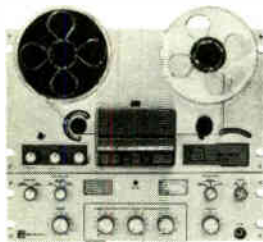

**MAGNECORD MODEL 1021**

Fully transistorized professional tape recorder/reproducer for monaural operation. For use in main or production control room.



**MAGNECORD MODEL 1022**

Fully transistorized professional tape recorder/reproducer two channel (stereo) for use in main or production control room.



**MAGNECORD MODEL 1028**

Professional quality 2 channel (stereo) tape recorder/reproducer for recording master tapes. (10½" reel capacity) Available in ½- or ¼-track.



**MAGNECORD MODEL 1048**

Professional 2 channel (stereo) recorder/reproducer for use in main studio, production studio or conference recording. (10½" reel capacity) Model 1048 is available in ½- or ¼-track.



DIVISION OF THE  
**TELEX CORPORATION**  
P. O. Box 1526 / Tulsa, Oklahoma 74101

MANUFACTURER OF TELEX HEADSETS  
AND OTHER FINE ACOUSTIC DEVICES



# Mr. Engineer: Picture yourself behind this console



It's the Rolls-Royce of sound equipment – and you need the BEST in today's highly competitive broadcasting and recording market!

It's made by Mid-America Electronics Corp., which in its many years of experience has gained fame throughout the electronics world for the excellence of its custom-designed and custom-manufactured instruments.

These superb electronic creations make it possible to bring out the truly magnificent effects impossible to achieve with regular equipment.

Built to exacting standards, these studio units will bring you up-to-date with the latest broadcasting and recording installations.

When you require SOUND for ANY purpose, whether a small mixing console, or a complete studio, call or write . . .



**MID-AMERICA ELECTRONICS CORP.**

1515 Euclid Avenue • Cleveland, Ohio 44115  
Telephone (216) 621-9362

HUGH MARSLAND CO, INC  
231 N EDGEWOOD AVENUE  
MINNEAPOLIS, MINN. 55426  
612 LI5-4481  
SY STERLING COMPANY  
7849 N LINDBERG BLVD  
HAZLEWOOD, MISSOURI  
314-837-1221  
BARTLETT ASSOCIATES  
470 MAMARONEK AVENUE  
WHITE PLAINS, N.Y. 10605  
914-949-6476  
BCS ASSOCIATES  
1039 WENDOVER AVENUE  
P O BOX 6426  
GREENSBORO, N.C. 27405  
919-273-1918  
SY STERLING COMPANY  
3300 S DIXIE DRIVE  
DAYTON, OHIO 45449  
513-298-7573  
SY STERLING COMPANY  
5827 MAYFIELD ROAD  
CLEVELAND, OHIO 44124  
216-442-8080  
ARNOLD BARNES COMPANY  
OKLAHOMA CITY OFFICE  
3510 MOCKINGBIRD LANE  
P O BOX 10586  
MIDWEST CITY, OKLA.  
405-737-4556  
BARTLETT ASSOCIATES  
130 W LANCASTER AVENUE  
WAYNE, PENN. 19087  
215-688-7525  
SY STERLING COMPANY  
4232 BROWNSVILLE ROAD  
PITTSBURGH, PA. 15227  
412-884-5515  
ARNOLD BARNES COMPANY  
740 S SHERMAN STREET  
RICHARDSON, TEXAS 75080  
214-235-4541  
TWX 214-231-1405  
ARNOLD BARNES COMPANY  
3230 MERCER STREET  
HOUSTON, TEXAS 77027  
713-622-3620  
ARNOLD BARNES COMPANY  
11211 JANET LEE ROAD  
BOX 13069  
SAN ANTONIO, TEXAS 78213  
512-342-7911  
ELSCO  
2275 SOUTH WEST TEMPLE  
SALT LAKE CITY, UTAH 84115  
801-466-8631  
PARATECH  
9210 28 AVENUE, NW  
SEATTLE, WASH. 98115  
206-784-6447  
REPS IN OTHER COUNTRIES  
MICROWAVE ASSOCIATES, INTL  
HYOE HOUSE, THE HYDE  
EDGWARE ROAD  
LONDON NW 9, ENGLAND  
TEL. COLINDALE 2284  
CANADIAN GENERAL ELECTRIC  
830 LANSDOWN AVENUE  
TORONTO, ONTARIO  
534-6511  
ENGLISH ELECTRIC DE VENEZUELA  
C A AVENIDA URANETA  
EOIFICIO LUZ ELECTRICA,  
2, PISO  
CARACAS, VENEZUELA  
54-51-16

**MID AMERICA ELECTRONICS CORP**  
SALES MANAGER  
FREDERICK C WOLF  
COMPANY ADDRESS  
1515 EUCLIO AVENUE  
CLEVELAND, OHIO 44115

**MILES REPRODUCER COMPANY**  
SALES MANAGER  
J. M. KUHLIK  
BRAND NAMES  
FILMGRAPH  
WALKIE-RECORDALL  
RECORDOPHONE  
DICTAFILM  
SONABAND  
TELEMIKE  
VOCAPHONE  
SOUNDTRAP  
COMPANY ADDRESS  
598 BROADWAY  
NEW YORK, NEW YORK 10012  
W45-6985

**J. W. MILLER COMPANY**  
SALES MANAGER  
J. HALL  
COMPANY ADDRESS  
5917 SO. MAIN ST.  
LOS ANGELES, CALIF. 90003

**D. B. MILLIKEN COMPANY**  
SALES MANAGER  
G. A. CRANOALL  
COMPANY ADDRESS  
131 N. FIFTH AVE.  
ARCADIA, CALIF. 91006  
COMPANY REPRESENTATIVES  
C. H. HOLZAPFEL  
501 PARK AVENUE N  
WINTERPARK, FLORIDA  
305 644 2929  
W E SMITH  
PO BOX 1141  
LANGLEY PARK, MD  
301 439 1133

**MINNEAPOLIS MAGNETICS, INC.**

SALES MANAGER  
FRANK ZEMAN  
COMPANY ADDRESS  
2915 HUNTINGTON AVE  
MINNEAPOLIS, MINN 55416  
**MINNESOTA MINING AND  
MANUFACTURING COMPANY  
MAGNETIC PRODUCTS DIVISION**  
GENERAL SALES MANAGER  
DANIEL E DENHAM  
NATIONAL SALES MANAGER  
AUDIBLE RANGE & VIDEO TAPE  
WILLIAM H MADDEN  
TELEVISION PRODUCTS DIV  
SALES MANAGER  
R V CLAPP  
REVERE-MINCOM DIVISION  
SALES & MARKETING MANAGER  
R J RROWN  
BRAND NAMES  
DYNACHROME  
DYNAPAN  
3M BRAND PROFESSIONAL  
RECORDER  
SCOTCH BRAND  
WOLLENSAK  
FASTSCAN  
TENZAR  
REVERE  
MINCOM  
111-TM  
175-TM

COMPANY ADDRESS  
MINNESOTA MINING AND MFG CO  
2501 HUDSON RD  
ST PAUL, MINN 55119  
COMPANY ADDRESS  
REVERE-MINCOM DIVISION  
300 SOUTH LEWIS ROAD  
CAMARILLO, CALIF 93010  
BRANCH OFFICES  
MINNESOTA MINING MFG CO  
446 NORTH LA BREA AVENUE  
HOLLYWOOD, CALIFORNIA  
213 931 1289  
6023 SOUTH GARFIELD AVE  
LOS ANGELES, CALIF 90022  
213 723 6641  
320 SHAW ROAD  
S SAN FRANCISCO, CALIF 94080  
415 761-1155  
1750 PENNSYLVANIA AVE N W  
SUITE 1100  
WASHINGTON, D. C. 20006  
202 298 9200  
5925 PEACHTREE IND BOULEVARD  
CHAMBLEE, GEORGIA 30005  
404 451 1661  
2880 UALENA STREET  
HONOLULU, HAWAII 96819  
996 483  
6850 SO HARLEM AVENUE  
ARGO P. O.  
BEDFORD PARK, ILLINOIS 60502  
312 585 7800  
155 4TH AVENUE  
NEEDHAM HEIGHTS, MASS 02194  
617 449 0300  
411 PIQUETTE AVENUE  
DETROIT, MICH. 48202  
313 875-7111  
PO BOX 3211  
935 BUSH AVENUE  
ST PAUL, MINNESOTA 55101  
612 733 1110  
10725 BAUR BOULEVARD  
PO BOX 510  
ST LOUIS, MISSOURI 63166  
314 991 1320  
700 GRAND AVENUE  
RIDGEFIELD, N. J. 07657  
201 943 6700  
330 GREENE STREET  
PO BOX 369  
BUFFALO, NEW YORK 14240  
716 894 5214  
2401 BREVARD STREET  
PO BOX 151  
HIGH POINT, N.C. 27261  
919 883 0141  
4835 PARA DRIVE  
CINCINNATI, OHIO 45237  
513 242 2313  
12200 BROOKPARK ROAD  
CLEVELAND, OHIO 44130  
216 267 1800  
5698 RISING SUN AVENUE  
PHILADELPHIA, PA 19120  
215 742 0200  
2121 SANTA ANNA AVENUE  
DALLAS, TEXAS 75228  
214 327 7311  
100 ANDOVER PARK WEST  
ANDOVER INDUSTRIAL PARK  
SEATTLE, WASHINGTON 98188  
206 244 7200

COMPANY REPRESENTATIVES  
REVERE-MINCOM DIVISION  
M KIMMEL  
300 SOUTH LEWIS ROAD  
CAMARILLO, CALIF  
805 482 1911  
J B MC CRUMB  
411 PIQUETTE AVENUE  
DETROIT, MICHIGAN 48202  
313 875-7111  
T A CORNELI  
5698 RISING SUN AVE  
PHILADELPHIA, PA 19120  
215 742 0200  
J L LANDIS  
346 WYCLIFFE ORIVE  
HOUSTON, TEXAS  
713 465 6157

**MIRATEL ELECTRONICS, INC.**  
SALES MANAGER  
ROBERT H HANSEN  
BRAND NAMES  
MIRATEL  
COMPANY ADDRESS  
3600 RICHARDSON STREET  
ST PAUL, MINN 55112  
COMPANY REPRESENTATIVES  
JAEGER ASSOCIATES, INC  
999 WOODCOCK ROAD  
ORLANDO, FLORIDA  
305 277 5041  
LAKE SYSTEMS CORPORATION  
75 N BEACON STREET  
WATERTOWN, MASS 02172  
617 926 0914  
DON J DUDLEY  
P O BOX K  
BRIGHT WATERS, NEW YORK  
516 665 9134

**MOLE - RICHARSON COMPANY**  
SALES MANAGER  
WARREN K. PARKER  
BRAND NAMES  
MOLE  
MOLARC  
MOLE-RICHARDSON  
SOLARSPOT  
MOLEQUARTZ  
COMPANY ADDRESS  
937 N SYCAMORE AVE.  
HOLLYWOOD, CALIF. 90038

**MOSELEY ASSOCIATES, INC.**  
DIRECT ALL INQUIRES TO  
COMPANY ADDRESS  
135 NOGAL DRIVE  
P O BOX 3192  
SANTA BARBARA, CALIF. 93105

**DONALD P. MOSSMAN, INC.**  
SALES MANAGER  
REN W. RIST  
COMPANY ADDRESS  
P.O. BOX 265  
BREWSTER, NEW YORK 10509  
COMPANY REPRESENTATIVES  
MOSSMAN PACIFIC INCORPORATED  
P O BOX 1105  
COVINA, CALIFORNIA 91723  
ENGINEERED SALES CO INC  
4738 N HARLEM AVENUE  
CHICAGO, ILLINOIS 60656  
312 UN 7-8434  
MOLER-EAOR ASSOCIATES  
320 HILLEN ROAD  
BALTIMORE, MARYLAND 21204  
301 VA 5 1130  
STAN PIERCE, INCORPORATED  
24 LINDEN STREET  
NORWOOD, MASSACHUSETTS 02062  
617 762 3165  
RALPH D ERNEST ASSOCIATES  
12818 PURITAN AVENUE  
DETROIT, MICHIGAN  
313 UN 1 7311  
G W MOLER COMPANY  
P O BOX 240  
HADDONFIELD, NEW JERSEY 08033  
609 428 2440  
REPS IN OTHER COUNTRIES  
PAINTON & COMPANY LIMITEO  
KINGSTHORPE, NORTHAMPTON,  
ENGLAND  
BURELC LIMITED  
45 NORTHLINE ROAD  
TORONTO 16, ONTARIO  
416 PL 5 3377  
BURLFC LIMITED  
1179 DECARIE BOULEVARD  
MONTREAL, QUEBEC  
514 RI 4 0165  
PAINTON -AUSTRALIA- PTY LTO,  
101 MURPHY STREET  
RICHMOND, VICTORIA AUSTRALIA

**MOTOROLA COMMUNICATIONS AND  
ELECTRONICS INC**  
COMPANY ADDRESS  
4501 W. AUGUSTA BLVO.  
CHICAGO, ILL. 60651  
COMPANY REPRESENTATIVES  
GEORGE CARROLL  
1616 ROLLINS ROAD  
BURLINGAME, CALIF. 95010  
415 697 3660  
JACK CONSIDINE  
2333 UTAH AVENUE  
EL SEGUNDO, CALIF 90245  
213 644 1101  
WALLY MILLER  
LAKE MIRROR ROAD  
FOREST PARK, GEORGIA 30050  
404 366 6035  
PAT KING  
1500 S HARLEM AVENUE  
FOREST PARK, ILLINOIS 60130  
312 771 8900  
WARREN BORNHOEFT  
325 ROESLER ROAD  
GLEN BURNIE, MARYLAND 21061  
301 761 4900  
GEORGE HILKERT  
15-00 POLLITT ORIVE  
FAIR LAWN, NEW JERSEY 07410  
201 791 1700  
ED JOSEPHS  
7138 ENVOY COURT  
DALLAS, TEXAS 75207  
214 ME 1 8410

**MOTOROLA SEMICONDUCTOR  
PRODUCTS, INC A DIV OF  
MOTOROLA, INC**  
SALES MANAGER  
C J GOODMAN

5005 E MCDOWELL RD  
PHOENIX, ARIZ 85008  
BRAND NAMES  
O PF TM  
STAR TM  
COMPATIBLE TM  
MEG-A-LIFE TM  
SURMETIC TM  
MIDA TM  
COMPANY ADDRESS  
ROX 955  
PHOENIX, ARIZONA 85001  
602 273 6900  
TWX 910 951 1334  
COMPANY REPRESENTATIVES  
ART POWELL, ESE MIL REP  
HOLIDAY OFC CENTER SUITE 46  
3322 S MEMORIAL PARKWAY  
HUNTSVILLE, ALA 3580  
205 881 5920  
TWX 510 579 2209  
DENTON SMITH, DSM  
DICK GALLOWAY, DSM  
2500 NORTH 44TH ST  
SOUTHWEST SAV. & LOAN BLDG  
PHOENIX, ARIZ 85008  
602 773 6364  
TWX 910 951 1334  
JIM PAINE, AREA MANAGER  
BOB VOGEL, RM  
SAM WEPRIN, RM  
SUNSET CENTER  
6725 SUNSET BLVD  
HOLLYWOOD, CALIF 90028  
213 HO 7 0821  
TWX 910 321 2303  
JOE HAWKINS, RM  
511 S BROOKHURST RD  
FULLERTON, CALIF 92633  
714 879 8111  
TWX 910 592 1234  
JIM NORD, RM  
CHARLIE SHAW, DSM  
DON SMITH, DSM  
604 PRICE AVE  
REDWOOD CITY, CALIF 94063  
415 365 5413  
TWX 910 378 5413  
BILL LEE, DSM  
7961 ENGINEER ROAD  
SAN DIEGO, CALIF 92111  
714 279 0010  
TWX 910 35 1228  
RON BAUMERT, DSM  
11115 COLORADO BLVO RM 205  
DENVER, COLO 80222  
303 757 6123  
TWX 910 931 2590  
FRED TUCKER, OSE  
2348 WHITNEY AVE  
HAMDEN, CONN 06518  
203 288 6478  
TWX 710 465 3346  
DAVE JOHNSON, RM  
BILL HIATT, OSM  
PAUL THORPE, DSM  
520 SOUTH HAITLAND AVE  
MAITLAND, FLA 32751  
305 644 3422  
TWX 810 853 0256  
FRED STOLTING, DSM  
LAKEVIEW BLDG RMS 210-211  
NORTH PALM BEACH, FLA 33403  
305 848 8651  
TWX 510 952 6677  
GLEN IAGGI, AREA MANAGER  
HAL ONSAGER, W CENTRAL RM  
FREQ SOUFAL, E CENTRAL RM  
KEN OLIPHANT, RM  
5940 WEST YOUHY AVE  
NILES, ILL 60648  
312 647 9802  
TWX 910 223 3662  
BILL BRADY, DSM  
MERCHANTS NATL BNK BLOG  
ROOM 803  
CEAR RAPIDS, IOWA 52401  
319 363 8244  
TWX 910 525 1301  
SAM MONTGOMERY, OSM  
BOB SMITH, OSM  
KEN SMYTH, DSM  
6200 ANNAPOLIS RD SUITE 422  
LANDOVER HILLS, MD 20784  
301 772 1500  
TWX 710 826 9665  
GERRY MCGONAGLE, RM  
PAUL YCCHUM, ACCT EXEC  
176 SECOND AVENUE  
WALTHAM, MASS 02154  
617 891 8500  
TWX 710 324 0462  
BOB BROWN, RM  
21600 GREENFIELD RD STE 205  
OAK PARK, MICH 48237  
313 LI 2 2174  
TWX 810 232 1681  
BOB BOTHE, N CENTRAL RM  
LEN ALTABELLO, ACCT EXEC  
HANK MERINO, ACCT EXEC  
7515 WAYZATA BLVO STE 204  
MINNEAPOLIS, MINN 55426  
612 545 0251  
TWX 910 576 2945  
RON ALBERTER, DSM  
6050 BROWN ROAD  
ST LOUIS, MO 63134  
314 JA 2 6565  
LOU SMITH, AREA MGR  
BERGEN MALL  
PARAMUS, N J 07652  
201 488 5100  
TWX 201 488 5100  
BILL BRYOIA, OSM  
HERB GOLDSTEIN, DSM  
JOHN MORAN, OSM

HUGH MARSLAND & CO INC  
6699 LINCOLN AVE  
CHICAGO, ILLINOIS  
312 676 1100  
TWX 312 677 6725  
HUGH MARSLAND & CO INC  
6730 EAST 19TH ST  
INDIANAPOLIS, IND  
317 356 4249  
BARTLETT ASSOCIATES INC  
4405 EAST-WEST HIGHWAY  
BETHESDA, MD  
301 656 3061  
TWX 301 365 8663  
INSTRUMENT DYNAMICS, INC  
WAKEFIELD INDUSTRIAL CENTER  
TEAL ROAD  
WAKEFIELD, MASS  
617 245 5100  
TWX 617 245 7479  
M P ODELL CO  
14027 PURITAN AVE  
DETROIT, MICHIGAN  
313 838 7324  
HUGH MARSLAND & CO INC  
231 N EDGEWOOD AVE  
MINNEAPOLIS, MINN  
612 545 4481  
HUGH MARSLAND & CO INC  
12635 BIG BEND BLVD  
ST LOUIS, MO  
314 966 3646  
HUGH MARSLAND & CO INC  
P O BDX 8729  
KANSAS CITY, MO  
913 DP 1 2122  
TWX 913 512 7308  
BARNHILL ASSOCIATES  
319 A WYOMING BLVD, NE  
ALBUQUERQUE, N M  
505 265 7766  
TWX 505 243 8349  
J A REAGAN CO INC  
419 CENTRAL AVE  
ALBANY, N Y  
518 436 9649  
TWX 518 474 3237  
J A REAGAN CO INC  
10 HUMPHREYS TERRACE  
NEW HARTFORD, N.Y.  
315 732-3775  
J A REAGAN CO INC  
528 CRESTMONT RD  
BINGHAMTON, N Y  
607 723 9661  
J A REAGAN CO INC  
327 WESTMORELAND RD  
BUFFALO, N Y  
716 632 2727  
MACHINE & PRODUCTS CO-FRANCE  
52 WALL STREET  
NEW YORK, N Y  
212 944 4370  
TWX 710 581 6739  
JAKE RUDISILL ASSOC INC  
2009 N TRYON ST  
CHARLOTTE, N C  
704 377 6901  
M P ODELL CO  
26614 CENTER RIDGE RD  
WESTLAKE, OHIO  
216 871-8000  
TWX 216 871-1390  
M P ODELL CO  
1250 W DOROTHY LANE  
DAYTON, OHIO  
513 298 9924  
BARTLETT ASSOCIATES INC  
130 W LANCASTER AVE  
WAYNE PENN  
215 688 7325  
TWX 215 688 0959  
M P ODELL CO  
P O BDX 10595  
PITTSBURGH, PA  
412 371 1231  
BARNHILL ASSOC  
RICHARDSON, TEXAS  
214 AD 1 2573  
KEMCO INC  
11520 BURDINE  
HOUSTON, TEXAS  
713 723 0400  
TWX 713 571 1080  
PARATECH  
2208 N W MARKET ST  
SEATTLE, WASH  
206 783 3900  
REPS IN OTHER COUNTRIES  
RADIDNICS LTD  
4938 YONGE ST  
WILLOWDALE, ONTARIO  
416 222 3261  
RADIONICS LTD  
8230 MAYRAND STREET  
MONTREAL 9, QUEBEC  
514 739 5517

MICRO-LINK SYSTEMS/  
VARIAN ASSOCIATES  
SALES MANAGER  
DAVID L. MCPHERSON  
COMPANY ADDRESS  
1375 AKRON STREET  
COPIAGUE, L.I., N.Y., 11726  
COMPANY REPRESENTATIVES  
ARTHUR J. ROCK  
WESTERN REGIONAL OFFICE  
4940 EL CAMINO REAL  
C/O BOX 201  
LOS ALTOS, CALIF. 94022  
415 326-4000  
VERNON BERTRANO OR  
PHIL JACOBSON  
VIDEO SYSTEMS, INC.  
6444 N. RIDGEWAY AVENUE

LINCOLNWOOD, ILL.  
312 OR 7-9000  
ROD MCARTHUR  
VIDEO SYSTEMS, INC.  
3743 GRAVOIS  
ST. LOUIS, MO.  
314 PR 2-3295  
SEYMOUR TYLER  
MICRO-LINK SYSTEMS  
1375 AKRON STREET  
COPIAGUE, N.Y., 11726  
516 598-2240  
EDWARD MILLING  
TAFT BROADCASTING CO.  
4808 SAN FELIPE ROAD  
HOUSTON, TEXAS  
713 WA 2-1010  
FRANK LEINS  
TAFT BROADCASTING CO.  
435 BRANIFF TOWER BLDG.  
DALLAS, TEXAS 75235  
214 FL 1-9644  
J. STANTON KECK  
AERO MARC COMPANY  
2304 RAINIER AVENUE, S.  
SEATTLE, WASHINGTON  
206 325-5880

MICROMEGA, DIVISION OF  
AMPHENOL CORPORATION  
SALES MANAGER  
A. D. BERK  
COMPANY ADDRESS  
4134 DEL REY AVE.  
VENICE, CALIF. 90291  
COMPANY REPRESENTATIVES  
VISUAL ELECTRONICS  
356 W 40TH STREET  
NEW YORK, N. Y.  
PE 6 5840

MICRO RECORD CORPORATION  
BRAND NAMES  
MICRO RECORD  
COMPANY ADDRESS  
487-28 SOUTH AVE.  
BEACON, NEW YDRK 12508

MICROWAVE ASSOCIATES, INC  
SALES MANAGER  
COMMUNICATIONS EQUIPMENT  
ERIK A STROMSTED  
COMPANY ADDRESS  
NORTHWEST INDUSTRIAL PARK  
BURLINGTON, MASS 02114  
COMPANY REPRESENTATIVES  
BCS ASSOCIATES  
2317 BOB WALLACE AVE, SW  
P O BDX 1273  
HUNTSVILLE, ALA. 35805  
205-534-1648  
COMMUNICATIONS ENGINEERING  
3350 MT VIEW DRIVE  
ANCHORAGE, ALASKA 99501  
BR2-2305  
ELSCO  
4533 N SCOTTSDALE RD.  
U R BUILDING, SUITE 112  
SCOTTSDALE, ARIZ. 85251  
602-946-9658  
MICROWAVE ASSOCIATES, INC  
9911 INGLEWOOD AVENUE  
INGLEWOOD, CALIF. 90301  
213-677-9115  
ELLIOTT RECHT ASSOCIATES  
175 S SAN ANTONIO ROAD  
LOS ALTOS, CALIF. 94022  
415-941-0336  
AMPEX PANAMERICAN CO  
EXPORT TO LATIN AMERICAN  
P O BDX 4000  
REDWOOD CITY, CALIF. 94061  
415 367-2911  
TWX 415 366-9014  
ELSCO COLORADO  
2785 N SPEER BLVD  
DENVER, COLORADO 80211  
303-433-2991  
TECHNICAL INSTRUMENTS  
575 BROAD STREET  
BRIDGEPORT, CONN. 06604  
203-368-4582  
BCS ASSOCIATES  
940 N FERN CREEK AVENUE  
P O BOX 6578  
ORLANDO, FLA.  
305-625-2764  
CAMERON G PIERCE & ASSOC.  
22 LAIKI PLACE  
KAILUA, HAWAII 96814  
265-502  
CAMERON G PIERCE & ASSOC.  
1259 SOUTH BERETANIA ST  
HONOLULU, HAWAII 96814  
567-308  
HUGH MARSLAND, CO, INC  
6699 LINCOLN AVENUE  
CHICAGO, ILLINDIS 60645  
312 DR6-1100  
HUGH MARSLAND CO, INC  
6730 E 19TH STREET  
INDIANAPOLIS, IND. 46219  
317 FL6-6249  
BARTLETT ASSOCIATES  
7979 OLD GEORGETOWN ROAD  
BETHESDA, MD. 20014  
301-656-3061  
TECHNICAL INSTRUMENTS  
122 WEST STREET  
WILMINGTON, MASS. 01887  
617-944-3930  
SY STERLING COMPANY  
21250 IO 1/2 MILE ROAD  
SOUTHFIELD, MICH. 48076  
313-357-3700



## Presenting Metrotech's Two-Direction Slow Speed Logger

12-16 Operating Days of Continuous, Unattended Logging Time for any Broadcast or Communications Requirement.

Tape cost less than 4¢ per hour — or \$1.00 for a 24-hour day.

Heavy duty Transport with latest solid state electronics is fully automatic and provides exceptional fidelity — 3 db from 200-2700 cps with adjustable equalization.



A complete line of Professional Recorders/Reproducers, operating at standard speeds, is also available and surpasses all N.A.B. specifications.

Write today for six-page illustrated brochure and price information.

# SERIES 500

**METROTECH INC.** 670 NATIONAL AVENUE  
MOUNTAIN VIEW, CALIF.

333 JERICHO TURNPIKE  
JERICHO, N Y 11753  
516 822 2822  
TWX 510 821 1895  
STEVE KELLY, RM  
WAYNE HOLZER, DSM  
3380 MONROE AVE  
ROCHESTER, N Y 14618  
716 DU 1 7220  
TWX 510 254 2893  
ROD DCONNOR, RM  
BEN GATES, ACCT EXEC  
P O BOX 1476  
POUGHKEEPSIE, N Y 12603  
914 GR 1 6635  
TWX 510 248 0015  
BOB GRIFFIN, DSM  
3806 UNION RD SUITE B  
RUFFALO, N Y 14225  
716 685 1233  
TWX 710 263 1392  
FRANK MAHONEY, DSM  
AL WILCOX, DSM  
167 PICKARD BLDG  
E MOLLOY RD  
SYRACUSE, N Y 13211  
315 454 9373  
TWX 710 541 0486  
JERRY STEWART, ACCT EXEC  
808 E ATKINSON, DSM  
PAUL KLEES BLDG RM 130  
3490 S OXIE DR  
DAYTON, OHIO 45439  
513 298 9976  
TWX 810 459 1638  
LOU NORRIS, OSM  
BILL MILLER, DSM  
CHAGRIN LEE PLAZA BLDG STE B  
16611 CHAGRIN BLVD  
SHAKER HEIGHTS, OHIO 44120  
216 921 5260  
TWX 810 421 8262  
BOB BURNS, RM  
HANK STEIN, ACCT EXEC  
29 BALA AVENUE  
BALA CYNWYD, PENN 19004  
215 TE 9 7070  
TWX 510 662 4344  
JOE SEMMER, DSM  
VERN HARRIS, DSM  
P O BOX 30667  
DALLAS, TEXAS 75230  
214 AD 5 8385  
TWX 910 867 4700  
RICK CARSON, SE  
4000 AURORA AVE N STE 221  
SEATTLE, WASH 98103  
206 ME 2 7532  
TWX 910 444 2051

**MULTRONICS, INC.**  
SALES MANAGER  
FRANK J LITTLE, JR  
BRAND NAMES  
NORD  
COMPANY ADDRESS  
5712 FREDERICK AVE  
ROCKVILLE, MARYLAND

**MVR CORPORATION**  
SALES MANAGER  
FRANK GONZALEZ, JR.  
BRAND NAMES  
VIDEODISC  
COMPANY ADDRESS  
470 SAN ANTONIO RD.  
PALO ALTO, CALIF 94306

**NARDA MICROWAVE CORPORATION**  
VICE PRESIDENT  
J. P. SCHINOLER  
BRAND NAMES  
NARDA MICROLINE-R  
COMPANY ADDRESS  
COMMERCIAL STREET  
PLAINVIEW, NEW YORK 11803  
COMPANY REPRESENTATIVES  
E. G. HOLMES AND ASSOCIATES  
4862 GOVERNORS DRIVE, W.  
HUNTSVILLE, ALABAMA  
205 837 6900  
O HALLORAN ASSOCIATES  
10700 VENTURA BLVD  
NORTH HOLLYWOOD, CALIF.  
213-TR 7-0173  
TWX 910 499 2190  
O HALLORAN ASSOCIATES  
3921 E BAYSHORE  
PALO ALTO, CALIF.  
415 OA 6-1493  
TWX 415 969 9144  
D. E. BOND ASSOCIATES  
2149 S. CLERMONT STREET  
DENVER, COLORADO 80222  
303 756 1234  
E G HOLMES AND ASSOCIATES  
316 1/2 S. BUMBAY STREET  
ORLANDO, FLORIDA 32803  
305 CH 1 2128  
TWX 305 275 1599  
E. G. HOLMES AND ASSOCIATES  
3667 CLAIRMONT RD. N.E.  
CHAMBLEE, GA. 30005  
404-451-6161  
TWX 404 231 3417  
INDUSTRIAL ELECTRONIC INC.  
646 QUEEN STREET BOX 135  
HONOLULU, HAWAII  
506 095  
SCIENTIFIC SALES COMPANY  
7132 N HARLEM AVENUE  
CHICAGO, ILLINOIS 60631  
312 775 7595  
SCIENTIFIC SALES COMPANY  
3720 N COLORADO AVENUE  
INDIANAPOLIS, INO.

317 545 9950  
POLY-ONICS INC  
4434 WEST 90TH TERRACE  
LEAWOOD, KANSAS 66206  
913-NI 8-4173  
TWX 913 642 8388  
ELECTRONIC MARKETING ASSOC.  
11501 HUFF COURT  
KENSINGTON, MD 20795  
301-946-0300  
TWX 710 825 9645  
TRI-TEK INC  
155A BEDFORD STREET  
BURLINGTON, MASS.  
617 272 4550  
MICRO SALES CORP  
19341 TRINITY  
DETROIT, MICH.  
313 537 6460  
SCIENTIFIC SALES COMPANY  
6121 EXCELSIOR BLVD  
MINNEAPOLIS, MINNESOTA  
612 484 8022  
POLY-ONICS INC  
47 VILLAGE SQ SHOPPING CNTR  
OFFICE NO 2  
HAZELWOOD, MISSOURI  
314 TE 7-0597  
TWX 314 921 3853  
SONCO  
CRYSTAL BROOK PROF. BLDG  
EATONTOWN, N.J.  
201-542-1441  
TWX 510 239 2810  
E. E. BOND ASSOCIATES  
P.O. BOX 11331  
ALBUQUERQUE, N.M.  
505 247 3442  
GRAY AND REED ASSOC., INC.  
9 DUMFRIES STREET  
HUNTINGTON STA., N.Y. 11749  
TWX 3 333  
OSSMANN INSTRUMENTS, INC  
101 PICKARD DRIVE  
SYRACUSE, N Y 13211  
315 GL 4-2461  
TWX 315 477 1162  
OSSMANN INSTRUMENTS INC  
VESTAL PKWY EAST  
P O BOX 245  
VESTAL, N.Y. 13850  
607-785-9947  
TWX 607 772 0209  
OSSMANN INSTRUMENTS INC  
3100 MONROE AVENUE  
ROCHESTER 18, N.Y.  
716 LU 6-0380  
TWX 716 221 1513  
E G HOLMES AND ASSOCIATES  
430 W GASTON STREET  
GREENSBORO, N. C. 27401  
919 BR 2 0855  
MICRO SALES CORP  
T-17 EXECUTIVE BUILDING  
1250 WEST OORDTHY LANE  
DAYTON, OHIO 45409  
513-298-3033  
TWX 513 944 0450  
MICRO SALES CORP  
2000 LEE ROAD  
CLEVELAND, 18, OHIO  
216 371 0522  
SONCO  
556 WEST DEKALB PIKE  
KING OF PRUSSIA, PENN. 19406  
215-265-3250  
TWX 215 265 2656  
SONCO  
PARK PLACE OFFICE BLDG  
CAMP HILL, PENN.  
717 SO 1-0577  
TWX 717 761 0407  
D. E. BOND ASSOCIATES  
P.O. BOX 12293  
EL PASO, TEXAS  
915 532 4048  
VIDAL ELECTRONICS  
3403 HIGH BLUFF DRIVE  
DALLAS, TEXAS 75234  
214 CH 7 4252  
SHOWALTER-JUOD INC  
1806 SOUTH BUSH PLACE  
SEATTLE 44, WASHINGTON  
206 EA 4-7911  
TWX 206 998 D323  
REPS IN OTHER COUNTRIES  
HEIGHTEN SCIENTIFIC CO LTD  
P O BOX 1408  
TAIPAI, TAIWAN, CHINA  
MR. K LAL BHARRI  
P O BOX 487  
NEW DELHI 1, INDIA  
HIODRIYA ELECTRIC CO LTD  
3-2-CHROME KYOBASHI, CHUO-KU  
TOKYO, JAPAN  
THE MODERN TRADING COMPANY  
P O BOX 7103 GHAFUO CHAMBERS  
VICTORIA ROAD  
KARACHI 3, PAKISTAN  
INGLOMARK  
INDUSTRIE-BELIEFERUNGS-  
GESELLSCHAFT  
MARKOWITZSCH AND CO  
MARIENHILFER STRASSE 133  
VIENNA XV, AUSTRIA  
REGULATION-MESURE S P R L  
22 RUE SAINT-HUBERT  
BRUSSELS 15, BELGIUM  
HANDELSFIRMAET-DITZ-  
SCHWEITZER  
KONGENSGADE 59  
COPENHAGEN, DENMARK  
SALIES S A  
11 RUE LEON MORANE  
PARIS 15, FRANCE  
ROHOE AND SCHWARZ VERTRIEBS-

GMBH  
HOME STRASSE 160-168  
CDLOGNE, WEST GERMANY  
ROHDE & SCHWARZ HANDELS-GMBH  
ERNST-REUTER-PLATZ 10  
BERLIN 10, GERMANY  
ROHDE & SCHWARZ VERTRIEBS-  
GMBH  
KORNERSTRASSE 34  
HAMBURG 39, GERMANY  
ROHDE & SCHWARZ VERTRIEBS-  
GMBH  
KRIEGSTRASSE 39  
KARLSRUHE, GERMANY  
ROHDE & SCHWARZ VERTRIEBS-  
GMBH  
RRIENNER STRASSE 43  
MUNICH 2, GERMANY  
AVELEY ELECTRIC LTO  
SOUTH DCKENDON  
ESSEX, ENGLAND  
KOSTAS KARAYANNIS  
18, ERMOU STREET  
ATHENS 126, GREECE  
DOTT, ING MARIO VIANELLO  
VIA L ANELLI, 13  
MILAN, ITALY  
553 081-553 811  
DOTT ING MARIO VIANELLO  
VIA S CROCE IN GERUSALEMME  
ROME, ITALY  
7-567 250 7-567 941  
INGENIEURSBUREAU PROJECTO  
PRINSENGRACHT 530  
AMSTERDAM, HOLLAND  
METRONIC  
P N BIORN TOLLBOGT 4  
OSLO, NORWAY  
AMERIKANSKA TELEPRODUKTER  
NYBOMVAGNAD 56  
STOCKHOLM, SV., SWEDEN  
MEGEX ZURICH  
BAOENERSTRASSE 588  
ZURICH 48, SWITZERLAND  
EASTRONICS LTD  
75 HAIFA RD P D BOX 21029  
MEVAG  
GALATA, BANKALAR CAD 71-73  
P O BOX 143  
ISTANBUL, TURKEY  
ALLAN CRAWFORD ASSOC. LTO.  
65 MARTIN ROSS AVENUE  
DOWNSVIEW, ONT.  
416 636 4910  
TWX 610 492 2119  
ALLAN CRAWFORD ASSOC. LTO.  
376 CHURCHILL AVENUE  
OTTAWA, ONT  
PA 5 1288  
ALLAN CRAWFORD ASSOC. LTO.  
6999 COTE DES NEIGES ROAD  
MONTREAL 26, QUEBEC  
739 6776  
TWX 610 421 3564  
WARBURTON FRANKI INDUSTRIES  
PTY LTD  
307 KENT STREET  
P O BOX 1523 G P O  
SYDNEY, AUSTRALIA  
WARBURTON FRANKI  
INDUSTRIES PTY LTD  
204 FLINDERS STREET  
GPO BOX 683F  
ADELAIDE, AUSTRALIA  
WARBURTON FRANKI  
INDUSTRIES PTY LTD  
13 CHESTER STREET  
FORTITUDE VALLERY, Q  
P O BOX 345  
BRISBANE, AUSTRALIA  
WARBURTON FRANKI  
INDUSTRIES PTY LTD  
22D PARK STREET  
SOUTH MELBOURNE  
G P O BOX 536E  
MELBOURNE, C I  
VICTORIA, AUSTRALIA  
W G LEATHAM LTD  
58 KENT TERRACE  
WELLINGTON, NEW ZEALAND  
DELTA LTD  
APARTADO AEREO 12175  
BOGOTA, COLUMBIA

**NESCO INSTRUMENTS**  
**DIV OF DATAPULSE, INC**  
SALES MANAGER  
M. B. COX  
COMPANY ADDRESS  
509 HINDRY AVE.  
INGLEWOOD, CALIF. 90306  
213 671 4334  
TWX 910 328 6109  
COMPANY REPRESENTATIVES  
JOHN OHALLORAN & ASSOCIATES  
3268 ROSECRANS BLVD.  
SAN DIEGO, CALIF 92110  
JOHN OHALLORAN & ASSOCIATES  
3921 E BAYSHORE BLVD.  
PALO ALTO, CALIF 94303  
JOHN OHALLORAN & ASSOCIATES  
10700 VENTURA BLVD.  
NORTH HOLLYWOOD, CALIF. 91604  
KELLEY ENTERPRISES  
336 E 4TH STREET  
LOVELAND, COLORADO 80537  
INSTRUMENT CONSULTANTS, INC  
2381 WHITNEY AVENUE  
HAMDEN, CONN 06518  
G F BOHMAN ASSOCIATES, INC  
7233 LAKE ELLENOR DRIVE  
ORLANDO, FLORIDA 32809  
RIDGWAY ASSOCIATES, INC  
3759 N HARLEM AVENUE  
CHICAGO, ILLINOIS 60634  
PENZNER ASSOCIATES, INC

P O BOX 4362  
OYERLAND PARK, KANSAS 66204  
BRIMBERG ASSOCIATES, INC  
814 THAYER AVENUE  
SILVER SPRING, MD 21204  
BRIMBERG ASSOCIATES, INC  
110 E PENNSYLVANIA AVENUE  
TOWSON, MD 21204  
INSTRUMENT CONSULTANTS, INC  
P O BOX 25  
WABAN, MASS 02168  
RIDGWAY ASSOCIATES, INC  
7720 MORGAN AVENUE, SOUTH  
MINNEAPOLIS, MINN 55423  
PENZNER ASSOCIATES, INC.  
BDX 76, CREVE COEUR STATION  
ST LOUIS, MO 63141  
CENTRAL ASSOCIATES  
44 NORTH DEAN STREET  
ENGLEWOOD, N J 07691  
J D RYERSON  
P O BOX 1400  
SYRACUSE, NEW YORK 13201  
CENTRAL ASSOCIATES  
11 COMMERCIAL STREET  
PLAINVIEW, L I, N Y  
RIDGWAY ASSOCIATES, INC  
22811 LORAIN ROAD  
FAIRVIEW PARK, OHIO 44126  
RIDGWAY ASSOCIATES, INC  
2400 E DOROTHY LANE  
DAYTON, OHIO 45420  
R K P ASSOCIATES  
107 FDRREST AVENUE  
NARBERTH, PENN 19072  
AIREP ELECTRONICS, INC  
P O BOX 36211  
HOUSTON, TEXAS 77036  
AIREP ELECTRONICS, INC  
P O BOX 9555  
DALLAS, TEXAS 75214  
HARRY LEVINSON COMPANY  
1211 E DENNY WAY  
SEATTLE, WASH 98122  
REPS IN OTHER COUNTRIES  
BALL INTL AGENCIES  
P O RDX 1676  
BOMBAY 1-BR, INDIA  
MDHATA MARKET BLDG  
PALTDN ROAD  
R ANKERSMIT LTO.  
90 RUE EDITH CAVELL  
UCCLLE, BRUSSELS, BELGIUM  
BIE & BERNSTEIN  
35 PILESTRODE  
COPENHAGEN, DENMARK  
QY FINDER AB  
MANNERHEIMINTIE 29,C  
HELSINKI 25, FINLAND  
SEINA  
16 RUE OAGUESSEAU  
BDULOGNE-BELLANCOURT  
SEINE, FRANCE  
NEUMULLER & COMPANY GMBH  
SCHRAUDOLPHSTRASSE 2A  
8 MUNICH 13, W GERMANY  
GRIFFIN & GEORGE LTD.  
EALING ROAD, ALPERTON  
WEMBLY, MIDOLESEX, ENGLAND  
SPECIAL-IND  
VIA O. MANIN 33  
MILAN, ITALY  
HUGO RISO A/S  
P O BOX 8  
TAASEN, OSLO 8, NORWAY  
HUGO RISO A/S  
TEKNISK IMPORT  
CARL GRONDAHES  
PARK-1, OSLO 8, NORWAY  
SCAN TELE AB  
TENGOAHLGATAN 24  
STOCKHOLM SO., SWEDEN  
N ZIVY 6 CIE, S A  
POSTFACH  
OBERWIL/BASEL, SWITZERLAND  
M KOCHN  
P O BOX 1147  
JERUSALEM, ISRAEL  
ATLAS INSTRUMENTS CORP  
DIV ATLAS ELECTRONICS LTD  
909 BEACH AVENUE  
VANCOUVER, B.C.  
ATLAS INSTRUMENTS CORP  
DIV OF ATLAS ELECTRONICS  
50 WINGOLD AVENUE  
TORONTO, ONTARIO  
ATLAS INSTRUMENTS CORP  
DIV ATLAS ELECTRONICS LTD  
342 1/2 ELGIN STREET  
OTTAWA, ONTARIO  
SAMPLE ELECTRONICS PTY LTO  
4 GROSE STREET, GLEBE  
SYDNEY, N.S.W., AUSTRALIA  
SAMPLE ELECTRONICS PTY LTO  
9/11 CREMORNE STREET  
RICHMOND, VIC., AUSTRALIA  
SAMPLE ELECTRONICS PTY LTD  
8 MATIPO STREET  
AUCKLAND, NEW ZEALAND

**NEUMADE PRODUCTS CORPORATION**  
SALES MANAGER  
L E JONES  
BRAND NAMES  
DYNAMICS  
SUPER X  
FIRETITE  
SEALITE  
NEUTYPE  
GRISWOOD  
NEUSCOPE  
NEUZIF  
NEULITE  
NEUATOR  
RENOVEX  
SHOWTIMER





## D-202ES — THE MOST NOTABLE ADVANCEMENT IN DYNAMIC MICROPHONE DEVELOPMENT



For Boom Operation—No frequency discriminating characteristics in off-axis pickup.

In the D-202ES, two independent microphone capsules are incorporated in a single microphone housing, connected by means of a cross-over network, free of phase distortion. Each of the capsules is optimally adjusted to a specific frequency pickup range; one for low frequencies, and the other for high frequencies. The cross-over is at 500 cps.

This unique arrangement achieves a wide, smooth frequency range (30-15,000 cps  $\pm$  2 db) and a cardioid pattern with a front-to-back discrimination of never less than 20 db over the entire frequency range. In addition, the microphone offers a 90° off-axis response which is completely parallel to the 0° (on-axis) curve.

These features offer several advantages in practical applications: The flat frequency response enables control of feedback at any frequency. The uniform front-to-back discrimination of at least 20 db virtually eliminates feedback and offers almost complete freedom in microphone and speaker placement.

MADE IN AUSTRIA BY AKG GMBH

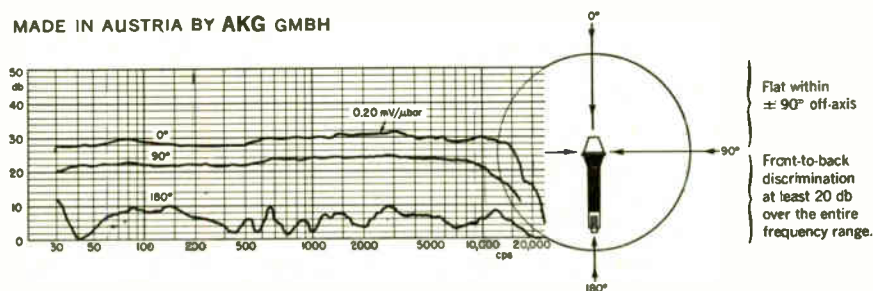

The parallel 90° off-axis response is of particular importance in sound reinforcement and recording applications, to achieve a natural reproduction of all frequencies introduced to the microphone  $\pm$  90° off-axis.

The D-202ES utilizes a sintered bronze screen which is extremely rugged and protects the microphone systems from iron particles and dust. It also acts as a windscreen and is waterproof.



**Norelco** PROFESSIONAL SOUND PRODUCTS  
 NORTH AMERICAN PHILIPS COMPANY, INC.  
 Professional Products Division, 100 East 42nd St., New York, N. Y. 10017





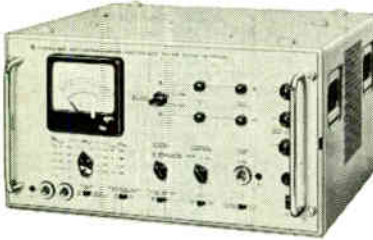
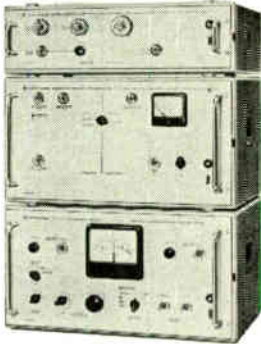

# Measure Vital Characteristics of Broadcasting Systems\*

| VIDEO NOISE  | GROUP DELAY  | FIELD STRENGTH  |
|--|--|---|
| <p><b>UPSIF VIDEO NOISE METER</b></p>  <p>Designed for noise voltage measurements on TV cameras, film scanners, video tape recorders, radio links, coaxial lines, TV transmitters, receivers and transposer, with synch. Signals.</p> <ul style="list-style-type: none"> <li>• 40 Hz to 5 MHz</li> <li>• 7 Measurement Ranges: 1/3/10/30/100/300/1000 mVpp</li> <li>• True RMS or Peak-to-Peak Indications</li> </ul> | <p><b>LFM TEST ASSEMBLY</b></p>  <p>Determine group (envelope) delay of video and TV transmission systems.</p> <ul style="list-style-type: none"> <li>• 0.1 - 10 MHz and 25-250 MHz (ext. to 1 GHz)</li> <li>• <math>\pm 10</math> to <math>\pm 1000</math> nsec.</li> <li>• Using Type SWOF sweep system group delay is instantaneously displayed on CRT.</li> </ul> | <p><b>HUZ FIELD STRENGTH METER</b></p> <p>Covers FM, TV, aircraft, police and mobile radio bands for determining propagation conditions, polarization and radiation patterns. Used as a selective voltmeter, it measures antenna gain and cable attenuation.</p> <ul style="list-style-type: none"> <li>• 47 to 225 MHz</li> <li>• 1 <math>\mu</math>V to 100 mV</li> <li>• FM &amp; AM Detection</li> <li>• Portable, Weights only 9 lbs.</li> <li>• Includes Built-In Rechargeable Batteries</li> </ul>  |

## VESTIGIAL SIDEBAND ANALYSIS In the presence of synch. signals

### SWEEP GENERATOR/RECEIVER

### HIGH QUALITY 1/2 W. X-MITTER

### STANDARD RECEIVER

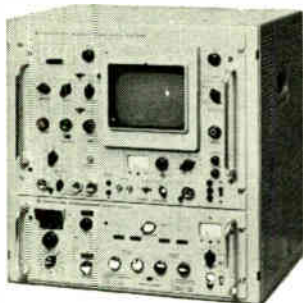

**SWOF VIDEOSKOP** A video sweep generator, tracking selective (3 kHz) receiver, and display unit. Range: Frequency, 20 kHz to 20 MHz, (1 GHz with sideband adapter); Sweep Width: 1 to 16 MHz, continuously variable; sweep duration 50 ms to 5.5 s.



**SBTF VESTIGIAL SIDEBAND SIGNAL GENERATOR** Modulation of vision and sound signals is accomplished in the IF, thereby permitting use of plug-in heads for VHF & UHF. SBTF generates exceptionally high quality NTS signal for development and production testing of receivers, and as low power Xmitter.



**AMF TV DEMODULATOR** A Nyquist demodulator as a ref. standard for TV Xmitter performance (B&W, color and sound). Video and audio frequency response, phase and group delay, intercarrier signal-to-noise ratio, etc. Models available for VHF and UHF.

\* MEETS REQUIREMENTS OF ALL U.S.A. BLACK AND WHITE AND NTS COLOR SYSTEMS

LITERATURE AVAILABLE Write for the new R/S Folder featuring a complete line of measuring and test equipment for the broadcasting industry.

Get The Extra Capability,  
Greater Reliability, and  
Longer Useful Life Of ...



## ROHDE & SCHWARZ

111 LEXINGTON AVENUE, PASSAIC, N. J. 07055 • (201) 773-8010

Inquiries outside the U.S.A.

should be directed to: Rohde & Schwarz, Muehlidorfstrasse 15, Munchen 8, West Germany.



415 369 6726  
CHICK RYEL & CO  
P O BOX 762  
WOODLAND HILLS, CALIF  
213 883 8118  
R & D SALES CO  
420 S FEDERAL BLVD  
DENVER, COLO  
303 934 5445  
MART HALLER INC - EXPORT  
P O BOX 1208  
MIAMI, FLA  
305 374 5225  
INTELECT, INC  
30 N SCHOOL ST  
HONOLULU, HAWAII  
566 366  
A M REPUSMER  
MIDWESTERN DIV SALES MGR  
P O BOX 2000  
PEORIA, ILL  
309 637 8416  
DAVID S FEHR  
EASTERN DIV SALES MGR  
509 WEBSTER ST  
MARSHFIELD, MASS  
617 834 9521  
STAN C OLSEN  
4201 WOODDALE AVE  
MINNEAPOLIS, MINN  
612 928 4158  
R W FARRIS CO INC  
1715 BALTIMORE AVE  
KANSAS CITY, MO  
816 421 1751  
DIPRD INC  
P O BOX 1427  
MARYLAND HEIGHTS, MO  
314 432 3444  
H E BLAKSLEY  
WESTERN DIV SALES MGR  
310 QUINCY ST  
RENO, NEVADA  
702 322 9300  
ANDREW A FOLEY ASSOC  
P O BOX 155  
MOORESTOWN, NEW JERSEY  
609 663-4545  
STEVE FISHER  
ELECTRONICS SALES CORP  
121 CEDAR LANE  
TEANECK, N J  
701 836 6661  
LEONARD D ALLEN INC  
P O BOX 205  
N SYRACUSE, N Y  
315 458 7470  
NEAL BEAR CORP  
3435 STREETSBO RD  
W RICHFIELD, OHIO  
216 699 3331  
NEBCO ASSOCIATES  
1974 GREGORY AVE  
MONROEVILLE, PA  
412 874 2111  
DIXIE ELECTRONIC ASSOC INC  
P O BOX 200  
MADISON, TENN  
615 895 5666  
MARION ATHANS  
P O BOX 134  
RICHARDSON, TEXAS  
214 231 3081  
JAS J BACKER CO  
221 W GALER ST  
SEATTLE, WASH  
206 283 6470  
REPS. IN OTHER COUNTRIES  
A L WHITEHEAD LTD  
P O BOX 25  
W VANCOUVER, B C  
604 922 1169  
R C KAHNERT SALES LTD  
359 ENFORD RD  
RICHMOND HILL, ONTARIO  
416 884 4574

#### ROME CABLE DIVISION

ALUMINUM CORP OF AMERICA  
SALES MANAGER  
GLENN A. BROADOCK  
BRAND NAMES  
ROME UNIFORMS  
COMPANY ADDRESS  
421 RIDGE ST.  
ROME, NEW YORK  
COMPANY REPRESENTATIVES  
GORDON F BLACK  
715 DARLIE WAY  
SAN FRANCISCO, CALIF.  
F ROY CHRISTIAN  
715 SOUTH GILBERT ST  
ANAHEIM, CALIF.  
RICHARD E GATES  
2315 SUNNYSIDE RIDGE RD  
ROLLING HILLS, CALIF.  
RICHARD H CORZINE  
8803 HUMMINGBIRD AVE  
FOUNTAIN VALLEY, CALIF 92708  
FRANK K DUERST  
1961 MAR VISTA AVE  
ALTADENA, CALIF.  
E G GILMORE JR  
2629 WEST LINCOLN AVE  
MONTEBELLO, CALIF.  
ROBERT D GOLLY  
301 SYCAMORE ST  
SAN CARLOS, CALIF.  
STEWART JOHNSTON  
157 ELKINS PLACE  
ARCADIA, CALIF.  
H LEE RAWLINGS  
37 GRESHAM LANE  
ATHERTON, CALIF.  
GEORGE H REMELMAN  
631 PICO AVE

SAN MATEO, CALIF. 94400  
MICHAEL E SEMD  
1655 KAMSOCK DRIVE  
SUNNYVALE, CALIF. 94087  
ORIS D STEDMAN  
230A WESTBORD AVE  
ALHAMBRA, CALIFORNIA  
JOHN W HAYES  
10 DOVER ROAD  
WESTPORT, CONNECTICUT  
DONALD A SELLERS  
7056 PONCE OLEON AVE  
JACKSONVILLE, FLORIDA  
THOMAS M MARTIN  
2860 PINE GROVE TERR NE APTS  
ATLANTA, GA. 30319  
WALTER J MCCANN  
3115 ASCOT COURT  
CHAMBLEE, GA  
F DOYLE RUCKER  
3412 SPREADING OAK DRIVE SW  
ATLANTA, GA. 30311  
EUGENE C WEST  
1488 RUNNYMEADE N F  
ATLANTA, GA. 30319  
RICHARD T EDWARDS JR  
P O BOX 421  
27 W 186 CARREL ST  
WINFIELD, ILL. 60190  
ATO C SHANNON  
1313 ND 43RD ST  
EAST ST. LOUIS, ILL. 62204  
THOMAS C SPRIGGS  
1980 BERKELEY RD  
HIGHLAND PARK, ILLINOIS  
ROBERT K VAN SLYKE  
487 AZTEC DRIVE CARDL STREAM  
WHEATON, ILLINOIS 60187  
RICHARD BLAKE SHANNON  
1716 MINTURN LANE  
INDIANAPOLIS, INDIANA  
MISS NORMA BRACKMAN  
23 THAYER RD  
BELMONT, MASS. 02178  
R T GILDERSLEEVE  
18 ELLIOTT CIRCLE  
MO. EASTON, MASS. 02356  
T S GILDERSLEEVE  
WALPOLE STREET  
DOVER, MASS. D2030  
JOHN F MELAVIN  
331 BOYLSTON ST  
BROCKTON, MASS. 02400  
ALFRED J DAWSON  
324D HARTSLOCK WOODS DRIVE  
BIRMINGHAM, MICH 48010  
313 626-1801  
ROBERT L JAFFRE  
7100 BROOKRIDGE ORIVE  
BIRMINGHAM, MICH. 48010  
PETER J LOPUSHINSKY  
RIVER GLEN APTS APTB-22  
32718 GRAND RIVER  
FARMINGTON, MICH. 48024  
J W CAMPBELL JR.  
1635 MONTICELLO DRIVE  
ST LOUIS, MO. 63138  
JERIAL L YOUNG  
2001 RAFT DR  
ST LOUIS, MISSOURI  
PAUL R OCONNOR  
401 HAMILTON ROAD  
RIDGEWOOD, NEW JERSEY  
EVERETT B JONES  
215 PETERSON DRIVE  
CAMILLUS, NEW YORK  
STEPHEN J LADDICK  
1943 JACKSON ROAD  
PENFIELD, NEW YORK  
JOHN A MAY  
6265 STAFFORD DRIVE  
NORTH OLMSTED, OHIO 44070  
RAYMOND L SHARKEY  
10631 CINDERELLA DR  
CINCINNATI, OHIO  
ROBERT R DAVIS  
3045 SOUTHWEST FAIRVIEW BLVD  
PORTLAND, ORE. 97201  
RICHARD A BIRD  
49 WOODBROOK WAY  
CHESTER, PA. 19014  
MISS MARGARET L JENNINGS  
1232 WISCONSIN AVE  
PITTSBURGH, PA. 15216  
G E ROLSTON JR  
12 HARVARD DRIVE  
MEDIA, PA. 19063  
ROBERT H SAWYER  
223 ROSEBRIAR AVE  
GLENSHAW, PA. 15116  
WILLIAM D BARWICK  
4326 WAYNESBORO  
HOUSTON, TEXAS  
G W PARKER  
14D26 TANGLEWOOD COURT  
DALLAS, TEXAS  
E H LINHARDT  
10703 VALLEY FORGE DRIVE  
HOUSTON, TEXAS  
JOE WILKINSON  
7834 VILLA CLIFF  
DALLAS, TEX 75228  
DA 8-7913  
WILLIAM S WILLIAMS  
3000 CAMBRIDGE ST  
ARLINGTON, TEXAS 76010  
DAVID C MCMAHON  
8213 GALWAY LANE  
RICHMOND, VA. 23228  
THOMAS E MCCARTHY  
5233 127TH S E AVE  
BELLEVUE, WASH. 98004  
RUDY J MORAVEC  
4878 SO 78TH ST  
GREENFIELD, WIS. 53220

#### ROTRON MANUFACTURING

COMPANY, INC.  
SALES VP  
PAUL M. BEARD  
BRAND NAMES  
CARAVEL  
CENTRIMAX  
FEATHER  
MUFFIN  
SAUCER  
SENTINEL  
SKIPPER  
WHISPER  
COMPANY ADDRESS  
HASSBROUCK LANE  
WOODSTOCK, NEW YORK 12498  
COMPANY REPRESENTATIVES  
FRYCO  
SCOTTSDALE, ARIZONA  
602 949-0120  
DEWCO SALES  
PALO ALTO, CALIF.  
ROTRON/PACIFIC  
GLENDALE, CALIF.  
213 849-3712  
GOSSARD AND ASSOCIATES  
DENVER, COLORADO  
303 985-0602  
G F BOHMAN ASSOCIATES  
ORLANDO, FLORIDA  
305 855-0274  
GASSNER AND CLARK  
CHICAGO, ILL.  
312 764-6121  
THOMAS AND MODRCIN ASSOC  
SHAWNEE MISSION, KANSAS  
913 432-2131  
CIRCUIT SALES COMPANY  
WAKEFIELD, MASS.  
617 245-5320  
CARRIER AND GABLE INC  
DETROIT, MICH.  
313 961-1786  
E C ELECTRONIC SALES  
MINNEAPOLIS, MINN.  
612 888-4625  
F F SYLVESTER ASSOCIATES  
SPRINGFIELD, N.J.  
201 376-3324  
MARTIN P ANDREWS INC  
FAYETTEVILLE, N.Y.  
315 637-3144  
F J CAMPISANO  
CINCINNATI, OHIO  
513 662-1616  
COMPONENTS ENGINEERING CO  
CLEVELAND, OHIO  
216 842-2737  
AMMON AND CHAMPION  
TULSA, OKLA.  
918 627-7670  
ROTRON ENGINEERING SALES OFF  
BALA-CYNWYD, PA.  
215 664-4337  
AMMON AND CHAMPION  
DALLAS, TEXAS  
214 357-8441  
AMMON AND CHAMPION  
HOUSTON, TEXAS  
713 729-1233  
RAY JOHNSTON COMPANY  
SEATTLE, WASHINGTON  
206 524-5170

#### ROUND HILL ASSOCIATES

SALES MANAGER  
R. E. MORRIS  
COMPANY ADDRESS  
434 SIXTH AVE.  
NEW YORK, NEW YORK 10011

#### RUSSCO ELECTRONICS MFG. INC.

SALFS MANAGER  
RUSSELL C. FRIEND  
COMPANY ADDRESS  
6879 N. SUNNYSIDE  
CLOVIS, CALIF. 93612  
COMPANY REPRESENTATIVES  
DUNLAP ELECTRONICS  
1750 EAST MCKINLEY  
FRESNO, CALIF.  
485-3060  
HIGHLAND ASSOCIATES  
600 MARBLE STREET  
BROOMFIELD, COLORADO  
ELECTRONIC EQUIP INC.  
526 PLASTER AVE NE  
ATLANTA, GEORGIA 30324  
876-8373  
BISCAYNE AUDIO CO.  
P O BOX 543  
DETROIT, MICH. 48232  
THE LEW-BONN CO  
1211 LASALLE AVE  
MINNEAPOLIS, MINN. 55403  
BROADCAST RECORDING SERV  
BOX 104 R 1  
LOVELAND, OHIO  
RADIO SUPPLY INC  
P O BOX 1972  
724 NO HUDSON  
OKLAHOMA, OKLA.  
BROADCAST EQUIP & SUPPLY  
BRISTOL, TENN. 37623  
MARTI ELECTRONICS  
105 POINDEXTER  
CLEBURNE, TEXAS  
GAR-TRONIC  
3135 WESTERN AVENUE  
SEATTLE, WASH. 98121  
F. B. RYAN MFG. CO., INC.  
RESIDENT  
JIM F. RYAN  
BRAND NAMES  
RYAN

COMPANY ADDRESS  
BOX 451  
CHARITON, IOWA 50049

#### HOWARD W SAMS & CO INC

SALES MANAGER  
TDM SURBER  
BRAND NAMES  
PHOTOFACT  
COUNTER-FACTS  
SAMS TECHNICAL INSTITUTE  
SAMS TECHNICAL BOOKS  
P F REPORTER MAG  
BROADCAST ENGINEERING MAG  
RADIO V TELEVISION MAG  
EDITORS & ENGINEERS  
AUDELS  
COMPANY ADDRESS  
4300 WEST 62ND STREET  
INDIANAPOLIS, INDIANA 46206  
317 291 3100

#### SARKIS-TARZIAN INC

MARKETING MGR  
BROADCAST EQUIPMENT DIV  
RUSS IDE  
COMPANY ADDRESS  
EAST HILLSIDE DR.  
BLOOMINGTON, INDIANA 47401  
COMPANY REPRESENTATIVES  
MURPHY COTA  
112 GALLATIN STREET S. W.  
HUNTSVILLE, ALABAMA  
205 536 9121  
W BERT KNIGHT CO  
P O BOX 11394  
PHOENIX, ARIZONA  
602 264 3578  
OLIVER BJERKE  
3237 BENTON  
SANTA CLARA, CALIF  
408 248 8975  
MOULTHROP & HUNTER  
165 11TH STREET  
SAN FRANCISCO, CALIF 94103  
415 UN 37800  
W BERT KNIGHT CO  
112 GLASGOW AVE  
INGLWOOD, CALIF 90301  
213 678 4711  
MC LOUD & RAYMOND CO  
PO BOX 22044  
DENVER, COLORADO 80222  
303 SK 6 1589  
GERBER SALES CO INC  
31 BROADWAY ST P O BOX 2917  
NEW HAVEN, CONN  
203 SP M 6279  
MURPHY & COTA  
712 WEST VASSAR AVENUE  
ORLANDO, FLORIDA  
305 GA 4 2167  
NUBAR DONOVAN  
3620 RIDGEWOOD ROAD, NW  
ATLANTA, GEORGIA  
404 233 3311  
RICHARD J. DOUGHERTY  
931 WILLOW LANE  
DUNDEE, ILLINOIS  
312 428 2877  
JOHN G TWIST CO  
5222 W DIVERSEY  
CHICAGO, ILLINOIS 60639  
312 777 2250  
MORRELL E BEAVERS  
2644 NORTH SEVENTH  
TERRE HAUTE, INDIANA  
NORTH 3845  
LESLIE DE VOE CO  
4010 WASHINGTON BLVD  
INDIANAPOLIS, INDIANA 46205  
317 AT 3 1395  
THUNDERBIRD SALES  
3802 W 95TH STREET  
LEAWOOD, KANSAS 66206  
913 NI 2 7220  
THUNDERBIRD SALES  
6405 E KELLOGG  
WICHITA, KANSAS 67207  
316 684 3941  
J H ELECTRONIC SALES  
P O BOX 6844  
TOWSON, MARYLAND 21204  
301 VA 5 4441  
JOE RYAN  
201 CHESTNUT  
EAST LONGMEADOW, MASS  
413 525 6553  
GERBER SALES CO INC  
176 2ND AVENUE  
WALTHAM, MASS D2154  
617 891 8040  
GERBER SALES CO INC  
P O BOX 447  
EAST LONG MEADOW, MASS01461  
413 525 3059  
GRANT SHAFFER CO  
14241 FENKELL AVENUE  
DETROIT, MICHIGAN 48227  
313 BR 3 5390  
SCOTT ELECTRONIC SALES  
5209 W 60TH STREET  
MINNEAPOLIS, MINNESOTA 55423  
612 929 2985  
THUNDERBIRD SALES  
PO BOX 6156  
ST LOUIS MISSOURI 63145  
314 TE 8 6688  
SIMBERKOFF SALES INC  
71 VALLEY STREET  
SOUTH ORANGE, NEW JERSEY  
201 763 7900  
J H ELECTRONIC SALES  
P O BOX 159





**"New York's Great New Sound is WNEW-FM- 'Where The Girls Are'— backed up by our Scully 280's."**

**MAX WEINER**  
Chief Engineer  
WNEW, New York

WNEW-FM is only one of a growing parade of broadcasters who specify SCULLY recording equipment because its superior performance is proven by the toughest test of all; the daily grind of schedules that must be met without a hitch. SCULLY offers the finest solid-state instrumentation available plus **exclusive plug-in construction . . .** for minimum down-time, fast, easy repair when necessary, no complicated wiring disconnects or desoldering. Relays, modular sub-assemblies, electronic chassis solid-state amplifiers are **all plug in.**



"Seven Scully units in our FM control rooms give our recording crew the precision, flexibility and operational ease they demand."



Alison Steele, one of the three glamour gals who make the new sound on WNEW-FM 14 hours daily.



Mr. Weiner, left, demonstrates Scully 280's to Program Director John Dale.

**SCULLY RECORDING INSTRUMENTS CORPORATION**

480 BUNNELL STREET, BRIDGEPORT, CONN. 06607 • TEL. (203) 335-5146

Makers of the renowned Scully Lathe, since 1919 symbol of precision in the recording industry.



JACK BERMAN CO INC  
1751 S LA CIENEGA  
LOS ANGELES, CALIF  
UP 0 4711  
F W MOULTHROP & ASSOC  
1530 E 12TH ST  
OAKLAND, CALIFORNIA  
AN 1 7676  
MILLAR-HUTTO ASSOCIATES INC  
1036 PEACHTREE STRFET N E  
ATLANTA, GA  
876 0919  
GENE PIETY FACTORS INC  
160 HOKAUEA ST BOX 2903  
HONOLULU, HAWAII  
83 7185  
RAY R MUTMACHER ASSOC INC  
6668 NORTHWEST HWY  
CHICAGO, ILLINOIS  
NE 1 3248  
OREN H SMITH COMPANY  
5255 NORTH LAWLER  
CHICAGO, ILLINOIS  
786 4476  
FORRISTAL-YOUNG SALES CO  
5500 BUENA VISTA SUITE 101  
MISSION, KANSAS  
432 1420  
STANLEY A HARRIS CO INC  
60 DFDHAM AVENUE  
NEEOHAM, MASS  
444 4780  
J MALCOLM FLORA INC  
165 WEST LIBERTY  
PLYMOUTH, MICHIGAN  
GL 3 4296  
NORTHERN STATES SALES COMPANY  
1109 WEST 78 1/2 STREET  
MINNEAPOLIS, MINN  
866 3668  
FORRISTAL-YOUNG SALES CO  
7110 OAKLAND AVENUE  
ST. LOUIS, MISSOURI  
MI 5 2360  
SIMBRKOFF SALES COMPANY  
71 VALLEY STREET  
SOUTH ORANGE, NEW JERSEY  
763 7900  
F EDWIN SCHMITT CO INC  
311 MEACHAM AVENUE  
ELMONT, L I, N Y  
437 8150  
MCFADDEN SALES COMPANY  
150 EAST BROAD STREET  
COLUMBUS, OHIO  
221 3363  
SAMUEL K MACDONALD INC  
1531 SPRUCE STREET  
PHILADELPHIA, PENN  
KI 5 1205  
CAMPION SALES COMPANY  
9002 CHANCELLOR ROW  
DALLAS, TEXAS  
ME 1 3390  
STEVENSON COMPANY  
2045 WALKER LANE  
SALT LAKE CITY, UTAH  
277 2515  
REPS IN OTHER COUNTRIES  
C M ROBINSON AGENCIES  
1550 ERIN STREET  
WINNIPEG, MANITOBA  
774 1855  
A C SIMMONDS & SONS LTD  
100 MERTON STREET  
TORONTO, ONTARIO  
485 9111

#### SIGMA INDUSTRIES INCORPORATED

SALES MANAGER  
K. C. MONROE  
COMPANY ADDRESS  
1115 OBRRIEN DRIVE  
MENLO PARK, CALIF. 94025  
COMPANY REPRESENTATIVES  
R A YOUNG & CO  
P O BOX 3884  
GLENDALE, CALIF  
213 245 3721  
MOUNTAIN STATES MACHINERY CO  
1526 BLAKE ST  
DENVER, COLO  
303 244 7421  
WM F HEMMINGER CO INC  
BOX 6008  
SARASOTA, FLA  
813 388 1800  
HAWAIIAN LTNG & SUPPLY CORP  
726 KOHOU ST  
HONOLULU, HAWAII  
964 889  
COURIER SALES INC  
2060 F 54TH MO 10  
INDIANAPOLIS, IND  
317 251 2401  
GITRE CO INC  
12909 W EIGHT MILE RD  
DETROIT, MICH  
313 341 9270  
R W FARRIS CO INC  
1715 BALTIMORE AVE  
KANSAS CITY, MISSOURI  
816 HA 1 1751  
DIPRO INC  
P O BOX 1427  
MARYLAND HEIGHTS, MO  
314 432 3444  
R A COLUCCI CO  
P O BOX 447  
MINEOLA, L I, N Y  
516 PT 6 D397  
RUMSEY ELECTRIC CO  
3RD & HUNTING PARK AVE  
PHILA, PA  
215 GL 5 9900  
R L WRIGHT & ASSOC

P O BOX 17447  
DALLAS, TEXAS  
714 285 8701  
M K WIDDEKIND CO INC  
815 W EWING ST  
SEATTLE, WASH  
206 AT 4 8020

#### SIGMA INSTRUMENTS INCORPORATED

SALES MANAGER  
FRANK BURRIDGF  
COMPANY ADDRESS  
170 PEARL STREET  
BRAINTREE, MASS. 02185  
COMPANY REPRESENTATIVES  
TECHNICAL MARKETING INC  
904 BOB WALLACE AVE ROOM 117  
HUNTSVILLE ALABAMA  
202 534 2487  
WILLIAMS ASSOCIATES  
1110 EAST MCDOWELL ROAD  
PHOENIX, ARIZONA  
602 254 6085  
PENWARDEN ASSOCIATES  
14547 TITUS ST  
VAN NUYS, CALIF  
713 782 4970  
MCCARTHY-KFLLY & ASSOC INC  
279 NORTH BAY SHORE BLVD  
SAN MATEO, CALIF  
415 DI 2 8351  
WILLIAMS ASSOCIATES  
4971 JACKSON STREET  
DENVER, COLORADO  
303 388 4391  
TECHNICAL MARKETING INC  
P O BOX 237  
LARGO, FLORIDA  
813 596 0503  
TECHNICAL MARKETING INC  
1511 E ROBINSON ST  
ORLANDO, FLORIDA  
305 424 8531  
SIGMA INSTRUMENTS INC  
3158 DES PLAINES AVENUE  
DES PLAINES, ILLINOIS  
312 296 5595  
LESLIE M DEVOE COMPANY  
4010 WASHINGTON BLVD  
INDIANAPOLIS, INDIANA  
317 283 1395  
JR SALES ENGR INC  
3550 COTTAGE GROVE AVE S E  
CEDAR RAPIDS, IOWA  
319 365 5259  
BARCOCK-BOHAKER-STIDDARD  
880 BONIFANT STREET  
SILVER SPRING, MARYLAND  
301 588 4047  
W R HUMMON & ASSOCIATES  
P O BOX 501  
FARMINGTON, MICHIGAN  
313 474 0661  
RHODE ELECTRONIC SALES  
2510 EAST 7TH AVENUE  
ST. PAUL, MINNESOTA  
612 777 8197  
JOHN DURBIN COMPANY  
12809 MANCHESTER ROAD  
ST. LOUIS, MISSOURI  
314 966 3003  
SIGMA INSTRUMENTS INC  
50 NORTH FRANKLIN TURNPIKE  
MARRON PLOG  
HO-HO-KUS, NEW JERSEY  
201 652 2900-6  
WILLIAMS ASSOCIATES INC  
3221 SILVER AVENUE S E  
ALBUQUERQUE, NEW MEXICO  
505 255 9632  
H C JOHNSON AGENCIES INC  
P O BOX 215  
FAYETTEVILLE, NEW YORK  
315 637 9383  
H C JOHNSON AGENCIES INC  
111 MOUNT HOPE AVENUE  
ROCHESTER, NEW YORK  
716 232 2688  
H C JOHNSON AGENCIES INC  
P O BOX 86  
BRANDYWINE STATION  
SCHENECTADY, NEW YORK  
518 374 5901  
H C JOHNSON AGENCIES INC  
8 LOS ROBLES STREET  
WILLIAMSVILLE, NEW YORK  
716 632 7880-1  
D G W INC  
1402 EAST MOREHEAD STREET  
CHARLOTTE, N CAROLINA  
704 334 7090  
D G W INC  
3389 NOTTINGHAM ROAD  
WINSTON-SALEM, N CAROLINA  
919 723 4205  
JACK C HOFFSTETTER COMPANY  
3605 NO DIXIE DRIVE  
DAYTON, OHIO  
513 278 6721  
JACK C HOFFSTETTER COMPANY  
742 KENRIDGE ORIVE  
CLEVELAND, OHIO  
216 449 0944  
SEATRONICS INC  
6415 CANYON COURT  
PORTLAND, OREGON  
503 292 8887  
BARCOCK-BOHAKER-STIDDARD  
130 W LANCASTER AVE  
WAYNE, PENNSYLVANIA  
215 688 8288  
P J SCANLON CO INC  
724 C SOUTH SHERMAN STREET  
RICHARDSON, TEXAS  
214 231 4661  
WILLIAMS ASSOCIATES INC

2461 SOUTH MAIN STREET  
SALT LAKE CITY, UTAH  
801 466 8709  
SFATRONICS INC  
5931 4TH AVENUE SOUTH  
SEATTLE, WASHINGTON  
REPS IN OTHER COUNTRIES  
FLECTRO-TEC MARKETERS LTD  
1624 WEST THIRD AVENUE  
VANCOUVER, BRITISH COLUMBIA  
604 731 6377-8-9  
ELECTRO-TEC MARKETERS LTD  
211-1767 MAIN ST NO  
WINNIPEG, MANITOBA  
338 2884  
D T SHAW COMPANY  
5150 DUNDAS STREET WEST  
ISLINGTON, ONTARIO  
416 231 2706  
D T SHAW COMPANY  
1966 GRAHAM BLVD  
MONTREAL, QUEBEC  
514 735 1541

#### THE SINGER COMPANY

SALES MANAGER  
MORTON G. SCHERAGA  
RRAND NAMES  
MARKETING MANAGER  
SENSITIVE RESEARCH  
PANORAMIC  
EMPIRE  
GERTSCH  
COMPANY ADDRESS  
915 PEMBROKE STREET  
BRIDGEPORT, CONN, 06608  
COMPANY REPRESENTATIVES  
CARL A STONE ASSOCIATES  
3855 CARDIFF AVE  
CULVER CITY, CALIF  
213 870 7771  
WILLIAMS ASSOCIATES  
4971 JACKSON ST  
DENVER, COLORADO  
303 388 4391  
BARD ASSOCIATES  
SHAWMUT @ BEACH STS  
LA GRANGE, ILL  
312 354 0660  
INSTRUMENT ASSOCIATES  
30 PARK AVE  
ARLINGTON, MASS  
617 648 2922  
BURLINGAME ASSOCIATES  
510 S FULTON AVE  
MOUNT VERNON, N. Y.  
914 664 7530  
JAMES L HIGHSMITH & CO  
3733 MONROE ROAD  
CHARLOTTE, N. C.  
704 333 7743  
ARNOLD BARNES CO  
740 S SHERMAN ST  
RICHARDSON, TEX  
214 235 4541  
RUSH DRAKE ASSOCIATES  
6133 MAYNARD AVE S  
SEATTLE, WASH  
206 725 2700  
REPS IN OTHER COUNTRIES  
WHITTAKER ELECTRONICS LTD  
42 HOWDEN AVE  
OTTAWA, ONT  
612 224 1221

#### SINGER PRODUCTS COMPANY

INCORPORATED  
SALES MANAGER  
ALVIN J. SCHWARTZ  
BRAND NAMES  
SINTRONIC  
COMPANY ADDRESS  
95 BROAD STREET  
NEW YORK, NEW YORK 10004

#### SITCO ANTENNA COMPANY

SALES MANAGER  
GUSTAVE BERLINER  
BRAND NAMES  
SITCO  
COMPANY ADDRESS  
10330 NE MARX  
PORTLAND, OREGON 97220

#### SOLA ELECTRIC

##### DIV SOLA BASIC INDUSTRIES

MARKETING MANAGER  
S. E. SPELTZ  
BRAND NAMES  
SOLA R  
SOLATRON R  
HERC-MITE R  
COMPANY ADDRESS  
1717 BUSSE ROAD  
ELK GROVE VILLAGE, ILL. 6000  
439 2800  
COMPANY REPRESENTATIVES  
DICK BELLEW SALES CO  
EL DORADO, ARKANSAS  
863 8325  
SOLA ELECTRIC  
LOS ANGELES, CALIF  
254 9223  
ELECTRONIC COMPONENT SALES  
LITTLETON, COLO  
798 8481  
MILLAR-HUTTO ASSOC  
WINTER PARK, FLORIDA  
647 7407  
MILLAR-HUTTO ASSOC  
ATLANTA, GA  
876 0919  
HALGIN SALES  
CEDAR RAPIOS, IOWA  
363 5119

HALGIN SALES  
MISSION, KANSAS  
722 2441  
DICK BELLEW SALES CO  
NEW ORLEANS, LA  
282 9629  
TESSCO  
TIMONIUM, MD  
252 5610  
NAT KRONSTADT ASSOC  
SILVER SPRING, MD  
585 6141  
SOLA ELECTRIC  
NEEDHAM HEIGHTS, MASS  
444 8280  
R C MERCHANT & CO  
DETROIT, MICH  
535 6000  
R C MERCHANT & CO  
BENTON HARBOR, MICH  
925 4211  
MEL FOSTER CO INC  
MINNEAPOLIS, MINN  
374 2612  
HALGIN SALES  
CLAYTON, MISSOURI  
721 4415  
SOLA ELECTRIC  
ENGLEWOOD CLIFFS, N. J.  
567 3880  
SOLA ELECTRIC  
CAMDFN, N. J.  
365 7744  
ELECTRONIC COMPONENT SALES  
ALBUQUERQUE, N M  
344 8130  
HARRIES & KERSHAW  
EAST AURORA, N Y  
652 1221  
HARRIES & KERSHAW  
WEBSTER, N Y  
671 6365  
HARRIES & KERSHAW  
FAYETTEVILLE, N Y  
446 3112  
MILLAR-HUTTO ASSOC  
CHARLOTTE, N. C.  
366 2061  
SOLA ELECTRIC  
CLEVELAND, OHIO  
521 8038  
SOLA ELECTRIC  
CINCINNATI, OHIO  
271 6870  
ROBERT E NESBITT CO  
DALLAS, TEXAS  
357 4601  
ROBERT E NESBITT CO  
HOUSTON, TEXAS  
528 3811  
ELECTRONIC COMPONENT SALES  
SALT LAKE CITY, UTAH  
262 3700  
NORTHWESTERN AGENCIES, INC  
SEATTLE, WASHINGTON  
623 8882  
WALTER M BRAUN  
MILWAUKEE, WIS  
332 1040

#### SOLITRON DEVICES INCORPORATED

SALES MANAGER  
ROBERT RUBIN  
COMPANY ADDRESS  
256 OAK TREE ROAD  
TAPPAN, NEW YORK 10983  
COMPANY REPRESENTATIVES  
R HALES PRIMDOR & ASSOC.  
1225 EAST NORTHVIEW AVENUE  
PHOENIX, ARIZONA  
602 944 9631  
WEB ELECTRONIC ASSOCIATES  
P O BOX 45734  
5716 W MANCHESTER  
LOS ANGELES, CALIF.  
213 617 8297  
WESTERN REGIONAL SALES OFFICE  
6311 YUCCA STREET  
HOLLYWOOD, CALIF. 90028  
213 464 0006  
WESTERN OIST. SALES OFFICE  
C/O WINCO INC  
P O BOX 881  
MT VIEW, CALIF 94042  
415 961 8510 OR 961 3599  
ELECTRONIC SALES  
995 S CLEMONT #302  
DENVER, COLORADO 80222  
303 756 4148  
CENTRAL REGIONAL SALES OFFICE  
C/O G MCL COLE COMPANY  
6710 W HIGGINS ROAD  
CHICAGO, ILLINOIS 60656  
312 774 3535  
TECHNICAL REPRESENTATIVES CO  
4000 MEADOWS DRIVE  
INDIANAPOLIS, INOIANA 46205  
317 546 4967  
TECHNICAL REPRESENTATIVES CO  
707 ANTHONY WAYNE BANK BLDG  
FT. WAYNE, INDIANA 46802  
219 742 1891  
ELECTRONIC SALES  
1310 HERTZ DRIVE S E  
CEDAR RAPIDS, IOWA  
319 364 4342  
JERRY BRESSON ASSOCIATES  
511 N CHARLES STREET  
BALTIMORE, MD.  
301 MU 5 0100  
CIRCUIT SALES COMPANY  
LAKEVIEW OFFICE PARK OOR 1  
591 NORTH AVENUE  
WAKEFIELD, MASS.  
617 245 5320  
NEW ENGLANO REGIONAL SALES OF

52 PICKERING STREET  
NEEDHAM, MASS.  
617 444 1152  
THE HARTWICK-VAN AUKER CO  
BOX 122 N E STATION  
19831 PURLING BROOK ROAD  
LIVONIA, MICH. 48152  
313 476 5757  
RHODE ELECTRONIC SALES  
2510 EAST 7TH AVENUE  
ST. PAUL, MINN. 55109  
617 777 8197  
JOHN DURBIN COMPANY  
12809 MANCHESTER RD  
ST. LOUIS, MO. 63131  
314 966 3003  
EASTERN REGIONAL SALES OFFICE  
37 ELM STREET  
WESTFIELD, N.J.  
201 232 4243  
G V L ASSOCIATES  
338 GREEN STREET  
SYRACUSE, NEW YORK  
315 478 7712  
S-J SALES ASSOCIATES  
148-05 ARCHER AVENUE  
JAMAICA, N.Y. 11435  
212 Ax 1 3232  
JAKE RUDISILL ASSOCIATES  
2009 MO TRVON STREET  
CHARLOTTE, N.C. 28206  
704 377 6901  
THE WHELAN CORPORATION  
2975 FAR HILLS AVENUE  
OAYTON, OHIO 45419  
513 298 9997  
THE WHELAN CORPORATION  
8323 CEDAR ROAD  
CHESTERLAND, OHIO 44026  
216 442 8340  
JERRY BRASSON ASSOCIATES  
107 FORREST AVENUE  
NARBERTH, PA. 19072  
215 TE 9 6770  
W PAT FRALIA COMPANY  
6100 CAMP BOWIE BLVD  
P O BOX 12625  
FORT WORTH, TEXAS 76116  
317 738 2394  
EASTERN REGIONAL SALES OFFICE  
1121 ARLINGTON BLVD  
T-321  
ARLINGTON, VIRGINIA  
301 725 1349  
LARRABEE & ASSOCIATES  
2117 SECOND AVENUE  
SEATTLE, WASHINGTON  
206 882 2358  
REPS IN OTHER COUNTRIES  
CANTRONICS LTD  
17 DELLBANK ROAD  
DOWNSVIEW, ONTARIO  
CANTRONICS LTD  
4252 BRAILLE AVENUE  
MONTREAL, QUEBEC  
416 636 8311

SONY CORPORATION OF AMERICA

SALES MANAGER  
H. L. JOHNSON  
COMPANY ADDRESS  
516 WEST FLORENCE AVE.  
INGLEWOOD, CALIF. 90301  
COMPANY REPRESENTATIVES  
V T RUPP CO  
1182 LOS ALTOS AVE  
LOS ALTOS, CALIF  
REEVES ELECTRONICS INC  
7512 SANTA MONICA BLVD  
LOS ANGELES, CALIF 90046  
213 876 3300  
GENERAL ELECTRONICS INC  
4158 PIEDMONT AVENUE  
OAKLAND, CALIFORNIA  
415 655 2711  
GORDON ENTERPRISES INC  
5362 NORTH CAHUENGA BLVD  
NORTH HOLLYWOOD, CALIFORNIA  
213 766 3725  
LANDERS ELECTRONIC  
735 ROUTE 5  
SOUTH WINOSOR, CONN D6074  
JAMES R EBERLY CO  
1207 POTOMAC ST N W  
WASHINGTON, O C 20007  
202 338 2277  
COMMUNITY UTILITY INC  
96D ORANGE AVE  
WINTER PARK, FLA  
VIDEOTRONICS INC  
P O BOX 4313  
ATLANTA, GEORGIA 30302  
404 525 8687  
INDUSTRIAL TELEVISION SER  
5224 W OIVERSEY  
CHICAGO, ILLINOIS  
402 466 2331  
WEBSTER ENGINEERING  
823 SO GREENWOOD AVE  
PARK RIDGE, ILLINOIS  
VIDEO LEASING  
154 EAST ERIE ST  
CHICAGO, ILL  
312 377 3286  
ELECTRONIC TECHNICAL SERVICES  
3844 NO COLLEGE AVE  
INDIANAPOLIS, INDIANA  
IMPERIAL EQUIPMENT COMPANY  
2381 N 24TH ST  
LAFAYETTE, INDIANA  
OAVIS ELECTRONICS  
W THIRO & JEFFERSON  
WATERLOO, IOWA 50701  
319 234 6626  
RADIO SUPPLY COMPANY INC  
115 LAURA

WICHITA, KANSAS 67211  
316 AM 7 5216  
AMERICAN SOUND SERVICE INC  
675 WEST THIRD ST  
COVINGTON, KENTUCKY 40208  
502 261 9024  
ELECTRONIC DEVICES INC  
411 CENTRAL AVENUE  
LOUISVILLE, KENTUCKY 40208  
502 637 7720  
LOUISIANA ELECTRONICS  
3121 CONVENTION ST  
BATON ROUGE, LOUISIANA  
504 348 4962  
INTERNATIONAL SOUND CORP  
3589 PARK HEIGHTS AVENUE  
BALTIMORE, MARYLAND 21215  
301 FO 7 6409  
DEMAMBRO SOUND EQUIPMENT  
1095 COMMONWEALTH AVE  
BOSTON, MASSACHUSETTS  
617 254 7870  
AMERICAN MICROWAVE  
COMMUNICATIONS INC  
204 NATL BANK BLDG BOX 216  
ALPENA, MICHIGAN  
517 356 1510  
THALNER ELECTRONIC LABS  
7150 JACKSON ROAD  
ANN ARBOR, MICHIGAN  
NORTHWEST ELECTRONICS  
336 HOOVER ST N E  
MINNEAPOLIS, MINNESOTA  
ARMET CORPORATION  
625 E MCDOWELL ROAD  
JACKSON, MISSISSIPPI  
601 353 3479  
CRAMER ENGINEERING  
8325 WORNALL ROAD  
KANSAS CITY, MISSOURI 64114  
816 DE 3 7914  
NOTIFIER ENGINEERING INC  
3700 N 56TH ST  
LINCOLN, NEBRASKA  
402 466 2331  
REE TELEVISION  
1200 W CHESTNUT ST  
UNION, NEW JERSEY  
201 678 8810  
VIDEO MON SALES & SERVICE  
1401 VALENCIA SOUTHEAST  
ALBUQUERQUE, NEW MEXICO  
VIDEO PROJECTS  
143-78 94TH AVE  
JAMAICA, N Y  
ALCOR INC  
215 SOUTH TIOGA STREET  
ITHACA, NEW YORK 14850  
607 4242  
PIONEER STANDARD  
ELECTRONICS INC  
5403 PROSPECT AVENUE  
CLEVELAND, OHIO  
216 432 0010  
MAGNETIC SERVIC CORP  
1628 WEST FIRST AVENUE  
COLUMBUS, OHIO  
THE SONAX COMPANY  
P O BOX 11415  
OKLAHOMA CITY, OKLAHOMA 73314  
405 CE 5 3611  
COLUMBIA ELECTRONICS COMPANY  
8755 S W CANYON ROAD  
PORTLAND, OREGON 97225  
503 292 2625  
ALLIED SOUND INC  
206 12TH AVE S  
NASHVILLE, TENN 37203  
SOUTHWEST SOUND EQUIPMENT CO  
1518 N ST. MARYS  
SAN ANTONIO, TEXAS  
CA 6 9271  
STROMBERG-CARLSON CORP  
2341 FARRINGTON  
DALLAS, TEXAS 75207  
214 ME 1 5470  
VIDEO WEST INCORPORATED  
P O BOX 1087  
PROVO, UTAH  
801 373 5239  
AERO MARC CO  
2304 RAINIER AVE S  
SEATTLE, WASHINGTON

SORENSEN OPERATION

RAYTHEON CO.  
MARKETING MANAGER  
ROBERT SLATER  
COMPANY ADDRESS  
RICHARDS AVENUE  
NORWALK, CONN. D6856

SOUNDRAFT INDUSTRIES

SALES MANAGER  
JOHN G. GILLIAM  
COMPANY ADDRESS  
P. O. BOX 1745  
ANN ARBOR, MICH. 48106  
313 663 6656

THE SOUND SCRIBER CORPORATION

VICE PRESIDENT - SALES  
FREDRICK A. BIERTUEMPFEL  
BRAND NAMES  
SOUND SCRIBER  
COMPANY ADDRESS  
6 MIDDELTOWN AVE.  
NORTH HAVEN, CONN. 06473  
COMPANY REPRESENTATIVES  
ROBERT YELLIN  
1819 W 6TH ST  
LOS ANGELES, CALIF  
NOEL CIMINI  
7026 W NORTH AVE  
CHICAGO, ILLINOIS  
JAMES MURPHY  
8121 GEORGIA AVE

SILVER SPRING, MD  
PHILLIP W HEYSE  
2611 HAMILTON AVE  
TRENTON, N JERSEY  
RICHARD BIRO  
913 STEMMONS TOWERS SO  
DALLAS, TEXAS  
REPS IN OTHER COUNTRIES  
BLAIR-BEHNSEN LTD  
835 CAMBIE ST  
VANCOUVER, B C  
JOHN PIERCE HOLOINGS LTD  
103 BLAKE ST  
TORONTO, ONTARIO  
N MARTINEAU & SON  
1019 BLEURY ST  
MONTREAL, QUEBEC

SOUTH SHORE RADIO-TELEPHONE INC

PRFIDENT  
JESS PETERS  
COMPANY ADDRESS  
6405 OLCOTT AVE.  
HAMMOND, IND. 46320  
219-TILDEN 4-9320

SOUTHWESTERN COMMUNICATION

CENTRAL  
SALES MANAGER  
JESSE L. RIPPUS  
COMPANY ADDRESS  
1512 INDIAN WELLS RD, BOX 64  
ALAMOGOROO, NEW MEXICO 88310

SPARTA ELECTRONIC CORPORATION

VICE PRESIDENT, SALES  
JACK J. LAWSON  
BRAND NAMES  
SPARTA-MATIC  
SPARTA  
COMPANY ADDRESS  
5851 FLORIN-PERKINS RD.  
SACRAMENTO, CALIF. 95828  
916-383-5553  
COMPANY REPRESENTATIVES  
JESS SWICEGOOD  
PO BOX 1828  
DOTHAN, ALABAMA 36302  
SY 2-2161  
EUGENE O BRADLEY  
1328 W FLOWER  
PHOENIX, ARIZONA 85D13  
AM 6-7292  
RICHARD R. BROOKS  
3706 W 225TH STREET  
TORRANCE, CALIF 90505  
373-2309  
HIGHLAND ASSOC  
C/O HENRY BROUGHALL  
600 MARBLE STREET  
BROOMFIELD, COLO 8002D  
466-3851  
GLENN E WEBSTER  
WEBSTER ENGR CO  
823 SO GREENWOOD AVE  
PARK RIDGE, ILLINOIS 60D06  
823-8206  
HARRISON RADIO INC.  
C/O HERBERT ARMS  
BOX 327  
CORDON, INDIANA 47112  
RE 8-5752  
JIM PIPER ASSOCIATES  
C/O JIM FLANAGAN  
TEN HAVEN STREET  
DOVER, MASS D2D3D  
934-2498  
DAVID VELDMSA  
AUOIO DISTR. INC.  
2342 DIVISION AVENUE SOUTH  
GRAND RAPIDS, MICH 495D7  
GL 2-5495  
CAROLINA RADIO SUPPLY  
C/O ROBERT WINDSOR  
838 HUFFMAN STREET  
GREENSBORO, N.C. 274D5  
BR 3-6358  
A C MC MILLAN  
16679 S W MAPLE CIRCLE  
LAKE OSWEGO, OREGON 97403  
636-6257  
CAROLINA RADIO SUPPLY  
C/O RUSS SUTTON  
221 W WASHINGTON STREET  
GREENVILLE, S.C. 296D2

SPEEQY-O ENTERPRISES

COMPANY ADDRESS  
6252 SANTA MONICA BLVD.  
HOLLYWOOD, CALIF. 9DD38  
REPS. IN OTHER COUNTRIES  
G. N. MACKENZIE LTO.  
433 JARVIS  
TORONTO, ONTARIO

SPENCER-KENNEY LABORATORIES

SALES MANAGER  
DON LEWIRE  
BRAND NAMES  
COLORBURST  
COLOR TAP  
COMPANY ADDRESS NO. 1  
1360 SOLDIERS FIELO ROAO  
BOSTON 35, MASS  
COMPANY ADDRESS NO. 2  
5800 N 19TH AVE.  
PHOENIX, ARIZONA  
COMPANY REPRESENTATIVES  
BILL BRYANT  
BOX 430  
FALKVILLE, ALABAMA  
205-355-2712  
WILLIAM MCGUCKIN  
5800 N. 19TH AVE #210  
PHOENIX, ARIZ.

602-264-2775  
HEINZ MATUSCHKA  
BOX 4426  
SAN RAFAEL, CALIF 94903  
415-472-1913  
BOB GAULT  
2233 LINDA JEAN DRIVE  
INOEPENDENCE, KAN.  
316-331-3078  
LLOYD TATE  
P. O. BOX 2731  
HARRISBURG, PENN  
717-766-2220  
BRUCE FRAZIER  
BOX 5387  
FT. WORTH, TEXAS  
817-244-2123

STACO, INCORPORATED

TECHNICAL SALES MGR.  
DOUGLAS JAMES  
BRAND NAMES  
ADJUST-A-VOLT  
STACO  
COMPANY ADDRESS  
2240 E. THIRD STREET  
DAYTON, OHIO 45403  
COMPANY REPRESENTATIVES  
MURPHY & COTA  
904 BOB WALLACE AVE SW  
HUNTSVILLE, ALABAMA  
THE RON MERRITT CO  
P O BOX 171  
ANCHORAGE, ALASKA  
HYDE ELECTRONICS  
2727 N CENTRAL AVE  
PHOENIX, ARIZONA  
WEST INC  
SUITE 512  
1 UNION BANK SQUARE  
ORANGE, CALIF  
STRAUBE ASSOCIATES  
483 WILLOW ROAD  
MENLO PARK, CALIF  
HYDE ELECTRONICS  
888 S LIPAN ST  
DENVER, COLORADO  
COAKLEY, BOYD & ABBETT  
6 GAYWOOD DRIVE  
WATERBURY, CONN  
MURPHY & COTA  
712 W VASSAR AVE  
ORLANDO, FLORIDA  
MURPHY & COTA  
2110 PEACHTREE RD  
ATLANTA, GEORGIA  
SAFFRO & ASSOC  
3736 DEMPSTER ST  
SKOKIE, ILLINOIS  
R O WHITESELL & ASSOC  
6620 E WASHINGTON ST  
INDIANAPOLIS, INDIANA  
R O WHITESELL & ASSOC  
203 W WAYNE ST  
FT WAYNE, INDIANA  
ELECTRONIC SALES CO  
1310 HERTZ DRIVE SE  
CEDAR RAPIDS, IOWA  
R O WHITESELL & ASSOC  
LEX MANOR BLDG, RM 223  
3620 LEXINGTON ROAD  
LOUISVILLE, KENTUCKY  
EASTERN COMPONENTS INC  
1002 INGLESIDE AVE  
BALTIMORE, MARYLAND  
COAKLEY, BOYD & ABBETT  
P O BOX 248  
1424 HIGHLAND AVENUE  
NEEDHAM, MASS  
R O WHITESELL & ASSOC  
168D1 WYOMING AVE  
DETROIT, MICHIGAN  
R O WHITESELL & ASSOC  
303 FIDELITY BLOG  
BENTON, HARBOR  
CLARK R GIBB CO  
240 DO HENNEPIN AVE  
MINNEAPOLIS, MINN  
L R HARRY & ASSOC  
7603 FORSYTH, RM 103  
CLAYTON, MISSOURI  
HYOE ELECTRONICS  
5206 CONSTITUTION NE  
ALBUQUERQUE, NEW MEXICO  
LEVISON SALES CO  
5 SUNRISE PLAZA  
VALLEY STREAM, LI, N Y  
ROBERT F LAMB CO  
3407 OELAWARE AVE  
BUFFALO, NEW YORK  
ROBERT F LAMB CO  
PO BOX 28  
SYRACUSE, NEW YORK  
ROBERT F LAMB CO  
PO BOX 661 UPTOWN STA  
KINGSTON, NEW YORK  
ROBURN AGENCIES  
431-435 GREENWICH ST  
NEW YORK, NEW YORK  
MURPHY & COTA  
P O BOX 6365  
GREENSBORO, N C  
MURPHY & COTA  
1106 BURKE ST  
WINSTON-SALEM, N C  
R O WHITESELL & ASSOC  
1172 W GAILBRAITH RD  
DAYTON, OHIO  
STACO INCORPORATED  
2240 EAST THIRD ST  
CINCINNATI, OHIO  
R O WHITESELL & ASSOC  
21139 LORAIN AVENUE  
CLEVELAND, OHIO  
R O WHITESELL & ASSOC  
1350 W FIFTH AVE  
COLUMBUS, OHIO  
R O WHITESELL & ASSOC

4133 S DIXIE AVE  
DAYTON, OHIO  
THE RON MERRITT CO  
2035 SW 58TH AVE  
PORTLAND, OREGON  
EASTERN COMPONENTS INC  
613 W CHELTENHAM AVE  
PHILADELPHIA, PENN  
R O WHITESSELL & ASSOC  
PENN CENTER BLDG  
201 PENN CENTER BLVD  
PITTSBURGH, PENN  
SCIENTIFIC SALES CO  
777 SD CENTRAL EXPRESSWAY  
RICHARDSON, TEXAS  
HYDE ELECTRONICS  
85 E SEVENTH SO  
SALT LAKE CITY, UTAH  
THE RDM MERRITT CO  
1320 PRDSPECT ST  
SEATTLE, WASHINGTON  
REPS. IN OTHER COUNTRIES  
BURLIC SALES LTD  
45 NORTHLINE RDAD  
TORONTO, ONTARIO  
BURLIC SALES LTD.  
1179 DECARIE BLVD.  
MONTRÉAL, QUÉBEC

#### STAINLESS INCORPORATED

PRESIDENT  
HENRY J. GUZEWICZ  
VP IN CHARGE OF ENGR.  
RICHARD J. EBERLF  
COMPANY ADDRESS  
THIRD STREET  
NORTH WALES, PA. 19454

#### STANCIL-MOFFMAN CORPORATION

SALES MANAGER  
WILLIAM V. STANCIL  
BRAND NAMES  
MINITAPE-R  
COMPANY ADDRESS  
921 NORTH HIGHLAND AVE.  
MOLLYWOOD, CALIF. 90038

#### STANDARD ELECTRONICS CORP

SALES MANAGER  
BILL ZILLGER  
COMPANY ADDRESS  
P. O. BOX 677  
FREEHOLD, N. J. 07728  
COMPANY REPRESENTATIVES  
JIMMY EVANS  
BIRMINGHAM, ALA  
785 7421  
PENINSULA ASSOCIATES  
PALO ALTO, CALIF  
322 1803  
REECHER HAYFDRD  
JACKSONVILLE, FLA  
356 3007  
GLENN WEBSTER  
PARK RIDGE, ILL  
823 8206  
BILL STRINGFELLOW  
ALBUQUERQUE, NEW MEXICO  
AX 8 2575  
VISUAL ELECTRONICS INTL  
NEW YORK, NEW YORK  
DE 6 5840  
LYLE KEYS  
SALT LAKE CITY, UTAH  
EL 9 7691  
JOHN MCCLAMRDCCK  
SEATTLE, WASH  
CH 4 9391  
REPS IN OTHER COUNTRIES  
NORTHERN ELECTRIC  
TORONTO, ONTARIO  
363 8651

#### STANDARD KOLLSMAN

INDUSTRIES INCORPORATED  
SALES MANAGER  
A. H. FORBES  
COMPANY ADDRESS  
2085 N. HANTHORNE AVE.  
MELROSE PARK, ILL. 60160

#### STANDARD RECORD MFG CO

SALES MANAGER  
CAROLINE RAIKES  
COMPANY ADDRESS  
70 NO SAN GABRIEL BLVD  
PASADENA, CALIF 91107  
213 681 0537

#### STEPHENS ELECTRONICS

OWNER  
JOHN F. STEPHENS  
COMPANY ADDRESS  
2302 NORTH ONTARIO ST.  
RURBANK, CALIF, 91504

#### S. STERLING COMPANY

SALES MANAGER  
SAM COOMBS  
COMPANY ADDRESS  
21250 10 1/2 MILE ROAD  
SOUTHFIELD, MICHIGAN  
313-357-3700  
COMPANY REPRESENTATIVES  
S STERLING CO  
7849 N LINDBERGH  
HAZELWOOD, MISSOURI  
314 TE 7 1221  
S STERLING CO  
9827 MAYFIELD ROAD  
CLEVELAND, OHIO  
216 HI 2 8080  
STERLING CO  
3300 S DIXIE DRIVE  
DAYTON, OHIO  
513 AX 8 7573

S STERLING CO  
4232 BROWNSVILLE ROAD  
PITTSBURGH, PENN  
412 343 2844

#### STRUTHERS-DUNN INCORPORATED

SALES MANAGER  
W. L. CAPEWELL  
BRAND NAMES  
DUMCO  
COMPANY ADDRESS  
LAMBS ROAD  
PITMAN, N. J. 08071  
COMPANY REPRESENTATIVES  
APPLEBEE-CHURCH INC  
13 OFFICE PARK CIRCLE  
BIRMINGHAM, ALABAMA 35223  
205 879 4417  
VINSON ASSOCIATES INC  
44 E INDIAN SCHOOL RD STE 6  
SCOTTSDALE, ARIZONA 85252  
602 947-7371  
TWX 602 949 0122  
LEDBETTER ASSOCIATES  
2124 ARTHUR AVENUE  
BELMONT, CALIFORNIA  
415 591 7774  
LEDBETTER ASSOCIATES  
P O BOX 528  
16618 VENTURA BLVD  
ENCINO, CALIFORNIA 91316  
213 789-8115  
TWX 213 783 3345  
R P MCALISTER  
WEST COAST REG MGR  
STRUTHERS-DUN INC  
P O BOX 224  
ENCINO, CALIFORNIA  
213 784 3233  
VINSON ASSOCIATES INC  
203 TUCKER BUILDING  
3600 S 1<sup>ST</sup> AVENUE  
ENGLEWOOD, COLORADO 80110  
303 789-2203  
TWX 303 789 1649  
J J GALLEHER COMPANY  
P O BOX 1376  
617-A CLEVELAND STREET  
CLEARWATER, FLORIDA  
813 446 7706  
E C WILSON  
SOUTHERN REG MGR  
STRUTHERS-DUN INC  
1152 CLEVELAND AVENUE  
CLEARWATER, FLORIDA  
813 442 2817  
APPLEBEE CHURCH INC  
1958 A MONROE DR N E  
P O BOX 13485  
ATLANTA, GEORGIA 30324  
404 875-7244  
TWX 404 527 0042  
REP INC  
1483 MONROE DRIVE N E  
ATLANTA, GEORGIA 30324  
404 876 1591  
ROCKFORD CONTROLS CO  
21W181 HILL AVENUE  
GLEN ELLYN, ILLINOIS 60137  
312 469-6016  
TWX 910 651 3250  
R L HELLMOUND  
MIDWESTERN REG MGR  
STRUTHERS-DUN INC  
1167 WILMETTE AVENUE RM 208  
WILMETTE, ILLINDIS  
312 469 6016  
REID ASSOCIATES INC  
526 MNB BUILDING  
CEDAR RAPIDS, IDWA 52401  
319 362 6302  
AVIDONICS ENGRG SALES CO  
230 IDA P O BOX 786  
WICHITA, KANSAS 67201  
316 264 6201  
STEMLER ASSOCIATES & CO  
25 W PENNSYLVANIA AVE  
TOWSON, MARYLAND 21204  
301 828-8853  
TWX 301 828 7046  
ELECTRICAL APPARATUS CO  
1200 SOLDIERS FIELD ROAD  
BOSTON, MASS 02134  
617 782 7440  
ROBERT MCBRIDE CO INC  
20830 RUTLAND  
SOUTHFIELD, MICH  
313 356 5724  
E MELIUS & ASSOC INC  
3758 N DUNLAP ST  
ST. PAUL, MINN 55112  
612 488-7293  
TWX 612 551 0053  
CARL P LOHR COMPANY  
1110 S BRENTWOOD BLVD  
ST. LOUIS, MISSOURI 63117  
314 725-9794  
TWX 314 556 0069  
E A MAIS CO  
P O BOX 9721  
KANSAS CITY, MO 64137  
816 761-3124  
TWX 910 760 1663  
PETEFISH KUNKEL CO  
9322 MANCHESTER RDAD  
ST. LOUIS, MO 63119  
314 968-0300  
TWX 910 760 1663  
GRIMM, SIEGEL ASSOC INC  
246 CLIFTDN AVENUE  
CLIFTON, N. J. 07011  
201 773 5010  
VINSON ASSOCIATES INC  
BOX 3295 STATION D  
ALBUQUERQUE, NEW MEX 87110  
505 298-7444

TWX 505 243 8401  
ROME ELECTRONICS INC  
110 SPRING STREET  
ROME, NEW YORK 13440  
315 337 5400  
H C ZANG AGENCY  
64 PRAIRIE AVENUE  
BUFFALO, NEW YORK 14207  
716 877 3677  
JAKE RUDISILL ASSOC INC  
2009 N TRYDN STREET  
CHARLOTTE, N. C. 28206  
704 377 6901  
BEEDLE EQUIPMENT CO  
P O BOX 36061  
6900 SILVERTON AVENUE  
CINCINNATI, OHIO 45236  
513 793 0140  
J L FINNIC & ASSOC  
4500 EUCLID AVE RM 213  
CLEVELAND, OHIO 44103  
216 431 7477  
RUSSELL F CLARK CO  
10517 LINDBERG AVENUE  
PITTSBURGH, PENNA 15225  
412 242-9500  
TWX 412 642 3196  
STRUTHERS-DUNN INC  
1505 RACE STREET  
PHILADELPHIA, PA 19102  
215 564-4020  
TWX 215 569 8575  
RANSOM INC  
SUITE 919 100 N MAIN BLDG  
MEMPHIS, TENN 38103  
901 527 3194  
VISTA ENGINEERING ASSOC  
CENTRAL EXCHANGE SUITE 5 E  
777 CENTRAL EXPRESSWAY NORTH  
RICHARDSON, TEXAS  
214 235 4547  
TWX 214 231 1400  
VISTA ENGINEERING ASSOC  
1614 S POST OAK  
HOUSTON, TEXAS 77027  
713 622 5680  
EICHER-RICHARDS COMPANY  
5 WEST HARRISON STREET  
SEATTLE, WASH 98119  
206 284 1811  
REPS IN OTHER COUNTRIES  
RENFREW ELECTRIC CO  
349 CARLAW AVENUE  
TORONTO, ONTARIO 111  
705 461-3511  
TWX 610 491 2287

#### MATTHEW STUART & CO., INC.

COMPANY ADDRESS  
3650 DYRE AVENUE  
BRONX, NEW YORK 10466

#### SUPERIOR CABLE CORPORATION

VP MARKETING  
J. H. BOWMAN  
SALES MANAGER  
JOHN W. ENGLISH  
BRAND NAMES  
SUPER SPLICE  
HICKORY BRAND  
CELL-O-AIR  
COMPANY ADDRESS  
P. O. BOX 489  
HICKORY, N. CAROLINA 28601  
COMPANY REPRESENTATIVES  
ROM J WESTWOOD  
161 W 25TH AVENUE RM 207  
SAN MATEO, CALIF  
415 349 3003  
FRANK L BOEDECKER  
P O BOX 391  
ETNA, CALIFORNIA  
916 467 3790  
L KENNETH POWLEY  
DISTRICT SALES MANAGER  
2199 NDRTH DECATUR RO OFC 4  
DECATUR, GEORGIA  
404 636 9575  
T J LYONS  
DISTRICT SALES MANAGER  
650 ROOSEVELT RD RM 207  
GLEN ELLYN, ILLINOIS  
312 858 0180  
MAURICE STROBEL  
38 W GLENLAKE AVENUE  
ROSELLE, ILLINDIS  
312 529 4499  
C E SCHNEGELSBERGER  
BROADWAY ROAD  
FRANKLIN, KENTUCKY  
502 586 6389  
R E WOHLBERG  
DISTRICT SALES MANAGER  
1806 SWIFT ST SUITE 104A  
NORTH KANSAS CITY, MO  
816 421 6806  
N C COX  
DISTRICT SALES MANAGER  
P O BOX 489  
HICKORY, N CAROLINA  
704 328 2171  
ROCKY MOUNT DIVISION  
HIGHWAY 301A NORTH BOX 1021  
ROCKY MOUNT, N C 27801  
919 446 8155  
MOMER P ROELLE  
DISTRICT SALES MANAGER  
WYANDOT BLDG PUBLIC SQUARE  
GALLION, OHIO  
419 468 4715  
MARVIN CHENAUAT  
DISTRICT SALES MANAGER  
130 CASA LINDA PLAZA STE 34  
DALLAS, TEXAS  
214 321 3242  
BROWNWOOD DIVISION

MORRIS SHEPARD DR PD BDX 698  
BROWNWOOD, TEXAS 76801  
915 645-2624  
TWX 910 897 5580  
ELECTRONICS DIVISION  
1001 PAMELA DR PD BDX 579  
EULESS, TEXAS 76039  
817 283 2893  
ELECTRONIC DIST SALES CRDP  
600 ALANTON TOWER  
DALLAS, TEXAS 75235  
214 357 7306

#### SWAGER TOWER CORPORATION

PRESIDENT  
WILLIAM E. SWAGER  
GENERAL MANAGER  
JOHN A. MCAULAY  
BRAND NAMES  
DURA TOWER  
COMPANY ADDRESS  
P. O. BOX 498  
FREMONT, INDIANA 46737  
219-495-2525

#### SWITCHCRAFT, INC.

INDUSTRIAL SALES MANAGER  
C. J. SCHULTZ  
DISTRIBUTOR SALES MANAGER  
A. F. ANDERSON  
BRAND NAMES  
THICK-PANEL JAX  
MICRO-JAX  
LITTEL JAX  
TP-JAX  
TINI-JAX  
LAMP-JAX  
TINI-EXTENSION JAX  
MT-JAX  
SHIELDED JAX  
HI-D JAX  
TINI-D JAX  
R-JAX  
LF-JAX  
EXTENSION JAX  
SF-JAX  
CV-JAX  
T-JAX  
M-JAX  
TWIN-JAX  
TWIN-PLUG  
CV PLUG  
LUG PLUG  
TINI-PLUG  
MICRO-PLUG  
FLAT-PLUG  
O-G CONNECTORS  
SLIM-LINE CONNECTORS  
MINI-CON CONNECTORS  
SWITCHCRAFT/PREH CONNECTORS  
MINI-MIX  
MIX-AMP  
GLO-BUTTON  
Y-ADAPTER  
TINI-TEE ADAPTER  
LITTEL SWITCH  
BUTTON SWITCH  
CORD SWITCH  
TINI-SWITCH  
T-SWITCH  
FF SWITCH  
NF SWITCH  
TF SWITCH  
LITTEL-LITE SWITCH  
MULTI-SWITCH  
NF-LITE SWITCH  
LEV-R SWITCH  
TELEVER SWITCH  
LEVER-LOCK SWITCH  
FEATHER LEVER SWITCH  
HOOK SWITCH  
RS SWITCH  
PUSH-PUSH SWITCHES  
LK SWITCH  
LEVER-LITE SWITCH  
MLK SWITCH  
CORDETTE SWITCH  
CORDMASTER SWITCH  
L-T SWITCH  
MULTI-LITE PUSHBUTTONS  
SHOWCASE PUSHBUTTONS  
BOX SWITCH  
DOUBLE-WIPE  
COMPANY ADDRESS  
5555 NO. ELSTON AVENUE  
CHICAGO, ILL. 60630  
312 774 1515  
TWX 312 265 1314  
COMPANY REPRESENTATIVES  
DAVID H. ROSS COMPANY  
534 EL CAMINO REAL  
SAN CARLOS, CALIF. 94070  
415-591-4411  
PAUL F. WILEY COMPANY  
1632 SILVERLAKE BLVD  
LOS ANGELES, CALIF. 90026  
213-663-8028  
GORDON MOSS ELECTRONICS INC.  
1530 13TH AVE P O BOX J  
GREELEY, COLO 80632  
303-353-1452  
ANDERSON SALES CO.  
DISTRIBUTOR ONLY  
133 MANSFIELD AVE  
WATERBURY, CONN 06705  
203 753 2487  
CARTWRIGHT AND BEAN  
395 TRITON ROAD  
ORMOND BEACH, FLA 32074  
305-677-3480  
CARTWRIGHT AND BEAN  
INDUSTRIAL ONLY  
609 E COLONIAL DRIVE  
ORLANDO, FLORIDA 32803  
305 425 8284  
CARTWRIGHT AND BEAN

# SERIES 700 BY TAPECASTER

YEARS AHEAD IN DESIGN

All solid state using highest quality silicon semiconductors

Designed to exceed NAB specifications

Full remote control features, START — STOP and RECORD PRESET

Designed for automation with auxiliary cue tone option

Premium Nortronics metal faced heads, Large illuminated control buttons

Hysteresis synchronous motor, Solid stainless steel top deck plate

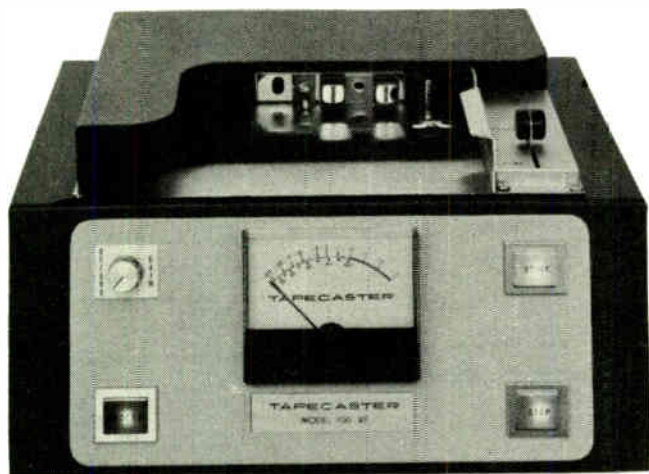

Model 700-RP \$450.00

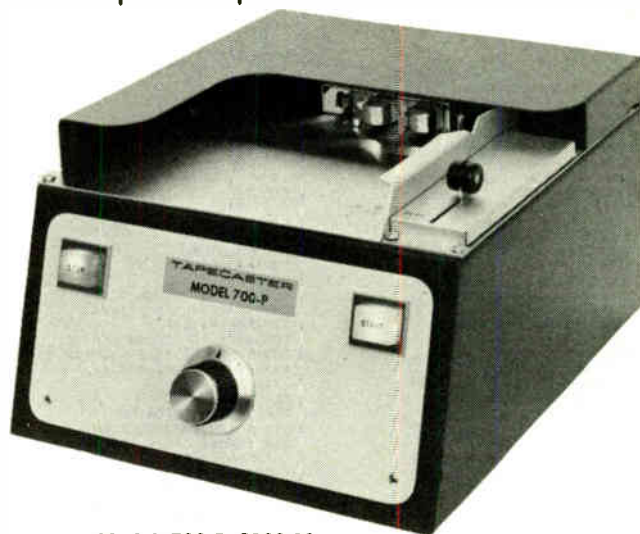

Model 700-P \$300.00

## TAPECASTER ELECTRONICS

Box 662, Rockville, Maryland 20851

DISTRIBUTOR ONLY  
20100 N E 25TH COURT  
NORTH MIAMI BEACH, FLA 33160  
305 945 2962  
CARTWRIGHT AND BEAN  
3223 CAINS HILL PLACE N. W.  
ATLANTA, GEORGIA 30305  
404-237-2273  
DOUGHERTY ENTERPRISES  
1164 WAIMANU ST  
P. O. BOX 3497  
HONOLULU, HAWAII 96814  
504-987  
SWITCHCRAFT, INC.  
INDUSTRIAL ONLY  
5555 NORTH ELSTON AVE  
CHICAGO, ILLINOIS 60630  
312 774 1515  
TWX 312 265 1314  
KLEM AND STEFFEN INC  
DISTRIBUTOR ONLY  
417 HARRISON ST  
P O BOX 1116  
OAK PARK, ILL 60204  
312 848 6444  
RINALDI SALES CO  
SPECIAL INDUSTRIAL ACCOUNTS  
5483 NORTHWEST HIGHWAY  
CHICAGO, ILLINOIS 60630  
312 763 4848  
COMET CORPORATION - EXPORT  
540 LAKE SHORE DRIVE  
CHICAGO, ILLINOIS 60611  
312-337-2292  
THOMAS AND SUKUP INC  
2060 EAST 54TH STREET  
INDIANAPOLIS, INDIANA 46220  
317-251-4574  
THOMAS L. OWELL INC  
9724 LAMAR AVE  
OVERLAND PARK, KANSAS 66207  
913-649-6049  
CARTWRIGHT AND BEAN  
1810 BULLARD AVE  
METAIRIE, LOUISIANA  
TRINKLE SALES COMPANY  
DISTRIBUTOR ONLY  
456 QUARTERFIELD RD  
GLEN BURNIE, MD 21061  
301 761 3439  
KEN RANDALL COMPANY  
821 SCARLETT DR  
TOWSON, MARYLAND 21204  
301-828-5310  
ANDERSON SALES  
177 STATE STREET  
BOSTON, MASS 02109  
617-227-2980  
ANDERSON SALES CO  
DISTRIBUTOR ONLY  
34 COOLIDGE AVE  
WESTFIELD, MASS 01085

413 568 7004  
R. C. MERCHANT & CO INC  
18411 W. MCNICHOLS RD  
DETROIT, MICHIGAN 48219  
313-535-6000  
P. C. MERCHANT & CO INC  
P. O. BOX 591  
BENTON HARBOR, MICHIGAN 49023  
616-925-4211  
MEL FOSTER COMPANY INC  
278 S. CEDAR LAKE ROAD  
MINNEAPOLIS, MINN 55405  
612-374-2612  
KEN RANDALL COMPANY  
250 HADDON AVENUE  
COLLINGSWOOD, N. J. 08108  
609-854-3323  
TRINKLE SALES CO  
MANOR BLDG-WEST  
7675 MAPLE AVENUE  
MERCHANTVILLE, N J 08019  
609 663 0303  
O. F. MASIN CO, INC.  
140 ROSTON POST RD  
LARCHMONT, NEW YORK 10538  
914-834-7500  
FRANK W. TAYLOR, INC  
INDUSTRIAL ONLY  
4455 E GENESEE ST  
P O BOX 86  
DEWITT, NEW YORK 13214  
315 446 0422  
CALLAHAN-FERGUSON CO  
107 GREENHEDGE DRIVE  
CAMILLUS, NEW YORK 13031  
315-488-5518  
CALLAHAN-FERGUSON CO  
117 FAYETTE STREET  
MANLIUS, NEW YORK 13104  
CARTWRIGHT AND BEAN  
625 HARWYN DRIVE  
CHARLOTTE, N. C. 28205  
704 333 6457  
NEAL BEAR CORPORATION  
3435 STREETSBORO ROAD  
WEST RICHFIELD, OHIO 44286  
216-659-3331  
NEAL BEAR CORPORATION  
2801 FAR HILLS AVENUE  
DAYTON, OHIO 45419  
513-299-3566  
RON MERRITT COMPANY  
SYLVAN BLDG RM 217  
2035 S W 58TH AVE  
PORTLAND, OREGON 97221  
503 222 7337  
NEBCO ASSOCIATES  
1974 GREGORY AVENUE  
MONROEVILLE, PENN 15146  
412-824-2111  
JOSE ARTURO FERNANDEZ  
PONCE DE LEON 400 STOP 7 1/2

BOX 5124  
PUERTO DE TIERRA 00906  
PUERTO RICO  
724-2854  
CARTWRIGHT AND BEAN  
560 SOUTH COOPER STREET  
CROSTOWN STATION  
P. O. BOX 760  
MEMPHIS, TENN 38104  
901-276-4442  
BRANUM SALES INC  
2334 HAVENHURST STREET  
P. O. BOX 14348  
DALLAS, TEXAS 75234  
214-247-7128  
GORDON MOSS ELECTRONICS, INC  
1502 PRESTON ST  
P. O. BOX 8022  
FOOTHILLS STATION  
SALT LAKE CITY, UTAH 84108  
801-485-2870  
RON MERRITT COMPANY  
132D PROSPECT STREET  
SEATTLE, WASH 98109  
206-682-7337  
KLEM-STEFFEN  
13845 CAPITOL DRIVE  
BROOKFIELD, WISCONSIN 53005  
414-781-7596  
REPS IN OTHER COUNTRIES  
ATLAS RADIO CORP. LTD.  
50 WINGOLD AVENUE  
TORONTO 19, ONTARIO  
416-781-6174

SYLVANIA ELECTRIC PRODUCTS INC.  
COMMERCIAL ELECTRONICS DIV.  
SALES MANAGER  
MAURICE GROSS  
BRAND NAMES  
SYLVANIA  
COMPANY ADDRESS  
BURLINGTON RO, P O BOX 268  
P O BOX 268  
BEDFORD, MASS 01730  
COMPANY REPRESENTATIVES  
I G PISCIOTTA  
1811 ADRIAN ROAD  
BURLINGAME, CALIF 94010  
415 697 3500  
KENNETH N THANSTROM  
6505 EAST GAYHART ST  
LOS ANGELES, CALIFORNIA  
213 723 5371  
J C VINING  
1602 FLORIDA AVE BOX 7134  
TAMPA, FLORIDA 33603  
813 223 1726  
CARL ROSEKRANS

2115 SYLVAN ROAD  
ATLANTA, GA 30310  
404 766 3633  
RICHARD F PRISKE  
2001 NORTH CORNELL AVE  
MELROSE PARK, ILL 60160  
312 345 0100  
LEONARD FRANKWITZ  
901 DEVERE DRIVE  
SILVER SPRINGS, MD 20903  
301 434 1299  
HUGH GILLOGLY  
BURLINGTON ROAD, BOX 268  
BEDFORD, MASS 01730  
617 275 0300  
JAMES A DHIMOS  
BURLINGTON ROAD, BOX 268  
BEDFORD, MASS 01730  
617 275 0300  
RUSSELL A PILCHER  
365 DEERFIELD RD  
COLUMBUS, OHIO 43228  
614 878 7880  
LOU DIAMOND  
7007 GULF FREEWAY BOX 26596  
HOUSTON, TEXAS 77032  
713 649 8306  
REPS. IN OTHER COUNTRIES  
A C STEWART  
AUTOMATIC ELECTRIC SALES  
185 BARTLEY DRIVE  
TORONTO, ONTARIO

SYLVANIA ELECTRIC PRODUCTS, INC  
SEMICONDUCTOR DIVISION  
SALES MANAGER  
F. FLOOD  
COMPANY ADDRESS  
100 SYLVAN ROAD  
WOBURN, MASS

SYNCRON CORPORATION  
PRESIDENT  
WILLIAM HENNESSEY  
COMPANY ADDRESS  
10 GEORGE STREET  
WALLINGFORD, CONN 06494  
COMPANY REPRESENTATIVES  
GILLINGHAM ASSOC  
HUNTINGTON BEACH, CALIF.  
WORLD WIDE PRODUCTS  
N MIAMI BEACH, FLORIDA  
PIPER ASSOCIATES  
10 HAVEN ST  
DOVFR, MASS.  
REPCO  
1174 DAY STREET  
SEAFORD, N.Y.  
PRES CLANCEY ASSOC  
OKLAHOMA CITY, OKLAHOMA

**TAPECASTER ELECTRONICS**  
BRAND NAMES  
TAPECASTER  
COMPANY ADDRESS  
BOX 662, 12326 WILKINS AVE.  
ROCKVILLE, MARYLAND 20851  
301 942-6666

**TAPE-ATHON CORPORATION**  
SALES MANAGER  
TOM AYE  
BRAND NAMES  
TAPE-ATHON  
COMPANY ADDRESS  
523 S. HINDRY  
INGLEWOOD, CALIF. 90307  
COMPANY REPRESENTATIVES  
VERNE LINSLEY CO  
2907 W VILLA ST  
PHOENIX, ARIZONA  
THOMAS M. MORRIS ASSOCIATES  
1315 EL SOLYO AVENUE  
CAMPBELL, CALIFORNIA  
ERNIE R. JENSEN & ASSOCIATES  
5315 8TH AVENUE DRIVE WEST  
BRADENTON, FLORIDA  
EVERETT P. BEAN  
3223 CAINS HILL PLACE N. W.  
ATLANTA, GEORGIA 30305  
BILL KOLANS & CO  
P. O. BOX 1932  
HONOLULU 5, HAWAII  
EDWARD N. SEVERSEN  
11435 CIRCLE DRIVE  
LA GRANGE, ILLINOIS  
DOUG COOK & ASSOCIATES  
1519 EAST 46TH STREET  
INDIANAPOLIS, INDIANA  
SCOTT ORMSBY SALES  
230 20TH STREET  
NEW ORLEANS, LA. 70124  
AB & T SALES CORPORATION  
3620 QUEEN MARY DRIVE  
OLNEY, MARYLAND  
WALTER R. HATFIELD CO.  
P. O. BOX 342  
LEXINGTON 73, MASS 02173  
BUTCHART-RATHSBURG & ASSOC.  
16637 F. WARREN AVENUE  
DETROIT, MICHIGAN  
NORTHLAND ASSOCIATES  
1012 19TH AVENUE SOUTH  
MOORHEAD, MINNESOTA  
J. G. BRALEY SALES  
11336 HIGH RIDGE DRIVE  
INDEPENDENCE, MO.  
PASTON-HUNTER COMPANY INC.  
P. O. BOX 129  
DEWITT STATION  
SYRACUSE, NEW YORK  
GILBERT E. MILLER ASSOCIATES  
P. O. BOX 171  
JERICHO, L. I. NEW YORK  
JAMES ELAM  
625 HARWYN DRIVE  
CHARLOTTE, N. C. 28205  
CHARLES F. PRICE  
1224 HARTFORD AVENUE  
CHARLOTTE, N. C. 28205  
MARK PITKOW  
8921 TURTON DRIVE  
PHILADELPHIA, PA. 19115  
JAMES CARTWRIGHT  
P. O. BOX 760  
CROSTOWN STATION  
560 SOUTH COOPER STREET  
MEMPHIS, TENN 38104  
THE BILL WYLD COMPANY  
1247 CAUDLE  
HOUSTON, TEXAS  
M K WIDDEKIND CO INC  
815 W EWING ST  
SEATTLE, WASH 98119  
REPS IN OTHER COUNTRIES  
E. J. PIGGOTT ENTERPRISES  
274 CHURCH STREET  
TORONTO 1, ONTARIO  
E. S. GOULD SALES CO LTD.  
11 LOUVAIN ST WEST  
MONTREAL, QUEBEC

**TECHNICAL APPLIANCE CORPORATION**  
SALES MANAGER - CONTRACT  
JOHN SEVERINSEN  
BRAND NAMES  
TACO  
TACOFORM  
COMPANY ADDRESS  
1 TACO AVENUE  
SHERRBURNE, NEW YORK 13460

**THE TECHNICAL MATERIEL CORPORATION**  
VICE PRESIDENT  
HENRY J. GEIST  
COMPANY ADDRESS  
707 FENMORE ROAD  
MAMARONECK, N. Y. 10543  
COMPANY REPRESENTATIVES  
RICHARD J. HOMER & ASSOC  
14436 SHERMAN WAY  
VAN NUYS, CALIF.  
213 781-1236  
WESTEC ELECTRONICS INC  
4117 EL CAMINO WAY  
PALO ALTO, CALIF.  
415 327-5850  
WESTEC  
P O BOX 781  
EL SEGUNDO, CALIF.  
213 327-1561  
LYNCH-GENTRY ASSOCIATES INC  
6646 CENTRAL AVE  
ST. PETERSBURG, FLA.  
813 347-5131  
FRANK GASSNER & CLARK

6644 NORTHWESTERN AVE  
CHICAGO, ILL.  
312 764-6121  
FAHST ASSOC.  
1123 MEADOW LARK DR  
BALTIMORE, MARYLAND  
301 242-4123  
TECHCOM ASSOCIATES  
862 EAST STREET  
TEWKSBURY, MASS.  
617 851-9704  
GEIST ASSOC INC  
131 WOODLAND MANOR  
NEW SHREWSBURY, N.J.  
201 542-0732  
POSITIVE CONSULTANT SERVICE  
2255 ARBY COURT  
RELLMORF, N.Y.  
516 221-2262  
DYNA-REPS  
200 S GRANTS LANE  
FT. WORTH, TEXAS  
817 732-6621  
EARL SELOVER  
568 MARCHANT ROAD  
NORFOLK, VIRGINIA  
703 588-5154

**TEKTRONIX, INC.**  
SALES MANAGER  
DICK HERDMAN  
BRAND NAMES  
SCOPFMORILE  
COMPANY ADDRESS  
P O BOX 500  
BEAVERTON, OREGON 97005  
COMPANY REPRESENTATIVES  
TEKTRONIX, INC  
LOS ANGELES REGION OFFICE  
SUITE 223, 1360 S ANAHEIM BD  
ANAHEIM, CALIF. 92805  
714 776-4963  
TEKTRONIX, INC  
PALO ALTO REGION OFFICE  
960 N SAN ANTONIO ROAD  
LOS ALTOS, CALIF. 94022  
415 941-0484  
TEKTRONIX INC  
ATLANTA REGION OFFICE  
SUITE 419  
3384 PEACHTREE ROAD, NE  
ATLANTA, GEORGIA 30326  
404 237-5503  
TEKTRONIX, INC  
CHICAGO REGION OFFICE  
3150 DES PLAINES AVENUE  
DES PLAINES, ILL. 60018  
312 299-7715  
TEKTRONIX INC  
PHILADELPHIA REGION OFFICE  
383 NORTH KINGS HIGHWAY  
CHERRY HILL, N.J. 08034  
609 667-1154  
TEKTRONIX, INC  
LONG ISLAND REGION OFFICE  
125 MINEOLA AVENUE  
ROSLYN HGT., L. I., N.Y. 11577  
516 HT 4-2308  
TEKTRONIX INC  
SYRACUSE REGION OFFICE  
F MOLLOY RD & PICKARD DR  
P O BOX 267  
SYRACUSE, N.Y. 13211  
315 455-6626  
TEKTRONIX INC  
DALLAS REGION OFFICE  
SUITE 470 6434 MAPLE AVENUE  
DALLAS, TEXAS 75235  
214 FL 7-6301

**TELECTRO INDUSTRIES, INC.**  
BRAND NAMES  
PILOT  
TELECTRO  
COMPANY ADDRESS  
100 ELECTRA LANE  
YONKERS, NEW YORK 10704

**TELE-DEVICES COMPANY**  
SYSTEMS ENGINEERING MGR.  
MANFRED P. DORN  
COMPANY ADDRESS  
5223 GERMANTOWN AVE.  
PHILADELPHIA, PA. 19144

**TELEMATION, INC.**  
MARKETING MANAGER  
RAY M. UNRATH  
CATV SALES MANAGER  
KENNETH L. LAWSON  
ETV SALES MANAGER  
ROBERT C. BACON  
BRAND NAMES  
WEATHER CHANNEL  
NEWS CHANNEL  
CHROMA-CHANNEL  
SAV-A-CHANNEL  
TELECTERN  
NEWS-A-THON  
COMPANY ADDRESS  
2275 SOUTH WEST TEMPLE  
SALT LAKE CITY, UTAH 84115  
801 466 8631

**TELEMET COMPANY**  
SALES MANAGER  
E. S. KING  
BRAND NAMES  
TELECHROME  
TELEMET  
COMPANY ADDRESS  
185 DIXON AVENUE  
AMITYVILLE, NEW YORK 11701  
COMPANY REPRESENTATIVES  
JOHN GUERRERO  
9841 S MAIN STREET

SANTA ANA, CALIF.  
714 K1 5-7171  
CHARLES H. GOLSEN  
1539 BEECHCLIFF DRIVE N E  
ATLANTA, GEORGIA  
404 634-5766  
D E CHAPMAN  
670 N ELIZABETH ST  
LOMBARD, ILL.  
312 MA 7-6026  
REPS. IN OTHER COUNTRIES  
AFROMOTIVE ENGR PRODUCTS LTD  
887 MONTEE DE LIESSE  
ST. LAURENT, QUEBEC  
514 747-4781

**TELEQUIP CORPORATION**  
COMPANY ADDRESS  
224 GLEN COVE AVE. BOX 831  
GLEN COVE, N.Y. 11542

**TELEFIS CORPORATION**  
SALES MANAGER  
JOSEPH MURPHY  
COMPANY ADDRESS  
645 N. MICHIGAN AVE.  
CHICAGO, ILL. 60611

**TELETRONIX DIVISION, BABCOCK ELECTRONICS CORPORATION**  
DIRECTOR OF MARKETING  
HENRY S. BROUGHALL  
COMPANY ADDRESS  
2952 RANDOLPH ST.  
COSTA MESA, CALIF. 92626

**TELEVISION UTILITIES CORP.**  
COMPANY ADDRESS  
10-11 30TH AVENUE  
LONG ISLAND CITY, N. Y. 11101

**TELEVISION ZOOMAR COMPANY**  
SALES MANAGER  
BILL PEGLER  
BRAND NAMES  
ZOOMAR  
COMPANY ADDRESS  
500 FIFTH AVE., SUITE 5520  
NEW YORK, NEW YORK 10036

**TELONIC INDUSTRIES, INC.**  
SALES MANAGER  
W. E. GREESON  
BRAND NAMES  
TELONIC  
COMPANY ADDRESS  
60 NORTH FIRST AVE.  
RFECH GROVE, INDIANA 46107  
COMPANY REPRESENTATIVES  
GENTRY ASSOCIATES  
418 CLINTON BLDG  
2109 W CLINTON STREET  
HUNTSVILLE, ALA. 35805  
205 534-9771 OR 536-5306  
TWX 510 579-2220  
T L SNITZER COMPANY  
15 NORTH 40TH PLACE SUITE 6  
PHOENIX, ARIZONA 85034  
602 273-1673  
TWX 602 255-0387  
T L SNITZER COMPANY  
5354 W PICO BLVD  
LOS ANGELES, CALIF. 90019  
213 938-2073  
TWX 213 937-2378  
T L SNITZER COMPANY  
1020 CORPORATION WAY  
PALO ALTO, CALIF. 94303  
415 968-8304  
TWX 415 969-9101  
T L SNITZER COMPANY  
317 14TH STREET  
DEL MAR, CALIF. 92014  
714 454-2191  
TWX 714 277-3197  
TELONIC ENGR. CORPORATION  
480 MERMAID AVENUE  
P O BOX 277  
LAGUNA BEACH, CALIF.  
714 494-9401  
TWX 910 596-1320  
D E ROND ASSOCIATES  
2149 S CLERMONT STREET  
DENVER, COLORADO 80222  
303 736-1234  
GENTRY ASSOCIATES  
2517 B EAST COLONIAL DRIVE  
P O BOX 11096  
ORLANDO, FLORIDA 32803  
305 424-0730  
TWX 510 579-2235  
GENTRY ASSOCIATES  
4152 49TH AVENUE SOUTH  
ST. PETERSBURG, FLA. 33711  
813 867-7820  
GENTRY ASSOCIATES  
201 NELSON STREET  
EAL GALLIE, FLA. 32935  
305 773-3411  
GENTRY ASSOCIATES  
P O BOX 13513 STA K  
ATLANTA, GEORGIA 30324  
404 233-3816  
HAR-KOM HAWAII INC  
2933 KOAPAKA STREET  
HONOLULU, HAWAII  
815-617  
TWX 723-251  
TECHNICAL REPS INC  
247 SOUTH PINECREST  
WICHITA, KANSAS 67218  
316 682-4140  
C E SNOW COMPANY  
3720 FARRAGUT STREET  
KENSINGTON, MD. 20795  
301 949-1010

C E SNOW COMPANY  
TERMINAL BLDG. SUITE 124C  
FRIENDSHIP INTL. AIRPORT  
BALTIMORE, MD. 21240  
301 761-5757  
ADELCO CORPORATION  
56 PICKERING STREET  
NEEDHAM, MASS. 02192  
617 444-4754  
TWX 617 444-1931  
GAINE ENGINEERING  
20531 MACK AVENUE  
DETROIT, MICHIGAN 48236  
313 881-3532  
TECHNICAL REPS INC  
7049 LAUPHER LANE  
HAZELWOOD, MO. 63042  
314 821-1000  
F & F ASSOCIATES  
58 ARCADIA ROAD  
WOODCLIFF LAKE, N.J. 07680  
201 778-6767  
D E ROND ASSOCIATES  
P O BOX 11331  
ALBUQUERQUE, N.M. 87112  
505 247-3442  
F & F ASSOCIATES  
461 OLD COUNTRY ROAD  
WESTBURY, L. I., N.Y. 11590  
516 334-1160  
TESCO ASSOCIATES  
114 MILES AVENUE  
SYRACUSE, N.Y. 13210  
315 476-3291  
GENTRY ASSOCIATES  
P O BOX 197  
JAMESTOWN, N.C. 27282  
919 883-4521  
GAINE ENGINEERING  
29603 BRUCE DRIVE  
WILLOWICK, OHIO 44095  
216 943-3731  
GAINE ENGINEERING  
NO 6 BARTON DRIVE  
PITTSBURGH, PENN. 15221  
412 371-3020  
C E SNOW COMPANY  
613 CHELTENHAM AVENUE  
PHILADELPHIA, PENN. 19126  
215 224-2626  
D E ROND ASSOCIATES  
P O BOX 12293  
EL PASO, TEXAS 79912  
915 532-4048  
TFXAS AVIONICS COMPANY  
4515 PRENTICE STREET  
DALLAS, TEXAS 75206  
214 368-3566  
TEXAS AVIONICS CO  
1108 MEYER  
SFARBOOK, TEXAS 77586  
713 474-3153  
RUSH S DRAKE ASSOCIATES  
6133 MAYNARD AVENUE SOUTH  
SEATTLE, WASH. 98108  
206 725-2700  
TWX 206 998-1255  
REPS. IN OTHER COUNTRIES  
WHITTAKER ELECTRONICS LTD  
1144 MILLSTREAM ROAD  
WEST VANCOUVER, B.C.  
604 926-3411  
TWX 610 924-6033  
WHITTAKER ELECTRONICS LTD  
42 HOWDEN AVENUE  
OTTAWA 5, ONTARIO  
613 224-1221  
TWX 610 562-1920  
WHITTAKER ELECTRONICS LTD  
1885 WILSON AVENUE  
WESTON, ONTARIO  
416 247-7454  
TWX 610 492-2383  
WHITTAKER ELECTRONICS LTD  
P O BOX 216  
ROXBORO, QUEBEC  
514 684-3000  
TWX 610 422-3980

**TELSTA CORPORATION**  
SALES MANAGER  
WILLIAM W. ALVING  
BRAND NAMES  
TELSTA  
TELSTA LAMPLIGHTER  
COMPANY ADDRESS  
1700 INDUSTRIAL ROAD  
SAN CARLOS, CALIF. 94070  
415-591-7611  
COMPANY REPRESENTATIVES  
STONEY F. KAHN  
REG SLS MGR - EASTERN DIV.  
P O BOX 9 HUGHES FORD ROAD  
FREDERICK, MD. 21701  
301 662-8264

**TELETRON, INC.**  
SALES MANAGER  
ANTHONY D. BAKER  
7 BALA AVENUE  
BALA CYNWYD, PA. 19004  
BRAND NAMES  
TELETRON  
EDICON  
COMPANY ADDRESS  
BOX 131, ROUTE 100 NORTH  
BOYERTOWN, PA. 19503  
COMPANY REPRESENTATIVES  
INDUSTRIAL ELECTRONIC SUPPLY  
413 W MAIN STREET  
EL DORADO, ARKANSAS  
501 862-4901  
WM J. PURDY CO  
312 7TH STREET  
SAN FRANCISCO, CALIF.  
415 863-3300

# JOIN THE CLUB



Telemet Test Signal Generator, Model 3508B1  
Multiburst/Stairstep/Ramp/Sine Sq. Pulse/Sine Sq. Window

**O**VER 300 of these units are in daily use throughout the television industry—and this doesn't include the individual test signal generator modules (3501, 3502, 3503, etc.), of which hundreds have been sold.

This kind of popularity doesn't just happen... it's the combined result of awareness of customer requirements, capable engineering, quality production and continuing service.

If you're not already a member of the Model 3508 club, why not join now? It costs no more to go first class.



## TELEMET COMPANY

185 DIXON AVENUE, AMITYVILLE, N. Y. • PHONE (516) 541-3600

S S KRINSKY & ASSOC  
6311 YUCCA STREET  
HOLLYWOOD, CALIF.  
213 465-0557  
ROBERTS ASSOCIATES  
2711 N E 9TH COURT  
POMPANO BEACH, FLORIDA  
305 942-6373  
TELECASTING SERVICES INC  
1058 W WASHINGTON BLVD  
CHICAGO, ILLINOIS  
312 738-1022  
K & M ELECTRONICS CO  
7360 DHMS LANE  
MINNEAPOLIS, MINN.  
612 941-1330  
TELTRON INC  
7 BALA AVENUE  
BALA CYNWYD, PA.  
215 664-6672  
BAKER MILLER TAYLOR CO  
7 BALA AVENUE  
BALA CYNWYD, PENN.  
215 664-6672  
JACK F MCKINNEY SALES CO  
1303 CHEMICAL STREET  
DALLAS, TEXAS  
214 631-9450  
WM LAMPHEAR CO INC  
159 WESTERN AVE WEST  
SEATTLE, WASHINGTON  
206 633-4900

TENSOLITE INSULATED WIRE  
CO., INC.  
VICE PRES SALES  
GEORGE W. HELLER  
BRAND NAMES  
TUFFLITE-TM  
FLEXOLON  
TENSOLON  
TENSOLFLEX  
COMPANY ADDRESS  
WEST MAIN STREET  
TARRYTOWN, NEW YORK 10591  
914 631-2300  
TWX 710 567-1202  
COMPANY REPRESENTATIVES  
CARTER ASSOCIATES, INC  
201 WEST FIRST ST BOX 99  
SCOTTSDALE, ARIZONA 85252  
602 947 4355  
STORM PRODUCTS  
4049 TRANSPORT ST  
PALO ALTO, CALIF 94303  
415 326 2913  
TWX 415 492 9283  
STORM PRODUCTS  
2251 FEDERAL AVE  
LOS ANGELES, CALIF 90064  
213 272-5371  
TWX 213 490 3964  
C F L COMPANY  
1391 SOUTH INCA ST  
DENVER, COLO 80223  
303 777 4381  
HATHAWAY ELECTRONICS, INC  
OUCILLO BUILDING  
CANANAN CONN 06018  
203 824 7721  
MASSEY ASSOCIATES  
1 THOMAS CIRCLE N W  
WASHINGTON, O C 20005  
202 628 1D23  
CORBETT ASSOCIATES  
2411 COVINA WAY  
ST PETERSBURG, FLA 33712  
813 867 2201  
GOLTEN COMPANY INC  
2750 WEST NORTH AVE  
CHICAGO, ILL 60647  
312 384 5959  
REIO ASSOCIATES  
526 N W B BUILDING  
CEDAR RAPIDS, IOWA 52401  
319 362 6302  
HATHAWAY ELECTRONICS, INC  
7-11 MYSTIC STREET  
ARLINGTON, MASS 02174  
617 646 1380  
BUSE SALES COMPANY  
212 SECOND ST BOX 68  
ST CHARLES, MO 63301  
314 739 1613  
LAZOR ASSOCIATES, INC  
28D EAST HIGHLAND DRIVE  
ROCHFESTER, NEW YORK 14610  
716 473 8337  
SHERIDAN ASSOCIATES INC  
P O BOX 37466  
CINCINNATI, OHIO 45237  
513 761-5432  
TWX 810 461 2670  
SHERIDAN ASSOCIATES INC  
P O BOX 7486  
CLEVELAND, OHIO 44130  
216 884-2D01  
SHERIDAN ASSOCIATES INC  
BOX 37 RIVERDALE STATION  
DAYTON, OHIO 45405  
513 277 8911  
GRIFFIN-CAMPBELL, INC  
25 SKIPPACK PIKE  
AMBLER, PENN 19002  
215 646 7535  
BLACKBURN ASSOCIATES  
137 WALNUT HILL VILLAGE  
BOX 20073  
DALLAS, TEXAS 75220  
214 351 9991  
FARWEST AGENCIES  
1241D SE 32ND ST BOX 805  
BELLEVUE, WASH 98004  
206 747-1515  
TWX 206 742 0836

REPS. IN OTHER COUNTRIES  
CANADA WIRE & CABLE CO LTD  
POSTAL STATION R  
TORONTO, ONTARIO  
421 0440

TEXAS ELECTRONICS, INC.  
SALES MANAGER  
JIM YOUNG  
COMPANY ADDRESS  
5529 REDFIELD  
P.O. BOX 7151 INWOOD STATION  
DALLAS, TEXAS 75209

TEXAS INSTRUMENT INCORPORATED  
SEMICONDUCTOR-COMPONENTS DIV.  
SALES MANAGER  
EDWARD P. ONEILL  
BRAND NAMES  
MICRO/G  
SENSISTOR  
SILECT  
TAB-PAC  
THIN-PAC  
UNI/G

COMPANY ADDRESS  
P. O. BOX 5012  
DALLAS, TEXAS 75222  
SALES OFFICES  
SAHARA OFFICE PARK BLDG  
SUITE 111  
3313 MEMORIAL PARKWAY S W  
HUNTSVILLE, ALABAMA 35801  
881-4761  
2535 W CAMELBACK RD SUITE 1D  
PHOENIX, ARIZONA 85017  
279-5531  
1800 NORTH ARGYLE  
HOLLYWOOD, CALIF. 90028  
466-7251  
5005 WEST CENTURY BLVD  
SUITE 278  
INGLEWOOD, CALIF. 90301  
673-3943  
230 CALIFORNIA AVE SUITE 201  
PALO ALTO, CALIF. 94306  
326-6770  
1505 EAST 17TH ST SUITE 201  
SANTA ANA, CALIF. 92701  
547-6506  
4158 ADAMS AVE  
SAN DIEGO, CALIF. 92116  
284-1181  
GEOPHOTO SERVICES INC BLDG  
2149 S HOLLY STREET  
DENVER, COLORADO 80222  
757-8329  
300 AMITY ROAD  
WOODBIDGE, CONN. 06525  
389-4521  
1875 CONNECTICUT AVE NW  
SUITE 913  
WASHINGTON, O.C. 20009  
234-9320  
618 EAST SOUTH ST SUITE 114  
ORLANDO, FLORIDA 32801  
422-9894  
SUITE 205 EXECUTIVE TOWERS  
5901 N CIGERO AVENUE  
CHICAGO, ILLINOIS 60646  
286-1000  
33 WASHINGTON STREET  
WELLESLEY HILLS, MASS. 02181  
237-9750  
SUITE 706, NORTHLAND TOWERS  
15565 NORTHLAND DR  
SOUTHFIELD, MICH. 48075  
357-1703, 4 AND 5  
GRIGGS-MIOWAY BLDG ROOM 154  
1821 UNIVERSITY AVE  
ST. PAUL, MINN. 55104  
646-2755  
US HIGHWAY #22 P O BOX 366  
UNION, N.J. 07083  
687-7200  
P O BOX 87 2209 E MAIN  
ENDICOTT, N.Y. 13760  
785-9987  
600 OLD COUNTRY RD.  
GAROEN CITY, LI, N.Y.  
742-1515  
131 FULTON AVE APT J2  
POUGHKEEPSIE, N.Y. 12603  
741-6095  
501 EAST FAYETTE STREET  
SYRACUSE, N.Y. 13202  
476-4031  
22035 CHAGRIN  
CLEVELAND, OHIO 44122  
751-2600  
SUITE 205 PAUL WELCH BLDG  
3300 SOUTH DIXIE DR  
DAYTON, OHIO 45439  
298-7513  
1015 BARCLAY BLDG  
ONE BELMONT AVE  
BALA CYNWYD, PENN. 19004  
839-638D  
SRO DEPT.  
P O BOX 5012  
DALLAS, TEXAS 75222  
235-2381  
3334 RICHMOND AVE SUITE 1D2  
HOUSTON, TEXAS 77D06  
526-3268  
700-108 AVENUE N E  
SUITE 172  
REFLEWUE, WASH. 98004  
658-0607

REPS. IN OTHER COUNTRIES  
TEXAS INSTR ASIA LIMITED  
404 TBR BUILDING  
NO 59, 2-CHROME, NAGATA-CHO  
CHIYOOA-KU, TOKYO, JAPAN  
TEXAS INSTRUMENTS FRANCE  
BOITE POSTALE 5

VILLENEUVE-LOUBET A. M.,  
FRANCE  
11 RUE  
TEXAS INSTRUMENTS FRANCE  
DE MADRID  
PARIS 80, FRANCE  
TEXAS INSTR DEUTSCHLAND GMBH  
HILDESHEIMERSTR. 19  
HANNOVER, W. GERMANY  
TEXAS INSTR DEUTSCHLAND GMBH  
WOLFRAMSTRASSE 26  
7 STRUTTART N. W. GERMANY  
TEXAS INSTR DEUTSCHLAND GMBH  
CLEMENSTRASSE 30  
BDDO MUNICH 23, W. GERMANY  
TEXAS INSTRUMENTS LIMITED  
MANTON LANE  
BEDFORD, ENGLAND  
TEXAS INSTRUMENTS ITALIA SPA  
VIA COLAULTI NR 1  
MILAN, ITALY  
TEXAS INSTRUMENTS HOLLAND  
KOLTHOFSTINGEL 8  
ALMELO, HOLLAND  
TEXAS INSTRUMENTS HOLLAND N V  
SEMICONDUCTOR BRANCH BENELUX  
ENSCHDESESTRAAT 19  
HENGFOLO-VV, NETHERLANDS  
TEXAS INSTRUMENTS SWEDEN A B  
TIMMERMANGATEN 34  
BOX 17116  
STOCKHOLM 17, SWEDEN  
TEXAS INSTRUMENTS INC  
118 RUE OU RHONE  
1204 GENEVA, SWITZERLAND  
TEXAS INSTRUMENTS INC  
280 CENTRE STR EAST  
RICHMOND HILL, ONTARIO  
889-7112  
TEXAS INSTR OE MEXICO S A  
PONIENTE 116 #489  
CO IND VALLEJO  
MEXICO 15, O.F.  
TEXAS INSTR AUSTRALIA LTO  
BOX 63 OLDHAM ROAD  
FLIZABETH, SOUTH AUSTRALIA  
TEXAS INSTR ARGENTINA SAICF  
PASAGE PORTUGAL 561  
BUENOS AIRES, SUC.5.  
ARGENTINA  
TEXAS INSTR ELECTRONICS  
DO BRAZIL LTOA  
RUA CESARIO ALVIM 770  
CAIXA POSTEL 3D.103  
5AO PAULO 6, BRAZIL

THE TEXWIDE COMPANY  
SALES MANAGER  
EDWARD PALEY  
BRAND NAMES  
FOAM-SWABS  
FREMOT FE  
OPTIC-CLOTH  
TEXWIDE  
COMPANY ADDRESS  
P.O. BOX 315  
HILLSDALE, NEW JERSEY D7642

THE THOMAS & BETTS CO  
SALES MANAGER  
J. DAVID PARKINSON  
BRAND NAMES  
COLOR-KEYED  
CONNECTO-BLOK  
SHIELD-KON SHIELD O  
TY-RAP  
SHUR-STAKE  
STA-KON  
COMPANY ADDRESS  
36 BUTLER STREET  
ELIZABETH, N. J. 07207  
COMPANY REPRESENTATIVES  
PAUL J. ROBINSON  
145 SO. ANDERSON ST  
LOS ANGELES, CALIF.  
ANGELUS 8-3191  
NOEL DEWESE  
23 BROOERICK RD.  
BURLINGAME, CAL.  
692-2323  
I. W. STRONG & ASSOC.  
635 CANOSA COURT  
DENVER, COLORADO  
292-69D0  
ROBERT H. WAGNER  
P. O. BOX 19875, STATION N.  
ATLANTA, GA.  
355-6260  
MYRON O. BIELAT  
930 LEE STREET  
ELK GROVE VILLAGE, LL.  
439-3190  
G. AUSTIN FINGER  
178 FORBES RO.  
BRAINTREE, MASS.  
843-0373  
EUGENE E. LOPER  
P. O. BOX 12417  
NO. KANSAS CITY, MO.  
VICTOR 2-0337  
E. J. DIXON  
15 PARK PLACE  
NEW YORK, N. Y.  
BARCLAY 7-8644  
RICHARD O. PERRY  
OAVIS BLDG, BOX 65  
FAYETTEVILLE, N. Y.  
637-9691  
RICHARD G. MCCALL  
2028 E. 7TH STREET  
CHARLOTTE, N. C.  
332-6423  
EDWARD F. KRAMER  
5826 STATE RD.  
CLEVELAND, OHIO  
888-0245

BILL R. CONNER  
1015 CHESTNUT STREET  
PHILADELPHIA, PA.  
GL 9-1445  
JOHN R. HUMBER  
P. O. BOX 6445  
HOUSTON, TEX.  
JACKSON 8-1610  
STROECKER INC.  
212 EYRES BLDG.  
2207 FIRST AVE., SOUTH  
SEATTLE, WASH.  
MAIN 3-0357  
R. W. HOSTETLER  
4920 W. VLIET STREET  
MILWAUKEE, WISC.  
GR 6-7470

THOMSON ELECTRIC CO., INC  
SUBSIDIARY OF THOMSON-HOUSTON  
VICE PRES MARKETING  
ERNEST L STERN  
COMPANY ADDRESS  
5D ROCKEFELLER PLAZA  
NEW YORK, NEW YORK 10020  
212 CI 5 0444

THOR ELECTRONICS CORPORATION  
SALES MANAGER  
ROY GETTIS  
COMPANY ADDRESS  
741 LIVINGSTON STREET  
ELIZABETH, N. J. 07207  
COMPANY REPRESENTATIVES  
HARRY HALINTON  
6418 N CENTRAL AVENUE  
CHICAGO, ILLINOIS  
312 763-2131  
MONATRON  
20850 SHELTON RD  
CLEVELAND, OHIO 44142  
716 243-6500  
HERMAN LEWIS  
1801 JOHN F KENNEDY BLVD  
PHILADELPHIA, PA. 19103  
215 LO 7-2068

TIMES WIRE AND CABLE, DIV. OF  
THE INTERNATIONAL SILVER CO.  
VP SALES  
R. W. BURTON  
BRAND NAMES  
TIMATCH  
COILGRIP  
COMPANY ADDRESS  
358 HALL AVENUE  
WALLINGFORD, CONN. 06492  
COMPANY REPRESENTATIVES  
DORTON ENTERPRISES INC  
P O BOX 1297  
SCOTTSDALE, ARIZONA  
602 946-6213  
WESTREP  
P O BOX 569A  
FULLERTON, CALIF. 92632  
714 879-409D  
MERV SOBOL  
TECH SERVICE REP-WEST COAST  
12191 PEARCE STREET  
GAROEN GROVE, CALIF. 92640  
213 624-6353  
ELECTRONIC COMPONENTS SALES  
2340 WEST MAIN STREET  
LITTLETON, COLORADO 8D120  
3D3 798-8481  
TWX 303 798-8114  
J F KERRIGAN & COMPANY  
P O BOX 5385  
HAMOEN, CONN. 06518  
203 288-2200  
WILLIAM MCNAIR - CATV REP  
385 HALL AVENUE  
WALLINGFORD, CONN.  
203 269-3385  
F F DESMOND  
EASTERN REG MGR  
60 GREAT OAK RD  
HUNTINGTON, CONN.  
203 925-1945  
CHARLES GERY  
15 SAXONY DRIVE  
TRUMBULL, CONN.  
203 268-724D  
GEARTNER ASSOCIATES INC  
JACK GEARTNER  
235 LINCOLN ROAD  
MIAMI BEACH, FLA. 33139  
305 538-8266  
GEARTNER ASSOCIATES INC  
21D1 MOHAWK TRAIL  
MAITLAND, FLORIDA 32751  
305 647-4000  
TWX 305 647-0442  
GEARTNER ASSOCIATES INC  
5999 S GROVE STREET  
ST PETERSBURG, FLA.  
813 867-1890  
LOUIS C ESTES ASSOCIATES  
SUITE 533-535  
DECATUR FEDERAL BLDG  
P O BOX 4071  
OCEATOR, GEORGIA 3D031  
404 373-8266-7  
TWX 404 527-1093  
GASSNER AND CLARK COMPANY  
6644 N WESTERN AVENUE  
CHICAGO, ILLINOIS 60645  
312 764-6121  
TWX 312 222-0903  
PENZNER ASSOCIATES  
BOX 4362  
OVERLAND PARK, KANSAS 66204  
J-H ELECTRONIC SALES  
P O BOX 6844  
TOMSON, MARYLAND  
301 825-6440



FRANCIS COLEMAN  
P O BOX 241  
CLINTON, MASS.  
617 894-1855  
R C NORDSTROM & COMPANY  
123 W BROWN STREET  
BIRMINGHAM, MICH. 48011  
313 JO 4-6128  
SCOTT ELECTRONIC SALES  
5209 WEST 60TH STREET  
MINNEAPOLIS, MINN.  
612 929-2985  
PENZNER ASSOCIATES  
BOX 1912  
BECHTOLD, STATION  
ST. LOUIS, MO. 63118  
ELECTRONIC COMPONENTS SALES  
P O BOX 3087  
ALBUQUERQUE, N.M.  
505 344-8130  
TWX 505 243-8378  
JOSEPH P. SCANLON COMPANY  
51 BLOOMFIELD PLACE  
ROCHESTER, N.Y.  
716 473-7553  
C R CHARITY  
2345 HENRY STREET  
NORTH BELLMORE, L I. N. Y.  
516 785-1598

ROCKE INTERNATIONAL CORP  
FOREIGN SALES  
13 EAST 40TH STREET  
NEW YORK, N.Y. 10016  
212 MU 9-020C  
D G W INC  
3389 NOTTINGHAM ROAD  
P O BOX 5316  
WINSTON-SALEM, N.C.  
919 PA 3-4205

D G W INC  
1402 E MOREHEAD STREET  
P O BOX 6096  
CHARLOTTE, N. C.  
704 ED 4-7090  
RIXAN ASSOCIATES  
33 WEST STRATFORD AVENUE  
DAYTON, OHIO  
513 222-0011  
AMMON AND CHAMPION COMPANY  
P O BOX 12274  
OKLAHOMA CITY, OKLA. 73112  
405 WI 2-8222

SEATRONICS INC  
6415 CANYON COURT  
PORTLAND, OREGON 97221  
503 292-8887  
PRECISION ELECTRONICS INC  
BOX 18  
FT. WASHINGTON INDUSTRY PARK  
FORT WASHINGTON, PA. 19034  
AMMON AND CHAMPION COMPANY  
P O BOX 35263  
DALLAS, TEXAS  
214 FL 7-8441

AMMON AND CHAMPION COMPANY  
P O BOX 35552  
HOUSTON, TEXAS  
713 PA 9-1233  
TWX 713 571-3133  
ELECTRONIC COMPONENTS SALES  
P O BOX 2066  
SALT LAKE CITY, UTAH  
801 262-3700  
SEATRONICS INC  
5931 FOURTH AVENUE SOUTH  
SEATTLE, WASH. 98108  
206 PA 5-4328

TWX 917 444-2073  
REPS. IN OTHER COUNTRIES  
L E FORWOOD  
A DESKIN SALES CORPORATION  
840-B CAMBIE ROAD  
RICHMOND, VANCOUVER, B.C.  
604 278-8510  
NICK WIEBE  
A DESKIN SALES CORPORATION  
27 CLAREMONT AVENUE  
WINNIPEG 6, MANITOBA  
204 453-1877

BILL BALFOUR  
A DESKIN SALES CORPORATION  
25 VALHALLA BLVD  
SCARBOROUGH, ONTARIO  
364-4505  
A DESKIN SALES CORPORATION  
1565 LOUVAIN STREET WEST  
MONTREAL 11, QUEBEC  
514 384-1420  
TWX 617 421-3793  
ANDRE LUSSIER - CATV ONLY  
SEATRONICS INC  
2330 NICHOLAS PERROT  
MONTREAL, QUEBEC  
FF 4-2910

TOPAZ, INCORPORATED  
SALES MANAGER  
HUGH NUTTER  
COMPANY ADDRESS  
3802 HOUSTON ST.  
SAN DIEGO, CALIF. 92110

TOWNSEND ASSOCIATES  
SALES MANAGER  
GEORGE R. TOWNSEND  
CONTRACT ADMIN.  
BOB BROMLEY  
COMPANY ADDRESS  
P O BOX 215  
FEEDING HILLS, MASS. 01030

TRAO CORPORATION  
VICE PRESIDENT - SALES  
ROBERT W. KING  
BRAND NAMES

AUTOMAX  
PHOTOCORDER  
COMPANY ADDRESS  
777 FLOWER STREET  
GLENDALE, CALIF. 91201  
COMPANY REPRESENTATIVES  
RICHARD FREEBOURG AND  
ROWLAND F. PETERSON  
777 FLOWER STREET  
GLENDALE, CALIF.  
245-9393  
VINCE KOENIG  
1608 FOREST GLEN RD  
SILVER SPRING, MD.  
301-597-3003  
LARRY HAMMAN  
18450 LIVERNOIS  
DETROIT, MICH.  
313-861-8224  
ED ZELASNEY  
2339 INWOOD PLAZA  
DALLAS, TEXAS  
214-FL-5656

TRANSCO PRODUCTS, INTERNATIONAL  
SALES MANAGER  
W. ROTH  
COMPANY ADDRESS  
95 BROAD STREET  
NEW YORK, NEW YORK 10034

TREPAC CORPORATION OF AMERICA  
SALES MANAGER  
W. W. WHITE  
BRAND NAMES  
DATATONE-R  
TREPAC-R

COMPANY ADDRESS  
30 W. HAMILTON AVE.  
ENGLEWOOD, N. J. 07631  
REPS. IN OTHER COUNTRIES  
ELECTRONIC ENTERPRISES  
46 KARANI BUILDING  
NEW CHARNI ROAD  
ROMBAY 4, INDIA  
TOMINAGA & COMPANY LTD  
IRASEN BLDG NO 5 NICHOME-  
KORUNACHO NIHOMBASHI  
CHUO-KU, TOKYO, JAPAN  
TREPAC CORPORATION OF CANADA  
1785 BOIS FRANC ROAD  
MONTREAL 9, QUEBEC  
DISTRIBUTORS CORP. PTY. LTD  
24-26 JOHNSTON STREET  
FRITZROY, VICTORIA  
AUSTRALIA

THE TRIPLETT ELECTRICAL  
INSTRUMENT CO.

SALES MANAGER  
N. A. TRIPLETT  
COMPANY ADDRESS  
286 HARMON ROAD  
BLUFFTON, OHIO 45817  
COMPANY REPRESENTATIVES  
SHEFLER-KAHN CO INC  
P O BOX 1587  
PHOENIX, ARIZ. 85001  
602 258-7893  
MOULTHROP & HUNTER  
165 ELEVENTH STREET  
SAN FRANCISCO, CALIF. 94109  
415 863-7880  
HOWARD M SAUL & ASSOCIATES  
5017 SAN VICENTE BLVD  
LOS ANGELES, CALIF. 90019  
213 938-3591  
MASSEY ASSOCIATES INC  
#1 THOMAS CIRCLE  
WASHINGTON, D.C. 20005  
202 628-1023

MILLAR-HUTTO ASSOCIATES INC  
1036 PEACHTREE ST NE  
ATLANTA, GA. 30309  
404 876-0919  
BILL KOLANS & CO  
P O BOX 2098  
HONOLULU, HAWAII 96805  
811-628

GEO PETTIT CO INC  
349 N ASHLAND AVE  
RIVER FOREST, ILL. 60305  
312 369-8940  
WALTER W BIEBERICH  
2817 PLAZA DR  
FT. WAYNE, IND. 46806  
219 745-2928  
THE CROCKETT SALES CO  
E B WILLIAMS  
1546 HARCOURT APT O  
NEW ORLEANS, LA. 70124  
504 288-7517  
ABM SALES INC  
10116 PURITAN AVENUE  
OETROIT, MICH. 48238  
313 862-1300

THE HEIMANN COMPANY INC  
5603 LYNDAL AVE S  
MINNEAPOLIS, MINN. 55419  
612 827-5457  
H A ROES & CO  
2601 CHERRY STREET  
KANSAS CITY, MO. 64108  
816 221-0866  
FRANK W TAYLOR CO INC  
4455 E GENESSEE  
DEWITT, N.Y. 13214  
315 446-0422  
D F TOBIAS & CO INC  
30 CHURCH STREET, RM 1612  
NEW YORK, N.Y. 10007  
212 267-4349  
CHAS H DOLFUSS JR & CO  
2108 PAYNE AVE., RM 707  
CLEVELAND, OHIO 44114  
216 771-1270  
MASSEY ASSOCIATES INC

# NOW. MONITOR AUDIO LEVELS AUTOMATICALLY

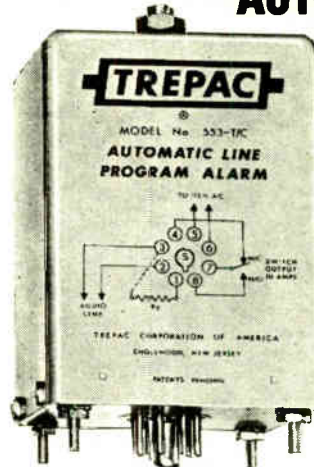

- TRANSISTORIZED
- COMPACT
- ACCURATE
- TROUBLE FREE
- RELIABLE

We Guarantee  
it for 5 Years

TREPAC MODEL 553 T/C AUTOMATIC PROGRAM ALARM senses variations of signal level, and provides automatic control of alarm or other associated equipment. It eliminates the need for continuous personal attention. The unit is activated whenever line program audio level deteriorates below a preset threshold.

The output power "switches" either off or on as desired when audio level drops for a specific length of time. In the absence of a signal, the unit will "switch" off after a fixed duration. Whenever audio programming returns to its nominal level, the output control "switches" on. All "switching" is done automatically.

Accurate time control predetermines wide range of timing intervals available. The time duration (or delay) is adjustable from 0.1 seconds to as long as 30 minutes, depending on the application.

## DATATONE® TRANSMITTERS RECEIVERS

MINIATURIZED TRANSISTORIZED SOLID/STATE NO TUNED REEDS NO TUNING FORKS

*Sensibly priced!*

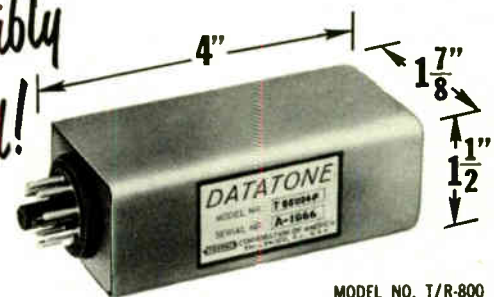

MODEL NO. T/R-800

### SPECIFICATIONS

**DATATONE TRANSMITTER:** Designed to bridge a 600 ohm transmission line with less than 1 db loading and through contact closure deliver an undistorted tone signal level of 1 Milliwatt. Calibrated internal attenuator permits setting output level to required signaling condition by simple terminal strapping.

**DATATONE RECEIVER:** Designed to bridge a 600 ohm transmission line with less than 0.5 db loading, and close contacts or power an external relay load upon receiving a tone pulse from its companion transmitter. A full dynamic range of greater than 35 db and a sensitivity of -35 dbm with sharp skirt filters, assures reliable operation with adjacent channel separation of as little as 100 cycles.

Both units are rated for continuous operation over a temperature range of 0°C to 50°C from a 12/24/48 VDC supply.

**TREPAC® CORPORATION OF AMERICA**

SOLID STATE ELECTRONICS for TELECOMMUNICATIONS

30 W. HAMILTON AVE., ENGLEWOOD, N. J.  
Phone: (201)-567-3810 TWX: 567-4977

1325 WEST CHESTER PIKE  
HAVERTOWN, PA. 19083  
215 789-2320  
GENE S ROOT & CO  
809 WAINWRIGHT OR  
PITTSBURGH, PA. 15228  
412 561-4125  
JOSE ARTURO FERNANDEZ  
P O BOX 5124  
PUERTA DE TIERRA STA  
PUERTO RICO DD906  
724-2854  
ADAMS-MCGREGOR INC  
66 LAKEVIEW ROAD  
LINCOLN, R.I. D2865  
401 726-1300  
LUND & COMPANY  
2215 N OLIVE ST  
OALLAS, TEXAS 75201  
214 748-8839  
F Y GATES CO INC  
455 EAST 4TH S, RM 212  
SALT LAKE CITY, UTAH 84111  
801 359-1101  
JAMES J BACKER CO  
221 W GALER STREET  
P O BOX 9327  
SEATTLE, WASH. 98119  
206 283-6470  
REPS. IN OTHER COUNTRIES  
C M ROBINSON AGENCIES LTO  
1550 ERIN STREET  
WINNIPEG 3, CANADA  
204 774-1855  
LEN FINKLER LTD  
2 TYCOS OR  
TORONTO 19, ONTARIO  
416 781-5231

**TROMPETER ELECTRONICS, INC.**

SALES MANAGER  
NILS STRID  
COMPANY ADDRESS  
8936 COMANCHE AVE.  
CHATSWORTH, CALIF. 91311  
COMPANY REPRESENTATIVES  
CURRIE AEROSPACE ASSOCIATES  
P O BOX 1424  
HUNTSVILLE, ALABAMA  
205 536-5650  
CARTER ASSOCIATES INC  
201 W FIRST STREET  
SCOTTSDALE, ARIZONA  
602 947-4355  
CURRIE AEROSPACE ASSOCIATES  
P O BOX 13229  
ORLANDO, FLORIDA  
305 855-0843  
KENNETH W MEYERS CO  
7256 W TOMMY AVENUE  
CHICAGO, ILLINOIS  
312 SP 4-6440  
PADDOCK-JOSLOW COMPANY  
721 ELLSWORTH DRIVE  
SILVER SPRING, MO.  
301 JU 8-7866  
VECTOR SALES INC  
774 PLEASANT STREET  
BELMONT, MASS.  
617 IV 9-1400  
L R HARRY AND ASSOC INC  
P O BOX 588  
GRANDVIEW, MD.  
816 SO 3-3634  
L & M ASSOCIATES  
511 VICTOR STREET  
SADDLE BROOK, N.J. 07663  
201 843-8700  
THE ROBERT F LAMB CO INC  
3407 DELAWARE AVE  
BUFFALO, N.Y.  
716 876-3757  
THE ROBERT F LAMB CO INC  
EAST MOLLÖY RD  
SYRACUSE, N.Y.  
314 454-2469  
THE ROBERT F LAMB CO INC  
259 FAIR STREET  
KINGSTON, N.Y.  
914 338-8833  
MEASUREMENT INSTRUMENTS INC  
4211 WOODBRIDGE  
COLUMBUS, OHIO  
614 451-1164  
L & M ASSOCIATES  
3801 BROOKVIEW ROAD  
PHILADELPHIA, PA.  
215 438-5666  
CARTER ASSOCIATES INC  
P O BOX 87  
GARLAND, TEXAS  
214 276-7151

**TRUSONIC**

SALES MANAGER  
EMILE J. PETRE  
BRAND NAMES  
STEPHENS  
STEPHENS TRU-SONIC  
FREE CONE  
STEREODOT  
COMPANY ADDRESS  
389 N. FAIR OAKS AVE.  
PASADENA, CALIF. 91103  
COMPANY REPRESENTATIVES  
F W MOULTHRDP COMPANY  
1530 EAST 12TH STREET  
OAKLAND 6, CALIF.  
AN 1-7676  
ROLAND OLANDER & COMPANY  
6313 SANTA MDNICA BLVD  
LOS ANGELES 38, CALIF.  
213 HO 9-6313  
HYDE ELECTRONICS COMPANY  
888 SOUTH LIPIAN STREET  
DENVER 23, COLORADO  
303 936-3465/6/7

OREN H SMITH COMPANY  
5255 NORTH LAWLER  
CHICAGO, ILLINOIS 60630  
286-4476  
K & M SALES COMPANY  
DAVIDSON BLDG  
1627 MAIN STREET SUITE 500  
KANSAS CITY 8, MISSOURI  
GR 1-1355  
HYDE ELECTRONICS COMPANY  
5206 CONSTITUTION AVE N E  
ALBUQUERQUE, N.M.  
505 268-1111  
ROYAL SOUND COMPANY INC  
114 EAST FORTIETH STREET  
NEW YORK, N.Y. 10016  
212 697-6837  
MIKE ROTH SALES COMPANY  
678 SOUTH GREEN ROAD  
CLEVELAND 21, OHIO  
EV 2-9990  
BUSHNELL SALES COMPANY  
P O BOX 20714  
DALLAS, TEXAS 75220  
214 FL 2-1846  
ROD MERRITT COMPANY  
1320 PROSPECT STREET  
SEATTLE, WASH. 98109  
MU 2-7337  
REPS. IN OTHER COUNTRIES  
ENGINEERED SOUND SYSTEMS INC  
167 KIPLING AVENUE SOUTH  
TORONTO 18, ONTARIO

**TRW ELECTRONICS**

MARKETING MANAGER  
R. L. ASHLEY  
COMPANY ADDRESS  
11DD GLENOON AVENUE  
LOS ANGELES, CALIF. 90D24  
COMPANY REPRESENTATIVES  
HECHT-HENSCHEN & ASSOC.  
3825 NORTH 99TH AVENUE  
PHOENIX, ARIZONA  
602 272-6677  
TRW SEMICONDUCTORS INC  
650 N SEPULVEDA  
EL SEGUNDO, CALIF. 90245  
213 322-6685  
GENE STRAUBE ASSOCIATES  
483 WILLOW ROAD  
MENLO PARK, CALIF.  
415 841-4450  
STRAUBE ASSOCIATES  
P O BOX 1649  
BOULDER, COLORADO  
303 443-8600  
CARTWRIGHT & BEAN  
20100 N E 25TH COURT  
NO MIAMI BEACH, FLA. 33160  
305 677-3480  
FLORIDA ELECTRONIC ENGR.  
609 E COLONIAL DRIVE  
ORLANDO, FLORIDA 32803  
305 425-0032  
CARTWRIGHT & BEAN  
395 TRITON ROAD  
ORMOND BEACH, FLORIDA  
305 677-3480  
CARTWRIGHT & BEAN  
3223 CAINS HILL PLACE  
ATLANTA, GEORGIA 30305  
404 237-2273  
JOHN G TWIST COMPANY  
5222 DIVERSEY AVENUE  
CHICAGO, ILL. 60639  
312 SP 7-2250  
TWX 312 265-1165  
R O WHITESELL ASSOC.  
CENTRAL BLDG RM 272  
FORT WAYNE, IND. 46802  
219 743-4411  
TWX 219 241-0894  
R O WHITESELL ASSOC  
HEADQUARTERS  
6620 E WASHINGTON ST  
INDIANAPOLIS, IND. 46219  
317 359-5374  
TWX 317 635-9766  
HERBERT B KIRKLAND ASSOC  
210 FIFTH ST SE  
CEDAR RAPIDS, IOWA 52401  
319 363-6425  
R O WHITESELL ASSOC  
3620 LEXINGTON RD  
LEX MANOR BLDG RM 223  
LOUISVILLE, KY.  
502 893-7303  
CARTWRIGHT & BEAN  
1812 BULLARD AVENUE  
METAIRIE, LOUISIANA 700D3  
504 834-8312  
TRW SEMICONDUCTORS INC  
P O BOX 8654  
BALTIMORE, MD. 2121D  
301 323-4300  
TRW SEMICONDUCTORS INC  
P O BOX 603  
NORWOOD, MASS.  
617 275-6076  
R D WHITESELL ASSOC  
303 FIDELITY BLDG  
BENTON HARBOR, MICHIGAN  
616 927-2041  
R O WHITESELL ASSOC  
16801 WYOMING AVE  
DETROIT, MICHIGAN  
313 862-2225  
TWX 313 342-0648  
E A DICKINSON ASSOC  
P O BOX F  
EXCELSIOR, MINN. 55331  
612 474-5273  
TWX 612 961-0471  
L R HARRY ASSOC  
P O BOX 588

GRANDVIEW, MO. 64030  
816 763-3634  
L R HARRY ASSOC  
7603 FORSYTHE  
CLAYTON, MO. 63105  
314 727-6123  
TRW SEMICONDUCTORS INC  
P O BOX 554  
MONTVALE, N.J. 07645  
201 484-5616  
TRW SEMICONDUCTORS INC  
P O BOX 67  
EAST ISLIP, N.Y. 11730  
516 433-3342  
TRW SEMICONDUCTORS INC  
P O BOX 24  
CAMILLUS, NEW YORK  
315 454-4451  
TRW SEMICONDUCTORS INC  
P O BOX 64  
YORKVILLE, N.Y.  
315 454-4451  
MACHINE & PRODUCTS CO  
FRANCE ONLY  
52 WALL STREET  
NEW YORK, N.Y. 10005  
212 WM 4-4370  
CARTWRIGHT & BEAN  
625 HARWYN DRIVE  
CHARLOTTE, N.C. 28205  
704 537-7965  
R O WHITESELL ASSOC  
1172 W GALBRAITH  
CINCINNATI, OHIO 45231  
513 521-2290, 91  
TWX 513 577-1750  
R O WHITESELL ASSOC  
21139 LORAIN AVENUE  
MAGEK BLDG.  
CLEVELAND, OHIO 44126  
216 337-2158  
TWX 216 333-3250  
R O WHITESELL ASSOC  
135 W FIFTH AVENUE  
COLUMBUS, OHIO  
614 488-9731  
TWX 614 759-0680  
R O WHITESELL ASSOC  
4133 S DIXIE AVENUE  
DAYTON, OHIO 45439  
513 298-9546  
TWX 513 944-0526  
ARNESON ASSOC  
P O BOX 12067  
PORTLAND, OREGON 97212  
503 646-3416  
TRW SEMICONDUCTORS INC  
P O BOX 11587  
PHILADELPHIA, PA. 19116  
215 687-1700  
R O WHITESELL ASSOC  
PENN CENTER BLDG  
201 PENN CENTER BLVD  
PITTSBURGH, PA. 15235  
412 242-0100  
CARTWRIGHT & BEAN  
560 SOUTH COPPER STREET  
P O BOX 760  
MEMPHIS, TENN. 38104  
901 276-4442  
VISTA ENGINEERING  
FIRST BANK & TRUST BLDG  
SUITE 430  
RICHARDSON, TEXAS 75080  
214 235-4547  
TWX 214 231-1400  
VISTA ENGINEERING  
7007 RATON DRIVE  
HOUSTON, TEXAS  
713 NA 2-5680  
ARNESON ASSOCS  
74 S LUCILE STREET  
SEATTLE, WASH. 98134  
206 725-7664  
E A DICKINSON ASSOC INC  
3612 GREENBAY AVENUE  
MILWAUKEE, WISCONSIN 53212  
414 264-1090  
REPS. IN OTHER COUNTRIES  
MITSUBISHI TRW COMPANY  
MITSUBISHI DENKI BLDG  
2-12 MARUNOUCHI CHIYODO-KU  
TOKYO, JAPAN  
212-6111  
E V JOHANSEN A/S  
ST KONGENSGADE 93  
COPENHAGEN K, DENMARK  
PALACE 7510  
TECHNIQUE ET PRODUITS  
BOULOGNE, SUR SEINE, FRANCE  
408-16-00  
HEK-OMSB LUBECK  
2400 LUEBECK  
POSTLACH 1810, WEST GERMANY  
52991  
M C P ELECTRONICS  
STATION WHARF WORKS  
ALPERTON, WEMBLEY  
MIDDLESEX, ENGLAND  
WEMRLY 1191  
TELEINSTRUMENT AB  
BOX 14,  
VALLINGBY, SWEDEN  
870345  
BAERLOCHER AG  
ZURICH, SWITZERLAND  
51-429900  
E G LOMAS LTD  
227 LAURIER AVE W  
DOWNS, ONTARIO  
613 CE 2-7106  
JACOBY, MITCHELL  
469-475 KENT STREET  
SYDNEY, N.S.W., AUSTRALIA  
26-2651

**TRYLON, INCORPORATED**

DIRECTOR OF MARKETING  
THOMAS R. HUMPHREY  
BRAND NAMES  
TRYLON  
COMPANY ADDRESS  
ELVERSON, PA. 19520  
COMPANY REPRESENTATIVES  
SAM G HARRIS  
2437 JACKSON PKWY  
VIENNA, VA.  
703 56C-4545

**T Y ELECTRONICS, INC.**

SALES MANAGER  
J. F. SODARO  
COMPANY ADDRESS  
BOX 187  
CULVER CITY, CALIF. 90230

**TURNER MICROPHONE COMPANY**

SALES MANAGER  
DOUG BATTIN  
BRAND NAMES  
TURNER  
COMPANY ADDRESS  
909 17TH STREET  
CEDAR RAPIDS, IOWA 52402  
COMPANY REPRESENTATIVES  
MORRIS F TAYLOR COMPANY  
2328 3RD WAY NE  
BIRMINGHAM, ALA. 35215  
205 853-3673  
WES ALDERSON COMPANY  
8548 WASHINGTON BLVD  
CULVER CITY, CALIF. 90231  
213 VE 7-1398  
LOGAN SALES COMPANY  
463 BREWSTER AVENUE BOX 1219  
REWOOD CITY, CALIF. 94063  
415 369-6726  
GORDON MOSS ELECTRONICS INC  
1530 13TH AVENUE  
P O BOX J  
GREELEY, COLORADO  
303 553-1452  
GORDON MOSS ELECTRONICS INC  
P O BOX 26172  
DENVER, COLORADO 80226  
303 936-4027  
COAKLEY BOYD & ABBETT INC  
6 GAYWOOD DRIVE  
WATERBURY, CONN.  
203 756-8766  
MORRIS F TAYLOR COMPANY  
900 LAKE ELBERT DRIVE  
WINTER HAVEN, FLORIDA 33880  
813 CY 4-2941  
MORRIS F TAYLOR COMPANY  
P O BOX 458 - MAIL  
261 LAKE TRIPLET OR.  
CASSELLBERRY, FLORIDA  
305 838-0821  
MORRIS F TAYLOR COMPANY  
5908 KENNETH AVENUE  
TAMPA, FLORIDA 33604  
813 238 2738  
WM M LINZ & ASSOC  
4001 WEST DEVON  
CHICAGO, ILLINOIS 60646  
312 MU 5-6060  
MORRIS-CUNNINGHAM & ASSOC  
6208 NORTH COLLEGE AVENUE  
INDIANAPOLIS, INDIANA 46220  
317 CL 5-2458  
KELLY-SCHMITZ-WINKLER ASSOC  
3831 43RD STREET  
DES MOINES, IOWA  
515 CR 9-235  
SCOTT ORMSBY SALES  
230 20TH STREET  
NEW ORLEANS, LOUISIANA 70124  
504 488-2414  
MORRIS F TAYLOR COMPANY  
9431 GEORGIA AVENUE BOX 111  
SILVER SPRING, MARYLAND 20907  
301 JU 9-4002  
MORRIS F TAYLOR COMPANY  
3601 ADAMS DRIVE  
SILVER SPRING, MD. 20902  
301 WM 6-3569  
COAKLEY BOYD & ABBETT INC  
P O BOX 248 1424 HIGHLAND  
NEEDHAM, MASS. 02192  
617 444-5470  
R A ALBRECHT COMPANY  
221 LONESOME OAK ROAD  
ROCHESTER, MICHIGAN 48063  
313 651-7081  
STAN CLOTHIER COMPANY INC  
12 WEST 58TH STREET  
MINNEAPOLIS, MINN. 55419  
612 869-3231  
SCOTT ORMSBY SALES CO  
147 CARTER ROAD  
BILOXI, MISS.  
601 432-8467  
KELLY-SCHMITZ-WINKLER ASSOC  
7546 TROOST AVENUE  
KANSAS CITY, MISSOURI 64131  
816 EM 3-5651  
KELLY-SCHMITZ-WINKLER ASSOC  
2319 HAMPTON AVENUE  
ST. LOUIS, MO. 63139  
314 ST 1-6111  
WILLGOLD ELECTRONIC SALES  
18 OLD FARM ROAD  
NORTH CALOWELL, N.J.  
201 CA 6-8363  
WILLGOLD ELECTRONIC SALES  
53 ARTHUR DRIVE  
PARISIPPANY, N.J. 07054  
MORRIS F TAYLOR COMPANY  
P O BOX 23  
MARLTON, N.J. 08053

215 MA 2-0383  
GORDON MOSS ELECTRONICS INC  
2418 BARCELONA DRIVE S W  
ALBUQUERQUE, N.M. 87105  
505 877-9392  
WILLGOLD ELECTRONIC SALES  
170 NORTH VILLAGE AVE  
ROCKVILLE CENTRE, N.Y. 11571  
516 764-4022  
MARSEY SALES INC  
206 PARK AVENUE  
ROCHESTER, N.Y. 14607  
716 442-9700  
MORRIS F TAYLOR COMPANY  
1224 ORESDEN DR., WEST  
CHARLOTTE, N.C. 28205  
704 KE 7-4878  
LES A MORROW COMPANY  
3123 WEST 117TH STREET  
CLEVELAND, OHIO 44111  
216 CL 1-5700  
MORRIS F TAYLOR COMPANY  
201 PENN CENTER BLVD.  
PITTSBURGH, PA. 15235  
412 823-8000  
MORRIS F TAYLOR COMPANY  
APT 105, 9 RICHLAND LANE  
CAMP HILL, PA. 17011  
717 233-3112  
ERNEST L WILKS COMPANY  
1821 NORTH BROADWAY  
CARROLLTON, TEXAS  
214 CH 2-5321  
GORDON MOSS ELECTRONICS INC  
1502 PRESTON STREET  
BOX 8022 Foothills Station  
SALT LAKE CITY 8, UTAH  
801 485-2870  
M K WIODEKINO COMPANY  
815 W EWING STREET  
SEATTLE, WASH. 98119  
AT 4-8020

TV CABLE SUPPLY COMPANY  
SALES MANAGER  
JAMES E. MORTON  
BRAND NAMES  
TVC  
VIDEO INSTRUMENT  
COMPANY ADDRESS  
BOX 38  
CARLISLE, PA. 17013

ULTRA AUDIO PRODUCTS  
FLOON INDUSTRIES, INC  
SALES MANAGER  
DON OLIVER  
BRAND NAMES  
SOUNDDESIGN  
CUSTOMIZER  
CIRCUITESTER  
SPECTACULITE  
COMPANY ADDRESS  
1140 S. ROBERTSON BLVD.  
LOS ANGELES, CALIF. 90035

UNGAR ELECTRIC TOOLS  
ELECTRONIC DIVISION OF  
FLOON INDUSTRIES, INC  
SALES MANAGER  
W. L. NEMRENZ  
BRAND NAMES  
IMPERIAL  
MINI-TIP  
MICRO-TIP  
PRINCESS  
UNGAR  
COMPANY ADDRESS  
2701 W. EL SEGUNDO BLVD.  
HAWTHORNE, CALIF. 90252  
213 757-2151  
COMPANY REPRESENTATIVES  
MORRIS F TAYLOR CO  
2328 3RD WAY, NE  
BIRMINGHAM, ALA. 35215  
205 853-3673  
UNGAR SALES ASSOC  
317 GLASGOW AVE  
INGLEWOOD, CALIF 90301  
213 678-5371  
ELVEY-PROCTOR CO  
1650 LAUREL ST  
SAN CARLOS, CALIF 94071  
415 593-1211  
KOETHER-COX CO  
1325 SOUTH INCA ST  
DENVER, COLO 80223  
303 773-5561  
MORRIS F TAYLOR CO  
5908 KENNETH AVE  
TAMPA, FLORIDA 33604  
813 238-2738  
G MCL COLE CO  
6514 WEST HIGGINS ROAD  
CHICAGO, ILL. 60656  
312 774-3535  
FRANK MCSWEENEY CO  
4123 N KEYSTONE BLVD  
INDIANAPOLIS, INO 46205  
317 547-1112  
STANLEY A HARRIS CO  
60 DEDHAM AVE  
NEEDHAM, MASS 02192  
617 444-4780  
ROBERT MILSK CO  
19375 JAMES COUZENS HWY  
DETROIT, MICH 48235  
313 342-6660  
RAY RIPLEY & ASSOC  
6838 PILLSBURY AVE SO  
MINNEAPOLIS, MINN 55423  
612 866-8682  
L R MASSEY CO  
304 E JEFFERSON ST  
GREENWOOD, MISS 38930

601 443-3038  
DIPRO INC  
P O BOX 1427  
MARYLAND HEIGHTS, MO 63042  
314 432-3444  
R W FARRIS CO INC  
1715 BALTIMORE AVE  
KANSAS CITY, MO 64108  
816 421-1751  
MORRIS F TAYLOR CO  
P O BOX 23  
MARLTON, N. J. 08053  
609 983-1712  
BITTAN ASSOC INC  
381 SUNRISE HWY  
LYNBROOK, LONG ISLAND, N Y  
516 593-3833  
LOUIS W APPELL CO  
11 WARRFN ST  
NEW YORK, N Y 10907  
212 964-4255  
LFONARO D ALLEN CO  
P O BOX 205  
NORTH SYRACUSE, N Y 13212  
315 478-7470  
MORRIS F TAYLOR CO  
1224 DRESDEN DR., W  
CHARLOTTE, N. C. 28205  
704 537-4878  
RAEHR-GREENLEAF & ASSOC  
14700 OETROIT AVE  
CLVELAND, OHIO 44107  
216 221-9030  
MORRIS F TAYLOR CO  
4341 CARLISLE PIKE  
CAMP HILL, PA. 17011  
717 761-2958  
MORRIS F TAYLOR CO  
201 PENN CENTER BLVD.  
PITTSBURGH, PA. 15235  
412 823-8500  
M F KLICPERA CO  
P O BOX 2668  
HOUSTON, TEXAS 77001  
713 748-0874  
JAMES J BACKER CO  
2211 W GALER ST  
SEATTLE, WASH 98119  
206 283-6470

UNITED RADIO SUPPLY INC  
INDUSTRIAL DIVISION  
SALES MANAGER  
JOHN RIES  
BRAND NAMES  
KUSTOM ELECTRONICS  
COMPANY ADDRESS  
829 W. BURNSIDE  
PORTLAND, OREGON 97209  
503-226-6334

UNITED STATES PLASTIC ROPE INC  
VICE PRESIDENT - SALES  
PETER M. LIND  
BRAND NAMES  
GLASTRAN  
COMPANY ADDRESS  
711 HAMILTON AVE.  
MENLO PARK, CALIF. 94025  
415-322-1881

UNITED STATES TOWERS  
OWNER  
JOHN J. HOKE  
COMPANY ADDRESS  
249 BARTOW LANE  
PETERSBURG, VA.  
732-9350

UNITED TRANSFORMER COMPANY  
SALES MANAGER  
J. R. BARRECA  
BRAND NAMES  
CAT  
COMPACT  
OCCOUNCER  
OI-T  
OI-T200  
DO-T  
OO-T400  
HIPERMALLOY  
HIT  
HVC VARIDUCTOR  
HV VARIDUCTOR  
LAB  
LINEAR STANOARD  
MAT  
MET  
MINIDUCTOR  
MINIFILTER  
QUONCER  
PIP  
S SERIES  
SPECIAL SERIES  
SUBOUNCER  
SUB-SUBOUNCER  
TELE-MINIFILTER  
TVC VARIDUCTOR  
ULTRA-COMPACT  
UNITED  
UTC  
VARIDUCTOR  
VARIMATCH  
VARIPOWER  
VARITRAN  
VIC VARIDUCTOR  
PIL  
MAS  
FLATS  
FE  
FI  
FO  
COMPANY ADDRESS  
150 VARICK STREET  
NEW YORK, NEW YORK 10013  
212-AL5-3500

COMPANY REPRESENTATIVES  
CARTFR ASSOCIATES INC  
P O BOX 94  
SCOTTSDALE, ARIZ 85252  
602 947-4355  
RECT ASSOC  
175 S SAN ANTONIO RD  
LOS ALTOS, CALIF  
415 941-0336  
FLARD F STRASSNER  
121 LOS FELIZ BLVD  
LOS ANGELES, CALIF  
213 666-1511  
UTC PACIFIC DIV.  
3631 EASTHAM DRIVE  
CULVER CITY, CALIF  
213 870-9755  
FRANKLIN SALES CO  
2149 SOUTH CLERMONT ST  
DENVER, COLO. 80222  
303 757-1371  
GERBER SALES CO INC  
31 BROADWAY  
NEW HAVEN, CONN 06515  
203 777-6279  
MILLAR-HUTTO ASSOC INC  
P O BOX 1603  
WINTER PARK, FLA 32790  
305 647-7407  
MILLAR-HUTTO ASSOC INC  
1036 PEACHTREE ST N E  
P O BOX 7116, STA C  
ATLANTA, GA 30309  
404 876-0919  
WHITMORE ASSOC  
4750 N MILWAUKEE AVE  
CHICAGO, ILL 60630  
312 286-2442  
LORENZ SALES INC  
320 30TH STREET S E  
CEGAR RAPIOS, IOWA 52403  
319 366-0774  
L D LOWERY INC  
6200 ANNAPOLIS RO  
HYATTSVILLE, MO 20784  
301 773-4977  
GERBRF SALFS CO INC  
176 SECOND AVE  
WALTHAM, MASS 02154  
617 891-8040  
FRED B HILL CO  
6110 EXCELSIOR BLVD  
MINNEAPOLIS, MINN 55416  
612 925-6727  
HARRIS-HANSON CO  
2814 S BRENTWOOD BLVD  
ST LOUIS, MO 63144  
314 647-4350  
FRANK W TAYLOR CO INC  
4455 EAST GENESEE ST  
DEWITT, N Y 13214  
315 446-0422  
COMTRONIC ASSOC  
1551 FRANKLIN AVE  
MINEOLA 11, L I, N Y  
516 741-8966  
BEN MILLER  
P O BOX 72  
LITTLE NECK, N Y 11363  
212 224-4673  
MILLAR-HUTTO ASSOC INC  
112 SO SHARON AMITY RD  
P O BOX 17566  
CHARLOTTE, N C 28211  
704 366-5579  
BEK ASSOC INC  
330 SALEM AVE  
OAYTON, OHIO 45406  
513 278-1343  
L D LOWERY INC  
2801 WEST CHESTER PIKE  
RODMALL, PA 19008  
215 356-5300  
GENE S ROOT & CO  
809 WAINRIGHT DRIVE  
PITTSBURGH, PA 15228  
412 561-6125  
J Y SCHOONMAKER CO INC  
5328 REOFIELD BOX 35266  
DALLAS, TEXAS 75235  
214 631-8480  
J Y SCHOONMAKER CO INC  
6001 GULF FREEWAY  
HOUSTON, TEXAS 77023  
713 926-9510  
JAS. J BACKER CO  
221 WEST GALER ST  
P O BOX 927  
SEATTLE, WASH 98119  
206 283-6470

UP-RIGHT SCAFFOLDS  
SALES MANAGER  
R. L. ESKEN  
BRAND NAMES  
HOLD-E-ZEE  
ROL-TITE  
COMPANY ADDRESS  
65 BROAD STREET  
ROCHESTER, N. Y. 14614  
COMPANY REPRESENTATIVES  
G C RATCLIFF  
1738 E ORANGE DR  
PHOENIX, ARIZ 85016  
602 266-8238  
DONALD E SAVARD CO

UPSON BROTHERS INCORPORATED  
SALES MANAGER  
H. VELEPEC  
BRAND NAMES  
HOLD-E-ZEE  
ROL-TITE  
COMPANY ADDRESS  
65 BROAD STREET  
ROCHESTER, N. Y. 14614  
COMPANY REPRESENTATIVES  
G C RATCLIFF  
1738 E ORANGE DR  
PHOENIX, ARIZ 85016  
602 266-8238  
DONALD E SAVARD CO

426 E VALLEY BLVD  
ALHAMBRA, CALIF 91801  
783-0504  
WILLARD IHLEFELD & ASSOC  
1201 SAN MARCO BLVD  
JACKSONVILLE, FLA 32217  
305 FL 9-282  
ANDERSON SALES CO  
23 W CALENDAR AVE  
LAGRANGE, ILL 60525  
312 FL 2-1514  
F T HARSH CO  
15 FARM HILLS LANE  
HINGHAM, MASS 02043  
617 749-3555  
SIFMERS, GODDEN, OLSON  
324 N FIRST ST  
MINNEAPOLIS, MINN 55401  
612 FE 2-7793  
CHAS H KOSLOWSKY CO  
406 W 34TH ST  
KANSAS CITY, MO 64111  
816 WE 1-8088  
EXPORT AGENCIES CORP  
EXPORT DNLY  
50 BROADWAY  
NEW YORK, N.Y. 10004  
212 WH 4-1141  
HIPKISS & HULBERT INC  
P O BOX 148  
KFMT, OHIO 44240  
216 673-4426  
G W K VOIGHT CO.  
33 W STATE ST  
MEDIA, PA 19063  
215 LO 4-9021  
D R WEFER  
P O BOX 534  
NORRISTOWN, PA 19001  
215 BR 5-4049  
LYNN & HEMPHILL  
2116 N PEARL ST  
OALLAS, TEXAS 75201  
214 RI 7-4745  
KENNETH L SHEPHERD CO  
2830 CANYON VIEW OR  
SALT LAKE CITY, UTAH 84109  
801 HU 4-5408  
DON RAYMOND  
90 S DEARBORN  
SEATTLE, WASH 98104  
206 682-0480  
REPS, IN OTHER COUNTRIES  
LYMAN AGENCIES LTO  
3765 E FIRST AVE  
BURNABY 2, B C  
604 299-7747  
S S LERNER AGENCIES  
137 WELLINGTON ST WEST  
TORONTO, ONTARIO  
416 JU 6-4587

UTICA CORPORATION  
NATIONAL SALES MANAGER  
ARTHUR FRIELICH  
BRAND NAMES  
TOWN & COUNTRY  
T & C  
UTI-COM  
UTI-CAL  
UTICA  
COMPANY ADDRESS  
2947 W. TOUHY AVENUE  
CHICAGO, ILLINOIS 60645  
COMPANY REPRESENTATIVES  
SOUTHWEST MARKETING  
133 E MCLELLAN BLVD  
PHOENIX, ARIZONA  
602 266-5361  
A HERMAN & ASSOC  
6611 SALT LAKE AVE  
BELL, CALIF  
588-1175  
MORTON FIELDS COMPANY  
8330 N SPRINGFIELD  
SKOKIE, ILLINOIS  
312 674-3018  
E O MAGNUS & ASSOC.  
5715 LINCOLN AVE  
CHICAGO, ILL  
312 334-1503  
W F BEYER COMPANY  
538 LONE OAK ROAD  
PAOUCAH, KY  
502 442-1176  
INDUSTRIAL COMPONENT CO  
908 W 46TH ST  
MINNEAPOLIS, MINN  
612 827-1703  
L R MASSEY COMPANY  
304 E JEFFERSON  
GREENWOOD, MISS.  
601 453-3038  
J W LEHNER COMPANY  
367 BRYNHILD ROAD  
COLUMBUS, OHIO  
614 268-5260  
TEX-ELEX  
4222 RICHMOND  
HOUSTON, TEXAS  
713 666-1636

UTILITY PRODUCTS COMPANY  
VICE PRESIDENT - SALES  
LOREN H. PEASE  
COMPANY ADDRESS  
3111 W. MILL ROAD  
MILWAUKEE, WISCONSIN 53209  
COMPANY REPRESENTATIVES  
F J PERKINS  
P O BOX 884  
GLENDALE, CALIF  
213 246-2034  
JOHN L MARSH ASSOC  
P O BOX 865

JUPITER, FLA  
305 746-4911  
ROBERT SPOFFORD  
144 CARLYLE CIRCLE  
PALM HARBOR, FLA  
813 937-3385  
WM O HOLCOMB  
541 KENILWORTH AVE  
KENILWORTH, ILL  
312 251-0028  
L G WENDEGATZ  
P O BOX 865  
RAYTOWN, MO  
816 FL 3-8300  
R R KINYON  
9216 CLAYTON RD  
ST LOUIS, MO  
314 WY 3-4348  
J G MANN  
860 KIMBALL AVE  
WESTFIELD, N J  
201 233-2164  
JAKE RUDISILL ASSOC INC  
2309 N TRYON ST  
CHARLOTTE, N C  
704 377-6901  
F R ANDERSON  
982 DREXEL RD  
LOWER MERFIELD TWP  
YARDLEY, PA  
715 HY 3-3134  
JOHN P SMITH  
P O BOX 2077  
SAN ANGELO, TEXAS  
915 655-2511

**UTILITY TOWER COMPANY**

SALES MANAGER  
V. G. DUVALL  
COMPANY ADDRESS  
ROX 12027  
3200 N W 38TH STREET  
OKLAHOMA CITY, OKLA. 73112  
WI 6-5551  
COMPANY REPRESENTATIVES  
DAVCO ELECTRONICS  
BATESVILLE, ARK.  
BAUER ELECTRONICS CORP  
SAN CARLOS, CALIF.  
GATES RADIO CO  
QUINCY, ILL.  
UTILITY TOWER CO  
MAYFIELD, KY  
CH 7-3642  
K & M ELECTRONICS  
MINNEAPOLIS, MINN.  
RADIO CORPORATION OF AMERICA  
CAMDEN, N.J.  
VISUAL ELECTRONICS CORP  
NEW YORK, N.Y.  
COLLINS RADIO CO  
DALLAS, TEXAS  
GENERAL ELECTRIC  
LYNCHBURG, VA.

**VALUE INCORPORATED**

SALES MANAGER  
CLIFFORD K. FEARN  
BRAND NAMES  
POLYANGLE  
COMPANY ADDRESS  
206 NORTH BROADWAY  
PENNSVILLE, N. J. 08070

**VEGA ELECTRONICS CORPORATION**

VICF PRESIDENT - MARKETING  
CHARLES F. SWISHER  
BRAND NAMES  
SOUNDSERVO  
VEGA-MIKE  
COMPANY ADDRESS  
1161 RICHARD AVE.  
SANTA CLARA, CALIF. 95090  
COMPANY REPRESENTATIVES  
DOBBS/STANFORD  
P O BOX 266  
SAN CARLOS, CALIF  
415 591 0339  
KOESSLER SALES CO  
818 N FAIRFAX AVE  
LOS ANGELES, CALIF  
213 653 1605  
SPARTA ELECTRONIC CORP  
5851 FLORIN-PERKINS ROAD  
SACRAMENTO, CALIF 95828  
916 452 5353  
JOHN B ANTHONY  
P O BOX 343  
WILTON, CONN  
203 762 3629  
LOREN F GREEN & ASSOC  
5218 W DIVERSEY AVE  
CHICAGO 39, ILL  
312 AV 6 6824  
MORRIS F TAYLOR CO  
P O BOX 111  
SILVER SPRING, MO  
301 JU 9 4002  
JIM PIPER ASSOC  
TEN HAVEN ST  
DOVER, MASS  
617 449 1144  
LOWELL-KANGAS & ASSOC INC  
P O BOX 26  
CREVE COEUR STATION  
ST LOUIS, MO  
314 ST 1 6290  
SINGER PRODUCTS CO INC  
95 BROAD STREET  
NEW YORK, N Y 10004  
212 WH 4 8700  
SCHROEDER SALES CO  
2254 EUCLID AVE

CLEVELAND, OHIO  
216 MA 1 5G75  
CHARLES LUCAS SALES CO  
P O BOX 13632  
DALLAS, TEXAS  
214 WH 2 5958  
STEVENSON CO  
P O BOX 17495  
SALT LAKE CITY, UTAH  
801 CR 7 2515  
VECTOR CORPORATION  
307 WALL ST  
SEATTLE, WASH  
206 623 6891  
REPS IN OTHER COUNTRIES  
IMPETUS, S A  
2 VIA BERNA  
6900 - LUGANO  
SWITZERLAND  
91 3 82 14  
DIVERSIFIED ELECTRONICS  
P O BOX 365  
SCAPOROUGH, ONTARIO  
416 267 2001

**VENT-RAK INCORPORATED**

SALES MANAGER  
JAMES L. WRIGHT, SR.  
BRAND NAMES  
CHASSIS-TRAK INC  
VENT-RAK INC  
COMPANY ADDRESS  
525 S. WEBSTER AVE.  
INDIANAPOLIS, INDIANA 46219  
COMPANY REPRESENTATIVES  
YOUNG & LAWRENCE ASSOC INC  
107 WILLIAMS AVE S E  
HUNTSVILLE, ALA 35801  
205 536 0176  
WILLIAMS ASSOC INC  
1110 E MCDOWELL RD SUITE A2  
PHOENIX, ARIZ 85004  
602 254 6085  
DYNAMIC ASSOC  
1011 INDUSTRIAL WAY, EAST  
RURLINGAME, CALIF 94010  
415 344 2521  
DYNAMIC ASSOC  
5190 W WASHINGTON BLVD  
LOS ANGELES, CALIF 90016  
213 933 5833  
WILLIAMS ASSOC INC  
4971 JACKSON ST  
DENVER, COLO 80216  
373 388 4391  
COAKLEY, BOYD, & ABBETT INC  
6 GAYWOOD DRIVE  
WATERBURY, CONN 06705  
203 756 8766  
YOUNG & LAWRENCE ASSOC INC  
601 N NEW YORK AVE  
WINTER PARK, FLORIDA 32789  
305 647 2528  
YOUNG & LAWRENCE ASSOC INC  
2403 W VINA DEL MAR BLVD  
ST PETERSBURG, FLORIDA 33726  
813 360 7550  
YOUNG & LAWRENCE ASSOC INC  
2025 PEACHTREE RD  
N E SUITE 837  
ATLANTA, GA 30309  
404 355 1906  
RINGLAND M KRUEGER CO  
5755 W IRVING PARK RD  
CHICAGO, ILL 60634  
312 282 8444  
THOMAS & SUKUP CO  
2060 E FIFTY-FOURTH ST  
INDIANAPOLIS, IND 46220  
317 251 4574  
ENGINEERING SERVICES CO  
1026 THIRO AVE S E  
CEDAR RAPIDS, IOWA 52403  
319 366 1591  
GENE ROSEN & ASSOC INC  
9501 WADSWORTH DRIVE  
BETHESDA, MD 20034  
301 365 5113  
COAKLEY, BOYD, & ABBETT INC  
1424 HIGHLAND AVE BOX 248  
NEEDHAM, MASS 02192  
617 444 5470  
MARTIN VOGT CO  
2817 BAMLET RD  
ROYAL OAK, MICH 48073  
313 549 3355  
MASSE & ASSOC  
P O BOX 7707  
3825 YORK AVE NORTH  
MINNEAPOLIS, MINN 55422  
612 588 0551  
ENGINEERING SERVICES CO  
6717 VERNON AVE  
ST LOUIS, MO 63133  
314 PA 6 2233  
ENGINEERING SERVICES CO  
7546 TROOST  
KANSAS CITY, MO 64131  
816 EM 3 6000  
R L RINGER CO  
P O BOX 114  
GLEN ROCK, N J 07452  
201 444 1434  
WILLIAMS ASSOC INC  
3221 SILVER AVE S E  
ALBUQUERQUE, N MEX 87106  
505 255 1638  
R L RINGER CO  
P O BOX 51  
DEWITT, NEW YORK 13214  
MISSILETRONIC INC  
1321 E MOREHEAD ST BOX 4375  
CHARLOTTE, N CAROLINA 28204  
704 377 1922  
COMPONENTS ENG CO  
7461 N LINDEN LANE

CLEVELAND, OHIO 44130  
216 842 2737  
COMPONENTS ENGINEERING CO  
11720 KNOLLSPRINGS CT  
CINCINNATI, OHIO 45246  
513 825 8686  
T J RAY CO  
8514 EAST 31ST PLACE  
TULSA, OKLAHOMA 74145  
918 627 1515  
ROGER MARTIN ASSOC  
P O BOX 1002  
4619 PENN OAK ST  
RELLAIRE, TEXAS 77401  
713 MO 8 3877  
WILLIAMS ASSOC INC  
2461 S MAIN STREET  
SALT LAKE CITY, UTAH 84115  
801 466 8709  
ELECTRONIC SALES CORP  
P O BOX 6535  
SEATTLE, WASH 98116  
206 WE 2 0330  
REPS IN OTHER COUNTRIES  
EUROELECTRON  
47 DBRECHLAN  
BILLTHOVEN, HOLLAND  
ELECTRONIC MARKETING CO  
OF CANADA  
3600 BARCLAY AVE  
MONTREAL 26, QUEBEC  
514 739 8C52-53

**VIDEON CORPORATION**

SALES MANAGER  
W. S. CRAIG  
COMPANY ADDRESS  
140 E. MAIN ST.  
HUNTINGTON, NEW YORK 11743  
516-427-6285

**VIKING OF MINNEAPOLIS**

DIVISION OF THE TELEX CORP  
SALES MANAGER  
RICHARD L. MORRIS  
COMPANY ADDRESS  
9600 ALDRICH AVE. 50.  
MINNEAPOLIS, MINN. 55420  
612 881 2636  
COMPANY REPRESENTATIVES  
WORLD WIDE PROO  
P O BOX 9212  
BIRMINGHAM, ALA  
205 595 7114  
I R STERN & CO  
4329 EAST TURNEY AVE  
PHOENIX, ARIZ 85018  
602 955 4703  
I R STERN & CO  
4109 BURBANK BOULEVARD  
BURBANK, CALIF 91505  
213 849 1195  
MEYER, ROSS & FLEMING  
113 10TH STREET  
SAN FRANCISCO, CALIF 94103  
415 431 0652  
R & D SALES CO  
1468 S FEDERAL BLVD  
DENVER, COLO 80219  
303 934 5445  
WORLD WIDE PRODUCTS  
1999 N E 150TH ST  
NORTH MIAMI BEACH, FLA  
305 949 3457  
WORLD WIDE PRODUCTS  
P O BOX 7102  
TAMPA, FLA  
813 227 5051  
MANREP CORP  
P O BOX 429  
N MIAMI BEACH, FLA 33160  
305 949 3457  
RAY HUTMACHER ASSOC INC  
6668-6670 NORTHWEST HWY  
CHICAGO, ILL 60631  
312 631 3248  
KELLY-SCHMITZ-WINKELER ASSOC  
3831 43RD STREET  
DES MOINES, IOWA 50310  
515 279 9235  
GENE ROSEN & ASSOC INC  
9501 WADSWORTH DRIVE  
BETHESDA, MD 20034  
301 365 5113  
MICHAEL SCOTT CO INC  
336 WASHINGTON ST  
WELLESLEY HILLS, MASS 02181  
617 235 0102  
RAY RIPLEY ASSOC  
6838 PILLSBURY AVE S  
MINNEAPOLIS, MINN 55423  
612 866 8682  
KELLY-SCHMITZ-WINKELER ASSOC  
7546 TROOST AVE  
KANSAS CITY, MO 64131  
816 363 5651  
KELLY-SCHMITZ-WINKELER ASSOC  
2319 HAMPTON  
ST LOUIS, MO 63139  
314 781 6111  
L-C-A SALES INC  
76 MAIN STREET  
TUCKAHOE, N Y 10707  
914 961 4700  
LSM ASSOCIATES  
109 EASTON AVE  
RUFFALO, NEW YORK  
716 852 3374  
LSM ASSOC  
218 EAST LAKE ROAD  
OERUYTER, NEW YORK  
315 852 3374  
LSM ASSOCIATES  
ORCHARD PARK  
PHELPS, NEW YORK  
315 548 4891

WORLD WIDE PRODUCTS  
P O BOX 2493  
GREENSBORO, N C  
919 274 0693  
SCHROEDER SALES CO  
2254 EUCLID AVE  
CLEVELAND, OHIO 44115  
216 621 5074  
CHARLES LUCAS SALES CO  
2004 S BECKLEY AVE  
DALLAS, TEXAS 75224  
214 942 5958  
WILLIAM R LANPHEAR CO  
4031 STONEYWAY AVE N  
SEATTLE, WASH 98103  
206 633 4900

**VISHAY RESISTOR PRODUCTS DIV**

SALES MANAGER  
J. R. CURLEY  
BRAND NAMES  
VISHAY  
COMPANY ADDRESS  
63 LINCOLN HIGHWAY  
MALVERN, PA. 19355  
COMPANY REPRESENTATIVES  
SPACE ENGINEERING SALES INC  
4306 GOVERNORS DRIVE SW  
SUITE R  
HUNTSVILLE, ALA  
205 837 6060  
E J FOLEY & ASSOC  
3840 N JOKAKE DR  
SCOTTSDALE, ARIZ  
602 945 2665  
MELCHIOR & MACPHERSON INC  
820-R CHERRY STREET  
SAN CARLOS, CALIF  
415 591 7383  
WESTERN CONTROLS  
2630 SEAMAN AVE  
EL MONTF, CALIF  
213 443 9376  
I W STRONG & ASSOC  
635 CANOSA COURT  
DENVER, COLO  
303 292 6900  
COMP REP ASSOCIATES  
14 BOWLING GREEN AVE  
NORTH HAVEN, CONN 06473  
203 239 9762  
W BEN WIMBERLY CO  
532 S FT HARRISON AVE  
CLEARWATER, FLA  
813 446 7072  
W BEN WIMBERLY CO  
500 S OSCEOLA  
ORLANDO, FLA  
305 425 3083  
TECHNICAL DEVICES INC  
6416 N CENTRAL AVE  
CHICAGO, ILL  
312 774 8252  
J A DOUGHERTY SALES CO  
320 HILLEN ROAD  
TOWSON, MD 21204  
301 823 0431  
COMP REP ASSOCIATES  
1116 GREAT PLAIN AVE  
NEEDHAM, MASS 02192  
617 444 2484  
WILLARD SPENSER CO  
21500 GREENFIELD RD  
OAK PARK, MICH 48237  
313 398 8005  
PINKNEY & ASSOC  
1925 NICOLLET AVE  
MINNEAPOLIS 3, MINN  
612 338 0523  
DESIGN & SALES ENG CO  
2050 WOODSON RD  
ST LOUIS, MO  
314 ST 1 3388  
DESIGN & SALES ENG CO  
3506 N W 58TH TERRACE  
KANSAS CITY, MO 64133  
816 GR 1 1640  
BRESSLER ASSOC  
4808 BERGENLINE AVE  
UNION CITY, N J 07087  
201 UN 4 9577  
E E HARRIES & CO INC  
15 CANTERBURY LANE  
E AURORA, N Y 14052  
716 652 1221  
E E HARRIES & CO INC  
110 FAYETTE CIRCLE  
FAYETTEVILLE, N Y 13066  
315 637 9871  
E E HARRIES & CO INC  
216 SHOREWOOD DRIVE  
WEBSTER, N Y  
716 671 6365  
DESIGN & SALES ENG CO  
10217 E 4TH STREET  
TULSA, OKLA 74127  
918 LU 7 8474  
ELECTRONIC SALES  
1825 NORTH EMERSON ST  
PORTLAND, OREGON 97217  
503 289 0980  
MASSE ASSOC INC  
1325 W CHESTER PIKE  
HAVERTOWN, PA  
215 JA 8 6384  
TEXAS AVIONICS CO  
4515 PRENTICE ST  
DALLAS, TEXAS  
214 EM 8 3566  
TEXAS AVIONICS CO  
1108 MYER  
SEABROOK, TEXAS 77586  
713 GR 4 3155  
ELECTRONIC SALES  
6969 CALIFORNIA ST  
P O BOX 6535  
SEATTLE, WASH

# "VITAL" BROADCAST VIDEO PRODUCTS

EXAMINE OUR PERFORMANCE AND CONVENIENCE FEATURES

## COLOR STABILIZING AMPLIFIER

Model VI-500 corrects a number of faults often encountered in television transmission. Also provides for independent control of video, sync. and chroma. Additional features include optional sync. addition to non-composite inputs, 0.4v. p.-p. sync. output, cable loss equalizer, white stretch, white clip and four video outputs. Remote control of all major operational functions optional. Power supply regulation and temperature compensation contribute to high operational stability.

Clamping—More than 35 db. reduction of extraneous 60 Hz sine wave. Automatic Video Level Control—Holds output luminance peaks constant within 3% for input level change of -3 to +10 db. Attack and release times 0.05 seconds. Differential Gain—Less than 1%, 10% to 90% APL at 1 volt peak to peak output. Differential Phase—Less than 0.5°, 10% to 90% APL at 1 volt peak to peak output. Chroma Control—Varies chroma response +4 db. of unity. Price: with white stretch . . . \$1750.00; With non-composite color output . . . \$1850.00.

## PULSE DISTRIBUTION AMPLIFIER

Model VI-20 delivers exceptionally clean pulses even when input pulses seriously degraded. Pulse reforming action eliminates overshoots, rounding, ringing, tilt, poor rise and fall times, and effects of line reflections. Output pulse shape and amplitude essentially independent of input pulse shape and amplitude, but timing remains unaltered. A unique feature is a front panel indicator lamp which flashes when pulses are lost. Input Level—1.5 to 10 volts peak to peak negative into a 75 ohm termination, loop-through or bridging connection. Output Levels—All four outputs identical, 3.5 to 4.5 volts peak to peak, continuously adjustable. Less than 2% change in output amplitude for 5 to 1 change in input amplitude or -30% change in line supply voltage. Price of four amplifiers complete with rock mounting frame . . . \$1100.00.

Built to meet your operating needs by engineers with extensive use experience. All comments or inquiries are welcomed.

CALL OR WRITE



VITAL INDUSTRIES

Dept. E.

3614 SOUTHWEST ARCHER ROAD  
GAINESVILLE, FLORIDA  
PHONE 378 1581

## VIDEO DISTRIBUTION AMPLIFIER

Model VI-10A features exceptionally low differential gain and phase and is designed for the most critical color or monochrome use. Plug-in construction, with self-contained regulated power supply, silicon semiconductors throughout and available with an optional accessory remote gain control.

Video Input—0.5 to 2 volts peak to peak; no significant change in performance for 2 volt, peak to peak. Outputs—All four outputs: 75 ohms, ±2%. Normal output levels: 1 volt, peak to peak. Isolation between outputs: 36 db. at 1 MHz. Gain—Continuously adjustable from -6 db. to +6 db. Differential gain—Less than 0.1%, 10% to 90% APL at 1 volt, peak to peak output, operating into any or all four output loads. Differential Phase—Less than 0.1°, 10% to 90% APL, at 1 volt, peak to peak output, operating into any of all four output loads. Frequency Response—±0.25 db. to 20 MHz Low Frequency Tilt—Less than 1% on a 60 Hz square wave. Signal to Noise Ratio—70 db. below 1 volt, peak to peak output. Price of four amplifiers complete with rock mounting frame . . . \$1100.00.

## SYNC & BLANKING ADDER

Model VI-41 is used to add composite sync. and blanking pulses to as many as 12 video sources by resistive mixing. Pulses to be added are amplified to high level and fed through relatively high mixing resistances to video circuits. Isolation between video terminals to which pulses are added is not adversely affected.

Inputs—4 volts, peak to peak nominal, both sync. and blanking pulses. Inputs terminated in 75 ohms ±2%. Outputs—Sync. added to video: 0 to 0.5 volt, peak to peak, continuously adjustable. Blanking added to video: 0 to 0.15 volts, peak to peak, continuously adjustable. Less than 1% change in added pulse amplitude for any supply voltage from 85 to 140 volts. Overshoots, Rounding and Ringing—Each less than 1%. Tilt—Less than 0.5% on vertical blanking pulses. Price . . . \$275.00.

206 WE 2 0330  
REPS IN OTHER COUNTRIES  
WILLARD SPENSER CO  
3238 CURRY ST  
WINDSOR, ONTARIO  
ELECTRO TEC MARKETERS LTD  
1624 WEST HIRD AVE  
VANCOUVER 9, B C  
ALEX L CLARK LTD  
206 HAMMOND BLDG  
63 ALBERT STREET  
WINNIPEG, MANITOBA  
ELECTRO TEC MARKETERS LTD  
1767 MAIN ST N OFF 211  
WINNIPEG, MANITOBA  
204 338 2884  
ALEX L CLARK LTD  
3751 BLOOR ST W  
ISLINGTON, ONTARIO  
416 231 3303  
ALEX L CLARK LTD  
2500 BATES ROAD RM 102  
MONTREAL 29, QUEBEC  
514 739 3231

### VISUAL ELECTRONICS CORPORATION

VICE PRESIDENT - SALES  
GEORGE H WAGNER  
BRAND NAMES  
VISUAL  
FLCON  
NORELCO  
PLUMBICON R  
ALLENIZED  
COMPANY ADDRESS  
356 WEST 40TH STREET  
NEW YORK, NEW YORK 10018  
COMPANY REPRESENTATIVES  
JACK DANIELS  
ELSCO  
4533 N SCOTTSDALE ROAD  
SCOTTSDALE, ARIZONA 85251  
602 946 4658  
ALFRED A KALLMAN  
1617 EL CENTRO AVE  
HOLLYWOOD 28, CALIF  
213 466 6417  
TWX 910 321 3853  
ROBERT W KUHL  
1208 POPLAR AVE  
SUNNYVALE, CALIF  
408 245 8696  
RICHARD WHITE  
ELSCO COLORADO, INC  
2875 NORTH SPEER BLVD  
DENVER, COLORADO 80211  
303 433 2991  
LEWIS RADFORD  
4246 PEACHTREE ROAD  
ATLANTA, GEORGIA  
404 237 9202  
TWX 810 751 8275

FELIX BONVOULOIR  
KEMPER BLDG  
20 NORTH WACKER DRIVE  
CHICAGO, ILLINOIS  
312 372 3383  
TWX 312 272 0165  
LINTON D MARGREAVES  
409 SOUTH KENTUCKY  
MASON CITY, IOWA  
515 423 2971  
ED CLAMMER  
594C AVON DRIVE  
BETHESDA, MARYLAND  
301 365 1767  
DANIEL GREEN  
3 BUCKINGHAM ROAD  
NATICK, MASS  
617 237 0334  
AL TIMMS  
621 BEVERLY DRIVE  
MAGNOLIA, NEW JERSEY  
609 783 7120  
MORRIS A MAYERS  
JESSICA C RAFSKY  
J P GALLAGHER  
356 WEST 40 STREET  
NEW YORK, NEW YORK 10018  
212 736 5840  
TWX 710 581 2810  
HENDRIK J ANTONISSE  
INTERNATIONAL HEADQUARTERS  
356 WEST 40 STREET  
NEW YORK, NEW YORK  
212 736 5840  
JAMES HOWARD  
411 PRICE STREET  
THOMASVILLE, N CAROLINA  
919 476 4430  
A W GRESOON  
319 HOMEWOOD AVE  
GREENSBORO, N CAROLINA  
919 292 1791  
PHILLIP D THOMPSON  
2550 WEYMOUTH ROAD  
WINSTON-SALEM, N CAROLINA  
919 765 3157  
CHESTER A SIEGRIST  
1107 CATHEDRAL STREET  
LEBANON, PA  
717 273 5691  
CARL C HAYWORTH  
1503 OCONNOR ROAD  
IRVING, TEXAS  
214 254 9063  
WAYNE MARCY  
4007 BELLAIRE  
HOUSTON, TEXAS  
713 668 4896  
SAM KICHAS & ROBERT BACON  
P O BOX 15068  
SALT LAKE CITY, UTAH  
801 466 8631

REPS IN OTHER COUNTRIES  
VISUAL ELECTRONICS  
CORPORATION CANADA LTD  
VICTORIA STATION  
MONTREAL 6, QUEBEC  
514 481 5500  
C R WEBSTER  
VISUAL ELECTRONICS INTL  
79 LONDON STREET  
READING, BERKSHIRE, ENGLAND  
ORE 4 50422  
MIGUEL PEREYRA  
VISUAL ELECTRONICS, S A  
GENOVA 20  
DESPICAMO 6  
MEXICO 6, D. F.  
28 88 82

### VITAL INDUSTRIES

SALES MANAGER  
WILLIAM BOEHME  
BRAND NAMES  
VITAL  
COMPANY ADDRESS  
3614 S. W. ARCHER ROAD  
GAINESVILLE, FLORIDA 32601  
COMPANY REPRESENTATIVES  
PENINSULA ASSOCIATES  
1447 BAYSHORE ROAD  
PALO ALTO, CALIF.  
415-322-1803  
ELECTRONIC SALES CORP.  
2275 S. W. TEMPLE  
SALT LAKE CITY, UTAH 84115  
801-466-8631  
REPS IN OTHER COUNTRIES  
CALDWELL A/V EQUIPMENT CO.  
135 MIDWEST ROAD  
SCARBOROUGH, ONTARIO  
751-0881

### VITRO ELECTRONICS

SALES MANAGER  
JOHN BIRCH  
BRAND NAMES  
NEMS-CLARKE  
VITRO  
COMPANY ADDRESS  
919 JESUP-BLAIR DRIVE  
SILVER SPRING, MD. 20910

### VUE-TRONICS INC.

SALES MANAGER  
FRED SILVA  
BRAND NAMES  
VUE-TRONICS  
COMPANY ADDRESS  
15844 STRATHERN ST  
VAN NUYS, CALIF 91406

### WABER ELECTRONICS INC

SALES MANAGER  
ARNOLD GOLDMAN  
BRAND NAMES  
SKINSULATED CIRCUITRY  
LAB-ON-WHEELS  
POWERLINE  
SKINNY MILTON  
SKINNY MARIE  
FAT PHEBE  
LONG JOHN  
STRING REAN  
VARI-FINE  
STEREO MAGIC  
COMPANY ADDRESS  
2000 N 2ND STREET  
PHILADELPHIA, PA 19122  
215 NE 4-3200  
COMPANY REPRESENTATIVES  
M K SMITH  
2805 1/2 CAHABA RD  
BIRMINGHAM, ALA  
205 871 9341  
HYDE ELECTRONICS CO INC  
4710 N 16TH ST  
PHOENIX, ARIZONA  
602 264 5609  
S LEWIS & ASSOC  
BOX 352  
N HOLLYWOOD, CALIF  
213 877 0461  
I BALLARD CO INC  
556 CLAY ST  
SAN FRANCISCO, CALIF  
415 781 1781  
HYDE ELECTRONICS CO INC  
888 S LIPAN ST  
DENVER, COLO  
303 936 3456  
M K SMITH CO  
1845 TEMPLE DR  
WINTER PARK, FLA  
305 647 0026  
M K SMITH CO  
31-16TH ST N W  
ATLANTA, GA  
404 875 8031  
G PIETY FACTORS INC  
160 MOKAUEA ST  
HONOLULU, HAWAII  
808 837 185  
HILL & GRAY INC  
871 GARFIELD ST  
OAK PARK, ILLINOIS  
312 378 7050  
R HILSK CO  
3231 N MERIDIAN SUITE 72  
INDIANAPOLIS, IND  
317 923 1545  
M E BETTIS CO  
423 NORTH FOUNTAIN  
WICHITA, KANSAS

316 MU 5 7441  
R MILSK CO  
6908 BEDFORD LANE  
LOUISVILLE, KY  
502 425 6984  
SCOTT ORMSBY SALES  
230 20TH ST  
NEW ORLEANS, LA  
504 488 2414  
R MILSK CO  
19375 JAMES COUZENS HWY  
DETROIT, MICH  
313 342 6660  
R MILSK CO  
200 N DIVISION AVE RM 205  
GRAND RAPIDS, MICH  
616 451 0615  
C R GIBB CO  
2400 HENNEPIN AVE  
MINNEAPOLIS, MINN  
612 377 1200  
F A BETTIS CO  
3718 BROADWAY  
KANSAS CITY, MO  
816 JE 1 1530  
M E BETTIS CO  
3706 BROADWAY  
KANSAS CITY, MO  
816 561 0772  
M E BETTIS CO  
9103 BESSEMER  
ST LOUIS, MO  
314 HA 9 2099  
HYDE ELECTRONICS CO INC  
5206 CONSTITUTION NE  
ALBUQUERQUE, NEW MEXICO  
505 265 8895  
HARRIS & ALDRICH SALES INC  
42-34 195TH ST  
FLUSHING, NEW YORK  
212 357 7350  
W TAUBER CO  
151 FAYETTE BLVD  
SYRACUSE, NEW YORK  
315 446 7394  
M K SMITH CO  
1605 CHATHAM AVE  
CHARLOTTE, N CAROLINA  
704 376 5951  
H LEWIS CO  
1801 J F KENNEDY BLVD  
PHILADELPHIA, PA  
215 567 2068  
TANNER CO  
486 BROADMOOR AVE  
PITTSBURGH, PA  
412 561 4687  
E L WILKS CO  
1821 N BROADWAY  
CARROLLTON, TEXAS  
214 242 5321  
HYDE ELECTRONICS CO INC  
85 E 7TH ST S  
SALT LAKE CITY, UTAH  
801 355 5361  
M K WIDDEKIND CO INC  
815 W EWING ST  
SEATTLE, WASH  
206 284 8020

**WALLACH & ASSOCIATES, INC.**

SALES MANAGER  
CHARLES D. WALLACH  
BRAND NAMES  
DISCABINETS  
DISCMOBILE  
MOBILE A-V CENTER  
REELMOBILE  
COMPANY ADDRESS  
5701 EUCLID AVE.  
P O BOX 18167  
CLEVELAND, OHIO 44118

**WARD ELECTRONIC INDUSTRIES**

SALES MANAGER  
G. KURT BUTENHOFF  
BRAND NAMES  
WARD  
COMPANY ADDRESS  
142 CENTRAL AVENUE  
CLARK, NEW JERSEY 07066  
201-382-3700  
COMPANY REPRESENTATIVES  
PAUL EDMONDS  
WARD ELECTRONIC INDUSTRIES  
17350 SUNSET BLVD  
PACIFIC PALISADES, CALIF.  
213 454-5731  
PAUL AUDET  
WARD ELECTRONIC INDUSTRIES  
636 TRAVERS COURT  
CHICAGO HGTS, ILL.  
312 754-0076

**WATERS MANUFACTURING, INC.**

SALES MANAGER  
ROBERT A. WATERS  
COMPANY ADDRESS

533 BOSTON POST ROAD  
WAYLAND, MASS. 01778

**WAVEFORMS, INCORPORATED**

SALES MANAGER  
A. E. RYERS  
COMPANY ADDRESS  
333 6TH AVENUE  
NEW YORK, NEW YORK 10014  
212-929-2795  
COMPANY REPRESENTATIVES  
KOESSLER SALES CO  
818 N FAIRFAX  
LOS ANGELES 46, CALIF  
OL 3-1605  
KENNETH B MEYERS CO  
7256 W TOUHY AVE  
CHICAGO 48, ILL  
SP 4-6440  
BORDEWIECK ENG SLAES CO  
221 GROVE STREET  
BRAintree 84, MASS  
VI 3-0845  
HARRIS HANSEN CO  
2814 SOUTH BRENTWOOD  
ST LOUIS, MO  
444-9494  
RCA 86CP DIV  
FRONT 6 COOPER STREET  
CAMDEN, N J  
WO 3-8000  
HAYS CO  
405 N BOWSER  
RICHARDSON, TEXAS  
231-1426

**WECKESSER COMPANY, INC.**

SALES MANAGER  
C. J. CZAPINSKI, JR.  
BRAND NAMES  
NY-GRIP  
STRAP-TITE  
TAB-LOC  
ETHO-LOC  
WEDGE LOCK  
STRAINCHECK  
COMPANY ADDRESS  
4444 WEST IRVING PARK ROAD  
CHICAGO, ILLINOIS 60641  
312 282 8626  
COMPANY REPRESENTATIVES  
EMORY DESIGN & EQUIP. CO.  
404 DEXTER AVENUE  
BIRMINGHAM, ALA. 35213  
205-871-1369  
HOWE & HOWE SALES  
4344 EAST INDIAN SCHOOL RD.  
PHOENIX, ARIZONA 85016  
602 265-9185  
WESCO ELECTRONICS  
2620 EAST WALNUT  
PASADENA, CALIF. 91107  
213 684-0880  
WIN. W. TOMPKINS & CO.  
3944 EL CAMINO REAL  
PALO ALTO, CALIF. 94306  
415 326-7940  
FRANKLIN SALES COMPANY  
2149 SOUTH CLERMONT  
DENVER, COLO. 80222  
303 757-1371  
WHITEHEAD FASTENERS  
P. O. BOX 190  
WINDSOR, CONN 06095  
203-688-4921  
KELLY SCHMITZ-WINKLER  
3831 43RD STREET  
DES MOINES, IOWA 50310  
515 CR 9-9235  
WHITEHEAD FASTENERS  
281 ALBANY  
CAMBRIDGE, MASS 02139  
617-TR6-4680  
JENSEN-MORROW SALES  
26711 WOODWARD AVENUE  
ROYAL OAK, MICHIGAN 48070  
313-544-3700  
SERVCO  
521 SOUTH 7TH STREET  
MINNEAPOLIS, MINN 55415  
612-339-8611  
KELLY SCHMITZ-WINKLER  
7546 TROOST AVE  
KANSAS CITY, MISSOURI 64131  
816-EM3-5651  
KELLY-SCHMITZ-WINKLER  
2319 HAMPTON AVENUE  
ST. LOUIS, MO. 63139  
314 ST 1-6111  
MILTON LOSS  
4322 NORTH 56TH STREET  
OMAHA, NEBRASKA 68104  
402 451-0124  
WHITEHEAD FASTENERS  
P. O. BOX 102, MILIK STA.  
CARTERET, NEW JERSEY 07008  
201-969-2000  
WHITEHEAD FASTENERS

2128 ELMWOOD AVENUE  
BUFFALO, N. Y. 14207  
716-TR6-3100  
WHITEHEAD FASTENERS  
P. O. BOX 212  
EAST SYRACUSE, N. Y. 13201  
315-HO3-6241  
INTERNATIONAL TECHNICAL PROD.  
EXPORT  
303 WEST 42ND STREET  
NEW YORK CITY, N.Y. 10036  
212 CI 6-2080  
E. A. ALEXANDER COMPANY  
15437 HEMLOCK POINT ROAD  
CHAGRIN FALLS, OHIO 44022  
216-EDB-6861  
CHARLES W. THOMAS, INC.  
4540 WORTH STREET  
PHILADELPHIA, PENN 19124  
215-PI4-3100  
CONTACT ELECTRONICS  
2403 FARRINGTON  
DALLAS, TEXAS 75207  
214 ME 1-9530  
RAY JOHNSTON COMPANY, INC.  
1011 NORTHEAST 69TH STREET  
SEATTLE, WASH. 98115  
206 LA 4-5170  
C. S. POLACHEK & ASSOCIATES  
4027 NORTH DOWNER AVE  
MILWAUKEE, WIS. 53211  
414-966-5565  
REPS. IN OTHER COUNTRIES  
NORTECH ELECTRONICS  
1335 LAWRENCE AVENUE EAST  
DON MILLS, ONTARIO  
416 447-6471

**WESTINGHOUSE ELECTRIC CORP.**

ELFCTRONIC TUBE DIVISION  
MARKET MANAGER  
L. L. GRANT  
COMPANY ADDRESS  
BOX 284  
ELMIRA, N Y 49502  
RE 9 3611  
SALES OFFICES  
ELECTRONIC COMPONENTS AND  
SPECIALTY PRODUCTS  
89 HOLIDAY OFFICE ENTER  
HUNTSVILLE, ALABAMA  
205 881-2591  
1802 S SANTA FE AVENUE  
COMPTON, CALIF. 90224  
213 636 0111  
1102 N 21ST AVENUE BOX 6144  
PHOENIX, ARIZONA 85005  
602 258-7211  
600 ST. PAUL AVENUE  
LOS ANGELES, CALIF. 90017  
213 482-9660  
BLOG, 73, HENDY AVENUE  
SUNNYVALE, CALIF. 94088  
408 735-3011  
55 W. FIFTH AVENUE  
DENVER, COLO. 80204  
303 534-8121  
360 MARKET STREET  
HARTFORD, CONN. 06103  
203 249-5792  
1625 K STREET, N.W.  
WASHINGTON, D.C. 20006  
202 628-8843  
367 N. ORANGE AVENUE  
ORLANDO, FLA. 32802  
305 425-4511  
1299 NORTHSIDE DRIVE, N.W.  
ATLANTA, GEORGIA 30302  
404 351-5230  
10 SOUTH RIVERSIDE PLAZA  
CHICAGO, ILL. 60606  
312 461-7200  
1560 STADIUM DRIVE  
INDIANAPOLIS, IND. 46207  
317 632-3301  
1055 TAYLOR AVENUE  
TOWSON, MARYLAND 21204  
301 828-5400  
800 BOYLSTON STREET  
BOSTON, MASS. 02199  
617 542-0600  
5757 TRUMBULL AVENUE  
DETROIT, MICH. 48232  
313 872-7010  
281 LEONARD STREET, N.W.  
GRAND RAPIDS, MICH. 49504  
616 456-1531  
3501 S. HIGHWAY 100  
MINNEAPOLIS, MINN 55416  
612-927-6551  
411 N. SEVENTH STREET  
ST. LOUIS, MISSOURI 63101  
314-421-6911  
67 EVERGREEN PLACE  
E. ORANGE, N J 07018  
201-469-0222  
43 W. FRONT STREET  
RED BANK, N J 07701

201-747-5800  
4301 OLD VESTAL ROAD BOX 148  
JOHNSON CITY, N. Y. 13850  
607-729-2258  
1501 FRANKLIN AVENUE  
MINEOLA, NEW YORK 11501  
516-248-9800  
711 EXCHANGE STREET  
ROCHESTER, N. Y. 14603  
716-232-4380  
ILLUMINATING BLDG  
55 PUBLIC SQUARE  
CLEVELAND, OHIO 44113  
216 579 2121  
1306 FARR DRIVE  
DAYTON, OHIO 45404  
513-461-3720  
3001 WALNUT STREET  
PHILADELPHIA, PENN 19104  
215-878-1300  
CHATHAM CENTER OFFICE BLDG.  
PITTSBURGH, PENN 15222  
412-255-3800  
8400 JOHN W. CARPENTER FWY  
DALLAS, TEXAS 75247  
714-631-2811  
507 DALLAS AVENUE  
HOUSTON, TEXAS 77002  
713-226-7791  
3451 MARGINAL WAY  
SEATTLE, WASH 98134  
206-623-7001  
538 N. BROADWAY AVENUE  
MILWAUKEE, WISCONSIN 53201  
414-276-1800

**WIDE RESPONSE**

SALES MANAGER  
J. C. CUBBAGE  
COMPANY ADDRESS  
2926 BENTLEY AVE.  
LOS ANGELES, CALIF. 90064  
213-477-5840

**WILKINSON ELECTRONICS, INC.**

BRAND NAMES  
WILKINSON  
COMPANY ADDRESS  
1937 W MACDADE BOULEVARD  
WOODLYN, PA. 19094

**W. WILSON CORPORATION**

SALES MANAGER  
DAVID D. SCHWARTZ  
BRAND NAMES  
MOVIE-MOVER  
WILSON  
COMPANY ADDRESS  
546 W. 119TH STREET  
CHICAGO, ILL. 60628

**XCELITE INCORPORATED**

PRESIDENT  
ARCH WARDEN  
BRAND NAMES  
XCELITE  
COMPANY ADDRESS  
THORNE AND BANK STREETS  
ORCHARD PARK, NEW YORK 14127

**YOKOGAWA ELECTRIC WORKS, INC.**

SALES MANAGER  
RIO IMAMURA  
BRAND NAMES  
HANDI-CRANK  
HANDI-MITE  
YEW  
COMPANY ADDRESS  
1995 PALMER AVE.  
LARCHMONT, NEW YORK 10538  
COMPANY REPRESENTATIVES  
HALLMARK STANDARDS INC  
145 LIBRARY LANE  
MARAMONCK, NEW YORK  
914 OW 8-8460  
REPS. IN OTHER COUNTRIES  
STARK ELECTRONIC INST SALES  
AJAX, ONTARIO  
416 WH 2-2120

**ZOLOMATIC CORPORATION**

SALES MANAGER  
CHARLES STENNING  
COMPANY ADDRESS  
5875 MELROSE AVE.  
HOLLYWOOD, CALIF. 90038

**ZOOMAR, INC.**

SALES  
WALTER P. STEVER  
BRAND NAMES  
ZOOMAR  
OPTICOMETER  
COMPANY ADDRESS  
55 SEA CLIFF AVE.  
GLEN COVE, N. Y. 11542

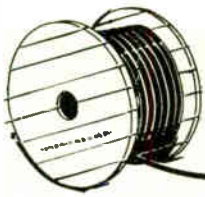

*Ready!*

# SUPERIOR L-O-N-G L-I-N-E LOW-LOSS COAXIAL TRUNK CABLE

"6 AWG bare soft drawn copper conductor"



| Maximum Attenuation db/100 ft. at 68°F |      |            |      |
|--|------|------------|------|
| Channel 6                              |      | Channel 13 |      |
| Nominal                                | 0.52 | Nominal    | 0.85 |
| Maximum*                               | 0.55 | Maximum*   | 0.89 |

\*These are limits as indicated by production to date. Until a permanent specification sheet is issued, these maximum values should be reconfirmed by our engineering department at the time of system design.

**TRUSTWORTHY!** When you look to SUPERIOR CABLE . . . you can depend on the data, depend on the promised performance . . . because SUPERIOR CABLE leads the industry in the determination to apply absolute quality controls, through every step of design and manufacture! Features of 4940: Cell-O-Air expanded polyethylene dielectric; "Coppergard" Shield; jackets marked with sequential footage at 2-foot intervals; reels fully sweep-tested.

- FULL SPECTRUM CAPABILITY
- LONG TERM TRANSMISSION STABILITY
- BUILT-IN RELIABILITY



Every reel SWEEP-TESTED over its full length!  
Measured Ch. 13 attenuation stenciled on each reel of 4940.



**5-YEAR  
GUARANTEE**  
ASK TO SEE IT!

For detailed information and prices, write



## SUPERIOR CABLE

SUPERIOR CABLE CORPORATION / HICKORY, NORTH CAROLINA 28601

1967/The Broadcast Industry BUYERS GUIDE 127

9848



MODEL CX 711

For the control room where simplicity is the key to accuracy.



MODEL CX 822

For the studio where flexibility means creative productions.

**MADE ONLY IN AMERICA**



# Leadership

**IN QUALITY  
DEPENDABILITY  
PERFORMANCE**

## ELECTRONIC ACHIEVEMENTS

- 👑 Performance as yet unequalled
- 👑 Two years proven Solid State circuitry
- 👑 Extremely low noise electronics
- 👑 Etched circuit modules

## TRANSPORT DEPENDABILITY

- 👑 Patented Electro-Magnetic Brakes never need adjusting
- 👑 Complete head accessibility
- 👑 Precision Construction
- 👑 Low Wow and Accurate Tuning



CROWN recorders and players have been designed for continuous perfect performance. Skilled American craftsmen fabricate, assemble and individually adjust each CROWN to give you unequalled recording quality.

Our best salesmen are the studios and control rooms that have been using CROWN year after year. *Ask them!*



CROWN offers 40 models of players and recorders to meet your most specific and exacting requirements.

FOR COMPLETE  
INFORMATION  
WRITE OR PHONE  
JOHN HAINES

**Crown** INTERNATIONAL

BOX 1000, ELKHART, INDIANA 46514 • PHONE (219) 523-4919





# Engineering Data

A collection of data selected to be of value to the engineer or technician.

Courtesy Andrew Corporation

## AUDIO NETWORKS

### Unbalanced Configurations

Unbalanced networks encompass the T-type, taper pads, bridged-T, L-type, pi, ladder, and potentiometer.

You will notice, when looking through the network design equations, that the factor  $k$  appears in all equations. The  $k$  factor represents the ratio of current, voltage, or power corresponding to a given value of attenuation expressed in decibels.

To simplify the calculation of attenuator networks, the values of the most frequently used expressions, as tabulated by P. K. McElroy, are given in Table 1. Values for the expressions are substituted in the equations, thus saving much time and resulting in greater accuracy.

It is recommended, when large amounts of attenuation are required, that the loss be divided between two or more attenuator networks. This reduces the possibility of leakage at the higher frequencies and simplifies the construction, because some circuit element values become quite small as the attenuation is increased. As an example, if 80 dB of attenuation is required, it is far more practical to employ two tandem-connected 40-dB pads than to construct one of 80-dB loss. The 80-dB pad would require a shunt resistor of 0.12 ohms for a T-type attenuator, whereas in the 40-dB network it would be 12 ohms.

The given loss of an attenuator can only be obtained when the input and output circuits of the attenuator network are terminated in the design impedance. Although the terms input and output are frequently used in the discussion of attenuators, in reality there is no input or output to an attenuator; it makes no difference to the network which side is connected to the source or terminating circuit as long as the impedance match is satisfied. If a pad designed to operate between 600 ohms and 250 ohms is reversed, the pad will operate; however, the mismatch will cause a loss of level and may result in serious frequency distortion because of the impedance mismatch. The actual loss in decibels, for a given mismatch of impedance, is shown graphically in Fig. 1.

*Material for the section "Audio Networks" has been adapted from the Howard W. Sams book Passive Audio Network Design, by Howard M. Tremaine.*

### T Configuration

A T-configuration network consists of three noninductive resistors, as shown in Fig. 2. T-type networks may be designed to operate between impedances of equal or unequal values. When properly designed, they will present an impedance match to both the source and load impedances regardless of the amount of loss. If the input and output impedance are of the same value, they are designated by the symbol  $Z$ . If they are of unequal values, symbols  $Z_1$  and  $Z_2$  are used. Symbols  $R_1$ ,  $R_2$ , and  $R_3$  are used only with unequal impedances. For equal impedance  $R_1$  appears in both the input and output sides, and the shunt resistor is then designated as  $R_2$  (Fig. 2A). The resistor values for a pad to operate between equal impedances may be calculated:

$$R_1 = \left( \frac{k-1}{k+1} \right) Z$$

$$R_2 = \left( \frac{k}{k^2-1} \right) 2Z$$

where,

$Z$  is the input and output impedance,

$R_1$  is the series resistor,

$R_2$  is the shunt resistor.

As an illustration, assume an attenuator is to be designed for a loss of 10 dB and is to operate in a 600-ohm circuit. Referring to Table 1, the  $k$  factor for  $R_1$  at a loss of 10 dB is 0.519, and for  $R_2$  it is 0.351; therefore:

$$\begin{aligned} R_1 &= 0.519 \times 600 \\ &= 311.4 \text{ ohms} \\ R_2 &= 0.351 \times 1200 \\ &= 421.2 \text{ ohms} \end{aligned}$$

Practical construction of this network would require two 310-ohm and one 420-ohm resistors.



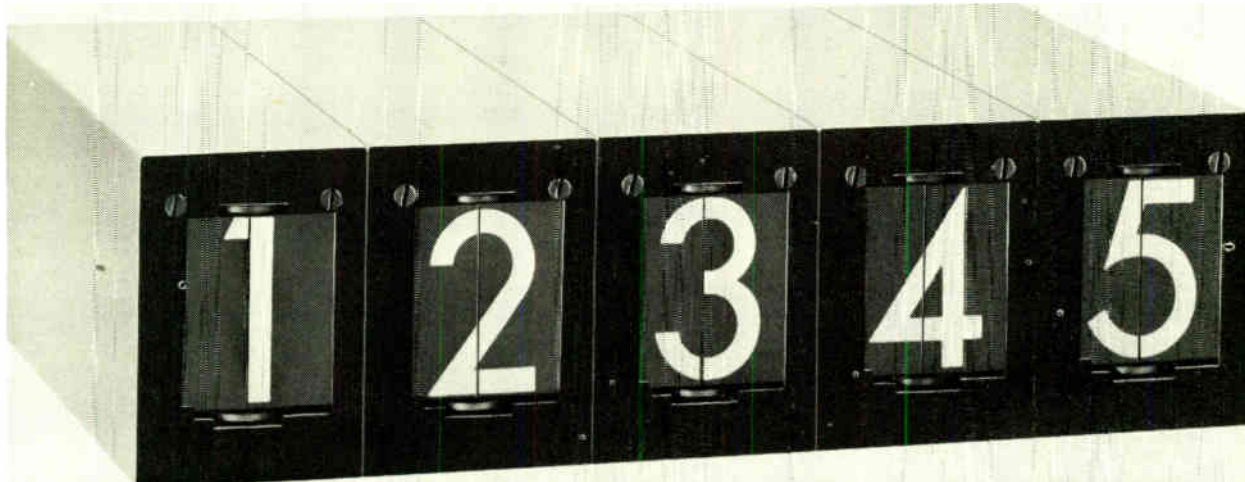

## Numbers your TV cameras can read without eye-strain.

Numbers, letters, symbols. If they're in lights, they can cause problems. Ghosts appear and bulbs burn out. Their images may permanently damage camera tubes. Now CBS Laboratories offers the way out: Model DDU-1A electro-mechanical indicator units with characters displayed on a flat plane for optimum readability with viewing angles as high as 145°.

Here's the perfect way to display election return figures, ball scores, stock market or commodity exchange quotations and similar information.

A vertical split-flap "book page" mechanism provides uniform reflectivity and maximum character clarity under both high and low ambient lighting conditions.

Our Digital Display Units are the business end of a complete digital display system, including power supply

and a compact digital display control that allow rapid selection of up to 192 digits, letters or symbols.

Operating power of only 2.7 watts per unit means cool operation and low power control circuitry. No power at all is required between postings.

Modular construction permits high packing density with significant space savings and maximum flexibility. Custom characters and colors are available on special order.

The DDU-1As are priced from \$32.50 to \$50.00 each, depending on quantity ordered. Our Model 192 Digital Display Control is priced at \$1094. Custom design controls for special applications are no problem. Our Display System Engineers will help to plan your total system.

### SPECIFICATIONS:

**Character Description** Maximum of 12 characters; digits 1 through 9, 0 and 2 blank positions supplied on standard unit

**Character Dimensions** Height: 1½ inches  
Width: 1¼ inches

**Unit Dimensions** Height: 2¾ inches  
Width: 2 inches  
Length: 7 inches

**Unit Weight** 1½ lbs.

**Power Requirements** Motor: 60 cycle, 115 volts, AC  
Relay: 24 volts, DC

**Operating Power** Maximum of 2.7 watts required

**Operating Speed** Consecutive change:  
0.25 seconds  
Complete 12-step cycle:  
3.0 seconds

**Mounting** Bottom mounting holes:  
2 front, 2 rear

**Connections** Jones Type P-318-AB Connector.

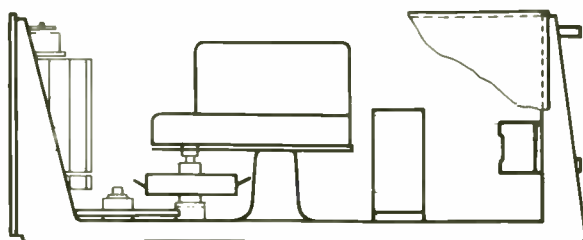

Model 192 Digital Display Control features fail-safe truth circuitry, automatic homing control, and provides positive control of up to 192 DDU-1As. Custom controls for larger systems are available.

**CBS LABORATORIES**  
Stamford, Connecticut. A Division of  
Columbia Broadcasting System, Inc.

|       |             |                 |                          |         |         |             |                 |          |         |         |             |       |
|-------|-------------|-----------------|--------------------------|---------|---------|-------------|-----------------|----------|---------|---------|-------------|-------|
| 34.5  | 0.018836    | 53.088          | 2,818.4                  | 0.96302 | 1.03840 | 0.018843    | 53.069          | 1.00071  | 0.98116 | 1.01920 | 0.019198    | 34.5  |
| 35.0  | 0.017783    | 56.234          | 3,162.3                  | 0.96506 | 1.03621 | 0.017788    | 56.216          | 1.00063  | 0.98222 | 1.01810 | 0.018105    | 35.0  |
| 36.0  | 0.015849    | 63.096          | 3,981.1                  | 0.96880 | 1.03221 | 0.015853    | 63.080          | 1.00050  | 0.98415 | 1.01610 | 0.016104    | 36.0  |
| 37.0  | 0.014125    | 70.795          | 5,011.9                  | 0.97214 | 1.02866 | 0.014128    | 70.781          | 1.00040  | 0.98588 | 1.01433 | 0.014328    | 37.0  |
| 37.5  | 0.013335    | 74.989          | 5,623.4                  | 0.97368 | 1.02703 | 0.013338    | 74.976          | 1.00036  | 0.98666 | 1.01352 | 0.013516    | 37.5  |
| 38.0  | 0.012589    | 79.433          | 6,309.6                  | 0.97513 | 1.02550 | 0.012591    | 79.420          | 1.00032  | 0.98741 | 1.01275 | 0.012750    | 38.0  |
| 39.0  | 0.0112202   | 89.125          | 7,943.3                  | 0.97781 | 1.02270 | 0.0112216   | 89.114          | 1.00025  | 0.98878 | 1.01135 | 0.011348    | 39.0  |
| 40.0  | 0.0100000   | 100.000         | 10,000.                  | 0.98020 | 1.02020 | 0.0100010   | 99.990          | 1.00020  | 0.99000 | 1.01010 | 0.010101    | 40.0  |
| 40.5  | 0.0094406   | 105.925         | 11,220.                  | 0.98130 | 1.01906 | 0.0094414   | 105.916         | 1.00018  | 0.99056 | 1.00953 | 0.0095306   | 40.5  |
| 41.0  | 0.0089125   | 112.202         | 12,589.                  | 0.98233 | 0.01799 | 0.0089134   | 112.193         | 1.00016  | 0.99109 | 1.00899 | 0.0089926   | 41.0  |
| 42.0  | 0.0079433   | 125.89          | 15,849.                  | 0.98424 | 1.01601 | 0.0079436   | 125.88          | 1.00013  | 0.99206 | 1.00801 | 0.0080070   | 42.0  |
| 43.0  | 0.0070795   | 141.25          | 19,953.                  | 0.98594 | 1.01426 | 0.0070795   | 141.24          | 1.00010  | 0.99292 | 1.00713 | 0.0071301   | 43.0  |
| 43.5  | 0.0066834   | 149.62          | 22,387.                  | 0.98672 | 1.01346 | 0.0066834   | 149.61          | 1.00009  | 0.99332 | 1.00673 | 0.0067286   | 43.5  |
| 44.0  | 0.0063096   | 158.49          | 25,119.                  | 0.98746 | 1.01270 | 0.0063096   | 158.49          | 1.00008  | 0.99369 | 1.00635 | 0.0063496   | 44.0  |
| 45.0  | 0.0056234   | 177.83          | 31,623.                  | 0.98887 | 1.01131 | 0.0056234   | 177.83          | 1.00006  | 0.99438 | 1.00566 | 0.0056551   | 45.0  |
| 46.0  | 0.0050119   | 199.53          | 39,811.                  | 0.99003 | 1.01007 | 0.0050119   | 199.53          | 1.00005  | 0.99499 | 1.00504 | 0.0050370   | 46.0  |
| 46.5  | 0.0047315   | 211.35          | 44,668.                  | 0.99058 | 1.00951 | 0.0047315   | 211.35          | 1.000045 | 0.99527 | 1.00475 | 0.0047540   | 46.5  |
| 47.0  | 0.0044668   | 223.87          | 50,119.                  | 0.99111 | 1.00897 | 0.0044668   | 223.87          | 1.000040 | 0.99553 | 1.00449 | 0.0044869   | 47.0  |
| 48.0  | 0.0039811   | 251.19          | 63,096.                  | 0.99207 | 1.00799 | 0.0039811   | 251.19          | 1.000032 | 0.99602 | 1.00400 | 0.0039970   | 48.0  |
| 49.0  | 0.0035481   | 281.84          | 79,433.                  | 0.99293 | 1.00712 | 0.0035481   | 281.84          | 1.000025 | 0.99645 | 1.00356 | 0.0035607   | 49.0  |
| 50.0  | 0.0031623   | 316.23          | 100,000.                 | 0.99370 | 1.00634 | 0.0031623   | 316.23          | 1.000020 | 0.99684 | 1.00317 | 0.0031723   | 50.0  |
| 51.0  | 0.0028184   | 354.81          | 125,890.                 | 0.99438 | 1.00565 | 0.0028184   | 354.81          | 1.000016 | 0.99718 | 1.00283 | 0.0028264   | 51.0  |
| 52.0  | 0.0025119   | 398.11          | 158,490.                 | 0.99499 | 1.00504 | 0.0025119   | 398.11          | 1.000013 | 0.99749 | 1.00252 | 0.0025182   | 52.0  |
| 54.0  | 0.0019953   | 501.19          | 251,190.                 | 0.99602 | 1.00400 | 0.0019953   | 501.19          | 1.000008 | 0.99801 | 1.00200 | 0.0019992   | 54.0  |
| 55.0  | 0.0017783   | 562.34          | 316,230.                 | 0.99645 | 1.00356 | 0.0017783   | 562.34          | 1.000006 | 0.99822 | 1.00178 | 0.0017815   | 55.0  |
| 56.0  | 0.0015849   | 630.96          | 398,110.                 | 0.99684 | 1.00317 | 0.0015849   | 630.96          | 1.000005 | 0.99842 | 1.00159 | 0.0015874   | 56.0  |
| 57.0  | 0.0014125   | 707.95          | 501,190.                 | 0.99718 | 1.00283 | 0.0014125   | 707.95          | 1.000004 | 0.99859 | 1.00141 | 0.0014145   | 57.0  |
| 58.0  | 0.0012589   | 794.33          | 630,960.                 | 0.99749 | 1.00252 | 0.0012589   | 794.33          | 1.000003 | 0.99874 | 1.00126 | 0.0012605   | 58.0  |
| 60.0  | 0.0010000   | 1,000.0         | 10 <sup>6</sup>          | 0.99800 | 1.00200 | 0.0010000   | 1,000.0         | 1.000002 | 0.99900 | 1.00100 | 0.0010010   | 60.0  |
| 65.0  | 0.00056234  | 1,778.3         | 3.1623 × 10 <sup>6</sup> | 0.99888 | 1.00112 | 0.00056234  | 1,778.3         | 1.000001 | 0.99944 | 1.00056 | 0.00056265  | 65.0  |
| 70.0  | 0.00031623  | 3,162.3         | 10 <sup>7</sup>          | 0.99937 | 1.00063 | 0.00031623  | 3,162.3         | 1.000000 | 0.99968 | 1.00032 | 0.00031633  | 70.0  |
| 75.0  | 0.00017783  | 5,623.4         | 3.1623 × 10 <sup>7</sup> | 0.99964 | 1.00036 | 0.00017783  | 5,623.4         | 1.000000 | 0.99982 | 1.00018 | 0.00017786  | 75.0  |
| 80.0  | 0.00010000  | 10,000.         | 10 <sup>8</sup>          | 0.99980 | 1.00020 | 0.00010000  | 10,000.         | 1.000000 | 0.99990 | 1.00010 | 0.00010001  | 80.0  |
| 85.0  | 0.000056234 | 17,783.         | 3.1623 × 10 <sup>8</sup> | 0.99989 | 1.00011 | 0.000056234 | 17,783.         | 1.000000 | 0.99994 | 1.00006 | 0.000056237 | 85.0  |
| 90.0  | 0.000031623 | 31,623.         | 10 <sup>9</sup>          | 0.99994 | 1.00006 | 0.000031623 | 31,623.         | 1.000000 | 0.99997 | 1.00003 | 0.000031624 | 90.0  |
| 95.0  | 0.000017783 | 56,234.         | 3.1623 × 10 <sup>9</sup> | 0.99996 | 1.00004 | 0.000017783 | 56,234.         | 1.000000 | 0.99998 | 1.00002 | 0.000017783 | 95.0  |
| 100.0 | 0.000010000 | 10 <sup>6</sup> | 10 <sup>10</sup>         | 0.99998 | 1.00002 | 0.000010000 | 10 <sup>6</sup> | 1.000000 | 0.99999 | 1.00001 | 0.000010000 | 100.0 |

(Courtesy Proceedings of the IRE.)

Taper Configuration

A taper pad is a T configuration (Fig. 2B) designed to operate between two circuits of unequal impedance. In this instance the symbols for the impedances become  $Z_1$  and  $Z_2$ , with  $Z_1$  being the larger of the two. The resistor values may be equated:

$$R_1 = Z_1 \left( \frac{k^2 + 1}{k^2 - 1} \right) - 2\sqrt{Z_1 Z_2} \left( \frac{k}{k^2 - 1} \right)$$

$$R_2 = Z_2 \left( \frac{k^2 + 1}{k^2 - 1} \right) - 2\sqrt{Z_1 Z_2} \left( \frac{k}{k^2 - 1} \right)$$

$$R_3 = 2\sqrt{Z_1 Z_2} \left( \frac{k}{k^2 - 1} \right)$$

As an example, assume a taper pad is to be designed to operate between a 500- and 250-ohm impedance, with a loss of 20 dB. First, it must be determined if a pad of 20-dB loss can be designed for an impedance ratio of two. This is determined by referring to the graph in Fig. 3. Entering the graph at the bottom, at a ratio of two, and following the line up to where it intersects the diagonal line, the minimum loss is read on the left margin as 7.8 dB. Therefore, the pad may be constructed without difficulty. If the desired loss was to be on

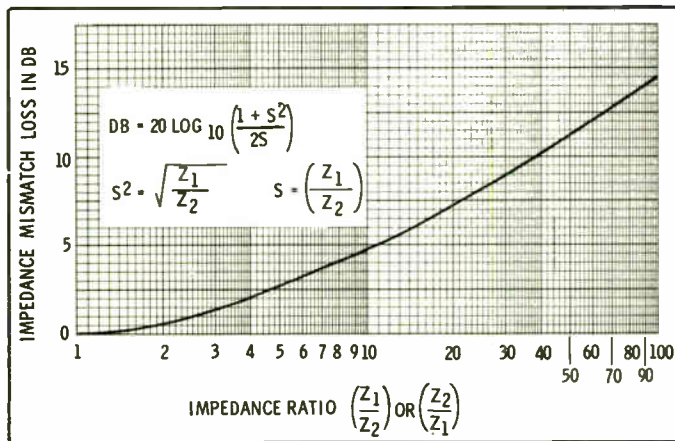

Fig. 1. Loss in level because of impedance mismatch.

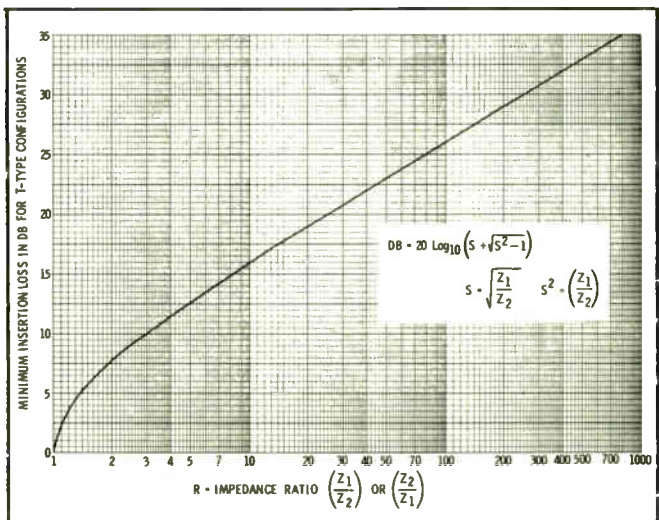

Fig. 3. Minimum loss chart for networks of unequal impedances.

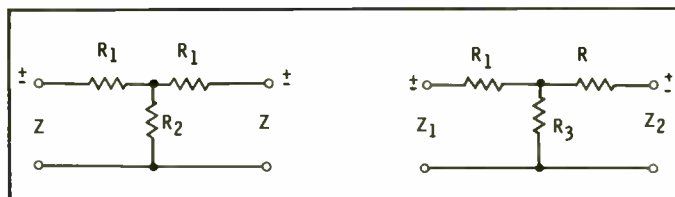

Fig. 2. Symbols used in the design of T-configuration networks.

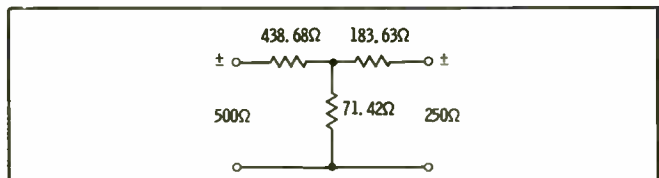

Fig. 4. Connections and circuit-element values for a 500- to 250-ohm taper pad with a 20-dB insertion loss.

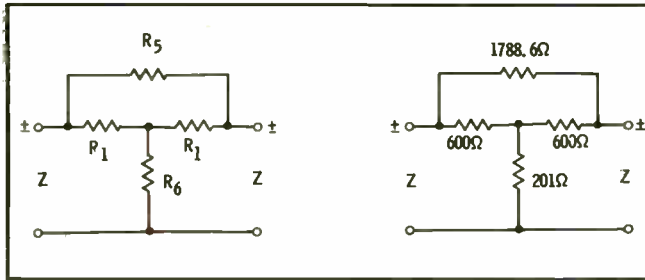

Fig. 5. Symbols and circuit-element values for a 600-ohm bridged-T attenuator with a 12-dB insertion loss.

the order of 6 dB, it could not be designed for such a loss. Using Table 1, the resistor values may now be calculated:

$$\begin{aligned} R_1 &= 500(1.0202) - 2(\sqrt{125,000}) \times 0.10101 \\ &= 510.1 - 2(353.55) \times 0.10101 \\ &= 510.1 - 71.42 \\ &= 438.68 \text{ ohms} \end{aligned}$$

$$\begin{aligned} R_2 &= 250(1.0202) - 2(\sqrt{125,000}) \times 0.10101 \\ &= 255.05 - 2(353.55) \times 0.10101 \\ &= 255.05 - 71.42 \\ &= 183.63 \text{ ohms} \end{aligned}$$

$$\begin{aligned} R_3 &= 2(\sqrt{125,000}) \times 0.10101 \\ &= 2(353.55) \times 0.10101 \\ &= 71.42 \text{ ohms} \end{aligned}$$

Practical values for the resistors would be 440, 185, and 72 ohms. The resistors are connected as shown in Fig. 4. If the 500-ohm side of the network is terminated in 500 ohms and an ohmmeter is connected across the 250-ohm side, the internal resistance will measure 250 ohms; when the procedure is reversed, the 500-ohm side will measure 500 ohms.

**Bridged-T Configuration**

The bridged-T attenuator is quite similar to the basic T network. The only difference in the configuration is the addition of the bridging resistor (R5), as shown in Fig. 5A. However, a bridged-T attenuator may only be used between circuits of equal impedance. In this network there are two resistors designated as R1, each resistor having a value equal to the line impedance; hence these values are known. This leaves only the bridging resistor (R5) and the shunt resistor (R6) to be determined. They are calculated as follows:

$$R_5 = (k - 1) Z$$

$$R_6 = \left( \frac{1}{k - 1} \right) Z$$

Assume that a bridge-T pad of 12-dB loss to work in a 600-ohm line circuit is to be designed. R1 will automatically equal 600 ohms. Solving for R5:

$$\begin{aligned} R_5 &= (3.981 - 1) \times 600 \\ &= 2.981 \times 600 \\ &= 1788.6 \text{ ohms} \end{aligned}$$

Now — get transistor reliability with Miratel general purpose monitors. Low first cost — minimum maintenance. High quality image resolution in all sizes — 8 to 23 inches. Also available in low cost vacuum tube type in kinescope sizes from 8 inches through 27 inches. Write for data and literature today. Miratel Electronics, Inc. 3620 Richardson St. New Brighton— St. Paul, Minn. 55112

- ... has more transistorized display experience than any other manufacturer
- ... is the first with large screen transistorized displays with 8 thru 27-inch picture tubes
- ... is the first with fully regulated all solid state monitors for both high and low voltages
- ... tests and certifies standard transistorized products to meet environmental requirements

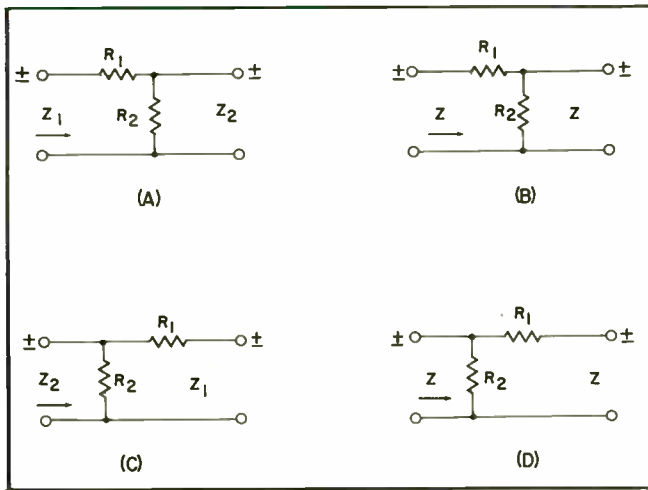

Fig. 6. L-type configurations.

Solving for  $R_2$ :

$$R_2 = 0.335 \times 600 = 201 \text{ ohms}$$

For this problem, the first  $k$  factor was taken from column three and the second factor from column 12 of Table 1. The resistors are connected as shown in Fig. 5B.

**L Configuration**

An L configuration consists of two circuit elements connected to form an inverted letter L. Actually there are four variations of this basic configuration, as shown in Fig. 6. An L-type attenuator has a minimum loss like the taper pad described previously. L-type attenuators cannot be designed to reflect an impedance match in both directions, only in the direction indicated by the arrows in the illustrations.

If an L-type network is inserted into a circuit that is impedance sensitive, the circuit characteristics could be affected. L configurations should not be used, except when a minimum loss that cannot be satisfied by a T-type configuration is required. The minimum loss for an L-type network may be determined from the graph in Fig. 7. The procedure for using this graph is the same as described for the T configuration in Fig. 3.

For unequal impedances the match may be in the direction of the larger or smaller impedance, but not both, as shown in Figs. 6A and C. When an L-type network is connected to circuits of equal impedance (Figs. 6B and D), the circuits are matched in one direction, but not in the other. However, the network may be designed to match either of the terminating impedances.

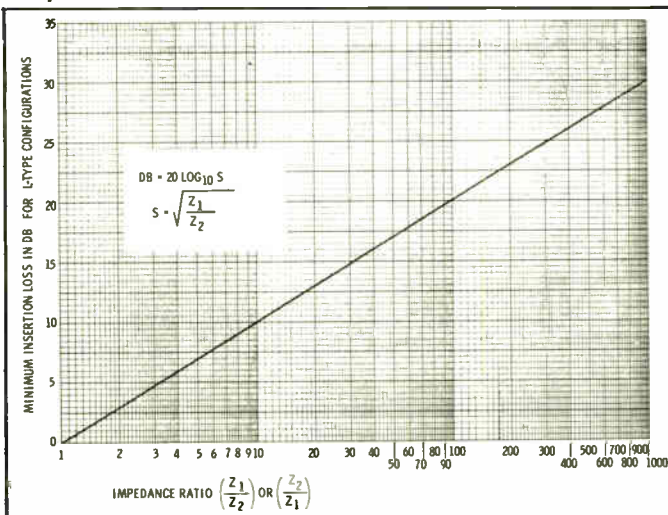

Fig. 7. Minimum loss graph for L-type attenuators.

The arrows in the illustrations indicate the direction of the impedance match. If the network is designed to match the impedance in the direction of the series resistor, the mismatch is always toward the shunt resistor. Impedance mismatch increases with an increase of loss. In some instances the ohmic value of the shunt resistor may become a fraction of an ohm, which can seriously affect the circuit in which it has been connected.

The configuration for an L-type network operating between unequal values of impedances ( $Z_1$  and  $Z_2$ ) is shown in Fig. 6A. Here the impedance match is toward the larger of the two ( $Z_1$ ). The values of the resistors may be equated:

$$R_1 = \left( \frac{Z_1}{S} \right) \left( \frac{kS - 1}{k} \right)$$

$$R_2 = \left( \frac{Z_1}{S} \right) \left( \frac{1}{k - S} \right)$$

where,

$$S = \sqrt{\frac{Z_1}{Z_2}}$$

For a condition where the impedances are equal and the impedance match is in the direction of the arrow (Fig. 6B), the values of the resistors are calculated:

$$R_1 = \left( \frac{k - 1}{k} \right) Z$$

$$R_2 = \left( \frac{1}{k - 1} \right) Z$$

If the impedances are unequal, and the impedance match is toward the smaller of the two impedances (Fig. 6C), the values of the resistors are determined by:

$$R_1 = \left( \frac{Z_1}{S} \right) (k - S)$$

$$R_2 = \left( \frac{Z_1}{S} \right) \left( \frac{k}{kS - 1} \right)$$

where,

$$S = \sqrt{\frac{Z_1}{Z_2}}$$

When the impedances are equal and the impedance match is in the direction of the shunt arm (Fig. 6D), the resistors are calculated by the following:

$$R_1 = (k - 1) Z$$

$$R_2 = \left( \frac{k}{k - 1} \right) Z$$

When selecting an L configuration, due consideration should be given to the effect it may have on the circuit into which it is to be connected. For example, if the series resistor is around 600 ohms, the shunt resistor approximately 60 ohms, and the configuration is used as an input or output termination for a transformer of an amplifier, there is no doubt that the frequency and distortion characteristics of the amplifier would be adversely affected. If the equipment terminated by the 60 ohms should happen to be a filter or equalizer, the frequency characteristics of these units would be *seriously* affected. Therefore, before considering the use of the L-type network, due consideration should be given to the effect on the circuit into which the network is to be connected.

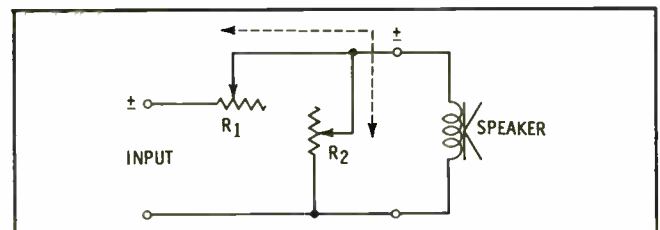

Fig. 8. L-type configuration used as speaker volume control.

# Spotmaster



**RA4CA REMOTE AMPLIFIER**

**RA-4CA** Extremely lightweight, four channel, all solid state remote amplifier featuring self contained AC and battery power supplies. Uses easily obtainable, low cost standard "D" cells with up to 200 hours of battery life. Switches automatically from AC to battery operation if AC power fails. Rugged black armorhyde aluminum case with snap-on front cover. Recessed microphone plugs and line terminals on rear panel. PA feed control on front panel. Price **\$385.00**.



**AD1A AUDIO DISTRIBUTION AMPLIFIER**

The AD1A Audio Distribution Amplifier is specifically designed for distributing audio signals to multiple points within a studio system. Standard unit has five highly isolated output channels which may be expanded up to 25 channels by the addition of AD1A-X extenders. Audio and VU meter monitoring facilities of the incoming signal as well as all output channels are included. The audio level of each output channel is individually adjustable. Distortion less than 1%, frequency response 40 - 20,000 cps. 100% solid state. Basic unit price **\$365.00**.



**PORTAPAK 1  
(REPRODUCER)**

**PortaPak 1** The ideal sales tool for the busy Time Salesman. A completely portable, play anytime—anywhere, cartridge playback unit at low cost. Handles all size NAB cartridges and is powered from its own self-contained, rechargeable nickel cadmium battery with built-in re-charger. Lightweight, compact, stainless steel case with two watts audio amplifier and speaker. 100% solid state. Vinyl carrying case available. Basic unit price **\$179.50**.



**TURNTABLE  
PREAMPLIFIER TT-20A**

**TT-20A** An economical high reliability, all solid state, NAB equalized turntable pre-amplifier. Features low distortion, low noise level operation with minimum current drain. May be operated from battery supply or companion AC power supply (Model PB4-B). Designed for use with VR11 pickup cartridges. Minimum installation effort and expense. Basic unit price **\$46.50**.

**RS-25**



**CARTRIDGE STORAGE RACKS**

**TAPE CARTRIDGE  
WINDER TP-1B**



**TP-1B** The SPOTMASTER Tape Cartridge Winder is a rugged, dependable and field tested tape cartridge loader which fills a need in every operation using cartridge equipment. New or old cartridges may be wound to any length. Handles all NAB cartridge sizes and runs at 22½ ips. Worn tape in old cartridges easily replaced. Available with or without tape timer calibrated in minutes and seconds. (illustrated) Tape timer for use on all types tape recording equipment may be purchased separately. Basic unit price **\$94.50**.

**RM-100**



**RACKS** A full line of cartridge storage racks. The Model RS-25 is welded steel construction handling 25 cartridges and designed for minimum space wall mounting. (only 4¾" wide X 34" long). The RM-100, in handsome formica trim, is designed for bench top or wall mounting. Measures only 2' X 2' and stores 100, series 300 cartridges. The RS-200, (not illustrated) is a Lazy Susan type all steel storage rack and stores 200 cartridges in minimum space. Rests on four heavy duty casters for floor mounting. Easily moves to new locations. Rack rotates on steel fabricated pedestal. Eight 25 unit rack sections are individually removable. Ideal for busy control rooms. Write for details. Price **\$12.50 up**.



**CARTRIDGES**

**CARTRIDGES** A large stock of Fidelipac cartridges for off the shelf delivery in all standard tape lengths. Custom lengths available on request at nominal cost. Empty cartridges and lubricated tape for use with TP-1B Tape Cartridge Winder at economy prices.



**BROADCAST  
ELECTRONICS, INC.**

8810 Brookville Road, Silver Spring, Maryland 20910  
301-588-4983

Write for complete details

Prices subject to change without notice

## Engineering Data

The question then arises as to why the L-type configuration is used at all. Contrary to the disadvantages of the L-type network, it does have certain advantages if employed in a circuit such as a volume control, voltage divider, volume indicator meter attenuator (multiplier), or in any circuit where the impedance match is not of great importance. However, the L-attenuator network cannot be employed for the VU meter; this instrument must see a constant impedance of 3,900 ohms.

The circuit for a speaker volume control using an L pad is given in Fig. 8. It will be observed, the series resistor of the network is toward the output of the amplifier. Mechanically, the two arms are mounted on a common shaft, and  $R_1$  and  $R_2$  are varied inversely with respect to each other.

### Pi Configuration

The pi configuration, sometimes referred to as a delta pad (Fig. 9), may be designed to operate between equal or unequal impedances, balanced or unbalanced. The pi attenuator is not usually found in commercial sound installations, but it is used quite extensively in the telephone industry. The resistance values for impedance of *equal* values (Fig. 9A) may be calculated with the following formulas:

$$R_1 = \left( \frac{k + 1}{k - 1} \right) Z$$

$$R_2 = \left( \frac{Z}{2} \right) \left( \frac{k - 1}{k} \right)$$

where,

- $R_1$  is the series resistor,
- $R_2$  is the shunt resistor,
- $Z$  is the input and output impedance.

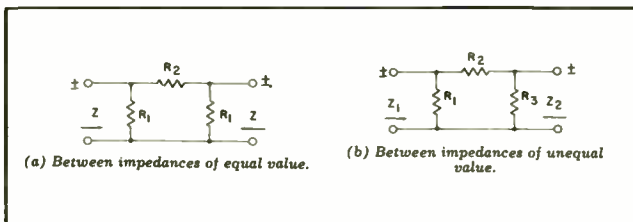

Fig. 9. Pi-type configurations.

For impedances of *unequal* values (Fig. 9B), the resistor values may be determined by the formulas:

$$R_1 = \left( \frac{k^2 - 1}{k^2 - 2kS + 1} \right) Z$$

$$R_2 = \left( \frac{\sqrt{Z_1 Z_2}}{2} \right) \left( \frac{k^2 - 1}{k} \right)$$

$$R_3 = \left( \frac{k^2 - 1}{k^2 - 2\frac{k}{S} + 1} \right) Z_2$$

where,

- $R_1$  and  $R_3$  are the shunt resistors,
- $R_2$  is the series resistor,
- $Z_1$  is the input impedance,
- $Z_2$  is the output impedance,

$S$  is equal to  $\frac{\sqrt{Z_1}}{\sqrt{Z_2}}$

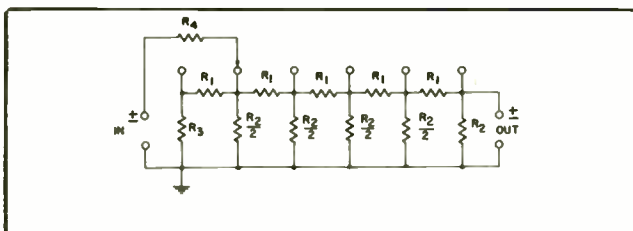

Fig. 10. Configuration for a ladder-type sound-mixer control.

### Ladder Configuration

The ladder configuration consists of a group of pi pads connected in tandem; it is designed to operate between impedances of the same value. Attenuators using this configuration, which are only manufactured in variable form, are used extensively for sound-mixer controls.

One disadvantage of the ladder-type configuration (Fig. 10) is that it has a fixed insertion loss of 6 dB. This 6-dB loss is exclusive of the variable attenuation. The insertion loss is caused by the series and shunt resistors and the resistor in the slide-arm circuit. The 6-dB loss is divided as follows: 3.5 dB in the ladder network resistors ( $R_1, R_2,$  and  $R_3$ ) and 2.5 dB in the series resistor ( $R_4$ ).

Another disadvantage of the ladder configuration is that the impedance is not constant over the entire operating range; however, this is of no great consequence since it occurs at the maximum and minimum loss positions. In a sound mixer the controls are fed into a combining network which prevents the slight mismatch of the impedances from being reflected to the output of the mixer.

Ladder networks have better attenuation characteristics, allowing virtually an infinite cutoff to about 120 dB of loss; whereas the T type extends downward in the order of 100 dB. The advantages of the ladder configuration are: (1) as the attenuation is increased the contact noise decreases in proportion (contact noise remains constant with the T type), and (2) impedance mismatch effects decrease in a direct proportion to the number of controls in a mixer-combining network. (With four controls the impedance mismatch is negligible.) The values for the components of a ladder configuration may be calculated:

$$R_1 = \left( \frac{k^2 - 1}{2k} \right) Z$$

$$R_2 = \left( \frac{k + 1}{k - 1} \right) Z$$

$$R_3 = \frac{R_2 \times Z}{R_2 + Z}$$

$$R_4 = \frac{Z}{2}$$

where,

- $R_1$  is the series resistor,
- $R_2$  is the shunt resistor,
- $R_3$  is the input shunt resistor,
- $R_4$  is the series resistor in the contact arm,
- $Z$  is the impedance.

*Note:* The value of  $k$  is dependent on the loss per step and not the total loss. The loss per step should not exceed 1.3 dB. Also, the value of  $R_2$  is halved for all but the output shunt resistor.

Ladder attenuators must be grounded at the low-potential side to prevent leakage at the higher frequencies.

### Minimum-Loss Configuration

A minimum-loss pad is a network designed to operate between circuits of *unequal* impedance with a *minimum* insertion loss for a given impedance ratio. Minimum-loss ratios are given for L-type configurations in Fig. 7, and for the T configuration in Fig. 3. However, for those desiring to solve the minimum loss mathematically, the L pad may be calculated:

$$\text{dB} = 20 \log_{10} (S)$$

where,

$$S = \frac{\sqrt{Z_1}}{\sqrt{Z_2}}$$

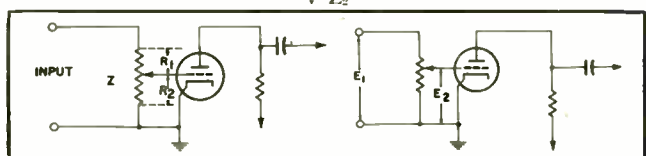

Fig. 11. Grid-circuit potentiometers.



**CCA****CCA OFFERS FROM STOCK AM-FM  
BROADCAST TRANSMITTERS AT REALISTIC PRICES****AM  
FM****DELUXE 1KW AM****DUAL RELIABLE 5KW AM****QUALITY AM**

|      | DELUXE    | DUAL RELIABLE |
|------|-----------|---------------|
| 250W | \$3,495.  | \$8,500.      |
| 500W | \$4,545.  | \$9,500.      |
| 1KW  | \$4,850.  | \$11,500.     |
| 5KW  | \$13,900. | \$19,500.     |
| 10KW | \$17,900. | \$31,500.     |
| 50KW | \$89,500. | \$104,000.    |

CCA offers an outstanding line of deluxe and "Dual Reliable" AM transmitters. All equipments stress conventional, high level plate modulation standard parts; full accessibility; silicon rectifiers, minimum tube costs, minimum maintenance requirements and lowest power consumption. "Dual Reliable" transmitters represent the epitome of conservative design.

**3RD GENERATION FM**

|                        |          |      |           |
|------------------------|----------|------|-----------|
| 10W                    | \$1,295. | 5KW  | \$9,900.  |
| 250W                   | \$3,495. | 10KW | \$13,500. |
| 1KW                    | \$5,195. | 15KW | \$17,500. |
| 3KW                    | \$7,995. | 20KW | \$22,500. |
| 10KW Amplifier \$9,900 |          |      |           |

CCA is the only major equipment supplier which utilizes high  $\mu$ , zero bias triodes. The use of these high power EIMAC triodes solve all the problems which "2nd Generation" tetrode designs exhibit. No need to neutralize, no complexities such as bias and screen supplies; and exceptional tube life with tremendous power output capability.

**3KW FM****10KW FM****SC-1D MULTIPLEX  
SUBSIDIARY GENERATOR**

The CCA SC-1D is an inexpensive but reliable subcarrier generator which can be used with all modern FM transmitters to achieve a 2nd broadcast channel.

**LA-1D AUDIO  
LIMITING AMPLIFIER**

A favorite of many broadcasters is the CCA-LA-1D audio limiter. This "workhorse" prevents overmodulation and performs this task without "thumping" or introducing distortion. Front panel controls for gain, output and "recovery time" make operation of the LA-1D an "engineer's delight".

**MODEL AMM-1D AM  
MODULATION MONITOR**

A popular addition to the CCA product line is our FCC type approved AM modulation monitor. This instrument guarantees instantaneous supervision of transmitter operation and is an essential tool for every broadcaster.

CCA Electronics offers a complete broadcast package including materials supplied by outstanding vendors such as towers, antenna, transmission line and studio equipment. Contact your area CCA representative for a quotation.

**CCA TRANSMITTER  
ACCESSORIES**

|                               |         |
|-------------------------------|---------|
| AMM-1D AM Modulation Monitor  | \$595.  |
| AMF-1D AM Frequency Monitor   | \$845.  |
| LA-1D Audio Limiter           | \$375.  |
| ACC-1D AGC Audio Amplifier    | \$320.  |
| RC-1D Remote Control System   | \$995.  |
| RFA-FM Remote FM RF Amplifier | \$395.  |
| RFA-AM Remote AM RF Amplifier | \$425.  |
| LTU Antenna Tuning Units      | *       |
| AM RF Loads                   | *       |
| AM Antenna Phasors            | *       |
| SC-1D FM Subcarrier Generator | \$495.  |
| SG-1D FM Stereo Generator     | \$1295. |

\*PRICE BASED ON POWER

**CCA**

**CCA ELECTRONICS CORPORATION**  
716 JERSEY AVENUE, GLOUCESTER CITY, CAMDEN COUNTY, NEW JERSEY  
SPECIALISTS IN BEACON, BROADCAST, COMMUNICATION & AIRPORT TRANSMITTERS

## Engineering Data

For the T (taper-pad) configuration:

$$\text{dB} = 20 \log_{10} (S + \sqrt{S^2 - 1})$$

$$S^2 = \frac{Z_1}{Z_2}$$

where,

$Z_1$  and  $Z_2$  are the input and output impedances,  $Z_1$  being the larger of the two.

### Grid-Circuit Potentiometers

A grid-circuit potentiometer (abbreviated pot) is actually an L-type configuration and is used primarily for controlling the gain in a circuit where the load on the slider or unmatched side is practically an open circuit, such as the control grid of a vacuum tube (Fig. 11). The total resistance of such controls varies from 50,000 ohms to 1 megohm or greater. To illustrate the design procedure, assume a potentiometer having a resistance of 100,000 ohms with a total attenuation of 30 dB in steps of 10 dB is required. It will be noted in Fig. 11A that the upper portion of the control is designated as  $R_1$  and the lower portion  $R_2$ . Therefore:

$$R_1 = \left(\frac{1}{k}\right) Z$$

$$R_2 = (Z - R_1)$$

where,

$Z$  is the total resistance of the potentiometer,  
 $R_1$  and  $R_2$  are the upper and lower portions of the resistance, depending on the position of the slider arm.

The factor  $(1/k)$  is taken from Table 1. Solving for the first 10-dB step:

$$\begin{aligned} R_1 &= 0.3162 \times 100,000 \\ &= 31,620 \text{ ohms} \\ R_2 &= 100,000 - 31,620 \\ &= 68,380 \text{ ohms} \end{aligned}$$

the second step (20 dB):

$$\begin{aligned} R_1 &= 0.100 \times 100,000 \\ &= 10,000 \text{ ohms} \\ R_2 &= 100,000 - 10,000 \\ &= 90,000 \text{ ohms} \end{aligned}$$

and the third step (30 dB):

$$\begin{aligned} R_1 &= 0.03162 \times 100,000 \\ &= 3,162 \text{ ohms} \\ R_2 &= 100,000 - 3,162 \\ &= 96,838 \text{ ohms} \end{aligned}$$

Taps will occur at 3,162 ohms, 10,000 ohms, and 31,620 ohms, upward from ground. The final design will consist of four resistors of 3,162, 6,838, 21,620, and 68,380 ohms for a total of 100,000 ohms. The resistors may consist of four carbon or wire-wound noninductive resistors, mounted on a switch frame.

Potentiometers may also be calibrated to indicate in terms of voltage, as shown in Fig. 11B. The voltage for any position may be computed:

$$E_2 = E_1 \left( \frac{R_1}{R_1 + R_2} \right)$$

Table 2. Work Sheet for Calculating Resistor Values

| Loss | $k-1$  | $R_5$<br>(Ohms) | $\frac{1}{k-1}$ | $R_6$<br>(Ohms) |
|------|--------|-----------------|-----------------|-----------------|
| 0    | —      | Zero            | —               | Infinite        |
| 1    | 1.122  | 30.5            | 8.195           | 2048.7          |
| 2    | 1.258  | 64.5            | 3.862           | 965.5           |
| 4    | 1.584  | 146.0           | 1.700           | 425.0           |
| 6    | 1.995  | 248.0           | 1.004           | 221.0           |
| 10   | 3.162  | 540.5           | 0.462           | 115.5           |
| 15   | 5.623  | 1155.8          | 0.216           | 54.0            |
| 20   | 10.000 | 2250.0          | 0.111           | 27.8            |
| 25   | 17.783 | 4200.0          | 0.059           | 14.8            |
| 30   | 31.623 | 7650.0          | 0.0326          | 8.15            |

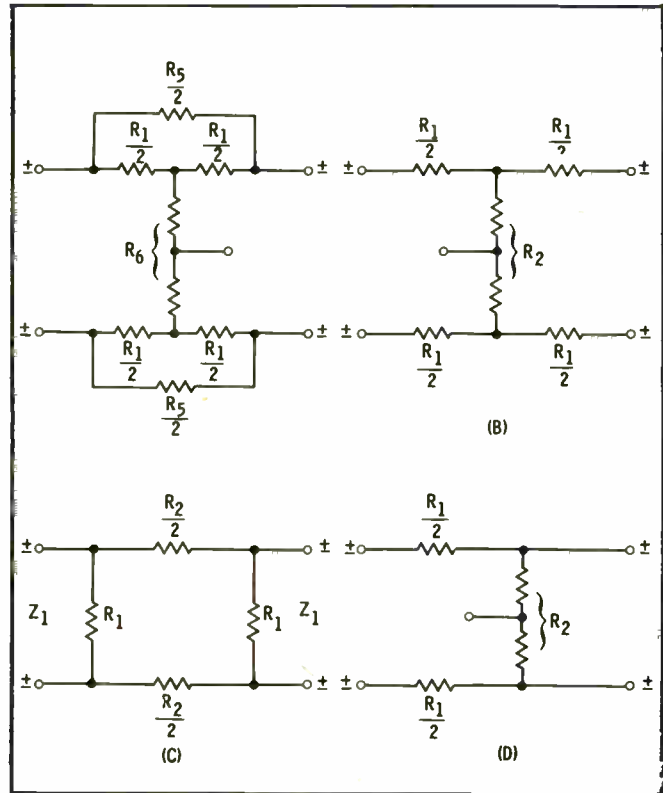

Fig. 12. Balanced networks.

As a rule, nonprofessional equipment uses potentiometers ranging from 100,000 ohms to 1 megohm in resistance. However, it is the practice in commercial equipment to keep the overall resistance to 50,000 ohms or less. To insure calibration accuracy, such controls are operated in the control grid of an amplifier stage, biased for class-A operation. In choosing the resistance value of a potentiometer, several factors must be considered. For example, if the control is to be used in the input of a high-gain triode, where the input impedance of the tube may be quite low at the higher frequencies, a low value of resistance is required. In addition, the input capacity to ground has a marked effect on the attenuation of the high frequencies; therefore, the lower the value of the potentiometer, the smaller this effect becomes. If grid current is permitted to flow in the input of a tube, the potentiometer will generate noise each time it is changed. Whenever possible, an input transformer with a potentiometer connected across the secondary of the transformer is recommended. When connected across a transformer, the potentiometer resistance is usually made equal to the secondary impedance of the transformer.

### Variable Attenuator Design

In reality the design of a variable attenuator consists of designing a group of fixed attenuators that may be switched in and out of a circuit at will. Before starting a design, the impedance and configuration are selected. A table similar to that shown in Table 2 is prepared, and the desired values of loss,  $k$ -factors, and the calculated values of resistances are then entered in the appropriate column.

Assume a bridged-T attenuator of 250 ohms impedance, having a total loss of -30 dB which is variable in steps of 1 dB, is to be designed, using the equations given under the heading "Bridge-T Configuration." The value of  $k$  is taken from Column 3 and the value of  $1/k - 1$  from Column 12 of Table 1. Since  $R_1$  equals the 250-ohm line impedance, only  $R_5$  and  $R_6$  require calculation. For the sake of brevity, only nine of the loss steps have been calculated in Table 2.

It should be noted at the zero-loss position,  $R_5$  has zero resistance and  $R_6$  is infinite. In practice, at zero attenuation a high value of resistance is switched in  $R_6$  to keep the circuit closed and to prevent contact noise. The value of the resistance depends on the impedance and loss of the network, but it should be of such a value that the pad is effectively out of the circuit.

The resistors are noninductively wound and mounted on a switch frame, with or without a detent. If possible, the entire unit should be mounted in a metal case to prevent damage to the resistors and reduce the possibility of pickup from extraneous electrical fields. The two switch arms are mounted on a common shaft, and the resistors are inserted inversely to each other, as for the L-type network. If over 40 dB of attenuation is required, the resistor coils must be carefully placed to reduce the possibility of leakage at the higher frequencies.

Variable attenuators can also be designed to match two impedances of unequal value, using a taper network as discussed under the heading "Taper Configuration." Such networks, however, are the exception rather than the rule. The procedure for their design is the same as for the equal-impedance network described previously.

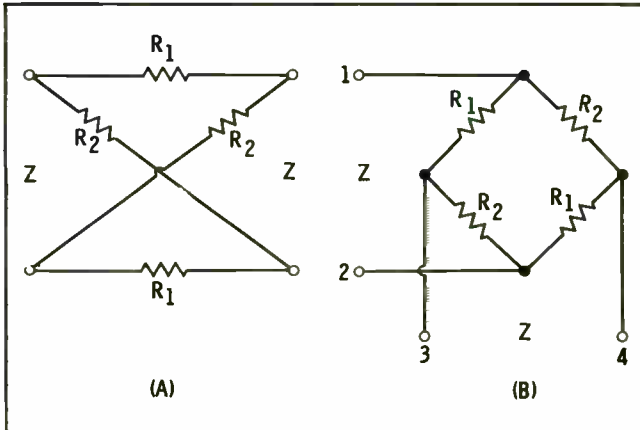

Fig. 13. Lattice network and its equivalent circuit.

### Balanced Configurations

Basically a balanced configuration consists of designing an unbalanced network, dividing the values of the series resistors in half, and connecting the halves on each side of the configuration. Balanced configurations include the bridged-T, H, O, U, lattice, and ladder networks. If the network is to be grounded, the shunt resistor is tapped in the exact electrical center and connected to ground. It will be noted that only the values of series resistors are divided; the shunt resistor remains as for the unbalanced network.

#### Bridged-T, H, O, and U Configurations

The balanced bridged-T configuration is given in Fig. 12A. Here you will notice that series resistors  $R_1$  (equal to the line impedance) are divided and connected in each side of the configuration. Resistor  $R_2$  is treated in the same manner. The value of  $R_2$  remains the same as for the unbalanced configuration, except that a tap has been added for the ground connection. For ease in winding,  $R_2$  may be made into two separate resistors connected in series. The balanced configuration will exhibit the same characteristics as the unbalanced version.

The balanced T, or H pad as it is commonly known, is shown in Fig. 12B. Like the bridged-T, its series resistors are divided and connected in each half of the configuration. Except for being balanced, the H pad is similar in all other respects to the T configuration. H-type configurations may be designed for matching impedances of unequal value, as described for the taper pad.

The O configuration (Fig. 12C) is in reality a balanced pi pad. The addition of one resistor converts the pi pad into a balanced configuration. Only the series resistors ( $R_2$ ) are divided. Resistors  $R_1$  remain as for the pi pad. This configuration does not adapt itself to grounding; however, it may be used in any circuit where a balanced to ground pad is employed, or in a symmetrical circuit free from ground. The O network may be designed for circuits of equal or unequal impedances.

U pads (Fig. 12D) are balanced L configurations. The rules for impedance matching for the L configuration apply equally for the balanced U configuration.

#### Lattice Configuration

The lattice network is a true balanced configuration. Therefore individual treatment is required for solving its circuit element values. If it is used in an unbalanced configuration, it degenerates into a pi configuration.

The configuration for the lattice network is shown in Fig. 13A. The difference between this network and the O configuration is that the shunt resistors ( $R_2$ ) are crossed over and connected to both the input and output circuits. The circuit element values may be calculated:

$$R_1 = \left( \frac{k - 1}{k + 1} \right) Z$$

$$R_2 = \left( \frac{k + 1}{k - 1} \right) Z$$

where,

- $R_1$  is the series resistor,
- $R_2$  is the shunt resistor,
- $Z$  is the line impedance.

Lattice networks can only be employed in ungrounded circuits of equal impedance.

If an equivalent circuit is drawn for the lattice pad (Fig. 13B), it resembles a balanced bridge circuit. The principal difference is that resistors  $R_1$  are lower in value than  $R_2$ . This difference unbalances the bridge and permits the signal to pass attenuated in an amount controlled by the ratio of resistors  $R_1$  and  $R_2$ .

#### Ladder Configuration

It was mentioned earlier that the ladder configuration is only manufactured in the variable form and that it is used extensively in sound-mixer circuits. Ladder networks may also be designed for balanced operation. This is accomplished by connecting two unbalanced networks side by side as shown in Fig. 14. However, the circuit elements do not divide in the same manner as for other networks. If the unbalanced configuration in Fig. 10 is compared with the balanced network of Fig. 14, it will be observed that resistors  $R_1$  are divided by two, but resistors  $R_2$  are no longer  $R_2/2$ ; instead,  $R_2$  is now twice the value at the output as for the unbalanced configuration.  $R_2$  remains at its original value each side of ground.

#### Bridging Configurations

A bridging (paralleling) pad is a special type of attenuator network designed to bridge one circuit while feeding another, without disturbing the impedance or frequency characteristics of the circuit bridged. In addition, the network can absorb only a fractional amount of power from the circuit bridged.

Two such networks are shown in Fig. 15. Fig. 15A is an unbalanced-L configuration. The difference between this configuration and the normal L configuration is that at the input side of the bridging pad ( $Z_1$ ) the impedance is very high (10,000 to 30,000 ohms) while the other side ( $Z_2$ ) matches the input impedance of the device being fed by the pad.

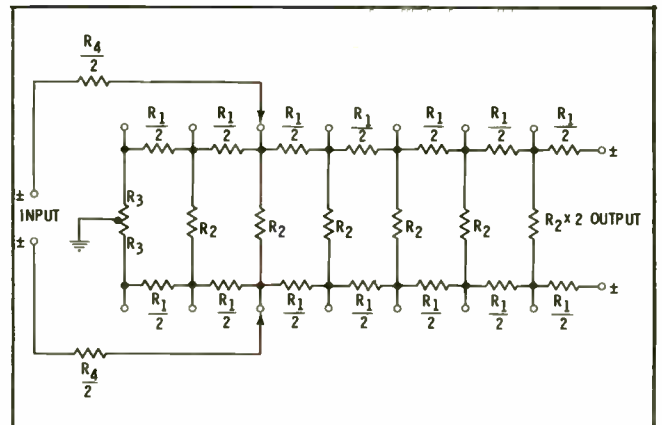

Fig. 14. A balanced ladder network.

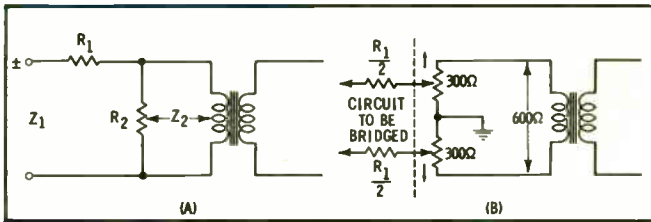

Fig. 15. Bridging input networks.

The loss of a bridging pad is stated for a given set of conditions; e.g., 40 dB of loss when bridging a 600-ohm circuit and feeding a 600-ohm circuit. If either the impedance bridged or series resistor  $R_1$  is changed in value, the insertion loss of the pad will change. Resistor values for the more commonly used pads and insertion losses are given in Table 3. The stated loss of these networks will only be valid when they are bridging 600 ohms and feeding 600 ohms. The loss for the same configuration, but using other values of  $R_1$  and impedance  $Z_2$ , may be equated:

$$dB = 10 \log_{10} \left( \frac{Z_1}{Z_2} \right) + 20 \log_{10} \sqrt{\frac{Z_1}{Z_2}} + \sqrt{\frac{Z_1}{Z_2}} - 1$$

where,

$Z_1$  is the impedance of the circuit to be bridged,  
 $Z_2$  is the impedance of the circuit fed by the network.

Bridging networks should be designed to have an input resistance of at least ten times that of the circuit to be bridged.

The configuration in Fig. 15A may be converted to a balanced network by dividing resistor  $R_1$  by two and placing half in each side of the configuration. A variable 30,000- to 600-ohm pad is shown in Fig. 15B.

When a bridging pad is connected across a circuit, a slight loss of level (usually ignored) takes place in the circuit being bridged. However, this loss may be computed:

$$dB = 20 \log_{10} \frac{2B_R + R}{2B_R}$$

where,

$B_R$  is the bridging input of the pad,  
 $R$  is the impedance of the circuit bridged.

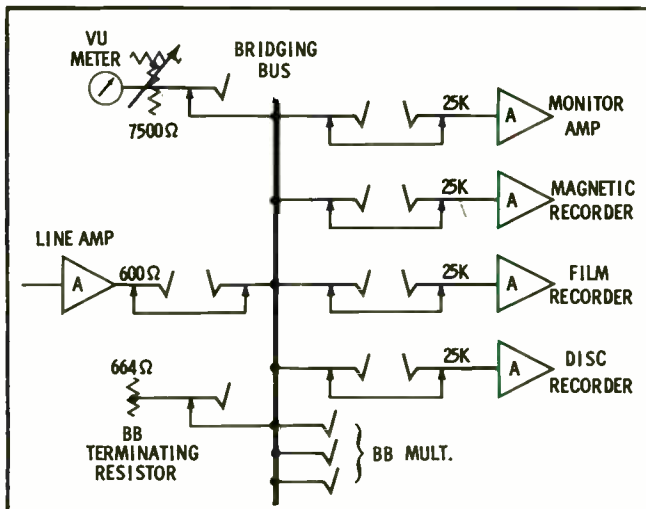

Fig. 16. A typical bridging-bus circuit.

Thus, for a pad of 10,000 to 600 ohms, bridged across a circuit of 600 ohms, the loss is

$$\begin{aligned} dB &= 20 \log_{10} \frac{20,000 + 600}{20,000} \\ &= 20 \log 1.03 \\ &= 20 \times 0.013 \\ &= 0.26 \text{ dB} \end{aligned}$$

Therefore, when a bridging pad of 10,000 ohms is connected across a circuit impedance of 600 ohms, the level in the 600-ohm circuit will drop 0.26 dB.

When the bridging pad is connected across a 600-ohm circuit, the impedance of the 600-ohm circuit will be lowered only 1 to 3%. This impedance reduction is of small consequence. This is the principal reason for using a bridging impedance of 20,000 to 30,000 ohms, although it may insert a considerable amount of loss. If the insertion loss of a bridging pad is too great, it may be replaced with a bridging transformer which has an insertion loss of 18 to 20 dB; however, if sufficient gain is available, the pad is the most economical.

A typical recording or broadcast studio-type bridging bus is shown in Fig. 16. The purpose of a bridging bus is to provide a circuit in the system where additional equipment may be connected. The bridging-bus circuit is a group of jacks connected in parallel and driven by an amplifier. It will be observed that the bridging bus and the equipment connected across the bus act as a load impedance for the amplifier driving the bus. The first step in bus-circuit design is to decide how many pieces of equipment will be permanently connected (normalled) across the bus.

For this illustration four bridging impedances of 25,000 ohms and a 7,500-ohm VU meter have been selected. A terminating resistor and three sets of bridging-bus multiple jacks for patching additional equipment are connected in parallel with the bridging bus. It will be assumed that any additional equipment to be patched across the bus will have a bridging impedance of at least 25,000 ohms and that the output impedance of the amplifier driving the bus is 600 ohms. First, the total impedance of the equipment permanently connected across the bus (exclusive of the bridging-bus termination) is determined. The four 25,000-ohm bridging inputs connected across the bus present a load resistance of 6,250 ohms. In parallel with this is the 7,500-ohm VU meter panel. Using Ohm's law for parallel circuits:

$$\begin{aligned} R_t &= \frac{6,250 \times 7,500}{6,250 + 7,500} \\ &= \frac{4.68 \times 10^7}{13.75} \\ &= \frac{4.68 \times 10^7}{1.37} \\ &= 3,416 \text{ ohms} \end{aligned}$$

The next step is to determine the value of the bridging-bus terminating resistor which, when connected in parallel with 3,416 ohms, will reflect an impedance of 600 ohms. Again using Ohm's law for parallel resistors:

$$\begin{aligned} BB &= \frac{3,416 \times 600}{3,416 - 600} \\ &= \frac{2.05 \times 10^6}{2.81} \\ &= \frac{2.05 \times 10^6}{2.81} \\ &= 729.53 \text{ ohms} \end{aligned}$$

Therefore, if the resistor of 729.53 ohms is connected in parallel with the bus and the foregoing load impedances, the amplifier will see 600 ohms.

Table 3. Resistor Values for Bridging Attenuators

| $R_1$<br>(Ohms) | Loss<br>(dB) | $R_2$<br>(Ohms) |
|-----------------|--------------|-----------------|
| 30,000          | 40.1         | 600             |
| 25,000          | 38.5         | 600             |
| 20,000          | 36.8         | 600             |
| 15,000          | 34.2         | 600             |
| 10,000          | 30.7         | 600             |
| 7,500           | 28.3         | 600             |
| 5,000           | 24.9         | 600             |
| 3,000           | 20.8         | 600             |

# Color!

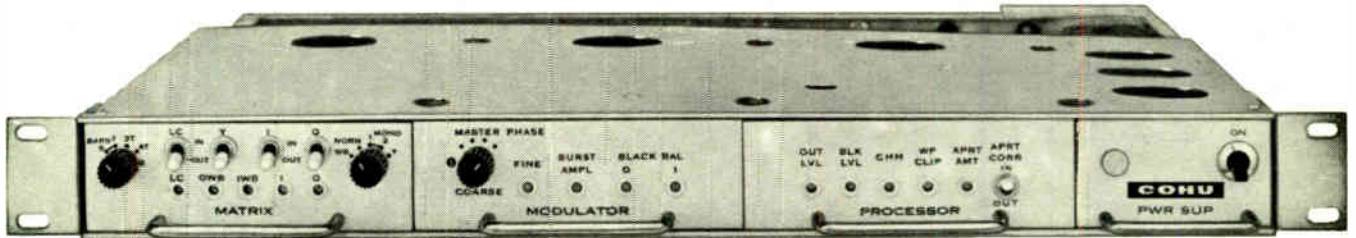

## With this solid-state video encoder by Cohu!

Incorporates all these special features in 1¾ inches of rack space:

- Accepts RGB or RGBM inputs (requiring only sync, blanking and subcarrier inputs in addition); and provides three line outputs
- Includes integral NTSC full or split color-bar and burst-flag generators
- Provides RGBM-luminance correction, to compensate for gamma error introduced by the monochrome pickup tube without loss of resolution, and luminance channel aperture correction
- Utilizes silicon-transistorized plug-in circuit modules
- Has subcarrier phase adjustable over a 370° range
- Should red or blue signal fail, front panel switch provides immediate compatible monochrome output by routing green input to luminance channel

Cohu's Model 9830-071 exceeds all NTSC and FCC specs and is completely compatible with all color systems. Available as options: circuits for controlling camera-to-bar, green-to-y, color-to-monochrome and burst on-off functions from remote locations.

Cohu also stocks sync generator and accessory systems, monochrome/color switching matrix, switcher control and remote control units, pulse and video distribution amplifiers, and portable monochrome and color vidicon cameras. Get full details direct or from your nearest Cohu engineering representative.



Box 623  
San Diego, Calif. 92112  
Phone: 714-277-6700

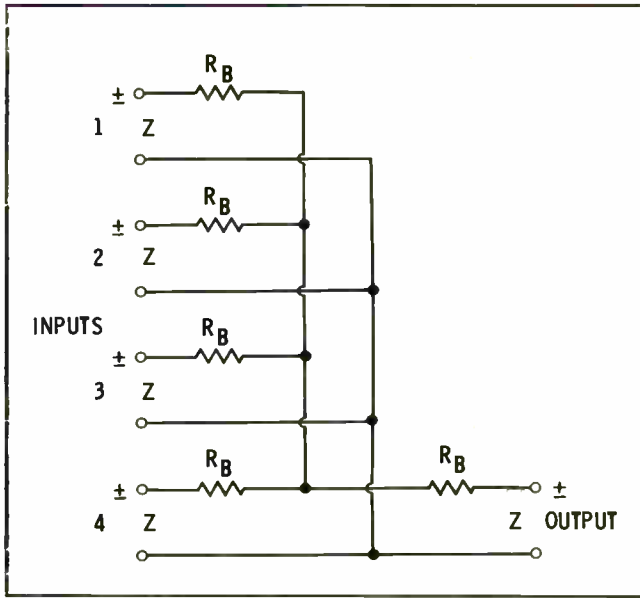

Fig. 17. A four-position combining network.

As a rule it is safe to load the output of a well designed amplifier to within 90% of its rated output impedance, which would be 540 ohms for a 600-ohm output impedance. This means that several more pieces of equipment could be patched across the bus without affecting the amplifier characteristics. If the bridging impedance is greater than 25,000 ohms, more equipment could be driven from the bus. Usually the bus impedance is set for around 625 ohms to permit additional equipment to be patched across the bus without loading the amplifier below 600 ohms.

If the bus is grounded on one side, unbalanced configurations are used. If the bus is balanced to ground or symmetrical, a balanced-type network is used. Standard bridging impedances used by the recording and broadcast industries include 7,500, 10,000, 25,000, and 30,000 ohms.

**Combining Networks**

Combining networks are employed to combine the inputs of several devices or lines. One of the most common uses for this type of configuration is in a sound-mixer circuit. Combining networks may be balanced or unbalanced, and they are usually confined to a common value of impedance.

The signal may consist of dialogue, music, and/or sound effects. The source may be a broadcast line, photographic film, or magnetic tape reproducers, phonograph records, a live pick-up, or a combination of all. The network must be designed so that changing the level of any one of the inputs has no effect on the level or frequency characteristics of the other signal sources. For broadcast and recording at least 10 positions are

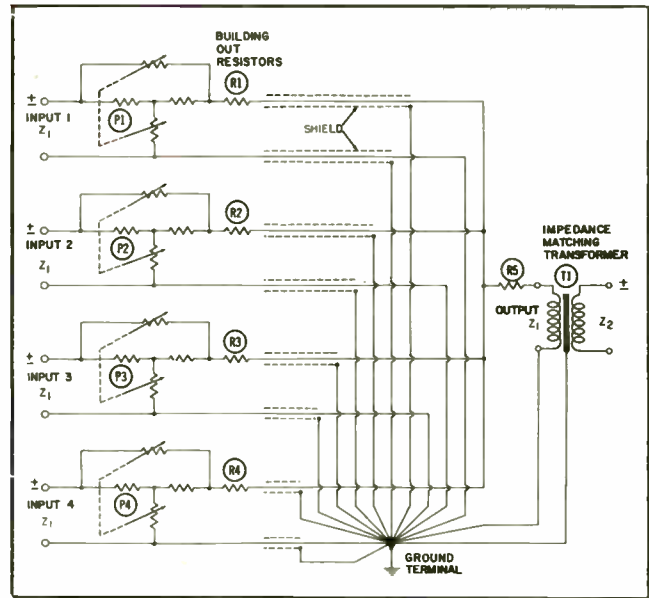

Fig. 18. A four-position, parallel-connected, unbalanced mixer network.

required; in many instances 20 or more are necessary. For recording purposes, equalizers, filters, and other devices are operated in conjunction with the combining networks, as shown in Fig. 17. The network consists of 5 resistors, designated as  $R_n$ . If the circuit is traced, it will be apparent that the five circuits are in parallel. The resistors provide isolation between the four input circuits and an impedance match for the four inputs and the output circuit. The value of the building-out resistors ( $R_n$ ) may be calculated:

$$R_n = \left( \frac{N - 1}{N + 1} \right) Z$$

where,

- $R_n$  is the building-out resistor,
- $N$  is the number of input circuits,
- $Z$  is the circuit impedance.

The loss of the network through any two branches is:

$$20 \log_{10} (N - 1)$$

where,

$N$  is the total number of circuits (4 inputs and 1 output).

Using this equation, the loss for a four-position network is 12 dB. Unused circuits of a combining network must be terminated in a resistive load that is equal to the normal terminating impedance. This type of combining network is often used in sound mixers similar to the one shown in the schematic diagram of Fig. 18.

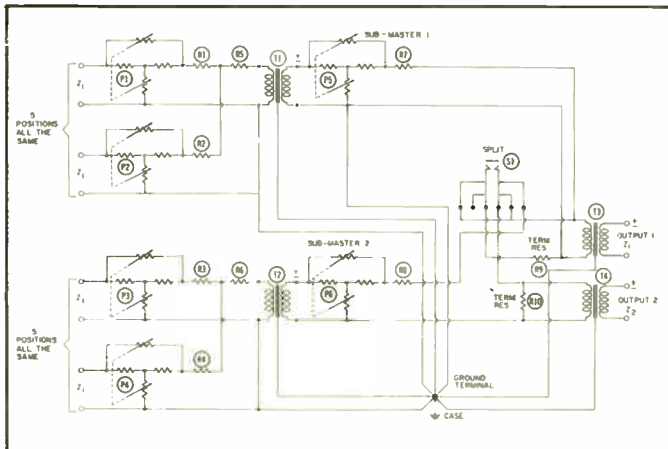

Fig. 19. A 10-position, split mixer network with keyswitch for combining the two sections into a single network.

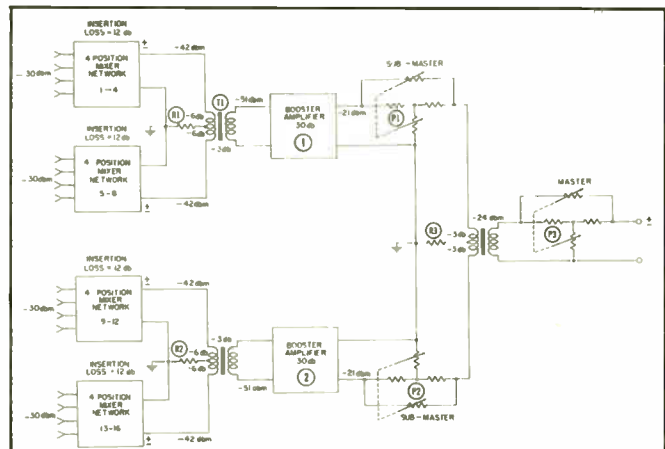

Fig. 20. A 16-position hybrid-coil mixer network.

A more elaborate mixer network and its associated equipment is shown in Fig 19. This network is termed a "split-mixer"; that is, it may be divided into two separate sections by means of a key switch (S1), or combined into a 10-position mixer. The ten positions are shown split into two groups of five positions each. Building-out resistors (R7 and R8) and submaster controls (P5 and P6) for adjusting the overall level of each group are located at the output of each group. Output transformers T3 and T4 may be used to feed a single or two separate recording channels. Such mixers are often used for recording where a vocal group and a large orchestra are located on separate stages during the recording session.

The controls may be of any configuration, provided they are unbalanced and therefore satisfy the impedance requirements. The common side of each mixer control is brought to a common ground point, using individual ground wires which are

shielded and covered with a protective plastic or cloth braid to prevent ground loops.

The unbalanced configuration may be changed to a balanced one by connecting half of each resistor in each side of the network as explained for other balanced networks. Of course, the mixer controls must also be changed to balanced configurations. Combining networks have a fixed loss caused by the resistance of the building-out resistors ( $R_{11}$ ). Increasing the number of mixer positions increases the insertion loss of the network.

To simplify the design procedure of a mixer network, the values of the building-out resistors for networks of 150, 200, 500, and 600 ohms are tabulated in Table 4. For mixer networks of 12 positions or more it is recommended that the controls be separated into groups of four and then combined by means of hybrid coils, as shown in Fig. 20. (The loss and amplifier gains shown in Fig. 20 are for a typical mixer.)

Table 4. Values of Building-Out Resistors and Insertion Loss for Parallel Sound-Mixer Networks

| Mixer Positions | Impedance 150Ω |                   |       | Impedance 200Ω |                   |       | Impedance 250Ω |                   |       | Impedance 500Ω |                   |       | Impedance 600Ω |                   |       |
|-----------------|----------------|-------------------|-------|----------------|-------------------|-------|----------------|-------------------|-------|----------------|-------------------|-------|----------------|-------------------|-------|
|                 | $R_{11}$ Ohms  | Insertion Loss—dB |       | $R_{11}$ Ohms  | Insertion Loss—dB |       | $R_{11}$ Ohms  | Insertion Loss—dB |       | $R_{11}$ Ohms  | Insertion Loss—dB |       | $R_{11}$ Ohms  | Insertion Loss—dB |       |
|                 |                | BT, T             | Lad.  |                | BT, T             | Lad.  |                | BT, T             | Lad.  |                | BT, T             | Lad.  |                | BT, T             | Lad.  |
| 2               | 50.0           | 6.00              | 12.00 | 66.6           | 6.00              | 12.00 | 83.3           | 6.00              | 12.00 | 166.0          | 6.00              | 12.00 | 200.0          | 6.00              | 12.00 |
| 3               | 75.0           | 9.50              | 15.50 | 125.0          | 9.50              | 15.50 | 100.0          | 9.50              | 15.50 | 250.0          | 9.50              | 15.50 | 300.0          | 9.50              | 15.50 |
| 4               | 90.0           | 12.00             | 18.00 | 120.0          | 12.00             | 18.00 | 150.0          | 12.00             | 18.00 | 300.0          | 12.00             | 18.00 | 360.0          | 12.00             | 18.00 |
| 5               | 100.0          | 14.00             | 20.00 | 133.0          | 14.00             | 20.00 | 166.0          | 14.00             | 20.00 | 333.0          | 14.00             | 20.00 | 400.0          | 14.00             | 20.00 |
| 6               | 107.0          | 15.60             | 21.60 | 142.8          | 15.60             | 21.60 | 178.5          | 15.60             | 21.60 | 357.0          | 15.60             | 21.60 | 428.4          | 15.60             | 21.60 |
| 7               | 112.5          | 16.90             | 22.90 | 150.0          | 16.90             | 22.90 | 187.5          | 16.90             | 22.90 | 375.0          | 16.90             | 22.90 | 450.0          | 16.90             | 22.90 |
| 8               | 116.6          | 18.10             | 24.10 | 155.5          | 18.10             | 24.10 | 194.0          | 18.10             | 24.10 | 388.0          | 18.10             | 24.10 | 466.0          | 18.10             | 24.10 |
| 9               | 120.0          | 19.08             | 25.08 | 160.0          | 19.08             | 25.08 | 200.0          | 19.08             | 25.08 | 400.0          | 19.08             | 25.08 | 480.0          | 19.08             | 25.08 |
| 10              | 123.0          | 20.00             | 26.00 | 163.8          | 20.00             | 26.00 | 202.2          | 20.00             | 26.00 | 409.0          | 20.00             | 26.00 | 491.0          | 20.00             | 26.00 |
| 11              | 124.9          | 20.82             | 26.82 | 166.5          | 20.82             | 26.82 | 208.0          | 20.82             | 26.82 | 416.0          | 20.82             | 26.82 | 499.0          | 20.82             | 26.82 |
| 12              | 127.0          | 21.58             | 27.58 | 169.1          | 21.58             | 27.58 | 210.8          | 21.58             | 27.58 | 422.5          | 21.58             | 27.58 | 507.0          | 21.58             | 27.58 |

From the discontent of man...

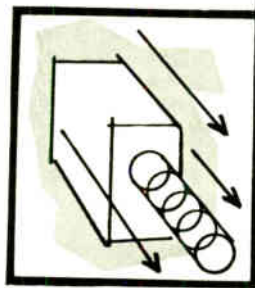
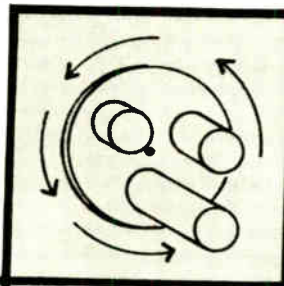

the world's best progress springs

Ella Wheeler Wilcox

Challenged by the limitations imposed by the cumbersome device of the turret, Zoomar has given the camera a new dimension—an exciting lifelike versatility approaching that of the human eye—a tool that dramatically helps to translate into being the skill and imagination of the engineer and operator. Zoomar, pioneer in the development of the zoom lens, continues its program of further progress and perfection.

Remote control zoom lenses for ITV cameras: Mark III, Mark IV, Mark VI, Mark X, Mark XX.

and the new compact mark IV-b

 **ZOOMAR, INC.** GLEN COVE, N. Y. 11542 • 518 676-1900 HOLLYWOOD, CALIF. 90028 • 213 465-2789

### DECIBEL TABLE

Courtesy Jampro Antenna Company

GIVEN: Decibels

TO FIND: Power and  $\left\{ \begin{matrix} \text{Voltage} \\ \text{Current} \end{matrix} \right\}$  Ratios

TO ACCOUNT FOR THE SIGN OF THE DECIBEL

For negative (-) values of the decibel—Both voltage and power ratios are less than unity. Use the two left-hand columns.

For positive (+) values of the decibel—Both voltage and power ratios are greater than unity. Use the two right-hand columns.

| ← -dB + →     |             |     |               |             | ← -dB + →     |             |      |               |             |
|---------------|-------------|-----|---------------|-------------|---------------|-------------|------|---------------|-------------|
| Voltage Ratio | Power Ratio | dB  | Voltage Ratio | Power Ratio | Voltage Ratio | Power Ratio | dB   | Voltage Ratio | Power Ratio |
| .9886         | .9772       | .1  | 1.012         | 1.023       | .4732         | .2239       | 6.5  | 2.113         | 4.467       |
| .9772         | .9550       | .2  | 1.028         | 1.047       | .4677         | .2188       | 6.6  | 2.138         | 4.571       |
| .9661         | .9333       | .3  | 1.035         | 1.072       | .4624         | .2138       | 6.7  | 2.163         | 4.677       |
| .9550         | .9120       | .4  | 1.047         | 1.096       | .4571         | .2089       | 6.8  | 2.188         | 4.786       |
| .9441         | .8913       | .5  | 1.059         | 1.122       | .4519         | .2042       | 6.9  | 2.213         | 4.898       |
| .9333         | .8710       | .6  | 1.072         | 1.148       | .4467         | .1995       | 7.0  | 2.239         | 5.012       |
| .9226         | .8511       | .7  | 1.084         | 1.175       | .4416         | .1950       | 7.1  | 2.265         | 5.129       |
| .9120         | .8318       | .8  | 1.096         | 1.202       | .4365         | .1905       | 7.2  | 2.291         | 5.248       |
| .9016         | .8128       | .9  | 1.109         | 1.230       | .4315         | .1862       | 7.3  | 2.317         | 5.370       |
| .8913         | .7943       | 1.0 | 1.122         | 1.259       | .4266         | .1820       | 7.4  | 2.344         | 5.495       |
| .8810         | .7762       | 1.1 | 1.135         | 1.288       | .4217         | .1778       | 7.5  | 2.371         | 5.623       |
| .8710         | .7586       | 1.2 | 1.148         | 1.318       | .4169         | .1738       | 7.6  | 2.399         | 5.754       |
| .8610         | .7413       | 1.3 | 1.161         | 1.349       | .4121         | .1698       | 7.7  | 2.427         | 5.888       |
| .8511         | .7244       | 1.4 | 1.175         | 1.380       | .4074         | .1660       | 7.8  | 2.455         | 6.026       |
| .8414         | .7079       | 1.5 | 1.189         | 1.413       | .4027         | .1622       | 7.9  | 2.483         | 6.166       |
| .8318         | .6918       | 1.6 | 1.202         | 1.445       | .3981         | .1585       | 8.0  | 2.512         | 6.310       |
| .8222         | .6761       | 1.7 | 1.216         | 1.479       | .3936         | .1549       | 8.1  | 2.541         | 6.457       |
| .8128         | .6607       | 1.8 | 1.230         | 1.514       | .3890         | .1514       | 8.2  | 2.570         | 6.607       |
| .8035         | .6457       | 1.9 | 1.245         | 1.549       | .3846         | .1479       | 8.3  | 2.600         | 6.761       |
| .7943         | .6310       | 2.0 | 1.239         | 1.585       | .3802         | .1445       | 8.4  | 2.630         | 6.918       |
| .7852         | .6166       | 2.1 | 1.274         | 1.622       | .3758         | .1413       | 8.5  | 2.661         | 7.079       |
| .7762         | .6026       | 2.2 | 1.288         | 1.660       | .3715         | .1380       | 8.6  | 2.692         | 7.244       |
| .7674         | .5888       | 2.3 | 1.303         | 1.698       | .3673         | .1349       | 8.7  | 2.723         | 7.413       |
| .7586         | .5754       | 2.4 | 1.318         | 1.738       | .3631         | .1318       | 8.8  | 2.754         | 7.586       |
| .7499         | .5623       | 2.5 | 1.334         | 1.778       | .3589         | .1288       | 8.9  | 2.786         | 7.762       |
| .7413         | .5495       | 2.6 | 1.349         | 1.820       | .3548         | .1259       | 9.0  | 2.818         | 7.943       |
| .7328         | .5370       | 2.7 | 1.365         | 1.862       | .3508         | .1230       | 9.1  | 2.851         | 8.128       |
| .7244         | .5248       | 2.8 | 1.380         | 1.905       | .3467         | .1202       | 9.2  | 2.884         | 8.318       |
| .7161         | .5129       | 2.9 | 1.396         | 1.950       | .3428         | .1175       | 9.3  | 2.917         | 8.511       |
| .7079         | .5012       | 3.0 | 1.413         | 1.995       | .3388         | .1148       | 9.4  | 2.951         | 8.710       |
| .6998         | .4898       | 3.1 | 1.429         | 2.042       | .3350         | .1122       | 9.5  | 2.985         | 8.913       |
| .6918         | .4786       | 3.2 | 1.445         | 2.089       | .3311         | .1096       | 9.6  | 3.020         | 9.120       |
| .6839         | .4677       | 3.3 | 1.462         | 2.138       | .3273         | .1072       | 9.7  | 3.055         | 9.333       |
| .6761         | .4571       | 3.4 | 1.479         | 2.188       | .3236         | .1047       | 9.8  | 3.090         | 9.550       |
| .6683         | .4467       | 3.5 | 1.496         | 2.239       | .3199         | .1023       | 9.9  | 3.126         | 9.772       |
| .6607         | .4365       | 3.6 | 1.514         | 2.291       | .3162         | .1000       | 10.0 | 3.162         | 10.000      |
| .6531         | .4266       | 3.7 | 1.531         | 2.344       | .3126         | .09772      | 10.1 | 3.190         | 10.23       |
| .6457         | .4169       | 3.8 | 1.549         | 2.399       | .3090         | .09550      | 10.2 | 3.236         | 10.47       |
| .6383         | .4074       | 3.9 | 1.567         | 2.455       | .3055         | .09333      | 10.3 | 3.273         | 10.72       |
| .6310         | .3981       | 4.0 | 1.585         | 2.512       | .3020         | .09120      | 10.4 | 3.311         | 10.96       |
| .6237         | .3890       | 4.1 | 1.603         | 2.570       | .2985         | .08913      | 10.5 | 3.350         | 11.22       |
| .6166         | .3802       | 4.2 | 1.622         | 2.630       | .2951         | .08710      | 10.6 | 3.388         | 11.48       |
| .6095         | .3715       | 4.3 | 1.641         | 2.692       | .2917         | .08511      | 10.7 | 3.428         | 11.75       |
| .6026         | .3631       | 4.4 | 1.660         | 2.754       | .2884         | .08318      | 10.8 | 3.467         | 12.02       |
| .5957         | .3548       | 4.5 | 1.679         | 2.818       | .2851         | .08128      | 10.9 | 3.508         | 12.30       |
| .5888         | .3467       | 4.6 | 1.698         | 2.884       | .2818         | .07943      | 11.0 | 3.548         | 12.59       |
| .5821         | .3388       | 4.7 | 1.718         | 2.951       | .2786         | .07762      | 11.1 | 3.589         | 12.88       |
| .5754         | .3311       | 4.8 | 1.738         | 3.020       | .2754         | .07586      | 11.2 | 3.631         | 13.18       |
| .5689         | .3236       | 4.9 | 1.758         | 3.090       | .2723         | .07413      | 11.3 | 3.673         | 13.49       |
| .5623         | .3162       | 5.0 | 1.788         | 3.162       | .2692         | .07244      | 11.4 | 3.715         | 13.80       |
| .5559         | .3090       | 5.1 | 1.799         | 3.236       | .2661         | .07079      | 11.5 | 3.758         | 14.13       |
| .5495         | .3020       | 5.2 | 1.820         | 3.311       | .2630         | .06918      | 11.6 | 3.802         | 14.45       |
| .5433         | .2951       | 5.3 | 1.841         | 3.388       | .2600         | .06761      | 11.7 | 3.846         | 14.79       |
| .5370         | .2884       | 5.4 | 1.862         | 3.467       | .2570         | .06607      | 11.8 | 3.890         | 15.14       |
| .5309         | .2818       | 5.5 | 1.884         | 3.548       | .2541         | .06457      | 11.9 | 3.936         | 15.49       |
| .5248         | .2754       | 5.6 | 1.905         | 3.631       | .2512         | .06310      | 12.0 | 3.981         | 15.85       |
| .5188         | .2692       | 5.7 | 1.928         | 3.715       | .2483         | .06166      | 12.1 | 4.027         | 16.22       |
| .5129         | .2630       | 5.8 | 1.950         | 3.802       | .2455         | .06026      | 12.2 | 4.074         | 16.60       |
| .5070         | .2570       | 5.9 | 1.972         | 3.890       | .2427         | .05888      | 12.3 | 4.121         | 16.98       |
| .5012         | .2512       | 6.0 | 1.995         | 3.981       | .2399         | .05754      | 12.4 | 4.169         | 17.38       |
| .4955         | .2455       | 6.1 | 2.018         | 4.074       | .2371         | .05623      | 12.5 | 4.217         | 17.78       |
| .4898         | .2399       | 6.2 | 2.042         | 4.169       | .2344         | .05495      | 12.6 | 4.266         | 18.20       |
| .4842         | .2344       | 6.3 | 2.065         | 4.266       | .2317         | .05370      | 12.7 | 4.315         | 18.62       |
| .4786         | .2291       | 6.4 | 2.089         | 4.365       | .2291         | .05248      | 12.8 | 4.365         | 19.05       |



## Engineering Data

| ← -dB+ →      |             |      |               |             |
|---------------|-------------|------|---------------|-------------|
| Voltage Ratio | Power Ratio | dB   | Voltage Ratio | Power Ratio |
| .2265         | .05129      | 12.9 | 4.416         | 19.50       |
| .2239         | .05012      | 13.0 | 4.467         | 19.95       |
| .2213         | .04898      | 13.1 | 4.519         | 20.42       |
| .2188         | .04786      | 13.2 | 4.571         | 20.89       |
| .2163         | .04677      | 13.3 | 4.624         | 21.38       |
| .2138         | .04571      | 13.4 | 4.677         | 21.88       |
| .2113         | .04467      | 13.5 | 4.732         | 22.39       |
| .2089         | .04365      | 13.6 | 4.786         | 22.91       |
| .2065         | .04266      | 13.7 | 4.842         | 23.44       |
| .2042         | .04169      | 13.8 | 4.898         | 23.99       |
| .2018         | .04074      | 13.9 | 4.955         | 24.55       |
| .1995         | .03981      | 14.0 | 5.012         | 25.12       |
| .1972         | .03890      | 14.1 | 5.070         | 25.70       |
| .1950         | .03802      | 14.2 | 5.129         | 26.30       |
| .1928         | .03715      | 14.3 | 5.188         | 26.92       |
| .1905         | .03631      | 14.4 | 5.248         | 27.54       |
| .1884         | .03548      | 14.5 | 5.309         | 28.18       |
| .1862         | .03467      | 14.6 | 5.370         | 28.84       |
| .1841         | .03388      | 14.7 | 5.433         | 29.51       |
| .1820         | .03311      | 14.8 | 5.495         | 30.20       |
| .1799         | .03236      | 14.9 | 5.559         | 30.90       |
| .1778         | .03162      | 15.0 | 5.623         | 31.62       |
| .1758         | .03090      | 15.1 | 5.689         | 32.36       |
| .1738         | .03020      | 15.2 | 5.754         | 33.11       |
| .1718         | .02951      | 15.3 | 5.821         | 33.88       |
| .1698         | .02884      | 15.4 | 5.888         | 34.67       |
| .1679         | .02818      | 15.5 | 5.957         | 35.48       |
| .1660         | .02754      | 15.6 | 6.026         | 36.31       |
| .1641         | .02692      | 15.7 | 6.095         | 37.15       |
| .1622         | .02630      | 15.8 | 6.166         | 38.02       |
| .1603         | .02570      | 15.9 | 6.237         | 38.90       |
| .1585         | .02512      | 16.0 | 6.310         | 39.81       |
| .1567         | .02455      | 16.1 | 6.383         | 40.74       |
| .1549         | .02399      | 16.2 | 6.457         | 41.69       |
| .1531         | .02344      | 16.3 | 6.531         | 42.66       |
| .1514         | .02291      | 16.4 | 6.607         | 43.65       |

| ← -dB+ → |        |      |        |        |
|----------|--------|------|--------|--------|
| .1496    | .02239 | 16.5 | 6.683  | 44.67  |
| .1479    | .02188 | 16.6 | 6.761  | 45.71  |
| .1462    | .02138 | 16.7 | 6.839  | 46.77  |
| .1445    | .02089 | 16.8 | 6.918  | 47.86  |
| .1429    | .02042 | 16.9 | 6.998  | 48.98  |
| .1413    | .01995 | 17.0 | 7.079  | 50.12  |
| .1396    | .01950 | 17.1 | 7.161  | 51.29  |
| .1380    | .01905 | 17.2 | 7.244  | 52.48  |
| .1365    | .01862 | 17.3 | 7.328  | 53.70  |
| .1349    | .01820 | 17.4 | 7.413  | 54.95  |
| .1334    | .01778 | 17.5 | 7.499  | 56.23  |
| .1318    | .01738 | 17.6 | 7.586  | 57.54  |
| .1303    | .01698 | 17.7 | 7.674  | 58.88  |
| .1288    | .01660 | 17.8 | 7.762  | 60.26  |
| .1274    | .01622 | 17.9 | 7.852  | 61.66  |
| .1259    | .01585 | 18.0 | 7.943  | 63.10  |
| .1245    | .01549 | 18.1 | 8.035  | 64.57  |
| .1230    | .01514 | 18.2 | 8.128  | 66.07  |
| .1216    | .01479 | 18.3 | 8.233  | 67.61  |
| .1202    | .01445 | 18.4 | 8.318  | 69.18  |
| .1189    | .01413 | 18.5 | 8.414  | 70.79  |
| .1175    | .01380 | 18.6 | 8.511  | 72.44  |
| .1161    | .01349 | 18.7 | 8.610  | 74.13  |
| .1148    | .01318 | 18.8 | 8.710  | 75.86  |
| .1135    | .01288 | 18.9 | 8.811  | 77.62  |
| .1122    | .01269 | 19.0 | 8.913  | 79.43  |
| .1109    | .01230 | 19.1 | 9.016  | 81.28  |
| .1096    | .01202 | 19.2 | 9.120  | 83.18  |
| .1084    | .01175 | 19.3 | 9.226  | 85.11  |
| .1072    | .01148 | 19.4 | 9.333  | 87.10  |
| .1059    | .01122 | 19.5 | 9.441  | 89.13  |
| .1047    | .01096 | 19.6 | 9.550  | 91.20  |
| .1035    | .01072 | 19.7 | 9.661  | 93.33  |
| .1023    | .01047 | 19.8 | 9.772  | 95.50  |
| .1012    | .01023 | 19.9 | 9.886  | 97.72  |
| .1000    | .01000 | 20.0 | 10.000 | 100.00 |

# VENT-RAK®

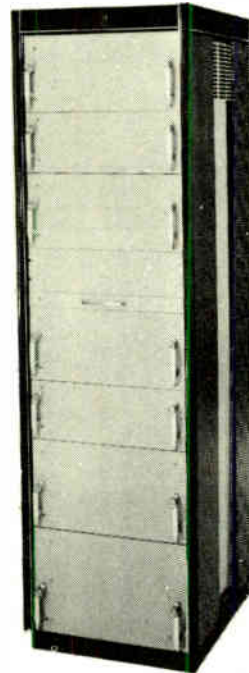

**NEW**  
**5000 Series**

**SLIM-LINE**

**Modular  
Electronic  
Cabinets**

JUST—21.375" SLIM—10/32 tapped RETMA pattern all vertical posts. Heavy tubular 12 gauge frame and instantly removable side and rear panels — Panels and frame trimmed in functional black anodized extruded aluminum present simplicity yet functional streamlined appearance — Stocked in two-tone baked enamel finish in Dark Gray with Light Gray — or — Charcoal Brown with Black—40 sizes with panel space for 19" panels from 26¼" to 77" and depths of 24, 26, 28 and 30"—Priced from \$123.50 to \$207.00 F.O.B. Indianapolis, Indiana—Available from Distributor and Factory stock.

## VENT-RAK®

525 S. Webster Avenue  
Indianapolis, Indiana 46219  
Telephone (317) 359-5407

# COAXIAL CABLE DATA

Courtesy Andrew Corporation

## Coaxial Transmission Line Attenuation and Power Rating

### Attenuation

The following pages show the attenuation versus frequency characteristics of all standard Andrew rigid and HELIAX transmission lines. The values shown are for 24°C (75°F) ambient, and increase slightly with higher temperature or applied power, up to approximately 13% above the curves at full average power rating. The curve at left shows this relationship. Inner and outer conductor temperature rise is also shown for reference.

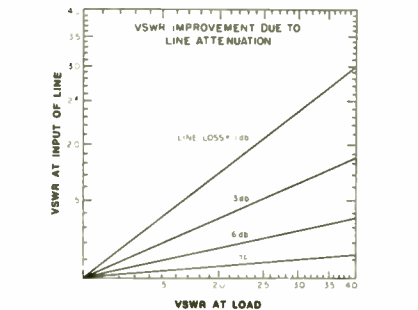
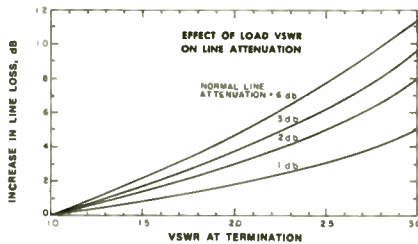
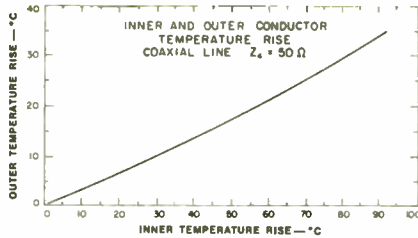
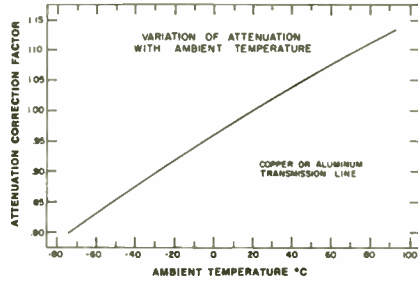

### Effect of VSWR on Attenuation

When transmission line is attached to an antenna, the VSWR of the antenna increases the attenuation of the line. This effect is quite small for normal conditions. The curve shows increase in line loss versus VSWR.

### Effect of Attenuation on VSWR

Antenna VSWR, as measured at the input to the connecting transmission line, is reduced by the attenuation of the line. The curves show this relationship.

### Power Ratings

Peak and average power ratings are both required to describe fully the capabilities of a given transmission line. Typically, peak power ratings limit the line for low frequency or pulse usage while average power ratings limit the higher frequency usage.

### Standard Peak Power Ratings

The permissible voltage between inner and outer conductor of a coaxial cable determines the peak power rating.

Voltage breakdown is independent of frequency, but varies with line pressure and VSWR. Peak power ratings are therefore generally stated for the following conditions: Unity VSWR, no modulation, and one atmosphere absolute dry air pressure. 100% AM modulation reduces the peak power rating by a factor of 4. Peak power rating is given by the following expression.

$$P_{pk} = \frac{(E_{rt})^2}{Z_0(1+M)^2 VSWR} (S_d)^2 \text{ watts}$$

Where M is modulation percentage expressed decimally, VSWR is voltage standing wave ratio on the line,  $S_d$  is dielectric strength of the pressurizing medium relative to air,  $E_{rt}$  is determined as follows:  $E_{rt} = 0.247 E_p$ .  $E_p$  is the DC production test voltage (the values in the table below are typical), and the constant 0.247 includes factors to relate DC voltage to RF voltage, to adjust to rms value, and includes a safety factor of 2. All of these factors are empirical and have been extensively verified.

| Outer Conductor OD, inches | 1/2   | 3/4    | 1      | 1 1/4  | 1 1/2  | 2      | 3      |
|----------------------------|-------|--------|--------|--------|--------|--------|--------|
| $E_p$ volts                | 6,000 | 11,000 | 16,000 | 19,000 | 26,000 | 35,000 | 50,000 |

**INCREASED PEAK POWER RATINGS** can be obtained through pressurization or the use of high dielectric strength gases or both. Variation of peak power rating with absolute pressure and use of dry air and Sulfur Hexafluoride ( $SF_6$ ) is shown at the right. These curves are based on voltage-pressure tests conducted on transmission lines and components.

**STANDARD AVERAGE POWER RATINGS** are determined by the safe long term operating temperature of the inner conductor when the cable is operated in a 40°C (104°F) ambient. The ratings are based upon an inner conductor temperature of 100°C (212°F) for HELIAX air dielectric coaxial cable (polyethylene) and 79°C (175°F) for foam HELIAX coaxial cable. Rigid line ratings are based upon an inner conductor temperature of 101°C (216°F).

The curve at the right indicates the variation of average power rating with ambient temperature. Average power rating may be calculated from the following:

$$P_{av} = \frac{16,380 \text{ } \sigma \text{ } d}{d B_1} \text{ watts}$$

where  $P_{av}$  = average power rating for conditions described above.

D is OD of line in inches;  $d B_1$  is measured attenuation derated for increase in loss at elevated temperature; and  $\sigma$  is heat emissivity coefficient of outer conductor in watts/in.<sup>2</sup>

For CW, AM, or FM applications, the average power rating of a cable is determined by derating the presented power curves according to VSWR. See expression below. SSB transmitters are generally rated by peak envelope power (PEP). Average power for these applications is considerably lower, typically about half the PEP. Television transmitter ratings are based on sync peak video power. Average power output for transmission line evaluation is 83% of nominal rating.

**DERATING AVERAGE POWER FOR VSWR** is accomplished by use of the derating factor (DF) calculated from the following formula.

$$D.F. = \frac{(VSWR^2 + 1)}{(2 VSWR)} + F^1 \frac{(VSWR^2 - 1)}{(2 VSWR)}$$

where  $F^1$  is a factor that varies with frequency and line size. Select the factor from the curve at right.

**INCREASED AVERAGE POWER RATINGS** are achievable by (1) treating the conductor surfaces for greater heat emissivity, (2) pressurizing the line, (3) using a gas with a larger heat transfer coefficient and (4) combination of these. For special applications your Andrew sales engineer will supply complete information.

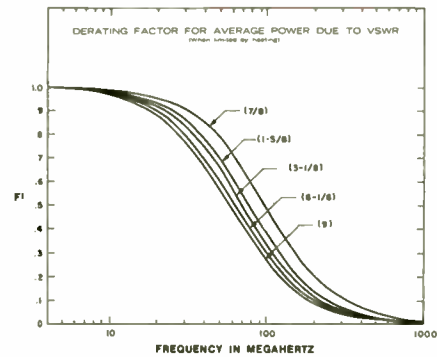
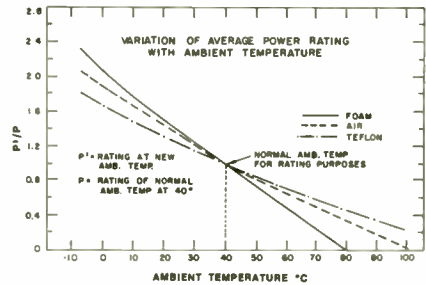
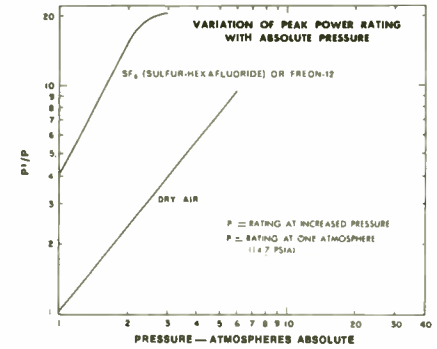

# COAXIAL CABLE DATA

Courtesy Andrew Corporation

Attenuation of Helix Coaxial Cables

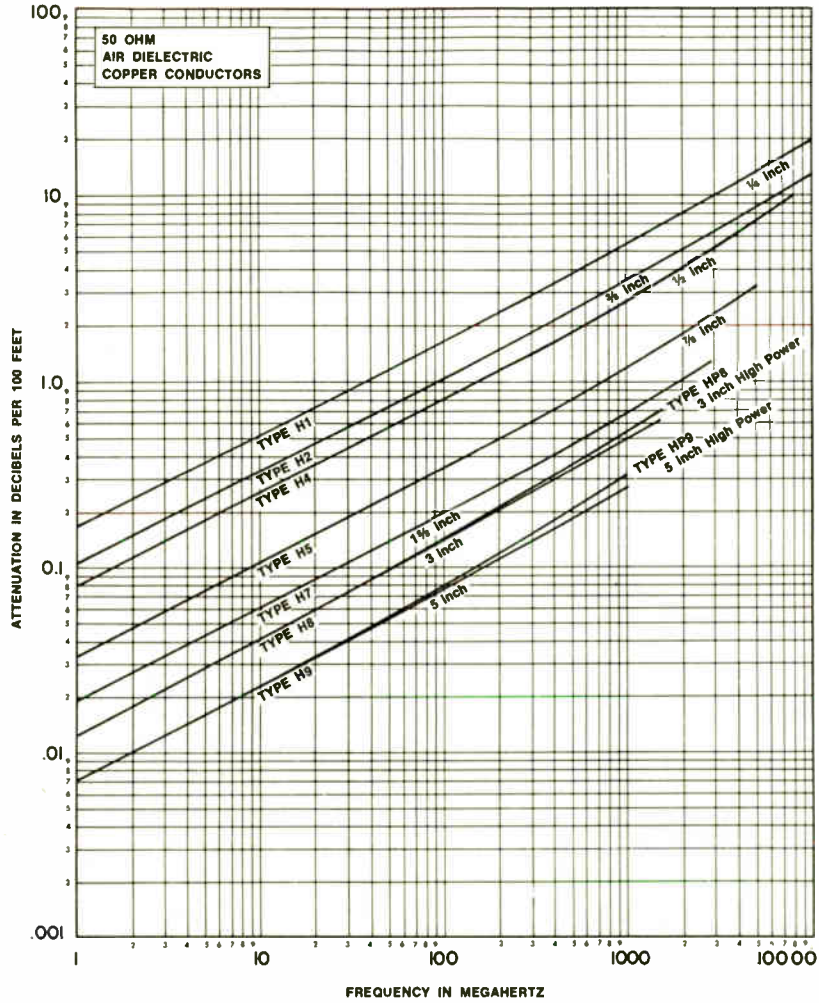

Power Rating of Helix Coaxial Cables

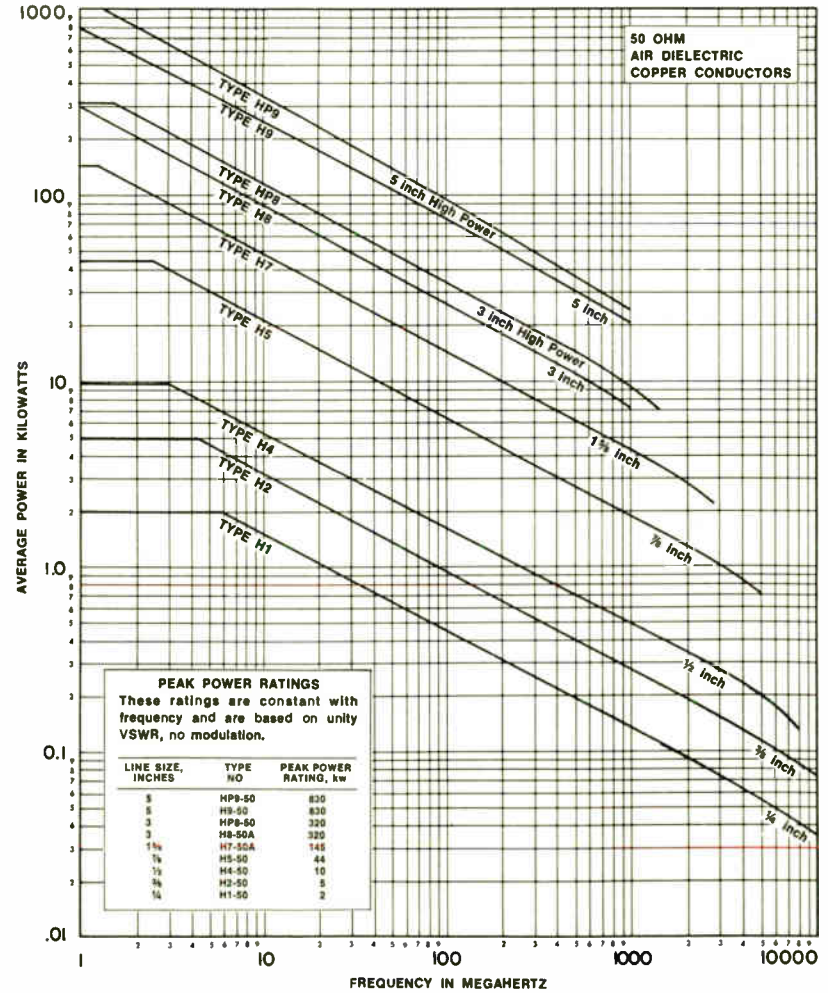

# COAXIAL CABLE DATA

Courtesy Andrew Corporation

Attenuation of Heliax Coaxial Cables

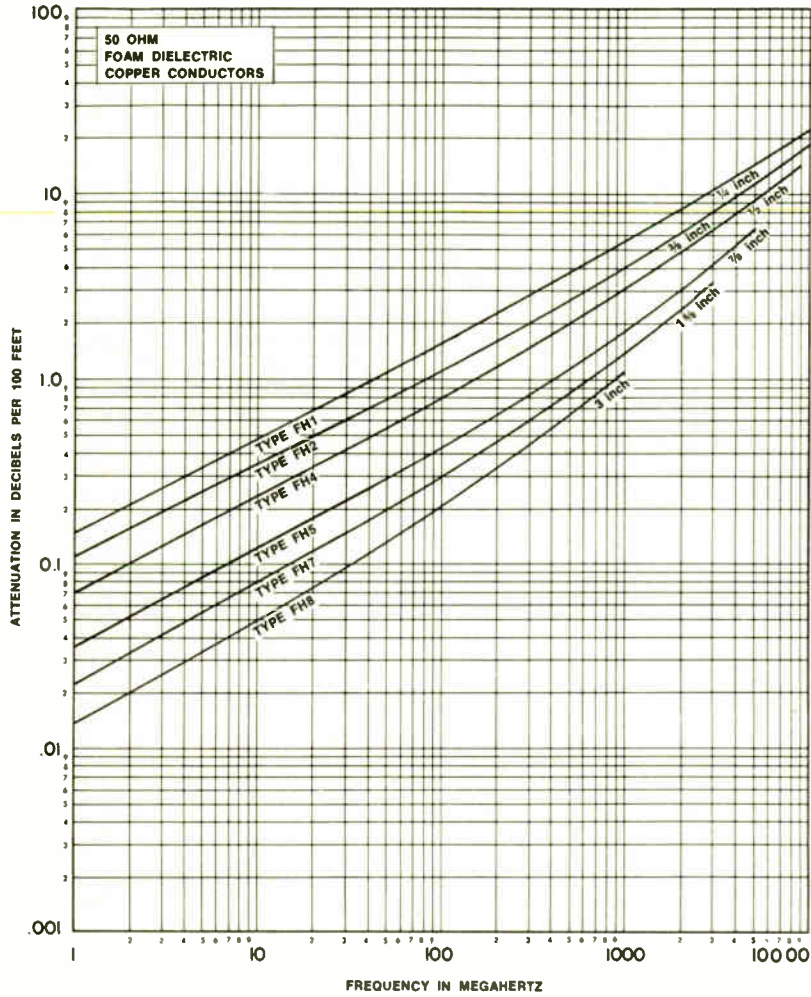

Attenuation curves based on:  
VSWR 1.0:1.0  
Ambient Temperature 24° C (75° F)

Conversion Data:  
1 dB/100 feet 3.28 dB/100 meters  
For 75 ohm cables, multiply values by .95.

Power Rating of Heliax Coaxial Cables

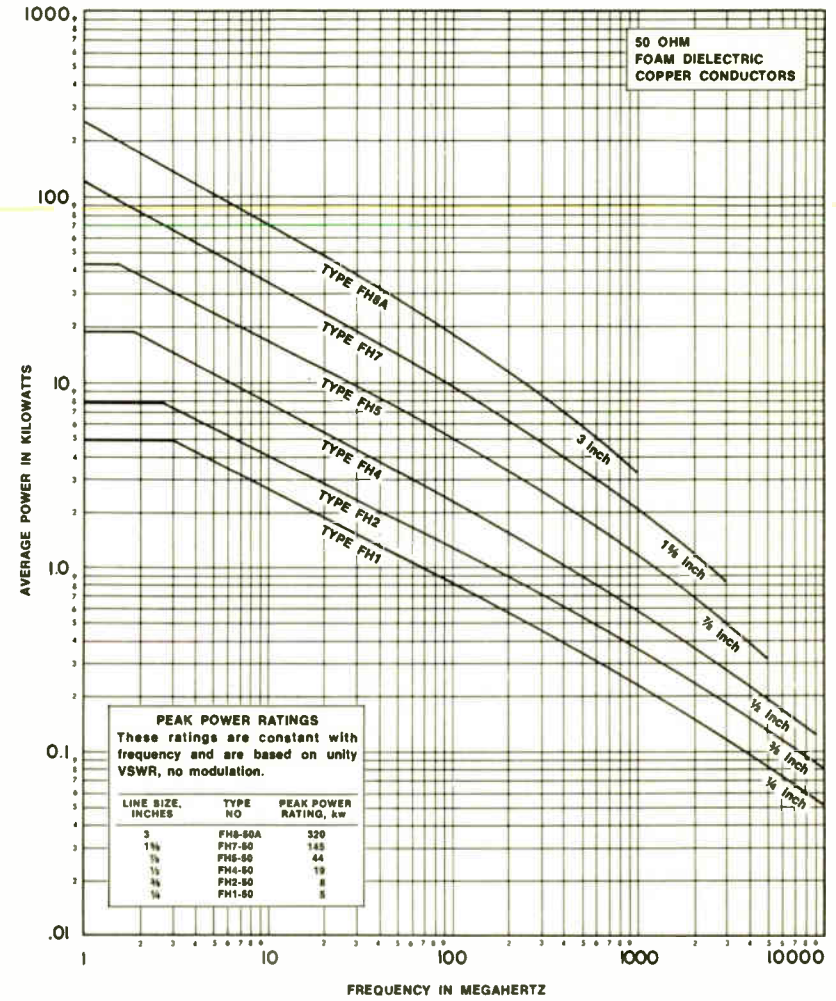

Power Ratings based on:  
VSWR 1.0:1.0  
Ambient Temperature 40° C (104° F)  
Inner conductor temperature 79° C (175° F)

Conversion Data:  
For ambient temperature 35° C (95° F), multiply values by 1.13

LOOK TO  
**WILKINSON**  
 FOR THE  
**SIGNS OF  
 EXCELLENCE!**

**WILKINSON**  
 • FM  
 TRANSMITTERS

**WILKINSON**  
 • AM  
 TRANSMITTERS

**WILKINSON**  
 • SOLID STATE AUDIO  
 CONSOLES  
 (Single channel  
 and stereo)

**WILKINSON**

- DIRECT REPLACEMENT SILICON RECTIFIERS
- COMPLETE ACCESSORY EQUIPMENT

**WILKINSON**  
 • MULTIPLEX SCA  
 GENERATORS  
 • FM STEREO  
 GENERATOR

**WILKINSON**  
 • FIELD INTENSITY  
 METERS  
 • MODULATION  
 MONITORS  
 • FREQUENCY  
 MONITORS  
 • FM EXCITER

For complete details on WILKINSON ELECTRONICS equipment write today to:  
**WILKINSON ELECTRONICS, INC.** ♦

1937 MACDADE BLVD. • WOODLYN, PA. 19094  
 TELEPHONE (AREA CODE 215) 874-5236 874-5237

# COAXIAL CABLE DATA

Courtesy Andrew Corporation

Attenuation of Heliax Coaxial Cables

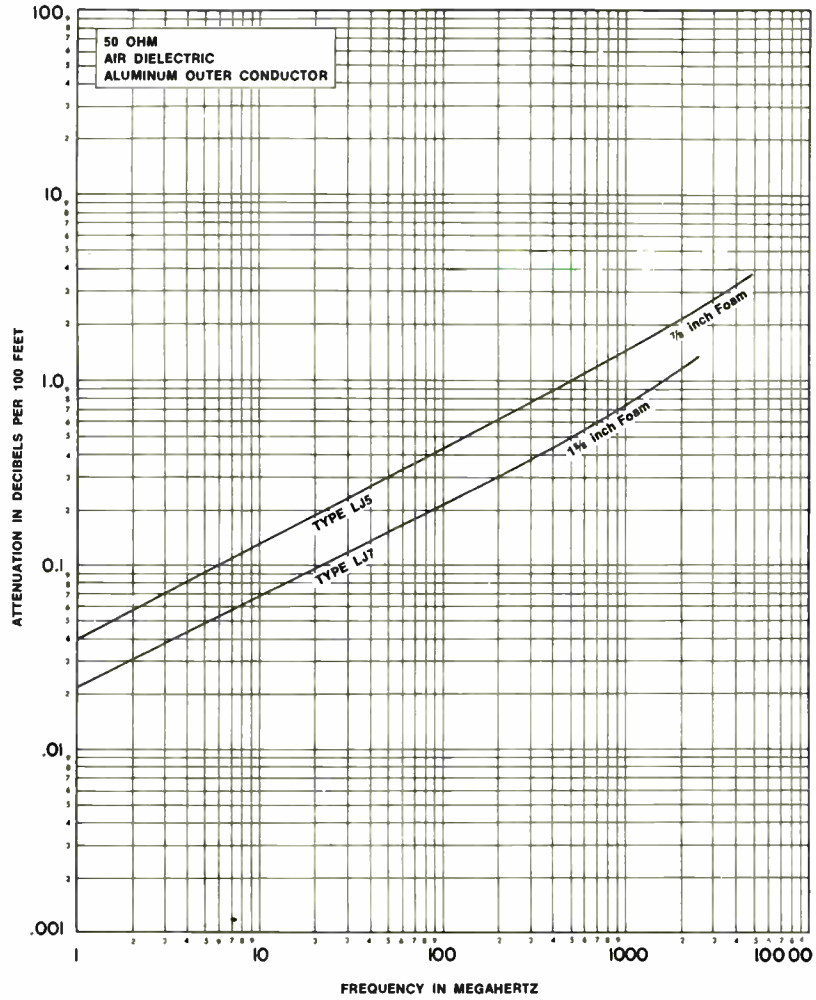

Attenuation curves based on:  
VSWR 1.0:1.0  
Ambient Temperature 24°C (75 F)

Conversion Data:  
1 dB/100 feet 3.28 dB/100 meters  
For 75 ohm cables, multiply values by .95.

Power Rating of Heliax Coaxial Cables

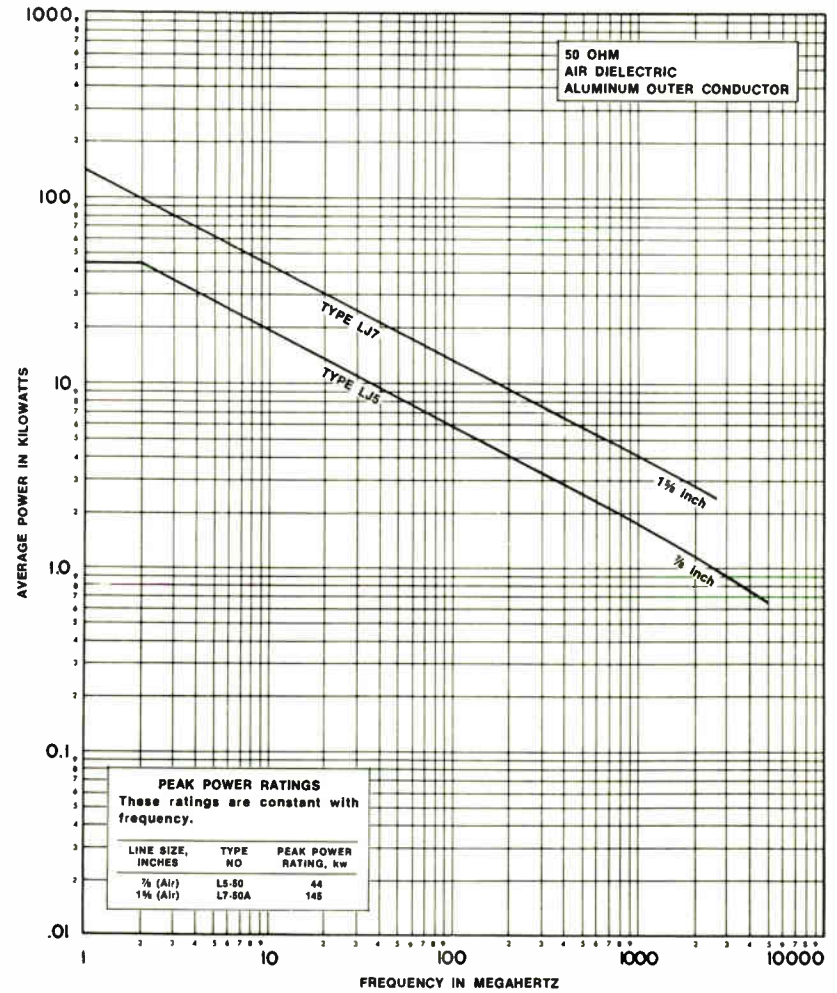

Power ratings based on:  
VSWR 1.0:1.0  
Ambient Temperature 40°C (104°F)  
Inner conductor temperature 100°C (212 F)  
One atmosphere absolute dry air pressure

Conversion Data:  
For 75 ohm cables, multiply values by .7C.  
For ambient temperature 35°C (95 F), multiply values by 1.08

NEMS-CLARKE

the equipment  
most specified for antenna  
and signal measurement

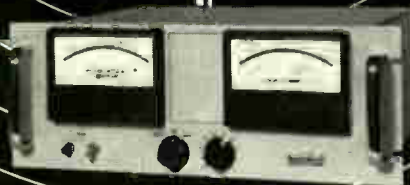

112 PHASE MONITOR

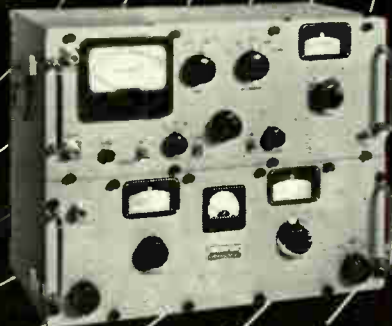

107A  
FIELD INTENSITY MONITOR

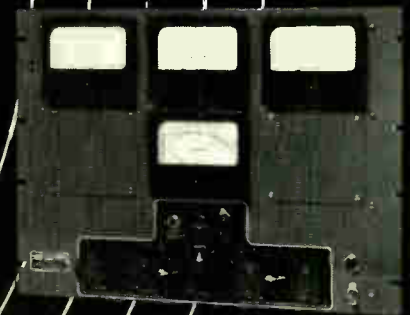

108E  
PHASE MONITOR



PPM-101  
PRECISION PHASE MONITOR



SDM-520  
SPECTRUM DISPLAY MONITOR



FIM-135  
FIELD INTENSITY METER

Over the years, the Nems-Clarke tradename has been the symbol of accuracy, quality and reliability in the field of antenna and signal measurements. Nems-Clarke equipment is FCC ap-

proved, and has been universally accepted as the standard of excellence throughout the industry. For further information on Nems-Clarke equipment, call or write:

V-28A

**Vitro ELECTRONICS**

Producers of NEMS-CLARKE Equipment • A Division Of Vitro Corporation Of America

919 Jesup-Blair Drive • Silver Spring, Maryland (301) 585-1000 • 2301 Pontius Avenue • Los Angeles 64, California (213) 477-6717

# COAXIAL CABLE DATA

Courtesy Andrew Corporation

Attenuation of Heliax Coaxial Cables

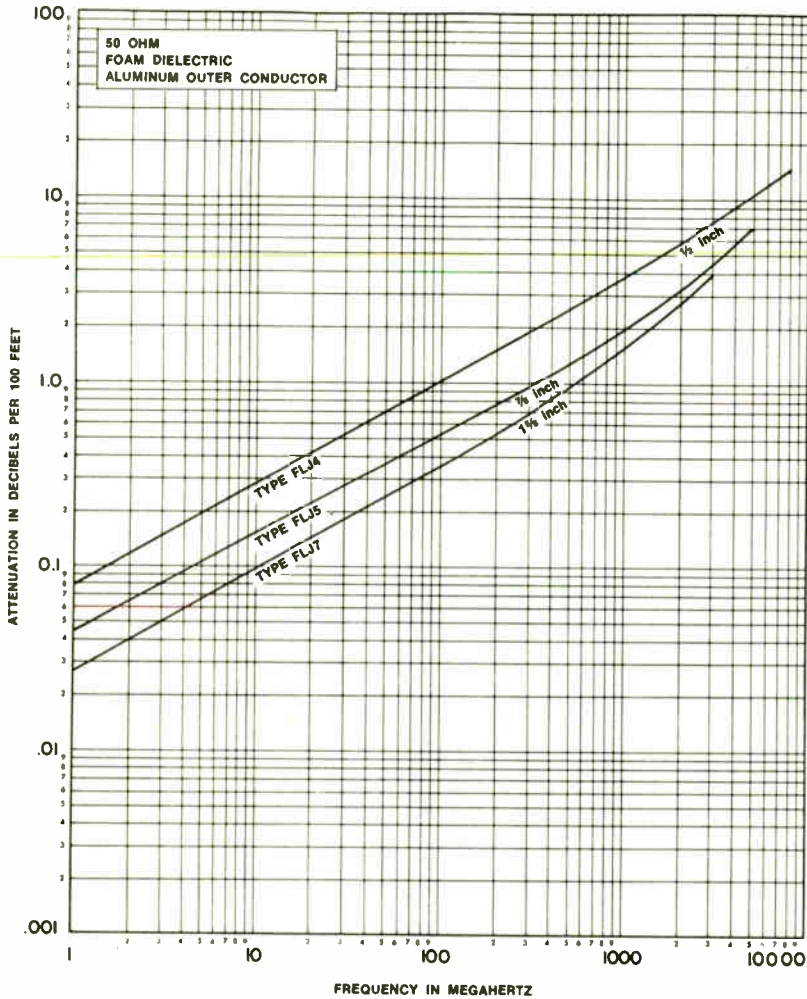

Attenuation curves based on:  
VSWR 1.0:1.0  
Ambient Temperature 24°C (75°F)

Conversion Data:  
1 dB/100 feet 3.28 dB/100 meters  
For 75 ohm cables, multiply values by .95.

Power Rating of Heliax Coaxial Cables

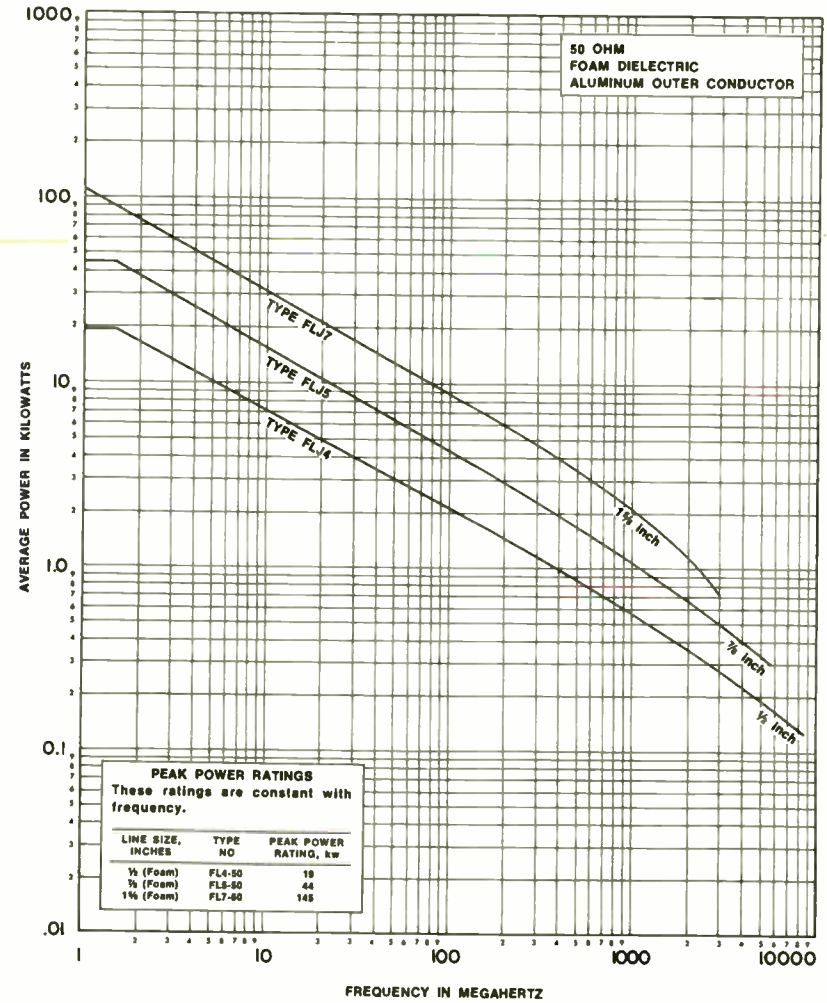

Power ratings based on:  
VSWR 1.0:1.0  
Ambient Temperature 40°C (104°F)  
Inner conductor temperature 79°C (175 F)

Conversion Data:  
For ambient temperature 35 C (95 F), multiply values by 1.13



**WORLD'S LARGEST SELLING  
AND WORLD'S NEWEST**

**Hand Size V-O-M's**



**MODEL 310**  
World's Largest Selling  
Volt-Ohm-Milliammeter



**MODEL 310-C**  
World's Newest  
Volt-Ohm-Milliammeter

**BOTH TESTERS  
SHOWN  
ACTUAL SIZE**

- 1** **HAND SIZE AND LIGHTWEIGHT**, but with the features of full-size V-O-M's.
- 2** **20,000 OHMS PER VOLT DC; 5,000 AC (310)—15,000 AC (310-C).**
- 3** **EXCLUSIVE SINGLE SELECTOR SWITCH** speeds circuit and range settings. The first miniature V-O-M's with this exclusive feature for quick, fool-proof selection of all ranges.

**SELF-SHIELDED Bar-Ring instrument; permits checking in strong magnetic fields. FITTING INTERCHANGEABLE test prod tip into top of tester makes it the common probe, thereby freeing one hand. UNBREAKABLE plastic meter window. BANANA-TYPE JACKS—positive connection and long life.**

Model 310—\$42.00      Model 310-C—\$53.00      Model 369 Leather Case—\$4.00

**ALL PRICES ARE SUGGESTED U.S.A. USER NET, SUBJECT TO CHANGE**

**THE TRIPLETT ELECTRICAL INSTRUMENT COMPANY, BLUFFTON, OHIO**

**310-C PLUS FEATURES**

1. Fully enclosed lever range switch
2. 15,000 Ohms per volt AC (20,000 O/V DC same as 310)
3. Reversing switch for DC measurements

**MODELS 100 AND 100-C**

Comprehensive test sets. Model 100 includes: Model 310 V-O-M, Model 10 Clamp-on Ammeter Adapter; Model 101 Line Separator; Model 379 Leather Case; Model 311 leads. (\$78.00 Value Separate Unit Purchase Price.)

MODEL 100—U.S.A. User Net..\$74.00  
MODEL 100 - C — Same as above, but with Model 310-C, Net.....\$84.00



**USES UNLIMITED: FIELD ENGINEERS • ELECTRICAL, RADIO, TV, AND APPLIANCE SERVICEMEN • ELECTRICAL CONTRACTORS • FACTORY MAINTENANCE MEN • ELECTRONIC TECHNICIANS • HOME OWNERS, HOBBYISTS**  
**THE WORLD'S MOST COMPLETE LINE OF V-O-M's • AVAILABLE FROM YOUR TRIPLETT DISTRIBUTOR'S STOCK**

# COAXIAL CABLE DATA

Courtesy Andrew Corporation

Attenuation of Rigid Transmission Lines

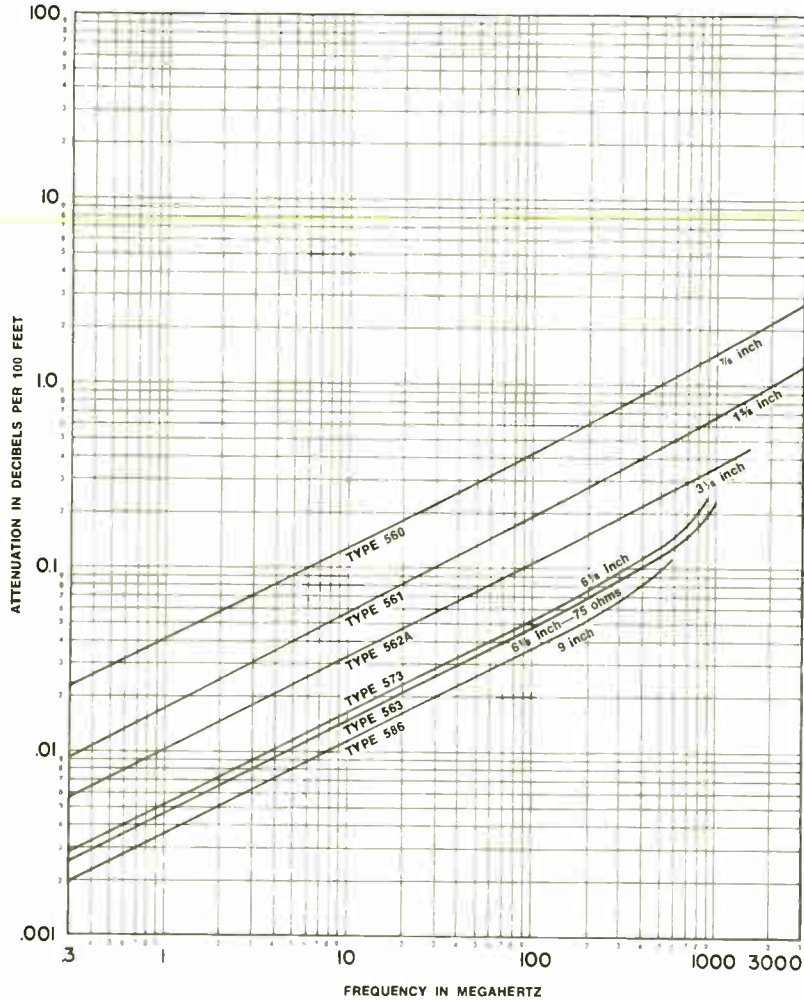

Attenuation curves based on:  
VSWR 1.0:1.0  
Ambient Temperature 24°C (75 F)

Conversion Data:  
1 dB/100 feet = 3.28 dB/100 meters  
Ambient Temperature 35 C (95 F)

Power Rating of Rigid Transmission Lines

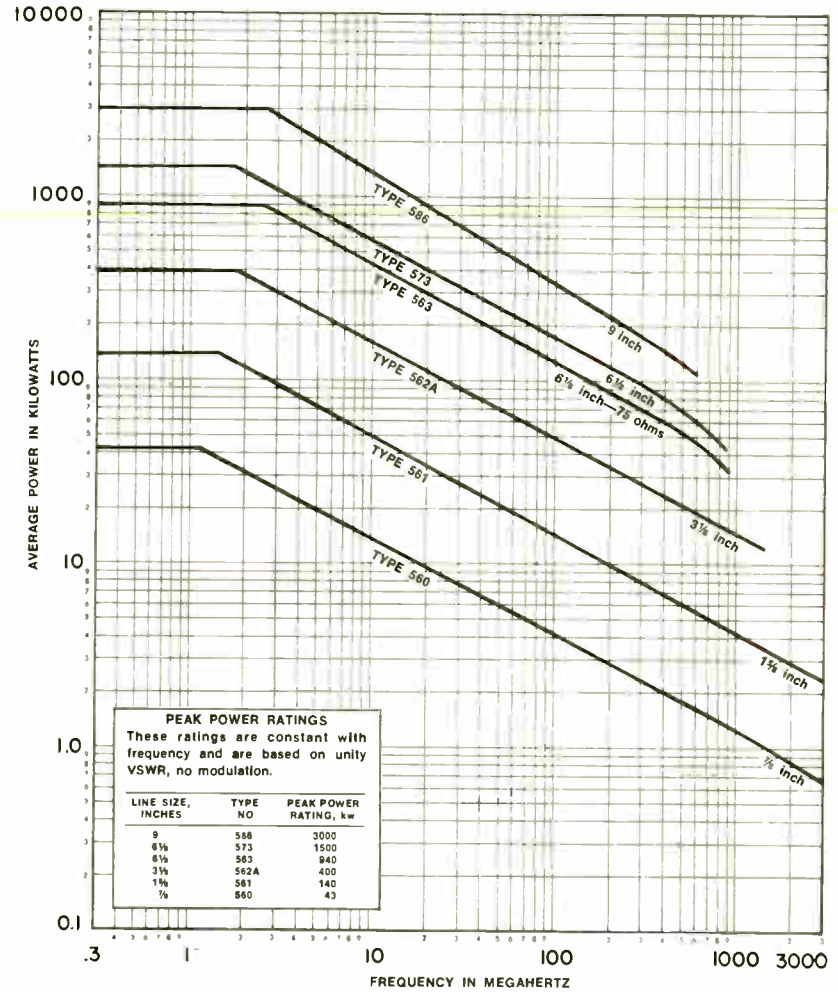

**PEAK POWER RATINGS**  
These ratings are constant with frequency and are based on unity VSWR, no modulation.

| LINE SIZE, INCHES | TYPE NO | PEAK POWER RATING, kw |
|-------------------|---------|-----------------------|
| 9                 | 586     | 3000                  |
| 6 1/2             | 573     | 1500                  |
| 6 1/2             | 563     | 940                   |
| 3 1/2             | 562A    | 400                   |
| 1 1/2             | 561     | 140                   |
| 7/8               | 560     | 45                    |

Power ratings based on:  
VSWR 1.0:1.0  
Ambient Temperature 40°C (104 F)  
Inner conductor temperature 102°C (216 F)  
One atmosphere absolute dry air pressure

Conversion Data:  
For ambient temperature 35 C (95 F), multiply values by 1.08

# TRANSMISSION LINES

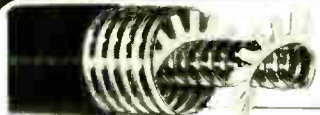

## HELIAX® FLEXIBLE COAXIAL CABLES



| AIR DIELECTRIC—50 ohms |     |      |      |      |       |      |       | FOAM DIELECTRIC—50 ohms |      |      |      |      |       |      |
|------------------------|-----|------|------|------|-------|------|-------|-------------------------|------|------|------|------|-------|------|
| Size, in.              | ¼   | ⅜    | ½    | ⅞    | 1 1/8 | 3    | 5     | Size, in.               | ¼    | ⅜    | ½    | ⅞    | 1 1/8 | 3    |
| Type No.               | H1  | H2   | H4   | H5   | H7    | H8   | H9    | Type No.                | FH1  | FH2  | FH4  | FH5  | FH7   | FH8  |
| Type No. Jacketed      | HJ1 | HJ2  | HJ4  | HJ5  | HJ7   | HJ8  | HJ9   | Type No. Jacketed       | FHJ1 | FHJ2 | FHJ4 | FHJ5 | FHJ7  | FHJ8 |
| Max. Freq. GHz         | 23  | 15.5 | 10.9 | 5.2  | 2.63  | 1.64 | 960Mc | Max. Freq. GHz          | 20   | 12   | 8.1  | 4.4  | 2.3   | 1.5  |
| Peak Power Rating, kw  | 2   | 5    | 9.8  | 44   | 145   | 320  | 830   | Peak Power Rating, kw   | 5    | 8    | 19   | 44   | 145   | 320  |
| Velocity, %            | 85  | 85   | 91.4 | 91.6 | 92.1  | 93.3 | 93.0  | Velocity, %             | 79   | 79   | 79   | 79   | 79    | 92   |
| Bending Radius, in.    | 2.5 | 3.7  | 5    | 10   | 20    | 30   | 50    | Bending Radius, in.     | 2.5  | 3.7  | 5    | 10   | 20    | 50   |
| Net Wt. lbs./ft.       | .07 | .14  | .20  | .43  | .72   | 1.2  | 3     | Net Wt. lbs./ft.        | .06  | .12  | .19  | .36  | 1.06  | 3    |



## CONNECTORS



| AIR DIELECTRIC—50 ohms |     |     |     |      |       |     |     | FOAM DIELECTRIC—50 ohms |     |     |      |      |       |     |
|------------------------|-----|-----|-----|------|-------|-----|-----|-------------------------|-----|-----|------|------|-------|-----|
| Size, in.              | ¼   | ⅜   | ½   | ⅞    | 1 1/8 | 3   | 5   | Size, in.               | ¼   | ⅜   | ½    | ⅞    | 1 1/8 | 3   |
| EIA Flange             | —   | —   | —   | 75AR | 87R   | 78R | 79R | EIA Flange              | —   | —   | 44AR | 45AR | 47R   | 48R |
| "N" Jack               | 71N | 72N | 74N | 75AN | 87N   | —   | —   | "N" Jack                | 41N | 42N | 44AN | 45AN | 47N   | —   |
| "N" Plug               | 71W | 72W | 74W | 75AW | —     | —   | —   | "N" Plug                | 41W | 42W | 44AW | 45AW | 47W   | —   |
| UHF Jack               | —   | —   | 74U | 75AU | 87U   | —   | —   | UHF Jack                | 41U | —   | 44AU | 45AU | —     | —   |
| LC Jack                | —   | —   | —   | 75AL | 87L   | 78L | —   | LC Jack                 | —   | —   | 44AL | 45AL | 47L   | —   |
| LC Plug                | —   | —   | —   | 75AM | 87M   | —   | —   | LC Plug                 | —   | —   | 44AM | 45AM | —     | —   |
| End Terminal           | 71T | —   | 74T | 75AT | 87T   | —   | —   | End Terminal            | —   | —   | 44AT | 45AT | —     | —   |
| Splice                 | 71Z | 72Z | 74Z | 75AZ | 87Z   | 78Z | 79Z | Splice                  | —   | —   | 44AZ | 45AZ | 47Z   | 48Z |
|                        |     |     |     |      |       |     |     | UHF Plug                | 41P | 42P | 44AP | 45AP | —     | —   |

## WAVEGUIDES



### HELIAX® ELLIPTICAL WAVEGUIDES

Flexible waveguide for use in microwave bands from 3.7 GHz to 13 GHz. Long lengths minimize layout and installation time. Connectors mate with MIL standard or EIA flanges.

| Type No. | Frequency GHz | Attenuation Midband db/100' |
|----------|---------------|-----------------------------|
| EW-37    | 3.7- 4.2      | .8                          |
| EW-44    | 4.4- 5.0      | 1.4                         |
| EW-56    | 5.6- 6.4      | 1.5                         |
| EW-59    | 5.9- 7.1      | 1.7                         |
| EW-71    | 7.1- 8.5      | 2.1                         |
| EW-85    | 8.5-10.0      | 2.8                         |
| EW-107   | 10.7-11.7     | 3.4                         |
| EW-122   | 12.2-13.2     | 4.3                         |

RECTANGULAR and CIRCULAR WAVEGUIDES Stocked in commonly used sizes.



## COAXIAL SWITCHES

Type 6750 (6 1/8" line), Type 6740A (3 1/8" line) and Type 6730A (1 1/8" line) permit rapid switching of pairs of transmission lines operating into the UHF frequency band. Peak power ratings are 100 KW in 1 1/8" size, 300 KW in 3 1/8" size and 1500 KW in 6 1/8" size. Control panel with indicators available for remote or manual control of Andrew switching systems.

**RIGID TRANSMISSION LINES** — Andrew offers a complete selection (1/2" to 9") of 50 ohm transmission lines and accessories. All items are fully compatible with applicable EIA standards.

| CHARACTERISTICS                |      |        |        |        |      |
|--------------------------------|------|--------|--------|--------|------|
| Size                           | 1/2" | 1 1/8" | 3 1/8" | 6 1/8" | 9"   |
| Type No.                       | 560  | 561    | 562A   | 573    | 586  |
| Max. Freq. MHz                 | 3000 | 2700   | 1600   | 750    | 440  |
| Peak Power, kw                 | 43   | 140    | 400    | 1500   | 3000 |
| Weight, pounds per 20 ft. sec. | 13   | 25     | 55     | 135    | 310  |

**DEHYDRATORS**—Type 1920, automatic dehydrator delivers dry air pressure at 5-8 psig with dew point of -37°F, output 1 cfm.

Low pressure dehydrators, dry air hand pumps, regulating and distribution systems, and alarm units are also available.



**CHICAGO\***  
Andrew Corporation  
P.O. Box 807  
Chicago, Illinois, U.S.A. 60642  
Phone: 312-349-3300

**NEW YORK**  
Andrew Corporation  
P.O. Box 416  
Ridgewood, New Jersey, U.S.A. 07451  
Phone: 201-445-2500

**WRITE FOR LATEST ANDREW FULL LINE CATALOG**

**WASHINGTON, D.C.**  
Andrew Corporation  
P.O. Box 5897  
Washington, D.C., U.S.A. 20014  
Phone: 202-654-2540

**DALLAS**  
Andrew Corporation  
P.O. Box 30506  
Dallas, Texas, U.S.A. 75240  
Phone: 214-235-1279

**LOS ANGELES\***  
Andrew California Corporation  
941 E. Maryland Ave.  
Claremont, California, U.S.A. 91711  
Phone: 714-626-3505

**SAN FRANCISCO**  
Andrew California Corporation  
701 Welch Road  
Palo Alto, California, U.S.A. 94304  
Phone: 415-323-3139

\*Plants

**MONTREAL**  
Andrew Antenna Company, Ltd.  
55 Little Rock Avenue  
Pointe Claire, Quebec, Canada  
Phone: 514-695-5365

**VANCOUVER**  
Andrew Antenna Company, Ltd.  
917 Thermal Dr.  
Coquitlam, N.W.  
British Columbia, Canada  
Phone: 604-936-6421

**AUSTRALIA**  
Andrew Antennas Pty. Ltd.  
437 St. Kilda Road  
Melbourne, Victoria, Australia

**EUROPE\***  
Andrew Antenna Systems  
Lochgelly, Fife, Great Britain

**TORONTO, ONTARIO\***  
Andrew Antenna Company, Ltd.  
P.O. Box 177  
Whitby, Ontario, Canada  
Phone: (416) 668-3348  
Toronto phone: (416) 364-4336

# GATES

## quick reference guide to products and coast-to-coast service

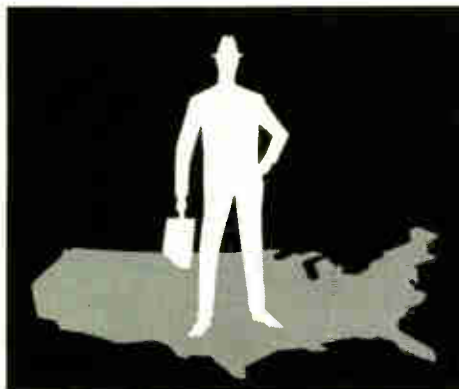

### DISTRICT MANAGERS

Alabama, Birmingham: P.O. Box 20160  
WILLIAM MOATS (205) 822-3625

California, Los Angeles: 1945 S. Figueroa  
EDWARD WILDER (213) 747-7129

California, Sacramento: P.O. Box 1914  
ROBERT STEIGER (916) 446-4470

Colorado, Denver: 8171 Orchard Drive  
HOWARD DEMPSEY (303) 429-5758

District of Columbia  
730 Federal Bldg., 1522 K Street, N.W.  
EDWARD SHUEY and JOHN ANDRE  
(202) 223-5508

Florida, Jacksonville: P.O. Box 8735  
RICHARD SPRUILL (904) 721-2779

Illinois, Glen Ellyn: 22W235 Burdette St.  
CLARENCE MORGAN (312) 469-0847

Illinois, Quincy: 19 Windy Hill  
PAUL TIMPE (217) 223-4701

Iowa, Waterloo: Box 2397, Station A  
STANLEY WHITMAN (319) 233-0561

Michigan, Lambertville: 7169 Burkenhead Place  
THOMAS SCHOONOVER (313) 856-3581

New York, Latham: 11 Ridgecrest  
ROBERT HALLENBECK (518) 785-9144

New York, New York: 800 Second Avenue  
JOE ENGLE (212) 687-7971

Oklahoma, Tulsa: 2719 S. Hudson Avenue  
URLIN WHITMAN (918) 836-4835

Oregon, Boring: Route 2, Box 584A  
LEWIS DENES (503) 658-2684

Pennsylvania, Pittsburgh  
P.O. Box 11772, Mt. Lebanon  
NEIL ARVESCHOUG (412) 343-4860

Puerto Rico, Rio Piedras: P.O. Box 89  
RAFAEL ACOSTA

Texas, Houston: 4019 Richmond Avenue  
LONDON ENGLAND (713) 666-4333

Texas, Houston: 4019 Richmond Avenue  
JOE WOODS (713) 666-4333

Virginia, Halifax: P.O. Box 246  
JOE COLE (703) 476-4514

Washington, D.C.  
730 Federal Bldg., 1522 K Street, N.W.  
WALTON AYER (202) 223-5508

The most complete broadcast equipment line in the industry . . .  
available from two separate stock-carrying service centers:

AM, FM & TV Transmitters  
Amplifiers, Audio, Video, RF  
Antennas & Accessories  
Audio Consoles & Accessories  
Audio Systems & Components  
Automation  
Booms, Microphone  
Cabinets, Racks, Panels  
Cartridge Equipment, Automatic Tape  
Chronometers, Clocks  
Communications Systems  
Consoles, Audio

Discs, Blank Recording  
Filters, RF  
Generators, Engine Driven  
Headsets, Headphones  
Heads, Magnetic Film, Magnetic  
Tape, Disc Recording & Playback  
Jack Panels & Accessories  
Lights & Lighting  
Loud Speakers & Accessories  
Microphones & Accessories  
Mobile Communications  
Monitors, Audio & Video  
Monitors, AM, FM & Phase  
Phasing Equipment  
Power Supplies  
Racks & Cabinets  
Recorders, Audio  
Remote Broadcast Pickup Equipment  
Speakers  
Stands, Microphone  
Switches & Accessories  
Tape, Audio  
Towers, Accessories, Services  
Transcription Equipment  
Transformers  
Transistors  
Transmission Line  
Transmitters, AM, FM, TV, SSB, HF  
Tubes  
Tuning Units, Antenna  
Turntables



**HARRIS**  
**INTERTYPE**  
**CORPORATION**

# GATES

GATES RADIO COMPANY • QUINCY, ILLINOIS 62301, U.S.A.

*A subsidiary of Harris-Intertype Corporation*

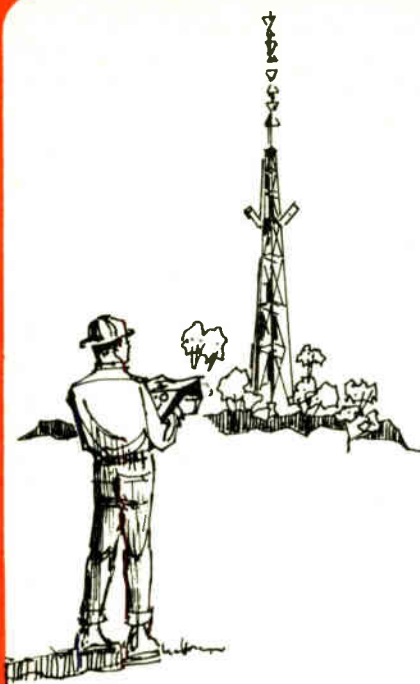

# CONSULTING ENGINEERS

A listing of known consulting engineers and their affiliations.

ADAIR, GEORGE P.  
GEORGE P ADAIR ENGINEERING CO

GEORGE P. ADAIR ENGINEERING CO  
901 TWENTIETH ST., N.W.  
WASHINGTON, D.C. 20006  
202 333-1116

STAFF

JOHN E DETTRA, JR  
MANUEL MAYDBRE, JR.  
WILLIAM J. HARDING  
BRUCE N SMITH

ADCOCK, ANTHONY H.  
INTERTEL, HOYLES, NIBLOCK

AKERMAN, BEN  
2646 SHADY VALLEY DR., NE  
ATLANTA, GEORGIA 30324  
404 261-3125

AMOD, LLOYD R  
188 W BAY BLVD  
PORT HUENEME, CAL 93041  
805 486 6844

ANDERSON, BURTON S.  
ANDERSON RADIO ENGINEERING CO

ANDERSON RADIO ENGINEERING CO  
P O BOX 1671  
GREENVILLE, S. C. 29602  
803 277-2876

ANDRUS, ALVIN H.  
JANSKY & BAILEY

AUGUSTITUS, FRANK G.  
A. D. RING & ASSOC.

BAILEY, STUART L.  
JANSKY & BAILEY

BAKER, JOSEPH  
JANSKY & BAILEY

BAKER, MARVIN C. JR.  
GAUTNEY & JONES

BARGER, TED  
CARL E SMITH CONS. RADIO ENGR

BARGHAUSEN, A. P.  
VIR N. JAMES

BARKLEY & DEXTER LABS, INC.  
50 FRANKFORT STREET  
FITCHBURG, MASS. 01422  
617 DIAMOND 3-3716

PRESIDENT  
JAMES M. MORAN  
STAFF  
LAWRENCE R. DAY  
NORMAN L. RIVERS  
MARTIN W. MYLLYKANGAS  
ERNEST A. CHARRON

ROBERT A. MATHIEU

BARNARD, ALVIN H.  
SINGLETON & BARNARD

BARNWELL, M. J.  
VIR N. JAMES

BARRON, KENNETH E.  
INTERTEL, HOYLES, NIBLOCK

JOHN H. BATTISON  
BOX 1534  
ANNAPOLIS, MD.  
301 263 6860

STAFF

M. HEWITT  
D. SMITH

BEECHER, WILLIS C.  
TRANSLUX BLDG.  
WASHINGTON, D.C. 20005  
202 393-5621

BEGUE, GEORGE P.  
JANSKY & BAILEY

BEHR, LAWRENCE PRESIDENT  
LAWRENCE BEHR ASSOCIATES, INC

LAWRENCE BEHR ASSOCIATES, INC.  
2501 EAST FOURTH STREET  
GREENVILLE, N. C. 27834

919 758-3966 OR 752-4971

PRESIDENT

LAWRENCE BEHR

VICE PRESIDENT

CARL V. VENTERS

VICE PRESIDENT

JASPER L. TRIPP JR.

E. E. BENHAM & ASSOC.

3141 CAMUENGA BLVD.  
W. HOLLYWOOD, CALIF. 90028  
213 466-3227

BENNETT, STANTON D  
C/O FIELD EMISSION CORP  
611 E THIRD ST  
MCMINNVILLE, ORE 97128  
472 5101

BENNS, WILLIAM E. JR.  
111 RICHARDSON STREET  
LOOKOUT MOUNTAIN, TENN. 37350  
615 821-3555

BERGEN, SERGE  
10828 FAIRCHESTER DRIVE  
FAIRFAX, VA. 22030  
703 273-2191

BERNARD ASSOC.  
237 E. 39TH STREET

NEW YORK, N.Y. 10016  
212 MURRAY HILL 6-7445  
SENIOR PARTNER  
BERNARD EICHMOLD  
ASSOCIATE  
GERALD C. SHARPE

BIDLACK, CECIL S.  
CARL E SMITH CONS. RADIO ENGR

BIRD, JAMES R.  
936 VIRGINIA DR.  
RID VISTA, CALIF.  
374-5101

ALSO

74 A STREET  
CONCORD, CALIF.  
415 682-7733

BITZER, RALPH J.  
ARCADE BLDG.  
ST. LOUIS, MO. 63101  
314 GARFIELD 1-4954

STAFF

HARVEY DAY  
THEODORE A. GILES

BLANCHARD, ROBERT R.  
BROADCAST ENGINEERING SERVICE

BLANTON, K. G.  
A. EARL CULLUM JR.

BLUMBERG, MARVIN  
A. D. RING & ASSOC.

BOLOTIN, FREDERICK D.  
CARL E SMITH CONS. RADIO ENGR

BOND, CLYDE H  
BOND & OAKLEY

BOND & OAKLEY  
P O BOX 2899  
RENO, NEV 89505  
322 9145

ASSOCIATES  
CLYDE H BOND  
RON OAKLEY

BOWEN, L. W.  
VIR N. JAMES

BRATTON, WILLIAM F JR  
DAVID STEEL & ASSOC

BRAUN, CYRIL M.  
14628 CLAUDE LANE  
SILVER SPRINGS, MD. 20904  
301 384-1529

BRAUN, WARREN 6  
680 NEW YORK AVE

HARRISONBURG, VA 22801  
703 434 4331

CHARLES E. BRENNAN  
405 E. LINCOLN AVE.  
MILWAUKEE, WIS. 53207  
ASSOCIATES

E. RAY COOKE  
PAUL E. LE SAGE  
RALPH E. EVANS

BRIDGES, LOREN F.  
CARL E SMITH CONS. RADIO ENGR

BROADCAST ENGINEERING SERVICE  
490 CARR STREET  
LAKEWOOD 26, COLO.  
303 237-5968

STAFF

ROBERT R. BLANCHARD

BROWNE ASSOCIATES  
TELECOMMUNICATIONS CONS  
642 NORTH WOODWARD AVE  
BIRMINGHAM, MICH 48011

JOHN F X BROWNE  
BROWNE ASSOCIATES

CAPPERS, WILLIAM F. JR.  
KEAR & KENNEDY

CARNES, FRANCES  
L. H. CARR & ASSOC.

CARR, WILLIAM B.  
4910 BLANEY AVE.  
FORT WORTH, TEX.  
817 BUTLER 1-1551

STAFF

LOUISE SESSIONS

CAVEGN, AMBROSE J.  
KEAR & KENNEDY

CHAMBERS, G RUSSELL  
414 FRENCH ST  
WILMINGTON, DEL 19801

OL 8 7127

STAFF  
ALBERT H SMITH

CHARRON, ERNEST A.  
BARKLEY & DEXTER LABS., INC.

CHIPP, RODNEY D.  
RODNEY D CHIPP & ASSOCIATES

RODNEY D CHIPP & ASSOCIATES  
15 WARD STREET  
BLOOMFIELD, N.J.  
201 748 0777

CMUFO, ROBERT  
CARL E. SMITH

CHURCHILL, DANIEL W.  
14 LEWIS STREET  
SPRINGFIELD, VT.  
802 885-2950

CICCORICCO, FRANCIS A.  
169 NORTH WEST STREET  
HOMER, N.Y.  
607 PIONEER 9-4400

COBB, MARIANNA WOODSON  
3849 N. 30TH STREET  
ARLINGTON, VA. 22207  
703 JACKSON 7-7410

COHEN, JULES  
JULES COHEN & ASSOC.

JULES COHEN & ASSOC.  
729-15TH STREET, NW  
WASHINGTON, D.C. 20005  
202 EXECUTIVE 3-4616  
PARTNERS  
JULES COHEN  
PAUL L. WIMMER  
BERNARD R. SEGAL  
ASSOCIATES  
WILLIAM C. KING JR.  
ALBERT F. CRIOER  
EDWARD A. KMOSENA

COHEN, JULIUS  
GEORGE C. DAVIS CONS. ENGR.

COLL, EDWARD T.  
CARL E SMITH CONS. RADIO ENGR

COLLIGAN, FRANCIS S.  
JOHN H. MULLANEY & ASSOC.

COMMERCIAL RADIO EQUIPMENT CO.  
1334 G STREET, NW  
WASHINGTON, D.C. 20005  
202 DISTRICT 7-1319  
GENERAL MANAGER  
EVERETT L. OILLARD  
ENGINEERING MANAGER  
EDWARD F. LORENTZ  
STAFF  
THOMAS J. ENGLISH  
ROBERT GEMMAN  
EARL JUDY

COOKE, E. RAY  
CHARLES E. BRENNAN ENGINEERS

CREUTZ, JOHN  
CREUTZ & SNOWBERGER

CREUTZ & SNOWBERGER  
724 14TH STREET, NW  
WASHINGTON, D.C. 20005  
202 EXECUTIVE 3-5670  
PARTNERS  
JOHN CREUTZ  
ARTHUR A. SNOWBERGER  
ENGINEER  
CHARLES SMITH

CRIOER, ALBERT F.  
JULES COHEN & ASSOC.

CROSBY, MURRAY G.  
93 MUTTONTOWN RD.  
SYOSSETT, L. I., N.Y. 11791  
516 WALNUT 1-6234

CROSS, JOHN S.  
5416 AUDUBON RD  
BETHESDA, MD 20014  
OL 2 7817

CROY, JAMES R.  
314 TRANS LUX BLDG  
WASHINGTON, D C 20005  
737 1210

CUELLAR, OSCAR LEON  
207 PIMA BLDG.  
TUCSON, ARIZ. 85701  
602 623-1121

A. EARL CULLUM JR.  
INWOOD POST OFFICE  
OALLAS, TEXAS 75209  
214 631-8360  
PARTNERS  
D. A. PETERSON  
T. A. WRIGHT  
C. M. DANIELL  
ASSOCIATES  
DEWOLF SCHATZEL  
L. F. HEITHECKER  
K. G. BLANTON

CULVER, RONALD H.  
LOHNS & CULVER

DAHLBERG, ELIZABETH L.  
LOHNS & CULVER

DANIELL, C. M.  
A. EARL CULLUM JR.

DAVEY, B. P.  
VIR N. JAMES

DAVIS, GEORGE C.  
GEORGE C. DAVIS CONSULTING ENGR

527 MUNSEY BLDG.  
WASHINGTON, D.C. 20001  
202 STERLING 3-0111  
PARTNERS  
GEORGE C. DAVIS  
WALTER L. DAVIS  
JULIUS COHEN  
RALPH E. DIPPELL JR.

DAVIS, WALTER L.  
GEORGE C. DAVIS CONS. ENGR.

DAY, HARVEY  
BITZER, RALPH J

DAY, LAWRENCE R.  
BARKLEY & DEXTER LABS., INC.

DEETERS, EDWARD W.  
WILLIAM L. FOSS INC.

DELAWDER, DOUGLAS B.  
SILLIMAN, MOFFET & KOWALSKI

DE SANTIS, ROBERT V.  
JANSKY & BAILEY

DETTA, JOHN E JR  
GEORGE P ADAIR ENGINEERING CO

DICKINSON, WILLIAM T.  
JANSKY & BAILEY

DIGRUTOLO, RODNEY L.  
SILLIMAN, MOFFET & KOWALSKI

DILLARD, EVERETT L.  
COMMERCIAL RADIO EQUIPMENT CO

DILTS, FREDERICK W.  
HAMMETT & EDISON

DIPPELL, RALPH E. JR.  
GEORGE C. DAVIS CONS. ENGR.

DORDAL, RAYMOND  
A. O. RING & ASSOC.

OUNCAN, R. S.  
JAMES C. McNARY

OU TREIL, L. J. N.  
L. J. N. DU TREIL & ASSOC.

L. J. N. DU TREIL & ASSOC.  
10044 GAIL CT.  
NEW ORLEANS 23, LA.  
504 721-2661  
VICE PRESIDENT  
L. J. N. DU TREIL

OU TREIL, LOUIS E.  
JOHN H. MULLANEY & ASSOC.

EATOUGH, CHARLES O.  
HAMMETT & EDISON

EDISON, EDWARD  
HAMMETT & EDISON

EICHWALD, BERNARD  
BERNARD ASSOC.

EMPRESAS ELECTRONICAS  
WALSER INC  
WALSER INC  
APARTADO 1005  
SAN JUAN, PUERTO RICO  
722 9970

ENGLISH, THOMAS J.  
COMMERCIAL RADIO EQUIPMENT CO

ENSTROM, HOWARD L  
JONES, ROBERT A

ESPY, OAWKINS  
BOX 3127 OLYMPIC STATION  
BEVERLY HILLS, CAL 90212  
BR 2 3344

EVANS, RALPH E.  
CHARLES E. BRENNAN

EVANS, R. N. PETER  
INTERTEL, HOYLES, NIBLOCK

FEIKERT, GRANT S.  
321 N. TWENTY-THIRD STREET  
CORVALLIS, ORE.  
503 753-7541

FLEET, JOHN H.  
JOHN H. MULLANEY

FLOM, MORTON  
5814 HUDSON AVE  
MONTREAL 29, QUEBEC  
514 484 4883

FM UNLIMITED INC.  
5449 AUGUSTA BLVD.  
CHICAGO, ILL. 60651  
312 379-7557  
PRESIDENT  
CHARLES KLINE

FORD, M. H.  
VIR N. JAMES

FORD, PAUL DEAN  
R R 2, BOX 50  
W. TERRE HAUTE, IND. 47885  
812 DREXEL 8903

FORO, WILLIAM E.  
PETE JOHNSON CONSULTING ENGR.

WILLIAM L. FOSS INC.  
927 15TH STREET, NW  
WASHINGTON 5, D. C.  
REPUBLIC 7-3883  
PRESIDENT  
EDWARD W. DEETERS

FRAZER, EDWARD J.  
INTERTEL, HOYLES, NIBLOCK

FRESE, GEORGE M.  
1011 DENIS AVE.  
EAST WENATCHEE, WASH. 98802  
509 TURNER 4-4558

FREY, A ALBERT  
ROBERT A JONES

FRIEDMAN, THOMAS B.  
209 QUADRO VECCHIO DRIVE  
PACIFIC PALISADES, CAL 90272  
213 454-2837

FULLER, O. C.  
VIR JAMES

GALL, FREDERICK  
INTERTEL, HOYLES, NIBLOCK

GALLAGHER, CHARLES I.  
GAUTNEY & JONES

GARLAND, GLADYS  
LOUIS A. KING

GAUTNEY, GEORGE E.  
GAUTNEY & JONES

GAUTNEY & JONES  
930 WARNER BLDG.  
WASHINGTON, D.C. 20004  
202 NATIONAL 8-7757  
PARTNERS  
GEORGE E. GAUTNEY  
CARL T. JONES  
STAFF  
MARVIN C. BAKER JR.  
MELVIN E. LAWSON  
HERMAN E. HURST JR.  
THOMAS L. GREEN  
GEORGE L. MORGAN JR.  
CHARLES I. GALLAGHER

GEMMAN, ROBERT  
COMMERCIAL RADIO EQUIPMENT CO

GILES, THEODORE A.  
RALPH J. BITZER

GODLEY, PAUL F.  
PAUL GODLEY CO.

GODLEY, PAUL F. JR.  
PAUL GODLEY CO.

GOLDBERG, BARNETT F  
1138 BULL ST  
COLUMBIA, S C 29201  
803 253 B347

GRADICK, L. E.  
VAN NOSTRAND RADIO ENGR SERV

GRAY, CLAUDE M.  
BOX 602  
BIRMINGHAM, ALA. 35201  
205 TREMONT 1-3570

GREELY, C. E.  
JANSKY & BAILEY INC.

GREEN, THOMAS L.  
GAUTNEY & JONES

GREER, PALMER A.  
ROUTE 1, WHITE HORSE RD.  
GREENVILLE, S. C. 29611  
803 246-3401

GURECKIS, PETER V.  
JOHN H. MULLANEY & ASSOC.

GUY, RAYMOND F.  
2320 N.E. 34TH COURT  
LIGHTHOUSE POINT, FLA.

HAGERTY, WILLIAM H.  
741 FOOTHILL DRIVE  
SAN MATEO, CALIF. 94402  
415 341-2459

HALL, FLOYD  
P O BOX 1017  
CRESTLINE, CALIF. 92325  
5852

HAMMETT & EDISON  
BOX 68, INTL. AIRPORT  
SAN FRANCISCO, CALIF. 94128  
415 342-5208  
PARTNERS  
ROBERT L. HAMMETT  
EDWARD EDISON  
STAFF

CHARLES D. EATOUGH  
LAWRENCE W. TEMPLETON  
FREDERICK W. DILTS

HAMMETT, ROBERT L.  
HAMMETT & EDISON

HARDING, WILLIAM J.  
GEORGE P ADAIR ENGINEERING CO

HARPER, ERNEST E  
3414 CHUCKANUT SHORE RD  
BELLINGHAM, WASHINGTON 98225  
RE 3 4198

HASKETT, JOHN D.  
HASKETT & VOLKMAN

HASKETT & VOLKMAN  
7265 MEMORY LANE  
CINCINNATI, OHIO 45239  
513 931-0307  
PARTNERS  
JOHN D. HASKETT  
DONALD F. VOLKMAN

HATFIELD, J. B.  
906 36TH AVENUE  
SEATTLE, WASH.  
206 EAST 4-7860

HAY, JAMES  
LOUIS A. KING

HEAD, HOWARD T.  
A. O. RING & ASSOC.

HEFFELFINGER, J. B.  
9208 WYOMING PL.  
KANSAS CITY, MO. 64114  
816 HILAND 4-7010

HEITHECKER, L. F.  
A. EARL CULLUM JR.

HEWITT, M.  
JOHN H. BATTISON

HOGAN FAXIMILE CORP.  
8600 BELLANCA AVENUE  
LOS ANGELES, CALIF. 90045

HOGAN, JOHN V.  
HOGAN FAXIMILE CORP.

HOLEY, W. J.  
1146 BRIARCLIFF PLACE, NE  
ATLANTA, GA. 30306  
404 TRINITY 4-3328

HOWARD, GEORGE P.  
JOHN H. MULLANEY & ASSOC.

HOYLES, HERBERT A.  
INTERTEL, HOYLES, NIBLOCK

HURST, HERMAN E. JR.  
GAUTNEY & JONES

HUTCHESON, GUY C.  
1100 W ABRAM ST., BOX 808  
ARLINGTON, TEX. 76011  
817 CRESTVIEW 4-8721

HUTTON, WILLIAM G.  
CARL E SMITH CONS RADIO ENGR

INTERTEL, HOYLES, NIBLOCK  
1331 THIRD AVENUE  
SEATTLE, WASH.  
206 623-6836  
CANADIAN OFFICES  
1234 MARINE DR.  
NORTH VANCOUVER, B.C.  
604 985-3136  
298 ELGIN STREET  
OTTAWA, ONTARIO  
613 236-0864  
PARTNERS  
HERT A. HOYLES  
R. N. PETER EVANS  
PETER A. NIBLOCK  
DR. HANS J. VON BAEYER  
FREDERICK GALL  
ASSOCIATES  
JOHN F. LEGG  
EDWARD J. FRAZER  
KENNETH E. BARRON  
DR. HOWARD TREMAINE  
TAK NEGORO  
ROBERT A. STRANCHAN  
H. GRANT MCCORMICK  
ANTHONY H. ADCOCK  
M. R. SMYTHE

ISBERG, R. A.  
1215 HENRY ST.  
BERKELEY, CALIF. 94709  
415 526-1446

JACKER, EDWARD W.  
420 S. CHASE STREET  
LOMBARD, ILL. 60148  
312 629-0942

JAMES, VIR N.  
345 COLORADO BLVD.  
DENVER, COLO. 80206  
303 333-5562  
ASSOCIATES  
A. P. BARGHAUSEN  
L. W. BOWER  
B. P. OAVEY  
M. J. BARNWELL  
C. J. NYSTROM  
O. C. FULLER  
P. H. PARMELEE

M. W. OWEN  
M. H. FORD  
S. R. MILSTEN

JANSKY & BAILEY  
DEPARTMENTS OF  
ATLANTIC RESEARCH CORP  
1812 K ST NW  
WASHINGTON, D C 20006  
202 296 6400  
CONSULTANT  
C. M. JANSKY JR.  
PRESIDENT  
STUART L. BAILEY  
VICE PRESIDENT  
DELMER C. PORTS  
BROADCAST-TELEVISION DEPT  
HEAD  
OSCAR REED JR.  
STAFF ENGINEERS  
ALVIN H. ANORUS  
JOSEPH BAKER  
GEORGE P. BEGUE  
ROBERT V. DESANTIS  
JEREMY F. PARKER  
ROGER E. PETERSON  
WILLIAM V. WEAKLEY  
SYSTEMS DEPARTMENT  
HEAD  
JOHN J. RENNER

JANSKY, C. M. JR.  
JANSKY & BAILEY

JOHNSON, EARL M. -PETE  
PETE JOHNSON CONSULTING ENGR.

PETE JOHNSON CONSULTING ENGRS.  
4112 MACCORKLE AVE., SE  
CHARLESTON, W. VA.  
304 DICKENS 2-6261  
STAFF  
EARL M. -PETE- JOHNSON  
WILLIAM E. FORD  
DONALD E. PAULEY

JONES, CARL T.  
GAUTNEY & JONES

JONES, ROBERT A.  
72 S. LAGRANGE RD.  
LAGRANGE, ILL. 60525  
312 352-2275  
ASSOCIATES  
HOWARD L. ENSTROM  
DONALD L. MARKELY  
STAFF  
A. ALBERT FREY

JUDY, EARL  
COMMERCIAL RADIO EQUIP CO

KAUFMAN, CARSON W.  
PAUL GODLEY CO.

KEAN, WALTER F.  
19 E. QUINCY ST.  
RIVERSIDE, ILL. 60546  
312 HICKORY 7-2401  
ASSOCIATES  
GEORGE M. SKLOM  
RONALD M. STEPHENS

KEAR, DR. FRANK G.  
KEAR & KENNEDY

KEAR & KENNEDY  
1302 18TH STREET, NW  
WASHINGTON, D.C. 20036  
202 483-9000  
PARTNERS  
DR. FRANK G. KEAR  
ROBERT E. L. KENNEDY  
SENIOR STAFF ENGINEER  
WILLIAM F. CAPPERS JR  
STAFF  
MRS. EILEEN LATROBE-BATEMAN  
AMBROSE J. CAVEGN  
NEIL M. SMITH  
JOHN L. SADLER

KEEL, JOHN J.  
1121 E. CAPITOL ST.  
WASHINGTON, D.C. 20003  
202 544-7943

KEMMAN, JAMES H.  
SILLIMAN, MOFFET & KOWALSKI

KENNEDY, ROBERT E. L.  
KEAR & KENNEDY

KERSHNER, STEPHEN W.  
KERSHNER & WRIGHT

KERSHNER & WRIGHT  
4206 WHEELER AVE.  
ALEXANDRIA, VA. 22304  
549-4633  
PARTNERS

STEPHEN W. KERSHNER  
CHARLES S. WRIGHT

KING, LOUIS A.  
801 ENGLISH ST.  
BRISTOL, TENN. 37621  
615 SOUTH 4-3141  
ASSOCIATES  
EARL TOLLIVER  
BOYO WRIGHT  
GLADYS GARLAND

KING, WILLIAM C. JR.  
JULES COHEN & ASSOC.

KIRKSEY, T. W.  
BOX 8068

MINNEAPOLIS, MINN. 55416  
612 939-7131

KLINE, CHARLES  
FM LIMITED INC.

KMOSEMA, EDWARD A.  
JULES COHEN & ASSOC.

KORONKA, STEPHEN  
MSI INC

KOWALSKI, CARL L.  
SILLIMAN, MOFFET & KOWALSKI

KRAMER, A. W.  
DE FUNIAK SPRINGS, FLA.  
305 TW 4-8041

ALSO  
WASHINGTON, D.C.  
202 REPUBLIC 7-8154

LAPPAS, FRANK  
LAPPAS & LINDBERG

LAPPAS & LINDBERG CO.  
141 W. JACKSON  
CHICAGO, ILL. 60604  
312 WABASH 2-1123  
FRANK LAPPAS

LATROBE-BATEMAN, F.  
KEAR & KENNEDY

LAUTZ, ROBERT F.  
A. D. KING & ASSOC.

LAWRENCE, JAMES F. JR.  
308 MONTEREY RD.  
S. PASADENA, CALIF.

LAWSON, MELVIN E.  
GAUTNEY & JONES

LEAPLEY, GRETCHEN H  
SILLIMAN, MOFFET & KOWALSKI

LEOFORD, DONALD F.  
A. D. KING & ASSOC.

LEE, PAUL H.  
5209 BANGOR DR.  
KENSINGTON, MD.  
201 WHITEHALL 6-7238

LEE, WILLIAM P.  
WLAK ELECTRONIC SERVICE INC.

LEGG, JOHN F.  
HOYLES, NIBLOCK & ASSOC.

LE SAGE, PAUL E.  
CHARLES E. BRENNAN ENGINEERS

LEGG, JOHN F.  
INTERTEL, HOYLES, NIBLOCK

LITTLEFIELD, J. G.  
PAUL GOOLEY CO.

LOHNES & CULVER  
MUNSEY BLDG.  
WASHINGTON, D.C. 20004  
202 DISTRICT 7-8215

PARTNERS  
GEORGE M. LOHNES  
RONALD H. CULVER  
ENGINEERS  
LAVERNE M. POAST  
ELIZABETH L. DAHLBERG  
ASSOCIATES  
FRED O. VEIHMEYER  
GEORGE A. POWSTENKO

LOHNES, GEORGE M.  
LOHNES & CULVER

LORENTZ, EDWARD F.  
COMMERCIAL RADIO EQUIPMENT CO

LUBCKE, HARRY E.  
2443 CRESTON WAY  
HOLLYWOOD, CALIF. 90028  
213 HOLLYWOOD 9-3266

LYNCH, CECIL  
2460 ILLINOIS AVE.  
MODESTO, CALIF. 95351  
209 523-3955

MALARKEY, TAYLOR & ASSOC  
1101 17TH ST NW  
WASHINGTON, D C 20036  
223 2345

MARKELY, DONALD L  
ROBERT A. JONES

MATHIEU, ROBERT A.  
BARKLEY & OEXTER LABS., INC.

MATISANS, DONALD  
OAVID STEEL & ASSOC

MATSON, WALLY  
REGAL ENGINEERING CO

MAY, RUSSELL P.  
711 14TH ST., NW  
WASHINGTON, D.C. 20005  
202 REPUBLIC 7-3984

MAYOBRE, MANUEL JR.  
GEORGE P. ADAIR ENGINEERING CO

WINFIELD SCOTT MCCrackEN  
ASSOCIATES  
2404 COLUMBIA PIKE

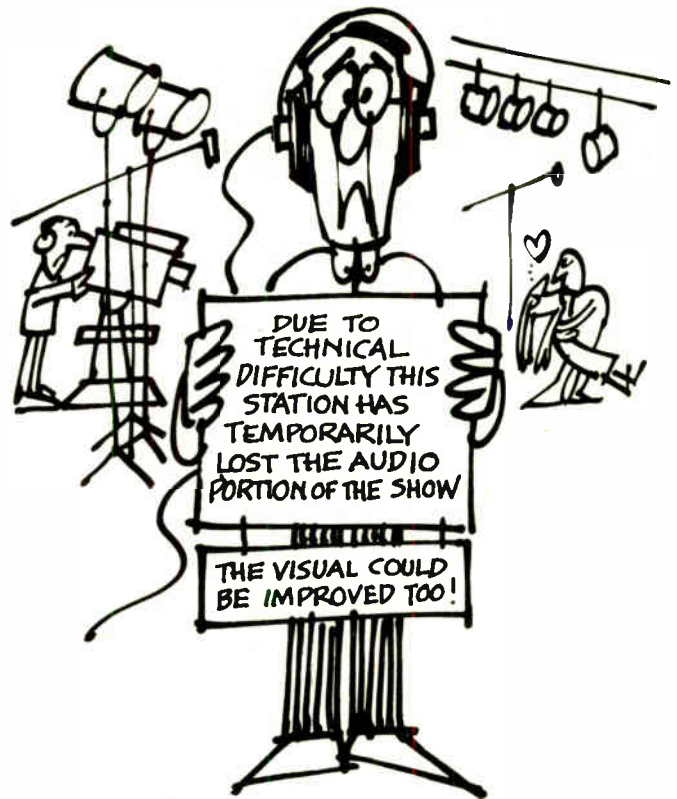

## If you're keeping your AM, FM, and TV signals all to yourself... something's wrong!

When you need help, count on RCA Service Company, geared through experience to broadcasting's special needs for maintenance of complex station equipment. Getting the signal to your audience requires equipment in top condition. RCA Broadcast Service sees to that. With a background unmatched in the industry for this kind of work, RCA offers broadcasters protection they can count on—a contract or per call basis.

Check some of the services available:

Camera Chains  
Video Tape Recorder Service  
TV Camera and Transmitter  
Overhaul  
Installation Supervision  
Microphone and Pickup Repairs  
Transmitter Performance  
Measurements

Antenna Inspection  
Measurements  
Console Repairs  
Microwave Service  
TV Projector Service  
Custom Fabrication  
Teletypewriter Maintenance

To protect performance of your equipment, call our field office near you! Or contact Broadcast Service, RCA Service Company, Bldg. 203-1, Camden, N. J. 08101.



The Most Trusted Name in Electronics

ARLINGTON 4, VA.  
703 JACKSON 8-8000

MCCORMICK, H. GRANT  
INTERTEL, HOYLES, NIBLOCK

FRANK H. MCINTOSH & ASSOC.  
4912 CORDELL AVENUE  
WASHINGTON, D.C. 20014  
202 652-4477

ALSO  
MCINTOSH LABORATORY INC.  
2 CHAMBERS STREET  
BINGHAMTON, N.Y.  
RA 3-5491

MCKENNA, JOHN R.  
JOHN H. MULLANEY & ASSOC.

MCNARY, JAMES C.  
NATIONAL PRESS BLDG.  
WASHINGTON, D.C. 20004  
202 DISTRICT 7-1205  
STAFF  
R. S. DUNCAN

MIDDLEBROOKS, JAMES L.  
1244 EUCALYPTUS AVENUE  
VISTA, CALIF.

MILSTEN, S. R.  
VIR M. JAMES

MITCHELL, FRANK T. JR.  
JANSKY & BAILEY

MITCHUM, MARTIN M.  
P D BOX 89  
ROLLA, MO.  
314 364-1533

MOBLEY, MAL JR.  
BROADCAST ENGR. SERVICES  
BOX 235  
NORTHBRIDGE, CALIF.  
EMPIRE 3-6869

MOFFET, JOHN A.  
SILLIMAN, MOFFET & KOWALSKI

MORAN, JAMES M., PRESIDENT  
BARKLEY & DEXTER LABS., INC.

MORGAN, GEORGE L. JR.  
GAUTNEY & JONES

MORRISSEY, T. G.  
164D BOULDER STREET  
DENVER, COLO. 80211  
303 GHAND 7-6265

MOSTROM, ROBERT A.  
CARL E SMITH CONS. RADIO ENGR

MSI INC  
ROUTE 46 & CISCO RD  
DENVER, CO 80239  
201 627 7400  
PRESIDENT  
VICTOR J NEXON  
CHIEF ENGINEER  
GEORGE H PHELPS  
STAFF ENGINEER  
STEPHEN KORONKA

MULLANEY, JOHN H.  
JOHN H. MULLANEY & ASSOC.

JOHN H. MULLANEY & ASSOC.  
DIVISION OF MULTITRONICS INC.  
5712 FREDERICK AVENUE  
ROCKVILLE, MD. 20852  
301 427-6666  
PRESIDENT  
JOHN H. MULLANEY  
VICE PRESIDENT  
PETER V. GURECKIS  
STAFF ENGINEERS  
JOHN R. MCKENNA  
LOUIS R. DUTREIL  
FRANCIS S. COLLIGAN  
GEORGE P. HOWARD  
JAMES F. PINKHAM

MUNN, E. HAROLD JR.  
57 EDISON COURT, BOX 220  
COLDWATER, MICH. 49036  
517 278-6793  
ASSOCIATES  
E. H. MUNN, JR.  
LEWIS E. MUNN  
VIRGIL ROYER

MUNN, E. H. JR.  
E. HAROLD MUNN, JR.

MUNN, LEWIS E.  
E. HAROLD MUNN JR.

MUSSELMAN, JOHN  
CARL E SMITH CONS. RADIO ENGR

MYLLYKAGAS, MARTIN W.  
BARKLEY & DEXTER LABS., INC.

MYSE, DARYAL A  
12TH FLOOR 1815 H ST NW  
WASHINGTON, D.C. 20006  
202 REPUBLIC 7-4926

NEGORO, TAK  
INTERTEL, HOYLES, NIBLOCK

NEXON, VICTOR J  
MSI INC

NIBLOCK, PETER A.  
INTERTEL, HOYLES, NIBLOCK

NYSTROM, C. J.  
VIR M. JAMES

OAKLEY, ROM  
BOND & OAKLEY  
OAKLEY, ROM  
445 CRUMMER LANE  
RENO, NEV.  
702 322-7538  
STAFF  
CYLDE H. BOND

ONEILL, BRIAN  
HOYLES, NIBLOCK & ASSOC.

OWEN, M. W.  
VIR M. JAMES

PARKER, JERMY F.  
JANSKY & BAILEY

PARMELEE, P. H.  
VIR M. JAMES

PAULEY, DONALD E.  
PETE JOHNSON CONSULTING ENGR.

PETERSON, D. A.  
A. EARL CULLUM JR.

PETERSON, ROGER E.  
JANSKY & BAILEY

PHELPS, GEORGE H  
MSI INC

PINKHAM, JAMES F.  
JAMES H. MULLANEY & ASSOC.

PDAST, LAVERNE M.  
LOHNES & CULVER

PORTS, DELMER C.  
JANSKY & BAILEY

PDWSTENKO, GEORGE A.  
LOHNES & CULVER

PURCELL, ROBERT L.  
RAYMOND E. ROHRER & ASSOC.

REED, OSCAR W. B. JR.  
JANSKY & BAILEY

REGAL ENGINEERING CO  
1395 SW CARDINELL DR  
PORTLAND, ORE 97201  
223 2443

RENNER, JOHN J.  
JANSKY & BAILEY

RICHARDSON, CLAIRE  
L. H. CARR & ASSOC.

WILLIAM E. RICHARDSON & ASSOC.  
1017 S.W. WASHINGTON  
PORTLAND, ORE.  
503 CAPITOL 8-7777

A. D. RING & ASSOC.  
1710 H STREET, NW  
WASHINGTON, D.C. 20006  
202 298-6850  
PARTNERS  
ANDREW D. RING  
HOWARD T. HEAD  
NARVIN BLUMBERG  
ASSOCIATES  
DONALD F. LEDFORD  
JOSEPH W. STIELPER  
RAYMOND DORDAL  
ROBERT F. LAUTZ  
FRANK G. AUGUSTITUS

RING, ANOREW D.  
A. D. RING & ASSOC.

RIVERS, NORMAN L.  
BARKLEY & DEXTER LABS., INC.

RAYMOND E. ROHRER & ASSOC.  
436 WYATT BLDG.  
WASHINGTON, D.C. 20005  
202 347-9781  
ASSOCIATES  
ROBERT L. PURCELL  
PAUL K. STEWART  
STAFF  
LILLIAN F. WELLS

ROUNDTREE, J. G.  
P O BOX 9044  
AUSTIN, TEX. 78756  
512 GLENDALE 2-3073

ROYER, VIRGIL  
E. HAROLD MUNN JR.

RUSH, JACK  
HAMMETT & EDISON

SADLER, J. D.  
KEAR & KENNEDY

SAXON, MERL  
622 HOSKINS ST., P O BOX 575  
LUFKIN, TEX. 75902  
713 NEPTUNE 4-9558

SCHAIRER, NEIL J.  
JANSKY & BAILEY

SCHATZEL, DEWOLF  
A. EARL CULLUM JR.

SCHOTTLAND, FREDERIC D.  
6513 WILMETT ROAD  
BETHESDA, MD. 20034  
301 365-0011

SEABROOKE, HARRY  
SILLIMAN, MOFFET & KOWALSKI

SEGAL, BERNARD R.  
JULES COHEN & ASSOC.

SESSIONS, LOUISE  
WILLIAM B. CARR & ASSOCIATES

SHARPE, GERALD C.  
BERNARD ASSOC.

SHARP, MUGENT S.  
1601 COLONIAL TERRACE  
ARLINGTON 9, VA.  
524-0489

SHARPE, GERALD C.  
BERNARD ASSOC.

SILLIMAN, MOFFET & KOWALSKI  
1405 G STREET, NW  
WASHINGTON, D. C. 20005  
202 REPUBLIC 7-6646  
PARTNERS  
ROBERT M. SILLIMAN  
JOHN A. MOFFET  
CARL L. KOWALSKI  
STAFF ENGINEERS  
DOUGLAS B. DELAWDER  
JAMES H. KEMMAN  
GRETCHEN H. LEAPLEY  
HARRY R. SEABOOKIE

SILLIMAN, ROBERT M.  
SILLIMAN, MOFFET & KOWALSKI

SINGLETON & BARNARD  
4646 SW COUNCIL CREST DRIVE  
PORTLAND, ORE. 97201  
503 223-1201, 228-4393 AND  
252-3535

SINGLETON, HAROLD C.  
SINGLETON & BARNARD

SKLON, GEORGE M.  
WALTER F. KEAN

SMITH, ALBERT H.  
CHAMBERS, G. RUSSELL

SMITH, BRUCE M.  
GEORGE P. ADAIR ENGINEERING CO

SMITH, CARL E.  
CARL E SMITH CONS. RADIO ENGR

CARL E. SMITH CONS. RADIO ENGR.  
8200 SNOWVILLE ROAD  
CLEVELAND, OHIO 44141  
216 JACKSON 6-4386  
PARTNERS  
CARL E. SMITH  
WILLIAM G. HUTTON  
CECIL S. BIDLACK  
ROBERT A. MOSTROM  
FREDERICK D. BOLOTIN  
ASSOCIATE  
LOREN F. BRIDGES  
STAFF  
JOHN MUSSELMAN  
H. W. VAN WAGENEN  
EDWARD T. COLL  
ROBERT M. SUBLETT  
TED BARGER

SMITH, CHARLES  
CREUTZ & SNOWBERGER

SMITH, D.  
JOHN H. BATTISON

SMITH, FREDERICK A.  
SEXCHANGE STREET  
CHARLESTON, S.C. 29401  
803 RA 3-1775

SMITH, JOHN W.  
HOGAN FAXIMILE

SMITH, NEIL M.  
KEAR & KENNEDY

SMYTHE, M. J.  
HOYLES, NIBLOCK & ASSOC.

SMYTHE, M. R.  
INTERTEL, HOYLES, NIBLOCK

SNOWBERGER, ARTHUR A.  
CREUTZ & SNOWBERGER

STEED, VERNON H.  
BOX 4742  
RICHMOND, VA.

DAVID STEEL & ASSOC  
2000 P ST NW SUITE 310  
WASHINGTON, D C 20036  
232 1010  
DAVID L STEEL SR  
ASSOCIATE  
STAFF  
DONALD MATISANS  
WILLIAM F BRATTON JR

STEEL, DAVID L SR  
DAVID STEEL & ASSOC

STEPHENS, RONALD M.  
WALTER F. KEAN

STEWART, PAUL K.  
RAYMOND E. ROHRER & ASSOC.

STIELPER, JOSEPH W.  
A. D. RING & ASSOC.

STILES, WALTER J  
SUITE 1623 TUCSON HOUSE  
1501 MIRACLE MILE  
TUCSON, ARIZONA 85705  
602 792 2108

STRACHAN, ROBERT A.  
INTERTEL, HOYLES, NIBLOCK

STRAIN, CHARLES E.  
4556 NORTHSIDE DR., NW  
ATLANTA, GA. 30327  
404 BLACKBURN 5-4556

SUBLETT, ROBERT M.  
CARL E SMITH CONS. RADIO ENGR

TAPP, JAY E.  
T & T RADIO MEASUREMENTS CO

TAYLOR, ARCHER S  
MALARKY, TAYLOR & ASSOC

TEMPLETON, LAWRENCE W.  
HAMMETT & EDISON

TENDICK, CULLEN B.  
912 RODDERICK AVENUE  
DXFORD, CALIF. 93032  
805 483-5243

TOLLIVER, EARL  
LOUIS A. KING

TOWNE, ALFRED E  
A E TOWNE ASSOCIATES INC

ALFRED E. TOWNE ASSOC. INC.  
420 TAYLOR STREET  
SAN FRANCISCO, CALIF. 94102  
415 775-3100

TREMAINE, DR. HOWARD  
INTERTEL, HOYLES, NIBLOCK

TRIPP, JASPER L. JR.  
LAWRENCE BEHR ASSOCIATES

T & T RADIO MEASUREMENTS CO  
2557 ATLANTIC AVENUE  
LONG BEACH 6, CALIF.  
213 GARFIELD 4-2015  
ASSOCIATE  
JAY E. TAPP

VAN NOSTRAND RADIO ENGR SERVICE  
P O BOX 3045  
DECATUR, GA. 30032  
404 241-5551  
ASSOCIATES  
W. L. VAN NOSTRAND  
L. E. GRADICK

VAN NOSTRAND, W. L.  
VAN NOSTRAND RADIO ENGR SERV

VAN WAGENEN, H. W.  
CARL E SMITH CONS. RADIO ENGR

VEIHMEYER, FRED D.  
LOHNES & CULVER

VENTERS, CARL V.  
LAWRENCE BEHR ASSOCIATES

VIEMMEYER, FRED D.  
LOHNES & CULVER

VOLKMAN, DONALD F.  
HASKETT & VOLKMAN

VOLKMAN, DONALD F.  
P O BOX 156  
CENTERVILLE, IND. 47330  
2753

VON BAEYER, DR. MANS J.  
INTERTEL, HOYLES, NIBLOCK

WALSER, ROBERT J  
EMPRESAS ELECTRONICAS

WEAKLEY, WILLIAM C.  
JANSKY & BAILEY

WEBSTER, EDWARD M.  
3133 CONN. AVE., NW  
WASHINGTON, D.C. 20008  
202 232-1523

WELLS, LILLIAN F.  
RAYMOND E. ROHRER & ASSOC.

WHITMARSH, T. F.  
HOGAN FAXIMILE CORP.

WILLIAMS, J. S.  
JULES COHEN

WILLIAMS, KENNETH JR.  
5915 6TH AVE. #14  
TACOMA, WASH. 98406  
206 SK 2-7200

WILLIAMS, MARTIN R.  
7401 EAST 14TH STREET  
INDIANAPOLIS, IND. 46219  
317 FLEETWOOD 6-0388

WILLIAMS, NATHAN  
110 ALGOMA BLVD.  
OSHKOSH, WIS. 54901  
414 235-3590

WIMMER, PAUL L.  
JULES COHEN & ASSOC.

WRATHALL, GRANT R.  
APTOS-SANTA CRUZ-, CAL 95003  
408 MURRAY 8-3352

WRIGHT, BOYD  
LOUIS A. KING

WRIGHT, CHARLES S.  
KERSHNER & WRIGHT

WRIGHT, LOWELL R.  
MUNSEY BLDG.  
WASHINGTON, D.C. 20004  
202 DISTRICT 7-1740

WRIGHT, T. A.  
A. EARL CULLUM JR.



# Spotmaster



**MODEL 505B  
(REPRODUCER)**



**MODEL 500B  
(RECORDER/REPRODUCER)**



**MODEL 500BR (RECORDER/REPRODUCER)**



**MODEL 405A  
(REPRODUCER)**



**MODEL 400A  
(RECORDER/REPRODUCER)**



**MODEL 500BS — STEREO**

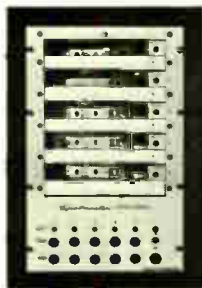

**MODEL 605B  
(REPRODUCER)**

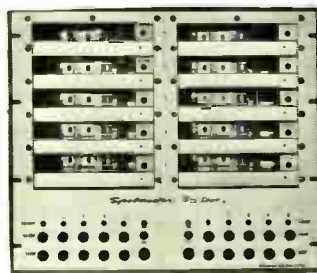

**MODEL 610B  
(REPRODUCER)**

**500/505 Super B SPOTMASTER Series 500 Super B** cartridge equipment is unexcelled in performance and long term proven reliability. Available in models to meet every programming need: record/reproduce, reproduce only—compact or rack mounted. Specifications and performance equal or exceed NAB standards. Features include ease of operation, high reliability, solid state plug-in amplifiers, 1, 2 or 3 automatic electronics cueing tones, separate record and play heads, biased cue recording, hysteresis synchronous motor, selective test meter switch, triple zener controlled power supply, transformer output, feather touch illuminated push button switches and a one year parts and labor guarantee. Prices start at **\$510.00**.

**400A/405A SPOTMASTER Series 400** equipment offers traditional SPOTMASTER performance and reliability for the economy minded station. Don't let their low price fool you. New solid state SPOTMASTER compact models are second-best only to the Super B Series. Offered in record-playback (Model 400) and playback-only (Model 405) versions, the compacts permit even the smallest station to enjoy SPOTMASTER pushbutton broadcasting. Compact units carry a 90-day parts and labor guarantee. Many of the features of the Super B equipment are included in the 400 series. Write for complete details. Prices begin at **\$415.00**.

Stereo SPOTMASTER stereo units are available in four different models. The compact 500B-S (combination record/reproduce); the compact 505B-S (reproduce only); the rack mount 500BR-S (combination record/reproduce); and the rack mount 505BR-S (reproduce only). Stereo equipment is a part of the Super B Series and carries essentially the same specifications. Prices begin at **\$645.00**. Write for complete details.

**Model 610B SPOTMASTER TEN • SPOT (610B) and FIVE • SPOT (605B)** multiple cartridge reproducer units are especially designed for use in broadcast stations, recording studios and other installations requiring the use of multiple cartridges on instant demand. Both units are capable of manual operation or may be incorporated into programmed automation systems making use of one, two or three NAB standard cueing tones. Each cartridge deck is removable from the front of the unit without affecting the operation of the remaining decks. A flywheel loaded common capstan supplies tape motive force, the flywheel in turn being driven by a heavy duty hysteresis synchronous motor. Each reproduce channel is separately equipped with cueing amplifiers and a program amplifier with the output level adjustable to +4 dbm by means of locking type controls. The amplifier power supply is transistorized and zener regulated. Facilities are provided on the rear panel for remote control and for inter connections between channels so as to permit automatic sequencing from channel to channel. All amplifiers are plug-in modular units. Enclosed plug-in relays are used throughout. Prices begin at **\$1750.00**.



**BROADCAST  
ELECTRONICS, INC.**

8810 Brookville Road, Silver Spring, Maryland 20910  
301-588-4983

Write for complete details

Prices subject to change without notice



## AUDIO EQUIPMENT

FOR

BROADCASTING — TELEVISION — RECORDING  
MOTION PICTURE — SOUND REINFORCEMENT

## AUDIO DISTRIBUTORS, INC.

"OFF THE SHELF" DELIVERY ON

TAPE RECORDERS — DUPLICATORS — MICROPHONES — TURNTABLES  
REVERB DEVICES — AMPLIFIERS — ATTENUATORS — EQUALIZERS  
COMPRESSORS — SPEAKER SYSTEMS — BROADCAST CONSOLES  
RECORDING CONSOLES — SOUND REINFORCEMENT EQUIPMENT

**LANGEVIN**      **ALTEC**              **EMT**              **NAGRA**              **SWITCHCRAFT**      **FAIRCHILD**  
**AMPEX**              **MCINTOSH**              **NEUMANN**              **TELEFUNKEN**  
**ATLAS**              **MAGNACORD**              **QRK**              **VIKING**  
**ELECTRO-VOICE**              **3M CO.**              **SPARTA**              **UHER**

## AUDIO DISTRIBUTORS, INC.

616-4520309 2342 SOUTH DIVISION AVE.

GRAND RAPIDS, MICHIGAN 49507

WE BUY - SELL - TRADE

### INDEX TO ADVERTISERS

|   |                 |  |        |  |       |
|---|-----------------|--|--------|--|-------|
| Air Space Devices, Inc.....   | 33              | Dayton Electronic Products Co.....               | 47     | RCA Electronic Components & Devices .....                          | C4    |
| Alford Manufacturing Co.....  | C3              | Dresser—Crane, Hoist & Tower Div.....            | 35     | RCA Service Co.....  | 159   |
| American Electronics Laboratories, Inc. ....                          | 19, 69          | Eimac Div. of Varian Associates.....             | 6, 7   | Revere-Mincom Div., 3M Co.....                                     | 23    |
| Andrew Corp. ....   | 155             | Electronics Missiles & Communications, Inc. .... | 39     | Riker Video Industries, Inc.....                                   | C2, 3 |
| Applied Electro Mechanics, Inc.....                                   | 43              | Electro-Voice, Inc. ....                         | 4      | Rohde & Schwarz.....   | 109   |
| Audio Distributors, Inc. ....   | 162             | Fairchild Recording Equipment Corp.....          | 49     | Sarkes-Tarzian, Inc. ....  | 8     |
| Ball Brothers Research Corp.....                                      | 73              | Gates Radio Co. ....                             | 156    | Scully Recording Instruments Corp.....                             | 113   |
| Belar Electronics Lab.....  | 75              | Gray Research & Development Co.....              | 89     | Shure Brothers, Inc. ....  | 27    |
| Belden Manufacturing Co.....  | 13              | Holland Electronics, Inc.....                    | 95     | Sparta Electronic Corp.....  | 31    |
| Bird Electronic Corp.....   | 45              | Howard W. Sams & Co., Inc.....                   | 51, 61 | Superior Cable Corp. ....  | 127   |
| Broadcast Electronics, Inc.....                                       | 135, 161        | International Nuclear Corp.....                  | 93     | Tapecaster Electronics .....                                       | 117   |
| Catel Co. ....  | 77              | Jampro Antenna Co.....                           | 15, 53 | Tektronix, Inc. ....   | 29    |
| CBS Laboratories, Div. of CBS .....                                   | 10, 11, 66, 131 | Kappa Networks, Inc.....                         | 91     | Telemet Co. ....   | 119   |
| CCA Electronics Corp. ....  | 137             | Magnecord Div. of the Telex Corp.....            | 99     | Teltron, Inc. ....   | 64    |
| Cleveland Electronics, Inc. ....                                      | 79              | Marti Electronics .....                          | 55     | Trepac Corporation of America.....                                 | 121   |
| Cohu Electronics, Inc.....  | 141             | Metrotech, Inc. ....                             | 103    | Triplett Electrical Instrument Co.....                             | 153   |
| Collins Radio Co.....   | 40              | Mid-America Electronics Corp.....                | 101    | Vent-Rak .....   | 145   |
| Continental Electronics, a Subsidiary of LTV Electrosystems, Inc..... | 37              | Miratel Electronics, Inc.....                    | 133    | Visual Electronics Corp. ....                                      | 65    |
| Cooke Engineering Co.....   | 81              | Mosely Associates, Inc.....                      | 57     | Vital Industries .....   | 125   |
| Crown International .....   | 128             | Norelco, Professional Sound Products.....        | 105    | Vitro Electronics, a Division of Vitro Corporation of America..... | 151   |
| Dage Bell Corp., a Subsidiary of Raytheon Co. ....                    | 21              | Norelco, Studio Equipment Division .....         | 16, 17 | Wilkinson Electronics, Inc.....                                    | 149   |
|   |                 | Nortronics Company, Inc.....                     | 25     | Zoomar, Inc. ....  | 143   |

# AMCI BROADCAST EQUIPMENT for VHF and UHF-TV and FM

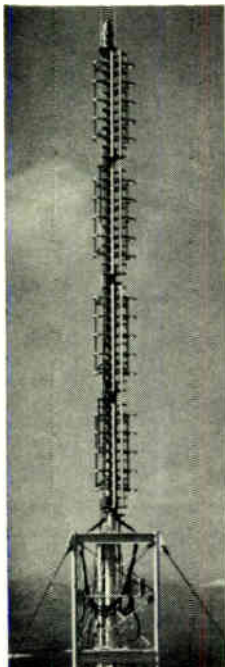

Directional VHF-TV  
Transmitting Antenna

## VHF-TV TRANSMITTING ANTENNAS

*Mast or tower-corner mounted*  
**DIRECTIONAL OR OMNIDIRECTIONAL**  
for Channels 5 to 13

Omnidirectional VHF-TV antennas with power gains up to 20. Directional VHF-TV antennas with power gains up to 36.

## UHF-TV TRANSMITTING ANTENNAS

*Mast, tower-corner, or truss-mounted*  
**DIRECTIONAL OR OMNIDIRECTIONAL**  
for Channels 14 to 83

Omnidirectional UHF-TV antennas with power gains up to 50. Directional UHF-TV antennas with power gains up to 80.

## FM TRANSMITTING ANTENNAS

*Mast or tower-corner mounted*  
**DIRECTIONAL OR OMNIDIRECTIONAL**  
For single or multi-station transmission.

## SPECIAL PURPOSE ANTENNAS

Empire State Building Master FM Antenna: two rows of dipoles around 102nd floor observation level, duplexers within tower, and transmission line, designed, built, and installed in 1965, permit up to 17 FM stations to broadcast simultaneously from the same antenna.

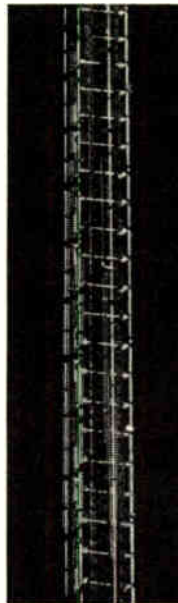

Side-mounted  
VHF-TV Transmitting  
Antenna

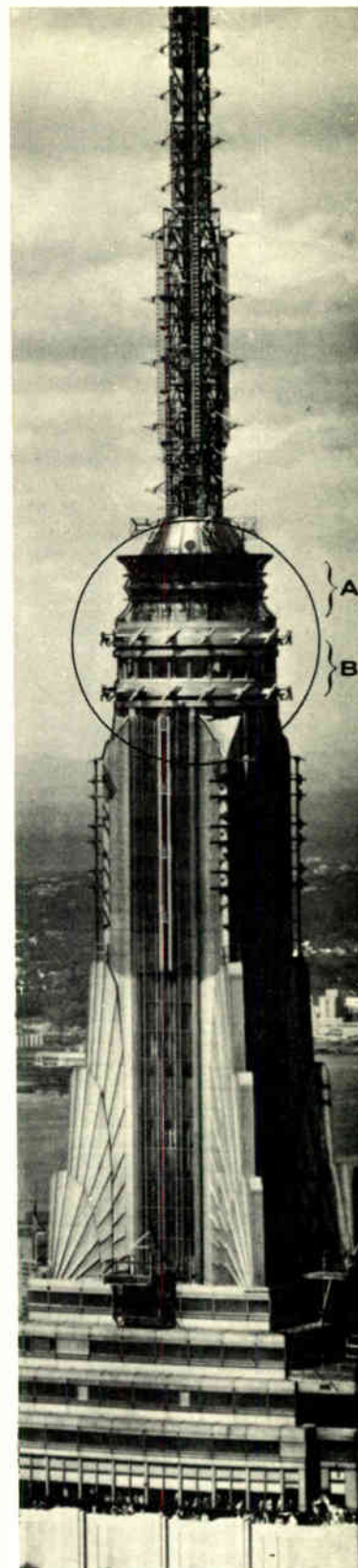

Special-purpose Antennas:  
a) antenna array for WOR-TV channel 9  
b) Empire State Building master FM antenna

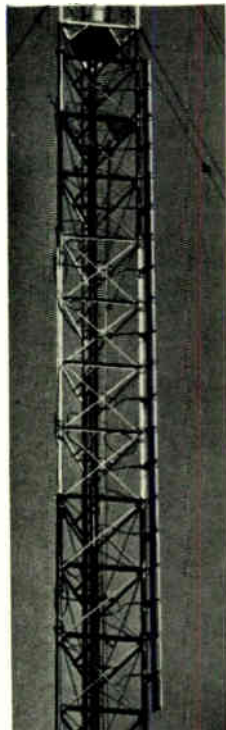

Side-mounted  
UHF-TV Transmitting  
Antenna

## DIPLEXING FILTERS

Temperature compensated. Aural-to-visual and visual-to-aural rejection over 30 db. For use with transmitters up to 50 kw.



## VESTIGIAL SIDE BAND FILTERS

Low insertion loss. Lower sideband of the color subcarrier frequency is attenuated 30 db. or more.

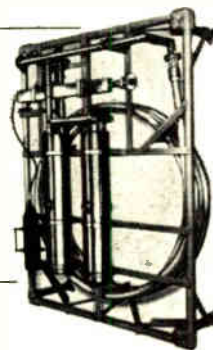

## COAXIAL SWITCHES

For 6 1/8" or 3 1/8", coaxial transmission lines. SWR over a specified 100 mc band under 1.03, high peak power models under 1.06 over a specified 50 mc band. CW power rating equal to the mating transmission line.



## OTHER PRODUCTS

- Standby Antennas
- Hybrids
- Impedance and Transfer Characteristic Plotters
- Dipoles
- Transfer Panels
- Variable Calibrated Attenuators
- Power Dividers
- RF Terminations
- Slotted Lines



# ALFORD MANUFACTURING COMPANY

120 Cross St., Winchester (Greater Boston), Mass. 01890

Telephone: 617-729-8050

TWX: 710-348-1063

Cable Address: AMCIBOS

World Radio History

**Announcing...**  
**for color and**  
**black and white,**  
**the new family of**  
**RCA image orthicons**  
**with a *big difference here***  
**that *shows up big here***

Now RCA brings you the "BIALKALI PHOTOCATHODE" in the new RCA-8673 and -8674 Image Orthicons. This major engineering innovation has greatly improved compatibility with its non-stick target, maintaining resolution and sensitivity over an extended tube lifetime and improving performance of *existing* color or black-and-white cameras. A simple change in a resistor chain provides proper voltages for a trio of these new Bialkali Photocathode Tubes. Wide-range, the 8673 and 8674 fit spectral requirements of all three channels... eliminating the need for another tube type for the blue channel.

Another big difference: the re-designed image section provides reduced distortion and freedom from "ghosts." These new tubes are available singly or as matched sets—a trio of 8673/S or 8674/S types for color service... types 8673 and 8674 for black and white. Main construction difference is in the target-to-mesh spacing. The closer-spaced 8673 enhances S/N ratio for quality performance under sufficient illumination. The 8674 has greater sensitivity under limited illumination. For complete information about the new RCA Bialkali Photocathode Image Orthicons, ask your RCA Broadcast Tube Distributor.

RCA Electronic Components and Devices, Harrison, N.J.



The Most Trusted Name in Electronics

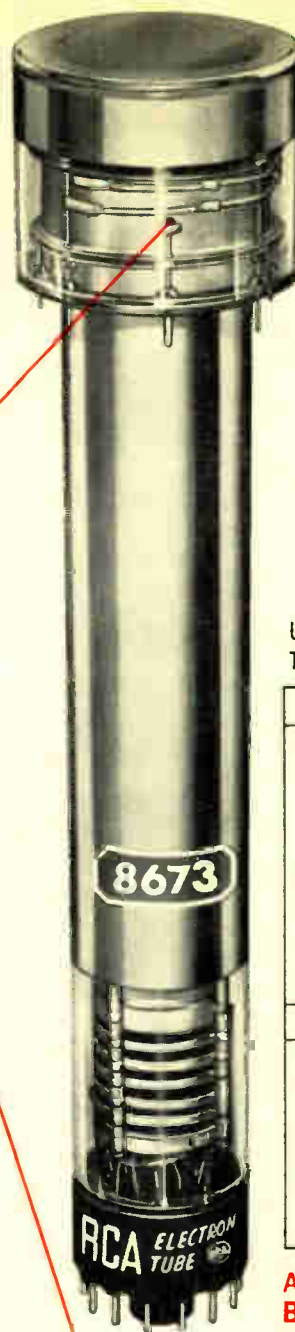

USE THIS CHART TO SELECT REPLACEMENT TYPES FOR THE TUBES YOU ARE NOW USING

| UNDER SUFFICIENT LIGHTING LEVELS  |        |
|---|--------|
| For color pick-up,<br>If you're now using ... You can replace with:         |        |
| 4513/S  | 8673/S |
| 7513/S  |        |
| For black & white pick-up,<br>If you're now using ... You can replace with: |        |
| 4513  |        |
| 7513  |        |
| 7513/L  | 8673   |
| 8093A   |        |
| 8093A/L   |        |
| UNDER LIMITED LIGHTING LEVELS   |        |
| For color pick-up,<br>If you're now using ... You can replace with:         |        |
| 4415S   | 8674S  |
| 4416S   |        |
| For black & white pick-up,<br>If you're now using ... You can replace with: |        |
| 7293A   |        |
| 7293A/L   | 8674   |

**AVAILABLE FROM YOUR RCA BROADCAST TUBE DISTRIBUTOR**

