

*Lawson W. Dams*

# DIAL CORD *Stringing* GUIDE

DC-3

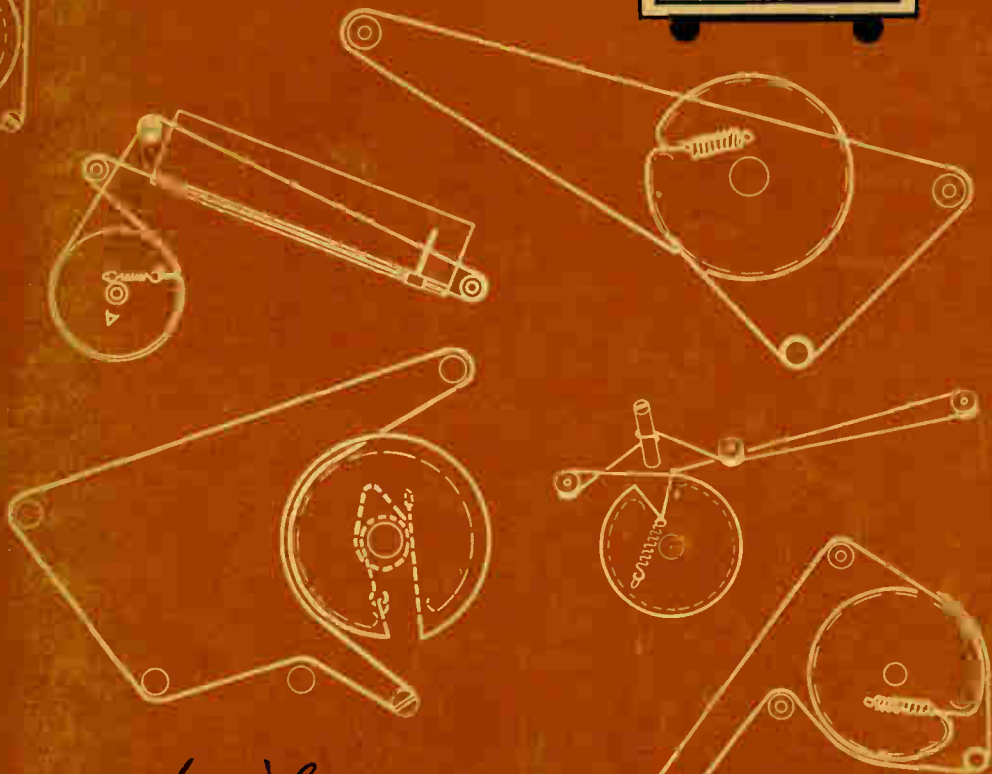

A *Lawson W. Dams* **PHOTOFACT PUBLICATION**

\$1.00

*Howard W. Sams*  
**DIAL CORD**  
*Stringing* **GUIDE**

**DC-3**

FIRST EDITION • JANUARY 1954

Reproduction or use, without express permission, of editorial or pictorial content, in any manner, is prohibited. No patent liability is assumed with respect to the use of the information contained herein.

Entire Contents Copyrighted 1954 by Howard W. Sams & Co., Inc.  
Indianapolis, Indiana, U. S. A.

Copyright Under International Copyright Union

All Rights Reserved Under Inter-American Copyright Union (1910)  
By Howard W. Sams & Co., Inc.

*Compiled and Published by*  
**HOWARD W. SAMS & CO., INC.**  
Indianapolis, Indiana

DC-3

## P R E F A C E

The restringing of a dial cord is a tedious job even when the stringing arrangement is quite simple. On the more complicated ones it is almost impossible to restring the cord without a diagram showing how the cord is strung between the shafts and pulleys. Even the exact number of turns around each shaft must be known in order to be assured that proper operation free of binds or slippage will be obtained.

Realizing the need for this type of data we have prepared this manual which is the third of the DIAL CORD STRINGING GUIDE series. The increased usage of dial cords in television receivers indicated that coverage of this type of equipment was warranted; therefore, we have included dial-stringing data on television receivers in this manual.

The index lists all receivers which were presented in the first two manuals of this series as well as those covered in this manual. Thus, it is necessary to look in only one place to determine the diagram number which pertains to the receiver being serviced. The diagrams presented in this manual are consecutively numbered, the first one being the next consecutive number after the last number in the preceding manual in the series. This prevents any possible confusion which might result from consulting a diagram in the wrong manual.

The acceptance of the first two manuals in this series has proved the value of this practical, easy-to-use data. Obtain a copy for your workbench to make your DIAL CORD STRINGING GUIDE series complete. A copy for your tool kit will be a real time saver, too.

*Lewis W. Davis*

## PROPERTIES OF DIAL DRIVE CORD

When it becomes necessary to replace a dial cord, this should be done with a cord especially developed for the purpose. Replacement should not be made with fish line, string or thread. The cost of the proper cord is a minor part of the repair job which is mainly labor.

In order to give satisfactory service for a long period of time, a drive cord must have the following mechanical properties:

1. Sufficient breaking strength.
2. Minimum elongation (stretch).
3. High resistance to abrasion.
4. High coefficient of friction.
5. Ability to withstand flexing.

The breaking strength should not be less than 20 pounds in a straight pull test and not less than 12 to 15 pounds when knotted. This allows tying and installing without danger of breaking. A higher tensile strength is of little advantage, as the normal operating tension on the cord, if properly installed, is seldom greater than one pound.

A good dial drive cord should have a minimum elongation or stretch. Standard specifications of leading receiver manufacturers permit less than 1/4" per foot elongation in 48 hours with an applied pull of 5 pounds. Substitute materials such as fish line often used in repair work will not meet this or some of the other requirements.

A dial cord is subject to friction whenever the set is tuned and must therefore possess reasonable resistance to abrasion. Nylon outer braiding performs

excellently in this respect and many cords are now made using this material.

A very important property for a dial drive cord is that it have a relatively high coefficient of friction. This requires that the cord should not become smooth or slick during use. The type of thread used for the outer braid, the diameter of the individual strands and the method of braiding, determine its performance and life in this respect.

Small diameter drive shafts and pulleys subject the cord to continual flexing as the set is tuned. Choice of core and braid material determine the flexibility. The cord is chemically impregnated after manufacture to improve its flexibility and keep it soft during life.

At present, various materials are used in the manufacture of cords to meet the foregoing requirements. Most common of these are nylon, silk, linen and fibreglas. Nylon and silk are suitable for outer braid material while linen, fibreglas or special low-stretch nylon are employed for cores.

#### GENERAL NOTES ON RE-STRINGING DIAL DRIVE SYSTEMS

It would appear from an inspection of the diagrams of this book that the designers have vied with each other to display their ingenuity in devising intricate and novel arrangements. This situation requires that any instructions which might be given here cannot be specific but must be of a general nature.

There are a number of considerations which apply to all drive cord systems and it is suggested that the following points be used as a check list to assure rapid and satisfactory dial cord replacement.

1. Study the diagram given in this guide and the receiver itself to determine the proper end of rotation of the large pulley on the tuning system,

and the position and direction of travel of the pointer, from which to start the stringing procedure. If the stringing indicated does not seem to exactly fit the case in point, it would be wise to study the diagrams of other receivers of the same manufacturer. In the interest of covering as many models as possible in this book, similar diagrams have been combined and consolidated where such combinations will still show the correct method of stringing. In these cases the position and proportion of the various parts of the system may have been altered slightly to produce a universal diagram.

2. All pulleys, drive shafts, tuning mechanisms and sliding indicators should be checked to determine that they rotate or slide freely and have no tendency to bind. All points should be lubricated sparingly. Special light dial oil as provided by the dial accessory manufacturers should be used. Care should be taken to see that none of the lubricant is left on the cord.
3. Before actually stringing the cord around the parts of the system determination should be made that all pulleys and slides are in such position that there will be no sharp bends in the cord and that parts are not subjected to side friction during operation.
4. It is wise to next examine the tension spring or springs. If these show any indication of having had turns removed or of having been permanently stretched, they should be replaced. The new spring should be of the same shape, size and length as the original. The manufacturers of dial accessories provide assortments of springs for this purpose.
5. If it is necessary to cut the cord to length before stringing and the old cord is not available as a guide, be sure to cut enough cord to allow as-

sembly including the tying of knots of the proper size. Since material is relatively inexpensive it is better to have a few inches of waste than to be forced to perform the operation over again.

6. If a number of holes for the fastening of the tension spring have been provided, the spring should be positioned in one of the inner holes. This will allow later adjustment to increase the tension if required.
7. After stringing, the tension should be checked to determine whether it is sufficient for reliable, proper operation. Be certain that the tension has not been made too great. In no case should the cord be as tight as a violin string. A cord which is too tight will place undue strain on all parts and will prevent the set from tuning easily.
8. The tuning system should be rapidly operated from one end to the other to make certain that no binding is present. At the same time a check should be made that there is no tendency for the cord to climb out of idler pulleys or jam at the end of motion on the drive shaft.
9. Before replacing the set in the cabinet a drop of cement should be placed on the point of fastening of the pointer or indicator and also on the knots of the cord where it is fastened to the tension spring or to the tuning drive pulley, as the case may be. This will prevent any subsequent tendency for the knot to become loose.





Name & Model or Chassis No.	Vol. 3 Diag. No.	Previous Vol. Vol. Diag. No.	Name & Model or Chassis No.	Vol. 3 Diag. No.	Previous Vol. Vol. Diag. No.	Name & Model or Chassis No.	Vol. 3 Diag. No.	Previous Vol. Vol. Diag. No.
<b>AIRLINE (Continued)</b>			<b>AIRLINE (Continued)</b>			<b>ALGENE</b>		
04WG803.	1.	44	64WG1052A	1.	67	AR5U.	2.	555
04WG804.	1.	45	64WG1207B	1.	69	AR5U.	2.	555
04WG1108A	1.	46	64WG1511A, B	1.	68	<b>ALTEC LANSING</b>		
05GSE-3020A,			64WG1512A, B	1.	68	ALC-101.....1118		
B, C.	1099		64WG1801C	1.	6	<b>AMC</b>		
05GSE-3037A,			64WG1804A, B, C	1.	71	125P.....1.....82		
-3042A.	1099		64WG1807A, B	1.	71	126.....1.....76		
05WG-1813A.	1100		64WG1809A, B	1.	68	<b>AMERICAN COMMUNICATIONS</b>		
05WG-2749D.	1101		64WG2007A, B	1.	6	(See Liberty)		
05WG-2752.	1102		64WG2009A, B	1.	68	<b>ANDREA</b>		
05WG-3038A,			64WG2010B	1.	68	BT-VK12.....1119		
-3045A.	1103		64WG2500A	1.	57	CO-U15.....2.....602		
14BR474.	1.	48	64WG2700A, B	1.	57	CO-VK15,		
14BR521A,			74BR1513B	2.	586	CO-VK16.....1120		
14BR522A.	1.	40	74BR1514B	2.	586	COVK-125.....1119		
14BR523A.	1.	48	74BR2001A, B	2.	587	CVK-126.....1119		
14BR613A.	1.	48	74BR2701A	2.	588	T-16.....2.....603		
14BR624A.	1.	48	74KR1210A	2.	589	T-U15.....2.....602		
14BR1474	1.	48	74KR2706B	2.	590	T-U16.....2.....603		
14WC469.	1.	47	74KR2713A	2.	591	T-VK12.....1119		
14WGS18, 14WGS19	1.	6	74WG1052E	1.	67	TVK-127B, M.....1119		
14WC610B,			74WG1056A	2.	593	<b>ANSLEY</b>		
14WC611B.	1.	49	74WG1207B	1.	69	Model 53.....2.....604		
14WC624A,			74WG1509A	1.	594	<b>APEX</b>		
14WC625A,			74WG1510A	2.	594	4B5.....2.....574		
14WC628A.	1.	11	74WG1511B,			<b>APPROVED ELECTRONIC</b>		
14WC680.	1.	42	74WG1512B	1.	68	<b>INSTRUMENT CORP.</b>		
14WC683A.	1.	51	74WG1802A,			FM Tuner.....2.....605		
14WC690.	1.	50	74WG1803A	2.	595	ARCADIA		
14WC737.	1.	52	74WG1804C	1.	71	37D14-600.....1.....78		
14WC739.	1.	47	74WG1807A, B	1.	71	<b>ARIA</b>		
14WG740, 14WG741.	1.	52	74WG2002A	2.	594	554-1-61A.....1.....79		
14WG756, 14WG757.	1.	56	74WG2004A	2.	595	<b>ARTONE</b>		
14WG807,			74WG2007B, C	1.	6	524.....1121		
14WC808M, MA			74WG2009B,			<b>ARVIN</b>		
14WC808W, WA.	1.	56	74WG2010B	1.	68	Model		
14WG1202B.			74WG2500A	1.	57	140P.....2.....606		
14WG1203B, M, W.	1.	54	74WG2504A, B, C	2.	596	150TC, 151TC.....2.....607		
15WG-2745C.....1104			74WG2505A	1.	70	152T, 153T.....2.....608		
54BR1501A.			74WG2700A, B	1.	57	160T, 161T.....2.....609		
54BR1502A.	1.	40	74WG2704A, B, C	2.	596	182TFM.....2.....610		
54BR1503A, B, C	1.	58	74WG2709A	2.	597	240P, 241P, 244P.....2.....611		
54BR1504A, B, C	1.	58	84GAA3967A.....1105			250P.....2.....612		
54BR1505A, B.	1.	55	84HA1529A.			280TFM, 281TFM.....2.....614		
54BR1506A, B.	1.	55	84HA1530A.....1106			350-PB, -PL,		
54KP1209A, B.	1.	53	84KR1520A	2.	592	351-PB, -PL,		
54WG1801A, B.	1.	6	84WG2015A	2.	598	352-PL, 353-PL.....1122		
54WG2007A, B.	1.	6	84WG2506	2.	601	355T, 356T, 357T.....1123		
54WG2500A.			84WG2506B	2.	599	358T.....2.....608		
54WG2700A.	1.	57	84WG2712A, B.	2.	600	450T, 451T.....1124		
62-123.....11			84WG2714A, F,			480T, 481T.....1125		
62-131, -133.	1.	11	G, H, J	2.	601	482-CB, 472-CM.....1126		
62-142.....11			84WG2718A, B	2.	600	480TFM, 481TFM.....1127		
62-144.....11			84WG2720A	2.	600	482CFB, 482CFM.....1128		
62-152.....11			84WG2721A, B	2.	601	547, A.....2.....614		
62-158.....11			84WG2724A	2.	600	552AN, N.....1.....77		
62-237.....11			84WG2728A	2.	600	555, A.....1.....77		
62-239.....11			84WG2732A, B	2.	600	558.....1.....81		
62-270.....11			84WG2734A	2.	600	664, A.....1.....6		
62-292.....11			93WG510	1.	72	665.....1.....83		
62-294.....11			93WG754,			2120CM, 2121TM,		
62-303.....11			93WG755.	1.	74	2123TM, 2124CCM,		
62-309.....11			93WG800.	1.	74	2126CM.....1129		
62-321.....11			93WG1102.	1.	80	2160, 2161, 2162,		
62-347.....11			93WG1103,			2164.		
62-373, -374.	1.	11	93WG1104.	1.	46	2180T, 2181T.....1130		
62-417.....11			93WG1110.	1.	80	2410P.....2.....611		
62-443.....11			94BR-1533A.....1107			4080T, 4081T.....1131		
62-447.....11			94BR-2740A,			6640.....1.....6		
62-449.....11			-2741A, B.....1108					
62-451.....11			94GAA3654A.....1109					
62-471, -472.	1.	61	94GSE-2735A,					
62-704, -705, -706,			-2736A.....1110					
-707, -708, -709,			94WG-1509A.....1111					
-710, -711, -712	1.	60	94WG-1804D.....1112					
62-752, -753.	1.	64	94WG-1811A.....1113					
62-801.....11			94WG-2742A, C,					
62-910.....11			D.....1114					
64BRI051A, B	1.	62	94WG-2745A.....1115					
64BRI205A,			94WG-2746A, B,					
64BRI206A.	1.	65	-2747A.....1114					
64BRI208A.	1.	63	94W-2748A, C,					
64BRI503, B.	1.	58	94WG-2749A.....1116					
64BRI504, B.	1.	58	94WG-3008A.....1117					
64BRI513A, B	2.	586	94WG-3016A, B,					
64BRI514A, B	2.	586	C.....1117					
64BRI808A.	1.	66	94WG-3028A.....1117					
64BR2200A.	1.	63	<b>ALLIED RADIO (See Knight)</b>					
64BR2701A.	1.	66						

Name & Model or Chassis No.	Vol. 3 Diag. No.	Previous Vol Vol. No.	Diag. No.	Name & Model or Chassis No.	Vol. 3 Diag. No.	Previous Vol Vol. No.	Diag. No.	Name & Model or Chassis No.	Vol. 3 Diag. No.	Previous Vol Vol. No.	Diag. No.
<b>ARVIN (Continued)</b>				<b>BELMONT (Continued)</b>				<b>BUICK</b>			
Chassis				5D110		2	622	980690, 980733		1	104
RE-202		1	77	5D128		1	98	980744, 980745		1	104
RE-204		1	81	5DA1		1	48				
RE-206		1	6	5P19		1	95	<b>BUTLER BROS.</b>			
RE-209		2	606	6D111 (Series A & B)		1	92	(See Air Knight or Sky Rover)			
RE-213			1123	6D120		2	623	<b>CAPEHART</b>			
RE-228, -1		2	607	8A59		1	66	35P7		1139	
RE-229		1	83	533 (Series B & C)		1	43	323M, 324M, 325F,			
RE-231		1	77	716		1	48	M, 326M, 332-B,			
RE-232		2	609	<b>BENDIX</b>				-M, 334-M		1140	
RE-233		2	608	PAR-80		2	624	1005B, M, W		1141	
RE-237		2	610	0526, 0526A, B, C,				1006B, M, W		1141	
RE-242		2	614	D, E, F		1	97	3011B, M, 3012B,		1140	
RE-243, RE-244		2	611	0626A		1	97	M			
RE-248		2	612	55L2, 55L3		2	625				
RE-253		2	613	55P2, 55P3		2	625	<b>CENTURY (20th)</b>			
RE-254, -255, -256,		2	611	55X4		2	626	100X, 101, 104		1	73
-259				65P4		2	627				
RE-267-1, -2			1122	75B5, 75M5,				<b>CHANCELLOR</b>			
RE-273			1123	75M8		2	628	35P		2	574
RE-277, RE-277-1, 1127				75P6		2	629	<b>CHEVROLET</b>			
RE-277-2			1122	75W5		2	628	985538		1	105
RE-281			1124	95B3, 95M3,				985696		1	108
RE-284			1125	95M9		2	628	985697		1	106
RE-287-1			1126	110, 110W, 111,				985792		1	109
RE-288-1			1128	111W, 112		2	625	985793		1	110
TE282			1131	114, 115		2	625	985794		1	106
TE289-2, -3			1129	300, 300W, 301,				986146		2	646
TE-290			1130	302		2	627	<b>CHRYSLER (See Mopar)</b>			
				416A		2	630	<b>CISCO</b>			
<b>ATLAS</b>				526MA, MB, MC,		2	631	1A5		2	574
AB-45		1	73	613		2	632	9A5		1	73
<b>AUDAR</b>				626A		1	97	<b>CLARION</b>			
PR-6		1	84	636A, B, C		1	98	C100, C101		1	11
PR-6A		1	85	646A		1	99	C102		1	113
				658A		1	100	C103, C104, C105		1	116
<b>AUTOMATIC</b>				676B, C, D		1	101	C105A		1	90
Tom Boy		2	555	697A		2	633	C108		1	13
Tom Thumb Buddy		2	615	736B		1	100	11011		1	115
Tom Thumb				847B, S		2	634	11305		1	90
Camera-Radio		2	616	951, 951W		1135		11801, 11802V-M		2	647
Tom Thumb Jr.		2	555	1217, B		2	635	12110M		2	648
B-44		2	616	1217D		2	636	12310W		2	649
C-60		1	86	1518, 1519		2	637	12708		2	619
C-60X		2	555	1521		2	637	13101		2	579
C-300			1075	1524, 1525		2	637	14601		2	574
D-200			1132	1531		2	638	<b>CLEARSONIC</b>			
F-100			1133	1533		2	638	5C66		1	11
M-86		2	618	6100		1136		<b>COLLINES AUDIO PRODUCTS</b>			
TV-P490			1134	<b>BEWSTER</b>				FMA-6		1142	
601, 602 (Series A)		1	73	9-1084, 9-1085,				45-D		1143	
601, 602 (Series B)		2	555	9-1086		1	103	<b>COLLINS RADIO</b>			
612X, 613X		1	73	<b>BROWNING</b>				75A-1		2	650
614X, 616X		1	86	FF-12		2	639	<b>COLONIAL</b>			
620		1	87	RJ-12		2	639	628		1	112
640 (Series B)		1	73	RJ-12A		2	640	671, A		1	112
660, 662, 666		2	619	RJ-14A		2	640	<b>CONCORD</b>			
720		2	620	RJ-20A			1137	CD61P		1	79
<b>AVIOLA</b>				RV-10		2	641	6CS1B, W		1	8
509		1	86	RV-10A		1138		6DS1B		1	117
601		1	89	RV-11		2	641	6DS11		1	117
606		1	91	<b>BRUNSWICK</b>				6DS1W		1	117
612		1	89	A1020		1	102	6DS1V		1	120
616		1	91	A2020		1	102	6DS1D		1	79
<b>BELL SOUND</b>				A2600		1	107	6DS1X		1	120
3715		2	621	A2700		1	102	6DS2W		1	114
3725		2	621	A3720		1	102	6ES1B		1	18
3728		2	621	B3683		2	642				
3750		2	621	C-3300		2	642				
<b>BELLTONE</b>				D-1000, D-1100		2	643				
500		1	90	D-6876		2	644				
<b>BELMONT</b>				T-4000, T-4000 1/2		2	644				
46D110		1	94	T-6000, S, SS,							
4B17		1	93	SX, T-6000 1/2		2	644				
4B112, 4B113		1	65	T-9000		2	643				
4BA1, 4BA2		1	48	1680		1	107				
5D16		1	48	1700		1	102				
				2800		1	107				
				2889		1	107				
				5000		2	645				

Name & Model or Chassis No.	Vol. 3 Diag. No.	Previous Vol. Vol. No.	Diag. No.
<b>CONCORD (Continued)</b>			
8F28W	1	119	
8T61W	2	555	
7G28C	1	38	
1-402, 1-403	2	814	
1-411	2	574	
1-501	1	18	
1-504	2	651	
1-509, 1-510	1	6	
1-516, 1-517	2	652	
1-601, 1-602, 1-603	1	38	
1-606	2	568	
1-608	1	119	
1-609	2	555	
1-611	2	653	
1-1201	2	654	

Name & Model or Chassis No.	Vol. 3 Diag. No.	Previous Vol. Vol. No.	Diag. No.
<b>CONTINENTAL</b>			
A-11, A-11PH	1	118	
B6	1	122	
B11	1	118	
L5	1	122	
XB6	1	122	
XL5	1	122	

Name & Model or Chassis No.	Vol. 3 Diag. No.	Previous Vol. Vol. No.	Diag. No.
<b>CO-OP</b>			
6AWC2, 6AWC3	2	655	
6A47WCR, 6A47WT,	2	655	
6A47WTR	2	655	

Name & Model or Chassis No.	Vol. 3 Diag. No.	Previous Vol. Vol. No.	Diag. No.
<b>CORONADO</b>			
05RA1-43-7755A,			
05RA1-43-7755B, 1144			
05RA1-43-7901A, 1145			
05RA2-43-8515A, 1146			
05RA4-43-9876A, 1147			
05RA37-43-			
8380A, 1148			
15RA1-43-7902A, 1149			
43-8005	2	656	
43-8301	1	13	
43-8451	1	124	
43-8485	2	857	
43-7601, 43-7601B,	1	38	
43-7602	1	38	
43-7851, 43-7652	1	66	
43-7851	2	599	
43-8160	1	121	
43-8180	1	11	
43-8213	1	124	
43-8240, 43-8241	1	127	
43-8305	1	71	
43-8312A	1	68	
43-8330	1	123	
43-8351, 43-8352	1	126	
43-8353, 43-8354	2	658	
43-8420	2	659	
43-8470	1	71	
43-8471	1	68	
43-8576	1	71	
43-8685	1	125	
43-9196	1	128	
43-9201	2	622	
94RA1-43-7656A,			
94RA1-43-7657A, 1150			
94RA1-43-7751A, 1151			
94RA1-43-8510A,			
94RA1-43-8511A, 1152			
94RA1-43-8510B,			
94RA1-43-8511B, 1153			
94RA31-43-			
9841A	1	1154	
94RA33-43-			
8130C, 94RA33-			
43-8131C, 1155			
7856A, 7857A, 1150			
7751, 1151			
7755A, B, 1144			
7901A, 1145			
7902A, 1149			
8130C, 8131C, 1155			
8380A, 1148			
8510A, 8511A, 1152			
8510B, 8511B, 1153			
8515, 1146			
9841A, 1154			
9876A, 1147			

Name & Model or Chassis No.	Vol. 3 Diag. No.	Previous Vol. Vol. No.	Diag. No.
<b>CORONET</b>			
C-2	1	130	
<b>CROMWELL</b>			
1020	1156		
<b>CROSFLEY</b>			
9-101, 9-102	2	660	
9-103, 9-104W	2	661	
9-113, 9-114W	2	661	
9-117	2	695	
9-118W	2	580	
9-119, 9-120W	2	560	
9-121, 9-122W	2	662	
9-201, 9-202M,			
9-203B	2	663	
9-207M	2	664	
9-209	2	665	
9-212M, 9-213B	2	665	
9-302	2	666	
10-135, 10-136E,			
10-137, 10-138,			
10-139, 10-140,	1157		
10-307M, 10-308,			
11-100U, 11-101U,	1158		
11-102U, 11-103U,			
11-104U, 11-105U,	1159		
11-126U, 11-127U,			
11-128U, 11-129U,	1160		
46FA, 46FB,	1	6	
56FA, 56FB, 56FC,	2	595	
56PA, 56PB,	1	11	
56TA, 56TA-L,			
56TC, 56TC-L,	1	73	
56TD	2	667	
56TG	1	131	
56TJ	1	129	
56TL-L, 56TN,			
56TN-L, 56TP,	1	73	
56TQ	2	668	
56TR, 56TS,	1	133	
56TU	1	131	
67TW	1	73	
68CP, 68CR	2	670	
68TA, 68TW	2	680	
86CR, 86CS,	1	132	
87CQ	2	671	
88CR	2	671	
88TA, 88TC	2	672	
106CS	1	66	
146CS, 148CP,			
148CQ	2	673	
<b>Chassis</b>			
285	1157		
301	1159		
312	1160		
<b>DALBAR</b>			
100	1	134	
400	1	11	
1000	1	134	
Bar combo Jr.	1	134	
Bar combo Sr.	1	134	
<b>DAVID BOGEN</b>			
R501	2	587	
<b>DEARBORN</b>			
100	2	814	
<b>DELCO</b>			
R1175	1	135	
R1176, R1177	1	136	
R1178, R1179	1	139	
R1181	1	138	
R1206, R1207,			
R1208, R1209	1	138	
R1212	1	137	
R1214	1	140	
R1216, R1217	1	141	
R1220	1	142	
R1227, R1228	1	143	

Name & Model or Chassis No.	Vol. 3 Diag. No.	Previous Vol. Vol. No.	Diag. No.
<b>DELCO (Continued)</b>			
R1229	1	143	
R1230A, R1231A,			
R1232A	1	73	
R1233	2	574	
R1234, R1235	1	143	
R1236, R1237	2	674	
R1238	2	574	
R1242	2	669	
R1243	2	675	
R1244			
R1245, R1246	2	676	
R1251, R1252,			
R1253, R1254,			
R1255	2	677	
R1408	1	73	
<b>DETROLA</b>			
554	1	79	
558, 558-1-49A	1	145	
568, 568-13-221D	1	14	
571, 571A, 571AL,			
571AX, 571B,			
571BL, 571BX,			
571L, 571X	1	117	
572	1	144	
572-220-226A	1	114	
576, 576-1-6A	1	144	
579	1	120	
582	1	14	
610A, 611A	2	878	
7156	2	679	
7270	1	146	
<b>DEWALD</b>			
A500, A500L,			
A500W	1	148	
A501, A502, A503	1	148	
A504, A505	1	149	
A507	2	680	
A509	2	681	
A514	2	882	
A802, A805,			
A808	1	150	
B-400	2	682	
B-402	2	683	
B-403	2	627	
B-504	2	884	
B-506	2	685	
B-510, B-512	2	686	
B-612	2	687	
B-814	2	688	
D-508	1161		
D-517	1162		
D-518	1163		
D-519	1165		
D-616	1164		
DT-120, DT-122	1165		
DT-161	1165		
DT-162R,			
DT-163A, 1166			
DT-190D,	1166		
DT-1020,			
DT-1020A, 1165			
DT-1030,			
DT-1030A,	1165		
DT-X-160,	1165		
E-520	1167		
E-170	1168		
ET-140R,			
ET-141R,	1166		
ET-171, ET-172	1166		
ET-190D,	1166		
511	1168		
<b>DU MONT</b>			
RA-103D,			
RA-104A	1169		
RA-109-A3	1170		
RA-109-A7	1170		
RA-110A	1169		
Sherbrooke			
(RA-109-A3, A7),	1170		
Sherbrooke			
(RA-109A-FAS),	1170		
Sherbrooke			
(RA-130A)	1170		

Name & Model or Chassis No.	Vol. 3 Diag. No.	Previous Vols Vol. No. Diag. No.	Name & Model or Chassis No.	Vol. 3 Diag. No.	Previous Vols Vol. No. Diag. No.	Name & Model or Chassis No.	Vol. 3 Diag. No.	Previous Vols Vol. No. Diag. No.
DYNAVOX			EMERSON (Continued)			EMERSON (Continued)		
3-P-801	2	689	547A	2	697	120098B	1178	
ECA			550 (Ch. 120058)	2	693	120098P	1178	
101, 102	1	19	551A	2	696	120099B	1178	
104	1	18	552	1	159	120132B	1187	
105	1	151	553A	2	696	EMPRESS		
108	1	18	557B	2	698	55, 56	1	174
108	1	154	558	2	699	ESPEY		
131	1	19	559A, 560	2	697	RR13, RR13L	1	168
132	2	690	563		1171	7B	2	567
201	1	452	567 (Ch. 120042)	1	165	18B		1193
204	2	574	568A	2	700	31		1194
ECHOPHONE			570		1172	52A		1193
EC112	1	153	573B	2	701	581	1	73
EC113	1	153	574		1172	651, 652, 653	1	15
EC306	1	157	575		1173	751		1193
EC403, EC404	2	677	576A	2	702	6511, -2, -S, 6514,		
EC800	1	147	577B	2	702	6518, 6517, 6520,		
EK306	1	157	578	2	697	-2, 6521, 6533,	1	15
EDWARDS			583	2	701	6540, 6541, 6542,		
Fidelotuner	2	691	584	2	699	6545, 6546, 6547,		
ELCAR			585, 586		1174	6580	1	15
602	1	155	587		1175	6611, 6612, 6613,		
ELECTRO			588	2	697	6614, 6615	1	172
B20	1	163	589		1176	6630, 6631, 6632,		
ELECTROMATIC			597		1176	6634, 6635	1	172
606A, 607A	1	156	602	2	703	7541	1	15
ELECTRONIC LABS			604A	2	702	FADA		
76E, 76K	1	187	613A		1177	P100	2	704
76RU	1	181	621 (Ch. 120098B)		1178	P130		1195
76W	1	187	622 (Ch. 120098P)		1178	SEC55, SEC70,		
710B, 710M	1	187	628		1178	SET85		1196
710PB, 710PC	2	692	630		1178	STC20, STC30,		
710T, 710W	1	187	634B		1179	STC70, STT65		1196
2701	1	187	635		1180	SPC10		1196
ELECTRO-TONE			636A		1175	SZ0T70		1196
555	1	18	640		1181	S1060, S1065		1196
706	1	18	641B		1182	802	1	178
712	1	18	642 (Ch. 120117A)		1183	805, 806	1	185
EMERSON			643A		1184	809, 810	1	73
501, 502, 503, 504	1	11	645		1185	637	1	175
505 (Ch. 12002 & 120041)	1	158	646A, 646B		1186	652	1	171
506	1	160	652 (Ch. 120032B)		1187	700	2	705
507, 509, 510,			653 (Ch. 120080B)		1188	711	2	574
510A, 511	1	158	656B, 657B		1189	740	2	574
511 (Ch. 120010)	1	73	666B (Ch.			795	2	706
512 (Ch. 120006)	1	162	120132B)		1190	830		1197
512 (Ch. 120056)	2	693	671B		1191	845		1198
514	2	693	672B		1192	855		1199
515 (Ch. 120056)	2	693	1002, 1003	1	189	1000 series	1	173
515	1	162	DS365, DS372	1	164	1001	1	175
516 (Ch. 120056)	2	693	EQ368, EQ410	1	166	FARNSWORTH		
516	1	162	ER369, ER370	1	166	BC68	1	176
518	1	158	EV384	1	166	BC103, BC105	1	177
519	2	555	FH413	1	162	BC601, BC601X	1	186
520	1	11	FH440	1	162	BK106, BK107,		
522, 523	1	158	FJ412	1	160	BK108	1	177
524	1	170	FW423	1	160	BK110, BK111,		
525	1	159	GB439, GB441	1	162	BK112	1	188
525	1	159	GH437, GH447,	1	160	BK602	1	186
526	2	694	GH2-447	1	160	BK6025, BK6025X	1	186
528	2	694	Chassis			BT20	1	73
531, 532, 533	1	162	120000	1	11	BT22	1	176
534	2	693	120002	1	158	BT52, BT53,		
535	1	159	120003	1	160	BT54	1	73
536, 536A	2	696	120006	1	162	BT55, BT56,		
537	2	694	120007	2	693	BT61, BT63	1	176
539	1	159	120012B	2	701	BT600, BT600X	1	186
540A	1	165	120016	2	697	CT70	1	187
541	1	73	120025B		1174	CK59, CK66	1	179
543, 544	1	159	120029	1	11	CK73, CK74, CK75	1	187
546	2	695	120030	2	555	CK111	1	177
			120036	2	696	CT50, CT51, CT52,		
			120038	2	694	CT53, CT54	1	179
			120039B	2	701	CT61, CT62		
			120041	1	158	CT63, CT64	1	179
			120042	1	185	DK73, DK75	1	187
			120043	1	184	EC260	1	28
			120046	2	694	EK-081, EK-082,		
			120048B	1	159	EK-083	2	707
			120049	2	698	EK-262, EK-263,		
			120049B	2	695	EK-263BL, EK-		
			120050	2	697	263WL, EK-264	1	28
			120055	2	693			
			120056	2	699			
			120058	2	699			
			120059	2	697			
			120069A	2	702			
			120072A	2	703			
			120082A	2	703			
			120088B		1174			
			120090B, D		1174			



Vol. 3		Previous Vola		Vol. 3		Previous Vola		Vol. 3		Previous Vola	
Name & Model or Chassis No.	Diag. No.	Vol. No.	Diag. No.	Name & Model or Chassis No.	Diag. No.	Vol. No.	Diag. No.	Name & Model or Chassis No.	Diag. No.	Vol. No.	Diag. No.
<b>GENERAL ELECTRIC (Continued)</b>				<b>GRANTLINE (Continued)</b>				<b>HOWARD (Continued)</b>			
376, 377, 378		2	744	805, 606, (Series A)		1	92	472C		2	769
400, 401	1218			651		1	15	472F		2	770
404, 405	1219			5610		2	757	474		2	555
408	1220			6547		1	15	482, 482A		2	761
410	1219			<b>HALLICRAFTERS</b>				500 Series		1	245
411	1218			CA-2, CA-2A,				718FM		1	249
417		1	230	CA-4		2	758	765, 768, 780,		1	248
502		2	733	S-38		1	235	806, 808,		1	247
600	1221			S-38B	1230			808 (Series X)		1	259
601, 603, 604	1222			S-40		1	236	810		1	247
650	1223			S-40A		2	759	865, 868,		1	245
752, 753	1224			S-40B	1231			901A-E, -H, -I,			
755	1225			S-41B, S-41G,				-M, -P, -W		1	73
757	1225			S-41W		1	242	906, 906C		1	253
800A, B, C, D	1226			S-47		2	877	909M		2	771
805, 806, 807,				S-51		2	555	920		1	73
809	1226			S-52		2	759	<b>HUDSON</b>			
811	1227A & B			S-53		2	760	DB39		1	256
814 (Fine Tuning)	1227A			S-55, S-56		2	761	DB40		1	252
814 (Focus Control)	1228			S-58, S-59		2	762	SA39		1	256
817	1226			S-72	1232			SA40		1	252
821	1226			S-78	1233			<b>JACKSON</b>			
830, 835, 840	1229			ST-74	1234			150, 153	1239		
<b>GENERAL IMPLEMENT</b>				SX-42		2	763	350	1240		
9A5		2	574	SX-43		2	764	<b>JEFFERSON TRAVIS</b>			
<b>GENERAL TELEVISION</b>				SX-71	1235			MR-2B, MR-3		1	251
1A5, 2A5, 3A5,				5R10	1236			<b>JEWEL</b>			
5A5		1	73	400, 406, 409,				500A, B, C, 501A,			
9A5		2	574	410, 411, 412,	2	677		B, C, 502A, B, C,			
14A4F		1	6	680, 681	1237			503A, B, C, 504A,			
15A5, 17A5, 19A5,				690	1237			B, C, 505A, B, C		1	18
21A4, 22A5C,				715, A, 716	1237			960, 960U, 961	1241		
23A6		1	73	730, 731	1237			5020, 5020U	1242		
4B5		2	574	740, 741	1237			5057U	1243		
5B5G, 5B5Y		2	745	810A, 811, 815,				<b>KAPPLER</b>			
9B6P		2	574	818, 820, 822	1238			102T		2	772
24B6, 25B5		2	574	860, 861	1238			<b>KARADIO</b>			
<b>GILFILLAN</b>				870, 871	1238			1276	1244		
56A, 56B, 56BC-1,				880	1238			<b>KNIGHT</b>			
56BCR, 56C, 56D,				<b>HARVEY-WELLS</b>				4D-450		2	633
56E		1	73	ATR-3-8	2	765		4G-420	1245		
58M, 58W		2	555	ATR-3-12	2	765		5A-150, 5A-152,			
66A, 66AM		1	229	<b>HOFFMAN</b>				5A-154		1	15
66B		1	73	A-200	1	239		5A-190		1	11
66D, 66DM		1	229	A-202	1	240		5B-180		1	18
66P, 66PM		1	231	A-300	1	82		5B-175, 5B-176		1	16
68BD		2	746	A-309	1	240		5C-290		2	573
68F		2	747	A-401	1	62		5B-185		2	773
68C, 66P, 66U		2	746	A-501	1	241		5C-290		2	573
108-48		2	749	A-700	1	238		5D-250, 5D-251		2	570
<b>GLOBE</b>				B-400	1	244		5D-455		2	572
5BP1		1	233	B-1000	1	18		5F-565		2	574
6AP1		1	228	C-501	2	766		6A-122		1	254
6D1		1	232	C-502	2	767		6A-122		1	261
6P1		1	232	C-503	2	767		6A-195		1	16
6U1		1	232	C-504	2	767		6B-122		1	254
7CP1		2	614	C-505	2	767		6B-127		1	261
62C		1	237	C-506, C-507	2	768		6C-225		2	578
456		2	750	C-508	2	768		6D-225, 6D-226		2	578
457		2	580	C-511	2	766		6D-235		2	745
500		2	751	C-512	2	767		6D-360		2	649
517		2	752	C-513	2	766		6G-400	1249		
517		1	11	C-514	2	767		6H-580	1246		
552		2	753	C-514	2	767		7B-220		2	754
553		2	614	C-1006, C-1007	2	767		7D-405		2	774
<b>GON-SET</b>				<b>HOWARD</b>				8B-210		1	258
10-11 (Meter Converter)		2	689	4BT		1	171	8D-340		2	645
<b>GOODRICH (See Mantola)</b>				220, 221		1	171	8G-200, 8G-201	1247		
<b>GRANTLINE</b>				270, 271		1	171	10B-249		2	775
500, 501		1	234	300 Series		1	243	11C-300		2	645
501-7		2	754	307-4, 307TP-2		1	243	11D-302		2	587
508-7		2	755	430 (Series 2)		1	246	19F-492, 19F-497,			
510-A		2	758	438		1	246	19F-448		2	776
				460-7		1	250	97-870	1248		
				472AC, 472AF		2	769	449	1249		
								511B	1250		

Name & Model or Chassis No.	Vol. 3 Diag. No.	Previous Voia Vol. No.	Diag. No.	Name & Model or Chassis No.	Vol. 3 Diag. No.	Previous Voia Vol. No.	Diag. No.	Name & Model or Chassis No.	Vol. 3 Diag. No.	Previous Voia Vol. No.	Diag. No.
<b>KNIGHT (Continued)</b>				<b>MAGUIRE (Continued)</b>				<b>MECK (Continued)</b>			
D-182		1	249	571		2	784	MM516C,			
D-197		1	249	661, 661A		1	289	MM516T,	1254		
<b>LAFAYETTE</b>				<b>MAJESTIC</b>				PM-5C5-DW10,			
B33		1	6					PM-5C5-PW10		1	6
B112		1	41	5A410, 5A430		1	272	RC-5C5-P		1	6
B195		1	183	5A445, 5A445R		2	614	RC-6A7-P6		2	802
BB9(A)		1	191	5AK711, 5AK731,				XOB, XQA, XQR,			
BB9(B)		1	190	5AK780		2	785	XRA, XRPT, XSA,			
FA15W, FA15Y		1	257	5LA5, 5LA6	1251			XSPT, XTA, XTR,	1254		
J62, J62C		1	237	5LA7, 5LA8	1252			XX900			
MCI0B, MCI0Y		1	11	6FM714		2	786	4C7		2	803
MC11, MC12		2	777	6FM773		2	787	6A8-W4		1	187
MC13		1	11	7C432, 7C447		1	274	<b>MEDCO (See Telesonic)</b>			
<b>LEARADIO</b>				<b>MEISSNER</b>							
R971		2	778	7FM877, 7FM888		2	787	8C		2	804
RM402C		2	779	7JL777R		2	788	9AJ	1255		
561, 562, 563,		1	260	7JL866		2	789	9-1065		1	6
565, 565BL, 566,				7P420		2	789	9-1091A, 9-1091B		1	805
567, 568		1	260	7S433, 7S450,		2	790	9-1091C	1256		
661		1	270	7S470		2	791	9-1093		2	806
1281PC		1	270	8FM744, 8FM775,				16A	1257		
6610PC, 6611PC,		2	761	8FM776, 8FM889		2	792	2961 Series		2	807
6612PC		1	270	9JL885		2	793	<b>MIDLAND</b>			
6614, 6615, 6616,				8S452, 8S473		1	273	M6B		1	278
6617PC, 6619		1	260	12FM475, 12FM778,		2	794	<b>MIDWEST</b>			
<b>LEWYTT</b>				<b>MANTOLA</b>							
				12FM779, 12FM895		2	794	<b>MINERVA</b>			
<b>LEWYTT</b>				Chassis							
615A		1	265	5B01A, 5B05A		2	785	L-702		1	171
711		2	560	6B02D		2	786	L-728		1	19
<b>LIXINGTON</b>				6B11D				W-117			
				7B04A		2	791	W-117-3		1	6
6545		1	15	7B09A, 7B09A1		2	789	W-117-B		1	171
<b>LIBERTY</b>				7C11D				W-710, W-710A			
				7C25A		2	788	W-728		1	19
A6K, A6P		1	264	8B06D, 8B07D,		2	792	410, 411		2	810
6K		1	264	8B08D, 8C07D		2	794	702H, 702H-1		2	810
507A		1	264	12B26E, 12C22E		1	272	729		2	704
<b>LINCOLN</b>				4501, 4504				<b>MONITOR</b>			
S13L-N		1	185	4508		2	614	M510		2	811
<b>LINCOLN (Allied Radio Corp)</b>				4702, 4703				M3070			
				4705		2	790	RA50		2	813
5A-110		1	26	4706, 4707		2	789	TAS6M, TWS6M		1	129
<b>LYRIC</b>				4708R				<b>MONTGOMERY WARD (See Airline)</b>			
546T, 546TY,				4810		1	273	<b>MOPAR</b>			
546TW		1	73	4810B		2	793	800, 801, 802		1	112
<b>MAGIC TONE</b>				41201				802			
				<b>MANTOLA</b>				802 Revised			
500, 501		1	19	R459		1	118	805	1258		
<b>MAGNAVOX</b>				R643				808, 809			
				R852, R852N		1	6	<b>MOTOROLA</b>			
CR-101, CR-101M		1	262	R854-PM, -PV		1	275	BK-6		1	279
CR-108M		1	266	R855W		1	275	CR-6		1	280
CR-122		1	266	R862, R862N		1	6	CR-76		2	815
CR-187, CR-188		1	263	R864PM, PV, W		2	795	CT-6		1	279
CR-189A, CR-189B		1	267	R7543		1	73	FD-6, FD-7		1	279
CR-190		1	271	R75143		2	574	NH6		1	279
CR-190A, CR-190B		2	780	R75152		2	796	OEB		1	279
CR-192A, CR-192B		1	267	R75343		2	574	PC6		1	279
CR-193		1	263	R76143		2	574	SROB	1260		
CR-197C		2	781	R76162		2	796	SR1B	1282		
CR-198A, CR-198B,				R76262		2	797	VF102, VF102A,		2	814
CR-198C		1	263	R78162		2	798	VF102C			
CR-200A, B, C, D,				24B6		2	574	VF103, VF103M	1261		
E, F		2	782	<b>MASON</b>				VK101, VK101M			
CR-207A, B, C, D		2	781	45-1A, 45-1B,		1	73	VT101		2	814
CR-208A, B		2	781	45-1P		1	73	<b>MAYFAIR</b>			
CR-210A, B		2	783	45-3, 45-4, 45-5		1	73	510, 510W		2	799
<b>MAGUIRE</b>				510, 510W				520, 520W			
				530, 530W		2	799	530, 530W		2	799
500BI, 500BW,				550, 550W		2	799	<b>MECK</b>			
500DI, 500DW,		1	269	<b>MECK</b>				CD-500, CE-500			
561BI, 561BW,				CR-500		2	801	EF-790, EG-791			
561DI, 561DW		1	269	<b>MANTOLA</b>				MMS10T, MMS12T, 1254			

Name & Model or Chassis No.	Vol. 3 Diag. No.	Previous Vol. Vol. No.	Diag. No.	Name & Model or Chassis No.	Vol. 3 Diag. No.	Previous Vol. Vol. No.	Diag. No.	Name & Model or Chassis No.	Vol. 3 Diag. No.	Previous Vol. Vol. No.	Diag. No.
<b>MOTOROLA (Continued)</b>				<b>MOTOROLA (Continued)</b>				<b>MOTOROLA (Continued)</b>			
5H11U, 5H12U,				68F11, 68F12,				HS-210		1272	
5H13U	1263			68F14, 68F14B,				HS-226		1267	
5K11U, 5K12U,				68F14M,	2		819	HS-228		1262	
5K13U	1264			68L11			824	HS-230		1279	
5K21U, 5K22U,				68T11, 68X11,				HS-234		1280	
5K23U	1265			68X11A, 68X12,				HS-243		1264	
6F11, 6F11B,	1266			68X12A	2		825	HS-244		1263	
6L1, 6L2	1267			69L11		1275		HS-245		1268	
6K11U, 6K12U	1268			69X11, 69X12		1276		HS-246		1271	
7F11, 7F11B	1269			71-A	1		313	HS-247		1270	
8FM21, 8FM21B,	1270			72-C	1		311	HS-253		1281	
9FM21, 9FM21B,	1271			75F21	1		315	HS-258		1262	
9-24, 9-24A	1		285	75F31, 75F31A,				HS-259		1265	
9-44			288	75F31B	2		826	HS-261		1281	
16-C	1		284	76F31	2		826	HS-262		1262	
16F1BH, H	1280			77FM21, 77FM22,				HS-264		1266	
17-D	1		287	77FM22M,				HS-265		1269	
17F1, A, B, BA,				77FM22WM,				HS-270, HS-271,			
17F2W, WA, 17F3B,				77FM23	2		823	HS-272		1262	
BA, 17F4, A, 17F5,				77XM21, 77XM22,				OB		1260	
A, B, BA,	1281			77XM22B	2		823	TS-3, TS-5, TS-7,	2		814
18-O, 18-B	1		289	78F11, 78F11M,				TS-8		1261	
25-F	1		290	78FM12M,				1B		1282	
26-C, 26-C7	1		291	78FM21,				<b>MURPHY</b>			
27-D, 27-D6	1		293	78FM21M,				113, 122		1	258
28-O, 29-B, 29-B6,	1		291	78FM22M,	2		827	<b>NATIONAL</b>			
30-P	1		291	79XM21, 79XM22		1277		HRO-50		1283	
35-F	1		294	81-C	1		306	NC-33		2	829
35-N	1		292	81F21, 81F22	1		308	NC-46		1	326
36-C1, 36-C2	1		295	81K31	1		316	NC-57		2	830
37-D1, 37-D2	1		296	82-A	1		317	NC-108R, NC-108T		2	831
38-O	1		291	83F1	1		312	NC-2-40DR,			
39-B1, 39-B2	1		291	83K1	1		321	NC-2-40DT		2	832
40-P	1		286	85F21, 85K21	1		309	<b>NATIONAL UNION</b>			
43-H	1		297	88FM21	2		827	571, 571A, 571B		1	117
44-K	1		298	93F1	1		312	G-613		1	324
45-B12	1		158	95F31, 95F31B,				G-619		1	189
45-N	1		299	95F33	1		320	<b>OLDSMOBILE</b>			
47B11	2		816	96FM21R		1278		982160		1	323
51-A, 51-C	1		73	103F21, 101R21	1		319	982282		1	327
51F11	1		300	103CK2	1		318	982375		1	323
51F12	1		301	103F1, 103F2	1		312	<b>OLYMPIC</b>			
51R11	1		300	103K1	1		322	6-501, 6-501VU,			
52-C	1		73	107F31, 107F31B,	2		828	6-501WU		1	328
53-A, -C,				250, 251	1		325	6-502, 6-502P,			
54-A, -C	1		73	<b>Chassis</b>				6-502U		1	328
55F11	1		303	AS-22	1		279	6-503		1	328
55X11	1		302	HS-2	1		19	6-504, 6-504L		1	6
55X11A	1		304	HS-2	1		158	6-801V, 6-801W,			
55X12	1		302	HS-2, HS-26	1		309	6-802		1	329
55X12A	1		304	HS-30, HS-31	1		303	6-804 Series		2	833
55X13	1		302	HS-32	1		310	6-806, 6-806A,			
55X13A	2		304	HS-36, HS-36A	2		826	6-806U		1	272
56K11	2		669	HS-38, HS-39	1		320	6-817, 6-817U,		1	329
57K11, 57K12	2		817	HS-50	1		304	7-421V, 7-421W,			
58A11, 58A12	2		669	HS-52	1		309	7-421X		2	834
58K11, 58K12	2		818	HS-58	2		820	7-435V, 7-435W,		2	834
59H11U, 59H12U	1272			HS-59	2		822	7-526		2	704
59X11, 59X12	1273			HS-60	2		817	7-532V, 7-532W,		2	833
59X21U, 59X22U	1274			HS-63	2		819	7-537		2	835
60-XW	1		301	HS-64	2		823	7-622, 7-638		2	774
61-A, 61-B	1		305	HS-69	2		821	7-724, 7-728		2	836
61-C, 61-D	1		306	HS-72	2		816	7-925, 7-934,			
61-E	1		305	HS-87	2		828	7-936		2	837
61-F	1		307	HS-89	2		823	8-451		2	838
61T21	1		308	HS-91	1		315	8-533V, 8-533W		2	839
61T23	1		314	HS-94	2		669	8-618		2	840
61X11, 61X12,				HS-97	2		823	8-925, 8-934,		2	841
61X13	1		301	HS-98	2		826	<b>PACKARD-BELL</b>			
62-A, 62-B	1		305	HS-102	2		823	5DA		1	73
62-E	1		305	HS-108	2		814	5D8		2	574
62-F1	1		312	HS-119	2		824	5FP		1	73
63-A, 63-E	1		305	HS-122	2		820	100		2	574
65F11, 65F12	1		303	HS-124	2		819	551, 551-D		1	333
65F21	1		309	HS-125	2		818	556		1	333
65T21, 65T21B,	1		310	HS-127, HS-127A,	2		825	561, 563		1	330
65X11, 65X11A,				HS-128, HS-132,							
65X12, 65X12A,				HS-133	2		827				
65X13, 65X13A,				HS-137	2		814				
65X14, 65X14A,				HS-144	2		825				
65X14B	1		19	HS-150, HS-155	2		827				
67F11, 67F12,				HS-158	2		669				
67F12B	2		819	HS-168		1277					
67F14	2		820	HS-170		1278					
67F16BN	2		821	HS-175		1275					
67L11	2		822	HS-180		1273					
67X11, 67X12,				HS-181		1276					
67X13	2		820	HS-192		1274					
67XM21	2		823								



Name & Model or Chassis No.	Vol. 3 Diag. No.	Previous Vol. Diag. No.	Name & Model or Chassis No.	Vol. 3 Diag. No.	Previous Vol. Diag. No.	Name & Model or Chassis No.	Vol. 3 Diag. No.	Previous Vol. Diag. No.		
<b>PACKARD BELL (Continued)</b>			<b>PHILCO (Continued)</b>			<b>PHILCO (Continued)</b>				
566		1	333	42-122		1	358	49-1077		1291
568		1	73	42-123		1	361	49-1100		2
571, 572		2	842	42-124, 42-125				49-1101		2
651		1	333	42-126		1	364	49-1175 (Code 122 & Code 124),		
661		1	331	42-350		1	357	49-1278 (Code 123),		
662		1	332	42-380		1	363	49-1279, 49-1280		1291
673A, 673B		2	843	42-395		1	363	49-1401		2
682		2	884	42-400		1	338	49-1405		2
771		2	845	42-706		1	343	49-1475, 49-1480		2
861		1	332	42-724		1	360	(Codes 121A or B, 123A or B, 123TA or B)		1292
872		2	846	42-730		1	366	49-1600, 49-1601,		
880, 880A		2	843	42-760, 42-761,				49-1602, 49-1603,		
881A, 881B		2	847	42-762		1	359	49-1604, 49-1605		2
884, 892	1284			42-788		1	356	49-1606, 49-1607		2
1052		1	334	42-1002		1	362	49-1813		1293
1054B		1	337	42-1003, 42-1005		1	367	50-T1104,		
1063		1	272	42-1008, 42-1009M,				50-T1105,		
1181, 1181A	1285			42-1009W		1	365	50-T1106		1294
1273		2	848	42-1012, 42-1013M,				50-T1400,		
1472		2	849	42-1013W		1	368	50-T1401,		
2301-TV (Radio Ch.)	1286			42-1015, 42-1016		1	338	50-T1402		1294
2302 (Radio Ch.)	1286			46-131		1	370	50-T1403,		
2801-TV, 2801A- TV (Radio Ch.)	1286			46-131 Revised		2	854	50-T1404,		
2803TV	1287			46-132		1	371	50-T1406 (Codes 123, 124, 125)		1294
<b>PHILCO</b>				46-142		2	854	50-T1406 (Codes 121 & 122)		1294
C-4608		1	111	46-200, 46-200-1,				50-T1432 (Code 122)		1294
C-4608 Revised		1	111	46-201, 46-202,		1	173	50-T1432 (Code 124)		1294
CR-2		2	850	46-250, 46-250-1,				50-T1476		
CR-4, CR-6		2	851	46-251		1	372	50-T1477		
CR-8		2	852	46-350		1	373	50-T1478		
CR-9		2	853	46-420, 46-420-1		1	377	50-T1479		1295
CR-12		2	852	46-421, 46-421-1		1	374	50-T1481		
CR-801, CR-503,				46-427		1	375	50-T1482		
CR-505	1288			46-460		1	376	50-T1484		1295
UN6-100		1	336	46-1201		1	379	50-520, 50-520-1,		1296
UN6-450, UN6-500		1	335	46-1203		1	378	50-522, 50-522-1,		
39-40, 39-45		1	339	46-1208		1	380	50-524		1297
39-55		1	342	46-1213		1	382	50-526		1298
39-116		1	342	46-1226		1	374	50-620		1299
39-770		1	338	47-204, 47-205		2	745	50-621		1300
40-110		1	341	47-227		2	855	50-920, 50-921,		
40-130, 40-135,				47-1230		2	856	50-922		1301
40-140, 40-145		1	340	48-141, 48-145		2	857	50-925, 50-926		1302
40-150, 40-155		1	344	48-150		2	858	50-1420, 50-1421,		
40-158		1	348	48-200, 48-200-1				50-1422, 50-1423		1303
40-160, 40-165		1	345	48-206, 48-214,				50-1720		1304
40-170CS		1	340	48-225, 48-230		2	859	50-1721, 50-1723,		
40-180, 40-185,				48-250, 48-250-1		2	860	50-1724		1305
40-190		1	344	48-300, 48-360		2	861	50-1727		1306
40-195, 40-200,				48-460, 48-460-1		2	861	51-T1443PL, PM,		1307
40-201		1	338	48-461		2	859	PW (Radio Ch.)		
40-205, 40-215				48-464		2	862	51-T1872, 51- T1874, 51-T1875,		
40-216, 40-217		1	342	48-472-I		2	863	51-T1876		1308
40-503, 40-506,				48-472 Revised		2	864	51-T2175, 51- T2176		1309
40-507		1	340	48-475		2	865	51-530, 51-532,		
40-516		1	342	48-482		2	866	51-534		1310
40-525, 40-526,				48-485		2	867	51-629		1311
40-527		1	340	48-1201		2	868	51-631		1312
40-710, 40-715		1	351	48-1253		2	869	51-632		1311
40-725, 40-748,				48-1256		2	870	51-934		1313
40-755, 40-756,				48-1260		2	868	51-1731, 51-1732		1314
40-780		1	349	48-1262		2	867			
40-2710		1	351	48-1263		2	871			
40-2725, 40-2780		1	349	48-1264		2	872			
41-230, 41-235		1	350	48-1266		2	856			
41-250, 41-255		1	353	48-1270		2	873			
41-260, 41-265		1	352	48-1274, 48-1276		2	874			
41-280, 41-285,				48-1282		2	867			
41-287, 41-290		1	353	48-1284		2	875			
41-295		1	338	48-1286		2	867			
41-296		1	353	48-1290		2	873			
41-300, 41-315X		1	338	48-2500						
41-316		1	342	48-2500-5	1289					
41-608, 41-609		1	355	49-101	1290					
41-610, 41-611		1	353	49-500, 49-500-1		2	745	100C		2
41-616		1	342	49-503		2	580	100T		2
41-629		1	353	49-504, 49-504-1		2	859	149C, 249C		2
41-712, 41-713		1	354	49-505		2	876	349C		2
41-714		1	346	49-506		2	745	6810		1
41-722, 41-745,				49-601, 49-602		2	877	8701, 8702, 8703		1
41-758, 41-759		1	347	49-605, 49-607		2	878	8710, 8711, 8712		1
41-788		1	356	49-900E, 49-900-1		2	879			
42PT-2, 42PT-4,				49-902		2	745			
42PT-7		1	343	49-904		2	880			
46-421		1	363	49-905		2	881			
				49-908		2	882			
				49-909		2	883			
				49-1076			1291			

**PHILHARMONIC**

100C		2	887
100T		2	888
149C, 249C		2	889
349C		2	890
6810		1	196
8701, 8702, 8703		1	196
8710, 8711, 8712		1	196

**PHILLIPS PETROLEUM CO.  
(See Woolarc)**

**PILOT**

T-411-U		1	381
T-500		1	73

Name & Model or Chassis No.	Vol. 3 Diag. No.	Previous Vols Vol. No.	Diag. No.	Name & Model or Chassis No.	Vol. 3 Diag. No.	Previous Vols Vol. No.	Diag. No.	Name & Model or Chassis No.	Vol. 3 Diag. No.	Previous Vols Vol. No.	Diag. No.
<b>PILOT (Continued)</b>				<b>RCA VICTOR (Continued)</b>				<b>RCA VICTOR (Continued)</b>			
T-510, T-511		1	381	QU-56C, QU-56M	1		432	11QK, 11QU, 11QQ	1		414
T-521		1	383	T-55, T-56, T-60,				11X-1	1		411
T-530		1	393	T-62, T-83	1		107	12AX, 12AX2	1		411
T-601		2	614	T-64, T-65, T-80,	1		433	12QK, 12QU, 12Q4	1		414
T-741		2	891	TA-128, TA-129, TA-169			1321	12X, 12X2	1		411
<b>POLICE ALARM</b>				TRK-5	1		395	14AX, 14AX2, 14X,			
PR-8	1315			TRK-9, TRK-12	1		410	14X2	1		411
PR-31	1316			TRK-90, TRK-120	1		410	15X	1		397
<b>PONTIAC</b>				TRK-5	1		395	16K, 16T2, 16T3,			
983867		1	384	U-10, U-12, U-20	1		107	16T4	1		413
983679		1	386	U-25, U-26	1		395	16X4	1		415
983680		1	394	U-30	1		414	16X11, 16X13,			
983775		1	386	U-40, U-42, U-43	1		107	16X14	1		397
983910		1	108	U-44, U-45	1		425	17K	1		139
983911		1	386	U-50	1		400	18T	1		139
984170		1	108	U-115	1		443	19K	1		417
984171		1	386	U-119	1		395	25BK	1		418
<b>PORTO BARADIO</b>				U-121	1		443	25BT2	1		419
PA510, PB520	2		892	U-122E	1		395	25BT3	1		418
<b>PREMIER</b>				U-123 (1 band)	1		441	26BP	1		421
15LW	1		127	U-123 (2 band)	1		443	26X1, 26X3, 26X4	1		397
<b>PURE OIL (See Puritan)</b>				U-124, U-125	1		395	27K	1		422
501		1	385	U-126	1		414	28T	1		139
501X		1	124	U-127E	1		443	28X, 28X5	1		140
502		1	385	U-128, U-129	1		414	29K, 29K2	1		141
502X		1	124	U-130	1		390	34X, 35X	1		411
503, 503W		1	388	U-132, U-134	1		401	36X	1		397
504, 504W		1	387	V-101	1		440	45X18	1		424
506, 506X, 507,				V-102	1		413	55AU	1		429
507W		1	20	V-140	1		446	55F, 55FA	1		419
508		1	25	V-170, V-175	1		413	55U	1		429
509		2	893	V-200	1		447	56X, 56X2, 56X3	1		431
515		2	894	V-201	1		139	56X5, 56X10, 56X11	1		397
<b>RCA VICTOR</b>				V-205	1		447	58AV, 58V, 59AV,			
A55	1317			V-209, V-210	1		142	59V1	1		142
A-106	1318			V-215, V-219	1			64F1, 64F2, 64F3	1		138
BK-42, BT-42	1		427	V-221, V-225	1		142	65AU	1		429
BX8	1319			V-300, V-301,				65BR9	1		899
BX55, BX57	1320			V-302	1		447	65U	1		429
B-52	1		419	V-405	1		447	65X1, 65X2	1		138
E-80	1		43	VHR-202, VHR-207	1		447	66BX	1		435
HF-2, HF-4	1		390	VHR-212	1		142	66X1, 66X2, 66X3,			
HF-6, HF-8	1		401	VHR-307, VHR-407	1		447	66X4, 66X9	1		436
K-50	1		107	X-55, X-60	1		107	68X11, 68X12,			
K-80	1		434	X711			1322	68X13, 68X14,			
K-81	1		107	4T141, 8T84			1323	68X15	2		900
K-82, K-81, K-82	1		434	5Q5, 5Q6, 5Q8	1		398	67AV1, 67V1	1		437
K-105	1		434	5Q12, 5Q12A	1		400	68R1, 68R2, 68R3,			
M-50, M-60	1		409	6Q1	1		398	68R4	2		901
M-70	1		439	6Q1, 6Q4, 6Q4X	1		400	75X11, 75X12	2		902
Q-11, Q-12	1		397	6Q7, 6Q8, 6QK3	1		402	77U	2		903
Q-14, Q-14E, Q-15,				7QB, 7QBK	1		403	77V1	2		904
Q-15E	1		412	7Q4, 7Q4X, 7QK4	1		405	77V2	2		905
Q-16, Q-16E, Q-17	1		416	7T143, (Radio Ch.)	1327			94BK2, 94BT2	1		442
Q-18	1		398	8BK6, 8BK65	2		895	95T5, 95T5LW	1		443
Q-22, Q-22A	1		391	8Q1	1		403	96BK6, 96BT6	1		442
Q-23	1		416	8Q8, 8QBK	1		406	96E	1		443
Q-24	1		391	8Q2	1		404	96E2	1		395
Q-25	1		420	8Q4	1		406	96K, 96K2, 96K5,			
Q-26	1		396	8QU5C, 8QU5M	1		404	96K6	1		395
Q-27	1		420	8R71, 8R72, 8R74,				96T, 96T1	1		443
Q-30, Q-31	1		423	8R75, 8R76	2		896	96T2, 96T3	1		395
Q-33	1		399	8TK29 (Radio Ch.)	1324			96T4, 96T5, 96T6	1		441
Q-44	1		426	8TK320	1324			96T7	1		395
QB-1, QB-2	1		391	8TR29	1324			96X1, 96X2, 96X3,			
QB-3	1		399	8TV321, B				96X4	1		444
QB-5	1		397	8TV323, B	1325			96X11, 96X12,			
QB-6, QB-9	1		391	8V90, 8V91	2		897	96X13, 96X14	1		444
QH-51C	1		428	8V111, 8V112	2		897	97E, 97K, 97KG,			
QK-23	1		392	8X53	2		898	97K2	1		395
QU-2C, QU-2M	1		392	8BX56	1326			97T, 97T2	1		395
QU-3C, QU-3M	1		396	9M1, 9M2	1		409	97X	1		443
QU-5	1		392	9QK, 9Q1	1		408	97Y	1		398
QU-7, QU-8	1		407	9Q4	1		405	98EY	1		395
QU-51M	1		428	9T89	1327			98EK	1		414
QU-52C, QU-52M	1		392	9T147	1327			98K2, 98T, 98T2	1		395
QU-55	1		430	9TW333	1325			98X, 98YG	1		414
				9W101, 9W102				99K, 99T	1		444
				9W103, 9W105	1328			110K, 110K2, 111K	1		415
				9X561, 9X562	1329			211K	1		141
				9X571, 9X572	1329			515	1		397
				9X641, 9X642	1330			516, 517, 522, 526,			
				9X651, 9X652	1331			527	1		411
				9Y51	1332			610V1, 610V2	2		906
				9Y510, 9Y511	1332			612V1, 612V2	1		
				10Q1	1		406	612V3	1		448
				10X	1		411	648PTK, 648PV (Radio Ch.)	1333		
								710V2	2		908

Name & Model or Chassis No.	Vol. 3 Diag. No.	Previous Vol. No.	Diag. No.	Name & Model or Chassis No.	Vol. 3 Diag. No.	Previous Vol. No.	Diag. No.	Name & Model or Chassis No.	Vol. 3 Diag. No.	Previous Vol. No.	Diag. No.
<b>RCA VICTOR (Continued)</b>				<b>RAYTHEON</b>				<b>SENTINEL (Continued)</b>			
711V1, 711V2, 711V3	2		907	RC-1618A, B, RC-1619A, B		1336		L-284NI, L-284NR, L-284W		2	928
730TV1, 730TV2 (Radio Ch.)	2		906	RC-1718A, B, RC-1719A, B		1336		263, 284, 273, 284GA		1	459
910KG, 911K	1		414	10AXF43		1335		2841, 284NA, 284NI, 284W		2	928
<b>Chassis</b>				<b>RECORDIO</b>				<b>Chassis</b>			
RC-604, RC-605	1		142	6B10, 6B20, 6B30, 6B32			1	285P		1	261
RC-608	1		437	7D42, 7D44			2	289T		1	23
RC-606C	2		905	7E40, 7E44			2	292K		1	454
RC-608	2		901	9G10		1337		293 Series		1	459
RC-640, RC-610A, RC-610B	2		906	9G40M, 9G42		1338		293CT		1	459
RC-613A	2		906	9H40B		1339		2931		2	929
RC-615	2		904	<b>Chassis</b>				293T, 293W		1	459
RC-618, RC-616A, RC-616B, C	2		897	7D1			2	2941, 294W, 294T		1	459
RC-616H, K	1325							295T		2	930
RC-618N	1325			<b>REGAL</b>				296B, 296M		2	775
RC-618, RC-618A, RC-618, RC-618B, RC-618C	2		897	BP48			2	302-I, 302-T, 302-W		2	932
RC-622	1328			CR761			2	305-I, 305-I-3, 305-W, 305-W3		2	933
RC-1004E	1		419	L760			2	309-I, 309-N, 309-R, 309-W		2	934
RC-1011	1		431	W700, W800, W801, W900, W901			1	313-I, 313-W		2	935
RC-1017				205			2	314-E, 314-I, 314-W		2	928
RC-1017A	1		429	747			2	315-I, 315-W		2	929
RC-1023B	1		397	777			2	316PM, 316PT		2	937
RC-1034	1		138	1049			1	332		2	935
RC-1037, RC-1037A	1		138	1107			2	333		2	929
RC-1038				1500			2	385PG, PI, PM, PW			1343
RC-1038A	1		436	1749			2	338-I, 338-R, 338-W			1344
RC-1040				7251			2	339-K			1345
RC-1040A	1		435	<b>REMLER</b>				340-C			1345
RC-1040C	2		895	MP-5-5-3			1	416, 419, 420, 420B			1346
RC-1045	2		899	5300B, 5300B1, 53001			2	423, 423B, 423-17			1347
RC-1046	2		900	5310			2	424, 424-17			1347
RC-1050				5400, 5410, 550, 5505, 5510, 5515, 5520			2	425, 428, 429, 430, 431, 432, 435			1347
RC-1050B	2		900	5530			2	435			1347
RC-1057A	2		903	6000		1340		<b>SETCHELL CARLSON</b>			
RC-1060				<b>SCOTT (E. H.)</b>				416		1	192
RC-1060A	2		896	16A			2	427		2	938
RC-1064 (Mod. 8X53)	2		898	510		1341		437		2	939
RC-1064 (Mod. 85X1)	1		138	800-B			1	447		2	940
RC-1068	1326			<b>SENTINEL</b>				458-RD			1348
RC-1070A	1322			IU-284GA			2	469			1349
RC-1077, A, B	1332			IU-284I, IU-284NA				570			1350
RC-1079, A, B, C	1329			IU-284NI, IU-284W			1	<b>SIGNAL</b>			
RC-1082	1319			IU-285, IU-285P			1	AF252		2	942
RC-1085, A	1331			IU-293I			1	241		2	941
RC-1087	1317			IU-293CT			2	341-A, 341-T		2	943
RC-1088, A	1320			IU-293T, IU-293W			1	<b>SILVERTONE</b>			
RC-1089	1323			IU-294I, IU-294N			1	R-381		1	460
RC-1092	1327			IU-294T, IU-294W			1	R-1161		1	458
RK-121				IU-312PG				41, 41A			1351
RK-121A	1233		448	IU-312PW		1342		51, 53			1352
RK-135, RK-135A, RK-135A-1	1324			IU-313I, IU-313W			2	54, 56			1352
RK-135D	1321			IU-314E, IU-314I, IU-314W			2	64, 65, 67			1353
<b>RADIOLA</b>				<b>IU-316PM, IU-316PT</b>				<b>IU-335PG, PI, PM, PW</b>			
61-1, 61-2, 61-3, 61-5	1		397	IU-338-I				125			1355
61-8, 61-9	2		898	IU-338-R				143, 143A			1356
61-10	1		397	IU-338-W		1345		179-16, 180-16, 194-16, 195-16			1357
75ZU	2		908	IU-339-K		1345		220, 222, 223, 224			1358
762X11, 762X12	2		909	IU-340-C		1345		225			1359
<b>RADIO CRAFTSMEN</b>				<b>IU-418</b>				<b>771</b>			
RC-1 (Tuner)	2		910	IU-419, IU-420		1346		1771		1	458
RC-10	1334			IU-420B		1347		1781, 1781A		1	482
<b>RADIONIC</b>				<b>IU-423, IU-423B, IU-423-17</b>				<b>2011</b>			
6W	1		167	IU-424		1347		2051		1	73
Y62N, Y728	2		911	IU-424-17		1347		2411		1	73
<b>RAY ENERGY</b>				<b>IU-425</b>				<b>2461</b>			
AD	1		449	IU-428, IU-429		1347		2511		1	73
AD4	1		453	IU-430, IU-431		1347		2761		1	458
SRB-1X	1		450	IU-432, IU-435		1347		4608, 4609		1	461
				L-284I, L-284NA			2	4628, 4629		1	461
								4638, 4639		1	461



Name & Model or Chassis No.	Vol. 3 Diag. No.	Previous Vol. Vol. No.	Diag. No.	Name & Model or Chassis No.	Vol. 3 Diag. No.	Previous Vol. Vol. No.	Diag. No.	Name & Model or Chassis No.	Vol. 3 Diag. No.	Previous Vol. Vol. No.	Diag. No.
<b>SPARTON</b>				<b>STEWART-WARNER (Continued)</b>				<b>STROMBERG-CARLSON (Continued)</b>			
4AW17, 4AW17A	2	974		B51T1, B51T2,				1121 (Series			
5AM26PS	1	500		B51T3	2	988		10-11-12)	1	520	
5A116	2	974		B61T1, B61T2	2	717		1121-HW, 1121-LW,			
5AW08	1	503		B72CR1	2	990		1121-M1-0,			
5AW16	2	974		C51T1, C51T2	2	989		1121-M2-W,			
6AM06	2	975		R3581, R3589	1	513		1121-M2-Y,	1	520	
6AW26PA	1	502		R3861, R3869	1	513		1121-PPM,			
6-66A	2	976		01-5H	1	509		1121-PPW,			
7AM46, 8AM46	1	499		01-6A, 01-6B,				1121-PGM,			
10AB76-PA,				01-6C	1	509		1121-PGW,			
10AM76-PA,				01-6D, 01-6DX,	1	507		1121-PLM,			
10BM76-PA,				01-6F, 01-6F9	1	508		1121-PLW,			
10BW76-PA	1	504		01-6G, 01-6E2	1	507		1121-PSM,	1	520	
100, 101,	2	974		01-8C7, 01-8C7-Z,				1135-PPM,			
121,	2	977		01-9A, 01-9A-Z,	1	506		1135-PLM,			
141,	2	977		010-6AX,				1135-PLW,	2	992	
141A	1373			010-6BX,				1200,	2	991	
141LXX	1374			010-6CX	1	509		1202,	2	993	
150, 151, 152,				11-6U, 11-6U-Z,	1	505		1204,	2	994	
155	1375			11-7A1, 11-7A9	1	508		1210M2-M,			
1000, 1001,				11-8D, 11-8F,				1210M2-W,			
1003	2	978		11-8R	1	510		1210M2-Y,	2	995	
1005, 1006,				11-8R8, 11-8R9	1	508		1210-PGM,			
1007, 1008,	2	979		11-9B, 11-9B-Z,	1	506		1210-PLM,			
1010	2	980		11-10A	1	510		1210-PGW,	2	995	
1015	1	504		51T746, 51T756	2	983		1220 Series	2	986	
1020, 1021, 1023	2	978		51T126, 51T136				1235 Series	2	992	
1030, 1030A,				51T146, 51T176	1	20		1400,	2	991	
1031, 1031A	2	961		61T16, 61T26	1	20		1407-PPM,			
1051, 1052	2	982		61TR36, 61TR46	1	511		1407-PLM	2	997	
1058, 1059,				62T16	1	512		1500,	1388		
1060, 1061,				62T36	1	20		1507,	1389		
1064, 1072	2	977		62TC16, 62TC26,				<b>SUPREME</b>			
1080	1376			62TC36	1	512		750,	2	998	
1080A	1373			72CR16, 72CR26	1	510		<b>SWANK</b>			
1081	1376			205GA, 205GZ	1	513		<b>DUI01</b>	1	521	
1081A	1373			9000-B, 9001-C,				<b>SYLVANIA</b>			
1210, 1211,	1374			9001-D, 9001-E,	1	20		1-075,	1390		
4900TV (Radio				9001-F, 9002				1-076,	1391A & B		
Ch.)	1376			9002A, 9002B,				1-090,	1391A		
5082, 5083				9002P, 9002R	2	984		1-113, 1-114,	1390		
(Radio Ch.)	1374			9003	1	514		1-124, 1-125,	1390		
5088, 5089,				9004	1	510		1-125-1,	1382		
5090 (Radio Ch.)	1374			9005-A, 9005-B	1	14		1-128,	1391A & B		
5182, 5183,				9007-A, 9007-F,				1-177,	1390		
5188, 5189				9007-G	1	516		1-197,	1390		
(Radio Ch.)	1374			9014-E	1	20		1-197-1,	1392		
<b>Chassis</b>				9017	1	20		1-210,	1390		
PC-5-6-26	1	502		9104-A, -B, -C	1379			1-245, 1-246	1390		
4E10	1375			9108A, B, 9113A	1380			1-245-1, 1-246-1,	1392		
5A7	2	974		9151-A	1381			1-247,	1391A		
5-06	1	503		9152-A, -B, -C	1382			540B, BA, 540H,			
5-16	2	974		<b>STRATOVOX</b>				HA, 540M, MA	1393		
5-28PS	1	500		579-1-58A	1	120		1110X, 1210X	1394		
6B9	2	982		<b>STROMBERG-CARLSON</b>				5130B, M, W,			
6L6	2	981		TC-10	1383			5140B, M	1395		
6-06	2	975		TC-19	1384			5150M	1396		
7L7	2	980		TS-15, TS-16,				7110XFA,			
7-46	1	499		TS-125	1385			7120MFA,			
8LP	2	977		16CM, 16TM,				7130MFA	1396		
8L10	1373			17CM, 17TM,				7140MA, 7140WA	1396		
8W10	1374			116CM, 116TM	1388			7150M	1396		
8-46	1	499		16RP, 17RP				7160B	1398		
8-57	2	979		116RP (TV Ch.)	1388			<b>Chassis</b>			
9L8A	1376			16RP, 17RP				1-108,	1391A & B		
10-77PA	1	504		116RP (Radio				1-139,	1390		
12L7	2	978		Ch.)	2	997		1-168,	1391A		
417, 417A	2	974		117 Series	1387A			1-186,	1392		
686A	2	976		119CDM, CM,				1-274,	1386		
<b>STARRETT</b>				119M5A, D, G,				1-290,	1395		
Jotham	1377			I, M, R, 119RPM2				1-357,	1396		
John Hancock	1378			(TV Ch.)	1387A			1-381,	1394		
<b>STEWART-WARNER</b>				119M5A, D, G, I,				1-437,	1396		
51T1, 51T2,				M, R, 119RPM2				1-442,	1396		
51T3, 51T4	1	515		(Radio Ch.)	1387B			<b>TELESONIC</b>			
A61CR1, A61CR2,				1100-H, 1100-H1	1	517		1635	1	6	
A61CR3, A61CR4	2	985		1101-HB, 1101-H1,				1636	2	999	
A61P1, A61P2,				1101HM	1	454		1642	1	167	
A61F3	2	986		1101-HPW	2	885		1643	2	1000	
A72T1, A72T2,				1101-HW,							
A72T3, A72T4	2	987		1101-HY	1	454					
A92CR3, A92CR3S,				1105 (Series 10-11)	1	519					
A92CR6, A92CR6S,	2	720		1110PTW (Series	1	519					

Name & Model or Chassis No.	Vol. 3 Diag. No.	Previous Vol. No.	Diag. No.	Name & Model or Chassis No.	Vol. 3 Diag. No.	Previous Vol. No.	Diag. No.	Name & Model or Chassis No.	Vol. 3 Diag. No.	Previous Vol. No.	Diag. No.
<b>TELETONE</b>				<b>TEMPLE</b>				<b>TRUETONE (Continued)</b>			
TV-208	1397			E510	1	189		D2027A	1415		
TV-208TR	1398			E511	1	11		D2127		1	182
TV-220	1398			E519	1	189		D2133		1	526
TV-250	1399			F811	1	324		D2149		1	41
TV-254, TV-255	1399			F818	1	523		D2210, D2211		1	40
TV-256	1399			F817	1	524		D2224		1	182
TV-282	1400			G410	2	893		D2261		1	48
TV-283	1399			G513	2	1012		D2610, D2611		1	527
TV-284	1398			G515, G516	1	189		D2612, D2613		1	20
TV-285	1399			G518	2	564		D2615		1	529
TV-300, TV-301	1401			G521	2	565		D2616		1	528
(Ch. TW)				G522	1	564		D2616B		2	1022
TV-304, TV-305	1401			G619	2	1013		D2619		2	1023
(Ch. TX)				G622	2	1014		D2620		1	531
TV-306, TV-307	1401			G721, G722, G723	2	1015		D2621		1	530
TV-308	1398			G724	2	566		D2622		1	275
TV-314	1402			G725	2	567		D2623		1	18
TV-316	1403			G1430	2	1016		D2624		1	78
TV-318, TV-322	1404			H622	2	1014		D2626		2	1024
TV-323	1404			<b>TEMPOTONE</b>				D2630		1	78
TV-324, TV-325	1405			500E Series				D2634		1	125
TV-326	1405			12L50, 12L50A				D2640		2	1025
TV-328, TV-329	1405			14B50, A				D2642		1	275
TV-330, TV-331	1405			14C50, A				D2644		1	13
TV-332, TV-333	1398			16G50A, 16R50A,				D2645		1	68
TV-335, TV-336	1405			16T50A				D2661		1	527
TV-340, TV-345	1405			5000, 5000-I				D2663		1	4
TV-348, TV-349	1405			5002				D2665		2	1026
TV-352	1405			5007, 5008, 5009,				D2692		2	1027
TV-358, TV-359	1405			5010, 5011, 5012,				D2710		2	1028
100, 100A, 101	2	1001		5015, 5019,				D2718		2	1029
109	1	258		5020				D2745		1	38
111, 113	2	1001		5021				D2748		2	1030
117-A	1	258		5022				D2810		2	1031
122, 123, 125				5027				D2815		2	1022
127, 130, 131	2	1001		5028, 5029				D2819		2	1032
133, 134	1	258		5030, 5031				D2919		2	1033
135	1	280		5036				D2963	1416		
138	2	1002		5051				D3619		1	95
142, 143, 144				5060, 5061				D3630, N		1	73
145	2	1003		5068				D3720		2	1034
148	2	1004		6040				D3721		2	1035
150	2	1005		6050				D3722		2	811
156	2	1006		6050				D3809, D3810		2	633
157	2	1005		Chassis				D3840		2	1036
158	2	1008		104, 105				D4620		2	656
159	2	1007		109				D4618		2	580
160	2	1009		800				D21093A	1417		
161, 162	2	1005		TRUETONE				D21094A	1410		
166, 167, 168	2	1005		D705				ULTRADYNE			
171	2	1005		D934				L-46			
172	2	1006		D1015, D1016				1			
174	2	1005		D1034A, B, C				UNITONE			
176	2	1006		D1042				88			
185	2	1010		D1046A, B, C, D				U. S. TELEVISION (Clearsonic)			
198	2	1008		D1070				5-16 Series,			
206	2	1008		D1117				5-46 Series			
208	2	1406		D1118				5A66, 5B66, 5C66,			
Chassis				D1124				5D66MPA			
Series A	2	1001		D1145				8-16M			
Series AA	2	1007		D1172, D1176				VAN CAMP			
Series AE	2	1005		D1202				576-1-6A			
Series AH	2	1010		D1215				VIEWTONE			
Series AT	2	1008		D1224				RC-201A,			
Series C, CA, D	1	258		D1612				RRC-201			
Series H	1	250		D1644				VOGUE			
Series J	1	258		D1645				553R, 554R			
Series N	2	1002		D1747, D1748				WALGREEN			
Series R	2	1003		D1752				568			
Series S	2	1004		D1835				571			
Series T	2	1006		D1836, A				WATTERSON			
TAC	1398			D1840				4581, RC4581			
TAH	1403			D1845				4582			
TAJ	1402			D1846A, B, C				ARC-4591A			
TAM	1404			D1849, D1850							
TAO	1398			Ch. 1							
TAP, TAP-1	1405			D1992 (Radio)							
TAP-2	1399			D1994 (Radio)							
TS	1399			Ch. 1							
TW, TX	1401			D2017, D2018							
TY, TZ	1398			D2020							
Series U	2	1006		D2025A							
Series Y	2	1009									
TELEVOX											
RP	2	1011									

Name & Model or Chassis No.		Vol. 3 Diag. No.	Previous Vola Vol. Diag. No.	Name & Model or Chassis No.		Vol. 3 Diag. No.	Previous Vola Vol. Diag. No.	Name & Model or Chassis No.		Vol. 3 Diag. No.	Previous Vola Vol. Diag. No.	
<b>WATTERSON (Continued)</b>				<b>WESTINGHOUSE (Continued)</b>				<b>WESTINGHOUSE (Continued)</b>				
4782		1	555	H-310T5,				V-2132	2	1049		
4790		1	132	H-310T5U,				V-2133	2	1037		
4800		2	1039	H-311T5,				V-2134	2	1050		
<b>WELLS-GARDNER</b>				H-311T5U	1425			V-2136		1419		
A10 Series		1	61	H-312P4,				V-2136-1, -2		1427		
A20 Series		1	64	H-312P4U,				V-2137		1418		
A22 Series				H-313P4,				V-2137-2		1419		
A23 Series				H-313P4U,				V-2148		1421		
A24 Series		1	60	H-314P4,				V-2150-41		1430		
S2		1	64	H-314P4U,				V-2150-81, A, B		1430		
T3 Series		1	64	H-315P4,				V-2150-81, -82,		1432		
JA17		1	46	H-315P4U	1426			-84		1432		
JA29		1	45	H-316C7,				V-2150-91A, -94,		1432		
LA62 Series				H-317C7	1427			-94C		1432		
LA62-4		1	183	H-318T5, U,				V-2151-1		1422		
LA63 Series				H-320T5, U,				V-2152-01		1431		
LA63-3, LA63-4		1	183	H-321T5, U,				V-2152-16		1433		
5A25S		1	72	H-322T5, U,				V-2153		1423		
6A43, 6A44		1	41	H-323T5, U	1428			V-2153-1		1426		
6A65 Series		1	47	H-324T7,				V-2156		1424		
6B10, 6B16,				H-325T7, U,				V-2157, -U, -1,		1428		
6B18		1	532	H-326C7	1427			-1U		1428		
7A40, 7A41		1	45	H-327T6U	1429			V-2157-2, -2U		1428		
7A66		1	526	H-336T5U,				V-2157-3U		1429		
7D11 Series		1	182	H-337T5U	1428			V-2161, U		1425		
8A30, 8A31		1	45	H-600T16,				V-2173		1434		
8A51 Series		1	41	H-601K12,				<b>WOOLAROC</b>				
<b>WESTINGHOUSE</b>				H-602K12	1430			3-1A, 3-2A	1	20		
H-104, A, H-105,				H-603C12	1431			3-3A	1	25		
A, H-107, A,				H-604T10, A	1432			3-4A	1	516		
H-108, A, H-110,				H-608C12	1431			3-5A	2	574		
H-111	1	533		H-609T10	1432			3-6A/5	2	1052		
H-113, H-114,				H-611C12,				3-9A, 3-10A	1	385		
H-116, H-117,				H-615C12	1433			3-11A	1	387		
H-119	1	535		H-633C17,				3-12A/3	2	1053		
H-122	1	534		H-634C17	1434			3-17A, 3-18A	2	1054		
H-125, H-126	1	536		H-1251		1	536	3-20A	1	584		
H-130	1	534		WR-12X7		1	537	3-29A	1	388		
H-133	1	539		WR-12X8		1	411	3-70A	2	1055		
H-137, H-138	1	533		WR-12X9				3-71A	2	761		
H-147	2	936		WR-12X12	1	397		3-81A	2	1016		
H-148, A	1	538		WR-12X14	1	415		<b>ZENITH</b>				
H-153, A	1	534		WR-12X15	1	137		G500	1435			
H-154	1	533		WR-12X16	1	140		G503	1436			
H-155, H-156	1	534		WR-13X8	1	411		G510, G510Y	1437			
H-157	2	1040		WR-42X3	1	413		G511, G511W,				
H-161	2	1041		WR-42X4, -42X5	1	437		G511Y	1438			
H-164	2	1042		WR-42X7	1	413		G616	1439			
H-165	2	1043		WR-42X14,				G615, G615W,				
H-166, H-167	2	1042		-42X15	1	437		G615Y	1440			
H-168, A, B	2	1041		WR-42X42	1	446		G680, G683,				
H-169	2	1044		WR-158	1	443		G685	1441			
H-171, A, C	1	534		WR-168, A	1	540		G723, G724	1442			
H-176	2	1045		WR-170, -172,				G725	1443			
H-182	2	1046		-175, -176	1	107		G881, G882,				
H-183, A	2	1047		WR-186	1	537		G883, G884,				
H-185	2	1048		WR-258	1	443		G885	1444			
H-186M, H-187	2	1049		WR-260	1	541		G2420E, -EOX,				
H-188	2	1037		WR-264	1	395		-R, ROX	1445			
H-190, H-191, A	2	1050		WR-270, WR-272	1	107		G2454R, -ROX	1445			
H-195	2	1048		WR-274	1	102		G2951, R, OX,				
H-198	1419			WR-280	1	102		ROX, G2952				
H-202	2	1051		WR-368	1	417		R, OX, ROX	1446			
H-203	1418			WR-368, -368,				H511, H511W,				
H-204	2	1051		-370	1	420		H511Y	1442			
H-207AM	1418			WR-372, -373	1	107		H661E, H661R,				
H-207A (DX),				WR-374	1	102		H665, R, RZ, Z	1447			
H-207B (DX)				WR-388	1	107		H723	1448			
(Radio Ch.)	1419			WR-473, -474	1	102		H723Z	1449			
H-212	1418			WR-476	1	102		H724	1448			
H-214, A, B	1420			WR-480, -482,				H725	1443			
H-217, A, B				-484	1	537		H880, H880R	1450			
(Radio Ch.)	1419			<b>Chassis</b>				H880RZ	1451			
H-220	2	1050		V-2102, -1	1	533		H2226E, R,				
H-251	1432			V-2103	1	534		H2227E, R	1452			
H-300T5				V-2103-3	1420			H2250R, H2255E	1452			
H-301T5	1421			V-2107	1	539		H2328E, EZ, E,				
H-302P5	1422			V-2118	2	1041		RZ, H2329R, RZ,				
H-303P4				V-2119-1	2	1042		H2330E, R	1453			
H-304P4	1423			V-2120	2	1043		H2341R	1453			
H-307T7				V-2122	2	1040		H2352R, RZ,				
H-308T7	1419			V-2123	2	1045		H2353E, EZ	1453			
H-309P5				V-2124-1	2	1044		H2437E, R,				
H-309P5U	1424			V-2127	2	1047		H2438R, H2439R,				
				V-2128, -1	2	1046		H2443E, H2445R	1454			
				V-2128-2	2	1051						
				V-2130-21DX,								
				22DX	1419							
				V-2131, -1	2	1048						

Name & Model or Chassis No.	Vol. 3 Diag. No.	Previous Vol. Diag. No.	Name & Model or Chassis No.	Vol. 3 Diag. No.	Previous Vol. Diag. No.	Name & Model or Chassis No.	Vol. 3 Diag. No.	Previous Vol. Diag. No.
ZENITH (Continued)			ZENITH (Continued)			ZENITH (Continued)		
H2447R, H2449E (TV Chassis).....	1454		7H918 .....	1457		5H01 .....	1442	
H3287, R (TV Ch.)..	1454		7H920, W .....	1443		8C01 .....	1.....	542
H-3287R (Radio Ch.).....	1451		7H921, 7H922 ..	1442		8C05, Z .....	1.....	544
H3467R (TV Ch.)..	1454		7ML592 .....	1.....	550	8C21 .....	1.....	549
H3468R (Radio Ch.).....	1455		7MN596 .....	1.....	546	8C22 .....	1.....	542
H3469E (TV Ch.)..	1454		7R887 .....	2.....	1061	8C40 .....	1.....	544
H3469E (Radio Ch.).....	1455		8G005 Y .....	1.....	542	8C41 .....	1.....	543
H3475R (TV Ch.)..	1454		8G005 Y T (Z1), (Z2)	2.....	1057	8C50 .....	2.....	555
H3475R (Radio Ch.).....	1455		8H023 .....	1.....	551	8E02, 8E05 ..	2.....	1058
H3477R (TV Ch.)..	1454		8H032, 8H033 ..	1.....	552	8E40 .....	2.....	1059
H3477R (Radio Ch.).....	1455		8H034 .....	1.....	551	8G01 .....	1441	
H3478E (TV Ch.)..	1454		8H050, 8H051 ..	1.....	552	8G05 .....	1440	
H3478E (Radio Ch.).....	1455		8H052, 8H061 ..	1.....	552	8H01 .....	1447	
H3479R (TV Ch.)..	1454		8H832, 8H891 ..	2.....	1062	7E01 .....	2.....	1060
H3479R (Radio Ch.).....	1455		9H079, E, R, ..	2.....	1062	7E02, Z .....	2.....	555
H3479E (TV Ch.)..	1454		9H082R, 9H085R,			7E22 .....	2.....	1061
H3479E (Radio Ch.).....	1455		9H088R .....	1.....	542	7F01 .....	1443	
H3479E (Radio Ch.).....	1454		9H881, 9H882R,			7F02 .....	1442	
H3479E (Radio Ch.).....	1455		9H885, 9H888R ..	2.....	1062	7F03 .....	1457	
H3479E (Radio Ch.).....	1456		9H995 .....		1458	7F04 .....	1442	
4G903, 4G903Y .....	1458		12H090, 12H091,			7G01, Z .....	1443	
4K018, 4K035 .....	1.....	542	12H092, 12H093,			7G02 .....	1442	
5D011, 5D027 .....	1.....	544	12H094 .....	1.....	35	7G04 .....	1442	
5D810 .....	2.....	555	14H789 .....	2.....	1063	7H02 .....	1448	
5G003 .....	1.....	544	28T964R (Radio			7H04 .....	1448	
5G003Z, ZZ .....	2.....	1056	Ch.) .....		1437	7H04Z .....	1449	
5G036 .....	2.....	1057	37T996RLP (Radio Ch.) .....		1458	8C01 .....	1.....	551
5R080, 5R086 .....	1.....	544	37T998RLPU (Radio Ch.) .....		1458	8C20 .....	1.....	552
6D014, W .....	1.....	542	42T999RLP (Radio Ch.) .....		1437	8C21 .....	1.....	542
6D015, Y .....	1.....	544	Chassis			8C40 .....	1.....	542
6D029, G .....	1.....	542	4C52, 4C53 .....	1.....	542	8C40T (Z1), (Z2)	2.....	1057
6D030 .....	1.....	544	4F40 .....		1456	8E20 .....	2.....	1062
6D815, W, Y .....	2.....	1058	5C01, Z, 5C02,			8G20 .....	1444	
6G001, Y .....	1.....	544	5C02, Z, 5C02,			8H20 .....	1451	
6G004Y .....	1.....	543	5C40Z, ZZ .....	1.....	544	8H20 Revised ..	1450	
6G038 .....	2.....	555	5E02 .....	2.....	1057	9E21 .....	2.....	1062
6G801 .....	2.....	1059	5G01 .....		1438	9E21Z .....	1458	
6MF590, 6MF591 ..	1.....	548	5G02 .....		1437	11C21 .....	1.....	35
6MF493 .....	1.....	545	5G03 .....		1439	13D22 .....	2.....	1063
6MN495, 6MN496 ..	1.....	547	5G40 .....		1435	22H20, Z .....	1452	
6MN595 .....	1.....	546	5G41 .....		1436	23H22, Z .....	1453	
6R084 .....	1.....	549				24G20, -OX ..	1445	
6R087 .....	1.....	542				24G21, -OX ..	1445	
6R886 .....	2.....	1058				24H20 .....	1454	
7H820, W .....	2.....	1060				29G20 .....	1446	
7H822, WZ, Z .....	2.....	555						



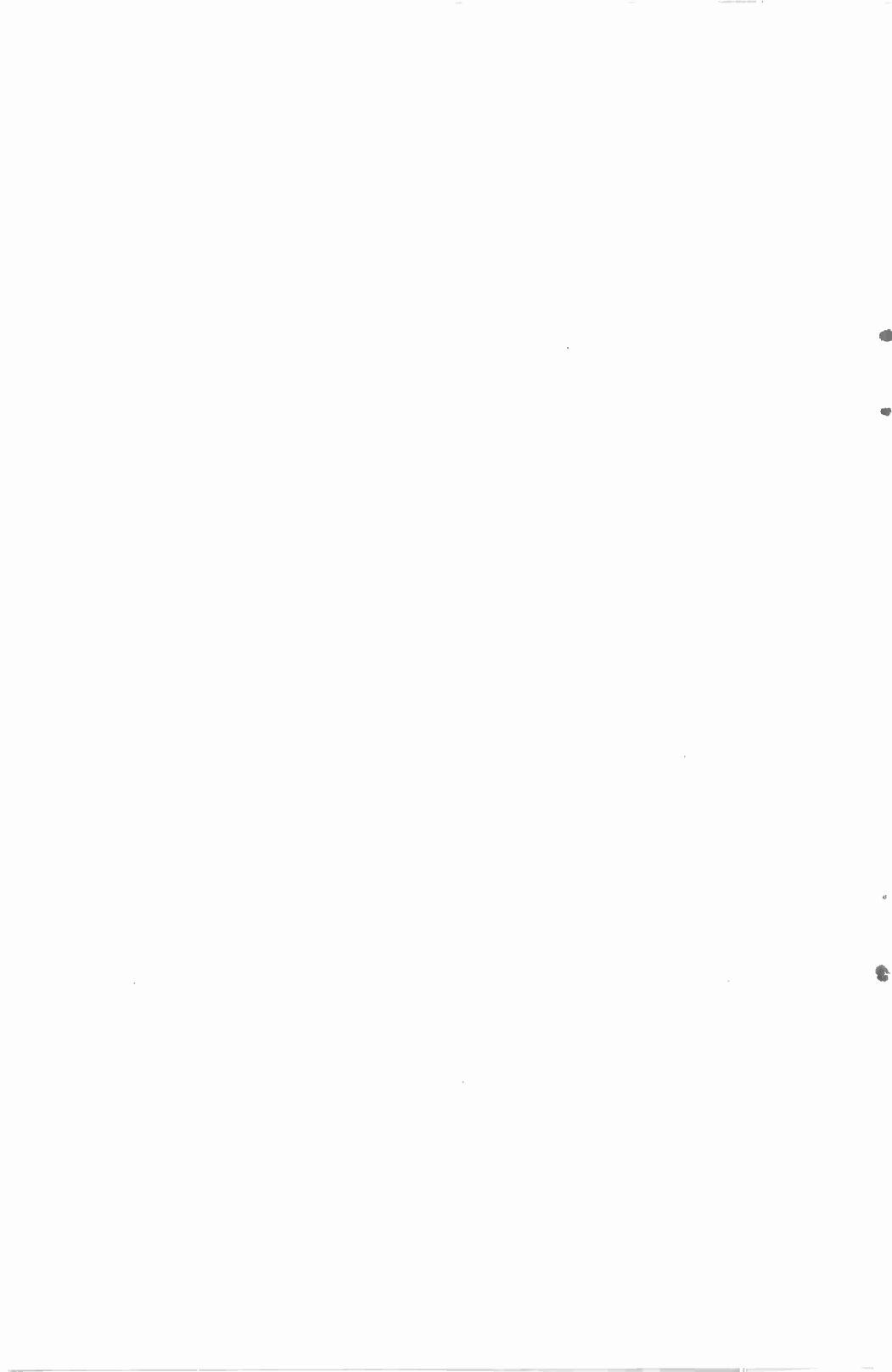

TUNING GANG FULLY CLOSED

1064

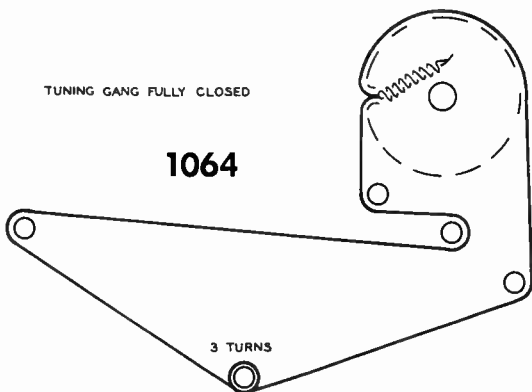

3 TURNS

TUNING GANG FULLY CLOSED

1065

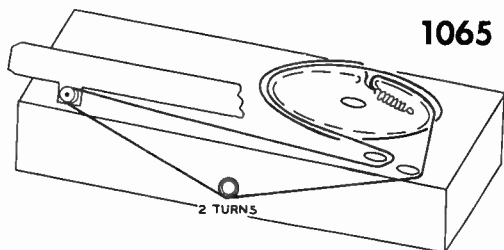

2 TURNS

TUNING GANG FULLY CLOSED

1066

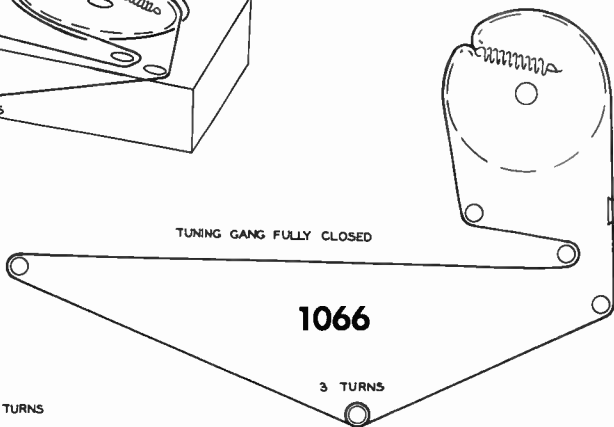

3 TURNS

2 TURNS

VOL. CONT. COUNTERCLOCKWISE

1067

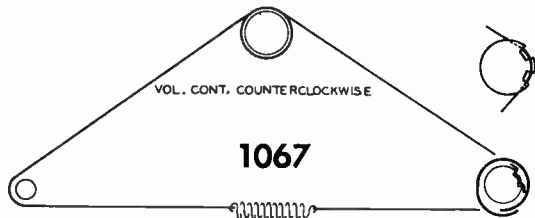

TUNING GANG FULLY CLOSED

1068

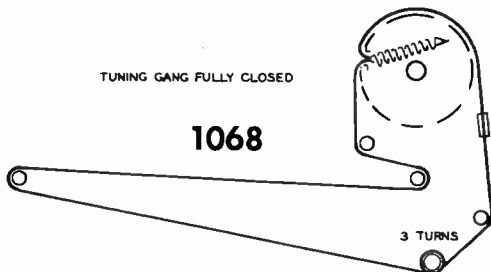

3 TURNS

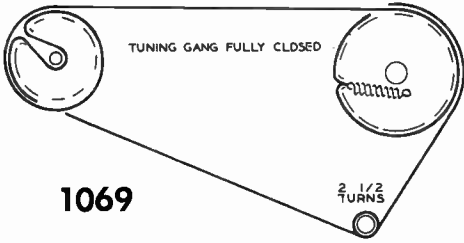

TUNING GANG FULLY CLOSED

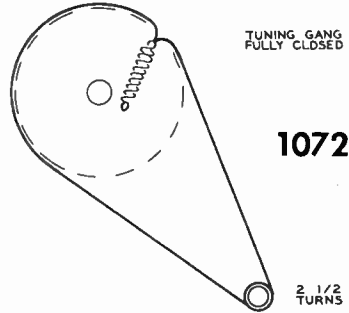
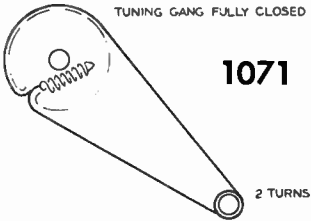
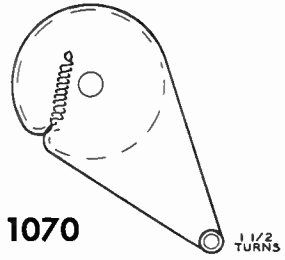

TUNING GANG FULLY CLOSED

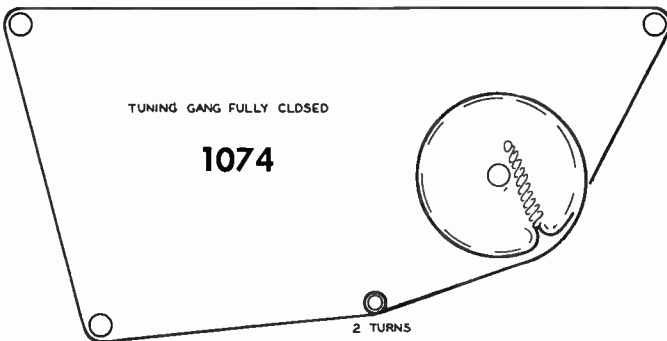
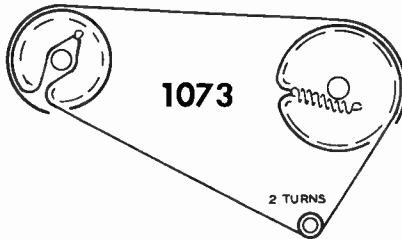

TUNING GANG FULLY CLOSED

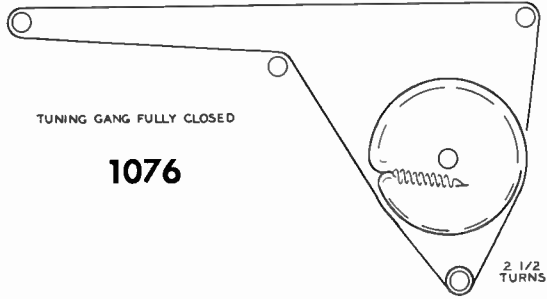
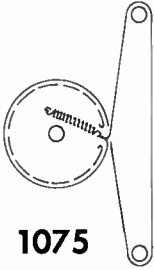

TUNING GANG FULLY CLOSED

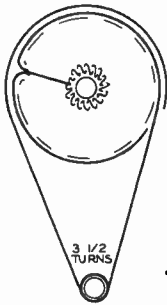

TUNING GANG FULLY CLOSED

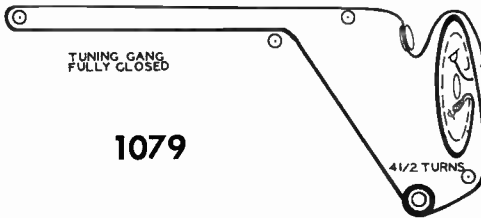
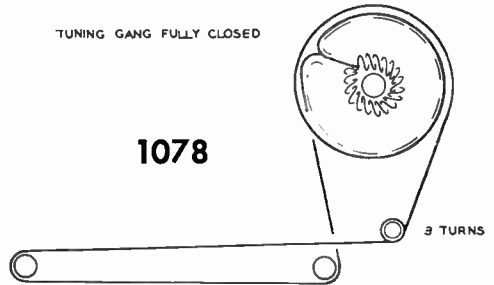

TUNING GANG FULLY CLOSED

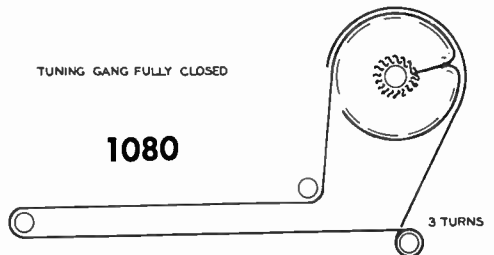

**1081**

TUNING GANG FULLY CLOSED

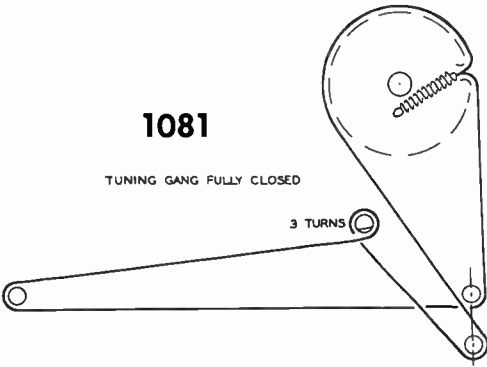

TUNING GANG FULLY CLOSED

**1082**

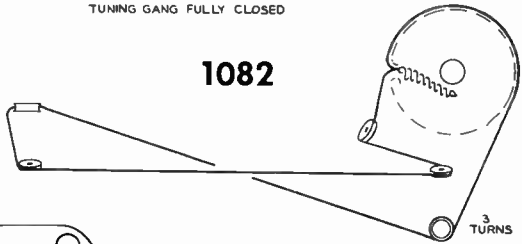

TUNING GANG FULLY CLOSED

**1083**

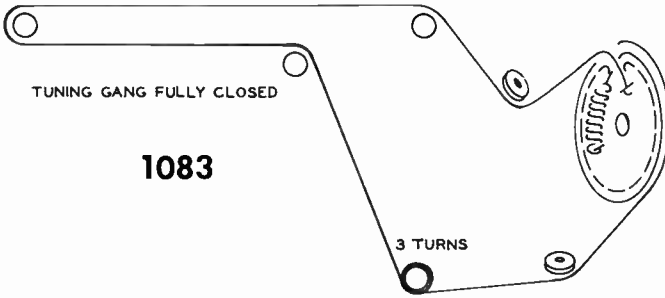

TUNING GANG FULLY CLOSED

**1084**

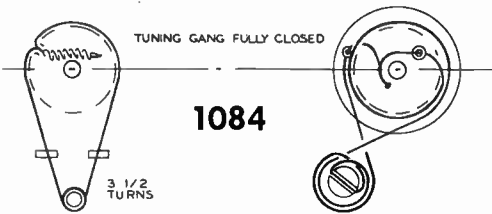

TUNING GANG FULLY CLOSED

**1085**



TUNING GANG FULLY CLOSED

**1086**

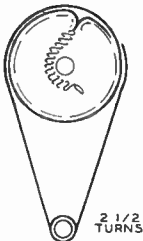

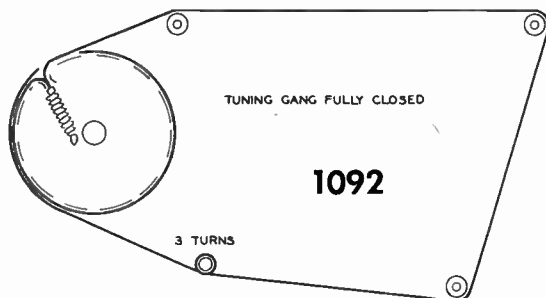
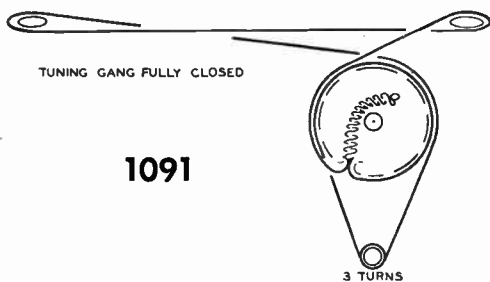
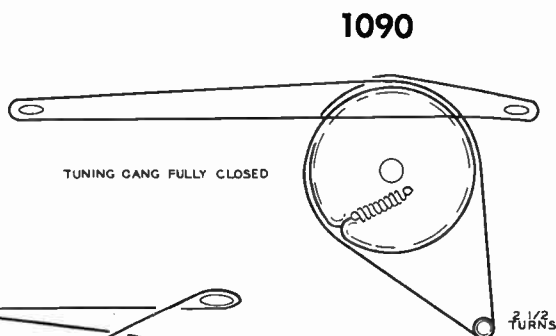
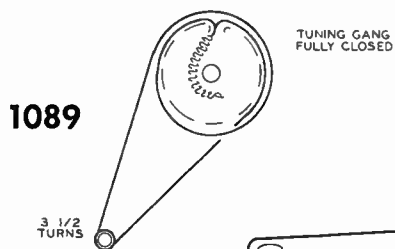
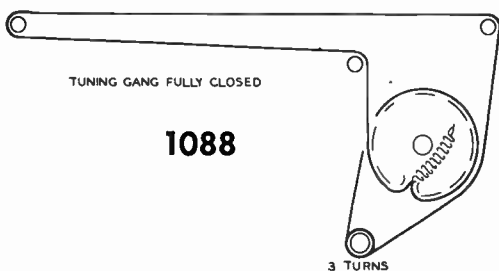
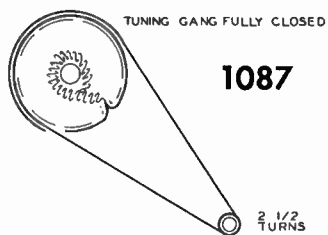

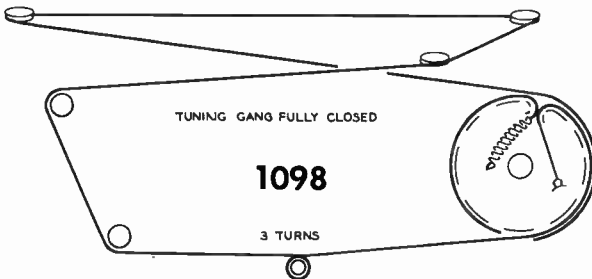
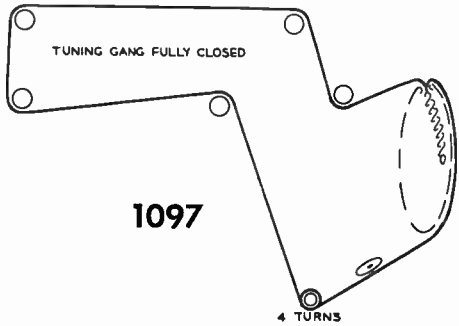
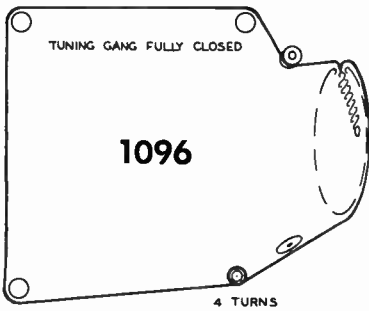
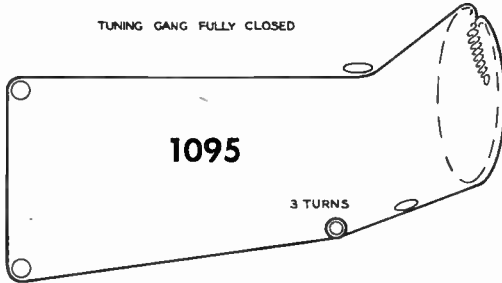
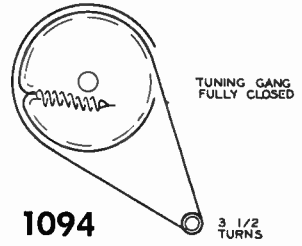
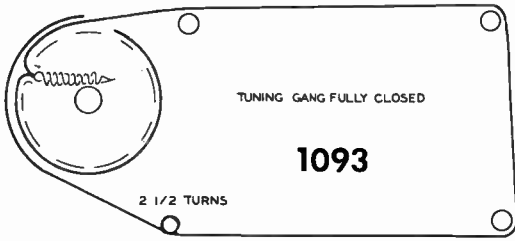

FULLY COUNTERCLOCKWISE

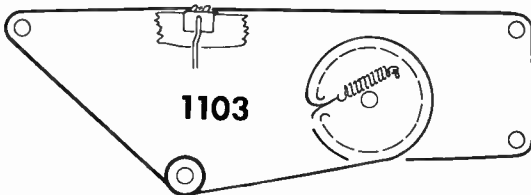
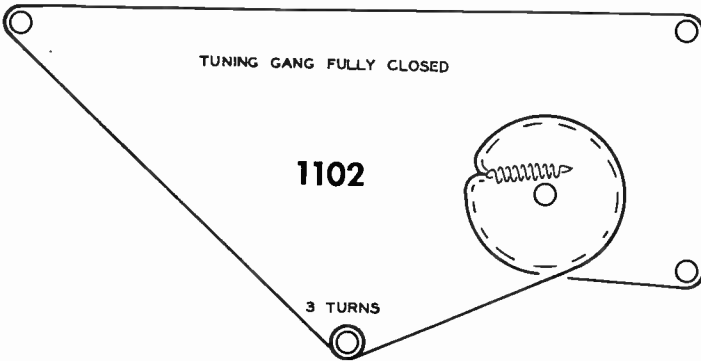
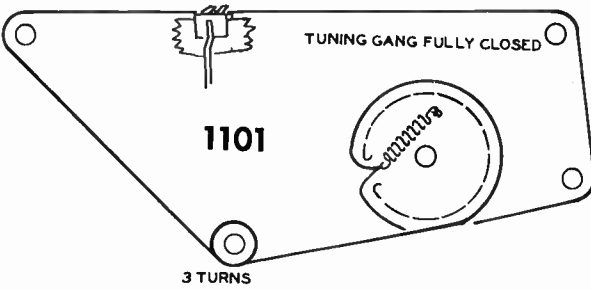
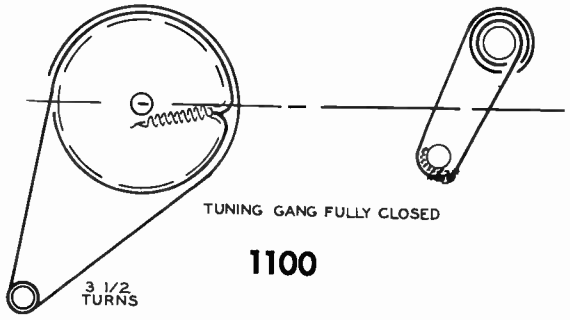
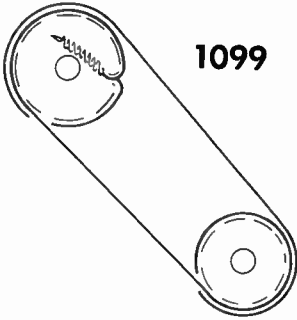



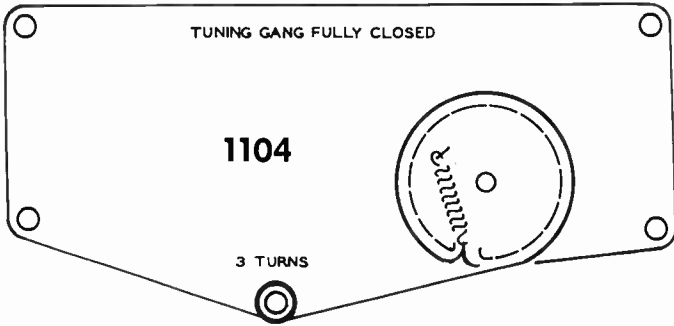

TUNING GANG FULLY CLOSED

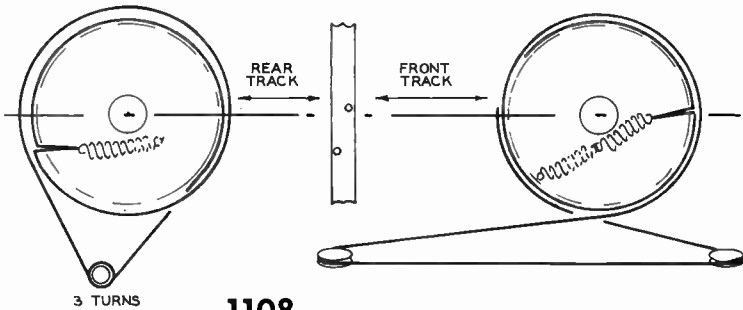
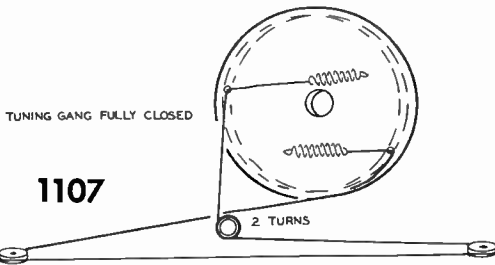
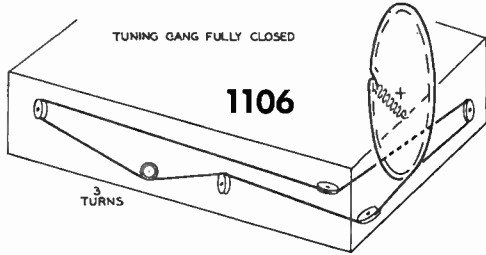
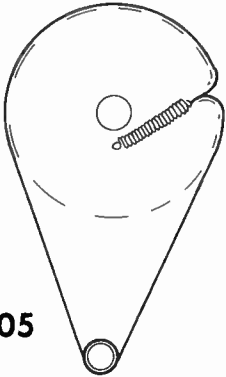

TUNING GANG FULLY CLOSED

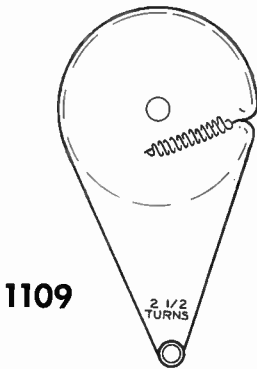

1109

TUNING GANG FULLY CLOSED

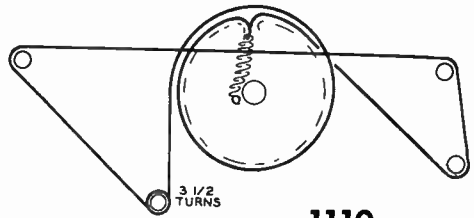

1110

TUNING GANG FULLY CLOSED

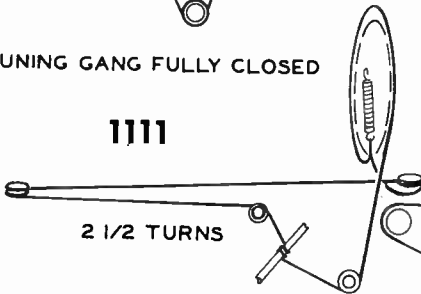

1111

TUNING GANG FULLY CLOSED

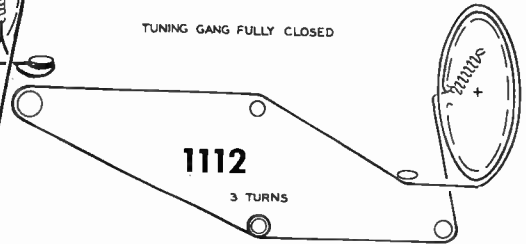

1112

TUNING GANG FULLY CLOSED

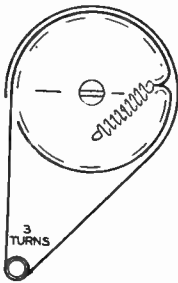

1113

3 1/2 TURNS

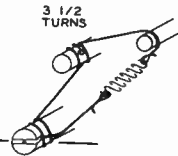

TUNING GANG FULLY CLOSED

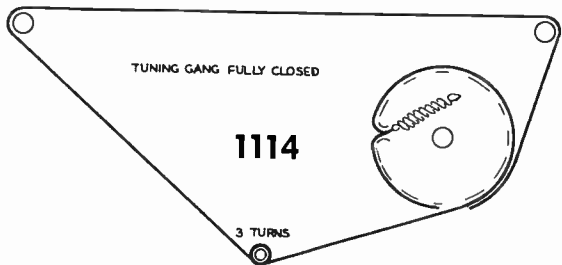

1114

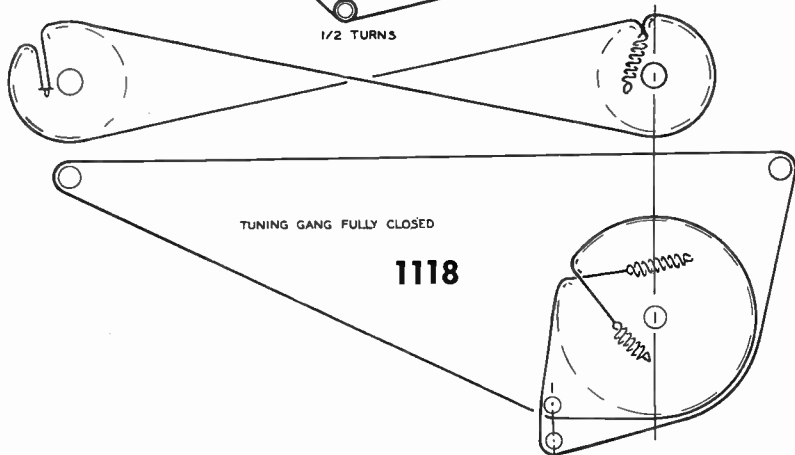
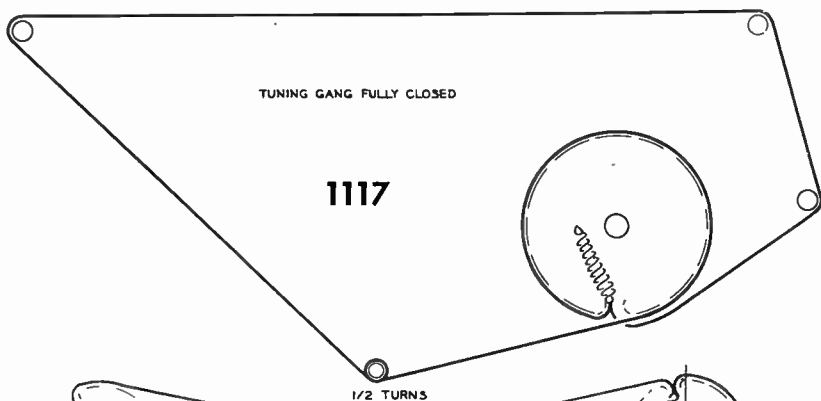
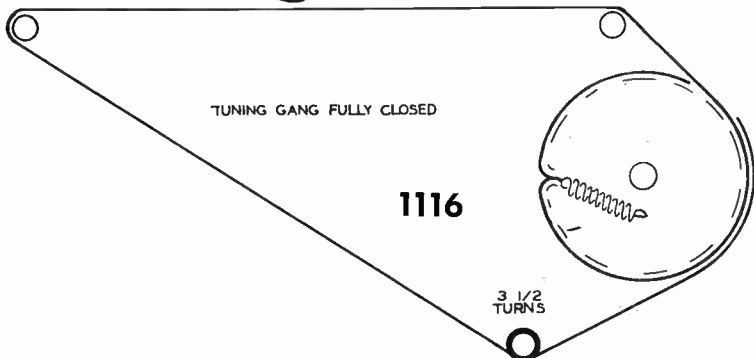
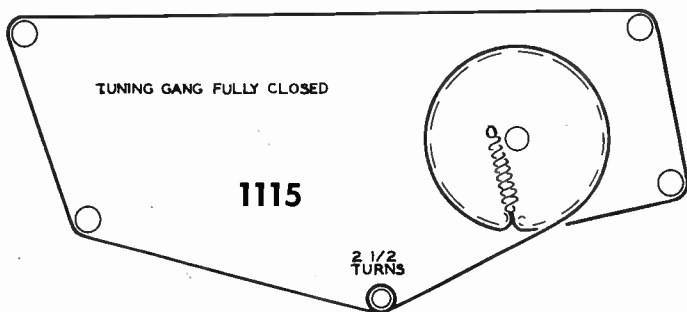

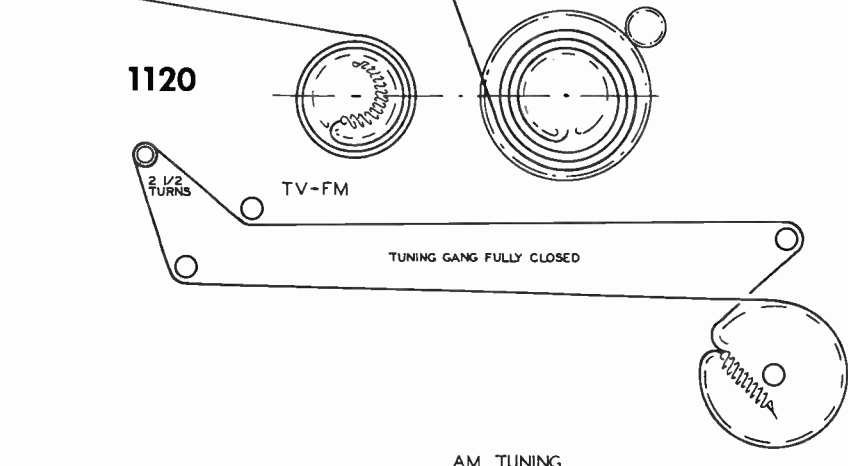
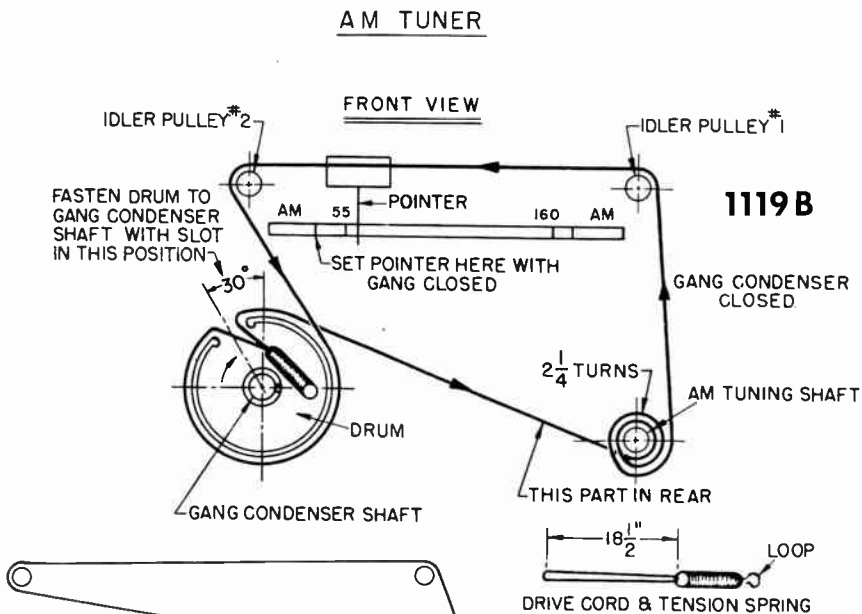
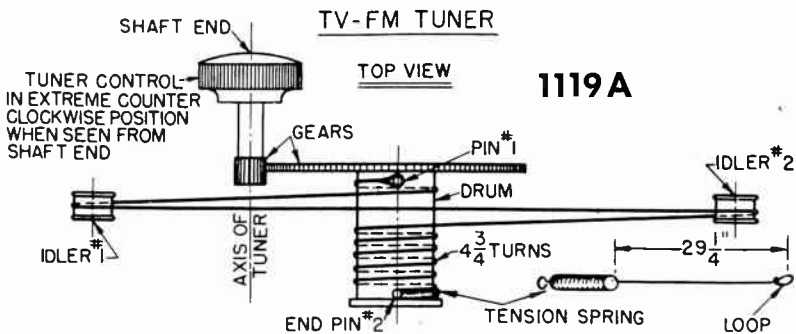

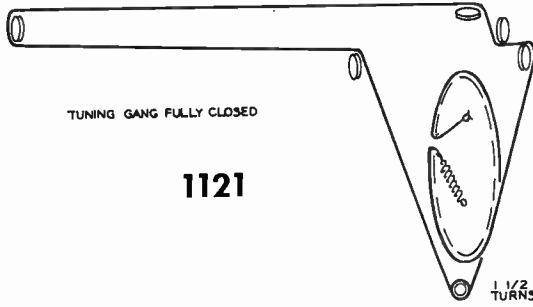

TUNING GANG FULLY CLOSED

1121

1 1/2  
TURNS

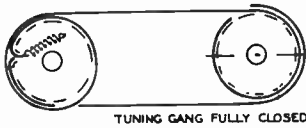

TUNING GANG FULLY CLOSED

1122

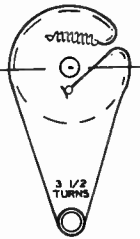

3 1/2  
TURNS

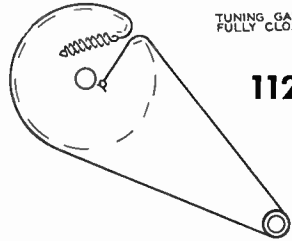

1 1/2  
TURNS

TUNING GANG  
FULLY CLOSED

1123

TUNING GANG FULLY CLOSED

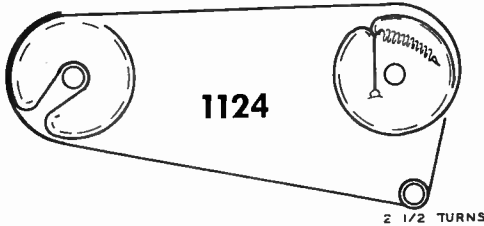

2 1/2  
TURNS

1124

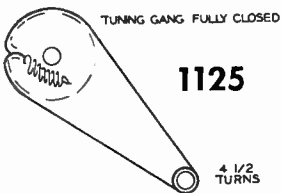

4 1/2  
TURNS

1125

TUNING GANG FULLY CLOSED

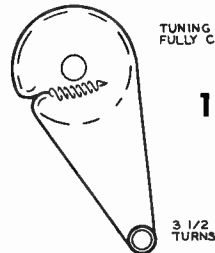

3 1/2  
TURNS

1126

TUNING GANG  
FULLY CLOSED

TUNING GANG FULLY CLOSED

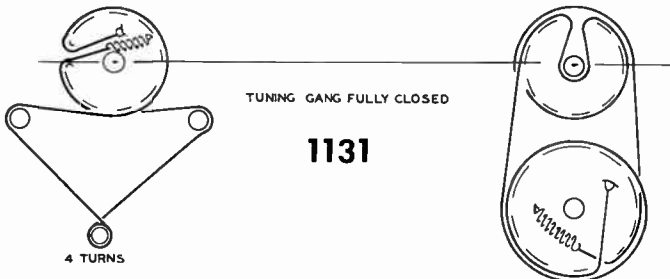
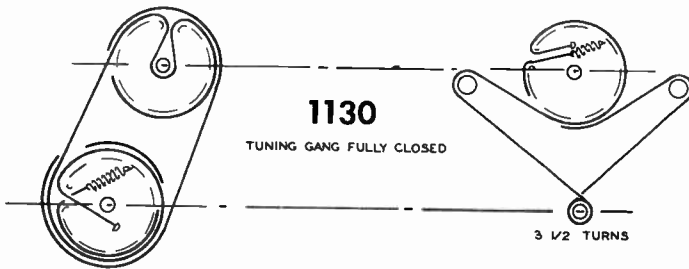
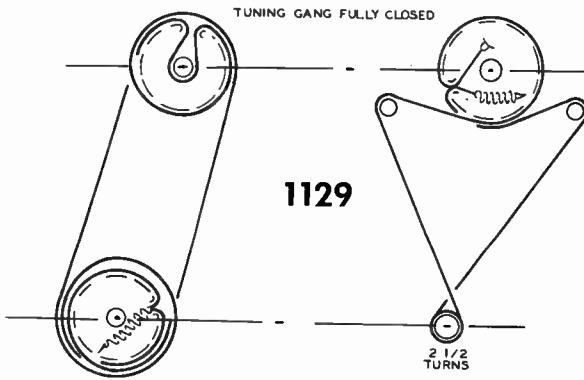
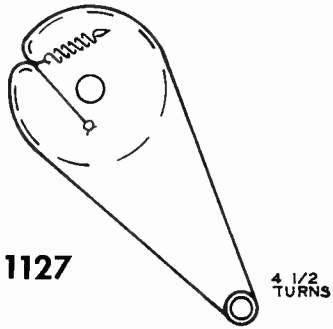

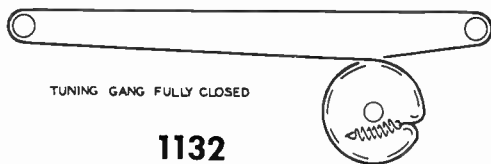

TUNING GANG FULLY CLOSED

1132

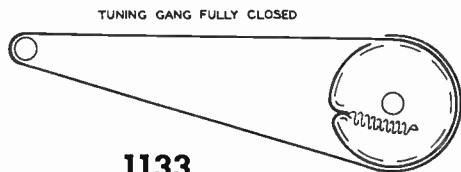

TUNING GANG FULLY CLOSED

1133

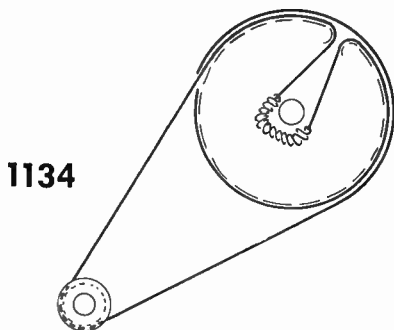

1134

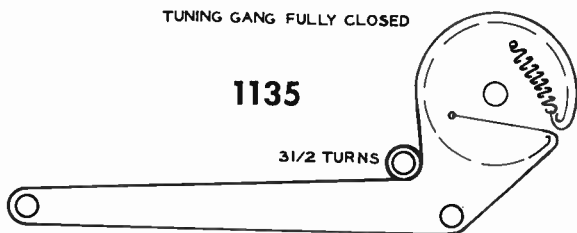

TUNING GANG FULLY CLOSED

1135

3 1/2 TURNS

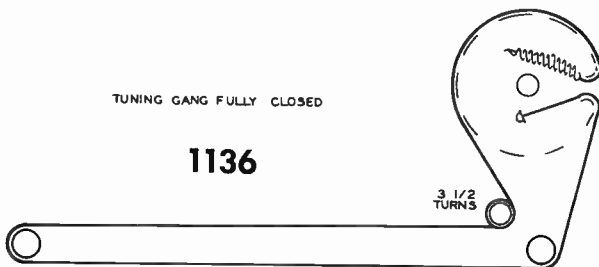

TUNING GANG FULLY CLOSED

1136

3 1/2  
TURNS

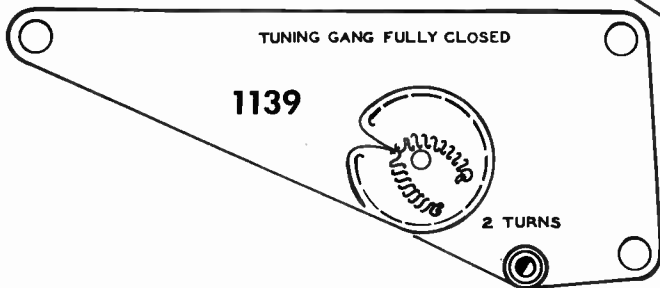
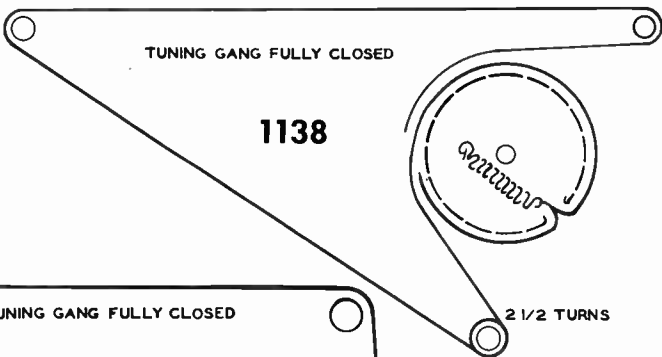
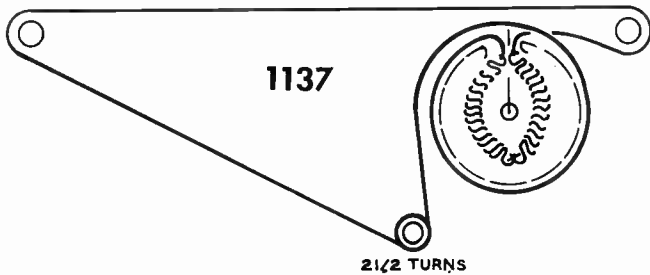
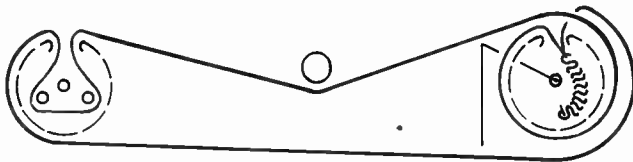

TUNING GANG FULLY CLOSED

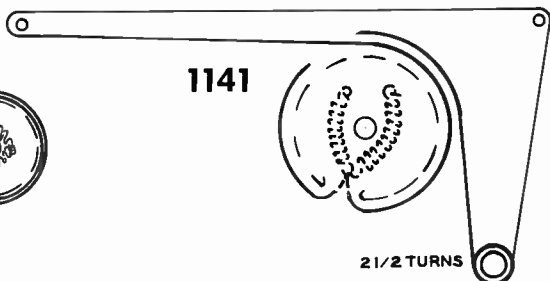
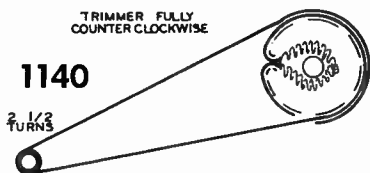



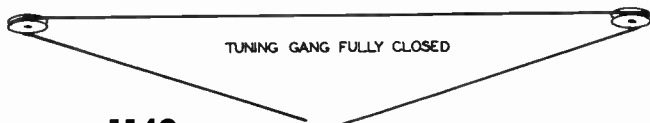

1142

1 1/2  
TURNS

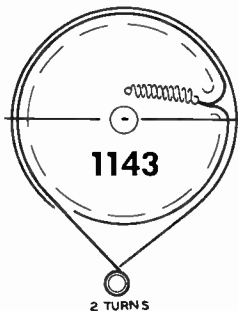
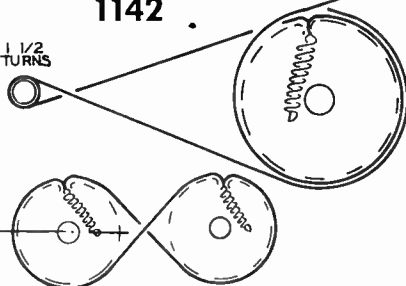

TUNING GANG FULLY CLOSED

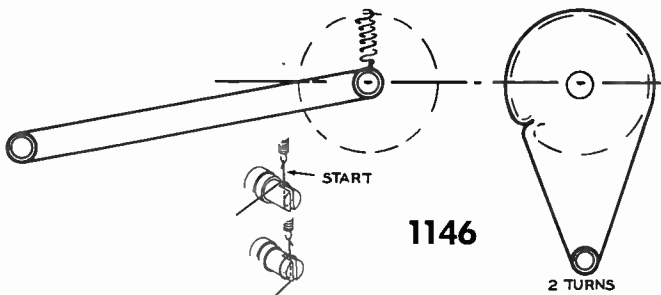
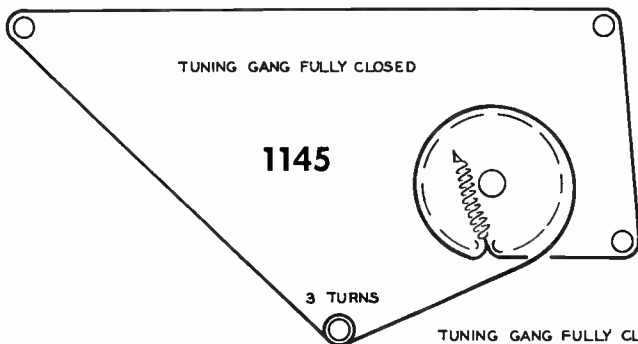
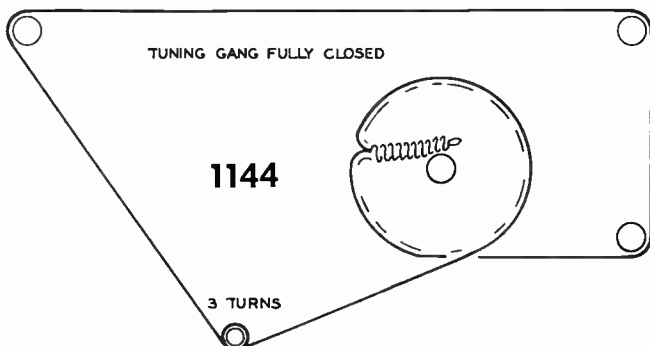

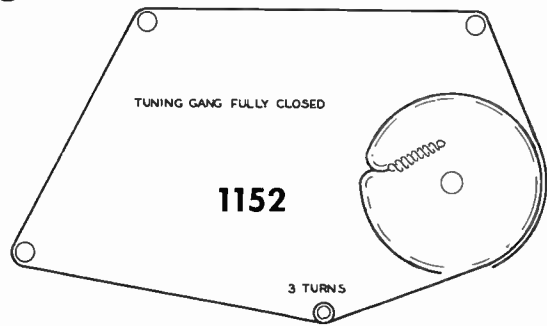
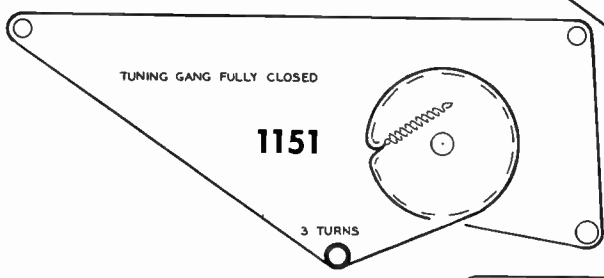
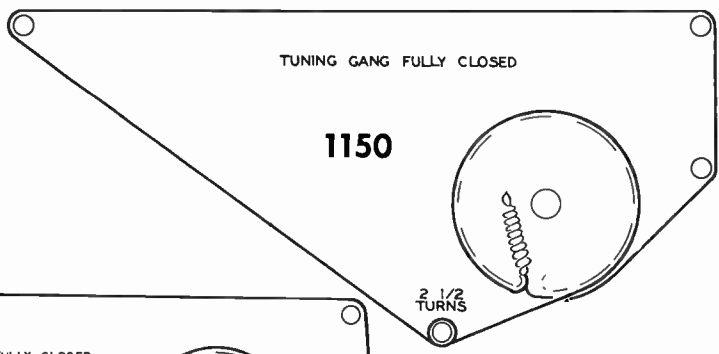
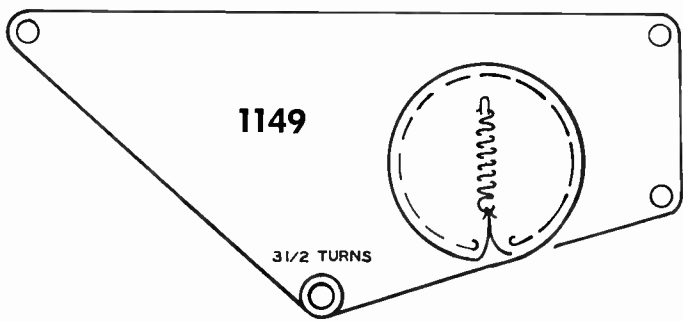
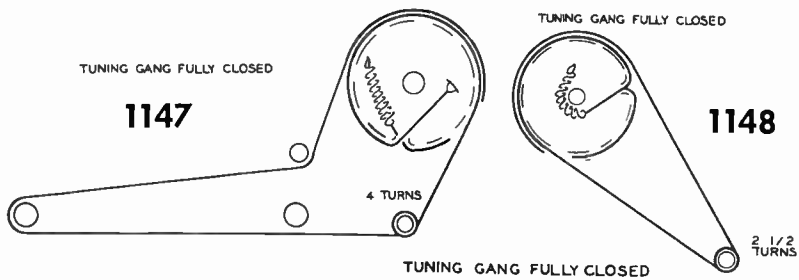

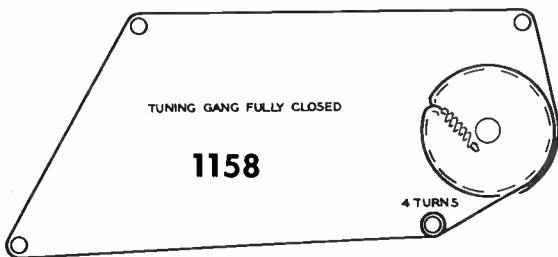
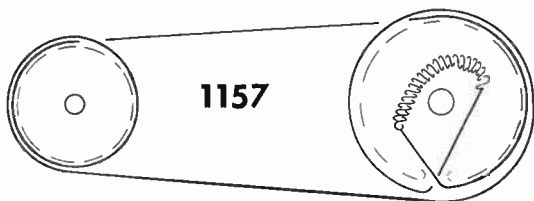
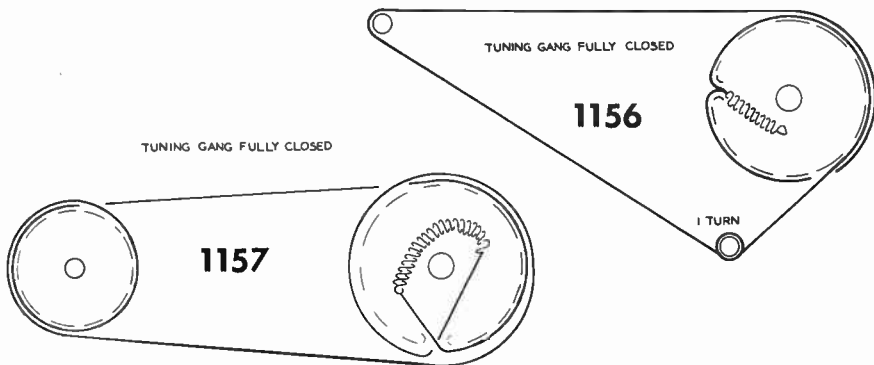
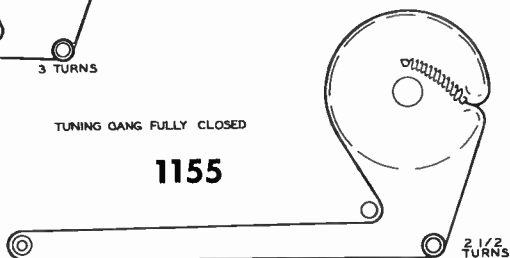
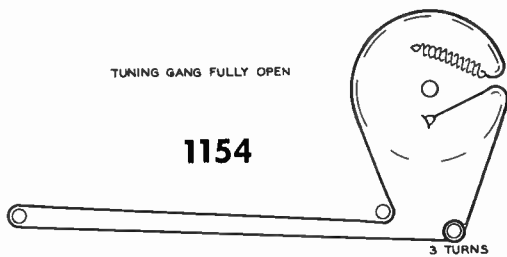
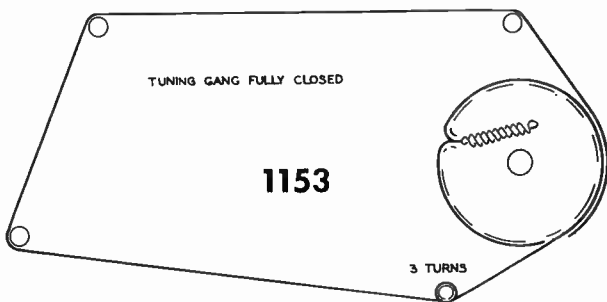

TUNING GANG FULLY CLOSED

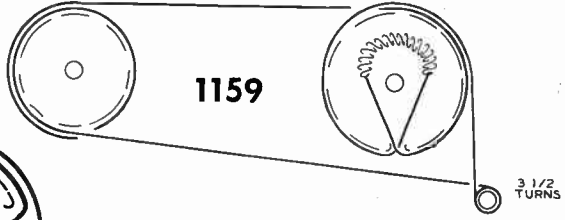

TUNING GANG FULLY CLOSED

1160

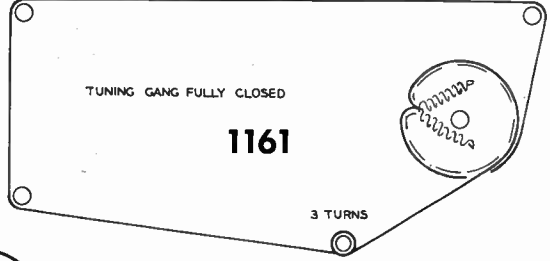
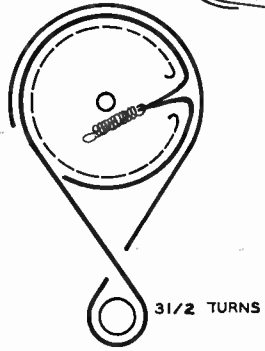

TUNING GANG FULLY OPEN

1162

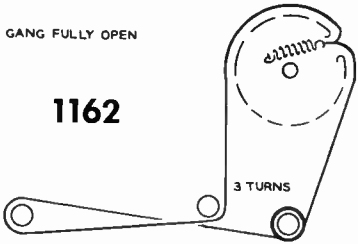

TUNING GANG FULLY CLOSED

1163

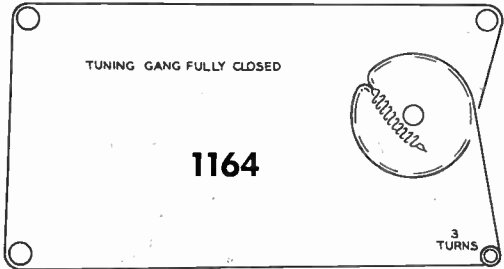
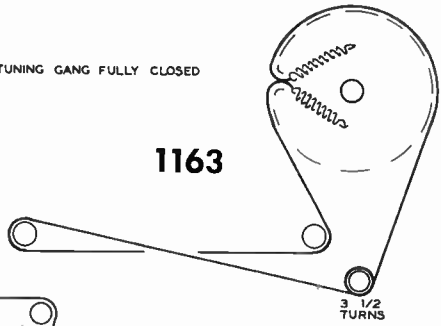

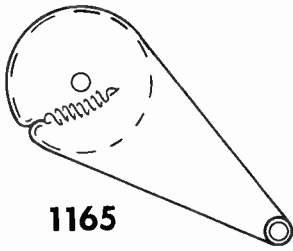

1165

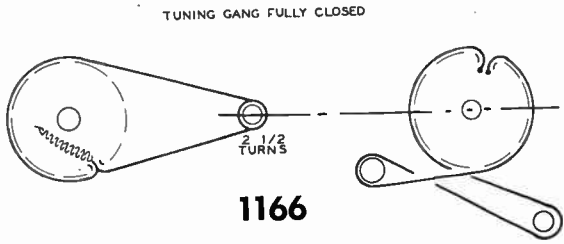

1166

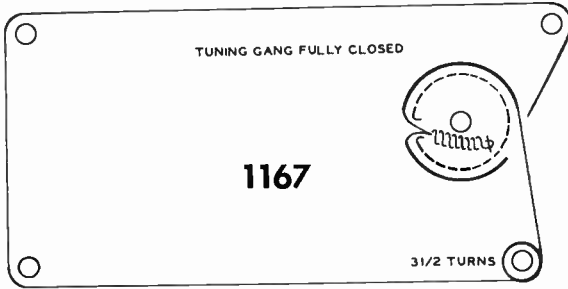

1167

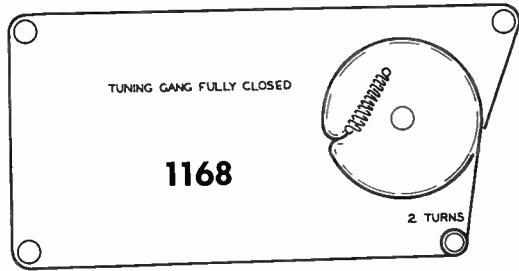

1168

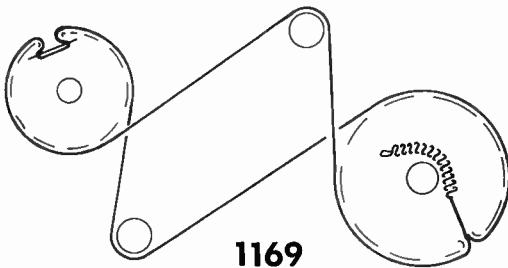

1169

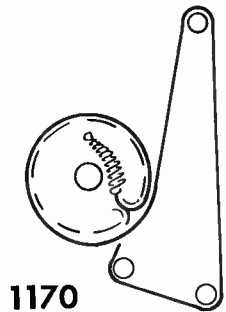

1170

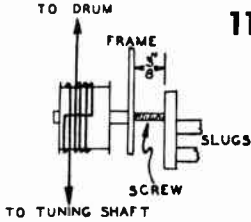

1171

DETAIL OF FM COLLAR  
STRINGING AND CORRECT  
SETTING OF SLUG TUNER  
WITH TUNING CONTROL  
FULLY COUNTER-CLOCKWISE.

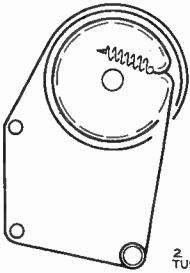
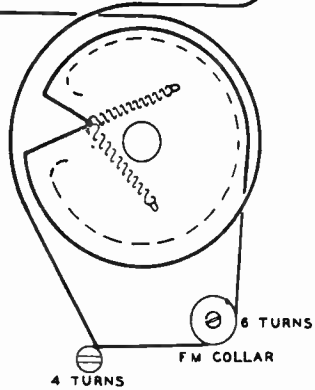

TUNING GANG  
FULLY CLOSED

1172

TUNING GANG FULLY CLOSED

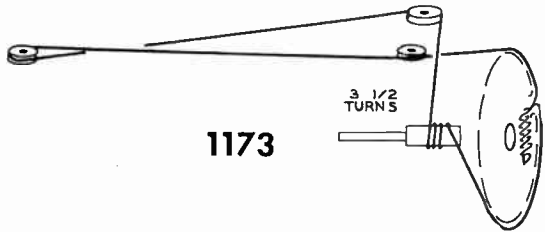

1173

TUNING GANG FULLY CLOSED

1174

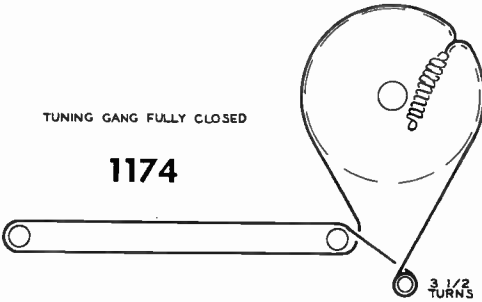

TUNING GANG FULLY CLOSED

1175

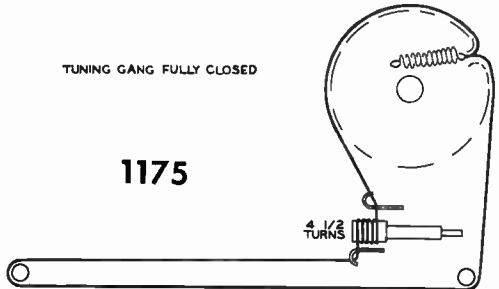

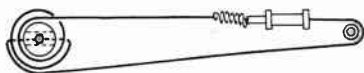

BANDSPREAD CORD

TUNING GANG FULLY CLOSED

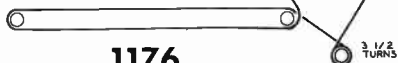

1176

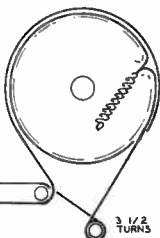

TUNING GANG FULLY CLOSED

2 1/2 TURNS

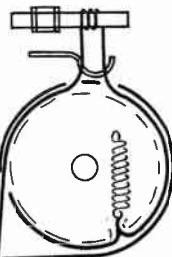

1177

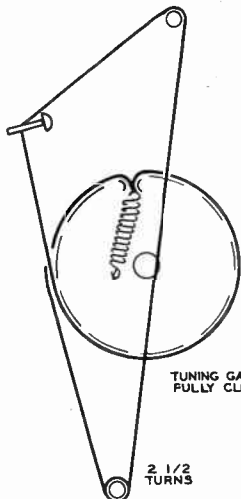
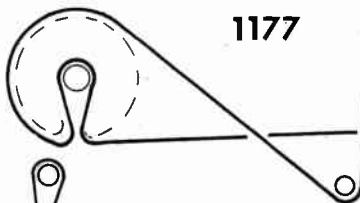

TUNING GANG FULLY CLOSED

2 1/2 TURNS

AM-FM DIAL

CHANNEL 2 POSITION

1178

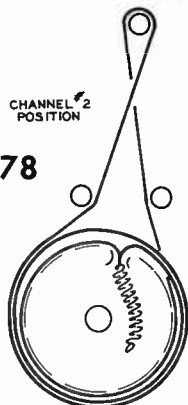

TV DIAL

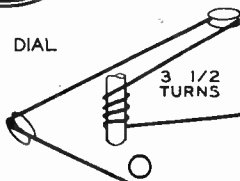

3 1/2 TURNS

1179

TUNING GANG FULLY CLOSED

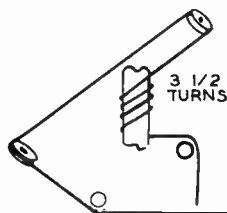

3 1/2 TURNS

1180

TUNING GANG FULLY CLOSED

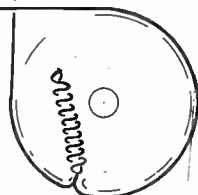

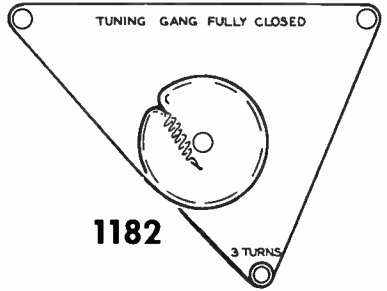
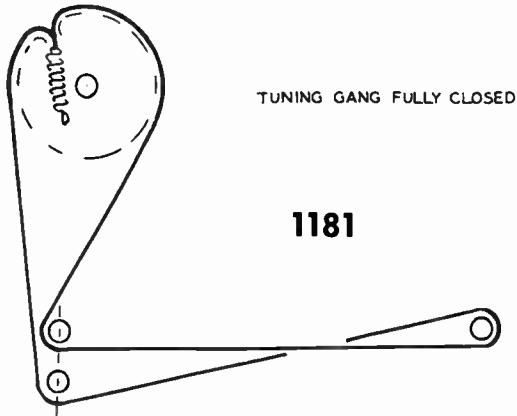

TUNING GANG FULLY CLOSED

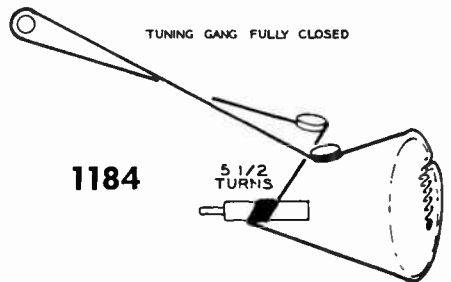
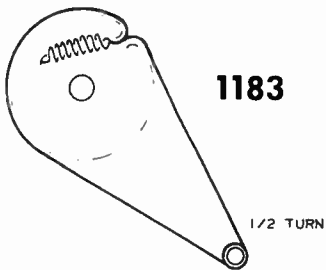

TUNING GANG FULLY CLOSED

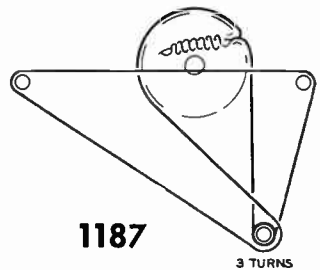
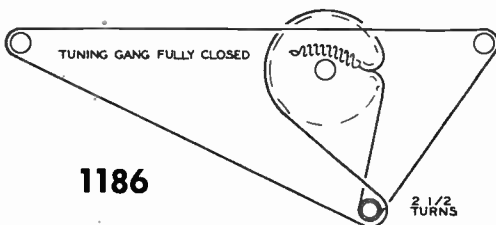
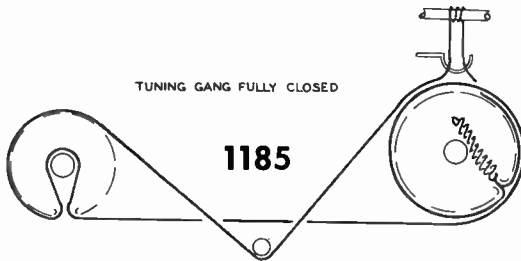



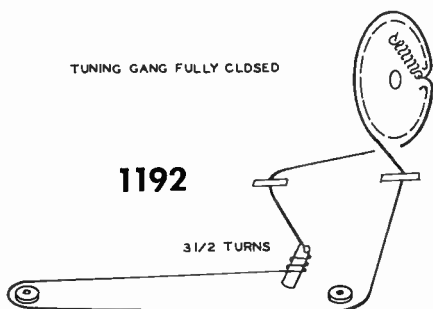
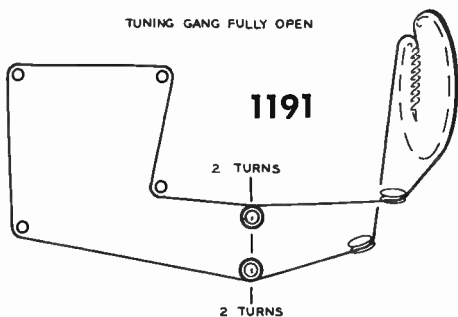
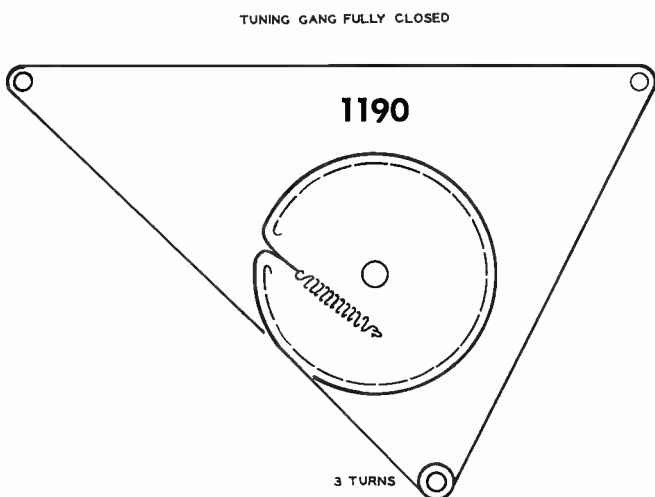
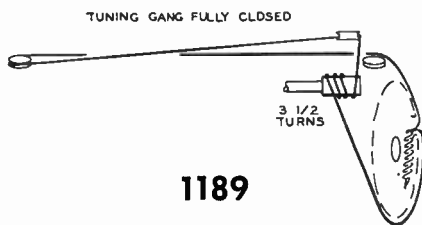
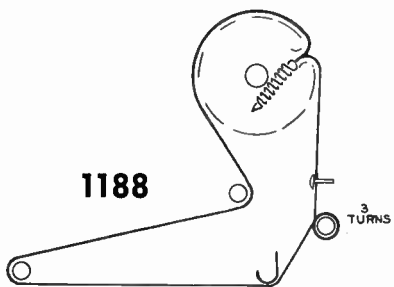

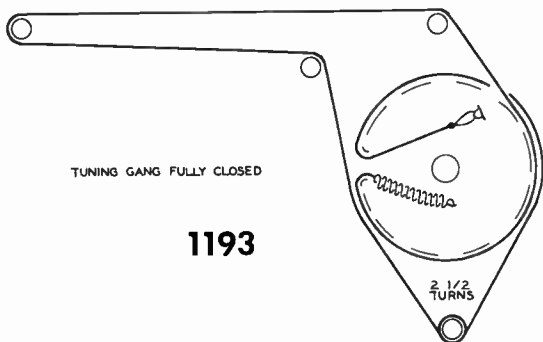

TUNING GANG FULLY CLOSED

**1193**

2 1/2  
TURNS

TUNING GANG FULLY  
CLOSED

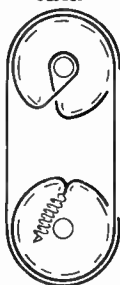

**1194**

TUNING GANG FULLY CLOSED

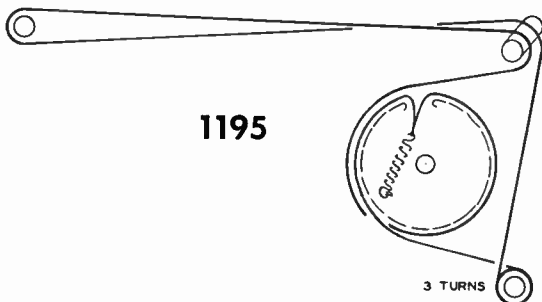

**1195**

3 TURNS

CORD RECESS  
CEMENTED



TUNING CAP FULLY MESHED  
VIEWED FROM FRONT

CORDLOCKING  
SLOTS  
KNOT  
CEMENTED

ANTI-BACKLASH  
PULLEY

**1196**

2 1/2  
TURNS

DRIVE CORD  
PULLEY LENGTH

POINTER CORD LENGTH  
FOR 180° ROTATION - 6 <sup>29</sup>/<sub>32</sub>" EXCLUSIVE OF KNOT

FOR 120° ROTATION - 7 <sup>9</sup>/<sub>16</sub>" EXCLUSIVE OF KNOT

6 <sup>1</sup>/<sub>4</sub>" EXCLUSIVE OF KNOT

USE FIBRE GLASS CORE,  
NYLON BRAID CORD

TUNING GANG FULLY CLOSED

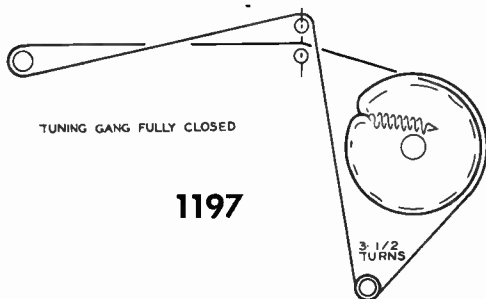

**1197**

3 1/2  
TURNS

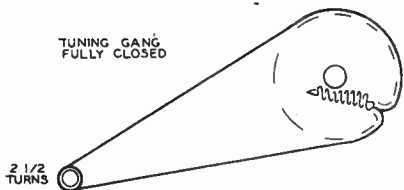

1198

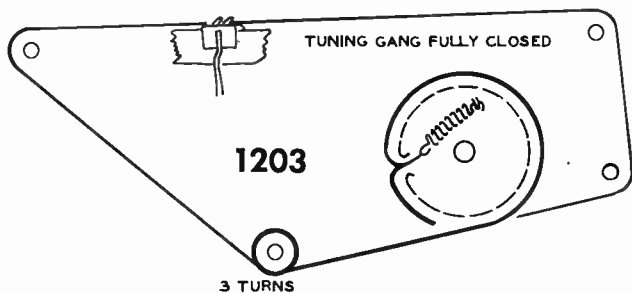
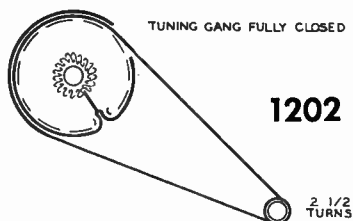
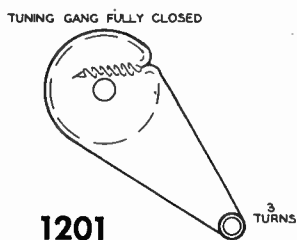
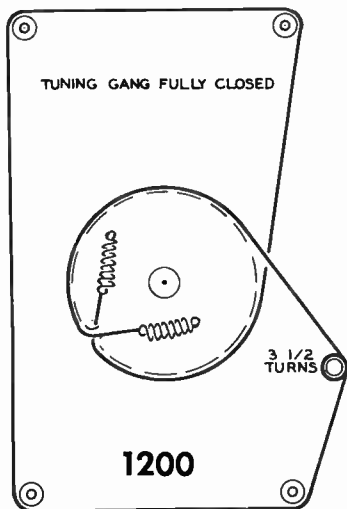
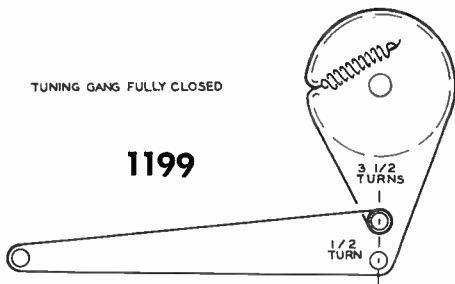

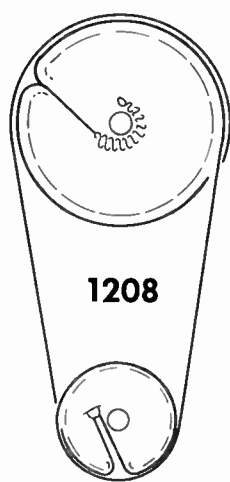
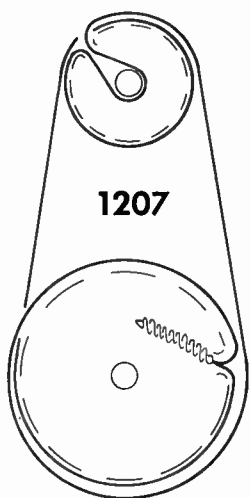
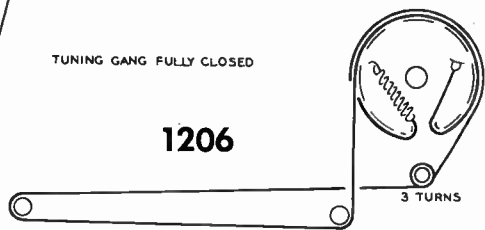
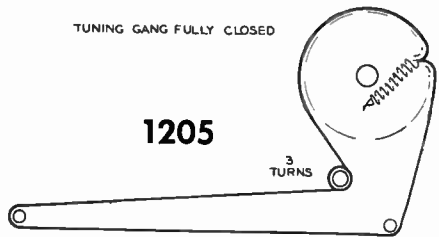
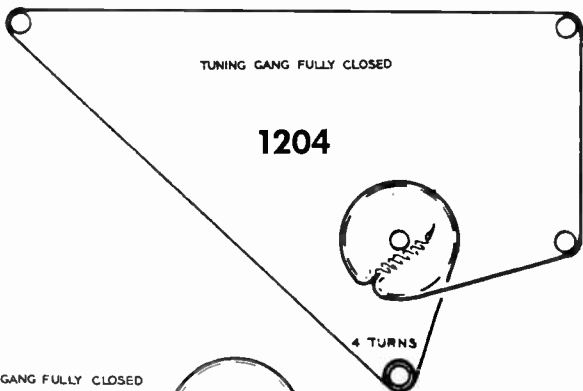

FINE TUNING CONTROL

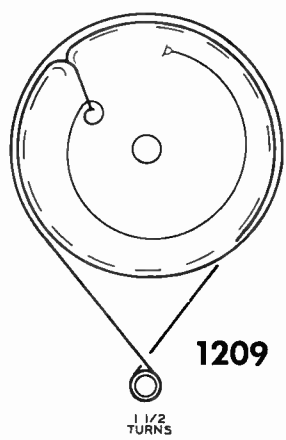

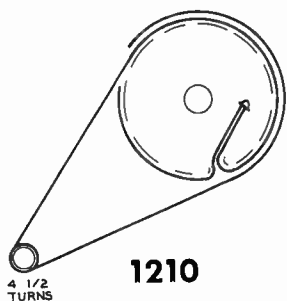

**1210**

FULLY COUNTERCLOCKWISE

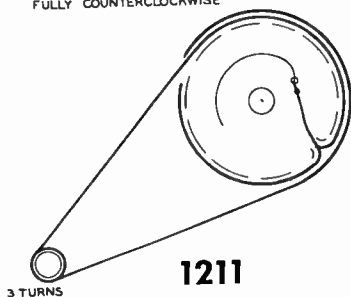

**1211**

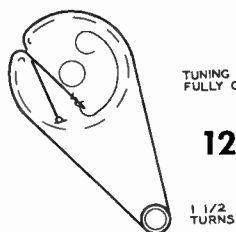

**1212**

TUNING GANG  
FULLY CLOSED

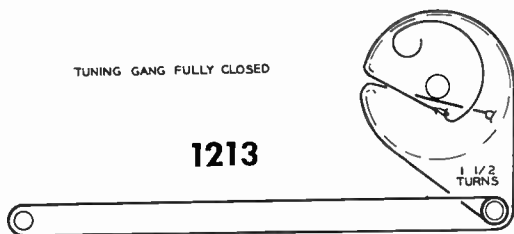

**1213**

TUNING GANG FULLY CLOSED

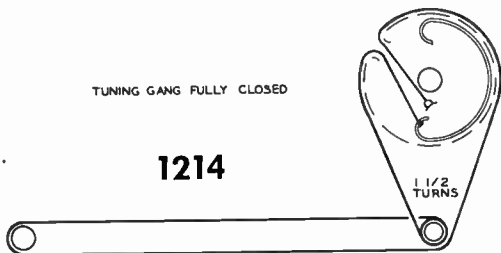

**1214**

TUNING GANG FULLY CLOSED

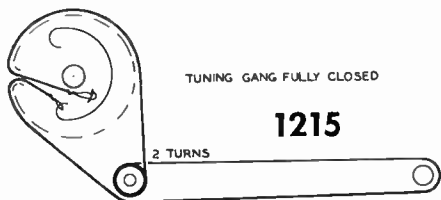

**1215**

TUNING GANG FULLY CLOSED

TUNING GANG FULLY CLOSED

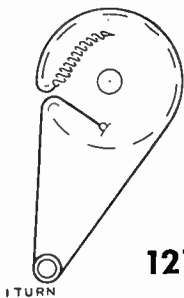

**1216**

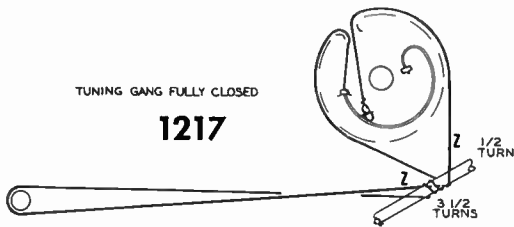

TUNING GANG FULLY CLOSED

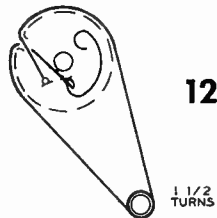

TUNING GANG FULLY CLOSED



TUNING GANG FULLY OPEN

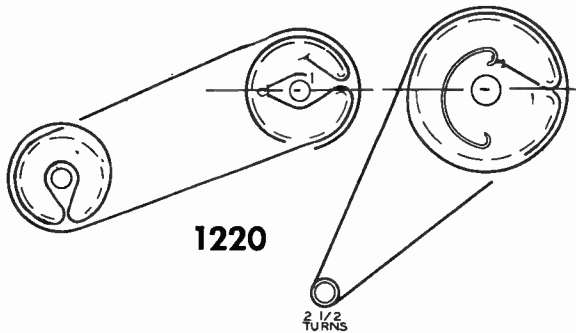

TUNING GANG FULLY CLOSED

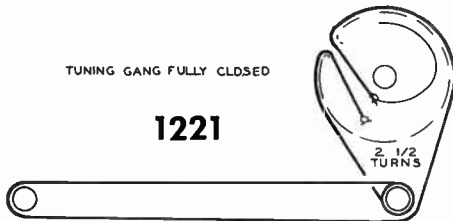

TUNING GANG FULLY CLOSED

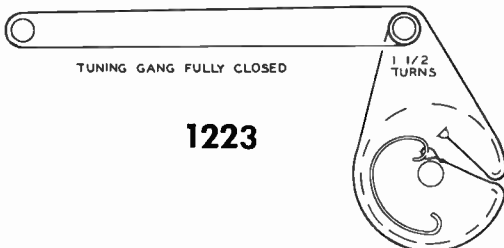
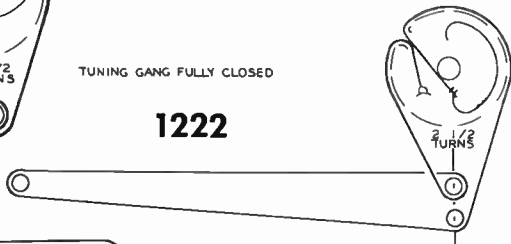

TUNING GANG FULLY CLOSED

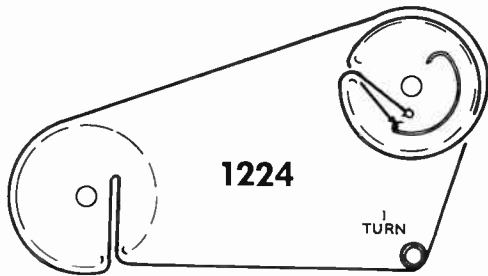

1 TURN

1225

TUNING GANG FULLY CLOSED

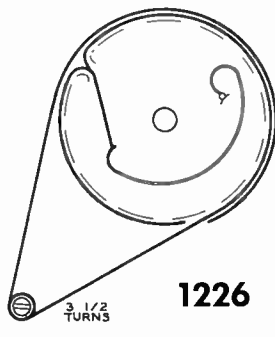
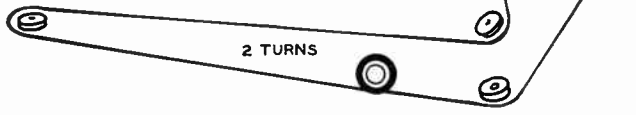

1226

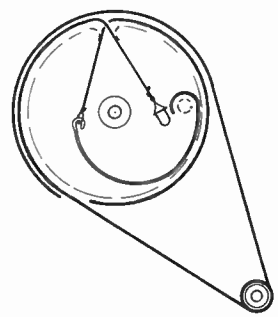

CONTROL EXTREME  
CLOCKWISE

FINE TUNING  
CONTROL

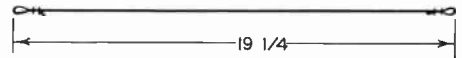

CONTROL EXTREME  
COUNTER - CLOCKWISE

FOCUS  
CONTROL

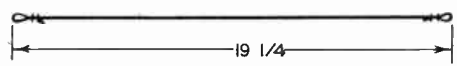

1228

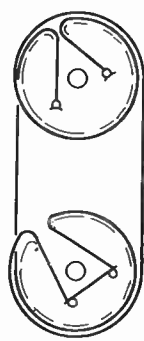

CONTROL EXTREME  
COUNTER - CLOCKWISE

FOCUS  
CONTROL

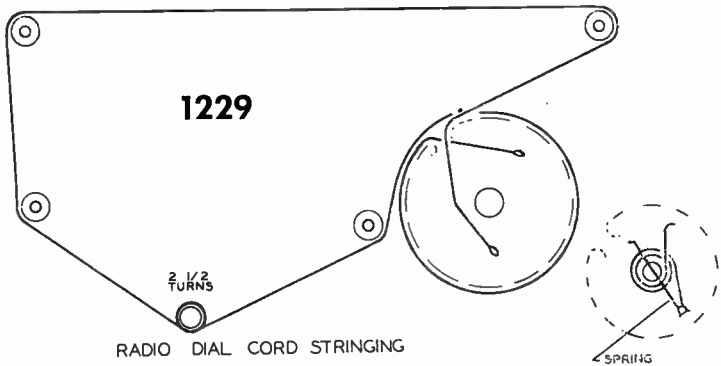

**1229**

RADIO DIAL CORD STRINGING

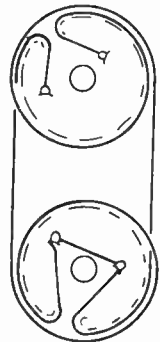

FOCUS CORD STRINGING

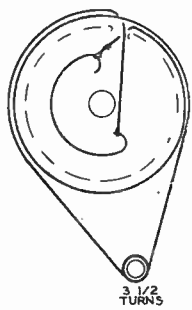

FINE TUNING CORD STRINGING

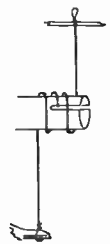

FM TUNER WINDLASS STRINGING

TUNING GANG FULLY CLOSED

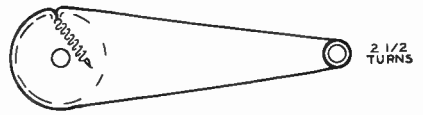

**1230**

TUNING GANG FULLY CLOSED

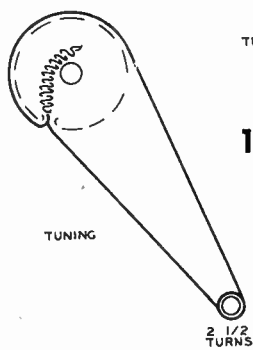

TUNING

2 1/2 TURNS

**1231**

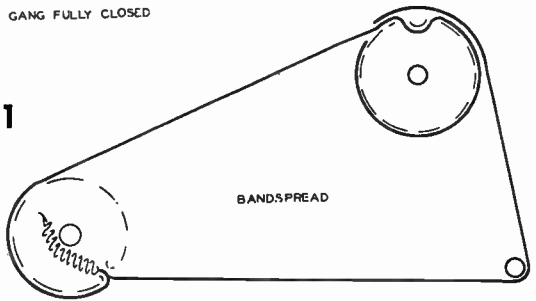

BANDSPREAD



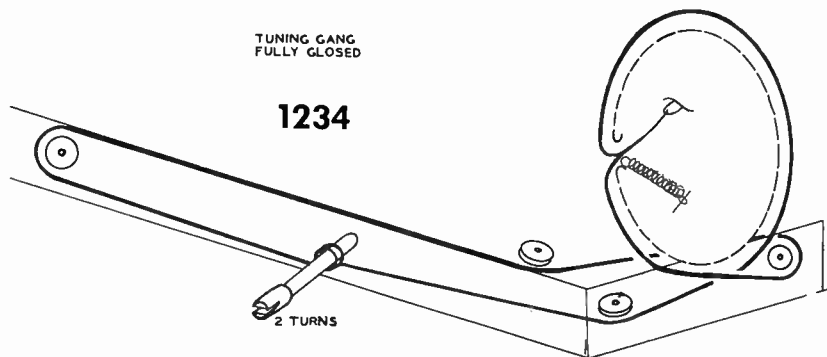
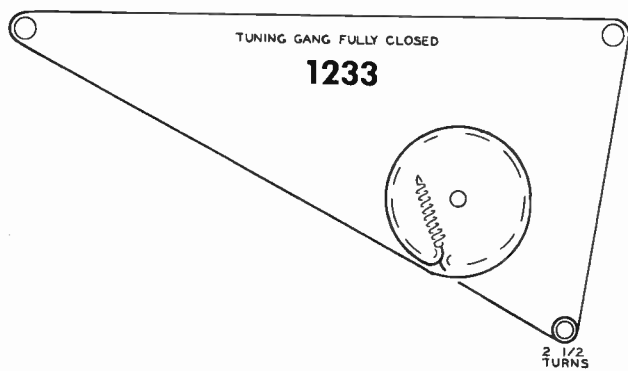
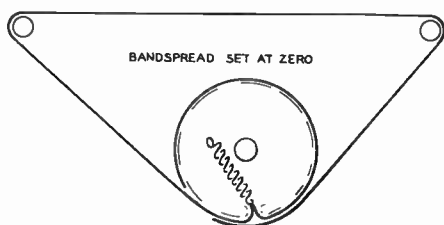
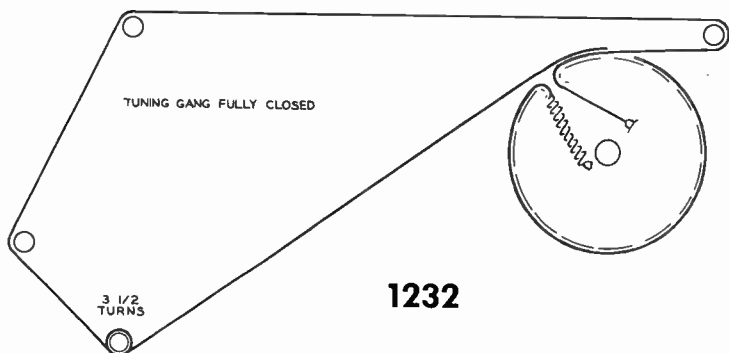

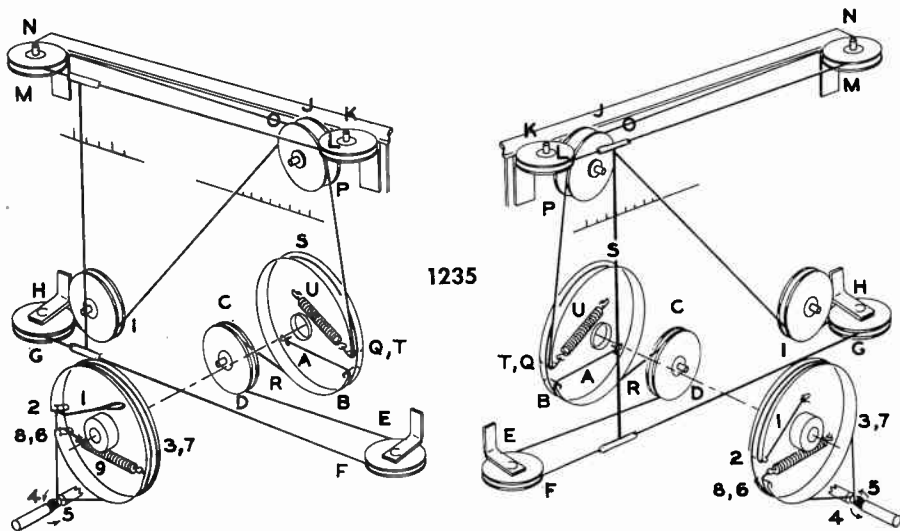

### RESTRINGING DIAL CORD

The dial drive system of the SX-71 consists of four separate spring drives. The two drive shaft string systems are identical; the two pointer drive systems are similar but right and left handed.

(1) DRIVE SHAFT - To restring either one, use a 26 inch length of 30 lb. test dial cord. Tie one end of the cord to position "1" on the drum and follow the stringing sequence "1" to "9" as shown. At position "9" stretch the tension spring and tie the cord securely to the spring. Note that the dial cord is wrapped around the drive shaft three and one half times for proper traction.

(2) POINTER DRIVE - To restring either one, use a 66 inch length of 30 lb. test dial cord. Tie one end of the dial cord to position "A" and follow the stringing sequence "A" to "U" as shown. At position "U" stretch the tension spring and tie the cord securely to the spring. Two small pieces of spaghetti tubing approximately one half inch long should be threaded on the cord, as shown, to provide a suitable purchase for the dial pointer. With the pointer drive, pulleys positioned as shown on the diagram, the tuning capacitor should be entirely closed. The pointer may now be fastened to the cord and aligned with the 0 position on the logging scale and the index marks on the dial scales. The ends of the pointer should be carefully crimped around the spaghetti tubing and cemented fast.

TUNING PLATES FULLY MESHD

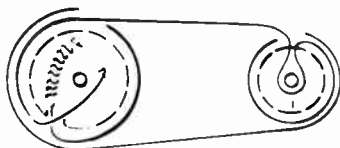

2 1/2 TURNS

BAND SPREAD TUNING

TUNING GANG FULLY CLOSED

**1236**

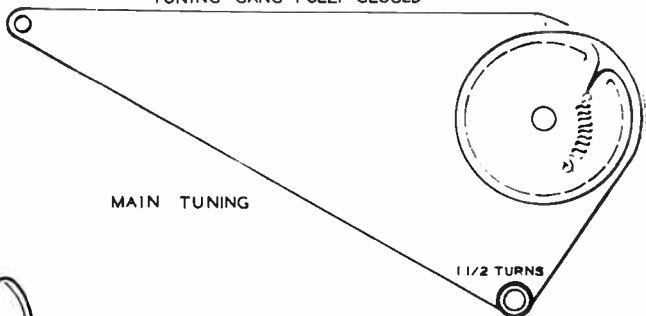

1 1/2 TURNS

TUNING GANG FULLY CLOSED

MAIN TUNING

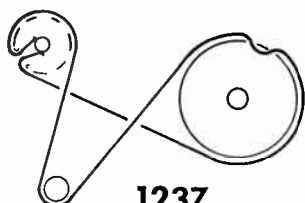

**1237**

TUNING GANG FULLY CLOSED

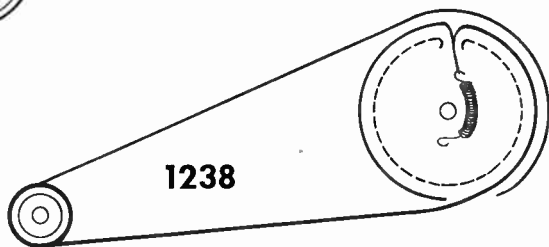

1 1/2 TURNS

**1238**

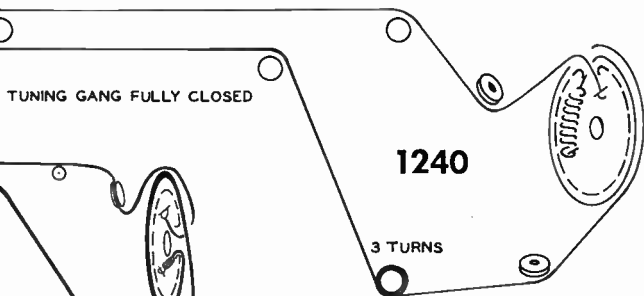

TUNING GANG FULLY CLOSED

**1240**

3 TURNS

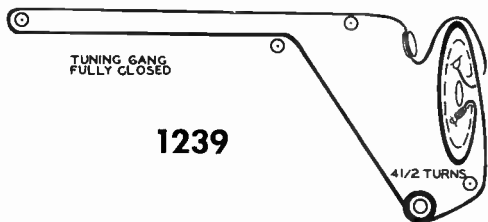

TUNING GANG FULLY CLOSED

**1239**

4 1/2 TURNS

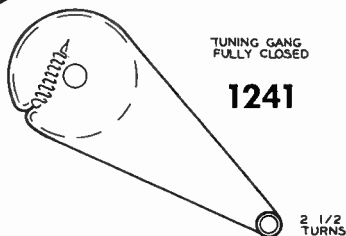

TUNING GANG FULLY CLOSED

**1241**

2 1/2 TURNS

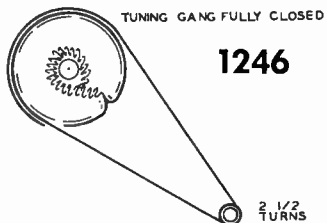
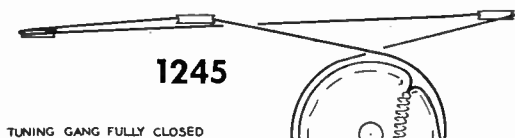
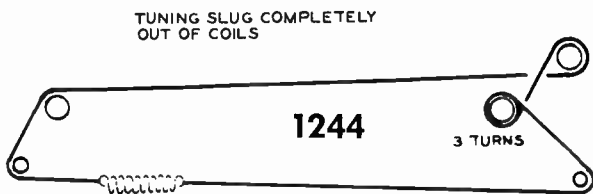
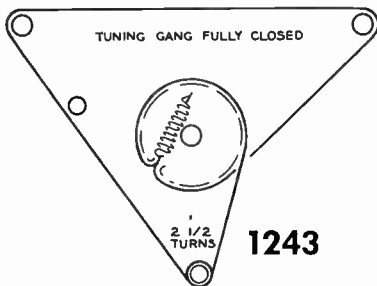
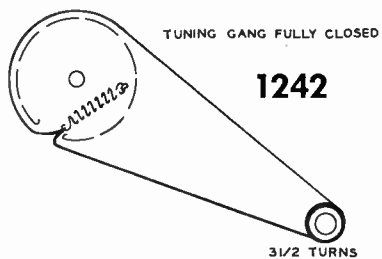

TUNING GANG FULLY CLOSED

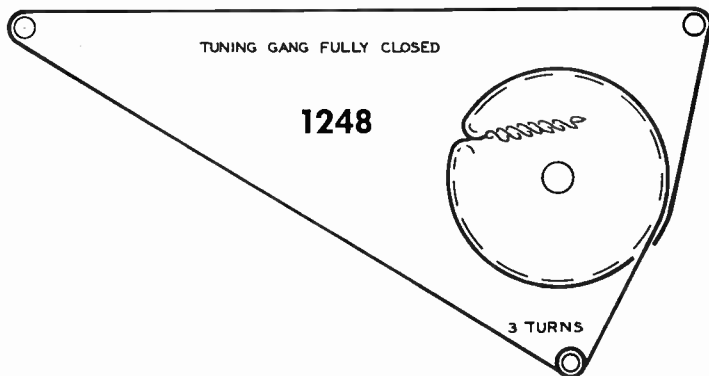
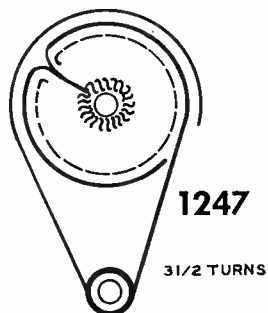

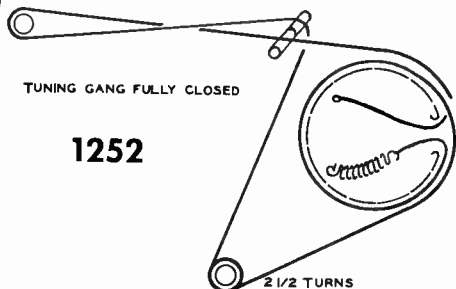
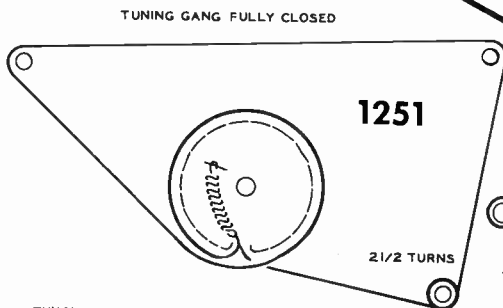
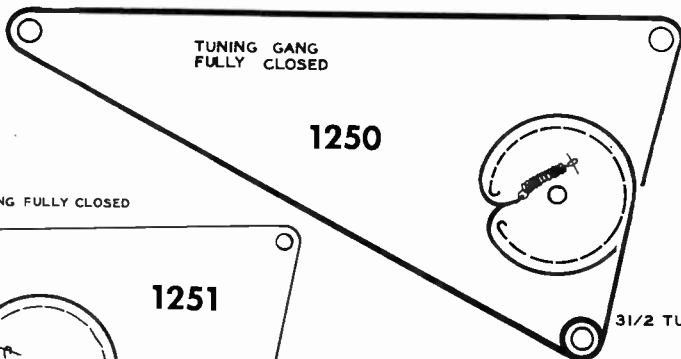
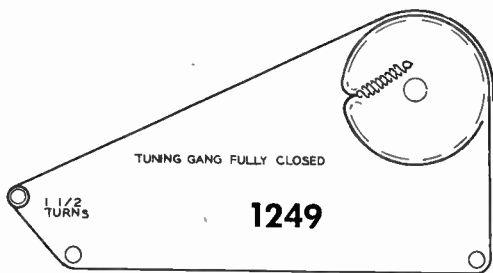

TUNING GANG FULLY CLOSED

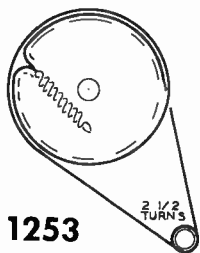

TUNING GANG FULLY CLOSED



TUNING GANG FULLY CLOSED

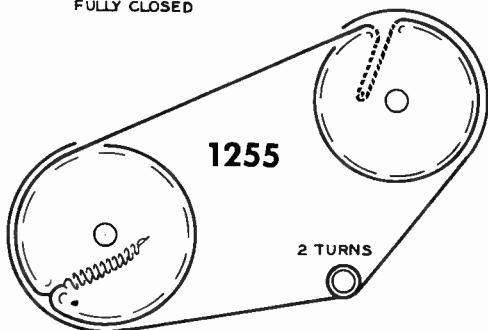

TUNING GANG FULLY CLOSED

1256

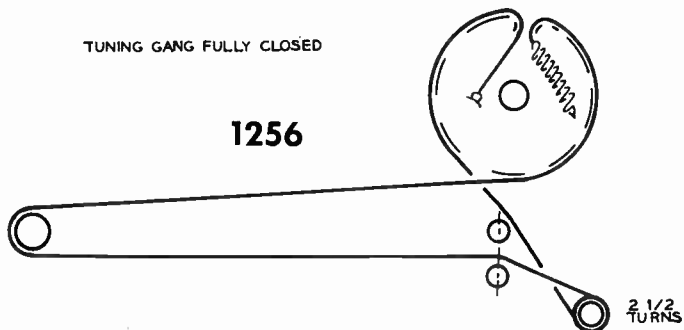

TUNING GANG FULLY CLOSED

1257

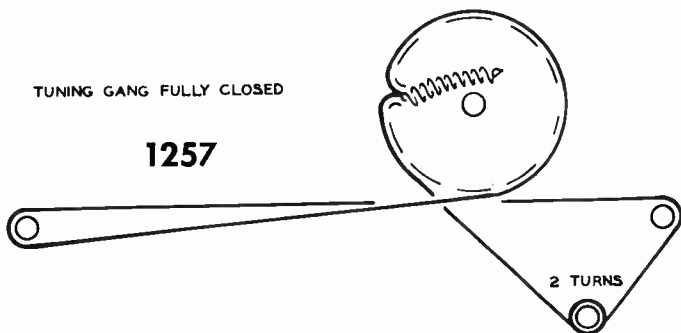

TUNED AT LOW END OF BAND

1258

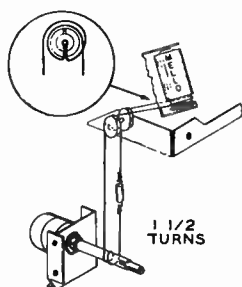
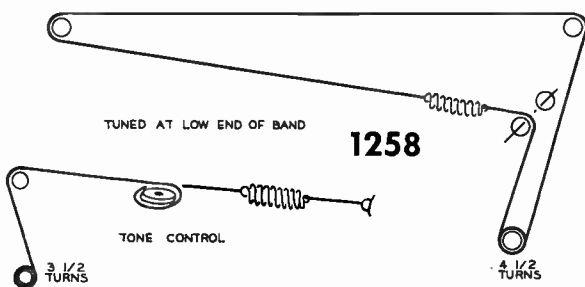

1259

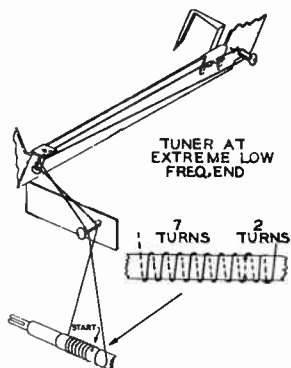

1260

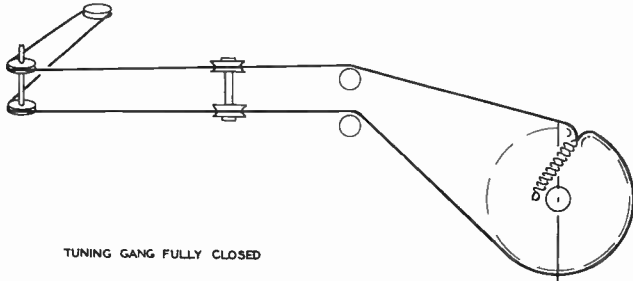
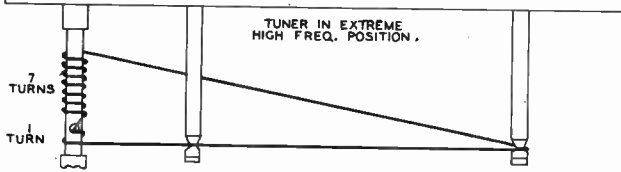

1261

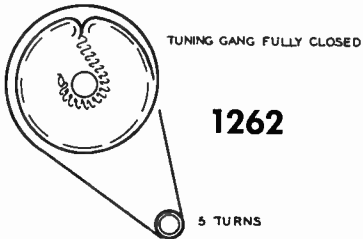
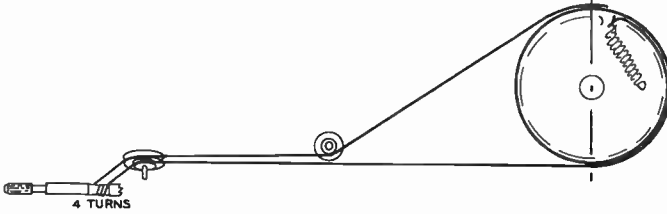

1262

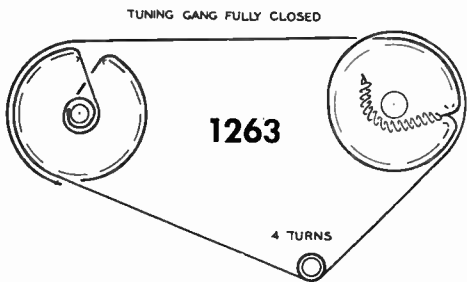

1263

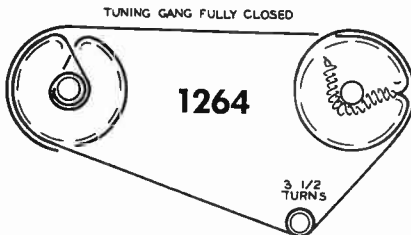

1264

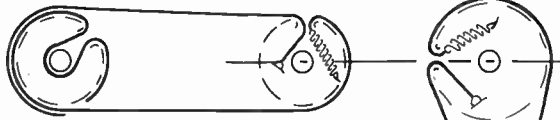

TUNING GANG FULLY CLOSED

**1265**

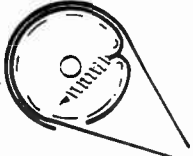

TUNING GANG FULLY CLOSED

3 TURNS

**1266**

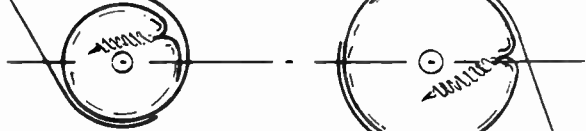

3 1/2 TURNS

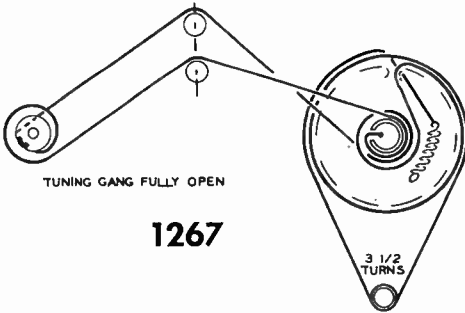

TUNING GANG FULLY OPEN

**1267**

3 1/2 TURNS

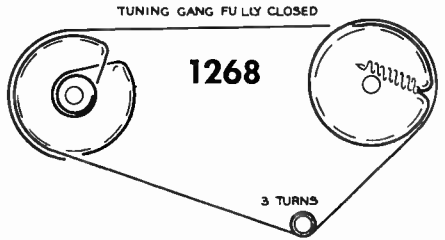

TUNING GANG FULLY CLOSED

**1268**

3 TURNS

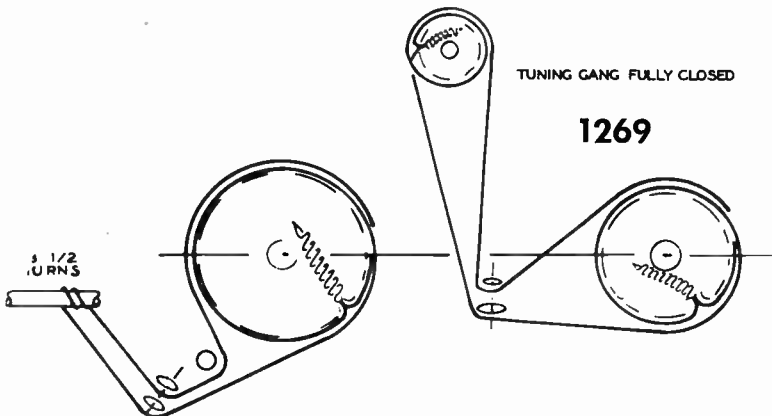

TUNING GANG FULLY CLOSED

**1269**

3 1/2 TURNS



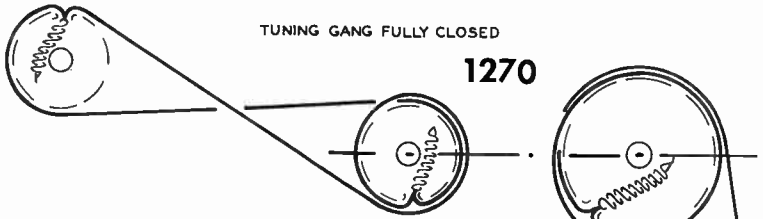

TUNING GANG FULLY CLOSED

1270

3 TURNS

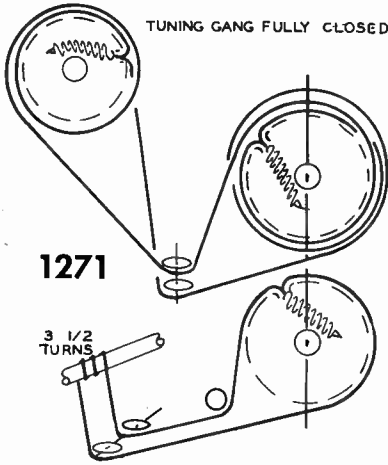

TUNING GANG FULLY CLOSED

1271

3 1/2 TURNS

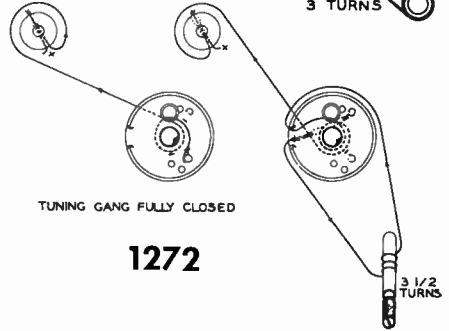

TUNING GANG FULLY CLOSED

1272

3 1/2 TURNS

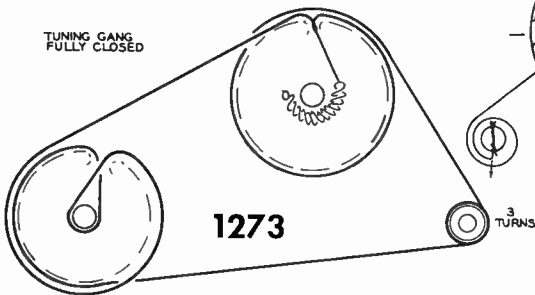

TUNING GANG FULLY CLOSED

1273

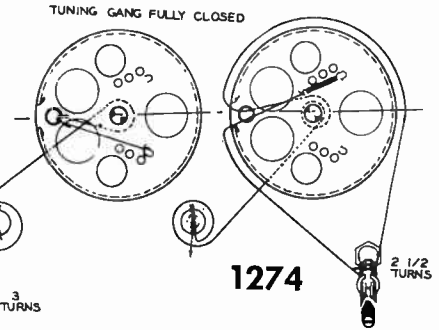

TUNING GANG FULLY CLOSED

1274

2 1/2 TURNS

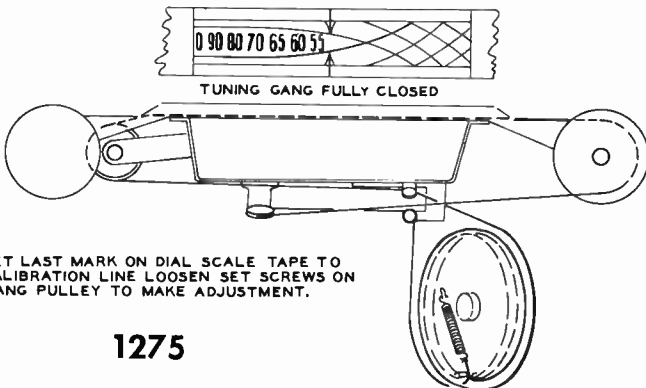

TUNING GANG FULLY CLOSED

SET LAST MARK ON DIAL SCALE TAPE TO CALIBRATION LINE LOOSEN SET SCREWS ON GANG PULLEY TO MAKE ADJUSTMENT.

1275

1276

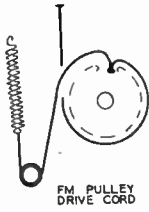
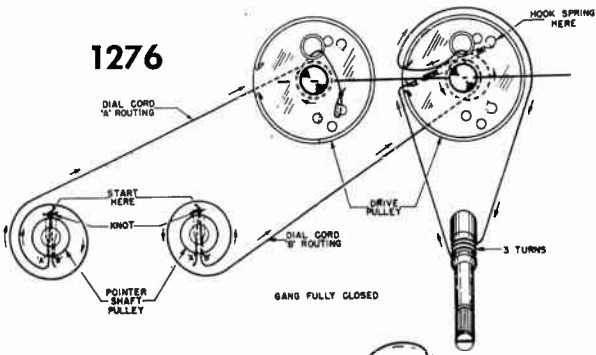

PULLEY DRIVE CORD

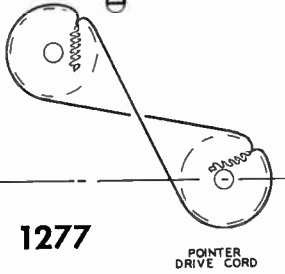

1277

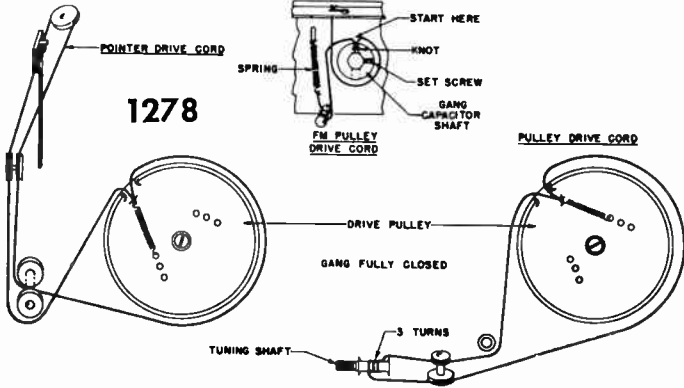

1278

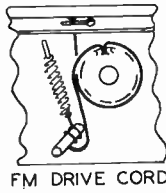
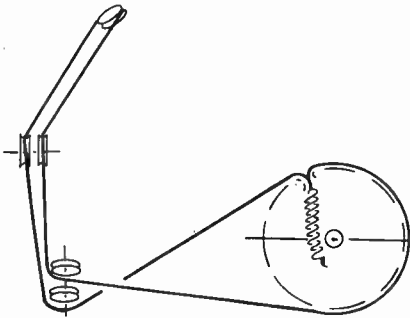

1279

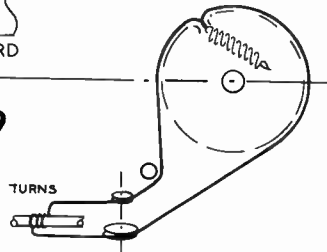

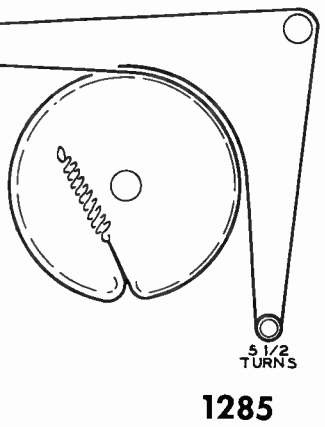
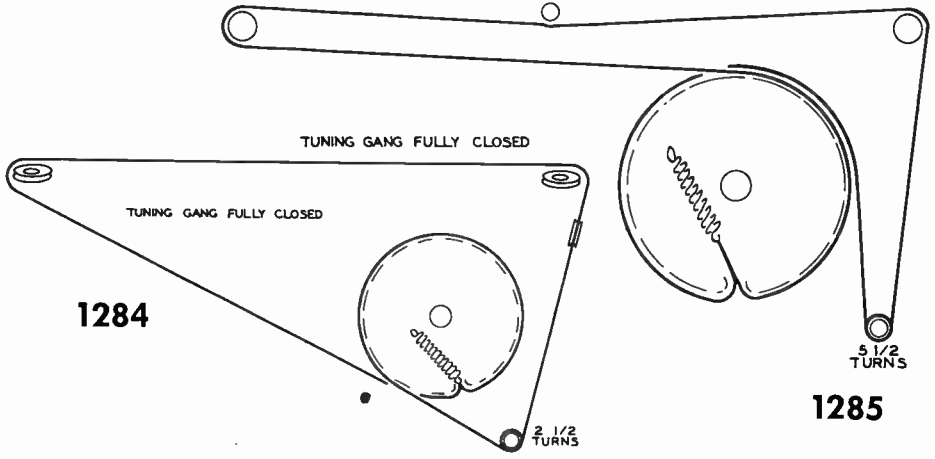
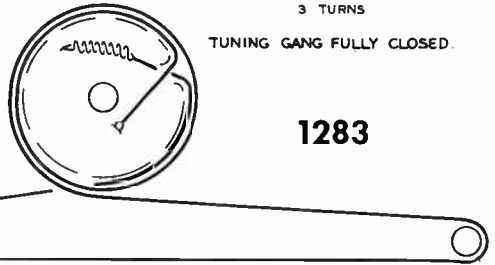
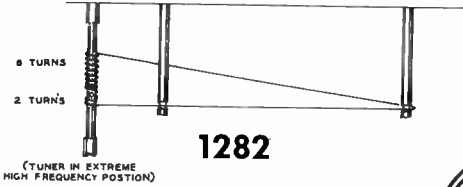
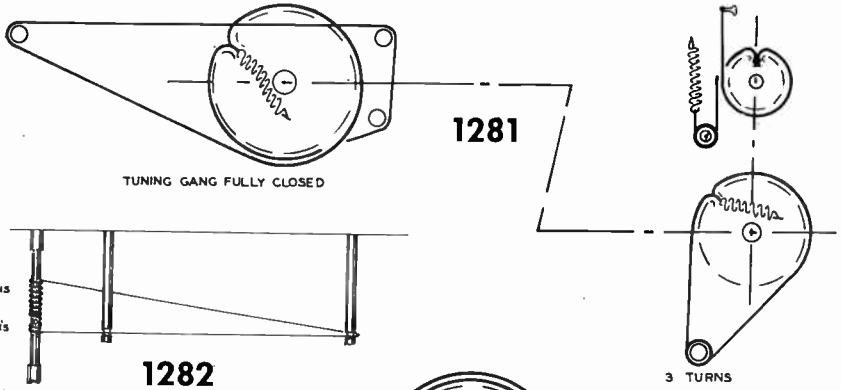
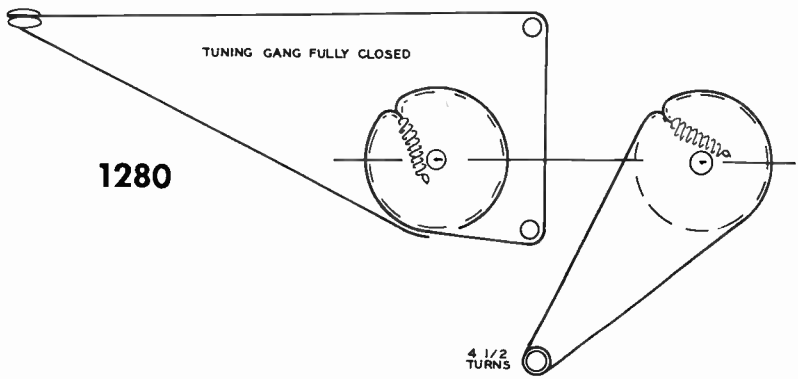

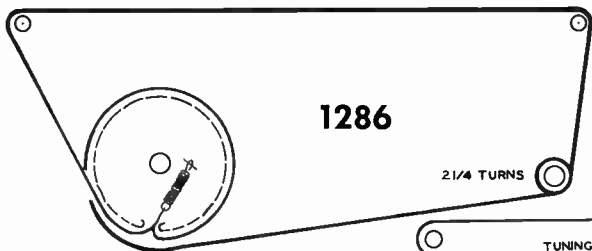

2 1/4 TURNS

1286

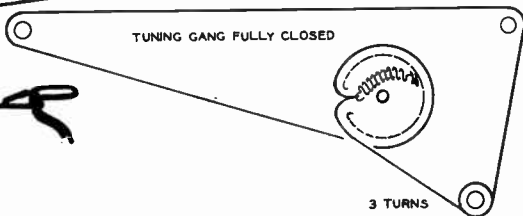

1287

TUNING GANG FULLY CLOSED

3 TURNS

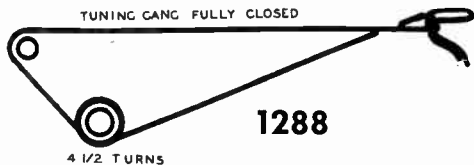

1288

TUNING GANG FULLY CLOSED

4 1/2 TURNS

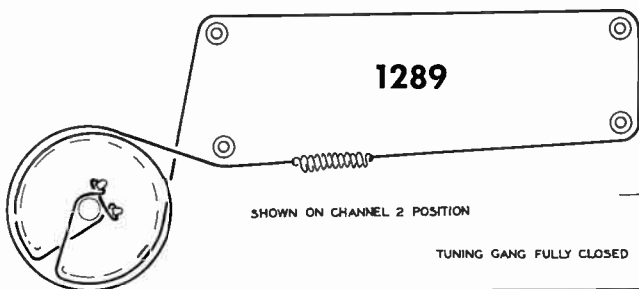

1289

SHOWN ON CHANNEL 2 POSITION

TUNING GANG FULLY CLOSED

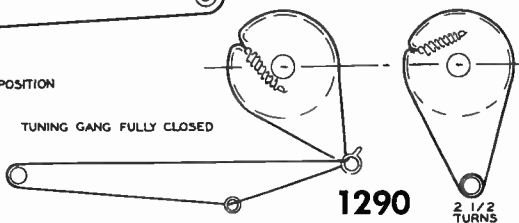

1290

2 1/2 TURNS

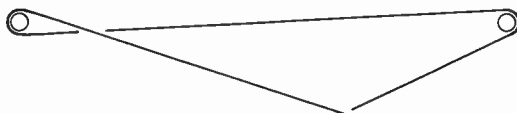

1291

3 TURNS

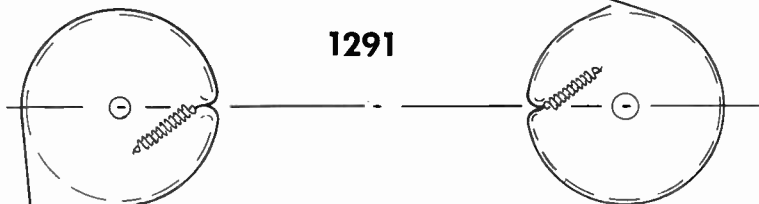

1292

TUNING GANG FULLY CLOSED

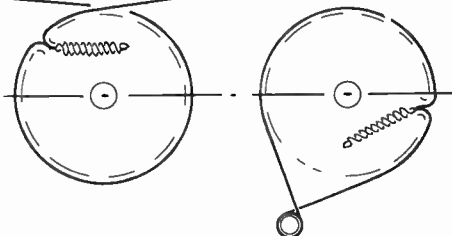
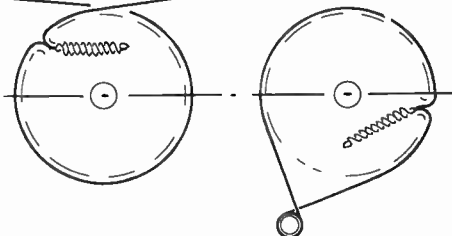

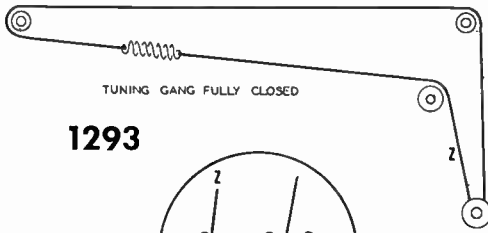

1293

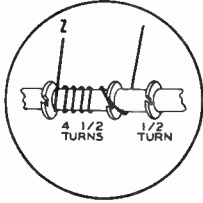

FULLY  
COUNTERCLOCKWISE

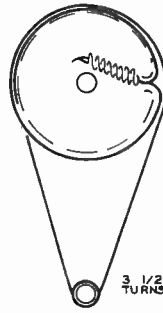

1294

3 1/2  
TURNS

TUNING GANG FULLY CLOSED

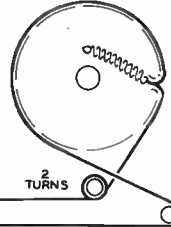

1296

2  
TURNS

TUNING GANG FULLY CLOSED

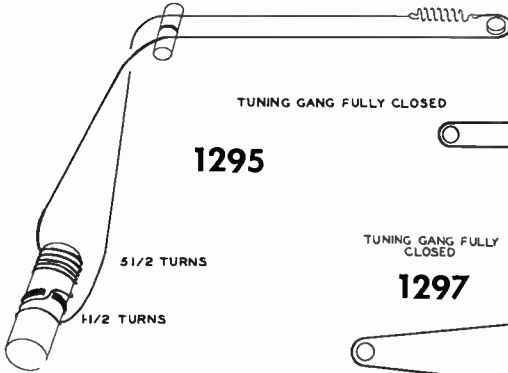

1295

5 1/2 TURNS

1 1/2 TURNS

TUNING GANG FULLY  
CLOSED

1297

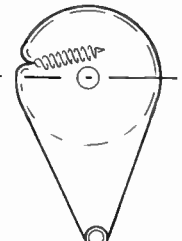
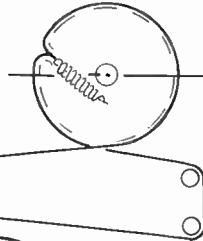

2 1/2  
TURNS

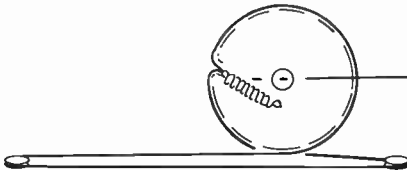

TUNING GANG FULLY CLOSED

1298

2 1/2  
TURNS

TUNING GANG FULLY CLOSED

1299

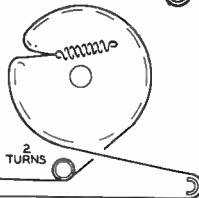

2  
TURNS

TUNING GANG FULLY CLOSED

1300

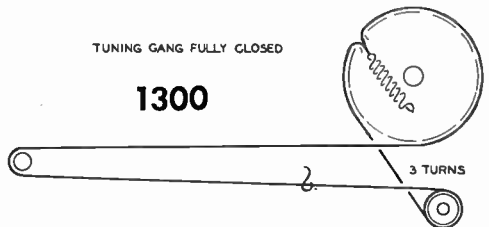

3 TURNS

TUNING GANG FULLY CLOSED

1301

TUNING GANG FULLY CLOSED

1302

2 1/2 TURNS

3 1/2 TURNS

1304

TUNING GANG FULLY CLOSED

3 1/2 TURNS

1303

TUNING GANG FULLY CLOSED

2 1/2 TURNS

1305

TUNING GANG FULLY CLOSED

TUNING GANG FULLY CLOSED

1306

3 TURNS

2 1/2 TURNS

TUNING GANG FULLY CLOSED

1307

2 1/2 TURNS

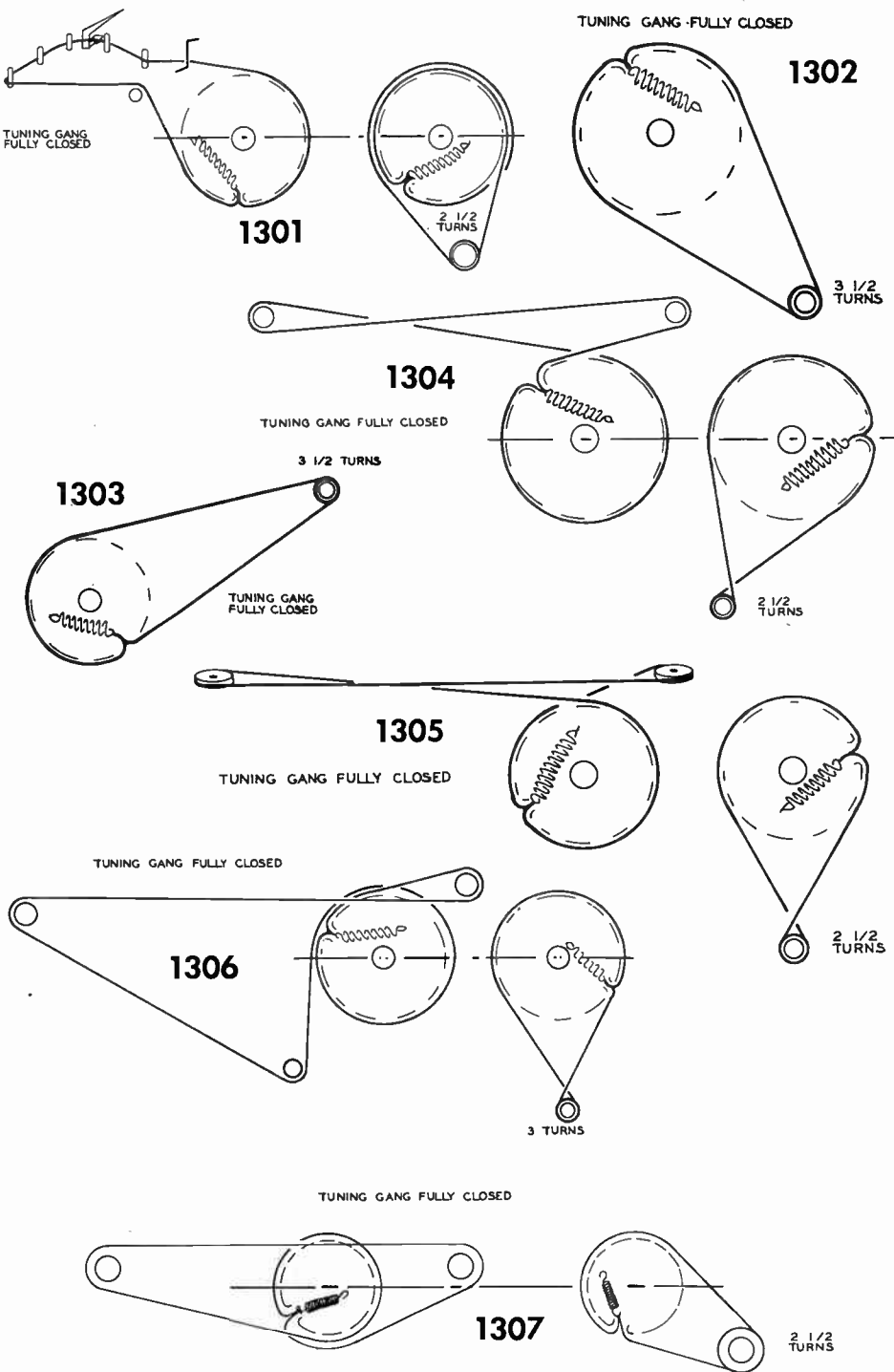

TUNING GANG FULLY CLOSED

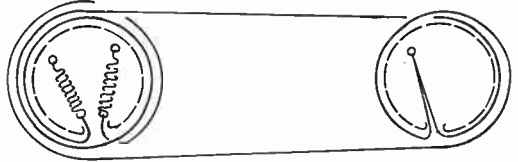
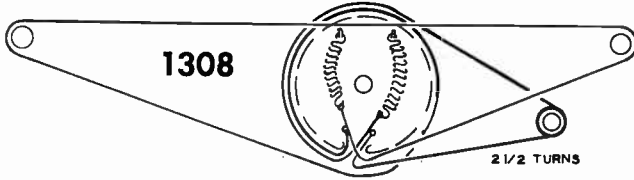

### REMOTE CONTROL DRIVE CORD STRINGING

1309

TUNING GANG FULLY CLOSED

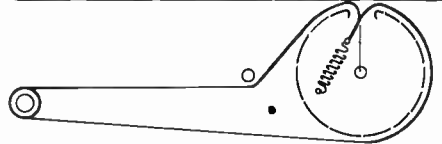

TUNING GANG FULLY OPEN

1310

2 TURNS

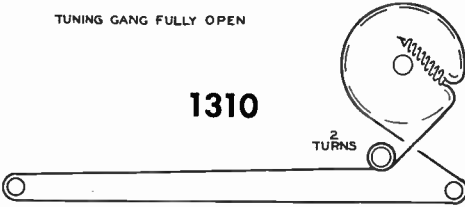

TUNING GANG FULLY CLOSED

3 TURNS

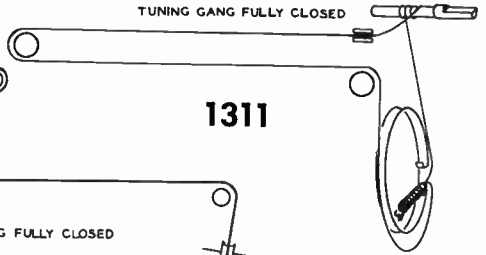

1311

TUNING GANG FULLY CLOSED

1312

3 TURNS

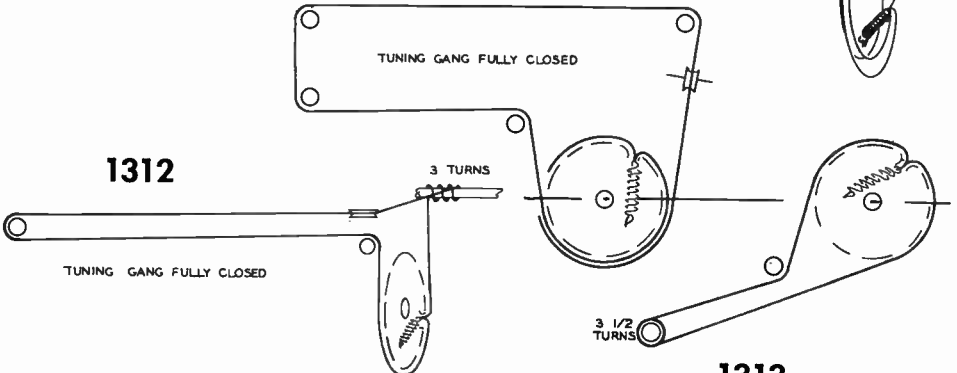

TUNING GANG FULLY CLOSED

3 1/2 TURNS

1313

TUNING GANG FULLY CLOSED

1314

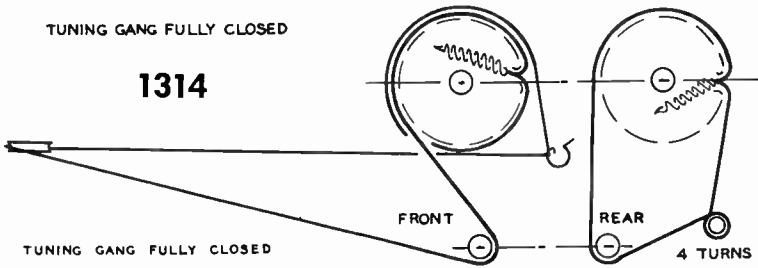

TUNING GANG FULLY CLOSED

1315

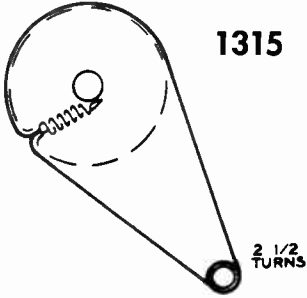

TUNING GANG FULLY CLOSED

1316

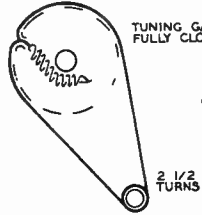

TUNING GANG FULLY CLOSED

1317

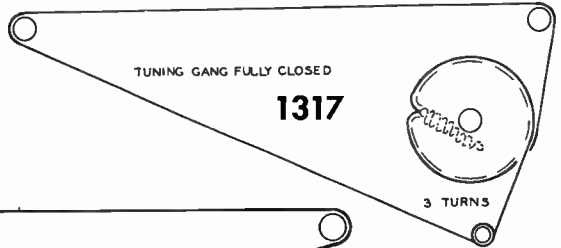

TUNING GANG FULLY CLOSED

1318

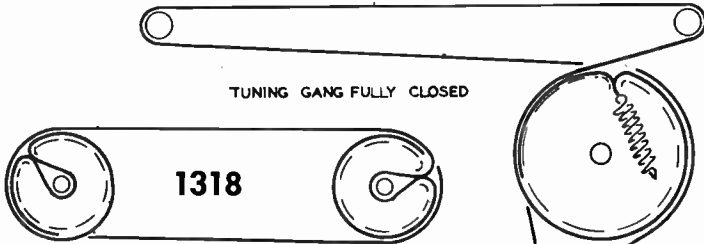

VOLUME CONTROL DRIVE

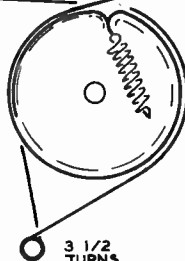

3 TURNS

TUNING GANG FULLY CLOSED

1319

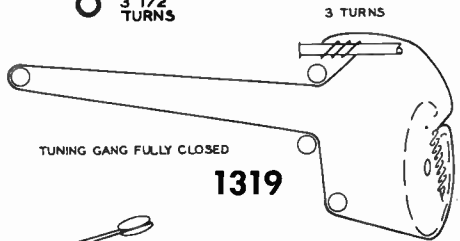

TUNING GANG FULLY CLOSED

1320

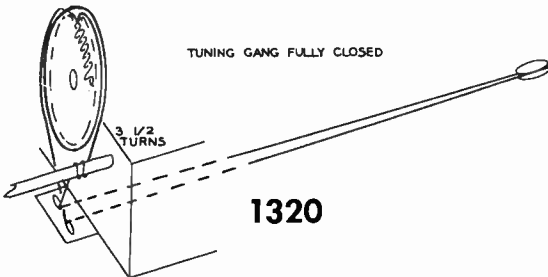



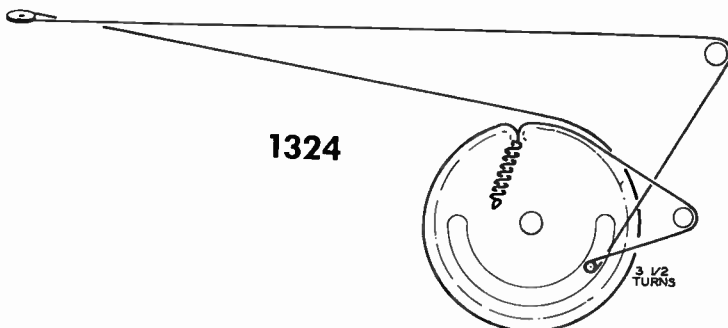
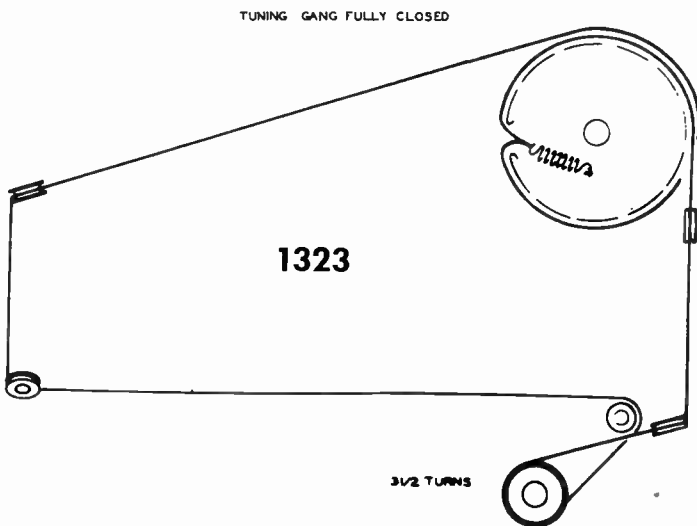
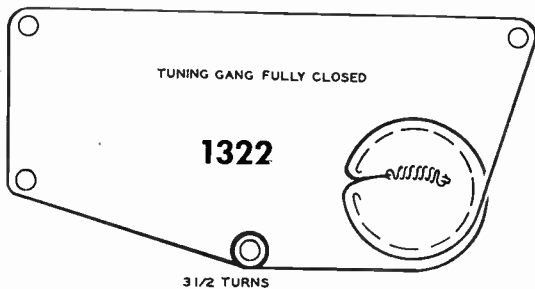
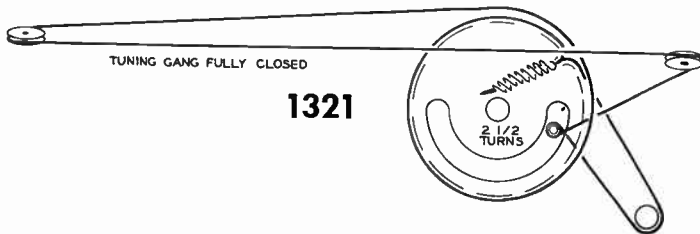



1325

TUNING GANG FULLY CLOSED

1326



TUNING GANG FULLY CLOSED

2 1/2  
TURNS

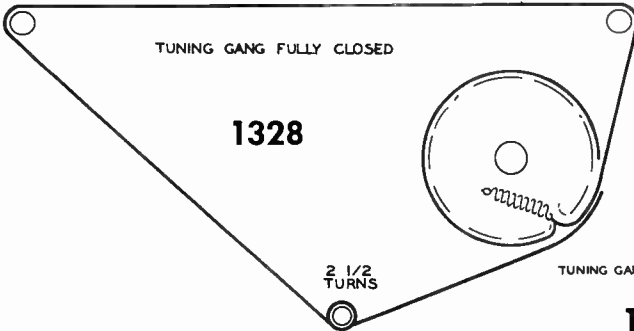
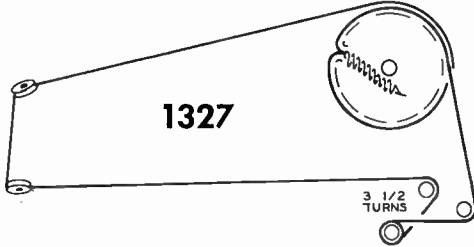

TUNING GANG FULLY CLOSED

1329

3 TURNS

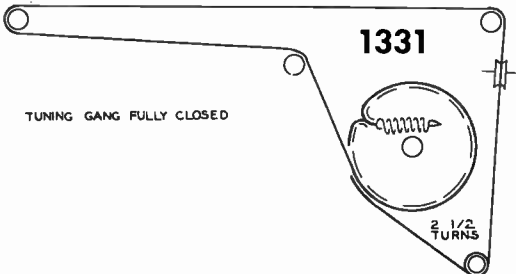
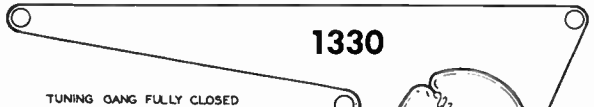
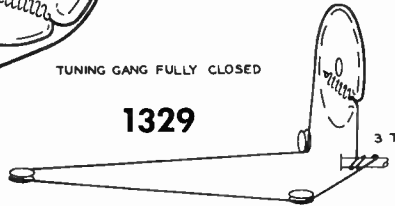

TUNING GANG FULLY CLOSED

TUNING GANG FULLY CLOSED

1332

3 1/2 TURNS

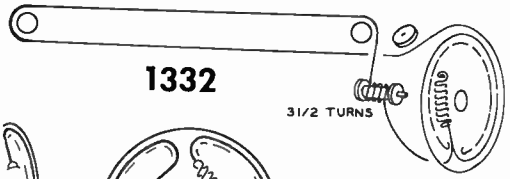

TUNING GANG FULLY CLOSED

1333

3 1/2 TURNS

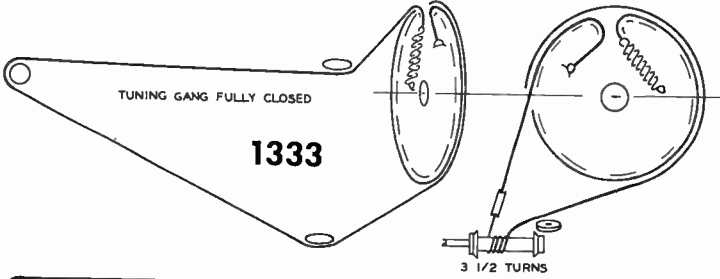

TUNING GANG FULLY CLOSED

1334

1/2 TURN

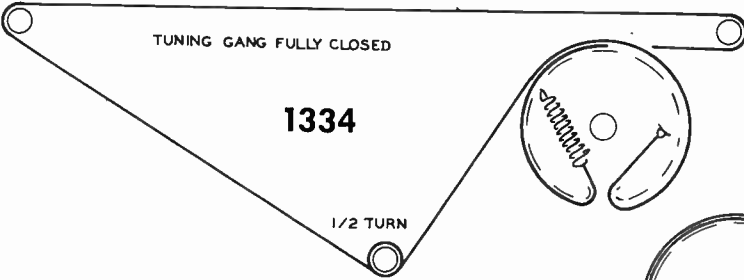

TUNING GANG FULLY CLOSED

1335

3 TURNS

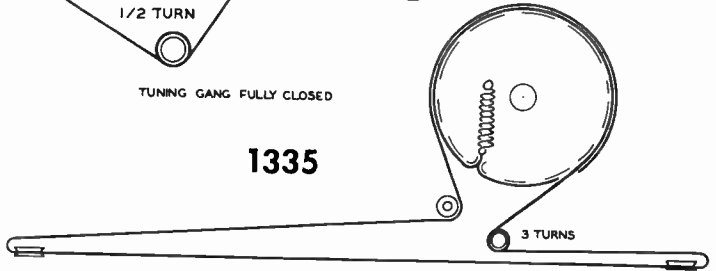

TUNING GANG FULLY CLOSED

1336

3 1/2 TURNS

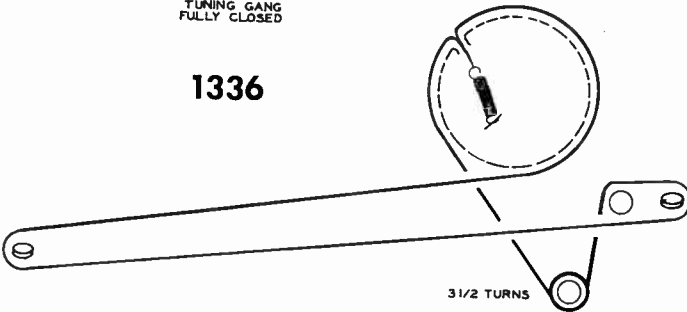

TUNING GANG FULLY CLOSED

1337

2 1/2 TURNS

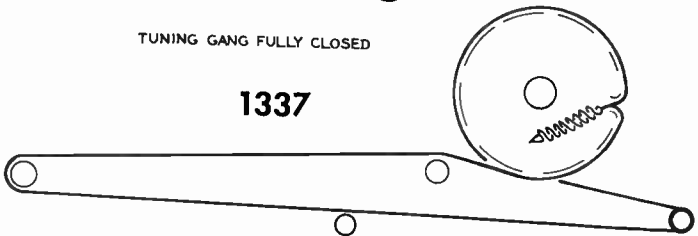

TUNING GANG FULLY CLOSED

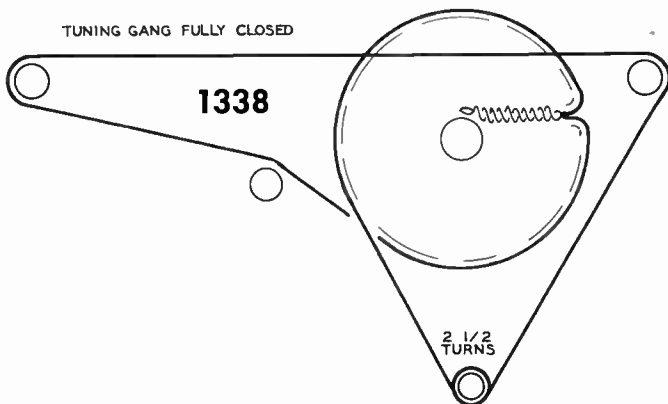

TUNING GANG FULLY CLOSED

1339

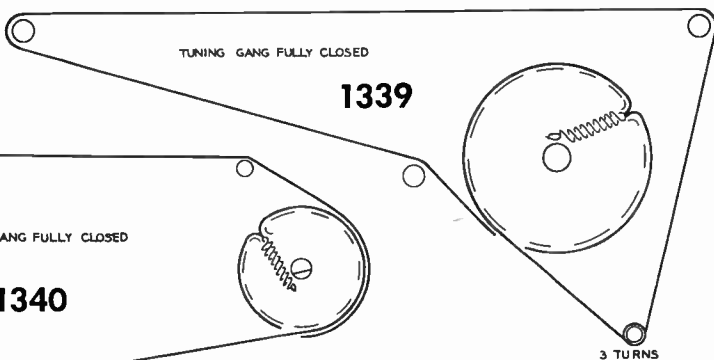

TUNING GANG FULLY CLOSED

1340

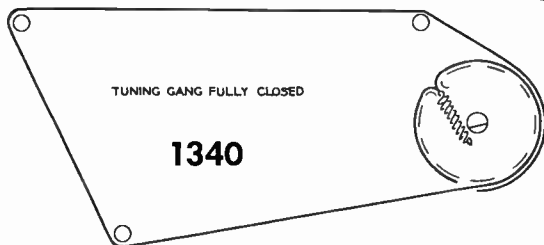

TUNING GANG FULLY CLOSED

1341

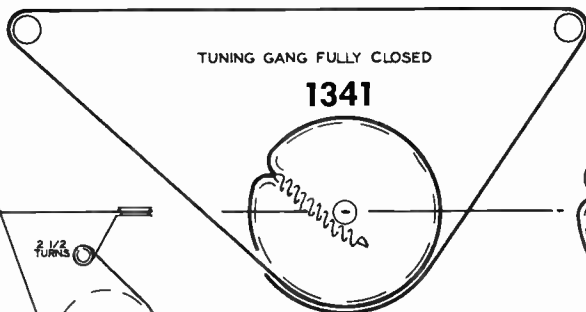

TUNING GANG  
FULLY CLOSED

2 1/2  
TURNS

1342

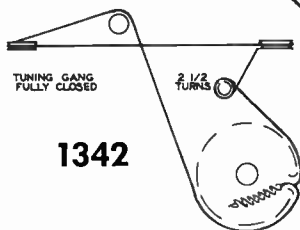

TUNING GANG FULLY CLOSED

1343

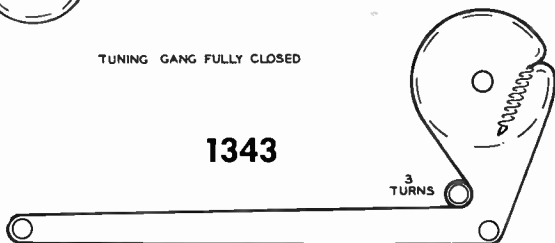

TUNING GANG FULLY CLOSED

**1344**

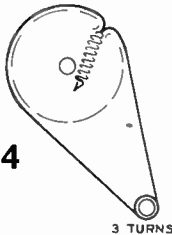

TUNING GANG FULLY CLOSED

**1345**

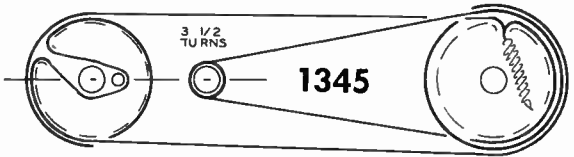

FULLY COUNTER CLOCKWISE

**1347**

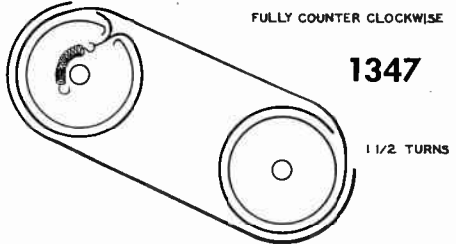

**1348**

TUNING GANG FULLY CLOSED

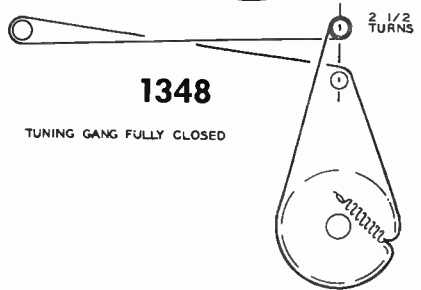

TUNING GANG FULLY CLOSED

**1349**

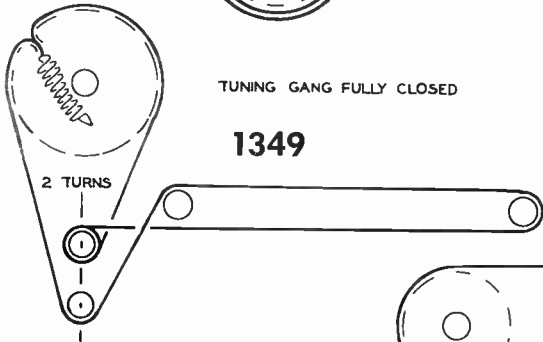

**1350**

TUNING GANG FULLY CLOSED



TUNING GANG FULLY CLOSED

**1351**

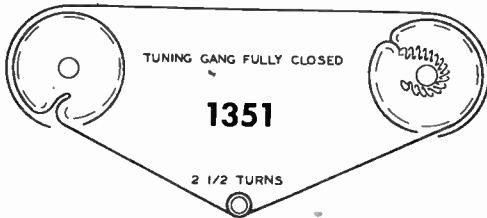

TUNING GANG FULLY CLOSED

**1352**

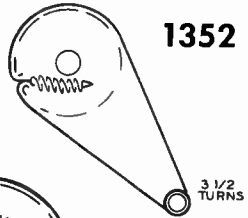

TUNING GANG FULLY CLOSED

**1353**

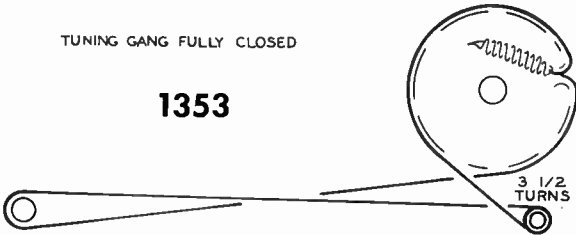

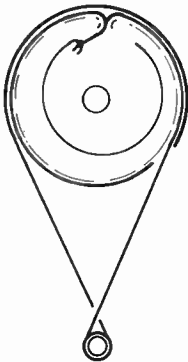

1 1/2 TURNS

**1354**

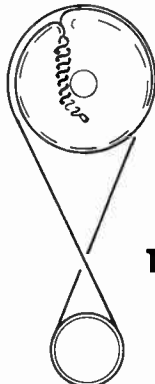

1 1/2 TURNS

**1355**

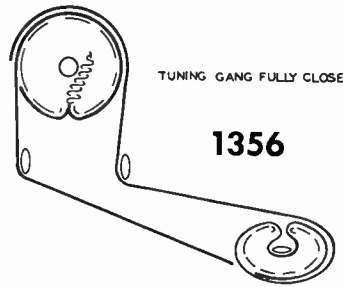

TUNING GANG FULLY CLOSED

**1356**

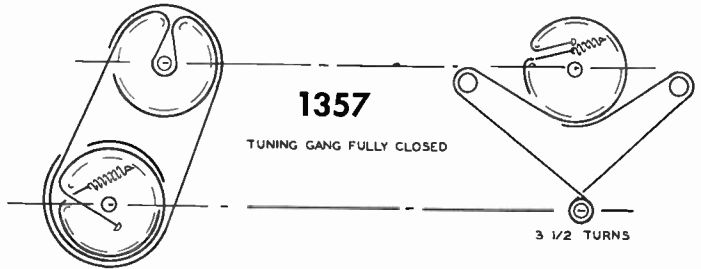

**1357**

TUNING GANG FULLY CLOSED

3 1/2 TURNS

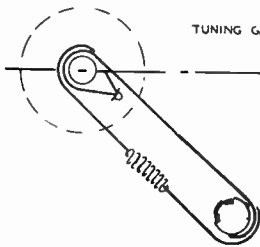

TUNING GANG FULLY CLOSED

**1358**

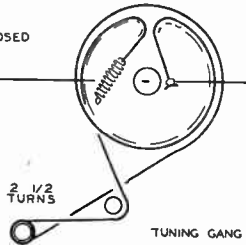

2 1/2 TURNS

TUNING GANG FULLY CLOSED

**1359**

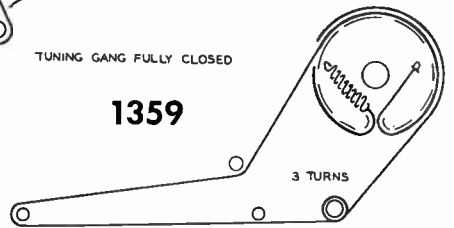

3 TURNS



TUNING GANG FULLY CLOSED

**1360**

TUNING GANG FULLY CLOSED

**1361**

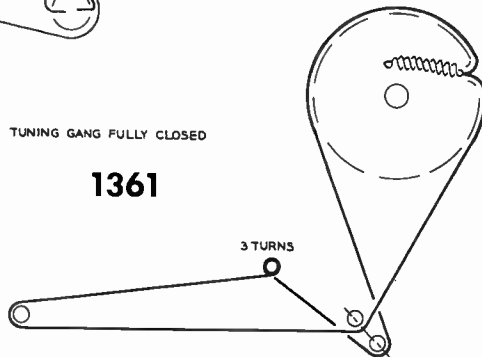

3 TURNS

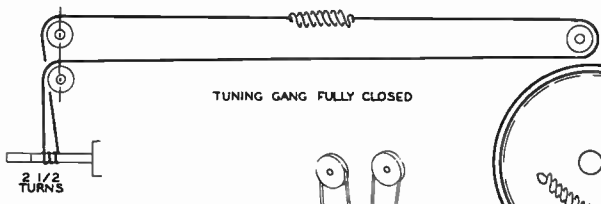

**1362**

TUNING GANG FULLY CLOSED

2 1/2  
TURNS

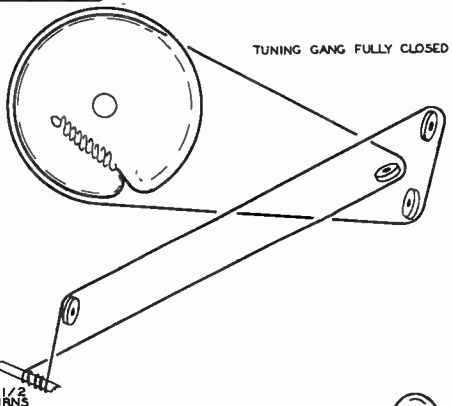

TUNING GANG FULLY CLOSED

3 1/2  
TURNS

TUNING GANG FULLY CLOSED

**1363**

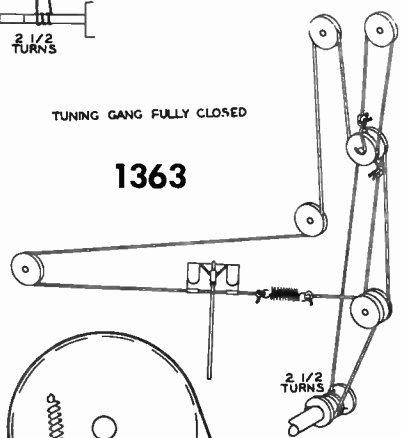

TUNING GANG FULLY CLOSED

2 1/2  
TURNS

TUNING GANG FULLY CLOSED

**1364**

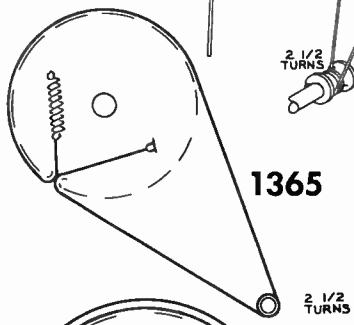

3 1/2  
TURNS

**1365**

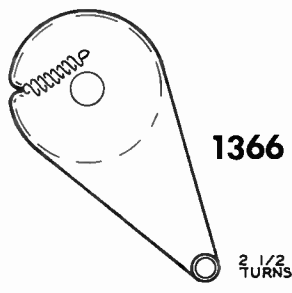

**1366**

2 1/2  
TURNS

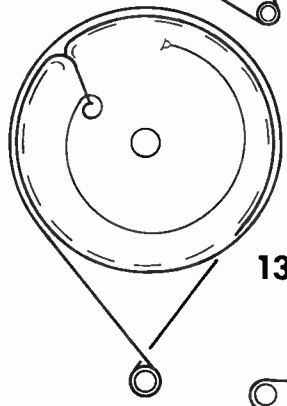

**1367**

TUNING GANG FULLY CLOSED

1 1/2  
TURNS

**1368**



2 1/2  
TURNS

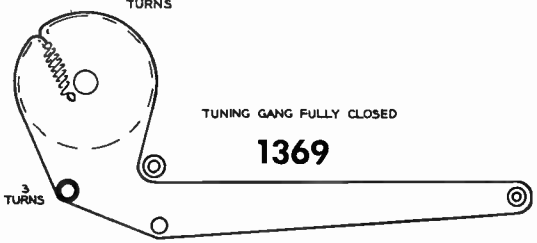

TUNING GANG FULLY CLOSED

**1369**

3  
TURNS

TUNING GANG FULLY CLOSED

**1370**

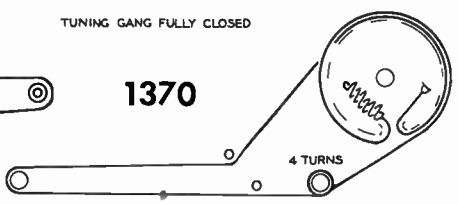

4  
TURNS

TUNING GANG FULLY CLOSED

1371

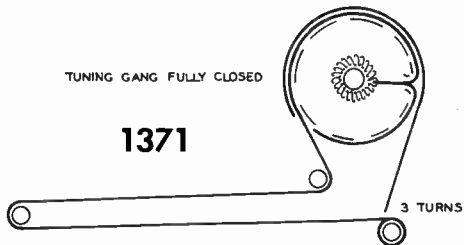

TUNING GANG FULLY CLOSED

1372

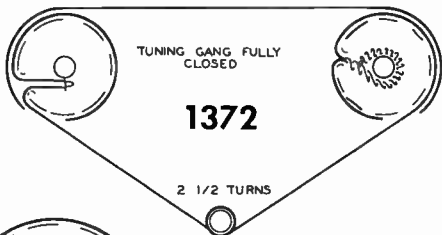

TUNING GANG FULLY OPEN

1373

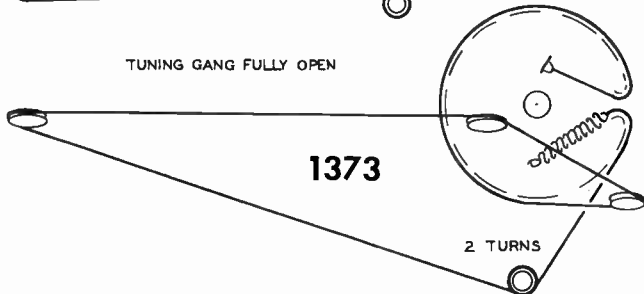

1374

TUNING GANG FULLY OPEN

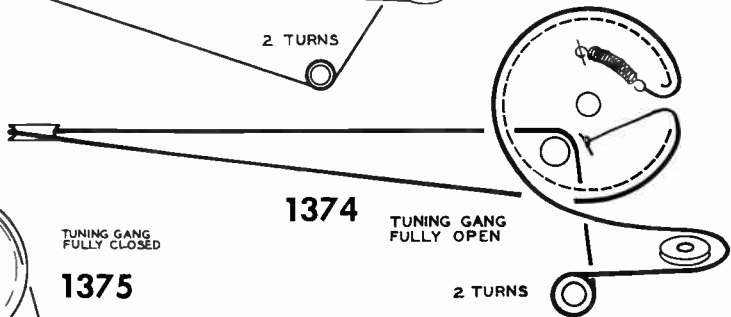

TUNING GANG FULLY CLOSED

1375

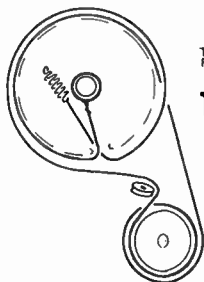

2 TURNS

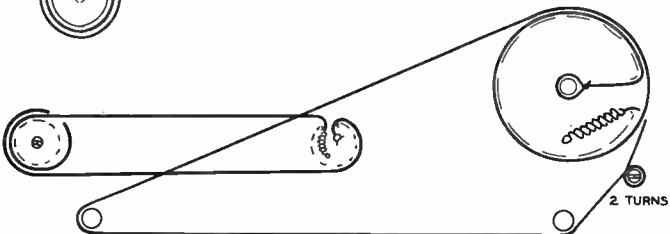

1376

FINE TUNING

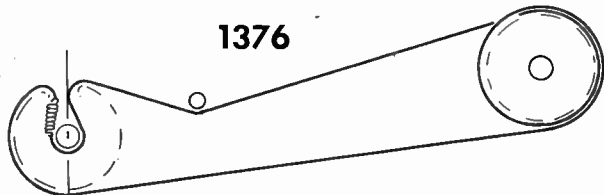

CHANNEL SELECTOR





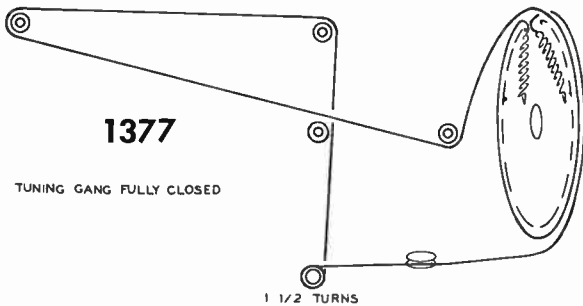

**1377**

TUNING GANG FULLY CLOSED

1 1/2 TURNS

TUNING GANG FULLY CLOSED

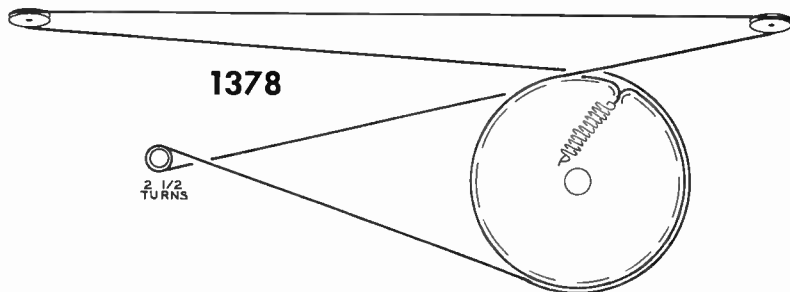

**1378**

2 1/2 TURNS

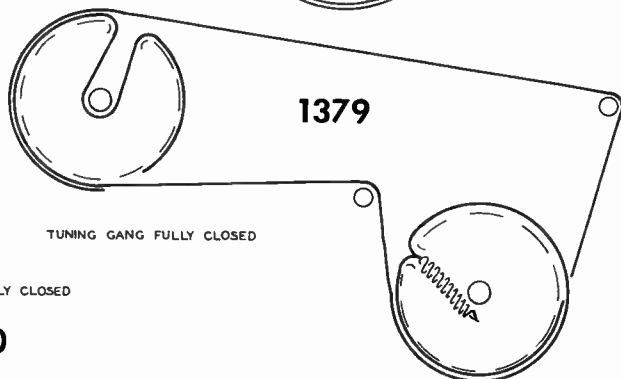

**1379**

TUNING GANG FULLY CLOSED

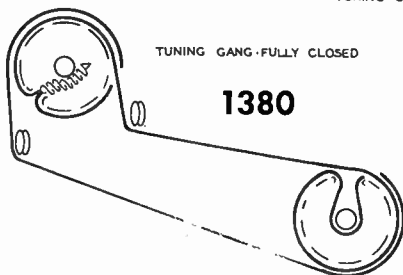

TUNING GANG FULLY CLOSED

**1380**

TUNING GANG FULLY CLOSED

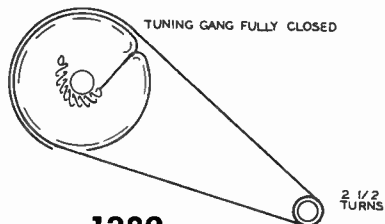

TUNING GANG FULLY CLOSED

**1382**

2 1/2 TURNS

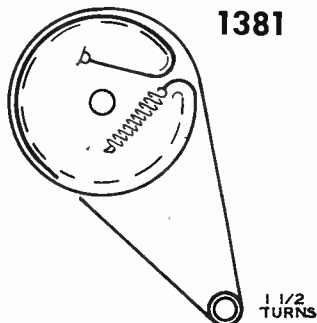

**1381**

1 1/2 TURNS

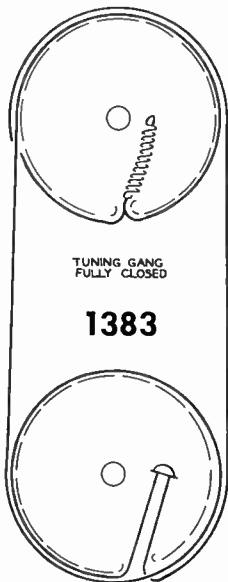

**1383**

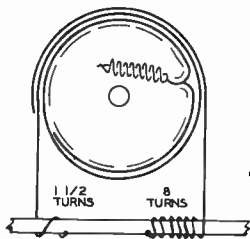

**1384**

**1385**

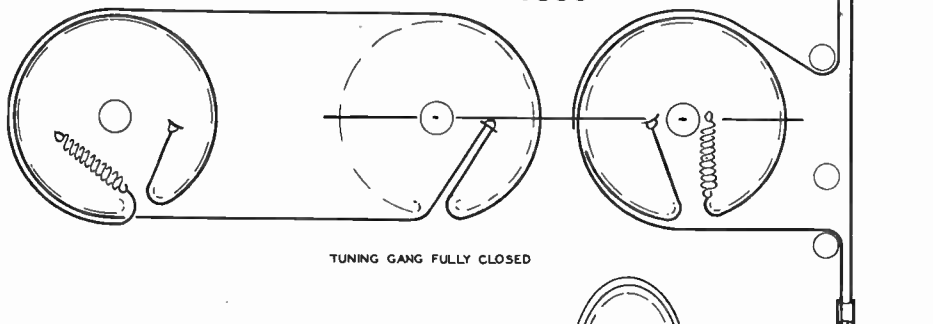

TUNING GANG FULLY CLOSED

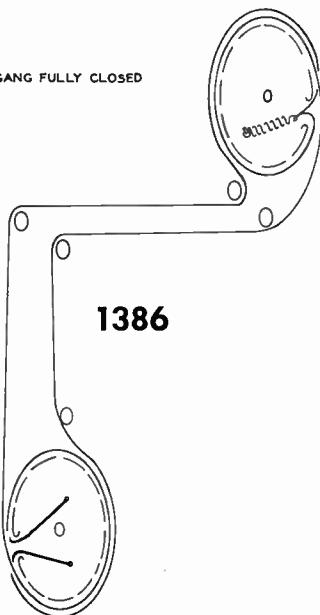

**1386**

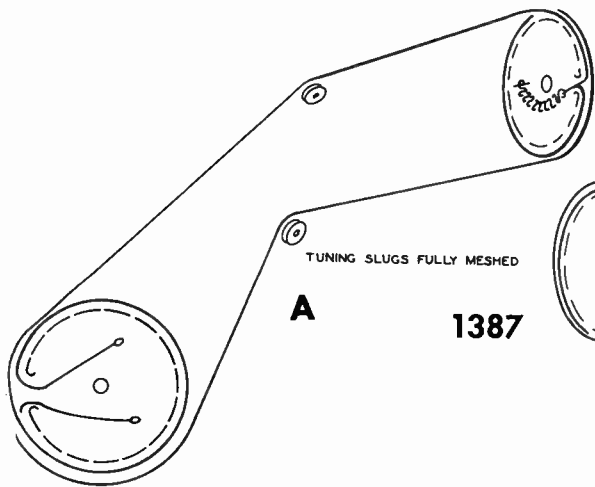

**A**

TUNING SLUGS FULLY MESHED

**1387**

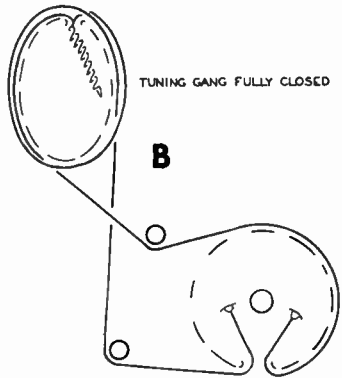

TUNING GANG FULLY CLOSED

**B**



TUNING GANG FULLY CLOSED

**1388**



3 TURNS

TUNING GANG FULLY CLOSED

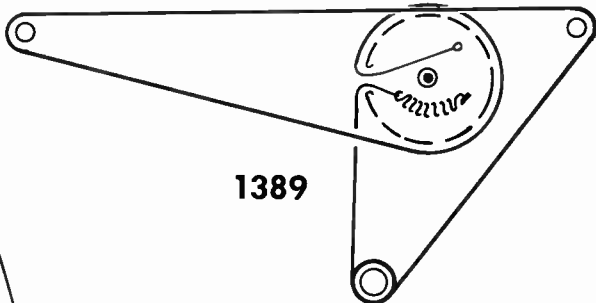

**1389**

3 1/2 TURNS

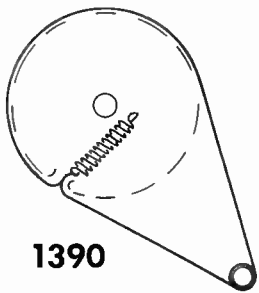

**1390**

1 1/2 TURNS

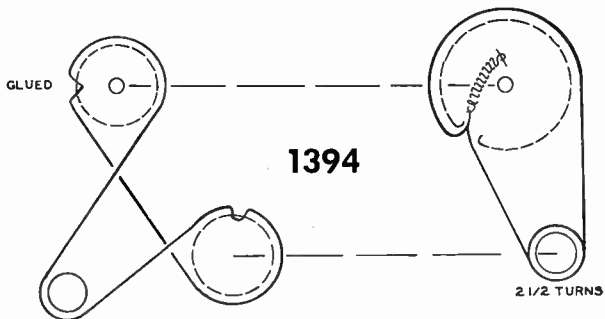
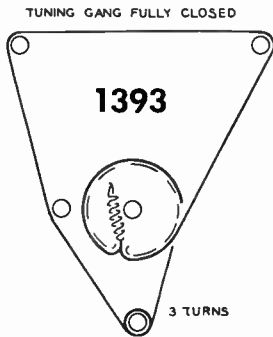
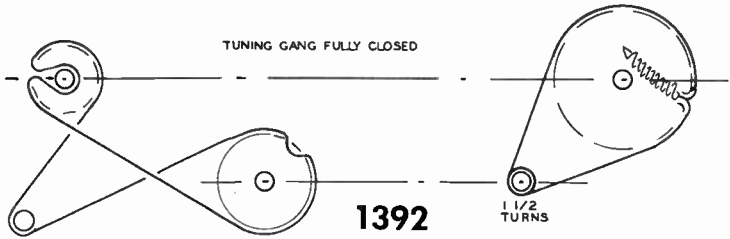
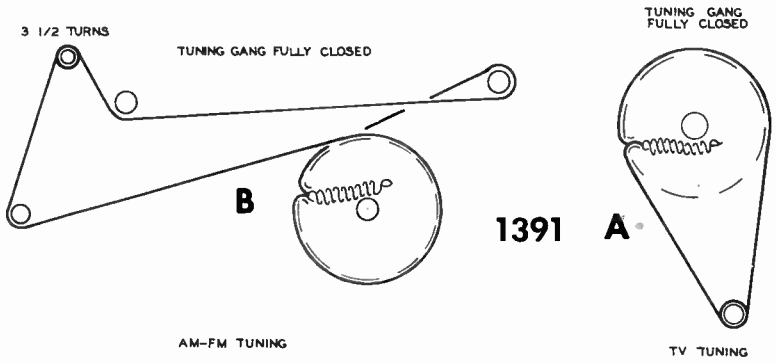

TUNING GANG FULLY CLOSED

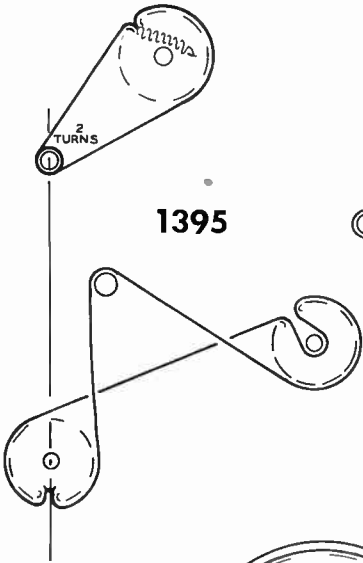

TUNING GANG FULLY CLOSED

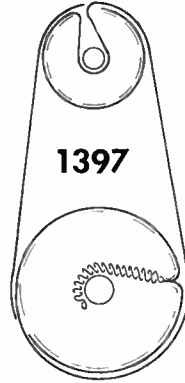
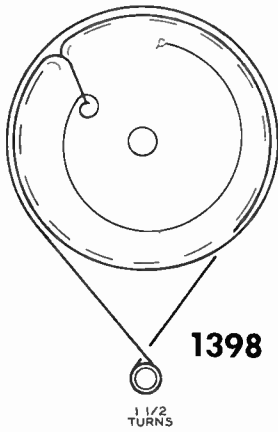
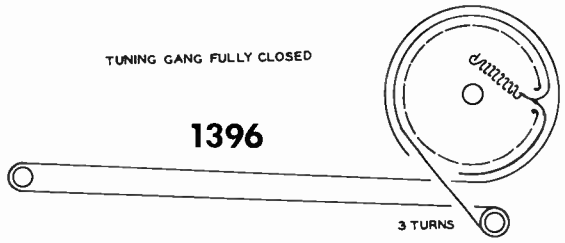

1399

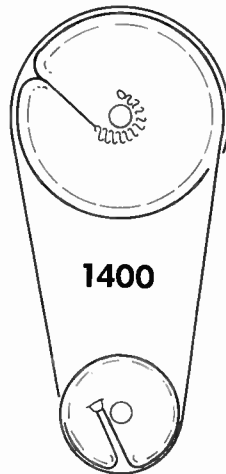
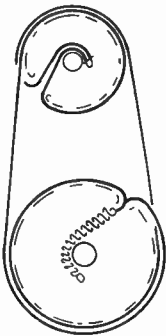

FINE TUNING CONTROL

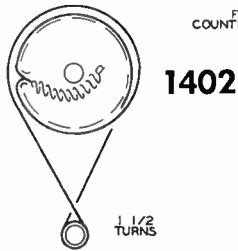
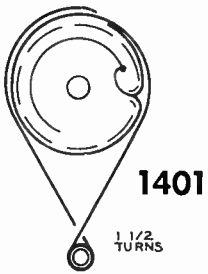

FULLY COUNTERCLOCKWISE FINE TUNING FULLY CLOCKWISE

**1403**

TUNING SHAFT FULLY COUNTERCLOCKWISE

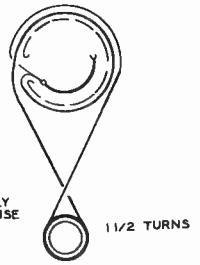

FULLY COUNTER CLOCKWISE

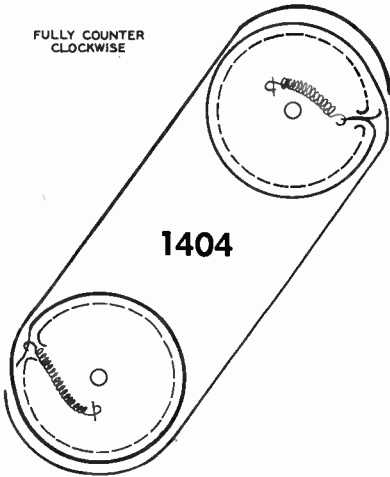

FINE TUNING FULLY CLOCKWISE

TUNING SHAFT FULLY COUNTER CLOCKWISE

TUNING GANG FULLY CLOSED

**1406**

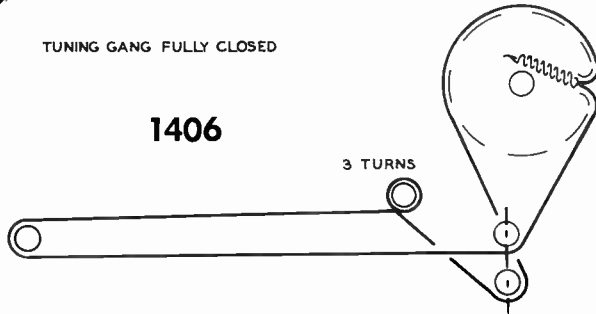

TRIMMER FULLY CLOCKWISE

**1407**

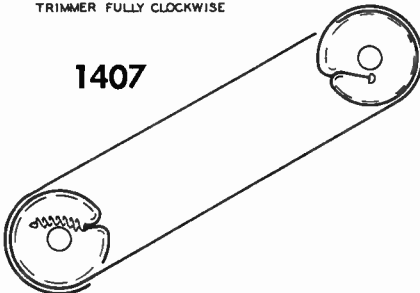

TUNING GANG FULLY CLOSED

**1408**

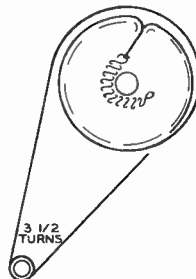

TUNING GANG FULLY CLOSED

1409

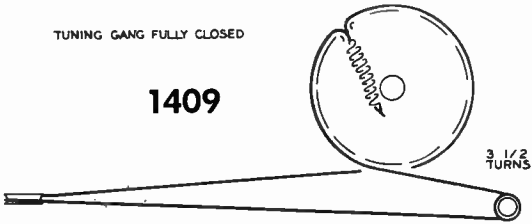

TUNING GANG FULLY CLOSED

1410

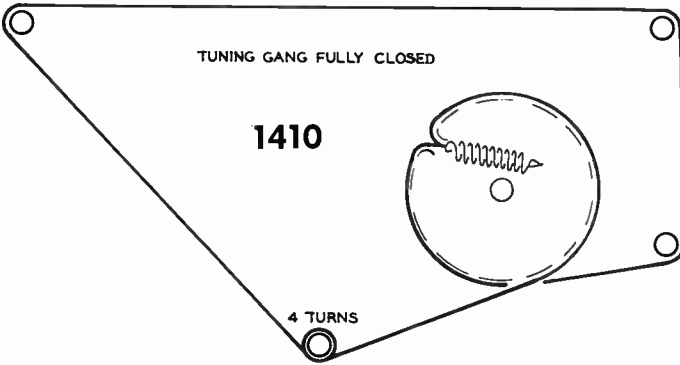

TUNING GANG FULLY CLOSED

1411

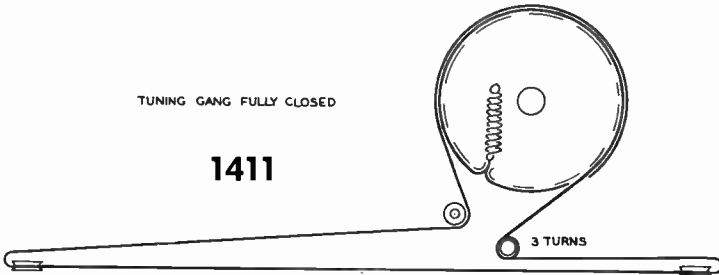

TUNING GANG FULLY CLOSED

1412

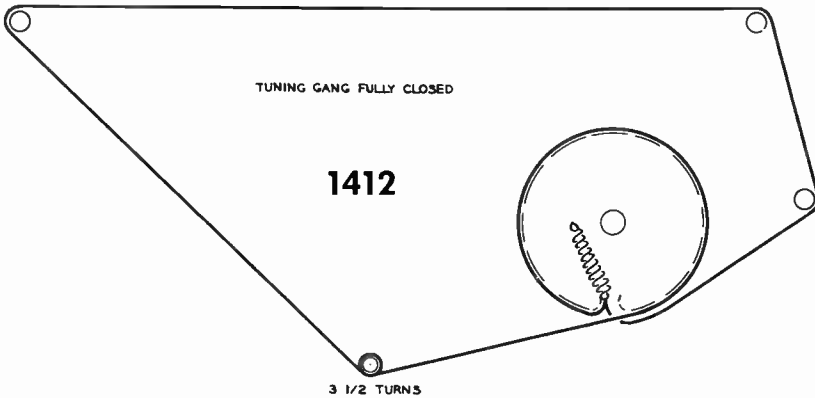



TUNING GANG FULLY CLOSED

**1413**

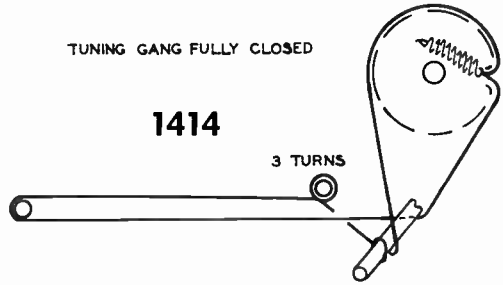

TUNING GANG FULLY CLOSED

**1414**

3 TURNS

TUNING GANG FULLY CLOSED

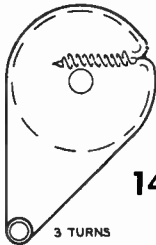

**1415**

3 TURNS

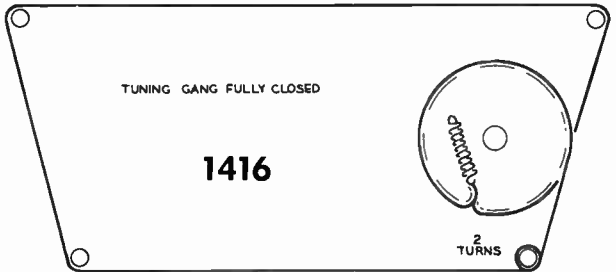

TUNING GANG FULLY CLOSED

**1416**

2 TURNS

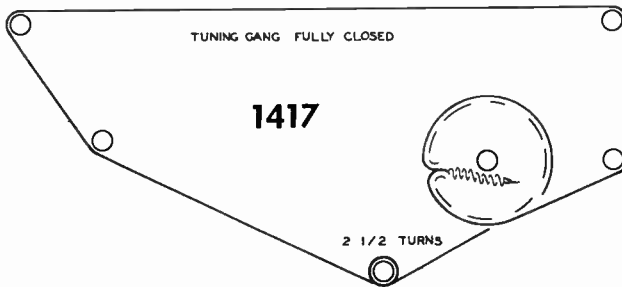

TUNING GANG FULLY CLOSED

**1417**

2 1/2 TURNS

TUNING GANG FULLY CLOSED

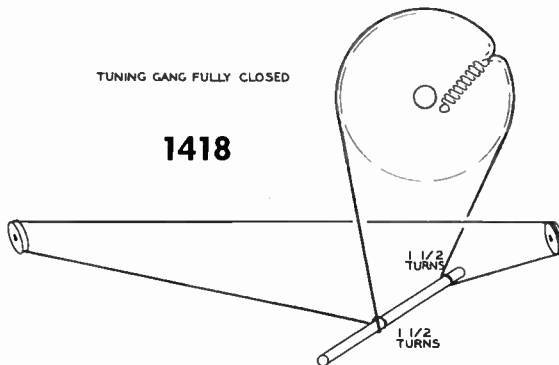

**1418**

1 1/2 TURNS

1 1/2 TURNS



TUNING GANG FULLY CLOSED

1419

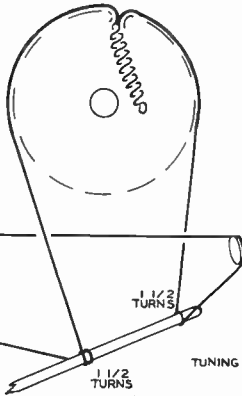

TUNING GANG FULLY CLOSED

1420

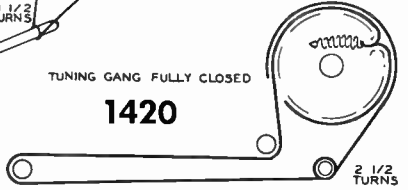

TUNING GANG FULLY CLOSED

1421

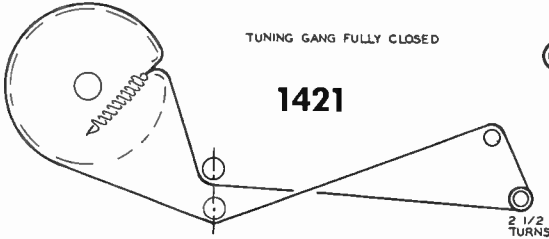

TUNING GANG FULLY CLOSED

1422

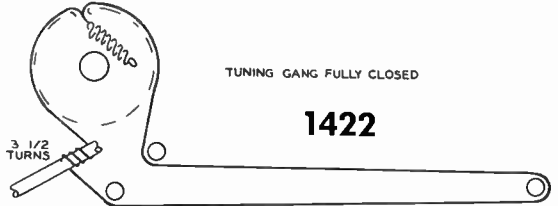

TUNING GANG FULLY CLOSED

1423

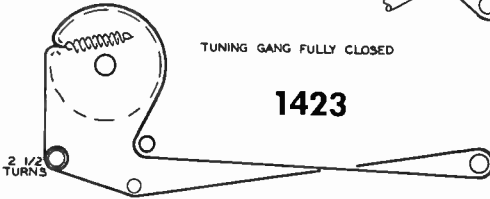

TUNING GANG FULLY CLOSED

1424

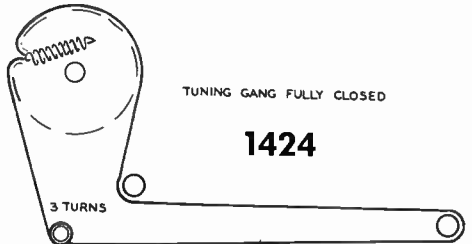

TUNING GANG FULLY OPEN

1425

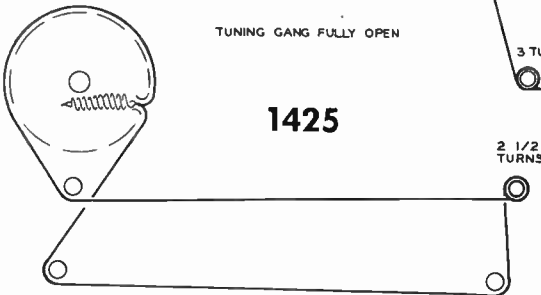

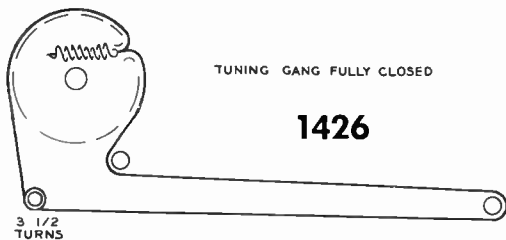

TUNING GANG FULLY CLOSED

**1426**

3 1/2  
TURNS

TUNING GANG FULLY OPEN

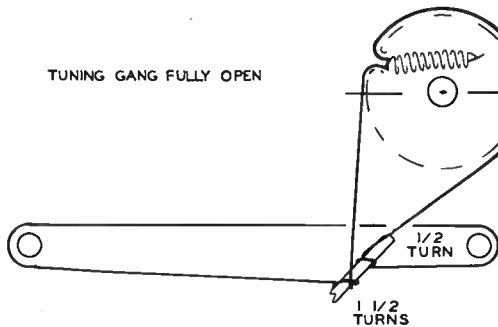

**1427**

1 1/2  
TURNS

TUNING GANG FULLY CLOSED

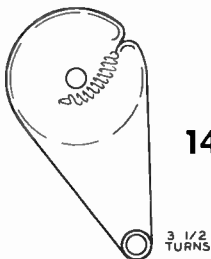

**1428**

3 1/2  
TURNS

TUNING GANG FULLY CLOSED

**1429**

2 1/2  
TURNS

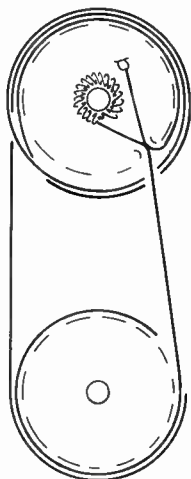
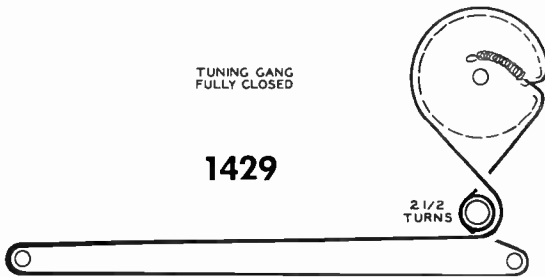

TRIMMER FULLY CLOSED

**1430**

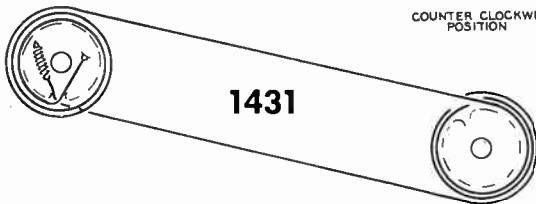

**1431**

COUNTER CLOCKWISE POSITION

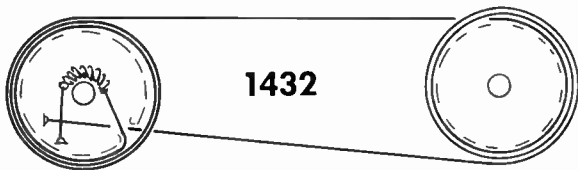

**1432**

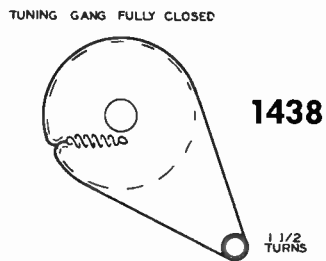
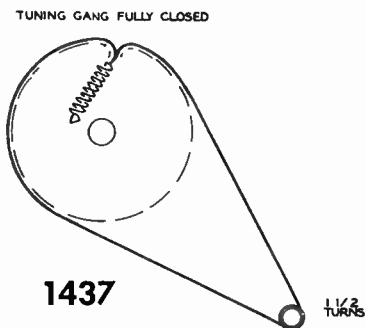
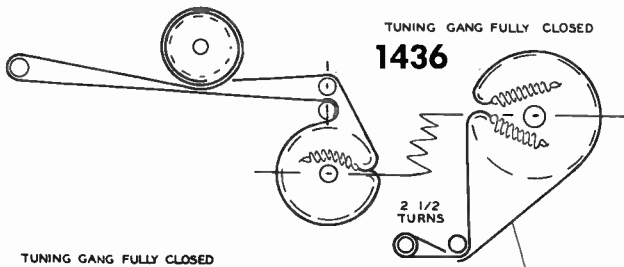
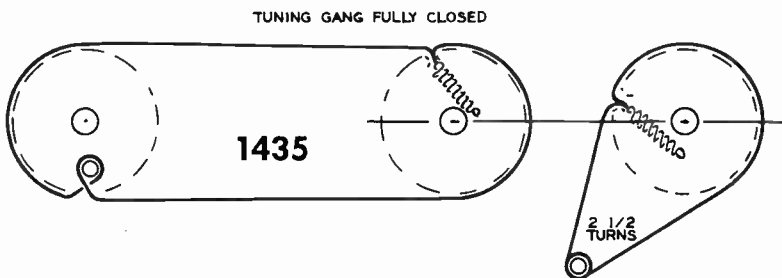
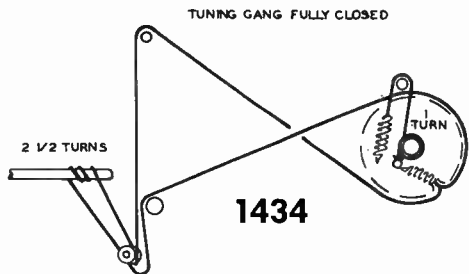
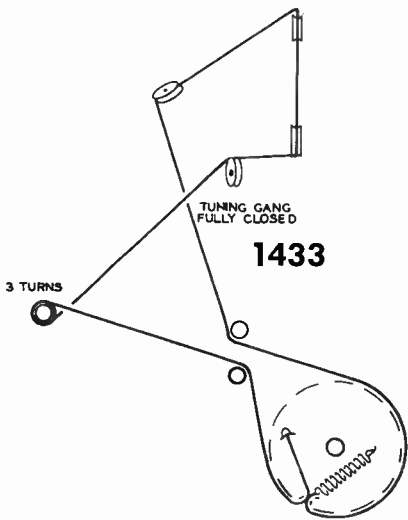

TUNING GANG FULLY CLOSED

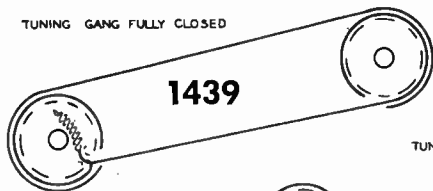

TUNING GANG FULLY CLOSED

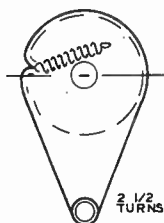
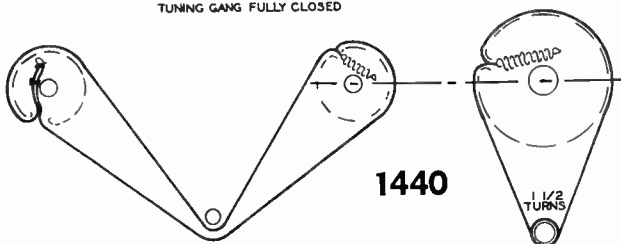

TUNING GANG FULLY CLOSED

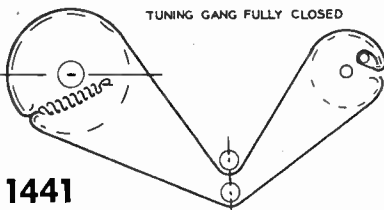

TUNING GANG FULLY CLOSED

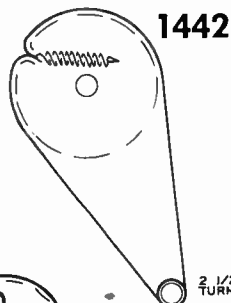

TUNING GANG FULLY CLOSED

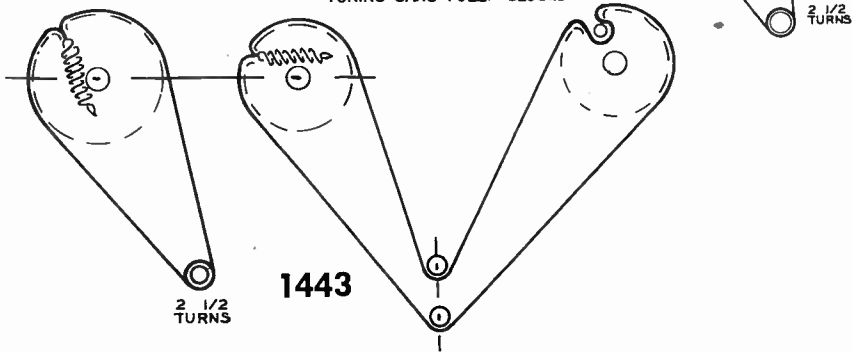

TUNING GANG FULLY CLOSED

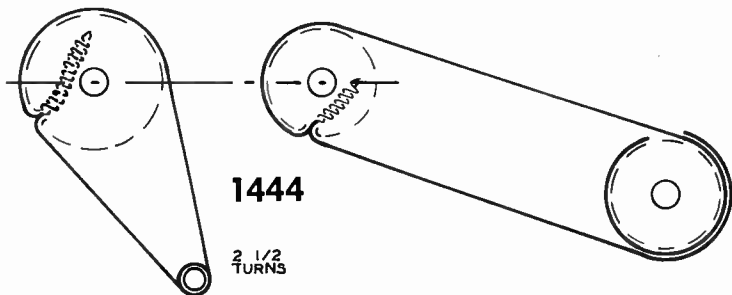

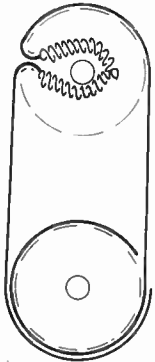

1445

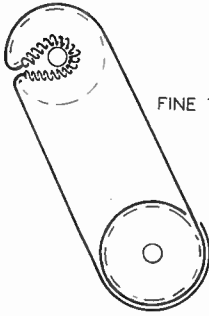

FINE TUNING

1446

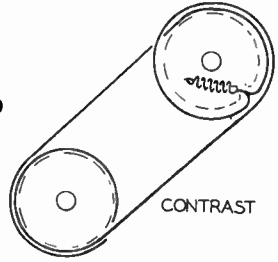

CONTRAST

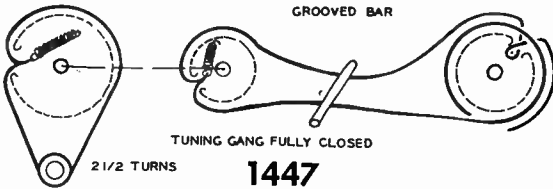

GROOVED BAR

TUNING GANG FULLY CLOSED

2 1/2 TURNS

1447

TUNING GANG FULLY CLOSED

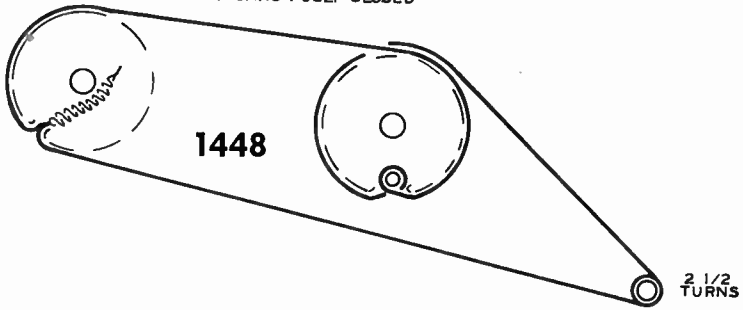

1448

2 1/2 TURNS

TUNING GANG FULLY CLOSED

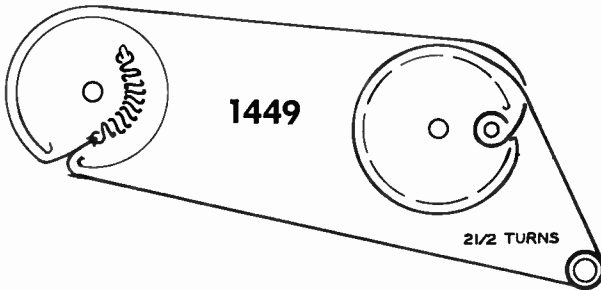

1449

2 1/2 TURNS

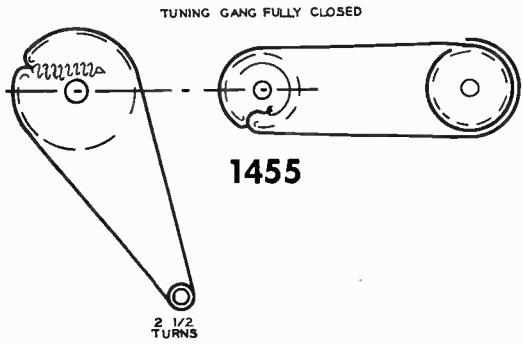
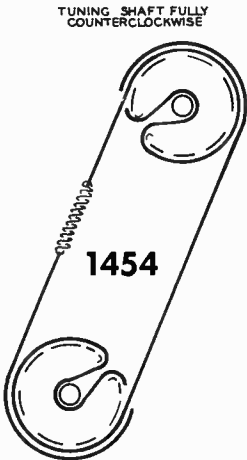
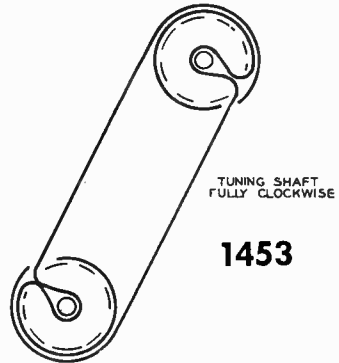
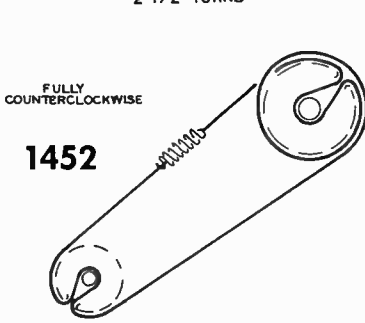
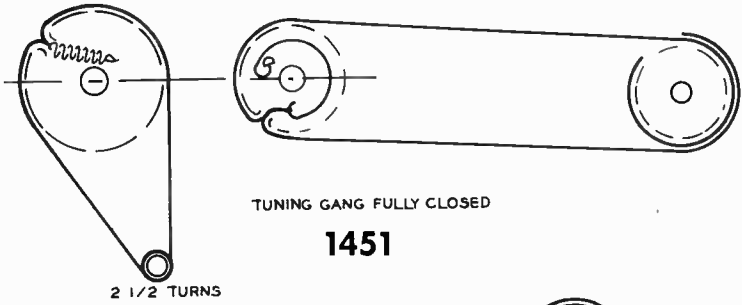
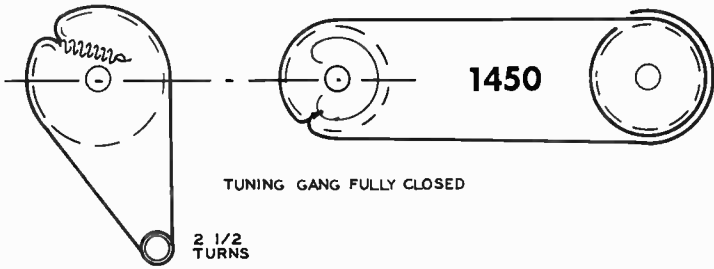

TUNING GANG FULLY CLOSED

2 TURNS

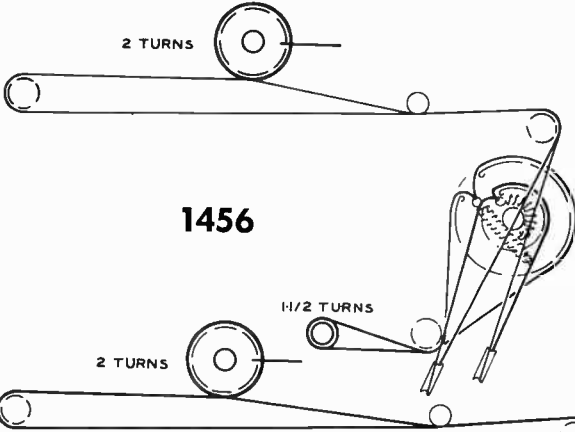

1456

2 TURNS

1 1/2 TURNS

TUNING GANG FULLY CLOSED

1 1/2 TURNS

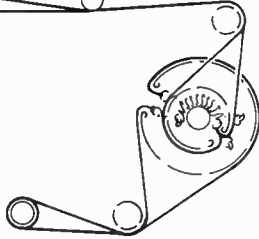

TUNING GANG FULLY CLOSED

1457

2 TURNS

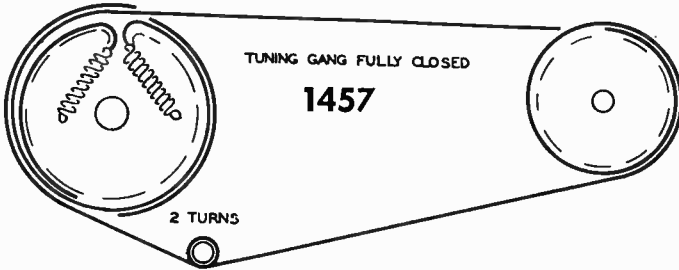

TUNING GANG FULLY CLOSED

1458

1 1/2 TURNS

