

LOW POWER TELECASTING

A Handbook for Station Owners
and Operators

by HAROLD E. ENNES



Antennas • Prediction of Coverage

Transmitters • Vidicon Camera

Station Installations

A

Howard W. Davis

PHOTOFACT PUBLICATION • OH-2



\$2.95

LOW POWER TELECASTING

A Handbook for Station Owners and Operators

by

HAROLD E. ENNES

Technical Editor and Systems Engineer,
Dage Television Division, Thompson Products, Inc.

Author of

"Principles and Practices of
Telecasting Operations"

FIRST EDITION — FIRST PRINTING

FEBRUARY 1957

OH-2



Reproduction or use, of editorial or pictorial content, in any manner, without express permission, is prohibited. No responsibility is assumed with respect to application or patent liability of the included material.

Entire Contents Copyrighted 1957 by Howard W. Sams & Co., Inc.
Indianapolis 5, Indiana

Printed in the United States of America

Published by

HOWARD W. SAMS & CO., INC., INDIANAPOLIS 5, INDIANA

A 

PHOTOFACT PUBLICATION

Library of Congress Catalog Card Number: 56-11016

Foreword

It is probably obvious to the reader of this book that Telecasting is currently in the throes of a revolutionary era. The birthpangs of this potential giant in industry have been unduly long.

The recent authorization of "low-power" transmitter installations is one healthy step forward in the over-all treatment. When all communities in the United States are afforded the possibility of local interest TV, a truly nationwide competitive system can be established. The allocation problem involved in making this opportunity practical will eventually be solved in the American way.

This book is dedicated to the job of supplying basic considerations of planning for the low-power field. It is intended to present, by handy Reference Charts and Tables, the possibilities and limitations of low-power service, as well as to reveal the technical advances made during the last few years in new types of economic studio equipment. It is significant to note that such advances may well lead to large savings in higher power installations. The contents are, therefore, pertinent to all engineers whether concerned with low, medium, or high-power telecasting.

HAROLD E. ENNES

Table of Contents

CHAPTER 1

<i>Television in the Scheme of Things</i>	<i>1</i>
What is Low-Power Television?—The need for Low-Power Television— Allocations, VHF, UHF—Experience With Low-Power Telecasting.	

CHAPTER 2

<i>Low-Power Antennas, Signal Propagation, and Prediction of Coverage</i>	<i>7</i>
Terminology—Use of Charts and Graphs—Effective Radiated Power—Free- Space Field Intensity—Field Intensity Considering Ground Effects—Effective Antenna Height—Estimated Coverage—Antenna Feed Systems for Low Power—Antennas for Low Power—	

CHAPTER 3

<i>Low Power Television Transmitters</i>	<i>23</i>
General Description of BT-200 Transmitter (VHF channels 2-13)—Power Supply—RF Exciter—Final Amplifiers—Aural Modulator—Visual Modu- lator—Directional Coupler (Reflectometer)—VSWR/Monitor In BT-200 Transmitter—UST-150 Transmitter (channels 14-83)—Exciter Unit— Translator Unit—Linear Power Amplifiers—Power Supplies—Accessory Equipment.	

CHAPTER 4

<i>The Vidicon Pickup Tube</i>	<i>37</i>
Operational Functions—Signal Polarity—Spectral Response—Persistence of Photo-Conductive Layer—Vidicon Burn-In—Factors of Vidicon Sensi- tivity—Vidicon Gamma.	

CHAPTER 5

<i>The Vidicon Camera Lens</i>	45
Comparative Fields of View—Depth of Field.	

CHAPTER 6

<i>The Vidicon Camera Chain for Live Pickup</i>	51
Functions of Controls and Switches (Camera Head)—Electronic Viewfinder—Function of Controls, Camera Control Console—Setup of Vidicon Camera Chains—Vidicon Dark-Current Method of Setup—Vidicon Highlight-Current Method of Setup—Matching Studio Cameras—Vidicon Beam Alignment—Complete Camera Setup—Vertical or Horizontal Centering Off Center—Changing or Installing New Vidicon—Maintenance and Servicing—Operations.	

CHAPTER 7

<i>The Vidicon Film Camera Chain</i>	71
The Optical Multiplexer—Camera—Multiplexer Physical Setup—Electrical Adjustments of Film Camera—RCA Vidicon Film Chain—The Long-Application Projector—Film Projector Remote Control.	

CHAPTER 8

<i>Station Installations</i> :	85
Basic Considerations in System Interconnections—Interconnecting Runs—Lighting for Pickup Areas—Power Requirements—Air Conditioning—Wiring—Treatment of Walls and Ceilings.	

APPENDIX

<i>Extracts from FCC Report and Order on TV Allocations (Docket No. 11532)</i>	101
<i>Index</i>	105

Television in the Scheme of Things

Our knowledge of television, tentative and liable to change, is the outgrowth of huge successes and hopeless flounderings. Knowledge of this kind can be healthy providing engineers, producers, managers, the owners, the government, and the TV public form a body of examination demanding expression. This pattern of free expression has been so well established by American citizens that there is little room for despair, but ample room for logic and caution.

It is an interesting question whether this age is the more remarkable for speedy recovery and repair from bad starts, or the equally swift dissemination of information pertaining to methods of recovery. We are quick both to create and to teach; therein lies the possibility of a text such as this so close on the heels of change. Perhaps the final pattern for nationwide competitive television has not yet been established, if, indeed, it could ever be final. Perhaps low-power provisions for local interest TV will not follow the proven path of local AM broadcasting. Yet the history of our people dictates success, and in the working out of this problem to ultimate satisfaction we are bound to derive a sense of pride and pleasure.

1-1 What is Low-Power Television?

The original rulings of the Federal Communications Commission limited the lowest authorized power (for cities of 50,000 population or less) to 1000

watts effective radiated power (ERP) at effective antenna height of 300 feet. Effective August 1, 1955, this ruling was changed to allow ERP's down to 100 watts, with no minimum antenna height specified.

Therefore, "low-power" is ordinarily taken as any ERP less than 1000 watts. The new ruling does not specify any relation to physical size or population of the area to be served.

This ruling allows savings in initial cost and upkeep far above and beyond what might appear on first casual thought. Initial and maintenance costs increase rapidly with power, not only in the transmitter itself, but in transmission lines, diplexers (where used), antennas, building space, power requirements, etc. At the time of the present writing, a "low-power" television station complete with two-camera chains for "live" studio pickup, film chain, monitors, transmitter, antenna, etc., can be installed for about one-fifth the initial cost, and maintained at one-tenth or less the cost of previous conventional stations with like facilities. It should be particularly noted that standards of good engineering practice (relative to quality of performance) have not been altered from "high-power" practice.

It should also be noted that "low-power television" as discussed in this text does not mean "satellite" operation. A satellite receives and retransmits programs of an existing high-power station. The meaning of low-power stations applied herewith

Low Power Telecasting

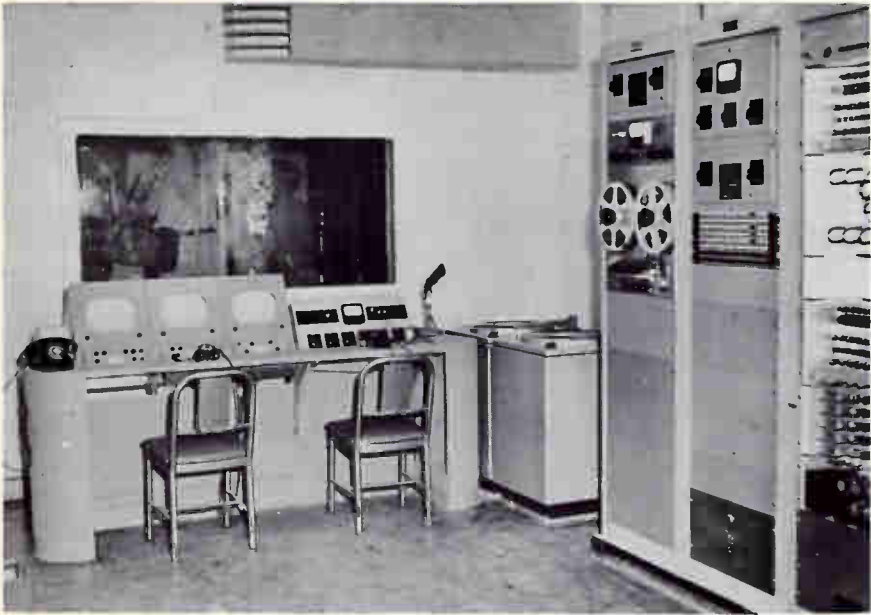

Control Room, U.S. Air Force Station CSL-TV, Azores. Official U.S. Air Force Photo.

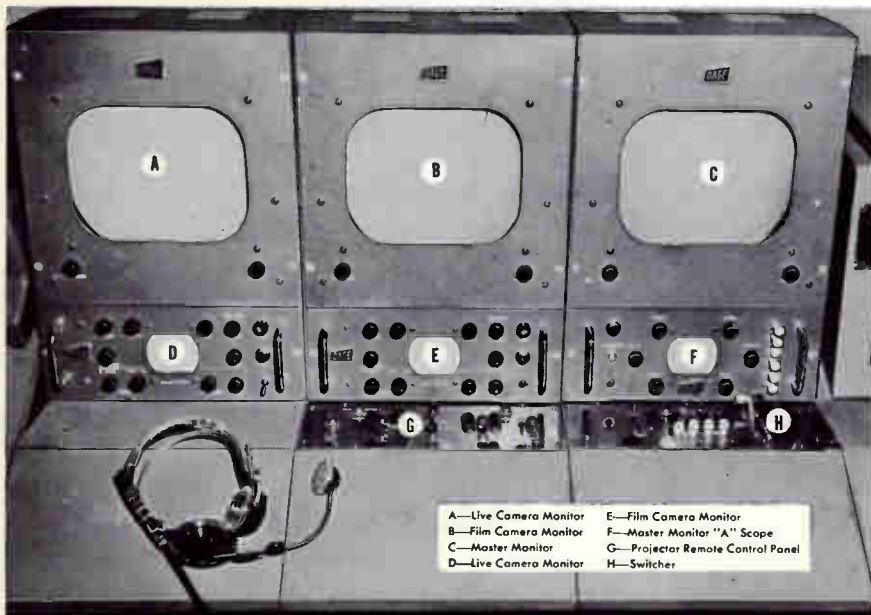

- | | |
|-----------------------|----------------------------------|
| A—Live Camera Monitor | E—Film Camera Monitor |
| B—Film Camera Monitor | F—Master Monitor "A" Scope |
| C—Master Monitor | G—Projector Remote Control Panel |
| D—Live Camera Monitor | H—Switcher |

Closeup of Video Controls. Official U.S. Air Force Photo.

concerns independent station operation, with or without network affiliation, which originate local live and/or film programs.

1-2 *The Need for Low-Power Television*

Whatever the outcome of the arguments, the heated debates, the calm deliberations that occur over the present dilemma of telecasting, low-power stations would appear to fill an important niche in the scheme of things. According to the Federal Communications Commission's original blueprint, some 2000 stations in or around 1200 communities in the continental United States would provide what could be considered a nationwide competitive TV service. Whether or not this foundation can be justified is not of immediate importance. The immediate problem is the efficient utilization of known principles that will enable profitable independent station operation in both small and large communities.

The rapid dwindling of applications for new stations, the large number of CP's (construction permits) that have been forfeited, the appalling increase of actual station failures, should warn us now that authorization of "low-power" is only a foundation upon which to erect an enduring structure. There must be no sacrifice of quality because of the limited area served. After all, it is conceivable that, in the final outcome, the entire nation will be served by a great number of "limited areas." Engineering can and must contribute low-cost equipment capable of meeting highest transmission standards without large highly-trained staffs for operation and maintenance. Programming can and must be brought in all its potential glory within the practicability of the small independent operator. Management can and must exercise the very imagination and

business sense that qualifies for management, to sense and satisfy the needs of the local audience. In the years to come, we strongly suspect it will be found that low-power will satisfy a need just as great as that met by local AM broadcast stations, if not greater. High power in television does not greatly increase the coverage area in the manner of high power AM broadcasting.

The authorization of low-power television stations provides present AM broadcast licensees with a favorable opportunity to start television service on a modest scale initially but with possibility of growth. Existing towers, transmitter buildings, and studios can, with little expansion or alteration, be utilized for television. Existing staffs can, with minimum of expansion, assume responsibilities of limited TV operation.

Now that the initial cost of transmitters, towers, and antennas can be greatly reduced, actual interest in non-commercial educational stations by colleges and universities can be proved or disproved. Many schools who offer television courses have complete studios already installed and equipped. These institutions can expand current operations to include telecasting at relatively low cost.

1-3 *Allocations, VHF, UHF*

At the present writing, an undercurrent of fear has become apparent in the UHF field. There have been many surrenders of CP's by prospective telecasters. Many UHF channels are going begging in areas either already served by VHF or where VHF channels are being hotly contested by numerous applicants. The majority of television-station failures have been those who tried UHF service.

Whatever the outcome of the current hearings on the allocations problem, unless UHF is deleted entirely, the

Low Power Telecasting

fact remains that 84% of the total television channels are UHF. Whenever a need exists to serve the people, that need will be met somehow. This goes as well for the need of higher effective sensitivity in UHF installations; it will come because it must, if UHF exists nationwide. A number of communities may be served only from UHF, without the bugaboo of VHF

television service could be satisfactorily crowded into the VHF bands. A 100 to 1 signal strength is required to prevent co-channel interference for an AM signal, whether considering audio or video. FM, with its 2-1 requirement for an interference-free signal, would allow a far greater number of audio broadcast stations with greater effective range. The economical

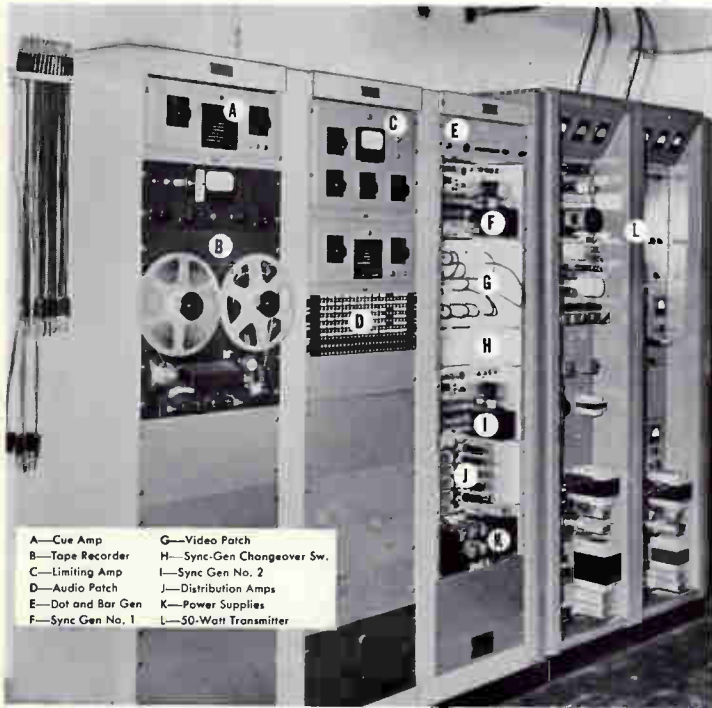

Rack Equipment at CSL-TV. Official U.S. Air Force Photo.

competition. Radiomen in these locations need no prodding to become proficient with UHF vagaries. But upon the rest of the nation's radiomen lies the burden of proving that a truly competitive television system can exist for the benefit of all.

It is conceivable but not probable (at the time of this writing) even with low-power installations and highly directional transmitting antennas, considered on a case-by-case basis, that all

factors have prevented FM from being utilized in this respect. The same factors are facing the much younger TV service.

Oldtimers readily recall the early days of AM broadcasting when battery-powered sets on the east coast pulled in KNX in California with all the clarity of local stations. This could be done reliably almost any winter night after the midnight hour. Yet any reader realizes that the more sensitive

the receiver, the less the usable range in the hours after sundown. The effective range of standard AM broadcasters has been drastically reduced because of the large number of co-channel stations. This has been a healthy condition for sound broadcasting, allowing close identification with the local community.

er the set sensitivity, and the less the possible area of service. And DX'ers will tell you that antenna orientation often does not "figger," under tropospheric propagation of VHF signals. UHF is far less susceptible to this characteristic.

All of which amounts to this: eventually, the great majority of radio per-



Studio Newscast at U.S. Air Force Base in Bermuda. Official U.S. Air Force Photo.

Do not scoff at this comparison of standard AM broadcast frequencies with VHF television. It is known that the effects of tropospheric propagation of TV signals is not as consistent and predictable (at present) as at standard AM frequencies. This very unpredictableness of VHF signals, especially channels 2-6, and the fact that such possible interference is becoming more apparent by the day (witness the number of DX reports), points up an important weakness in the future. The more the number of stations, the great-

sonnel may, at some time, be faced with the proper handling of UHF. UHF service and improvement in UHF receivers may eventually bring about the day when UHF provides the only reliable service to the greatest number of people in the United States. Why not handle it from the beginning with the respect it deserves? UHF is far less susceptible to long-distance interference, and to atmospheric and man-made disturbances, than is VHF. The economic factors must eventually be adjusted.

1-4 Experience With Low-Power Telecasting

It may be a surprise to some readers that considerable experience has been gained in low-power telecasting. A broad background in this service has been accumulated largely through United States Air Force installations at far flung bases around the world. These stations have provided local film and live programs for Air Force personnel and local inhabitants of the communities.

The first such station was installed in Limestone, Maine, with an effective radiated power (ERP) of approximately 20 watts. The transmitter is providing satisfactory service to the entire base area and to local communities within a radius somewhat greater than 5 miles.

The second installation was made in

October, 1954, at Lajes Field, Azores. This station (CSL-TV) operates with an ERP of 30 watts, from an antenna 20 feet above the transmitter building giving an effective height of approximately 100 feet above the base area. CSL-TV provides a clear signal for stock model receivers over the entire base which extends 3.5 miles from the transmitter to the shore line. Since the signal extends over the ocean, the ultimate limit of useable signal has not been determined.

Since 1954, low-power stations have been installed for Air Force bases in Iceland, Greenland, Bermuda, and 10 other locations, for a total of 15 installations, with every indication that the total will increase to about 30 stations over the next several years. From this start, considerable practical experience has been gained to effect a good start for local commercial telecasters.

Low Power Antennas, Signal Propagation, and Prediction of Coverage

In the study and engineering evaluation of low-power television service, new types of radiators and the predicted coverage of "low-power" signals offer particularly informative and surprising subjects. Herein lies the justification of its very existence; the fact that low-power TV can deliver service more than favorably comparable to "local" AM coverage, establishing the basis of a truly nationwide television service.

2-1 Terminology

Field strength is given in terms of dbu, which indicates db above 1 microvolt per meter.

Power is often referred to in terms of dbk, which indicates db above 1 kilowatt of power.

Advantages:

1. Transmission line losses may be directly subtracted (from transmitter power level) in db above or below 1 kw power.
2. Antenna gain in db may be directly added to transmitter power level.
3. An increase of 1 db at the transmitter results in an increase of 1 db received field strength.

Two field intensity contours are con-

sidered in the study of signal propagation. These are specified as:

1. Grade-A Service, or a signal that should give a satisfactory noise-free picture on the "average" receiver.
2. Grade-B Service, or a signal that may result in intermittent noise in the picture on the "average" receiver.

The required field strength in dbu for each of the foregoing classes of service varies according to channel of operation (frequency) and is tabulated in Table 2-1.

Under actual conditions in practice, it is apparent that the extreme variations of terrain over any particular path, the variable noise levels, and the inherent differences in receiver and antenna performance, precludes the possibility of establishing any definite basis for establishing a "satisfactory" or "unsatisfactory" signal. Therefore, we must "hedge" a little in such estimates. For this reason, we have presented the "Hedge Chart" of Table 2-2 based upon present experience. It is evident that modern "hot" receivers give grade-A pictures with grade-B signals in many instances. Both receivers and antennas have improved on the "average" since 1946 when the FCC curves were established. The "Hedge Chart" is actually conservative in its

TABLE 2-1
Required Median Field Strength in DBU at Outer Limits of Service.

Grade of Service	Ch 2-6	Ch 7-13	Ch 14-83
A	68	71	74
B	47	56	64

tabulations, and does not consider high-gain receiving antennas.

2-2 Use of Charts and Graphs

For Convenience:

Fig. 2-1 is a graph relating dbu to actual microvolts per meter. (Hereafter designated as $\mu\text{V}/\text{meter}$.)

Fig. 2-2 is a graph relating dbk to actual watts of power.

Fig. 2-3 graphically illustrates the theoretical induced voltage for a 300-

ohm dipole for a given field intensity (dbu) at a given frequency. This graph emphasizes that actual field strength at a given distance is meaningless unless effective antenna length (TV Channel) is considered at the same time. This is analyzed in Section 2-6.

Fig. 2-4 is a graph of db attenuation to % efficiency, or % efficiency to db attenuation. Particularly useful for relating transmission-line characteristics.

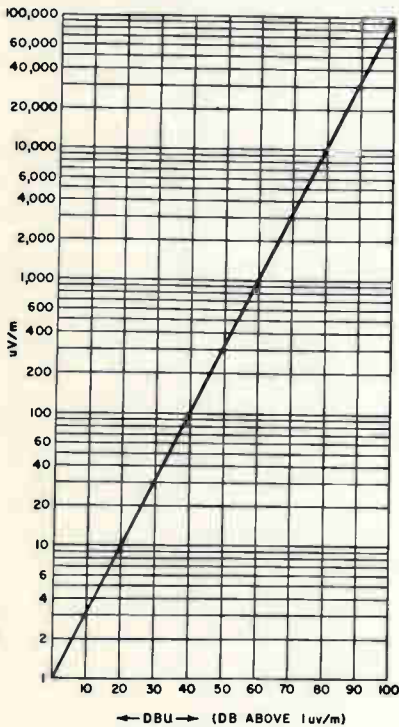

Fig. 2-1. Graph Relating DBU to Actual Microvolts Per Meter.

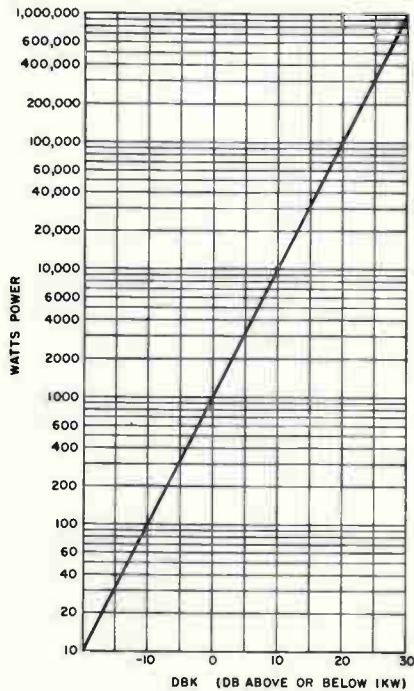

Fig. 2-2. Graph Relating DBK to Actual Watts of Power.

TABLE 2-2
Hedge Chart

Channels	Estimated Field Intensity in DBU (DB Referred to 1 Microvolt/Meter)		
	Probably Unsatisfactory	Questionable	Probably Satisfactory
2-6	Less than 40 dbu	40-47 dbu	over 47 dbu
7-13	Less than 50 dbu	50-56 dbu	over 56 dbu
14-83	Less than 60 dbu	60-65 dbu	over 65 dbu

Example (Fig. 2-1) :

- 0 dbu = 1 μ V/meter
- 20 dbu = 10 μ V/meter
- 40 dbu = 100 μ V/meter etc.

Example (Fig. 2-2) :

- 0 dbk = 1 kw power
- 10 dbk = 0.1 kw or 100 watts
- +10 dbk = 10 kw or 10,000 watts, etc.

Considering the necessary field strength for FCC Grade-A Service (Table 2-1) :

Channels 2-6 require 68 dbu, or (from graph of Fig. 2-1) 2500 μ V/meter field strength.

Channels 7-13 require 71 dbu, or (from Fig. 2-1) 3600 μ V/meter.

Channels 14-83 require 74 dbu, or (from Fig. 2-1) 5000 μ V/meter.

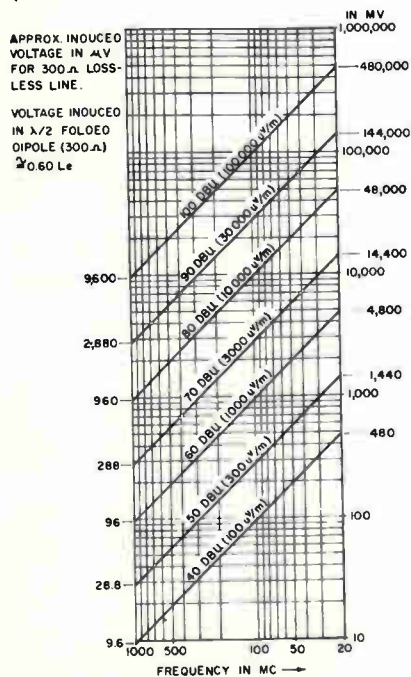

Fig. 2-3. Theoretical Induced Voltage for a 300-ohm Dipole for a Given Field Intensity at a Given Frequency.

2-3 Effective Radiated Power (ERP)

Effective radiated power is the actual power radiated from the antenna. This is dependent upon transmitter power output, transmission line loss, and antenna gain.

ERP is given in terms of peak visual carrier. For example, when the visual

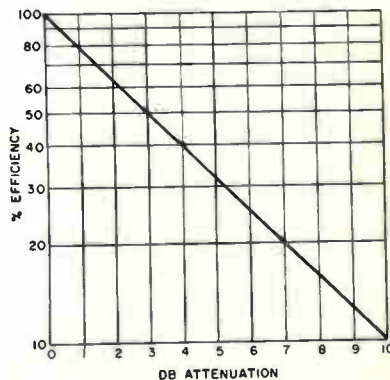

Fig. 2-4. Graph of DB Attenuation to % Efficiency.

induced voltage is greater than the stress across one meter (28.8 millivolts).

To find E across a 600-mc receiving antenna in the field of 288 millivolts/meter as in the previous example:

$$\begin{aligned} E &= Le \\ &= 0.16 \times 0.288 \\ &= 0.04608 \text{ volts or } 46 \text{ millivolts} \end{aligned}$$

Note that exactly the same voltage is induced in each antenna although the field strength at 600 mc is 10 times greater than at 60 mc with equivalent powers from a standard dipole.

Previous examples have shown the theoretical open-circuit voltage induced. Practical examples should include the effect of characteristic impedance termination, such as 72 ohms or 288 ohms. (The impedance of a folded dipole is 4 times the impedance of a half-wave dipole, or $4 \times 72 = 288$ ohms. This is ordinarily called a 300 ohm line).

When power density of the signal is considered rather than the field strength in volts/meter, then:

$$E = PR \tag{5}$$

where:

- E = induced voltage
- P = induced watts of power
- R = characteristic resistance of transmission line

In practice, this is found to be equivalent to:

$$E = 0.32 Le \text{ (for 72 ohm lossless line)} \tag{6}$$

$$E = 0.64 Le \text{ (for 288 ohm lossless line)} \tag{7}$$

where:

- E = Induced voltage across receiver antenna terminals
- L = Actual length of antenna ($\lambda/2$ for half-wave dipole)
- e = Field strength in volts/meter

The graph of Fig. 2-3 illustrates the theoretical induced voltage across the half-wave dipole receiver antenna terminals for 288 ohm (ordinarily called 300 ohm) line based on equation (7).

Example (1):

For a given field strength of 1000 $\mu\text{V/m}$ (60 dbu):

Induced voltage at 100 mc = 960 μV

Induced voltage at 1000 mc = 96 μV

Example (2):

Note in "Hedge Chart" (Table 2-2) the values estimated as minimum, below which reception will probably be unsatisfactory:

For channels 2-6, 40 dbu. At 70 mc (approximate center of low band VHF), the theoretical induced voltage is 140 μV .

For channels 7-13, 50 dbu. At 200 mc the theoretical induced voltage is 140 μV .

For channels 14-83, 60 dbu. At 700 mc the theoretical induced voltage is 140 μV .

Thus, an average spread of approximately 10 dbu is necessary between the low VHF, high VHF, and UHF bands to achieve the same induced voltage in the receiver antenna.

2-7 Effective Antenna Height

Before estimating the coverage from a given location, it is necessary to determine the effective antenna height of the transmitter antenna. This is found for a given direction as illustrated by Fig. 2-5.

This example is for a tower of 190 feet above ground, with an antenna of 20 feet over-all. The measurement is made above ground to the center of the radiator. As shown, this would be 200 feet above ground. Plots are made on topographic maps showing elevation heights in feet above sea level. In cities, heights of buildings are added to this figure. Plots are made along

TABLE 2-2
Hedge Chart

Channels	Estimated Field Intensity in DBU (DB Referred to 1 Microvolt/Meter)		
	Probably Unsatisfactory	Questionable	Probably Satisfactory
2-6	Less than 40 dbu	40-47 dbu	over 47 dbu
7-13	Less than 50 dbu	50-56 dbu	over 56 dbu
14-83	Less than 60 dbu	60-65 dbu	over 65 dbu

Example (Fig. 2-1) :

- 0 dbu = 1 μ V/meter
- 20 dbu = 10 μ V/meter
- 40 dbu = 100 μ V/meter etc.

Example (Fig. 2-2) :

- 0 dbk = 1 kw power
- 10 dbk = 0.1 kw or 100 watts
- +10 dbk = 10 kw or 10,000 watts, etc.

Considering the necessary field strength for FCC Grade-A Service (Table 2-1) :

Channels 2-6 require 68 dbu, or (from graph of Fig. 2-1) 2500 μ V/meter field strength.

Channels 7-13 require 71 dbu, or (from Fig. 2-1) 3600 μ V/meter.

Channels 14-83 require 74 dbu, or (from Fig. 2-1) 5000 μ V/meter.

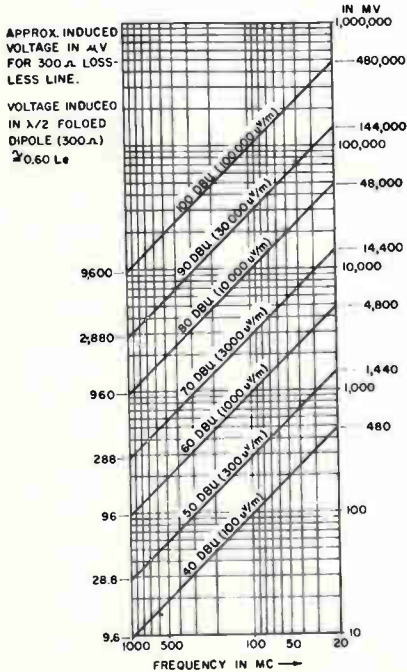

Fig. 2-3. Theoretical Induced Voltage for a 300-ohm Dipole for a Given Field Intensity at a Given Frequency.

2-3 Effective Radiated Power (ERP)

Effective radiated power is the actual power radiated from the antenna. This is dependent upon transmitter power output, transmission line loss, and antenna gain.

ERP is given in terms of peak visual carrier. For example, when the visual

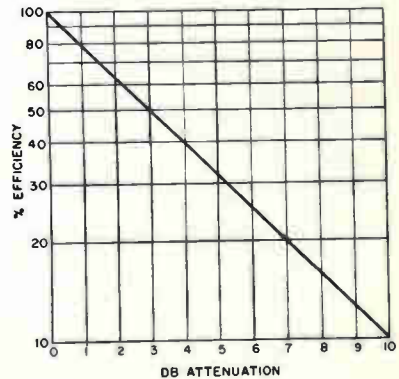

Fig. 2-4. Graph of DB Attenuation to % Efficiency.

carrier is rated at 200 watts, peak power is implied. The aural carrier is rated in terms of rms values and is limited by FCC regulations to 50% to 70% of the (peak) visual carrier. Prevailing practice is to run the aural carrier at 50% of visual carrier. With existing receivers, an aural carrier at 50% of visual carrier has somewhat greater range than the visual carrier; therefore, greater power for the aural carrier is not economical. Also, in the instances of color transmission, more than 70% aural carrier emphasizes the problem of sound-bar beats with the color subcarrier in the average receiver.

Example of determining ERP:

Given:

Transmitter output: 200 watts

Tower height: 100 feet

Over-all length of transmission line: 125 feet

Type of transmission line: 1½" air dielectric line

Antenna gain: Power gain of 2

Channel of Operation: Channel 11 (198-204 mc)

% efficiency of 125 feet of above transmission line: 90% (at 200 mc)

Computation:

Transmitter output: 200 watts

Power to antenna: 200 watts times transmission line efficiency:

$200 \times 0.9 = 180$ watts

Antenna gain effect: $180 \times 2 = 360$ watts ERP

In this example, if a diplexer between transmitter and antenna is used (Section 2-9), any losses would be added to the transmission line loss.

2-4 Free-Space Field Intensity

Although free-space field intensity is only of academic interest to the practicing engineer, such information is often needed to complete FCC application forms. Whenever such information is required, the following formula should be used:

$$e = \frac{7\sqrt{\text{ERP}}}{d} \quad (1)$$

where:

e = free-space field intensity in volts/meter

ERP = effective radiated power (see Section 2-3)

d = distance in meters (1 mile = 1610 meters)

Assume a half-wave dipole is radiating 1 KW of power, find the free-space field intensity at 1 mile (1610 meters):

$$\begin{aligned} e &= \frac{7\sqrt{1000}}{1610} \\ &= \frac{(7) (31.6)}{1610} \\ &= 0.1374 \text{ volts/meter} \\ &= 137.4 \text{ mv/meter} \end{aligned}$$

All antenna gains (or losses) are related to this "standard half-wave dipole" which gives 137.4 millivolts/meter at one mile with 1000-watts power.

In free-space, e is independent of the frequency (wavelength) of operation.

2-5 Field Intensity Considering Ground Effects

In practice, ground effects must be considered, and e becomes a function of frequency or λ . In this case, the formula for e reduces to:

$$e = \frac{3.2 ah \sqrt{\text{ERP}}}{d^2 \lambda} \quad (2)$$

where:

e = microvolts/meter

a = height (feet) of transmitter antenna

h = height (feet) of receiver antenna

ERP = effective radiated power
(see Section 2-3)

d = distance in miles

λ = wavelength in meters

Note that since λ is in the denominator, the shorter the wavelength (higher the frequency), the greater the received field strength. This is directly offset by the effective antenna length to be discussed in the following paragraphs.

2-6 Effective Antenna Length

The field strength at a given distance for a given power and antenna height, increases directly with frequency. The field strength for a 600-mc signal will be 10 times the field strength of a 60-mc signal at given distance. This may be proven as follows, using equation (2).

Given:

ERP = 225 watts

a = 100 feet

h = 30 feet

d = 1 mile

At 60 megacycles (5 meters):

$$e = \frac{(3.2) (100) (30) \sqrt{225}}{(1)^2 (5)}$$

$$= \frac{144,000}{5}$$

$$= 28,800 \mu\text{V/m}$$

$$= 28.8 \text{ millivolts/meter}$$

At 600 mc (0.5 meters):

$$e = \frac{144,000}{0.5}$$

$$= 288,000 \mu\text{V/m}$$

$$= 288 \text{ millivolts/meter}$$

proving the opening statement of this section, that field strength for a 600-mc signal will be 10 times that of a 60-mc signal at a given distance.

The foregoing illustrates that field strength in itself is not significant. Receiving antennas regardless of type and gain are based upon the dipole principle for maximum efficiency. The open-circuit voltage (E) induced across the antenna terminals depends upon the *effective length* which, for a half-wave dipole, varies inversely with frequency. Considering only open-circuit voltage (disregarding the effect of antenna termination in characteristic impedance), effective length of a half-wave dipole is:

$$L = \frac{\lambda}{\pi} \quad (3)$$

where:

L = effective length

λ = wavelength in meters

$\pi = 3.1416$

At 60 mc (5 meters):

$$L = \frac{5}{3.1416} = 1.6 \text{ meters (approx.)}$$

At 600 mc (0.5 meters):

$$L = \frac{0.5}{3.1416} = 0.16 \text{ meters (approx.)}$$

The open-circuit induced voltage (E) is equivalent to antenna effective length (L) lying parallel to the wave-front multiplied by e in volts per meter. Or:

$$E = Le \quad (4)$$

Example:

To find E (open circuit) across a 60-mc receiving antenna lying parallel to the 28.8 millivolts/meter in the previous example:

$$E = Le$$

$$= 1.6 \times 0.0288$$

$$= 0.04608 \text{ volts or } 46 \text{ millivolts}$$

Since the effective length is actually 0.6 meter longer than one meter, the

induced voltage is greater than the stress across one meter (28.8 millivolts).

To find E across a 600-mc receiving antenna in the field of 288 millivolts/meter as in the previous example:

$$\begin{aligned} E &= Le \\ &= 0.16 \times 0.288 \\ &= 0.04608 \text{ volts or } 46 \text{ millivolts} \end{aligned}$$

Note that exactly the same voltage is induced in each antenna although the field strength at 600 mc is 10 times greater than at 60 mc with equivalent powers from a standard dipole.

Previous examples have shown the theoretical open-circuit voltage induced. Practical examples should include the effect of characteristic impedance termination, such as 72 ohms or 288 ohms. (The impedance of a folded dipole is 4 times the impedance of a half-wave dipole, or $4 \times 72 = 288$ ohms. This is ordinarily called a 300 ohm line).

When power density of the signal is considered rather than the field strength in volts/meter, then:

$$E = PR \tag{5}$$

where:

- E = induced voltage
- P = induced watts of power
- R = characteristic resistance of transmission line

In practice, this is found to be equivalent to:

$$E = 0.32 Le \text{ (for 72 ohm lossless line)} \tag{6}$$

$$E = 0.64 Le \text{ (for 288 ohm lossless line)} \tag{7}$$

where:

- E = Induced voltage across receiver antenna terminals
- L = Actual length of antenna ($\lambda/2$ for half-wave dipole)
- e = Field strength in volts/meter

The graph of Fig. 2-3 illustrates the theoretical induced voltage across the half-wave dipole receiver antenna terminals for 288 ohm (ordinarily called 300 ohm) line based on equation (7).

Example (1):

- For a given field strength of 1000 $\mu\text{V/m}$ (60 dbu):
- Induced voltage at 100 mc = 960 μV
- Induced voltage at 1000 mc = 96 μV

Example (2):

Note in "Hedge Chart" (Table 2-2) the values estimated as minimum, below which reception will probably be unsatisfactory:

For channels 2-6, 40 dbu. At 70 mc (approximate center of low band VHF), the theoretical induced voltage is 140 μV .

For channels 7-13, 50 dbu. At 200 mc the theoretical induced voltage is 140 μV .

For channels 14-83, 60 dbu. At 700 mc the theoretical induced voltage is 140 μV .

Thus, an average spread of approximately 10 dbu is necessary between the low VHF, high VHF, and UHF bands to achieve the same induced voltage in the receiver antenna.

2-7 Effective Antenna Height

Before estimating the coverage from a given location, it is necessary to determine the effective antenna height of the transmitter antenna. This is found for a given direction as illustrated by Fig. 2-5.

This example is for a tower of 190 feet above ground, with an antenna of 20 feet over-all. The measurement is made above ground to the center of the radiator. As shown, this would be 200 feet above ground. Plots are made on topographic maps showing elevation heights in feet above sea level. In cities, heights of buildings are added to this figure. Plots are made along

each radial at 45 degrees starting with true North, from 2 to 10 miles from the radiator. Along the radial shown by Fig. 2-5, the average is 235 divided by number of check points (5) which is 47 ft. The antenna effective height is then $200 - 47 = 153$ feet. The greater the number of check points, the greater the accuracy. In the example illustrated, the tower is located at a lower than average terrain. If the topography was reversed, (tower on hill or knoll) and the ground sloped so that the values shown were negative, the effective height would be:

$$200 + 235 = 435 \text{ feet}$$

2-8 Estimated Coverage

The graphs of Figs. 2-6A, 2-7A, and 2-8A show the estimated coverage for the indicated television channels, and Grade-A and -B service for ERP's of 100, 300, and 500 watts. Since interpolation is necessary for exact powers (ERP's), these graphs are not intended for official use. They are based upon the FCC 50-50 curves published in the Rules & Regulations obtainable

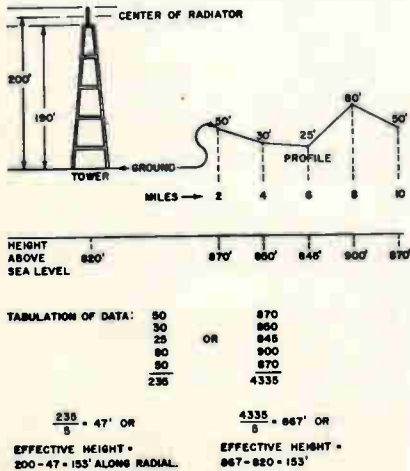

Fig. 2-5. Profile Resulting from Terrain Only. In Cities, Heights of Buildings are Added.

from the Government Printing Office, Washington, D.C.

At the time of this writing, the FCC requirements for minimum field

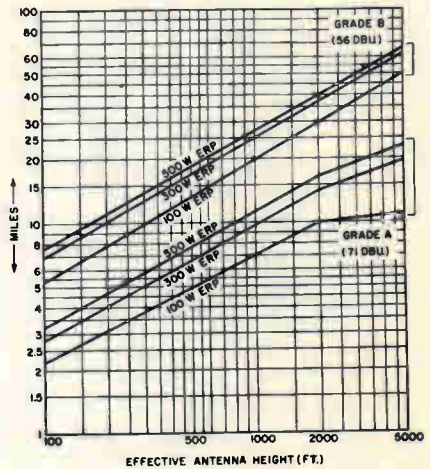

Fig. 2-6A. Approximate Grade-A and Grade-B Service Areas for Channels 2-6.

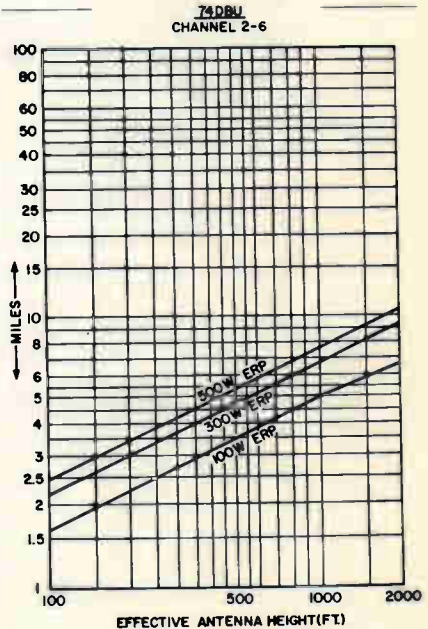

Fig. 2-6B. Approximate Minimum Field Strength Contour for Principal Community To Be Served. (Based on FCC 50-50 Curves.)

strength for the principal community to be served, has not been changed from the original requirements. The principal community may be taken as

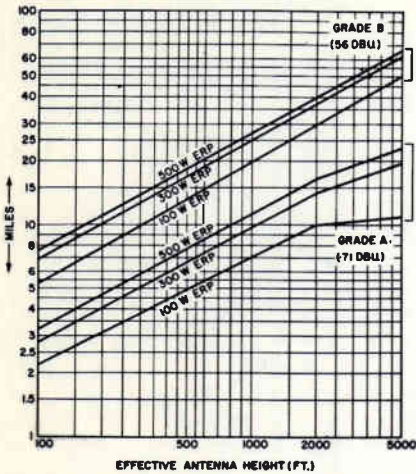

Fig. 2-7A. Approximate Grade-A and Grade-B Service Areas for Channels 7-13.

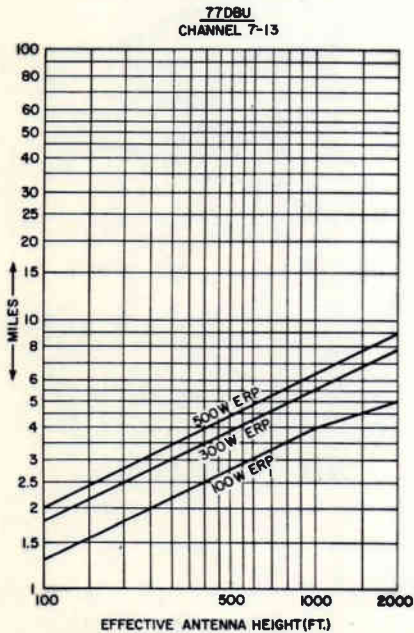

Fig. 2-7B. Approximate Minimum Field Strength Contour for Principal Community To Be Served. (Based on FCC 50-50 Curves.)

the city limits of the city, or town, to which the channel has been assigned. The minimum field strengths are:

Channels 2-6: 74 dbu

Channels 7-13: 77 dbu

Channels 14-83: 80 dbu

Figs. 2-6B, 2-7B, and 2-8B are the graphs of estimated contours for this requirement.

Example 1: Channels 2-6 (Fig. 2-6A) for an effective antenna height of 100 feet and an ERP of 100 watts, Grade-A service (68 dbu) could be expected for approximately 2 1/4 miles from the transmitter. Grade-B service (47 dbu) would extend approximately 8 miles.

Note that increasing the power 5 times (500 watts ERP) at the same effective antenna height of 100 feet would extend the Grade-A service to 3 1/4 miles estimated. Note also that if the effective antenna height is doubled to 200 feet while retaining the original ERP of 100 watts, the Grade-A service would be extended to about 3 1/4 miles. This emphasizes the following general rule:

DOUBLING THE ANTENNA HEIGHT IS APPROXIMATELY EQUAL TO A POWER INCREASE OF 5 TIMES. STATED IN ANOTHER WAY, A POWER INCREASE OF APPROXIMATELY 5 IS NECESSARY AT A GIVEN EFFECTIVE ANTENNA HEIGHT TO BE EQUIVALENT TO DOUBLING THE ANTENNA HEIGHT AT THE SAME ERP.

Example 2: Channels 7-13 (Fig. 2-7A) for effective antenna height of 100 feet at 100 watts ERP, Grade-A service is estimated to about 2 1/4 miles and Grade-B service to slightly over 5 miles. This emphasizes another general rule:

AS THE FREQUENCY OF OPERATION IS INCREASED, THE SECONDARY COVERAGE (GRADE B) IS MORE DRASTICALLY REDUCED THAN IS THE GRADE-A COVERAGE.

Example 3: Channels 14-83 (Fig. 2-8) for an effective antenna height of 100 feet at 100 watts ERP, Grade-A

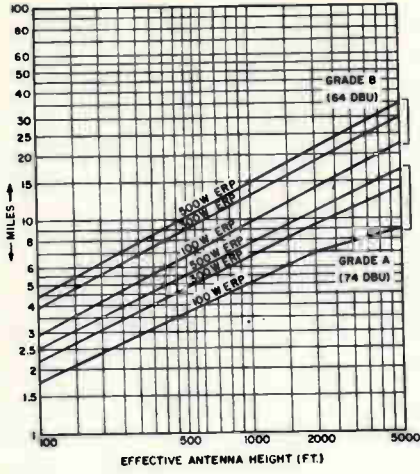

Fig. 2-8A. Approximate Grade-A and Grade-B Service Areas for Channels 14-83.

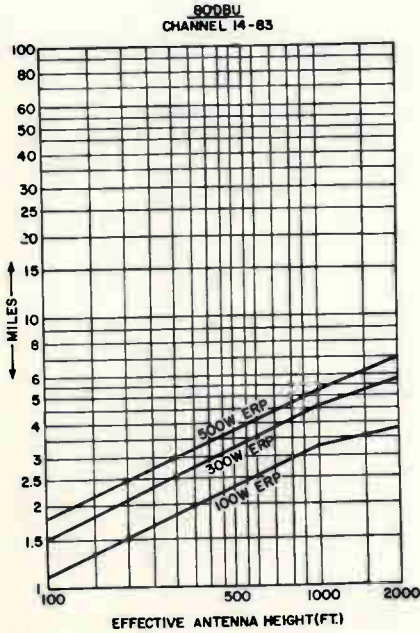

Fig. 2-8B. Approximate Minimum Field Strength Contour for Principal Community To Be Served. (Based on FCC 50-50 Curves.)

service is estimated to approximately 1.75 miles while Grade-B service would extend to about 2.9 miles. This again emphasizes that an increase of operation frequency most severely affects the Grade-B service area.

In practice, it is found that effective antenna heights (and predicted coverage) will, in general, be different along each plotted radial. Assume the conditions as illustrated by Fig. 2-9. The solid line shows the actual radial pattern as estimated from the resultant effective antenna heights indicated along the respective radials. This is the type of pattern that would actually be plotted on polar graph paper for FCC application data. The dotted line then shows the average of the pattern, which is obtained by the total effective heights of 1225 feet divided by number of radials (8) which is 153.1 feet. In practice this could be accomplished by a planimeter, or drafting instrument which integrates the area enclosed within the solid curve to the average shown by the dotted curve.

2-9 Antenna Feed Systems for Low Power

A large saving in initial cost of an installation is inherent for low power

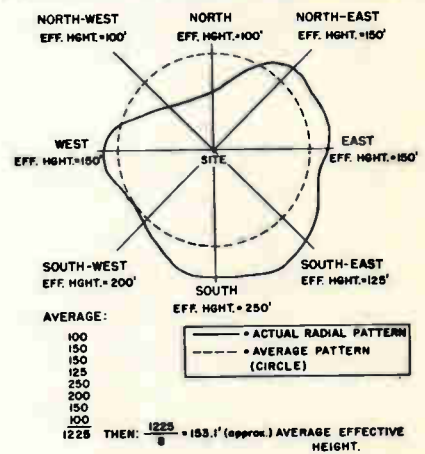

Fig. 2-9. Plotting of Actual Radial Pattern for Estimated Coverage.

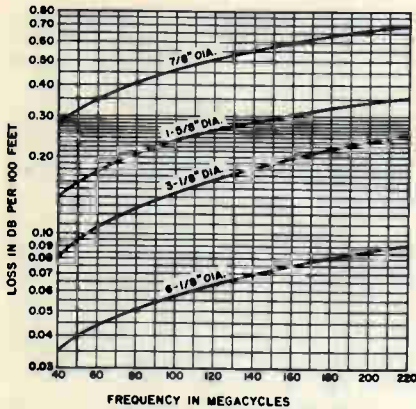

Fig. 2-10A. Attenuation Versus Frequency for Air-Dielectric Coax Line.

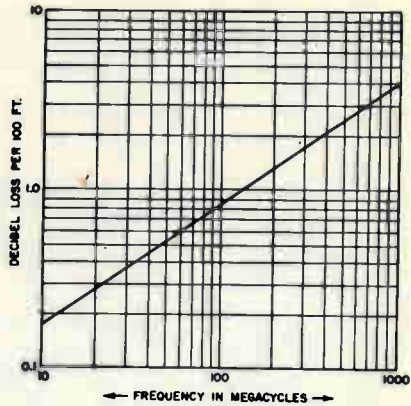

Fig. 2-10C. RG17/U Coax DB Attenuation Versus Frequency.

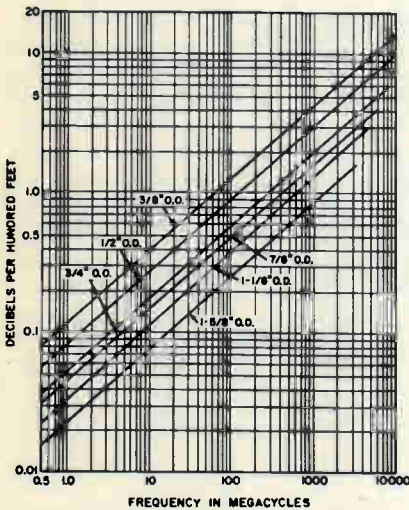

Fig. 2-10B. 50-Ohm Semi-Flexible Styroflex Cable Attenuation Versus Frequency. Courtesy of Phelps Dodge Copper Products, Inc.

due to the rapidly decreasing expense of smaller transmission lines. For short runs of less than 100 feet, inexpensive RG/17U solid coax line, requiring no pressurization, may be used (for VHF channels 2-13). The important consideration is the increase of attenuation vs. antenna height (length of feed line) above ground.

Example: From Fig. 2-10C, the attenuation of RG/17U at 200 mc is

approximately 1.5 db/100 feet. If a transmitter delivers 200 watts to a 100-foot line run to an antenna of unity gain, 1.5 db is approximately 71% efficiency. (See Fig. 2-4.) Therefore, the power at the antenna is $200 \times 0.71 = 142$ watts.

If the tower height is doubled in an attempt to increase coverage, the total transmission-line run of 200 feet results in a 3 db attenuation, or (from Fig. 2-4) an efficiency factor of 50%. The power delivered to the antenna is now $200 \times 0.5 = 100$ watts. Use of the graphs of predicted coverage reveals that no *practical* increase of coverage can be obtained unless a larger transmission line (air dielectric) is used.

Many low-power installations will use separate visual and sound antennas to avoid the necessity of a diplexer unit. The diplexer permits one antenna to serve both the visual and aural signals, fed by separate transmission lines.* The latest innovation in low-power transmitter circuitry permits a common output amplifier for both carriers, permitting one line and

* Detailed in: "Principles and Practices of Telecasting Operations," by Harold E. Ennes, published by Howard W. Sams & Co., Inc.

one antenna for both picture and sound. (Described in next chapter.)

Present AM licensees may find it economical to use an existing AM tower for mounting the TV radiator, particularly in the case of small local stations located in the central area of the city to be served. How this is done without detuning the AM tower is illustrated by Fig. 2-11. A quarter-wave transmission line (at the AM operating frequency) is open at the antenna end and shorted at the "bazooka" end. This "bazooka" provides an anti-resonant circuit (parallel resonant), or a high impedance between the AM tower and the outside circuit of the TV transmission line. To provide exact optimum tuning, the bazooka may be made somewhat less than one-quarter wavelength, which provides a series inductive effect. A variable capacitor may then be used across the open end to effect the shunt capacitor for tuning the parallel-resonant circuit for maximum isolation.

Expansion of the inner conductor of rigid coax lines with temperature variations is adequately handled by spring-loaded inner-conductor connectors. Expansion of the outer conductor is provided for by spring-suspended coax line hangers used in support to the tower. Fig. 2-12 shows a typical installation with all the fittings required.

A recently developed flexible coax line (Styroflex) will find many applications in low-power installations.

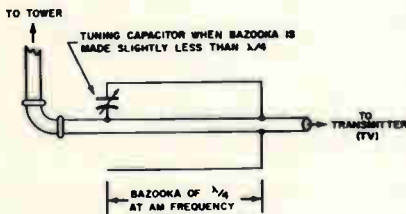

Fig. 2-11. Method Used to Isolate TV Radiator Feed Line from AM Tower When TV Antenna is Mounted Atop AM Tower. The FCC Requires New Tower Impedance Measurements When This Method is Used.

This line may be obtained in reels of any practical length required, and requires no flanged fittings between sections of lines.

The Teflon air-dielectric lines must be used in UHF installations (channels 14-83) to avoid exorbitant power loss.

In many instances, AM transmitters are located 2 to 10 miles or more from the principal city, to obtain best ground conductivity required for AM operating frequencies. In the great majority of these cases, it is advisable to install the low-power TV transmitter within the city, usually at the studio itself. A relatively short tower at this location will often provide better local coverage for TV signals than would be the case if installed at the existing AM transmitter locations. It will become conventional to install low-power transmitters at the TV studio location.

2-10 Antennas for Low Power

Radical new approaches in design of radiators for low-power TV transmitters may be expected within the very near future. This is necessary since little cost-saving can be expected from

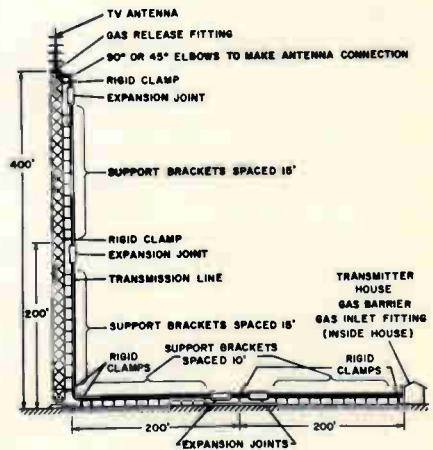

Fig. 2-12. Typical Installation Showing Fittings Required.

the low power rating of an antenna as compared to radiators able to handle larger power inputs. In either case, mechanical features of tensile strength, compressive strength, flexural strength, de-icing features, etc., are factors to be considered.

All TV radiators, if traced back far enough in their evolution of design, are based upon the dipole principle. The problems are basic to either high or low power:

1. Voltage standing wave ratio (VSWR) better than 1.1 to 1 over a sufficient bandwidth. For separate antennas on visual and aural outputs, the visual antenna must provide this low VSWR over a bandwidth of 4.5 mc. If the same antenna is used for both visual and sound carriers, the bandwidth must be close to 6 mc.
2. The radiator must be matched to a standard 50-ohm transmission line. In practice, lines with Z_0 between 50-52 ohms are used.
3. At the time of this writing, omnidirectional radiators must be used. In special cases where some horizontal directivity is allowed, the attenuation in the undesired direction must be no more than 10 db. It is possible that this restriction may be lifted in the future, allowing a larger number of VHF stations using highly directional radiators.
4. The tower must be lighted according to local and CAA regulations.

Bandwidth simply implies that the antenna maintains a definite impe-

dance over the band of frequencies required. The bandwidth of a dipole is determined mainly by the physical diameter in ratio to the necessary length of the dipole arms. The number of elements, or stacking of bays affects the characteristic impedance of the radiator.

Wide bandwidth of an ordinary folded dipole is obtained by using large diameter elements.

Horizontal gain is achieved by the stacking of bays in the vertical direction. This cuts the power ordinarily wasted in vertical radiation and concentrates this power in the useful horizontal direction.

Omnidirectional radiation (circular) from dipoles is basically achieved by the configuration of elements shown in Fig. 2-13. Three dipoles, excited in phase, are bent to form a circle. Radiation is essentially uniform in the horizontal plane. Uniform radiation may also be achieved by three straight dipoles arranged in the same plane at 120-degree angles. This is the more common method found in practice.

The impedance of the radiator is influenced by a number of design factors. For example, a folded dipole can be changed in Z_0 by changing the ratio of the diameters of the upper and lower arms. However, due to practical effect on bandwidth, folded dipoles are ordinarily constructed of identical diameters for upper and lower arms. An input impedance of 50-52 ohms is derived by using a matching section as included in Fig. 2-13. The principle of operation is the same as the "bazooka" of Fig. 2-11. In the application of Fig. 2-13, the matching section not only feeds the balanced antenna from an unbalanced line, but is cut to a length of opposite reactance sign to the reactance of the antenna to achieve 50-ohms impedance. In practice, means are provided to tune this section for minimum VSWR.

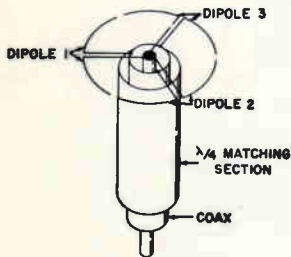

Fig. 2-13. Three Dipoles Bent to Form Circle. All Dipoles in Phase (Paralleled).

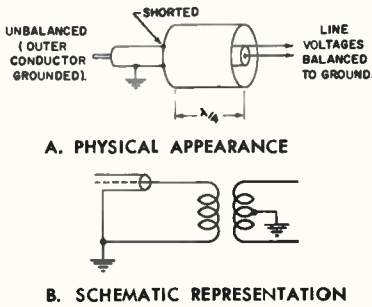

Fig. 2-14. Bazooka for Feeding Balanced Output of Transmitter to Unbalanced Line.

The principle of operation of the "bazooka" is illustrated by Fig. 2-14, when used as an unbalanced to balanced transformer, or vice-versa. The use of concentric transmission lines as tuned circuits or reactive elements is covered by this author in "Principles and Practices of Telecasting Oper-

ations".* This is the principle of the *balun* often incorporated in some makes of duplexers where this method of single antenna excitation is used.

One of the simplest antenna installations is illustrated in Fig. 2-15. The lower ring is fed by means of RG/17U solid coax from the visual output of the transmitter. The upper ring, spaced one-half wavelength above, is separately fed with RG/17U coax from the aural-transmitter output. The gain of the single ring is approximately 0.8, which results in a visual ERP of 30 watts, and an aural ERP of 15 watts. The lower ring is only 20 feet above the transmitter building, and the use of the solid coax cable is entirely practical in this instance. The transmitter building is situated on an advantageous knoll on the island so that line of sight is available to the far reaches of the base.

* Published by Howard W. Sams & Co., Inc.



Fig. 2-15. Antenna Installation at United States Air Force TV Station, CSL-TV, Azores. The Rings are Separately Excited from Aural and Visual Transmitters. Official United States Air Force Photo.

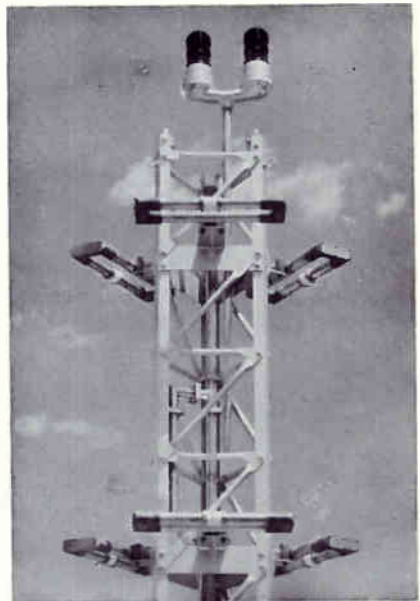

Fig. 2-16. Low-Power Antenna with Power Gain of Two. Courtesy of Prodelin, Inc.

A two-bay antenna using folded dipoles available for Channels 7-13 is illustrated by Fig. 2-16. Fig. 2-17 is a close-up view of a single bay of three dipoles. Each bay, or "loop," is composed of three folded dipoles arranged symmetrically around the lattice structure at 120-degree spacing. The folded dipoles are formed of 1½ inch transmission-line copper tubing bolted directly to the structure. Signal energy is supplied to each loop with 1½ inch coax line via a 1½ inch matching transformer which in turn is fed from a single transmission line input. The entire feed system and dipoles are pressurized.

The power gain of this antenna is 2 (one per bay). The maximum power input is equal to that of 1½ inch transmission line, i.e. 7.8 kw on Channel 13. The horizontal pattern is omnidirectional within ± 2 db. The input connection is single 50 ohm, 1½ inch RETMA flange to which any 50-ohm line may be adapted. The VSWR is better than 1.1 to 1 over a 6-mc channel. A simplified drawing and the mechanical specifications are shown in Fig. 2-18.

A radiator for UHF channels 14-83 by the same manufacturer (Pradelin, Inc., Kearney, N. J.) is illustrated in Fig. 2-19.

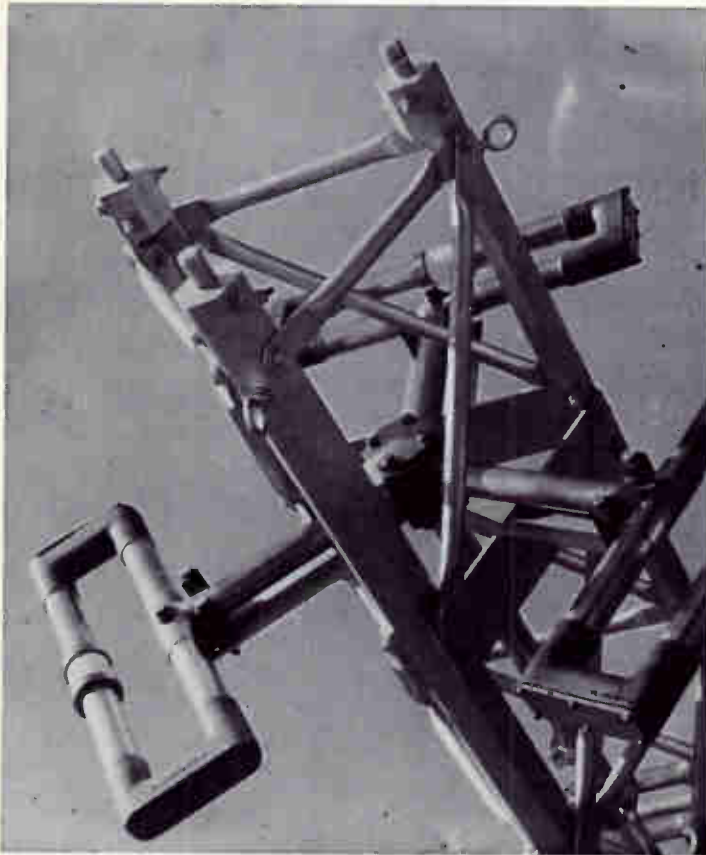

Fig. 2-17. Close-Up View of Single Triad Bay. Courtesy of Pradelin, Inc.

Making use of recent advances in glass fiber reinforced plastics, Prodelin employs a new light-weight plastic tube that provides four-way mechanical economy by supporting, housing, weather-proofing, and protecting the antenna radiating elements within.

means of main-beam tilt and/or null fill-in and is called a "modified" antenna.

Three antenna types are required to cover all seventy UHF channels, one each for channels 14 to 31, 32 to 54, and 55 to 83. Each type is to be available with 2, 4, or 8 loops; each loop with a power gain of approximately unity. By means of simple adjustments each antenna type can be adjusted for optimum performance on any channel within the foregoing type limitations.

The model KTV is fitted with a base plate and dual obstruction light and requires only a single transmission

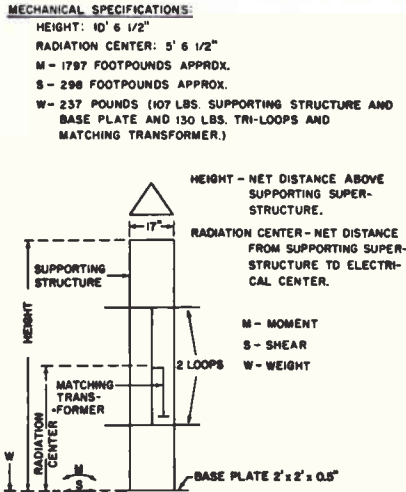

Fig. 2-18. Drawing and Mechanical Specifications of Prodelin ETV-2 Antenna.

It is pointed out that further manufacturing economy can be effected by a reduction in the number of types needed to cover all the seventy UHF channels. Prodelin claims this can be accomplished with only three extremely broad band Cover-Loop types, one each for channels 14 through 31, 32 through 54, and 55 through 83.

The Cover-Loop antenna is a low-power UHF-TV transmitting antenna for low-power TV broadcast and satellite station use and provides a means of radiating aural and visual signals with definite gains and predetermined horizontal and vertical radiation patterns. The model KTV is an omnidirectional antenna with a normal vertical pattern, i.e. no intentional null fill-in, and is called a "conventional" antenna. The vertical pattern can be easily contoured to customer specifications by

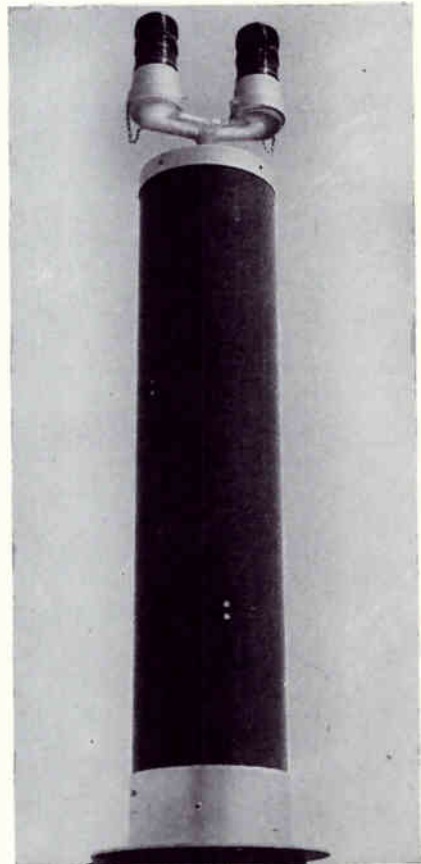

Fig. 2-19. A UHF Antenna. Courtesy of Prodelin, Inc.

line feed. Ice formation can be alleviated by the use of strip heaters to maintain the temperature inside the cover assembly higher than outside under icing conditions.

This antenna is composed of two, four, or eight radiating loops mounted on a light weight self-supporting structure thus forming the radiating assembly. Each loop consists of three flat-sheet type dipoles arranged symmetrically around the structure at 120-degree spacing. The radiating assembly is contained within a cover assembly comprised mainly of a plastic pipe which forms the primary antenna support and in addition houses, weather proofs, and protects the radiating assembly.

Electrically, the Cover-Loop antenna is an extremely broad-band antenna. Signal energy is supplied each loop via a semi-rigid coax cable comprising of an individual feed-line system which in turn is fed from a single transmission-line input. Because all radiating loops are fed in parallel they are always *in phase* at all frequencies and the beam direction is fixed and independent of frequency. The radiated pattern is thus much more stable with variations of temperature and humidity. Since the loops are individually

fed with matched 50-ohm lines, it is convenient to control the radiation pattern to provide both null fill-in and beam tilt. Null fill-in can be accomplished by feeding some of the loops near the center of the array in phase quadrature. Beam tilt can be provided by progressive phasing of successive loops; that is, by cutting feeder cables to predetermined lengths.

Mechanically, the Cover-Loop antenna is ideal for antenna gains up to about eight. The cover assembly comprises a polyester resin, fibre-glass reinforced plastic pipe fitted at the base with a mounting plate. The top plate is fitted with a dual obstruction light. The seamless plastic pipe provides excellent corrosion resistance, high tensile strength, greater resistance to impact loads, and has the lowest weight-to-strength ratio of any piping material. Because of its low heat transfer rate, extremely low-power deicing equipment is feasible.

Obviously, any of the existing TV radiators, such as the "bat-wing" or current-sheet antenna commonly found in high power installations may be used for low power. This is particularly advantageous if the licensee is reasonably certain of going to higher power at a future date.

Low Power Television Transmitters

A large share of the burden of success for low-power telecasters will lie in the quality and reliability of the transmitter. It is evident from the beginning that the small technical staff ordinarily allows one, certainly no more than two, engineers qualified for supervisory capacity. Therefore the possibility of an undue number of "technical emergencies" must be eliminated.

The following description of two existing low-power transmitters will serve to give the reader an insight to the careful design and engineering incorporated. Such design is the culmination of years of actual field experience in installation, operation, and maintenance of low-power stations.

3-1 General Description of BT-200 Transmitter (VHF Channels 2-13)

The BT-200 Television Transmitter, (Fig. 3-1) designed and fabricated generally to military specifications, is a complete unit that functions as a sound and picture transmitter with a variable power output of 50 to 200 watts. The equipment is suitable for both monochrome and color telecasting.

The stability characteristic of the visual transmitter is such that at an ambient temperature of 20 degrees Centigrade only minor touch up may be required 30 minutes after a cold start. No additional adjustments should be necessary. The visual carrier drift averages approximately ± 20 cps. Under the same operating conditions, the

aural transmitter responds in a similar manner, with the exception of a cold start drift of approximately ± 1000 cps and a warm drift of approximately ± 200 cps.

Design parameters, carefully established with particular attention paid to all low level stages, grid circuits, time constants, and filtering, enable the transmitter to achieve optimum

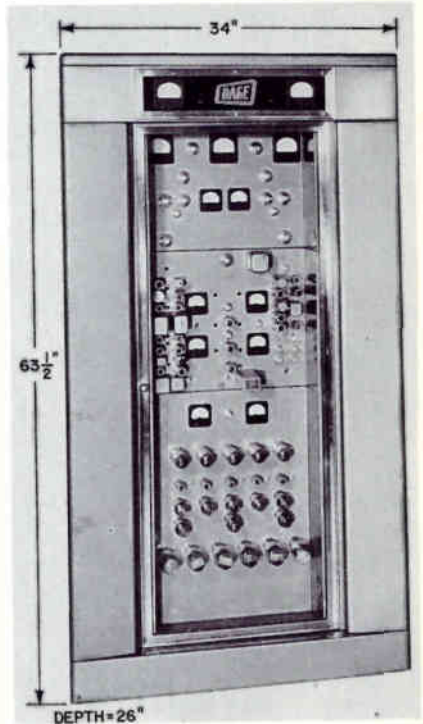

Fig. 3-1. The Dage Model BT-200 Transmitter.

signal-to-noise ratios. The aural modulator section, for example, averages approximately -65 db below ± 25 kc deviation.

All key control circuits are continuously monitored by meters. All other circuits incorporate test points allowing the measurements of DC and where practicable RF. This same design allows stage by stage testing without demounting the equipment.

The majority of components are well overrated with most tubes operating well under CCS ratings.

An advanced type of fabrication is employed allowing a symmetrical arrangement of components, minimum lead dress, minimum space, and maximum accessibility. This same construction allows the transmitter to meet

rigid vibration and shock requirements.

The packaging is such that a minimum of space is utilized. The transmitter employs unitized construction with the power regulator, RF-Visual-Aural Exciter, and Final amplifiers on three standard 19" recessed panels that pull down from the front of the transmitter allowing easy access for rapid maintenance (Fig. 3-2). This same construction allows, if desired, the power transformer panel to be located remotely with the transmitter mounted in a conventional rack. The complete transmitter block diagram is shown in Fig. 3-3.

The transmitter operates on standard 117 volt, 50/60 cps, single-phase power line. Units are available for 220-volt operation. Power consumption is approximately 3kw.

3-2 Power Supply

The BT-200 television transmitter power supply incorporates 40° rise in temperature power transformers with a 100% power overload factor.

When the master circuit-breaker power switch located in the rear of the cabinet, is closed, power is supplied to the convenience outlets, to the crystal heater, and to 3 primary circuit-breaker switches located in the front wings. One circuit breaker supplies power to filament transformers through a line-voltage control transformer, and to a time-delay relay.

After a 60-second delay, the timer closes the primary circuit which enables a circuit breaker switch to supply power to the primaries of the medium voltage transformers, in addition to operating a "ready" relay through door interlock switches.

The closing action of the "ready" relay allows the third circuit breaker switch to supply power through the line-voltage transformer and high-low plate power relay to the high voltage transformer.

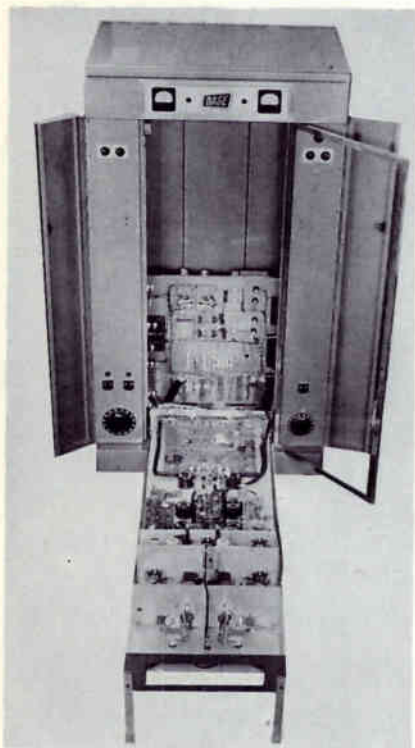

Fig. 3-2. The BT-200 Transmitter Shown in the Servicing Position.

In the normal position the high-low relay is actuated through the "tune-operate" switch and connects the two primaries in parallel, allowing full plate voltage. When the "tune-operate" switch is in the "Tune" position, it releases the relay applying power to the two primaries in series, allowing only half rated output voltage to be delivered.

Two tubes (3B25's) serve as high-voltage rectifiers for the final amplifiers.

One tube (a 5R4GY) supplies approximately 800 volts DC through a filter network for the +550 volts DC regulator section.

Two tubes (5U4G) connected in parallel, supply approximately 375 volts through a filter network for the +300 volts DC regulator section.

One tube (5R4GY) supplies approximately -275 volts DC through a filter network for the bias regulator section.

One tube (5R4GY) supplies approximately -800 volts through a filter network for the -550 volts DC regulator section.

Diffused junction germanium rectifiers deliver approximately -135 volts

DC through a filter network to a voltage regulator (0A3), which is referenced to the -550 volts DC power supply, thereby delivering -625 volts DC.

The regulator section of the power supply incorporates four vacuum-tube regulator circuits and one gas type regulator, in addition to the final screen grid protection circuits.

3-3 RF Exciter

An overtone crystal is used for a higher initial frequency and the frequency multiplication required would be less than that for a conventionally-cut crystal. The crystal can vibrate at only one overtone at a time. Since the overtone frequency is not an exact multiple of the fundamental, the crystal housing is marked with the proper operating frequency. The grid inductance L201 (Fig. 3-4) in conjunction with the crystal holder and V201 input capacity permits the crystal to operate on the proper overtone.

The overtone crystal generates an RF signal between the grid and cathode of the first section of V201 (12AT7). The RF signal developed

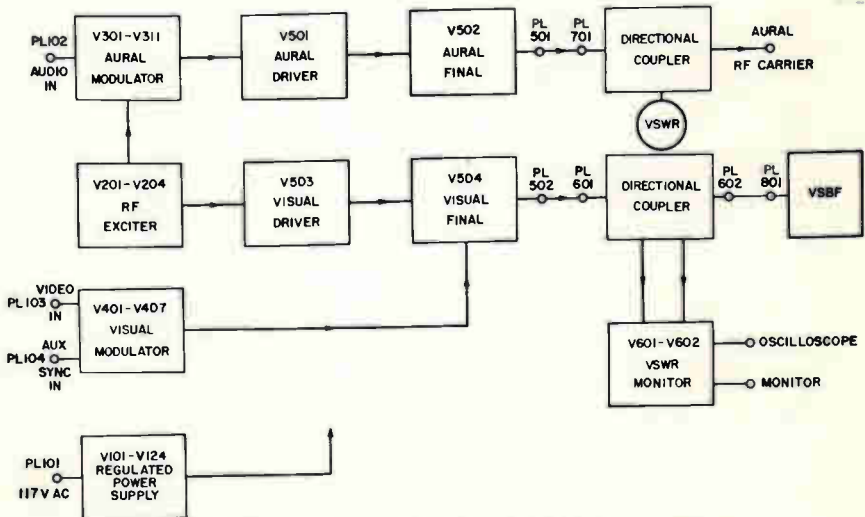

Fig. 3-3. Block Diagram of the Dage BT-200 TV Transmitter.

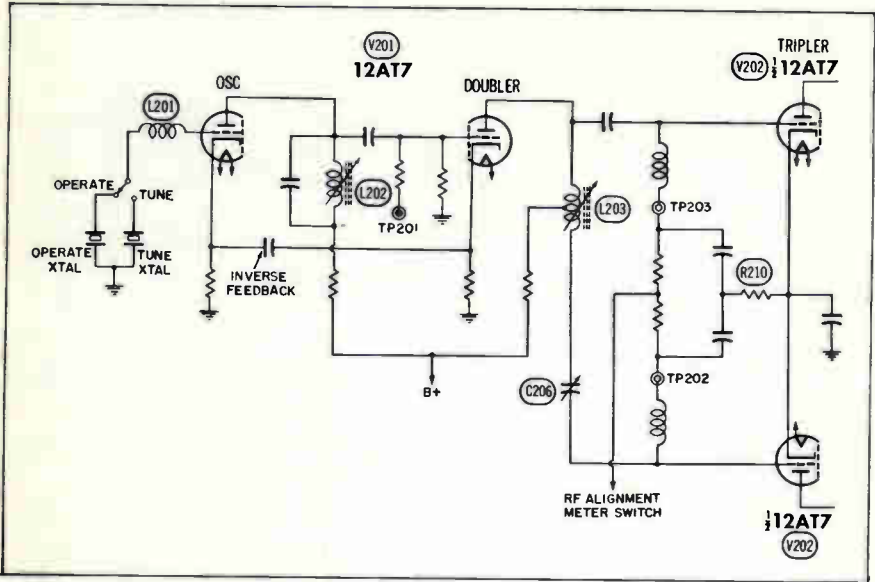

Fig. 3-4. Simplified Schematic of the Frequency Generator Section, Exciter Unit.

across L202 in the plate circuit of this section is coupled to the grid of the second section which serves as either a straight-through amplifier or a doubler amplifier. The cathode of this stage is not bypassed thereby allowing increased frequency stabilization due to degeneration. A portion of this cathode voltage is coupled back to the cathode of the oscillator stage thereby stabilizing the overtone oscillator circuit. The output signal developed across L203 in the plate circuit of V201 is coupled to a push-pull amplifier V202 (12A7). This amplifier may be used either straight-through or as a tripler stage with the signal developed across the plate circuit load of V202 being coupled in push-pull to the grids of buffer amplifier V203 (12A7). (Remaining circuits not shown in Fig. 3-4. See complete block diagram, Fig. 3-3.) V203 isolates any stray harmonics generated by V201 and V202 when used as a doubler and/or tripler. The output of V203 developed across L209 in the plate circuit of V203 is coupled

in push-pull to V204 (6524) which serves as the exciter power amplifier. The output signal from V204 is coupled by two separate paths to the visual driver stage V503 and to the balanced modulator V311 in the aural modulator stage. (See Block Diagram, Fig. 3-3.)

The "Tune" crystal is used when tuning the final plate circuit for lower-sideband suppression.*

Balancing of RF drive on the V202 grids is simply adjusted by placing the negative lead of an 0 to 50 volts DC meter into TP 202 and tuning L203 for maximum bias indication. This reading is compared with the reading at TP 203. If the readings are not within 5% or better of each other, a slight adjustment of C206 is made to balance the RF grid drives. The following RF stages are balanced in the same manner.

* "Principles and Practices of Telecasting Operations," by Harold E. Ennes—See Page 475.

3-4 Final Amplifiers

The aural RF signal developed by the upper sideband of the balanced modulator tube V311 (described in Section 3-5) is coupled to the push-pull aural driver amplifier V501 (6524). The output from V501 is coupled directly to the grid of V502 (4X150), which serves as the aural final RF amplifier. The output from V502 is coupled through the directional coupler PL108, located on the rear of the cabinet. Varying degrees of RF power output are controlled by a power-control switch which controls the screen voltages of both the aural driver V501 and the aural final V502.

The RF driving power is coupled from the exciter amplifier V204 to the push-pull visual driver amplifier V503 (6524). The output of V503 is coupled directly to the grid of the visual final amplifier V504 (4X150). The output of V504 is coupled through the directional coupler and the vestigial sideband filter to the visual antenna connector PL107. Varying degrees of RF power output are controlled by a power-control switch which controls the screen voltage of the visual driver amplifier V503. Screen-dropping resistors cannot be used satisfactorily in the visual final

due to excessive shift in the DC component of the video signal. The black level control controlling the current through V407, the video modulator tube, sets the amount of bias delivered to the grid of the visual final amplifier V504. The bias placed on this tube is such that V504 is operating as a Class-B linear amplifier.

3-5 Aural Modulator (See Block Diagram, Fig. 3-5)

An audio input signal at +10 dbm fed into PL102 and monitored by a VU meter is fed to a 75 microsecond pre-emphasis transformer which in turn feeds audio input transformer T302. Potentiometer R302 serves as an audio gain control which in turn sets the amount of deviation for the transmitter. From R302 the audio signal is fed to a reactance tube V301 (6CL6) which is tied across the V302 (6AK6) oscillator circuit. A reactance in conjunction with a capacitor provides a 90° displacement between the plate current and the plate voltage of reactance tube V301 causing this tube to appear as a reactance to the oscillator coil T303 with the magnitude of this reactance determined by the transconductance of V301; therefore, the audio signal, the AFC feedback, and the

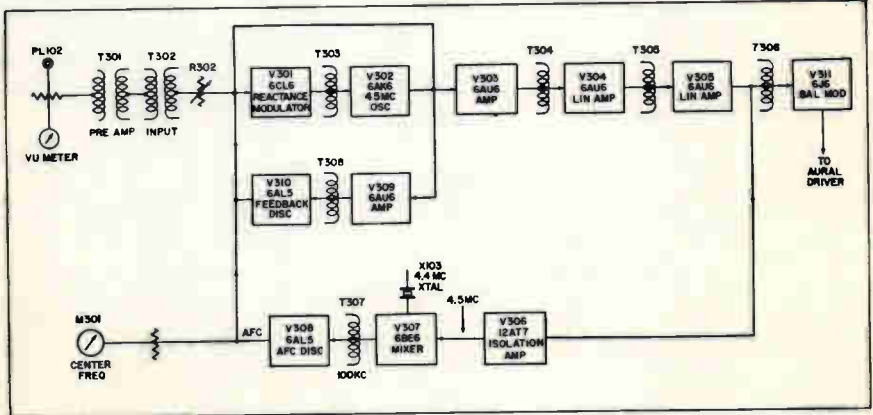

Fig. 3-5. Block Diagram of the Aural Modulator Section in the BT-200 Transmitter.

audio feedback appearing at the grid of V301 controls the effective capacitance across the oscillator circuit with the result of direct frequency modulation and frequency stabilization. The stabilized frequency-modulated RF signal developed on the plate of V302 is amplified by conventional limiter amplifiers V303 (6AU6), V304 (6AU6), and V305 (6AU6).

From the plate of V305 the 4.5 mc signal is fed down to V306 (12AT7) which serves as an isolation amplifier driving V307 (6BE6) mixer tube. Crystal X301 generates a 4.4 mc signal between the grid and cathode of V307 which when mixed with the 4.5 mc signal produces a 100 kc signal across the AFC discriminator transformer T397. Isolation amplifier V306 is necessary to prevent this 100 kc signal component from being fed back to the plate circuit of V305. The output of T307 drives AFC discriminator V308 (6AL5). The secondary of T307 is a modified Foster-Seely discriminator with a center frequency of 100 kc. This discriminator has a bandpass of

6 kc peak to peak. The DC control voltage developed by V308 is fed back to the reactance modulator tube V301.

The 4.5 mc signal fed from V302 is amplified by V309 (6AU6), and detected by discriminator transformer T308, and discriminator tube V310 (6AL5) with its resultant audio feedback voltage fed back to the control grid of V301. Any nonlinearity in the signal developed by V301 and V302 is thus corrected by this feedback network reducing distortion to a very low degree under wideband deviation conditions. The amount of feedback is established by the value of a fixed resistor. The 4.5 mc discriminator network used in the audio feedback loop is the same as the AFC discriminator in the frequency stabilizing loop with the exception that shunt resistors hold the nonconducting impedance of each diode of V310 to a very low value which results in extremely good linearity on a bandpass of 300 kc.

The output of V305 drives V311 (6J6) which acts as a balanced modulator. The RF drive from V204 is

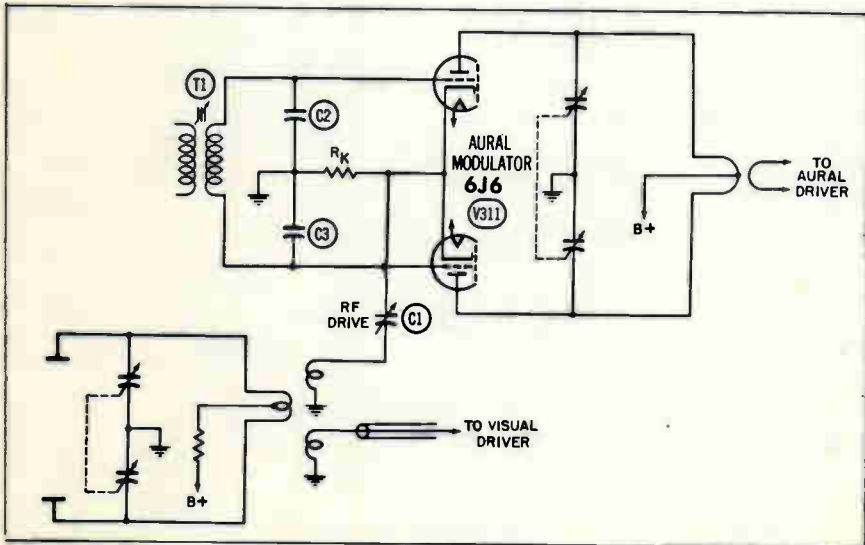

Fig. 3-6. Simplified Schematic of the Balanced Modulator.

applied to the common cathode of V311 through a capacitor which matches the RF drive into the cathode impedance of V311 while blocking the DC component developed at the cathode of V311. (See Fig. 3-6.)

The following conditions exist:

1. RF carrier drive on common cathodes across R_k .
2. Grids "hot" to 4.5 mc FM signal.
3. Grids "cold" (RF ground) to carrier drive.
4. Plates in push-pull.

The above conditions result in:

A. Since RF drive is applied in series to the input while the output is push-pull, cancellation is made of the applied carrier frequency.

B. The 4.5 mc signal, applied in push-pull input which is in series with the RF signal, appears in the plate as sidebands 4.5 above and below the cancelled RF frequency.

C. Since it is necessary to select the upper sideband for further amplification as an FM carrier, the plate circuit of V311 will tune only to the upper sideband. This is fed to the aural driver amplifier.

D. The final result is that the aural carrier output is an FM modulated carrier exactly 4.5 mc above the visual carrier frequency.

3-6 Visual Modulator (See Block Diagram Fig. 3-7)

A 1.4 volt P-P composite signal applied to PL103 on the rear of the cabinet is fed through a low-pass video filter T403 which limits any spurious high-frequency response of the system and on to termination and gain control resistors. The signal is then applied to V401 (6CL6) and V402 (6CL6). V402 is biased in such a manner that when the White Stretch control R405 is properly adjusted, the tube only conducts on the peak values of the video input voltage, thus serving as a White Stretch amplifier. This compensates for the usual white compression which results under Class B grid modulation of the final stage. The video amplifier V401 and the White Stretch amplifier V402 drive the video amplifier V403 (6CL6), which in turn drives the video modulator tube V407 (6524) and

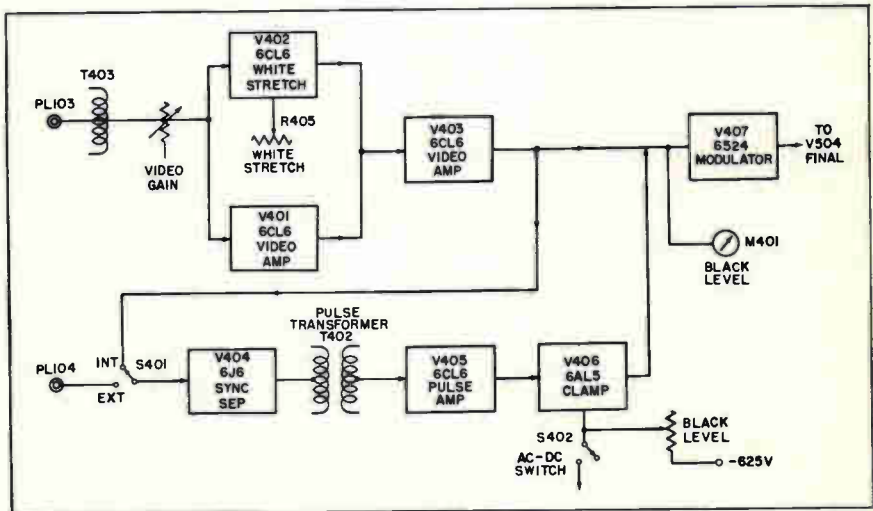

Fig. 3-7. Simplified Block Diagram of the Video Modulator Section.

grounded grid sync separator V404 (6J6). External sync may be fed through PL104 to the sync selector switch S401, if it is desired to run separate sync. Should the incoming signal be degraded in the sync region, the use of external sync at PL104 to properly drive the clamper V406 will effectively restore the black level and improve the transmitted sync. Note that sync is used only to drive the clamp stage.

The separate synchronized signal charges pulse transformer T402, which in turn is damped during the sync interval by the plate resistance of V404. Following the sync pulse, V404 is cut off and the pulse transformer rings with a heavily damped oscillation, causing an output pulse of approximately two microseconds in width. The damped oscillation is applied between grid and cathode of V405 (6CL6) pulse amplifier and phase inverter, which selects and amplifies the first half cycle of the damped oscillation. This connection is known as a bootstrap circuit because the output pulse at the cathode of V405 lifts the secondary winding of pulse transformer T402 above ground and in doing so avoids degeneration of the input pulse. Consequently, larger push-pull voltages are developed by V405 with a relatively small pulse input. These sync pulses are applied to V406, restoring the DC component of the picture, and clamping the grid of the modulator to the required instantaneous bias at the instant corresponding to the backporch of the pedestal.

V407 (6524) is a DC coupled amplifier with the plates tied to a bias load resistor. The output of this network directly feeds the grid of visual final amplifier V504. The AC-DC switch S402 in the "Operate" position is turned to DC, which allows the clamp tube V406 to be in full operation. When thrown to the AC position a bias voltage fed to V405, V406, and

V407, cuts off V405 and V406 and holds modulator tube V407 at approximately the same current level.

3-7 Directional Coupler (Reflectometer)

Physical arrangement and schematics of a directional coupler are shown by Fig. 3-8. The loop may have both magnetic and capacitive coupling to the transmission line. The capacitive coupling is small, with large reactance to the carrier frequency. Therefore, the current which flows through the resistor is in quadrature (90°) with the line current. The loop voltage and resistor voltage drop are in series. For a wave traveling in one direction, the voltage across the transmission line and the current in the line are in phase at a magnitude set by the line characteristic impedance. Since the coupled voltage is in quadrature with the line current and the resistor voltage is in quadrature with line current, the loop voltage is in phase with the resistor voltage and the addition gives the directional coupler output voltage.

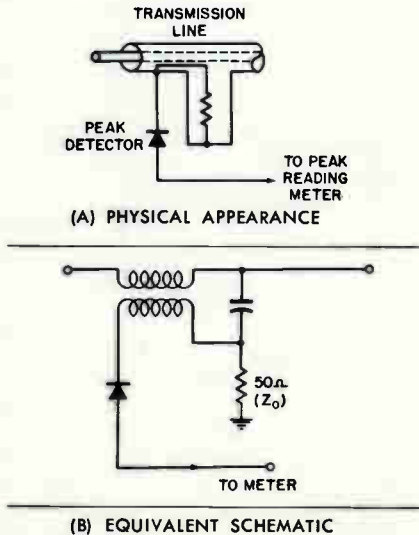

Fig. 3-8. Directional Coupling Principle.

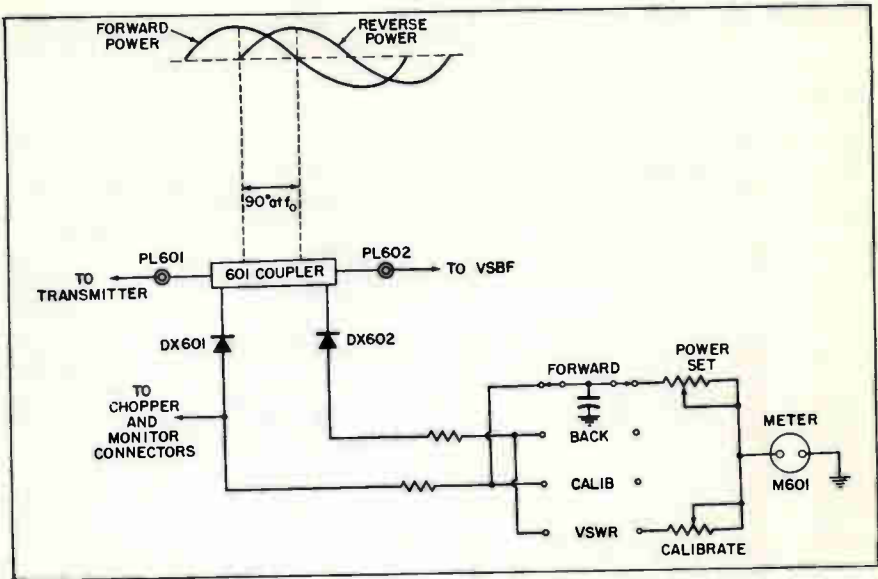

Fig. 3-9. Directional Coupler Used in the BT-200 Transmitter.

In the event of a standing wave (wave on transmission line from opposite direction), the loop induced voltage is out of phase with the resistor voltage drop. Now, if the loop is adjusted so that these voltage drops are made equal, the coupler output voltage will be zero. In this way the directional coupler can distinguish between waves of opposite directional flow. It can be calibrated to measure power output, or by comparing voltages of opposite current flow, it can measure load mismatch or voltage standing-wave ratio.

It is necessary to calibrate, then assure maintenance of correct calibration of the reflectometer in terms of peak power output. (For visual carrier.) For low power transmitters, water-cooled dummy antenna loads are not necessary. The transmitter may be fed to a dummy load with an internally-connected RF meter which measures average power. The dummy must originally have been calibrated by a known standard such as calorimetric measurement by temperature rise of a water column to obtain average power.

The peak power is then 1.68 times the average power.* Measurement must be made by the black level carrier with the pedestal adjusted to exactly 75% of peak carrier.

3-8 VSWR/Monitor In BT-200 Transmitter (See Fig. 3-9)

The visual RF output ties through directional coupler Z601 to the vestigial sideband filter which, in turn, feeds the visual antenna transmission line. Rectifier DX601 rectifies a portion of the forward power and delivers this signal to the VSWR meter circuit and the visual monitoring circuit. Crystal DX602 rectifies any reflected power caused by impedance mismatches. These two voltages are displayed on power meter M601 calibrated to indicate peak RF watts. The standing wave ratio between forward and reflected power is directly read on the

* "Principles and Practices of Telecasting Operations," by Harold E. Ennes. See pp. 471-473.

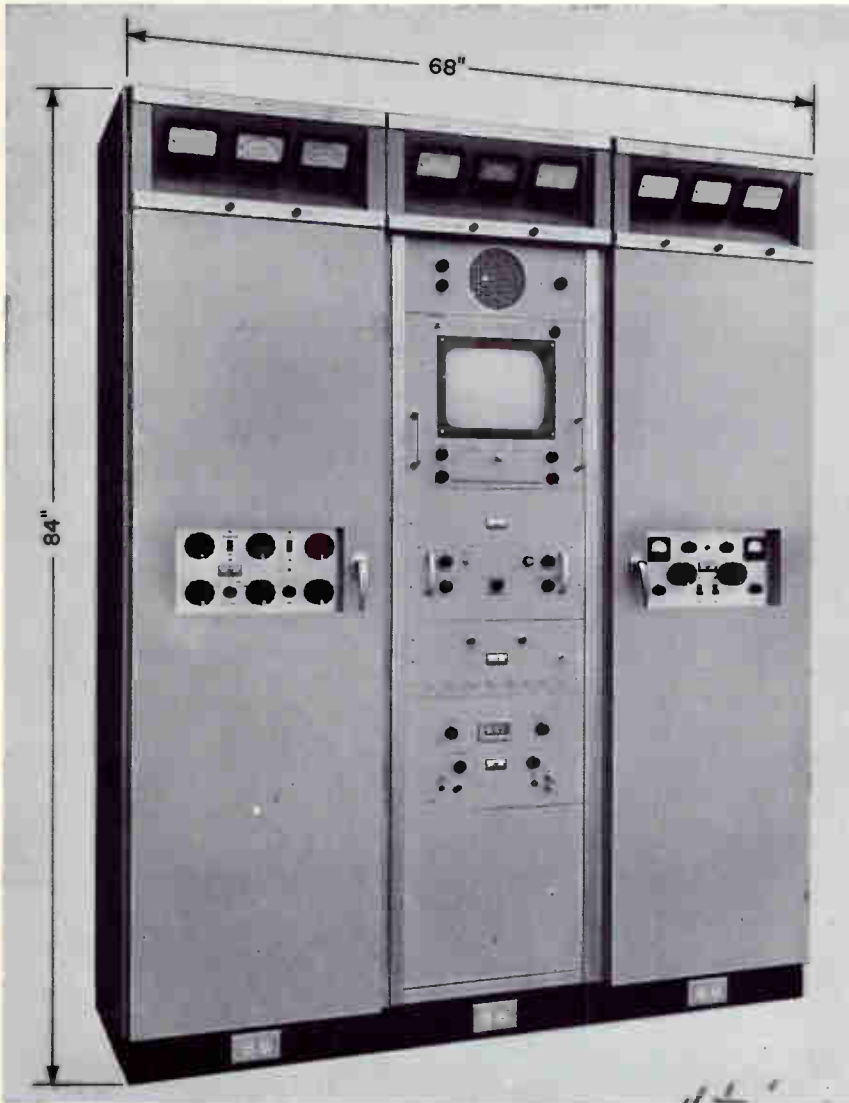

Fig. 3-10. The UST-150 Transmitter. Courtesy of ACL Products, Inc.

VSWR scale when the meter is placed in the VSWR position.

In addition to driving the VSWR circuit, the rectified DC component and video modulation is fed to a chopper relay which, by means of a contact momentarily shorted to ground, estab-

lishes the percentage of modulation by the depth of the displayed video signal referenced to ground.**

** "Principles and Practices of Telecasting Operations," by Harold E. Ennes. See pp. 517-518.

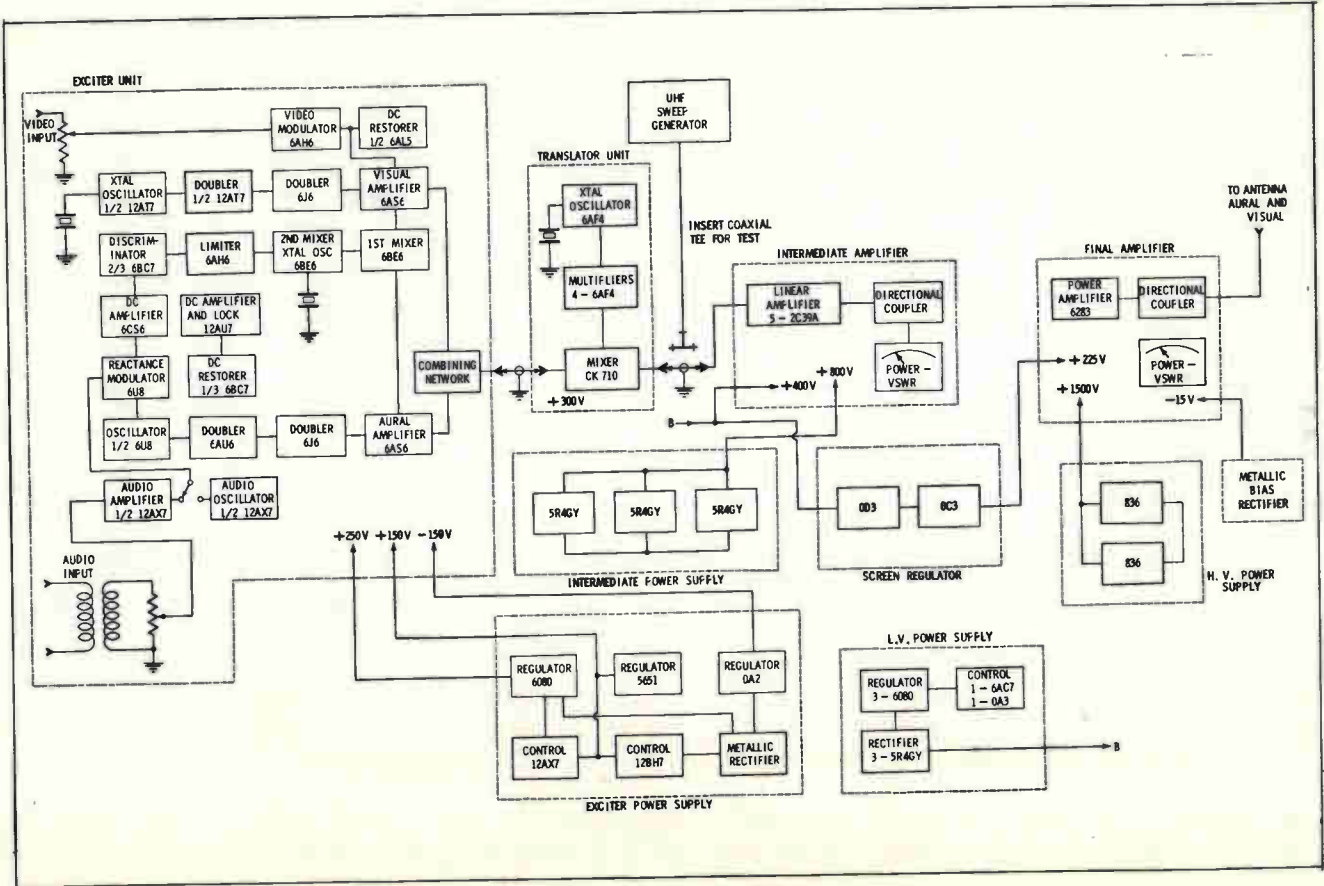

Fig. 3-11. Simplified Block Diagram for UST-150 Television Transmitter.

The video signal is further fed to a monitor amplifier so that a standard video monitor may be used for picture observation.

The aural RF output ties through another directional coupler to the aural RF output connector. Its operation is exactly the same as the visual directional coupler except that it is calibrated in effective (RMS) power instead of peak power.

3-9 UST-150 Transmitter (Channels 14-83)

The ACL* UST-150 television transmitter is capable of furnishing 150-watts peak visual power and 75-watts aural power output. The equipment is suitable for both monochrome and color telecasting to provide effective coverage for smaller communities of restricted areas. The radiated power can, of course, be multiplied by the power gains of available transmitting antennas.

The UST-150 equipment is a complete low-power television transmitter contained in three standard cabinet racks. (See Fig. 3-10.) The circuit design features low-level modulation and a common linear amplifier for both the aural and visual carriers. A single transmission line and antenna is employed to radiate the combined signals. The Diplexer and separate transmission lines are eliminated with this arrangement. Vestigial-sideband transmission is accomplished without an external filter by easy tuneup and adjustment of the linear amplifier, utilizing the built-in sweep generator. Picture and sound monitoring facilities are incorporated in the equipment so that an external control console is not required. The UST-150 will operate on any UHF channel 14 to 83.

The transmitter is powered from a domestic type 117-volt single phase cir-

cuit. The power consumption is under 2kw. Low-cost long life air-cooled tubes are used throughout. The equipment is exceptionally stable and will operate over long periods of time with only minor adjustment.

Fig. 3-11 illustrates the complete block diagram of this transmitter.

3-10 Exciter Unit

The crystal-oscillator frequency is suitably multiplied to obtain the desired output frequency. The 6AS6 visual amplifier is suppressed-grid modulated and produces a power level of the order of 1 milliwatt. The sound channel is similar with a reactance-modulated oscillator in place of the crystal. A portion of the aural and unmodulated visual signals are mixed to produce a 4.5 mc beat. This beat signal is applied to a crystal-referenced discriminator circuit, locking the two channels to within 4.5 mc \pm 1000 cycles. The modulated visual and aural signals are combined in a low-level mixing network, and fed over a common line to drive the translator unit.

3-11 Translator Unit

The exciter output signal is raised to the UHF channel frequency by mixing with a crystal-controlled signal generated in the translator. The combination of the exciter and translator crystal-controlled signals results in a frequency stability for the visual carrier of \pm 1000 cycles. The upper sideband beat signal in the translator mixer passes through a frequency selective network to drive the cascaded linear power amplifiers.

3-12 Linear Power Amplifiers

The intermediate amplifiers consist of five cavity-tuned stages utilizing 2C39A planar triodes. These grounded-grid circuits are stagger tuned to pro-

* ACL Products, Inc., New Rochelle, N. Y.

duce the desired bandwidth. The final amplifier is also a cavity tuned grounded-grid circuit utilizing a 6283 planar tetrode. This stage produces 150-watts peak visual power output and 75-watts aural.

The output stage feeds the antenna through a directional coupler which reads output power directly. The directional coupler can also be used to give an indication of the voltage standing wave ratio looking into the antenna. A similar coupler unit is provided between the output of the intermediate amplifier (2C39A's) and the input to the final amplifier (6283), so that driving power to the final can be closely adjusted.

3-13 Power Supplies

High vacuum rectifier regulated power supplies are provided for the exciter, translator, intermediate, and final amplifier units. The equipment can be operated at ambient temperatures from 10° Centigrade minimum to 45° Centigrade maximum. The application of plate power is controlled by time-delay relays. All power feeds are fused and front-panel mounted.

Fuse holders have built in neon-indicating lamps for instantaneous fault isolation.

3-14 Accessory Equipment

A UHF sweep generator is incorporated in the transmitter for rapid tune up. The sweep signal is coupled into the linear amplifier with a coaxial tee, to which the output of the translator is also fed. With this arrangement, the aural and visual carrier signals are available as markers on the demodulated sweep waveform. An ordinary service oscilloscope, plugged into the test jacks on the amplifier front panel, is used to display the demodulated sweep after transmission through the equipment. Crystal demodulators built into the directional couplers provide the easily interpreted waveform which gives a quantitative measure of the frequency response.*

* "Principles and Practices of Tele-casting Operations," by Harold E. Ennes. See pp. 206-209, and pp. 488-493 for complete description of linear amplifier tuning.

The Vidicon Pickup Tube

Due to the low initial cost, long life, and simplicity of adjustment, it is probable that a large percentage of low power telecasters will utilize studio cameras employing the Vidicon pickup tube. Vidicon cameras for film use are already replacing iconoscope film chains in the majority of stations, both low and high power.

Due to this increasing popularity of the Vidicon tube for film and live telecasting, it is important for the technicians and students to become familiar with this tube and associated circuitry. The capabilities and limitations of the Vidicon will be discussed, as well as advantages and disadvantages relative to the Image Orthicon for live telecasting.

4-1 Operational Functions

The Vidicon (Fig. 4-1) is a small television camera tube only $6\frac{1}{4}$ inches in length by 1 inch in diameter. Its relative simplicity (compared to the larger Image Orthicon) allows use with very compact component arrangements.

Fig. 4-1 is an exaggerated drawing of this pickup tube to illustrate operational functions, and should be followed during the discussion below.

The light-sensitive element may be visualized as consisting of two separate elements electrically: (1) a transparent conducting film coating on the inner surface of the glass faceplate, and (2) a thin layer of photo-conductive material on the scanning side.

(This is greatly exaggerated in the drawing.)

Five grids are used. Grid No. 1 is the control grid and has a picture cut-off value of -55 to -110 volts. Grid No. 2 is an accelerator grid usually operated at a fixed positive voltage of approximately 300 volts. Grids 3, 4, and 5 are focusing electrodes. When dynamic focusing is used, parabola waveshapes are applied to grid 3; otherwise, grids 3, 4, and 5 are tied together. This grid potential (between plus 200 and 300 volts) creates an electrostatic field which, in conjunction with the uniform magnetic field from the external focusing coil, causes the electron scanning beam to focus at the photo-conductive target. When the current through the external focusing coil is fixed, the focusing grid voltage is made variable to allow optimum electrical focus of the beam.

Note that the stream of negative electrons are prevented from being captured by the highly positive attraction of grids 3 and 4 by the concentrated electromagnetic field which provides a "stiff" beam, held on a course down the tube axially toward the target coating on the inner faceplate. If current through the focus coil were decreased from normal value, the beam of electrons would be less "stiff," and a given deflection current through the deflection yoke would cause a larger scan across the target. This feature is often used to provide a fixed amount of "overscan" for test purposes as described in Chapter 6.

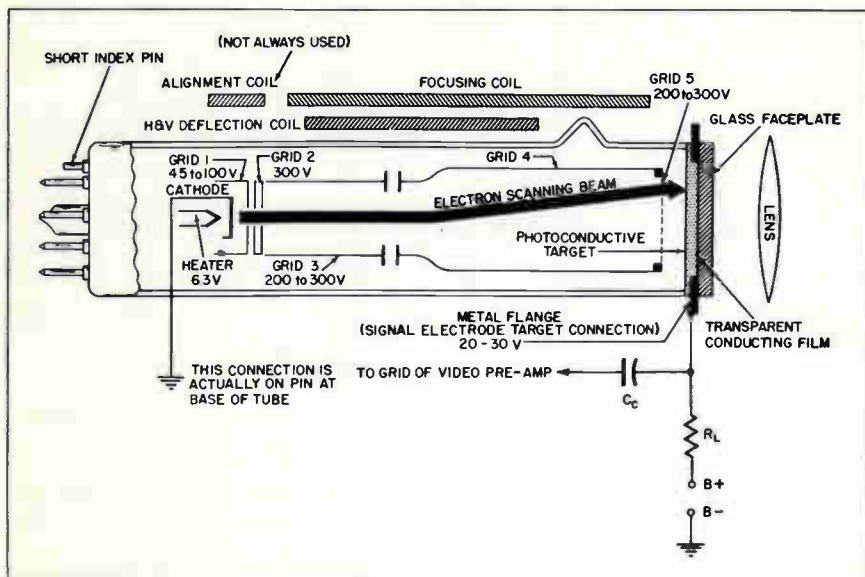

Fig. 4-1. Exaggerated Dimensional Drawing Showing Operational Function of the Vidicon Pickup Tube.

Grid No. 5 is actually a fine mesh screen adjacent to the photo-conductive layer. This grid is connected to grid No. 4 and is therefore of the same positive potential. Its purpose is to provide a uniform field on the beam side of the target so that the scanning beam impinges on the photo-conductive layer perpendicularly, regardless of the angle from which it approaches. The target is maintained at a much lower positive potential (20 to 60 volts) and the arrangement may be seen to provide a "decelerating" action of the scanning beam. Hence, grid No. 5 is often termed the decelerator grid.

The electron gun is conventional, with a 6.3 volt heater used to heat a thermionic cathode, which may be placed at ground potential as shown in the drawing.

Consider first the "signal path" under dark conditions with no light being transmitted by the camera lens. The metal ring around the front end of the tube is the signal lead connection, and

the load resistor is connected to this electrode in series with the B-plus supply. The complete circuit may then be seen to constitute ground, the scanning beam, the light sensitive surface, the load resistor R_L , B plus, through the power supply to B- or ground again.

Under no light conditions, the photo-conductive layer is essentially an insulator exhibiting a very high resistance. One plate of the electrically separate plates is charged to the positive potential of the signal electrode, while the other plate is floating. For the purpose of understanding the basic theory, we may think of the two plates as forming a capacitor with a dielectric resistance that is variable under conditions to be described. In the present analysis (no illumination reaching the target), the beam of negative electrons being swept across the target area, under the influence of the scanning current through the deflection yoke, will be deposited upon the positive target

surface until it is charged down to cathode potential. Thereafter, the remaining beam electrons are turned back under the influence of the positive grids to form a return beam. This beam is not used in Vidicon application. Although a considerable charge now exists across the opposite plates of the light sensitive element, the resistance is so high that very little current is passed. What little current does exist is termed the "dark current" of the tube. (See Fig. 4-2.)

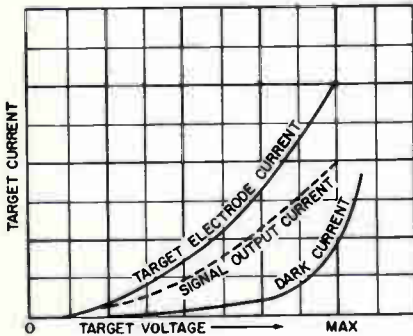

Fig. 4-2. As Target Voltage is Raised, Dark Current Increases More Rapidly than Signal Current. The Useful Signal Current (Dashed Line) is the Target Electrode Current Minus the Dark Current.

Assume now that a light image is focused by the lens on the light sensitive element. The transparent conducting film on the inner surface of the glass faceplate will now conduct slightly an amount depending upon the intensity of the light at that particular point. The lowered resistance adjacent to this particular conducting element robs a few electrons from the plate on the gun side, causing it to rise slightly toward the positive potential of the target supply. In this way, a positive potential pattern in accordance with the light distribution in the focused image is caused to exist on the gun side of the target. Thus more electrons are extracted from the total beam current to satisfy this deficiency of electrons on the target. This increased current in

the signal path which includes R_L causes a greater voltage drop through this resistor, which in turn causes the point where the coupling capacitor C_c is connected to swing in the negative direction. Since no light conditions result in minimum current and highlights cause maximum current, the grid of the first preamplifier tube is observed to swing in the negative direction for highlights in the scene, and positive for black portions.

4-2 Signal Polarity

The polarity of a television signal is always given in terms of *picture black*, since the blanking signal amplitude is always approximately near picture black and is held at a given reference level for any particular system. Therefore the polarity of the signal at the output of the Vidicon is said to be black positive, or simply positive polarity. This output polarity is just opposite to that of the Image Orthicon tube.

4-3 Spectral Response

The spectral response of the type 6326 Vidicon is of interest in broadcast applications. Spectral sensitivity characteristic curves are illustrated in Fig. 4-3. The normal response of the human eye (shown by the dashed curve B in Fig. 4-3) is from 4000 to 7000 Angstrom units. Violet is the shortest wavelength visible (in the 4000 Angstrom region, while red in the 7000 Angstrom region is the longest visible wavelength).

Curve A is the spectral sensitivity on the basis of equal values of signal-output current at all wavelengths, such as under "daylight" conditions with a degree Kelvin rating around 6500° K. Curve C illustrates the effect on this curve when incandescent lighting at 2870° K is used to illuminate the scene. It may be observed that whereas the

range of maximum response under "daylight" conditions is in the blue region of the color spectrum, the rising characteristic curve toward the red end of ordinary incandescent lighting brings the response curve over so that the rendered gray-scale maximum sensitivity occurs in the green-yellow region, comparable to the human eye.

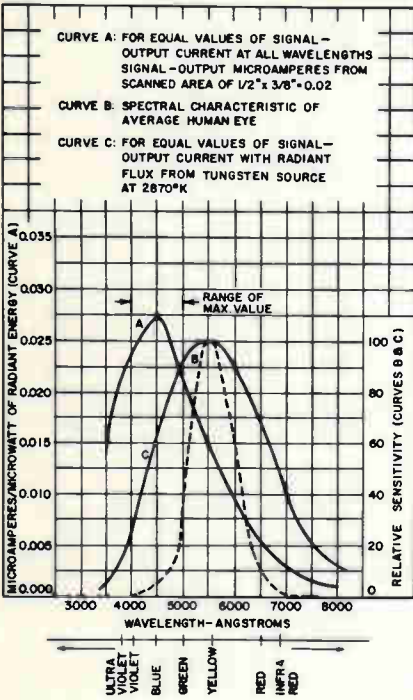

Fig. 4-3. Spectral Sensitivity of the Vidicon Tube. Courtesy of RCA.

Thus, experienced production personnel may closely estimate the Vidicon interpretation of a given scene by direct observation. The response of the Vidicon, however, extends into both the ultra-violet and infra-red as shown.

4-4 Persistence of Photo-Conductive Layer

Lighting conditions are also important in "persistence" characteristics of

the Vidicon when used to transmit moving objects. Persistence of the photo-conductive layer is a measurement of the decay in signal-output current from an initial value of 0.2 microamps after illumination is cut off. In the 6326 Vidicon, with adequate illumination on the photocathode, sudden removal of the light will cause the 0.2 microamps to decay to 0.02 microamps in 100 milliseconds. This decay rate is favorably comparable to the Image Orthicon. The persistence is greater (longer decay time) at low levels of illumination. When this problem arises, the use of greater illumination will eliminate smearing on rapidly moving objects.

4-5 Vidicon Burn-In

Image "burn-in," when the Vidicon target is operated within normal voltage limits, is an extremely rare occurrence. Vidicon cameras have been retained in fixed position on a brightly illuminated test chart for an entire day, with only negligible image burn that disappeared readily after a few minutes of normal scan on a lighted matte surface. An occasional Vidicon will show greater tendency toward image retentivity at high target voltage. Retentivity tends to increase at low levels of illumination.

The reader familiar with the Image Orthicon camera will recognize the foregoing as a definite operational advantage for the Vidicon. The Image Orthicon camera must be kept continually in motion, especially on scenes containing sharp contrasty lines, to prevent serious image burn-in on the photocathode.

Although the Vidicon is relatively free of image burn-in under operational conditions, continual use (scanning) will "set-in" a definite raster on the target area which must be considered in replacing a Vidicon tube after removal for any reason. This is normal

to either the Vidicon or the Image Orthicon.

The Vidicon photo-conductive layer is deposited on a circular signal electrode. The *useful* area is a "quality" rectangle of $\frac{1}{2}$ inch x $\frac{3}{8}$ inch within this circular area. This means that if an area greater than this $\frac{1}{2}$ inch x $\frac{3}{8}$ inch rectangle is scanned, the tube is being used outside of guaranteed limits. Edge flare and uneven sensitivity will result. Scanning an area less than the "quality" area will generally result in reduced resolution. During the normal scan of the photo layer, a conditioning of the layer takes place which results in a change in sensitivity. Thus, normal use should produce a $\frac{1}{2}$ inch x $\frac{3}{8}$ inch rectangle within the total circle of the photo-conductive layer which has a different sensitivity than the area surrounding this rectangle. This area is referred to as a *normal raster "burn."* It usually appears on a monitor screen as a lighter rectangle surrounded by darker edges. Increasing the target (signal electrode) voltage will increase tendency to excessive burn. If the full $\frac{1}{2}$ inch x $\frac{3}{8}$ inch area is not used **INITIALLY**, a smaller raster "burn" will be produced. This is *underscanning*. If **FULL SIZE** scanning is later produced, the underscanned area will be visible in the picture. It will, of course, be noticeable at the edges of the picture because the center of the normal and underscanned rasters will overlap. See Fig. 4-4.

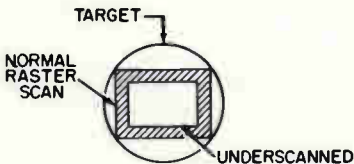

Fig. 4-4. A Prolanged Period of Underscanning Results in Edge Effects When Normal Scan is Later Used.

(Note: This "normal" raster burn may not necessarily be present when tube is new.)

During the testing and aging of the Vidicon and the testing of the camera, the normal raster area will usually be "set" or "burned-in." If improper setting of camera horizontal and/or vertical centering controls is made so that a different area from the "set" area is used, the burn will be visible as a difference in picture brightness at one or more of the edges of the picture. Continued operation under these conditions will result in multiple raster burns.

Fig. 4-5. Shifted to Right and Down.

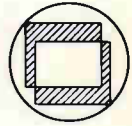
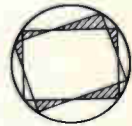

Fig. 4-6. The Effect When Vidicon is Rotated.



(See Figs. 4-5 and 4-6.) Consequently, every effort should be made, when Vidicon centering is shifted or if the Vidicon is removed from the camera and subsequently replaced, to assure that the *same* area is used as was previously scanned. In other words, centering controls and scanning controls are adjusted so that the new setting overlaps exactly on the old. This will also require that the Vidicon be rotated to the same orientation on its longitudinal axis as previously.

4-6 Factors of Vidicon Sensitivity

Factors affecting Vidicon sensitivity may be outlined as follows:

1. The signal output increases with an increase in light level for a given target voltage.
2. The signal output increases with an increase in target voltage for a given light level.
3. As the target voltage is increased, "dark current" increases more rapidly than signal current. Thus, the ratio of

useful signal current to dark current is decreased.

4. The higher the target voltage, the more the beam current necessary to discharge highlights. The more the beam current, the less the possible resolution due to inability of obtaining sharp beam focus. Also, shading increases due both to large beam current and to dark current from high target voltage.

5. Considerable variation exists between Vidicons in relation of target voltage to target current for a given light level. Since it is the variation of target current that determines signal output, the target current is the factor to consider in the study of sensitivity. For film telecasting, a large amount of light is available and the highlight target current will be around $0.3 \mu\text{amp}$ with relatively low target voltage. For live studio pickup, highlight target current will be around 0.15 to $0.2 \mu\text{amp}$ with medium to high target voltage.

6. "Dark current" should be a maximum of $0.02 \mu\text{amp}$ in either case. This limits maximum usable target voltage for broadcast work where contrast range and freedom from shading is important.

For practical telecast operations, the Vidicon has two basic sensitivities as follows:

A. Maximum practical sensitivity for live studio pickups. It requires 150 to 200 foot/candles incident light on the pickup area. It calls for medium to high target voltage, adjusted so where dark current will equal no more than $0.02 \mu\text{amp}$ as illustrated by Fig. 4-7. With this method of operation, a brightness range of slightly more than 30:1 is possible.

B. Optimum sensitivity for film telecasting. Projector lamps place about 10 foot/candles highlight illumination on the face of the Vidicon, whereas live studio incident illumination of 150 to 200 foot/candles places less than 1 foot/candle at the Vidicon

faceplate. (Depending upon f :stop of lens used.) For film telecasting, lower target voltage is possible and dark current is far under $0.02 \mu\text{amp}$, usually about $0.005 \mu\text{amp}$. This provides greatest extended brightness (60:1) and contrast range, with maximum possible resolution and minimum possible shading.

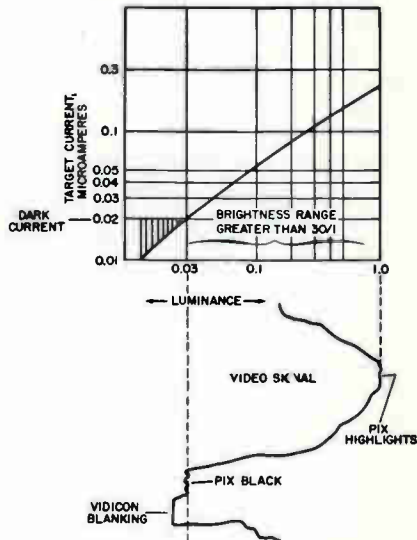

Fig. 4-7. Brightness Transfer with Target Voltage Adjusted High So That Dark Current is Maximum Allowable $0.02 \mu\text{amp}$. (Maximum Usable Sensitivity.)

It should be noted from the foregoing that even when the Vidicon is operated at maximum practical sensitivity (for high-quality telecasting), the brightness range is more than 30:1. The Image Orthicon, usually operated so that highlights occur at the "knee" of the operating curve, seldom is capable of greater than a 20:1 brightness range. In addition, a different dynamic transfer curve exists for the Image Orthicon between high-key and low-key scenic content, which is not true for the Vidicon.

The usual practice in conventional TV studios using Image Orthicon cameras is to employ around 100 foot/can-

dles incident light on the pickup area. In practice, to achieve comparable depth of field for the Vidicon camera, about 200 foot/candles is required. The problem of depth of field in studio techniques is fully discussed in Chapter 6.

4-7 Vidicon Gamma

The gamma of the Vidicon between 0.02 μ amp and 0.2 μ amp target current

is 0.65, particularly advantageous for film telecasting. This remains constant in the Vidicon while gamma in the Iconoscope and Image Orthicon vary with operating conditions. The usual motion picture film has a gamma of 1.4 to 1.7. Multiplying the gamma of the two, assuming a median value for film as 1.55 gives unity for over-all gamma.

The Vidicon Camera Lens

The effect of camera lens focal length upon the area of view covered is directly related to the size of the scanned target area in the pickup tube. To see how this differs between the Image Orthicon and the Vidicon for a given focal length lens (F), note the relative scanned areas as illustrated by Fig. 5-1.

The ratio of diagonals between the Vidicon and the Image Orthicon is $0.62/1.6 = 0.387$. The horizontal angle of a 2 inch F lens on an Image Orthicon camera is 34° . A 2 inch F lens on a Vidicon camera has a horizontal angle of $34 \times 0.387 = 13.05^\circ$. Thus for a given F lens, the Vidicon lens angle is narrower, covering less field of view at a given distance, resulting in a larger image size.

5-1 Comparative Fields of View

The horizontal field covered for a given F lens is related to the active area of the surface upon which the image is focused by the following ratio:

$$\frac{F}{\text{Scanned Area Width}} = \frac{\text{Distance of subject from lens (inches)}}{\text{Width of Field (inches)}}$$

This is stated that the F is to the scanned area as the distance of subject is to the width of field.*

* "Principles and Practices of Tele-casting Operations," by Harold E. Ennes. See p. 43.

To eliminate the ratio and obtain the width of field directly in feet, let:

F = Focal length
of lens in
inches

W = Width of
field in feet

D = Distance fo-
cused upon
in feet

Width of scanned area = 0.5 for
Vidicon

Then:

$FW = 0.5D$ and therefore

$$W = \frac{0.5D}{F} \text{ feet}$$

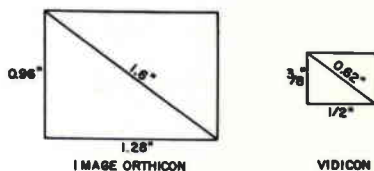

Fig. 5-1. Comparative Photocathode Areas of the Image Orthicon and the Vidicon.

For example, to find the width of field of a 2 inch F lens on a Vidicon camera when focused at 20 feet:

$$W = \frac{(0.5)(20)}{2} = \frac{10}{2} = 5 \text{ feet}$$

The height of field is then $0.75 \times 5 = 3.75$ feet.

The horizontal angle of view of a Vidicon lens is approximately equal to:

$$H \text{ angle} = \frac{27}{F \text{ in inches}}$$

TABLE 5-1
Lens Angles for the Vidicon Camera.

LENS	HORIZONTAL	VERTICAL
½"	54°	40.5°
1"	27°	20.25°
2"	13.5°	10.1°
3"	9°	6.75°
6"	4.5°	3.38°

The vertical angle is ¾ of the horizontal angle. Table 5-1 lists the actual H and V angles for the five different Vidicon lenses.

To visualize the relative fields of view for a given F lens between the Image Orthicon cameras and the Vidicon cameras, the width of field (W) for the Image Orthicon is:

$$W = \frac{1.28D}{F}$$

Therefore the width of field of a 2 inch F lens on Image Orthicon camera when focused at 20 feet becomes:

$$W = \frac{(1.28)(20)}{2} = \frac{25.6}{2} = 12.8 \text{ feet}$$

The height of field is then $0.75 \times 12.8 = 9.6$ feet.

Note again that the field of view on the Vidicon camera (for given F lens) is very close to 0.387 of the Image Orthicon application.

For convenience and comparative purposes, Table 5-2 lists the horizontal and vertical fields for the Vidicon lens up to a distance of 80 feet, and Table 5-3 tabulates the same data for the Image Orthicon.

5-2 Depth of Field

For the image to appear in sharp focus on the TV monitor, the maximum allowable diameter of circle of confusion* can be no more than two scanned lines. Since the Vidicon photocathode is ⅜ inch high (0.375 inch) and considering 490 active lines (525 minus 6 to 7% blanking per frame), then: $0.375/490 = 0.000765$ inch = 1 scanned line. Therefore two scanned lines = 0.0015 inch or approximately 1/666 inch. We may take this for prac-

* "Principles and Practices of Telecasting Operations," by Harold E. Ennes. See pp. 44-48.

TABLE 5-2
Fields of View for the Vidicon Camera.

LENS	10'		20'		30'		40'		50'		60'		70'		80'	
	W	H	W	H	W	H	W	H	W	H	W	H	W	H	W	H
½"	10	7.5	20	15	30	22.5	40	30	50	37.5	60	45	70	52.5	80	60
1"	5	3.75	10	7.5	15	11.2	20	15	25	18.7	30	22.5	35	26.2	40	30
2"	2.5	1.87	5	3.7	7.5	5.62	10	7.5	12	9.0	15	11.2	17.5	13.1	20	15
3"	1.6	1.25	3.3	2.5	5.0	3.75	6.6	5.0	8.3	6.2	10	7.5	11.6	8.75	13	10
6"	0.8	0.62	1.6	1.2	2.5	1.87	3.3	2.5	4.1	3.1	5.0	3.75	5.8	4.37	6.6	5

$$W = \frac{0.50}{F} H = 0.75 W$$

W = Width of Field in Feet
D = Distance Focused Upon in Feet
F = Focal Length of Lens in Inches

tical purposes as 1/700 inch. This would be the maximum allowable circle of confusion when considering depth of field with the Vidicon lens.

To become familiar with depth of field characteristics, it is necessary to know the "hyperfocal distance" of a lens. The hyperfocal distance is that distance at which the nearest object is in sharp focus when the lens is focused upon infinity. If, then, the lens is focused upon this hyperfocal distance, all objects from *one-half* the focused distance to infinity will be in sharp focus. Thus, it may be observed that the shorter the hyperfocal distance of a lens, the greater the depth of field. The shorter the focal length (F), the shorter the hyperfocal distance and the greater the depth of field.

To obtain the hyperfocal distance of a given F lens at a given f:stop:

$$H = \frac{(F)^2 (1/dc)}{(f:) (12)}$$

where:

F = Focal length in inches

1/dc = Reciprocal of diameter of maximum allowable circle of confusion

f: = Stop number

H = Hyperfocal distance in feet

Then to find the hyperfocal distance of a 1 inch F lens stopped to f:1.5,

$$\begin{aligned} H &= \frac{(1)^2 (700)}{(1.5) (12)} \\ &= \frac{700}{18} \\ &= 39 \text{ feet (approximately)} \end{aligned}$$

Then to find the depth of field of the 1-inch F lens, stopped to f:1.5 when focused at 10 feet:

$$\begin{aligned} \text{Near} &= \frac{(H) (D)}{H+D} \\ &= \frac{(39) (10)}{49} \\ &= \frac{390}{49} \\ &= 8 \text{ feet (approximately)} \end{aligned}$$

Thus the nearest object in sharp focus will be 8 feet. Then:

$$\begin{aligned} \text{Far} &= \frac{(H) (D)}{H-D} \\ &= \frac{390}{29} \\ &= 13.7 \text{ feet (approximately)} \end{aligned}$$

Therefore, the depth of field is from 8 to 13.7 feet, or about 5.7 feet.

We may now examine the problem of depth of field with the Vidicon camera as compared to that of the Image Orthicon camera.

With the latest wideband, high signal-to-noise ratio video amplifiers, it is possible to stop the Vidicon lens to f:5.6 for most scenes with 200 foot/candles incident illumination. However, for practical considerations, we will limit the f: stop value to f:4 for the Vidicon at 200 foot/candles, and compare the depth of field to that of the Image Orthicon stopped to f:8 which is a common value used at 100 foot/candles incident illumination. Note that this condition assumes that the user realizes the difference in sensitivity between the two pickup tubes, and allows higher illumination for the Vidicon camera. The value of 200 foot/candles is a practical amount especially considering small studio dimensions likely to be encountered in low-power station installations.

To properly compare relative depths of fields, it is necessary to consider the lens which will give approximately the same fields of view.

Note from Tables 5-2 and 5-3 that the Vidicon 2-inch lens focused at 40 feet gives a field of view of 10 x 7.5 feet. A 6-inch Image Orthicon lens focused at 50 feet gives a field of view of 10.5 x 8 feet, which is a good comparison.

The hyperfocal distance for a Vidicon 2-inch lens stopped to f:4 is 58.4 feet. Then, when focused at 40 feet:

TABLE 5-3
Fields of View for the Image Orthicon.

LENS F	10'		20'		30'		40'		50'		60'		70'		80'		100'	
	W	H	W	H	W	H	W	H	W	H	W	H	W	H	W	H	W	H
1½"	8.5	6.4	17	12.8	25.5	19.2	34	25.6	42.5	32	51	38.4	59.5	44.8	68	51	85	64
2"	6.4	4.8	12.8	9.6	19.2	14.4	25.6	19.2	32	24	38.4	28.8	44.8	33.6	51	38.4	64	48
3"	4.25	3.2	8.5	6.4	12.75	9.6	17	12.8	21	16	25.5	19.2	30	22.5	32	24	42	32
4"	3.2	2.4	6.4	4.8	9.6	7.2	12.8	9.6	16	12	19.2	14.4	22.4	16.8	25.5	19.2	32	24
6"	2.12	1.6	4.25	3.2	6.4	4.8	8.5	6.4	10.5	8	12.75	9.6	15	11.25	16	12	21	16

$$W = \frac{1.28D}{F}$$

$$\begin{aligned} \text{Near} &= \frac{(58.4)(40)}{98.4} \\ &= \frac{2336}{98.4} \\ &= 23.7 \text{ feet, nearest} \\ &\quad \text{point in focus} \end{aligned}$$

$$\begin{aligned} \text{Far} &= \frac{2336}{18.4} \\ &= 127 \text{ feet, farthest} \\ &\quad \text{point in focus} \end{aligned}$$

Thus the depth of field for the Vidicon under the foregoing conditions is from 23.7 feet to 127 feet.

The hyperfocal distance of an Image Orthicon lens must consider that the maximum circle of confusion (no more than two scanned lines) is 1/250 inch. (Height of 1.0 scanned area is 0.96 inch. Considering 490 active lines, 1 scanned line = 0.96/490 = 0.00196 inch; therefore, two scanned lines = 2 × 0.00196 = 0.0039 inch or approximately 1/250 inch.) In this case, the hyperfocal distance of the Image Orthicon 6 inch lens stopped to f:8 is:

$$\begin{aligned} H &= \frac{(6)^2 (250)}{8 \times 12} \\ &= \frac{9000}{96} \\ &= 93.7 \text{ feet} \end{aligned}$$

Then, when focused at 50 feet:

$$\begin{aligned} \text{Near} &= \frac{(93.7)(50)}{93.7 + 50} \\ &= \frac{4685}{143.7} \\ &= 32.6 \text{ feet, nearest} \\ &\quad \text{point in focus} \end{aligned}$$

$$\begin{aligned} \text{Far} &= \frac{4685}{43.7} \\ &= 107.2 \text{ feet, farthest} \\ &\quad \text{point in focus} \end{aligned}$$

Thus the depth of field for the Image Orthicon under the foregoing conditions is from 32.6 to 107.2 feet, somewhat under that for the Vidicon camera covering the same field of view.

Table 5-4 lists the hyperfocal distance for the Vidicon lenses at the designated stop numbers. Tables 5-5,

TABLE 5-4
Hyperfocal Distance in Feet for Vidicon Lens.

LENS	f:1.5	f:2.0	f:2.5	f:2.8	f:4.0	f:5.6
1"	38.9	29.2	23.3	20.8	14.6	10.4
2"	155.5	116	93.3	83.5	58.4	41.6
3"	350	262	210	187.5	131	93.7

The Vidicon Camera Lens

5-6, and 5-7 show the approximate and the distances for the most widely depth of fields at various *f*: numbers used Vidicon lenses.

TABLE 5-5
Depth of Field for 1-Inch Lens on Vidicon.

DISTANCE (FT.)	<i>f</i> :1.5	<i>f</i> :2.5	<i>f</i> :4.0	<i>f</i> :5.6
3	2.8-3.25	2.6-3.4	2.5-3.8	2.3-4.2
10	8-13.4	7-17.5	5.9-31.7	5.1-260
25	15.2-70	12-inf.	9.2-inf.	7.4-inf.
50	22-inf.	16-inf.	11.3-inf.	8.6-inf.

TABLE 5-6
Depth of Field for 2-Inch Lens on Vidicon.

DISTANCE (FT.)	<i>f</i> :1.5	<i>f</i> :2.5	<i>f</i> :4.0	<i>f</i> :5.6
3	2.95-3.08	2.9-3.15	2.85-3.17	2.8-3.25
10	9.4-10.7	9-11.25	8.55-12	8-13.2
25	21.6-30	19.7-34.2	17.5-43.6	15.6-62.5
50	37.8-73.5	32.6-108	27-348	23-inf.

TABLE 5-7
Depth of Field for 3-Inch Lens on Vidicon.

DISTANCE (FT.)	<i>f</i> :2.5	<i>f</i> :4.0	<i>f</i> :5.6
10	9.55-10.5	9.3-10.8	9-11.2
25	22.3-28.4	21-31	19.8-34.2
50	40.4-65.6	36.2-81	32.6-107

The Vidicon Camera Chain for Live Pickups

Since the Vidicon camera chain is a relative newcomer to the application of live studio telecasting, the following description concerning functions of controls will help to familiarize the reader with its operating characteristics. Fig. 6-1 illustrates the camera to be described.

6-1 Functions of Controls and Switches (Camera Head)

(A) Right Side. (Video preamplifier chassis. See block diagram in Fig. 6-2.)

FOCUS: LOCAL-REMOTE Switch. In LOCAL position, allows control of camera electrical focus at the camera position. In REMOTE position, electrical focus of the camera is adjusted at the Camera Control Console.

CAM FOCUS: Controls voltage on the Vidicon focus electrode when FOCUS LOCAL-REMOTE switch is placed in LOCAL position. This establishes electrical focusing of the Vidicon beam in conjunction with a fixed electromagnetic focus field developed in the focus coil surrounding the Vidicon. (See Chapter 4.)

SWEEP: NORMAL-OVERSCAN Switch. Double-pole single-throw switch shown in Fig. 6-3. In NORMAL position, this switch shorts a resistor in series with the magnetic focus-coil

current and a resistor in series with the electrostatic focus grid of the Vidicon. This supplies normal coil current and normal Vidicon focus grid voltage. When placed in OVERSCAN position, the short is removed from both resistors reducing focus coil current. Since this weakens the magnetic focus field, beam "stiffness" is reduced causing target overscan. The lowered voltage on the Vidicon focus grid maintains approximate electrical focus in the OVERSCAN position. Overscanning allows the image to be displayed on the monitor within the dark ring of the target to check positioning of the target area within the deflection field.

VIDEO PEAK: This chassis contains three video peaking adjustments which are conventional transformer peaking slugs for wide-band adjustment and alignment.

HIGH PEAK, APERTURE CORRECTION, AND HIGH-FREQUENCY PHASE: These controls are closely interrelated in practice. Fig. 6-4A illustrates the typical uncompensated amplifier response curve where high frequencies are lost due to normal shunt-tube and circuit capacitances. Fig. 6-4B illustrates the purpose of peaking coils to compensate for normal high-frequency losses. This is the "ideal" response curve including the pickup-tube effects.

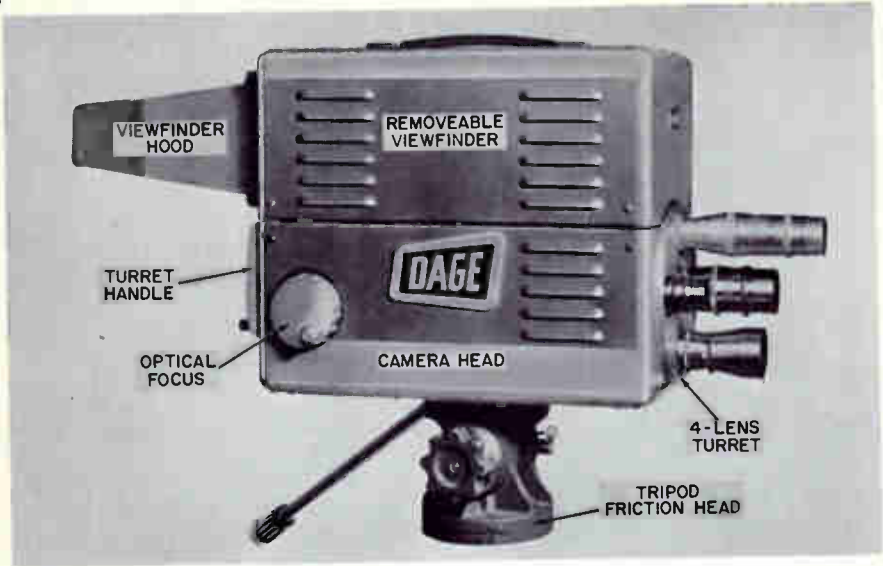

Fig. 6-1A. Photo of Dage Model 320-A Vidicon Camera for Studio or Film Telecasting.

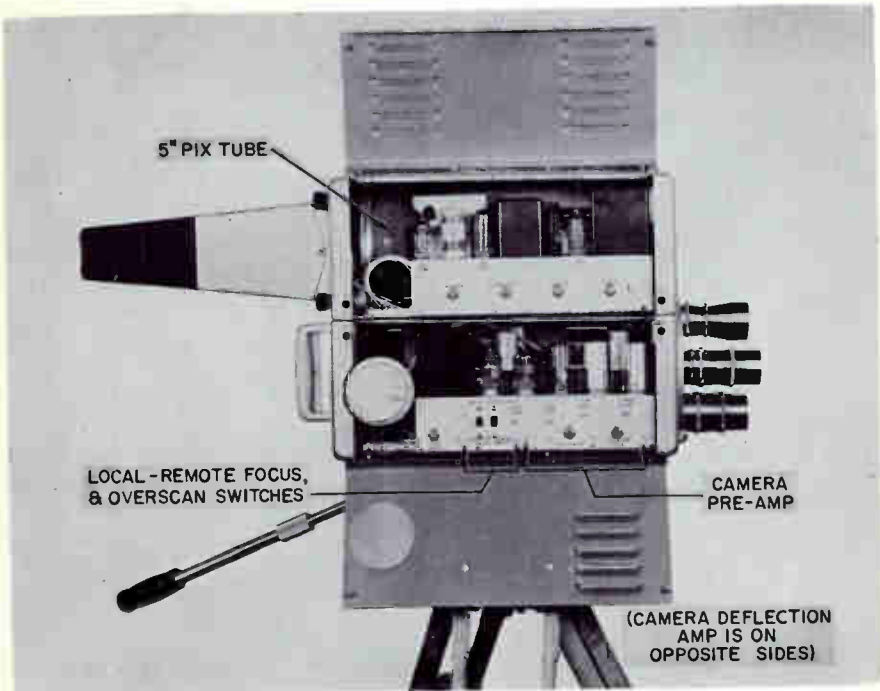

Fig. 6-1B. Dage Model 320-A Camera With Sides Exposed.

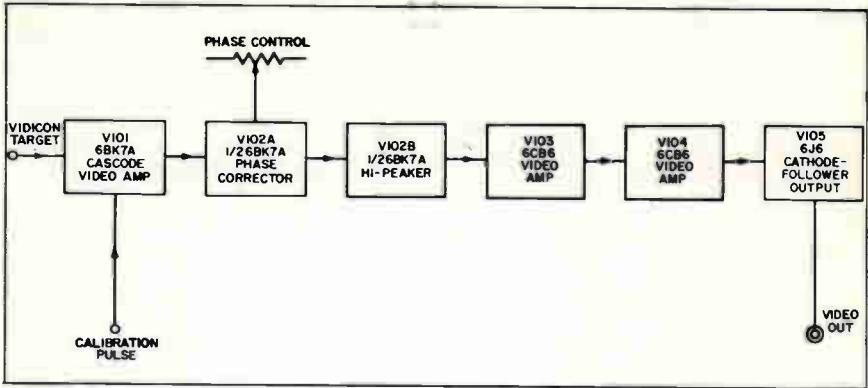

Fig. 6-2. Block Diagram of Video Preamplifier.

The round shape and finite size of the pickup-tube scanning beam is equivalent to inserting a low-pass filter in series with the signal. Consider the case of the system's "maximum demand" where the spot encounters the sharp transition from black to white, or a black bar on a white background. Since the beam is round and is not infinitely small, this maximum demand cannot be faithfully handled. This is equivalent to a loss of high frequencies which provide the fine picture detail. Therefore, the amplifier itself must approach the curve illustrated in Fig. 6-4C in order to compensate for the pickup tube "aperture" effect. At the same time, the means employed to achieve an over-all "flat" frequency response must provide minimum phase distortion to prevent smearing of the vertical edges. Since the aperture effect of the pickup tube exhibits loss of high-frequency response without phase shift, while high-peaking and aperture correction does introduce phase shift, an additional phase correction is necessary for best transmission.

The second video amplifier stage V102A provides phase correction. (See Fig. 6-5.) This provision allows maximum high peaking for fine picture detail without an unacceptable smearing of the sharp contrast vertical edges in

the image. The ideal phase vs. frequency characteristic is a straight line that rises linearly through multiples of pi at zero frequency, with frequency plotted along the X axis and the phase angle along the Y axis. The scale is linear, and indicates that the phase angle increases linearly with frequency, maintaining the same time delay for all frequencies. Departure from this characteristic results in phase distortion most noticeable as trailing white edges following black edges on a gray or white background.

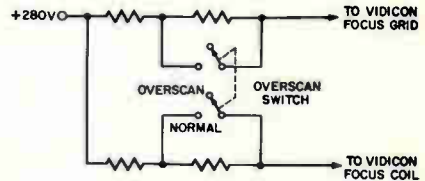

Fig. 6-3. Function of NORMAL-OVERSCAN Switch. Shown in OVERSCAN Position.

It should be observed that this analysis is the same as considering the square-wave response of the video amplifier. A pulse or square wave is composed of a large order of odd harmonics. If a fundamental frequency sine wave is plotted on graph paper and harmonics added to the plot, it is noted that the odd-order harmonics steepen the sides and add across the top to "square off" the resultant curve.

If this curve is then clipped, the conventional pulse with steep sides and flat top results. Passing this pulse through an amplifier with linear phase shift retains all harmonics in their proper phase relation and no pulse shape distortion occurs.

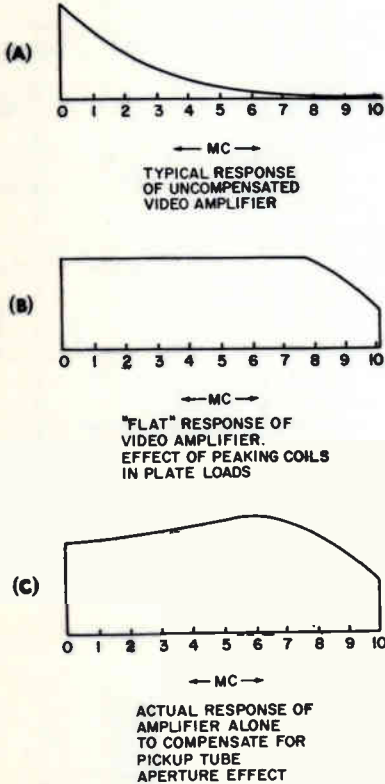

Fig. 6-4. Video Amplifier Response Curves.

If the phase characteristic departs from the ideal straight slope and bows upward away from the frequency (X) axis, the increasing slope with frequency is an indication that the time delay is increasing with frequency. The shifted components making up the pulse now add in such a manner that a leading-edge overshoot and trailing-edge undershoot occurs on the passed pulse. Conversely, if the phase characteristic curve bows toward the X axis,

the decreasing slope with frequency indicates a decrease in time delay with frequency. The shifted pulse frequency components now add to produce a leading-edge undershoot and a trailing-edge overshoot. It is noted that one type of phase distortion may be compensated by an equal and opposite phase correction. A lagging phase shift is corrected by an equal leading phase shift, and vice-versa.

Observation of Fig. 6-5 shows that the third video amplifier (high-peaker stage) is fed from both plate and cathode of the phase corrector V102A. Thus, the V102B grid is driven by signals 180 degrees apart. Phase or amplitude changes in the generator impedance of V102A itself is prevented by the low values of plate and cathode resistors. High frequencies are coupled through the small value of C108 at the cathode while the main video signal is plate coupled through the HIGH-FREQUENCY PHASE control R114. Since the cathode and plate signals are 180-degrees out of phase, this adjustment allows optimum placement of the out-of-phase signal relative to the video signal to compensate for phase distortion in the following high-peaker and amplifier stages. This is adjusted in practice for elimination of leading whites or trailing smears on the wedges of a test-chart picture, and actual setting depends upon the amount of high-peaking necessary as well as the over-all video amplifier alignment.

High-peaking is accomplished by the extremely low value of plate load resistor (R118) of V102B. With series peaking coil L107, the plate load increases with an increase of frequency. Since gain is in ratio to plate load, high-frequency response is boosted in this stage. L107 is adjustable to provide control of high-peaking. Extra aperture correction is achieved by cathode peaking. The small value of capacitance across the adjustable shunt

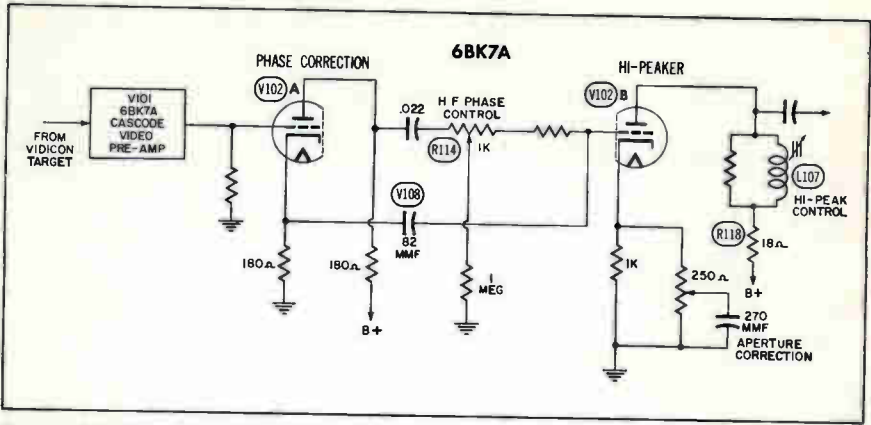

Fig. 6-5. Simplified Schematic of Phase Correction Circuit Used With Hi-Peaking and Aperture Correction.

resistor provides a high frequency bypass while retaining the lower frequencies in an inverse-feedback path.

(B) Left Side. (Deflection amplifier chassis. See block diagram in Fig. 6-6.)

These controls are the conventional height, width, centering, and linearity

controls for the centering of target sweep and obtaining the proper aspect ratio with linear (constant velocity) scanning.

V. AND H. DYNAMIC FOCUS CONTROLS: Loss of resolution in the

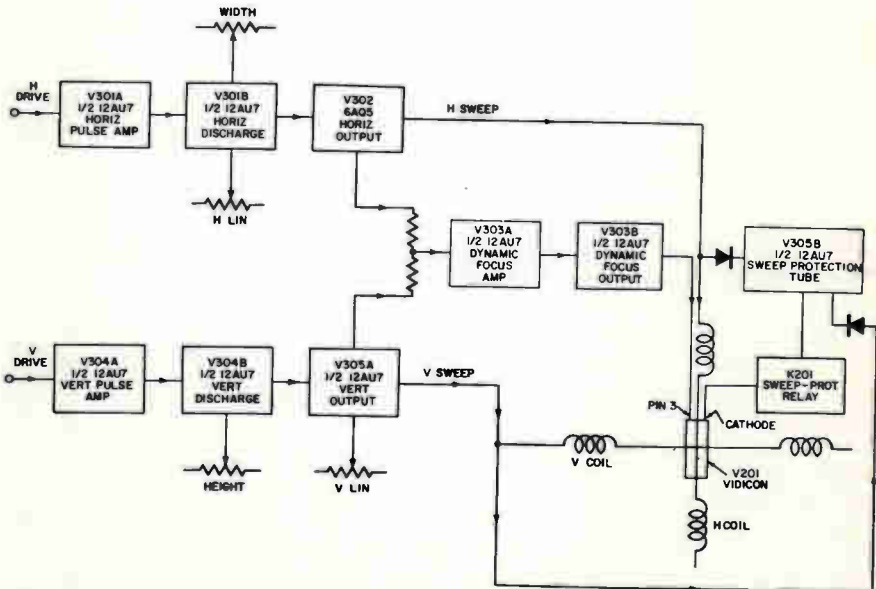

Fig. 6-6. Block Diagram of Deflection Amplifier.

edges and corners of the picture is a challenge well known to the trade. This results largely from the fact that optimum focus adjustment should be made for best center resolution since picture interest is ordinarily contained in the central pickup area. This adjustment is not optimum for corner resolution. Dynamic focus allows automatic compensation of beam focus in step with deflection away from central area sweep.

Vidicon grid No. 3 is supplied with a DC focus voltage upon which is superimposed an AC parabolic waveshape by dynamic-focus amplifier V303. (See block diagram Fig. 6-6.) An R-C network integrates the sawtooth voltage from the H sweep to form a parabola at the line frequency. Another R-C network performs the same function for field parabola. Amplitudes are individually adjusted. The signals, mixed at grid of V303A, are amplified and coupled into grid No. 3 (pin 3) of the Vidicon to be superimposed upon the DC voltage of this focusing grid.

Due to the waveshape of a parabola voltage, the focusing potential increases as the beam is deflected away from center at the line rate, and on top and bottom at the field rate. This function maintains optimum beam-spot size over the entire scanned area of the pickup tube.

LOSS OF SWEEP. PROTECTION CIRCUIT: Fig. 6-7 shows a simplified diagram of a protection circuit used for the Vidicon in case of horizontal or vertical sweep loss.

The Vidicon cathode returns through the cathode resistor to one terminal of relay K1. With sweep-protection tube V305B conducting, plate current flows through the relay winding closing contacts 4 and 6. This completes the Vidicon cathode circuit so that beam current can flow in the tube.

Tube V305B must be conducting for the Vidicon cathode circuit to be closed.

A portion of the horizontal-sweep output voltage is rectified by D2. A portion of the vertical-sweep output voltage is rectified by D1. This total pulsating DC (positive polarity) is smoothed to a relatively pure DC by the R-C filter network and applied to the grid of V305B. The time constant of R1 and C1 in the grid circuit smooths out any remaining variations over a field period so that a relatively pure DC which is dependent upon the existence of both H and V sweep voltages is placed upon the grid.

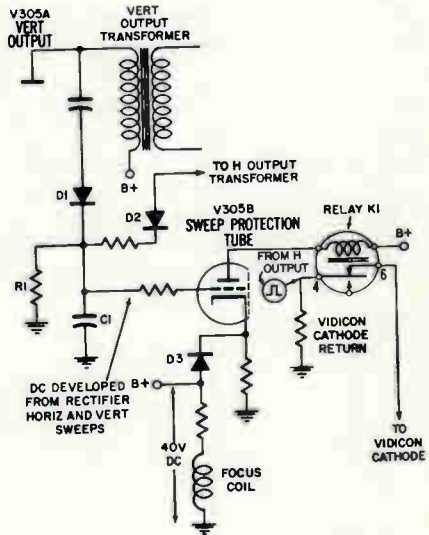

Fig. 6-7. Simplified Schematic Diagram of Vidicon Sweep Protection Circuit.

The cathode of V305B is held at a minimum positive potential of 40 volts so that the tube cannot conduct until the grid becomes sufficiently positive to intercept the grid-cathode cut-off point. A convenient source of 40 volts is the voltage drop across the series focus coil. This reference voltage is applied to the cathode of V305B by the rectifier D3. If either the H or the V sweep output voltage fails, the V305B grid falls below cut-off voltage and the tube cannot conduct. Lack of

The Vidicon Camera Chain for Live Pickups

plate current through the winding of K1 opens the 4-6 contact and the Vidicon cathode circuit is opened.

VIDICON BLANKING: The Vidicon scanning beam must be cut off during horizontal and vertical retrace intervals (blanking), otherwise the retrace would cause spurious target charges on the following line and field scans. The beam is cut off at the horizontal rate by a positive pulse appearing at the cathode return across the H output transformer resistor during the retrace interval. The beam is extinguished at the vertical rate by coupling a negative-going retrace pulse from the vertical saw-former capacitor into the Vidicon grid.

6-2 · Electronic Viewfinder (See block diagram in Fig. 6-8)

The video signal from the camera preamplifier is amplified and compen-

sated for the viewfinder picture tube. Horizontal and vertical drive pulses are also amplified to drive their respective discharge tubes. Thus, the viewfinder is controlled in height, width, and linearity independently of camera-head controls. The viewfinder is readily removable from the top of the camera head (plug-in) and the camera needs no readjustment for normal operations whether the viewfinder is on or off.

As shown by the block diagram, amplified vertical blanking is injected at the picture-tube cathode so that the screen may be made as bright as desirable without the occurrence of retrace lines.

High voltage (7 kv) for the picture tube is supplied by a well shielded RF power supply to conserve space and weight. The tube has electrostatic focus and electromagnetic deflection.

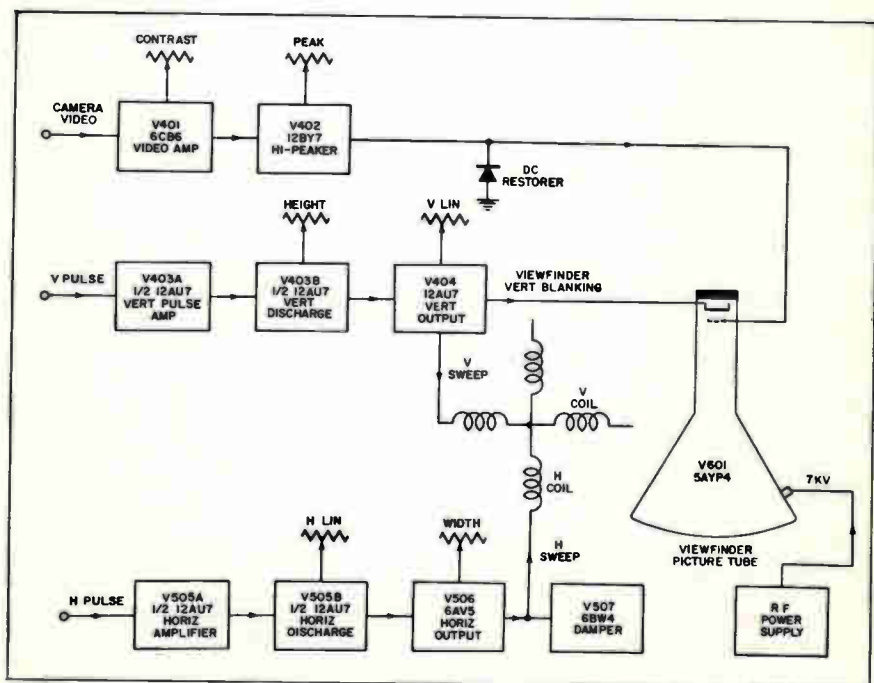

Fig. 6-8. Block Diagram of Electronic Viewfinder.

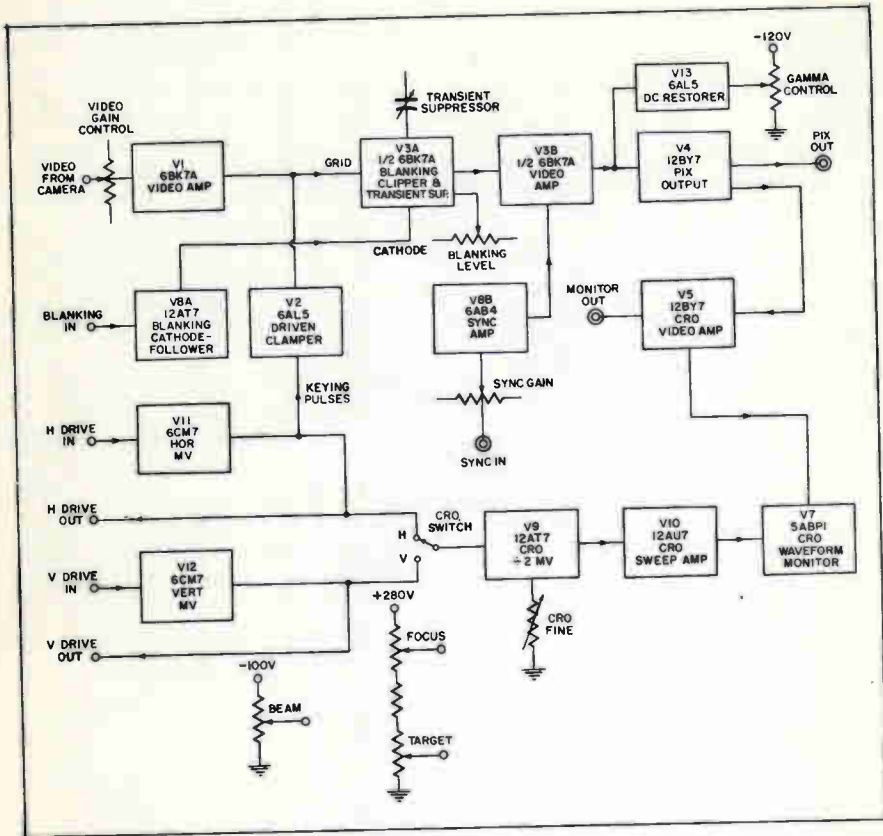

Fig. 6-9. Block Diagram of Camera Control.

6-3 Function of Controls—Camera Control Console (See block diagram in Fig. 6-9)

Fig. 6-10 illustrates the usual arrangement of the camera control consoles and the master monitor. The switcher control panel is normally mounted on the master monitor desk with the switcher amplifier located in the lower compartment.

CAMERA FOCUS: Controls the voltage on the Vidicon focus electrode (G3, G4). In conjunction with the fixed focus field developed in the focus coil, this control determines Vidicon focusing. Its adjustment range is approximately 150 to 250 volts.

TARGET: Sets Vidicon target voltage. The range of the target voltage available from the voltage divider is approximately +5 to +100 volts. The ordinary operating range is from 20 to 35 volts for film, and up to 50 or 60 volts for live studio pickup. This value varies considerably between individual Vidicons for a given scene and lighting.

BEAM: Controls the bias voltage on the Vidicon grid (G1). The amount of bias voltage determines the beam current. The lower the beam current required, the better the resolution of the image. The beam voltage is adjustable over a range of approximately 0 to

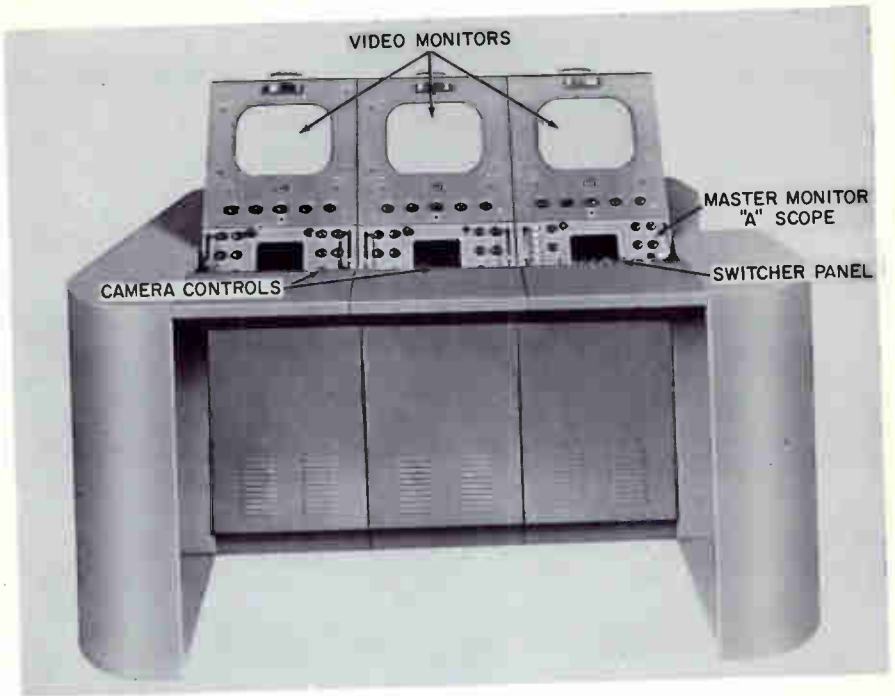

Fig. 6-10. Camera Control Consoles and Master Monitor.

-100 volts. Voltage for all controls is taken from an external electronically-regulated power supply.

C.R.O. H-V: This switch provides oscilloscope observation of the video at either the line or field rate.

In the H position the picture is observed as a horizontal oscilloscopic display.

In the V position, the video may be seen as an oscilloscopic display at the vertical (field) rate.

C.R.O. FINE: This control changes the time constant of the grid circuit of the C.R.O. multivibrator V9. Adjustment of this control is made for the desired oscilloscope pattern.

BLANKING LEVEL: This control determines the clipper level. Clockwise rotation will move the black level farther into the white region. The

usual level is 5 to 10% of the difference between the sync-pedestal and reference-white level.

GAIN: This control adjusts the amount of video signal fed from the camera to the camera control. It is adjusted so that the total picture and blanking amplitude is 1.0 volt, or 1.4 volts when sync is inserted.

SYNC GAIN: Controls the amount of sync signal fed to the sync insertion amplifier V8B. This control is set for the desired sync amplitude, approximately 0.4 volt for composite 1.4 volt systems. Sync is inserted in the Control Unit only when one camera chain is used without subsequent switching. In multiple camera chains, sync is inserted in the switcher amplifier.

TARGET CALIBRATE: (See Fig. 6-11.) This switch removes the blank-

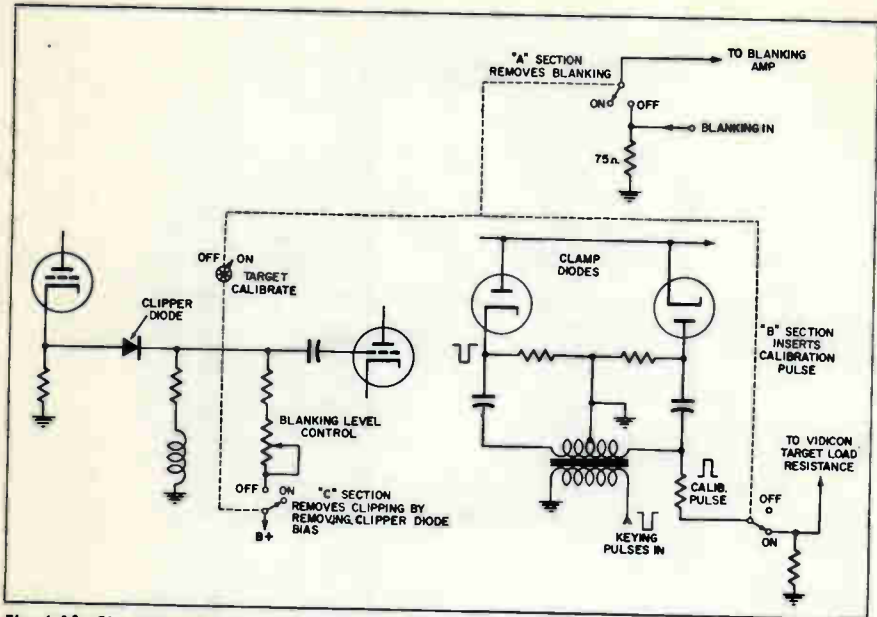

Fig. 6-11. Simplified Schematic Diagram of Target Calibration Pulse Switch Shown in "ON" Position.

ing signal, removes clipper bias so that the signal is not clipped, and inserts a pulse into the input stage of the camera pre-amp equivalent to 0.35 microamperes of target current. This is the recommended Vidicon highlight current for film transmission, and is also useful in target-voltage adjustment for studio pickups as described later.

Several circuits involving new philosophy of circuit design are used in this control unit with which the reader should become familiar. One of these is the method of clipping and transient suppression.

The simplified schematic of the blanking clipper and transient suppressor stage is shown in Fig. 6-12. Cathode-follower clipping eliminates the irregularities characteristic of the more conventional plate clipping. The conventional plate-coupled amplifier with clamped grid must perform essentially as a DC amplifier, with all the inherent disadvantages of interelec-

trode capacitances and contact potentials. Clipping transients are particularly bothersome to eliminate in such design.

V3A is a cathode-coupled stage with crystal diode D1 serving as the blanking clipper. The negative terminal of the diode is connected to a positive bias voltage available across R1 through R3 and the BLANKING LEVEL control R2. Signal voltage at the cathode of V3A must rise above this potential to be transferred to the V3B grid. Since the blanking level at this point is a negative excursion, the pedestal is clipped at a point determined by clipper bias and adjusted by the BLANKING LEVEL control R2.

Transients are effectively eliminated by variable capacitor C1 from the plate of V3A to the grid of V3B. High-frequency transients on the sides of the blanking pulse are conveniently "neutralized" by this 180-degree coupling. The positive pulse from the V8A plate overrides the negative pulse that

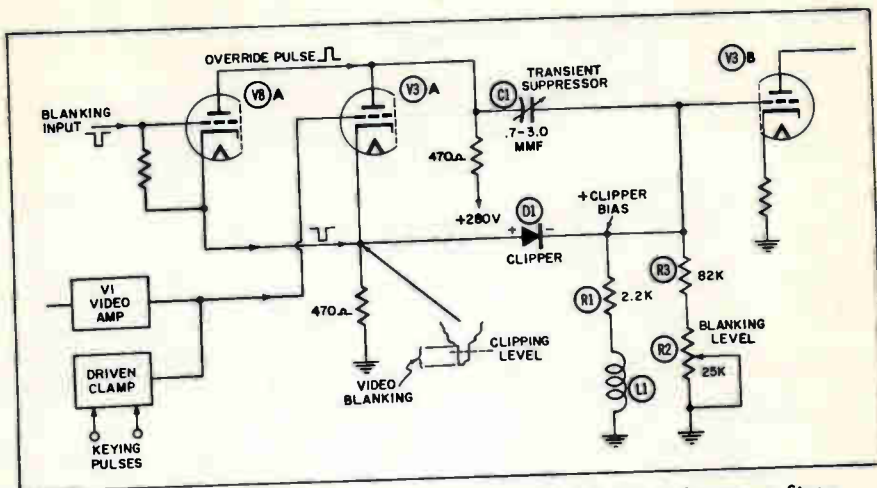

Fig. 6-12. Simplified Schematic of Blanking, Clipper, and Transient Suppressor Stage.

would occur at the V3A plate from cathode-injected blanking, and allows the neutralizing capacitor to effectively eliminate transients. The addition of L1 serves to sharpen the leading edges of the blanking waveform.

Another circuit to become acquainted with is the "GAMMA" control. Although of controversial value, conditioning of the public to the high gamma pictures obtained with motion pictures and earlier types of TV pickup tubes has led to a request for pictures with more "snap." Despite the extended gray scale of which the Vidicon is capable, such "portrait" quality pictures are sometimes referred to as "soft" compared to the compressed white and black scale obtained with earlier TV pickup tubes, and with present Image Orthicons. In order to accommodate the desire for a picture having such a compressed scale, a "white compression" (gamma control) circuit has been incorporated. Laboratory and field tests show that inclusion of this circuit provides a response characteristic comparable to that obtained with Image Orthicon type pickups for live studio pickups. This is particularly advantageous when using a mixture of Image Orthicon and Vidicon

cameras at the same time and is, perhaps, the only justification for use in practice. The gamma circuit is incorporated in the picture-output amplifier V4 in the Camera Control. (See Fig. 6-13.) Note that the DC restorer (V13)

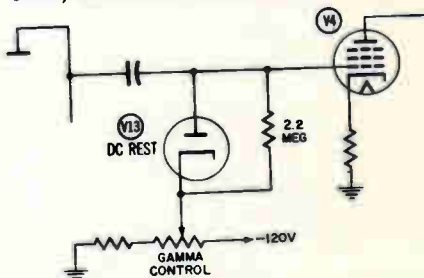

Fig. 6-13. Simplified Schematic of White Compression (GAMMA CONTROL) Circuit.

bias may be varied over a negative range. Increasing grid bias moves the picture white signal into the curved toe of the E_g-I_p curve of V4. This squeezes or compresses the white portion of the signal by producing a lower gain in this region than is obtained by the black portion of the signal on the steeper part of the characteristic. The polarity of the signal at this point is positive black. The control enables better transmission of certain motion picture films made originally for theater

projection, with excessive density range (contrast) for good television transmission. The control is also useful in some cases to match Vidicon gray-scale response on multiple camera pickups of the same scene.

Note from the Block Diagram of Fig. 6-9 that both vertical drive and horizontal drive pulses are fed to multivibrator circuits so that camera linearity is independent of input pulse width from the sync generator.

6-4 Setup of Vidicon Camera Chains

Optimum adjustment of the Vidicon camera differs between live pickup and film, and whether or not the Vidicon target current is measured or calibrated by some means. In this chapter we are concerned with the set up of the camera for live studio pickups. Section 6-4A describes the adjustment in systems not incorporating target current calibration, while Section 6-4B covers technique of adjustment in systems employing target current calibration.

6-4A Vidicon Dark-Current Method of Setup

In this procedure, the Vidicon is adjusted first for maximum sensitivity as

used under poor lighting conditions in industrial applications, then readjusted for broadcast quality. The technique follows:

1. Adjust camera control for normal amount of *setup* between blanking level and black as observed on waveform CRO. Then adjust video monitor brightness control for a raster just above cutoff (barely visible) as in (1) of Fig. 6-14.
2. Cap camera lens. Rotate beam control to maximum (clockwise) position (minimum bias voltage). Then rotate target control clockwise (increasing target voltage).
3. With maximum beam current, it will be noted that as this target voltage is increased, complete discharge of the target will be observed by the video monitor raster going dark and the blanking level collapsing to straight line as in (2) of Fig. 6-14. This is an artificially created overload in which the Vidicon signal drives to the blanking level (for normal blanking level or *setup* adjustment) causing loss of *setup* and consequent raster cutoff of the video monitor under the above conditions of adjustment. The uniformly dark raster indicates uniform, or flat dark current.
4. Further increase in target voltage will bring dark current into normal

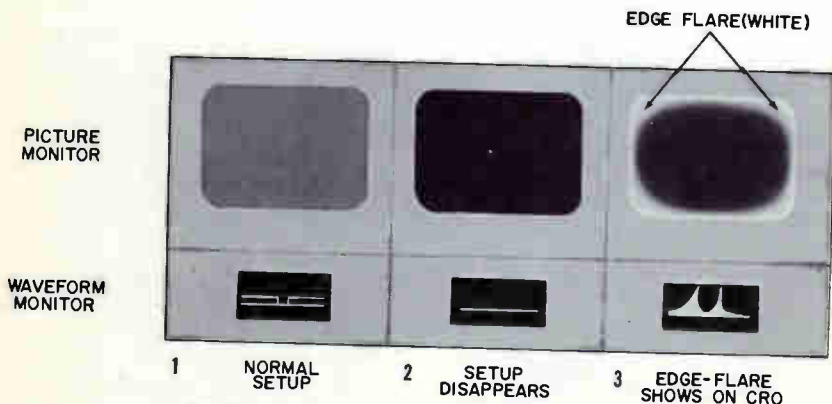

Fig. 6-14. Vidicon Dark-Current Method of Setup.

highlight signal levels as revealed by edge-flare on the video monitor and waveform monitor as in (3) of Fig. 6-14. The target control should now be backed off counterclockwise (decrease of target voltage) until all edge-flare disappears. **THIS IS MAXIMUM PERMISSIBLE TARGET VOLTAGE**, and is the maximum possible sensitivity adjustment for the particular Vidicon in use.

5. Rotate beam control to off (maximum counterclockwise), for maximum Vidicon bias. It will be noted that *setup* level reappears on the CRO waveform monitor and the video monitor raster again becomes visible.

6. Uncap lens, and train camera on test pattern chart using same illumination level as will be used for the studio pickup. (Somewhere in the 100 to 200 ft./candle range.) Rotate beam control clockwise. It will be noted that the lens may be stopped down to f:4 or even f:5.6 before the image begins to "wash out." Increase the beam current just to the point where the highlights are discharged as observed on the video monitor. This may also be adjusted by watching the waveform monitor, and increasing the beam until the waveform no longer increases in amplitude as the beam control is rotated clockwise. Further increase of the beam pulls the waveform downward, and excessive shading occurs in the picture as well as loss of resolution.

7. In smaller studios not requiring extreme depth of field, resolution may be further increased by opening the lens to f:1.5 or f:2, and by decreasing target voltage and beam current. Remember that the less target voltage, the less the beam current required to discharge highlights. The less the beam current, the more effectively the beam can be focused; this results in higher resolution, better signal-to-noise ratio, and freedom from shading.

6-4B Vidicon Highlight-Current Method of Setup

This technique employs a target current calibration pulse mentioned previously.

1. Set GAIN control on Camera Control panel at mid-range. Turn BEAM control off (maximum counterclockwise).

2. Throw TARGET CAL switch to calibrate position. This kills the pedestal and removes clipping in the camera control amplifiers, and inserts a pulse into the input stage of the camera preamp equivalent to 0.35 microamperes of target current. (Recommended target highlight current for film transmission.) Adjust the CRO BRIGHTNESS, FOCUS, and FINE (frequency) controls for proper CRO DISPLAY at the line frequency.

3. Adjust the picture GAIN control for a pulse height on the CRO waveform screen equal to 1.0 volt calibration. Connect external CRO to the PIX output jack at rear of Camera Control chassis and check output levels of the pulse.

The output must be adjusted to 1 volt peak-to-peak value for the calibration pulse. Readjust picture GAIN control on front panel to obtain 1 volt peak-to-peak signal at the output.

4. If Camera Control CRO waveform monitor now shows different pulse height, adjust the CRO GAIN control until the pulse top again occurs at the 1.0-volt calibration line.

5. With camera trained on test chart, open lens to widest stop possible to use on the show to follow, such as f:1.5 or f:2.0. Use the same amount of illumination as will be used on production.

6. Bring BEAM and TARGET controls up together until highlight in video waveform corresponds to 1.0-volt level set by calibration pulse. (See Fig. 6-15.) Use just enough beam current to discharge highest highlight.

7. Actually, the above step is an optimum adjustment for film transmission where projector lamps allow a great excess of light in comparison to studio applications. (See Chapter 4.) Therefore, if a poor gray-scale response is noted (all blacks or whites with few or no "in-between" shades), the following steps are taken.

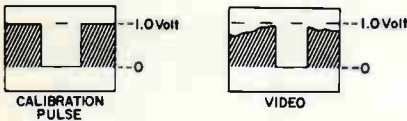

Fig. 6-15. Vidicon Highlight-Current Method of Setup Using the Calibration Pulse.

8. Excessive contrast with poor gray-scale rendition is normally caused by use of excessive target voltage in an attempt to get a standard sensitivity based on a higher available light level. Reduce target voltage (and beam current) until optimum gray-scale response is achieved. Remember, the beam current should always be just sufficient to prevent the highest highlight from "blooming" on the monitor.

9. It will now be noticed that the video waveform on the CRO waveform monitor (Camera Control unit) is lower in amplitude. All that is necessary at this point is to increase the video GAIN control until the highlights again reach the standard 1.0-volt calibration line on the CRO graticule.

6-5 Matching Studio Cameras

For best studio production, it is important to insure the use of matched cameras on a multi-camera show. This includes gray-scale match and color response match to prevent the effect of a distinctly different "eye" when switching between cameras on a common scene. Matching of Vidicon cameras is far less complicated than matching Image Orthicon cameras since the dynamic transfer curve of

the Vidicon does not change between high-key and low-key scenic content as is inherent with the Image Orthicon.

1. Set up standard gray scale and place cameras side by side. Assure that lighting is evenly distributed from all angles. Check the gray scale steps on a common master monitor by switching between cameras. Ordinarily, only a very slight readjustment of target voltage on one of the cameras is necessary to achieve a perfect gray scale match.

2. Set up three primary color strips (red, green, blue), in line with the gray scale horizontally. Actual hue is not important since a comparison (in color to gray-scale rendition) between two or more cameras is the intention of this check. Use the same type of illumination as will be used on studio pickup. Compare gray scale wedges on common master monitor as in step 1. The color stripes should match on identical steps of gray scale for each camera. If not, using a one-stop difference in the iris f: number will ordinarily establish a match, with slight readjustment of target voltage. Vidicons that will not match should not be used in multiple camera pickups. The GAMMA control may also be varied in some cases to effect a more perfect color match.

6-6 Vidicon Beam Alignment

Variations in gun and target assembly which occur during the manufacture of the Vidicon cause a misalignment of the beam which can be corrected by application of a transverse magnetic field applied at the base end of the tube over the G1-G2 aperture. Alignment of the Vidicon beam improves over-all resolution, center-to-edge resolution, eliminates flutter, reduces uneven dark current, and provides a more uniform sensitivity. Of course, all of these conditions may not be at fault in the same tube.

Beam alignment is provided in the camera under discussion through the use of two small circular permanent magnets installed on the phenolic end-plate of the deflection-focus coil assembly. This eliminates the need for a critically regulated alignment coil current.

These magnets are $\frac{1}{2}$ inch in diameter and $\frac{1}{10}$ inch thick. They are magnetized across the diameter. By rotating each magnet, the fields may be adjusted so that they are either aiding or opposing each other. This provides a variable field to produce the required alignment field.

The magnets can easily be rotated by using a pencil with a rubber eraser tip to move the spring-loaded magnets.

The procedure is as follows: Focus the camera on a test chart and lock camera in place. Resolve picture and view on monitor. Obtain best electrical and optical focus. Next, rotate electrical focus back and forth and observe center of picture. If alignment adjustment is *not* required, the picture will rotate about its center with no lateral or vertical shift. If the picture appears to shift laterally or vertically, adjust the magnets until the picture rotates about its center as the electrical focus is varied back and forth. Do not confuse the mushrooming of the picture as it passes through focus with the lateral or vertical shift mentioned previously. When correct beam alignment is obtained, the entire picture should rotate about its center with no apparent side (or up and down) movement of the picture. An easy way to check this is to note the displacement of the four sides of the picture. The four corners should rotate equal amounts as focus is varied. Also note that this condition should be consistent with good focus and a reduction in edge flare.

6-7 Complete Camera Setup

Following is the complete procedure in the setup of a Vidicon camera for

the purpose of familiarizing the reader with this equipment.*

When the Vidicon in the camera has been moved or rotated within the deflection yoke, or a new Vidicon is being installed, proceed with the adjustment given here. This is also the initial procedure for new cameras.

1. First, the line picture monitor should be adjusted so that all four sides of the scanning raster are visible. You should be able to see *all* of the picture displayed on the line picture monitor tube. Next, be certain that the sweeps on the line monitor are linear. It is desirable to use a bar generator to check the linearity of the monitor. If the line picture monitor (normally the Master Monitor) sweeps are not linear, then the following camera adjustments will not be correct. Adjust width and height controls on the line picture monitor for a 4×3 aspect ratio. Also, check that this ratio does not change when a signal is applied to the monitor, or brightness or contrast controls are adjusted.

2. With camera lens capped, turn CAMERA HEIGHT control, CAMERA VERTICAL LINEARITY control, CAMERA HORIZONTAL LINEARITY control, and CAMERA WIDTH control to full rotation clockwise. (In DAGE cameras.) This will produce an overscanning of the Vidicon mosaic. In later cameras, the NORMAL-OVERSCAN switch is simply placed in the OVERSCAN position. If the Vidicon is operated for any period of time with an *underscanned* mosaic, "burn-in" will be evident at the edges of the raster when later proper adjustments are made. An *underscanned* mosaic also produces a lower resolution.

3. Place test pattern card in front of camera. Check the level of lens, turret, and card with a spirit level. *Be sure*

* Courtesy of DAGE TV Division of Thompson Products, Inc.

that center of test pattern is in line with center of lens. It is desirable to mask off the edges of the test chart being used for alignment with black tape in order to clearly define the edges of the 4 and 3 area.

4. Illuminate test pattern *evenly* with about 100 foot/candles of illumination.
5. Set GAIN control on Camera Control to approximately $\frac{1}{2}$ of full rotation.
6. Go through procedure described in previous Sections 6-4A or 6-4B.
7. Uncap lens and open iris to f:4.
8. The image on the line picture monitor and the camera viewfinder should appear as a compressed image of the test pattern against a circular or oval gray background, since we are now overscanning the target area. The round edges of the gray background are the edges of the Vidicon photo-layer. The edges are visible as a result of *overscanning* the layer. In other words, we are now scanning out over the edges of the entire Vidicon photoconductive surface. This surface is, as mentioned previously, circular but will not appear as such because the camera scanning circuits are non-linear when operated in the extreme overscanning position. (This is not true of cameras employing the OVERSCAN switch since automatic focus is established.) For the time being, ignore the fact that the test pattern image may be rotated or twisted.
9. If the Vidicon raster cannot be moved into the center, there is a possibility that the yoke has been magnetized and this is displacing the beam beyond the range of the centering controls. In this case, it will be necessary to demagnetize the yoke as per instructions in the next section.
10. With the Vidicon *raster* properly centered, shift the camera physically until the test pattern image is centered within the "dark current" ring or flare. Remember, the Vidicon "dark current" represents a residual current

which ideally should be zero but practically is not. This current increases with an increase in target (signal electrode) voltage and appears on the line picture monitor screen as a white flare around the edge of the tube. With the test pattern centered within the usable area of the photoconductive layer, lock the camera head so the camera will not move during the subsequent adjustments.

11. Next, adjust CAMERA HEIGHT; CAMERA VERTICAL LINEARITY; CAMERA HORIZONTAL LINEARITY; and CAMERA WIDTH controls for proper aspect ratio and linearity. (Switch in NORMAL position.) The test pattern image should just fill the 4×3 raster of the line picture monitor. During these adjustments, use as low a TARGET voltage as possible. Do not worry at this point about picture quality. The proper scan is our consideration at this time.
12. Rotate the electrical FOCUS control through a range of optimum focus to check for proper beam alignment as was previously stated in Section 6-6. If the picture is tilted at optimum focus, loosen deflection yoke retaining screw and rotate the yoke for straight raster.
13. Go through the fine points of adjustment for best resolution as described previously under Sections 6-4A or 6-4B. After such adjustment of target voltage, this control can be left set and will need only a minor change after 20 to 50 hours of operation. This, of course, assumes that the same lighting levels will prevail on all shows.
14. Always use proper setup of level between picture black and blanking. This is 5 to 10% of maximum picture white. The Vidicon black level remains constant under drastic changes in scene reflectance when cameras are properly adjusted.

6-8 Vertical or Horizontal Centering Off Center

The deflection yoke in the camera has an overwrap of iron wire which can be magnetized by momentarily high currents going through either the horizontal or vertical deflection coils. This condition can be brought about by defective tubes in the horizontal- or vertical-scan circuits or a momentary short in the circuits during servicing or any other condition causing unusual current. If the picture is seriously displaced either horizontally or vertically beyond the range of either the horizontal or vertical centering controls, all voltage in these circuits should be checked carefully and compared with the voltage table furnished by the manufacturer. If these are found to have been normal, magnetization is probably the cause. To return the picture to its proper position, it will be necessary to demagnetize the yoke overwrap.

Proceed as follows:

1. Disconnect yoke socket.
2. Attach the output of a variac (with switch OFF) to the FOCUS COIL leads.
3. Set variac arm on 115 volts and plug into line.
4. Turn variac ON. Reduce voltage to zero in about 5 seconds rotation.
5. Turn AC off, remove wires and return FOCUS COIL to circuit. The yoke should be demagnetized.

6-9 Changing or Installing New Vidicon

Mechanical:

The lens turret is removed by removing the knurled knob and the knurled tension nut in the center of the turret. This exposes the lens mounting plate which is held in place by four recessed screws. Remove the screws and lift the mounting plate off, exposing the Vidicon face. Slip off the target contact ring.

Open the right side of the camera and remove the Vidicon base socket. Two mounting brackets may be seen near the base; the front bracket (toward the lens) supports the deflection coil assembly; the rear bracket supports the Vidicon tube. Do not remove these brackets, but loosen until the Vidicon can be slipped out through the front opening of the camera. Remove the new Vidicon from its packing case and inspect the face plate for dirt, dust, or fingerprints. Use soft, lint-free cloth or lens tissue for cleaning. *Note that when handling Vidicon, the face-plate end should always be up. Never handle by holding base end up.* There is always the possibility of loose cathode particles, dust, etc., falling on the mosaic surface or face plate which will result in spots on the observed image.

Insert the Vidicon with the glass tip seal-off point pointing at exactly your 3 o'clock position facing front of camera. The tip should be just inside the gap in the cushioning rubber gasket. The tube should be inserted until the tip is recessed within this gasket. This places the Vidicon target in position to enable the camera target contact ring to be snapped into place. Align the short index pin on the Vidicon base with the groove on the base socket and connect the socket. Replace turret mounting plate. Check to see if Vidicon face plate is centered in aperture of mounting plate. If the Vidicon face plate is not centered, the optical image will be displaced on the Vidicon mosaic and the central portion of the Vidicon will not be used. The edge of the Vidicon mosaic will usually show an edge flare in the resolved picture and it is necessary to place the optical image in the central portion of the Vidicon mosaic so that the effects of the edge flare are at a minimum.

Mount turret plate with tension nut. The knurled round nut is a tension adjustment and should be adjusted so

that the turret plate moves freely without binding but not so loose as to cause wobble. The adjustment can then be locked with the knurled cap.

At this point, it will be well to turn the camera on *with lens capped*. Adjust the target and beam controls to resolve mosaic of Vidicon. There will usually be resolved a scanning pattern which is the result of normal burn-in during the testing and aging process. The Vidicon should be rotated until the burn-in pattern area is aligned with the scanning pattern to which you have adjusted your camera. This will prevent annoying white edges showing as the result of using a different area of the mosaic than was used in the tube manufacturer's aging and test equipment. Do not subsequently rotate Vidicon from this position.

Optical:

After the Vidicon has been installed mechanically, it is necessary to adjust its horizontal position within the yoke so that the fine focus knob (on side of camera) will have the correct range of focus.

Proceed as follows:

1. Install 1" lens and focus on an object about two feet distant. A test chart is excellent for this purpose.
2. Set lens focus ring to *infinity*.
3. With test chart two feet from lens, turn camera on and observe image on monitor. By means of the focus knob on side of camera, rock deflection yoke and Vidicon assembly back (farthest from lens) until stop is reached.
4. Move Vidicon within yoke until the image is in sharp focus. Be careful not to rotate tube from its previously correct setting.
5. Tighten Vidicon and yoke clamps. This adjustment should enable the operator to obtain a range of adjustment for all scenes with the focus knob alone, thus requiring no lens focus-ring adjustment.

6-10 Maintenance and Servicing

The maintenance and trouble shooting of a Vidicon camera chain is no different than that of the Image Orthicon camera.*

6-11 Operations

Operating techniques are primarily concerned with the interpretation of the Vidicon and associated amplifiers. It is very desirable that the lighting brightness, or contrast range, be held within a 30 to 1 ratio when under control such as in the studio. Users of the Vidicon type pickup tube will find that under such controlled lighting, practically no readjustment of TARGET, BEAM, GAIN, and BLANKING controls need be made after initial optimum settings.

When telecasting from out-of-doors under uncontrolled lighting conditions, greater precautions are necessary. It is always advisable to use sunshades on the lens to prevent excess stray light from the sides and to enable shooting toward the sun when necessary. Even without sunshine, contrast ratio is much greater than under controlled studio lighting, and constant attention must be given to the controls for good picture rendition.

Whether in the field or in the studio, always select the proper *f*: stop number on the iris for the amount of light available. Smaller stop openings (larger *F* numbers) allow greater depth of field requiring minimum optical focusing on "travel" or "follow" shots. Sufficient time should be taken on rehearsals to know the pertinent times during any production when it is necessary for the camera operator

* For complete description of maintenance and trouble shooting, see Chapter 8, "Principles and Practices of Telecasting Operations," by Harold E. Ennes.

to change stop openings or to rotate the lens turret for choice of a different lens. It is far better to change stop openings than to attempt electrical adjustments to compensate for blooming of highlights or a dark picture.

Pertinent facts relative to choice of lens are: an insufficient angle of field (vertically or horizontally) requires a shorter focal length lens, or greater distance from the pickup area. An insufficient depth of field (area in which objects are sharply focused) requires a smaller stop opening (usually requiring an increase in light level) or choice of a shorter focal length lens. The latter covers a greater angle of view and the image is smaller. Greater depth of field for any given focal length lens may also be achieved by moving the camera back. Again, the image is smaller.

FOCUSING: The focusing knob on the side of the camera will enable a range of adjustment from less than two feet to infinity when the focus collar on the lens is set to infinity using $\frac{1}{2}$ inch, 1 inch, and 2 inch lenses. For longer lenses, it may be necessary to set the approximate distance on the lens collar. The focus knob on the camera can then be used for a substantial range around this setting.

USE OF GAMMA CONTROL: In cases where the production department may request pictures with sharpened contrast, rotate the GAMMA control clockwise and note the level at which an increase of GAIN control no longer results in an increase of highlight level on the waveform monitor, for the lighting and subject matter concerned. Slight readjustment of the TARGET control may be necessary to obtain maximum gray-scale response. This control may prove useful in matching the gray-scale response of cameras used on multiple-camera shows. Compare wedges (steps) of gray scale on

the CRO waveform monitors and match this amplitude response as closely as possible. Such camera matching aids considerably when switching between cameras to eliminate the disturbing effects of widely different gray scales. Always compare on a common Master Monitor by switching between cameras. Then match all monitors in picture and contrast as closely as possible.

INTERPRETATION OF USABLE PICTURE AREA: It should be borne in mind that camera blanking (camera

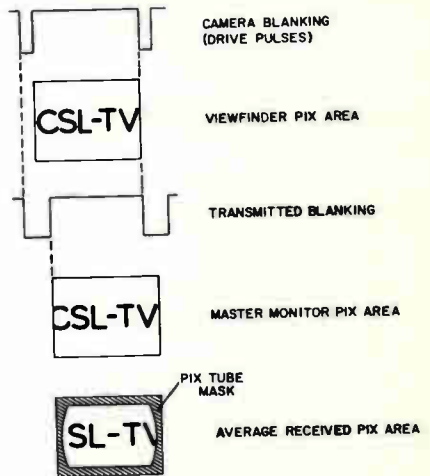

Fig. 6-16. Relative Picture Areas of Active Information.

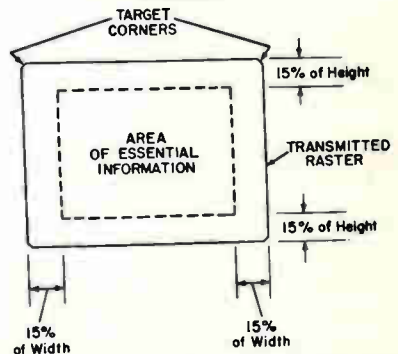

Fig. 6-17. Master Monitor Reference for Area of Essential Information to Compensate Average Receiver Sweep Adjustments.

drive pulse) is normally less than transmitted blanking. Fig. 6-16 illustrates the usual result. Note that the viewfinder field of view, particularly on the left side of the raster, is more inclusive than that visible on the camera control monitor or master monitor.

To add to this problem, average receiver sweeps are adjusted to "roll-off" horizontally and vertically beyond the picture tube mask in order to avoid annoying black sides. Therefore, if the cameraman focuses his camera so that an area such as a station identification

card is barely included on his viewfinder, the final result is an incomplete presentation on the receiver.

The solution is to mark off 15% of the horizontal raster at each side, and 15% of the vertical raster at top and bottom on the master monitor. See Fig. 6-17. Keep all essential information within this area. It is helpful for beginners to mark-off the camera viewfinder after careful checks with the master monitor so that the cameraman will automatically hold this essential area within proper lens field of view.

The Vidicon Film Camera Chain

The same camera is used for film as for live studio pickup. (Fig. 7-1.) The film camera is mounted on a permanently installed base with a fixed relationship between the slide projector and the motion-picture film projectors. Only one lens need be used on the camera; and when once optically focused, needs no additional adjustments other than daily checks for optimum performance.

7-1 The Optical Multiplexer

This description concerns the most common and practical means of using one camera for telecasting slides and motion pictures from three sources. These three sources are normally two motion-picture projectors and one slide projector with a means of storing a number of slides which can be selected in sequence and operated from the camera control position.

The Dage Optical Multiplexer (Figs. 7-1 and 7-2) is the result of experimentation to determine the optimum method of film and slide pickup with the Vidicon tube. This method permits obtaining the quality of direct projection on the Vidicon, yet it eliminates the acute vibration problems that go with direct projection. It also provides for the economy of picking up more than one projector with the same camera.

Compared with the pickup method of using a shadow box containing a rear projection screen, the Optical Multiplexer possesses many advantages.

Foremost among these is the increased light efficiency. This makes it possible to operate the Vidicon at lower values of target voltage with the attendant advantages of freedom of flare and shading problems, maximum resolution capability of the Vidicon, and increased life of the Vidicon. The absence of the screen eliminates the loss of resolution from grain size of the screen, and the uneven light distribution that results in hot spots, bright edges, etc. The loss of contrast caused by any light leakage into the shadow box is also eliminated. The Optical Multiplexer requires no shadow box, and may normally be used in a fully-lighted projection room. The cover is used to provide protection from dust. The window in the cover adjacent to mirror B (see Fig. 7-2) is also a semi-mirror to achieve equal light levels on the field lens from each projector.

The Optical Multiplexer consists of a rigid steel support having a base for bolting to the floor, and topped by a flat plate on which are mounted the optical elements. The optical center line is 48 inches from the floor, which matches the standard television projector. The optical elements consist of a high quality 5 inch diameter lens, and a pair of semi-transparent mirrors, which combine the images from 3 separate sources onto a common optical axis. Each projector is focused on the plane of the field lens, causing a real image to exist at that plane. This real image is then picked up by the lens on the Vidicon camera.

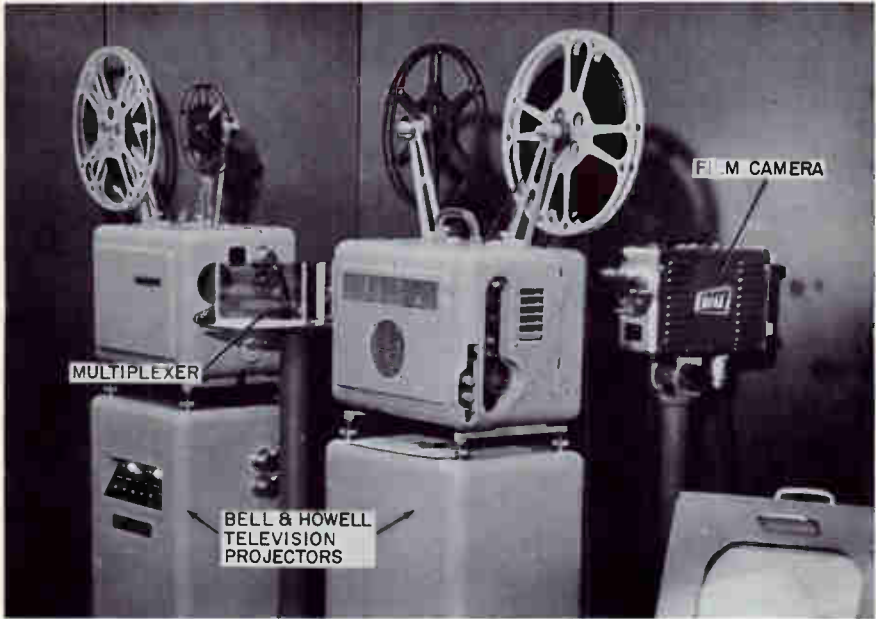

Fig. 7-1. One Camera Used for As Many As Two Movie Projectors and One Slide Projector. (The Camera Shown Is An Earlier Model Than That of Fig. 6-1.)

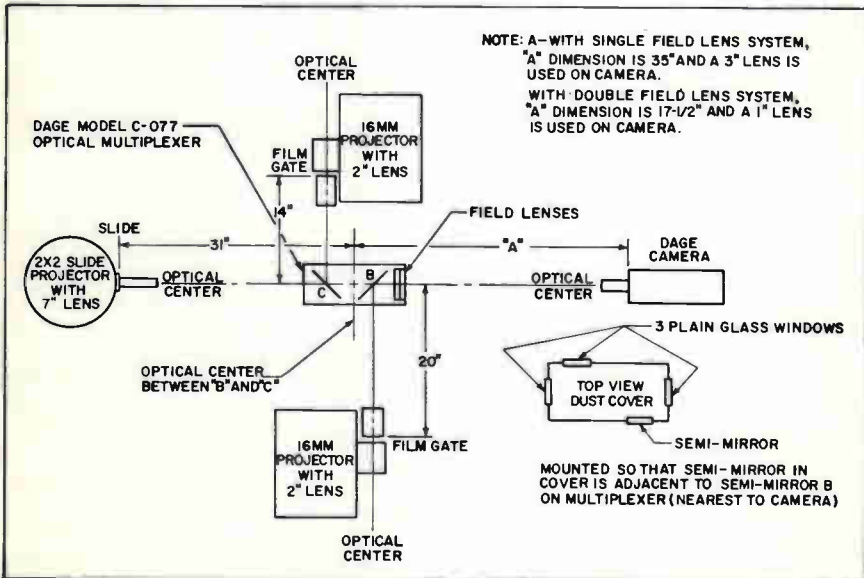

Fig. 7-2. Projection Room Layout Using Three Picture Sources With Dage Optical Multiplexer.

For proper operation of the system, two things are essential. The first is that all images must be on the common optical axis. If the two 16 mm projectors are close to the locations shown on Fig. 7-2, minor corrections can be made by mirror adjustments. The slide projector, however, must be positioned exactly on the optical axis. The second is that the proper focal length lens be used on the camera and all projectors. The optimum lens combination for a 3-projector pickup is shown in Fig. 7-2; a 3 inch lens on the camera, 2 inch lens on each of the 16 mm projectors, and a 7 inch lens on the 2×2 slide projector. A 6 inch or a 5 inch lens may be used on the slide projector, providing the distance from the slide to the center of the Optical Multiplexer is reduced to $25\frac{1}{2}$ inches and 20 inches, respectively. The use of the 5 inch lens is not recommended, as it may be difficult to obtain even illumination over the entire area of the slide. These spacings of the slide projectors assume the use of a $15/16 \times 1\frac{1}{2}$ inch mask on the 2×2 slides. Means for a slight adjustment should be provided to accommodate slides of slightly differing dimensions.

The 16 mm projectors used must have a standard 3-2 pulldown mechanism for television use, or an equivalent method of converting 24 film frames/sec to the TV 30 frames/sec. Projectors having a long shutter opening are especially recommended, as they eliminate the need for phasing the projectors to the synchronizing generators.

Any 2×2 slide projector having a single light source and a single lens may be used, providing the lamp used is at least 150 watts. Generally, the ones preferred are the remote control models, which may be loaded in advance with a number of slides, and changed from the control room.

When four picture sources are to be used, it is recommended that two cam-

eras and two Optical Multiplexers be used, each with one 16 mm projector and one slide projector. This will permit flexibility of operation, such as superimposition of slide over film, smooth changeover between 16 mm projectors, and previewing of upcoming slides with consequent reduction of production errors.

For installation, see the Multiplexer Assembly drawing (Fig. 7-2), and proceed as described in the following section.

7-2 Camera—Multiplexer Physical Setup

1. Assemble camera pedestal to base, and slide projector pedestal to its base.
2. Mount the Multiplexer assembly on the pedestal, and adjust by means of spirit-level indicator for leveling in both directions. Assure that *reflecting* surfaces of transparent mirrors are facing their respective movie projectors. This is determined by the "fingernail test." Place the fingernail against the surface. If the object and image meet, this is the reflecting surface which should face the movie projector. If a space exists between object and image, this is the back surface of the semi-mirror. Should this surface be erroneously mounted to face the movie projector, ghost images would appear in the picture.
3. Place movie projectors in front of their respective windows as given approximately in Fig. 7-2. **CAUTION: DO NOT BOLT DOWN AT THIS TIME.** With 2 inch projection lenses, the projector No. 1 film gate should be 14 inches from optical center of the multiplexer. Projector No. 2 (with 2 inch lens) should have its film gate 20 inches from optical center.* These

* For basic data in designing custom installations, see Multiplexer Data Sheet, TABLE 7-1. The "calculated throw" will be slightly longer than necessary in practice.

TABLE 7-1
Multiplexer Data Sheet

Necessary Focal Length of Projector Lens:

$$F = \frac{(D)(m)}{(m + 1)^2} \text{ (Approx. formula)}$$

Necessary Distance Between Film and Image for Given Focal Length:

$$D = \frac{(m + 1)^2}{m} \times F \text{ (Approx. formula)}$$

where,

F = Focal Length in Inches.

D = Distance from Film to Field Lens in Inches.

m = Magnification Required. (See Table below.)

Material for Proj.	Aperture Size (Inches)	Required Magnification for Vidicon Only	Required Magnification for 3 x 4 Pattern On Field Lens
16mm film	0.284 x 0.380	1.3	10.55 (Approx.)
35mm film	0.612 x 0.816	0.61	4.9 (Approx.)
2 x 2 slide	0.844 x 1.125	0.44	3.55 (Approx.)
4 x 5 opaque	3 x 4	0.125	1.0 (Approx.)

"Throw" of Typical Film Projectors to Place 3" x 4" Image on Field Lens.

Projector	Focal Length Lens	Calculated Throw (Approx.) From Film Gate to Field Lens
16mm film	2"	24"
16mm film	3"	36"
35mm film	4"	28.4"
35mm film	5"	35.5"
2 x 2 slide	5"	28.5"
2 x 2 slide	6"	34.2"
4 x 5 opaque	6"	24"

are the initial trial positions and may vary several inches due to tolerances in focal length of projection lenses.

4. This step is the start of the optical light path alignment. Two conditions must be satisfied: (1) the light pattern from each motion picture projector and from the slide projector must form a sharply defined 3×4 inch rectangle in the central area of the field lens, and (2) the camera must be focused on the real images in dead optical center to avoid distortions.

Trace a rectangle of 3 inches high by 4 inches wide on thin white paper. This dimension (3×4 inches) is the correct size of the light pattern to be obtained upon the field lens. Hold the paper with the rectangle tightly in front of the field lens. Adjust slide in base slot (slide to rear or to front) until size of light pattern is exactly that of the 3×4 rectangle. Check that the 3×4 light pattern falls in the exact center of field lens area when test pattern slide is focused. Tighten slide projector base bolt.

5. Turn on the shutter and projection lamp of one Movie Projector. Hold the paper with the traced rectangle over the cover window for that projector and adjust the projector horizontally and vertically until the light pattern falls in the center. Then remove cover.

Place the ruled paper on the field lens. Adjust the transparent mirror for that projector until the light pattern is in the center of the field lens. Adjust distance of the projector from side cover until light rectangle is the standard 3×4 inches on the field lens. Retouch position of the transparent mirror if necessary and tighten. Bolt the projector to floor in this position.

6. Repeat step 5 for other movie projector.

7. Position camera and interconnect to control unit in same manner as for other camera chains. (See Chapter 8 for example of interconnection.)

8. Use calibration pulse method of setting GAIN and TARGET adjustments. (Chapter 6.)

9. Critically position the camera so that the image on the field lens is obtained with sharpest resolution. It will be necessary to slightly readjust optical focus of all projectors since the image as seen by the camera has a focal plane in the center of the field lens rather than on one side as established by preceding paper test.

10. Tighten camera head and bolt pedestal to floor. Re-check all optical and electrical focus adjustments. Shading is caused by improper optical alignment which may be either projector placement or transparent mirror adjustment on movie projectors. All mirrors have slightly oversize mounting holes and friction washers so that mirrors may be rotated and slanted over a wide range. Position for elimination of all shading.

In connection with Vidicon shading, it should be understood that the light output of a photoconductive type pickup tube is directly proportional to the rate of scan. Therefore, *so long as the scanning waveform is linear*, no inherent shading takes place in the Vidicon. This eliminates need for electrical shading corrective controls. Any shading which is apparent in the film chain is caused by optical misalignment, providing the camera deflection circuits have been adjusted for linear sweeps.

7-3 Electrical Adjustments of Film Camera

The electrical adjustments of the film camera are identical to that outlined in Chapter 6 except that the calibration pulse method of setting TARGET voltage is more accurate. Also, since the light level will remain much more consistent with film (even though of varying density) the TARGET con-

trol may normally be left set after initial adjustment.

It is advisable, however, to obtain an average density slide and try lowering the TARGET control to obtain sharpest resolution on the test-pattern slide. **NOTE: NEVER TRY TO READJUST ELECTRICAL FOCUS DURING PROGRAMS.** This control must be adjusted for optimum resolution on test-chart signal. No readjustment should be necessary for many hours of operation. The same is not true for optical focus, since slides may have varying thicknesses of mount holders, and motion picture film is subject to slight curl or buckling which can change optical focus.

ALWAYS ASSURE THAT THE MULTIPLEXER COVER IS INSTALLED. Otherwise, the semi-mirror serving as the window for the projector nearest the camera is not in place. Since the opposite movie projector light passes through one semi-mirror in travel to the field lens, the

light from the nearest projector would be almost twice in intensity. This would necessitate complete readjustment of target voltage and video gain (as well as beam current) in switching between projectors. With the cover in place, light levels from all three projectors are balanced and no electrical readjustments are necessary.

Another type of multiplexer equalizes light intensity by using a high-efficiency reflection semi-mirror for the far projector and a lower-efficiency reflection semi-mirror for the near projector.

7-4 RCA Vidicon Film Chain

RCA Vidicon Film Camera Equipment is designed to meet the requirements of any size television station. The Vidicon camera itself may be mounted directly on either a 16 mm or 35 mm projector (Fig. 7-3) or integrated into an optical multiplexing system (Fig. 7-4). The Vidicon Cam-

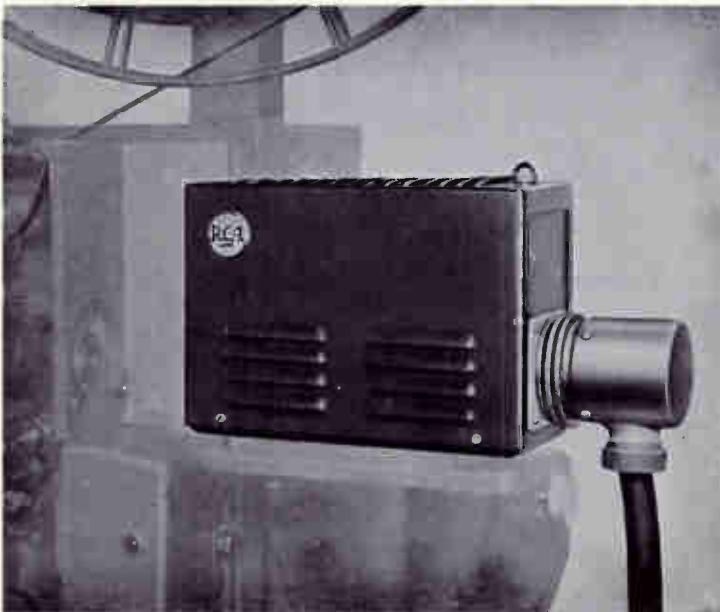

Fig. 7-3. Camera Mounted Directly On Projector. Courtesy of RCA.

era Chain consists of the camera connected by a standard 24 conductor camera cable to the camera control chassis and deflection chassis which may be located up to 200 feet from the camera.

All control circuits are rack mounted for better serviceability, ease of maintenance and performance checks, and to reduce the heat dissipated at the operating position. Only the remote control panel, which contains the operating circuits, is located in the console housing. This panel uses only DC control voltages and can be placed up to 200 feet from the camera control and deflection chassis. The control panel is designed to mount in the recessed portion of a standard RCA Console Housing associated with the TM-6B Master Monitor. The camera control and camera deflection chassis occupy only 31½ inches of rack space.

All tube circuitry for deflection of the Vidicon tube is located in the deflection chassis—none in the camera. Deflection voltage is generated in the rack-mounted deflection chassis and delivered to the camera via the camera cable. Because of its high frequency spectrum, horizontal deflection is carried through the camera cable on a coaxial line. Since the frequency spectrum of the vertical deflection circuit is much lower than that of the horizontal, vertical deflection is carried over unshielded leads in the camera cable.

Some video circuitry is located in the camera for adequate preamplification, high peaking, camera blanking, and a feedback pair for driving the video output coaxial line to the camera control unit. Although negative film is not recommended for best results, a polarity switch is located on the remote control panel so that negative film

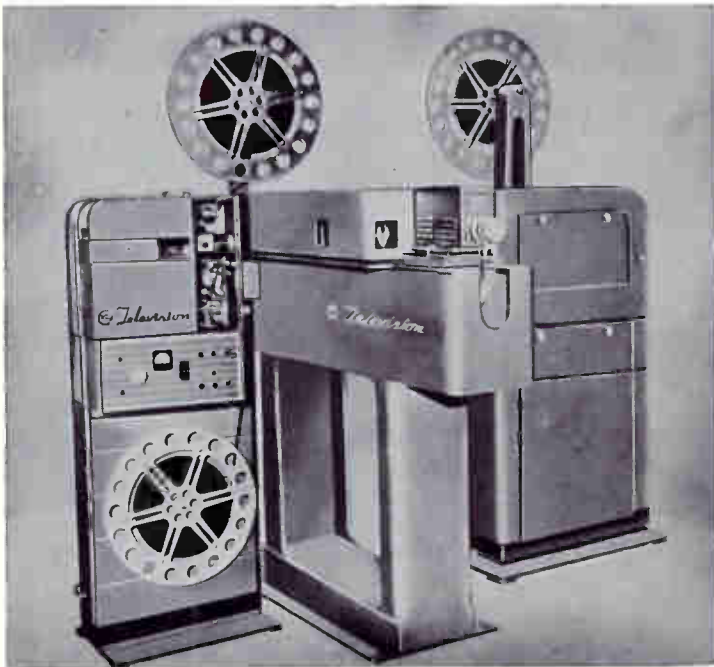

Fig. 7-4. The RCA Camera-Multiplexer Assembly. Courtesy of RCA.

can be used when the situation demands. In the camera control chassis, blanking is added, black level is set, aperture correction is introduced, and sync addition is provided if required. An output amplifier capable of driving three 75-ohm lines with sending and receiving end terminations is also included in the camera control chassis. For reasons of multiplexing, both horizontal and vertical deflection reversing switches are included.

The remote control panel contains these controls: PEDESTAL, GAIN, WALL FOCUS, SIGNAL ELECTRODE, BEAM, HORIZONTAL SIZE, HORIZONTAL CENTERING, VERTICAL SIZE, and VERTICAL CENTERING. A meter is used on the panel to monitor signal electrode voltage and beam current for the Vidicon. Zero adjustment is provided for this meter.

The Vidicon Multiplexer, Type TP-11 (Fig. 7-4), is designed as an integral part of RCA's Vidicon film reproduction system. It is used in the sys-

tem to enable a single Vidicon camera to handle signals from two 16 mm or 35 mm slide projectors, one 2×2 dual-disk projector, and a Telop opaque and slide projector. For compactness and extra convenience, the Vidicon camera mount and an adjustable 2×2 slide projector shelf are built into the unit. Precision optics maintain the "live" picture quality and "realism" of the Vidicon film reproduction.

The TP-11 Vidicon Multiplexer employs a pair of semi-mirrors for transmitting and reflecting the proper amount of light through the optical system onto the photoconductive surface of the Vidicon camera tube. The use of mirrors permits the permanent arrangement of the film equipment for maximum program efficiency. Either of the two movie projectors or the 2×2 slide projector may be switched on or off electrically while the mirrors remain in a fixed position. The opaque projector is accommodated by utilizing a remotely controlled moving mirror assembly. (See Fig. 7-5.)

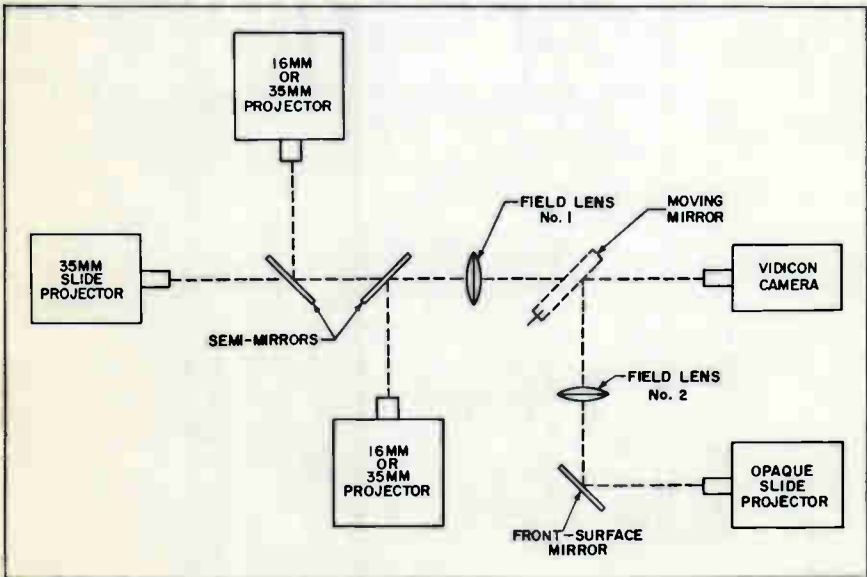

Fig. 7-5. Basic Arrangement of the RCA TP-11 Vidicon Multiplexer.

The equipment is mounted on a rigid pedestal which is provided with two adjustable supporting shelves for leveling the Vidicon camera and the slide projector. The semi-mirrors and field lens are mounted on an adjustable optical bench plate. The complete optical system is covered so that it is light-tight and dust-free.

7.5 The Long-Application Projector

A distinct advantage of the Vidicon camera for film telecasting over the Iconoscope type is that a projector with light-application time greater than 30% of the time for a single television field can be used. This eliminates the need for synchronization of film pulldown with the sync generator field rate, which is necessary in the "Ike" chain to flash the light onto the Iconoscope mosaic during blanking intervals only.

The 24 frames/sec film rate of the projector must still be converted to the 30 frame/sec rate of the TV system. Therefore, either the conventional 3-2 pulldown intermittent must be used, or a fast pulldown, 120-cycle shutter in the method described in the following.

It is recalled that standard theater projectors normally use a 48-cycle shutter such that each picture frame is projected (illuminated) twice. This is made compatible to the TV system

by projecting one frame 3 times, the next twice, the next 3 times, etc. Since the 24 frames/sec are scanned an average of 2½ times, $24 \times 2.5 = 60$ scanned fields/sec for the TV system. This requires the conventional 3-2 pulldown intermittent mentioned previously. In the Bell & Howell projector (shown in Fig. 7-1), the following method is used.

Fig. 7-6 illustrates the basic action of conversion.

Pull-down time = 0.00463 sec = 4,630 μsec.

1/60 sec. (1 TV field) = 16,660 μsec.

Light application pulse = 0.00277 sec = 2,770 μsec.

Two light pulses per field = $2 \times 2,770 = 5,540$ μsec.

5,540 μsec = 33% (approx.) of 1 television field.

The 120-cycle shutter produces 5 light pulses for each film frame, 4 per television frame, or two per television field. Note therefore that 1 film frame is equal to 2½ television fields, to obtain the necessary conversion from projected film rate to the television field rate.

7-6 Film Projector Remote Control

The film projector remote-control panel is mounted on the sloping portion of the Film Camera Control Con-

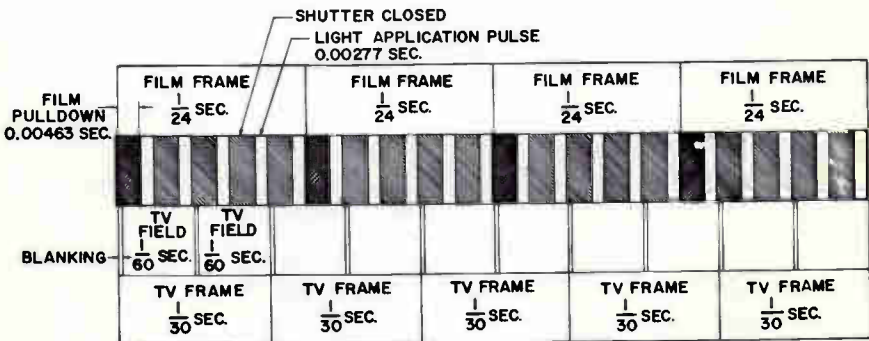

Fig. 7-6. Television Projector Time Cycle.

sole. (See Fig. 7-7.) Switches with appropriate indicator pilot lights enable the following operations:

1. Pilot light indication when projector is threaded and READY.
2. START of motor and projection lamp on either motion picture projector.
3. SHOW of either motion-picture projector after START of motor.
4. STOP of either motion-picture projector motor.
5. Automatic changeover from motion-picture projector No. 1 to motion-picture projector No. 2 (or vice-versa). This automatically "undouses" the chosen projector and "douses" the opposite projector.
6. SHOW or OFF for slide projector.
7. SLIDE CHANGE for slide projector.

The audio relay control may also be used if desired so that operation of

the projector SHOW switch automatically switches the sound output to the appropriate fader on the Audio Console.

Fig. 7-8 illustrates the units under control of this panel. Fig. 7-9 is a drawing of the control circuits discussed in the following.

When projector No. 1 is being threaded, the projector operator has the REMOTE switch in the OFF position at the projector. When threading is completed and ready to run, this switch is placed in the ON position, lighting the green READY light for projector No. 1 on the control panel. (Film Camera Control panel.) When the film video operator receives the director's cue to "Roll Projector No. 1" (or equivalent cue) he throws the lower-left toggle switch from STOP to RUN position. This starts the projector motor and projection lamp, and

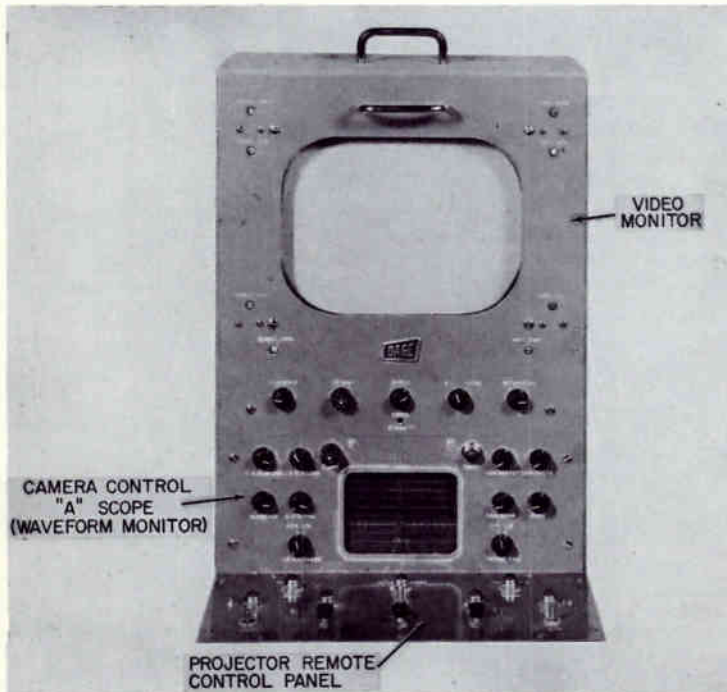

Fig. 7-7. Film Camera Control. Courtesy of Doge TV.

lights the amber light immediately above the STOP-RUN toggle switch. The sound and picture is synchronized within about 3 seconds. Usually 3 to 5 seconds elapse before the director's cue to "Take projector No. 1" (or equivalent cue) is given. Upon this cue, the film video operator punches (momentarily) the SHOW pushbutton for projector No. 1. This operates latching relay K1 which closes the circuit between terminals 12-13 on the rear panel terminal board to operate the audio changeover relay (where used); and energizes projector No. 1 pilot lamp (red) immediately above the SHOW switch. This pushbutton also operates one half of each electrical dowsers coil on that movement of the

solenoid-operated dowsers blade for No. 1 projector "undouses" or uncovers the lens; while the dowsers blade on projector No. 2 "douses" or covers that lens.

Operation for projector No. 2 is the same as that described for projector No. 1. Assume it is desired to change from No. 1 to No. 2 on a continuous show involving such changeover. The projector operator will have projector No. 2 threaded and the REMOTE switch thrown to ON position. When the first short series of "motor cue" marks appear at the upper-right corner of the film from projector No. 1, the director will give the cue "Roll projector 2" (or equivalent). The film video operator throws the projec-

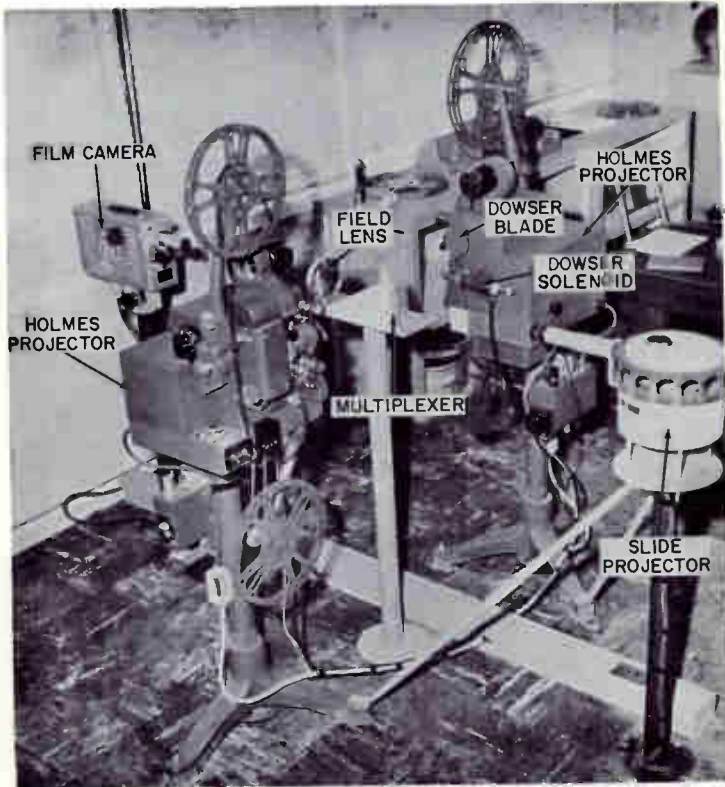

Fig. 7-8. Temporary Installation at CSL-TV, Azores.

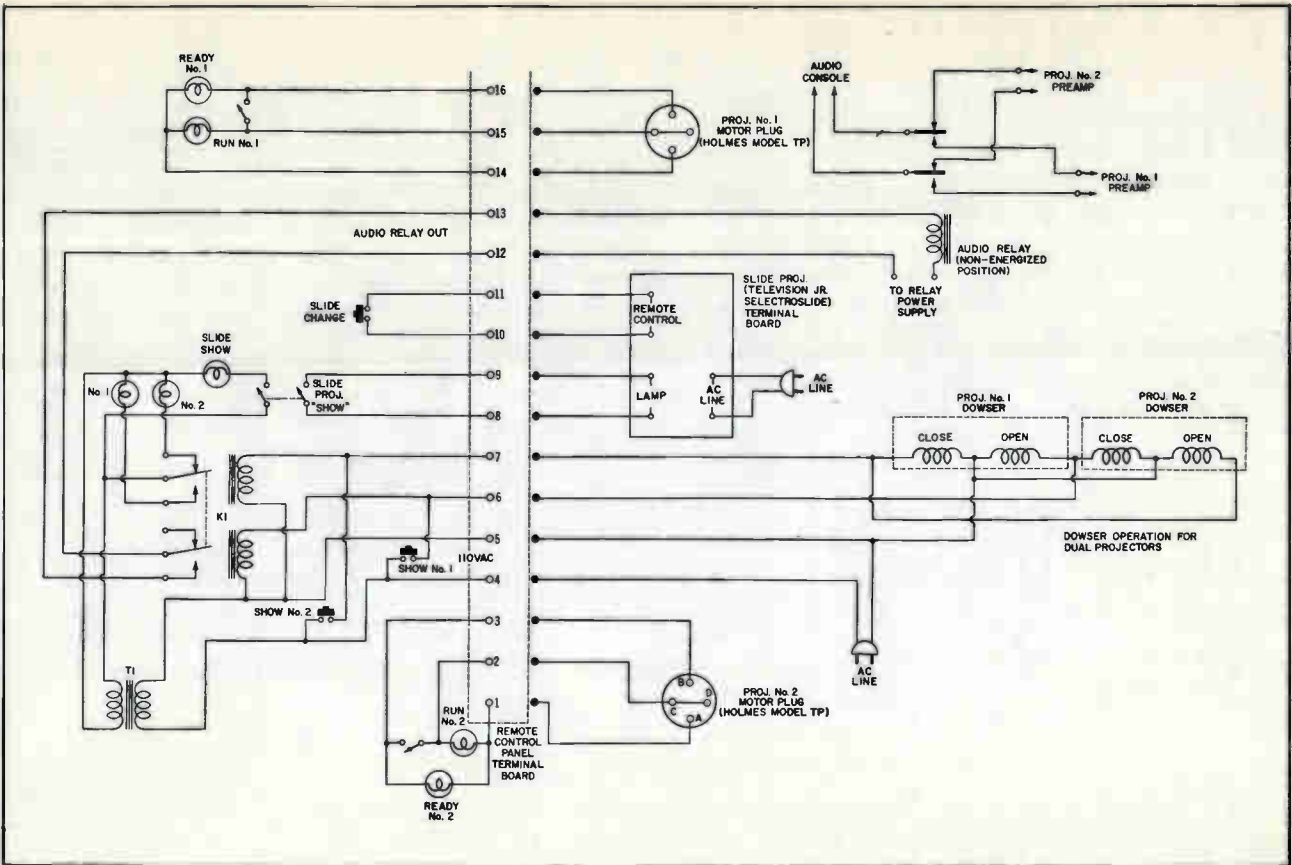

Fig. 7-9. Wiring Diagram of Remote Control for Two Projectors With Automatic Audio Switchover, and One Slide Projector.

tor No. 2 toggle switch from STOP to RUN position. When the second series of "changeover" cue marks appear on the film being projected, the director cues "Take projector 2." The film video operator punches the momentary contact SHOW pushbutton for projector No. 2. Operation is the same in principle as that described in the preceding paragraph. The video operator may then throw projector No. 1 toggle switch to STOP position, or the projector operator may throw projector No. 1 REMOTE switch to OFF position, and stop the projector from that position.

The slide-projector control and pilot lights are in the central portion of the Film Camera Control Console remote panel. The toggle switch in the center is OFF in the down position and is up in the SHOW position. Operation of this switch to SHOW position lights the slide projection lamp, and the red pilot lamp immediately above the slide projector OFF-SHOW toggle switch. To energize the slide-projector motor

which turns the drum containing the slides, the CHANGE pushbutton is momentarily depressed. This places the following slide into projection position. The drum rotates the space of one slide each time the CHANGE switch is depressed.

Operation of the toggle switch to OFF position opens the circuit to the projection lamp in the slide projector.

When it is desirable to use automatic audio changeover simultaneously with projector changeover, a double-pole, double-throw relay and suitable power supply is necessary. (See Fig. 7-9.) The relay power circuit is completed by the shorted terminals 12-13 under operation of the SHOW pushbutton for projector No. 1. Therefore, the No. 1 projector preamp output must be connected to the contacts made for relay OPERATE. Projector No. 2 audio output is connected to the contacts made when the relay is not energized. The audio-console input is tied to the common terminals of the relay.

Station Installations

There is no such thing as a "typical installation" for television-station studios and control rooms. Obviously, the equipment required varies over a considerable range depending upon the size and extent of the particular station activities and programming. Arrangement of operating consoles, racks, telecine equipment, and transmitter which influence interconnection runs, size of conduit, and the like are always influenced by size and arrangement of available space or design required in new buildings. Therefore, the discussion which follows must necessarily be broad in scope to allow ample flexibility of application. Particular layouts should be taken as "examples" rather than "typical."

8-1 *Basic Considerations in System Interconnections*

Fig. 8-1 illustrates an example of a system layout for one two-camera live studio, a telecine room, control room, patch panel, distribution amplifiers, and spare sync generator with a changeover switch. Rack-mounted equipment is identified by Fig. 8-2. Although not shown, camera-chain power supplies could be mounted in the bottom of racks 1 and 2. For the particular equipment discussed in previous chapters, one 800-ma regulated supply is necessary for each camera chain (camera, control unit, and monitor) and one for the Master Monitor-Switcher console. An example of video and audio control console placement is

shown by Fig. 8-3. These consoles normally face the window dividing the studio and control room.

From the diagram of Fig. 8-1, note that the output of the sync generator changeover switch goes directly to four of the distribution amplifiers (H drive, blanking, and sync pulses). The inputs are "looped through" by means of paralleled connectors on the rear of the DA's to the patch panel where normal system distribution is completed. The outputs of the DA's also appear at the patch panel to provide isolated outputs for test equipment use, external equipment of temporary nature, etc. This installation permits any desired use of the pulses without disturbing the normal operation of the system.

In this example, the fifth distribution amplifier (DA) has inputs and outputs on the video patch panel to use as video distribution when desired.

The driving and blanking lines loop-through the camera controls and are terminated at the film-camera control in this instance. The lines are always terminated in 75 ohms at the point farthest from the distribution source. The H and V drive pulses are relayed via the camera cable to their respective cameras, and also to the video monitor for that camera so that non-composite camera signals (signals without sync) may be monitored. This places the monitors in a "driven" condition.

The composite-video output from the MONITOR OUT at the switcher feeds the monitor in the studio and the "on air" monitor in the telecine room.

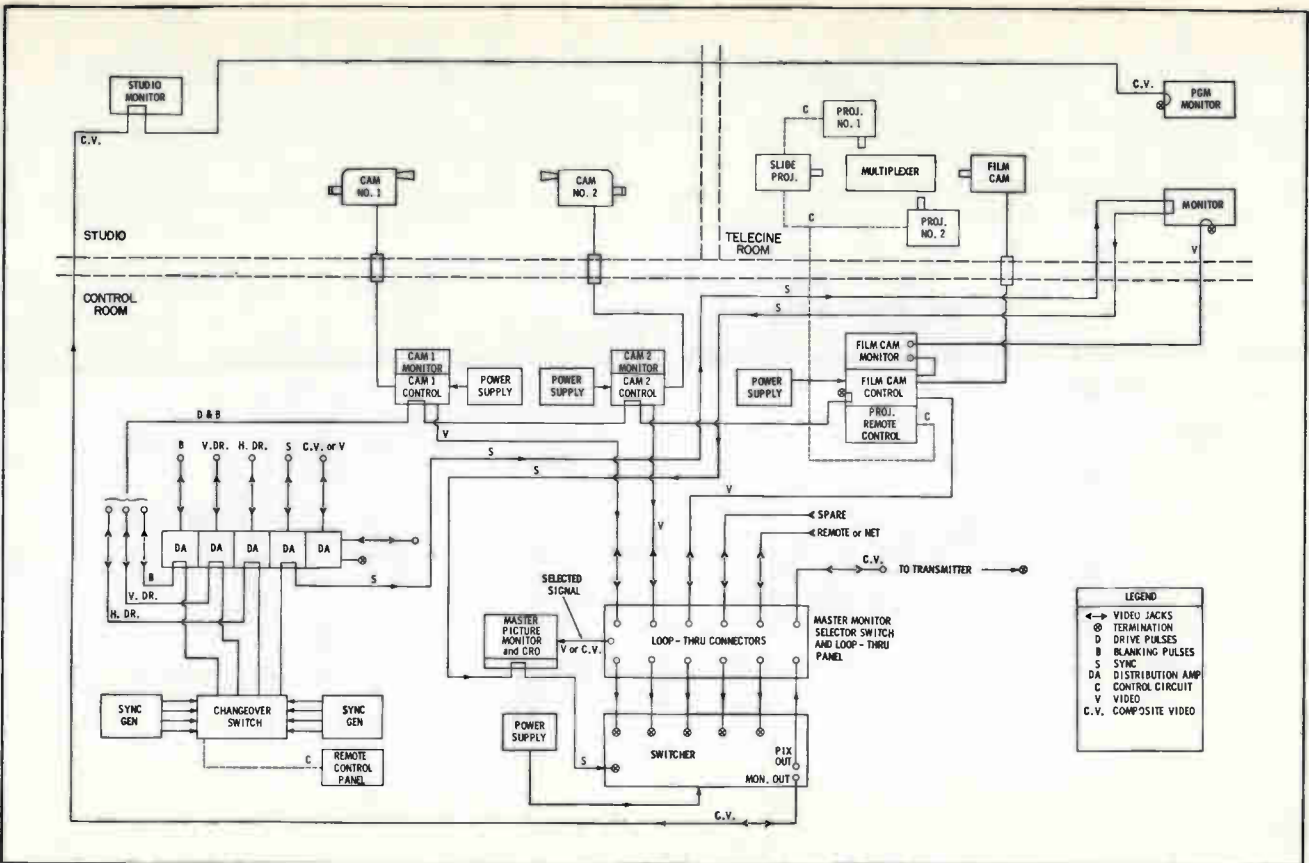

Fig. 8-1. An Example of a System Layout for a Studio, Control Room, and Telecine Room. 86 •

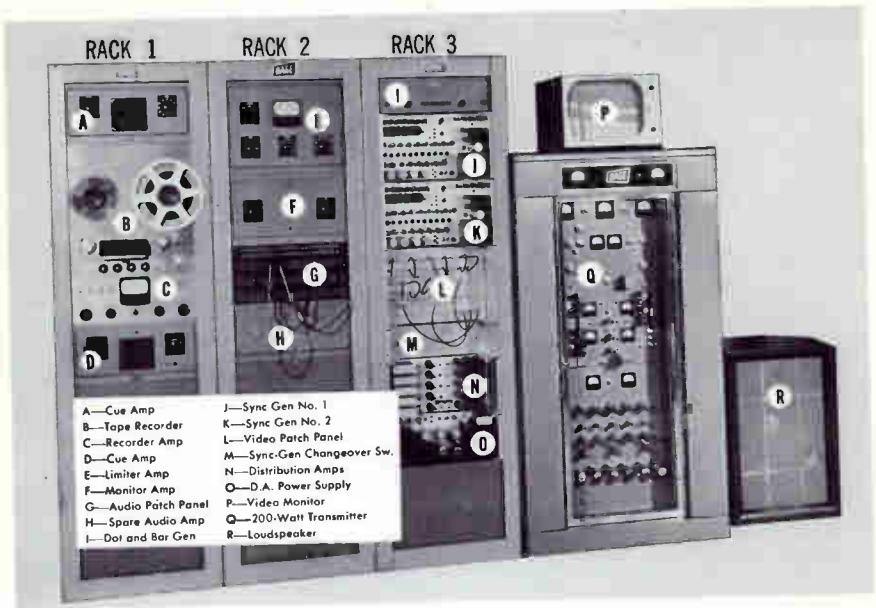

Fig. 8-2. Rack-Mounted Equipment.

When this room is separate from the control room, an additional monitor is needed for preview as shown. Since

this is a noncomposite signal, this monitor must be driven as in the case of the camera monitor. In Fig. 8-1,

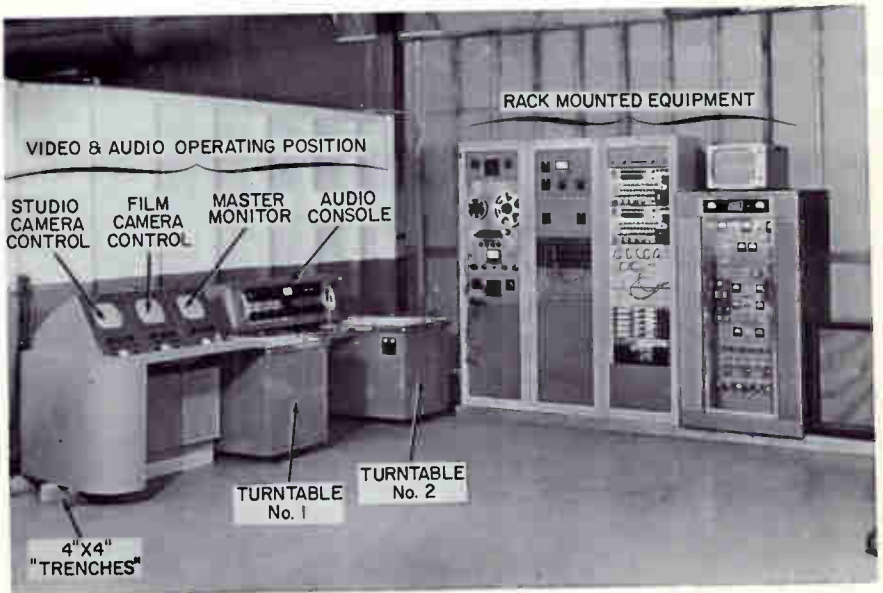

Fig. 8-3. Temporary "In-Plant" Training Setup at Dage TV.

composite sync is looped through this monitor on to the switcher where sync is inserted on the signal. The telecine preview monitor could obtain its sync from the output of the sync DA, providing an isolated feed. This would prevent inadvertent removal of transmitted sync if the monitor should be temporarily disconnected for any reason. Some monitors do not use sync for the driven condition, and require H and V drive pulses. In this case, the H and V drive cables would loop-through the film-camera control and terminate at the telecine room monitor. Again, it would be advisable to drive this monitor through the outputs of the DA's so that this line is isolated from the system drive. Since the video monitors on the camera control consoles are bridged across the H and V drive sig-

nals with short coax-cable runs, this problem does not prevail for camera monitors. The monitor receives the drive signals through a single interconnecting cable to the camera-control unit which also supplies power and video signals.

The video output of each camera control appears on the jack panel where it is normally patched through to the master monitor selector-switch panel, and looped-through to the switcher inputs. This provision enables a single camera chain to be patched directly to the transmitter line in case of switcher trouble, provided sync is inserted at the camera control. Many stations loop sync pulses through all camera controls (with SYNC GAIN turned OFF) for use in case of such emergencies.

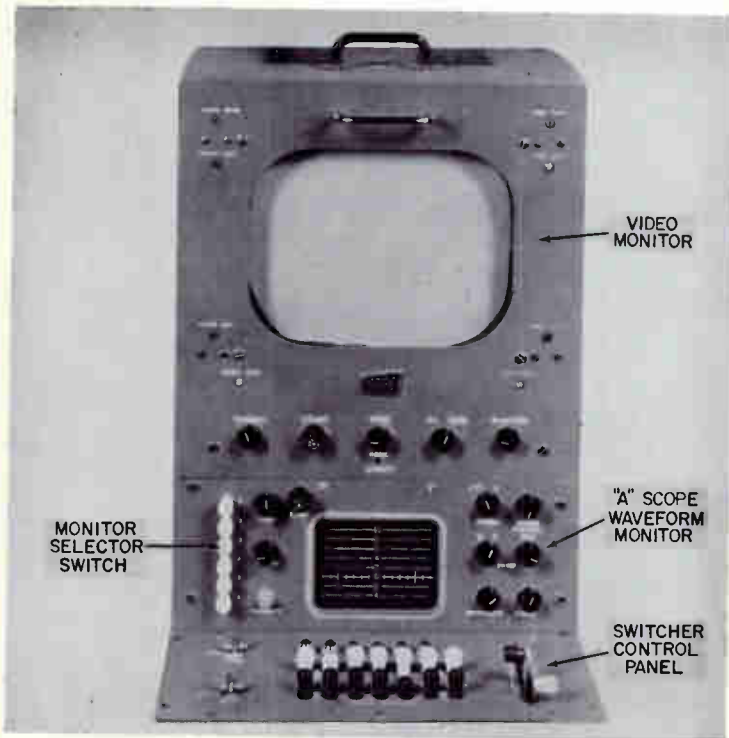

Fig. 8-4. Master Manitar and Switcher.

All incoming signals from the cameras, net or remote lines, may be previewed for correct level adjustments by the master-monitor selector switch. (See Fig. 8-4.) This feeds the signal both to the picture monitor and the waveform monitor. The six-pushbutton switch is normally connected for handling three noncomposite signals and three composite signals. When a pushbutton is depressed on a non-composite channel, sync is automatically inserted in the monitors. For composite signals, such as output of switcher (on-air signal) or incoming network signals, sync is automatically removed and a sync-stripper stage utilizes the sync from the signal for monitor sweeps.

There are several methods and differing philosophies of monitor feeds and interconnections. Ordinarily, camera control amplifiers, switcher amplifiers, stabilizing amplifiers, and some distribution amplifiers have two outputs; one for program video, and another for monitor feed. In some amplifiers, the monitor output is a separate output amplifier paralleled with the program output amplifier tube to provide isolation of the monitoring line from the program line. This permits maximum flexibility in that monitors may be changed, added to, or removed at any time without the danger of disturbing program circuits. Unless the monitor output, which employs a separate tube, has a provision for video level adjustment, this output cannot be used to feed the master-monitor selector switch where all levels are checked on the waveform monitor for proper amplitude. In this case, monitor outputs are used only to feed video monitors where absolute or calibrated signal levels are not necessary. The program video is then looped-through the master monitor and on to the switcher control. If the isolated monitor amplifier has provision for calibrating the monitor video level with that of the

program output, the monitor output may be used to feed the master monitor and all necessary video monitors.

Both of the foregoing methods have advantages and disadvantages. If the program output is being monitored, assurance is automatic that the signal is actually being sent to the transmitter line; but has the disadvantage that any disturbance on the extra looping-through path will upset the program signals. If the calibrated monitor output is feeding the master monitor, there is no assurance that the program output tube is delivering signal to the program line; but any disturbance or changes of the monitoring lines cannot upset the program signal. This method is more satisfactory, since the master monitor is most often viewing the switcher output, and the switcher amplifier is fed from the program output of each camera control. When any other button on the master-monitor selector switch is depressed, the purpose is only for preview of that picture source.

The latest trend in the solution of this problem is to design an output stage with such low internal impedance that several 75-ohm circuits are available for outputs. This design, usually incorporating inverse feedback, has an internal output impedance of 75 ohms, and two outputs may be isolated by the simple means of 75-ohm resistors. This provides a means of checking levels at the master monitor and general monitor feeds from a common program picture source, while retaining the advantage of an isolated monitor line. Also, the use of such simple passive circuit elements assures stability of waveform and picture information not influenced by vacuum-tube characteristics.

8-2 Interconnecting Runs

The dimensions of the rack mounted equipment illustrated in Fig. 8-2 are shown on the drawing of Fig. 8-5. An

example of a layout for a combined transmitter and control room is presented by Fig. 8-6.

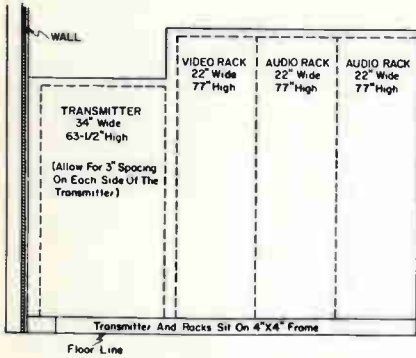

Fig. 8-5. Dimensions of Racks Illustrated in Fig. 8-2.

A very economical and entirely satisfactory method of providing raceways for interconnections is to use 4 inches x 4 inches wooden frames to support the racks and video control consoles. The same frames may be run along the walls as shown in Fig. 8-6 to serve as ducts or raceways for interconnecting cables. The ducts may be covered with plywood. When this type of installation is made, it is recommended that power cabling be run in an appropriate size conduit placed in

the ducts, with coaxial cables simply run alongside the conduit. All audio cables should be shielded, and grounded ONLY at the one common point for the particular rack housing the audio equipment.

The spacing between video controls and the studio wall is influenced by servicing accessibility of the particular equipment used. In the example of Fig. 8-6, eighteen inches is indicated as the distance from the wall to the video-control consoles. This is ample space for the type of console illustrated by Fig. 8-7 where all components may be reached from the front by chassis hinging arrangements. In this case, only sufficient space to enable the checking of cable connections at the rear of the chassis is required. The length of the frame is, of course, dependent upon the number of control units used.

In installations where conduit is to be installed, or existing conduit is to be used, see Conduit Capacity Data, Table 8-1.

8-3 Lighting for Pickup Areas

Excellent live telecasting is possible with the Vidicon camera only when

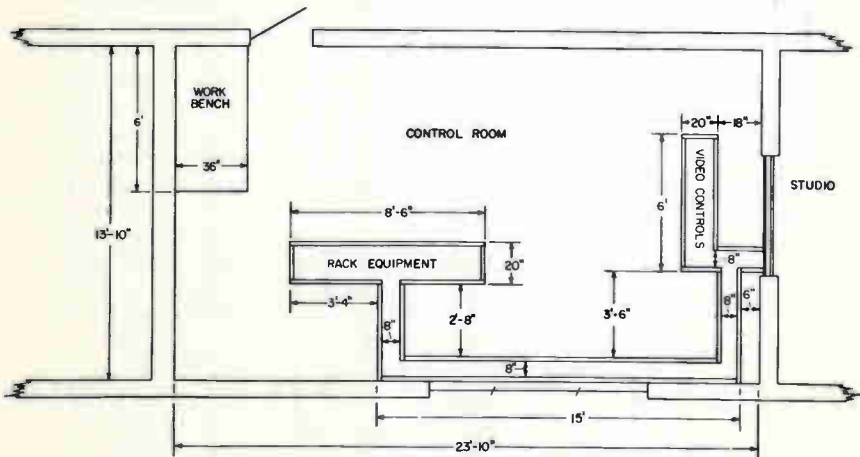

Fig. 8-6. Example of Control-Room Layout.

proper consideration is given to lighting the active pickup area of the studio.

To obtain from 150 to 200 ft./candles incident light on the pickup area with average distance between the subjects and the lighting source (small studios), it is necessary to figure approximately 50 watts of light source power per square foot of active pickup area. As an example, Fig. 8-8 illustrates two pickup areas and suggested lighting facilities.* Area, No. 1 contains approximately 110 sq. ft., and area No. 2 contains approximately 60 sq. ft.

Obviously, a single light source should not be used. To avoid shadow

* Note: The relative arrangement of fixtures shown is not necessarily optimum for all types of shows. The lights are arranged in practice for best picture balance.

effects, it is necessary to distribute the lighting with flood lights to supply tonal base lighting, and spot lights to accentuate or key the scene. For area No. 1, the total power from the six indicated light sources should be $110 \times 50 = 5,500$ watts. Note that with the following lamp sizes in the indicated fixtures, the total is 5,500 watts:

(A) 15" Baby Scoops	500W ea. = 1,000W
(B) 6" Spots	750W ea. = 1,500W
(C) 18" Scoops	1500W ea. = 3,000W
	Total = 5,500W

For area No. 2, the total power from the four indicated light sources should be $60 \times 50 = 3,000$ watts. Note that the following lamp sizes could be used in the fixtures to obtain the required lighting:

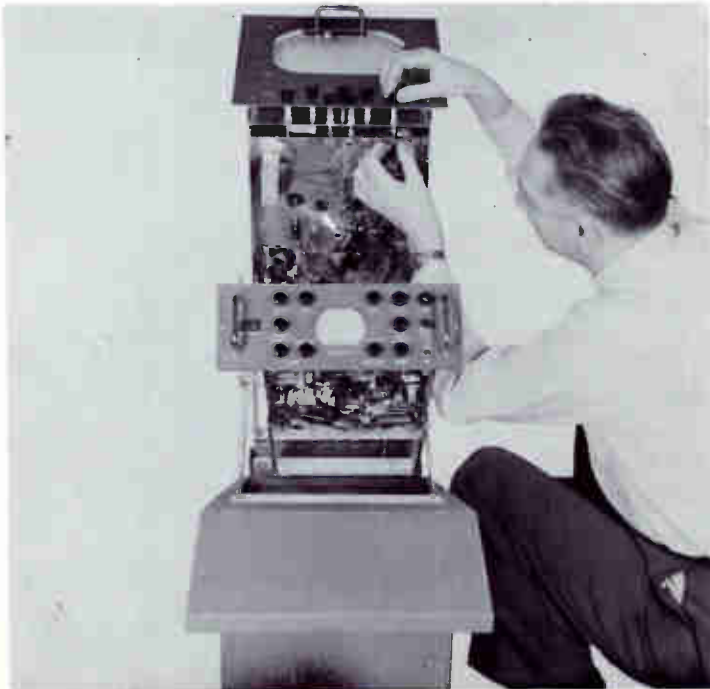

Fig. 8-7. Servicing Position of Camera-Control Console.

Low Power Telecasting

(B) 6" Spots 500W ea. = 1,000W
 (C) 18" Scoops 1000W ea. = 2,000W
 Total = 3,000W

The foregoing figures are based on the use of standard television lighting facilities as manufactured by Kliegl, Century, and others in the field.

In small studio pickup areas, as discussed in the foregoing, the lights are normally mounted on floor standards which may be moved into any position

desired. Larger studios often employ permanently-wired overhead fixtures in combination with floor fixtures as illustrated in Fig. 8-9.*

Branch circuit switches are normally separated into groups of 5 to 15 switches, with an output from each branch circuit made available by an in-

* For complete discussion of studio lighting techniques, see "Principles & Practices of Telecasting Operations," by Harold E. Ennes.

TABLE 8-1
 Conduit Capacity Data.

Trade Size (Inches)	Actual Ins. Diam. (Inches)	Cross. Sec. Area (Sq. In.)	40% Area* (Sq. In.)	Maximum per Conduit			
				RG11/U	RG49/U	Cam Cable	RTMA Mic. Cable
0.5	0.62	0.30	0.120	1	2	—	1
0.75	0.82	0.53	0.21	1	4	—	2
1.0	1.05	0.86	0.34	2	7	—	4
1.25	1.38	1.50	0.60	4	13	1	8
1.5	1.60	2.0	0.81	6	17	1	10
2.0	2.06	3.30	1.34	10	29	2	17
2.5	2.45	4.8	1.90	15	41	3	25

*"National Electrical Code" specifies only 40% of conduit can be occupied. Many local codes follow this ruling.

Video coax may be run in same conduit with shielded balanced pair (balanced to ground) audio circuits, where proper grounding procedures are followed. DO NOT RUN WITH UNSHIELDED AUDIO PAIRS, UNBALANCED AUDIO, OR POWER SUPPLY CABLES. In any case it is good engineering practice to run video in separate conduit where possible. VIDEO GROUND MAIN SHOULD BE SEPARATE FROM AC SYSTEM GROUND MAIN. Grounding bus is preferably copper with 0.1 ohm maximum resistance to main video system ground.

Cable Type	Minimum Radius for Conduit Bends	Actual Minimum Radius for Cable Bends
RG59/U	6 inches	2.5 inches
RG11/U	10 inches	4.0 inches
Camera Cable	12 inches	8.0 inches

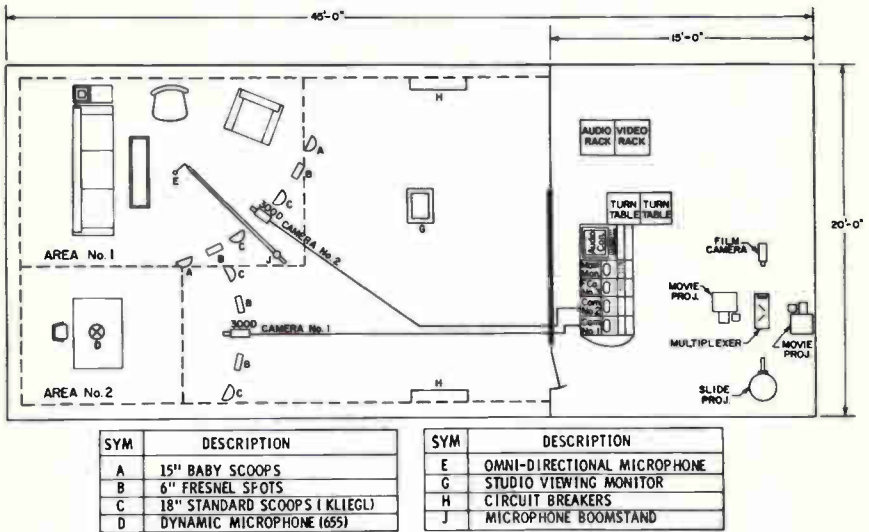

Fig. 8-8. Example of Studio Lighting.



Fig. 8-9. Studio View from Control Room at Northwestern University, Showing Mixture of Ceiling and Floor Lights.

dividual receptacle. Switches are normally silent-acting circuit breakers rated at 20 amps for small installations.

Lighting in the control room should be quite low for proper picture and waveform monitoring. A few stations have attempted to use bright lighting in the control room by installing hoods over the picture and waveform monitors. It is far better practice to keep the lighting subdued and employ small script lights where necessary to follow cue sheets.

8-4 Power Requirements

Considerable thought should be given by the installation engineer to the best division of equipment as to primary power supply, and to the required power service to be furnished by the local power company.

In the initial planning stages, it is helpful to tabulate the total value of primary equipment fuses. (It should be understood that the actual equipment load is under the fuse ratings.) Following is an example:

3 Camera Chains @ 10	
amps each	30 amps
1 Master Monitor & Switcher	
@ 10 amp.	10 amps
3 Racks @ 20 amps each	60 amps
Telecine Room Equipment ..	60 amps
Audio Console & Turntable ..	5 amps
Transmitter	30 amps
<hr/>	
Total for equipment (excluding lights)	195 amps

To meet the proper safety factor (maximum use of auxiliary AC outlets for test gear, etc., and to allow for future equipment additions) the equipment would be supplied by an order for a 300-amp service, or three 100-amp services. This means that the incoming primary line would be fused at 300 amps or 100 amps which, in turn, is divided into a number of separately

fused branch circuits for equipment feed. The service intended for equipment should always be separated from the service supplying offices, etc.

It is the usual practice to order 3-wire service with a grounded neutral. This is equivalent to two separate services as indicated by Fig. 8-10. This service would be adequate for the average low-power installation to handle all equipment and lights. An extra service for office equipment, air-conditioning, heating units, and the like is required.

8-5 Air Conditioning

Air conditioning for temperature and humidity in control room and studios is mandatory for most sections of the United States if optimum equipment performance is to be expected. Although the effect of temperature in individual components may be very small as the temperature increases, the accumulative effects over the average operating day can become quite noticeable. Such troubles as poor focus, drifting linearity, waveform instability, and loss of resolution can often be attributed to excessive temperature changes occurring after adjustment and alignment of camera chains.

It is a fundamental truth that if equipment areas and studio areas are maintained within reasonably comfortable temperatures for personnel, rack equipment and components within camera and monitor housings will remain within optimum operating temperatures. If the room temperature is held no higher than 80-degrees fahrenheit and humidity within the 40 to 45 per cent range, both personnel and equipment should operate efficiently.

Obviously, the required capacity of air conditioning depends upon the size of control rooms and studios, average seasonal temperature of the location,

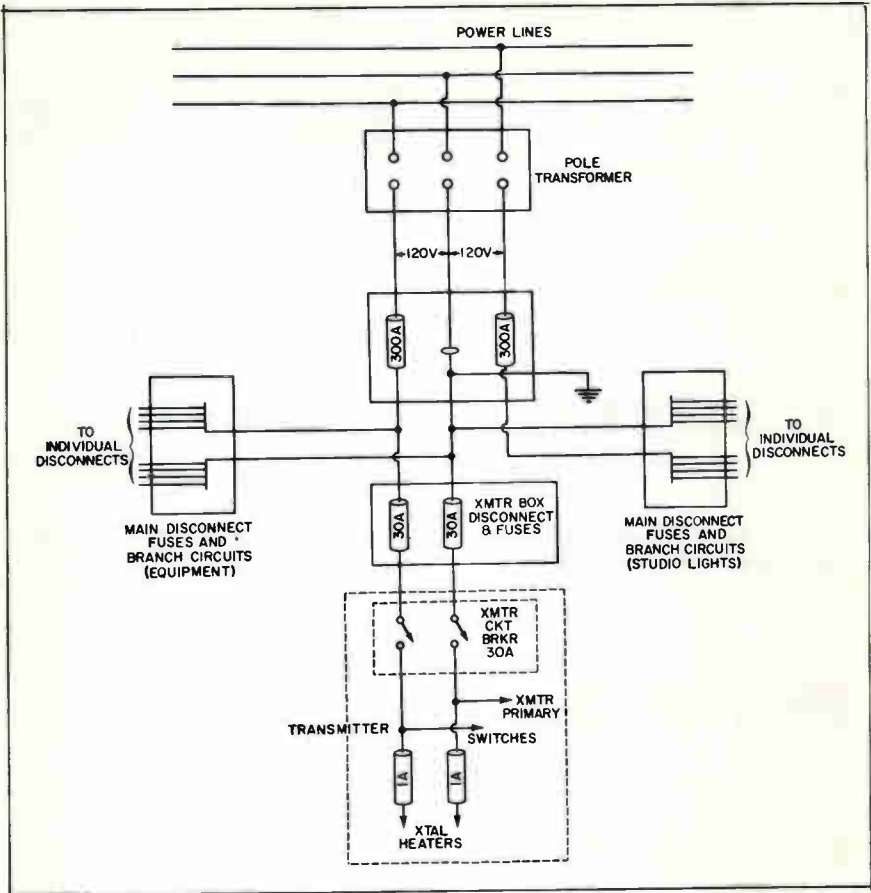

Fig. 8-10. Example of Power Distribution for Equipment and Lights.

and the amount of equipment and lighting installed. A competent air-conditioner engineer as close to the community as possible should be consulted. It is usually necessary to provide sound-isolation baffles in ducts and outlets of the air stream to prevent sound leakage from control room to studio and between studios, and to prevent whistles, noise, etc., caused by the forced air movement. This is more of a problem in television than regular aural broadcasting since TV mike techniques require greater mike-to-performer distances than the more in-

timated techniques used in regular broadcasting.

Due to the comparatively high heat radiation of large regulated power supplies, sync generators (especially those employing magnetic binary dividers) should be mounted in a separate rack from the power supplies.

8-6 Wiring

Camera cables are normally obtained already attached to the appropriate connectors for the equipment. Standard length is 50 feet. Longer

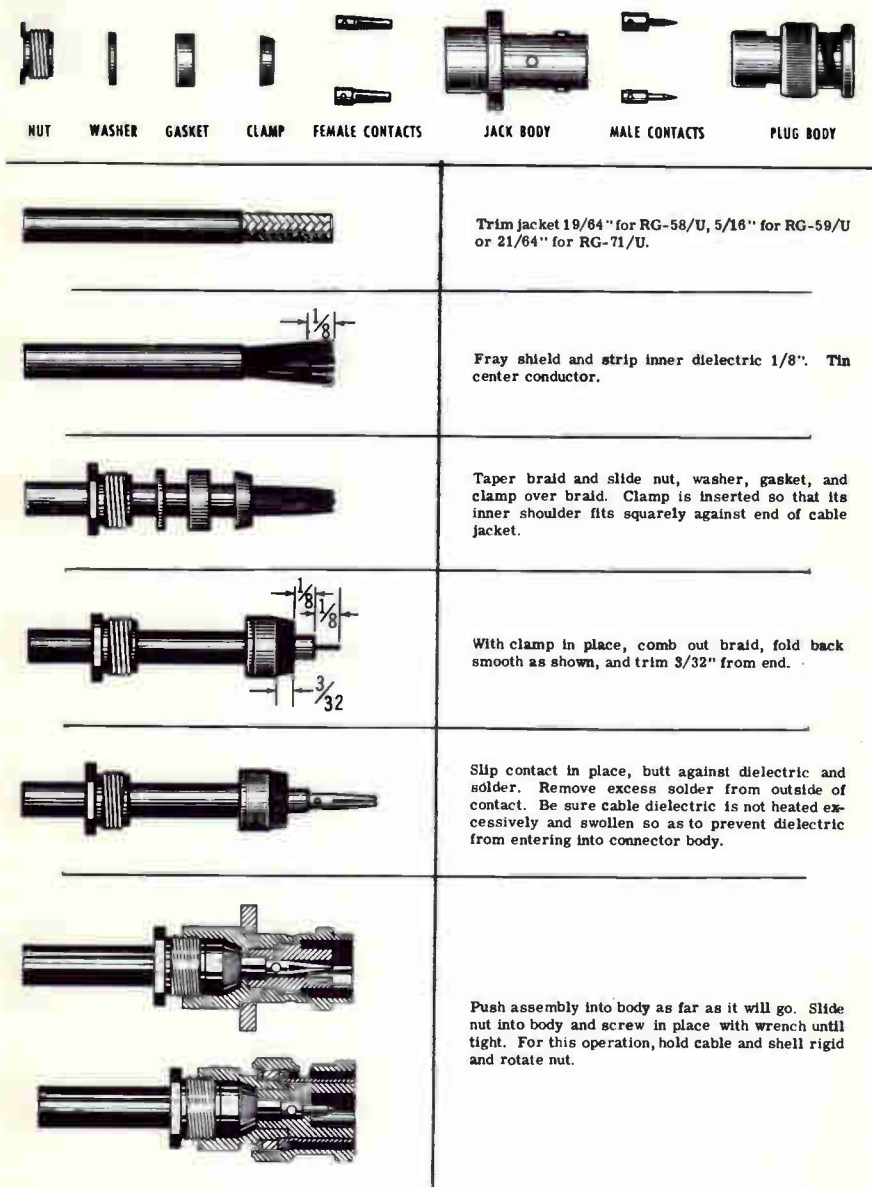

Fig. 8-11. Connector Assembly Instructions for RG-59/U Cable. Series BNC. Courtesy American Phenolic Corp.

ASSEMBLY OF CABLES TO 83-1SP PLUG

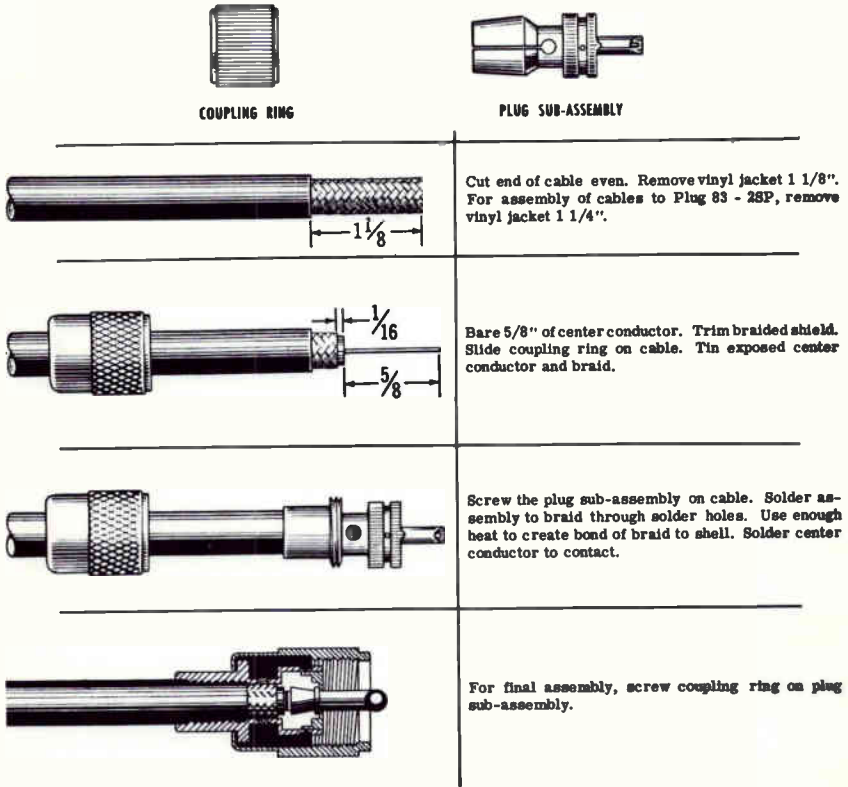

Fig. 8-12. Connector Assembly Instructions for RG-8/U Cable. Series UHF. Courtesy American Phenolic Corp.

lengths are obtainable or several 50-foot lengths may be connected together.

The small RG-59/U coax cable is adequate for interconnections within the average small station installation. Due to the attenuation and phase characteristics, however, runs over 75 feet should be made by the larger RG-8/U which has lower attenuation and better phase characteristics for long runs.

Figs. 8-11 and 8-12 illustrate assembly methods. The BNC type of connector is normally used for the RG-59/U, and the UHF type for the RG-

8/U. When other type connectors are required, the assembly instructions should be obtained and closely followed unless the technician is already familiar with this technique. Catalogues containing assembly instructions are obtainable from the American Phenolic Corp., Chicago 50, Illinois.

Video coax is obtainable in stock lengths with connectors already installed, or some manufacturers will supply custom lengths with connectors on special order. However, it is usually more economical and more accurate to run the coax the exact length required for each run, then install the connec-

Low Power Telecasting

tors. This eliminates excess length of cable and results in a neat installation. Spare cables of varying lengths with connectors installed should be kept on hand for emergency use.

The proper procedure for carrying the ground point throughout the system is indicated in Fig. 8-13. Note that each unit is provided with a common ground point. This ground point is carried to the system main ground as shown. Even though rack-mounted equipment has ground return made to the chassis, the *insulated* ground wire should be carried throughout the cables from the unit ground. All grounding wires or cables should be insulated to avoid chance grounds that result in "ground loops." The common unit ground to which all unit grounds are connected may be a heavy copper bus

with appropriate securing bolts for wires and cables. **THESE CONNECTIONS SHOULD, IN ADDITION, BE SOLDERED TO THE BUS,** to prevent high electrical resistance from developing. The grounding wires from individual units should be large enough that no more than 0.1 ohms maximum DC resistance exists, and the longer run from the common unit ground to the main system ground should be of sufficient size that this run also has a maximum DC resistance of 0.1 ohm. A good main ground for the audio-video is obtained on the cold-water pipe just as it enters the building from the ground.

Note also the method of wiring the standard 3-wire mike cable to the microphone connectors. Remember it is the function of this insulated wire to

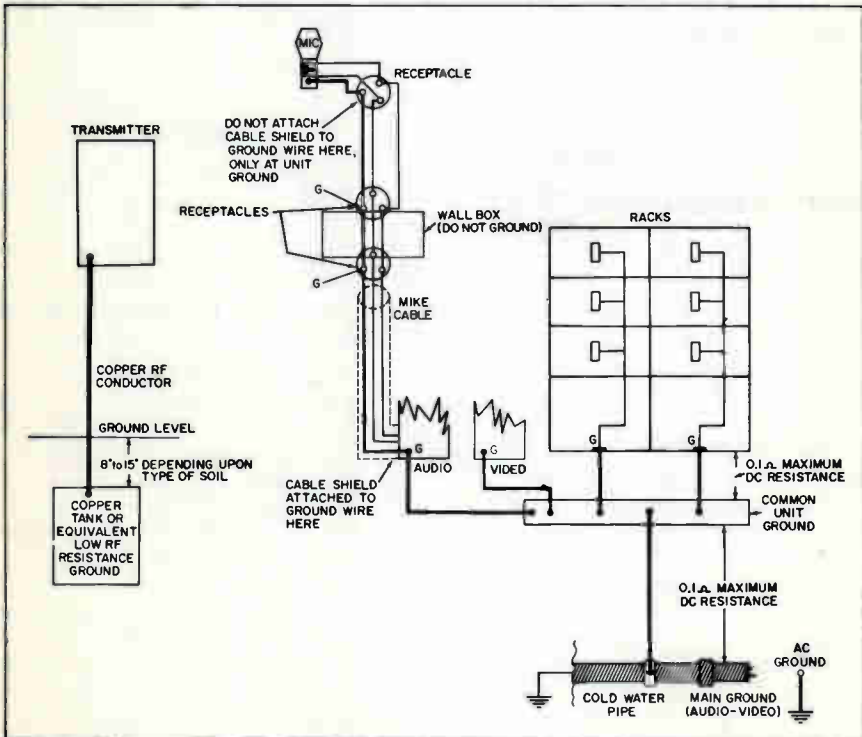

Fig. 8-13. Ideal Grounding Procedure.

CARRY THE GROUND TO THE MICROPHONE GROUND TERMINAL, with no intervening contact to ground between unit ground and the mike.

The audio-video ground should **ALWAYS** be separate from the AC service ground, and (ideally) from the transmitter RF ground. While it is entirely possible in many cases to use the main ground for RF and audio-video, occasional troubles are encountered such as spurious RF frequencies causing bars or interference patterns in the picture, audio hash, video instability, etc., seemingly unexplainable in practice. It is entirely practicable to first try using the same ground which is often adequate due to the relatively low power of the transmitter. In case troubles such as those mentioned previously are not remedied by conventional trouble shooting, it is advisable to eliminate all possibility of grounding troubles by following the procedure of Fig. 8-13. The RF ground lead should be a heavy conductor made up of large copper-stranded wire for lowest RF resistance.

If a copper tank is not readily available, a copper rod may be driven into the ground 10 to 12 feet as a substitute.

All wires and cables running to terminal boards should be secured by clamps to prevent the weight of cables from pulling against the terminals. It is advisable to solder spade lugs on the wire ends for securing to terminal boards instead of wrapping the wire itself under the screws.

8-7 *Treatment of Walls and Ceilings*

The walls and ceilings of TV studios must be deadened to sound wave reflection to minimize a hollowness in the sound from distant mike placement, and stray noises which are inevitable from camera movement and general stage "business." This may be accomplished simply by the use of perforated acoustical tile placed over heavy insulation board, for the ceiling and walls.

The same treatment is advisable for the control room and telecine room where this room is separated from the control room. This aids in preventing sound leakage between walls into the live studio pickup area. The loudspeakers may then be run at any desired level without interference.

In medium to large size studios, this treatment results in rather "dead" surroundings not compatible to good musical pickups. Portable hard "flats" should be placed around musicians or musical instruments to provide the required "liveness" for music, while retaining quiet sound control in the remaining pickup area.

In any studio that still exhibits too much sound reflection, further control may be acquired by use of heavy drapery around the pickup area.

The glass partition between control room and studio should be comprised of two glass plates at a slight angle to each other with dead airspace between. This provides the desired visual contact between studio and control room without acoustical linkage between the two.

APPENDIX

Extracts from FCC Report & Order on TV Allocations (Docket No. 11532)

At the time of this writing, a new FCC REPORT & ORDER ON TELEVISION ALLOCATIONS (Docket No. 11532) is being considered. Three main points are involved:

1. Recommendation that all, or a large part of, United States television service be shifted to UHF frequencies.
2. Increase of maximum ERP for UHF stations from 1,000 kw to 5,000 kw. (From 30 dbk to 37 dbk.)
3. New figures for estimating coverage. Depending upon spacing between transmitters, Grade B coverage may be limited by noise only, or by interfering signal(s) from co-channel station(s). The dbu required for Grade B coverage has been considerably lowered in light of advances in the art which have taken place since the original Sixth Report & Order.

The graphs of Figs. A-1, A-2, and A-3 illustrate estimated Grade B contours (for 100, 300, and 500 watts ERP) under provisions of this new proposal. These graphs, as is the case for coverage estimates given previ-

ously in the text, consider coverage estimates in presence of noise only; not considering interference from a co-channel station with its transmitter sufficiently near to cause such interference. (See Table II.)

Following are extracts from the latest FCC proposal. Interested readers are urged to purchase the latest revised RULES GOVERNING RADIO BROADCAST SERVICES from the Government Printing Office, Wash-

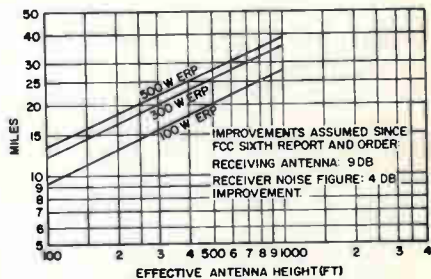

Fig. A-2. Approximate Limits, Grade B Service, in Presence of Noise Only for Channels 7-13 (44 dbu). Under New Proposal (Docket No. 11532).

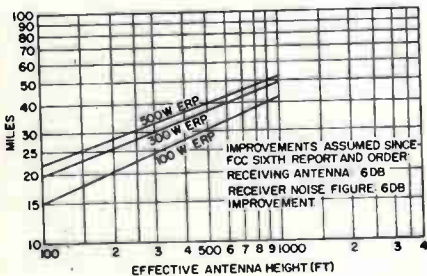

Fig. A-1. Approximate Limits, Grade B Service, in Presence of Noise Only for Channels 2-6 (35 dbu). Under New Proposal (Docket No. 11532).

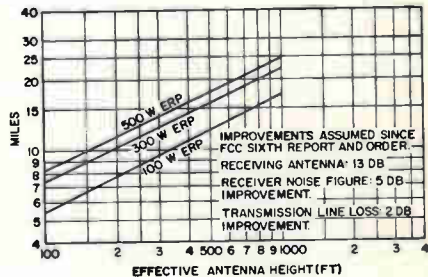

Fig. A-3. Approximate Limits, Grade B Service, in Presence of Noise Only for Channels 14-83 (53 dbu). Under New Proposal (Docket No. 11532).

ington 25, D.C., after obtaining current price information from that source.

The accompanying tables, which have been drawn up on the basis of new propagation data,* provide the basis for determining the Grade B service contours of television stations in the presence of noise and co-channel interference.

In order that rapid determinations may be reached, an abbreviated method is to be used in employing the tables. In constructing the tables it has been assumed that a contour which reflects the effect of each interfering station separately will approximate that derived from computing the simultaneous effect of several interfering signals since the interference from the nearest station will predominate.

The tables are based on new minimum local field intensities of 35, 44 and 53 dbu in the presence of noise for low VHF, high VHF and UHF, respectively, and on a maximum receiving antenna discrimination of 6 db for VHF and 13 db for UHF. These new figures are employed in light of experience and improvement in the art since the Sixth Report and Order. They represent the following changes from the values employed at the time of the Sixth Report and Order: A 6 db improvement in the receiver noise figure for low VHF, a 4 db improvement in the receiver noise figure and a 3 db improvement in the receiving antenna gain for high VHF, and a 5 db improvement in the receiver noise figure and a 2 db improvement in transmission line loss for UHF. Maximum power for VHF stations, 1,000 kw for UHF stations and 1,000-ft. transmitting antenna heights have been assumed in compiling the tables. All of the data underlying the tables are based on the foregoing assumptions

and on 90% service time probability.

Table I gives the distance of a television station's signal as limited by noise for 50% and 70% of the locations for the low band VHF, high band VHF and UHF in the presence of noise only.

TABLE I

Distance to Noise Limited Contour for Locations Indicated

	Low Vhf	High Vhf	Uhf
At 50% Locations	78 Miles	70 Miles	49 Miles
At 70% Locations	71 Miles	66 Miles	45 Miles

Table II gives the minimum spacing between co-channel stations in order that their Grade B contours will be limited by noise only. When stations are spaced at distances less than those indicated, their service areas will be limited by the resulting interference.

TABLE II

Minimum Spacing Required So That Grade B Service Contour Is Limited by Noise Only

	Low Vhf	High Vhf	Uhf
Offset	271 Miles	247 Miles	155 Miles
Non-Offset	364 Miles	326 Miles	239 Miles

TABLE III

Distance (d_1 in Miles) to Grade B Interference Free Service Contour in the Direction of an Interfering Station at Spacing Indicated

SPACING (Miles)	LOW VHF		HIGH VHF		UHF	
	Offset	Non-Offset	Offset	Non-Offset	Offset	Non-Offset
100	26.5		31.0		37.0	
110	30.0		34.0		40.5	
120	32.5		37.5		43.0	
130	35.5		40.0		45.0	
140	38.5		43.0		47.0	
150	41.0		46.0		48.0	
155					49.0	
160	44.0		48.5			
170	47.0		51.0			
180	50.0		53.5			
190	52.5		56.5			41.5
200	55.5	37.5	58.5	42.5		43.0
210	58.5	40.0	61.0	45.5		44.5
220	61.5	42.5	63.5	48.0		46.5
230	64.5	45.0	66.0	51.0		48.0
240	67.5	48.0	68.5	53.5		49.0
250	70.5	50.5	70.0	55.0		
260	74.0	53.0		57.0		
270	77.5	55.5		59.0		
280	78.0	57.5		61.0		
290		60.0		63.0		
300		62.0		65.0		
310		65.0		67.0		
320		67.0		69.0		
330		69.0		70.0		
340		72.0				
350		74.0				
360		77.0				
370		78.0				

* See "Present Knowledge of Propagation in the VHF and UHF TV Bands," W. C. Boese and H. Fine TRR 2.4.15., Nov. 15, 1955.

Table III gives the point, on a direct line between stations, at which Grade B service will be limited by co-channel interference on the basis of the single station method of computation.** Linear interpolations may be used for distances between those listed.

Table IV gives the radii of the interfering signals which reduce the 70%

** The figures in the table were computed by obtaining the point on a line between stations at which the desired field exceeds the undesired by the required ratio. This does not give the precise point at which Grade B service is limited since receiver noise factor is not considered. In dealing with stations in the low VHF band, it would be necessary to consider non-offset sta-

TABLE IV

Distance (d₂) From Undesired Station at Which Interfering Signal Will Reduce the 70% Location Noise Limitation of Desired Station to an Overall Grade B Limitation

	Low Vhf	High Vhf	Uhf
Offset	208 Miles	188 Miles	124 Miles
Non-Offset	307 Miles	274 Miles	210 Miles

noise limitation to an over-all limitation of 50%.

tions as far removed as 650 miles in order to take noise also into account. When using the simple method employed here for the spacings usually encountered the results may place the service contours from 1 to 4 miles beyond the actual figure that will be obtained if noise were also taken into account. Nevertheless, we believe the suggested method affords results of sufficient accuracy for present purposes.

Index

- A**
- Acoustics, 99
 - Air-conditioning, 94, 95
 - Air Force (U.S.) installations, 6
 - Allocations, (See FCC)
 - Angle of field, 45, 46, 69
 - Antenna
 - diplexer, 16, 19
 - cost, 3
 - effective height (transmitter), 12, 13
 - effective length (receiver), 8, 11, 12
 - field gain, 7, 10, 11-13
 - power gain, 20
 - transmission line, 7, 8, 9, 15-17
 - transmitter, 12, 17-22
 - Aperture correction, 51, 54, 55
 - Aural transmitter, (see Transmitter)
 - Automatic frequency control (AFC), 27, 28
- B**
- Balun, 19
 - Bazooka, 17, 19
- C**
- Camera, 51-70
 - adjustments, 62-70
 - aperture correction, 51, 54, 55
 - control console, 58-62
 - film, 71-79
 - focus (dynamic), 55, 56
 - focus (electrical), 51
 - focus (optical), 68, 69
 - gray-scale response, 64, 69
 - matching, 64
 - operation, 68-70
 - overscan, 51, 65, 66
 - peaking (amplifier), 51-55
 - phase correction, 51-54
 - sweep loss protection, 56
 - viewfinder, 57, 70
 - Camera Control, 58-70
 - adjustments (set up), 62-70
 - blanking level, 59
 - CRO monitor, 59
 - gain, 59
 - gamma, 61
 - sync, 59
 - target calibrate, 58, 59-62
 - transient correction, 60, 61
 - Clipper circuit, 60, 61
 - Coverage area, 1, 3, 6, 7-22, 101, 102
 - CSL-TV, 6
- D**
- DBU, 7-9
 - DKB, 7, 8
 - Dipole, standard, 10, 11
 - Diplexer, 16, 19
 - Directional coupler, (see Reflectometer)
 - Distribution amplifier, 85-87
 - Dousing, 81
- E**
- Educational TV, 3
 - Effective radiated power (ERP), 1, 9, 10, 101
- F**
- FCC,
 - allocations, 3-5
 - minimum power, 1, 13, 14
 - Field strength, 7, 8, 10-12, 13-15
 - free space, 10
 - Film,
 - audio changeover, 80, 82, 83
 - camera, 71-79
 - gamma, 43
 - optical multiplexer, 71-79
 - projector, 73-75, 79
 - Focal length, 45
 - Focus (dynamic), 55, 56
 - Focus (electrical), 51
 - Focus (optical), 68, 69
 - Frequency modulation, 4, 27-29
- G**
- Gamma,
 - amplifier, 61, 64, 69
 - film, 43
 - vidicon, 43
 - Grounds, 98, 99
 - Gray-scale response, 64, 69
- H**
- High frequency compensation, 51-55
 - Horizontal field (lens), 45, 46, 48
 - Hyperfocal distance (lens), 47, 48

I

- Illumination, studio, 90-94
- Installation (Station), 85-99
 - acoustical treatment, 99
 - air-conditioning, 94, 95
 - grounds, 98, 99
 - interconnection, 85-90
 - lighting, 90-94
 - power, 94
 - wiring, 95-99
- Interconnection, 85-90

J

- Jacks (video), 87, 88

L

- Lens, 45-49
 - angle of field, 46, 70
 - depth of field, 46-49
 - focal length, 45
 - horizontal field, 45, 46, 70
 - hyperfocal distance, 46-49
 - projector, 73
 - turret, 67, 68
 - vertical field, 46, 70
- Lighting, studio, 90-94

M

- Modulation, 29, 30
 - FM, 4, 27-29, 32
 - monitor, 85-89
- Multiplexer (optical), 71-79

O

- Operating (camera chain), 68-70
- Optical multiplexer (film), 71-79

P

- Patch panel (video), 85
- Phase correction, 51-54
- Pickup tube, see Vidicon
- Power (DBK), 7, 8
- Power requirements (station), 94
- Power supply,
 - camera chain, 85, 86, 94
 - transmitter, 24, 25, 35
- Projector, (see Film, projector)
 - audio changeover, 80, 83
 - dousing, 81
 - remote control, 79-83
 - slide, 72, 73

R

- Reflectometer, 30, 31
- Remote projector control, 79-83

S

- Satellite, 1
- Service area, 1, 3, 6, 7-22, 101, 102
- Slide projector, 72, 73
- Standards of good engineering practice, 1
- Studio acoustics, 99
- Studio lighting, 90-94
- Sweep loss protection, 56

T

- Terminations, 85, 88
- Transmitter,
 - AFC, 27, 28
 - aural modulator, 23, 27-29
 - cost, 3
 - power amplifier, 27, 34, 35
 - power definition, 9
 - power supply, 24, 25, 35
 - RF exciter, 25, 26, 34
 - stability, 23
- UHF, 34, 35
 - VHF, 23-34
 - visual modulator, 29, 30
- Transmission line, 7, 9, 15-17, 30, 31

U

- UHF, 3-5
 - receivers, 5
 - transmitter, 34, 35
- United States Air Force Installation, 6
- Usable picture area, 70

V

- Vertical field (lens), 46, 70
- Vidicon, 37-43
 - beam alignment, 64, 65
 - burn-in, 40
 - camera, 51-70
 - function, 37-39
 - gamma, 43
 - installation, 67, 68
 - persistance, 40
 - polarity, 39
 - sensitivity, 41-43
 - spectral response, 39, 40
 - target calibration, 58, 59-62
- Viewfinder, 57, 70
- Voltage standing wave ratio, (VSWR),
 - 18, 20, 30-33

W

- Wiring, 95-99

Y

- Yoke magnetization, 66, 67