

FIRST RADIO BOOK  
FOR BOYS

ALFRED MORGAN

# FIRST RADIO BOOK FOR BOYS

BY

ALFRED MORGAN



*Illustrated by the Author*

D. APPLETON-CENTURY COMPANY

INCORPORATED

New York

London

1941

1941 @  
illustrated  
& photos.  
incl a cup  
set, have  
radio &  
Model Co  
much stain  
18

COPYRIGHT, 1941, BY  
D. APPLETON-CENTURY COMPANY, INC.

All rights reserved. This book, or parts thereof, must not be reproduced in any form without permission of the publisher.

## *Preface*

EVERY year thousands of boys build their first radio set. They glean their information from magazines, pamphlets, and the direction sheets supplied with kits of parts. This is not easy. It would seem that no one has much interest in the rank beginner.

But here is a book describing in detail the construction of several radio receivers which are as simple as it is possible to make them and get good results from their operation. All this apparatus for which plans and instructions are given has been built by twelve-year-old boys. If you can solder and are a careful workman you too can build it. No attempt has been made to go into any great detail regarding the principles of radio. Principles have been explained only enough so that you will have some understanding of what you are doing.

If you wish to know more about the "why and wherefore" of radio and to have your questions about it answered, you should read the author's "Getting Acquainted with Radio," also published by D. Appleton-Century Company.

ALFRED MORGAN

## Contents

	PAGE
OFF THE RECORD . . . . .	1
CHAPTER	
I. AN EXPLANATION OF RADIO . . . . .	9
II. THINGS YOU SHOULD KNOW ABOUT ANTENNAE, GROUND CONNECTIONS, RADIO SYMBOLS, AND SOLDERING . . . . .	22
III. THINGS YOU SHOULD KNOW ABOUT THE PARTS USED TO BUILD RADIO APPARATUS . . . . .	37
IV. BUILDING YOUR FIRST RADIO SET . . . . .	65
V. MORE CRYSTAL DETECTORS AND CRYSTAL RE- CEIVERS . . . . .	76
VI. BUILDING YOUR FIRST RECEIVER WITH A VACUUM TUBE DETECTOR . . . . .	101
VII. HOW TO BUILD AMPLIFIERS . . . . .	114
VIII. BUILDING YOUR FIRST RECEIVER FOR 110 VOLTS .	125
IX. HOW TO BUILD A 2-TUBE A.C.-D.C. RECEIVER WITH SPEAKER . . . . .	145
X. RADIO LICENSES AND LEARNING TO TELEGRAPH .	154
XI. HOW TO BUILD A PHONOGRAPH OSCILLATOR AND USE A RADIO RECEIVER AS AN ELECTRIC PHONO- GRAPH . . . . .	171
INDEX . . . . .	189

## Photographs

No head-phones are necessary in order to hear signals with the 2-tube A.C.-D.C. receiver . . . . .	<i>frontispiece</i>
	FACING PAGE
Soldering plays an important part in the successful building of radio apparatus . . . . .	68
Begin your radio adventures by building a receiver with a crystal detector . . . . .	69
The selective crystal set is tuned with a variable condenser and a coupler . . . . .	98
With this one-tube receiver you can tune in broadcasting and amateur stations, short-wave police calls, ships at sea and airplane messages . . . . .	99
A one-stage audio-frequency amplifier . . . . .	140
The 2-tube A.C.-D.C. regenerative receiver . . . . .	140
Rear view of the 2-tube A.C.-D.C. receiver with speaker. . .	141

## Off the Record

MORE years ago than I care to remember, while I was still a boy in grammar-school, I became intensely interested in a new wonder, a scientific infant then known as wireless telegraphy. To be exact, it was in 1903. This was only two years after a young scientist named Guglielmo Marconi had astonished the world by sending telegraph signals across the Atlantic Ocean between Wales and Nova Scotia without any interconnecting wire or cable. My interest in the new art was awakened principally by reading articles about it in *The Scientific American*.

By reading and experimenting, I gleaned enough information to build my own wireless telegraph set. With two binding posts, two brass rods, a glass tube, and some filings from the edge of a dime, I made a "coherer." From an old electric door-bell I made a "tapper." An old telephone bell was changed into a sensitive "relay." These three instruments, properly connected and adjusted, composed the receiver. A telegraph key, a "jump-spark coil," and a spark gap made up the transmitter. The spark gap consisted of two pieces of brass rod with the ends separated about  $\frac{1}{32}$  of an inch. The "jump spark coil" was an old telephone induction coil which I fitted with an inter-

rupter and a condenser. It produced a short, hot spark which jumped about  $\frac{3}{8}$  of an inch, and was I proud of it! This may seem a collection of rough and crude apparatus, but it embodied the same principles utilized in some of the commercial equipment in use at that time.

The battery, too, was home-made. Four carbon rods and four zinc rods suspended in fruit jars containing a mixture of sulphuric acid, bichromate of potash and water, generated current for the coil. I had a great deal of trouble with my parents over this battery—wherever a drop of the terrific liquid contained in the jars fell on rug or clothing, it ate a hole. The coherer and spark coil were endured with suspicion, but the battery soon became a distinct social outcast.

However, my "wireless" was a success. It worked, and I was happy.

With it, I could send messages through space for 150 to 200 feet. Some people who saw this crude and mysterious apparatus in operation were intelligently interested. Others were amazed and skeptical. Some thought it a fake, and still others considered that I was quite "nutty" to fool with and believe in such a preposterous thing as telegraphing without wires.

You will find that there are still these four different kinds of people in the world.

Wireless telegraphy was developing rapidly in those days. Coherers were soon replaced by microphonic "de-

Just after the turn of the century when boys first began to tinker with "wireless" telegraphy, messages were received with a coherer. A coherer consisted of a few nickel and silver filings between two metal plugs enclosed in a glass tube. The rest of the apparatus comprised a tapper made from an old door-bell, a sensitive relay and a battery. The sketch shows the receiving equipment in a typical amateur wireless station in 1905.

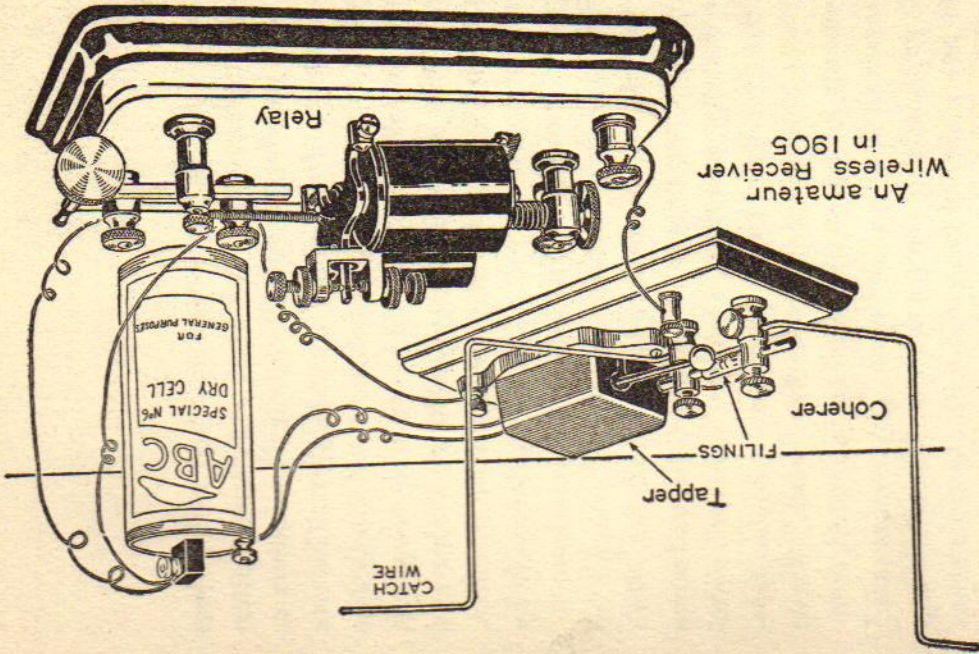

tectors" which employed a telephone receiver and were much more sensitive. So I built several kinds of microphonic detectors. I learned how to build an "electrolytic" detector during a visit to the wireless telegraph station, called PT, at the Brooklyn Navy Yard.

I hurried home from that visit and set to work. First, I rewound a telephone receiver with fine wire (No. 40 B.S.) to make it more sensitive, and built a "tuning coil" by winding some wire on a piece of wooden curtain pole. Then, with some nitric acid and Wollaston wire (silver-coated platinum wire .001 of an inch in diameter) purchased from Eimer and Amend, I built an electrolytic detector. This was accomplished by breaking a hole in an electric light bulb, poking out the filament and then partly filling the bulb with dilute nitric acid. A piece of Wollaston wire was attached to a fine screw and arranged so that the end dipped in the acid solution.

I was extremely happy when I found that I could receive signals from the Brooklyn Navy Yard at my home in Montclair, New Jersey, with this new equipment.

At that time boys actively interested in wireless telegraphy probably numbered less than a baker's dozen. They were scattered about the country but were destined to grow into that intrepid band called "hams" and "amateurs"—now nearly 100,000 strong.

I visited the Children's Museum in Brooklyn, where an unusual young woman, Miss Mary Day Lee, a mem-

ber of the Museum staff, not only encouraged boys to experiment with electricity and wireless telegraphy but actually was able to aid and assist them. My hat is still

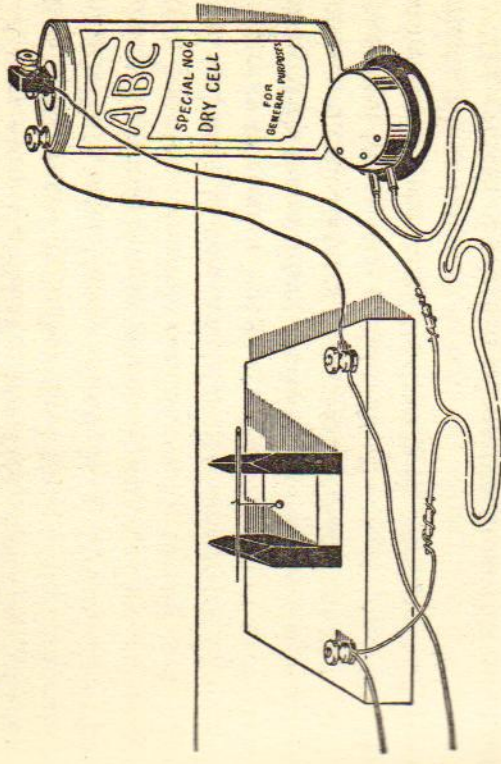

#### THE FIRST DETECTORS

The coherer of the early days of wireless telegraphy was soon superseded by various microphonic detectors. One form of microphonic detector once used by many amateurs consisted of a steel needle resting on the sharpened edges of two carbon blocks. This was connected in series with a battery and a telephone receiver. Observe the old-fashioned dry cell illustrated in the sketch above. Notice the carbon in the center of the cell is a flat plate and not the round rod used in the dry cells of to-day.

off to the young woman who could discuss with you the fine points of winding a spark coil. There at the Museum I also met Austen M. Curtiss and Lloyd Espenschied, boys of my own age and two of Brooklyn's four known "wireless amateurs" at that time.



Wireless telegraphy was growing and changing rapidly in those days. More and more ships were being equipped with apparatus and more land stations built.

There was a United Wireless Telegraph Company station at 42 Broadway in New York City, a Marconi station at Sea Gate, near Coney Island, N. Y. Crystal detectors using Carborundum or silicon replaced other less sensitive detectors. Variable condensers for tuning came into use and with all this, a new crop of amateurs, equipped not only to receive but to crash and splutter every evening with transmitters consisting of home-made spark coils and transformers that no one could tune out. Each one tried to see who could make the most noise. By this time there were many thousands of amateurs scattered about this country.

The growth of wireless telegraphy from this point on is a story too long to recite here. So we will skip to that time just before the World War when that marvelous device called the three-element vacuum tube was coming into wide use. Wireless had grown up. It had become radio.

But so had the amateurs grown up. Since the earliest days of wireless there had existed this earnest band of experimenters of varying capabilities. Some were amateurs in the sense that wireless to them was only a hobby. They were attracted by the novelty and interest of signaling to each other and cared little about scientific in-

vestigation. On the other hand, there were many who had a standard of knowledge equal to that of professional radio men.

During the war, the activities of the amateurs necessarily ceased. Many of them lent their knowledge and skill to their country. Some of the most able and proficient instructors and operators in the Army and Navy were ex-amateurs.

After the war, amateurs using very small power, by ingenuity, resource and perseverance, developed short-wave radio transmission and reception to such a degree that it proved to be a far more dependable method of long-distance communication than the long waves used by commercial companies. For many years, the professional radio engineer neglected short waves only to have it shown to him that there was an unknown set of phenomena of extreme usefulness at his very door and that it had been first found and developed by "amateurs."

All these years, while radio was growing up, so was I. I became a manufacturer of radio apparatus. I manufactured both amateur and commercial equipment, and apparatus for the United States Army and Navy. I pioneered in broadcasting. But all this time I still remained an amateur at heart, a "kid" with a spark coil and a crystal detector.

I have never lost a sense of awe for radio science or a fellow-feeling with the lad who likes to putter with an-

tennae and oscillators. There are many scientific and engineering books about radio. There are many books for young men who want to "get on the air" with a modern transmitter and communications receiver. But the lad who is a rank beginner, who wishes to build a crystal receiver and a one- or two-tube set has been neglected. It is for him that I have written this book.

enough energy to operate a speaker. This is true of both crystal and vacuum tube detectors.

But by sending the energy supplied by a detector through the device called an amplifier the energy may be

## CHAPTER VII

### How to Build Amplifiers

AN AMPLIFIER is simpler to build than a radio receiver. You can assemble and wire a one-stage amplifier in an hour, and the parts will cost less than two dollars.

An amplifier will add greatly to the power and range of a crystal detector or a one-tube receiver. It will increase the strength of the sounds in the head-phones. Faint signals, too weak to be heard plainly, can be made quite audible with an amplifier.

Signals which are fairly strong can be so increased in volume that they can be heard with the head-phones lying on the table. Much of the time you can use a speaker in place of the phones.

The speaker which is part of most factory-built broadcast receivers makes it possible for a group of people to listen to the same receiving equipment simultaneously. In principle, a speaker is a large telephone receiver, large enough to produce sounds hundreds of times louder than those sent forth by a telephone receiver. A speaker requires a great deal more energy to operate than does a telephone receiver. A detector alone does not furnish

114

### PLAN ONE-TUBE AMPLIFIER

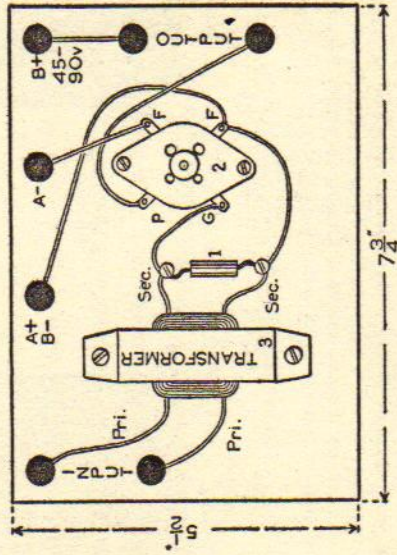

Use a type 30 tube with this amplifier. Sometimes the operation of the amplifier is improved if the secondary terminals of the transformer are reversed. Try changing the transformer terminal connected to socket terminal C from C to F and F from F to G. When you find which way is best, make the connections permanent.

amplified or increased so as to operate a speaker. The same sort of vacuum tube which is used as a detector may be used as an amplifier, but the most efficient amplifier tubes are especially made for that purpose.

## TWO KINDS OF AMPLIFIERS

It is possible to use two kinds of amplification to intensify radio signals. Both methods employ a vacuum tube. A *radio-frequency amplifier* amplifies the signals before

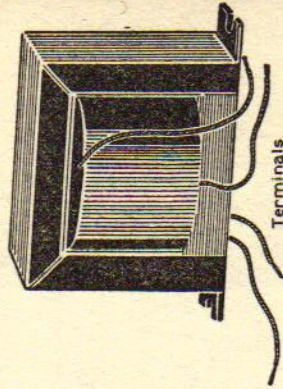
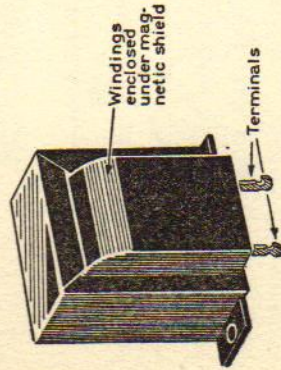

## AMPLIFYING TRANSFORMERS

An audio-frequency amplifying transformer consists of two windings: a primary winding and a secondary winding, wound on an iron core. The transformer may or may not be enclosed in a metal shield or case. The transformer at the left in the illustration above is shielded, that at the right is unshielded. Either type is satisfactory for building the amplifiers described in this book.

they are fed into the detector. An *audio-frequency amplifier* increases the energy after it has passed through the detector. Most radio receivers utilizing several tubes employ both kinds of amplifiers.

An audio-frequency amplifier increases currents whose frequency is low enough so that they produce sounds capable of being heard by the human ear. Radio-frequency amplifiers increase currents whose frequency is too high

to produce sound that can be heard by the human ear. Audio-frequency amplifiers are used in other fields besides radio. They are employed on long-distance telephone lines; in making phonograph recordings; in talking moving pictures, television, electrical stethoscopes; and for a number of other purposes.

## HOW TO BUILD

## A ONE-STAGE AUDIO-FREQUENCY AMPLIFIER

A one-stage audio-frequency amplifier is easiest to build. If its input terminals are connected to the phone

## PICTORIAL CIRCUIT FOR ONE-TUBE AMPLIFIER

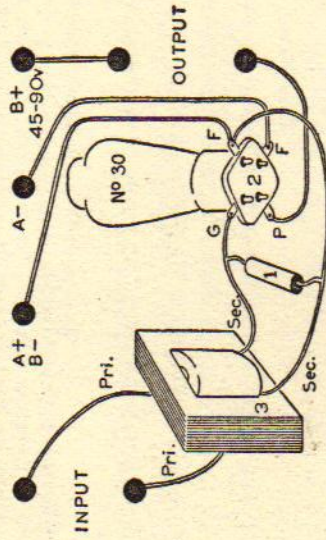

It is a simple matter to build and wire a one-tube, or single-stage amplifier. When connected to a single-tube receiver, the amplifier will greatly increase the strength of the signals.

posts of any of the crystal detector receivers described in Chapters IV and V or the one-tube regenerative receiver described in Chapter VI you will be amazed and pleased

## SCHEMATIC CIRCUIT FOR ONE-TUBE AMPLIFIER

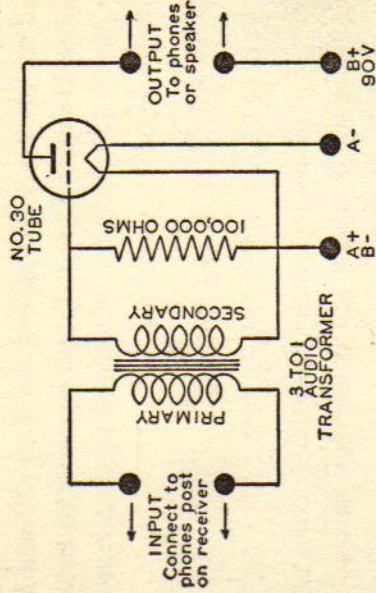

The input terminals of the amplifier should be connected to the output or phone binding posts on the receiver, thus replacing the phones. A pair of phones or a speaker is connected to the output terminals of the amplifier. A "B" battery of from 45 to 90 volts should be used on the amplifier. Ninety volts will produce louder signals than 45 volts.

by the increase produced in the strength of signals. In that way a crystal detector or a one-tube receiver can be made to operate a small speaker.

In order to build a one-stage amplifier the following parts are required:

- 1 Wood base,  $7\frac{3}{4}'' \times 5\frac{1}{2}'' \times \frac{3}{4}''$
- 1 100,000-ohm,  $\frac{1}{2}$ -watt resistor (1)
- 1 4-prong socket (2)
- 1 3 to 1 radio audio transformer (3)
- 1 No. 30 radio tube

Their total cost need not be more than \$1.75.

An audio-frequency transformer usually consists of an

iron core upon which is wound a primary coil of fine wire, and on top of this, a secondary of fine wire. Usually, there are from  $2\frac{1}{2}$  to  $3\frac{1}{2}$  times as many turns of wire in the secondary coil as there are in the primary. There are four

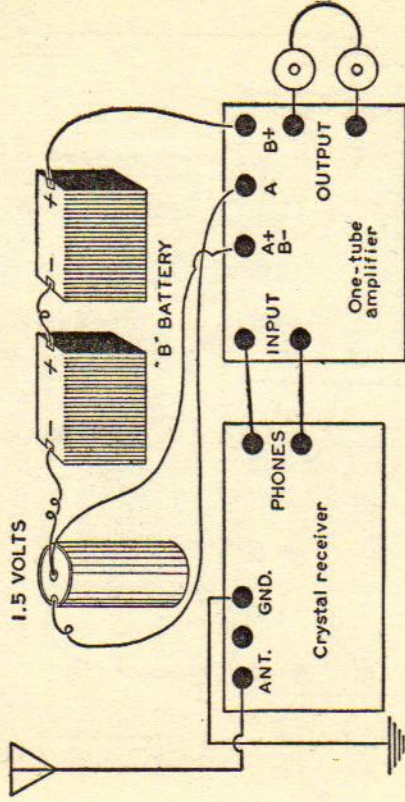

## HOW TO CONNECT A CRYSTAL RECEIVER TO AN AMPLIFIER

An amplifier will greatly increase the strength of the signals produced by a crystal detector. The pictorial circuit diagram above shows how to connect a crystal receiver to a one-tube amplifier. The batteries play no part in the operation of the crystal detector. Their energy is utilized solely by the amplifier.

terminals on the transformer. Two are primary terminals and two are secondary terminals.

The base upon which the parts are assembled should be a piece of dry white pine  $7\frac{3}{4}'' \times 5\frac{1}{2}'' \times \frac{3}{4}''$  which has been shellacked or varnished.

The parts should be mounted on the base as shown in the plan.

Wiring is simple. Consult both the schematic and the pictorial circuit diagrams. Use push-back wire and rosin-core solder.

The amplifier does not require any tuning or adjust-

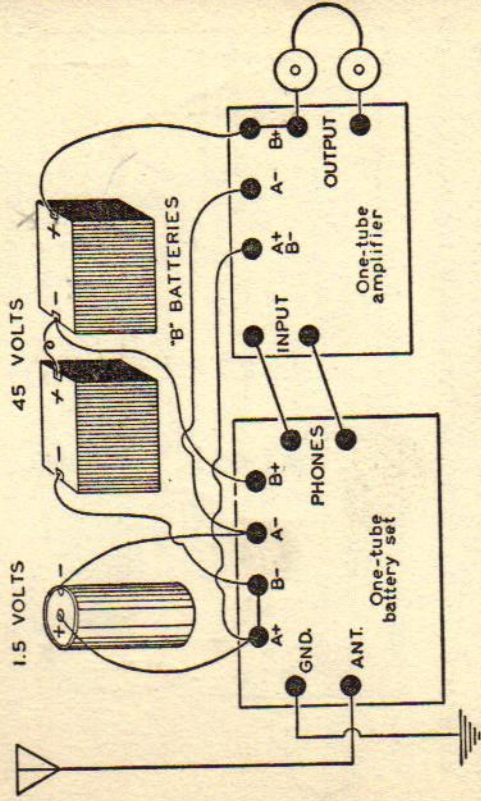

#### HOW TO CONNECT THE ONE-TUBE AMPLIFIER TO THE ONE-TUBE RECEIVER

The headphones are connected to the OUTPUT terminals of the amplifier. The INPUT terminals of the amplifier are connected to the PHONES terminals of the receiver. The same batteries provide current for both the receiver and the amplifier.

ment. Put a No. 30 radio vacuum tube in the socket, and it is ready to use. Current for the filament of the tube is supplied by a 1½-volt dry cell. The B current is furnished by two 22½-volt or one 45-volt B battery. It is necessary

for the positive and negative terminals of the B battery to be connected to the proper posts.

The circuit diagrams show how to connect the batteries to the amplifier and how to connect the amplifier to a crystal receiver and the one-tube battery-operated regenerative receiver. These show only the external connections and are known as "block" diagrams.

The output terminals of the amplifier may be connected to a pair of head-phones or to a small speaker of the permanent magnet type.

When the amplifier is not in use, disconnect the batteries.

#### HOW TO BUILD

#### A TWO-STAGE AUDIO-FREQUENCY AMPLIFIER

A two-stage amplifier amplifies much more than a one-stage. In a one-stage amplifier, the amplifying process takes place once. In a two-stage amplifier, it takes place twice. A faint signal, so weak as to be barely audible in the head-phones, can be strengthened by a two-stage amplifier so that it will come out of a speaker with good volume.

There are two methods of coupling an audio-frequency amplifier to a detector or to another amplifier. One method, called *resistance coupling*, uses a resistance unit. The other employs a transformer and is called *transformer*

PLAN FOR TWO-STAGE AUDIO-FREQUENCY AMPLIFIER

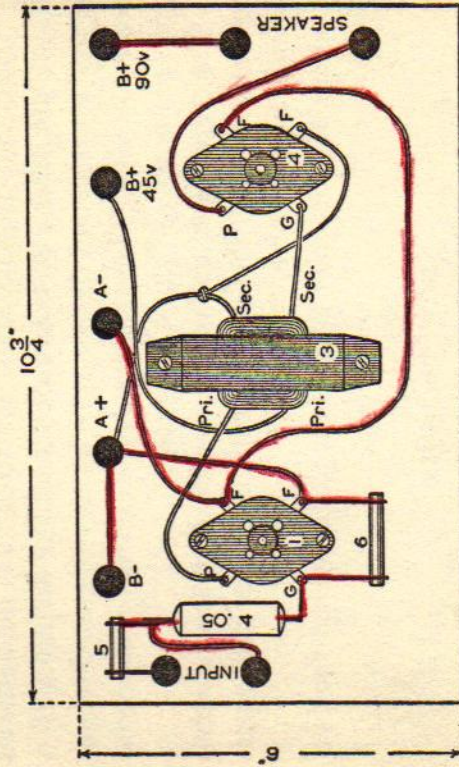

A two-stage amplifier will produce much louder signals than a one-stage. It will operate a loud speaker.

The two-stage amplifier shown in the above plan can be connected to any of the receivers described in this book and the head-phones replaced with a speaker.

The first stage of this amplifier does not utilize any transformer. It is coupled to the detector by the resistance marked 5. The second stage is transformer (3) coupled to the first stage.

*coupling.* The one-stage amplifier already described in this chapter utilizes transformer coupling.

The two-stage amplifier shown on this page uses resistance coupling in the first stage and transformer coupling in the second stage.

The following parts are required in order to assemble the amplifier:

- 1 Wood base 9" x 5 1/2" x 3/4"
- 2 No. 30 vacuum tubes
- 2 4-prong sockets for No. 30 tubes
- 1 Audio-frequency transformer (ratio 2 1/2 to 1 or 3 to 1)
- 1 .05 Mfd. tubular paper condenser
- 1 50,000-ohm 1/4-watt resistor
- 1 500,000-ohm 1/2-watt resistor
- 8 Binding posts or terminals

The wood base should be dry and should be given a coat of varnish or shellac. Arrange the parts on the base as shown in the plan. Connect with push-back wire. Solder

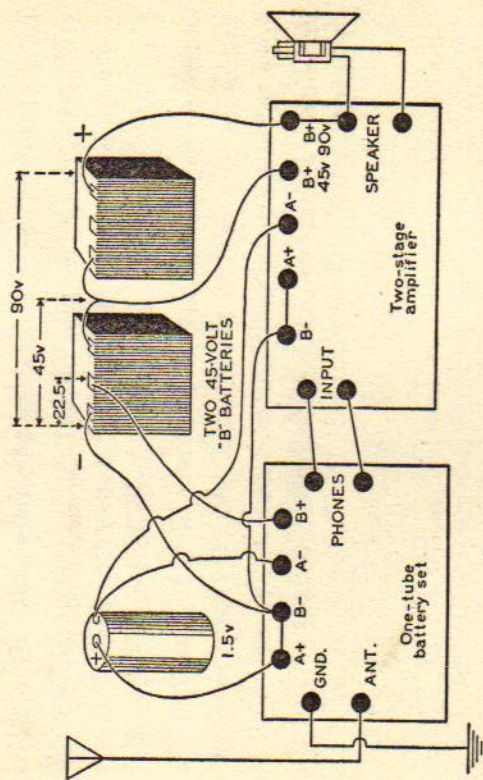

HOW TO CONNECT THE ONE-TUBE BATTERY SET TO THE TWO-STAGE AMPLIFIER

The same batteries supply current to both the receiver and the amplifier. One of the 45-volt B batteries is tapped so that 22 1/2 volts are supplied to the detector.

all connections with rosin-core solder. The circuit is simpler than that of a receiving set. Consult both the plan and the schematic circuit diagram, and check each connection with a pencil mark as the wire is put in place.

When the amplifier has been wired and checked, it is ready to use. Place a No. 30 tube in each of the sockets. Connect the input terminals on the amplifier to the terminals marked PHONES on the receiver. Connect a small permanent magnet-type speaker to the terminals marked SPEAKER.

In order to obtain full volume from the speaker it will be necessary to use a B battery of ninety volts. Four 22½-volt batteries or two 45-volt batteries connected in series will supply this voltage. The first stage requires only forty-five volts. The full voltage of ninety is used on the last stage. One of the diagrams shows how to connect the amplifier to a crystal receiver. A second diagram shows how to connect the amplifier to a one-tube receiver. The A battery furnishes current for both. So does one of the B batteries.



## CHAPTER VIII

### *Building Your First Receiver for 110 Volts*

BY FIRST building crystal receivers and battery-operated vacuum tube receivers, you gain valuable experience which will enable you to build 110-volt operated receivers without possibility of harm to radio parts or to yourself.

If you know something about electric currents and can connect the parts of a receiver by consulting a circuit diagram without making mistakes, you are ready to build a receiver operated from the 110-volt house current.

#### THE ONE-TUBE "CLOUD-HOPPER"

This is a dependable one-tube 110-volt operated short-wave receiver which can be built quickly and easily.

It requires no ground connection. Plug into the nearest 110-volt outlet, connect the antenna, and it is ready. Using the proper plug-in coils, you can tune in all the broadcast stations that you would ordinarily get on your regular home radio. A standard set of broadcast coils covers the broadcast band which extends from 550 to 1500 kilocycles or 545 to 175 meters. This section of the radio spectrum is set aside for regular commercial radio

broadcasting and chain programs in the United States.

With a set of short-wave coils, you can listen to another portion of the radio waves. The range from about 16 to about 217 meters is covered by four separate plug-in coils. With them you can tune in amateur stations in the United States and other countries, airplane and short-wave police calls, commercial radiophone transmission, ships at sea, and foreign short-wave stations.

It is not practical to receive waves shorter than 16 meters with the "Cloud Hopper"; a short-wave receiver built for short wave lengths is necessary.

The "Cloud-Hopper" uses a single No. 12A7 tube. The heaters of the tube may be lighted from the 110-volt current when used with a 360-ohm line cord resistor. The resistance built in the cord reduces the current to the proper value for the tube and no A battery is necessary.

A No. 12A7 is really two tubes in one. That is why it has so many prongs on the base (seven). In addition to the heater, cathode grid, screen grid and plate of a detector it includes the heater, cathode and plate of a rectifier. The rectifier portion of the tube rectifies or changes the 110-volt alternating current into direct current so that it can be used in place of a B battery.

To build the "Cloud-Hopper" you will need the parts and materials listed below.

- 1 Wood base 9" x 6 1/2" x 3/4"
- 1 Piece sheet metal, 8" x 6"

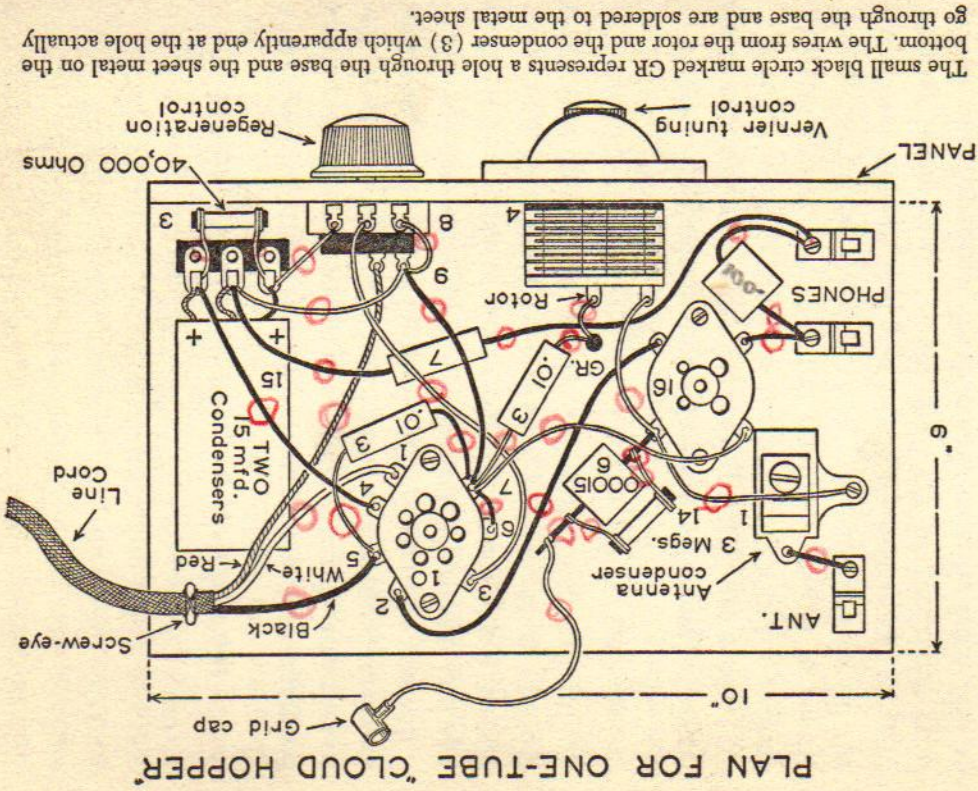

The small black circle marked GR represents a hole through the base and the sheet metal on the bottom. The wires from the rotor and the condenser (3) which apparently end at the hole actually go through the base and are soldered to the metal sheet.

- 1 Plywood panel, 9" x 5½" x ¼"
- 1 3-30 Mmfd. Trimmer Condenser (1)
- 1 4-prong socket (2)
- 3 .01 Mfd. 400-volt tubular paper condensers (3)
- 1 100 Mmfd. Variable Condenser (4)
- 1 Vernier dial (5)
- 1 .00015 Mfd. mica condenser (6)
- 1 .002 Mfd. mica condenser (7)
- 1 50,000-ohm volume control (8) and switch (9)
- 1 12A7 Radio tube (10)
- 1 7-prong type FF socket for 12A7 tube (11)
- 1 Grid cap (12)
- 1 40,000-ohm, ½-watt resistor (13)
- 1 3-megohm, ¼-watt resistor (14)
- 1 4-4 Mfd. 250-volt double section electrolytic condenser (15)
- 1 Set 4-prong broadcast coils (16)
- 1 Set 4-prong short-wave coils (16)
- 1 360-ohm line cord resistor (17)
- 3 Binding posts
- 1 .1 Mfd. 200-volt tubular condenser
- Screws, push-back wire, etc.

First make a wooden base, 9" x 6½" x ¾". Shellac or varnish the sides, ends, top and bottom so as to make it moisture-proof and prevent it from warping. Then attach an 8" x 6" metal sheet to the underside with several small wire nails. If you use a round-headed upholsterer's nail at each corner, they will raise the base so that the metal sheet will not scratch any table or desk that the receiver may rest upon. The metal sheet may be thin galvanized iron or sheet-tin. You can cut a piece from an old one-gallon

can or buy a piece at a plumbing shop. The metal sheet is necessary in order to provide a "ground" for the circuit. The variable tuning condenser and one of the fixed paper condensers are shown in the circuit diagram to have one

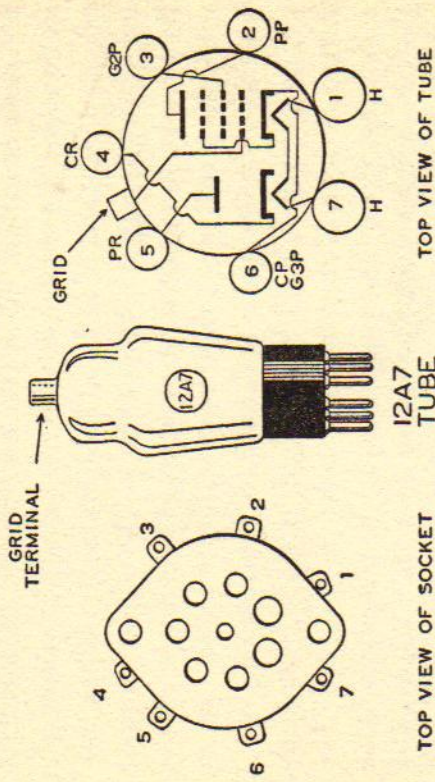

The 12A7 type of tube has seven prongs on its base. The grid terminal is a metal cap on the top of the tube. In order to establish connection with the grid terminal, a grid clip is necessary. This device is shown in another illustration.

terminal "grounded." This means that they are connected to the metal sheet on the underside of the base.

The various parts which make up the receiver, with the exception of the variable tuning condenser and the regeneration control, are mounted on the wooden base in the relative position shown in the plan.

The plywood panel should be shellacked or varnished on both sides and fastened to the front edge of the base.

The volume control, which serves as the regeneration control, and the tuning condenser are mounted on the back of the panel. The vernier dial and the regeneration control knob are on the front of the panel. The tuning is not close or critical when you are listening to broadcast stations and the condenser does not have to be accurately adjusted. Any sort of dial and knob will serve. When tuning short waves, it is a different story. The condenser must be accurately adjusted. A very small movement of the rotor plates will tune a short wave station in or out. Consequently a vernier dial is necessary for short waves.

The parts should all be fastened in place before any wiring is done. The wires are shown in the plan. The schematic circuit diagram should also be consulted. Make the connections with the utmost care. As each wire is soldered in place, check it on the diagram with a pencil so that none are overlooked. Follow the rule used in wiring all radio apparatus: use rosin-core solder.

In order to connect one terminal (the rotor) of the variable condenser and one terminal of the fixed condenser which are shown to be "grounded" in the schematic circuit diagram, drill two small holes through the base and the metal sheet. Slip a wire from the condenser through the hole and solder to the underside of the metal sheet. In the illustration showing the plan of the set, these wires are marked G where they pass through the holes in the set.

In the plan the terminals of the tube socket are numbered so that you can easily identify them with the schematic circuit diagram.

The grid on a No. 12A7 tube is connected to a terminal

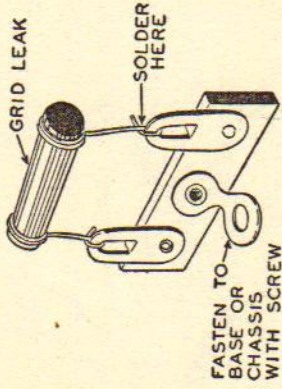

MOUNTING STRIP



GRID CLIP

Mounting strips are handy for supporting grid leaks, resistors and small condensers. A grid clip is necessary in order to make connection to tubes whose grid terminal is a grid cap.

on top of the bulb. You will need a grid "cap" which will fit this terminal. Solder a wire to the cap and make it long enough so that it will reach one terminal of the grid condenser and grid leak.

Eight terminals on a tube will make the circuit and the wiring appear very complicated to the novice. Actually it is simple. Work slowly and carefully, make certain each connection is properly made, and you will probably not have any trouble assembling the "Cloud-Hopper."

The line cord resistor is anchored by tying it to a screw eye in the base. There does not seem to be any standard

color code for marking the wires in line cord resistors. The cord which the author used in making the original model of the "Cloud-Hopper" consisted of a red, a white, and a black wire. The red wire contained the resistance. The

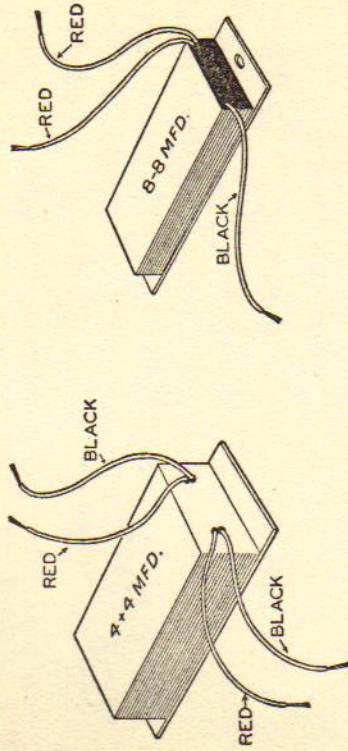

#### DRY ELECTROLYTIC CONDENSERS

Both these condensers are "double," that is, consist of two condensers within one case. Double condensers may have four terminals or three. Terminal wires are red and black. The red wire is positive and is sometimes marked positive or with a plus sign. All the circuit diagrams in this book are marked so as to show the positive terminal of the electrolytic condensers. A plus sign is used as the mark; when the condenser is connected in circuit the polarity must be observed.

red and the black wires were connected together at the plug.

When wiring the receiver, notice that the double-section 4-4 Mfd. electrolytic condenser has both red and black terminal wires. The red terminals are marked with a plus sign in the circuit diagram and on the plan.

When all connections have been made and checked, the receiver is ready for testing.

Place the No. 12A7 tube in its socket and slip the grid cap on the terminal at the top of the tube. Place a broad-casting plug-in coil in the four-prong socket. Connect the antenna to the antenna binding post and plug the line cord resistor into a 110-120-volt outlet. Connect a set of head-phones to the PHONES terminals.

Turn the regeneration control knob so that the switch is closed and the tube lights. Slip on the head-phones and turn the regeneration control still more to the right until, as the variable tuning condenser is rotated slowly, you hear a series of whistles and squeals in the phones. You may also have to adjust the antenna trimmer condenser slightly with a screw-driver in order to achieve this condition. The whistling can be cleared up and broadcasting signals brought in by a slight adjustment of the regeneration control and tuning condenser.

Failure of the set to operate, provided you are using a good tube, will probably be due to a mistake in wiring. If you can not produce any squeals or whistles in the phones, the set is not regenerating. Sometimes failure of the receiver to regenerate is due to a reversed winding on the tickler coil. If you are certain that failure of the receiver to regenerate is not due to any other cause, reverse the connections T and T on the coil socket.

Each time that one of the plug-in coils is changed, it will be necessary to readjust the antenna trimmer condenser.

When a whistling sound is produced in the phones, the detector is oscillating. The antenna condenser should be adjusted so that by turning the regeneration control, you can make the set whistle or oscillate at any point on the dial. Once the antenna condenser is adjusted properly, it should not be changed until a different coil is used.

Amateur phone stations come in best when the regeneration control is adjusted just below the point where whistles are heard. Telegraph signals come in best just above this point. Radio reception is much better at night than it is during daylight. Low-powered amateur stations sending out waves 10 to 42 meters in length (or frequency of 30,000 to 7,000 kilocycles) can communicate amazing distances during the night hours.

You will soon learn how to tune the "Cloud-Hopper" and with a little practice be able to pick up stations from an amazing distance. Long-distance radio reception is almost always better during the winter than during the summer.

HOW TO BUILD A 2-TUBE A.C.-D.C. REGENERATIVE RECEIVER

This is also a good model to choose as your first venture in building a receiver operated on the 110-volt house lighting current. It will operate on either alternating or direct current. Although two tubes are utilized and at

SCHMATIC CIRCUIT FOR ONE-TUBE "CLOUD HOPPER"

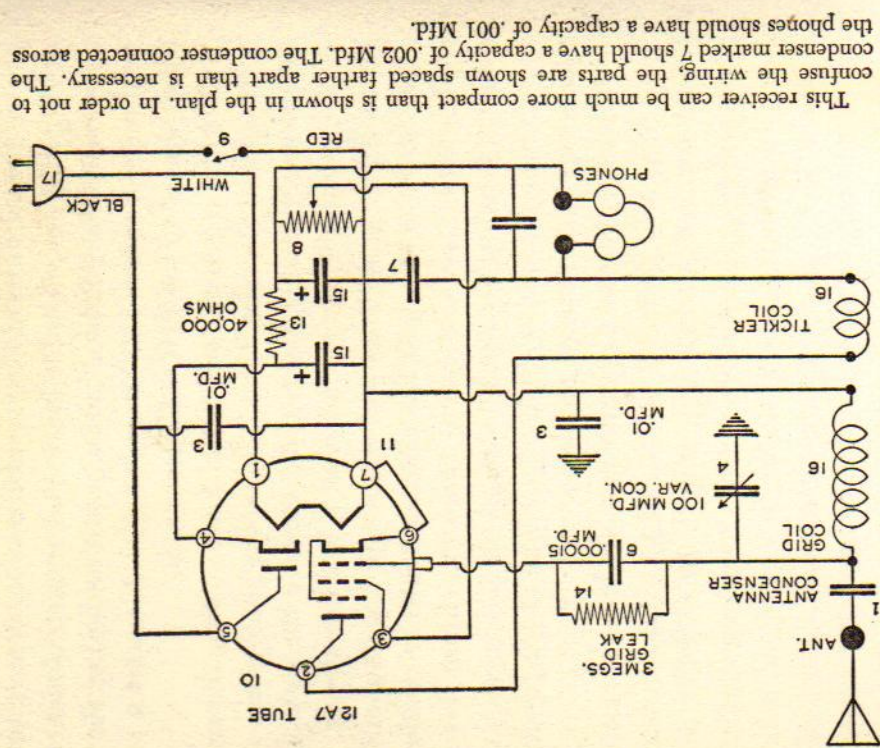

This receiver can be much more compact than is shown in the plan. In order not to confuse the wiring, the parts are shown spaced farther apart than is necessary. The condenser marked 7 should have a capacity of .002 Mfd. The condenser connected across the phones should have a capacity of .001 Mfd.

first the circuit looks complicated to the novice, it is easier to wire than the "Cloud-Hopper." There is less chance of making a mistake in the socket connections.

In the "Cloud-Hopper" a detector and a rectifier for supplying direct current to the detector are combined in one tube. The tube consequently has eight terminals. In this model two No. 76 radio tubes are used. One tube acts as a detector, the other as a rectifier which changes the alternating current supply to direct current to operate the detector. No. 76 tubes have four elements: a heater, a cathode, a grid, and a plate. The base is provided with five prongs and fits a standard five-prong socket.

This receiver is simple to operate. There are only two variable controls, the tuning condenser and the regeneration control. By means of a set of five standard four-prong plug-in coils, a complete range of wave-lengths from 17 to 545 meters may be covered. No ground connection is used, but an antenna is necessary.

In selectivity, wave-length range, and distance-getting ability this set and the "Cloud-Hopper" are equals.

Notice that no panel is shown in the plan. If you are interested in tuning in broadcast stations only, you can mount the tuning condenser directly on the base and use a bracket to support the regeneration control. A vernier control on the tuning condenser is not necessary.

But if you wish to tune in short-wave stations, the tuning condenser must be accurately adjusted and a vernier

control is necessary. A panel is required to support the condenser.

You will need the parts and materials listed below. Some of these have been keyed or numbered in the list so

TYPE 76 TUBE  
AND SOCKET

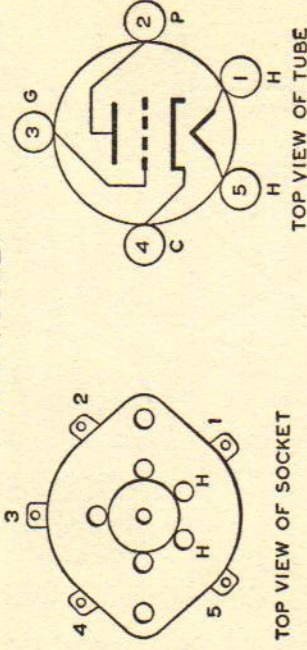

The type 76 tube has five prongs, all of the same size. The prongs are not spaced evenly and there is only one position in which the tube can be slipped into the socket.

that you can identify them in both the schematic circuit and the wiring diagram.

- 1 Wooden base, 12" x 6" x 3/4"
- 1 Plywood panel 12" x 5 1/2" x 1/4"
- 1 Piece sheet metal 11" x 5"
- 1 4-prong wafer socket for plug-in coils (1)
- 2 5-prong wafer sockets for No. 76 tubes (2 and 3)
- 2 Type 76 tubes
- 1 .0001 Mfd. variable tuning condenser (4)
- 1 3-inch dial and knob for tuning condenser (17)
- 1 10,000-ohm potentiometer or volume control (6) with switch (5) and control knob (16)

- 1 Double section 8-8 Mfd. cardboard case, dry electrolytic condenser (7)
- 1 .01 Mfd. tubular condenser
- 1 .00005 Mfd. mica condenser (9)
- 1 .0001 Mfd. mica condenser (10)
- 1 .005 Mfd. mica condenser (12)
- 1 .002 Mfd. mica condenser (13)
- 1 2-megohm grid leak or 1/4-watt resistor (11)
- 1 6,000-ohm, 1/2-watt resistor (14)
- 1 40,000-ohm, 1/2-watt resistor (15)
- 1 330-ohm line cord resistor (18)
- 3 Binding posts or terminals
- Screws, push-back wire, etc.

Shellac or varnish the sides, ends, top, and bottom of the wooden base so as to make it moisture-proof. The metal sheet is then attached to the underside with several small wire nails. The sheet is 5" x 11", not quite as large as the base. It may be thin galvanized iron or sheet-tin. You can get a piece at a plumbing shop or perhaps cut it from an old one-gallon can. The purpose of the metal sheet is to provide a "ground" for the grid coil, control resistance, tuning condenser, etc., as shown in the circuit diagram. The black dots marked GR on the plan, where a wire apparently ends, represent holes drilled through the wooden base and metal sheet on the bottom. The wires pass through the holes and are soldered to the metal sheet.

The various parts which make up the receiver are mounted on the wooden base in the relative positions

The wires pass through the holes and are soldered to the metal sheet. A plain condenser tuning knob and dial are shown in this sketch. This will be satisfactory for tuning broadcasting stations, but if you wish to tune in short waves it is advisable to equip the receiver with a vernier control.

PLAN OF 2-TUBE AC-DC REGENERATIVE RECEIVER

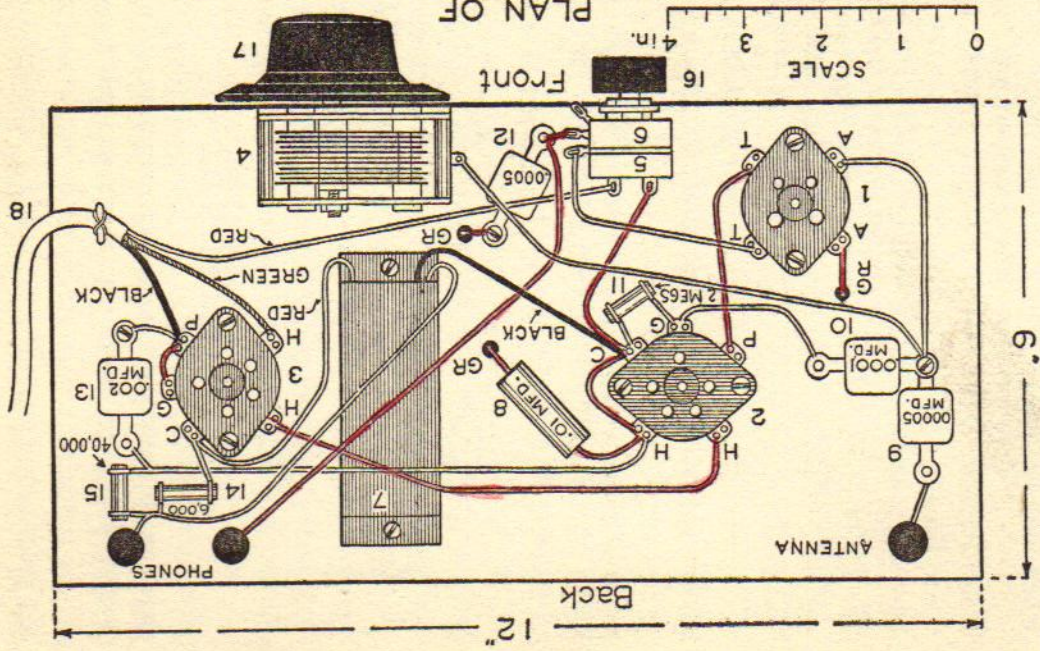

12" 6" ANTENNA PHONES



shown in the plan on page 138. A four-inch scale is shown in the lower left-hand corner of the illustration. If this is traced on a piece of paper, it may be used to measure the distances on the plan. The parts shown on the plan are spaced farther apart than is actually necessary. This was done in order to make the wiring easier to understand.

The three sockets are mounted on small spacers which raise them up from the base. The variable condenser and the potentiometer are at the forward edge of the base so that they are convenient to adjust. The condenser is fastened in place by two screws which pass through the wooden base from the underside. The potentiometer is mounted in a small bracket bent out of sheet metal as shown in one of the illustrations.

When the parts have been fastened in place, the set is ready for wiring. The connecting wires are shown in the plan. The schematic circuit diagram should also be consulted. Follow the connections with the utmost care. As each wire is soldered in place, check it on the diagram with a pencil. Then none will be overlooked. Have the soldering iron hot and keep it clean. Use only rosin-core solder and push-back wire. After completing the wiring, check it carefully.

Here are some facts and explanations of the circuit which may help in wiring.

The frame and the rotating plates of the variable con-

denser (4) are grounded to the metal sheet on the bottom of the base.

One terminal of the grid or antenna coil (19) is grounded to the metal sheet on the bottom of the base. The other terminal of the coil is connected to the grid condenser (10). The other terminal of the grid condenser (10) is connected to the grid terminal on the detector tube socket (2).

The 2-megohm grid leak (11) is connected across the grid and plate terminals of the detector tube socket (2).

In the illustration showing the plan of the set, wires leading to the metal sheet pass through holes in the base and are marked G.

Notice that only the center and one outside terminal on the potentiometer (6) are used.

On the plan, the terminals of the four-prong socket (1) to which the grid or antenna coil (19) will be connected when the coil is plugged in are marked A and A. The terminals of the grid coil (20) are marked T and T.

The small mica condensers are fastened to the base by a screw passing through the eye in one of the terminals.

The line cord resistor (18) is tied to a screw-eye in the base near the front right-hand corner. This anchors the cord so that the terminals are relieved from strain. The cord which was used in building the original receiver from which these plans were made consisted of one black,

one red, and one green-covered wire. The green and the black wire were connected together at the plug, but the green wire contained a resistance of 330 ohms.

The heaters of the two tubes are connected in series

## 2-TUBE A.C.-D.C. REGENERATIVE RECEIVER

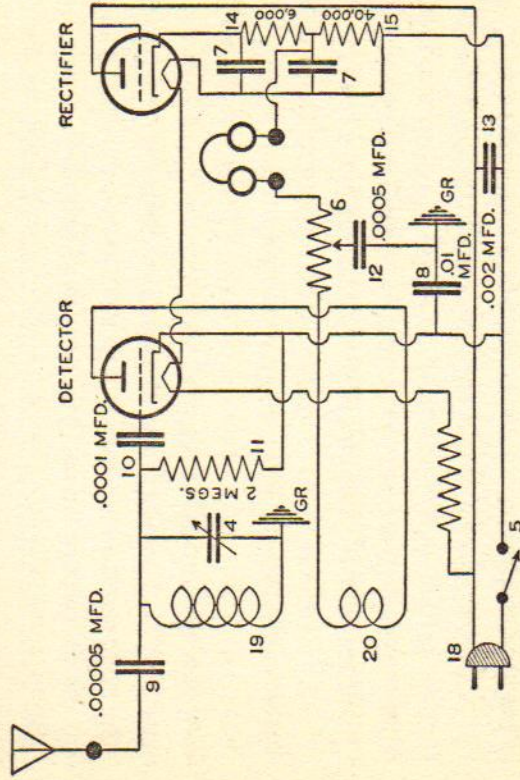

The ground connections (marked GR) are connections made to the metal sheet on the bottom of the base. Although the switch (5) which turns the filament current on and off is close to the resistor cord plug (18) in the diagram, it is actually part of the regeneration control (6).

and fed with current from the red and green wires in the line resistor cord. Thus the 330-ohm resistance in the line cord reduces the current to the proper value so that it

will not burn out the heaters. The switch (5) is included in the circuit so that twisting the knob (16) turns the heater current on and off.

The double-section 8-8 Mfd. condenser should be fastened to the base with two screws. Notice that two of the terminal wires are red and one is black. Be certain to connect them as shown on the plan.

When all the connections have been made and checked, the receiver is ready for testing.

Place a No. 76 tube in sockets 2 and 3 and one of the broadcasting coils in socket 1.

Connect the antenna to the ANTENNA binding post and plug the line cord resistor into a 110-120-volt outlet. If it is an A.C. outlet it will not matter how you put the plug in, but if it is a D.C. outlet you may have to pull the plug out and put it back in with the plugs reversed before the current will flow through the receiver in the proper direction.

Connect a telephone receiver or a set of ear-phones to the PHONES binding posts. Turn the knob (16) so that the switch is closed and the tubes light. It will be a minute or so before the tubes are hot enough to operate.

Slip on the ear-phones and tune in a broadcast station by slowly turning the variable tuning condenser knob (17). Turn the potentiometer knob (16) to control the regenerative action of the detector. At first it is best to turn this until a distinct hiss is heard in the phones. When

the variable condenser is rotated slowly, a series of whistles and squeals will be heard in the phones, each indicating a different broadcast station. The whistling can be cleared by a slight adjustment of the variable condenser and the regeneration control knob. Broadcast signals should then be heard. Weak signals necessitate a very careful and close adjustment of all the controls.

If the set has been properly wired, no trouble should be experienced in getting it into satisfactory operation. In the event that no squeals or signals are heard, recheck all connections. Make certain that both tubes are lighted.

If no squeals or whistles are heard in the phones when the tuning controls are rotated, it is an indication that the receiver is not regenerating. Sometimes failure of the receiver to regenerate is due to the tickler-coil winding being reversed. In that case it will be necessary to reverse the connections T and T on the coil socket (1). Do not make this change, however, until you are certain that failure of the receiver to regenerate is not due to any other cause.

## CHAPTER IX

### How to Build a 2-Tube A.C.-D.C. Receiver with Speaker

WHEN YOU look over the schematic circuit and the plan for this receiver, you will realize that it is somewhat more

#### TYPE 6C6 TUBE AND SOCKET

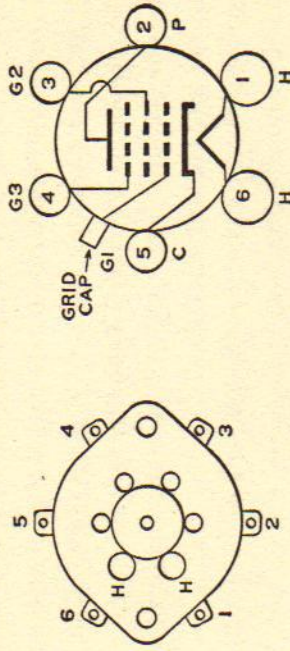

TOP VIEW OF SOCKET

TOP VIEW OF TUBE

Type 6C6 tube has six prongs and a grid cap. You will need a grid clip in order to make connection to the cap. The two prongs (HH) connected to the heater are larger than the others and serve to locate the tube in its socket. In the diagram above, the prongs are numbered to match the corresponding socket terminal to which they connect when the tube is inserted.

elaborate than the two-tube receiver described in the last chapter. The tubes make it so. It employs a type 6C6 and a 25A7-G. The type 6C6 is known to radio engineers as a triple-grid detector amplifier. It has six contact pins on the

base and a grid cap on top. The 25A7-G is "two tubes in one." It is a rectifier-pentode, in radio language. The rectifier portion changes the 110-volt alternating current into rectified direct current. The pentode acts as a power amplifier. It is the amplifying action of the pentode which increases or strengthens the energy delivered by the detector so that it will operate a small speaker. The 25A7-G has eight contact pins on the base. Eight connections to the 25A7-G tube and seven to the 6C6 make the circuit seem complicated. It is in making these connections that the novice is most likely to make a mistake. But if you proceed slowly and carefully, consulting the plan and circuit diagrams and checking each wire before and after you put it in place, you will not have any trouble.

An antenna fifty feet long will give good reception for both near and distant stations.

The following parts are required for building a 2-tube A.C.-D.C. set with speaker:

- 1 Wood base  $14\frac{1}{4}'' \times 5\frac{3}{4}'' \times \frac{3}{4}''$
- 1 Plywood panel  $14\frac{1}{4}'' \times 5\frac{1}{2}'' \times \frac{1}{4}''$
- 1 Piece of sheet metal  $14'' \times 5''$
- 1 Type 6C6 Tube
- 1 Type 25A7 Tube
- 1 5-prong socket
- 1 6-prong socket
- 1 8-prong socket
- 1 Set 5-prong plug-in coils
- 1 4-inch permanent magnet speaker
- 1 360 Mmfd. variable condenser

### TYPE 25A7-G TUBE AND SOCKET

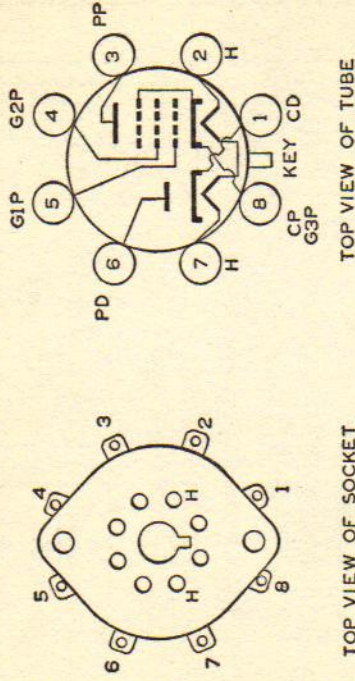

To the novice, the most confusing part of wiring a radio receiver is making the connections to the socket. It is, of course, absolutely necessary to make these correctly or the heaters, grids, plates, etc., in the tube will not be properly connected in the circuit. The diagram above will help when making connections to a type 25A7-G tube. The base of the tube has eight prongs, all of the same size. The prongs are located in the proper socket hole by a key on the base of the tube which fits into a slot in the socket. There are no identifying numbers or letters on tubes and sockets as shown in the diagram. In the illustration the prongs connected to the heater terminals and their holes in the socket are marked H. Also all prongs are numbered so as to correspond with the numbers alongside the socket terminals to which they connect.

- 1 10,000-ohm volume control with switch and knob
- 1 290-ohm line cord resistor
- 1 Vernier dial
- 4 .01 Mfd. tubular paper condensers
- 1 .05 Mfd. tubular paper condensers
- 1 .02 Mfd. tubular paper condensers
- 1 .0005 mica condensers
- 2 .0001 mica condensers
- 1 250,000-ohm  $\frac{1}{4}$ -watt resistor

- 1 5-megohm 1/4-watt resistor
- 2 500,000-ohm 1/4-watt resistors
- 1 2-megohm 1/4-watt resistor
- 1 750-ohm 1-watt resistor
- 1 50,000-ohm 1/4-watt resistor
- 2 20-Mfd. 200-volt electrolytic condensers
- 1 Grid cap clip
- 1 Binding post
- Screws, solder, push-back wire, etc.

The procedure in assembling and wiring the receiver is the same as that used for the receivers described in Chapter VIII. You will need a dry wooden base 14 1/2" x 5 3/4" x 3/4" and a plywood panel 14 1/4" x 5 1/2" x 1/4". Both should be shellacked or varnished. Whenever condensers, resistors, and other radio parts are mounted on a wooden base or panel, it is essential that the wood be dry. Damp or unseasoned wood is not an insulator. Shellacking or varnishing both surfaces and all edges of a base or panel will keep moisture out.

The plan shows the position of the various parts as they should be mounted on the base and panel. You can use the scale shown in the lower left-hand corner as a rule or measure to determine dimensions and distances. The regeneration control and switch (10,000-ohm volume control), the tuning control, and the speaker are mounted on the back of the panel. The speaker is mounted directly behind a circular hole 3 5/8" in diameter cut in the panel so as to permit the sound waves to pass through. If the re-

Use this plan in arranging the various parts of the receiver on the base and panel. Distances in inches can be determined with a pair of dividers and the scale at the lower left. Four mounting strips (not shown in the illustration) can be used to good advantage when wiring this receiver.

PLAN OF 2-TUBE A.C.-D.C. SET WITH SPEAKER

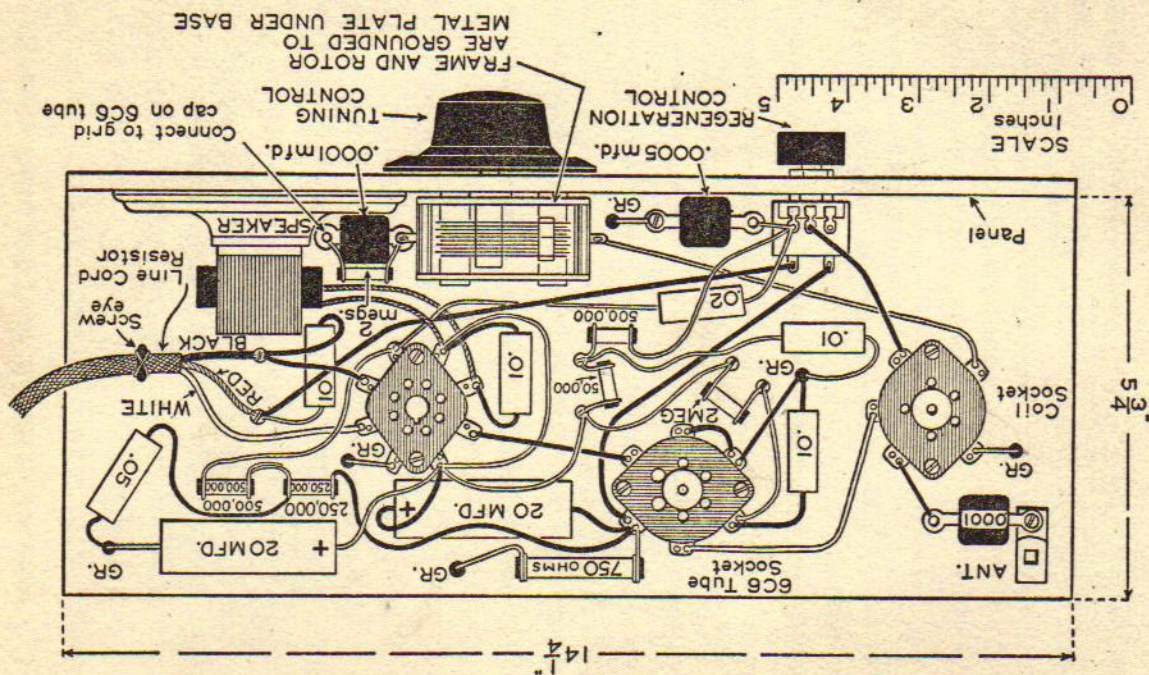

PLAN OF 2-TUBE A.C.-D.C. SET WITH SPEAKER

ceiver is to be used to tune in broadcast stations only, an ordinary dial and knob fitted to the tuning condenser will be satisfactory. But if short waves are to be tuned in, the much more accurate adjustments of the tuning condenser then necessary make a vernier dial control advisable. It may be necessary to shorten both the condenser shaft and the regeneration control shaft before the knobs can be fitted properly.

Mounting strips (see page 131) can be used to good advantage to support some of the resistors and condensers. In place of mounting strips you can use small brass nails or brass screws driven into the base. The plan shows screws.

The end of the line cord resistor should be anchored by tying to a screw-eye in the base.

The 14" x 5" sheet metal may be brass, copper, tin, or galvanized iron. In fact, if you are skilful at soldering and can solder to iron and steel, one of these metals may be used. The metal sheet should be attached to the underside of the wooden base with small brads. A round-headed upholsterer's nail in each corner will raise the metal above the surface of a table or desk upon which the receiver may rest and protect the varnish from scratches. The purpose of the metal sheet is to provide a "ground" to which several of the condensers may be connected. The rotor of the variable tuning condenser is connected to this artificial ground to prevent what is termed "body capacity effect."

Without this, your hand, as it is moved to or from the tuning knob on the variable condenser, would have an effect on the tuning. Twenty-five years ago, when experimenters first began to use the regenerative detector, it was not unusual to tune the variable condenser with a hard rubber rod two feet long, so that the hands would produce no body effect.

If base-mounting sockets are used, they can rest directly on the base. If wafer sockets are used, they should be set on spacers which raise them up from the base.

When all the parts are in place, the set is ready for wiring. The connecting wires, as they were arranged in the original model of this receiver, are shown in the plan. The schematic circuit should also be consulted.

Here is a method which may make the wiring easier. Push-back wire is made in different colors. Procure some red, green, and black. Wire part of the set with red push-back wire. As you do this, trace or check each corresponding wire on the plan and schematic circuit diagram with a red pencil. Then wire another portion of the set with green and check or trace the corresponding wires in the illustrations with a green pencil. Finish the wiring with black wire and check or trace with a black pencil. This may make it easier to avoid mistakes and to avoid omitting any wires. Use rosin-core solder only.

The condensers shown to be "grounded" in the schematic circuit diagram have one terminal connected to the

metal sheet on the underside of the base. Drill a hole for each "ground" connection through the wooden base and through the sheet metal. Slip the wire into the hole and solder to the sheet metal.

The plug-in coils used with this receiver should have five prongs. They can be obtained from several radio firms which carry parts for amateurs.

When the wiring has been completed and checked, the receiver is ready to put into operation. Place a broadcast plug-in coil in the coil socket. Put a 6C6 and a 25A7-G tube into the proper sockets. Put the plug on the line cord resistor into a 110-volt outlet. If it is an A.C. outlet it will not matter how it is plugged in. If it is a D.C. outlet it may be necessary to take the plug out, turn it 180 degrees and put it back in so as to reverse the polarity of the current. Connect the antenna to the antenna binding post or connector. No ground is necessary, and no connection should be made to any grounded metal.

Do not set the receiver on a radiator or any other grounded object.

Switch on the set by turning the regeneration control in a clockwise direction. Wait for about thirty seconds for the tubes to heat up. Then turn the volume control more in a clockwise direction and rotate the tuning control until either music or speech or a whistling sound is heard. If a whistling is heard, turn the regeneration control counter-clockwise until it disappears and music or speech is heard.

You will find this schematic circuit diagram as well as the plan useful when wiring the receiver. All the grounds are connections to the metal plate on the bottom of the wooden base.

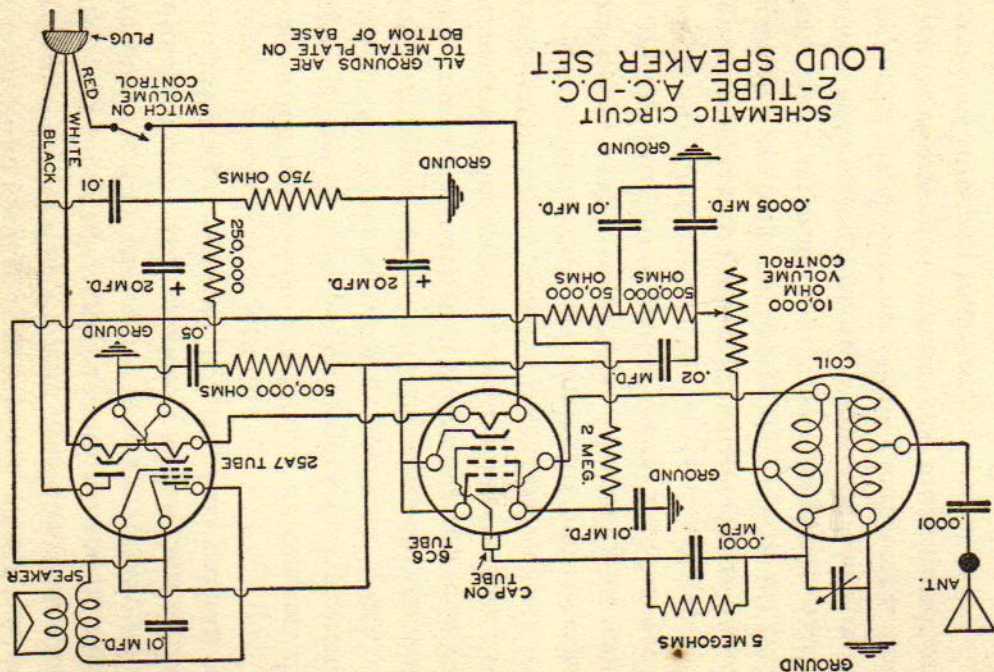

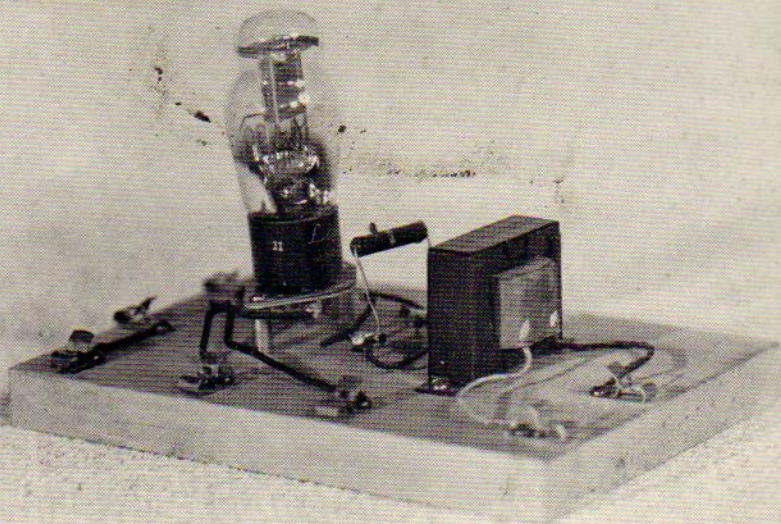

A one-stage audio-frequency amplifier. This device will greatly increase the signal strength of any of the receivers described in this book.

The 2-tube A.C.-D.C. regenerative receiver.

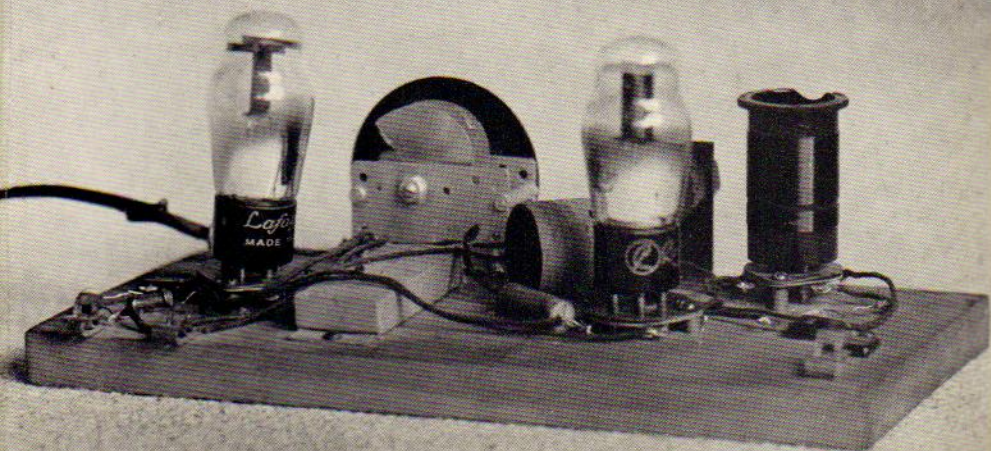





Rear view of the 2-tube A.C.-D.C. receiver with speaker.