

A HISTORY
OF
WIRELESS TELEGRAPHY
1838-1899

INCLUDING SOME BARE-WIRE PROPOSALS
FOR SUBAQUEOUS TELEGRAPHS

BY

J. J. FAHIE

MEMBER OF THE INSTITUTION OF ELECTRICAL ENGINEERS, LONDON, AND OF
THE SOCIÉTÉ INTERNATIONALE DES ÉLECTRICIENS, PARIS;

AUTHOR OF

'A HISTORY OF ELECTRIC TELEGRAPHY TO THE YEAR 1837,' ETC.

WITH FRONTISPIECE AND ILLUSTRATIONS

SECOND IMPRESSION

WILLIAM BLACKWOOD AND SONS
EDINBURGH AND LONDON
MDCCC



ØRSTED



AMPÈRE



FARADAY



HENRY

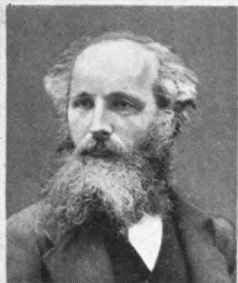

CLERK-MAXWELL



HERTZ

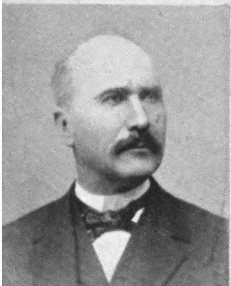

BRANLY



TESLA



MARCONI



GALVANI

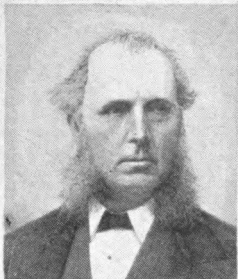

WILLOUGHBY SMITH



MARCONI

5 4 1 8 2

JUN 12 1900

Y Q N

F 14

Dedicated

TO

W. H. PREECE, ESQUIRE, C.B., F.R.S.,

Past President, Institution of Electrical Engineers ;

President, Institution of Civil Engineers,

&c., &c.,

The First Constructor of a Practical

Wireless Telegraph,

AS A SLIGHT TOKEN OF ESTEEM AND FRIENDSHIP,

AND IN ACKNOWLEDGMENT OF MANY

KINDNESSES

EXTENDING OVER MANY YEARS.

PREFACE.

EARLY in 1897 there was a great flutter in the dove-cotes of telegraphy, and holders of the many millions of telegraph securities, and those interested in the allied industries, began to be alarmed for the safety of their property. Mysterious paragraphs about the New, Wireless, or Space Telegraphy, as it was variously called, kept appearing in the papers; and the electrical profession itself—certainly some leading members of it—seemed disposed to accept implicitly the new marvels, without the grain of salt usual and proper on such occasions.

In a lecture on Submarine Telegraphy at the Imperial Institute (February 15, 1897), Professor Ayrton said: "I have told you about the past and about the present. What about the future? Well, there is no doubt the day will come, maybe when you and I are forgotten, when copper wires, gutta-percha coverings, and iron sheathings will be relegated to the Museum of Antiquities. Then, when a person wants to telegraph to a friend, he knows not where, he will call in an electro-magnetic voice, which will be

heard loud by him who has the electro-magnetic ear, but will be silent to every one else. He will call, 'Where are you?' and the reply will come, 'I am at the bottom of the coal-mine,' or 'Crossing the Andes,' or 'In the middle of the Pacific'; or perhaps no reply will come at all, and he may then conclude the friend is dead."

Soon after, in the course of a debate in the House of Commons (April 2, 1897) on the Telephone monopoly, one of the speakers said: "It would be unwise on the part of the Post Office to enter into any very large undertakings in respect of laying down telephone wires until they had ascertained what was likely to be the result of the Röntgen form of telegraph, which, if successful, would revolutionise our telephonic and telegraphic systems."

When cautious men of science spoke, or should I not say dreamt thus, and when sober senators accepted the dream as a reality and proceeded to legislate upon it, we can imagine the ideas that were passing in the minds of those of the general public who gave the subject a thought. Well, two years have now elapsed, and the unbounded potentialities of the new telegraphy have been whittled down by actual experiment to small practical though still very important proportions; and so, those interested in the old order can sleep in peace, and can go on doing so for a long time yet to come.

Having in the course of many years' researches in electric lore collected a mass of materials on this subject—for the idea embodied in the new telegraphy is by no means new—and having been a close observer of its recent and startling developments, I have thought that a popular account of its

origin and progress would not now be uninteresting. This I have accordingly attempted in the following pages.

At an early stage in the evolution of our subject, objection was taken to the epithet Telegraphy without Wires, or, briefly, Wireless Telegraphy, as a misnomer (*e.g.*, the 'Builder,' March 17, 1855, p. 132), and in recent times the objection has been repeated. Induction, Space, and Ethereal Telegraphy have been suggested, but though accurate for certain forms, they are not comprehensive enough. A better name would be Telegraphy without Connecting Wires, which has also been suggested, but it is too cumbrous—an awkward mouthful. Pending the discovery of a better one, I have adhered to the original designation Wireless Telegraphy, which actually is the popular one, and for which, moreover, I have the high sanction of her Majesty's Attorney-General.

In the course of a discussion on Mr W. H. Preece's paper on Electric Signalling without Wires ('Journal Society of Arts,' February 23, 1894), Sir Richard Webster laid down the law thus: "I think the objection to the title of the paper is rather hypercritical, because ordinary people always understand telegraphing by wire as meaning *through* the wire, going from one station to the other; and these parallel wires, not connected, would rather be looked upon as parts of the sending and receiving instruments. I hope, therefore, that the same name will be adhered to in any further development of the subject." If thus the name be allowable in Mr Preece's case where, to bridge a space of, say, one mile, two parallel wires, each theoretically one mile long, are requisite, or double the amount required in

the old form of telegraphy, it cannot be objected to in any of the other proposals which are described in these pages, certainly not to the Marconi system, where a few feet of wire at each end suffice for one mile of space, or, to put it accurately, where the height of the vertical wires varies as the square root of the distance to be signalled over.

At the outset of my task I was met with the difficulty of arranging my materials—whether in simple chronological order, or classified under heads, as Conduction, Induction, Wave, and Other or Miscellaneous Methods. Both have their advantages and disadvantages, but after consideration I decided to follow in the main the chronological order as the better of the two for a history which is intended to be a simple record of what has been done or attempted in the last sixty years by the many experimenters who have attacked the problem or contributed in any way to its solution.

Having settled this point, the further question of subdivision presented itself, and as the materials did not lend themselves to arrangement in chapters, I decided to divide the text into periods. The first I have called The Possible Period, which deals with first suggestions and empirical methods of experiment, and which, by reason of the want of delicacy in the instruments then available, may not inaccurately be compared with the Palæolithic period in geology. The second is The Practicable (or Neolithic) Period, when the conditions of the problem came to be better understood, and more delicate instruments of research were at hand. The third—The Practical Period—brings the subject up to date, and deals with the proposals of

Preece (Electro - Magnetic), of Willoughby Smith (Conductive), and of Marconi (Hertzian), which are to-day in actual operation.

The whole concludes with five Appendices, containing much necessary information for which I could not conveniently find room in the body of the work. Appendix A deals with the philosophic views of the relation between electricity and light before and after Hertz, who, for the first time, showed them to be identical in kind, differing only in the degree of their wave-lengths. Appendix B gives in a popular form the modern views of electric currents consequent on the discoveries of Clerk-Maxwell, Hertz, and their disciples. Appendix C reproduces the greater part of Professor Branly's classic paper on his discovery of the Coherer principle, which is one of the foundation-stones of the Marconi system. Appendix D contains a very interesting correspondence between myself and Prof. Hughes, F.R.S., which came too late for insertion in the body of the work, and which is too important from the historical point of view to be omitted.

In Appendix E Mr Marconi's patent specification is reproduced, as, besides being historically interesting as the first patent for a telegraph of the Hertzian order, it is in itself a marvel of completeness. As the apparatus is there described, so it is used to-day after three years' rigorous experimentation, the only alterations being in points of detail—a finer adjustment of means to ends. This says much for the constructive genius of the young inventor, and bodes well for the survival of his system in the struggle for existence in which it is now engaged.

In the presentation of my materials I have allowed, as far as possible, the various authors to speak in their own words, merely condensing freely and, where necessary, translating obsolete words and phrases into modern technical language. This course in a historical work is, I think, preferable to obtruding myself as their interpreter. For the same reason I have given in the text, or in footnotes thereto, full references, so that the reader who desires to consult the original sources can readily do so.

I seem to hear the facetious critic exclaim, "Why, this is all scissors and paste." So it is, good sir, much of it; and so is all true history when you delete the fictions with which many historians embellish their facts. What one person said or what another did is not altered by the presence or absence of quotation marks. However, the only credit I claim is that due to collecting, condensing, and presenting my facts in a readable form—no light task,—and if my critics will award me this I will be satisfied.

Since the following pages were written, two excellent contributions have been made by Prof. Oliver Lodge and Mr Sydney Evershed in papers read before the Institution of Electrical Engineers, December 8 and 22, 1898. These will be found in No. 137 of the 'Journal,' and, together with the discussion which followed, should be studied by all interested in this fascinating subject. Mr Marconi has followed up these papers with one on his own method, which was read before the Institution on the 2nd of March last, and was repeated by general request on the 16th *idem*. He does not carry the matter farther than I have done in the text, but still the paper is worth reading

—if only as an exposition in a nutshell of his beautiful system.

As a Frontispiece I give a group of twelve portraits of eminent men who may be fitly called the Arch-builders of Wireless Telegraphy. At the top stands Oersted (Denmark), who first showed the connection between electricity and magnetism. Then follow in order of time Ampère (France), Faraday (England), and Henry (America), who explained and extended the principles of the new science of electro-magnetism. Then come Clerk-Maxwell (England) and Hertz (Germany), who showed the relation between electricity and light, the one theoretically, and the other by actual demonstration. These are followed by Branly (France), Lodge (England), and Righi (Italy), whose discoveries have made possible the invention of Marconi. The last three are portraits of Preece and Willoughby Smith (England) and Marconi (Italy), who divide between them the honour of establishing the first practical lines of wireless telegraph—each typical of a different order.

ST HELIER'S, JERSEY,
September 1899.

CONTENTS.

FIRST PERIOD—THE POSSIBLE.

	PAGE
PROFESSOR C. A. STEINHEIL—1838	1
EDWARD DAVY—1838	6
PROFESSOR MORSE—1842	10
JAMES BOWMAN LINDSAY—1843	13
J. W. WILKINS—1845	32
DR O'SHAUGHNESSY (AFTERWARDS SIR WILLIAM O'SHAUGH- NESSY BROOKE)—1849	39
E. AND H. HIGHTON—1852-72	40
G. E. DERING—1853	48
JOHN HAWORTH—1862	55
J. H. MOWER—1868	70
M. BOURBOUZE—1870	71
MAHLON LOOMIS—1872	73

SECOND PERIOD—THE PRACTICABLE.

PRELIMINARY : NOTICE OF THE TELEPHONE IN RELATION TO WIRELESS TELEGRAPHY	79
PROFESSOR JOHN TROWBRIDGE—1880	85

PROFESSOR GRAHAM BELL—1882	96
PROFESSOR A. E. DOLBEAR—1883	99
T. A. EDISON—1885	103
W. F. MELHUISE—1890	114
C. A. STEVENSON—1892	122
PROFESSOR ERICH RATHENAU—1894	130

THIRD PERIOD—THE PRACTICAL.

SYSTEMS IN ACTUAL USE.

W. H. PREECE'S METHOD	136
WILLOUGHBY SMITH'S METHOD	162
G. MARCONI'S METHOD	177

APPENDIX A.

THE RELATION BETWEEN ELECTRICITY AND LIGHT — BEFORE AND AFTER HERTZ	246
--	-----

APPENDIX B.

PROF. HENRY ON HIGH TENSION ELECTRICITY BEING CONFINED TO THE SURFACE OF CONDUCTING BODIES, WITH SPECIAL REFERENCE TO THE PROPER CON- STRUCTION OF LIGHTNING-RODS	261
ON MODERN VIEWS WITH RESPECT TO THE NATURE OF ELECTRIC CURRENTS	264

APPENDIX C.

VARIATIONS OF CONDUCTIVITY UNDER ELECTRICAL IN- FLUENCE	276
--	-----

APPENDIX D.

RESEARCHES OF PROF. D. E. HUGHES, F.R.S., IN ELECTRIC WAVES AND THEIR APPLICATION TO WIRELESS TELE- GRAPHY, 1879-1886	289
---	-----

APPENDIX E.

REPRINT OF SIGNOR G. MARCONI'S PATENT	296
---	-----

INDEX	321
-----------------	-----

A HISTORY OF WIRELESS TELEGRAPHY. 1838-1899.

FIRST PERIOD—THE POSSIBLE.

“Awhile forbear,
Nor scorn man’s efforts at a natural growth,
Which in some distant age may hope to find
Maturity, if not perfection.”

PROFESSOR C. A. STEINHEIL—1838.

Just mentioning *en passant* the sympathetic needle and sympathetic flesh telegraphs of the sixteenth and seventeenth centuries, a full account of which will be found in my ‘History of Electric Telegraphy to 1837’ (chap. i.), we come to the year 1795 for the first glimmerings of telegraphy without wires. Salvá, who was an eminent Spanish physicist, and the inventor of the first electrochemical telegraph, has the following bizarre passage in his paper “On the Application of Electricity to Telegraphy,” read before the Academy of Sciences, Barcelona, December 16, 1795.

After showing how insulated wires may be laid under

the seas, and the water used instead of return wires, he goes on to say: "If earthquakes be caused by electricity going from one point charged positively to another point charged negatively, as Bertolon has shown in his 'Électricité des Météores' (vol. i. p. 273), one does not even want a cable to send across the sea a signal arranged beforehand. One could, for example, arrange at Mallorca an area of earth charged with electricity, and at Alicante a similar space charged with the opposite electricity, with a wire going to, and dipping into, the sea. On leading another wire from the sea-shore to the electrified spot at Mallorca, the communication between the two charged surfaces would be complete, for the electric fluid would traverse the sea, which is an excellent conductor, and indicate by the spark the desired signal."¹

Another early telegraph inventor and eminent physiologist, Sömmerring of Munich, has an experiment which, under more favourable conditions of observation, might easily have resulted in the suggestion at this early date of signalling through and by water alone. Dr Hamel² tells us that Sömmerring, on the 5th of June 1811, and at the suggestion of his friend, Baron Schilling, tried the action of his telegraph whilst the two conducting cords were each interrupted by water contained in wooden tubs. The signals appeared just as well as if no water had been interposed, but they ceased as soon as the water in the tubs was connected by a wire, the current then returning by this shorter way.

Now here we have, *in petto*, all the conditions necessary

¹ Later on in these pages we shall see that Salvá's idea is after all not so extravagant as it seems. We now know that large spaces of the earth *can* be electrified, giving rise to the phenomenon of "bad earth," so well known to telegraph officials.

² Historical Account of the Introduction of the Galvanic and Electro-magnetic Telegraph into England, Cooke's Reprint, p. 17.

for an experiment of the kind with which we are dealing, and had it been possible for Sömmerring to have employed a more delicate indicator than his water-decomposing apparatus he would probably have noticed that, notwithstanding the shorter way, some portion of the current still went the longer way ; and this fact could hardly have failed to suggest to his acute and observant mind further experiments, which, as I have just said, might easily have resulted in his recognition of the possibility of wireless telegraphy.

Leaving the curious suggestion of Salvá, which, though seriously meant, cannot be regarded as more than a *jeu d'esprit* — a happy inspiration of genius — and the what-might-have-come-of-it experiment of Sömmerring, we come to the year 1838, when the first intelligent suggestion of a wireless telegraph was made by Steinheil of Munich, one of the great pioneers of electric telegraphy on the Continent.

The possibility of signalling without wires was in a manner forced upon him. While he was engaged in establishing his beautiful system of telegraphy in Bavaria, Gauss, the celebrated German philosopher, and himself a telegraph inventor, suggested to him that the two rails of a railway might be utilised as telegraphic conductors. In July 1838 Steinheil tried the experiment on the Nürnberg-Fürth railway, but was unable to obtain an insulation of the rails sufficiently good for the current to reach from one station to the other. The great conductivity with which he found that the earth was endowed led him to presume that it would be possible to employ it instead of the return wire or wires hitherto used. The trials that he made in order to prove the accuracy of this conclusion were followed by complete success ; and he then introduced into electric telegraphy one of its greatest improvements—the earth circuit.¹

¹ For the use of the earth circuit before Steinheil's accidental discovery, see my 'History of Electric Telegraphy to 1837,' pp. 343-345.

Steinheil then goes on to say: "The inquiry into the laws of dispersion, according to which the ground, whose mass is unlimited, is acted upon by the passage of the galvanic current, appeared to be a subject replete with interest. The galvanic excitation cannot be confined to the portions of earth situated between the two ends of the wire; on the contrary, it cannot but extend itself indefinitely, and it therefore only depends on the law that obtains in this excitation of the ground, and the distance of the exciting terminations of the wire, *whether it is necessary or not to have any metallic communication at all for carrying on telegraphic intercourse.*

"An apparatus can, it is true, be constructed in which the inductor, having no other metallic connection with the multiplier than the excitation transmitted through the ground, shall produce galvanic currents in that multiplier sufficient to cause a visible deflection of the bar. This is a hitherto unobserved fact, and may be classed amongst the most extraordinary phenomena that science has revealed to us. It only holds good, however, for small distances; and it must be left to the future to decide whether we shall ever succeed in telegraphing at great distances without any metallic communication at all. My experiments prove that such a thing is possible up to distances of 50 feet. For greater distances we can only conceive it feasible by augmenting the power of the galvanic induction, or by appropriate multipliers constructed for the purpose, or, in conclusion, by increasing the surface of contact presented by the ends of the multipliers. At all events, the phenomenon merits our best attention, and its influence will not perhaps be altogether overlooked in the theoretic views we may form with regard to galvanism itself."¹

In another place, discussing the same subject, Steinheil

¹ Sturgeon's Annals of Electricity, vol. iii. p. 450.

says: "We cannot conjure up gnomes at will to convey our thoughts through the earth. Nature has prevented this. The spreading of the galvanic effect is proportional, not to the distance of the point of excitation, but to the square of this distance; so that, at the distance of 50 feet, only exceedingly small effects can be produced by the most powerful electrical effect at the point of excitation. Had we means which could stand in the same relation to electricity that the eye stands to light, nothing would prevent our telegraphing through the earth without conducting wires; but it is not probable that we shall ever attain this end."¹

Steinheil proposed another means of signalling without wires, which is curiously *à propos* of Professor Graham Bell's photophone. In his classic paper on "Telegraphic Communication, especially by Means of Galvanism," he says: "Another possible method of bringing about transient movements at great distances, without any intervening artificial conductor, is furnished by radiant heat, when directed by means of condensing mirrors upon a thermo-electric pile. A galvanic current is called into play, which in its turn is employed to produce declinations of a magnetic needle. The difficulties attending the construction of such an instrument, though certainly considerable, are not in themselves insuperable. Such a telegraph, however, would only have this advantage over those [semaphores] based on optical principles—namely, that it does not require the constant attention of the observer; but, like the optical one, it would cease to act during cloudy weather, and hence partakes of the intrinsic defects of all semaphoric methods."²

¹ Die Anwendung des Electromagnetismus, 1873, p. 172. We now have these means in "the electric eye" of Hertz! See pp. 181, 256 *infra*.

² Sturgeon's Annals of Electricity, March 1839. Acting on this suggestion, in June 1880 the present writer, while stationed at

EDWARD DAVY—1838.

While arranging, in 1883, the Edward Davy MSS., now in the library of the Institution of Electrical Engineers, the present writer discovered two passages which he at first took to have reference to some kind of telephonic relay; but on closer consideration it would appear that Davy had in view some contrivance based on the conjoint use of sound and electricity, much as Steinheil suggested the joint use of electricity and heat. The following are the passages to which I refer:—

At the end of a long critical examination of Cooke and Wheatstone's first patent of June 12, 1837, he says: "I have lately found that there is a peculiar way of propagating signals between the most distant places by self-acting means, and without the employment of any conducting wires at all. It is to be done partly by electricity, but combined with another principle, of the correctness of which there can be no doubt. But until I know what encouragement the other¹ will meet with I shall take no

Teheran, Persia, and while yet ignorant of Professor Bell's method, worked out for himself a photophone, or rather a tele-photophone, which will be found described in the 'Electrician,' February 26, 1881. On my temporary return to England in 1882, I found that as early as 1878 Mr A. C. Brown, of the Eastern Telegraph Company, was working at the photophone. In September of that year he submitted his plans to Prof. Bell, who afterwards said of them: "To Mr Brown is undoubtedly due the honour of having distinctly and independently formulated the conception of using an undulatory beam of light, in contradistinction to a merely intermittent one, in connection with selenium and a telephone, and of having devised apparatus, though of a crude nature, for carrying it into execution" ('Jour. Inst. Elec. Engs.,' vol. ix. p. 404). Indeed the photophone is as much the invention of Mr Brown as of Prof. Bell, who, however, has all the credit for it in popular estimation.

¹ That is, his chemical recording telegraph. See my 'History of Electric Telegraphy,' London, 1884, p. 379.

steps in this, as it may happen there will be other rivals. To give you a general idea of it, a bell may be rung at the first station, and then in the next instant a bell will ring at the next station a mile off, and so on for an unlimited series, though there is nothing between them but the plain earth and air! At the termination of the series, the signals may be given in letters, as in the present contrivance."

Again, in a paper of numbered miscellaneous memoranda, No. 20 reads as follows: "20. The plan proposed (101) of propagating communications by the conjoint agency of sound and electricity—the original sound producing vibrations which cause sympathetic vibrations in a unison-sounding apparatus at a distance, this last vibration causing a renewing wire to dip¹ and magnetise soft iron so as to repeat the sound, and so on in unlimited succession."

It is not easy to say from these passages (which are all we could find on the subject) what plan Davy had in contemplation. In the first quotation he speaks of bells, for which we may read a powerful trumpet at one end, and a concave reflector to focus the sound at the other end; or some arrangement like the compressed-air telephone, proposed by Captain Taylor, R.N., in 1844; or the modern siren; or, in short, any means of producing sharp concussions of the air, such as were known in his day. Let us suppose he used any of these methods for projecting sound waves, then, at the focus of the distant reflector he may have designed a "renewing wire," so delicately poised as to respond to the vibration, and so

¹ *I.e.*, causing a relay to close a local circuit containing an electro-magnet. Davy always spoke of the relay as the "renewer" or the "renewing wire"; and by dip he meant to dip into mercury, or, as we say nowadays, to close the circuit.

close a local circuit in which was included the electromagnetic apparatus for recording the sound, or for renewing it as required.

In the second passage he speaks of something on the principle of the tuning-fork. Now, tuning-forks in combination with reflectors may be practicable for short distances, but it is difficult to see how their vibrations could be utilised, at the distance of a mile, for "causing a renewing wire to dip."

However this may be, Davy's idea deserves at least this short notice in a history of early attempts at wireless telegraphy; for, although hardly possible of realisation with the apparatus at his command, it is perfectly feasible in these days of megaphones and microphones. As regards its practical utility, that is a question for the future, as to which we prefer not to prophesy.¹

Davy's idea was probably the result of an incautious dose of the Auticatelephor of Edwards, which made a great stir a few years previously, and which, at first sight, might be taken to be a telegraph without *apparently* any connecting medium. We take the following announcement from the 'Kaleidoscope' of June 30, 1829 (p. 430):—

"THE AUTICATELEPHOR.

"We have received several papers descriptive of a new and curious engine, with the above name, invented by Mr T. W. C. Edwards, Lecturer on Experimental Philosophy

¹ Such a plan as Davy's was again suggested, in 1881, by Signor Senlicq d'Andres ('Telegraphic Journal,' vol. ix. p. 126), who, however, proposed to use, instead of a renewing wire or relay, the mouthpiece of a microphonic speaker, rendered more sensitive by a contact lever with unequal arms. Mr A. R. Sennett has also worked at the idea in more recent years. His method is very clearly described in the 'Jour. Inst. Elec. Engs.,' No. 137, p. 908.

and Chemistry, and designed for the instantaneous conveyance of intelligence to any distance. After noticing some of the greatest inventions of preceding times, Mr Edwards undertakes to demonstrate clearly and briefly, in the work which he has now in the press,¹ the practicability and facility of transmitting from London, *instantaneously*, to an agent at Edinburgh, Dublin, Paris, Vienna, St Petersburg, Constantinople, the Cape of Good Hope, Madras, Calcutta, &c., any question or message whatever, and of receiving back again at London, within the short space of one minute, an acknowledgment of the arrival of such question or message at the place intended, and a distinct answer to it in a few minutes. In principle this engine is altogether different from every kind of telegraph or semaphore, and requires neither intermediate station nor repetition. In its action it is totally unconnected with electricity, magnetism, galvanism, or any other subtle species of matter; and although the communication from place to place is instantaneous, and capable of ringing a bell, firing a gun, or hoisting a flag if required, yet this is not effected by the transit of anything whatever to and fro; nor in the operation is aught either audible or visible, except to the persons communicating. It may be proper, however, to state that a channel or way must previously be prepared, by sinking a series of rods of a peculiar description in the ground, or dropping them in the sea; but these, after the first cost, will remain good for ages to come, if substantial when laid down.”²

¹ In 1883 we searched for this book in vain. Under the name T. W. C. Edwards we found in the British Museum Catalogue no less than twenty entries of translations from Greek authors, and of Greek and Latin grammars, &c.; but nothing to show that the writer was either a natural philosopher or a chemist.

² See also the ‘Mechanics’ Magazine,’ vol. xiii., First Series, p. 182.

From the concluding words of this paragraph it would seem that the Auticatelephor was simply an application to telegraphy of pneumatic or hydraulic pressure in pipes—cautiously styled “rods of a peculiar description.” On this supposition the last sentence may be paraphrased thus: “It may be proper, however, to state that a channel or way must previously be prepared, by laying down a continuous series of hollow rods or tubes under the ground or along the sea-bottom.” If our supposition be correct, and if Edwards contemplated the use of compressed air, his proposal was certainly novel; but if he designed the use of compressed water, the idea was by no means new. Without going back to the old Roman plan of *Æneas Tacticus*, we have its revival by Brent and others towards the close of the last century, and the still more practical arrangements of Joseph Bramah in 1796, of Vallance in 1825, and of Jobard in 1827.

PROFESSOR MORSE—1842.

The idea of a wireless telegraph next appears to have presented itself to Professor Morse. In a letter to the Secretary of the Treasury, which was laid before the House of Representatives on December 23, 1844, he says:—

“In the autumn of 1842, at the request of the American Institute, I undertook to give to the public in New York a demonstration of the practicability of my telegraph, by connecting Governor’s Island with Castle Garden, a distance of a mile; and for this purpose I laid my wires properly insulated beneath the water. I had scarcely begun to operate, and had received but two or three characters, when my intentions were frustrated by the

accidental destruction of a part of my conductors by a vessel, which drew them up on her anchor, and cut them off. In the moments of mortification I immediately devised a plan for avoiding such an accident in future, by so arranging my wires along the banks of the river as to cause the water itself to conduct the electricity across. The experiment, however, was deferred till I arrived in Washington; and on December 16, 1842, I tested my arrangement across the canal, and with success. The simple fact was then ascertained that electricity could be made to cross a river without other conductors than the water itself; but it was not until the last autumn that I had the leisure to make a series of experiments to ascertain the law of its passage. The following diagram will serve to explain the experiment:—

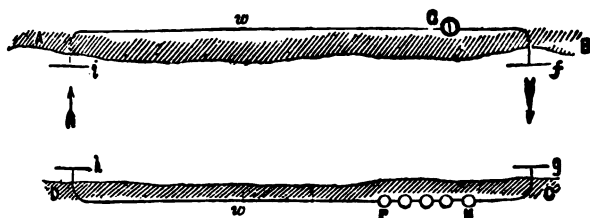

Fig. 1.

“A, B, C, D, are the banks of the river; N, P, is the battery; G is the galvanometer; w w, are the wires along the banks, connected with copper plates, f, g, h, i, which are placed in the water. When this arrangement is complete, the electricity, generated by the battery, passes from the positive pole, P, to the plate h, across the river through the water to plate i, and thence around the coil of the galvanometer to plate f, across the river again to plate g, and thence to the other pole of the battery, N.

“The distance across the canal is 80 feet; on August 24 the following were the results of the experiment:—

No. of the experiment.	1st.	2nd.	3rd	4th.	5th.	6th.
No. of cups in battery	14	14	14	7	7	7
Length of conductors, <i>w, w</i>	400	400	400	400	300	200
Degrees of motion of galvanometer	32 & 24	13½ & 4½	1 & 1	24 & 13	29 & 21	21½ & 15
Size of the copper plates, } <i>f, g, h, i</i>	5 by 2½ ft.	16 by 13 in.	6 by 5 in.	5 by 2½ ft.	5 by 2½ ft.	5 by 2½ ft.

“Showing that electricity crosses the river, and *in quantity in proportion to the size of the plates in the water*. The distance of the plates on the same side of the river from each other also affects the result. Having ascertained the general fact, I was desirous of discovering the best practical distance at which to place my copper plates, and not having the leisure myself, I requested my friend Professor Gale to make the experiments for me. I subjoin his letter and the results.¹

“NEW YORK, Nov. 5th, 1844.

“MY DEAR SIR, — I send you herewith a copy of a series of results, obtained with four different-sized plates, as conductors to be used in crossing rivers. The batteries used were six cups of your smallest size, and one liquid used for the same throughout. I made several other series of experiments, but these I most rely on for uniformity and accuracy. You will see, from inspecting the table, that the distance along the shores should be *three times greater* than that from shore to shore across the stream; at least, that four times the distance does not give any increase of power. I intend to repeat all these experiments under

¹ We omit the tables of results, as of no present value. They can be seen in Vail's book, quoted *infra*.

more favourable circumstances, and will communicate to you the results.—Very respectfully, L. D. GALE.

“Professor S. F. B. MORSE,
Superintendent of Telegraphs.’

“As the results of these experiments, it would seem that there may be situations in which the arrangements I have made for passing electricity across rivers may be useful, although experience alone can determine whether lofty spars, on which the wires may be suspended, erected in the rivers, may not be deemed the most practical. The experiments made were but for a short distance; in which, however, the principle was fully proved to be correct. It has been applied under the direction of my able assistants, Messrs Vail and Rogers, across the Susquehanna river, at Havre-de-Grace, with complete success, a distance of nearly a mile.”¹

JAMES BOWMAN LINDSAY—1843.

The next to pursue the subject was J. B. Lindsay of Dundee, whose extensive labours in this, as well as in the department of electric lighting, have hitherto been little appreciated by the scientific world. Through the kind assistance of Dr Robert Sinclair of Dundee, I have lately collected a number of facts relating to this extraordinary man, and as I believe they will be new to most of my readers, I will draw largely from them in what follows.²

James Bowman Lindsay was born at Carmyllie, near Arbroath, on September 8, 1799, and but for the delicacy

¹ Vail's American Electro-Magnetic Telegraph, Philadelphia, 1845.

² Extracts from the writer's articles in the 'Electrical Engineer,' vol. xxiii. pp. 21, 51.

of his constitution would have been bred a farmer. At an early age he evinced a great taste for reading, and every moment that he could spare from his work as a linen-weaver was devoted to his favourite books. Often, indeed, he would be seen on his way to Arbroath with a web of cloth tied on his back and an open book in his hands; and, after delivering the cloth and obtaining fresh materials for weaving, he would return to Carmyllie in the same fashion. Encouraged by these studious habits, Lindsay's parents wisely arranged that he should go to St Andrews University. Accordingly, in 1821 he entered on his studies, and, self-taught though he had hitherto been, he soon made for himself a distinguished place among his fellow-students, particularly in the mathematical and physical sciences, in which departments, indeed, he became the first student of his time. Having completed the ordinary four years' course, Lindsay entered as a student of theology, and duly completed his studies in the Divinity Hall; but he never presented himself for a licence, his habits of thought inclining more to scientific than to theological pursuits. In the long summer vacations he generally returned to his occupation of weaving, though latterly he took up teaching, and thus enjoyed more time for the prosecution of his own studies.

Coming to Dundee in 1829, he was appointed Science and Mathematical Lecturer at the Watt Institution, then conducted by a Mr M'Intosh. Soon after, Alexander Maxwell, the historian of Dundee, became a pupil, and this is the picture he has left us of Lindsay:—

“When I was with Mr M'Intosh, I attended classes that were taught by Mr Lindsay, a man of profound learning and untiring scientific research, who, had he been more practical, less diffident, and possessed of greater worldly wisdom, would have gained for himself a good place

amongst distinguished men. As it was, he remained little more than a mere abstraction, a cyclopædia out of order, and went through life a poor and modest school-master.

“By the time I knew him he was devoting much of his attention to electricity, to the celerity with which it was transmitted to any distance, and to the readiness with which its alternating effects may be translated into speech—and I have no doubt he held in his hand the modern system of the telegraph, but it needed a wiser man than he to turn it to practical use. He also produced from galvanic cells a light which burned steadily for a lengthened period.

“His acquaintance with languages was extraordinary, and almost equalled that of his famous contemporary, the Cardinal Mezzofanti. In 1828 he began the compilation of a dictionary in fifty languages, the object of which was to discover, if possible, by language the place where, and the time when, man originated. This stupendous undertaking, which occupied the main part of his life's work, he left behind in a vast mass of undigested manuscript, consisting of dissertations on language and cogitations on social science—a monument of unpractical and inconclusive industry. In 1845 he published ‘A Pantecontaglossal Paternoster,’ intended to serve as a specimen of his fifty-tongued lexicon.

“In 1858 he published ‘The Chrono-Astrolabe,’ for determining with certainty ancient chronology—a work on which he had been engaged for many years; and in 1861 ‘A Treatise on Baptism,’ which is a curious record of his philosophical knowledge. . . .

“In 1832 he obtained a situation as travelling tutor, which was to take him abroad for some time. We loved him as much as consists with a boy's nature to love his

teacher, and subscribed for a silver snuff-box as a slight mark of our regard.¹ . . .

“I am afraid that the situation of travelling tutor did not turn out well, for within two years Lindsay was back again in Dundee, and resumed his position of assistant teacher, arduously following at the same time his favourite studies.”²

The scope of his teaching at this time is shown by the following notice which appeared in the ‘Dundee Advertiser’ of April 11, 1834 :—

“J. B. Lindsay resumes classes for cultivating the intellectual and historical portions of knowledge and instruction on April 14, 1834, in South Tay Street, Dundee.

“In a few weeks hence a course of lectures will be formed on frictional, galvanic, and voltaic electricity ; magnetism ; and electro-magnetism. The battery, already powerful, is undergoing daily augmentation. The light obtained from it is intensely bright, and the number of lights may be increased without limit.

“A great number of wheels may be turned [by electricity], and small weights raised over pulleys.

“Houses and towns will in a short time be lighted by electricity instead of gas, and heated by it instead of coal ; and machinery will be worked by it instead of steam—all at a trifling expense.

“A miniature view of all these effects will be exhibited, besides a number of subordinate experiments, including the discoveries of Sir Humphry Davy.”

In March 1841, Lindsay was appointed teacher in the

¹ On a previous occasion (July 1829) he was presented with a new hat (!) by the pupils “for the attention he had bestowed in facilitating their studies.”

² Alex. Maxwell’s (unpublished) Autobiographical Notes and Reminiscences.

Dundee Prison on a salary of £50 a-year, a post which he held for upwards of seventeen years, till October 1858. It is stated that shortly after taking up this office he could have obtained an appointment in the British Museum, a situation which would have been most congenial to his tastes, and which would certainly have led to a lasting recognition of his great abilities; but, being unwilling to leave his aged mother, he declined the offer—a rare example of devotion and self-denial. . . .

Lindsay was a bachelor, and lived alone, buried, it might be said, in his books, collections of which, in history and philosophy, science and languages, were heaped in every corner of his dwelling—a small house of three apartments (11 South Union Street). The kitchen was filled with electrical apparatus, mostly the work of his own hands; and his little parlour was so crowded with books, philosophical apparatus, and other instruments of his labour, that it was difficult to move in it. To provide these things, he denied himself through life the ordinary comforts and conveniences,—bread and coffee, and other simple articles, forming the principal part of his diet. His house in time acquired a celebrity as one of the curiosities of Dundee, and men of learning from distant parts, not only of the kingdom but of the world, often came to pay him a visit.

In July 1858, on the recommendation of Lord Derby, then Prime Minister, her Majesty granted Lindsay an annual pension of £100 a-year, “in recognition of his great learning and extraordinary attainments.” This well-deserved bounty relieved him from the drudgery of a prison teacher, and henceforth to the close of his life he devoted himself entirely to literary and scientific pursuits.

Although never robust, Lindsay on the whole enjoyed tolerably good health through life, but trouble came at last.

On June 24, 1862, he was seized with diarrhœa, which carried him off on June 29, 1862, in the sixty-third year of his age.¹

Although languages and chronology took up much (I am inclined to think too much) of Lindsay's time, still electricity and its applications were his first, as they were always his favourite, study. Amongst some notes and memoranda, bound up with his manuscripts in the Albert Institute, Dundee, he says:—

“Previous to the discovery of Oersted, I had made many experiments on magnetism, with the view of obtaining from it a motive power. No sooner, however, was I aware of the deflection of the needle and the multiplication of the power by coils of wire than the possibility of power appeared certain, and I commenced a series of experiments in 1832. The power on a small scale was easily obtained, and during these experiments I had a clear view of the application of electricity to telegraphic communication. The light also drew my attention, and I was in a trilemma whether to fix upon the power, the light, or the telegraph. After reflection I fixed upon the light as the first investigation, and had many contrivances for augmenting it and rendering it constant. Several years were spent in experiments, and I obtained a constant stream of light on July 25, 1835. Having satisfied myself on this subject, I returned to some glossological investigations that had been left unfinished, and was engaged with these till 1843. In that year I proposed a submarine telegraph across the Atlantic, after having proved the possibility by a series of experiments. Inquiries on other subjects have since that time engaged my attention, but I eagerly desire to return to electricity.”

The first public announcement of Lindsay's success in

¹ Norrie's Dundee Celebrities of the Nineteenth Century, Dundee, 1873.

electric lighting was contained in a short paragraph in the 'Dundee Advertiser' of July 31, 1835; and on October 30 following the same paper published a letter on the subject from Lindsay himself:—

“ELECTRIC LIGHT.

“SIR,—As a notice of my electric light has been extensively circulated, some persons may be anxious to know its present state, and my views respecting it.

“The apparatus that I have at present is merely a small model. It has already cost a great deal of labour, and will yet cost a good deal more before my room is sufficiently lighted. Had circumstances permitted, it would have been perfected two years ago, as my plans were formed then. I am writing this letter by means of it, at 6 inches or 8 inches distant; and, at the present moment, can read a book at the distance of $1\frac{1}{2}$ foot. From the same apparatus I can get two or three lights, each of which is fit for reading with. I can make it burn in the open air, or in a glass tube without air, and neither wind nor water is capable of extinguishing it. It does not inflame paper nor any other combustible. These are facts.

“As I intend in a short time to give a lecture on the subject, my views on the further progress will be unfolded then. A few of these, however, may be mentioned just now.

“Brilliant illumination will be obtained by a light incapable of combustion; and, on its introduction to spinning mills, conflagrations there will be unheard of. Its beauty will recommend it to the fashionable; and the producing apparatus, framed, may stand side by side with the piano in the drawing-room. Requiring no air for combustion, and emitting no offensive smell, it will not deteriorate the

atmosphere in the thronged hall. Exposed to the open day, it will blaze with undiminished lustre amidst tempests of wind and rain ; and, being capable of surpassing all lights in splendour, it will be used in lighthouses and for telegraphs. The present generation may yet have it burning in their houses and enlightening their streets. Nor are these predictions the offshoots of an exuberant fancy or disordered imagination. They are the anticipated results of laborious research and of countless experiments. Electricity, moreover, is destined for mightier feats than even universal illumination.

J. B. LINDSAY.

“DUNDEE, Oct. 28, 1835.”

Lindsay's connection with electric telegraphy forms a very interesting episode. We have seen that from about the year 1830 he was familiar with telegraphic projects, and that he made them the subject of illustration in his classes. At this date electric telegraphs were distinctly in the air, but, like electric lighting, they had hardly advanced beyond the laboratory stage.¹ Lindsay does not appear to have carried them much further for several years, for it was not until 1843 that he conceived the bold idea of a submarine telegraph to America by means of a naked wire and earth-batteries, “after having proved the possibility by a series of experiments.”

It is true that at this time the earth-battery was known. It was first proposed by Kemp, of Edinburgh, in 1828 ; Prof. Gauss in 1838 suggested its employment for telegraphic purposes, and Steinheil, acting on the suggestion, actually used it with some success on the Munich-Nanhofen

¹ From the public exhibition of Baron Schilling's needle instrument in Germany in 1835-36 dates the first real start of electric telegraphy. See my 'History of Electric Telegraphy to 1837,' chap. ix.

Railway, twenty-two miles long ; and Bain in October 1842 employed it for working clocks. Similarly, the idea of signalling with uninsulated wire and without any wire at all was not new, for, as we have seen, the possibility of doing so was in a manner forced on the notice of Steinheil in 1838 and on Morse in 1842, but Lindsay was certainly the first to combine the two principles in his daring proposal of an Atlantic telegraph ; and this, be it remembered, at a time when electric telegraphy was still a young and struggling industry, and when submarine telegraphy was yet a dream.

On June 19, 1845, a short paragraph appeared in the 'Northern Warder,' Dundee, referring to a New York project of communicating between England and America by means of a submerged copper wire "properly covered and of sufficient size." This called forth the following letter from Lindsay, which was published in the same paper on June 26 following :—

"ELECTRIC TELEGRAPH TO AMERICA.

"SIR,—The few lines I now send you have been occasioned by a notice in your last in reference to an electric telegraph to America. Should the plan be carried into effect the following hints should be attended to : The wire should be of pure copper, as otherwise it would be injured by the electro-chemical action of the water. The wire must not be composed of parts joined by soldering, but welded together ; this welding can be performed by electricity. In order to prevent the action of water on the wire, a button of a more oxidable metal should be welded to it at short distances ; the best metal for this purpose would be lead. If soldered to the wire, it must be soldered by lead alone. No third metal must be used. If welded,

it may be done by electricity. In this way the wire resting on the bottom of the sea might last a long time. The one end of the wire is then to be soldered or welded to a plate of zinc immersed in the ocean on the coast of Britain, and the other end similarly joined to a plate of copper deposited in the same ocean on the coast of America. In reference to the expense, suppose the wire to be a ninth or tenth of an inch diameter, then the length of 100 inches would contain a cubic inch of copper, and three miles of wire would contain a cubic foot, weighing 9000 ounces, of the value of about £36 sterling. Owing to the inequalities in the bottom of the ocean, the distance to America might be 3000 miles, and the expense £36,000 sterling—a trifle when compared with the resulting benefit. The only injury that the wire is likely to undergo is from submarine eruptions. It may be broken by these. The two ends, however, being accessible, the greater part of the wire may be drawn up, and the necessary length of wire welded to it. It should be remembered that this welding must be done by electricity. To Calcutta, by the Cape of Good Hope, the expense would be £200,000. The wire from Calcutta to Canton would cost £70,000, to New Zealand £120,000, to Tahiti nearly £200,000. A wire might be placed round the coast of Britain, and another along the coast of America. There might be stations at different towns and electric clocks agreeing with each other to a second of time. Each town might have a specific time for intelligence. Suppose Dundee to have the hour from nine to ten. From nine to ten minutes past nine, messages are sent and answers received between Dundee and New York. From ten minutes to twenty minutes past nine communication is made between Dundee and Quebec. The rest of the hour is for intercourse between Dundee and other towns. The same is done with Edinburgh,

Glasgow, Liverpool, &c., each town having an hour for itself.—L.

“DUNDEE, *June 21, 1845.*”

From this letter it is clear that Lindsay then contemplated an uninsulated wire across the Atlantic in connection with what have come to be known as earth-batteries at the stations along the coasts. His plan of protecting the wire from the corrosive action of the sea-water was evidently borrowed from Sir Humphry Davy's proposal of 1824 for the protection of the copper sheathing of ships by strips of zinc; while the further suggestion, on which he insists so much, of welding the various lengths of wire by electricity, if not original with him, was at all events a very early recognition of a process which has cropped up again in recent years, and which is now largely employed.¹

Between 1845 and 1853 Lindsay does not appear to have done anything in furtherance of his Atlantic project, being probably wholly absorbed in his linguistic and chronological studies. At all events, we hear nothing from him until March 11, 1853, when a notice appeared in the ‘Dundee Advertiser’ of a lecture which he proposed to give on the ensuing Tuesday at the Thistle Hall.

In the same paper a week later a report of the lecture is given as follows :—

“TELEGRAPHIC COMMUNICATION.

“On Tuesday evening our learned and ingenious townsman, Mr J. B. Lindsay, delivered a lecture on the above subject, one with which he has an acquaintance second to

¹ Electric welding was proposed by Joule in 1856; by Wilde in 1865; and by Prof. Elihu Thomson (America) and Dr Benardos (Russia) in 1887.

no man in the kingdom. It would be impossible, in the limited space at our disposal, to give any *vidimus* of the lecture; we can only indicate the outline of a recent discovery made by Mr Lindsay, involving a principle which, if capable of acting irrespective of distance (and we see no reason to doubt that it is), must by-and-by revolutionise all our ideas of time and space. Mr Lindsay stated the principle to be that submerged wires, such as those now used for telegraphic intelligence between this country and Ireland and France, were no longer necessary. By a peculiar arrangement of the wires at the sides of rivers or seas, the electric influence can be made to pass on through the water itself. This proposition was certainly startling, but he illustrated it on a small scale by means of a water-trough, and, so far as the experiment went, it faithfully developed the principle. Mr Lindsay, after concluding these experiments, proceeded to point out the lines which appeared to him most eligible for transmitting telegraphic intelligence throughout the world; and, having done so, he wound up with a peroration of great beauty, in which the wonders to be achieved by electric influence in the days to come were eloquently set forth. It is a fine sight to see this learned and philosophic man pursuing the studies of science and literature, not for the sake of any empty applause, but for those pure pleasures they are in themselves so well fitted to bestow. At the same time it is gratifying to know that there are many people capable of appreciating the modest and retiring character of Mr Lindsay,—a fact which was clearly evidenced on Tuesday evening by the numerous and most respectable meeting which then assembled to hear his scientific lecture.”

In the following August Lindsay delivered another lecture (probably the same) in Glasgow, and so sanguine

was he at this time of the practicability of his method that he actually patented it on June 5, 1854. The following account, which I have condensed from the specification of his patent, explains the *modus operandi*, and also shows how well he understood the conditions of the problem :—

“My invention consists of a mode of transmitting telegraphic messages by means of electricity or magnetism through and across water without submerged wires, the water being made available as the connecting and conducting medium by the following means :—

“On the land, on the side from which the message is to be sent, I place a battery and telegraph instrument, to which are attached two wires terminating in metal balls, tubes, or plates placed in the water or in moist ground adjacent to the water at a certain distance apart, according to the width of the water to be crossed (the distance between the two balls, plates, or tubes to be greater than across the water when practicable). On the land which is situated on the opposite side of the water, and to which the message is to be conveyed, I place two similar metal balls, plates, or tubes, immersed as above stated, and having wires attached to them which lead to, and are in connection with, another battery and needle indicator, or other suitable telegraphic instrument. A, A in the diagram (fig. 2) show the position of the battery and instrument on one side of the water, Z; B, B, the battery and instrument on the opposite side; C, D, E, F, metallic or charcoal terminators; G, H, I, K, wires insulated in the usual way, and connecting the terminators, batteries, and instruments, as shown.

“As regards the power or primary agent, it may be either voltaic, galvanic, or magnetic electricity, and the apparatus for evolving the same, such as is used for ordinary telegraphic purposes.

“As regards the indicating apparatus, I propose to employ any of the instruments in known use which are most efficient for my purpose, observing that the needle indicator may be arranged either in a vertical or in a horizontal position, and that the coil of wire which actuates

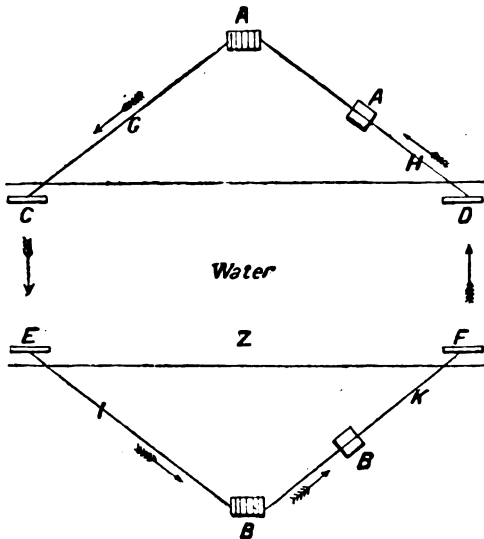

Fig. 2.

the needle may be increased or diminished according to circumstances.

“Suppose it is required to transmit a message from A, the operator completes the circuit of the electric current as ordinarily practised.¹ It will be evident that the current

¹ That is, by a key, which is not shown in the diagram. The absence of keys, no doubt, led a writer to say that Lindsay's method consisted “in providing strong enough batteries, one to send the current half the distance and the other to attract it the other half”!

will have two courses open to it, the one being directly back through the water from c to d , and the other across the water from c to e , along the wires ik , through the instrument B , and back from f to d . Now, I have found that if each of the two distances cd and ef be greater than ce and df , the resistances through ce and df will be so much less than that through the water between c and d , that more of the current will pass across the water, through the opposite wires, and recross at f , than take the direct course cd ; or, more correctly speaking, the current will divide itself between the two courses in inverse ratio to their resistances. As cases may arise, from local or other causes, such as not to admit of the distance between the immersed plates being greater than the distance across the water, I propose, then, to augment the force of the batteries, and to increase the size of the plates, so as to compel a sufficient portion of the current to cross. I prefer, however, when circumstances admit of it, employing the first method."

Lindsay's first public trials were across the Earl Grey Docks at Dundee, and then across the Tay at Glencarse, where the river is nearly three-quarters of a mile wide. Of the few friends who assisted at these experiments Mr Loudon of Dundee is, I believe, the only one now left. He tells us that Lindsay would station them on one side of the Tay, enjoining them to watch the galvanometer and note down how the needle moved. He would then insert his plates in the water on their side of the river, and, crossing over to the opposite side, would complete his arrangements. With a battery of twenty-four Bunsen cells he would make a few momentary contacts, reversing the connections a few times so as to produce right and left deflections of the galvanometer needle. Then he would return and compare the

deflections of the needle which they had noted with the order in which he had himself made the battery contacts, and on finding them to correspond he would be supremely happy.¹

In 1854 Lindsay was in London, and brought his plans to the notice of the Electric Telegraph Company. It is now curious to remark that Mr W. H. Preece, who, as we shall see later on, became himself in after years an eminent wireless-telegraph inventor, was the officer who was deputed to assist him and report on his method. Mr Preece tells us that these were almost the first electrical experiments of any importance in which he ever took part, and in a letter to the writer, dated October 15, 1898, he adds: "I remember Lindsay very well. He came up to London with his 'great invention,' and I assisted him in making his experiments in our gutta-percha testing tank at Percy Wharf on the Thames. We used the old sand battery and galvanometers—ohms and volts were not invented then—and showed that by varying the distance apart of the plates on each side of the tank we varied the strength of the signals. I have no record of the results, but they showed the feasibility of the plan. I had, however, to crush poor Lindsay by telling him that it was not new. Morse in 1842 had done the same thing, and Alexander Bain had also tried about the same time a similar experiment on the Serpentine, but I have not found any published record of it."²

In August 1854 Lindsay carried out a series of experiments at Portsmouth, in which, according to a notice in the 'Morning Post' (August 28), he completely succeeded

¹ Kerr, *Wireless Telegraphy*, 1898, p. 40.

² In this, I think Mr Preece's memory betrays him. Bain's experiments had to do with an insulated wire in connection with earth-batteries. See 'The Artisan,' June 30, 1843, p. 147.

in transmitting signals across the mill dam, where it is about 500 yards wide.¹

Lindsay repeated these experiments at intervals and at various places, indeed whenever and wherever he had the chance, his greatest performance being across the Tay, from Dundee to Woodhaven, where the river is nearly two miles broad. On one of these occasions, and when an Atlantic telegraph began to be seriously debated, the difficulty of finding a steamer large enough to carry the cable was discussed, when Lindsay quietly remarked, "If it were possible to provide stations at not more than twenty miles distant all the way across the Atlantic, I would save them the trouble of laying any cable."

In September 1859 Lindsay read a paper before the British Association at Aberdeen "On Telegraphing without Wires," which drew from Lord Rosse, the president of the section, special commendation. Prof. Faraday and (Sir) G. B. Airy, then Astronomer-Royal, also added their approval of the views enunciated. Prof. Thomson (now Lord Kelvin) was also present, and, as is well known, was then deeply engaged with Atlantic cable projects. History does not say what *he* thought of the poor Dundee

¹ These experiments were also noticed in 'Chambers's Journal' for September 1854, as follows: "Again has an attempt been made to send a signal through water without a wire—this time at Portsmouth, where it was attended with partial success. The thing has often been tried: a few years ago, a couple of *savants* might have been seen sending their messages across those minor lakes known to Londoners as the Hampstead Ponds!" Can any reader tell me who these *savants* were?

About this time experiments in wireless telegraphy were evidently popular. Van Reese at Portsmouth; Gintl, the first inventor of a duplex telegraph, in Austria; Bonelli in Italy, and Bouchotte and Douat in France (and doubtless others), all were engaged on the problem, but with what results I do not know, as I have not met with any detailed accounts of their experiments.

lecturer, but, with the experience of forty years, we can easily guess.

A brief abstract of the paper was published in the Annual Report of the Association for 1859, but a fuller account appeared in the 'Dundee Advertiser,' from which I take the following interesting details:—

“The author has been engaged in experimenting on the subject, and in lecturing on it in Dundee, Glasgow, and other places since 1831. Recently he had made additional experiments, and succeeded in crossing the Tay where it was three-quarters of a mile broad. His method had always been to immerse two plates or sheets of metal on the one side, and connect them by a wire passing through a coil to move a needle, and to have on the other side two sheets similarly connected, and nearly opposite the two former. Experiments had shown that only a fractional part of the electricity generated goes across, and that the quantity that thus goes across can be increased in four ways: (1) by an increased battery power; (2) by increasing the surface of the immersed sheets; (3) by increasing the coil that moves the receiving needle; and (4) by increasing the lateral distance of the sheets. In cases where lateral distance could be got he recommended increasing it, as then a smaller battery power would suffice. In telegraphing by this method to Ireland or France abundance of lateral distance could be got, but for America the lateral distance in Britain was much less than the distance across. In the greater part of his experiments the distance at the sides had been double the distance across; but in those on the Tay the lateral distance was the smaller, being only half a mile, while the distance across was three-quarters of a mile.

“Of the four elements above mentioned, he thought that if any one were doubled the portion of electricity

that crossed would also be doubled, and if all the elements were doubled the quantity transmitted would be eight times as great. In the experiments across the Tay the battery was of 4 square feet of zinc, the immersed sheets contained about 90 square feet of metal, the weight of the copper coil was about 6 lb., and the lateral distance was, as just stated, less than the transverse; but if it had been a mile, and the distance across also a mile, the signals would, no doubt, have been equally distinct. Should this law (when the lateral distance is equal to the transverse) be found correct, the following table might then be formed:—

Zinc for battery.	Immersed sheets.	Weight of coil.	Distance crossed.
sq. ft.	sq. ft.	lb.	miles.
4	90	6	1
8	180	12	8
16	360	24	64
32	720	48	512
64	1440	96	4096
128	2880	192 ¹	32,768

“But supposing the lateral distance to be only half the transverse, then the space crossed might be 16,000 miles; and if it was only a fourth, then there would be 8000 miles—a much greater distance than the breadth of the Atlantic. Further experiments were, however, necessary

¹ My readers will smile at the suggestion of such galvanometer coils, but they should remember that forty years ago matters electrical were largely ordered by the rule of thumb. The electro-magnet first used by Morse on the Washington-Baltimore line (1844), and exhibited in Europe, weighed 185 lb. The arms were 3½ inches long and 18 inches diameter, the wire (copper) being that known as No. 16—the same size as the line wire, it being then supposed that the wire of the coils and of the line should be of the same size throughout. Down to 1860 not a few practical telegraphists held this view. See D. G. FitzGerald in the London ‘Electrical Review,’ August 9, 1895, p. 157.

to determine this law, but, according to his calculations, he thought that a battery of 130 square feet, immersed sheets of 3000 square feet, and a coil of 200 lb., would be sufficient to cross the Atlantic with the lateral distance that could be obtained in Great Britain."

After the reading of the paper Lindsay carried out some very successful experiments across the river Dee, in the presence of Lord Rosse, Prof. Jacobi of St Petersburg, and other members of the Association. In February 1860 he made Liverpool the scene of his operations, but there, strange to say, he had not the success which hitherto attended him. The experiments failed, being "counteracted by some unaccountable influence which he had not before met with." However, in the following July he was again successful at Dundee in his experiments across the Tay, below the Earn, where the river is more than a mile wide. In communicating these results to the 'Dundee Advertiser' (July 10, 1860), he says: "The experiment was successful, and the needle was strongly moved; but as I had no person with me capable of sending or reading a message, it [regular telegraphic signalling] was not attempted."

This was Lindsay's last public connection with the telegraph, but to the end of his life (June 29, 1862) he remained perfectly convinced of the soundness of his views and of their ultimate success.

J. W. WILKINS—1845.

In the New York 'Electrical Engineer' of May 29, 1895, it was claimed for Prof. Trowbridge (of whom we shall have more to say later on) that he was the first to telegraph without wires in 1880.

The paragraph in which this claim, unfounded as we already see, was advanced, besides drawing renewed attention to Prof. Trowbridge's experiments, had the merit of calling forth an interesting communication from our own Mr J. W. Wilkins, one of the very few telegraph officers of Cooke & Wheatstone's days still with us, and whose early and interesting reminiscences I hope we may yet see.¹

Writing in 'The Electrician,' July 19, 1895, Mr Wilkins says :—

“Nearly fifty years ago, and thirty years before Prof. Trowbridge ‘made original researches between the Observatory at Cambridge and the City of Boston,’ the writer of these lines had also researched on the same subject, and a year or two later published the results of his investigations in an English periodical—the ‘Mining Journal’ of March 31, 1849—under the heading ‘Telegraph communication between England and France.’ In that letter, after going into the subject very much like the American Professor in 1880, there will be found my explanation—also not differing much from the Professor’s—as to how the thing was to be done; except that, in my case, I proposed a new and delicate form of galvanometer or telegraph instrument for the purpose, while he made use of the well-known telephone. I suggested the erection of lengths of telegraph wires on the English and French coasts, with terminals dipping into the earth or sea, and as near parallel as possible to one another; and I suggested a form of telegraph consisting of ‘coils of finest wire, of best conductibility,’ with magnets to deflect them, on the passage of a current of electricity through them, which I expected would take place on the discharge of electricity through the circuits on either side of the water;

¹ Mr Wilkins is the author of two English patents: (1) Improvements in Electric Telegraphs, January 13, 1853; and (2) Improvements in obtaining power by Electro-Magnetism, October 28, 1853.

anticipating, of course, that a portion of the current would flow from the one pair of earth-plates—terminals of one circuit—to the other pair of terminals on the opposite shore.

“It may be interesting to relate how I came to think that telegraphy without wires was a possibility, and that it should have appeared to me to have some value, at a time when gutta-percha as an insulator was not imagined, or the ghost of a proposition for a submarine wire existed. At that time, too, it was with the utmost difficulty that efficient insulation could be maintained in elevated wires if they happened to be subject to a damp atmosphere.

“It was in the year 1845, and while engaged on the only long line of telegraph then existing in England—London to Gosport—that my observations led me to question the accepted theory that currents of electricity, discharged into the earth at each end of a line of telegraph, sped in a direct course—instinctively, so to say—through the intervening mass of ground to meet a current or find a corresponding earth-plate at the other end of it to *complete the circuit*. I could only bring myself to think that the earth acted as a reservoir or condenser—in fact, receiving and distributing electricity almost superficially for some certain or uncertain distance around the terminal earths, and that according to circumstances only. A year later, while occupied with the installation of telegraphs for Messrs Cooke & Wheatstone (afterwards the Electric Telegraph Company), a good opportunity offered of testing this matter practically upon lengths of wire erected on both sides of a railway. To succeed in my experiment, and detect the very small amount of electricity likely to be available in such a case, I evidently required the aid of a very sensitive galvanometer, much more so indeed than the

long pair of astatic needles and coil of the Cooke & Wheatstone telegraph, which was then in universal use as a detector. The influence of magnetism upon a wire conveying an electric current at once suggested itself to me, and I constructed a most sensitive instrument on this principle, by which I succeeded in obtaining actual signals between lengths of elevated wires about 120 ft. apart. This, however, suggested nothing more at the moment than that the current discharged from the earth-plates of one line found its way into the earth-plates of another and adjacent circuit, through the earth. Later on, I had other opportunities of verifying this matter with greater distances between the lines of wire, and ultimately an instance in which the wires were a *considerable distance apart*, and with no very near approach to parallelism in their situation. Then it was that it entered my head that telegraphing without wires *might be a possibility.*"

The following extracts from the letter in the 'Mining Journal,' above referred to, may now be reproduced with interest. I have slightly altered the phraseology with a view of making the writer's meaning more clear and connected :¹—

"Allow me, through the medium of your valuable journal, to draw attention to a principle upon which a telegraphic communication may be made between England and France without wires. I take for certain (as experiments I have made have shown me) that when the poles of a battery are connected with any extended conducting medium, the electricity diffuses itself in radial lines between

¹ Mr C. Bright has recently reprinted this letter *verbatim* in 'Jour. Inst. Elec. Engs.,' vol. xxvii. p. 958, as containing "the first really practical suggestion in the direction of inductive telegraphy"; but, as we now see, it is not the first suggestion, and it is certainly not inductive.

the poles. The first and larger portion will pass in a straight line, as offering the least resistance; the rays will then form a series of curves, growing larger and larger, until, by reason of increasing distance, the electricity following the outer curves is so infinitesimal as to be no longer perceptible.

“These rays of electricity may be collected within a certain distance—focussed as it were—by the interposition of a metallic medium that shall offer less resistance than the water or earth; and, obviously, the nearer the battery, the greater the possibility of collecting them. I do not apprehend the distance of twenty miles being at all too much to collect a sufficient quantity of electricity to be useful for telegraphic purposes. If, then, it is possible, as I believe, to collect in France some portion of the electricity which has been discharged from a battery in England, all that is required is to know how to deal with it so that it shall indicate its presence.

“The most delicate of the present telegraph apparatus, the detector, being entirely unsuited for the purpose, I propose the following arrangement: Upon one shore I propose to have a battery that shall discharge its electricity into the earth or sea, with a distance between its poles of five, ten, or twenty miles, as the case may be. Let a similar length of wire be erected on the opposite coast, as near to, and parallel with, it as possible, with its ends also dipping into the earth or sea. In this circuit place an instrument consisting of ten, twenty, or more round or square coils of the finest wire of best conductibility, suspended on points or otherwise between, or in front of, the poles of an electro-, or permanent, magnet or magnets. Any current passing through the coil would be indicated by its moving or shifting its position with reference to the poles of the magnet. This would constitute a receiving apparatus of the most

delicate character, for its efficiency would depend not so much on the strength of the current passing as on the power of the magnet, which may be increased at pleasure.

“I hope some one will take up this suggestion and carry it out practically to a greater extent than my limited experiments have enabled me to do. Of its truth for long as well as for short distances I am satisfied, and only want of means and opportunity prevent me carrying it out myself.”

In a recent letter to the writer *à propos* of this early proposal, Mr Wilkins says:—

“I will just say that all thought of induction was absent in my first experiments. I modified my views in this respect a year or two later, but I did not attach sufficient importance to the matter to follow up my communication to the ‘Mining Journal,’ especially as at that time a cable was actually laid across the Channel, which I could not doubt would be a success, and a permanent one too. I rather courted forgetfulness of the proposition. Whatever my opinion at the time was as to the source of the electricity that I discovered in the far removed and disconnected circuit, the result was the same, and the means I used to obtain it the same in principle as those which make the matter an accomplished fact to-day—viz., elevated lengths of wire, and the discharge of electricity from the one on to a delicate receiving apparatus in the circuit of the other.

“As regards the form of receiving apparatus which I suggested for indicating the signals, I did then, and do now, attach great importance to the happy idea. It happens to be the most delicate form of detector or galvanometer, and is identical in principle with Lord Kelvin’s apparatus for long cable working, which, in his Siphon Recorder Patent, he says is as sensitive as his Mirror Galvanometer.”

This principle, as the practical reader knows, has been largely used in telegraphy. Besides Lord Kelvin’s appli-

cation of it, we have the Brown and Allan Relay, the Weston Relay, and Voltmeter, and other contrivances of a similar nature;¹ but Mr Wilkins was himself the first to put it in practice, and under the following interesting circumstances: In 1851 he went to America to assist Henry O'Reilly of New York, a well-known journalist, who had a concession from the patentees of the Morse system for the erection of telegraph lines, at a royalty per mile. Disputes soon arose, and the Morse Syndicate sought to prevent O'Reilly from using their relay, without which the Morse instruments would be useless for long distances. In this difficulty O'Reilly adopted Bain's electro-chemical apparatus, and employed it for a time on the People's Telegraph from New York to Boston, *viâ* Albany. But finding that it was impossible to use this instrument in connection with intermediate stations, O'Reilly was again in a difficulty, when Mr Wilkins came to the rescue by saying he could devise a relay which did not require an iron armature, or electro-magnet of the ordinary form, and which would therefore be independent of the Morse patent. Very soon relays consisting of movable coils of wire, suspended between the poles of a magnet, were constructed in the workshop of John Gavitt, a friend of O'Reilly's, and then famous as a bank-note engraver. The instruments were placed in the circuit of the People's Telegraph, and O'Reilly was saved—but only for a time, as in the end he was beaten by his powerful opponents. The Wilkins relay was put aside and soon forgotten, but forty-three years later it was brought forward again by Mr Weston as an original invention.²

¹ The germ of all these instruments, as well as the Axial Magnets of Prof. Page and Royal E. House, was sown by Edward Davy in England in 1837. See my 'History of Electric Telegraphy,' 1884, pp. 356, 357.

² See the New York 'Electrical Engineer,' February 21, 1894.

DR O'SHAUGHNESSY (AFTERWARDS SIR WILLIAM
O'SHAUGHNESSY BROOKE)—1849.

One of the first difficulties encountered in the early days of the telegraph in India was the crossing of the great water-ways that abound in that country; and it was this difficulty which first directed the attention of Dr O'Shaughnessy, the introducer of the system in India, to the subject of subaqueous telegraphy.

In 1849 he laid a bare iron rod under the waters of the river Huldee, 4200 feet wide, with batteries and delicate needle instruments in connection on each bank. Signals were passed, but "it was found that the instruments required the attention of skilful operators, and that in practice such derangements occurred as caused very frequent interruptions."

He next tried the experiment without any metallic conductor, using the water alone as the sole vehicle of the electric impulses, but, though he again succeeded in passing intelligible signals, he found that the battery power for practical purposes would be enormous (he used up to 250 cells of the nitric acid and platinum form), and therefore prohibitively expensive.

Although for practical purposes he soon abandoned the idea of signalling across rivers with naked wires, and without any wires at all, O'Shaughnessy for many years took great interest in the subject. Thus as late as 1858 we find him performing some careful experiments in the lake at Ootacamund, and in his Administration Report of the Telegraph Department for that year he says: "I have long since ascertained that two naked uncoated wires, kept a moderate distance—say 50 or 100 yards—apart, will transmit electric currents to considerable distances (two to three miles) sufficiently powerful for signalling with needle instruments."

E. AND H. HIGHTON—1852-72.

The brothers Edward and Henry Highton, who were well-known inventors in the early years of electric telegraphy, took up the problem of transaqueous communication about 1852. In Edward Highton's excellent little book, 'The Electric Telegraph: Its History and Progress,' published in that year, he says: "The author and his brother have tried many experiments on this subject. Naked wires have been sunk in canals, for the purpose of ascertaining the mathematical law which governs the loss of power when no insulation was used. Communications were made with ease over a distance of about a quarter of a mile. The result, however, has been to prove that telegraphic communications could not be sent to any considerable distance without the employment of an insulated medium."

On the other hand, Henry Highton long continued to believe in its practicability, and made many further experiments to that end. These were embodied in a paper read before the Society of Arts on May 1, 1872 (Telegraphy without Insulation), from which I condense the following account:—

"I have for many years been convinced of the possibility of telegraphing for long distances without insulation, or with wires very imperfectly insulated; but till lately I had not the leisure or opportunity of trying sufficient experiments bearing on the subject. I need hardly say that the idea has been pronounced on all hands to be entirely visionary and impossible, and I have been warned of the folly of incurring any outlay in a matter where every attempt had hitherto failed. But I was so thoroughly

convinced of the soundness of my views, and of the certainty of being able to go a considerable distance without any insulation, and any distance with very imperfect insulation, that I commenced, some three or four months since, a systematic series of experiments with a view to test my ideas practically.

“I began by trying various lengths of wire, dropped in the Thames from boats, and found that I could, without the slightest difficulty, exceed the limits allowed hitherto as practicable. This method, however, was attended with much difficulty and inconvenience, owing to the rapidity of the tides and the motion of the boats. I next tried wires across the Thames, but had them broken five or six times by the strength of the current and by barges dragging their anchors across them.

“I then put the instrument in my own room, on the banks of the river, and sent a boat down stream with a reel of wire and a battery to signal to me at different distances. The success was so much beyond my expectations, that I next obtained leave to lay down wires in Wimbledon Lake. As the result of all these experiments I found that water is so perfect an insulator for electricity of low tension that wires charged with it retained the charge with the utmost obstinacy; and, whether from the effect of polarisation (so-called), or, as I am inclined to suppose, from electrification of the successive strata of water surrounding the wire, a long wire, brought to a state of low electrical tension, will retain that tension for minutes, or even hours. Notwithstanding attempts to discharge the wire every five seconds, I have found that a copper surface of 10 or 12 square feet in fresh water will retain a very appreciable charge for a quarter of an hour; and even when we attempt to discharge it continuously through a resistance of about

thirty units [ohms], it will retain an appreciable though gradually decreasing charge for five or six minutes.¹

“Since that time I have constructed an artificial line, consisting of resistance coils, condensers, and plates of copper in liquids, acting at once as faults and as condensers, so that I might learn as far as possible to what extent the principle of non-insulation can be carried, and I have satisfied myself that, though there are difficulties in very long lengths absolutely uninsulated, yet it is quite feasible to telegraph, even across the Atlantic, with an insulation of a single unit instead of the 170,000 units [absolute] of the present cables.

“The instrument with which I propose to work is the gold-leaf instrument, constructed by me for telegraphic purposes twenty-six years ago,² acted upon by a powerful electro-magnet, and with its motions optically enlarged. The exclusive use of this instrument in England was purchased by the Electric and International Telegraph Company, but it was never practically used, except in Baden, where a Government commission recommended it as the best. One of its chief merits is its extreme lightness and delicacy. Judging by the resistance it presents to the electric current, it would appear that the piece of gold-leaf in the instrument now before us does not weigh more than $\frac{1}{2000}$ th part of a grain; let us even say that it weighs four times more, or $\frac{1}{500}$ th part of a grain. In order, then, to make a visible signal we only have to move a very, very small fraction of a grain through a very, very small fraction of an inch. You may judge of its delicacy

¹ It does not appear to have struck our author that these effects would militate against the practical application of his method.

² A special arrangement of this instrument, adapting it for long and naked (or badly insulated) lines, was patented February 13, 1873. For reports of its great delicacy see ‘Telegraphic Journal,’ February 15, 1874.

when I show you that the warmth of the hand, or even a look, by means of the warmth of the face turned towards a thermopile, can transmit an appreciable signal through a resistance equal to that of the Atlantic cable (experiment performed). Another great merit of this instrument is its ready adaptability to the circumstances in which it may be placed, as it is easy to increase or diminish the length, or breadth, or tension of the gold-leaf. Thus, increase of length or diminution of breadth increases the resistance, but also increases the sensitiveness; and again, partaking as it does partly of the character of a pendulum and partly of a musical string, the rapidity of vibration is increased by giving it greater tension and greater shortness, though by doing so the sensitiveness is diminished; so that you can adjust it to the peculiar circumstances of any circuit. Again, you notice the deadness of the movements and the total absence of swing, which, whenever a needle is used, always more or less tends to confuse the signals. The greatest advantage of all is that we can increase the sensitiveness without increasing the resistance, simply by increasing the power of the electro-magnet.

“Having now explained the construction of the instrument, and pointed out its merits, I proceed to show by experiment how tenaciously a piece of copper in water will retain a state of electrical tension. Here is a tub of fresh water, with copper plates presenting to each other about 14 square feet of surface. I charge these plates with a Daniell cell, and you see how they retain the charge; in fact, they will go on gradually discharging for several minutes through the small resistance of the gold-leaf instrument. I now do the same with a tub of salt water, and the result is still the same, though less marked. In fact, these plates, with the water between, represent the two metallic surfaces of a Leyden jar, and the water retains the elec-

tricity of this small tension with much more obstinacy than the glass of a Leyden jar does the electricity of a higher tension.¹

“Indeed, it is a fact of the highest importance in telegraphy that when there is a fault, electricity of a high tension, say of twenty or thirty Daniell cells, will almost wholly escape by it, and leave nothing for the instrument; whereas electricity of a small tension, as from a single cell of large surface, will pass through the instrument with very little loss of power. This is strikingly shown by the use of an ordinary tangent galvanometer. I cannot well show it to a large audience like the present, therefore I will only inform you that when I have taken two currents, each marking 30° on the galvanometer, the one of high tension from thirty Daniell cells, and the other of low tension from a single cell of small internal resistance, a fault equivalent to the exposure of a mile of No. 16 wire in sea-water will annihilate all appreciable effects on the galvanometer when using the current of high tension, whereas the current of low tension will still show as much as 20°. You see, then, the importance of using currents of low tension from a battery of large surface, and how a faulty cable can be worked with such currents when it is absolutely useless with currents of high tension.

“There are three ways of signalling without insulation: one, only feasible for short distances; a second, which I think will be found the most practicable; and a third, in the practical working of which for very long distances several difficulties (though by no means insuperable) present themselves.

¹ These experiments are not clearly described in the report from which we are quoting. If we understand them aright, they are rather electrolytic than Leyden-jar effects. In any case, as the tubs were presumably fairly well insulated, they have no bearing *ad rem*.

“To explain the first plan, we will take the case of a river, and in the water near one bank place the copper plates A B, and connect them with a wire, including the battery P. Near the opposite bank submerge similar plates, c D, connected by a wire, in the circuit of which is placed the galvanometer G. Between A and B the current will pass by every possible route, in quantities inversely proportional to their resistances; parts will pass direct by A B; and other portions by A, c, D, B, and by A, c, G, D, B. Now, if the plates be large, and A C and B D respectively

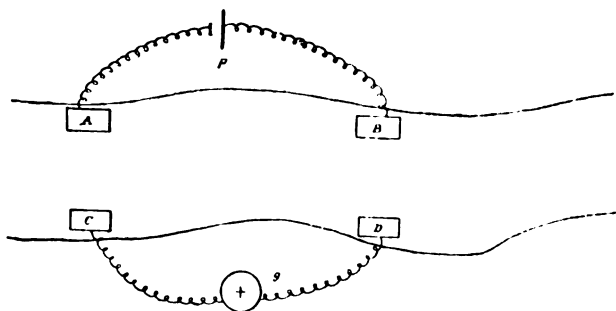

Fig. 3.

comparatively near to each other, an appreciable current will pass from A to c, through G, and back from D to B; but if the plates be small, the battery power small, and the distance from A to B and from c to D comparatively short, no appreciable amount will pass through the galvanometer circuit. I do not hesitate to say that it is possible, by erecting a very thick line wire from the Hebrides to Cornwall, by the use of enormous plates at each extremity, and by an enormous amount of battery power—*i.e.*, as regards *quantity*—to transmit a current which would be sensibly perceived in a similar line of very thick wire, with

very large plates, on the other side of the Atlantic. But the trouble and expense would probably be much greater than that of laying a wire across the ocean.

“The second is the simplest and most feasible plan—namely, laying across the sea two wires kept from metallic contact with each other, and working with that portion of the current which prefers to pass through this metallic circuit instead of passing across the liquid conductor, using currents of low tension from batteries of large surface.

“The third method is to lay a single wire imperfectly insulated, and to place at the opposite end beyond the instrument a very large earth-plate. Any electrical tension thrown on this wire transmits itself more or less to the opposite end, and will be shown on any instrument of small resistance and sufficient delicacy. There are certain difficulties in this way of working, such as the effects of earth-currents and currents of polarisation which keep the needle or gold-leaf permanently deflected from zero, necessitating special means of counteraction. I have no doubt, from my experiments, that these difficulties may be overcome; but still I think the simplest and most feasible, and not more expensive, plan will be to work with two naked wires kept apart from metallic contact, using electricity of a very low tension.”¹

Soon after this Mr Highton turned a complete *volte face*, and went back to wires *perfectly* insulated, but at a

¹ The following cutting from ‘Once a-Week’ (February 26, 1876) is given here in the hope that some American reader will kindly supply details, if any are procurable: “The ‘New York Tribune’ gives an account of what appears to be a very remarkable discovery in electrical science and telegraphy. It is claimed that a new kind of electricity has been obtained, differing from the old in several particulars, and notably *in not requiring for transmission that the conducting wires shall be insulated*. The difference is scarcely greater in kind than between polarised and non-polarised light, or between ordinary

ridiculously small cost! On April 20, 1873, he sent the following letter to the 'Times':—

“CHEAP TELEGRAPHY.

“SIR,—Some months ago I read a paper to the Society of Arts on the possibility of telegraphing for great distances without insulation, for which they were good enough to vote me a medal. I now find, however, that by the discovery of a new insulating material perfect insulation can be provided at a *ridiculously* small cost.

“I find by the addition of this material, which is simply tar chymically modified, nearly 200,000 per cent is added to the insulating power of a thin coating of gutta-percha. I hope the result will shortly be found in the great cheapening of telegraphy.—Yours, &c., H. HIGHTON.”

The new material here referred to was a preparation of vegetable tar and oxide of lead, which almost instantly solidified on application. In some experiments at the Silvertown Works, it was found that No. 18 copper wire, covered with gutta-percha weighing only 21 lb. to the mile, had its insulation increased nearly 200,000 per cent, representing an insulation per mile of nearly three billion ohms!—enough, as the inventor needlessly remarked, for any lengths possible on the surface of the earth.¹

iron and that which has been so changed by contact with platinum that the strongest nitric acid fails to attack it. A genuine discovery of the sort would be of inestimable service in cheapening the telegraph, cable rates would soon be permanently reduced, and the unsightly poles that now disfigure our cities would quickly disappear.”

¹ For reports on this cable see 'Telegraphic Journal,' vol. ii. pp. 104, 129.

G. E. DERING—1853.

The problem of wireless telegraphy was taken up about this time by Mr George Dering of Lockleys, Herts, who was, like his old Rugby tutor, Henry Highton, a prolific inventor of electrical and telegraphic appliances, patents for which he took out on eleven separate occasions between 1850 and 1858, and many of which came into practical use in the early Fifties. His needle telegraph, patented December 27, 1850, was in use in the Bank of England early in 1852, connecting the governor's room with the offices of the chief accountant, chief cashier, secretary, engineer, and other officials. About the same time it was partially used on the Great Northern Railway, and exclusively so on the first Dover-Calais cable (1851), where it did excellent service, working direct between London and Paris for a long time (including the busy period of the Crimean war), until supplanted by the Morse recording instrument.

In the same specification of 1850, Dering patented three methods of carrying off atmospheric electricity from the line-wires: (a) "Two roughened or grooved metallic surfaces separated by fine linen, one of which is included in the line-wire circuit, and the other is in connection with the earth." This was afterwards (in 1854) repatented by (Sir) William Siemens, and is now known as Siemens' Serrated-Plate Lightning-Guard. (b) "The attraction or repulsion occurring between dissimilarly or similarly electrified bodies respectively. Thus metal balls may be suspended from the line-wire by wires, which on separating under the influence of the lightning-discharge make contact with plates connected with the earth; or the separation may simply break connection between the line-wire and the instrument."

(c) "Introducing a strip of metallic leaf into the circuit, this being fused by the passage of the atmospheric electricity." This very effective method has also been reintroduced in later years, and always as a novelty, by various telegraph engineers.

Dering's telegraphic appliances made a goodly show at the Great Exhibition of 1851, side by side with Henley's colossal magnets, and received "honourable mention." They were again on view at the Paris International Exhibition of 1855, where they were awarded a medal for general excellence.

Dering's proposals for a transmarine telegraph are contained in his patent specification of August 15, 1853, from which we condense the following account:—

"The present invention is applicable to submarine telegraphs, and also to the means of communication by underground or over-ground wires. Heretofore, in constructing electric telegraphs where the whole circuit has been made of metal, and also where the conducting property of the earth has been employed as a part of the circuit, it has been usual, and it has been considered absolutely necessary, to cause the wires to be thoroughly insulated, the consequence of which has been that the expense of laying down electric circuits has been very great, particularly where the same have crossed the sea or other waters, where not only have the wires been insulated, but in order to protect the insulating matter from injury further great cost has been caused by the use of wire rope, or other means of protection.

"Now, I have discovered that a metallic circuit formed of wires, either wholly uninsulated or partially so, may be employed for an electric telegraph, provided that the two parts of the circuit are at such a distance apart that the electric current will not all pass direct from one wire to the

other by the water or earth, but that a portion will follow the wire to the distant end.

“To carry out my invention, I cause two uninsulated or partially insulated wires to be placed in the water or in the earth, at a distance apart proportionate to the total length of the circuit, the said wires being insulated where they approach one another to communicate with the instruments, in order to prevent the current passing through the diminished water or earth space between them. The batteries (or other suitable source of electricity) employed are to be constructed in the proportion of their parts in conformity with the well-known laws which regulate the transmission of electric currents through multiple circuits—that is, they should possess the properties generally understood by the term *quantity* in a considerably greater degree than is usual for telegraphing through insulated wires, which may be effected (in the case of galvanic batteries) by using plates of larger dimensions, or by other alterations in the exciting liquids or plates. The proper distance at which to place the conductors from one another is also determined by the same laws, all of which will be readily understood by persons conversant with the principles of electrical science. In practice I find that from one-twentieth to one-tenth the length of the line-wires is a sufficient distance.

“Another method of carrying out my invention consists in establishing circuits composed in part of the uninsulated or partially insulated conductors, and in part of the conducting property of the sea, across which the communication is to be made, or of the earth or the moisture contained therein in the case of land telegraphs. For this purpose the connections are effected at such a distance in a lateral direction that a sufficient portion of the current will pass across the water or earth space and enter the corresponding wire connection at the other extremity. The connecting

wires at the *termini* must be effectually insulated as in the first method.

“A third method consists in placing in the sea or earth two wires of dissimilar metal having the quality of generating electricity by the action of the water or moisture with which they are in contact. If at one extremity the wires be attached respectively to the two ends of the coil of an electro-magnet or other telegraphic apparatus, it will be found that the instrument is acted on by the current generated by the wires. If now at the other extremity the wires be connected, a portion of the current will complete its circuit through this connection, instead of all passing through the electro-magnet, where consequently the effect will be diminished; and if means be adopted to indicate this greater or less power, signals may be indicated at one end by making and breaking contact at the other. If desirable, currents derived from galvanic batteries, or other source, may be employed as auxiliary to those generated in the outstretched wires.

“In the different means of communication which I have described, if strong conductors are required, as in submarine lines, wire rope may be employed, either alone or attached to chains for greater strength and protection, or the conducting wires may be attached to hempen ropes, or enveloped within them. The metal composing the wires may be iron or copper or any other suitable kind, and it may be coated with varnish, by which means the amount of exposed surface will be diminished, and the metal preserved from corrosion.

“I will now suppose the case of a line to be carried out upon the principle which I have described, say from Holyhead to Dublin, a distance of about sixty miles. It would be necessary, first, to select two points on each coast from three to six miles apart, and to connect these points on each

coast by insulated wires. Next, the two northern points are to be connected by a submerged uninsulated conductor, and the two southern points by a similar conductor, unless the water be employed as a substitute in the manner before described. Thus an oblong parallelogram of continuous conductors is formed, having for its longer sides the uninsulated conductors, and for its shorter sides the insulated wires along the coasts. If now these latter wires be cut at any parts, and instruments and batteries be connected in circuit, signals may be transmitted by any of the means ordinarily employed with insulated wires.

“Or, to take the case of a longer line, say from England to America, I should select two points, as the Land’s End in Cornwall and the Giant’s Causeway in Ireland or some suitable place on the west coast of Scotland, and corresponding points on the American shore. Next, I should unite the two points in each country by insulated wires, and, finally, submerge two uninsulated conductors across the Atlantic, or one if the water be employed to complete the circuit. Then by introducing, as before, suitable telegraphic instruments and batteries the communication will be established.

“From the foregoing description it will be seen that the cost of laying down electric telegraphs, whether submarine or otherwise, is, by this invention of employing distance between the conductors as a means of insulation, reduced to little more than the mere cost of the wires, together with that of an insulated wire at each end; while the numerous difficulties which attend the insulation of long lengths of wire are avoided, as also the chances of the communication being interrupted by accidents to the insulation.”

At the time of this patent, and for many years after, the difficulties just referred to were only too real. Many of

the cables laid between 1850 and 1860 failed after a longer or shorter period, and chiefly through defective insulation. Hence, no doubt, the persistency with which telegraph engineers in the Fifties sought in telegraphy without insulation, and telegraphy without wires, other and more economical ways of solving the great problem of transmarine communication.

Dering's experiments were performed across the river Mimram at Lockleys, Herts, with bare parallel wires of No. 8 galvanised iron, laid at a distance apart of about 30 feet, or one-tenth of the space to be traversed. With a small battery power of only two or three Smee cells the signals were easily readable.

At one of these performances on August 12, 1853, the chairman and directors of The Electric Telegraph Company of Ireland (one of several mushroom companies then started) were present, and so impressed were they with the results obtained that they there and then decided to adopt the system for their intended line between Portpatrick and Donaghadee. This is a fact not generally known in the history of early submarine telegraph enterprises, and what is still less known, for there is no record of it, is that the project was actually attempted. In a recent letter, Mr Dering, who I am glad to say is still with us, has given me some interesting details of the attempt which I now publish, feeling sure that they will be new to the reader.

On September 23, 1853, the necessary wire in bundles was shipped to Belfast, which, "for the sake of ultra economy," consisted of single No. 1 galvanised iron instead of twisted strand wire as Dering had recommended. On examination the wire proved to be so unreliable, with numerous weak and brittle places—chiefly at the factory welds—that Dering urged delay and the substitution of

stranded wire. "Had we been wise," writes Mr Dering, "we should have abandoned the attempt with this unsuitable material, but it was resolved to go on and risk it—testing the wire as far as might be beforehand and removing the weak parts. I, however, addressed a formal letter to the board of directors in London, stating that the wire was so unreliable I must decline all responsibility as to the laying it down, but that I would do the best I could."

After carefully testing the various lengths, removing all weak parts and bad welds as far as they could be discovered, and jointing and tarring the whole into one long length, the wire was paid into the hold of the *Albert*. On November 21 a start was made, a shore-end wire was laid from Milisle, carried out to sea, and buoyed. Next morning the *Albert*,¹ piloted by H.M.S. *Asp* (Lieut. Aldridge), picked up the buoyed end, joined it to the wire on board, and paid out successfully for about $3\frac{1}{2}$ miles, when the wire broke at a factory weld, and the ship returned to Donaghadee "in a gale of wind."

The next few days were occupied in some alterations to the paying-out machinery, found by experience to be desirable, and on the 26th another start was made. The wire on board was joined to the buoyed end at 4 miles from shore, and paying-out proceeded successfully as far as mid-channel (about 12 miles) when the wire broke, again at a factory weld, and the end was lost in 82 fathoms of water. The ship then returned to the buoy and tried to underrun the wire, but it soon broke again, and for the moment further attempts were abandoned.

Previous to this two unsuccessful attempts had already been made to connect Great Britain and Ireland by cables made on the lines of the Dover-Calais cable of 1851, one,

¹ With Dr Hamel on board, the famous Russian scientist of Alpine celebrity, as the representative of his Government.

undertaken by Messrs Newall & Co., between Holyhead and Howth, June 1, 1852, which failed three days after; and the other, a heavy six-wired cable, undertaken by the same firm, between Portpatrick and Donaghadee, October 9, 1852, which broke in a gale after sixteen miles had been paid out.

In June 1854 Messrs Newall recovered the whole of this sixteen miles of cable, and completed the laying to Portpatrick, thus rendering another attempt at a bare wire cable unnecessary, if, indeed, it was still thought desirable.

Mr Dering's faith in the soundness of his views is still unshaken, for he goes on to say: "Instead of a single wire, as in 1853, I should now advocate the use of a bare strand of wires for each of the conductors. And I must add, considering the craving there is at present for Wireless Telegraphs, that it seems to me not altogether improbable that the less ambitious but (for, at all events, long distances) far more feasible plan of using bare wires will yet have its innings." And who, in these days of electrical marvels, will dare to say him nay? I, for my part, will not, for I have seen more unlikely things come to pass. The dream of to-day, "idle and ridiculous" as it may seem, has been so often realised on the morrow, that the cautious historian of science must not look for finality in any of its applications.¹

JOHN HAWORTH—1862.

On March 27, 1862, Mr Haworth patented "An improved method of conveying electric signals without the intervention of any continuous artificial conductor," in

¹ For recent applications of the bare-wire principle, see Melhuish, p. 114, *infra*.

reference to which a lecturer of the period said :¹ "I have not met one single gentleman connected with the science of telegraphy who could understand his process, or its probability of success. I applied to him for some information, but he is unwilling to communicate any particulars until experiment has sufficiently demonstrated the practicability of his plans."

In the discussion which followed, Mr Cromwell Varley, electrician of the old Electric and International Telegraph, and the old Atlantic Telegraph, Companies, said : "Being informed that Sir Fitzroy Kelly and the learned chairman (Mr Grove) had seen Haworth's system in operation, and that the latter gentleman was a believer in it, he had tried the experiment upon a very small scale in his own garden, with apparatus constructed according to the instructions of Mr Haworth. His two stations were only 8 yards apart, and, although he used a very sensitive reflecting galvanometer, and twelve cells of Grove's nitric acid battery, he could not get any signals, although the experiments were varied in every conceivable way."

Under these circumstances it will not be surprising if I, too, after a careful study of the specification, and with the light thrown upon it by a further patent of October 30, 1863, have failed to understand the author's method. Indeed, I feel in much the same mental condition towards it as Tristram Shandy's connoisseurs, who, "by long friction, incumbition, and electrical assimilation, have the happiness, at length, to get all be-virtu'd, be-pictured, be-butterflied, and be-fuddled." However, I will do my best to translate the terrible phraseology of the letters patent into plain English ; and if after this my readers cannot divine the mode of action I will not blame them—nor must they blame me ! My description of the apparatus is based on

¹ T. A. Masey, Society of Arts, January 28, 1863.

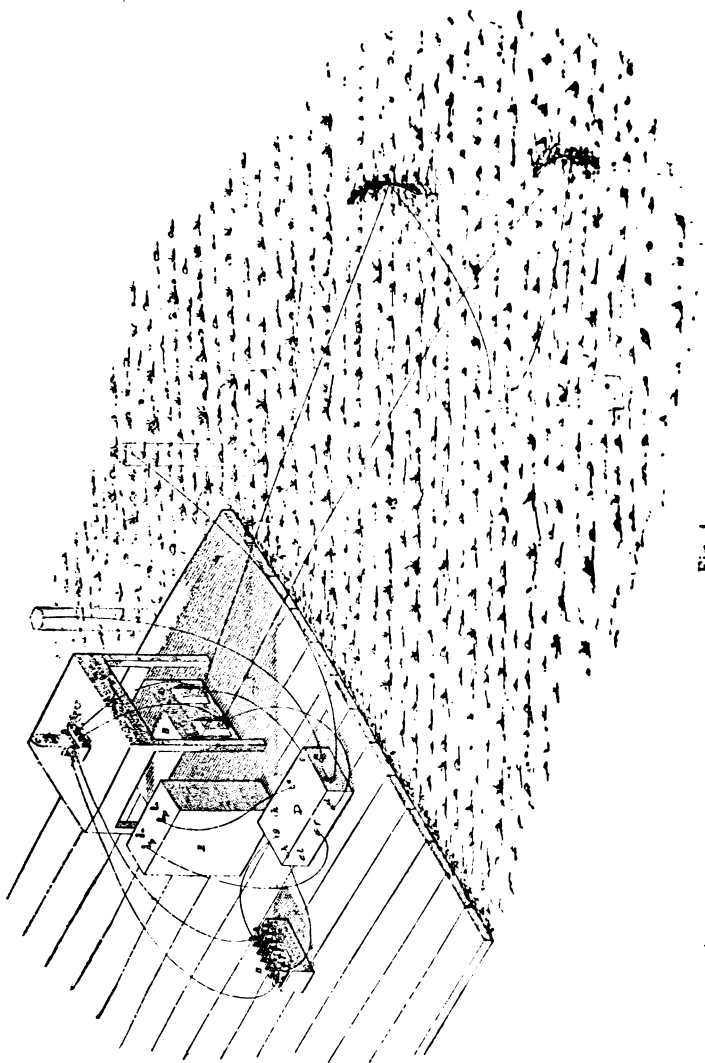

Fig. 4.

the complete specification and drawings of the second patent, which were lodged in the Patent Office on April 30, 1864, and which must therefore be supposed to contain the inventor's last word on the subject.

A, z (fig. 4) are copper and zinc plates respectively, curved as shown, and buried in the earth about 3 feet apart. The superficies varies according to distance and other circumstances: thus, for distances up to 75 miles plates 1 foot square suffice; over 75 and up to 440 miles, plates 24 by 16 inches are required. G, F are copper cylinders, 24 by 4 inches, buried in earth, which is always moist. At a point distant about 3 feet from the

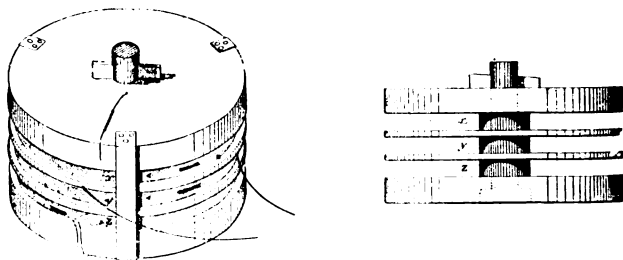

Fig. 5.

centres of A and z a wooden box J is buried, containing a coil of insulated copper wire, No. 16 gauge, wound upon a wooden reel. The ends of the coil are attached to binding screws shown on top of the box. B is a wooden box containing a wooden reel divided into three compartments, x, y, z (fig. 5). x is filled with fine covered-copper wire, the ends of which are brought together and secured on the outside of the reel. y is filled with thicker covered-copper wire, wound in the same direction as x, and the ends are severally connected to binding-screws, shown on the outside. z is half filled with insulated iron wire, wound in the same direction as x and y; the ends are fastened together

on the outside of the reel as with coil *x*. The compartment is then filled with more of the same iron wire, wound double, and in the reverse direction to the coil below it. These double wires are not twisted, nor bound together, nor allowed to cross one another, but are wound evenly in layers side by side; and the ends of each coil are secured together on the outside of the reel as in the case of the lower coil, and adjacent thereto. Usually the wire of coil *x* is No. 32 gauge; *y*, No. 16; and *z*, No. 20; but the sizes

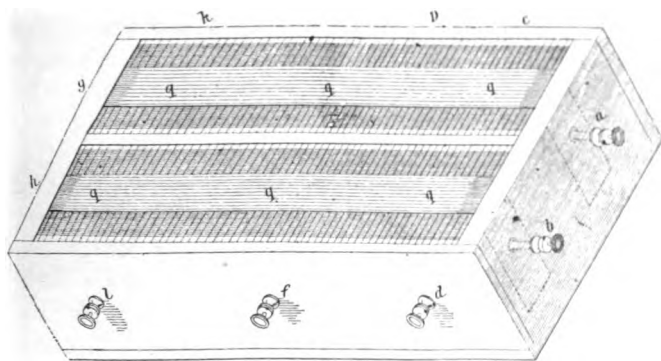

Fig. 6.

and quantities required must vary according to distance and other circumstances.

c is any suitable telegraph instrument of the needle pattern.

d is a condenser of a kind which an electrical Dominic Sampson would call prodigious! A wooden box divided lengthwise into two compartments well coated with shellac. In each compartment is placed a band of stout gold-foil—both well insulated, and connected at their ends to the binding-screws *a*, *g*, and *b*, *h*, respectively (fig. 6). Each compartment is filled with sixty rectangular plates of gutta-

percha, on which insulated copper wire, No. 32 gauge, is wound in one continuous length from the first plate to the last, and the ends are attached to the binding-screws *a, g,* and *b, h,* respectively. "I fix binding-screws *c, d, e, f, k,* and *l* in the positions shown, and connect them with the wire upon the plates in its passage through the box. I then pass from end to end of each compartment over the plates, and lying on them, but well insulated from them, another band of stout gold-foil, and connect each end of it with the screws *a, g,* and *b, h,* respectively."

E is another wooden box, containing a reel similar to **B**, but divided into only two compartments, each of which is filled with two copper wires, one covered and the other uncovered, wound side by side, and all four of different gauges from No. 18 to 30. The ends of one of the covered coils are brought to the screws *p, p,* shown on top of the box; the ends of the other covered coil are fastened on the outside of the reel; and the ends of the two uncovered coils are likewise fastened on the outside of the reel, "but in such a position that they can never come in contact with any uncovered part of the coated wire. Between each of the layers of wire I place a strip of non-metallic paper to insulate it from the layers above and below, and when in winding I arrive within an inch of the circumference of the reel I employ gutta-percha tissue in addition to the non-metallic paper."

II is a Smee's battery, the size and power of which will depend on circumstances, such as the distance to which it is intended to convey the message; the strength and direction of earth-currents; and even the state of the weather—more power being required in dry than in damp weather. "For a distance of ten miles, from Notting Hill to Croydon, I have found a Smee's battery of two cells at each end, containing plates 3 by 5 inches, to suffice.

For about fifty miles, from Notting Hill to Brighton, I have used with success a battery of three cells at each end; and from Notting Hill to Bangor, in Wales, I have required six cells at each end. Generally speaking, I have found that less power is required to convey a message from north to south and from south to north than from east to west, or from west to east."

The connections of the various instruments are shown by lines, and an exactly similar set of instruments is arranged at the place with which it is desired to correspond.

And now as to the *modus operandi*: when the handle of the needle instrument, c, is worked in the act of signaling, what happens? Here the trouble comes in. The author, I regret to say, is silent as to what happens, and I won't be so rash as to make a guess; but I would suggest the question as a safe prize-puzzle for the Questions and Answers column of some technical journal! Seriously, it seems to me that the results, if any, must be a perfect chaos of battery currents, earth-battery currents, earth-currents, induction currents, and currents of polarisation—all fighting in a feeble way for the mastery; and yet some men, besides the author, believed these effects to be intelligible signals!

The remarks of Mr Varley, quoted above, drew that gentleman into an angry correspondence in the pages of the old 'Electrician' journal, from which I give a few extracts. In the number for February 20, 1863, a student wrote:—

"It is evident that Mr Varley must be imperfectly acquainted with the electric laws relating to earth conduction, or, by simply replacing his delicate galvanometer by a few turns of stout wire, he might certainly have obtained the signals. What is obviously required in an experiment of this kind is to oppose as little resistance

as possible to the current of derivation by which the signal is produced. The resistance of a galvanometer 'of the most sensitive kind' must clearly be enormous in comparison with that of the other paths through which the electricity is free to pass.

"Since the question of signalling without wires was first referred to in 'The Electrician,' I have myself, with a less power than twelve Grove cells, obtained signals through more than 8 yards of garden-ground; but it is well known that signals have been transmitted without wires through a much greater distance, both in England and America."

This is followed by a short letter from Mr Haworth, which we need not quote, as it contains nothing in the way of explanation.

Mr Varley replied as follows in the next number of 'The Electrician' (February 27, 1863):—

"I make it a rule never to pay any attention to anonymous correspondents. As Mr Haworth, however, has commented upon the remarks I made a short time since at the Society of Arts, allow me to draw attention to the fact that, the discussion having been prolonged beyond the time allotted for that purpose, the detail of the experiments could not then be fully entered into.

"Mr Haworth paid me 'one' visit a short time ago, when I asked him if he had any objection to his invention being tested by actual experiment: he said he had not, and pointed out to me how to arrange the various parts of the apparatus. I have preserved the pencil sketch made at the time, as indicated and approved by him. This was strictly followed in the experiments.

"The apparatus used was constructed especially for this purpose. The primary coils were *thoroughly* insulated with gutta-percha, the secondary coils by means of a resinous

compound and india-rubber. The plates of copper and zinc at each station were but an inch and a half from each other; they were each 6 inches square. The two stations were only 8 yards apart.

“The apparatus at each station consisted of a plate of copper and a plate of zinc, connected to a flat secondary coil containing nearly a mile of No. 35 copper wire. The secondary coil was placed immediately behind the plates, and behind this was placed a flat primary coil.

“At the sending station the primary coil was connected with six cells of Grove’s battery, and contact intermitted. At the receiving station the primary coil was connected with one of Thomson’s reflecting galvanometers, of small resistance, no more than that of an ordinary telegraph instrument.

“With this disposition of apparatus *no current* could be obtained.

“Crossing a river without wires is an old experiment. In March 1847 I tried experiments in my own garden, and also across the Regent’s Canal, with a single cell of Grove’s battery. Feeble but evident currents were sent across the canal 50 feet wide. The current received was but a minute fraction of that leaving the battery. In this case the distance across the canal was but one quarter of that separating the plates on each bank. When, however, these plates were brought near together, as in Haworth’s specification, no visible signal could be obtained.

“This experiment has been repeated by numbers in various parts of the world, and with the same well-known results. When tried by me in 1847, I was unaware that the idea had occurred to Professor Morse, or any one else.

“To account for Mr Haworth’s assertions that he has worked from Ireland to London, and between other distant places, I can only suppose that he has mistaken some

irregularity in the currents generated by his copper and zinc plates for signals.

“If he *can* telegraph without wires, why does he not connect England with America, when he can earn £1000 per diem forthwith, and confer upon the world a great blessing?

“Before speaking at the Society of Arts, I called at Mr Haworth’s house several times, and found him out on all occasions. I wrote him more than once, giving him the negative results of my experiments, &c. He, however, paid no attention to any of my communications.

“I have not been able to meet with a single individual who has seen a message transmitted by Mr Haworth; and every one of those who are reported to have seen it, and with whom I have come in contact, positively deny it when questioned.

“I have no hesitation in stating—1st, That Mr Haworth’s specification is unintelligible: it is a jumble of induction plates, induction coils, and coils of wire connected together in a way that can have no meaning.

“2ndly, That he cannot send electric signals without wires to any useful distance.

“3rdly, From my acquaintance with the laws of electricity, I cannot believe it possible that he has ever communicated between distant stations as stated in his specification, No. 843, 1862.

“4thly, Supposing for a moment that he could work, as stated, any person constructing a similar apparatus in the neighbourhood would be able to read the communications, and they no longer would be private.”

In the number for March 6, 1863, Mr James M. Holt, writing from Kensington Park Gardens, W., said:—

“I regret that Mr Varley’s experiments have proved unsuccessful; but this does not surprise me, as, if I read

his letter correctly, he did not follow Mr Haworth's specification closely—if, indeed, at all. It would seem that he constructed only *parts* of the apparatus, and did not even connect those parts in the manner prescribed in the specification.

"I have seen Mr Haworth's apparatus at work repeatedly, and have myself read off from the indicator the messages which have arrived—and these 'irregular currents mistaken for signals' have consisted of words and sentences transmitted as correctly as by the electric telegraph. My house has been one station, and Brighton, or Kingstown in Ireland, the other.

"I can certify that the delay in bringing out this discovery arises from causes over which Mr Haworth has no control. Accident has injured his apparatus. He will be delighted to transmit signals across the Atlantic as soon as the necessary machinery is ready, but he considers—not unwisely—that it is most important to make success doubly sure by previous repeated tests and experiments."

This is followed by two letters from other eyewitnesses, vouching for the success of Haworth's experiments, and the correspondence concludes with the following letter from Mr Haworth himself:—

"SIR,—Will you kindly allow me space for a line in reply to Mr Varley? I never received his letter of the 27th of January, and am truly sorry for any apparent discourtesy on my part. I fear other letters have shared the same fate.

"From Mr Varley's account of his experiments I find several particulars in which there has been considerable misapprehension on his part; but I cannot spare the time—nor can I ask you for the space—to give further explanations. It certainly is a new feature in electricity, if the earth's currents alone can register words and sentences on

the dial-plate. I hope shortly to be able to convince the most sceptical by ocular demonstration. For the present I am content to wait, being anxious rather to perfect my discovery than to push it.—I am, sir, yours truly,

“JOHN HAWORTH.

“*March 3, 1863.*”

After this we hear nothing more of Mr Haworth, though no doubt the publication and discussion of his views kept the subject alive for a time.¹ Thus, in ‘The Electrician’ for January 23, 1863, the editor has a long article on “The Earth as Part of a Voltaic Circuit,” in which he reviews the problem so well that we cannot refrain from quoting him largely. He says :—

“The case, communicated by ‘E. S.’ and corroborated by Mr R. S. Culley, of a telegraphic circuit being worked through a broken wire, the ends of which were in contact with earth, appears in some quarters to have been taken in confirmation of the notion that electric signals may be transmitted to any required distance without the use of a metallic conductor. It may be necessary, therefore, to point out that this supposed confirmation has no existence in fact. There are no grounds whatever for supposing that any case similar to those which have been noticed by our correspondents is not susceptible of being readily explained in accordance with the known laws of electrical science. It is altogether different when we come to the practical problem of signalling by electricity without a conducting wire. If we have hitherto been silent in regard to this question, which seems to have latterly engaged some amount of public attention, it is that the means proposed for its solution are,

¹ In Béron’s ‘Météorologie Simplifiée,’ Paris, 1863, pp. 936, 937, there is a hazy description of a wireless telegraph, apparently based on the same lines as Haworth’s.

to us, simply incomprehensible. We cannot dispute their efficiency, since we are forced to admit that we cannot perceive upon what principle efficiency is aimed at. While, in such case, it would clearly be unjustifiable to deny without disproving, or to use the word 'impossible' in reference to what has been put forward as an accomplished fact, the only alternative is to await, 'with modest scepticism,' the verification and elucidation of the 'fact' thus asserted.

"To render intelligible the phenomenon observed in the broken wire circuit, we must have recourse to the law of derived currents. Divested of all technicality, this is simply that, when several conducting paths are offered for the passage of a current, the quantity of electricity traversing each path respectively will be inversely proportionate to its resistance. If, therefore, in this instance, the resistance between the broken extremities of the wire, added to the resistance of the wire from the point of rupture to the 'line' earth-plate, *plus* the resistance between the two earth-plates, be less than the resistance between the broken portion of the wire in contact with earth and the battery earth-plate, the quantity of electricity traversing the signalling instrument at the distant station cannot be reduced to the extent of one-half the normal signalling power. Under these circumstances, therefore, signals might be received almost as usual. Provided that the earth connections of the main circuit were very perfect, and the point of rupture nearer to the receiving than to the sending station, or that the broken ends of wire were resting upon ground freshly moistened by rain and covering a dry substratum, it is quite possible that the signals would not be very perceptibly reduced. . . .

"We pass over some other experiments of interest in connection with earth conduction, in order to make out the best case possible for those who believe in the present

practicability of signalling by means of voltaic electricity, without any insulation between the two halves of the circuit. Instead of placing our interposed plates in a direct line between the earth-plates in a circuit, let us arrange them in a path which must be traversed by an indirect or derived current, as in the following figure, in which B is the battery, E+ and E- the two earth-plates, and e e' the two interposed plates.

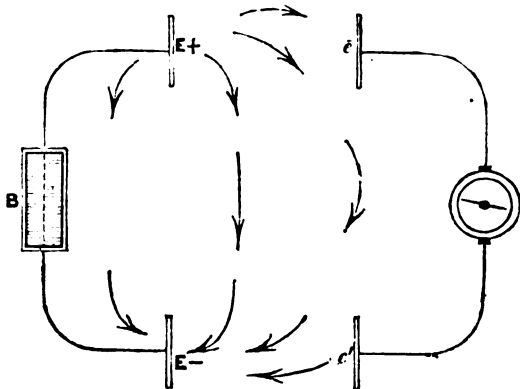

Fig. 7.

“At whatever distance the two systems may be placed apart, a current will undoubtedly traverse the galvanometer between the plates *e e'*, whenever the circuit of the battery is completed. We make the admission unreservedly, from the point of view of theory; the practical deductions to be drawn from it have yet to be considered. We have to calculate the force of the current which may traverse from *e* to *e'* through the galvanometer or receiving instrument, or, in other words, the proportionate quantity of electricity taking this path, compared with the total dynamic effect of the battery.

“Now we have reason to believe that something like the following plausible method of arriving at a conclusion upon this point is adopted by some of the more advanced among those who hold the untenable view above referred to:—

“Let the wire and battery resistance in the “transmitting system,” $E +$, B , $E -$, equal 1000 units;

“The resistance of the receiving system $e e'$, equal 100 units;

“And let the resistance between the earth-plates $E +$ and $E -$, and between $E +$ and e , and $E -$ and e' , be inappreciable.

“Then the resistance in the direct circuit completed by the battery plates $E +$ and $E -$ will equal 1000.

“And the total resistance in the indirect circuit through $e e'$, will equal 1100 units.

“And, by the law of derived currents, if the force of the current traversing the direct circuit be represented by 1100, that of the current traversing $e e'$ will be 1000.’

“It will be scarcely necessary for us to point out the fallacy of this mode of reasoning. It assumes the existence of two paths only for the return currents—the path of least resistance between $E +$ and $E -$, and that through $e e'$. But it will readily be seen that the earth affords a multitude of paths of conduction for the earth portion of the circuit, of which that from e to e' is one. The latter is therefore included in the resistance between the earth-plates $E +$ and $E -$ specified as inappreciable. As this *inappreciable* resistance is to the resistance of wire from e to e' , so will be the relative force of the currents traversing the transmitting and receiving systems respectively. The ratio, in a circuit, without metallic conduction of moderate length, approximates to that of infinitely great to infinitely small. Can any practical system be based upon these data?”

J. H. MOWER—1868.

Of the next proposal with which we have to deal in these pages, I find amongst my notes only a single cutting from the New York 'Round Table' of (August or September) 1868. I give it, *in extenso*, for what it is worth, and hope some American reader may be able to furnish details and further developments if any:—

“Mr Mower has elaborated a discovery which, if the description given by the 'New York Herald' is to be relied upon, will revolutionise trans-oceanic, and generally all subaqueous, telegraphy. For some years he had been engrossed in electrical experiments, when the Atlantic cable gave a special direction to his investigations into generating and conducting substances, the decomposition of water, the development of the electrical machine, &c., &c. By this summer his arrangements had been so far perfected that, a few weeks ago, he was able to demonstrate to himself and his coadjutor the feasibility of his project, on a scale approximate to that which it is designed to assume.

“Selecting the greatest clear distance on an east and west line in Lake Ontario—from a point near Toronto, Canada West, to one on the coast of Oswego County, New York—at his first attempt he succeeded in transmitting his message, without a wire, from the submerged machine at one end of the route to that at the other. The messages and replies were continued for two hours, the average time of transmission for the 138 miles being a little less than three-eighths of a second.

“The upshot of the discovery—on what principle Mr Mower is not yet prepared to disclose—is, that electric

currents can be transmitted through water, salt or fresh, without deviation vertically, or from the parallel of latitude. The difficulty from the unequal level of the tidal waves in the two hemispheres will be obviated, it is claimed, by submerging the apparatus at sufficient depth. The inventor, we are told, is preparing to go to Europe to secure there the patent rights for which the caveats have been filed here. At the inconsiderable cost of 10,000 dollars he expects within three months to establish telegraphic communication between Montauk Point, the eastern extremity of Long Island, and Spain, the eastern end of the line striking the coast of Portugal at a point near Oporto.

“The statement of the discovery is enough to take away one’s breath ; but, with the history of the telegraph before us, we no more venture to deny than we do to affirm its possibility.”

M. BOURBOUZE—1870.

During the investment and siege of Paris by the German forces in the winter of 1870-71, many suggestions were made for the re-establishment of telegraphic communication between Paris and the provinces. Acoustic methods were tried, based on the transmission of sound by earth and water. A Mr Granier proposed a form of aerial line which was thought to be feasible by the distinguished aeronaut, Gaston Tissandier. The wire (to be paid out from balloons) was to be enclosed in gutta-percha tubing, inflated with hydrogen gas so as to float 1000 to 1500 metres above the earth.

Amongst other suggestions was one by M. Bourbouze, a well-known French electrician, which only need concern

us in these pages.¹ His proposal was to send strong currents into the river Seine from a battery at the nearest approachable point outside the German lines, and to receive in Paris through a delicate galvanometer such part of these currents as might be picked up by a metal plate sunk in the river. After some preliminary experiments between the Hotel de Ville and the manufactory of M. Claparède at St Denis, it was decided to put the plan in practice. Accordingly, on December 17, 1870, M. d'Almeida left the beleaguered city by balloon, descended after many perils at Champagne outside the enemy's lines, and proceeded *viâ* Lyons and Bordeaux to Havre. Thence the necessary apparatus was ordered from England and conveyed to Poissy, where M. d'Almeida regained the banks of the Seine on January 14, 1871. Here, however, the river was found to be completely frozen over, and the attempt at communicating with Paris was deferred to January 24. Meanwhile the armistice was proclaimed, and the project was allowed to drop.

M. Bourbouze did not, however, abandon his idea, and, thinking he found in the principle of La Cour's phonic wheel telegraph a better means of indicating the signals than the galvanometer, he again took up the problem. Between 1876 and 1878 an occasional notice of his experiments appeared in the technical journals, but they are all provokingly silent on the point of actual results over considerable distances.²

¹ On March 27, 1876, Bourbouze requested to be opened at the Academy of Sciences a sealed packet which he had deposited on November 28, 1870. It was found to contain a note entitled "Sur les Communications à Distance par les Cours d'Eau." The contents of the document, so far as I know, have not been published.

² See, amongst other accounts, the 'English Mechanic,' September 8, 1876; 'Engineering,' April 13, 1878; and the French journal, 'La Nature,' July 8, 1876. For Bourbouze's earlier experiments, see 'La Lumière Électrique,' August 19, 1879.

MAHLON LOOMIS—1872.

In 1872 Mr Mahlon Loomis, an American dentist, proposed to utilise the electricity of the higher atmosphere for telegraphic purposes in a way which caused some excitement in America at the time.

It had long been known that the atmosphere is always charged with electricity, and that this charge increases with the ascent: thus, if at the surface of the earth we represent the electrical state or charge as 1, at an elevation of 100 feet it may be represented as 2; at 200 feet as 3; and so on in an ascending series of imaginary strata. Hitherto this had been considered as a rough-and-ready way of stating an electrical fact, just as we say that the atmosphere itself may, for the sake of illustration, be divided into strata of 100 or any agreed number of feet, and that its density decreases *pro rata* as we ascend through each stratum. But Mr Loomis appears to have made the further discovery that these electrical charges are in some way independent of each other, and that the electricity of any one stratum can be drawn off without the balance being immediately restored by a general redistribution of electricity from the adjacent strata. On this assumption, which is a very large one, he thought it would be easy to tap the electricity at any one point of a stratum, preferably an elevated one where the atmosphere is comparatively undisturbed, which tapping would be made manifest at any distant point of the same stratum by a corresponding fall or disturbance there of the electrical density; and thus, he argued, an aerial telegraph could be constructed.

The following is an extract from his (American) patent, dated July 30, 1872:—

“The nature of my discovery consists in utilising natural

electricity, and establishing an electrical current or circuit for telegraphic and other purposes without the aid of wires, artificial batteries, or cables, and yet capable of communicating from one continent of the globe to another.

“As it was found possible to dispense with the double wire (which was first used in telegraphing), making use of but one, and substituting the earth instead of a wire to form the return half of the circuit; so I now dispense with both wires, using the earth as one-half the circuit and the continuous electrical element far above the earth's surface for the other half. I also dispense with all artificial batteries, but use the free electricity of the atmosphere, cooperating with that of the earth, to supply the current for telegraphing and for other useful purposes, such as light, heat, and motive power.

“As atmospheric electricity is found more and more abundant when moisture, clouds, heated currents of air, and other dissipating influences are left below and a greater altitude attained, my plan is to seek as high an elevation as practicable on the tops of high mountains, and thus establish electrical connection with the atmospheric stratum or ocean overlying local disturbances. Upon these mountain-tops I erect suitable towers and apparatus to attract the electricity, or, in other words, to disturb the electrical equilibrium, and thus obtain a current of electricity, or shocks or pulsations, which traverse or disturb the positive electrical body of the atmosphere between two given points by connecting it to the negative electrical body of the earth below.”

To test this idea, he selected two lofty peaks on the mountains of West Virginia, of the same altitude, and about ten miles apart. From these he sent up two kites, held by strings in which fine copper wires were enclosed. To the ground end of the wire on one peak he connected an electrical

detector—presumably of the electrometer kind—and on the other peak a key for connecting the kite wire to earth when required. With this arrangement we are told that messages were sent and received by making and breaking the earth connection, “the only electro-motor being the atmospheric current between the kites, and which was always available except when the weather was violently broken.”

So well did this idea “take on” in the States that we learn from the New York ‘Journal of Commerce’ (February 5, 1873) that a bill had passed Congress incorporating a company to carry it out. The article then goes on to say: “We will not record ourselves as disbelievers in the Aerial Telegraph, but wait meekly and see what the Doctor will do with his brilliant idea now that both Houses of Congress have passed a bill incorporating a company for him. Congressmen, at least, do not think him wholly visionary; and it is said that the President will sign the bill; all of which is some evidence that air telegraphy has another side than the ridiculous one. The company receive no money from the Government, and ask none. As we understand the Loomis plan, it is something to this effect—and readers are cautioned not to laugh too boisterously at it, as also not to believe in it till demonstrated. The inventor proposes to build a very tall tower on the highest peak of the Rocky Mountains. A mast, also very tall, will stand on this tower, and an apparatus for ‘collecting electricity’ will top the whole. From the loftiest peak of the Alps will rise another very tall tower and ditto mast, with its coronal electrical affair. At these sky-piercing heights Dr Loomis contends that he will reach a stratum of air loaded with electricity; and we cannot say that he will not. Then, establishing his ground-wire connections the same as in ordinary telegraphs, he feels confident that he can send

messages between the mast-tops, the electrified stratum of air making the circuit complete. The inventor claims to have proved the feasibility of this grand scheme on a small scale. We are told that, from two of the spurs of the Blue Ridge Mountains, twenty miles apart, he sent up kites, using small copper wire instead of pack-thread, and telegraphed from one point to the other."

At intervals in the next few years brief notices of the Loomis method appeared in the American journals, some of which were copied into English papers. The last that I have seen is contained in the 'Electrical Review' of March 1, 1879, where it is stated that "with telephones in this aerial circuit he (Loomis) can converse a distance of twenty miles," to which the editor significantly adds a note of interrogation.

The fact is, however much Mr Loomis and his Wall Street friends believed that dollars were in the idea, the technical press never took it very seriously. This is shown by the following cutting, which we take from the New York 'Journal of the Telegraph,' March 15, 1877: "The never-ending procession of would-be inventors who from day to day haunt the corridors and offices of the Electrician's department at 195 Broadway, bringing with them mysterious packages tied up in newspapers, was varied the other day by the appearance of a veritable lunatic. He announced that that much-talked-of great discovery of a few years ago, aerial telegraphy, was in actual operation right here in New York. A. M. Palmer, of the Union Square Theatre, together with one of his confederates, alone possessed the secret! They had unfortunately chosen to use it for illegitimate purposes, and our visitor, therefore, felt it to be his solemn duty to expose them. By means of a \$60,000 battery, he said, they trans-

mitted the subtle fluid through the aerial spaces, read people's secret thoughts, knocked them senseless in the street; ay, they could even burn a man to a crisp, miles and miles away, and he no more know what had hurt him than if he had been struck by a flash of lightning, as indeed he had!¹ The object of our mad friend in dropping in was merely to ascertain how he could protect himself from Palmer's illegitimate thunderbolts. Here the legal gentleman, lifting his eyes from 'Curtis on Patents,' remarked: 'Now, I'll tell you what you do. Bring a suit against Palmer for infringement of Mahlon Loomis's patent. Here it is' (taking down a bound volume of the 'Official Gazette'), 'No. 129,971. That'll fix Palmer.' But the madman protested that this would take too long, and meanwhile he was in danger of his life every minute, and casually remarked that it had occurred to him that by appearing on the streets in a robe of pea-green corded silk, gutta-percha boots, and a magenta satin hat with a blue-glass skylight in the top of it, he would be effectually protected from injury during his daily perambulations."

In conclusion of this period of our history, it will suffice to say that between 1858 and 1874 many patents were taken out in England for electric signalling on the bare wire system of Highton and Dering, with or without the use of the so-called "earth battery." As they are all very much alike, and all unsupported, so far as I have seen, by any experimental proofs, it would be a tiresome reiteration to describe them, even in the briefest way. I therefore content myself with giving the following list, which will be useful to those of my readers who desire to consult them.

¹ This lunatic must be still abroad, for we occasionally hear much the same thing of the diabolic practices of Tesla and Marconi.

Name of patentee.	No. and date of patent.
B. Nickels . . .	2317 October 16, 1858.
A. V. Newton . . .	2514 November 9, 1858.
A. Barclay . . .	56 January 7, 1859.
Do. . . .	263 January 28, 1859.
J. Molesworth . . .	687 March 18, 1859.
H. S. Rosser . . .	2433 October 25, 1859.
W. E. Newton . . .	1169 May 11, 1860.
H. Wilde	2997 November 28, 1861.
Lord A. S. Churchill .	458 February 20, 1862.
H. Wilde	3006 December 1, 1863.
Do.	2762 October 26, 1865.
T. Walker	2870 November 6, 1866.
Do.	293 January 23, 1874.

SECOND PERIOD—THE PRACTICABLE.

PRELIMINARY : NOTICE OF THE TELEPHONE IN RELATION TO WIRELESS TELEGRAPHY.

“Give me the ocular proof,
Make me see't ; or, at least, so prove it,
That the probation bear no hinge, nor loop,
To hang a doubt on.”

WE have now arrived at a period in the history of our subject at which experiments begin to assume a character more hopeful of practical results. All that went before was more or less crude and empirical, and could not be otherwise from the very necessities of the case. The introduction of the telephone in 1876 placed in the hands of the electrician an instrument of marvellous delicacy, compared with which the most sensitive apparatus hitherto employed was as the eye to the eye aided by the microscope. Thus, Prof. Pierce of Providence, Rhode Island, has found that the Bell telephone gives audible signals with considerably less than one-hundred-thousandth part of the current of a single Leclanché cell. In testing resistances with a Wheatstone bridge, the telephone is far more sensitive than the mirror galvanometer ; in ascertaining the continuity of fine wire coils it gives the readiest answers ; and for all the different forms of atmospheric electrical discharges—and

they are many—it has a language of its own, and opens up to research a new field in meteorology.

The sound produced in the telephone by lightning, even when so distant that only the flash can be seen in the horizon, and no thunder can be heard, is very characteristic—something like the quenching of a drop of molten metal in water, or the sound of a distant rocket; but the remarkable circumstance for us in this history is, that this sound is always heard just *before* the flash is seen, showing that there is an inductive disturbance of the electricity *overhead*, due to the *distant* concentration preceding the disruptive discharge. Thus, on November 18, 1877, these peculiar sounds were heard in Providence, and the papers next morning explained them by reporting thunderstorms in Massachusetts. Sounds like those produced by lightning, but fainter, are almost always heard many hours before a thunderstorm actually breaks.¹

The Bell telephone was tried for the first time on a wire from New York to Boston on April 2, 1877, and soon afterwards its extraordinary sensitiveness to induction currents, and currents through the earth (leakages) from distant telegraph circuits, began to be observed.² Thus, in August 1877, Mr Charles Rathbone of Albany, N.Y., had been experimenting with a Bell telephone which was attached to a private telegraph line connecting his house with the Ob-

¹ 'Journal of the Telegraph,' N.Y., December 1, 1877. See also 'Jour. Inst. Elec. Engs.,' vol. vi. p. 523, vol. vii. p. 329; 'The Electrician,' vol. ix. p. 362.

² The disturbing effects of induction on ordinary telegraph wires on the *same* poles had long before this been noticed. See Culley's paper and the discussion thereon in the 'Jour. Inst. Elec. Engs.,' vol. iv. p. 54. See also p. 427 for Winter's interesting observations in India in 1873. As far back as 1868 Prof. Hughes, at the request of the French Telegraph Administration, undertook a series of experiments with a view of finding a remedy. The results are given in his paper read before the Inst. Elec. Engs., March 12, 1879.

servatory. One evening he heard some singing which he thought came from the Observatory, but found on inquiry that that was not the case. He then carefully noted what followed, and next morning sent a note to the newspapers stating the facts and giving the names of the tunes which he had heard. This elicited the information that the tunes were those of an experimental concert with Edison's singing telephone over a telegraph wire between New York and Saratoga Springs. It was then resolved to follow up this curious discovery, and, accordingly, when Edison's agent gave another concert in Troy, arrangements were made to observe the effects. A wire running from Albany to Troy alongside the Edison wire was earthed with a Bell telephone in circuit at each end. The concert was heard as before, the music coming perfectly clear, and the tunes distinguishable without the least difficulty.

Later in the evening the instruments were put in circuit on one of the wires running from Albany to New York. Again the music was heard, and much louder, so that by placing the telephone in the centre of the room persons seated around could hear with perfect distinctness.

These observations were made on six separate occasions between August 28 and September 11, and, strangely enough, two other and independent observers in Providence, 200 miles away, noted the same effects on five out of the six dates given by Mr Rathbone.¹

Dr Channing, one of the observers in Providence, has published a very interesting account² of his observations, from which I will make a few extracts. During five

¹ 'Journal of the Telegraph,' N.Y., October 1 and 16, and November 1, 1877. For other early observations of the same kind see 'The Telegraphic Journal,' March 1, 1878, p. 96; 'Journal of the Telegraph,' March 16, 1878; 'The Electrician,' vol. vi. pp. 207, 303.

² 'Journal of the Telegraph,' December 1, 1877, and reproduced in the 'Jour. Inst. Elec. Engs.,' vol. vi. p. 545.

evenings in the latter part of August and first part of September 1877 concerts were given in the Western Union Office, N.Y., for the benefit of audiences in Saratoga, Troy, and Albany respectively. The performers sang or played into an Edison musical telephone, actuated by a powerful battery, and connected with one or other of the above-named places by an ordinary telegraph line, with return through the ground.

In Providence, on the evening of the first concert, Dr Channing and a friend were conversing through Bell telephones over a shunt wire, made by grounding one of the American District Telegraph wires at two places, a quarter of a mile apart, through the telephones and several hundred ohms resistance. At about half-past eight o'clock they were surprised by hearing singing on the line, at first faint, but afterwards becoming clear and distinct. Afterwards, during that and subsequent evenings, various airs were heard, sung by a tenor or soprano voice, or played on the cornet. On investigation, the music heard proved to be the same as that of the Edison concerts performed in New York.

The question how this music passed from the New York and Albany wire to a shunt on the District wire in Providence is of scientific importance. The Edison musical telephone consists of an instrument which converts sound waves into galvanic waves at the transmitting station, and another apparatus which reconverts galvanic waves into sound waves at the receiving station. The battery used in these concerts consisted of 125 carbon-bichromate cells (No. 1½), with from 1000 to 3000 ohms resistance interposed between the battery and the line. The line wire extended from the Western Union office, *viâ* the Harlem Railway, to Albany. On the same poles with this Albany wire, for sixteen miles, are carried four other wires, all

running to Providence, and also, for eight miles, a fifth wire from Boston, *via* New London, to Providence. All these lines, including the Albany wire, are understood to have a common earth connection at New York, and to be strung at the usual distance apart, and with the ordinary insulation.

At Providence six New York and Boston wires run into the Western Union office on the same poles and brackets for the last 975 feet with an American District wire. This wire belongs to an exclusively metallic circuit of four and a half miles, having, therefore, no earth connection. Finally, in a shunt on this wire, the telephones were placed as before described.

It will thus be seen that the music from the Albany wire passed first to the parallel New York-Providence wires; secondly, from these to a parallel District wire in Providence; and thirdly, through a shunt on the District wire to the telephones.

This transfer may have taken place by induction, by cross-leakage, or, in the first instance, in New York by a crowded ground connection; but in the transfer in Providence from the New York-Boston to the District wire there was no common ground connection, and it is difficult to suppose that sufficient leakage took place on the three brackets and three poles (common to the New York and District wires) to account for it. Without wholly rejecting the other modes of transfer, Dr Channing ascribes to induction the principal part in the effects.

The next question arises, What proportion of the electrical force set in motion in New York could have reached the listeners on the short shunt line in Providence? Whether induction or cross-leakage or crowded ground was concerned, who will say that the New York-Providence wires had robbed the Albany wire of one-tenth or even one-hundredth

of its electrical force? When this reached Providence, did the New York wires in the course of 975 feet give up to the District wire one-tenth or one-hundredth of *their* force? Lastly, when the District circuit had secured this minute fraction, did the shunt, with its 500 ohms resistance as against the few ohms of the shunted quarter-mile, divert one-hundredth part of this minute fraction from the District wire? Plainly, the music reproduced in the Providence telephone did not require one ten-thousandth, nor one hundred-thousandth of the force originally imparted to the Albany wire.

In December 1877 Prof. E. Sacher of Vienna undertook some careful investigations with a view of measuring the inductive effect in telephone circuits. He found that signals from three Smee cells sent through one wire, 120 metres long, could be distinctly heard in the telephone on another and parallel wire 20 metres distant from it.¹

Early in 1879 M. Henri Dufour tried similar experiments, and with the same results. Two covered copper wires were stretched parallel over a length of 15 metres, and at distances apart varying from 15 to 45 centimetres. In connection with one of the wires were the battery and the ordinary Morse apparatus, the gas-pipes being used to complete the circuit. The ends of the other wire were joined to the telephone so as to form a complete metallic circuit. The current employed produced a deflection of 60° on the galvanometer. Under these conditions all the motions of the key were distinctly heard in the telephone, and the author was satisfied that a telegraphist would have understood the signals, even when the distance between the two wires was 45 centimetres.²

When we consider the shortness of these wires, the effects are sufficiently striking; but before this, equally

¹ Electrician, vol. i. p. 194.

² Ibid., vol. ii. p. 182.

striking results had been obtained on actual telegraph lines, where there was no battery, and where the infinitesimal currents produced by speaking into a Bell telephone on one wire were able to induce currents in a parallel wire sufficient to render the words audible in another telephone in its circuit. Dr Channing found this to be possible "under very favourable conditions."¹

Another striking illustration is furnished by Prof. Blake, of Brown University, U.S., who talked with a friend for some distance along a railway (using the two lines of rails for the telephonic circuit), hearing at the same time the Morse signals passing along the telegraph wires overhead.²

PROFESSOR JOHN TROWBRIDGE—1880.

Such are a few of the early instances noted of the extreme sensitiveness of the telephone, by the aid of which the problem of wireless telegraphy was now to be attacked with a fair measure of success, and advanced a long way towards a practical solution.

Mr J. Gott, then superintendent of the Anglo-American Telegraph Company at St Pierre, was, I believe, the first to suggest the employment of the telephone in this connection. In a brief communication, published in the 'Jour. Inst. Elec. Engs.' (vol. vi. p. 523), he says: "The island of

¹ For a curiously similar case, the result of a wrong connection of the line wires, see the 'Telegraphic Journal,' vol. ix. p. 68.

² The absence of insulation in this experiment recalls the fact that a telephone line using the earth for the return circuit often works better when the insulation is defective, as it is then less affected by extraneous currents. Thus, in 1882, the Evansville (Ind.) Telephone Exchange Company worked 400 miles of line without insulators of any kind (the wires being simply attached to the poles), and generally with better results than when insulators were used. ('Electrician,' vol. ix. p. 481.)

St Pierre is, perhaps, better insulated than most places. Hundreds of yards from the station, if a wire be connected to earth, run some distance, and put to earth again, with a telephone in circuit, the signals passing through the cables can be heard."

There are two offices on the island,—one used for repeating the cable business on the short cables between Sydney, C.B., and Placentia, N.F., and operated by the Morse system, with a comparatively powerful battery; the other is the office at which the Brest and Duxbury cables terminate, and is furnished with very delicate instruments—the Brest cable, which is upwards of 2500 miles long, being operated by Thomson's exceedingly sensitive dead-beat mirror galvanometer; whilst on the Duxbury cable the same inventor's instrument, the siphon recorder, is used. The Brest instrument was found seriously affected by earth-currents, which flowed in and out of the cable, interfering very much with the *true* currents or signals, and rendering it a difficult task for the operator to decipher them accurately. The phenomenon is not an uncommon one; and the cause being attributed to the *ground* used at the office, a spare insulated wire, laid across the island, a distance of nearly three miles, and a metal plate connected to it and placed in the sea, was used in lieu of the *office ground*. This had a good effect, but it was now found that part of the supposed earth-currents had been due to the signals sent by the Morse operator into his wire, for when the recorder was put in circuit between the ground at the cable office and the sea ground—three miles distant—the messages sent by the Morse were clearly indicated,—so clearly, in fact, that they were automatically recorded on the tape.

It must be clearly understood that the two offices were in no way connected, nor were they within some 200 yards of

each other; and yet messages sent at one office were distinctly read at the other, the only connection between the two being through the earth, and it is quite evident that they could be so read simultaneously at *many* offices in the same neighbourhood. The explanation is clear enough. The potential of the ground at the two offices is alternately raised and lowered by the Morse battery. The potential of the sea remains almost, if not wholly, unaffected by these, and the island thus acts like an immense Leyden jar, continually charged by the Morse battery and discharged, in part, through the short insulated line. Each time the Morse operator depressed his key he not only sent a current into his cable, but electrified the whole island, and this electrification was detected and indicated on the recorder.¹

As the result of these experiences, Mr Gott gave it as his opinion that "speaking through considerable distances of earth without wires is certainly possible with Bell's telephone, with a battery and Morse signals."

Professor John Trowbridge of Harvard University, America, was, however, the first to systematically study the problem, and to revive the daring project of an Atlantic telegraph without connecting wires, and the less ambitious but equally useful project of intercommunication between ships at sea.² In fact, Trowbridge's researches may truly be

¹ See now Salvá's curious anticipation in 1795 of this phenomenon, p. 1, *ante*. The peculiarity, due to geological formation, is not confined to St Pierre; it is often met with in practice, though usually in lesser degrees. See some interesting cases, noted by G. K. Winter and James Graves, 'Jour. Inst. Elec. Engs.,' vol. i. p. 88, and vol. iv. p. 34.

² Mr H. C. Strong of Chicago, Illinois, claims to have suggested in 1857, in a Peoria, Ill., newspaper, the possibility of communication between ships at sea by means of a wireless telegraph then recently invented by his friend Henry Nelson of Galesburg. See Mr Strong's letter in the New York 'Journal of the Telegraph,' August 15, 1877.

said to form a new starting-point in the history of our subject, for, as we shall see later on, it is chiefly to him that Messrs Preece, Bell, and other experimenters in this field owe their inspirations. His investigations, therefore, deserve to be carefully followed.¹

The observatory at Harvard transmits time-signals from Cambridge to Boston, a distance of about four miles, and the regular recurrence of the beats of the clock afforded a good means of studying the spreading of the electric currents from the terminal of the battery which is grounded at the observatory. In all the telephone circuits between Boston and Cambridge, in the neighbourhood of the observatory line, the ticking of the clock could be heard. This ticking had been attributed to induction, but this, according to Prof. Trowbridge, is an erroneous conclusion, as he shows by a mathematical analysis into which we need not enter. The result goes to show that, with telephones of the resistance usually employed, no inductive effect will be perceived by the use of even ten quart Bunsen cells between wires running parallel, a foot apart, for a distance of 30 or 40 feet.

For this and other reasons, he says, it is impossible to hear telephonic messages by induction from one wire to another, unless the two run parallel and very close to each other for a long distance. This distance generally exceeds the limit at which the ordinary Bell telephone ceases to transmit articulate speech. The effects which have usually been attributed to induction are really, he says, due to the earth connections and to imperfect insulation.

Having determined in this manner that the echoes of the

¹ They are given at length in a paper, "The Earth as a Conductor of Electricity," read before the American Academy of Arts and Sciences in 1880. See also 'Silliman's American Journal of Science,' August 1880, which I follow in the text.

time-signals observed on the telephone lines were not due to induction, but to leakage from the clock circuit, Prof. Trowbridge proceeded to study the extent of the equally electrified or equi-potential surfaces of the ground surrounding the clock battery. His method of exploration was to run a wire 500 or 600 feet long to earth at each end, including a telephone of 50 to 60 ohms resistance. Evidence of a current in this exploratory circuit was plainly shown by the ticking sound which making and breaking the circuit caused in the telephone, and the time-signals could be distinctly heard in a field 220 yards from the observatory where one earth of the time-signal wire is located. At a distance of a mile from the observatory, and not in the direct line between that place and the Boston telephone office, the time-signals were heard by connecting through a telephone the gas-pipes of one building with the water-pipes of another only 50 feet apart. In another experiment at the Fresh Pond lake in Cambridge, signals sent from Boston to Waltham (ten to twelve miles) were heard by simply dipping the terminal wires of the telephone in the lake, and some distance apart, where they must have been far away (? four miles) from the battery earth.

Prof. Trowbridge performed a large number of similar experiments, varied in every way, all going to prove (1) that a battery terminal discharging electricity to earth is the centre of waves of electrical energy, ever widening, and ever decreasing in strength or potential as they widen; and (2) that on tapping the earth in the way described at two points of different potentials (not very distant, if near the central source, and more removed the farther we recede from the source) we can obtain in the telephone evidence of their existence. Prof. Trowbridge then goes on to say:—

“In a discussion on the earth as a conductor, Steinheil

says: ¹ 'We cannot conjure up gnomes at will to convey our thoughts through the earth. Nature has prevented this. The spreading of the galvanic effect is proportional . . . to the square of the distance; so that, at the distance of 50 feet, only exceedingly small effects can be produced. . . . Had we means which could stand in the same relation to electricity that the eye stands to light, nothing would prevent our telegraphing through the earth without conducting wires.'

"The telephone of Prof. Bell, though far from fulfilling the conditions required by Steinheil, is nevertheless our nearest approach to the desideratum.

"The theoretical possibility of telegraphing across the Atlantic without a cable is evident from the survey which I have undertaken. The practical possibility is another question. Powerful dynamo-electric machines could be placed at some point in Nova Scotia, having one end of their circuit grounded near them and the other end grounded in Florida, the connecting wire being of great conductivity and carefully insulated throughout. By exploring the coast of France, two points on surface lines not at the same potential could be found; and by means of a telephone of low resistance, Morse signals sent from Nova Scotia to Florida could be heard in France. Theoretically, this is possible; but practically, with the light of our present knowledge, the expenditure of energy on the dynamo-electric machines would be enormous."²

Professor Trowbridge has suggested the applicability of this method to the intercommunication of ships at sea.

¹ See p. 5, *ante*.

² A writer in the 'Electrician' (vol. v. p. 212), commenting on this passage, says: "Prof. Trowbridge seems to overlook the advantage of employing large condensers between the dynamo machines and the earth. They would prove of great service in exalting the earth potentials at the terminal stations."

Let, he says, a steamer be provided with a powerful dynamo. Connect one terminal of the dynamo with the water at the bow of the steamer, and allow a long wire, insulated except at its extreme end, to drag over the stern, and be buoyed so as not to sink. The current from the dynamo will thus pass into the water and spread out over a large area, as before explained, saturating, so to speak, the water with electricity. Suppose this current be interrupted by any suitable means, say one hundred times a second. Let the approaching steamer be provided with a telephone wire, the ends of which dip into the water at her bow and stern respectively. On entering the saturated area the telephone will respond to the interruptions of the dynamo by giving out a continuous buzzing sound. If now in the dynamo circuit we have a manipulating arrangement for breaking up the electric impulses into long and short periods, corresponding to the Morse alphabet, one ship can speak to the other. It is hardly necessary to add that by providing each steamer with a dynamo circuit and a telephone circuit reciprocal correspondence could be maintained, it being only necessary for the steamer desiring to listen to stop and disconnect the dynamo. The success of this method of communicating between ships in a fog depends upon the distance between the ends of the dynamo circuit and upon the strength of the current, or electrical impulses imparted to the water.

It is probable that a dynamo capable of maintaining one hundred incandescent lamps could establish a sufficient difference of potential between the water at the bow and at the end of a trailing wire, half a mile long, to affect a telephone on an approaching ship while yet half a mile distant.

In a discussion on Prof. Graham Bell's paper, read before the American Association for the Advancement of Science,

1884, Prof. Trowbridge described another plan, using instead of the telephone circuit a sensitive galvanometer connected up to a cross-arm of wire, whose ends dip into the water at each side of the ship. When one vessel comes within the area electrically saturated by another, the galvanometer will show how the equipotential lines are disturbed, and if a map of these lines be carefully traced we can fix the position of the approaching ship. He adds: "The method could also be applied to saturating the water around a rock, and you could take electrical soundings, so to speak, and ascertain your position from electrical maps carefully made out."

In a later paper published in the 'Scientific American Supplement,' February 21, 1891, Prof. Trowbridge discusses the phenomena of induction, electro-magnetic and static, as distinguished from leakage or earth conduction, and with reference to their employment in wireless telegraphy.

The hope, he says, that we shall be able to transmit messages through the air by electricity without the use of connecting wires is supposed by some to indicate its realisation at a future day. Let us examine how near we are at present to the realisation of this hope.

He supposes that the chief use of any method by which connecting wires could be dispensed with would be at sea in a fog. On land for considerable distances it is hardly probable that any electrical method could be devised in which air or the ether of space could advantageously replace a metallic conductor. The curvature of the earth would probably demand a system of frequent repetition, which is entirely obviated by the use of a wire. If, however, an electrical or magnetic system could be made to work through the air even at the distance of a mile, it would be of very great use at sea in averting collisions; for any system of signals depending upon the use of fog-horns or

fog-whistles is apt to mislead on account of the reflection of the sound from layers of air of different densities and from the surface of the water. The difficulty of ascertaining the direction of a fog-horn in a thick fog is well known. The waves of sound, even if they are carefully directed by a trumpet or by parabolic reflectors, diverge so rapidly that there is no marked difference in the intensity between a position in the direct line and one far to one side.

The most obvious method of signalling by electricity through the air is by electro-magnetic induction. Suppose

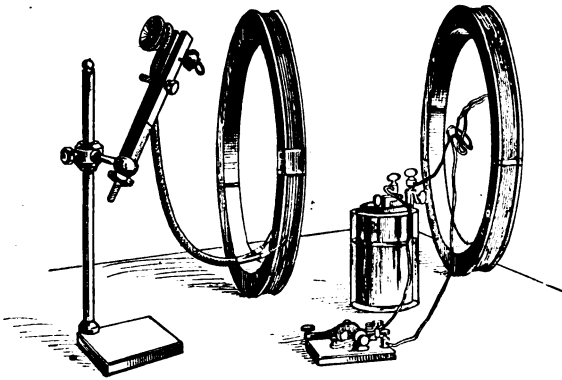

Fig. 8.

we have a coil of copper wire consisting of many convolutions, the ends of which are connected with a telephone (fig. 8). If we place a similar coil, the ends of which are connected to a battery through a key, within a few feet of the first and parallel to it, each time the current is made and broken in the battery coil instantaneous currents are produced by induction in the other coil, as can be heard by the clicks in the telephone.

To illustrate induction at a distance, Prof. Joseph Henry

placed a coil of wire, $5\frac{1}{2}$ feet in diameter, against a door, and at a distance of 7 feet another coil of 4 feet diameter. When contact was made and broken with a battery of eight cells in the first coil, shocks were felt when the terminal wires of the second were placed close together on the tongue.

In all such methods the wires or coils which produce an electrical disturbance in a neighbouring coil are never more than a few feet apart. Now let us suppose that a wire is stretched ten or twelve times, to and fro, from yard-arm to yard-arm of a steamer's foremast, and connected at the ends either with a powerful battery or dynamo, or with a telephone, as may be required either for signalling or for listening. Let an approaching steamer have a similar arrangement. If now the current on one vessel be interrupted a great number of times per second, a musical note will be heard in the telephone of the other vessel, and *vice versa*. The sound will be strongest when the two coils are parallel to each other. If, therefore, the coils be movable the listener can soon find the position of greatest effect, and so fix the direction in which the signalling steamer is approaching.

It may not even be necessary to connect the telephone with the coil, for it has been found that if a telephone, pure and simple, be held to the ear and pointed towards a coil in which a current of electricity is rapidly interrupted, the makes and breaks will be heard, and this even when the wire coil of the telephone is removed, leaving only the iron core and the diaphragm.¹

¹ Mr Willoughby Smith was, I believe, the first in recent times to observe these effects. See his paper on "Volta-Electric Induction," 'Jour. Inst. Elec. Engs.,' vol. xii. p. 457. But exactly similar effects, *mutatis mutandis*, were described by Page in 1837, to which he gave the name of Galvanic Music, and which he found to be due to the fact that iron when magnetised and demagnetised gave out a

Nothing could seem simpler than this, but, unfortunately, calculation shows that under the best conditions the size of the coils would have to be enormous. Prof. Trowbridge has computed that to produce an audible note in the telephone at a distance of half a mile, a coil of ten turns of 800 feet radius would be necessary; but it is evident that a coil of this size would be out of the question. Instead, however, of increasing the size of the coil beyond the practical limits of the masts and yard-arms, we could increase the strength of the current so as to be effective at the distance of half a mile; but, again, calculation shows that this strength of current would be beyond all practical limits of dynamo construction, unless we discover some method of tuning, so to speak, two coils so that the electrical oscillations set up in one may be able to evoke in the other sympathetic vibrations.¹

Since, then, we have little, apparently, to hope for from electro-magnetic induction in signalling through a fog, cannot we expect something from static induction? This form of induction can be well illustrated by an early experiment of Prof. Henry. An ordinary electrical machine was placed in the third storey of his house, and a metal plate 4 feet in diameter was suspended from the prime conductor. On the first floor or basement, 30 feet below in a direct line, was placed a similar plate, well insulated. When the upper plate was charged by working the machine, the lower plate showed signs of electrification, as was evidenced by its effect on the pith-ball electroscope.²

sound. De la Rive, in 1843, rightly traced this sound to the slight elongation of iron under the magnetic strain—a fact which, in its turn, was first observed by Joule in 1842. For Page's discovery see the 'Magazine of Popular Science,' 1837, p. 237.

¹ Prof. Oliver Lodge is now engaged on this very problem. See p. 235, note 2, *infra*.

² See an excellent account of Henry and his work in the New

The distance to which this electrical influence can be extended depends upon the charging power of the machine and the dimensions of the plate. If we could erect an enormous metal plate on a hill, insulated and powerfully charged, it is probable that its electrical influence could be felt at the distance of the horizon ; but here, again, the question of practical limits comes in as a bar, so that, at the present time (February 1891), this method of signalling without wires seems as little practicable as the others.

After following me in this study of Prof. Trowbridge, the reader may well begin to despair, for while the learned Professor's investigations are extremely interesting, his conclusions are very disappointing. But the darkest hour is just before the dawn, and so it is in this case.

PROFESSOR GRAHAM BELL—1882.

Following the lines suggested by Prof. Trowbridge, Prof. Bell carried out some successful experiments, an account of which is given in his paper read before the American Association for the Advancement of Science in 1884.

“A few years ago,” he says, “I made a communication on the use of the telephone in tracing equipotential lines and surfaces. I will briefly give the chief points of the experiment, which was based on experiments made by Prof. Adams of King's College, London. Prof. Adams used a galvanometer instead of a telephone.

“In a vessel of water I placed a sheet of paper. At two points on that paper were fastened two ordinary sewing

York ‘Electrical Engineer,’ January 13, 1892, and succeeding numbers, from the pen of his daughter, Mary A. Henry. Abstracts of these papers are given in the ‘Electrician,’ vol. xxviii. pp. 327, 348, 407, 661.

needles, which were also connected with an interrupter that interrupted the circuit about one hundred times a second. Then I had two needles connected with a telephone: one needle I fastened on the paper in the water, and the moment I placed the other needle in the water I heard a musical sound from the telephone. By moving this needle around in the water, I would strike a place where there would be no sound heard. This would be where the electric tension was the same as in the needle; and by experimenting in the water you could trace out with perfect ease an equipotential line around one of the poles in the water.

“It struck me afterwards that this method, which is true on the small, is also true on the large scale, and that it might afford a solution of a method of communicating electrical signals between vessels at sea.

“I made some preliminary experiments in England, and succeeded in sending signals across the river Thames in this way. On one side were two metal plates placed at a distance from each other, and on the other two terminals connected with the telephone. A current was established in the telephone each time a current was established through the galvanic circuit on the opposite side, and if that current was rapidly interrupted you would get a musical tone.

“Urged by Prof. Trowbridge, I made some experiments which are of very great value and suggestiveness. The first was made on the Potomac river.

“I had two boats. In one boat we had a Leclanché battery of six elements and an interrupter for interrupting the current very rapidly. Over the bow of the boat we made water connection by a metallic plate, and behind the boat we trailed an insulated wire, with a float at the end carrying a metallic plate, so as to bring these two terminals about 100 feet apart. I then took another boat and sailed off. In

this boat we had the same arrangement, but with a telephone in the circuit. In the first boat, which was moored, I kept a man making signals; and when my boat was near his I would hear those signals very well—a musical tone, something of this kind: tum, tum, tum. I then rowed my boat down the river, and at a distance of a mile and a quarter, which was the farthest distance I tried, I could still distinguish those signals.

“It is therefore perfectly practicable for steam-vessels with dynamo machines to know of each other’s presence in a fog when they come, say, within a couple of miles of one another, or, perhaps, at a still greater distance. I tried the experiment a short time ago in salt water of about 20 fathoms in depth. I used then two sailing-boats, and did not get so great a distance as on the Potomac. The distance, which we estimated by the eye, seemed to be about half a mile; but on the Potomac we took the distance accurately on the shore.”

Later, in urging a practical trial of his method, Prof. Bell further said: “Most of the passenger steamships have dynamo engines, and are electrically lighted. Suppose, for instance, one of them should trail a wire a mile long, or any length, which is connected with the dynamo engine and electrically charged. The wire would practically have a ground connection by trailing in the water. Suppose you attach a telephone to the end on board. Then your dynamo or telephone end would be positive, and the other end of the wire trailing behind would be negative. All of the water about the ship will be positive within a circle whose radius is one-half of the length of the wire. All of the water about the trailing end will be negative within a circle whose radius is the other half of the wire. If your wire is one mile long, there is then a large area of water about the ship which is affected either positively or negatively by the dynamo engine and the

electrically charged wire. It will be impossible for any ship or object to approach within the water so charged in relation to your ship without the telephone telling the whole story to the listening ear. Now, if a ship coming in this area also has a similar apparatus, the two vessels can communicate with each other by their telephones. If they are enveloped in a fog, they can keep out of each other's way. The ship having the telephone can detect other ships in its track, and keep out of the way in a fog or storm. The matter is so simple that I hope our ocean steamships will experiment with it."¹

PROFESSOR A. E. DOLBEAR—1883.

Prof. Dolbear of Tuft's College, Boston, was also, about the same time as Graham Bell, engaged on the problem of a wireless telegraph, and produced a very simple and workable (at least for short distances) apparatus, which he patented in the United States, and of which he gave a description at a meeting of the American Association for the Advancement of Science in 1883. I take the following account from his specification as published in the 'Scientific American Supplement,' December 11, 1886 :—

"In the diagram, A represents one place (say Tuft's College) and B a distant place (say my residence).

"c is a wire leading into the ground at A, and D a wire leading into the ground at B.

"g is an induction coil, having in the primary circuit a microphone transmitter T, and a battery f' , which has a number of cells sufficient to establish in the wire c, which is connected with one terminal of the secondary coil, an electro-motive force of, say, 100 volts. The battery is so

¹ Public Opinion, January 31, 1886.

connected that it not only furnishes the current for the primary circuit, but also charges or electrifies the secondary coil and its terminals c and H .¹

“Now, if words be spoken in proximity to transmitter T , the vibration of its diaphragm will disturb the electric condition of the coil G , and thereby vary the potential of the ground at A , and the variations of the potential at A will cause corresponding variations of the potential of the ground at B , and the receiver R will reproduce the words spoken in proximity to the transmitter, as if the wires c D were in contact, or connected by a third wire.

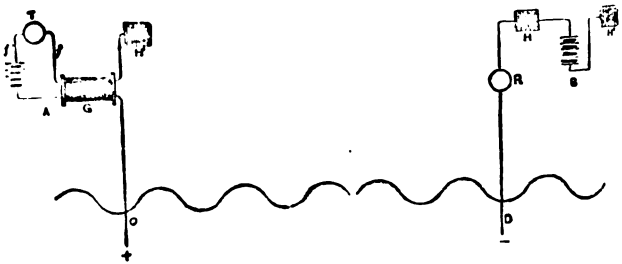

Fig. 9.

“There are various well-known ways of electrifying the wire c to a positive potential far in excess of 100 volts, and the wire D to a negative potential far in excess of 100 volts.

“In the diagram, H H' H^2 represent condensers, the condenser H' being properly charged to give the desired effect. The condensers H and H^2 are not essential, but are of some benefit; nor is the condenser H' essential when the secondary coil is otherwise charged. I prefer to charge all these condensers, as it is of prime importance to keep the grounds of wires c and D oppositely electrified, and while, as is

¹ The diagram, which we have carefully copied, does not show how this is done, but the practical reader will easily supply the necessary connections.

obvious, this may be done by either the batteries or the condensers, I prefer to use both."

Prof. Dolbear states that communication by this method is quite practicable at a distance of half a mile at least, but its possible range he had not yet determined.

In the article from which I am quoting the author gives some additional particulars which are worth repeating. "My first results," he says, "were obtained with a large magneto-electric machine with one terminal grounded through a Morse key, the other terminal out in free air and only a foot or two long; the receiver having one terminal grounded, the other held in the hand while the body was insulated, the distance between grounds being about 60 feet. Afterward, much louder and better effects were obtained by using an induction coil having an automatic break and with a Morse key in the primary circuit, one terminal of the secondary grounded, the other in free air, or in a condenser of considerable capacity, the latter having an air discharge of fine points at its opposite terminal. At times I have employed a gilt kite carrying a fine wire from the secondary coil. The discharges then are apparently nearly as strong as if there was an ordinary circuit.

"The idea is to cause a series of electrical discharges into the earth at a given place without discharging into the earth the other terminal of the battery or induction coil—a feat which I have been told so many, many times was impossible, but which certainly can be done. An induction coil isn't amenable to Ohm's law always! Suppose that at one place there be apparatus for discharging the *positive* pole of the induction coil into the ground, say 100 times per second, then the ground will be raised to a certain potential 100 times per second. At another point let a similar apparatus discharge the *negative* pole 100 times per second; then between these two places there will be a greater difference

of potential than in other directions, and a series of earth-currents, 100 per second, will flow from the one to the other. Any sensitive electrical device, a galvanometer or telephone, will be disturbed at the latter station by these currents, and any intermittence of them, as can be brought about by a Morse key in the first place, will be seen or heard in the second place. The stronger the discharges that can be thus produced, the stronger will the earth-currents be of course, and an insulated tin roof is an excellent terminal for such a purpose. I have generally used my static telephone receiver in my experiments, though the magneto will answer.

“I am still at work upon this method of communication, to perfect it. I shall soon know better its limits on both land and water than I do now. It is adapted to telegraphing between vessels at sea.

“Some very interesting results were obtained when the static receiver with one terminal was employed. A person standing upon the ground at a distance from the discharging point could hear nothing; but very little, standing upon ordinary stones, as granite blocks or steps; but standing on asphalt concrete, the sounds were loud enough to hear with the telephone at some distance from the ear. By grounding the one terminal of the induction coil to the gas or water pipes, leaving the other end free, telegraph signals can be heard in any part of a big building and its neighbourhood without *any connection whatever*, provided the person be well insulated.”

When we come to speak of the Marconi system, we shall see how near Dolbear got to that great discovery in his acute observation of the heightened effects obtained by projecting into free air the ungrounded terminal wires of the sending and receiving apparatus.¹ His use of condensers

¹ Compare his sending apparatus with that of Marconi, fig. 41, p. 203, *infra*.

and gilt kites "carrying fine wire" was another step in the direction of Marconi ; and had he used *thick* instead of *fine* wire he would have obtained even better results. However, Hertz had not yet come to make clear the way which Dolbear saw but as in a glass darkly!¹

T. A. EDISON—1885.

Electric communication with trains in motion, like communication with ships at sea and with lighthouses, has long been a favourite problem with electrical engineers : indeed it is much the older of the two, and dates back to the first days of electric telegraphy.

In 1838 Edward Davy, the rival of Cooke and Wheatstone, proposed such a system. In a lecture on "Electric Telegraphy," delivered in London during the summer of 1838, he says :—

"I have a few words to say upon another application of electricity—namely, the purposes it will answer upon a railway, for giving notices of trains, of accidents, and stoppages. The numerous accidents which have occurred on railways seem to call for some remedy of the kind ; and when future improvements shall have augmented the speed of travelling to a velocity which cannot at present be deemed safe, then every aid which science can afford must be called in to promote this object. Now, there is a contrivance, secured by patent, by which, at every station along the railway line, it may be seen by mere inspection of a dial what is the exact situation of the engines running either towards or from the station, and at what speed they are

¹ Mr C. Dolbear, a son of the Professor, is understood to be engaged on some form of wireless telegraph which is reported to have worked successfully over a distance of 500 yards. Details are wanting.

travelling. Every time the engine passes a milestone, the pointer on the dial moves forward to the next figure, a sound or alarm accompanying each movement.

“Not only this, but if two engines are approaching each other, by any casualty, on the same rails, then, at a distance of a mile or two, a timely notice can be given in each engine by a sound or alarm, from which the engineer would be apprised to slacken the speed; or, if the engineer be asleep or intoxicated, the same action might turn off the steam, independently of his attention, and thus prevent an accident.”¹

In 1842 William Fothergill Cooke published his ‘Telegraphic Railways,’ descriptive of a crude system of train signals, which was tried, in 1843, in the Queen Street tunnel, Glasgow, and in the Clay Cross tunnel, Derby; and, on a more extensive scale, in 1844, on the Great Eastern Railway, between Norwich and Yarmouth.

Dujardin in 1845, Brett and Little in 1847, Edwin Clark in 1854, Bonelli in 1855, and many others, proposed various systems of train signalling; but as they are all based on ordinary telegraphic principles and require connecting wires, they do not specially concern us in this history.

Mr A. C. Brown, an officer of the Eastern Telegraph Company, claims to have been the first to suggest, in 1881, the method of induction for communicating with moving trains. In a letter published in the ‘Electrician,’ March 21, 1885, he says:—

“My object was chiefly to provide an efficient means of fog-signalling, by enabling the signalman to communicate directly with the drivers or guards. I proposed to run a

¹ See the writer’s ‘History of Electric Telegraphy,’ 1884, p. 407. The most perfect block system of the present day does not do anything like this. Davy’s plan was actually patented by Henry Pinkus! See his patent specification, No. 8644, of September 24, 1840.

wire along the permanent way, parallel with the rails, and to wind a coil of wire round the engine, or carriage to be communicated with, in such a way as to get as long a length of wire parallel to, and as near to, the line-wire as possible, so as to be well exposed to the inductive action thereof. I then proposed to place in the signal-boxes a battery, signalling key, and rapid make-and-break instrument, or *buzzer*, and to thereby signal to the train, using a telephone in circuit with the train-coil as a receiver. By using an ordinary carbon transmitter in the line-wire, I also found it quite practicable to speak verbally to the train, so as to be distinctly heard in the telephone.

“This design was embodied in a paper which, in the year 1881, I laid before the managing director of the United Telephone Company, but want of time and opportunity prevented its being put into practice. It was experimentally tried at that time, using wire coils, properly proportioned in length, resistance, and distance apart to the conditions that would be obtained in practice. It has since been simplified and arranged to produce both visible and audible signals on the engine or car by induction from a No. 8 iron line-wire across a space of 6 inches, with a current of only one quarter ampère, or such as can easily be produced by the ordinary Daniell batteries used in railway work.”¹

In 1883 Mr Willoughby Smith threw out a similar suggestion towards the end of his paper on “Voltaic-Electric Induction,” read before the Institution of Electrical Engineers, November 8 of that year:²—

“Telegraph engineers,” he says, “have done much towards accomplishing the successful working of our present railway system, but still there is much scope for improve-

¹ For another proposal of Mr Brown, see p. 176, *infra*.

² Compare also his remarks, ‘Jour. Inst. Elec. Eng.’ March 23, 1882, p. 144.

ments in the signalling arrangements. In foggy weather the system now adopted is comparatively useless, and recourse has to be had at such times to the dangerous and somewhat clumsy method of signalling by means of detonating charges placed upon the rails.

“Now, it has occurred to me that Volta-Electric induction might be employed with advantage in various ways for signalling purposes. For example, one or more spirals could be fixed between the rails at any convenient distance from the signalling station, so that, when necessary, intermittent currents could be sent through the spirals; and another spiral could be fixed beneath the engine, or guard’s van, and connected to one or more telephones placed near those in charge of the train. Then, as the train passed over the fixed spiral, the sound given out by the transmitter would be loudly reproduced by the telephone, and indicate by its character the signal intended.

“One of my experiments in this direction will perhaps better illustrate my meaning. The large spiral was connected in circuit with twelve Leclanché cells and the two make-and-break transmitters before described. They were so connected that either transmitter could be switched into circuit when required, and this I considered the signalling station. The small spiral was so arranged that it passed in front of the large one at the distance of 8 inches, and at a speed of twenty-eight miles per hour. The terminals of the small spiral were connected to a telephone fixed in a distant room, the result being that the sound produced from either transmitter could be clearly heard and recognised every time the spirals passed each other. With a knowledge of this fact I think it will be readily understood how a cheap and efficient adjunct to the present system of railway signalling could be obtained by such means as I have ventured to bring to your notice this evening.”

In 1885 Mr T. A. Edison had his attention directed to the subject, and with his usual thoroughness he soon produced a very complete system, with the assistance of Messrs Gilliland, Phelps, and W. Smith — to the last-named of whom the original idea is said to be due.¹

The inevitable *avant-coureur* appeared in the technical journals of the period, and as it is delightfully characteristic of the great magician of Menlo Park, we venture to reproduce it here: "Mr Edison's latest invention, an arrangement to telegraph from moving trains, is thus described by a recent visitor to his laboratory: Overhead was a board eight inches wide, suspended from the ceiling by ropes fastened to one of its edges. One side of it was covered with tinfoil, and was facing toward a wall 20 feet distant. 'That,' said Mr Edison, 'is my railroad signal; I make electricity jump 35 feet, and carry a message. This is something quite new; no induction has ever been known that extended over 3 or 4 or 5 feet. This invention uses what is called static electricity, and it makes every running train of cars a telegraph station, accessible to every other telegraph station on the road. Messages may be sent to and from conductors, and to and from passengers. It requires no extra wire, either under the cars or at the side of the cars, but uses the ordinary telegraph just as it is put up at the side of the track. This white board is a receiver and transmitter. A board like it is to be fastened lengthwise along the peak of each car, where it will be out of the way and will not be a blemish. When the train is telegraphed to, the message jumps from the wire

¹ Although I have not seen any acknowledgment of their indebtedness, Mr Edison and his coadjutors can hardly have been ignorant of Mr Willoughby Smith's very clear proposal, of which their contrivance is but the practical realisation. Given the idea, the rest was easy enough.

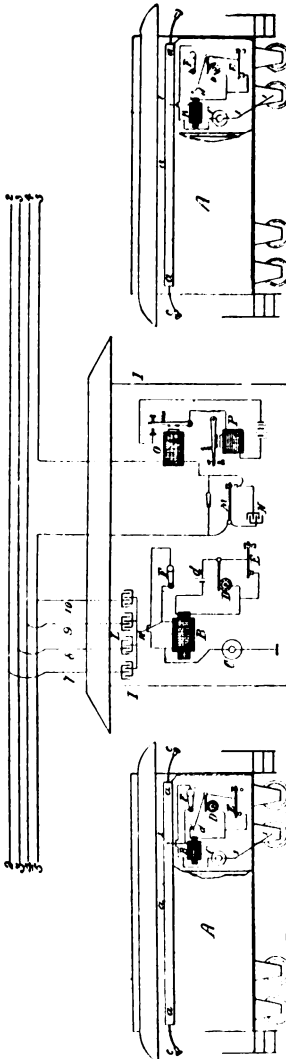

Fig. 10.

on the side of the track and alights on this board, and is conveyed to the apparatus in the train below. It works beautifully from those wires strung yonder. I was as much astonished as anybody at finding out what could be done. It costs very little, moreover, as 300 miles of road can be equipped for 1000 dols.'"

This contrivance was patented in England on June 22, 1885, in the joint names of T. A. Edison and E. T. Gilliland, and is fully described in their specification, No. 7583, of which the following is an abstract:—

The object of the invention is to produce apparatus for telegraphing between moving trains, or between trains and stations, by induction and without the use of connecting wires. The accompanying drawing (fig. 10) represents a station and portions of two trains with the apparatus for signaling. The carriage to be used as the signal office

has placed upon its top or side, or upon each side, a metallic condensing surface running the entire length of the car. This consists of a strip a of metal, say a foot wide, well insulated by blocks of glass; or it may be thin sheet metal or metallic foil secured to canvas, and similarly insulated from the body of the car. To increase the total condensing surface, all the carriages of the train are preferably provided with such strips, which are connected electrically by suitable couplings c when the train is made up. A wire l is connected with this condensing surface, and extends through the apparatus to the carriage-truck so as to form an earth connection through the wheels and the rails upon which they travel. The apparatus just mentioned consists of an induction coil B , the secondary wire of which is of extremely high resistance, and is in the circuit of wire l , in which is also connected a telephone c of high resistance. This is preferably an electro-motograph telephone, the chalk cylinder of which is kept in constant rotation by a suitable motor, electrical or mechanical; but a magneto-electric or other suitable form of telephone may be employed.

In the primary circuit of the induction coil B are a local battery d and a revolving circuit-breaker D . This is a wheel having its surface broken by cross strips of insulation; upon it rests a spring, the circuit being through the spring to the spindle of the wheel. This wheel is kept in rapid motion by a suitable motor, electrical or mechanical, the current vibrations produced by it being a great number per second and audible in the telephone receiver.

The circuit-breaker is shunted by a back point key E , which, normally, short-circuits it and prevents it from affecting the induction coil. A switch F short-circuits the secondary wire of the induction coil when receiving, and is opened in transmitting.

The ordinary telegraph wires 2, 3, 4, 5, run on poles at the side of the track, and, grounded at their ends, are utilised collectively for conveying the signals. They form the other surface of the condenser (the strips on the carriages forming one surface), while the intervening body of air is the dielectric.

In signalling between trains, signals are transmitted by working the key κ in the office upon one train. This causes static impulses at the condensing surface upon the carriages which affect the telegraph wires. These in turn affect the condensing surface upon the carriages of the other train, and cause impulses which are audible in the telephone.

At each signalling station Γ there is erected between the telegraph wires a large metallic condensing surface κ (fig. 11). This may be attached to a frame supported from the telegraph poles or from separate poles. A wire 6 runs from this condensing surface to the station, where it is connected to ground through the same character of transmitting and receiving apparatus already described for the carriages.

Instead of using this condensing surface outside of the station, a separate wire (7, 8, 9, 10, fig. 10) may be attached to each telegraph wire (or to each of as many as it is desired to utilise) and run into the station, where it is connected to one side of a condenser L , of ordinary form. The other sides of the several condensers L are connected together, and by a common wire 11 to ground through the transmitting and receiving apparatus.

The telegraph wires are kept constantly closed for transmitting the induction impulses by shunting the regular Morse keys m by condensers n . These condensers do not interfere with the carrying on of the ordinary telegraphing over such wires, at the same time that they form constantly closed paths for the induction impulses independent of the

working of the ordinary Morse keys. The ordinary Morse relay and sounder are shown at o and r respectively.

The stations being connected for railway signalling inductively with the line wires the same as are the trains, signals are received and transmitted by a station the same as by a

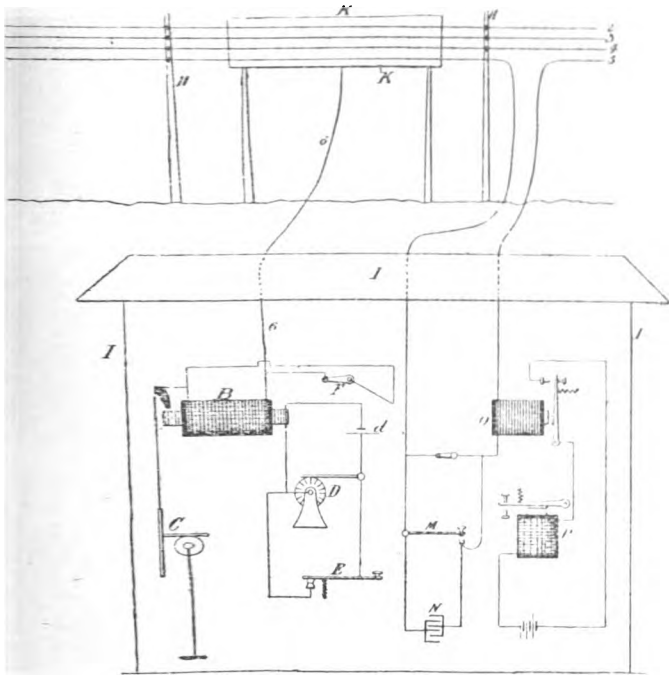

Fig. 11.

train. The trains and stations are connected inductively with the line wires in multiple arc, so to speak, signals being transmitted by keys, circuit breakers, and induction coils, and received by telephones.

The signalling is conducted by Morse characters, or

by numerical signals in accordance with an established code.

Speaking of the potentialities of his system, Edison, early in 1886, said: "The outcome is easy to predict. Special correspondents may, in the future, wire their despatches straight to the offices of their journals. Railway business will be expedited to a degree undreamt of as things are, and the risk of accidents will be largely diminished by knowing the position of trains and the cause of delay or accident, if any, at every stage of their route. Ships at sea, many miles apart, will be able to communicate by means of balloon-kites, soaring several hundred feet above their decks. Messages can be passed from ship to ship, and a casualty like that of the Oregon telegraphed to the nearest land. In times of war the applications of the air-telegraph system are obvious. Regions now remote from telegraphs could be brought within the civilised circle by means of mountain or forest stations equipped with the new apparatus. Even the man of business of the future may communicate with his employés as he journeys to and from his office, and save time or make money while he is literally on the wing. Not the least interesting feature of this new departure in telegraphy is the thought that, in its turn, it may be the harbinger of still more wondrous modifications of the system which has girdled the earth in a space inconceivably short when compared with that imagined by the fairy romancer who created Puck."¹

The Edison system was first put in operation at Staten Island, U.S.; then, a few months later, on the Chicago, Milwaukee, and St Paul line; and by October 1887 it was established on the Lehigh Valley Railroad, as related in the following paragraphs:—

"The success of what is called 'railway train telegraphy'

¹ Weekly Irish Times, April 10, 1886.

is now assured, and October 6, 1887, will be a red-letter day in the history of the electric telegraph. On that day a special train left Jersey City with about 230 members of the Electric Club and guests of the Consolidated Railway Telegraph Company, in order to witness the working of the system on the Lehigh Valley Railroad. The system is a combination of the best features of the inventions of Edison, Gilliland, Phelps, and Smith, and although the speed often reached the rate of about sixty miles an hour, messages were sent from and received on the train without difficulty, although the current or the 'induction' had to jump from the train to the line wires, a distance of 25 feet. About four hundred messages were sent as the train ran from Perth Junction to Easton, amongst them a rather long one from Colonel Gouraud to Mr John Pender in London."¹

"One of the most interesting triumphs of invention has been achieved on the Lehigh Valley Railroad during the snowstorms of the past winter in the United States. This railway for some months has been using on its trains the system of communication known as train telegraphy. The wire, being of steel, and stretched upon stout poles only 15 or 16 feet high, withstood the fury of the storm. The consequence was that all snowed-up trains on the Lehigh Valley Railroad kept up constant communication with the terminus of the road, could define exactly their position, and, in short, had all the advantages of perfect telegraphic communication."²

Soon after this the system fell into desuetude, and for a very simple reason—nobody wanted it. Whatever "special correspondents" and "the man of business" in the future may require, they, apparently, prefer nowadays to be free from telegrams of all sorts "while on the wing."

¹ Public Opinion, November 4, 1887.

² Ibid., April 13, 1888.

W. F. MELHUIISH—1890.

We have seen (p. 39 *ante*) that the want of some form of wireless telegraph was peculiarly felt at a very early date in India, where the rivers are many and wide, and where for various reasons cables are liable to frequent breakage, causing interruptions which are as likely as not to be of long duration, owing to the great rush of waters and the flooding of banks.

I have already given some account of Dr O'Shaughnessy's experiments in this direction. It is all too short, but, unfortunately, it is all that I have been able to gather.

About the year 1858 Mr Blissett, a superintendent in the Indian Telegraph Department, resumed the inquiry, and obtained a fair measure of success by employing land-lines of considerable length on each bank of the river. In 1876 Mr Schwendler, then electrician, made some trials across the Hooghly at Barrackpore, near Calcutta, which were continued at intervals by his successor, the late Mr W. P. Johnston.

On September 9, 1879, this gentleman tried the following arrangement for signalling across the water of a canal. Fig. 12 shows the connections:—

E = 10 Bunsen's cells joined in series ;

R, a needle instrument having a resistance of 1 ohm ; also
a telephone having a resistance of 4.25 ohms ;

w = a resistance of 1
ohm
e = four Minotto cells
joined parallel

} This arrangement exactly balanced
the natural current through the
receiving instrument.

A, B, C, D were copper plates, 8 feet 8 inches by 4 feet 4 inches by 1-16th inch thick, buried on the banks of the canal. B was buried 15 yards distant from A, and D the same distance from C. All the plates were parallel to the

canal. The resistance between A and B was 7.5 ohms, and that between c and d was the same. Under these conditions

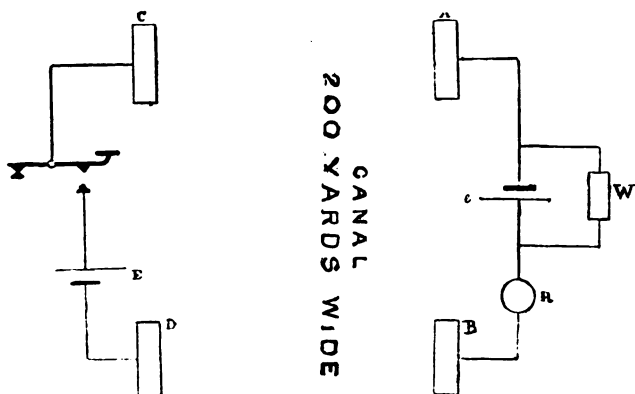

Fig. 12.

both the needle instrument and the telephone gave distinct and readable signals.

After several days of experiment with another method

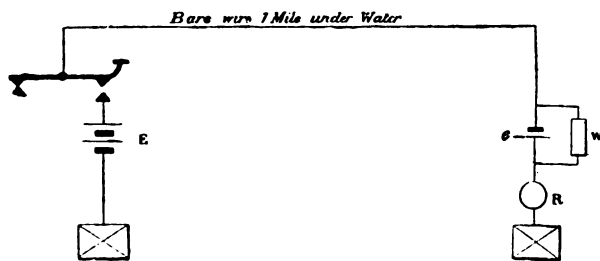

Fig. 13.

(fig. 13), using a single bare 600 lb. per mile galvanised wire, the following results were obtained:—

E = 15 Bunsen's cells in series ;

R, a polarised Siemens relay of 21 ohms resistance ;

$e = 4$ Minottos joined parallel } Balanced the natural
 $w = 10$ ohms } current.

The signals received were quite regular and safe; the tongue of a relay worked an ordinary sounder in local circuit, and no difficulty was experienced in balancing the natural current through the relay.

A trial with bare wire for a distance of one and a half mile was not successful. Indeed, as it appeared that in order to obtain signals the battery power must be increased as the square of the distance, the limit of signalling through a bare wire under water is very soon reached.

Subsequently, three miles of the same wire, but partially insulated by being passed through a mixture of pitch and tar, answered perfectly for the hour that the instruments were in circuit.

At various times during the year 1888 Mr Johnston carried out many experiments across canals and the river Hooghly, and as the result of these and other careful investigations he was led to the following conclusions:—

1. That up to one and a half mile it is perfectly easy to signal through a bare wire under water.
2. That for greater distances, judging from experiments, practical signalling is not possible.

In April 1889 Mr Johnston died, and the duties of electrician were entrusted to Mr Melhuish, who immediately took up the inquiry, and in the end produced some very considerable results, for which, I believe, the Government of India gave him the handsome honorarium of 5000 rupees.

The results of his investigations are embodied in a paper which was read before the Institution of Electrical Engineers on April 10, 1890:—

“Having studied,” he says, “the recorded labours of my predecessor, and learnt that by pursuing the same lines

it was hopeless to expect to be able to signal through a bare wire across a river that had a greater breadth than one and a half mile, I resolved to change the class of signalling apparatus and to continue the experiment. Discarding continuous steady currents and polarised receiving relays, I adopted Cardew's vibrating sounder, and the sequel will show how completely successful the change of instruments proved to be. I began from the beginning, and tried to signal across a water-way without a metallic conductor by laying down two earth-plates on each of its opposite banks. Readable signals having been exchanged, the distance separating each pair of plates was varied, with the view of ascertaining how close the plates might be brought together, the signals remaining still readable. Readable signals were exchanged when the distance separating the plates was equal to the breadth of the river, reading becoming more difficult as the plates were made to approach each other, and clearer and more distinct as the distance between the plates was made to exceed the breadth of the river. I learnt from these experiments that in order to obtain signals of sufficient distinctness for the practical purpose of transmitting messages, it would be necessary to construct a line on each bank of a river much longer than the breadth of the river; and as the rivers along the coasts in India are extremely wide, I became impressed with the impracticable character of such an undertaking, and decided to strike out a new line.

“ This new line was the laying of two bare uninsulated iron wires across the water-way parallel to each other, and separated by a certain distance, the ends on each bank being looped together by means of an insulated conductor. Hence, though much of the circuit was laid under water, it was nevertheless a continuous metallic circuit. Beginning first with a complete square, by laying

the wires as many yards apart as the river was wide, signals were instantly exchanged that were incomparably louder than those that were exchanged when the same area was bounded by four earth-plates. The length of each of the two wires under water was next gradually increased to 740 yards, and the distance separating them gradually diminished to 35 yards, the strength of the signals diminishing proportionately, and ceasing to be readable when the wires were further approached. The conclusion arrived at from these experiments was that, for the practical and useful purpose of signalling messages across a broad river, in the absence of an insulated cable, a complete metallic circuit was at least desirable. Acting on this conclusion, it was sought to apply it practically, and the following experiment was carried out: At a distance of fifteen miles west of Calcutta a cable is laid across the river Hooghly, which at this point is 900 yards wide. The iron guards of this cable were employed to form one of the metallic conductors, and at a distance of 450 yards down-stream a single wire, weighing 900 lb. per mile, was laid across the river to form the second metallic conductor, insulated land-lines having been run up to loop the two parallel conductors together. The experiment was quite a success, the signals being readable without difficulty.

“An experiment was next made on a defective cable across Channel Creek, at the mouth of the river Hooghly. This creek is crossed by two cables laid in the same trench; the length of each is 3000 yards, and one of them had been completely parted by a steamer’s anchor. Several attempts were made to signal across by using the guards of one of the cables as a lead, and the guards of the other as a return wire, but the efforts proved unsuccessful owing to the too close proximity of the cables. For every crossing

there is a certain minimum distance apart at which the cables must be laid, and if this minimum, which depends on the breadth of the river, be exceeded, an absolute short-circuit becomes established. But although it was not possible here to signal through the iron guards, the most perfect signals were passed through the two conductors when they were formed into a loop, notwithstanding the fact that the two ends of the broken conductor were exposed in the sea and were lying at a considerable distance apart. An experiment was now made in order to ascertain what chance there might be in the future of signalling across the two conductors, should an accident occur to the good cable. Accordingly, the conductor of the good cable was disconnected in the cable-house from the signalling apparatus and placed upon the ground, when the signals, though greatly diminished in volume, still continued to be distinctly readable. It may, therefore, be reasonably inferred that should the good cable suffer a similar fate to that of the defective cable, communication can, by means of Cardew's sounders, be kept up by looping the ruptured conductors until arrangements can be made for laying a new cable or repairing the defective ones.

"It will probably suffice if from the succeeding experiments that were made to test the efficiency of the vibrating sounder in the case of conductors breaking down at river crossings I select the following three, exhibiting as they do progressive evidence of the value of this signalling instrument, and culminating in establishing it beyond dispute as one that can be relied on for carrying on independent communication through the iron guards of cables while the insulated copper conductors form parts of other circuits.

"*Experiment No. 1.*—The local line from the Central Office, Calcutta, to Garden Reach is about four miles in length, and at about midway the wire spans a small river.

Vibrating sounders having been put in circuit at each end of this line, the wire where it crosses the river was taken down and laid along the bed of the water-way. Signals were loud and clear at both ends.

“From the success of this experiment it may be inferred that on any ordinary line, should the wire from accidental causes come off the insulator and make earth by touching the bracket, standard, or ground, or should the wire break and both ends of it be lying on the ground or in a water-course, communication could still be maintained by means of the vibrating sounders.

“*Experiment No. 2.*—The line wire which connects the town of Chandernagore with Barrackpore is about ten and a half miles long, 900 yards of which consist of a cable laid across the river Hooghly. Vibrating sounders having been joined up in the telegraph offices at Barrackpore and Chandernagore, the insulated conductor of the cable was thrown out of circuit, and the line wire on each side of the river was joined to the iron guards of the cable. Thus for a length of half a mile out of ten and a half miles the conductor was wholly under water, yet it was found quite feasible to transmit messages between the two offices.

“From the success of this experiment it may be reasonably inferred that in the case of certain cable crossings, where the rivers are not too wide, should the copper conductor of the cable make dead earth, or become insulated by parting, communication could still be kept up between the two offices on either side.

“*Experiment No. 3.*—The terminus of the Northern Bengal State Railway at Sara is separated from that of the Eastern Bengal State Railway at Damukdia by the river Ganges. The opposite banks of the river in this locality are connected by two independent cable crossings. The length of one of these crossings is one mile 610 yards, and

of the other four miles. The distance which separates the two cable-houses on the Damukdia side is three miles 1584 yards, and on the Sara side the cable-houses are only one mile 211 yards apart, giving a mean lateral distance in alignment of two miles 880 yards. The two cable-houses on each bank of the river have an insulated connecting land-line.

"The connecting land-lines having been joined to the iron guards of the cables, two vibrating sounders were placed in circuit, one on each side of the river, when signals so strong were transmitted across that it was not difficult to read them at a distance of 6 feet away from the receiving telephone.

"From the marked success of this experiment it may be inferred that at all river cable crossings where the cables are laid in separate alignments (and the farther apart the better), should the cables become interrupted, communication may still be maintained from bank to bank by using vibrating sounders, thus avoiding the delay, inconvenience, and cost of a boat service.

"It should also be remembered in the case of such a parallel cable crossing that, besides the circuits afforded by the copper conductors when these are in working order, there is always an additional local circuit available by means of the iron guards between the opposite cable-houses, and that this circuit could be used by means of the vibrating sounder as a talking circuit, in cases of necessity, without interrupting through working on either of the cables.

"It is desirable in circumstances similar to these to reduce all the resistance external to the actual connecting lines to as small a quantity as possible, and therefore, when messages are being transmitted, the telephone at the sending end should be removed from the circuit, as also should the vibrator from the receiving end. To effect this twofold

purpose a special form of signalling key is requisite, and should be used. The action of this key, together with the

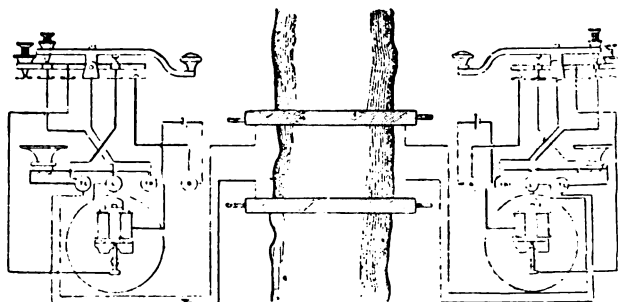

Fig. 14.

complete set of connections for a parallel cable crossing, is shown in fig. 14.”¹

C. A. STEVENSON—1892.

Early in 1892 Mr Stevenson threw out the suggestion that telegraphic communication could be established between ship and ship by means of coils of wire.²

In his paper read before the Royal Society of Edinburgh, March 19, 1894, he refers to this suggestion, and says that a trial of his method on a large scale had recently been made with a view of ultimately employing it for effecting communication between Muckle Flugga, in the Shetlands, and the mainland.

As regards the efficacy of the principle, the inductive effect of one spiral on another at a distance has long been

¹ Melhuish's plan is the practical realisation of the early proposals of Highton and Dering. See pp. 40, 48, *ante*.

² *Engineer*, March 24, 1892.

known ; but hitherto, even with a very strong battery, it was impossible to bridge a greater distance than 100 yards, which for practical purposes was, of course, useless.

It is evident that if two coils are placed so that their axes are coincident, their planes being parallel, or if they be placed so that their planes are in the same plane, they will be in good positions for electric currents sent in one to be apparent by induction in the other.

For a small diameter, and where the electrical energy is small and the number of turns small, the first position is best ; but where the energy is great and the number of turns great—in fact, when it is wished to carry the induction to many times the diameter of the coils—then it will be found that it is better to let the two coils be in the same plane, as when the axes are coincident, and the coils a greater distance apart in comparison with the diameter, the difference of distance from one side of the coil, say top of primary coil to top and bottom of secondary, becomes almost a vanishing quantity ; whereas, when the coils are lying on their side in the same plane, the difference of distance from back of primary to back of secondary, and from front of primary to front of secondary, does not fall off so fast, and consequently is more efficacious. Besides, it becomes impracticable to erect coils of large diameter with their planes vertical, but it is easy to lay them on their sides.

Mr Stevenson made a large number of laboratory experiments on the interaction of coils, with the view of calculating the number of wires, the diameter of coils, the number of ampères, and the resistance of the coils that would be necessary to communicate with Muckle Flugga ; and, after a careful investigation, it was evident the gap of 800 yards could, with certainty, be bridged by a current of one ampère with nine turns of post-office wire in each coil,

the coils being 200 yards in diameter, and with two good telephones on the hearing coil.

Two coils, on telegraph-poles and insulators, were erected at Murrayfield, one coil being on the farm of Damhead and the other on the farm at Saughton, and as nearly as was possible on a similar scale, and the coils of similar shape to what was wished at Muckle Flugga. On erecting the coils, communication was found impossible, owing to the induction currents from the lines from Edinburgh to Glasgow, the messages in those lines being quite easily read, although the coils were entirely insulated and were not earthed. The phonophore which the North British Railway Company have on their lines kept up nearly a constant musical sound, which entirely prevented observations. On getting the phonophore stopped, it was found that 100 dry cells, with 1·2 ohms resistance each and 1·4 volts, gave good results, the observations being read with great ease in the secondary by means of two telephones. The cells were reduced in number down to fifteen, and messages could still easily be sent, the resistance of the primary being 24 ohms and the secondary no less than 260 ohms. If the circuit had been of good iron, with soldered joints and well earthed, the resistance would have been only 60 ohms. The induced current generated in the secondary would therefore be in the ratio of 480 [? 520] to 210, or, allowing for the resistance in the two telephones, we get practically only half the current we would have got if the line had been a permanent in place of a temporary one.

A trial was made of the parallel-wire system:¹ with 20 cells the sound was not heard, and with 100 cells it was heard as a mere scratch in comparison with the sound with the coil system with only 15 cells. A trial was made with

¹ *I.e.*, Mr Preece's method, to be presently described. See p. 154 *et seq.*, *infra*.

the phonophore : the coils worked with 10 cells with perfect ease, and a message was received with only 5 cells. Speech by means of Deckert's transmitter was just possible, but it is believed that if the hearing circuit had been of less resistance it would have been easy to hear.

"It is difficult," says Mr Stevenson, "to understand how this system of coils, in opposition to the parallel-wire system, has not been recognised as the best ; for assume that, with the arrangement we had, we heard equally with 100 cells by both systems, both having the same base (200 yards), then, by simply doubling the number of turns of wire on the primary and using thick wire, the effect would have been practically doubled, whereas by the parallel-wire system there is nothing for it but to increase the battery power. The difficulty of the current is thus removed by using a number of turns of wire. It must always be borne in mind that the effect is the result of simply increasing the diameter, keeping current and resistance the same. The larger the diameter the better. What is wanted is to get induction at a great distance from a certain given base with a small battery power, and the laboratory experiments and the trials in the field show that the way to overcome the difficulty of the current is by using a number of turns of wire. The secret of success is to apportion the resistance of primary and secondary, and the number of turns on each, to a practical battery power."

1. *Coil System.*—At 870 yards from centre to centre of coils, averaging each 200 yards diameter, with nine turns of wire, it was found that with a phonophore messages were sent with five dry cells, the resistance in primary being 30 ohms and the resistance of secondary 260 ohms, the current being 0·23 ampère, which, with nine turns, gives 2 ampère turns.

2. With a file as a make and break, it worked with 10 cells, giving 0·4 ampère or 3·6 ampère turns.

3. *Parallel-Wire System*.—With a file as a make and break, and with parallel lines earthed, it was heard with 100 cells, giving 1·1 ampère.

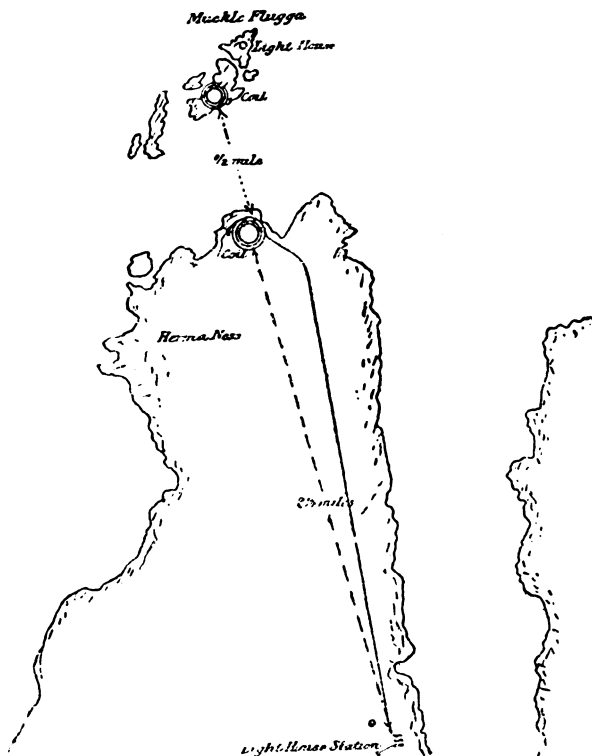

Fig. 15.

The primary coil circuit was entirely metallic in the Murrayfield trials, as it would have to be if erected at Muckle Flugga; but the secondary coil was earthed. When, however, the secondary was also made a complete

insulated metallic circuit, with eight turns of wire, there seemed to be little difference in the result.

The calculation of the diameter necessary to hear at a given distance is simple, from the fact that the hearing distance is proportional to the square root of the diameter of one of the coils, or directly as the diameter of the two coils, so that with any given number of ampères and number of turns, to hear double the distance requires double the diameter of coils, and so on.¹

In concluding his paper, Mr Stevenson says:—

“It has been attempted to be shown that the coil system is not only theoretically but practically the best; and I trust that we will soon hear of the Admiralty, &c., experimenting with it, and ultimately putting it in practice. Meantime my brother has recommended the Commissioners of Northern Lighthouses to erect the coil system at Muckle Flugga, and the Commissioners have approved; and I hope soon to hear of the erection of this novel system of communication at the most northern point of the British Isles, as well as on our warships to assist in their manœuvring, by the establishment of instantaneous communication unaffected by wind or weather.

“The application of the coil system to communication with light vessels is obvious—viz., to moor the vessel in the ordinary way, and lay out from the shore a cable, and circle

¹ Professor Lodge has recently shown that the law of distance is not the square root of diameter, but the two-thirds power, with a given primary current; and so doubling the circumference of each coil will permit signalling over more than double the distance, if other things can be kept the same. For such magnification, however, the thickness of the wire must be magnified likewise, or else more power will be consumed in the enlarged coil; and this consideration, as well as others, would speedily make the cost prohibitive, unless some fresh revolutionary devices are employed. For these see the ‘*Jour. Inst. Elec. Engs.*,’ No. 137, p. 803.

the area over which the lightship moorings will permit her to travel by a coil of the cable of the required diameter, which will be twice the length of her chain cable. On board the vessel there will be another coil of a number of turns of thick wire. Ten cells on the lightship and ten on the shore will be sufficient for the installation.”¹

In a recent communication² Mr Stevenson gives some additional particulars. Referring to his proposed installation at the North Unst lighthouse, on Muckle Flugga, he tells us a gap of half a mile had to be bridged. The Commissioners of Northern Lighthouses being impressed with the experiments shown them on a small scale—even through stone and mortar—decided on the larger experiment, but financial difficulties intervened, and the project was allowed to drop.

“It is well to remember,” he says, “that in the Murrayfield trials a small number of cells was purposely used. Theory and formulæ give one the impression at first sight that a single outstretched wire is always best—the simple fact of getting a greater effect at a distance as a coiled wire is uncoiled and made straight supporting this impression; but formulæ, if they are to be practical, ought to take into account a *limited* area and *workable* amounts of resistance, current, &c., and then the fact is disclosed that the coiling of wires (whether condensers be used with them or not) becomes an advantage for most work which the engineer will be called upon to deal with.

¹ Probably acting on Mr Stevenson's suggestion in the 'Engineer' of March 24, 1892, Mr Sydney Evershed devised a plan of communicating with lightships, for which he applied for a patent on May 28, 1892. The method was actually tried in August 1896 on the North Sand Head (Goodwin) lightship, but failed utterly. See his patent specification, No. 10,161; also his paper on Telegraphy by Magnetic Induction, 'Jour. Inst. Elec. Engs.,' No. 137, p. 852.

² 'Jour. Inst. Elec. Engs.,' No. 137, p. 951.

"It is not necessary, as has been stated, that the coils should be identical in size and shape. Far from it; each case must be treated for size and configuration by itself. For instance, in the case of Muckle Flugga, my design was for a line two miles in length on the mainland, with a coil at the end enclosing a larger area than the one on the rock, which latter was opened out to the maximum possible. Again, in the case of Sule Skerry and the Flannan Islands, on the north-west of Scotland, where telegraphy by induction would be of great value, it would be impossible to make the coils of large diameter, but the coil on the mainland should be of large dimensions; indeed a single long wire with the ends earthed would be, perhaps, the best arrangement.

"For guarding a dangerous coast, a similar wire of many miles in length would be suitable for communicating warning signals to vessels on board of which were detectors, with coils necessarily of small dimensions. There are two ways of doing this, both of which I have tried. First, by means of a submarine cable along the line of coast. In this case the currents set up in the cable have to bridge only the sheet of water to the vessel, say twenty fathoms; or, if an electro-magnet be let down from the ship, only four or five fathoms. But here the cost and maintenance of a cable would be a weighty objection. The other way is to erect a pole line on shore, either along the coast or in the form of a coil on a peninsula. The main difference from the first plan is that the currents would have to be stronger to bridge the distance of several miles instead of a few fathoms; but the cost in comparison with a cable would be very small. I have tried this system with two miles of pole line and a coil about a quarter of a mile distant with perfect and never-failing success.

"I have made numerous trials of the coil *versus* parallel-

wire system since 1891, and I have found—and other observers seem also to have found—that it is not practical to work the latter more than three or four times the length of base; whereas by coils I have found it possible to work many times their diameter. Thus in 1892, at the Isle of May lighthouse, I signalled to a distance 360 times the diameter of an electro-magnet coil with currents from a de Meritens' magneto-electric machine. Again, at Murrayfield, I signalled four times the base with five dry cells; and I have in Edinburgh a coil with iron core 17 inches diameter, which with one cell can easily signal through a space twenty-five times its diameter."¹

PROFESSOR ERICH RATHENAU—1894.

The last example of a wireless telegraph with which we have to deal in this part of our history is an arrangement devised by Prof. Rathenau of Berlin, with the assistance of Drs Rubens and W. Rathenau, and which was found to be practicable up to a distance of three miles in water.

Reports of the experiments of Messrs Preece, Stevenson, and others in England having appeared in the technical journals on the Continent, Prof. Rathenau, at the request of the Berlin Electrical Society, undertook to make a thorough investigation of the subject *de novo*.

After a careful study of the work of these electricians he felt convinced that the favourable results obtained in England, especially by Mr Preece, were largely due to conduc-

¹ Though never tried practically in England, Mr C. Bright points out that this system has been experimented on by the Lighthouse Board in America under the direction of Prof. Lucien Blake, and was favourably spoken of in their report for 1895: 'Submarine Telegraphs,' London, 1898. See also some recent remarks of Mr Stevenson, 'Jour. Inst. Elec. Engs.,' No. 139, p. 307.

tion. To verify this opinion he commenced a course of rigorous experimentation; and to prevent inductive effects entering into the calculation he decided to use ordinary battery currents, and in one direction only.

The outcome of the inquiry was published in an article which he contributed to the Berlin 'Elektrotechnische Zeitschrift,'¹ from which I make a few extracts. When a current is sent through two electrodes immersed in a conducting liquid, the electrical equilibrium between these

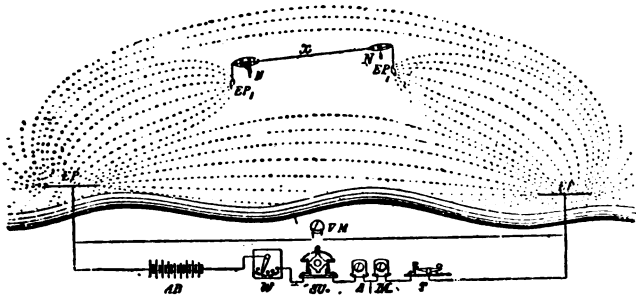

Fig. 16.

electrodes is not effected in a straight line, but in lines which spread out in the manner shown in fig. 16. Now, if we place in the liquid medium an independent conductor of electricity, it will attract or condense upon its surface a certain number of these lines, which can be utilised for the excitation of a properly constructed receiving apparatus. The distance at which these electrical effects can be produced is found to depend upon two factors—the available current strength and the distance between the electrodes.

It was thought best to conduct the experiments on the

¹ Abstract in 'Scientific American Supplement,' January 26, 1895, which I follow in the text.

lake Wannsee, near Potsdam, on account of the facilities in the way of apparatus afforded by the proximity of an electric-light station. The arrangement is shown in fig. 16. AB is a battery of 25 cells, w a set of resistance coils (0 to 24 ohms), SU an interrupter driven by a motor, AM an ampèremeter, VM a voltmeter, T a Morse key, $EP EP$ two zinc plates immersed in the water, 500 yards apart, and connected by cable as shown. The receiving circuit comprises two zinc plates, EP_1 and EP_1 , suspended by cable x from two boats, from 50 to 100 yards apart, and nearly three miles from the sending station; $N N$ are telephones included in the circuit of x . For the purpose of transmitting signals, intermittent currents were sent from the battery, which, by depressing the key for long and short intervals, could be heard in the telephones as dashes and dots of the Morse code.

The object was to establish experimentally the best relation between the various factors—*i.e.*, the relation between the current strength in the primary circuit and the hearing distance for the telephones in the secondary circuit; the effect of various distances between the electrodes $EP EP$ upon the clearness of the signals; the distance between $EP_1 EP_1$ which gave the most audible effect; and, finally, the effect of altering the shape and size of the plates.

On account of the non-arrival of some apparatus specially designed for these tests, the average current strength sent through the water did not exceed three ampères with 150 intermissions or current impulses per second. Again, the water of the Wannsee containing but a very small admixture of mineral salts offered a high resistance, so that it was found necessary to use large plates of 15 square yards surface.

With this arrangement no difficulty was encountered in the transmission of signals from the electric-light station

to the boats anchored off the village of New Cladow—a distance, as has been said, of nearly three miles; and Prof. Rathenau was satisfied that, by a slight change in the construction of the ordinary telephone, signals could be sent over much greater distances.

“Lord Rayleigh,” he says, “has stated that the sensitiveness of the telephone for currents with 600 reversals per second is about 600 times greater than for currents having but 130 reversals per second, but in my experiments the number of impulses did not exceed 150 per second. To get the best possible result in this system of transmission, a telephono should be used having a carefully tuned metallic tongue in place of the ordinary iron disc. Then, knowing the number of current-breaks in the primary circuit, the tongue should be so tuned as to vibrate in unison with that number, thereby producing much more distinct signals.

“I may point out that the resistance of the receiving circuit should be as small as possible. At first I found it difficult to produce a call in the distant receivers, but this apparently knotty problem may be solved by attaching a microphone to the membrane of the receiver, which, acting upon a relay in a local circuit, produces the call.

“It does not seem necessary to point out that by the use of several current generators, each one producing a definite number of current impulses, a number of non-interfering messages may be sent through the water to distant telephones, each being constructed to respond to but one definite rate of vibration; or by means of one current generator a message may be sent (simultaneously) to several distant telephone receivers.

“The usefulness of this method of transmission would be much increased if means can be found to produce a written message. On the suggestion of Dr Rubens an

apparatus is now being constructed, generally on the plan of Dr Wien's optical telephone. It is expected that the use of this apparatus will enable us to transform the acoustical into optical signals, and to register these photographically."

Fig. 17 shows the locality of these experiments. It will

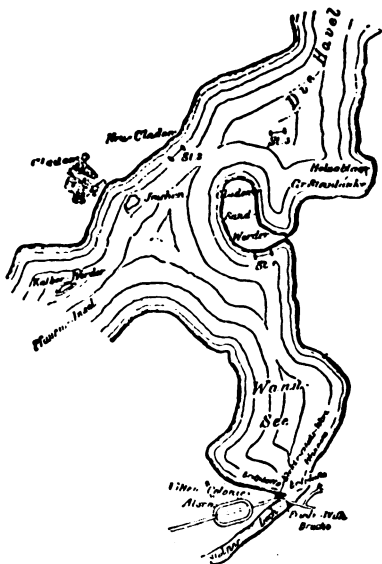

Fig. 17.

be noticed that a large sandbank intervenes between the stations, but without any appreciable effect on the results.

Prof. Rathenau concludes a very interesting paper with the enumeration of the chief points to be observed for increasing the effective signalling distance :—

“1. Great current strength in the primary circuit.

“2. Increasing the distance between the primary electrodes.

“3. Increasing the distance between the receiving electrodes.

“4. Replacing the metallic diaphragm of the telephone receiver by a light tongue.

“5. Which should be tuned to respond to a definite rate of vibration.¹

¹ Experiments, based on the same conductive principle, were tried in Austria about the same time, but with what success I cannot say, as the results, for military reasons, have not been published.

THIRD PERIOD—THE PRACTICAL.

SYSTEMS IN ACTUAL USE.

“The invention all admired ; and each how he
To be the inventor missed—so easy seemed
Once found, which yet unfound most would have thought
Impossible.”

W. H. PREECE'S METHOD.

MR PREECE, lately the distinguished engineer-in-chief of our postal telegraphs, has made the subject of wireless telegraphy a special study for many years, his first experiment dating back to 1882.¹ From that year up to the present he has experimented largely in all parts of the country, and has given us the results in numerous papers—so numerous, in fact, that they offer a veritable *embarras des richesses* to the historian. In what follows I can only attempt a *résumé*, and that a condensed one ; but to the reader greatly interested in the subject I would advise a careful study of all the papers, a list of which I append :—

1. Recent Progress in Telephony : British Association Report, 1882.

¹ Indeed, it so happens that one of the first experiments he ever made in electricity was on this very subject in 1854. See p. 28, *ante*.

2. On Electric Induction between Wires and Wires : British Association Report, 1886.
3. On Induction between Wires and Wires : British Association Report, 1887.
4. On the Transmission of Electric Signals through Space : Chicago Electrical Congress, 1893.
5. Electric Signalling without Wires : Journal of the Society of Arts, February 23, 1894.
6. Signalling through Space : British Association Report, 1894.
7. Telegraphy without Wires : Toynbee Hall, December 12, 1896.
8. Signalling through Space without Wires : Royal Institution, June 4, 1897.
9. Ætheric Telegraphy : Institution of Electrical Engineers, December 22, 1898.¹

In his first-quoted paper of 1882, speaking of disturbances on telephone lines, Mr Preece says : "The discovery of the telephone has made us acquainted with many strange phenomena. It has enabled us, amongst other things, to establish beyond a doubt the fact that electric currents actually traverse the earth's crust. The theory that the earth acts as a great reservoir for electricity may be placed in the physicist's waste-paper basket, with phlogiston, the materiality of light, and other old-time hypotheses. Telephones have been fixed upon a wire passing from the ground floor to the top of a large building (the gas-pipes being used in place of a return wire), and Morse signals, sent from a telegraph office 250 yards distant, have been distinctly read. There are several cases on record of telephone circuits miles away from any telegraph wires, but in a line with the earth terminals, picking up telegraphic signals ; and when an electric-light system uses the earth, it is stoppage to all telephonic communication in its neighbourhood. Thus,

¹ This list does not pretend to be complete. Doubtless there are other papers, which have escaped my notice.

communication on the Manchester telephones was not long ago broken down from this cause ; while in London the effect was at one time so strong as not only to destroy all correspondence, but to ring the telephone - call bells. A telephone system, using the earth in place of return wires, acts, in fact, as a shunt to the earth, picking up the currents that are passing in proportion to the relative resistances of the earth and the wire.”¹

Mr Preece then describes the experiment which he had recently (March 1882) made of telegraphing across the Solent, from Southampton to Newport in the Isle of Wight, without connecting wires. “The Isle of Wight,” he says, “is a busy and important place, and the cable across at Hurst Castle is of consequence. For some cause the cable broke down, and it became of great importance to know if by any means we could communicate across, so I thought it a timely opportunity to test the ideas that had been promulgated by Prof. Trowbridge. I put a plate of copper, about 6 feet square, in the sea at the end of the pier at Ryde (fig. 18). A wire (overhead) passed from there to Newport, and thence to the sea at Sconce Point, where I placed another copper plate. Opposite, at Hurst Castle, was a similar plate, connected with a wire which ran through Southampton to Portsmouth, and terminated in another plate in the sea at Southsea Pier. We have here a complete circuit, if we include the water, starting from Southampton to Southsea Pier, 28 miles ; across the sea, 6 miles ; Ryde through Newport to Sconce Point, 20 miles ; across the water again, 1½ mile ; and Hurst Castle back to Southampton, 24 miles.

“We first connected Gower-Bell loud-speaking telephones in the circuit, but we found conversation was impossible. Then we tried, at Southampton and Newport, what are called *buzzers* (Theiler’s Sounders)—little instruments that

¹ For early notices of the same kind, see pp. 79-85, *ante*.

make and break the current very rapidly with a buzzing sound, and for every vibration send a current into the circuit. With a *buzzer*, a Morse key, and 30 Leclanché cells at Southampton, it was quite possible to hear the Morse signals in a telephone at Newport, and *vice versâ*.

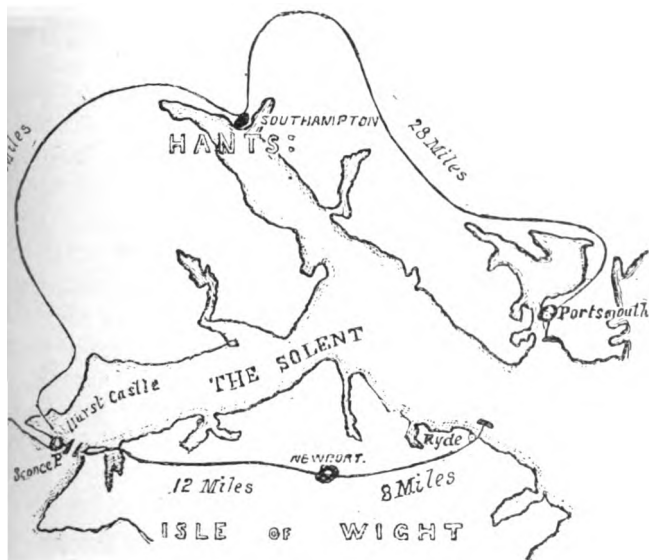

Fig. 18.

Next day the cable was repaired, so that further experiment was unnecessary.”¹

Mr Preece, however, kept the subject in view, and in 1884 he began a systematic investigation, theoretically and experimentally, of the laws and principles involved—an

¹ Captain Hippisley, R.E., who conducted these trials, thought that the presence of the broken cable across the Solent somewhat vitiated the results, as its heavy iron sheathing may have aided in conducting the current.

investigation which he has hardly yet completed. In his papers read at the International Electrical Congress, Chicago, August 23, 1893, and at the Society of Arts, London, February 23, 1894, he gives a *résumé* of his experiments from 1884 to date.

He begins the latter paper by asking the same momentous question which a lady once put to Faraday, What is electricity? Faraday, with true philosophic caution, replied (I quote from memory): "Had you asked me forty years ago, I think I would have answered the question; but now, the more I know about electricity, the less prepared am I to tell you what it is." Mr Preece is not quite so epigrammatic, nor nearly so cautious; but, then, we have learned a great deal since Faraday's time. "Few," he says, "venture to reply boldly to this question—first, because they do not know; secondly, because they do not agree with their neighbours, even if they think they know; thirdly, because their neighbours do not agree among themselves, even as to what to apply the term. The physicist applies it to one thing, the engineer to another. The former regards his electricity as a form of ether, the latter as a form of energy. I cannot grasp the concept of the physicist, but electricity as a form of energy is to me a concrete fact. The electricity of the engineer is something that is generated and supplied, transformed and utilised, economised and wasted, meted out and paid for. It produces motion of matter, heat, light, chemical decomposition, and sound; while these effects are reversible, and sound, chemical decomposition, light, heat, and motion reproduce those effects which are called electricity."¹

¹ "Substantialists" call it a kind of matter. Others view it as a form of energy. Others, again, reject both these views. Prof. Lodge considers it a form, or rather a mode of manifestation, of the

In experiments of this kind it is necessary to point out that if we have two parallel conductors, separated from each other by a finite space, and each forming part of a separate and distinct circuit, either wholly metallic or partly completed by the earth, and called respectively the *primary* and the *secondary* circuits, we may obtain currents in the latter either by conduction or by induction; and we may classify them into those due to—

1. Earth-currents or leakages.
2. Electro-static induction currents.
3. Electro-magnetic induction currents.

It is very important to eliminate (1), which is a case of conduction, from (2) and (3), which are cases of induction, pure and simple.

1. *Earth-currents or Leakages.*

When a linear conductor dips at each end into the earth, and voltage is impressed upon it by any means, the resulting return current would probably flow through the earth in a straight line between these two points if the conductivity of the earth were perfect; but as the earth, *per se*, is a very poor conductor (and probably is so only because it is moist), lines of current-flow spread out symmetrically in a way that recalls the figure of a magnetic field. These diffused currents are evident at great distances, and can be easily traced by means of exploring earth-plates or rods. The primary current is best produced by alternating currents of such a frequency as to excite a distinct musical

ether. Prof. Nikola Tesla demurs to this view, but sees no objection to calling electricity ether associated with matter, or bound ether. High authorities cannot even yet agree whether we have one electricity or two opposite electricities.

note in a telephone, and if these currents rise and fall periodically and automatically, they produce an unmistakable wail, which, if made and broken by a Morse key into short and long periods, can be made to represent the dots and dashes of the Morse alphabet. The secondary circuit, which contains the receiving telephone, is completed in the case of an earth area by driving two rods into the ground, and in the case of water by dipping plates therein, 5 to 10 yards apart.

It is therefore necessary to be able to distinguish these earth-currents from those due to induction, as they are apt to give false effects, and to lead to erroneous conclusions. This is easily done, if the instrument be sensitive enough, by making the primary current continuous when the earth-current also becomes continuous, whereas the induction currents will be momentary, and will only be observed at the beginning and end of the primary or inducing current.

2. *Electro-static Induction Currents.*

When a body, **A**, is electrified by any means and isolated in a dielectric, as air, it establishes an electric field about it; and if in this field a similar body, **B**, be placed, it also is electrified by induction. If **B** be placed in connection with the earth, or with a condenser, or with any very large body, a charge of the same sign as **A** is conveyed away, and it (**B**) remains electrified in the opposite sense to **A**. **A** and **B** are now seats of electric force or stress. The dielectric between them is displaced or, as we say, *polarised*—that is, it is in a state of electric strain, and remains so as long as **A** remains charged; but if **A** be discharged, or have its charge reversed or varied, then similar changes occur in **B**, and in the dielectric separating them. **A** may be an extended wire forming part of a complete primary circuit,

and its charge may be due to a battery or other source of electricity; then, in the equally extended secondary wire B (fig. 19), the displaced charge in flowing to earth establishes a momentary current whose direction and duration depend on the current in A, and on its rate of variation.

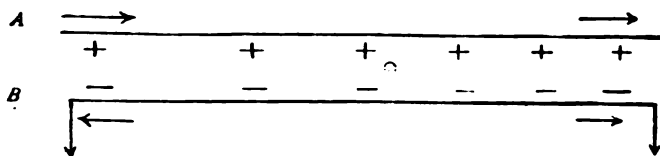

Fig. 19.

The strained (polarised) state of the dielectric, and the charges on A and B, remain quiescent so long as the current flows steadily; but when it ceases we have again, and in both circuits, momentary currents, as shown by the arrows (fig. 20), which flow until equilibrium is restored.

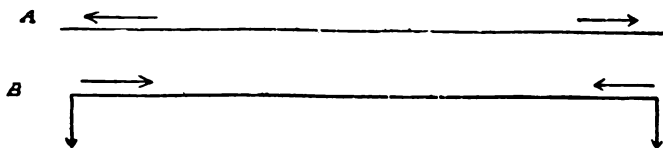

Fig. 20.

The secondary currents due to discharge, like those due to charge, flow in opposite directions at each end, and there is always some intermediate zero point.

It is thus easy in long circuits, by observing their direction, to differentiate currents of induction due to electrostatic displacement from those due to electro-magnetic disturbance.

The effects of electro-static induction do not play an important part in the inquiry immediately before us, but they are of great consequence in questions of speed of sig-

nalling in submarine cables and long, well-insulated land-lines, and in clearness of speech in long-distance telephony.¹

3. *Electro-magnetic Induction Currents.*

Magnetic force is that which produces, or tends to produce, polarisation in magnetisable matter (as iron, nickel, cobalt), and electro-magnetic disturbance or stress in non-magnetisable matter and the ether. An electric current in a conductor is a seat of magnetic force, and establishes in its neighbourhood a magnetic field. The lines of force in this field are equivalent to circles in a plane perpendicular to the direction of the current, which circles, during the rise of the current, flow outwards or expand, and, during the fall of the current, flow inwards or contract, much like the waves on the surface of smooth water when a pebble is thrown in, but moving with the speed of light. Thus any linear conductor placed in the field of another parallel conductor carrying a current is cut at right angles to itself by these lines of force—in one direction as the current rises, and in the opposite direction as the current falls. This outward and inward projection of magnetic force through such linear conductor excites electric force in that conductor, and if it form part of a circuit an electric current is set up in that circuit.

So far for the theory of the subject. Now for its experimental elucidation. Besides those cases of interference mentioned on page 137, others were of frequent occurrence in the experience of the postal-telegraph officials, the most striking being that known as the Gray's Inn Road case. In 1884 it was there noticed that messages sent in the ordinary

¹ For an interesting investigation of electro-static phenomena on telephone circuits, see Mr Carty's papers in the 'Electrician,' December 6, 1889, and April 10, 1891.

way through insulated wires, buried in iron pipes along the road, could be read upon telephone circuits erected on poles on the house-tops 80 feet high. To cure the evil the telegraph wires had to be taken up and removed to a more distant route.¹

In 1885 Mr Preece arranged an exhaustive series of experiments in the neighbourhood of Newcastle, which were ably carried out by Mr A. W. Heaviside, to determine whether these disturbances were due to electro-magnetic induction, and were independent of earth conduction; and also to find out how far the distance between the wires could be extended before this influence ceased to be evident. Insulated squares of wire, each side being 440 yards long, were laid out horizontally on the ground one quarter of a mile apart, and distinct speech by telephones was carried on between them; while when removed 1000 yards apart inductive effects were still appreciable.

With the parallel lines of telegraph, ten and a quarter miles apart, between Durham and Darlington, the ordinary working currents in the one were clearly perceptible in a telephone on the other. Even indications were obtained in this way between Newcastle and Gretna, on the east and west coasts, forty miles apart; but here the observations were doubtless vitiated by conduction or leakage through

¹ The following are more recent cases of the same kind. Currents working the City and South London Electric Railway affect recording galvanometers at the Greenwich Observatory, four and a half miles distant; and even a diagram of the train service could be made out by tapping any part of the metropolitan area.

Some ten years ago one of the dynamos at the Ferranti electric-light station at Deptford by some accident got connected to earth, with the result that the whole of the railway telegraphs in the signal-boxes of the railways in South London were temporarily put out of order and rendered inoperative, while the currents flowing in the earth were perceived in the telegraph instruments so far northwards as Leicester and so far south as Paris.

the large network of telegraph wires between those two places.¹

The district between Gloucester and Bristol, along the banks of the Severn, was next (1886) selected, where for a length of fourteen miles, and an average distance apart of four and a half miles, no intermediate disturbing lines existed. Complete metallic circuits were employed, the return wires passing far inland, in the one case through Monmouth, and in the other through Stroud. In one wire currents of about .5 ampère were rapidly made and broken by mechanical means, producing on a telephone a continuous note which could be broken up by a Morse key into dots and dashes, as in Cardew's vibrator. Weak disturbances were detected in the secondary circuit, showing that here the range of audibility with the apparatus in use was just overstepped. The unexpected fact was also shown in these experiments that, whether the circuits were entirely metallic or earthed at the ends, the results were the same.²

Similar trials were made on lines along the valley of the Mersey. A new trunk line of copper wires that was being erected between London and the coast of North Wales was then experimented upon, and some interesting results were obtained in the district between Shrewsbury and Much Wenlock, and between Worcester and Bewdley.

In the autumn of the same year (1886) some admirable results were obtained by Mr Gavey, another of Mr Preece's able assistants, near Porthcawl, in South Wales—a wide expanse of sand well covered by the tide, thus giving the opportunity of observing the effects in water as well as in air. Two horizontal squares of insulated wire, 300 yards each side, were laid side by side at various distances apart

¹ British Association Report, 1886.

² These experiments were repeated with more experience and greater success in 1889.

up to 300 yards, and the inductive effects of one on the other noted. Then one coil was suspended on poles 15 feet above the other, which was covered with water at high tide. No difference was observable in the strength of the induced signals, whether the intervening space was air or water or a combination of both, although subsequent experience (1893) showed that with a space of 15 feet the effect in air was distinctly better than through water.

The conclusion drawn from all these experiments was that the magnetic field extends uninterruptedly through the earth, as it does through the air; and that if the secondary circuit had been in a coal-pit the effect would be the same. In fact, Mr Arthur Heaviside succeeded in 1887 in communicating between the surface and the galleries of Broom-hill Colliery, 350 feet deep. He arranged a circuit in a triangular form along the galleries about two and a quarter miles in total length, and at the surface a similar circuit of equal size over and parallel to the underground line. Telephonic speech was easily carried on by induction from circuit to circuit.¹

As the result of all these experiments and innumerable laboratory investigations, Mr Preece deduced the following formulæ. The first shows the strength of current C_2 induced in the secondary circuit by a given current C_1 in the primary circuit—

$$C_2 = \frac{C_1}{R} \frac{\sqrt{L^2 + D^2} - D}{D} \times I,$$

¹ Subsequent experiments showed that the conclusion arrived at for earth and air was only partially true for water. Telephonic speech was carried on in Dover Harbour through 36 feet of water, but no practical signals could be obtained through 400 feet at North Sand Head, Goodwin Sands, showing that the effect must diminish in water with some high power of the distance.

² This formula does not allow for the reverse effect of the return current through the earth, as to which no data exist at present.

where R equals the resistance of the secondary circuit, D the distance apart of the two circuits, L the length of the inductive system, and I the inductance of the system. The value of I , obtained by experiment on two parallel squares of wire, 1200 yards round and 5 yards apart, was found to be $\cdot 003$.

The second equation gives approximately the maximum distance X which should separate any two wires of length L , C_1 being the primary current and R the resistance of the secondary circuit.

$$X = 1.9016 \frac{\sqrt{C_1 L}}{R}$$

The constant 1.9016 was obtained by experimenting on two parallel wires, each one mile long, when the primary circuit, being excited by one ampère, the limit of audibility in the secondary was reached at 1.9016 miles. This formula shows the desirability of using copper wires of the largest size practicable, so as to reduce the value of R . Other very important elements of success are (1) the rate at which the primary currents rise and fall, the faster the better, and (2) the reduction to a minimum of such retarding causes as capacity and self-induction.

Having thus threshed out the laws and conditions of electro-magnetic disturbances, and determined the distance at which they could be usefully applied, it only remained for Mr Preece to put his conclusions to a practical test. Accordingly, when the Royal Commission on electric communication between the shore and lighthouses and light-ships was appointed in June 1892, he made his proposals to the Government, and on receiving sanction forthwith proceeded to carry them out.

The Bristol Channel proved a very convenient locality to test the practicability of communicating across distances of

three and five miles without any intermediate conductors. Two islands, the Flat Holm and the Steep Holm, lie off Penarth and Lavernock Point, near Cardiff, the former having a lighthouse upon it (fig. 21). On the shore two thick copper wires combined in one circuit were suspended on poles for a distance of 1267 yards, the circuit being

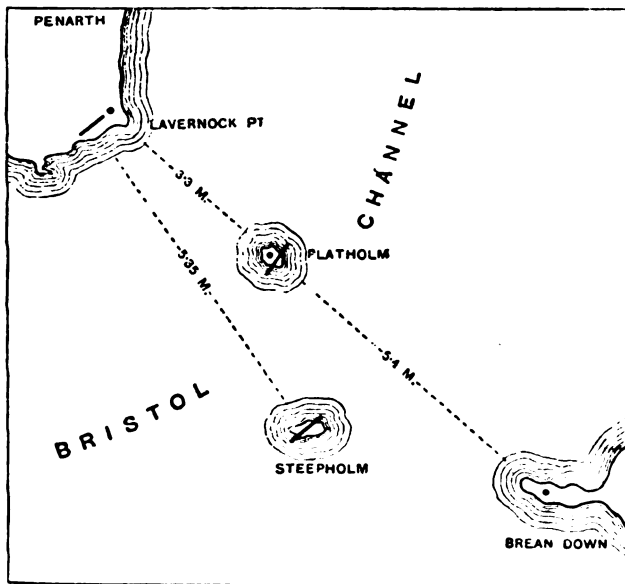

Fig. 21.

completed by the earth. On the sands at low-water mark, 600 yards from this primary circuit and parallel to it, two gutta-percha covered copper wires and one bare copper wire were laid down, their ends being buried in the ground by means of bars driven in the sand.

One of the gutta-percha wires was lashed to an iron wire to represent a cable. These wires were periodically covered

by the tide, which rises here at spring to 33 feet. On the Flat Holm, 3.3 miles away, another gutta-percha covered copper wire was laid for a length of 600 yards.

There was also a small steam launch having on board several lengths of gutta-percha covered wire. One end of such a wire, half a mile long, was attached to a small buoy, which acted as a kind of float to the end, keeping the wire suspended near the surface of the water as it was paid out while the launch slowly steamed ahead against the tide. Such a wire was paid out and picked up in several positions between the primary circuit and the islands.

The apparatus used on shore was a 2-h.p. portable Marshall's engine, working a Pyke and Harris's alternator, sending 192 complete alternations per second of any desirable strength up to a maximum of 15 ampères. These alternating currents were broken up into Morse signals by a suitable key. The signals received on the secondary circuits were read on a pair of telephones—the same instruments being used for all the experiments.

The object of the experiments was not only to test the practicability of signalling between the shore and the lighthouse, but to differentiate the effects due to earth conduction from those due to electro-magnetic induction, and to determine the effects in water. It was possible to trace without any difficulty the region where they ceased to be perceptible as earth-currents and where they commenced to be solely due to electro-magnetic waves. This was found by allowing the paid-out cable, suspended near the surface of the water, to sink. Near the shore no difference was perceptible, whether the cable was near the surface or lying on the bottom, but a point was reached, just over a mile away, where all sounds ceased as the cable sank, but were received again when the cable came to the surface. The total

absence of sound in the submerged cable was rather surprising, and led to the conclusion either that the electro-magnetic waves of energy are dissipated in the sea-water, which is a conductor, or else that they are reflected away from the surface of the water, like rays of light.

Experiments on the Conway Estuary, showing the relative transparency of air and water to these electro-magnetic waves, tend to support the latter deduction; for if much waste of energy took place in the water, the difference would be more marked. As it is, there seems to be ample evidence that the electro-magnetic waves are transmitted to considerable distances through water, though how far remains to be found.¹

There was no difficulty in communicating between the shore and Flat Holm, 3·3 miles. The attempt to speak between Lavernock and Steep Holm, 5·35 miles, was not so successful: though signals were perceptible, conversation was impossible. There was distinct evidence of sound, but it was impossible to differentiate the sounds into Morse signals. If either line had been longer, or the primary currents stronger, signalling would probably have been possible.

In 1894 Mr Preece carried out some satisfactory experiments near Frodsham, on the estuary of the Dee, which was found to be a more convenient locality than the Conway sands. Here, as at Conway and other places, squares and rectangles were formed of insulated wires, and numerous measurements were made (with reflecting galvanometers and telephones) of the effects due to varying currents in the primaries, and at varying distances between them and the secondaries.

In Scotland also some very successful trials were made. There happens to be a very convenient and accessible loch

¹ See note, p. 147, *ante*.

in the Highlands—Loch Ness—forming part of the route of the Caledonian Canal between Inverness and Banavie, having a line of telegraph on each side of it. Five miles on each side of this loch were taken, and so arranged that any fractional length of telegraph wire on either side could be taken for trial. Ordinary, and not special, apparatus was employed. Sending messages, as before, by Morse signals and speaking by telephone across a space of one and a quarter miles was found practical, and, in fact, easy; indeed, the sounds were so loud that they were found sufficient to form a call for attention.

The following apparatus was in use on each side of the loch: A set of batteries consisting of 100 dry cells, giving a maximum voltage of 140; a rapidly revolving rheotome, which broke up the current into a musical note; a Morse key, by which these musical notes could be transformed into Morse signals; resistance coils and ampère-meters to vary the primary current; two Bell telephones joined in multiple arc to act as receivers. For the transmission of actual speech simple granular carbon microphones, known as Deckert's, were used as transmitters, and a current of two ampères was maintained through these and two Bell telephones in circuit with the line wire.

Any lingering fear that earth conduction had principally to do with these results was removed by making the earth's terminals on the primary circuit at one end at Inverness nine miles away, and at the other end in two directions in a parallel glen about six miles away.

One very interesting fact observed at Loch Ness was that there was one particular frequency in the primary circuit that gave a decided maximum effect upon the telephones in the secondary circuit. This confirms the presence of resonance, and is, of itself, a fact sufficient to prove

the effects as being due to the transformation of electromagnetic waves into electric currents.¹

During the same year (1894) experiments were carried out between the island of Arran and Kintyre across Kil-

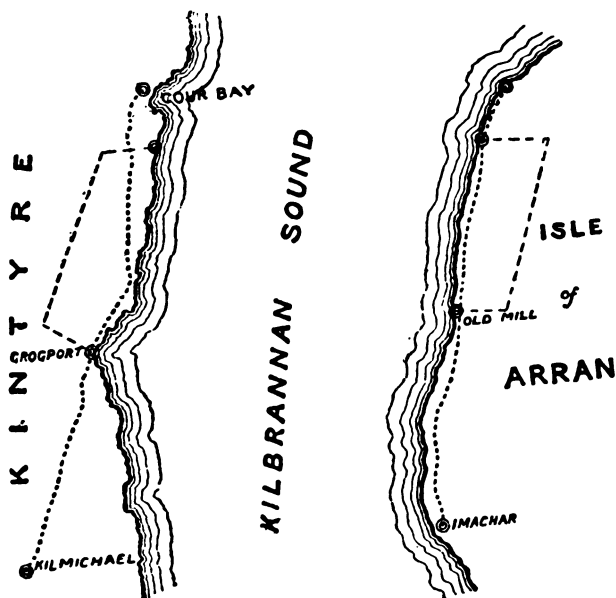

Fig. 22.

brannan Sound. Two parallel lines on opposite sides, and four miles apart, were taken (fig. 22); and, in addition, two gutta-percha covered wires were laid along each coast, at a height of 500 feet above sea-level and five miles apart horizontally.

¹ This is still a moot question, many competent authorities, as Lodge, Rathenau, W. S. Smith, and Stevenson, being of opinion that the effect is partly inductive and partly conductive. See Dr Lodge's contention, 'Jour. Inst. Elec. Engs.,' No. 137, p. 814.

Incidentally some extremely interesting effects of electromagnetic resonance were observed during the experiments in Arran. A metallic circuit was formed partly of the insulated wire 500 feet above the sea-level and partly of an ordinary line wire, the rectangle being two miles long and 500 feet high. Wires on neighbouring poles, at right angles to the shorter side of the rectangle, *although disconnected at both ends*, took up the vibrations, and it was possible to read all that was signalled on a telephone placed midway in the disconnected circuit by the surgings thus set up.

The general conclusions arrived at as the result of these numerous and long-continued experiments may be briefly summed up as follows:¹—

The earth acts simply as a conductor, and *per se* it is a very poor conductor, deriving its conducting property principally, and often solely, from the moisture it contains. On the other hand, the resistance of the "earth" between the two earth plates of a good circuit is practically nothing. Hence it follows that the mass of earth which forms the return portion of a circuit must be very great, for we know by Ohm's law that the resistance of a circuit increases with its specific resistance and length, and diminishes with its sectional area. Now, if the material forming the "earth" portion of the circuit were, like the sea, homogeneous, the current-flow between the earth plates would follow innumerable but definite stream lines, which, if traced and plotted out, would form a hemispheroid. These lines of current have been traced and measured. A horizontal plan on the surface of the earth is of the form illustrated in fig. 23, while a vertical section through the earth is of the form shown in fig. 24.

With earth plates 1200 yards apart these currents have

¹ British Association Report, 1894, Section G.

been found on the surface at a distance of half a mile behind each plate; and, in a line joining the two trans-

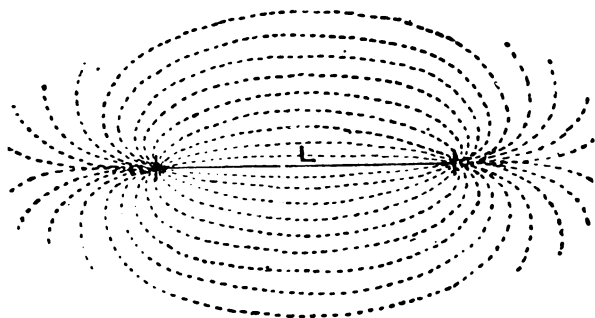

Fig. 23.

versely, they are evident at a similar distance at right angles to this line.

Now this hemispheroidal mass could be replaced electrically by a resultant conductor (R, fig. 24) of a definite form

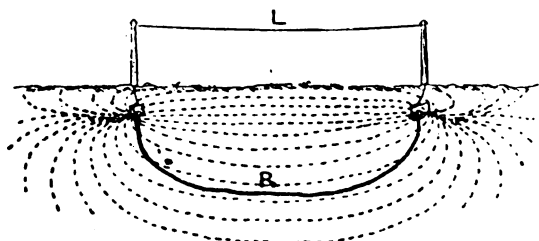

Fig. 24.

and position; and, in considering the inductive action between two circuits having earth returns, it is necessary to estimate the position of this imaginary conductor. This was the object of the experiments at Frodsham.

If the material of the earth be variable and dry the hemi-

spheroid must become very much deformed and the section very irregular: the lines of current-flow must spread out farther, but the principle is the same, and there must be a resultant return. The general result of the experiments at Frodsham indicates that the depth of the resultant earth was 300 feet, while those at Conway are comparable with a depth of 350 feet. In the case of Frodsham the primary coil had a length of 300 feet, while at Conway the length was 1320 feet. At Loch Ness, and between Arran and Kintyre, where the parallel lines varied from two to four miles, the calculated depth was found to be about 900 feet. The depth of this resultant must, therefore, increase with the distance separating the earth plates, and this renders it possible to communicate by induction from parallel wires over much longer distances than would otherwise be possible.

The first and obvious mode of communicating across space is by means of coils of wire opposed to each other in the way familiar to us through the researches of Henry and Faraday. All the methods here described consisted in opposing two similar coils of wire having many turns, the one coil forming the primary circuit and the other coil the secondary circuit.

Vibratory or alternating currents of considerable frequency were sent through the primary circuit, and the induced secondary currents were detected by the sound or note they made on a telephone fixed in the secondary circuit.

The distance to which the effective field formed by a coil extends increases with the diameter of the coil more than with the number of turns of wire upon it. A single wire stretched across the surface of the earth, forming part of a circuit completed by the earth, is a single coil, of which the lower part is formed by the resultant earth return, and the distance to which its influence extends depends upon the

height of the wire above the ground and the depth of this resultant earth.

In establishing communication by means of induction, there are three dispositions of circuit available—viz., (a) single parallel wires to earth at each extremity; (b) parallel coils of one or more turns; (c) coils of one or more turns placed horizontally and in the same plane.

The best practical results are obtained with the first arrangement, more especially if the conformation of the earth admits of the wires being carried to a considerable height above the sea, whilst the earth plates are at the sea-level. By adopting this course the size of the coil is practically enlarged, and even if it be necessary to increase the distance between the parallel wires in order to get a larger coil, the result is still more beneficial. In a single-wire circuit we have the full effect of electro-static and electro-magnetic induction, as well as the benefit of any earth conduction, but in closed coils we have only the electro-magnetic effects to utilise.

In one experiment two wires of a definite length were first made up into two coils forming metallic circuits, then uncoiled and joined up as straight lines opposed to each other, with the circuit completed by earth. The effects, and the distance between which they were observable, were very many times greater with the latter than with the former arrangement.

The general law regulating the distance to which we can speak by induction has not been *rigorously* determined, and it is hardly possible that it can be done, owing to the many disturbing elements, geological as well as electrical. In practice we have to deal with two complete circuits of unknown shape, and in different planes. We have obtained some remarkably concordant and accurate results in one place; but, on the other hand, we have met with equally

discordant results in another place. Still, from the approximate formula before given, we deduce the important fact that for parallel lines the limiting distance increases directly as the square of the length, which shows that if we can make the length of the two lines long enough it would be easy to communicate across a river or a channel. Of course, as previously pointed out, the formula does not take into account the effects of the reverse magnetic waves generated by the return current through the earth, and at present no data exist on which a satisfactory calculation can be based; but, for example, there is little doubt that two wires, ten miles long, would signal through a distance of ten miles with ease.

“Although,” says Mr Preece in conclusion, “communication across space has thus been proved to be practical in certain conditions, those conditions do not exist in the cases of isolated lighthouses and light-ships, cases which it was specially desired to provide for. The length of the secondary must be considerable, and, for good effects, at least equal to the distance separating the two conductors. Moreover, the apparatus to be used on each circuit is cumbersome and costly, and it may be more economical to lay an ordinary submarine cable.

“Still, communication is possible even between England and France, across the Channel, and it may happen that between islands where the channels are rough and rugged, the bottom rocky, and the tides fierce, the system may be financially possible. It is, however, in time of war that it may become useful. It is possible to communicate with a beleaguered city either from the sea or on the land, or between armies separated by rivers, or even by enemies.

“As these waves are transmitted by the ether, they are independent of day or night, of fog, or snow, or rain, and therefore, if by any means a lighthouse can flash its indicat-

ing signals by electro-magnetic disturbances through space, ships could find out their positions in spite of darkness and of weather. Fog would lose one of its terrors, and electricity become a great life-saving agency."

At the Society of Arts (February 23, 1894), Mr Preece gave rein to his imagination, and, looking beyond these mundane utilities, concluded his address with the following magnificent peroration:—

"Although this short paper is confined to a description of a simple practical system of communicating across terrestrial space, one cannot help speculating as to what may occur through planetary space. Strange mysterious sounds are heard on all long telephone lines when the earth is used as a return, especially in the calm stillness of night. Earth-currents are found in telegraph circuits and the aurora borealis lights up our northern sky when the sun's photosphere is disturbed by spots. The sun's surface must at such times be violently disturbed by electrical storms, and if oscillations are set up and radiated through space, in sympathy with those required to affect telephones, it is not a wild dream to say that we may hear on this earth a thunderstorm in the sun.

"If any of the planets be populated with beings like ourselves, having the gift of language and the knowledge to adapt the great forces of nature to their wants, then, if they could oscillate immense stores of electrical energy to and fro in telegraphic order, it would be possible for us to hold commune by telephone with the people of Mars."

The first application of Mr Preece's system to the ordinary needs of the postal-telegraph service was made on March 30, 1895, when the cable between the Isle of Mull and Oban, in Scotland, broke down. As there was no ship available at the moment for effecting repairs, communication was established by laying a gutta-percha-covered copper wire,

one and a half mile long, along the ground from Morven, on the Argyllshire coast, while on Mull the ordinary telegraph (iron) wire connecting Craignure with Aros was used, the mean distance separating the two base lines being about two miles. No difficulty was experienced in keeping up communication, and many public messages were transmitted for a week until the cable was repaired. In all about 160 messages were thus exchanged, including a press telegram of 120 words.

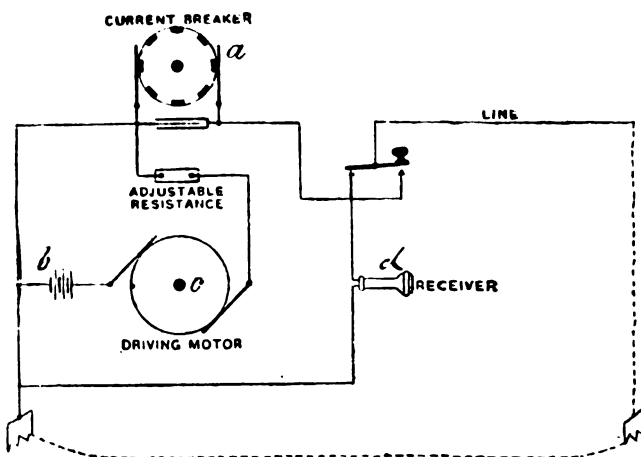

Fig. 25.

The diagram (fig. 25) shows the apparatus and connections, as regards which it is only necessary to say that *a* is a rheotome, or make-and-break wheel, driven so as to produce about 260 interruptions of the current per second, which give a pleasant note in the telephone, and are easily read when broken up by the key into Morse dots and dashes; *b* is a battery of 100 Leclanché cells, of the so-called dry and portable type; *c* is a switch to start and stop

the rheotome as required ; and *d* is a telephone to act as receiver.

Since March of last year (1898) this system has been permanently established for signalling between Lavernock Point and the Flat Holm, and has been handed over to the War Office. Permanent lines of heavy copper wire have been erected parallel to each other, one being on the Flat Holm and the other on the mainland.

The heavy and cumbrous Pyke and Harris alternator of the earlier experiment over the same line (p. 150, *ante*) has been replaced by 50 Leclanché cells. The frequency has been raised to 400 makes and breaks per second, thus greatly increasing the strength of the induced currents. By the use of heavy copper base lines the resistances have been made as low as practicable. There is no measurable capacity, self-induction is eliminated, and there is no impedance. Hence the signals are perfect, and the rate of working is only dependent on the skill of the operator. It is said that as many as 40 words per minute have been transmitted without the necessity for a single repetition—a speed which few telegraphists can achieve, and still fewer can keep up.

Last summer Mr Sydney Evershed's relays were added to work a call-bell, which was the only thing wanted to make the system complete and *practical*.¹

It should be added, in conclusion, that the installation was carried out under the immediate superintendence of Mr Preece's able assistant, Mr Gavay, who for many years has been intimately associated with him in these researches.

¹ For a description of this very sensitive instrument see Evershed's paper, 'Jour. Inst. Elec. Engs.,' No. 137, p. 864.

WILLOUGHBY SMITH'S METHOD.

Mr Smith's researches in wireless telegraphy date back to 1883. His first suggestions, of the induction order, were contained in a paper on Voltaic-Electric Induction, which he read before the Institution of Electrical Engineers on November 8 of that year. These have already been noticed in our account of Edison's invention (p. 105, *ante*).

Somewhat later, early in 1885, Mr Smith turned his attention to conduction methods, and worked out a plan which, in a modified form, has been in actual operation for the last three years.

The *rationale* of the system is described by Mr Smith as follows :—

“ Messages have been sent and correctly received through a submarine cable two thousand miles in length, the earth being the return half of the circuit, by the aid of the electricity generated by means of an ordinary gun-cap containing one drop of water ; and small though the current emanating from such a source naturally was, yet I believe it not only polarised the molecules of the copper conductor, but also in the same manner affected the whole earth through which it dispersed on its way from the outside of the gun-cap to its return, through the cable, to the water it contained. I further believe that the time will come, perhaps sooner than may be expected, when it will be possible to detect even such small currents in any part of the world in the same way that it is now possible to do in comparatively small sections of it.

“ For researches of this description it is necessary to employ as sensitive an instrument as it is possible to obtain, to pick up, so to speak, such minute currents. Now, there is that wonderful instrument the telephone. I say wonderful advisedly, for as far as I know it is not to be equalled for the

simplicity of its mechanical construction and the ease with which it can be manipulated, and yet is so peculiarly sensitive. I have used it in most of my experiments as the receiving instrument, although of course there are other well-known instruments that could be employed, as all depends upon the potential of the current to be detected. The sending arrangement was either an ordinary Morse key so manipulated for a short or long time as to give the necessary sounds in the telephone to represent dots and dashes, or a double key and two pieces of mechanism giving dissimilar sounds were employed with good results. I gave much time and thought to the subject, the results of each experiment giving me much encouragement to proceed.

“Of the many experiments made I select the following, as I think it will clearly illustrate my system for telegraphing to a distant point not in metallic connection with the sending station. A wooden bathing-hut on a sandy beach made a good shore station, from which were laid two insulated copper wires 115 fathoms in length. The ends of the wires, scraped clean, were twisted round anchors, their position being marked by buoys about 100 fathoms apart, and in about 6 fathoms of water. Midway between the two a boat was anchored with a copper plate hanging fore and aft about 10 fathoms apart, and consequently about 45 fathoms from either end of the anchored shore wires. This boat represented the sea station, and, owing to the state of the sea, a very wet and lively one it proved; therefore, taking this fact into consideration, together with the crude nature of the experiment, it was remarkable with what distinctness and ease messages were passed. The last message sent from shore was, ‘Thanks: that will do; pick up anchors and return.’ To this the reply came from the boat, ‘Understand,’ and they then proceeded to carry out instructions. The boat employed was a wooden one, but it would have

been much better for my purpose had it been of metal, for then I should have used it instead of one of the collecting plates, as the larger the surface of these plates the better the results obtained.”¹

This method was secured by patent, June 7, 1887, from the specification of which (No. 8159) I take the following particulars: At the present time wherever electric telegraph communication is established between the shore and a lighthouse, either floating or on a rock, at a distance from the shore, it is effected through an insulated conductor or cable. Much difficulty is, however, experienced owing to the rapid wearing of the cable, so that it is liable to break whenever a storm comes on, and when, consequently, it is most required to be in working order. By this invention communication can be effected between the sending station and the distant point without the necessity of metallic connection between them.

A in the drawing (fig. 26) is a two-conductor cable led from a signal-station B on shore towards the rock C. At a distance from the rock one of the conductors is led to a metallic plate D submerged on one side of the rock, and at such a distance from it as to be in water deep enough for it not to be affected by waves. The other conductor is led to another metallic plate E similarly submerged at a distance from the opposite side of the rock. F F are two submerged metallic plates, each opposite to the plates D and E respectively. G G are insulated conductors leading from the plates F F to a telephone of low resistance in the lighthouse H.

To communicate from the shore, an interrupter or reverser I and battery K are connected to the shore ends of the two-wire cable. The telephone in the lighthouse circuit then responds to the rapid makes and breaks or reversals of the current, so that signalling can readily be

¹ Electrician, November 2, 1888.

carried on by the Morse alphabet. If a vibrating interrupter or reverser be used, a short or long sound in the telephone can be obtained by a contact key held down for short or long intervals.

A more convenient way is to use two finger-keys, one of which by a series of teeth on its stem produces a few breaks or reversals of the current, whilst the other key when depressed produces a greater number of breaks or reversals.

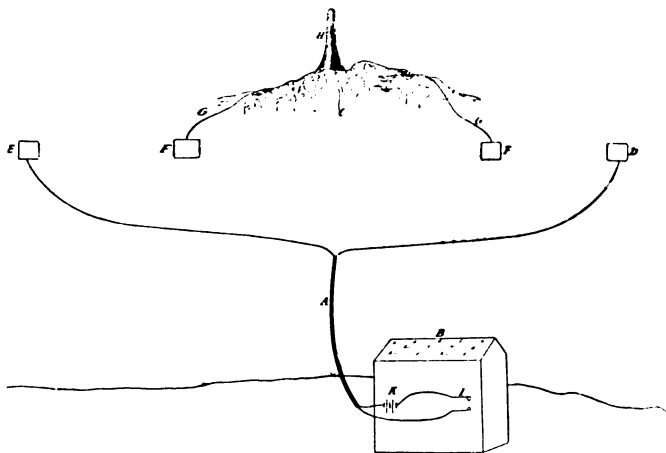

Fig. 26.

For communicating from the lighthouse to the shore a battery and make-and-break apparatus are coupled to the insulated conductors on the rock, and a telephone to the shore ends.

In the same way communication could be carried on from the shore to a vessel at a distance from it, if the vessel were in the vicinity of two submerged plates or anchors, each having an insulated conductor passing from it to the shore, and if two metallic plates were let go from

the vessel so that these plates might be at a distance apart from one another. The position of the two submerged plates might be indicated by buoys. In this way communication might be effected between passing vessels and the shore, or between the shore and a moored lighthouse or signal-station.

A similar result might be obtained with a single insulated conductor from the shore by the use of an induction apparatus, the ends of the secondary coil being connected by insulated conductors to the submerged plates.

An important modification of this method was subsequently effected by Messrs Willoughby S. Smith & W. P. Granville,¹ based on the following reasoning:—

In fig. 27 *A B* represents an insulated conductor of any desired length, with ends to earth *E E* as shown. *c* is a



Fig. 27.

rock island on which is extended another insulated wire *c D*, with its ends also connected to earth. Now, if a current is caused to flow in *A B*, indications of it will be shown on a galvanometer in the circuit *C D*. This is Mr Preece's arrangement at Lavernock-Flat Holm.

¹ See their patent specification, No. 10,706, of June 4, 1892.

Now, if we rotate the line AB round A until it assumes the position indicated in fig. 28, we have Messrs Smith & Granville's arrangement, where, owing to the proximity

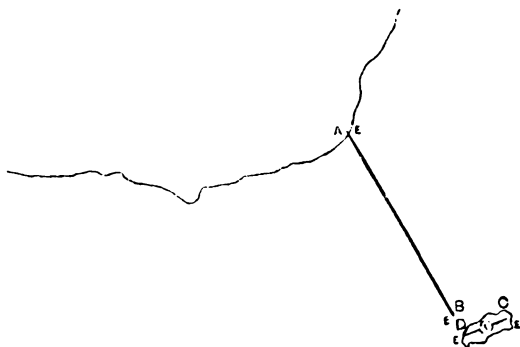

Fig. 28.

of B to D , signalling is practicable with a small battery power. Thus, where the distance from B to D was 60 yards, one Leclanché cell was found to be ample. As

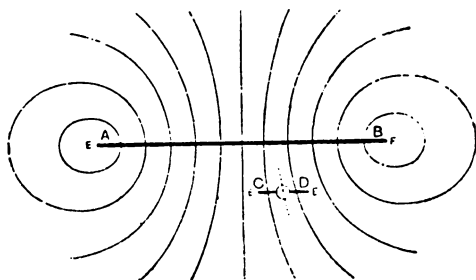

Fig. 29.

a permanent current in AB causes a *permanent* deflection on the galvanometer in CD , this deflection cannot be produced otherwise than by conduction.

Again, let AB (fig. 29) represent an insulated conductor

having its ends submerged in water (the distance between A and B being immaterial). Now cause a current to flow continuously, and it will be found that the water at each end of the conductor is charged either positively or negatively (according to the direction of the current) in equipotential spheroids, diminishing in intensity as the distance from either A or B is increased. To prove this, provide a second circuit, connected with a galvanometer, and with its two ends dipping into the water. Now, it will be found that a current flows in the C D circuit as long as the current in A B is flowing; the current in C D diminishes as C and D are moved farther away from B, and also diminishes to zero if the points C D are turned until they both lie in the same equipotential curve as shown by the dotted line.

It must be well understood that although, for the sake of clearness, the equipotential curves are shown as planes, yet in a body of water they are more or less spheres extending symmetrically around the submerged ends of the conductor, and therefore it is evident from the foregoing that the position of C D, in relation to B, must be considered not only horizontally but vertically.¹

Early in 1892 the Trinity Board placed the Needles Lighthouse at the disposal of the Telegraph Construction and Maintenance Company, so that they might prove the practicability of the method here described. The Needles

¹ This fact, Mr Smith thinks, fully explains Mr Preece's launch experiments (p. 150, *ante*). For instance, when the launch towing the half-mile of cable parallel to the wire on the mainland was close to the shore, the cable, although allowed to sink, could only do so to a very limited extent, and therefore still remained in a favourable position for picking up the earth-currents from A B (fig. 29); but when one mile from the shore, and in deep water, the cable was able to assume somewhat of a vertical position with the two ends brought more or less into the same equipotential sphere, it naturally resulted in a diminution or cessation of the current in the C D or launch circuit, and hence the absence of signals,

Lighthouse was chosen on account of its easy access from London.

In May 1892 an ordinary submarine cable was laid from Alum Bay to within 60 yards of the lighthouse rock, where it terminated, with its conductor attached to a specially constructed copper mushroom anchor. An earth plate close to the pier allowed a circuit to be formed through the water. On the rock itself two strong copper conductors were placed, one on either side, so that they remained immersed in the sea at low water, thus allowing another circuit to be formed through the water in the vicinity of the rock.

The telephone was first tried as the receiving instrument, with a rapid vibrator and Morse key in the sending circuit. This arrangement was afterwards abandoned, as it was not nearly so satisfactory as a mirror-speaking galvanometer, and the men, being accustomed to flag work, preferred to watch a light rather than listen to a telephone. The speaking galvanometer used is a specially constructed one, and does not easily get out of repair, so that, everything being once arranged, the men had only to keep the lamp in order.

Messrs Smith & Granville devised a novel and strong form of apparatus for a "call," and by its means any number of bells could be rung, thus securing attention. The instruments both on rock and shore were identical, and, in actual work, two to three Leclanché cells were ample.

By the means above described, communication was obtained through the gap of water 60 yards in length. This by no means is the limit, for it will be apparent that the gap distance is determined by the volume of water in the immediate neighbourhood of the rock, as well as by the sensitiveness of the receiving instrument and the magnitude of the sending current.

This method is well suited for coast defences. For instance, if a cable is laid from the shore out to sea, with its

end anchored in a known position, then it would be easy for any ship, knowing the position of the submerged end, to communicate with shore by simply lowering (within one or two hundred yards of the anchored end) an insulated wire having the end of its conductor attached to a small mass of metal to serve as "earth," the circuit being completed through the hull of the ship and the sea.¹

As this method has been in practical use at the Fastnet Lighthouse for the last three years, the following account of the installation, which has been kindly supplied by Mr W. S. Smith, will be of interest:—

"The difficulty of maintaining electrical communication with outlying rock lighthouses is so great that it has become necessary to forego the advantages naturally attendant upon the use of a submarine cable laid in the ordinary way continuously from the shore to the lighthouse, inasmuch as that portion of the cable which is carried up from the sea-bed to the rock is rapidly worn or chafed through by the combined action of storm and tide. By the use of the Willoughby Smith & Granville system of communication this difficulty is avoided, for the end of the cable is not landed on the rock at all, but terminates in close proximity thereto and in fairly deep undisturbed water. This system, first suggested in 1887 and practically demonstrated at the Needles Lighthouse in 1892, has—on the recommendation of the Royal Commission on Lighthouse and Lightship Communication—been applied to the Fastnet, one of the most exposed and inaccessible rock lighthouses of the United Kingdom.

"The Fastnet Rock, situated off the extreme S. W. corner of Ireland, is 80 feet in height and 360 feet in length, with a maximum width of 150 feet, and is by this system placed

¹ 'Electrician,' September 29, 1893. See also the 'Times,' November 24, 1892.

in electrical communication with the town of Crookhaven, eight miles distant.

“The shore end of the main cable, which is of ordinary construction, is landed at a small bay called Galley Cove, about one mile to the west of the Crookhaven Post Office, to which it is connected by means of a subterranean cable of similar construction having a copper conductor weighing 107 lb. covered with 150 lb. of gutta-percha per nautical mile. The distant or sea end of the main cable terminates seven miles from shore, in 11 fathoms of water, at a spot about 100 feet from the Fastnet Rock; and the end is securely fastened to a copper mushroom-shaped anchor weighing about 5 cwt., which has the double duty of serving electrically as an ‘earth’ for the conductor, and mechanically as a secure anchor for the cable end.

“The iron sheathing of the last 100 feet of the main cable is dispensed with, so as to prevent the possibility of any electrical disturbance being caused by the iron coming in contact with the copper of the mushroom; and, as a substitute, the conductor has been thickly covered with india-rubber, then sheathed with large copper wires, and again covered with india-rubber—the whole being further protected by massive rings of toughened glass.

“To complete the main cable circuit, a short earth line, about 200 yards in length, is laid from the post office into the haven.

“By reference to the diagram (fig. 30) it will be seen that if a battery be placed at the post office, or anywhere in the main cable circuit, the sea becomes electrically charged—the charge being at a maximum in the immediate vicinity of the mushroom, and also at the haven ‘earth.’ Under these conditions, if one end of a second circuit is inserted in the water anywhere near the submerged mushroom—for instance, on the north side of the Fastnet—it partakes,

more or less, of the charge ; and if the other end of this second circuit is also connected to the water, but at a point more remote from the mushroom—for instance, at the south side of the Fastnet—then a current will flow in the second circuit, due to the difference in the degree of charge at the two ends ; and accordingly a galvanometer or other sensitive

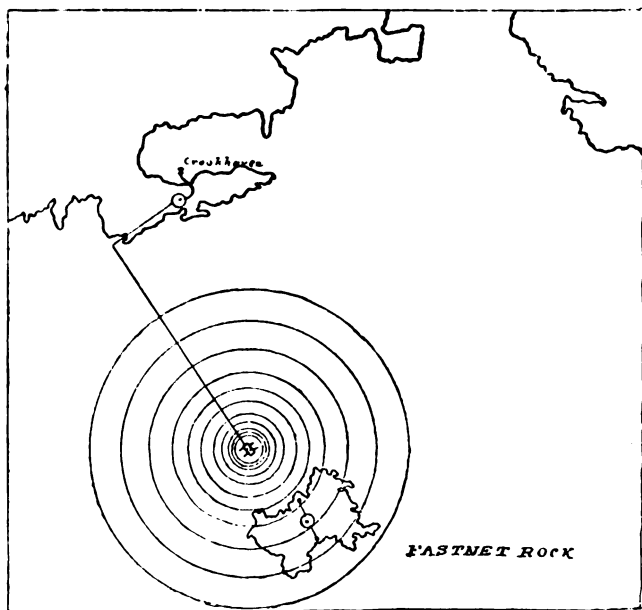

Fig. 30.

instrument placed in the Fastnet circuit is affected whenever the post office battery is inserted in the main cable circuit, or, *vice versa*, a battery placed in the Fastnet circuit will affect a galvanometer at the post office.

“In practice ten large-size Leclanché cells are used on the rock, the sending current being about 1·5 ampères, and

in this case the current received on shore is equal to about $\cdot 15$ of a milliampère. The received current being small, instruments of a fair degree of sensitiveness are required, and such instruments, when used in connection with cables having both ends direct to earth, are liable to be adversely affected by what are known as 'earth' and 'polarisation' currents, consequently special means have been devised to prevent this.

"The receiving instrument is a D'Arsonval reflecting galvanometer, which has been modified to meet the requirements by mounting the apparatus on a vertical pivot, so that by means of a handle the galvanometer can be rotated through a portion of a circle—thus enabling the zero of the instrument to be rapidly corrected. This facility of adjustment is necessary on account of the varying 'earth' and 'polarisation' currents above mentioned.

"An entirely novel and substantial 'call' apparatus has also been designed, which automatically adapts itself to any variation in the earth or polarisation current. It consists essentially of two coils moving in a magnetic field, and these coils are mounted one at each end of a balanced arm suspended at its centre and free to rotate horizontally within fixed limits. The normal position of the arm is midway between two fixed limiting stops. Any current circulating in the coils causes the whole suspended system to rotate until the arm is brought into contact with one or other of the stops—the direction of rotation depending upon the direction of the current. A local circuit is thus closed, which releases a clockwork train connected to a torsion head carrying the suspending wire, and thus a counterbalancing twist or torsion is put into the wire, and this torsion slowly increases until the arm leaves the stop and again assumes its free position. If, however, the current is reversed within a period of say five or ten seconds, then

the clockwork closes a second circuit and the electric bell is operated. By this arrangement, whilst the relay automatically adjusts itself for all variations of current, the call-bell will only respond to definite reversals of small period and not to the more sluggish movements of earth-currents. It is evident that one or more bells can be placed in any part of the building. The receiving galvanometer and the 'call' relay have worked very satisfactorily, and any man of average intelligence can readily be taught in two or three weeks to work the whole system.

"To enable the two short cables that connect the lighthouse instruments with the water to successfully withstand the heavy seas that at times sweep entirely over the Fastnet, it has been found necessary to cut a deep 'chase' or groove down the north and south faces of the rock from summit to near the water's edge, and to bed the cables therein by means of Portland cement. And since the conductors must make connection with the water at all states of sea and tide, two slanting holes $2\frac{1}{2}$ inches in diameter have been drilled through the solid rock from a little above low-water mark to over 20 feet below. Stout copper rods connected with the short cables are fitted into these holes, and serve to maintain connection with the water even in the roughest weather, and yet are absolutely protected from damage."

Mr Granville supplies some interesting particulars as to the difficulties of their installation at the Fastnet.¹ "The rock," he says, "is always surrounded with a belt of foam, and no landing can be made except by means of a jib 58 feet long—not at all a pleasant proceeding. Now, here is a case where the Government desired to effect communication telegraphically, but, as had been proved by very costly experiments, it was impossible to maintain a continuous cable, the cable being repeatedly broken in the immediate vicinity

¹ Jour. Inst. Elec. Eng., No. 137, p. 941.

of the rock. This, therefore, is a case where some system of wireless telegraphy is absolutely necessary, but neither of the systems described would answer here.¹ Dr Lodge advises us to eschew iron, and to avoid all conducting masses. But the tower and all the buildings are built of boiler-plate, and that which is not of iron is of bronze. In fact, the rock itself is the only bit of non-conducting, and therefore non-absorbing, substance for miles around. It is very clear in a case of this sort—and this is a typical case—that it is absolutely impracticable to employ here Dr Lodge's method. Now we hear in regard to the method used—and successfully used—at Lavernock, that a certain base is required, of perhaps half a mile, a quarter of a mile, or a mile in length; and that base must bear some proportion to the distance to be bridged. But where can you get any such base on the rock? You could barely get a base of 20 yards, so *that* method utterly fails. Then we come to the case suggested by Mr Evershed, of a coil which would be submerged round the rock. Well, where would the coil be after the first summer's breeze, let alone after a winter gale? Why, probably thrown up, entangled, on the rock. A few years ago, during a severe gale, the glass of the lantern, 150 feet above sea-level, was smashed in; and at the top of the rock, 80 feet above the sea-level, the men dare not, during a winter's gale, leave the shelter of the hut for a moment, for, as they said—and I can well believe it—they would be swept off like flies. This is a practical point, and therefore one I am glad to bring to the notice of the Institution; and, I repeat, if wireless telegraphy is to be of use, it must be of use for these exceptional cases."

Strange as it may seem, we have been using, on occasion, wireless telegraphy of this form for very many years without

¹ *I.e.*, those advocated by Professor Lodge and Mr Sydney Evershed. See 'Jour. Inst. Elec. Engs.,' No. 137, pp. 799, 852.

recognising the fact. Every time in ordinary telegraphy that we "work through a break," as telegraphists say, we are doing it. An early instance of the kind is described in the old 'Electrician,' January 9 and 23, 1863. Many years ago, in Persia, the author has often worked with the ordinary Morse apparatus through breaks where the wire has been broken in one or more places, with the ends lying many yards apart on damp ground, or buried in snow-drifts. As the result of his experiences in such cases the following departmental order was issued by the Director, Persian Telegraphs, as far back as November 2, 1881: "In cases of total interruption of all wires, it is believed that communication may in most cases be kept up by means of telephones. Please issue following instructions: Fifteen minutes after the disappearance of the corresponding station, join all three wires to one instrument at the commutator. Disconnect the relay wire from the key of said instrument, and in its stead connect one side of telephone, other side of which is put to earth. Now call corresponding station slowly by key, listening at telephone for reply after each call. Should no reply be received, or should signals be too weak, try each wire separately, and combined with another, until an arrangement is arrived at which will give the best signals." The Cardew sounder or buzzer has in recent years been added, and with very good results. It will thus be seen that Mr Willoughby Smith's plan is really an old friend in a new guise.¹

¹ In 1896 Mr A. C. Brown, of whose work in wireless telegraphy we have already spoken (p. 104, *ante*), revived the early proposals of Gauss (p. 3), Lindsay (p. 20), Highton (p. 40), and Dering (p. 48), *re* the use of bare wire or badly insulated cables in connection with interrupters and telephones. He also applies his method to cases where the continuity of the cable is broken. "Providing the ends remain anywhere in proximity under the water, communication can usually be kept up, the telephone receivers used in this way being so

G. MARCONI'S METHOD.

“ Even the lightning-elf, who rives the oak
 And bars the tempest, shall bow to that yoke,
 And be its messenger to run.”

—*Supple's Dampier's Dream.*

We now come to the crowning work of Mr Marconi in wireless telegraphy ; but before describing this method it will be desirable to make ourselves acquainted with the principles involved in the special apparatus which he employs, and which differentiates his system from all those that have hitherto occupied us. For this we need only go back a few years, and make a rapid survey of the epoch-marking discoveries of a young German philosopher, Heinrich Hertz.¹

To properly appreciate the work of Hertz we must carry our minds back two hundred years, to the time when Newton made known to the world the law of universal gravitation. Here, in the struggle between Newtonianism and the dying Cartesian doctrine, we have the battle-royal between the rival theories of action-at-a-distance and action-by-contact. The victory was to the former for a time ; and in the hands

exceedingly sensitive that they will respond to the very minute traces of current picked up by the broken end on the receiving side from that which is spreading out through the water in all directions from the broken end on the sending side.” (See Mr Brown's patent specification, No. 30,123, of December 31, 1896.)

Recently he has been successful in bridging over in this way a gap in one of the Atlantic cables ; but in this he has done nothing more than the present writer did in 1881, and Mr Willoughby Smith in 1887.

¹ Hertz was born in Hamburg, February 22, 1857, and died in Bonn, January 1, 1894. For interesting notices of his all too brief life, see, *inter alia*, the ‘Electrician,’ vol. xxxiii. pp. 272, 299, 332, and 415.

of Bernouilli, and, subsequently, of Boscovich, the doctrines of Newtonianism were carried far beyond the doctrines of the individual Newton. In fact, Newton expressed himself as being opposed to the notion of matter acting where it is not; though, as we see by his support of the emission theory of light, he was not prepared to accept the notion of a luminiferous ether. Newton, however, suggested that gravitation might be explained as being due to a diminution of pressure in a fluid filling space. Thus the doctrine of an empty space, requiring the infinitely rapid propagation of a distance-action, held the field, and was recognised by scientists of the eighteenth century as the only plausible hypothesis.

History repeats itself; and again the battle-royal was fought, this time, early in the nineteenth century, in favour of the ether hypothesis; and action-at-a-distance was mortally wounded. Before the phenomena of interference of light and the magnetic and electro-static researches of Faraday, both the idea of empty space action and that of the emission of light failed; and the propagation of force through the ether, and of light by vibratory conditions of the ether, came to be held as necessary doctrines. Later still,¹ Maxwell assumed the existence of, and investigated the state of, stress in a medium through which electro-magnetic action is propagated. The mathematical theory which he deduced gives a set of equations which are identical in form with the equations of motion of an infinite elastic solid; and, on this theory, the rate of propagation of a disturbance is equal to the ratio of the electro-magnetic

¹ The date usually assigned to Clerk-Maxwell's electro-magnetic theory of light is 1864; but his first communication on the subject to the Royal Society was in 1867; while the full development only appeared in his great work, 'Electricity and Magnetism,' which was published in 1873.

no!
 was not
 18, 1864.

and electro-static units. The experimental determination by Maxwell and others, that this ratio is a number equal to the velocity of light in ether in centimetres per second, is a fact which gave immense strength to the Maxwellian hypothesis of identity of the light and electro-magnetic media. But, although this is the case, the Maxwellian hypothesis, even when taken in conjunction with the experimental support which he deduced for it, fell far short of being a complete demonstration of the identity of luminous and electro-magnetic propagation.¹

To the genius of Hertz we owe this demonstration. One of the most important consequences of Maxwell's theory was that disturbances of electrical equilibrium produced at any place must be propagated as waves through space, with a velocity equal to that of light. If this propagation was to be traced through the small space inside a laboratory, the disturbances must be rapid, and if a definite effect was to be observed, they must follow each other at regular intervals; in other words, periodical disturbances or oscillations of extreme rapidity must be set up, so that the corresponding wave-length, taking into account the extraordinarily high velocity of propagation (186,000 miles per second), may be only a few inches, or at most feet. Hertz was led to an experiment which satisfied these conditions, and thus supplied the experimental proof which Maxwell and his school knew must come sooner or later.

The oscillatory nature of the discharge of a Leyden jar, under certain conditions, was theoretically deduced by Von Helmholtz in 1847; its mathematical demonstration was given by Lord Kelvin in 1853; and it was experimentally verified by Feddersen in 1859. When a Leyden jar, or a condenser, of an inductive capacity k , is discharged through a circuit of resistance R and self-induction L , the result is an

¹ Lord Kelvin's Address, Royal Society, November 30, 1893.

instantaneous flow, or a series of oscillations, according as κ is greater, or less, than $2\sqrt{\frac{L}{K}}$; and in the latter case the oscillatory period or amplitude is given in the equation—

$$T = 2\pi \sqrt{KL}$$

where π is the constant 3·1415 ('Phil. Trans.,' June 1853).¹

In his collected papers² Hertz tells us that his interest in the study of electrical oscillations was originally awakened by the announcement of the Berlin prize of 1879, which was to be awarded for an experimental proof of a relation between electro-dynamic forces and dielectric polarisation in insulators. At the suggestion of his master and friend, Von Helmholtz, the young philosopher took up the inquiry, but soon discovered that the then known oscillations were too slow to offer any promise of success, and he gave up the immediate research; but from that time he was always on the look-out for phenomena in any way connected with the subject. Consequently, he immediately recognised the importance of a casual observation which in itself and at another time might have been considered as too trivial for further notice. In the collection of physical apparatus at Karlsruhe he found an old pair of so-called Riess's or Knochenhauer's spirals—short flat coils of insulated wire, with the turns all in the same plane (?Prof. Henry's spirals). While performing some experiments with them at a lecture he was giving, he noticed that the discharge of a very small Leyden jar, or of a small induction coil, passed through the one was able to excite induced currents in the

¹ For a concise exposition of the theory of electrical oscillations, see Prof. Edser's paper, 'Electrical Engineer,' June 3, 1898, and following numbers.

² 'Electric Waves,' London, 1893. For an interesting account of pre-Hertzian observations, see Lodge's 'The Work of Hertz,' p. 61. Also Appendix D. of this work.

other, provided that a small spark-gap was made in the circuit of the first spiral. Thus was made the all-important discovery of the "effective spark-gap" which started Hertz on the road of his marvellous investigations.

A very little consideration of this phenomenon enabled him, even at this early stage, to lay down the following propositions :—

1. If we allow a condenser, such as a Leyden jar, of small capacity, to discharge through a short and simple circuit with a spark-gap of suitable length, we obtain a sharply defined discharge of very short duration, which is the long-sought-for sudden disturbance of electrical equilibrium—the *exciter* of electrical vibrations.

2. Such vibrations are capable of exciting in another circuit of like form resonance effects of such intensity as to be evident even when the two circuits are separated by considerable distances. In this second circuit Hertz had found the long-sought-for *detector* of electric waves.

With the exciter to originate electric waves and the detector to make them evident at a distance, all the pheno-

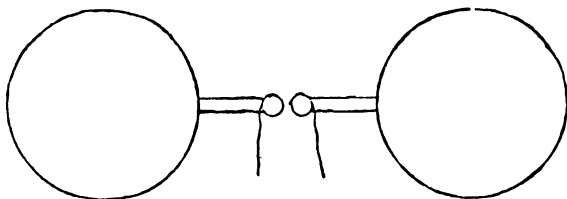

Fig. 31.

mena of light were, one after another, reproduced in corresponding electro-magnetic effects, and the identity of light and electricity was completely demonstrated.¹

In his paper "On very Rapid Electric Oscillations," Hertz

¹ See Appendix A for a clear exposition of the views regarding the relation of the two *before* and *after* Hertz.

occupied himself with some of these phenomena. As an exciter he used wire rectangles, or simple rods (fig. 31) to the ends of which metallic cylinders or spheres were connected, the continuity being broken in the middle where the ends were provided with small spherical knobs between which the sparks passed. The exciter was charged by an ordinary Ruhmkorff induction coil of small size.

The detector was mostly a simple rectangle or circle of wire (fig. 32), also provided with a spark-gap.

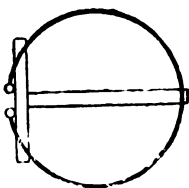

Fig. 32.

When vibrations are set up in the detector and sparks pass across the gap, the greater length of these sparks indicates the greater intensity of the received wave impacts. When, therefore, the dimensions of the detector are so adjusted as to give the maximum sparks with a given exciter the two

circuits are said to be in resonance, or to be electrically tuned.¹

In the course of his experiments on electric resonance, Hertz observed a phenomenon which for a time was inexplicable. It was seen that the length and brightness of the sparks at the detector were greatly modified by the sparks given off at the exciter. If the latter were visible from the detector spark-gap the sparks given off there were small and hardly perceptible, but became larger and brighter as soon

¹ Fortunately this condition of resonance or syntony is not essential to the excitement of sparks, else wireless telegraphy by Hertzian waves would not be so advanced as it is to-day. Thus, when a good exciter is in action it will cause little sparks between any conducting body in its vicinity and a wire held in the hand and brought near to the body, showing that the influence of the exciter extends to all conducting bodies, and not merely to those which are tuned to it. Of course it still holds good that, *ceteris paribus*, the maximum effect is obtained with resonance.

as a screen was placed between the two instruments. By carefully thought-out experiments he showed that this singular action was due solely to the presence of ultra-violet light, thus furnishing a proof of the connection between light and electricity.¹

Having made himself familiar with the phenomena of electrical resonance, Hertz went on to study the propagation of electric vibrations through space—the most difficult, as it is probably the most important, of all his researches. The results he gave to the world in 1888, in his paper “On the Action of a Rectilinear Electric Oscillation on a Neighbouring Circuit.” When sparks pass rapidly at the exciter electric surgings occur, and we have a rectilinear oscillation which radiates out into surrounding space. The detectors, whose spark-gaps were adjustable by means of a micrometer screw, were brought into all kinds of positions with respect to the exciter, and the effects were studied and measured. These effects were very different at different points and in the different positions of the detector. In short, they were found to obey a law of radiation which was none other than the corresponding law in optics.

In his paper, “On the Velocity of Propagation of Electro-dynamic Actions,” he gave experimental proof of the hitherto theoretical fact that the velocity of electric waves in air was the same as that of light, whereas the velocity in *wires* was found to be much smaller—in the ratio of 4 to 7. For the moment he was puzzled by this result: he suspected an error in the calculations, or in the conditions of the experiment, but—and here he showed himself the true philosopher—he did not hesitate to publish the actual results, trusting

¹ Prof. K. Zickler has recently proposed to use this property for telegraphy. He has succeeded on a small scale, and thinks that with a 25-ampère lamp and suitable reflectors the effect would be possible over several kilometres.—‘Elektrische Zeitung,’ July 1898.

to the future to correct or explain the discrepancy. The explanation was soon forthcoming. Messrs E. Sarasin and L. de la Rive of Geneva took up the puzzle, and ended by showing that the deviations from theory were caused simply by the walls of Hertz's laboratory, which reflected the electric waves impinging on them, so causing interferences in the observations. When these investigators repeated the Hertzian experiment with larger apparatus, and on a larger scale, as they were able to do in the large turbine hall of the Geneva Waterworks, they found the rate of propagation to be the same along wires as in air.¹

In his paper, "On Electro-dynamic Waves and their Reflection," Hertz further developed this point, and showed the existence of these waves in free space. Opposite the exciter a large screen of zinc plate, 8 feet square, was suspended on the wall; the electric waves emitted from the exciter were reflected from the plate, and on meeting the direct waves interference phenomena were produced, consisting of stationary waves with nodes and loops. When, therefore, Hertz moved the circle of wire which served as a detector to and fro between the screen and the exciter, the sparks in the detector circuit disappeared at certain points, reappeared at other points, disappeared again, and so on. Thus there was found a periodically alternating effect corresponding to nodes and loops of electric radiation, showing clearly that in this case also the radiation was of an undulatory character, and the velocity of its propagation finite.

In a paper, "On the Propagation of Electric Waves along Wires," March 1889, Hertz shows that alternating currents or oscillations of very high frequencies, as one hundred million per second, are confined to the surface of the conductor along which they are propagated, and do not penetrate

¹ 'Comptes Rendus,' March 31, 1891, and December 26, 1892. See also the 'Electrician,' vol. xxvi. p. 701, and vol. xxx. p. 270.

the mass.¹ This is a very important experimental proof of Poynting's theory concerning electric currents, which he had deduced from the work of Faraday and Maxwell. According to this theory, the electric force which we call the current is in nowise produced *in* the wire, but under all circumstances enters from without, and spreads itself in the metal comparatively slowly, and according to similar laws as govern changes of temperature in a conductor of heat. If the electric force outside the wire is very rapidly altering in direction or oscillating, the effect will only enter to a small depth *in* the wire; the slower the alterations occur, the deeper will the effect penetrate, until finally, when the changes follow one another infinitely slowly, the electric effect occupies the whole mass of the wire with uniform density, giving us the phenomenon of the so-called current.

Reviewing his experiments on this subject, Hertz says: "A difference will be noticed between the views here put forward and the usual theory. According to the latter, conductors are represented as those bodies which alone take part in the propagation of electric disturbances; non-conductors are the bodies which oppose this propagation. According to our view, on the contrary, all transmission of electrical disturbances is brought about by non-conductors; conductors oppose a great resistance to any rapid changes in this transmission. One might almost be inclined to maintain that conductors and non-conductors should, on this theory, have their names interchanged. However, such a paradox only arises because one does not specify the kind of

¹ It should be stated here that long ago Prof. Henry, the Faraday of America, held the same views, and proved them, too, by an experiment which is strangely like one of Hertz's, though, of course, he did not explain them as Hertz does. Henry's views are given clearly in two letters addressed to Prof. Kedzie of Lansing, Michigan, in 1876. Being of historical interest, as well as of practical value, I give them entire in Appendix B.

conduction or non-conduction considered. Undoubtedly metals are non-conductors of electric force, and just for this reason they compel it under certain circumstances to remain concentrated instead of becoming dissipated; and thus they become conductors of the apparent source of these forces, electricity, to which the usual terminology has reference.”¹

In the course of his experiments Hertz had succeeded in producing very short electric waves of 30 centimetres in length, the oscillations corresponding to which could be collected by a concave cylindrical mirror and concentrated into a single beam of electric radiation. According to Maxwell's theory of light, such a beam must behave like a beam of light, and that this is the case Hertz abundantly proved in his next paper, “On Electric Radiation.” He showed how such radiation was propagated in straight lines like light; that it could not pass through metals, but was reflected by them; that, on the other hand, it was able to penetrate wooden doors and stone walls. He also proved, by setting up metallic screens, that a space existed behind them in which no electric action could be detected, thus producing electric shadows; and, by passing the electric rays through a wire grating, he was able to polarise them, just as light is polarised by passage through a Nicol prism. Perhaps the most striking experiment of all in this field was his last one, in which he directed the ray on to a large pitch prism weighing 12 cwts.: the ray was deflected, being, in fact, refracted like a ray of light in a glass prism.

¹ As this is a matter of some complexity to all who, like myself, belong to the old way of thinking—the *ancien régime*—and as, moreover, it is of great practical importance, especially as regards the proper construction of lightning protectors, and the supply mains of electric light and power, I have thought it useful to give in Appendix B some extracts, which I hope will make the new views intelligible to the ordinary reader. Lodge's ‘Modern Views of Electricity’ should also be consulted.

Thus he gave to the experimental demonstration of Maxwell's electro-magnetic theory of light its finishing touch, and the edifice was now complete. Hertz's marvellous researches were presented in succession, as rapid and surprising almost as the sparks with which he dealt, to the Berlin Academy of Sciences, between November 10, 1887, and December 13, 1889. They were collected and published in book form, in 1893, under the title of 'Electric Waves' (English translation edited by Prof. D. E. Jones), to which the reader is referred for further information.

Here it will suffice, in conclusion, to briefly sum up the chief results of these epoch-making investigations. In the first place, Hertz has freed us from the bondage of the old theory of action-at-a-distance; and as regards electric and magnetic effects, he has shown that they are propagated through the ether which fills all space with finite velocity. The mysterious darkness which surrounded those strange distance-actions—that something can act where it is not—has now been cleared away. Further, the identity of the form of energy in the case of two powerful agents in nature has been conclusively established; light and electrical radiation are essentially the same, different manifestations of the same processes, and so the old elastic-solid theory of optics is resolved into an electro-magnetic theory. The velocity of propagation of light is the same as that of electro-magnetic waves, and these in turn obey all the laws of optics. The scope of optics is thus enormously widened; to the ultra-violet, visible, and infra-red rays, with their wave-lengths of thousandths of a millimetre, are now to be added, lower down the scale, electro-magnetic waves, producible in any length from fractions of an inch to thousands of miles.

Hertz's ordinary waves were many metres long, and he does not appear to have ever worked with waves of less than 30 centimetres. Righi, however, by employing ex-

citers with small spheres, obtained waves of 2·5 centimetres; while Prof. Chunder Boze of Calcutta, using little pellets of platinum, was able to produce them of only 6 millimetres. The smaller the pellets the shorter the electric waves, until we come in imagination to the pellet of the ultimate atom, whose waves should closely approximate to light.

The following table compares approximately some of the known vibrations in ether and air :—

Ether vibrations per second—		
	billions (?)	=
10,000	" (?)	= Röntgen rays.
8,000	"	= Actinic "
5,500	"	= Violet "
4,000	"	= Green "
2,800	"	= Red "
1,000 to 2,000	"	= Infra red "
50 thousands to 2,000 billions		= Radiant heat.
		= Hertzian waves.

Air vibrations per second—

33,000	=	Highest audible note.
4,000	=	Highest musical note.
2,000	=	Highest soprano.
150 to 500	=	Ordinary voice.
32	=	Lowest musical note.
16	=	" audible "

In another direction we owe much to Hertz's investigations; we are brought nearer to a solution of the question, What is electricity? He shows us that it is not an entity of the nature of a fluid as in the older theories; what we wished to explain by assuming an electricity is in reality nothing but a condition of a medium which, although hypothetical, manifests itself by its effects—namely, the ether which fills all space and permeates all matter.¹

¹ Our account of Hertz's investigations is chiefly drawn from Prof. Ebert's paper in the 'Electrician,' vol. xxxiii. pp. 333-335.

The work of Hertz was immediately taken up, and is now being carried on (doubtless towards fresh conquests, for there is no finality in science) by a whole army of investigators, of whom we need only mention a few—as Lodge, Righi, Branly, Sarasin, and de la Rive—whose discoveries, especially as regards the exciter and detector, more immediately concern us in this history.

The exciter of Hertz, although sufficing for his special purposes, had the disadvantage that the sparks in a short time oxidised the little knobs and roughened their surfaces, which made their action irregular and necessitated their frequent polishing. Messrs Sarasin & de la Rive of Geneva obviated this difficulty by placing the knobs in a vessel containing olive-oil. The effect of this arrangement was at once to augment the sparks at the detector, so that when it was placed close to the exciter the sparks were a perfect blaze; and at 10 metres' distance, with detectors of large diameter (.75 to 1 metre), they were still very bright and visible from afar. It is true that here, too, the oil carbonises in time and loses its transparency; but if a considerable quantity, as two or three litres, be employed, there is no perceptible heating, and the intensity of the sparks is hardly altered, even after half an hour's continuous working. Prof. Righi substituted vaseline-oil, made suitably thick by the addition of solid vaseline. His exciter is composed of two metal balls, each set in an ebonite frame; a parchment envelope connects these frames and contains the oil which thus fills the spark-gap. Righi attributes the increased efficiency of his exciter (1) to the heightening effect which a cushion of (insulating) liquid seems to have on the electric potential which gives rise to the sparks—a sort of (to adopt an expressive French phrase) *reculant pour mieux sauter*; and (2) to some sort of regularising effect making their production more uniform. Like Sarasin and de la Rive, he found

that the use of vaseline obviated the necessity of frequent cleaning of the knobs, for even after long usage, when the liquid had become black and a deposit of carbon had formed on the opposing surfaces, the apparatus continued to work satisfactorily. Righi also found that solid knobs gave better results than hollow ones, the oscillations in the former case being perceptible in the detector at nearly double the distance attained in the latter case.

The detector usually employed by Hertz consisted of a metal wire bent into a rectangle or a circle (see fig. 32), and terminated by two little knobs between which the sparks played. But this form is not obligatory: any two distinct conducting surfaces separated by a spark-gap will serve equally well. Many kinds of detectors have been employed, but in this place we need only concern ourselves with those of the microphonic order, which alone enter into the construction of the Marconi system of telegraphy.¹

Just mentioning the well-known electrical behaviour of selenium under the action of light; the fact observed by Prof. Minchin that his delicate "impulsion-cells" were affected by Hertzian waves; the Righi detector, consisting of thin bands of quicksilver (as used for mirrors) rendered discontinuous by cross-lines lightly traced with a diamond; and the original Lodge "coherer," consisting of a metallic point lightly resting on a metal plate,²—we come to the special form known as Branly's detector, or, as he prefers to call it, the radio-conductor.

¹ For other forms of detectors, based on physiological, chemical, electrical, thermal, and mechanical principles, see Lodge's 'The Work of Hertz and his Successors,' pp. 25, 56.

² For the first suggestions of Lodge's detector see his paper, "On Lightning-Guards for Telegraphic Purposes," 'Jour. Inst. Elec. Engs.,' vol. xix. pp. 352-354. Even before this the learned professor succeeded in detecting electric waves by means of a telephone, 'Jour. Inst. Elec. Engs.,' vol. xviii. p. 405.

The observance of the phenomenon manifested in Branly's detector goes back much further than is usually supposed. Mr S. A. Varley was, I believe, the first to notice it, and as long ago as 1866 he applied it in the construction of a lightning protector for telegraph apparatus.

In his paper read before the British Association (Liverpool meeting, 1870), he says:—

“The author, when experimenting with electric currents of varying degrees of tension, had observed the very great resistance which a loose mass of dust composed even of conducting matter will oppose to electric currents of moderate tension.

“With a tension of, say, fifty Daniell cells, no appreciable quantity will pass across the dust of blacklead or fine charcoal powder loosely arranged, even when the battery poles are approached very near to one another.

“If the tension be increased to, say, two or three hundred cells, the particles arrange themselves by electrical attraction close to one another, making good electrical contact, and forming a channel or bridge through which the electric current freely passes.

“When the tension was still further increased to six or seven hundred cells the author found the electricity would pass from one pole to the other through a considerable interval of the ordinary dust which we get in our rooms, and which is chiefly composed of minute particles of silica and alumina mixed with more or less carbonaceous and earthy matters.

“Incandescent matter offers a very free passage to electrical discharge, as is indicated by the following experiments. The author placed masses of powdered blacklead and powdered wood charcoal in two small crucibles; no current would pass through these masses whilst they were cold, however close the poles were approached, without actually touching. The battery employed in this experiment was only twelve cells.

“The crucibles were then heated to a red heat, and electricity freely passed through the heated powder; and on testing the resistance opposed by the heated particles, placing the poles 1 inch apart, and employing only six cells, the average resistance opposed by the blacklead was only four British Association units, and that opposed by the wood charcoal five units. The average resistance of a needle telegraph coil may be taken at 300 units, or ohms as they are now termed.

“These observations go to show that an interval of dust separating two metallic conductors opposes practically a decreasing resistance to an increasing electrical tension, and that incandescent particles of carbon oppose about $\frac{1}{60}$ th part of the resistance opposed by a needle telegraph coil. Reasoning upon these data, the author was led to construct what he terms a ‘lightning-bridge,’ which he constructs in the following way:—

“Two thick metal conductors terminating in points are inserted usually in a piece of wood. These points approach one another within about $\frac{1}{8}$ th of an inch in a chamber cut in the middle of the wood.

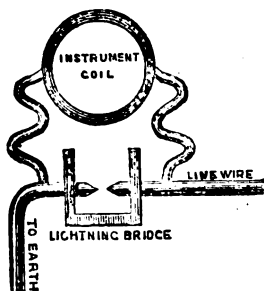

Fig. 33.

“This bridge is placed in the electric circuit in the most direct course which the lightning can take, as shown in the diagram (fig. 33), and the space separating the two points is filled loosely with powder, which is placed in the chamber,

and surrounds and covers the extremities of the pointed conductors.

“The powder employed consists of carbon (a conductor)

and a non-conducting substance in a minute state of division. The lightning finds in its direct path a bridge of powder, consisting of particles of conducting matter in close proximity to one another ; it connects these under the influence of the discharge, and throws the particles into a highly incandescent state. Incandescent matter, as has been already demonstrated, offers a very free passage to electricity, and so the lightning discharge finds an easier passage across the heated matter than through the coils.

“The reason a powder consisting entirely or chiefly of conducting matter cannot be safely employed is that, although in the ordinary conditions of things it would be found to oppose a practically infinite resistance to the passage of electricity of the tension of ordinary working currents, when a high tension discharge occurs the particles under the influence of the discharge will generally be found to arrange themselves so closely as to make a conducting connection between the two points of the lightning-bridge. This can be experimentally demonstrated by allowing the secondary currents developed by a Ruhmkorff's coil to spark through a loose mass of blacklead.

“The crucial test, however, is the behaviour of the bridge in practice.

“These lightning-bridges have been in use since January 1866. At the present time there are upwards of one thousand doing duty in this country alone, and not a single case has occurred of a coil being fused when protected by them.

“It is only right, however, to mention that three cases, but three cases only, have occurred where connection was made under the influence of electrical discharge between the two metallic points in the bridge.

“The protectors in which this occurred were amongst those first constructed, in which a larger proportion of con-

ducting matter was employed than the inventor now adopts. The points also in those first constructed were approached to $\frac{1}{2}$ th of an inch from one another ; and the author has no doubt, from an examination of the bridges afterwards, that under the influence of a high tension discharge connection was made between the two metallic points by a bridge of conducting matter, arranged closely together, and if the instruments *had been shaken to loosen the powder*, all would have been put right. In one of these three cases—and it was the only one in which the author was supplied with the details—he ascertained that the protector was attached to a needle telegraph, having the ordinary magnetic needles made of tempered steel magnetised ; and on the removal of the bridge after the discharge, so completely had the electricity been carried away by the bridge, that the magnetism of the magnetic needle was found not to have been affected.”¹

In the little-known researches of the Italian professor, Calzecchi-Onesti, we find this curious phenomenon again cropping up. In 1884-85 Prof. Calzecchi-Onesti found that copper filings heaped between two plates of brass were conductors or non-conductors of electricity according to the degree of heaping, and that in the latter case they could be made conductors under the influence of induction. Fig. 34 illustrates his experiment. In the circuit of a small battery A he placed a telephone B, a galvanometer C, and two brass plates D E, separated by the copper filings. So long as the

¹ Mr Preece tells us the arrangement acted well, but was subject to what we now call coherence, which rendered the cure more troublesome than the disease, and its use had to be abandoned. Mr Preece also says that the same action is very common in granulated carbon microphones like Hunnings', and shaking has to be resorted to to decohere the carbon particles to their normal state. But here the coherence is only partially, if at all, an electrical effect, being chiefly, if not entirely, due to mechanical pressure.

short-circuit arrangement F (a wire dipping into mercury) was open, the galvanometer showed traces of a very feeble current across the filings; but, on dipping the wire for a moment into the mercury and then withdrawing it, a sharp click is heard in the telephone and the galvanometer indicates the passing of a strong current, showing that the filings must now be conductors. This change he traced to the induced

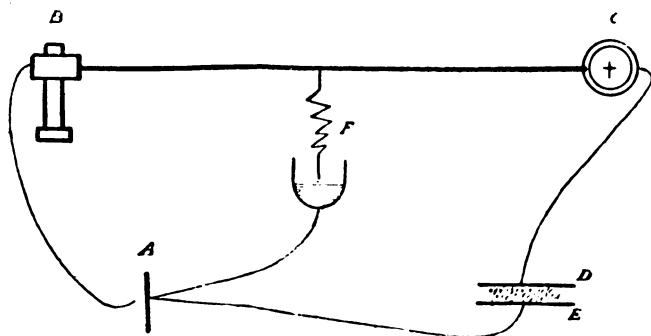

Fig. 34.

current of the telephone coil (the extra-current *direct*) at the moment of opening the short-circuit. He repeated this experiment with various powders or filings of metal, and ended by showing that some of them became conductors under the influence of a very feeble spark, while others became so only after being subjected to strong sparks as from an electrical machine.

These important observations were published in 'Il Nuovo Cimento,' 1884, p. 58,¹ but attracted no attention; and it was only after Prof. E. Branly, of the Catholic University of Paris, had published his results in 1890 that the earlier discoveries of Varley and Onesti came to be remembered and appreciated at their proper value.

¹ See also 'Jour. Inst. Elec. Engs.,' vol. xvi. p. 156.

Prof. Branly's investigations are very clearly described in 'La Lumière Electrique, May and June 1891.'¹ As this now classic paper deals with facts which are at the very foundation of the Marconi system, I give some extracts from it in Appendix C. Here, therefore, I need only say that Branly verified and extended Calzecchi-Onesti's observations, and made the further (and for our purpose *vital*) discovery that the conducting power, imparted to filings by electric discharges in their vicinity, can at once be destroyed by simply shaking or tapping them.

The Branly detector, as constructed by Prof. Lodge, is shown in fig. 35. It consists of an ebonite or glass tube

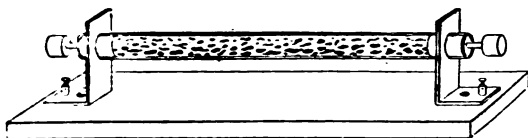

Fig. 35.

about 7 inches long, half-an-inch outer diameter, and fitted at the ends with copper pistons, which can be regulated to press on the filings with any required degree of pressure. To bring back the filings to their normal non-conducting state, Lodge applied to the tube a mechanical tapper, worked either by clockwork or by a trembling electrical mechanism.²

These, then, the exciters and the detectors of Hertzian waves, are the bricks and mortar, so to speak, of the Marconi system, and it now only remains to see how they have been shaped and put together to produce a telegraph without connecting wires, which is the realisation of the dream of

¹ See also an abstract in the 'Electrician,' vol. xxvii. pp. 221, 448.

² Dr Rupp of Stuttgart has proposed to suppress the tapper and to effect decoherence by making the detector revolve on its axis. See 'Elektrotechnische Zeitschrift,' April 14, 1898, or 'Electrical Review,' April 22, 1898.

Steinheil in 1838. And, first, we must notice two or three applications, or suggested applications, which preceded the announcement of Marconi's invention. We do so without in the least meaning to detract one iota from the merit due to the young Irish-Italian inventor,¹ for we believe the idea was entirely original with him, and was unprompted by any suggestions from outside. The history of the applications of science to art shows us that these applications often occur simultaneously to several persons, and it is, therefore, not strange that such is the case in the present instance.

Sir William Crookes, the eminent chemist and electrician, was, I believe, the first to distinctly foresee the applicability of Hertzian waves to practical telegraphy. In a very interesting paper on "Some Possibilities of Electricity,"² he gives us the following marvellous forecast of the Marconi system:—

"Rays of light will not pierce through a wall, nor, as we know only too well, through a London fog; but electrical vibrations of a yard or more in wave-length will easily pierce such *media*, which to them will be transparent. Here is revealed the bewildering possibility of telegraphy without wires, posts, cables, or any of our present costly appliances. Granted a few reasonable postulates, the whole thing comes well within the realms of possible fulfilment. At present experimentalists are able to generate electric waves of any desired length, and to keep up a succession of such waves radiating into space in all directions. It is possible, too,

¹ Guglielmo Marconi was born in Marzabotto, near Bologna, 25th April 1874, and was educated at Leghorn, and at the Bologna University, where he was a sedulous attendant at the lectures of Prof. A. Righi.

² Fortnightly Review, February 1892, p. 173. Prof. Lodge has since kindly pointed out to me that about 1890 Prof. R. Threlfall of Sydney, N.S. Wales, threw out a suggestion of the same kind at a meeting of the Australasian Association for the Advancement of Science.

with some of these rays, if not with all, to refract them through suitably shaped bodies acting as lenses, and so to direct a sheaf of rays in any given direction. Also an experimentalist at a distance can receive some, if not all, of these rays on a properly constituted instrument, and by concerted signals messages in the Morse code can thus pass from one operator to another.

“What remains to be discovered is—firstly, simpler and more certain means of generating electrical rays of any desired wave-length, from the shortest, say a few feet, which will easily pass through buildings and fogs, to those long waves whose lengths are measured by tens, hundreds, and thousands of miles; secondly, more delicate receivers which will respond to wave-lengths between certain defined limits and be silent to all others; and thirdly, means of darting the sheaf of rays in any desired direction, whether by lenses or reflectors, by the help of which the sensitiveness of the receiver (apparently the most difficult of the problems to be solved) would not need to be so delicate as when the rays to be picked up are simply radiating into space, and fading away according to the law of inverse squares. . . .

“At first sight an objection to this plan would be its want of secrecy. Assuming that the correspondents were a mile apart, the transmitter would send out the waves in all directions, and it would therefore be possible for any one living within a mile of the sender to receive the communication. This could be got over in two ways. If the exact position of both sending and receiving instruments were known, the rays could be concentrated with more or less exactness on the receiver. If, however, the sender and receiver were moving about, so that the lens device could not be adopted, the correspondents must attune their instruments to a definite wave-length, say, for example, 50 yards. I assume here that the progress of discovery would give

instruments capable of adjustment by turning a screw, or altering the length of a wire, so as to become receptive of waves of any preconcerted length. Thus, when adjusted to 50-yard waves, the transmitter might emit, and the receiver respond to, rays varying between 45 and 55 yards, and be silent to all others. Considering that there would be the whole range of waves to choose from, varying from a few feet to several thousand miles, there would be sufficient secrecy, for the most inveterate curiosity would surely recoil from the task of passing in review all the millions of possible wave-lengths on the remote chance of ultimately hitting on the particular wave-length employed by those whose correspondence it was wished to tap. By coding the message even this remote chance of surreptitious tapping could be rendered useless.

“This is no mere dream of a visionary philosopher. All the requisites needed to bring it within the grasp of daily life are well within the possibilities of discovery, and are so reasonable and so clearly in the path of researches which are now being actively prosecuted in every capital of Europe, that we may any day expect to hear that they have emerged from the realms of speculation into those of sober fact. Even now, indeed, telegraphing without wires is possible within a restricted radius of a few hundred yards, and some years ago I assisted at experiments where messages were transmitted from one part of a house to another without an intervening wire by almost the identical means here described.”¹

In 1893 Nikola Tesla, the lightning-juggler, proposed to

¹ The experiments here referred to were made in 1879 by Prof. Hughes, who has kindly supplied the author with an account of them. As this interesting and important document was received too late for embodiment in the text, I must ask my readers to refer to Appendix D.

transmit electrical oscillations to any distance through space, by erecting at each end a vertical conductor, connected at its lower end to earth and at its upper end to a conducting body of large surface. Owing to press of other work this experiment was never tried, and so has remained a bare suggestion.¹

At the Royal Institution, June 1, 1894, and later in the same year at the Oxford meeting of the British Association, Prof. Lodge showed how his form of Branly detector could be made to indicate signals at a distance of about 150 yards from the exciter, but at this time the applicability of his experiment to practical long-distance telegraphy was hardly grasped by him. Referring to this in his 'Work of Hertz' (p. 67, 1897 edition), he says:—

“Signalling was easily carried on from a distance through walls and other obstacles, an emitter being outside and a galvanometer and detector inside the room. Distance without obstacle was no difficulty, only free distance is not very easy to get in a town, and stupidly enough no attempt was made to apply any but the feeblest power so as to test how far the disturbance could really be detected.

“Mr Rutherford, however, with a magnetic detector of his own invention, constructed on a totally different principle, and probably much less sensitive than a coherer, did make the attempt (June 1896), and succeeded in signalling across half a mile full of intervening streets and houses at Cambridge.”

Between 1895 and 1896 Messrs Popoff, Minchin, Rutherford, and others applied the Hertzian method to the study of atmospheric electricity; and their mode of procedure, in the use of detectors in connection with vertical exploring rods, was much the same as that of Marconi.

¹ See a full account of Tesla's marvellous researches in 'Jour. Inst. Elec. Engs.' for 1892, No. 97, p. 51.

Popoff's arrangement especially is so like Marconi's that we are tempted to reproduce it from the 'Elektrichestvo' of St Petersburg for July 1896. Fig. 36 shows the apparatus, the action of which is easily understood. The

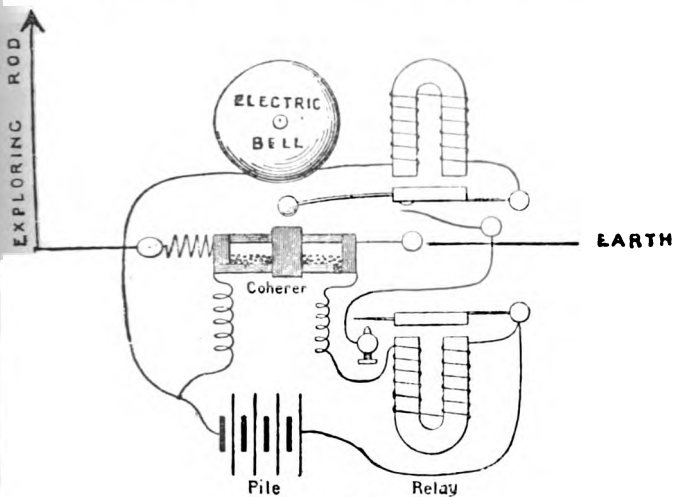

Fig. 36.

relay actuates another circuit, not shown, containing a Richard's register, which plots graphically the atmospheric perturbations.

Prof. Popoff's plans were communicated to the Physico-Chemical Society of St Petersburg in April 1895; and in a further note, dated December 1895, he adds: "I entertain the hope that when my apparatus is perfected it will be applicable to the transmission of signals to a distance by means of rapid electric vibrations—when, in fact, a sufficiently powerful generator of these vibrations is discovered." We shall see presently that Popoff was looking in the wrong direction. It was not so much a more powerful generator

(which is easily obtained) that was wanted, as a more sensitive detector than the ordinary Branly-Lodge arrangement which he used. Mr Marconi, we shall see, supplied this, and in doing so did the main thing necessary to make Popoff's apparatus a practical telegraph.¹

Mr Preece tells us that in December 1895 Captain Jackson, R.N., commenced working in the same direction, and succeeded in getting Morse signals through space before he heard of Marconi. His experiments, however, were treated as confidential at the time, and have not been published.

In 1896 the Rev. F. Jervis-Smith had a detector made of finely-powdered carbon, such as is used in incandescent electric lamps, for observing atmospheric electricity; and a little later (? after Marconi's announcement) he actually applied it to telegraphic purposes over a distance of more than a mile. This form of detector was to a certain extent self-adjusting in that it did not require any tapping device.²

I now come to Mr Marconi, whose special application of Hertzian waves to practical telegraphy will be easily understood if my readers have carefully followed me in the preceding pages.

His apparatus for short distances, with clear open spaces, consists of the parts which are shown in diagrammatic form in figs. 37, 38, 39, and 40. The apparatus at the sending station consists of a modified Righi exciter A

¹ On hearing of Marconi's success in England, Prof. Popoff tried his apparatus *quasi* telegraph (presumably using more sensitive detectors), and in April 1897 succeeded in signalling through a space of 1 kilometre, then through $1\frac{1}{2}$, and finally through 5 kilometres, with vertical wires, 18 metres high.

² Quite recently, October 1898, I have seen it stated that Signor Rovelli has found that a detector made of iron filings acts well, and requires no tapping.

(fig. 37), a Ruhmkorff coil B, a battery of a few cells c, and a Morse key K.

The exciter consists of two solid brass spheres A B (fig. 38), 11 centimetres in diameter and 1 millimetre apart, yielding with a 6-inch spark coil waves of about 25 centimetres long. The spheres are fixed in an oil-tight case of parchment or ebonite, so that an outside hemisphere of each is exposed, the other hemispheres being immersed in vaseline-oil thickened by the addition of a little vaseline. As already explained, the use of oil has several advantages, all of which combine to increase the effect, and therefore the distance at which this effect

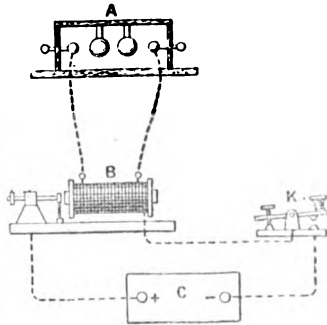

Fig. 37.

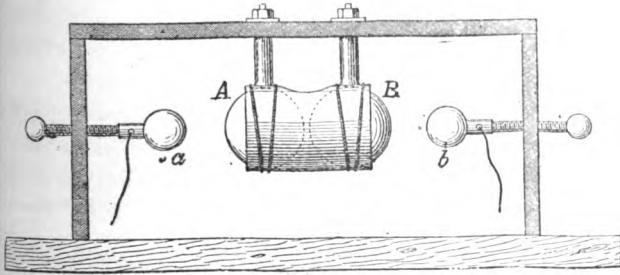

Fig. 38.

can be detected. It keeps the opposing surfaces of the spheres clean and bright; it gives to the electric waves a uniform and regular (periodic) character; and it reduces

the length of these waves to the small limits best adapted for signalling.¹ Two small balls, also of solid brass, *a b*, are fixed in a line with the large ones, usually about 2·5 centimetres apart, and are capable of adjustment. The larger the spheres and balls, and the greater the distances separating them, the higher the potential of the spark, and consequently the greater the distance at which the oscillations are perceptible. The balls *a b* are connected each to one end of the secondary coil of the Ruhmkorff apparatus *B*. The primary wire of the induction coil is excited by the battery *c*, thrown in and out of circuit by the key *κ*. The efficiency of the sending apparatus depends greatly on the power and constancy of the induction coil: thus a coil yielding a 6-inch spark will be effective up to three or four miles; but for greater distances than this more powerful coils, as one emitting 20-inch sparks, must be used.²

The various parts of the sending apparatus are generally so constructed and adjusted as to emit per second about 250 million waves of about 1·2 metres long.

At the receiving station *N* (fig. 39) is Marconi's special form of the Branly-Lodge detector, shown full size in fig. 40. This is the part which gave him the most trouble. While for laboratory experiments a detector of little delicacy sufficed to give indications on a sensitive mirror galvanometer at a distance of a few yards, Mr Marconi had to seek an

¹ Mr Marconi's later experience has led him to doubt these advantages, and to discard the use of oil. See 'Jour. Inst. Elec. Engs.,' No. 139, p. 311.

² But there is a limit; powerful induction coils of the Ruhmkorff kind are difficult to make and keep in order, and do not by reason of their residual magnetism admit of the very rapid make-and-break action required. Doubtless other and more effective means of excitement will soon be discovered, as Tesla's oscillators, or by the use of Wehnelt's electrolytic contact-breaker, which can be made to interrupt a current one thousand times and more per second. See 'Jour. Inst. Elec. Engs.,' No. 131, p. 317.

arrangement which would respond sufficiently to the very feeble waves which are found at a great distance from the source, so as to allow of the passage of a current strong

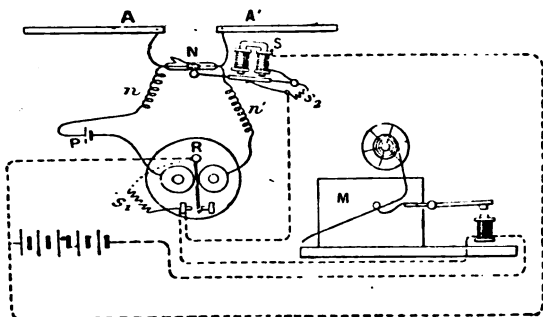

Fig. 39.

enough to actuate a telegraph relay. His detector consists of a glass tube, 4 centimetres long and 2.5 millimetres interior diameter, into which two silver pole-pieces, 1 milli-

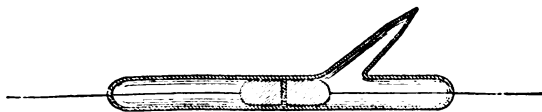

Fig. 40.

metre apart, are tightly fitted, so as to prevent any scattering of the powder. The small intervening space is filled with a mixture of 96 parts of nickel and 4 of silver, not too finely powdered, and worked up with a trace of mercury.

By increasing the proportion of silver powder the sensitiveness of the detector is increased *pro rata*; but it is better for ordinary work not to have too great sensitiveness, as the detector then too readily responds to atmospheric electricity and other stray currents. Similarly, the smaller the powder space the more sensitive is the instrument; but

if too small, the action is capricious. The quantity of powder required is, of course, very small, but it must be treated with care; it must neither be too compressed nor too loose. If too tight the action is irregular, and often the particles will not return to their normal condition, or "decohere," as Lodge expresses it; if too loose coherence is slight, and the instrument is not sufficiently sensitive. The best adjustment is obtained when the detector works well under the action of the sparks from a small electric trembler at one metre's distance. The tube is then hermetically sealed, having been previously exhausted of air to about $\frac{1}{1000}$ th of an atmosphere. This, though not essential, is desirable, as it prevents the oxidation of the powder.

In its normal condition the metallic powder, as already stated, is practically a non-conductor, offering many megohms resistance. The particles (to use Mr Preece's expressive words) lie higgledy-piggledy, anyhow, in disorder. They lightly touch each other in a chaotic manner; but when electric waves fall upon them they are polarised—order is installed—they are marshalled in serried ranks and press on each other,—in a word, they cohere, electrical continuity is established, and a current passes, the resistance falling from practical insulation to a few ohms or a few hundred ohms according to the energy of the received impacts. Usually it ranges from 100 to 500 ohms.

The detector is included in the circuit of two electromagnetic impedance or choking coils $n n'$, a local battery of one or two Leclanché cells p , and a fairly sensitive polarised relay as ordinarily used in telegraphy r . The impedance or choking coils, consisting of a few turns of insulated copper wire on a glass tube, containing an iron bar 5 or 6 centimetres long, are intended to prevent the electric energy escaping through the relay circuit. Prof. Silvanus Thompson doubts the efficacy of this contrivance, but Mr

Marconi's experience shows its great utility. Thus, when the coils are removed, all other things remaining the same, the signalling distance is reduced by nearly one-half.

$\Delta \Delta'$ are resonance plates or wings (copper strips) whose dimensions must be adjusted so as to bring the detector into tune electrically with the exciter.

The relay actuates two local circuits on the parallel or shunt system, one containing an ordinary Morse instrument \mathfrak{M} , and the other the tapper s . The relay and tapper are provided with small shunt coils s_1 and s_2 to prevent sparking at the contacts, which would otherwise impair the good working of the detector. The Morse instrument and the tapper may also be connected in series in one circuit, in which case the former may be made to act as a buzzer, the signals being read by sound. Indeed, the Morse machine may be left out altogether and the signals be read from the sound of the tapper alone. The printing lever of the Morse is so adjusted—an easy matter—as not to follow the rapid makes and breaks of the local current caused by the action of the tapper. Consequently, although the current in the coils of the Morse is rapidly discontinuous, the lever remains down (and prints) so long as the detector is influenced by the waves sent out by the exciter. In this way the lever gives an exact reproduction of the movements of the distant sending key, dots and dashes at the key coming out as dots and dashes in the Morse. The speed at which signalling can be carried on is but little slower than that in ordinary (Morse) telegraphy, fifteen words a minute being easily attained.

In practice, the sending part of the apparatus should be screened as much as possible by interposed metal plates from the receiving instruments, so as to prevent local inductive interferences; or better, the detector may be shut up in a metal box.

This arrangement is effective for short distances, up to two miles, with clear open spaces, especially if parabolic reflectors are erected behind the exciter and detector, and carefully focussed so as to throw the electric rays in the right direction. But for long distances, and where obstacles intervene, as trees, houses, hills—in fact, for practical purposes—certain modifications are necessary which are

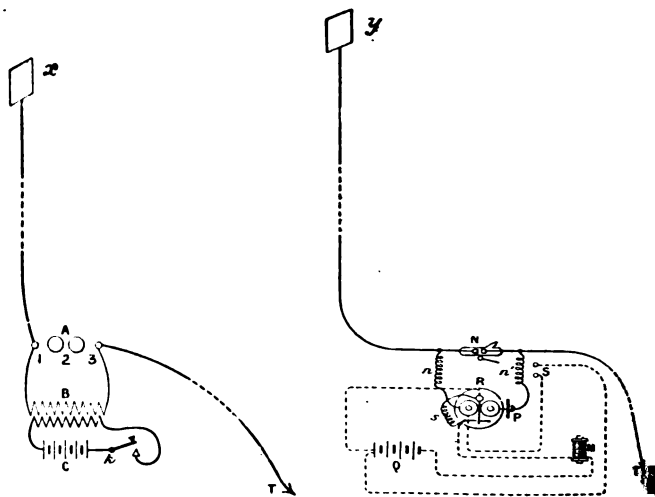

Fig. 41.

shown in fig. 41. Reflectors are discarded which are troublesome and expensive to make and difficult to adjust. One knob of the exciter is connected to a stout insulated wire, led to the top of a mast and terminating in a square sheet or a cylinder of zinc, or a pennant-like structure of wire netting. For still greater distances the wire may be flown from a kite or balloon¹ covered with tinfoil.

¹ In a recent popular lecture it is seriously stated that, when kites are used to carry the conductors, "the electricity obtained from the

The other knob of the exciter is connected to a good earth.

At the receiving station the resonance wings of the detector are discarded, and one side is connected to a vertical wire and the other side to earth, as in the case of the exciter. Of course, in practice only one vertical wire is required at each station, as by means of a switch it can be connected with the exciter for sending, or with the detector for receiving, as may be necessary. The parallelism of the plates x and y should be preserved as much as possible in order to obtain the best effects.

The *raison d'être* of the earth connections is not yet clearly understood. An earth wire on the exciter for *long* distances is essential, but at the detector it may apparently be dispensed with without any (appreciable) effect.¹ Breaking the connection does not prove to me that earth does not enter into the effect. It only increases the resistance of the earth-connecting medium, which now is not wire, but consists of the walls, floor, table, and base-board of the instrument. Again, why suppose that sparks are emitted at the top of the vertical wire only? Why not also into the ground, giving us a complete closed circuit through the ether above and through the ground below? If I may hazard an opinion I would say that the Marconi effect is but, on a large scale, an electrical machine effect such as every schoolboy is

air, when they were flown high enough, was sufficient to enable the operator to do away with a primary battery" ! (' Electrical Engineer,' October 1, 1897). This is the Mahlon Loomis idea *redivivus* (see p. 73 *ante*), and is as true as another "vulgar error"—to wit, that Marconi, and now Tesla, can explode torpedoes and powder-magazines at their own sweet will. This, of course, might be done, *if* they could plant a properly adjusted exploding apparatus near the powder; but if they could do this, they could, as Mr Preece says, do many other funny things.

¹ Jour. Inst. Elec. Eng., No. 137, pp. 801, 802, 900, 918, 946, 962.

familiar with, and that it conforms to the same laws and conditions.

However this may be, an earth wire (and a good one too) should be used on the detector as well as on the exciter, if only as a protection from lightning. The vertical wire is practically a lightning-catcher, and the detector is an excellent lightning-guard *when* connected to earth. But if disconnected from earth, and lightning strikes the wire, then we may expect all the disastrous results which follow from a badly constructed or defective lightning-protector. The fear, then, that the Marconi apparatus is dangerous may be put aside. Being excellent lightning-conductors and lightning-guards in one, they may, in my opinion, be safely used, even in a powder-magazine.

Delicate as the apparatus undoubtedly is, and complicated as it may seem, its action is simplicity itself to the telegraphist, differing only in the kind of electricity and the medium of communication from that of the everyday telegraph. On depressing the key *k* (fig. 41) to make, say, a dash, induced currents are set up in the secondary coil of the Ruhmkorff machine, which pass in sparks across the spark-gaps 1, 2, and 3, and out into space at *x*. The sparks at *x* set up electric oscillations in the ether, which are radiated into space in waves. On arriving at the receiving station some of these waves strike the wire *y*, are carried to the detector, which coheres, allowing the local battery to act; the relay closes, and the Morse instrument sounds, or prints the signal as may be required, the tapper all the while doing its work of decohering.

Marconi's first trials on a small scale were made at Bologna, and these proving successful he came to England and applied for a patent, June 2, 1896.¹ Soon after, in

¹ This being the first patent of the *New Telegraphy* order, is historically interesting. I have therefore thought it convenient to reproduce it in Appendix E, with the original rough drawings.

July, he submitted his plans to the postal-telegraph authorities, and, to his honour be it said, they were unhesitatingly—even eagerly—taken up by Mr Preece, although, as we have already seen, he was introducing a method of his own.

The first experiments in England were from a room in the General Post Office, London, to an impromptu station on the roof, over 100 yards distant, with several walls, &c., intervening. Then, a little later, trials were made over Salisbury Plain for a clear open distance of nearly two miles. In these experiments roughly-made copper parabolic reflectors were employed, with resonance plates on each side of the detector (see figs. 37, 39).

In May 1897 still more extensive trials were made across the Bristol Channel between Lavernock and Flat Holm, 3·3 miles, and between Lavernock and Brean Down, near Weston-super-Mare, 8·7 miles (see fig. 21, *ante*). Here the reflectors and resonance plates were discarded. Earth and vertical air wires were employed, as in fig. 41, the vertical wires being in the first case 50 yards high, while in the second case kites carrying the wires were had recourse to.

The receiving apparatus was set up on the cliff at Lavernock Point, which is about 20 yards above sea-level. Here was erected a pole, 30 yards high, on the top of which was a cylindrical cap of zinc, 2 yards long and 1 yard diameter. Connected with this cap was an insulated copper wire leading to one side of the detector, the other side of which was connected to a wire led down the cliff and dipping into the sea. At Flat Holm the sending apparatus was arranged, the Ruhmkorff coil used giving 20-inch sparks with an eight-cell battery.

On the 10th May experiments on Mr Preece's electromagnetic method (already fully described) were repeated, and with perfect success.

The next few days were eventful ones in the history of

Mr Marconi. On the 11th and 12th his experiments were unsatisfactory—worse, they were failures—and the fate of the new system trembled in the balance. An inspiration saved it. On the 13th the receiving apparatus was carried down to the beach at the foot of the cliff, and connected by another 20 yards of wire to the pole above, thus making a height of 50 yards in all. Result, magic! The instruments, which for two days failed to record anything intelligible, now rang out the signals clear and unmistakable, and all by the addition of a few yards of wire! Thus often, as Carlyle says, do mighty events turn on a straw.

Prof. Slaby of Charlottenberg, who assisted at these experiments, has told us in a few graphic words the feelings of those engaged. "It will be for me," he says, "an ineffaceable recollection. Five of us stood round the apparatus in a wooden shed as a shelter from the gale, with eyes and ears directed towards the instruments with an attention which was almost painful, and waited for the hoisting of a flag, which was the signal that all was ready. Instantaneously we heard the first *tic tac, tic tac*, and saw the Morse instrument print the signals which came to us silently and invisibly from the island rock, whose contour was scarcely visible to the naked eye—came to us dancing on that unknown and mysterious agent the ether!"

After this the further experiments passed off with scarcely a hitch, and on the following day communication was established between Lavernock and Brean Down.

The next important trials were carried out at Spezia, by request of the Italian Government, between July 10 and 18, 1897. The first three days were taken up with experiments between two land stations 3·6 kilometres apart, which were perfectly successful. On the 14th, the sending apparatus being at the arsenal of San Bartolomeo, the receiving instruments were placed on board a tug vessel, moored at various

distances from the shore. The shore wire was 26 metres high, and could be increased to 34 if necessary; the tug wire was carried to the top of the mast, and was 16 metres high. The results were unsatisfactory: signals came, but they were jumbled up with other weird signals, which came from the atmosphere (the weather was stormy) in the way which telegraph and telephone operators know so well. On the 15th and 16th (the weather having moderated) better results were obtained, and communication was kept up at distances up to 7.5 kilometres.

On the 17th and 18th the receiving apparatus was transferred to a warship (ironclad), and, with a shore elevation of 34 metres and a ship elevation of 22 metres, signals were good at all distances up to 12 kilometres, and fairly so at 16 kilometres.

During these experiments it was observed that whenever the funnels, iron masts, and wire ropes of the vessels were in line with the shore apparatus the detector did not work properly, which was to be expected from the screening property of metals; but another and more serious difficulty was also encountered. When the vessel got behind a point of the land which cut off the view of the shore station, the signals came capriciously, and good working was not established until the shore was again in full view. Here was a difficulty which must be surmounted if the new system was to be of any practical utility. We have seen in our account of the work of Hertz that electric waves pass without appreciable hindrance through doors and walls and, generally, non-conducting bodies, being only arrested by metals and other conductors; but in practice, when we come to deal with doors and walls in large masses—as trees, buildings, hills, especially if near the vertical wires—they partake of the nature of metals, and largely absorb the waves, just as light passes through a thin sheet of glass, but is obscured or

absorbed by a thick sheet. This difficulty is in the nature of things, and must always remain. It is surmountable to a very great extent by increasing the height of the vertical wires, terminating with suitable capacity areas, and by increasing the power of the sending and the delicacy of the receiving apparatus ; but we speedily reach a limit in these directions, so that as far as one can see at present the effective distance of the new system must be small compared with the older methods.

Fig. 42, which I borrow from Mr Preece, shows how hills are apparently bridged over.

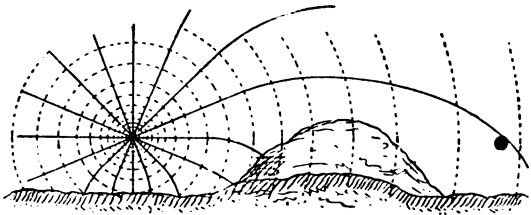

Fig. 42.

From a long series of experiments in Italy in 1895 Mr Marconi worked out a law of distance which all his later experience seems to verify. "The results," he says, "showed that the distance at which signals could be obtained varied approximately as the square of the height of the capacity areas from earth, or, perhaps, as the square of the length of the vertical conductors. This law furnishes us with a safe means of calculating what length the vertical wire should be in order to obtain results at a given distance. The law has never failed to give the expected results *across clear space* in any installation I have carried out, although it usually seems that the distance actually obtained is slightly in excess. I find that, with parity of other conditions, vertical wires 20 feet long are sufficient for communicating

one mile, 40 feet four miles, 80 feet sixteen miles, and 80 on.

“Professor Ascoli has confirmed this law, and demonstrated mathematically, using Neumann’s formula, that the inductive action is proportional to the square of the length of one of the two conductors if the two are vertical and of equal length,¹ and in simple inverse proportion of the distance between them. Therefore the intensity of the induced oscillation does not diminish with the increase of distance if the length of the vertical conductors is increased in proportion, or as the square root of the distance. That is, if the height of the wire is doubled, the possible distance becomes quadrupled.”²

On his return to Germany after witnessing the Marconi experiments in England, Prof. Slaby in September 1897 engaged in some very instructive experiments in the vicinity of Potsdam, first between Matrosenstation and the church at Sacrow, 1·6 kilometre, and then between the former place and the castle of Pfaueninsel, 3·1 kilometres. I take the following particulars from the ‘Electrical Engineer,’ December 3, 1897 :—

Prof. Slaby recently, at a technical college in Berlin, gave an interesting report of his experiments on telegraphy without wires, or, as he wants it to be called, “spark telegraphy.” He mentioned an experiment made by himself by which he was able to send by means of one wire two different messages simultaneously without interfering with each other. He

¹ If of unequal lengths then the action is proportional to the product of the two lengths, which, however, must not be too dissimilar.

² This law is correct for clear open spaces over water ; but over land allowance must be made for obstacles, as trees, buildings, hills, &c., which carry off some of the passing energy. The conductors must be parallel (‘Jour. Inst. Elec. Engs.’ No. 137, p. 902), but need not necessarily be of the same height, although it is preferable that they should be so.

explained that the continuous current used in ordinary telegraphy is conducted along the middle of the wire, and he proved that electric waves on their way through the ether are attracted by wires which come in their way, and that they travel along the outside of those wires without influencing the interior. In making use of these observations he succeeded in sending a wave message along the outside of the wire while another message was proceeding through the centre by the continuous current.

Prof. Slaby says that, in conjunction with Dr Dietz, he made many experiments with "spark telegraphy" before Marconi's inventions became known, but did not achieve any important results.¹

After his return, however, from England he experimented still further. The Emperor of Germany was present at some of these experiments, and put a number of sailors and the large royal gardens at Potsdam at his disposal. The receiver was erected at the naval station and the transmitter on Peacock Island. The first experiments gave no result, because the coherers used were a great deal too sensitive, and contained, among other things, too much silver, and were affected by the electricity in the atmo-

¹ Referring to these experiments in his book, 'Die Funkentelegraphie,' Berlin, 1897, Prof. Slaby handsomely acknowledges Marconi's merits in the following words: "Like many others, I also had taken up this study, but never got beyond the limits of our High School. Even with the aid of parabolic reflectors and great capacity of apparatus I could not attain any further. Marconi has made a discovery. He worked with means the full importance of which had not been recognised, and which alone explain the secret of his success. I ought to have said this at the commencement of my subject, as latterly, especially in the English technical press, the novelty of Marconi's process was denied. The production of the Hertzian waves, their radiation through space, the sensitiveness of the electric eye, all were known. Very good; but with these means 50 metres were attained, but no more."

sphere, and in consequence were constantly affected even when no signals were sent from the sending station. Further experiments showed that the results increased in the same measure as the sensitiveness of the coherer decreased. Prof. Slaby uses now very rough and jagged nickel filings which have been carefully cleaned and dried. As the receiving station could not be seen from the island, the sending station was removed to a church a little farther away, and the exciter was put between the columns of the portico, while the mast which carried the wire was erected on the spire. The experiments then went very well.

When the sending apparatus was put back a little farther into the church, and the wire was put for about a length of 2 yards parallel with the stone slabs of the floor and a yard and a half above it, it ceased to work properly, because the waves seek the earth. Hence one must not bring the wire too near to the earth, or lay it parallel when near the earth. When the sending apparatus was moved back to the island, it was found that trees near the wire proved an obstacle because they received the waves. Therefore the Professor says that it is best to so arrange that the wires on the receiver and on the transmitter can be seen from each other. Even the sail of a little boat or the smoke from a steamer cause small interruptions, which make the words more or less indistinct. The waves get through impedimenta, and even through buildings, but there is always much loss. In order to make the wire which was placed on the island more visible from the mainland, it was lengthened from 25 to 65 yards, and placed upon a boat on the river. That did not remedy matters; but when the wire on the receiver was also lengthened to 65 yards very good results followed, showing that the length of the wire is of great importance.

Prof. Slaby next proceeded, early in October, to experi-

ment over an open stretch of country, free from all intervening obstacles, between Rangsdorf (sending station) and Schöneberg (receiving station), a distance of 21 kilometres. Captive balloons raised to a height of 300 metres were employed. On the first two days the results were disappointing, and the fault was found to be in the vertical conductors, which consisted of the wire cables holding the balloons. With a double telephone wire there was a slight improvement; and eventually, on the 7th October, "fine insulated copper wire of .46 millimetres diameter was substituted with excellent results."¹

Correspondence was now always good, except when disturbed by atmospheric discharges (the weather being stormy). At such times the signals were distorted and confused, and often the discharges were so strong as to unpleasantly shock the operators, making it necessary to handle the apparatus with the greatest care. Here is another serious difficulty with which Mr Marconi has to contend, and from which we see no escape short of total suspension of operations during stormy weather—namely, the great liability to accident and derangement, not merely from lightning flashes, to which all telegraph systems are subject, but from all those other electrical disturbances of the atmosphere which have hitherto been of little account. The greater the distance worked over, the higher must be the conductors, and, consequently, the greater must be the danger.

The apparatus used by Prof. Slaby differed somewhat from Marconi's, the following being the more important points:—

1. A Weston galvanometer relay, which, it is curious to

¹ The statement in inverted commas needs verification, as theoretically one would suppose the larger wires should have given the better result.

note, is our old friend in modern guise, the Wilkins' relay, used by Mr Wilkins in his wireless telegraph experiments in 1845 (see p. 38, *ante*).

2. An ordinary Branly-Lodge detector with hard nickel powder only.
3. No impedance or "choking" coils.¹

The further course of Marconi's experiments is so succinctly given by the chairman of the Wireless Telegraph Company in a recent address, October 7, 1898, that we cannot do better than follow him.²

"A year ago," he says, "when this company was started (July 1897), Mr Marconi happened to be in Italy making experiments for the Italian Government, and for the King and Queen at the Quirinal. On his return to this country, the first long-distance trial was made between Bath and Salisbury. The receiver in this case was given to a post-office official, who went to Bath and by himself rigged up a station, at which he received signals thirty-four miles distant from where they were sent at Salisbury. After this we put a permanent station at Alum Bay, Isle of Wight. This station at first was used in connection with a small steamer that cruised about in the neighbourhood of Bournemouth, Boscombe, Poole Bay, and Swanage, a distance of eighteen miles from the Needles Hotel station, with which it was in constant telegraphic communication.

"Various exhibitions were given later—one at the House of Commons, where a station was erected, and another station at St Thomas's Hospital opposite (May 1898). Within

¹ About this time Dr Tuma of Vienna was engaged on similar experiments, using, however, instead of a Ruhmkorff coil a Tesla oscillator or exciter, with nickel powder only in the detector. I have not seen any detailed account of these experiments.

² I have incorporated a few passages from Mr Marconi's recent paper (Institution of Electrical Engineers, March 2, 1899), so as to make the account more complete. These are shown in brackets thus [].

an hour of the time our assistants arrived to put up the installation, the system was at work. We had many exhibitions at our offices, at which a number of people attended; amongst others Mr Brinton, a director of the Donald Currie line of steamers, who asked if we could report a ship passing our station. This was done. The ship was the Carisbrooke Castle, on her first voyage out, and as she passed the Needles a message reporting the fact was wirelessly telegraphed to Bournemouth, and there put on the ordinary telegraph wires for transmission to Mr Brinton.

“After this Lord Kelvin visited our station at Alum Bay, and expressed himself highly pleased with all he saw. He sent several telegrams, *via* Bournemouth, to his friends, for each of which he insisted on paying one shilling royalty, wishing in this way to show his appreciation of the system and to illustrate its fitness for commercial uses. The following day the Italian Ambassador visited the station. Among other messages, he sent a long telegram addressed to the Aide-de-camp to the King of Italy. As it was in Italian, and as Mr Marconi's assistant at Bournemouth had no knowledge of that language, it may be taken as a severe test—as, in fact, a code message. The telegram was received exactly as it was sent. Previously, we had a display for the ‘Electrical Review’ and the ‘Times,’ both of which papers sent representatives. They put the system to every possible test, and, among others, sent a long code message, which had to be repeated back. In their reports they stated that this was done exactly as sent.

[In May Lloyd's desired to have an illustration of the possibility of signalling between Ballycastle and Rathlin Island in the north of Ireland. The distance between the two positions is seven and a half miles, of which about four are overland and the remainder across the sea, a high cliff

also intervening between the two positions. At Ballycastle a pole 70 feet high was used to support the wire, and at Rathlin a vertical conductor was supported by the lighthouse 80 feet high. Signalling was found quite possible between the two points, but it was thought desirable to bring the height of the pole at Ballycastle to 100 feet, as the proximity of the lighthouse to the wire at Rathlin seemed to diminish the effectiveness of that station. At Rathlin we found that the lighthouse-keepers were not long in learning how to work the instruments, and after the sad accident which happened to poor Mr Glanville, that installation was worked by them alone, there being no expert on the island at the time.^{1]}

“Following this, in July last (1898) we were requested by a Dublin paper, the ‘Daily Express,’ to report the Kingstown regatta. In order to do this we erected a [land] station at Kingstown, and another on board a steamer which followed the yachts. A telephone wire connected the Kingstown station with the ‘Daily Express’ offices, and as the messages came from the ship they were telephoned to Dublin and published in successive editions of the evening papers.²

“After this, Mr Marconi was requested to put up a station at Osborne to connect with the Prince of Wales’ yacht Osborne. Bulletins of the Prince’s health (his Royal Highness, as we all know, met with a lamentable accident just before then) were reported to her Majesty: not only that, but the royalties made great use of our system during the Cowes week. After the regatta had concluded the Prince

¹ Mr Glanville, a promising young electrician (only twenty-five years old), was missing from Saturday to the Tuesday evening following, when his body, terribly mutilated, was found at the foot of a cliff 300 feet high in Rathlin Island.

² Very full illustrated accounts of this remarkable experiment are given in the Dublin ‘Mail,’ July 20, 21, and 22, 1898.

wished to cruise about, and he did so as far as Bembridge on one occasion. The next day they went over to the Needles, at the opposite side of the Isle of Wight. The royal yacht was kept in telegraphic communication with the Osborne station on the first day. On the second occasion they were able not only to communicate with Osborne, but also with our station at the Needles Hotel. They rang up the Needles Hotel when seven or eight miles away, and immediately had a reply, although about the highest land in the Isle of Wight lay between the royal yacht and the Needles Hotel station.

“Within the last few days we have had to move our station at Bournemouth four miles farther west, where we have put up the same instruments, the same pole, and everything at the Haven Hotel, Poole, which is eighteen miles from Alum Bay. This increase of distance has no detrimental effect on our work; in fact it seems rather easier, if anything, to receive signals at the Haven Hotel than at our former station: thus, the height of the conductor at Bournemouth was 150 feet, but this is now reduced to 100 feet, which is a very great improvement.¹

[The vertical conductors are stranded $\frac{7}{32}$ copper wire insulated with india-rubber and tape. A 10-inch spark induction coil is used at each station, worked by a battery of 100 Obach cells M size, the current taken by the coil being 14 volts of from 6 to 9 ampères. The sparks take place between two small spheres about 1 inch diameter, this form of transmitter having been found more simple and more effective than the Righi exciter previously used. The length of spark is adjusted to about 1 centimetre, which, being much shorter than the coil can give, allows a large margin for any irregularity that may occur. No care is now taken to polish the spheres at the place where the

¹ The height has since been reduced to 60 feet.

sparks occur, as working seems better with dull spheres than with polished ones.]

"We have sent our assistants to various countries to make demonstrations in connection with our patent rights; and lately we sent one of our staff to Malta, where some excellent experiments were carried out for the Government officials.

"The Marconi invention is the only (electric) telegraph by means of which a moving object can be kept in communication with any other moving object, or a fixed station, and therefore any one can see the great use of the invention, not only to the Royal Naval authorities, but also to the mercantile marine. A ship fitted with Mr Marconi's apparatus can not only keep in telegraphic communication with the shore up to any reasonable distance—it has been thoroughly tested up to twenty-five miles off the shore—but ships can also, if properly equipped, be warned of approaching danger or their proximity to dangerous coasts which are fitted with the wireless apparatus.¹

"The weather has no effect—at any rate no adverse

¹ I fear the apparatus is not yet adapted for this. Take the case of an outlying rock lighthouse. As the electric waves would radiate in all directions, a ship in darkness or a fog could not say from the intercepted rays what her position was, whether north, south, east, or west of the lighthouse, which may be a matter of vital importance for her.

By reverting, however, to the original form of the apparatus (discarding vertical wires), and by revolving a metallic screen about the detector until the position of maximum effect is obtained, the ship could possibly fix the direction whence come the rays. But this, though important, is not enough. As the ship does not know her distance from the rock, it does not tell her enough as to her exact position. The distance might possibly be ascertainable if the detector could be calibrated to varying degrees of electric energy—a very great difficulty.

effect. The only thing we find is that on a foggy day, when a place is obscured, everything is made easier for us. Our worst electrical day is a fine, bright, sunny day in July, when everything can be seen; but directly everything becomes obscured the facilities of wireless telegraphy are increased. I had a telegram handed to me just as I came in, querying if the Government or the Post Office were not, as has been reported, trying to stop us. So far from that being the case, they have actually requested us to put the system up between Guernsey and Sark, and they have offered us a post office at each end for the instruments. That matter is occupying our attention, and we shall go on with it at once. Also, as we wish to work the thing in France as well as in England, we now intend to put up a station between Calais and Dover. There is not the least doubt of success being achieved, because we are doing a parallel distance to-day without the slightest difficulty. The sea between Calais and Dover is the same sea as between the Isle of Wight and Poole, so the things being equal in both cases we may expect the same success between Calais and Dover as between the other points."

[In December of last year the Company thought it desirable to demonstrate that the system was available for telegraphic communication between lightships and the shore. This, as you are aware, is a matter of much importance, as all other systems tried so far have failed, and the cables by which ships are connected are exceedingly expensive, and require special moorings and fittings, which are troublesome to maintain and liable to break in storms. The officials of Trinity House offered us the opportunity of demonstrating to them the utility of the system between the South Foreland Lighthouse and one of the following light-vessels—viz., the Gull, the South Goodwin, and the East Goodwin. We naturally chose the one farthest away—the East Good-

win—which is just twelve miles from the South Foreland Lighthouse.

[The apparatus was taken on board in an open boat and rigged up in one afternoon. The installation started working from the very first, December 24, without the slightest difficulty. The system has continued to work admirably through all the storms, which during this year have been remarkable for their continuance and severity. On one occasion, during a big gale in January last, a very heavy sea struck the ship, carrying part of her bulwarks away. The report of this mishap was promptly telegraphed to the superintendent of Trinity House, with all details of the damage sustained.

[The height of the wire on board the ship is 80 feet, the mast being for 60 feet of its length of iron, and the remainder of wood. The aerial wire is led down among a great number of metal stays and chains, which do not appear to have any detrimental effect on the strength of the signals. The instruments are placed in the aft-cabin, and the aerial wire comes through the framework of a skylight, from which it is insulated by means of a rubber pipe. As usual, a 10-inch coil is used, worked by a battery of dry cells, the current taken being about 6 to 8 ampères at 14 volts.

[Various members of the crew learned in two days how to send and receive, and in fact how to run the station ; and owing to the assistant on board not being as good a sailor as the instruments have proved to be, nearly all the messages during very bad weather are sent and received by these men, who, previous to our visit to the ship, had probably never heard of wireless telegraphy, and were certainly unacquainted with even the rudiments of electricity. It is remarkable that wireless telegraphy, which had been considered by some as rather uncertain, or that might work one

day and not the next, has proved in this case to be more reliable, even under such unfavourable conditions, than the ordinary land wires, very many of which were broken down in the storms of last month.¹

[The instruments at the South Foreland Lighthouse are similar to those used on the ship; but as we contemplate making some long-distance tests from the South Foreland to the coast of France, the height of the pole is much greater than would be necessary for the lightship installation alone.²]

It has been objected to the Marconi system that, with the removal of the reflectors and the resonance wings on the detectors, the condition of privacy in telegrams no longer holds good, since any one provided with the necessary apparatus can receive the signals at any point within the circle of which the sending station is the centre and the receiving station the radius. Another, and in some cases more serious, objection is that any one by erecting a wire or wires in the vicinity of a Marconi station can propagate therefrom Hertzian waves, which by interference will so confuse the effects as to make correct signalling impracticable. It is not even necessary to propagate counter-waves: a large sheet of metal (or several such sheets) erected high in air, in line with the stations, and connected by a wire to the earth, will intercept much of the energy, and the more so as it is near to either of the stations, and at right angles to the direction of the waves. Thus, if used for naval or military purposes, an enemy could either tap the dispatches or render them unintelligible at pleasure. The latter objection is from the nature of things unavoidable, and in

¹ *Pace* Mr Marconi, the system is affected by stormy weather. See p. 218 *ante*; also 'Jour. Inst. Elec. Eng.,' No. 137, p. 945.

² This has since been done. See all the London papers of March 29 and 30, 1899.

practice must limit the application of the system to lines of communication sufficiently apart as not to interfere with one another. The first objection, however, can be obviated by reverting to the condition of syntony or resonance, and it is in this direction that improvements may soon be expected.¹

Dr Oliver Lodge, F.R.S., the distinguished Professor of Physics, University College, Liverpool, and the great disciple and expounder of Hertz in England, has long been engaged on this problem of a Hertzian-wave telegraph—more especially with a view of securing syntony in the sending and receiving apparatus, and thereby limiting the communications to similarly attuned instruments, the absence of which selective character is at present one of the great drawbacks of the Marconi system.

We have seen (p. 200, *ante*) that as early as June 1, 1894, Prof. Lodge had exhibited apparatus which was effective for signalling on a small scale, but, as he says, “stupidly enough no attempt was then made to apply any but the feeblest power, so as to test how far the disturbance could really be detected. . . . There remained, no doubt, a number of points of detail, and considerable improvements in construction, if the method was ever to become practically useful.”² These he has since worked out, and some of

¹ Indeed we already hear of radical changes. Mr Pasqualini, who is charged with the working of the Marconi system under the Italian Government, is reported to have found that electrical oscillations do not entirely explain the process, and, following out his idea, has altered the apparatus greatly. He is able to signal with certainty over a distance of twenty-four miles “with apparatus that requires no attention, and is not erratic like Marconi’s” (‘Electrical Engineer,’ April 7, 1899). Then, news comes from Vienna that Mr Bela Schäfer, a student of the Buda-Pesth Polytechnic, has so altered the Marconi apparatus that he is able to determine the presence and course of a ship six to eight miles distant.

² The Work of Hertz, pp. 67, 68.

them are embodied in his patent, No. 11,575, of May 10, 1897, "Improvements in Syntonised Telegraphy without Line Wires."

As capacity areas, spheres or square plates of metal may be employed; but for the purpose of combining low resistance with large electro-static capacity, cones or triangles are preferred, with the vertices adjoining and their larger areas spreading out into space. Or a single insulated surface may

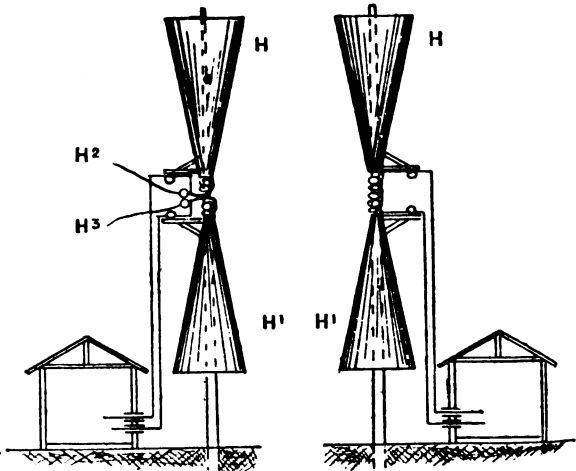

Fig. 43.

be used in conjunction with the earth—the earth, or conductors embedded in it, constituting the other capacity area. As radiation from these surfaces is greater in the equatorial than in the axial direction, so, when signalling in all directions is desired, the axis of the emitter should be vertical. Moreover, radiation in a horizontal plane is less likely to be absorbed during its passage over partially conducting earth or water.

Fig. 43 shows the arrangement for long-distance signalling.

$H H^1$ are large triangular sheets of metal, which by means of suitable switches (not shown) can be connected to the sending or the receiving apparatus as desired. Those on the left-hand side of the figure are shown in connection with polished knobs $H^2 H^3$ (protected by glass from ultra-violet light), which form the adjustable spark-gap of the exciter. Between each capacity area and its knob is inserted a self-inductance coil of thick wire or metallic ribbon (see H^4 , fig. 44) suitably insulated, the object of which is to prolong the electrical oscillations in a succession of waves, and thereby obtain a definite frequency or pitch, rendering syntony possible, since exactitude of response depends on the fact that with the emission of a number of successive waves the feeble impulse at the receiving station is gradually strengthened till it causes a perceptible effect, on the well-known principle of sympathetic resonance.

The capacity areas and inductance coils are exactly alike at the two communicating stations, so as to have the same frequency of electrical vibration. This frequency can be altered either by varying the capacity of the Leyden jars used in the exciting circuit, or by varying the number and position of the inductance coils, or by varying both in the proper degree, thus permitting only those stations whose rate of oscillation is the same to correspond.

To actuate the exciter a Ruhmkorff coil may be used, or a Tesla coil, a Wimshurst machine, or any other high tension apparatus.

Fig. 44 shows the details of the arrangement for exciting and detecting the electric waves. When used as a transmitter the receiving circuit is disconnected from the capacity areas by a suitable switch (not shown). Let us first consider the arrangement as a transmitter. Putting the Ruhmkorff coil A in action, it charges the Leyden jars $J J$, whose outer coatings are connected, first, through a self-inductance

coil H^5 of fairly thin wire, so as to permit of thorough charging of the jars; and, second, to the "supply gaps" H^6 H^7 . When the jars are fully charged to sparking-point, sparks occur at the "starting-gap" H^8 . These precipitate sparks at the "supply gaps," which evoke electrical charges in the capacity areas H^1 . These charges surge through the inductance coils H^4 , and spark into each other across the "discharge gap" between the knobs H^2 H^3 . This last

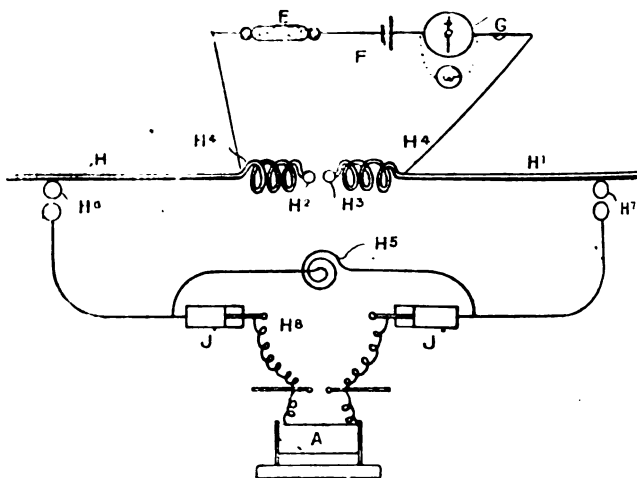

Fig. 44.

discharge, according to Prof. Lodge, is the chief agent in starting the oscillations which are the cause of the emitted waves; but it is permissible to close the "discharge gap," and so leave the oscillations to be started by the sparks at the "supply gaps" only, whose knobs must then be polished and protected from ultra-violet light, "so as to supply the electric charge in as sudden a manner as possible."

When used as a receiver the "discharge-gap" is bridged over by a suitable cut-out, and connection is made with the

receiving circuit, as shown on the top of fig. 44. As detector, Lodge uses—

1. His own original form of coherer, fig. 45, wherein a metallic point *N* rests lightly on a flat metallic surface *o* (for instance, a needle point of steel or platinum making light contact with a steel or aluminium bar like a watch spring), fixed at one end *P*, and delicately adjustable by a micrometer screw *Q*, so as to regulate the pressure at the point *N*. Or—

2. A Branly tube filled with selected iron filings of

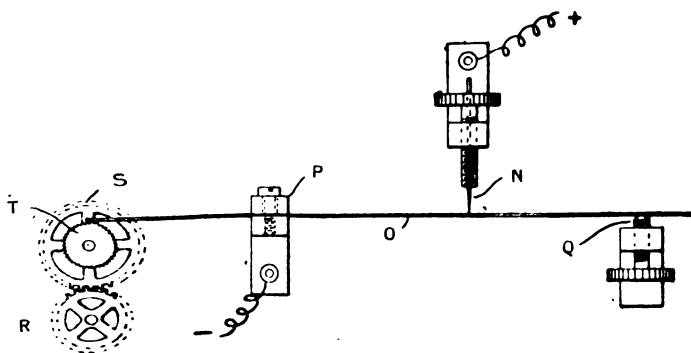

Fig. 45.

uniform size, sealed up in a good vacuum, and with the electrodes, which are of platinum, reduced to points a short distance apart.

His latest form of the Branly coherer is shown full size in fig. 46, and is said to be exceedingly sensitive and certain in its action, especially in a very high vacuum. *A A* is a glass tube held tightly by ebonite supports *B B*; *C* is a pocket or reservoir for spare filings, which can be added to, or taken from, the effective portion as required by inverting the tube; *D D* are the *silver* electrodes immersed in the filings, which are, as before, of carefully selected iron of

uniform size as nearly as possible ; E is one of the terminals of the silver electrodes, the other of which is hidden from view.

The instrument is secured by the clamp screw F to any convenient support, to which the tapping or decohering apparatus is applied.¹

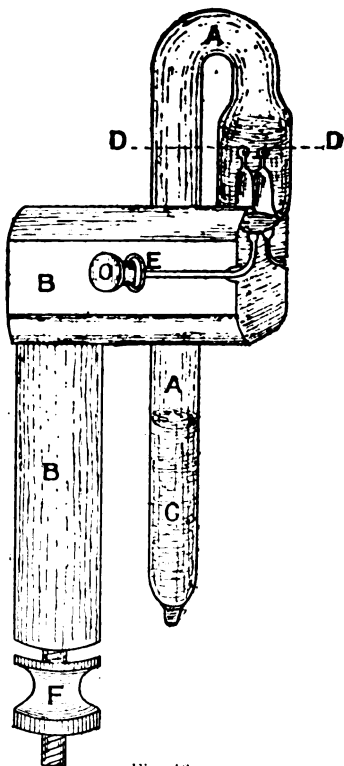

Fig. 46.

When an electric wave from a distant exciter arrives and stimulates electric vibrations in the syntonised capacity areas, the electrical resistance of the coherer suddenly and greatly falls and permits the small battery F, fig. 44, to actuate a relay G, or a telephone, or other telegraphic instrument.

To break contact, or to restore the original great resistance of the coherer, any form of mechanical vibration suffices, as a clock, or a tuning-fork, or a cog-wheel (as in fig. 45), or other device for causing a shake or tremor, and kept in

motion by a spring, or weight, or by electrical means.

¹ It appears that to Professor Blondel is due the credit of first constructing a coherer of this kind in August 1898. See the 'Electrician,' vol. xliii. p. 277.

Indeed, the mere motion of any clockwork attached to the coherer stand will suffice, an exceedingly slight, almost imperceptible, tremor being all that is usually required.

Usually the coherer is arranged in simple series with the battery and telegraphic instrument, and is so joined to the capacity areas as to include in its circuit the self-inductance coils—an arrangement which Prof. Lodge considers of great advantage, or, as he says, “an improvement on any mode of connection that had previously been possible without these coils.”

The patent specification figures and describes another way—viz., enclosing the inductance coils in an outer or secondary coil (constituting a species of transformer), and making this coil part of the coherer circuit. In this case the coherer is stimulated by the waves in the secondary coil rather than primarily by those in the inductance coils, which with their capacity areas are thus left free to vibrate without disturbance from attached wires.

In all cases it is permissible, and sometimes desirable, to shunt the coils of the telegraphic instrument G by means of a fine wire or other non-inductive resistance coil w , “in order to connect the coherer more effectively and closely to the capacity areas.”

At the Royal Society *Conversazione* on May 11, 1898, a complete set of Lodge's apparatus was shown in action, in which certain modifications in the signalling and recording parts were introduced at the suggestion of Dr Alexander Muirhead. Instead of the ordinary Morse key, Muirhead's well-known automatic transmitter with punched tape was employed at one end of the suite of rooms, and a siphon-recorder as the receiving instrument at the other end. The recorder was so arranged as to print, not as usually zigzag traces, but (the needle working between stops) a momentary

deflection mark for a dot and a longer continued mark for a dash.

The siphon-recorder is so quick in its responses that it indicates each one of the torrent of sparks emitted from the sending apparatus : hence a dash is not merely a deflection held over, but is made up of a series of minute vibrations ; and even a dot is seen to consist of similar vibrations, though of course of a lesser number. If the speed of signalling is slow and the recorder tape moves slowly, these vibrations appear as actual dots and dashes ; but each signal, when examined with a microscope, is seen to consist of a short or long series of lines representing the constituent vibrations.

At a slow rate of working the signals can thus be got with exceeding clearness ; but for actual signalling this is not at all necessary, and it is possible to attain a high speed, making such brief contacts that a single deflection of the recorder needle indicates a dot, and three consecutive deflections a dash. The paper thus marked does not look like the ordinary record, but more resembles the original Morse characters as depicted on pp. 404 and 409 of Shaffner's 'Telegraph Manual' (New York, 1859), and is easily legible with a little practice.

An ordinary telephone was also available as a receiver, connected through a transformer coil, in which the dots and dashes were heard very clearly and distinctly.

The apparatus is reported to have worked well (except at the high speeds, when it occasionally missed fire), and did not seem to be in the least affected by any of the numerous electrical exhibits in the neighbourhood, although some of them must have set up considerable radiation of Hertzian waves.

Based on the same principles—viz., the emission of electric waves at one place and their detection by some

form of coherer at another place—there is naturally a similarity in the outlines of the Lodge system and that of Marconi for short distances (where vertical wires are not used), as depicted in fig. 39, *ante*. The differences are differences of arrangement and detail only, but they appear to be fraught with some important consequences.

In the first place, Prof. Lodge claims that his arrangement of the sending apparatus is a more persistent exciter, in that it emits a longer train of longer waves,¹ which by acting cumulatively on the detector breaks down its insulation, when more powerful but fewer impulses of shorter waves might be inoperative. Then in the next place, this element of persistency permits of the use of syntonising contrivances, by means of which the rate of oscillation of any desired set of instruments can be accurately attuned so that only these instruments can correspond, without affecting or being affected by other sets tuned to a different frequency, thus securing the undoubted advantage of privacy in the communications.

Lodge's arrangement has worked well in the laboratory and lecture-room, but he does not appear to have tried it (which is a pity) over any considerable distance, so that it remains to be seen how far he can go without having recourse to vertical wires, which Marconi finds so essential for practical work over distances of more than two or three miles.²

A few words as to the future, by way of conclusion, and our task is completed. On this point we find some recent remarks of Prof. Silvanus Thompson so appropriate that we quote them in full, as being more authoritative than anything

¹ For some important observations on this point see Mr A. Campbell Swinton, 'Jour. Inst. Elec. Engs.,' No. 139, p. 317.

² For Professor Lodge's newest developments see his paper, 'Jour. Inst. Elec. Engs.,' No. 137, p. 799, which deserves careful study.

we could ourselves say. Prof. Thompson has thoroughly studied the subject, and therefore "speaks by the card."

"It has been shown," he says, "that there are three general methods of transmitting electric signals across space. All of them require base lines or base areas. The first—conduction—requires moist earth or water as a medium, and is for distances under three miles the most effective of the three. The second—induction—is not dependent upon earth or water, but will equally well cross air or dry rock. The third—electric wave propagation—requires no medium beyond that of the ether of space, but is interfered with by interposed things such as masts or trees. Given proper base lines or base areas, given adequate methods of throwing electric energy into the transmitting system, and sufficiently sensitive instruments to pick up and translate the signals, it is possible, in my opinion, so to develop each of the three methods that by any one of them it will be possible to establish electric communication between England and America across the intervening space. It is certainly possible, either by conduction or by induction; whether by waves I am somewhat less certain. Conduction might very seriously interfere with other electric agencies, since the waste currents in the neighbourhood of the primary base line would be very great. It is certainly possible either by conduction or induction to establish direct communication across space with either the Cape, or India, or Australia (under the same assumptions as before), and at a far less cost than that of a connecting submarine cable.

"Instruments which operate by means of alternating currents of high frequency, like Mr Langdon-Davies's phonophore, are peculiarly liable to set up disturbance in other circuits. A single phonophore circuit can be heard in lines a hundred miles away. When this first came to my notice it impressed me greatly, and coupled in my mind with the

Ferranti incident mentioned above" (see note, p. 145, *ante*), "caused me to offer to one of my financial friends in the City, some eight years ago, to undertake seriously to establish telegraphic communication with the Cape, provided £10,000 were forthcoming to establish the necessary basal circuits in the two countries, and the instruments for creating the currents. My offer was deemed too visionary for acceptance. The thing, however, is quite feasible. The one necessary thing is the adequate base line or area. All the rest is detail."¹

En attendant, we have the Marconi system, which has been proved to be practicable up to thirty-five miles, and within this limit there ought to be a wide and useful field for activity. Thus, many outlying islands are within this distance from each other and from the continents, with which communication at *all* times has hitherto been practicable only by the use of cables, which are always costly to make and lay, and often costly to keep in repair. Here, especially between places where the traffic is not great, is a large field to be occupied as cables grow old and fail.

Then we have just seen from the address of the chairman of the Wireless Telegraph Company that negotiations are going on with Lloyd's which, if carried into practical effect, will result in an extensive application for signalling between Lloyd's stations and outward and inward bound vessels passing in their vicinity. Indeed it is not rash to predict that the lighthouses and lightships around the coasts, not only of the British Isles but of all countries, will in time be supplied with wireless telegraphs, keeping up constant correspondence with all who go down to the sea in ships. Then, again, there is the application to intercommunication between ships at sea. Ships carrying the Marconi apparatus can carry on a definite conversation with the occu-

¹ Journal, Society of Arts, April 1, 1898.

pants of lighthouses and lightships and with each other. It will readily be seen that this might, in many cases, be far more serviceable than the few light signals now obtainable, or the signalling by flags—a tedious process at best, and one that is often full of uncertainty, if not of positive error.

Turning from sea to land, we find, for the reasons we have already indicated, a more circumscribed field of application—at all events until means are devised for focusing the electric rays and rendering the apparatus syntonie. But even then, although by these means we will be able to record messages only where intended, there still remain cross interferences of which I fear we can never be rid, and therefore we can never use the system in a network of lines as now, where wires cross, recross, and overlap each other in all ways and directions. The waves of electricity, like waves of light and sound in similar circumstances, would so interfere with each other that the result would be chaos. Therefore wireless telegraphy can only be used in lines removed from each other's disturbing influences, as in sparsely populated countries and undeveloped regions.

However, many cases of impromptu means of communication arise where, as Prof. Lodge says, it might be advantageous to "shout" the message, spreading it broadcast to receivers in all directions, and for which the wireless system is well adapted, seeing that it is so inexpensive and so easily and rapidly installed,—such as for army manœuvres, for reporting races and other sporting events, and, generally, for all important matters occurring beyond the range of the permanent lines.

But for the regular daily correspondence of a nation with its lines ramifying in all directions and carrying enormous traffics, the Marconi system is not adapted, no more than any other wireless method that has been

proposed, or is likely to be invented. So, for a long time to come we must keep to our present telegraphic and telephonic wires, using the wireless telegraph as an adjunct for special cases and contingencies such as I have mentioned.

POSTSCRIPT.

April 17, 1899.

On the 27th of last month communication was established by the Marconi system between England and France. As all the London daily papers of March 29 and 30 contain full and glowing accounts of this installation, it may not be necessary to do more than to refer my readers to these reports. Still I think it desirable, so as to bring my record quite up to date, to add these few words as the book is passing through the press.

“On this side of the Channel the operations took place, by permission of the Trinity House, in a little room in the front part of the engine-house from which the power is derived for the South Foreland lighthouses. The house is on the top of the cliffs overlooking the Channel. The demonstrations are being conducted for the benefit of the French Government, who have the system under observation, and besides Signor Marconi there were present at the Foreland yesterday Colonel Comte du Bontavice de Heussey, French Military Attaché in England; Captain Ferrie, representing the French Government; and Captain Fieron, French Naval Attaché in England. During the afternoon a great number of messages in French and English crossed and recrossed between the little room at the South Foreland and the Châlet D'Artois, at Wimreux, near Boulogne.

“The whole of the apparatus stood upon a small table about 3 feet square, in the centre of the room. Underneath the table the space was fitted with about fifty primary cells; a

10-inch induction coil occupied the centre of the table. The spark is $1\frac{1}{2}$ centimetre long, or about three-quarters of an inch; the pole off the top of which the current went into space is 150 feet high. The length of spark and power of current were the same as used for communication with the East Goodwin lightship, a fact which seems remarkable when it is considered that the distance over which the messages were sent yesterday was nearly three times as great. The greater distance is compensated for by the increased height of the pole.

“Throughout the whole of the messages sent yesterday there was not once a fault to be detected—everything was clearly and easily recorded. The rate of transmission was about fifteen words a minute.”¹

The first international press message sent by the new system was secured by the ‘Times,’ and is as follows:—

“(From our Boulogne Correspondent.)

“WIMREUX, March 28.

“Communication between England and the Continent was set up yesterday morning by the Marconi system of wireless telegraphy. The points between which the experiments are being conducted are South Foreland and Wimreux, a village on the French coast two miles north of Boulogne, where a vertical standard wire, 150 feet high, has been set up. The distance is thirty-two miles. The experiments are being carried on in the Morse code. Signor Marconi is here conducting the trials, and is very well satisfied with the results obtained.

“This message has been transmitted by the Marconi system from Wimreux to the Foreland.”

Other demonstrations (for Mr Marconi will no longer

¹ The Daily Graphic, March 30, 1899.

permit us to call them "experiments"—and rightly) are now contemplated, as between Newhaven and Dieppe, sixty-four miles ; between Nice and Cape Corso in Corsica, over a hundred miles ; between the South Foreland and the Eiffel Tower, about 230 miles ; and, finally, between England and America, which, as shown in the First Period of this history, was the dream of the earliest experimenters in wireless telegraphy.

A press telegram of April 12 says : "The Wireless Telegraph Company have been approached by the representative of a proposed syndicate which desires to acquire the sole rights of establishing wireless telegraphic communication between England and America. The directors of the Company will consider the matter at their first meeting, which is fixed for an early date."

Thus I end my task as I began it, with a dream—the self-same dream ! As to its realisation in the distant future who can say nay ?

"There are more things in heaven and earth, Horatio,
Than are dreamt of in our philosophy."

In conclusion, I give a few extracts from a letter (the 'Times,' April 3, 1899) of Prof. Fleming of the University College, London. Prof. Fleming is an expert in electrical science, and therefore his views may be taken as representing the last word on our subject :—

To the Editor of the 'Times.'

"SIR,—During the last few days I have been permitted to make a close examination of the apparatus and methods being employed by Signor Marconi in his remarkable telegraphic experiments between South Foreland and Boulogne, and at the South Foreland lighthouse have been allowed by

Q

the inventor to make experiments and transmit messages from the station there established both to France and to the lightship on the Goodwin Sands, which is equipped for sending and receiving ether wave signals. Throughout the period of my visit messages, signals, congratulations, and jokes were freely exchanged between the operators sitting on either side of the Channel, and automatically printed down in telegraphic code signals on the ordinary paper slip at the rate of twelve to eighteen words a minute. Not once was there the slightest difficulty or delay in obtaining an instant reply to a signal sent. No familiarity with the subject removes the feeling of vague wonder with which one sees a telegraphic instrument merely connected with a length of 150 feet of copper wire run up the side of a flagstaff begin to draw its message out of space and print down in dot and dash on the paper tape the intelligence ferried across thirty miles of water by the mysterious ether. . . .

“I cannot help thinking that the time has arrived for a little more generous appreciation by his scientific contemporaries of the fact that Signor Marconi has by minute attention to detail, and by the important addition of the long, vertical air wire, translated one method of space telegraphy out of the region of uncertain delicate laboratory experiments and placed it on the same footing as regards certainty of action and ease of manipulation, so far as the present results show, as any of the other methods of electric communication employing a continuous wire between the two places. This is no small achievement. The apparatus, moreover, is ridiculously simple and not costly. With the exception of the flagstaff and 150 feet of vertical wire at each end, he can place on a small kitchen table the appliances, costing not more than £100 in all, for communicating across thirty or even a hundred miles of channel. . . .

“In the presence of the enormous practical importance

of this feat alone, and of the certainty with which communication can now be established between ship and shore without costly cable or wire, the scientific criticisms which have been launched by other inventors against Signor Marconi's methods have failed altogether in their appreciation of the practical significance of the results he has brought about.

"The public, however, are not in the least interested in learning the exact meed of merit to be apportioned to various investigators in the upbuilding of this result. They do, however, want to know whether the new method of communication across the Channel established by the expenditure of a few hundred pounds will take the place to any considerable extent of submarine cables which have cost many thousands of pounds to lay and equip. They do also desire to learn what reasons, if any, will prevent every lighthouse and lightship round our coasts from being forthwith furnished with the necessary apparatus for placing it in instantaneous and secure connection with the mainland. They also hope to hear that the methods can be applied to enable ships to be able in addition to communicate instantly, in case of need, with shore stations. To understand how far these things can be done, and to appreciate the necessary or present limitations of the method, it is requisite to explain that each vertical wire or rod connected to a Marconi receiving or sending apparatus has a certain 'sphere of influence.' Signor Marconi has proved by experiment up to certain limits that the distance to which effective signalling extends varies as the square of the height of the rod. A wire 20 feet high carries the effective signal one mile, 40 feet high four miles, 80 feet sixteen miles, and so on. Up to the present time he has not yet discovered any method of shielding any particular rod so as to render it responsive only to signals coming from one station, and not from all

others within its sphere of influence. In spite, however, of what has been said, there is no inherent impossibility in attaining this desired result. At present all signals sent from the South Foreland to France affect the receiver on board the Goodwin lightship. But this offers no difficulty. In an ordinary electric bell system in a hotel the servant recognises the room from which the signal comes by means of a simple apparatus called an indicator, and a very similar arrangement can be applied to distinguish the origin of an ether wave signal when several instruments are at work in a common region. Subsequent inventions, as also, perhaps, the promulgation of some necessary Board of Trade regulations for the use of the ether, will prevent official ether wave receivers from being disturbed by vagrant electric waves sent out by unauthorised persons in their neighbourhood. The practical upshot, however, of the matter is that at present if more than two stations are not established within certain regions, these stations, pair and pair, can communicate with each other freely and regularly by means of ether wave signals sent out and received by long vertical rods or wires. No state of the atmosphere, and neither darkness nor storm, interrupts, so far as yet found, the freedom of communication.

“Up to the present time none of the other systems of wireless telegraphy employing electric or magnetic agencies has been able to accomplish the same results over equal distances. Without denying that much remains yet to be attained, or that the same may be affected in other ways, it is impossible for any one to witness the South Foreland and Boulogne experiments without coming to the conclusion that neither captious criticism nor official lethargy should stand in the way of additional opportunities being afforded for a further extension of practical experiments. Wireless telegraphy will not take the place of telegraphy with wires

—each has a special field of operations of its own. But the public have a right to ask that the fullest advantage shall be taken of that particular service which ether wave telegraphy can now render in promoting the greater safety of those at sea ; and that, in view of our enormous maritime interests, this country shall not permit itself to be outraced by others in the peaceful contest to apply the outcome of scientific investigations and discoveries in every possible direction to the service of those who are obliged to face the perils of the sea. If scientific research has forged a fresh weapon with which in turn to fight Nature, 'red in tooth and claw,' all other questions fade into insignificance in comparison with the inquiry how we can take the utmost advantage of this addition to our resources.—I am, &c.,

“J. A. FLEMING.

“UNIVERSITY COLLEGE, LONDON.”

APPENDIX A.

THE RELATION BETWEEN ELECTRICITY AND LIGHT
—BEFORE AND AFTER HERTZ.*Before Hertz.*

SUBSTANCE of a lecture by Prof. Oliver Lodge, London Institution, December 16, 1880.¹

Ever since the subject on which I have to speak to-night was arranged, I have been astonished at my own audacity in proposing to deal, in the course of sixty minutes, with a subject so gigantic and so profound that a course of sixty lectures would be inadequate for its thorough and exhaustive treatment. I must, therefore, confine myself to some few of the most salient points in the relation between electricity and light, and I must economise time by plunging at once into the middle of the matter without further preliminary.

What *is* electricity? We do not know. We cannot assert that it is a form of matter; neither can we deny it. On the other hand, we cannot certainly assert that it is a form of energy; and I should be disposed to deny it. It may be that electricity is an entity *per se*, just as matter is an entity *per se*. Nevertheless, I can tell you what I mean by electricity by appealing to its known behaviour.

Here is a voltaic battery. I want you to regard it, and all electrical machines and batteries, as kinds of electricity-pumps, which drive the electricity along through the wire very much as a water-pump can drive water along pipes.

¹ Based on a report in 'Design and Work,' February 5, 1881.

While this is going on, the wire manifests a whole series of properties, which are called the properties of the current.

[Here were shown an ignited platinum wire, the electric arc between two carbons, an electric machine spark, an induction coil spark, and a vacuum tube glow. Also a large nail was magnetised by being wrapped in the current, and two helices were suspended and seen to direct and attract each other.]

To make a magnet, then, we only need a current of electricity flowing round and round in a whirl. A vortex or whirlpool of electricity is in fact a magnet, and *vice versa*. And these whirls have the power of directing and attracting other previously existing whirls according to certain laws, called the laws of magnetism. And, moreover, they have the power of exciting fresh whirls in neighbouring conductors, and of repelling them according to the laws of diamagnetism. The theory of the actions is known, though the nature of the whirls, as of the simple streams of electricity, is at present unknown.

[Here was shown a large electro-magnet and an induction-coil vacuum discharge spinning round and round when placed in its field.]

So much for what happens when electricity is made to travel along conductors—*i.e.*, when it travels along like a stream of water in a pipe, or spins round and round like a whirlpool.

But there is another set of phenomena, usually regarded as distinct and of another order, but which are not so distinct as they appear, which manifest themselves when you join the pump to a piece of glass or any non-conductor and try to force the electricity through that. You succeed in driving some through, but the flow is no longer like that of water in an open pipe; it is as if the pipe were completely obstructed by a number of elastic partitions or diaphragms. The water cannot move without straining and bending these diaphragms, and if you allow it, these strained partitions will recover themselves and drive the water back again. [Here was explained the process of charging a Leyden jar.] The essential thing to remember is that we may have electrical energy in two forms, the static and the kinetic;

and it is therefore also possible to have the rapid alternation from one of these forms to the other, called vibration.

Now we will pass to the second question: What do you mean by light? And the first and obvious answer is, Everybody knows. And everybody that is not blind does know to a certain extent. We have a special sense-organ for appreciating light, whereas we have none for electricity. Nevertheless, we must admit that we really know very little about the intimate nature of light—very little more than about electricity. But we do know this, that light is a form of energy; and, moreover, that it is energy rapidly alternating between the static and the kinetic forms—that it is, in fact, a special kind of energy of vibration. We are absolutely certain that light is a periodic disturbance in some medium, periodic both in space and time—that is to say, the same appearances regularly recur at certain equal intervals of distance at the same time, and also present themselves at equal intervals of time at the same place; that, in fact, it belongs to the class of motions called by mathematicians undulatory or wave motions.

Now how much connection between electricity and light have we perceived in this glance into their natures? Not much truly. It amounts to about this: That on the one hand electrical energy may exist in either of two forms—the static form, when insulators are electrically strained by having had electricity driven partially through them (as in the Leyden jar), which strain is a form of energy, because of the tendency to discharge and do work; and the kinetic form, where electricity is moving bodily along through conductors, or whirling round and round inside them, which motion of electricity is a form of energy, because the conductors and whirls can attract or repel each other and thereby do work.

On the other hand, light is the rapid alternation of energy from one of these forms to the other—the static form where the medium is strained, to the kinetic form when it moves. It is just conceivable then that the static form of the energy of light is *electro-static*—that is, that the medium is *electrically* strained—and that the kinetic form of the energy of light is *electro-kinetic*—that is, that the motion is not ordinary motion,

but electrical motion—in fact, that light is an electrical vibration, not a material one.

On November 5 last year there died at Cambridge a man in the full vigour of his faculties—such faculties as do not appear many times in a century—whose chief work had been the establishment of this very fact, the discovery of the link connecting light and electricity, and the proof—for I believe that it amounts to a proof—that they are different manifestations of one and the same class of phenomena,—that light is, in fact, an electro-magnetic disturbance. The premature death of James Clerk Maxwell is a loss to science which appears at present utterly irreparable, for he was engaged in researches that no other man can hope as yet adequately to grasp and follow out; but fortunately it did not occur till he had published his book on 'Electricity and Magnetism,' one of those immortal productions which exalt one's idea of the mind of man, and which has been mentioned by competent critics in the same breath as the 'Principia' itself.

The main proof of the electro-magnetic theory of light is this: The rate at which light travels has been measured many times, and is pretty well known. The rate at which an electro-magnetic wave disturbance would travel, if such could be generated (and Mr Fitzgerald, of Dublin, thinks he has proved that it cannot be generated directly by any known electrical means), can be also determined by calculation from electrical measurements. The two velocities agree exactly.

The first glimpse of this splendid generalisation was caught in 1845, five-and-thirty years ago, by that prince of pure experimentalists, Michael Faraday. His reasons for suspecting some connection between electricity and light are not clear to us—in fact, they could not have been clear to him; but he seems to have felt a conviction that if he only tried long enough, and sent all kinds of rays of light in all possible directions across electric and magnetic fields in all sorts of media, he must ultimately hit upon something. Well, this is very nearly what he did. With a sublime patience and perseverance which remind one of the way Kepler hunted down guess after guess in a different field of research, Faraday combined electricity, or magnetism, and light in all manner of ways, and

at last he was rewarded with a result—and a most out-of-the-way result it seemed. First, you have to get a most powerful magnet, and very strongly excite it; then you have to pierce its two poles with holes, in order that a beam of light may travel from one to the other along the lines of force; then, as ordinary light is no good, you must get a beam of plane polarised light and send it between the poles. But still no result is obtained until, finally, you interpose a piece of a rare and out-of-the-way material which Faraday had himself discovered and made, a kind of glass which contains borate of lead, and which is very heavy or dense, and which must be perfectly annealed.

And now, when all these arrangements are completed, what is seen is simply this, that if an analyser is arranged to stop the light and make the field quite dark before the magnet is excited, then directly the battery is connected and the magnet called into action a faint and barely perceptible brightening of the field occurs, which will disappear if the analyser be slightly rotated. [The experiment was shown.] Now, no wonder that no one understood this result. Faraday himself did not understand it at all. He seems to have thought that the magnetic lines of force were rendered luminous, or that the light was magnetised; in fact he was in a fog, and had no idea of its real significance. Nor had any one. Continental philosophers experienced some difficulty and several failures before they were able to repeat the experiment. It was, in fact, discovered too soon, and before the scientific world was ready to receive it, and it was reserved for Sir William Thomson briefly, but very clearly, to point out, and for Clerk Maxwell more fully to develop, its most important consequences.

This is the fundamental experiment on which Clerk Maxwell's theory of light is based; but of late years many fresh facts and relations between electricity and light have been discovered, and at the present time they are tumbling in in great numbers.

It was found by Faraday that many other transparent media besides heavy glass would show the phenomenon if placed between the poles, only in a less degree; and the very important observation that air itself exhibits the same phenom-

enon, though to an exceedingly small extent, has just been made by Kundt and Röntgen in Germany.

Dr Kerr, of Glasgow, has extended the result to opaque bodies, and has shown that if light be passed through magnetised *iron* its plane is rotated. The film of iron must be exceedingly thin, because of its opacity; and hence, though the intrinsic rotating power of iron is undoubtedly very great, the observed rotation is exceedingly small and difficult to observe; and it is only by very remarkable patience and care and ingenuity that Dr Kerr has obtained his result. Mr Fitzgerald, of Dublin, has examined the question mathematically, and has shown that Maxwell's theory would have enabled Dr Kerr's result to be predicted.

Another requirement of the theory is that bodies which are transparent to light must be insulators or non-conductors of electricity, and that conductors of electricity are necessarily opaque to light. Simple observation amply confirms this. Metals are the best conductors, and are the most opaque bodies known. Insulators such as glass and crystals are transparent whenever they are sufficiently homogeneous, and the very remarkable researches of Professor Graham Bell in the last few months have shown that even *ebonite*, one of the most opaque insulators to ordinary vision, is certainly transparent to some kinds of radiation, and transparent to no small degree.

[The reason why transparent bodies must insulate, and why conductors must be opaque, was here illustrated by mechanical models.]

A further consequence of the theory is that the velocity of light in a transparent medium will be affected by its electrical strain constant; in other words, that its refractive index will bear some close but not yet quite ascertained relation to its specific inductive capacity. Experiment has partially confirmed this, but the confirmation is as yet very incomplete.

But there are a number of results not predicted by theory, and whose connection with the theory is not clearly made out. We have the fact that light falling on the platinum electrode of a voltameter generates a current, first observed, I think, by Sir W. R. Grove; at any rate it is mentioned in his 'Correlation of Forces'—extended by Becquerel and Robert Sabine to other substances, and now being extended to fluorescent and

other bodies by Professor Minchin. And finally—for I must be brief—we have the remarkable action of light on selenium. This fact was discovered accidentally by an assistant in the laboratory of Mr Willoughby Smith, who noticed that a piece of selenium conducted electricity very much better when light was falling upon it than when it was in the dark. The light of a candle is sufficient, and instantaneously brings down the resistance to something like one-fifth of its original value.

This is the phenomenon which, as you know, has been utilised by Professor Graham Bell in that most ingenious and striking invention, the photophone.

I have now trespassed long enough upon your patience, but I must just allude to what may very likely be the next striking popular discovery, and that is the transmission of light by electricity. I mean the transmission of such things as views and pictures by means of the electric wire. It has not yet been done, but it seems already theoretically possible, and it may very soon be practically accomplished.

THE RELATION BETWEEN ELECTRICITY AND LIGHT.

After Hertz.

Substance of a lecture by Prof. Oliver Lodge, Ashmolean Society, Oxford, June 3, 1889.¹

For now wellnigh a century we have had a wave-theory of light; and a wave-theory of light is certainly true. It is directly demonstrable that light consists of waves of some kind or other, and that these waves travel at a certain well-known velocity, seven times the circumference of the earth per second, taking eight minutes on the journey from the sun to the earth. This propagation in time of an undulatory disturbance necessarily involves a medium. If waves setting out from the sun exist in space eight minutes before striking our eyes, there must necessarily be in space some medium in which they exist and which conveys them. Waves we cannot have unless they be waves in something.

¹ Based on a report in the (London) 'Electrician,' September 6, 1889.

No ordinary medium is competent to transmit waves at anything like the speed of light; hence the luminiferous medium must be a special kind of substance, and it is called the ether. The *luminiferous* ether it used to be called, because the conveyance of light was all it was then known to be capable of; but now that it is known to do a variety of other things also, the qualifying adjective may be dropped.

Wave motion in ether light certainly is; but what does one mean by the term wave? The popular notion is, I suppose, of something heaving up and down, or perhaps of something breaking on the shore in which it is possible to bathe. But if you ask a mathematician what he means by a wave, he will probably reply that the simplest wave is

$$y = a \sin (p t - n x),$$

and he might possibly refuse to give any other answer. And in refusing to give any other answer than this, or its equivalent in ordinary words, he is entirely justified; that *is* what is meant by the term wave, and nothing less general would be all-inclusive.

Translated into ordinary English, the phrase signifies "a disturbance periodic both in space and time." Anything thus doubly periodic is a wave; and all waves—whether in air as sound waves, or in ether as light waves, or on the surface of water as ocean waves—are comprehended in the definition.

What properties are essential to a medium capable of transmitting wave motion? Roughly we may say two—*elasticity* and *inertia*. Elasticity in some form, or some equivalent of it, in order to be able to store up energy and effect recoil; inertia, in order to enable the disturbed substance to overshoot the mark and oscillate beyond its place of equilibrium to and fro. Any medium possessing these two properties can transmit waves, and unless a medium possesses these properties in some form or other, or some equivalent for them, it may be said with moderate security to be incompetent to transmit waves. But if we make this latter statement one must be prepared to extend to the terms elasticity and inertia their very largest and broadest signification, so as to include any possible kind of restoring force and any possible kind of persistence of motion respectively.

These matters may be illustrated in many ways, but perhaps

a simple loaded lath or spring in a vice will serve well enough. Pull aside one end, and its elasticity tends to make it recoil; let it go, and its inertia causes it to overshoot its normal position: both causes together cause it to swing to and fro till its energy is exhausted. A regular series of such springs at equal intervals in space, set going at regular intervals of time one after the other, gives you at once a wave motion and appearance which the most casual observer must recognise as such. A series of pendulums will do just as well. Any wave-transmitting medium must similarly possess some form of elasticity and of inertia.

But now proceed to ask what is this ether which in the case of light is thus vibrating? What corresponds to the elastic displacement and recoil of the spring or pendulum? What corresponds to the inertia whereby it overshoots its mark? Do we know these properties in the ether in any other way?

The answer, given first by Clerk Maxwell, and now reiterated and insisted on by experiments performed in every important laboratory in the world, is—

The elastic displacement corresponds to electro-static charge (roughly speaking, to electricity).

The inertia corresponds to magnetism.

This is the basis of the modern electro-magnetic theory of light. Now let me illustrate electrically how this can be.

The old and familiar operation of charging a Leyden jar—the storing up of energy in a strained dielectric—any electro-static charging whatever—is quite analogous to the drawing aside of our flexible spring. It is making use of the elasticity of the ether to produce a tendency to recoil. Letting go the spring is analogous to permitting a discharge of the jar—permitting the strained dielectric to recover itself, the electro-static disturbance to subside.

In nearly all the experiments of electro-statics ethereal elasticity is manifest.

Next consider inertia. How would one illustrate the fact that water, for instance, possesses inertia—the power of persisting in motion against obstacles—the power of possessing kinetic energy? The most direct way would be to take a stream of water and try suddenly to stop it. Open a water-

tap freely and then suddenly shut it. The impetus or momentum of the stopped water makes itself manifest by a violent shock to the pipe, with which everybody must be familiar. The momentum of water is utilised by engineers in the "water-ram."

A precisely analogous experiment in electricity is what Faraday called "the extra current." Send a current through a coil of wire round a piece of iron, or take any other arrangement for developing powerful magnetism, and then suddenly stop the current by breaking the circuit. A violent flash occurs if the stoppage is sudden enough, a flash which means the bursting of the insulating air partition by the accumulated electro-magnetic momentum.

Briefly, we may say that nearly all electro-magnetic experiments illustrate the fact of ethereal inertia.

Now return to consider what happens when a charged conductor (say a Leyden jar) is discharged. The recoil of the strained dielectric causes a current, the inertia of this current causes it to overshoot the mark, and for an instant the charge of the jar is reversed: the current now flows backwards and charges the jar up as at first; again flows the current, and so on, discharging and charging the jar with rapid oscillations until the energy is all dissipated into heat. The operation is precisely analogous to the release of a strained spring, or to the plucking of a stretched string.

But the discharging body thus thrown into strong electrical vibration is embedded in the all-pervading ether, and we have just seen that the ether possesses the two properties requisite for the generation and transmission of waves—viz., elasticity, and inertia or density; hence, just as a tuning-fork vibrating in air excites aerial waves or sound, so a discharging Leyden jar in ether excites ethereal waves or light.

Ethereal waves can therefore be actually produced by direct electrical means. I discharge here a jar, and the room is for an instant filled with light. With light, I say, though you can see nothing. You can see and hear the spark indeed,—but that is a mere secondary disturbance we can for the present ignore—I do not mean any secondary disturbance. I mean the true ethereal waves emitted by the electric oscillation going on in the neighbourhood of this recoiling dielectric.

You pull aside the prong of a tuning-fork and let it go : vibration follows and sound is produced. You charge a Leyden jar and let it discharge : vibration follows and light is excited.

It is light just as good as any other light. It travels at the same pace, it is reflected and refracted according to the same laws ; every experiment known to optics can be performed with this ethereal radiation electrically produced, and yet you cannot see it. Why not ? For no fault of the light ; the fault (if there be a fault) is in the eye. The retina is incompetent to respond to these vibrations—they are too slow. The vibrations set up when this large jar is discharged are from a hundred thousand to a million per second, but that is too slow for the retina. It responds only to vibrations between 4000 billions and 7000 billions per second. The vibrations are too quick for the ear, which responds only to vibrations between 40 and 40,000 per second. Between the highest audible and the lowest visible vibrations there has been hitherto a great gap, which these electric oscillations go far to fill up. There has been a great gap simply because we have no intermediate sense-organ to detect rates of vibration between 40,000 and 4,000,000,000,000,000 per second. It was, therefore, an unexplored territory. Waves have been there all the time in any quantity, but we have not thought about them nor attended to them.

It happens that I have myself succeeded in getting electric oscillations so slow as to be audible. The lowest I have got at present are 125 per second, and for some way above this the sparks emit a musical note ; but no one has yet succeeded in directly making electric oscillations which are visible, though indirectly every one does it by lighting a candle.

Here, however, is an electric oscillator which vibrates 300 million times a second, and emits ethereal waves a yard long. The whole range of vibrations between musical tones and some thousand millions per second is now filled up.

These electro-magnetic waves have long been known on the side of theory, but interest in them has been immensely quickened by the discovery of a receiver or detector for them. The great though simple discovery by Hertz of an "electric eye," as Sir W. Thomson calls it, makes experiments on these waves for the first time possible, or even easy. We have now a sort

of artificial sense - organ for their appreciation — an electric arrangement which can virtually “see” these intermediate rates of vibration.

The Hertz receiver is the simplest thing in the world—nothing but a bit of wire, or a pair of bits of wire, adjusted so that when immersed in strong electric radiation they give minute sparks across a microscopic air-gap.

The receiver I have here is adapted for the yard-long waves emitted from this small oscillator ; but for the far longer waves emitted by a discharging Leyden jar an excellent receiver is a gilt wall-paper or other interrupted metallic surface. The waves falling upon the metallic surface are reflected, and in the act of reflection excite electric currents, which cause sparks. Similarly, gigantic solar waves may produce auroræ ; and minute waves from a candle do electrically disturb the retina.

The smaller waves are, however, far the most interesting and the most tractable to ordinary optical experiments. From a small oscillator, which may be a couple of small cylinders kept sparking into each other end to end by an induction coil, waves are emitted on which all manner of optical experiments can be performed.

They can be reflected by plain sheets of metal, concentrated by parabolic reflectors, refracted by prisms, concentrated by lenses. I have at the College a large lens of pitch, weighing over 3 cwt., for concentrating them to a focus. They can be made to show the phenomenon of interference, and thus have their wave lengths accurately measured. They are stopped by all conductors, and transmitted by all insulators. Metals are opaque, but even imperfect insulators, such as wood or stone, are strikingly transparent, and waves may be received in one room from a source in another, the door between the two being shut.

The real nature of metallic opacity and of transparency has long been clear in Maxwell's theory of light, and these electrically produced waves only illustrate and bring home the well-known facts. The experiments of Hertz are in fact the apotheosis of that theory.

Thus, then, in every way Maxwell's brilliant perception of the real nature of light is abundantly justified ; and for the first time we have a true theory of light, no longer based upon

analogy with sound, nor upon a hypothetical jelly or elastic solid.

Light is an electro-magnetic disturbance of the ether. Optics is a branch of electricity. Outstanding problems in optics are being rapidly solved now that we have the means of definitely exciting light with a full perception of what we are doing, and of the precise mode of its vibration.

It remains to find out how to shorten down the waves—to hurry up the vibration until the light becomes visible. Nothing is wanted but quicker modes of vibration. Smaller oscillators must be used—very much smaller—oscillators not much bigger than molecules. In all probability—one may almost say certainly—ordinary light is the result of electric oscillation in the molecules of hot bodies, or sometimes of bodies not hot—as in the phenomenon of phosphorescence.

The direct generation of *visible* light by electric means, so soon as we have learnt how to attain the necessary frequency of vibration, will have most important practical consequences.

For consider our present methods of making artificial light: they are both wasteful and ineffective.

We want a certain range of oscillation, between 7000 and 4000 billion vibrations per second,—no other is useful to us, because no other has any effect upon our retina; but we do not know how to produce vibrations of this rate. We can produce a definite vibration of one or two hundred or thousand per second—in other words, we can excite a pure tone of definite pitch; and we can command any desired range of such tones continuously by means of bellows and a keyboard. We can also (though the fact is less well known) excite momentarily definite ethereal vibrations of some millions per second, as I have explained; but we do not at present seem to know how to maintain this rate quite continuously. To get much faster rates of vibration than this, we have to fall back upon atoms. We know how to make atoms vibrate,—it is done by what we call “heating” the substance; and if we could deal with individual atoms unhampered by others, it is possible that we might get a pure and simple mode of vibration from them. It is possible, but unlikely; for atoms, even when isolated, have a multitude of modes of vibration special to themselves, of which only a few are of practical use to us,

and we do not know how to excite some without also the others. However, we do not at present even deal with individual atoms; we treat them crowded together in a compact mass, so that their modes of vibration are really infinite.

We take a lump of matter, say a carbon filament or a piece of quicklime, and by raising its temperature we impress upon its atoms higher and higher modes of vibration, not transmitting the lower into the higher, but superposing the higher upon the lower, until at length we get such rates of vibration as our retina is constructed for, and we are satisfied. But how wasteful and indirect and empirical is the process! We want a small range of rapid vibrations, and we know no better than to make the whole series leading up to them. It is as though, in order to sound some little shrill octave of pipes in an organ, we are obliged to depress every key and every pedal, and to blow a young hurricane.

I have purposely selected as examples the more perfect methods of obtaining artificial light, wherein the waste radiation is only useless, and not noxious. But the old-fashioned plan was cruder even than this: it consisted simply in setting something burning, whereby not the fuel but the air was consumed; whereby also a most powerful radiation was produced, in the waste waves of which we were content to sit stewing, for the sake of the minute—almost infinitesimal—fraction of it which enabled us to see.

Every one knows now, however, that combustion is not a pleasant or healthy mode of obtaining light; but everybody does not realise that neither is incandescence a satisfactory and un wasteful method, which is likely to be practised for more than a few decades, or perhaps a century.

Look at the furnaces and boilers of a great steam-engine driving a group of dynamos, and estimate the energy expended; and then look at the incandescent filaments of the lamps excited by them, and estimate how much of their radiated energy is of real service to the eye. It will be as the energy of a pitch-pipe to an entire orchestra.

It is not too much to say that a boy turning a handle could, if his energy were properly directed, produce quite as much real light as is produced by all this mass of mechanism and consumption of material. There might, perhaps, be something

contrary to the laws of nature in thus hoping to get and utilise some specific kind of radiation without the rest ; but Lord Rayleigh has shown in a short communication to the British Association at York that it is not so, and that therefore we have a right to try to do it.

We do not yet know how, it is true, but it is one of the things we have got to learn.

Any one looking at a common glowworm must be struck with the fact that not by ordinary combustion, nor yet on the steam-engine and dynamo principle, is that easy light produced. Very little waste radiation is there from phosphorescent things in general. Light of the kind able to affect the retina is directly emitted ; and for this, for even a large supply of this, a modicum of energy suffices.

Solar radiation consists of waves of all sizes, it is true ; but then solar radiation has innumerable things to do besides making things visible. The whole of its energy is useful. In artificial lighting nothing but light is desired ; when heat is wanted it is best obtained separately by combustion. And so soon as we clearly recognise that light is an electrical vibration, so soon shall we begin to beat about for some mode of exciting and maintaining an electrical vibration of any required degree of rapidity. When this has been accomplished, the problem of artificial lighting will have been solved.

APPENDIX B.

PROF. HENRY ON HIGH TENSION ELECTRICITY BEING CONFINED TO THE SURFACE OF CONDUCTING BODIES, WITH SPECIAL REFERENCE TO THE PROPER CONSTRUCTION OF LIGHTNING-RODS.

(*Extracted from the 'Journal of the Telegraph,' New York, Sept. 1, 1877.*)

WASHINGTON, March 11, 1876.

DEAR SIR,—In answer to your letter of the 7th inst., I have to say that the discrepancy which exists as to the question whether electricity passes at the surface or through the whole capacity of the rod has arisen principally from experiments on galvanic electricity, which, having little or no repulsive energy, passes through the whole substance of the rod, and also from experiments in which a very large quantity of frictional electricity is transmitted through a small wire: in this case the metal is resolved into its elements and reduced to an impalpable powder.

In the case, however, of the transmission of atmospheric electricity through a rod of sufficient size to transmit the discharge freely, there can be no doubt that it tends to pass at the surface, the thickness of the stratum of electricity varying with the diameter of the rod and the amount and the intensity of the charge.

To test this by actual experiment I made the following arrangement: through a gun-barrel about 2 feet in length a copper wire was passed, the ends projecting. The middle of the wire in the barrel was coiled into the form of a magnetising spiral, and the ends of the gun-barrel were closed with plugs of tinfoil, so as to make a perfect metallic connection between the wire and the barrel. On the outside of the barrel another magnetising spiral was placed, the whole arrangement being shown in the sketch.

A powerful charge was now sent through the copper wire from a Leyden jar of about two gallons' capacity. The needle within the barrel showed not the least sign of magnetism, while the one on the outside was strongly magnetic.

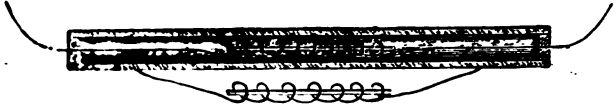

From this experiment I conclude that a gas-pipe can convey an ordinary charge of electricity from the clouds as well as a solid rod of the same diameter.

The repulsive energy of the electrical discharge at right angles to the axis remains of the same intensity as in the case of a static charge. This I have shown to be the case by drawing sparks of considerable intensity from a conductor, one end of which was connected with the ground while sparks were thrown on the other end from a large prime conductor. This spark is of a peculiar character, for though it gives a pungent shock and sets fire to combustible substances, such as an electrical pistol, it does not affect a sensitive gold-leaf electrometer. The fact is, it consists of two sparks, the one negative and the other positive. The rod during the transmission of the electricity through it is charged + at the upper end, and immediately in advance of this point it is charged - by induction, and the electricity passes through it in the discharge in the form of a series of + and - waves.—Yours very truly,

JOSEPH HENRY, *Sec. Smithsonian Inst.*

Prof. R. C. KEDZIE, Lansing, Michigan.

WASHINGTON, *April 15, 1876.*

DEAR SIR,—Your letter was received by due course of mail, but a press of business connected with the preparation of the Annual Report for 1875 and the Lighthouse Board has prevented an earlier reply.

I have now to say that, as far as I know, I am the only person who has made a special study of the conduction of frictional electricity in regard to lightning-rods. It has long been established by Coulomb and others that the electricity of a charged conductor exists in a thin stratum at the surface, and this is a

necessary consequence of the repulsion of electricity for itself, every particle being repelled from every other as far as possible. From this it was hastily assumed that electricity in motion also moves at the surface; but this was an inference without physical proof until I commenced the investigation. I found from a series of experiments that *frictional* electricity—that is, electricity of repulsive energy, such as that from the clouds—does pass at the surface, but that *galvanic* electricity, the kind to which Faraday, Daniell, De La Rive, and others refer, passes through the whole capacity of the conductor. This latter fact, however, was previously established by others. I further found that whenever a charge of electricity was thrown on a rod explosively, however well connected the rod was with the earth, it gave off sparks in the course of its length sufficient to fire an electric pistol and light flocculent substances. I also found that, in sending a powerful discharge from a battery of nine jars through a wide plate, no electricity passed along the middle of the plate, but that it was accumulated in its passage at the edges.

From all my study of this subject I do not hesitate to say that the plan I have given of lightning-rods is the true one, and that a tube of a sufficient degree of thickness serves to conduct the electricity as well as a solid mass, provided the thickness is sufficient to give free conduction. A very heavy charge sent through a wire frequently deflagrates it, but no discharge from the clouds, of which I have any knowledge, has ever sufficed to deflagrate a gas-pipe of an inch in diameter.

The plan of increasing the surface of a rod by converting the metal into a ribbon is objectionable. It tends to increase the power of the lateral discharge, and gives no increase of conducting power.

Another fallacy is much insisted on—viz., the better conduction of copper than iron. It is true that copper is a better conductor of *galvanic* electricity, which pervades the whole mass, but in regard to *frictional* electricity the difference in conducting capacity is too small to be of any importance. Iron is sufficiently good in regard to conduction, and withstands deflagration better than copper: besides this, it is much cheaper.—Yours truly,

JOSEPH HENRY.

Prof. R. C. KEDZIE.

ON MODERN VIEWS WITH RESPECT TO THE NATURE OF
ELECTRIC CURRENTS.

Substance of a lecture by Prof. H. A. Rowland, American Institute of Electrical Engineers, May 22, 1889.¹

How great, then, the difference between a current of water and a current of electricity! The action of the former is confined to the interior of the tube, while that of the latter extends to great distances on all sides, the whole of the space being agitated by the formation of an electric current in any part. To show this agitation, I have here two large frames with coils of wire around them. They hang face to face about 6 feet apart. Through one I discharge this Leyden jar, and immediately you see a spark at a break in the wire of the other coil, and yet there is no apparent connection between the two. I can carry the coils 50 feet or more apart, and yet, by suitable means, I can observe the disturbances due to the current in the first coil.

The question is forced upon us as to how this action takes place. How is it possible to transmit so much power to such a distance across apparently unoccupied space? According to our modern theories of physics, there must be some medium engaged in this transmission. We know that it is not the air, because the same effects take place in a vacuum, and therefore we must fall back on that medium which transmits light, and which we have named the ether—that medium which is supposed to extend unaltered throughout the whole of space, whose existence is very certain, but whose properties we have yet but vaguely conceived.

I cannot in the course of one short hour give even an idea of the process by which the minds of physicists have been led to this conclusion, or the means by which we have finally completely identified the ether which transmits light with the medium which transmits electrical and magnetic disturbances. The great genius who first identified the two is Maxwell, whose electro-magnetic theory of light is the centre around

¹ Based on reports in the (London) 'Electrician,' June 21 and 28 1889.

which much scientific thought is to-day revolving, and which we regard as one of the greatest steps by which we advance nearer to the understanding of matter and its laws. It is this great discovery of Maxwell which allows me to attempt to explain to you the wonderful events which happen everywhere in space when one establishes an electric current in any other portion.

In the first place, we discover that the disturbance does not take place in all portions of space at once, but proceeds outward from the centre of the disturbance with a velocity exactly equal to the velocity of light; so that when I touch these wires together so as to complete the circuit of yonder battery, I start a wave of ethereal disturbance which passes outward with a velocity of 185,000 miles per second, and continues to pass outwards for ever, or until it reaches the bounds of the universe. And yet none of our senses informs us of what has taken place unless sharpened by the use of suitable instruments. Thus, in the case of these two coils of wire, suspended near each other, when the wave from the primary disturbance reaches the second coil we perceive the disturbance by means of the spark formed at the break in the coil. Should I move the coils farther apart, the spark in the second coil would be somewhat delayed, but the distance of 185,000 miles would be necessary before this delay could amount to as much as one second. Hence the effects we observe on the earth take place so nearly instantaneously that the interval of time is very difficult to measure, amounting in the present case to only $\frac{1}{150000000}$ th of a second.

It is impossible for me to prove the existence of this interval, so infinitesimal is it, but I can at least show you that waves have something to do with the action observed. For instance, I have here two tuning-forks mounted on sounding-boxes and tuned to exact unison. I sound one and then stop its vibrations with my hand; instantly you hear that the other is in vibration, caused by the waves of sound in the air between the two. When, however, I destroy the unison by fixing this piece of wax on one of the forks, the action ceases.

Now, this combination of a coil of wire and a Leyden jar forms a vibrating system of electricity, and its time of vibration is about 10,000,000 times a second. Here is another

combination of coil and jar, the same as the first, and therefore its time of vibration is the same. You see how well the experiment works, because the two are in unison. But let me take away this second Leyden jar, thus destroying the unison, and you see that the sparks instantly cease. Replacing it, the sparks reappear. Adding another on one side, they disappear again, only to reappear when the system is made symmetrical by placing two on each side.

This experiment and that of the tuning-forks have an exact analogy to one another. In each we have two vibrating systems connected by a medium capable of transmitting vibrations, and they both come under the head of what we know as sympathetic vibrations. In the one case, we have two mechanical tuning-forks connected by the air; in the other, two pieces of apparatus, which we might call electrical tuning-forks, connected by the ether. The vibrations in one case can be seen by the eye or heard by the ear, but in the other case they can only be perceived when we destroy them by making them produce a spark. The fact that we are able to increase the effect by proper tuning demonstrates that vibrations are concerned in the phenomenon. This can, however, be separately demonstrated by examining the spark by means of a revolving mirror, when we find that it is made up of many successive sparks corresponding to the successive backward and forward movements of the current.

Thus, in the case of a charged Leyden jar whose inner and outer coatings have been suddenly joined by a wire, the electricity flows back and forth along the wire until all the energy originally stored up in the jar has expended itself in heating the wire or the air where the spark takes place, and in generating waves of disturbance in the ether which move outward into space with the velocity of light. These ethereal waves we have demonstrated by letting them fall on this coil of wire, causing the electrical disturbance to manifest itself by electric sparks.

I have here another more powerful arrangement for producing electro-magnetic waves of very long wave length, each one being about 500 miles long. It consists of a coil within which is a bundle of iron wires. On passing a powerful alternating current through the coil the iron wires are rapidly magnetised

and demagnetised, and send forth into space a system of electro-magnetic waves at the rate of 360 in a second.

Here also I have another piece of apparatus for sending out the same kind of electro-magnetic waves, and on applying a match we start it also into action. But the last apparatus is tuned to so high a pitch that the waves are only $\frac{1}{100000}$ inch long, and 55,000,000,000,000 are given out in one second. These short waves are known by the name of light and radiant heat, though the name radiation is more exact. Placing any body near the lamp so that the radiation can fall on it, we observe that when the body absorbs the rays it is heated by them. Is it not possible for us to get some substance to absorb the long (or electro-magnetic) waves of disturbance, and so obtain a heating effect? I have here such a substance in the shape of a sheet of copper, which I fasten on the face of a thermopile, and I hold it where these waves are strongest. As I have anticipated, great heat is generated by their absorption, and soon the plate of copper becomes very warm, as we see by this thermometer, by feeling it with the hand, or even by the steam from water thrown upon it. In this experiment the copper had not touched the coil or the iron wire core, although if it did they are very much cooler than itself. The heat has been produced by the absorption of the waves in the same way as a blackened body absorbs the rays of shorter wave length from the lamp.

In these experiments, so far, the wave-like nature of the disturbance has not been proved. We have caused electric sparks, and have heated the copper plate across an interval of space, but have not in either of these cases proved experimentally the progressive nature of the disturbance.

A ready means of experimenting on the waves, obtaining their wave length and showing their interferences, has hitherto been wanting. This deficiency has been recently supplied by Prof. Hertz, of Carlsruhe.

I scarcely know how to present this subject to a non-technical audience and make it clear how a coil of wire with a break in it can be used to measure the velocity and length of ethereal waves. However, I can but try. If the waves moved very slowly, we could readily measure the time the first coil took to affect the second, and show that this time was longer as the

distance was greater. But it is absolutely inappreciable by any of our instruments, and another method must be found. To obtain the wave length Prof. Hertz used several methods, but that by the formation of stationary waves is the most easily grasped. I hold in my hand one end of a spiral spring, which makes a heavy and flexible rope. As I send a wave down it, you see that it is reflected at the farther end, and returns again to my hand. If, however, I send a succession of waves down the rope, the reflected waves interfere with the direct ones, and divide the rope into a succession of nodes and loops which you now observe. So, a series of sound waves, striking on a wall, forms a system of stationary waves in front of the wall. Indeed we can use any waves for this purpose, even ethereal waves. With this in view Prof. Hertz established his apparatus in front of a reflecting wall, and observed the nodes and loops by the sparks produced in a ring of wire, somewhat resembling the coil I have been using, but much smaller. It is impossible for me to repeat this experiment before you, as it is a very delicate one, and the sparks produced are almost microscopic. Indeed I should have to erect an entirely different apparatus, as the waves from the one before me are nearly a quarter-mile long. To produce shorter waves we must use apparatus very much smaller—tuned, as it were, to a higher pitch, so that several stationary waves, or nodes and loops, of a few yards long could be obtained in the space of this room.

The testing coil would then be moved to different parts of the room, and the nodes would be indicated by the disappearance of the sparks, and the loops by the greater brightness of them. The presence of stationary waves would thus be proved, and their half-wave length found from the distance from node to node, for stationary waves can always be considered as produced by the interference of two waves advancing in opposite directions.

The closing of a battery circuit, then, and the establishment of a current of electricity in a wire, is a very different process from the formation of a current of water in a pipe, though after the first shock the laws of the flow of the two are very much alike. Furthermore, the medium around the current of electricity has very strange properties, showing that it is accompanied by a disturbance throughout space. The wire is

but the core of the disturbance, which latter extends indefinitely in all directions.

One of the strangest things about it is that we can calculate with perfect exactness the velocity of the wave propagation and the amount of the disturbance at every point and at any instant of time ; but as yet we cannot conceive of the details of the mechanism which is concerned in the propagation of an electric current. In this respect our subject resembles all other branches of physics in the partial knowledge we have of it. We know that light is the undulation of the luminiferous ether, and yet the constitution of the latter is unknown. We know that the atoms of matter can vibrate with purer tones than the most perfect piano, and yet we cannot even conceive of their constitution. We know that the sun attracts the planets with a force whose law is known, and yet we fail to picture to ourselves the process by which it takes our earth within its grasp at the distance of many millions of miles and prevents it from departing for ever from its life-giving rays. Science is full of this half-knowledge.

So far we have considered the case of alternating electric currents in a wire connecting the inner and outer coatings of a Leyden jar. The invention of the telephone, by which sound is carried from one point to another by means of electrical waves, has forced into prominence the subject of these waves. Furthermore, the use of alternating currents for electric lighting brings into play the same phenomenon. Here, again, the difference between a current of water and a current of electricity is very marked. A sound wave, traversing the water in the tube, produces a to-and-fro current of water at any given point. So, in the electrical vibration along a wire, the electricity moves to and fro along it in a manner somewhat similar to the water, but with this difference : the disturbance from the water-motion is confined to the tube, and the oscillation of the water is greatest in the centre of the tube ; while in the case of the electric current the ether around the wire is disturbed, and the oscillation of the current is greatest at the surface of the wire and least in its centre. The oscillations in the water take place in the tube without reference to the matter outside the tube, whereas the electric oscillations in the wire are entirely dependent on the surrounding space, and the

velocity of the propagation is nearly independent of the nature of the wire, provided it is a good conductor.

We have then in the case of electrical waves along a wire a disturbance outside the wire and a current within it, and the equations of Maxwell allow us to calculate these with perfect accuracy and give all the laws with respect to them.

We thus find that the velocity of propagation of the waves along a wire, hung far away from other bodies and made of good conducting material, is that of light, or 185,000 miles per second ; but when it is hung near any conducting matter, like the earth, or enclosed in a cable and sunk into the sea, the velocity becomes much less. When hung in space, away from other bodies, it forms, as it were, the core of a system of waves in the ether, the amplitude of the disturbance becoming less and less as we move away from the wire. But the most curious fact is that the electric current penetrates only a short distance into the wire, being mostly confined to the surface, especially where the number of oscillations per second is very great.

The electrical waves at the surface of a conductor are thus, in some respects, very similar to the waves on the surface of water. The greatest motion in the latter case is at the surface, while it diminishes as we pass downwards and soon becomes inappreciable. Furthermore, the depth to which the disturbance penetrates into the water increases with increase of the length of the wave, being confined to very near the surface for very short waves. So the disturbance in the copper penetrates deeper as the waves and the time of oscillation are longer, and the disturbance is more nearly confined to the surface as the waves become shorter.¹

There are very many practical applications of these theoretical results for electric currents. The most obvious one is to the case of conductors for the alternating currents used

¹ A striking illustration of this skin-deep penetration of high-voltage electricity was communicated by Lord Armstrong to Sir William Thomson (now Lord Kelvin) at the Newcastle meeting of the British Association in 1889. A bar of steel about a foot long, which Lord Armstrong was holding in his hand, was allowed accidentally to short circuit the two terminals of a dynamo giving an alternate current of 85 ampères, at a difference of potential of 103 volts. He instantly felt a sensation of

in producing the electric light. We find that when these are larger than about half an inch diameter they should be replaced by a number of conductors less than half an inch diameter, or by strips about a quarter of an inch thick, and of any convenient width.

Prof. Oliver Lodge has recently drawn attention to another application of these results—that is, to lightning-rods. Almost since the time of Franklin there have been those who advocated the making of lightning-rods hollow in order to increase the surface for a given amount of copper. We now know that these persons had no reason for their belief, as they simply drew the inference that electricity at rest is on the surface. Neither were the advocates of the solid rods quite correct, for they reasoned that electricity in a state of steady flow occupies the whole area of the conductor equally. The true theory, we now know, indicates that neither party was entirely correct, and that the surface is a very important factor in the case of a current of electricity so sudden as that from a lightning discharge. But increase of surface can best be obtained by multiplying the number of conductors, rather than making them flat or hollow. Theory indicates that the current penetrates only one-tenth the distance into iron that it does into copper. As the iron has seven times the resistance of copper, we should need seventy times the surface of iron that we should of copper. Hence I prefer copper wire about a quarter of an inch diameter and nailed directly to the house without insulators, and passing down the four corners, around the eaves, and over the roof, for giving protection from lightning in all cases where a metal roof and metal down-spouts do not accomplish the same purpose.

Whether the discharge of lightning is oscillatory or not does not enter into the question, provided it is only sufficiently sudden. I have recently solved the mathematical problem of the electric oscillations along a perfectly conducting wire join-

burning and dropped the bar. His fingers were badly blistered, though on examining the bar a few seconds afterwards it was found to be *quite cold*. This proved that the action lay at the surface, and had not time to sensibly penetrate the substance of the bar. There were two little hollows burned out of the metal at the points where it touched the dynamo terminals.—J. J. F.

ing two infinite and perfectly conducting planes parallel to each other, and find that there is no definite time of oscillation, but that the system is capable of vibrating in any time in which it is originally started. The case of lightning between a cloud of limited extent and the earth along a path through the air of great resistance is a very different problem. Both the cloud and the path of the electricity are poor conductors, which tends to lengthen the time. If I were called on to estimate as nearly as possible what took place in a flash of lightning, I would say that I did not believe that the discharge was always oscillating, but more often consisted of one or more streams of electricity at intervals of a small fraction of a second, each one continuing for not less than $\frac{1}{100000}$ second. An oscillating current with 100,000 reversals per second would penetrate about $\frac{1}{80}$ inch into copper and $\frac{1}{300}$ inch into iron. The depth for copper would constitute a considerable proportion of a wire $\frac{1}{4}$ inch diameter, and as there are other considerations to be taken into account, I believe it is scarcely worth while making tubes, or flat strips, for such small sizes.

It is almost impossible to draw proper conclusions from experiments on this subject in the laboratory, such as those of Prof. Oliver Lodge.¹ The time of oscillation of the current in most pieces of laboratory apparatus is so very small, being often the $\frac{1}{100000000}$ of a second, that entirely wrong inferences may be drawn from them. As the size of the apparatus increases, the time of oscillation increases in the same proportion, and changes the whole aspect of the case. I have given $\frac{1}{100000}$ of a second as the shortest time a lightning-flash could probably occupy. I strongly suspect it is often much greater, and thus departs even further from the laboratory experiments of Prof. Lodge, who has, however, done very much towards drawing attention to this matter and showing the importance of surface in this case. All shapes of the rod with equal surface are not, however, equally efficient. Thus, the inside surface of a tube does not count at all. Neither do the corrugations on a rod count for the full value of the surface they

¹ For Prof. Lodge's views see his paper, 'Jour. Inst. Elec. Engs.,' vol. xix. p. 352, and the very interesting discussion thereupon.—J. J. F.

expose, for the current is not distributed uniformly over the surface; but I have recently proved that rapidly alternating currents are distributed over the surface of very good conductors in the same manner as electricity at rest would be distributed over them, so that the exterior angles and corners possess much more than their share of the current, and corrugations on the wire concentrate the current on the outer angles and diminish it in the hollows. Even a flat strip has more current on the edges than in the centre.

For these reasons, shape, as well as extent of surface, must be taken into account, and strips have not always an advantage over wires for quick discharges.

The fact that the lightning-rod is not melted on being struck by lightning is not now considered as any proof that it has done its work properly. It must, as it were, seize upon the discharge, and offer it an easier passage to the earth than any other. Such sudden currents of electricity we have seen to obey very different laws from continuous ones, and their tendency to stick to a conductor and not fly off to other objects depends not only on having them of small resistance, but also on having what we call the self-induction as small as possible. This latter can be diminished by having the lightning-rod spread sideways as much as possible, either by rolling it into strips, or better, by making a network of rods over the roof with several connections to the earth at the corners, as I have before described.

Thus we see that the theory of lightning-rods, which appeared so simple in the time of Franklin, is to-day a very complicated one, and requires for its solution a very complete knowledge of the dynamics of electric currents. In the light of our present knowledge the frequent failure of the old system of rods is no mystery, for I doubt if there are a hundred buildings in the country properly protected from lightning. With our modern advances, perfect protection might be guaranteed in all cases, if expense were no object.

We have now considered the case of oscillations of electricity in a few cases, and can turn to that of steady currents. The closing of an electric circuit sends ethereal waves throughout space, but after the first shock the current flows steadily without producing any more waves. However, the properties of the space around the wire have been permanently altered, as

we have already seen. Let us now study these properties more in detail. I have before me a wire in which I can produce a powerful current of electricity, and we have seen that the space around it has been so altered that a delicately suspended magnetic needle cannot remain quiet in all positions, but stretches itself at right angles to the wire, the north pole tending to revolve around it in one direction and the south pole in the other. This is a very old experiment, but we now regard it as evidence that the properties of the space around the wire have been altered rather than that the wire acts on the magnet from a distance.

Put, now, a plate of glass around the wire, the latter being vertical and the former with its plane horizontal, and pass a powerful current through the wire. On now sprinkling iron filings on the plate they arrange themselves in circles around the wire, and thus point out to us the celebrated lines of magnetic force of Faraday. Using two wires with currents in the same direction we get these other curves, and, testing the forces acting on the wire, we find that they are trying to move towards each other.

Again, pass the currents in the opposite directions and we get these other curves, and the currents repel each other. If we assume that the lines of force are like rubber bands which tend to shorten in the direction of their length and repel each other sideways, Faraday and Maxwell have shown that all magnetic attractions and repulsions are explained. The property which the presence of the electric current has conferred on the ether is then one by which it tends to shorten in one direction and spread out in the other two directions.

We have thus done away with action at a distance, and have accounted for magnetic attraction by a change in the intervening medium, as Faraday partly did almost fifty years ago. For this change in the surrounding medium is as much a part of the electric current as anything that goes on within the wire.

To illustrate this tension along the lines of force, I have constructed this model, which represents the section of a coil of wire with a bar of iron within it. The rubber bands represent the lines of force which pass around the coil and through the iron bar, as they have an easier passage through the iron than

the air. As we draw the bar down and let it go, you see that it is drawn upward and oscillates around its position of equilibrium until friction brings it to rest. Here, again, I have a coil of wire with an iron bar within it with one end resting on the floor. As we pass the current, and the lines of magnetic force form around the coil and pass through the iron, it is lifted upwards, although it weighs 24 lb., and oscillates around its position of equilibrium exactly the same as though it were sustained by rubber bands as in the model. The rubber bands in this case are invisible to our eye, but our mental vision pictures them as lines of magnetic force in the ether drawing the bar upward by their contractile force. This contractile force is no small quantity, as it may amount, in some cases, to one or even two hundred pounds to the square inch, and thus rivals the greatest pressure which we use in our steam-engines.

Thus the ether is, to-day, a much more important factor in science than the air we breathe. We are constantly surrounded by the two, and the presence of the air is manifest to us all; we feel it, we hear by its aid, and we even see it under favourable circumstances, and the velocity of its motion as well as the amount of moisture it carries is a constant topic of conversation. The ether, on the other hand, eludes all our senses, and it is only with imagination, the eye of the mind, that its presence can be perceived. By its aid in conveying the vibrations we call light we are enabled to see the world around us; and by its other motions, which cause magnetism, the mariner steers his ship through the darkest night when the heavenly bodies are hid from view. When we speak in a telephone, the vibrations of the voice are carried forward to the distant point by waves in the ether, there again to be resolved into the sound waves of the air. When we use the electric light to illuminate our streets, it is the ether which conveys the energy along the wires as well as transmits it to our eye after it has assumed the form of light. We step upon an electric street-car and feel it driven forward with the power of many horses, and again it is the ether whose immense force we have brought under our control and made to serve our purpose—no longer a feeble, uncertain sort of medium, but a mighty power, extending throughout all space, and binding the whole universe together.

APPENDIX C.

VARIATIONS OF CONDUCTIVITY UNDER ELECTRICAL
INFLUENCE.

Substance of a paper by Prof. E. Branly, of the Catholic University of Paris.¹

The object of this article is to describe the first results obtained in an investigation of the variation or resistance of a large number of conductors under various electrical influences. The substances which up to the present have presented the greatest variations in conductivity are the powders or filings of metals. The enormous resistance offered by metal in a state of powder is well known ; indeed, if we take a somewhat long column of very fine metallic powder, the passage of the current is completely stopped. The increase in the electrical conductivity by pressure of powdered conducting substances is also well known, and has had various practical applications. The variations of conductivity, however, which occur on subjecting conducting bodies to various electrical influences have not been previously investigated.

The Effect of Electric Sparks.—Let us take a circuit comprising a single cell, a galvanometer, and some powdered metal enclosed in an ebonite tube of one square centimetre cross section and a few centimetres long. Close the extremities of the tube with two cylindrical copper tubes pressing against the powdered metal and connected to the rest of the circuit. If the powder is sufficiently fine, even a very sensitive galvanometer does not show any evidence of a current passing. The resistance is of the order of millions of ohms, although the same metal melted or under pressure would only offer (the dimensions being the same) a resistance equal to a fraction of an ohm. There being, therefore, no current in the circuit, a Leyden

¹ Based on reports in the (London) 'Electrician,' June 26 and August 21, 1891.

jar is discharged at some little distance off, when the abrupt and permanent deflection of the galvanometer needle shows that an immediate and a permanent reduction of the resistance has been caused. The resistance of the metal is no longer to be measured in millions of ohms, but in hundreds. Its conductivity increases with the number and intensity of the sparks.

Some 20 or 30 centimetres from a circuit comprising some metallic filings contained in an ebonite cup, let us place a hollow brass sphere, 15 to 20 centimetres in diameter, insulated by a vertical glass support. The filings offer an enormous resistance and the galvanometer needle remains at zero. But if we bring an electrified stick of resin near the sphere, a little spark will pass between the stick and the sphere, and immediately the needle of the galvanometer is violently jerked and then remains permanently deflected. On some fresh filings being placed in the ebonite cup, the resistance of the circuit will again keep the needle at zero. If now the charged brass sphere is touched with the finger, there is a minute discharge and the galvanometer needle is again deflected. With a few accumulators the experiment can easily be made without a galvanometer. The circuit consists of the battery, some metallic powder, a platinum wire, and a mercury cup. The resistance of the powder is so high that the interruption of the circuit takes place without any sparking of the mercury cup. If now a Leyden jar is discharged in the neighbourhood of the circuit the powder is rendered conducting, the platinum wire immediately becomes red hot, and a violent spark occurs on breaking the circuit.

The influence of the spark decreases as the distance increases, but its influence is observable several metres away from the powder, even with a small Wimshurst machine. Repeating the spark increases the conductivity; in fact, with certain substances successive sparks produce successive jerks, and a gradually increasing and persistent deflection of the galvanometer needle.

Influence of a Conductor traversed by Condenser Discharges.—While using the Wimshurst machine it was noticed that the reduction in the resistance of the filings frequently took place before discharge. This led me to the following experiment:

Take a long brass tube, one end of which is close to the circuit containing the metallic powder; its other end, several metres distant from the circuit, is fairly close to a charged Leyden jar. A spark takes place and the conductor is charged. At the same instant, the conductivity of the metallic powder is greatly increased.

The following arrangement, owing to its efficacy, convenience, and regularity of action, was used by me in most of my researches, and I shall briefly call it the Δ arrangement (fig. 1).

The source of electricity is a two-plate Holtz machine driven at from 100 to 400 revolutions. A sensitive substance is introduced into one of the arms of a Wheatstone bridge, or into the circuit of a single Daniell cell at a distance of some 10 metres from the Holtz machine. Between the discharge knobs of the machine and the Wheatstone bridge, and connected to the former, there are two insulated brass tubes, $\Delta \Delta'$, running parallel to one another 40 centimetres apart. The Leyden jars usually attached to a Holtz machine may be dispensed with, the capacity of the long brass tubes being in some measure equivalent to them.

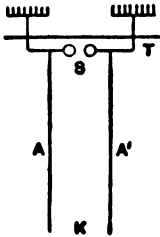

Fig. 1.

The knobs s were 1 mm., .5 mm., or .1 mm. apart. When the plates were rotated, sparks rapidly succeeded each other. Experiments showed that these sparks had no direct effect at a distance of 10 metres. The two tubes $\Delta \Delta'$ are not absolutely necessary; the diminution of resistance is easily produced if only one is employed, and in some cases, indeed, a single conductor is more efficacious. An increase in the speed of the machine increases its action to a marked extent. The sparks at s may be suppressed by drawing the knobs apart, but the conductor Δ will still continue to exert its influence, especially if there is a spark-gap anywhere about.

Effects of Induced Currents.—The passage of induced currents through a sensitive substance produces similar effects to those described above. In one instance an induction coil was taken, having two similar wires. The circuit of the secondary wire was closed through a tube containing filings, the galvanometer

being also in circuit. Care was taken to ascertain before introducing the filings into the circuit that the currents on make and break gave equal and opposite deflections. Filings were then introduced into the circuit, the primary being made and broken at regular intervals. The following table gives the results obtained in the case of zinc filings :—

ZINC FILINGS.

Galvanometer throws.		Galvanometer throws.	
1st closing	. . . 1°	1st opening	. . . 18°
2nd „	. . . 64°	2nd „	. . . 100°
3rd „	. . . 146°	3rd „	. . . 140°

Effects of passing Continuous Currents of High E.M.F.—If a continuous current of high E.M.F. is employed, it renders a sensitive substance conducting. The phenomenon may be shown in the following manner. A circuit is made up consisting of a battery, a sensitive substance, and a galvanometer. The E.M.F. of the battery is first 1 volt, then 100 volts, then 1 volt. Below I give the galvanometer deflections obtained with an E.M.F. of 1 volt for three different substances before and after the application of the E.M.F. of 100 volts :—

Before application of current.	After application of current.
16	100
0	15
1	500

In the case of some measurements taken on a Wheatstone bridge, a prism of aluminium filings interposed between two copper electrodes offered a resistance of several million ohms before a high E.M.F. was applied, but only offered a resistance of 350 ohms after the application of this pressure for one minute. The time during which the powder should be interposed in the battery circuit should not be too short. Thus, in one instance the application for 10 seconds of 75 mercury sulphate cells produced no effect, but their application for 60 seconds resulted in the resistance being reduced from several megohms to 2500 ohms.

It should be observed that the phenomenon of suddenly increased conductivity occurs even if the sensitive substance is

not in circuit with a battery at the time it is influenced. Thus, the metallic filings, after having been placed in circuit with a Daniell cell, and their high resistance observed, may then be completely insulated and submitted in this condition to the action of a distant spark, or of a charged rod, or of induced currents. If, after this, the filings are replaced in their original circuit, the enormous increase in their conductivity is immediately apparent.

The conductivity produced by these various methods takes

place throughout the whole mass of the metallic filings, and in every direction, as the following experiment will show. A vertical ebonite cup containing aluminium powder (fig. 2) is placed between two metal plates A, B; laterally the powder is in contact with two short rods c, D, which pass through the sides of the ebonite cylinder. A and B can be connected to two terminals of one of the arms of the Wheatstone bridge, c and D being free, and *vice versa*. Whatever arrangement is adopted, if a battery of 100 cells is joined up for a few seconds with one or the other of the pairs of terminals, the increase in

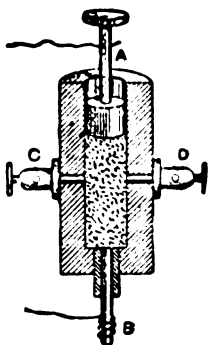

Fig. 2

the conductivity is immediately visible in that direction, and is found to exist also in the direction at right angles.

Substances in which Diminution of Resistance has been observed.—The substances in which the phenomenon of the sudden increase of conductivity is most easily observed are filings of iron, aluminium, copper, brass, antimony, tellurium, cadmium, zinc, bismuth, &c. The size of the grains and their nature are not the only elements to be considered, for grains of lead of the same size, but coming from different quarters, offer at the same temperature great differences in resistance (20,000 to 500,000 ohms). Extremely fine metallic powder, as a rule, offers almost perfect resistance to the passage of a current. But if we take a sufficiently short column and exert a sufficiently great pressure, a point is soon reached when the electrical influence will effect a sudden increase in the conductivity.

Thus, a layer of copper reduced by hydrogen, which does not become conducting under the influence of the electric spark or otherwise, will become so on being submitted to a pressure of 500 grammes to the square centimetre (7 lb. per square inch). Instead of using pressure, I employed as a conductor in some experiments a very fine coating of powdered copper spread on a sheet of unpolished glass or ebonite *E* (fig. 3), 7 centimetres long and 2 centimetres broad. A layer of this kind, polished with a burnisher, has a very variable resistance. With a little care one can prepare sheets which are more or less sensitive to electrical action.

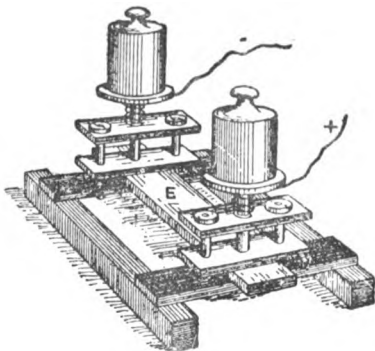

Fig. 3.

Metal powders or metal filings are not the only sensitive substances, as powdered galena, which is slightly conducting under pressure, conducts much better after having been submitted to electrical influence. Powdered binoxide of manganese is not very sensitive unless mixed with powdered antimony and compressed.

Making use of the *A* arrangement with very short sparks at *s* (fig. 1), the phenomenon of increased conductivity can be observed with platinised and silvered glass, also with glass covered with gold, silver, and aluminium foil. Some of the mixtures employed had the consistency of paste. These were mixtures of colza oil and iron, or antimony filings, and of ether or petroleum and aluminium, and plumbago, &c. Other mixtures were solid. If we make a mixture of iron filings and Canada balsam, melted in a water bath, and pour the paste into a little ebonite cup, the ends of which are closed by metallic rods, a substance is obtained which solidifies on cooling. The resistance of such a mixture is lowered from several megohms to a few hundred ohms by an electric spark. Similar results are obtained with a solid rod composed of fused flowers

of sulphur and iron or aluminium filings, also by a mixture of melted resin and aluminium filings. In the preparation of these solid sensitive mixtures, care must be taken that the insulating substance should only form a small percentage of the whole.

Some interesting results are also obtained with mixtures of sulphur and aluminium, and with resin and aluminium, when in a state of powder. When cold these mixtures, as a rule, do not conduct either directly or after they have been exposed to electrical influences, but they become conducting on combining pressure with electrical influences. Thus, a mixture of flowers-of-sulphur and aluminium filings in equal volumes was placed in a glass tube 24 mm. in diameter. The weight of the mixture was 20 grammes, and the height of the column 22 mm., with a pressure of 186 grammes per square centimetre ($2\frac{1}{2}$ lb. per square inch). The mixture is not conducting, but after exposure to electrical influence, obtained by the Δ arrangement, the resistance falls to 90 ohms. In a similar manner a mixture of selenium and aluminium, placed in a tube 99 mm. long, was not conducting until after it was exposed to the combined influence of pressure and electricity.

The following is one of the group of numerous experiments of a slightly different character. A mixture of flowers-of-sulphur and fine aluminium filings, containing two of sulphur to one of aluminium, is placed in a cylindrical glass tube 35 mm. long. By means of a piston, a pressure of 20 kilogrammes per square centimetre (284 lb. per square inch) was applied. It was only necessary to connect the column for 10 seconds to the poles of a 25-cell battery, for the resistance originally infinite to be reduced to 4000 ohms.

The arrangement shown in fig. 4 illustrates another order of experiment. Two rods of copper were oxidised in the flame of a Bunsen burner, and were then arranged to lie across each other, as shown, and were connected to the terminals of the arm of a Wheatstone bridge, the high resistance of the circuit being due to the layers of oxide. Amongst the many measurements made, I found, in one case, a resistance of 80,000 ohms, which, after exposure to the influence of the electric spark, was reduced to 7 ohms. Analogous effects are obtained with oxidised steel rods. Another pretty experiment is to place a

cylinder of copper, with an oxidised hemispherical head, on a sheet of oxidised copper. Before exposure to the influence of the electric spark, the oxide offers considerable resistance. The experiment can be repeated several times by merely moving the cylinder from one place to another on the oxidised sheet of copper, thus showing that the phenomenon only takes place at the point of contact of the two layers of oxide.

It may be worth noting that, for most of the substances enumerated, an elevation of temperature diminishes the resistance, but the effect of a rise of temperature is transient, and is incomparably less than the effect due to currents of high potential. For a few substances the two effects are opposed.

Restoration of Original Resistance.—The conductivity caused by the various electrical influences lasts sometimes for a long period (twenty-four hours or more), but it is always possible to make it rapidly disappear, particularly by a shock.

The majority of substances tested showed an increase of resistance on being shaken previous to being submitted to any special electrical influence, but after having been influenced the effect of shock is much more marked. The phenomenon is best seen with the metallic filings, but it can also be observed with metallised ebonite sheets with mixtures of liquid insulators and metallic powders, mixtures of metallic filings and insulating substances (compressed or not compressed), and finally with solid bodies.

I observed the return to original resistance in the following manner :—

The sensitive substance was placed at κ (fig. 1), and formed part of a circuit which included a Daniell cell and galvanometer. At first no current passes. Sparks are then caused at s , and the needle of the galvanometer is permanently deflected. On

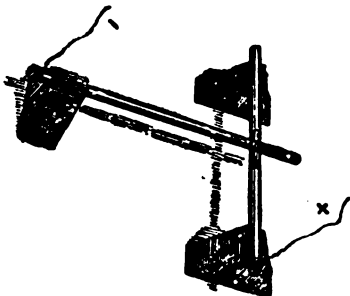

Fig. 4.

smartly tapping the table supporting the ebonite cup in which the sensitive substance is contained, the original condition is completely restored. When the electric action has been of a powerful character, violent blows are necessary. I employed for the purpose of these shocks a hammer fixed on the table, the blows of which could be regulated.

With some substances, when feebly electrified, the return seemed to be spontaneous, although it was slower than the return of the galvanometer needle to equilibrium. This restoration of the original resistance is attributable to surrounding trepidations, as it was only necessary to walk about the room at a distance of a few metres, or to shake a distant wall. This spontaneous return to original resistance after weak electrical action was visible with a mixture of equal parts of fine selenium and tellurium powders. The restoration of resistance by shock was not observable so long as the electrical influence was at work.

After having been submitted to powerful electric action, shock does not seem to entirely restore substances to their original state; in fact, the substances generally show greater sensitiveness to electric action. Thus, a mixture of colza oil and antimony powder being exposed to the influence of arrangement A, a spark of 5 mm. was at first necessary to break down the resistance; but after the conductivity had been made to disappear by means of blows, a spark of only 1 mm. was sufficient to again render the substance conducting. Finely powdered aluminium has an extremely high resistance. A vertical column of powdered aluminium 5 mm. long of 4 square cms. cross-section, submitted to considerable pressure, completely stopped the current from a Daniell cell. The influence of arrangement A produced no effect, but, by direct contact with a Leyden jar, the resistance was reduced to 50 ohms. The effect of shock was then tried, and after this the sparks produced by arrangement A were able to reduce the resistance.

The following experiment is also of the same kind: Aluminium filings placed in a parallelipidic trough completely stopped the current from a Daniell cell, and the resistance offered to a single cell remained infinite after the trough had been placed in the circuit of 25 sulphate of mercury cells for 10 seconds. The aluminium was next placed in circuit with a battery of 75

cells ; a single Daniell cell was then able to send a current through the substance. The original resistance was restored by shock, but not the original condition of things, since a single cell was able to send a current after the aluminium had been circuited for 10 seconds with a battery of only 25 cells. I may add that if the restoration of resistance was brought about by a *violent* shock, it was necessary to place the aluminium in circuit with 75 cells for one minute before the resistance was again broken down.

It must be observed that electrical influence is not always necessary to restore conductivity after an apparent return to the original resistance, repeated feeble blows being sometimes successful in bringing this about. Both in the case of slow return by time and sudden return by shock, the original value of the resistance is often increased. Rods of Carré carbon, 1 metre long and 1 mm. in diameter, were particularly noticeable for this phenomenon.

Return to Original Resistance by Temperature Elevation.—A plate of coppered ebonite rendered conducting by electricity, and placed close to a gas-jet, quickly regained its original resistance. A solid rod of resin and aluminium, or of sulphur and aluminium, rendered conducting by connection to the poles of a small battery, will regain its original resistance by shock ; but if the conducting state has been caused by powerful means, such, for instance, as direct contact with a Leyden jar, shock no longer has any effect, at least such a shock as the fragile nature of the material can stand. A slight rise of temperature, however, has the desired result. By suitably regulating the electric action it is possible to get a substance into such a condition that the warmth of the fingers suffices to annul conductivity.

Influence of Surroundings.—Electric action gives rise to no alteration of resistance when the substance is entirely within a closed metal box. The sensitive substance, in circuit with a Daniell cell and a galvanometer, is placed inside a brass box (fig. 5). The absence of current is ascertained, the circuit broken, and the box closed. A Wimshurst machine is then worked a little way off, and will be found to have had no effect. The same result will be obtained if the circuit is kept closed during the time the Wimshurst machine is in operation.

If a wire connected at some point to the circuit is passed out through a hole in the box to a distance of 20 to 50 cms., the influence of the Wimshurst machine makes itself felt. On

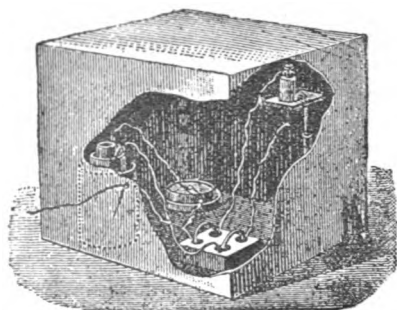

Fig. 5.

tapping the lid to restore resistance, the galvanometer needle remains deflected so long as the sparks continue to pass. If, however, the wires are pushed in so that they only project a few millimetres, the sparks still passing, a few taps suffice to bring back the needle to zero. On touching the end of the

wire with the fingers or a piece of metal, conductivity is immediately restored. The movements of the galvanometer needle were rendered visible in these experiments by looking through a piece of wide-mesh wire-gauze with a telescope. The respective position of the things was reversed; that is to say, a Ruhmkorff coil and a periodically discharged Leyden jar were placed inside, and the sensitive substance outside, the box, with the same results.

In some later experiments with a larger metallic case, and with the Daniell cell, sensitive substance, delicate galvanometer, and Wheatstone bridge placed inside, I found that a double casing was necessary in order to absolutely suppress all effects. A glass covering afforded no protection.

Considerations on the Mechanism of the Effects produced.—What conclusions are we to draw from the experiments described? The substances employed in these investigations were not conductors, since the metallic particles composing them were separated from each other in the midst of an insulating medium. It was not surprising that currents of high potential, and especially currents induced by discharges, should spark across the insulating intervals. But as the conductivity *persisted* afterwards, even for the weakest thermo-electric

currents, there is some ground for supposing that the insulating medium is transformed by the passage of the current, and that certain actions, such as shock and rise of temperature, bring about a modification of this new state of the insulating body. Actual movement of the metallic particles cannot be imagined in experiments where the particles in a layer a few millimetres thick were fixed in an invariable relative position by extreme pressures, reaching at times to more than 100 kilogrammes per square cm. (1420 lb. to the square inch). Moreover, in the case of solid mixtures, in which the same variations of resistance were produced, displacement seems out of the question. To explain the persistence of the conductivity after the cessation of the electrical influence, are we to suppose in the case of metallic filings a partial volatilisation of the particles creating a conducting medium between the grains of metal? In the case of mixtures of metallic powders and insulating substances agglomerated by fusion, are we to suppose that the thin insulating layers are pierced by the passage of very small sparks, and that the holes left behind are coated with conducting material? If this explication is admissible for induced currents, it must hold good for continuous currents. If so, we must conclude that these mechanical actions may be produced by batteries of only 10 to 20 volts electromotive force, and which only cause an insignificant current to pass. The following experiment is worth quoting in this connection :—

A circuit was formed by a Daniell cell, a sensitive galvanometer, and some aluminium filings in an ebonite cup. The galvanometer needle remained at zero. The filings were cut out of this circuit, and switched for one minute into circuit with a battery of 43 sulphate of mercury cells. On being replaced in the first circuit, the filings exhibited high conductivity. The result was the same when 10 or 20 cells were employed, or when the current was diminished by interposing in the circuit a column of distilled water, 40 cm. long and 20 mm. in diameter. The cells used (platinum, sulphate of mercury, sulphate of zinc, zinc) had a high internal resistance. Thus, 43 cells (60 volts), when short circuited, only gave a current of 5 milliamperes. The same battery, with the column of distilled water in circuit only, caused a deflection of 100 mm. on a scale one metre off, with an astatic galvanometer wound with 50,000 turns. We

can, therefore, see how infinitesimally small the initial current must have been when the filings were added to the circuit. The battery acted, therefore, essentially by virtue of its electromotive force.

If mechanical displacement of particles or transportation of conducting bodies seem inadmissible, it is probable that there is a modification of the insulator itself, the modification persisting for some time by virtue of a sort of "coercive force." An electric current of high potential, which would be completely stopped by a thick insulating sheet, may be supposed to gradually traverse the very thin dielectric layers between the conducting particles, the passage being effected very rapidly if the electric pressure is great, and more slowly if the pressure is less.

Increase of Resistance.—An increase of resistance was observed in these investigations less often than a diminution; nevertheless, a number of frequently repeated experiments enable me to say that increase of resistance is not exceptional, and that the conditions under which it takes place are well defined. Short columns of antimony or aluminium powder, when subjected to a pressure of about 1 kilogramme per square cm. (14.2 lb. per square inch), and offering but a low resistance, exhibited an increase of resistance under the influence of a powerful electrification. Peroxide of lead, a fairly good conductor, always exhibited an increase, so also did some kinds of platinised glass, while others showed alternate effects. For instance, a sheet of platinised glass, which offered a resistance of 700 ohms, became highly conducting after 150 sulphate of mercury cells had been applied to it for 10 seconds. This condition of conductivity was annulled by contact with a charged Leyden jar, and reappeared after again applying 150 cells for 10 seconds, and so on. Similar effects were obtained with a thin layer of a mixture of selenium and tellurium poured, when fused, into a groove in a sheet of mica placed between two copper plates. These alternations were always observed several times in succession, and at intervals of several days.

These augmentations and alternations are in no way incompatible with the hypothesis of a physical modification of the insulator by electrical influence.

APPENDIX D.

RESEARCHES OF PROF. D. E. HUGHES, F.R.S., IN ELECTRIC WAVES AND THEIR APPLICATION TO WIRELESS TELEGRAPHY, 1879-1886.

It may be desirable to place briefly on record the circumstances under which the following remarkable communication was written.

While revising the last sheets of this work, it occurred to the author to ask Sir William Crookes for some particulars of the experiments to which he alluded in his 'Fortnightly' article, some passages from which are quoted on pp. 197-199. On April 22, 1899, Sir William replied as follows :—

DEAR MR FAHIE,—The experiments referred to at page 176 of my 'Fortnightly' article as having taken place "some years ago" were tried by Prof. Hughes when experimenting with the microphone.

I have not ceased since then urging on him to publish an account of his experiments. I do not feel justified in saying more about them, but if you were to write to him, telling him what I say, it might induce him to publish.

It is a pity that a man who was so far ahead of all other workers in the field of wireless telegraphy should lose all the credit due to his great ingenuity and prevision.—Believe me, very truly yours,
WILLIAM CROOKES.

On receipt of this letter I wrote to Prof. Hughes. In reply he said :—

"Your letter of 26th instant has brought upon me a flood of old souvenirs in relation to my past experiments on aerial telegraphy. They were completely unknown to the general public, and I feared that the few distinguished men who saw them had forgotten them, or at least had forgotten how the results shown them were produced. . . .

"At this late date I do not wish to set up any claim to

priority, as I have never published a word on the subject; and it would be unfair to later workers in the same field to spring an unforeseen claimant to the experiments which they have certainly made without any knowledge of my work."

On second (and my readers will say, wiser) thoughts, Prof. Hughes sent me the following letter, in the eliciting of which I consider myself especially fortunate and privileged:—

40 LANGHAM STREET, W., April 29, 1899.

DEAR SIR,—In reply to yours of the 26th inst., in which you say that Sir William Crookes has told you that he saw some experiments of mine on aerial telegraphy in about December 1879, of which he thinks I ought to have published an account, and of which you ask for some information, I beg to reply with a few leading experiments that I made on this subject from 1879 up to 1886:—

In 1879, being engaged upon experiments with my microphone, together with my induction balance, I remarked that at some times I could not get a perfect balance in the induction balance, through apparent want of insulation in the coils; but investigation showed me that the real cause was some loose contact or microphonic joint excited in some portion of the circuit. I then applied the microphone, and found that it gave a current or sound in the telephone receiver, no matter if the microphone was placed direct in the circuit or placed independently at several feet distance from the coils, through which an intermittent current was passing. After numerous experiments, I found that the effect was entirely caused by the extra current, produced in the primary coil of the induction balance.

Further researches proved that an interrupted current in any coil gave out at each interruption such intense extra currents that the whole atmosphere in the room (or in several rooms distant) would have a momentary invisible charge, which became evident if a microphonic joint was used as a receiver with a telephone. This led me to experiment upon the best form of a receiver for these invisible electric waves, which evidently permeated great distances, and through all apparent obstacles, such as walls, &c. I found that all microphonic contacts or joints were extremely sensitive. Those formed of a

hard carbon such as coke, or a combination of a piece of coke resting upon a bright steel contact, were very sensitive and self-restoring; whilst a loose contact between metals was equally sensitive, but would cohere, or remain in full contact, after the passage of an electric wave.

The sensitiveness of these microphonic contacts in metals has since been rediscovered by Mons. Ed. Branly of Paris, and by Prof. Oliver Lodge, in England, by whom the name of "coherer" has been given to this organ of reception; but, as we wish this organ to make a momentary contact and not cohere permanently, the name seems to me ill-suited for the instrument. The most sensitive and perfect receiver that I have yet made does not cohere permanently, but recovers its original state instantly, and therefore requires no tapping or mechanical aid to the separation of the contacts after momentarily being brought into close union.

I soon found that, whilst an invisible spark would produce a thermo-electric current in the microphonic contacts (sufficient to be heard in the telephone in its circuit), it was far better and more powerful to use a feeble voltaic cell in the receiving circuit, the microphonic joint then acting as a relay by diminishing the resistance at the contact, under the influence of the electric wave received through the atmosphere.

I will not describe the numerous forms of the transmitter and receiver that I made in 1879, all of which I wrote down in several volumes of manuscripts in 1879 (but these have never been published), and most of which can be seen here at my residence at any time; but I will confine myself now to a few salient points. I found that very sudden electric impulses, whether given out to the atmosphere through the extra current from a coil or from a frictional electric machine, equally affected the microphonic joint, the effect depending more on the sudden high potential effect than on any prolonged action. Thus, a spark obtained by rubbing a piece of sealing-wax was equally effective as a discharge from a Leyden jar of the same potential. The rubbed sealing-wax and charged Leyden jar had no effect until they were discharged by a spark, and it was evident that this spark, however feeble, acted upon the whole surrounding atmosphere in the form of waves or invisible rays,

the laws of which I could not at the time determine. Hertz, however, by a series of original and masterly experiments, proved in 1887-89 that they were real waves similar to light, but of a lower frequency, though of the same velocity. In 1879, whilst making these experiments on aerial transmission, I had two different problems to solve: 1st, What was the true nature of these electrical aerial waves, which seemed, whilst not visible, to spurn all idea of insulation, and to penetrate all space to a distance undetermined. 2nd, To discover the best receiver that could act upon a telephone or telegraph instrument, so as to be able to utilise (when required) these waves for the transmission of messages. The second problem came easy to me when I found that the microphone, which I had previously discovered in 1877-78, had alone the power of rendering these invisible waves evident, either in a telephone or a galvanometer, and up to the present time I do not know of anything approaching the sensitiveness of a microphonic joint as a receiver. Branly's tube, now used by Marconi, was described in my first paper to the Royal Society (May 8, 1878) as the microphone tube, filled with loose filings of zinc and silver; and Prof. Lodge's coherer is an ordinary steel microphone, used for a different purpose from that in which I first described it.¹

During the long-continued experiments on this subject, between 1879 and 1886, many curious phenomena came out which would be too long to describe. I found that the effect

¹ Prof. Hughes is rightly regarded as the real discoverer of the electrical behaviour of a bad joint or loose contact, the study of which in his hands has given us the microphone; but as in the case of Hertzian-wave effects before Hertz, so, long before Hughes, "mere phenomena of loose contact," as Sir George Stokes called them, must have often manifested themselves in the working of electrical apparatus. For an interesting example see Arthur Schuster's paper read before the British Association in 1874 (or abstract, 'Telegraphic Journal,' vol. ii. p. 289), where the effects are described as a new discovery in electricity, and disguised under the title of the paper, "On Unilateral Conductivity." Schuster suspected the cause—"Two wires screwed together may not touch each other, but be separated by a thin layer of air"—but he missed its real significance. The phenomenon was a kind of bye-product, cropped up while he was engaged on other work, and so was not pursued far enough.—J. J. F.

of the extra current in a coil was not increased by having an iron core as an electro-magnet—the extra current was less rapid, and therefore less effective. A similar effect of a delay was produced by Leyden-jar discharges. The material of the contact-breaker of the primary current had also a great effect. Thus, if the current was broken between two or one piece of carbon, no effect could be perceived of aerial waves, even at short distances of a few feet. The extra current from a small coil without iron was as powerful as an intense spark from a secondary coil, and at that time my experiments seemed to be confined to the use of a single coil of my induction balance, charged by six Daniell cells. With higher battery power the extra current invariably destroyed the insulation of the coils.

In December 1879 I invited several persons to see the results then obtained. Amongst others who called on me and saw my results were—

Dec. 1879.—Mr W. H. Preece, F.R.S. ; Sir William Crookes, F.R.S. ; Sir W. Roberts - Austen, F.R.S. ; Prof. W. Grylls Adams, F.R.S. ; Mr W. Grove.

Feb. 20, 1880.—Mr Spottiswoode, Pres. R.S. ; Prof. Huxley, F.R.S. ; Sir George Gabriel Stokes, F.R.S.

Nov. 7, 1888.—Prof. Dewar, F.R.S. ; Mr Lennox, Royal Institution.

They all saw experiments upon aerial transmission, as already described, by means of the extra current produced from a small coil and received upon a semi-metallic microphone, the results being heard upon a telephone in connection with the receiving microphone. The transmitter and receiver were in different rooms, about 60 feet apart. After trying successfully all distances allowed in my residence in Portland Street, my usual method was to put the transmitter in operation and walk up and down Great Portland Street with the receiver in my hand, with the telephone to the ear.

The sounds seemed to slightly increase for a distance of 60 yards, then gradually diminish, until at 500 yards I could no longer with certainty hear the transmitted signals. What struck me as remarkable was that, opposite certain houses, I could hear better, whilst at others the signals could hardly be perceived. Hertz's discovery of nodal points in reflected waves

(in 1887-89) has explained to me what was then considered a mystery.

At Mr A. Stroh's telegraph instrument manufactory Mr Stroh and myself could hear perfectly the currents transmitted from the third storey to the basement, but I could not detect clear signals at my residence about a mile distant. The innumerable gas and water pipes intervening seemed to absorb or weaken too much the feeble transmitted extra currents from a small coil.

The President of the Royal Society, Mr Spottiswoode, together with the two hon. secretaries, Prof. Huxley and Prof. G. Stokes, called upon me on February 20, 1880, to see my experiments upon aerial transmission of signals. The experiments shown were most successful, and at first they seemed astonished at the results; but towards the close of three hours' experiments Prof. Stokes said that all the results could be explained by known electro-magnetic induction effects, and therefore he could not accept my view of actual aerial electric waves unknown up to that time, but thought I had quite enough original matter to form a paper on the subject to be read at the Royal Society.

I was so discouraged at being unable to convince them of the truth of these aerial electric waves that I actually refused to write a paper on the subject until I was better prepared to demonstrate the existence of these waves; and I continued my experiments for some years, in hopes of arriving at a perfect scientific demonstration of the existence of aerial electric waves produced by a spark from the extra currents in coils, or from frictional electricity, or from secondary coils. The triumphant demonstration of these waves was reserved to Prof. Hertz, who by his masterly researches upon the subject in 1887-89 completely demonstrated not only their existence but their identity with ordinary light, in having the power of being reflected and refracted, &c., with nodal points, by means of which the length of the waves could be measured. Hertz's experiments were far more conclusive than mine, although he used a much less effective receiver than the microphone or coherer.

I then felt it was now too late to bring forward my previous experiments; and through not publishing my results and means employed, I have been forced to see others remake the dis-

coveries I had previously made as to the sensitiveness of the microphonic contact and its useful employment as a receiver for electric aerial waves.

Amongst the earliest workers in the field of aerial transmission I would draw attention to the experiments of Prof. Henry, who describes in his work, published by the Smithsonian Institute, Washington, D.C., U.S.A., vol. i. p. 203 (date unknown, probably about 1850), how he magnetised a needle in a coil at 30 feet distance, and magnetised a needle by a discharge of lightning at eight miles' distance.¹

Marconi has lately demonstrated that by the use of the Hertzian waves and Branly's coherer he has been enabled to transmit and receive aerial electric waves to a greater distance than previously ever dreamed of by the numerous discoverers and inventors who have worked silently in this field. His efforts at demonstration merit the success he has received; and if (as I have lately read) he has discovered the means of concentrating these waves on a single desired point without diminishing their power, then the world will be right in placing his name on the highest pinnacle in relation to aerial electric telegraphy.—

Sincerely yours,

D. E. HUGHES.

J. J. FAHIE, Esq.,

Claremont Hill, St Helier's, Jersey.

In the fifty years (just completed) of a brilliant professorial career at Cambridge, Sir George Stokes has given, times out of number, sound advice and helpful suggestions to those who have sought him; but in this case, as events show, the great weight of his opinion has kept back the clock for many years. With proper encouragement in 1879-80 Prof. Hughes would have followed up his clues, and, with his extraordinary keenness

¹ The 'Polytechnic Review,' March 25, 1843, says: "Professor Henry communicated to the American Society that he had succeeded in magnetising needles by the secondary current in a wire more than 220 feet distant from the wire through which the primary current, excited by a single spark from an electrical machine, was passing." Indeed, Prof. Henry noted many cases of what we now call Hertzian-wave effects, but what he and every one else in those days thought were only extraordinary cases of induction. Many experimenters after Henry must have observed similar effects. See for example the 'Electrician,' vol. xliii. p. 204.—J. J. F.

in research, there can be no doubt that he would have anticipated Hertz in the complete discovery of electric waves, and Marconi in the application of them to wireless telegraphy, and so have altered considerably the course of scientific history.

As a recent commentator pithily says: "Hughes's experiments of 1879 were virtually a discovery of Hertzian waves before Hertz, of the coherer before Branly and of wireless telegraphy before Marconi and others." The writer goes on to say, "Prof. Hughes has a great reputation already, but these latter experiments will add enormously to it, and place him among the foremost electricians of all time"¹—praise which, knowing the learned professor as I do, I consider none too great.

APPENDIX E.

REPRINT OF SIGNOR G. MARCONI'S PATENT.

No. 12,039, A.D. 1896.

*Date of Application, 2nd June 1896. Complete Specification
Left, 2nd Mar. 1897; Accepted, 2nd July 1897.*

PROVISIONAL SPECIFICATION.

IMPROVEMENTS IN TRANSMITTING ELECTRICAL IMPULSES AND SIGNALS, AND IN APPARATUS THEREFOR.

I, Guglielmo Marconi, of 71 Hereford Road, Bayswater, in the county of Middlesex, do hereby declare the nature of this invention to be as follows:—

According to this invention electrical actions or manifestations are transmitted through the air, earth, or water by means of electric oscillations of high frequency.

At the transmitting station I employ a Ruhmkorff coil having in its primary circuit a Morse key, or other appliance

¹ The 'Globe,' May 12, 1899. See also an able and appreciative paper by Mr John Munro, in the 'Electrical Review,' vol. xlv. p. 883.

for starting or interrupting the current, and its pole appliances (such as insulated balls separated by small air spaces or high vacuum spaces, or compressed air or gas, or insulating liquids kept in place by a suitable insulating material, or tubes separated by similar spaces and carrying sliding discs) for producing the desired oscillations.

I find that a Ruhmkorff coil, or other similar apparatus, works much better if one of its vibrating contacts or brakes on its primary circuit is caused to revolve, which causes the secondary discharge to be more powerful and more regular, and keeps the platinum contacts of the vibrator cleaner and preserves them in good working order for an incomparably longer time than if they were not revolved. I cause them to revolve by means of a small electric motor actuated by the current which works the coil, or by another current, or in some cases I employ a mechanical (non-electrical) motor.

The coil may, however, be replaced by any other source of high tension electricity.

At the receiving instrument there is a local battery circuit containing an ordinary receiving telegraphic or signalling instrument, or other apparatus which may be necessary to work from a distance, and an appliance for closing the circuit, the latter being actuated by the oscillations from the transmitting instrument.

The appliance I employ consists of a tube containing conductive powder, or grains, or conductors in imperfect contact, each end of the column of powder or the terminals of the imperfect contact or conductor being connected to a metallic plate, preferably of suitable length so as to cause the system to resonate electrically in unison with the electrical oscillations transmitted to it. In some cases I give these plates or conductors the shape of an ordinary Hertz resonator consisting of two semicircular conductors, but with the difference that at the spark-gap I place one of my sensitive tubes, whilst the other ends of the conductors are connected to small condensers.

I have found that the best rules for making the sensitive tubes are as follows:—

1st. The column of powder ought not to be long, the effects being better in sensitiveness and regularity with tubes contain-

ing columns of powder or grains not exceeding two-thirds of an inch in length.

2nd. The tube containing the powder ought to be sealed.

3rd. Each wire which passes through the tube, in order to establish electrical communication, ought to terminate with pieces of metal or small knobs of a comparatively large surface, or preferably with pieces of thicker wire, of a diameter equal to the internal diameter of the tube, so as to oblige the powder or grains to be corked in between.

4th. If it is necessary to employ a local battery of higher E.M.F. than that with which an ordinarily prepared tube will work, the column of powder must be longer and divided into several sections by metallic divisions, the amount of powder or grains in each section being practically in the same condition as in a tube containing a single section. When no oscillations are sent from the transmitting instrument the powder or imperfect contact does not conduct the current, and the local battery circuit is broken; but when the powder or imperfect contact is influenced by the electrical oscillations, it conducts and closes the circuit.

I find, however, that once started, the powder or contact continues to conduct even when the oscillations at the transmitting station have ceased; but if it be shaken or tapped, the circuit is broken.

I do this tapping automatically, employing the current which the sensitive tube or contact had allowed to begin to flow under the influence of the electric oscillations from the transmitting instrument to work a trembler (similar to that of an electric bell), which hits the tube or imperfect contact, and so stops the current and, consequently, its own movement, which had been generated by the said current, which by this means automatically and almost instantaneously interrupts itself until another oscillation from the transmitting instrument repeats the process. Whilst for certain purposes I prefer working the trembler and the instruments on the same circuit which contains the sensitive tube or contact, for other purposes I prefer working the trembler and the instruments on another circuit, which is made to work in accordance with the first by means of a relay. It is by means of actions from the current, which the sensitive tube or contact allows to pass when the oscilla-

tions influence it, that I prefer starting the apparatus that has to interrupt automatically the same current.

In order to prevent the action of the self-induction of the local circuits on the sensitive tube or contact, and also to destroy the perturbing effect of the small spark which occurs at the breaking of the circuit inside the tube or imperfect contact, and also at the vibrating contact of the trembler or at the movable contact of the relay, I put in derivation across those parts where the circuit is periodically broken a condenser of suitable capacity, or a coil of suitable resistance and self-induction, so that its self-induction may neutralise the self-induction of the said circuits; or preferably I employ in derivation on different parts of the circuit conductors or so-called semi-conductors of high resistance and small self-induction, such as bars of charcoal or preferably tubes containing water or other suitable liquid, in electrical communication with those conductors of the local circuits which are liable in course of self-induction to assume such differences of potential as to transmit jerky currents such as would influence the sensitive tube or contact so as to prevent its working with regularity.

In some cases, however, I find it suitable to employ an independent trembler moved by the current from another battery. This trembler is prevented from generating jerking or vibrating currents by means of the appliances which I have described. This trembler is kept going all the time during which one expects oscillations to be transmitted, and, as already described, the powder or imperfect contact closes the circuit of a local battery, in which are included the instruments which one desires to work, for the time during which the electrical oscillations are transmitted, breaking the circuit in case of the mechanical vibrations as soon as the oscillations from the transmitting machine cease. When transmitting through the air, and it is desired that the signal or electrical action should only be sent in one direction, or when it is necessary to transmit electrical effects to the greatest possible distance without wires, I place the oscillation producer at the focus or focal line of a reflector directed to the receiving station, and I place the tube or imperfect contact at the receiving instrument in a similar reflector directed towards the transmitting instrument.

When transmitting through the earth or water I connect one end of the tube or contact to earth and the other end to conductors or plates, preferably similar to each other, in the air and insulated from earth.

I find it also better to connect the tube or imperfect contact to the local circuit by means of thin wires or across two small coils of thin and insulated wire preferably containing an iron nucleus.

Dated this second day of June 1896.

GUGLIELMO MARCONI

COMPLETE SPECIFICATION.

IMPROVEMENTS IN TRANSMITTING ELECTRICAL IMPULSES AND SIGNALS, AND IN APPARATUS THEREFOR.

I, Guglielmo Marconi, of 67 Talbot Road, Westbourne Park, formerly residing at 71 Hereford Road, Bayswater, in the county of Middlesex, do hereby declare the nature of this invention and in what manner the same is to be performed to be particularly described and ascertained in and by the following statement:—

My invention relates to the transmission of signals by means of electrical oscillations of high frequency, which are set up in space or in conductors.

In order that my specification may be understood, and before going into details, I will describe the simplest form of my invention by reference to figure 1.

In this diagram A is the transmitting instrument and B is the receiving instrument, placed at say $\frac{1}{4}$ mile apart.

In the transmitting instrument R is an ordinary induction coil (a Ruhmkorff coil or transformer).

Its primary circuit C is connected through a key D to a battery E, and the extremities of its secondary circuit F are connected to two insulated spheres or conductors G H fixed at a small distance apart.

When the current from the battery E is allowed to pass through the primary of the induction coil, sparks will take place between the spheres G H, and the space all around the

spheres suffers a perturbation in consequence of these electrical rays or surgings.

The arrangement *A* is commonly called a Hertz radiator, and the effects which propagate through space Hertzian rays.

The receiving instrument *B* consists of a battery circuit *J*, which includes a battery or cell *K*, a receiving instrument *L*, and a tube *T* containing metallic powder or filings, each end

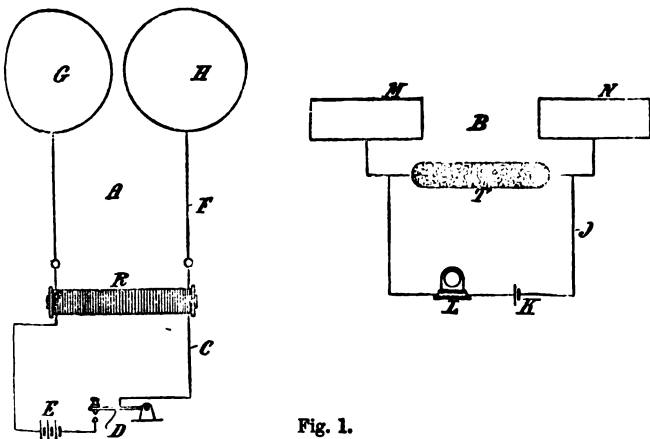

Fig. 1.

of the column of filings being also connected to plates or conductors *M N* of suitable size, so as to be preferably tuned with the length of wave of the radiation emitted from the transmitting instruments.

The tube containing the filings may be replaced by an imperfect electrical contact, such as two unpolished pieces of metal in light contact, or coherer, &c.

The powder in the tube *T* is, under ordinary conditions, a non-conductor of electricity, and the current of the cell *K* cannot pass through the instrument; but when the receiver is influenced by suitable electrical waves or radiation the powder in the tube *T* becomes a conductor (and remains so until the tube is shaken or tapped), and the current passes through the instrument.

By these means electrical waves which are set up in the

transmitting apparatus affect the receiving instrument in such a manner that currents are caused to circulate in the circuit J, and may be utilised for deflecting a needle, which thus responds to the impulse coming from the transmitter.

Figures 2, 3, 4, &c., show various more complete arrangements of the simple form of apparatus illustrated in figure 1.

I will describe these figures generally before proceeding to describe the improvements in detail.

Figure 2 is a diagrammatic front elevation of the instruments of the receiving station, in which $k k$ are the plates corresponding to $m n$ in figure 1. g is the battery correspond-

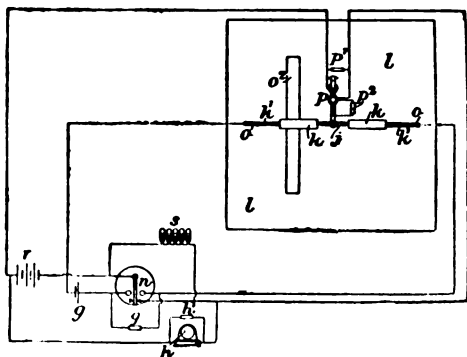

Fig. 2.

ing to κ , h is the reading instrument corresponding to L , n is a relay working the reading instrument h in the ordinary manner. p is a trembler or tapper, similar to that of an electric bell, which is moved by the current that works the instrument.

Figure 3 is a diagrammatic front elevation of the instruments at the transmitting station, in which $e e$ are two metallic spheres corresponding to $G H$ in figure 1.

c is an induction coil corresponding to R . b is a key corresponding to D , and a is a battery corresponding to E .

Figure 4 is a vertical section of the radiator or oscillation producer mounted in the focal line of a cylindrical parabolic

reflector *f* in which a side view of the spheres *e e* of figure 3 is given.

Figure 5 is a full-sized view of the receiving plates *k k* and sensitive tube *j*.

Figure 5A is a modified form of sensitive tube.

Figure 6 is a modification of the oscillation producer in which the spheres *e e* and *d d* are mounted in an ebonite tube *d³*.

Figure 7 is another modification of the oscillation producer in which the spheres are substituted by hemispheres.

Figure 8 is a modified form of receiver in which the plates *k k* are curved instead of being straight.

Figure 9 is another form of transmitter in which two large metallic plates *t² t²* are employed.

Figure 10 shows a modification of the arrangements at the transmitting station, and figure 11 a modification of the arrangements of the receiving station, which enables one to signal through obstacles such as hills or mountains.

Figure 12 shows a detector which is useful for determining the proper length of the plates *k k* of the receivers.

Figure 13 shows an improved interrupter (make-and-break) which is applicable to the induction coil of the transmitter.

Figure 14 shows a water resistance, the use of which shall be explained.

My invention relates in great measure to the manner in which the above apparatus is made and connected together. With some of these forms I am able to obtain Morse signals, and to work ordinary telegraphic instruments and other apparatus; and with modifications of the above apparatus it is possible to transmit signals not only through comparatively small obstacles such as brick walls, trees, &c., but also through or across masses of metal, or hills, or mountains, which may intervene between the transmitting and receiving instruments.

I will first describe my improvements which are applicable to the receiving instruments.

My first improvement consists in automatically tapping or disturbing the powder in the sensitive tube, or in shaking the imperfect contact, so that immediately the electrical stimulus from the transmitter has ceased, the tube or imperfect contact regains its ordinary non-conductive state. This part of my invention is illustrated in figure 2, in which *j* represents the

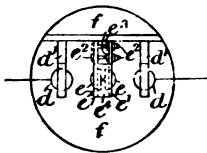

Fig. 7.

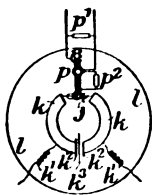

Fig. 8.

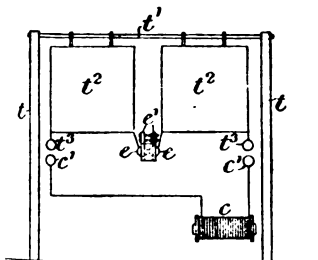

Fig. 9.

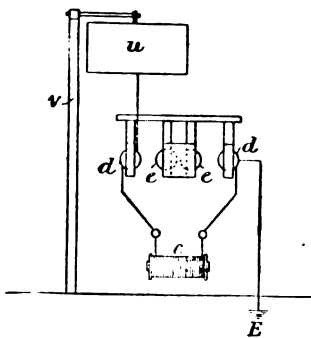

Fig. 10.

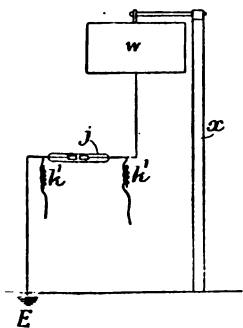

Fig. 11.

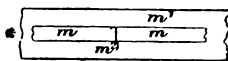

Fig. 12.

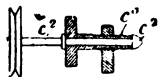

Fig. 13.



Fig. 14.

U

sensitive tube and p the trembler or tapper. The current which flows through the sensitive tube or contact, and which is commenced under the influence of the electrical oscillations from the transmitting instrument, is allowed to actuate (directly, or indirectly by means of a relay) the trembler, which is similar to an electric bell. This trembler must be so arranged, as hereinafter explained, that the effect of the sparking at its vibrating contacts, and the jerky currents caused by self-induction, &c., are neutralised or removed.

The small hammer of the trembler hits the tube or imperfect contact and so stops the current, and consequently its own movement, which had been generated by the said current; and by this means the current automatically and almost instantaneously interrupts itself until another oscillation from the transmitting instrument again makes the sensitive tube or imperfect contact a conductor.

I find, however, that the current which can be started by the sensitive tube or contact is not sufficiently strong to work an ordinary trembler and receiving instrument.

To overcome this difficulty, instead of obliging the current of the circuit which contains the sensitive tube or contact to work the trembler and instrument, I use the said current for working a sensitive relay n (figure 2), which closes and opens the circuit of a stronger battery r , preferably of the Leclanché type. This current, which is much stronger than the current which runs through the sensitive tube or contact, works the trembler and other instruments. To prevent the sparks and jerks of current which would be caused by the self-induction of the relay from interfering with the action of the receiver, certain means must be taken similar to those referred to above in reference to the trembler or tapper, which will be explained hereafter. In the apparatus I have made I have found that the relay n should be one possessing small self-induction, and wound to a resistance of about 1000 ohms. It should preferably be able to work regularly with a current of a milliampère or less. The trembler or tapper p on the circuit of the relay n is similar in construction to that of a small electric bell, but having a shorter arm. I have used a trembler wound to 1000 ohms resistance, having a core of good soft iron hollow and split lengthways like most electro-magnets used in telegraph instruments.

The trembler must be carefully adjusted. Preferably the blows should be directed slightly upwards, so as to prevent the filings from getting caked. In place of tapping the tube the powder can be disturbed by slightly moving outwards and inwards one or both of the stops of the sensitive tube (see figure 5, $j^1 j^2$), the trembler p (figure 2) being replaced by a small electro-magnet or magnets or vibrator whose armature is connected to the stop.

I ordinarily work the receiving instrument h , which may be of any description, by a derivation as shown from the circuit, which works the trembler p . It can also, however, be worked in series with the trembler.

It is desirable that the receiving instrument, if on a derivation of the circuit which includes the trembler or tapper, should preferably have a resistance equal to the resistance of the trembler p .

A further improvement consists in the mode of construction of the sensitive tube.

I have noticed that a sensitive tube or imperfect contact, such as is shown in figure 1 τ , is not perfectly reliable.

My tube as shown in figure 5 is, if carefully constructed, absolutely reliable, and by means of it the relay and trembler &c., can be worked with regularity like any other ordinary telegraphic instrument.

In figure 5, j is the sensitive tube containing two metallic plugs j^2 connected to the battery circuit, between which is placed powder of a conductive material j^1 . The two plugs should preferably be made of silver, or may be two short pieces of thick silver wire of the same diameter as the internal diameter of the tube j , so as to fit tightly in it. The plugs $j^2 j^2$ are joined to two pieces of platinum wire j^3 . The tube is closed and sealed on to the platinum wires j^3 at both ends. Many metals can be employed for producing the powder or filings j^1 , but I prefer to use a mixture of two or more different metals. I find hard nickel to be the best metal, and I prefer to add to the nickel filings about four per cent of hard silver filings, which increase greatly the sensitiveness of the tube to electric oscillations. By increasing the proportion of silver powder or grains the sensitiveness of the tube also increases; but it is better for ordinary work not to use a tube of too great

sensitiveness, as it might be influenced by atmospheric or other electricity.

The sensitiveness can also be increased by adding a very small amount of mercury to the filings and mixing up until the mercury is absorbed. The mercury must not be in such a quantity as to clot or cake the filings : an almost imperceptible globule is sufficient for a tube. Instead of mixing the mercury with the powder, one can obtain the same effects by slightly amalgamating the inner surfaces of the plugs which are to be in contact with the filings. Very little mercury must be used, just sufficient to brighten the surface of the metallic plugs without showing any free mercury or globules.

The size of the tube and the distance between the two metallic stops or plugs may vary under certain limits : the greater the space allowed for the powder, the larger or coarser ought to be the filings or grains.

I prefer to make my sensitive tubes of the following size—the tube j is $1\frac{1}{2}$ inch long and $\frac{1}{10}$ or $\frac{1}{12}$ of an inch internal diameter. The length of the stops j^2 is about $\frac{1}{2}$ of an inch, and the distance between the stops or plugs $j^2 j^2$ is about $\frac{1}{30}$ of an inch.

I find that the smaller or narrower the space is between the plugs in the tube, the more sensitive it proves ; but the space cannot under ordinary circumstances be excessively shortened without injuring the fidelity of the transmission.

Care must be taken that the plugs $j^2 j^2$ fit the tube exactly, as otherwise the filings might escape from the space between the stops, which would soon destroy the action of the sensitive tube.

The metallic powders ought not to be fine, but rather coarse, as can be produced by a large and rough file.

The powder should preferably be of uniform grain or thickness.

All the very fine powder or the excessively coarse powder ought to be removed from it by blowing or sifting.

It is also desirable that the powder or grains should be dry and free from grease or dirt, and the files used in producing the same ought to be frequently washed and dried, and used when warm.

The powder ought not to be compressed between the plugs,

but rather loose, and in such a condition that when the tube is tapped the powder may be seen to move freely.

The tube *j* may be sealed, but a vacuum inside it is not essential, except the slight vacuum which results from having heated it while sealing it. Care should also be taken not to heat the tube too much in the centre when sealing it, as it would oxidise the surfaces of the silver stops, and also the powder, which would diminish its sensitiveness. I have used, in sealing the tubes, a hydrogen and air flame.

A vacuum is, however, desirable, and I have used one of about $\frac{1}{1000}$ of an atmosphere obtained by a mercury pump.

In this case a small glass tube must be joined to a side of the tube *j* (figure 5), which is put in communication with the pump and afterwards sealed in the ordinary manner.

If the sensitive tube has been well made, it should be sensitive to the inductive effect of an ordinary electric bell when the same is working from one to two yards from the tube.

A sensitive tube well prepared should also instantly interrupt the current passing through it at the slightest tap or shake, provided it is inserted in a circuit in which there is little self-induction and small electro-motive force, such as a single cell.

In order to keep the sensitive tube *j* in good working order it is desirable, but not absolutely necessary, not to allow more than one milliampère to flow through it when active.

If a stronger current is necessary, several tubes may be put in parallel, provided they all get shaken by the tapper or trembler; but this arrangement is not always quite as satisfactory as the single tube.

It is preferable, when using sensitive tubes of the type I have described, not to insert in the circuit with it more than one cell of the Leclanché type, as a higher electro-motive force than 1.5 volts is apt to pass a current through the tube, even when no oscillations are transmitted.

I can, however, construct sensitive tubes capable of working with a higher electro-motive force.

Fig. 5A shows one of these tubes. In this tube, instead of one space or gap filled with filings, there are several spaces $j^1 j^1$, separated by plugs of tight-fitting silver wire. A tube thus

constructed—observing also the rules of construction of my tubes in general—will work satisfactorily if the electro-motive force of the battery in circuit with the tube is equal to about 1.2 volts multiplied by the number of gaps.

With this tube also it is well not to allow a current of more than one milliampère to pass through it.

Figure 5 also shows the plates $k k$, which are joined to each end of the sensitive tube, and which correspond to the plates $m m$ in figure 1.

The plates k (figure 5) are of copper or other metal, about half an inch or more broad, and may be about $\frac{1}{80}$ of an inch thick, and preferably of such a length as to be electrically tuned with the length of the wave of the electrical oscillations transmitted.

The means I adopt for fixing the proper length of the plates $k k$ is as follows: I stick a rectangular strip of tinfoil (see figure 12) m about 20 inches long (the length depends on the supposed length of the wave that one is measuring), by means of a weak solution of gum, on to a glass plate m^1 (figure 12); then by means of a very sharp penknife or point and ruler I cut across the middle of the tinfoil, leaving a mark of division m^2 . If this glass plate is held a few feet away from the origin of the electrical disturbances, and in such a position that the strips of tinfoil are about parallel to the line joining the centres of the two spheres in the transmitting apparatus, sparks will jump from one strip to the other at m^2 . When the length of the strips of tinfoil m has been so adjusted as to approximate to the length of wave emitted from the oscillator, the sparking will occur at a greater distance from the oscillation producer when the strips are of suitable length. By shortening or lengthening the strips, therefore, it is easy to find the length most appropriate to the length of wave emitted by the oscillation producer. The length so found is the proper length for the plates k , or rather these should be about half an inch shorter on account of the length of the sensitive tube j (figure 5) connected between them.

The plates k , tube j , &c., are fastened to a thin glass tube o , preferably not longer than 12 inches, firmly fixed at one end to a firm piece of wood o^2 , or the sensitive tube j may be fixed firmly at both ends—*i.e.*, preferably grasped near the ends of

the tube containing the powder, and not at the ends of the tube o , which serves as support.

By means of a tube with multiple gaps, as shown in figure 5A, it is also possible to work the trembler and also the signalling or other apparatus direct on the circuit which contains the sensitive tube, but I prefer when possible to work with the single-gap tube and the relay as shown. With a sensitive and specially constructed trembler it is also possible to work the trembler with the single-gap tube in series with it without a relay.

In order to increase the distance at which the receiver can be actuated by the radiation from the transmitter, I place the receiver (*i.e.*, the sensitive tube and plates) in the focal line of a cylindrical parabolic reflector l (figure 2), preferably of copper, and directed towards the transmitting station.

In determining the proper length of the plates of the receiver by means of the detector shown in figure 12, it is desirable to try the detector in the focus or focal line of the reflector, because the length of the strips or plates which gives the best result in a reflector differs slightly from the length which gives the best results without reflectors.

The reflector l (figure 2) should be preferably in length and opening not less than double the length of wave emitted from the transmitting instrument.

It is slightly advantageous for the focal distance of the reflector to be equal to one-fourth or three-fourths of the wavelength of the oscillation transmitted.

The plates k (figure 2) may be replaced by tubes or other forms of conductors.

A further improvement has for its object to prevent the electrical disturbances which are set up by the trembler and other apparatus in proximity or in circuit with the tube from themselves restoring the conductivity of the sensitive tube immediately after the trembler has destroyed it, as has been described.

This I effect by introducing into the circuits at the places marked p^1 , p^2 , q , h^1 , in figure 2 high resistances having as little self-induction as possible. The action of the high resistances is that, while preventing any appreciable quantity of the current from passing through them when the apparatus is working,

they nevertheless afford an easy path for the currents of high tension which would be formed at the moment when the circuit is broken, and thus prevent sparking at contacts or sudden jerks of currents, which would restore or maintain the conductivity of the sensitive tube.

These coils may conveniently be made by winding the wire (preferably of platinoid) on the bight, as it is sometimes termed, or double wound, to prevent them producing self-induction.

In figure 2, p^1 is one of these resistance coils which is inserted in a circuit connecting the vibrating contacts of the trembler p . I have used in the apparatus a coil which had a resistance about four times the resistance of the trembler p .

p^1 represents a similar resistance (also of about four times the resistance of the trembler) inserted in parallel across the terminals of the trembler.

A similar resistance q , figure 2, is placed in parallel on the terminals of the relay r (*i.e.*, the terminals which are connected to the circuit containing the sensitive tube).

The coil q should preferably have a resistance of about three or four times the resistance of the relay.

A similar resistance h^1 of about four times the resistance of the instrument is inserted in parallel across the terminals of the instrument.

In parallel across the terminals of the relay (*i.e.*, corresponding to the circuit worked by the relay) it is well to have a liquid resistance s constituted of a series of tubes, one of which is shown full size in figure 14 partially filled with water acidulated with sulphuric acid. The number of these tubes in series across the said terminals ought to be about ten for a circuit of 15 volts, so as to prevent, in consequence of their counter electro-motive force, the current of the local battery from passing through them, but allowing the high tension jerk of current generated at the opening of the circuit in the relay to pass smoothly across them without producing perturbing sparks at the movable contact of the relay.

A double-wound platinoid resistance may be used instead of the water resistance, provided its resistance be about 20,000 ohms.

A resistance similar to h should be inserted in parallel on

the terminals of any apparatus or resistance which may be apt to give self-induction and which is near or connected to the receiver.

Condensers of suitable capacity may be substituted for the above-mentioned coils, but I prefer using coils or water resistances.

Another improvement has for its object to prevent the high frequency oscillations set up across the plates of the receiver by the transmitting instrument, which should pass through the sensitive tube, from running round the local battery wires and thereby weakening their effect on the sensitive tube or contact.

This I effect by connecting the battery wires to the sensitive tube or contact, or to the plates attached to the tube through small coils (see k^1 in the figures) possessing self-induction, which may be called choking coils, formed by winding in the ordinary manner a short length (about a yard) of thin and well-insulated wire round a core (preferably containing iron) two or three inches long.

Another improvement consists in a modified form of the plates connected to the sensitive tube, in order to make it possible to mount the receiver in an ordinary circular parabolic reflector. This part of my invention is illustrated in figure 8, in which l is an ordinary concave reflector. In this case the plates k k are curved and connected at one end to the sensitive tube j , and at the other to a small condenser formed by two metallic plates k^2 of about one inch square or more, facing each other with a very thin piece of insulating material k^3 between them. p is the trembler. The condenser may be omitted without much altering the effects obtainable.

The connection to the local circuit is made through two small choking coils k^1 k^1 as already described.

The adjustment of the whole is similar to that already described for the other receivers.

The receiver should be put in such a position as to intercept the reflected ring of radiations which exists behind or before the focus of the reflector, and ought to be preferably tuned with the length of wave of the oscillation transmitted, in similar manner to that before described, except that a ring of tinfoil with a single cut through it is employed.

I will now describe my improvements which are applicable to the transmitting instruments.

My first improvement consists in employing four spheres for producing the electrical oscillations.

This part of my invention is illustrated in figure 3, $d d, e e$, and in figure 6, $d d, e e$. The spheres $d d$, figure 3, are connected to the terminals c^1 of the secondary circuit of the induction coil c . The spheres $d d$ are carried by insulating supports $d^1 d^1$.

Preferably the supports d^1 consist of plates of ebonite having holes to receive the balls, which are fixed by heating them sufficiently to fuse the ebonite and then holding them in place until they cool. $e e$ are two similar balls on supports $e^1 e^1$, whose distance apart can be adjusted by ebonite bolts and nuts $e^2 e^2$ acting against other nuts e^3 . e^4 is a flexible membrane, preferably of parchment paper, glued to the supports e^1 and forming a vessel which is filled with dielectric liquid, preferably vaseline-oil slightly thickened with vaseline.

The oil or insulating liquid between the spheres $e e$ increases the power of the radiation, and also enables one to obtain constant effects, which are not easily obtained if the oil is omitted.

The balls d and e are preferably of solid brass or copper, and the distance they should be apart depends on the quantity and electro-motive force of the electricity employed, the effect increasing with the distance (especially by increasing the distance between the spheres d and the spheres e) so long as the discharge passes freely. With an induction coil giving an ordinary 8-inch spark the distance between e and e should be from $\frac{1}{25}$ to $\frac{1}{30}$ of an inch, and the distance between d and e about one inch.

When it is desired that the signal should only be sent in one direction, I place the oscillation producer in the focus or focal line of a reflector directed to the receiving station.

f (figure 3) and f (figure 4) show the cylindrical parabolic reflector made by bending a metallic sheet, preferably of brass or copper to form, and fixing it to metallic or wooden ribs f^1 (figure 3).

Other conditions being equal, the larger the balls the greater is the distance at which it is possible to communicate. I have

generally used balls of solid brass of 4 inches diameter, giving oscillations of 10 inches length of wave.

Instead of spheres, cylinders or ellipsoids, &c., may be employed.

Preferably the reflector applied to the transmitter ought to be in length and opening the double at least of the length of wave emitted from the oscillator.

If these conditions are satisfied, and with a suitable receiver, a transmitter furnished with spheres of 4 inches diameter connected to an induction coil giving a 10-inch spark will transmit signals to two miles or more.

If a very powerful source of electricity giving a very long spark be employed, it is preferable to divide the spark-gap between the central balls of the oscillator into several smaller gaps in series. This may be done by introducing between the big balls smaller ones (of about half an inch diameter) held in position by ebonite frames.

Figure 6 shows a more compact form of oscillation producer. In this each pair of balls d and e is fixed by heat or otherwise in the end of tubes d^2 of insulating material, such as ebonite or vulcanite. The tubes d^2 fit tightly in another similar tube d^3 having covers d^4 , through which pass the rods d^5 connecting the balls d to the conductors. One (or both) of the rods d^5 is connected to the ball d by a ball-and-socket joint, and has a screw thread upon it working in a nut in the cover d^4 . By turning the rod, therefore, the distance of the balls e apart can be adjusted. d^6 are holes in the tube d^3 , through which the vaseline-oil can be introduced into the space between the balls e .

A further improvement consists in causing one of the contacts of the vibrating brake applied to the induction coil to revolve rapidly.

This improvement has for its object to maintain the platinum contacts of the interrupter in good working order, and to prevent them sticking, &c.

This part of my invention is illustrated in figure 3 (c^2 , c^3 , c^4).

I obtain this result by having a revoluble central core c^2 (figure 3 and figure 13) in the ordinary screw c^3 , which is in communication with the platinum contacts. I cause the said

central core with one of the platinum contacts attached to it to revolve by coupling it to a small electric motor c^4 .

This motor can be worked by the same circuit that works the coil, or if necessary by a separate circuit—the connections are not shown in the drawing.

By this means the regularity and power of the discharge of an ordinary induction coil with a trembler brake are greatly improved.

The induction coil c (figure 3) may, however, be replaced by any other source of high-tension electricity.

When working with large amounts of energy it is, however, better to keep the coil of the transformer constantly working for the time during which one is transmitting, and, instead of interrupting the current of the primary, interrupting the discharge of the secondary.

In this case the contacts of the key should be immersed in oil, as otherwise, owing to the length of the spark, the current will continue to pass after the contacts have been separated.

A further improvement has for its object to facilitate the focussing of the electric rays.

This part of my invention is illustrated in figure 7, in which a view is given of the modified oscillation producer mounted in the focus of an ordinary parabolic reflector f .

The oscillator in this case is different from the one I have previously described, because instead of being constituted of two spheres it is made of two hemispheres $e e$ separated by a small space filled with oil or other dielectric. The spark between the hemispheres takes place in the dielectric from small projections at the centres of the hemispheres. The working and adjusting of this oscillator are similar to that of the one previously described.

This arrangement may be also solidly mounted in an ebonite tube, as shown in figure 6.

A receiver which may be used with this transmitter is shown in figure 8, and has already been described.

It is not essential to have a reflector at the transmitters and receivers, but in their absence the distance at which one can communicate is much smaller.

Figure 9 shows another modified form of transmitter with

which one can transmit signals to considerable distances without using reflectors.

In figure 9, $t t$ are two poles connected by a rope t^1 , to which are suspended by means of insulating suspenders two metallic plates $t^2 t^2$ connected to the spheres e (in oil, or other dielectric, as before) and to the other balls t^3 in proximity to the spheres c^1 , which are in communication with the coil or transformer c . The balls t^3 are not absolutely necessary, as the plates t^2 may be made to communicate with the coil or transformer by means of thin insulated wires. The receiver I adopt with this transmitter is similar to it, except that the spheres e are replaced by the sensitive tube or imperfect contact j (figure 5), whilst the spheres t^3 may be replaced by the choking coils k^1 in communication with the local circuit. If a circular-tuned receiver of large size be employed, the plates t^2 may be omitted from the receiver. I have observed that, other conditions being equal, the larger the plates at the transmitter and receiver, and the higher they are from earth, and to a certain extent the farther apart they are, the greater is the distance at which correspondence is possible.

For permanent installations it is convenient to replace the plates by metallic cylinders closed at one end, and put over the pole like a hat, and resting on insulators. By this arrangement no wet can come to the insulators, and the effects obtainable are better in wet weather.

A cone or hemisphere may be used in place of a cylinder. The pole employed ought preferably to be dry and tarred.

Where obstacles, such as many houses or a hill or mountains, intervene between the transmitter and the receiver, I have devised and adopt the arrangement shown in figures 10 and 11.

In the transmitting instrument, figure 10, I connect one of the spheres d to earth E preferably by a thick wire, and the other to a plate or conductor u , which may be suspended on a pole v and insulated from earth. Or the spheres d may be omitted and one of the spheres e be connected to earth and the other to the plate or conductor u .

At the receiving station, figure 11, I connect one terminal of the sensitive tube or imperfect contact j to earth E , preferably also by a thick wire, and the other to a plate or conductor w ,

preferably similar to w . The plate w may be suspended on a pole x , and should be insulated from earth. The larger the plates of the receiver and transmitter, and the higher from the earth the plates are suspended, the greater is the distance at which it is possible to communicate at parity of other conditions.

The figure does not show the trembler or tapping arrangement. $k^1 k^1$ are the choking coils, which are connected to the battery circuit, as has been explained with reference to the previous figures.

At the receiver it is possible to pick up the oscillations from the earth or water without having the plate w . This may be done by connecting the terminals of the sensitive tube j to two earths, preferably at a certain distance from each other and in a line with the direction from which the oscillations are coming. These connections must not be entirely conductive, but must contain a condenser of suitable capacity, say of one square yard surface (parafined paper as dielectric).

Balloons can also be used instead of plates on poles, provided they carry up a plate or are themselves made conductive by being covered with tinfoil. As the height to which they may be sent is great, the distance at which communication is possible becomes greatly multiplied. Kites may also be successfully employed if made conductive by means of tinfoil.

When working the described apparatus, it is necessary either that the local transmitter and receiver at each station should be at a considerable distance from each other, or that they should be screened from each other by metal plates. It is sufficient to have all the telegraphic apparatus in a metal box (except the reading instrument), and any exposed part of the circuit of the receiver enclosed in metallic tubes which are in electrical communication with the box (of course the part of the apparatus which has to receive the radiation from the distant station must not be enclosed, but possibly screened from the local transmitting instrument by means of metallic sheets).

When the apparatus is connected to the earth or water the receiver must be switched out of circuit when the local transmitter is at work, and this may also be done when the apparatus is not earthed.

Having now particularly described and ascertained the nature of my said invention, and in what manner the same is to be performed, I declare that what I claim is—

1. The method of transmitting signals by means of electrical impulses to a receiver having a sensitive tube or other sensitive form of imperfect contact capable of being restored with certainty and regularity to its normal condition substantially as described.

2. A receiving instrument consisting of a sensitive imperfect contact or contacts, a circuit through the contact or contacts, and means for restoring the contact or contacts, with certainty and regularity, to its or their normal condition after the receipt of an impulse substantially as described.

3. A receiving instrument consisting of a sensitive imperfect contact or contacts, a circuit through the contact or contacts, and means actuated by the circuit for restoring with certainty and regularity the contact or contacts to its or their normal condition after the receipt of an impulse.

4. In a receiving instrument such as is mentioned in claims 2 and 3, the use of resistances possessing low self-induction, or other appliances for preventing the formation of sparks at contacts or other perturbing effects.

5. The combination with the receivers such as are mentioned in claims 2 and 3 of resistances or other appliances for preventing the self-induction of the receiver from affecting the sensitive contact or contacts substantially as described.

6. The combination with receivers such as herein above referred to of choking coils substantially as described.

7. In receiving instruments consisting of an imperfect contact or contacts sensitive to electrical impulses, the use of automatically working devices for the purpose of restoring the contact or contacts with certainty and regularity to their normal condition after the receipt of an impulse substantially as herein described.

8. Constructing a sensitive non-conductor capable of being made a conductor by electrical impulses of two-metal plugs or their equivalents, and confining between them some substance such as described.

9. A sensitive tube containing a mixture of two or more powders, grains, or filings, substantially as described.

10. The use of mercury in sensitive imperfect electrical contacts substantially as described.

11. A receiving instrument having a local circuit, including a sensitive imperfect electrical contact or contacts, and a relay operating an instrument for producing signals, actions, or manifestations substantially as described.

12. Sensitive contacts in which a column of powder or filings (or their equivalent) is divided into sections by means of metallic stops or plugs substantially as described.

13. Receivers substantially as described and shown in figures 5 and 8.

14. Transmitters substantially as described and shown at figures 6 and 7.

15. A receiver consisting of a sensitive tube or other imperfect contact inserted in a circuit, one end of the sensitive tube or other imperfect contact being put to earth whilst the other end is connected to an insulated conductor.

16. The combination of a transmitter having one end of its sparking appliance or poles connected to earth, and the other to an insulated conductor, with a receiver as is mentioned in claim 15.

17. A receiver consisting of a sensitive tube or other imperfect contact inserted in a circuit, and earth connections to each end of the sensitive contact or tube through condensers or their equivalent.

18. The modifications in the transmitters and receivers, in which the suspended plates are replaced by cylinders or the like placed hat-wise on poles, or by balloons or kites substantially as described.

19. An induction coil having a revolving make and break substantially as and for the purposes described.

Dated this 2nd day of March 1897.

GUGLIELMO MARCONI.

INDEX.

- Aerial telegraph, an, 73 *et seq.*
Andres, Signor Senlicq d', 8 fn.
Armstrong, Lord, 270 fn.
Ascoli, Prof., 215.
Atlantic telegraph, an, Lindsay's proposals, 21 *et seq.*—a telegraph without a cable, 90.
Auticatelephor of Edwards, 8 *et seq.*
Barclay, A., 78.
Bell, Prof. Graham, his photophone, 5 and fn.—experiments in communicating between ships at sea, 96 *et seq.*—251, 252.
Béron's 'Météorologie Simplifiée' referred to, 66 fn.
Blake, Prof. Lucien, experiment showing sensitiveness of the telephone, 85—130 fn.
Blissett, Mr, 114.
Blondel, Prof., 232 fn.
Bonelli, 29 fn., 104.
Bouchotte, 29 fn.
Bourbouze, M., 71 *et seq.*
Boze, Prof. Chunder, 188.
Branly, Prof. E., 189 *et seq.*, 195 *et seq.*—on variations of conductivity, 276 *et seq.*—291.
Brett, 104.
Bright, Mr C., 130 fn.
Brooke, Sir William O'Shaughnessy, experiments in subaqueous telegraphy, 39.
Brown, Mr A. C., the inventor of the photophone, 5 fn.—induction in train signalling, 104 *et seq.*—176 fn.
Call apparatus on the Fastnet rock, 173.
Calzecchi-Onesti, Prof., 194 *et seq.*
Carty, Mr, on the electro-static phenomena on telephone circuits, 144 fn.
Channing, Dr, experiments showing sensitiveness of the telephone, 81 *et seq.*
Churchill, Lord A. S., 78.
Clark, Edwin, 104.
Coherer. *See* Detector.
Coils, communication between ships, &c., by, 122 *et seq.*, 156.
Conduction methods of communication, 130 *et seq.*, 162 *et seq.*—variations of conductivity under electrical influence, 276 *et seq.*
Cooke, William Fothergill, his system of train signals, 104.

- Crookes, Sir William, 197, 289.
- Davy, Edward, 6 *et seq.*—plans for telegraphing without wires, *ib.*—proposal for communication with trains in motion, 103.
- Dering, G. E., his needle telegraphy, 48—methods of carrying off atmospheric electricity from the line-wires, *ib.*—proposals for a transmarine telegraph, 49 *et seq.*—attempt to apply his system, 53 *et seq.*
- Detector, Wilkins's, 36 *et seq.*—Lord Kelvin's and other relays, 37 *et seq.*—Highton's 42 *et seq.*—Hertz's, 182, 190—Righi's, *ib.*—Lodge's "coherer," *ib.*—Branly's radio-conductor, *ib.*, 196—Mr Rutherford's detector, 200—Rev. F. Jarvis-Smith's, 202—Marconi's, 204 *et seq.*—Lodge's form of the Branly coherer, 231 *et seq.*
- Dietz, Dr, 216.
- Dolbear, Prof. A. E., his system of wireless telegraphy, 99 *et seq.*
- Dolbear, Mr C., 103 fn.
- Douat, 29 fn.
- Dufour, M. Henri, experiment in inductive effect in telephone circuit, 84.
- Dujardin, 104.
- "Earth as Part of a Voltaic Circuit, the," extract from 'The Electrician' on, 66 *et seq.*
- Earth, Salvá's suggestion to electrify, 2—the earth battery, 20—Steinheil's discovery of the earth circuit, 3—earth-currents or leakages, 141 *et seq.*
- Edison, Mr T. A., his system of train signals, 107 *et seq.*
- Edser, Prof., 180.
- Edwards, Mr T. W. C., the Auticatelephor of, 8 *et seq.*
- Electric currents, nature of, 264 *et seq.*—electric waves and their application to wireless telegraphy, 289 *et seq.*
- Electrical oscillations, 179 *et seq.*—radiation, 186.
- Everashed, Mr Sydney, plan for communicating with lightships, 128 fn.—his relays, 161—175.
- Exciter, Hertz's, 182, 189—Sarasin and de la Rive's, *ib.*—Righi's, *ib.*—Marconi's, 203 *et seq.*
- Fahie, J. J., reference to 'History of Electric Telegraphy to 1837' by, 1, 3 fn., 20 fn., 104 fn.
- Faraday, Michael, 249.
- Feddersen, 179.
- Fitzgerald, Mr, of Dublin, 249, 251.
- Fleming, Prof., on Marconi's system, 241 *et seq.*
- Galvanometer. *See* Detector.
- Gauss, 3.
- Gavey, Mr, 146, 161.
- Gilliland, E. T., 107 *et seq.*
- Gintl, 29 fn.
- Glanville, Mr, 221.
- Gott, Mr J., use of the telephone in wireless telegraphy, 85 *et seq.*
- Granier, Mr, proposal of an aerial line, 71.
- Granville, W. P., 166.
- Grove, Sir W. R., 251.
- Hamel, Dr, account of Salvá's experiment, 2.

- Haworth, John, unintelligibility of his proposals, 55 *et seq.*—summary of his specification, 58 *et seq.*—Mr Varley's correspondence with, 61 *et seq.*—Mr Haworth's reply, 65.
- Heaviside, Mr A. W., 145, 147.
- Helmholtz, 179.
- Henry, Prof. Joseph, experiments in induction, 93 *et seq.*—185 fn.—on high tension electricity, 261 *et seq.*—295.
- Hertz, Prof. Heinrich, 177 *et seq.*, 267 *et seq.*
- Highton, Edward and Henry, experiments in transaqueous telegraphy, 40 *et seq.*
- Hippisley, Capt., R.E., 139 fn.
- Hughes, Prof. D. E., 199 fn.—on electric waves, 289 *et seq.*
- India, subaqueous telegraphy in, 39, 114 *et seq.*
- Induction, employment in wireless telegraphy of, 92 *et seq.*—electro-static currents, 142 *et seq.*—electro-magnetic currents, 144 *et seq.*—communication by means of induction, 157 *et seq.*
- Insulation, telegraphing without, 21 *et seq.*, 39 *et seq.*, 49, 53, 115 *et seq.*, 176 fn.
- Jackson, Capt., R.N., 202.
- Jervis-Smith, Rev. F., 202.
- Johnston, Mr W. P., arrangement for signalling across a canal, 114 *et seq.*
- Kelvin, Lord, 179, 220, 256, 270 fn.
- Kerr, Dr, of Glasgow, 251.
- Kerr's 'Wireless Telegraphy' referred to, 28 fn.
- Langdon-Davies, Mr, his phonophone, 236.
- Lighthouses, telegraphic communication with, 164 *et seq.*
- Lightning, effect of, on telephone, 80.
- Lightships, communication with, Evershed's plan, 128 fn.—by Marconi's system, 224 *et seq.*
- Lindsay, James Bowman, outline of his life, 13 *et seq.*—experiments in electric lighting, 18 *et seq.*—proposals for telegraph to America, 20 *et seq.*—experiments without wires, 24 *et seq.*—Mr Preece's recollection of, 28.
- Little, 104.
- Lodge, Prof. Oliver, 95 fn.—on the law of distance, 127 fn.—his conception of electricity, 140 fn.—175, 189, 190, 196, 197 fn., 200, 227, 291—on the relation between electricity and light, 246 *et seq.*, 271 *et seq.*
- Loomis, Mahlon, 73 *et seq.*
- Marconi, Guglielmo, 197 *et seq.*, 295—reprint of his specification, 296 *et seq.*
- Maxwell, James Clerk-, 178, 186, 249, 254, 257, 264 *et seq.*
- Melhuish, Mr W. F., experiments in signalling across rivers in India, 116 *et seq.*
- Minchin, Prof., 190, 200, 252.
- Molesworth, J., 78.
- Morse, Prof., 10 *et seq.*—experiments in telegraphing through water without wires, 11 *et seq.*
- Mower, J. H., 70 *et seq.*
- Muirhead, Dr Alexander, 233.
- Munro, Mr John, 296 fn.

- Nelson, Henry, of Galesburg, 87 fn.
- Newton, A. V., 78.
- Newton, W. E., 78.
- Nickels, B., 78.
- Norrie's 'Dundee Celebrities of the Nineteenth Century' quoted, 18 fn.
- O'Shaughnessy, Dr. *See* Brooke, Sir William O'Shaughnessy.
- Page's discovery of galvanic music, 94 fn.
- Pasqualini, Mr, 227 fn.
- Photophone, Steinheil's proposal, 5—the true inventor of the, *ib.* fn.
- Pierce, Prof., experiments showing sensitiveness of the telephone, 79.
- Popoff, Prof., 200 *et seq.*
- Poynting's theory concerning electric current, 185.
- Preece, W. H., papers by, 136 *et seq.*—disturbances on telephone lines, 137 *et seq.*—experiment in telegraphing across the Solent without wires, 138 *et seq.*—definition of electricity, 140 — *résumé* of his experiments, 141 *et seq.*—194 fn., 202, 206, 211, 214.
- Radio-conductor. *See* Detector.
- Railway: use of rails as conductors, 3 — railway telegraphs, 103 *et seq.*
- Rathbone, Mr Charles, experiments showing sensitiveness of telephone, 80.
- Rathenau, Prof. Erich, experiment on the conductive principle, 130 *et seq.*
- Relay, Wilkins's, 38.
- Righi, Prof., 189, 190.
- Rive, L. de la, explanation of "Galvanic Music," 94 fn.—184, 189.
- Rosser, H. S., 78.
- Rovelli, Signor, 202 fn.
- Rowland, Prof. H. A., on the nature of electric currents, 264 *et seq.*
- Rupp, Dr, 196 fn.
- Rutherford, 200.
- Sacher, Prof. E., inductive effect in telephone circuits, 84.
- Salvá, suggestion to use the sea as a conductor, 1—87.
- Sarasin, E., 184, 189.
- Schäfer, Mr Bela, 227 fn.
- Schilling, Baron, the needle telegraph of, 20.
- Schuster, Arthur, 292 fn.
- Schwendler, Mr, 114.
- Sennett, Mr A. R., 8 fn.
- Shaffner's 'Telegraph Manual' referred to, 234.
- Ships, plans for intercommunication between, at sea, 90 *et seq.*, 96 *et seq.*, 102, 122 *et seq.*
- Siemens' Serrated-Plate Lightning-Guard, 48.
- Slaby, Prof., 212, 215 *et seq.*
- Smith, Mr Willoughby, on "Volta-Electric Induction," 94 fn.—induction in train signalling, 105 *et seq.*—his system of wireless telegraphy, 162 *et seq.*
- Sömmerring, experiment in signalling through water, 2.
- Steinheil, Prof. C. A., 3 *et seq.*—experiments with railway rails as conductors, *ib.*—discovery of the earth circuit, *ib.*—signalling without wires, 4 *et seq.*—suggestion of the photophone, 5—89.

- Stevenson, Mr C. A., his coil system, 122 *et seq.*
- Stokes, Sir George, 292 fn., 295.
- Strong, Mr H. C., of Chicago, 87 fn.
- Sturgeon's 'Annals of Electricity' quoted, 4, 5.
- Sympathetic needle and sympathetic flesh telegraphs, 1.
- Taylor, Capt., R.N., the compressed air telephone of, 7.
- Telephone in relation to wireless telegraphy, 79 *et seq.*
- Tesla, Prof. Nikola, his conception of electricity, 140 fn.—199 *et seq.*
- Thompson, Prof. Silvanus, 206, 235.
- Thomson, Sir W. *See* Kelvin, Lord.
- Threlfall, Prof. R., 197 fn.
- Trains, electric communication with moving, 103 *et seq.*
- Trowbridge, Prof. John, 32 *et seq.*—experiments with the telephone, 87 *et seq.*—an Atlantic telegraph without a cable, 90—communication between ships at sea, *ib. et seq.*—induction in wireless telegraphy, 92 *et seq.*
- Tuma, Dr, 219 fn.
- Vail's 'American Electro-Magnetic Telegraph' quoted, 13.
- Van Reese, 29 fn.
- Varley, Mr S. A., 191.
- Walker, T., 78.
- Welding by electricity, 23.
- Wilde, H., 78.
- Wilkins, J. W., 32 *et seq.*—proposal for telegraph communication without wires, 33 *et seq.*—the Wilkins relay, 36 *et seq.*
- Zickler, Prof. K., 183 fn.

THE END.

Catalogue
of
Messrs Blackwood & Sons'
Publications

PERIODS OF EUROPEAN LITERATURE. Edited by
PROFESSOR SAINTSBURY.

- THE FLOURISHING OF ROMANCE AND THE RISE OF ALLEGORY.** (15TH AND 16TH CENTURIES.) By GEORGE SAINTSBURY, M.A., Professor of Rhetoric and English Literature in Edinburgh University. Crown 8vo, 5s. net.
- THE LATER RENAISSANCE.** By DAVID HANNAY. Crown 8vo, 5s. net.
- THE FOURTEENTH CENTURY.** By F. J. SNELL. Crown 8vo, 5s. net.
- THE AUGUSTAN AGES.** By OLIVER ELTON. Crown 8vo, 5s. net.
- THE ROMANTIC TRIUMPH.** By T. S. OMOND. Crown 8vo. [Shortly.]
- THE TRANSITION PERIOD.** By G. GREGORY SMITH. Crown 8vo. [In the press.]

The other Volumes are:—

- | | |
|---|---|
| THE DARK AGES . . . Prof. W. P. Ker. | THE MID-EIGHTEENTH |
| THE EARLIER RENAISSANCE. The Editor. | CENTURY J. Hepburn Millar. |
| THE FIRST HALF OF THE SEVENTEENTH | THE ROMANTIC REVOLT Prof. C. E. Vaughan. |
| CENTURY . . . Prof. H. J. C. Grierson. | THE LATER NINETEENTH |
| | CENTURY The Editor. |

PHILOSOPHICAL CLASSICS FOR ENGLISH READERS.

Edited by WILLIAM KNIGHT, LL.D., Professor of Moral Philosophy in the University of St Andrews. In crown 8vo Volumes, with Portraits, price 3s. 6d.

- | | |
|---|--|
| <i>Contents of the Series.</i> —DESCARTES, by Professor Mahaffy, Dublin.—BUTLER, by Rev. W. Lucas Collins, M.A.—BERKELEY, by Professor Campbell Fraser.—FICHTE, by Professor Adamson, Glasgow.—KANT, by Professor Wallace, Oxford.—HAMILTON, by Professor Vetch, Glasgow.—HEGEL, by the Master of Balliol.—LEIBNIZ, by J. Theo- | dore Merz.—VICO, by Professor Flint, Edinburgh.—HOBBS, by Professor Croom Robertson.—HUME, by the Editor.—SPINOZA, by the Very Rev. Principal Caird, Glasgow.—BACON: Part I. The Life, by Professor Nichol.—BACON: Part II. Philosophy, by the same Author.—LOCKE, by Professor Campbell Fraser. |
|---|--|

FOREIGN CLASSICS FOR ENGLISH READERS. Edited by

Mrs OLIPHANT. CHEAP RE-ISSUE. In limp cloth, fcap. 8vo, price 1s. each.

- | | |
|--|--|
| DANTE, by the Editor.—VOLTAIRE, by General Sir E. B. Hamley, K.C.B.—PASCAL, by Principal Tulloch.—PETERARCH, by Henry Reeve, C.B.—GOETHE, by A. Hayward, Q.C.—MOLIÈRE, by the Editor and F. Tarver, M.A.—MONTAIGNE, by Rev. W. L. Collins.—RABELAIS, by Sir Walter Besant.—CALDERON, by E. J. Hasell.—SAINT SIMON, by C. W. Collins. | CERVANTES, by the Editor.—CORNEILLE AND RACINE, by Henry M. Trollope.—MADAME DE SÉVIGNÉ, by Miss Thackeray.—LA FONTAINE, AND OTHER FRENCH FABULISTS, by Rev. W. Lucas Collins, M.A.—SCHILLER, by James Sime, M.A.—TASSO, by E. J. Hasell.—ROUSSEAU, by Henry Grey Graham.—ALFRED DE MUSSET, by C. F. Oliphant. |
|--|--|

ANCIENT CLASSICS FOR ENGLISH READERS. Edited by

the REV. W. LUCAS COLLINS, M.A. CHEAP RE-ISSUE. In limp cloth, fcap. 8vo, price 1s. each.

- | | |
|---|--|
| <i>Contents of the Series.</i> —HOMER: ILIAD, by the Editor.—HOMER: ODYSSEY, by the Editor.—HERODOTUS, by G. C. Swayne.—CÆSAR, by Anthony Trollope.—VIRGIL, by the Editor.—HORACE, by Sir Theodore Martin.—ÆSCHYLUS, by Bishop Copleston.—XENOPHON, by Sir Alex. Grant.—CICERO, by the Editor.—SOPHOCLES, by C. W. Collins.—PLINY, by Rev. A. Church and W. J. Brodrick.—EURIPIDES, by W. B. Donne.—JUVENAL, by E. Walford.—ARISTOPHANES, by the Editor.—HESIOD AND THEOGONIE, by | J. Davies.—PLAUTUS AND TERENCE, by the Editor.—TACITUS, by W. B. Donne.—LUCIAN, by the Editor.—PLATO, by C. W. Collins.—GREEK ANTHOLOGY, by Lord Neaves.—LIVY, by the Editor.—OVID, by Rev. A. Church.—CATULLUS, TRIBULLUS, AND PROPERTIUS, by J. Davies.—DEMOSTHENES, by W. J. Brodrick.—ARISTOTLE, by Sir Alex. Grant.—THUCYDIDES, by the Editor.—LUCRETIUS, by W. H. Mallock.—PINDAR, by Rev. F. D. Morice. |
|---|--|

CATALOGUE

OF

MESSRS BLACKWOOD & SONS'

PUBLICATIONS.

ALISON.

History of Europe. By Sir ARCHIBALD ALISON, Bart., D.C.L.

1. **From the Commencement of the French Revolution to the Battle of Waterloo.**

LIBRARY EDITION, 14 vols., with Portraits. Demy 8vo, £10, 10s.

ANOTHER EDITION, in 20 vols. crown 8vo, £6.

PEOPLE'S EDITION, 18 vols. crown 8vo, £2, 11s.

2. **Continuation to the Accession of Louis Napoleon.**

LIBRARY EDITION, 8 vols. 8vo, £6, 7s. 6d.

PEOPLE'S EDITION, 8 vols. crown 8vo, 34s.

Epitome of Alison's History of Europe. Thirtieth Thousand, 7s. 6d.

Atlas to Alison's History of Europe. By A. Keith Johnston.

LIBRARY EDITION, demy 4to, £8, 5s.

PEOPLE'S EDITION, 31s. 6d.

Life of John Duke of Marlborough. With some Account of his Contemporaries, and of the War of the Succession. Third Edition. 2 vols. 8vo. Portraits and Maps, 80s.

Essays: Historical, Political, and Miscellaneous. 3 vols. demy 8vo, 45s.

ACROSS FRANCE IN A CARAVAN: BEING SOME ACCOUNT OF A JOURNEY FROM BORDEAUX TO GENOA IN THE "ESCARGOT," taken in the Winter 1889-90. By the Author of 'A Day of my Life at Eton.' With fifty Illustrations by John Wallace, after Sketches by the Author, and a Map. Cheap Edition, demy 8vo, 7s. 6d.

ACTA SANCTORUM HIBERNIÆ; Ex Codice Salmanticensi.

Nunc primum integre edita opera CAROLI DE SMEDT et JOSEPHI DE BACKER, e Soc. Jesu, Hagiographorum Bollandianorum; Auctore et Sumptus Largiente JOANNE PATRICIO MARCHIONE BOTHEAE. In One handsome 4to Volume, bound in half roxburgh, £2, 2s.; in paper cover, 31s. 6d.

ADOLPHUS. Some Memories of Paris. By F. ADOLPHUS. Crown 8vo, 6s.

AFLALO. A Sketch of the Natural History (Vertebrates) of the British Islands. By F. G. AFLALO, F.R.G.S., F.Z.S., Author of 'A Sketch of the Natural History of Australia,' &c. With numerous Illustrations by Lodge and Bennett. Crown 8vo, 6s. net.

AIKMAN.

- Manures and the Principles of Manuring.** By C. M. AIKMAN, D.Sc., F.R.S.E., &c., Professor of Chemistry, Glasgow Veterinary College; Examiner in Chemistry, University of Glasgow, &c. Crown 8vo, 6s. 6d.
- Farmyard Manure: Its Nature, Composition, and Treatment.** Crown 8vo, 1s. 6d.

ALLARDYCE.

- The City of Sunshine.** By ALEXANDER ALLARDYCE, Author of 'Bariscourt,' &c. New Edition. Crown 8vo, 6s.
- Balmoral: A Romance of the Queen's Country.** New Edition. Crown 8vo, 6s.

- ALMOND.** Christ the Protestant; and other Sermons. By HELY HUTCHINSON ALMOND, M.A. Oxon., Hon. LL.D. Glasgow; Head-master of Loretto School. Crown 8vo, 5s.

- ANCIENT CLASSICS FOR ENGLISH READERS.** Edited by Rev. W. LUCAS COLLINS, M.A. Price 1s. each. For List of Vols. see p. 2.

- ANDERSON.** Daniel in the Critics' Den. A Reply to Dean Farrar's 'Book of Daniel.' By ROBERT ANDERSON, LL.D., Barrister-at-Law, Assistant Commissioner of Police of the Metropolis; Author of 'The Coming Prince,' 'Human Destiny,' &c. Post 8vo, 4s. 6d.

- AUTOBIOGRAPHY OF A CHILD.** Crown 8vo, 6s.

AYTOUN.

- Lays of the Scottish Cavaliers, and other Poems.** By W. EDMONSTOUNE AYTOUN, D.C.L., Professor of Rhetoric and Belles-Lettres in the University of Edinburgh. New Edition. Fcap. 8vo, 3s. 6d.
- CHEAP EDITION. 1s. Cloth, 1s. 3d.

- An Illustrated Edition of the Lays of the Scottish Cavaliers.** From designs by Sir NOEL PATON. Cheaper Edition. Small 4to, 10s. 6d.

- Bothwell: a Poem.** Third Edition. Fcap., 7s. 6d.

- Poems and Ballads of Goethe.** Translated by Professor AYTOUN and Sir THEODORE MARTIN, K.C.B. Third Edition. Fcap., 6s.

- Memoir of William E. Aytoun, D.C.L.** By Sir THEODORE MARTIN, K.C.B. With Portrait. Post 8vo, 12s.

- BEDFORD & COLLINS.** Annals of the Free Foresters, from 1856 to the Present Day. By W. K. R. BEDFORD, W. E. W. COLLINS, and other Contributors. With 55 Portraits and 59 other Illustrations. Demy 8vo, 21s. net.

- BELLAIRS.** Gossips with Girls and Maidens, Betrothed and Free. By LADY BELLAIRS. New Edition. Crown 8vo, 3s. 6d. Cloth, extra gilt edges, 5s.

- BELLESHEIM.** History of the Catholic Church of Scotland. From the Introduction of Christianity to the Present Day. By ALPHONS BELLESHEIM, D.D., Canon of Aix-la-Chapelle. Translated, with Notes and Additions, by D. OSWALD HUNTER BLAIR, O.S.B., Monk of Fort Augustus. Cheap Edition. Complete in 4 vols. demy 8vo, with Maps. Price 21s. net.

- BENTINCK.** Racing Life of Lord George Cavendish Bentinck, M.P., and other Reminiscences. By JOHN KENT, Private Trainer to the Goodwood Stable. Edited by the Hon. FRANCIS LAWLEY. With Twenty-three full-page Plates, and Facsimile Letter. Third Edition. Demy 8vo, 25s.

- BICKERDYKE.** A Banished Beauty. By JOHN BICKERDYKE, Author of 'Days in Thule, with Rod, Gun, and Camera,' 'The Book of the All-Round Angler,' 'Curiosities of Ale and Beer,' &c. With Illustrations. Cheap Edition. Crown 8vo, 2s.

BINDLOSS. In the Niger Country. By HAROLD BINDLOSS.
With 2 Maps. Demy 8vo, 12s. 6d.

BIRCH.

Examples of Stables, Hunting-Boxes, Kennels, Racing Establishments, &c. By JOHN BIRCH, Architect, Author of 'Country Architecture, &c. With 30 Plates. Royal 8vo, 7s.

Examples of Labourers' Cottages, &c. With Plans for Improving the Dwellings of the Poor in Large Towns. With 34 Plates. Royal 8vo, 7s.

Picturesque Lodges. A Series of Designs for Gate Lodges, Park Entrances, Keepers', Gardeners', Bailiffs', Grooms', Upper and Under Servants' Lodges, and other Rural Residences. With 16 Plates. 4to, 12s. 6d.

BLACKIE.

The Wisdom of Goethe. By JOHN STUART BLACKIE, Emeritus Professor of Greek in the University of Edinburgh. Fcap. 8vo. Cloth, extra gilt, 6s.

John Stuart Blackie: A Biography. By ANNA M. STODDART.
With 8 Plates. Third Edition. 2 vols. demy 8vo, 21s.
POPULAR EDITION. With Portrait. Crown 8vo 6s.

BLACKMORE.

The Maid of Sker. By R. D. BLACKMORE, Author of 'Lorna Doone,' &c. New Edition. Crown 8vo, 6s. Cheaper Edition. Crown 8vo, 3s. 6d.

Dariel: A Romance of Surrey. With 14 Illustrations by Chris. Hammond. Crown 8vo. 6s.

BLACKWOOD.

Annals of a Publishing House. William Blackwood and his Sons; Their Magazine and Friends. By Mrs OLIPHANT. With Four Portraits. Third Edition. Demy 8vo. Vols. I. and II. £2, 2s.

— Vol. III. John Blackwood. By his Daughter, Mrs GERALD PORTER. With 2 Portraits and View of Strathtyrum. Demy 8vo, 21s.

Blackwood's Magazine, from Commencement in 1817 to November 1899. Nos. 1 to 1009, forming 166 Volumes.

Index to Blackwood's Magazine. Vols. 1 to 50. 8vo, 15s.

Tales from Blackwood. First Series. Price One Shilling each, in Paper Cover. Sold separately at all Railway Bookstalls.

They may also be had bound in 12 vols., cloth, 18s. Half calf, richly gilt, 30s.
Or the 12 vols. in 6, roxburgh, 21s. Half red morocco, 28s.

Tales from Blackwood. Second Series. Complete in Twenty-four Shilling Parts. Handsomely bound in 12 vols., cloth, 30s. In leather back, roxburgh style, 37s. 6d. Half calf, gilt, 52s. 6d. Half morocco, 55s.

Tales from Blackwood. Third Series. Complete in Twelve Shilling Parts. Handsomely bound in 6 vols., cloth, 15s.; and in 12 vols. cloth, 18s. The 6 vols. in roxburgh, 21s. Half calf, 25s. Half morocco, 28s.

Travel, Adventure, and Sport. From 'Blackwood's Magazine.' Uniform with 'Tales from Blackwood.' In Twelve Parts, each price 1s. Handsomely bound in 6 vols., cloth, 15s. And in half calf, 25s.

New Educational Series. See separate Educational Catalogue.

BLACKWOOD.**New Uniform Series of Novels (Copyright).**

Crown 8vo, cloth. Price 3s. 6d. each. Now ready:—

- THE MAID OF SKER.** By R. D. Blackmore.
WENDERHOLME. By P. G. Hamerton.
THE STORY OF MARGRÉDEL. By D. Storrer Meldrum.
MISS MARJORIBANKS. By Mrs Oliphant.
THE PERPETUAL CURATE, and THE RECTOR. By the Same.
SALEM CHAPEL, and THE DOCTOR'S FAMILY. By the Same.
A SENSITIVE PLANT. By E. D. Gerard.
LADY LEE'S WIDOWHOOD. By General Sir E. B. Hamley.
KATIE STEWART, and other Stories. By Mrs Oliphant.
VALENTINE AND HIS BROTHER. By the Same.
SONS AND DAUGHTERS. By the Same.
- MARMORNE.** By P. G. Hamerton.
REATA. By E. D. Gerard.
BEGGAR MY NEIGHBOUR. By the Same.
THE WATERS OF HERCULES. By the Same.
FAIR TO SEE. By L. W. M. Lockhart.
MINE IS THINE. By the Same.
DOUBLES AND QUITS. By the Same.
ALTIORA PETO. By Laurence Oliphant.
PICCADILLY. By the Same. With Illustrations.
LADY BABY. By D. Gerard.
THE BLACKSMITH OF VOZ. By Paul Cushing.
MY TRIVIAL LIFE AND MISFORTUNE. By A Plain Woman.
POOR NELLIE. By the Same.

Standard Novels. Uniform in size and binding. Each complete in one Volume.

- FLORIN SERIES, Illustrated Boards.** Bound in Cloth, 2s. 6d.
- TOM CRINGLE'S LOG.** By Michael Scott.
THE CRUISE OF THE MIDGE. By the Same.
CYRIL THORNTON. By Captain Hamilton.
ANNALS OF THE PARISH. By John Galt.
THE PROVOST, &c. By the Same.
SIR ANDREW WYLIE. By the Same.
THE ENTAIL. By the Same.
MISS MOLLY. By Beatrice May Bucht.
REGINALD DALTON. By J. G. Lockhart.
- PEN OWEN.** By Dean Hook.
ADAM BLAIR. By J. G. Lockhart.
LADY LEE'S WIDOWHOOD. By General Sir E. B. Hamley.
SALEM CHAPEL. By Mrs Oliphant.
THE PERPETUAL CURATE. By the Same.
MISS MARJORIBANKS. By the Same.
JOHN: A Love Story. By the Same.

- SHILLING SERIES, Illustrated Cover.** Bound in Cloth, 1s. 6d.
- THE RECTOR, and THE DOCTOR'S FAMILY.** By Mrs Oliphant.
THE LIFE OF MANSIE WAUCH. By D. M. Molr.
PENINSULAR SCENES AND SKETCHES. By F. Hardman.
- SIR FRISKELE PUMPKIN, NIGHTS AT MESS, &c.**
THE SUBALTERN.
LIFE IN THE FAR WEST. By G. F. Ruxton.
VALERIUS: A ROMAN STORY. By J. G. Lockhart.

BON GAULTIER'S BOOK OF BALLADS. Fifteenth Edition. With Illustrations by Doyle, Leech, and Crowquill. Fcap. 8vo, 5s.

BOWHILL. Questions and Answers in the Theory and Practice of Military Topography. By Major J. H. BOWHILL. Crown 8vo, 4s. 6d. net. Portfolio containing 34 working plans and diagrams, 3s. 6d. net.

BRADDON. Thirty Years of Shikar. By Sir EDWARD BRADDON, K.C.M.G. With Illustrations by G. D. Giles, and Map of Oudh Forest Tracts and Nepal Terai. Demy 8vo, 18s.

BROWN. The Forester: A Practical Treatise on the Planting and Tending of Forest-trees and the General Management of Woodlands. By JAMES BROWN, LL.D. Sixth Edition, Enlarged. Edited by JOHN NISBET, D. O.Ec., Author of 'British Forest Trees,' &c. In 2 vols. royal 8vo, with 350 Illustrations, 42s. net.

BROWN. A Manual of Botany, Anatomical and Physiological. For the Use of Students. By ROBERT BROWN, M.A., Ph.D. Crown 8vo, with numerous Illustrations, 12s. 6d.

BRUCE.

In Clover and Heather. Poems by WALLACE BRUCE. New and Enlarged Edition. Crown 8vo, 3s. 6d.

A limited number of Copies of the First Edition, on large hand-made paper, 12s. 6d.

Here's a Hand. Addresses and Poems. Crown 8vo, 5s. Large Paper Edition, limited to 100 copies, price 21s.

BUCHAN. *Introductory Text-Book of Meteorology.* By **ALEXANDER BUCHAN, LL.D., F.R.S.E.,** Secretary of the Scottish Meteorological Society, &c. New Edition. Crown 8vo, with Coloured Charts and Engravings. *[In preparation.]*

BURBIDGE.

Domestic Floriculture, Window Gardening, and Floral Decorations. Being Practical Directions for the Propagation, Culture, and Arrangement of Plants and Flowers as Domestic Ornaments. By **F. W. BURBIDGE.** Second Edition. Crown 8vo, with numerous Illustrations, 7s. 6d.

Cultivated Plants: Their Propagation and Improvement. Including Natural and Artificial Hybridisation, Raising from Seed Cuttings, and Layers, Grafting and Budding, as applied to the Families and Genera in Cultivation. Crown 8vo, with numerous Illustrations, 12s. 6d.

BURKE. *The Flowering of the Almond Tree, and other Poems.* By **CHRISTIAN BURKE.** Fott 4to, 5s.

BURROWS.

Commentaries on the History of England, from the Earliest Times to 1865. By **MONTAGU BURROWS,** Chichele Professor of Modern History in the University of Oxford; Captain R.N.; F.S.A., &c.; "Officier de l'Instruction Publique," France. Crown 8vo. 7s. 6d.

The History of the Foreign Policy of Great Britain. New Edition, revised. Crown 8vo, 6s.

BURTON.

The History of Scotland: From Agricola's Invasion to the Extinction of the last Jacobite Insurrection. By **JOHN HILL BURTON, D.C.L.,** Historiographer-Royal for Scotland. Cheaper Edition. In 8 vols. Crown 8vo, 8s. 6d. each.

History of the British Empire during the Reign of Queen Anne. In 3 vols. 8vo. 36s.

The Scot Abroad. Cheap Edition. Crown 8vo, 3s. 6d.

The Book-Hunter. Cheap Edition. Crown 8vo, 3s. 6d.

BUTE. *The Altus of St Columba.* With a Prose Paraphrase and Notes. By **JOHN, MARQUESS OF BUTE, K.T.** In paper cover, 2s. 6d.

BUTE, MACPHAIL, AND LONSDALE. *The Arms of the Royal and Parliamentary Burghs of Scotland.* By **JOHN, MARQUESS OF BUTE, K.T., J. R. N. MACPHAIL,** and **H. W. LONSDALE.** With 131 Engravings on wood, and 11 other Illustrations. Crown 4to. £2, 2s. net.

BUTLER.

The Ancient Church and Parish of Abernethy, Perthshire. An Historical Study. By **Rev. D. BUTLER, M.A.,** Minister of the Parish. With 13 Collotype Plates and a Map. Crown 4to, 25s. net.

John Wesley and George Whitefield in Scotland; or, The Influence of the Oxford Methodists on Scottish Religion. Crown 8vo, 5s.

Henry Scougal and the Oxford Methodists; or, The Influence of a Religious Teacher of the Scottish Church. Fcap. 8vo, 3s. 6d.

BUTT.

Theatricals: An Interlude. By **BEATRICE MAY BUTT.** Crown 8vo, 6s.

Miss Molly. Cheap Edition, 2s.

Eugenie. Crown 8vo, 6s. 6d.

Elizabeth, and other Sketches. Crown 8vo, 6s.

Delicia. New Edition. Crown 8vo, 2s. 6d.

CADELL. *Sir John Cope and the Rebellion of 1745.* By the late General **Sir ROBERT CADELL, K.C.B.,** Royal (Madras) Artillery. With 2 Maps. Crown 4to, 12s. 6d. net.

- CAFFYN.** *Seventy-One not Out, the Reminiscences of William Caffyn, Member of the All England and United Eleven, of the Surrey County Eleven, of the Anglo-American Team of 1859, and of the Anglo-Australian Teams of 1861 and 1863.* Edited by "Mid-On." With numerous illustrations. Crown 8vo, 6s.
- CAIRD.** *Sermons.* By JOHN CAIRD, D.D., Principal of the University of Glasgow. Seventeenth Thousand. Fcap. 8vo, 5s.
- CALDWELL.** *Schopenhauer's System in its Philosophical Significance (the Shaw Fellowship Lectures, 1893).* By WILLIAM CALDWELL, M.A., D.Sc., Professor of Moral and Social Philosophy, Northwestern University, U.S.A.; formerly Assistant to the Professor of Logic and Metaphysics, Edin., and Examiner in Philosophy in the University of St Andrews. Demy 8vo, 10s. 6d. net.
- CALLWELL.** *The Effect of Maritime Command on Land Campaigns since Waterloo.* By Major C. E. CALLWELL, R.A. With Plans. Post 8vo, 6s. net.
- CAMPBELL.** *Balmerino and its Abbey. A Parish History. With Notices of the Adjacent District.* By JAMES CAMPBELL, D.D., F.S.A. Scot., Minister of Balmerino; Author of 'A History of the Celtic Church in Scotland.' A New Edition. With an Appendix of Illustrative Documents, a Map of the Parish, and upwards of 40 Illustrations. In 1 vol. demy 8vo. [In the press.]
- CAPEs.**
Our Lady of Darkness. By BERNARD CAPEs. Crown 8vo, 6s.
The Adventures of the Comte de la Muette during the Reign of Terror. Crown 8vo, 6s.
- CHARTERIS.** *Canonicity; or, Early Testimonies to the Existence and Use of the Books of the New Testament. Based on Kirchoffer's 'Quellensammlung.'* Edited by A. H. CHARTERIS, D.D., Professor of Biblical Criticism in the University of Edinburgh. 8vo, 18s.
- CHENNELLS.** *Recollections of an Egyptian Princess.* By her English Governess (Miss E. CHENNELLS). Being a Record of Five Years' Residence at the Court of Ismael Pasha, Khédivé. Second Edition. With Three Portraits. Post 8vo, 7s. 6d.
- CHRISTISON.** *Early Fortifications in Scotland: Motes, Camps, and Forts. Being the Rhind Lectures in Archæology for 1894.* By DAVID CHRISTISON, M.D., F.R.C.P.E., Secretary of the Society of Antiquaries of Scotland. With 379 Plans and Illustrations and 3 Maps. Fcap 4to, 21s. net.
- CHURCH AND FAITH.** *Being Essays on the Teaching of the Church of England.* By Dr WACE, Dean FARRAR, Dr WRIGHT, Rev. R. E. BARTLETT, Principal DRURY, Canon MEYRICK, Professor MOULE, Chancellor SMITH, MONTAGUE BARLOW, Sir RICHARD TEMPLE, Bart., E. H. BLAKENEY, and J. T. TOMLINSON. With Introduction by the LORD BISHOP OF HEREFORD. Post 8vo, 7s. 6d. net.
- CHURCH SERVICE SOCIETY.**
A Book of Common Order: being Forms of Worship issued by the Church Service Society. Seventh Edition, carefully revised. In 1 vol. crown 8vo, cloth, 8s. 6d.; French morocco, 5s. Also in 2 vols. crown 8vo, cloth, 4s.; French morocco, 6s. 6d.
Daily Offices for Morning and Evening Prayer throughout the Week. Crown 8vo, 8s. 6d.
Order of Divine Service for Children. Issued by the Church Service Society. With Scottish Hymnal. Cloth, 8d.
- CLOUSTON.** *The Lunatic at Large.* By J. STORER CLOUSTON. Crown 8vo, 6s.
- COCHRAN.** *A Handy Text-Book of Military Law. Compiled chiefly to assist Officers preparing for Examination; also for all Officers of the Regular and Auxiliary Forces. Comprising also a Synopsis of part of the Army Act.* By Major F. COCHRAN, Hampshire Regiment Garrison Instructor, North British District. Crown 8vo, 7s. 6d.

- COLLINS.** The Don and the Undergraduate. A Tale of St Hilary's College, Oxford. By W. E. W. COLLINS. Crown 8vo, 6s.
- COLQUHOUN.** The Moor and the Loch. Containing Minute Instructions in all Highland Sports, with Wanderings over Crag and Corrie, Flood and Fell. By JOHN COLQUHOUN. Cheap Edition. With Illustrations. Demy 8vo, 10s. 6d.
- CONDER.**
 The Bible and the East. By Lieut.-Col. C. R. CONDER, R.E., LL.D., D.C.L., M.R.A.S., Author of 'Tent Work in Palestine,' &c. With Illustrations and a Map. Crown 8vo, 5s.
 The Hittites and their Language. With Illustrations and Map. Post 8vo, 7s. 6d.
 The Hebrew Tragedy. In 1 vol. fcap. 8vo. *[In the press.]*
- CORNFORD.** R. L. Stevenson. "Modern English Writers." By L. COPE CORNFORD. Crown 8vo, 2s. 6d.
- COUNTY HISTORIES OF SCOTLAND.** In demy 8vo volumes of about 350 pp. each. With Maps. Price 7s. 6d. net.
- Fife and Kinross.** By ÆNEAS J. G. MACKAY, LL.D., Sheriff of these Counties.
- Dumfries and Galloway.** By Sir HERBERT MAXWELL, Bart. M.P.
- Moray and Nairn.** By CHARLES RAMPINI, LL.D., Sheriff-Substitute of these Counties.
- Inverness.** By J. CAMERON LEES, D.D.
- Roxburgh, Selkirk, and Peebles.** By Sir GEORGE DOUGLAS, Bart.
- Prehistoric Scotland and its Place in European Civilisation.** Being a General Introduction to the "County Histories of Scotland." By ROBERT MUNRO, M.A., M.D., Author of 'Prehistoric Problems,' 'The Lake-Dwellings of Europe,' &c. With numerous Illustrations.
- Aberdeen and Banff.** By WILLIAM WATT, Editor of Aberdeen 'Daily Free Press.' *[In the press.]*
- CRAWFORD.** Saracinesca. By F. MARION CRAWFORD, Author of 'Mr Isaacs,' &c., &c. Cheap Edition. Crown 8vo, 3s. 6d.
- CRAWFORD.**
 The Doctrine of Holy Scripture respecting the Atonement. By the late THOMAS J. CRAWFORD, D.D., Professor of Divinity in the University of Edinburgh. Fifth Edition. 8vo, 12s.
 The Fatherhood of God, Considered in its General and Special Aspects. Third Edition, Revised and Enlarged. 8vo, 9s.
 The Preaching of the Cross, and other Sermons. 8vo, 7s. 6d.
 The Mysteries of Christianity. Crown 8vo, 7s. 6d.
- CROSS.** Impressions of Dante, and of the New World; with a Few Words on Bimetallism. By J. W. CROSS, Editor of 'George Eliot's Life, as related in her Letters and Journals.' Post 8vo, 6s.
- CUMBERLAND.** Sport on the Pamirs and Turkistan Steppes. By Major C. S. CUMBERLAND. With Map and Frontispiece. Demy 8vo, 10s. 6d.
- CURSE OF INTELLECT.** Third Edition. Fcap. 8vo, 2s. 6d. net.
- CUSHING.** The Blacksmith of Voe. By PAUL CUSHING, Author of 'The Bull i' th' Thorn,' 'Cut with his own Diamond.' Cheap Edition. Crown 8vo, 3s. 6d.
- DARBISHIRE.** Physical Maps for the use of History Students. By BERNHARD V. DARBISHIRE, M.A., Trinity College, Oxford. Two Series:—Ancient History (9 maps); Modern History (12 maps). *[In the press.]*

- DAVIES.** *Norfolk Broads and Rivers; or, The Waterways, Lagoons, and Decoys of East Anglia.* By G. CHRISTOPHER DAVIES. Illustrated with Seven full-page Plates. New and Cheaper Edition. Crown 8vo, 6s.
- DESCARTES.** *The Method, Meditations, and Principles of Philosophy of Descartes.* Translated from the Original French and Latin. With a New Introductory Essay, Historical and Critical, on the Cartesian Philosophy. By Professor VERRILL, LL.D., Glasgow University. Eleventh Edition. 6s. 6d.
- DOUGLAS.**
The Ethics of John Stuart Mill. By CHARLES DOUGLAS, M.A., D.Sc., M.P., late Lecturer in Moral Philosophy, and Assistant to the Professor of Moral Philosophy in the University of Edinburgh. Post 8vo, 6s. net.
John Stuart Mill: A Study of his Philosophy. Crown 8vo, 4s. 6d. net.
- DOUGLAS.** *Chinese Stories.* By ROBERT K. DOUGLAS. With numerous Illustrations by Parkinson, Forestier, and others. New and Cheaper Edition. Small demy 8vo, 5s.
- DOUGLAS.** *Iras: A Mystery.* By THEO. DOUGLAS, Author of 'A Bride Elect.' Cheaper Edition, in Paper Cover specially designed by Womrath. Crown 8vo, 1s. 6d.
- DZIEWICKI.** *Entombed in Flesh.* By M. H. DZIEWICKI. Crown 8vo, 3s. 6d.
- ELIOT.**
George Eliot's Life, Related in Her Letters and Journals. Arranged and Edited by her husband, J. W. CROSS. With Portrait and other Illustrations. Third Edition. 3 vols. post 8vo, 42s.
George Eliot's Life. With Portrait and other Illustrations. New Edition, in one volume. Crown 8vo, 7s. 6d.
Works of George Eliot (Standard Edition). 21 volumes, crown 8vo. In buckram cloth, gilt top, 2s. 6d. per vol.; or in roxburgh binding, 3s. 6d. per vol.
 ADAM BEDE. 2 vols.—THE MILL ON THE FLOSS. 2 vols.—FELIX HOLT, THE RADICAL. 2 vols.—ROMOLA. 2 vols.—SCENES OF CLERICAL LIFE. 2 vols.—MIDDLEMARCH. 3 vols.—DANIEL DERONDA. 3 vols.—SILAS MARNER. 1 vol.—JUBAL. 1 vol.—THE SPANISH GIPSY. 1 vol.—ESSAYS. 1 vol.—THEOPHRASTUS SUCH. 1 vol.
Life and Works of George Eliot (Cabinet Edition). 24 volumes, crown 8vo, price £6. Also to be had handsomely bound in half and full calf. The Volumes are sold separately, bound in cloth, price 5s. each.
Novels by George Eliot. New Cheap Edition. Printed on fine laid paper, and uniformly bound.
 Adam Bede. 3s. 6d.—The Mill on the Floss. 3s. 6d.—Scenes of Clerical Life. 3s.—Silas Marner: the Weaver of Raveloe. 2s. 6d.—Felix Holt, the Radical. 3s. 6d.—Romola. 3s. 6d.—Middlemarch. 7s. 6d.—Daniel Deronda. 7s. 6d.
Essays. New Edition. Crown 8vo, 5s.
Impressions of Theophrastus Such. New Edition. Crown 8vo, 5s.
The Spanish Gypsy. New Edition. Crown 8vo, 5s.
The Legend of Jubal, and other Poems, Old and New. New Edition. Crown 8vo, 5s.
Silas Marner. New Edition, with Illustrations by Reginald Birch. Crown 8vo, 6s.
Scenes of Clerical Life. Pocket Edition, 3 vols. pott 8vo. 1s. net each; bound in leather, 1s. 6d. net each. Illustrated Edition, with 20 Illustrations by H. R. Millar, crown 8vo, 2s. 6d. Popular Edition, royal 8vo, in paper cover, price 6d.

ELIOT.

Adam Bede. Pocket Edition. In 3 vols. pott 8vo, 3s. net; bound in leather, 4s. 6d. net. Popular Edition, royal 8vo, in paper cover, price 6d.

Wise, Witty, and Tender Sayings, in Prose and Verse. Selected from the Works of GEORGE ELIOT. New Edition. Fcap. 8vo, 2s. 6d.

ELTON. **The Augustan Ages.** "Periods of European Literature." By OLIVER ELTON, B.A., Lecturer in English Literature, Owen's College, Manchester. Crown 8vo, 5s. net.

ESSAYS ON SOCIAL SUBJECTS. Originally published in the 'Saturday Review.' New Edition. First and Second Series. 2 vols. crown 8vo, 6s. each.

FAHIE. **A History of Wireless Telegraphy.** 1838-1899. By J. J. FAHIE, Member of the Institution of Electrical Engineers, London, and of the Société Internationale des Electriciens, Paris; Author of 'A History of Electric Telegraphy to the Year 1837,' &c. With Illustrations. Crown 8vo, 6s.

FAITHS OF THE WORLD, The. **A Concise History of the Great Religious Systems of the World.** By various Authors. Crown 8vo, 5s.

FALKNER. **The Lost Stradivarius.** By J. MEADE FALKNER, Author of 'Moonfleet,' &c. Second Edition. Crown 8vo, 6s.

FERGUSON. **Sir Samuel Ferguson in the Ireland of his Day.** By LADY FERGUSON, Author of 'The Irish before the Conquest,' 'Life of William Reeves, D.D., Lord Bishop of Down, Connor, and Drumore,' &c., &c. With Two Portraits. 2 vols. post 8vo, 21s.

FERGUSON. **Scots Poems.** By ROBERT FERGUSSON. With Photogravure Portrait. Pott 8vo, gilt top, bound in cloth, 1s. net.

FERRIER.

Philosophical Works of the late James F. Ferrier, B.A. Oxon., Professor of Moral Philosophy and Political Economy, St Andrews. New Edition. Edited by Sir ALEXANDER GRANT, Bart., D.C.L., and Professor LUSHINGTON. 3 vols. crown 8vo, 34s. 6d.

Institutes of Metaphysic. Third Edition. 10s. 6d.

Lectures on the Early Greek Philosophy. 4th Edition. 10s. 6d.

Philosophical Remains, including the Lectures on Early Greek Philosophy. New Edition. 2 vols. 24s.

FLINT.

Historical Philosophy in France and French Belgium and Switzerland. By ROBERT FLINT, Corresponding Member of the Institute of France, Hon. Member of the Royal Society of Palermo, Professor in the University of Edinburgh, &c. 8vo, 21s.

Agnosticism. Being the Croall Lecture for 1887-88.

Theism. Being the Baird Lecture for 1876. Ninth Edition, Revised. Crown 8vo, 7s. 6d. *[In the press.]*

Anti-Theistic Theories. Being the Baird Lecture for 1877. Fifth Edition. Crown 8vo, 10s. 6d.

Sermons and Addresses. Demy 8vo, 7s. 6d.

FORD.

'Postle Farm. By GEORGE FORD. Crown 8vo, 6s.

The Larramys. Second Edition. Crown 8vo, 6s.

FOREIGN CLASSICS FOR ENGLISH READERS. Edited by Mrs OLIPHANT. Price 1s. each. *For List of Volumes, see page 2.*

FOSTER. **The Fallen City, and other Poems.** By WILL FOSTER. Crown 8vo, 6s.

FRANCILLON. **Gods and Heroes; or, The Kingdom of Jupiter.** By R. E. FRANCILLON. With 8 Illustrations. Crown 8vo, 5s.

FRANCIS. *Among the Untrodden Ways.* By M. E. FRANCIS (Mrs Francis Blundell), Author of 'In a North Country Village,' 'A Daughter of the Soil,' 'Frisse and Pustian,' &c. Crown 8vo, 3s. 6d.

FRASER. *Philosophy of Theism.* Being the Gifford Lectures delivered before the University of Edinburgh in 1894-96. By ALEXANDER CAMPBELL FRASER, D.C.L. Oxford; Emeritus Professor of Logic and Metaphysics in the University of Edinburgh. Second Edition, Revised. Post 8vo, 6s. 6d. net.

GALT. *Novels* by JOHN GALT, With General Introduction and Prefatory Notes by S. R. CROCKETT. The Text Revised and Edited by D. STORRAR MELDRUM, Author of 'The Story of Margrédél.' With Photogravure Illustrations from Drawings by John Wallace. Fcap. 8vo, 3s. net each vol.

ANNALS OF THE PARISH, and THE AYRSHIRE LEGATEES. 2 vols.—SIR ANDREW WYLIE. 2 vols.—*THE ENTAIL; or, The Lairds of Grippy.* 2 vols.—*THE PROVOST, and THE LAST OF THE LAIRDS.* 2 vols.

See also STANDARD NOVELS, p. 6.

GENERAL ASSEMBLY OF THE CHURCH OF SCOTLAND. *Scottish Hymnal, With Appendix Incorporated.* Published for use in Churches by Authority of the General Assembly. 1. Large type, cloth, red edges, 2s. 6d.; French morocco, 4s. 2. Bourgeois type, limp cloth, 1s.; French morocco, 2s. 3. Nonpareil type, cloth, red edges, 6d.; French morocco, 1s. 4d. 4. Paper covers, 8d. 5. Sunday-School Edition, paper covers, 1d., cloth, 2d. No. 1, bound with the Psalms and Paraphrases, French morocco, 8s. No. 2, bound with the Psalms and Paraphrases, cloth, 2s.; French morocco, 3s.

Prayers for Social and Family Worship. Prepared by a Special Committee of the General Assembly of the Church of Scotland. Entirely New Edition, Revised and Enlarged. Fcap. 8vo, red edges, 2s.

Prayers for Family Worship. A Selection of Four Weeks' Prayers. New Edition. Authorised by the General Assembly of the Church of Scotland. Fcap. 8vo, red edges, 1s. 6d.

One Hundred Prayers. Prepared by the Committee on Aids to Devotion. 16mo, cloth limp, 6d.

Morning and Evening Prayers for Affixing to Bibles. Prepared by the Committee on Aids to Devotion. 1d. for 6, or 1s. per 100.

Prayers for Soldiers and Sailors. Prepared by the Committee on Aids to Devotion. Thirtieth Thousand. 16mo, cloth limp. 2d. net.

GERARD.

Reata: What's in a Name. By E. D. GERARD. Cheap Edition. Crown 8vo, 3s. 6d.

Beggar my Neighbour. Cheap Edition. Crown 8vo, 3s. 6d.

The Waters of Hercules. Cheap Edition. Crown 8vo, 3s. 6d.

A Sensitive Plant. Crown 8vo, 3s. 6d.

GERARD.

A Foreigner. An Anglo-German Study. By E. GERARD. Crown 8vo, 6s.

The Land beyond the Forest. Facts, Figures, and Fancies from Transylvania. With Maps and Illustrations. 2 vols. post 8vo, 25s.

Bis: Some Tales Retold. Crown 8vo, 6s.

A Secret Mission. 2 vols. crown 8vo, 17s.

An Electric Shock, and other Stories. Crown 8vo, 6s.

GERARD.

One Year. By DOROTHEA GERARD. Crown 8vo, 6s.

The Impediment. Crown 8vo, 6s.

A Forgotten Sin. Crown 8vo, 6s.

A Spotless Reputation. Third Edition. Crown 8vo, 6s.

GERARD.

The Wrong Man. Second Edition. Crown 8vo, 6s.

Lady Baby. Cheap Edition. Crown 8vo, 3s. 6d.

Recha. Second Edition. Crown 8vo, 6s.

The Rich Miss Riddell. Second Edition. Crown 8vo, 6s.

GERARD. Stonyhurst Latin Grammar. By Rev. JOHN GERARD.
Second Edition. Fcap. 8vo, 8s.

GOODALL. Association Football. By JOHN GOODALL. Edited
by S. ARCHIBALD DE BEAR. With Diagrams. Fcap. 8vo, 1s.

GORDON CUMMING.

At Home in Fiji. By C. F. GORDON CUMMING. Fourth
Edition, post 8vo. With Illustrations and Map. 7s. 6d.

A Lady's Cruise in a French Man-of-War. New and Cheaper
Edition. 8vo. With Illustrations and Map. 12s. 6d.

Fire-Fountains. The Kingdom of Hawaii: Its Volcanoes,
and the History of its Missions. With Map and Illustrations. 2 vols. 8vo, 25s.

Wanderings in China. New and Cheaper Edition. 8vo, with
Illustrations, 10s.

Granite Crags: The Yö-semité Region of California. Illus-
trated with 8 Engravings. New and Cheaper Edition. 8vo, 8s. 6d.

GRAHAM. Manual of the Elections (Scot.) (Corrupt and Illegal
Practices) Act, 1890. With Analysis, Relative Act of Sederunt, Appendix con-
taining the Corrupt Practices Acts of 1883 and 1885, and Copious Index. By J.
EDWARD GRAHAM, Advocate. 8vo, 4s. 6d.

GRAND.

A Domestic Experiment. By SARAH GRAND, Author of
'The Heavenly Twins,' 'Ideals: A Study from Life.' Crown 8vo, 6s.

Singularly Deluded. Crown 8vo, 6s.

GRANT. Bush-Life in Queensland. By A. C. GRANT. New
Edition. Crown 8vo, 6s.

GRAY. Old Creeds and New Beliefs. By W. H. GRAY, D.D.,
Edinburgh. Crown 8vo, 5s.

GREGG. The Decian Persecution. Being the Hulsean Prize
Essay for 1896. By JOHN A. F. GREGG, B.A., late Scholar of Christ's College,
Cambridge. Crown 8vo, 6s.

GRIER.

In Furthest Ind. The Narrative of Mr EDWARD CARLYON of
Ellswether, in the County of Northampton, and late of the Honourable East India
Company's Service, Gentleman. Wrote by his own hand in the year of grace 1697.
Edited, with a few Explanatory Notes, by SYDNEY C. GRIER. Post 8vo, 6s.

His Excellency's English Governess. Second Edition. Crown
8vo, 6s.

An Uncrowned King: A Romance of High Politics. Second
Edition. Crown 8vo, 6s.

Peace with Honour. Second Edition. Crown 8vo, 6s.

A Crowned Queen: The Romance of a Minister of State.
Crown 8vo, 6s.

Like Another Helen. The History of the Cruel Misfortunes
and Undeserved Distresses of a Young Lady of Virtue and Sensibility, Resident
in Bengall during the Years 1755-57. Edited by SYDNEY C. GRIER. Second
Edition. Crown 8vo, 6s.

GROOT.

A Lotus Flower. By J. MORGAN-DE-GROOT. Crown 8vo, 6s.
Even If. Crown 8vo, 6s.

- HAGGARD.** *Under Crescent and Star.* By **Lieut.-Col. ANDREW HAGGARD, D.S.O.**, Author of 'Dodo and I,' 'Tempest Torn,' &c. With a Portrait. Second Edition. Crown 8vo, 6s.
- HALIBURTON.** *Horace in Homespun.* By **HUGH HALIBURTON.** A New Edition, containing additional Poems. With Illustrations by A. S. Boyd. In 1 vol. post 8vo. *[In the press.]*
- HAMERTON.**
Wenderholme: A Story of Lancashire and Yorkshire Life. By **P. G. HAMERTON**, Author of 'A Painter's Camp.' New Edition. Crown 8vo, 5s. 6d.
- Marmorne.* New Edition. Crown 8vo, 3s. 6d.
- HAMILTON.**
Lectures on Metaphysics. By **Sir WILLIAM HAMILTON, Bart.**, Professor of Logic and Metaphysics in the University of Edinburgh. Edited by the **Rev. H. L. MANSEL, B.D., LL.D.**, Dean of St Paul's; and **JOHN VEITCH, M.A., LL.D.**, Professor of Logic and Rhetoric, Glasgow. Seventh Edition. 2 vols. 8vo, 24s.
- Lectures on Logic.* Edited by the **SAME.** Third Edition, Revised. 2 vols., 24s.
- Discussions on Philosophy and Literature, Education and University Reform.* Third Edition. 8vo, 21s.
- Memoir of Sir William Hamilton, Bart., Professor of Logic and Metaphysics in the University of Edinburgh.* By **Professor VEITCH**, of the University of Glasgow. 8vo, with Portrait, 18s.
- Sir William Hamilton: The Man and his Philosophy.* Two Lectures delivered before the Edinburgh Philosophical Institution, January and February 1838. By **Professor VEITCH.** Crown 8vo, 2s.
- HAMLEY.**
The Operations of War Explained and Illustrated. By **General Sir EDWARD BRUCE HAMLEY, K.C.B., K.C.M.G.** Fifth Edition, Revised throughout. 4to, with numerous Illustrations, 80s.
- National Defence; Articles and Speeches.* Post 8vo, 6s.
- Shakespeare's Funeral, and other Papers.* Post 8vo, 7s. 6d.
- Thomas Carlyle: An Essay.* Second Edition. Crown 8vo, 2s. 6d.
- On Outposts.* Second Edition. 8vo, 2s.
- Wellington's Career; A Military and Political Summary.* Crown 8vo, 2s.
- Lady Lee's Widowhood.* New Edition. Crown 8vo, 3s. 6d. Cheaper Edition, 2s. 6d.
- Our Poor Relations. A Philozoic Essay.* With Illustrations, chiefly by **Ernest Griset.** Crown 8vo, cloth gilt, 3s. 6d.
- The Life of General Sir Edward Bruce Hamley, K.C.B., K.C.M.G.* By **ALEXANDER INNES SHAND.** With two Photogravure Portraits and other Illustrations. Cheaper Edition. With a Statement by **Mr EDWARD HAMLEY.** 2 vols. demy 8vo, 10s. 6d.
- HANNAY.** *The Later Renaissance. 'Periods of European Literature.'* By **DAVID HANNAY.** Crown 8vo, 5s. net.
- HARE.** *Down the Village Street: Scenes in a West Country Hamlet.* By **CHRISTOPHER HARE.** Second Edition. Crown 8vo, 6s.
- HARRADEN.**
The Fowler. By **BEATRICE HARRADEN**, Author of 'Ships that Pass in the Night.' Third Edition. Crown 8vo, 6s.
- In Varying Moods: Short Stories.* Thirteenth Edition. Crown 8vo, 5s. 6d.

HARRADEN.

Hilda Strafford, and The Remittance Man. Two Californian Stories. Eleventh Edition. Crown 8vo, 3s. 6d.

Untold Tales of the Past. With 40 Illustrations by H. R. Millar. Square 8vo, gilt top, 6s.

HARRIS.

From Batum to Baghdad, *via* Tiflis, Tabriz, and Persian Kurdistan. By WALTER B. HARRIS, F.R.G.S., Author of 'The Land of an African Sultan; Travels in Morocco,' &c. With numerous Illustrations and 2 Maps. Demy 8vo, 12s.

Taflet. The Narrative of a Journey of Exploration to the Atlas Mountains and the Oases of the North-West Sahara. With Illustrations by Maurice Romberg from Sketches and Photographs by the Author, and Two Maps. Demy 8vo, 12s.

A Journey through the Yemen, and some General Remarks upon that Country. With 8 Maps and numerous Illustrations by Forestier and Wallace from Sketches and Photographs taken by the Author. Demy 8vo, 16s.

Danovitch, and other Stories. Crown 8vo, 6s.

HAY. The Works of the Right Rev. Dr George Hay, Bishop of Edinburgh. Edited under the Supervision of the Right Rev. Bishop STRAIN. With Memoir and Portrait of the Author. 5 vols. crown 8vo, bound in extra cloth, £1, 1s. The following Volumes may be had separately—*viz.* :

The Devout Christian instructed in the Law of Christ from the Written Word. 2 vols., 8s.—The Pious Christian instructed in the Nature and Practice of the Principal Exercises of Piety. 1 vol., 2s.

HEMANS.

The Poetical Works of Mrs Hemans. Copyright Edition. Royal 8vo, with Engravings, cloth, gilt edges, 7s. 6d.

Select Poems of Mrs Hemans. Fcap., cloth, gilt edges, 3s.

HENDERSON. The Young Estate Manager's Guide. By RICHARD HENDERSON, Member (by Examination) of the Royal Agricultural Society of England, the Highland and Agricultural Society of Scotland, and the Surveyors' Institution. With an Introduction by R. Patrick Wright, F.R.S.E., Professor of Agriculture, Glasgow and West of Scotland Technical College. With Plans and Diagrams. Crown 8vo, 5s.

HERKLESS. Cardinal Beaton: Priest and Politician. By JOHN HERKLESS, Professor of Church History, St Andrews. With a Portrait. Post 8vo, 7s. 6d.

HEWISON. The Isle of Bute in the Olden Time. With Illustrations, Maps, and Plans. By JAMES KING HEWISON, M.A., F.S.A. (Scot.), Minister of Rothesay. Vol. I., Celtic Saints and Heroes. Crown 4to, 15s. net. Vol. II., The Royal Stewards and the Brandanes. Crown 4to, 15s. net.

HOME PRAYERS. By Ministers of the Church of Scotland and Members of the Church Service Society. Second Edition. Fcap. 8vo, 8s.

HORNBY. Admiral of the Fleet Sir Geoffrey Phipps Hornby, G.C.B. A Biography. By Mrs FRED. EGBERTON. With Three Portraits. Demy 8vo, 16s.

HUEFFER. The Cinque Ports: A History. By F. MADOX HUEFFER. With Photogravure and other Illustrations by William Hyde. In 1 vol. royal 4to. [In the press.]

HUTCHINSON. Hints on the Game of Golf. By HORACE G. HUTCHINSON. Ninth Edition, Enlarged. Fcap. 8vo, cloth, 1s.

HYSLOP. The Elements of Ethics. By JAMES H. HYSLOP, Ph.D., Instructor in Ethics, Columbia College, New York, Author of 'The Elements of Logic.' Post 8vo, 7s. 6d. net.

IDDESLEIGH. Life, Letters, and Diaries of Sir Stafford Northcote, First Earl of Iddesleigh. By ANDREW LANG. With Three Portraits and a View of Pynes. Third Edition. 2 vols. post 8vo, 81s. 6d.

POPULAR EDITION. With Portrait and View of Pynes. Post 8vo, 7s. 6d.

JEAN JAMBON. Our Trip to Blunderland; or, Grand Excursion to Blundertown and Back. By JEAN JAMBON. With Sixty Illustrations designed by CHARLES DOYLE, engraved by DALRIEL. Fourth Thousand. Cloth, gilt edges, 6s. 6d. Cheap Edition, cloth, 2s. 6d. Boards, 2s. 6d.

JEBB.

A Strange Career. The Life and Adventures of JOHN GLADWYN JEBB. By his Widow. With an Introduction by H. RIDER HAGGARD, and an Electrograving Portrait of Mr Jebb. Third Edition. Demy 8vo, 10s. 6d. CHEAP EDITION. With Illustrations by John Wallace. Crown 8vo, 8s. 6d.

Some Unconventional People. By Mrs GLADWYN JEBB, Author of 'Life and Adventures of J. G. Jebb.' With Illustrations. Cheap Edition. Paper covers, 1s.

JERNINGHAM.

Reminiscences of an Attaché. By HUBERT E. H. JERNINGHAM. Second Edition. Crown 8vo, 5s

Diane de Breteuille. A Love Story. Crown 8vo, 2s. 6d.

JOHNSTON.

The Chemistry of Common Life. By Professor J. F. W. JOHNSTON. New Edition, Revised. By ARTHUR HERBERT CHURCH, M.A. Oxon.; Author of 'Food: its Sources, Constituents, and Uses,' &c. With Maps and 102 Engravings. Crown 8vo, 7s. 6d.

Elements of Agricultural Chemistry. An entirely New Edition from the Edition by Sir CHARLES A. CAMERON, M.D., F.R.C.S.I., &c. Revised and brought down to date by C. M. AIKMAN, M.A., B.Sc., F.R.S.E., Professor of Chemistry, Glasgow Veterinary College. 17th Edition. Crown 8vo, 6s. 6d.

Catechism of Agricultural Chemistry. An entirely New Edition from the Edition by Sir CHARLES A. CAMERON. Revised and Enlarged by C. M. AIKMAN, M.A., &c. 95th Thousand. With numerous Illustrations. Crown 8vo, 1s.

JOHNSTON. Agricultural Holdings (Scotland) Acts, 1883 and 1889; and the Ground Game Act, 1880. With Notes, and Summary of Procedure, &c. By CHRISTOPHER N. JOHNSTON, M.A., Advocate. Demy 8vo, 5s.

JOKAL. Timar's Two Worlds. By MAURUS JOKAL. Authorised Translation by Mrs HEGAN KENNARD. Cheap Edition. Crown 8vo, 6s.

KEBBEL. The Old and the New: English Country Life. By T. E. KEBBEL, M.A., Author of 'The Agricultural Labourers,' 'Essays in History and Politics,' 'Life of Lord Beaconsfield.' Crown 8vo, 5s.

KENNEDY. A Life on the Ocean Wave. By Vice-Admiral Sir WILLIAM KENNEDY, K.C.B., Author of 'Sport, Travel, and Adventure in Newfoundland and the West Indies.' With Illustrations from Sketches by the Author. In 1 vol. demy 8vo. [In the press.]

KERR. St Andrews in 1645-46. By D. R. KERR. Crown 8vo, 2s. 6d.

KINGLAKE.

History of the Invasion of the Crimea. By A. W. KINGLAKE. Cabinet Edition, Revised. With an Index to the Complete Work. Illustrated with Maps and Plans. Complete in 9 vols., crown 8vo, at 6s. each.

— **Abridged Edition for Military Students.** Revised by Lieut.-Col. Sir GEORGE SYDENHAM CLARKE, K.C.M.G., R.E. Demy 8vo, 15s. net.

— **Atlas to accompany above.** Folio, 9s. net.

History of the Invasion of the Crimea. Demy 8vo. Vol. VI. Winter Troubles. With a Map, 16s. Vols. VII. and VIII. From the Morrow of Inkerman to the Death of Lord Raglan. With an Index to the Whole Work. With Maps and Plans. 28s

Eothen. A New Edition, uniform with the Cabinet Edition of the 'History of the Invasion of the Crimea.' 6s.

CHEAPER EDITION. With Portrait and Biographical Sketch of the Author. Crown 8vo, 8s. 6d. Popular Edition, in paper cover, 1s. net.

KIRBY. In Haunts of Wild Game: A Hunter-Naturalist's Wanderings from Kahlamba to Libombo. By FREDERICK VAUGHAN KIRBY, F.Z.S. (Maqaqamba). With numerous Illustrations by Charles Whympier, and a Map. Large demy 8vo, 25s.

KNEIPP. My Water-Cure. As Tested through more than Thirty Years, and Described for the Healing of Diseases and the Preservation of Health. By SEBASTIAN KNEIPP, Parish Priest of Würshofen (Bavaria). With a Portrait and other Illustrations. Authorised English Translation from the Thirtieth German Edition, by A. de F. Cheap Edition. With an Appendix, containing the Latest Developments of Pfarrer Kneipp's System, and a Preface by E. Gerard. Crown 8vo, 8s. 6d.

LANG.

A History of Scotland from the Roman Occupation. By ANDREW LANG. Demy 8vo. [Vol. I. in the press.]

Life, Letters, and Diaries of Sir Stafford Northcote, First Earl of Iddesleigh. With Three Portraits and a View of Pynes. Third Edition. 2 vols. post 8vo, 31s. 6d.

POPULAR EDITION. With Portrait and View of Pynes. Post 8vo, 7s. 6d.

The Highlands of Scotland in 1750. From Manuscript 104 in the King's Library, British Museum. With an Introduction by ANDREW LANG. Crown 8vo, 5s. net.

LANG. The Expansion of the Christian Life. The Duff Lecture for 1897. By the Rev. J. MARSHALL LANG, D.D. Crown 8vo, 5s.

LEES. A Handbook of the Sheriff and Justice of Peace Small Debt Courts. With Notes, References, and Forms. By J. M. LEES, Advocate, Sheriff of Stirling, Dumbarton, and Clackmannan. 8vo, 7s. 6d.

LENNOX AND STURROCK. The Elements of Physical Education: A Teacher's Manual. By DAVID LENNOX, M.D., late R.N., Medical Director of Dundee Public Gymnasium, and ALEXANDER STURROCK, Superintendent of Dundee Public Gymnasium, Instructor to the University of St Andrews and Dundee High School. With Original Musical Accompaniments to the Drill by HARRY EVERITT LOSEBY. With 130 Illustrations. Crown 8vo, 4s.

LEWES. Dr Southwood Smith: A Retrospect. By his Granddaughter, Mrs C. L. LEWES. With Portraits and other Illustrations. Post 8vo, 6s.

LINDSAY.

Recent Advances in Theistic Philosophy of Religion. By Rev. JAMES LINDSAY, M.A., B.D., B.Sc., F.R.S.E., F.G.S., Minister of the Parish of St Andrew's, Kilmarnock. Demy 8vo, 12s. 6d. net.

The Progressiveness of Modern Christian Thought. Crown 8vo, 6s.

Essays, Literary and Philosophical. Crown 8vo, 3s. 6d.

The Significance of the Old Testament for Modern Theology. Crown 8vo, 1s. net.

The Teaching Function of the Modern Pulpit. Crown 8vo, 1s. net.

LOCKHART.

Doubles and Quits. By LAURENCE W. M. LOCKHART. New Edition. Crown 8vo, 3s. 6d.

Fair to See. New Edition. Crown 8vo, 3s. 6d.

Mine is Thine. New Edition. Crown 8vo, 3s. 6d.

LOCKHART.

The Church of Scotland in the Thirteenth Century. The Life and Times of David de Bernham of St Andrews (Bishop), A.D. 1239 to 1258. With List of Churches dedicated by him, and Dates. By WILLIAM LOCKHART, A.M., D.D., F.S.A. Scot., Minister of Colinton Parish. 2d Edition. 8vo, 6s.

Dies Tristes: Sermons for Seasons of Sorrow. Crown 8vo, 6s.

LORIMER.

The Institutes of Law : A Treatise of the Principles of Jurisprudence as determined by Nature. By the late JAMES LORIMER, Professor of Public Law and of the Law of Nature and Nations in the University of Edinburgh. New Edition, Revised and much Enlarged. 8vo, 18s.

The Institutes of the Law of Nations. A Treatise of the Jural Relation of Separate Political Communities. In 2 vols. 8vo. Volume I., price 16s. Volume II., price 20s.

LUGARD. **The Rise of our East African Empire : Early Efforts in Uganda and Nyasaland.** By F. D. LUGARD, Captain Norfolk Regiment. With 130 Illustrations from Drawings and Photographs under the personal superintendence of the Author, and 14 specially prepared Maps. In 2 vols. large demy 8vo, 42s.

LYNDEN - BELL. **A Primer of Tactics, Fortification, Topography, and Military Law.** By Capt. C. P. LYNDEN-BELL. With Diagrams. Crown 8vo, 3s. net.

MABIE.

Essays on Nature and Culture. By HAMILTON WRIGHT MABIE. With Portrait. Fcap. 8vo, 3s. 6d.

Books and Culture. Fcap. 8vo, 3s. 6d.

M^CCHESNEY.

Miriam Cromwell, Royalist : A Romance of the Great Rebellion. By DORA GREENWELL M^CCHESNEY. Crown 8vo, 6s.

Kathleen Clare : Her Book, 1637-41. With Frontispiece, and five full-page Illustrations by James A. Shearman. Crown 8vo, 6s.

M'COMBIE. **Cattle and Cattle-Breeders.** By WILLIAM M'COMBIE, Tillyfour. New Edition, Enlarged, with Memoir of the Author by JAMES MACDONALD, F.R.S.E., Secretary Highland and Agricultural Society of Scotland. Crown 8vo, 3s. 6d.

M'CRIE.

Works of the Rev. Thomas M'Crie, D.D. Uniform Edition. 4 vols. crown 8vo, 24s.

Life of John Knox. Crown 8vo, 6s. Another Edition, 3s. 6d.

Life of Andrew Melville. Crown 8vo, 6s.

History of the Progress and Suppression of the Reformation in Italy in the Sixteenth Century. Crown 8vo, 4s.

History of the Progress and Suppression of the Reformation in Spain in the Sixteenth Century. Crown 8vo, 3s. 6d.

MACDONALD. **A Manual of the Criminal Law (Scotland) Procedure Act, 1887.** By NORMAN DORAN MACDONALD. Revised by the LORD JUSTICE-CLERK. 8vo, 10s. 6d.

MACDOUGALL AND DODDS. **A Manual of the Local Government (Scotland) Act, 1894.** With Introduction, Explanatory Notes, and Copious Index. By J. PATTEN MACDOUGALL, Legal Secretary to the Lord Advocate, and J. M. DODDS. Tenth Thousand, Revised. Crown 8vo, 2s. 6d. net.

MACINTYRE. **Hindu-Koh : Wanderings and Wild Sports on and beyond the Himalayas.** By Major-General DONALD MACINTYRE, V.C., late Prince of Wales' Own Goorkhas, F.R.G.S. Dedicated to H.R.H. the Prince of Wales. New and Cheaper Edition, Revised, with numerous Illustrations. Post 8vo, 8s. 6d.

MACKENZIE. **Studies in Roman Law. With Comparative Views of the Laws of France, England, and Scotland.** By LORD MACKENZIE, one of the Judges of the Court of Session in Scotland. Seventh Edition, Edited by JOHN KIRKPATRICK, M.A., LL.B., Advocate, Professor of History in the University of Edinburgh. 8vo, 21s.

M'PHERSON. **Golf and Golfers. Past and Present.** By J. GORDON M'PHERSON, Ph.D., F.R.S.E. With an Introduction by the Right Hon. A. J. BALFOUR, and a Portrait of the Author. Fcap. 8vo, 1s. 6d.

MAGNUS AND HEADLAM. Prayers from the Poets. A Calendar of Devotion. By LAURIE MAGNUS and CECIL HEADLAM. In 1 vol. fcap. 8vo. [In the press.]

MAIN. Three Hundred English Sonnets. Chosen and Edited by DAVID M. MAIN. New Edition. Fcap. 8vo, 3s. 6d.

MAIR.

A Digest of Laws and Decisions, Ecclesiastical and Civil, relating to the Constitution, Practice, and Affairs of the Church of Scotland. With Notes and Forms of Procedure. By the Rev. WILLIAM MAIR, D.D., Minister of the Parish of Earliston. New Edition, Revised. Crown 8vo, 9s. net.

Speaking; or, From Voice Production to the Platform and Pulpit. In 1 vol. crown 8vo. [In the press.]

MARSHMAN. History of India. From the Earliest Period to the present time. By JOHN CLARK MARSHMAN, C.S.I. Third and Cheaper Edition. Post 8vo, with Map, 6s.

MARTIN.

The Æneid of Virgil. Books I.-VI. Translated by Sir THEODORE MARTIN, K.O.B. Post 8vo, 7s. 6d.

Goethe's Faust. Part I. Translated into English Verse. Second Edition, crown 8vo, 6s. Ninth Edition, fcap. 8vo, 3s. 6d.

Goethe's Faust. Part II. Translated into English Verse. Second Edition, Revised. Fcap. 8vo, 6s.

The Works of Horace. Translated into English Verse, with Life and Notes. 2 vols. New Edition. Crown 8vo, 21s.

Poems and Ballads of Heinrich Heine. Done into English Verse. Third Edition. Small crown 8vo, 5s.

The Song of the Bell, and other Translations from Schiller, Goethe, Uhland, and Others. Crown 8vo, 7s. 6d.

Madonna Pia: A Tragedy; and Three Other Dramas. Crown 8vo, 7s. 6d.

Catullus. With Life and Notes. Second Edition, Revised and Corrected. Post 8vo, 7s. 6d.

The 'Vita Nuova' of Dante. Translated, with an Introduction and Notes. Third Edition. Small crown 8vo, 5s.

Aladdin: A Dramatic Poem. By ADAM OEHLENSCHLÆGER. Fcap. 8vo, 5s.

Correggio: A Tragedy. By OEHLENSCHLÆGER. With Notes. Fcap. 8vo, 3s.

MARTIN. On some of Shakespeare's Female Characters. By HELENA FAUCIT, Lady MARTIN. Dedicated by permission to Her Most Gracious Majesty the Queen. With a Portrait by Lehmann. Sixth Edition, with a new Preface. Demy 8vo, 7s. 6d.

MARWICK. Observations on the Law and Practice in regard to Municipal Elections and the Conduct of the Business of Town Councils and Commissioners of Police in Scotland. By Sir JAMES D. MARWICK, LL.D., Town-Clerk of Glasgow. Royal 8vo, 80s.

MATHESON.

Can the Old Faith Live with the New? or, The Problem of Evolution and Revelation. By the Rev. GEORGE MATHESON, D.D. Third Edition. Crown 8vo, 7s. 6d.

The Psalmist and the Scientist; or, Modern Value of the Religious Sentiment. Third Edition. Crown 8vo, 5s.

Spiritual Development of St Paul. Fourth Edition. Cr. 8vo, 5s.

The Distinctive Messages of the Old Religions. Second Edition. Crown 8vo, 5s.

Sacred Songs. New and Cheaper Edition. Crown 8vo, 2s. 6d.

MAXWELL.

- The Honourable Sir Charles Murray, K.C.B. A Memoir.**
By Sir HERBERT MAXWELL, Bart., M.P., F.S.A., &c., Author of 'Passages in the Life of Sir Lucian Elphin.' With Five Portraits. Demy 8vo, 18s.
- Life and Times of the Rt. Hon. William Henry Smith, M.P.**
With Portraits and numerous Illustrations by Herbert Railton, G. L. Seymour, and Others. 2 vols. demy 8vo, 25s.
- POPULAR EDITION. With a Portrait and other Illustrations. Crown 8vo, 3s. 6d.
- Scottish Land-Names: Their Origin and Meaning.** Being the Rhind Lectures in Archaeology for 1893. Post 8vo, 6s.
- Meridiana: Noontide Essays.** Post 8vo, 7s. 6d.
- Post Meridiana: Afternoon Essays.** Post 8vo, 6s.
- A Duke of Britain. A Romance of the Fourth Century.**
Fourth Edition. Crown 8vo, 6s.
- Dumfries and Galloway.** Being one of the Volumes of the County Histories of Scotland. With Four Maps. Demy 8vo, 7s. 6d. net.

MELDRUM.

- Holland and the Hollanders.** By D. STORRAR MELDRUM.
With numerous Illustrations and a Map. Second Edition. Square 8vo, 6s.
- The Story of Margrédel** Being a Fireside History of a Fife-shire Family. Cheap Edition. Crown 8vo, 8s. 6d.
- Grey Mantle and Gold Fringe.** Crown 8vo, 6s.

MELLONE. Studies in Philosophical Criticism and Construction.

By SYDNEY HERBERT MELLONE, M.A. Lond., D.Sc. Edin. Post 8vo. 10s. 6d. net.

MERZ. A History of European Thought in the Nineteenth Century.

By JOHN THEODORE MERZ. Vol. I., post 8vo, 10s. 6d. net.

MICHIE.

- The Larch: Being a Practical Treatise on its Culture and General Management.** By CHRISTOPHER Y. MICHIE, Forester, Cullen House. Crown 8vo, with Illustrations. New and Cheaper Edition, Enlarged, 5s.
- The Practice of Forestry.** Crown 8vo, with Illustrations. 6s.

MIDDLETON. The Story of Alastair Bhan Comyn; or, The Tragedy of Dunphail. A Tale of Tradition and Romance.

By the Lady MIDDLETON. Square 8vo, 10s. Cheaper Edition, 5s.

MINTO.

- A Manual of English Prose Literature, Biographical and Critical; designed mainly to show Characteristics of Style.** By W. MINTO, M.A., Hon. LL.D. of St Andrews; Professor of Logic in the University of Aberdeen. Third Edition, Revised. Crown 8vo, 7s. 6d.

Characteristics of English Poets, from Chaucer to Shirley.

New Edition, Revised. Crown 8vo, 7s. 6d.

MINTO.

- Plain Principles of Prose Composition.** Crown 8vo, 1s. 6d.
- The Literature of the Georgian Era.** Edited, with a Biographical Introduction, by Professor KNIGHT, St Andrews. Post 8vo, 6s.

MITCHELL.

- The Scottish Reformation. Its Epochs, Episodes, Leaders, and Distinctive Characteristics.** Being the Baird Lecture for 1899. By the late ALEXANDER F. MITCHELL, D.D., Emeritus Professor of Church History in St Andrews University. Edited by D. HAY FLEMING. In 1 vol. crown 8vo.

[In the press.]

MODERN ENGLISH WRITERS. In handy crown 8vo volumes, tastefully bound, price 2s. 6d. each.

Matthew Arnold. By Professor SAINTSBURY.

[Ready.
Ready.]

Stevenson. By L. COPE CORNFORD.

In Preparation.

TENNYSON. By Andrew Lang.

RUSKIN. By Mrs Meynell.

GEORGE ELIOT. By Sidney Lee.

BROWNING. By Augustine Birrell.

FROUDE. By John Oliver Hobbes.

HUXLEY. By Edward Clodd.

THACKERAY. By Charles Whibley.

DICKENS. By W. E. Henley.

MOIR.

Life of Mansie Wauch, Tailor in Dalkeith. By D. M. MOIR.

With CRUIKSHANK'S Illustrations. Cheaper Edition. Crown 8vo, 2s. 6d.

Another Edition, without Illustrations, fcap. 8vo, 1s. 6d.

Domestic Verses. Centenary Edition. With a Portrait. Crown 8vo, 2s. 6d. net.

MOMERIE.

Defects of Modern Christianity, and other Sermons. By Rev.

ALFRED WILLIAMS MOMERIE, M.A., D.Sc., LL.D. Fifth Edition. Crown 8vo, 5s.

The Basis of Religion. Being an Examination of Natural Religion. Third Edition. Crown 8vo, 2s. 6d.

The Origin of Evil, and other Sermons. Eighth Edition, Enlarged. Crown 8vo, 5s.

Personality. The Beginning and End of Metaphysics, and a Necessary Assumption in all Positive Philosophy. Fifth Ed., Revised. Cr. 8vo, 3s.

Agnosticism. Fourth Edition, Revised. Crown 8vo, 5s.

Preaching and Hearing; and other Sermons. Fourth Edition, Enlarged. Crown 8vo, 5s.

Belief in God. Fourth Edition. Crown 8vo, 3s.

Inspiration; and other Sermons. Second Edition, Enlarged. Crown 8vo, 5s.

Church and Creed. Third Edition. Crown 8vo, 4s. 6d.

The Future of Religion, and other Essays. Second Edition. Crown 8vo, 3s. 6d.

The English Church and the Romish Schism. Second Edition. Crown 8vo, 2s. 6d.

MONCREIFF.

The Provost-Marshal. A Romance of the Middle Shires. By the Hon. FREDERICK MONCREIFF. Crown 8vo, 6s.

The X Jewel. A Romance of the Days of James VI. Cr. 8vo, 6s.

MONTAGUE. Military Topography. Illustrated by Practical

Examples of a Practical Subject. By Major-General W. E. MONTAGUE, C.B., P.S.C., late Garrison Instructor Intelligence Department, Author of 'Campaigning in South Africa.' With Forty-one Diagrams. Crown 8vo, 5s.

MORISON.

Rifts in the Reek. By JEANIE MORISON. With a Photogravure Frontispiece. Crown 8vo, 5s. Bound in buckram for presentation, 6s.

Doorside Ditties. With a Frontispiece. Crown 8vo, 3s. 6d.

Æolus. A Romance in Lyrics. Crown 8vo, 3s.

There as Here. Crown 8vo, 3s.

* * A limited impression on hand-made paper, bound in vellum, 7s. 6d.

Selections from Poems. Crown 8vo, 4s. 6d.

Sordello. An Outline Analysis of Mr Browning's Poem. Crown 8vo, 3s.

Of "Fifine at the Fair," "Christmas Eve and Easter Day," and other of Mr Browning's Poems. Crown 8vo, 3s.

MORISON.

- The Purpose of the Ages.** Crown 8vo, 9s.
Gordon : An Our-day Idyll. Crown 8vo, 3s.
Saint Isadora, and other Poems. Crown 8vo, 1s. 6d.
Snatches of Song. Paper, 1s. 6d. ; cloth, 3s.
Pontius Pilate. Paper, 1s. 6d. ; cloth, 3s.
Mill o' Forres. Crown 8vo, 1s.
Ane Booke of Ballades. Fcap. 4to, 1s.

MUNRO.

- John Splendid. The Tale of a Poor Gentleman and the Little Wars of Lorn.** By NEIL MUNRO. Sixth Edition. Crown 8vo, 6s.
The Lost Pibroch, and other Sheiling Stories. Fourth Edition. Crown 8vo, 3s. 6d.

MUNRO.

- Rambles and Studies in Bosnia-Herzegovina and Dalmatia.** With an Account of the proceedings of the Congress of Archaeologists and Anthropologists held at Sarajevo in 1894. By ROBERT MUNRO, M.A., M.D., F.R.S.E., Author of the 'Lake Dwellings of Europe,' &c. With numerous illustrations. Demy 8vo, 12s. 6d. net.
Prehistoric Problems. With numerous Illustrations. Demy 8vo, 10s. net.

- Prehistoric Scotland and its Place in European Civilisation.** Being a General Introduction to the "County Histories of Scotland." With numerous Illustrations. Crown 8vo, 7s. 6d. net.

MUNRO. On Valuation of Property. By WILLIAM MUNRO, M.A., Her Majesty's Assessor of Railways and Canals for Scotland. Second Edition, Revised and Enlarged. 8vo, 3s. 6d.**MURDOCH. Manual of the Law of Insolvency and Bankruptcy:** Comprehending a Summary of the Law of Insolvency, Notour Bankruptcy, Composition-Contracts, Trust-Deeds, Cessios, and Sequestrations; and the Winding-up of Joint-Stock Companies in Scotland: with Annotations on the various Insolvency and Bankruptcy Statutes; and with Forms of Procedure applicable to these Subjects. By JAMES MURDOCH, Member of the Faculty of Procurators in Glasgow. Fifth Edition, Revised and Enlarged. 8vo, 12s. net.**MY TRIVIAL LIFE AND MISFORTUNE: A Gossip with no Plot in Particular.** By A PLAIN WOMAN. Cheap Edition. Crown 8vo, 3s. 6d. By the SAME AUTHOR.

POOR NELLIE. Cheap Edition. Crown 8vo, 3s. 6d.

NEAVES. Songs and Verses, Social and Scientific. By An Old Contributor to 'Maga.' By the Hon. Lord NEAVES. Fifth Edition. Fcap. 8vo, 4s.**NICHOLSON.**

- A Manual of Zoology, for the Use of Students.** With a General Introduction on the Principles of Zoology. By HENRY ALLEYNE NICHOLSON, M.D., D.Sc., F.L.S., F.G.S., Regius Professor of Natural History in the University of Aberdeen. Seventh Edition, Rewritten and Enlarged. Post 8vo, pp. 956, with 555 Engravings on Wood, 18s.

- Text-Book of Zoology, for Junior Students.** Fifth Edition. Rewritten and Enlarged. Crown 8vo, with 358 Engravings on Wood, 10s. 6d.

- A Manual of Palæontology, for the Use of Students.** With a General Introduction on the Principles of Palæontology. By Professor H. ALLEYNE NICHOLSON and RICHARD LYDEKKER, B.A. Third Edition, entirely Rewritten and greatly Enlarged. 2 vols. 8vo, £3. 3s.

- The Ancient Life-History of the Earth.** An Outline of the Principles and Leading Facts of Palæontological Science. Crown 8vo, with 276 Engravings, 10s. 6d.

NICHOLSON.

On the "Tabulate Corals" of the Palæozoic Period, with Critical Descriptions of Illustrative Species. Illustrated with 15 Lithographed Plates and numerous Engravings. Super-royal 8vo, 21s.

Synopsis of the Classification of the Animal Kingdom. 8vo, with 106 Illustrations, 6s.

On the Structure and Affinities of the Genus *Monticulipora* and its Sub-Genera, with Critical Descriptions of Illustrative Species. Illustrated with numerous Engravings on Wood and Lithographed Plates. Super-royal 8vo, 18s.

NICHOLSON.

Thoth. A Romance. By JOSEPH SHIELD NICHOLSON, M.A., D.Sc., Professor of Commercial and Political Economy and Mercantile Law in the University of Edinburgh. Third Edition. Crown 8vo, 4s. 6d.

A Dreamer of Dreams. A Modern Romance. Second Edition. Crown 8vo, 6s.

NICOL. Recent Archæology and the Bible. Being the Croall Lectures for 1898. By the Rev. THOMAS NICOL, D.D., Professor of Divinity and Biblical Criticism in the University of Aberdeen; Author of 'Recent Explorations in Bible Lands.' Demy 8vo, 9s. net.

OLIPHANT.

Masollam : A Problem of the Period. A Novel. By LAURENCE OLIPHANT. 3 vols. post 8vo, 25s. 6d.

Scientific Religion; or, Higher Possibilities of Life and Practice through the Operation of Natural Forces. Second Edition. 8vo, 16s.

Altiora Peto. Cheap Edition. Crown 8vo, boards, 2s. 6d.; cloth, 3s. 6d. Illustrated Edition. Crown 8vo, cloth, 6s.

Piccadilly. With Illustrations by Richard Doyle. New Edition, 3s. 6d. Cheap Edition, boards, 2s. 6d.

Traits and Travesties; Social and Political. Post 8vo, 10s. 6d.

Episodes in a Life of Adventure; or, Moss from a Rolling Stone. Cheaper Edition. Post 8vo, 3s. 6d.

Haifa : Life in Modern Palestine. Second Edition. 8vo, 7s. 6d.

The Land of Gilead. With Excursions in the Lebanon. With Illustrations and Maps. Demy 8vo, 21s.

Memoir of the Life of Laurence Oliphant, and of Alice Oliphant, his Wife. By Mrs M. O. W. OLIPHANT. Seventh Edition. 2 vols. post 8vo, with Portraits. 21s.

POPULAR EDITION. With a New Preface. Post 8vo, with Portraits. 7s. 6d.

OLIPHANT.

The Autobiography and Letters of Mrs M. O. W. Oliphant. Arranged and Edited by Mrs HARRY COGHILL. With Two Portraits. Cheap Edition. Crown 8vo, 6s.

Annals of a Publishing House. William Blackwood and his Sons; Their Magazine and Friends. By Mrs OLIPHANT. With Four Portraits. Third Edition. Demy 8vo. Vols. I. and II. £2, 2s.

A Widow's Tale, and other Stories. With an Introductory Note by J. M. BARRIE. Second Edition. Crown 8vo, 6s.

Who was Lost and is Found. Second Edition. Crown 8vo, 6s.

Miss Marjoribanks. New Edition. Crown 8vo, 3s. 6d.

The Perpetual Curate, and The Rector. New Edition. Crown 8vo, 3s. 6d.

Salem Chapel, and The Doctor's Family. New Edition. Crown 8vo, 3s. 6d.

Chronicles of Carlingford. 3 vols. crown 8vo, in uniform binding, gilt top, 3s. 6d. each.

OLIPHANT.

Katie Stewart, and other Stories. New Edition. Crown 8vo, cloth, 2s. 6d.

Katie Stewart. Illustrated boards, 2s. 6d.

Valentine and his Brother. New Edition. Crown 8vo, 3s. 6d.

Sons and Daughters. Crown 8vo, 3s. 6d.

Two Stories of the Seen and the Unseen. The Open Door
—Old Lady Mary. Paper covers, 1s.

OLIPHANT. Notes of a Pilgrimage to Jerusalem and the Holy Land. By F. R. OLIPHANT. Crown 8vo, 3s. 6d.

OMOND. The Romantic Triumph. "Periods of European Literature." By T. S. OMOND. In 1 vol. crown 8vo. [In the press.]

O'NEILL. Songs of the Glens of Antrim. By MOIRA O'NEILL. Square fcap. 8vo. [In the press.]

PATON.

Spindrift. By Sir J. NOEL PATON. Fcap., cloth, 5s.

Poems by a Painter. Fcap., cloth, 5s.

PATON. Castlebraes. Drawn from "The Tintie MSS." By JAMES PATON, B.A., Editor of 'John G. Paton: an Autobiography,' &c., &c. Cheap Edition. Crown 8vo, 3s. 6d.

PATRICK. The Apology of Origen in Reply to Celsus. A Chapter in the History of Apologetics. By the Rev. J. PATRICK, D.D., Professor of Biblical Criticism in the University of Edinburgh. Post 8vo, 7s. 6d.

PAUL. History of the Royal Company of Archers, the Queen's Body-Guard for Scotland. By JAMES BALFOUR PAUL, Advocate of the Scottish Bar. Crown 4to, with Portraits and other Illustrations. £2, 2s.

PEILE. Lawn Tennis as a Game of Skill. By Lieut.-Col. S. C. F. PEILE, B.S.C. Revised Edition, with new Scoring Rules. Fcap. 8vo, cloth, 1s.

PERIODS OF EUROPEAN LITERATURE. Edited by Professor SAINTSBURY. For List of Volumes, see page 2.

PETTIGREW. The Handy Book of Bees, and their Profitable Management. By A. PETTIGREW. Fifth Edition, Enlarged, with Engravings. Crown 8vo, 3s. 6d.

PFLEIDERER. Philosophy and Development of Religion. Being the Edinburgh Gifford Lectures for 1894. By OTTO PFLEIDERER, D.D., Professor of Theology at Berlin University. In 2 vols. post 8vo, 15s. net.

PHILLIPS. The Knight's Tale. By F. EMILY PHILLIPS, Author of 'The Education of Antonia.' Crown 8vo, 3s. 6d.

PHILOSOPHICAL CLASSICS FOR ENGLISH READERS. Edited by WILLIAM KNIGHT, LL.D., Professor of Moral Philosophy, University of St Andrews. In crown 8vo volumes, with Portraits, price 3s. 6d.

[For List of Volumes, see page 2.]

POLLARD. A Study in Municipal Government: The Corporation of Berlin. By JAMES POLLARD, C.A., Chairman of the Edinburgh Public Health Committee, and Secretary of the Edinburgh Chamber of Commerce. Second Edition, Revised. Crown 8vo, 3s. 6d.

POLLOK. The Course of Time: A Poem. By ROBERT POLLOK, A.M. New Edition. With Portrait. Fcap. 8vo, gilt top, 2s. 6d.

PORT ROYAL LOGIC. Translated from the French; with Introduction, Notes, and Appendix. By THOMAS SPENCER BAYNES, LL.D., Professor in the University of St Andrews. Tenth Edition, 12mo, 4s.

PRESTWICH. Life and Letters of Sir Joseph Prestwich, M.A., D.C.L., F.R.S. Formerly Professor of Geology in the University of Oxford. Written and Edited by his WIFE. With Portraits and other Illustrations. Demy 8vo, 21s.

PRINGLE. The Live Stock of the Farm. By ROBERT O. PRINGLE. Third Edition. Revised and Edited by JAMES MACDONALD. Crown 8vo, 7s. 6d.

PUBLIC GENERAL STATUTES AFFECTING SCOTLAND from 1707 to 1847, with Chronological Table and Index. 3 vols. large 8vo, £3, 8s.

PUBLIC GENERAL STATUTES AFFECTING SCOTLAND, COLLECTION OF. Published Annually, with General Index.

RAMSAY. Scotland and Scotsmen in the Eighteenth Century. Edited from the MSS. of JOHN RAMSAY, Esq. of Ochtertyre, by ALEXANDER ALLARDYCE, Author of 'Memoir of Admiral Lord Keith, K.B.,' &c. 2 vols. 8vo, 31s. 6d.

RANJITSINHJI. The Jubilee Book of Cricket. By PRINCE RANJITSINHJI.

ÉDITION DE LUXE. Limited to 350 Copies, printed on hand-made paper, and handsomely bound in buckram. Crown 4to, with 22 Photogravures and 85 full-page Plates. Each copy signed by Prince Ranjitsinhji. Price £5, 5s. net.

FINE PAPER EDITION. Medium 8vo, with Photogravure Frontispiece and 106 full-page Plates on art paper. 25s. net.

POPULAR EDITION. With 107 full-page Illustrations. Sixth Edition. Large crown 8vo, 6s.

RANKIN.

Church Ideas in Scripture and Scotland. By JAMES RANKIN, D.D., Minister of Muthill; Author of 'Character Studies in the Old Testament,' &c. Crown 8vo, 6s.

A Handbook of the Church of Scotland. An entirely New and much Enlarged Edition. Crown 8vo, with 2 Maps, 7s. 6d.

The First Saints. Post 8vo, 7s. 6d

The Creed in Scotland. An Exposition of the Apostles' Creed. With Extracts from Archbishop Hamilton's Catechism of 1552, John Calvin's Catechism of 1556, and a Catena of Ancient Latin and other Hymns. Post 8vo, 7s. 6d.

The Worthy Communicant. A Guide to the Devout Observance of the Lord's Supper. Limp cloth, 1s. 3d.

The Young Churchman. Lessons on the Creed, the Commandments, the Means of Grace, and the Church. Limp cloth, 1s. 3d.

First Communion Lessons. 25th Edition. Paper Cover, 2d.

RANKINE. A Hero of the Dark Continent. Memoir of Rev. Wm. Affleck Scott, M.A., M.B., C.M., Church of Scotland Missionary at Blantyre, British Central Africa. By W. HENRY RANKINE, B.D., Minister at Titwood. With a Portrait and other Illustrations. Cheap Edition. Crown 8vo, 2s.

ROBERTSON.

The Poetry and the Religion of the Psalms. The Croall Lectures, 1893-94. By JAMES ROBERTSON, D.D., Professor of Oriental Languages in the University of Glasgow. Demy 8vo, 12s.

The Early Religion of Israel. As set forth by Biblical Writers and Modern Critical Historians. Being the Baird Lecture for 1888-89. Fourth Edition. Crown 8vo, 10s. 6d.

ROBINSON. Wild Traits in Tame Animals. Being some Familiar Studies in Evolution. By LOUIS ROBINSON, M.D. With Illustrations by STEPHEN T. DADD. Cheaper Edition. Demy 8vo, 6s.

- ROPER.** *A Claim on Klondyke. A Romance of the Arctic El Dorado.* By EDWARD ROPER, F.R.G.S., Author of 'By Track and Trail through Canada,' &c. With 10 Full-page Illustrations. Crown 8vo, 6s.
- RUTLAND.**
Notes of an Irish Tour in 1846. By the DUKE OF RUTLAND, G.C.B. (LORD JOHN MANNERS). New Edition. Crown 8vo, 2s. 6d.
Correspondence between the Right Honble. William Pitt and Charles Duke of Rutland, Lord-Lieutenant of Ireland, 1781-1787. With Introductory Note by JOHN DUKE OF RUTLAND. 8vo, 7s. 6d.
- RUTLAND.**
Gems of German Poetry. Translated by the DUCHESS OF RUTLAND (LADY JOHN MANNERS). [New Edition in preparation.]
Impressions of Bad-Homburg. Comprising a Short Account of the Women's Associations of Germany under the Red Cross. Crown 8vo, 1s. 6d.
Some Personal Recollections of the Later Years of the Earl of Beaconsfield, K.G. Sixth Edition. 6d.
Employment of Women in the Public Service. 6d.
Some of the Advantages of Easily Accessible Reading and Recreation Rooms and Free Libraries. With Remarks on Starting and Maintaining them. Second Edition. Crown 8vo, 1s.
A Sequel to Rich Men's Dwellings, and other Occasional Papers. Crown 8vo, 2s. 6d.
Encouraging Experiences of Reading and Recreation Rooms, Aims of Guilds, Nottingham Social Guide, Existing Institutions, &c., &c. Crown 8vo, 1s.
- SAINTSBURY.**
Matthew Arnold. "Modern English Writers." By GEORGE SAINTSBURY, M.A., Professor of Rhetoric and English Literature in Edinburgh University. Crown 8vo, 2s. 6d.
The Flourishing of Romance and the Rise of Allegory (12th and 13th Centuries). "Periods of European Literature." Crown 8vo, 5s. net.
- SCHEFFEL.** *The Trumpeter. A Romance of the Rhine.* By JOSEPH VICTOR VON SCHEFFEL. Translated from the Two Hundredth German Edition by JESSIE BECK and LOUISA LORIMER. With an Introduction by Sir THEODORE MARTIN K.C.B. Long 8vo, 3s. 6d.
- SCOTT.** *Tom Cringle's Log.* By MICHAEL SCOTT. New Edition. With 19 Full-page Illustrations. Crown 8vo, 3s. 6d.
- SELKIRK.** *Poems.* By J. B. SELKIRK, Author of 'Ethics and Aesthetics of Modern Poetry,' 'Bible Truths with Shakespearian Parallels,' &c. New and Enlarged Edition. Crown 8vo, printed on antique paper, 6s.
- SELLAR'S** *Manual of the Acts relating to Education in Scotland.* By J. EDWARD GRAHAM, B.A. Oxon., Advocate. Ninth Edition. 8vo, 12s. 6d.
- SETH.**
Scottish Philosophy. A Comparison of the Scottish and German Answers to Hume. Balfour Philosophical Lectures, University of Edinburgh. By ANDREW SETH (A. S. Pringle Pattison, LL.D.), Professor of Logic and Metaphysics in Edinburgh University. Third Edition. Crown 8vo, 5s.
Hegelianism and Personality. Balfour Philosophical Lectures. Second Series. Second Edition. Crown 8vo, 5s.
Man's Place in the Cosmos, and other Essays. Post 8vo, 7s. 6d. net.
Two Lectures on Theism. Delivered on the occasion of the Sesquicentennial Celebration of Princeton University. Crown 8vo, 2s. 6d.

- SETH.** A Study of Ethical Principles. By JAMES SETH, M.A., Professor of Moral Philosophy in the University of Edinburgh. Fourth Edition. Revised. Post 8vo, 7s. 6d.
- SHARPE.** Letters from and to Charles Kirkpatrick Sharpe. Edited by ALEXANDER ALLARDYCE, Author of 'Memoir of Admiral Lord Keith, K.B.,' &c. With a Memoir by the Rev. W. K. R. BEDFORD. In 2 vols. 8vo. Illustrated with Etchings and other Engravings. £2, 12s. 6d.
- SIM.** Margaret Sim's Cookery. With an Introduction by L. B. WALFORD, Author of 'Mr Smith: A Part of his Life,' &c. Crown 8vo, 5s.
- SIMPSON.** The Wild Rabbit in a New Aspect; or, Rabbit-warrens that Pay. A book for Landowners, Sportsmen, Land Agents, Farmers Gamekeepers, and Allotment Holders. A Record of Recent Experiments conducted on the Estate of the Right Hon. the Earl of Wharncliffe at Wortley Hall. By J. SIMPSON. Second Edition, Enlarged. Small crown 8vo, 5s.
- SIMPSON.** Side-Lights on Siberia. Some account of the Great Siberian Iron Road: The Prisons and Exile System. By J. Y. SIMPSON, M.A., B.Sc. With numerous Illustrations and a Map. Demy 8vo, 16s.
- SINCLAIR.**
Mr and Mrs Nevill Tyson. By MAY SINCLAIR. Crown 8vo, 8s. 6d.
Audrey Craven. Second Edition. Crown 8vo, 6s.
- SKELTON.**
The Table-Talk of Shirley. By Sir JOHN SKELTON, K.C.B., LL.D., Author of 'The Essays of Shirley.' With a Frontispiece. Sixth Edition, Revised and Enlarged. Post 8vo, 7s. 6d.
The Table-Talk of Shirley. Second Series. With Illustrations. Two Volumes. Second Edition. Post 8vo, 10s. net.
Maitland of Lethington; and the Scotland of Mary Stuart. A History. Limited Edition, with Portraits. Demy 8vo, 2 vols., 28s. net.
The Handbook of Public Health. A New Edition, Revised by JAMES PATTEN MACDOUGALL, Advocate, Secretary of the Local Government Board for Scotland, Joint-Author of 'The Parish Council Guide for Scotland,' and ABRAHAM MURRAY, Chief Clerk of the Local Government Board for Scotland. In Two Parts. Crown 8vo. Part I.—The Public Health (Scotland) Act, 1897, with Notes. 8s. 6d. net.
Part II.—Circulars of the Local Government Board, &c. [In preparation.]
- The Local Government (Scotland) Act in Relation to Public Health. A Handy Guide for County and District Councillors, Medical Officers, Sanitary Inspectors, and Members of Parochial Boards. Second Edition. With a new Preface on appointment of Sanitary Officers. Crown 8vo, 2s.
- SMITH.** The Transition Period. "Periods of European Literature." By G. GREGORY SMITH. In 1 vol. crown 8vo. [In the press.]
- SMITH.** Retrievers, and how to Break them. By Lieutenant-Colonel Sir HENRY SMITH, K.C.B. With an Introduction by Mr S. E. SHIRLEY, President of the Kennel Club. Dedicated by special permission to H.R.H. the Duke of York. Cheaper Edition, enlarged. With additional Illustrations. Paper cover, 1s. net.
- SMITH - WILLIAMS.** The Magic of the Desert. A Romance. By W. SMITH-WILLIAMS. Crown 8vo, 6s.
- SNELL.** The Fourteenth Century. "Periods of European Literature." By F. J. SNELL. Crown 8vo, 5s. net.

"SON OF THE MARSHES, A."

From Spring to Fall; or, When Life Stirs. By "A SON OF THE MARSHES." Cheap Uniform Edition. Crown 8vo, 3s. 6d.

Within an Hour of London Town: Among Wild Birds and their Haunts. Edited by J. A. OWEN. Cheap Uniform Edition. Cr. 8vo, 3s. 6d.

With the Woodlanders and by the Tide. Cheap Uniform Edition. Crown 8vo, 3s. 6d.

On Surrey Hills. Cheap Uniform Edition. Crown 8vo, 3s. 6d.

Annals of a Fishing Village. Cheap Uniform Edition. Crown 8vo, 3s. 6d.

SORLEY. The Ethics of Naturalism. Being the Shaw Fellowship Lectures, 1884. By W. R. SORLEY, M.A., Fellow of Trinity College, Cambridge, Professor of Moral Philosophy, University of Aberdeen. Crown 8vo, 6s.

SPIELMANN. Millais and his Works. By M. H. SPIELMANN, Author of 'History of Punch.' With 28 Full-page Illustrations. Large crown 8vo. Paper covers, 1s; in cloth binding, 2s. 6d.

SPROTT. The Worship and Offices of the Church of Scotland. By GEORGE W. SPROTT, D.D., Minister of North Berwick. Crown 8vo, 6s.

STEEVENS.

In India. By G. W. STEEVENS. With Map. Second Edition. Crown 8vo, 6s.

With Kitchener to Khartum. With 8 Maps and Plans. Nineteenth Edition. Crown 8vo, 6s.

Egypt in 1898. With Illustrations. Crown 8vo, 6s.

The Land of the Dollar. Third Edition. Crown 8vo, 6s.

With the Conquering Turk. With 4 Maps. Demy 8vo, 10s. 6d.

STEPHENS.

The Book of the Farm; detailing the Labours of the Farmer, Farm-Steward, Ploughman, Shepherd, Hedger, Farm-Labourer, Field-Worker, and Cattle-man. Illustrated with numerous Portraits of Animals and Engravings of Implements, and Plans of Farm Buildings. Fourth Edition. Revised, and in great part Re-written, by JAMES MACDONALD, F.R.S.E., Secretary Highland and Agricultural Society of Scotland. Complete in Six Divisional Volumes, bound in cloth, each 10s. 6d., or handsomely bound, in 3 volumes, with leather back and gilt top, £3, 3s.

Catechism of Practical Agriculture. 22d Thousand. Revised by JAMES MACDONALD, F.R.S.E. With numerous Illustrations. Crown 8vo, 1s.

The Book of Farm Implements and Machines. By J. SLIGHT and R. SCOTT BURN, Engineers. Edited by HENRY STEPHENS. Large 8vo, £2, 2s.

STEVENSON. British Fungi. (Hymenomycetes.) By Rev. JOHN STEVENSON, Author of 'Mycologia Scotica,' Hon. Sec. Cryptogamic Society of Scotland Vols. I. and II., post 8vo, with Illustrations, price 12s. 6d. net each.

STEWART. The Good Regent. A Chronicle Play. By Professor SIR T. GRAINGER STEWART, M.D., LL.D. Crown 8vo, 6s.

STEWART AND CUFF. Practical Nursing. By ISLA STEWART, Matron of St Bartholomew's Hospital, London; and HERBERT E. CUFF, M.D., F.R.C.S., Medical Superintendent North-Eastern Fever Hospital, Tottenham, London. With Diagrams. In 2 vols. crown 8vo. Vol. I. 3s. 6d. net.

STODDART.

John Stuart Blackie: A Biography. By ANNA M. STODDART. With 8 Plates. Third Edition. 2 vols. demy 8vo, 21s.

POPULAR EDITION, with Portrait. Crown 8vo, 6s.

Sir Philip Sidney: Servant of God. Illustrated by MARGARET L. HUGGINS. With a New Portrait of Sir Philip Sidney. Small 4to, with a specially designed Cover. 5s.

STORMONTH.

Dictionary of the English Language, Pronouncing, Etymological, and Explanatory. By the Rev. JAMES STORMONTH. Revised by the Rev. P. H. PHELP. Library Edition. New and Cheaper Edition, with Supplement. Imperial 8vo, handsomely bound in half morocco, 18s. net.

Etymological and Pronouncing Dictionary of the English Language. Including a very Copious Selection of Scientific Terms. For use in Schools and Colleges, and as a Book of General Reference. The Pronunciation carefully revised by the Rev. P. H. PHELP, M.A. Cantab. Thirteenth Edition, with Supplement. Crown 8vo, pp. 800. 7s. 6d.

The School Dictionary. New Edition, thoroughly Revised. By WILLIAM BAYNE. 16mo, 1s.

STORY. **The Apostolic Ministry in the Scottish Church** (The Baird Lecture for 1897). By ROBERT HERBERT STORY, D.D. (Edin.), F.S.A. Scot., Principal of the University of Glasgow, Principal Clerk of the General Assembly, and Chaplain to the Queen. Crown 8vo, 7s. 6d.

STORY.

Poems. By W. W. Story, Author of 'Roba di Roma,' &c. 2 vols. 7s. 6d.

Fiammetta. A Summer Idyl. Crown 8vo, 7s. 6d.

Conversations in a Studio. 2 vols. crown 8vo, 12s. 6d.

Excursions in Art and Letters. Crown 8vo, 7s. 6d.

A Poet's Portfolio: Later Readings. 18mo, 3s. 6d.

STRACHEY. **Talk at a Country House.** Fact and Fiction. By Sir EDWARD STRACHEY, Bart. With a portrait of the Author. Crown 8vo, 4s. 6d. net.

STURGIS. **Little Comedies, Old and New.** By JULIAN STURGIS. Crown 8vo, 7s. 6d.

TAYLOR. **The Story of my Life.** By the late Colonel MEADOWS TAYLOR, Author of 'The Confessions of a Thug,' &c., &c. Edited by his Daughter. New and Cheaper Edition, being the Fourth. Crown 8vo, 6s.

THOMAS. **The Woodland Life.** By EDWARD THOMAS. With a Frontispiece. Square 8vo, 6s.

THOMSON.

The Diversions of a Prime Minister. By BASIL THOMSON. With a Map, numerous Illustrations by J. W. Cawston and others, and Reproductions of Rare Plates, from Early Voyages of Sixteenth and Seventeenth Centuries. Small demy 8vo, 15s.

South Sea Yarns. With 10 Full-page Illustrations. Cheaper Edition. Crown 8vo, 3s. 6d.

THOMSON.

Handy Book of the Flower-Garden: Being Practical Directions for the Propagation, Culture, and Arrangement of Plants in Flower-Gardens all the year round. With Engraved Plans. By DAVID THOMSON, Gardener to his Grace the Duke of Buccleuch, K.T., at Drumlanrig. Fourth and Cheaper Edition. Crown 8vo, 5s.

The Handy Book of Fruit-Culture under Glass: Being a series of Elaborate Practical Treatises on the Cultivation and Forcing of Pines, Vines, Peaches, Figs, Melons, Strawberries, and Cucumbers. With Engravings of Hothouses, &c. Second Edition, Revised and Enlarged. Crown 8vo, 7s. 6d.

THOMSON. **A Practical Treatise on the Cultivation of the Grape Vine.** By WILLIAM THOMSON, Tweed Vineyards. Tenth Edition. 8vo, 5s.

- THOMSON.** *Cookery for the Sick and Convalescent.* With Directions for the Preparation of Poultices, Fomentations, &c. By **BARRA THOMSON.** Fcap. 8vo, 1s. 6d.
- THORBURN.** *Asiatic Neighbours.* By **S. S. THORBURN,** Bengal Civil Service, Author of 'Bannú; or, Our Afghan Frontier,' 'David Leslie: A Story of the Afghan Frontier,' 'Musalmans and Money-Lenders in the Panjab.' With Two Maps. Demy 8vo, 10s. 6d. net.
- TIELE.** *Elements of the Science of Religion.* Part I.—Morphological. Part II.—Ontological. Being the Gifford Lectures delivered before the University of Edinburgh in 1896-98. By **C. P. TIELE,** Theol. D., Litt. D. (Bonon.), Hon. M.R.A.S., &c., Professor of the Science of Religion, in the University of Leiden. In 2 vols. post 8vo, 7s. 6d. net. each.
- TRANSACTIONS OF THE HIGHLAND AND AGRICULTURAL SOCIETY OF SCOTLAND.** Published annually, price 5s.
- TRAVERS.**
Windyhaugh. By **GRAHAM TRAVERS** (Margaret G. Todd, M.D.) Fourth Edition. Crown 8vo, 6s.
Mona Maclean, Medical Student. A Novel. Fourteenth Edition. Crown 8vo, 6s.
Fellow Travellers. Fourth Edition. Crown 8vo, 6s.
- TRYON.** *Life of Vice-Admiral Sir George Tryon, K.C.B.* By Rear-Admiral **C. C. PENROSE FITZGERALD.** Cheap Edition. With Portrait and numerous Illustrations. Demy 8vo, 6s.
- TULLOCH.**
Rational Theology and Christian Philosophy in England in the Seventeenth Century. By **JOHN TULLOCH,** D.D., Principal of St Mary's College in the University of St Andrews, and one of her Majesty's Chaplains in Ordinary in Scotland. Second Edition. 2 vols. 8vo, 16s.
Modern Theories in Philosophy and Religion. 8vo, 15s.
Luther, and other Leaders of the Reformation. Third Edition, Enlarged. Crown 8vo, 3s. 6d.
Memoir of Principal Tulloch, D.D., LL.D. By **Mrs OLIPHANT,** Author of 'Life of Edward Irving.' Third and Cheaper Edition. 8vo, with Portrait, 7s. 6d.
- TWEEDIE.** *The Arabian Horse: His Country and People.* By Major-General **W. TWEEDIE,** C.S.I., Bengal Staff Corps; for many years H.B.M.'s Consul-General, Baghdad, and Political Resident for the Government of India in Turkish Arabia. In one vol. royal 4to, with Seven Coloured Plates and other Illustrations, and a Map of the Country. Price £3, 3s. net.
- TYLER.** *The Whence and the Whither of Man.* A Brief History of his Origin and Development through Conformity to Environment. The Morse Lectures of 1895. By **JOHN M. TYLER,** Professor of Biology, Amherst College, U.S.A. Post 8vo, 6s. net.
- VANDERVELL.** *A Shuttle of an Empire's Loom; or, Five Months before the Mast on a Modern Steam Cargo-Boat.* By **HARRY VANDERVELL.** Second Edition. Crown 8vo, 6s.
- VEITCH.**
Memoir of John Veitch, LL.D., Professor of Logic and Rhetoric, University of Glasgow. By **MARY R. L. BRYCE.** With Portrait and 3 Photogravure Plates. Demy 8vo, 7s. 6d.
Border Essays. By **JOHN VEITCH, LL.D.,** Professor of Logic and Rhetoric, University of Glasgow. Crown 8vo, 4s. 6d. net.
The History and Poetry of the Scottish Border: their Main Features and Relations. New and Enlarged Edition. 2 vols. demy 8vo, 16s.
Institutes of Logic. Post 8vo, 12s. 6d.
Merlin and other Poems. Fcap. 8vo, 4s. 6d.

VEITCH.

Knowing and Being. Essays in Philosophy. First Series. Crown 8vo, 5s.

Dualism and Monism; and other Essays. Essays in Philosophy. Second Series. With an Introduction by R. M. Wenley. Crown 8vo, 4s. 6d. net.

WACE. **Christianity and Agnosticism.** Reviews of some Recent Attacks on the Christian Faith. By HENRY WACE, D.D., late Principal of King's College, London; Preacher of Lincoln's Inn; Chaplain to the Queen. Second Edition. Post 8vo, 10s. 6d. net.

WADDELL. **An Old Kirk Chronicle: Being a History of Auld-hame, Tynninghame, and Whitekirk, in East Lothian.** From Session Records, 1615 to 1850. By Rev. P. HATELY WADDELL, B.D., Minister of the United Parish. Small Paper Edition, 200 Copies. Price £1. Large Paper Edition, 50 Copies. Price, £1, 10s.

WAGHORN. **Cricket Scores, Notes, &c. From 1730-1773.** Written as reported in the different newspapers. To which are added two Poems, with remarks, published in 1773, on Kent v. Surrey; also Rules of the game when betting was permitted. Compiled by H. T. WAGHORN. With a Frontispiece. Demy 8vo, 6s. net.

WALFORD. **Four Biographies from 'Blackwood': Jane Taylor, Hannah More, Elizabeth Fry, Mary Somerville.** By L. B. WALFORD. Crown 8vo, 5s.

WARREN'S (SAMUEL) WORKS:—

Diary of a Late Physician. Cloth, 2s. 6d.; boards, 2s.

Ten Thousand A-Year. Cloth, 3s. 6d.; boards, 2s. 6d.

Now and Then. The Lily and the Bee. Intellectual and Moral Development of the Present Age. 4s. 6d.

Essays: Critical, Imaginative, and Juridical. 5s.

WATSON. **Sir Sergeant.** A Story of Adventure that ensued upon "The '45." By W. L. WATSON. Crown 8vo, 6s.

WENLEY.

Socrates and Christ: A Study in the Philosophy of Religion.

By R. M. WENLEY, M.A., D.Sc. D.Phil., Professor of Philosophy in the University of Michigan, U.S.A. Crown 8vo, 6s.

Aspects of Pessimism. Crown 8vo, 6s.

WHITE.

The Eighteen Christian Centuries. By the Rev. JAMES WHITE. Seventh Edition. Post 8vo, with Index, 6s.

History of France, from the Earliest Times. Sixth Thousand. Post 8vo, with Index, 6s.

WHITE.

Archæological Sketches in Scotland—Kintyre and Knapdale.

By Colonel T. P. WHITE, R.E., of the Ordnance Survey. With numerous Illustrations. 2 vols. folio, £4, 4s. Vol. I., Kintyre, sold separately, £2, 2s.

The Ordnance Survey of the United Kingdom. A Popular Account. Crown 8vo, 5s.

WILLIAMSON. **The Horticultural Handbook and Exhibitor's Guide.** By W. WILLIAMSON, Gardener. Revised by MALCOLM DUNN, Gardener to his Grace the Duke of Buccleuch and Queensberry, Dalkeith Park. Cheap Edition. Crown 8vo, paper cover, 1s.

WILLS. *Behind an Eastern Veil. A Plain Tale of Events occurring in the Experience of a Lady who had a unique opportunity of observing the Inner Life of Ladies of the Upper Class in Persia.* By C. J. WILLS, Author of 'In the Land of the Lion and Sun,' 'Persia as it is,' &c., &c. Cheaper Edition. Demy 8vo, 8s.

WILLSON. *The Greek Gulliver. Being a Translation of Lucian's 'Vera Historia.'* By ST J. B. WYNNE WILLSON, M.A. With numerous Illustrations by A. Payne Garnett. In 1 vol. fcap. 4to. [In the press.]

WILSON.

Works of Professor Wilson. Edited by his Son-in-Law, Professor FERRIER. 12 vols. crown 8vo, £2, 8s.

Christopher in his Sporting-Jacket. 2 vols., 8s.

Isle of Palms, City of the Plague, and other Poems. 4s.

Lights and Shadows of Scottish Life, and other Tales. 4s.

Essays, Critical and Imaginative. 4 vols., 16s.

The Noctes Ambrosianæ. 4 vols., 16s.

Homer and his Translators, and the Greek Drama. Crown 8vo, 4s.

WORSLEY.

Homer's Odyssey. Translated into English Verse in the Spenserian Stanza. By PHILIP STANHOPE WORSLEY, M.A. New and Cheaper Edition. Post 8vo, 7s. 6d. net.

Homer's Iliad. Translated by P. S. Worsley and Prof. Conington. 2 vols. crown 8vo, 21s.

WOTHERSPOON. *Kyrie Eleison ("Lord, have Mercy"). A Manual of Private Prayers. With Notes and Additional Matter.* By H. J. WOTHERSPOON, M.A., of St Oswald's, Edinburgh. Cloth, red edges, 1s. net; limp leather, 1s. 6d. net.

YATE. *England and Russia Face to Face in Asia. A Record of Travel with the Afghan Boundary Commission.* By Captain A. C. YATE, Bombay Staff Corps. 8vo, with Maps and Illustrations, 21s.

YATE. *Northern Afghanistan; or, Letters from the Afghan Boundary Commission.* By Colonel C. E. YATE, C.S.I., C.M.G., Bombay Staff Corps, F.R.G.S. 8vo, with Maps, 18s.

ZACK.

On Trial. By ZACK. Second Edition. Crown 8vo, 6s.

Life is Life, and other Tales and Episodes. Second Edition. Crown 8vo, 6s.

11/99.

481 1440

1

**K.F. WENDT LIBRARY
UW COLLEGE OF ENGR.
215 N. RANDALL AVENUE
MADISON, WI 53706**

**SPECIAL
COLLECTIONS**

~~RM 240 - WENDT LIBRAR~~

✓

TQ
F14

890592983:



b8905929833



