

# MAKING WIRELESS OUTFITS

*A Concise and Simple Explanation of the Construction and  
Use of an Inexpensive Wireless Equipment for Send-  
ing and Receiving up to 100 Miles, Giving  
Full Details and Illustrations.*

BY

**NEWTON HARRISON, E.E.**

*Instructor of Electrical Engineering,  
Newark Technical School.*



NEW YORK:  
SPON & CHAMBERLAIN, 123 LIBERTY ST.

LONDON:  
E. & F. N. SPON, LTD., 57 HAYMARKET, S.W.

1909

*unbound*

THE NEW YORK  
PUBLIC LIBRARY  
**125369B**  
1911

Copyright, 1909.  
By SPON & CHAMBERLAIN.

*Replacing missing copy. 70317*

---

Press of McIlroy & Emmet, 22 Thames Street, New York City.

26374

654  
H7

## PREFACE.

---

More than one reader has sought in vain for a simple exposition of wireless telegraphy. More than one amateur has wished to make an outfit sufficiently complete to send and receive through empty space. The satisfaction of using one's own brain and one's own hands to plan and build such wonderful apparatus is far greater than words can express. This worthy ambition can be fulfilled only if the explanation is concise and the construction simple. It is believed that both these objects have been attained in this little book.

All great investigators began as amateurs. All the successful men of science and engineering believed in trying things. They had to plan and build for themselves. Often no text-books were available and frequently the field of science they explored had never been trodden before. If they succeeded it was because they were patient in self education. They stuck to an idea, and tested it to the full.

Those holding this modest work in their hands are more fortunate. Many problems are solved in it. Many suggestions are given that avoid a cir-

cuitous route. The reader will be helped to plan and build if these pages are carefully considered. This book is written for the purpose of enabling the reader to build his own apparatus. When the wireless outfit is built and operated along the lines described, an intimate experience will be gained, which will make every moment that was thus spent, a source of pleasant remembrance.

NEWTON HARRISON, E. E.

## CONTENTS.

---

### CHAPTER I.

How the waves are made. How the waves are received. Antennæ, or aeri-als to catch the waves. How the coherer is made. Making the decoherer. What the relay is for. The receiving circuits connected up. The relay adjustment. Making the relay and sounder. Drilling holes in brass..... 9

### CHAPTER II.

Marconi's coherer. The coherer mixture of metals. The spark coil or transmitter. A one and one half inch spark. The iron wire core. A standard six inch spark coil. To get a six inch spark. Parts and action of a spark coil. Functions of the parts of a spark coil. Primary coil. Vibrator. Secondary coil. Condenser. The spark gap. The metal pole receivers, or antennæ. Effect of daylight on electric waves. Connection of antennæ to stations 25

### CHAPTER III.

Metal towers. Ground connections and antennæ connections. Use of gas pipes for ground. Antennæ for ships. Tuning circuits. Length of spark discharge and spark voltage..... 40

## CHAPTER IV.

Power required for long distance wireless telegraphy. Dimensions of coils for different spark lengths. The telegraphic codes. Morse code. Continental code. Earth connections in the country.....	54
---	----

## TABLES.

I.—Heights for antennæ, with distances between stations.....	36
II.—Brass knobs $\frac{8}{10}$ inches in diameter.....	52
III.—Dimensions for different spark lengths.....	57

## LIST OF ILLUSTRATIONS.

---

	PAGE
1 Piece of glass tubing .....	11
2 Brass support for tube .....	12
3 Metal plug for glass tube .....	13
4 Mounting of coherer .....	14
5 Large wooden base for coherer and decoherer...	16
6 Receiving circuit .....	18
7 The independent decoherer circuit .....	20
8 Parts of relay and sounder .....	21
9 Relay mounted .....	22
10 Mounting of armature of relay .....	23
11 Marconi's coherer .....	26
12 Condenser connected to interrupter .....	27
13 Paraffined paper and tinfoil in position .....	28
14 Appearance of a condenser set up .....	30
15 Secondary built up of four small coils .....	31
16 Elements, or parts, of the spark coil .....	32
17 Mounted coil as indicated in the parts of Fig. 16..	33
18 Electric waves moving in enlarging spheres in all directions .....	37
19 Use of a primary and secondary at the receiving end .....	38
20 Grounding to a gas pipe .....	43
21 Antennae on board ship .....	44
22 Combination of condenser and coil to produce various sizes of electric waves .....	47
23 Dr. Hertz's transmitter .....	48
24 Method of tuning two stations .....	49
25 Wireless waves crossing each other .....	51
26 An equipment for a 100 mile transmission plant ..	55
27 Method of getting a ground with a metal plate...	59





PROPERTY OF  
THE CITY OF NEW YORK

## CHAPTER I.

---

**The Receiving and Sending Station.** A wireless telegraphic outfit consists of two parts: the transmitting or sending station and the receiving station. The station in each case is a group of parts which are used for their individual purposes. For instance, the sending station must throw out electric waves. This means that its parts must be so constructed that the so-called waves it sends out can be detected or received in a distant device. The receiving station therefore must be so made that its parts enable it to detect the presence of electric waves and send out a signal whenever they are acting on it.

**How the Waves are Made.** The electric waves are made by means of a coil, which develops a stream of sparks between its two knobs. This coil really consists of two separate windings of wire, one fine and the other coarse. The coarse winding is connected to the battery; the fine winding has its ends connected to two brass knobs

or balls. When the coil is in action a bright discharge of crackling sparks takes place between the brass balls. When this transpires electric waves are produced. They spread in all directions and travel at the rate of over 186,000 miles a second. A further description will be given later on of the exact place the coil has in the system.

**How the Waves are Received.** The electric waves sent out by the transmitting station strike a series of wires which direct them so that they act on some metal filings contained in a glass tube. The glass tube is fitted at each end with a metal plug against which the filings touch. Only a pinch of filings of nickel and silver is required for the purpose. The electric waves striking the filings in the tube enable a battery current to pass through them, which otherwise would not. It is thus seen that the electric waves do not *produce* the signal but only *cause* it. The glass tube with metal plugs and pinch of filings is called a coherer. It is the sensitive part of the wireless telegraphic outfit and will hereafter be described in detail. When the sparks appear in the transmitting coil, the space around is filled with thousands of waves. These waves are longer or shorter depending upon the size of the discharge knobs, the distance between them, the construction of the coil, and the length of the antennae.

**Antennae or Aerials to Catch the Waves.** To receive the waves and direct them to the coherer,

towers or metallic poles are employed. They are called aerials, because they extend into the air, forming a sort of electric net. The coherer is connected to them, and is thus made more sensitive to the electric waves in its vicinity. In transatlantic wireless telegraphy they are always used. Every ocean steamship has its antennae strung from the masts above the deck. It uses them for sending as well as receiving messages. They are merely made of thick wire mechanically strung and able to stand the wear and tear of bad weather.

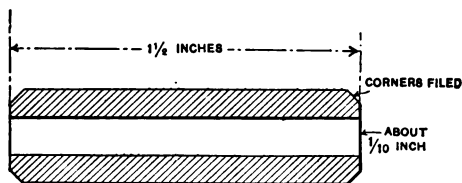

FIG. 1.—Piece of glass tubing.

They are arranged so as to be raised or lowered when the station is being tuned to catch the waves of another station.

**How the Coherer is Made.** A tube of rather thick glass (Fig. 1) is obtained about one-tenth of an inch in diameter. The piece of tube need not be more than one inch and a half in length. The sharp edges had better be filed or ground down before the tube is used. After this has been done the tube must be mounted.

To mount the tube on a wooden base, two brass fittings must be made (Fig. 2) to support it.

These are for the purpose of not only holding the tube in place, but giving a little adjustment to the metal plugs employed.

A couple of pieces of well fitting wire are then to be cut off and tried in the glass tube. The wire may be brass or copper, either will do. It must slide in and out of the tube easily but it must not be loose enough to shake. The wire must be rounded

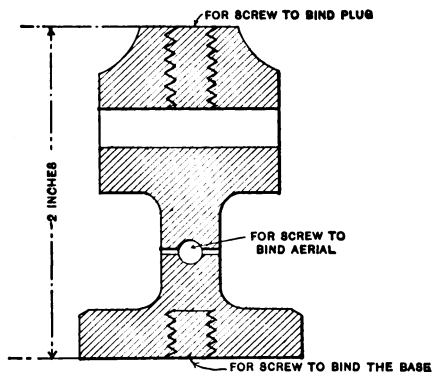

FIG. 2.—Brass support for tube.

at one end and squared off at the other as shown in the sketch, Fig. 3.

The brass fittings shown in sketch (Fig. 2) are made as drawn for three distinct purposes. First, to hold firmly to the wooden base; second, to grip the wire in the glass tube when it has been adjusted; and third, to support or connect to the aerial and ground wire as will be seen. For these reasons a screw is used coming up from the base.

An adjusting screw is used at the opposite end. And another screw is necessary to clamp the aerial in one fitting and the ground wire in the other, In Fig. 4 is shown the general arrangement of the parts. The tube is indicated in place supported by the two brass plugs held by the two main pieces. The reader can use his discretion as to size of parts as it is not absolutely necessary to have everything exact in this respect.

For instance, if he cannot turn the brass as indicated in Fig. 4, two pieces of brass rod can be used of about one-half to three-quarters of an

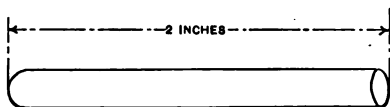
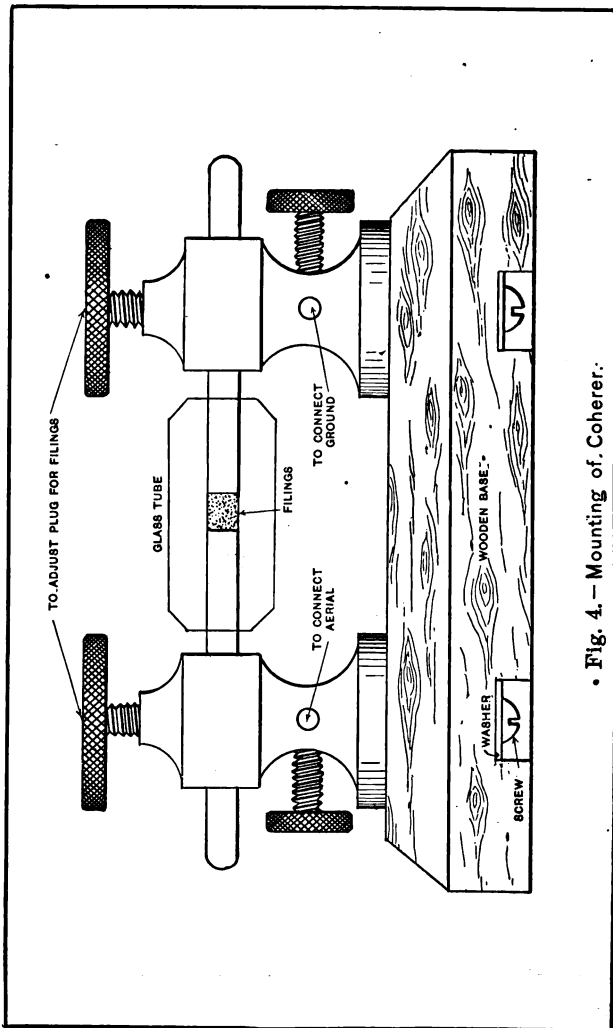

FIG. 3.—Metal plug for glass tube.

inch diameter instead. Each piece must be drilled and tapped as described, however.

The idea is, to have the glass tube properly held, with a means of adjusting the plugs inside of it. The reason why the plugs must be adjustable, is because the filings between their respective ends inside the tube must not be compressed too much. When the receiving station is being tested, the coherer must be sensitive. It cannot be sensitive if the filings are packed. The inner ends of the plugs should be from one-eighth to a quarter of an inch apart, to have the filings act right, when the waves strike them.



• Fig. 4. — Mounting of Coherer.

After the waves have acted, the telegraph sounder or buzzer will continue to operate unless the tube is rapidly tapped by the hammer of an electric bell. This disarranges the filings and allows the coherer to be ready to receive another signal. The device or part doing this is called the decoherer.

**Making the Decoherer.** The decoherer as stated is simply the hammer of an electric bell tapping the tube or coherer as it is called. It is included in the electric circuit in such a way that after the signal has been received, it then acts. It disarranges the filings simply by the mechanical vibration it sets up. This is necessary because the electric waves provides a path through the powder which enables a battery current to pass. This battery current continues until the filings are disturbed or decohered by means of the vibrating hammer.

The following statement was made by S. P. Thompson, and covers the ground so thoroughly that it is repeated for the instruction of the reader.

“ The conduction of *powdered metals* is remarkable. A loose heap of filings scarcely conducts at all, owing to the want of cohesion or to the existence of films of air or dust, but it becomes instantly a good conductor if an electric spark is allowed to occur anywhere within a few yards of it. The resisting films of air are broken down by *minute internal discharges* in the mass. A very

slight agitation by tapping at once makes the powder non-conductive."

A block to support the vibrator must be made and mounted on the wooden base. The vibrator is simply an electric bell with the gong removed. When it is mounted on the block care must be

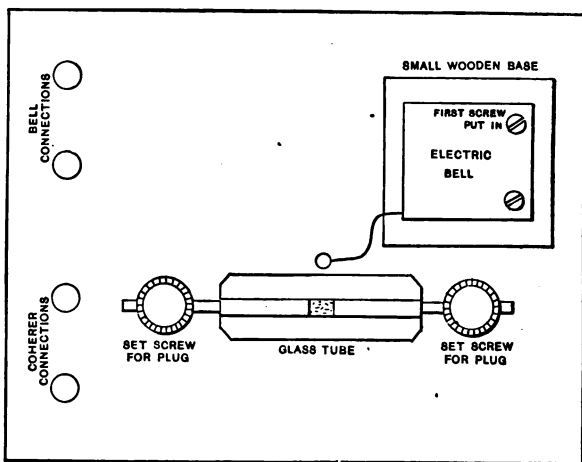

FIG. 5.—Large wooden base for coherer and decoherer.

taken that the hammer does not strike the tube too vigorously or the coherer may break. The wooden block must be thick enough to place the hammer of the bell in line with the glass tube. By putting in one screw, and swinging the bell around until the hammer is adjusted the best effect is produced.

In Fig. 5 the idea is presented with the parts



shown as mentioned in the previous paragraph. In the following sketch (Fig. 6) the entire idea is shown, which includes the connections of the coherer, decoherer, batteries, and the buzzer, bell or sounder employed in conjunction with the relay.

**What the Relay is for.** The relay is simply an electromagnet wound with fine wire so as to make it sensitive to weak currents. When it operates, an armature attracted by it closes a contact and thus enables a more powerful current from another battery to act on a loud signalling device.

When the electric waves act on the coherer the powder allows the battery connected to it, to send a weak current through. This current cannot pass through the coherer under ordinary conditions because the powder is non-conductive until the waves affect it.

But the powder when once conducting the battery current, will continue to do so, unless it is mechanically disarranged by a tapper striking the coherer. Therefore let it be clearly understood, that the electric waves provide a bridge in the coherer, over which the current of the battery connected to the coherer can pass.

In wireless work, a sounder used in Morse telegraphy is employed. The connections therefore are two-fold; one set which includes the coherer and its battery; and another set which includes the sounder, bell, or buzzer, and its battery as well as the decoherer.

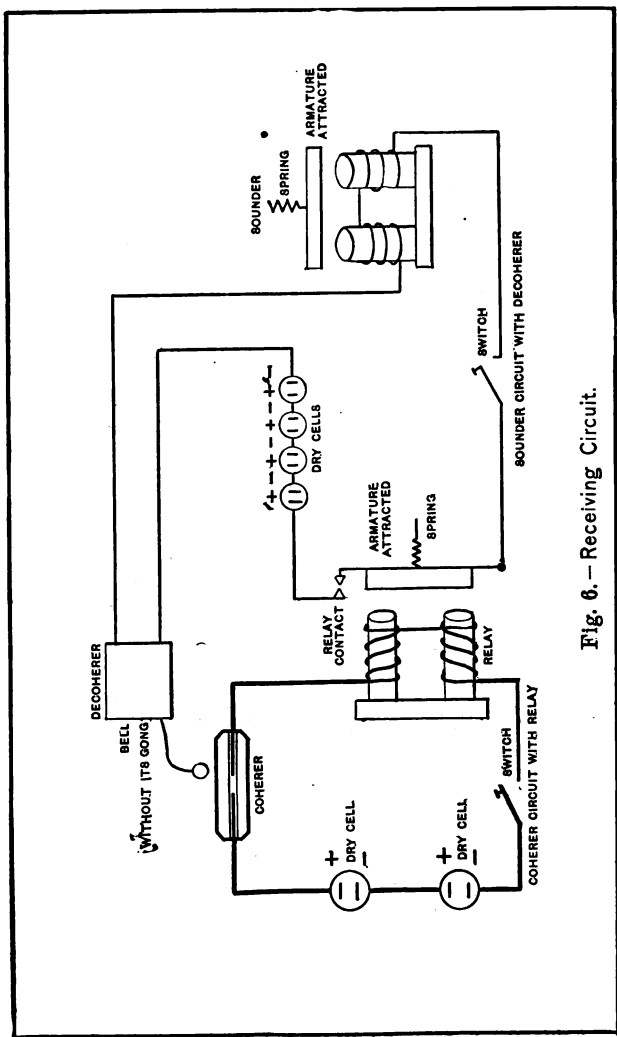

Fig. 6. - Receiving Circuit.

**The Receiving Circuits Connected up.** The circuit as shown (Fig. 6) is really composed of two distinct circuits. The first is that composed of the coherer circuit with its relay. The second is that composed of the sounder or signalling circuit with the decoherer. In this second circuit the decoherer operates when the sounder clicks. It is evident that if a contact be attached to the armature of the sounder, the decoherer can be made to work only after the sounder has clicked. This connection which may or may not be added, is shown in sketch Fig. 7 as indicated. If the decoherer circuit is made separate, the sounder itself is connected directly with its own three or four cells, and the two wires shown which lead to the decoherer are cut out. If it is desired to simplify the device still further, the sounder can be cut out and only the buzzing of the decoherer used instead of the sounder clicks.

**The Relay Adjustment.** The relay armature must be firmly mounted, so that there is no lost motion. The contacts are generally made of platinum, but if this is difficult to obtain brass may be used instead if it is kept polished. The only reason why platinum is used is because it does not tarnish and therefore contact is always positive. The relay is generally purchased, though it can be made by one of mechanical ability. When made, the relay must be so well adjustable, that a very weak current will make it operate. In very

fine telegraphic relays the armature is set so close to the magnet that a sheet of paper is put between, when the springs are tightened, to allow for the distance.

**Making the Relay and Sounder.** The material needed for this purpose is as follows: four pieces of rod wrought iron of about three inches length and

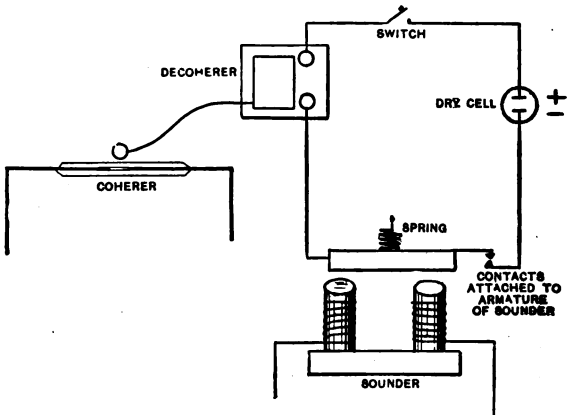

FIG. 7.—The independent decoherer circuit.

one half inch diameter. Three eighths of an inch stuff will do, but the iron must be well annealed for the purpose. To anneal it, lay the iron rod in a hot fire and when bright red, let it gradually cool. The fire may be allowed to die out and serve the same end. The purpose of annealing is to get the iron into such a condition that it will

take and lose magnetism quickly. If this is done the armature will not stick to the cores and good results will be possible. The sketch (Fig. 8) shows the part needed for the purpose of making a relay and sounder.

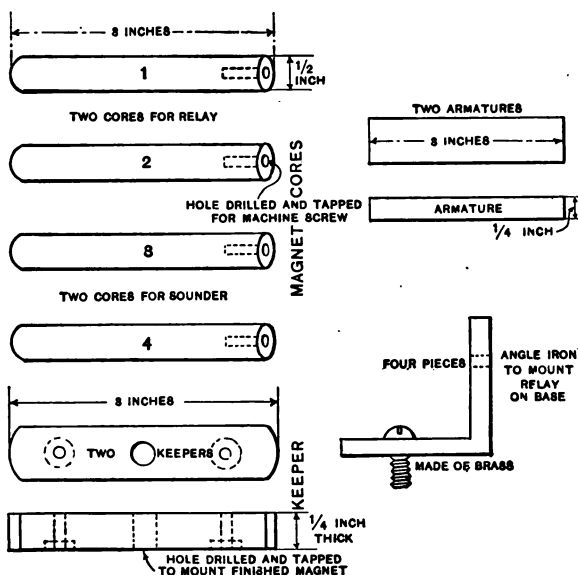

FIG. 8.—Parts of relay and sounder.

The cores, the keeper, the armature and the angle iron to mount the relay or sounder on the wooden base are shown. The contacts are indicated in another sketch (Fig. 9). It is best to chamfer the edges of the core ends which attract

the armature. The telegraph sounder is wound with No. 18 wire Brown and Sharp gauge. The relay is wound with No. 25 wire Brown and Sharp gauge. It is better to use a finer wire than this for the relay if possible, but it will prove somewhat expensive if chosen of a finer gauge and add to the cost.

In Fig. 9, the armature is mounted on a brass

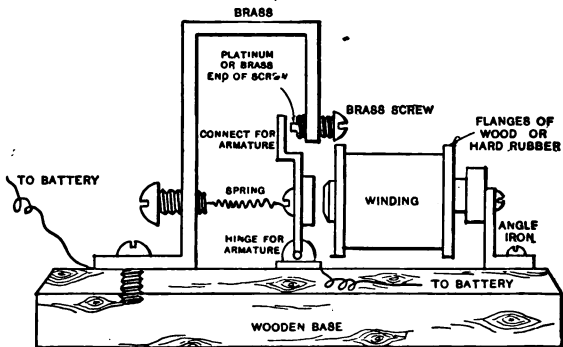

FIG. 9.—Relay mounted.

piece which hinges below in two supports. These supports are better shown in Fig. 10. Though appearing a little crude in construction this device will serve its purpose in practice, particularly if the machine work is well done. Everything can be made with the aid of sheet brass in strips, with a little patient filing and fitting. The sounder is simply the same thing with or without the contacts as the case may be.

If the contacts are used for the sounder then the decoherer can be made to operate only after the signal has been received. For a loud sounder click, the spring must be stronger than in the relay. The fact that a stronger battery current

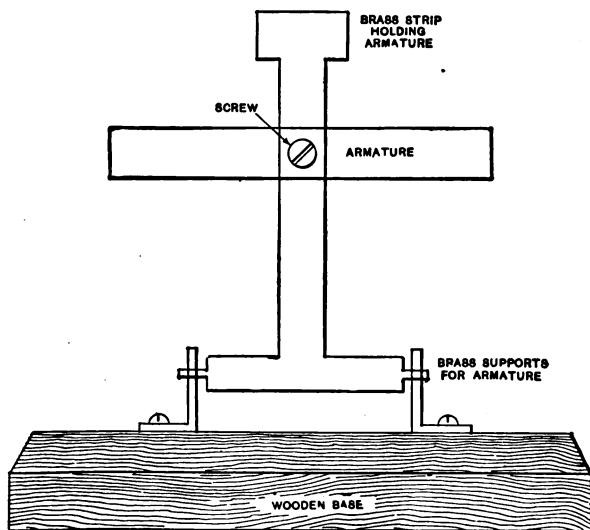

FIG. 10.—Mounting of armature of relay.

with a thicker wire is used means a loud click when the sounder operates. The construction of both instruments, sounder and relay being the same in this case, means the saving of time and trouble. Special care must be taken in getting the connections correct.

**Drilling Holes in Brass.** If a drill is not easy to obtain and the brass is thin enough, a hole can be made with a punch and hammer and the burr carefully removed with a file. The hole can then be trimmed with a reamer, which can be bought, or made by using another punch ground down to have edges to suit the purpose. As there are various kinds of brass on the market, the best for this purpose is not too brittle. If so it will naturally break when bent and spoil the work. The brass may be drawn or annealed by heating it in the flame of a bunsen burner and testing it for ability to bend without breaking.



## CHAPTER II.

---

**Marconi's Coherer.** Marconi made coherers out of a tube about one and one half inches long and one-twelfth of an inch in diameter internally. The tube was plugged at each end with silver wire and the wires were brought to within one thirtieth of an inch of each other inside the tube. Its appearance is shown in Fig. 11 as actually employed in service.

Since the time the first working types have been made and used others have appeared of various principles. They operate by electrolytic action, and others by means of a magnetic system, but the construction and use of these is a little too much for those engaged in amateur experiments.

**The Coherer Mixture of Metals.** In the Marconi system, the mixture of filings found most suitable was as follows:

Nickel filings.....	90 parts
Silver filings.....	10 "
Mercury.....	a trace.

For ordinary purposes the following may be done with every reason for success: take a dime and file it with a file of medium roughness. A bastard file is too coarse and a French file too fine. The powder should be about the fineness of coarse sand, and a file of a cut about midway between the two just mentioned would suit. After filing the silver dime to an extent suitable to the purpose, a nickel five-cent piece is treated in the same manner. The total amount can only be roughly

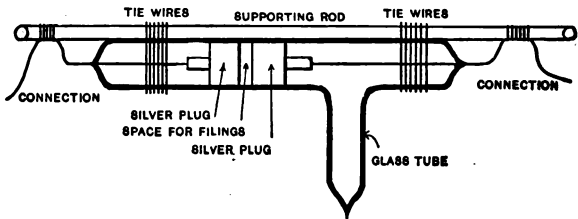

FIG. 11.—Marconi's coherer.

judged, but it is advisable to have powder in stock for future use, so a small vial of it can be prepared and held for emergencies. Enough to cover the tip of the blade of a pen-knife will be sufficient for the coherer. But if more is placed in the glass tube, the plugs must not be brought together so as to compress the powder in any way. It must lie free between the terminals of the coherer and be adjusted by constant signaling from the transmitting station.

The tube must be kept free from moisture, as its presence will tarnish the filings, and possibly

cause a mild electrolytic action to take place. The fact that a certain amount of dust may be present in the filings is also bad. When the coins are filed, the files themselves must be clean or particles of iron and steel will mix with the nickel and silver and cause trouble when the test is made.

**The Spark Coil or Transmitter.** The spark is

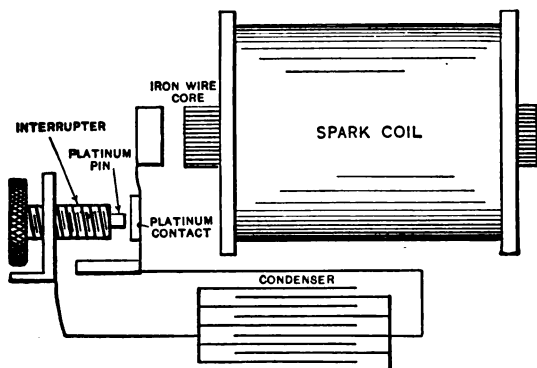

FIG. 12.—Condenser connected to interrupter.

produced by means of a coil built to send out electric waves. The electric waves are caused by the discharge of the electricity at the terminals. What are called electric oscillations are waves set up when the current is interrupted, and made to act on a condenser. A condenser is only a collection of tinfoil sheets separated from each other by paraffined paper. The sheets of tinfoil are grouped in two sets; one set connected to one end of the

interrupter, and the other set to the other end of the interrupter (Fig. 12.)

The paraffined paper is prepared by selecting sheets of white paper of the size required and placing them one at a time in a tray of melted paraffine, soaking them, removing them, and then letting them drip. This is done by selecting a flat tin tray and gently heating the paraffine in it by

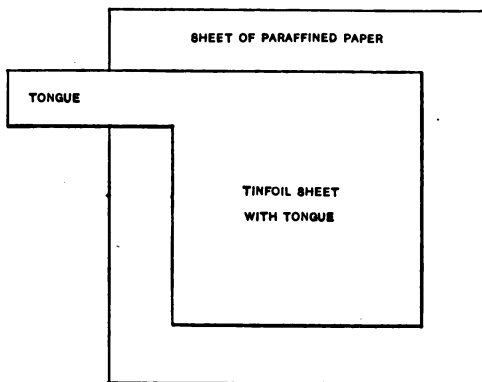

FIG. 13.—Paraffined paper and tinfoil in position.

means of a stove or a small bunsen flame. Reference will be made to this later on.

**A One and a Half Inch Spark.** To get a one and a half inch spark a primary and a secondary coil must be built as follows:

1. Size of iron wire core  $8\frac{1}{2}$  inches long and about  $\frac{3}{4}$  inch diameter.
2. Wind core with 2 layers of No. 14 Brown and Sharp gauge double cotton covered wire.

4. Wind a secondary of about 2 pounds of No. 36 Brown and Sharp gauge double cotton covered wire.

5. A condenser made up of paraffined paper and tinfoil.

6. The tinfoil consisting of about 50 sheets of tinfoil; dimensions 6 inches square.

The tinfoil is cut with a tongue so as to facilitate the making of connections. Fig. 13 shows the manner in which this is done. The condenser is built up by a sheet of paraffined paper, a sheet of tinfoil, another sheet of paraffined paper, another sheet of tinfoil, etc. The precaution to be taken is that of having the tongue of one sheet of tinfoil on the opposite side to the other tongue as shown in the sketch (Fig. 14). The whole is then placed in a wooden box which has two terminals to connect to the condenser tongues respectively.

**The Iron Wire Core.** The use of soft iron wire for a core is common and has its application because of the ease with which such wire can be magnetized and demagnetized. A number of lengths are cut off and used as the core of the primary of a spark coil. The primary coil is the one connected to the batteries and vibrator, and therefore to the condenser. When the current flows through the primary coil, the iron core attracts the armature of the vibrator. When it is attracted it moves and breaks the circuit, and the condenser charges up.

3. Allow the ends of the iron wire core to project.

A paper tube will hold the iron wire core in shape until it is wound with the primary wire. The primary wire may be wound directly on the core or on a paper tube around it. In this case the core and winding are separable, which is a good thing if repairs are to be made. The secondary may be built up in the same way, or

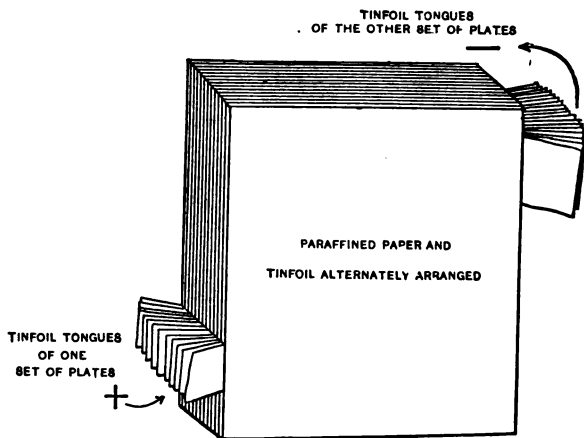

FIG. 14.—Appearance of a condenser set up.

wound in short coils, placed side by side, and connected up as shown in Fig. 15.

**A Standard Six Inch Spark Coil.** The condenser is generally laid in the hollow base of the coil or it can be connected up separately. The size of condensers is difficult to determine except by ex-

periment. The best way to experiment is to build a set of condensers of about twenty plates each and about 6 by 6 inches in size. When the coil is built add one set and then another, etc., until the best effect is produced. The amateur cannot do better than this to get good results unless he copies a coil built by a reliable manufacturer or follows the data given in Table III.

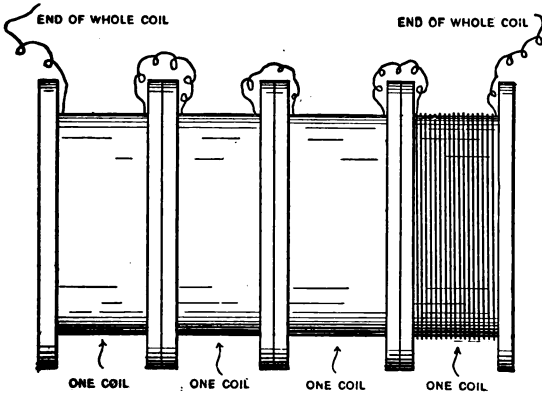

FIG. 15.—Secondary built up of 4 small coils.

### To Get a 6-Inch Spark.

1. Core, 13 inches long and  $1\frac{1}{4}$  inches in diameter.
2. Winding on core for primary, two layers of No. 14 Brown and Sharp gauge double cotton covered.
3. Winding of secondary,  $6\frac{1}{2}$  pounds of No. 36 Brown and Sharp gauge double cotton covered.

**Parts and Action of a Spark Coil.** A few words will now be said about the parts and action of a spark coil. To recapitulate: The spark coil consists essentially of a primary and secondary winding. In addition to these windings, and a condenser, may be found a vibrator, by means of which the

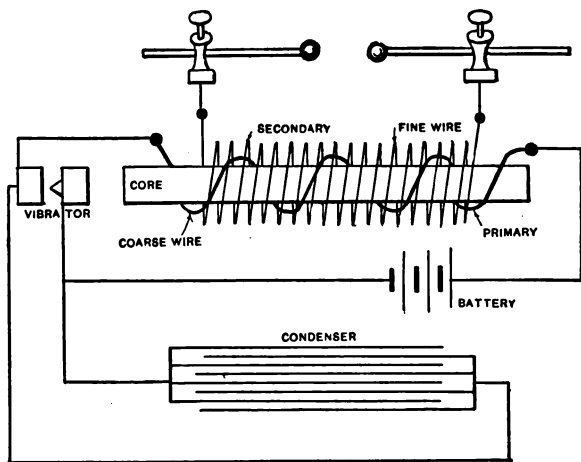

FIG. 16.—Elements, or parts, of the spark coil.

current in the primary coil is interrupted. The sketch shows this clearly in Fig. 16.

The other sketch (Fig. 17) shows the finished coil as described. The vibrator is mounted and shown, as well as the condenser situated in the base. Tabulating the parts with respect to their functions gives the following:



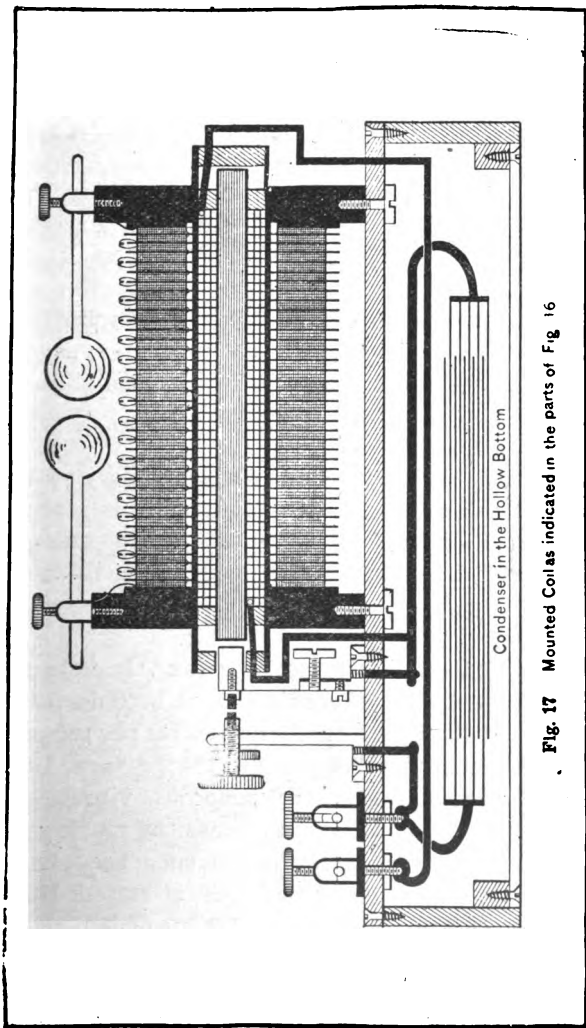

Fig. 17 Mounted Coil as indicated in the parts of Fig. 16

**Functions of the Parts of a Spark Coil. Primary Coil.** Receives the electrical energy and transforms it into magnetic energy.

**Vibrator.** Interrupts the current entering the primary coil, thus permitting induction to take place between it and the secondary coil.

**Secondary Coil.** A coil of fine wire surrounding the primary coil. It receives the magnetic energy of the primary and transforms it by mutual induction into a high pressure current.

**Condenser.** This is made in the customary manner of tinfoil and paraffined paper. It is placed in the break of the vibrator to take up the energy that would be otherwise wasted there by self induction.

**The Spark Gap.** If the spark gap, and the coil and its discharge knobs are considered, it becomes evident that the size and number of waves per second are dependent upon these conditions. A large bell produces slower and more sonorous vibrations than a small bell. In the same sense the spark gap of an oscillatory circuit will influence the character of the waves produced. It is stated that the wave length of an oscillator provided with very small parts is twice the length of the oscillator circuit.

Sir Oliver Lodge used an oscillator composed

of a large polished brass ball between two of lesser size to act as the discharging ends of a large coil. These waves possessed great penetrating power, passing through walls and wooden doors and houses as though they were transparent. The fact developed here is that whereas visible light will only pass through glass in the customary manner, this new type of invisible light wave meets with no difficulty in passing through so called opaque bodies. A metal screen is effective against them, however, as the waves are absorbed in this case, giving up their energy and dying out.

**The Metal Pole Receivers, or Antennae.** To receive the waves, and to tune the station, towers or metallic poles are employed, called antennae. The coherer is connected with them, and is thereby made more readily sensitive to electric waves in the vicinity. In transatlantic wireless telegraphy they are indispensable. Ocean liners are peculiarly serviceable in the art of telegraphing without wires, and in consequence, stations have been installed in many of them, thus keeping up communication when at sea with either shore.

Marconi used antennae about 20 feet high in his experiments over a mile of distance. The general idea is that the antennae must be as high as possible on all occasions to facilitate signaling.

The following figures are arbitrary but may prove useful to the reader in obtaining results with his own apparatus.

TABLE I.  
HEIGHTS OF ANTENNAE.

Height of Antennae.	Distance between Stations.
20 feet.....	1 mile
40 " .....	2 to 5 miles
60 " .....	10 to 20 "
80 " .....	30 to 60 "
100 " .....	75 to 150 "
150 " .....	200 to 300 "
200 " .....	350 to 500 "
250 " .....	600 to 2000 "

Natural conditions are bound to have their effect on the distance to which signals can be transmitted. The following indicates this with astonishing emphasis.

**Effect of Daylight on Electric Waves.** Marconi discovered in the course of his experiments with ocean wireless, that during the day the extreme limit of distance reached by a certain outfit was 700 miles. The same power and apparatus used at night enabled the operators to reach a distance of 2100 miles. The difference apparently was that due to daylight and according to the report it represented 1400 miles. This means that either light waves or an effect produced by the sun interferes with the free development of electric waves in wireless work.

**Connection of Antennae to Stations.** The electric rod or wire set up to catch the waves is somewhat of the nature of a pipe set in a stream to catch

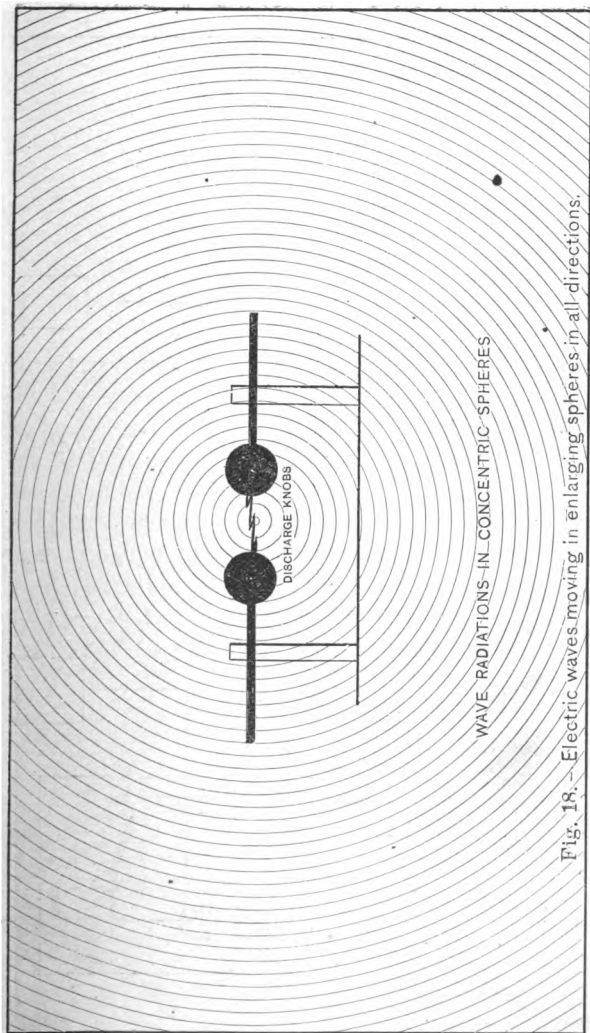

Fig. 18. — Electric waves moving in enlarging spheres in all directions.

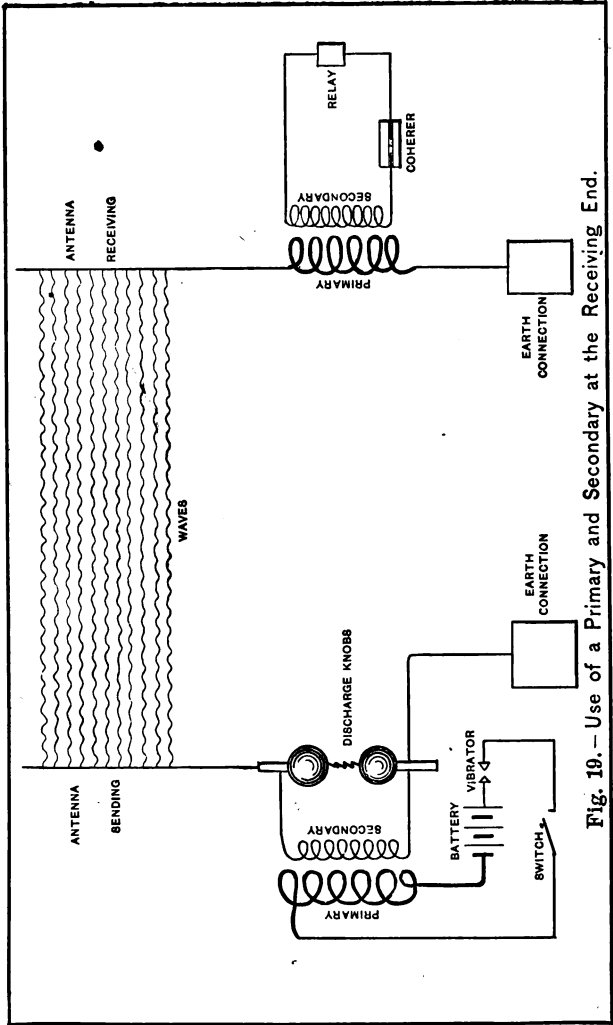

Fig. 19. — Use of a Primary and Secondary at the Receiving End.

some of the current. It might also be compared to a hole drilled in a hollow sphere, containing a lit candle, to let a beam of light escape. The spark gap is the center of a wave disturbance which spreads in all directions. Any number of coherers can catch the wave as the illustration will serve to show (Fig. 18.)

The number of waves per second and their length are of the greatest importance to the operator setting up the instrument. If two separate stations are in the neighborhood of each other, the best and only way to avoid interference is for each to produce a different wave. Then the apparatus of one is not apt to be greatly affected by that of the other. A telephone receiver greatly aids in catching messages.

The following sketch Fig. 19 will give a practical idea of the connections of a wireless station with antennae set up.

## CHAPTER III.

---

**Metal Towers.** Metal towers are used to a great extent instead of mere metal poles in wireless work. Marconi has erected a plant of this description as follows: At Cape Cod sites were selected for the erection of 4 towers of lattice metal work each 220 feet in height. The towers were connected together by copper wires which were then bunched together in one juncture and connected to apparatus beneath. The general arrangement of the myriad of finer copper wires presents the appearance of an inverted cone with its apex at the ground. The entire system has as its object the catching of waves from the other wireless station at Poldhu, Cornwall, England.

At this place about 20 masts or towers of this description were arranged in a circle. According to the records about 400 copper wires each 200 feet in length were employed. For heavy long distance work special apparatus is employed such as coils of carefully calculated induction, condensers of a certain known capacity, specially designed



spark gap apparatus, a telephone receiver in the place of the sounder, etc. The current is supplied by a dynamo and storage battery. The storage cells are used in the majority of cases direct, unless an unusual amount of power is required for particular experiments. For very long distances a certain condition, called tuning, must be established which does not demand a very large amount of power. About  $\frac{1}{4}$  of a horse power is sufficient for 200 miles although more is sometimes used.

#### **Ground Connections and Antenna Connections.**

When the switch of the transmitter is pressed, the vibrator of the coil operates and a torrent of sparks passes between the knobs, The sketch, Fig. 19, shows that one connection passes from one knob to the antenna, and another connection passes from the other knob to the earth. The action as thus shown is not entirely wireless; it is half wireless and half wire or contact. Ordinarily the two wires were employed to complete the circuit for telegraphing, the earth forming one connection in telegraphy and the overhead wire the other. Wireless telegraphy dispenses with the overhead wire, but it still holds on to the earth connection.

The receiving station can consist as already described of only a coherer, a relay and sounder; or a telephone receiver instead of the sounder; but the use of a primary and secondary coil augments the result to such a degree that if the reader cares to employ it, it will be found worth while.

Two coils can be employed, one of about 18 B. & S. wire double cotton covered and from 10 to 50 turns around a glass tube of an inch diameter. The other coil of about No. 25 B. & S., or even finer, double cotton covered, as experiment will determine, is also wound around a glass tube. This is much smaller so as to fit inside the first when it is wound.

If the coherer is only employed direct, then one terminal of it is connected to the antenna and the other terminal to the earth. In the case shown the coil receiving the oscillations or waves is connected this way and its effect upon the second coil makes the coherer much more responsive than it would otherwise be. If the coil connected to the coherer can be built so that the number of turns used are regulated to get tuning effects better results are obtained.

**Use of Gas Pipes for Grounds.** In the city, amateurs can readily use the gas pipe in the house as an effective ground. This will enable two people at extreme ends of the city to communicate with ease if the antenna are sufficiently high to be free from other electrical disturbances from central stations, power houses, other wireless experimenters and the users of X-ray coils and apparatus. The coherer connection may be made to the gas pipe and also one of the spark coil conductors. If this is done though, the gas pipe must be scraped and cleaned and a good copper wire contact made. Tinfoil may help in this respect (Fig. 20).

But the whole joint must be carefully taped to protect it from the effects of the air and moisture. The possibility of getting a flux so as to solder the wire and pipe depends upon what the market affords. It is best to make the ground in the cellar if convenient, because frequently gas pipes are forced together with paint and red lead or some other oily mixture. This is apt to insulate to some

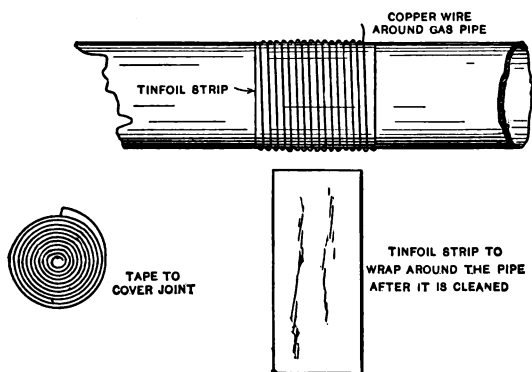

FIG. 20.—Grounding to a gas pipe.

degree, although the pipes in one house may be free from this effect and the pipes of another house affected contrarily. A simple test of using the section of pipe as part of a bell circuit will quickly determine the truth.

**Antennae for Ships.** On board steel ships the system observed is that of having the antennae connections up near the top of the masts. By

means of a block and tackle they can be raised or lowered for tuning to the waves of other ships. The entire vessel, it is almost needless to state, is in contact with salt water. Both the sea and itself constitute a conductor of the highest order for ground connections. The antennae are composed of copper strands or rope attached to a yard, slung near the

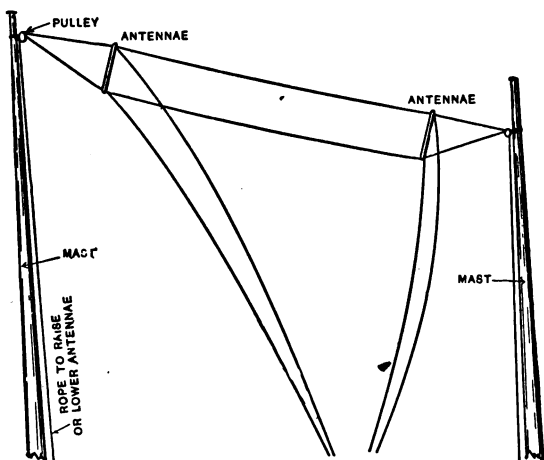

FIG. 21.—Antennae on board ship.

masthead, clearly shown in Fig. 21. Aerials descend from the yard to the operator's cabin. The copper strand is strong and wearable, and about one quarter of an inch thick. About two of this description are employed and serve as efficient wave-traps in transatlantic signaling. The conditions on sea are very much better in some re-

spects than on land. The opportunities for coherers to be affected are limited entirely to the number of wireless waves traveling in the luminiferous ether. On the other hand, on land, disturbances systematically occur due to different causes, and for this reason coherers are apt to respond at odd moments to influences proceeding from anything but a transmitting station.

The difficulty which exists even to-day is in the tuning of the receivers so that only waves of a certain character will affect them. The indiscriminate production of wireless waves will not be permitted after awhile by either the federal or the military and naval authorities. The use of heavy discharges from large spark coils and static machines means an ether disturbance which produces hundreds of millions of waves per second. They reach on all sides, and are quite sufficient to swamp the stations near by trying to attend to routine work. For this reason legislation may interfere with the attempt of some amateurs to enjoy themselves too freely at the expense of others.

**Tuning Circuits.** Circuits may be tuned to each other by a very simple method. If tuned, it is easier to get the stations to cooperate and respond readily to each other. The method employed is dependent upon the length of the waves. For instance, if one station sends out 1000 foot waves, its signals will be readily received by a station

whose coherer is only sensitive to 1000 foot waves. It is difficult to make a coherer indifferent to all waves, but it can be so adjusted by means of the antennae, discharge knobs and spark gap that it produces the best results with a certain length of electric wave.

It is evident therefore that the transmitter must produce a given sized wave at the start, and then further adjustment of the receiving circuit will be possible. The length of a wave depends upon the electrical conditions existing in a circuit. Among such conditions, two are referred to as the self induction or inductance, and the capacity of the circuit.

The inductance is created by means of a coil; the capacity by means of the antennae the condenser or the discharge knobs of a spark coil. The discharge knobs of a coil may be altered in this respect by connecting other condensers to them or by using larger or smaller knobs to increase or decrease the capacity.

If a condenser built as previously described of tinfoil and paraffined paper is connected to a coil of wire having a movable iron core (Fig. 22) the discharge of the condenser will produce waves of a length dependent upon the position of the iron core in the coil.

When the iron core is pulled out the inductance is not very high, but when it is all in, the inductance is very great and therefore between these two extremes other positions may be selected

which in conjunction with the condenser, will produce slow or fast electric oscillations and waves. The coil may be built so that its sections or turns can be increased or diminished at will by a sliding contact touching various sections. Marconi could reach 30 miles with a tuned system

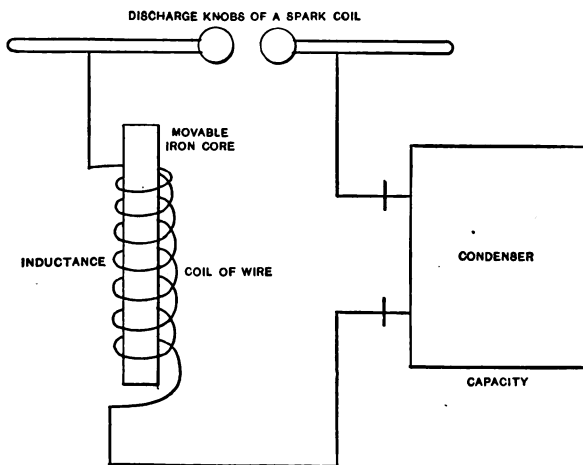

FIG. 22.—Combination of condenser and coil to produce various sizes of electric waves.

which otherwise will signal only a few hundred feet.

If the electric oscillations are rapid the waves are short, but if the oscillations are not fast the waves are long. The effect of this combination is like that existing in a pail of water. If the pail is tilted abruptly the water will dash back and forth.

If instead of a pail a tub of water is employed the waves are larger and slower. The greater the receptacle, the greater the waves. The smaller the receptacle the shorter the waves.

By using balls or knobs of a given size, and a certain spark gap, a certain size of wave is produced. For instance, Dr. Heinrich Hertz used a device shown in Fig. 23 to produce electric waves of a 16-foot length. He called his device a radiator of electric waves and built it with two metallic spheres 6 inches in radius connected by a wire 40 inches

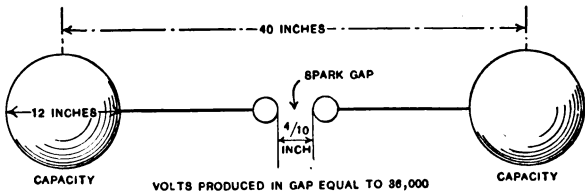

FIG. 23.—Dr. Hertz's transmitter.

inches in length interrupted by a spark gap of four-tenths of an inch.

The technical name of resonance is given to a condition like this when established with respect to another circuit. Two circuits set up and acting in resonance, would be each supplied with inductance from a coil and capacity, from a condenser to cooperate over a distance as shown in Fig. 24.

A coherer connected into the second or receiving circuit would only operate when the two circuits



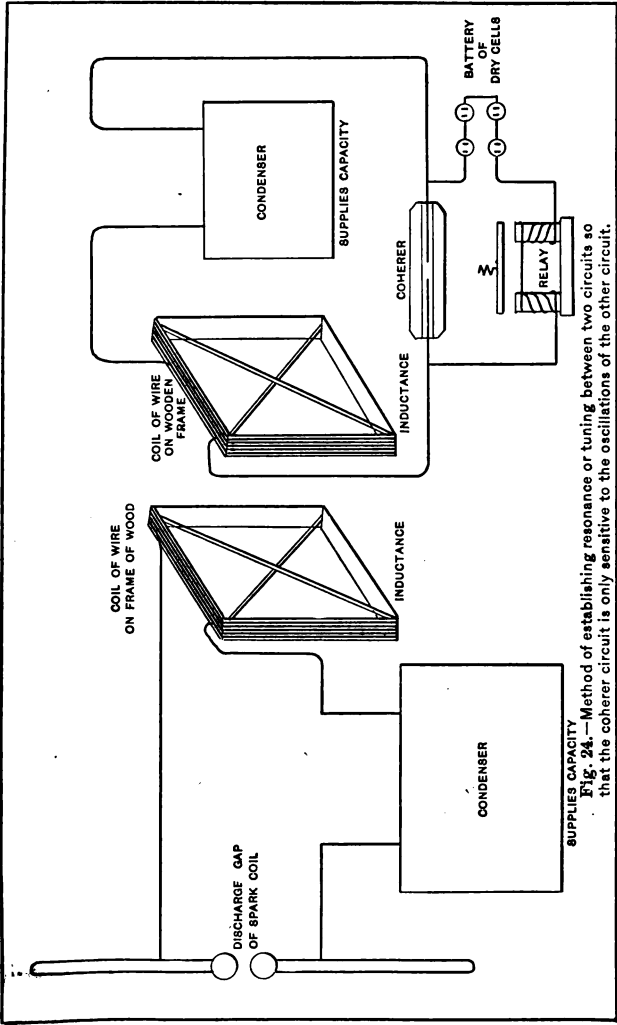

Fig. 24.—Method of establishing resonance or tuning between two circuits so that the coherer circuit is only sensitive to the oscillations of the other circuit.

are correctly adjusted, but when that adjustment is attained they are tuned to each other and the coherer circuit cannot respond to any other waves than those produced by the first or transmitting circuit. Dr. J. A. Fleming in his article on Electrical Oscillations and Electrical Waves, used a system like Fig. 24 to establish resonance between two circuits and in it speaks as follows of Marconi's work:

“ Mr. Marconi has made great use of electrical resonance in experiments he has been conducting in developing his system of wireless telegraphy, and he has already achieved some very remarkable results in establishing independent wireless telegraphic communication between pairs of places in the same area, and yet entirely preventing interference between them.

“ Thus communication was long ago established by the Marconi system for the Admiralty between Portsmouth and Portland, two places about 65 miles apart in a straight line, and having hills 800 feet high in the line of sight. Across this line of communication and included in it there is another 30 mile Marconi circuit between stations at Niton in the Isle of Wight and Poole near Bournemouth. These two lines, Portsmouth-Portland and Niton-Poole, cross each other at a not very great angle (Fig. 25). By the employment of properly tuned receiving and transmitting circuits Mr. Marconi has rendered these circuits quite independent of each other, so that no signaling which goes on be-

tween Poole and Niton interferes with or can be read on the Portsmouth-Portland stations. What has been done here can be carried out indefinitely, and the objections as to interference of stations which imperfectly informed persons are in the habit of raising with regard to Mr. Marconi's system of wireless telegraphy, as a matter of fact no longer exist."

This extract therefore serves to establish the fact

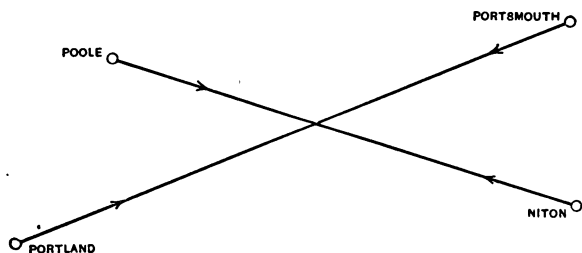

FIG. 25.—Wireless waves crossing each other from stations unaffected by interference:

in the mind of the reader, that after conquering the minor difficulties of constructing, setting up and operating a wireless outfit, the more advanced stage of the art is worthy of study and experiment.

### Length of Spark Discharge and Spark Voltage.

The appended table shows the spark voltage between brass balls  $\frac{8}{10}$  of an inch in diameter, for various spark lengths. It is taken from a table prepared by A. Heydweiller on "Spark Poten-

tials" published in the *Ann. der Physik.*, Vol. 48, page 235 (1898).

TABLE II.  
BRASS KNOBS 8/10 INCH IN DIAMETER.

Length of Spark.	Volts of Spark.	Length of Spark.	Volts of Spark.
.04 inch	4,700	1.08 inches	54,900
.08 "	8,100	1.12 "	55,800
.12 "	11,400	1.16 "	56,700
.16 "	14,500	1.20 "	57,500
.20 "	17,500	1.24 "	58,300
.24 "	20,400	1.28 "	59,000
.28 "	23,250	1.32 "	59,700
.32 "	26,100	1.36 "	60,400
.36 "	28,800	1.40 "	61,100
.40 "	31,300	1.44 "	61,800
.44 "	33,300	1.48 "	62,400
.48 "	35,500	1.52 "	63,000
.52 "	37,200	1.56 "	63,600
.56 "	38,700	1.60 "	64,200
.60 "	40,300	1.64 "	64,800
.64 "	41,300	1.68 "	65,500
.68 "	43,200	1.72 "	66,000
.72 "	44,700	1.76 "	66,600
.76 "	46,100	1.80 "	67,200
.80 "	47,400	1.84 "	67,800
.84 "	48,600	1.88 "	68,300
.88 "	49,800	1.92 "	68,800
.92 "	51,000	1.96 "	69,300
.96 "	52,000	2.00 "	69,800
1.00 "	53,000	2.04 "	70,300
1.04 "	54,000		

A spark coil can be better understood as a device which produces a high pressure spark from a low pressure current. This is evident when it is realized that a low pressure primary battery or a set of storage cells are generally connected to the primary coil. This power is transformed by the coil into a high pressure by means of the finely wound secondary to which the discharge knobs are connected. The knowledge of the volts produced by the coil when in operation is useful if special calculations are to be made for the purpose of discovering how much power is wasted in the spark and how much is preserved in the form of electric waves and used for wireless signals.

## CHAPTER IV.

---

**Power Required for Long Distance Wireless Telegraphy.** The best references on this subject are found in the records of the work done by the best authorities. The two items to consider, as already stated, are first, the energy lost in the spark itself as heat and light, etc.; and second, the energy radiated after this loss is sustained in the form of waves through and by the antennae. The induction coil itself radiates a great deal of power, which in addition to that wasted by the spark when it arcs, represents a considerable loss. Prof. Fleming of England makes the following statement relative to Fig. 26 as shown, with some modifications by the author.

“ Another important practical measurement is that of finding the power wasted in the spark as compared with the power radiated in the form of waves. When a plain Marconi aerial wire, having a spark gap at the bottom is charged and discharged, two losses occur in connection with the apparatus as stated.

“ Taking a spark gap say of  $\frac{2}{10}$  inch in length

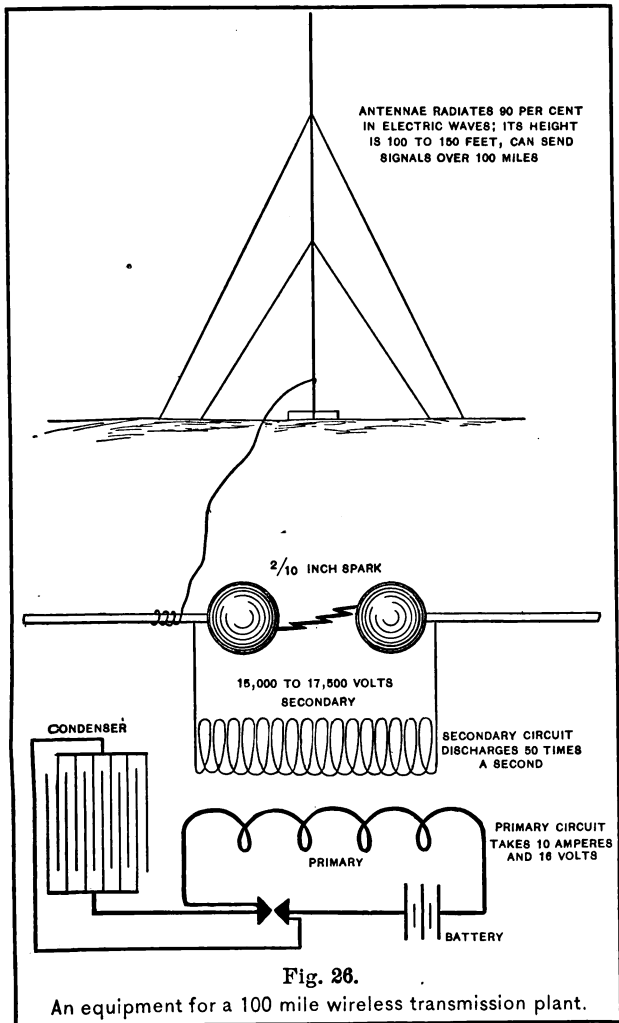

for an ordinary plain aerial, the ratio of the radiation in waves to the power wasted in the spark is about 10 to 1, and hence the radiation efficiency of the antenna is about 90 per cent.

“Supposing such an antenna has the capacity say of  $1/5000$  of a microfarad and is charged to 15,000 volts, corresponding to about a  $2/10$  inch spark at the spark knobs and occurs 50 times a second, the power given to the aerial is only 1.25 watt and 90 per cent of this is about 1 watt.

“Such an aerial can affect a suitable receiver 100 miles away. On the other hand, to supply such an aerial would involve the use of an induction coil taking say 10 amperes at 16 volts, and therefore although the efficiency of the antenna *per se* is comparatively high, there is a considerable loss of energy somewhere else. This loss of energy takes place in the induction coil, and in the arc discharge which accompanies the spark of the induction coil, hence the moral is that the improvement of the efficiency of a wireless plant is to be looked for in the improvement in the efficiency of the sparking device.”

The point presented, that the coil and spark waste a lot of energy has been spoken of by others before this. A large coil unless made with judgment will not be as effective as a small coil for long distance wireless.

#### **Dimensions of Coils for Different Spark Lengths.**

Those interested in building a coil can find sufficient data to help them in the table given. It has



been compiled by H. S. Norrie, author of a very practical work entitled "Induction Coils, How to Make, Use and Repair Them." The reader will find in the items given a good synopsis of the dimensions necessary for the construction of a  $\frac{1}{2}$ , 1, 2, 6 and 12 inch spark coil.

TABLE III.  
DIMENSIONS FOR DIFFERENT SPARK LENGTHS.

	$\frac{1}{2}$ inch	1 inch	2 inches	6 inches	12 inches
Foil Sheets.....	5½ x 4	6 x 4	6 x 6	10 x 5	12 x 8
Number.....	40	40	60	60	60
Paper Sheets....	6½ x 5	9 x 5	8½ x 7	12 x 7	14 x 10
Number.....	60	60	80	80	80
Core Length....	5	7	9	12	19
Core Diameter..	$\frac{5}{8}$ "	$\frac{3}{4}$ "	1"	1½"	1½"
Primary size B. & S.....	16	14	14	12	10
Secondary size B. & S.....	36	36	36	36	38
Core size B. W. G.....	22	22	22	22	22
Quantity in lbs. of secondary wire.....	$\frac{1}{4}$	1¼	2½	7	12
Layers of pri- mary.....	3	3	2	2	2
Area of paper, sq. inches....	2000	2700	4800	6600	11000
Area of tinfoil, sq. inches....	880	960	2100	3000	5760

The use of the table is obvious at first glance, but an example may be reassuring to the amateur.

For instance, a 12 inch coil requires foil sheets for the condenser, 12x8 inches in length and breadth; 60 of them to give the proper capacity, etc. The paper cut is for the condenser though some can also be used to insulate the layers of the primary coil. The core length diameter, size of wire, etc., require no explanation. The main point to carefully observe is good insulation in winding, and if possible the separation of the secondary coil into sections. By this method the individual parts are kept up to a high standard, and if one of the sections should fail in insulation it can be detected by a test, removed and remedied. The last two items in the table only give the relative amounts of tinfoil and paper used in each coil.

**The Telegraphic Codes.** The Morse code is mainly in use in Europe as well as America, but the European code in many places is preserved through custom. Therefore both are given to satisfy the reader as to the difference between them. The Morse code can be learned by ear or eye. The operator generally listens to the sounder, but if the noise is objectionable the printed tape answers the same purpose.

**Earth Connections in the Country.** If the countryside is rocky and a rock strata lies close to the soil surface the best ground is made near a stream. As a rule a pit is dug and filled at the bottom with coke, and a plate of metal laid on top and then more coke. The earth is heaped on this and the metal rod or wire used as a ground

connection. If the soil is dry, a great deal of trouble may be experienced until the ground is electrically good. The best method is to test by means of an overhead wire between points and see whether a complete circuit can be established.

Grounds which are good in the spring and fall when the rain is plentiful and the earth moist may fail in the summer when the season is very

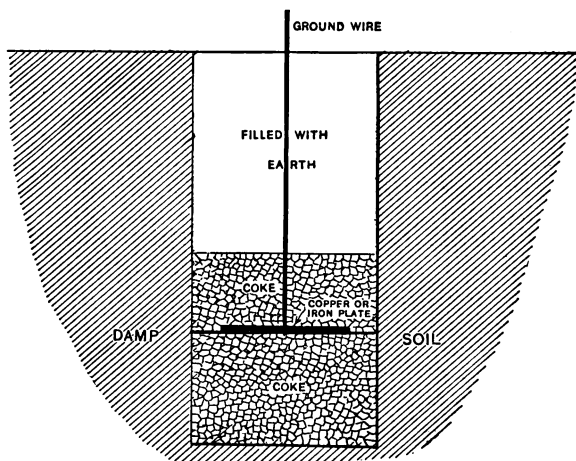

FIG. 27.—Method of getting a ground with a metal plate.

dry. It is therefore best to be sure of the local conditions each season before concluding that they are perfectly satisfactory at all times. A hole dug near a well will do if a stream or marshy ground is not available. The antennae of the wireless near Coney Island, New York City, have been set up near the coast in very moist soil.

TELEGRAPH CODES.

Continental.	Letters.	Morse.
—	A	— —
— — — —	B	— — — —
— — — —	C	— — — —
— — — —	D	— — — —
—	E	—
— — — —	F	— — — —
— — — —	G	— — — —
— — — —	H	— — — —
— —	I	— —
— — — — —	J	— — — — —
— — — —	K	— — — —
— — — —	L	— — — —
— — — —	M	— — — —
— —	N	— — — —
— — — —	O	— — — —
— — — — —	P	— — — — —
— — — — —	Q	— — — — —
— — — —	R	— — — —
— — — —	S	— — — —
—	T	—
— — — —	U	— — — —
— — — — —	V	— — — — —
— — — —	W	— — — —
— — — —	X	— — — —
— — — — —	Y	— — — — —
— — — — —	Z	— — — — —
	&	— — — —

41

2525 17

Continental. Punctuations, etc. Morse.

-----	.	-----
-----	:	-----
-----	;	-----
-----	?	-----
-----	!	-----
-----	,	-----
-----	£	-----
-----	¶	-----
-----	Italics	-----
-----	( )	-----
-----	Quotations	-----

B1 26374

Numerals.

-----	1	-----
-----	2	-----
-----	3	-----
-----	4	-----
-----	5	-----
-----	6	-----
-----	7	-----
-----	8	-----
-----	9	-----



21















JUL 30 1941



