

New Third Enlarged Edition

---

THE A·B·C  
OF  
WIRELESS TELEGRAPHY

*A PLAIN TREATISE ON HERTZIAN  
WAVE SIGNALING*

EMBRACING THEORY, METHODS OF OPERATION, AND  
HOW TO BUILD VARIOUS PIECES OF THE  
APPARATUS EMPLOYED

BY

EDWARD TREVERT

*Author of "Everybody's Hand-Book of Electricity," "Experimental  
Electricity," "Something About X-Rays for Everybody,"  
Electrical Therapeutic Hand Book, etc., etc.*

---

ILLUSTRATED

---

LYNN, MASS.  
BUBIER PUBLISHING COMPANY

1907



**GUGLIELMO MARCONI.**

**From the photograph taken especially for McClure's Magazine, by James Vey, St. Johns, Newfoundland. This was only a few days after the first wireless message had been received from across the ocean.**

*Reproduced "by Courtesy of McClure's Magazine;  
Copyrighted 1902, by the S. S. McClure Co."*

**COPYRIGHTED 1902,  
BY BUBIER PUBLISHING CO.**

—

**COPYRIGHTED 1904,  
BY BUBIER PUBLISHING CO.**

129479  
MAY 22 1909  
TQW  
.B35

AWG 5652

## PREFACE.

---

IN the following pages it is the aim of the author to give some information relating to Wireless Telegraphy: the theory, the apparatus employed, and the methods of operation. Directions are also given for making some of the various pieces of apparatus, and illustrations are inserted where they will make the text clearer. I have made no attempt to make this a technical work, but rather to give the information in such plain language that anyone interested in the subject may understand it.

EDWARD TREVERT.

LYNN, MASSACHUSETTS,  
April, 1902.

## PREFACE TO SECOND EDITION

---

IN 1902 the author placed this little work before the public. Since then the first edition has been exhausted.

In order to bring the book up to date new matter has been inserted in the form of Appendices, which will give the reader some of the latest information upon the subject. Diagrams and engravings have also been added to enhance the value of the book.

EDWARD TREVERT.

LYNN, MASSACHUSETTS.

April, 1904.

# CONTENTS.

---

CHAPTER	PAGE
I. ELECTRICITY AND MAGNETISM . . . . .	I
II. HISTORICAL NOTES . . . . .	17
III. EXPERIMENTS WITH HERTZIAN WAVES . . . . .	25
IV. ELECTRIC BATTERIES FOR WIRELESS TELEGRAPHY, . . . . .	40
V. THE MARCONI SYSTEM OF WIRELESS TELEGRAPHY, . . . . .	48
VI. GENERAL INFORMATION ABOUT WIRELESS TELEGRAPHY . . . . .	55
VII. CONCLUSION . . . . .	73
APPENDIX	
A. THE MARCONI WIRELESS STATION AT CAPE COD . . . . .	83
B. THE STONE SELECTIVE SYSTEM . . . . .	87
C. SPACE TELEPHONY FOR LONG DISTANCES . . . . .	95
D. GUARINI'S WIRELESS FIRE-ALARM SYSTEM . . . . .	105
E. ADDITIONAL INFORMATION . . . . .	109

# WIRELESS TELEGRAPHY.

---

## CHAPTER I.

### ELECTRICITY AND MAGNETISM.

WHAT is electricity? This is a question very often asked but has never been fully answered. The best theory to-day is that electricity is a wave motion in the ultimate molecules of bodies. It has been fairly proven that it is not the atmosphere that transmits light; and as light is a kind of wave motion, and in all wave motion something must be moved, we naturally come to the conclusion that there must be some medium permeating all space capable of wave motion, and scientists have called this medium the "ether." As far as we know, the ether is not affected by gravity, nor does it offer any resistance to a body moving in it.

Although the ether is not considered as matter,

stresses of various kinds may be set up in it, sometimes in straight lines, sometimes in curved lines. Professor Sloane says: "Stress of ether represents static charges, and the discharge relieves the stress. When the discharge is continuous it is called a current. The passage of a current stresses the ether and establishes a field of force. A current of electricity cannot go quietly through the ether because it produces stress or waves in it. These waves are identical with light waves."

Radiant heat is the same kind of waves. When you feel the warmth of the sun on your body it is the same thing as light. We call it heat, but it is invisible radiation. From these theories we have come to the conclusion that light and heat are electrical waves.

**Magnetism.**— Whenever there is a current of electricity moving from one point to another, we always have a manifestation that we call "magnetism." The conditions exist at right angles to the direction of the flow of the current.

The Ampère theory of magnetism is that every molecule of a magnet has a minute current of elec-



---

tricity circulating around it. An aggregation of the molecules with their currents is the production of a compact body with a current circulating outside of it (the magnet). Starting at the north pole, this current travels around it in a direction opposite to that traveled by the hands of a watch. Starting at the south pole it is the reverse. There is no energy expended in keeping up this current after it is once started, because each one of the constituent currents is of such minute dimensions that it maintains itself. Hardened steel retains its magnetism, while soft iron seems to lose it.

**Induction.** — The phenomenon of induction plays an important part in wireless electric wave signaling. Induction may be defined as the “action which one insulated electric body has on all other bodies.” This action, like all others dependent on radiating forces, will diminish inversely as the square of the distance. The inducing body must be insulated from the body induced, otherwise a discharge will take place between them instead of induction. A medium of some kind must exist; but if it is a non-conductor sufficiently resistant to

prevent direct transference, induction will take place.

**Conductors and Insulators.** — Some bodies allow electricity to pass along them more freely than others; these are called conductors. Those which offer much resistance to the passage of the current are called insulators, or non-conductors. The best conductors are metals. Silver seems to be the best conductor, and copper next. Copper is largely used because it is commercially cheaper. The worst conductors are dry air, all resinous bodies, and oil. There is no such thing as a perfect insulator, or a perfect conductor. The best conductor will offer some resistance to the passage of a current, while, on the other hand, the best insulator will leak, or let some current pass.

**Hertzian Waves.** — These waves take their name from Dr. Hertz, who devoted a great deal of his time to the elucidation of their properties. They do not undulate as rapidly as heat waves, and, as far as can be learned, vibrate at the rate of 230,000,000 per second, and travel at a velocity of 186,400 miles per second. They are longer

---

than those of light, and are capable of reflection, refraction, and polarization. They may be set up by any sudden discharge of electricity, such as that produced by an induction coil, Leyden jar, or a lightning flash. In order that these waves may be made evident to our senses they must be received by something which is capable of taking up the same rate of vibration, or that is in tune with them, as we will say, comparing them to sound waves.

Dr. Hertz proved experimentally that the discharge from a Leyden jar is not the mere leveling of the difference of potential between the two coatings of the jar. He showed that there was a series of extremely rapid surging waves, oscillating until an equilibrium was established. He also proved that these surging waves were capable of inducing similar waves in bodies near them, provided these bodies were of such electrical capacity as to be able to vibrate electrically and at the same rate as the body which emitted them. This is precisely what happens in the vibrations of sound waves. For example : if a tuning-fork be set into vibration, and another fork is brought in close

proximity to it, it will set up vibrations and emit a musical sound provided they are in tune with one another. This is caused by the sound waves propagated by the air. Professor Lodge showed by experiment (it was really Dr. Hertz's original experiment slightly modified by Lodge) that an electric conductor may be adjusted or tuned to respond to the oscillations set up by the discharge of a Leyden jar. The experiment is as follows: take a pair of Leyden jars exactly alike; separate them a short distance from one another. Now, if you charge and discharge the first jar you will find that the waves set up in the second circuit can be made to cause it to overflow across a short air gap, provided that they are put in tune with one another. Paste a strip of tin-foil over the lips of the second jar. By means of a sliding-piece in the second circuit which can be moved backwards and forwards, the length of the second circuit can be varied so as to syntonize (or tune) it to the exact rate of vibration as the first. The moment that the first jar is discharged a minute but brilliant spark is visible on the second jar between the edge

of the strip of tin-foil, coming from the inner coating and outer coating of the jar. Of course, owing to the small capacity of these jars, the waves are very short, and their time of duration correspondingly limited. These effects may be intensified by increasing the size of the jars, or by removing the coating farther from one another. A diagram

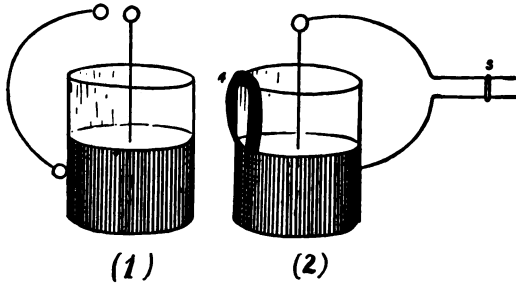
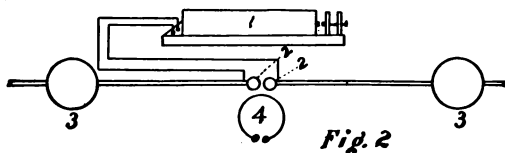

*Fig. 1*

of the jars is shown in Fig. 1. 1 is the first Leyden jar connected to a source of electricity of high potential suitable for the purpose, and furnished with a discharging circuit. 2 is the second jar furnished with a similar circuit. 3 is the sliding-piece which syntonizes (or tunes) it to the same vibrations as the first jar. 4 is the strip of tin-

foil which is pasted to the inner coating of the jar, passing over the top, and reaching nearly down to the edge of the outer coating. Of course the reader understands that in the experiment the two jars are entirely separate from each other. Great precision of tuning is necessary.

A standard Hertz Oscillator and Resonator is shown in Fig. 2. It consists of a powerful induc-



tion coil, with the terminals of its secondary coil connected with the oscillator. This latter consists of a pair of brass rods ending in a pair of brass knobs. These knobs should be kept well polished. The distance between the knobs is adjustable. There are also two large metal spheres (3-3), which are fitted to slide on the brass rods. By altering the position of these spheres, the oscillator can be put into tune with the resonator (4),

---

which consists of a wire bent into an early complete circle, or it may be of rectangular shape, terminating in a pair of small polished brass balls very near together.

With the assistance of the resonator, Hertz explored the space in the neighborhood of the oscillator; and demonstrated the existence of electric waves, and also succeeded in differentiating between electrostatic and magnetic waves. He proved also that these oscillations have all the properties of light and heat waves.

By comparison, we have the following: The human ear is capable of hearing waves in the air of not less than 16 nor more than 44,000 per second; which waves we call sound. When you see a coal glowing at a red heat or anything at that temperature, it is sending out waves at the rate of 40,000,000,000 per second. It is estimated that the sun is sending out light waves whose rate of motion is over 500,000,000,000,000 vibrations per second. Hertzian waves vibrate at the rate of about 230,000,000 per second. In order to show that these Hertzian waves are the same as

the light waves, Dr. Hertz took waves of a kind produced by alternating currents, and caused them to do just what light waves will do: that is, he caused them to interfere with each other. Speaking of this experiment, Professor Thomson says, "He (Hertz) found places where the waves would wipe each other out. He knew that light waves themselves did just the same thing. He found furthermore,—and this is curiously true,—that he could take magnetic waves and produce other similar effects. Suppose we take a brilliantly polished parabolic mirror, say of silver, and we put a little coil here, and send currents of these very rates of vibration through the coil (Fig. 3). The

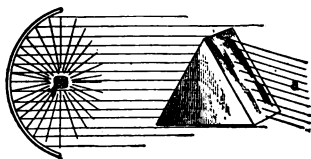

Fig. 3.

electric wire conveying these alternating currents sends electro-magnetic waves out into the space around it, and they are reflected from the mirror



---

according to the laws of light, so as to become a parallel bundle of rays. He then placed some distance away and in front of the reflector a prism of pitch. He used pitch because it is cheap and because it is an insulator. He passed the waves through that prism and they went right through the black pitch, went clear through, but they did not come out in the straight direction. They are turned. They are refracted. They are bent, just as the light was bent ; but these waves are  $3\frac{1}{2}$  feet long, and light waves are 1-40,000 of an inch long, or less.

“ How does he know that the waves were refracted in that way ? He simply constructs an electrical device consisting of a coil of insulated wire with the ends approaching quite near each other. This device is called a resonator or electrical sympathizer. With this device he feels around in the space. He constructs a device which will respond to waves  $3\frac{1}{2}$  feet long. He feels around the pitch prism and in the space beyond ; and just as soon as he gets in the path of the waves he sees that he is in path of the ray, for the coil gives a little

spark between its ends. He now gets further away and feels in the space again. He follows these rays to the point where they leave the prism out through different angular positions, traces them out through space. He has not got eyes that can see waves  $3\frac{1}{2}$  feet long ; but by the electrical device he can give himself eyes, and that electrical device is nothing more nor less than the tiny coil resonator. If he makes the coil too big to respond or sympathize with waves  $3\frac{1}{2}$  feet long, he sees nothing ; but make it just right, the right length, tune it up, and if there are any of those waves in the space then the little coil will sympathize with them and there will be seen a little spark at its ends."

✓ Electric waves or impulses are produced when a momentary current is made to pass along a wire upon another similar wire entirely separate from it, but parallel to it, and of the same length. Preece, in his early attempts to transmit messages across space, used this principle. The apparatus used by him consisted of two triangles of insulated wire, one at the sending end and one at the receiv-

ing end. The former was connected with a source of electricity whereby short, powerful, intermittent currents could be sent over the circuit and along the triangle. For example: a number of battery cells and a telegraph key may constitute the transmitting apparatus, while the receiving triangle may be connected to a delicate galvanometer or a very sensitive telephone. It is possible to transmit intelligible signals to considerable distance through space or even through solid earth by means of the induction-current set up in the triangle No. 2 under the influence of the momentary current sent through triangle No. 1. A diagram of this apparatus is shown in Fig. 4. The best results are obtained when the bases of the triangles are of equal lengths, and not separated from each other by a distance greater than this length. For this reason the application of this method of signaling through space is necessarily limited. For illustration: If you wish to signal in this manner from Lynn to Salem (the distance is five miles), it would be necessary to stretch a line of wire five miles long on the Lynn side and another wire precisely similar

and parallel to it on the Salem side. Thus the expense of construction would make it very impracticable. Referring to Fig. 4: A is the battery, B

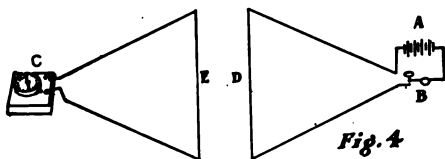

is the tapping-key, C is the galvanometer, D is the transmitting triangle, and E is the receiving triangle.

**The Coherer.** — We now come to the peculiar property of coherence, which enables us to make use of the difference of resistance that is set up in a piece of apparatus termed a coherer, and allows a current of electricity to pass from a local battery along the cohering points, and then ring a bell, work a telegraph relay, and sound or otherwise make it clearly evident to our senses that Hertzian waves have been sent out by the transmitter. If a current of electricity be sent round a glass tube containing iron filings, the filings which originally

appeared as a confused mass without order, immediately take up a symmetrical position, the individual particles arranging themselves in lines transversely to the direction of the flow of the current : this is due to the fact that every manifestation of electricity is accompanied by a magnetic effect. The same thing, or something very similar, occurs if a tube containing metallic filings, and furnished with pro-

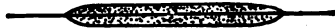

*Fig. 5*

jecting wires, be placed in the path of the Hertzian waves set up by the transmitter : the effect is not quite so marked or so distinctly visible to the eye as where a current is passing over the tubes ; but coherence does take place, and the resistance of the filings to the passage of a current of electricity is greatly lowered, and on this principle the coherer is made. If a battery be connected up in series with such a tube and with an electric bell or a current detector, the resistance presented by the filings (in their ordinary conditions) may be so great as to prevent sufficient current passing to either

bell or the current detector to show any indication of its flow; but immediately on receiving the impact of an Hertzian wave, the resulting coherence so lowers the resistance of the filings that the current flows freely, and rings the bell, or causes the needle of the current detector to deflect very sensibly. Such an arrangement, of a tube with projecting wires, is called a "Coherer." A very simple form of coherer is shown in Fig. 5, and is known as the "Branly Tube."

## CHAPTER II.

## HISTORICAL NOTES.

IN 1853 J. B. Linsay demonstrated that a message could be transmitted across water at points 500 yards apart without continuous wires, and he patented this invention in 1854. Preece made some very interesting experiments between the years of 1884 and 1894, which culminated in his induction system, which was described in chapter I. Riess, Henry, Paalzow and Oliver Lodge made many experiments, and proved the existence of surging waves during the discharge of a Leyden jar. Henry called attention to the great distance to which the induction effect of these surging discharges could extend, and mentions the fact that a single spark of about an inch in length from the prime conductor of a machine passing to the end of a circuit of wire placed in an upper room produced an induction sufficiently powerful to magne-

tize needles in a parallel circuit of iron placed in the cellar beneath, at a perpendicular distance of thirty feet, with two floors and ceilings, each fourteen inches thick, intervening." Dr. Hertz, between the years of 1886 and 1891, by means of a series of experiments gave to the world the knowledge of these electric waves, and their effects on surrounding bodies, so that we can now put them to practical use. Hertz's results were all obtained with only a simple resonator, the same as shown in Fig. 2, Chapter I., a detector of the presence of electric waves. Professor Hughes in 1880 used the microphonic transmitter to detect the presence of ethereal waves. This Lodge called a coherer.

In 1889 Lodge was investigating the action of lightning guards used for protecting telegraphic instruments from the effects of lightning discharges. These were made by adding as a shunt to the circuit containing the instrument, an open circuit with a small air-gap, with terminals consisting of a pair of small brass balls, across which the discharge jumped, rather than flow round the coils of the instrument which had great self-induction,



---

and therefore offered much opposition to a sudden rush of current. Lodge found that when the knobs were placed too close together, even a Leyden jar discharge would often short-circuit the gap, the knobs being found, both by electrical and mechanical tests, to be feebly united at a single point. The knobs really became a coherer.

When the knobs were in mechanical contact, and separated only by an extremely thin film, consisting probably of oxide, very feeble sparks were found to be sufficient to produce this effect. The adhesion of the two surfaces was demonstrated by means of an electric bell placed, together with a single battery cell, in the circuit, and every time a spark occurred the bell rang, and continued to ring until the table on which the apparatus was standing, or some part of the support of the knobs, was tapped, so as to shake them asunder again. In the meantime, Hertz's experiments had attracted general attention from physicists. Professor Minchin in 1891, when working with some photo-electric cells, and especially some which behaved abnormally, as it seemed to him at the time,

and which he called "impulsion cells," found that when a Hertz oscillator was working in another part of the room, the electrometer connected with his cells responded, and by means of this detector, which certainly depended on the coherer principle, he succeeded in signaling without wires over a considerable number of yards.

Professor Boltzmann used a charged gold-leaf electroscope for a like purpose, arranging it so that the electroscope was just on the point of discharging across a minute air-gap, so that its leaves were deflected by a definite amount. It was found, when in this condition, to be extremely sensitive to Hertzian waves, which, if excited in any part of the room, would bridge over the gap and discharge the instrument.

This, as Professor Lodge points out, is not a detector depending on the principle of cohesion, but it led him, when repeating the experiment in a modified form, to the conclusion that cohesion could be effected by the surgings due to the regular Hertzian waves.

In 1891 Professor Branly, in Paris, published

---

some experimental researches of the greatest importance, in which he showed that metals in the state of powder or filings, and also various mixtures of metallic powders with non-conducting ones, which ordinarily offer an extremely high resistance to the passage of an electric current, fell enormously and quite suddenly in resistance, whenever an electric spark occurred in the neighborhood. This lowered resistance continued for some time, but the powder could be instantly restored to its high resistance state by tapping it, and in some cases by increasing the temperature.

Guglielmo Marconi has probably done more to perfect and put wireless telegraphy on a commercial basis than any one man. His discoveries were first announced in 1896. In March, 1897, *McClure's Magazine* published the first magazine article ever published about him in this country. In June, 1899, it was announced that he had been successful in signalling across the English Channel without wires. On Dec. 14, 1901, Marconi announced to the world that he had succeeded in establishing communication by Hertzian waves through space

between Cornwall, England, and St. Johns, Newfoundland, a distance of nearly 2,000 miles. In St. Johns he attached the aerial wire to a kite which had an elevation of about 400 feet, while at Cornwall there were twenty masts 210 feet high each with a suspended wire, though not all of them were used. The transmitter required a current from a dynamo sufficient to light 300 incandescent lamps, the resulting spark being so brilliant that no one could look at it with unshaded eyes. Popoff is now experimenting in Russia, and has a system bearing his name which the Russian Government is now using.

Professor M. I. Pupin has a system of wireless telegraphy ; and his method of tuning to protect the secrecy of messages is said to be perfect.

Julio Cervera Baviera, of Spain, has a system of wireless telegraphy which is somewhat complicated, but possesses some merits not included in other systems.

Braun has a system of wireless telegraphy which the Austrian government has adopted.

Gurrini has shown that it is possible to extend

---

greatly the range of the Marconi form of receiver by using in conjunction with it a delicate form of relay or as he calls it a "repeater" (this relay is in conjunction with the coherer), which, on receiving, the impact of the waves from the transmitter, automatically closes the circuit with another coil battery and transmitter, and thus transmits the message to a greater distance.

"Professor A. Slaby, inventor of the process of wireless telegraphy which the German Emperor has lately ordered to be used by all German warships, which is known as the Slaby-Arco system, has, in an interview in Berlin, given to Nikola Tesla the credit for making possible all the systems of wireless telegraphy now known.

"Professor Slaby refers to Mr. Tesla as the 'father of wireless telegraphy,' according to the published reports of his interview; and says that Tesla first explained and worked out in his book 'Inventions and Researches,' published in 1894, the theory which thereafter Marconi was the first to demonstrate practically. While he gives Marconi the credit for the demonstration, Professor Slaby ascribes the origin of wireless telegraphy to the New York inventor.

"Probably few people outside of those interested in technical studies have read this first announce-

ment of the theory and of the outline of a process for carrying it out that gave to the world the system of communication now in daily use on the seas. Indeed few know that Tesla promulgated it years before the first wireless message was sent.

The book referred to by Professor Slaby as published in 1894, was really a republication of the facts and speculations put forth by Mr. Tesla in a lecture delivered before the National Electric Light Association, at St. Louis, at its sixteenth convention which was in session from February 28, to March 2, 1891." — *From the New York Sun.*

## CHAPTER III.

## EXPERIMENTS WITH HERTZIAN WAVES.

A SIMPLE experiment in wireless telegraphy is shown in Fig. 6, and may be performed in the following manner.

Take a piece of glass tube  $1\frac{1}{2}$  inch long by  $\frac{3}{8}$  inches bore, fit it at each end with corks. Through the center of each cork push a piece of No. 16 copper wire. Be sure and clean the portion of the wire that is to go inside of the tubes. Now remove one cork, and nearly fill the tube with iron filings (these must be perfectly clean and free from grease). Insert the cork again and adjust the wires so that they nearly, but not quite, touch each other in the tube. This tube now is a simple "coherer," and may be attached in a horizontal position to an ordinary electric bell by one of the protruding wires. The other protruding wire of the coherer is attached to one pole of an

ordinary "Grenet" battery, while the other pole of the battery is connected to the now remaining free pole of the bell. Now gently push the wires passing through the coherer making them approach each other until the bell just rings; then draw them apart until it just stops ringing. Now your receiver is complete.

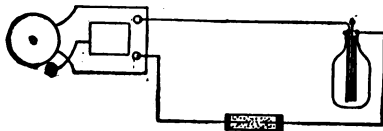

*Fig. 6.*



The next thing to do is to improvise a transmitter; this may be done as follows: Take a Leyden jar of about one pint capacity and charge it, this may be done with a Wimshurst machine (8-inch plate size will be large enough), or from a current from induction coil, the current being supplied by a battery of three or four bicromate cells. When a jar is brought within six or eight



inches of the coherer and discharged by means of an ordinary discharging rod, the electric waves set up by the discharge will cause the particle of the coherer to cohere, thus allowing the current from the battery to pass through them to the bell, which will ring and continue to ring until the filings are decohered, which may be done by tapping the tube.

In all wireless telegraphy experiments a system of "tuning" must be employed in order to establish perfect unison between the transmitter and receiving apparatus. This tuning is very essential to the privacy of the message. The transmitter and receiver are so tuned, or syntonized, to each other that no message can be "tapped" or received except by the instrument for which it is intended. The Marconi receiving apparatus has two wings, or "capacities," which are used not only as conductors of Hertzian waves to the coherer, but as tuning accessories; without these the receiver would not respond so rapidly or accurately.

✓ **The Receiver.** — A simple receiver can be made by using a common telegraph sounder, or even an

electric bell. In the path between the sounder (or bell) and the battery place the coherer. The coherer in its ordinary state presents so much resistance to the battery current that sounder or bell will not work. But if the coherer is put in tune with the transmitter, which is to emit the Hertzian waves when a spark passes between the electrodes (oscillators) of the transmitter, the waves set up by it will break down the resistance of the coherer, and cause the battery current to pass, and operate the sounder or bell.

A difficulty to overcome is, unless some means be employed to restore the particles in the coherer to their original non-conducting state, the current from the battery will continue to flow through the sounder or bell. We must decohere the filings. For this purpose we have a little rod and hammer arranged in such a manner that when the sounder or bell works it taps against the glass of the coherer, and effects the decoherence of the filings. A diagram of the Marconi original apparatus is shown in Fig. 7.

By referring to the diagram you will be-

come familiar with the parts and understand its operation.

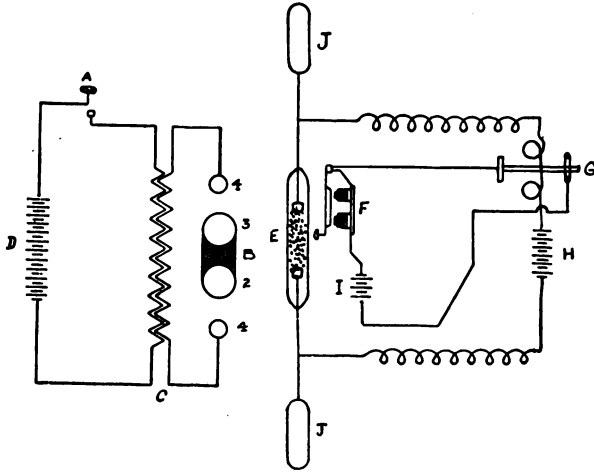

Fig. 7.

**Transmitter.**

*A* is the contact breaker.

*B* is the tube of vaseline oil in which the large brass balls are half immersed.

4—4 are the two brass balls.

*C* is the induction coil.

*D* is the battery.

**Receiver.**

*E* is the coherer.

*F* is the decoherer.

*G* is the telegraph sounder.

---

*H* is the battery which operates the sounder.  
*I* is the battery which operates the decoherer.  
*JJ* are the resonators.

The coherer is also connected to the earth and to the sky pole. This pole varies in height, depending upon the distance that a message is to be sent, anywhere from 100 to 150 feet.

In large wireless telegraphy stations eighteen or twenty poles are arranged in a circle. Around the top of the poles is stretched a wire screen, thoroughly insulated from the poles which receive the Hertzian waves from the transmitter at the sending station.

**How to make a Coherer.** — First take a glass tube  $1\frac{1}{2}$  inches long with a  $\frac{3}{16}$  inch bore, then take two pieces of silver rod each about  $\frac{1}{8}$  inch long to fit the tube, and solder on the one end of each a piece of No. 20 bare copper wire. Now fit one of the pieces of silver with the wire attached to it into the tube, and seal the tube off round the wire. Now take a small quantity of mediumly coarse silver and nickel filings, and mix them in proportion; to silver four parts, nickel ninety-six parts.

Add a trace of metallic mercury, and place a few of them in the tube; these filings can be made by filing a ten-cent silver piece, and a five-cent nickel, with a coarse file. Now insert the other silver rod with wire attached, allowing a space of about one millimeter between the silver rods. The space should be a little more than half filled with the prepared filings. The last rod should also be sealed in the glass like the first. The coherer may now be used, but it will last longer and work better if the air is exhausted from the tube when it is sealed. By this means the filings are prevented from oxidization. Fig. 8 shows the coherer finished.



*Fig. 8.*

Another way to make a coherer is to take a piece of glass tube about  $1\frac{1}{2}$ " long, with a  $\frac{3}{32}$ " bore, and insert at each end a small piece of brass rod  $\frac{3}{32}$ " in diameter. File this with a fine file until it fits the glass tube, then smooth it off with emery paper until it is bright and clean. As with the

coherer previously described, leave a space in the middle of the tube between the brass rods of about 1 millimeter, in which place the silver and nickel filings. The coherer may be mounted upon metal standards made of large size binding posts with thumb screws, in order that it may be adjusted and the rods retained in place. Fig. 9 shows this form of a coherer mounted on a base board.

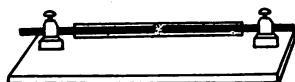

*Fig. 9.*

**How to make a Transmitter.**— Procure three or four cells of some good closed circuit battery, such as the Grenet, Bunsen, or a small storage cell, also a Ruhmkorff coil, one that will give a  $\frac{1}{2}$ -inch spark will do. Of course the larger the coil the further you can transmit the messages. A coil giving a  $\frac{1}{2}$  inch spark will do for  $\frac{1}{4}$  of a mile distance and for lecture room experiments. Now take a common telegraph key and connect it in series with the battery and coil. A diagram of connections is shown in Fig. 10. 1 is the battery, 2 is the tele-

graph key, 3 is the Ruhmkorff coil, 4 is the oscillators. The oscillators are two solid brass balls about  $\frac{7}{16}$  of an inch diameter; these are not included with the small-sized coils, so that the experimenter will have to procure them separately. The

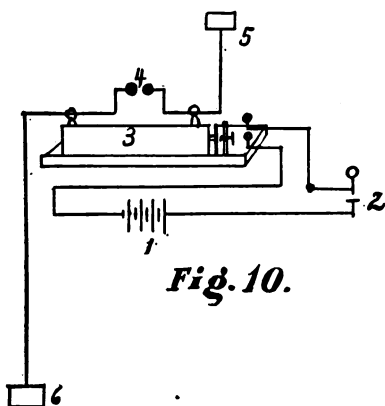

author has in use some that came off of some old electric bells; they were used for the hammer or striker. These should be well polished and always kept bright and clean, so that you may get a good snappy spark. Bore a hole in the brass balls and insert a short piece of No. 16 brass wire, then sol-

---

der it in. The wire should then be bent into shape, thus, Z. The oscillators should now be adjusted so that the air gap between them will be about  $\frac{1}{8}$  of an inch; this is for the reason that a "fat" spark emits waves of greater intensity than a long thin one, and hence is better to use in "Wireless Telegraphy." 5 is the copper plate about a foot or a foot and a half square which is fastened to the pole or sky rod; this pole should be about 25 to 50 feet high. An insulated wire is soldered to the plate, and its free end attached to the rod of one of the oscillators. The other oscillator is connected to the ground plate 6, by an insulated wire. This ground plate is the same size as the one on the sky pole, and is buried in the ground to the depth of 2 feet. Where it is convenient the ground wire may be attached to the water pipe. As the coil comes already mounted on a baseboard, it is better to mount the telegraph key on a separate baseboard of convenient size. The key acts as a circuit breaker, and with it one may tap out the Morse alphabet, but it must be done slowly, and sufficient time given each dot and dash for the passage of a good spark.



**How to make a Receiver.**— Having previously described the coherer we will omit it. It is one of the most important parts of the receiver. Procure a common form of electric bell having a  $2\frac{1}{2}$ -inch gong, 5 dry batteries, and a “pony” relay, wound for 100 ohms. For convenience’ sake we will make the bell do double service, viz., give the signals and act as a decoherer. To the hammer of the bell attach a piece of No. 16 brass wire one inch long. This may be done by drilling a hole in the knob or hammer of the bell, inserting one end of the wire ; solder it firmly. Be sure that the bell will ring freely when it is lying, gong upwards, on the baseboard. Fig. 11 shows the bell with wire

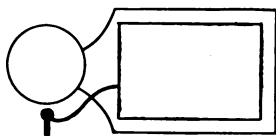

*Fig. 11.*

fastened in position. The bell, dry batteries, coherer, and relay should now all be mounted on a baseboard about 12 by 7 inches. Fig. 12 shows

how to connect up the apparatus. All the apparatus excepting the coherer can be procured at an electrical supply store, and it is much cheaper to buy it than to make it yourself. Referring to Fig. 12, A is the coherer, B is the decoherer, C is the bell, D is the relay, E is the battery to bell through relay contact, F is the battery to relay and coherer,

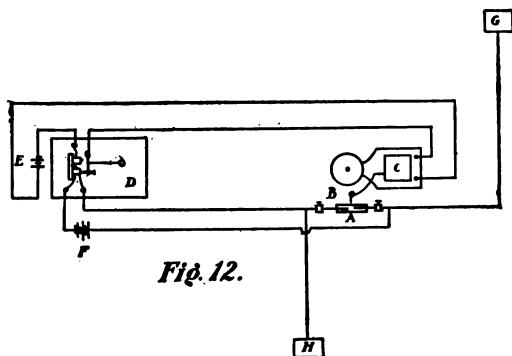
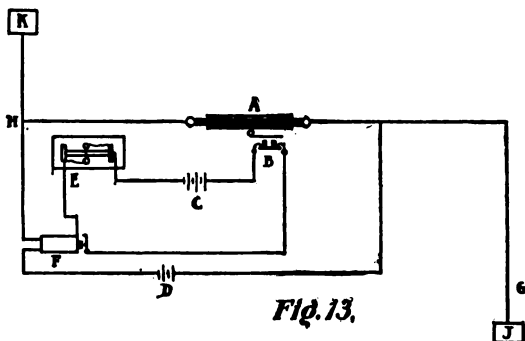

*Fig. 12.*

G is the plate on sky pole and H is the plate in ground. Considerable care and patience will be necessary to adjust the receiver, but a little perseverance will meet with success. On account of the position the bell occupies in relation to the coherer, the use of this form of receiver is limited.

Mr. S. R. Bottone is the author of this arrangement for making the bell do the double service of giving the signal and decohering the coherer.

Another form of transmitter is to use a regular 4-ohm telegraph sounder in place of the bell and to use a separate decoherer. The decoherer can



*Fig. 13.*

- |  |                                 |
|--|---------------------------------|
| <i>A</i> is the coherer.                   | <i>F</i> is the relay.          |
| <i>B</i> is the decoherer.                 | <i>G</i> is the wire to ground. |
| <i>C</i> is the second circuit battery.    | <i>H</i> is the aerial wire.    |
| <i>D</i> is the coherer and relay battery. | <i>J</i> is the ground plate.   |
| <i>E</i> is the sounder.                   | <i>K</i> is the aerial plate.   |

be made from an electric bell, by taking off the gong and making the hammer do the tapping. The magnets of the decoherer should be wound to 4

ohms resistance, the same as the sounder. The author is indebted to Mr. A. Frederick Collins, in the "Scientific American," for this idea. Fig 13 shows a diagram of connections.

A very interesting experiment may be done as follows: connect a small electric motor (most any of the \$1.00 toy motors will do) in circuit with the local battery and the relay, and arrange it so that when the armature of the relay operates it completes the circuit, and sets the motor running. Now having the apparatus thus arranged, press the telegraphic key, and the moment that the spark oscillates between the oscillators of the Ruhmkorff

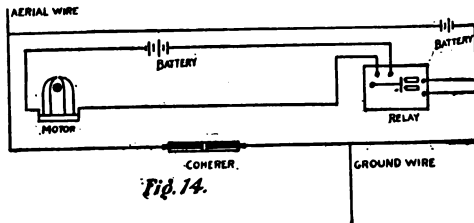
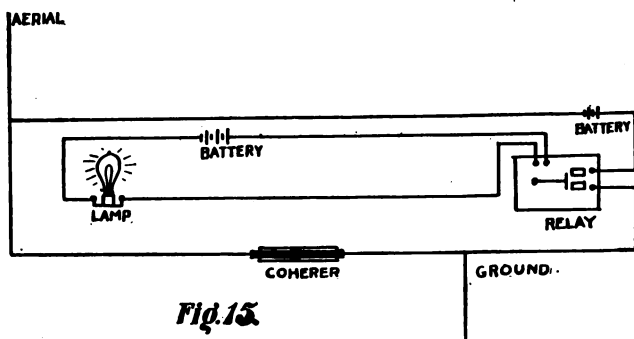

Fig. 14.

coil, the motor starts running, and will continue to run until you decohere the coherer by tapping it with a lead pencil, or some other light article.

The coherer is in circuit with another local battery and the relay, the tapper being cut out. A diagram of the connections is given in Fig. 14. This is a very pretty lecture-room experiment.

Another fascinating experiment is to remove the motor and replace it with a small incandescent



*Fig. 15.*

battery lamp of about one candle power. Having done this, press the telegraphic key as before, and the lamp will light every time that the spark jumps the space between the oscillators of the Ruhmkorff coil, providing, that you decohere the coherer as before as with the motor. A diagram of the lamp in circuit is given in Fig. 15.

## CHAPTER IV.

## ELECTRIC BATTERIES FOR WIRELESS TELEGRAPHY.

A GOOD closed circuit battery will be needed to operate the induction coil — one giving a large, strong current. Either a storage battery, a Bunsen, a Grenet, or a plunge battery will be suitable. Three or four cells connected in series will be sufficient to operate a  $\frac{1}{2}$ -inch spark coil.



Grenet Battery American Form.

**The Grenet Battery**, shown in the engraving, consists of a glass jar or bottle. A well amalgamated zinc plate forms one pole, and a pair of carbon plates, one on each side of the zinc, joined at the hard rubber top, form the other pole. The zinc plate is fixed to a brass rod,

by which it can be drawn up out of the solution when not in use. To charge this battery proceed as follows :—

To three pints of cold water add five fluid ounces of sulphuric acid. When this becomes cold add six ounces (or as much as the solution will dissolve) of finely pulverized bichromate of potash. Mix well.

Pour the above solution into the glass cell until it nearly reaches the top of the spherical part ; then draw up the zinc and place the element in the cell. The fluid should not quite reach the zinc when it is drawn up.

**The Bunsen Cell** consists of a glass jar containing the amalgamated zinc cylinder and dilute sulphuric acid. In the inner porous cup a plate of carbon dips into concentrated nitric acid. There is no polarization for the hydrogen liberated at the zinc plate, in passing through the nitric acid on its way to the

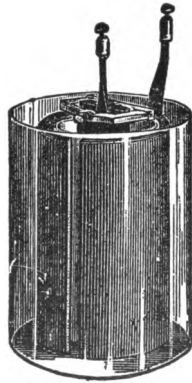

The Bunsen Cell.

---

carbon plate, decomposes the nitric acid, and is itself oxidized, producing water and the red fumes of nitric peroxide gas. This gas does not produce polarization, as it is readily soluble in nitric acid. This battery has a large amount of electro-motive force and a low internal resistance. (See illustration.)

**The Storage Cell or Accumulator.** — The possibility of storing electrical energy was first suggested in 1801, by Guatherot's discovery that two plates of the same metal immersed in acid, after having been subjected to the action current of electricity in one direction, would produce a secondary current of electricity in the opposite direction. In 1849 Gaston Planté devised a storage-battery consisting of plates of lead immersed in dilute sulphuric acid. Camille A. Faure made the remarkable discovery that a paste of oxide of lead mechanically applied to the plates, brought them instantly into the condition to receive a charge which was only accomplished by Planté after months of electrical treatment. For illustration of a modern storage cell we will take the following.



**The American or Morrison Storage Cell.** — The plate for this cell consists of a ribbon of lead folded on itself, until of sufficient size for the plate.

A slot is mortised on the ends of the strip, and the frame of lead is passed around and clamps the tape firmly together.

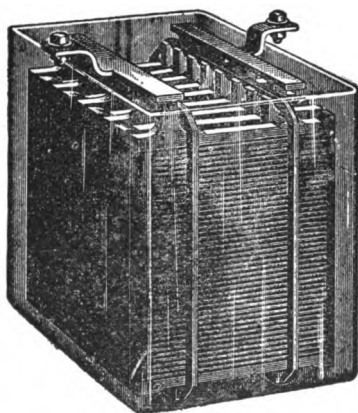

**The American Storage Cell.**

The plates are then pickled in a solution of nitromuriatic acid for about four hours, the pickle being nearly boiling. They are then taken out and allowed to dry in the sun and then formed by the Planté process.

The American Battery Company has also made this plate by pasting, according to the Faure process, and they have given very fine results, being remarkably free from sulphating; and when looked after and not allowed to buckle — except as to cutting through evaporation of electrolyte — give good results.

**The Plunge Battery.** — This battery is shown on page 44. It consists of a number of carbon

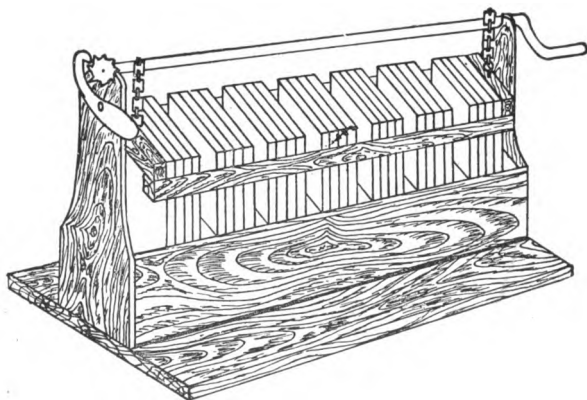

**The Plunge Battery.**

and zinc plates fastened on a frame-work so arranged that they may be raised out of the jars from

the liquid all at one time by simply turning a crank. A bicromate of potash and dilute sulphuric acid solution is used with this form of battery. It gives a large current and about 2 volts to each cell. Full directions for making a plunge battery will be found in "Dynamos and Electric Motors; All About Them."

**Dry Batteries.** — It is often necessary to arrange batteries so that they may stand considerable jarring, or even overturning, when a liquid would be spilled. Therefore came the invention of the dry battery: of this type the Burnley dry battery is one of the leading batteries of the present time.

**Burnley Dry Battery.** — The battery shown in the cut is made by filling in the space between a hollow carbon cylinder and a metal plate which faces both external and internal surfaces of the cylinder, with the chemicals in a dry or rather a pasty form. The whole is then sealed tight into the covering



**The Burnley Dry Battery.**

and is ready for use. Neither of the elements is consumed during action, but the chemicals are

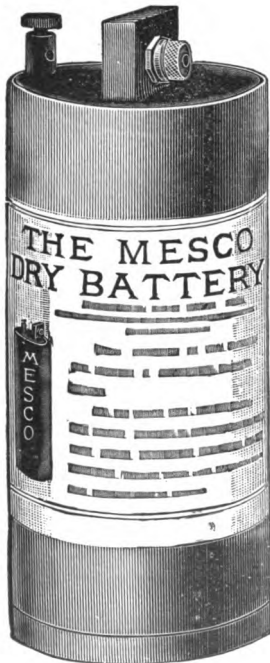

**The Mesco Dry Battery.**

decomposed. It is, therefore, free from the effects of polarization during the greater portion of its life, and can be restored again when exhausted by passing a current from its positive to its negative pole, being thus, in a certain sense, a storage battery. Its E.M.F. is about 1.40 volts, and it will give a current of 7 amperes, as its internal resistance is  $\frac{1}{2}$  ohm.

**The Mesco Dry Battery** is one of the best dry batteries on the market. Its electro-motive force is about 2 volts; it gives about 8 to 10 amperes current. See illustration.

**The No. 2 Samson Battery.** — This is the reg-

ular or circular zinc form of the battery. It is contained in a jar  $4\frac{1}{2}$  inches square, and is 8 inches over all. The cell has a voltage of from 1.40 to 1.47, and an amperage on short circuit of from 12 to 16 amperes. As this battery is intended solely

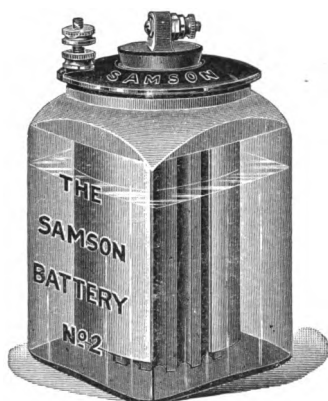

$4\frac{1}{2} \times 4\frac{1}{2} \times 8$  inches.  
Samson Battery.

for intermittent work, this large current is but momentary. This cell is adapted for wireless telegraphy apparatus, and all special work requiring a battery having great initial strength, and capable of quick recovery after hard work. The parts are interchangeable.

## CHAPTER V.

## THE MARCONI SYSTEM OF WIRELESS TELEGRAPHY.

THE arrangement of an apparatus for long distance work is shown in Fig. 16. A is the coherer tube with silver pole-pieces; B is a local cell connected with the coherer and a sensitive telegraphic relay. When the Hertzian waves im-

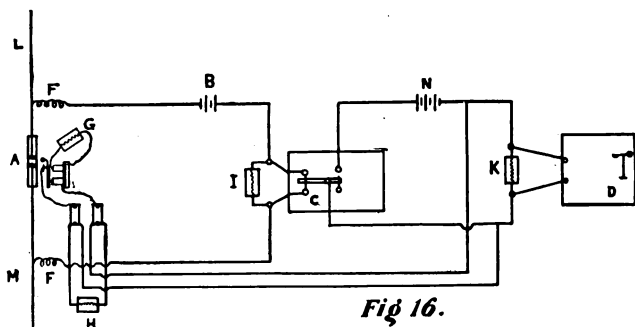

pinge on the coherer its resistance falls enough to allow the current from the cell B to flow through it and energize the electro-magnet of the relay C,

---

and close a circuit containing a battery (composed of a number of cells connected together) with a Morse telegraphic sounder, D, and a trembling electric bell, E, with the gong removed, which acts as a decoherer. The hammer of the bell is so adjusted as to tap the coherer tube and shake the filings in it enough to decohere them.

Small choking coils, F, F, (these are coils wound so as to have self-induction) are introduced between the coherer and the relay. The function of these coils is to compel the greater part of the oscillatory current induced in the circuit by the electric waves to traverse the coherer, instead of wasting most of its energy in the circuit afforded by the relay. Marconi found that if these coils were omitted, and other circumstances remained the same, the distance at which the signals could be distinguished is reduced to nearly half that attained when they are employed. Marconi also found that unless provision was made against it, the relay, the sounder, and the tapper, all produced disturbing effects on the receiver ; but he remedied these effects by introducing suitable non-inductive resis-

tances G, H, I, and K, in parallel with them. This shunting prevented all sparking at the contacts and sudden perturbations, due to the local battery current, both of which would otherwise produce disturbing effects on the coherer. L is the aerial wire, and M is wire to ground plate, N is the local battery operating the sounder and decoherer.

Marconi has invented a "Reflector System." This is an arrangement whereby the receiver answers only to waves coming in a certain definite

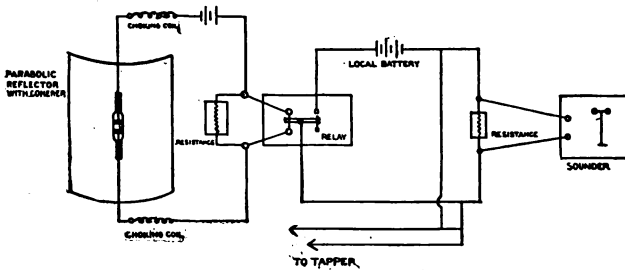

Fig. 17

direction. This apparatus differs from the one last described in that the vertical wire and earth connection are done away with and are replaced by two copper strips, the sizes of which must be



carefully adjusted so that the receiver may be in tune (or syntony) with the waves sent out by the transmitter. A parabolic cylindrical reflector is placed so that the tube of the coherer lies with its axis in its focal line. Fig. 17 shows a plan of the receiving apparatus. A plan of the transmit-

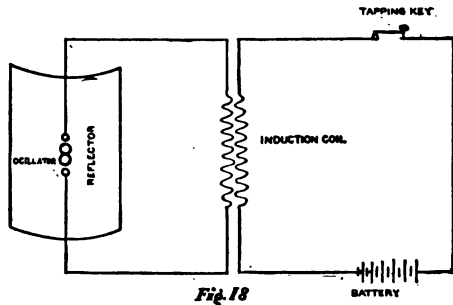

Fig. 18

ting apparatus is shown in Fig. 18. With this an oscillator designed by Righi is placed in the focal line of the parabolic cylindrical reflector in order to concentrate the waves in the right direction.

Regarding this system, Marconi says, in a paper read before the Institute of Electrical Engineers :

“There exists a most important case to which the reflector system is applicable, namely, to enable

ships to be warned by lighthouses, light vessels, or other ships, not only of their proximity to danger, but also of the direction from which the warning comes. If we imagine that A is a lighthouse, provided with a transmitter of electric waves, constantly giving a series of intermittent impulses or flashes, and B a ship provided with a receiving apparatus placed in the focal line of a reflector, it is plain that, when the receiver is within range of the oscillator, the bell will be rung only when the reflector is directed towards the transmitter, and will not ring when the reflector is not directed towards it. If the reflector is caused to revolve by clock-work, or by hand, it will, therefore, give warning only when occupying a certain section of the circle in which it revolves. It is therefore easy for a ship in a fog to make out the exact direction of the point A, whereby, by the conventional number of taps or rings, she will be able to discern either a dangerous point to be avoided, or the port or harbor for which she is endeavoring to steer."

A photo-engraving of one of Marconi's Wireless

Telegraphy Stations is shown on page 53. It is situated on the shore of South Wellfleet, Cape Cod, Mass. The tops of the poles are about 365

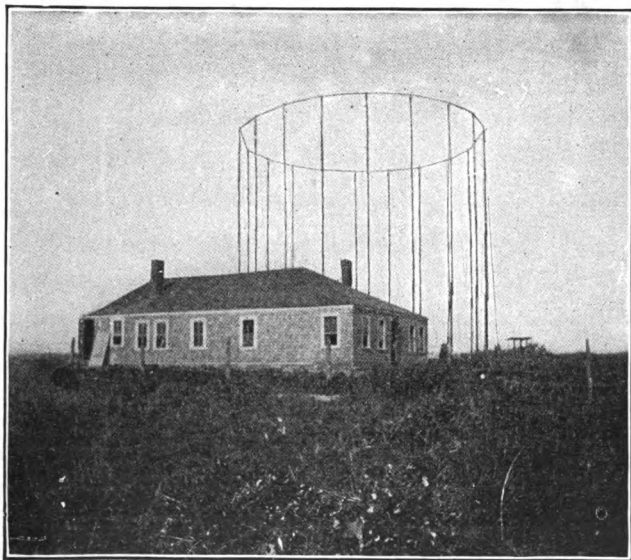

**Cape Cod Marconi Wireless Telegraph Station.**

feet above the level of the sea, and are placed in a circle, as you can see by the picture. The photograph was taken by Miss M. R. Orne. From the position from which this picture was taken, only

one of the buildings can be seen. The buildings and poles are situated on a high sand bluff on the ocean side. This station is maintained to communicate with ships at sea.

Speaking of Marconi's recent success in establishing communication across the Atlantic Ocean, Ray Stannard Baker says in *McClure's Magazine*: "He told me that one of the projects which he hoped soon to attempt, was to communicate between England and New Zealand. If the electric waves follow the curvature of the earth, as the Newfoundland experiments indicate, he sees no reason why he should not send signals 6000 or 10,000 miles as easily as 2000.

"Then there is the whole question of wireless telegraphy on land, a subject hardly studied, although messages have already been sent upward of sixty miles over land."

## CHAPTER VI.

**GENERAL INFORMATION ABOUT WIRELESS TELEGRAPHY.**

MR. WILLIAM MARCONI, inventor of wireless telegraphy, arrived in New York, Saturday, March 1, 1902, aboard the American Line Steamship Philadelphia, upon which were conducted the most interesting and important experiments that have yet been made in the transmission of actual wireless messages to very great distances. The station at Poldhu, in Cornwall, undertook to keep in communication with the Philadelphia as long as might be possible. Six messages were received during the first four days of the run, these beginning when the vessel was 250 miles distant from the sending station. On Feb. 25, at 10.30 P.M., the last actual message was received at a distance of 1551 statute miles, but at midnight of the next day, the distance then being 2099 miles, intelligible signals, consist-

---

ing as in the case of the first transatlantic experiment of the letter "S" repeated in several combinations, were distinctly obtained. All the messages were sent in one direction, the sending appliances on the steamer not being sufficiently powerful to attempt to return messages to the Cornish sending station.<sup>1</sup>

**Disruptive Discharges.** — "Mr. K. R. Johnson has taken up the study of the conditions of the formation of disruptive discharges. The conclusions he arrives at are that a higher potential difference is required for the first discharge than for following ones, while the oscillations are more intense from the first spark than those that follow it, The intensity of oscillation augments with the striking distance. The length of waves given out augments also in proportion with their intensity. Breakdown potential differences are more regular when the negative pole of the apparatus is earthed. The potential difference of the spark he finds also to be independent of the capacity connected to the extremities of the wire."<sup>2</sup>

<sup>1</sup> From the *Electrical Review*.

<sup>2</sup> *Eclairage Electrique*, Paris.

---

Speaking of the "Slaby System," Alfred G. Dell says in the *Electrical Review* :

"I see by a statement of Professor A. Slaby, under date of Berlin, April 2, 1902, that he claims he published discoveries of his system of wireless telegraphy in December, 1900.

"By referring to an abstract in an electrical journal I find he concludes there is a loop at the top of the aerial receiving wire and a node at the earthed end, and he extends a wire from the end earthed until he supposes he has reached another loop the same as exists at the top of the aerial wire, and at that point places his coherer. Whether the vertical wire is divided in such a manner seems to me to be in doubt, as I know of no experiments that prove there is such a division, but be that as it may, I am sure from experiments that there are segments formed along such wires, and if the coherer is placed half way between two nodes it will be at the place of the greatest energy. A Hertzian circle has a loop at its spark-gap and a node directly opposite, which experiments fully prove.

“If a grounded wire is touched to the Hertzian circle directly opposite the spark-gap, that is, at a point an equal distance on each side from the spark-gap, there is no interference with the spark. I have cut the wire at the same place touched by the earthed wire and found but little if any interference, whereas if any other part of the circle is touched or cut there is interference. I have also made experiments with Geissler tubes, proving the same as above. By referring to the *Electrical Review* of May 10, 1899, you will find an article, ‘Wireless Telegraphy,’ written by me, in which there is the following: ‘I always found the waves in long receiving wires divided themselves into segments, the greatest energy always appearing at a loop half way between two nodes, the energy diminishing each way from a loop as a node was approached and falling off to almost nothing at a node.

“‘If the coherer is placed at or near a node the action of the coherer would be considerably less than when placed at or near a loop.’

“This is the whole key to Professor Slaby’s ar-



---

rangement, and anticipates his publication by one year and six or seven months.

“I published nothing about the construction or how to place the coherer at a loop, but claim I first published the principle of such an arrangement, and believe it is the most scientific arrangement yet invented. I hope he may have great success with it, but I cannot see why others may not apply the same principle, as I have prior right of publication, and it is free to all.”

We quote from an article in the *Boston Herald*, portions of speeches made by Elihu Thomson and Dr. Kennelly at the monthly dinner of the Commercial Club in Boston. Dr. Kennelly said :

“In speaking of the tremendous possibilities of Marconi’s feat of receiving a message on a ship 1551 miles from the sending point, he said that this feat indicated a glorious possibility which can only expand in the future ; it cannot contract. One of these possibilities, which he expressed the hope we shall all see, is the equipping of all the large lighthouses so that they shall be able to warn vessels of the dangers of rocks, no matter

what the weather, and thus reduce the awful casualties of wrecks.

“He then explained the theory of wireless telegraphy, and the mechanism by which it is operated. The telegraph wire, he said, directs a current in a line with itself ; in wireless telegraphy the current is expanded like a huge soap bubble, the size and strength of the bubble depending upon the force which generates it. The higher into the air the wire is extended the farther you can send, because you get a larger bubble. The rotundity of the earth doesn't seem to matter much ; the tips of the sending and receiving wires may be eclipsed, and yet signals may go on without interruption.

“The ordinary distance at which a ship may be ‘picked up’ is 25 miles. Marconi has shown that it is possible to pick up a ship at a distance of 1550 miles. There seems to be no theoretical limitation to the possibilities in this direction, although even Marconi has not yet been able to answer back from a ship at a distance of 1550 miles.

---

“The ear has a discerning power of 10 octaves, and the eye of one octave. It is possible to knock with a hammer on a bar of steel pitched so high that no sound results which the human ear can discern, and yet if this experiment is tried on a dog the dog winces, showing that he hears. Speculating upon what wireless telegraphy may do in the future, he said it suggests capabilities for senses which the human being has not ; and that through the medium of this new discovery it may be possible to explore a now impossible world and translate its doings.

“Professor Thomson proceeded to develop some other elements of the subject. One of the questions put to him was : Must the ship keep on a certain line in order to be communicated with ? He replied that this was not necessary. Wherever it touched the circumference of the electric current, which Dr. Kennelly had figuratively described as a soap bubble, it could be communicated with, provided it had the necessary receiving apparatus. In this way an arctic explorer might be communicated with, or an explorer travel into the wilder-

ness, without reference to any special path, and communicate with his base of supplies or his friends, provided he carried with him a balloon and the necessary equipment for sending and receiving messages.

“The antennæ, or wire used in wireless telegraphy, was merely a means to an end. Marconi used about 800,000 alternates per second, but if this power could be increased the wire would glow with red, yellow, violet, and white light, according to the amount of the power used. When a white light had been attained, there would not be a bit of current passing through the wire. It would all escape into the surrounding air.

“He illustrated the operation of the wireless telegraph by citing the familiar effect of striking one tuning-fork in a room a blow, and noting the effect upon another tuning-fork of the same pitch. The sound from the first tuning-fork would be taken up by the second, and continued even after the first had been silenced. This was the operation of sound waves. In wireless telegraphy ether waves are used, which neither fog, nor stone walls,

---

nor anything else can stop. He also explained how a multiple system might be operated, and how secrecy of messages could be preserved.

“After briefly reciting the experiences of some of the other scientists who had engaged themselves upon this subject, he said :

. . . . .

“I think Marconi is to be given the credit for pointing out the way in long distance work, and he has proved that there is practically no limit or distance to which these messages may not be sent, provided they only have power enough behind them.

“One of the things to which he said he looked forward as a result of this new discovery and its development was the instantaneous dissemination of news from one point in the world to all other points.”

Without secrecy no system of wireless telegraphy can ever become a commercial success, or compete with the present telegraph or cable systems. For this reason it is necessary to employ a system of tuning, or syntonizing. Marconi has

constructed a receiver which responds only to a certain transmitter. For example, if the transmitter sends out waves which vibrate at the rate of 200,000,000 times per second, the corresponding receiver is syntonized to receive waves of that rate of vibration only. It is also found that receiving instruments respond to various atmospheric disturbances when they are not syntonized. A sytonic radiator must be one which produces persistent oscillations instead of having them damped out almost immediately, and, the more freely a radiator gives out its energy to the ether, the more rapid must be the damping; hence, a radiator cannot be made sytonic without making it feebler. Marconi found that the long aerial wire of the transmitter formed one of the principal difficulties in the way of sytonic operation. It was the means of sending signals over long distances, with but a small expenditure of energy. The electrical oscillations set up in the long vertical wire formed a powerful radiator, but its oscillations are rapidly damped out so that it is not a persistent oscillator. Such a radiator gives out all

---

its energy in a small number of rapidly diminishing oscillations, hence, receivers of very different periods will respond to it, since they receive nearly all of the energy at once. Now if the same amount of energy is distributed over a large number of comparatively feeble impulses, no one of these will be strong enough to break down the resistance of the coherer, but with a properly tuned receiver the accumulative results of the impulses will produce continually increasing oscillation in the receiver until the oscillation is strong enough to break down the resistance of the coherer, and allow the local current to pass through it and cause the apparatus to work.

M. Gautier announces that the first step has been made in the discovery of wireless telephony. He ascribes the discovery to M. Maiche, the French inventor, and the experiments were carried out in the forest of St. Germaine. The transmitter was placed in a house on the outskirts of the forest, and it was connected with the earth in the same manner in which lightning rods are connected. Two iron posts, ninety feet apart, connected by

wire, were planted in the ground about a thousand yards distant. Voices and other sounds at the transmitter were clearly heard at an ordinary telephone receiver attached to one of the posts. M. Maiche claims that the communication is in a straight line and not by wave current, but by a circuit current, thus enabling a given spot to be aimed at. If the receiver is not placed exactly in the direction given at the current, there will be no transmission, and receivers on either side of the line of transmission will not be at all affected.

As the subject of wireless telegraphy has not yet apparently lost interest for the general reader, says Professor J. A. Fleming in the *London Times*, I venture to ask a little more space to make known for the first time some recent achievements by Mr. Marconi which have astonished those who have been allowed to examine them. Every one is aware that in his system of electric wave telegraphy an important feature is the employment of an elevated conductor, which generally takes the form of a wire suspended from a mast. When Mr. Marconi attracted attention by his feat of



---

establishing communication across the Channel without wires, critics raised a not altogether valid argument against its commercial utility, that a wave or signal sent out from one transmitter would affect equally all received within its sphere of influence, and hence the privacy of the communication would be destroyed. No one felt the force of this objection more strongly than the distinguished inventor himself, whose original work has caused so many others to attempt to follow in his steps. For the last two years he has not ceased to grapple with the problem of isolating the lines of communication, and success has now rewarded his skill and industry. Technical details must be left to be described by him later on, but meanwhile I may say that he has modified his receiving and transmitting appliances so that they will only respond to each other when properly tuned to sympathy. I am well aware that other inventors have claimed to be able to do the same thing, but I do not fear refutation in saying that no one has given practical proof of possessing a solution of this problem which for a moment can compare with that Mr. Marconi is now in a position to furnish.

---

These experiments have been conducted between two stations 30 miles apart, one near Poole in Dorset and the other near St. Catherine's in the Isle of Wight. At the present moment there are established at these places Mr. Marconi's latest appliances, so adjusted that each receiver at one station responds only to its corresponding transmitter at the other. During a three days' visit to Poole, Mr. Marconi invited me to apply any test I pleased to satisfy myself of the complete independence of the circuits, and the following are two out of many such tests: Two operators at St. Catherine's were instructed to send simultaneously two different wireless messages to Poole, and without delay or mistake the two were correctly recorded and printed down at the same time in Morse signals on the tapes of the two corresponding receivers at Poole.

In this first demonstration each receiver was connected to its own independent ærial wire hung from the same mast. But greater wonders followed. Mr. Marconi placed the receivers at Poole one on top of the other, and connected them both

---

to one and the same wire, about 40 feet in length, attached to a mast. I then asked to have two messages sent at the same moment by the operators at St. Catherine's, one in English and the other in French. Without failure each receiver at Poole rolled out its paper tape, the message in English perfect on one and that in French on the other. When it is realized that these visible dots and dashes are the result of trains of intermingled electric waves rushing with the speed of light across the intervening 30 miles, caught on one and the same short aerial wire, and disentangled and sorted out automatically by the two machines into intelligible messages in different languages, the wonder of it all cannot but strike the mind.

Your space is too valuable to be encroached upon by further details, or else I might mention some marvelous results, exhibited by Mr. Marconi during the same demonstrations, of messages received from a transmitter 30 miles away and recorded by an instrument in a closed room merely by the aid of a zinc cylinder, 4 feet high, placed on a chair. More surprising is it to learn that,

whilst these experiments have been proceeding between Poole and St. Catherine's others have been taking place for the Admiralty between Portsmouth and Portland, these lines of communication intersecting each other ; yet so perfect is the independence that nothing done on one circuit now affects the other, unless desired. A corollary of these latest improvements is that the necessity for very high masts is abolished. Mr. Marconi now has established perfect independent wireless telegraphic communication between Poole and St. Catherine's, a distance of 30 miles, by means of a pair of metal cylinders elevated 25 or 30 feet above the ground at each place.

I need not enlarge on the possibilities thus opened out for naval and military purposes. The importance of this practical solution of the problem of independent electric wave telegraphy, in which each wireless circuit is as private as one with a wire, is obvious without comment. My desire is solely to mention the above facts for the benefit of general readers, whose minds will thus perhaps be eased of any doubts lest this bril-

---

liant application of electrical discoveries should, like some others, fall short in satisfying the requirements of practical use and be relegated to the region of imperfect inventions or unfulfilled hopes.

The following is quoted from the *Boston Globe*:

“The navy department of the German empire has decided to establish a chain of wireless telegraph stations along the entire German coast. Recently trials have been conducted at Kiel to determine whether the department shall use the Braun system or the Slaby-Arco system, in the latter of which Emperor William has shown great interest.

Thirty-two German warships have already been equipped with the Slaby-Arco system of wireless telegraphy, while eight more are to have this system installed. Official reports say that the Slaby-Arco system gives the most satisfactory results, as, by this system, wireless messages are transmitted a distance of 125 miles.

. . . . .  
Professor Adolf Slaby of Berlin, the inventor of the wireless system which has just been tested by

---

the German government, backed by the word of his collaborator, Count de Arco, and the German emperor, claims that he has at last completed an absolutely satisfactory system of wireless telegraphy, which is portable, capable of easy transportation, and which is in every way as complete and satisfactory as any telegraph system in use to-day.

. . . . .

Professor Slaby's apparatus is simple. It consists of one portable storage battery, connected with an inclosed Ruhmkorff coil with key also inclosed ; three valuable induction coils, one box kite, one bird kite, coherer, receiver, telephones, and windlass. These various parts can all be packed in a knapsack if necessary, and are very light. The system is designed principally for field and military work, and for places where there is little possibility of another system."

## CHAPTER VII.

## CONCLUSION.

WONDERFUL advances in wireless telegraphy are being made almost daily ; and suggestions are continually advanced for utilizing the results. New plans and systems are being constantly discovered for sending wireless messages, some inventors using ethereal waves, while others are using the transmission of electrical impulses by earth's currents.

Isaac Storey of Lancaster, England, has invented a system of transmitting correct time over a radial distance of six miles by wireless telegraphy, by placing a transmitter (synchronized with Greenwich time) in the center of any large city, and by attaching a simple receiving device to each of the clocks. By using this system he could supply all of them with accurate time within a circle of twelve miles in diameter. Storey has also invented a sys-

---

tem by which torpedoes may be steered by electrical waves.

**Capacities.** — Marconi attached “capacities or wings” to his coherer. These are two copper or brass strips about 12 inches long, 1 inch wide, and about  $\frac{1}{8}$  of an inch thick. These are considered essential, so as to put the coherer in tune and obtain the advantage which results from electrical sympathy. The rate of oscillation of electrical charges in these wings depends on their length, which must be determined by experiment.

**Choking Coils.** — The author knows of no better way to describe these than to use Marconi’s own language. He says, “Another improvement has for its object to prevent the high frequency oscillations set up across the plates of the receiver by the transmitting instrument, which should pass through the sensitive tube, from running round the local battery wires, and thereby weakening their effect on the sensitive tube or contact. This I effect by connecting the battery wires to the sensitive tube or contact, or to the plates attached to the tube through small coils possessing self-induction,



---

which may be called choking coils, formed by winding in an ordinary manner a short length (about a yard) of thin and well-insulated wire round a core (preferably containing iron) 2 or 3 inches long."

R. A. Fessenden is experimenting with wireless telegraphy under the directions of the United States Weather Bureau, and claims to have made some important discoveries. Professor Fessenden claims that his experiments have resulted in means being found of increasing the proportion of energy utilized to an astonishingly great extent, and of enabling a wire, only a meter in height, to radiate as much energy, and also to emit waves of the same period, as a wire 100 meters high used as a radiator on Marconi's system. He also claims superiority of his system, owing to the fact that it can be operated without fear of having the messages intercepted.

**The Morse Inker.** — This may be inserted in place of the sounder. With this you can get the dots and dashes of the Morse telegraph alphabet on a ribbon of paper by the pen or pointed instrument

striking it corresponding with the number of times that the current is switched on (and with the same precision) by pressing the telegraphic key at the transmitter, which causes the Hertzian waves to act on the coherer at the receiver. The ribbon of paper is fed by clock-work.

**Syntonic Apparatus.** — The use of syntonic apparatus has made it possible to send wireless messages over long distances with conductors of moderate height. Signals have been successfully sent and received over a distance of about 32 miles with cylinders only 4 feet 2 inches high and 3 feet 4 inches in diameter. For example, a portable apparatus for military purposes is constructed in the following manner: The whole arrangement is mounted on a motor car. On the roof of the car there is placed a cylinder, which can be lowered when traveling, but when in use is placed upright, and is only about 20 feet high. An induction coil, giving a 10-inch spark, is operated by storage batteries and taking about 100 watts is used for transmitting, and the storage batteries can be recharged by a small dynamo which is driven by

the car motor. The ground wire is attached to a strip of wire netting which drags along on the ground when the car is in motion.

**Morse Telegraph Alphabet.** —

a	b	c						
—	—...	...						
d	e	f	g	h	i	j	k	
—...	.	—.	—	....	..	—.	—	
l	m	n	o	p	q	r	s	t
—	—	—.	..	....	—.	...	...	—
u	v	w	x	y	z	&	.	
—	—	—	—	—	—	—	—	—
?	'	1	2	3	4			
—	—	—	—	—	—			
5	6	7	8	9	10			
—	—	—	—	—	—			

**The Baviera System of Wireless Telegraphy.** —

In describing this system, the London *Electrician* says :—

“The coherer generally employed by Cervera is made as follows : Between two small parallel ivory disks, whose distance apart can be adjusted at pleasure by means of three fine screws, are the

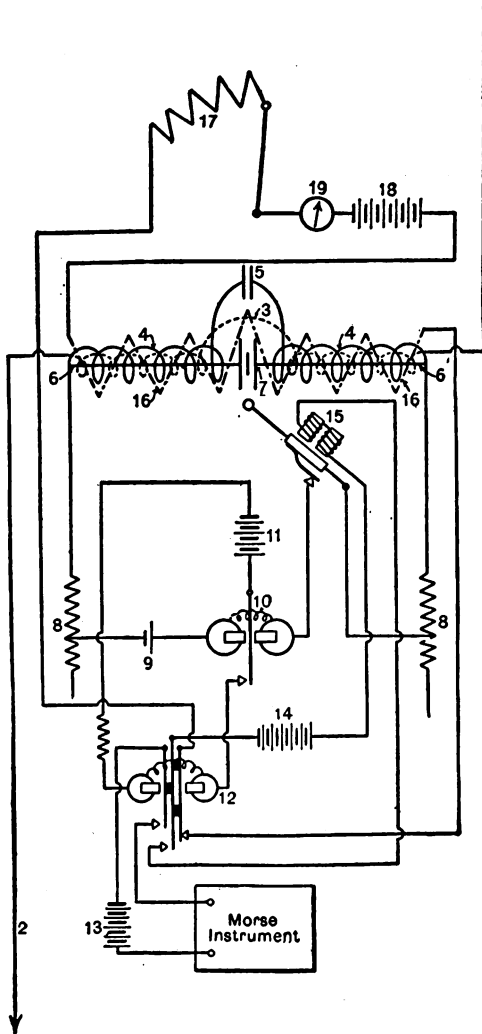

The Baviera System.

---

EXPLANATION OF THE BAVIERA SYSTEM  
ILLUSTRATED ON PAGE 78.

1. Air wire.
2. Earth connection.
3. Primary coil of the transformer.
4. Secondary coil of the transformer.
5. Condenser.
6. Soft-iron electrodes in connection with the secondary coil "4."
7. Coherer.
8. Adjustable resistance.
9. Battery of coherer circuit.
10. First relay.
11. Battery of the circuit closed by the relay.
12. Multiplying relay.
13. Battery for Morse instrument.
14. Tapper battery.
15. Tapper.
16. Winding of electromagnet regulating the sensibility of the coherer.
17. Resistance to regulate the sensibility of coherer.
18. Battery for the regulating electromagnet.
19. Milliampere meter.

---

metallic poles which press against the filings. These two poles have two wires or strands of well-annealed soft iron, which are the two branches (one being a prolongation of the other) of the coherer core. The length of each of these branches varies from 4 cm. to 6 cm., and the diameter is 2 mm. An ivory disk with a circular orifice at its center contains two other ivory disks which press against the filings."

Comparing Lodge's and Tesla's systems of wireless telegraphy, Prof. Sylvanus P. Thompson says in the London *Saturday Review*: "In the method of Lodge, the Hertzian waves (or electric waves) generated by a snapping spark between the polished balls of a so-called 'oscillator' are received at the distant station upon a receiving apparatus consisting of an extended arm or conductor in combination with a 'coherer,' a sensitive tube containing minute metal filings, by means of which a local battery is relayed on to a suitable telegraph instrument, usually a Morse sounder or recorder. The coherer is kept in its sensitive state by receiving gentle vibrations from an automatic 'tapper.'

---

“In the apparatus of Tesla torrents of high-frequency sparks are poured out from a secondary induction coil at a place in the circuit where the discharge is blown aside by a magnetic field or — as in Elihu Thomson’s variant — by a blast of air. Every one of such recurring sparks starts its own wave, with effects that are cumulative and therefore capable of being detected at much greater distances.”

**Wireless Telephony.** — Quite a number of inventors are now working and experimenting trying to perfect a system of wireless telephony. So far some wonderful results have been accomplished. A. F. Collins of Philadelphia, Pa., claims to have transmitted speech through the telephone, without wires, over a distance of one mile. Armstrong and Orling claim to have held conversation through the solid earth ; this apparatus worked at a distance of four miles.

**Nickel.** — This seems to be the best metal to use in the coherer, as it is the most sensitive to the Hertzian waves, and it is the most easily decohered.

**The Future.** — Wireless telegraphy is now being rapidly extended almost to every quarter of the earth, and we firmly believe as Marconi says “that it is only a question of months not years” before practical communication without wires will be commercially established between the continents across thousands of miles of ocean. Tesla has predicted that not only intelligible signals will be sent over long distances without wires, but even electric power will be transmitted as well. What discoveries in electrical science the future will bring forth “no man knoweth.”



## APPENDIX A.

### THE MARCONI WIRELESS STATION AT CAPE COD, SOUTH WELLFLEET, MASS.

SINCE the illustration on page 53 of the Cape Cod Station was photographed the large poles carrying the aerial wires were blown down by a heavy gale, and an entirely new structure has been built. It consists of four braced wooden towers, each 215 feet high, their bases set in solid concrete. They are set in the form of a square about 200 feet apart. There are four horizontal supporting cables 3 inches in diameter fastened to the tops of the towers, for holding the aerial wires. At present there are fifty aerial wires on the north side which hang down, are drawn together and form the cable that enters the operating-room. An engine and dynamo are used to generate the electric power. It is stated that Marconi no longer uses a coherer, but has sub-

stituted a detector of much more reliability. The following diagram shows the method of hanging the aerial wires:

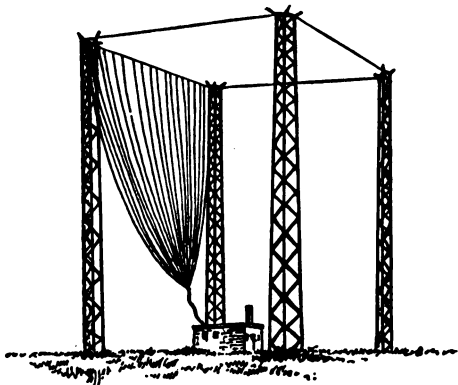
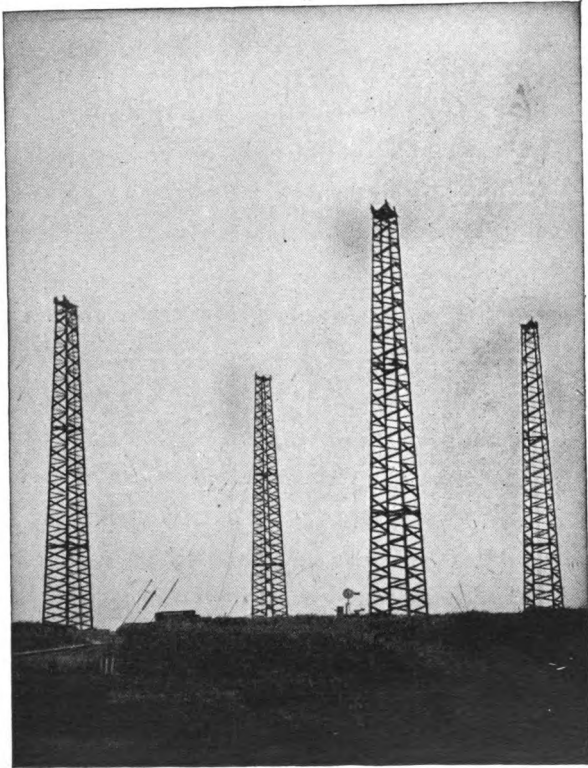

Fig. 17.

On January 19, 1903, Marconi succeeded in sending a wireless message from this station to the wireless station at Poldhu, in Cornwall, England. The message was from President Roosevelt to King Edward, and was as follows:

“His Majesty, King Edward VII, London, England. In taking advantage of the wonderful triumph of science, research and ingenuity which has been achieved in perfecting a system of wireless teleg-



**The Marconi Wireless Station at Cape Cod.**

raphy, I extend on behalf of the American people most cordial greetings and good wishes to you and to all people of the British Empire. THEODORE ROOSEVELT. Wellfleet, Mass., Jan. 19, 1903."

The above message was sent to the Table Head, Nova Scotia, Station, with instructions to forward by cable, but the Poldhu Station also received it and copied every word.

An illustration of the new tower and station at South Wellfleet, Cape Cod, Mass., is shown on page 85.

## APPENDIX B.

### THE STONE SELECTIVE SYSTEM.

THIS system is the invention of John S. Stone, and the inventor claims that he can send and receive wireless messages through space without interference from other systems or from electrical disturbances of any kind, and without interference with any other station than the one the message is intended for.

The sending station is located at present in Cambridge, a little to the left of Massachusetts avenue after crossing the Harvard bridge from Boston. It is a low rough building of frame covered with boards and tarred paper, merely a temporary makeshift, intended for experimental purposes only.

All about is the recently made land of the upper Back Bay, with a few solitary dwelling blocks near at hand. The placid Charles flows a pistol-shot away to the south. In the first experiments the

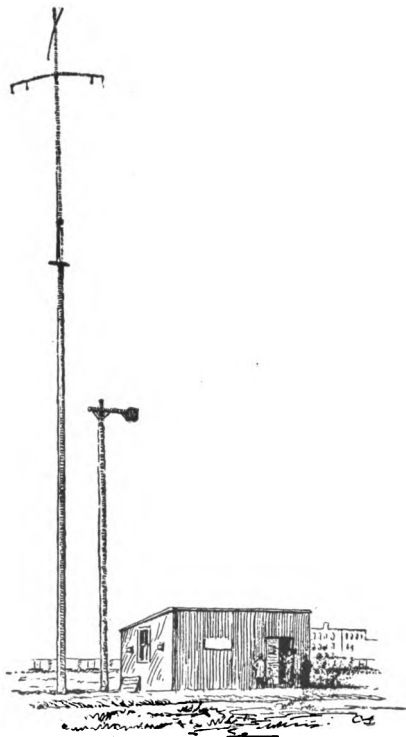

**The Sending Station at Cambridge.**

The vertical wires, from their fineness, are not shown.

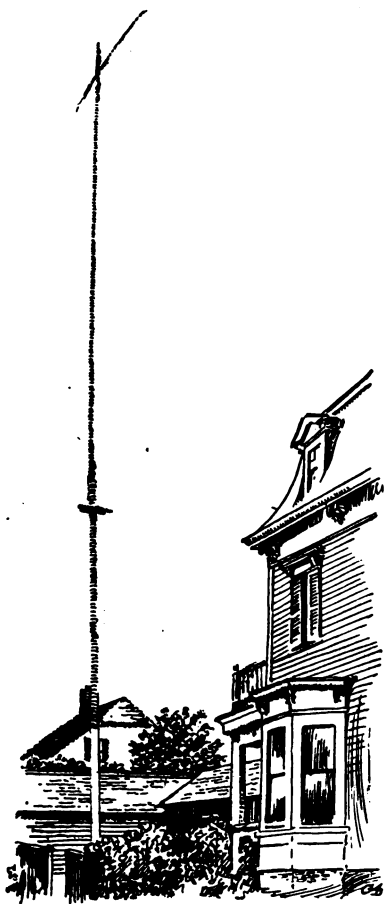

**The Receiving Station at Lynn.**

Located in the little house just back of the piazza.

electric waves had to cross Massachusetts avenue direct, thus giving the system as severe a test as it could have, as the trolley-cars pass along this avenue

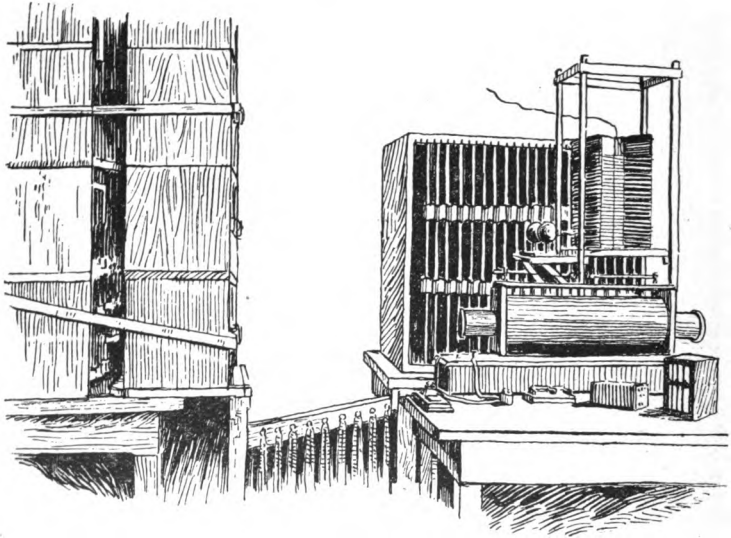

**The Sending Apparatus.**

as often as anywhere in Boston. The system stood the test. It was tried repeatedly, under varying conditions of the severest sort. Then it was deemed that the time had come to extend the distance, and Lynn was fixed upon because of the great center of



---

electrical activity presented at West Lynn by the General Electric Works, and the busy trolley lines of the Boston and Northern Street Railroad.

And here, just the depth of one house lot from the Broad street car line, was located the receiving station.

The distance between the two stations is twelve miles. Wireless messages have been sent between these stations with perfect accuracy, and the inventor pronounces the system a success.

#### THE RECEIVING APPARATUS.

On the central cross-shaped frame is the primary of the transformer, which is connected in series with the vertical wire. On each side of this is a coil which forms part of the resonant circuit in connection with the air condensers. In front is seen a telegraphic sounder which acts as an indicator, and a decoherer. The decoherer is a simple tripod of steel needles resting on the aluminum plate just to the right of the sounder. To the right is the relay, which is a modified Weston-d'Arsonval galvanometer. To the front of this relay is a battery and

a potentiometer for obtaining a suitable potential across the coherer. Across the relay is connected a condenser which thus practically short-circuits it for the high-frequency oscillations set up in the resonant circuit, thus eliminating the relay resistance. Back of the sounder is the battery for operating it, and back of that an electrolytic condenser which, in connection with a resistance, is used to prevent sparking at the relay terminals.

By pushing in or pulling out one of the glass condenser plates, the receiver can be put out or restored to tune. In front of the condenser boxes, on an ordinary table, is a telegraphic sounder and what is known as a coherer, this particular coherer being composed of three needles held in a piece of cork, like a tiny stool, the legs resting upon a plate of aluminum. There is also a relay and battery, with a potentiometer for obtaining a suitable potential across the coherer.

## THE SENDING APPARATUS.

In front is seen the step-up transformer or induction coil. In the present work a clockwork mechanism, not shown, makes connection with this coil every three seconds by closing a mercury switch. The mercury is at the bottom of the water column, and the hydrostatic pressure of the water forms a very effective brake. Back of this, and just above the coil, are the two balls forming the spark gap. To the right is seen the step-up transformer, the primary being formed of standard copper wire wound on a cross-shaped frame of wood. Above this is the secondary of bare wire wound in a similar way. To the rear is seen the air condenser. Alternate plates are connected together by a heavy copper band and brass clips. These plates are 34 inches square and are held in position by the slots in the inclosing box.

There are two sets of sending apparatus at Cambridge and two sets of receiving apparatus at Lynn. One set of sending and receiving apparatus was tuned together and might be termed line A. The

other set was tuned in like manner, forming line B. It was stated that during the period beginning at 4.05, signals would be sent over line A, line B being silent, and that during the other period signals would be sent over line B, line A being silent.

The above description and illustrations were kindly furnished to the author by the *Lynn Item*.

## APPENDIX C.

## SPACE TELEPHONY, FOR LONG DISTANCES.\*

ABOUT two decades ago Prof. Bell was enabled to telephone short distances over a beam of light, by means of a selenium cell which was located in the focus of a reflector. Recently, some most interesting experiments in long distance wireless telephoning have been carried out by Mr. Ernest Ruhmer, at his Physikalisches Laboratorium, at 248 Friedrichstrasse, in Berlin, Germany.

With the apparatus constructed at his laboratory, Mr. Ruhmer has been able to transmit speech over a beam of light for a distance of  $7\frac{1}{2}$  kilometers. The accompanying illustration shows some of the apparatus employed, including the selenium cells, reflectors, and other apparatus — the latest apparatus he has constructed for wireless telephoning includ-

\* From Bubier's "Popular Electrician," by F. C. Perkins.

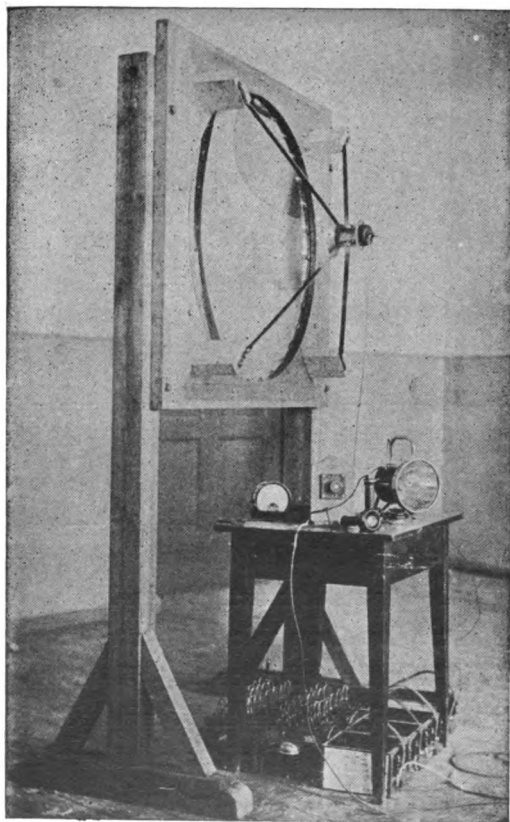

**Ruhmer's Beam of Light Wireless Apparatus.**

---

ing a flaming arc lamp, a selenium cell, a Shuckert parabolic reflector 32 centimeters in diameter, as well as a searchlight and set of storage-battery cells. The searchlight is provided with a parabolic mirror of 45 centimeters diameter. The storage battery used consists of a number of cells having a pressure of from 20 to 40 volts.

The arc lamp employed by Mr. Ruhmer operates at a pressure of 220 volts, the flaring arc having a total length of about 10 mm. The arc lamp is supplied with a current of from 10 to 15 amperes when the wireless telephoning is carried on at distances from four to seven and a half miles, while for short distances, up to 2 kilometers, a current of 5 amperes is sufficient, and up to 4 kilometers the current is increased to 10 amperes. The arc lamp and sending apparatus have been somewhat improved during this year over that employed at the Wamsee experiments of 1902. The arc lamp is arranged for operating at from 60 to 110 volts, with a current of 2 to 5 amperes, while the receiving apparatus used with the above sending apparatus has a parabolic reflector 45 centimeters in diameter, and from 10 to 30

cells of storage battery are used with a pressure of from 20 to 60 volts.

At the transmitting station a carbon transmitter is employed and a battery superimposing waves on the arc light circuit. The beam of light is received by the parabolic reflector several miles distant from the sending station, and a selenium cell which has a resistance of more than 100,000 ohms in the dark, and only several hundred ohms in sunlight, is located in the focus of the reflector. The accompanying illustration shows the receiving apparatus, which includes a battery and a couple of telephone receivers connected with the selenium cell. The selenium cell recently designed by Mr. Ruhmer is mounted in an incandescent lamp bulb, which has an Edison base, and may be easily screwed into a lamp socket. The three sizes of selenium cells of this type are 18 mm. in diameter, of cylindrical form, and measuring 50 mm., 25 mm., and 12.5 mm. in length. The resistance in the dark is about 20,000 ohms, while when illuminated by a 16 candle-power incandescent lamp the resistance decreases to about one-tenth of this amount. Special cells may also be obtained,



---

reducing the resistance by one hundred times when brought to the light.

At Wamsee, near Berlin, a most interesting series of experiments in long distance telephony was carried out by Mr. Ruhmer in 1902, the sending station being located on the electric launch "Germania." This storage-battery boat was equipped with a Shuckert searchlight, which was utilized for the speaking arc, while the receiving station was located at Wamsee, a distance of 7 kilometers.

The latest experiments, 1903, have shown that wireless telephony is entirely successful at a distance of 15 kilometers. The great receiving station employed for these successful experiments was equipped with a glass parabolic mirror of 90 cm. aperture. The double station for sending and receiving is equipped with a Shuckert searchlight of special construction, having an aperture of 35 cm.; also an accumulator battery and receiving apparatus for registering heliographic signs in Morse-form.

Mr. William J. Hammer, in his recent paper before the American Institute of Electrical Engineers and the American Electro-chemical Society, at New

York, gave some most interesting data on the properties and application of selenium. He states that the Swedish scientist, Berzelius, discovered selenium in 1817, as a by-product from the distillation of sulphuric acid from iron pyrites. He further states that "the proximity of the earth and moon suggested to Berzelius the name 'selenium,' after the Greek 'selene' (moon); this being the result also of the striking similarity of the properties of selenium with those of tellurium, which is a term derived from the Latin 'tellus' (earth). Its atomic weight is 79.5; specific gravity when crystalized, 4.788; its observed vapor, specific gravity at 2.588 degrees F., 5.68. It is a non-metallic element, which possesses characteristics similar to phosphorus, sulphur and tellurium. When melted at 212 degrees Centigrade and allowed to cool rapidly, it forms a brown amorphous mass of conchoidal fracture. In this condition it is a high class insulator. It has been said that a small piece of it would represent the resistance of a wire stretched from the earth to the sun. When heated for quite a time at a temperature of 100 degrees Centigrade, selenium becomes a conductor of electricity to a

---

limited degree, this increasing with an increase of current and varying according to the direction. Selenium has neither taste nor smell.

“The red vapor arising from selenium when subject to intense heat is exceedingly poisonous, and care should therefore be taken when experimenting with selenium in liquid form. Selenium is usually supplied commercially in a vitreous form.

“In order to obtain crystalline selenium, in which form it is useful for selenium cells, it must be kept, as already stated, at from 100 degrees to 200 degrees Centigrade for some time, the black mass being changed into a hard slate-colored metallic looking substance. In this form even the thinnest films are opaque to light, whereas in the vitreous form the film would be transparent and ruby red in color.

“In 1851 Hittori first discovered the effects of temperature on selenium, but it was not until February 12, 1873, that Mr. Willoughby Smith sent a communication to President Latimer Clark, of the Society of Telegraph Engineers of London, calling attention to the effect of light in reducing the re-

sistance of selenium. An assistant of Mr. Willoughby Smith, a Mr. May, who was a telegraph clerk at Valencia, called attention to the fact that some pencils of selenium, which had been used to give a high resistance in connection with some of the cable-testing work conducted by Mr. Willoughby Smith, showed a marked change in resistance when the silding cover of the box which held the selenium was removed, and the selenium was exposed to sunlight. These selenium pencils vary in length from 5 to 10 centimeters, and were 1 to  $1\frac{1}{2}$  mm. in diameter; they were hermetically sealed in glass tubes with connecting wires of platinum at each end. Little credence was given to the original announcement; and it was only after Earl Ross verified this statement, and proved that the action was due solely to light, and showed the effects of the light of different portions of the spectrum, that it met with serious consideration. Since that time much work has been done in investigating the properties of selenium, especially by Messrs. Sheldford Bidwell, J. W. Giltay, Lord Ross and Sale, Draper and Moss Hittori, Adams and Day, Ayrton

---

and Perry, Sir W. C. Siemens, Mercadier Fritts, Minchin, Ruhmer, Webb, Bell and Taintor, and many others."

Mr. Hammer also gives a most interesting description of the use of the Ruhmer selenium cell in connection with the Photographophone, which is an instrument for recording speech on a moving film, and it is said may be employed as a receiving instrument with the wireless telephone system in which a beam of light is employed. He also gives data in reference to a Pintsch gas buoy which is controlled by a Ruhmer selenium cell. As these buoys are to be available only at night, it is desirable that the gas be turned off during the day time, which allows one charge of compressed gas to last from several months to a year. An electric switching device is arranged in series with the selenium cells so as to turn on the gas as soon as the sun rises in the morning, and turn it off at night time, this being accomplished by the greatly reduced resistance of the selenium cell during the day-time and its increased resistance during the night, a single dry battery and a pair of solenoids or magnets only

being necessary to operate the valve when properly controlled by the selenium cell. Mr. Hammer states that a number of these buoys have been in operation near Hamburg, Berlin, and in the Baltic Sea, for a number of months, with great success, turning on the light every morning, and turning it off at night, with perfect reliability.

## APPENDIX D.

GUARINI'S WIRELESS FIRE-ALARM  
SYSTEM.\*

A PRACTICAL fire-alarm system is claimed to have been developed by Mr. Emile Guarini, of Brussels, Belgium, in which he utilizes his system of wireless telegraphy. The accompanying diagram shows the apparatus which he employs at the transmitting as well as the receiving station. In Mr. Guarini's fire-alarm system he employs a mercury thermometer as indicated at 1, 2, in the diagram, which has a platinum contact, 3, connected with a battery, and a circuit through an electro-magnet, 6. The armature of this electro-magnet, 7, is arranged to release a toothed wheel, 10, which revolves, producing a series of makes and breaks on a contact piece, which is connected with a battery, 12, and a primary winding of an induction coil. The secondary or high

\* D. C. Perkins, in Bubier's "Popular Electrician."

tension winding of the induction coil, 15, is connected with the ground, 16, and with its antenna, 14. At the receiving station, the receiving antenna, 20,

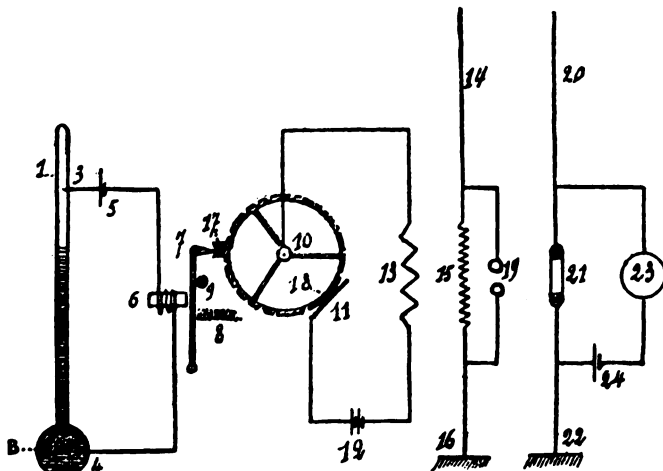

Guarini's Connections of his Wireless Fire-Alarm System.

is connected with a coherer, 21, which is in turn connected in series with a battery, 24, and a registering Morse apparatus, 23. This apparatus has been thoroughly tested by Mr. Guarini, and is said to have given excellent satisfaction. The receiving apparatus is located at the engine-house, and the



transmitting apparatus is located in the various buildings which are to be protected by the fire-alarm system.

This wireless fire-alarm system operates as follows: When the heat from the fire is sufficient to cause the mercury in the thermometer to rise to the platinum wire, 3, which corresponds to a temperature of 40 degrees Reaumer, the circuit through the battery, 5, and electro-magnet, 6, is closed, and the armature, 7, of this electro-magnet is attracted, thus releasing the toothed wheel, 10, which is made to revolve by means of a spring, weight, or other motive power. As the wheel revolves, it causes a series of makes and breaks to be made at the contact piece, 11, which is in series with the battery and primary coil, 13, of the induction coil. Electrical impulses are thus produced, and are transmitted by the antenna, 14, and are received by the antenna, 20, at the receiving station in the engine-house. These electrical impulses, when they excite the coherer, cause the Morse register to give the desired message, at the same time an electric gong calls the attention of the firemen in the engine-house, while an incan-

---

descent lamp is also lighted at the same time as the alarm is sounded. This apparatus is said to have given excellent service, and is very simple to install. Mr. Guarini even suggests that a receiving equipment might be mounted upon the engine and truck, and signals be given even while the engines are on the way to the fire.

Considerable criticism of this system of wireless fire-alarm has been presented in the English technical journals by different engineers, taking the ground that the signals might be interfered with by the wireless telegraph stations in the towns. One writer from Glasgow, Geo. H. Oatway, among other things says in the London *Electrical Engineer*: "If it is possible, and this is proven, to interpolate 'rats' in a wireless message, what guarantee is there that the presence of an extra dash or dot from some other system, or a jumble of complete messages, may not confuse the brigade?"

---

## APPENDIX E.

### ADDITIONAL INFORMATION.

#### THE SPEAKING ARC.

IN these columns various accounts have been given of the highly interesting experiments made with the speaking arc, which have resulted in a form of "wireless telephony" that may very probably be brought to the point of practical application in certain exceptional situations, where expense is no object. The latest experiments with arc-light telephony were carried out in Germany, and now two Russian investigators have found that an ordinary flame can be made to talk. These two gentlemen, rejoicing in the names of Gabritschewsei and Batschinski (it is to be hoped they made the flames say their own names), experimented with flames of various kinds, such as those produced by a Bunsen burner, a kerosene lamp and a candle, and made each one of them speak. From the two terminals

---

of the secondary of an induction coil short leads were taken to insulated Bunsen burners, kerosene lamps, or to short candle ends. A battery and transmitter, capable of taking currents up to four amperes, were connected to the primary of the induction coil. A distance of about thirty yards separated the transmitter from the flame. In the experiments each of the flames gave an excellent rendering of singing, whistling and even speech. In these experiments it will be noticed that the flame is the receiver, not the transmitter or translator, as in the Ruhmer experiments. The essential conditions for success are to have sufficiently great changes of potential at the flame electrodes. Two flames, one connected to each terminal of the induction coil and the two connected together by a third wire, make an arrangement that gave the loudest results. — *American Telephone Journal.*

#### USING A TELEPHONE AS A RECEIVER.

This may be done as shown in figure 20. A is the coherer; B is the battery; C is the telephone; D is the aerial wire, and E is the ground wire. F, F

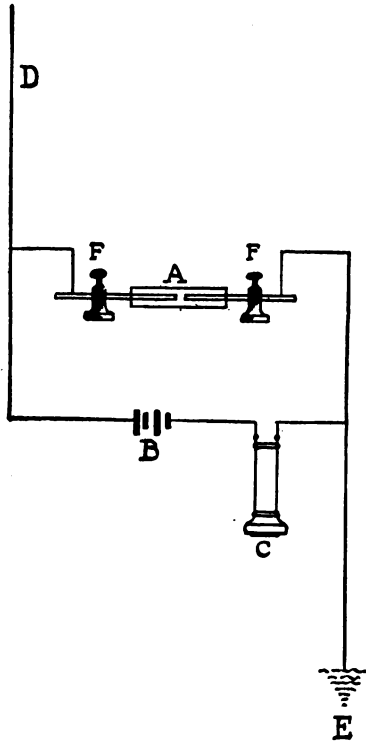

Fig. 20.

are the binding posts which hold the brass rods of the coherer.

The carbon coherer is made just the same as the one described on page 32, Fig. 9, only the nickel and silver filings are replaced by medium coarse carbon particles. No decoherer is needed, as the carbon particles decohere themselves when not being impinged upon by the Hertzian waves. The telephone is a very sensitive instrument, and gives audible sounds in response to the slightest change of resistance in the circuit, so that you may get a long buzzing or a short buzzing sound, depending upon the length of the wave effecting it. In this way the alphabet may be tapped out at the sending station and heard in the telephone when the waves were too weak to work a relay and sounder.

#### THE GUARINI AUTOMATIC REPEATER.\*

This is an apparatus which is designed to pick up a message received at one station and pass it on to a second. An aerial wire at the repeating station is connected through the contact of a relay and through

\* *Nature*, London.

---

the primary of a transformer to earth. It is also connected through a spark gap to earth. The coherer is connected in series with the secondary of the transformer and a condenser. When the signal is received, the resistance of the coherer is broken down and a battery sends a current through it and a second relay, which closes a circuit actuating the first relay. The effect of this is to disconnect this latter relay from the aerial wire and connect it to a circuit containing a series of batteries and the secondary of a transformer. The primary of this transformer is connected in a circuit containing a spark gap and a condenser. This causes a spark to pass across the gap and sends the message on.

THE PHELPS, EDISON AND SMITH SYSTEMS OF  
WIRELESS TELEGRAPHY.

In 1884 a system of wireless telegraphy, invented by L. G. Phelps, was put in operation on the branch road of the New York, New Haven & Hartford Railroad running from Mott Haven, N. Y., to New Rochelle, N. Y. This was an experimental line, and operated as follows:

A No. 12 copper wire was put in a wooden trough, 2 inches by 2 inches, and laid between the rails and nailed to the tires. The baggage-car was wound with a coil of wire, beginning at the roof and run underneath the car down to within about two feet of the main wire on the track.

The ordinary Morse system was used, and to the circuit in the baggage-car was connected a polarized relay. A pole-changing key was used to transmit the signals from the line station, and the message was received on the baggage-car by having an ordinary Morse sounder in the local of the relay. To receive messages at the station, however, a rhotome was used on the baggage-car, connected with the main circuit. The rhotome was of a very high pitch and induced the signals in the main line wire, and the message was received at the Mott Haven Station by means of a telephone in the main line circuit.

The system was afterward changed by having a rhotome put in circuit with the main line, and messages were induced in the helix on the baggage-car and received there by means of a



---

telephone. The system was subsequently transferred to the Lehigh Valley Railroad, with the main office at Flemington, N. J. There the ordinary line telegraph wire was used, and all of the telegraph keys in local stations along the Lehigh Valley were shunted with condensers.

In this case a rhotome or vibrator was used, which was placed in the primary of an induction coil and the secondary connected East and West with the main line.

The cars were also wound with helixes of wires, which were afterward discarded, and the tin roofs of the cars were connected. The latter plan was invented by W. Smith and Thomas A. Edison.

In the use of this system, all of the wire fences running parallel to the Lehigh Valley Road, in some cases three and four miles away, were statically charged, and if a telephone was held near them at right angles, or a line connected with them to ground the main line, messages could be read. The latter plan was used for some time, but owing to the wire running over mountains and down valleys, it was decided to build a special pole line for

the system, which was done, and during the blizzard of 1888 all of the Lehigh Valley Railroad regular trains and wreck trains on the New Jersey division were equipped with the system, and it worked perfectly. The system was abandoned because the stations were so close together, and having a block system in use on the road the necessity for it did not exist.

Experiments were made on Long Island Sound by Mr. Phelps to telegraph to boats and also for telephoning to boats, but without practical results.

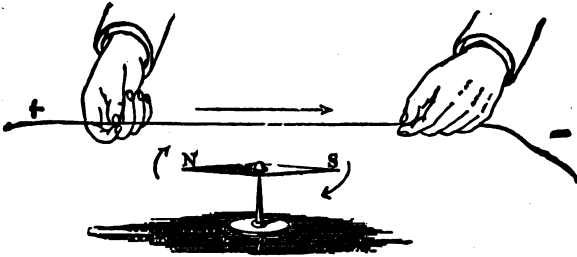

# BUBIER'S Popular Electrician.

---

**A SCIENTIFIC ILLUSTRATED MONTHLY**

**For the Amateur and Public at Large.**

Containing descriptions of all the new inventions as fast as they are patented; also lists of patents filed each month at the Patent Office in Washington, D. C. Interesting articles by popular writers upon scientific subjects written in a way that the merest beginner in science can understand. Also a Question and Answer Column free to all subscribers.

**Price, Postpaid, 50c. a Year.**

**SAMPLE COPY FIVE CENTS.**

 **Send for it. You will be more than pleased.**

**Bubier Publishing Co., Lynn, Mass.**

# A NEW BOOK!

BY EDWARD TREVERT.

AUTHOR OF { Everybody's Hand-Book of Electricity.  
How to Make Electric Batteries at Home.  
Experimental Electricity.  
Dynamos and Electric Motors.

## **"Electricity and its Recent Applications."**

---

Containing nearly 350 pages and about 250 Illus.

This work is printed on extra fine heavy paper, is bound in neat cloth binding, and lettered in gold. It is particularly adapted to the use of Students.

### — CONTENTS. —

- CHAP. 1.—Electricity and Magnetism.
- CHAP. 2.—Voltaic Batteries.
- CHAP. 3.—Dynamos, and How to Build One.
- CHAP. 4.—The Electric Arc, and The Arc Lamp.
- CHAP. 5.—Electric Motors and How to Build One.
- CHAP. 6.—Field Magnets.
- CHAP. 7.—Armatures.
- CHAP. 8.—The Telegraph and Telephone.
- CHAP. 9.—Electric Bells.—How Made, How Used.
- CHAP. 10.—How to Make an Induction Coil.
- CHAP. 11.—The Incandescent Lamp.
- CHAP. 12.—Electrical Mining Apparatus.
- CHAP. 13.—The Modern Electric Railway.
- CHAP. 14.—Electric Welding.
- CHAP. 15.—Some Miscellaneous Electric Inventions of the Present Day.
- CHAP. 16.—Electro-Plating.
- CHAP. 17.—Electric Gas Lighting Apparatus.
- CHAP. 18.—Electrical Measurement.
- CHAP. 19.—Resistance and Weight Table for Cotton and Silk Covered and Bare Copper Wire.
- CHAP. 20.—Illustrated Dictionary of Electrical Terms and Phrases.

---

PRICE \$2.00.

---

**BUBIER PUBLISHING CO., Lynn, Mass.**

*Only 10 Cents.*

*Only 10 Cents.*

---

**PRACTICAL BOOKS**  
ON  
**ELECTRICITY**

---

- No. 1. How to make a Dynamo.
  - No. 2. How to make a Telephone.
  - No. 3. How to make an Electric Motor.
  - No. 4. How to make a Storage Battery.
  - No. 5. How to make a Winshurst Electric Machine.
  - No. 6. How to make a Magneto Machine.
  - No. 7. How to make a Medical Induction Coil.
  - No. 8. How to make a Pocket Accumulator.
  - No. 9. How to make a Plunge Battery.
  - No. 10. How to make a Voltmeter.
  - No. 11. How to make a Galvanometer.
  - No. 12. How to make a Hand Dynamo.
  - No. 13. How to make a Talking Machine.
  - No. 14. How to make a  $\frac{1}{2}$  H. P. Dynamo or Motor.
  - No. 15. How to make a Toy Motor.
  - No. 16. How to make an Electric Bell.
  - No. 17. How to make a Telegraph Instrument.
  - No. 18. How to Wind Armatures.
  - No. 19. How to Wind Field Magnets.
  - No. 20. How to make an Ammeter.
- 

**These books are illustrated and the price is only**

**10 CENTS EACH.**

**BUBIER PUBLISHING CO.,**

**P. O. Box 709, LYNN, MASS.**

# THE LATEST AND BEST Electrical Books

For Amateurs and Students.

## TREVERT'S WORKS.

	PRICE
Experimental Electricity . . . . .	\$1.00
Everybody's Hand Book of Electricity, . . . . .	.50
Paper Edition, 25 Cents.	
How to Make Electric Batteries at Home, . . . . .	.25
Dynamos and Electric Motors and all about them, . . . . .	.50
Armature and Field Magnet Winding, . . . . .	1.50
How to Make a Dynamo, . . . . .	.10
Electric Railway Engineering, . . . . .	2.00
Electricity and its Recent Applications, . . . . .	2.00
A Practical Treatise on Electro Plating, . . . . .	.50
How to Make and Use Induction Coils, . . . . .	.50
Electric Bell Fitting and Electric Gas Lighting- Hand Book, . . . . .	.50
Electrical Measurements for Amateurs, . . . . .	1.00
How to Build Dynamo Electric Machinery, . . . . .	2 50

## Miscellaneous Authors.

Questions and Answers about Electricity, . . . . .	.50
Edited by E. T. Bubier 2d.	
A Hand Book of Wiring Tables, A. E. Watson . . . . .	.75
A Practical Treatise on the Incandescent Lamp, . . . . .	.50
J. E. Randall.	
Electric Motor Construction, for Amateurs, . . . . .	1.00
C. D. Parkhurst.	
How to Make a 1-horse Power Motor or Dynamo, . . . . .	.50
A. E. Watson, Paper Edition, 25 Cents.	
A Practical Hand-book of Modern Photography for Amateurs, E. T. Bubier 2d. . . . .	.50
Arithmetic of Magnetism and Electricity, . . . . .	1.00
John T. Morrow and Thorburn Reid.	
How to Make and Use a Telephone, George H. Cary . . . . .	1.00
Transformers; their Theory, Construction and Application Simplified, by Caryl D. Haskins . . . . .	1.25
What is Electricity, Elihu Thomson . . . . .	.25

## Bubier Publishing Co.,

Send money by P. O. Order or Registered Letter at our risk:







**SPECIAL**  
**COLLECTIONS**

89060666062



b89060666062a