

The Principles Underlying Radio Communication



RADIO PAMPHLET No. 40

December 10, 1918

Signal Corps, U. S. Army



Washington : Government Printing Office : 1919

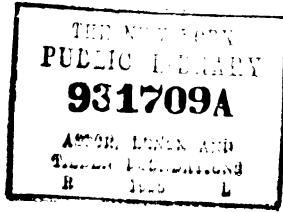

War Department
Office of the Chief Signal Officer

RECEIVED
JUL 1925
WAR DEPT

THE PRINCIPLES UNDERLYING RADIO COMMUNICATION.

Prepared by the Bureau of Standards under the direction of the Office of the Chief Signal Officer of the Army, Training Section.

Acknowledgment is made of the valuable service rendered the Signal Corps by the Bureau of Standards through the work of Dr. J. H. Dellinger and the following men engaged with him in the writing of this book:

Dr. F. W. Grover.

Prof. C. M. Smith.

Prof. G. F. Wittig.

Dr. A. D. Cole.

Dr. L. P. Wheeler.

Prof. H. M. Royal.

ADDITIONAL COPIES
OF THIS PUBLICATION MAY BE PROCURED FROM
THE SUPERINTENDENT OF DOCUMENTS
GOVERNMENT PRINTING OFFICE
WASHINGTON, D. C.
AT
55 CENTS PER COPY



PREFACE.

In this book are presented briefly the basic facts and principles of electromagnetism and their application to radio communication. In the effort to present these topics in a simple manner for students with very little mathematical preparation, it has been necessary at times to use definitions, illustrations, and analogies which would not be used in a work prepared for more advanced students. Frequent references to standard books are given for further study, and students should be encouraged, as far as possible, to consult them.

TABLE OF CONTENTS.

INTRODUCTION.

	Page.
1. What radio communication means	15
2. Fundamental ideas of electric circuits	16

Chapter 1. Elementary Electricity.

A. ELECTRIC CURRENT.

3. Effects of electric current	23
4. Magnitude and direction of current	24
5. Measurement of electric current and quantity of electricity	25
6. Electrons	26

B. RESISTANCE AND RESISTIVITY.

7. Resistance and conductance	27
8. Resistivity and conductivity	28
9. Temperature coefficient	30
10. Current control	31
11. Conducting materials	32
12. Non-conducting or insulating materials	34

C. POTENTIAL DIFFERENCE, EMF., AND OHM'S LAW.

13. The meaning of emf	36
14. Ohm's law	38
15. Sources of emf	42
16. Internal voltage drop and line drop	46

D. BATTERIES.

17. Kinds of cells	49
18. Simple primary cell	49
19. Types of primary cells	51
20. Dry cells	52
21. Storage cells	53
22. Internal resistance in batteries	59

E. ELECTRIC CIRCUITS.

	Page.
23. Current flow requires a complete circuit.....	60
24. Series and parallel connections.....	61
25. Divided circuits. The shunt law.....	66
26. The potentiometer.....	67
27. The Wheatstone bridge.....	69
28. Heat and power losses.....	70

F. CAPACITANCE.

29. Dielectric current.....	71
30. Condensers.....	72
31. Dielectric properties.....	74
32. Types of condensers.....	76
33. Electric field intensity.....	77
34. Energy stored in a condenser.....	78
35. Condensers in series and in parallel.....	79

G. MAGNETISM.

36. Natural magnets.....	81
37. Bar magnets.....	81
38. The magnetic field.....	82
39. Magnetic flux and flux density.....	83
40. The magnetic field about a current.....	84
41. The solenoid and the electromagnet.....	84
42. Magnetic induction and permeability.....	85
43. The force on a current in a magnetic field.....	86

H. INDUCTANCE.

44. The linking of circuits with lines of magnetic flux.....	87
45. Induced electromotive force.....	88
46. Self inductance.....	90
47. Mutual inductance.....	91
48. Energy relations in inductive circuits.....	92

I. ALTERNATING CURRENT.

49. Reactance.....	93
50. Nature of an alternating current.....	93
51. Average and effective values of alternating current.....	95
52. Circuit with resistance only.....	97
53. Phase and phase angle.....	97
54. Alternating current in a circuit containing inductance only.....	98

	Page.
55. Circuit containing inductance and resistance.....	100
56. Charging of a condenser in an alternating current circuit.	102
57. Circuit containing capacitance, inductance, and resistance.....	104
58. The alternating current transformer.....	105

J. MEASURING INSTRUMENTS.

59. Hot wire instruments	106
60. Magnetic instruments	108

Chapter 2. Dynamo-Electric Machinery.

61. Generators and motors.....	115
--------------------------------	-----

A. THE ALTERNATOR.

62. Production of emf. by revolving field.....	115
63. Direction of emf.....	117
64. Emf. curve.....	117
65. Cycle, period, frequency.....	117
66. Multipolar magnets.....	118
67. Field and armature.....	118
68. Coil-wound armature.....	119
69. Concentrated and distributed windings.....	121
70. Magnetic circuit.....	121
71. Field excitation.....	124
72. Stator and rotor.....	125
73. Arrangement of parts.....	125
74. Other forms of alternator.....	125
75. Polyphase alternator.....	128

B. ALTERNATOR THEORY, LOSSES, ETC.

76. Equations for frequency and emf.....	132
77. Dependence of driving power on current.....	131
78. Losses.....	133
79. Rating. Name plate data.....	135
80. Efficiency.....	136
81. Regulation.....	136
82. Armature impedance and armature reaction.....	137
83. Effect of power factor on regulation.....	137
84. Effect of speed on regulation.....	138
85. Voltage control.....	138

C. DIRECT CURRENT GENERATORS.

	Page.
86. Commutation	138
87. Ring and drum winding.....	141
88. Separate excitation, series, shunt, compound.....	144
89. Characteristics of terminal voltage.....	146
90. Emf. equation.....	148
91. Voltage control.....	149
92. Effect of varying speed.....	149

D. SPECIAL ALTERNATORS FOR RADIO USES.

93. Audio frequency and radio frequency.....	149
94. Audio frequency generators.....	150
95. Radio frequency generators.....	161

E. MOTORS.

96. Uses of d. c. and a. c. motors	164
97. D.c. shunt motor	164
98. D.c. series motor.....	172
99. Other d.c. motors.....	173
100. Combination a.c. and d.c. motors.....	173
101. Induction motors.....	173

F. MOTOR-GENERATORS AND DYNAMOTORS.

102. Motor-generators.....	175
103. Rotary converters.....	177
104. Dynamotors.....	177
105. Double current generators.....	178
106. Common troubles.....	179

Chapter 3. Radio Circuits.

A. SIMPLE RADIO CIRCUITS.

107. The simplicity of radio theory.....	182
108. The simple series circuit.....	183
109. Series resonance.....	185
110. Tuning the circuit to resonance.....	190
111. Resonance curves.....	191
112. The wavemeter	193
113. Parallel resonance.....	195
114. Capacitance of inductance coils.....	199

TABLE OF CONTENTS.

11

B. DAMPING.

	Page.
115. Free oscillations.....	200
116. Frequency, damping, and decrement.....	205

C. RESISTANCE.

117. Resistance ratio of conductors.....	208
118. Brush, spark, dielectric, and radiation resistance.....	211

D. COUPLED CIRCUITS.

119. Kinds of coupling.....	212
120. Double hump resonance curve.....	214
121. Forced oscillations.....	216
122. Free oscillations of coupled circuits with small damping.....	218
123. Impulse excitation. Quenched gap.....	221

Chapter 4. Electromagnetic Waves.

A. WAVE MOTION.

124. Three ways of transmitting energy.....	223
125. Properties of wave motion.....	223
126. Wave trains, continuous and discontinuous.....	224

B. PROPAGATION OF WAVES.

127. Waves propagated by elastic properties of medium.....	225
128. Properties of electromagnetic waves.....	225
129. Modification of waves in free space near earth.....	226
130. Static.....	228

C. THEORY OF PRODUCTION AND RECEPTION OF ELECTROMAGNETIC WAVES.

131. Magnetic field produced by moving lines of electric displacement.....	229
132. Mechanism of radiation from a simple oscillator.....	230
133. Action in receiving.....	232

D. TRANSMISSION FORMULAS.

134. Statement of formulas.....	234
135. Examples of use.....	235
136. General deductions.....	235

E. DEVICE FOR RADIATING AND RECEIVING WAVES.

	Page.
137. Description of the antenna.....	236
138. Different types.....	238
139. Current and voltage distribution in an antenna.....	239
140. Action of the ground. Counterpoises.....	240

F. ANTENNA CHARACTERISTICS.

141. Capacitance.....	242
142. Inductance.....	243
143. Resistance.....	243
144. Wave length and its measurement.....	244
145. Harmonics of wave length.....	246
146. Directional effect.....	246

G. ANTENNA CONSTRUCTION.

147. Towers and supports.....	247
148. Insulators.....	247
149. Antenna switch. Conductors.....	248
150. Grounds and counterpoises.....	249

H. CLOSED COIL AERIALS.

151. Directional curve.....	250
152. Constants of closed coil aerials.....	251

Chapter 5. Apparatus for Transmission and Reception (Exclusive of Vacuum Tubes).

A. APPARATUS FOR DAMPED WAVE TRANSMISSION.

153. Function of transmitting apparatus.....	254
154. Simple spark discharge apparatus.....	254
155. Transmitting condensers.....	257
156. Spark gaps.....	257
157. Simple induction coil set.....	262
158. Operation of induction coils from power lines.....	263
159. Portable transmitting sets.....	264
160. Simple connections for the production of electric waves.....	265
161. Inductively coupled transmitting set.....	268
162. Direct coupled transmitting set.....	270
163. Comparison of coupled and plain antenna sets.....	271
164. Tuning and resonance.....	272

	Page.
165. Coupling.....	272
166. Damping and decrement.....	274
167. Additional appliances.....	275
168. Adjustment of a typical set for sharp wave and radiation.....	277
169. Efficiency of the set.....	278
170. Calculations required in design.....	278
171. Simple field measurements.....	283

B. APPARATUS FOR UNDAMPED WAVE TRANSMISSION.

172. Advantages of undamped oscillations.....	287
173. Use of high frequency alternators.....	287
174. Arc sets.....	288
175. Calibration and adjustment of sets.....	290

C. APPARATUS FOR RECEPTION OF WAVES.

176. General principles.....	290
177. Typical circuits for reception of damped waves.....	293
178. Typical circuits for reception of undamped waves.....	299
179. Crystal detectors.....	302
180. Telephone receivers.....	305
181. Receiving coils and condensers.....	306
182. Measurement of received current.....	310

Chapter 6. Vacuum Tubes in Radio Communication.

183. Introduction.....	311
------------------------	-----

A. ELECTRON FLOW IN VACUUM TUBES.

184. Current in a two-electrode tube.....	311
185. Actual forms of two-electrode tubes.....	314
186. The three-electrode tube.....	315
187. Effect of grid.....	317
188. Characteristic curve.....	317
189. Effect of an alternating emf. applied to grid.....	319
190. Practical forms of three-electrode tubes.....	320

B. THE VACUUM TUBE AS A DETECTOR.

191. Simple detector circuit and explanation of its action....	322
192. Effect of incoming signals upon the plate current.....	325

C. THE VACUUM TUBE AS AN AMPLIFIER.		Page.
193. General principle.....		326
194. Elementary theory of amplification.....		328
195. Audio frequency amplification.....		330
196. Regenerative amplification.....		330
197. Vacuum tube amplifier with crystal detector.....		331
D. THE VACUUM TUBE AS A GENERATOR.		
198. Conditions for oscillation.....		332
199. Practical considerations in using vacuum tubes as oscillation generators.....		334
200. Tubes suitable for developing considerable power.....		335
201. Heterodyne and autodyne receiving by vacuum tubes..		336
E. RADIO TELEPHONY.		
202. Voice modulation of radio currents by vacuum tubes..		337
203. Other methods of voice modulation.....		339
204. Practical use of vacuum tubes in radio telephony.....		339
Appendices.		
APPENDIX 1. SUGGESTED LIST OF LABORATORY EXPERIMENTS.		342
APPENDIX 2. UNITS		350
APPENDIX 3. SYMBOLS		354

INTRODUCTION.

1. **What Radio Communication Means.**—In military service all possible means of communication are used, including the most primitive. However, the best and most rapid are the electrical methods. These include the ordinary wire telegraph and telephone and the wireless or radio apparatus. Without wire connecting lines, radio messages are sent from one point to another on the battle front, from ship to shore, across the oceans, to airplanes, and even to submerged submarines.

When a pebble is thrown into the smooth water of a pond it starts a series of circular ripples or waves, which spread out indefinitely with a speed of a few hundredths of a meter¹ per second. Similarly, an electric disturbance starts electric waves, which spread out in all directions, and travel with the velocity of light, or 300,000,000 meters per second. It is by means of these electric waves that radio messages are sent.

In order to make use of electric waves for the practical purpose of sending messages, it is necessary—

(a) To produce regular electric disturbances in a circuit which start the waves. (These disturbances are electric currents which reverse rapidly in direction.)

(b) To get the waves out into surrounding space, through which they travel with great speed. (This is done by means of the transmitting antenna.)

(c) By means of these waves, to set up electric currents in a receiving circuit at the distant station. (The device which these waves strike as they come in, and which turns them over to the receiving circuit, is called the receiving antenna.)

(d) To change these currents so that they may be detected by electric instruments. (The operator usually receives the message through signals in a telephone receiver.)

The student of radio communication needs a more thorough knowledge of electrical theory than that needed for some branches

¹The meter and other units are explained in Appendix 2, p. 350.

of electrical work. This fact needs emphasis for the beginner. Of course a man can learn to operate and care for apparatus without having a real understanding of its underlying principles. It only requires that he have a certain type of memory, industry, and a little common sense. But a man with only this kind of knowledge of his subject is of limited usefulness and resourcefulness, and can not advance very far. The real radio man must have some training in the whole subject of electricity and magnetism, as well as a rather intimate familiarity with some restricted parts of it. An understanding of radio communication requires some knowledge of the following subjects:

- (a) Direct and alternating currents and dynamo machinery.
- (b) High frequency alternating currents, including the subject of condenser discharge.
- (c) Conduction of electric current in a vacuum as well as in wires.
- (d) Electric waves, which involves some acquaintance with modern ideas of electricity and the ether.
- (e) The apparatus used for the production and reception of electric waves.

2. Fundamental Ideas of the Electric Circuit.—It is common knowledge that a battery supplies what is known as a current of electricity. To obtain the current there must be a complete closed, conducting path from the battery through the apparatus which is to be acted on by the current, and back again to the battery.

For example, when connecting up an electric bell, a wire is carried from one binding post of the battery (Fig. 1) to one of the binding posts of the bell, and a second wire is brought from the other binding post of the bell back to the remaining binding post of the battery. Any break in the wire immediately causes the current to stop and the bell to be silent. This furnishes an easy method of controlling the ringing of the bell, since it is only necessary to break the circuit at one point to stop the current, or to connect across the gap with a piece of metal to start the current going again. Thus we have the button for accomplishing the act of control, and the battery supplies the energy required to ring the bell.

Similar considerations apply when we are using the city lighting circuit. Wires are brought, more or less directly, from the lighting station to the lamp, and a small break in the path through the socket is provided. This can be bridged by a metal spring actuated by the key. Or the opening and closing of the circuit can be accom-

plished by a similar mechanism in the wall of the room, or by a knife switch (Fig. 2) in a small cupboard.

Sometimes the lamps suddenly go out, and we say that a fuse has been blown. A short length of wire, through which the current has been passing, is of an easily fusible metal which has melted away because too strong a current has been passing. Or it may be that it has become necessary to open a switch at the power house. It makes absolutely no difference where the break is made in the circuit, the result is the same; the current suddenly stops. Electricity must, then, be regarded as flowing in every part of the circuit,

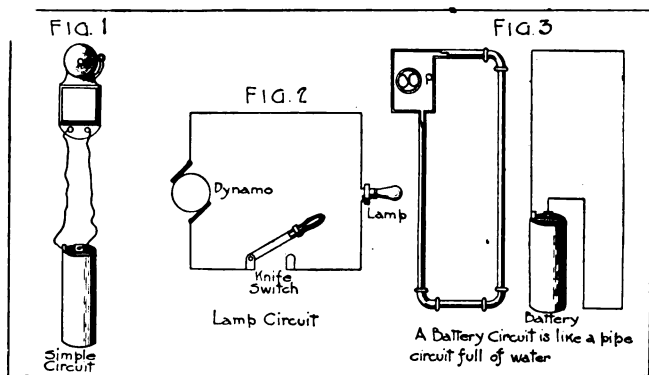

so that electricity is leaving the battery or dynamo at one side, and coming back to it at the other side.

Current.—The current flowing in a circuit is no stronger at one point of the circuit than at another. This can be proved by connecting a measuring instrument called an ammeter into the circuit at different points, *a*, *b*, or *c*, Fig. 2. It is found to register the same at whatever point this test is made. A useful illustration of the electric circuit is a closed circuit of pipe (Fig. 3) completely filled with water, and provided with a pump, *P*, or some other device for causing the water to circulate. The amount of water which leaves a given point in each second is just the same as the amount which arrives in the same length of time. Now in the electric circuit we have no material fluid, but we suppose that there

exists a substance, which we call electricity. Electricity behaves in the electric circuit much like an incompressible fluid in a pipe line. We are very sure that electricity is not like any material substance which we know, but the common practice among students and shop men of calling it "juice" shows that they think of it as like a fluid. We will, then, imagine the electric current to be a stream of electricity flowing around the circuit.

One way of measuring the rapidity with which water is flowing is to let it pass through a meter which registers the total number of quarts or gallons which pass through. By dividing the quantity by the time it has taken to pass we obtain the rapidity of flow. There are instruments by means of which it is possible to measure the total quantity of electricity which passes any point in the circuit during a certain time. If we divide this quantity by the time, we obtain the amount of electricity which has passed in one second. This is a measure of the current strength.

In practical work, however, the strength of the current is measured by instruments (ammeters) which show at each moment just how strong the current is, in somewhat the same manner as we may estimate the swiftness of a stream by watching a chip on the surface. This kind of an instrument enables us to tell at a glance what the current is without the necessity for a long experiment, and further we may detect changes in the strength of the current from moment to moment. In this connection it will be remembered that two measuring instruments are to be found on an automobile. The speedometer shows what the speed of the car is at each moment, so that the driver may know instantly whether he is exceeding the speed limit, and govern himself as he sees fit. The other instrument shows how many miles have been covered on the trip, and of course the average speed may be calculated from its indications, if the length of the trip has been timed. The instrument for measuring total quantity of electricity corresponds to the recorder of the total miles traversed; the ammeter corresponds to the speedometer.

Electromotive Force.—The water will not flow in the pipe line, Fig. 3, unless there is some force pushing it along, as, for example, a pump, and it cannot be kept flowing without continuing the pressure. Electricity will not flow in a circuit unless there is a battery or other source of electricity in the circuit. The battery is for the purpose of providing an electric pressure. To this is given the name "electromotive force"—that is, a force which moves the electricity.

This is usually abbreviated to "emf." The larger the number of cells which are joined in the circuit the greater the electric pressure and the larger the current produced, just as the rapidity of flow of the water in the pipe line may be increased by increasing the pump pressure.

Resistance.—There is always some friction in pipe, whatever its size or material, and this hinders the flow of the water to some extent. If it were not for the friction, the water would increase indefinitely in speed. Similarly, there is friction in the electric circuit. This is called the "resistance" of the circuit. The greater the resistance the smaller the current which can be produced in the circuit by a given battery, just as the greater the friction the less

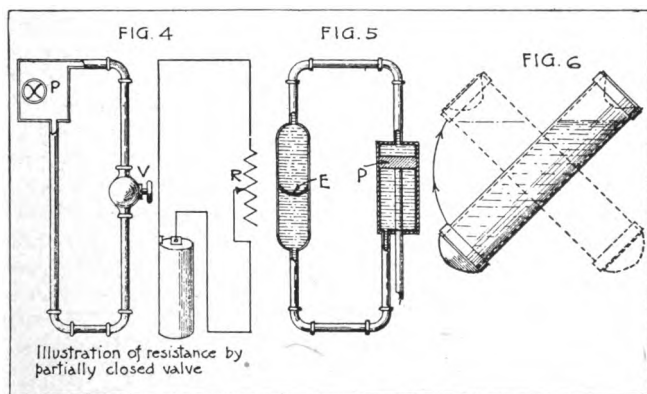

rapid the flow of water with a given pump acting. A resistance coil at any point in the circuit corresponds to a partially closed valve in the pipe at any point (Fig. 4).

Steady and Variable Currents.—A pump producing a steady pressure gives rise to a steady flow of water. The same is true of batteries and certain dynamos which produce a steady emf. A steady electric current in one direction is called a "direct current." We may suppose, however, that the water is given a succession of pushes all in the same direction, but separated by intervals when the water is not being pushed. Such a case occurs in the circulation of the blood by the heart beats. Likewise, a current of this nature may

be produced in a circuit where the emf. acts intermittently. To such a current the name "pulsating current" is very appropriately applied.

A very important variety of current for radio work is that known as "alternating current." This is analogous to the kind of flow which would be produced if, instead of being acted on by a pump, the water were agitated by a paddle which moved back and forth rapidly over a short distance, without traveling beyond certain limits. Under this impetus the water no sooner gets up speed in one direction than it is compelled to slow up and then gather speed in the opposite direction, and so on over and over again. The water simply surges, first in one direction, and then in the other, so that a small object suspended in the water would not travel continuously around the pipe line, but would simply oscillate back and forth over a short distance.

Effect of Condenser.—As a further case, let us suppose that an elastic partition E is arranged in the pipe (Fig. 5), so that no water can flow through or around it. If a pump P , or a piston, acts steadily, the water moves a short distance until the partition is stretched enough to exert a back pressure on the water equal to the pressure of the pump, and then the movement of the water as a whole ceases. If, on the contrary, a reciprocating motion is given to the water by P , the water moves back and forth, stretching the partition first in one direction and then in the other, and the water surges back and forth between short limits which are determined by the elasticity of the partition. We have in this case an alternating current of water in spite of the presence of the partition.

An electric condenser acts just like an elastic partition in a circuit. No direct current can flow through it, but an alternating current, of an amount depending on the nature of the condenser, can flow when an alternating emf. acts on the circuit.

As an extreme case, we may imagine the pipe line replaced by a long tube filled with water and the ends closed by elastic walls (Fig. 6). Suppose an alternating pressure to be given to the water in the tube, or even let the tube be tipped, first in one direction and then in the other. The water will oscillate back and forth a short distance in the tube, first stretching the wall at one end and then the wall at the other. A small alternating flow is thus set up, although there is not a complete circuit for the water to flow through. Analogous to this case is that of the electrical oscillation

of an antenna. Such a flow of electricity without a complete circuit is called a "displacement current." It is always necessary, in order to produce a displacement current, that the circuit shall have electrical elasticity somewhere; that is, that an electric condenser shall be present.

The importance of the electric current lies in the fact that it is an energy current. A current of water transports energy; so does a current of air. It is the motion that counts, and to utilize the energy of motion we must do something tending to stop the motion. Any material substance, by virtue of its mass, can be made to act as a vehicle for transporting energy from one place to another provided only it is set into motion. In the case of the electric current, we do not need to inquire whether electricity has mass. We are concerned, in the use of electrical apparatus, with the transformation of the energy of the current into other familiar forms of energy—heat, light and motion. The electric current is the vehicle by which we transmit energy from the central station to the consumer, and we are not, for practical purposes, concerned with the method of carrying the energy, any more than we need to inquire into the nature of the belt by which mechanical energy is carried from one wheel to another, or into the chemical nature of the water which is furnishing the power in a hydraulic plant.

The electric current itself cannot be seen, felt, smelt, heard, or tasted. Its presence can be detected only by its effects—that is, by what happens when it gives up some of its energy. Thus, an electric current may give up some of its energy, and cause a motor to turn. Electrical energy has been given up, and mechanical energy takes its place. Similarly, electric energy may disappear and heat or light may appear in its place, or a chemical effect may arise. When a person feels an electric shock, it is not the current itself he feels, but the muscular contractions caused by the passage of the current. The electric lamp has an effect on the eye. We do not, however, see the electric current in the lamp, but the effect on the eye is due to the light waves sent off by the hot filament. The energy of the current has been changed over into heat in the lamp. When we hear a buzzing in the telephone, it is not the electric current we hear, but merely the vibration of the thin diaphragm. The electric current has used some of its energy in moving the diaphragm. The acid taste noticed when the tongue is bridged across the poles of a dry battery is due to the

chemical decomposition of the saliva into other compounds as a result of the passage of the current through it.

In the next section, the electric current is studied through the effects it produces, and in later sections it is given a more exact and detailed treatment.

CHAPTER 1.

ELEMENTARY ELECTRICITY.

A. Electric Current.

3. Effects of Electric Current.—Electricity may be stored in an apparatus called a condenser (see Sec. 30) as air is stored under pressure in a tank, and certain characteristic effects accompany this condition. However, the most practical applications of electricity follow from the movement of electric charges—that is, electric current. Quantity of electricity is of importance in connection with such subjects as electrons (Sec. 6) and capacitance.

A wire in which an electric current is flowing usually looks exactly like a wire without current. Our senses are not directly impressed by the phenomena of electricity, and hence it is necessary to depend upon certain effects which are associated with the flow of current through a conductor when it is desired to determine whether or not a current exists. Some of these effects are as follows:

(a) If a straight wire is brought near a small magnet, such as a compass needle, which is so placed that the axis about which it turns is parallel to the axis of the wire (Fig. 7) then the needle is deflected a certain amount and tends to become tangent to a circle about the wire. It then remains in the new position as long as the current does not vary.

(b) A wire with a current passing through it will be at a higher temperature than the same wire before the current flows. This can be readily detected by a sensitive thermometer, and under some conditions, as in an ordinary incandescent lamp, the rise of temperature is so great as to cause the filament to glow.

(c) If the wire through which the current is flowing is cut, and if the separated ends are attached respectively to two metallic plates immersed in a solution of some substance like copper sulphate, there will be a chemical change in the solution accompanied by a deposition of the metal copper on one of the plates.

The attention of the student should be fixed upon these effects of the current, rather than upon the current itself. It is in terms

of these effects that electric currents are detected, measured and applied. Thus the magnetic effect is the basis of dynamo-electric machinery and radio communication; the heating effect makes possible electric cooking and electric lighting; and the chemical effect is the basis of electroplating. All three effects are utilized in making electric measurements.

It must be kept in mind that such expressions as "flow" and "current," and many other electrical terms are merely survivors from an earlier day when electricity was supposed to be a fluid, which actually flowed. Such terms are, however, helpful in forming mental pictures of the real phenomena of electricity.

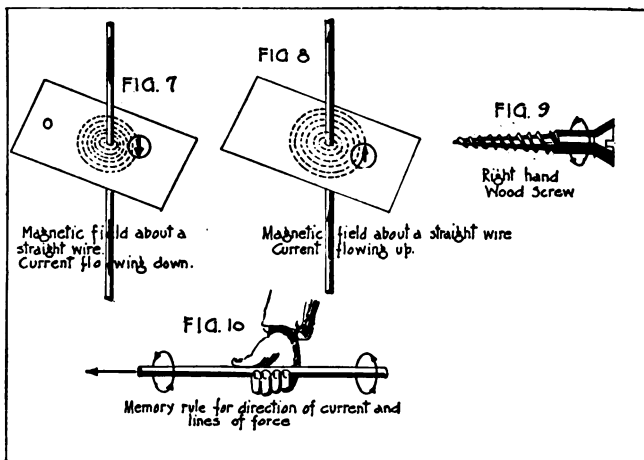

Attention must always be centered on the facts and effects which these terms represent and the words or phrases themselves must not be taken too literally.¹

4. **Magnitude and direction of current.**—By means of the magnetic effect it is readily shown that electric current has direction. If the wire in Fig. 7 be withdrawn from the plate, *O*, and reinserted in the opposite direction, the compass needle will indicate a direction (Fig. 8) nearly opposite to that of its original position. The same result is secured by interchanging the wires at the poles of the battery.

¹ Read Franklin and MacNutt, General Physics, p. 238.

The direction of flow of electric current is in any event a matter of arbitrary definition, and in practice the student will usually determine the direction by means of an instrument with its terminals marked + and -. It is assumed that current enters the instrument at the + terminal and leaves it at the - terminal.

The magnetic effect may also be used in specifying the direction of the current. See Sec. 40. Again referring to Fig. 7, it is seen that as the current flows down through the plane, the compass needle, at every point in the plane, tends to set itself tangent to one of the concentric circles about the wire. The north seeking, or north pointing pole of the needle will point in a clockwise direction around the current as the observer looks along the conductor in the direction of the current. Other useful rules for remembering the same relative directions are as follows:

(a) Grasp the wire with the right hand, and with the thumb extended along the wire in the direction of the current. The curved finger tips will then indicate the direction of the magnetic effect, Fig. 10.

(b) Imagine a wood screw being advanced into a block in the direction of the current, Fig. 9. The direction of its rotation then indicates the direction of the magnetic field around the wire or conductor.

The student should assure himself of complete familiarity with one of these rules by considerable practice with a small compass and a simple electric circuit.

5. Measurement of Electric Current and Quantity of Electricity.—All three of the simple ways by which electric current may be detected (see Sec. 3) provide means of current measurement. The magnetic effect of the current may be used by mounting a wire and a magnet in such positions that when a current flows in the wire either the magnet or the wire moves. The heating effect of the current is utilized in hot wire instruments (Sec. 49), where the increase in length of the heated wire is utilized to move a pointer over a dial. These principles are used in a great variety of instruments for the measurement of current. The amount of current is read from the scale or dial of the instrument. The scale is usually graduated at the time when the instrument is standardized, in a unit¹ called the "ampere." The instruments are called "ammeters."

¹ See Appendix 2 on "Units," p. 356.

The ampere is a unit the magnitude of which has been defined by international agreement. In its definition the third effect of the electric current, described above, is made use of. The mass of a metal which is deposited out of a solution by an electric current depends on the product of the strength of the current by the time it is allowed to flow. Thus a certain current flowing for 100 seconds is found, experimentally, to be able to deposit as much of a metal as a current 100 times as great passing for one second, etc. Remembering that the strength of the current is the rapidity of flow of electricity, it is evident that the product of strength of current by time of flow gives the total quantity of electricity which has passed.

The mass of a metal deposited by the current is, then, proportional to the total quantity of electricity which has flowed through the solution. Equal quantities of electricity will deposit different masses of different metals, but the mass of any chosen metal is always the same for the same quantity of electricity.

The ampere (properly called the international ampere) is that unvarying current which, when passed through a neutral solution of silver nitrate, will deposit silver at the rate of .001118 gram per second.

A convenient way of remembering this figure is that it is made up of one point, two naughts, three ones, and four twos—8. While current could be regularly measured by the process used in establishing this unit this is not done in actual practice. The measuring instruments used in actual measurements are, however, standardized more or less directly in terms of the unit thus defined.

6. Electrons.—When electric current flows in a conductor there is a flow of extremely small particles of electricity, called electrons. The study of these particles is important not only in connection with current flow, but also in light and heat and chemistry. The reason for this is that all matter contains them. Matter of all kinds is made up of atoms, which are extremely small portions of matter (a drop of water contains billions of them). The atoms contain electrons which consist of negative electricity. The electrons are all alike, and are in turn much smaller than the atoms. Besides containing electrons, each atom also contains a certain amount of positive electricity. Normally the positive and negative electricity are just equal. However, some of the electrons are not held so firmly to the atom but what they can escape when the atom is violently jarred. When an electron leaves an atom, there is then less negative electricity than positive in the atom; in this condition

the atom is said to be positively charged. When on the other hand an atom takes on one or more extra electrons, it is said to be negatively charged.

The atoms in matter are constantly in motion, and when they strike against one another an electron is sometimes removed from an atom. This electron then moves about freely between the atoms. Heat has an effect upon this process. The higher the temperature, the faster the atoms move and the more electrons given off. If a hot body is placed in a vacuum, the electrons thus given off travel from the hot body out into the surrounding space. This sort of a motion of electrons is made use of in the vacuum tube, which is the subject of Chapter 8 of this book. The motion of the electrons inside a wire or other conductor is the basis of electric current flow. This is briefly discussed, with the various important properties of electrons, in Circular No. 74 of the Bureau of Standards, page 8. (This circular will hereafter be referred to as C. 74.)

B. Resistance and Resistivity.

7. **Resistance and Conductance.**—The flow of current through a circuit is opposed by a property of the circuit called its "resistance" (symbol R). The resistance is determined by the kinds of materials of which the circuit is made up, and also by the form (length and cross section) of the various portions of the circuit. Provided that the temperature is constant, the resistance is constant, not varying with the current flowing through the circuit. This important relation is called Ohm's law and will be discussed further in Section 14. All substances may be grouped according to their ability to conduct electricity, and those through which current passes readily are called "conducting materials" or "conductors," while those through which current passes with difficulty are called "insulating materials" or "non-conductors." However, there is no known substance which admits current without any opposition whatever, nor is there any known substance through which some small current cannot be made to pass. There is no sharp distinction between the groups, as they merge gradually one into the other. Nevertheless, it should be kept in mind that conductors have a conducting power which is enormously greater than the conducting power of an insulator. The minute current which can be forced through an insulator under certain circumstances is aptly called a "leakage current." An ideal insulator would be one which would allow abso-

lutely no current to flow. Examples of good conducting materials are the metals and that class of liquid conductors called electrolytes. Examples of insulating materials are dry gases, glass, porcelain, hard rubber, and various waxes, resins, and oils.

A circuit which offers but little resistance to a current is said to have good conductance. Representing this by g we may write

$$g = \frac{1}{R}; \text{ or } R = \frac{1}{g} \quad (1)$$

For example, a circuit having a resistance of 10 ohms will have a conductance of 0.1 and one of 0.01 ohm will have a conductance of 100. The unit of resistance called the "ohm" is defined in terms of a standard consisting of pure mercury, of accurately specified length, mass and temperature.

The international ohm is the resistance offered to the flow of an unvarying current by a column of mercury 106.3 centimeters high and weighing 14.4521 grams at a temperature of 0° C.

For very small resistances, the millionth part of an ohm is used as a unit and is called the "microhm." For high resistances a million ohms is used as a unit and is called the "megohm."

The opposition to flow of current referred to above is analogous to friction between moving water and the inner surface of the pipe through which it flows. It is always accompanied by the production of heat. If an unvarying current is maintained through a conductor, this production of heat is at a constant rate. The total heat, produced in t seconds, is found to be proportional to the resistance of the circuit, to the square of the current and to the time, thus

$$W = RI^2t \quad (2)$$

From this it follows that R , for a given portion of the circuit, might be measured by the heat generated in that portion. The heat will be measured in "joules" when the current is in amperes, the resistance in ohms and the time in seconds. To find the heat in calories, the relation $W/J = H$ will be used, where W is in joules and J , (4.18), is the number of joules in one calorie. The relation given in equation (2) is sometimes called Joule's law.

8. Resistivity and Conductivity.—For a given piece of wire of uniform cross section, its resistance is found to be proportional directly to its length, and inversely to its cross sectional area; and in addition the resistance depends upon the kind of material of

which the wire is composed. These relations may be expressed in the following equation

$$R = \rho \frac{l}{s} \quad (3)$$

where R is the measured resistance of the sample, l is the length, s is its cross section and ρ is a constant, characteristic of the given material. Solving this equation for ρ we have

$$\rho = R \frac{s}{l} \quad (4)$$

If a piece of material is chosen having unit cross section and unit length, it is seen that ρ is equal to the resistance of the piece, measured between opposite faces. The factor ρ is called the "resistivity" of the substance, and is defined as the resistance between opposite faces of the unit cube. The ohm or the microhm is commonly used as the unit of resistance and the centimeter as the unit of length. Instead of expressing resistivity in these units it may also be given in terms of ohms per foot of wire one mil (0.001 inch) in diameter, or in ohms per meter of wire one millimeter in diameter.

Another group of resistivity units is based upon the mass of a sample instead of its volume, for example: (a) the resistance of a uniform piece of wire of one meter length and of one gram mass; or (b) the resistance of a wire of one mile length and of one pound mass. Practically, for some purposes, the mass resistivity is preferable to the volume resistivity for the following reasons: (a) sufficiently accurate measurements of cross section of specimens are frequently difficult, or, for some shapes, impossible; (b) material for conductors is usually sold by weight rather than volume, and hence the data of greatest value are most directly given. The mass units and volume units are readily interconverted, provided that the density of the material is known. If in equation (3) we substitute for s the value of v/l , where v is the volume, and for v its equivalent $\frac{m}{d}$, where m is the mass and d is the density, we have

$$R = \rho d \frac{l^2}{m} \quad (5)$$

The quantity ρd is called the mass resistivity of the material. The volume resistivity may then be transformed into mass resistivity, or vice versa, taking care that all the quantities are given in

consistent units. As examples of resistance the following will be useful:

1. One ohm is the resistance of about 157 feet of number 18 copper wire, (diameter about 1 mm., or 40 mils or 0.04 in.).

2. One thousand feet of number 10 iron wire (diameter about 2.5 mm., or 102 mils or 0.1 in.) has a resistance of about 6.5 ohms.

Tables of resistivity for various materials are given in Table 21, C. 74.

Just as conductance is the reciprocal of resistance when considering the properties of a circuit as a whole, so "conductivity" is the reciprocal of resistivity when considering the properties of a given material. Its unit is the "mho," or "reciprocal ohm."

9. **Temperature Coefficient.**—The electrical resistance of all substances is found to change more or less with any change in temperature. All pure metals and most of the metallic alloys show an increased resistance with rising temperature. Carbon and most liquid conductors like battery solutions, show a decrease in resistance as the temperature increases. Experiment shows that the resistance at a temperature t can be calculated, if the resistance at zero temperature (melting point of ice) has been measured. The formula is

$$R_t = R_0 + R_0 \alpha_0 t \quad (6)$$

where R_0 is the resistance of the sample at zero, and α_0 is the change in 1 ohm when the temperature changes from zero to 1° C. The factor α_0 is called the "temperature coefficient" of resistance for the material. Solving equation (6) for α_0 we have

$$\alpha_0 = \frac{R_t - R_0}{R_0 t} \quad (7)$$

Equation (7) shows that α_0 is the value of the change in the resistance per ohm per degree change in temperature, or it is the fractional change of the total resistance for 1 degree change in temperature. If the resistance of the material decreases with a rise in temperature, then the temperature coefficient is said to be negative.

If a reference temperature t_1 is chosen, which is not zero, then the resistance R_2 , at some other temperature t_2 , which is higher than t_1 , may be found from the resistance R_1 at t_1 by the following equation,

$$R_2 = R_1 [1 + \alpha_1 (t_2 - t_1)] \quad (8)$$

Calculations of this sort are simplified by the use of a table of values of α , for various initial reference temperatures. See Table 21, C. 74.

10. **Current Control.**—In electrical work the need is constantly arising for adjusting a current to a specified value. This is usually done by varying the resistance of the circuit. Changes in the resistance of a circuit can be made by means of resistors, which consist in general of single resistance units, or groups of such units made of suitable material. These may be variable or fixed in value. Variable resistors are frequently called "resistance boxes" or "rheostats," depending on their current carrying capacity and range.

A resistance box consists of a group of coils of wire assembled compactly in a frame or box. (Figs. 11, 12, and 13.) It is so arranged that single coils or any desired combination of such coils may be

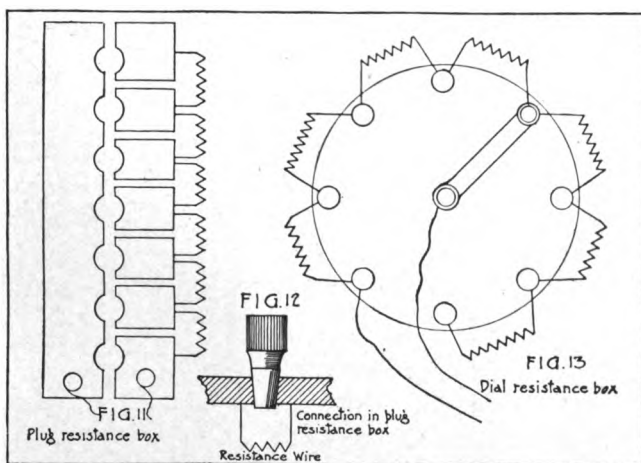

introduced into the circuit by manipulating the switches or plugs. The extreme range of such a device may be from a hundredth or a tenth of an ohm, up to 100,000 ohms. Each of its component units is accurately standardized and marked with its resistance value. By this means, it is possible to know precisely what resistance is introduced into the circuit by the resistance box. The coils are wound with relatively fine wire, and in such a way that they do not have any appreciable magnetic fields about them. They are intended solely for carrying feeble currents, usually no more than a fraction of an ampere.

The name "rheostat" is, in general, applied to a similar device, but with a larger current carrying capacity and a smaller range. Its coils are usually open to the air and it may be adjusted continuously or by steps. (Figs. 14 and 15.) The familiar groups of grids supported beneath the floor of street cars is a good example of rheostat. The individual units are not accurately measured and marked as they are in the resistance box, and it is usually not necessary to know the values of the separate steps. A frequently used resistor for large currents is made by immersing plates in a tank of a conducting liquid. Adjustments are made by varying the distance between the plates. For smaller ranges, the carbon compression rheostat is much used in laboratory work. In this type, a number of carbon plates are brought into more or less intimate contact by a variable screw pressure.

Resistors of single fixed values are convenient for many purposes. If they are carefully made and precisely measured they are often

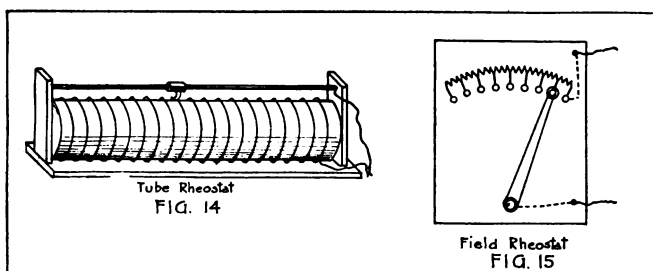

called standard resistance coils. Such standards may be secured in range from 0.00001 ohm to 100,000 ohms, and of any desired current carrying capacity and degree of precision.

Banks of incandescent lamps in various arrangements are often used as resistors. The resistance of such lamps is subject to large variations in value with changes in temperature. However, when operating under steady conditions, either hot or cold, they are satisfactory for many purposes. Such a rheostat offers the advantage of being readily adjustable by turning lamps off or on. It is compact and there is no danger of overheating.

11. **Conducting Materials.**—Conducting materials, usually metals or metallic alloys, are utilized in electric circuits with two different purposes in view. In one case a high degree of conductivity is

required, while in the other case relatively high resistivity is desired. These cases will be discussed in turn.

(a) If the conductor is transmitting energy to a distant point by means of the electric current it is seen from equation (2) that some energy will be wasted in the conductor in the form of heat. This loss should be kept as small as possible, and to this end great care is taken in choosing the size and material of the conductor. For reasons of economy the cross section must not be too great, hence a desirable material for conducting lines must have low resistivity and must be abundant and relatively cheap to produce. Such a material is copper. Where lightness is important and where increased dimensions are not a disadvantage, aluminum is much used. Steel is used where great strength is desired and where the current is small, as in telegraph lines. For lines which must stand great strain and at the same time be good conductors, such as radio antennae, a stranded phosphor bronze wire is often used.

(b) On the other hand, a material which is to be used for resistor coils should have the following properties:

1. The resistivity should be high, so that a large resistance may be realized without too great a bulk.

2. The resistivity should be constant, so that when a coil is once adjusted to a given value there will be no progressive changes in its resistance as time goes on.

3. The temperature coefficient should be small, so that changes in temperature will not appreciably affect the resistance values.

4. The thermoelectric effect (see Sec. 15) between the chosen substance and copper or brass should be small, so that variations in temperature between different parts of the circuit will not cause troublesome thermal currents.

Copper, although widely used as a conductor, has too low a resistivity and too large a temperature coefficient to be useful in resistor units. Iron likewise is neither high enough in resistivity nor constant enough in its behavior, except for use in certain types of rheostats. Many of the alloys of copper and nickel have a sufficiently high resistivity, but they develop large thermal emfs. against brass and copper, which makes them undesirable for precision resistors. In the alloy manganin, however, a very satisfactory resistance material is realized. It has high resistivity, and practically negligible temperature coefficient and thermoelectric effect.

Table 21, C. 74, gives the properties of some pure metals and the composition and electrical properties of certain of the more common alloys.

Wire Gauges.—Sizes of wires are specified in two general ways, either by giving the actual diameter in millimeters or in mils (1 mil = 0.001 in.), or by assigning to the wire its place in an arbitrary series of numbers called a wire gauge. Only two of these arbitrary wire gauges are of importance in American practice, the American Wire Gauge and the Steel Wire Gauge. To avoid confusion the name of the gauge must always be given with the gauge number. Most steel wire is specified in terms of the steel wire gauge. Wire used in electrical work, such as copper, aluminum and the copper-nickel alloys; is specified in terms of the American Wire Gauge. This is the only gauge in which the successive sizes have a definite mathematical relation.

It is convenient to remember that any change of three sizes of this gauge, doubles (or halves) the resistance of a wire; a change of six sizes doubles (or halves) the diameter, and therefore quadruples (or divides by four) the resistance of the wires.

12. **Non-conducting or Insulating Materials.**—The importance of good conductors, in practical applications of electricity, has been dwelt on in the preceding section. It is however equally important to have non-conducting materials in order that electric current may be confined to definite and limited paths. Such materials are commonly called insulators or dielectrics. It is a familiar fact that electric wires are covered with layers of cotton, silk, rubber and other non-conducting compounds, and are supported on porcelain knobs or in clay tubes. This is done to prevent the current from escaping along a chance side path before the desired terminal point is reached.

Strictly, there is no such thing as a perfect non-conductor. The materials commonly used for this purpose have volume resistivities ranging from 10,000 ohms to 10^{17} ohms between opposite faces of the unit cube. This means that 1 volt impressed across such a unit cube by means of proper metal terminals, would cause a current of from $\frac{1}{10,000}$ to $\frac{1}{10^{17}}$ ampere to flow. (See Sec. 13.)

Most insulating substances show a decrease in volume resistivity with increase in temperature. These changes are irregular and sometimes rapid. They are not directly proportional to the changes in temperature. Humidity is of great influence, and tends to lower

the volume resistivity in such materials as slate, marble, bakelite and hard fiber. Very frequently surface leakage is of greater importance than volume conduction, and this surface leakage is largely dependent upon the moisture film upon the surface. Some substances acquire a surface film of moisture more readily than others. In any event, care must be taken to ensure that its effects are either eliminated or allowed for.

In work involving high potential differences the property of dielectric strength is of greater importance than volume resistivity. If the potential difference applied between opposite sides of a sheet of dielectric material exceeds a certain critical value, the dielectric will break down, as though under a mechanical stress, and a spark will pass between the terminals. In case the dielectric is a liquid or a gas, its continuity is immediately restored after the spark has passed. However, in a solid dielectric the path of the spark discharge is a permanent defect, and if enough energy is being supplied from the source, a continuous current will persist, which flows along the arc or bridge of vapor formed by the first spark. "Dielectric strength" is a property of the material which resists this tendency to break down. It is measured in terms of volts or kilovolts required to pierce a given thickness of the material. Values of dielectric strength of air are given in Chapter 5, Section 171. It is a quantity that cannot be specified or measured very precisely, because the results vary with (a) the character of the voltage, whether direct or alternating, (b) the distance between the terminals, (c) the time for which the voltage is applied, and (d) the shape of the terminals. The presence of moisture lowers the dielectric strength. Dry air is one of the best of the insulating substances, but its dielectric strength is lower than that of many liquids and solids.

In addition to the constant currents which flow through or over insulating substances, due to the "body leakage" and "surface leakage" we find two other currents which are temporary, but which it is important not to overlook.

1. The "displacement current" which is discussed later in Section 29. This current appears and becomes negligible in a very short time, not more than a few thousandths of a second.

2. The "absorption current" which persists longer and is observed when an emf. is applied to a plate of a dielectric by means of electrodes as in the case of a condenser. (See Sec. 31.)

At first there is a considerable rush of current but this falls off with the time at first rapidly, then more slowly. It may not become negligible for several hours. It is due to some rearrangement of the molecules of the substance under the stress of the applied emf.

C. Potential Difference, Emf., and Ohm's Law.

13. **The Meaning of Emf.**—In Section 2, it was stated that one of the important electrical quantities is the electromotive force, which is the cause of the electric current. In order to fix in mind the ideas underlying the electric circuit, it will be helpful to consider

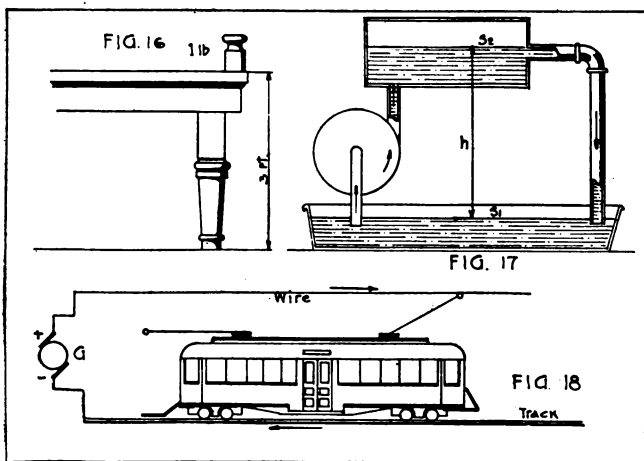

some illustrations drawn from experiences familiar to every one. Assume that a body of 1 pound weight is raised from the floor to a table, through a height of 3 feet (Fig. 16). Work is done upon the body, and the amount of work done is given by $1 \times 3 = 3$ ft.-lb. The body has acquired "potential energy" by this change in its position. That is, it is capable of falling back to the floor by itself, and in falling back it will, when brought to rest, do an amount of work exactly equal to that which was done in lifting it.

The difference in level between floor and table may be expressed in either of two ways; first, in the ordinary way, by stating directly the vertical distance through which the body was raised; and second,

by stating the amount of work required to carry 1 lb. of matter from the lower to the higher level. This difference in level, then, defines a very definite difference in condition between the two positions. The higher position, considered as a point in space, has a characteristic which distinguished it from the lower position, and that is the amount of potential energy possessed by a body when placed there. In other words, a body placed at this point is able, by virtue of its position, to do a certain amount of work. If we assume that the body has unit mass this characteristic is called the gravitational potential of the point. The higher position is said to have a higher potential than the lower position, and the difference in potential, measured in terms of work, is a measure of the difference in height.

Following this illustration a little further, we may consider the case of a simple pump, which raises water from a level S_1 to some higher level S_2 (Fig. 17). The water raised by the pump to the level S_2 possesses potential energy or energy of position. That is, it is able to fall back by itself to the lower level, and in falling back it will do an amount of work exactly equal to that which was done in lifting it. Instead of measuring the difference in level by the height h , as before, it may be measured in terms of the work done in lifting 1 lb. of water from S_1 to S_2 . This difference in level may be called the difference in potential between S_1 and S_2 .

The purpose of the pump is to transform the energy supplied by some steam engine or other prime mover into potential energy, with the corresponding difference in level or pressure head. This establishes what might be called a watermotive force, which causes or tends to cause a flow of water through a return connecting pipe.

Coming now to the electrical case, let us consider that electric current is supplied to the motors of an electric car by means of a generator G , Fig. 18, and two conductors, the trolley wire and the track. Mechanical energy is being supplied to the generator by some source of power, such as a steam engine, and is being transformed into electrical energy. This transformation results in a flow of current as indicated by the arrows, when a complete circuit is made through the car motors. This condition is described by saying that there is a difference of electric potential between the terminals of the generator, or between the trolley wire and the track. It is the purpose of any electric generator to set up this difference of potential between its terminals, which corresponds to the difference in level

of the water in the earlier illustrations. Difference of electric potential is then a difference in electric condition which determines the direction of flow of electricity from one point to another.

Just as height of water column or difference in level may be regarded as establishing a pressure or watermotive force, which in turn causes a flow of water when the valves in the pipe are open, so the electric potential difference may be regarded as establishing an electromotive force which causes a flow of electricity when a conducting path is provided. Electromotive force may be defined as that which causes or tends to cause an electric current.

The unit of electromotive force is the volt. It is that emf. which will cause a current of 1 ampere to flow through a resistance of 1 ohm.

The relation between electromotive force, current, and resistance is called Ohm's law. This law is discussed further in the next section.

The potential difference between two points may be measured in terms of the work done in conveying a unit quantity of electricity from one point to the other. In general

$$E = \frac{W}{Q}$$

where E is in volts, W is in joules and Q is in coulombs. (See Appendix 2, Units.) In practice, however, it is measured by direct application of an instrument called a "voltmeter." (See Sec. 50.)

14. **Ohm's Law.**—If the pressure upon a pipe line is increased, the flow of water through it in gallons per minute is increased. Ohm found that an increase in the emf. applied to a given conductor caused a strictly proportional increase in the current. Doubling the emf. causes exactly twice as great a current as before, trebling the emf., three times as great a current, etc. This means that for a given conductor the ratio of emf. to current is a constant, and this constant has been called the resistance of the conductor. This important relation is known as Ohm's law, and may be written:

$$\frac{E}{I} = R \quad (9)$$

or, in the alternative forms,

$$E = RI \quad (10)$$

and

$$I = \frac{E}{R} \quad (11)$$

Ohm's law derives its great importance from the fact that it applies to each separate portion of an electric circuit and also to the circuit as a whole.

Case I. Ohm's Law for a Portion of a Circuit.—Assume some part of a complete circuit, R , Fig. 19, which is held at a constant temperature, and has no battery or other source of emf. between the points A and B . If current from an outside source is then caused to flow through R , and correct instruments are used for measuring current and voltage, respectively, the following data may be taken, showing that R has a value of 2 ohms, and that R being constant the current is directly proportional to the voltage.

R Ohms.	E Volts.	I Amperes.
2	1	$\frac{1}{2}$
	2	1
	4	2
	6	3
	8	4
	10	5

Suppose two straight lines OY and OX are drawn at right angles to each other, Fig. 20. Divide each line into units and set down the proper numbers at regular intervals along these two lines.¹ The numbers on the OY axis may be used to represent values of E , and the numbers on the OX axis to represent values of I .

At a point 1 on the E axis draw a light line parallel to the OX axis, and from the point $\frac{1}{2}$ on the OX axis draw a light line parallel to the OY axis. Where these two lines intersect make a dot. Proceed in this way for all the corresponding values of E and I in the table above, and then connect the dots by a line. It is seen that the ratio of E to I is the same for every point that may be taken on the line OP . This means that E and I are connected by a constant factor and I is said to be directly proportional to E . This process is called plotting the relation between the two quantities E and I . Proportionality is indicated by the straightness of the plotted line.

Again, assume that a constant voltage E' is applied across the terminals of R , Fig. 19. By some suitable means, change the

¹ These lines are called axes. OY is called the axis of ordinates and OX is called the axis of abscissas. A distance measured along OY is called an ordinate. A distance measured along OX is called an abscissa.

values of R through a considerable range. The following are some values which careful observation might yield.

E' Volts.	R Ohms.	I Amperes.
24	2	12
	3	8
	4	6
	6	4
	8	3
	12	2

Plot the values of R and I on cross-section paper, Fig. 21, and the curve AA is obtained.

Also we may plot reciprocals of R (values of $1/R$) on the axis of abscissas, against values of I on the axis of ordinates, Fig. 22. It

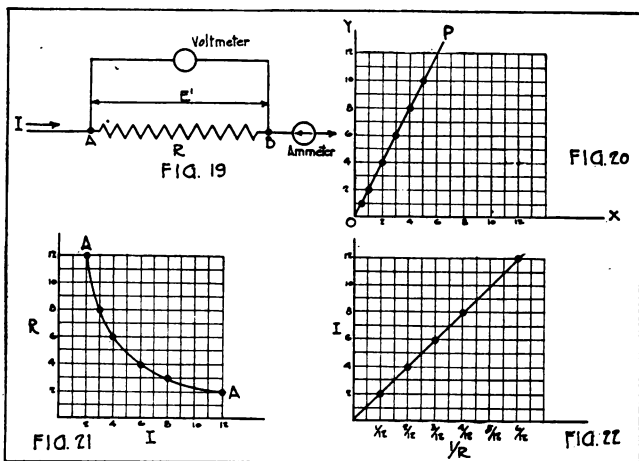

is now seen that I is proportional directly to the reciprocal of R , or in other words, I is inversely proportional to R . The student should make some experiments of this sort with a resistance box, battery, ammeter and voltmeter. He should also make a careful record of the readings taken, and then should plot them on cross-section paper, as suggested above. From such a study it will be found that:

(a) For a constant resistance, the current flowing is directly proportional to the voltage.

(b) For a constant voltage the current is inversely proportional to the resistance.

It is customary to speak of the current flowing "in" a circuit; of the resistance "of" a circuit and of the emf. "between the terminals" of, or "across" any portion of a circuit.

The relation expressed in equation (10) applied to a part of a circuit is used so much practically, that the value of E' between A and B (Fig. 19) has been given various names. It is called (a) the RI drop, (b) the potential drop, or (c) the fall of potential in the portion of the circuit between A and B . If a branch circuit which contains a current indicating instrument, such as a voltmeter, (Fig. 19) is connected between these two points, a flow of current is shown to be taking place. The point A is at a higher electric potential than B , and hence current will flow along the path $A-Vm-B$.

Case II. Ohm's Law for a Complete Circuit.—In extending this idea to the entire circuit, the total resistance of the circuit must be used. This must include the internal resistance of the generator or battery, or the sum of the resistances of all the generators, if there is more than one. Likewise the voltage must be the resultant or algebraic sum of all the emfs. in the circuit. Ohm's law for the complete circuit may then be written in the form:

$$I = \frac{\pm E_1 \pm E_2 \pm E_3 \pm \dots}{R_1 + R_2 + R_3 + \dots} = \frac{E}{R} \quad (12)$$

In this equation R must be the sum of all the resistances in circuit, including the resistances of all the batteries or generators. In the same way E must be the sum of all the emfs., each with its proper sign. For example, there might be a number of batteries in series (see Sec. 24) and one or more of these might be connected into the circuit with the poles reversed. These emfs. would have to be subtracted, hence the negative sign for the terms in the numerator.

Another way of stating this general law when all parts of the circuit are in series is to equate the total emf. impressed on the circuit to the sum of the RI drops in every separate portion of the circuit,

$$E = RI = R_1I + R_2I + R_3I + \dots \quad (13)$$

Ohm's law is to be regarded as an experimental truth, which has been established by countless tests for all metals and conducting

liquids. For gases at low pressures it does not hold, nor does it apply to certain non-conductors, such as insulating oils, rubber, and paraffin.

15. **Sources of Emf.**—There are a number of ways in which electric energy can be derived from other forms of energy. Each one of these energy transformations sets up a condition which causes current to flow, that is, it produces an emf. The principal sources of emf. will be discussed briefly in the following sections.

Static or Frictional Electricity.—When a piece of hard rubber is brought into close contact with a piece of cat's fur and then separated from it, two things may be noticed:

1. The bodies have both acquired new properties, and are said to be electrified.

2. A force is required to separate the bodies and work is done if they are moved apart.

Both bodies now have the power of attracting light bits of chaff or tissue paper. The rubber is said to have a negative charge and the fur, a positive charge. These charges exist in equal amounts and taken together they neutralize each other. An uncharged body is said to be neutral. When these charges are at rest upon conductors they are called electrostatic charges. Electric charges may be communicated to small light bodies, like pith balls, and if these are suspended from silk threads the effects and properties of the charges may be studied in terms of the motions and behavior of the pith balls. Two pith balls charged oppositely are found to attract each other, and two with like charges to repel each other. The force between them in either case is proportional to the product of the charges and inversely proportional to the square of the distance between them. The force is also proportional directly to the value of the dielectric constant. (See Sec. 31.)

Electrostatic forces are ordinarily very small. There are many substances other than the two mentioned, which become charged by friction with other materials. As glass is such a substance, the glass face of an instrument should never be wiped with a cloth just previous to use, as it thus may accidentally become charged to such an extent as to affect the light needle below it and cause a considerable error in its reading. In case this has happened, breathing upon the glass or wiping it with a moist cloth will remove the charge.

If two bodies carrying opposite charges are connected by a conductor, a momentary flow of current takes place, and the two bodies

come to the same electrical condition. If the original charges were equal, both bodies are discharged.

Electrostatic experiments can be best performed on a cold day when the air is dry.¹

Batteries.—When two plates of different substances, such as two metals, or a metal and carbon, are placed in a water solution of certain salts or acids, there is found to be a difference of potential between them. If the exposed parts of the plates, called the electrodes, are connected by a conductor, current will flow. The following list contains the names of some of the substances which are used as battery electrodes. The order of the arrangement is such that when any two are taken, current will flow through the wire from the one appearing higher in the list to the one farther down:

- + Carbon.
- Mercury.
- Copper.
- Iron.
- Lead.
- Cadmium.
- Tin.
- Zinc.
- Magnesium.

The salt and acid solutions used are conductors of electricity, but their conductivity is not so high as that of the metals. They are called "electrolytes."² Some examples are solutions of sulphuric acid, copper sulphate, potassium chloride, and sodium chloride or common salt. Ordinary water from the service pipes contains enough dissolved substance so that it conducts electricity to a slight extent. With any two materials of the table dipped in one of the solutions mentioned, there will be produced an emf. and a

¹ For further study of electrostatic phenomena the student is referred to Crew, *General Physics*, Chap. IX; Franklin and MacNutt, *General Physics*, Chap. XV; Starling, *Electricity and Magnetism*, V; S. P. Thompson, *Elementary Lessons in Electricity and Magnetism*, Index; W. H. Timbie, *Elements of Electricity*, Chap. XI; Watson, *A Textbook of Physics*, pp. 633-680.

² Not only do electrolytes conduct electricity, but when a current is passed through them, the molecules of the acid or of the salt are decomposed or broken up. The metallic part of the molecule, or its hydrogen, always travels toward the terminal from which the current leaves the solution, and is deposited there. This is the basis of electroplating processes, and it is in terms of such a process that the ampere was defined. (See Sec. 5.)

resulting flow of current. The farther apart the selected materials stand in the list the greater will be the effect produced.

This arrangement for producing a current is called a "voltaic cell." Several types of this cell will be described in sections 17 to 19.

Thermoelectricity.—Assume pieces of two different metals CJ and $C'J$, Fig. 23, soldered together at the point J . The other ends are connected by a copper wire through the galvanometer g . If the point of contact, or junction J , is heated to a temperature above that

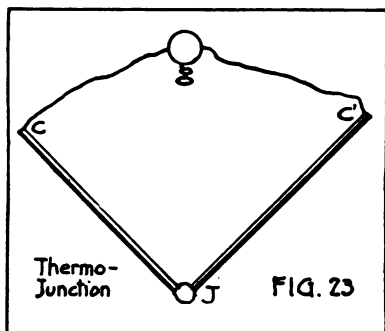

of C and C' , there will be a flow of current through the galvanometer. This is commonly explained by saying that at the junction J , heat energy is transformed into electrical energy, and this junction is regarded as the seat of an emf. In case the temperature of J is lower than that of CC' , the direction of the current will be reversed. In the following table some common metals

are so arranged that when any two of them are chosen for the circuit, current flows across the heated junction from any one to one standing lower in the list.

Bismuth.
Platinum.
Copper.
Lead.
Silver.
Antimony.

The presence at the junction of an intermediate metal or alloy like solder, will not affect the value of the emf. developed, because whatever effect is developed at one point of contact with the solder, is annulled at the other. Of the pure metals, a thermocouple made of bismuth and antimony gives the greatest thermoelectromotive force for a given difference in temperature. However, certain alloys are frequently used for one or both of the materials. The purity and

physical state of these materials is an important factor in securing uniformity of results. A thermoelement or thermocouple may be calibrated with a given galvanometer; that is, a curve may be plotted coördinating microvolts and temperatures. It then becomes a valuable device for measuring temperatures, especially where other forms of thermometer cannot be used. For the range from liquid air temperatures, -190° C., to 200° or 300° C., copper-advance or iron-advance thermocouples are often used. For high temperatures, upward of 1700° C., a thermocouple of platinum and a platinum-rhodium alloy is used.

Thermocouples find application in radio measurements in hot wire ammeters. See Section 59.

Induced Emf.—Electromotive force may be set up in a circuit by the expenditure of mechanical work in pushing wire conductors across magnetic lines of force. See Section 45. Also when electric current in any circuit is caused to vary, an emf. which is the result of this variation arises in a nearby circuit. The principles which apply to these cases are fully stated in Sections 45 and 47. The development of machinery based upon these principles is the subject of Chapter 2.

The RI Drop.—When for some purpose a voltage is desired which is less than that of the available battery or generator, or one which can be readily adjusted to any desired value, it is often convenient to take advantage of the *RI* drop across a given resistance, as described in Section 14, and to arrange a circuit as in Fig. 24. The current from the battery which flows through the resistance *ab* can be adjusted to any desired value by properly choosing the value of *ab*.

Since the voltage drop along *ab* is directly proportional to the resistance *r*, any desired fraction, $\frac{1}{n} E'$ may be obtained by setting the contact *c* at such a point that the resistance *ac* is equal to $\frac{1}{n} r$. This follows from equation (10) where it is seen that the emf. across any resistance is directly proportional to that resistance so long as the current remains constant. This is nearly enough true for practical purposes if it be assumed that the resistance of *ab* is relatively large as compared to the internal resistance of the battery. The resistance *ab* may be in the form of a resistance box with a travelling contact at *c*, or it may be a uniform homogenous wire, with an adjustable contact point at *c*. Such a device for subdividing a

voltage is called a "voltage divider," and has often been erroneously called a potentiometer.

Standard of Electromotive Force.—The emfs. due to the ordinary battery cells are usually between 1 and 2 volts. A certain type of cell has been selected by international agreement as a standard of emf. The type now most used is called the Weston standard cell, because it was first suggested by Weston. It is also called the "cadmium cell," because cadmium is used as the negative electrode. This cell is made from carefully selected chemicals of great purity, and when used under controlled temperature conditions its voltage can be depended upon to remain constant within a few parts in

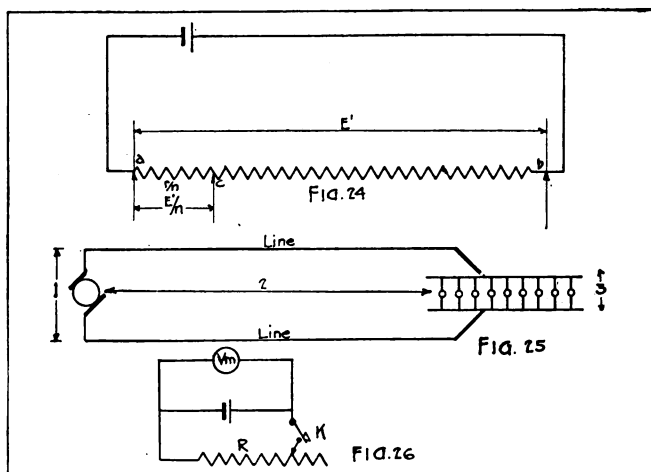

100,000. At 20°C. , its emf. is 1.0183. The value of the volt is maintained by reference to similar cells kept in the national standardizing laboratories.

16. **Internal Voltage Drop and Line Drop.**—Reference to equation (12), page 41, will show that the voltage or emf. of the generator, whether battery or dynamo, must always be thought of as being expended in three parts, as follows:

1. That part which sends current through the generator itself, called the "internal drop."
2. That part which sends current through the line, called the "line drop."

3. That part which sends current through the terminal apparatus, such as lamps, motors, or heating coils. This is the useful part of the emf., the first two being wasted so far as useful work is concerned.

This division of the generated emf. is illustrated in Fig. 25. Since part 3 is the part which is applied in the external circuit, it is clear that the generator must always supply a higher voltage than is needed at the terminals in order to take care of parts 1 and 2. The above facts may be again stated in the form

Total emf. = drop in generator + drop in line + useful drop in load.

Voltage Drop in Battery or Generator.—Assume a circuit as shown in Fig. 26. As long as the key K is open, the battery is not sending current through the circuit R . A high resistance voltmeter V_m gives a reading E which is the full open circuit voltage of the cell. The voltmeter current is so small that the cell may be regarded as supplying no current through it. If, without removing the voltmeter, the key K is closed, a current I flows through the external circuit R , and the voltmeter reading is seen to drop back to some value E' which is less than E . As R is made smaller the value of E' continues to decrease, until when $R=0$, that is when the poles of the cell are short-circuited, the voltmeter shows no deflection whatever. The voltmeter indicates at any instance *the then existing value of the voltage at the cell terminals* and this may vary from the open circuit voltage or emf. E , to zero, depending upon the external circuit condition. For any value of R the current flowing is given by the equation

$$I = \frac{E}{r+R} \quad (14)$$

where r is the internal resistance of the cell, or

$$E = RI + rI \quad (15)$$

Thus the emf. E , is equal to the sum of the potential drop in the cell and the RI drop in the external circuit. Denoting RI by E' , we may write equation (15) in the form

$$E' = E - rI \quad (16)$$

The quantity E' is called the "terminal potential difference," or the "terminal voltage" of the cell, and it is always less than the full emf. by the RI drop in the cell itself. It may be defined as the useful part of the emf., or that part which is available for sending current through the external circuit.

The emf. E is determined once for all by the choice of materials used in the cell, and it can not be in any way altered after the cell is once chosen. The terminal voltage however can be varied through all possible values from E to zero. Anything that may be done to lessen the internal resistance of the battery, such as putting several cells in parallel (see Sec. 24), will lower the RI drop and correspondingly increase the terminal voltage E' . After the RI drop has been subtracted from the emf. E , the balance is the terminal voltage, or that part of the emf. which is available for work in the external circuit. The current drawn from the battery must be regarded as flowing through the entire circuit. As this value of I increases, the internal voltage drop in the battery increases, and a correspondingly smaller fraction of the total emf. is available for the external circuit.

What has been said here of a cell is equally true of any other form of generator.

Voltage Drop in the Line.—Suppose that a d.c. generator, capable of supplying 115 volts at the outgoing wires of a powerhouse is furnishing current to a distant building for lighting lamps which require 110 volts. Suppose that the line resistance is 0.1 ohm and that the lamps require 50 amp. of current. There is then a line drop of 5 volts, and the available voltage at the generator is just right to operate the lamps at their rated voltage. Suppose, however, that other apparatus near the lamps, say, the motor of an electric elevator, is put in operation, and that this requires 100 amp. of current. The line drop is then increased by 10 volts, or 15 volts in all, and the voltage available at the distant end of the line has fallen to 100 volts. This is not enough to maintain the lamps at full brightness and they are dimmed perceptibly every time the elevator is operated. To correct this difficulty, a new line of lower resistance must replace the old one; that is, the line drop must be decreased, so that for the maximum current demand the lamps will not fall below 110 volts.¹

Another example of the line drop is seen in the dimming of the lights of a trolley car when the car is starting. The resistance of the trolley wire is kept low by using a large cross section of copper, and the track resistance is kept as low as possible by careful bonding at

¹ *Problem.*—Assuming that the distance from powerhouse to lamps is $\frac{1}{2}$ mile, calculate the resistance of the line which is necessary to maintain the lamp voltage at 110 volts. Find also the size of copper wire which should be used for this line.

the rail joints. However, a few defective joints raises the track resistance and increases the line drop to such a degree that the necessary lamp voltage cannot be maintained when the car starts.

D. Batteries.

17. **Kinds of Cells.**—An electric battery is made up of a group of cells so arranged as to produce a greater effect than one alone. The term “battery” is sometimes incorrectly used to mean one such cell. We have seen that the cell is a device for converting chemical energy into electrical energy. There are two principal types of cells. One, in which the action can only be renewed by putting in new chemicals or parts, is called a “primary” cell. In the other type of cell the necessary chemicals can be renewed by a charging process; i. e., sending current through the cell in a direction opposite to that which the cell itself produces. Such cells are called “secondary” or “storage” cells. They can be used over and over again without putting in fresh chemicals. A group of these is commonly called a storage battery. These will be discussed more fully in Section 21.

18. **Simple Primary Cell.**—If a plate of pure zinc and a plate of copper, not in contact with each other, are immersed in dilute sulphuric acid, no chemical action takes place. When the plates are connected by a wire or other conductor outside of the liquid a current flows in the wire and a chemical action occurs in the cell. The sulphuric acid attacks the zinc, forming zinc sulphate, and the hydrogen liberated from the acid appears at the copper plate. The direction of the current flow is from the copper plate out around the metallic circuit to the zinc plate and then back through the acid to the copper plate. The direction of this current in the external circuit is arbitrarily said to be from the copper or positive plate to the zinc or negative plate. In diagrams, such as Fig. 27, p. 50, the positive plate is indicated by a plus sign (+), and the negative plate is indicated by a negative sign (-). If an ammeter or voltmeter is connected into the circuit its positive terminal is connected to the positive plate of the cell.

Every primary cell has two plates, called “electrodes” or poles, and a liquid called the “electrolyte.” The electrodes are metals or carbon, and the two electrodes cannot be the same substance. Among the commonly used electrolytes are solutions of sulphuric acid, copper sulphate, ammonium chloride, and other chlorides.

The voltage given by the usual cells is between 1 and 2 volts per cell. The voltage of a cell depends mainly upon the pair of substances used as electrodes, and is affected somewhat also by the electrolyte. Thus, a great many different electrolytes are used to make up cells with copper and zinc as electrodes, but all give close to 1 volt per cell. This fact is often very useful when a certain voltage is wanted and no regular source is available. By taking two different metals and placing them in any acid which does not attack them violently, or even in water, an emergency source of voltage can often be secured.

Local Action.—When a piece of pure zinc is placed in a solution of sulphuric acid, no action is observed to take place and no hydrogen is evolved. When the plate of zinc contains impurities, however, such as particles of iron or carbon, a considerable action with the

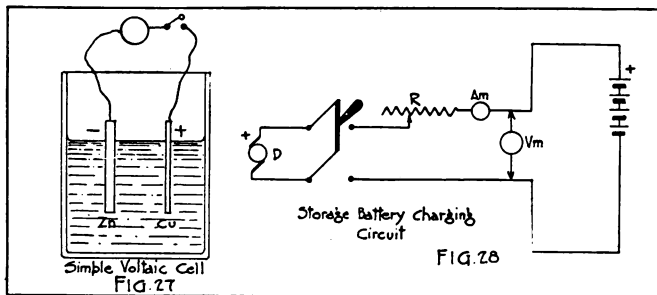

evolution of hydrogen is noticed as soon as the zinc is put into the acid. The reason for this is that each particle of a foreign substance in the surface of the zinc acts with a neighboring particle of zinc as a voltaic cell, and the effect is that of a number of tiny cells, all exhausting themselves in producing local currents which are purely wasteful. This sort of local action in the ordinary cell contributes nothing to the useful energy output of the cell.

Polarization.—The current given by the simple cell described above does not remain constant, but begins to diminish soon after the circuit is closed. The hydrogen which is liberated from the acid, when current flows, accumulates in the form of small bubbles on the copper plate. It thus diminishes the area of contact of the liquid with the copper, and so increases the resistance in the cell. The presence of the hydrogen furthermore diminishes the voltage gener-

ated in the cell. Both the reduction of the generated voltage and the increase of resistance decrease the current given by the cell. This behavior caused by the hydrogen is called polarization. The effect disappears a while after the circuit is opened, by gradual diffusion of the hydrogen away from the copper surface. Polarization may be prevented by placing some substance around the copper plate to remove the hydrogen or prevent its formation. It is for this reason that primary cells contain a chemical substance called the "depolarizer" in addition to the electrolyte.

The action of the depolarizer is limited to the positive plate, and it is kept from contact with the negative plate in various ways. In the "gravity cell," one of the forms of Daniell cell mentioned in the table just below, the depolarizer is copper sulphate solution, which is kept separate from the electrolyte by the action of gravity. Being denser than the electrolyte, it remains at the bottom of the vessel. The copper is placed at the bottom, in the depolarizer, and the zinc is placed at the top in the electrolyte. Another method of keeping the depolarizer away from the negative electrode is by the use of a porous cup or partition, through which the current can pass, but the liquids can diffuse only with difficulty. This may be of paper, cloth, or porous porcelain.

Characteristics of Good Primary Cells.—For best results a battery cell is usually desired which has as large an emf. as possible. This depends upon what materials are chosen for the plates, but not at all upon their size or arrangement. If a large current output is desired, the internal resistance of the cell must be low. This depends upon the electrolyte chosen, and also upon the size and arrangement of the plates. Large plates, close together, set in an electrolyte of low volume resistivity are the conditions necessary for low internal resistance. Constant emf. is only possible if the cell is free from polarization. Economy in operation depends on low first cost of materials and freedom from waste due to local action. The operation of the battery should not yield disagreeable or poisonous fumes. Dry cells, such as are described below, have all of the desirable characteristics here mentioned except that they do polarize.

19. Types of Primary Cells.

Closed Circuit Cells.—Cells which are used with the electrical circuit closed for fairly long periods of time must be particularly free from polarization; i. e., the cell must have an effective depolar-

izer around the positive plate to prevent hydrogen from collecting on it. The make-up, generated voltage and approximate resistance of typical cells are given in the following table.

Name.	Positive electrode.	Negative electrode.	Electrolyte.	Depolarizer.	Volts.	Internal resistance, ohms.
Daniell.....	Copper.	Zinc..	Sulphuric acid.	Copper sulphate.	1.1	1
Chromic acid....	Carbon.	Zinc..	Sulphuric acid.	Chromium peroxide.	2.0	0.2
Edison-Lalande.	Copper.	Zinc..	Caustic potash.	Copper oxide...	0.8	0.03
Silver chloride...	Silver..	Zinc..	Ammonium chloride.	Silver chloride.	1.0	2

The silver chloride cell is classed as a dry cell, being made in such a way that the electrolyte cannot spill. This cell will last a much longer time than the more common kind of dry cell described below.

Cells for Intermittent Service.—For service such as ringing door bells, operating telephone buzzers, and ignition devices, a primary cell may be used which does not have a powerful depolarizer. The cell can recuperate from polarization during the intervals of rest with the aid of only a slow acting depolarizer. The cell universally used for such service is the sal ammoniac cell, having carbon as the positive and zinc as the negative electrode, ammonium chloride (sal ammoniac) as the electrolyte, and manganese dioxide as the depolarizer. The voltage generated is about 1.5 volts.

20. Dry Cells.—The sal ammoniac cell is now used almost universally in the form of the so-called dry cell. The solution of sal ammoniac is contained in an absorbent material and the cell is thoroughly sealed, so that spilling is impossible.

The zinc serves as the container for the cell, being a can made of sheet zinc about 0.045 cm. (0.018 in.) thick. The positive electrode is a large rod of carbon in the center of the cell, and this is surrounded by a mixture of manganese dioxide and carbon. This mixture, saturated with the sal ammoniac solution, is bulky and occupies most of the interior of the cell. The electrolyte, sal ammoniac solution, is contained partly in the mass of depolarizing mixture and partly in the porous separator that is placed between the zinc and the depolarizer. The separator is usually a thick pulpboard in large

American cells. In small cells and nearly all European cells it is a cloth bag, spaced in from the zinc so that it is surrounded by some of the electrolyte in the form of a paste.

The standard dry cell, called "No. 6," is 15 cm. (6 in.) high by 6.5 cm. (2.5 in.) in diameter and weighs about 900 grams (2 lb.). There are two principal classes of these cells—ignition cells for heavy service and telephone cells for light and intermittent service. There is also an intermediate cell for general service, having characteristics between these two. The ignition cells deliver an instantaneous current of about 30 amp. when short circuited, provided they are new and little used. They lose their energy and become useless in about six months. The telephone cells give about 20 amp. on a momentary short circuit. They last longer than the cells made for heavy service, the usual life being about a year.

Miniature dry cells, used for flash lights and for plate batteries for low power vacuum tubes, are made in sizes varying from 4 to 10 cm. in height, weighing from 14 to 100 grams. They maintain their effectiveness only a few months.

The voltage generated in an unused dry cell is from 1.5 to 1.65 volts. An emf. lower than 1.45 volts in a new cell indicates deterioration or defect. However, when a current is being drawn from a cell, the voltage at its terminals is less because part of the generated voltage is used in overcoming the internal resistance of the cell. (See Sec. 16.)

The standard size No. 6 dry cells give a total of about 25 watt-hours of energy. The amount delivered increases somewhat with increasing temperatures. The higher the temperature, however, the faster does the cell deteriorate when not in use. It is usually best therefore to keep dry cells at a temperature below 25° C.¹

The dry battery is chiefly useful for supplying (a) relatively large current for a brief instant or (b) very small current for a long time. Owing to its rapid polarization, the dry cell is not able to deliver a steady current for a long time in service, such as operating lamps or motors. The storage battery is much better adapted to this kind of service.

21. Storage Cells.²—The essential difference between the primary cell previously described and the secondary or storage cell is in the

¹ For further information on dry cells, see Circular of the Bureau of Standards No. 79, Dry Cells, 1918; Trans. Amer. Electrochem. Soc., 21, p. 275, 1912; Electrician, 69, p. 6, 1912; 71, p. 481, 1913.

² See also S. C. Radio Pamphlet No. 8.

manner of renewing the active material of the plates. When the primary cell is exhausted, it is renewed by renewing the electrolyte and removing the worn out zinc plate and putting a fresh one in its place. Dry cells cannot be so renewed. In the storage battery, however, the necessary chemical condition of the plates is restored by the action of a current from an outside source. The direction of this current is opposite to that of the current supplied by the cell. While the cell is giving out current, it is said to be discharging. While it is receiving current from some outside source, it is said to be charging. In Fig. 28, p. 50, is shown a typical circuit for charging storage cells. The dynamo *D* is connected through the ammeter and rheostat *R* to the battery, so that the positive pole of the dynamo is connected to the positive pole of the battery, thus sending the charging current against the emf. of the battery. This is very important. A mistake in connection may cause permanent injury to the battery. Storage batteries in general have low internal resistances, and hence they will yield relatively large currents. Although this is an advantage, there is also the danger of excessive currents in case of an accidental short circuit. Voltage changes throughout the period of discharge are small, and so fairly constant currents can be maintained. There are two types of storage cell in common use: (a) the lead plate, acid electrolyte cell; (b) the nickel, iron plate, alkaline electrolyte cell. Each of these will be described in the following sections.

The Lead Plate, Acid Electrolyte Cell.—In this type of cell (Fig. 29) the plates are made of lead, and contain many apertures, so that either plate is sometimes called a "grid." Into these holes in the plate there is forced, by heavy pressure, a paste made by mixing certain lead salts (red lead, Pb_3O_4 and litharge, PbO) with sulphuric acid. If two plates thus prepared are immersed in a 20 per cent solution of sulphuric acid, and if an electric current is passed between them, hydrogen will accumulate at the pole from which the current leaves the cell. This hydrogen reduces the paste to spongy lead. In the meantime oxygen is being taken up by the other plate and the paste is being changed here to a higher oxide (lead peroxide, PbO_2). The cell now really contains a lead peroxide plate (positive) and a spongy lead plate (negative). These materials in a solution of sulphuric acid yield at first on open circuit an emf. of about 2.2 volts. This quickly drops to about 2 volts.

After the charging current is cut off, if the cell is connected to a circuit, current will flow from the cell in a direction opposite to that of the charging current. As the discharge goes on, the voltage gradually falls. The discharge should never be carried beyond the point at which the open circuit voltage is 1.75.

Lead plate batteries are usually arranged with one more negative than positive plate. The container must be made from a material

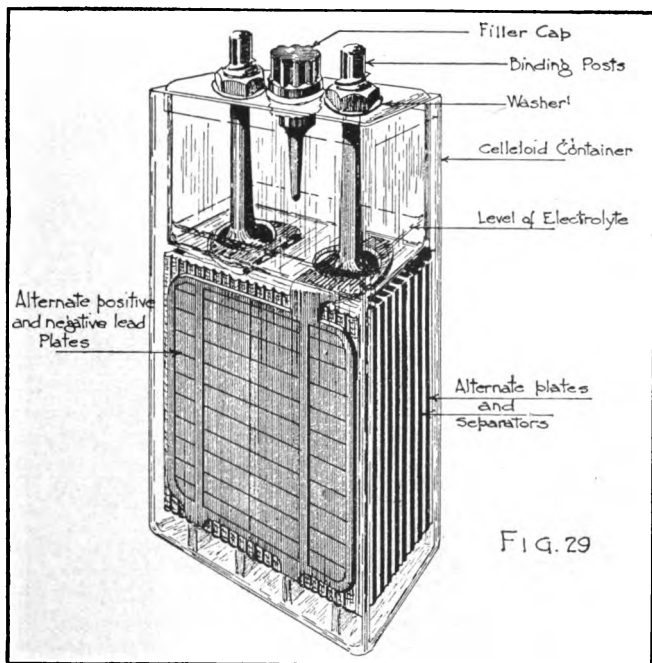

which the acid will not attack, such as glass or hard rubber. The negative plates will be a dark gray color, and the positive plates will be a reddish brown. The chemical changes in charge and discharge require time, and the processes can not be unduly hastened without injury to the cell. The manufacturer always specifies in amperes the normal rate of charge or discharge, and the life and efficiency of the cell are greatly decreased if this normal rate is disregarded.

There is a chemical combination between the sulphuric acid and the lead, which results in the formation of lead sulphate during the process of discharge. This uses up acid and during this time the density of the electrolyte grows less. When the cell is again charged, sulphuric acid is returned to the solution, and the density rises. For testing density of battery solutions an instrument called the "hydrometer" is used. The density of the electrolyte is the best indication of the condition of charge or discharge of the cell. The manufacturers will furnish with the cells, information as to the correct values of the density. The lead sulphate is grayish white in color. It is insoluble in sulphuric acid and is a non-conductor of electricity. It should be entirely reconverted into lead when the cell is charged. If the cell is repeatedly charged or discharged at the normal current rate, the amount of lead sulphate formed will be small and not essentially harmful. However, charging or discharging at an excessive rate, or allowing the cell to remain idle in a discharged condition, will cause an excessive deposit of lead sulphate and the plates are then said to be "sulphated." The growth of the crystals of the sulphate sets up stresses which tend to buckle the plates and crowd out the active material, thus hastening disintegration. The presence of the non-conducting coating also practically cuts off the parts of the plate thus covered and reduces the capacity of the cell. The condition is difficult to remove, and it can only be prevented by a careful following of the manufacturers' rules for charging, discharging, and care. During the charge, hydrogen is given off which forms an explosive mixture with the air. An open flame should therefore not be brought near the cells while they are charging.

It has been mentioned that there is a certain charge or discharge rate specified by the manufacturer, which is most favorable for each size and type of cell. As the size of the plates increases, larger charge and discharge currents may be used. The capacity of a storage battery is rated in terms of "ampere-hours," abbreviated as "amp-hr." For example, a 40-amp-hr. cell might yield 1 amp. for 40 hours, or 10 amp. for 4 hours. However, if 5 amp. is the normal discharge rate for this cell, it should not be charged nor discharged at a greater rate, and 5 amp. for 8 hours represents the correct conditions.

The ampere-hour capacity depends upon the size of the plates, and upon the depth of the active material. The efficiency of either type of storage cell is expressed in terms of ampere-hours per pound

weight of cell. This is found to be not very different for the two types, provided that both have been given correct care and regular and careful treatment. The student should be especially warned against directly short-circuiting a lead cell. Owing to its low resistance, dangerously large currents may flow, also it is certain to injure the cell.

The Nickel-Iron Plate, Alkaline Electrolyte Cell.—In this type of storage cell, Fig. 30, developed by Edison, the positive plate consists of alternate layers of nickel hydrate and pure nickel flake,

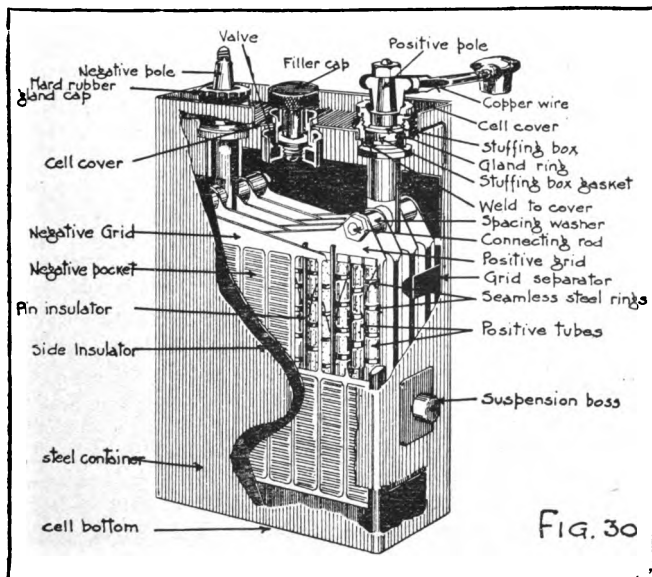

packed in perforated nickel plated steel tubes. Several of these are mounted side by side in a steel frame. The negative plate consists of iron oxide held in a somewhat similar way. These plates are immersed in a 20 per cent solution of caustic potash in water, and the whole is sealed into a welded sheet steel container. The electrolyte acts only as a carrier of oxygen between the plates and does not form chemical compounds with the active materials. It remains practically constant in composition and density throughout charge and discharge.

The voltage while charging may rise to 1.8. When discharge begins, the voltage drops at once to about 1.4, then falls gradually, averaging about 1.2 until near the end. The discharge should not be carried beyond the point at which the open circuit voltage is 0.9. During the charging process hydrogen gas is given off, and since this forms an explosive mixture with air, an open flame must never be brought near the cells. The level of the solution must be kept above the tops of the plates. If after repeated cycles of charge and discharge the density of the electrolyte is found to be as low as 1.16, the cells should be completely discharged, and the old electrolyte should be replaced by new. The care and use of Edison storage batteries are treated in great detail in Radio Pamphlet No. 8, and this should be consulted.

Comparison of the Two Types.—The lead cell will suffer serious injury if not charged and discharged within its proper limits and in a regular and careful manner. The Edison cell, however, is very rugged and will maintain its efficiency even with considerable misuse. A lead cell which has been fully charged will discharge in a few weeks if left standing idle, and its capacity will be considerably decreased. It suffers a still greater loss of capacity if allowed to stand idle while discharged or in a partly discharged condition. The Edison cell, on the other hand, will retain its charge over a long period of idleness, and it may be allowed to stand idle for an indefinite time, either wholly or partly discharged, without injury. A complete short circuit does not injure an Edison cell, but will seriously injure a lead cell. The Edison cell can be charged or discharged at rates which differ greatly from the normal, without injury. The lead cell, however, must be charged or discharged at a rate very close to its normal rate. In the lead cell pure water must be used to replace evaporation losses. In the Edison cell any water may be used which is free from acids and sulphur.

Some Additional Points.—In charging, it is necessary to allow about 2.5 volts for each lead cell, and about 1.75 volts for each Edison cell. If the line voltage is not sufficient to charge the entire set of cells in series, they may be divided into groups and these groups may be placed in parallel.

The polarity of the charging line may be tested with a voltmeter, since the + and - terminals are always marked on the instrument. If a voltmeter is not at hand, a pair of wires from the line may be dipped into a jar of slightly acidulated water. Gas bubbles

will form about one wire (the negative) much faster than about the other (the positive). A convenient pole testing paper may be made by dipping strips of paper in a solution of potassium iodide in water. If the wires are placed on such a strip of paper a few centimeters apart, and gradually brought closer together (avoiding direct contact), a brown color will appear about the + pole. Glycerin may be added to keep the solution from drying out. To guard against a short circuit of the terminals a lamp should be included in the circuit.

22. Internal Resistance in Batteries.—It has been stated in Section 16 that the open circuit voltage or emf. of any battery is always greater than the terminal voltage measured while the cell is delivering current. The relation between the emf. E , the terminal potential difference E' , and the internal resistance r is given by,

$$E - E' = rI \quad (17)$$

Moreover, the voltage that must be impressed across a storage cell to charge it is greater than the emf. of the cell, by the voltage drop within the cell itself. Representing charging voltage by E'' , and with the other symbols having the same meaning as above,

$$E'' - E = rI \quad (18)$$

From measurements of current and open and closed circuit voltage, the internal resistance of the battery may be calculated. The voltmeter used in these measurements should have a high resistance, so that only a feeble current is drawn through its coil. A potentiometer is ideal for this measurement (see Sec. 26), because it does not draw any current from the cell at the instant of making the measurement.

It is important to understand that the quantity r , which has been called the internal resistance of a battery, is not a constant, but varies with the current drawn from the cell. In some cells (e. g., the gravity cell) the resistance decreases with an increase of current. In others (e. g., the dry cell) there is a rapid polarization which tends to increase with the current output, and the back emf. of polarization opposes the emf. of the cell and decreases the current flow. The effect is the same as an increase in resistance of the battery. Thus it is seen that although the factor r is an important one, and is treated as a resistance, it is not altogether a true ohmic resistance. A better name for it is the apparent or effective resistance.

E. Electric Circuits.

23. Current Flow Requires a Complete Circuit.—In order to maintain a steady flow of current, there must be a continuous conducting path. This path is called the “electric circuit,” and it must extend out from the generator and back to it again. The amount of current which flows will be larger as the resistance of the circuit is less. If some part of the circuit is made of very high resistance material, the current which is maintained is relatively small. The complete circuit consists of two parts, (a) the external part of the circuit, which connects the poles of the battery or dynamo outside; and (b) the internal part of the circuit, which is made up of the liquid conductor of the battery or the wires in the dynamo. When the wire of a complete circuit is cut and the ends separated, the circuit is said to be opened or broken. If the ends of the wire are again joined, the circuit is said to be closed.

Current Value Does not Vary Along the Circuit.—The beginning student often has the idea that a current may start out from a source at a given strength and then in some way become used up or dwindle away as it goes on along the circuit. This is entirely a wrong conception and, at the outset, it must be understood that in simple circuits for steady currents, in which we are dealing with resistance only, the current has the same value at whatever point in the circuit is under consideration. As an illustration of this, consider the circuit of Fig. 31, made up of a battery or dynamo G , a lamp e , and a resistor R . If the circuit is cut at a , b , c , or at any other point, and a current-measuring instrument (an ammeter) inserted, it will indicate the same value of current. What this value may be is determined of course by the voltage applied and the total resistance in the circuit but whatever its value, it is constant throughout the circuit. This is not the case with a.c. circuits, which have distributed capacity. (See Sec. 139.)

The same idea may be applied to a circuit such as that shown in Fig. 32. The total current I divides at a into two parts, i_1 and i_2 . The sum of these components is exactly equal to I . In other words, whatever current flows up to the point a , flows away from there. Also the currents i_1 and i_2 unite again at b to form the current I , which has the same value as before.

Another important law is that the sum of the voltage drops in every part of the circuit, including the generator, is equal to the emf. of

the generator. This has already been explained in connection with Ohm's law, Section 16.

24. Series and Parallel Connections.

(a) *Resistances in Series.*—If several resistors are connected as shown in Fig. 33, so that whatever current flows through one of them must flow through all the others, they are said to be in "series." The single equivalent resistance which may replace the entire group without changing the value of the current, is equal to the sum of the separate resistances. This may be proved as follows. The voltages

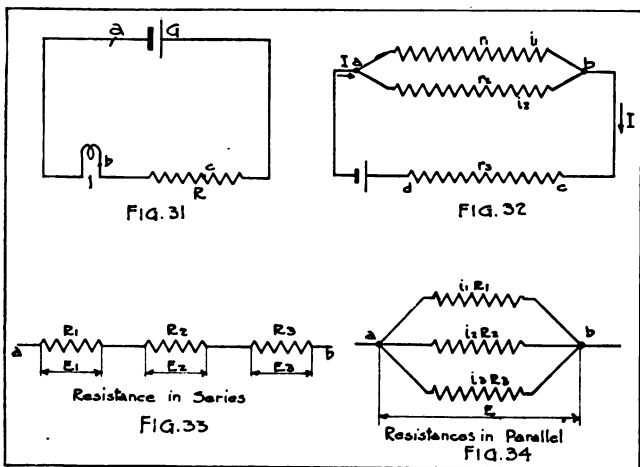

across R_1, R_2, R_3 , etc., may be represented by E_1, E_2, E_3 , etc. We may then write

$$\begin{aligned} E_1 &= R_1 I \\ E_2 &= R_2 I \\ E_3 &= R_3 I \end{aligned}$$

Since the over-all voltage between a and b is the sum of the voltages across the separate parts of the circuit, we may write for the total voltage E ,

$$\begin{aligned} E &= E_1 + E_2 + E_3 = R_1 I + R_2 I + R_3 I \\ &= I [R_1 + R_2 + R_3] \\ &= I R \end{aligned}$$

where R replaces the sum of all the terms in the bracket, and is seen to be the sum of the separate resistances.

If a number of equal resistances are connected in series, we may write for the equivalent resistance of the group,

$$R = nr \quad (19)$$

where n is the number and r is the resistance of each. *When resistances are connected in series, it must be remembered that the current is constant and the total voltage is subdivided among the various parts of the circuit.*

(b) *Resistances in Parallel.*—If several resistances are connected as shown in Fig. 34, so that only a part of the current passes through each resistance, they are said to be connected in “parallel” or “multiple.” The voltage E between points a and b is the same over any branch. We may then write, from equation (11),

$$i_1 = \frac{E}{R_1} \quad i_2 = \frac{E}{R_2} \quad i_3 = \frac{E}{R_3}$$

Since the total current must be the sum of the three branch currents, we may add the three equations and

$$i_1 + i_2 + i_3 = I = E \left[\frac{1}{R_1} + \frac{1}{R_2} + \frac{1}{R_3} \right]$$

or

$$\frac{I}{E} = \frac{1}{R_1} + \frac{1}{R_2} + \frac{1}{R_3} \quad (20)$$

From equation (9) it appears that the voltage divided by the current gives the resistance, hence the left-hand member of equation (20) is the reciprocal of the equivalent resistance, or $\frac{1}{R}$.

Hence

$$\frac{1}{R} = \frac{1}{R_1} + \frac{1}{R_2} + \frac{1}{R_3} \quad (21)$$

Two resistances in parallel occur so often in practice, that it is well to consider this case further. Solving equation (21) for R when there are only two component resistances we have,

$$R = \frac{R_1 R_2}{R_1 + R_2} \quad (22)$$

Thus, two resistances in parallel have a joint or equivalent resistance, given by the product of the resistances divided by their sum.

When there are a large number of single resistances, all of the same value, in parallel, it can be shown that the equivalent resistance of the group is given by

$$R = \frac{r}{n} \quad (23)$$

where r is the value of one resistance, and n is the number of them.

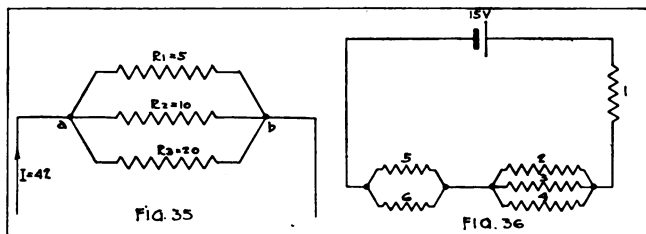

When resistances are connected in parallel it must be remembered that the voltage across ab , Fig. 34, is constant, and the total current is subdivided among the several branches.¹

¹ *Exercise 1.*—A current of 42 amp. flows in a circuit, Fig. 35, and divides into three parts in the three branches, of resistance 5 ohms, 10 ohms, and 20 ohms, respectively. Find the current in each branch.

Solution.—The total resistance R between a and b is given by

$$\frac{1}{R} = \frac{1}{5} + \frac{1}{10} + \frac{1}{20}$$

$$R = \frac{20}{7} \text{ ohms.}$$

The RI drop between a and b is, from equation (10), $E = \frac{20}{7} \times 42 = 120$ volts. The several currents may then be calculated from Ohm's law,

$$i_5 = \frac{120}{5} = 24 \text{ amp.}$$

$$i_{10} = \frac{120}{10} = 12 \text{ amp.}$$

$$i_{20} = \frac{120}{20} = 6 \text{ amp.}$$

Exercise 2.—A battery of internal resistance 1 ohm and 15 volts emf. is sending current through a circuit with resistances as shown in Fig. 36. Find (1) the total current, (2) the RI drops across resistances 1, 4, and 5, (3) the currents through 1, 4, and 5.

(c) *Batteries in Series and Parallel.*—It is frequently necessary, when using batteries, to increase the effect which a single cell can produce. This is done by connecting the batteries in any one of three ways:

1. In series. Here the + side of one cell is connected to the - side of the next one, and so on for all the cells. (Fig. 37.)

2. In parallel. In this case all the + terminals are connected together and all the - terminals are connected together. (Fig. 38.)

3. In a combination of series and parallel groups. Several group of cells in series may be connected in parallel, Fig. 39, or several groups of cells in parallel may be connected in series. (Fig. 40.)

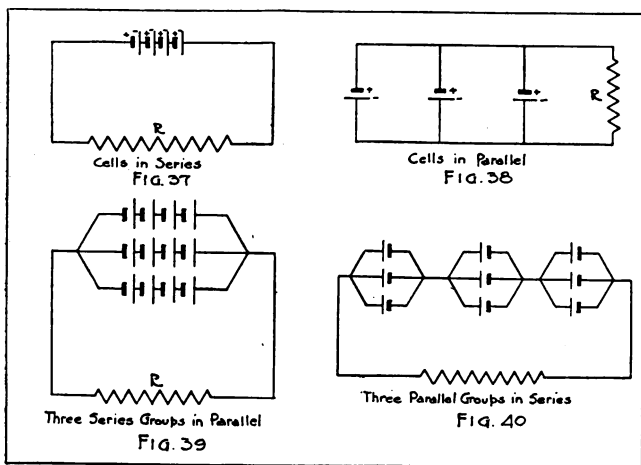

The proper combination to use in any given case is dependent upon circumstances, but in general a series arrangement builds up voltage, but at the same time it increases the internal resistance, while a parallel arrangement, by decreasing the internal resistance, permits greater current to flow. If we represent the number of cells by n , the emf. of each cell by E , the internal resistance of one cell by r , and the external resistance by R , we may write Ohm's law for each of the above cases.

For series arrangement,

$$I = \frac{nE}{R + nr} \quad (24)$$

For parallel arrangement,

$$I = \frac{E}{R + \frac{r}{n}} \quad (25)$$

For n cells in series in each group, and m such groups in parallel,

$$I = \frac{nE}{R + \frac{nr}{m}} \quad (26)$$

If it is desired to build up a large current through R with a given number of dry cells, especially when their internal resistance has become relatively large through age, a series arrangement may actually cause the internal resistance to increase faster than the voltage. Hence, adding cells in series would result in a decrease of current. The best use of a given number of cells to produce a stated current, under fixed external circuit resistance, can only be determined by a careful application of Ohm's law and the above equation, having the entire circuit in mind.¹

¹ *Exercise.*—Assume a battery of two dry cells in series, each cell having an emf. of 1.5 volts and an internal resistance of 0.3 ohm. Each battery then has an emf. of 3 volts and an internal resistance of 0.6 ohm. Suppose that the external resistance in the circuit is 0.2 ohm, and that a current of 6 amp. is to be established.

Solution.—If we try one battery, Ohm's law gives

$$I = \frac{3.0}{0.2 + 0.6} = 3.75 \text{ amp.}$$

This is not enough current, so we will try two batteries in series,

$$I = \frac{6.0}{0.2 + 1.2} = 4.28 \text{ amp.}$$

The current is still too small and it is seen that although the voltage has been doubled, the current has only been increased by about 14 per cent. Trying three batteries in series,

$$I = \frac{9}{0.2 + 1.8} = 4.5 \text{ amp.}$$

This is still too small and only represents an increase of 20 per cent, although the voltage was increased threefold. We will now try an arrangement of two batteries in parallel,

$$I = \frac{3}{0.2 + \frac{0.6}{2}} = 6.0 \text{ amp.}$$

In general the largest current from a given number of cells will be obtained when they are so grouped that the internal resistance of the battery is equal to the external resistance of the circuit. Batteries will be connected in series when the external resistance is large, and in parallel when the external resistance is small. In lighting systems, with many incandescent lamps in parallel, the lamp resistance is large compared to the line resistance, and very nearly the full voltage is realized at the lamp socket.

25. **Divided Circuits. The Shunt Law.**—Electric circuits are frequently arranged so that the total current is subdivided, and made to flow through two or more branches in parallel. As shown in Fig. 41 the total current I divides into two parts, i_1 and i_2 , which

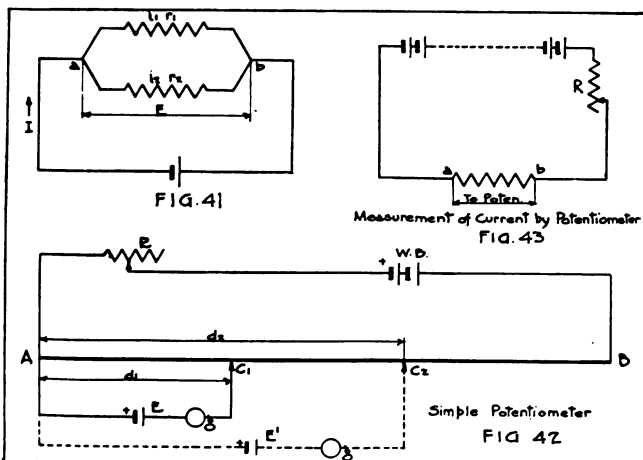

flow in branches r_1 and r_2 respectively. When so arranged, either branch is called a *shunt* (side track or by pass) with respect to the other. The voltage between points a and b is of course the same over either of the branches. We may then write,

$$i_1 = \frac{E}{r_1} \quad (a)$$

$$i_2 = \frac{E}{r_2} \quad (b)$$

Dividing (a) by (b) we have

$$\frac{i_1}{i_2} = \frac{r_2}{r_1} \quad (27)$$

The currents in the two branches are inversely proportional to the resistances of their respective paths. This relation is called the "shunt law." In other words, it means that the branch of lower resistance carries the larger current, and the branch of higher resistance carries the smaller current.

This law is of constant application in electric circuits. Suppose that the only ammeter available is one with a scale range of 0-5 amp., and suppose that a current of 50 amp. has to be measured. The shunt law at once suggests that we may proceed as follows. With 50 amp. flowing in the main circuit, and with 5 amp. as the safe current through the ammeter, a shunt s must be provided capable of carrying the rest of the current or 45 amp. We may then write from equation (27),

$$\frac{i_a}{i_s} = \frac{5}{45} = \frac{s}{r} \quad (28)$$

where r is the resistance of the ammeter, and s is the resistance of the shunt.

Then
$$s = \frac{1}{9}r$$

Thus to carry the required amount of current, the shunt resistance must be one-ninth of that of the ammeter. In general it can be proved that if I is the total current,¹

$$i_a = I \left[\frac{s}{s+r} \right] \quad (29)$$

The factor $\frac{s+r}{s}$ is called the "multiplying factor" of the shunt, and is in the above case equal to 10.

26. The Potentiometer.²—The potentiometer is primarily an arrangement of circuits for measuring potential difference or voltage. With the aid of certain accessories it can be used for measuring voltages over all ranges, and by means of Ohm's law these measurements can be applied to the determination of a wide range of current values. A uniform homogeneous wire, usually a meter or more in length (Fig. 42), is stretched between binding posts on a baseboard, by the

¹ For proof of this equation see Swoope, Lessons in Practical Electricity, p. 146.

² The word "potentiometer" is used here in its original sense, meaning an arrangement of circuits for measuring potential difference. In apparatus catalogues and in textbooks on radio circuits the word is often inaccurately used in the sense of a voltage divider. (See Sec. 15.)

side of a graduated scale. In series with this wire is a constant source of current, usually a storage battery WB and a variable resistor R . From equation (10) it is clear that by properly adjusting R the voltage between A and B can be varied through wide limits. Let us assume that (1) the end A is connected to the $+$ side of the battery WB , (2) the resistance of AB is uniform from end to end, and (3) the current through AB is constant and of such a value that the RI drop along the wire is about 2 volts. If a standard cell, of voltage E (about 1.0183), has its $+$ pole connected to the point A , a certain point c_1 can be found, such that when contact is made at this point, the galvanometer g (see Sec. 50) will show no deflection. The absence of deflection on the galvanometer means that the RI drop in the wire AB up to the point c_1 is just equal, and opposed to the voltage of the standard cell. The distance Ac_1 may be represented by d_1 . Now let some other cell E' , whose voltage is to be tested, be put in place of the standard cell E . If the voltage of this cell does not exceed the RI drop in AB , another point c_2 can be found, for which there is no current through the galvanometer. The distance Ac_2 may be called d_2 , and the RI drop over this length of wire is just equal and opposed to the voltage of the cell E' to be tested. Since the RI drops along the wire are directly proportional to the lengths, we may write

$$\frac{E}{E'} = \frac{d_1}{d_2}$$

and

$$E' = E \frac{d_2}{d_1} \quad (30)$$

This simple form of the apparatus is only capable of measuring a voltage not much greater than that of the standard cell. If very much higher voltages are to be measured, the high voltage is put across the terminals of a voltage divider (Sec. 15), and some definite fraction of it is then measured against the standard cell, as described above.

Also, any range of current can be measured by means of the potentiometer. The current to be measured is passed through a standard resistance ab of known value R , Fig. 43. This is so chosen that the RI drop across it lies within the voltage range of the potentiometer. The determination of current then consists in measuring the voltage across ab in terms of the standard cell, and calculating the current by Ohm's law.

27. **The Wheatstone Bridge.**—This is a simple circuit for measuring an unknown resistance in terms of a known resistance. The method depends upon the fact that in a branched circuit, Fig. 44, the voltage drop from *a* to *c* must be the same over the path *abc* as it is over the path *adc*. It then follows that for any point *b* which may be chosen on the upper circuit *abc*, there must be some point *d* on the lower branch, such that there will be no difference of potential between it and the point *b*. The point *d* can be found by connecting one terminal of a galvanometer at *b* and moving the contact point connected to the other terminal along the lower wire until there is no deflection. This means that there is no current flowing, and hence no potential difference between *b* and *d*. When the points *b* and *d* have been located in this way, it can be shown¹ that there is a simple definite relation between the resistances of

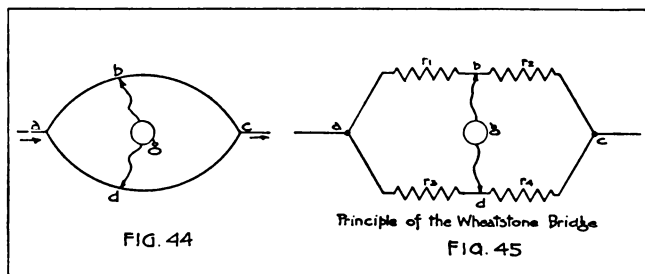

the four arms of the circuit. (See Fig. 45.) If three of these resistances are known, the fourth, r_4 , can be readily calculated from the equation

$$\frac{r_1}{r_2} = \frac{r_3}{r_4}$$

or

$$r_4 = r_3 \frac{r_2}{r_1} \quad (31)$$

In practice the branch *adc* may be made from a long, uniform and homogeneous wire, in which case it is not necessary to know the resistance values. If the portion *abc* is such a wire, the ratio of the lengths l_1 and l_2 of the segments will be the same as the ratio of the resistances. The equation (31) may then be written

$$r_4 = r_3 \frac{r_2}{r_1} = r_3 \frac{l_2}{l_1} \quad (32)$$

¹ For proof of this equation see Timble, Elements of Electricity, p. 107.

28. Heat and Power Losses.—In Section 7 it was shown that when current flows through a resistance, heat is generated in it. It is important to understand that this effect does not refer to heating the resistor to a definite temperature, but rather it has to do with the generation of heat at a definite rate. This rate may be expressed in joules per second, calories per second, watts, or horsepower. When the rate of supply of heat due to the electric current is just equal to the rate of loss of heat by conduction or radiation, then the temperature becomes constant. The final temperature of any resistance coil through which current is passing depends upon its surroundings. If it is open to the air, radiation is more free. In coils which are inclosed, the temperature may rise rapidly and unless care is taken, the insulation may be softened or even burned.

When the heat is dissipated at as fast a rate as it is produced, so that the temperature of the resistor remains constant, the resistance becomes constant.

$$\text{Equation (2) is} \quad W = JH = RI^2t \quad (2)$$

Since from Ohm's law, $I = E/R$ we may write

$$W = JH = R \frac{E^2}{R^2} t = \frac{E^2}{R} t \quad (32)$$

$$\text{Again substituting} \quad R = \frac{E}{I},$$

$$\text{we have} \quad W = JH = \frac{E^2 I}{E} = EI t \quad (33)$$

These three equations will give the energy in joules when amperes, ohms, volts, and seconds are used.

Power is the time rate of change of energy. If the three equations above are divided by the time t , we have the corresponding three equations for power.

$$P = \frac{W}{t} = RI^2 \quad (34)$$

$$= E^2/R \quad (35)$$

$$= EI \quad (36)$$

Exercise 1. What power is required to operate 1000 incandescent lamps, each of which requires $\frac{1}{2}$ amp. and 110 volts?

First solution.—From equation (36), each lamp requires

$$\frac{1}{2} \times 110 = 55 \text{ watts.}$$

For 1000 lamps—

$$\begin{aligned} 1000 \times 55 &= 55,000 \text{ watts} \\ &= 55 \text{ kw.} \end{aligned}$$

Since

746 watts=1 horsepower,

$$\frac{55,000}{746} = 73.7 \text{ h.p.}$$

Second solution.—The resistance of each lamp is given by

$$R = \frac{E}{I} = \frac{110}{\frac{1}{2}} = 220 \text{ ohms.}$$

Using equation (34)

$$P = 220 \times \frac{1}{2} = 55 \text{ watts for 1 lamp.}$$

For 1000 lamps—

$$P = 1000 \times 55 = 55 \text{ kw.}$$

Exercise 2. An instrument has 1210 ohms resistance in its coils, and a voltage of 110 volts is impressed. Calculate the rate of dissipation (watt-loss) in the coils.

F. Capacitance.

29. **Dielectric Current.**—So far, only steady currents and their flow in conductors have been considered. In a perfect insulating

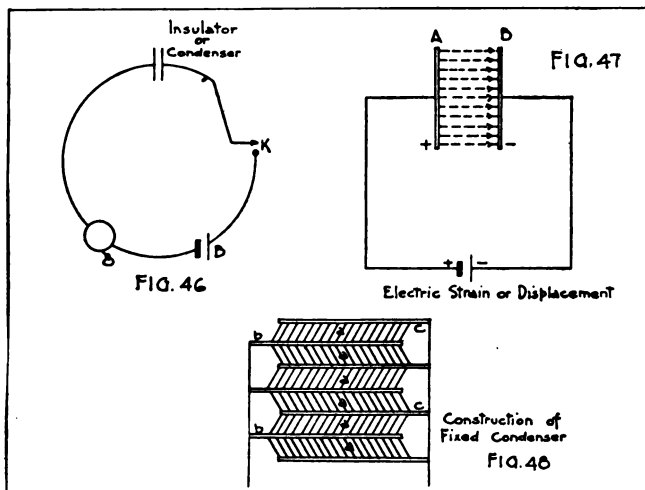

material, current can flow only momentarily. If an electromotive force is applied between two points of an insulator, a momentary flow of current takes place which soon ceases. The current flow is very different from that in a conductor. If a very sensitive indicator of current *g*, Fig. 46, is connected into the circuit, it shows a sudden deflection when the key is closed. This deflection soon drops to zero. The momentary flow of electricity is due to the production of

a sort of electric strain or "displacement" of electricity. This is resisted by a sort of elastic reaction of the insulator that may be called electric stress. On account of this reaction of the electric stress, the electric strain due to a steady applied emf. reaches a steady value, and the current becomes zero. When the electric strain is subsequently allowed to diminish, a current again exists in the opposite direction. A current of this kind, called a "displacement current," exists only when the electric strain or displacement is changing. When considering the existence of electric strain or displacement in an insulating material, the material is called a "dielectric," and the displacement current is sometimes called a "dielectric current."

We do not think of this electric displacement as being due to the actual passage of matter, on which the charge is carried from one plate to the other, nor even from one molecule to another within the substance. It is rather as if, in each molecule, a positive charge is moved to one end and a negative charge to the other. Then with all the positive charges pointing in one direction, the effect is that a certain change has been transmitted clear across the dielectric. An illustration may aid in making this idea clearer. In a dense crowd of people, a sudden push or shove on one person will be sent through from person to person. Energy is transmitted, and yet no single person has passed all the way across.

When a dielectric is in the electrically strained condition, it possesses potential energy in the "electrostatic" form. (For a brief discussion of energy, see C. 74, p. 9.)

30. Condensers.—Displacement is produced in a dielectric by placing the dielectric between metal plates and connecting a battery or other source of emf. to these plates. Such an arrangement consisting of metal plates separated by a non-conducting material is called a condenser. Thus in Fig. 47, *A* and *B* are the metal plates of the condenser. The dotted lines indicate the directions of the electric strain or displacement. The plate from which the displacement takes place is called the positive or + plate of the condenser. Conversely, the other plate is called the negative or - plate. The dielectric may be air or other gas, or any solid or liquid that is not a conductor. When the battery is connected to the condenser, a displacement current begins to flow, continuing until the electric displacement reaches its final or steady value. The displacement produced depends upon (a) the voltage applied to the condenser

and (b) the kind of dielectric. A continuous or direct current can flow only in conductors. An alternating current, in which the direction periodically changes sign, can flow also in condensers in the form of a dielectric current. (See Sec. 58.) In this case, the electric strain or displacement reverses its direction with every reversal of the current. The existence of the electric strain or displacement in the dielectric is equivalent to the presence of a certain quantity or charge of electricity.

For a given condenser, its charge Q is found to be directly proportional to the applied voltage E . This relation may be written

$$Q = CE \quad (37)$$

where C is a constant. For any given condenser the value of this constant is seen to be the ratio of the charge to the voltage, or

$$C = \frac{Q}{E} \quad (38)$$

This constant is called the "capacitance" of the condenser. The units used for capacitance are the "microfarad" and the "micromicrofarad," abbreviated as "mfd." and "micro-mfd." (See definition in Appendix 2, p. 350.)

The capacitance changes when different dielectric materials are used. If the plate area is increased, the capacitance increases in direct ratio, and as the plates are brought closer together, the capacitance increases. (Formulas for calculating the capacitance of condensers are given in C. 74, p. 235.)

Charging of Condensers.—During the brief time in which the charge is accumulating in a condenser, the voltage $\frac{Q}{C}$ due to this charge is increasing. This voltage tends to oppose the applied or charging voltage. When $\frac{Q}{C}$ has become equal to E , the charging process comes to an end. It will be noticed that equation (37) does not contain a time factor; therefore the same amount of charge is stored in a condenser whether it is built up slowly or quickly. However, the rate of building up the charge depends upon the value of the capacitance and resistance of the circuit. The larger the product of the factors C and R the greater is the time required to arrive at any given fraction of the applied voltage; this product CR is called the time constant of the circuit.

31. **Dielectric Properties.**—A simple experiment will show that the charge accumulated in a condenser, for a given voltage and distance apart of the plates, depends upon the kind of dielectric material. A pair of plates with dry air between them is charged by a certain emf., and the quantity or amount of charge is measured by some suitable means. If now a slab of paraffin be inserted between the plates, it is found that for the same voltage the charge is increased. Denoting the capacitance with air by C_a and the capacitance with paraffin by C_p , we may write

$$\frac{C_p}{C_a} = K$$

where K is a constant. By simply changing the dielectric material, and without changing the geometric arrangement of the plates, we find that the capacitance has been increased. Air is commonly used as the standard of comparison, and the factor K is called the "dielectric constant"¹ of the material. *The dielectric constant of any substance may then be defined as the ratio of the capacitance of a condenser using this substance as the dielectric, to the capacitance of the same condenser with air as the dielectric.* This ratio is seen to be the factor by which the capacitance of an air condenser must be multiplied in order to find the capacitance of the same condenser when the new substance is used. Some values are given below.

Substances.	Values of dielectric constant.
Paper, dry.....	1.5
Paper (treated as used in cables).....	4
Paraffin.....	2 to 3.3
Ebonite.....	2 to 3.2
Petroleum.....	2.1
Transformer oil.....	2.5
Mica.....	4 to 8
Glass.....	4 to 10
Water.....	81

A wide variation is seen in the values given for some substances, inasmuch as the properties of such materials differ greatly with the rapidity or slowness with which the charge is applied or withdrawn. Quite different values of K will be found, if the measurements are made with a rapidly reversed voltage and with a slowly applied

¹ Sometimes called also "inductivity" or "specific inductive capacitance."

voltage from a battery. For accurate values, the conditions of use must be very precisely stated.

Dielectric materials are not perfect insulators, but do have a very small electric conductivity. A condenser will permit a very small current to flow through it continuously when a voltage is applied to its terminals, and it will discharge itself slowly, if allowed to stand with its terminals disconnected. This is called the "leakage" of the condenser. Materials differ greatly in this respect. A pair of plates with dry air as dielectric will retain the charge almost indefinitely after the voltage is cut off, while in some paper condensers the charge disappears by leakage in a few minutes.

If an emf. gives a condenser a certain charge when applied for a short time, and a greater charge when applied for a longer time, the dielectric is said to possess "absorption." There is a gradual penetration of the electric strain into the dielectric, which requires time. When the terminals of a charged condenser are connected by a conductor, a current flows and the condenser discharges. The charge which flows out instantaneously upon discharge is called the "free charge." With some dielectrics, if the terminals are connected a second time, another and smaller discharge occurs, and this may be repeated several times. This so-called residual charge is due to the absorbed charge, and indicates a slow recovery of the dielectric from the electric stress. In condensers made with oil or well selected mica for the dielectric, absorption is small. It is larger with glass, and very troublesome with bakelite and similar materials. After charging such a condenser with a high voltage, the absorbed charge continues to be given up for a long time. Absorption is accompanied by the production of heat in the dielectric. This represents a loss of energy.

The ratio of the free charge of a condenser to the voltage across its terminals is called the "geometric capacitance." Any measurements of capacitance which make use of a prolonged time of charging, yield values larger than the geometric capacitance. Measurements made with high-frequency alternating currents give values which approach closely to the geometric capacitance.

Summary.—An elastic body is distorted or strained by placing it under the action of a stress; and the effect produced is measured in terms of the flexibility of the material. A dielectric substance is strained electrically by placing it under the action of an emf., and the effect produced is measured in terms of the capacitance of the

condenser. It is of interest to note that the capacitance of an electric condenser is directly analogous to flexibility, or stretchability of an elastic body.

32. Types of Condensers.—In order to increase the capacitance of a condenser, we may—

1. Increase the area of the plates.
2. Diminish the distance between the plates.
3. Use a substance of larger dielectric constant.

In general, condensers are classified in two groups, as they may be designed respectively, for (a) low voltage—less than 500 volts, or (b) high voltage—several thousand volts. Increasing the plate area tends to increase the bulk and weight of the condenser. Bringing the plates very close together makes necessary the use of a substance of high dielectric strength if the voltage is high. For low voltage service, where large capacitance is essential, the condenser plates are made of tin foil with thin sheets of mica or paraffined paper between them. The sheets are piled up as shown in Fig. 48, p. 71. The dielectric layers are represented by *aa*, and the two sets of conducting plates by *bb*, and *cc*, respectively. These are pressed into a compact form and held in place by a clamp, flowing the entire set of plates with melted paraffin or wax. If the condenser must withstand a very high voltage, the plates will be more widely separated and usually air or oil is used as the dielectric. If it is desired to have the capacitance of the condenser variable instead of fixed, the construction usually takes the form shown in Fig. 49. Two sets of interleaved plates are insulated from each other, and one set is mounted so that it can be rotated with respect to the other. Such a condenser can be calibrated so that the capacitance corresponding to any angular setting of the rotating part is known. Condensers used in radio circuits are represented by certain symbols. These may be found in Appendix 3, page 354.

It is not always necessary that the conducting plates in the condenser should be sheets of metal. The earth is a conductor and frequently replaces one plate in the system. A wire stretched on a pole line forms one plate of a condenser, and the other plate may be the neighboring return wire of the circuit, or it may be the earth itself. Several wires in a connected group will have more capacitance with respect to the earth than a single wire. Such a condenser is the radio antenna. (Fig. 50.) The conducting core of a submarine cable forms one plate of a condenser, the insulating material is the dielectric and the sea water is the other

plate. Similarly in a telephone cable, paper is the dielectric, and any single conductor of the cable may be regarded as one plate, the other plate being the adjacent wire of the pair, or the lead sheath of the cable itself. The great length of such wires and cables gives them large surface and hence large capacitance. A mile of standard sea cable may have a capacitance of about $\frac{1}{3}$ mfd. A mile of standard telephone cable should not have capacitance of more than about 0.08 mfd. The capacitance of a pair of No. 8 copper wires, 1000 ft. in length and 12 in. apart is about 0.0032 mfd. Two square plates 10 cm. on a side, separated

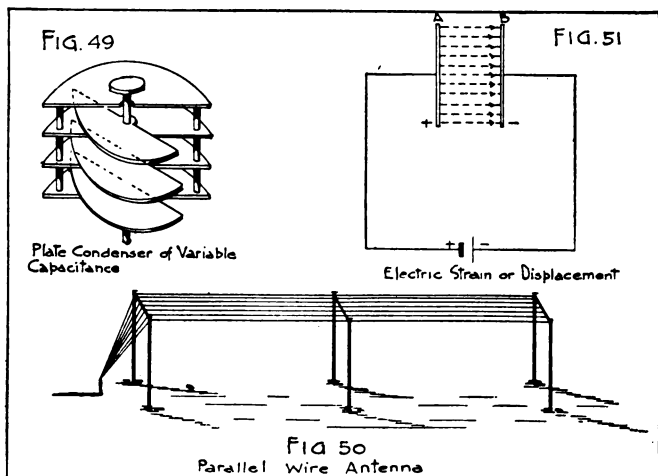

by 1 mm. of dry air have a capacitance of approximately 100 micro-mfd. (For such calculations see C. 74, p. 235.)

33. **Electric Field Intensity.**—Consider the air condenser shown in Fig. 51, having an emf. E applied across its terminals. The emf. is the cause of the electric strain or displacement which is in the direction shown by the dotted lines. The emf. between the plates of the condenser is equivalent to a force acting at every point of the dielectric, which would cause a body having a charge of electricity to move. This is called the electric field intensity and is defined as the force per unit charge of electricity. The space in which this field intensity acts is called an electric field.

The value of the electric field intensity at any point inside the condenser shown in Fig. 51 is the ratio of the emf. across the condenser to the distance between the plates. Electric field intensity \mathcal{E} is thus given by

$$\mathcal{E} = \frac{E}{d} \quad (39)$$

where E is the emf. between two points in the dielectric a distance d apart. \mathcal{E} is commonly expressed in volts per centimeter. It is a quantity of importance in connection with electric waves.

The electric field in the condenser of Fig. 51 is the same everywhere in direction and in value. This is called a uniform field. There are many other kinds of fields. The electric field about two small unlike charges is shown in Fig. 52. Another example

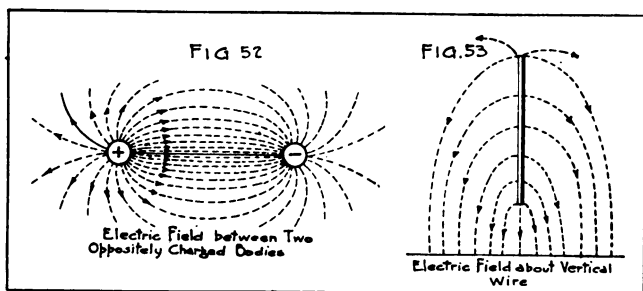

is given by two bodies, one of which is a long vertical wire, and the other is a conductor extended in a horizontal direction. These amount to two conductors separated by a dielectric (air), thus fulfilling the definition of a condenser. Suppose the lower body is the earth itself, which is a conductor. The field about the system will be represented by Fig. 53. This represents the form of condenser and electric field in the case of the radio antenna.

34. Energy Stored in a Condenser.—The electric strain in the dielectric of a charged condenser represents a store of energy. The amount of energy stored in this way is found as follows. The work done in placing a charge in a condenser is the product of the charge by the voltage between the plates. Suppose a condenser is charged by applying to it an emf. which begins at a zero value and rises to E volts. The increase in voltage is uniform and hence the

average voltage is $\frac{1}{2} E$. The energy stored in the condenser is the product of this by the charge, thus

$$W = \frac{1}{2} QE \quad (40)$$

Since $Q = CE$, from equation (37), we may write

$$W = \frac{1}{2} CE^2 \quad (41)$$

The work is expressed in joules when the capacitance is in farads and the emf. is in volts. A capacitance of 0.001 mfd. charged with an emf. of 20,000 volts has a store of energy given by

$$W = \frac{1}{2} \frac{0.001}{10^6} \times 20,000^2 = 0.2 \text{ joules}$$

From equation (41) it appears that time does not enter into the energy equation. For a given condenser charged to a given voltage it requires the same total amount of energy, whether the charge is acquired slowly or rapidly.

The total amount of work done in charging a condenser divided by the time, gives the power expended. This may be written,

$$P = \frac{1}{2} \frac{CE^2}{t}$$

or

$$P = \frac{1}{2} CE^2 N \quad (42)$$

where T is the time in seconds required to complete the charge, and N is the number of charges completed in one second of time. If the condenser in the above problem is charged by a generator giving an alternating emf. with a frequency of 500 cycles per second, the power becomes

$$P = \frac{1}{2} CE^2 N = 0.200 \times 1000 = 200 \text{ watts.}$$

It will be noted that the condenser is charged and discharged twice in every complete cycle of the a.c. generator; also that E is the maximum emf.

35. Condensers in Series and in Parallel.—Just as it is sometimes found convenient to combine resistances into series or parallel groups, so it is often desirable to combine condensers. The capacitance of the group, however, is not calculated the same way as in the case of resistances.

Condensers in Parallel.—Fig. 54 shows three condensers connected in parallel. The condensers are all under the same impressed emf., and they accumulate charges proportional to their

respective capacitances. It has been stated in Section 30 that capacitance is proportional to plate area. Connecting condensers in parallel is equivalent simply to increasing the plate area. If C_1 , C_2 , C_3 , etc., represent, respectively, the capacitances of the condensers of the group, and if C represents the equivalent capacitance of the entire group, we may then write

$$C = C_1 + C_2 + C_3 + \dots \quad (43)$$

Parallel connection of condensers always gives a larger capacitance than that of any single member of the group.

Condensers in Series.—If several condensers are connected as shown in Fig. 55 they are said to be connected in series. In finding the equivalent capacitance of such a group, it must be kept in mind that

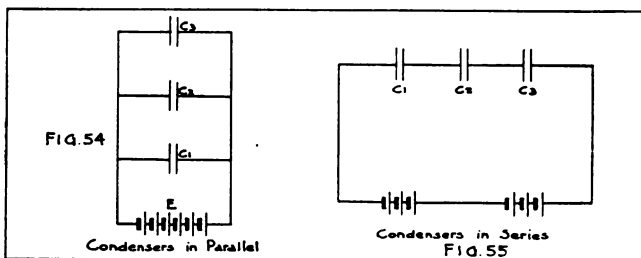

the same charge is given to each condenser, and that the total voltage E is subdivided among the condensers in direct ratio to their capacitances. Using symbols as above we may then write

$$E = E_1 + E_2 + E_3 + \dots$$

or since in general $E = \frac{Q}{C}$

$$\frac{Q}{C} = \frac{Q}{C_1} + \frac{Q}{C_2} + \frac{Q}{C_3} + \dots$$

Whence
$$\frac{1}{C} = \frac{1}{C_1} + \frac{1}{C_2} + \frac{1}{C_3} + \dots \quad (44)$$

Series connection of condensers always gives a smaller capacitance than that of any single member of the group. (See problems below.)

1. A condenser has a capacitance of 0.014 mfd., and it is charged with an emf. of 30,000 volts.

Find (a) the charge in the condenser, (b) the energy stored, (c) the power expended when charged by a 500-cycle a.c. generator.

2. A condenser is built up of 15 parallel and circular plates. Each plate is 20 cm. in diameter and the separation is 1 mm. Petroleum is used as a dielectric. Calculate the capacitance. (See C. 74, p. 235.)

3. Three condensers have capacitances of 0.02, 0.20 and 0.05 mfd., respectively. Find the equivalent capacitance, (a) when they are all in series; (b) when they are all in parallel.

G. Magnetism.

36. **Natural Magnets.**—One of the forms in which iron is found in the earth is the black oxide of iron (chemical formula Fe_3O_4), called magnetite or magnetic iron ore. A piece of this substance is called a "natural magnet," and it has two very remarkable properties as follows:

(a) If a piece of it is dipped into iron filings the filings will adhere to it.

(b) If a piece of it is suspended by a silk thread, or by a thin untwisted cord, it will set itself with its longer axis very nearly in a north and south direction.

37. **Bar Magnets.**—A small rod of iron or steel which is brought near to a piece of magnetite, or which is rubbed on it in a certain

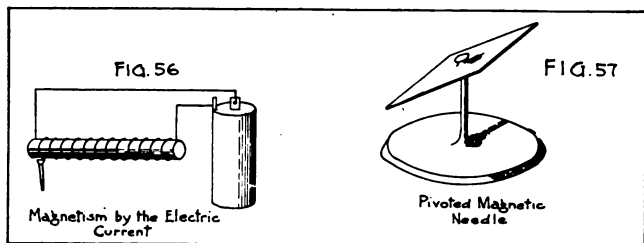

way, shows the same properties, and is said to be "magnetized." If the rod or bar is made of rather hard steel, the effect persists after the iron ore has been taken away, and the magnetized rod is then called a "permanent magnet," or simply a bar magnet. These permanent magnets may be made in the form of straight bars of round or square section, usually with the length rather large as compared to the diameter. They are also often bent into various shapes, a common form being the horseshoe or U-shaped magnet.

Magnets may also be made by passing an electric current through a coil of wire which surrounds the rod. (See Fig. 56.) If the rod is made of soft iron, it is only magnetized as long as the current flows. It is then called a temporary magnet or an "electromagnet." Examples of electromagnets are seen in induction coil and buzzer cores, in telegraph sounders and relays and in telephone receivers. Electromagnets are very useful because the magnetism is so easily controlled by variations in the current strength. If the bars are of hardened steel, the magnetism due to the current remains after the current ceases and a permanent magnet is the result.

A slender magnetized steel rod mounted carefully on a pivot (Fig. 57) will turn very nearly into the north and south position, and is called a "compass needle." It is used by sailors and surveyors for determining directions. The end which points north is called

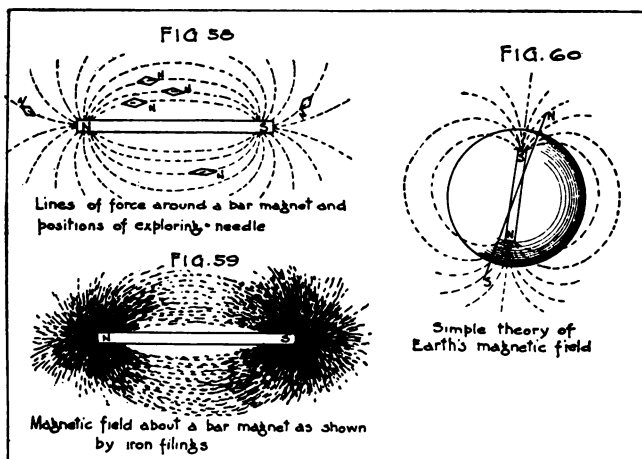

the north-pointing or simply the "north pole." The other end is called the south pole.

38. **The Magnetic Field.**—If a compass needle is placed at various positions near a large bar magnet, it changes its direction as shown in Fig. 58. This shows that in the space all around the magnet there are forces which act on magnetic poles. If iron filings are

sprinkled on a level sheet of paper which lies over the magnet, the filings arrange themselves as shown in Fig. 59. Each little particle of iron acts like the compass needle and points in a definite direction at a given position. These direction lines, called "magnetic lines of force," all appear to center in two points near the ends of the bar magnet. These points are called the "poles" of the magnet. Two magnetic poles are said to be alike when they both attract or both repel the same pole. If one attracts and the other repels the same pole, they are said to be unlike. *Like poles repel each other and unlike poles attract each other.* It is then easy to determine which is the north and which is the south pole of a bar magnet by means of the direction in which the north pole of a compass needle points.

The region all about a magnet, in which these forces on the poles of magnetic needles may be detected, is called the "magnetic field." The intensity of a magnetic field may be defined in terms of the force which acts on a given magnetic pole, or it may be defined in another way, as described in a following paragraph. The direction of a magnetic field is defined as the direction in which the north pole points.

The earth has a magnetic field about it which is represented by Fig. 60. This field is similar to that which exists about a bar magnet placed within the earth with its ends at the North and South Poles of the earth.

39. Magnetic Flux and Flux Density.—The arrangement of the iron filings in Fig. 59 shows that there is a greater effect at some points than at others. It also suggests that the lines of force may be thought of as similar to stream lines in a moving fluid. From this point of view there is said to be a magnetic flux through the space occupied by the magnetic field. This is represented by lines drawn closer together where the field is strong and farther apart where the field is weak. The magnetic field must not be thought of as made up of filaments, like a skein of yarn, because it really is continuous. However, electrical engineers represent a magnetic flux by drawing one line through the field for each unit of the flux. The number of such lines through each square centimeter of the field perpendicular to the lines is the "magnetic induction" or "flux density." The unit of flux density exists in a magnetic field when the unit of magnetic flux is distributed over a square centimeter of area, taken perpendicular to the direction of the flux.

40. **The Magnetic Field about a Current.**—It has already been pointed out in Section 3 that there is a magnetic field about a wire in which a current is flowing. Experiments with the compass show that this magnetic field has lines of force in the form of concentric circles about the wire. These circles lie in planes at right angles to the axis of the wire. If the wire is grasped by the right hand with the thumb pointing in the direction of the current, the fingers will show the direction of the magnetic field (Fig. 10). This field extends to an indefinite distance from the conductor, but for points farther from the wire the effect becomes more feeble, and the more sensitive must be the apparatus for detecting it. If the current

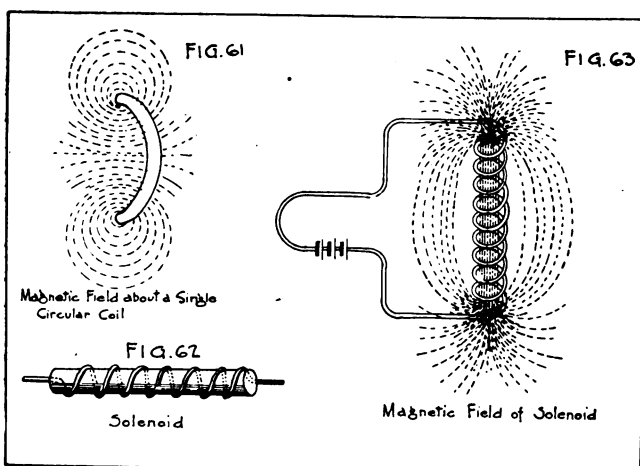

stops, the magnetic field, together with its effects, disappears. When current is started through the wire, we may think of the magnetic field as coming into being and sweeping outward from the axis as a center. This disappearing and rebuilding of the magnetic field as the current decreases and increases will be made use of in Section 46, in explaining some important principles which apply in radio circuits.

41. **The Solenoid and the Electromagnet.**—If the wire which carries a current is bent into a circle, the magnetic field is of the form shown in Fig. 61. At the center of the circle the field is uniform only for a very small area. If many turns are wound close together

in what may be called a bunched winding, the intensity of the magnetic field is increased in direct proportion to the number of turns. When the wire is wound closely with many turns, side by side along the surface of a cylinder, the coil is called a "solenoid," Fig. 62. In this case, the magnetic field is nearly uniform for a considerable distance near the center of the coil, and the solenoid has the properties of a bar magnet. This is seen by comparing the magnetic fields of Figs. 63 and 59. The intensity of the field and the magnetic flux density within the solenoid, depend entirely upon the strength of the current and the number of turns of wire per centimeter. The same magnetizing effect can be secured with many turns and a weak current, or with a few turns and a strong current, provided only that the product of wire turns times amperes of current is the same in each case. This product is called the "ampere-turns." In round numbers the magnetizing field strength, represented by the symbol H , is given by

$$H = \frac{5}{4} \left(\frac{\text{ampere-turns}}{\text{length}} \right) \quad (45)$$

If I is the current in amperes the accurate formula may be written ¹

$$H = \frac{4}{10} \pi \frac{NI}{l} \quad (46)$$

42. Magnetic Induction and Permeability.—If the space within the solenoid is filled with iron, the magnetic flux lines are very greatly increased. This is due to a property of iron called magnetic "permeability." To say that iron is more permeable than air means that the magnetism is stronger when iron is present than it would be if the space were filled with air alone.² Permeability varies according to the quality of the iron, from a few units to a few thousand. For example, to say that the permeability of a certain sample of iron is 1000 means that the magnetic flux through 1 cm. of cross section of the iron is 1000 times as great as the flux through

¹ For proof of this formula see C. 74, p. 15.

² Time is required for the magnetization to travel inward from the surface to the axis of the iron core. Hence, if the current is rapidly reversed in direction, the magnetic wave started by one-half cycle does not have time to travel inward appreciably before the reversed half cycle recalls it and starts a wave of opposite sign. As a consequence the magnetism is confined to the outer layers of the iron core. For this reason iron is not as effective in increasing the number of flux lines in high frequency circuits, as it is with steady currents or low frequency currents.

the same area before the iron was present. The total magnetic flux through an iron core within a magnetizing coil, divided by the area of cross section, gives the "magnetic induction," which is represented by the symbol B . We may denote total flux through the iron by ϕ_1 , then

$$\phi_1 = BA \quad (47)$$

where A is the area of cross section of the iron core. If the intensity of the magnetizing field within a solenoid is denoted by H , then the total magnetic flux through the solenoid is given by

$$\phi_a = HA \quad (48)$$

where A is the area of cross section and ϕ_a is the total flux through the air core. The permeability is defined as the ratio of B to H .

It is important that the student should remember that the magnetic induction depends upon (a) the number of ampere-turns and (b) the property of iron called permeability. The number of ampere-turns is under the control of the operator. The permeability depends upon the quality of the iron itself.

If the current in the windings is reversed, the direction of the magnetic field is also reversed. The student should learn at least one rule for remembering the relation between the direction of the current and the direction of the magnetic flux. Two such memory helps are here given.

(a) Look along the direction of the lines of magnetic flux through the solenoid, and the current is in a clockwise direction.

(b) Grasp the solenoid with the right hand, the fingers pointing along the wires in the direction of the current. The thumb then points in the direction of the magnetic flux inside of the solenoid.¹

43. The Force on a Conductor Carrying Current in a Magnetic Field.—If two different magnetic fields are brought together in the same space, with their directions parallel, a force is always developed. If the lines of magnetic flux are in the same direction, the two fields mutually repel one another, and if the flux lines are in opposite directions the two fields will be drawn together. When a current flows in a wire which is at right angles to a magnetic field, a force will act on the wire. A rule which will help the student to remember the direction of the motion, together with

¹ Apply each of the above rules to Fig. 62. Also wind an experimental solenoid with a few feet of wire, connect it to a dry cell and mark in some way the direction of current through the windings. Test its polarity with a compass, remembering that like poles repel and unlike poles attract.

the directions of current and field, is the so-called "left-hand rule." Extend the forefinger of the left hand in the direction of the magnetic field, and hold the middle finger at right angles to it in the direction of the current. The extended thumb, held at right angles to both the other directions, indicates the direction of the motion. Note that this rule calls for the use of the left hand. Compare this with the right hand rule of Section 45.

When the wire which carries the current is at right angles to the direction of the magnetic field, the pushing force on the wire is equal to the product of the current, the intensity of the magnetic field, and the length of wire which lies in the magnetic field.

If the wire makes some other angle with the direction of the magnetic field, the direction of the force is still the same as for the right angle position, and the value of the force is smaller. In the single instance that the direction of the current coincides with the direction of the magnetic field the force is zero.

This push on a single wire is in most cases small, but by arranging many wires in a very intense magnetic field, very large forces may be obtained. The powerful turning effect of an electric motor depends upon these principles. (See Sec. 96.)

H. Inductance.

44. The Linking of Circuits with Lines of Magnetic Flux.—There is always a magnetic field about an electric current. The lines of magnetic flux are closed curves and the electric circuit is also closed. The lines of magnetic flux are then thought of as always interlinked with the wire turns of the circuit. (See Fig. 64.) The number of flux lines through a coil will depend upon the current, and any change in the current will change the number of linkings. If there are two turns of wire the circuit will link twice with the same magnetic flux, and so, for any number of turns, the number of linkings increases with the number of turns. Let ϕ represent the number of magnetic flux lines, N the number of linkings and n the number of wire turns. Then it is seen that the number of linkings is always given by

$$N = n \phi \quad (49)$$

A change in N may be brought about by (a) a change in ϕ , due to a change in the current, or (b) a change in the number of wire turns.

Again the loop of wire, Fig. 65, not now connected to any battery,

may be placed near a bar magnet, or a solenoid which has current flowing in it. Some of the flux lines will pass through the loop. The number of these flux lines is represented by ϕ as before, and every turn of wire will link with the flux lines. Then the number of linkings is given by

$$N = n \phi \quad (50)$$

which is the same expression as in the other case.

The number of flux lines may be changed by changing the number of wire turns, or by changing the number of flux lines through the loop. The latter may be done by rotating the loop, or by moving

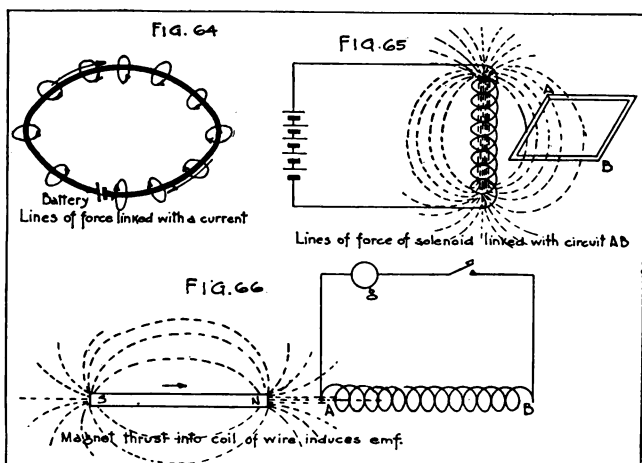

it with respect to the magnet. If a solenoid is used, the change can be made by variations in the current through its coils.

45. **Induced Electromotive Force.**—Whenever there is any change in the number of linkings between the magnetic flux lines and the wire turns, there is always an emf. induced in the circuit. If the circuit is closed, a current will flow. This is called an induced current. Some of the ways in which this is accomplished are described in the following paragraphs.

1. A bar magnet is pushed into a closed coil of wire, Fig. 66. During the time the magnet is moving, there will be indications on the galvanometer g that current is flowing. When the magnet is

drawn back, away from the coil, a current is induced in the opposite direction. The direction of this induced current will always be such as to oppose the change to which it is due. That is, if the magnet is approaching the coil, the current will flow in AB so that A is a north pole, and hence the magnet will be repelled. If the key k is open the induced current cannot flow. If it is closed an induced current does flow, and sets up a magnetic field about the coil. It can be shown that more work is required to move the magnet with respect to the coil when the key is closed, than when it is open. These facts are expressed in the law of Lenz, which states that *whenever an induced current arises, by reason of some change in linkings, the magnetic field about the induced current is in such a direction as to oppose the change.* A helpful, mechanical illustration of Lenz's law is seen in the effort necessary to move a stationary body. Owing to the mass of the body, a force is necessary to start it, and if one tries to move it suddenly, he will experience a considerable reacting force. This reacting force will be greater the more sudden the change in the motion of the body. Similarly in the electric circuit, the induced emf. will be greater the more sudden the change in the number of linkings.

2. The same effects as those described in (1) may be secured if the bar magnet is replaced by a solenoid carrying current.

3. The effects may also be produced by two solenoids fixed in the position shown in Fig. 67. If a current is started in one of them, A , there will be a current induced in the other, which will continue to flow as long as the current in A is increasing. If the current in A becomes steady, there is no current induced in B . If the current in A falls off, the induced current in B is reversed in direction. In all cases it must be remembered that the magnetic field about the induced current tends to oppose the change that is causing the induced current.

4. A further example of induced currents is found in the case of two straight wires, Fig. 68, close together. If the electric current stops (Fig. 69), starts, or varies in one of them in any way, there are corresponding induced currents in the other. This case of parallel straight wires is seen in certain telephone lines where cross talk occurs, or where there is interference from a.c. power lines. Although we think of the straight and parallel portions of the circuit, we must not overlook the fact that these are only portions of completely closed circuits.

The magnitude of the induced emf. in all of the above cases depends upon the time rate of change of the number of linkings. This may be expressed by the equation

$$Emf. = \frac{N}{t} = \frac{n\phi}{t} \quad (51)$$

where t is the time in seconds in which the change $n\phi$ takes place. This is the basic principle of dynamo-electric machinery.

46. **Self Inductance.**—With a single circuit carrying current, as shown in Fig. 64, the magnetic flux ϕ which threads through

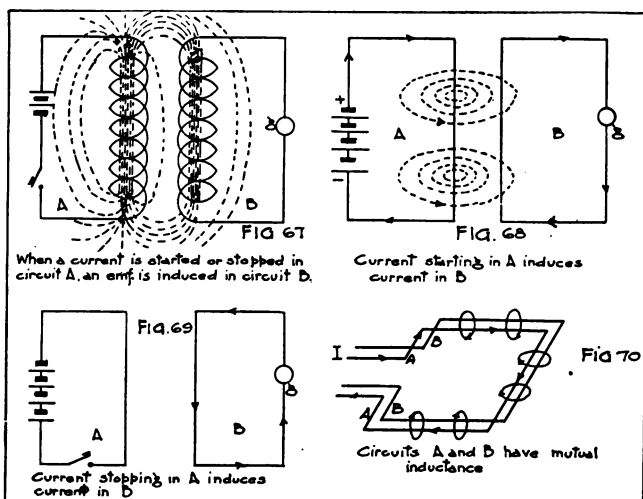

the circuit (and hence the number of linkings N) is directly proportional to the current strength. This fact may be expressed by the formula

$$N = LI \quad (52)$$

where L is called the "self inductance," or simply the "inductance" of the circuit.

The value of L depends upon the number of wire turns, upon the shape and size and upon the permeability of the medium about the circuit. For air the permeability is 1. The inductance does not depend upon the current which is flowing, except when iron is

present. By coiling up a piece of wire in many turns and introducing it into the circuit, the inductance of the circuit may be greatly increased. In that case the inductance is said to be concentrated. It must not be overlooked that the entire circuit has inductance. This may be distributed more or less uniformly throughout the circuit.

If a piece of wire is connected to one terminal of a dry cell, and tapped on the other terminal, a very slight spark may be seen in a darkened room. If a coil of many turns of wire is included in series with this cell, the same process of tapping will show brilliant sparks, particularly if the coil has an iron core. The explanation of this lies in the fact that the cell voltage of about 1.5 is too feeble to cause much of a spark. However, when the large inductance is included in the circuit, there is a large number of linkings between wire turns and flux lines. If these flux lines collapse suddenly, as they do when the circuit is broken, there will be a large change in the number of linkings taking place in a very small interval of time.

From equation (51), this means that a large voltage will be set up. This principle is made use of in ignition apparatus and spark coils of various types. According to Lenz's law, the induced emf. will be in such a direction as to oppose the change which causes it. In this case, when the circuit is broken, the change is from some value of current I to zero. Therefore the induced emf. will be in the same direction as the original current, and will try to keep the current flowing. On the other hand, when a battery is being connected to an inductive circuit by means of a switch, the rising current will establish a set of magnetic flux lines which will, as they grow, induce an emf. which tends to keep the current from rising.

47. **Mutual Inductance.**—Consider a circuit AA , Fig. 70, with a current I flowing through it. The magnetic flux through A is directly proportional to I , and that part of the total flux which interlinks with a near-by coil B is also proportional to I . This means that the total number of interlinkings N , between flux lines that arise in the A circuit, and wire turns of the B circuit, is proportional to the current I in the circuit A . This fact may be represented by the equation

$$N = MI \quad (53)$$

where M is the constant of proportionality. This factor M is called the "mutual inductance" of the two circuits. When currents are

started, stopped or varied in coil *A*, the mutual inductance shows itself by an emf. induced in coil *B*. The induced emf. may be calculated by

$$E = M \frac{I'}{t} \quad (54)$$

where *I'* is the amount by which the current in the *A* circuit varies in the time *t*.

In radio circuits the mutual inductance is often used to transfer power from one circuit to another when there is no conducting path between them.

48. Energy Relations in Inductive Circuits.—In mechanics it is well known that a piece of matter cannot set itself in motion and that energy must be supplied from outside. So in the electric circuit, a current cannot set itself in motion, and energy must be supplied by some form of generator (source of emf.). It has already been explained how a magnetic field arises about electric circuits. When this field collapses or disappears, the energy stored in the field is returned to the circuit. It can be shown that the energy thus associated with a magnetic field is given by the equation

$$W = \frac{1}{2} L I^2 \quad (55)$$

where *I'* is the value of the current and *L* is the self inductance. The student who is familiar with the laws of mechanics will note that this equation is quite similar to that for kinetic energy of a moving body

$$\text{Kinetic energy} = \frac{1}{2} m s^2$$

where *m* is the mass of the body and *s* is its speed.

Illustration of Inductance.—When a nail is forced into a piece of wood, the mere weight of the hammer as it rests on the head of the nail will produce but little effect. However, by raising the hammer and letting it acquire considerable speed, the kinetic energy stored is large, and when the motion of the hammer is stopped this energy is used in forcing the nail into the wood. In the electric circuit a cell with its small emf. can cause only a feeble spark. By including a piece of wire with many turns in the circuit, however, energy is stored as shown in equation (55). A small current will enable a large amount of energy to be stored in the magnetic field, if *L* is large. Then when the circuit is broken and the field collapses, this large amount of energy is released suddenly, and a hot spark of considerable length is the result.

The close relations between capacitance, inductance and resistance will be more fully discussed in Chapter 4.

I. Alternating Current.

49. **Reactance.**—A steady current in a circuit meets no other hindrance than the resistance of the circuit. If the current changes, this is no longer true. If the circuit has inductance, the current is opposed by the emf. induced by the variation of the current. (See Sec. 46.) If a condenser is present, this is constantly charging or discharging as the current changes, and it exerts a controlling influence on the passage of the current. If both inductance and capacitance are included in the circuit, they tend to offset each other in their effects, but usually one or the other exerts a predominating influence, with the result that there is added to the resistance an extra opposition to the current, which is known as the "reactance."

The more rapid the changes of the current, the greater the induced emf. in a circuit and consequently the greater the inductive reactance. On the contrary, the reactance of a condenser is less, the more rapidly the current varies, as can be understood when we reflect that the greater the number of charges and discharges of the condenser performed each second, the greater the total quantity of electricity which flows around the circuit in that interval, that is, the greater the current. In general, the reactance of a radio circuit is very much greater than the resistance.

To calculate the current in a radio circuit, then, it is necessary to know how to calculate the reactance and how to combine it with the resistance, in order to determine the total hindrance or "impedance" to the current. Since the reactance, however, depends upon the way in which the current is varying, it is evident that this must be definitely specified in each case. The problem cannot be solved for all imaginable kinds of variation of the current. Radio currents, however, belong to the general class of alternating currents, and for these, the theory is rather simple. In the following sections is given a brief treatment, not of general alternating current theory, but merely of those alternating current principles which are essential to an understanding of the actions in radio circuits.

50. **Nature of an Alternating Current.**—An alternating current is one in which electricity flows around the circuit, first in one direction and then in the opposite direction, the maximum value of the

current in one direction being equal to the maximum value in the other. All the changes of current occur over and over again at perfectly regular intervals.

Sine Wave.—To get an insight into the nature of such a current, suppose a case where the alternations occur so slowly that we may follow the changes of current with an ammeter. In the table below are given values of the so-called “sine wave current” at successive equal intervals of time. The maximum value is taken as 10 amp.

Time (sec.).	Current (amp.).	Time (sec.).	Current (amp.).	Time (sec.).	Current (amp.).
0	0	13	— 2.59	25	2.59
1	2.59	14	— 5.00	26	5.00
2	5.00	15	— 7.07	27	7.07
3	7.07	16	— 8.66	28	8.66
4	8.66	17	— 9.66	29	9.66
5	9.66	18	—10.00	30	10.00
6	10.00	19	— 9.66	31	9.66
7	9.66	20	— 8.66	32	8.66
8	8.66	21	— 7.07	33	7.07
9	7.07	22	— 5.00	34	5.00
10	5.00	23	— 2.59	35	2.59
11	2.59	24	0	36	0
12	0				

The ammeter in such a case would creep slowly up to a maximum indication of 10 amp., return gradually to zero, reverse its direction and build up to a value of 10 amp. in the opposite direction, then decrease to zero again, build up again in the original direction, and so on. It is, of course, to be understood that the current assumes in turn all possible values between zero and the maximum value (10 amp. in this case), and that the current has the same value throughout the circuit at every moment. The current in this case, as well as that of a steady current, may be regarded as like the flow of an incompressible fluid. The emf. is, however, to be regarded here as a variable electric pressure, which acts first in one direction and then in the other.

The values of current in the preceding table are plotted in Fig. 71 as ordinates (vertically), and the corresponding lengths of time elapsed since the start, as abscissas (horizontally), and a smooth curve drawn through the points enables one to determine what is the value of the current for any moment lying between any two of those which are included in the table. It is to be noted that the changes of current repeat themselves. Thus in the table the current is the same at 1 sec. and 25 sec. after the start; at 7 sec. and 31 sec.,

etc. The interval of 24 seconds in this example is the "period" of this alternating current. The current passes through a complete "cycle" of changes in one period.

A current like that just treated is the same as that which would be produced in a circuit attached to a coil revolving very slowly in a uniform magnetic field. (See Chap. 3, Sec. 62.) The motion has been assumed slow in order that the changes can be followed with ordinary direct current instruments. In order to represent the current developed by an ordinary low frequency alternating current generator, we must, however, imagine the coil to revolve more than a thousand times more rapidly. Thus the usual a.c. lighting circuits carry currents whose period is only about $\frac{1}{60}$ second. The current passes through 60 complete cycles each second, that is,

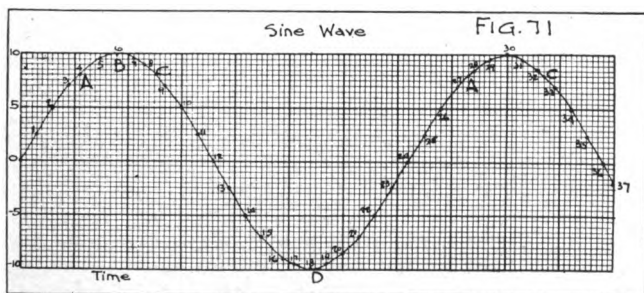

its "frequency" is 60 cycles per second. Ordinary alternating-current generators cannot use magnetic fields which are entirely uniform, so that the current obtained never passes through its changes in exactly the same way as the ideal sine current pictured in Fig. 71. The difference is, however, usually so small in well-designed machines that it does not need to be taken into account.

The frequency of radio currents is enormously greater than the usual low frequency alternating currents. In order that Fig. 71 may properly represent a radio current, we must suppose a whole cycle to be completed in, say, $\frac{1}{1000000}$ to $\frac{1}{10000000}$ second.

51. Average and Effective Values of Alternating Current.—In just the same way as we have analyzed alternating current by imagining it to change slowly, it is possible to get an insight into complicated movements, like the throwing of a ball or the galloping of a horse, by running a motion-picture film of the action so slowly that the separate pictures on the film can be examined one at a time.

When a direct current ammeter is traversed by an ordinary alternating current, the changes of current are altogether too rapid to be followed by the needle of the instrument. It can only take up an average position corresponding to the average of all the values through which the current passes during a cycle. However, since the current passes through the same values in one direction that it does in the other, the average value during the cycle must be zero. That this is the case can be shown by connecting a direct current ammeter into an alternating current circuit. The ammeter needle stands still at zero, or else merely presents a blurred appearance while standing at zero. The same remarks apply to the use of a d.c. voltmeter in an a.c. circuit.

A.C. Voltmeters and Ammeters Indicate Effective Values.—Alternating current voltmeters and ammeters may be of several different types (hot wire, dynamometer or electrostatic, see Sec. 60), all of which, however, give a deflection in the same direction whichever the direction of the current. The force on the moving portion of such an instrument is, at every moment, proportional to the square of the current through the instrument. When an alternating current passes, the average deflection taken up by the pointer is, therefore, proportional to the average of the squares of all the values of current during the cycle. For a true sine current, the average of the squares of all the values of current during the cycle can be shown to have a value of one-half the square of the maximum value.

Equivalent Direct Current.—The heating effect of a current is, at every moment, proportional to the square of its value at that moment. The average heating effect of an alternating current must, therefore, be proportional to the average of the squares of all the values of the current during the cycle, or must be proportional to one-half the square of the maximum current. The same heating effect would, of course, be produced by a steady current, whose square is equal to the average of the squares of the alternating current taken over the whole cycle. That is, the "effective current" is equal to the value of the direct current which would produce the same heating effect in the circuit in question. Since its square is equal to one-half the square of the maximum value, the effective value of the current is

$$I = \sqrt{\frac{(\text{maximum})^2}{2}} \quad (56)$$

or equal to the maximum value divided by $\sqrt{2}$. This is the same as the maximum value multiplied by 0.707.

The effective current in the table above is 7.07 amp., and this would be the current indicated by an a. c. ammeter in the circuit, although the current varies between 10 amp. in one direction and 10 in the other. The same heating effect would result if a direct current of 7.07 amp. were sent through the circuit. Likewise, an a. c. voltmeter will always read the effective value of the voltage, which is equal to the maximum voltage multiplied by 0.707.

52. Circuit with Resistance Only.—Let us imagine a circuit with resistance R ohms, and with such small inductance and capacitance that they may be neglected. Let us suppose, further, that sine wave alternating emf. is applied to the circuit. At every moment, the current will be found by dividing the emf. at that instant by the resistance of the circuit. The current is zero at those moments when the emf. is also zero, and is a maximum when the emf. is a maximum. In fact, the changes of current keep step with those of emf. The current and emf. are said to be "in phase" or to have "zero phase angle." Since the effective values of emf. and current are each the same fraction of their respective maximum values, the effective current I will be calculated from the effective emf. E by the relation

$$I = \frac{E}{R} \quad (57)$$

That is, in this special case, Ohm's law holds, even when the current is alternating. An ordinary incandescent lamp circuit approximates this ideal circuit.

The power in the circuit is, at every moment, equal to the product of the values of current and emf. which hold at that moment. The average power taken over the whole cycle is equal to the product of the effective current by the effective emf., that is, average $P = IE$. The power is used up in the circuit entirely in heating the resistance R .

53. Phase and Phase Angle.—The values of current given in the table above are those which hold for certain definite moments in the cycle of change of the current. Each time the cycle is repeated, the same values are run through, and any chosen value will be reached at a perfectly definite fraction of the way through the cycle. Each maximum in the positive direction, for example, occurs just

one-quarter of a cycle after the preceding zero value. The points *A* in Fig. 71 have the same phase, although each is in a different cycle from the others. The current has the same value at the points *C* as at *A*, but points *C* are not in the same phase as *A*, since at *A* the current is increasing, and at *C* it is decreasing.

The phase is, then, a certain aspect or appearance, occurring at the same definite part of each succeeding cycle. Difference in phase is nothing more than difference in position in the cycle. It is best referred to as difference in time, expressed as the fraction of the length of a cycle. Thus, the difference of phase of points *B* and *O*, Fig. 71, is one-quarter of a cycle; that of points *B* and *D* one-half cycle, etc. It is also customary to express difference in phase as an angle. A difference of phase of one complete cycle is regarded as equivalent to the angle of a whole revolution or circumference, that is, to 360° . One-quarter cycle is accordingly 90° , and two points with a difference of phase of one-quarter cycle are said to have a difference of phase of 90° , etc.

The idea of phase angle is useful when two emfs. are acting in the same circuit or when the current and the emf. which produces it do not pass through their maxima at the same moment. Fig. 72 shows the waves of emf. and current in a circuit where the emf. and current differ in phase by about one-eighth of a cycle; i. e., they have a phase angle of about 45° .

When a circuit has resistance but no inductance or capacitance, the emf. and current are in phase or the phase angle is zero. Their waves, shown in Fig. 73, pass through zero at the same moments and reach their maximum values at the same moments.

The case of opposite phase shown in Fig. 74, in which two emfs. are represented, is such that, although they pass through their zero values at the same moments, at other times one is always acting in the opposite direction to the other. Their phase angle is 180° .

In any series circuit where the reactance is not zero the applied emf. and the current have a difference of phase.

54. Alternating Current in a Circuit Containing Inductance Only.—Such a circuit would be approximately represented by one with a large inductance coil wound with such large wire that only a very small resistance would be offered to the current.

If an alternating emf. is applied to the circuit, an alternating current flows, and the changes of the current induce an emf. in the circuit which is greater, the greater the inductance and the more

rapidly the current changes; that is, the greater the frequency of the current.

The current i changes most rapidly at the points A , B , and C , Fig. 75, where it is passing through zero value. The induced emf. must therefore be a maximum at those points. Since it always opposes the change of current, it must be at its maximum negative value in the figure at the points of the axis, A and C , and at its positive maximum at point B . At points D and E , the current does not change for a moment, so that the induced emf. must be zero at

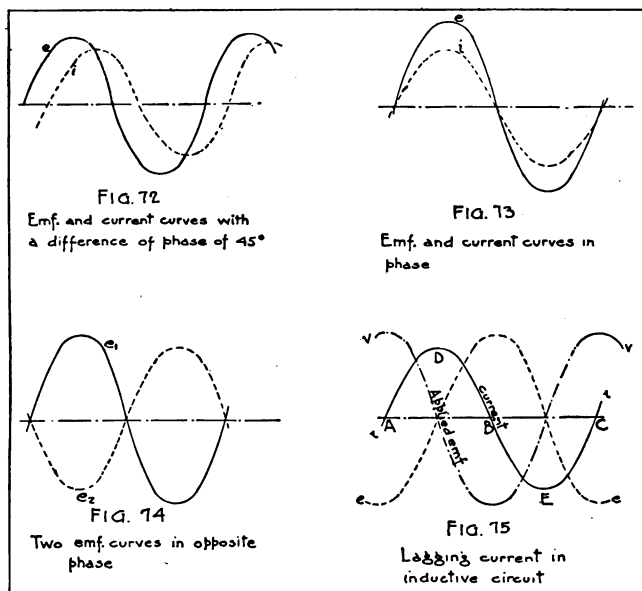

those times. It is not difficult to show that when we have a sine alternating current there is also a sine alternating emf. induced as shown in curve e , Fig. 75.

In this kind of a circuit, this induced emf. has to be overcome at each moment, but the applied emf. is not requisitioned for any other service. Accordingly the applied and induced emfs. are at every moment equal and opposite. The applied emf. wave is therefore given by curve v , Fig. 75, drawn with its vertical heights just equal and opposite to those of the curve e . It is evident that

the current lags one-quarter of a cycle in its changes behind those of the applied emf. The current is said therefore to lag 90° in phase behind the applied emf.

The effective value of the induced emf. can be shown to have the value $2\pi fLI$, in which f is the frequency, L the inductance in henries, I the effective value of the current in amperes, and $\pi=3.1416$, or nearly $3\frac{1}{4}$. An effective applied emf. E , therefore, will produce a current whose effective value is

$$I = \frac{E}{2\pi fL} \quad (58)$$

Inductive Reactance.—The quantity $X=2\pi fL$ is known as the reactance of the inductance coil. It is larger, the greater the frequency and the greater the inductance, as would be expected, and has a considerable value in many cases. The reactance is measured in ohms. As an example, suppose a coil of 0.1 henry at 100,000 cycles per sec. The reactance is $X=6.283 \times 100,000 \times 0.1=62,830$ ohms. That is, such a circuit throttles down the current as much as a resistance of 62,830 ohms would do. There is this difference, however, between the effects of an inductance and a resistance, that no energy is dissipated in heat in an inductance. In one-half of the cycle energy is taken from the circuit, it is true, but this is stored up in the magnetic field around the coil, and in the next half cycle the magnetic field collapses on the coil and gives the energy back to the circuit. Thus, in the long run, energy is neither gained nor lost in the circuit.

55. Circuit Containing Inductance and Resistance in Series.—It is, of course, impossible to arrange a circuit which has absolutely no resistance. In addition to overcoming the induced emf., a portion of the applied emf. has to be employed to force the current through the resistance of the circuit. Thus, if the current at any moment is passing through the value i , the emf. necessary to force the current through the resistance is Ri , and that which is overcoming the induced emf. is Xi , so that the value e which the applied emf. has at that moment is $e=Ri+Xi$. This equation shows the simple and obvious connection between the value of the current at any instant, and the corresponding instantaneous value of the emf. which is producing it. However, it cannot be used to calculate the effective current from the effective applied voltage, for the reason that the two emfs. Ri and Xi are not in phase. When the former is passing through zero value, the latter is at its maximum and vice versa, so

that the sum of the two emfs. has a maximum value less than the sum of their individual maximum values.

This is in line with the results of the following experiment. Let a coil of inductance L be joined in series with a resistance R , and let three voltmeters a , b , and c be applied, as shown, Fig. 76, to measure the emf. between the points A and B , B and C , and A and C . The voltages measured by the voltmeters are effective values, and it is found that the reading of c is not equal to the sum of the readings of a and b as would be the case with a direct current.

The voltmeter a gives the emf. RI and the voltmeter b the emf. XI , where I is the effective value of the current, which would be measured by an a.c. ammeter in the circuit. Analysis shows that

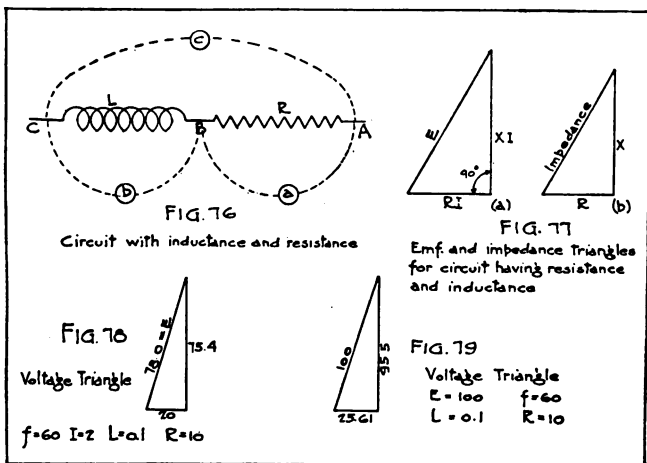

the reading E of the voltmeter c is represented by the hypotenuse of the right triangle whose sides are RI and XI . See Fig. 77-a.

The effective applied emf. E in such a case is therefore related to the voltages RI and XI by the equation (relation between sides and hypotenuse of a right triangle),

$$E^2 = (RI)^2 + (XI)^2 = I^2 (X^2 + R^2) \tag{59}$$

Accordingly, the effective value of the current produced by the effective applied emf. E is

$$I = \frac{E}{\sqrt{X^2 + R^2}} \tag{60}$$

Impedance.—The quantity $\sqrt{X^2+R^2}$ is known as the “impedance” of the circuit. It takes the place in alternating current theory of the resistance in Ohm’s law. It is related to the resistance and reactance as the sides of the right triangle, Fig. 77-b.

As an example, suppose in Fig. 78 that $L=0.1$ henry, $R=10$ ohms, $f=60$ cycles per second. Find what applied emf. is necessary to cause an effective current of 2 amp. to flow.

$$RI = 20 \text{ volts}$$

$$X = 6.283 \times 60 \times 0.1 = 37.7 \text{ ohms}$$

$$XI = 75.4 \text{ volts.}$$

The applied emf. must therefore be by (59)

$$E = \sqrt{(20)^2 + (75.4)^2} = 78.0 \text{ volts.}$$

The reverse problem is to find what current will flow in the circuit, when a given emf., say 100 volts, is applied. The impedance is $\sqrt{R^2+X^2} = \sqrt{(10)^2 + (37.7)^2} = 39$ ohms.

Therefore the current will be $\frac{100}{39.0} = 2.56$ amp. The emf. on the resistance is $2.56 \times 10 = 25.6$ volts and that on the reactance $2.56 \times 37.7 = 95.5$ volts, so that the voltage triangle is that given in Fig. 79.

Power Factor.—The power dissipated in heat in this circuit is of course $I^2R = (2.56)^2 \times 10 = 65.5$ watts. The product of the effective current and effective voltage is $100 \times 2.56 = 256$ “volt-amperes.” To obtain the dissipated power from this product, it is therefore necessary to multiply by $\frac{65.5}{256} = 0.256$. Note that this is the same as $\frac{10 \text{ ohms}}{39 \text{ ohms}}$. The number which it is necessary to multiply into the product of volts and amperes, in order to get the power, is called the “power factor.” The power factor of the above circuit is 0.256. A circuit with resistance only and no inductance or capacitance has a power factor of 1. A resonant circuit (see Chap. 4) is another example of power factor equal to 1. The power factor in other cases always lies between zero and one. The power in any circuit is calculated, then, by the formula

$$P = EIF \quad (61)$$

the power factor being given by the general formula

$$F = \frac{\text{resistance}}{\text{impedance}} \quad (62)$$

56. Charging of a Condenser in an Alternating Current Circuit.—A steady emf. is not able to pass a steady current through a condenser. When the circuit is first closed, a charging current flows into the

condenser, until the voltage between the plates of the latter has risen to the same value as the applied voltage. If the voltage is removed and the circuit completed by a wire, a discharge current flows out of the condenser in the opposite direction to the charging current. The discharge ceases when the plates of the condenser have no potential difference. (See Sec. 30.)

With an alternating emf. in the condenser circuit, an alternating current is constantly flowing into and out of the condenser to keep the voltage between the plates equal to the instantaneous value of the applied emf. The current is largest at those moments when the applied emf. is changing most rapidly; it is zero at the moments when the emf. is for a moment stationary at its maximum values. If curve *e*, Fig. 80, represents a sine alternating emf., it can be shown that the charging current curve will be like curve *i*; that is, the

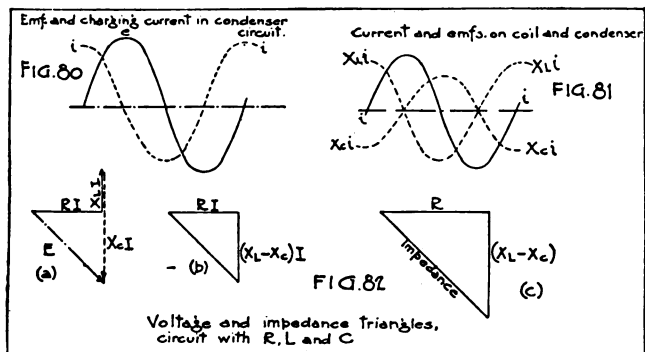

charging current is 90° "ahead" of the applied emf. in phase. (Contrast this with the relations in the inductive circuit.) The charging current will, in general, be greater the greater the capacitance *C*, and the greater the frequency of the emf.

Reactance of Condenser.—Analysis shows that the effective value *I* of the charging current is $I = 2\pi f C E$. The reactance of the condenser is accordingly

$$X = \frac{E}{I} = \frac{1}{2\pi f C} \tag{63}$$

where *C* is the capacitance in farads. This shows that the reactance of the condenser is greater, the smaller the capacitance and the lower the frequency. (Contrast with the reactance of an inductance.) The reactance, as before, is measured in ohms.

As an example, we find that the reactance of a condenser of 0.1 mfd. at 60 cycles is

$$\frac{10^6}{6.283 \times 60 \times 0.1} = 26,500 \text{ ohms.}$$

At 100,000 cycles, the reactance is only 15.9 ohms. From this it appears that the condenser offers much less obstruction to flow of current at high frequency than at low frequency, and hence, that a given alternating emf. causes a much larger current flow, if the alternations are rapid, than if they are slow.

No energy is dissipated in a perfect condenser. Energy is stored in the dielectric of the condenser while it is being charged, but this is all restored to the circuit when the condenser discharges. Actually, no condenser is perfect, although well designed air condensers may be regarded as essentially so. Heat is always dissipated to a measurable extent in condensers with solid dielectrics. The condenser acts as though a certain resistance were joined in series with it. The actual value of this supposititious series resistance depends upon the capacitance and the frequency, as well as upon the nature of the dielectric. It is less, the greater the capacitance and, in general, inversely proportional to the frequency.

57. Circuit Containing Capacitance, Inductance and Resistance in Series.—When an inductance and capacitance are joined in series and subjected to an alternating emf., the current through them both is the same and the emf. on the condenser is $X_c i$ and that on the inductance $X_L i$, where the instantaneous current has the value i , X_L is the reactance of the coil and X_c the reactance of the condenser. The curves for these voltages may be derived by combining the curves of Figs. 75 and 80. The curves $X_L i$ and $X_c i$, Fig. 81, show that at every moment the voltage on the condenser opposes that on the inductance. The circuit acts as though it possessed a single reactance equal to the difference of the reactance of the coil and the reactance of the condenser. If the latter is the larger, the circuit behaves like a condenser circuit, and if the coil has the greater reactance, the circuit behaves like an inductive circuit.

The effective values of the voltages in the circuit are shown in Figs. 82-a and b. The impedance is found by combining the resistance and the resulting impedance in the triangle diagram of Fig. 82-c. The value of the impedance is evidently

$$Z = \sqrt{R^2 + (X_L - X_c)^2} \quad (64)$$

58. **The Alternating-Current Transformer.**—Remembering the principles of induced currents in Section 45, it is evident that when an alternating current is flowing in a circuit, the alternating magnetic field will cut in and out through any neighboring circuit, and induce an alternating emf. in the latter. This induced emf. will depend upon the mutual inductance of the two circuits (Sec. 47) the current in the inducing circuit, and the frequency of this current. It can be shown that, if I is the effective value of the current, M the mutual inductance and f the frequency, the effective value of the emf. induced will be $2\pi fMI$. In low-frequency work, M is made as large as possible by winding the two circuits on an iron form, so that almost all of the magnetic flux produced by the current passes through the second circuit. This arrangement is called a “transformer.” (See Fig. 83.) The induced voltage is to the applied voltage in the ratio of the number of turns on the two coils, the larger voltage being found in the circuit which makes the greater number

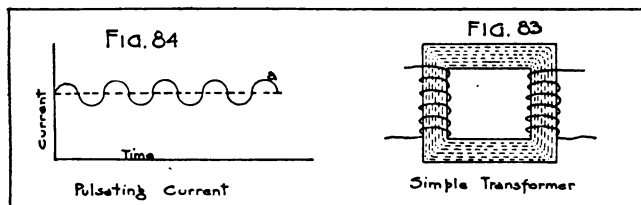

of turns around the iron. Thus, if one coil has 1000 turns and the other 100, and an emf. of 200 volts is applied to the latter, an emf. of 2000 volts is induced in the former. When current is drawn from the second circuit, it is found that the currents in the two circuits are nearly in the ratio of the numbers of turns, the greater current being found in the lower voltage circuit.

At radio frequencies, the effectiveness of iron in increasing the magnetic flux is not so great as at low frequencies. (See Sec. 42, foot-note.) To increase the mutual inductance, the coils are made large and are brought near each other. Usually no iron core is employed. For a further treatment, see Section 121 on coupled circuits.

A common use of a transformer with radio frequencies is to obtain an alternating current from a pulsating current. For example in the use of vacuum tubes for amplifying received signals, Section 194, Chapter 8, pulsations are produced in the plate current, above and

below its normal steady value. By passing the plate current through the primary of a transformer, an amplified alternating emf. is obtained in the secondary, and this emf. is applied to the grid circuit of a second vacuum tube, and so on. If curve *a*, Fig. 84, represents a pulsating current, the latter may evidently be regarded as compounded of a steady current (dotted line) and an alternating current. The steady current has no inducing effect in the transformer, but the alternating part induces an alternating emf. in the secondary circuit.

J. Measuring Instruments.

From what has gone before, it will be plain that the presence of an electric current can be known by such effects as the production of heat, magnetic action, or chemical changes. All of these effects are greater with a strong current than with a weak one, therefore all can be used to give an idea of the magnitude of a current. Instruments have been invented which take advantage of each of those effects, but some are more conveniently used than others. Those about which the student of radio particularly needs to know are based on two effects of the electric current; the magnetic effect and the heating effect.

Meters can be used either to indicate the current in amperes flowing in a circuit, in which case they are called ammeters, or to indicate the potential difference in volts between two points, in which case they are voltmeters.

59. Hot Wire Instruments.—Currents of radio frequency are generally measured by means of instruments which depend on the heating of a wire or strip of metal. They are therefore called "thermal" ammeters. These are again divided into two main classes, the expansion and the thermocouple instruments. The first takes advantage of the lengthening of a metal wire or strip when it is heated. Fig. 85 illustrates the principle. The current to be measured flows along the wire *AB*, which is of a material having sufficient resistance to cause it to become hot. In heating, it stretches somewhat. That permits it to be pulled aside by the spring *S* acting through the thread *T*. The latter passes around the shaft *P*, and by turning it causes the pointer to move over the scale a greater or less distance, depending on the current in *AB*.¹ The scale is graduated (marked off) in amperes so that the position of the pointer shows directly how large the current is.

¹ This principle is used in meters made by the General Radio and Roller-Smith Cos.

The thermocouple type of ammeter ¹ utilizes the fact that when the junction of two dissimilar metals is heated, an emf. is developed (see Sec. 15). A pair of metals used for this purpose is called a "thermocouple." The value of the emf. depends on the combination of metals and ordinarily increases directly as the temperature is increased.

In Fig. 86, the thermocouple consists of the two wires *c* and *d*, and their junction is in contact with the hot wire *AB*, in which the radio frequency current is flowing. The emf. produced by the heat at the junction is applied to *G*, an instrument of the type shown in Fig. 88 below, and causes a pointer to deflect; the millivoltmeter

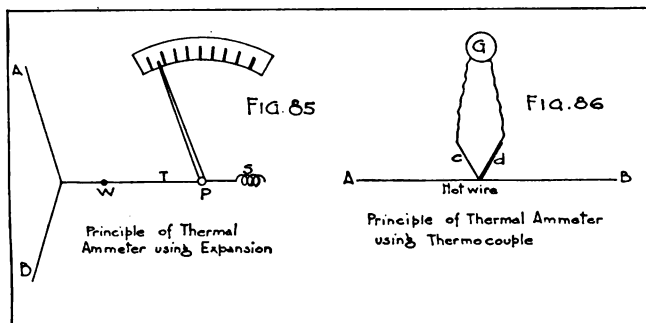

G responds to the direct current sent through it by the emf., as will be explained in the next section.

It is to be noted that the heat due to a given number of amperes of alternating current is the same as that of an equal number of amperes, direct current. In fact, an ampere is defined, in alternating currents, as being such a current that the heat it produces in a given conductor is the same as is produced by 1 amp., direct current. (See Sec. 51.) The emf. produced at the junction does not depend on the direction of the current in *AB*, but merely on the amount of heat produced. This emf. is always in the same direction; it can therefore be measured by a d.c. instrument. Thus the combination is useful for measuring high frequency currents.

The heat developed varies as the square of the current, and the emf. of the thermocouple varies, quite closely, as the heat

¹ Such instruments are made by the Weston Electrical Instrument Co. and the Roller-Smith Co.

developed, so the indications of ammeters of the thermal type change, practically, as the square of the current. Consequently the scale is not uniform, being more open at the upper end than at the lower.

In Fig. 86 the thermocouple is made to appear separate from the rest of the instrument; in commercial ammeters the thermocouple and the indicating instrument are placed inside the same case, and the scale is made to read the amperes in the radio frequency circuit.

When a hot wire instrument is needed for currents of more than a few amperes, it is not practicable to build it with a single heating wire. This is true both for expansion and for the thermocouple type. Several hot wires or strips are therefore used, arranged cylindrically so that the radio currents divide equally among them. Then, either the effect on one of them alone is used to operate the indicating mechanism, or if thermocouples are used, the emfs. of several can be combined in series, so that their effects are added.

On some of the older radio equipments, instruments are found which are incorrectly called wattmeters. They are, as a matter of fact, simply ammeters in which the scale, instead of being marked in amperes, is marked proportionally to the square of the number of amperes. They are properly called "current-square meters."

60. Magnetic Instruments.—While the heating effect of the current is used for measurements at radio frequency, the magnetic effect is the one utilized in most instruments for direct and for low frequency alternating current. The simplest and most common instrument for measuring direct current depends upon the force between a permanent magnet and wire carrying current.

D. C. Milliammeter.—Fig. 87 represents a rectangular coil *C* of fine insulated wire between the poles *NS* of a permanent magnet.¹ The coil consists of a number of turns wound on a light metal frame, which is pivoted in jewel bearings like those of a watch. *SS* are spiral springs resembling the hairspring of a watch, but somewhat heavier and made of material that is a better electrical conductor than steel. They serve the double purpose of conducting the current and controlling the position of the coil. *O* is a cylindrical piece of soft iron that serves as a good magnetic path between *N* and *S*, and causes a strong and uniform magnetic field to exist in the spaces between *N* and *O*, and between *O* and *S*.

¹ Instruments with a movable coil in the field of a permanent magnet are called the "moving-coil" type.

Assume that *A* and *B* are connected to a source of emf., so that current flows as indicated by the arrows. In the portion of the coil next to the *N* pole of the magnet the current flows downward in each turn of wire. The direction of the magnetic field is always from *N* toward *S*. By the "left-hand rule" (Sec. 43), it is seen that the force on the wires is toward the front (out of the paper). On the side of the coil near the *S* pole the current is up; that side tends to be pushed toward the rear (into the paper). As a whole, therefore, the coil tends to turn on its pivots. This motion is opposed

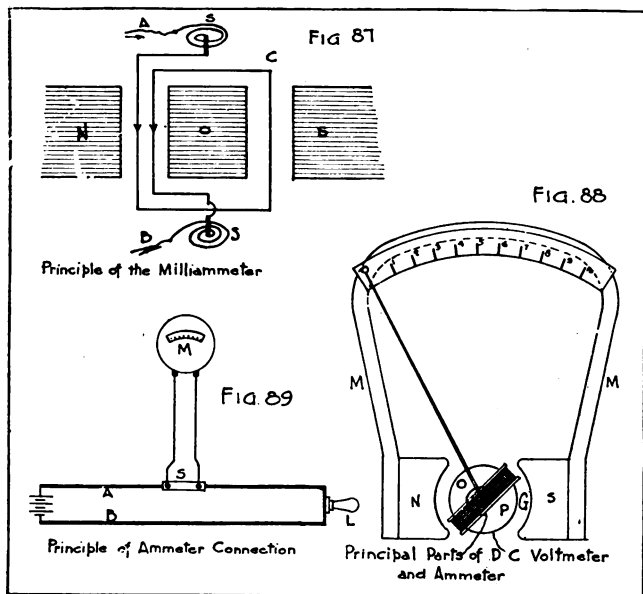

by the springs, and for each strength of current, there is some position of the coil in which the force due to the current and the force due to the springs balance. A pointer can therefore be attached to the coil so as to indicate, by its position over a scale, the current in amperes, in the coil. With the strong magnets, delicate parts, and fine workmanship found in good instruments, it takes only a very small fraction of an ampere to move the pointer over its entire range; the scale may be graduated in thousandths of an ampere

and the instrument used as a "milliammeter." Also, with certain modifications to be described presently, the instrument can be used to indicate millivolts, and is then called a "millivoltmeter."

The arrangement of the parts of such an instrument is shown in Fig. 88. Attached to the ends of the permanent magnet MM are the soft iron pole-pieces NS , and between them is the cylindrical soft iron core O , mounted on supports not shown in the sketch. This arrangement provides a strong and uniform magnetic field in the narrow gap G . The coil C is free to turn in this gap, which is wide enough merely to allow the necessary clearance. P is the upper spiral spring, above the top of the coil. The other one is under the core O . The pointer is a thin tube of aluminum, flattened at the end. The whole is inclosed in a dust tight case, with a glass over the scale. From the description it should be evident that abuse, such as setting the meter down with a jar, or applying excessive currents, will ruin it.

Moving Coil Galvanometer.—For very delicate measurements, where even a milliammeter is not sensitive enough, the pivots and springs are done away with and the coil is suspended by a long fine wire or strip, which conducts the current to it and at the same time opposes the turning effort due to the current. Another fine wire at the bottom provides the other connection to the coil. If the suspension wire is fine enough and the coil has many turns, such an instrument, called a "moving coil galvanometer," can be used to measure currents less than a millicent of an ampere. No pointer is used; a tiny mirror, attached to the coil, changes the direction of light reflected from it as the coil turns.

Ammeters.—An instrument of the type of Fig. 88 can be built only for small currents, otherwise the coil and other parts would be so huge as to be unwieldy. For larger currents the scheme of Fig. 89 is used. The current in A is to be measured. S is a short resistor called a "shunt," consisting of one or several strips of a special alloy large enough to carry the current.

The current divides, most of it going through S , because its resistance is small. A little of it flows through the millivoltmeter M , of which the resistance is large compared with S . This current in M , though small, is a perfectly definite fraction of the total (Sec. 25); therefore, if we know how great it is, we can know at once how great the total is.

For example, if the resistance of S is 0.01 ohm and that of M is 0.99, then the current divides in the same ratio, the larger part flowing in the path of smaller resistance. Out of every unit of current 0.99 flows by way of S and only 0.01 passes through the millivoltmeter. The total is 100 times as great as the current in M . If the resistances are 0.001 and 0.999, then the total is 1000 times as great. The small current in the meter is an accurate measure of the much larger current in A ; for any one shunt the scale is therefore made to read directly in amperes of total current.

The number of amperes giving full scale deflection is also stamped on the shunt. It should agree with the scale of the meter.

Instruments of moderate range, say up to 75 amp. in one type, may be had with the shunt built in, concealed within the case. The binding posts are then of massive brass, with good sized holes for attaching wires.

Aside from avoiding rough treatment, or connecting it to carry a greater current than it is built for, the chief precaution in using an ammeter is to connect it as shown in Fig. 89, p. 109, and not as in Fig. 90, which connection would cause its instant destruction. That is, the circuit is interrupted at some point and the shunt (or the meter as a whole if it is self-contained) is inserted. If not a self-contained instrument, the millivoltmeter should then be connected to the terminals of the shunt *after* the latter has been securely connected in the circuit.

Voltmeters.—The type of movement used in ammeters is also used in voltmeters, but the latter are connected to the circuit in a different way, which involves certain differences between the instruments.

In Fig. 90, A and B represent two wires connected to the terminals of a battery. It is desired to measure the difference of potential, in volts, between them. M is a meter like that of Fig. 88 and R is a wire of such great length and small diameter that its resistance is sufficient to keep the current sent through the instrument within proper limits. In one very well-known make this resistance is around 15,000 ohms for a meter reading up to 150 volts.

The current flowing through the instrument, by Ohm's law, is equal to the volts between A and B divided by the resistance of R plus M . Any change in the voltage will cause an exactly proportional change in the current in the meter. Therefore it is pos-

sible to graduate the scale directly in volts. As a matter of fact, for ordinary voltages, R is usually wound on thin mica cards which occupy little space and are fastened permanently inside the case of the instrument, out of the way of the user. He has merely to connect one binding post of the meter to each of the two points in question. The pointer indicates, on the scale, the voltage between them. The main precautions to be taken in using a voltmeter are (1) never to connect it between points of higher

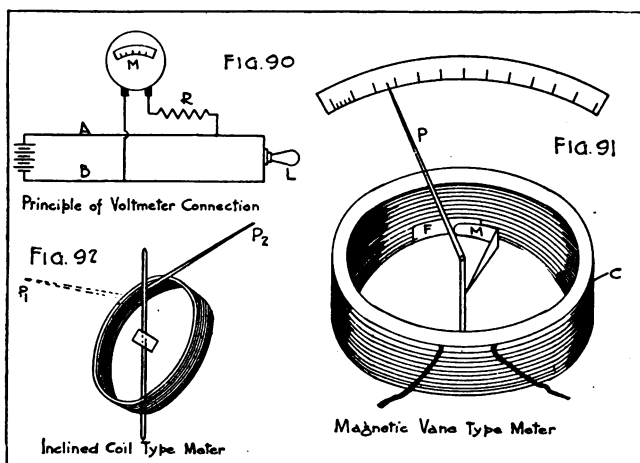

voltage than the scale will indicate, even for an instant, and (2) not to shake or otherwise roughly handle it.

The resistance of a voltmeter may be made sufficiently low, without introducing serious sources of inaccuracy, to permit of its being used to measure small fractions of one volt, in fact one standard form is made to give full scale deflection on 0.02 volt. Such instruments are graduated in millivolts and are called "millivoltmeters." Even when it is used as in Fig. 89, p. 109, to measure current, there are reasons why the instrument should have some resistance besides that of the copper wire in the coil. This accounts for the statement, made in connection with that figure, that M is a millivoltmeter.

Ammeters and voltmeters can readily be distinguished, not only by the marking of the scale, but by the terminals. Those of an ammeter are large, and made to receive fairly thick wire; those of a voltmeter are smaller, having insulating caps; the screw threads are fine, and it is evident that they are made to receive only thin wires, as is to be expected because a voltmeter takes a very small current, usually less than 0.01 amp.

Other Types of Meters.—For low frequency a.c. measurements, instruments with a permanent magnet cannot be used, and the thermal type has not had as wide application as those types which make use of the magnetic effect of the current on a piece of soft iron.

Fig. 91 illustrates the principle of one soft iron type. Current flowing around the coil C magnetizes the thin iron strip F , which is fixed in position by a stationary support. In the same way it magnetizes the other strip M , which is movable, being supported from the same shaft that carries the pointer P . The tops of both strips are at any instant of the same polarity, and the bottom edges of both are of the opposite polarity to this (but of the same polarity to each other). They therefore repel each other; the strip M moves to the right, and the pointer turns with it. The motion is opposed by spiral springs, as in Fig. 87.

If an instrument of this type is to be used as an ammeter, the coil is made of a few turns of large wire; if it is to be a voltmeter, many turns of fine wire are used and a resistance R is placed in series with the coil, inside of the case, as in Fig. 90.

It will be seen that such an instrument will respond to alternating currents, for when the current reverses the magnetization of both of the iron vanes reverses at the same time, so they continue to repel each other.

Another way of utilizing the magnetic effect is shown in Fig. 92. The coil is inclined, and a little iron vane, also inclined, is carried on the pointer spindle. When the pointer is held in the position P_1 by the controlling spring, the vane does not point in the direction of the axis of the coil. Current sets up a field and magnetizes the vane which then tends to set itself along the axis of the coil, turning the spindle in doing so, and moving the pointer against the force of the spring to some position P_2 . The difference between ammeters and voltmeters of this type is the same as in the preceding form.

Telephone Receiver.—The magnetic effect of the current is utilized in a somewhat different way in the telephone receiver. Fig. 93 shows, in diagram, the working parts of a “watch-case” receiver of the kind used in radio head sets. In the plan (b), *MX* is a permanent magnet, shaped like the letter C, to which are attached the soft iron strips terminating in the pole pieces *N* and *S*. This magnet is held in the bottom of a circular metallic cup, not shown in (b.) The pole pieces project upward in the center of the cup as shown in the upper figure (a). A coil of insulated wire is wound around each pole piece. In high grade instruments the wire is very fine and the two

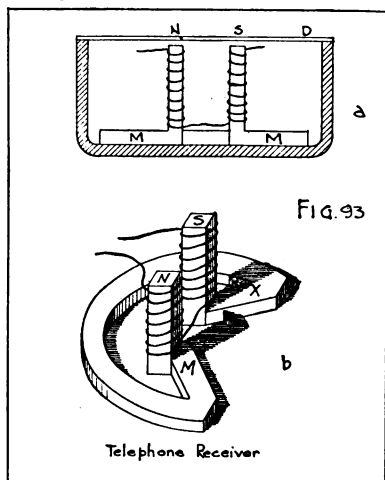

coils contain some thousands of turns—around 10,000, roughly. Above the pole pieces, and close to them, is a thin circular disk *D* of sheet iron, called the “diaphragm.” The diaphragm of a receiver can be seen through the hole in the center of the hard rubber ear-piece.

When current flows around the coils in one direction, it increases the pull on the diaphragm due to the permanent magnet. If it is weakened or if it flows in the opposite direction the attraction is lessened. A telephone current consists of pulsations in a steady current, or, more rarely, of rapid reversals of direction.

CHAPTER 2.

DYNAMO-ELECTRIC MACHINERY.

61. **Generators and Motors.**—In the preceding chapter some laws of electric and magnetic circuits are discussed, and attention is directed to the relations between electric currents and magnetic fields. In the present chapter certain practical applications will be described, in which use is made of all those laws, but which are based particularly on three experimental facts; namely, that—

1. When a conductor is moved across a magnetic field, an emf. is induced in the conductor.

2. When a current flows in a conductor in a magnetic field, a cross-push is exerted on the conductor.

3. When a current is sent around an iron core, the core is magnetized.

The forces involved are not necessarily small, as is sometimes imagined, but may run into hundreds or even thousands of kilograms. Such forces can be used for power applications on a large scale, by means of machinery, called “dynamo-electric” or, for short, “electrical” machinery.

Electric machines are used for conversion of power from mechanical to electrical form, or vice versa. If driven by some sort of prime mover like a steam engine, gas engine, or water wheel, they convert mechanical power into electrical power and are called “generators.” If supplied with current and used to drive machinery, vehicles, or other devices, thus converting electrical power into mechanical power, they are called “motors.”

While there are various types of motors and various types of generators, the difference is more in the use than in the construction or appearance; in fact the difference between most motors and the corresponding kinds of generators is so slight that the same machine can be used for both purposes with no changes, or only minor ones. Electric machines may be built for either direct or alternating current.

A. The Alternator.

62. **Production of Emf. by Revolving Field.**—It was pointed out in Chapter 1, Section 45, that the motion of a conductor across a magnetic field causes an electromotive force in the conductor. This

is true whether it is the conductor or the magnetic field that actually moves; the essential thing is that there shall be relative motion of one with respect to the other.

One way in which such relative motion may be secured is illustrated by Fig. 94. Suppose the magnet *NS* is made to rotate con-

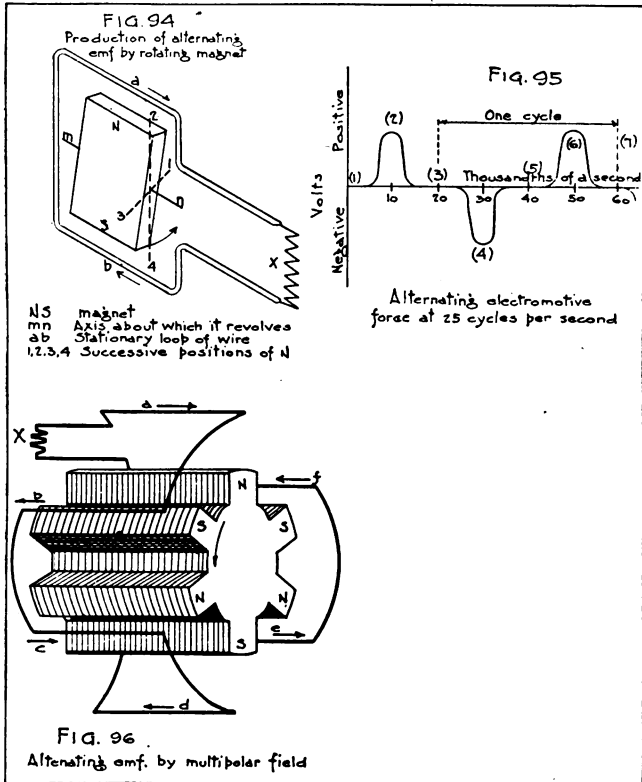

tinuously in a vertical plane about the axis *mn*. The loop of wire *ab* is stationary. Its ends are connected to some external part of the circuit, *X*. As the field from the *N* pole sweeps across *a*, an electromotive force is induced in it to the right and at the same time an electromotive force is induced to the left in *b* by the passing of the *S*

pole. Thus the emf. produced tends to send a current in a clockwise direction around the loop *ab*, as indicated by the arrows.

When the magnet has made half a revolution the poles have exchanged places with respect to *a* and *b* and the electromotive forces are counter-clockwise around *ab*. As the magnet continues to be rotated, there are thus two pulses of electromotive force (and of current if the circuit is closed) in opposite directions for each revolution of the magnet. The device described constitutes a simple "alternating current generator" or "alternator."

63. Direction of Emf.—The direction of the electromotive force, induced in the conductor can be determined by the "right-hand rule." This rule as generally stated assumes that the magnetic field is stationary and that the conductor moves across it. The extended thumb, forefinger and middle finger of the right hand give respectively the directions of motion of the conductor, of magnetic flux, and of the electromotive force induced.

If the magnetic field is moving, and the conductor stationary, the rule is readily applied by recalling that the relative motion is the essential thing. Thus in Fig. 94 the effect of having the north pole move toward the reader, passing conductor *a*, is the same as if the conductor were to move away from the reader, passing pole *N*.

64. Emf. Curve.—If the electromotive force is called positive when to the right in *a*, and negative when to the left, the changes in it may be shown by a curve like Fig. 95. Successive moments of time are taken along the horizontal axis, and the corresponding electromotive forces are shown by the height of the vertical ordinates. When the north pole is in position 1, Fig. 94, no emf. is induced. This is shown by the point marked 1, Fig. 95. A short time afterward, in position 2, Fig. 94, a certain maximum emf. is induced, shown by point 2, on the curve. When the pole has moved to position 3 the electromotive force has decreased to zero, and in position 4 it has reached a negative maximum. It then decreases again to zero and the whole series is repeated.

A curve like the one in Fig. 95 is often called an electromotive force curve or wave.

The emf. curves generated by commercial alternators have a variety of shapes, but ordinarily they are not very different from sine curves, and for reasons given in Chapter 1 are usually treated as such.

65. Cycle, Period, Frequency.—A regularly recurring series of values of electromotive force, from any point in the series to the cor-

responding point in the next series, is called a "cycle." The portion of the curve in Fig. 95 from 3 to 7 represents a cycle; similarly, the portion from 2 to 6. The time required for one cycle is the "period." The number of cycles per second is called the "frequency."

In American commercial practice, 60 and 25 cycles per second are the most common frequencies for alternating current circuits. The corresponding periods are $\frac{1}{60}$ and $\frac{1}{25}$ of a second. Other frequencies, for example 50 cycles, are used in Europe. For certain purposes in radio telegraphy, 500-cycle generators are used. Quite recently, special machines have been developed for generating frequencies as high as 100,000 cycles per second, to be applied directly to the radio circuits. This frequency corresponds of a radio wave length of 3000 meters.¹

66. Multipolar Magnets.—To produce a frequency of 60 cycles per second by the use of a single magnet with two poles requires a speed of rotation of 60 revolutions per second. Such a speed is not practicable for large machines. To get 500 cycles would require 500 r.p.s., or 30,000 r.p.m. (revolutions per minute). By arranging a number of similar north and south poles alternately, as in Fig. 96, and providing corresponding conductors, a lower speed of rotation may be used. As in Fig. 94, the magnet is supposed to be made to rotate, while the conductors *a, b, c, d, e, f* remain stationary.

When the upper north pole is coming toward the reader, electromotive forces will be induced in the several conductors in the direction of the arrows. The conductors are all connected in series, except between *f* and *a*, where connection is made to an external part of the circuit, *X*. All are in the same relative position to the several magnetic poles; their electromotive forces are equal, and in the case shown, the total is six times as great as the electromotive force in any one conductor.

For every revolution of the magnet, each conductor is passed three times by an *N* and three times by an *S* pole. Each pair of poles gives rise to a cycle, so for each revolution there are three cycles of emf. in the conductors. Thus, for a given speed, the frequency is three times as high as it would be if there were but one pair of poles.

67. Field and Armature.—The magnets (*NS*, in Fig. 96, p. 116) which produce the magnetic field of an alternator are called the "field magnets." If there is but one north and one south pole, the machine

¹ Wave length explained in Sec. 125.

is said to be "bipolar;" if there are several pairs of poles the machine is "multipolar."

The conductors in which the electromotive forces are induced constitute the "armature winding." The winding is supported, usually by being imbedded in slots, well insulated, on an iron or steel core called the "armature core." Winding and core together

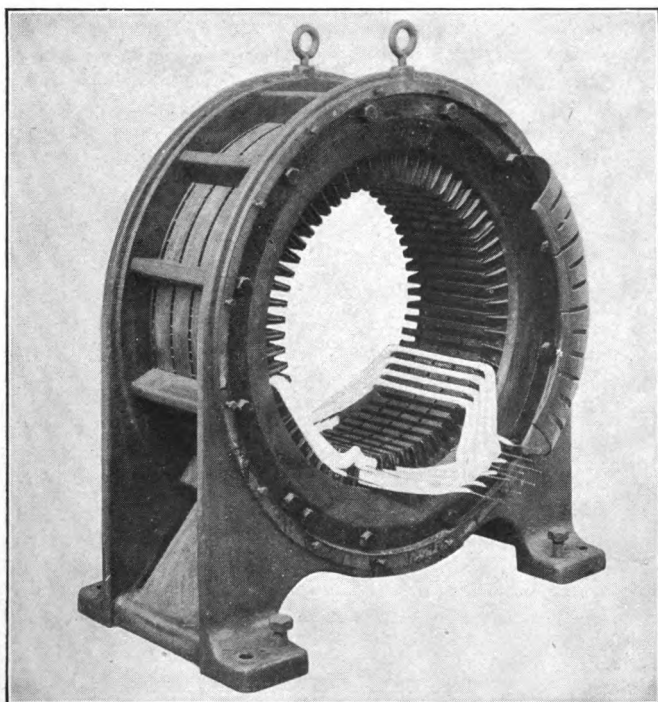

FIG. 97.—Windings partially assembled in a 25-cycle synchronous motor.

constitute the "armature," though this term is also used, loosely, when the armature winding alone is meant.

68. **Coil-Wound Armature.**—The electromotive force developed in one conductor of an ordinary generator is only a volt or two, not enough for practical use. Armature windings, therefore, consist of a large number of conductors, usually combined into coils (see Fig. 97) of several turns each, which are pushed into slots in the face of

the armature core and then connected by soldering. The joints have to be carefully covered with tape or other insulating material.

The coils are made of copper wire covered with insulation (usually cotton) wound to the proper shape on a form, wrapped with tape, and finally covered or impregnated with an insulating compound. The core slots are often lined with heavy paper or fiber. After being placed on the core, the coils are held by wedges of fiber or wood driven into the tops of the slots.

The core is built up of thin flat sheets of soft iron or steel, ring-shaped, with teeth on the inner edge. See Fig. 98. Enough sheets

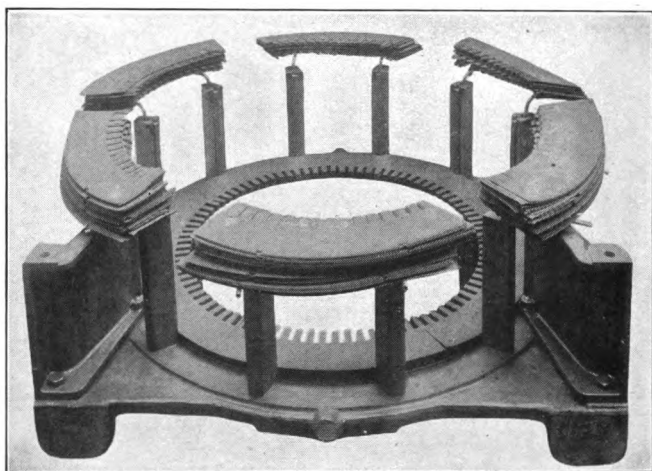

FIG. 98.—Laminations partly assembled, making up the armature core of a skeleton frame alternator.

are stacked up to make a cylinder of the length desired. Occasionally a separator is included to provide air ducts through the core for ventilation. The three dark rings around the core in Fig. 97 show where the ducts are. The teeth are carefully lined up, and the spaces between them become the troughs or slots for the windings.

How the emf. increases and decreases in such a winding can be studied from Fig. 99. Here the coils are drawn as if the armature were unrolled and opened out flat. The magnet poles are supposed at the given instant to be over the rectangles marked *N* and *S*. Each

of the numbered lines in the figure may represent either a single conductor or one side of a coil. Only a portion of the armature winding is represented.

Imagine the poles in Fig. 99 to be moving toward the right, the conductors 1, 2, 3, etc., remaining stationary. Starting at the instant when a north pole is just approaching conductor 1, and a south pole conductor 5, electromotive forces will be induced in the directions shown by the arrows. As conductors 2 and 6, 3 and 7, etc., are reached additional electromotive forces are induced. The maximum comes when the *N* pole covers 1, 2, 3 and 4, and the *S* pole covers 5, 6, 7 and 8. After that the resultant electromotive force begins to decrease, falling to zero and then beginning to increase in the opposite direction. In this manner an alternating emf. is gotten in which the changes occur gradually as conductors get into or out

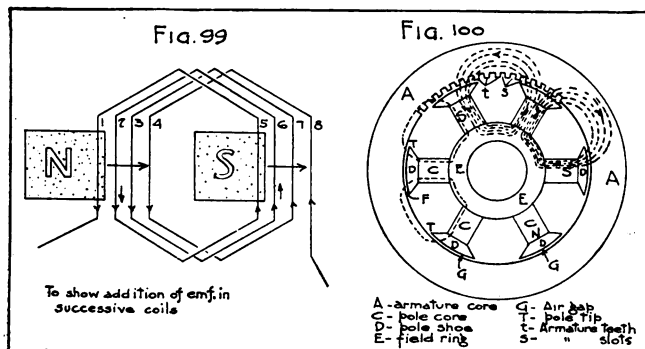

of the magnetic field one by one, or at least coil by coil. In addition the edges of the poles are usually tapered off ("chamfered") to make the changes still smoother.

69. **Concentrated and Distributed Windings.**—Sometimes all the turns for one pair of poles are combined into one coil, which is put into a single pair of large slots, one for each pole. Such a winding is a "concentrated" winding. (See Fig. 103.) When the portion of the core under each pole face contains a number of slots in which the coils are placed, the winding is "distributed." (See Figs. 97, 99, 100.)

70. **Magnetic Circuit.**—It is important to get an understanding of the magnetic path in an electric machine. Various shapes are

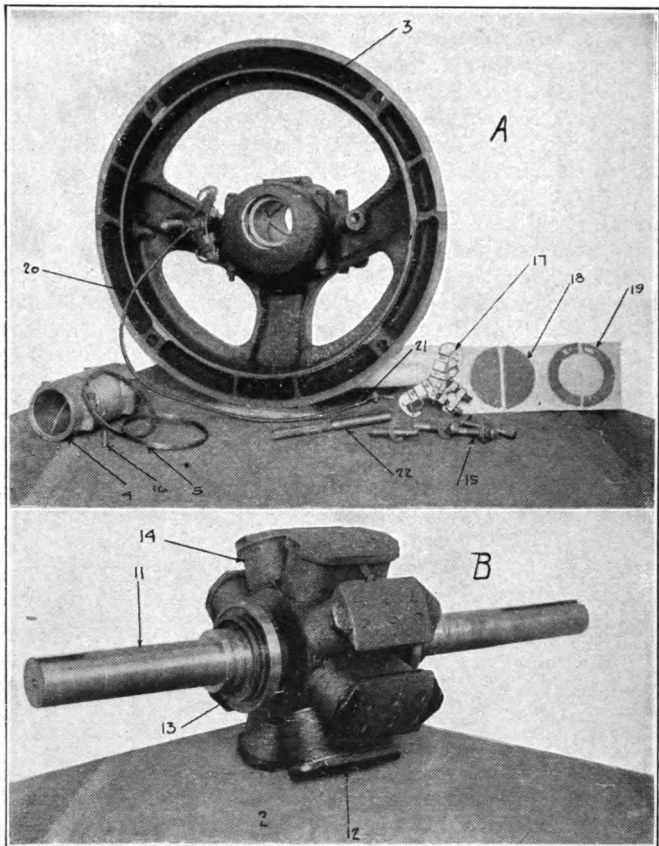
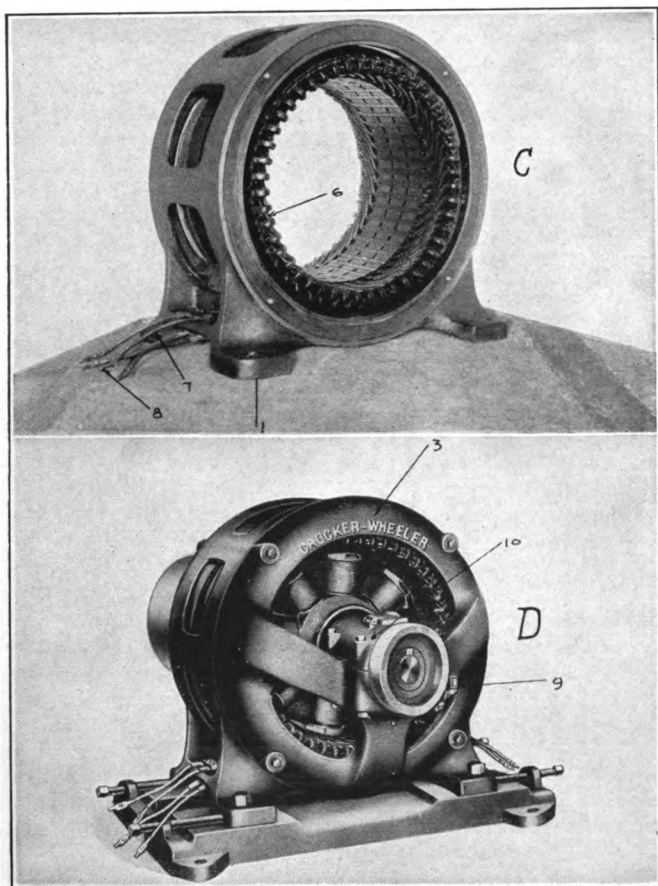

FIG. 101-A-B (C and D on opposite page).—Alternating current generator, 150 KVA., 900-R.P.M., 60-cycle. Dismantled parts listed below.

- | | | |
|--------------------------|--|---|
| 1. Stator frame. | 9. Oil gauge. | 16. Journal box set screw. |
| 2. Complete rotor. | 10. Oil hole cover. | 17. Twin unit brush holder, with brushes. |
| 3. Shields. | 11. Shaft. | 18. Dust cap. |
| 4. Journal boxes. | 12. Pole shoe. | 19. Dust washer. |
| 5. Oil rings. | 13. Collector ring. | 20. Rotor leads. |
| 6. Stator winding. | 14. Field coil. | 21. Rotor lead cable tips. |
| 7. Stator leads. | 15. Cap screws for holding shields to frame. | 22. Brush stud. |
| 8. Cable tips for leads. | | |



possible, but an understanding of one makes all others easy. Fig. 100 is a diagram indicating the parts of a typical magnetic circuit, with their names. It is not intended to show details of mechanical construction. The fine lines in the upper part of the figure show the path of the magnetic flux for one pair of poles. The paths for the other poles are similar. The armature conductors are placed in the slots *ss*.

71. **Field Excitation.**—Thus far nothing has been said as to how the magnetic field is produced. While permanent magnets might be used, they are not satisfactory for practical purposes, except in the very little machines called “magnetos.” Electromagnets are therefore used. The poles are fitted with coils or spools of wire, usually of a large number of turns, through which direct current is sent from some external source.

The coils are connected to a pair of metallic rings, called “slip-rings” or collector rings, which are in contact with conducting strips, called “brushes,” connected to the source of current. As the entire field structure rotates, current is brought to the coils through the sliding contacts of the stationary brushes with the revolving slip rings.

The source of direct current is usually a separate small direct current generator, which when used for this purpose is called an

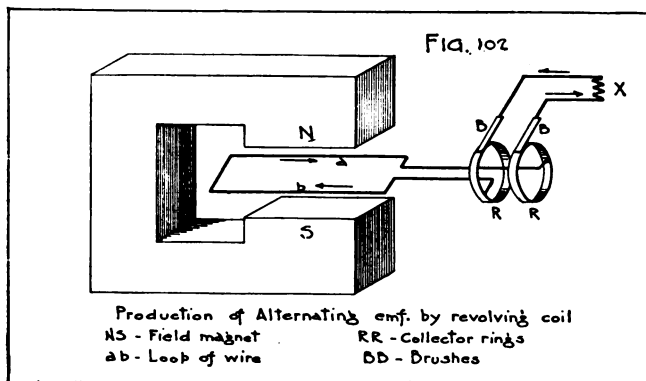

“exciter.” If used for one alternator alone its output will range from 1 to 3 per cent of the rating of the alternator. When the alternator is very small, like those used in the Signal Corps portable radio sets, the exciter is larger, by comparison.

72. **Stator and Rotor.**—When it is desired to refer to the stationary and rotating members of a dynamo-electric machine without regard to their functions the former is called the “stator” and the latter the “rotor.”

73. **Arrangement of Parts.**—A good idea of the parts of a revolving-field alternator is obtainable from the pictures in Fig. 101, which show a complete machine, as well as views of the most important parts. The general view shows how the parts fit together.

Through the holes in the ventilated iron frame of the stator the outside of the core is visible. On the inside of the core the laminations can be dimly seen. The two dark rings which seem to divide the core into thirds are ventilating ducts. Where the windings lie in the slots they are concealed by the wedges, but the ends of the coils are in plain view. Note that the coil ends are given a twist to make a neat construction. The four terminals at the left of the stator indicate a two-phase machine (Section 76).

The right hand end shield shows one brush holder in place, to the left of the bearing; the little hole to the right of the bearing is for the stud on which the other brush holder (lying in front) is to be mounted.

The brushes of one set slide on one collector ring, and those of the other set on the other ring. Two brushes are used in each set, in this particular machine, in order to have a large and reliable contact. The ends of the cables leading to the brushes are in view on the right of the complete generator.

On the rotor the pole shoes are noticeable, held on by six screws. One of the connections between field coils is seen between the upper pole shoe and the one just in front of it, near the center of the shoe. The massive ring to which the pole cores are attached is also visible. There are two collector rings close together, though it is a little difficult to distinguish them in the picture.

74. Other Forms of Alternator.—Thus far we have considered alternators of which the field magnets revolve, while the armature is stationary. That is the construction generally used on large machines, one reason being that it makes the armature easier to insulate. But it is also possible to have the field magnets stationary while the armature is made to revolve. Small machines are often built this way. The principle is shown in Fig. 102.

The magnetic field occupies the space between the poles N and S of the stationary field magnet. The turn of wire ab is made to revolve about a horizontal axis in this magnetic field. When a is passing under the N pole, coming toward the reader, the electromotive force in it is to the right, and that in b which is cutting through the same field (the direction of the magnetic flux is from the N pole into the S pole), but moving away from the reader is to the left. Current will therefore flow in the turn of wire, and by way of the collector rings and brushes in the external circuit, as shown by the arrows.

When the loop has made half a revolution, a is passing in front of the S pole and the electromotive force in a is toward the left. In b it is toward the right. In the external portion, X , of the circuit the flow of current will then be opposite in direction to the arrows.

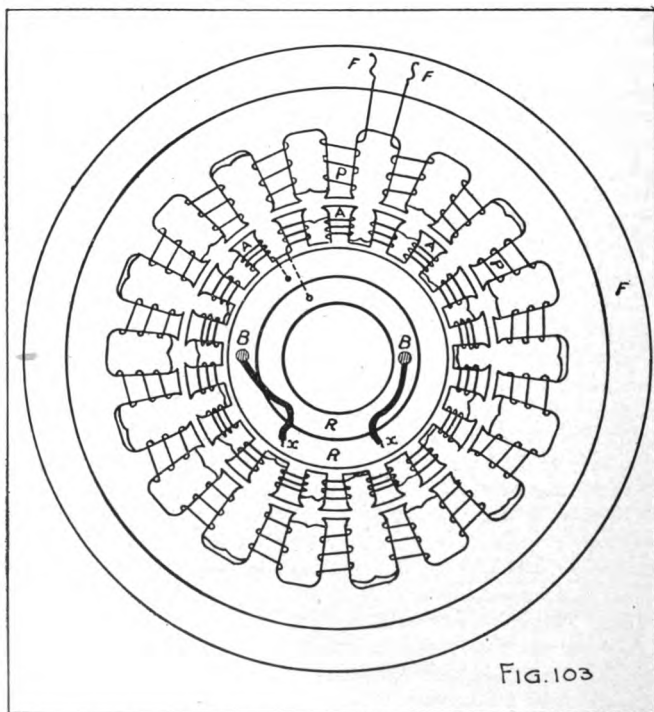

FIG. 103.—Circuit diagram of revolving armature alternator. A, armature; F, frame; P, poles; R, collector rings; B, brushes; FF, terminals of field circuit; XX, leads to external circuit.

The continued rotation of the loop thus causes an alternating current to flow in the circuit.

The simple bipolar magnet of Fig. 102 may be replaced by a multipolar electromagnet consisting of a massive cylindrical frame called the "yoke," from which poles project radially inward. Direct current is sent through coils or spools on the magnet poles. The same kinds of windings are used for the revolving armature as are

used for the stationary kind; the only difference is that they are put on the outside instead of on the inner face of the core.

A machine in which the field magnets are stationary, while the conductors, in which the electromotive force is induced are rotated, is said to be of the "revolving armature" type. A diagram of such a machine, used in one form of radio pack set, is given in Fig. 103.¹ The armature winding in this case is of the concentrated type. A picture of a generator very much like it appears in Fig. 122.

It has previously been shown that, when the field is made to revolve, slip-rings have to be used in the field circuit. Similarly, when the armature is the part that revolves, there must be slip-

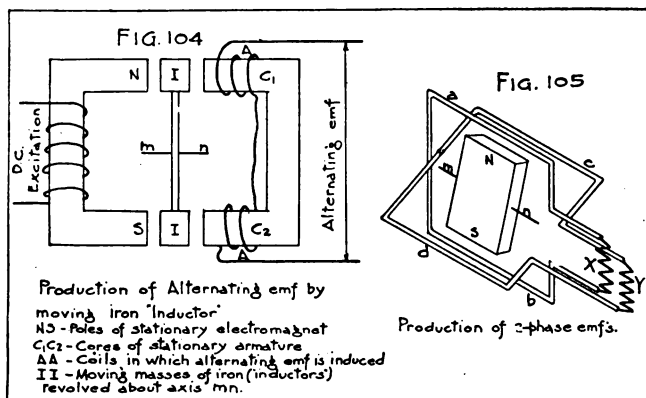

rings in the armature circuit to provide connection with the external portion. Such rings are shown at *R R* in Fig. 102.

Inductor Alternator.—Another type of alternator is of especial interest in connection with radio telegraphy. It is called the "inductor alternator," and is used particularly for the generation of continuous high frequency currents, say around 100,000 cycles per second, but is also used for lower frequencies.

The principle on which such machines operate is illustrated in elementary form in Fig. 104. The field magnet and the armature

¹ The little machine to which this diagram applies has 18 field poles and 18 armature teeth, runs 3333 r.p.m., and generates current of 500 cycles frequency. It is designed for an output of 250 volt-amperes, to be used in a field radio pack set. The windings are shown only in diagram; actually the field coils average 250 turns each; the armature coils 19 turns each. The sketch is practically to scale, except the collector rings, which are drawn smaller so as not to conceal the armature. The whole diameter across the frame is about 15 cm. (6 in.).

are both stationary. A considerable gap separates the armature core from the faces of the field poles. In this gap are masses of iron, I , free to revolve in a plane perpendicular to the plane of the paper about the axis mn . These masses of iron are called "inductors." Imagine them made to revolve by an external force. When the inductors are in the position shown, between N and C_1 , and S and C_2 there is a certain magnetic flux, due to the d.c. excitation. When the inductors are not in that position there are long air gaps in the magnetic circuit, which have a very much smaller permeability than the iron inductors. The flux is consequently less. The increase and decrease of magnetic flux in the coils AA sets up an alternating emf., because any change in the flux inclosed by a circuit sets up an emf. in the circuit (Sec. 45) in the one direction while the flux is increasing, and in the opposite direction while it is decreasing.

In this type of alternator, the passing of each mass or inductor causes a complete cycle of emf., whereas with alternators of either the revolving field or the revolving armature type it requires the passage of two poles to cause a cycle.

75. **Polyphase Alternators.**—Suppose that in Fig. 94, p. 116, another loop similar to ab , but entirely independent of it, were placed at right angles to ab , as shown at cd in Fig. 105. The rotation of NS would induce in the second loop an alternating emf. identical with that in the first, having the same frequency and the same series of values. The sole difference would be that they would reach corresponding points in the cycle at different instants of time, for at the moment when the poles were in line with the conductors of one loop and it was having maximum emf. induced, the other loop would have none.

Suppose the emf. wave of the first winding is given by curve I, Fig. 106. Then curve II will represent the emf. of the other winding. The two curves are first shown separately and then combined into one diagram. They are alike in shape, showing that the two emfs. go through the same series of values, but II is always a quarter of a cycle behind I (see Sec. 55). Suppose the distance 0—4 represents $\frac{1}{5}$ second. Then whatever happens in I, at any instant, happens in II just $\frac{1}{20}$ second later. This is expressed by saying that there is a "phase difference" of a quarter cycle between them, or that the two emfs. differ in phase by a quarter cycle.

Two emfs. which differ in phase by a quarter of a cycle are said to be in quadrature. A generator giving such a pair of emfs. in quadrature is called a "two-phase" alternator. The two windings considered

separately are called "phase windings," or, somewhat loosely, the "phases." Either one may be thought of as phase I and the other as phase II.

It will now be plain why the pictures of Fig. 101, show four terminals at the left. Two belong to one phase and two to the other.

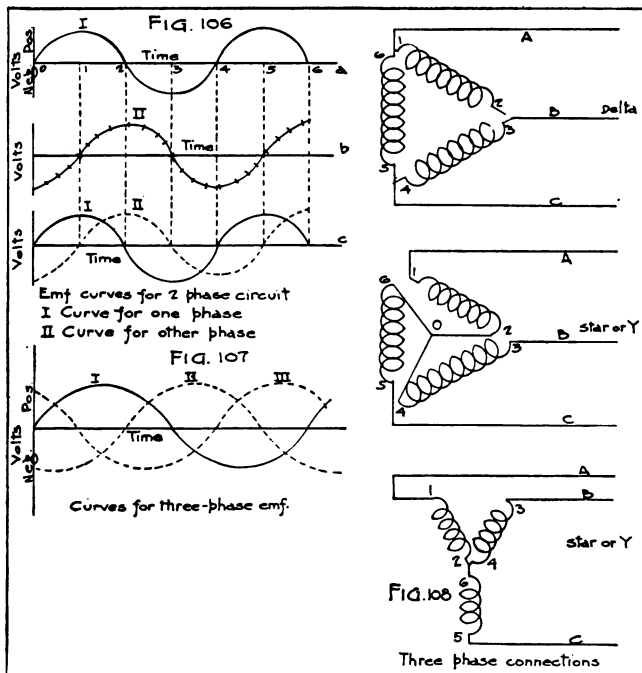

There may be more than two phases, in fact, modern power-generators usually have three phase windings.

Definitions.—A machine for a simple alternating current is called a "single phase" machine. Generators used exclusively for radio communication are generally single phase.

A machine for alternating current of two or more phases is called a "polyphase" machine; polyphase generators are either two-phase or

three-phase, almost without exception. They are used for power purposes. •

Arrangement of Windings.—An idea of the way the windings of a polyphase generator are arranged may be obtained by referring back to Fig. 99. Suppose another winding to be added, identical with the one shown, but occupying the spaces left vacant by the first winding.¹ As the magnet poles move along, the windings come into play alternately.

Notice that in a single phase generator half the surface of the armature core has to be left vacant. In a polyphase generator, on the contrary, the windings may cover the entire surface and usually do.

Next, suppose the two-phase windings were each made narrower, leaving space for a third winding just as large as each of the first two. We should then have three phase windings, and a given field pole would pass them one after the other. Thus would be produced three emfs. differing in phase by equal amounts.

By properly selecting the terminals, the three emfs. would follow one another as represented in Fig. 107, and it will be seen that now the difference between them is one-third of a cycle. In the time of one cycle each of the three comes to a positive peak one after the other. The emf. curves are shown in Fig. 107. The emfs. are often spoken of as differing by 120° .

It might be expected that a three-phase machine would have six terminals. As a matter of fact, the phases are usually so connected in the machine that three terminals are sufficient, as illustrated in Fig. 108. The three coils stand for the three armature windings. When joined as in the upper sketch, they are said to be connected in "delta" when one end of each coil is brought to a common junction as at *O* in the middle figure they are connected in "Y" or "star." The lower figure is the same as the middle one, in that terminals 2, 4, 6 are all joined together and 1, 3, 5 are connected to the line-wires *A*, *B*, *C*. By changing the position on the paper the connections are made to look simpler.

The scheme of connections is ordinarily of no interest to the operator, except in case of trouble, and cannot be determined without a close examination. The wires by which the connections are made are carefully wrapped and tucked away at the end of the

¹ The reader who has difficulty in imagining the second winding may trace, on transparent paper, the winding shown and may then slide the paper to one side by the proper amount.

armature, concealed by an overhanging part of the frame, or by the end shield, which has to be taken off before the connections can be traced.¹

B. Alternator Theory, Losses and Efficiency.

76. **Equations for Frequency and Emf.**—The frequency of the emf. generated by an alternator of the revolving field or revolving armature type is given by the equation:

$$f = \frac{pn}{2} \text{ or } f = \frac{pn'}{120} \quad (65)$$

where f = frequency in cycles per second.

p = number of poles.

n = revolutions per second.

n' = revolutions per minute.

The passing of each pair of poles, $\frac{p}{2}$ in number gives rise to one cycle. If there are n revolutions per second, the number of cycles per second is therefore $\frac{p}{2} \times n$. The second form of the equation is given, because the speed is commonly given in revolutions per minute.

For example: What frequency will a 12-pole alternator give when running at 5000 r.p.m.?

With 12 poles, each revolution gives 6 cycles. In a minute there will be $6 \times 5000 = 30,000$ cycles. In a second there are $30,000 \div 60 = 500$ cycles. The machine gives 500 cycles per second. By the second formula we get the same answer

$$f = \frac{12 \times 5000}{120} = 500 \text{ cycles per second.}$$

For the inductor type the frequency is the same as the number of inductors which pass a given point per second. Thus 40 teeth at 25 r.p.s. give 1000 cycles per second. The inductors are usually in the form of teeth, somewhat like gear teeth, that project from the revolving part.

The emf. generated in an alternator depends on how much magnetic flux is cut by the conductors per second. Increasing either the magnetic flux from each pole, or the number of poles that pass a given conductor in a second, or the number of conductors connected in series (so that the effects in them are added together) increases the

¹ Discussion of this subject can be found in any textbook on alternating current machinery. See, for example, Timbie and Higbie, First Course, pp. 114-128; Franklin & Esty, Elements of Electrical Engineering, vol. 2.

emf. of the machine in a corresponding way. This may all be stated in one equation.

$$E = \phi N f k \quad (66)$$

where E = effective volts (Section 53), as shown by a voltmeter.

ϕ = magnetic flux per pole, in maxwells or "lines of magnetic force."

N = number of turns of armature winding connected in series.

f = frequency in cycles per second.

k = a multiplier that depends on the arrangement of the winding and certain mathematical relations not necessary to consider here.¹

77. Dependence of Driving Power on Current.—The power consumed in an electrical circuit at any instant is proportional to the emf. and also to the current. It is therefore proportional to their product. If the current is made to flow by means of a generator, and if the generator is driven by an engine of some sort, the power that has to be developed by the engine evidently depends upon the power used in the circuit. It is worth while to trace the reason why increased current in a generator calls for more power from the engine that drives it.

Let the simple loop in Fig. 102 be made to rotate at constant speed by any "prime mover" suitably governed. This prime mover may be anything that will make the loop go around—a man turning a crank, a gasoline engine, a steam engine, an electric motor, etc. At the instant when the loop is in the plane of the paper, and a is coming toward the reader, an emf. is being induced in it, in the direction of the arrow. If the circuit is closed, a current flows in the same direction. But it is known (see Section 43) that when a conductor, carrying a current, is in a magnetic field, the conductor tends to move across the field. The force on the conductor is proportional to the strength of the field and to the current. The

¹ The student who has some previous knowledge of electricity will see that if $2f$ poles pass a conductor per second, the average flux cut per second is $2f \times \phi$. To generate 1 volt requires passing 10^8 lines of flux per second. Hence the average volts per conductor are $2f \times \phi \div 10^8$. Each turn consists of two conductors in series, so we multiply by 2. The voltmeter reads not average but effective volts. For sine waves the effective volts are 1.11 times the average, so we multiply by 1.11. Collecting all the numbers it is seen that k in the formula stands in part for $\frac{2 \times 2 \times 1.11}{10^8}$ or $\frac{4.44}{10^8}$.

It also includes a factor, not greater than 1, depending on the kind of winding used, because if the winding is distributed, the emfs. in the various turns do not rise and fall together (there is a difference in phase), and this must also be taken into account.

direction of the force is given by the left hand rule.¹ Applying the left hand rule to conductor *a*, it is seen that the force on it is away from the reader, opposite to the direction in which the conductor is being driven, so that the wire is harder to push than it would be if there were no current. The greater the current in the conductor, the greater must be the force exerted to drive it around, and therefore the greater must be the power developed by the prime mover in keeping up a given speed. The same reasoning applied to *b* shows that it acts with *a* in opposing rotation.

78. **Losses.**—Of the mechanical energy supplied to a generator by its prime mover, not all appears in electrical form in the circuit. Some is unavoidably transformed into heat, and thus lost for practical purposes. The losses, which may be called power losses or energy losses, may be classified as—

1. Mechanical losses.
2. Copper losses.
3. Core losses.

Mechanical losses are those due to friction in the bearings, friction at the brush contacts, and friction between the air and the moving part of the machine, commonly called windage. The latter is not important in low speed machines, but becomes prominent in the case of very high speed generators. Generators of the kind we are discussing are driven at nearly constant speed, so the mechanical losses do not depend much on the load, whether large or small. They do depend very greatly on the condition of the bearings and brushes. Some points regarding the care of machines in this respect are given at the end of this chapter, in Section 106.

Copper losses are due to the flow of current against the resistance of the field and armature windings. They are therefore divided into two parts, field copper loss and armature copper loss. The former is also called "excitation loss." Since the field coils have resistance (usually high) some heat is produced as the necessary current for magnetization is made to flow through them. Like all heat losses due to current in a conductor, the heating is proportional to the square of the current, being, in watts,

$$W = I_f^2 R_f \quad (67)$$

where I_f is the current in amperes in the field coils and R_f is the resistance of the whole field circuit.

¹ The thumb, forefinger, and middle finger, all at right angles, giving respectively the directions of motion, flux, and current.

To get the same terminal voltage at the armature, when the current in the latter is large, requires more magnetization than when the armature current is small. This in turn requires more field current, hence the field copper loss, or excitation loss, is somewhat greater at large loads than at small loads; that is, it varies somewhat with the load.

Like the field loss, the armature copper loss is of the I^2R type; it varies as the square of the armature current, and therefore as the square of the load on the generator. The armature resistance is made as small as is expedient. In a large generator it may be only a small fraction of 1 ohm, but the loss due to the great current generated will nevertheless be considerable.

Core losses, or losses in the magnetic circuit, are of two classes, due to "hysteresis" and "eddy currents." Hysteresis losses are caused by the rapid reversals of the magnetism of the armature core. Each molecule of the core may be regarded as a tiny magnet, and when the magnetization of the core is changed in direction, the molecules have to be pulled around against their mutual magnetic attractions. It takes energy to accomplish this. In an electric machine there is a double reversal during each cycle. This makes many reversals per second and requires considerable power.

Eddy currents are little electric currents induced in the iron sheets of which the armature core is made up. The thinner the sheets, the smaller are the currents; in fact, it is because of the eddy currents that the core has to be laminated.

Both hysteresis and eddy currents produce heat in the core, and in producing heat they use up power which has to be furnished by the prime mover. Therefore they are wasteful, and the designers of electric machinery plan to keep them as small as possible.

No specific statement can be made regarding the magnitudes of the various losses described in the preceding paragraphs, because they depend on many factors, such as the size, the operating speed, and special features of design. But in order to give the reader some idea, it may be said roughly that at full load, for generators of the usual types, the mechanical or frictional losses may range from 6 per cent for a 1-kw. machine, to 1 per cent for the 1000-kw. size; the excitation loss, from 6 to 1 per cent; the armature resistance loss, from 4 to 1 per cent; and the core loss from 4 to 2 per cent.

It will now be clear why the allowable power output of a generator has a limit. Usually machines are heavy enough to give a large margin of strength, but they cannot well be made large enough to

allow for the heat produced by severe overloads long continued. The increased current causes heat to be produced more rapidly, and the temperature rises. High temperature is injurious to the insulation. For example, it is found that cotton should not be continuously heated as hot as the boiling point of water. Cotton is the usual insulation for the copper wires used in machinery. If the insulation is spoiled, the current can follow other paths than those it should, and the machine is ruined.

79. Rating; Name Plate Data.—Practically all electrical apparatus, whether for alternating or for direct current generator, motor, or other device, is designed for certain definite conditions of operation. It is standard commercial practice to attach firmly to every electrical machine before it leaves the factory, a brass information tag called a "name plate." This usually gives the serial number by which the machine can be identified, tells the maker's name; states whether the machine is a generator or a motor; what is the maximum continuous power output; whether for direct or alternating current; if alternating, for what frequency and how many phases; at what speed it is to be operated; at what voltage; the maximum current for continuous operation. Some of these items are at times omitted, but most of them are essential. A person who wishes to become familiar with electrical machinery should form the habit of examining the name plate of every machine to which he has access, and note the differences in size, construction and use.

It has been previously said that electrical power is measured in watts (or kilowatts, "kw.," when large). In a direct current circuit, watts are the product of volts times amperes. With alternating current something else has to be taken into account, and to get the average power we must multiply the volts-times-amperes by the "power factor."¹ We might expect to find a.c. machines rated in watts or kilowatts, but if we look at the name plate of a generator we are likely to find the letters "kva." (kilovolt-amperes). That is, instead of actual watts the permissible output is expressed as a product of amperes times volts divided by 1000. The reason is plain, if we remember that the whole question of what an electric machine will stand hinges altogether on the heating.

¹ Power factor is, in fact, the number by which we must multiply volt-amperes to get true watts. (See Sec. 57.) It is commonly expressed in per cent. It cannot be over 100 per cent and is usually less. It depends entirely on the sort of circuit that happens to be connected to the generator, since this as well as the generator itself controls the phase difference existing between volts and amperes.

The heating of the field coils and armature core depends upon the voltage generated, because that is determined by the strength of the magnetic field, which in turn depends on the current in the field coils. The heating of the armature conductors is determined by the armature current; whether or not that is in phase with the emf. makes no difference. The total heating, then, depends on the volts and the amperes, regardless of the power output which may be large or small, depending on the phase relation between the two.

80. Efficiency.—The ratio of the useful output of a device to its input, is called its "efficiency."

In all kinds of machinery it is impossible to avoid some losses of power, so the output is less than the input and the efficiency is less than 100 per cent. It is lower for small electrical machines than for large ones, and for a given machine it varies with the extent to which the machine is loaded. Certain losses go on regardless of the load; those are the mechanical losses, field excitation and core losses. Others increase with the load; the armature copper loss rapidly, some additional core losses and a portion of the excitation loss more slowly. When the output is small, most of the power input is used up in the constant losses, and the efficiency is low. With very large outputs, the variable losses become excessive, again lowering the efficiency. For some intermediate load, usually not far from the rated load given on the name plate, the efficiency is a maximum. At full load, and for the usual designs, it may range from 80 per cent for a 1-kw. generator to 95 per cent for a 1000-kw. generator.

81. Regulation.—Electric generators are, with few exceptions, intended to be operated at constant or nearly constant speed. Assuming that the speed is constant, and that the field excitation is also constant, the generated voltage would likewise be constant, regardless of the current output if it were not for certain disturbing influences. A generator operating under these conditions is often called a "constant potential" or "constant voltage" machine.

The current output depends on what is going on in the external circuit. In a city it might depend on the number of lamps turned on. In the case of a generator supplying energy to a spark gap, it would depend largely on the adjustment of the gap. The term "load" is commonly used in this connection. Sometimes it means the devices themselves, which are connected to the line, and sometimes the current taken by them. There is generally no trouble in knowing which is meant.

Suppose we have a certain voltage generated when the load is zero. Then if the machine is made to supply current to a circuit, the voltage at its terminals will in general be lowered, and the greater the current, the more will the voltage be reduced. The term by which the behavior of a generator is described in this respect is called the "regulation." It is found by subtracting the voltage at full load from the voltage at no load, dividing by the full load voltage and multiplying by 100 to get the result in per cent.

Expressed as a formula—

$$\text{Regulation} = \left(\frac{V_0 - V_t}{V_t} \right) \times 100 \text{ per cent.}$$

where V_0 = voltage at no load and
 V_t = voltage at full load.

A small percentage regulation means that the voltage remains quite steady when the load is changed.

82. Armature Impedance and Armature Reaction.—There are two reasons why the voltage of a generator is lower when it is supplying current than when it is not supplying current, even if the speed is entirely steady and the direct current flowing around the field magnets is the same.

(a) The armature windings are bound to have some resistance and some reactance. It requires an emf. to send current through the armature, therefore. This emf., called the armature impedance drop, has to be subtracted from the emf. generated to get the emf. left to send current through the external circuit. The greater the current, the greater the armature impedance drop, and the less the emf. left for the external circuit.

(b) The armature winding and core constitute an electromagnet. When current flows in the windings, the magnetic field caused by it is combined with the magnetic field due to field strength, with consequent decrease in armature voltage, since the resultant magnetic field is what determines the generated emf.

The change in the field flux by reason of the current flowing in the armature is called "armature reaction." Armature reaction occurs in direct current as well as in alternating current machines, and in motors as well as generators.¹

83. Effect of Power Factor on Regulation.—The reduction of terminal voltage due to the current flowing in the armature depends,

¹ Swoope, p. 362; Rowland, p. 230; Franklin and Esty, *Dynamos and Motors*, p. 256.

not only on the magnitude of the current, but also on its phase relation to the emf., which is indicated by the power factor. A lagging current causes a greater reduction in terminal voltage than the same number of amperes in phase, the effect increasing with the lag. Thus at 80 per cent power factor it may be twice as great as at 100 per cent. Conversely, a leading current, such as is taken by condensers, improves the regulation, so that the terminal voltage may actually be higher when current is flowing than when there is none.

84. **Effect of Speed on Regulation.**—Since the emf. is proportional to the rate of cutting of flux, it follows that fluctuations of speed are attended with proportional fluctuations of voltage, provided the field excitation is not changed at the same time.

85. **Voltage Control.**—The simplest way to control the voltage of a generator is by adjusting the strength of the magnetic field by means of the field current. For this purpose an adjustable resistance is inserted in the circuit of the latter, called a field rheostat.

One kind consists of a quantity of wire of an alloy having a comparatively high resistance, mounted on insulating supports in a perforated iron box with a slate face, or embedded in an insulating enamel. A handle is provided for making contact with any one of a number of brass studs attached to the resistance wire at various points, so that more or less of it can be in circuit. Terminals are provided for connecting the rheostat to the field circuit. Fig. 109 shows the principle.

The place of the field rheostat in the scheme of connections is seen in Fig. 110, which represents the stationary armature and revolving field of an alternator, with arrangements for supplying current to the alternator field from the exciter *E*, current being controlled by the field rheostat *R*.

Small alternators for field use in radio telegraphy are often used without a field rheostat. The voltage is kept steady enough for practical purposes by driving the machine at the right speed.

C. Direct Current Generators.

86. **Commutation.**—Fig. 102, page 124, illustrates the principle used when alternating currents are generated by revolving an armature in a stationary magnetic field. But if each end of the loop is

connected to a half cylinder of metal (*C*, Fig. 111), on which rests a stationary brush *B+* or *B-*, than as the loop is revolved the connection to the external circuit is reversed every half revolution, and the pulsations of current are always in the same direction. The reversing device is called a "commutator." The brushes must be

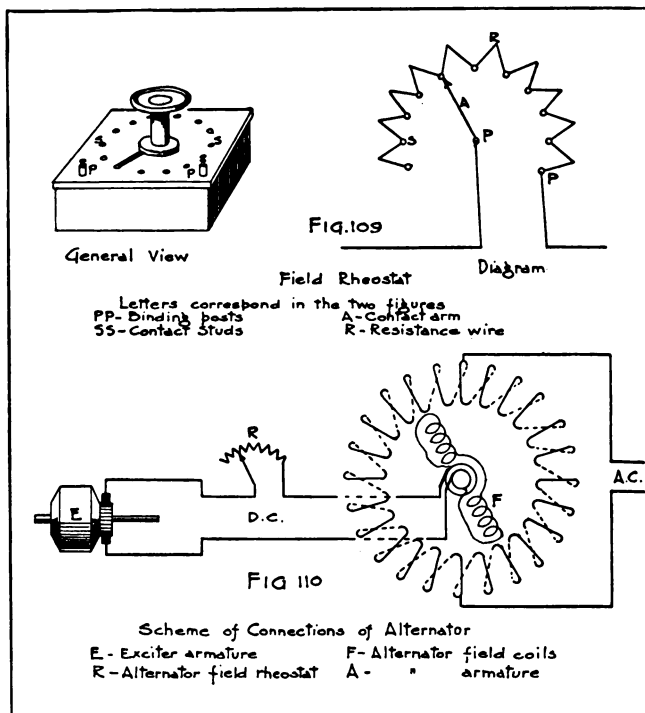

so set that the reversal of connections occurs at the instant when the current in the loop is zero and about to reverse.

Thus in the figure, *a* is near the *N* pole, and if it is coming toward the reader the emf. will be toward the right. At that instant the current will flow out through the segment in contact with the upper brush to the external circuit; that is, the upper brush is +. After a quarter revolution the conductors will be moving along the flux

and not cutting across it, so there will be no emf. Each brush will be just in the act of passing from one segment to the other.

After a half revolution from the position shown, *b* will have exchanged places with *a*. Now the emf. in *b* will be toward the right, and current will flow out to the external circuit through *B+*. Thus the same brush is always positive. In the external circuit the current always flows in the same direction, though in the armature conductors the current is alternating.

If an emf. curve similar to Fig. 95, p. 116, were plotted for this circuit, with time measured along the horizontal axis, and volts at any

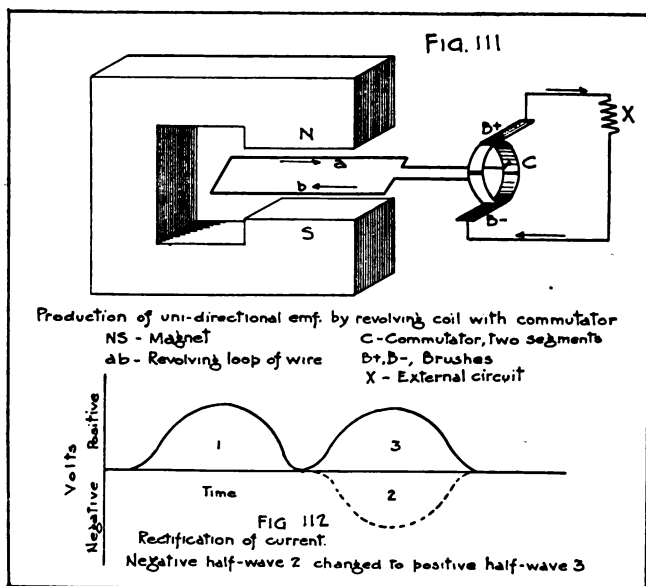

instant along the vertical axis, the result would be somewhat like Fig. 112. Instead of a positive and a negative half wave, there would be two positive halves, the negative being rectified by means of the commutator.

Again, as with alternators, the need of higher emfs. than can be developed by a single loop, and of more effective utilization of the material, make necessary the use of coil-wound armatures and multipolar field magnets. With a commutator consisting of only a few

segments, say as many segments as there are magnet poles, the current would still be pulsating.

To get a steady, practically constant emf., commutators are used having many segments—several hundred in the case of large generators and motors, and usually not fewer than 20 or 30 even on very small machines for 110-volt circuits. Such a commutator consists of bars of copper, slightly wedge-shaped, separated by thin insulating sheets of mica, the whole assembled in the form of a cylinder held together by strong end clamps. The segments are insulated from the clamps by suitably shaped rings, usually of molded mica insulation. Connections leading to the armature conductors are

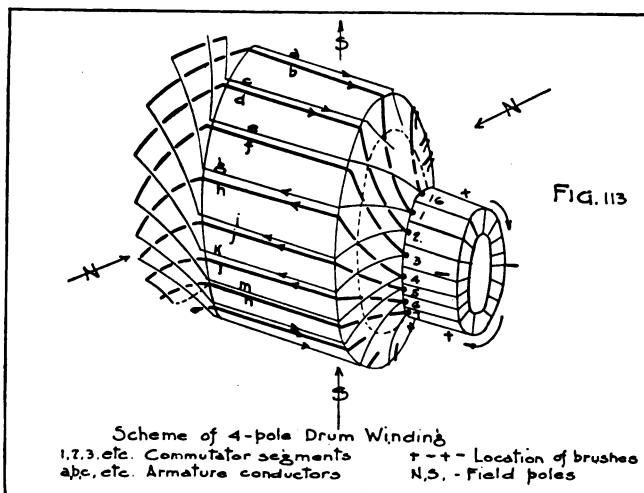

soldered into slots in the segments, which commonly have lugs or "risers" for the purpose, extending upward at the end toward the armature.

87. **Ring and Drum Windings.**—Armature windings fall into two broad classes, called "ring" and "drum" windings, according to the way the conductors are mounted on the core. In the first of these the wire is laid on the outside and passed through the hollow space inside of the core, being threaded through and through much as a napkin ring or a bridle ring might be covered with string.

Ring windings are scarcely ever used nowadays. Modern machines have windings of the type shown in Fig. 113, called "drum"

windings. The conductors are all on the outer face of the core, and the two branches of a turn lie under adjacent poles, of opposite polarity. These two features are characteristic of all kinds of drum winding. In the kind illustrated in the diagram, starting with commutator segment 1, we pass up to conductor *b*, which at the instant shown is under a *S* pole. It is connected at the back of the armature to *i*, which lies under a *N* pole and is soldered into segment 2. Starting at 2, we have *d* under the edge of the *S* pole back-connected to *k* under the edge of the *N* pole; *k* is attached to segment 3. Continuing in the same way all around the armature we finally have 16 loops connected to the 16 commutator segments. It will be understood that an actual machine has a great many more turns in the armature winding and a larger number of commutator segments.

At the four segments marked + or -, contact is made with brushes leading to the external circuit. By the "right-hand rule" the emf. in conductors under the *N* pole is toward the back end, so current flows into the armature at segment 3. The brush on that segment is therefore negative. The brush at segment 7 is positive, because there the current flows out of the armature. Similar reasoning applied to the conductors under the *S* poles leads to the same result as to polarity of the brushes, which are thus seen to be alternately, one positive and the next negative, as we go around the commutator. If a machine having more than two sets of brushes is examined it will be found that all the positive brushes are joined by a heavy conductor and all the negative brushes by another. Then one connection is made from the group of positive brushes to the external circuit, and one from all the negative brushes.

In speaking of alternators, the actual construction of armatures was described; that is, the use of machine-wound coils in slots in the face of a laminated core. D.c. armatures are made the same way except that the ends of the coils are soldered to the commutator segments.¹

The main steps are shown in Figs. 114, 115, and 116. The first shows the copper segments, with their sheets of mica between them, assembled in the form of a ring and held together by a firm temporary clamp. The next picture shows the commutator fastened on the front end of the armature core. The "risers" are to be seen

¹ Brief information on the care of commutators and proper position of brushes is given at the end of this chapter in Sec. 106 on "Common troubles."

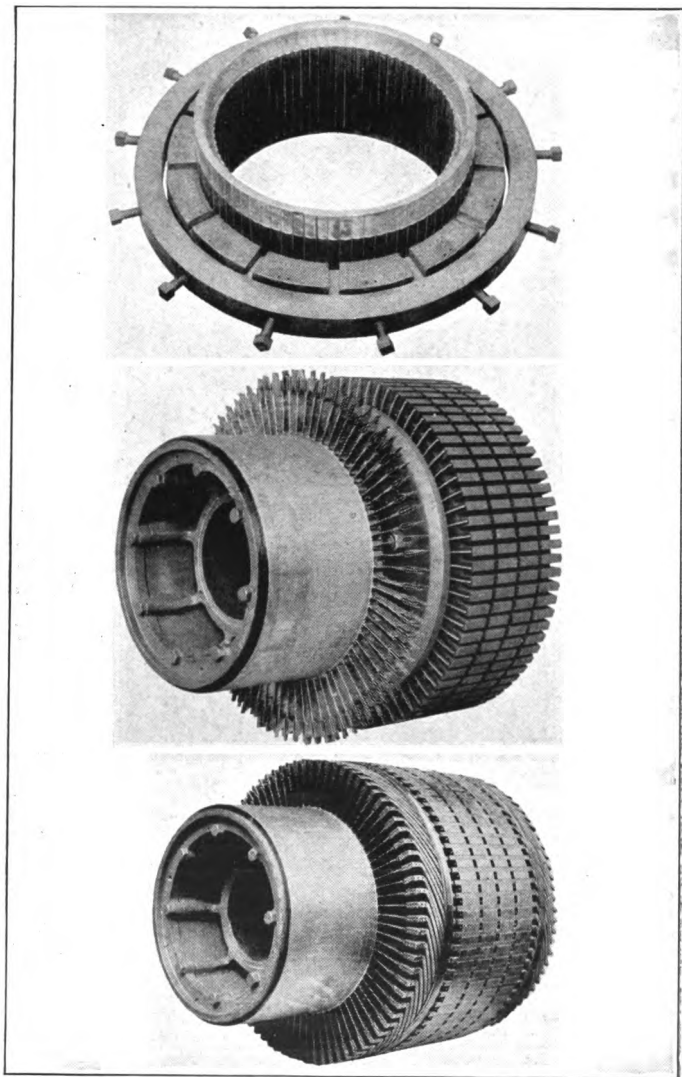
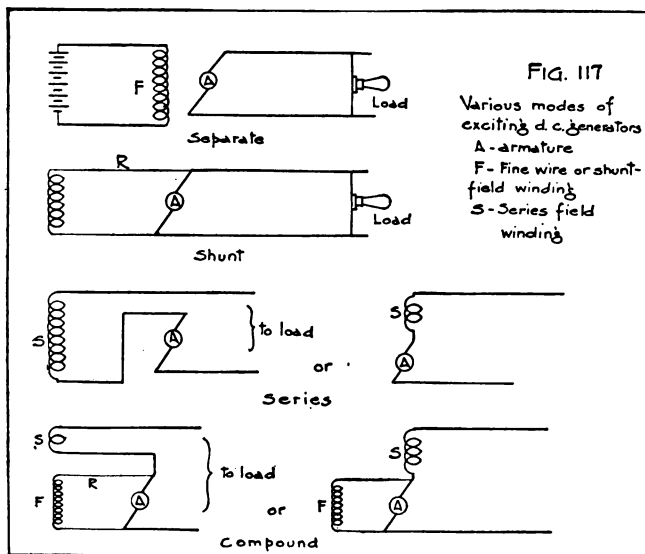

FIG. 114.—(Upper) Method of assembling commutator segments. FIG. 115.—
 (Middle) Commutator and armature core assembled showing risers. FIG. 116.—
 (Lower) Armature complete with windings connected to risers.

coming up from the ends of the segments for connection to the armature coils. On the core, built up of thin laminations, note the teeth, slots, and three rows of air ducts for ventilation. The last picture shows the coils in the slots of the core. Their ends have been soldered to the commutator.

88. **Excitation: Separate, Series, Shunt, Compound.**—While alternators require d.c. from a separate source for their field excitation, direct current dynamos excite their own fields. Depending on the scheme of connections between the armature and the field coils, this



gives rise to several arrangements, all of which are of practical importance. In this discussion we leave out of consideration the "magneto", which depends for its magnetic field on a group of permanent magnets.

Fig. 117 shows the several ways of exciting the field magnets, and incidentally illustrates the conventional symbols generally used for an armature and for field windings. In this sort of diagram no attempt is made to draw a picture of the machine. A whole set of

field coils, for example, is represented by a single coil, the armature and brushes by a single circle¹ and two strokes.

Separate.—The first sketch indicates that current for the field coils comes from a source, like a battery, entirely independent of the armature. Such a machine is said to be “separately excited.”

Shunt.—The next indicates that the current from the armature divides; some goes to the load circuit, some to the field coils; the two unite again and flow back into the armature at the brush of opposite polarity. When the current from the armature divides, a portion flowing through the field winding, the machine is spoken of as a “shunt generator.” Only a small fraction of the total current which a machine is able to generate continuously is required for shunt field excitation; it may be 5 or 6 per cent for a 1-kw. generator, and as little as perhaps 2 per cent for a 100-kw. generator.

Shunt field windings consist of many turns of fine wire (insulated, of course). There may readily be 2000 or 3000 turns. For instance, the little exciter for the 500-cycle audio frequency generator described on p. 152, is a direct current shunt generator. Each of its two field coils has 2800 turns of wire about 0.25 mm. (0.01 in.) in diameter. Using this great quantity of fine wire has two consequences; because of its high resistance it lets only a small current flow; because of the large number of turns this small current suffices to produce the desired magnetomotive force (which depends on the “ampere turns”).

Series.—When the whole current from the armature flows through the field coils, the generator is “series excited.” Two ways of representing a series generator are shown in Fig. 117. Heavy wire is used for series coils. They have to carry the full current output of the machine; fine wires would overheat and destroy the insulation. The necessary ampere turns are secured by virtue of having a large number of amperes and comparatively few turns of wire.

Compound.—When a generator is provided with two sets of field coils, one of fine wire connected in shunt and the other of a few turns of heavy conductor connected in series with the armature, it is called a “compound wound” generator, or more commonly just a “compound” generator. Two ways of representing it are shown in Fig. 117.

¹ Note difference from alternator, which has two circles, representing slip rings.

89. Characteristics of Terminal Voltage.—Why are so many different kinds of connection used for field excitation? Ordinarily the load on a generator will vary. By this we mean that there are changes in the number of devices switched on; lamps may be turned on or off, or motors started and stopped. Such changes of load automatically affect the terminal voltage of the generator, but they affect it differently, according to the kind of field excitation used.

To see why the effects differ, in each case consider the dynamo driven at a steady speed without load. Then imagine the load (current through the armature) to be successively increased. If separate excitation is used, a certain emf. is generated at no load. When current flows in the armature, some of this emf. is used up in sending the current through the resistance of the armature itself. There is also another effect, due to "armature reaction,"¹ which weakens the magnetic field. Both increase as the armature current increases. Hence the terminal volts are less when the armature current is large, than when it is small. Curve *a*, Fig. 118, shows this graphically. The load current in amperes is plotted along the horizontal axis, the terminal volts along the vertical axis. The greater the current, the lower the voltage. The difference between no load and full voltage shown in the diagram corresponds to a regulation² of some 8 per cent, and applies to rather large machines, say of 100 kw. or more. For a smaller one, the difference would be greater.

When shunt excitation is used the reduced terminal voltage sends a reduced current through the field coils, so the magnetic flux is weaker, the greater the armature current. Hence the terminal voltage falls off more than it does with separate excitation. Thus curve *b*, Fig. 118, droops more than curve *a*. The dashed part shows how the voltage falls off when the machine is greatly overloaded.

With series excitation, the condition is very different. When no current flows, only the weak residual magnetism of the iron is available, and the emf. generated is consequently very small. Curve *c* shows it by starting only a very little above the zero value. If current is taken from the machine, this current, flowing in the field

¹ Armature reaction is explained in Section 82 and also in Franklin and Esty's *Elem. of E. E.*, vol. 1, p. 151; Franklin and Esty, *Dynamos and Motors*, p. 176; Timbie and Higbie, *Direct and Alternating Currents*.

² Defined in Section 81.

coils, strengthens the magnetic field and so causes a greater emf. to be generated. The greater the current taken by the external circuit, the greater will be the voltage. Hence curve *c* rises.

In the compound generator the two effects are combined. Depending on the relative proportions of the two windings, the voltage at full load may be made equal to that at no load, or greater, or less; the latter is rare. Curve *d*, Fig. 118, is for a generator somewhat

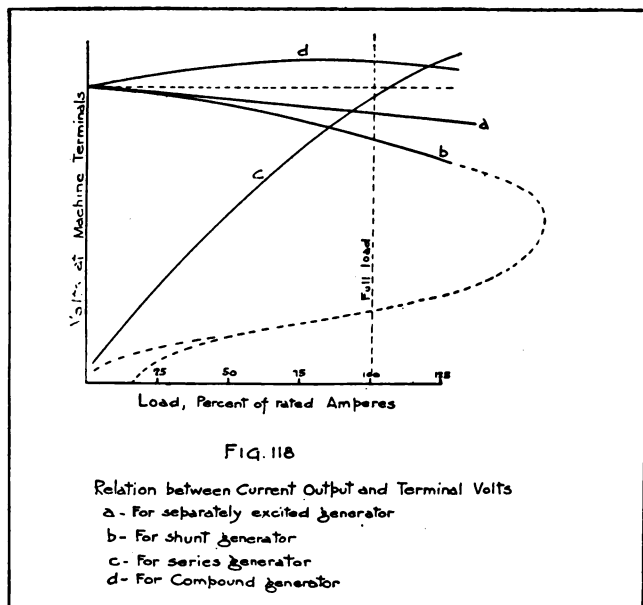

“over-compounded.” If the full load voltage were the same as the no load voltage, the generator would be “flat-compounded.”

In examining a generator, it is usually impossible to determine whether the field coils are of fine or thick wire without tearing them open, because they are protected with wrappings of tape, hard cord, or other covering. To distinguish between shunt and series coils is, however, quite easy by looking at the connections. Those between the shunt field coils on the different poles are small because they have to carry only a small current, those between the series coils are

heavy, consisting of thick, wide straps of copper on the larger generators.

90. Emf. Equation.—It has been stated that the emf. developed in a conductor depends on the rate of cutting the magnetic flux ¹ and is equal in volts to the number of magnetic lines of force cut per second, divided by 10^8 . On an armature a number of such conductors are connected in series and their emfs. are therefore added. Thus in Fig. 113, the conductors which would have to be traversed in going from one brush on the commutator to the next through the armature constitute one such group. There are three other similar paths, and these four paths are all in parallel, so the resulting emf. is the same as that of one path alone, but the current that goes to the external circuit is the sum of the currents in the four paths.

Let N = the number of conductors in series.

n = number of revolutions per second (not per minute) of the armature.

p = number of magnetic poles.

ϕ = magnetic flux per pole.

Then the flux cut per second by any conductor is $n \times p \times \phi$ lines. Dividing by 10^8 gives the average volts. If there are N conductors in series, the total emf. is

$$E = \frac{n \times p \times \phi \times N}{10^8} \text{ volts.} \quad (68)$$

This formula shows that the voltage of a generator can be changed by changing the speed n , the flux ϕ , the number of poles p , or the number of conductors N . The last two, of course, are fixed once for all when the machine is built; the first two can be changed quickly by the operator, and afford practical means of controlling the voltage.

This formula means exactly the same thing as the one given for induced emf. in Chapter 1, namely that $E = \frac{N\phi}{t}$. It is merely necessary to note that if $n \times p$ poles are passed per second, then the time required to cut the flux ϕ is only $\frac{1}{n \times p}$ th of a second; this takes the place of t in the denominator; or what amounts to the same thing as dividing by $\frac{1}{n \times p}$, we multiply by $n \times p$. The reason for the factor 10^8 in the denominator has been explained.

¹ Chapter 1, Section 45.

91. Voltage Control.—The practical way of controlling the voltage of separately excited, shunt and compound generators is by having an adjustable resistance, called a “field rheostat” (Fig. 109), in circuit with the fine wire (shunt field) coils. The points *R* in Fig. 117, show where such a rheostat might be put in the circuit of each machine.

92. Effect of Varying Speed.—A rise or fall of speed causes the emf. of a separately excited generator to rise or fall in about the same proportion. In shunt and compound generators the effect is greater. That is why engines for driving such generators have to have good governors, if a steady voltage is wanted.

Because of these characteristics, each type of generator has its special uses. For instance, the exciter for the a.c. generator of a radio field set is a simple shunt generator, because the load does not change much. The shunt generator is good also for charging storage batteries. Incandescent lamps need a very steady voltage that is not changed when some of them are turned on or off. A compound generator meets this requirement.

D. Special Alternators for Radio Use.

93. Audio Frequency and Radio Frequency.—Alternating currents are generated at various frequencies, covering a remarkably wide range. Depending on their application, the frequencies in practical use fall into three well defined classes:

(a) *Commercial* frequencies, which nowadays generally mean 25 or 60 cycles per second.

(b) *Audio* frequencies, around 500 to 1000 cycles per second.

(c) *Radio* frequencies, usually between 100,000 and 1,000,000, but extending in extreme cases down to perhaps 10,000 and up to several million cycles per second.

Commercial frequencies are used for lighting and power. The great machines in the central stations which supply our cities with current operate at these frequencies.

Audio frequencies are those conveniently heard in the telephone. When alternating currents are sent through a telephone, the diaphragm of the latter vibrates. The vibrations are heard as sound. The more rapid the vibrations, the shriller the tone. Vibrations at the rate of 4000 or 5000 per second give a shrill whistle, while the lowest notes of a bass voice have somewhat under 100. If a 500-cycle generator supplies current to a spark gap and the spark jumps

once on the positive and once on the negative half-wave, then at the receiving station, the signal is heard in the telephone as a musical tone of 1000 vibrations per second.

Radio frequencies occur in the circuits of radio apparatus, for instance in an antenna. They are too rapid to cause a sound, in a telephone, which can be heard by the human ear. They may be generated by dynamo-electric machines of highly specialized construction, but are usually produced by other means.

94. Audio Frequency Generators.—To show how the methods described in the preceding sections are applied in actual generators, a few typical machines, used in radio sets, will be briefly described. Whether or not these are of the latest design is not important. Changes of detail are constantly being made, but they do not affect the principles used and can be readily understood after the workings of similar machines have been grasped. The examples of machines here given will also illustrate how the form of generator and the auxiliaries used with it are influenced by the source of power available for driving it.

The generator is only one part of a unit for converting energy into the electrical form. The other part depends on the source of energy available; it may be heat derived from coal or gasoline; it may be falling water, moving air, human muscles, or a charged storage battery.

Crank Driven.—The field radio pack set furnishes an example of a self-contained generating unit driven by hand. These sets have been changed somewhat from time to time and can therefore be described only in a general way. The generator is cylindrical in shape and is entirely incased, including the ends, in a metal shell. At one end of it is a flywheel for equalizing the speed. At the other is the train of gears, running in oil and inclosed in a housing, through which power is transmitted from the crank shaft to the generator shaft. The crank shaft is turned by means of a pair of cranks.

The alternator is a 250-watt, 500-cycle machine of the revolving armature type. The exciter¹ is built in with the alternator, so that the two have but one frame and one set of bearings, and the same shaft carries both armatures. Near one end, on opposite sides of the shell, is a pair of holes giving access to the d. c. brushes which bear on the commutator of the exciter² and near the other end are

¹ A little generator of d. c. for the fixed coils of the alternator. See Sec. 71.

² The commutator is described in Sec. 86.

similar holes for the a.c. brushes that bear on the collector rings. The crank is turned at the rate of 33 to 50 r.p.m., depending on the machine (that is, the date of the model), and the generators make 3300 to 5000 r.p.m., the cranks being geared to them at a ratio of 1 to 100.

The diagram and data of Fig. 103 apply to the alternator of such a set, the armature having 18 teeth, the same as the number of field

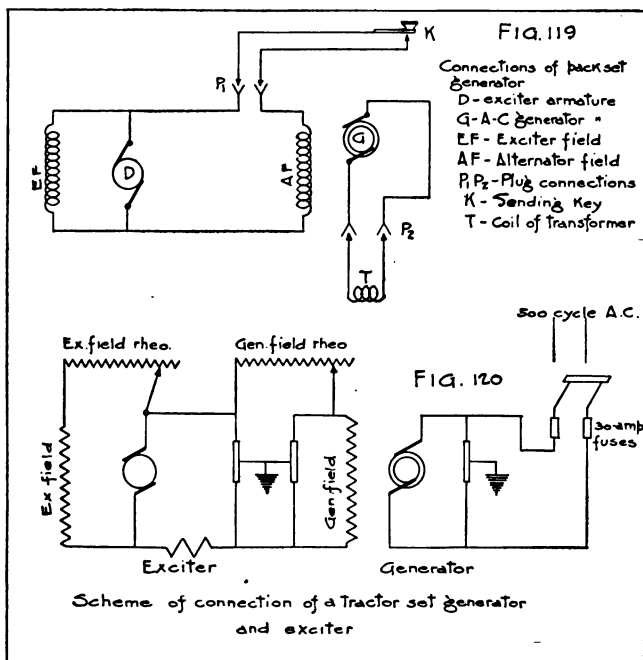

poles. To get 500 cycles it must make 3333 r.p.m., which corresponds to a crank speed of about 33 r.p.m.

The connections are shown in Fig. 119. The field coils of the exciter are connected directly to the brushes. The circuit to the alternator field coils passes through a receptacle P₁ on the side of the machine. A two-wire cable can be plugged in at this point, for the sending key. While the key is closed, field current flows and a.c. is

generated in the armature. Another receptacle P_2 provides for connecting the alternator armature to the transformer from which current is supplied for the spark.

In view of the high speed at which these generators run (some make 5000 r.p.m.) the brushes have to fit very smoothly and the bearing surfaces, particularly the d.c. commutator, have to be in good condition. For ease of turning, they should not be pressed in harder than necessary; on the other hand, unless the contact is good, the set fails to operate satisfactorily. The most common troubles, electrically, are due to a dirty commutator, poor brush contacts, or to turning the brushes in replacing them, so that the curve of the brush does not match the curve of the commutator.

Gasoline Engine Driven.—Hand power is not practical, except for very small generators, since a man can develop only about one-tenth of a horsepower if he has to keep it up for more than a short time. One of the most convenient sources of larger power is the gasoline engine. It is particularly suitable for isolated stations, or for the more powerful portable sets, like the field radio tractor sets. Detailed information about any particular set is supposed to be furnished with the set, but certain features are likely to be common to all.

The speed of rotation of the alternator is almost always much higher than that of an engine; it is therefore stepped up by pulleys and belts, or sprockets and chain, or gears, the smaller pulley or sprocket or gear being on the generator shaft.

The generator may be of any of the three possible types previously described; for example, one of the permanent Signal Corps stations uses an inductor alternator (Sec. 74); one kind of tractor set also has the inductor type; another has the revolving armature. If it becomes necessary to open the machine, it is easy to discover which type it is. If the rotor, or revolving part, has no windings at all, then we are dealing with an inductor alternator; if the circuit leading to the transmitting apparatus (not necessarily the key, because that may be in the field circuit) comes from the slip rings, then the revolving part must be the armature.

In one of the sets of this latter type the alternator and its exciter are two separate machines, connected by a coupling so that both revolve together. A frequency indicator in front of the chauffeur guides him in controlling the speed of the engine so as to maintain the right frequency—500 cycles per second. The combination is chain driven from the main transmission. The same engine that

drives the truck is used to furnish power for the generator, the one or the other being thrown in as desired.

The following name plate data of this particular set will illustrate some of the statements made in earlier sections:

Generator frequency, 500 cycles; poles, 30; kva., 2.5; open circuit volts, 245; loaded key volts, 110; 2 kw. at 0.80 p. f.; 2000 r.p.m.

Exciter, shunt type: poles, 2; load volts, 110; load amperes, 2.7; 0.3 kw.

From the speed, 2,000 r.p.m., and the stated number of poles, 30, each revolution gives 15 cycles and the cycles per second will be $15 \times 2,000 / 60 = 500$, which checks with the figure given.

From the loaded key volts, 110, and the rating, 2.5 kilovolt-amperes or 2500 volt-amperes, the full load current is $2500 / 110$ or 22.7 amperes. The product of volts, amperes, and power factor gives power in watts; thus $110 \times 22.7 \times 0.80 = 2000$ watts, or 2 kw. The great difference between the volts on open circuit, 245, and volts when loaded, 110, shows that the armature has a high impedance. It must not be assumed that this loss of voltage is all due to resistance, and so represents a waste of power. Much of it is due rather to the demagnetizing action mentioned in Section 82, which causes a reduction in the effective magnetism and therefore in the emf. generated.

The scheme of connections in Fig. 120 shows that the exciter voltage can be controlled by means of the exciter field rheostat. This, in itself, would govern the 500-cycle voltage fairly well, but a second control is provided in the generator field rheostat. High-resistance connections between each machine and the ground provide a leakage path for high voltage charges and prevent their accumulation.

Fan Driven.—Audio frequency generators have an important application in furnishing current for communicating from airplanes. Fan motors have been used as a source of power, though it has been objected that they increase the head resistance of the plane. There is no theoretical reason why any type of self-contained generator might not be used, but because of the high rotative speeds obtainable with fans and the need of lightness, special machines have been developed with the fan mounted directly on an extension of the shaft. One very recent form is described on page 159.

Motor Driven, by A.C. Motor.—When electric current is to be had, but not at the desired frequency, use may be made of a combination of a motor, adapted to the circuit that is available, and a 500-cycle generator. Such a combination is called a "motor-generator

set." For use with 110-volt, 60-cycle alternating current, sets are built using the same sort of generator (with built-in exciter) described in connection with hand driven apparatus. Mounted on a common

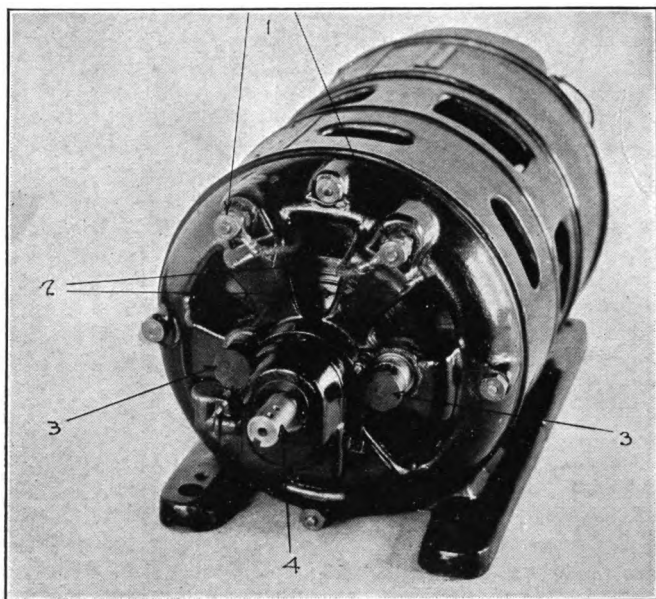

FIG. 121.—Small 500-cycle motor-generator set (2500 r.p.m.; 24 poles on stator; 24 teeth on rotor; 110 volts; 3.2 amp.; 0.35 kva.)

1. Field terminals.
2. Collector rings.

3. Armature terminals.
4. Shaft of both units.

bedplate with it is an a.c. motor. The shafts are connected by a flexible coupling.

Except for the mechanical connection between the shafts, the two machines are entirely independent. Electrically there is no connection. The motor is designed to run automatically, at the proper speed for the generator, or perhaps it would be better to say that there are certain definite speeds at which 60-cycle a.c. motors have to

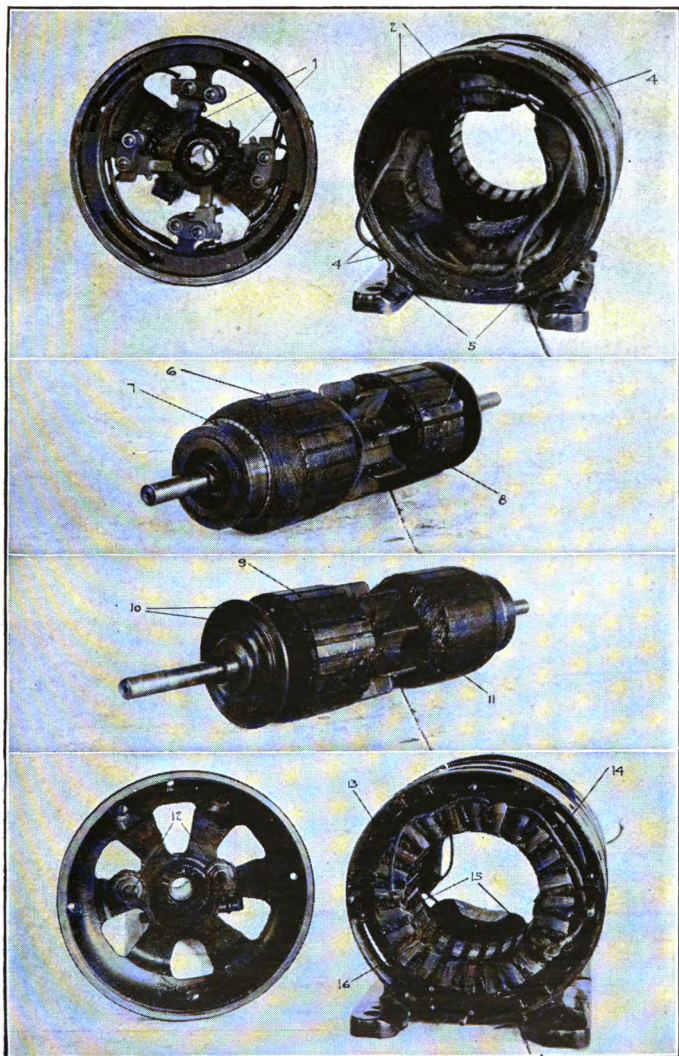
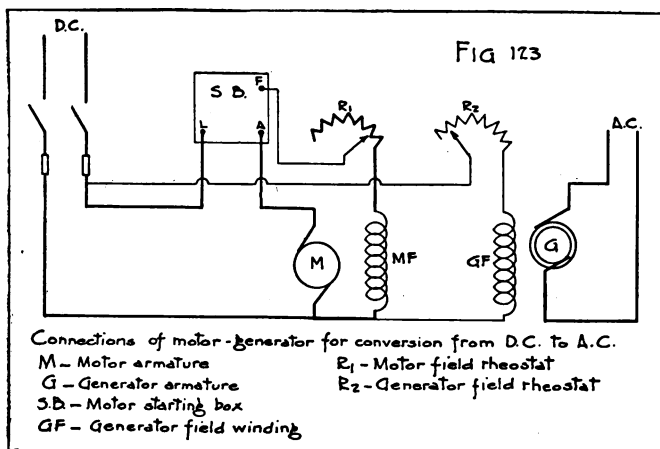

FIG. 122.—Motor-generator set of Fig. 121 partly dismantled.

- | | |
|---------------------------------------|--|
| 1. Motor brushes. | 9. Generator armature core. |
| 2. Motor field windings. | 10. Collector rings. |
| 3. Motor field poles. | 11. Motor armature windings. |
| 4. Motor field yoke. | 12. Generator brushes. |
| 5. Terminals of motor field windings. | 13. Generator field windings. |
| 6. Motor armature core. | 14. Generator field yoke. |
| 7. Commutator. | 15. Terminals of generator field windings. |
| 8. Generator armature windings. | |

run, and the generator has such a number of poles that it gives the desired frequency when driven by a motor operating at one of these speeds. Voltage control of the generator is secured by means similar to those shown in Fig. 120.

Motor Driven by D. C. Motor.—When direct current at 110 volts is available, the arrangement is somewhat different. The exciter is unnecessary, because current for the field coil of the alternator may be taken directly from the line. It is then possible to combine the generator and a 110-volt, direct current, shunt motor (see Sec. 97)



into a very compact unit. The two armatures are on the same shaft and the two frames are joined in one structure.

Fig. 121 represents such a unit, which is shown partly disassembled in Fig. 122. The generator happens to be of the same design as that shown in diagram in Fig. 103, but being built for nearly 50 per cent more power, it is somewhat larger, has more poles, and runs at a correspondingly lower speed to give the same frequency. The two armatures are seen on their common shaft; the collector rings are near one end and the commutator near the other.

One scheme of connections for such a unit is seen in Fig. 123, which shows the d.c. motor connected to its line by way of a switch

and starting box.¹ The rheostat shown in circuit with the motor field may be omitted. Its purpose is to give control of the motor speed,² if such control is desired, in order to get some definite frequency quite accurately in the a.c. circuit. From the d.c. line, connection is made also to the generator field winding, the flow of current being controlled by another rheostat which determines the magnetization and therefore the generator voltage. Thus the generator frequency may be governed by means of the motor field rheostat and the voltage by the generator field rheostat.

Motor Driven Inductor Alternators.—Thus far in this part of the chapter, attention has been centered on revolving armature generators. It is equally feasible to generate 500-cycle current by means of inductor alternators. Fig. 124 represents a motor-driven inductor alternator for conversion from direct to alternating current at 500 cycles. The table following gives the data as taken from the name plate.

Name plate data for motor-generator shown in Fig. 124.

	D.C. motor.	A.C. generator.
Volts.....	120	125
Amperes.....	7.3	5
Revolutions per minute.....	2500	2500
Rating.....	1 h. p.	0.625 kva.
Shunt field amperes.....	0.4
Cycles per second.....	500

Here again the two distinct machines, motor and generator, are combined in a single compact unit. The armatures are on one shaft and the two frames are made into one structure, though openings are left for ventilation. These, as well as other openings at the ends of the machine, are screened to keep out foreign material, while permitting a free flow of air for cooling. The generator frame is cast in the form of a cylindrical shell. At each end is inserted a laminated armature core, with teeth projecting radially inward, on which the armature winding is placed. Between the two arma-

¹ Described in Sec. 97.

² How this is done is explained in Sec. 97.

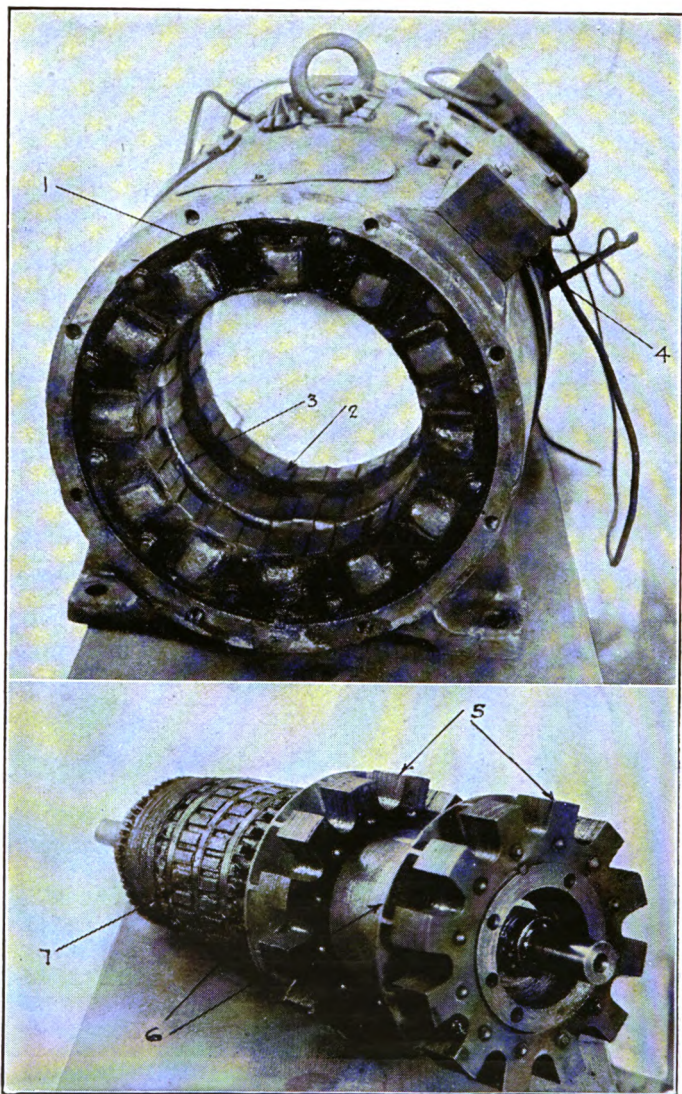

FIG. 124.—Inductor alternator type motor-generator set.

- | | |
|--|--------------------------|
| 1. Generator armature coils, first row. | 4. Terminal box. |
| 2. Generator armature coils, second row. | 5. Inductor teeth. |
| 3. Generator field coil. | 6. Brass disks. |
| | 7. D. c. motor armature. |

ture cores is the field winding, a single large coil which fits inside the cylindrical shell where it is rigidly held in place. This coil produces a magnetic flux parallel with the shaft. The armature winding is in two groups, one on each core. Each group consists of 12 coils, and the coils are all connected in series.

The portion of the set so far described is stationary. The rotor is a solid cylindrical core, at each end of which is a ring of 12 teeth projecting radially outward. The core is magnetized by the stationary field winding previously mentioned. To trace the magnetic circuit, begin at the core. One end of it is *N*, the other *S*. The flux passes out through all the rotor teeth at the *N* end, across the air gaps, into the adjacent stator teeth, through the corresponding gap into the rotor teeth at the *S* end, and thence into the central core again. As the rotor is made to revolve, the teeth are alternately in line with the armature coils then opposite the spaces between coils. The flux through the coils consequently pulsates, and alternating emfs. are induced.

So far as the diagram of connections is concerned, Fig. 123 applies to this case quite as well as to the preceding one, for the shunt motor and generator field are supplied with direct current in either event, and alternating current flows from the alternator armature, whether that be revolving or stationary.

Self Excited Inductor Alternator.—A very novel construction has lately been worked out for fan drive on airplanes. A simplified diagram of it is given in Fig. 125, from which the electrical and magnetic circuits may be traced, and the principle of its operation may be followed. For the moment, ignore the windings on the rotor. The machine is then seen to be an inductor alternator. The a.c. winding is on the 16 stator teeth, each tooth and its adjacent slot spanning $1/24$ of the circumference. These teeth, in groups of 4, form four polar projections.

The polar projections are made to have opposite polarities around the stator, so that there are two *N* and two *S* poles, by means of direct current sent through the field coils *F*, each of which consist of a large number of turns. The field coils are all connected in series to the source of direct current, to be mentioned hereafter, but the connections are omitted from the sketch to avoid having so many lines.

When the rotor is made to revolve, the flux through the stator teeth pulsates, and alternating emfs. are induced in the coils encir-

cling them. By symmetry, whatever happens in any one coil is also going on at the same time in eleven others. The passage of the inductor across a pair of consecutive, oppositely wound teeth gives rise to one cycle. The generator here represented is intended for

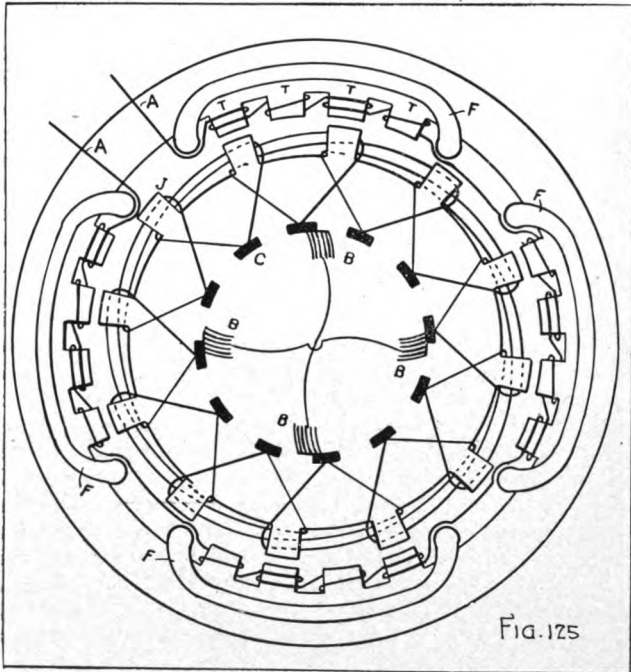

FIG. 125.—Self-excited inductor type alternator. (4,500 r. p. m.; 75 volts; 5 amp., 900 cycles per second.) A, terminals of a. c. winding; B, brushes for taking d. c. from commutator; C, commutator segments; F, d. c. field coils; J, inductors; T, stator teeth.

operation at 4500 r.p.m. and at that speed, with the 12 inductors as shown, gives a frequency of 900 cycles per second.

Besides having on it the inductors for the alternator, the rotor also functions as a d.c. armature. That accounts for the windings shown

on the rotor. How such an armature generates direct currents is explained in Section 87. For present purposes it suffices to say that the armature consists of a large number of turns, wound of course for four poles; each turn spans three teeth. In the diagram the connections have been simplified for purposes of illustration, and the number of commutator segments shown is much smaller than on the actual machine. Connections not shown in the figure, are made between the field coils and the four brushes, two positive and two negative. The brushes are shown in the diagram on the inside of the commutator, for clearness; actually they are on the outside. The direct current from this armature is what energizes the field coils.

It will thus be seen that the rotor serves two entirely distinct purposes:

1. It carries the inductors for the a.c. generator, which has stationary field and armature coils.
2. It carries the d.c. armature which corresponds to the exciter in other machines.

95. Radio Frequency Generators. Alexanderson High Frequency Alternator.—Frequencies as high as 100,000 cycles per second have been secured by a special form of alternator¹ of the inductor type. It can be seen at once that 100,000 inductor teeth have to pass a given point every second. This extraordinary number can be obtained only by having a great many teeth on the rotor and driving it at an unusually high velocity besides. In a 2-kw. generator, the rotor has 300 inductors and makes 20,000 r.p.m. which gives the required 6,000,000 inductors per minute. With a rotor about 30 cm. (1 ft.) in diameter this allows 0.3 cm. ($\frac{1}{8}$ in.) for each slot and tooth together, and even then the rim travels something like 19 km. (12 miles) a minute. The armature conductors are laid zigzag in little slots in the flat face of the core, this face being perpendicular to the shaft. (See Fig. 126.)

The rotor consists of a steel disk with a thin rim and much thicker hub, shaped for maximum strength. Instead of having teeth on the edge, it is slotted with little windows, the inductors in the form of spokes, and leaving a solid rim of steel. Then to cut down the air

¹ Developed by E. F. W. Alexanderson, of the General Electric Co., U. S. Pats. 1,008,577; 1,110,028. Description of several models is given in Goldsmith's *Radio Telephony*, beginning at p. 117. See also *G. E. Review*, vol. 16, p. 16 (1913).

friction, the slots are filled with non-magnetic material such as phosphor-bronze, finished off smoothly with the face of the disk. These machines embody a number of novel features made necessary by the small space per inductor and the exceptional speed. Their construction became possible only through engineering skill of a very high order and by fine workmanship. They are not suitable for field

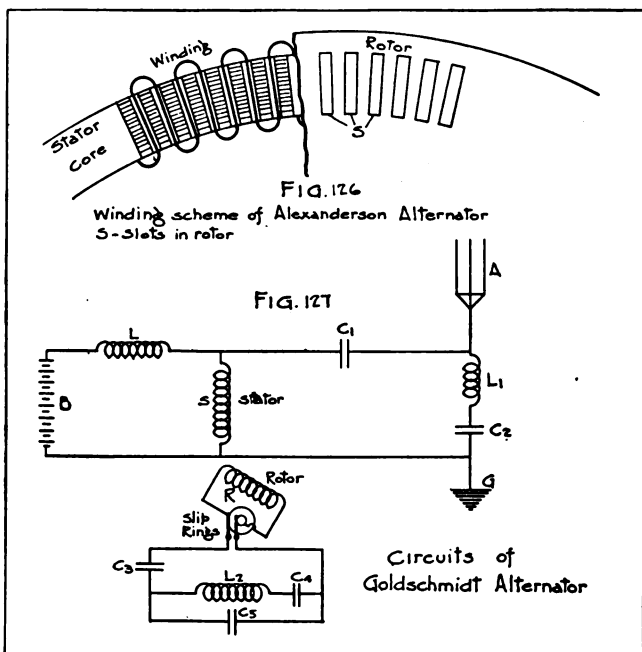

use, however, and for that reason a detailed description is not given here.

Goldschmidt Alternator.—A principle not previously mentioned in connection with electrical machinery is utilized in the generators of certain high power German stations. Advantage is taken of the building up of large currents by electrical resonance (see Sec. 109) in

the rotor and stator circuits of the machine itself, as well as of the multiplication of frequency by the effect of rotor currents on the stator windings.¹

Without undertaking to give the proof here, it may be stated that when a rotor is revolved, and at the same time alternating currents are made to flow at a frequency corresponding to the speed of rotation and to the number of poles, then, due to these currents, pulsations take place in the strength of the magnetic field of the machine at double the frequency of the alternating currents.

The circuits (in simplified form) are shown in Fig. 127. Imagine S to be the stator winding, energized by some source of direct current, such as a battery, B . In the magnetic field due to the stator there is revolved a rotor, represented by the coil R . Suppose it is revolved at such a speed that the alternating emf. induced in R has a frequency of 10,000 cycles per second. By way of the slip rings this emf. is impressed on the circuit $C_3L_2C_4$, which is tuned (Section 110), so that, when the inductance of R is taken into account the natural frequency is the same as that of the emf. Then heavy currents will flow in the rotor.

According to the statement made above, pulsations will take place in the magnetic flux at the rate of 20,000 per second. These will induce a 20,000-cycle emf. in S . If the inductances and capacitances $SC_1L_1C_2$ are chosen for resonance at that frequency, large currents will flow in the stator at the same time with the steady current from the battery. These high frequency currents are prevented from flowing through the battery by the high inductance L .

The 20,000-cycle stator currents cause a 20,000-cycle pulsation of the magnetic flux in which the rotor revolves, and when the rotor revolves in this pulsating field it gives rise to a triple frequency emf.; that is, 30,000 per second in the illustration chosen. The condenser C_5 has such a capacitance that the circuit RC_3C_5 resonates to that frequency, and the 30,000-cycle currents in the rotor, in view of the rate of rotation of the latter, cause a 40,000-cycle pulsation of magnetic flux with respect to the stator windings. That in turn induces a 40,000-cycle emf. in S . Remembering that the antenna A and the ground G constitute a condenser (see Section 137), which

¹ The following brief description of the Goldschmidt alternator is based on a fuller one in Goldsmith's *Radio Telephony*, pp. 103-103, where further information may be found. See also C. 74, p. 224.

has the same relation to the stator circuit that C_2 has to the rotor circuit, it is seen that by proper tuning the circuit SC_1AG can be made to resonate at the final frequency.

Thus by providing suitable circuits, it is possible to get a frequency four times as great as that corresponding to the actual speed and number of poles of the machine.

The principle has been explained as though the machines were bipolar. Clearly, that would necessitate extraordinary speeds. Instead, the large generators used in transatlantic service have 360 poles and are driven at 4000 r.p.m. by 250-h.p. motors. The fundamental frequency is therefore 12,000, which is quadrupled as has just been explained, giving 48,000 at the antenna. To secure satisfactory operation the finest sort of workmanship is necessary in building them.

E. Motors.

96. **Uses of D.C. and A.C. Motors.**—It has already been noted that an electric motor is almost identical with a generator in structure, but its function is reversed; it converts electrical power into mechanical power. It is important to have the motor suited to the kind of circuit on which it is to be used; a.c., or d.c., the right voltage, etc. Common voltages are 110 to 120; 220 to 240; 500 to 550; also, for a.c., 440. Lower voltages are used on battery circuits. A.c. motors, like generators, may be single phase, two phase, three phase, etc.; and d.c. motors may have series, shunt, or compound excitation.

97. **D.C. Shunt Motor.**—If a shunt generator is used for charging a storage battery and the engine is shut off, the generator will continue running, provided the battery is large enough, but an ammeter in the circuit shows that the current has reversed. The battery is discharging and the generator is running as a motor. The action is explained by the fact that when a current is sent through a conductor in a magnetic field, there is a force that tends to push the conductor across the field (see Section 43). The left hand rule gives the directions.

Consider the simple loop in Fig. 128, between the poles NS of an electromagnet. If the wires $+$ and $-$ are connected to a source of direct current, the iron will be magnetized. At the same time current flowing in the direction of the arrows in the loop causes a

force toward the front in the conductor near the *N* pole and a force toward the back in the conductor near the *S* pole. The loop turns. The effect of the commutator is to make the rotation continuous, by making the proper connection to the conductors as they come into place.

By a line of reasoning very much like that for the d.c. generator, we can pass from this simple case to that of a four-pole drum-wound motor illustrated in Fig. 129. The directions of current and rotation are shown by arrows.

Limiting Speed.—It might be expected that a shunt motor would speed up indefinitely, but actually it soon comes to a definite speed,

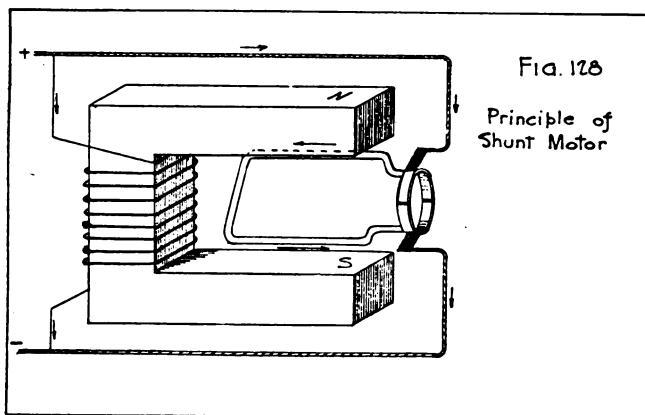

and then continues to turn so fast, but no faster. As soon as the armature begins to rotate, it generates an emf. according to the right hand rule. This action is exactly the same as in a generator.

The emf. generated is opposite to the direction of current shown by the arrows, and is for that reason called a "counter electromotive force." The faster the armature turns, the greater the counter emf. becomes. It cannot turn so fast that the counter emf. is as great as the line voltage, because then the two would balance, there would be nothing to make the current flow through the armature, and consequently no pull to keep it turning. For example,

suppose the armature resistance of a certain motor is 0.25 ohm, and suppose that a current of 4 amp. in the armature furnishes just enough pull to keep it rotating. If the speed is high enough to make the counter emf. 109 volts when the line voltage is 110, the current is 4 amp.¹

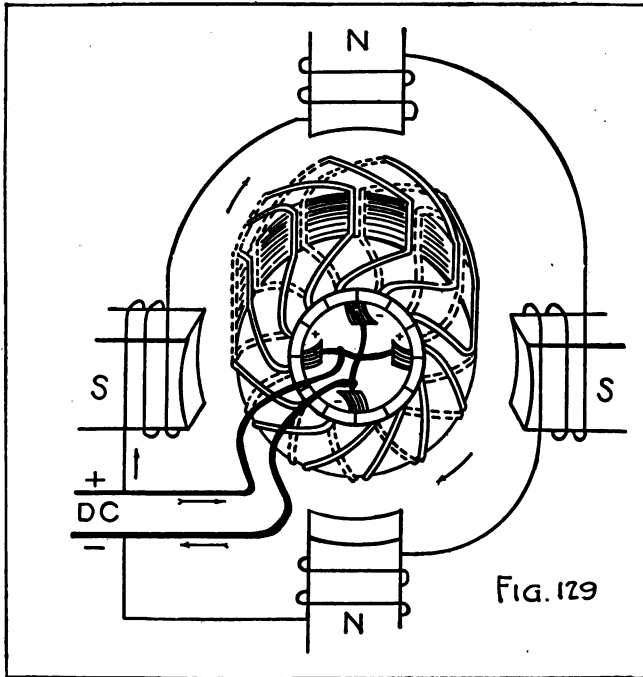

FIG. 129.—Diagram of circuits of a 4-pole shunt motor.

Next, suppose the motor is driving machinery that calls for five times as great a pull. The speed falls off a little. When it has fallen enough to make the counter emf. 105 volts, the current is 20

$$^1 I = \frac{E}{R} \quad E = 110 - 109 = 1 \text{ volt.} \quad R = 0.25 \text{ ohm.} \quad I = \frac{1}{0.25} = 4 \text{ amp.}$$

amp.¹ If that is enough to drive the load, the speed will be steady at the new rate. So by changing its speed a very little, the motor automatically takes more or less current, but always just enough to drive its load.

The magnets are always of the same strength, regardless of load, because the current around them depends only on the line volts and the resistance of the field coils. It is entirely independent of the current in the armature.

Comparison of Generator and Motor Actions.—In both generator and motor we have an emf. developed in the armature by rotation in a magnetic field. Also, in both we have currents which cause a pull on the armature conductors. If the machine is to act as a generator, its armature must be driven at such a speed that its emf. is higher than the voltage at its terminals, due to emfs. in other parts of the circuit. Then current flows with the emf. This current causes a back-drag on the armature and makes it harder to turn. If the machine acts as a motor, its emf. is lower than that of the circuit to which it is connected. The current flows against this motor emf., now called a counter emf., and causes a forward pull on the armature which keeps it turning.

Starting Box.—The resistance of a motor armature is small. The counter emf. developed by rotation is what keeps the current from becoming excessive. When the motor is first connected to the line, it is not rotating and there is no counter emf. Some other way must be found to keep the current moderate. The simplest way is to put resistance in series with the armature,² and then gradually reduce it (“cut it out”) as the armature gains speed. The resistance is usually in the form of wires or grids, mounted in a ventilated iron box, the whole known as a “starting rheostat” or “starting box.” Various forms are used; Fig. 130 shows the connections in one type. The parts drawn in solid lines are supported on an insulating face plate, commonly slate. The internal connections are drawn in dashed lines. Fig. 131 shows how the starting box is connected between the fused main switch and the motor.

When the resistance is all cut out, the iron strip *K* comes against the electromagnet *M*, and the handle is held in place. If the switch

¹ $E = 110 - 105 = 5$ volts. $R = 0.25$ ohm. $I = \frac{5}{0.25} = 20$ amp.

² The field excitation is not cut down, but is of full strength from the start.

(Fig. 131) is opened, or the line becomes "dead" for any other reason, the magnet ceases to hold *K*, and a spring *S* (Fig. 130) pulls the handle back against the buffer *B*, thus protecting the motor against injury in case the current is turned on again.

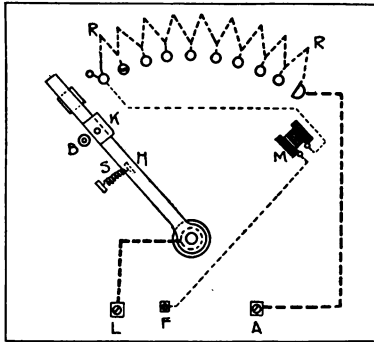

FIG. 130

Starting box for shunt motor

L- Connection to line F- Connection to shunt field
A- Connection to armature.

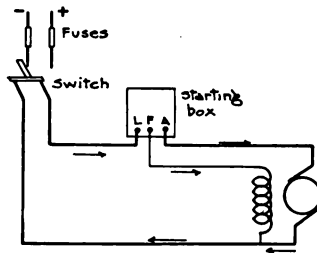

FIG. 131

Connections of shunt motor and starting box

Some starting boxes have four terminals. The internal connections of one box of that kind are shown in Fig. 132, and the connections to the motor in Fig. 133. The extra terminal is marked *L-*. It is needed because the electromagnet for the "no voltage

release" is connected directly across the line, the high resistance Z , being contained in the box to keep the current for it small.

Connections to a starting box must be made according to the way the terminals are marked on the box. They are almost always

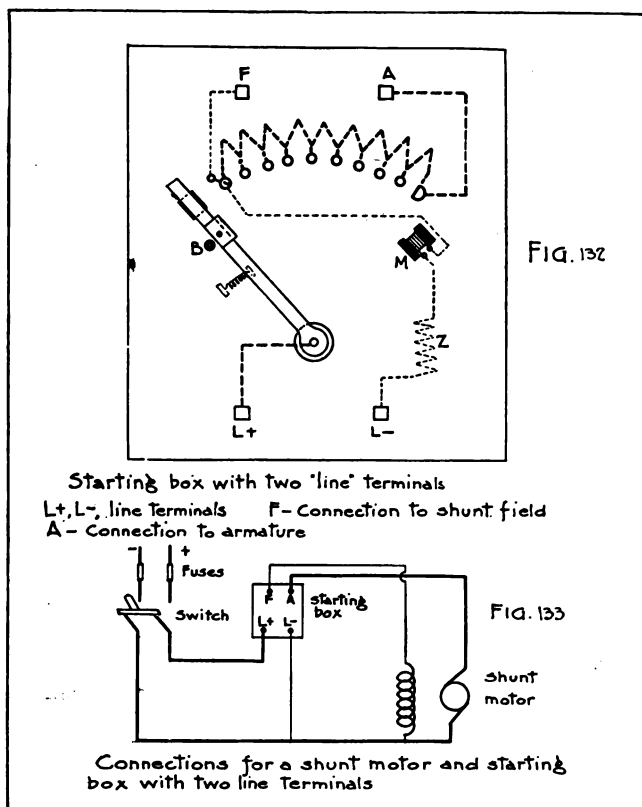

stamped with letters or with the words "line," "field," "armature," but will not always be found at the places shown in Figs. 130 and 132.

At the motor the circuits are often brought out on a terminal board after the fashion of Fig. 134. Care must be taken not to get them confused, for example, by connecting the field in place of the armature, or by making the sort of mistake shown in the right hand diagram (marked "wrong") of Fig. 134, where the "A" terminal of the starting box is wrongly connected to the *junction* of armature and field, and the "—Line" is wrongly connected to the armature alone. Wrong connections are bound to cause trouble.

Starting and Stopping.—The proper operations for starting are:

1. See that handle of starting box is in the "off" position.
2. Close switch (see Figs. 131, 133).
3. Move starting handle to first contact. Armature should begin to turn. If it fails, open the switch at once, for something is wrong—

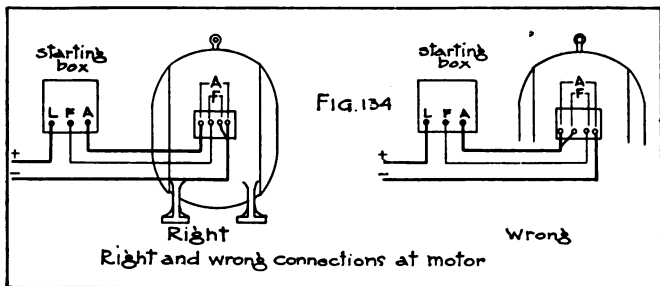

perhaps a faulty connection, loose contact, blown fuse, excessive overload, wrong brush position, etc.

4. As armature gains speed, move handle over contacts, one step at a time. Move slowly if load is great, taking if necessary as much as 30 seconds. When the load is slight and the motor small, a few seconds may suffice.

The operation for stopping is: Open main switch. In a few seconds the handle should snap back sharply. If it fails, move it back by hand and look for dirty contacts. Sometimes wiping the contact studs and putting on just a trace of vaseline will cure the trouble.

Very small motors, rated at a fraction of a horsepower, are often connected directly to the line without a starting rheostat by simply closing a switch.

Reversing Direction.—In the diagram (Fig. 134) the mains are marked + and -. As a matter of fact, it makes no practical differ-

ence if the one marked + is really -, and vice versa. The motor runs in the same direction. It can be reversed by taking off the two connections at *F* (left hand diagram, Fig. 134) and interchanging them. Care must be taken that the brushes rest on the commutator at the right place and point the right way for smooth running, as described in Section 106.

Speed Regulation and Control.—For reasons given under the heading “Limiting speed” a shunt motor generally runs a little more slowly when loaded (driving machinery) than when running free. The change of speed is called the “speed regulation.” For most motors the regulation is good, the change in speed between no load and full load being only 5 per cent or less. Shunt motors are therefore often called “constant speed” motors.

This supposes that the voltage applied to the motor is constant. If it is too low, the speed falls off, as well as the power which the motor can develop. If it is too high, the motor will overspeed somewhat and is likely to overheat and to spark injuriously at the commutator. The speed can be changed, if necessary, by several methods. Only two will be described.

A resistance in series with the armature circuit only (not the joint line to armature and field) will reduce the speed. The conductor must be large enough to carry the armature current without overheating. The ordinary starting rheostat will not serve, as it is not made large enough for continuous duty. It would quickly overheat. Sometimes special rheostats are provided for starting, which are large enough to be left in circuit continuously. They are then usually marked “Regulating rheostat, for continuous duty.”

The objection to this scheme is that it wastes power and that, if the load changes, the speed changes too. It has the advantage of being simple.

A resistance in series with the shunt field winding increases the speed. This seems contradictory. The explanation is that when the field current is reduced, the magnetism is weakened. The conductors have to move faster to generate about the same counter emf. as before, and since this counter emf. is always nearly as great as the applied voltage the speed has to increase.

The objection to this method is that the motor may overspeed and burst the armature by centrifugal force if too much resistance is used in the field circuit. There is also danger of damaging the commutator by sparking. It is not wise to raise the speed more than 10 or

15 per cent above that marked on the name plate unless the operator is very sure no harm will follow.

98. D.C. Series Motor.—The field coils of a motor may be made of thick wire and connected in series with the armature, so that the same current flows through both. It is then called a “series” motor. The difference in connections, compared with a shunt motor, is the same as for the corresponding kinds of generator. (See Fig. 117.) Series motors differ in their behavior from shunt motors in two important ways. They do not operate at constant speed, but run very much more slowly when heavily loaded; and, at the lower speeds they develop a large turning force. They are therefore used on street cars, for cranking gasoline engines on automobiles, and similar duty where high turning effort is wanted for starting a load.

Suppose there is some current, say, 5 amp., flowing in armature and field coils. Now imagine the load to increase until the current is 10 amp. Two things happen. If the magnetism remained the same, the doubled armature current would cause double the pull. But the magnetism does not remain constant. When the current doubles, the field magnetism increases, because the 10 amp. flow in the field coils as well as in the armature. Thus the doubling of the armature current and the increased magnetization combined make the pull much more than double. Also the stronger field would make the counter emf. automatically increase if the speed remained unchanged. But this is impossible because the counter emf. must always be a little less than the line voltage, else no current will flow to keep the motor going, so the speed must fall off.

The turning force mentioned above is called “torque”. From the explanation just given, the torque of a series motor at starting is seen to be great, because at starting the speed is low and the armature current large. The less the load, the higher the speed. If the driving belt slips off, a series motor, unless it is quite small, can overspeed enough to wreck itself. Series motors are therefore direct connected or geared to the driven machinery. Shunt motors, on the contrary, will not over-speed and belts may safely be used.

Speed Control.—The only way of controlling the speed of a series motor that need be mentioned here is by using a rheostat. Except for small motors, one is needed anyway for starting. If large enough it can be left in circuit to keep down the speed. Of course this is wasteful, because the heat produced in the rheostat uses electrical power.

99. **Other D.C. Motors.**—Connected like compound generators (Fig. 117), compound motors are used for special purposes, but the worker with radio equipment is not likely to run across them and for that reason they are not treated here.¹

100. **Combination A. C. and D. C. Motors.**—Reversing the current in the line to which a series motor is connected has no effect on the direction in which the armature turns. If the current is reversed in the field coils alone, the magnetism is reversed, and the armature turns the opposite way. Reversing the current in the armature too, makes a second reversal of force, that is, the armature turns as it did at the beginning. This is still true when the reversals are so rapid that the current is truly alternating, so the same motor can be used for a.c. and d.c. But in that case some special construction is necessary; for example, the magnets are built up of laminations, instead of being in a solid piece.

101. **Induction Motors.**—When the terminals of any coil are connected to a circuit, the current sets up a magnetic field in and around the coil. When a number of coils are arranged in the form of a stationary two-phase or three-phase armature² and connected to a corresponding two-phase or three-phase power circuit, there comes the remarkable result, that the alternating currents, flowing in the coils, produce, inside of the armature, a magnetic field which rapidly and continuously revolves. The iron core and the copper coils are both stationary; only the magnetism changes. If the changes of current are made slowly, a compass needle placed in the open space within the armature will spin just as if it were directed by an imaginary magnet with its poles sliding along the face of the armature.

Next, let an iron core with suitable coils on it be placed inside this armature, on a shaft, so that it can turn. The revolving magnetic field cuts across the conductors of this movable "rotor"; that sets up emfs.; currents flow, and now we have conductors with currents in them in a magnetic field. Consequently the rotor begins to turn. It speeds up until it turns nearly as fast as the moving magnetic field. How fast that is depends on the construction of the stationary armature, and the frequency (cycles per second) of the alternating current supplied.

¹ Compound motors are explained in Rowland, p. 126; Franklin and Estey, *Dynamos and Motors*, p. 144; Timbie, p. 221.

² See Fig. 101.

The machine just described is an "induction" motor.¹ Its parts are called the stator (stationary part) and rotor (part that revolves) just as in an alternator. Nothing has been said about any connection between the rotor and an external electric circuit. In the simplest form of induction motor there is no such connection. The rotor is dragged around magnetically at a practically constant speed. A pulley on the rotor shaft can be used with a belt to deliver power to some other machine.

In some forms of induction motor there are connections between the rotor, which in that case has slip rings, and an external circuit. But the external circuit is not a power circuit; it merely consists of resistances for controlling the motor speed.

The terms "squirrel cage" and "wound" are often used to describe rotors; the first means the simple kind with conductors of plain bars of metal and no slip rings or other moving contacts; the second means the kind having coils like an armature, and, commonly, slip rings.

If one of the connections to a three-phase induction motor is opened, leaving only two attached, the rotor continues to turn. Two wires can supply only a simple a.c. (single phase), so it is evident that an induction motor can be used on a single phase circuit. But it will not start on a single phase without a special starter.

Like d.c. motors, those for a.c. have to be operated at about the voltage for which they were built. In addition, they have to be connected to a line of the right frequency. Then they run at certain definite speeds, which are nearly as high at full load as when running free. On 60-cycle circuits, the common speeds for small motors are a little under 1800, 1200, and 900 r.p.m.

Starting.—Small induction motors are started by simply connecting them to the right kind of power circuit by a switch, double-pole (two blades, for two wires) for single phase, three-pole for three-phase, and four-pole for two-phase motors. With polyphase (two or three-phase) motors, this produces the revolving magnetic field as previously explained. With single phase, the action is different. It was said, earlier in this section, that an induction motor will not start on one phase, but will continue if started somehow. One way

¹ For further explanation of action see Timbie and Higbie, A.C. Machinery, Second Course, pp. 429-449; Franklin and Estey, Dynamos and Motors, pp. 340-362 Rowland, pp. 252-270.

might be to give it a start by hand. Generally that is not a practical method. A second way is to use a "phase splitter." That merely means that the current goes through the stator by two paths in parallel, one having more inductance or capacitance than the other. Inductance in any branch of a circuit causes a phase-lag in that branch. The armature must have two sets of coils, and if the currents in them differ as to phase, the motor starts as a sort of two-phase machine. After it gets up to speed, one winding (the "starting" winding) is disconnected. That may be done by hand, a special two-way switch being provided with a starting and a running position or there may be an automatic centrifugal cut out in the motor.¹

A third way is by "repulsion motor" action. Then the rotor has a commutator and brushes, like those for d.c. The stator is connected to the supply line, the rotor is not. The brushes are connected together by a short circuiting conductor. When currents flow in the stator, other currents are induced in the rotor² and it begins to turn. At the proper speed, a centrifugal device short-circuits the commutator and so converts the machine into a simple induction motor. At the same time, the brushes are lifted automatically, to reduce friction.

Larger three-phase motors are started by applying a fraction of full voltage, obtained by a combined transformer and double-throw switch known as a "compensator."³

F. Motor-Generators and Dynamotors.

102. **Motor-Generators.**—When electric current is to be had, but not in the form needed, the change is made by transformers,⁴ rectifiers, motor-generators or dynamotors, according to circumstances. The first named, change a.c. at one voltage to another voltage at the same frequency. The second, change a.c. to pulsating d.c. The last two are used for changing a.c. at one frequency to a.c. at another frequency or to steady d.c., or the reverse; also for changing d.c. from one voltage to another.

¹ Split phase starting is described in Timbie and Higbie, A.C. Electricity, Second Course, pp. 510-512.

² See Timbie and Higbie, A.C. Electricity, Second Course, p. 514; Rowland, p. 270; Franklin and Estey, pp. 383, 386; Standard Handbook, p. 542.

³ For details, and other methods of starting, see Timbie and Higbie, A.C. Electric., p. 454; Franklin and Estey, *Dynamos and Motors*, p. 360; Standard Handbook, pp. 520, 1292, 1293.

⁴ Described in Sec. 62.

The most easily understood way to make the change is by the use of a suitable combination of motor and generator, built for the same speed and mounted on a common base, the shafts being coupled together. Such a combination is a "motor-generator."

Motors and generators have been described. The combination brings no new ideas. Each part can be thought of by itself, without regard to the other. Examples of such machines have been given.¹ In radio practice they are used particularly for battery charging and for supplying spark and arc circuits.

Battery Charging.—Motor-generators for battery charging are used where the supply is a.c. or d.c. at the wrong voltage. In the latter case if the d.c. voltage is too high, a rheostat may be used, but it wastes power. When several low voltage batteries have to be charged, they may be connected in series and the power wasted in resistance thereby reduced.

The generator of a battery charging unit is usually shunt-wound. The voltage of a storage battery rises as it gets charged. Also, at the beginning it is allowable to use a larger current than toward the end of the charge. The voltage of a shunt generator is lower when it is delivering a large current than when the current is small.² Therefore such a generator, connected to a discharged battery and given the proper setting, produces a large current which gradually decreases as the battery voltage rises. It is also possible to use a compound generator, so designed that the voltage is substantially constant, whatever the current, within the limits of the machine. In that case the initial rate of charging the battery is higher than when a shunt generator is used, but falls off in the same way. A high rate of charging at the beginning cuts down the time required for the whole process, and is therefore desirable, provided it does not injure the battery. Modern portable batteries will stand charging in this way and compound generators may consequently be used. The proper treatment for a given battery must be learned from instructions pertaining to that particular form.

Motor-generators are used also for connection to ordinary lighting circuits (about 110 volts) to get 500 or 600 volts d.c. for arc transmitters,³ or for connection to such circuits or to low voltage storage batteries to get a.c. at 500 to 900 cycles for use with transformers in audio frequency spark transmitters.⁴ Such apparatus has been described in Section 94.

¹ Sec. 94, Figs. 121, 122, 124.

² Shown in Fig. 118.

³ See Sec. 174.

⁴ See Sec. 154.

103. **Rotary Converters.**—If connections are made to a pair of collector rings from opposite sides of a two-pole d.c. armature, it will generate alternating current. At the same time, direct current can be taken from the commutator. In that case the machine is a “double current generator.” If not driven by an engine, but connected to a d.c. circuit, it operates as a shunt motor and can be used to generate a.c. Operated on a.c. as a motor, it delivers d.c. When used for such conversion, it is called a rotary converter. When an a.c. generator is used as a motor (not an induction motor) it requires d.c. for field excitation and operates at the exact speed (called “synchronous” speed), corresponding to the frequency of the supply. The d.c. for the rotary converter field comes from the commutator. On the other hand, when such a converter is used to generate a.c., the frequency depends on the speed of rotation of the armature, which can be controlled as previously described for the shunt motor.

The rotary converter has the advantage of accomplishing in a single machine what the motor-generator does in two. Its disadvantage is that the voltage at the generator end depends entirely on the voltage supplied to it as a motor, the a.c. voltage in the case of a single phase converter being about 71 per cent of the d.c. voltage, slightly more or less depending on the direction of the conversion. Thus, if operated on a 10-volt storage battery, it would give about 7 volts a.c. Also, frequencies anything like 500 cycles, which it is desirable to get in radio communication from d.c. with storage batteries as a source, are impossible; either the speed or the number of commutator segments would have to be increased beyond reason.

Instead of single phase, rotary converters can be built for two-phase or three-phase currents, the former by four connections equally spaced on the armature and four rings, the latter by three connections and three collector rings. The statements made for bipolar machines are equally true for multipolar rotary converters, if it is understood that each ring has as many connections to the armature as there are pairs of poles.

104. **Dynamotors.**—Rotary converters cannot be used for changing direct current at one voltage to d.c. at another voltage. The most compact machine for that purpose is the “dynamotor.” An application which will occur to the radio student is the securing of several hundred volts for the plate potential of vacuum transmitting tubes

from batteries giving only 10 or 12 volts. (See Fig. 135.) In the dynamotor two separate armature windings are placed on a common core. One acts as a motor, the other as a generator. There is but one frame and one set of field magnets. The two windings are connected to commutators at opposite ends of the shaft. The ratio of voltages is fixed when the machine is built, so the output voltage

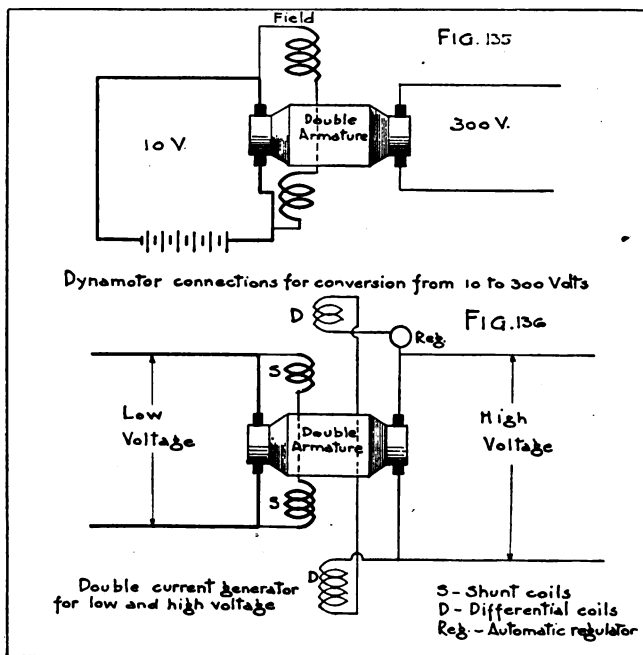

depends on the voltage applied. The field coils receive current from the same source as the motor armature.

105. **Double Current Generators.**—A dynamotor can be driven by mechanical power as a generator, and can then deliver d.c. at two different voltages. Such machines have been designed for fan drive on airplanes, the low and high voltages being used for the filament and plate currents, respectively, of vacuum tube transmitters.

To get constant voltages, in spite of the varying speed at which

the armature is driven, the field flux must be weakened as the speed rises. Current taken from one commutator is sent around the field coils, supplying the main magnetization. A weaker current from the other commutator is sent around the opposite way, giving a differential effect. (Fig. 136). If the speed rises, and consequently the voltage, the current in the second winding is made to increase considerably by a sensitive automatic regulator. The flux is therefore reduced, counteracting the effect of the rise in speed.

106. Common Troubles.—Electrical machinery is subject to the same troubles as other machinery, such as rough, gritty, dry or tight bearings, bad alignment, sprung shaft, etc., which show themselves by heating, taking excessive power, and vibration. The bearings must be clean and smooth. Care must be taken never to spring or jam the shaft. There must always be enough oil of good quality in the oil wells to keep the bearings thoroughly lubricated. Most generators and motors are oiled by means of brass rings that ride on the shaft and dip into the oil and carry it up as they turn. Sometimes these are injured in taking the machine apart; then they do not turn properly; the bearing runs dry and heats.

Some machines have ball bearings. They should run very easily, but are subject to the same troubles as a bicycle bearing, such as broken balls, grit, adjustment too tight. In general if a bearing gets too hot to be borne with the hand, it needs attention; the trouble is likely to grow worse, until finally the shaft binds firmly and cannot be turned. The job of getting it free again may then be a very tedious and troublesome one.

Another point of friction is at the brushes. If they are pressed in too firmly, they rub harder than necessary. They should be fitted smoothly so as to give the full area of electrical contact, then excessive pressure will not be needed. They should be only tight enough to make good contact and prevent sparking or flashing. When carbon brushes are working properly, the metal surface on which they rub becomes finely polished, and wears down very slowly. This is particularly noticeable in the case of copper commutators on direct current machines.

Besides those of a mechanical nature there may be electrical troubles, some requiring expert attention, others easily found and cured. The most common electrical troubles are caused by loose, wrong or missing connections, and dirt.

Connections (usually accidental) that allow current to pass by a piece of apparatus, instead of flowing through it, are called "short circuits." They are a common source of trouble.

A systematic way of hunting troubles is as follows:

1. Make or find a circuit diagram, unless thoroughly familiar with the connections and positive they are right. In drawing diagrams follow each branch of the circuit from the source (+terminal of battery or generator armature) completely around (through the -terminal) to the place of beginning. Remember that no current will flow in a circuit or in any part of a circuit unless there is a difference of potential in it.

2. Trace the wiring according to the diagram.

3. While tracing, see that—

(a) Fuses are good, if any are in circuit.

(b) Connections are clean and good.

(c) Contact is not prevented by insulating caps of binding screws or insulation of wire.

(d) Wires do not touch, making short circuits.

(e) There are no extra wires or connections.

(f) There are no breaks in wire inside of the insulation. This occasionally happens with old lamp cord. The broken place is very limber, and can be pulled in two more readily than a sound place.

4. Look for defects in the apparatus itself.

In a generator, besides loose connections, electrical troubles easily remedied are, for d.c.:

5. Failure to generate emf., caused by—

(a) Brushes not in the right place. On nearly all d.c. generators of reasonably modern construction, the proper position for the brushes on the commutator is nearly opposite the middle of the field poles, or slightly forward (in the direction of rotation) of that point. The exact location, found by trial, is that which gives sparkless commutation. Brushes are set right at the factory, and should be left as they are, unless there is good reason to believe that they have since been shifted.

(b) Brushes not making good contact because of bad fit or too little pressure. Test by lifting them slightly, one by one, to detect loose springs; also try pressing brushes to commutator with dry stick. Remedy by working fine sandpaper back and forth, sharp side out,

between commutator and brush (holding it in such a way that the toe of the brush is not ground off) or by tightening brush springs, as needed.

Brushes are designed, either to press against the commutator squarely, pointing toward the center of the shaft, or, more commonly, to trail somewhat as an ordinary paint brush might trail if held against the commutator. However, there is also in very satisfactory use a form of holder by which the brushes are held pointing against the direction of rotation. Instead of sliding up or down in a box they are pressed against a smooth face of brass by springs.

(c) Field connections reversed.

6. Sparking, when caused by

(a) Roughened commutator; cured by holding *fine* sandpaper (not emery) against it while running.

(b) Brushes shifted; for remedy see 5, above. It is very important that all brushes be at the proper points. This means, for example, that if the brushes are supposed to touch at four points, spaced a quarter way around the commutator, they shall, actually be exactly a quarter of a circumference apart, as tested by fine marks on a strip of paper held against the commutator.

7. Heating of commutator due to brush friction. Reduce tension of springs.

In a.c. generators look for—

8. Loose connections and bad contacts at brushes. Position of brushes on rings is immaterial, as there is no commutation.

In d.c. shunt motors, motor-generators, or dynamotors, the simple troubles are:

9. Failure to start, or starting suddenly with speed quickly becoming excessive, due to wrong connections. See Section 97.

10. Sparking, caused by excessive load or wrong brush position. See 5 and 6 above. The proper position for motor brushes is slightly backward, (against the direction of rotation) of the center of the field poles.

CHAPTER 3.

RADIO CIRCUITS.

A. Simple Radio Circuits.

107. **The Simplicity of Radio Theory.**—The principles of alternating currents developed in Chapter 1 are applicable to radio circuits. Radio currents are merely very high frequency alternating currents. The fundamental ideas of sine waves (Section 50) apply to what are known as continuous or “undamped waves.” “Damped waves” also behave in many ways like sine waves; for some purposes slight modifications of the sine wave theory are needed. These are treated in Part B below.

The frequencies of alternation of radio currents are very high. Ordinary alternating current power circuits use frequencies from 25 to 60 cycles per second. The lowest radio frequencies, however, lie above some 20,000 cycles per second, and the upper limit may be put at perhaps 10,000,000 cycles per second. Such an enormous difference in frequency should naturally give rise to some differences in the behavior of radio circuits as distinguished from low frequency alternating current circuits.

In low frequency a.c. circuits the principal opposition to the current is offered by the resistance. The inductive reactance and capacitive reactance are far greater than the resistance in a radio circuit, and resistance plays only a minor rôle. The reactance of such small inductances as are provided by a few turns of wire is of importance, and condensers whose small capacitance would very effectually prevent the flow of ordinary alternating currents readily allow the passage of radio currents. The mutual inductance effect of one circuit on another is much greater, when radio frequencies are used, than is the case with ordinary alternating current circuits. The enormous frequencies used in radio work give rise also to much larger skin effect, eddy currents, and dielectric losses than would be the case if the same circuit were worked at low frequency.

Furthermore, measuring instruments commonly used for alternating current work are, for the most part, unsuitable for use in

radio circuits, or require modified methods of connection. Instruments whose indications depend upon the heating effect (Section 59) are, in general, suitable for radio work. Direct current instruments may also be used but in connection with rectifying devices. The telephone receiver, so useful in low frequency work, requires a rectifier also. At low frequencies, the diaphragm of the receiver vibrates with the current, giving an audible singing note of the same frequency as the alternating current. Radio currents execute their changes, however, altogether too quickly to be followed by the telephone directly, and even were it possible for the diaphragm to vibrate so rapidly, the sound produced would be of too high pitch to be heard by the ear. It is found to be necessary, therefore, to break up the radio currents into groups of rectified waves. Each

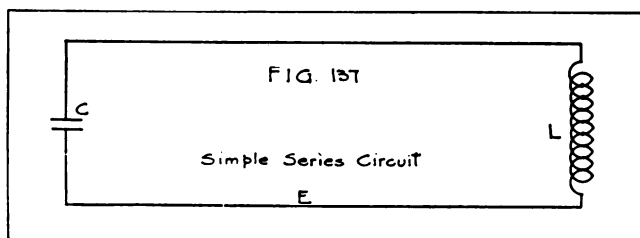

group gives a single impulse to the diaphragm, and if the impulses follow regularly with sufficient rapidity a musical note is produced.

108. **The Simple Series Circuit.**—The simplest form of radio circuit is one having resistance, inductance, and capacitance in series, as in Fig. 137. An alternating emf. is supposed to be applied at *E*.

In Chapter 1, Section 57, it has been shown that the value of the current produced in a circuit, to which an alternating emf. is applied, may be calculated by the equation,

$$\text{Current} = \frac{\text{emf.}}{\text{impedance.}}$$

If the effective value of the emf. is used here, the equation gives the effective value of the current. (Sec. 51.)

The impedance *Z* depends not only on the resistance *R*, but on the reactance *X* of the circuit as well. (Secs. 55, 57.) For a sine wave of applied emf.

$$Z^2 = R^2 + X^2 \quad (69)$$

That is, the square of the impedance is found by adding the squares of the resistance and the reactance. The impedance can therefore never be less than the resistance, and may be very much greater. If the resistance in the circuit is very small in comparison with the reactance, the impedance is practically equal to the reactance. The impedance is measured in ohms.

As has been pointed out (Sec. 49), the reactance is the opposition offered to the current by an inductance or a capacitance. The reactance of an inductance coil is equal to 2π times the frequency, times the inductance. For a capacitance the reactance is equal to $\frac{1}{2\pi fC}$ (Sec. 56), in which f is the frequency and C is the capacitance. In their reactive effects an inductance and a capacitance tend to offset one another, so that the total reactance of an inductive coil and a condenser in series is found by taking the difference of their individual reactances.

Example.—Let us calculate the reactance of the combination of a coil of 500 microhenries inductance in series with a condenser of 0.005 mfd. capacitance at several different frequencies.

Frequency cycles per second.	Reactance of coil (ohms).	Reactance of condenser (ohms).	Total react- ance (ohms).
60	0.188	-530,000	-530,000
1,000	3.142	-31,840	-31,837
100,000	314.2	-318.4	-4.2
100,700	316.23	-316.23	0
1,000,000	3,142	-31.84	-3,110

The table shows at a glance that the reactance of the coil is small at low frequencies, increases as the frequency rises, and becomes very considerable at the higher frequencies, such as occur in radio work.

The behavior of the condenser is just the reverse. At the lowest frequency it offers a very large reactance, but at radio frequencies the impedance is vastly smaller. For very high frequencies the reactance would be negligible.

In most radio circuits the resistance of the circuit can be kept as small as a few ohms. It is therefore obvious that only in the case of the 100,000 cycles, in the table, would it be necessary to take account of the resistance in calculating the impedance.

For example, if $R=5$ ohms, the impedance for the frequencies in the table above, will have the values 530,000, 31,837, 6.5, 5 and 3110, respectively. In all except the third and fourth cases, the difference between the reactance and the impedance is less than one part in a million of the total.

It is thus apparent that in many cases the impedance of a circuit depends almost entirely on the reactance of the circuit. Only in those cases where the reactance is small is it necessary to take the resistance into account.

109. **Series Resonance.**—It would seem at first sight, then, that radio circuits would offer for the most part a high impedance and that therefore very little current could flow, except with very large emf. This is in general true of any radio circuit if the frequency be taken at random. However, by properly adjusting the value of the frequency, the reactance of the circuit may be made zero. This is at once evident, when we remember that the inductive reactance increases with the frequency, while the capacitive reactance diminishes. At some definite frequency, then, the inductive reactance of the coil must have the same value as the capacitive reactance of the condenser, and since they act against each other, the total reactance will be zero.

This may be shown graphically. In Fig. 138 are plotted the curves *A* and *B* of the reactances of the coil and condenser, respectively, of the previous example. Frequencies are measured along the horizontal axis and reactances along the vertical axis. The reactances of curve *B* are taken as negative to distinguish between the opposing effects of the inductive and capacitive reactances. Curve *C* is obtained by taking the algebraic sum of the reactances of curves *A* and *B*. It is the curve of resultant reactance in the circuit. For the particular values of *C* and *L* chosen in this example, the circuit acts like an inductive reactance at all frequencies greater than a value of slightly above 100,000 cycles, while below that point it has the character of a capacitive reactance. Furthermore for only a narrow range of frequencies, 99,000 to 103,000, perhaps, the reactance of the circuit is less than 10 ohms. For most frequencies the reactance is much greater than this.

The frequency which makes the capacitive and inductive reactances equal is called the "resonance frequency" of the circuit, and the circuit is said to be in "resonance," or to be "tuned" to the frequency in question. It is important to be able to calculate the

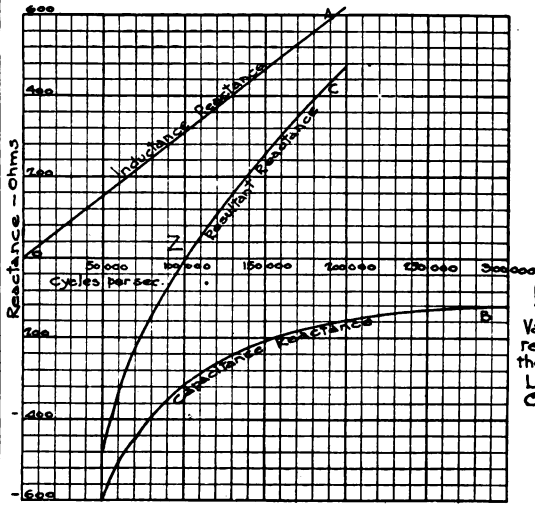

FIG. 138
 Variation of reactance with the frequency
 $L = 500$ microhenries
 $C = 0.005$ mfd.

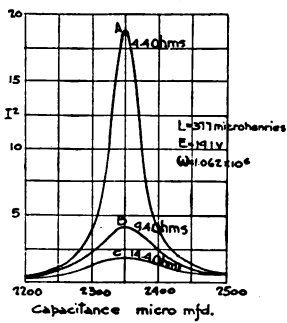

FIG. 139
 Resonance Curves for Series Circuit with Different Resistances

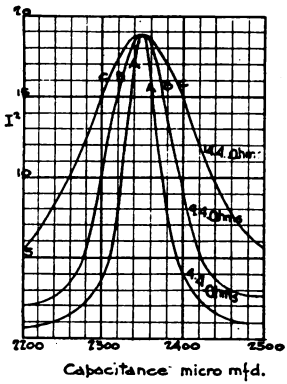

FIG. 140
 Effect of Resistance on the Shape of Resonance Curve

frequency for resonance. To do so, the condition must be fulfilled, that

$$2\pi fL = \frac{1}{2\pi fC} \quad (70)$$

which shows that the frequency at resonance must be

$$f = \frac{1}{2\pi\sqrt{LC}} \quad (71)$$

Applying this relation to the example under discussion, and substituting therein $L=0.0005$ henry, $C=5/10^9$ farad, the resonance frequency is found to about 100,700 cycles per second. The reactances of both the coil and the condenser at this frequency are the same and have the value 316.2 ohms. This value may, of course, be calculated by using for f the value of the resonance frequency in either of the expressions $2\pi fL$ or $\frac{1}{2\pi fC}$. It is of interest to note that each of these expressions for reactance reduces simply to $\sqrt{\frac{L}{C}}$, when the frequency has the resonance value.

There exists, then, for any series circuit containing inductance and capacitance, a definite value of the frequency, for which the total reactance in the circuit is zero, and the impedance is simply equal to the resistance of the circuit. This frequency is called the resonance frequency, and the circuit is said to be in a condition of resonance. The impedance has its smallest value, and the current which flows in the circuit when the applied emf. has any value whatever has the largest value possible with that value of frequency.

These facts may be readily verified experimentally by inserting in a simple radio circuit a suitable ammeter for measuring the current. If now the frequency of the applied emf. is gradually raised, the current will at first be small and will increase very slowly as the frequency is increased. In the immediate neighborhood of the resonance frequency, the current will suddenly begin to increase rapidly, for small changes of frequency, and after passing through a maximum, will rapidly decrease again as the frequency is raised to still higher values. The results of such an experiment may be shown by a curve in which frequencies are measured in the horizontal direction, while the values of the current corresponding are

plotted vertically. Since most instruments suitable for measuring radio currents give deflections proportional to the square of the current, it is customary to plot the squares of the current, or the deflections of the instrument, rather than the current itself. Such "resonance curves" are plotted in Fig. 139, and they show plainly the "resonance peak."

On account of its great importance in radio work the phenomenon of resonance requires further study. To fix our ideas, let us suppose that a circuit whose inductance and capacitance have the values already chosen in the previous example, has a resistance of 5 ohms and that an emf. of 10 volts is applied in the circuit. The maximum possible value of the current is found by dividing the applied voltage by the resistance, which gives 2 amp. This current will flow when the frequency has the critical value of 100,700 cycles per second. To study the distribution of emf. over the different parts of the circuit we have to remember (Sec. 55) that the emf. between any two points of the circuit has to have a value equal to the product of the current by the impedance between the two points. Accordingly the emf. between the ends of the resistance is $2 \times 5 = 10$ volts, that on the coil is $2 \times 316.23 = 632.46$ volts, and the same emf. is found between the terminals of the condenser also.

The existence of such a large voltage on both the coil and the condenser explains how it is possible to obtain such a relatively large current through the large reactances of the coil and condenser. The small applied voltage is employed only in keeping the current flowing against the resistance of the circuit, not for driving the current through the coil or condenser. To explain the presence of the large voltages on coil and condenser, it must be remembered, as was shown in Section 59, that when a current is flowing through an inductance and capacitance in series, the emf. on the inductance opposes that on the capacitance at every moment. The sum of the voltages on the two is therefore found by subtracting their individual values. Since at the resonance frequency the emf. on the inductance has the same value as the emf. on the capacitance, the emf. between the terminals of the two in series is therefore zero.

Energy is supplied to the circuit by the source at a rate which may be determined (when the resonance condition has been established) by simply multiplying the emf. by the current. (Sec. 55.) That is, in the present instance, the power is $10 \times 2 = 20$ watts. The power dissipated in heat in the resistance may be calculated by taking the

product of the resistance by the square of the current. (Sec. 51.) In this case it is $5 \times 2^2 = 20$ watts. The source, therefore, supplies energy to the circuit at just the right rate to make good the energy dissipated in heat in the resistance. After the current has reached the final effective value (2 amp. in this case), no further energy is supplied to the coil or condenser by the source, but their energy is simply transferred back and forth, from one to the other, without loss or gain in the total amount, nor is any outside agency necessary to maintain this condition.

Mechanical Example of Resonance.—Many mechanical examples of resonance might be cited. It is a well known fact that the order to “break step” is often given to a company of soldiers about to pass over a bridge. Neglect of this precaution has sometimes resulted in such violent vibrations of the bridge as to endanger it. This is especially the case with certain short suspension bridges.

When a shock is given to a bridge it vibrates, and the frequency of the vibrations, that is, the number of vibrations per second, is always the same for the same bridge, whatever the source of the shock. The frequency of vibration is analogous to the resonance frequency of the circuit. For if an impulse be applied to the bridge at regular intervals, tuned so that the number of impulses per second is exactly equal to the number of vibrations natural to the bridge in the same time, violent vibrations may be set up, although the individual impulses may be small. In fact, when the bridge is thus vibrating, the impulses need to have only just force enough to overcome the frictional forces and thus keep the vibrations from dying away. The much greater forces involved in the vibrations themselves correspond to the large voltages acting on the coil and condenser. The voltage on the condenser is of the same nature as the large forces which exist in the beams of the bridge when they are stretched, while the voltage on the coil corresponds to the very considerable momentum of the moving bridge. The small force of the impulses given the bridge corresponds to the small applied emf. in the electrical case.

If the vibrations of the bridge ever become so violent as to rupture it, it means that the beams have been stretched beyond their breaking point. Similarly, the dielectric of the condenser may be broken by the emf. existing between its terminals, in cases where the resonance current is too large.

110. Tuning the Circuit to Resonance.—The practical importance of resonance lies in the fact that it enables the impedance of a circuit to be made equal to the resistance alone. It must be remembered that the reactance of the small inductances in the circuit, which are unavoidable, become important at radio frequencies and may often be much greater than the resistance.

This fact, taken in connection with the smallness of the emf. of incoming signals, would make it impossible to obtain any but minute currents in the receiving apparatus with inductance alone in the circuit. From this standpoint, the sole function of the tuning of the circuit to resonance is to offset the inductive reactance by an equal capacitive reactance, so that the impedance may be made as small as the resistance.

The circuit may be tuned to resonance in three ways—

- (a) By adjusting the frequency of the applied emf.
- (b) By varying the capacitance in the circuit.
- (c) By varying the inductance in the circuit.

Of these, the first case has already been treated. The other two find application in receiving circuits where the frequency of the incoming waves is beyond the control of the operator in the use of coupled circuits and in the adjustment of the frequency of the waves emitted in certain methods of sending.

The possibility of tuning a circuit is of course not confined to radio circuits, but is present also with ordinary alternating current circuits, and is becoming common in telephone work. However, at low frequencies the values of the inductance and capacitance involved are relatively great, so as to make it inconvenient to vary their values in steps sufficiently small. Furthermore, in low frequency work the reactances of the coils likely to occur in the circuit are small, and the large quantities of power involved render the use of condensers relatively uncommon. The inductances and capacitances used in radio work, on the other hand, are relatively small, and the construction of coils of continuously variable inductance (variometers or variable inductors) and of apparatus of variable capacitance (variable condensers) offers no particular difficulties.

From formula (71) it appears that it is the product of the inductance and capacitance, rather than their actual values, which determine the resonance frequency. To tune a circuit to a given frequency, the inductance may be large or small, provided only

that the capacitance may be so adjusted that the product of inductance and capacitance shall have the value corresponding to the frequency assumed.

111. **Resonance Curves.**—A resonance curve is a curve which shows the changes of current in a circuit, when changes are made which cause the resonance condition to be somewhat departed from. For example, the current (or square of the current) may be plotted for different values of the frequency somewhat above or below the resonance frequency. Or, the curve may show the change in current, when the capacitance (or inductance) is somewhat raised and lowered with respect to the value which holds for the condition of resonance. Such curves are often determined experimentally, in whole or in part, on account of their value in calculating the damping of the circuit. (Damping is treated in Sec. 116 below.) Such, for example, are the curves of Fig. 139, in which are plotted the values of the current squared, to some arbitrary scale, for different values of the capacitance of the variable condenser. The inductance of the circuit was fixed at the value 377 microhenries. Three different curves were determined with the resistance in the circuit fixed at the values 4.4, 9.4 and 14.4 ohms, respectively.

Sharpness of Resonance.—It was of course to be expected that the value of the current at resonance (height of the peak), should be greater, the smaller the resistance in the circuit, but attention needs to be called particularly to the sharpness of the curve with the smallest resistance and to the flatness of the curve with greatest resistance. This is the characteristic of resonance curves in general, and is a necessary consequence of the equations for the impedance. It may be shown still more clearly, if the scales to which the three curves are plotted are so altered that the peaks of the three curves have the same height. This has been done in Fig. 140.

The same results may be seen by calculating the square of the impedance with different settings of the condenser and with different resistances in the circuit. The resonance frequency in this case was 169,100 cycles per second, which shows that with the inductance of 377 microhenries the setting of the condenser at resonance is almost exactly 2350 mfd. The reactance of condenser and coil at this frequency is 400.56 ohms in each case.

The following table shows the impedances for three different settings of the condenser when the resistance of the circuit has the three values corresponding to those of the curves. The squares of the cur-

rents are, of course, less in proportion as the squares of the impedance are greater.

Setting of condenser (micro-mfd).	Impedance squared.		
	For $R=4.4$	For $R=9.4$	For $R=14.4$
2300	94.1	163.1	282
2350	19.3	88.3	207
2400	90.0	158.9	278

For the smallest resistance, the square of the current is about 4.7 times as great at resonance as when the capacitance is changed by 50 micro-mfds. in either direction. For 9.4 ohms in circuit the ratio is about 1.8, and for the largest resistance, only about 1.35. These calculated ratios agree very well with the experimental values. The close connection of the shape of the resonance curve with its resistance, points to the possibility of calculating the total resistance in the circuit from measurements of the resonance curve. For this method of measuring radio resistance see C. 74, Sections 49 and 50.

The calculations here given, as well as an inspection of the curves of Fig. 139, show that the resonance curve is not symmetrical. That is, the current has not the same value when the capacitance is a certain amount less than the resonance value, that it has when the value of the capacitance is greater by the same amount. The question of this lack of symmetry is treated in the next section.

Symmetry of Resonance Curves.—The curves of Fig. 138 show the changes of coil reactance, curve *A*, and condenser reactance, curve *B*, together with the total reactance, curve *C* (their sum) when the frequency is changed. The curve of total reactance is not symmetrical about the axis where it passes through its zero value (point *Z*, Fig. 138). The resonance peak (Fig. 139) is, therefore, unsymmetrical also. That is, the current is not the same for two frequencies, one slightly higher than the resonance frequency, and the other the same number of cycles lower than the resonance frequency. The explanation is found in the shape of the curve of condenser reactance.

The same lack of symmetry exists when the inductance and the frequency are held constant and the capacitance is varied to obtain resonance, because the shape of the curve of condenser reactance in this case is the same as in the preceding. However, if the frequency and capacitance are held constant, and the resonance condition is reached by varying the inductance, a symmetrical resonance peak is

obtained; equal changes of the inductance, above and below the setting for resonance, will cause the current to fall to the same value. The difference of this case from the two preceding lies in the fact that curves of condenser and coil reactance and hence of total reactance, are here straight lines.

To summarize then, the resonance curve is symmetrical when the tuning is accomplished by varying the inductance (C and f constant), but is not symmetrical in the two other methods of tuning, viz., by varying the capacitance (L and f constant) or by varying the frequency (C and L constant).

112. **The Wavemeter.**—The phenomenon of resonance enables one to obtain relatively large currents in a circuit to which only

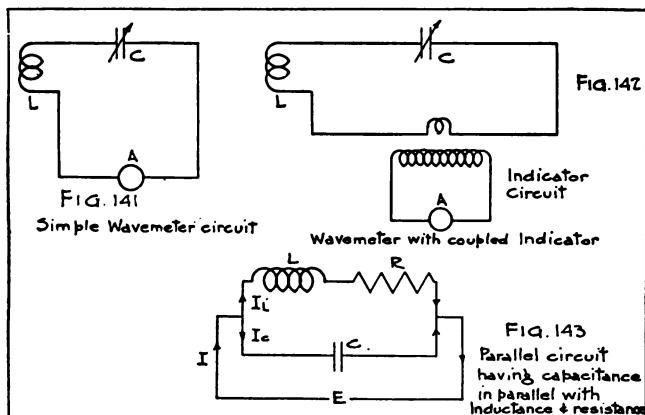

a small emf. is applied, provided only that the circuit is properly tuned. To determine when the condition for resonance is realized with a given frequency in a given circuit, or to measure the frequency at which a circuit of predetermined constants should be in resonance, use is made of the "wavemeter." This is the most important instrument used in radio measurements. It consists essentially of a series circuit, which includes an inductance and a capacitance, both of which are of known values. Either the inductance or the capacitance may be of fixed value while the other will be variable. A hot wire ammeter, thermo-junction, or other suitable device for measuring radio currents is inserted, either directly into the circuit (Fig. 141), or, better, is coupled electromagnetically to it, the cou-

pling being made as loose (Sec. 119) as will permit of a suitable maximum deflection of the ammeter (Fig. 142).

If the frequency of the current in a given circuit is to be measured, the coil of the wavemeter circuit is placed near the circuit in question, and the capacitance of the wavemeter is varied, until the indicating device shows that the current in the wavemeter circuit is a maximum. In making the final adjustment the wavemeter coil should be moved as far away from the circuit in question as is possible and yet provide a convenient maximum deflection of the current indicating device.

From the known value L of inductance of the wavemeter coil and the capacitance C_r , corresponding to the setting of the condenser at resonance, the desired frequency may be calculated from equation (72) which gives

$$f = \frac{1}{2\pi\sqrt{LC_r}} \quad (72)$$

What is generally desired, however, is not so much the frequency as the wave length (Sec. 124) of the electromagnetic waves radiated by the circuit. The wave length λ is connected with the frequency f by the fundamental relation

$$\lambda = \frac{c}{f} \quad (73)$$

in which c is the velocity of electromagnetic waves in space and has the value of 300,000,000 meters per second. Expressing C_r in mfd. and L in microhenries, as is commonly convenient, the fundamental wavemeter equation giving the wave length in meters is

$$\lambda = 1884 \sqrt{LC_r} \quad (74)$$

For example, if $L=1000$ microhenries and $C_r=0.001$ mfd., the wave length emitted by the circuit is 1884 meters.

A wavemeter is usually provided with a buzzer or some other auxiliary device by means of which oscillations may be set up in the wavemeter circuit. These will have a wave length which may be calculated by equation (74) from the inductance and capacitance of the wavemeter circuit. By coupling any desired circuit with the wavemeter circuit an emf. is introduced into the former, when the buzzer is working, the frequency of which is the same as that existing in the wavemeter circuit. This frequency may be calculated by (74) from the known inductance of the wavemeter

coil and the capacitance corresponding to the setting of the condenser. If, further, it is desired to tune the circuit in question to the frequency emitted by the wavemeter circuit, it is only necessary to couple the current indicator to the circuit to be tuned, to cause the wavemeter to emit waves and to vary the capacitance or inductance of the circuit to be adjusted, until the indicator shows a maximum current.

113. **Parallel Resonance.**—In the preceding sections it has been shown how to obtain the maximum current in a circuit for a given applied emf. The principle of resonance, utilized for this purpose, finds application also in the solution of the reverse problem of keeping currents of a certain frequency out of any chosen part of a circuit without, however, preventing the passage of currents of other frequencies. To such an arrangement is given the appropriate name of a "filter." A filter consists essentially of an inductance coil, joined in parallel with a condenser. This combination is interposed between the emf. in question and that portion of the circuit from which the undesirable currents are to be excluded. Any such combination of inductance and capacitance, taken at random, will oppose currents of a single frequency only, whose value depends principally on the values of the inductance and capacitance. To render such an arrangement effective against currents of a certain chosen frequency, it is necessary to adjust the capacitance and inductance to have a definite relation. The solution of this problem requires a knowledge of the principles of "parallel resonance."

Fig. 143 shows a coil of inductance L and resistance R , joined in parallel with a condenser of capacitance C . The current I flows from the alternating source of emf. E , through the main circuit, and at the branch point divides, a part I_l flowing through the coil, and the remainder, I_c through the condenser. At every moment, the current I has a value which is the algebraic sum of the values of I_l and I_c existing at that same moment. Let us suppose, first, that the emf. E has a definite frequency, and that the inductance of the coil is invariable. Current measuring instruments may be arranged to measure the three currents. If the capacitance is varied continuously, and the indications of the ammeters recorded, the following experimental facts will be observed.

In general, the currents in the coil and condenser will be unequal, and the current I may be less than either. As the capacitance is varied, the currents in the coil and condenser may be made to

approach equality, and at the same time the main current will decrease. At length, for some critical value of the capacitance, the main current will reach a very small minimum value, while the current in the coil and the condenser current are nearly equal. Further, each is many times larger than the main current. As the capacitance is now varied still further, the main current begins to increase, and the coil and condenser currents are no longer so nearly equal.

As an example, assume the inductance of a coil to be 1000 microhenries and its resistance 2 ohms. An effective emf. of 10 volts and a frequency of 71,340 cycles per second is applied. (This

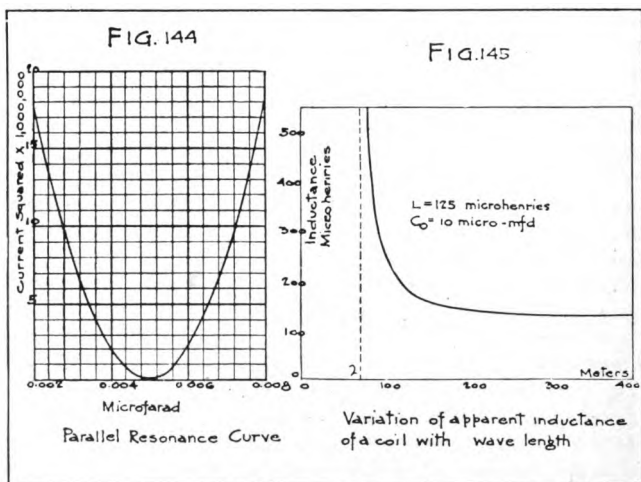

value of frequency was chosen, since it gives a minimum current I , with a condenser of almost exactly 0.005 mfd.) The changes of the current in the main circuit, as the capacitance is varied from 0.002 to 0.008 mfd. are shown in Fig. 144, in which values of the capacitance are measured horizontally and values of the square of the current vertically. The latter values in the figure are multiplied by a million. The minimum current is not zero, but its value is only about 0.0001 amp., a value whose square is too small to be easily distinguished in the figure. The corresponding currents in the coil and condenser are each about 0.02236 amp. Their difference

is only about 1/100,000 part of this value, the condenser current being the larger by this minute amount.

In practice, then, if we imagine some troublesome emf. to be introduced into the circuit at E (Fig. 143), by induction or otherwise, the employment of a parallel combination of inductance and capacitance can be made to very completely prevent this emf. from causing currents to flow in the circuit, provided only that the values of inductance and capacitance are properly chosen. And such a filter does not prevent the passage of currents of other frequencies.

If, for example, we suppose that the emf. E has a frequency of 100,000 cycles, in the above case the combination of 1000 microhenries and 0.005 mfd. would allow 0.01549 amp. to flow in the main circuit. That is, this filter has 155 times as much stopping effect for currents of 71,340 cycles per second as for currents of 100,000 cycles, and for frequencies further away the effect would be greater. Filters of this kind are used in airplane radio telephone sets to remove noises produced by the electric generator used in the set; for example, in the type SCR-68 sets. A similar filter is used in connection with the type EE-1 buzzerphone.¹

The results of theory show that to filter out currents of a frequency f , the necessary relation between inductance and capacitance is given in the following equation:

$$C = \frac{L}{R^2 + (2\pi fL)^2} \quad (75)$$

The current in the main circuit is, under this condition,

$$I = \frac{ER}{R^2 + (2\pi fL)^2} \quad (76)$$

In all practical radio circuits, however, the resistance of a circuit is so small in comparison with the inductive reactance, that it may be neglected. The equation (75), under these circumstances, goes over into the same equation that holds for series resonance, that is—

$$2\pi fL = \frac{1}{2\pi fC}$$

Otherwise expressed, then, it may be stated, that when the condition of parallel resonance is realized, the loop circuit which contains the coil and condenser in series is very closely in a condition

¹ See S. C. Electrical Engineering Pamphlet No. 1.

of series resonance. Recalling the fact that, in the series resonance condition, the emf. on the condenser is equal and opposite to that on the coil, it is easy to see that there is here a flow of current back and forth between the coil and condenser. Viewed from the main circuit (Fig. 143), the current in the coil is, at every moment, opposite to the condenser current, so that the main current, which is their algebraic sum, is at every moment merely the difference between the condenser and coil currents. These latter being nearly equal in value, we have the explanation of the existence of the relatively large currents in the coil and condenser, when the main circuit is almost free from current.

The ideal filter would be one in which the resistances of the inductance coil and all the connecting wires in the two branch circuits were actually zero. In such a case, the condition for parallel resonance would be rigorously the same as for series resonance, equation (70), the condenser current would be exactly equal to the current in the coil, and absolutely no current would flow in the main circuit. The filter effect would be perfect. No energy would therefore flow from the source E , but this would merely give the condenser an initial charge, and thereafter current would flow between the two branch circuits, even if the main circuit were removed. See Section 115, on free oscillations.

In any actual case there must, however, be some resistance in the circuit, and the energy for the heating in the resistance must come from outside. The emf. E must cause just enough current to flow in the main circuit to make good this loss of energy. It is easy to show that these conclusions follow also from the equations previously cited. When the resonance condition is established, the main current and the emf. E are in phase, so that the power is equal to the product of the emf. E and the main current, that is, to $\frac{E^2 R}{R^2 + (2\pi fL)^2}$. The power lost in heating is equal to the square of the current in the coil multiplied by the resistance of the coil. The current in the coil is, however (Section 57), $\frac{E}{\sqrt{R^2 + (2\pi fL)^2}}$, so that the power in heating has the value $\frac{E^2 R}{R^2 + (2\pi fL)^2}$ as before. The fact that the main current should be zero, when the resistance is zero, is in line with equation (76) for I , and with the fact also that the heating must be zero in that case.

Besides tuning the filter by varying the capacitance, it is of course possible to obtain parallel resonance by varying the inductance instead. For a given coil and condenser, it is also possible to obtain parallel resonance by adjusting the frequency of the applied emf. It must be noted, however, that when either the inductance or the frequency is varied, the conditions for minimum current in the main circuit are slightly different and are not the same as when the capacitance is varied. These three conditions differ appreciably only when the resistance is large. For radio circuits, the resistance is usually so small that no difference can experimentally be detected between all these conditions for minimum current. For zero resistance, all three coincide and are expressed by equation (75).

114. **Capacitance of Inductance Coils.**—A coil used in radio circuits can seldom be regarded as a pure inductance. While the capacitances between turns of a coil are small, they approach the same magnitude as other capacitances used in radio circuits. A coil is to be considered as a combination of inductance and capacitance in parallel. It is found that the capacitance C_0 of a coil does not change appreciably with frequency. Neither does the inductance itself, but the apparent or equivalent inductance L_a of this combination of inductance and capacitance does vary with frequency as indicated by the equation

$$L_a = \frac{L}{1 - \omega^2 C_0 L} \quad (77)$$

The variation with wave length is shown in Fig. 145. When the coil is the main coil of a circuit, it is usually desirable to introduce the emf. into the circuit by induction in the coil itself rather than in series with the coil. The capacitance of the coil is then merely added to the capacitance of the condenser. When the emf. is in series with the coil, one effect of the coil capacitance is to increase the resistance introduced into the circuit by the coil and thus reduce the current.

The capacitance of coils frequently give rise to peculiar and undesirable effects in radio circuits. Among these are effects caused by the capacitances of those parts of a coil which are not connected in the circuit. The turns which are supposedly "dead" may actually produce considerable effect, both upon the resistance and frequency of resonance of the circuit. Thus, the capacitance

of the unused part 2 of the coil in Fig. 146 causes a second circuit to be closely coupled to circuit 1. This may cause the circuit 1 to respond to two frequencies and exhibit the other phenomena of coupled circuits described in Section 120 below. (See also C. 74, Sec. 19.)

B. Damping.

115. **Free Oscillations.**—Thus far it has been assumed that a constant alternating voltage has been applied to radio circuits, in which case the alternating currents produced are of constant amplitude. Such currents may be regarded as analogous to the forced oscillations which are produced in a mechanical system like a swing or a pendulum, when it is acted upon by a force which varies periodically.

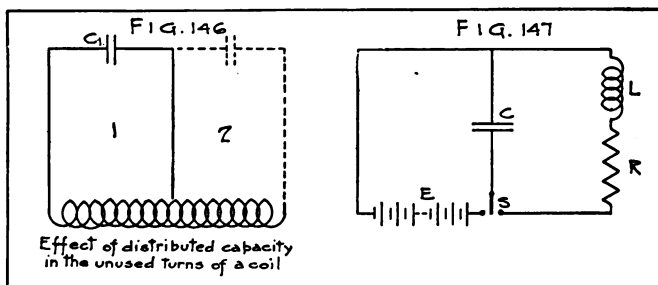

The system is forced to vibrate with the same frequency as that of the force.

It is, however, possible to produce oscillations of current in a circuit without the necessity of providing a source of alternating emf. A common method is merely to charge a condenser and then to allow it to discharge through a simple radio circuit.

This may be accomplished, for example, by the simple means shown in Fig. 147. By throwing the switch S to the left, the condenser C is charged by the battery E , but when the switch is thrown to the right, it is discharged into the circuit containing the resistance R and the inductance L . If the resistance R is not too great, electric oscillations are set up which, however, steadily die away as their energy is dissipated in heat in the resistance. As in Fig. 148, the current becomes less and less as the oscillations go on.

To explain this action, we must follow more closely what takes place in the circuit from the moment when the condenser, charged up to a

certain potential difference, is inserted in the discharge circuit. When the condenser starts to discharge itself, a current flows out of it, and the potential difference of the plates decreases as a result. At the moment when the plates have reached the same potential, current is still flowing out of the condenser. The current has energy and cannot be stopped instantly. In fact, to bring the current to zero value, it is necessary to oppose it by an emf., and the amount of emf.

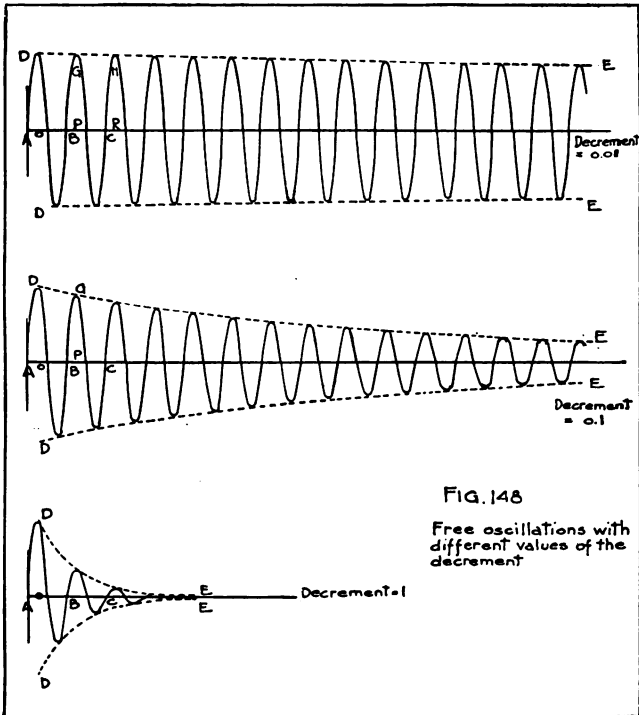

necessary is greater the more quickly one wishes to stop the current. It is similar to the case of a moving body. On account of its motion the body possesses energy, and cannot be brought to rest instantly. The greater the force which is opposed to it, the more quickly it may be brought to rest; but unless its motion is opposed by some force, it continues to move indefinitely without change of velocity.

The flow of current from the condenser, then, does not cease when the condenser has discharged itself, and, as a result, that plate which was originally at the lower potential takes on a higher potential than the other. The condenser is beginning to charge up in the opposite direction. The potential difference of the plates now acts in such a direction as to oppose the flow of the current, which decreases continually as the potential difference of the plates rises. If the resistance of the circuit were zero, the current would be zero (reversing) at that moment when the potential difference of the plates had become just equal to the original value. That is, the condenser would be as fully charged as at the beginning, only with the potential difference of the plates in the direction opposite to that at the start. Now begins a discharge of electricity from the condenser in the opposite direction to the first discharge, and this discharging current flows until the condenser has become fully recharged in the original direction. The cycle of operations then repeats itself, and so on, over and over again.

The action in the circuit may thus be described as a flow of electricity around the circuit, first in one direction and then in the other. The rate of flow (current) is greatest when the plates have no potential difference, and the current becomes zero and then begins to build up in the opposite direction at the moment when the potential difference of the plates reaches its maximum value. This alternate flow of electricity around the circuit first in one direction and then in the other is known as an "electrical oscillation." Since no outside source of emf., such as an a.c. generator, is acting in the circuit, the oscillations are said to be "free" oscillations.

Mechanical free oscillations are well known. Such, for example, are the swinging of a pendulum, and the vibration of a spring which has been bent to one side and then let go. In the case of the pendulum, the velocity with which it moves corresponds to the value of the current in the electrical case, while the height of the pendulum bob corresponds to the potential difference of the condenser plates. When the bob is at its highest point, its velocity is zero, corresponding to the condenser when the plates are at their maximum potential difference and no current is flowing. When the pendulum bob is at its lowest position, it is moving most rapidly. Similarly, when the plates of the condenser have zero potential difference, the current flowing has its maximum value. The pendulum does not stop moving when it passes through its lowest point; neither does the current cease at the moment when the condenser plates are at the same po-

tential. The pendulum rises with a gradually decreasing velocity toward a point at the other end of the swing as high as the starting point. The current gradually decreases as the condenser charges up to an opposite potential difference equal to the original value. The return swing of the pendulum corresponds to the flow of current in the direction opposite to the original discharge.

A pendulum swinging in a vacuum and free from all friction would continue to swing indefinitely, each swing carrying it to the same height as the starting point. Similarly, electric oscillations would persist indefinitely in a circuit, that is, they would be "undamped" if there were no resistance to the current.

Actually, electric oscillations die down in a circuit and finally cease altogether, just as an actual pendulum will make shorter and shorter swings and finally come to rest. Since the occurrence of free oscillations in a circuit presupposes no interference with the circuit from outside, the circuit receives no energy beyond that imparted to it at the moment when the oscillations begin. Thereafter the circuit is self-contained, and any loss of its energy in heat and electromagnetic waves reduces by just so much the energy available for maintaining the oscillations. This loss of energy goes on continuously and the oscillations die away to nothing. They are said to be "damped" oscillations.

At the start there is a definite amount of energy present in the circuit, namely, the energy of the charge given the condenser. The amount of this energy depends upon the capacitance of the condenser and the square of the potential difference between its plates (emf. to which it is charged). This energy exists in the dielectric of the condenser, which is in a strained condition due to the charge. As soon as the current begins to flow the condenser gives up some of its energy, and this begins to be associated with the current and is to be found in the magnetic field around the current, that is, principally in the region around the inductance coil. As the current rises in value under the action of the emf. of the condenser, energy is continually leaving the condenser and being stored in the magnetic field of the inductance coil. When the plates of the condenser have no potential difference, the whole energy of the circuits resides in the magnetic field of the coil and none in the condenser. Energy is then drawn from the coil as the current decreases and energy is stored up in the condenser as it is recharged.

If the resistance of the circuit were zero and no energy were radiated in waves or dissipated in other ways, the total energy of

the circuit would be constant. The energy dissipated in heat and electric waves is, however, lost to the circuit, so that the total amount of energy, found by adding that present in the condenser to that in the inductance, steadily decreases. Finally all the original store of energy given the circuit has been dissipated and the oscillations cease.

The energy lost when a steady current is flowing in a circuit depends not only on the value of the current, but on the resistance of the circuit, and in a radio circuit this resistance is replaced by a somewhat larger quantity of the same kind, the "effective resistance." (See Sec. 117.) The greater the effective resistance, the greater the amount of energy dissipated per second when a given current flows.

Ohm's law shows that to keep a current I flowing through a resistance R an emf. RI is necessary and this has to be furnished by the

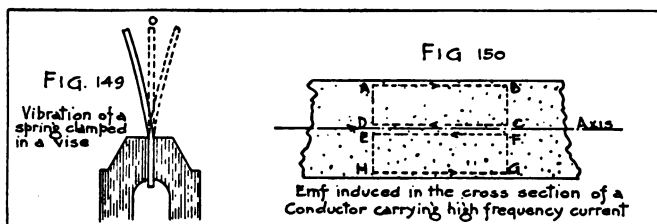

battery, generator, or other source. In an oscillating circuit the same is true, and that portion of the emf. in the circuit which is employed in forcing the current against the resistance is of course not available for charging the condenser or building up the discharge current. The changes of current in the circuit described above are thereby hindered, and the current does not rise to as great a value as it would in the absence of resistance. The maximum of emf. between the plates of the condenser is less each time the condenser is discharged, and thus the oscillations of the current die away.

A good analogy to damped electrical oscillations in a circuit is found in the vibrations of a flat spring, clamped at one end in a vise, and then bent to one side and released, Fig. 149. The spring vibrates from side to side with decreasing amplitude, until finally it comes to rest in its unbalanced position O . When the spring is bent, energy is stored up in it—the energy of bending. On being released

the spring moves and gains energy of motion, while the energy of bending decreases. If there were no friction, the loss of one kind of energy would be just offset by the gain of the other kind and the sum total would remain constant. The spring would move past the natural undisturbed position O , under the influence of its energy of motion, and would be brought to rest at a position just as far to the other side of O as was the starting point.

Friction has, however, the effect of opposing the motion and causing a dissipation of energy in heat, and each excursion away from the resting point is smaller than the one preceding.

Free oscillations, then, can take place in a circuit containing inductance and capacitance. These would be undamped in the ideal case where the resistance can be regarded as zero. In all practical cases of free oscillations, however, the oscillations are damped. To produce undamped waves it is necessary to provide some source of power to make good the energy dissipated in the oscillating circuit. Strictly speaking, undamped free oscillations are impossible in actual circuits. It is of importance to study the effect of the resistance in determining the rapidity with which the oscillations die away.

116. Frequency, Damping, and Decrement of Free Oscillations.—

If the resistance of the oscillating circuit is constant, it is possible to calculate the period of the free oscillations in the circuit and to find the rate at which the oscillations die away. If L , C and R are, respectively, the inductance, capacitance, and resistance of the circuit, then free oscillations in the circuit will have the frequency

$$f = \frac{1}{2\pi} \sqrt{\frac{1}{LC} - \frac{R^2}{4L^2}} \quad (78)$$

This is known as the "natural frequency" of the circuit. Similar considerations apply to the pendulum and vibrating spring discussed above. Each vibrates in a period natural to it, which depends upon the dimensions, material of the vibrating system, and the friction against which it moves.

If it should happen, in any case, that the quantity $\frac{R^2}{4L^2}$ is equal to or greater than $\frac{1}{LC}$ then free oscillations in the circuit are impossible; the current in the circuit does not reverse its direction at all, but simply dies away. The circuit is said to be in the "aperiodic"

condition, that is, without period. Seldom do such cases occur in radio circuits. Usually, the quantity $\frac{R^2}{4L^2}$ instead of being larger than $\frac{1}{LC}$ is very small in comparison with the latter. We may therefore as a rule, use without error as the expression for the natural period

$$f = \frac{1}{2\pi\sqrt{LC}} \quad (79)$$

which is the same expression as for the frequency of the applied emf. necessary in order that the circuit shall be in the resonance condition.

The rapidity with which the oscillations die away depends, not only on the resistance of the circuit, but on the inductance also. The greater the resistance and the smaller the inductance, the more rapid is the damping and the rate at which the oscillations decrease. If the resistance, capacitance, and inductance of the circuit have fixed values, it may be shown that each successive maximum of current is the same fraction of the preceding maximum, as the latter is of the maximum immediately preceding it. If, for example, the second maximum is 0.9 of the first, the third will be 0.9 of the second, etc. However, instead of adopting as a numerical measure of the rate of decrease, this ratio itself, it is found more convenient in the mathematical theory of damping to adopt the natural logarithm of the ratio of any maximum to the next following maximum with the current in the same direction, i. e., the logarithm of the ratio of two maxima one cycle apart. This number is known as the "logarithmic decrement," or "decrement," for short.

In cases where the resistance of the circuit is not exceedingly large, the decrement is equal to π times the quotient of the resistance by the inductive reactance of the circuit, calculated for the natural frequency of the circuit. That is, the decrement is equal to $\pi\left(\frac{R}{2\pi fL}\right)$, so that increasing the resistance or decreasing the inductance, both increase the decrement. The natural frequency being practically independent of the resistance, that is, equation (79) being sufficiently accurate, the capacitive reactance is equal to the inductive reactance. Thus the decrement is π times the quotient of the resistance by the capacitive reactance at the natural frequency of the circuit.

Examples of Decrements.—Fig. 148 gives a graphic idea of the dissipation of the oscillations in three cases where the decrements are 0.01, 0.1, and 1. These correspond to circuits of very small damping, moderate damping, and excessive damping, respectively. Each curve starts from the same value of current at the first maximum, and for each the natural period of the circuit is the same. The latter is represented by the horizontal distance, AB, BC , etc., in each. The difference between the curves is striking. In the case of a decrement of 0.01, the oscillations decrease only very gradually; this case approximates that of undamped waves. In the extreme case of a decrement of 1, the oscillations become negligible after only four or five periods. To construct such curves the following simple method may be used.

Assume a certain number of divisions in the horizontal direction to represent the period of the oscillations, for example, five. Then the curve must cross the horizontal axis every two and one-half divisions. Choose a convenient number of divisions to represent the first maximum of the current, for example, ten. The curves DE (Fig. 148) are next drawn to scale, starting with the chosen value for the first maximum. The curves DE have the property that the height of the curve falls off by equal fractions of its value for equal horizontal intervals.

For instance, if the decrement is 0.1, we find, since 0.1 is the natural logarithm of 1.105, that the first maximum OD in the positive direction is 1.105 times as great as the next, PG , and so on for any two successive maxima in the same direction. If, therefore, we take $OD=10$ division, PG will equal $\frac{10}{1.105}=9.05$ division, RH will be $\frac{9.05}{1.105}=8.19$, etc. The oscillations must be confined between the two curves DE , and since the crossing points have also been located, as well as the positions of the maxima, it is not difficult to sketch in the curve of oscillations free hand, making the loops of approximately sine shape.

Number of Oscillations.—Although, strictly speaking, the oscillations never would become absolutely zero, they actually become negligible after a certain time. A knowledge of the logarithmic decrement enables us to calculate how many complete oscillations will be executed before their amplitude has fallen below a certain fraction of the first oscillation. This number is greater the smaller the decrement.

If, for example, we arbitrarily choose to find the number of oscillations which will be completed before the maximum of current will fall below 1 per cent of the value at the start, we have simply to take the quotient of the natural logarithm of 100 by the decrement. The natural logarithm of 100 is, near enough, 4.6. The number of oscillations is thus 4.6 divided by the decrement. Thus in the three cases given in Fig. 148 the numbers of complete oscillations will be 460, 46 and 4.6, corresponding to the decrements 0.01, 0.1, and 1, respectively.

The maximum possible value of decrement would be infinite, but the United States radio laws require that values greater than 0.2 shall not be used on account of the interference of highly damped stations with other stations. The number of complete oscillations calculated by the above rule is 23 for a decrement of 0.2.

The decrement gives an idea of the efficiency of a sending apparatus. The smaller the decrement, the sharper the tuning possible, and, therefore, the greater the proportion of the emitted energy which can be utilized in the receiving apparatus. The larger the decrement the larger the proportion of energy which serves no useful purpose, and which may cause serious disturbance to other stations.

In the case of a spark circuit the idea of logarithmic decrement is not exactly applicable. On account of the variable resistance of the spark, the oscillations fall off according to a different law than that just discussed. (See C. 74, p. 230.)

C. Resistance.

117. Resistance Ratio of Conductors.—When a steady emf. is applied between the ends of a conductor, the current quickly rises to the final Ohm's law value, and distributes itself uniformly over the cross section of the wire. During the interval between the moment when the emf. is applied, and the moment of attainment of the final steady state, the current distribution over the cross section is not uniform. This effect is due to self-induced emfs. in the cross section of the conductor. Suppose that a section be taken through the axis of a cylindrical conductor and that the applied emf. tends to produce a current in the direction of the arrow (Fig. 150). The magnetic lines in the cross section will be circles, in planes at right angles to the axis, and with their centers in the axis. In the figure, the lines will be directed out of the paper in the region above the axis

and into the paper in the region below the axis. As the total current rises in value, the number of lines of force through any portions of the cross section, such as $ABCD$ and $EFGH$, will be increasing, and by Lenz's law (Sec. 45) this change of field will give rise to induced emfs. which tend to oppose the changes of the field. The directions of these induced emfs. will accordingly be those indicated by the small arrows, and it is easy to see that the increase of the current is aided in those portions of the cross section which lie near the surface of the conductor, and hindered at the portions nearer the axis. That is, the current reaches its final value later at the axis of the cross section than at points on the surface of the wire. On the other hand, if the circuit is broken after the distribution of current has reached the uniform state, the outer portions of the conductor will first be free from current.

These effects may be accurately described by the statement that the current grows from the outer layers of the wire inward, and that the current inside the conductor attains the same value as that at the surface, only after a finite interval of time.

When a rapidly alternating emf. is impressed upon the conductor, (a) the phase of the current inside the conductor lags behind that of the current at the surface by an amount which is greater the nearer the point is to the axis; and (b) the amplitude of the current is largest at the surface and decreases as the axis is approached because sufficient time has not been allowed for the final steady value to be reached before the emf. was changed. This non-uniformity of current distribution in the cross section is known as the "skin effect," and it is equivalent to a reduction of the cross section of the conductor with consequent increase in its resistance.

From these considerations, it will be seen that in addition to its dependence on the frequency, the skin effect will be more serious, the thicker the conductor and the greater the permeability and conductivity of the material of which it is composed; for the thicker the conductor, the longer the interval which must elapse before a change in emf. will be felt at the center of the conductor and thus the greater the difference in the current density at different points of the cross section. With given dimensions, the greater the permeability of the wire, the greater the emf. induced in its mass. The better the conductivity, the less the ratio of the effective current to the value at the surface.

A numerical calculation of the magnitude of the skin effect can be made only in a few special cases for which Circular 74, pages 299-308, should be consulted. Table 18 of Circular 74 will enable one to see at a glance how great diameter of wire is allowable, in order that the increase of resistance due to skin effect shall not exceed 1 per cent of the direct current value. Such data are of use in estimating the size of wire suitable for a hot wire ammeter, in order that its resistance may not vary in the range of frequency for which it is intended. For larger diameters of wire the effect increases rapidly and cases where the high frequency resistance is five to ten times the direct current value are not rare. These facts must be kept in mind when estimating the current carrying capacity of a conductor. The "resistance ratio" is defined as the ratio of resistance at the frequency in question to the resistance to direct current. Then, for the same heating, the allowable current at the high frequency will be less in the ratio of the square root of the resistance ratio.

Since the skin effect tends to render useless for the carrying of the current the inner portions of the cross section of a wire, thin tubing, or a thin layer of good conducting material plated on the surface of a poor conducting cylinder is a form of conductor suitable for carrying currents of radio frequency. In fact, tubing which is very thin in comparison with its radius has for the same cross section a smaller high frequency resistance than any other single conductor.

To reduce the skin effect, a conductor is often built up of a number of very fine conducting strands. The resistance ratio of such a combination is, however, on account of the mutual inductance of the strands, appreciably greater than the resistance ratio of one of the strands. To be effective, the strands should be placed as far apart as practicable, and the diameter of the individual strands should not exceed about 0.1 mm. The most effective form of stranded conductor, although expensive to make, is one where the strands are so twisted as to form a woven tube. For further particulars see pages 306-308, of Circular 74.

Effective Resistance.—The resistance of a circuit at high frequency is never the same as the resistance measured by direct current. To define what is meant by the resistance at high frequencies, we have to divide the power lost in heating or otherwise dissipated, by the square of the effective current. This quotient is known as the "effective resistance" at the frequency in question.

The effective resistance of a circuit carrying currents of radio frequency may be very appreciably affected by the presence of neighboring conducting bodies. The energy of any eddy currents which may be induced in the latter is drawn from the circuit in question, whose effective resistance is thereby increased. On account of the high frequency, this effect can be astonishingly large in good conductors and may be appreciable in the presence of such a poor conducting path as a painted surface.

Different portions of the same circuit should not be placed in close proximity. The mutual effects of the currents which flow in opposite directions in two parallel cylindrical wires is, for example, such as to cause the maximum current densities in the two cross sections to be shifted to points nearer the other conductor, with an increase in the effective resistance of each conductor above the value it would possess in the absence of the other. In other cases (p. 302, C. 74) the effective resistance may be reduced by the presence of the other lead. An important example of the effect of the mutual inductance of neighboring conductors on their effective resistances is furnished by a system of parallel wires connected in parallel. In this case more current, at radio frequencies, flows in the outer wires than in the inner, and the differences may become very important. This is a point which cannot be overlooked in the design of hot wire ammeters to carry large currents.

118. Brush, Spark, Dielectric, and Radiation Resistance.—As has already been explained (Secs. 31 and 58), no dielectric is perfect. Some heating takes place in it, and we may artificially represent a condenser as equivalent to a pure capacitance in series with a resistance. The introduction of a condenser into a radio circuit has therefore the effect of increasing the effective resistance of the circuit, and, except in especially designed air condensers, this effect cannot be neglected. Care needs therefore to be taken that poor dielectric materials be kept away from regions of intense electric field.

When operating condensers at high voltages, large energy losses may occur in the so-called brush discharge, and this effect will generally give rise to a very considerable increase in the effective resistance of the condenser.

If a spark gap is included in a circuit, the resistance of the spark will have to be included in the total effective resistance of the circuit. This spark resistance depends upon a number of circumstances, and the laws of its variation are very complex. In general,

a short spark gap has a larger conductivity per unit length than a long one. Thus a series of short spark gaps is better than a single one of the same length as the sum of the lengths of the shorter gaps. The pressure and nature of the gas between the terminals also affect the resistance which is materially decreased with reduction of pressure. Further, the nature of the terminals and the constants of the remainder of the circuit all affect the spark resistance.

Some of the power supplied to a circuit which is carrying a radio current, is radiated from the circuit in the form of electromagnetic waves (see Chap. 5). This may be regarded as the useful work obtained from the circuit, and for transmission purposes the power radiated should be made as large as possible, in comparison to the power dissipated in the circuit itself, and in its immediate surroundings. The power radiated at any frequency is found to be proportional to the square of the current flowing, so that the radiative

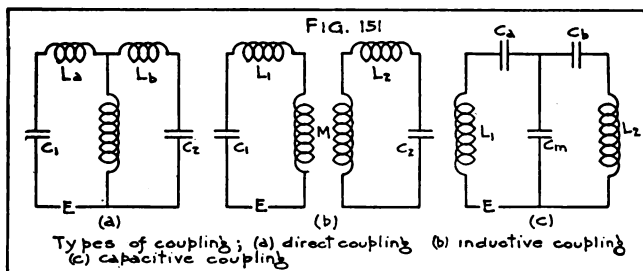

effect may be regarded, artificially, as causing a definite increase in the effective resistance of the circuit. This fictitious resistance increase is known as the "radiation resistance," and is found to be directly proportional to the square of the frequency, or inversely proportional to the square of the wave length.

D. Coupled Circuits.

119. **Kinds of Coupling.**—When two circuits have some part in common, or are linked together through a magnetic or an electrostatic field, they are said to be "coupled." When the part in common is an inductance (Fig. 151-a), the two portions of the circuit are said to be "direct coupled." In Fig. 151-c the part in common is a capacitance and this gives an example of "capacitive coupling." In the important case in which the circuits are mutually inductive

(Fig. 151-b) the circuits are said to be "inductively coupled." More rarely the coupling is an "electrostatic" kind in which the plates of a condenser in one circuit are placed between those of a condenser in the other circuit.

It is customary to denote as the "primary" that circuit in which the applied emf. is found, the other being regarded as the "secondary" circuit. When two circuits are coupled they react on one another so that the current in each circuit is not the same as would be the case were the other circuit absent. The extent of the reaction is, however, very different in different cases. Circuits are said to be "closely coupled" when any change in the current in one is able to produce considerable effects in the other. When either circuit is little affected by the other, the coupling is regarded as "loose." The coupling between two inductively coupled circuits is made looser by increasing the distance between the two coupling coils.

A more exact measure of the closeness of the coupling is given by what is called the "coefficient of coupling" (denoted by k). Its value in the case of direct coupling (Fig. 151-a) is given by

$$k = \frac{M}{\sqrt{(L_a + M)(L_b + M)}} \quad (80)$$

If the total inductances of the circuits in Fig. 151-b are denoted by L_1 and L_2 , we have for inductive coupling

$$k = \frac{M}{\sqrt{L_1 L_2}} \quad (81)$$

and for capacitive coupling (Fig. 151-c),

$$k = \sqrt{\frac{C_a C_b}{(C_a + C_m)(C_b + C_m)}} \quad (82)$$

As the coupling is made very loose, k approaches zero as its limit for the closest possible coupling k would be unity.

The coupling of two direct coupled circuits may be increased by increasing the amount of inductance which is common to the two circuits, maintaining constant the total inductances $(L_a + M)$ and $(L_b + M)$ of the two circuits. To make the coupling of the inductively coupled circuits closer, their mutual inductance is increased by moving the coils nearer or by increasing the inductance of either coil. For example, the coefficient of coupling of an antenna may

be increased by adding turns to the coil of the oscillation transformer, enough inductance being subtracted from the loading coil to keep the total inductance of the circuit constant. Capacitive coupling is closer, the smaller the common capacity C_m is in comparison with the capacities C_a and C_b .

In some types of receiving apparatus the coupling condenser is connected in a different manner from that shown in Fig. 151-c (see Sec. 177), and in that case the coupling is loosened by a decrease of capacitance in the coupling condenser.

The reaction of either circuit on the other affects, not only the value of the currents in the coils, as would be expected, but has an important influence on the frequency to which the circuits respond most vigorously. This is explained in the following.

120. Double Hump Resonance Curve.—It may be shown (Secs. 16 to 18 of C. 74) that the reactance of either of the circuits, primary or secondary, is zero, that is, the impedance is a minimum, for two separate frequencies f' and f'' , which are different from the natural frequencies f_1 and f_2 , for which the primary and secondary circuits are in resonance when taken alone. With loose coupling f' and f'' differ little from f_1 and f_2 . With closer coupling, however, the differences become very appreciable. If f' be used to denote the lower of these two frequencies, then it may be shown that f' is always still lower than the lower of the two natural frequencies f_1 and f_2 , while the higher frequency f'' is always higher than the higher of the two natural frequencies. Increasing the closeness of the coupling has always the effect of spreading f' and f'' further apart. Furthermore, the difference between f'' and the higher of the two natural frequencies is always greater than the corresponding difference between f' and the lower of the natural frequencies.

These conclusions may be tested by means of a wavemeter. As has been already pointed out (Sec. 112), the current induced in a wavemeter circuit is a maximum when the wavemeter is tuned to the frequency of the exciting current. Suppose the wavemeter to be very loosely coupled to either the primary circuit or the secondary. Let the frequency of the current in the primary be varied by small steps and adjust the setting of the wavemeter for each frequency until the indicator shows a maximum current in the wavemeter circuit. If the settings of the wavemeter condenser and the corresponding deflections of the indicating instrument are plotted, a resonance curve is obtained which will show two humps or peaks corresponding to the frequencies f' and f'' . The positions of the

two humps will be found to be different for a second resonance curve, taken with a different coupling between the primary and the secondary. The coupling between the wavemeter circuit and the circuit which is exciting it must be made as loose as practicable in order that the wavemeter circuit may not react appreciably on the other circuits and thus change their currents.

A more direct method of showing the two frequencies is furnished by simply inserting a hot wire ammeter or thermocouple in the circuit to be examined and noting the changes in its readings as the frequency is continuously varied.

In the case of the usual coupled radio circuits, the two circuits, primary and secondary, are adjusted independently to the same natural frequency. That is, f_1 is made equal to f_2 . When the coupling is made loose, both f' and f'' approach the same value, f'' from above and f' from below, and at very loose coupling, $f' = f'' = f_1 = f_2$.

It might be supposed that in the special case where $f_1 = f_2$, the currents in the circuits would be a maximum for a single frequency only, namely, at the value of f to which they are both tuned. Nevertheless, both experiment and theory show that each circuit, even in this case, offers a minimum impedance at two different frequencies, just as is found for the more general case. The two frequencies f' and f'' lie on either side of the value f , though not at equal intervals from the latter, the difference $f'' - f$ being always greater than $f - f'$.

When $f_1 = f_2$, the effect of the coupling on the values of f' and f'' is shown by the simple relations

$$f' = \frac{f}{\sqrt{1+k}}, \quad f'' = \frac{f}{\sqrt{1-k}}$$

If the coupling is made more and more loose, the two frequencies f' and f'' approach one another, and the two humps of the resonance curves finally merge and become indistinguishable from a single hump.

In the absence of a secondary current, there is no reaction on the primary, which is no longer a coupled circuit, and will necessarily be in resonance at a single frequency only (f by hypothesis). The same remarks apply to the secondary when the primary circuit is broken.

The further treatment of coupled circuits naturally follows two different lines, according to whether the primary is excited by a

sine wave of a definite frequency (producing oscillations), or whether the primary circuit is given a single impulse and then allowed to oscillate freely.

121. Forced Oscillations.—When a sine emf. of frequency f is applied to the primary, the currents in the two circuits, primary and secondary, are at first very complicated, consisting of oscillations of the two frequencies f' and f'' , superposed upon forced waves of frequency f . The free oscillations quickly die away, and there remain sine currents of frequency f in both the primary and secondary.

High Frequency Transformer.—It can be shown that to obtain the maximum current in the secondary circuit, a certain value of the coupling of the coils is necessary. If the coupling be made either closer or looser than this value, the secondary current falls off in value. In general, the proper coupling for maximum secondary current will depend upon the resistances of the primary and secondary and their reactances, and can be determined better by actual experiment than by calculation. For one important case, however, the values of the coupling and the maximum secondary current can be expressed very simply.

If the primary and secondary circuits are separately tuned to the frequency of the applied alternating emf. E , the maximum possible secondary current has the value $I_2 = \frac{E}{2\sqrt{R_1 R_2}}$ where R_1 and R_2 are the primary and secondary resistances. The value of the mutual inductance (coupling) which gives the maximum secondary current may be calculated from the relation $2\pi f M = \sqrt{R_1 R_2}$. The primary current under these circumstances assumes the value $I_1 = \frac{E}{2R_1}$ which is one-half the resonance value of the primary current when the secondary is absent.

These relations and the dependence of the secondary current on the coupling are illustrated in Fig. 152, which shows the changes of the secondary current as the mutual inductance between the coils is varied. The resistances $R_1 = 2.0$ and $R_2 = 12.5$ ohms are assumed, and the secondary current is plotted in terms of its maximum value, which is taken as 1. As abscissas are taken, not the mutual inductance itself but $2\pi f M$, so that the curve is applicable to different frequencies, assuming, of course, that in every case the two circuits are tuned to the frequency in question. Maximum secondary current is, in this example, obtained for $2\pi f M = \sqrt{2.0 \times 12.5} = 5$. Supposing,

for instance, that the frequency is 100,000, the coils must be so placed that their mutual inductance is $\frac{5}{2\pi \times 100,000}$, or 7.96 microhenries.

Current and Voltage Ratios.—The current ratio (secondary to primary) in the high frequency transformer, when adjusted to give maximum current, has been shown to be $\sqrt{\frac{R_1}{R_2}}$, so that, in general, it may be increased by decreasing the secondary resistance or by increasing the primary resistance.

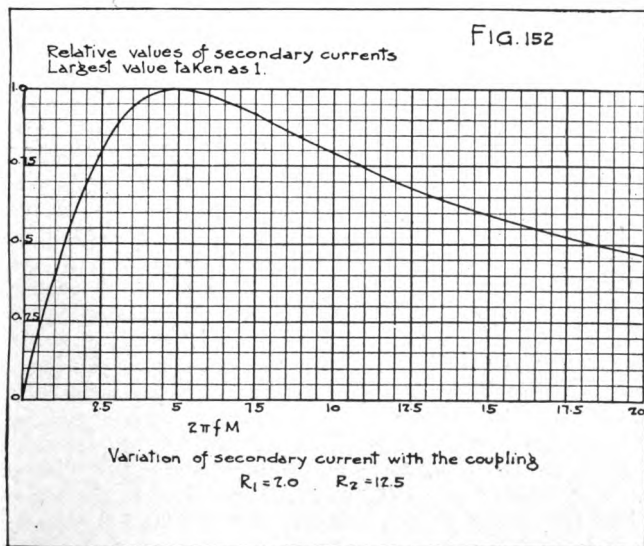

The voltage ratio is in general more complicated. If the two currents are tuned to one another and to the impressed frequency, the voltage ratio (secondary to primary) approaches the value $\sqrt{\frac{C_1}{C_2}}$ as the resistances in the circuits are made smaller. If the circuits are not tuned to the same frequency, but are closely coupled, the voltage ratio approaches the ratio of the number of turns on the two coils (when the resistance may be neglected), which is the case of the usual alternating current transformer.

122. Free Oscillations of Coupled Circuits with Small Damping.— Suppose the condenser in the primary circuit is given a charge, and the primary circuit is closed directly or through a spark gap. If the secondary circuit is open, the primary will oscillate freely, the frequency of the current being given by the equation $f_1 = \frac{1}{2\pi\sqrt{L_1 C_1}}$, the damping of the oscillations being determined by the ratio $\frac{R_1}{2\tau f L_1}$ as treated in Section 116.

As soon as the secondary is closed, the matter is complicated by the reaction of each circuit upon the other. An emf. is induced in the secondary by the changes of the primary current, and thereby a forced oscillation is started in the secondary. The secondary condenser is charged by this current and starts a free oscillation, whose period will depend on the constants of the secondary circuit. This latter wave will induce a forced oscillation in the primary, and similarly the oscillation which was forced in the secondary by the primary, will react on the primary, modifying the original oscillation in the primary which produced it. The oscillations in the primary will then further react on the secondary, and so on.

Naturally, the result will be very complicated. but it is evident that each circuit is the seat of two waves. one free and the other forced by the other circuit. Each of the waves which we have designated as free is, however, not entirely so. since it forces an oscillation of its own frequency in the other circuit, and has to supply the energy for this induced wave. This has the effect of modifying the frequencies of these waves from the natural values f_1 and f_2 already treated. Of the two waves in the primary, the free wave has (with loose coupling) the greater amplitude, and the same is true of the secondary except that here the amplitudes of the waves are more nearly equal. With close coupling, the forced wave in the primary becomes stronger, owing to the increased amplitude of the secondary free wave. Finally, with very close coupling, those waves predominate the frequency of which is f' . The frequency f'' of the other waves lies so far above the natural frequency of either circuit that only feeble oscillations of this frequency are present.

In general therefore the oscillations in both the primary and secondary circuits are compounded of two damped oscillations of different frequencies. It is of interest to study a little more closely the nature of the complex oscillations resulting from the super-

position in a single circuit of the two oscillations of different frequencies.

Damping Curves of Coupled Circuits.—Fig. 153 shows two sine waves *A* and *B* of equal amplitudes but of different frequencies. Curve *C* is obtained by taking the algebraic sum of the ordinates of *A* and *B*. It is seen to be a curve the oscillations of which alternately increase and die away. The frequency of these fluctuations is equal to the difference of the frequencies of the components *A* and *B*. The curve *C* passes through its zero values at nearly regular intervals of time, excepting at those moments when the resultant amplitude is passing through its minimum, when the curve makes an additional passage through zero at the moment the resultant maximum amplitude is zero. It is also noticeable that the loops of the curve *C* are only approximately of sine shape.

An exactly analogous case is furnished by the resultant sound wave coming from two tuning forks which are vibrating with some-

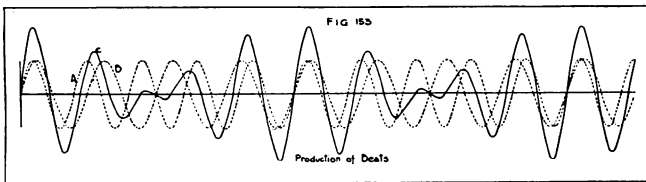

what different frequencies. The sound which is heard alternately increases and decreases in loudness, giving the phenomenon of "beats." The number of beats per second is equal to the difference in frequencies of the two forks. Thus, if two forks have frequencies of 259 and 255 vibrations per second, they combine to give a sound which beats four times per second.

Free oscillations in coupled circuits are damped, so that in addition to the alternate waxing and waning of the resultant oscillation, the energy of the oscillation as a whole dies away according to the laws already treated in Section 116. Fig. 154 shows the nature of the damped oscillations in the primary and secondary circuits. The primary decrement is assumed to be 0.1 and that of the secondary 0.05. The two coexistent frequencies are supposed to have the ratio of 4 to 5. The curve of oscillations is in each case drawn as a full line. The dotted curves show the beating effect described above, while the dashed curves give an indication of the damping

effect. It is noticeable that the primary current is passing through its maximum values at the moments when the secondary current is zero, and vice versa. Further when the primary is passing through a period of intense oscillation the secondary oscillations are small, etc.

Another important conclusion which can be drawn from Fig. 154 is that the energy of the coupled system is transmitted alternately from the primary to the secondary, and back again from the secondary to the primary. Thus, at certain moments the energy is entirely in the primary, at others entirely in the secondary, and at other instants partly in the primary and partly in the secondary.

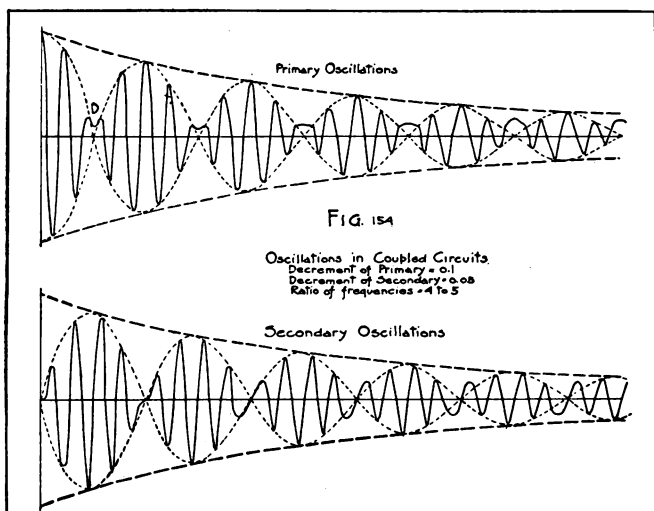

This transfer of energy, first in one direction and then in the other, shows that the primary and secondary play alternately the rôle of driving circuit.

From the standpoint of radiation of energy, it is desirable to hinder the return of energy to the primary, after it has once been given to the secondary. Since the closed primary circuit is of such a nature as to radiate very little energy (see Sec. 136), no useful purpose is served by the transfer of energy back to the primary, and some of the energy thus handed back is necessarily lost in heating in the primary. Further, the radiation of the energy of the secondary in

waves of two different frequencies is undesirable. The receiving circuit can be tuned to give a maximum of current for either one of the incoming wave frequencies, but not for both at the same time. The partition of the radiated energy of the secondary in waves of two frequencies is therefore wasteful, since only that wave to which the receiving circuit is tuned is effective, while practically none of the energy of the other wave is usefully employed, and it may cause interference with other stations.

123. Impulse Excitation. Quenched Gap.—If by some means or other, the energy of the primary circuit can be transferred to the secondary and then all connection between the circuits can be removed before any energy can be handed back to the primary, we may avoid the disadvantages just mentioned. In this case, the secondary will oscillate simply in its own natural frequency, and the loss of energy in the primary can be restricted to the short interval during which the primary is acting. By properly choosing the resistance of the secondary, the damping of the radiated wave may be kept small, and since only a single frequency is radiated, the advantages of close tuning of the receiving circuit can be realized. Such a method of excitation is known as “impulse excitation,” and is analogous to the mechanical case where a body is struck a single sharp blow, and thereafter executes vibrations, the period of which depends entirely on the inertia and elasticity constants of the body itself, and not at all on the nature of the body from which the impulse has emanated.

One means of obtaining an impulse excitation of the secondary is to insert so much resistance in the primary that its current falls away aperiodically (see Sec. 116). This has, however, the disadvantage that considerable energy is lost in the primary due to the heating of the rather large resistance of the primary by the initially rather large primary current. A more satisfactory arrangement is the “quenched gap.” By dividing the spark gap in the primary into a number of short gaps in series, the cooling effect of the relatively large amount of metal is available for carrying away the heat of the spark discharge. This is found to be sufficient, in the case of a properly designed quenched gap, to prevent the reestablishment of a spark discharge after the first passage of the primary oscillations through their condition of maximum amplitude to zero, as at point *D*, Fig. 154. The secondary, at this moment, is the seat of the whole of the energy of the system and thereafter oscillates at the single frequency natural

to it. The damping of the primary does not have to be made excessive, and the energy lost in the primary is restricted to the heating during the short interval before the quenching of the primary oscillations.

Fig. 155 shows the form of the oscillations in the two circuits for this case. The curves are the same as in Fig. 154 up to point *D*,

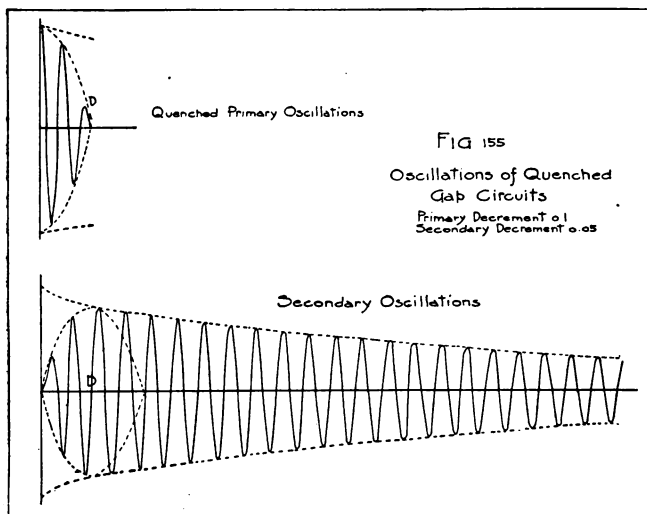

after which the secondary curve is a simple feebly damped oscillation. The construction and operation of the quenched gap are treated further in Chapter 5, Section 156.

CHAPTER 4.

ELECTROMAGNETIC WAVES.

A. Wave Motion.

124. **Three Ways of Transmitting Energy.**—All of the ways of signaling between distant places operate by one or by a combination of these three methods:

- (a) By a push or pull on something connecting the two places.
- (b) By projectiles.
- (c) By wave motion.

Thus think of all the ways in which you can arouse a dog asleep at the other side of the room. You can prod him with a long stick (method *a*). You can throw something at him; if you hit him it is a case of method *b*; if you miss him, the noise made when the missile hits the wall or floor may wake him, in which case we have a combination of methods *b* and *c*. You can whistle or call (method *c*). You can flash a light in his eyes (method *c*). Any way that you can think of is an example of one of these three methods. Of the three methods the most important for our purpose is the third.

125. **Properties of Wave Motion.**—Everyone is familiar with water waves. Many of their properties are common to all kinds of waves. Thus the alternate crests and hollows, though invisible in many types of waves are present in all. Examples of different wave shapes are shown in Figs. 80 and 95, Chapters 1 and 2. The simplest wave shape is the sine wave (Fig. 80).

Also, as in the case of water waves, all waves have a definite wave length λ , which is the distance between successive crests or successive hollows. If we use the term phase to mean the position at any time of a point on the wave outline, we can say that in general the wave length is the distance between two successive points in the same phase.

Furthermore, waves of all kinds travel with a definite velocity. If one looks at a fixed point on the surface of a pool over which ripples are moving, he can see that a crest appears at that point a

definite number of times in any given interval of time. The number so appearing in one second is called the frequency, f . If now the frequency is multiplied by the length of one wave, we get the distance moved by the waves in one second, which is the velocity, c , or, in symbols, $c = \lambda f$. The velocity of waves of different kinds is very different in amount. Thus ripples on water travel with velocities of from 10 to 100 cm. per second; for sound waves in air the velocity is 330 meters per second; and the velocity of light and electric waves is 300,000,000 meters per second.¹

The more the surface of the water is displaced by the waves from its position of rest, the greater is the amount of energy being passed along. The amount of energy transmitted by water waves is connected with the height of the crests and the depth of the troughs. This also is true of all kinds of waves. The greatest displacement from the position of rest that any point undergoes is called the "amplitude" of the wave. Thus we say that the energy in wave motion depends upon the amplitude. The amount of energy in the wave depends on the work which has to be done to produce the displacement. This is in general equal to the product of the resisting force and the distance moved. Now in the case of many kinds of waves, including electric waves, the resisting force is proportional to the distance moved. Hence the work done and the energy transmitted is proportional to the *square* of the amplitude of the wave.

126. **Wave Trains, Continuous and Discontinuous.**—If a stone is dropped into a quiet pool of water, a "train" of waves is started which soon passes out from the starting point in all directions, leaving the surface behind it undisturbed. If a second stone is dropped just at the moment that the surface at the starting point has completed one up-and-down excursion, another wave train will start in phase with the first, and the two will form one train. If the process is repeated once after each complete vibration of the surface at the starting point, continuous waves are produced. Similarly, if we hold a vibrating body so that it touches the surface, continuous waves are produced. By interrupting the vibrations of the body, we can produce interrupted or discontinuous trains of waves.

¹ *Example.*—What is the wave length of waves having a frequency of 100,000 cycles per second which travel with a velocity of 300,000,000 meters per second.

$$\lambda = \frac{c}{f} = \frac{300,000,000}{100,000} = 3000 \text{ meters.}$$

Examples of these two kinds of wave trains are met with often. Thus the sound from a musical instrument where the strings are set in vibration by picking (as with a mandolin) is transmitted in discontinuous trains, while that from an instrument whose strings are bowed (as a violin) is transmitted by more nearly continuous waves. Similarly, in radio we have to do with both kinds, continuous waves being furnished by high frequency alternators, the Poulsen arc, and the oscillating vacuum tube, while discontinuous trains are given by condenser discharges in spark circuits. In these latter the amplitude of the waves diminishes steadily in each wave train; these are called "damped" waves. Such waves are discussed in Section 115.

B. Propagation of Waves.

127. **Waves Propagated by Elastic Properties of Medium.**¹—In the case of ripples on the surface of water it is plain to the eye that the waves are transmitted by the passing on of the up-and-down motion of the surface at the source. This is possible because at the surface of the water the particles of the water are held together by forces which resist their displacement. When one particle is displaced, its neighbors are dragged with it to some extent. In technical terms, the medium of transmission is said to have "elastic" properties and the forces brought into play are said to be elastic forces. The velocity of the waves (ripples) depends on the nature and amount of these elastic forces.

In the case of sound waves in air, we do not ordinarily see the vibrations of the particles of the air. The vibrations are quite small and the waves travel so fast that only under quite unusual conditions can they be made visible. But the mechanism by which the energy is transmitted is found to be of the same kind as in the case of water ripples. By the delicate elastic connections between neighboring portions of the air a vibration at one point is passed on to another. Sound waves are of another type than water waves only because the structure of air is different from that of water. Hence the elastic reaction to displacement is different in the two media. This is the sole cause of the differences between any two types of waves.

128. **Properties of Electromagnetic Waves.**—In the case of electromagnetic waves, often called "electric waves," the displacements produced are of the kind already considered in the section on capaci-

¹ For further explanation of the radiation of electric waves, see Starling, "Electricity and Magnetism," pp. 423-429.

tance (Sec. 2J). The elastic reactions set up by such displacement currents can be found by the same laws which determine the electric and magnetic forces due to any current. It is beyond the scope of this book to show the nature of these electrical elastic forces. It will be sufficient, however, to state that they are such as to produce waves in which (in free space)—

(a) The displacement (and the electric field intensity) are at right angles to the direction of motion of the wave train.

(b) The magnetic field intensity resulting from the displacement current is at right angles to the displacement and to the direction of the wave train.

(c) The variations in the displacement (or the electric field intensity) and the magnetic field intensity are in phase.

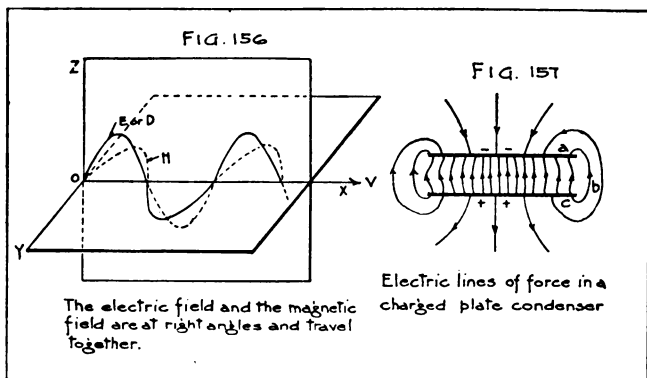

(d) The velocity of the waves is 3×10^8 meters per second, the same as the velocity of light.

These relations are shown in Fig. 156, where the curve marked *E* or *D* shows the variations in the electric field intensity or displacement, and that marked *H* the variations in the magnetic field intensity, the wave moving in the direction shown by *v*.

129. Modification of Waves in Free Space Near the Earth.—Such waves if started at a point in free space travel in all directions with the same velocity. They may be modified in various ways as they proceed. Thus, if they pass into a region of different dielectric constant, they are in general changed slightly in direction and partly reflected. Their energy is also absorbed to a greater or less

extent in their passage through any medium. This absorption is greater for short than for long waves. In a perfect conductor no waves could be transmitted, since in such a medium there is no elastic opposition to the displacement of electricity. A perfectly conducting sheet would reflect all of the wave energy falling on it. However, a conductor parallel to the direction of motion of a wave acts as a guide to the wave, through the action of currents induced in it by the varying magnetic field of the wave. It takes less energy from the waves, the better conductor it is. In the use of electric waves in radio communication, all of these modifications occur and serve to explain many of the irregularities of received signals. We can think of the space through which radio signals are sent as being bounded below by a sheet of varying conductivity (the earth's surface) and above—at a distance of from 30 to 50 miles—by another conducting region. This upper region where the air is much rarefied is a fairly good conductor, owing to its ionization by radiations from the sun. The region in between these conducting layers is usually a good dielectric. Thus, this region acts more or less as a speaking tube does for sound waves, though its action is much more complicated. The electromagnetic waves are set up near the earth's surface. They are partly transmitted as guided wave trains along the earth's surface, modified by refractions and absorption at its irregularities; another part, however, goes off as space waves, which by reflections at the upper and lower layers of the conducting boundaries may recombine with the guided wave in such a way as either to add or subtract their effects, depending on circumstances. In the daytime the upper conducting boundary will be less definitely marked than at night, on account of partial ionization of the air by the sun's radiations. Hence, there will be less reflection of the space wave in the daytime, and consequently the guided wave will produce the greater part of the effect at the receiving station. In the night, however, when the upper boundary is more sharply defined, there is more reflection of the space wave, and in general signals received at night are stronger than in daytime. Night signals are, however, more variable in intensity, particularly for short waves. This is especially true during the time when the sunset line is passing between two communicating stations. This is in general what we should expect, as the upper boundary would be quite variable under such circumstances. Clouds and other meteorological conditions would cause great variations in the sharpness of this boundary sur-

face, and this may explain the rapid fluctuations in the strength of received signals often observed.

From all these considerations it can be seen that the conditions under which received signals will be most uniform in intensity are:

- (a) Transmission using long waves.
- (b) Transmission by daylight.
- (c) Transmission over short distances.
- (d) Transmission over uniform conducting surface of sea water.

It is only under these conditions that the performance of different transmitting stations can be fairly compared.

130. **Static.**—The transmission of signals by electromagnetic waves is often interfered with by stray waves and static charges called “strays” or “atmospherics,” which give rise to variable currents in the receiving antennas. These cause troublesome, interfering sounds of a harsh, irregular nature in the radio receiver. These effects are most frequent in summer and especially in a thunderstorm. They are often very pronounced when a thunderstorm is a few miles away. They appear to be of two kinds; (a) charges of electricity which come from the surrounding atmosphere upon the antenna and then discharge to ground producing a current; and (b) electromagnetic waves which are produced by distant lightning or other electromagnetic disturbance in the atmosphere. Strays are the worst enemy of radio communication, especially in tropical countries. No satisfactory method of eliminating them has been devised. They are much reduced by taking certain precautions. One is the use of loose coupling between the receiving antenna and detecting circuit. Another is the use of waves of zero or small decrement and receiving apparatus which can be very sharply tuned. The use of a musical note in the transmitted signals also helps to overcome disturbance from strays. Strays have been found in some cases to be reduced by using small antennas or closed coil receiving aerials, with amplifiers.¹

C. Theory of Production and Reception of Electromagnetic Waves.

To produce a train of waves of any kind, a vibrating body is necessary. The vibrations of this body have next to be communicated to a continuous medium, after which the elastic properties of the medium

¹ Information on strays and special methods of overcoming them is given in Fleming, “Electric Wave Telegraphy and Telephony,” 3d ed., pp. 774, 851, and Goldsmith, “Radio Telephony,” p. 220.

take care of the transmission of the waves. In the case of electromagnetic waves the vibrating body is an oscillating electric charge in a circuit (the sending antenna circuit), while the means by which these oscillations are communicated to free space can best be described in terms of the motion of the lines of force which, when at rest, are used to picture the field about electric charges as in Fig. 53.

These lines are to be looked at as lines along which there is a displacement of electricity against the elastic force of the medium. Thus they cannot exist in conductors (in which no such elastic forces exist). Under the action of the elastic forces the displaced electricity is continually urged to return to its position of rest. In other words, there is a tension along the lines of force. In addition there must be a pressure at right angles to the lines of force, otherwise those lines would always be straight and parallel under the action of the tensions. These pressures can be thought of as arising from the repulsion between the displaced charges of the same sign in neighboring lines.

131. Magnetic Field Produced by Moving Lines of Electric Displacement.—Consider what happens to the lines of force when a condenser is discharged. Before the discharge begins, the field is as shown in Fig. 157. Now, suppose a wire to replace the line *abc*, thus discharging the condenser. The displacements previously existing along *abc* vanish, or, in other words, the line shrinks to nothing when the tension is relieved. But this, at the same time, does away with the sidewise pressure on the neighboring lines, which as the pressure from the lines outside of them still remains, move inward toward the wire under the action of this unbalanced pressure. Their ends slide along the plates of the condenser during this motion and when they come to the wire the displacements along their length vanish. This process continues until all the lines have vanished and the condenser is discharged.

Now, while this is happening to the electric lines of force in the field, a current has been flowing in the condenser plates and the wire *abc*; also the magnetic lines of force which always accompany any current have sprung into existence and continue to exist as long as the current flows. In the space between the condenser plates, these magnetic lines of force will be directed up from the plane of the paper at right angles, both to the electric lines of force and to the direction of their motion. These two facts can be described in terms of the

motion of the lines by saying that the motion of the ends of the electric lines along a conductor causes a current to flow in it, while the motion of the electric lines at right angles to their own length produces magnetic lines of force in the other direction, which is perpendicular to the direction of motion. If the motion of the electric line is parallel to its length, there will be no magnetic field produced. From this point of view, what takes place in the medium is the cause of what takes place in conductors. The energy in the former (in the case we are considering) appears in the latter as heat.

132. **Mechanism of Radiation from a Simple Oscillator.**—Now consider what takes place when the discharge is oscillatory instead of in one direction. To fix our ideas, let us take the case of the simple

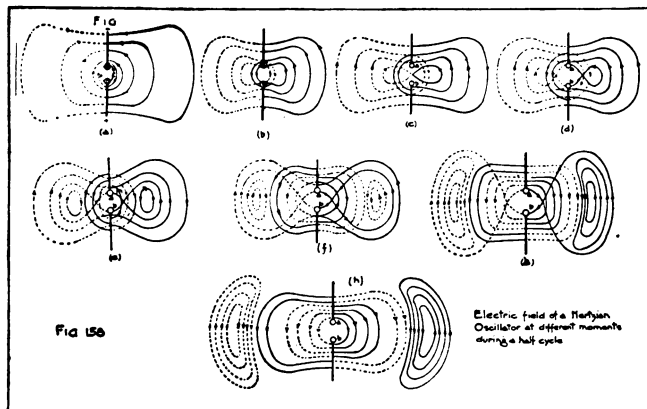

Hertzian oscillator, the electrostatic field of which, before the gap becomes conducting, is shown in Fig. 158-a. (The field to the left is shown by dotted lines, in order to be able to keep track of each line clearly in its motion as shown in the following figures.) When a spark passes and the gap becomes conducting, the electric line of force ab vanishes and those from each side begin to move up under the unbalanced sidewise pressure, as before. Here, however, when the ends of the line abc reach the gap, we must suppose that it has sufficient momentum so that the ends cross and the middle portion travels across the gap. After two lines have done this, the state of things is as represented in Fig. 158-b. There will soon come a different state of things, however, owing to the shape of the lines.

When the ends get to the gap before the middle portion, as shown in Fig. 158-c, they will cross as before, and soon thereafter we will have the loop formed as in Fig. 158-d. Now, at some time as the ends continue to go up, this loop will break, forming two parts m and n , as shown in Fig. 158-e. This is because at that moment the angle of intersection becomes so acute that each part of the line will be moving parallel to its length, in which case neither half will have any magnetic field and, consequently, no momentum to carry them by each other. The process goes on as shown in Figs. 158-f, g, and h, the last of which shows the state of things when one half oscillation has been completed, and the charges on the oscillator have been reversed in sign. A cylindrical sheet of lines of force has then been detached from the oscillator and is traveling outward. At this moment those lines left attached to the oscillator have been stretched as far as their momentum can carry them, and they begin to contract again and repeat the process, provided the gap is still conducting. In the next half wave length, another cylindrical sheet of lines of force will be snapped off, so to speak, and the process will continue until the energy lost as heat in the oscillator has exhausted the supply of lines which remain attached to it. These cylindrical sheets, as they spread out, become more and more nearly plane, the plane being perpendicular to the motion away from the oscillator. During the process shown in Figs. 158-b to 158-g, that is, while the current in the oscillator is flowing upward, the motion of the electric lines of force generate magnetic lines (not shown), which form circles around the oscillator running into the paper to the right and coming out on the left. These magnetic lines vanish at any point, when the electric lines of the attached field come to rest as in Figs. 158-a or 158-h, but continue with the moving electric lines of the radiated cylindrical sheet. When the cylindrical sheets have moved so far that they can be considered practically as planes, then the magnetic lines also lie in these planes, but perpendicular to the electric lines and to the direction of motion.

In the case of a simple vertical antenna, the mechanism of radiation is quite similar. In this case, however, since the lower end of the antenna is earthed, only the upper halves of the waves shown in Figs. 158-a to 158-h are produced, so that the field looks like that shown in Fig. 159, where the electric lines are shown in elevation and the magnetic lines in plan, while in between is shown the wave form common to both. At any one point in space, the

lines approach and separate like a bellows. When the wave has progressed so far that the lines can be regarded as sections of planes, the state of things will be as shown in Fig. 160 for the electric lines, while the same figure will also represent the magnetic lines if rotated through 90° about the line oz . Where the surface over which the waves travel is not a perfect conductor the ends of the lines will be as shown in Fig. 161.

The same method of picturing the process of wave production applies to other forms of radiating systems of either the open antenna

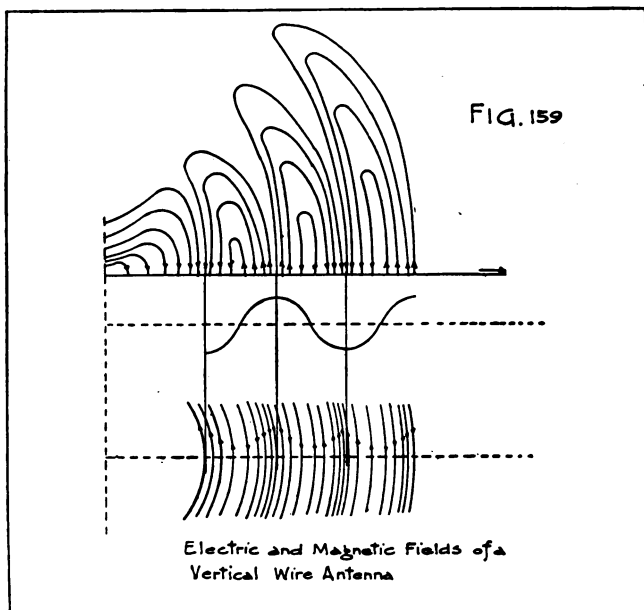

or the closed coil type (see Sec. 151). In all forms loops are formed, and detached in the same general way. In some of them the distribution of the lines of force is such as to favor the production of more such loops than in others; this means that such an antenna will be a better radiator than the others.

133. **Action in Receiving.**—The mechanism of the reception of waves by an antenna can be followed through in terms of the lines

of force in an analogous manner. Thus suppose the antenna to be located with respect to the incoming wave train as shown in Fig. 162. Then the upper ends of the lines as they arrive travel down the antenna as shown in the dotted lines and give rise to moving charges of electricity in the antenna, or the receiving action can be thought of in another way. As the advancing waves sweep across the receiving antenna the electric field intensity along the antenna alternates in value. This is equivalent to an alternating voltage between the top of the antenna and the ground. A still different way of looking at the receiving action depends upon the principle that an emf. is induced in a conductor whenever there is relative motion between the conductor and a magnetic field. The

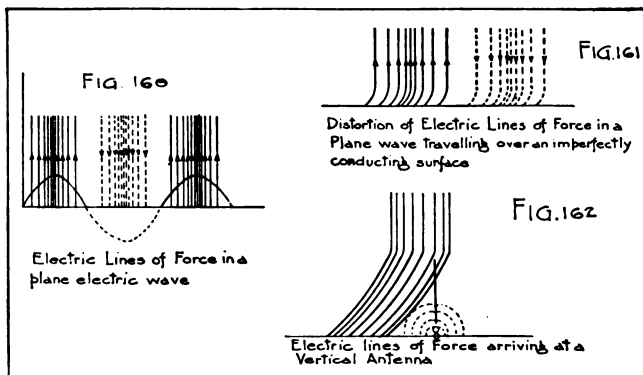

moving wave has a magnetic field which sweeps past the antenna, and thus there is relative motion between the antenna and this magnetic field, which results in an emf. in the antenna. This emf. is what causes the received current in the antenna.

The reception of electromagnetic waves in a closed coil used in place of an antenna can be explained by the same principles. The explanation is somewhat difficult because of the differences of phase between those currents in different parts of the coil. For such antennas it is more convenient to think of the current as produced by the changing magnetic flux through the coil, due to the alternations of the magnetic field associated with the wave. Either way of looking at it leads to the same result.

D. Transmission Formulae.

134. **Statement of Formulae.**—When the general ideas of wave production and reception discussed above are put into exact mathematical language, it is possible to deduce certain practically useful formulae connecting the currents in the sending and receiving antennae, their heights, resistances, and distance apart. While it is beyond the scope of this book to derive them, they are given without proof to aid the student in gaining an idea of the magnitude of the effects to be expected at various distances and with different types of antennae. In the formulae which follow h stands for the height of an antenna or coil, I for current, λ for wave length, d for the distance apart of the two antennae or coil aeriels, while the subscripts s and r refer to the sending and receiving ends, respectively. R stands for the resistance of the receiving circuit. All lengths are supposed to be in meters.

If the waves are sent out by a simple flat top antenna and received on a similar one, we have

$$I_r = \frac{188h_s h_r I_s}{R\lambda d} \quad (83)$$

If the waves are sent out by a simple antenna and received on a closed coil, we have

$$I_r = \frac{1184h_s h_r l_r N_r I_s}{R\lambda^2 d} \quad (84)$$

where l_r is the length of the receiving coil and N_r the number of turns of wire with which it is wound.

If the waves are sent out by a closed coil and received on a simple antenna, we have

$$I_r = \frac{1184h_s l_s h_r N_s I_s}{R\lambda^2 d} \quad (85)$$

where l_s is the length of the sending coil and N_s the number of turns of wire with which it is wound.

If the waves are sent out by a closed coil and received on a similar one, we have

$$I_r = \frac{7450h_s l_s h_r l_r N_s N_r I_s}{R\lambda^3 d} \quad (86)$$

In all of these formulae, if d is greater than 100 kilometers, they must be multiplied by the factor $\epsilon - 0.000047 \frac{d}{\sqrt{\lambda}}$ in order to get

more accurate results. (Both d and λ are in meters, and ϵ is equal to 2.718.)

135. Examples of Use.—To illustrate the use of the formulae suppose it is desired to know how much current must be put into a plain antenna 20 meters high sending a 300-meter wave, in order that the current in a similar antenna 50 km. away shall be detectable easily with a crystal detector (that is, shall be about 1/10,000 amp.), the resistance of the receiving antenna being 10 ohms.

Solving the first equation for I_s , we have:

$$I_s = \frac{R\lambda d I_r}{188 h_s h_r} = \frac{10 \times 300 \times 50,000 \times \frac{1}{10000}}{188 \times 20 \times 20} = \frac{1}{5} \text{ amp. approximately.}$$

As another example, suppose that the receiving antenna, in the first example, is replaced by a square coil of 2 ohms resistance, having sides 2 meters long and wound with 10 turns of wire. If the sending current is $\frac{1}{5}$ amp. as before, what will be the current in the receiving coil? Using the second formula

$$I_r = \frac{1184 h_s h_r l_r N_r I_s}{R \lambda^2 d} = \frac{1184 \times 20 \times 2 \times 2 \times 10 \times \frac{1}{5}}{2 \times 300 \times 300 \times 50,000} = 2.1/10^5 \text{ amp.}$$

For a current of this size it would be best to use a simple vacuum tube receiver instead of a crystal detector.

As a third example, suppose the sending aerial to consist of a single square turn of wire 10 meters on a side, in which the current is $\frac{1}{5}$ amp. at $\lambda=1000$ meters. With how many turns should a square coil 2 meters on a side and having a resistance of 5 ohms be wound to receive at a distance of 50 km., if a vacuum tube which can detect a current of 1/10⁸ amp. is used? Solving the fourth equation for N_r we have

$$N_r = \frac{R \lambda^2 d I_r}{7450 h_s l_s h_r l_r N_s I_s} = \frac{5 \times 10^9 \times 5 \times 10^4 \times 1/10^8}{7450 \times 10 \times 10 \times 2 \times 2 \times 1 \times \frac{1}{5}} = 4 \text{ turns(about).}$$

136. General Deductions.—From the formulae certain general conclusions can be drawn. Thus since λ appears in the denominator, it follows that, for given heights of antennae, sending current, receiver resistance, and distance apart, there will be more current in the receiver, the shorter the wave length used. On the other hand, there is more absorption of short waves than long ones, as was stated when we were considering the modifications that free waves undergo (Sec. 129). This effect is taken account of in the correction factor

to be used for large distances. In this factor, λ enters in such a way as to make the received current less when the wave length is short than when it is long. Hence, in general, we conclude that to get the greatest possible received current, we should use short waves for short distances and long waves for long distances.

It may be seen from the formulae that, for simple antennae, the received current (for a given wave length, sending current, receiver resistance, and distance apart) is greater, the greater the heights of the antennae. In the case of closed-coil aerials under the same conditions, the received current is greater the larger the areas and the number of turns of the coils. For the dimensions actually used, antennae are much more effective radiators and receivers than closed coils. In order to secure the same radiation or received current with a closed coil as with an antenna, other conditions being the same, its dimensions must be made nearly as great as the antenna height. However, it is often possible to put more current into a transmitting coil than into the corresponding antenna, and also the resistance of a receiving coil is usually smaller than that of the corresponding receiving antenna. Hence the closed coil can be a smaller structure than the antenna.

The closed coil has some other advantages. For a given power input in the transmitter, the closed coil aerial is not at quite such a disadvantage with the ordinary antenna as the formulae show, because a larger fraction of the radiation is sent out in the direction desired. As a receiver, the closed coil has the very great advantage that the direction of the waves it receives can be determined. These points are discussed further in the next chapter.

E. Device for Radiating and Receiving Waves.

137. Description of the Antenna.—The antenna is used in radio communication for two purposes, (1) to radiate electric waves, and (2) to receive or detect electric waves which come to it. An antenna consists essentially of one or more wires, suspended at some elevation above the earth. When electric waves reach an antenna, they set up an alternating emf. between the wires and the ground, and the longer and higher the wires, the greater the emf. produced. As a result of this emf., an alternating current will flow in the antenna wires. The energy of the current is absorbed from the passing wave, just as some of the energy of a water wave is used up in causing vibrations in a slender reed which stands in its way.

A receiving antenna needs to be large, in order to gather in enough energy from the electric waves to affect the receiving apparatus. Likewise a sending antenna needs to have large dimensions, in order to send electric waves to a greater distance. The same antenna is often used for both sending and receiving. An antenna used for

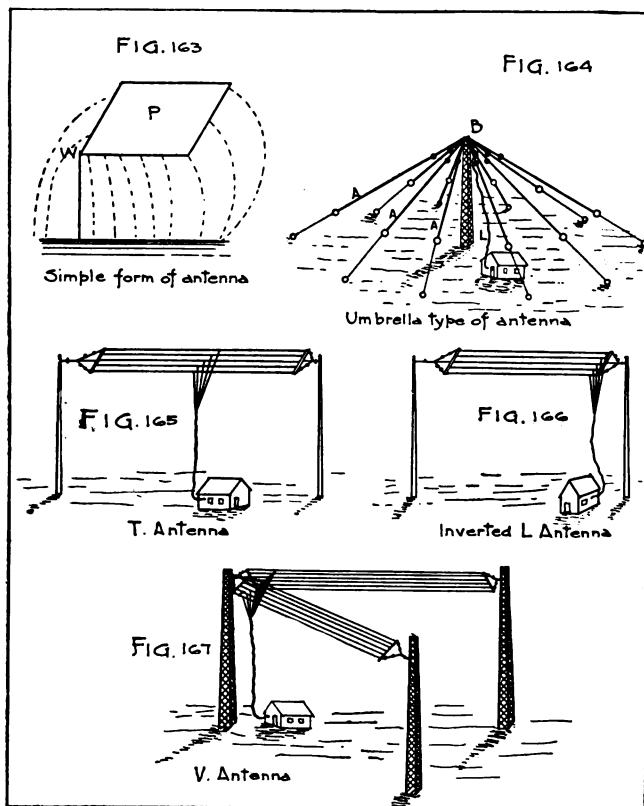

receiving only may, however, be made simpler than one which is also required for sending purposes.

The simplest form of antenna would be a plate *P*, Fig. 163, supported above the earth and insulated from it, except for the connec-

tion through the wire W , called the "lead-in wire" or "lead-in." The plate and the earth form the two terminals of a condenser, the space between them furnishing the dielectric. When an alternating emf. is introduced into the wire, charging currents flow into and out of P and the earth, the dielectric being strained first in one direction and then in the other. As has been explained in the previous chapter, these strains are equivalent to displacement currents of electricity through the dielectric, which serves to complete the circuit. A region in which the dielectric is undergoing alternating strains is the starting point of electric waves. The larger the plate and the higher it is raised from the earth, the greater the amount of space in which this strained condition exists, and the more powerful the waves which are radiated.

In practice, wires are used for an antenna instead of plates. A single vertical wire is, for its size, the best radiator, but it has to be made extremely long in order to get sufficient capacitance for long wave or long distance work (Section 142). Antennae of different numbers of horizontal or inclined wires instead are, however, practicable and radiate very well. It must be thoroughly understood that an antenna is merely a large condenser and may have various shapes consistent with this condition, although some forms will radiate electric waves much better than others.

138. **Different Types.**¹—The umbrella type of antenna, Fig. 164, consists of a number of wires which diverge from the top of a mast, and are attached to anchors in the ground through insulators, A , as shown in the figure. Lead-in wires L are brought down from the junction of the wires B to the apparatus. The portions of wire BA take the place of the plate P of Fig. 163. This antenna may be erected quickly, and is used for radio pack sets.

An antenna of horizontal parallel wires, supported between two masts and insulated therefrom, is common. This is the standard form for ship stations. According as the lead-in wires are attached at the end of the horizontal wires (Fig. 165) or at their center (Fig. 166) the antenna is said to be of the inverted L or of the T type. The V antenna consists of two sets of horizontal or slightly inclined wires, supported by three masts, so that the horizontal portions form an angle, Fig. 167.

For short distance sending, simpler antennæ may be used, such as, for example, a simple wire supported between two stakes at a height of only a few feet from the ground. For emergencies, a long

¹ See also S. C. Radio Pamphlet No. 2.

insulated wire may be laid upon dry ground, the apparatus being inserted at the middle, forming what is known as a "ground antenna." For receiving stations equipped with amplifiers or other delicate receiving apparatus, very simple antennæ may be employed, even for long-distance work.

139. **Current and Voltage Distribution in an Antenna.**—When an emf. is introduced into an antenna, a charging current flows in the wires as was described in the ideal case of Fig. 163. If we attempt to form a picture of this process in the wire antenna, we must remember that every inch of the wire forms a little condenser, with the earth acting as the other plate. The antenna is said to have a distributed capacitance.

As the electricity flows from the bottom of the antenna, some of it accumulates on each portion *A* of the wire, causing a displacement

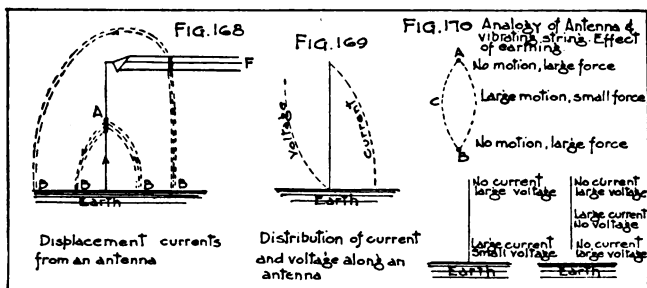

current through the dielectric to earth, as shown in *AB* (Fig. 168). The current in the wire accordingly diminishes as the free end *F* of the antenna is approached, and becomes zero at that end. The current is evidently different at different parts of the antenna, being zero at the free end and a maximum where the antenna is connected to the ground (Fig. 169). This is in marked contrast to the case of a direct current, which always has the same value at every point of the circuit. The difference here is brought about by the very high frequency of the currents.

The voltage of the antenna, on the contrary, is zero at the grounded end and has a maximum value at the free end. In fact, the latter is the point where the most intense sparks can be drawn off; therefore the insulation of the antenna from nearby objects and the earth must be particularly good at this point. (In Fig. 169 the voltage and cur-

rent are supposed to be measured by the horizontal distance from the solid vertical line.)

A large capacitance to earth, concentrated at any point of the antenna, causes a large change in the current at that part of the antenna. If this bunched capacitance is located at the top of the antenna, such as is the case with a flat topped antenna of long wires, with only a few vertical lead-in wires, the average current in the flat top portion will be large, and it increases slightly in strength as the charges pass down through the lead-in wire (picking up the charges there), hence giving a large current through the receiving apparatus. It is a distinct advantage to have as large a part of the total capacitance of the antenna as possible at the top.

140. Action of the Ground. Counterpoises.—The electric oscillations in an antenna may be regarded as somewhat analogous to the vibrations of a string, stretched between two points *A* and *B*, and plucked at the middle, *C*, in Fig. 170. The stretching forces on the string are greatest at the points *A* and *B*, while the portion *C* is under very small force. The motion of the string is most considerable at *C*, while the points *A* and *B* do not move. If we regard current as similar to motion and voltage to force, we can see (according to statement in the preceding section) that the top of the antenna resembles in its behavior the end *A* (or *B*) of the string, while the bottom of the antenna corresponds to the point *C* of the string.

The part played by the earth may now be understood. If we suppose for a moment that the antenna is disconnected from the ground and insulated, then the lower free end would become a point where the current would be zero and where the variations of voltage would be large (corresponding to point *B*, Fig. 170). The portion where the current would be a maximum would lie at some elevated point. To set a string in vibration requires the smallest force when it is plucked at the middle. Right at the ends it is almost impossible to set it in vibration. Just so, the antenna, if disconnected from earth, would be almost impossible to set in vibration if the emf. were applied at the bottom end. For successful working, the exciting apparatus would have to be joined to inaccessible points of the wire higher up. It is necessary, then, to make sure that the lower end of the antenna is a region where a current is large, and with a good ground this condition is satisfied.

In places where the ground has poor conductivity (dry, rocky soil, with ground water at some considerable depth) it becomes difficult to satisfy the above condition. In such cases an earth capaci-

tance or "counterpoise" must be used. This is merely an insulated mass of metal M of large extent (Fig. 171) placed near the ground. The lower end of the antenna is joined to the metal which forms the upper plate of a condenser, while the more moist layers W of the earth, deep below the surface, form the lower plate. As far as the antenna is concerned, the counterpoise takes the place of the ground. The antenna can, therefore, be excited by suitable apparatus placed in the antenna, or coupled to it just above M or near the ground. (The connecting of the generating apparatus to the antenna is treated in Sec. 160.) In some cases, a netting of wires placed near the earth is used as a counterpoise, in others, insulated wires are carried from the base of the antenna and laid out upon the ground.

In airplane radio outfits a counterpoise must necessarily be used. This is furnished by the metal wires of the framework, the engine,

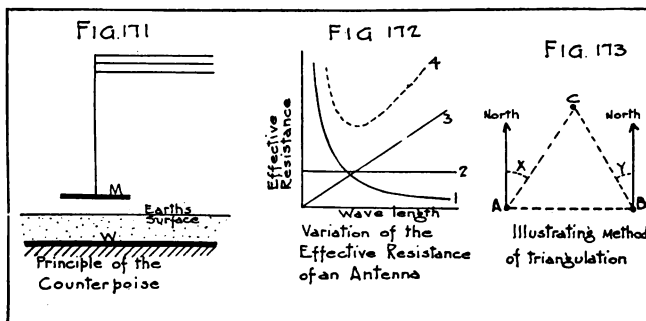

stay wires, metallized wings, etc. The antenna proper consists of a weighted wire let down from the airplane, which trails behind when in flight. A reel allows this to be coiled up when a landing is to be made. On airplanes the antenna is below the counterpoise, but the action is not different from the ordinary antenna and counterpoise systems.

F. Antenna Characteristics.

The behavior of an antenna depends upon its capacitance, inductance, and effective resistance just as is the case with any oscillating circuit. The capacitance and inductance determine the length of the radiated waves (see Sec. 116); the resistance determines the damping.

141. **Capacitance.**—The energy which can be given to a condenser, when it is charged to a voltage E , is equal to one-half the capacitance, C , multiplied by the square of the voltage. The energy which is supplied to an antenna each second when it receives N charges per second is, therefore (as given in Sec. 34),

$$P = \frac{1}{2} CE^2 N$$

We may, evidently, increase the supply of power to an antenna by increasing the number of charges per second, or by raising the voltage.

It is not practicable to raise the rate of charging beyond about 1000 to 1500 sparks per second. The voltage on the antenna cannot be made greater than about 50,000 volts without loss of power through leakage and brush discharges. The only remaining factor which can be varied is C in the above formula; therefore, a high power sending antenna must have a large capacitance. Large capacitance means many wires of great length; that is, a large and costly structure.

The capacitance of a single wire parallel to the ground can be calculated approximately, as also the capacitance of certain simple arrangements of parallel wires (see C. 74, pp. 237–242). Even in the simplest cases, however, the presence of houses, trees and other neighboring objects, and the difficulty of allowing for the lead-in wire, makes any precise calculation impossible. It should be noted, however, that the capacitance of a wire is proportional to its length. The capacitance of two wires near together is less than the sum of their capacitances, and, in general, although each added wire adds something to the capacitance, it adds much less than the capacitance it would have alone in the same position. As an indication of what values of antenna capacitance may be expected, the following values may be cited:

Airplane and small amateur antennae, about 0.0005 mfd.

Ship antennae, 0.0007 to 0.0015 mfd.

Large land station antennae, 0.005 to 0.015 mfd.

That is, in spite of their size and extent, antennae do not possess greater capacitance than is found in ordinary variable air condensers (see Sec. 32).

The capacitance of an antenna is easily measured by a substitution method (L. W. Austin). The wire from the antenna and that from the ground are connected to an inductance coil of such value as to give a wave length five or more times the fundamental (Sec.

144). A generating circuit is loosely coupled to this and varied to resonance. The connections to antenna and ground are then removed from the inductance coil and replaced by a variable condenser, which is then varied to resonance. The condenser setting gives the antenna capacitance. This is subject to a small correction for the antenna inductance, which, however, may usually be neglected.

142. **Inductance.**—Although principal stress has been laid upon the conception of the antenna as a condenser, the inductance which its wires necessarily possess is of equal importance in determining the wave length of the radiated waves. The antenna is, in fact, an oscillating circuit, and as such the wave length or frequency of free oscillation depends upon the product of the inductance and capacitance. See formula (79), Section 116.

The inductance in general is not large—50 to 100 microhenries is a common range of values—but larger capacitance is necessarily associated with larger inductance, so that high-power antennae are naturally long wave antennae. Methods for measuring inductance and capacitance of antennae are described in C. 74, pp. 79, 83 to 86, and 98. Antenna inductance is more commonly obtained from a combination of measurements of capacitance and wave length.

143. **Resistance.**—The wires of an antenna offer resistance to the current, which is greater for the high frequency antenna current than it would be for a steady current, on account of the skin effect (see Sec. 117). In addition to this, the radiation of energy in waves causes a further increase in the apparent resistance of the antenna. The “effective resistance of the antenna” is defined as the quotient of the power given to the antenna by the square of the antenna current. That is, if R is the effective resistance, the total power put into the antenna is RI^2 , where I is measured at the base of the antenna. The effective resistance is different for different frequencies, as is shown below.

The total power is dissipated in the following ways, (1) as heat in the antenna wires and earth connection, (2) brush discharge, (3) leakage over or through insulators, (4) heat in the dielectric surrounding the antenna, and in any condensers that are in the antenna circuit, and (5) radiated waves. Part of (5) will also be turned into useless heat by inducing eddy currents in near-by conductors, such as guy wires or metal masts. If $R'I^2$ represents all the power except that radiated, and $R''I^2$ represents the power radiated as waves,

then it is evident that $R'I^2 + R''I^2 = RI^2$, or $R' + R'' = R$, the effective resistance. R'' is called the "radiation resistance." It might be defined as that resistance which, if placed at the base of the antenna, would cause as great a dissipation of energy as the energy radiated in waves. It will be different at different frequencies. It gives an idea of the radiating power of the antenna for each ampere of antenna current.

When the effective resistance of an antenna is measured at a number of frequencies and the results are plotted, a curve is obtained like curve 4, Fig. 172. The shape of the curve is explained by considering the laws according to which the different kinds of resistance in the antenna vary with the wave length. The radiation resistance decreases as the square of the wave length increases. Such a variation is represented by curve 1, Fig. 172. The resistance of the conductors and earth connection is nearly constant with different wave lengths, curve 2. The dielectric resistance increases nearly as the wave length, curve 3. Curve 4 is the sum of curves 1, 2, 3. If the losses in the dielectric are very small the curve does not have a minimum, as at *A*, but becomes horizontal at the right end. If these are negligible, the curve merely falls toward a limiting value.

To reduce the dielectric losses no portion of the antenna should be in contact with buildings or trees. To reduce eddy current losses care should be taken to have the antenna a reasonable distance from guy wires, and especially large masses of metal. Guy wires may be cut up and insulated in sections. On shipboard, induced currents are produced in iron stacks and guy wires near the antenna, and in cases where the frequency of the waves agree with the natural frequency of oscillation of these metal objects, considerable power losses may result. These show themselves, when they are present, as humps on the experimental curve 4, Fig. 172, at the frequencies in question.

The effective resistance of an antenna is often as high as 20 to 30 ohms at the fundamental wave length. The minimum value may be 5 to 10 ohms for a land station and as low as 2 ohms for a ship station.

144. Wave Length, and Its Measurement.—The wave length of the waves emitted by an antenna, when no added inductance or capacitance is inserted in the antenna circuit, is known as its "fundamental wave length." By putting inductance coils ("loading coils") in the antenna circuit, longer waves may be radiated, while on the

contrary, capacitances put in series with the antenna enables it to produce shorter waves than the fundamental. The use of a series condenser is avoided where possible, since it has the effect of decreasing the total capacitance of the antenna circuit (Capacitances in Series, Sec. 35) and thereby diminishing the amount of power which can be given to the antenna. The addition of some inductance has a beneficial effect, since the decrement of the antenna is thereby lessened and a sharper wave results. It is not advisable to load the antenna with a very great inductance, however, as it is not an efficient radiator of waves. The waves emitted are very much longer than the fundamental wave length. As a general rule, small sending stations, for short ranges, work best on short waves, and long-distance stations on long waves. Long waves have the advantage for long-distance work that they are not absorbed in traveling long distances to the extent that short waves are.

The United States radio laws specify that high-power stations shall use waves longer than 1600 meters, that the Navy has the range from 1600 to 600 meters, that ship stations shall transmit on a wave length of 300, 450, or 600 meters, while amateurs, when permitted to work, must confine themselves to waves shorter than 200 meters. The majority of high power stations use waves longer than 3000 meters, and 10,000 to 15,000 meters are used by some.¹

Measurement of Antenna Wave Length.—For a simple vertical wire grounded antenna the fundamental wave length is slightly greater than four times the length of the wire. The constant is often used as 4.2, and applies approximately also to flat top antennas (*L* or *T* types) with vertical lead-in wire, the total length being measured from the transmitting apparatus up the lead-in wire and over to the end of the flat top. It is usually easier, and certainly more accurate, to measure the wave length radiated from an antenna directly by the use of a wavemeter. (Sec. 112.) The wavemeter coil needs merely to be brought somewhere near the antenna or lead-in wire and the condenser of the wavemeter adjusted to give maximum current in the wavemeter indicator. The wave length corresponding to the wavemeter setting is then the length of the waves radiated

¹ It appears likely that in the future the legally prescribed values will be changed. Possibly the range of from 200 to 2000 meters will be reserved for land stations, except for a small range around 600 meters for airplanes, while ship stations will be required to use 2000 to 6000 meters, and above this limit high power stations will work.

by the antenna. If the loading coil and series condenser are cut out, the measured wave length is the "fundamental wave length" of the antenna.

145. **Harmonics of Wave Length.**—A simple radio circuit has a reactance equal to zero at a single frequency, namely, the resonance frequency, and the maximum current possible with the given emf. will then flow. This result is strictly true only when the capacitance and inductance are concentrated at definite points of the circuit. In an antenna, however, the inductance and capacitance are distributed, and it is found that a maximum of current is obtained for a whole series of different frequencies or wave lengths.

What is called the "fundamental frequency" is the lowest frequency for which the current attains a maximum, when not loaded with either capacitance or inductance. Denoting this by f , there are in the same antenna other resonance frequencies $3f$, $5f$, $7f$, etc., called the "harmonic frequencies" of the antenna. With the usual methods of producing current in an antenna it radiates principally waves of its fundamental frequency alone; free oscillations of the harmonic wave lengths are almost entirely lacking. However, when emfs. having the harmonic frequencies are applied, vigorous oscillations of those frequencies may be set up.

146. **Directional Effect.**—It is desirable, for certain purposes, that the energy of a transmitting antenna may be sent in a particular direction. The range of a station may thus be increased and interference decreased. Still more important is the ability of an antenna to receive waves coming from a single direction, but to offer no response to waves from other directions. This is valuable as an effective means of reducing interference, since in general the interfering station is not likely to lie in the same direction as that with which it is desired to communicate.

A further and very important application of antennæ with directional characteristics is the possibility of triangulation. If C , Fig. 173, is a transmitting station, and the waves come in to station A from a direction which makes an angle x with the north, while at station B waves from C arrive from the direction BC , which makes an angle y with the north, then the positions of the stations A , B , C can be calculated, provided only that the distance AB and the angles x and y are known. If C is an enemy station, it may be located by measurements of its direction, as observed from receiving stations A and B whose positions are known. Or, if C is supposed

to be a lighthouse station, which is radiating signals, a vessel can determine its unknown position *A*, even in a fog, by observing the direction of *C*, and then after sailing a known distance *AB*, making similar radio observations of the direction of *C* from its new position *B*. The positions *A* and *B* and the ship's course can be worked out. Even in clear weather it is often desirable to have a means of checking up astronomical observations of the ship's position, since a small error of observation may have serious consequences when a vessel is near the coast.

All forms of unsymmetrical antennæ, such as the inverted *L* and the *V*, are somewhat directional in their characteristics, at least on land. The so-called ground antennæ give considerably better transmission along their length than at right angles. Closed coil aerials have, however, shown themselves particularly adapted to this kind of work. Further details are given in Sections 151, 152 below.

G. Antenna Construction.

147. **Towers and Supports.**—For land stations wooden masts have been much employed. For portable antennæ these are made in sections which fit together like a fishing rod. For higher power stations, latticed metal masts are common, and in some cases, tubular metal masts in telescoping sections. Except in special instances, guy ropes or wires are necessary, and in some cases the support is sustained entirely by these. It has been quite generally regarded as a structural advantage to allow a small freedom of movement to the mast, so that it may rock slightly in the wind. A simple one-wire antenna may be held by any support that is available. When a tree is used to support either end, a rope should run out for some distance from the tree, and the wire be attached to this by an insulator, so that the antenna wire itself may not be in or near the tree. The standard flat top ship antenna makes use of the ship's masts for supports. The antenna wires are stretched between two booms or spreaders from which halyards run to the masts.

148. **Insulators.**—The insulation of an antenna is a matter requiring careful attention. The system depicted in Fig. 174 is typical of a ship's antenna. In the case of the antennæ for large land stations, the guy ropes are interrupted by insulators. Porcelain, hard rubber, or electrose rods into which eyebolts are molded are common. A form of nearly spherical porcelain insulator, so grooved as to carry the two wires firmly without their coming in contact, is

shown in Fig. 175. In the event of this insulator breaking, the wires do not part.

Where the lead-in wires from the antenna pass through the walls of the house in which the sending and receiving apparatus is installed, special care needs to be taken to ensure good insulation. A form much used for this purpose is shown in Fig. 176. In the case of some large aerials, the supporting mast itself has to be insulated

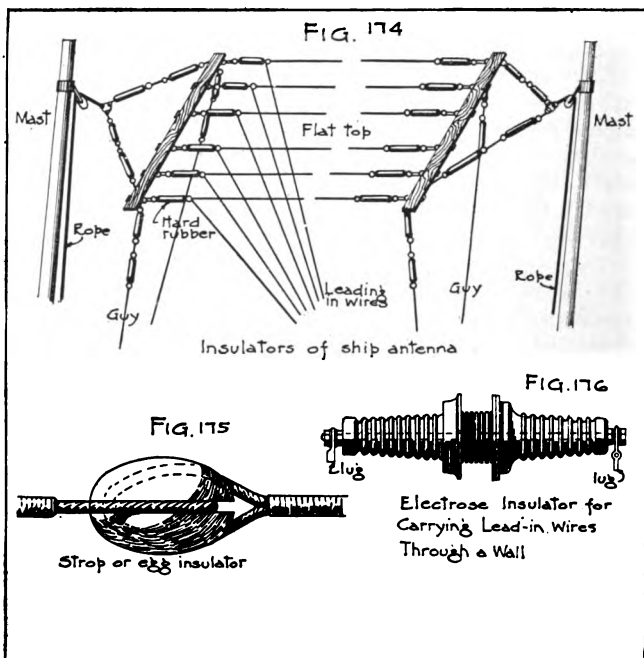

from the ground at its base. The design of an insulator which combines sufficient mechanical strength with good dielectric properties is a difficult matter.

149. **Antenna Switch. Conductors.**—An antenna switch is a necessity in all permanent installations. This has the function of disconnecting the receiving apparatus from the antenna completely,

when a message is to be sent, and vice versa. The action of such a switch is made such that it is impossible for the operator to make a mistake and impress the large sending voltage upon the delicate receiving apparatus. Since the currents in the antenna wires have a high frequency, the resistance at radio frequencies is larger than at ordinary low frequencies. (See Sec. 117.) Phosphor bronze wires of seven or more strands are commonly used.

150. Grounds and Counterpoises.—To obtain a good conducting ground connection is a comparatively easy matter in a ship station. In a steel ship, a wire is merely attached to the hull of the ship and the good conductivity of the sea water assures an intimate connection with the ground. On a wooden ship, a large plate of metal is attached to the outside of the hull, under water, and the ground wire is connected to it.

The ground connections of some land stations are often very elaborate, a considerable number of copper plates or heavy wires, arranged radially from the foot of the antenna, being buried in moist earth. In general, the endeavor is made to insure a considerable area of conducting material in contact with the moist earth. Counterpoises are especially useful when the soil is dry and rocky, or when time is not available for making a ground connection. The counterpoise may consist of a considerable area of wire netting, supported parallel to the ground, or laid upon it; or insulated wires may be carried radially from the foot of the antenna, being held at a short distance from the ground. The amount of wire used in the counterpoise should be as much as, or more than, that used in the antenna proper. The antenna should always be grounded through a special switch, when not in use, to avoid possible damage from lightning.

H. Closed Coil Aerials.

Although closed circuits are by no means as powerful radiators or receivers of electric waves as the usual forms of antenna, they possess strong directional characteristics, and are used in installations where this property is especially desired. An inverted L antenna is very common when it is desired to transmit in a single chosen direction, but for directional receiving, the closed coil is universally used. The relative strength of signal obtainable with antennæ and closed coils may be calculated from the transmission formulæ given in Section 134.

The problem of confining the radiated waves to a limited range of directions has not, however, been very satisfactorily solved. There is a marked tendency for the wave front to become spherical as the wave travels forward, and thus lose the form it had in the vicinity of the radiator.

A much more important consideration is the location of the direction from which waves come to the receiving station, and for this the action of an aerial consisting of a flat coil of few turns is very successful.

151. **Directional Curve.**—Fig. 177 gives a graphical idea of the variation of the received current in the coil when its plane is revolved so as to make different angles with the direction of the incoming waves. In the figure, the direction of the incoming waves is along the line AB . If OA represents the received current when the plane of the coil is along this direction, then the effect of rotating the coil, so that its plane stands in the direction MN , is to reduce the received current from OA to ON . When the plane of the coil makes a right angle with the direction of waves, the line MN would become tangent to both circles and the distance ON would become zero. No current should then be received when the plane of the coil is at right angles to the direction of the incoming waves. From the symmetry of the diagram, it is clear, however, that the received current should be the same for two positions of the coil at 180° with one another, for example, OA and OB , or ON and OM . Usually, however, there are other considerations that enable the operator to determine in which of the two possible directions the transmitting station lies.

To make a determination of direction, the closed coil aerial, standing with its plane vertical, is connected to a variable condenser to form a closed oscillating circuit. The circuit is tuned by means of the condenser, to the wave length of the incoming wave. A suitable detecting circuit is connected to the terminals of the condenser. A horizontal graduated circle is provided to identify the position of the plane of the coil. The coil is then rotated on its vertical axis, until the signals disappear. There will usually be a certain range of angular positions of the coil for which no response will be obtained in the detector. This is easily explained by Fig. 177. If the radius of the circle, drawn with O as a center, represents the smallest received current which causes a noticeable effect in the detecting

circuit, then it is evident that for positions of the coil lying within the angles COD and EOF , no signal can be received.

To determine the direction of the waves, the positions C and D are noted on the graduated scale, for which the signals just disappear and just become audible, respectively, and then the coil is turned about 180° and the two similar positions E and F are sought. By taking the average of the circle readings at C and D , and E and F , that position of the coil may be determined which lies at right angles with the desired direction. The instrument is set up at the start, so that the scale reading will give directly the direction of the waves in degrees from the north and south line.

With proper design, it is possible to determine the direction of a sending station to within 1° or 2° of the correct value. To obtain such accuracy, however, one must be careful that no masses

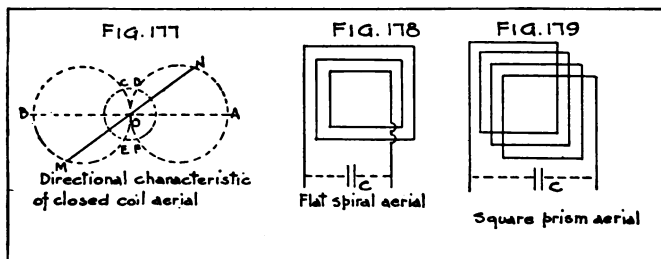

of iron, or other metal, or any object which is capable of distorting the wave front lies in the vicinity of the coil. Neglect of this precaution may give rise to determinations of direction which may be easily as much as 15° in error, and, in the case of very short waves, even worse. Where a mass of metal has a fixed position relative to the radio apparatus, for instance the engine in an airplane, the set may be so calibrated as to eliminate the error which the engine would otherwise cause in the direction indicated.

152. **Constants of Closed Coil Aerials.**—It is found that the maximum received current in a closed-coil aerial is greater, the larger the number of turns of wire on the coil, the greater the area of the coil, and the greater its inductance. The current varies inversely as the resistance and the square of the wave length. For-

mulae for the current received in terms of current in the distant transmitting aerial are given in Section 134.

It would seem at first sight that the increase in resistance, due to increasing the number of turns and their area, would be offset by the rapid increase of the inductance with the number of turns and the area of the coil. The resistance to high frequency currents is, however, dependent on the wave length and increases rapidly as the latter approaches the value of the fundamental wave length of the coil. The fundamental wave length of a coil aerial is that which is radiated by the coil when no capacitance is present in the circuit except that between the turns of the coil itself (Sec. 114.) Compare with Sec. 145. As a guiding rule it may be stated that a closed coil aerial should not be used to receive waves which are shorter than about two or three times the fundamental wave length. That is, to receive short waves a coil of small inductance and capacitance should be used. Such a coil must have few turns. To receive longer waves, coils of a larger number of turns may be used. Experience shows that best results are obtained with one or two turns embracing a large area for use with short waves, and for long waves, coils with 20 to 30 turns, not so large in area.

For convenience of construction, square coils are found to be the most suitable. The wire may be wound in a flat spiral, Fig. 178, or on the surface of a square prism, Fig. 179. Flat spirals of only a few turns are used, since the inner turns rapidly become less useful as the area diminishes. The spacing of the wires is determined by the allowable capacitance of the coil.

The capacitance of a coil of given dimensions increases with the number of turns, at first rapidly, and then more slowly. With the wires close together, the capacitance is a maximum and grows rapidly less when the wires are separated, until a certain critical spacing is reached; beyond which the capacitance changes very slowly.

For a square coil 8 ft. on a side, the wires should be placed at least 0.35 in. apart; for one 4 ft. square, 0.2 in.; and for a 2 ft. coil, $\frac{1}{8}$ in. Increasing the distance between the wires decreases the inductance of the coil; at the same time it reduces the capacitance. However, it is found that, for a given length of wire, properly spaced as just indicated, the fundamental wave length of the coil is about the same with different dimensions. This fact is illustrated in the following table, where 96 ft. of wire are used in each case.

Characteristics of Closed Coil Aerials:

Length of a side of the square (feet).	Number of turns.	Spacing of wires (inch).	Inductance (microhenries).	Capacitance (micro-mfd.)	Fundamental wave length (meters).
8	3	1	96	75	160
6	4	1	124	66	170
4	6	1	154	55	174
3	8	1	193	49	183

These coils should be used with a condenser of sufficient capacitance to bring them into resonance at 500 to 600 meters. The first coil would be most suitable for these wave lengths, on account of its small high frequency resistance, and greater effective area.

The range of coil stations when used with field sending sets is, of course, short. When used to receive powerful stations, however, surprisingly good results have been obtained. Thus the great European transatlantic stations have been heard in Washington with coil aerials such as have been described, using vacuum tube amplifiers. An instance is on record where all the great European stations were received in France by a coil aerial only 18 cm. square, having 200 turns.

CHAPTER 5.

APPARATUS FOR TRANSMISSION AND RECEPTION (Exclusive of Vacuum Tubes.)

A. Apparatus for Damped Wave Transmission.

153. **Function of Transmitting Apparatus.**—Electric waves, by means of which radio communication is carried on, are produced by the transmitting apparatus. Power must be supplied by some kind of electric generator; this must be converted into high frequency currents which flow in the transmitting aerial and cause electric waves which travel out through space. The waves may be undamped or damped. Damped waves consist of groups or trains of oscillations repeated at regular intervals, the amplitude of the oscillations in each train decreasing continuously. The number of these trains of waves per second is some audible frequency. When such waves strike a receiving apparatus (described later), they cause a tone in the telephone receiver. Signals are produced by means of a sending key, which lets the trains of waves go on for a short length of time (producing a dot) or a longer time (producing a dash).

The principles of damped and of undamped waves are the same in many respects, so that much of what is told regarding damped wave apparatus applies to undamped waves as well. Particular attention is first given to damped waves, as the apparatus is simple and easily adjusted, and is suitable for portable sets and for short-distance communication.

154. **Simple Spark Discharge Apparatus.**—Damped oscillations are produced when a condenser discharges in a circuit containing inductance. The condenser is discharged by placing it in series with a spark gap and applying a voltage to it high enough to break down or spark across the gap. As explained in Section 115, the oscillations produced when the condenser discharges in such a circuit are damped and soon die out. Methods of producing a regular succession of such condenser discharges are explained in the following. A high voltage must be applied to the condenser at regular intervals. This is done by the use of a transformer. Through the primary of the transformer is passed either an alternating current or a current

regularly interrupted by a vibrator operated by the transformer (induction coil). For the use of the induction coil, as in radio trench sets, see Section 157. The principle is best studied first in the alternating current method.

In Fig. 180, P and S are the primary and secondary of a step-up transformer (Section 58), which receives power from an a.c. generator. The primary may be wound for 110 volts, and the secondary for 5000 to 20,000 volts. By means of the transformer the condenser C is charged to a high voltage, and stores up energy. When the voltage becomes great enough it breaks down the spark gap and the discharge takes place as an oscillatory current in the inductance coil L and its leads. See Section 115. The main discharge does not take place through the turns of S on account of its relatively high impedance. The transformer is sometimes still further protected

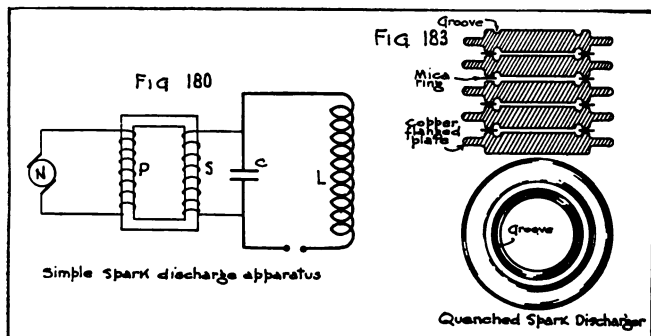

from the condenser discharge by inserting choke coils (not shown in Fig. 180) in the leads between the transformer and condenser. These obstruct the high frequency current, but do not hinder the passage of the low frequency charging current into the condenser. Fig. 181 shows a transformer used in radio sets.

The standard generator frequency is 500 cycles per second. This causes the condenser to discharge 1000 times a second, once for each positive and negative maximum if the spark gap is of such length as to break down at the maximum voltage given by the transformer. The number of sparks per second is called the "spark frequency." With the standard spark frequency of 1000 per second the amount of power the set sends out is considerably greater

than it would be at a low frequency like 60 cycles per second, because the transmitted radio waves are more nearly continuous, as will be shown later. The radiated wave trains strike a receiving antenna more frequently and their amplitude does not need to be so great to produce the same effect as stronger waves received at longer intervals of time. The higher frequency produces a tone in the receiving telephone that is more easily heard, because the ear is most sensitive to sound waves of about 1000 per second and also the tone is more easily heard through atmospheric disturbances.

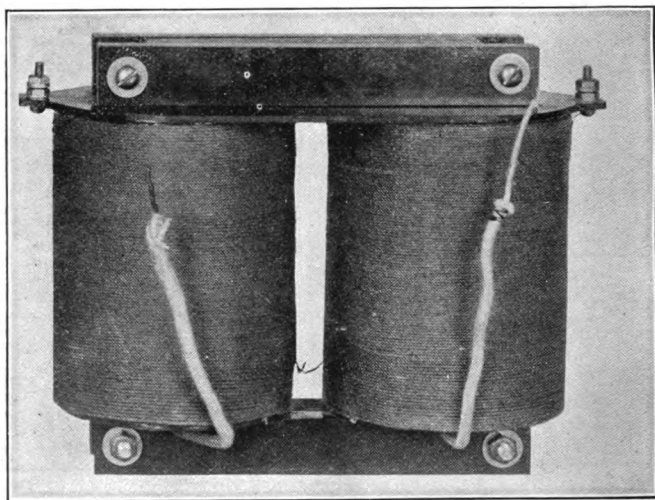

FIG. 181.—Step-up transformer for charging condenser.

A 60-cycle supply may be used if the number of sparks per second is increased by using a rotary spark gap giving several sparks per cycle. See Section 156.

Each condenser discharge produces a train of oscillations in the circuit, and each train of oscillations consists of alternations of current which grow less and less in amplitude. This is illustrated in Fig. 192, and the comparative lengths of the trains of oscillations and the lapse of time between their occurrence are discussed in Section 160.

155. **Transmitting Condensers.**—Before discussing the means of getting the oscillations into an antenna (Section 160), the apparatus used in generating the oscillations will be described in detail.

The most common types of condensers used in radio transmitting circuits use mica or glass as the dielectric, with tinfoil or thin copper as the conducting coatings. Compressed air and oil condensers are sometimes used, but are bulky. For very high voltages the condenser plates are immersed in oil to prevent brush discharge. For moderate voltages a coating of paraffin over glass jars, especially at the edges of the metal foil, will satisfactorily reduce brush discharge. For calculation of the size of transmitting condenser needed see Section 170.

156. **Spark Gaps.**—When the gap is broken down by the high voltage it becomes a conductor, and readily allows the oscillations of the condenser discharge to pass. During the interval between discharges the gap cools off and quickly (see Section 160 and Fig. 193) becomes non-conducting again. If the gap did not resume its non-conducting condition, the condenser would not charge again, since it would be short circuited by the gap, and further oscillations could not be produced. The restoration of the non-conducting state is called “quenching.” A device called the “quenched gap” for very rapid quenching of the spark is described below in this section. Additional appliances for the prevention of arcing are discussed in Section 167.

Plain Gap.—A plain spark gap usually consists of two metal rods so arranged that their distance apart is closely adjustable. See Fig. 182. It is important that the gap be kept cool or it will arc; for that reason the sparking surfaces should be ample. Often the electrodes have fins for radiating away the heat. An air blast across the gap will greatly aid the recharging by removing the ionized air, to which the conducting power of the gap is due. At the sparking surfaces an oxide slowly forms which being easily removed in the case of zinc or magnesium, is not very troublesome. With other metals in general the oxidation is serious and is rapid enough to make operation unstable and inconvenient.

With a given condenser, the quantity of electricity stored on the plates at each charging is proportional to the voltage impressed (Section 30), and this can be regulated by lengthening or shortening the spark gap to obtain a higher or lower voltage at the beginning

of the discharge. The length of the gap which can be employed is limited by the voltage that the transformer is capable of producing, the ability of the condenser dielectric to withstand the voltage, and the fact that for readable signals the spark discharge must be regular. If the gap is too long, sparks will not pass, or only at irregular intervals. The condenser is endangered also. If the gap is too short it may arc and burn the electrodes. Arcing causes a short circuit of the transformer, and the heavy current that flows interferes with the high frequency oscillations. An arc gives a yellowish color and is easily distinguished from the bluish white, snappy sparks of normal operation. Even if no arc takes place,

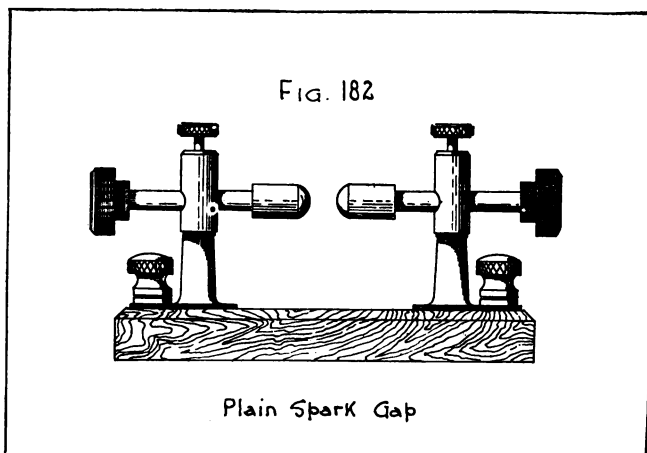

the voltage is reduced by using too short a gap and this results in reduced power and range. The length for smooth operation can usually be determined by trial.

Quenched Gap.—It is found that a short spark between cool electrodes is quenched very quickly, the air becoming non-conducting almost immediately after it is broken down, or as soon as the current falls to a low value. This action is also improved, if the sparking chamber is air tight. The standard form of quenched gap consists of a number of flat, copper or silver discs of large surface, say 7 cm. to 10 cm. in diameter at the sparking surface, with their faces separated by about 0.2 mm. To provide the necessary total length of

gap for high voltage charging, a number of these small gaps are put in series, so that the spark must jump them all, one after the other. The discs are separated by rings of mica or paper, see Fig. 183. Fig. 184 shows a commercial type of quenched gap. The motor-driven blower attached serves to keep the discs cool. They are usually made with projecting fins for radiating the heat, and in one design air spaces are provided between the pairs of discs which form the successive gaps. The number of gaps is determined by the voltage, allowing about 1200 volts for each gap. Eight or ten gaps are usually sufficient.

The quenched gap is not used in sets having a supply frequency as low as 60 cycles per second. The sparks obtained at that frequency are found to be irregular and not of good tone. For this case a rotary gap is used, as explained below. For 500-cycle supply the quenched gap is adjusted to break down at the maximum value of the applied voltage; that is, with its total length so adjusted as to give one spark for each half cycle of the emf. See Fig. 185. Discharges at other times are not possible, and as a result of this regularity a clear note is obtained. This quenched gap is considered as standard for power up to about 10 kw. One advantage of the quenched gap not previously explained, is that it aids the production of a so-called pure wave. This is discussed in Section 163. It has also the advantage of being noiseless, on account of the very short gaps and the enclosure of the spark.

Rotary Gap.—A rotary gap consists of a wheel with projecting points or knobs, with a stationary electrode on each side of the wheel. See Fig. 186. The spark jumps from one stationary electrode to one of the moving points, flows across the wheel, and then, after leaping the corresponding gap on the other side, passes out at the second stationary electrode. The number of sparks per second is thus determined by the speed of the wheel which is motor driven so that signals of high pitch can be produced. For a modified form of rotary gap see Fig. 187. An advantage of the rotary gap is its prevention of arcing, because of its motion and the fanning action, and because the electrodes brought successively up to the spark gap have time to cool in their idle intervals.

In the case of a "synchronous" rotary gap the speed is so maintained as to bring the knobs near together at just the moment when the alternating voltage upon the condenser reaches its maximum value, positive and negative. Thus 500 cycles will produce 1000

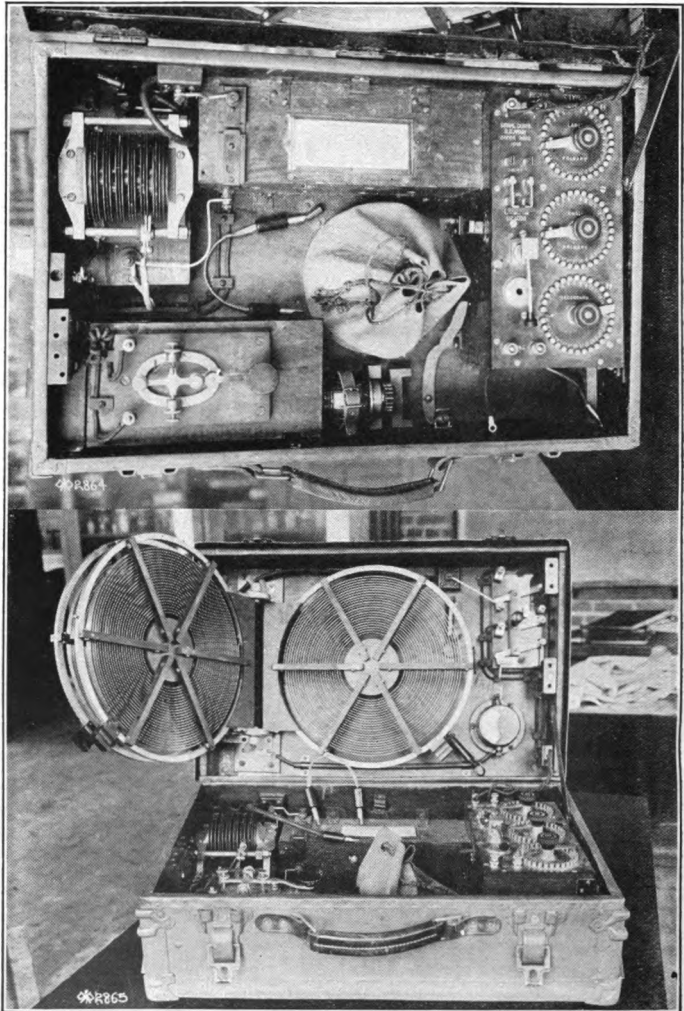
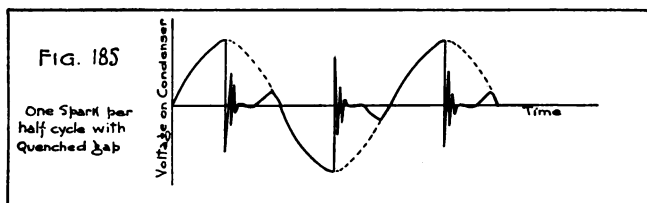

FIG. 184.—Radio telegraph transmitting and receiving set, type SCR-49 (pack set), showing quenched spark gap in back left corner of box.

sparks a second. This regular occurrence of the discharges gives smooth and efficient operation, and a pure musical tone. The synchronizing is made possible by attaching the rotating element



of the spark gap to the shaft of the generator which charges the condenser. A rotary gap not so timed is called "non-synchronous."

Attempts to produce a high pitch from a 60-cycle source by a synchronous gap giving, say, exactly 6 sparks per half cycle, have not given satisfaction, because the applied voltage is not the same at the time of the different sparks, and while the note is of high

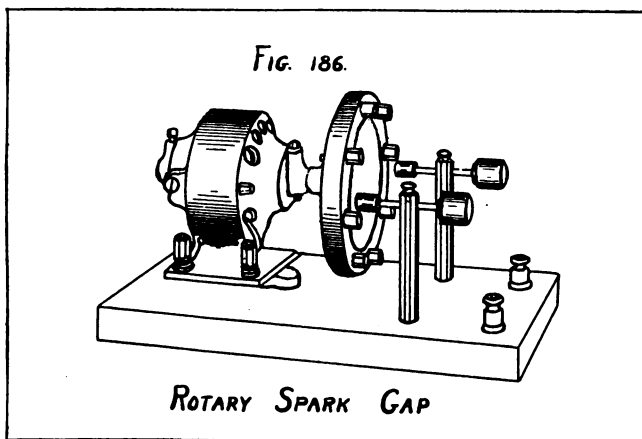

pitch, it is not musical. It has been found better to use a non-synchronous gap in such a case, producing a large number of sparks per second and letting them occur wherever they may happen

during the cycle. The irregularities will somewhat balance up. While the tone is not strictly musical, it can be made of high pitch. The non-synchronous gap is best used if nothing but a 60-cycle or other low frequency source is available. Such a low frequency, however, is being avoided in modern apparatus. The standard frequency is 500 cycles per second at present, although there is a decided tendency toward the adoption of 900 cycles per second.

The plain spark gap is not now used except in small sets; quenched or rotary gaps are the rule. The plain gap cannot be properly de-ionized to allow the condenser to recharge, and it is very difficult, or impossible, to prevent arcing when large power is used, especially with a large number of sparks per second, as in modern practice. As regards the choice between the quenched and rotary gaps the rotary

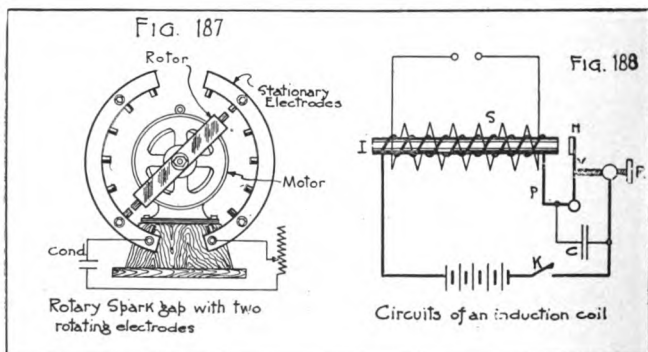

does not find favor because it is very noisy. Another objection to the rotary gap, for use on airplanes, is that when the gap is driven by a small airfan, the tone given by the radio transmitter varies with every change of speed or direction of the airplane.

157. Simple Induction Coil Set.—For short distance communication in trenches, and in general for power below $\frac{1}{4}$ kw., it is common to use an induction coil or a power buzzer instead of an alternator and transformer, to charge the condenser. The wiring of an induction coil is shown in Fig. 188. *P* is the primary coil of a few turns (heavy lines); *S* is the secondary of many turns of fine wire; *I* is an iron core magnetized by the primary current; and *H* is a piece of soft iron at the end of a spring forming a sort of vibrating hammer; *R* is an adjusting screw for the vibrator; *C* is a condenser of a few

microfarads shunted around the vibrator points to prevent their burning. The vibrator points may be replaced when necessary by drilling a hole and driving in a piece of silver. V shows the vibrator points where the primary current is made and broken in rapid succession as long as the key K is closed. When current flows, H is first attracted, breaking the current at V after which the spring causes it to return to its first position, remaking the current. The action is then repeated. The frequency of operation depends upon the mass of the hammer H and the stiffness and length of the spring. It is similar in that respect to an electric bell. This piece of apparatus is really an open core transformer, the changes of current being produced by the automatic interrupter or vibrator, which is operated by the magnetism of the core. The source of power is usually a storage battery of 8 to 20 volts. Owing to the changes of primary current, rapid changes of magnetic flux occur and produce a high voltage in the large number of turns of the secondary coil.

Referring again to Fig. 180, consider the induction coil put in place of the a.c. transformer. When the coil is put into operation, with its secondary terminals connected to the condenser and discharge circuit, a continuous stream of sparks will pass across the spark gap as long as the key is pressed.

158. Operation of Induction Coils from Power Lines.—Fairly large power induction coil sets are used as emergency transmitters on ships. These employ batteries, so as to be independent of the ship's generator. On land, however, when a battery is not available, it is possible to operate an induction coil from a d.c. 110-volt power line by inserting a rheostat in series. In this case, it is absolutely necessary to shunt the transmitting key with a condenser similar to the vibrator condenser, or else a serious arc at the key will take place at the first attempt to signal, and the current will not be broken when the key is released. Of course, the method of inserting a rheostat is very wasteful, as the RI^2 loss in the rheostat is large, much greater in fact, than the power actually used in the radio apparatus.

A scheme to avoid a voltage as high as the 110 volts across the break at the key is to use a voltage divider consisting of two rheostats in series, as in Fig. 189. Suppose the spark coil has 2 ohms resistance in the primary, and requires 10 volts to operate it. If one rheostat is set at 10 ohms and the other at 2 ohms, with the induction coil and key in a shunt around the 2-ohm coil, then the voltage applied

to the induction coil will be 10 volts with the key closed. Note that the voltage across the key when open is 18.3 volts.

With a.c. supply the methods are different. One method of operating an induction coil from 110 volts a.c. is to use a small, step-down transformer to reduce the voltage to an equivalent battery voltage. This requires no series resistance or reactance, and is a fairly efficient method. Induction coils are sometimes operated on 110-volt a.c. power lines by insertion of a series reactance. The vibrator in the primary circuit is not necessary if the supply is 500-cycle, and it is preferable to clamp it permanently in the closed position. The set then becomes similar to Fig. 180. Induction coils may have the primary wound for 110 volts, in which case no transformer nor series reactance or resistance is needed.

159. **Portable Transmitting Sets.**—For portable sets, or for Army field use the simplest apparatus for short distances is a small induc-

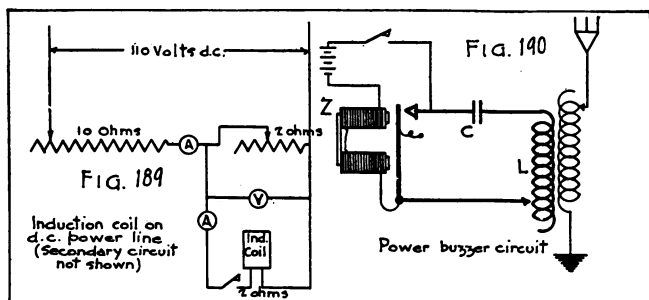

tion coil set, operated from a storage battery. A plain spark gap may be used, for simplicity, but the use of a quenched gap will usually improve the operation. When fairly long distances are to be covered it is advisable to replace the induction coil by a small step-up transformer. A source of alternating current then takes the place of the battery. For a small set this source may be a generator which is driven by hand through gearing. For larger power the generator may be driven by the engine of a motorcycle or some other gasoline engine.

For short distance work the condenser may be charged and radio oscillations produced, without an induction coil, by the use of a power buzzer and a storage battery or a few dry cells. See Fig. 190. The buzzer is shown at Z. The more voltage applied to it the greater

is the charge given to the condenser C . When the vibrator arm is at the right in the diagram, the condenser discharges through the inductance L . This forms the closed oscillating circuit. The condenser should be comparatively small; the apparatus is limited to short wave lengths.

For very short distances the more common military practice is to use "ground telegraphy" or "T.P.S." (*télégraphie par sol*) instead of radio. For the theory and practical application of ground telegraphy, which uses no wires between the two points of communication, see Radio Pamphlets Nos. 10, 15, and 18.

160. Simple Connections for the Production of Electric Waves.—Up to this point, have been shown the means by which an oscillating discharge is produced in a condenser circuit. It is necessary now to learn how the oscillations can be gotten into an antenna so they may be sent out as radio waves. The wiring connections for the different methods are given in this and the following sections, showing first the simplest transmitting connections and then leading up to standard sets.

The simplest possible wave transmitter is a straight wire cut in the middle by a small spark gap. See Fig. 191. If the wire were not cut, and if oscillations could be produced in it, the charges would travel rapidly back and forth owing to the capacitance and inductance of the wire and waves would move out into space as explained in Chapter 4. The oscillations taking place in the wire are of the same nature as those in the circuit CL of Fig. 180. The student should learn to think of the wire as uncut, for the gap becomes a conductor when the spark is passing. Oscillations are produced by the same means described in Section 154, using a high voltage to start a discharge across the spark gap. This is done by connecting a transformer or an induction coil to the gap. The use of an induction coil is shown in Fig. 191. The two halves of the wire charge up as a condenser until the potential difference rises so high that the insulating property of the gap is broken down. There is then a discharge across the gaps and oscillations pass freely until the energy is spent. The gap then becomes non-conducting again as has been explained, and permits a renewed charging. The process is repeated as many times a second as the vibrator works.

The interval from one break at the vibrator to the next may be about 0.01 second, while it will take only in the neighborhood of 0.00001 second for the discharge to be completely accomplished

(basis of illustration is a wave length of 150 meters, 20 waves to a train). Thus it is seen that there is a comparatively large time interval between successive wave trains, in which the gap may cool and be restored. A sketch of the discharge current is shown in Fig. 192, but the wave trains are not shown nearly far enough apart for the case of a damped oscillator such as that of Fig. 191. To show how relatively large the time interval between successive wave trains is, it might be stated that, in this illustration, the length of the wave train itself compares with the length of the idle interval between wave trains about in the same ratio as one day compares with three years.

The next theoretical step toward a standard radio transmitting set is to add large metal plates to the outer ends of the straight wires.

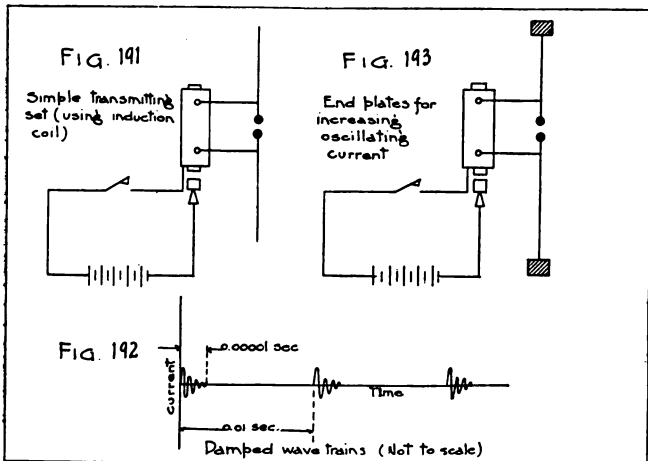

See Fig. 193. This increases the capacitance of the oscillator and causes larger charges to accumulate for the same potential difference, thus giving a larger flow of current back and forth in the wire and sending out more electric and magnetic lines of force. The strength of signals and the range are thus increased.

It is shown in Section 132 that the lower half of the oscillating system, Figs. 191 or 193, may be replaced by the ground, the action of the upper half remaining as before. Also, it is customary to replace the upper capacitance plate of Fig. 193 by one or more wires,

horizontal or nearly so. See Fig. 194. A relatively large capacitance can thus be added, and the constructional difficulties and arrangements of support are simplified. This assemblage of wires forms the "antenna." A variable inductance coil inserted in the antenna wire will permit tuning to different frequencies or wave lengths. Thus a simple transmitting outfit is built up.

The arrangement shown in Fig. 194 is called the plain antenna set to distinguish it from the inductively coupled set explained below. It is a good radiating system, but the waves emitted are of such high decrement that they cannot be readily tuned out in

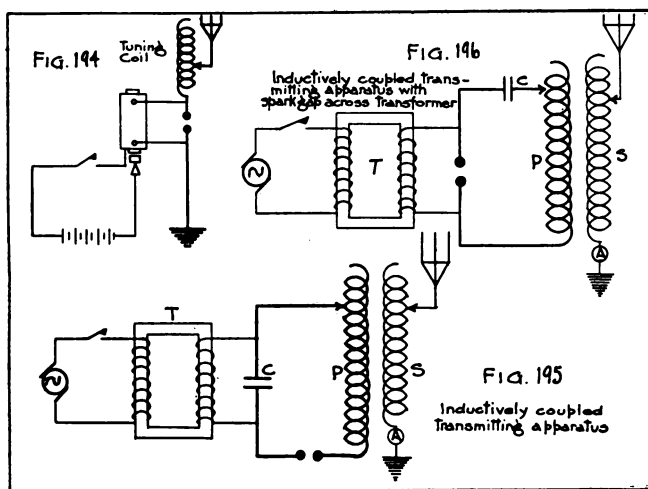

receiving apparatus when one does not desire to receive them. See Section 116. Hence this system is not permissible in general practice. Its advantages besides simplicity are, however, its effectiveness in cases where the sending operator wants all possible stations to hear him, as for instance when a ship needs help, and secondly its military use in purposely drowning out or "jamming" other signals which an enemy is trying to receive. The connection is very quickly made by inserting the spark gap directly between the antenna and ground wires, and connecting the current source across the gap. Arcing in the gap must be guarded against, and care

should be taken not to open the gap too wide, or the antenna insulation may break down.

161. **Inductively Coupled Transmitting Set.**—Instead of connecting the spark gap directly in series with the antenna it may be placed in a separate oscillating circuit like that of Fig. 180 and this circuit then coupled with the antenna. In the most common method the coil of the oscillating circuit (called the "closed" circuit to distinguish it from the open or antenna circuit) is coupled inductively to the inductance coil in series with the antenna. The circuits thus become Fig. 195. One of the advantages of this method is that the condenser in the closed circuit may have much greater capacitance than the antenna and thus may store more energy for each alternation of the supply voltage; this energy is handed over to the antenna which thus becomes a more powerful radiator. Other features of the method are given in Section 163 below.

As before, either an induction coil or a transformer with a.c. supply voltage may be used. In Fig. 195 the latter is shown. *T* is an iron core transformer, somewhat similar in construction to the ordinary transformer used in electric light systems. The two inductance coils *P* and *S* constitute what is sometimes called an "oscillation transformer." A hot wire ammeter is in series with the antenna. The positions of the spark gap and condenser are sometimes interchanged, bringing the spark gap across the transformer. See Fig. 196. There is no practical difference in the operation.

The condenser discharge cannot take place through the transformer *T* on account of its very great impedance, but passes across the spark gap and through the few turns of the primary coil *P*, producing a rapidly changing magnetic flux within the coil. The secondary coil *S* is placed near or inside of coil *P*, so that part of the alternating magnetic flux of *P* passes through *S*. There are three principal styles of oscillation transformer, the double helix, hinged coil, and flat spiral types. See Figs. 197, 198, 199. In order to have a low resistance the conductor is usually a copper ribbon of large surface, or edgewise wound copper strip. The amount of coupling, or the mutual inductance, between them is varied by moving one or both of the pair. Connections are made to such coils by movable clips, so that any desired amount of self inductance may be used.

The hot wire ammeter is used for measuring the current in the antenna circuit. For merely tuning to resonance a low resistance

lamp such as a small flashlight lamp may be used in place of the hot wire ammeter, the maximum current being indicated by the

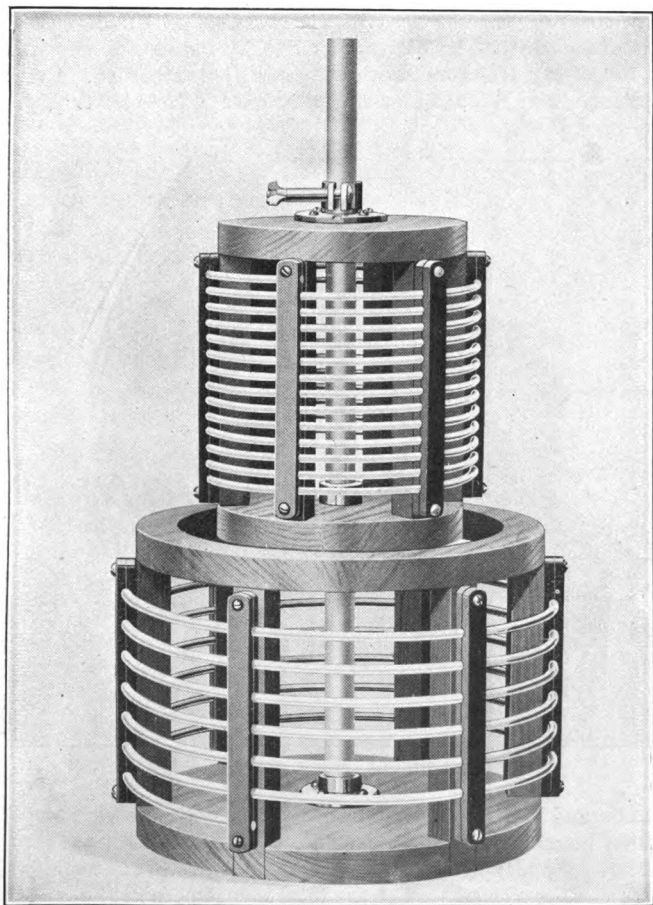

FIG. 197.—Double helix oscillation transformer; coils separated axially.

maximum brightness of the lamp filament. If the current is too great for the lamp it should be shunted by a short length of wire.

The ammeter or lamp may be short circuited except when actually needed, in order to keep the resistance of the antenna circuit low.

162. **Direct Coupled Transmitting Set.**—Direct instead of inductive coupling may be used between the closed circuit and the antenna circuit, as in Fig. 200. (Direct coupling was explained in Sec. 119). One inductance coil is all that is needed. By the contacts shown, as much or as little of the inductance as desired

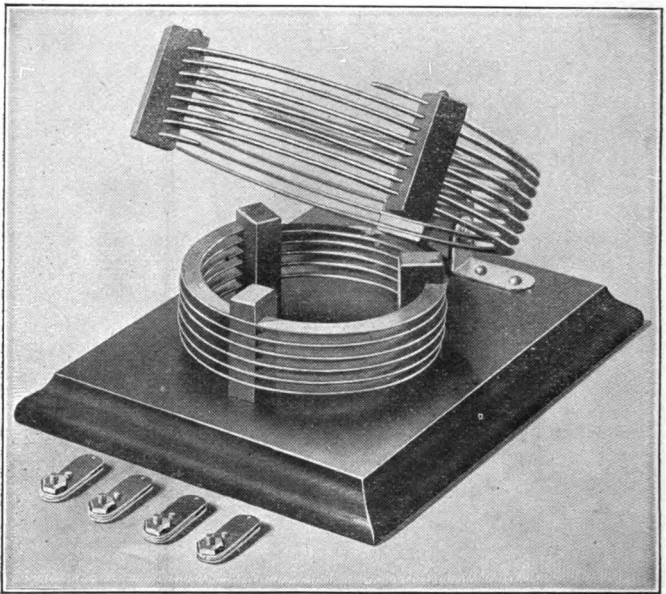
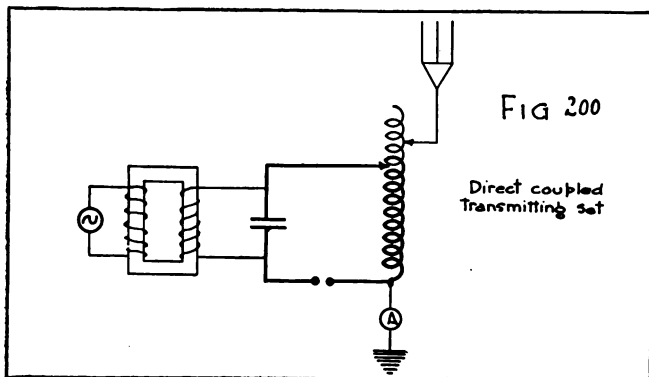
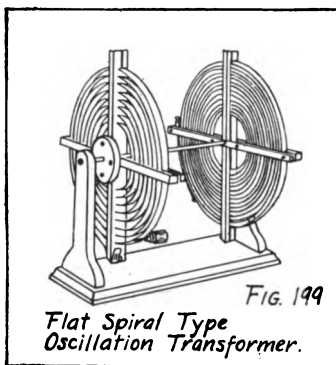

FIG. 198.—Hinged coil oscillation transformer.

can be used in either circuit. In order to tune to some wave lengths it may be necessary to have an additional coil in series in the closed circuit. By making the part of the inductance that is common to both circuits a small part of the total inductances in the circuits, the coupling can be made as loose as desired. Since direct and inductive coupling are strictly equivalent, the discussion of one applies to both.

163. **Comparison of Coupled and Plain Antenna Sets.**—In the plain antenna set of Fig. 194 the spark gap is in series with the antenna. Thus the resistance of the gap is present and helps to make the decrement of the radiated waves high. While high decrement is an advantage in special cases, as explained in Section 160, it is usually not desirable. When the spark gap is in a separate circuit, coupled either inductively or directly to the antenna, as in Figs. 195 or 200, the resistance of the spark gap does not enter into the antenna resistance. The decrement of the wave sent out by the set is subject to control. The condenser in the closed circuit may have large capacitance and thus store a great amount of energy and, if a plain spark gap is used, produce a discharge that persists a relatively long time before dying away. This oscillating current in the closed circuit forces oscillations in the antenna of the same small decrement.



When a quenched gap is used, it would make the decrement much worse if used in the antenna circuit. When used in the closed circuit, however, the oscillations in the closed circuit have such a high

decrement that they stop almost immediately, and simply start the antenna circuit oscillating, which thereafter oscillates with its natural decrement which may be small.

On account of the small decrement of the oscillations in the antenna circuit the instantaneous voltages do not reach as high values, with a given current and power output, as they do when the oscillations are strongly damped. Thus the voltages in the antenna are not as great, when the coupled circuit is used, and the antenna insulators are not as likely to fail.

164. **Tuning and Resonance.**—A very pronounced maximum of current is obtained in the antenna circuit when its natural period of oscillation is the same as that of the primary circuit. This occurs when $L_s C_s = L_p C_p$. (See Chapter 3, Section 116). L_s is the inductance of the antenna circuit, including the antenna itself, lead-in wire and the secondary coil of the air core transformer. C_s is the capacitance of the same circuit. L_p is the inductance of the primary circuit, and since the wiring is short the inductance is nearly all in the coil L . Likewise, since C has a large capacitance, C_p is practically the capacitance of this condenser. It is not necessary in operation to measure any of these quantities. The hot wire ammeter will show by trials when the products are equal, or a wavemeter will enable the operator to adjust each circuit P and S to the same frequency, or to any desired wave length. The principal case where the inductances and capacitances need to be known is in the design of a set which differs from previous sets so much that the proper size of apparatus is not known. To adjust the apparatus to send out long waves, a large inductance may be used in series with the antenna. It is preferable, however, to use a large antenna thus obtaining large capacitance, which stores up large charges and allows a large radiating current.

165. **Coupling.**—When the antenna and closed circuits are adjusted independently to the same frequency or wave length, and then closely coupled together, waves of two frequencies appear in each circuit. See Section 120. For showing the double wave in radio apparatus, a wavemeter (see Section 112) placed near either of these coupled radio circuits will be found to indicate a maximum response at two different wave lengths. If then the coupling between the two circuits is diminished, the two wave lengths approach each other and the wave length for which the circuits were set, and at a very loose coupling only one wave length will be discernible. Figs. 201

to 204 show resonance curves for the case where the primary and secondary are adjusted separately to 600 meters, and then are coupled by bringing the secondary and primary coils near together (when the coupling is inductive). When the coupling is direct it is made closer by making a larger part of the inductance of each circuit common to both circuits. These effects are more pronounced when a plain or rotary rather than a quenched gap is used.

Fig. 201 might allow of fairly sharp tuning on one of the wave lengths, but only the energy of one wave could be utilized by a receiving apparatus. Figs. 202 and 203 would be the equivalent of a

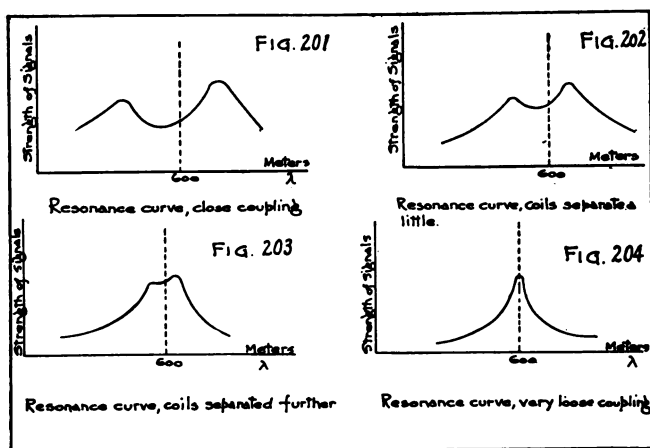

single wave of very broad shape or high decrement, such that the strength of the signals is nearly the same over a wide range of wave lengths. In Fig. 204 the signals are strong at, or near, only one wave length, and diminish rapidly if any of the apparatus adjustments are changed. This is said to be a "pure" wave. It is desirable to have as sharp a resonance curve as possible, and hence loose coupling is the rule when a plain gap is used. The advantage is that all the power sent out is concentrated into a narrow range of wave lengths, and that receiving stations can tune to one wave which they desire to receive at and not receive others.

Action of the Quenched Gap; Relation to Coupling.—Refer again to the inductively coupled apparatus of Fig. 195 and to the waves of Fig. 154 in Chapter 3. Also refer to the description of the quenched gap in Section 156. The action of the quenched gap is to open the primary circuit, by suppression of the spark at the end of its first train of waves (point *D* in Fig. 154). This prevents the secondary from inducing oscillations in the primary again, that is, from giving energy back to the primary. The secondary or antenna oscillations are not thereafter interfered with by the primary and the antenna goes on oscillating until the energy is all dissipated as waves or heat (see Fig. 155). The length of the train will depend only upon the decrement of the antenna circuit. By reducing the resistance, the dielectric losses, the brush discharges and leakage, the antenna current may be made to oscillate for a comparatively long time, at the frequency for which the set was adjusted. This quenching of the primary avoids the double waves of Figs. 201, 202 and 203, even with close coupling. In fact, the coupling should be close for good operation with the quenched gap. Some care has to be taken in the adjustment of the coupling, but when adjusted properly this gap gives a high pitched, clear note. The wavemeter will readily show when a single sharp wave is obtained (see Section 168), and the sound in the telephone receiver will indicate the proper adjustment for good tone. The quenched gap is very efficient, because the close coupling produces a large current in the antenna.

It is well to note that the principles of operation of the quenched gap and plain gap are exactly opposite. The former aims to stop the primary oscillations quickly, after the secondary has been brought to full activity. The latter aims to keep the primary oscillations going as long as possible, all the time giving energy to the secondary as it is radiated away; the coupling is loose and the primary decrement is kept low. The rapid decrease of the oscillations in a quenched gap circuit are assisted by having a large ratio of capacitance to inductance. This has the incidental advantage that the voltages across the condenser and coil are thus kept low.

166. Damping and Decrement.—If the energy in the antenna circuit is dissipated at too rapid a rate, owing either to radiated waves or heat losses, the oscillations die out rapidly and not enough waves exist in a received train to set up oscillations of a well defined period in a receiving antenna. Such waves are strongly damped and have

a large decrement. They produce received currents of about the same value for a considerable range of wave lengths. Thus selective tuning is not possible. To increase the number of waves sent out in each wave train from the open circuit (that is, to make the oscillations last longer) the resistance of the circuits must be kept low. When using a plain spark gap the coupling between closed and antenna circuits must be small enough not to take energy too fast from the closed oscillating circuits. At each condenser discharge the primary has a train of oscillations which at best die out long before another train starts (see Fig. 192); these oscillations are stopped more quickly, however, if the energy is drawn rapidly out of the circuit by the antenna. Close coupling is permissible only when a quenched gap is used, (see remarks at the end of the preceding section.) With any other kind of gap the secondary is kept oscillating by energy continually received from the primary.

A great many factors contribute to the resistance of the antenna circuit, and this must be kept as low as possible. The antenna must have a good, low resistance ground, must use wires of fairly low resistance, and must not be directly over trees or other poor dielectrics. The resistance of the closed circuit particularly must be very low. Heavier currents flow here than in the antenna wires. For this reason the closed circuit wires should be short and of large surface, preferably stranded wires or copper tubing. The condenser should be a good one, free from power loss.

167. Additional Appliances.—A number of additional appliances are necessary or desirable for the operation of a damped wave generating set. The operation is improved by having a variable reactance (iron core inductor) in series with the alternator, to tune the alternator circuit to the alternator frequency. See C. 74, p. 230.

Changes of Wave Length.—In many sets of apparatus it is customary to have connections arranged by means of which different chosen wave lengths, say 300 or 600 meters, can be transmitted without the necessity of a readjustment of the apparatus after each change. An antenna alone without any inductance coil has a natural wave length of its own, dependent upon its inductance and capacitance. See Sections 116 and 145. The antenna is usually so designed that its natural wave length is shorter than the wave length to be used, and the wave length is brought up by adding inductance in series or merely by the added inductance of the secondary of the oscillation transformer. In the case of a small antenna such as

that on a small ship, it is necessary to use a large inductance. Since it is desirable to have the coupling loose, a part of the secondary inductance can be in a separate coil called the antenna "loading coil." This is coupled to the primary. Fig. 205 shows this arrangement. For a quick change of wave length a single switch is often provided, which, by a mechanism of levers, changes simultaneously the adjustments on all three coils. From these coils are taken out taps over which three switch blades pass adjusting all the inductances to approximately the values needed for the particular wave length desired, keeping the circuits in resonance and at the proper coupling. For fine adjustments an additional variable inductor may be provided in the primary and in the secondary.

Fig. 205 also shows an arrangement whereby the operator can obtain wave lengths shorter than the natural wave length of the antenna

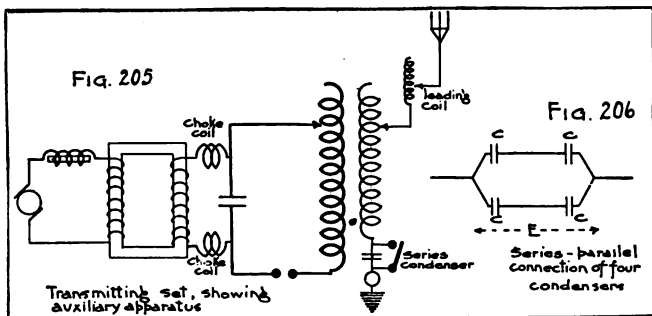

by inserting a condenser in series, (see Section 35), in the antenna circuit. In this case the loading coil will be set at zero turns to diminish the wave length. The condenser inserted must be capable of withstanding high voltages similar to those in the main transmitting condenser. By using a small capacitance the wave length can be reduced to approach one-half of the natural wave length. It should not be reduced that much, however, for the radiation is inefficient if the condenser is too small. A zero capacitance (an open circuit cutting off the antenna entirely from the ground) would be necessary to produce half wave length exactly.

Choke coils.—Fig. 205 shows also choke coils to prevent the high frequency condenser discharge from getting into the transformer and puncturing the insulation. The coils choke down the radio frequency current but do not obstruct the low frequency charging

current from the transformer. They must be specially designed so that they do not have capacitance enough to allow the radio frequency current to pass. They can often be dispensed with.

168. **Adjustment of a Typical Set for Sharp Wave and Radiation.**—The set is assumed to be an inductively coupled set, arranged as in Fig. 205. The first step in adjusting it to work properly is to tune the closed circuit to the wave length which is to be used. This is done by the aid of a wavemeter having in its circuit a sensitive hot wire ammeter. The wavemeter is placed at a distance of one or more meters from the coil of the closed circuit, and with the set in operation but the antenna circuit opened, the wavemeter coil is so turned that a small current is observed in the wavemeter ammeter. With the wavemeter set at the chosen wave length the closed circuit inductance is varied until resonance is obtained. If no resonance point is found it is probable that the closed circuit inductance or capacitance is either too large or too small. This inductance should be varied and a resonance point will be located after a few trials.

The next process is to adjust the coupling to obtain a pure, sharp wave, that is, to get as much of the power as possible into the wave length that is to be used. With both antenna and closed circuits closed, the coupling between them is varied. If the spark gap is not a quenched gap, the coupling is first made fairly loose and the antenna loading coil is varied until resonance is obtained, as observed on the hot wire ammeter in series with the antenna. The coupling is then made closer until two points of resonance appear. It is desirable to have a pure wave, that is, have only one resonance point. Therefore the coupling is loosened until it is certain that there is just one sharp point of resonance. If the set has a quenched gap, the coupling is kept close, and varied only enough to insure a single, sharp wave.

It is necessary next to adjust the apparatus to give maximum current. Keeping the wave length and coupling adjustments fixed, vary the voltage and length of the spark gap and the inductance in series with the alternator until a good clear spark tone and maximum current in the antenna circuit are obtained. It is desirable to repeat the coupling adjustment and then this adjustment again. When the set has a quenched gap, best operation is usually obtained when the inductance in series with the alternator (Section 167) is somewhat greater than that required for resonance to the alternator frequency.

169. **Efficiency of the Set.**—To maintain good efficiency, all resistances in the circuits must be kept as low as possible. A number of suggestions for keeping resistances low were given in Section 166. It is also necessary to avoid brush discharges and arcs, to keep all connections tight, condenser plates and other parts of circuits free from dust and moisture, and antenna well insulated. Brush discharges may be reduced by eliminating sharp points or edges on conductors, or by coating the edges of metal plates with paraffin. The guy wires of the antenna should be divided into short lengths with insulators between them, to reduce the flow of current in them. The inductance coils and the spark gap must be properly designed.

The efficiency may be defined as the ratio of the power radiated away as electric waves from the antenna to the power input in the transformer. The power input P in the transformer may be measured by an ordinary wattmeter. The power radiated from the antenna can be expressed in the form RI^2 where I is the current in the ammeter at the base of the antenna and R is the radiation resistance. The efficiency is then RI^2 divided by P . As explained in Section 143, the radiation resistance cannot be measured directly, but can be found from the total effective antenna resistance by subtracting those resistances which give rise to heat losses.

Representative values for the efficiency of the entire set are 2 per cent to 15 per cent. The transformer efficiency may be roughly 85 per cent to 95 per cent. The closed oscillation circuit losses are very large in proportion to the power transferred, a fair value of efficiency being about 25 per cent (by careful design and adjustment using the quenched gap this may sometimes be increased to 50 per cent). The efficiency of the antenna circuit (radiated power divided by power given to the antenna) may be between 20 per cent and 2 per cent or lower, or may be made as high as 50 per cent if special pains are taken. The product of the three separate percentages gives the over all efficiency. For an interesting table of comparative values of efficiencies, see J. A. Fleming's "Wireless Telegraphist's Pocket Book," pp. 221 and 223.

170. **Calculations Required in Design.**—This section gives methods for determining the values of condensers and coils to be used in transmitting apparatus, and enables one to calculate the capacitance or inductance of such condensers and coils as are commonly employed. The most important design formula is the one for wave length,

$$\lambda_m = 1884 \cdot \sqrt{CL}$$

where C is in microfarads and L in microhenries and λ in meters.

Transmitting Condensers.—The amount of capacitance needed in the condenser in the closed transmitting circuit may be determined from the formula

$$C = \frac{2 \times 10^6 P}{NE_0^2} \tag{87}$$

where C is the capacitance in mfd., P is the power in watts, N is the number of condenser charges per second, and E_0 is the maximum emf. in volts. It may be seen from this that if a low voltage E_0 is used, the capacitance needed for a given power will be large and if a high voltage is used the capacitance may be smaller. There is a large reduction of capacitance with a small increase of voltage because the voltage term is squared, therefore to avoid using unduly large condensers it is well to use

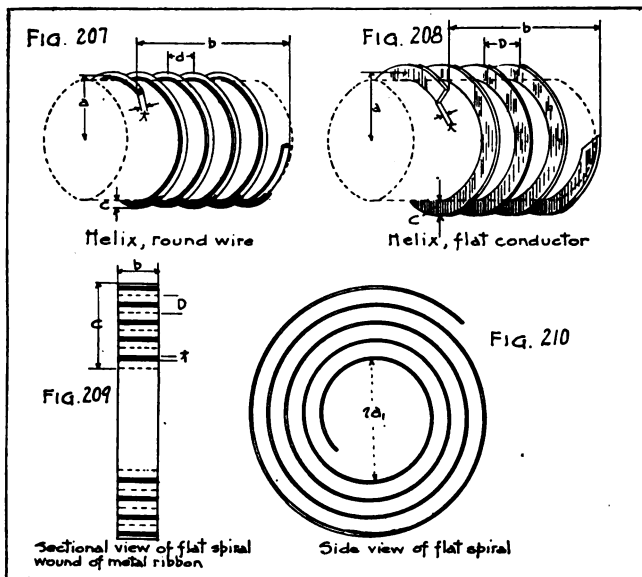

as high a voltage as possible without brush discharge taking place. For instance, if the voltage were doubled, a condenser only one fourth as large could be used for the same power. As an illustration, if it is desired to use $\frac{1}{2}$ kw. at 12,000 volts, with 1000 sparks per second,

$$C = \frac{2 \times 10^6 \times 500}{1000 \times 144 \times 10^6} = 0.007 \text{ mfd.}$$

Knowing the total capacitance required, the number of sheets of dielectric required to make up the condenser is obtained from the formula,

$$C = 0.0885 \times \frac{1}{10^6} \times K \frac{nS}{\tau} \tag{88}$$

where K is the dielectric constant, n is the number of sheets of dielectric, S is the area in cm.² and τ the thickness in cm. Supposing that mica is not available, it may be required to find the number of sheets of glass required to make up the condenser of 0.007 mfd. required above. Suppose the sheets are 15 by 20 cm., 0.25 cm. thick, and the dielectric constant is 7. Substituting in the formula just given,

$$n = \frac{0.25 \times 0.007 \times 10^6}{0.0885 \times 7 \times 15 \times 20} = 9$$

Thus nine sheets of this dielectric are needed.

It should be noted that the higher the spark frequency N , the smaller may be the condenser used to give the same power. For this reason, as well as the others previously given, it is a distinct advantage to use a high spark frequency.

When the voltage at which it is desired to operate the spark gap is so high that it will break down the particular insulation used in the condensers, or cause brush discharge, the connection of four condensers each of capacitance C , as shown in Fig. 206, p. 276, will give a resultant capacitance C , while subjecting each condenser to only half the full voltage.

Inductance Coils.—The principal inductance coils in a radio set are the primary and secondary of the oscillation transformer and the antenna loading coil, and the

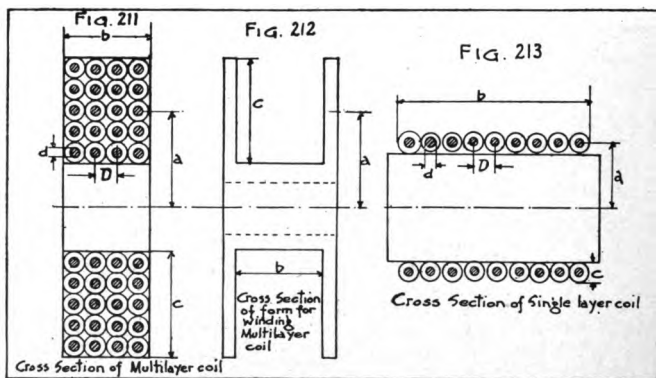

three corresponding coils of the receiving set. The three coils, oscillation primary, and secondary, and loading coil, are very similar. In actual practice few operators know even approximate values of the inductances; a standard form is used, depending somewhat on the size of the set, and adjustments by clips or taps enable the proper values to be used. In order to design a set, the inductances of the coils are calculated and an allowance made for the small inductance in the leads and other parts of the circuit. The form usually used for coils in transmitting circuits are either the helix (single layer spaced coil) of round wire, or edgewise wound strip, Figs. 207 and 208, or the flat spiral or pancake of bare metal ribbon, Figs. 209 and 210. For wavemeters a multi-layer coil is used having wires insulated and close together, Figs. 211 and 212. For receiving coils the common form is a single layer of insulated wires, Fig. 213. The coils are supported or held together by some insulating material, and no iron is used in them.

Helix of Round Wire.—The inductance of the coil of Fig. 205 is given in microhenries by

$$L = \frac{0.0395a^2n^2K}{b} \tag{89}$$

where a and b are shown in Fig. 211, a being the mean radius of the solenoid and b the total length of the solenoid; n is the number of turns of wire; d is the diameter of the bare wire; and K is a shape factor depending upon the relative dimensions, all lengths being expressed in centimeters. A brief table of values of K is given below. In the figure, D is the pitch of the winding or the distance between centers of adjacent wires; c is the radial thickness of the winding.

As an example, find the inductance of a solenoid having 15 turns of bare wire of diameter 0.4 cm., pitch of winding 1.1 cm., diameter of core 24 cm. In the formula $d=0.4$ cm., $D=1.1$ cm., $n=15$, $b=nD=16.5$ cm., $a=12+.2=12.2$ cm. Then with $\frac{2a}{b} = \frac{24.4}{16.5} = 1.48$, K is found as 0.598. From the above formula the inductance in microhenries is given by

$$L = \frac{0.0395 \times 12.2^2 \times 15^2}{16.5} \times 0.598 = 48.0$$

If it is desired to compute the inductance more closely than a few per cent, more accurate formulæ should be used as given in C. 74, p. 253.

TABLE OF VALUES OF K .
(Shape Factor of Helical Inductance Coils.)

Diameter Length	K	Diameter Length	K	Diameter Length	K
0.00	1.000	0.70	0.761	3.50	0.394
.05	0.979	0.80	.735	4.00	.365
.10	.959	0.90	.711	5.0	.320
.15	.939	1.00	.688	6.0	.285
.20	.920	1.25	.638	7.0	.258
.25	.902	1.50	.595	8.0	.237
.30	.884	1.75	.558	9.0	.219
.40	.850	2.00	.526	10.0	.203
.50	.818	2.50	.472	25.0	.105
.60	.789	3.00	.429	100.0	.035

Helix of Edgewise Wound Strip.—Refer to Fig. 208. For this case the formula is

$$L = \frac{0.0395 a^2 n^2 K}{b} - \frac{0.0126 n^2 a c}{b} \tag{90}$$

microhenries, where K is given in the table above.

As an illustration of use of the formula, a helix of 30 turns is wound with metal strip 0.635 cm. wide by 0.159 cm. thick with a winding pitch of 0.635 cm., to form a solenoid of mean diameter 25.4 cm. Here $D=0.635$ cm., $a=12.7$ cm., $c=0.635$ cm., $b=nD=30 \times 0.635=19.05$ cm. For $\frac{2a}{b}=1.333$, $K=0.623$.

Then from the above formula

$$L = \frac{0.0395 \times 12.7^2 \times 900 \times 0.623}{19.05} - \frac{0.0126 \times 900 \times 12.7 \times 0.635}{19.05}$$

$$L = 187.4 - 4.9$$

$$L = 182.5 \text{ microhenries.}$$

Flat Spiral.—See Figs. 209 and 210. The inductance is given by

$$L = 0.01257 \, a n^2 \times \left[2.303 \left(1 + \frac{b^2}{32a^2} + \frac{c^2}{96a^2} \right) \log_{10} \frac{8a}{d} - y_1 + \frac{c^2}{16a^2} y_3 \right] \quad (91)$$

where $a = a_1 + \frac{1}{2}(n-1)D$; $d = \sqrt{b^2 + c^2}$; and y_1 and y_3 are shape factors given in the following table. See example below.

Shape Factors for Flat Spiral Inductance.

b/c	y_1	y_3	b/c	y_1	y_3
0	0.500	0.597	0.50	0.796	0.677
0.025	.525	.598	.55	.808	.680
.05	.549	.599	.60	.818	.702
.10	.592	.602	.65	.826	.715
.15	.631	.608	.70	.833	.729
.20	.665	.615	.75	.838	.742
.25	.695	.624	.80	.842	.756
.30	.722	.633	.85	.845	.771
.35	.745	.643	.90	.847	.786
.40	.764	.654	.95	.848	.801
.45	.782	.665	1.00	.848	.816

Illustration.—A flat spiral of 38 turns is wound with copper ribbon whose cross sectional dimensions are 0.953 cm. (3/8 in.) by 0.795 cm. (1/32 in.), the inner diameter being 10.3 cm., and the measured pitch 0.4 cm. Here $n=38$, $b=0.953$, $D=0.4$, $c=nD=38 \times 0.4=15.2$ cm.; $2a_1=10.3$ therefore $a=5.15 + \frac{37}{2} \times 0.4=12.55$ cm.; $d=\sqrt{0.953^2+15.2^2}=15.23$ cm.; $\frac{8a}{d}=6.592$; $\frac{b^2}{32a^2}=0.0002$; $\frac{c^2}{96a^2}=0.0152$; $\frac{c^2}{16a^2}=0.091$; $b/c=0.0627$. Then from the table, $y_1=0.5604$ and $y_3=0.599$. From the above formula,
 $L=0.01257 \times 12.55 \times 38^2 \times [2.303 \times 1.015 \times \log_{10} 6.592 - 0.5604 + 0.091 \times 0.599]$
 $L=323.3$ microhenries.

This is correct to $\frac{1}{2}$ of 1 per cent.

Multi-Layer Coil.—The coil is made of insulated wire closely wound as in Fig. 211. Such coils are used in wavemeters. The insulating frame on which the coil is wound has the cross section shown in Fig. 212. The inductance is given by

$$L = \frac{0.0395 \, a^2 n^2 K}{b} - \frac{0.0126 \, n^2 a c}{b} \quad (0.693 + E)$$

where E is given by the following table:

b/c	E	b/c	E
1	0.000	12	0.289
2	.120	14	.286
3	.175	16	.302
4	.208	18	.306
5	.229	20	.310
6	.245	22	.313
7	.256	24	.316
8	.266	26	.318
9	.273	28	.320
10	.279	30	.322

As an illustration, a coil has 15 layers of insulated wire, with 15 turns to a layer the mean radius being 5 cm. The coil is 1.5 cm. deep and 1.5 cm. in axial length. Here $a=5$, $n=225$, $b=c=1.5$. From the tables K is 0.267 and E is zero. Then the formula gives

$$L = \frac{0.03948 \times 25 \times 225^2}{1.5} \times 0.267 - \frac{0.01257 \times 225^2 \times 5 \times 1.5}{1.5} \times 0.693$$

$$L = 8887 - 2205$$

$$L = 6682 \text{ microhenries.}$$

Single Layer Coil.—Refer to Fig. 213. The inductance is computed by the formula (89). As an illustration, a coil has 400 turns of wire in a single layer, pitch of winding 0.1 cm., radius of coil out to center of wire 10 cm. Here $a=10$, $n=400$, $D=0.1$, $b=nD=40$. With $\frac{2a}{b} = \frac{20}{40} = 0.5$, K is found as 0.818.

$$L = \frac{0.03948 \times 100 \times 400^2}{40} \times 0.818 = 1290 \text{ microhenries.}$$

For any other inductance calculations see C. 74, Sections 66 to 73.

171. Simple Field Measurements.—On high power radio transmitting sets it is desirable to have instruments reading the current taken from the generator, the voltage of the same, the power so taken and the frequency of the current. The four instruments, ammeter, voltmeter, wattmeter and frequency meter, are permanently mounted on the switchboard. The measurements of the various radio quantities are explained below.

Voltage.—A simple method of measuring a voltage, either at radio or low frequencies is to measure the distance a spark jumps between electrodes of a given shape and size in air. Following is a table showing approximately the “spark voltages” in air between brass balls 2 cm. in diameter for various spark lengths.

Spark Length in Cm.	Spark Voltage.
0.1	4,700
0.2	8,100
0.3	11,400
0.4	14,500
0.5	17,500
0.6	20,400
1.0	31,300
2.0	47,400

Current.—The principal current measurement in practice is that of the current in the antenna. A hot wire ammeter is inserted in the lead-in or ground wire. If its reading is lower than normal, it indicates trouble in the adjustment of the apparatus, or in the grounding.

and means decreased distance of transmission. In order to avoid undue interference with other stations, the ammeter current should be kept as small as will give the needed range. As has been stated before, a low resistance lamp can be used in place of the ammeter. When the closed circuit and antenna are not in resonance, the lamp burns feebly or not at all. Current measurements are also necessary in connection with some of the various measurements.

Wave Lengths.—The theory and use of the wavemeter have been discussed in Sections 112 and 168. A wavemeter placed in inductive coupling with a coil or antenna carrying radio current will show pronounced increase of current in its own coil and condenser when it is tuned to resonance with the source. The wave length is read directly from the wavemeter setting for resonance, or from a calibration curve. A receiving set can be used to measure the wave lengths of received waves if it is first standardized in terms of wave lengths. This standardization is done by the arrangement of apparatus shown in Fig. 214, where Z is a buzzer, LC a wavemeter, and A the inductance coil of the receiving circuit.

The operator listens in the telephone of the receiving set, (not shown in the figure). As the wavemeter condenser knob is turned the loudest sound is heard when the wavemeter circuit is tuned to the same wave length as that for which the receiving set is adjusted. The wave length is then read from the wavemeter scale or calibration curve. Continuing in this manner, the receiving circuit can be calibrated as a wavemeter, by setting it at many different adjustments and reading the wave lengths at resonance each time. The wavemeter need never be used, after that, for received waves, and the operator always knows where to tune for any wave length.

Inductance.—To find the unknown inductance L_x of a coil, a tuned source, which need not be a wavemeter, is excited by a buzzer, shown at Z in Fig. 215-A. A wavemeter with a coil of known inductance L is brought near and its variable condenser C adjusted to resonance by means of a detector and telephone. L is then replaced by L_x and a new value of capacitance C_1 is found for resonance. Then $LC = L_x C_1$ and L_x is found as $L \frac{C}{C_1}$, or as $L \left(\frac{\lambda}{\lambda_1} \right)^2$ if the wavemeter reads directly in wave lengths. The value thus measured is the apparent inductance which depends somewhat on the frequency of oscillation. (See Section 114.) Values of L_x can be obtained at different frequencies of the source.

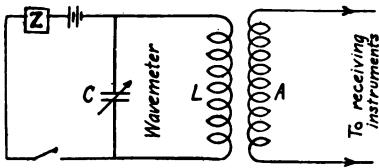

Fig. 214
Wave Length Calibration
of a Receiving Set.

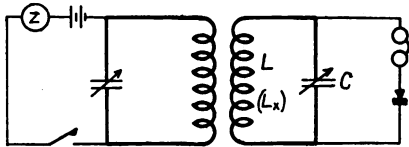

Fig. 215-A

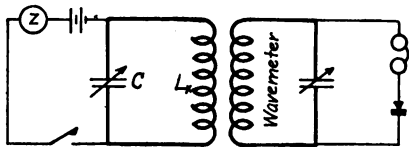

Fig. 215-B

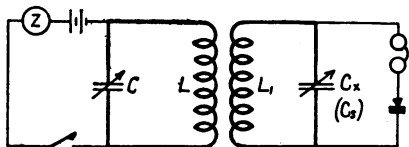

Fig. 216-A

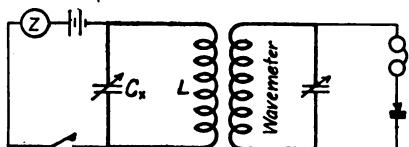

Fig. 216-B

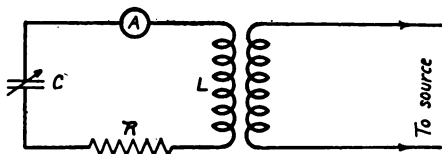

Fig. 217

A second way is by the use of a standard condenser instead of a standard coil; (See Fig. 215-B). L_x is connected to the standard condenser C and that circuit is set in oscillation by the buzzer Z . The wave length is measured by a wavemeter, and L_x is computed from $\lambda_m = 1884 \sqrt{CL_x}$.

Capacitance of condensers.—The simplest method is that of comparison with a standard variable condenser. A tuned circuit LC is excited by a buzzer, Z in Fig. 216-A. The unknown condenser C_x is placed in series with an inductance coil L_1 and the buzzer circuit adjusted to resonance, using the detector and telephone of the circuit under test. The unknown condenser C_x is then replaced by the standard condenser C_s which is now adjusted to resonance with the buzzer circuit. The capacitance of the unknown condenser is then the same as that read on the standard.

If a standard condenser is not obtainable, the capacitance of the unknown variable condenser can be found by connecting it to an inductance of known value L and exciting the circuit by a buzzer. The wave length is read on a wavemeter (Fig. 216-B). C_x is found from $\lambda_m = 1884 \sqrt{C_x L}$.

Accurate results are easily obtained by the first method described, that of comparison; but the second method is open to error because of the distributed capacitance of the lead wires and the coil, and the inductance of the leads. The effect is slight if the capacitances employed are large.

Resistance and Decrement.—Three simple methods are available for measurement of high frequency resistance or decrement, (1) resistance substitution, (2) resistance variation, and (3) reactance variation. After the resistance R is known, a simple relation $\delta = 19.7 RfC$ enables the decrement to be computed, or vice versa. C is the capacitance at resonance and is known from the condenser setting. Of the three methods, the first is the best if a variable high frequency resistance standard is available; the second is a good all round method, requiring resistance standards, but these need not be variable; the third requires no resistance standard, and is especially suited to measuring the decrement of a wave. In all three methods, the best results are obtained if the exciting source gives continuous or only slightly damped current. In the resistance substitution method, the resistance R to be measured is inserted in a tuned circuit with a variable condenser C and inductance coil L coupled loosely to the source, as shown in Fig. 217. A hot wire ammeter is

inserted at *A*. The circuit is tuned to the source and the reading of *A* noted. The resistance *R* is then replaced by a variable resistance standard which is adjusted until the ammeter reading is the same as it was before. The known amount of resistance inserted is the same as *R*. Resistance standards for radio work must be of fine wire to avoid skin effect, and must be short and straight in order to have very little inductance. For additional information on measurements see Circular 74.

B. Apparatus for Undamped Wave Transmission.

172. **Advantages of Undamped Oscillations.**—Undamped oscillations are not broken up into groups like damped oscillations. Exactly similar current cycles follow one another continuously, except as they are interrupted by the sending key, or subjected to gradual fluctuations of intensity as when used for radio telephony. Undamped oscillations are produced by a high frequency alternator, an arc, or vacuum tubes. This chapter does not take up vacuum tubes and their uses, these being treated in the following chapter. The main advantages of undamped waves are the following: (1) Radio telephony is made possible. (2) Extremely sharp tuning is obtained and consequent reduction of interference between stations working close together. A slight change of adjustment throws a receiving set out of tune, and the operator may pass over the correct tuning point by too rapid a movement of the adjusting knobs. (3) Since the oscillations go on continuously instead of only a small fraction of the time, as in the case of damped waves, (Section 160) their amplitudes need not be so great, and hence the voltages applied to the transmitting condenser and antenna are much lower. (4) With damped waves the pitch or tone of received signals depends wholly upon the number of sparks per second at the transmitter. With undamped waves the receiving operator controls the tone of the received signals, and this can be varied and made as high as desired to distinguish it from strays, and to suit the sensitiveness of the ear and the telephone. These advantages, freedom from interference from other stations through selective tuning, the use of high tones and low voltages, and the greater freedom from strays combine to permit a higher speed of telegraphy than could otherwise be obtained.

173. **Use of High Frequency Alternators.**—For the production of continuous oscillations an alternating current generator of very high

frequency can be used. See Section 95. This is connected directly or inductively to the antenna and ground. See Fig. 218. This constitutes the simplest possible connection for producing continuous waves. However, to obtain a wave length as short as 1500 meters, the frequency of the alternating current must be as high as 200,000 cycles per second. The generator speed required to produce this frequency is so high that a special type of construction is needed for such a machine. It is also necessary to have apparatus for keeping the speed constant, so that the wave length will not change (since $f\lambda_m=300,000,000$). This method is not available for

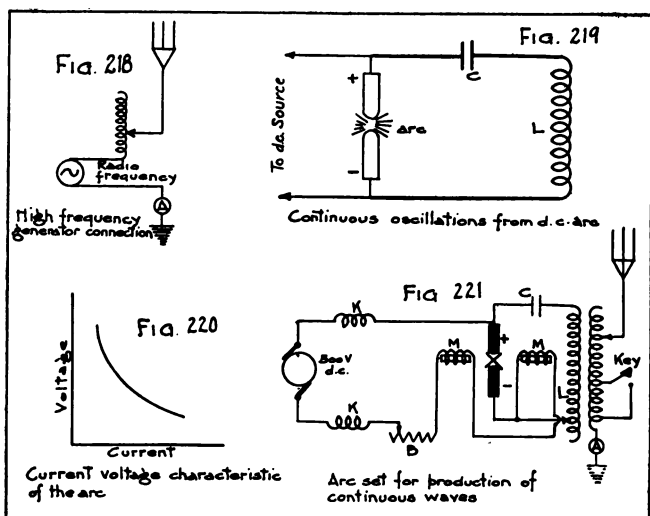

generating very short waves; for these, the oscillating vacuum tube is used. See Section 198.

174. **Arc Sets.**—A much used method for producing undamped waves of rather great wave length is by means of a d.c. arc operated on about 500 volts. It has been discovered that an electric arc between proper electrodes shunted by an inductance coil and a condenser will produce undamped oscillations through the shunt circuit. The connection is shown in Fig. 219. The operation is as follows.

The current through the arc is always in the same direction but may vary in magnitude. It is found that when the current in the arc increases, the voltage at its terminals falls off (see Fig. 220). Suppose the arc to be burning steadily with the CL circuit disconnected. If now the circuit is connected, the condenser C begins charging with the left plate in Fig. 219 positive, and draws current away from the arc. The potential difference of the arc increases (Fig. 220) and helps the charging. The charging continues until the counter emf. of the condenser equals that applied. As the charging nears its end, the charging current becomes gradually less, and the arc current as a whole increases to its normal value, with a corresponding drop in voltage. The condenser then begins to discharge downward through the arc, increasing the arc current, and lowering its voltage. Lowering the voltage across the terminals of the arc aids the condenser to discharge, and the effect of the inductance in the circuit tends to keep the current flowing, and a charge is accumulated on the condenser plates of the opposite sign from the first one. As the charge now nears its end, the charging current downward through the arc becomes gradually less, and the arc current decreases, causing the voltage to rise. From Fig. 219 it is seen that the rise of d.c. voltage is such as to attempt to charge the left plate of C positive, and the positive charges on the right hand plate begin at once to come back, going up through the arc and decreasing the current. There is a consequent further rise of voltage (Fig. 220), and in a direction to assist first the condenser discharge, and then the recharge in the opposite direction (on the left hand plate). The action now begins all over again, and thus continuous oscillations take place through the circuit.

Use is made of this phenomenon by coupling the coil L to the antenna, as in Fig. 221, where the schematic diagram of a complete arc transmitting set is shown. The d.c. generator is shown with choke coils KK to prevent the high frequency oscillations from getting back into the generator. B is a ballast resistance. A larger oscillating current is produced if the arc is burned in a strong magnetic field, producing a quenching action on the arc, and for that purpose the magnets MM are provided. Also the arc burns in a closed chamber having hydrogen passing through. The positive electrode is copper and the negative solid carbon, both being of large size and cooled by a water jacket. The shunt circuit CL is the same as in Fig. 219. The key is arranged to short circuit some of the turns of

inductance in the antenna circuit, the correct number of turns being adjusted for resonance with the key closed. Then with the key open, the antenna circuit is out of tune with the arc oscillations and the current is negligible, thus forming the intervals between dots and dashes.

A simple modification of Fig. 218 or Fig. 221 will enable the apparatus to be used for radio telephone transmission. One method is to insert in the ground wire a telephone transmitter capable of carrying the antenna current. The vibrations within the transmitter caused by sound waves alter the resistance and modify the radio oscillations and transmitted waves.¹

175. Calibration and Adjustment of Sets.—With a high frequency alternator the frequency and hence the wave length are determined by the speed of the generator and the number of poles. The inductance and capacitance of the antenna should be of such values as to give the circuit the same natural frequency as the generated current. This is brought about by adjusting the antenna loading coil to give maximum current in the hot wire ammeter (Fig. 218).

Much the same method is used with arc sets. The desired wave length is obtained by adjustment of C or L in Figs. 219 and 221, the antenna circuit being opened, and the wave length being set on a wavemeter which is brought near. The antenna circuit is then adjusted to the same wave length by varying the loading coil until the hot wire ammeter gives a maximum reading. A pilot lamp can be used instead of the ammeter, since it can be adjusted by a shunt to light only when the circuits are in resonance. Sometimes this lamp is connected inductively by a loop of wire instead of being directly in the ground wire.

C. Apparatus for Reception of Waves.

176. General Principles.—Receiving sets are divided into two general classes, those for damped waves, and those for undamped waves. Sets for damped waves in practice involve the simpler connections and form a good starting point for the discussion, although it will be shown later in introducing undamped wave sets, that a

¹In Chapter 6, Sections 202 to 204 this action is explained, and improved methods are given for carrying on radio telephony by means of vacuum tubes. For discussion of the behavior of an electric arc, and its application to radio work, the reader is referred to Fleming's Principles of Electric Wave Telegraphy and Telephony (3rd edition), pp. 95 to 115, with special notice of pp. 111 and 112.

very slight modification of the damped wave apparatus will give one method of receiving undamped waves. Damped waves are commonly received by a crystal detector or a vacuum tube detector (see Sections 179 and 191) and a telephone receiver. The tone heard in the telephone is that of the groups of damped waves. Undamped waves are ordinarily received by a vacuum tube method which produces beats (see autodyne method, p. 336). These will be made clear in the diagrams which follow, where, for the purpose of explaining principles, the simplest possible sets will be shown first, even though not now used in military work.

The fundamental principle of reception of signals is that of resonance. If the receiving circuits are tuned to oscillate at the same

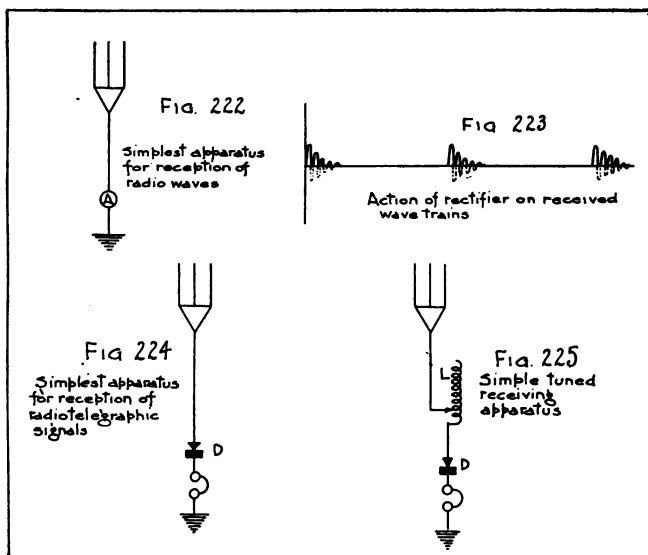

natural frequency as the incoming waves, then these waves, though extremely feeble, will after a few impulses, build up comparatively big oscillations in the circuits. In reality, then, for reception of signals, all that is needed is an antenna circuit tuned to the same wave lengths as that of the transmitting station, and an instrument capable of evidencing the current which flows in the antenna connecting wire. This is shown in Fig. 222. This is the simplest pos-

sible arrangement for reception, and will operate on either damped or undamped waves. A current indicating instrument is shown at *A*. In practice the current is too feeble for any hot wire ammeter. An ammeter is more suitable for quantitative measurements than for receiving telegraphic signals, since the dots and dashes are not readily distinguished unless made so slowly as to be impracticable for transmitting messages.

Use of the Telephone.—A more sensitive receiving device is a telephone receiver having a large number of turns of wire compactly wound. The current is made manifest by vibrations of the diaphragm at audible frequency, but the frequency of a radio current is so high that the diaphragm cannot possibly follow it. The effect is as if the diaphragm tried to go both ways at once, with the result that no observable motion takes place. To remove this difficulty a crystal rectifier is put into the circuit, which permits current to flow in one direction, but not in the other; or more exactly, the current in the reverse direction is negligibly small compared with the current in the principal direction. See Fig. 51. Referring to the reception of damped waves, it is well to remember that the waves are in widely separated groups. The action of a crystal rectifier upon damped oscillations is shown in Fig. 223; the lower halves of the waves are drawn dotted to indicate the portion of the current that is cut off by the rectifier.

It is found that the cumulative effect of one group or train of waves, for instance that due to one condenser discharge at the transmitter, pulls the telephone diaphragm away from its neutral position. The number of such pulls per second is equal to the number of wave trains per second. With a 300-meter wave having 1000 wave trains per second the radio frequency is 1,000,000 and the audio frequency is 1000, or one is a thousand times as high as the other. The upper limit of audio frequency for the human ear is 16,000 to 20,000 sound waves per second, so that even if the telephone diaphragm could, without a rectifier, follow the radio frequency, the ear would not hear the signals. In telegraphic signaling, either a dot or a dash lasts long enough to contain many wave groups, and in the telephone, where the pitch corresponds to the spark frequency, a tone is heard during the length of the dot or dash.

Simple Receiving Sets.—In Fig. 224 is shown the simplest connection for reception with a telephone receiver. It is suitable only for damped waves. At *D* is shown the rectifier, commonly

called a "detector," although it detects nothing; it alters the waves so that the telephone can detect them. The apparatus as shown receives best from a transmitter of the same, or nearly the same wave length. It is true that the presence of the detector and telephone introduces high resistance in the antenna circuit and thus renders it not very selective, so that it will respond to a wide range of wave lengths. Tuning to resonance is made possible if a tuning coil is introduced such as L in Fig. 225, to vary the inductance of the circuit and hence the wave length. This is a connection exactly analogous to the plain antenna of Fig. 194, with the spark gap (the point where the energy enters the antenna) replaced by the detector and telephone (the point where the used energy leaves the antenna).

It is well to notice how simple is the apparatus actually needed for reception, contrary to what the uninitiated person supposes. Three pieces of apparatus, telephone receiver, rectifier and tuning coil will receive effectively from damped wave stations. The main disadvantage of the connection of Fig. 225 is in not being able to tune out stations that one does not wish to hear. Also the amplitude of the oscillations is much diminished by the high resistance of the detector and telephone. The principal resistance is that of the detector.

The apparatus of Fig. 225 gives about the same results if the telephone is in shunt with the detector instead of in series with it. In this case the explanation of the action is as follows. Suppose that the current flows easily upward through the rectifier, but not downward. During a group of incoming waves, the antenna thus receives an accumulated positive charge, and during the intervals between wave groups it discharges downward through the telephone. It cannot send current downward through the rectifier. Thus pulsations of current pass through the telephone with successive wave groups.

177. **Typical Circuits for Reception of Damped Waves.**—To avoid the difficulties attendant upon the presence of the detector in the antenna circuit, it is customary to place the detector in a separate circuit coupled to the antenna; or another viewpoint is that the detecting instruments are placed as a shunt to the tuning coil. For instance Fig. 226 is an improvement and requires no more apparatus than Fig. 225 except that the tuning coil has two adjustable connections instead of one. Oscillations now take place freely between the antenna and ground. Two telephone receivers are shown, connected in series, one for each ear.

Direct Coupled Receiving Set.—A further improvement, as regards selectivity, is shown in Fig. 227, where a variable condenser C_2 has been added. This is called the direct coupled connection. Let L_1 be the inductance in the antenna circuit, C_1 the capacitance between the antenna and ground, and L_2 and C_2 the corresponding constants of the closed circuit, shown by heavy lines. The antenna circuit is called the primary, since the energy enters the set there. The circuit containing L_2 and C_2 is called the secondary and is the closed oscillating circuit. In the same manner in which the transmitting antenna circuit is a good radiator of power, so the receiving antenna circuit is a good absorber. It is tuned to resonance with the incoming waves by adjustment of L_1 . The power is given over magnetically to the secondary, which is tuned to

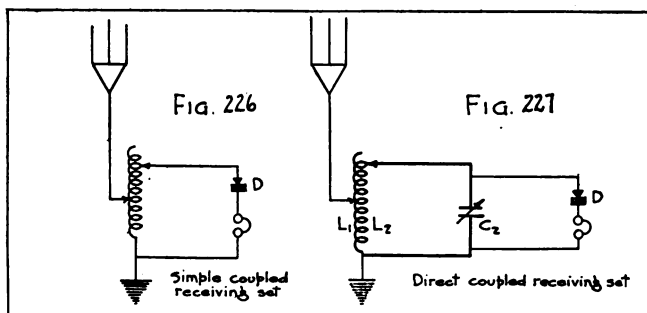

resonance by adjustments of L_2 and C_2 . Comparatively large oscillations result in the secondary, producing voltages across the condenser which are detected by the crystal and telephone, and which are not in either oscillating circuit. The oscillations are not damped thereby, and sharp tuning is obtained.

Attention is invited to the analogy of Fig. 227 with the coupled transmitting set of Fig. 200 in Section 166. The open absorber of one corresponds to the open radiator of the other; the closed oscillating circuits correspond, each having its L and C ; shunted around the condenser in one case (Fig. 227) is the apparatus where the used energy is taken out, namely, the detector and telephone, and in the other case the apparatus where the energy is put in, namely, the power transformer with its generator.

Inductively Coupled Receiving Set.—In Fig. 228 is shown the inductively coupled receiving set. This may be taken as the standard upon which all later changes are based. A fixed condenser of about 0.005 mfd. is shunted around the telephone and this increases the strength of the signals. Its action is explained as follows. Suppose the principal current flows downward through the detector and telephone. While this current flows, the fixed condenser is charged with top plate positive. When the reversal of the radio oscillation comes, the current through *D* and *T* ceases. Then the condenser discharges down through *T* and tends to maintain the current till the next oscillation downward through the instruments. In this

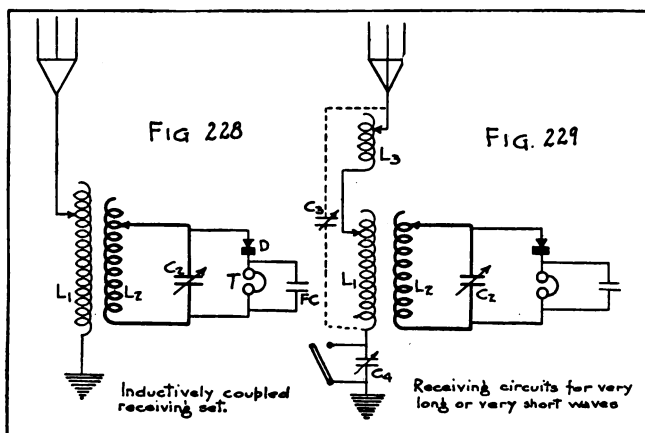

way the gaps between the successive pulsations of rectified current are filled in, and the cumulative effect of a wave group is strengthened. In practice the telephone cord, containing as it does two conductors separated by dielectric, forms a condenser which in some cases is sufficient so that an added fixed condenser gives no improvement.

The connection in Fig. 228 is similar in its action to the direct coupled arrangement of Fig. 227. In either case, on account of the coupling between the primary and secondary coils, there are reactions of each coil upon the other, with consequent double oscillations when the coils are near together. See Section 163. Sharp

tuning becomes impossible. It is found, however, that if the resistance of the circuits is low, extremely sharp tuning is obtained. The antenna is tuned to the incoming waves by changes of the inductance L_1 . Sometimes if very sharp primary tuning is desired, a variable condenser is shunted around L_1 , and fine adjustments are made therewith. The secondary is tuned to the primary, the operations of tuning being done alternately until the telephone gives the best response. In the secondary the coarser tuning is done by changes of the inductance L_2 , and the fine tuning with the variable condenser C_2 .

Comparing Figs. 195 and 228, it will be found that the circuits are the same. One finds in both places the antenna circuit (radiator or absorber), the closed oscillating circuit, the coupling coils, and the power inserted or detected in shunt connections to the condenser. The main difference of apparatus is that instead of a high voltage condenser as in Fig. 195, C_2 is a small variable air condenser, and instead of spaced-turn coils of large wire, the coils of the receiving apparatus have many turns of insulated wire closely wound.

For receiving a longer wave in the primary circuit than is possible by using all of the inductance L_2 a series inductance L_3 , called a loading coil, is added. See Fig. 229. Also, a variable condenser may be connected as shown at C_3 to increase the wave length and afford fine tuning. The secondary may also be provided with an extra inductance in series with L_2 if needed. For receiving short waves on a large antenna, series condenser C_4 is inserted in the ground wire. It is short circuited when not in use.

In the typical set of Fig. 228, a crystal rectifier (Section 179) is used as the detector. The principal disadvantage of this type of detector is that it can not be depended upon to stay in adjustment. A good deal of time is required for the frequent readjustments. Fig. 230 shows exactly the same connection, but with the crystal detector replaced by a Fleming valve, V . This is a glass bulb containing two electrodes and having the air exhausted. One electrode in the vacuum is a lamp filament which is heated by current from a storage battery A . The other electrode is a metal plate. The heated filament gives off a stream of electrons (Section 184) toward the plate. Current from incoming electric waves can pass through the vacuum in only one direction determined by the electrons, the current in the opposite direction being suppressed.

In this way the tube acts as a rectifier. It is very stable and about as sensitive as a good crystal.

A still further improvement is shown in Fig. 231, using a vacuum tube having three electrodes. It is seen here that the circuits joined to the filament and the nearer electrode are exactly the same as in Fig. 230. The telephone, however, is in a circuit with a battery *B*, and the signals received thereby are much louder than in the case of Fig. 230. For the theory of action of the three-electrode vacuum tube as a detector see the next chapter, Section 191.

Capacitively Coupled Receiving Set.—A method of coupling receiving apparatus to the antenna circuit which affords compactness

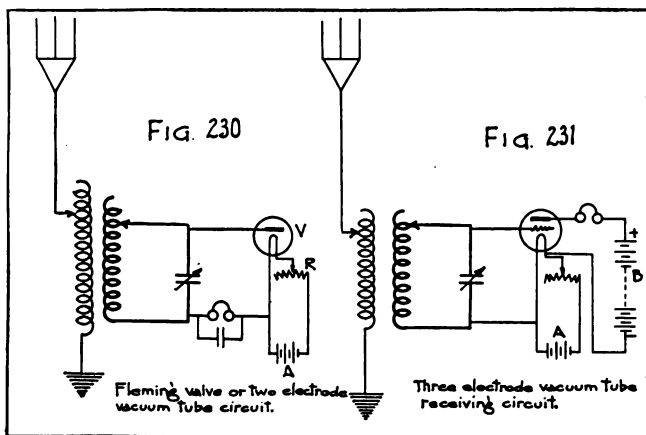

is shown in Fig. 232. By fixing the primary and secondary coils L_1 and L_2 permanently at right angles to each other, inductive coupling between the two is prevented. Instead, the coupling between the two circuits is effected through the condensers CC , which are referred to as "coupling condensers." Such an arrangement is called "electrostatic" or "capacitive" coupling. The condensers are arranged so that by turning one handle both are varied together. One of the condensers, C , the one connected to earth, may be omitted, but better results are usually obtained with two. The advantages of capacitive coupling are as follows. (1) The coils are of compact form. They are wound as rings with rectangu-

lar or square winding section, thus giving large inductances in small space. This is a great saving of room compared with sets using variable inductive coupling where the coils must be so constructed that one of them can move with respect to the other, and where they are usually wound on long tubes in order to get suitable variation of coupling. (2) The coils are fixed. In the inductive type they must sometimes be separated many centimeters for very loose coupling. (3) The coupling is quickly and easily changed.

Sets for Quick Tuning.—When simplicity of tuning is the principal requirement, and it is desired to reduce the tuning operations to a

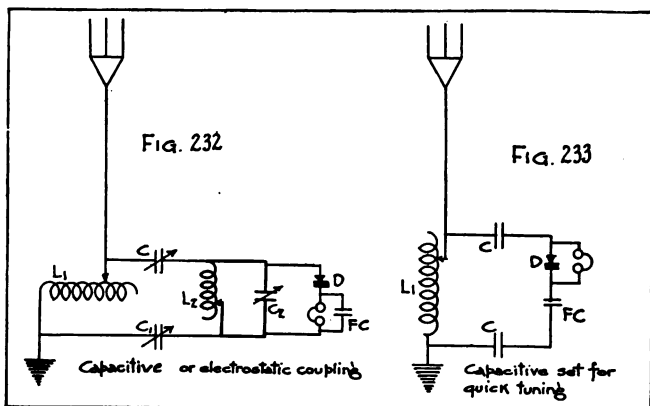

minimum number, even at the expense of a certain amount of selectivity, the following methods are used.

In Fig. 233 is shown a modification of the capacitive connection of Fig. 232; in practice the change from one to another is accomplished by one switch. The secondary is removed, and the telephone is put in shunt with the detector instead of with the fixed condenser FC . If a medium value of coupling is used it is not usually necessary to alter it, therefore the only tuning adjustment is that of the primary inductance.

Another device for quick tuning is shown in Fig. 234. This employs an inductive coupling. The primary is tuned sharply to the incoming waves, while the secondary is untuned. With the connections as shown, the secondary will respond in practically the

same manner to a wide range of wave lengths, owing to the high resistance of the detector. Then the only adjustment the operator has to make is that of the primary inductance. Sometimes additional provision is made for adjustment of the coupling by separating the coils; this gives variation in the sharpness of tuning and in the signal strength.

"Standby" Circuits.—These are also called "pick-up" circuits. When listening for possible calls from a number of stations it is convenient to have apparatus which will respond to a wide variety of wave lengths. The circuit of Fig. 233 will do this to a limited extent if the coupling is close. This is also true of Fig. 234. Prob-

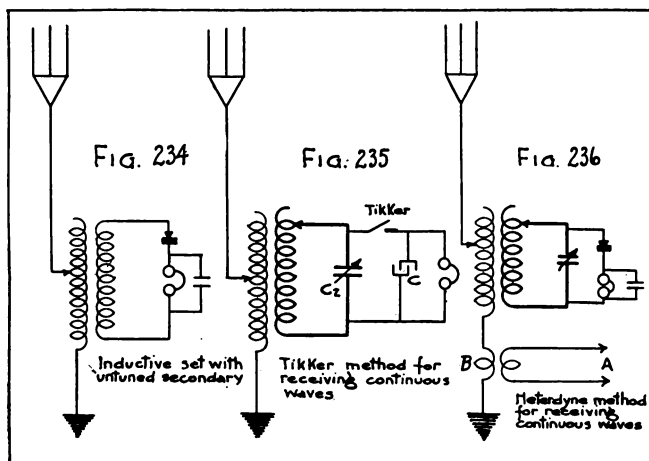

ably the most broadly tuned of all the receiving sets is the plain aerial connection already shown in Fig. 224 or Fig. 225. It is, however, too broadly tuned to be used if many stations are transmitting.

A fairly good pick-up circuit is the ordinary inductive set of Fig. 228 when used with a tight coupling. The decrement is then high, and the tuning broad. A switch may be provided, if desired, to put the receiving instruments over into the antenna circuit.

178. Circuits for the Reception of Undamped Waves.—While damped waves are transmitted as detached groups or trains, un-

damped waves are usually not separated into groups. Undamped waves, even if rectified, will not be detected in a telephone receiver unless the waves are broken up into groups in some way. This is because the telephone diaphragm and the ear cannot respond to so high a frequency as that of the radio oscillations. Hence it is necessary to interrupt the undamped wave dot or dash into many groups by rapid interruptions of the current. It is arranged in practice to have, for example, 1000 interruptions a second, and as long as a signal continues a note of pitch 1000 is heard. These interruptions may be made to take place either at the transmitter or at the receiving station. A method for producing them at the transmitting station is to insert a rapidly operating circuit breaker called a "chopper" in the antenna wire; or if it is inconvenient to break the current, the chopper may be used to short circuit some of the turns of the antenna inductance coil to throw the circuits out of resonance periodically. This divides up the waves into groups to which the receiving telephone can respond. A rather more convenient method is to have the chopping done at the receiving station, for then the receiving operator can control the pitch of the received signals. There are at least five ways of modifying the waves at a receiving station to obtain an audible frequency: (1) a chopper in series with the detector and telephone; (2) a variable condenser with rapidly rotating plates; (3) a "tikker" used instead of a detector; (4) a "heterodyne" in a separate circuit; (5) an "autodyne" or vacuum tube device arranged so that the detecting tube also produces the heterodyne action. The last method is explained in Section 201.

Chopper.—This may be any device for rapidly making and breaking the current. It is inserted in the circuit of the detector and telephone as in the ordinary damped wave set of Fig. 228. It consists of a rotating toothed wheel with a stationary contact touching the successive teeth or a break controlled by an electrically operated tuning fork, or it is sometimes a light high speed vibrator similar to that of an electric bell.

Rotating Plate Condenser.—If the movable plates of the tuning condenser C_2 in Fig. 228 are rotated rapidly the apparatus will be in tune once for each revolution. Each of these revolutions will produce an impulse of the telephone diaphragm. The speed can be adjusted so that the impulses will cause sounds while waves are being received. In practice it is found best to keep part of the ca-

capacitance of the condenser C_2 constant, and vary only a part of it. If the main plates were rotated the apparatus would give sounds at only a small sector of each revolution, near the resonance adjustment. To accomplish a more prolonged train of impulses during one revolution the adjustment can be held near resonance for a larger proportion of the time if the rotating condenser is made very small, and is put in parallel with C_2 . The latter does not then rotate except for ordinary hand tuning. The capacitance of C_2 plus the maximum capacitance of the rotating condenser is adjusted to give resonance. The circuit is not far from this condition when the moving plates are farthest apart, so that the signals affect the receiver during a considerable portion of the revolution.

Tikker.—See Fig. 235. The tikker is usually a stationary fine wire of steel or gold with its end running in the groove of a smooth, rotating brass wheel. It is a slipping contact device. The wire does not remain in perfect contact with the wheel, but owing to the slight irregularities there are variations of contact, which in effect keep making and breaking the circuit. With the tikker contact open, suppose the secondary inductance and condenser C_2 to be tuned to resonance with the incoming waves. If now the tikker is closed when C_2 has any stated value of charge, some of the charge will be given to the condenser C and furthermore the radio oscillations cease because the addition of C throws the apparatus out of tune. When the tikker is opened the condenser C discharges through the telephone, and in the meantime the secondary oscillations build up again, ready to give a charge over to C when the contact is closed. In this manner the current impulses through the telephone are of the same frequency as the operation of the tikker, and this can be controlled by the speed of the wheel. The capacitance of C should be about 1 mfd. No separate rectifier is needed. The tone obtained is not musical, since C_2 is charged to different potential differences at the different times when the tikker closes, and the action depends also upon somewhat irregular contact.

Heterodyne.—In this method an apparatus is arranged to produce undamped electric oscillations in the receiving circuit, of nearly the same frequency as that of the waves which are being received, and their combined action is made to affect the receiving telephone. Beats are produced having a frequency equal to the difference of the frequencies of the two waves. The connections are shown diagrammatically in Fig. 236. Any source of undamped or slightly damped

oscillations is connected at *A*. In the antenna circuit at *B* is a single turn or loop, coupled inductively to *A*. The antenna circuit thus gets the effect of the oscillations from *A* as well as from the incoming waves. Suppose those received have a frequency of 100,000, and the heterodyne *A* is adjusted to give a frequency of 99,000. As long as both act, the telephone will respond to a pitch of 1000 vibrations per second, which is of course audible. When the incoming waves cease the heterodyne continues to act alone at 99,000 cycles, but is inaudible. Therefore signals are heard only during the time when the incoming radio waves are received.

Receiving from a Radio Telephone Transmitter.—While a radio telephone transmitting apparatus operates on undamped waves it is not necessary, or indeed permissible, to use a chopper, tikker, or heterodyne at the receiving station. The transmitted waves are modified or varied in intensity by the spoken sounds and these sounds are reproduced in the telephone of the ordinary receiving set such as is used for damped waves.

179. **Crystal Detectors.**—A very simple and convenient kind of detector is obtained by the contact of two dissimilar solid substances, properly chosen. The number of substances which have been found suitable for use in such detectors is large. This type of detector is easily portable, but requires frequent adjustment and is less sensitive than a vacuum tube. For field sets where a compact and easily portable form of detector is required, the crystal detector is very convenient. The use of crystal detectors is largely confined to such work now, and even in the portable military sets is rapidly giving way to the vacuum tube detector.

Crystals.—Among the combinations of solid substances which have been used as contact detectors may be mentioned silicon with steel, carbon with steel and tellurium with aluminum. The most important contact detectors, however, consist of crystals, natural or artificial in contact with a metallic point. Examples of such minerals are galena, iron pyrites, molybdenite, bornite, chalcopyrite, carborundum, silicon and zincite. The first three are respectively lead sulphide, iron sulphide and molybdenum sulphide. Bornite and chalcopyrite are combinations of the sulphides of copper and iron. Carborundum is silicon carbide, formed in the electric furnace. The fused metallic silicon commonly used is also an electric furnace product. Zincite is a natural red oxide of zinc.

Probably the three most widely used crystals are galena, silicon and iron pyrites. Sensitive specimens of iron pyrites are more

difficult to find than sensitive galena, but they usually retain their sensitiveness for a longer time than galena. These sensitive pyrite detectors are often sold under the trade name of "Ferron." The detector sold under the name of "Perikon" consists of a bornite point in contact with a mass of zincite. Fig. 237 shows a silicon-antimony detector; other detectors have this same general appearance.

Properties.—In order to act as a detector for radio signals a crystal contact should either (1) allow more current to flow when a given voltage is applied in one direction than when it is applied in the

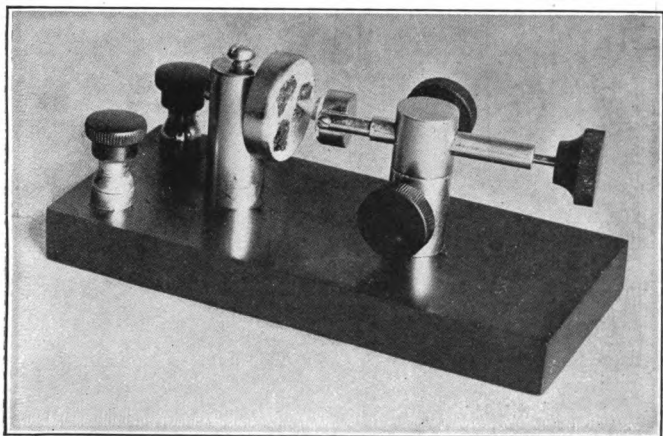
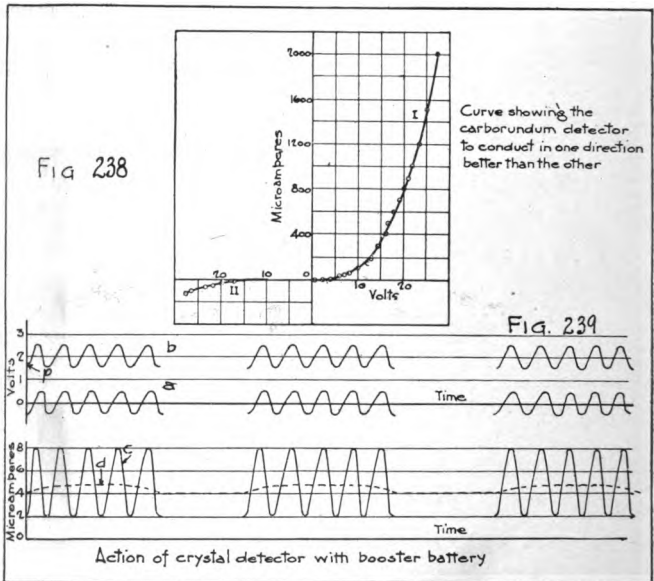

FIG. 237.—One method of mounting crystal detectors.

opposite direction, or (2) its conductivity should vary as different voltages in the same direction are applied. Practically all detectors formed by the contact of two dissimilar substances possess both of these properties, at least to a slight extent.

To make use of the latter property, a battery is required in series with the crystal, as explained below. Some crystals, such as galena, silicon and iron pyrites give about as good results as simple rectifiers as when the battery method is used. They are ordinarily used without the battery, to simplify the apparatus.

Fig. 238 shows a current-voltage characteristic curve for carborundum in contact with a metal. The current flows much more readily in one direction than in the other under equal but opposite emfs. For example, under a constant impressed emf. of 10 volts in one direction a current of 100 microamp. is obtained, while with the voltage reversed the current is only 1 microamp. This illustrates the property of "unilateral conductivity," or rectification. Furthermore, as regards the second property, when the voltage is applied in the direction giving the larger current, the conductivity (ratio of



current to voltage) increases as the voltage increases. This is shown by the right hand portion of the figure. The characteristic curve of any ordinary metallic conductor would be a straight line.

Booster Battery.—In order to make use of the second property namely the bending of the current-voltage characteristic, a local or "booster" battery is inserted in series with the crystal. Using the battery makes the crystal operate at a voltage which corresponds with the sharpest bend of the curve, so that a slight increase of volt-

age in one direction will produce a fairly large increase of current, while an equal decrease of voltage on the crystal will produce a relatively smaller decrease of current.

The application is made clear in Fig. 239. Suppose the crystal used with a booster battery adjusted to supply 2 volts to the circuit. Consider this circuit to be subjected to incoming electric waves which produce a small emf., say 0.5 volts, periodically added and subtracted. Curve *a* represents the voltage induced in the circuit by the incoming waves. The resultant voltage wave acting on the crystal is at each instant two volts greater than the value of the induced emf., and is represented by curve *b*. Under the instantaneous applied emf. of 1.5 volts, shown at point *p* in curve *b*, the crystal will allow a current of 2 microamp. to pass as shown in Fig. 239-*c*; for 2 volts in curve *b* a current of 4 microamp. will pass as shown in Fig. 239-*c*, and for 2.5 volts a current of 8 microamp. will pass. Curve *c* represents the condition which would exist in a circuit containing no inductance. The actual current wave through the telephone, as smoothed out by the inductance of the telephone and the other inductance of the circuit, is shown in curve *d*. In this discussion the curves are shown for the case where the incoming waves are undamped. The average value of the current *d* is somewhat above 4 microamp. during the time the incoming wave group is acting. Between groups it drops to just 4 microamp. (with 2 volts applied). Thus the current comes in pulses which will cause a sound to be emitted by the telephone. This sound will be determined by the number of wave trains received per second. These may be groups of damped waves, or continuous waves broken up by a tikker.

180. **Telephone Receivers.**—The distinctive features of telephone receivers for radio work are lightness of the moving parts and the employment of a great many turns of wire around the magnet poles. The lightness of the moving parts enables them to follow and respond to rapid pulsations of current. The large number of turns of wire causes a relatively large magnetic field to be produced by a feeble current. The combined effect is to give a very sensitive receiving device. Inasmuch as the size of wire used is always about the same (around A.W.G. No. 40 copper), the amount of wire and therefore the number of turns is usually specified indirectly by stating the number of ohms of resistance in the coils. Telephone receivers of fair sensitiveness for radio work have 1000 ohms in each receiver

(measured on direct current), while the better ones usually have 1500 to 2000 ohms per receiver.

The most common type, called the magnetic diaphragm type, has a U-shaped permanent magnet with soft iron poles, and a thin soft iron diaphragm very close to the poles so that it vibrates when the attraction is rapidly varied, producing sounds to correspond with the frequency of the pulsations of current. See Section 60.

The only other important type is called a mica diaphragm receiver. The regular diaphragm is of mica, and is put in the usual place in the receiver, but of course is not acted upon directly by the magnets. Between the magnet poles a soft iron armature is pivoted, inside of a solenoidal telephone winding. It is arranged so that as it moves in response to changes of magnetism a small stiff wire attachment transmits the motion to the mica diaphragm. The armature is so arranged that there is no pull upon it at all except when pulsations of current are passing through the coil. This is contrary to the ordinary magnetic telephone receiver where the magnet poles are always exerting a pull on the diaphragm. If there is no strain in the diaphragm between pulsations the vibratory movements due to incoming signals are much greater than if a strain were already existing in the diaphragm or armature. In the mica telephone this unrestrained vibration is communicated to the mica diaphragm near the ear.¹

Impedance.—The impedance of a telephone receiver to alternating current increases rapidly with frequency, and at radio frequency is so great as to permit practically no current to pass. By the use of detectors, however, the current that passes in the telephone consists of a series of pulses of audio frequency, usually from 500 to 1200 pulses or vibrations per second. A typical telephone receiver having a direct current impedance (resistance) of 2000 ohms was found at 400 cycles per second to have an impedance of 2900 ohms, and at 800 cycles an impedance of 3900 ohms, rising to 4400 ohms at 1000 cycles per second.

181. Receiving Coils and Condensers.—The coils used in receiving apparatus are very simple in construction, being usually wound in a single layer of wire on a bakelite, pasteboard, or other insulating tube. The wire is usually stranded and covered with an insulation of silk or cotton. In some types one or two sliders make contact with any desired turn of wire, the insulation being scraped off on

¹ For a detailed account and tracing out of the magnetic circuits see Bucher's Practical Wireless Telegraphy, page 168.

top of the wires along a narrow path lengthwise of the coil. The more common field sets use no slider but have switches whose points are connected by tap wires to the turns of wire in the coil. One switch takes care of single turns, and the other switch makes contact to groups of, say, ten turns each. To cover 100 turns, for instance, one switch should have 9 points of ten turns each, and a zero point, making 10 points in all, and the units switch would also have 9 points,

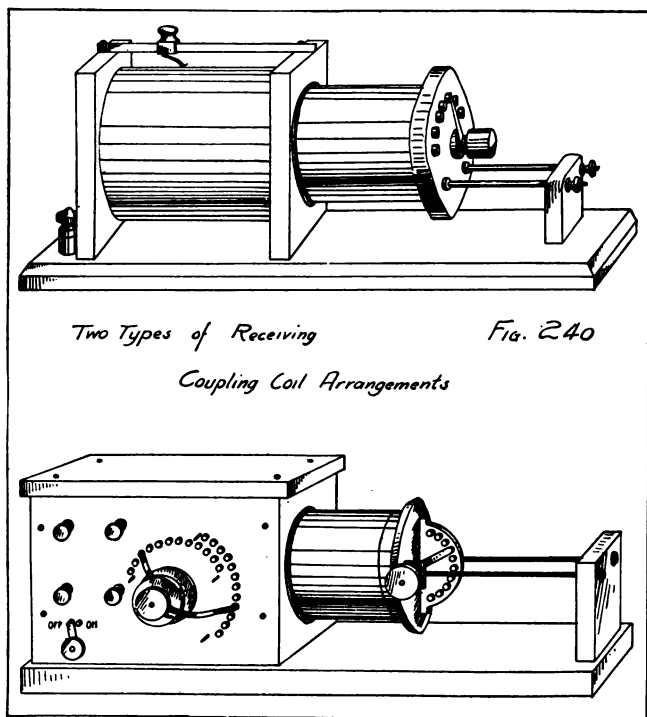

and a zero point. Then any number from 0 to 100 turns could be used. If a coil had 400 turns the first switch in groups of 20 turns could have 20 points including zero, and the unit switch could also have 20 points for nineteen unit turns and zero.

Fig. 240 shows two receiving transformers, in one of which the primary adjustment is made by a slider touching each turn of wire, and the secondary adjustment is made by a switch in groups of 30

to 40 turns. The finer secondary tuning is done by a variable condenser. The coupling between the coils is loosened by pulling the secondary out of the primary. The other receiving transformer has control of both coils by switches.

Loading coils are merely large coils used to increase the inductance of the circuit when the inductance of the receiving transformer is not great enough to be tuned to the wave length received. Ordinary tuning coils and the coils of receiving transformers of the inductively coupled type are usually 12 to 20 cm. long and 8 to 12 cm. in diameter, with single layer windings, while some of the com-

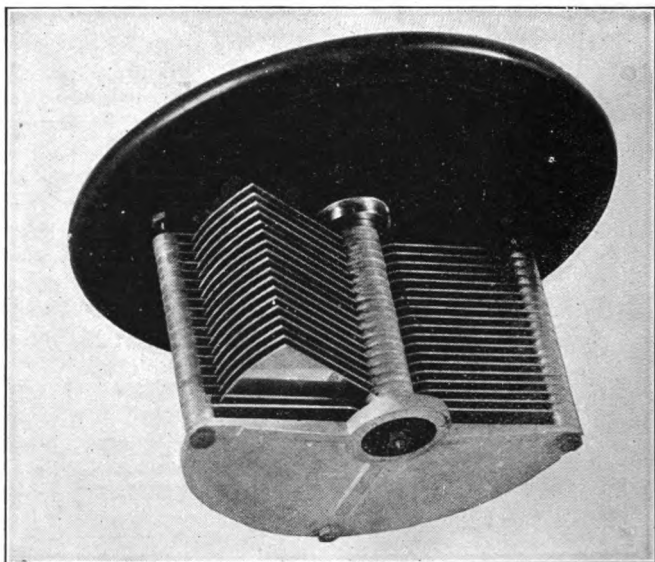

FIG. 241.—Rotary variable air condenser.

mon loading coils for long waves are 50 cm. or more in length. The inductance of the 12 cm. coils runs from 1000 to 5000 microhenries, while the large loading coils have in the neighborhood of 50 millihenries. The inductance of any particular coil can be calculated by reference to Section 170.

Fig. 241 shows a type of variable condenser with air dielectric, which is generally used. The maximum capacitance is usually 0.0005 mfd., adjustable to a minimum of nearly zero. A set of semi-circular metal plates is rotated between a corresponding set of fixed

plates, forming alternate layers of air dielectric with adjacent conductors of opposite polarity. In working with vacuum tubes most of the tuning is done with variable condensers. In the primary it sometimes happens that, with continuous waves, the tuning must

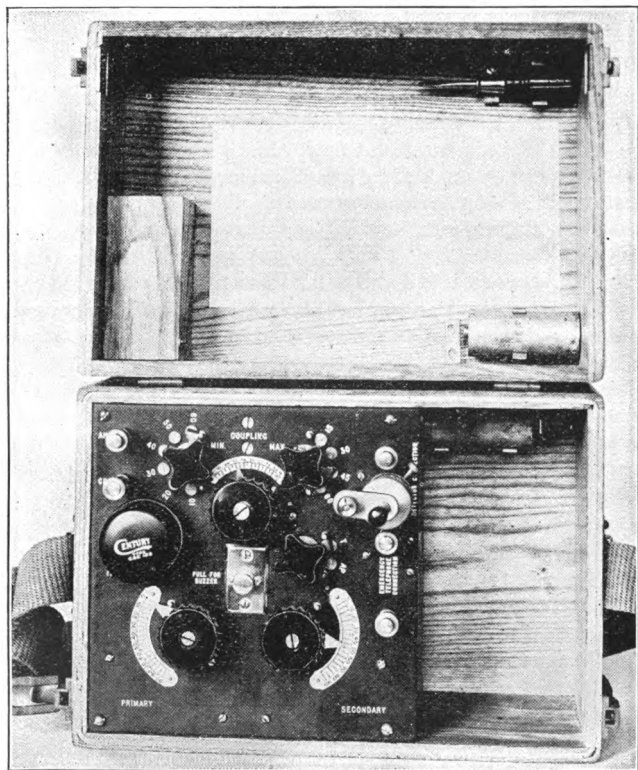

FIG. 242.—Simple receiving set (type SCR-54-A) of the portable, cabinet type.

be closer than that afforded by single turns of the primary coil, so a variable condenser is placed in parallel with the coil and used for fine tuning.

Fig. 242 shows a typical simple receiving set in cabinet form, with the tap switches and variable condensers, and a handle for changing the coupling between primary and secondary coils.

182. Measurement of Received Current.—It is possible to measure current received in a radio receiving set by the use of a crystal detector and a galvanometer. This is a rather delicate experiment, and information regarding it is given in C. 74, pages 167 to 170. The method ordinarily used is the shunted telephone method. A resistance is placed in parallel with the telephone and reduced until the limit of audibility in the telephone is reached, that is, until the sound in the telephone becomes so weak that the operator can just barely distinguish dots and dashes. If t is the impedance of the telephone for the frequency of the current impulses through it, s the impedance of the shunt, I_t the least current in the telephone which gives an audible sound, and I the total current flowing in the combination of the telephone and shunt,

$$\frac{I}{I_t} = \frac{s+t}{s}$$

This ratio, $s+t$ to s , is called the "audibility." It can be expressed in units of current if properly calibrated. It is ordinarily used in making rough comparative measurements. It is, of course, affected by the sensitiveness of the operator's ear.

For detecting currents of the order of 0.0001 amp., the crystal detector and telephone are used; for 0.000001 amp., the ordinary vacuum tube and telephone are used; for 0.00000001 amp., the vacuum tube connected for regenerative amplification and telephone are used.

CHAPTER 6.

VACUUM TUBES IN RADIO COMMUNICATION.¹

183. **Introduction.**—The advent of vacuum tubes, sometimes called electron tubes, has resulted in great advances in radio communication. As such tubes may be used for a variety of purposes, to generate, to amplify, and to modulate radio oscillations, as well as to detect them, they are now used in most types of radio apparatus. New applications have come rapidly, and possibilities of further developments are most promising. One fact of importance is that such tubes make possible the use of apparatus that is easily portable—a primary consideration in military communication. The principles underlying the uses of vacuum tubes, and their operation under the widely different conditions met in actual practice, therefore deserve careful study.

A. Electron Flow in Vacuum Tubes.

184. **Current in a Two-Electrode Tube.**—If two wires are connected to a battery, one to each terminal, the other ends may be brought very close together, in air, yet so long as they do not touch, no current flows between them. The two ends may be enclosed in a bulb like that of an incandescent lamp, and the air pumped out, leaving a vacuum, and still so long as the ends are separated, no current flows. A common experience illustrates this. When the filament in an electric lamp breaks, the current stops and the light goes out. But if one of the two wire ends mentioned above is heated to a bright red, or hotter, it is an interesting fact that a current can be made to flow across the apparently empty space between them.

Call the two ends of wire the "electrodes." The current between the hot and the cold electrode is made possible by the electrons given off by the hot electrode (explained further in the next paragraph), and is a large enough current to be measured by sensitive instruments and to have highly important uses in radio communication.

¹ See also S. C. Radio Pamphlet No. 1, Part 2.

The question will perhaps arise as to how a single electrode can be heated when it is inside of a glass bulb. That is readily done by shaping it into a loop, of which both ends are brought through the base of the bulb. These ends are connected to a battery of a few cells, the current from which heats the loop like an ordinary incandescent lamp filament. Thus one of the electrodes becomes a hot filament. For the other electrode a little plate of metal is used. A bulb containing a hot and a cold electrode as described forms a "two-electrode vacuum tube."

The action of these vacuum tubes depends upon the fact that when a metal is heated in a vacuum it gives off electrons into the surrounding space. (See Section 6.) As the electrons have a negative charge, the charge remaining on the metal is positive, therefore few of the electrons go very far, but are attracted back to the metal so that there is a kind of balance established between the outgoing and the returning electrons. Now suppose a battery is connected between the two electrodes, filament and plate. This battery is *B* in Fig. 243, and is so connected as to make the plate potential positive with respect to the filament. The electrons, consisting of negative electricity, are attracted by the plate *P*, are captured by it, and return no more to the filament *F*. Thus the battery causes a continuous flow of electrons (negative electricity) from the filament to the plate; that is, an electric current is flowing in the space between them.

The current ceases when the filament is cold, because no electrons are then escaping from the metal. No current will flow if the battery is wrongly connected, since, when the plate is negative with respect to the filament, the negative charge of the plate will repel the electrons back into the filament.

The distinction between direction of *current* and direction of *electron flow* must be carefully noted. It happens that for a great many years the direction from the positive toward the negative terminal has been arbitrarily called the direction of the current. Now it is found that these little electrons travel from the negative toward the positive electrode. The direction of current and the direction of motion of the electrons are therefore *opposite*.

Ionization.—The above explanation of the mechanism of the flow of current between the filament and plate (commonly called the "plate current") in a vacuum tube applies to the case where

the vacuum is very complete. If there is more than the merest trace of gas remaining in the tube, the operation is more complicated, and a larger current will usually flow with the same applied voltage. This happens in the following manner.

In a rarefied gas, some of the electrons present are constituent parts of atoms and some are free. These free electrons move about

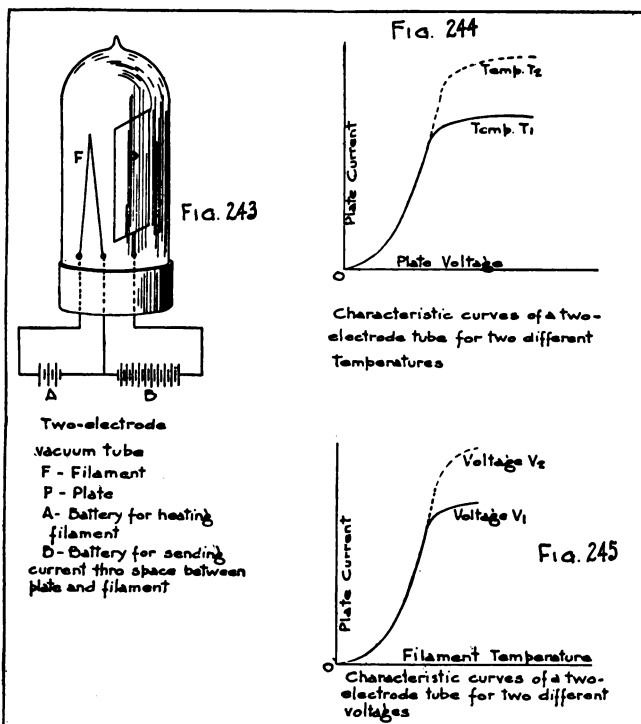

with great velocity, and if one of them strikes an atom, it may dislodge another electron from the atom. Under the action of the emf. between plate and filament, the newly freed electron will acquire velocity in one direction (that of the colliding electron) and the

positively charged remainder of the atom will move in the opposite direction. Thus both of the parts of the disrupted atom become carriers of electricity and contribute to the flow of current through the gas. This action of a colliding electron upon an atom is called "ionization by collision", and on account of it relatively large plate currents are obtained in vacuum tubes having a poor vacuum. The earlier "audion" tubes were of this sort, but tubes are now, as a rule, made with better vacua than formerly, so that ionization by collision is responsible for but a small part of the current flow.

At first it would seem to be an advantage to have ionization by collision, because a larger plate current can be obtained, but there are two difficulties which have proved so great that tubes are now usually made to have only the pure electron flow. The first of these difficulties is a rapid deterioration of the filament when a large plate current flows. The positively charged parts of the atoms are driven violently against the negatively charged filament, and since they are much more massive than electrons (an oxygen or nitrogen ion has about 25,000 times the mass of an electron) this bombardment actually seems to tear away the surface of the filament. The second disadvantage of tubes with poor vacuum is that too large a battery voltage may cause a "blue glow" discharge; the difficulties connected with the presence of this visible kind of current flow are mentioned in Section 191.

185. Actual Forms of Two-Electrode Tubes.—A tube similar to that described above was the earliest used in radio practice. It was called the "Fleming valve." It rectifies a high-frequency current somewhat as a crystal detector (Section 179) does. This rectifying action takes place because a current flows when the negative terminal of a battery is applied to the heated filament and the positive one to the plate, whereas the current becomes practically zero if the battery connection is reversed. The latter happens because the negatively charged plate repels the negative electrons and stops the current flow. The Fleming valve was used as a detector, but has been replaced by the three-electrode tube discussed below because the latter has proved to be much more sensitive.

Another type of two-electrode tube is the "kenotron," developed by the General Electric Co. It has a much better vacuum than the Fleming valve, and is made in larger dimensions. It is used as a rectifier of currents of high voltage and low frequency. It changes

alternating current into a pulsating current all in one direction. Small currents (well below 1 amp.) are rectified by these tubes, and power up to several kilowatts can be handled even if the applied voltage exceeds 25,000.

A third form of two-electrode tube, which promises to be useful for military purposes, is the "tungar rectifier."¹ These tubes contain rarefied argon gas and their relatively large currents are produced mainly through ionization by collision. These are useful for charging storage batteries from a 110-volt a. c. line. One size charges a battery of from 6 to 12 volts at from 1 to 2 amp.; a larger size charges a 6 or 12 volt battery at 6 amp.

186. The Three-Electrode Vacuum Tube.—A great improvement upon the two-electrode tube for radio purposes, consists in the addition of a third electrode, inside the tube, in the form of a metallic gauze or "grid" of fine wires between the filament and the plate. This makes it possible to increase or decrease the current between plate and filament through wide limits. It is important to understand how this result is obtained.

It is necessary first to consider what happens in a two-electrode tube having a good vacuum, when either the voltage of the battery *B* or the temperature of the filament is varied.

Effect of Plate Voltage.—Suppose first that the filament temperature is kept constant. Then a definite number of electrons will be sent out per second.² The number of electrons that travel across the tube and reach the plate per second determines the magnitude of the current through the plate circuit. The number of electrons that reach the plate increases as the voltage of the battery *B* increases. If this voltage is continuously increased, a value will be reached at which all the electrons sent out from the filament arrive at the plate. No further increase of current is possible by increasing the voltage and this current is called the saturation current. This is illustrated in Fig. 244, (full line curve) which shows that when the voltage applied to the plate is small, (horizontal distance) the current flowing between filament and plate, called the "plate current" (vertical distance) is also small, but if the voltage is made

¹ R. E. Russell—General Electric Review, 20, p. 209; 1917.

² The law giving the number of electrons emitted per second, as it depends upon the temperature of the filament, was first given by O. W. Richardson, whose book, "The Emission of Electricity from Hot Bodies" (1916) describes his experiments in great detail. See also J. J. Thomson, "Conduction of Electricity through Gases," p. 161, and I. Langmuir, Physical Review, 2, p. 450; 1913.

larger, the plate current increases more rapidly than the voltage, up to a certain value. The bend in the curve shows that when the voltage has been made large enough, there is little further gain in current.

If now the temperature of the filament is raised by means of the heating battery to a higher constant value and the same voltage steps again applied, the plate current curve will coincide with that obtained before, until the bend is reached, then it will rise higher, as shown by the dotted portion of the curve in the Fig. 244. The explanation of this is that the number of electrons sent out by the filament increases with the temperature, approximately as the square of the excess of filament temperature above red heat, and thus more are available to be drawn over to the plate. Thus a higher value of plate current will be obtained before reaching the limiting condition when all the electrons emitted arrive at the plate. When this finally happens the curve, as before, bends over until nearly horizontal.

Effect of Filament Temperature.—Suppose now that the voltage of battery B is kept at a constant value V_1 , and the filament temperature gradually raised by increasing the current from the heating battery. The number of electrons sent out will continue to increase as the temperature rises. The electric field intensity (Section 33) due to the presence of the negative electrons in the space between filament and plate may at last equal and neutralize that due to the positive potential of the plate so that there is no force acting on the electrons near the filament. This effect of the electrons in the space is called the "space charge effect." It must not be supposed that the space charge effect is caused by the same electrons all the time. Electrons near the plate are constantly entering it, but new electrons emitted by the filament are entering the space, so that the total number between filament and plate remains constant at a given temperature. After the temperature of the filament has reached the point where the effect of the electrons present in the space between filament and plate neutralizes the effect of the plate voltage, any further increase of the filament temperature is unable to cause an increase of the current. The tendency of the filament to emit more electrons per second, because of the increased temperature, is offset by the increase in space charge effect, which would result if electrons were emitted more rapidly; or, more exactly, for any extra electrons emitted, an equal number of those in the space are repelled back into the filament. If now the plate voltage is in-

creased to a new value V_2 , the plate current curve will rise higher before bending over as shown by the dotted portion of the curve in Fig. 245, because it takes a larger space charge to offset the effect of the plate at the higher voltage.

187. **Effect of Grid.**—In the three-electrode tube, the additional electrode, or grid, is interposed between filament and plate, in the stream of electrons which constitute the plate current. If a voltage is impressed upon it by means of a third battery, shown at C in Fig. 246, this modifies the space charge effect. The electrons traveling from filament to plate pass between the grid wires. If the grid is given a potential more negative than the filament, it will repel the electrons, but many of them will still pass through, owing to their high velocity, and reach the plate. If the grid potential is made still more negative, the plate current will diminish until finally it may be stopped completely.

Suppose, however, the grid is given a positive potential instead of negative. More electrons are now drawn toward the plate than would otherwise pass, and the plate current increases. The grid charge partially neutralizes the effect of the space charge. As in the two-electrode tube, a limit to the magnitude of the plate current will finally be reached, when the space charge due to the large number of negative electrons in the tube, fully counteracts the influence of the positive charges on grid and plate. The attainment of the limiting or *saturation* value of the plate current is assisted by the absorption of more electrons into the grid if its positive potential is increased. This absorption gives rise to a very small current in the circuit $FGCF$ (Fig. 246) which is called the grid current. The total electron flow is the sum of the plate current and the grid current. As the potential of the grid is made more and more positive, more and more electrons will be absorbed.

188. **Characteristic Curves.**—The above principles may be illustrated by curves obtained by experiment, known as the characteristic curves of a vacuum tube.

One form of these curves shows the relation between plate current and grid voltage. For example, a certain tube was tested by keeping the filament at a constant temperature by a steady current through it from battery A (Fig. 246). A constant voltage of 35 volts between plate and filament was maintained by the battery B , and varying voltages from 0 to 7 volts were applied to the grid G by the battery C . For each value of grid voltage the current flowing

between filament and plate was noted in the microammeter *M*. The result is plotted in Fig. 247 and in the upper curve of Fig. 248. It shows that as the grid voltage increases from -3 to $+7$ volts,

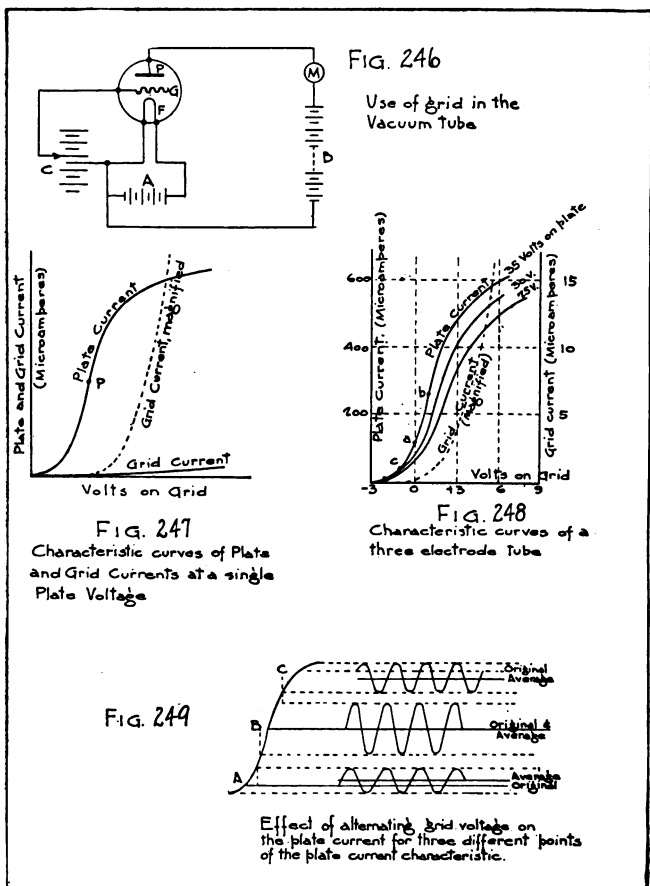

the plate current increases from zero, slowly at first, then more rapidly, but above 2 volts more slowly again. Similar tests with lower plate voltages, 30 volts and 25 volts respectively, gave similar

results except that the plate currents were smaller, as shown in the two other full line curves of Fig. 248.

Another important characteristic curve shows the relation between grid current and grid voltage. This curve is also shown in Figs. 247 and 248. It is at once evident that the grid current is very small in comparison with the plate current. In order to get a clearer idea of the dependence of the grid current on the grid voltage, it is customary to draw the grid current to a magnified scale. For example, the grid current measurements made in the above mentioned case when the plate voltage was held at 30 volts, are shown in Fig. 248 to such a scale that the same vertical distance which represents 200 microamp. of plate current indicates only 5 microamp. of grid current. Note that the grid current is zero for a very small negative grid voltage, but rapidly increases with increasing positive grid voltage.

189. Effect of an Alternating Emf. Applied to Grid.—It is evident from these curves that if an alternating emf. is applied to the grid (that is, if it is made alternately + and -), the plate current will periodically increase and decrease, keeping step with the variations in grid emf. Suppose the grid potential to be the same as that of the filament (grid voltage zero in Fig. 246) the upper curve of the figure shows that the value of the plate current will be 100 microamp. when there are 35 volts on the plate. Then if an alternating emf. of 1 volt (maximum value) is impressed between grid and filament, the plate current will keep changing from the value of the ordinate of point *b* (Fig. 248) to that of point *c*, that is, from about 250 to about 50 microamp.

Thus an increase of one volt in the emf. applied to the grid produces an increase in the plate current of 150 milliamp. (from 100 to 250), while a decrease of the same amount in grid voltage causes a reduction of only 50 milliamp. The effect then of applying a high frequency oscillating voltage to the grid will be to cause a higher "average" value of plate current during the time of such voltage application. The preceding discussion relates to what happens when the points *a*, *b*, and *c* are on the lower bend of the characteristic curve. When the grid voltage is so adjusted that the plate current has a value somewhere on the upper bend of the characteristic curve, the effect of applying an oscillating voltage to the grid will again be to cause oscillations of the plate current. Here, however, the effect of the alternating grid voltage is to cause

a "lower" average value of the plate current. If the grid voltage is adjusted to such a value that the plate current assumes a value on the straight portion of the characteristic (say point *P*, Fig. 247), oscillations of the grid voltage cause oscillations of the plate current, but the average value of the plate current is, in this case, unchanged.

These facts are shown in Fig. 249. At the left is represented the plate characteristic, and three points *A*, *B*, and *C* are designated, on the lower bend, straight portion and upper bend, respectively. To the right is shown the effect of an alternating grid voltage in each case. The dotted lines represent the original values of the plate current. The full curves show the oscillations of plate current, caused by the oscillations of the grid voltage, and the full straight lines the average plate current during these oscillations. As will be shown later, cases *A* and *C* represent conditions suitable for use of the tube as a detector, and *B* the condition for use as an amplifier. There is no appreciable time lag between grid voltage and plate current and thus no phase difference, even when the frequency of alternation is several million per second.

With different kinds of tubes different values of the grid voltage are necessary, in order to obtain a value of plate current at the desired part of the characteristic. This adjustment is accomplished by the *C* battery in the grid circuit (Fig. 246). Since the plate current is so sensitive to small changes of grid voltage, it is often desirable to provide a voltage divider on the *C* battery to facilitate the close adjustment of the grid voltage. In C. 74, p. 203, is illustrated such an arrangement which is useful in experimental determinations of the characteristic curves.

190. **Practical Forms of Three-Electrode Tubes.**¹—In Fig. 250 are shown a number of French and American tubes. Those in (A) are French. The two smallest tubes are the ones most commonly used; they serve for detectors, amplifiers, and generators. The one with two projections is used for short wave length apparatus, the idea of the construction being to keep the connections to grid and plate as widely separated as possible, to minimize capacitance between them. Both types have a straight filament, the grid is a spiral wire surrounding the filament, and the plate is a cylinder surrounding both. A number of Western Electric Co. tubes are shown in (B) General Electric Co. tubes (called by that company "pliotrons") in (C), and DeForest Radio Telephone and Telegraph Co. tubes (called by that company "audions") in (D). The DeForest Co.

¹ See also *Electrical World* for Feb. 22, 1919, Vol. 73, No. 8; article by Capt. Ralph Bown.

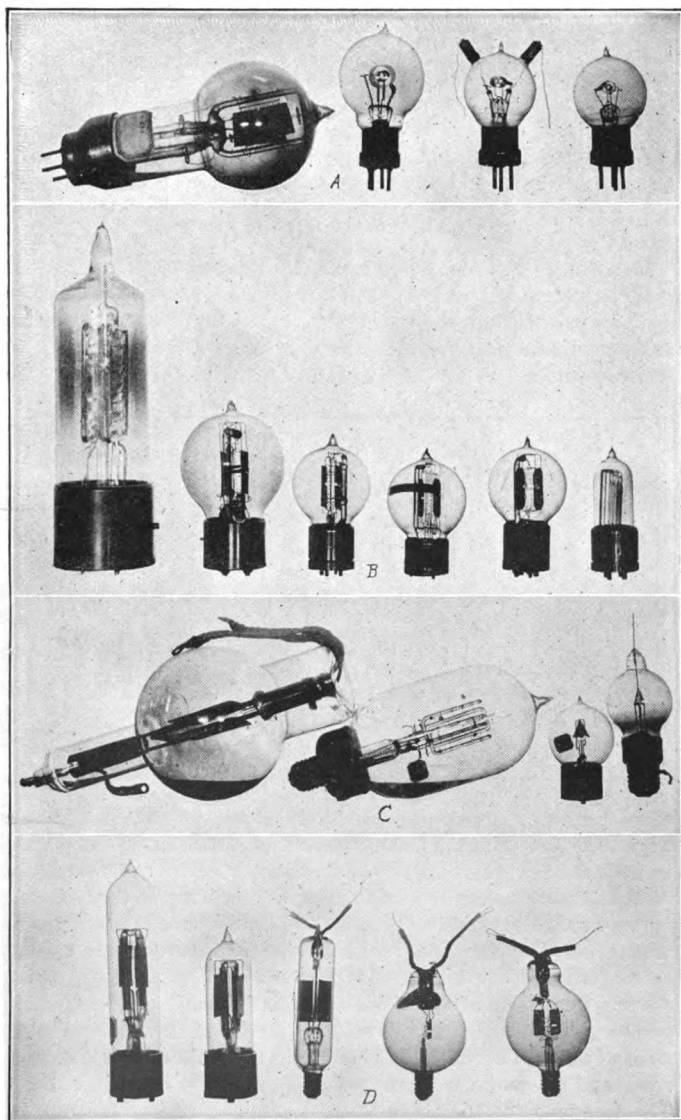
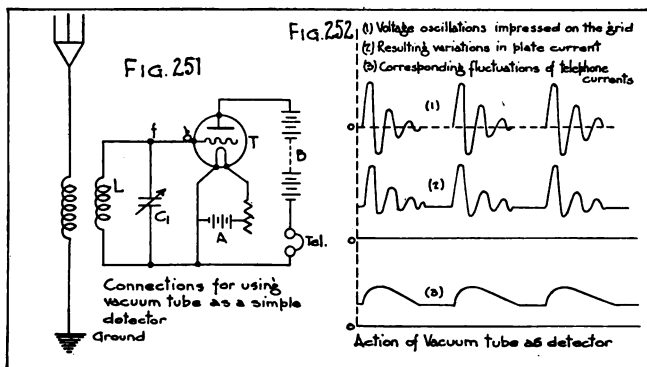

FIG. 250.—French and American vacuum tubes.

makes larger tubes, called "oscillions." In all modern American tubes the filament is a wire doubled back one or more times; the grid is a pair of metal lattices, one on each side of the filament; and the plate is a pair of metal planes parallel to the two parts of the grid. The larger tubes are used as generators of radio current

B. The Vacuum Tube as a Detector.

191. **Simple Detector Circuit and Explanation of its Action.**—In order to understand how a vacuum tube acts when used as a detector, consider the circuit shown in Fig. 251. Suppose the receiving antenna picks up a signal. Oscillations in the tuned circuit LC_1 are set up, because L is inductively coupled to the antenna circuit. The



radio frequency alternating voltage between the terminals of L is impressed between the filament and the grid, and (as was explained in Section 189) brings about changes in the plate current. If the plate current is normally at a point on the bend of the characteristic curve, say in the region a to c , Fig. 248, the increase of plate current when the grid voltage is positive is greater than the decrease of plate current when the grid voltage is negative. On the average the plate current is increased while the signal is passing. Fig. 252 shows graphically the simultaneous values of (1) high frequency oscillations of the grid current, (2) high frequency variations of plate current, and (3) audio frequency fluctuations of telephone current. The frequency of the wave trains should be within the range of

audible sound, preferably between 300 and 2000, because the telephone inductance smooths out each train of high frequency oscillations into a single pulse and the pulse frequency must, therefore, be within the audible range in order that the signals may be heard.

In some cases it is necessary to use a C battery between points f and g (Fig. 251), in order to bring the plate current to the bend of the characteristic curve (Fig. 248). This, however, does not change the action; the variations of the plate current are brought about by the alternating emf. between the terminals of the coil L just the same as when the C battery is absent. It is interesting to note here that we are employing resonance in the circuit LC_1 to obtain as large an emf. as possible between the terminals of the coil and condenser with a given signal (see Section 109).

If the grid battery voltage is adjusted so that the plate current has a value near the upper bend of the plate current-grid voltage curve instead of the lower bend, the action will be essentially the same, but the effect of the arrival of a wave train will be to decrease momentarily the plate current instead of to increase it. As before, there will be fluctuations of the plate current keeping time with the arrival of wave trains, and a sound in the telephone of a pitch corresponding to the number of wave trains per second.

Care must be taken in the use of receiving tubes that the B battery voltage is never high enough to cause the visible "blue glow" referred to in Section 184. The tube becomes very erratic in behavior, when in this condition, and is very uncertain and is not sensitive as a receiver. This is because the plate current becomes so large that it is unaffected by variations of the grid voltage. Characteristic curves will not repeat themselves if the tube shows the blue glow and sharp breaks may appear in any or all of the curves. Furthermore the tube gets hot and its safety is endangered by the blue glow discharge.

Condenser in Grid Lead.—If the circuit of Fig. 253 is used, having a condenser in series with the grid, the action of the tube as a detector is different. It now depends upon the form of the grid voltage—grid current curve (dotted curve of Fig. 248). When the grid voltage is the same as that of the filament and there are no grid oscillations, Fig. 248 indicates that under these conditions the grid current is zero; that is, no electrons are passing from filament to grid. Now suppose

that a series of wave trains falls upon the antenna of Fig. 253 as shown in (1) of Fig. 254. If the circuit LC_1 is tuned to the same wave length as the antenna circuit, oscillations will be set up in it, and similar

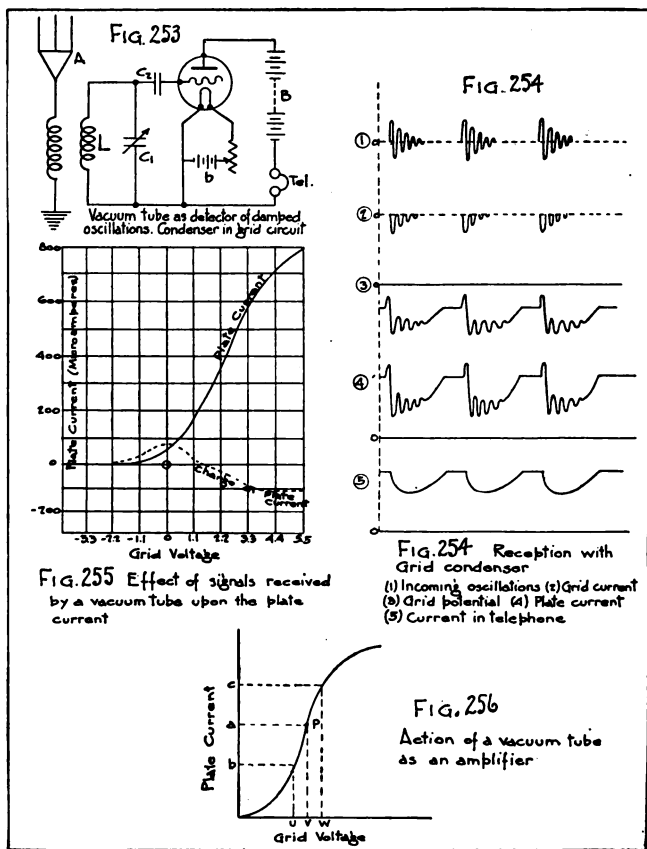

voltage oscillations will be communicated to the grid by means of the stopping condenser C_2 .¹ Each time the grid becomes positive, elec-

¹ A suitable value for the capacitance of the condenser C_2 is about 0.0001 mfd.

trons will flow to it, but during the negative half of each oscillation no appreciable grid current will flow. This is shown in curve (2) of Fig. 254. Thus during each wave train the grid will continue gaining negative charge and its average potential will fall as shown in (3) of the same figure. This negative charge on the grid opposes the flow of electrons from filament to plate, causing on the whole, a decrease in the plate current. At the end of each wave train this charge leaks off through either the condenser or the walls of the tube (or both), and the plate current rises again to its normal value as shown in (4) of the same figure. This should happen before the next wave train comes along, but sometimes the leak is not fast enough for this discharge to take place. In this case a better result is secured if a resistance of a megohm or so is shunted across the condenser. Such a resistance is called a "grid leak."

The telephone diaphragm cannot vibrate at radio frequency but the high inductance of its coils smooths out the plate current variations into some such form as is shown at (5) in the figure. Thus as in the case of the circuit of Fig. 251, the note heard in the telephone corresponds in pitch with the frequency of the wave trains. If the waves falling upon the antenna are undamped waves they may be detected using either of these circuits, if they are first divided off into audio frequency groups. (For methods see Chapter 7, Section 178). To receive undamped waves which are not divided up into groups of audible frequency, vacuum tubes may be used in special ways called the heterodyne and autodyne methods. See Section 201 below.

192. Effect of Incoming Signals upon the Plate Current.—The theory of detector action just given involves a change in both the plate current and grid current of the receiving tube. It is easily shown experimentally that such changes take place. The result of one such experiment is shown in Fig. 255. The solid line curve is similar to those of Fig. 248 and shows for a particular tube with a constant plate voltage the values of plate current for various values of grid voltage between -5.5 and $+5.5$ volts. The lower (dotted) curve shows how much the plate current changed when a signal was being received. The circuit was so arranged that the effect of the signal was to add a high-frequency oscillating voltage to the adjustable steady voltage applied to the grid, as explained in Section 191. The height of the dotted curve shows, for

each value of grid voltage, how much the plate current was changed by the signal. It will be noted that in some cases the effect is an increase of plate current, but in other cases a decrease corresponding to the different parts of the plate current curve, as explained in Section 189. Thus when the steady voltage applied was +1.1 volts, the plate current was increased by about 35 microamp., and when the voltage was zero, by 70 microamp. With +1.3 volts applied there was no change at all in the plate current when the signal came in, while for +5 volts there was a decrease of more than 100 microamp. produced by the same strength of signal. Since it is the plate current that passes through the telephone receiver it is evident that with this particular tube the signals received are clearest with zero or about 5 volts positive applied to the grid, but 1 to 1.5 volts should be particularly avoided. Different tubes show similar results but the voltage values differ somewhat.

The tubes generally supplied to the Signal Corps for receiving (types VT-1, VT-11 and VT-21) are all so designed that they operate to good advantage—like the tube considered above—when the grid is kept at the same voltage as the negative end of the filament, that is, grid voltage zero.

C. The Vacuum Tube as an Amplifier.

193. **General Principle.**—It was shown in Section 191 that a vacuum tube acts as a detector or rectifier because an alternating voltage applied to the grid circuit can be made to produce unsymmetrical oscillations in the plate circuit. While the tube is thus acting as a detector, it is also as a matter of fact acting as an amplifier. That is, greater oscillations are produced in the plate circuit for a given alternating voltage in the grid circuit than would be produced by the same voltage directly in the plate circuit. This explains why the vacuum tube is a more sensitive detector than the crystal detector, which acts as a rectifier only.

It is sometimes desired to amplify an alternating current without any rectifying or detecting action. This is done by keeping a voltage on the grid of such value that the symmetry of the oscillations in the plate circuit is not altered. Thus if there is a steady voltage applied on the grid of such value that the plate current is on the part of the characteristic curve that is practically straight (as point *P* in Fig. 256) then a small change in grid voltage in either direction causes the plate current to increase or decrease by the same amount.

For instance, if the grid voltage is increased from v to w , (Fig. 256) or decreased by an equal amount from v to u , the current will, in the first case, increase from a to c and in the second fall off by an equal amount, from a to b . In other words the wave form of the grid voltage variation will be repeated in the fluctuating plate current. The latter will now be equivalent to an alternating current superimposed upon the steady plate current from the B battery. The magnitude of the alternating current part of the plate current will be greater, the steeper the slope of the curve at the point P .

The *power* expended in maintaining the oscillations in the grid current is far less than that involved in the corresponding plate current change, because the grid current is much smaller than the plate current and the voltage is also less. For example, referring to the vacuum tube whose characteristic curves are given in Fig. 248, if the grid voltage oscillates so that the plate current fluctuates between the values a and b , the grid current changes from about 1 to 2 microamp., average voltage 2.2 volts. The corresponding change in plate current is from 300 to 400 microamp., with average voltage perhaps 35 volts. Remembering that amperes \times volts = watts, we have in the grid circuit a power expenditure of 2.2 microwatts and in the plate circuit a corresponding power change of 3500 microwatts. This much increased power is drawn from the energy stored in the B battery. The signals may be thought of as exerting a sort of relay action on the plate circuit, causing magnified power to be drawn from the B battery. The tube is said in this case to act as an "amplifier." The variations of current in the grid circuit have been compared to the slide valve of an engine since they admit energy from the battery into the plate circuit, much as the slide valve admits heat energy into the cylinder of the engine.

To utilize the amplified alternating current in the plate circuit, the primary of a transformer T (Fig. 257), may be placed in the plate circuit. From the secondary of this transformer, the alternating current (see Section 60) is delivered to a crystal detector or other receiver; or, if further amplification is desirable, to the grid circuit of a second amplifying tube, as shown in Fig. 257. From this second tube it then goes to a receiving tube or crystal. This method of using two or more tubes for amplification is called *cascade amplification*.

Instead of passing on the amplified energy by means of a transformer coupling, the coupling may be simply a resistance or a reactance. An example of this is shown in Fig. 258 where a crystal

detector is shown as the receiver. To get the greatest power output from the tube a resistance should be used in the plate circuit of a value equal to the average internal resistance of the tube, just as in the case of a direct current generator of constant voltage, the great-

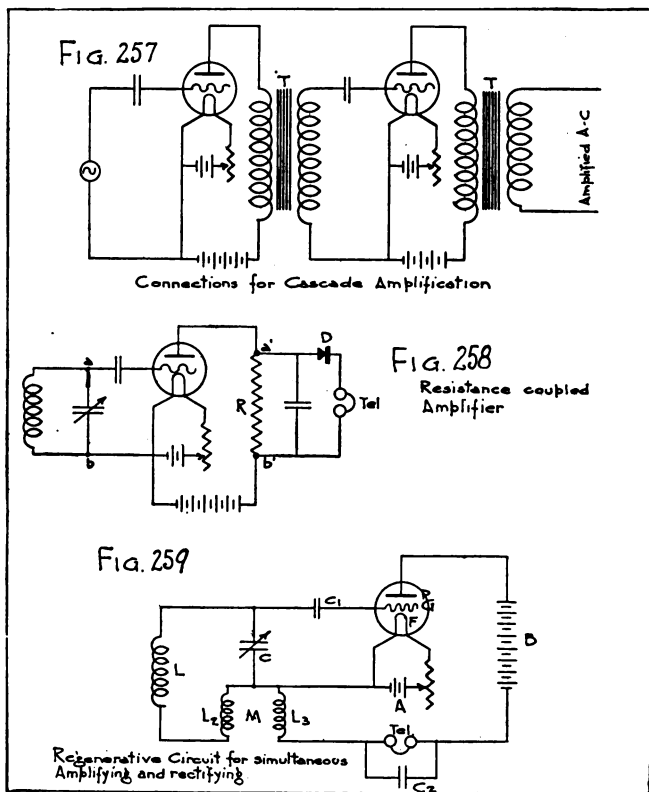

est power output occurs when the internal resistance equals the external.

194. **Elementary Theory of Amplification.**—The characteristic curves of a vacuum tube show that an increase in the grid voltage

makes a much greater increase in the plate current than the same increase in the plate voltage itself would do. Consider, for instance, the two upper curves of Fig. 248, p. 318. From the curve marked "30 volts" we see that the plate current increases from 200 to 400 microamp. when the grid voltage is increased from 1.2 to 3 volts, or 110 microamp. per volt change. If on the other hand, the grid voltage is left unchanged at 1.2 volts and the plate voltage increased to 35 volts, the upper curve shows that the plate current increases to 280 microamp.; a change of 80, or 16 microamp. for each volt. In other words a volt added to the grid voltage makes about 7 times as much change in the plate current as a volt added to the plate voltage would make. This number which represents the relative effects of grid voltage and plate voltage upon plate current is called the "amplification constant" of the tube.¹ The greater this amplification constant is, the more efficient is the tube as an amplifier of weak signals. It may be defined as the ratio of the change in plate current per volt on the grid to the change in plate current per volt on the plate.

The two principal constants of a tube are the amplification constant just defined and the internal resistance. The latter is the resistance to an alternating current between plate and filament in the tube. These two constants may be calculated from the characteristic curves of the tube, or may be measured by a simple method like a bridge measurement.² The voltage amplification given by an amplifying circuit may be calculated from these two constants of the vacuum tube.

The voltage amplification may be defined as the ratio of the voltage change produced in the output apparatus in the plate circuit to the change in the voltage impressed on the grid. Thus in the resistance coupled amplifier, of Fig. 258, it is the ratio of the voltage between a' and b' at the terminals of R to the voltage applied between a and b . Calling the amplification constant K and the internal resistance R_o , it can be shown that the voltage amplification for such an amplifier is

$$\frac{KR}{R+R_o}$$

¹ The theory of amplification has been worked out in more detail by Langmuir, Proc. Inst. Radio Engineers, 3, p. 261, 1915; by Vallauri, L'Elettrotecnica, 3, p. 43, 1917; and by H. J. Van der Bijl, Physical Review, 12, p. 171, 1918.

² For information on such measurements see papers, by J. M. Miller, Proceedings Institute of Radio Engineers, 6, p. 141, 1918; and H. J. Van der Bijl, Physical Review, 12, p. 171, 1918.

195. **Audio Frequency Amplification.**—In the preceding discussion of amplification, it was pointed out that after a radio frequency current is amplified it is passed through some rectifying device. This latter is not necessary when an audio frequency current is amplified, for the amplified current can be received with a telephone receiver placed in the plate circuit of the amplifier. It is sometimes desired to amplify the audio frequency current produced in a radio rectifying device. In this case the radio current consisting of groups of oscillations is first passed into the rectifying device, and the pulses of current having the group frequency are passed on into the amplifier. The amplifying process may be carried on through several steps, as in cascade amplification shown in Fig. 257. An amplifier consisting of two type VT-1 tubes in cascade is said to give an amplification of 10,000 times.

196. **Regenerative Amplification.**—It is possible to increase the sensitiveness of a vacuum tube as a detector enormously by a method which makes use of its amplifying action.¹ The connections are shown in Fig. 259. The explanation of the amplifying action is as follows. Oscillations in the circuit LL_2C , applied to the grid through the condenser C_1 , produce corresponding variations in the continuous plate current, the energy of which is supplied by the battery B . This plate current flows through L_3 and by means of the mutual inductance M , some of the energy of the plate oscillations is transferred back to the grid circuit, and the current in the circuit LL_2C is thus increased. This produces amplified grid oscillations which, by means of the grid, produce larger variations in the plate current, thus still further reinforcing the oscillations of the system. Simultaneously with this amplification the regular detecting action goes on; the condenser C_1 is charged in the usual way, but accumulates a charge which is proportional, not to the original signal strength, but to the final amplitude of the oscillations in the grid circuit. The result is a current in the telephone much greater than would have been obtained from the original oscillations in the circuit.

To obtain maximum voltage on the grid, the circuit LL_2C should have large inductance and small capacity. The connection between L_2 and L_3 must be so made that their mutual inductance is of proper sign to produce an emf. which will aid the oscillations instead of opposing them. Various modifications of this method are used.

¹ This is due to E. H. Armstrong and is described by him in Proceedings Institute of Radio Engineers, 3, p. 215, 1915.

The condenser C may be across L_3 , so that the tuned oscillatory circuit is in series with the plate instead of the grid. Or, C may be connected across all of the inductance in series, the oscillation circuit then including L , L_2 , and L_3 .

Combination Radio and Audio Regenerative Amplification.—A single vacuum tube can be used to amplify and detect radio frequency current and simultaneously amplify the telephone pulses of audio frequency. The circuits are shown in Fig. 260. Here M_2 represents the coupling for the radio frequency, and the coils are of relatively small inductance. M_3 is the coupling for the audio frequency, and the transformer is made up of coils having an inductance of a

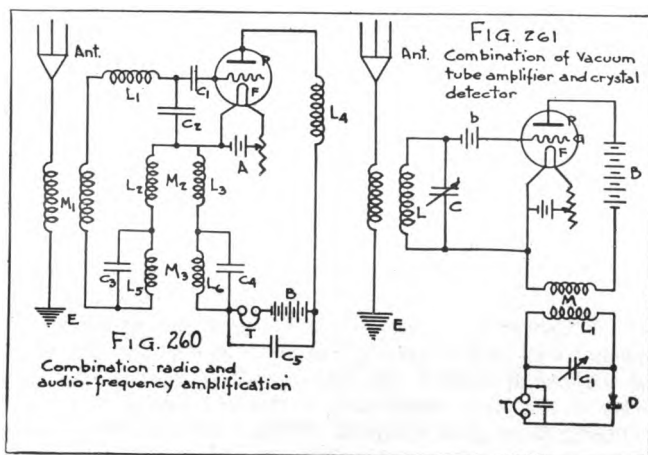

henry or more. The variable condensers C_3 and C_4 have the double purpose of tuning M_3 to the audio frequency and of by-passing the radio frequencies. The radio frequency variations in the plate current flow through the circuit $PFL_3C_4C_5L_4$ and at the same time the audio frequency variations flow through $PFL_3L_5TBL_4$. The total amplification of weak signals by this method is about 100 times that of the ordinary audion bulb. On stronger signals the amplification is smaller.

197. Vacuum Tube Amplifier with Crystal Detector.—The characteristic curves of a vacuum tube show that the best value of grid voltage for amplification is not the same as for best detecting action,

which is an argument for using separate tubes for these two purposes. This adds somewhat to the complexity of the apparatus, and leads some operators to prefer the combination of a vacuum tube for amplifying and a crystal detector for receiving.¹ Such a circuit is shown in Fig. 261.

The oscillating circuit LC is coupled to the antenna and is tuned to the frequency of the latter, which is that of the incoming waves. The alternations of voltage between the terminals of the coil L are applied between the filament F and grid G through the battery b , which has been previously adjusted in voltage so that the plate current has a value corresponding to a point on the straight part of its characteristic.

The amplified oscillations in the plate circuit are communicated to the oscillating circuit L_1C_1 which is coupled to the plate circuit through the coil M . The circuit L_1C_1 is tuned to the frequency of the received waves like the other two circuits. The alternations of voltage between the terminals of the coil L_1 are rectified in the crystal detector D in the usual way, and cause an audio frequency current to flow in the telephone receivers.

D. The Vacuum Tube as a Generator.

198. **Conditions for Oscillation.**—The vacuum tube can be made to generate high frequency currents, and thus act as a source of radio current for the transmission of signals or other purposes. The principle may be illustrated by Fig. 259. As explained previously, the coupling M between the coils L_2 and L_3 transfers some of the power in the plate circuit back to the grid circuit, thus greatly increasing the original voltage on the grid. If the coupling is made so close that the voltage fed back to the grid circuit is greater than the voltage originally there, the oscillation will continue even though the original source which caused the oscillation is removed. Continuous or undamped oscillations may be generated by a vacuum tube used thus as an "oscillator" of any frequency between one per second and 10,000,000 per second.²

A great variety of circuits have been used for generating oscillations by means of vacuum tubes. A simple and practical circuit

¹ G. Martinez, *L'Elettrotecnica*, 4, p. 278, 1917.

² "The Pilotron Oscillator for Extreme Frequencies."—W. C. White, *G. E. Review*, 19, p. 771, 1916.

for the purpose is shown in Fig. 262. The inductance L_3 and the capacitance C are given values that will produce the frequency desired. Any electrical disturbance may start oscillations in L_3C , for example, the slight rush of current produced by closing the battery circuit or changing the value of C . By means of the coupling M , this applies a voltage to the grid. The grid then amplifies the oscillations in the plate circuit, and by means of the coupling M a still larger oscillating voltage is impressed upon the grid. This is often spoken of as a "feed back" action. If L_2 , L_3 , C , and the resistance of the circuit L_3C have suitable values, oscillations are produced in the circuit and are built up to some final value as shown in Fig. 263. At the upper left corner of the figure is shown the plate current-grid voltage characteristic curve of the tube;

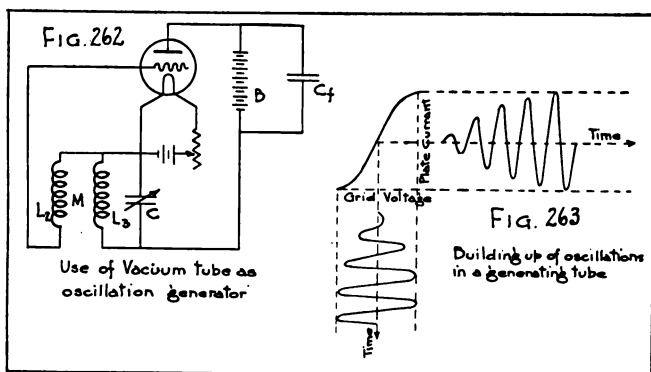

below is shown the building up of the grid voltage oscillations, and to the right the growth of the oscillations in the plate current. After a time a limit is reached in the magnitude of oscillations. This limit may correspond with an oscillation amplitude reaching from one bend of the characteristic curve to the other. Any further increase in grid voltage oscillations produces little further increase in plate current. This is shown by the flattening out of the characteristic curve at each end.

The readiness of a tube to oscillate depends upon the slope of the characteristic curve (Fig. 263) and the internal resistance of the tube. If the curve has a steep slope, it means that a small change in grid voltage will cause a large change in plate current. Such a

tube is sensitive and oscillates readily. In order that the tube may oscillate at all, the coupling between L_2 and L_3 must be closer than a certain value. Mathematical analysis shows that in general grid and plate should be of opposite potential, with respect to the filament, and that grid voltage should be small compared with plate voltage. Thus the type VT-2 tube used by the Signal Corps as a generator, normally operates with a plate voltage of +300 and a grid voltage of -20, while the receiving and amplifying tube type VT-1 has a plate voltage of +20 and a grid voltage of zero.¹

199. Practical Considerations in Using Vacuum Tubes as Oscillation Generators.—It is necessary to connect the terminals of the coil in the grid circuit (L_2 in Fig. 262) by trial in such direction as to assist rather than oppose the oscillations in the plate circuit coil. The two coils L_2 and L_3 may be conveniently wound, end to end, on the same supporting core. With given coils, as the capacitance is increased, there comes a point where the oscillation current breaks or falls off to zero. It is then necessary to use coils of greater inductance to obtain longer wave lengths.

The vacuum tube is far superior to the buzzer as a source of oscillations for measurement purposes. To secure constancy in both amplitude and frequency, it is desirable where several tubes are used in the same circuit, to have separate batteries for each tube. With care in this regard, constancy in both amplitude and frequency may be secured to one-tenth of one per cent.

A circuit suitable for producing oscillations and transferring their power to a radiating antenna is shown in Fig. 264. Here the coupling between grid and plate circuits is secured by means of two inductances, L_1 and L_2 connected in series in the antenna circuit. These are inductively connected, the one to L_3 in the grid circuit and the other to L_4 in the plate circuit. One or the other is variable. See also circuits given below in Radio Telephony.

The coupling between grid and plate circuits needed for securing oscillations in a tube need not be inductive; capacitive coupling may be used. One such circuit is given in Fig. 265. Condenser C_2 provides the coupling. Inductances L_1 and L_2 are variable and approximately equal. C_f is a fixed condenser which serves as a by-pass for the high frequency current around the battery. The frequency is determined mainly by values of L_1 , L_2 and C_2 .

¹ A fuller discussion of the conditions for generating oscillations in a tube may be found in a paper by L. A. Hazeltine in Proceedings Institute of Radio Engineers, 6, p. 63, 1918.

200. **Tubes Suitable for Developing Considerable Power.**—The output of the vacuum tube as a generator cannot be large unless the tube has a vacuum sufficiently good to permit a large *B* battery voltage; this is because the power output cannot exceed the product of plate current and plate voltage. For example, the type VT-14 tube, supplied by the Signal Corps as an oscillation generator, is operated with about 350 volts on the plate and has a power out-

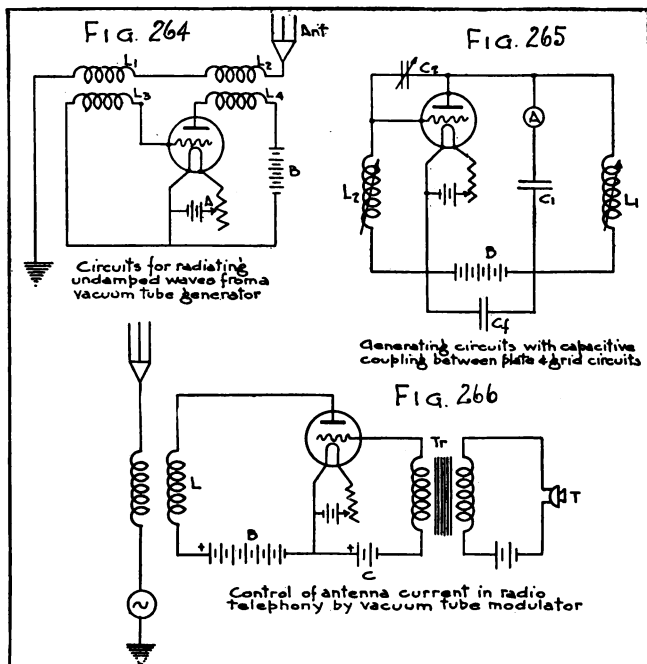

put of about 3 watts. Large pliotrons (see Fig. 250) are capable of developing very much more power because they are able to stand several thousand volts on the plate and also carry a plate current as high as 400 milliamp. Ability to stand a high voltage in the plate circuit depends principally upon the use of a very high vacuum. Ability to carry a large plate current varies with the size of the tube and the facilities for getting rid of the heat developed. Thus the

power output of a single large tube may be as high as a kilowatt, and since a number of such tubes can be operated in parallel, a large amount of power can be handled. In the long distance radio telephone experiments between Arlington, Va., and Hawaii in 1916, the power supplied to the Arlington antenna, amounting to 9 kilowatts, was furnished by a large number of generator tubes operating in parallel, each with 600 volts on its plate. The antenna current was 60 amp.

201. Heterodyne and Autodyne Receiving by Vacuum Tubes.—If two tuning forks mounted on resonance boxes, one vibrating 256 and the other 260 times per second are sounding together, a listener a short distance away will hear a sound alternately swelling out and dying away four times per second. These tone variations are called “beats.” Similarly, if two sources of undamped electrical oscillations act simultaneously upon the same circuit, one of frequency 500,000 and the other of 501,000, the amplitude of the combined oscillation will successively rise to a maximum and fall to a minimum 1000 times per second. If rectified by a vacuum tube or a crystal, their variations will produce an audible note of frequency 1000 in a suitable receiving telephone. If one of the two oscillations is the received signal in the antenna and the other is generated by a circuit in the receiving station, we have “heterodyne” or “beat” reception. In the receiving telephone, a musical note is heard, the pitch of which is readily varied by slight variation of tuning of the local generating circuit.

If a regenerative circuit similar to that of Fig. 259, p. 328, is used (L being coupled to the antenna), the same tube may be used as a detector and as a generator of local oscillations. This is called “autodyne” reception.¹ The procedure is to tune the antenna circuit to the incoming signals and adjust the local oscillating circuit so that it is slightly out of tune with the incoming signals. Thus beats of audible frequency are produced. Measurements have shown that this method is so sensitive that signals can be heard when the power received is equal to only $\frac{1.5}{10^{15}}$ watt.

By these methods of reception very faint signals can be received. Also interference from other stations is reduced to a minimum,

¹ A detailed explanation of autodyne receiving is given in C. 74, p. 215. For further information see also articles by L. De Forest, *Electrical World*, 65, p. 465, 1915; E. H. Armstrong, *Proceedings Institute of Radio Engineers*, 3, p. 215, 1915; 4, p. 264, 1916; G. Vallauri, *L'Elettrotecnica* 3, p. 43, 1917.

because a slight difference in frequency of the interfering signal would give a note of entirely different pitch, or even inaudible. For instance, if the local oscillation had a frequency of 500,000 ($\lambda=600$ meters), the received oscillation 501,000 and the interfering oscillation 502,000, the interfering note would have the frequency 2000, or be a whole octave higher in pitch than the received note. If the interfering source had a frequency 530,000, its beat tone would be so high as to be entirely inaudible.

E. Radio Telephony.

202. **Voice Modulation of Radio Currents by Vacuum Tubes.**—The principles of radio telephony are the same as those of radio telegraphy

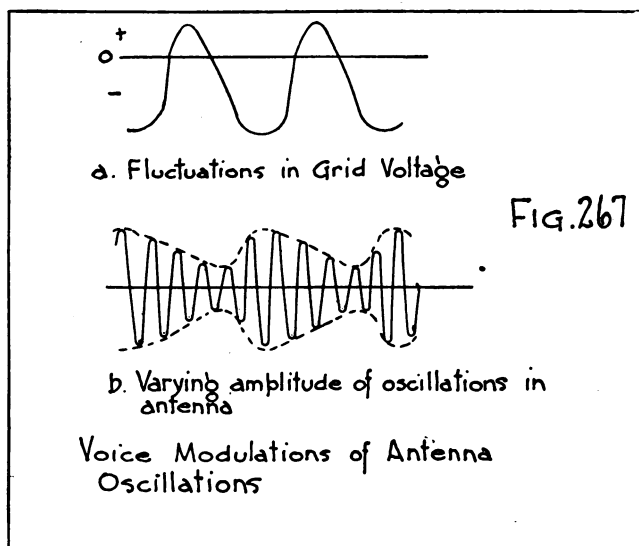

by undamped waves except that the sending key is replaced by apparatus which varies the sending current in accordance with the sound waves produced by the voice. A wave of radio frequency is sent out by the antenna, the intensity of which varies with the frequency of the voice sound waves. The sound waves have a frequency much lower than the radio frequency, so that each sound wave lasts over a considerable number of radio alternations, as in the lower curve of Fig. 267. The radio wave is thus transmitted in

pulses, and is received on any ordinary apparatus used for receiving damped wave radio telegraphic signals.

The power involved in the sound waves generated in ordinary speech is relatively very small, perhaps 0.00000001 watt, yet this must be made to control a kilowatt or more of radio frequency power in long distance radio telephony. The effect of the sound waves must therefore be amplified. The way in which the audio frequency is made to control the amplitude of the radio oscillation will now be explained.

Suppose a generator of radio oscillations is placed in series with the antenna, as in Fig. 266. Various types of arc, quenched spark, timed spark, high frequency alternators, and vacuum tube oscillators have all been used as sources with some success. The controlling device is usually the combination of a telephone transmitter with an arrangement of vacuum tube circuits, as shown in Fig. 266. The plate circuit of the vacuum tube is inductively coupled to the antenna by the coil *L*. The grid of the tube is kept at a negative voltage by the battery *C*. The current through the antenna coil induces potential differences between filament and plate, but this produces only very slight changes in plate current on account of the large negative voltage of the grid. Now suppose voltage variations of audio frequency are impressed on the grid by means of the telephone transmitter *T* and the transformer *Tr*. As the grid becomes less negative or even somewhat positive, the rectified plate current increases, absorbing power from the antenna and diminishing the amplitude of the antenna oscillations. The high frequency oscillations in the antenna therefore show variations in amplitude which keep time with the audio frequency variations of voltage in the grid circuit, diminution of antenna current corresponding with increasing positive potential of grid. These variations are illustrated in Fig. 267. In the upper part of the figure the fluctuations of grid voltage due to the telephone transmitter appear; in the lower part of the figure are shown the resulting variations in the amplitude of the high frequency oscillations in the radiating antenna.

The audio frequency variations of amplitude in the radio frequency wave will be reproduced in the antenna of the receiving station, and these will be rectified in the receiving circuit giving in the telephone receiver audio frequency variations of current, corresponding in frequency and wave form to the boundary of the curve in the lower part of Fig. 267 (as shown by the dotted line). For another and perhaps simpler explanation of modulation, see S. C. Radio Pamphlet No. 1, page 46.

203. Other Methods of Voice Modulation.—The most striking demonstration of the possibilities of radio telephony was that carried out in 1916 when spoken messages sent out from Arlington, Virginia, were heard in Paris and in Hawaii, the latter a distance of 5100 miles. In these experiments the oscillations were generated, modulated and received by vacuum tubes. Other methods, however, of generation and also of voice modulation, have met with success. Two of these methods are mentioned here.

Control by Microphones.—The usual method is to introduce special microphones directly into the antenna circuit. An ordinary microphone transmitter can carry but 0.2 amp. of current involving power consumption of only 2 watts, without injurious heating. In order to control considerably greater quantities of power, various modifications have been used. For example, Lorenz used as many as 25 microphones joined in parallel, Fessenden developed special water cooled microphones, Egner and Holmstrom used oil cooling, Marzi a microphone with a moving stream of carbon grains, Chambers and also Vanni microphones in which the varying resistance was supplied by a stream of conducting liquid impinging upon the vibrating diaphragm.

Ferromagnetic Control.—This method of controlling the radiation of an antenna by the voice depends upon the fact that the permeability of iron varies with the intensity of magnetization. (See Chapter 1, Section 42.) As the magnetization increases, the permeability rapidly increases to a maximum, and then slowly drops. Consequently if we pass a gradually increasing current through an iron core solenoid, the inductance of the coil at first increases rapidly and then decreases slowly. Two systems based on this principle are in use at present, one developed by the Telefunken Co. (Germany), the second by the General Electric Co. (U. S. A.). For a full discussion of the circuits employed and their action, see A. N. Goldsmith's "Radio Telephony" (1918), Chapter 8, pp. 182-203.

204. Practical Use of Vacuum Tubes in Radio Telephony.—An example of the use of a vacuum tube for modulating the oscillations in a radiating antenna has been given. In radio telephony vacuum tubes have been used also for generating the high frequency oscillations needed as well as for modulating them. Oscillions, plotrons, and other high power tubes are well adapted for such use.

In the illustration given (Fig. 266), the modulation of the antenna current for radio telephony was secured by applying the voltage variations produced by a telephone transmitter to the grid of the

controlling tube, the plate circuit of the same tube being inductively coupled to a radiating antenna. When the source of radiated energy is an oscillating vacuum tube, a different method of voice modulation can be used. In the example cited, the modulating tube acted directly upon the high-frequency a.c. output, but with a vacuum tube source, the control of the direct current in the plate circuit may accomplish the same end. An example of this method is found in a radio telephone set developed for Signal Corps use. To understand the operation of this principle, it is convenient to think of the effect of variation of grid voltage as a change in the resistance between the plate and filament of the tube. Consider, for instance, the 30-volt curve of Fig. 248, p. 318. With 3 volts on the grid, 30 volts on the plate produce a current of 400 microamp., whereas with 1.4 volts on the grid, the same plate voltage produces 200 microamp. That is, there is effectively a resistance in the plate circuit of 75,000 ohms in the first case and of 150,000 ohms in the second case. Now suppose the modulator tube and the oscillating tube are connected together in parallel, the plate circuit of each across the same d.c. source. The telephone transmitter is connected to the primary of a transformer whose secondary is connected to the grid circuit of the modulator tube. Thus the resistance of the modulator tube will be considerably varied by the voice speaking into the transmitter, and the amount of direct current passing through it will be subject to audio frequency changes. Suppose that the plates of the modulating and oscillating tubes, joined in parallel, are fed by a constant current d.c. dynamo. As the current taken by the modulator varies in response to the voice variations, the amount of current taken by the plate circuit of the oscillating tube—in parallel with it on a constant current source—will vary inversely. This scheme is illustrated in Fig. 268.

The telephone transmitter and the transformer are shown at *T* and *Tr*. The modulating and oscillating vacuum tubes are shown at *M* and *O*. The d.c. generator shown at *D* has a double winding on its armature, each with its own commutator. One supplies 275-volt current for the two plate circuits in parallel, and the other lights the two filaments in series. The connection of the generator to the plates is through the high inductance coils L_2 and L_3 . These coils change the 275-volt energy from a constant voltage supply to a constant current supply, thus furnishing a constant power output which is divided between the oscillator and modulator tubes in

accordance with the control exercised through the grid circuit of the modulator. Type VT-2 tubes can be used both for modulator and oscillator.

The receiving set used with this transmitter contains three tubes, one functioning as detector and two as amplifiers. Type VT-1 tubes are suitable for both purposes. The wide range of usefulness of the vacuum tube in modern radio practice is well illustrated in this set, whose five tubes are used for four different purposes, namely, for generating oscillations, for controlling amplitude of same by voice modulation, for amplification, and for reception.

The General Electric Co. pliotrons are suitable generator tubes for long distance radio telephony. The vacuum is so good that they

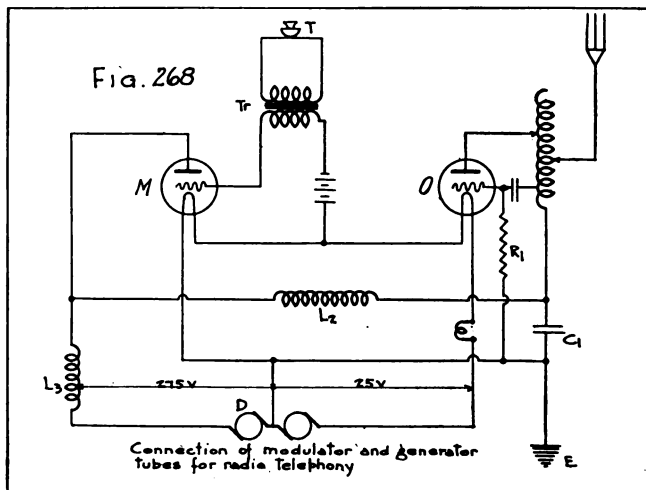

can stand thousands of volts between plate and filament without showing any blue glow. The output is several hundred watts, and a number of such tubes may be used together in parallel.

It appears that radio telephone sets in which vacuum tubes are used both for generating and modulating currents of radio frequency are likely to find use in military operations of far greater importance than they have in the present war and they were beginning to play a very real part during the year 1918.¹

¹ For further information on radio telephony see Goldsmith's "Radio Telephony."

APPENDIX 1.

SUGGESTED LIST OF LABORATORY EXPERIMENTS.

Experiment 1. Effects Produced by Electric Current.—(a) *Magnetic.*—Put in series a 4-volt storage battery, key, 3-ohm rheostat, and about 2 meters (about 7 ft.) of copper wire of about 1 mm. (0.04 in.) diameter. Place a portion of the copper wire parallel to a small compass needle and 1 cm. (0.4 in.) or more above it. Repeat, with the wire just below the compass needle. Repeat with battery connection reversed. Test out the right hand rule for direction of current. Connect a small electromagnet in the circuit, and note behavior like a permanent magnet.

(b) *Heat.*—Take electromagnet out of the circuit and connect in about a half meter of iron wire about $\frac{1}{4}$ mm. in diameter. Reduce resistance in rheostat until all out, and observe iron wire get hot. Shorten iron wire and repeat. Replace iron wire by a short piece of 2-amp. fuse wire. Reduce resistance in rheostat until wire melts.

(c) *Chemical.*—Immerse two copper wires connected to a battery in a vessel containing copper sulphate solution (about 10 per cent, slightly acid). Allow current to flow for some time and note effect.

Experiment 2. Ohm's Law.—(a) *Current inversely proportional to resistance.*—Connect in series a 4-volt storage battery, a milliammeter (10 to 150 milliamp.) and a 400-ohm rheostat. Reduce resistance by about 8 approximately equal steps. Make list of corresponding values of resistance and current.

(b) *Current Proportional to Emf.*—Connect in series two similar cells, a milliammeter, and about a 40-ohm resistor. Note the current. Take out one cell and note current again.

$$\frac{E}{I} = \frac{2E}{I'} = R$$

Experiment 3. Voltmeter-Ammeter Method of Measuring Resistance.—Send enough current through an incandescent lamp to make the filament bright. Measure current by ammeter in series, and voltage by voltmeter connected across the lamp, and calculate

resistance. Measure resistance in this manner of the filament of a type VT-1 or type VT-2 tube taking its normal current.

Experiment 4. Use of Wheatstone Bridge.—Connect apparatus of which resistance is desired to the terminals marked X. Press battery key, tap galvanometer key lightly. Suitable resistances to measure are those of filaments (cold) of vacuum tubes, milliammeter, microammeter, field of pack set generator, sliding contact rheostat.

Experiment 5. Series and Parallel Connections.—(a) *Test of the Relation, $\frac{1}{R} = \frac{1}{r_1} + \frac{1}{r_2}$ or $R = \frac{r_1 r_2}{r_1 + r_2}$.*—Apparatus: milliammeter (10 to 150 milliamp.), resistance box, 1 to 50-ohm fixed resistor, 1 dry cell of measured voltage. Measure R of two resistors (say 70 and 50), (a) when they are connected in parallel, and (b) when they are connected in series. Correct for resistance of milliammeter R_a , thus

$$R = \frac{E}{I} - R_a$$

Compare with values given by formula

$$R = \frac{50 \times 70}{120} = 29.1, \text{ etc.}$$

Try similarly 50, 70 and 100 in series and parallel.

(b) *Cells in Parallel.*—To show that polarization is reduced (with moderate current) put 3 ordinary dry cells in parallel. Put the battery in a 15-ohm circuit, with an ammeter, and repeat with 1 cell of the same sort.

Experiment 6. Polarization and Recovery of Dry Batteries.—Use small batteries, S. C. type BA-3, 3 cells each. In circuit with resistance 30 ohms for 6 minutes take open circuit voltage at start and at end of each 2 minutes. Similarly with 20 ohms, 10 and 5 in succession. Test recovery with voltmeter each 10 minutes as long as convenient.

Experiment 7. Storage Battery Curves for Charge and Discharge.—Make tests with 4-volt battery used for filament lighting if available.

(a) *Charging.*—Read charging current and voltage between terminals of battery at regular intervals, recording voltage, current and time. With each set of readings the charging circuit should be open long enough to read the open circuit voltage of the battery. Calculate the apparent internal resistance of the battery for each reading. Measure the specific gravity of the electrolyte by means of a

hydrometer at regular intervals during the charge and plot a curve showing the change with time on charge.

(b) *Discharging*.—Take similar readings at frequent intervals at the start and not so frequently later. Present results in curves with time as abscissas.

Experiment 8. Test of Motor-Generator Set or Dynamotor.—(a) Use the type DM-1 dynamotor. This is run by a 10-volt storage battery and supplies d.c. current at 300 volts. Read input volts and amperes, and generator volts and milliamperes, when external resistance (which is large) is so regulated as to give about eight current values well spaced between 0 and 160 milliamp. Calculate generator watts and efficiency for each output of current read.

(b) Study connections and make diagram of generator of radio pack set.

Experiment 9. Reactance and Impedance.—(a) Given a coil of about 10 ohms and 0.2 henry (spool 3000 turns No. 16 wire, coil 8.5 in. long, 2 in. internal, 5 in. external diam.), connect it to a 60-cycle, 110-v. a. c. line and measure current with an a.c. ammeter. Calculate impedance.

(b) With Wheatstone bridge measure direct current resistance.

(c) From formula, $\text{Impedance} = \sqrt{R^2 + (2\pi fL)^2}$, calculate the value of the reactance and of L .

(d) Attach a generator like that of the pack set to above coil and measure current and voltage. Taking value of L found in (c), calculate value of f for this machine.

Experiment 10. Wavemeter.—(a) *Measurement of an Unknown Wave Length*.—Portable wavemeter, hot wire ammeter indicator in coupled circuit, or crystal detector and telephones. Suitable unknown circuits, antenna excited oscillating circuit supplied by pliotron.

(b) *Wavemeter as Source of Known Wave Length*.—Set condenser of wavemeter to a chosen wave length, and excite wavemeter circuit by means of a buzzer. Tune a series circuit containing an inductance coil and a condenser (one of them variable) to the wavemeter frequency, coupling an untuned hot wire ammeter circuit (or crystal detector and telephone) to the circuit to be tuned.

(c) *Resonance Curve*.—Arrangement in (b) with hot wire ammeter or crystal and galvanometer can be used. Observe deflections of the indicator with different settings of the condenser (or coil) in

the circuit to be tuned to resonance, the wavemeter serving as a source of constant frequency during the measurements. Plot the readings of the current indicator as ordinates and the setting of the condenser or inductor as abscissas.

Experiment 11. Measurement of Inductance and Capacitance Using a Wavemeter.—(a) *Measurement of Capacitance.*—With a known variable condenser as a standard, join the unknown condenser in series with an inductance coil, the circuit being provided with an indicator to show resonance. Couple to a wavemeter circuit excited by a vacuum tube. Vary the frequency of the exciter until the indicator shows that the unknown circuit is in resonance. Replace the unknown condenser by the known, and keeping the exciting frequency unchanged, vary the known variable condenser until the circuit is again in resonance with the exciting circuit. The unknown capacitance is equal to the value of the known which has replaced it. Suitable unknown:—variable air condenser, or capacitance of an antenna.

(b) *Measurement of Inductance.*—Exactly the same procedure may be used as for an unknown capacitance, provided a known variable inductance coil is available.

(c) *Use of a Calibrated Wavemeter as an Exciter.*—Either inductance and capacitance may be measured, provided a standard of inductance or capacitance is available. When the test circuit is in resonance, the product of its inductance and capacitance may be calculated from the wave length indicated by the wavemeter. Either the inductance or capacitance of the test circuit will be known, or can be derived by measurements of the same kind, starting from the standard.

Experiment 12. Calibration of a Receiving Set, Using a Wavemeter.—Excite a wavemeter by a buzzer. Couple the wavemeter to the inductance coil of the receiving set. With the inductance coil and condenser of the receiving set at any desired settings, vary the wave length emitted by the wavemeter until the sound is a maximum in the telephone of the receiving set. The reading of the wavemeter indicates the wave length for which the set is adjusted, with the inductance and condenser settings in question.

Or, the wavemeter may be adjusted to a chosen wave length, and the combination of inductance, capacitance and coupling determined by experiment, which give the loudest sound in the telephone for this wave length. A record of the results of such

an experiment will make it possible for the operator to adjust the apparatus quickly to receive signals of a desired wave length.

Experiment 13. Effect of Resistance on Resonance Curves.—Make measurements for obtaining the form of the resonance curve of a circuit as in Experiment 10. Add a known resistance of a few ohms and obtain a second resonance curve. Increase the resistance again by the same amount and map out a third resonance curve. From the values of the maximum currents in the three curves, and the values of the inserted resistances determine the total resistance in the three cases. Calculate the impedances from the known inductance, capacitance and resistance at several points on each curve, and check the observed currents at those points.

Experiment 14. Inductive Coupling.—(a) Use a wavemeter to map a curve showing the relation between current and wave length in an oscillating circuit which is closely coupled to a spark source. The source and oscillating circuit should preferably be separately tuned to the same frequency. Carry the curve through a great enough range of wave lengths to show the double hump curve. Loosen the coupling and repeat. The humps should be nearer together. By taking a third resonance curve with very loose coupling a single hump may be obtained.

(b) Make similar measurements with the same circuit coupled to a quenched gap source, both with close coupling and loose coupling.

(c) Measure the coefficient of coupling in any one of these cases. To do this measure as in Experiment 11, the following: (1) the inductances of each of the coupled coils giving values L_1 and L_2 ; (2) the inductance of the two coils joined in series, giving L' ; (3) the inductance of the two coils in series with the connections of one reversed, giving L'' . Then if L' is the larger value, the mutual inductance M is given by $M = \frac{L' - L''}{4}$ and the coefficient of coupling

$$\text{is } k = \frac{M}{\sqrt{L_1 L_2}}.$$

Experiment 15. Measurement of Decrement.—The circuit whose decrement is to be measured is excited by a vacuum tube or some damped source of known decrement. The capacitance of the circuit is varied until the circuit is in resonance as shown by its current indicator, which should give readings proportional to the current squared. Having read the capacitance for resonance, increase it or

decrease it until the current squared is only one half of its maximum value and again read the capacitance. The sum of the decrements of the unknown circuit and the source may then be calculated. If a vacuum tube source is used its decrement is zero. If a decremeter is available, use it to measure the decrement of a transmitting antenna. Note the effect of adding resistance to the circuit, and of adding inductance, retuning of course in the latter case. For methods of calculation and additional information see C. 74, pp. 180 to 199. Check the decrement of a circuit here measured by the method of Experiment 16, calculating decrement from the resistance, capacitance, and inductance of the circuit.

Experiment 16. High Frequency Resistance of Conductors.—The wire or coil whose resistance is to be measured is made part of a resonant circuit, which includes a thermoelement and galvanometer to measure relative values of the square of the current. The circuit is excited by coupling to a vacuum tube source, and the capacitance or inductance adjusted until the thermoelement shows a maximum current, which is recorded. A known resistance is then added, and the maximum current again noted. The total resistance of the circuit is then calculated. Similar measurements of the total resistance are made with the unknown resistance removed, the circuit being retuned to give maximum current. The resistance of the unknown is obtained by subtraction. The wave length of the source may be obtained by a wavemeter. The direct current resistance of the unknown should be measured with a Wheatstone bridge.

Measure the resistance of the unknown at several wave lengths, and calculate the resistance ratios (See C. 74, Sec. 74). Plot the resistance ratio as ordinates, and the reciprocal of the wave length as abscissas.

Suitable objects for test: copper wire, single layer coil, piece of metal strip, antenna. Extension of experiment: measure a resistance by the method of Experiment 15.

Experiment 17. Study of Rectifiers.—(a) Arrange a voltage divider in the circuit of a steady battery, with a voltmeter to measure the voltage taken off to a circuit which includes a crystal rectifier in series with a galvanometer or other instrument capable of detecting currents of a few microamperes. A reversing switch may be employed to reverse the direction of the current through the crystal. Measure the current through the crystal for each direction of the voltage and for a number of values of voltage up to 20 volts. Measure the currents for the same values of alternating voltages of 60 cycles.

(b) Make similar tests with a Fleming valve. Note which way the current flows through the tube and compare with theory.

(c) Examine and trace out the connections of a tungar rectifier. Measure the current and voltage on the a.c. end and the current and voltage on the d.c. end. Note how the alternating current varies as the direct current load is varied.

Experiment 18. Characteristic Curves of Type VT-1 Tube with Constant Filament Current.—Connect up the tube with a rheostat and ammeter in the filament circuit, so that the filament current may be adjusted to its normal value and held constant. Arrange a battery of 5 to 10 volts with a voltage divider so connected that the grid voltage may be made positive or negative with respect to the filament. The voltage divider allows its value to be adjusted in small steps. The plate battery should consist of a sufficient number of cells to permit the operation of the tube under normal working conditions. A suitable low reading milliammeter or calibrated galvanometer should be included in the plate circuit. The grid circuit will require a galvanometer to read the small grid current. A low reading voltmeter will be necessary to measure the grid voltage.

Adjust the plate voltage to the normal value for the tube in question and, keeping it constant, vary the grid voltage in steps, recording for each setting the plate and grid currents and plate voltage. Plot the plate current as ordinates with grid voltages as abscissas. Make a second curve with grid currents as ordinates and grid voltages as abscissas.

Obtain similar characteristic curves with the plate voltage adjusted to other values lower than the normal voltage.

Experiment 19. Characteristic Curves of Type VT-1 Tube as Changed by a Signal.—Arrange a circuit containing a coil, a key, and sufficient resistance so that the current which will flow when connection is made to a 60-cycle, 110-volt line will be only a few tenths of an ampere. The apparatus used in the previous experiment is also to be changed only to the extent of including an inductance in the grid circuit.

Bring up the coil which is carrying the 60-cycle current, from a distance until the coupling is sufficient to cause a moderate change in the plate and grid circuits. Adjusting the grid voltage to different values, observe the plate and grid currents, both when the key is open and when it is closed. Plot in two curves the changes in plate current and grid current as ordinates against grid voltages as

abscissas. Draw conclusions as to the most suitable values of grid voltage, in order that such signals may produce the greatest changes in the plate current, and in order that the tube may be a good rectifier.

Experiment 20. Type VT-2 Tube as Source of Oscillations.—Connect the tube as in Fig. 262 with a hot wire ammeter in the oscillation circuit, and with a given setting of the condenser in the oscillation circuit, vary the coupling until the ammeter indicates the maximum current. Record this, and measure the wave length of the oscillations by means of a wavemeter. Adjust the circuit to other wave lengths, recording the maximum current which can be obtained in each case. Make similar tests with the other schemes of connection in C. 74, Figs. 147 and 148.

Experiment 21. Heterodyne Reception.—Arrange a vacuum tube circuit to act as a transmitter of oscillations. These oscillations are to be received in a second circuit in which independent oscillations may be produced. The latter circuit may be that of an oscillating vacuum tube, connected as in C. 74, Fig. 145. The receiving circuit and the circuit which is transmitting signals should be tuned to the same frequency by a preliminary test with a wavemeter. Start the receiving tube to oscillate and then increase the coupling to the source of signals. Vary the inductance or capacitance in the receiving circuit a very little. The pitch of the note received in the telephones should be very sensitive to the smallest change of inductance or capacitance, and it should be easy to make it pass from the lowest to the highest audible frequency. Try to adjust the receiving circuit without the preliminary tuning of the transmitting and receiving circuits.

APPENDIX 2.

UNITS.

Every measurement must be expressed in terms of two factors. One of these is a definite amount of the thing measured, called the unit; the other is a mere number, being the number of times the unit is taken. Thus we speak of a certain action taking place in 15 seconds. The second is the unit in which the time specified is measured. A standard is a different thing from a unit; it is the representation of a unit. It is necessary that there be authoritative standards representing certain units. When a length is measured by a number of different measuring sticks, differences in the results can sometimes be detected. The true length would be given by comparison with some one measuring stick that had been agreed upon as the standard. The standards representing various units, for the use of the United States, are kept at the Bureau of Standards in Washington. Measurements are frequently made in ordinary work without any reference to the existence of a standard. A standard can be destroyed and the unit still be used as before. While in many measuring processes standards are actually used (as for example, in weighing on a balance, the weights used on one side are actually standards), in many other measuring processes standards are not used, but instead marks upon a measuring instrument enable one to express the measurement in terms of units. Thus, a voltmeter is a means of measuring voltage, and the resulting measurements are expressed in terms of a unit called the volt.

Electrical units are based upon the units of the metric system, which is the name given to the system of units used on the Continent of Europe; it is a much simpler system than the English and American systems of units. The fundamental units in the metric system are the meter, the gram, and the second. The "meter" is defined as the length of a certain metal standard bar which is preserved at an international bureau near Paris. The "gram" is a thousandth part of a certain mass of metal kept as a standard of

mass at the same place. Each Government has copies of these two fundamental standards. The "second" is the familiar unit of time.

These units are comparatively familiar to the radio man. Thus the meter is universally used for the expression of the length of radio waves. The meter is a little more than one yard in length. The gram is not far from one-thirtieth of an ounce. The relations between these units and the American and English units is given approximately in the following:

- 1 inch=2.540 centimeters=25.40 millimeters
- 1 foot=30.48 centimeters=0.3048 meter
- 1 yard=91.44 centimeters=0.9144 meter
- 1 mile=1.609 kilometers=1609 meters
- 1 ounce (avoirdupois)=28.35 grams
- 1 pound=0.4536 kilogram=453.6 grams
- 1 liquid quart=0.9463 liter
- 1 dry quart=1.101 liters
- 1 millimeter=0.03937 inch
- 1 centimeter=0.3937 inch
- 1 meter=3.281 feet=1.094 yards
- 1 kilometer=0.6214 mile
- 1 gram=15.43 grains=0.03527 ounce (avoirdupois)
- 1 kilogram=2.205 pounds
- 1 liter=1.057 liquid quarts=0.2642 gallon
- 1 hectoliter=90.81 dry quarts=2.838 bushels

In connection with the units of the metric system, certain prefixes are used to indicate smaller or larger units. (Thus the word "centi" is used to designate 100th part.) These prefixes are shown in the following list with their abbreviations:

Prefix	Abbreviation	Meaning.
micro		One millionth
milli	m	One thousandth
centi	c	One hundredth
deci	d	One tenth
deka	dk	Ten
hekto	h	One hundred
kilo	k	One thousand
mega	M	One million

Without giving any historical information as to the development of electric and magnetic units, it may be said that those now used are the so-called international electric units. The international units are based on four fundamental units, the ohm, ampere, centimeter, and second. The first of these is the unit of resistance, and is defined in terms of the resistance of a very pure conductor of specified dimensions. The ampere is the unit of current and is defined in terms of a chemical effect of electric current, the amount of silver deposited from a certain solution for a current flow for a definite time. The other electric units follow from these in accordance with the principles of electrical science. Some of the units thus defined are given in the following definitions which are those adopted by international congresses of science, and universally used in electrical work.

The "ohm" is the resistance of a thread of mercury at the temperature of melting ice, 14.4521 grams in mass, of uniform cross section, and a length of 106.300 centimeters.

The "ampere" is the current which when passed through a solution of nitrate of silver in water in accordance with certain specifications, deposits silver at the rate of 0.00111800 of a gram per second.

The "volt" is the electromotive force which produces a current of one ampere when steadily applied to a conductor the resistance of which is one ohm.

The "coulomb" is the quantity of electricity transferred by a current of one ampere in one second.

The "farad" is the capacitance of a condenser in which a potential difference of one volt causes it to have a charge of one coulomb of electricity.

The "henry" is the inductance in a circuit in which the electromotive force induced is one volt when the inducing current varies at the rate of one ampere per second.

The "watt" is the power expended by a current of one ampere in a resistance of one ohm.

The "joule" is the energy expended in one second by a flow of one ampere in one ohm.

The watt and joule are not primarily electric units, but they need to be learned in connection with electric units because the energy required or the power expended in electrical processes are among the most important phases of the actions. Another unit of

quantity of electricity, in addition to the coulomb, is the "ampere-hour," which is the quantity of electricity transferred by a current of one ampere in one hour. The units of capacitance actually used in radio work are the "microfarad" and the "micromicrofarad" (a millionth of a millionth of a farad), and not the farad, which is too large a unit. The units of inductance used are the "microhenry" and the "millihenry."

For further information on electric and magnetic units see Circular of the Bureau of Standards No. 60, "Electric Units and Standards," which, like all other publications of that Bureau, may be obtained upon written application.

ABBREVIATIONS OF UNITS.

Unit.	Abbreviation.	Unit.	Abbreviation
amperes	amp.	kilometers.....	km.
ampere-hours.....	amp-hr.	kilowatts.....	kw.
centimeters.....	cm.	kilowatt-hours.....	kw-hr.
centimeter-gram-sec-		kilovolt-amperes.....	kva.
ond.....	cgs.	meters.....	m.
cubic centimeters....	cm ³	microfarads.....	mfd.
cubic inches.....	cu. in.	micromicrofarads....	micro-mfd.
cycles per second.....	~	millihenries.....	mh.
degrees Centigrade....	° C	millimeters.....	mm.
degrees Fahrenheit...°	F	pounds.....	lb.
feet.....	ft.	seconds.....	sec.
foot-pounds.....	ft-lb.	square centimeters....	cm ²
grams.....	g.	square inches.....	sq. in.
henries.....	h.	volts.....	v.
inches.....	in.	watts.....	w.
kilograms.....	kg.		

APPENDIX 3.

SYMBOLS USED FOR PHYSICAL QUANTITIES.

Physical Quantity.	Symbol.	Physical Quantity.	Symbol.
area.....	S or A	magnetic flux.....	ϕ
base of napierian logarithms=2.718.....	ϵ	magnetic induction.....	B
capacitance.....	C	mass.....	m
coupling coefficient.....	k	mutual inductance.....	M
current, instantaneous value.....	i	number of revolutions....	n
current, effective value....	I	period of a complete oscillation.....	T
decrement.....	δ	permeability.....	μ
density.....	d	phase angle.....	Θ
dielectric constant.....	K	phase difference.....	ψ
electric field intensity....	\mathcal{E}	potential difference.....	V
electromotive force, instantaneous value.....	e	power, instantaneous value.....	P
electromotive force, effective value.....	E	power, average value....	P
energy.....	W	quantity of electricity....	Q
force.....	F	ratio circumference of circle to diameter=3.1416.	π
frequency.....	f	reactance.....	X
frequency $\times 2\pi$	ω	resistance.....	R
gravity, acceleration of...	g	temperature coefficient...	α
height.....	h	time.....	t
impedance.....	Z	velocity.....	v
inductance, self.....	L	velocity of light.....	c
length.....	l	wave length.....	λ
magnetic field intensity...	H	wave length in meters....	λ_m
		work.....	W

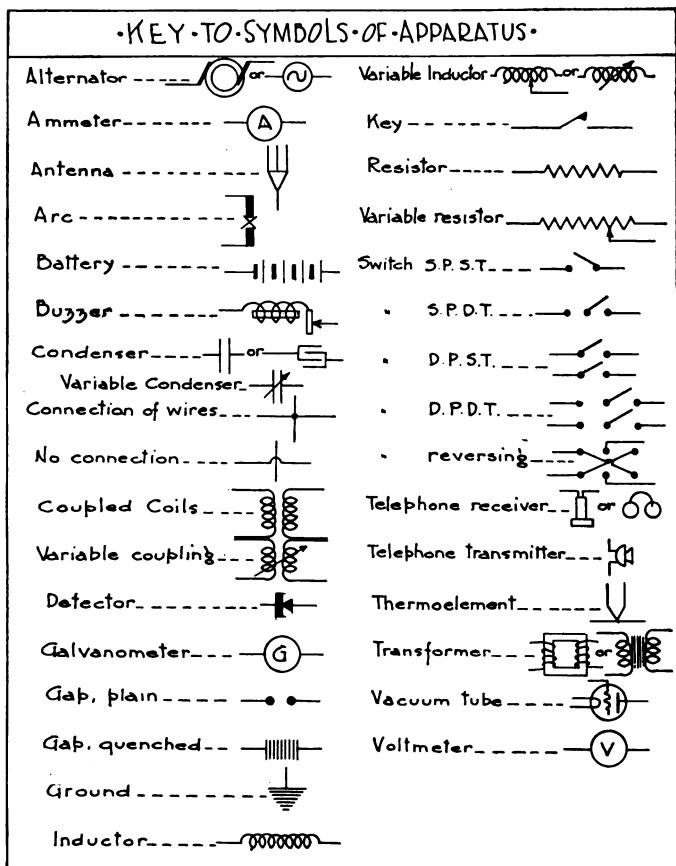

245 Wave-lets 282

292 Dmc-van. circuit

182 Circuits (always a.c.)

302 + Crystal detectors

311 + V. T. 326 332 generator

330 Regenerative amplifiers

Verhugo Spire

(1911)

- 18. e.m.f.
- 21 Has e. mass?
- 24 " Flow, current, & survival's
- 26 ampere
- " Electrons
- 28 Ohm 30 law 38 42
- 33 phosphor bronze antenna
- " Manganese resistors
- 38 Volt
- 43 Carbon to ...
- " Electrolytes
- 54+ Storage bats
- 60 current value does not vary ...
- 66 Shunt
- 85 Electrolyte ...
- 89 Henry ...
- 110+ Induct
- 127 Inductor alternating
- 134 synchronous ...
- 135 k.v.a kilo-volt-amperes
- " power factor
- (138) Eff
- 149 frequency 183
- 153 Multi- ...
- 159 Fan drive, ...
- 164 ...
- 177 ...
- 179- ...
- 180 ...

