

WIRELESS TELEGRAPHY

A POPULAR EXPOSITION.

By

G. W. de Tunzelmann
G. W. de TUNZELMANN, B.Sc.,

Consulting Engineer,

*Member of the Institution of Electrical Engineers ;
of the Société Internationale des Electriciens, Paris ;
and of the Elektrotechnische Gesellschaft, Berlin.*

THIRD EDITION.

London

THE OFFICE OF "KNOWLEDGE,"

326, HIGH HOLBORN.

1902.

Eng 4749.02

Apr. 13, 1914

HARVARD UNIVERSITY

SCHOOL OF ENGINEERING

Substituted for a copy lost

24.31

21

KNOWLEDGE

AN

ILLUSTRATED MAGAZINE OF SCIENCE.

MONTHLY SIXPENCE. Established 1881.

IT GIVES IN POPULAR STYLE THE MOST RECENT PAPERS WRITTEN BY THE ABLEST EXPONENTS IN ALL THE PRINCIPAL DEPARTMENTS OF SCIENCE.

BEAUTIFULLY ILLUSTRATED.

ANNUAL SUBSCRIPTION, POST FREE, 7s. 6d.

Offices: 326, High Holborn, London, England.

JUN 20 1917

LIBRARY

UNIVERSITY OF MICHIGAN

PREFACE.

THIS little volume is based upon a series of papers on Wireless Telegraphy which were published in "Knowledge" during the course of 1900; but the subject has been developing so rapidly that very considerable additions have been necessary to bring these papers up to date.

Two new Chapters, viz., VII. and VIII., have been added, dealing with results which have been obtained or have become accessible since the completion of the series referred to, and a good deal of new matter has been added to all the Chapters except the first, besides some re-arrangement which appeared conducive to clearness.

The object which I have had in view is twofold. In the first place I have attempted to set forth the history and practice of wireless telegraphy, in a manner adapted to any readers who are interested in knowing something

of the historical development and practical working of electric telegraphy without the aid of connecting wires to guide the message between the communicating stations.

In the second place I have attempted in Chapters II., III., and IV., the far more difficult task of providing readers, who know little or nothing of electrical theory, with the means of learning something about the physical facts upon which the practice of etheric telegraphy is based.

The most difficult portion of this has been to give an account of what physicists understand by the ether in a form intelligible to the non-mathematical reader, as almost all that we know about it has been arrived at by means of the mathematical treatment of observed electrical (including optical) phenomena, and much of it demands the use of the most refined methods of modern mathematical analysis, that wonderful instrument which has extended our knowledge of the physical constitution of the universe in a manner which may be compared to that in which the astronomer's range of vision has been extended by the telescope.

What I have endeavoured to do, therefore, is to

enable the general reader to glance through the mathematical telescope and see something of the wonderland which it reveals. It is, unfortunately, impossible to make this as easy for him as to obtain a view of the wonders of the heavens through a great telescope. Not only is the vision necessarily more blurred than the astronomical one, but it is the mental eye in place of the bodily one which has to be applied to the telescope, and the process of looking into the instrument has been transformed into the more fatiguing one of following a line of thought which is necessarily of a somewhat abstract nature.

In writing my chapter on the Ether I have been greatly indebted to two recently published and extremely interesting works, viz., Larmor's "Æther and Matter," and Paul Drude's "Lehrbuch der Optik."

I should have liked to add to Chapter III. on the "Mechanical Representations of Electric Actions," some account of Lord Kelvin's representation of a rotationally elastic ether by means of a theoretically built up gyrostatic model, with Professor Larmor's additions, to illustrate the constitution of electrons in such an ether. It

did not, however, appear to me to be possible to make the descriptions helpful to the non-mathematical reader without adding a chapter on the dynamics of spinning tops and cognate phenomena, which would have extended the work beyond the limits intended, and, therefore, I reluctantly abandoned it.

With two exceptions I have avoided the use of even the simplest mathematical formulæ. One of these, on page 51 of Chapter IV., is of the very simplest character, and saves many words; the other, which occurs on page 26 of Chapter II., may perhaps require an apology. Lord Kelvin's investigation, in the account of which it occurs, is not very accessible to many readers who have the quite elementary knowledge of mechanics requisite to follow the argument, and for their sake I have included it. Other readers can easily skip the argument and merely note the final result.

G. W. DE TUNZELMANN.

CONTENTS.

INTRODUCTION.

CHAPTER I.	PAGE
<i>The Earth Current and Electro magnetic Induction Systems</i>	12
CHAPTER II.	
<i>Ether and Ether Waves</i>	20
CHAPTER III.	
<i>Mechanical Representations of Electric Actions... ..</i>	37
CHAPTER IV.	
<i>Electric Waves</i>	51
CHAPTER V.	
<i>The Discovery and Development of the Coherer</i>	60
CHAPTER VI.	
<i>The System of Popoff and Marconi</i>	70
CHAPTER VII.	
<i>The Marconi Long-distance Syntonic System</i>	86
CHAPTER VIII.	
<i>Conclusion</i>	100

WIRELESS TELEGRAPHY.

INTRODUCTION.

IN the ordinary commercial system of telegraphy, signals are transmitted between two distant stations by means of electric currents made to flow through a circuit consisting of an insulated wire connecting the two stations and the earth. The wire being connected with the earth, or "earthed," as the telegraphist expresses it, at each of the stations, in order to make a complete circuit or loop round which the electric flow takes place.

When a new system of sending electric signals, in which no connecting wire was required between the two stations, came into prominence it was named from the most striking feature to the ordinary observer, namely the absence of the connecting wire.

The name is not logically defensible, for on the one hand the method of signalling known as "Wireless Telegraphy" involves the use of wires both in the transmitting and in the receiving apparatus, and on the other hand it includes systems of signalling which are not popularly supposed to be electrical at all.

The term etheric telegraphy, which has also been suggested, is just as open to the latter objection as the one in common use, and personally I should be inclined to suggest the term Hertz Wave Telegraphy or Hert-

zian Telegraphy, for the system of telegraphing without connecting wires which is now exciting so much interest and attention. Though greatly developed by the researches of Lodge, Marconi, and others, Hertzian telegraphy depends entirely upon exciting at the transmitting station and detecting at a distant receiving station ether waves of a certain character, the existence of which had been deduced theoretically by Professor Clerk Maxwell, but first experimentally demonstrated by the late Dr. Hertz, of Carlsruhe, who published the results in a series of papers in "Wiedemann's Annalen" beginning in July, 1887.

In addition to the method of signalling through space by means of Hertzian ether waves, there are two other methods worthy of notice, and which form the subject matter of the opening chapter.

The next three chapters are devoted to the consideration of the phenomena which form the basis of the Hertzian wave method, now usually associated with the name of Marconi, whose genius, combined with indefatigable industry, have evolved a commercially practicable system of communication from the results of numerous researches by many workers. A fifth chapter deals with the discovery and development of the coherer, while the two concluding ones are devoted to the description of the methods and instruments now in commercial use.

In adopting this course I have, after briefly describing the two comparatively undeveloped methods referred to above, followed what I believe to be the simplest and most logical order of development of the subject of Hertzian Telegraphy, viz., the study, in the first place, of the medium in which the disturbances are excited, secondly, an inquiry into the nature of these disturbances; and here so little is definitely known that I can do little more than set forth hypotheses which would more or less fully explain the observed

phenomena; and which may assist the reader in following them, by fixing his attention on mental images, which, however, he must carefully guard himself from considering as anything more than images which may possibly have a more or less distant resemblance to the actual facts; and, finally, an account of the apparatus and methods which have been employed in the winning of such knowledge as we have so far obtained, or which are now being employed in putting it to practical use.

CHAPTER I.

THE EARTH CURRENT AND ELECTRO-MAGNETIC INDUCTION SYSTEMS.

THE system of communicating between two stations without connecting wires by means of electric currents traversing the earth and sea, and the electro-magnetic induction system, in which an oscillatory current in a wire forming part of a closed circuit at one station sets up an outspreading and continually varying magnetic field in the surrounding space, which will give rise to a weaker oscillatory current in a parallel wire forming part of a closed circuit at a distant portion of the field of influence, had both been practically employed prior to the successful use of Hertzian waves for telegraph work.

They are both well worthy of brief notice, both on account of their intrinsic interest, and also because it is quite within the bounds of possibility that they may develop in the future into rivals of the system which is now attracting such general attention.

In the earliest attempts at electric telegraphy a complete metallic circuit was employed, requiring a pair of wires to connect any two stations.

In the year 1838, Steinheil tried unsuccessfully to utilise the two lines of rails of a railway in place of overhead telegraph wires, but, as has so often happened, his investigations into the cause of his failure led him to a most important discovery.

He found the reason to be that the earth was so good a conductor, that the electric current from the transmitting station, instead of flowing along one of the rails to the distant station and returning by the other, as he had anticipated, simply flowed across to

the other rail through the earth on which they rested, and this at once suggested to him that it should only be necessary to have one wire between the two stations, provided this wire was earth-connected at each station, and this he found to be the case.

He also suggested that, the earth being so good a conductor, it might be possible to do away with connecting wires altogether, but I am not aware of his having devised any means by which this could be done.

Four years later the American Professor Morse, who took so large a share in the development of electric telegraphy, succeeded in transmitting messages across a canal, 80 feet in width, and afterwards across the Susquehanna River, a distance of nearly a mile, by the

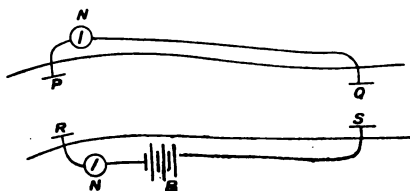

FIG. 1.—Morse's method of transmitting messages across the Susquehanna River.

method shown in Fig. 1, where B is a battery, N N a pair of needle instruments for transmitting and receiving signals, and P Q R S are immersed metallic plates connected with insulated wire.

He obtained very good results when the distances from P to Q and R to S were three times as great as those from P to R and from Q to S.

In this connection I cannot refrain from pausing for a moment to refer to J. B. Lindsay, of Dundee, a Scotch schoolmaster of the very slenderest means, who made several important electrical discoveries, though unfortu-

nately very little was heard of them except by his immediate neighbours, until they were unearthed some few years ago, when they were only of historical interest. He carried out a long series of experiments similar to those of Morse, quite independently but a year later.

After this, the subject appears to have excited very little attention, until in the year 1880, Professor John Trowbridge, of Harvard College, discovered that all the neighbouring telephone circuits were affected by the time signals sent from Harvard to Boston, some four miles away. He investigated the cause of these disturbances, and found that they were not due to induction, but to earth currents produced by leakage from the clock circuit.

Trowbridge saw at once that this might be utilised for the purpose of sending telegraphic messages without connecting wires, and he proposed attempting to telegraph across the Atlantic by sending alternating currents from a large dynamo through an insulated cable extending from Nova Scotia to Florida and earthed at each end, and placing another long wire with a telephone in its circuit down the coast of France.

He proposed signalling to ships at sea by means of similar means, and also by means of magnetic induction between coils carrying interrupted currents and using a telephone as detector, but he found that it would be necessary, either to employ coils far too large for use on board ship, or extremely heavy currents.

During the following year Graham Bell, the inventor of the telephone, began some interesting experiments, of which I will only describe one, which he carried out on the Potomac River.

A battery and an interruptor were placed in a boat and connected by a wire about 100 feet long, one end of which was soldered to a metallic plate immersed in the water near the bow, while the other end was at-

tached to a similar plate, which was buoyed by a float and allowed to trail astern. Bell himself was in another boat similarly equipped, except that the battery and interruptor were replaced by a telephone, and he found that he could clearly distinguish the signals at a distance of a mile and a quarter from the first boat. He strongly urged that a similar method should be employed for communicating between steamships, the steamer's electric lighting dynamo being used to replace the battery.

In 1882, Mr. W. H. Preece, now Sir William Preece, began to turn his attention to the subject with a view to effecting communication with lighthouses and lightships, where continual interruptions occur owing to the cables being broken or damaged by the heavy seas.

One of his earlier experiments was to establish a telegraphic circuit between Southampton, and Newport in the Isle of Wight.

As shown in Fig. 2, one wire was carried from Portsmouth through Southampton to Hurst Castle, the

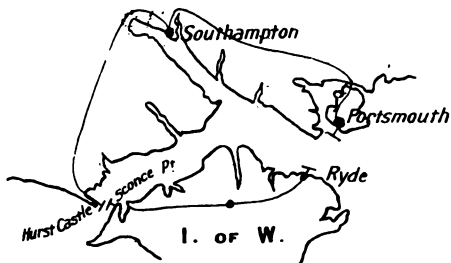

FIG. 2.—Preece's method of transmission between Southampton and Newport.

two ends being connected to large metallic plates immersed in the sea at Southsea Pier and Hurst Castle respectively. Another overhead wire was carried from

Ryde, through Newport, to Sconce Point, and the ends connected as before to metallic plates immersed in the sea.

With 30 Leclanché cells and a buzzer and Morse key at Southampton, the signals were found to be perfectly audible at Newport in a telephone on the circuit.

Three years later Mr. Preece arranged some interesting experiments on wireless telegraphy by electromagnetic induction in the neighbourhood of Newcastle, which were carried out by Mr. A. W. Heaviside. Two squares of wire, each side a quarter of a mile in length, were placed at distances varying from a quarter of a mile to 1,000 yards apart. In the former case the signals could be easily read by a telephone in the receiving circuit, and audible sounds were produced even at the greater distance.

Further experiments were made with parallel telegraph lines, ten and a quarter miles apart, between Durham and Darlington, and it was found that the ordinary working currents in one line produced distinctly audible sounds in a telephone in the other.



FIG. 3.—Preece's method of transmission between Lavernock Point and the Islands Steep Holm and Flat Holm.

Equally successful experiments were made between parallel lines of telegraph on the East and West Coasts

about forty miles apart, but in these experiments there arose the question whether the effects might not be due in part to leakage from the network of telegraph wires covering the intervening country.

The first practical application of the results of these experiments was to establish communication between Lavernock Point, near Cardiff, and two islands, Flat Holm at a distance of about three and a third miles, and Steep Holm at a distance of rather more than five and a third miles. (See Fig. 3.)

On the shore a copper wire, *a b*, 1267 yards in length, was suspended on poles and earthed at each end. In this circuit was an alternating dynamo capable of giving a current up to 15 ampères, and a Morse key for breaking up the alternations into signals. At a distance of 600 yards from this circuit, on the sand at low water mark,

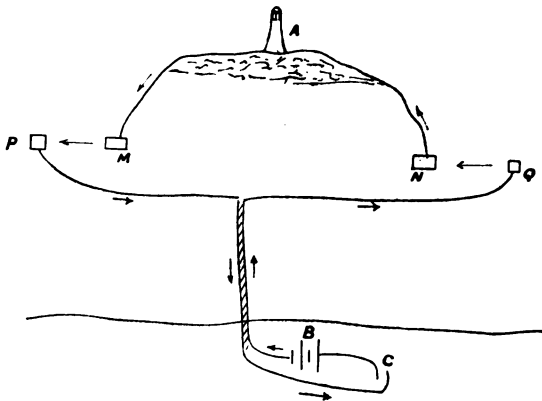

FIG. 4.—Willoughby Smith's method of communication between a lighthouse and the shore.

a secondary circuit, composed of two gutta percha covered, and one bare copper, wires, were laid down, and

B

their ends buried in the ground; the object of this circuit being to distinguish, by experimental evidence, between earth conducted and aerially transmitted signals. On the two islands, gutta percha covered wires, *c d*, and *e f*, each 600 yards long, and parallel to those on shore, were laid down. The signals

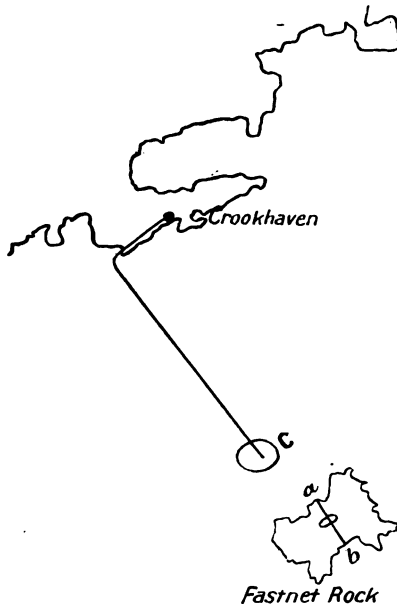

FIG. 5.—Method of Willoughby Smith and Granville employed in communicating between Crookhaven and the Fastnet Rock.

in the telephone on Steep Holm were audible, but not sufficiently distinct to be read, but messages were easily read off in the telephone on Flat Holm.

I will conclude this chapter by a brief reference to a method devised and patented by Mr. Willoughby Smith, and a modification patented by him in conjunction with Mr. W. P. Granville.

In Fig. 4 a lighthouse is shown at A, and insulated wires lead from the terminals of a telephone in the lighthouse to metallic plates, M N, submerged on opposite sides of the rock. Two other plates, P and Q, submerged to a sufficient depth to be unaffected by waves, are connected by an insulated cable, having in circuit with it a battery, B, and an interruptor, C. The course of the current is shown by the arrows. The modification of Mr. Willoughby Smith's method is shown in Fig. 5, which illustrates its application to communication between the Fastnet Rock, off the S.W. coast of Ireland, and the town of Crookhaven, eight miles away. An insulated cable from the shore is earthed at the shore end, and also by means of a heavy copper anchor, C, near the rock. A conductor, *a b*, containing a receiving instrument, which in this case is a d'Arsonval galvanometer, is earthed at *a* and *b* on opposite sides of the rock by connection with submerged masses of copper, and whenever a current flows through one circuit there will be a difference of potential produced at the ends of the other circuit, resulting in a flow of current which is shown by the galvanometer.

CHAPTER II.

ETHER AND ETHER WAVES.

SIR ISAAC NEWTON formulated a theory of light known as the corpuscular theory, according to which light was supposed to be due to very minute particles or corpuscles projected with enormous velocity from luminous bodies. Newton adopted this merely as a working hypothesis which gave a fairly reasonable explanation of what was known of light, but he was by no means satisfied with it. It accounted for the ordinary phenomena of reflection and refraction, but in order to account even for the simpler phenomena of polarised light it was necessary to make various more or less complicated additional assumptions. Still for a long time the corpuscular theory found a number of adherents to maintain it against the theory developed by Huyghens and others that light was a wave motion, the great objection to the acceptance of the undulatory theory being the necessity of assuming the existence of a medium filling the whole space occupied by the visible universe and having properties of a character hitherto quite unfamiliar. It was not until it became possible to make comparative measurements of the velocity of light in media of varying density that the corpuscular theory was definitely overthrown, since it demanded that the speed of transmission of light should increase with the density of the medium, whereas it is found that it decreases as the density increases, as is required by the wave theory. Since then new phenomena have been predicted from the wave theory and experimentally verified, and the whole theory of spectrum analysis rests upon it, so that it, and therefore the existence of the luminiferous ether, is no longer regarded as a working hypothesis but as

a fact, the evidence in its favour being quite as strong as that for the truth of Newton's law of Universal Gravitation.

At the present time we not only know that light and radiant heat are due to etheric vibrations but we know the exact nature of the vibrations, and as regards light we know the lengths of the waves corresponding to the various colours of the spectrum. We know, too, that heat waves are exactly similar to light waves except that they are of greater length, and the only reason that we cannot make measurements of heat waves with the same degree of accuracy as of light waves is that we have no special organ for the heat sense corresponding to the eye, which forms an instrument of extreme sensitiveness for light observations.

Sound waves are transmitted by ordinary matter, either solid, liquid or gaseous, and, as is well known, sound cannot be transmitted through a space which does not contain matter of very sensible density, a comparatively thin stratum of even such an imperfect vacuum as can be obtained by the aid of a good ordinary air-pump being sufficient to stop it entirely. When sound travels through a solid mass of matter the vibration takes place in all possible directions, but when it is transmitted through fluids, whether liquid or gaseous, the vibrations are entirely longitudinal, that is to say the motion of the moving particles is always parallel to the direction in which the sound is travelling. The reason of this is that while fluids possess volume elasticity, or resistance to change of volume, they have no rigidity, or resistance to change of shape, and substances without rigidity can only transmit longitudinal vibrations, the transverse vibrations being entirely due to resistance to shearing, that is, to the sliding of one portion of the substance over another.

It has long been known from the phenomena of light that the vibrations are entirely transverse, that is to

say, any particle of the vibrating medium remains throughout its motion always in the plane perpendicular to the direction of transmission of the ray of light, the longitudinal vibrations being non-existent. No explanation of this suppression of the longitudinal vibrations was obtained until Maxwell showed theoretically that it was characteristic of electro-magnetic waves, and suggested the probability of light waves being simply electro-magnetic waves having wave lengths between the limits within which the human eye was capable of responding to them.

These phenomena show, that for extremely rapid motions such as light waves, which traverse some 186,000 miles in a second, the ether must behave like an extremely elastic solid, while for comparatively slow motions such as those of the planets (the earth's speed in its journey round the sun is considerably under 20 miles a second), it offers so little resistance that in most cases it is imperceptible to us; so that for slow motions it must have the properties of a practically perfect fluid. In the case of Encke's comet astronomers believe they can just detect evidence of the existence of a resisting medium in space, but that is all.

If any reader is disposed to object to the assumption of a medium behaving in such very different ways with regard to motions of different speeds, it may assist in convincing him that the objection is not a valid one, to direct his attention to the similar behaviour of such a familiar substance as pitch. In moderately cold weather this material has all the appearance of a solid, and will resist a blow or momentary heavy pressure. If, however, a denser body than the pitch, such as a bullet for example, be laid upon its surface, it will gradually sink until it rests upon whatever is supporting the pitch. If on the other hand the pitch is placed upon a less dense body, such as cork, the latter will float up through it in the course of time. The pitch, therefore, exposes great

resistance to rapid motion, but the smallest pressure causes it to give way if sufficient time is given, or, in other words, when the motion slows down sufficiently the resistance becomes negligible, thus offering very close analogy to the behaviour of the luminiferous ether.

Between fifty and sixty years ago that great philosopher and experimentalist, Michael Faraday, seems to have had a kind of instinctive glimmering of an idea that there was some connection between electricity and light. In the then state of knowledge there was nothing apparently to warrant it, but he tried a number of experiments on the effects of electric and magnetic fields upon rays of light before he obtained any result.

He allowed a beam of plane polarised light to pass through holes in the poles of a powerful electro-magnet, so that the direction of transmission of the ray was parallel to the lines of force of the magnetic field. A very dense kind of glass containing borate of lead, a glass which Faraday had himself discovered and made some years before, was then placed between the poles, when it was found that if an analyser was so arranged as to stop all the light before the magnet was excited, then on excitation taking place there was a slight brightening of the field which could be reduced to darkness again by slightly rotating the analyser.

Neither Faraday nor anyone else was able at the time to account for a fact obtained through the coincidence of a number of circumstances all requisite for success, though not one of them could have been predicted, and which furnishes a wonderful example of the thoroughness and utter disregard of repeated failures which was one of the leading characteristics of Faraday's experimental work.

The meaning of this experiment was first pointed out by Sir William Thomson, now Lord Kelvin, and its important consequences were fully investigated by

Maxwell, who in all probability was led by it to formulate his electro-magnetic theory of light.

I have already pointed out that the vibrations forming a ray of light are all in a plane perpendicular to the direction of the ray. In general the vibrations take place in all possible directions in this plane, but it is possible by allowing a beam of light to pass through certain crystals, and by other means, to break up these vibrations in all possible directions in the plane into vibrations in two directions at right angles to each other, and it is further possible by simple means to divide these into two distinct groups, and then to separate them from each other. These two groups of vibrations are so related to each other that either may be obtained from the other by turning it through a right angle about an axis in the direction of propagation. When the two groups are separated each is said to be plane polarised.

Faraday's discovery was that it was possible by means of a magnetic field to produce rotation of the plane of polarisation.

Maxwell called attention to the fact that the observed velocity of light was, within the limits of errors of observation, identical with the rate of propagation of an electro-magnetic disturbance, deduced theoretically from certain electrical measurements, and cited other experimental facts in its favour; and many other facts since discovered have confirmed Maxwell's conclusions, more particularly the work of Hertz, which I shall consider later in some detail, and in which he demonstrated experimentally that electro-magnetically excited waves could be made to interfere with each other and could be reflected and refracted exactly like light waves.

Heat and light are therefore found to be mere special cases of electro-magnetic waves which may vary through all gradations of wave lengths varying from thousands

of miles down to a few hundred thousandths of an inch in the case of light waves, and the great electromagnetic spectrum extends, we know, much further even than this, for we can detect, by their effect on photographic chemicals, the existence of waves far beyond the violet end of the spectrum, that is to say of waves shorter than the shortest light waves which the eye can perceive.

Lord Kelvin, in a paper published in the "Transactions of the Royal Society of Edinburgh" in May, 1854, has shown how a probable minimum limit may be assigned to the density of the ether, considered as an elastic solid.

The French physicist, Pouillet, as the result of a series of carefully-made measurements, had found that the heating effect of direct sunlight falling on a surface of a square centimetre at the distance of the earth from the sun amounted to 1.7633 gramme Centigrade units of heat per minute, or 1.234×10^6 ergs per second. This would evidently be the amount of energy due to sunlight contained in a prism with a base having an area of a square centimetre and with a height equal to the velocity of light in centimetres per second, viz., 3.004×10^{10} , which gives as the energy per cubic centimetre per second :

$$\frac{1.234 \times 10^6}{3.004 \times 10^{10}} = 4.1 \times 10^{-5} \text{ ergs.}$$

Lord Kelvin deduces from this datum a superior limit to the velocity of a vibrating particle of the medium transmitting radiant heat or light, on the assumption that the amplitude of vibration is a small fraction of the wave length and that the maximum velocity of a vibrating particle is small compared with the speed of propagation of waves. The first assumption is certainly justifiable, and the second follows from it, for considering the case of plane polarised light where the vibration is a simple harmonic one, which will be the case where

it is homogeneous, or all of one wave length, if V be the velocity of wave transmission, v the maximum velocity of a vibrating particle, A the semi-amplitude or distance of the vibrating particle at the extremity of an excursion from the position of equilibrium, and λ the wave length, then it is known that

$$\frac{v}{V} = 2\pi \frac{A}{\lambda}$$

Now the whole mechanical energy of homogeneous plane polarised light in an infinitely small space containing only ether particles sensibly in the same plane of vibration is entirely potential when the particles are at rest at either end of an excursion, entirely kinetic when the particles are in the position of equilibrium, and partly potential and partly kinetic in all other cases.

This energy being constant in amount is equal to $\frac{1}{2} m v^2$, where m is the mass in vibration, for v is a maximum in the position of equilibrium. If, therefore, ρ is the mass of vibrating matter in unit volume, or, in other words, the density of the matter, the mechanical value of the energy is $\frac{1}{2} \rho v^2$.

In the case of circularly polarised light, in which every particle describes a circle with constant velocity, the energy is half potential and half kinetic, so that if v is the constant velocity the energy is ρv^2 .

In the case of elliptically polarised light, the value lies between the two. Moreover, for co-existent series of waves of different periods polarised in the same plane, the mechanical energy is the sum of the portions due to each, from which it follows that the maximum velocity is the sum of the separate velocities.

The same reasoning applies to circularly polarised light of different periods. It follows, therefore, that the mechanical energy must certainly be less than the product of half the mass into the square of the maximum velocity acquired by a particle in the case of plane polarised waves, and it may be concluded that for any

radiation, unless homogeneously circularly polarised, the mechanical value of the disturbance is less than the product of the mass into the maximum velocity of a vibrating particle.

That is to say, 4.1×10^{-5} ergs is less than ρv^2 , and therefore very much less than ρV^2 , or ρ is certainly very much greater than $\frac{4.1 \times 10^{-5}}{(3.0004)^2 \times 10^{20}}$.

If we assume $V=100v$, which is a reasonable assumption to make, then ρ comes out as somewhere about $\frac{4}{9} \times 10^{-21}$. Now the ratio of rigidity to density is equal to the square of the speed of transmission, which gives for the rigidity $\frac{4}{9} \times 10^{-21} \times 9 \times 10^{20}$, or about $\frac{4}{9}$. This is small compared to the density of any known solid. Steel is the most rigid substance known to us, and its rigidity is as high as 8×10^{11} .

It is not only in free space that luminous and other electrical vibrations are transmitted by ether. Water and other fluids, for example, transmit light, but it cannot be the fluid which acts as the medium, for it has no rigidity, and is therefore incapable of transmitting transverse vibrations. Even in transparent solids the waves must be transmitted by ether penetrating the interstices of the matter composing them, for the rate of transmission is far too great for the matter itself to be the medium.

The ether, however, within different kinds of matter is largely modified to an extent depending on the substance. For example, in heavy glass the speed of transmission of a luminous wave is only about two-thirds of the speed in free space. Considering the ether as an elastic solid it must, therefore, either have its density increased or its rigidity diminished by the presence of the particles of glass.

Many considerations would appear to favour the latter hypothesis in preference to the former one. If the ether is capable of having its density varied it must be com-

pressible, and therefore its structure must be molecular, and these molecules must be elastic, and then if we are to adhere to our plan of assuming that every action between distant bodies is due to actual pushing or pulling of bodies actually in contact with them, we shall require a second ether to explain the elasticity of the molecules of the first.

We are, therefore, driven to the conclusion that the ether is to be regarded as continuous and therefore incompressible, so that the modification of ether (always assuming it to be an elastic solid) in contact with matter must consist in a diminution of rigidity and not in an increase of density.

This conclusion would appear to be strongly confirmed by the simple explanation which it gives of opacity. There is no such thing as a perfectly opaque body, but some come very near it, and on our theory, which is practically that of McCullagh, the explanation is that in such bodies the rigidity of the ether approaches the vanishing point. If we adopted Fresnel's theory of the increase of density of ether in contact with matter we should have to suppose the density of the ether in practically opaque bodies to be increased to an enormous extent.

Another point in favour of this view is that if we assume with McCullagh that the diminution in rigidity is due to a sort of straining of the ether towards the particles of matter, we get, as Professor Lodge has pointed out, at something like the explanation of gravitation, for under those circumstances two bodies would tend to draw together.

Objectors to the ether on the ground of the complication involved in the co-existence of two apparently so distinct things as matter and ether may be interested to learn that Lord Kelvin has suggested a simplification of a very beautiful character.

While fluids at rest have no rigidity, portions of them

may become rigid by being set in rapid motion, as is well illustrated by the smoke rings which some smokers are very skilful in blowing from their mouths and which may easily be produced in air, water, and other fluids.

Lord Kelvin made the beautiful suggestion that the apparently unchangeable atoms of different kinds might simply be vortex rings of various shapes in the ether, which from this point of view must act as a perfect fluid.

We will now consider the question as to what kind of ether waves are most suitable for the transmission of signals to a distance.

The conditions to be fulfilled are clearly two in number. Firstly, in order that the waves may not be stopped by intervening obstacles, such as portions of land and water, we require oscillations for which the opacity of different kinds of matter is least, or, in other words, those oscillations for which ordinary terrestrial bodies are most transparent.

Secondly, in order that the signals may be distinguishable at as great distances as possible with a moderate expenditure of energy, we require those oscillations for which the largest possible proportion of the energy supplied from the source, the transmitting instrument, may be taken up by the medium.

We know that ordinary light waves, the lengths of which are measured in hundred-thousandths of an inch, fulfil the second condition in the most satisfactory manner, but unfortunately they do not fulfil the first, for the thinnest films of most substances are sufficient to stop them. Still, they were employed for the first attempts at wireless telegraphy, which is far more ancient than the system of telegraphing by means of wires. In the earliest examples of which we have any record, the requisite ethereal oscillations were excited by means of large bonfires, and the difficulty of fulfilling the second condition was evaded by placing both the

transmitting instrument, consisting of the bonfire, and the receiving instrument, which was simply the eye of the watchman, on the highest hills available, so that the waves excited had only to encounter the comparatively transparent atmosphere. The semaphore of a hundred years ago and the heliograph of to-day offer further examples of wireless telegraphy by means of electric oscillations of extremely short wave length.

All bodies become less opaque to electric waves as the wave length increases. The reason of this, according to theory, is that the quenching of the waves does not take place immediately on entering any opaque medium, as would be the case if it were a perfect conductor of electricity, but the waves die out after a certain number of vibrations, depending on the opacity of the medium.

It is clear, therefore, that in the case of a medium which will permit of half-a-dozen vibrations before the wave is quenched, a very thin film will suffice to stop light waves which are of the order of a hundred-thousandth of an inch in length, while a much thicker stratum would be required to stop the Hertzian waves which may be from a foot to some few yards in length, and again, no practicable thickness would stop the waves from an alternating dynamo, say with a periodicity of 100 vibrations a second, as in this case the wave length would be something like a couple of thousand miles.

Unfortunately, as the wave length increases, the second condition is less and less perfectly fulfilled.

The reason for this is extremely interesting. Sir George Gabriel Stokes, so long ago as 1849, showed by mathematical reasoning from observed optical phenomena, that when a wave of light is excited from a given source, the radiation is emitted, not from the source itself, but from a point a quarter wave length in advance of it. This very curious phenomenon is completely explained when light waves are admitted to be of electro-magnetic origin.

When an electric disturbance is set up at a certain point, it is always accompanied by a magnetic disturbance, the electric and magnetic forces being at right angles to each other, and to the direction of propagation. The electric disturbance occurs a quarter of a period later than the magnetic, but it starts a quarter of a wave length in advance, so that, except within the first quarter wave length, the two travel together, their zero and maximum values always occurring at the same points.

Within the first quarter wave length, however, the two disturbances sometimes reinforce and sometimes oppose each other, and the result of this, as Professor Poynting has shown, is that, within the first quarter wave length, the energy originally proceeding from the source of the disturbance is sometimes travelling forward, and sometimes backward towards the source, so that, although more goes forward than comes backward, a large proportion is wasted.

Beyond the first quarter wave length, however, the two disturbances tend always to cause an outward flow of energy.

It is, therefore, easily seen that in the case of a wave a hundred-thousandth of an inch in length, the point from which the radiation begins being only the four-hundred-thousandth of an inch from the source, there will be very little energy returning to the source.

On the other hand, in the case of a dynamo such as referred to above, with a wave length of some 2,000 miles, the emission point would be some 500 miles from the source, so that very little of its energy would reach this point, by far the larger proportion being returned to the source.

We see, then, that the two conditions to be fulfilled are diametrically opposed to each other, and it becomes a matter for experimental investigation to determine what kind of wave lengths are most advantageous for

telegraph work under varying conditions as to distance and other circumstances.

The invariable co-existence of the two above-mentioned components, the electric and the magnetic waves, in every electro-magnetic disturbance, is a phenomenon worthy of more than passing notice.

The electrical oscillations are found to be identical with those which would follow from Fresnel's theory of a solid elastic ether, while the magnetic ones are identical with those of McCullagh's theory.

In free ether and in isotropic bodies, that is, bodies whose properties do not vary with the direction, the directions of oscillation are the same as those of the electric and magnetic forces respectively, and in consequence of this, either of the mechanical theories referred to above would account for all the optical phenomena due to electro-magnetic waves, except the known absence of longitudinal oscillations in the case of light waves. In crystals the properties are in general not independent of direction, but even in this case no differences would arise in any phenomena due to rays passing through the crystal and observed in an external isotropic medium. As these are the only kinds of observation which are possible, both theories continued to have their adherents until the electro-magnetic theory displaced them.

The latter theory, as formulated by Maxwell, while it made the great advance of accounting for the transversality of light waves, failed, in common with the older mechanical theories, to account for various secondary optical phenomena, and in some minor respects appeared to be in contradiction with observed results.

It did not, therefore, meet with general acceptance until after Hertz's experiments had conclusively demonstrated the existence of the electro-magnetic waves of the Faraday-Maxwell theory. This demonstration directed the attention of many physicists to the investi-

gation of the apparent discrepancies between the electromagnetic theory and observed optical phenomena.

These investigations have led to the disappearance of the discrepancies one after the other, not by the aid of arbitrary assumptions made merely to account for the phenomena in question, but by additions to the theory deduced from known properties of vibrating molecules, together with a theory of the constitution of matter and its relation to the ether which appears from Professor Joseph Larmor's investigations to be the only one which can possibly lead to a dynamical explanation of the known phenomena of light and other other waves.

The development of electrical theory has for a long time been tending towards the recognition of an atomic distribution of electricity, so much so that Maxwell even made use of the expression "an atom of electricity." He and von Helmholtz have both pointed out that Faraday's quantitative laws of electrolysis necessarily lead to this conclusion, and that each atom of matter has its definite electric equivalent, which is the same for every kind of atom. The great difficulty which arises in connection with this conception is to explain how these atomic charges, or electrons, can be transferred from one molecule of matter to another.

The theory propounded by Professor Larmor is that the atomic charge is of the essence of each of the ultimate atoms, of which an aggregation, moving round each other in unchanged orbits, forms the ordinary material molecule; so that the transference of electric charge will involve transference or interchange of these constituent sub-atoms themselves between the molecules, that is, it will always involve chemical change, as Faraday held on experimental grounds to be the case.

Two species of electrons, positive and negative, must be assumed, so that the most modern electrical theory is really bringing to life in a new form the once dis-

c

credited hypothesis of distinct positive and negative electricities.

The electrostatic attractions and repulsions between these electrons must necessarily be conveyed through the ether by elastic deformation, and, therefore, every atom must consist entirely or partly, according to whether its electron forms the whole or only a part of it, of a nucleus of permanent strain in the ether. It follows that a positive electron differs from a negative one only as the left hand differs from the right, or in other words, as the reflection of an object in a plane mirror differs from the object itself.

It will be seen that this theory, like Lord Kelvin's theory of vortex atoms, tends towards getting rid of the duality of ether and matter by considering matter as a structure in the ether, but the latter does not as such take account of the existence of electric charges, and is, therefore, in the light of our present knowledge insufficient. The electron theory does not, however, exclude that of Lord Kelvin, for example, as Professor Larmor points out, a system of similar electrons ranged along a circle, moving round it within the limits of speed required for stability, and constrained by the attraction of an electron of opposite sign at the centre would constitute a vortex ring in the surrounding ether, but, on the other hand, electron molecules of stable form may be imagined which would not constitute vortex rings, and there does not at present appear to be any reason for limiting the more general theory. The system of electrons in a molecule, besides satisfying the conditions of dynamical stability, must be such that the energy of the molecule will not be dissipated by radiation, and Professor Larmor has shown that this condition can be satisfied. When matter is regarded in this way as a structure in the ether the proper method of determining the properties of the latter will not be to reason from the properties of matter, as was done in the elastic

solid theories, but to endeavour to derive them from more fundamental considerations. As I have pointed out earlier in this chapter, if the ether is to be regarded as the final fundamental reality, it must be a uniform medium consisting of a *plenum* filling all space. In order to be capable of transmitting electro-magnetic vibrations it must have elasticity of some kind, and it must behave as a fluid offering little or no resistance to the motion through it of solid masses such as the planets and other heavenly bodies.

As far back as 1839, McCullagh showed by means of abstract dynamical reasoning that the requisite conditions would be fulfilled if the elasticity were of a purely rotational type. The ether would then offer no resistance to any irrotational motion, but would resist elastically any differential rotation of an element of volume, very much as a spinning top resists any angular deflection of the axis about which it is spinning.

An electron molecule without electric charge, a molecule, for example, which is chemically saturated, would pass freely through such an ether without resistance when moving at a uniform speed, very much as a knot would slip along a frictionless cord. The uniform motion of a solid built up of such molecules would also be unresisted provided it carried no electric charge, and was not either electrically or magnetically polarised; for under these circumstances it would not give rise to any pushing aside of the ether, or any disturbance of it in bulk. Accelerated motions, either of masses or of molecules, would experience a resistance of the nature of inertia, so that this known property of matter would be accounted for without the necessity of assuming the presence in its molecules of any constituents other than the electrons. The only case in which any further resistance would be experienced by a moving body or molecule would be if its speed approached that of radiation, that is to say, the speed of propagation of light.

As long as the speed of translation is so small in comparison with that of radiation that the square of their ratio may be neglected, the total inertia of a molecule due to its electron components is simply the sum of the portions due to each electron by itself, so that the law of constancy of mass throughout molecular transformations is accounted for.

Professor Larmor has not as yet made any attempt to investigate the nature of the structure of the electrons themselves, which, as far as electrical phenomena are concerned, may be treated as mere point singularities in the ether. He shows, however, that they must necessarily be of finite size, or otherwise the properties of a molecule would depend only on the form of its system of electrons with their orbital motions, and not on the scale of the system, and thus would not be in accordance with the known facts respecting the limits of variation in the size of material molecules. Certain energy considerations, moreover, involve the necessity of the existence of some kind of structure in the electrons, although at present we have little more than vague indications of the means of arriving at any conclusions as to its nature.

CHAPTER III.

MECHANICAL REPRESENTATIONS OF ELECTRIC ACTIONS.

ALL that I can do towards explaining the mechanism of transmission of electric actions is to lay before my readers mechanical arrangements capable of producing the observed results, and which may therefore enable us to obtain a better grasp of the phenomena by fitting them together into some sort of mental picture, although as we advance, the images which have helped us in the earlier stages have to be discarded for others.

As the properties of a uniform plenum, such as we have been led to regard the ether, is altogether outside the field of direct experience, we have to fall back on the comparatively unsatisfactory expedient of building up our ideal mechanisms out of the already complex structures which constitute matter, which alone is within our immediate knowledge.

Clerk Maxwell was the first to give helpful suggestions in the way of mechanical models illustrating electric actions. His model was modified and improved by Professor Fitzgerald, and later, Professor Oliver J. Lodge has treated this question in a most exhaustive manner in a series of papers extending over the last twenty years. It is upon the store the latter has provided that I shall mainly draw at present.

We may consider ourselves as living in a sort of ocean of electricity, and as water is so much more familiar to us than electricity, it may help our conceptions to imagine for a moment that we are living under the sea, and consider the water as taking the place of the ocean of electricity really surrounding us, but the analogy then will not be quite complete. Water can be displaced

by solid and other bodies, whereas in the electric ocean the amount of electricity contained within a given space is just the same, whether part of that space is occupied by matter of any kind, or whether it is what we call empty.

There is no possibility of putting electricity into any body in the way that we fill a bucket with water. When living under the water our buckets must always be full of water. We may change the water, but only by displacing it by an equal quantity from some other portion of the all-pervading ocean. As water cannot pass through the sides and bottom of the bucket, so in the same way insulators will not allow electricity to pass through them. The space occupied by the material of the bucket is not full of water, while the space occupied by an insulating material contains exactly the same amount of electricity as if the material were not there; but this will not seriously affect the use of the analogy. There is another and far more important difference between the two oceans; of water, and of electricity. While the water can move freely from one part of the ocean to another it is not so with electricity in so called empty space, this being an insulator. We find that electric waves can be sent through space, and therefore some small backward and forward motion must be possible, but no continuous flow. The electric ocean must therefore be considered as entangled in a sort of jelly, which will allow of slight vibratory displacements, but in order to get a continuous flow, some kind of tubes or channels must be made in the jelly, and these are called conductors.

In order to get a flow through a tube we must have some means of driving the electricity along, such as would be provided by a pump in the case of water, and for the flow to be continuous the tube must form a closed circuit. An analogy for a circuit composed partly of conductors and partly of insulators may be

found in an endless tube containing diaphragms of some elastic substance, such as indiarubber, stretched across it at intervals.

A section of such a tube is shown in Fig. 6. The

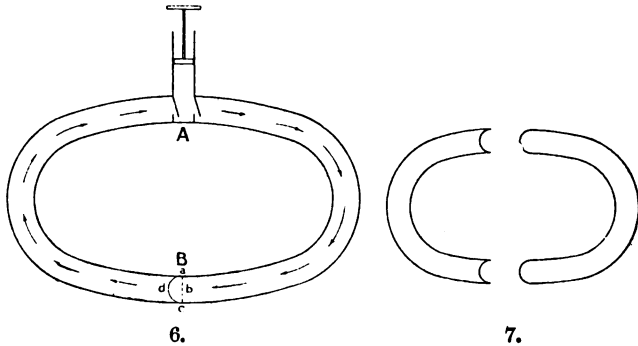

FIG. 6.—Hydraulic Model of a Circuit consisting partly of Conductors and partly of Insulators.

FIG. 7.—Hydraulic Model of a pair of equally and oppositely charged Conductors.

pump, A, has valves so adjusted as to send a current of water down the tube in the direction shown by the arrows. At B is an elastic diaphragm stretching across the tube. Before the pump is worked the diaphragm will be subject to equal pressure on opposite sides, and will therefore remain flat, as shown in section by the straight line, *a, b, c*. By working the pump the pressure on the right-hand side of the diaphragm will be increased and that on the left diminished, and the diaphragm will be bent into some such form as is represented by the curved line. If diaphragms are placed across the tube at each side of the pump, A, and the pump is then removed, and the tube divided through the diaphragm so as to leave each end enclosed, two tubes with their

diaphragms will appear, as shown in Fig. 7, and the right-hand half of the tube will contain more, and the left-hand half less, than half of the water originally in the tube. These two tubes represent two equally and oppositely charged conductors, and it will be seen that according to this representation it is impossible to charge a conductor positively without at the same time giving an equal negative, or opposite charge, to some other conductor.

The greatest visible effects are produced when the whole of one conductor is brought as near as possible to the whole of the other while maintaining insulation between them. This is very conveniently done by pasting sheets of tinfoil on the inside and outside of a glass jar, or on the opposite faces of a sheet of glass, forming the well-known Leyden Jar, and it will be seen

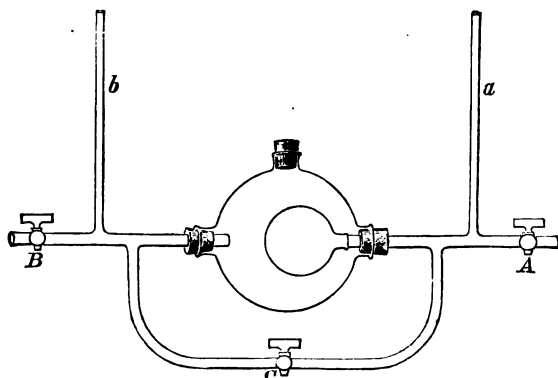

FIG. 8.—Skeleton Diagram of Lodge's Hydraulic Model of Leyden Jar.

From Lodge's "Modern Views of Electricity."

that this consists simply of a pair of conductors insulated from each other, and that the case of charging or dis-

charging any conductor is a case of the charge or discharge of a Leyden Jar.

Professor Lodge has designed an elaborate model of a Leyden Jar; Fig. 8 being a skeleton diagram, and Fig. 9 an illustration of the actual model.

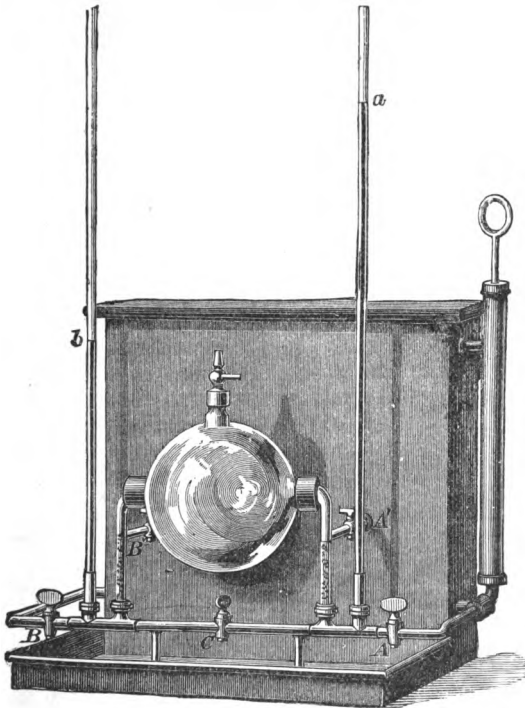

FIG. 9.—Lodge's Hydraulic Model of Leyden Jar.

From Lodge's "Modern Views of Electricity."

A thin indiarubber bag is tied over the mouth of a

tube provided with a stopcock, A, and the tube is inserted by means of a cork into a three-necked globular glass vessel. One of the other openings must have a stopcock, B, while the third opening is closed with a cork, or preferably another stopcock, as soon as the whole vessel, both inside and outside the bag, is filled with water free from bubbles of air. A third tube, usually closed by a stopcock, C, represents a discharger; and open gauge tubes, *a* and *b*, represent electroscopes attached to the two coatings of the jar respectively, while a water pump screwed on to A corresponds to a source of electricity, such as a battery, or a frictional or influence machine. If the two terminals of the source are attached to the two coatings of the jar, then A must be connected to B by means of a tube, while if one terminal of the source and one coating of the jar are connected with the earth, the more usual arrangement, then A and B must both be connected with a tank of water representing the earth. In this model the gradual distension of the indiarubber bag represents the charging of the jar. In Fig. 9, two extra stopcocks, A' and B', leading direct to the tank, have been added, to save the trouble of disconnecting the pump in order to connect A directly with the tank, when illustrating the charging of a jar by alternate contact.

If the two tubes shown in Fig. 7 are placed together so as to form a single ring with two diaphragms across it, both in a state of strain, then if one of these is broken the pressures on the opposite sides of the remaining one will become equalised, and therefore the diaphragm will return to its normal condition of flatness. Owing, however, to the elasticity of the material of the diaphragm, there will be a slight oscillation on either side before it permanently assumes its position of equilibrium.

A current of water cannot be started or stopped suddenly, and similarly it is found that when an

electric current is started it takes an appreciable time, though a very small one, to attain its full strength. Again, when an electric current is arrested by breaking the circuit, a very much larger spark is obtained than the one observed on closing the circuit, and the more sudden the break the larger the resulting spark. If, however, an electric current really possesses inertia, as a stream of water does, it should give rise to mechanical as well as to electrical effects. These have been looked for in vain by Clerk Maxwell, Professor Lodge, and others. It may be that an electric current consists of two equal streams in opposite directions; or, again, perhaps the hydraulic analogy is only of use in explaining a few of the more obvious phenomena; it certainly does not account for the existence of the magnetic fields in the neighbourhood of conductors carrying electric currents or any of the phenomena depending on them.

The existence of these magnetic fields leads, moreover, to the question whether we can regard the electricity as forced along the conductor by a simple pressure, analogous to that which drives water along a pipe, or whether the energy required to maintain the flow is transmitted through the insulating medium to every portion of the boundary between it and the conductor. Professor Poynting has shown that the latter is really the case. The energy which drives an electromotor, for instance, or maintains a series of electric lamps, is not conveyed through the conducting wires. The dynamo gives its energy to the surrounding medium, thereby inducing certain strains in it which spread in all directions. If there were no conducting wires a permanent condition of strain would be set up in the medium, but when the energy reaches the conductors some of it is dissipated, and the continuous flow of a current of electricity thus becomes possible. When an attempt is made to transmit too much energy by means

of an electric cable it is the insulation and not the copper wire which gives way.

An electric current does not start simultaneously at every point in the section of a conductor, but the starting or stopping begins at the outside, and penetrates inwards the more rapidly, the worse the conductivity of the material. If this were infinite the current would never penetrate beyond the outer skin of the conductor.

Professor Lodge illustrates this by the experiment of spinning a tumbler of liquid, with some small particles in suspension, to make the motions of the different portions visible. The outer layers begin to move first, and the motion gradually penetrates inwards, and when the spinning of the tumbler is stopped the outside portions of the liquid stop first. If the liquid is very viscous, like treacle, the motions spread rapidly, corresponding to a bad conductor of electricity, but if extremely mobile then the inward propagation is much slower, corresponding to a good conductor. The analogue of a perfect conductor would be found in an absolutely non-viscous liquid, and in such the motion would never penetrate beyond the outermost skin.

Suppose now we wind a conductor into a coil and pass an electric current through it. We find that it behaves in every way as a magnet, in fact it is a magnet as long as the current continues to flow; hence Ampère's theory that magnetic substances owe their properties simply to electric whirls in their molecules. These whirls are not confined to the iron or steel of a magnet, but spread into the surrounding space, forming what is known as the magnetic field, and this may be mapped out by means of iron filings which cling, end to end, along lines coinciding at every point with the direction of the magnetic force, and are known as "lines of force." These lines of force must constitute the axes of molecular whirls, and every such line forms a closed curve, part of which is in the iron, and the remainder

in the air or other surrounding media. The effect of such whirls, if they consisted of a material fluid, may be illustrated by means of a model suggested by Professor Lodge.

Two circular boards connected by elastic walls form a drum which can be filled with liquid. The upper board is then hung from a horizontal whirling table, while a weight is suspended from the lower one. When the drum is spun round, the sides bulge out, and the ends approach each other, raising the weight. A magnetic field will be represented by means of a number of chains, each made by attaching drums end to end, and following the contour of a line of force in the field. It will be seen then that when rotation is set up the end boundaries will be drawn together, representing magnetic attraction, while the lines of force drive each other apart sideways, representing magnetic repulsion.

Professor Lodge indicates the whirls in an insulating medium by means of cogwheels gearing into one another and also into those of the conductor, and in order to get over the difficulty that two contiguous wheels must be rotating in opposite directions, he assumes them to be equivalent to positive and negative electricity alternately. One of these models, representing a section of a magnetic field, is illustrated in Fig. 10, the wheels representing positive electricity being marked +, and those representing negative electricity being marked —.

If these rotate alternately in opposite directions the electrical rotation or circulation in the field will be all in one direction. In a medium of this kind, with all the wheel work revolving properly, there will be nothing of the nature of an electric current, for at every point of contact of two wheels positive and negative electricity respectively are travelling at the same rate in the same direction, but a current may evidently be represented by making the wheels gear imperfectly and

work with slip, and a line of slip among the wheels will represent a linear current.

Professor Lodge points out that such a line of slip

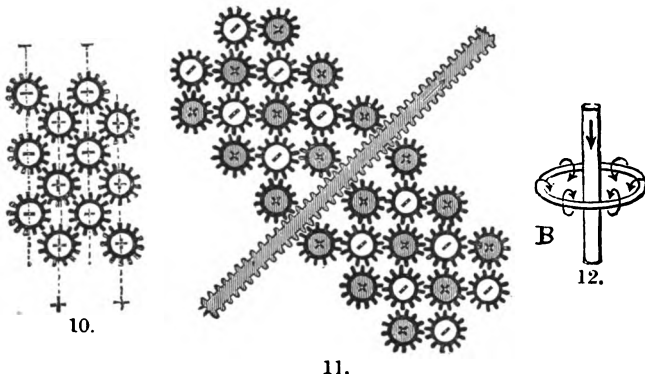

FIG. 10.—Lodge's Model illustrating a Section of a Magnetic Field.

FIG. 11.—Lodge's Model illustrating a Section, taken through the wire, of a Wire carrying an Electric Current with its Magnetic Field.

FIG. 12.—Illustrating a Magnetic Vortex Whirl encircling a Wire carrying an Electric current.

From Lodge's "Modern Views of Electricity."

must always form a closed curve, as is required by the fact that electricity must flow in a closed circuit. For if only one wheel slip, the current coincides with its circumference; if a row slip, the direct and return circuits are on opposite sides of the row; and if an area of any shape with no slip inside it is enclosed by a line of slip the circuit may be of any shape but always closed.

In an insulator or dielectric there is no slip in the gearing, so a conduction current is impossible, but a metallic conductor must be considered as a case of

friction gearing with more or less lubrication and slip; thus, turning one wheel will only start the next one gradually, so that, until all the wheels are in full spin, there is a momentary current. In a perfect conductor there must be no gearing, and such faultless lubrication that no spin can be transmitted from one wheel to another.

In a magnetic medium, which is not magnetised, the whirls are to be considered as taking place about axes pointing indiscriminately in all directions, or, more accurately, according to the researches of Professor Hughes, the various chains of whirls must form closed curves within the magnetic substance.

When the medium is magnetised these are broken up, and a preponderating orientation in a certain direction takes place, and this may be most simply treated by assuming that a certain proportion of the whirls are accurately faced in this direction, the others facing equally in all directions.

When a magnetic disturbance is propagated through an insulator in which all the wheels gear perfectly into each other, propagation of spin through the mass will take place with extreme rapidity, as there can be no slip, but only a slight distortion and recovery. In a conductor, on the other hand, so long as the spin is either increasing or decreasing, slip will be going on throughout, and a certain time will elapse before a steady state is attained. In highly magnetic substances, such as iron, and in a lesser degree nickel and cobalt, we know that this time is greatly increased, and may be represented in our model by increasing the mass of the moving wheelwork, either by giving greater mass to each of the wheels or by taking more of them, or by a combination of the two methods.

Take the case of a current in a copper wire gradually increasing, and producing magnetic spin in the surrounding medium. A section of the field through the wire.

may be represented by a rack gearing into a train of wheelwork, as shown in Fig. 11. As soon as the rack begins to move the wheels will begin to rotate until the whole of the surrounding medium is in a whirling condition. Previous to a steady state of spin being attained the motion of the rack will be opposed by the inertia of the wheelwork, representing the opposing E.M.F. of self-induction, or electro-magnetic inertia, and, when the medium is in a state of spin, the stopping of the rack will be opposed in a similar manner. If the diagram is rotated round the rack the wheels become circular vortex rings. As the distance from the rack increases their cores increase in diameter, and therefore the rate of spin diminishes, until at great enough distances the medium will hardly be disturbed. Slip takes place entirely along the wire, while the axes of spin are at right angles to it. If slip could take place without friction, and the consequent dissipation of energy in the form of heat, we should have the analogue of a perfect conductor, if such a substance existed. As a matter of fact no such substance is known, and, therefore, in order to maintain a current in a conductor, the energy continually being dissipated in the form of heat must be continually supplied from some source of power, such as a dynamo or battery.

I want now to apply the foregoing representations to the explanation of the action of a telegraph wire as employed in ordinary telegraphy. What happens here is that a magnetic field at the sending station is made to excite a magnetic field at the receiving station with comparatively small loss. The wire makes it possible to produce this secondary field in any place desired. To understand how this is to be explained we will return to the consideration of the rack and train of wheels, but in the first place assume for greater simplicity that the wire is a perfect conductor. The rack must therefore be removed and replaced by a smooth rod, so that

the magnetic spin may cease at its surface and transmit no energy into the wire. Assume at the same time that the rotation of the wheels is in some manner maintained just as if the rack were being pushed along. Then in the bounding surface of the rod representing the conducting wire there exists the state of slip, which has been shown to correspond with an electric current, and it will be seen that the function of the rod or conductor is simply to provide a space free from the magnetic wheelwork, so as to allow of the free rotation in opposite directions of the wheels on the opposite side of any longitudinal section through the rod. If the space were not thus kept free the wheels would interlock, and the only magnetic field would be the ordinary state of spin about the lines of force, rapidly diminishing in intensity as the distance from the battery or other source of energy is increased. With this space, however, kept free by means of the perfectly conducting wire or smooth rod in the model, there will be an intense magnetic field everywhere immediately in the neighbourhood of the wire and diminishing in intensity as the distance from the wire increases.

All along the wire there will be, in fact, vortex whirls, as shown in Fig. 12, where B is a conductor carrying a current the direction of which is indicated by the arrow. The direction of spin of the positive whirls is shown by the curved arrows. All that is required in order to enable the wire to act in this manner is to have some arrangement capable of exciting vortex whirls about some portion of the wire, which must form a closed circuit, and these vortex whirls will then travel along the wire and produce their effect at the distant stations. These whirls are not found in the wire itself, but in the insulating sheath, so it will be seen that the wire transmits nothing, but only directs the energy on its way by holding apart the mutually opposing wheelwork of the insulator.

In practice the wire is not, of course, a perfect conductor, but the effect of this is merely that the slip on its surface is imperfect. Some of its own wheelwork is therefore set in motion, except along the axis of the wire. Two distinct results follow from this. In the first place, the frictional slip in the imperfect conductor causes a dissipation into heat of some of the energy supplied, and therefore only a portion of the initial energy at the sending station is transmitted to the receiving end. In the second place, every time the wheelwork is started, there will be a certain delay, increasing with the diameter of the wire, and which will also be comparatively large if the wheelwork of the conductor is very massive, as would be the case if an iron wire were employed.

CHAPTER IV.

ELECTRIC WAVES.

As far back as 1842, the American Professor Joseph Henry, pointed out that the phenomena accompanying the discharge of a Leyden jar suggested that it was of an oscillatory character, as was indicated by the water model described in Chapter III.; and Helmholtz, in 1847, in his celebrated essay on the Conservation of Energy, made the same assumption, and pointed out that the oscillations would become continually smaller until the entire energy was dissipated by the opposing resistances. In 1853, Lord Kelvin showed mathematically that in general the discharge of a Leyden Jar was oscillatory, and in 1859 and subsequent years Feddersen confirmed this experimentally. The time of a complete oscillation depends on the electrical resistance and two other constants of the circuit known as its self-induction, or inductance, and its capacity. When the resistance is small compared with the inductance, as it is in all cases, occurring in wireless telegraph work, its effect is negligible, and the time T is given by the formula—

$$T = 2\pi \sqrt{LS},$$

where L and S are the self induction and capacity of the circuit respectively.

The meaning of these electrical constants will be more clearly understood by a comparison of the electrical oscillations with mechanical oscillations of a simple character, such as those of a straight spring fixed at one end and having a weight attached to the other.

The flexibility of the spring is the analogue of the capacity, and the inertia of the loaded spring that of

self induction. An increase in either of them will diminish the rate of oscillation. In the electrical case the capacity of the circuit may be increased by making the jar larger, and as the self induction is due to the magnetisation of the medium surrounding the current it may be augmented by increasing the length of the circuit. Owing to the fact that there is very little magnetising effect, except close to the conductor, the area included in the circuit makes very little difference, so that the circuit may be wound into a coil, making the arrangement more compact. If the oscillations were slower the self induction might be still further increased by filling the space inside the coil with iron, but with these extremely rapid oscillations the iron is protected from magnetisation by the currents, opposed to those in the coil, which are induced by the latter in the outer skin of the iron, and the result is that the introduction of iron does not increase the self induction but actually diminishes it.

When the spring is set in motion the vibrations rapidly die away. This damping action is caused by the friction of the different portions of the spring, the energy of vibration being thereby dissipated into molecular vibrations or heat. It may be increased still further by immersion in a viscous medium, and if sufficiently viscous the motion may become *dead-beat*, that is to say, simply a single excursion and return to the position of equilibrium. Another cause of damping is the transference of energy to the medium by the production of waves in it, and if the spring is so shaped as to increase this effect the damping will also be increased. The electric oscillations which occur when a Leyden jar is discharged are damped in a very similar manner, the resistance of the circuit corresponding to friction, in the case of the spring; but, in order to destroy its oscillatory character, except in the case of very large condensers, such as are used in submarine

telegraphy, it is necessary to include in the circuit some very bad conductor, such as a wet string or a block of wood. The rapid damping of the oscillations of a Leyden jar discharge when the circuit is so designed as to be an efficient exciter of electric waves follows necessarily from the principle of the conservation of energy, just as in the case of the spring.

The Hertz oscillator, or exciter of electric waves, is simply a Leyden jar of such design as to facilitate the transference of the energy of the electric oscillations of its discharge to the surrounding ether, and therefore a comparatively large amount of energy is required to maintain it in action. Several years before Hertz's experiments were made, Professor Fitzgerald, of Dublin, had suggested, from theoretical considerations, that it should be possible to excite such electric waves in the ether by means of the discharge of Leyden jars of suitable design, and about the same time that Hertz began these investigations Professor Oliver Lodge was, in connection with the theory of the lightning conductor, making a series of experiments on the discharge of small condensers, which led him on to the observation of ether waves within the wires, but not transmitted by the material of the wires themselves.

As Hertz himself suggests, Professor Lodge would in all probability have succeeded in discovering the ether waves in air had he not anticipated him.

Hertz tells us that in 1886 he was experimenting with a pair of what he calls Riess or Knochenhauer spirals, but which should be more properly called Henry spirals, spirals of silk-covered copper tape first used by Professor Joseph Henry about 1838 in his researches on mutual and self induction. Hertz noticed that in order to obtain sparks in one of these spirals the large batteries which had hitherto been employed might be replaced by even a small Leyden jar, provided—and this was the important point—that the discharge was made

to spring across a spark-gap. This observation led to the splendid series of researches which experimentally demonstrated the truth of Maxwell's theory of electromagnetic waves, and laid the foundation for the method of telegraphy which Signor Marconi and others have so successfully developed into a practical system.

It is well known to musicians as well as to students of acoustics that when a certain musical note is sounded, a string or pipe which would give out this note will respond to it, and in a similar manner an electric conductor may be adjusted or tuned to respond to the oscillations set up by the discharge of a Leyden jar. This is well shown in an experiment made by Professor Lodge after reading Hertz's papers. He took a pair of Leyden jars with circuits about a yard in diameter, and separated by a distance of about two yards, and found that when the first jar was charged and discharged the waves set up in the second circuit could be made to cause it to overflow across a short air-gap, provided by pasting a slip of tinfoil over the lip of the second jar, by experimentally adjusting a slider by means of which the length of the second circuit could be varied. Lodge calls this syntonising the pair of jars. A closed circuit such as this is a feeble radiator, because it is not well adapted for the transfer of its energy to the surrounding ether, some thirty or forty oscillations taking place before there is any serious damping. Great precision of tuning is therefore necessary.

It will be instructive to compare this arrangement of Professor Lodge's with a standard Hertz oscillator and resonator, as shown in Fig. 13. A powerful induction coil, A, having the terminals of its secondary circuit connected with the oscillator, which consists of a pair of brass rods terminating in small polished knobs, B, the distance between which is adjustable, while two large metal spheres, C, C, slide on the brass rods. By

altering the positions of these spheres the oscillator can be tuned into syntony with the resonator, D, consisting

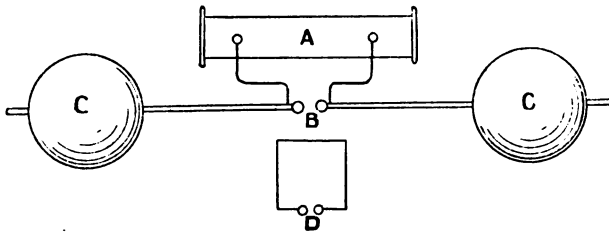

FIG. 13.—Hertz Oscillator and Resonator.

of a wire rectangle or circle, terminating in a pair of polished brass knobs, which should be very close together.

If Lodge's exciting jar had its two coatings removed to a considerable distance apart, and the dielectric separating them were made to extend out into the room, we should obtain the equivalent of the Hertz oscillator, which is of the most suitable form to facilitate the transference of its electric wave energy to the surrounding ether. When the coatings are close together, as in Lodge's form, the magnetic energy largely predominates over the electrostatic. When the distance between them is increased and the dielectric more exposed, the electrostatic energy becomes more nearly equal to the magnetic, and therefore the arrangement gains in efficiency as a radiator, since in true radiation the two energies must be nearly equal. The spheres, C, C, may, if desired, be replaced by large metal plates.

By means of calculations from the readings of an electrometer inserted in the air-gap, D, Fig. 13, Bjerknæs succeeded in obtaining curves representing the damping of the oscillations. Figure 14 shows the oscillations

obtained with a dumb-bell oscillator, such as that illustrated in Fig. 13, and it will be observed that they die away with extreme rapidity.

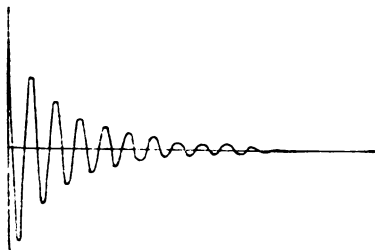

FIG. 14.—Oscillations of Dumb-bell Hertz Oscillator.

The persistent character of the oscillations excited in a ring resonator by an oscillator tuned to syntonism with it is shown in Fig. 15.

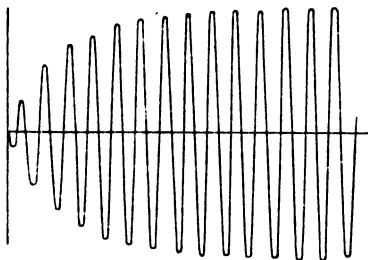

FIG. 15.—Oscillation of Ring-shaped Hertz Resonator excited by Syntonous Oscillation.

Just as in the case of acoustic resonance, when the resonator has its natural oscillations strongly damped, the tuning of the oscillator into syntonism with it is of comparatively small importance, but if its oscillations are persistent then exact tuning is essential. Exact

syntony is also necessary whenever the exciter is a persistent oscillator, as otherwise it will tend to destroy at one moment the oscillations which it set up a moment before. This is well shown in Fig. 16, which exhibits

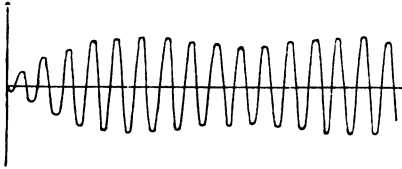

FIG. 16.—Oscillation of Ring-shaped Hertz Resonator excited by Oscillation not quite Syntonic with it.

the oscillations of a ring resonator, excited by an oscillation not quite in syntony with it.

To understand how an electrical oscillation, or its equivalent, an oscillating charged body, can excite electric waves in the ether, I will ask my readers to refer again to Fig. 11, Chapter III. Let the rack represent the electrically charged body, and imagine it is oscillating backwards and forwards in the direction of its length. This will set up a rotary oscillation in the wheelwork, and the wheelwork being, as has been assumed throughout, elastic, this rotary oscillation will be propagated with a velocity depending on the elasticity and the density, as has already been explained. The axes of the wheels represent the direction of the magnetic rotary oscillation, and this is perpendicular to the line of rack which represents the direction of the electrical oscillation. The direction in which the wave is advancing is perpendicular to both of them. Hertz, by exploring with his resonator the space in the neighbourhood of an oscillator, succeeded, not only in demonstrating the existence of electric waves, but in differentiating between the electrostatic and magnetic oscillations. He also

succeeded in proving they had all the well-known properties of light and heat waves.

He found that electric shadows could be cast by means of metallic screens, showing that the propagation was rectilinear, that electric waves were reflected from the surfaces of conductors, and that they could be brought to a focus by means of concave reflectors. He was also able to obtain evidence of polarisation by reflection, and proved that the waves could be refracted by passing through prisms made of hard pitch. He demonstrated, too, the possibility of producing interference, which, of course, would take place with any kind of wave motion.

In order to explain by means of Lodge's mechanical model the reflection of electric waves, consider the diagram Fig. 17, in which a rack, again representing a

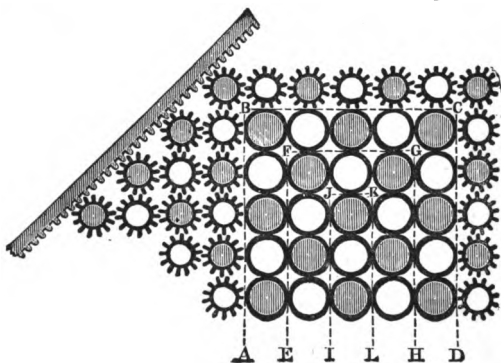

FIG. 17.—Diagram illustrating the Reflection of Electric Waves at the Surface of a Conductor.

From Lodge's "Modern Views of Electricity."

charged body, is to be supposed oscillating backwards and forwards and transmitting a disturbance through the wheelwork, as before. If the cogwheels gear perfectly into one another, that is to say, if the medium is a

perfect insulator, the disturbance will spread without loss until it reaches the outer layer of the conducting region, A, B, C, D, where there will be a certain amount of slip, and a lesser amount of oscillation will penetrate to the next layer, E, F, G, H, and less again to I, J, K, L. If a conductor is sufficiently thick it must therefore be opaque to electric radiation. Now a good conductor dissipates but little energy into heat, and therefore the greater part of the radiation must be reflected and not absorbed.

Refraction, too, can be easily explained by Lodge's model, for consider an advancing wave impinging upon the boundary of a medium of greater density or less elasticity, or both. If the new medium is a perfect insulator there will be no slip, and therefore no dissipation of energy at the surface. If not there will be some slip and consequent dissipation. In either case some will be reflected and some transmitted, and the transmitted portion will begin at the boundary to travel more slowly, and therefore if the incidence is oblique, will necessarily follow a different path—that is to say, it will be refracted.

CHAPTER V.

THE DISCOVERY AND DEVELOPMENT OF THE COHERER.

HERTZ's splendid results were all obtained with only the simple resonator shown in Fig. 13 (Chapter IV.) as a detector of the presence of electric waves. This would, however, not have been nearly sensitive enough for transmitting signals over considerable distances, even with the most perfect oscillators or transmitting instruments, and such transmission, therefore, only advanced into the realm of the possible with the discovery of the microphonic transmitter, or, as Professor Lodge calls it, the *coherer*, which was not brought into general use for this purpose until years later, although it had been discovered and actually used for the detection of the presence of the Hertzian waves by that great and patient experimentalist, Professor Hughes (whose loss we have so recently had to lament), as far back as 1880, some half-dozen years before Hertz began his investigations.

Only last year Mr. J. J. Fahie, who was then writing a history of wireless telegraphy, wrote to Professor Hughes saying that he had heard from Sir William Crookes that many years ago he had seen some experiments of the Professor's, in which he had signalled from one part of a house to another without connecting wires, and while expressing regret at his not having already published them begged him now to do so.

Professor Hughes in his reply stated that, while making some experiments with his induction balance in 1879, he found that he was at times unable to obtain a perfect balance in the instrument, through an apparent want of insulation in the coils, but that further investigation had shown the real cause to be a loose contact or microphonic joint set up in some portion of the circuit. He therefore applied the micro-

phone in the circuit, and found that a sound was produced in the telephone receiver whether the microphone was placed directly in the circuit or independently at a distance of several feet from the coils through which an intermittent current was passing. This he found to be due to induced currents set up in the primary coil of the induction balance. He soon found that when an interrupted current was sent through any coil, a microphonic receiver placed anywhere in the room was affected at every interruption of the primary circuit. Further investigations were then made to determine the best form of receiver, and Professor Hughes found that all microphonic joints were extremely sensitive. Those formed of hard carbon, such as coke, or a combination of a piece of coke, resting upon a bright steel contact, were both sensitive and self restoring, but a loose contact between metals, while equally sensitive, would cohere, or remain in full contact after the passage of an electric wave. He soon found that while an invisible spark would produce a current in the microphonic contacts, a far more powerful effect could be produced by inserting a weak battery in the receiving circuit, when the microphonic joint acted as a relay by increasing or diminishing the resistance at the contact, owing to the action of the electric waves transmitted through the air.

In 1879 and 1880 these results were shown to several well-known physicists, including Sir George Gabriel Stokes. Experiments on aerial transmission were exhibited over distances extending up to nearly 500 yards, when the signals could no longer be distinguished with certainty. Sir George Stokes, considering that these effects were simply those of ordinary electromagnetic induction, did not accept Professor Hughes's suggestion that they were due to electric waves transmitted through the air, and unfortunately this failure-

to convince Sir George and other physicists to whom the phenomena were shown led Professor Hughes to postpone making them generally known until he was prepared with a more complete demonstration of the existence of these waves. While Professor Hughes was continuing his investigations in this direction, Hertz's papers were published, and then he thought it too late to bring forward these earlier experiments. Had Professor Hughes, with his great experimental skill and intimate knowledge of telegraphy, made his results known at the time, and been encouraged to devote himself to their practical application, the system of telegraphy now commonly known by the name of the Marconi system, would in all probability have been in use years earlier under the name of the Hughes system of wireless telegraphy. As Professor Hughes observed at the end of his reply to Mr. Fahie, the result of his neglect to publish his results at the time forced him to see others remake the discoveries he had previously made as to the sensitiveness of the microphonic contact, and its useful employment as a receiver for electrical ether waves.

A capital historical sketch of the course of this discovery was given by Professor Lodge in the *Electrician* for November 12th, 1897, from which much of what follows has been taken. In this article he suggests that probably the earliest discovery of cohesion under electric influence was contained in a forgotten observation of Guitard in 1850, that when dusty air was electrified from a point the dust particles tended to cohere into strings or flakes, and points out that the same thing occurs in the formation of snowflakes under the influence of atmospheric electrification, and in the cohesion of small drops into large ones in the neighbourhood of a charged cloud, forming the familiar thunder shower. In 1866 Mr. S. A. Varley described at a meeting of the British Association a lightning

protector based on his observations of the diminution of electric resistance of a heap of dust caused by passing a current from a few hundred battery cells through it. Again, in 1884, Professor Calzecchi Onesti described in the *Nuovo Cimento* his discovery of similar effects produced by electric sparks. It was not, however, until Branly had rediscovered them, and Lodge had devised his coherer based upon Branly's researches, that these early anticipations received tardy recognition. In 1879, Lord Rayleigh showed that when a stick of rubbed sealing wax was brought within a few yards of a small fountain which was scattering its spray in all directions, the scattering ceased, the broken jet rising and falling in large heavy drops.

The next stage, with the exception of Professor Hughes's work, which it must be borne in mind remained unknown during the whole of the development described in what follows, was the re-discovery by Professor Lodge and the late J. W. Clark of Guitard's dust phenomenon, when experimenting on the cause of the dust-free region of air discovered by Professor Tyndall as existing over hot bodies, and erroneously ascribed by him to the dust being burnt up, but which was shown by Lodge, Osborne Reynolds, and others to be really due to molecular bombardment, phenomena analogous to those occurring within a Crookes' radiometer.

Before, however, arriving at this explanation, experiments were made to see if it was caused electrically, and it was found that when the hot body was placed in a thick smoky atmosphere, and then charged with electricity, the smoky atmosphere immediately became clear. In 1889, Professor Lodge was investigating the action of the lightning guards used for protecting telegraphic instruments from the effect of the sudden rushes due to lightning discharges. These were made by adding as a shunt to the circuit containing the instrument, an open circuit with a small air-gap, with terminals con-

sisting of a pair of small brass balls, across which the discharge jumped, rather than flow round the coils of the instrument, which had great self-induction, and therefore offered much opposition to a sudden rush of current. Lodge found that when the knobs were placed too close together even a Leyden jar discharge would often short circuit the gap, the knobs being found both by electrical and mechanical tests to be feebly united at a single point. When the knobs were in mechanical contact, and separated only by an extremely thin film, consisting probably of oxide, very feeble sparks were found to be sufficient to produce this effect. The adhesion of the two surfaces was demonstrated by means of an electric bell placed, together with a single battery cell, in the circuit, and every time a spark occurred the bell rang, and continued to ring until the table on which the apparatus was standing, or some part of the support of the knobs, was tapped, so as to shake them asunder again. The arrangement was found to form a convenient detector in the syntonie Leyden jar experiment described in Chapter IV.

If the electric bell was placed on the same table as the sparking knobs, or, better, were allowed to touch them, its tremor was found to be quite sufficient to effect this separation, unless the spark and, therefore, the adhesion had been too strong. In the meantime, Hertz's experiments had attracted general attention from physicists. Professor Minchin, in 1891, when working with some photo-electric cells, and especially some which behaved abnormally, as it seemed to him at the time, and which he called "impulsion cells," found that when a Hertz oscillator was working in another part of the room the electrometer connected with his cells responded, and by means of this detector, which certainly depended on the coherer principle, he succeeded in signalling without wires over a considerable number of yards.

Professor Boltzmann, about the same time, used a charged gold-leaf electroscope for a like purpose, arranging it so that the electroscope was just on the point of discharging across a minute air-gap, so that its leaves were deflected by a definite amount. It was found, when in this condition, to be extremely sensitive to Hertz waves, which, if excited in any part of the room, would bridge over the gap and discharge the instrument.

This, as Professor Lodge points out, is not a detector depending on the principle of cohesion, but it led him, when repeating the experiment in a modified form, to the conclusion that cohesion could be effected by the surges due to the regular Hertz waves.

One of the modifications adopted by him was to make the gap of carbon, and to connect it, with its wave collector, to the terminals of the 110-volt electric light leads, so that whenever a Hertz oscillator was discharged across the gap, the spark would close the circuit and set up an arc. This method was suggested by his observation of the behaviour of some incandescent lamps used to light his lecture tables, the lamps being shaded on one side, and prevented from rotating by means of a pair of copper wires stretched across the lecture room. As long as the wires were there the lamp fuzes used to blow whenever a Hertz oscillator was worked in the room, owing to these wires acting as collectors, and they were therefore replaced by silk threads, when the fuzes ceased to blow.

In 1891, Professor Branly, of the Catholic Institute in Paris, published some experimental researches of the greatest importance, in which he showed that metals in the state of powder or filings, and also various mixtures of metallic powders with non-conducting ones, which ordinarily offer an extremely high resistance to the passage of an electric current, fell enormously and quite suddenly in resistance whenever an electric spark

E

occurred in the neighbourhood. This lowered resistance continued for some time, but the powder could be instantly restored to its high resistance state by tapping it, and in some cases by increasing the temperature. Branly found that when the powders had once been submitted to powerful electric action mechanical shocks did not restore them entirely to their original state, but that they continued to show themselves very much more sensitive to electrical actions. Some few bodies, such as peroxide of lead, had their resistance increased by the action of the electric sparks, and others again had their resistance alternately increased and diminished. These latter results formed the starting point of a long series of researches by Professor J. Chunder Bose, of Calcutta University, which have quite recently led him to his theory of "Electrical Response in Living and non-Living Matter," which bids fair to form the basis for an epoch-making generalisation in the co-ordination of inorganic and organic phenomena. Professor Bose has also in the course of this great work succeeded in devising a receiver and detector of electro-magnetic radiation which will in all probability prove to be as great an advance upon the present "coherer" as that was on the original Hertz receiver. Branly's results became known to Professor Lodge at the end of 1893, when he at once proceeded to try the Branly tubes of filings, and found them greatly superior in manageability to either the Boltzmann gap or his own delicately adjusted cohering knobs, but immediately afterwards he, in conjunction with Professor Fitzgerald, devised a coherer consisting of a sewing needle resting upon aluminium foil, which they found to be of extraordinary sensitiveness and at the same time reasonably manageable. Professor Lodge then made a whole series of what he describes as quasi-optical experiments with the new detector, and, before long, various improved methods of arranging the filings were

discovered, especially that of sealing them up *in vacuo* or in hydrogen, in order to protect them from oxidation by the air, the effect of which would be to produce too great a thickening of the extremely thin film separating them from one another. When brass filings immersed in hydrogen were used, they soon became too clean, and their sensitiveness so great that it was impossible to restore the original high resistance by tapping. Professor Lodge consequently preferred the vacuum obtained by the use of a Sprengel mercury pump. He states that almost any filings tube was capable of detecting signals sent from a distance of 60 yards, with a mere six-inch sphere used as oscillator, and without the slightest trouble, but that he found the single point coherer much more sensitive than any filings tube.

For tapping back, the use of an electric bell mounted on the base of a filings tube was not found very satisfactory, owing to the disturbances produced by the small sparks occurring at its contact breaker, to which this more delicate detector responded as well as to the signals which it was meant to attend to, while the less delicate knob apparatus had not been so affected. A tapper, consisting of a rotating spoke wheel driven by the clockwork of a Morse instrument, and giving the coherer a series of jerks at regular intervals, was therefore employed.

Mr. Rollo Appleyard and Lord Rayleigh have devised a liquid coherer consisting of two globules of mercury separated by a thin film of grease, such as paraffin oil. When a battery cell is connected up in a circuit with these globules, they are pressed together every time the circuit is closed, and Lord Rayleigh has observed that it takes an appreciable time before they come into contact, as though a film had to be mechanically squeezed out from between the oppositely charged metallic surfaces, and this suggested that cohesion might in every case be simply a result of electrostatic attraction, and

that the molecular films separating solids in contact might be squeezed out in a similar manner. The force of attraction between two surfaces differing in potential by a volt and separated by the smallest known thickness of thin film (which is about 10^{-7} centimetres) would be equivalent to about 650 pounds to the square inch, a quite sufficient pressure to make this explanation a perfectly possible one.

Professor Bose, as the result of his own researches, arrives at the conclusion that the phenomena of electric coherence, which he finds to be exhibited to a greater or lesser extent by every kind of material, living or non-living, are really due to a condition of molecular strain induced by electric radiation. According to his investigations the phenomena of so-called cohesion and de-cohesion are due simply to the changes in electrical conductivity due to these strains. When the radiation is feeble the restoration usually takes place spontaneously when the exciting cause ceases, and with some substances, which may be said to have a high electric elasticity, the same holds good even in the case of strong impulses.

According to this explanation the phenomenon of permanent cohesion is due to the substance being strained beyond the limit of its electric elasticity, and restoration to the initial condition has to be assisted by setting up molecular agitation, which can be effected by tapping, or by raising the temperature.

The careful consideration of Professor Bose's experimental results can, in the author's opinion, leave little room for doubt that his explanation is true to the extent that many of the phenomena which have been known under the name of electric cohesion are due to molecular strain.

It does not, however, appear to account satisfactorily for the enormous and very sudden changes in conductivity observed in certain cases, as, for instance, the

tubes of metallic powders used by Lodge and others as receivers, or detectors, or electric waves. Nor would it, again, explain the over-sensitiveness observed by Lodge with brass filings in an atmosphere of hydrogen.

Professor Bose's explanation should therefore be considered as supplementing rather than supplanting the one suggested by the experiments of Appleyard and Rayleigh.

CHAPTER VI.

THE SYSTEM OF POPOFF AND MARCONI.

WITH the exception of the unpublished experiments of Professor Hughes referred to in Chapter V., nothing seems to have been done in the way of utilising Hertzian electric waves for the purposes of telegraphic communication before the year 1895.

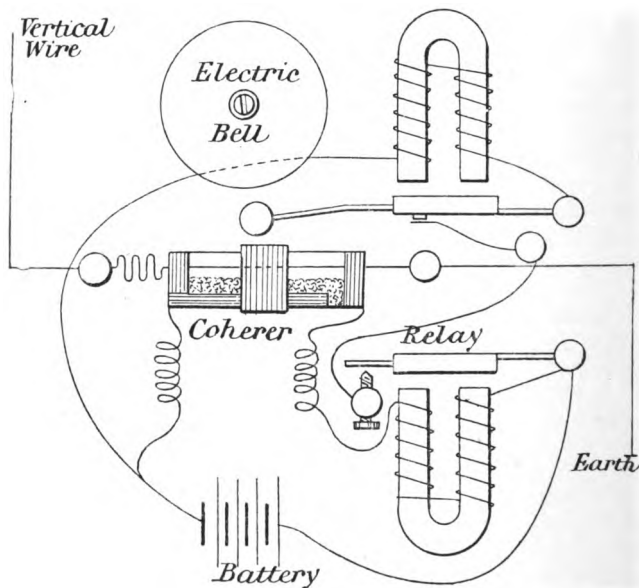

FIG. 18.—Popoff's Hertzian Wave Receiver.

In April of that year, Professor A. Popoff, of the Cronstadt Torpedo School, described to the Russian

Physical Society the apparatus shown in Fig. 18, which he employed as a receiver for Hertzian waves. It consisted of a tube coherer built in two sections, and having one of its terminals connected with a vertical wire, and the other with the earth. When a wave fell upon the coherer, causing its resistance to fall from an almost infinite value down to a few hundreds of ohms, a current from the battery was enabled to flow through the circuit and energise the electro-magnet of an ordinary Siemens telegraph relay, thereby closing a circuit, not shown in the illustration, containing a large battery and a telegraphic recorder, which continued in action as long as the current flowed through the battery in the coherer circuit. As soon, however, as coherence was set up, the electro-magnet of the electric bell was energised simultaneously with that of the relay, and the bell-hammer striking upon the central plate of the coherer caused decoherence, so that, unless the waves continued and re-established the state of cohesion, the recorder was thrown out of action.

Using a Hertz oscillator with 30 centimetre spheres, Popoff was able to send signals over a distance of a kilometre, which he extended to five kilometres by replacing the Hertz oscillator by a Bjerknes one with spheres 90 centimetres in diameter.

Very shortly afterwards Captain Jackson made some experiments for the Admiralty at Devonport, and succeeded in sending messages from one ship to another. His apparatus, however, and the results obtained with it, were treated as confidential and have not been published.

In June, 1896, Guglielmo Marconi, a young Italian, and a pupil of Professor Righi, applied for provisional protection for "Improvements in transmitting Electrical Impulses and Signals and in Apparatus therefor," and filed a complete specification on the 2nd of March, 1897. At the time of making his provisional application Marconi's apparatus was in a somewhat crude form,

but it contained important improvements in details, and in July, 1896, he had the good fortune of obtaining the assistance and support of the Postal-Telegraph Department, through the good offices of Sir W. H. Preece, who was then the Chief Engineer of the Post Office.

With this powerful co-operation, combined with his own indefatigable industry and experimental skill, Signor Marconi succeeded in overcoming a host of difficulties, and in developing a commercially practical system of telegraphy based on Hertzian electric waves.

The transmitting apparatus employed for long distances, when it is not required to concentrate the waves in a definite direction, is shown in Fig. 19.

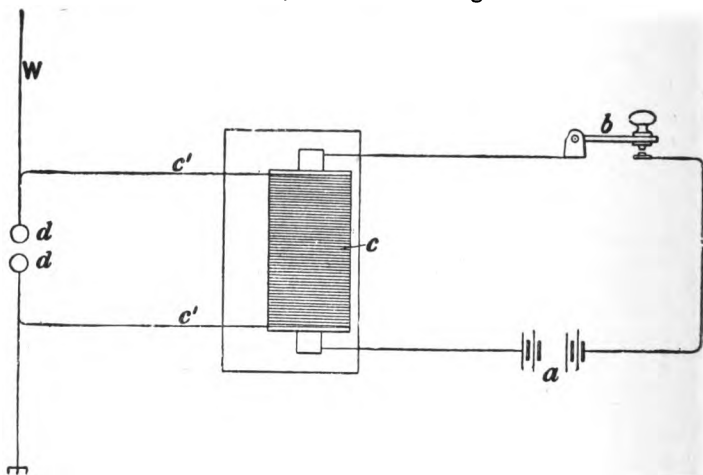

FIG. 19.—Long Distance Marconi Transmitter.

From "The Journal of the Institution of Electrical Engineers," Vol. 28, 1899.

The small spheres, d, d , are connected by the wires, c', c' , with the secondary terminals of an induction coil, c , and one of them is also connected with the vertical

wire, *W*, while the other is earth-connected. When the Morse key, *b*, is depressed, the coil is energised by the battery, *a*, and therefore, as long as it is kept down, a stream of sparks is maintained between the spheres, *d*, *d*.

When it is desired to send a beam of rays in some definite direction, the transmitter used by Marconi is one devised by Professor Righi, of Bologna, and shown in Fig. 20. The two large spheres, *e*, *e*, are 11 centimetres

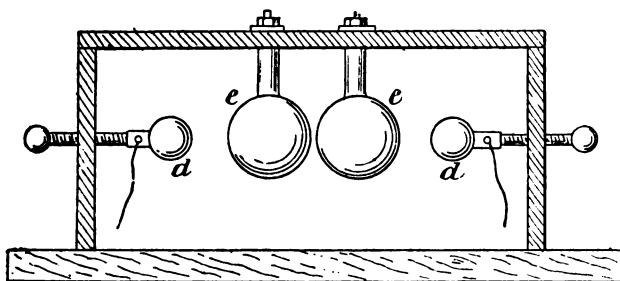
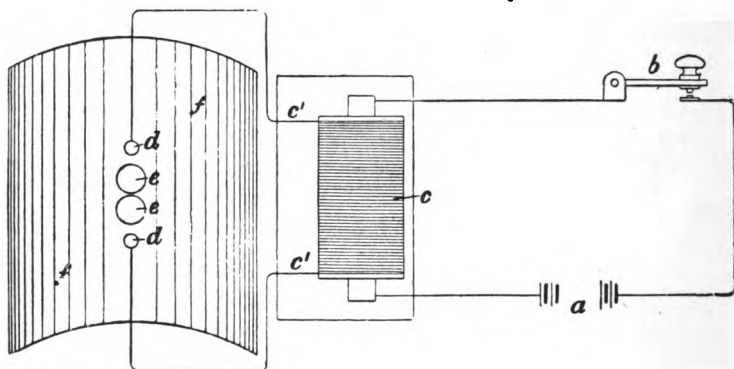

FIG. 20.—Righi Oscillator for use with Reflector.

in diameter, and are separated by a space of a millimetre. In order to concentrate the beam of rays in the required direction the oscillator is placed in the focal line of a parabolic cylindrical reflector, as shown in Fig. 21.

The most important part of the receiver is the coherer, which consists of a small glass tube (Fig. 22), about two and a half millimetres in internal diameter and some four centimetres in length. Two silver pole pieces are lightly fitted into this tube, separated by a gap of about a millimetre, containing a mixture of 96 parts of nickel and 4 parts of silver, not too finely granulated, and worked up with the merest trace of mercury. This powder must not be packed too tight, or the action will be irregular

and over-sensitive to slight outside disturbances, while if too loose it will not be sufficiently sensitive. It



From "The Journal of the Institution of Electrical Engineers," Vol. 28, 1899.

is found that the best adjustment is obtained when the coherer works well under the action of the sparks from a small electric trembler placed at a distance of about

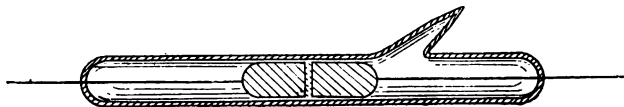

FIG. 22.—Marconi Coherer.

a metre. The tube is then exhausted on a mercury pump until the pressure falls to about a millimetre, when the tubulure for exhausting it is sealed off. The tubes are tested over a distance of 18 miles before being put into use, and when all the requisite precautions are observed, Signor Marconi finds them as reliable as any other telegraphic instruments, and not liable to get out of

order when in use. His experience in this is confirmed by that of Professor Fleming. If the tubes are not exhausted they are found to grow gradually less sensitive, probably from slight oxidation going on, and this of course would not be permissible in commercial instruments.

The general arrangement of the receiving apparatus for long distance work without a reflector is shown in Fig. 23. j, j^1 , is the coherer tube, with its silver pole

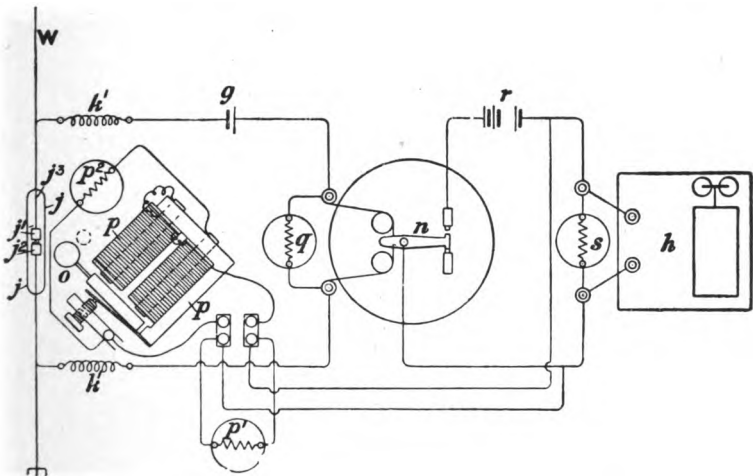

FIG. 23.—Marconi Receiver with Vertical Wire and Earth Connection.

From "The Journal of the Institution of Electrical Engineers," Vol. 28, 1899.

pieces, j^1 , j^2 . The coherer forms part of a circuit containing a local cell, g , and a sensitive telegraph relay. When electric waves impinge upon the coherer its resistance falls from a nearly infinite value to something between 500 and 100 ohms, which allows

the cell, *g*, to energise the electro-magnet of the relay, *n*, and close a circuit containing a larger battery, *r*, together with a Morse recorder, *h*, and a trembling electric bell, *p*, to act as decoherer. The hammer, *o*, of the bell is so adjusted as to tap the coherer tube and shake the filings in it. If at the moment in which these actions took place the electric waves in the resonator had died away, this tap would restore the coherer to its normal condition of practically infinite resistance, and a dot only would be recorded on the tape of the Morse machine. If, however, the key of the transmitter were kept depressed, then waves would succeed each other at very short intervals, so that the acquired conductivity of the coherer would only be momentarily destroyed by the tap of the bell-hammer, and immediately re-established by the electric waves. Now the armature of the Morse recorder is somewhat heavy, and therefore has considerable inertia, so that it cannot follow the very rapid vibrations of the tongue of the relay. The practical result, therefore, is that the Morse instrument gives an exact reproduction of the dots and dashes produced by the movements of the key at the transmitting station, although during each movement of the key, however short, the armatures of the relay and of the tapper go through a series of rapid vibrations dependent on each other.

Small choking coils, k , k' —that is to say, coils wound so as to have self-induction or electric inertia—are introduced between the coherer and the relay, their effect being to compel the greater part of the oscillatory current induced in the circuit by the electric waves to traverse the coherer, instead of wasting most of its energy in the alternative path afforded by the relay. If these coils are omitted, other circumstances remaining the same, Signor Marconi finds that the distance at which the signals can be distinguished is re-

duced to nearly half that attained when they are employed.

In order to screen the receiver from the violent surgings which would be set up when using the transmitters at the same station, he enclosed the whole of the receiving apparatus, with the exception of the recorder, in a metallic box. As some of the waves picked up by the recorder would, by travelling along the leads into the receiver, injure the coherer, he chokes off all such effects by interposing suitable choking coils between the recorder connections and the terminals of the receiver. These choking coils consist of a few turns of insulated wire wound in layers, each layer being separated from the adjacent ones by means of sheets of tinfoil in metallic connection with the enclosing box. This earthed tinfoil prevents the waves from passing inductively from one turn of the choking coil to the next. The earthed terminal of the receiver is connected to the box and need never be touched. Signor Marconi also found that, unless provision was made against it, the relay, the tapper, and the recorder all produced disturbing effects on the receiver, but he got rid of these effects by introducing suitable non-inductive resistances, q , p^2 , and s , in parallel with them, or, as telegraphists say, he shunted them with these resistances. This prevented all sparking at the contacts, and sudden perturbations, or jerks, due to the local battery current, all of which would otherwise produce disturbing effects on the coherer.

When it is desired that the receiver should only pick up waves coming in a certain definite direction, the arrangement shown in Fig. 24 is employed. This differs from that shown in Fig. 23 only in the vertical wire and earth connection being done away with, and replaced by the two copper strips, k , k , the sizes of which must be carefully adjusted so that the receiver may be in sympathy with the transmitted waves; and in a parabolic cylin-

drical reflector being placed so that the coherer tube lies with its axis in its focal line.

My readers will observe the considerable similarity

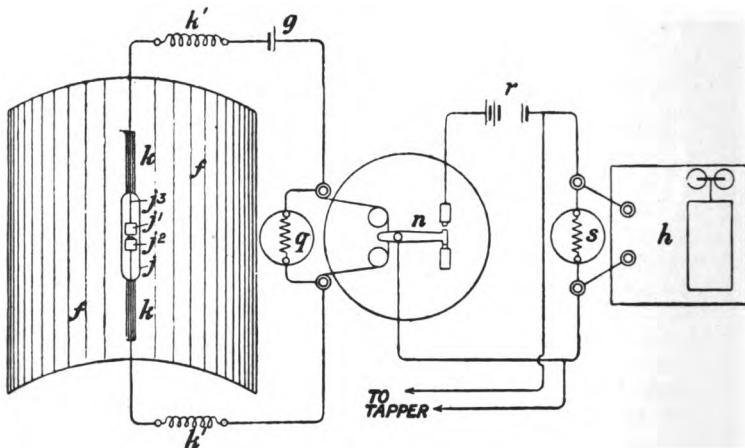

FIG. 24.—Marconi Receiver with Parabolic Reflector.

From "The Journal of the Institution of Electrical Engineers," Vol. 28, 1899.

between Marconi's apparatus and that of Popoff; although I believe that, when Signor Marconi designed his apparatus, Popoff's results were unknown to him. Both used the coherer to actuate a relay, and thereby bring into action a telegraph recorder, and both used a tapper to cause decoherence. Popoff also anticipated Marconi in the use of a vertical wire and earth connection on his receiving instrument, but does not seem to have recognised its necessity on the transmitter.

The use of the tall vertical wire on both transmitter and receiver forms one of the most notable of Marconi's improvements, and the one which has perhaps played the largest part in his successful transmission of signals over long distances. A horizontal wire is no use, even

if added at the top of a long vertical wire, so as to keep it at a great distance from the earth. The effect of the long wire is to increase the length of the waves generated in the ether, and, therefore, as was pointed out in Chapter II., to augment their power of penetrating obstacles, the wave length being about four times the length of the wire. The reason that it acts so much better in a vertical position than in any other is that that position is the one which is least favourable to the production of induced oscillating currents in the earth, which, if set up, must dissipate uselessly the amount of energy required to excite them.

Signor Marconi finds that a conductor with considerable capacity, such as a sheet of wire net, attached to the top of the vertical wire by means of an insulating rod, is to some extent equivalent to increasing the length of the wire. He found experimentally that, if the wires at the two stations are equal in height, the distance to which signals could be transmitted was approximately proportional to the square of that height, the actual maximum distance being somewhat in excess of that calculated from this assumption. Professor Ascoli has confirmed this result mathematically.

One of the Marconi masts, 150 feet high, was erected at the South Foreland in 1899. This mast is now of historic interest, as being the one which was used for the first transmission of messages by the new system of telegraphy between England and France, the French station being at the village of Wimereux, near Boulogne, and at a distance of 32 miles from the South Foreland. In place of using a high mast the vertical wire might, where the opportunity exists, be suspended from the top of a cliff or of a lofty building, and Marconi has in this way successfully transmitted messages between Bournemouth and Alum Bay in the Isle of Wight, a distance of about 14 miles. No mast was employed at the latter station,

the vertical wire being allowed to hang over the edge of the cliff, the instrument and earth connections being at the top, while the lower end of the wire, which was about 100 feet long, hung free in space, the wire being kept at a distance of about 30 feet from the face of the cliff.

I am not aware that any attempts have been made to employ the Marconi apparatus with reflectors for greater distances than two miles. Hertz found that to obtain good results with reflectors they must be large compared with the wave length, and the distance of the mirror from the oscillator must not be less than a quarter of the wave length, as clearly follows from what I explained in Chapter II., that the emission point of the waves is a quarter of a wave length from the vibrating source.

It will be seen, therefore, that it would hardly be practicable to employ reflectors in conjunction with high masts for transmitting beams of rays in a given direction. For example, with the vertical wire 150 feet long, such as that in use at the South Foreland, the wave length would be about 600 feet. The dimensions of the mirror would therefore have to be large compared with this, and placed at a distance not less than 150 feet from the oscillator.

The use of reflectors is, however, of considerable value for communicating between ships, or ships and the shore, at short distances.

By the use of reflectors it is possible to project the electric waves in an almost parallel beam, which will have no effect upon any receiver not lying in its course, whether this receiver be syntonized with the waves or not. This, as Signor Marconi has pointed out, would enable several forts, hill-tops, or islands to communicate with each other in war time, without any fear of the enemy tapping or interfering with the signals, for, if the forts were on a small height, the beams could easily be

directed so as to pass over any position that might possibly be occupied by the enemy.

In some experiments, made over a distance of one and three-quarter miles, Signor Marconi observed that quite a small movement of the reflector of the transmitting instrument was sufficient to stop the reception of the signals by the receiver. The zone, within which the receiver had to be placed for a given position of the transmitting reflector, not being more than about 100 feet in breadth.

“There exists,” says Signor Marconi, in his paper read in March, 1899, before the Institution of Electrical Engineers, “a most important case to which the reflector system is applicable, namely, to enable ships to be warned by lighthouses, light-vessels or other ships, not only of their proximity to danger, but also of the direction from which the warning comes. If we imagine that A is a lighthouse, provided with a transmitter of electric waves, constantly giving a series of intermittent impulses or flashes, and B a ship provided with a receiving apparatus placed in the focal line of a reflector, it is plain that, when the receiver is within range of the oscillator, the bell will be rung only when the reflector is directed towards the transmitter, and will not ring when the reflector is not directed towards it. If the reflector is caused to revolve by clockwork, or by hand, it will therefore give warning only when occupying a certain section of the circle in which it revolves. It is therefore easy for a ship in a fog to make out the exact direction of the point A, whereby, by the conventional number of taps or rings, she will be able to discern either a dangerous point to be avoided or the port or harbour for which she is endeavouring to steer.”

In the course of a lecture before the Society of Arts, delivered in May of last year, Signor Marconi gave some interesting examples of the practical working of his system.

He stated that in March, 1900, there were five installations of the system in use on ships of the Royal Navy in South African waters, and in the following May the Admiralty decided to extend its adoption to 32 more ships and land stations. The conditions of the contract were, that each apparatus, before being accepted, should be satisfactorily worked by naval signalmen between two ships anchored at Portsmouth and Portland, over a distance of 62 miles, of which 18 miles lay overland, with intervening hills, and the height of the aerial wire was limited to 49 metres on each ship. The apparatus was all delivered within a comparatively short time, none of them were rejected as unsatisfactory, and he had been informed that messages had been received and transmitted by naval signalmen between ships more than 160 kilometres apart.

The system is in use for communication between the Borkum Riff and Borkum Lightship in Germany, where an ordinary commercial charge is made for messages received from ships. According to an official report of the Imperial Postal authorities at Oldenburg, 518 such messages from ships at sea had been transmitted from the lightship between May 15th and the end of October, 1900, and 47 messages had been transmitted to ships.

In November, 1900, communication was established between La Panne, near Ostend, and the Belgian mail steamer, *Princess Clementine*, which runs between Ostend and Dover.

The receiving and transmitting apparatus on board the *Princess Clementine* were installed in one of the private deck cabins. From this cabin wires run up the foremast, which has been lengthened for the purpose, and to the top of which is stayed a spar, making an angle of 45° with the mast. This spar carries the receiver and transmitter. The total height was originally nearly 100 feet, but during some very severe weather

which occurred two days after the first installation, the topmast was lowered, as the captain feared it might be carried away. It was found, however, that communication could be maintained between La Panne and Dover Harbour, a distance of 43 miles, when the height of the mast was reduced to 22 metres.

The installation of the Marconi system on the *Princess Clementine* has already been the means of saving both life and property. A barque was recently wrecked on the Rattel Bank, and that steamer happening to pass shortly afterwards, immediately sent a message to Ostend, and, before leaving the neighbourhood of the wreck, she was able to communicate the welcome intelligence to the shipwrecked crew that assistance was on its way to them, the result being that all lives were saved.

On another occasion the *Princess Clementine* herself went ashore on the Belgian coast during a fog. Within a few minutes of the accident it was known at Ostend, a tug was immediately sent off to assist, and she was got safely off on the next tide.

On another occasion, on coming within sight of the Ruytingen Lightship, situated between 15 and 16 miles from Dunkirk, the latter vessel signalled the *Princess Clementine* that their lighting apparatus was out of order. The captain of the mail steamer immediately ordered a message to be despatched to La Panne, whence it was repeated to Dunkirk, and from there a crew was sent off immediately to effect the necessary repairs, thus averting the danger of having the lights of the lightship unexpectedly extinguished.

The results of the trial have indeed been so satisfactory that the other vessels of the same fleet are to follow suit.

The system is also in use on board the Nord Deutsche

Lloyd mail steamer, *Kaiser Wilhelm der Grosse*. The *Lucania* has more recently been fitted up with the apparatus, with the result that the time of isolation from communication with land during the crossing of the Atlantic has been shortened by about twenty-four hours, consequently other Atlantic liners will very shortly have it in use.

Since the beginning of March last the Marconi system has been employed for ordinary commercial telegraphy between the Sandwich Islands, and it has been installed for the French Government for communication between Atibes, in France, and the island of Corsica, a distance of 124 miles, and has been found perfectly successful.

The greatest distance over which communication has yet been established by his system is, according to Signor Marconi's statement, between the Lizard, in Cornwall, and St. Catherine's, in the Isle of Wight, 186 miles away. The aerial conductor at each station consisted of four parallel vertical wires, one and a half metres apart and 48 metres long, or of a strip of wire netting of the same length. It is noteworthy that the energy employed did not exceed 150 watts.

The few instances given above are sufficient to show how vastly the dangers of the deep will be lessened when wireless telegraphy comes into general use for shipping.

It will be for the Government to provide the apparatus to the lighthouses and lightships round our coasts. The principal passenger lines will probably not be long in adopting it universally, for the travelling public will begin to demand it as soon as they fully understand how greatly it will add to their safety.

Its adoption on merchant vessels will naturally be a slower process, but once it is in use in all lighthouses and lightships, we may, I think, not unreasonably anticipate that Lloyds and the other great marine insurance corporations will in their own interest require

its adoption as one of the conditions essential to insuring a vessel upon the most advantageous terms, making sufficient reductions on the premiums to vessels so equipped to make it the interest of every owner to have it installed, putting aside entirely the additional safety which it will ensure to the crews in his service.

CHAPTER VII.

THE MARCONI SYNTONIC SYSTEM.

THE system of wireless telegraphy described in the last chapter is subject to one very great defect, which must necessarily become increasingly serious as its employment becomes more general. This is the interference of simultaneous messages, coming from different stations, every one of which affects all receivers within range.

This difficulty has been foreseen from the beginning, and Marconi states that it has already caused a good deal of trouble in the English Channel, where the ether is even at present very frequently in a most lively condition from wireless messages emanating from various sources.

It is also found that the receiving instruments respond to various atmospheric disturbances. Great difficulty in deciphering messages has in consequence been experienced on many occasions.

The only remedy for this is the employment of transmitters and receivers tuned or syntonized, so that any given receiver will respond only to the impulses which are intended for it, and will be unaffected by others.

This was the state of things existing in the earliest of Hertz's experiments, as also in those of Professor Lodge, but these appliances were not capable of transmitting messages over any considerable distances, and those first devised for long distance work were not of a kind which it was possible to syntonize.

If my readers have studied the contents of Chapter IV., they will be aware that a syntoniac radiator must necessarily be one which produces persistent oscillations instead of having them damped out almost immediately, and, moreover, that the more freely a radiator gives

out its energy to the ether, the more rapid must be the damping. It follows, therefore, that a radiator cannot be made syntononic without making it feebler.

To use an acoustic illustration, a vibrating tuning fork is the analogue of the syntononic radiator, while that of the non-syntononic would be found when a whip is cracked, or a gun fired.

The crack of a whip or the explosion of a gun can be detected by the ear at considerable distances, but they cannot, by any adjustment of dimensions or other conditions, be made to cause a distant whip to crack or gun to go off. The tuning fork, on the other hand, can be made to produce a response in a suitably chosen one at a distance, but the greatest distance at which this is possible is very much smaller than that at which the explosion of a gun, or even the crack of a whip, is audible.

In the early days of wireless telegraphy the position was practically that the tuning fork had been discarded in favour of the whip or the gun in order to increase the carry. The next thing to be sought for was something of the nature of the tuning fork, but capable of the longer carry.

Professor Lodge has devised and patented a number of interesting forms of syntononic transmitters, and, though I am not aware of these having been successfully tried over any considerable distances, I understand that a syndicate has recently been formed with a view of practically working some of these patents.

Signor Marconi has also devoted much of his time and attention to the same object, and it will cause no surprise that, devoting his whole time and energy to the development of wireless telegraphy, and with the unexampled facilities which have been at his disposal for experimenting on a large scale, he should have followed up his earlier successful results in short distance syntononic signalling, described in the last

chapter, by being first in the field with a practically successful syntonic system for long distance transmission.

Signor Marconi recognised at a comparatively early stage that the long aerial wire of the transmitter, which had proved of such value in enabling him to cover great distances, formed one of the principal difficulties in the way of syntonic working.

It made it possible to send signals to considerable distances with a very small expenditure of energy, a straight rod in which electrical oscillations are set up forming a powerful radiator. For that very reason, its oscillations are rapidly damped out, so that it is not a persistent oscillator.

Owing to the fact that such a radiator gives out all its energy in a few rapidly diminishing oscillations, receivers of very different periods will respond to it, since they receive nearly the whole energy at once.

If the same amount of energy were distributed over a large number of comparatively feeble impulses, no one of these would suffice to break down the resistance of the coherer, but with a properly tuned receiver the accumulative results of the series would produce a continually increasing oscillation in the receiver, until it was of sufficient strength to affect the coherer.

Notwithstanding, however, the disadvantages of this form of transmitter, a selection of messages was found possible, with several different transmitters having wires of different lengths, and using different receivers with induction coils, or oscillation transformers, as they may be called, wound with secondaries of varying lengths so as to be in tune with the waves emitted by the several transmitters.

The receiving apparatus was similar to the one shown in Fig. 26, with the exception of the second aerial wire A', which was only adopted later. The aerial wire A was earthed at E, through an induction coil g^1 , and primary transformer j^1 . The coherer T, instead of being

in the circuit A E, as in the apparatus described in Chapter VI., was placed in series with the secondary coil j^2 . By bringing the ends of the secondary to two

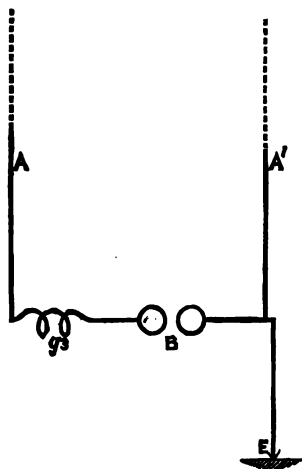

FIG. 25.—Early form of Synton Transmitter.

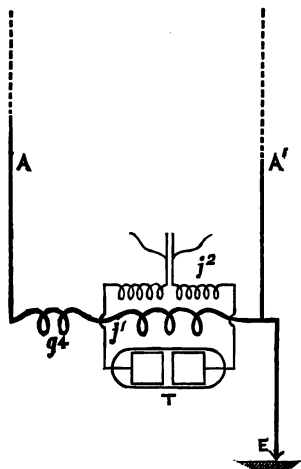

FIG. 26.—Early form of Synton Receiver.

From "The Electrical Review."

separate terminals, as shown, any desired inductance and capacity could be included in its circuit at will.

In the Society of Arts lecture, referred to in the last chapter, Signor Marconi gave an instance of this.

At St. Catherine's, in the Isle of Wight, there was a transmitting station 31 miles from the receiving station at Poole, with a vertical wire 45 metres in length, and at sea, 10 miles from the receiving station, a ship with a transmitting wire 27 metres long, and therefore emitting much shorter waves than those coming from the land station. It was then found that when two receivers were connected to the vertical wire of the

receiving station at Poole, one having an induction coil in tune with the St. Catherine wave length, and the other with the wave length of the ship's transmitter, messages sent simultaneously from both stations could be read off at Poole, each message affecting only its own receiver.

These results, however, though satisfactory as far as they went, by no means provided a complete solution of the problem, for it was found impossible to obtain the two distinct messages at the receiving station when the two transmitting stations were at equal distances from it. If the 27-metre transmitter were placed at the same distance from Poole as the 45-metre one, *i.e.*, 31 miles, the waves emitted by the 27-metre wire would, when they reached Poole, be too feeble to affect the receiver. On the other hand, if the 45-metre transmitter were placed at a distance of 10 miles from the receiver, then the waves it emitted would be strong enough to affect the other receiver and blur its signals.

It was clear, therefore, that some form of radiator with less rapid damping must be sought for.

Various methods of increasing the capacity of the radiator were then tried.

The most obvious method of doing this was to increase the size of the conductor, but this, by increasing the surface in contact with the free ether, increased the radiation, and, therefore, the damping, which was not what was wanted; besides, large plates or exposed areas are altogether impracticable on board ship, and are difficult to maintain in position during wind.

Marconi found the way out of this difficulty by the adoption of the arrangement shown in Fig. 25, which consists simply of an ordinary vertical radiator, A, placed near an earthed conductor, A¹E.

The effect of this earthed conductor is to increase the capacity of the radiator in a very much greater proportion than the radiative power. A vertical radiator,

A^1 , was also added to the receiver as shown in Fig. 26.

Syntonic signalling could be carried on with this arrangement much better than with anything that had been previously tried, and Marconi sought for further improvement by continuing his investigations in the direction suggested by this result.

The next step was to obtain a further large increase in capacity by making the pair of conductors, $A A^1$,

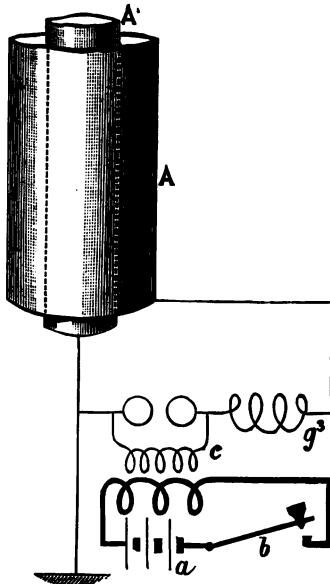

FIG. 27.—Syntonic Transmitter.

From "The Electrical Review."

take the form of concentric cylinders, the inside one being the one put to earth. This arrangement, which is shown in Fig. 27, was found, as was to be expected,

a much more efficient transmitter than the type previously tried; a , b , are the sending battery and Morse key respectively, in circuit with the primary of a transformer, of which the secondary, c , is connected across the terminals of the spark gap, which is placed in series with an inductive resistance, g^s . A necessary condition of this system is that the two conductors should be of unequal inductance, it being found preferable that the earthed conductor should have the smaller inductance.

Signor Marconi suggests what appears undoubtedly to be the true explanation of the necessity of this inequality, viz., that a difference in the phases of the oscillations in the two conductors is essential to adequate radiation, as if they were in the same phase their combined effect would be practically *nil*.

In the earlier experiments this was effected by making the earthed conductor shorter than the other one. Afterwards the inductive coil, g^s (Figs. 25 and 27), was introduced between the spark gap and the radiator. When this was done the oscillation period of the receiving cylinder could be made to correspond with that of one of several transmitters, so that it would receive signals from the selected transmitter only.

With zinc cylinders only 7 metres high and one and a half metres in diameter, used both for transmitting and receiving, good signals were easily obtained between St. Catherine's, in the Isle of Wight, and Poole, a distance of 31 miles, and these signals were in no way interfered with, nor could they be read by the other wireless telegraph apparatus which was in use in the immediate vicinity. This was doubtless owing to the fact that the large capacity of the receiver due to its large superficial area, and the smallness of the interval separating the plates made it a resonator with a decided period of its own, preventing it from responding to oscillations differing from it in period.

Owing to the same cause it was found to be unaffected by the stray ether waves, which, with the older forms of apparatus, sometimes gave much trouble. These disturbances were most frequent in the summer and were probably caused by atmospheric disturbances.

Professor Fleming, in the discussion which followed the reading of Signor Marconi's paper at the Society of Arts, made use of a very telling mechanical analogy which may help my readers to grasp the effect produced by capacity and self-induction in the receiver.

He pointed out that a cork, floating on the water, would be bobbed up and down by any wave, long or short, which went over it; but a heavy log of wood, floating on the water, and tethered to the sea bottom by a helical spring, would only be caused to bob up and down by a train of waves having a special period. The value of this period would depend on the mass of the log and the stiffness of the spring, which, as explained on page 51 of Chapter IV., correspond to self-induction and capacity respectively.

Another very successful method was suggested by Lodge's experiments with syntonic Leyden jars, a spark gap circuit containing a condenser, e , as shown in Fig. 28, being associated with an adjustable radiator wire, $A d d'$, in order to make the arrangement a sufficiently powerful radiator for sending signals to a distance.

The idea of using the transformer, d' , for producing the oscillations in the radiator was first suggested in a patent specification of Prof. Lodge's.

Marconi's intention was to associate with this compound radiator a receiver tuned to the frequency of the oscillations excited in the vertical wire by the condenser circuit.

The earlier trials were not a success, as he had failed to recognise the necessity of tuning to the same oscillation period, or to octaves of the same period, the two electrical circuits, one containing the condenser

Wireless Telegraphy.

and oscillator and the primary of the oscillation transformer, and the other the secondary, d' , of the transformer, and the aerial wire.

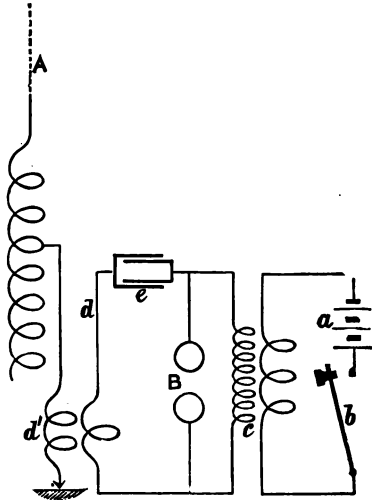

FIG. 28.—Syntonic Transmitter with Adjustable Radiator.

From "The Electrical Review."

Unless this condition be fulfilled, the different periods give rise to oscillations of different frequency, with a resultant effect of a feeble and unsatisfactory character.

To obtain the best results the oscillations in the two circuits should not only have the same frequency, but be in the same phase.

In order to enable this to be done the vertical radiator was arranged so that its inductance could be varied by means of a sliding contact as shown in Fig. 28, and the condenser, e , was so constructed as to permit of its capacity being adjusted.

The receiving apparatus is shown in Fig. 29. A vertical conductor, A, of adjustable inductance, as in the case of the transmitter, is connected through the

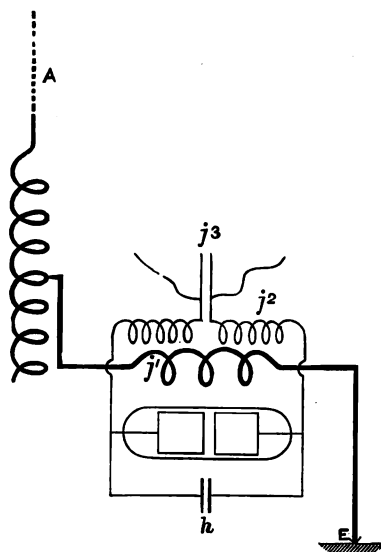

FIG. 29.—Syntonic Receiver.
From "The Electrical Review."

primary coil, j^1 , of an oscillation transformer to the earth at E. The secondary, j^2 , of the oscillation transformer is connected with the coherer, as in the earlier arrangement shown in Fig. 26, and in parallel with this is an adjustable condenser, h . As in Fig. 26, the ends of the secondary circuit are brought to terminals j^3 , by means of which any desired inductance and capacity can be introduced.

The best results are obtained when the period of free

electrical oscillation of the circuit $A j^1 E$ is syntonice with the divided circuit $j^3 h$.

As the resistances of the four circuits of the transmitter and receiver will in general be negligible in comparison with the inductances, and therefore, by the formula on page 51 the necessary and sufficient conditions for them all to be in tune will be that the product of capacity by inductance should be the same for each of them.

When the induction coils have their secondaries wound, each in one layer, with a distance of a couple of millimetres or more between adjacent turns, the capacity will be so small as to be negligible, and the period of such a coil will be sensibly half* that of an earthed vertical conductor of equal length, so that the oscillations in the coil will be an octave higher than those of the vertical conductor, and will, therefore, be in tune with them.

If, therefore, the two secondaries and the two vertical conductors are all made of the same length, the only further adjustment required will be that of the capacity of the condenser of the transmitter, which is easily affected, either by using a condenser with movable plates, or one consisting of Leyden jars, which can be varied in number.

If a very small capacity be taken to begin with, supposing the receiver to be within range of the transmitter, and this is gradually increased, signals will begin to affect the receiver when the capacity has attained a certain value.

If the capacity is still further increased the distinctness of the signals will increase, reach a maximum, and then diminish, and ultimately the signals will become imperceptible.

* Marconi in his paper takes the oscillation period of the coil to be equal to that of the vertical conductor under these conditions, but theory shows this to be incorrect.

Signals will still continue to be sent off by the transmitter if its two circuits are maintained in syntony by adding inductance to the vertical wire as the capacity of its other circuit increases, but they will not affect the receiver unless inductance or capacity be added between the terminals, j^3 , of the receiver, to enable it to respond to the lower frequency waves now proceeding from the transmitter.

My readers will now understand that if there are receivers at different stations, tuned to different periods of electrical vibration, and if these are known at any transmitting station, the operator there will be able to send to any one of the receiving stations messages which will affect its receiver only, and not those at the other stations.

Moreover, several differently tuned transmitters may be connected to the same vertical wire through connections differing in inductance, and may be used for sending a series of messages simultaneously to a corresponding set of receivers, also in connection with a common vertical wire.

A further improvement has recently been made in the shape of a combination of the two syntonic systems described above.

In the transmitter shown in Fig. 30 the cylinders are connected to the secondary, $d d'$, of the transmitting transformer.

In the receiver the portion $A' A d d' E$ is retained, taking the place of $A j^1 E$ in Fig. 29, and the battery and spark gap circuits in Fig. 28 are replaced by the coherer circuit $j^2 h$ of Fig. 29, j^2 forming the secondary circuit of the receiving transformer, of which d' (Fig. 30) is now the primary.

All the circuits must be tuned to the same period in the manner already described.

The use of syntonic apparatus has made it possible

to transmit signals over very considerable distances with conductors of quite moderate height.

For example, signalling has been carried out with

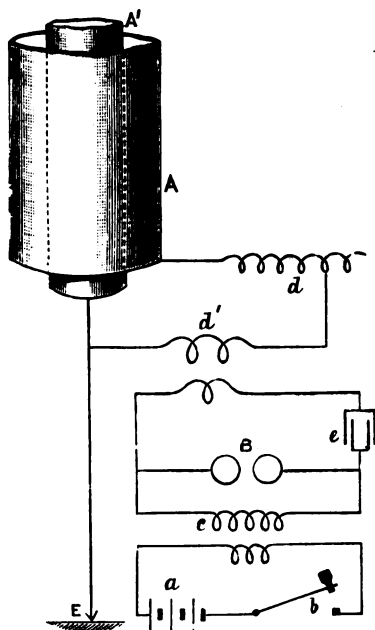

FIG. 30.—Syntonic Transmitter.

From "The Electrical Review."

success over a distance of 50 kilometres with cylinders only $1\frac{1}{4}$ metres high and 40 inches in diameter.

This has made it possible to construct extremely portable apparatus for military purposes; a convenient method being to carry the whole arrangement on a motor car.

On the roof of the car there is placed a cylinder, which can be lowered when travelling, and when in use is only between six and seven metres high. A 25 centimetre spark induction coil, worked by accumulators, and taking about 100 watts, is used for transmitting, and the accumulators can be recharged by means of a small dynamo driven by the car motor. With this arrangement signalling has been carried on with ease over distances up to 31 miles.

A strip of wire net laid on the ground is found to provide a sufficiently good earth connection, and, by allowing it to drag along the ground, the earth connection can be maintained when the car is in motion.

Signor Marconi states that he has recently obtained equally good results without the wire net, by utilising the electrical capacity of the boiler of the motor car.

CHAPTER VIII.

CONCLUSION.

MANY workers are now engaged in the development of wireless telegraphy, and, as Marconi's patents have been published, it has been found, as was to be expected, that many of his results had been rediscovered by others, together with new facts and new forms of apparatus.

I have referred to the promised coherer of Professor Bose, of which as yet no details are known, and to the fact that Professor Lodge's syntonic system is already finding commercial support. Some of the patents already published by the latter show great signs of promise, but enough has not yet been made known of his system to enable me to give my readers any connected account of it.

In Russia Popoff has continued his researches, and his apparatus is now in use by the Russian Government on board its warships, and is also being supplied to the lighthouses in the Black Sea. No less than two hundred sets were shipped from Vladivostok to Port Arthur towards the end of 1900, to be supplied to Russian warships in the Pacific, and for establishing communication between the two ports by means of stations along the Korean coast. If, however, he has made any important improvements they have not yet been made generally known.

More is known of the work of Professor Slaby in Germany, where his apparatus is being manufactured by the Allgemeine Elektricitats Gesellschaft. It appears to differ from that employed by Marconi only in minor details, and though some of these may be found to be improvements, they do not at present appear to be of sufficient importance to call for detailed description.

Some experiments which have been carried out since January of last year by the United States Weather Bureau, under the direction of the chief of the Bureau, Professor Moore, appear from a recent paper by Mr. R. A. Fessenden in *The Electrical World and Engineer*, of New York, to have resulted in important advances. Unfortunately Mr. Fessenden's paper does little more than state the results, without explaining how they have been obtained, his reason being the same cause which is withholding knowledge in other cases previously referred to, viz., unpublished patents.

As explained in Chapter VII., Marconi reduced the damping of his radiators by increasing their capacity and by decreasing their inductance. Any alterations in these quantities will alter the period unless they are such that their product is unchanged. This follows from the formula for the time of a complete oscillation given on page 51, Chapter IV. Another method of reducing the damping, and one which has no effect on the period of oscillation, is the reduction of the resistance, which has the additional advantage of reducing the proportion of energy transformed into heat, and wasted, since it is ultimately transformed into radiation of periods which produce no useful effect.

Special attention appears to have been given to this point in the experiments carried out by the United States Weather Bureau, which, according to Mr. Fessenden, have resulted in means being found of increasing the proportion of energy utilized to an astonishingly great extent, and of enabling a wire only a metre in height to radiate as much energy, and also to emit waves of the same period, as a wire a hundred metres high used as a radiator on Marconi's system.

He also states that the Weather Bureau, as the result of these experiments, consider Marconi's syntonic system to be defective in practice, because, by means of an electric device analogous to the siren, electric tones of

rapidly varying pitch can be produced which would make any syntonised messages in its neighbourhood absolutely unintelligible. He adds that they have discovered several methods of selective signalling which are not open to this objection, but gives no hint as to their nature. A young Italian, Signor Guarini, has for some time past been carrying out some interesting, and partially successful experiments with an automatic repeater, or relay, for extending the range over which ether telegrams may be transmitted when intermediate stations are possible. The repeaters are placed at the intermediate stations, and repeat the message, on the principle of the ordinary telegraph relay, that is to say, the message received at the station where the repeater is placed re-transmits it by bringing into action a transmitter, actuated by a local battery, at the repeater station.

In order to render this of commercial value certainty of automatic action must be attained, and as this stage has not as yet been reached I have not included a description of Guarini's apparatus and experiments in this volume.

Etheric telegraphy is now being rapidly extended in almost every quarter of the globe.

The United States Government has recently installed the Marconi system at San Francisco, where stations with masts 75 feet high have been established, one at Alcatraz Island, and the other at Fort Mason, and the Chilian Government, some months ago, arranged with the Marconi Wireless Telegraph Company for the establishment of a service of communication between Punta Arenas and Ancud.

The success of the system installed on board the Cunard liner *Lucania*, already referred to in Chapter VI., induced Messrs. Elder Dempster and Co. to cable a petition to the Canadian Government asking for the establishment of stations along the St. Lawrence and

Belle Isle, and the petition was not only favourably received, but immediate steps were taken to carry out its suggestions.

Both the uses and the defects of the non-syntonic system described in Chapter VI. are well illustrated by an incident which occurred during the naval manœuvres of the year 1901, and was reported in the "Pall Mall Gazette" of August 17, from which the following paragraph is extracted:—"When 'war' was declared Vice-Admiral Wilson very cleverly turned to account his thorough grasp of the new method of signalling. To the signal staff of his flagship he gave orders that they should not work their own wireless instruments, but should use these to read off the messages transmitted between the enemy's ships when the latter were near enough. . . . By thus using his wireless telegraphy instruments as ears instead of tongues, Vice-Admiral Wilson was able to gather a good deal of valuable information about his opponent. Sir Gerard Noel, the Commander-in-Chief of 'B' fleet, it appears, adopted the ordinary naval code for his war signals, with the slight alteration that instead of making only three letters, he made five, two of which were dropped when deciphering the message. It did not take the quick-witted signalmen of 'X' fleet long to get the key to 'B' fleet's code sufficiently to read all of the messages that were picked up by their instruments. Vice-Admiral Wilson took good care to issue for his own fleet a code that could not be deciphered by the foe."

After the reading of Signor Marconi's paper at the Society of Arts, to which I have referred in Chapters VI. and VII., the Chairman, Professor Ayrton, in proposing a vote of thanks to the author, made some remarks of sufficient interest to be repeated for the benefit of my readers, while at the same time forming a fitting conclusion to the volume.

Although still far away, the Professor observed, he

thought they were gradually coming within thinkable distance of the realisation of a prophecy he ventured to make four years ago, of a time when if a person wanted to call to a friend, he knew not where, he would call in a loud electro-magnetic voice, heard by him who had the electro-magnetic ear, silent to him who had it not.

“Where are you?” he would say.

A small reply would come, “I am at the bottom of a coal mine,” or, “Crossing the Andes,” or, “In the middle of the Pacific.” Or, perhaps, in spite of all the calling, no reply would come, and the person would then know his friend was dead. Let them think of what that meant, of the calling which went on every day from room to room of a house, and then think of that calling extending from pole to pole; not a noisy babble, but a call audible to him who wanted to hear and absolutely silent to him who did not; it was almost like dreamland and ghostland, not the ghostland of the heated imagination cultivated by the Psychical Society, but a real communication from a distance based on true physical laws. On seeing the young faces of so many present he was filled with green envy that they, and not he, might very likely live to see the fulfilment of his prophecy.

ISENTHAL & CO.,

Contractors to H.M. War Office, Admiralty, India Office, Colonial Office, &c.,
85, MORTIMER STREET, LONDON, W.

INDUCTION COILS

AND APPARATUS FOR

WIRELESS TELEGRAPHY

As supplied in large numbers to the Admiralty
for use in the Ships of the British Navy.

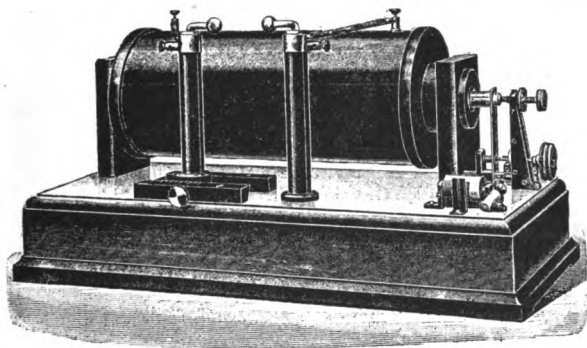

Special Type of Coil constructed for Wireless Telegraph Work in
H.M. Navy.

“UNIVERSAL” MERCURY JET INTERRUPTER
(works direct on any voltage up to 250 volts), large
numbers of which have been ordered by the Admiralty.

Prices for complete outfits or separate parts on application.

A. ROSENBERG & CO.,

Manufacturing Electricians,
MAKERS of EVERY REQUISITE for WIRELESS TELEGRAPHY.

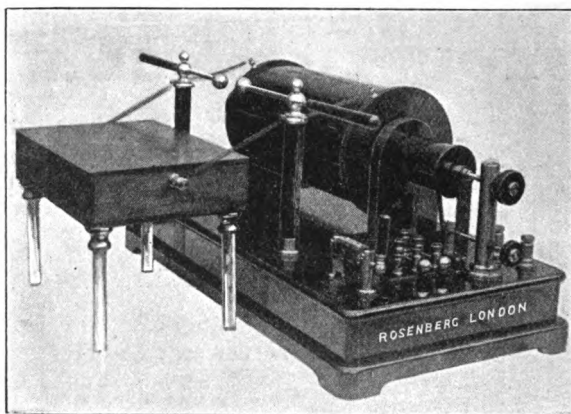

The above illustrates our Induction Coil connected to secondary condenser for Wireless Telegraphy.

Our Special Wireless Telegraphy Coils are cheaper than other makers', are the finest and most efficient made, and give the best results for long distance work.

Our apparatus is used by most of the leading experimentalists at home and abroad.

Single Section (or one Bobbin) Coils up to 15 in. spark in air. Double Section (or two Bobbin) Coils up to 25 in. Multiple Section Coils up to 50 in., are **MADE IN OUR OWN WORKS BY BRITISH WORKMEN.**

Complete Outfits from £7 10s.

(Receiver, Transmitter and Batteries).

For Colleges, Schools, Educational Institutions, Lecturers, &c.

We were among the first to carry on experiments in Wireless Telegraphy, our clients have therefore the advantage of our seven years' experience at their disposal.

COMPLETE OUTFITS OR SEPARATE PARTS SUPPLIED FROM STOCK, or made to Customers' own designs.

INVENTORS' IDEAS WORKED OUT TO INSTRUCTIONS.

Estimates for complete Outfits on Application.

**21, SOUTHAMPTON ROW, HOLBORN,
LONDON, W.C.**

Telegraphic Address:
"PURGAMENT, LONDON."

Telephone:
No. 2411 GERRARD.

HARRY W. COX, LTD.,
9, 10 & 11, CURSITOR STREET,
CHANCERY LANE, LONDON,
Manufacturers of
INDUCTION COILS
and all ACCESSORIES for
WIRELESS TELEGRAPHY,
And X-RAY WORK.

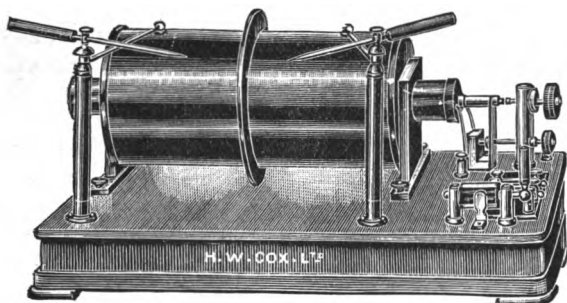

Our Coils are not only less costly than other makers', but give results unexcelled by any of them. They are in use by the Government, Hospitals, X-Ray and Wireless Telegraphy Workers throughout the world. Every Coil Guaranteed against breaking down.

Sole Makers of the Improved Pattern
MACKENZIE-DAVIDSON MERCURY BREAK.

Working direct on any circuit from 12 to 100 volts.

Absolutely the Best for Wireless Telegraphy and X-Ray work.

SPECIAL SET OF APPARATUS FOR DEMONSTRATION
PURPOSES IN WIRELESS TELEGRAPHY, £7 15s.

PRICES AND PARTICULARS ON APPLICATION.

“APPS-NEWTON” INDUCTION COILS. FACILE PRINCEPS.

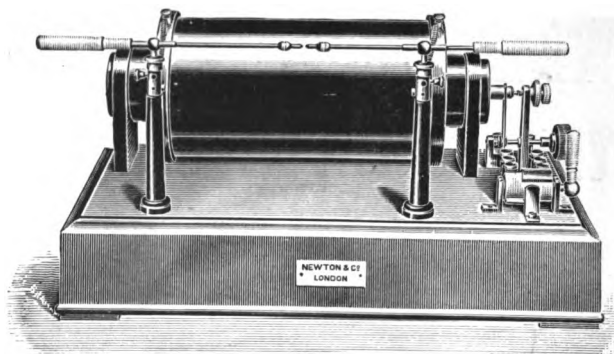

‘APPS’ PATENTED INDUCTION COILS are now manufactured concurrently by
NEWTON & CO., 3, FLEET STREET, LONDON.

The “APPS-NEWTON” Coils, though more expensive than many other makers’, are the finest and most efficient in the world, and give far better effects in X-ray work and wireless telegraphy.

These coils are in use in many of the principal hospitals at home and abroad, and large numbers are in use for Wireless Telegraphy **all over the World.**

Messrs. **NEWTON & CO.** have manufactured a large number of 10-in. Coils and Transmitters for Marconi’s Wireless Telegraphy Company, and also for the Admiralty for use on H.M. ships.

THE “NEWTONIAN”

NEW DOUBLE-POLE MOTOR MERCURY BREAK.

This new break has many advantages over the older forms now on the market, being the outcome of long experience with mercury breaks of all sorts. Thoroughly efficient, very simple, inexpensive, and absolutely reliable.

PRICE 6 GUINEAS.

Lantern Slides of Wireless Telegraphy, set of 25. Plain Slides, 1s. each.

Particulars on Application.

Illustrated Price List post free.

NEWTON & CO.,

**Opticians and Scientific Instrument Makers to His Majesty The King and
The Government,**

3, FLEET STREET, LONDON, E.C.

This book should be returned to
the Library on or before the last date
stamped below.

A fine of five cents a day is incurred
by retaining it beyond the specified
time.

Please return promptly.

DUE MAY 17 1920

DUE MAR 20 1922

DUE JAN 5 1923

Eng 4249.02
Wireless telegraphy;
Cabot Science

006766167



3 2044 092 004 225