

WIRELESS TELEGRAPHY AND TELEPHONY SIMPLY EXPLAINED

A PRACTICAL TREATISE

*Embracing Complete and Detailed Explanations of
the Theory and Practice of Modern Radio
Apparatus and its Present Day Applica-
tions, together with a chapter on the
Possibilities of its Future Development*

By ALFRED P. MORGAN

EDITOR MECHANICAL AND ELECTRICAL DEPARTMENT OF THE "BOY'S MAGAZINE,"
AUTHOR OF "WIRELESS TELEGRAPH CONSTRUCTION FOR AMATEURS," ETC.



VERY FULLY ILLUSTRATED

NEW YORK
THE NORMAN W. HENLEY PUBLISHING CO.
132 NASSAU STREET
1913

**COPYRIGHT, 1912, BY
THE NORMAN W. HENLEY PUBLISHING COMPANY**

**Composition, Electrotyping and Printing
By J. J. LITTLE & IVES Co., New York**

178951
NOV -4 1913
TQW
M82

PREFACE

Probably no marvel of modern science so grips the imagination as the mystery of those quivering impulses which go forth invisibly to link a ship sailing over the seas with the shores of the distant land.

The author has endeavored to furnish a comprehensive explanation, in simple language, of the theory and practice of this wonderful art, and to explain, as far as possible, the importance of the position occupied by wireless telegraphy to-day and the possibilities of to-morrow.

The title of this book naturally limits the amount of discussion that can be undertaken, and so, in the space at command, there has not been any real attempt made to enter into any engineering or constructive details further than is necessary to make the text clear.

Much that might properly be made a part of the preface has been embodied in the book, in order to avoid repetition, and to also bring certain matter to the attention of those readers who consider a preface to be merely an opportunity for the author of a book to express opinions very often quite foreign to the title, and so unconcernedly skip it with hardly more than a passing glance.

The author wishes to extend his sincere thanks to Mr. H. W. Young, Editor of *Popular Electricity*; to Mr. John Firth, to Colonel George P. Scriven, and to the *Scientific American*, for their kindness in supplying photographs for some of the illustrations, and to his friend, Mr. Safford Adams, who has kindly read the proofs and made many valuable suggestions.

ALFRED P. MORGAN.

January, 1913.

**TO
NIKOLA TESLA**

**WHOSE GENIUS HAS HARNESSSED ELECTRICITY TO THE DAILY
WORK OF MAN AND WHOSE INVENTIONS ARE THE BASIS OF ALL
MODERN WIRELESS TRANSMISSION, THIS BOOK IS DEDICATED.**

TABLE OF CONTENTS

CHAPTER I

	PAGES
Introductory: The Principles of Wireless Transmission and Reception: Ether; Electromagnetic Waves; How Waves Are Created; High-frequency Oscillations; Transmitting and Receiving Apparatus	I-II

CHAPTER II

The Means for Radiating and Intercepting Electric Waves; The Effect of Intervening Country Upon Electric Waves; Effects of Locality; "Static"; Lightning and What It Is; Aerial Masts; Types of Aerials; Directive Action of Aerials; Insulation of the Aerial; Earth Connections	12-26
---	-------

CHAPTER III

The Transmitting Apparatus; Current Supply; Magnetic Induction; Magnetic Fields; The Induction Coil: The Interrupter; Electrolytic Interrupters; Open Core Transformers; Closed Core Transformers; Direct Current; Alternating Current; Oscillation Condensers; The Helix; Spark Gaps; Rotary Gaps; Quenched Gaps; Aerial Switches; Anchor Gaps; Keys	27-47
---	-------

CHAPTER IV

The Receiving Apparatus; The Detector; Telephone Receivers; How Electric Waves Affect the Receiving Apparatus;	
--	--

Perikon Detector; Silicon Detector; Pyron Detector; Carborundum Detector; Galena Detector; Molybdenite Detector; The Potentiometer; The Tuning Coil; What Tuning Accomplishes; How Undesirable Messages Are Excluded: The Loading Coil; The Fixed Condenser; Variable Condensers; The Purpose of the Condenser . . .	48-69
--	-------

CHAPTER V

Tuning and Coupling; How Tuning Is Accomplished; The Results of Tuning; The Effects of Coupling; Inductive Helixes; The Loose Coupler; The Hot Wire Ammeter; Directive Wireless Telegraphy; The Braun System; Bellini and Tosi Method	70-82
---	-------

CHAPTER VI

The Dignity of Wireless Telegraphy; Its Applications and Service; Wireless Telegraphy in Warfare; Wireless in the Army; Wireless in the Navy; The Wireless Telegraph Automobile; Wireless on an Airship; Wireless Telegraphy as an Aid to Press Work; The Wireless Codes; How a Message Is Transmitted and Received; The Breaking-in System	83-104
---	--------

CHAPTER VII

The Ear; How We Hear; Sound; Sound Waves; The Nature of Sound; Speech; The Larynx and Vocal Chords; The Structure of Speech; Manometric Flames	105-113
--	---------

CHAPTER VIII

The Telephone; The Telephone Transmitter; The Telephone Receiver; The Photophone; Selenium Cells; The Thermophone; The Electric Arc; The Speaking Arc; Wireless Telephony by Means of a Beam of Light	114-123
---	---------

CHAPTER IX

	PAGES
The Wireless Telephone; The Difficulties of Wireless Telephony; A Simple Wireless Telephone; The Effects of Speech Upon Wireless Telephone Apparatus; The Requirements of Wireless Telephone Apparatus; The Production of Undamped Electrical Oscillations; The Poulsen Arc; Wireless Telephone Apparatus; The Majorana Transmitter; The Receiving Apparatus; The Audion; Transmission of Wireless Telephone Messages	124-136

CHAPTER X

Remarks; Maxwell's Theory; Hertz's Discovery; Electromagnetic Waves; The Position of Wireless Telegraphy in the World To-day; The Field for Wireless Telephony; The Status of the "Amateur"; Wireless of the Future; The Transmission of Power by Wireless	137-148
--	---------

LIST OF ILLUSTRATIONS

	PAGE
Fig. 1.—Throw a stone into a pool of water and little waves will radiate from the spot where the stone struck . . .	1
Fig. 2.—A Leyden jar is a glass jar lined inside and outside with tinfoil for about two-thirds of its height . . .	3
Fig. 3.—A static machine connected to a Leyden jar . . .	4
Fig. 4.—A Leyden jar discharging through a coil of wire . . .	5
Fig. 5.—Curved line representing an oscillatory discharge of a Leyden jar	5
Fig. 6.—Navy type of Leyden jars	6
Fig. 7.—The simplest practical transmitter	7
Fig. 8.—A cross-section of the aerial and atmosphere	9
Fig. 9.—Under the same conditions, but viewed from above	9
Fig. 10.—A simple receiving arrangement	10
Fig. 11.—An amateur aerial and station	13
Fig. 12.—The Army wireless station at Fort Gibbons	14
Fig. 13.—Lightning discharge near Montclair, N. J.	15
Fig. 14.—Photo of double lightning discharge passing to earth near the First Orange Mountain, Montclair, N. J.	17
Fig. 15.—Vertical aerials of the grid, fan and inverted pyramid types	18
Fig. 16.—A diagram showing pyramid aerial	19
Fig. 17.—A diagram illustrating the directive action of a flat-top aerial	20
Fig. 18.—Aerials of the "V" and inverted "L" types	20
Fig. 19.—A diagram showing the arrangement of a "T" aerial	21
Fig. 20.—Flat top aerials of the inverted "U" and "T" types	21
Fig. 21.—Umbrella aerial	22
Fig. 22.—An amateur aerial (flat top)	23
Fig. 23.—Diagram showing the difference between loop and straightaway aerials	24
Fig. 24.—Showing how wires are arranged and insulated	25
Fig. 25.—Aerial insulator	25

	PAGE
Fig. 26.—Leading-in insulator	25
Fig. 27.—A side view of the aerial shown in Fig. 22 . . .	26
Fig. 28.—Diagram showing how batteries may be arranged .	27
Fig. 29.—The power plant of a Marconi transatlantic station	28
Fig. 30.—If a magnet be suddenly plunged into a hollow coil of wire a momentary current will be induced in the coil	29
Fig. 31.—Magnetic phantom formed by a bar magnet . . .	30
Fig. 32.—Magnetic phantom formed by a wire carrying cur- rent	31
Fig. 33.—Magnetic phantom formed by a coil of wire carry- ing current	31
Fig. 34.—Diagram of induction coil	32
Fig. 35.—Induction coil for wireless telegraph purposes .	32
Fig. 36.—Induction coil primary and secondary	33
Fig. 37.—Interrupter for induction coil	34
Fig. 38.—Electrolytic interrupter	34
Fig. 39.—Open and closed core transformers	35
Fig. 40.—Lines representing direct and intermittent direct cur- rents	36
Fig. 41.—Diagram representing alternating current	36
Fig. 42.—High potential humming transformer	37
Fig. 43.—High potential closed core transformer for wireless work	37
Fig. 44.—Leyden jar set for oil immersion	38
Fig. 45.—Oil immersed condenser	39
Fig. 46.—Diagram showing construction of condenser . . .	40
Fig. 47.—Tubular condenser	40
Fig. 48.—Helix	41
Fig. 49.—Close coupled helix	41
Fig. 50.—Spark gap	42
Fig. 51.—Circuit showing tuned transmitting system employ- ing close coupled helix	42
Fig. 52.—Photo of spark gap	43
Fig. 53.—Quenched spark gap	43
Fig. 54.—Diagram of aerial switch	44
Fig. 55.—Photo of aerial switch	44
Fig. 56.—Anchor gap	45
Fig. 57.—Wireless key	45
Fig. 58.—Photo of wireless key	46
Fig. 59.—Key and aerial switch	46

LIST OF ILLUSTRATIONS

xiii

	PAGE
Fig. 60.—Portable receiving set and case	49
Fig. 61.—Complete receiving outfit	49
Fig. 62.—Portable pack set	50
Fig. 63.—Complete receiving set	51
Fig. 64.—Showing the construction of a watch case telephone receiver	52
Fig. 65.—Pickard adjustable telephone receivers	53
Fig. 66.—Illustrating the valve action of a rectifying detector	54
Fig. 67.—A new type of silicon detector	54
Fig. 68.—Diagram drawing analogy between rectifying action of a detector and pump	55
Fig. 69.—Pyron detector	56
Fig. 70.—Perikon detector	57
Fig. 71.—Silicon detector	58
Fig. 72.—Electrolytic detector	58
Fig. 73.—Electrolytic detector in circuit	59
Fig. 74.—Potentiometer	59
Fig. 75.—Diagram showing how potentiometer is connected in a circuit	60
Fig. 76.—Analogy between swinging and tuning	61
Fig. 77.—Receiving a message in a Marconi transatlantic station	62
Fig. 78.—Tuning coil of the double slide type	63
Fig. 79.—Diagram showing fixed condenser in circuit	63
Fig. 80.—Fixed condenser	64
Fig. 81.—Rotary variable condenser	65
Fig. 82.—Interior of rotary variable condenser, showing construction	66
Fig. 83.—Dr. Seibt's rotary variable condenser	67
Fig. 84.—Sliding plate variable condenser	68
Fig. 85.—Diagram showing arrangement of rotary variable condenser in receiving circuit	68
Fig. 86.—Chain and ball arranged to illustrate the effect of tuning	71
Fig. 87.—Loose coupled helix	72
Fig. 88.—Hot-wire ammeter	73
Fig. 89.—The principle of the hot-wire ammeter	73
Fig. 90.—Diagram showing loose coupled helix in circuit	74
Fig. 91.—Loose coupled tuning coil	75
Fig. 92.—Loose coupled tuner	75

	PAGE
Fig. 93.—Diagram showing position of loose coupler in circuit	76
Fig. 94.—Fort Gibbons, Alaska, wireless station	77
Fig. 95.—Transmitting condenser	77
Fig. 96.—Braun's method for directing wireless telegraph signals	78
Fig. 97.—Bellini-Tosi radio-goniometer	79
Fig. 98.—Arrangement of Bellini and Tosi for directive wireless telegraphy	80
Fig. 99.—Complete receiving and transmitting outfit	81
Fig. 100.—Special lightweight wireless telegraph set for airship service	83
Fig. 101.—Telefunken wireless cart, showing transmitter	84
Fig. 102.—Telefunken wireless cart for military service	85
Fig. 103.—Telefunken wireless wagon set in operation at Fort Leavenworth	86
Fig. 104.—Wireless room aboard the U. S. transport "Buford"	88
Fig. 105. The apparatus set up for operation	89
Fig. 106.—Wireless equipped automobile	90
Fig. 107.—Co. D Signal Corps at San Antonio	91
Fig. 108.—U. S. Signal Corps pack set shown open and closed	92
Fig. 109.—The receiving apparatus of the airship "America"	93
Fig. 110.—Interior of the N. Y. Herald Press station	94
Fig. 111.—Operating the U. S. Signal Corps airship wireless apparatus	95
Fig. 112.—The N. Y. Herald station, showing aerial	96
Fig. 113.—Operator Jack Irwin overhauling the wireless apparatus for the dirigible balloon "America"	97
Fig. 114.—Morse code	98
Fig. 115.—Continental code	99
Fig. 116.—Transmitting equipment of the high-power station at Nauen	100
Fig. 117.—Duplex receiving apparatus	101
Fig. 118.—Breaking-in system	102
Fig. 119.—The receiving apparatus of the station at Nauen	104
Fig. 120.—Diagram of the ear	105
Fig. 121.—The ossicles	106
Fig. 122.—Bon jour	107
Fig. 123.—Experiment showing sounding bodies are in vibration	108

	PAGE
Fig. 124.—Method of registering vibrations of a tuning fork	109
Fig. 125.—Way line made by a bristle attached to a tuning fork prong in vibration when passed over smoked glass	109
Fig. 126.—Illustrating the action of air waves	110
Fig. 127.—The vocal chords in position for making a sound	110
Fig. 128.—The vocal chords when relaxed	111
Fig. 129.—Koenig's manometric flame apparatus	111
Fig. 130.—Appearance of manometric flame in revolving mirror	112
Fig. 131.—Diagram of a telephone transmitter	115
Fig. 132.—Diagram showing the principle and construction of the telephone receiver	115
Fig. 133.—The photophone	116
Fig. 134.—Photophone receiving apparatus	117
Fig. 135.—Photophone transmitting apparatus	118
Fig. 136.—Powerful searchlight arranged to transmit speech over a beam of light	120
Fig. 137.—The electric arc	121
Fig. 138.—Circuit showing how a singing arc is arranged	122
Fig. 139.—A logical form of wireless telephone which is impractical	125
Fig. 140.—DeForest wireless telephone equipment	126
Fig. 141.—Wireless telephone receiving apparatus (induction method)	127
Fig. 142.—Fessenden wireless telephone transmitting phonograph music	128
Fig. 143.—Diagram illustrating why damped oscillations will not carry the voice	129
Fig. 144.—How the sound waves of the voice are impressed upon undamped oscillations	130
Fig. 145.—Arrangement of the speaking arc	131
Fig. 146.—Diagram showing how a wireless telephone transmitting system is arranged	131
Fig. 147.—Poulsen wireless telephone equipment	132
Fig. 148.—The Majorana wireless telephone transmitter	133
Fig. 149.—Showing the brush discharge from a Marconi transatlantic aerial at night	135
Fig. 150.—An amateur wireless telegraph station	138
Fig. 151.—The high-power naval wireless telegraph station under construction at Washington, D. C.	139

	PAGE
Fig. 152.—The curved lines represent the radius of the government high-power wireless stations and show the zones over which direct communication may be had with ships .	141
Fig. 153.—The aerial system of a transatlantic station . . .	142
Fig. 154.—Fong Yee, a Chinese amateur wireless operator .	144
Fig. 155.—Tesla world power plant	145
Fig. 156.—Twenty-five-foot sparks from a Tesla transformer	147

Wireless Telegraphy

CHAPTER I.

INTRODUCTORY: WIRELESS TRANSMISSION AND RECEPTION.
THE ETHER. ELECTRICAL OSCILLATIONS. ELECTRO-
MAGNETIC WAVES.

Wireless telegraphy, that marvelous art which has made possible the instantaneous transmission of intelligence between widely distant parts having no apparent physical connection save that of the earth, air, and water, is one of those wonders of science which appeal to the average mind as either incomprehensible or only explainable through the use of highly technical language. Contrary to this general opinion, however, the whole theory and practice of the wireless transmission of messages is capable of the simplest explanation.

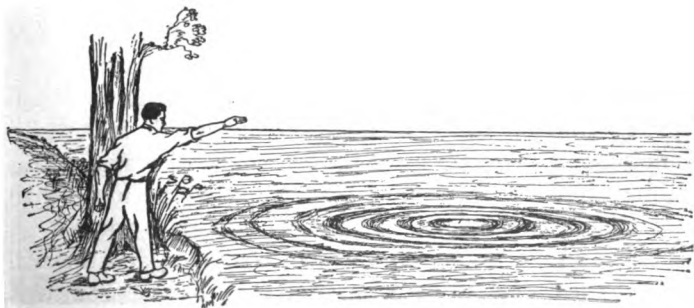

FIG. 1.—Throw a stone into a pool of water and little waves will radiate from the spot where the stone struck.

I

Throw a stone into a pool of water. A disturbance is immediately created, and little waves will radiate from the spot where the stone struck the water, gradually spreading out into enlarging circles until they reach the shores or die away. By throwing several stones in succession with varying intervals between them it would be possible to so arrange a set of signals that they would convey a meaning to one who is initiated, standing on the opposite side of the pool. The little waves are the vehicle which transmits the intelligence, and the water the *medium* in which the waves travel.

Wireless telegraph instruments are simply a means for *creating and detecting waves in a great pool of ether.*

Scientists suppose that all space and matter is pervaded with a hypothetical *medium* of extreme tenuity and elasticity, called *luminiferous ether*, or simply *ether*.

Although ether is invisible, odorless, and practically weightless, it is not merely the fantastic creation of speculative philosophers, but is as essential to our existence as the air we breathe and the food we eat. By imagining and accepting its reality, it is possible to explain and understand many scientific puzzles. The universe is a vast pool of ether. It is all-pervading. There is no void. It is diffused even among the molecules of which solid bodies are composed. The study of this substance is, perhaps, one of the most fascinating and important duties of the physicist.

Ninety million miles away from our earth is a huge flaming body of vapors and gases, called the sun. This seething mass of flame and heat furnishes us more than mere winter and summer and night and day, for we on this earth are not living on our own resources, and the real work of the world so necessary for even bare existence is accomplished by the energy of the sun stored up in coal, in plants and trees and mountain torrents.

Light is known to be vibrations of an extremely rapid period—*electromagnetic waves*, they are called. Heat can be shown to be of the same nature. Traveling at the rate of over 180,000 miles per second, these two great gifts of the sun come streaming continually down to us over the inconceivable distance of almost 100,000,000 miles. Both require a medium for their propagation. The ether supplies it. It is the substance with which the universe is

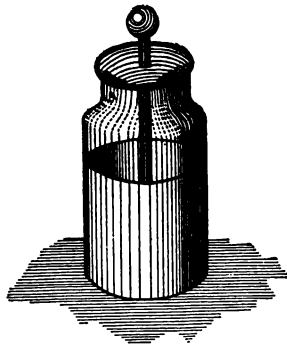

FIG. 2.—A Leyden jar is a glass jar lined inside and out with tinfoil for about two-thirds of its height.

filled. Incidentally it is also the seat of all electrical and magnetic forces.

In throwing the stone into the pool of water, muscular energy of the arm is transferred to the stone, and the latter, upon striking the surface of the pond, imparts a portion of that stored energy to the little waves which are immediately created in the water. In setting up electromagnetic waves for wireless communication the energy imparted to the ether is *electrical* energy, developed by certain interesting instruments explained further on.

Let us consider briefly how the *waves* are created in a wireless telegraph station. Almost every one has seen and

heard the brilliant snapping spark produced by the discharge of a Leyden jar. A Leyden jar in its common form is a glass jar lined inside and out with tinfoil for about two-thirds of its height. A brass rod, terminating in a knob, connects below with the inner coating, usually by means of a loose chain. It may be described as a device which is capable of storing electricity in the form of energy and discharging this energy again in actual electricity.

This discharge has been the subject of many interesting investigations of direct interest.

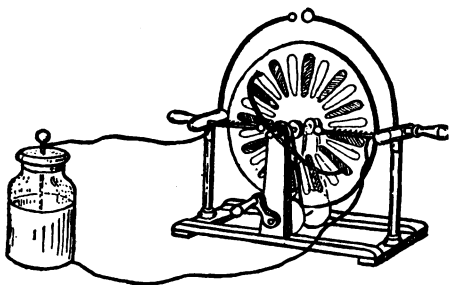

FIG. 3.—A static machine connected to a Leyden jar.

The inner and outer coatings are connected to the terminals of a static electric machine (an apparatus for generating electricity), and the machine set in rotation. After the jar has been charged, the electric machine is disconnected and one end of a coil of heavy wire connected to the outside coating, while the other end of the wire is made to approach the knob connected with the inner coating. Before the end of the wire reaches the knob a discharge occurs through the coil, producing a noisy brilliant spark between the wire and the knob. The discharge appears like a single spark, but in reality it is composed of a great many following each other in rapid succession. The jar discharges its energy, first by a tremendous rush of

current in one direction, and then another discharge somewhat smaller than the first in the opposite direction. There

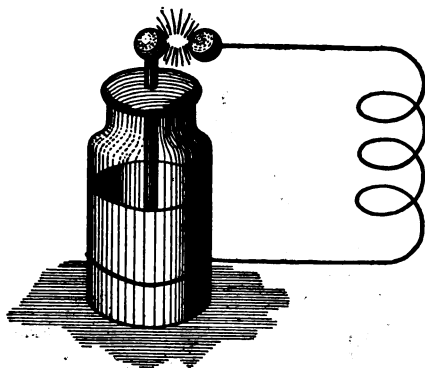

FIG. 4.—A Leyden jar discharging through a coil of wire produces a brilliant spark and *high frequency oscillations* are created.

is a series of these discharges in reverse directions, but each discharge is less and less, until the whole amount of

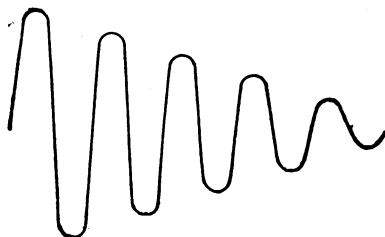

FIG. 5.—Curved line representing an oscillatory discharge of a Leyden jar.

energy is expended. The complete series of discharges takes place in an almost immeasurable fraction of time. It is from this phenomenon that the electrical term “high frequency oscillations,” so often heard of in “wireless” parlance, is derived.

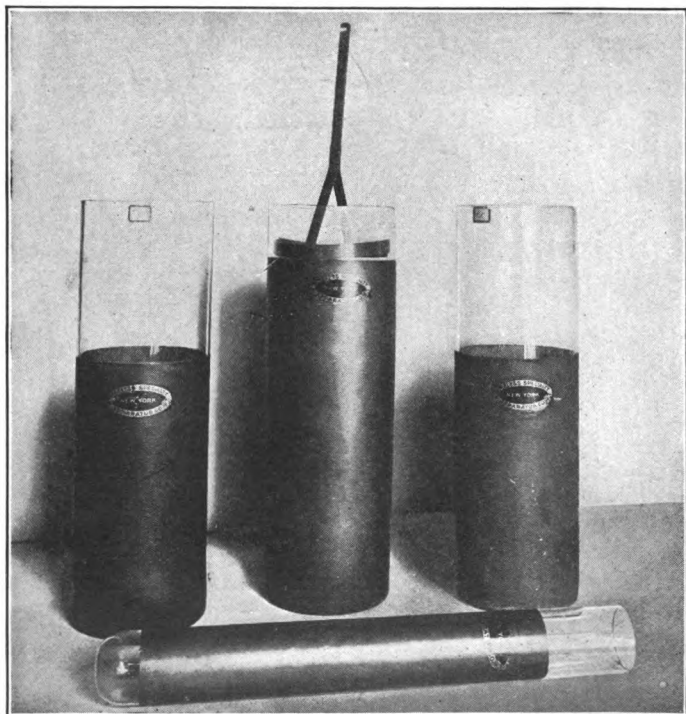

FIG. 6.—Navy type of Leyden jars. Coated with copper deposited upon the surface of the glass.

High frequency oscillations are the “pebbles” which, dropped into the vast pool of ether, everywhere, set up “ripples” called *electromagnetic waves* (identical with the electromagnetic waves of light, but *longer* and so beyond the limits of our spectrum and the vision of the eye). The manner in which this is accomplished may be explained by saying that the charge creates a state of strain in the surrounding ether, and then abruptly releases it. Ether possesses a high degree of elasticity, so that when the state of

strain is thus suddenly released, it immediately returns to its former state. The sudden motion of the ether results in waves which spread out from their source in enlarging circles.

Wireless telegraphy, as it is practiced to-day, is based upon the fact that a system of wires or circuits, through which *high frequency* oscillations are surging, becomes a source of electromagnetic waves. Various methods have been devised for making the system more efficient and capable of giving better results with a given amount of power.

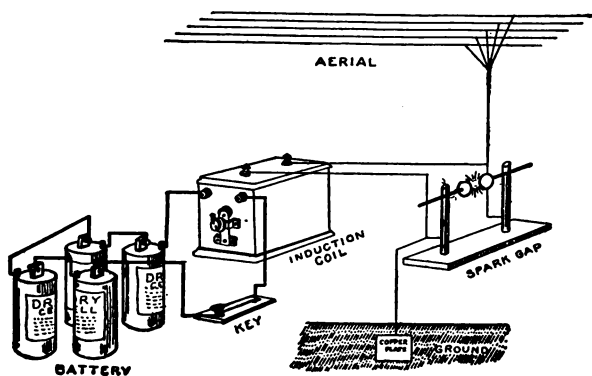

FIG. 7.—The simplest practical transmitter that it is possible to devise for the purpose of sending messages.

Fig. 7 is a diagram showing the simplest practical transmitter that it is possible to devise for the purpose of sending messages a sufficient distance to be of any value.

It would be impractical to use a static electric machine for wireless transmission, and so an *induction coil* or *transformer* is employed. These latter instruments are for the purpose of raising electric currents of a comparatively low voltage to the high potential, where they have the power of generating high frequency oscillations.

In the illustration the current from a battery is led into the primary of an induction coil. The *primary* is simply a coil consisting of a few turns of wire, which induces a high voltage in a second coil consisting of a larger number of turns, and called the *secondary*. The terminals of the secondary are led to a spark gap—an arrangement composed of two polished brass balls, separated by a small air space. One of the balls, in turn, is connected to a metal plate buried in the earth, and the other to a network of wires suspended high in the air and insulated from all surrounding objects.

As noted above, a Leyden jar consists of two metallic coatings, separated by a wall of glass. The purpose of the coatings is to form a *conductor* and carry an electric charge. A Leyden jar possesses a characteristic called, in electricity, *capacity*. Any two conductors separated by an insulating medium possess "capacity" and all the properties of a Leyden jar or condenser.

The waves generated by a Leyden jar would be somewhat weak and confined to its own immediate neighborhood, so recourse is had to the *aerial* and *ground*, in order to increase the area over which the oscillations exert their influence in setting up the electric waves. The aerial system corresponds to one coating of the Leyden jar, and the ground to the other. The insulating medium in between, corresponding to the glass, or *dielectric*, is the atmosphere.

When the key connected to the induction coil is pressed, the battery current flows through the primary and induces a high voltage current in the secondary, which charges the aerial and ground exactly as the static machine charges the two coatings of the Leyden jar. A spark then leaps across the spark gap and the current surges back and forth through the aerial, generating "high frequency oscillations" which,

in turn, set up a state of strain in the surrounding ether, and cause the waves to travel out from the system.

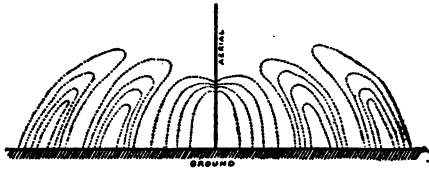

FIG. 8.—If a cross section of the aerial and atmosphere could be made in the same manner that an apple is sliced with a knife and the waves held stationary, they would appear as above.

These waves follow the contour of the earth, and so may cross mountains and valleys, and travel anywhere. They radiate from the aerial like the ripples from a pebble in a pool of water, in gradually enlarging circles. If a cross section of the aerial and atmosphere could be made in the same manner that an apple can be sliced with a knife, and the waves held stationary long enough to see them, they would appear as in Fig. 8. The curved lines represent the lines of strain induced by the oscillations. Each group of lines represents a wave. It will be noticed as they radiate farther from the aerial that they become larger and spread out.

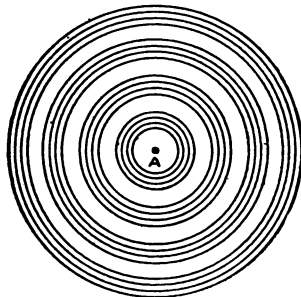

FIG. 9.—Under the same conditions, but when viewed from above, the appearance would be that of a series of concentric circles.

The electromagnetic waves have the power of exciting oscillations in a conductor on which they impinge. This is made use of for the purpose of receiving the messages. When the waves strike the aerial of a distant station they set up high frequency oscillations, which are usually too weak to make their presence known except with the aid of a sensitive device, called a detector.

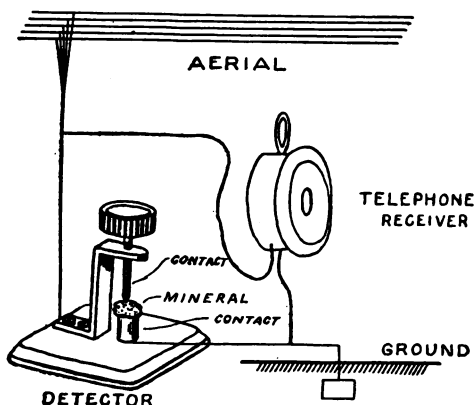

FIG. 10.—A simple receiving arrangement. The detector rectifies the oscillatory currents passing from the aerial to the ground so that they will flow through the telephone receiver and register as sound.

The most prominent type of detector in use to-day is a crystal of silicon, iron pyrites, zincite or certain other minerals. The mineral is placed between two contact points, one or both of which are adjustable so that the most sensitive portion of the mineral may be selected. A telephone receiver is connected across the terminals of the detector. When the electromagnetic waves from the transmitting station strike the aerial of the receiving station, they set up therein a series of high frequency oscillations, corresponding to the Morse signals emitted from the transmitter. The

oscillations flow back and forth through the aerial and ground, striking the *mineral detector* on their journey. The high frequency oscillations are *alternating* currents, because they *reverse* their direction many thousand times per second. Such a current will not pass through the telephone receiver, because the little magnets contained therein exert a choking action on alternating currents of high frequency and effectually block their passage. The mineral detector acts as a valve, allowing the current to pass through in one direction, but not permitting it to return or go in the opposite direction. The result is a series of impulses flowing in one direction only, and therefore called a *direct* current. Such a current will flow through a telephone receiver and produce a motion of the diaphragm which imparts its motion to the surrounding air, the result being sound waves audible to the ear. By varying the periods during which the key is pressed and the oscillations are being produced, according to a prearranged code, the sounds in the receiver may be made to assume an intelligible meaning.

CHAPTER II.

THE MEANS FOR RADIATING AND INTERCEPTING ELECTRIC WAVES. AERIAL SYSTEMS. EARTH CONNECTION.

Every radiotelegraphic station may be summed up as comprising these elements: first of all, certain appliances collectively forming the transmitter and serving to create the waves; secondly, the receiving apparatus, whose function is to detect the signals of some far-distant sending station, and lastly, an external organ called the aerial, or antenna, consisting of a huge system of wires elevated high in the air above all surrounding objects, either vertically or sloping, or partly horizontal and partly vertical, which radiates or intercepts the electromagnetic waves, accordingly as the station is transmitting or receiving.

The antenna is at once both the mouth and the ear of the wireless station. Its site and arrangement will greatly determine the efficiency and range of the apparatus.

The site selected is preferably such that the aerial will not be in the immediate neighborhood of any tall objects, such as trees, smokestacks, telephone wires, etc., because such objects not only absorb an appreciable amount of energy when the station is transmitting messages, but also noticeably shield the aerial from the effects of incoming signals and limit its range.

The nature of the ground over which the waves must travel also enters into the question, and is always considered in locating a station. In gliding over the surface of the earth, the waves generate weak currents in the earth

itself. If the ground is very stony or dry, these earth currents encounter considerable resistance, and the possible

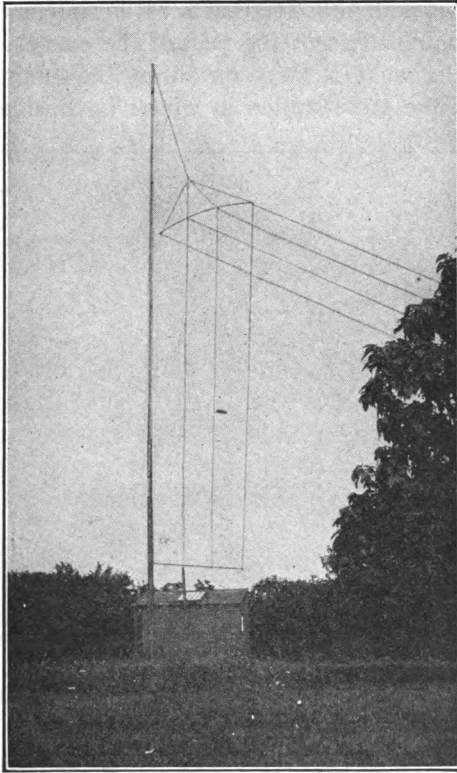

FIG. II.—An amateur aerial and station.

distance of transmission over soil of this sort is very much less than if it were moist. Moist soil and water offer very little resistance, and the difference in the results obtainable at the receiving station when the waves travel over an area of this sort is very marked.

A station which can only send 100 miles over land can send messages three or four hundred miles over the ocean.

Forests exert a very decided effect upon the electric waves. Each individual tree acts as an antenna, reaching up into the air and absorbing part of the energy. The difference in the range of a station during the summer months and that of the same station in winter is considerable. In

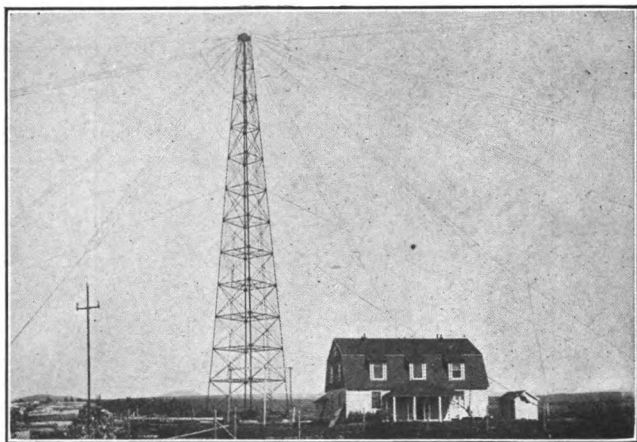

FIG. 12.—The Army wireless station at Fort Gibbons, Alaska, showing steel lattice work mast and aerial system.

summer the trees are full of sap and, being much better conductors of electricity when in this condition, act in the capacity of innumerable aerials rising in the air, and able to absorb appreciable amounts of energy. During these same months the air becomes highly *ionized*, in which state the air molecules carry an electric charge, and are particularly opaque to the waves. This condition also usually exists in the presence of sunlight, the result being that the most favorable time for the wireless transmission of messages are the hours around midnight.

Locality is another factor which usually receives a fair share of attention in selecting the site. Certain sections of the country, for seemingly no apparent reason, are very hard to transmit messages, either to or from. Wireless stations located on the Pacific Coast, for instance, are more efficient than those situated along the Atlantic seaboard,

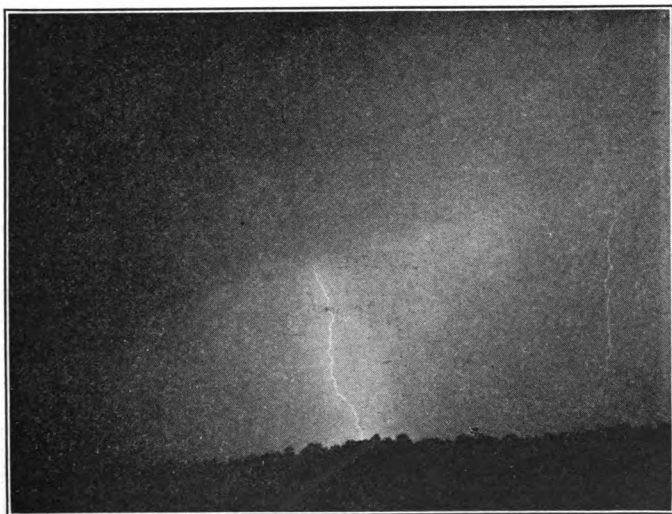

FIG. 13.—Lightning discharge near Montclair, N. J.

while those in the tropical regions are only able to send short distances in comparison to those farther north or south. Messages seem to travel better in the direction of the lines of longitude than along the lines of latitude.

“Static,” that “bugbear” of the wireless operator, is very much more in evidence in the eastern parts of the United States and in South America than it is on the western coast of the country. If any one should ask a wireless operator what “static” is, he would probably reply, “a nui-

sance." In reality, it is caused by atmospheric electricity. When atmospheric electricity "jumps," it is called "lightning." A lightning discharge sets up very powerful waves in the ether, which strike the aerial of the wireless station and produce a peculiar rumbling, scratching sound in the telephone receivers, and sometimes seriously interfere with a message. In fact, it is possible for a wireless operator to predict a thunder shower by many hours from the sounds he is able to hear in his telephone receivers.

The cause of lightning is the accumulation of electric charges in the clouds. The electricity resides on the surface of the particles of water in the cloud. These charges grow stronger as the particles of water coalesce to form larger drops, because, as they unite, the surface increases proportionally less than the volume and, being forced to lodge on a smaller space, the electricity becomes more "concentrated," so to speak. For this reason the combined charge on the surface of the larger drop is more intense than were the charges on the separate particles, and the "potential" is increased. As the countless multitudes of drops grow larger and larger, in the process of forming rain, the cloud soon becomes heavily charged.

Through the effects of a phenomenon called "induction," a charge of the opposite kind is produced on a neighboring cloud or on some object of the earth beneath. These charges continually strive to burst across the intervening air and neutralize each other. As soon as the potential becomes sufficient to break down this layer of air, a lightning stroke from one to ten miles long takes place. The heated air in the path of the lightning expands with great force, but immediately other air rushes in to fill the partial vacuum, thus producing atmospheric waves, which impress the ear as the sound called *thunder*.

Wireless stations belonging to the United States navy



FIG. 14.—Photo of double lightning discharge passing to earth near the First Orange Mountain, Montclair, N. J.

and located on land are usually housed in a small building in the immediate neighborhood of the tall wooden mast which supports the aerial. Commercial stations are usually situated on the top floor of a high office building, or a hotel, and the aerials supported by a steel lattice-work tower. Amateurs place a small pole on the roof of the house, or in a tree, and locate their station in any convenient room near the top of the house.

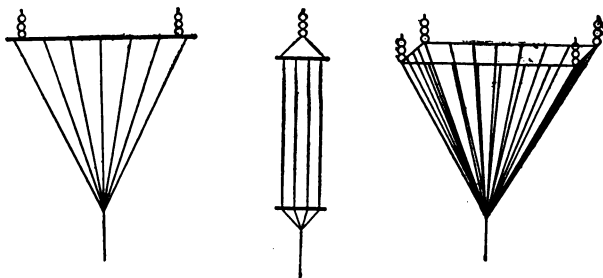

FIG. 15.—Vertical aerials of the “grid,” “fan” and “inverted pyramid” types.

Aerials are of numerous classes and forms, but the most prominent types can be divided into two main groups, called respectively, the “flat-top” and “vertical” antenna.

The vertical aerials are the older form, and are usually employed for long-distance work or ultra-powerful stations. The aerials intended for transmission from Europe to America, installed by Marconi, consisted of huge inverted pyramids, supported by four heavy lattice-work towers, over 200 feet high. Vertical aerials also sometimes take the form of an umbrella, or fan, where only one supporting pole is available. Iron pipe masts may be employed for the purpose, by setting on an insulating base. The umbrella aerial is used extensively in the army and portable sets.

The flat-top aerials are gradually coming into very extended use. They are used to the exclusion of all others on shipboard. They need not be so high as a vertical type aerial in order to be as efficient. Flat-top aerials consist of a vertical portion and a nearly horizontal portion. The

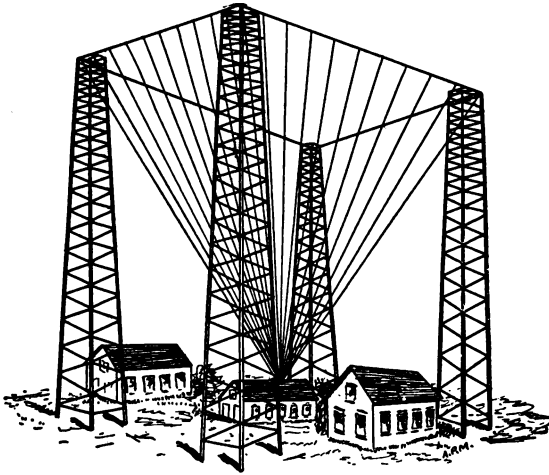

FIG. 16.—A diagram showing pyramid aerial.

horizontal portion is practically useless, as far as its work in radiating waves is concerned, it being used for the purpose of increasing the *capacity* of the aerial. An increase in capacity in an aerial means that more energy can be stored and radiated. Flat-top aerials have the objection, however, of possessing a *directive* action; that is, they receive, or radiate waves, better in one direction than in the other. A flat-top aerial always receives or transmits better in the direction that the ends point than in a direction at right angles to the wires.

The accompanying diagram is an illustration to show the effects of the directive action of a flat-top aerial. The black

lines marked A B, and appearing very much like a little grating, represent an aerial of the inverted "L" type, looking down on it from above. B is the *free* end of the aerial, and A the *closed* end, or end to which the wires leading

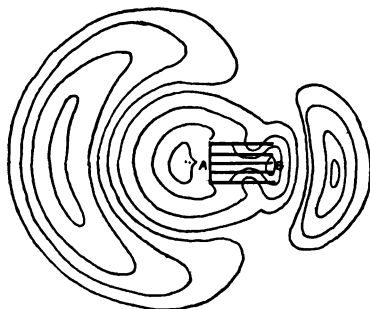

FIG. 17.—A diagram illustrating the directive action of a flat-top aerial.

down to the station are attached. If a snapshot of the lines of strain produced in the ether as the waves move away from the aerial could be taken, they would appear like the curved lines in the illustration. It can be readily seen that those passing outward from the aerial in a direction *opposite* to that in which the free end points are the strongest, and that the radiation in that direction is the best.

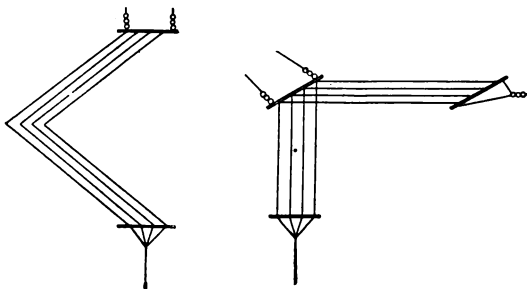

FIG. 18.—Aerials of the "V" and inverted "L" types.

The "V" aerial and also the inverted "L" type both receive waves much better when they come from a direction opposite to that in which the free end points.

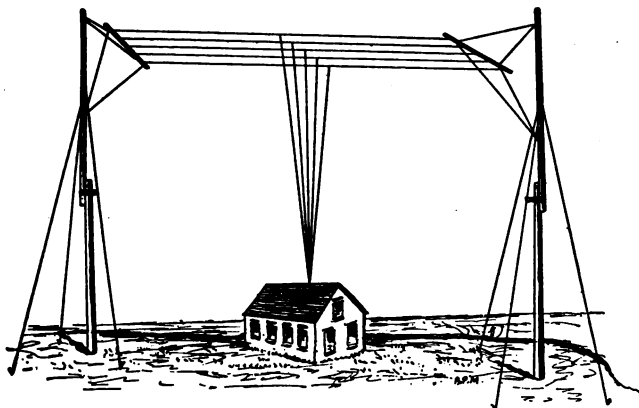

FIG. 19.—A diagram showing the arrangement of a "T" aerial.

Probably the most interesting feature of the directive action of aerials lies in the fact that a land station is able to determine the approximate bearing of a ship signaling with a horizontal aerial.

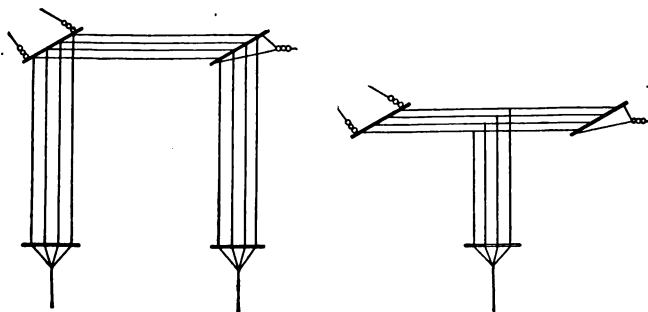

FIG. 20.—Flat top aerials of the inverted "U" and "T" types.

It is beyond the scope of the book to enter into all of the engineering details pertaining to the installation of a wireless station, but a few remarks and instructions for the benefit of those who may be interested in this phase of the subject may be appreciated.

The flat-top "T" aerial gives the best "all around" results. The vertical and umbrella forms are close seconds.

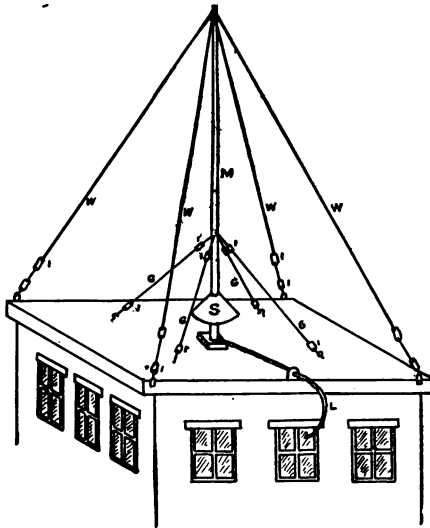

FIG. 21.—Umbrella aerial.

For the very best results, the top or horizontal portion of a "T" aerial should be slightly shorter than the vertical section.

The umbrella type of antenna is very efficient. Instead of a wooden mast, an iron pipe terminating above in a system of wires, inclining downward and serving both as part of the aerial and as guys to support the pole, is often used. The bottom of the pole is placed on an insulating base, pro-

tected from the rain by a small shelter. The wires are insulated near the lower ends by strain-insulators. The

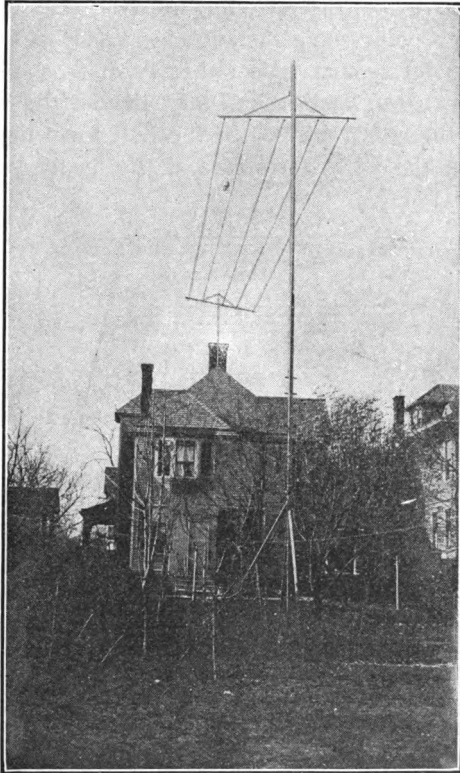

FIG. 22.—An amateur aerial (flat-top).

action of the wires is to serve as a capacity extension to the aerial.

*Vertical aeri*als are not as efficient as either of those forms just mentioned. They require to be 50 per cent.

higher than a flat-top aerial, in order to be of the same value.

The "L" and "V" types are somewhat directional. They are used where the highest point must be near the station, with a lower point some distance away. It is possible to secure excellent results with either type.

The terms *straightaway* and *loop* denote the method of connecting the aerial wires. In the first form the upper or free ends of the wires terminate at the insulators. In the

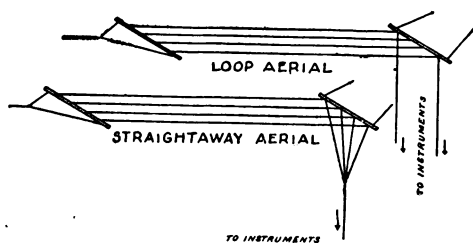

FIG. 23.—Diagram showing the difference between "loop" and "straightaway" aerials.

loop form they are all connected together, and divided into two sections, each of which is led separately into the operating room.

The straightaway aerial is the most efficient in most cases, but wherever great height cannot be obtained, or the aerial is necessarily short, the loop aerial will give the best results.

Bare copper wire is the best, and is generally used for aerials. Wherever the stretch is 100 feet or over, however, so that the wires are subjected to considerable strain from their own weight, phosphor bronze is used because of its greater tensile strength. Commercial and navy stations employ stranded wire. High frequency currents have the peculiar property of traveling near the surface of wires

and conductors. They do not permeate to the center of the wire, as do normal currents. The surface of a stranded wire is greater in comparison to its cross-section than a solid conductor of the same diameter, and therefore is often employed because it offers less resistance to currents of this sort.

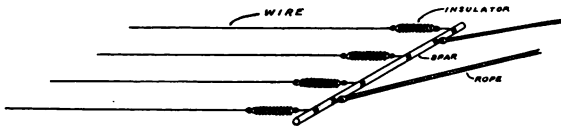

FIG. 24.—Showing how wires are arranged and insulated.

Aluminum wire is very light, and causes very little strain on the pole or cross-arms. It offers more resistance than copper, but some of the larger sizes may be used with equally good results.

Iron wire must never be used, even if galvanized or tinned. It possesses a certain reactance tending to choke off the high frequency currents.

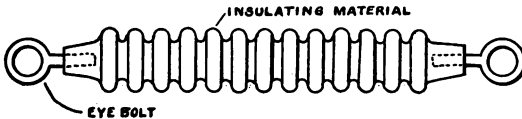

FIG. 25.—Aerial insulator.

The aerial is always very carefully insulated from its supports and surrounding objects by special insulators, capable of withstanding severe strains, made of a moulded material having an iron ring imbedded in each end.

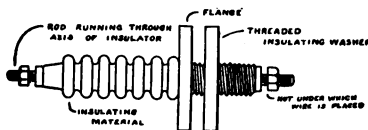

FIG. 26.—Leading-in insulator.

The wires leading from the aerial to the operating room are called the "rat-tail," or "lead-in." They must be very carefully insulated by leading through a bushing placed in the wall or window of the operating room.

One of the most important factors in a wireless station is the proper earthing arrangement. The usual method is to use large copper plates buried in moist earth, or thrown in the sea. On shipboard it is merely necessary to connect the earth wire to the metallic plates of which the hull of the vessel is built. Amateurs employ the water or gas pipes in the house, the former being preferred. Connections are established by means of a ground clamp.

In the country, where water-pipes are not available, the best way is to bury a sheet of copper three or four feet deep in moist earth.

A very efficient earth can be formed by spreading a large area of chicken wire netting over the ground. This method is the best where the earth is very dry or sandy, and no other way is readily convenient.

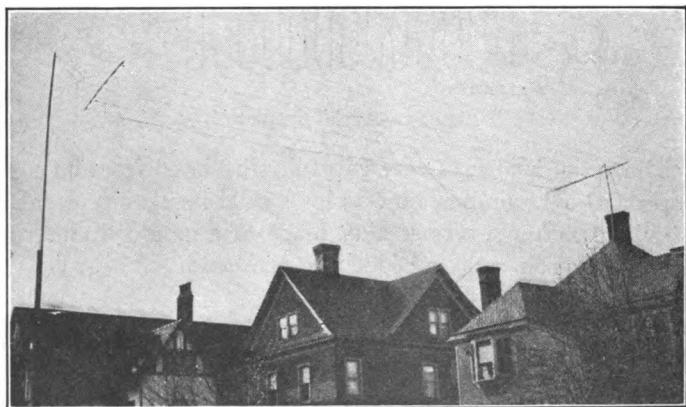

FIG. 27.—A side view of the aerial shown in Fig. 22.

CHAPTER III.

THE TRANSMITTING APPARATUS.

The principal instruments composing the apparatus used for sending the wireless messages comprise an *induction coil*, or in its place a *transformer*, a *key*, a *spark gap*, a *condenser*, and a *helix*.

THE CURRENT SUPPLY available will determine the type of the instruments, and whether an induction coil or a transformer is used. Unless current mains for light and power are already installed, it must be generated by an engine and dynamo, or recourse had to batteries. Induction coils may be operated on either direct or alternating current. Dry cells are most commonly employed to furnish

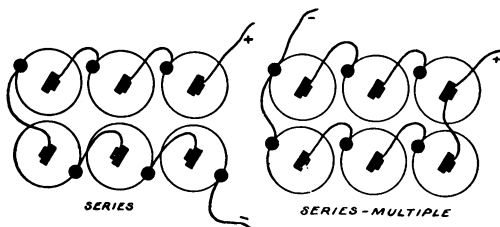

FIG. 28.—Diagram showing how batteries may be arranged in “series” or “series multiple.”

the current for small induction coils, but a storage or some form of renewable primary cell, such as the Fuller and Edison, is necessary if the coil is a large one.

When dry cells are used, they should be connected in

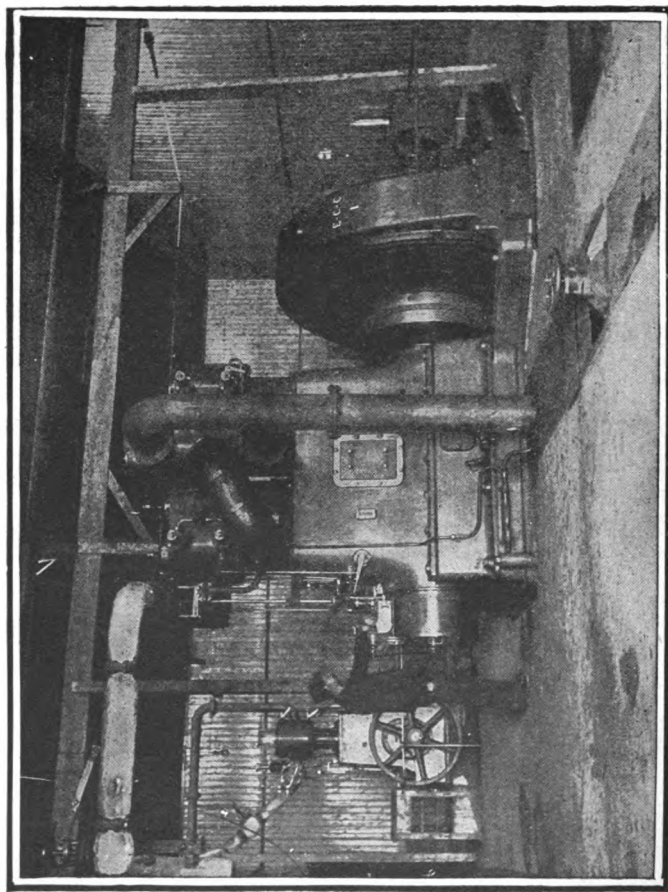

Fig. 29.—The power plant of a Marconi transatlantic station, showing engine and generator.

series multiple, as shown in the accompanying diagram. This method of connecting distributes the load, and considerably lengthens the life of the battery.

When the source of current supply is *alternating*, an induction coil may be operated as a *transformer*. Both induction coils and transformers are instruments for raising the voltage of the ordinary available current from a comparatively low value, 6-220 volts, to a quantity (15,000-

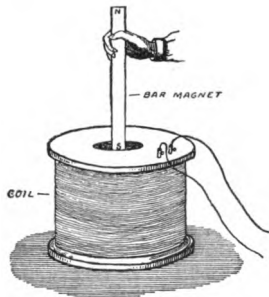

FIG. 30.—If a magnet is suddenly plunged into a hollow coil of wire a momentary electric current will be induced in the coil.

20,000 volts), where it can properly charge the aerial and create a *state of strain*, or, as it is called in technical parlance, an *electro-static field*.

Both the induction coil and transformer depend for their operation upon the principles of *magnetic induction*. In 1831, Michael Faraday, a famous English chemist and physicist, discovered that if a magnet be suddenly plunged into a hollow coil of wire, that a momentary current of electricity is generated in the coil. As long as the magnet remains motionless, it induces no current in the coil, but when it is *moved* back and forth, it sets up the currents. The source of electrical energy is the mechanical work

done in moving the magnet. The medium which changes the mechanical energy into electricity is called the magnetic field. The magnetic field is a peculiar state or condition of the space in the immediate neighborhood of a magnet. Its real nature is very hard to explain and not easily understood. Suffice it to say, however, that the current is induced in the coil of wire only when the magnetic field *is changing*, either decreasing or increasing. *The change is produced by moving the magnet* because its influence on

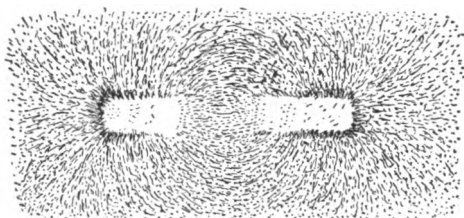

FIG. 31.—Magnetic phantom formed by bar magnet.

the coil will be great or small accordingly as it is near or far.

It is possible to show the existence of the magnetic field by placing a sheet of glass over a bar magnet and then sprinkling iron filings on the glass. They will settle down in curving lines as in Fig. 31, forming a *magnetic phantom*. The curved lines formed by the filings represent the direction of the lines of force which make up the magnetic field.

If we should examine the space in the immediate neighborhood of a coil of wire carrying a current of electricity it would be found that a similar state of affairs existed there and that the coil also possessed a magnetic field composed of lines of force flowing around it.

This is readily shown by punching a small hole in a piece

of cardboard and passing a wire carrying a current of electricity through the hole. If iron filings are sprinkled on the cardboard, they will arrange themselves in circles

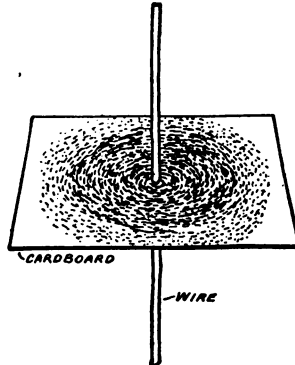

FIG. 32.—Magnetic phantom formed by wire carrying current.

around the wires, forming a magnetic phantom and showing that a coil of wire carrying a current of electricity generates a magnetic field in its vicinity. By forming the wire into a coil the magnetic field generated is much stronger, for the then combined effect of the wires is secured.

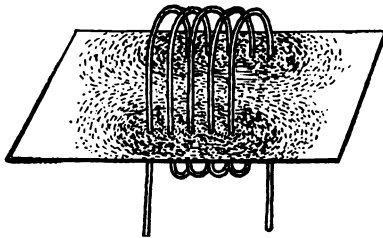

FIG. 33.—Magnetic phantom formed by coil of wire carrying current.

The induction coil and transformer are simply instruments utilizing the principle that a coil of wire carrying

a current possesses a magnetic field which will induce a current of electricity in another neighboring coil.

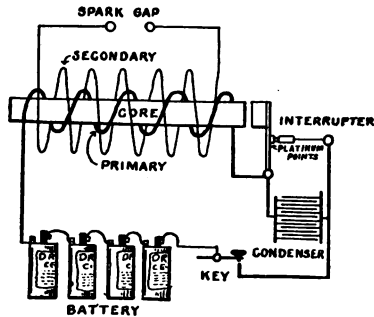

FIG. 34.—Diagram of induction coil.

THE INDUCTION COIL consists essentially of a *primary* winding of heavy wire wound around a soft iron core and surrounded by a secondary coil consisting of many thousand turns of fine wire, carefully insulated. The current from a battery is sent through the primary coil and sets up a magnetic field. The magnetic field induces a

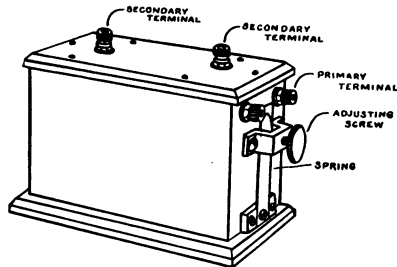

FIG. 35.—Induction coil for wireless telegraph purposes.

current in the secondary whose voltage is approximately proportional to the ratio of the turns of the secondary to the primary. Thus, if the secondary contains one hun-

dred times as many turns of wire as the primary the induced voltage will be one hundred times the voltage of the original primary current. The purpose of the iron core is to concentrate the magnetic field and make the coil more efficient. Since currents are only induced in the secondary when the magnetic field is *changing*, an automatic device called an *interrupter* or sometimes a *vibrator*, is employed to rapidly turn the current flowing through the primary on and off. The interrupter consists

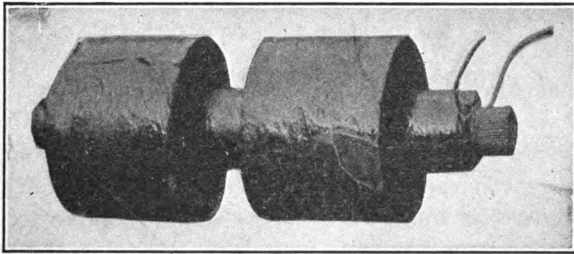

FIG. 36.—Induction coil, primary and secondary.

of a spring carrying a platinum point against which presses a second piece of platinum on the end of an adjustable thumbscrew. Platinum is necessary because the current of electricity would quickly oxidize and burn up any other material. The interrupter spring is placed near the end of the core so that the magnetism of the latter will draw it forward away from the thumbscrew and interrupt the current. As soon as the current ceases to flow the core loses its magnetism and the spring returns to its former position repeating the cycle very rapidly a large number of times per second. The interrupter is fitted with a *condenser* shunted across its terminals to stop sparking at the platinum points and also to make the currents in the secondary more intense.

The voltage of the currents in the secondary is high enough to leap across an air gap in a torrent of sparks. The spark of an induction coil intended for wireless work

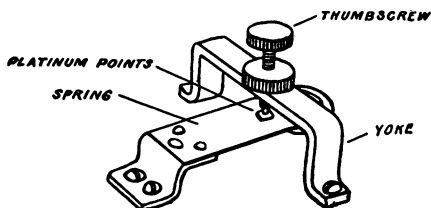

FIG. 37.—Interrupter for induction coil.

should be thick and heavy. It should be sufficiently hot and flaming to ignite a piece of paper. A rapid vibrator giving a high pitched spark is better than a slow one not only because it causes a more intense and powerful spark but because the human ear is the most sensitive to high pitched sounds and such a spark is more easily read at the receiving station.

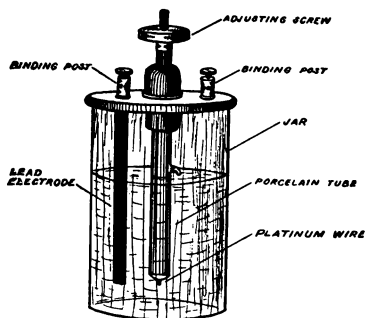

FIG. 38.—Electrolytic interrupter.

When the coil is a very large one and operated on the 110 volt current an *electrolytic* interrupter is substituted

for the mechanical type. One pole of the current is connected to a lead plate placed in a jar containing a mixture of sulphuric acid and water. The other side of the current is connected to a platinum wire placed in a porcelain tube so that only a small part of the lower end is in contact with the solution. When the current passes a bubble forms at the end of the wire shielding it from the liquid, and thus interrupting the current. The bubble is almost im-

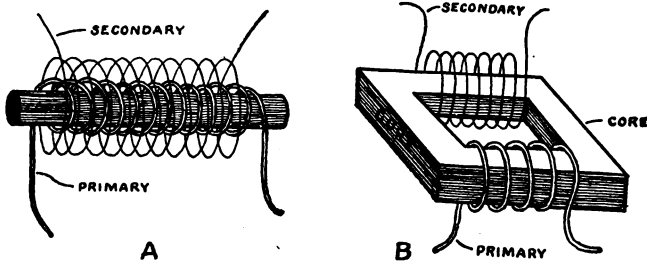

FIG. 39.—Open and closed core transformers.

mediately discharged however and the current allowed to flow an instant before a new one forms. This operation is repeated continuously at a frequency sometimes as high as a thousand per second. An electrolytic interrupter is both an expensive and a troublesome device. There are other types of interrupters of value in wireless service but the limitations of space prohibit any account.

THE TRANSFORMER is acknowledged to be the best practice as a means of stepping up the voltage of a circuit for wireless telegraph purposes. Alternating current is necessary to operate a transformer. There are two distinct types of transformers known as the "open" and "closed core" accordingly as the shape of the latter is straight like that of an induction coil or in the form of a hollow rectangle. The closed core transformer consists of two coils

of insulated wire, forming a *primary* and a *secondary*, wound upon a rectangular core like that shown in Fig. 39B. The core is built up of sheets of iron called laminations, to reduce the heating and increase the efficiency of the machine.

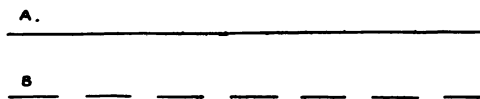

FIG. 40.—Lines representing direct and intermittent direct currents.

As noted above currents are only induced in a coil when the magnetic field is changing. The interrupter is employed to rapidly “make” and “break” the circuit. Every time that the circuit is made the primary coil creates a field and every time it is broken it is destroyed. A *direct* current is a current which passes in one direction only. It may be represented by a straight line as A in Fig. 40. Its voltage is usually very constant and does not vary greatly. In the case of electric lighting circuits the normal voltage is usually 110. If an interrupter is included in the circuit the current may be represented by a broken line, the spaces corresponding to the periods when the

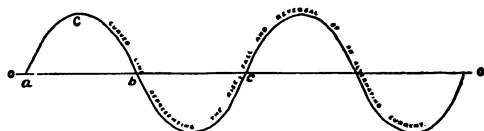

FIG. 41.—Diagram representing alternating current.

current is “broken” and the lines to the periods it is flowing. The interrupter creates an intermittent direct current.

An *alternating current* is one which reverses its direction and passes first one way and then the other. It may

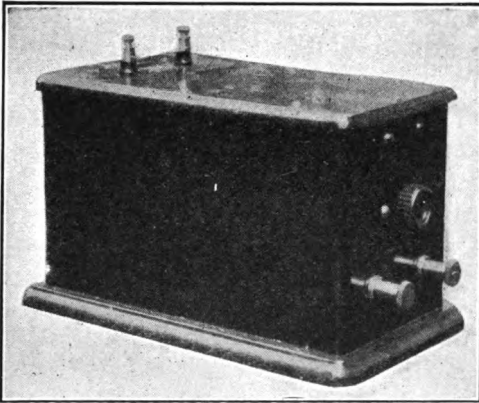

FIG. 42.—High potential "Humming" transformer.

be represented by the curved line shown in Fig. 41. It starts at zero and rises to a maximum, gradually dying away to zero, then passes in the *opposite* direction, rising

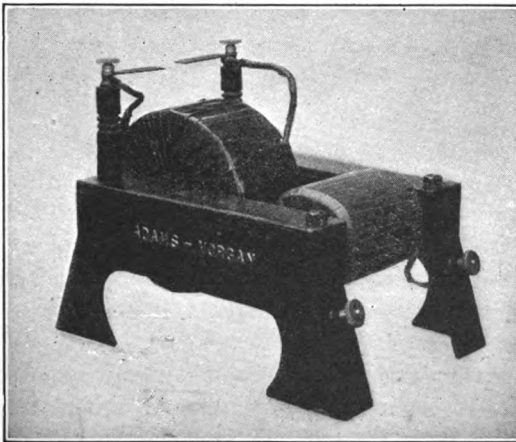

FIG. 43.—High potential closed core transformer for wireless work.

to a maximum and dying away again. This is repeated a definite number of times per second; when the current rises from zero, reverses and returns to zero it is said to have passed through a cycle. From *a* to *c* represents a

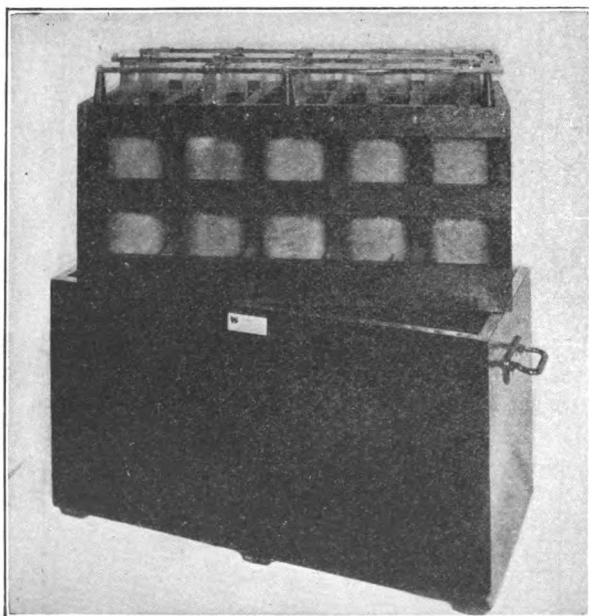

FIG. 44.—Leyden jar set for oil immersion to prevent losses from brush discharges.

cycle—from *a* to *b* is an alternation. The usual *frequency* of commercial alternating currents is 60 cycles or 7200 alternations per minute.

From these facts we may readily see why the troublesome interrupter may be eliminated when alternating current is used. Every time that the current rises and falls the magnetic field *changes*.

Considerable care must be used in proportioning the windings so that they possess sufficient reactance. Reactance is the tendency of a coil to resist the flow of an alternating current. A reactance coil is sometimes placed

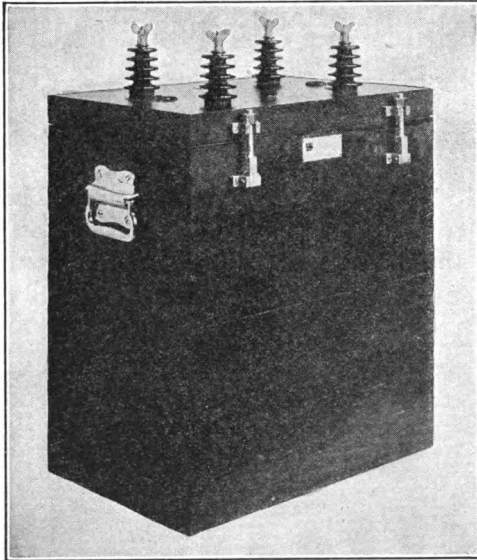

FIG. 45.—Oil immersed condenser.

in circuit with an open core transformer to prevent the spark from *arcing*. Arcing is the tendency of the spark to pass across the gap without charging the condenser and creating any high frequency oscillations.

THE CONDENSER, it will be remembered is the means of storing up the energy, which suddenly rushing across the spark gap, produces the *oscillations* necessary to generate the electric waves. A battery of leyden jars may be used as a transmitting condenser in connection with small induction coils. Their objection in large stations

is that they are very cumbersome and some energy is lost by the brush discharges around the tops of the jars. The usual form of condenser consists of alternate sheets of

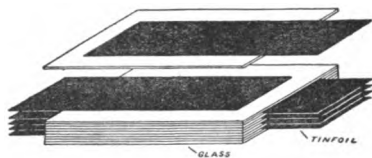

FIG. 46.—Diagram showing construction of condenser.

tinfoil and glass plates arranged in a pile. The alternate sheets of tinfoil are connected together to form the terminals of the instrument. The condenser is usually encased in a wooden box poured full of wax or oil to increase



FIG. 47.—Tubular condenser.

the insulation and efficiency. Condensers are arranged in units so that any desired *capacity* may be readily secured

by adding the proper number of units. The capacity of a condenser is its relative ability to receive and retain an electrical charge.

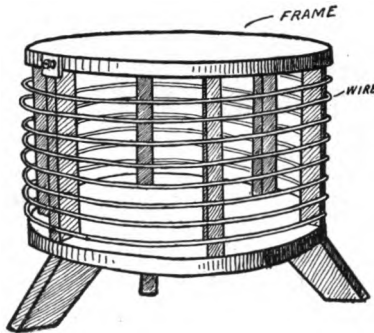

FIG. 48.—Helix.

THE HELIX is an instrument consisting of copper or brass wire wound around a frame of hard rubber or sea-

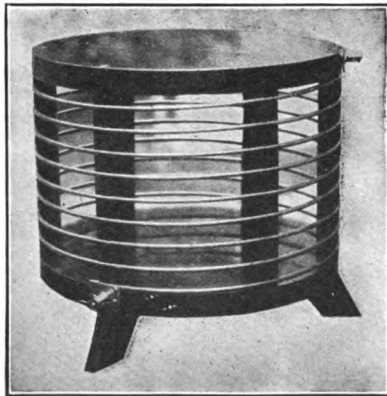

FIG. 49.—Close coupled helix.

soned wood. A certain amount of *inductance* is necessary in a wireless telegraph circuit in order to develop high

frequency oscillations. Inductance is the property of an electric circuit by virtue of which lines of force are developed around it. The helix furnishes the inductance

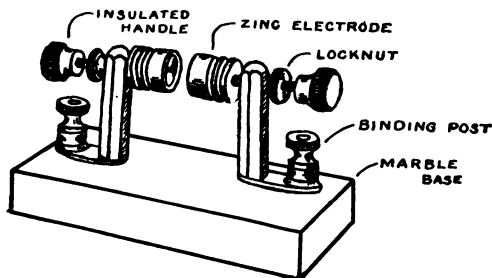

FIG. 50.—Spark gap.

in the circuit or at least the greater part. Connections are established to the turns of the helix by means of clips which snap on and off the wires.

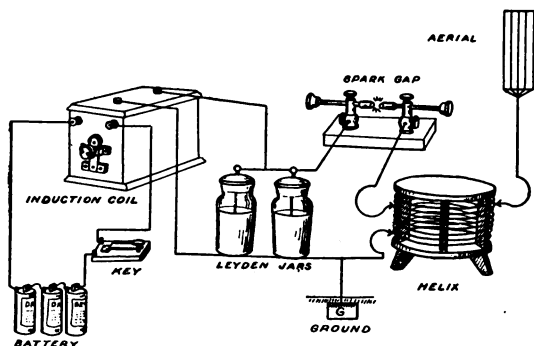

FIG. 51.—Circuit showing tuned transmitting system employing close coupled helix.

THE SPARK GAP is the medium for discharging the aerial and condenser and setting up the oscillations. It usually consists of a pair of electrodes supported by suitable stand-

ards and so arranged that the distance between the electrodes can be accurately adjusted. The electrodes usually take the form of hollow faced cylindrical rods having

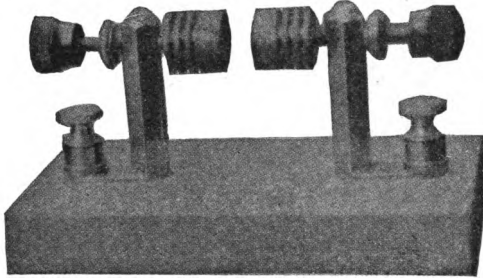

FIG. 52.—Photo of spark gap.

flanges to radiate the heat generated and prevent the spark from arcing. Various metals are used for spark gaps. Silver is probably the best but its expense is prohibitive. A special hard zinc alloy is most generally used.

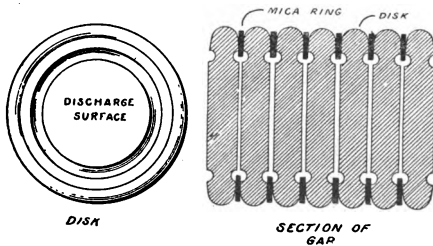

FIG. 53.—Quenched spark gap.

Spark gaps take other forms, two of which are interesting and important enough to describe here.

The first is the rotary gap. This consists of a number of small electrodes set around the periphery of a wheel

mounted upon the shaft of an electric motor. Two other adjustable electrodes are so mounted that the small elec-

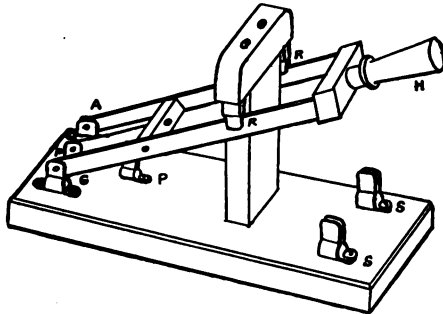

FIG. 54.—Diagram of aerial switch.

trodes on the revolving member pass between. When the motor is set in operation the wheel revolves at a high rate

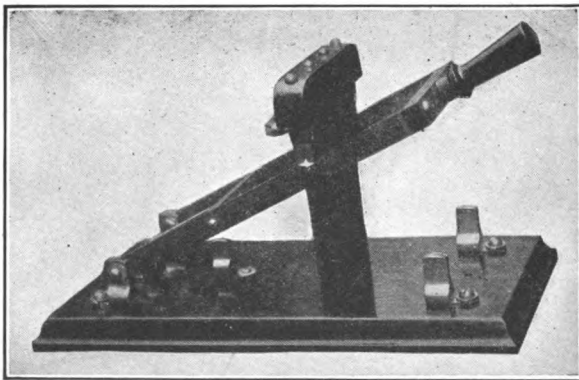

FIG. 55.—Photo of aerial switch.

of speed interrupting the spark and causing a peculiar musical pitch to be emitted. A rotary spark gap almost entirely eliminates the arcing of the spark.

The quenched gap consists of a number of disks of brass about five inches in diameter having thin mica washers set between and arranged in a pile as in the illustration. The quenched gap radiates considerably more energy than any other form of gap and also has the advantage of being

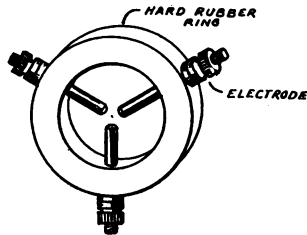

FIG. 56.—Anchor gap.

practically noiseless. The crashing discharge of an ordinary gap produces a very disagreeable penetrating noise hard to eliminate. In most commercial stations the spark is muffled to a certain extent by enclosing it in a cylinder of micanite or some other insulating substance.

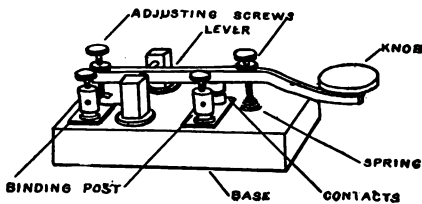

FIG. 57.—Wireless key.

THE AERIAL SWITCH is necessary for quickly connecting the aerial and ground to either the transmitting or receiving apparatus. Amateurs very often employ a small "double pole double throw" switch. The switch used in commercial stations is built in the manner shown in Fig. 55.

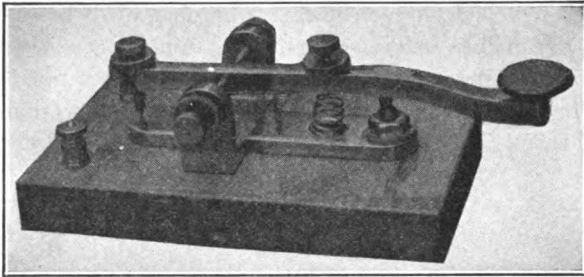

FIG. 58.—Photo of wireless key.

AN ANCHOR gap is a simple little device consisting of a hard rubber ring bearing two or three small electrodes

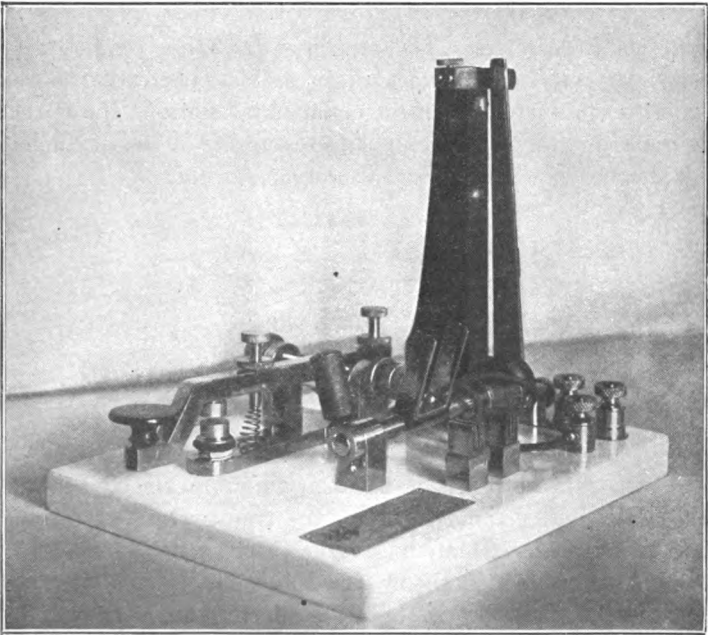

FIG. 59.—Key and aerial switch,

or sparking points. It is a necessary part of the transmitting apparatus wherever a loop aerial is used. One electrode is connected to the transmitting apparatus and the other two to the opposite sides of the aerial so that the currents divide between the two halves and equalize.

THE KEY is a hand operated switch which controls the electric currents passing through the transformer or coil shutting them on or off at will and so controlling the electric oscillations in the antenna to send out short or long trains of ether waves in accordance with the dot or dash signals of the Morse alphabet.

The key used in a wireless station is necessarily much larger and heavier than those employed in ordinary Morse line work, in order to carry the heavy currents used by the transmitter. In spite of their size and weight, however, such keys when properly designed may be handled with perfect ease.

CHAPTER IV.

THE RECEIVING APPARATUS.

The receiving instruments form the most interesting and ingenious part of a wireless station. They are the ears of the wireless station. They are wondrously sensitive but yet simple and incapable of much complication. The receiving station forms an exact counterpart of the transmitter, and the train of actions taking place are the reverse of those of the latter. The purpose of the transmitter is to change ordinary electric currents into electrical oscillations and thus set up *electric waves*, while the receptor converts the waves into oscillations and thence into currents which are capable of manifesting themselves in a telephone receiver. The instruments necessary for receiving comprise a

Detector	Fixed Condenser
Telephone Receivers	Tuning Device

Other instruments such as a potentiometer, test buzzers, variometers, variable condensers, etc., complete the outfit and improve its selectivity and sensitiveness.

THE DETECTOR forms the most vital part of the receptor. In explaining its action it may be well to recall and enlarge upon the description already set forth on page 11, where it was explained that electromagnetic or as they are more commonly called when identified with wireless telegraphy, Hertzian waves have the power of exciting *oscillations* in

any conductor upon which they impinge. Electrical oscillations, it will be remembered, are alternating currents of

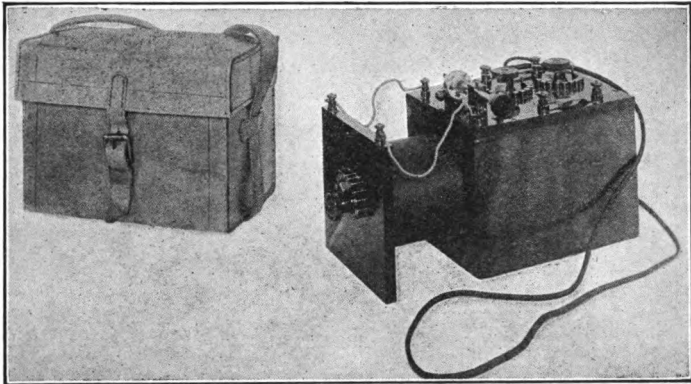

FIG. 60.—Portable receiving set and case.

very high frequency. They are generated in the aerial of the receiving station by the action of the waves coming

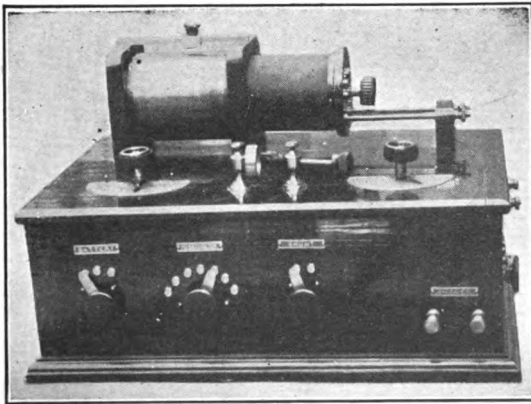

FIG. 61.—Complete receiving outfit.

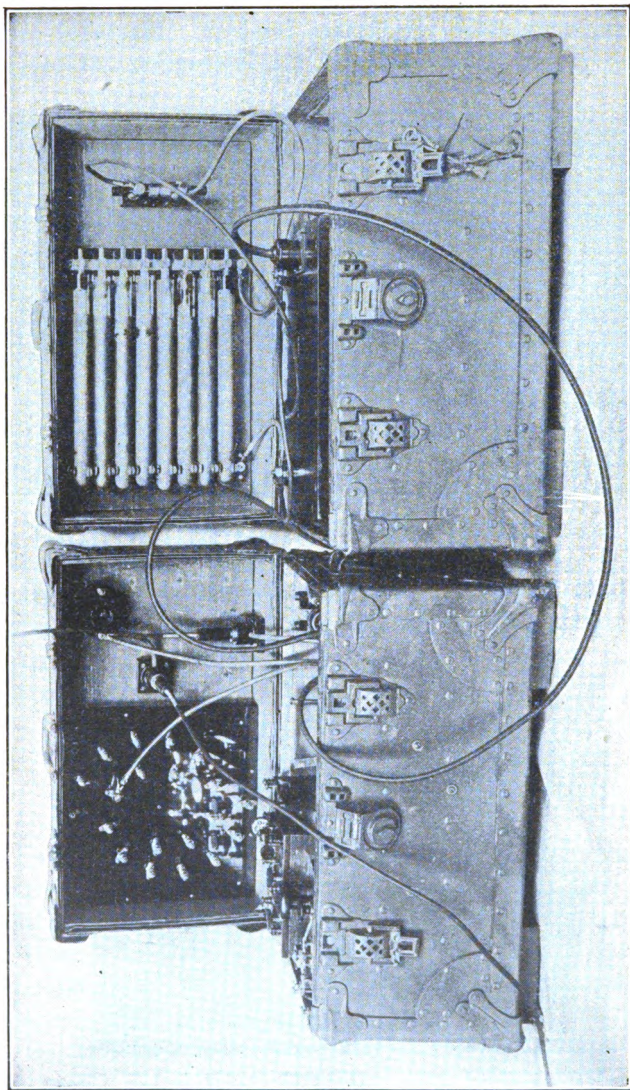

FIG. 62.—Portable pack set. The receiving outfit is contained in the left hand case; also the key and interrupter. The tubular condenser, spark gap, and induction coil may be seen in the right hand case.

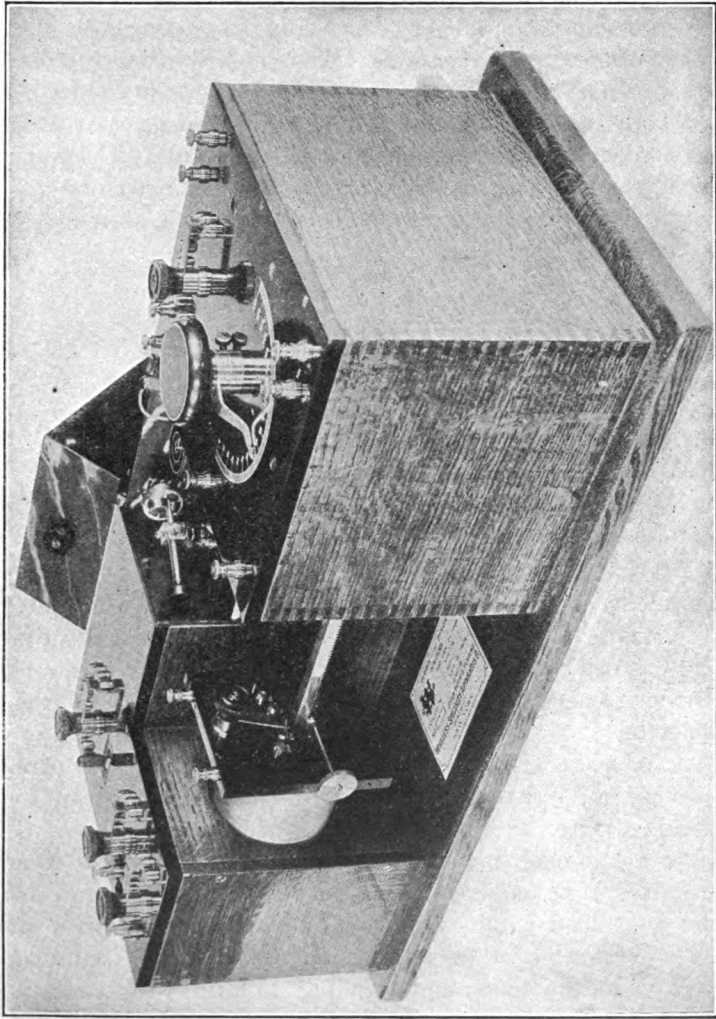

FIG. 63.—Complete receiving set, consisting of two "Perikon" detectors, potentiometer, loose coupler, variable condenser, etc.

from the distant transmitting station. These currents are exceedingly feeble, too feeble in fact to operate any form of electrical apparatus except a telephone receiver, which is one of the most sensitive instruments in existence.

There are probably more different forms of detector than any other piece of radiotelegraph apparatus. Those in most common use to-day are the mineral detectors. A small crystal of certain minerals, iron pyrites, silicon, ga-

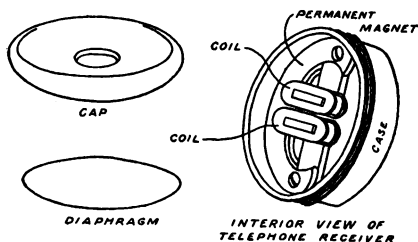

FIG. 64.—Showing construction of a "watch case" telephone receiver.

lena, etc., is placed between two contact points which are adjustable so that the pressure may be regulated and the most sensitive portion of the mineral selected. A telephone receiver is shunted across the terminals of the detector.

A telephone is shown in diagram in Fig. 64. It consists of a U shaped permanent magnet of bar steel, so mounted as to exert a polarizing influence upon a pair of little electromagnets, before the poles of which an iron diaphragm is mounted. For convenience these elements are assembled within a small cylindrical casing usually of hard rubber. The permanent magnet exerts a continual pull upon the diaphragm tending to distort it, concave inwards. When alternating currents are sent through the receiver coils, that part of the alternation which is flowing

in the proper direction to form a magnetic field flowing in the same direction as that of the permanent magnet will strengthen the latter and assist it in attracting the diaphragm and causing it to further approach the magnet. That portion of the current flowing in the opposite direction detracts from the magnetic pull and allows the di-

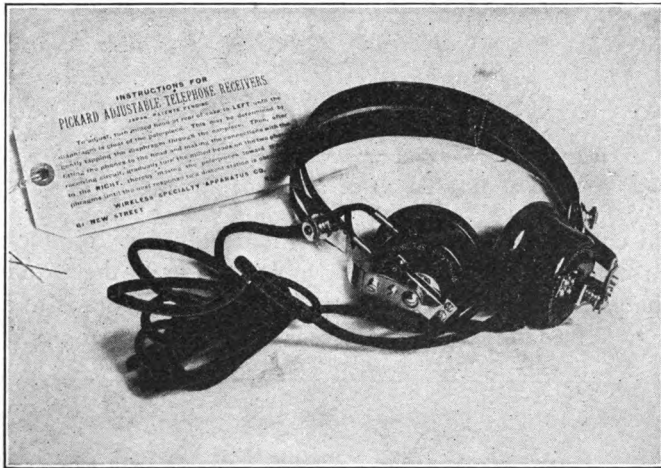

FIG. 65.—Pickard adjustable telephone receivers for wireless purposes.

aphragm to recede from the magnet. The diaphragm thus takes up a vibrating motion corresponding to the electrical waves supplied to the coil and it imparts motion to the surrounding air, the result being *sound*.

It might reasonably be asked why a telephone receiver could not be directly connected to the aerial and ground so that it would respond directly to the high frequency currents generated by the incoming waves without the medium of a detector. There are two very good reasons why such a method would not be possible, the first being that

the little magnet coils contained in the telephone receivers exert a choking action upon alternating currents of *high frequency* which effectually blocks their passage. Low frequency alternating currents, intermittent direct currents

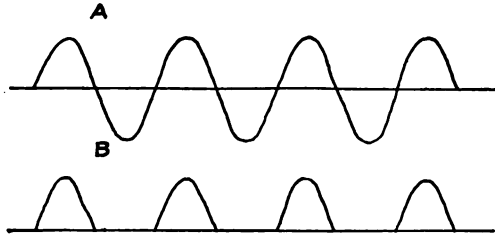

FIG. 66.—Illustrating the valve action of a rectifying detector.

and continuous direct currents will readily pass, producing a sound—each time there is any change in their value. The purpose and action of most types of detectors is to act as a valve allowing the current to pass through in one

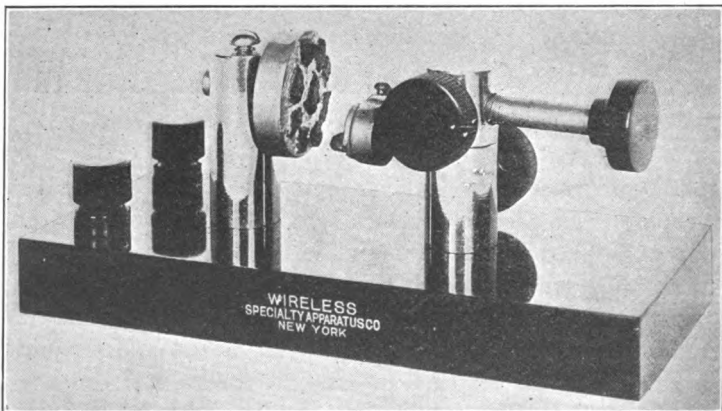

FIG. 67.—A new type of silicon detector in which a crystal of *arsenic* may be brought to bear against the surface of one of several *silicon* crystals.

direction but not permitting it to pass in an opposite one. The high frequency oscillating currents may be represented by a curved line crossing and recrossing a zero line and gradually decreasing in amplitude as shown by A in Fig. 66.

The detector, *acting as a valve*, eliminates one half of the alternating current so that the result may be represented by B, in reality a pulsating direct current which rises and falls but is able to flow through the telephone receiver and produce a motion of the diaphragm with consequent sound waves audible to the ear.

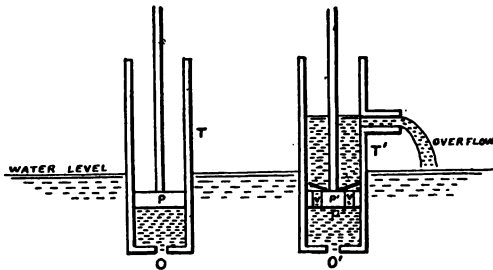

FIG. 68.—Diagram drawing analogy between rectifying action of a detector and a pump.

The accompanying sketches and the following analogy drawn between the electric currents and the flow of a stream of water may serve to render a better conception of how it is possible for the *valve action* of a detector to rectify an alternating flow, continuously reversing its direction to an intermittent current passing in one direction only. The illustration shows two pumps A and B. Each pump is immersed in a pool of water and consists of a cylindrical tube T and T' having a small opening, O and O', at the lower end to admit the water and a piston, P and P', operating up and down inside the tube. Every time

that the piston P is raised in the pump A it will draw in water through the small hole O. As soon as it descends, however, the water will reverse its direction and pass out. The action of the water represents that of an *alternating* current because it passes in first one direction and then in the other. The pump B is *fitted with a valve* whose action is to permit the water to flow in one direction only. The

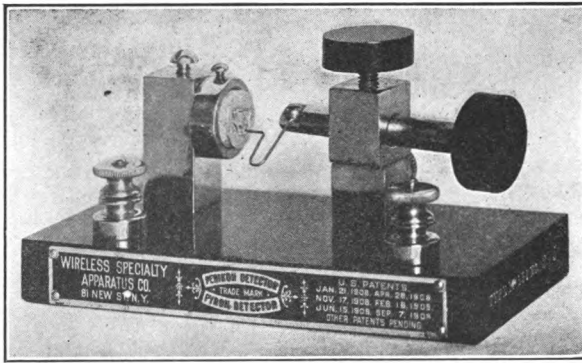

FIG. 69.—Pyron detector in which a fine wire is brought to bear against a crystal of iron pyrites.

valve is fitted to the piston P'. It is a little flap which opens a hole in the piston when the latter is descending and closes when it is rising. Suppose that the piston is raised. Water will be drawn in through the little hole O'. As soon as the piston reaches the limit of the stroke it commences to descend. In falling it exerts a slight pressure on the valve which opens and allows the water to pass through. The hole in the piston is larger than the hole in the pump and so there is almost none of the water forced back into the pool. The next up stroke of the piston draws more water in, that which is on top flowing out through the overflow. The nature of the stream passing through

the hole O' is *intermittent*, passing principally in *one* direction. It may be likened to the intermittent direct current produced by the detector.

Some of the many forms of detectors are interesting because of the ingenious manner in which equivalent re-

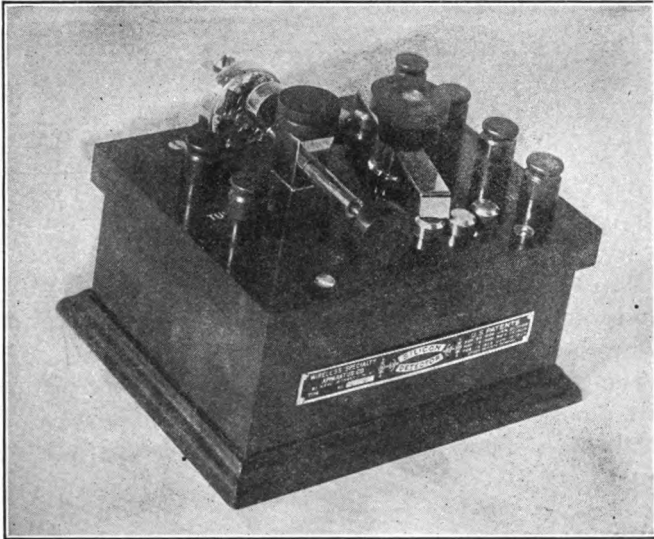

FIG. 70.—Perikon detector.

sults are attained. The illustration shows a type of detector known as the "Perikon." Two minerals, *zincite* (oxide of zinc) and *chalcopyrites* (copper-iron sulphide), are mounted in adjustable cups so arranged that the surfaces of the minerals can be brought into variable contact with one another.

Another very good rectifying detector is that consisting of a flat surface of highly polished silicon mounted in a

small cup. A flat brass point mounted on the end of an adjustable thumbscrew is brought to bear on the silicon.

Other mineral detectors of value are the Pyron, molybdenite and galena.

The carborundum detector is a form of crystal rectifier

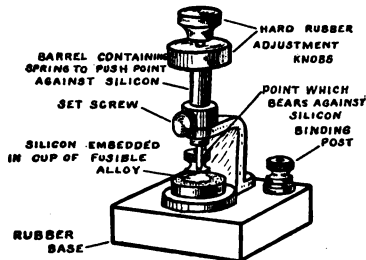

FIG. 71.—Silicon detector.

consisting of a fragment of carborundum held between two carbon blocks.

The electrolytic detector consists of a very fine platinum wire (.001-.0003 of an inch in diameter) dipping into a small cup of dilute nitric acid. A large platinum electrode

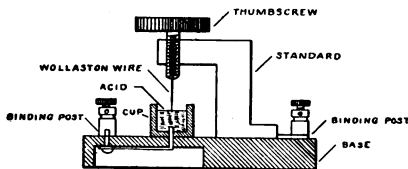

FIG. 72.—Electrolytic detector.

is sealed in the bottom of the cup so as to make an electrical connection with the liquid. This form of detector is exceedingly sensitive, probably more so than any other. The electrolytic detector requires a battery. When a slight current passes through the circuit, very minute bubbles are

formed at the wire, insulating it from the liquid and thus shutting off the battery current from the telephone receivers. However, upon the arrival of any electric waves

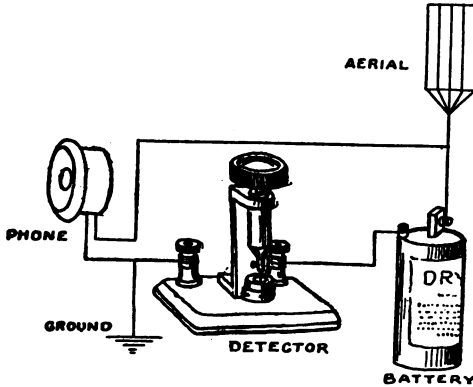

FIG. 73.—Electrolytic detector in circuit.

and consequent high frequency oscillations the latter destroy the bubbles clustering around the little wire and permit the current to flow. Upon the cessation of the high

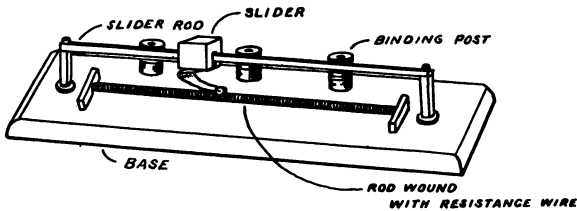

FIG. 74.—Potentiometer.

frequency currents the bubbles immediately form again, only to become broken down by each train of oscillations produced in the aerial. The intermittent currents can be detected by a buzz in the telephone receivers.

The carborundum detector also requires a battery although its action is somewhat different from that just described.

When a battery is used in connection with a detector, an instrument known as a potentiometer becomes necessary. A potentiometer is simply a device for accurately adjusting the voltage of a battery to a value where it will render the detector the most responsive to the incoming signals.

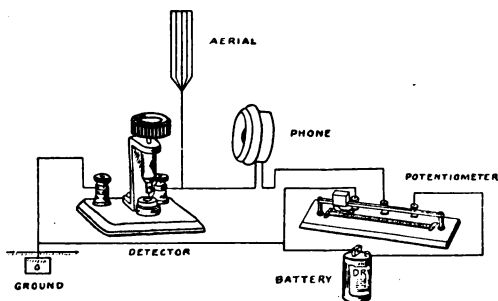

FIG. 75.—Diagram showing how potentiometer is connected in circuit.

The Tuning Coil is a device for accurately adjusting the oscillation circuits to receive the waves.

Its action may be illustrated to a certain extent by pressing down the loud pedal of a piano and at the same time whistling a note loudly and clearly. Listen carefully and some of the wires in the piano will be heard sounding the note whistled. At each vibration of the note of the whistle a wave of pressure went forth from the lips and reaching the wires gave them all a tiny impulse. The impulses followed each other rapidly at definite intervals giving each of the wires the same push each time. The wires which are tuned to produce the note on the piano corresponding to that of the whistle will vibrate energetically enough to

produce a sound themselves. They are the wires to which the impulses are rightly tuned so that each one adds to the motion it has already acquired. We all know how a child sitting in a swing may be made to swing back and forth by giving a succession of little impulses properly timed. The small pushes are superimposed on one another, the result being a single large motion.



FIG. 76.—Analogy between swinging and tuning.

The “impulses” generated in the receiving aerial are exceedingly weak and in order to produce an effect must be timed so as to follow one another in proper succession. Tuning devices are for this purpose and by their means the receiving circuits and instruments may be carefully adjusted to the same wave length or “note” as the transmitter so that the high frequency currents in the aerial will arrive at the proper time to oscillate or surge back and forth to produce the maximum results. a

In this way it is possible to convey intelligence over long distances by the repetition of small impulses without it

being necessary to send any very energetic ones. By arranging the stations so that each one emits its own definite wave different in period or *length* from that of the others it is possible to operate several stations at the same time in

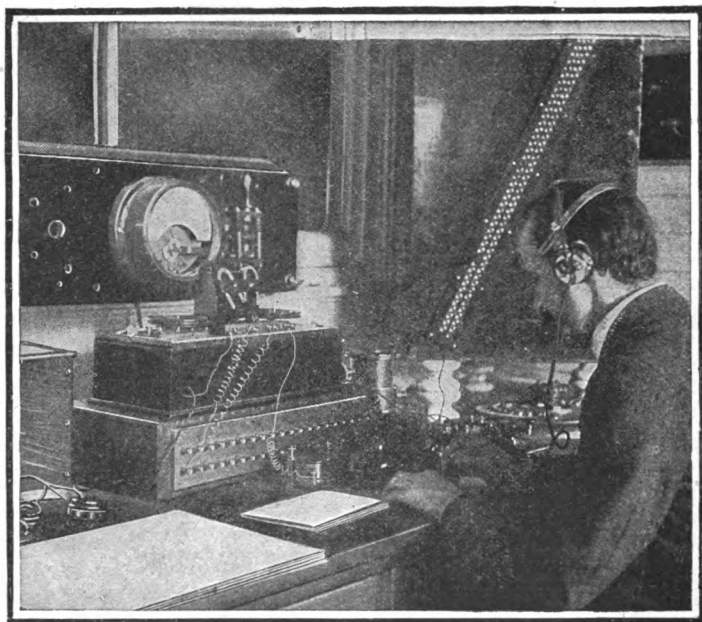

FIG. 77.—Receiving a message in a Marconi transatlantic station.

the same neighborhood without interfering with one another. The apparatus is then said to be *selective* because the instruments can be adjusted in a few seconds to receive from any desired station and to exclude others.

The tuning coil consists of a cylinder wound with bare copper wire spaced so that the turns do not touch one another. Variable contacts called "sliders" are so ar-

ranged that connection can be made almost instantly to any desirable turn of wire. The tuning coil is connected to the aerial and receiving apparatus in the manner illus-

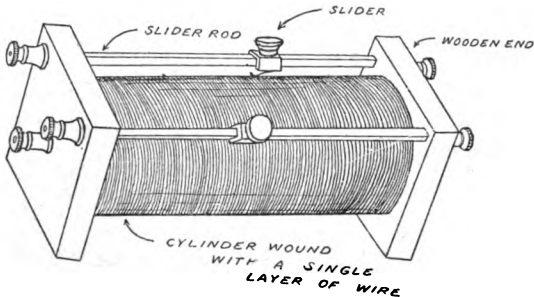

FIG. 78.—Tuning coil of the double slide type.

trated in Fig. 79. By moving the sliders back and forth the wave length of the system may be added to or detracted from and any desired "tune" quickly reached so that it is

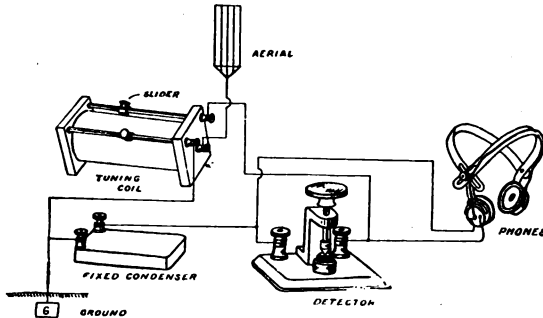

FIG. 79.—Diagram showing fixed condenser in circuit.

possible to listen to any station desirable and exclude the others. The cylinder over which the wire is wound usually consists of a thick cardboard tube treated so as

to be moisture proof. Bare wire is preferable to all forms of insulated wire. The coil is usually three to four inches in diameter and eight to twelve inches long.

Tuning coils are known as "single slide," "double slide" and "three slide" according to the number of contacts they are fitted with.

The loading coil is a supplementary tuning coil used to furnish extra inductance in case it is desirable to obtain a greater range of resonance or tuning.

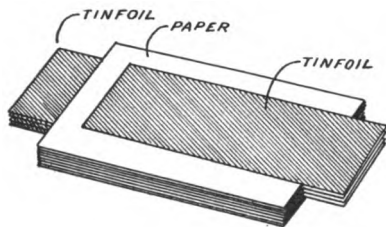

FIG. 80.—Fixed condenser.

It is merely a single slide tuning coil connected in series with the regular tuning device. It is not always a necessity but is often part of the equipment when it may be necessary to adjust the apparatus to receive long wave lengths.

Condensers are devices for collecting and storing electricity. They play a very important part in both the transmitting and receiving operations. Condensers and Leyden jars have already been described in connection with the transmitting apparatus.

The condensers used in receiving are very much smaller in size and *capacity* but are the same in principle. There are two general types of receiving condensers called "fixed" and "variable" accordingly as the capacity is alterable or not.

Fixed condensers consist of a few sheets of tinfoil interposed between sheets of paraffined paper or in some cases mica. The condenser is inclosed in a suitable case, usually a hollow molded block of insulating composition, and is provided with suitable terminals to facilitate connection.

When a conductor is charged with electricity it has the power of exerting an opposite charge in any adjacent con-

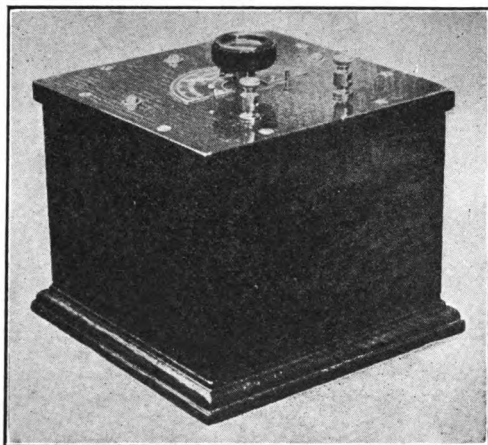

FIG. 81.—Rotary variable condenser.

ductors. The two halves of a condenser constitute adjacent conductors, the separating medium in between being called the dielectric. An alternating current will pass through a condenser because the charge on the plates keeps changing from negative to positive and back from positive to negative again. A direct current will not pass through a condenser.

These facts are utilized to considerable advantage in the receptor of a wireless station. As has already been explained, the high frequency oscillatory currents will not

readily pass through the coils of the telephone receivers, but a path is provided through the condenser. The detector rectifies the alternating current into a direct current which the condenser opposes and forces to pass through the telephone receiver and produce sounds.

When a battery is used in connection with a detector a condenser is also necessary to oppose the direct current of

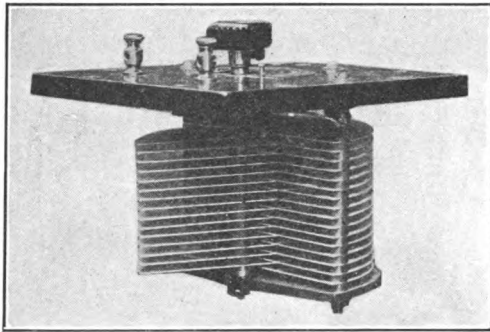

FIG. 82.—Interior of rotary variable condenser showing construction.

the battery and prevent it from flowing around through the tuning coil instead of through the detector. The capacity of the condenser may be smaller if the resistance of the telephone receiver is very great for the reason that as the wire grows smaller it offers greater impedance to the current. The opposite also holds true and condensers of large capacity are better fitted for use with telephone receivers of low resistance.

Variable condensers are divided into two general types, the "rotary" and the "sliding" plate, accordingly as the plates forming the condenser are adjusted with a rotary or a sliding motion. The rotary type consists of a number of movable semi-circular aluminum plates which swing

between a series of fixed semi-circular plates of a slightly larger diameter. The plates must not touch one another and move back and forth with perfect freedom. The *dielectric* is formed by the air spacing between the plates.

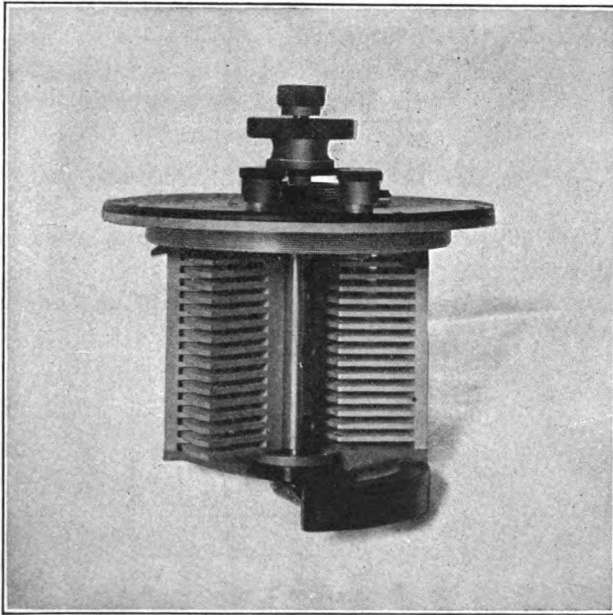

FIG. 83.—Dr. Seibt's rotary variable condenser. The plates are turned from a solid casting and the separation between is only .01 inch.

The advantage of an air dielectric is that no losses of energy take place through *hysteresis*. Hysteresis is the *lagging* which takes place in the process of charging and discharging. A thumb knob is fitted to the movable plates and provided with a pointer moving over a graduated scale so that the degree of capacity in use is indicated.

In the sliding plate type of variable condenser the plates are either square or rectangular in shape and move back

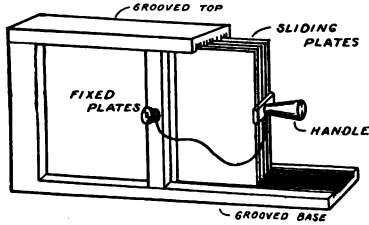

FIG. 84.—Sliding plate variable condenser.

and forth in grooves cut in a hardwood frame as shown in the illustration.

Variable condensers are used for tuning and adjusting

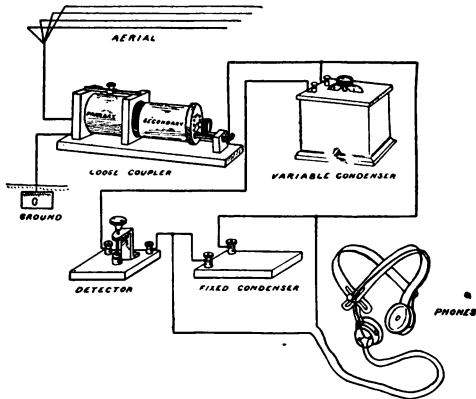

FIG. 85.—Diagram showing arrangement of rotary variable condenser in receiving circuit.

the receiving circuit in the same way that a tuning coil is employed, namely to increase or decrease the electrical length of the circuit so that it will respond to different

wave lengths. The condensers are capable of finer adjustment than tuning coils because the change is gradual and even and is not in jumps from one step to another as from one turn to the next turn of the coil. If the desired point of resonance should happen to come between two wires of the coil and not in a position to be reached by the slider, the variable condenser can be adjusted to reach the exact degree of resonance and thus bring the circuit into finer adjustment than would otherwise be possible. The exact way in which this is accomplished and the effect upon the circuit will be left to the next chapter.

CHAPTER V.

TUNING AND COUPLING, DIRECTIVE WAVE TELEGRAPHY.

Tuning has been mentioned in several places but not explained in any greater measure than was necessary to render a conception which would enable the reader to follow the text intelligently in order not to depart from the subjects under discussion there and consequently defeat the purpose of clearness.

The great importance and value of properly "tuning" the circuit of radiotelegraphic apparatus cannot be over-estimated and for that reason the subject can hardly be passed without some further explanation. Its effects are two-fold. In the first place it is always desirable and highly important that wireless messages should be, so far as is possible, *selective*, inasmuch as there are often several stations in the same immediate neighborhood operating at the same time. This result is reached by tuning and it is possible for them all to transmit different messages at the same time without confusion by the proper arrangement of the *wave length*. The second effect is the transmission of messages over long distances with the comparative consumption of small amount of power by adjusting the "period" or electrical length of the circuits until the oscillations "flow in harmony" with each other and resonance is secured.

Perhaps the only way that these results may be made clearly intelligible is by resort to a graphical example. Suppose that a very heavy weight were suspended from a

chain as shown in the illustration and that it is struck at regular intervals, *once every second*, with a hammer. Every time that the hammer strikes the ball it will give it an impulse and cause it to swing slightly. If the chain is short, the ball will swing faster, while if it is long it will swing more slowly. We will suppose that the

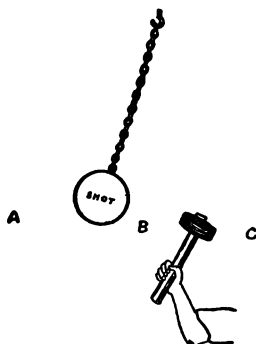

FIG. 86.—Chain and ball arranged to illustrate effect of tuning.

ball is struck from such a direction that it starts to swing over toward A. The ball is so heavy and the hammer so light in comparison however that the ball does not swing very far and soon commences a return journey. If it should return to the point B just as the hammer delivers another blow the force of the blow will be expended in stopping the ball rather than adding to its motion because they are both traveling in *opposite* directions. However if the chain is lengthened so that it has a period of swing lasting one second, the succeeding blow will strike the ball after it has reached the point C and is on its return journey, thus imparting fresh energy because both the ball and hammer *come together at the right time* when they are both swinging together. Proper adjustment of the length of the chain will make it possible for the hammer to always

descend at the right moment to add its energy and motion to that previously given the ball. The result will be considerable increase in the amplitude of the swing.

From this we may easily perceive how it is possible by shortening or lengthening the period of an electrical circuit to so adjust it that resonance is secured and each succeeding oscillation will take place at the proper time to assist the

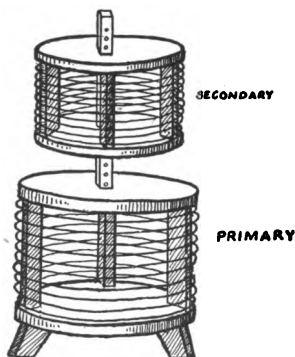

FIG. 87.—Loose coupled helix.

previous one, not dying away after one or two surges and becoming what is known in technical language as rapidly “damped.”

The instruments for accomplishing these things consist as previously explained, in the case of a transmitter, of the *helix* and in the receiving station of various *tuning coils* and condensers.

Helix and tuning coils are divided into the “inductive” or “loose” and the “direct” or close coupled types. Inductive tuning coils are known as “loose-couplers” and “receiving transformers.” Inductive helixes consist simply of two helixes, separated from one another as shown in the accompanying illustration. The upper helix, called the

secondary, can be raised or lowered upon a central support. Varying the distance between the primary and secondary is varying the "coupling." There are several advantages



FIG. 88.—Hot-wire ammeter.

derived by using loose coupled sending helices, the chief of which lie in the fact that it is possible to radiate larger amounts of energy and also decrease the "damping."

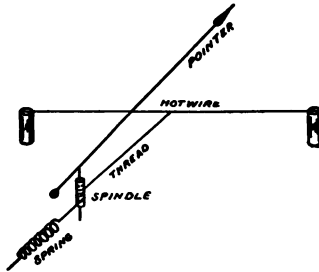

FIG. 89.—The principle of the hot-wire ammeter.

In order to tune a transmitter, the "hot-wire" ammeter is necessary. This instrument makes use of the property which electrical conductors possess to become heated and expand when a current is passed through them.

The accompanying diagram serves to illustrate the principle of the "hot-wire" meter. A piece of platinum wire is stretched tightly between two rigidly fixed posts. A thread leads from the center of the "hot wire" to a small spindle around which it passes once or twice. The spindle is also connected to a spring which exerts a continual tendency to turn the spindle but is prevented from so doing by the

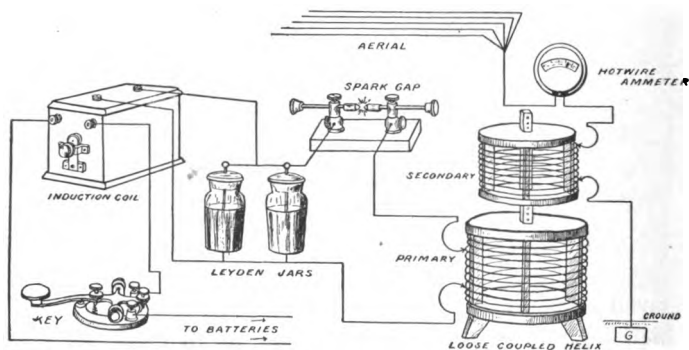

FIG. 90.—Diagram showing loose coupled helix in circuit.

thread attaching to the hot wire. Any tendency on the part of the string to slacken a little, however, will immediately permit the spring to turn the spindle. When a high frequency current is passed through the platinum wire it becomes heated and expands. The expansion of the wire allows the thread to slacken slightly with the immediate result that the spindle turns. The spindle carries a pointer at the upper end which shows the amount of turning. It is therefore easy to tell the comparative strength of current flowing accordingly as the deflection is great or small.

The meter is placed in series with the aerial and when the high frequency currents pass through it they heat and

expand a fine wire, causing the needle to move over a graduated scale and indicate the amount of current passing. The apparatus is "tuned" or in resonance when the

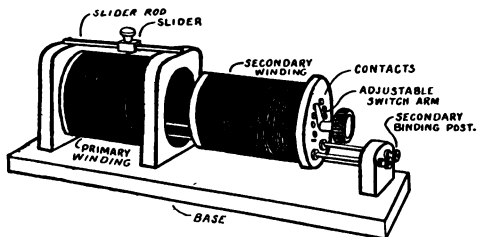

FIG. 91.—Loose coupled tuning coil.

length of the spark gap, the condenser and the helix have been so adjusted that the oscillations flow freely through the system and the maximum amount of current is indicated by the ammeter.

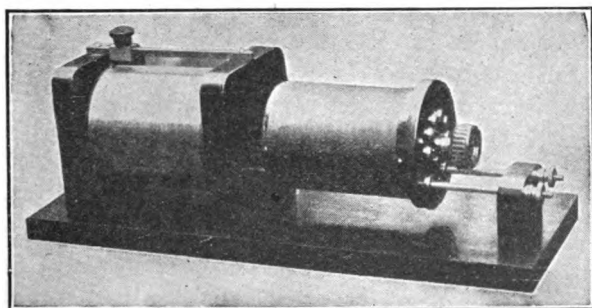

FIG. 92.—Loose coupled tuner.

The loose coupled tuning coil consists of two windings wound over two concentric cylinders, forming a primary and a secondary. The secondary is the smaller winding and slides in and out of the primary so that the "coupling"

is variable. The primary is adjustable by means of a slider and the secondary by means of a multi-pointed switch. The slider is usually connected to the aerial and one end of the coil to the ground. The detector, etc., are connected to the terminals of the secondary. Variable condensers may be added with good results to both the primary and secondary circuits.

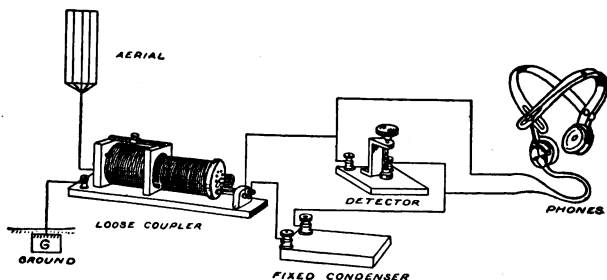

FIG. 93.—Diagram showing position of loose coupler in circuit.

Loose couplers also take the form of doughnut tuners in which the secondary revolves instead of slides. The coupling is variable in such an instrument by simply turning the secondary.

The wave emitted from a transmitter is in reality made up of two waves of different lengths. The variation in the lengths of these two waves is dependable upon a factor known as the coefficient of coupling. It is almost impossible to clearly explain the phenomenon and in order not to confuse and complicate by a rather lengthy explanation it may be well to simply state that its effect is to make selective tuning difficult unless the coupling of the receiving station can be varied to correspond with that of the transmitter and ask the reader to take it for granted. Varying the coupling adjusts the difference in the two

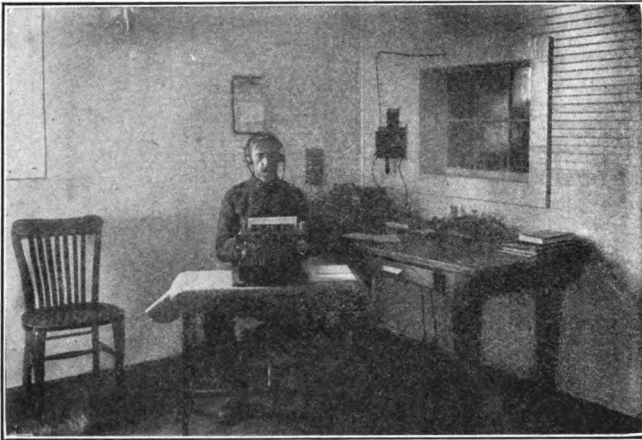

FIG. 94.—Fort Gibbons, Alaska, wireless station.

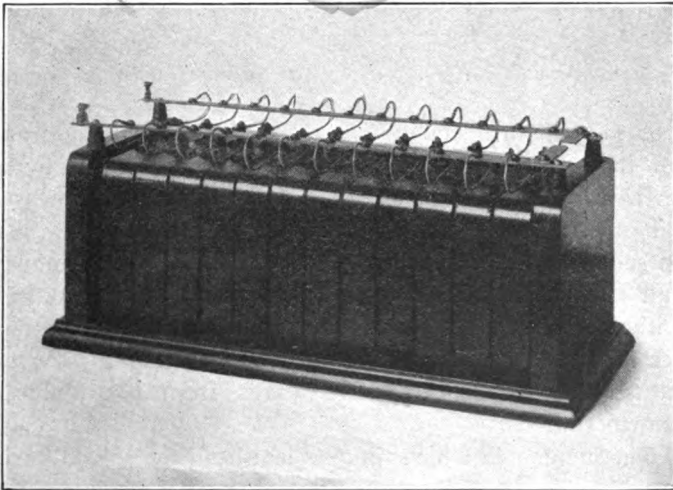

FIG. 95.—Transmitting condenser (molded dielectric).

wave lengths and when properly accomplished renders the apparatus highly selective.

Directive Wireless Telegraphy is an interesting phase of this new art which is receiving considerable attention in the hands of investigators and has resulted in the devisement of several successful systems for confining the propagation of the electric waves to certain directions.

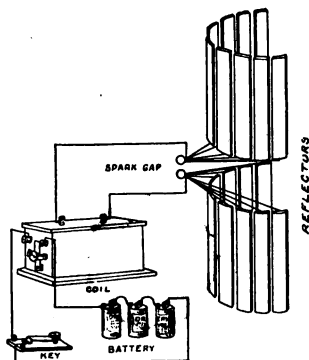

FIG. 96.—Braun's method for directing wireless telegraph signals.

A general diffusion of waves is often very undesirable for the reasons that the message may be received by an unfriendly neighbor or enemy and also because it is wasteful of energy. By so directing the waves that they may be sent over the earth to any desired point of the compass and only in that direction, it is possible to communicate without disturbing another station and also for a vessel at sea to secure its bearings and position by tuning its apparatus to respond to electric waves from two different known stations.

The manner in which the problem has been solved varies considerably according to the inventor. All are interesting and ingenious.

It will be remembered that electric waves possess all the characteristics and properties of light waves, etc., and may be reflected, refracted and polarized.

Ferdinand Braun has devised a system consisting of a number of metallic strips arranged to compose a parabolic surface. Another similar set of strips below the first set



FIG. 97.—Bellini-Tosi radio-goniometer for directive wireless telegraphy.

completes the arrangement. The two sets are connected to the terminals of a spark gap and induction coil. This apparatus acts as a huge reflector and sends out waves in one direction only, but however interesting and ingenious it may be is not entirely practical.

Another method devised by Braun employs two or more aerials at certain distances apart. The alternating currents used to excite the oscillations differ in *phase*, i. e. are

so arranged that they have different comparative values at the same moment. It is possible to send very strong signals in a direction lying in the same plane as the aerials. By the use of three or more antennæ suitably differing in their phase of excitation and situated at the vertices of a

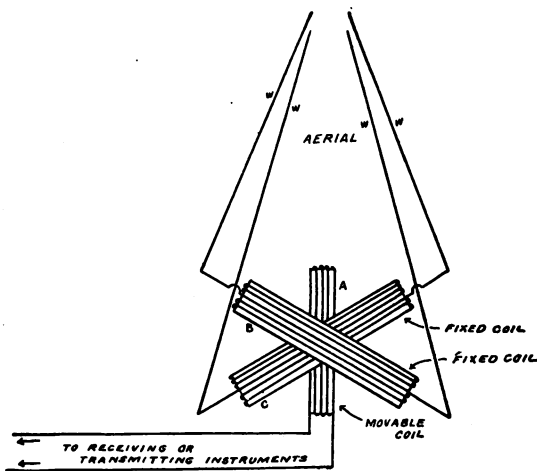

FIG. 98.—Arrangement of Bellini and Tosi for directive wireless telegraphy.

triangle it is possible to send strong signals in certain directions only.

Messrs. Bellini and Tosi have devised a very ingenious method of directly transmitting and receiving electric waves as shown in the accompanying diagrams. The antenna consists of two closed or nearly closed circuits of triangular shape arranged in two perpendicular planes. The two aerials each contain a circular coil of wire perpendicular to each other with their windings in the planes of the antenna circuits respectively. A third coil is connected to the receiving apparatus when the messages are

incoming and to the condenser, spark gap and coil when the signals are to be transmitted.

Waves coming in from any particular direction produce oscillations in the two aerial circuits whose intensity varies according to the direction in which the waves come. These currents passing through the coils generate a magnetic field having a direction perpendicular to that from which the waves come. The strength of the currents in

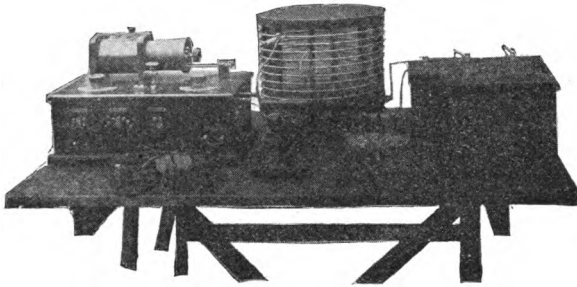

FIG. 99.—Complete receiving and transmitting outfit.

the movable coil will depend upon its position in the resultant magnetic field and will be at a maximum when the coil embraces as many as possible of the lines of magnetic force.

By providing the movable coil with a pointer it is possible to thereby determine the plane in which the station producing the signals lies. Any ambiguity regarding the final position of the station, whether it is located in the same direction indicated by the pointer or in the opposite one, is only removed by general knowledge of the location of existing stations.

The processes involved in sending messages are the reverse of those entering into the receiving apparatus. The movable coil being connected with the condenser, gap and

transformer or induction coil creates a magnetic field which induces oscillating currents in the other two coils and consequent waves in the aerial whose strongest exertions will lie in a plane determined by the third coil. Changing the position of the latter will send the messages in any direction desired.

CHAPTER VI.

THE DIGNITY OF WIRELESS. ITS APPLICATIONS AND SERVICE.
WIRELESS IN THE ARMY AND NAVY. WIRELESS ON
AN AEROPLANE. HOW A MESSAGE IS SENT
AND RECEIVED.

Wireless telegraphy and that precocious infant, wireless telephony, have outlived all the speculative and tentative achievements of their early days and have established themselves in an important and settled position among our methods of conveying intelligence.

The field has been so greatly enlarged in recent years and the apparatus and methods so improved that the broadest possible view of its future development and importance

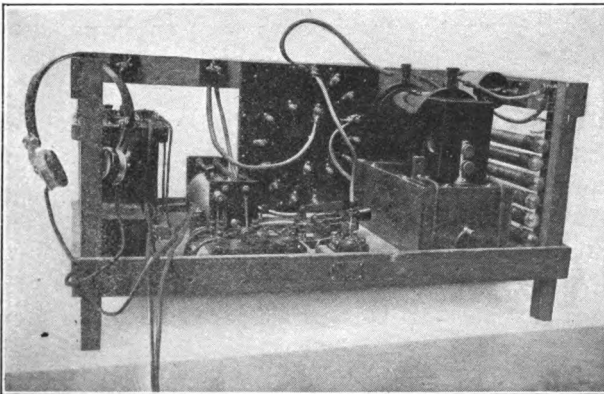

FIG. 100.—Special light weight wireless telegraph set for airship service.

is justified. And there must inevitably come the time when our merchant marine and wireless service will come under such reasonable regulation that it will be removed from any dependence upon stock jobbing wireless telegraph and telephone companies.

Official sources show that the equipping of sea-going



FIG. 101.—Telefunken wireless cart, showing transmitter.

vessels with wireless apparatus is progressing at a rapid rate and it is not difficult in the face of certain facts to appreciate the enormous volume of business that sooner or later will be handled by wireless. Three hundred and sixty-three United States naval vessels and about eight hundred merchant vessels are equipped at this writing. The large number of commercial shore stations, army forts and posts, and those used by corporations, isolated stations, etc., for various private purposes comprise a list which reaches an enormous total.

Whatever may have been the status of wireless previous

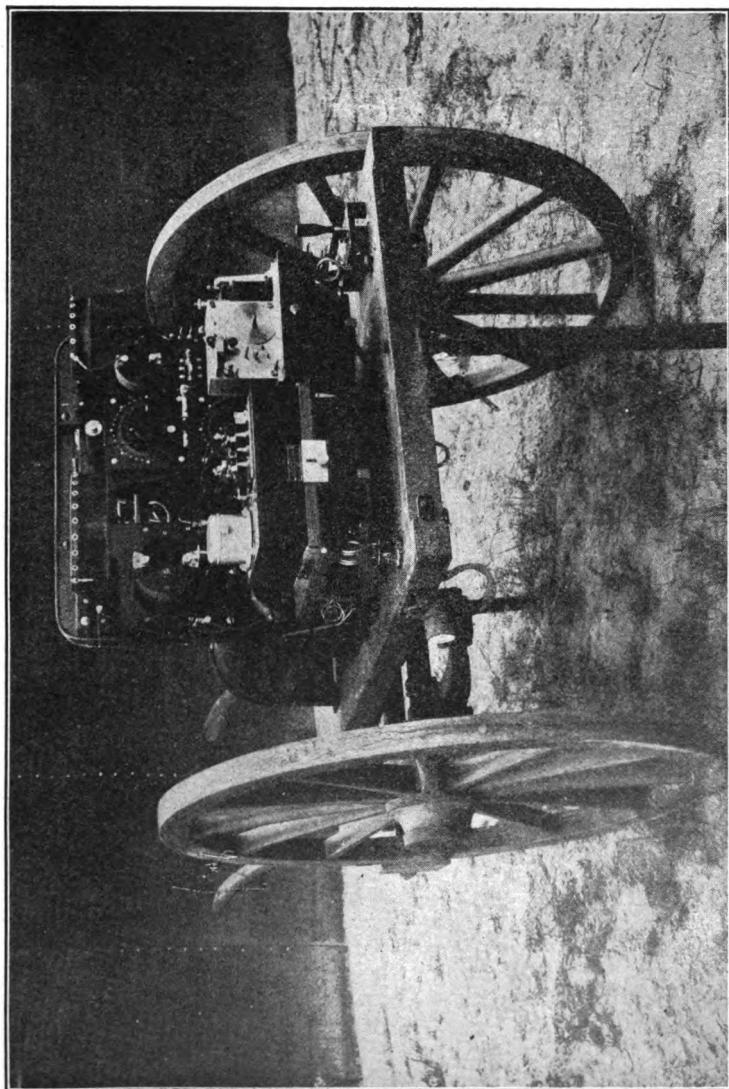

FIG. 102.—Telefunken wireless cart for military service, showing receiving apparatus.

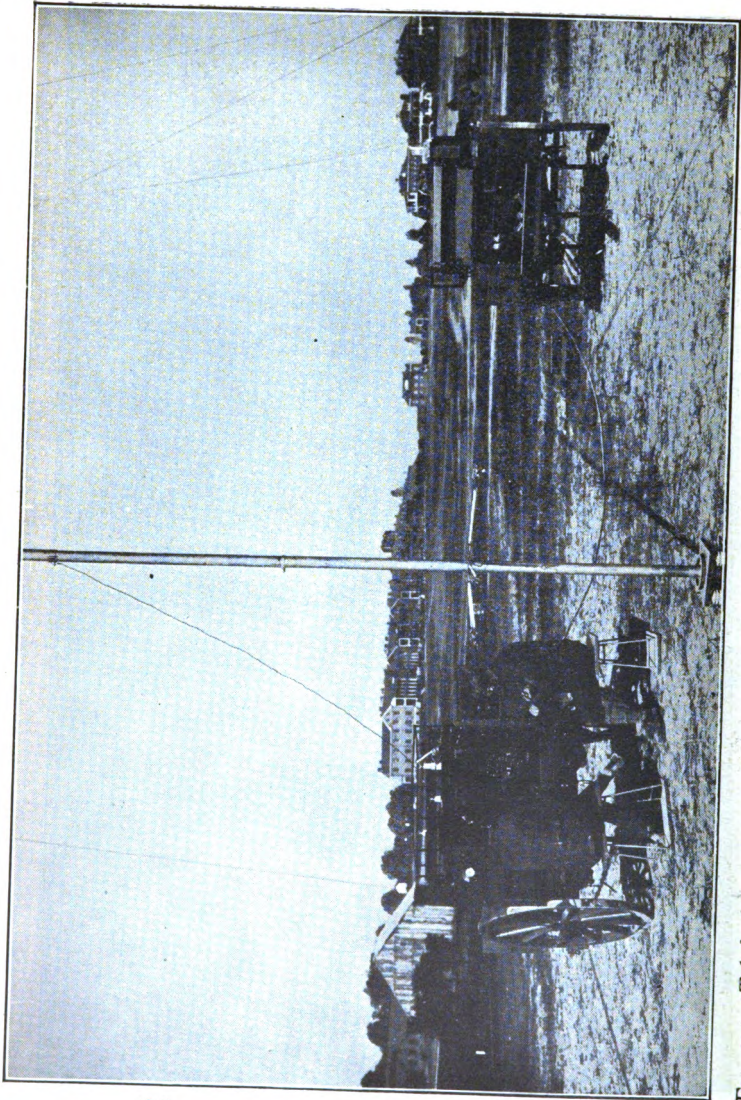

Fig. 103.—Telefunken wireless wagon set in operation at Fort Leavenworth, Kansas. The aerial is of the umbrella type supported by a steel pole resting on a porcelain base.

to the Titanic disaster, it now occupies a position far more important than that taken merely from any commercial standpoint, for it is no longer merely a convenience to business or a means of furnishing the latest news for the entertainment of passengers, but is a life-saving proposition taking its place with the elaborate and costly systems of railroad signals.

It is a curious fact that many of the most startling and newest inventions find ready and peculiar application as an aid in modern warfare. The nerves of every war vessel and fort are the wires of the telephones, telegraphs, telautographs, dynamos, storage batteries etc., that transmit orders by speech or in writing, find the range, fire the guns, explode the mines and seek out the enemy with a powerful searchlight.

Every battle-ship, cruiser, etc., of the United States Navy is now equipped and with the completion of the new ultra-powerful station at Washington the War Department will be enabled to issue instructions to a ship no matter where it may be on the ocean or in what harbor it may lie.

The government maintains an elaborate equipment at the Brooklyn Navy Yard where the future wireless operators of the Navy are given a course extending from seven to ten weeks. The first few days are spent in mastering the theory. The second week usually commences alternate study and practice of the Continental Code which lasts throughout the entire course or until thoroughly mastered. Each week some special branch of study is given out such as repairing and overhauling certain instruments. At the end of seven weeks the student can usually send and receive 15 words a minute. He is then given two weeks to prepare for an examination which if passed rates him as an electrician, third class, and qualifies him for active work.

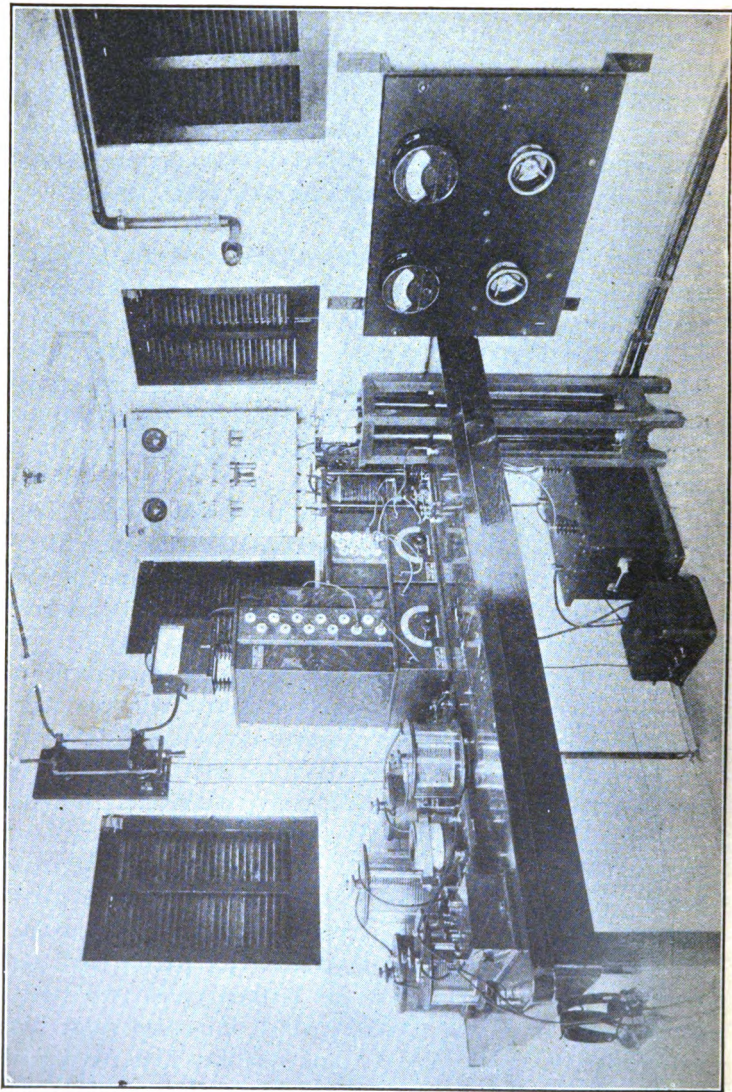

FIG. 104.—Wireless room aboard the U. S. transport "Buford."

It is certain that wireless telegraphy and telephony will be important factors in military campaigns of the future. For coast defense, wireless is as valuable as on the ocean.

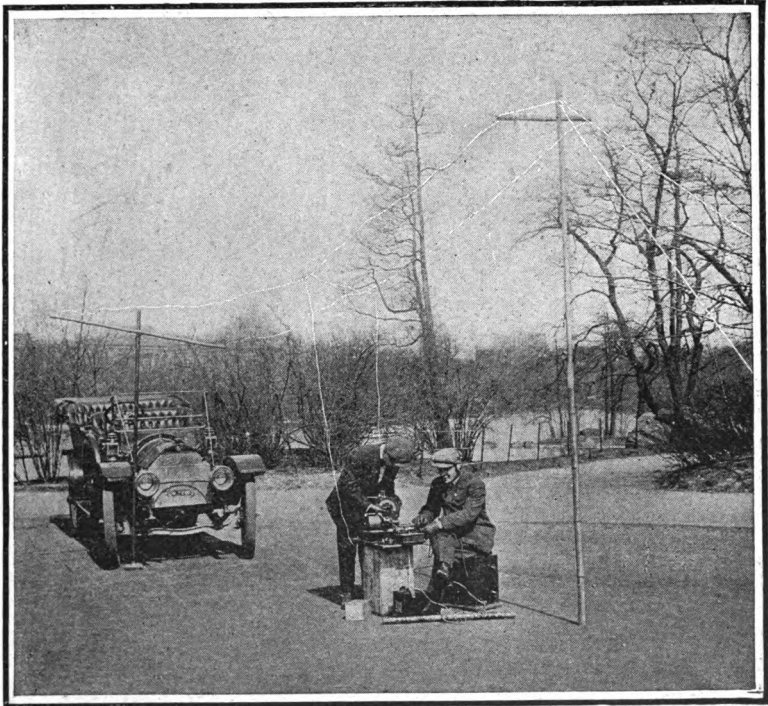

FIG. 105.—The apparatus set up for operation.

This method of transmitting army orders is quite dependable. With the most recent developments and improvements it is now possible to direct the movements of a great army and navy simultaneously from a centrally located point.

One of the most interesting and spectacular applications

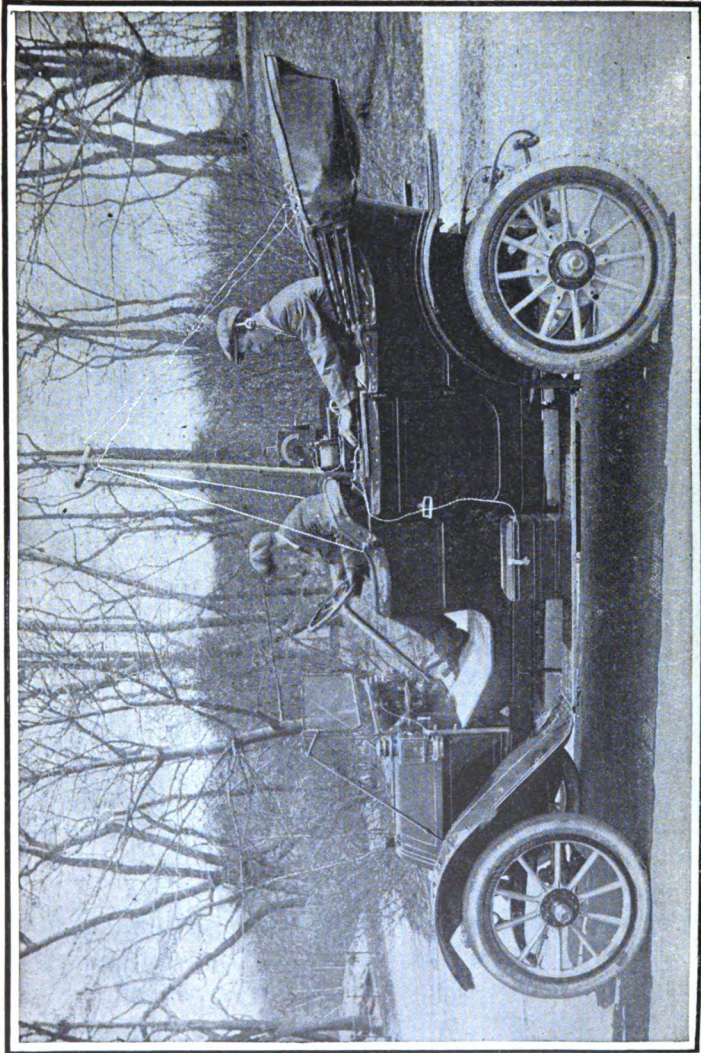

FIG. 106.—Wireless equipped automobile.

of wireless telegraphy in military service is the wireless telegraph automobile.

The automobile is a stock pattern touring car of 30 H. P. provided with a special body arranged to carry six passengers. The seats are elevated so as to afford storage space below for the entire wireless equipment and a truly astonishing amount of miscellaneous supplies.



FIG. 107.—Company D Signal Corps at San Antonio, Texas, 1911, showing pack sets and telescoping pole carried by pack mules.

The mast used to elevate the aerial is of light steel construction divided into eight sections which nest into one another with admirable economy of space. The socket for the foot of the mast is located in the center of the tonneau. Only a few minutes are required to raise the mast and aerial. The same gasoline motor employed to drive the automobile also drives a small dynamo which supplies the electric current for the transmitting apparatus.

Two of these cars have been experimentally operated over a number of the old battle-fields of the Civil War.

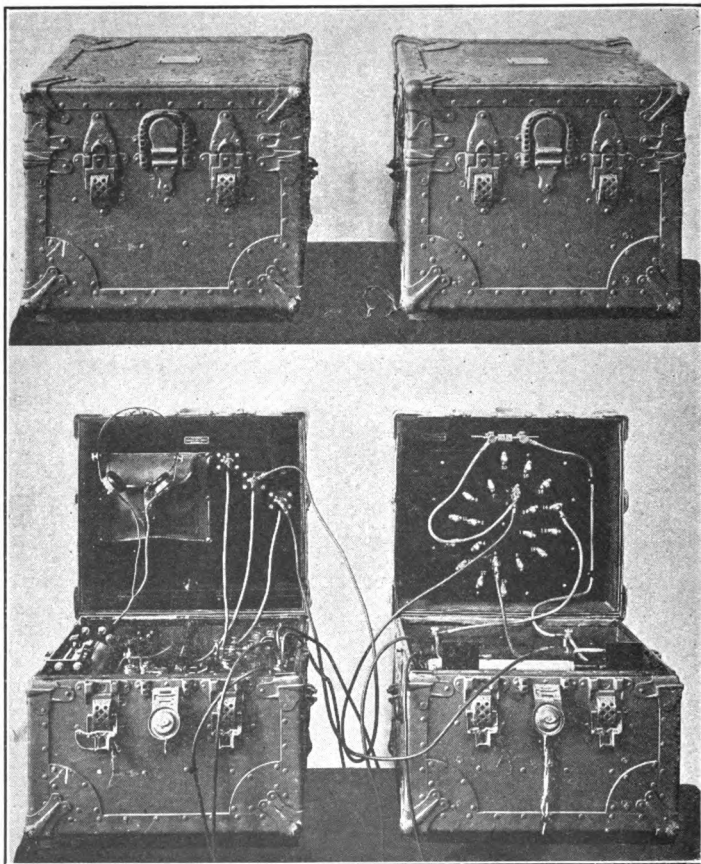

FIG. 108.—U. S. Signal Corps pack sets shown open and closed. Receiving apparatus on the left.

The tests were made under all sorts of road and weather conditions but no great difficulty was experienced in establishing communication over distances varying from 35 to 50 miles.

There is probably no application of wireless telegraphy, however, quite as picturesque as the combination of wireless and an aeroplane and the idea of a double seated aeroplane carrying an aviator and a wireless operator hovering over a hostile country to keep the commanding

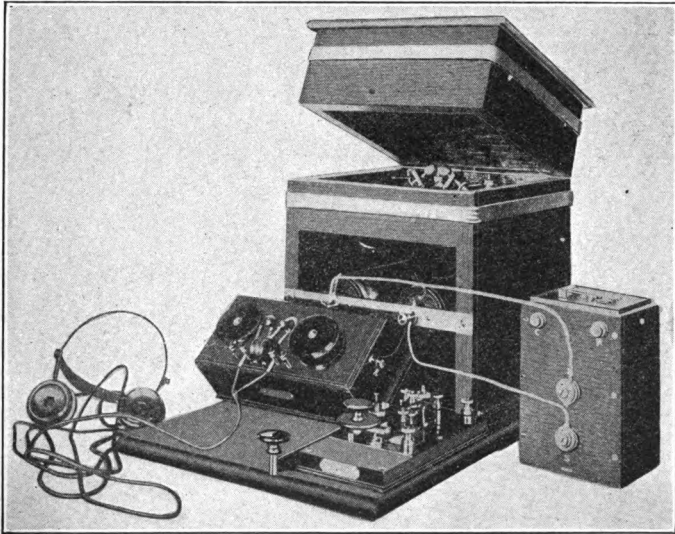

FIG. 109.—The receiving apparatus of the airship "America" (Wellman expedition).

officer informed of all conditions and movements of the enemy.

The huge dirigible balloon Akron in which Melville Vaniman proposed to cross the Atlantic Ocean was fitted with wireless equipment in order to transmit news of the expedition en route to various of the daily newspapers of New York and London and also in case of an accident or emergency to summon aid.

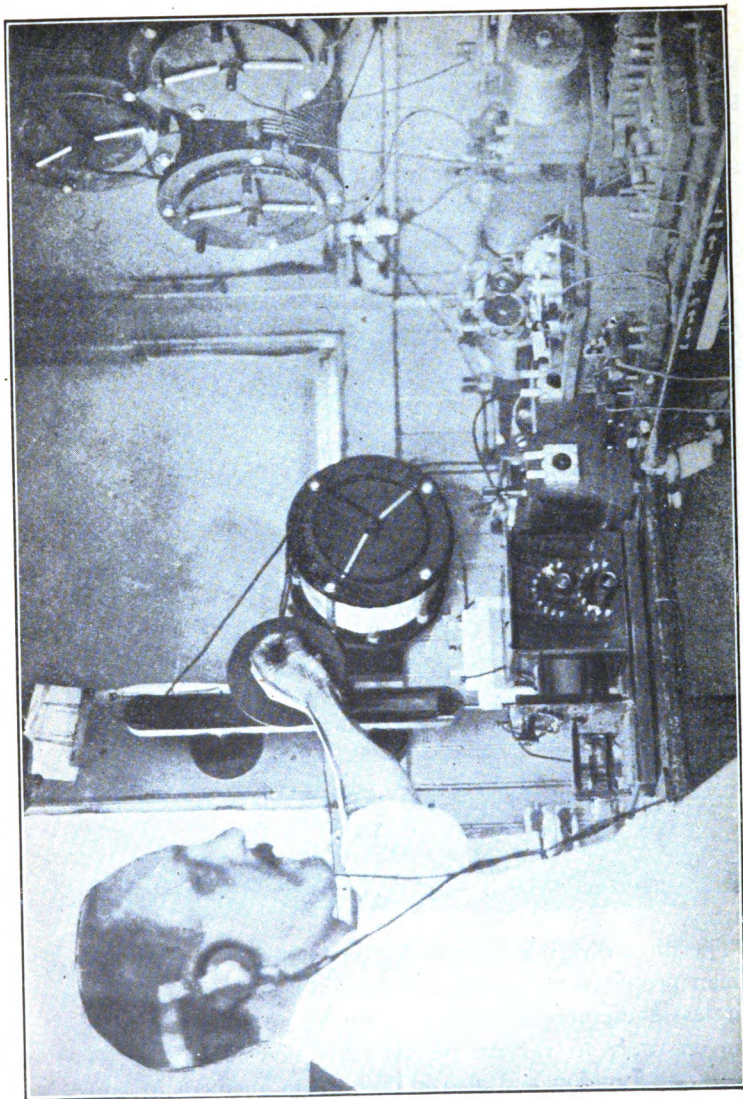

FIG. 110.—Interior of the N. Y. "Herald" (O. H. X.) press station.

The equipment is interesting because of the peculiar conditions imposed upon instruments to be used under such circumstances. A three kilowatt transformer, the latest type of musical rotary gap and a valve detector were included in the outfit. It was proposed to obtain the necessary ground connection by trailing a 1200 foot phosphor

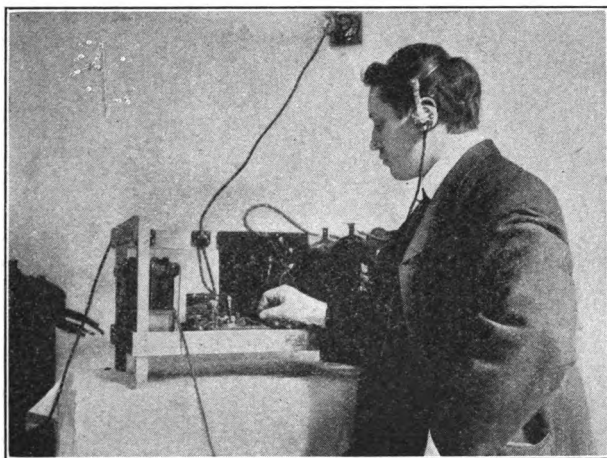

FIG. III.—Operating the U. S. Signal Corps airship wireless apparatus.

bronze ground lead in the ocean. The frame of the balloon was to be used as the aerial. Should it have become necessary to take the lifeboat which the balloon carried, a kite would have been raised and by substituting a copper wire in lieu of a string an aerial provided, and once more a C Q D and its appeal for aid would have gone vibrating forth through the ether.

Several enterprising newspapers have recognized the value of wireless telegraphy in collecting shipping news

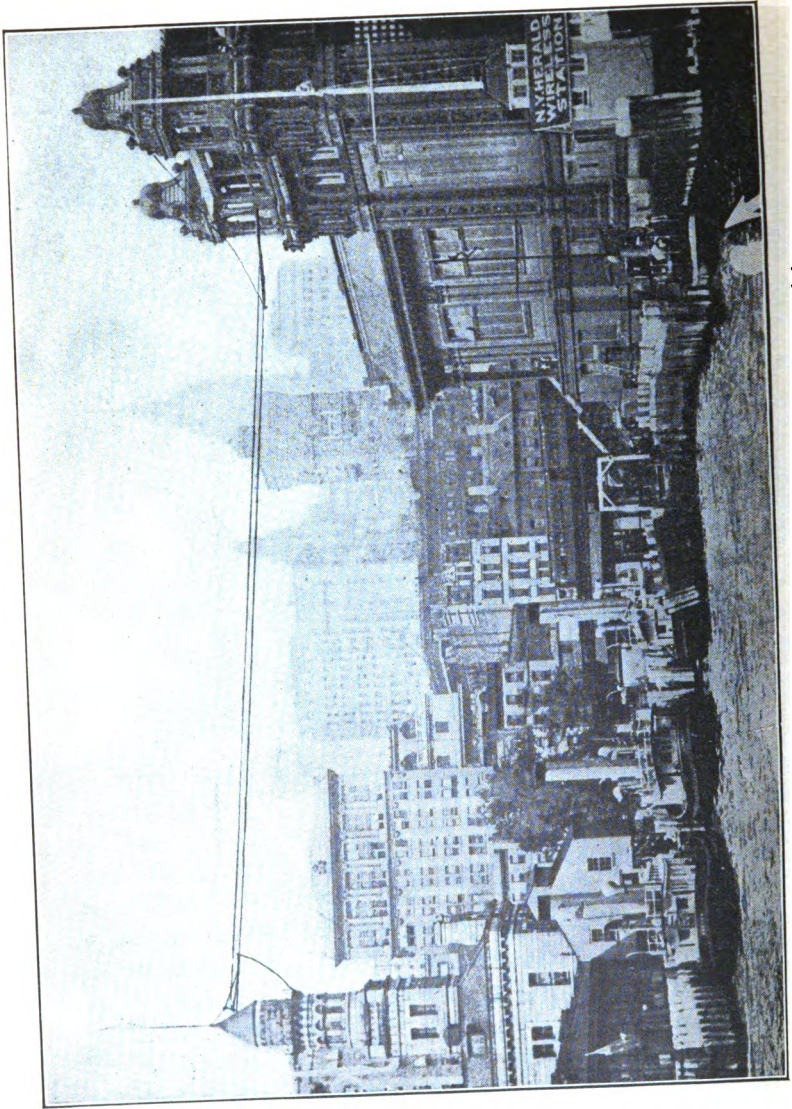

FIG. 112.—The N. Y. "Herald" station, showing aerial.

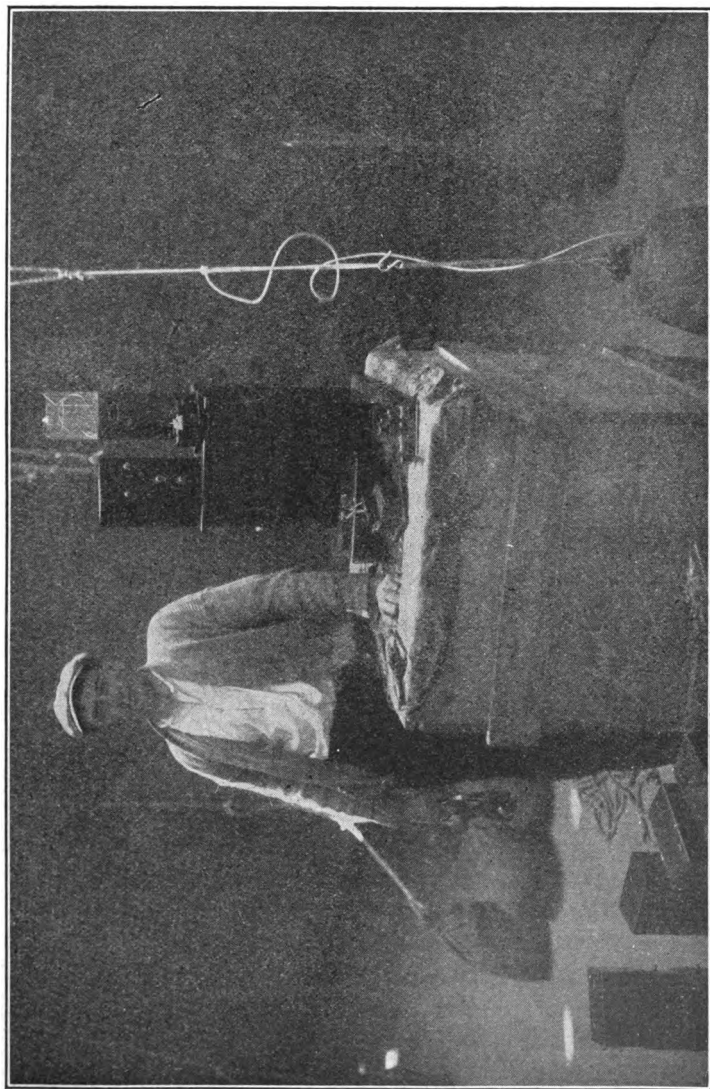

FIG. 113.—Operator Jack Irwin overhauling the wireless apparatus for the dirigible balloon "America."

and have installed outfits for the assistance of their reporting bureau. This innovation in modern journalism has quickly developed into a useful feature of those publications which have seen fit to adopt it. When the baseball season is under way every steamship within calling distance wants the latest baseball scores or sporting results.

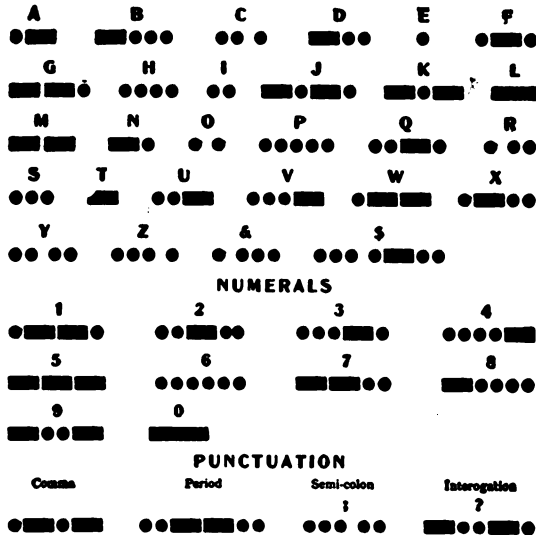

FIG. 114.—Morse code.

Railroads have found an auxiliary wireless service to be of the utmost value in relieving the heavily loaded wire lines between important centers. During some of the winter storms and blizzards, when miles of wires were down in all directions, wireless has been the sole means of communication in certain instances.

The process of sending a wireless message is very simple. The aerial switch is usually kept in such a position that the

receiving instruments are connected to the ground and aerial so that the operator is always able to hear any one calling him. We will suppose for illustration that the land station at 42 Broadway, New York City, wishes to transmit a message to the steamer "Horatio Hall."

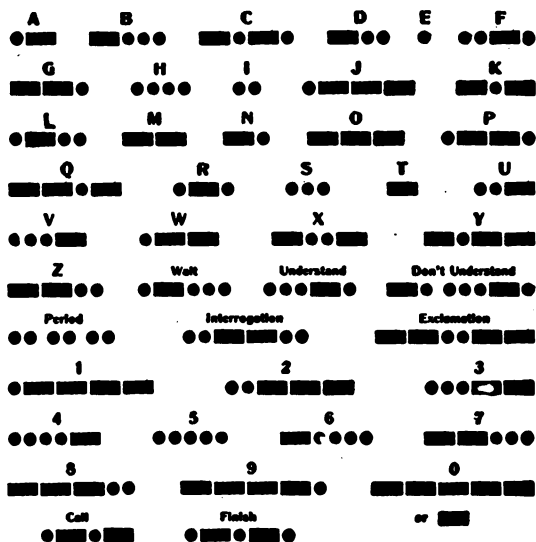

FIG. 115.—Continental code.

Every wireless station on land or sea has assigned to it two or more "call letters," which distinguish it from all other stations, and serve as the key to messages intended for it to receive and when signed to a message as an indication of its origin. The "call" of the land station in this case is N. Y., and that of the steamer, J. H.

In order to send the message to the ship, N. Y. throws the aerial into position for sending. This act also starts the motor generator set supplying current to the trans-

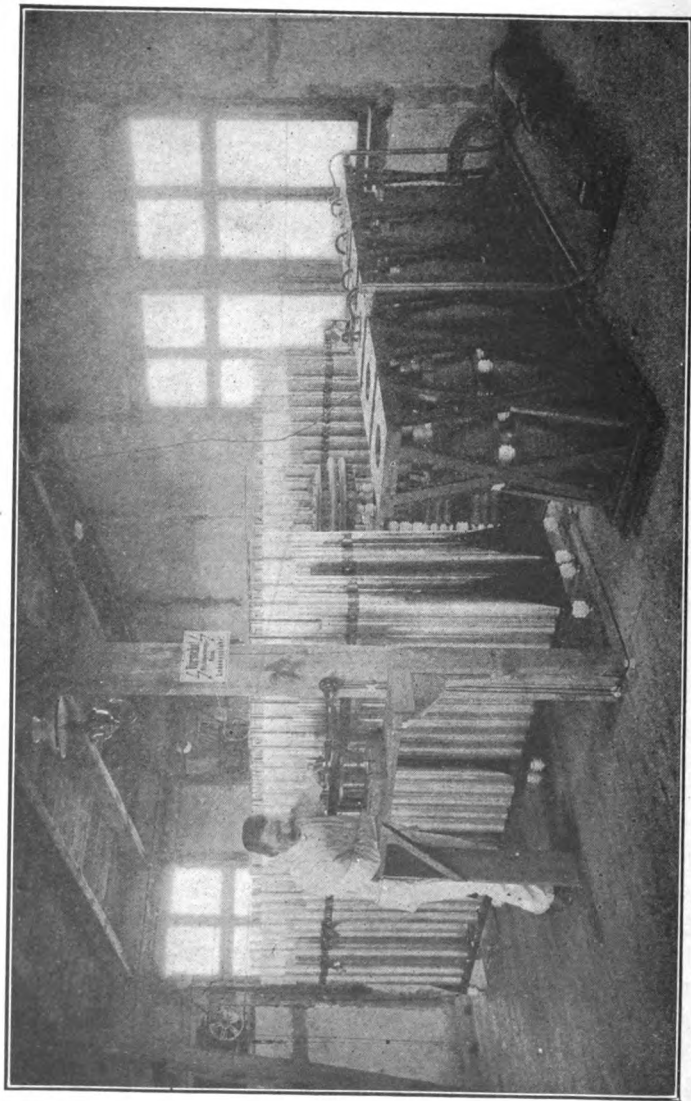

FIG. 116.—Transmitting equipment of the high power station at Nauen, twenty-five miles northwest of Berlin, Germany, showing six induction coils (in the foreground) arranged to charge the Leyden jars (composed of 360 units).

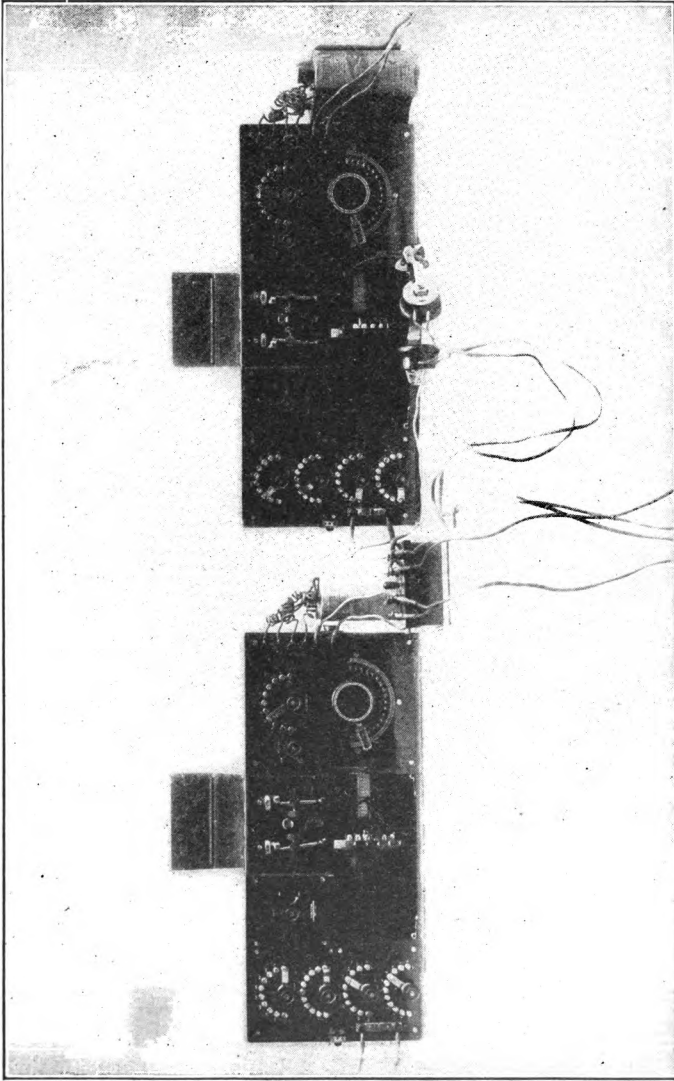

FIG. 117.—Duplex receiving apparatus. The set to the left may be adjusted to receive short wave lengths and that to the right to receive long waves. When the handle of the "listening" key, shown in the center of the illustration, is in the center, the left hand phone of the head set is connected to the instruments on the left and the right hand phone to those on the right, so that the operator is always ready to receive either short or long waves if received. Swinging the key connects both phones to either set at will.

former. Pressing the key, the operator then signals in the telegraph code J. H., J. H., J. H.—M. S. G.—N. Y.—and gives the “finish” signal. M. S. G. is the abbreviation for message. The N. Y. operator then throws his switch back into the receiving position and waits for a reply. If one is not forthcoming shortly the calling process is repeated.

As soon as the operator on board the steamer hears the call, he waits until the finish signal is received, and then

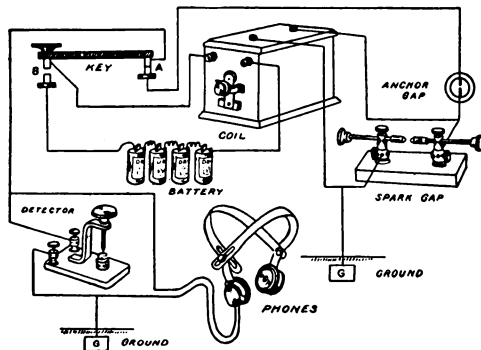

FIG. 118.—Breaking-in system.

responds in the following manner: N. Y., N. Y., N. Y.—J. H.—O. K., O. K.—G. A.—G. A.—N. Y., J. H.—and gives the “finish signal.” O. K. is the abbreviation for “all right,” and G. A. means “go ahead.” Upon receipt of this, the land station transmits the body of the message, and signs its call and finish signal. If the steamer understands the message, she replies “O. K.,” and signs.

There are two Codes in general use for wireless telegraph purposes, the Morse and Continental. It takes about five per cent. longer space of time to send a message in Continental than it does in Morse, but the former has the advantage of not containing any letters requiring proper

spacing in order to be recognizable. American coastwise steamers use the Morse code; transatlantic ships use the Continental code.

One of the greatest disadvantages of most systems of wireless telegraphy lies in the fact that no arrangement is provided for simultaneously transmitting and receiving wireless signals. It is usually necessary for one operator listening to another to have to wait until the finish signal is given before he can reply or interrupt in case he cannot understand part of the message, because the receiving apparatus of the transmitting station is necessarily disconnected from the aerial and the ground during the period a message is being sent. If it were to be connected at this time the powerful currents of the transmitter would rush through the receiving apparatus into the ground without setting up any very powerful waves in the aerial and seriously injure the delicate receiving instruments.

The Breaking-in-System is a method of simultaneously transmitting and receiving wireless signals. This is accomplished by providing the transmitting key with a second set of contacts, so arranged that when the key is released between the dots and dashes of the code the aerial and ground are automatically connected to the receiving apparatus. When the key is pressed the receptor is automatically cut off. The advantages of such a system are more or less obvious. When interference or a misunderstanding occurs the fact can be immediately signaled to the sending operator, and the message commenced over again.



FIG. 119.—The receiving apparatus of the station at Nauen. The message is being printed on tape by a recording device.

CHAPTER VII.

THE EAR. HOW WE HEAR. SOUND AND SOUND WAVES. THE VOCAL CHORDS. THE STRUCTURE OF SPEECH.

On either side of the head, lodged in a cavity which they do not completely fill, and situated in the midst of a dense and solid mass of bone, entering into the base of the skull and forming the temporal bone, are two membranous bags called the *membranous labyrinth* and the *scala media of the cochlea*. Each bag is filled with a liquid, and is also surrounded and supported by a fluid which fills the cavity in which they are lodged. Certain small, hard bodies, free to move around, lie in the fluid of the bag. The ends of

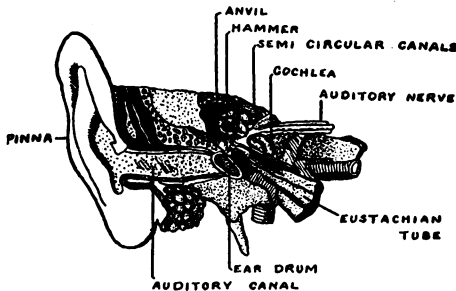

FIG. 120.—Diagram of the ear.

the *auditory nerve* of hearing are distributed around the wall of the sac, so that they are subjected to the blows of the little particles of calcareous sand, or *otoconia*, as they are called, whenever the fluid in the bags is disturbed.

The membranous lining on which the ultimate ends of the nerves are spread is virtually a sensitive beach, and the little otoconia, showers of pebbles and sand, which are raised and let fall by each succeeding wavelet of sound. This wonderful mechanism constitutes the inner ear.

The ear, as a whole, consists of three parts: the *outer ear*, which is a trumpet-shaped passageway called the *pinna* serving to collect the sound waves and pass them on through

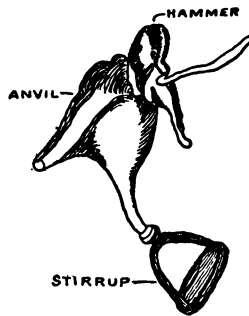

FIG. 121.—The ossicles.

the auditory canal to a small membrane called the *ear-drum*; the *ossicles*, a series of three little bones, the hammer, the anvil, and the stirrup, they are called; and the *inner ear* just described.

The foot of the stirrup is connected with an oval membrane, which closes a hole in the inner ear. Sounds passing through the auditory canal cause the drum to vibrate and send tremors through the bones to the liquid in the little sacs. The tumbling of the “pebbles” against the filaments of the auditory nerve sends the intelligence to the brain.

The impression which the mind receives through the organ of hearing is called sound. All bodies which produce sounds are in a state of vibration, and they communi-

cate their vibrations to the surrounding air and thus set it into waves, just as a stick waved back and forth in a pool of water creates ripples.

Sound implies vibration, and whenever a sound is heard

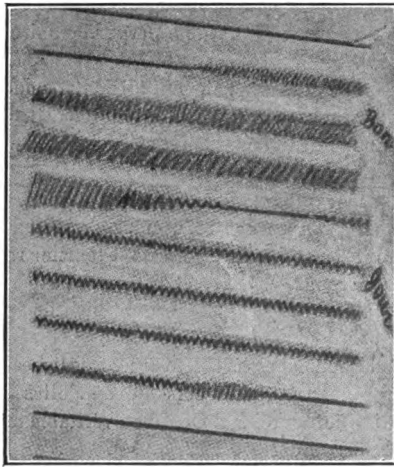

FIG. 122.—Bon jour ("good day" in French) as represented by a wave picture. The picture was made by a mirror arranged to move under the influence of the voice and to cast a beam of light upon a strip of sensitized paper.

some substance, a solid, a liquid, or a gas is in vibration and the surrounding air is in unison with it.

Sound has been likened to a picture painted not in the space and color of substance but in time and motion. What really passes out from the source is merely a rhythmical motion of the air particles, manifesting themselves as changes in pressure, spreading out in ever-widening spheres through the atmosphere. The order of these compressions is different for every sound. The musical sounds of an orchestra embody a different set of vibrations for

each note of each particular instrument. If the fluctuations in pressure of a sound wave are irregular and non-periodic, the sound is called a *noise*; if they are cyclic, and follow a regular and sufficiently rapid periodic lag, the sound is *musical*.

We may easily satisfy ourselves that in every instance in which the sensation of sound is produced the body from

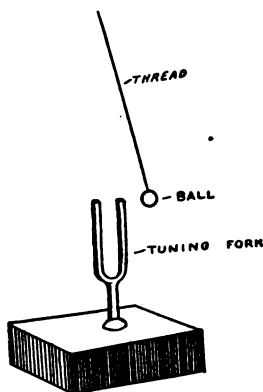

FIG. 123.—Experiment showing sounding bodies are in vibration.

whence the sound comes must have been thrown into a state of rapid tremor, implying the existence of a motion to and fro of the particles of which it consists.

If the face of a tuning fork prong be touched with a small ball of cork suspended from a fine silk fiber, after the fork has been struck and caused to emit its note, the cork will be violently repelled from the latter. *Why?* Because the prong of the fork is *in vibration*.

If a small wire or bristle is fastened to the prong of the fork and a piece of smoked glass drawn across it while the fork is giving forth a sound, the trace of the point will appear as a wavy line, showing that while the glass was drawn along the prong went to and fro many times.

The vibrations or disturbances set up in the air by a sound emitting body are known as sound waves. These waves consist of a series of condensations and rarefactions

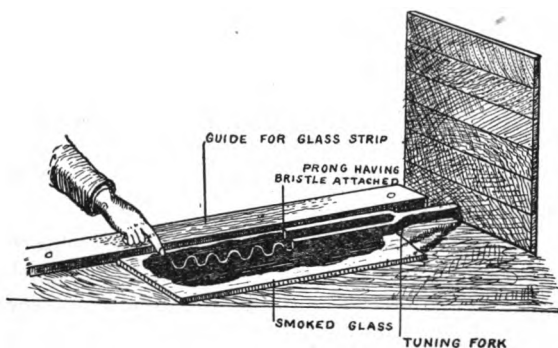

FIG. 124.—Method of registering vibrations of a tuning fork.

succeeding each other at regular intervals, each air particle swinging to and fro in a very short path.

Air waves cannot be seen by the naked eye, but their nature may be easily represented or illustrated. Fig. 126



FIG. 125.—Wavy line made by a bristle attached to a tuning fork prong in vibration when passed over smoked glass.

gives a pictorial representation of the crowding together of the air particles during the passage of a wave. The loudness of the sound depends upon the amount and suddenness of the change in pressure, and the note or pitch on the number of complete to and fro motions of the particles per second.

The *timbre* of a sound or the quality that distinguishes the note of a violin from that of a piano depends upon the

smoothness or abruptness of the changes in pressure. Therein lies the difficulty of the production of sound by means of a phonograph or telephone, for the sound waves



FIG. 126.—Illustrating the action of air waves.

must resemble each other in every detail in order that the result may be like the original.

The mechanism with which we speak or sing is composed of two flexible membranes, stretched side by side across a small cylindrical box located at the top of the wind-pipe. The membranes are called the *vocal chords*, and the

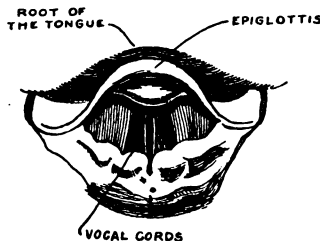

FIG. 127.—The vocal cords in position for making a sound.

box the *larynx*. The chords are so arranged and controlled by muscles that their tension may be changed at will. In breathing, the air to and from the lungs passes freely between the chords. When the controlling muscles are tightened, so as to stretch the chords, the edges are also brought parallel and quite close to each other. If the breath from the lungs is then forced through the narrow slit between them, they vibrate like the reed of a musical instrument, and produce the sounds of the voice. The multitude of sounds which it is possible for a human being to produce

are the result of various degrees of stretching of the vocal chords, together with the movements of the mouth, lips and tongue.

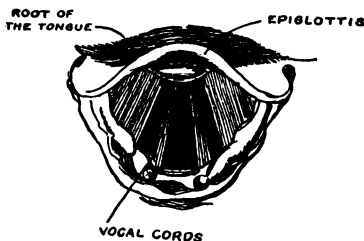

FIG. 128.—The vocal cords when relaxed.

Speech is the sound produced by the vocal chords of a human being, modified by the movements of the lips, tongue, and cavity of the mouth. The consonants are made by

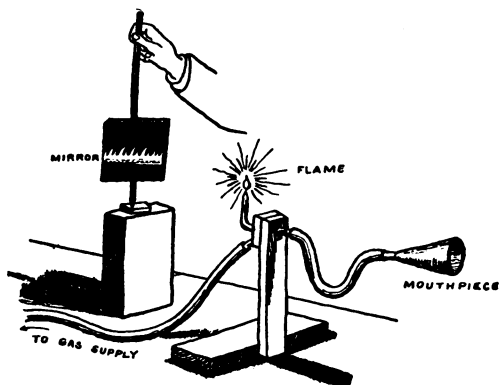

FIG. 129.—Koenig's manometric flame apparatus.

movements of the tongue and lips obstructing the sounds at their beginning or end, while the vowels are formed by a steady voice modified by the resonance of the different shapes or sizes given the parts of the mouth. The waves

produced in this manner are transmitted to the ear, and the sensation of sound is caused by the impact of the *otoconia* against the auditory nerve, giving a series of impressions, musical or unmusical, pleasing or displeasing, as the case may be. Many interesting experiments showing the nature of the sounds of the human voice may be performed by means of a simple apparatus invented by Koenig of Paris. A box is separated into two compartments by a rubber membrane. Gas is led into one of these compart-

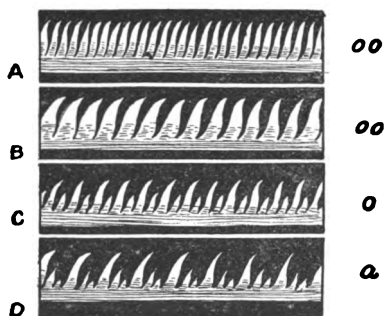

FIG. 130.—Appearance of manometric flames in a revolving mirror.

ments by a rubber tube, and then allowed to issue to a burner. The other compartment is connected to a megaphone.

Two pieces of mirror are arranged so as to revolve in front of the lighted jet or burner. When the human voice is produced in front of the megaphone, the air waves strike the membrane and cause changes of pressure in the gas. The height of the flames varies with each change in the pressure, and when viewed in the mirror resemble a band of light having an edge like a saw. The teeth are faithful representations of the changes in the voice, and immediately take on a new appearance when a new sound is emitted. The shape of the teeth changes with

the tone, and the number of teeth with the pitch. Fig. 130 shows the flames produced by singing the sound *oo*, as in *tool*. The same sound an octave lower in pitch will show as in B, where there are just one-half as many teeth or vibrations. The sound of *oo* is a simple sound. If *o* on the note



Fig. 130 a.

is sung into the megaphone, the image in the mirror will appear like that shown by C, being made up of alternating large and small teeth, the former corresponding to every alternate vibration of the octave of the higher sound coinciding with a vibration of the octave below.

The sound causing the flame to appear, as in D, is made up of two simple vibrations combined.

CHAPTER VIII.

THE TELEPHONE TRANSMITTER AND RECEIVER. THE PHOTO-
PHONE. THE THERMOPHONE. THE SELENIUM
CELL. THE SPEAKING ARC.

The telephone is an instrument for the transmission of sounds to a distance by the agency of electricity, wherein the speaker talks to an elastic plate of thin sheet-iron, which vibrates and transmits its every movement, electrically, causing it to vibrate in an identical manner and emit the same sounds.

The transmission of the vibrations depends upon well-known principles of electricity, and consists, not of an actual transmission of the sounds, but the passage of electric waves, or impulses, which keep perfect accord and agree in phase and period with the atmospheric waves produced by the voice. These in turn, through the medium of an electromagnet, cause vibrations of a plate or membrane, which agitates the air in a manner similar to the original disturbance, and thus emits sounds.

The parts of the apparatus which take up the sound waves and change them into electric currents compose the *transmitter*. In the form of transmitter most commonly used, the motions of the diaphragm cause variations in the strength of a current flowing from a battery by varying the resistance in the path of the electric current.

The sounds are directed to the mouthpiece, which causes the vibrations of the air to strike the diaphragm, on the back and center of which is fastened a small cup-

shaped piece of carbon. A second cup is mounted in a rigid position directly in back of the first. The space between is filled with small polished granules of carbon.

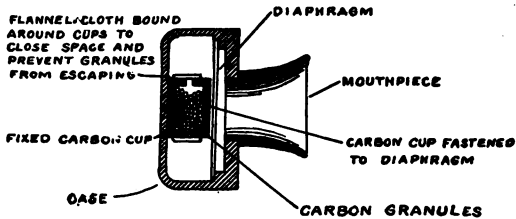

FIG. 131.—Diagram of a telephone transmitter.

When these are in a perfectly free and loose state their resistance to an electric current is very great, and they allow almost none to flow.

When slightly compressed their resistance is greatly lowered, and they permit the current to pass. The vibrations of the diaphragm exert a varying pressure upon the gran-

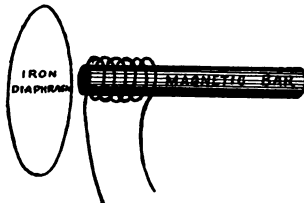

FIG. 132.—Diagram showing the principle and construction of the telephone receiver.

ules, with a corresponding variation in their resistance and the amount of current flowing.

The receiver, as has already been explained, consists of a thin iron disk, placed very near but not quite touching the end of a small bar of steel, permanently magnetized, about which is wound a coil of fine insulated wire. The

ends of this coil are connected to the wires leading from the transmitter and battery. The varying currents of electricity, produced by the transmitter, generate corresponding changes in the magnetism of the receiving instrument, and thus, by alternately attracting and repelling the diaphragm, cause it to vibrate and emit sounds.

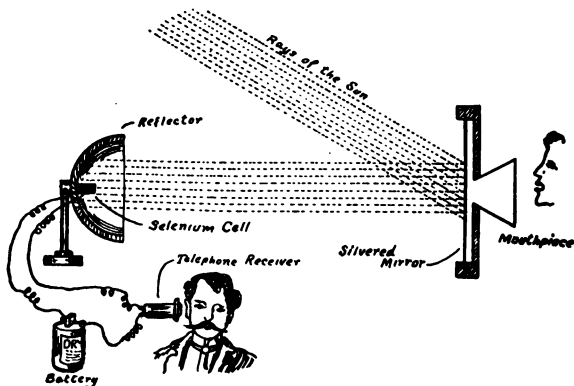

FIG. 133.—The photophone.

Alexander Graham Bell, the ingenious inventor of the telephone, with the aid of Sumner Tainter was the first who achieved success in the attempts to transmit speech without the aid of connecting wires between the source of intelligence and the receptor.

In 1873 Willoughby Smith announced that the element *selenium* possesses the abnormal property of changing its electrical resistance under the influence of light. Bell and Tainter took advantage of this discovery, and devised *selenium cells*, in which selenium is formed into narrow strips between the edges of broad conducting plates of brass. The resistance of the cell in the darkness is approximately twice the resistance when illuminated.

This property of the cell was immediately applied to the

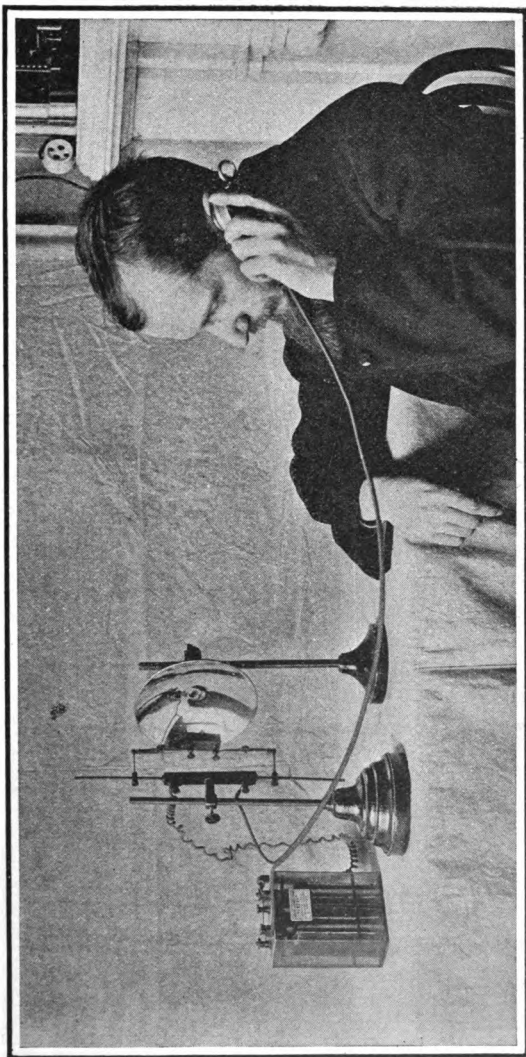

FIG. 134.—Photophone receiving apparatus.

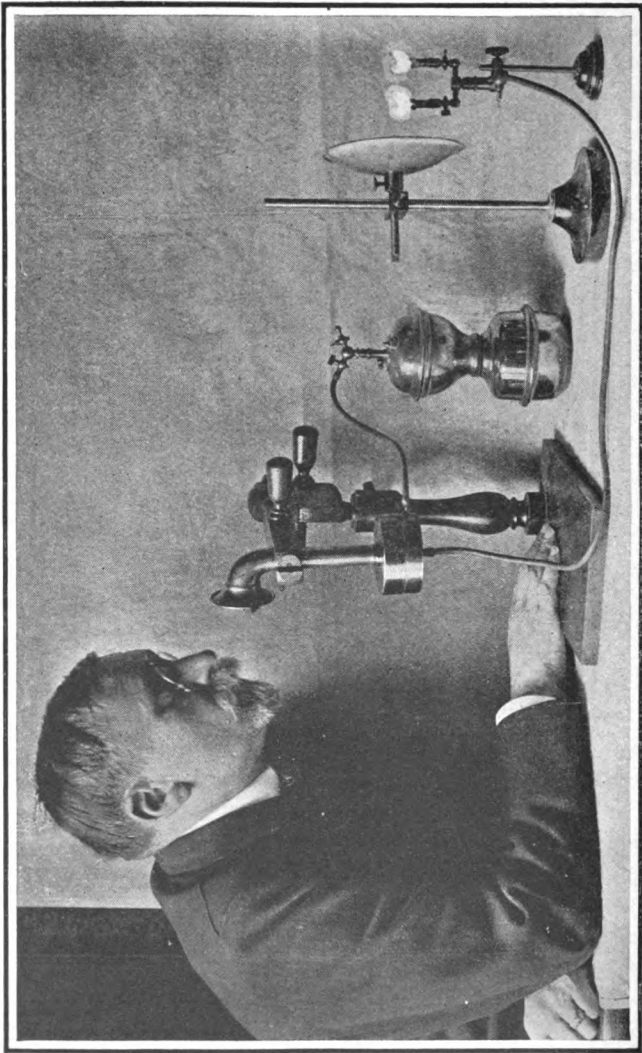

FIG. 135.—Photophone transmitting apparatus using acetylene flame to furnish light.

construction of the *photophone*, an instrument which transmits sounds to a distance by means of a beam of light reflected to a distant spot from a thin mirror thrown into vibration by the voice. Over fifty different forms were devised but the most successful consisted of a transmitter composed of a glass disk, silvered to reflect a pencil of light focused from the sun, or an arc lamp. This glass disk was used as a diaphragm similar to that of an ordinary telephone transmitter, except that the rear side of it was made free to reflect the beam of light. Bell used for this purpose disks about two inches in diameter and the thickness of ordinary paper. The receiver consisted of a parabolic reflector, with a selenium cell placed at its focus. In series with the cell was placed a battery and telephone receiver.

When the membrane was set into vibration by the sound waves, it became alternately concave and convex, the normally parallel rays of light correspondingly converging and diverging. The receiving station was thus under the influence of light rays of rapidly varying intensity in perfect phase with the vibrations of the voice. The reflector concentrated the rays on the selenium cell, and their varying strength changed its resistance and caused a pulsating current to flow through the receiver and reproduce the speech produced at the transmitter.

In another arrangement employed by Bell and Tainter, they used the rays of a powerful electric arc lamp, and by varying the electric current supplying the arc caused the light to fluctuate and produce the same results at the receiver.

These ingenious inventors also devised a method of transmitting speech called the *thermophone*. The transmitter remained the same as in the photophone—a thin silvered membrane, or glass diaphragm, stretched across the

back of a mouthpiece, and arranged to reflect the rays of the sun, or the light of an arc lamp.

The receiver was a small glass bulb containing a plate of mica covered with lampblack, or little charred pieces of

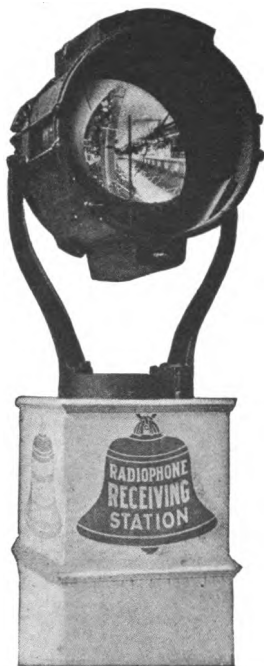

FIG. 136.—Powerful searchlight arranged to transmit speech over a beam of light.

cork. The glass bulb was placed in the focus of a reflector, which collected the rays and concentrated them. The variations in the intensity of the heat radiations caused the air in the bulb to expand or contract with each vibration. Rubber tubes extended from the bulb to the ears of the observer, and the pulsations of air, traveling through the

tube as sound waves, would strike the ear-drum and reproduce the speech.

Both of these methods were later very much improved by the employment of Koenig's manometric flame in place of the silvered mirror as a transmitter. As explained in the last chapter, speech delivered into the mouthpiece causes the gas to become compressed or rarefied in direct accordance with the sound waves, and the flame rises and falls with a rapidity too great to be detected by the naked

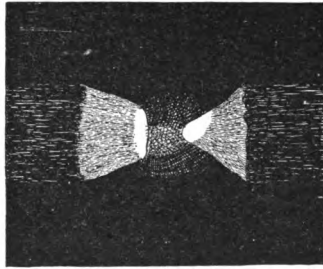

FIG. 137.—The Electric arc.

eye. These rapid alterations in the intensity of the illumination of the flame act on the selenium cell, and reproduce the original voice perfectly in the telephone receiver.

It is obvious, however, that such methods as these are only capable of transmitting speech over very limited distances, and if greater ranges are to be traversed much more powerful transmitters must be employed for the purpose.

Ernest Ruhmer, after long and laborious researches, finally succeeded in transmitting speech many miles by taking advantage of the *speaking arc*, discovered by Simon, who observed that an arc lamp gave out a loud rattling noise if its current supply was interfered with. An electric arc consists of two carbon rods, connected to a generator.

When the carbons are brought into contact for a moment and then drawn apart to a short distance, a kind of electric flame or *arc* is produced between the points of carbon, and a brilliant white light is emitted by the white hot points of the carbon electrodes.

Ruhmer immediately made the arc serve as a telephone receiver and *speak* by utilizing the pulsating current of a telephone transmitter to vary the current supplying the arc.

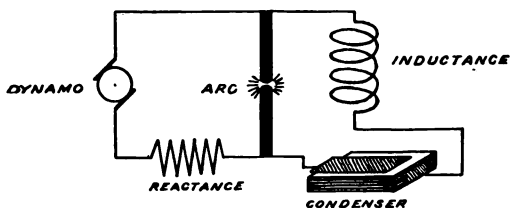

FIG. 138.—Circuit showing how a singing arc is arranged.

The arc could thus be made to sing, whistle or reproduce music and the human voice perfectly, if the sounds were clearly conveyed into the transmitter. Further investigations showed that every alteration of current caused by the action of the transmitter also caused an alteration in the intensity of the light and radiation of the lamp. The speaking arc could therefore be used as a perfect photophone transmitter by directing the rays toward the receiving station with the aid of a parabolic reflector.

In 1902 Ruhmer performed a series of experiments in Germany on the Wannsee, near Berlin. A large motor-boat, the *Germania*, was fitted with an electric searchlight connected with a microphone, so as to form a speaking arc. The receiving station was located on the shore, so that the distance between the stations could be easily enlarged by moving the boat.

The receptor was an ordinary selenium cell, placed at the focus of a large reflector and connected with a telephone receiver and battery. No difficulty was encountered in reproducing the speech over varying distances up to about three miles.

CHAPTER IX.

THE WIRELESS TELEPHONE.

The applications of any of the wireless telephone systems thus far described are very limited, for at the best they only operate under the most favorable conditions, and then over rather limited distances. In the case of any system whereby the speech must be transmitted over a beam of light, the great resulting limitations are that the transmission can only take place in a straight line over water or clear country, and that stormy weather or a fog will interrupt communication.

None of these objections are present, however, when recourse is had to Hertzian, or electromagnetic waves. Wireless transmission of speech has therefore followed in the wake of wireless telegraphy, and the methods and apparatus employed are very similar.

Some who have followed the text closely might reasonably ask why it would not be possible to establish wireless telephony by simply connecting a telephone transmitter in some manner to an ordinary wireless telegraph, and by directing speech into the latter, vary the strength of the oscillations emitted.

Such a system, at first thought, seems very plausible, and many experimenters have devised countless methods trying to attain this result, only to meet with ultimate failure. The reason is very simple.

Suppose that an induction coil, having a high-speed interruptor, and therefore able to produce a very rapid stream

of sparks at the gap, is connected to the aerial and ground in the usual manner and a telephone transmitter placed in series with the ground wire. When the coil is set in operation the sparks jump across the gap, each spark setting up a train of oscillations. If speech is conveyed into the

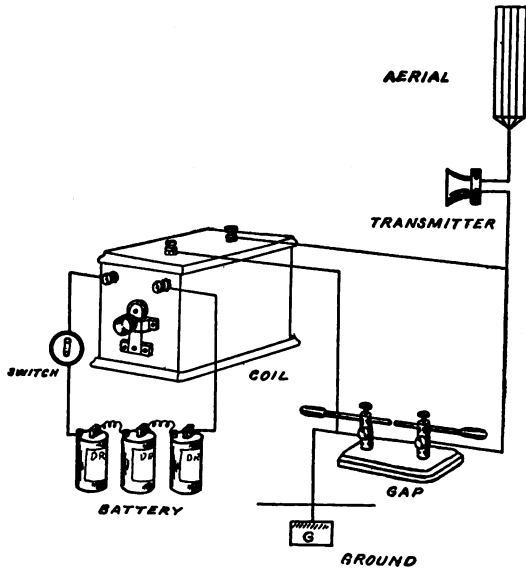

FIG. 139.—A "logical" form of wireless telephone which is impracticable.

transmitter, the resistance in the path of the oscillations will be varied and correspondingly also the strength of the waves emitted. The sounds will be reproduced to a certain extent by the receptor. Whistling, certain musical tones, and words containing many vowels are sometimes heard in the receptor, with sufficient distinctness to be recognizable. The voice cannot, however, be heard at all times, and the system is of no real value other than an interesting experiment.

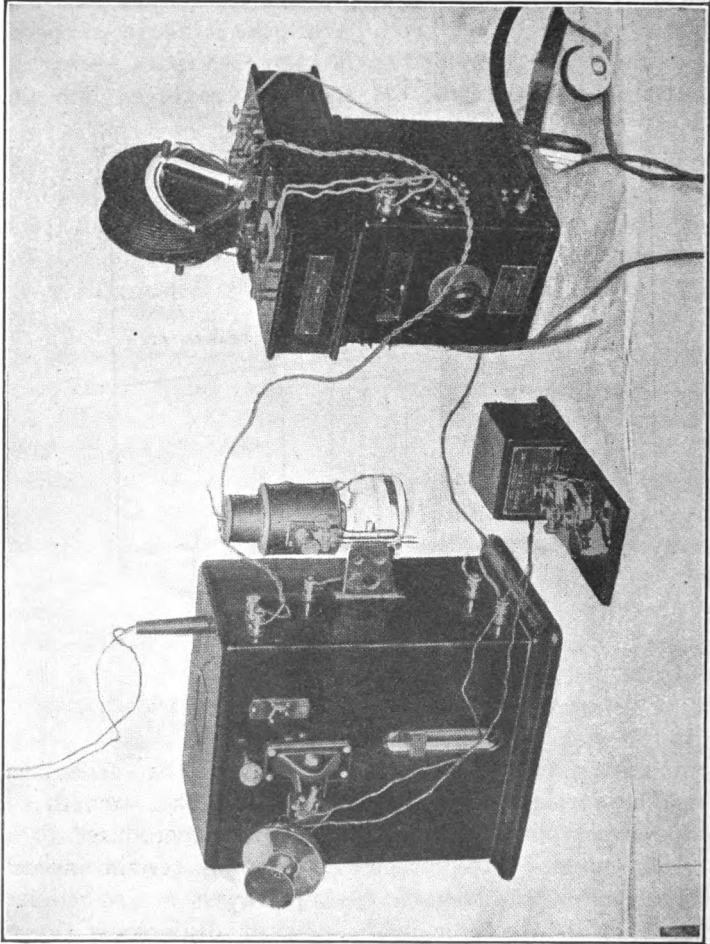

FIG. 140.—De Forest wireless telephone equipment.

The reason is very simple and readily explained. For the sake of clearness we will suppose that the speed of the interruptor attached to the coil is 100 per second. It will therefore produce 100 sparks per second at the spark gap if the electrodes are close together. The passage of the



FIG. 141.—Wireless telephone receiving apparatus (induction method).

sparks is not continuous, each one only occupying a very small space of time. The pause between each is very distinct, although it could not be detected with the naked eye. The ten straight lines in Fig. 141 represent ten sparks which cover a period of one-tenth of a second, since they pass at the rate of 100 per second. Each spark produces a train of oscillations, which surge back and forth in the aerial, rapidly dying out, however, or becoming *damped* in the manner already explained.

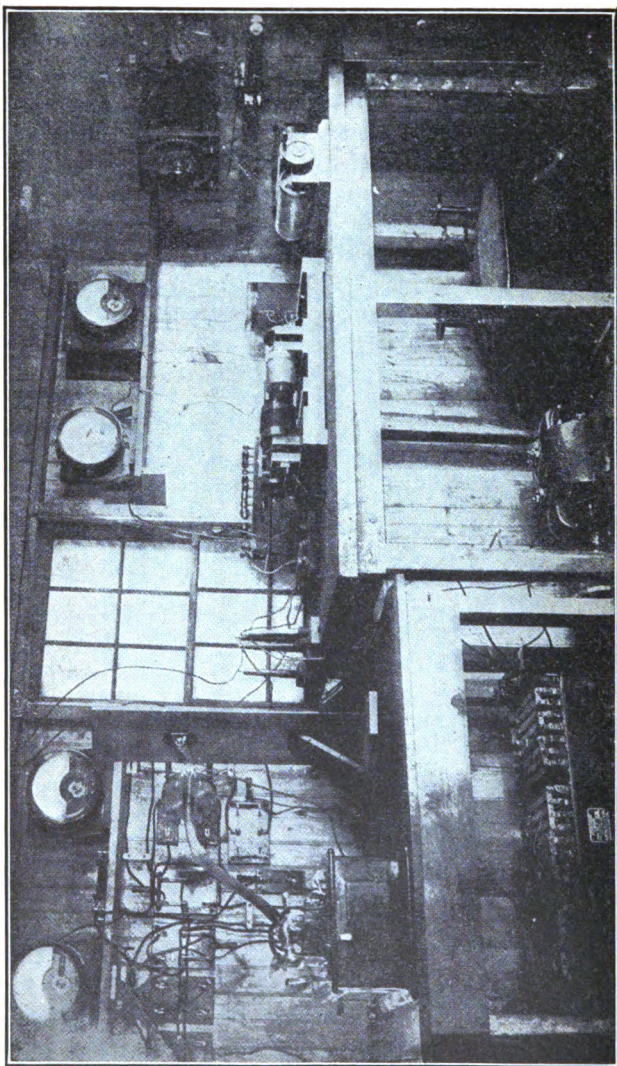

FIG. 142.—Fessenden wireless telephone transmitting phonograph music.

It may now readily be realized that there are long pauses between the sparks when there are no oscillations in the aerial, and, consequently, no electromagnetic waves passing between the transmitter and receptor during those periods.

The wavy line, C, represents the vibrations of the human voice when producing speech. Part of it has been represented by a continuous line, and part by a dotted line. The portions represented by the dotted line occur when there are no oscillations in the aerial, and consequently these

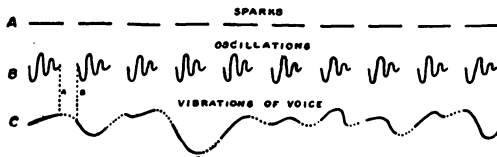

FIG. 143.—Diagram illustrating the reason why damped oscillations will not carry the voice.

portions are not transmitted. The continuous portions are the only ones reaching the receptor. Literally, there are "holes in the voice," and the result is a jumble of sounds, sometimes bearing a resemblance to speech, but usually untranslatable.

The fault lies in the method of producing the oscillations which are *damped* and therefore do not exist continuously. If they could be made to keep on swinging and at a sufficiently high speed so that their tone would be inaudible and not confuse the speech, the problem would be solved. In other words, three things are necessary for the successful operation of a wireless telephone.

1. A means of producing and radiating a stream of *undamped* electrical waves sufficiently continuous to transmit the *upper harmonics* of the voice, on which the quality and recognition of the speech depends.

2. Means for varying or modulating the stream of electrical waves in accordance with the sound waves.

3. A receiver, continuously responsive and capable of corresponding with sufficient rapidity to the speech harmonics.

In order to obtain the desired result, recourse is had to an arc lamp as a generator of *undamped high frequency oscillations*.

When an arc is properly connected with a condenser and

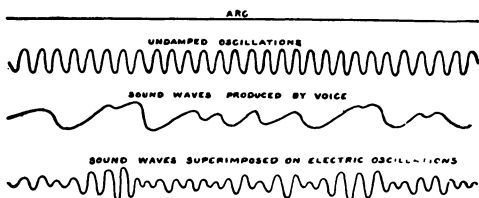

FIG. 144.—How the sound waves of the voice are impressed upon undamped oscillations.

an impedance coil it will emit a musical note. The note is due to rapid changes in the arc, a very important factor which led to its recognition as a value in wireless telephony.

When the condenser and inductance are shunted across an arc supplied with direct current, the condenser immediately becomes charged, and the current through the arc is diminished. The potential difference across the latter is therefore instantly increased, tending to further charge the condenser. This increase of charge reacts on the arc, increasing its current. The condenser discharges, through the inductance coil, and becomes charged in the opposite direction, just like a spring, which released, goes beyond its normal position and then returns.

The operation is repeated many times per second (usu-

ally over 1,000,000), setting up *persistent undamped oscillations*.

Perhaps a better conception of how it is possible for a

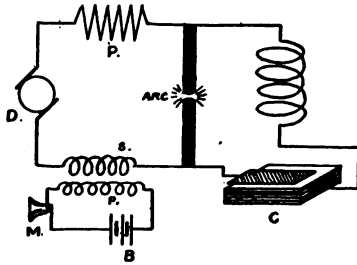

FIG. 145.—Arrangement of the speaking arc.

continuous current, such as that which supplies the arc, to change into alternating current, vibrating backward and forward, may be gained by comparison with the steady forward motion of a violin bow, which produces a to and fro motion of the strings.

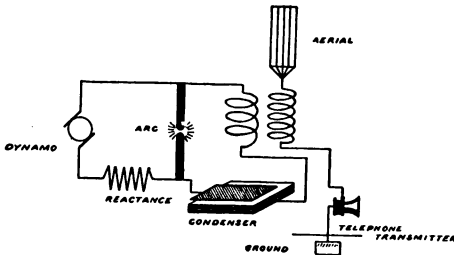

FIG. 146.—Diagram showing how a wireless telephone transmitting system is arranged.

It was later discovered by Poulsen that if one of the arc electrodes was kept cool by making it of copper and passing water through it that the efficiency was greatly increased. A further improvement was obtained by burning the arc

in an atmosphere of coal gas or hydrogen. By surrounding the arc with a powerful magnetic field, its resistance is greatly increased and the voltage raised.

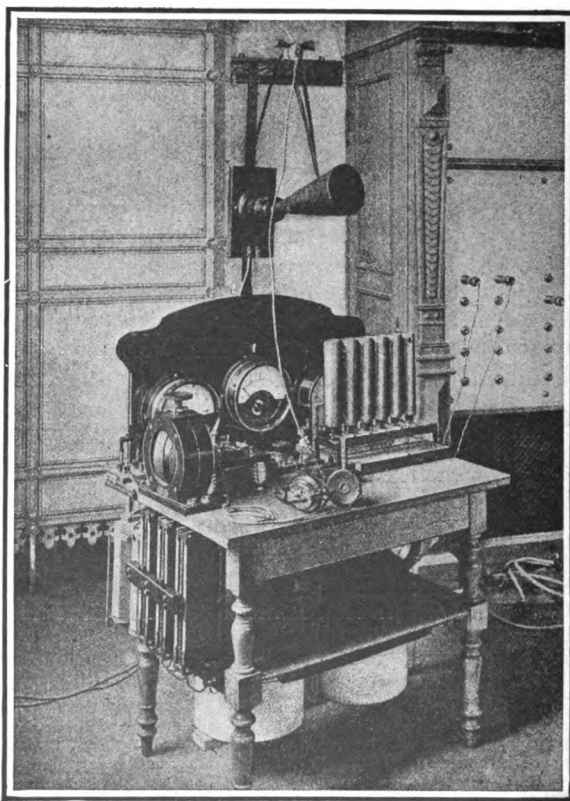

FIG. 147.—Poulsen wireless telephone equipment.

The condenser shunted around the arc usually consists of a number of metal plates, placed above one another in a tank of insulating oil. The inductance is simply a single helix or bare wire.

By connecting a telephone transmitter to the arc in the same manner that it is connected to the speaking arc, the oscillations can be varied in accordance with the vibrations of the voice. The apparatus is connected to the aerial and the earth through the medium of a loose-coupled helix, formed by providing the helix in series with the arc and condenser, with a secondary winding.

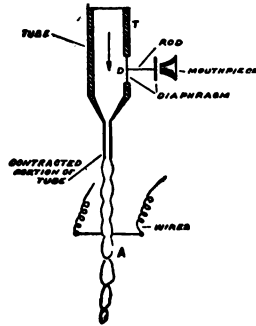

FIG. 148.—The Majorana wireless telephone transmitter.

The ordinary carbon transmitter, in its common form, is unsuited for wireless telephonic work, on account of its inability to handle large amounts of power. Many modifications have been designed, the usual procedure being to make it on a larger scale.

One of the most interesting forms, and also probably the best, is that devised by an Italian inventor, Majorana.

Its action will be clear from the illustration. T is a tube in which water or some other liquid is allowed to flow in the direction of the arrow. The bottom of the tube is contracted so that the stream will issue in a fine jet. The tube is made of strong, rigid material, except at one point, D, where an opening is covered with a thin elastic diaphragm. This diaphragm is connected by means of a short

rod to a second diaphragm, which is provided with a mouthpiece. The water normally flows out of the jet in a smooth, unbroken column, breaking into drops at about the point A. As soon as it is disturbed in any way, however, the distance from the outlet of the tube and the point where the drops commence becomes shortened. The vibrations of the voice, thrown into the mouthpiece and striking the diaphragm, are transmitted to the membrane through the medium of the little rod, and so cause corresponding changes in the pressure of the fluid in the tube. Each variation or disturbance in the pressure increases or decreases the length of the stream before it breaks into drops.

A pair of fine wires are inserted in the stream where the contractions are the strongest. Connection is established between the wires by the liquid. If the stream is narrow its resistance will be greater than if it were expanded at that point. The contracted portion of the liquid will jump up and down with the vibrations of the voice, and thus alter the amount of current flowing.

The receiving apparatus consists of some form of detector and a telephone receiver and battery. The usual form of detector employed is the electrolytic. The currents generated in the receiving aerial by the incoming waves vary in amplitude with those of the transmitting aerial, and, being in perfect accordance with the vibrations conveyed into the transmitter, cause the detector and telephone transmitter to reproduce the speech perfectly.

Experiments in wireless telephony have developed an interesting type of detector, known as the "Audion." This consists of a six-volt, low-candlepower, incandescent lamp, having a small, nickel plate fastened a short distance from the filament, and a "grid" bent from wire placed midway between the two. When the filament is lighted from a battery, it throws off a stream of extremely small particles

charged with electricity and called "ions." These ions pass through the grid and discharge against the plate. When the aerial is connected to the "grid," and the plate to the ground, the stream of ions carries that part of the alternating current in the aerial which flows in the same direc-

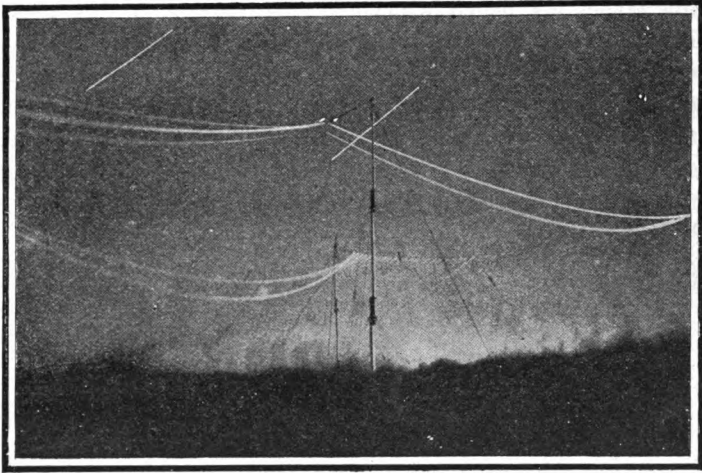

FIG. 149.—Showing the brush discharge from a Marconi transatlantic aerial at night.

tion, across, but does not allow the current tending to pass in the opposite direction. In reality it is a valve, or "rectifier," opening one way and closing the other; thus changing the current into an intermittent, direct current, capable of manifesting itself in a telephone receiver.

The Audion is a very sensitive device, and is much employed for wireless telephone purposes.

With such a system it has been found possible to transmit speech and music to a distance of two hundred miles. In fact, even greater distances have been covered, and there

does not seem to be any good reason why it is limited to any range.

Transmission by wireless telephone is considerably more distinct than by wire line, and the fine inflections of the voice are brought out much better.

Unlike the ordinary line telephone, no rumbling or roaring noises are heard which confuse the speech, and there is absolute silence in the wireless telephone receiver, except when talking is going on. Any noises or sounds produced in the transmitting station, such as walking about the room, or the breathing of the person speaking into the transmitter, are reproduced faithfully at the receiving station many miles away.

CHAPTER X.

REMARKS. ACCOMPLISHMENTS. MAXWELL'S THEORY.
HERTZ'S DISCOVERY. THE FUTURE.

The history of wireless telegraphy and telephony is a striking example of how it is possible for scientists laboring in the field of pure research and stimulated by accumulated knowledge and imagination to arrive at discoveries of the most vital importance. Heinrich Hertz and Clerk Maxwell in experimental effort to attain other results unwittingly laid the foundation of this art.

In 1867 Maxwell proposed the theory that light is not mere mechanical motion of the ether, but consists of electrical undulations. These undulations are partly magnetic and partly electrical. Moreover, according to the theory, the phenomena of electromagnetism and also that of light are due to certain modes of motion in the ether, electric currents, and magnetism, being due to whirls, or body displacements in the substance of the ether, while light is due to vibrations to and fro.

Twenty years later Hertz discovered the most convincing experimental proofs of Maxwell's wonderful theory, and succeeded in producing electromagnetic waves in such a manner that their propagation through space could be examined, and it readily showed that while they were much longer than the ordinary waves of light, they possessed the same properties, were capable of being reflected, polarized, refracted, etc., and traveled at the same speed.

The waves that Hertz produced are the *electromagnetic* or *Hertzian* waves of radiotelegraphy.

Many thousand commercial wireless stations dot the face of the earth. Daily time signals, weather reports and storm warnings flash to ships far out in the ocean from government observatories. Late at night, in the midnight hours,

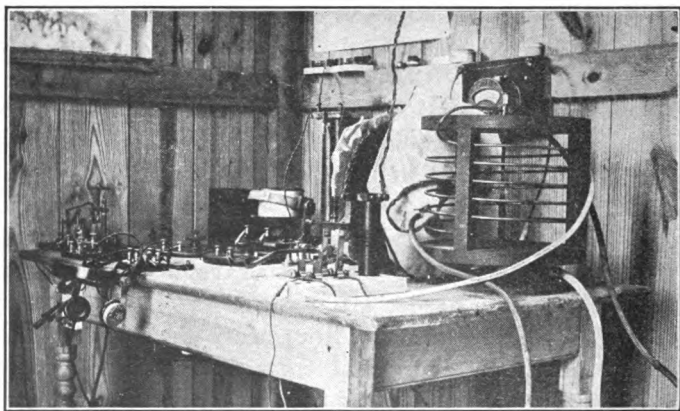

FIG. 150.—An amateur wireless telegraph station.

when the world is asleep, powerful land stations commence to whisper press dispatches, and the next morning the ocean daily, containing the same news as our morning paper, is laid on the breakfast table of the ocean greyhound. A distress signal sends revenue cutters scurrying along the coast, and brings rescue to hundreds of imperiled lives. The Navy Department issues an order, and a few minutes later it is in the hands of the commanding officer of a fleet, a thousand miles away. Wireless links two continents across a table, and yet this wonderful apparatus is so simple that a sixteen-year-old boy can build instruments with a

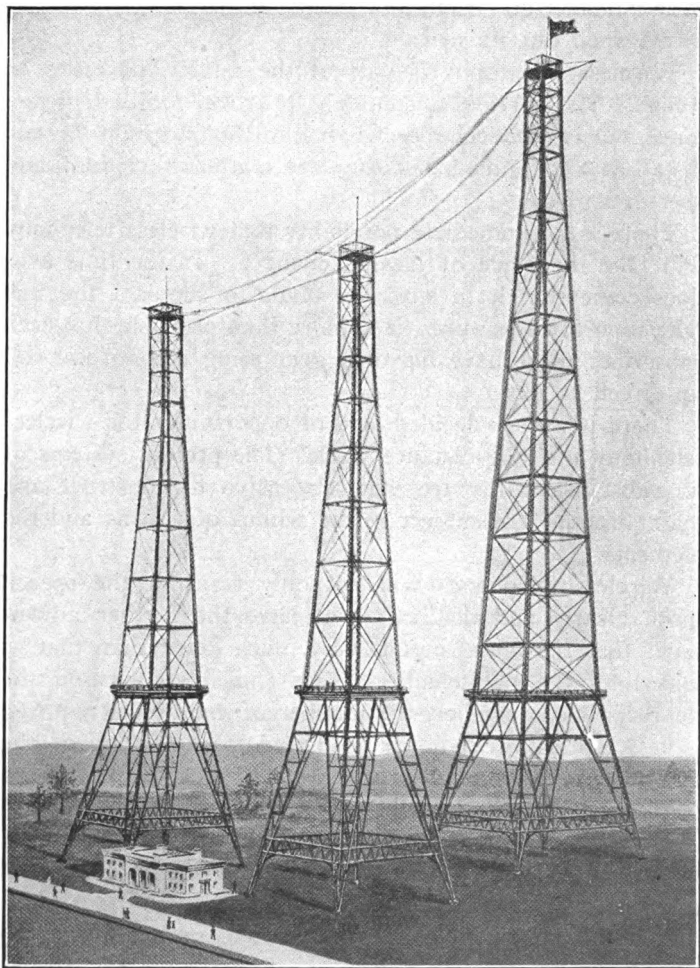

FIG. 151.—The high-power Naval wireless telegraph station under construction at Washington, D. C.

little guidance and listen to a far-distant station, 1,500 miles away, spell out its news.

Wireless telegraphy is part of the established order of things. The wireless telephone is practical for limited distance, but is not a commercial rival of the telegraph. Great distances are claimed, but they are matters for proof and speculation.

There is no immediate possibility that wireless telephony will take the place of local exchanges. If the time ever does come that it in any way tends to supplant the line telephone for some uses, it is more than probable that each subscriber must have his own generating station and call up direct.

There is a very decided field of opportunity for wireless telephony for long-distance work. The present systems of long-distance wires are very expensive to construct and maintain, and are subject to the whims of storms and the elements.

Wireless telephones will not only transmit the speech more clearly and distinctly, but have the further advantages that the initial cost is very much lower than that of wire lines, the maintenance is almost nil in comparison, the depreciation is smaller, the number of employees required is less, and a break-down is limited to the inside of the station, where it could be quickly remedied by the substitution of a duplicate spare piece of apparatus.

Furthermore, no franchises or rights of way would need to be purchased. No serious difficulty would be encountered because of interference.

Wireless telephony, like wireless telegraphy, but to an even greater extent, is peculiarly suited for the conveyance of marine intelligence. Wireless telephony occupies a unique position in this regard—no operator is required. The additional expense of an operator is an objection to

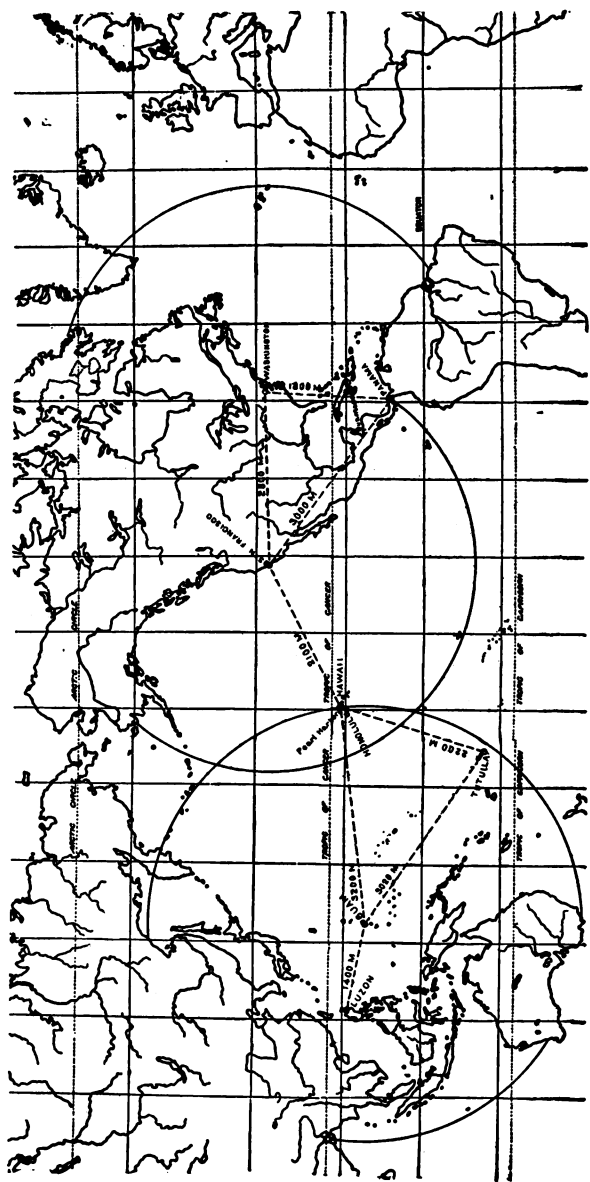

FIG. 152.—The curved lines represent the radius of the government high power wireless stations and show the zones over which direct communication may be had with ships.

the wireless telegraph in many cases, and forbids its installation. Anybody can operate the wireless telephone. It is also much quicker—words can be spoken more rapidly than they can be put into Morse signals and translated.

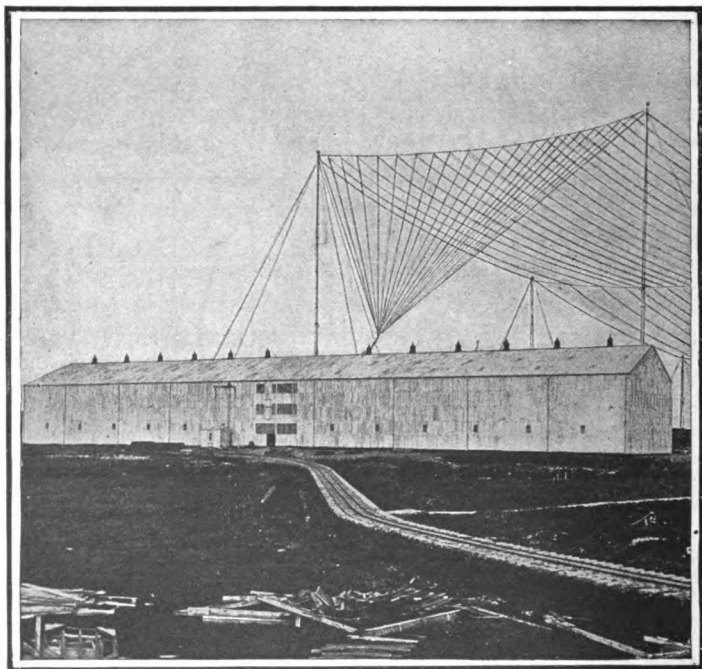

FIG. 153.—The aerial system of a transatlantic station.

The wireless telephone enables a passenger on board ship to communicate direct with his home by relaying the message over the line wires. By the same means the captain of a ship can call his home office and communicate with the owner of the vessel.

Telegraphs and telephones are the nerves of the world,

carrying swift messages from its brain centers to its hands, annihilating distance in thought. All differences between men as individuals and people as nations can be traced to the lack of close contact. Reduce or annihilate all distance in thought and action, and mankind would possess unbounded opportunities for peaceful economic and healthful development. No force more vital than the possibilities of wireless has ever presented itself or could be demanded to attain such an end. Such a statement, in the light of actual developments, might even be considered conservative, and is neither absurd nor the dream of a vivid imagination. The greatest obstacle to all efforts in radically new directions is the resistance of the human race. The antagonism of prejudice and skepticism can only disappear when the world as a whole grasps a new proof and learns to appreciate it. Inertia must be overcome, and the great masses set to thinking and striving toward an end before the awe-inspiring genie finally bursts forth and amazes the Aladdins of science.

Within the memory of older men and women are primers of science, which speculate about the developments of electrical force, and guardedly discuss its possibilities.

And now, electricity—this mysterious agent—has multiplied the muscular strength of man a billion times. The tasks of Hercules are now but chores to be accomplished by the closing of a switch. Mighty rivers roar through intake and turbine to drive the wheels of industry in a distant city and turn the night into day. Any attempt to chronicle all the applications of this wondrous power would be absurd. Such is electricity to-day.

Only a few years ago Langley launched his famous aerodrome over the waters of the Potomac, while the world stood by and sneered, ridiculed a man whose work is now one of the classics of aeronautical literature, and scoffed at

a machine whose principles embodied the conclusions of years of careful thought and scientific effort.

A decade later and aeroplanes have become a living reality. A man and a little frame of sticks and canvas can



FIG. 154.—Fong Yee, a Chinese amateur wireless operator at Oakland, Cal., who is also an aviator and has been summoned home by the republican Chinese government to demonstrate apparatus of his own invention to the Chinese army.

throw off the fetters of gravity and go soaring dizzily two miles up into the blue sky, and daring more, come skimming and diving back to earth with motor dead. Such wonders only came to pass, however, when numbers of men accepted the problem as one to be solved by trying, and bent their energies toward its solution. Science has not reached the limits of its resources. It never will. The

art of wireless may always be embarrassed by novelty in many directions.

One of the greatest steps forward toward the day when



FIG. 155.—Tesla world power plant (experimental station).

methods and appliances regarded as permanent as the mountains will pass and be considered only as the curious remnants of a cruder age is the interest of 200,000 wireless amateurs in the United States. Some of these will develop into men who will bring some of the wonders of the future to their full fruition.

What is this great change that can be coolly and precisely forecast? Along what lines will these wonderful developments come? The answer is "wireless"—not the wireless of a Marconi or a De Forest, but the wireless of a Tesla—of "high potential magnifying transmitters"—of "nodes" and "loops"—of oscillatory currents that leave their conductors behind—the "wireless" of the day when a system is introduced enabling any person to reach any other on the globe, not simply through a spoken word or thought conveyed, but visually a perfect transmission of images which will enable one person to see another, as though that other were by his side—"wireless" of a time when the great operations of commerce and industry will be vitalized by huge wireless power stations, turning the machinery of factories, lighting cities, or sending swift aeroplanes and ships darting to the farthest points of the earth.

Of course, there may be something of the dramatic in such assertions, but they are founded upon scientific facts, and, if imaginary, are scientifically imaginary. The wonderful mysteries of oscillatory currents, whose natural medium is the ether, currents which object to being confined to wires and cables, and defy all ordinary laws; currents that will melt masses of metal with the violence of an explosion, but yet pass through the human body without producing any sensation; currents that will instantly manifest themselves 2,000 miles away from their source, with no visible means of propagation, are the open sesame to the treasures of a wonderful future.

There are many places in the world where water power is available capable of generating almost unlimited electrical energy. The present difficulty lying in the way of its utilization is the limitation of electrical transmission by wire, for not only is the cost of long lines of copper tre-

mendous, but power can only be carried in this manner for limited distances. Central distributing wireless power stations could send the power of Niagara, which alone might be made to supply a fifth of all the power in the

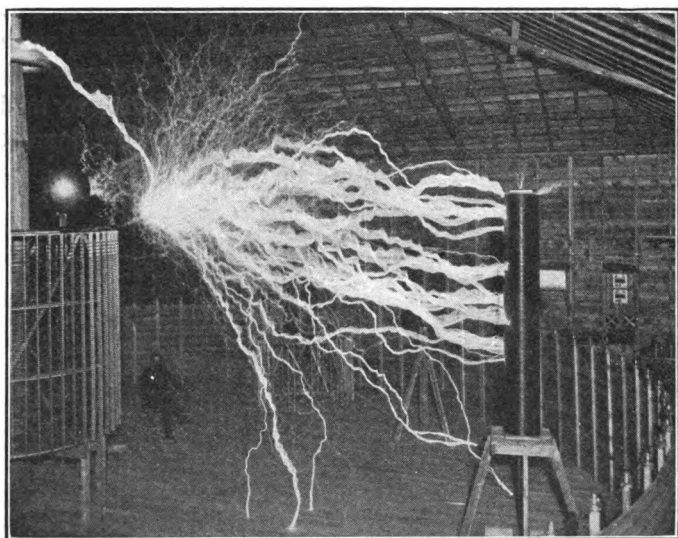

FIG. 156.—Twenty-five foot sparks from a Tesla transformer.

United States, and the energy of Victoria to the ends of the earth with little loss. The Great Falls of Zambesi, in the heart of Africa, could be made to run the subway trains, the factories, lights, railroads, ferries, trucks, heaters, etc., in that vast, most complex, most bewildering and inspiring city of the Western World, the City of New York. Ocean vessels would no longer carry thousands of tons of coal, locomotives would not wheeze and cough a trail of soot and smoke through the country, chimneys would cease to

belch, and aeroplanes would travel silently and swiftly overhead.

It is easy, in the face of certain facts, to conjure up situations which would be pleasant and make for the betterment of the world. Any one whose imagination is vivid enough can make a prediction, but when the great truth is accidentally revealed, or experimentally confirmed, as the case may be, and rendered absolutely sure of accomplishment, will its incalculable consequences continue to baffle the imagination and carry us further into the land of wonderment? Only the future knows.

THE END.

INDEX

A

- Action of directive aerials, 19, 20.
- Aerial, 8, 9.
amateur, 13, 18, 23, 26.
fan, 18.
flat top, 18, 19, 22, 23.
insulator, 25.
inverted pyramid, 18.
inverted "L," 20, 21, 24.
inverted "U," 21.
loop, 24.
mast, 18.
purpose of, 12.
straightaway, 24.
switch, 44, 45, 46.
transatlantic, 142.
types of, 18.
umbrella, 18, 22.
under influence of waves, 10.
"V" type, 20, 21, 24.
wire, 24, 25.
- Aeroplane, wireless on, 93.
- Air, ionization of, 14.
waves, 109.
- Airship, "Akron," 93.
"America," 97.
lightweight apparatus for, 83.
wireless apparatus, 95.
- Alternating current, 11, 36, 37,
cycle, 38.

- Amateur, aerial, 13, 18, 23, 26.
aerial switch, 45.
station, 11, 23, 26, 138.
wireless experimenter, 145.
- Antenna, purpose of, 12.
- Apparatus, transmitting, 27.
- Arc, 121, 122.
Poulsen, 131.
speaking, 121, 122.
- Arcing, 39.
- Army, aerial, 18.
orders issued by wireless, 88.
station at Fort Gibbons, 14.
- Arsenic, 55.
- Atlantic, seaboard stations, 15.
- Audion detector, 134, 135.
- Auditory canal, 106.
nerve, 105.
- Automobile wireless, 89, 90, 91.

B

- Battery, detector, 58, 60, 66.
- Bellini-Tosi system of directive telegraphy, 80, 81, 82.
- Bell's photophone, 116.
- Braun, system of directive waves, 78, 79.
- Breaking-in system, 102, 103.
- Brush discharge from aerial, 135.
from condenser, 38.

C

- Call letters, 99.
- Capacity, 8, 41, 42, 64, 66.
- Code, Continental, 87, 99.
 - Morse, 98.
- Coast defense, 89.
- Coil, carrying current, 30, 31.
 - doughnut tuning, 76.
 - induction, 7.
 - loading, 64.
 - loose coupled tuning, 75, 76.
- Condenser, 27, 33, 132.
 - fixed, 4, 64, 65.
 - oil immersed, 39.
 - oscillation, 39, 40.
 - rotary, 65, 66, 67.
 - sliding plate, 66, 68.
 - tubular, 40, 50.
 - variable, 48, 65, 66.
- Continental Code, 99.
- Core, transformer, 36.
 - induction coil, 32.
- Coupling, 73, 76.
- Currents, alternating, 11, 36, 37, 52.
 - direct, 11, 36.
 - earth, 13.
 - high frequency, 11, 24, 48, 54.
 - intermittent, 36.
 - secondary, 33.
 - supply, 27.
- Cycle, 38.

D

- Damping, 72, 73, 127.
- DeForest, 146.
 - system of wireless telephone, 126.

- Detector, 10, 48.
 - action, 11, 54, 55.
 - audion, 134, 135.
 - carborundum, 58, 60.
 - electrolytic, 58, 59.
 - mineral, 52.
 - molybdenite, 58.
 - perikon, 57.
 - pyron, 56.
- Dielectric, 67.
- Directive action, 19, 20.
- Directive wireless telegraphy, 78, 79, 80, 81, 82.
- Discharge, brush, 38, 135.
 - Leyden jar, 4.
 - of gap, 45.
- Doughnut tuner, 76.
- Dry cell, 27.
- Duplex receiving apparatus, 101.
- Dynamo, 27, 28.

E

- Ear, 105, 106.
 - drum, 106.
- Earth, 8.
 - amateur, 26.
 - currents, 13.
 - shipboard, 26.
 - wire, 26.
- Edison cells, 27.
- Electrolytic, detector, 58, 59.
 - interrupter, 34, 35.
- Electromagnetic waves, 3, 6, 7, 48, 59, 124.
- Electrostatic strain, 6, 7, 8, 29.
 - field, 29.
- Ether, 2, 8, 137.

F

- Faraday, Michael, 29.
 Fessenden wireless telephone,
 128.
 Field, electrostatic, 29.
 magnetic, 30, 32.
 Flat top aerials, 18, 19, 22.
 Fong Yee, 144.
 Forests, effects of, 14.
 Fort Gibbons, station at, 14, 77.
 Frequency, 38.
 Fuller cells, 27.

G

- Galena, 52, 58.
 Germania, 122.
 Government stations, ranges of,
 141.
 Ground, 8.
 effect of, 12.

H

- Harmonics of voice, 129.
 Heat, 3.
 Helix, 27, 41, 42.
 loose, coupled, 72.
 Herald press station, 94, 96.
 Hertz, Heinrich, 137.
 Hertzian waves, 124, 138.
 Hot wire ammeter, 73, 74.
 Hysteresis, 67.

I

- Inductance, 42, 64, 132.
 Induction coil, 27, 28, 50.

- coil, principle of, 31, 32,
 33.
 coil, purpose of, 7.
 magnetic, 29.
 Interrupter, 33, 36.
 electrolytic, 34, 35.
 Insulator, aerial, 25.
 leading-in, 25.
 Inverted pyramid aerial, 181, 191.
 Ionization of air, 14.
 Ions, 135.
 Iron pyrites, 10, 52, 56.

K

- Key, 27, 45, 46, 47, 50.
 Koenig's apparatus, 111.

L

- Langley, 143.
 Larynx, 110.
 Lead-in, 26.
 Leyden jar, 4.
 capacity of, 8.
 discharge of, 4, 5.
 Navy type, 6.
 set, 38.
 Light, transmission of, 3.
 nature of, 3.
 Lightning, 13, 16, 17.
 Loop aerial, 24, 47.
 Loose coupler, 72, 75.

M

- Magnet, 29.
 Magnetic field, 30, 32, 38, 132.
 induction, 29.

Majorana transmitter, 133, 134.
 Manometric flame apparatus, 109,
 112, 121.
 Marconi, 146.
 Marconi aerial, 135.
 transatlantic receiving station,
 62.
 Maritime stations, 84.
 Mast, aerial, 91.
 Maxwell, Clerk, 137.
 Maxwell's theory, 137.
 Messages, how sent and re-
 ceived, 98, 99.
 Minerals, 10, 11.
 detector, 52.
 Molybdenite, 58.
 Morse code, 98.
 signals, 10.

N

Navy course, 87.
 Leyden jars, 6.
 stations, 16.
 station at Washington, 139.
 transport, "Buford," 88.
 New York, 147.
 Noise, 108.

O

Oscillations, 5, 7, 8, 10, 11, 39,
 42, 48, 49.
 damped, 129.
 undamped, 130, 131.
 Oscillatory currents, 146.
 Ossicles, 106.
 Otoconia, 105, 106.

P

Pacific Coast stations, 15.
 Perikon detector, 51, 57.
 Phantom, magnetic, 30, 31.
 Photophone, 116, 119.
 receiving apparatus, 117.
 transmitting apparatus, 118.
 Potentiometer, 48, 51, 59, 60.
 Poulsen, arc, 131.
 wireless telephone, 132.
 Primary, induction coil, 8, 32.
 Pyron detector, 56, 58.
 Radio-goniometer, 79.
 Range of stations, 14.
 naval high power stations, 141.
 Rat-tail, 26.
 Reactance, 25.
 Receiver, telephone, 10, 11, 16,
 48, 115.
 Receiving, apparatus at Nauen,
 104.
 duplex apparatus, 101.
 Marconi apparatus, 62.
 complete outfit, 49, 51.
 portable pack set, 50.
 portable set, 49.
 Receptor, simple, 10.
 Resonance, 70, 72, 75.
 Ruhmer, Ernest, 121.

S

Scala media, 105.
 Secondary, induction coil, 8, 32.
 current, 33.
 Seibt condenser, 67.
 Selenium, 116.
 cells, 116.
 Signal Corps, 91.
 pack sets, 92.

Silicon, 10, 52, 57.
 Simon, 121.
 Smith, Willoughby, 116.
 Sound, 53, 166, 107, 108.
 musical, 108.
 noise, 108.
 timbre, 110.
 waves, 109.
 Spark, anchor gap, 45, 46, 47.
 discharge, 4.
 from Tesla transformer, 147.
 gap, 8, 27, 42, 62.
 induction coil, 34.
 quenched gap, 45.
 rotary gap, 43, 44.
 Speaking arc, 121, 122.
 Speech, 11.
 Static, 15.
 machine, 4.
 Station, amateur, 11, 23, 26, 138.
 Atlantic seaboard, 15.
 determination of, 21.
 Fort Gibbons, 14, 77.
 Herald, 94, 96.
 Marconi, 62.
 maritime, 84.
 Nauen, 100, 104.
 Navy stations, 16, 17.
 Pacific coast, 15.
 radio-telegraphic, 12.
 Storage cells, 27.
 Straightaway aerial, 24.
 Strain, electrostatic, 6, 7, 8, 29.
 Sunlight, effects of, upon transmission, 14.
 Switch, aerial, 44, 45, 46.

T

"T" aerial, 21.

Tainter's photophone, 116.
 Telefunken wireless cart, 84, 85, 87.
 Telephone, 114.
 Telephone receiver, 52, 53, 66, 115.
 Pickard, 53.
 Telephone transmitter, 114, 115.
 Tesla, 146.
 transformer, 147.
 world power plant, 145.
 Test, buzzer, 48.
 Thermophone, 119, 120.
 Thunder, 16.
 Timbre, 110.
 Titanic disaster, 87.
 Transformer, 27, 29.
 closed core, 35.
 core, 36.
 high potential, 37.
 humming type, 37.
 open core, 35.
 purpose of, 7.
 Transmission of wireless messages, effects of sunlight upon, 14.
 effects of locality upon, 15.
 by Army, 89.
 by Navy, 138.
 music, 135.
 principles of, 2.
 Transmitter, Majorana, 133, 134.
 purpose of, 12.
 simple, 7.
 Telefunken, 84.
 telephone, 114, 115.
 wireless telephone, 133.
 Transmitting, apparatus, 27.
 condenser, 77.
 portable pack set, 50.
 Tuning, 60, 61, 62, 63, 68.

Tuning, coil, 60, 61, 62, 63, 68.
doughnut coil, 76.
loose coupled coil, 75, 76.

U

Umbrella aerial, 18, 22.
Undamped oscillations, 130, 131.
Upper Harmonics, 129.

V

"V" type aerial, 20, 21, 24.
Vanniman, Melville, 93.
Variometer, 48.
Vertical aerials, 18, 19, 23.
Vocal chords, 110, 11.

W

Wave length, 62, 69, 70.

Waves, electromagnetic, 3.
generation of, 3, 6, 7, 8.
Hertzian, 48.
length, 62, 69, 70.
reception of, 10.
sound, 11.

Wellman expedition, 93.

Wire, aerial, 24, 25.

Wireless telegraphy, in press
service, 98.
in railroad service, 98.
on airships, 93.
in the Navy, 86.
in the Army, 88.

Wireless telephone, 124, 125, 126.
advantage of, 140.
Poulsen, 132.

Wireless telephony, 83.

Wireless transmission, 2.

Wollaston wire, 58.

Z

Zincite, 57.

BOOKS FOR HOME STUDY



**PRACTICAL SCIENTIFIC
TECHNICAL**

EACH BOOK IN THIS CATALOGUE IS WRITTEN BY
AN EXPERT AND IS WRITTEN SO YOU
CAN UNDERSTAND IT

THE NORMAN W. HENLEY PUBLISHING COMPANY

Publishers of Scientific and Practical Books

132 Nassau Street

New York, U. S. A.

Any book in this Catalogue sent prepaid on receipt of price.

SUBJECT INDEX

PAGE		PAGE	
Accidents.....	18	Manual Training.....	22
Air Brakes.....	17, 19	Marine Engines.....	22
Arithmetics.....	20	Marine Steam Turbines.....	29
Automobiles.....	3	Mechanical Movements.....	20, 21
Balloons.....	3	Metal Turning.....	16
Bevel Gears.....	14	Milling Machines.....	21
Boilers.....	22	Mining.....	22, 23
Brazing.....	3	Oil Engines.....	13
Cams.....	15	Patents.....	15
Car Charts.....	4	Pattern Making.....	23
Change Gear.....	14	Perfumery.....	23
Charts.....	3, 4, 22	Pipes.....	28
Chemistry.....	23	Plumbing.....	24
Coal Mining.....	23	Producer Gas.....	13
Coke.....	4	Punches.....	7
Compressed Air.....	5	Railroad Accidents.....	18
Concrete.....	5	Receipt Book.....	23, 25
Cyclopedia.....	4, 20	Refrigeration.....	15
Dictionaries.....	7	Rope Work.....	15
Dies.....	7	Rubber Stamps.....	25
Drawing.....	8, 24	Saws.....	26
Drop Forging.....	7	Sheet Metal Working.....	7
Dynamo.....	9, 10, 11	Shop Tools.....	21
Electricity.....	9, 10, 11, 12	Shop Construction.....	20
Engines and Boilers.....	22	Shop Management.....	20
Factory Management.....	12	Sketching Paper.....	8
Flying Machines.....	3	Smoke Prevention.....	13
Fuel.....	13	Soldering.....	3
Gas Manufacturing.....	14	Splices.....	15
Gas Engines.....	13, 14	Steam Engineering.....	26, 27
Gears.....	14	Steam Heating.....	27
Heating, Electric.....	9	Steam Pipes.....	28
Hot Water Heating.....	27	Steel.....	28
Horse-Power Chart.....	4	Superheated Steam.....	17
Hydraulics.....	15	Switchboards.....	9, 11
Ice Making.....	15	Tapers.....	16
India Rubber.....	25	Telephone.....	12
Interchangeable Manufacturing.....	20	Threads.....	22
Inventions.....	15	Tools.....	20, 22
Knots.....	15	Turbines.....	29
Lathe Work.....	16	Ventilation.....	27
Lighting (Electric).....	9	Valve Gear.....	19
Link Motion.....	17	Valve Setting.....	17
Liquid Air.....	16	Walschaert Valve Gear.....	19
Locomotive Bolders.....	18	Watchmaking.....	29
Locomotive Engineering.....	17, 18, 19	Wiring.....	9, 11, 12
Machinist's Books.....	20, 21, 22	Wireless Telephones and Telegraphy.....	12

ANY OF THESE BOOKS PROMPTLY SENT PREPAID TO ANY ADDRESS IN THE WORLD ON RECEIPT OF PRICE.

How to Remit.—By Postal Money Order, Express Money Order, Bank Draft or Registered Letter.

CATALOGUE OF GOOD, PRACTICAL BOOKS

AUTOMOBILE

THE MODERN GASOLINE AUTOMOBILE—ITS DESIGN, CONSTRUCTION, MAINTENANCE AND REPAIR. By VICTOR W. PAGE, M. E.

The latest and most complete treatise on the Gasoline Automobile ever issued. Written in simple language by a recognized authority, familiar with every branch of the automobile industry. Free from technical terms. Everything is explained so simply that anyone of average intelligence may gain a comprehensive knowledge of the gasoline automobile. The information is up-to-date and includes, in addition to an exposition of principles of construction and description of all types of automobiles and their components, valuable money-saving hints on the care and operation of motor cars propelled by internal combustion engines. Among some of the subjects treated might be mentioned: Torpedo and other symmetrical body forms designed to reduce air resistance; sleeve valve, rotary valve and other types of silent motors; increasing tendency to favor worm-gear power-transmission; universal application of magneto ignition; development of automobile electric-lighting systems; block motors; underslung chassis; application of practical self-starters; long stroke and offset cylinder motors; latest automatic lubrication systems; silent chains for valve operation and change-speed gearing; the use of front wheel brakes and many other detail refinements.

By a careful study of the pages of this book one can gain practical knowledge of automobile construction that will save time, money and worry. The book tells you just what to do, how and when to do it. Nothing has been omitted, no detail has been slighted. Every part of the automobile, its equipment, accessories, tools, supplies, spare parts necessary, etc., have been discussed comprehensively. If you are or intend to become a motorist, or are in any way interested in the modern Gasoline Automobile, this is a book you cannot afford to be without. Nearly 600 6x9 pages—and more than 500 new and specially made detail illustrations, as well as many full page and double page plates, showing all parts of the automobile. Including nine large folding plates. Price.....\$2.50

BALLOONS AND FLYING MACHINES

MODEL BALLOONS AND FLYING MACHINES. WITH A SHORT ACCOUNT OF THE PROGRESS OF AVIATION. By J. H. ALEXANDER.

This book has been written with a view to assist those who desire to construct a model airship or flying machine. It contains five folding plates of working drawings, each sheet containing a different sized machine. Much instruction and amusement can be obtained from the making and flying of these models.

A short account of the progress of aviation is included, which will render the book of greater interest. Several illustrations of full sized airship and flying machines of the latest types are scattered throughout the text. This practical work gives data, working drawings, and details which will assist materially those interested in the problems of flight. 127 pages, 45 illustrations, 5 folding plates. Price \$1.50

BRAZING AND SOLDERING

BRAZING AND SOLDERING. By JAMES F. HOBART.

The only book that shows you just how to handle any job of brazing or soldering that comes along; tells you what mixture to use, how to make a furnace if you need one. Full of valuable kinks. The fifth edition of this book has just been published, and to it much new matter and a large number of tested formulas for all kinds of solders and fluxes have been added. Illustrated 25 cents

CHARTS

MODERN SUBMARINE CHART—WITH 200 PARTS NUMBERED AND NAMED.

A cross-section view, showing clearly and distinctly all the interior of a Submarine of the latest type. You get more information from this chart, about the construction and operation of a Submarine, than in any other way. No details omitted—everything is accurate and to scale. It is absolutely correct in every detail, having been approved by Naval Engineers. All the machinery and devices fitted in a modern Submarine Boat are shown, and to make the engraving more readily understood all the features are shown in operative form, with Officers and Men in the act of performing the duties assigned to them in service conditions. This CHART IS REALLY AN ENCYCLOPEDIA OF A SUBMARINE. It is educational and worth many times its cost. Mailed in a Tube for.....25 cents

CATALOGUE OF GOOD, PRACTICAL BOOKS

BOX CAR CHART.

A chart showing the anatomy of a box car, having every part of the car numbered and its proper name given in a reference list. 20 cents

GONDOLA CAR CHART.

A chart showing the anatomy of a gondola car, having every part of the car numbered and its proper reference name given in a reference list. 20 cents

PASSENGER CAR CHART.

A chart showing the anatomy of a passenger car, having every part of the car numbered and its proper name given in a reference list. 20 cents

WESTINGHOUSE AIR-BRAKE CHARTS.

Chart I.—Shows (in colors) the most modern Westinghouse High Speed and Signal Equipment used on Passenger Engines, Passenger Engine Tenders, and Passenger Cars. Chart II.—Shows (in colors) the Standard Westinghouse Equipment for Freight and Switch Engines, Freight and Switch Engine Tenders, and Freight Cars. Price for the set . . . 50 cents

TRACTIVE POWER CHART.

A chart whereby you can find the tractive power or drawbar pull of any locomotive, without making a figure. Shows what cylinders are equal, how driving wheels and steam pressure affect the power. What sized engine you need to exert a given drawbar pull or anything you desire in this line. 50 cents

HORSE POWER CHART.

Shows the horse power of any stationary engine without calculation. No matter what the cylinder diameter of stroke; the steam pressure or cut-off; the revolutions, or whether condensing or non-condensing, it's all there. Easy to use, accurate, and saves time and calculations. Especially useful to engineers and designers. 50 cents

BOILER ROOM CHART. By GEO. L. FOWLER.

A Chart—size 14 x 28 inches—showing in isometric perspective the mechanisms belonging in a modern boiler room. Water tube boilers, ordinary grates and mechanical stokers, feed water heaters and pumps comprise the equipment. The various parts are shown broken or removed, so that the internal construction is fully illustrated. Each part is given a reference number, and these, with the corresponding name, are given in a glossary printed at the sides. This chart is really a dictionary of the boiler room—the names of more than 200 parts being given. It is educational—worth many times its cost. 25 cents

CIVIL ENGINEERING

HENLEY'S ENCYCLOPEDIA OF PRACTICAL ENGINEERING AND ALLIED TRADES. Edited by JOSEPH G. HORNER, A. M. I. E. M.

This set of five volumes contains about 2,500 pages with thousands of illustrations, including diagrammatic and sectional drawings with full explanatory details. This work covers the entire practice of Civil and Mechanical Engineering. The best known experts in all branches of engineering have contributed to these volumes. The Cyclopedic is admirably well adapted to the needs of the beginner and the self-taught practical man, as well as the mechanical engineer, designer, draftsman, shop superintendent, foreman, and machinist. The work will be found a means of advancement to any progressive man. It is encyclopedic in scope, thorough and practical in its treatment of technical subjects, simple and clear in its descriptive matter, and without unnecessary technicalities or formulae. The articles are as brief as may be and yet give a reasonably clear and explicit statement of the subject, and are written by men who have had ample practical experience in the matters of which they write. It tells you all you want to know about engineering and tells it so simply, so clearly, so concisely, that one cannot help but understand. As a work of reference it is without a peer. \$6.00 per single volume. For complete set of five volumes, price \$25.00

COKE

COKE—MODERN COKING PRACTICE; INCLUDING THE ANALYSIS OF MATERIALS AND PRODUCTS. By T. H. BYROM and J. E. CHRISTOPHER.

A handbook for those engaged in Coke manufacture and the recovery of By-products. Fully illustrated with folding plates. It has been the aim of the authors, in preparing this book, to produce one which shall be of use and benefit to those who are associated with, or interested in, the modern developments of the industry. Contents: I. Introductory. II. Gen-

CATALOGUE OF GOOD, PRACTICAL BOOKS

eral Classification of Fuels. III. Coal Washing. IV. The Sampling and Valuation of Coal, Coke, etc. V. The Calorific Power of Coal and Coke. VI. Coke Ovens. VII. Coke Ovens, continued. VIII. Coke Ovens, continued. IX. Charging and Discharging of Coke Ovens, X. Cooling and Condensing Plant. XI. Gas Exhausters. XII. Composition and Analysis of Ammoniacal Liquor. XIII. Working-up of Ammoniacal Liquor. XIV. Treatment of Waste Gases from Sulphate Plants. XV. Valuation of Ammonium Sulphate. XVI. Direct Recovery of Ammonia from Coke Oven Gases. XVII. Surplus Gas from Coke Oven. Useful Tables. Very fully illustrated. Price **\$3.50 net**

COMPRESSED AIR

COMPRESSED AIR IN ALL ITS APPLICATIONS. By GARDNER D. HISCOX.

This is the most complete book on the subject of Air that has ever been issued, and its thirty-five chapters include about every phase of the subject one can think of. It may be called an encyclopaedia of compressed air. It is written by an expert, who, in its 665 pages, has dealt with the subject in a comprehensive manner, no phase of it being omitted. Includes the physical properties of air from a vacuum to its highest pressure, its thermodynamics, compression, transmission and uses as a motive power; in the Operation of Stationary and Portable Machinery, in Mining, Air Tools, Air Lifts, Pumping of Water, Acids, and Oils; the Air Blast for Cleaning and Painting, the Sand Blast and its Work, and the Numerous Appliances in which Compressed Air is a Most Convenient and Economical Transmitter of Power for Mechanical Work, Railway Propulsion, Refrigeration, and the Various Uses to which Compressed Air has been applied. Includes forty-four tables of the physical properties of air, its compression, expansion, and volumes required for various kinds of work, and a list of patents on compressed air from 1875 to date. Over 500 illustrations, 5th Edition, revised and enlarged. Cloth bound, **\$5.00**. Half Morocco, price **\$6.50**

CONCRETE

ORNAMENTAL CONCRETE WITHOUT MOLDS. By A. A. HOUGHTON.

The process for making ornamental concrete without molds has long been held as a secret, and now, for the first time, this process is given to the public. The book reveals the secret and is the only book published which explains a simple, practical method whereby the concrete worker is enabled, by employing wood and metal templates of different designs, to mold or model in concrete any Cornice, Archivolt, Column, Pedestal, Base Cap, Urn or Pier in a monolithic form—right upon the job. These may be molded in units or blocks, and then built up to suit the specifications demanded. This work is fully illustrated, with detailed engravings. Price **\$2.00**

CONCRETE FROM SAND MOLDS. By A. A. HOUGHTON.

A Practical Work treating on a process which has heretofore been held as a trade secret by the few who possessed it, and which will successfully mold every and any class of ornamental concrete work. The process of molding concrete with sand molds is of the utmost practical value, possessing the manifold advantages of a low cost of molds, the ease and rapidity of operation, perfect details to all ornamental designs, density, and increased strength of the concrete, perfect curing of the work without attention and the easy removal of the molds regardless of any undercutting the design may have. 192 pages. Fully illustrated. Price **\$2.00**

CONCRETE WALL FORMS. By A. A. HOUGHTON.

A new automatic wall clamp is illustrated with working drawings. Other types of wall forms, clamps, separators, etc., are also illustrated and explained. **50 cents**

CONCRETE FLOORS AND SIDEWALKS. By A. A. HOUGHTON.

The molds for molding squares, hexagonal and many other styles of mosaic floor and sidewalk blocks are fully illustrated and explained. **50 cents**

PRACTICAL CONCRETE SILO CONSTRUCTION. By A. A. HOUGHTON.

Complete working drawings and specifications are given for several styles of concrete silos, with illustrations of molds for monolithic and block silos. The tables, data and information presented in this book are of the utmost value in planning and constructing all forms of concrete silos. **50 cents**

MOLDING CONCRETE CHIMNEYS, SLATE AND ROOF TILES. By A. A. HOUGHTON.

The manufacture of all types of concrete slate and roof tile is fully treated. Valuable data on all forms of reinforced concrete roofs are contained within its pages. The construction of concrete chimneys by block and monolithic systems is fully illustrated and described. A number of ornamental designs of chimney construction with molds are shown in this valuable treatise. **50 cents**

CATALOGUE OF GOOD, PRACTICAL BOOKS

MOLDING AND CURING ORNAMENTAL CONCRETE. By A. A. HOUGHTON.
The proper proportions of cement and aggregates for various finishes, also the methods of thoroughly mixing and placing in the molds, are fully treated. An exhaustive treatise on this subject that every concrete worker will find of daily use and value. 50 cents

CONCRETE MONUMENTS, MAUSOLEUMS AND BURIAL VAULTS. By A. A. HOUGHTON.
The molding of concrete monuments to imitate the most expensive cut stone is explained in this treatise, with working drawings of easily built molds. Cutting inscriptions and designs is also fully treated. 50 cents

MOLDING CONCRETE BATH TUBS, AQUARIUMS AND NATATORIUMS.
By A. A. HOUGHTON.
Simple molds and instruction are given for molding many styles of concrete bath tubs, swimming pools, etc. These molds are easily built and permit rapid and successful work. 50 cents

CONCRETE BRIDGES, CULVERTS AND SEWERS. By A. A. HOUGHTON.
A number of ornamental concrete bridges with illustrations of molds are given. A collapsible center or core for bridges, culverts and sewers is fully illustrated with detailed instructions for building 50 cents

CONSTRUCTING CONCRETE PORCHES. By A. A. HOUGHTON.
A number of designs with working drawings of molds are fully explained so any one can easily construct different styles of ornamental concrete porches without the purchase of expensive molds. 50 cents

MOLDING CONCRETE FLOWER POTS, BOXES, JARDINIÈRES, ETC. By A. A. HOUGHTON.
The molds for producing many original designs of flower pots, urns, flower boxes, jardinières, etc., are fully illustrated and explained, so the worker can easily construct and operate same. 50 cents

MOLDING CONCRETE FOUNTAINS AND LAWN ORNAMENTS. By A. A. HOUGHTON.
The molding of a number of designs of lawn seats, curbing, hitching posts, pergolas, sun dials and other forms of ornamental concrete for the ornamentation of lawns and gardens, is fully illustrated and described. 50 cents

CONCRETE FOR THE FARM AND SHOP. By A. A. HOUGHTON.
The molding of drain tile, tanks, cisterns, fence posts, stable floors, hog and poultry houses and all the purposes for which concrete is an invaluable aid to the farmer are numbered among the contents of this handy volume. 50 cents

POPULAR HANDBOOK FOR CEMENT AND CONCRETE USERS. By MYRON H. LEWIS,

This is a concise treatise of the principles and methods employed in the manufacture and use of cement in all classes of modern works. The author has brought together in this work all the salient matter of interest to the user of concrete and its many diversified products. The matter is presented in logical and systematic order, clearly written, fully illustrated and free from involved mathematics. Everything of value to the concrete user is given including kinds of cement employed in construction, concrete architecture, inspection and testing, water-proofing, coloring and painting, rules, tables, working, and cost data. The book comprises thirty-three chapters, as follows:

Introductory. Kinds of Cements and How They are Made. Properties, Testing and Requirements of Hydraulic Cement. Concrete and its Properties. Sand, Broken Stone and Gravel for Concrete. How to Proportion the Materials. How to Mix and Place Concrete. Forms for Concrete Construction. The Architectural and Artistic Possibilities of Concrete. Concrete Residences. Mortars, Plasters and Stucco and How to Use Them. The Artistic Treatment of Concrete Surfaces. Concrete Building Blocks. The Making of Ornamental Concrete. Concrete Pipes, Fences, Posts, Etc. Essential Features and Advantages of Reinforced Concrete. How to Design Reinforced Concrete Beams, Slabs and Columns. Explanations of the Methods and Principles in Designing Reinforced Concrete Beams and Slabs. Systems of Reinforcement Employed. Reinforced Concrete in Factory and General

CATALOGUE OF GOOD, PRACTICAL BOOKS

Building Construction. Concrete in Foundation Work. Concrete Retaining Walls, Abutments, and Bulkheads. Concrete Arches and Arch Bridges. Concrete Beam and Girder Bridges. Concrete in Sewerage and Drainage Works. Concrete Tanks, Dams and Reservoirs. Concrete Sidewalks, Curbs and Pavements. Concrete in Railroad Constructions. The Utility of Concrete on the Farm. The Waterproofing of Concrete Structure. Grout or Liquid Concrete and Its Use. Inspection of Concrete Work. Cost of Concrete Work. Some of the special features of the book are: 1. The Attention Paid to the Artistic and Architectural Side of Concrete Work. 2. The Authoritative Treatment of the Problem of Waterproofing Concrete. 3. An Excellent Summary of the Rules to be Followed in Concrete Construction. 4. The Valuable Cost Data and Useful Tables given. A valuable Addition to the Library of Every Cement and Concrete User. Price.....\$2.50

WATERPROOFING CONCRETE. By MYRON H. LEWIS.

Modern Methods of Waterproofing Concrete and Other Structures. A condensed statement of the Principles, Rules, and Precautions to be Observed in Waterproofing and Damp-proofing Structures and Structural Materials. Paper binding. Illustrated. Price..50 cents

DICTIONARIES

STANDARD ELECTRICAL DICTIONARY. By T. O'CONNOR SLOANE.

An indispensable work to all interested in electrical science. Suitable alike for the student and professional. A practical hand-book of reference containing definitions of about 5,000 distinct words, terms and phrases. The definitions are terse and concise and include every term used in electrical science. Recently issued. An entirely new edition. Should be in the possession of all who desire to keep abreast with the progress of this branch of science. Complete, concise and convenient. 682 pages. 393 illustrations. Price \$3.00

DIES—METAL WORK

DIES: THEIR CONSTRUCTION AND USE FOR THE MODERN WORKING OF SHEET METALS. By J. V. WOODWORTH.

A most useful book, and one which should be in the hands of all engaged in the press working of metals; treating on the Designing, Constructing, and Use of Tools, Fixtures and Devices, together with the manner in which they should be used in the Power Press, for the cheap and rapid production of the great variety of sheet metal articles now in use. It is designed as a guide to the production of sheet metal parts at the minimum of cost with the maximum of output. The hardening and tempering of Press tools and the classes of work which may be produced to the best advantage by the use of dies in the power press are fully treated. Its 505 illustrations show dies, press fixtures and sheet metal working devices, the descriptions of which are so clear and practical that all metal-working mechanics will be able to understand how to design, construct and use them. Many of the dies and press fixtures treated were either constructed by the author or under his supervision. Others were built by skillful mechanics and are in use in large sheet metal establishments and machine shops. Price \$3.00

PUNCHES, DIES AND TOOLS FOR MANUFACTURING IN PRESSES. By J. V. WOODWORTH.

This work is a companion volume to the author's elementary work entitled "Dies, Their Construction and Use." It does not go into the details of die making to the extent of the author's previous book, but gives a comprehensive review of the field of operations carried on by presses. A large part of the information given has been drawn from the author's personal experience. It might well be termed an Encyclopedia of Die Making, Punch Making, Die Sinking, Sheet Metal Working, and Making of Special Tools, Sub-presses, Devices and Mechanical Combinations for Punching, Cutting, Bending, Forming, Piercing, Drawing, Compressing and Assembling Sheet Metal Parts, and also Articles of other Materials in Machine Tools. 2d Edition. Price. \$4.00

DROP FORGING, DIE SINKING AND MACHINE FORMING OF STEEL. By J. V. WOODWORTH.

This is a practical treatise on Modern Shop Practice, Processes, Methods, Machines, Tools, and Details, treating on the Hot and Cold Machine-Forming of Steel and Iron into Finished shapes; Together with Tools, Dies, and Machinery involved in the manufacture of Duplicate

CATALOGUE OF GOOD, PRACTICAL BOOKS

Forgings and Interchangeable Hot and Cold Pressed Parts from Bar and Sheet Metal. This book fills a demand of long standing for information regarding drop forging, die-sinking and machine forming of steel and the shop practice involved, as it actually exists in the modern drop forging shop. The processes of die-sinking and force-making, which are thoroughly described and illustrated in this admirable work, are rarely to be found explained in such a clear and concise manner as is here set forth. The process of die-sinking relates to the engraving or sinking of the female or lower dies, such as are used for drop forgings, hot and cold machine forging, swedging and the press working of metals. The process of force-making relates to the engraving or raising of the male or upper dies used in producing the lower dies for the press-forming and machine-forging of duplicate parts of metal.

In addition to the arts above mentioned the book contains explicit information regarding the drop forging and hardening plants, designs, conditions, equipment, drop hammers, forging machines, etc., machine forging, hydraulic forging, autogenous welding and shop practice. The book contains eleven chapters, and the information contained in these chapters is just what will prove most valuable to the forged metal worker. All operations described in the work are thoroughly illustrated by means of perspective half-tones and outline sketches of the machinery employed. 300 detailed illustrations. Price. **\$2.50**

DRAWING—SKETCHING PAPER

LINEAR PERSPECTIVE SELF-TAUGHT. By HERMAN T. C. KRAUS.

This work gives the theory and practice of linear perspective, as used in architectural, engineering, and mechanical drawings. Persons taking up the study of the subject by themselves will be able by the use of the instruction given to readily grasp the subject, and by reasonable practice become good perspective draftsmen. The arrangement of the book is good; the plate is on the left-hand, while the descriptive text follows on the opposite page, so as to be readily referred to. The drawings are on sufficiently large scale to show the work clearly and are plainly figured. The whole work makes a very complete course on perspective drawing, and will be found of great value to architects, civil and mechanical engineers, patent attorneys, art designers, engravers, and draftsmen. **\$2.50**

PRACTICAL PERSPECTIVE. By RICHARDS and COLVIN.

Shows just how to make all kinds of mechanical drawings in the only practical perspective isometric. Makes everything plain so that any mechanic can understand a sketch or drawing in this way. Saves time in the drawing room, and mistakes in the shops. Contains practical examples of various classes of work. 3rd Edition. **50 cents**

SELF-TAUGHT MECHANICAL DRAWING AND ELEMENTARY MACHINE DESIGN. By F. L. SYLVESTER, M.E., Draftsman, with additions by ERIK OBERG, associate editor of "Machinery."

This is a practical treatise on Mechanical Drawing and Machine Design, comprising the first principles of geometric and mechanical drawing, workshop mathematics, mechanics, strength of materials and the calculations and design of machine details. The author's aim has been to adapt this treatise to the requirements of the practical mechanic and young draftsman and to present the matter in as clear and concise a manner as possible. To meet the demands of this class of students, practically all the important elements of machine design have been dealt with, and in addition algebraic formulas have been explained, and the elements of trigonometry treated in the manner best suited to the needs of the practical man. The book is divided into 20 chapters, and in arranging the material, mechanical drawing, pure and simple, has been taken up first, as a thorough understanding of the principles of representing objects facilitates the further study of mechanical subjects. This is followed by the mathematics necessary for the solution of the problems in machine design which are presented later, and a practical introduction to theoretical mechanics and the strength of materials. The various elements entering into machine design, such as cams, gears, sprocket wheels, cone pulleys, bolts, screws, couplings, clutches, shafting and fly-wheels have been treated in such a way as to make possible the use of the work as a textbook for a continuous course of study. It is easily comprehended and assimilated even by students of limited previous training. 330 pages, 215 engravings. Price. . . . **\$2.00**

A NEW SKETCHING PAPER.

A new specially ruled paper to enable you to make sketches or drawings in isometric perspective without any figuring or fussing. It is being used for shop details as well as for assembly drawings, as it makes one sketch do the work of three, and no workman can help seeing just what is wanted. Pads of 40 sheets, 6 x 9 inches, **25 cents**. Pads of 40 sheets, 9 x 12 inches, **50 cents**; 40 sheets, 12 x 18, Price **\$1.00**

CATALOGUE OF GOOD, PRACTICAL BOOKS

ELECTRICITY

ARITHMETIC OF ELECTRICITY. By Prof. T. O'CONNOR SLOANE.

A practical treatise on electrical calculations of all kinds reduced to a series of rules, all of the simplest forms, and involving only ordinary arithmetic; each rule illustrated by one or more practical problems, with detailed solution of each one. This book is classed among the most useful works published on the science of electricity covering as it does the mathematics of electricity in a manner that will attract the attention of those who are not familiar with algebraical formulas. 20th Edition. 160 pages. Price \$1.00

COMMUTATOR CONSTRUCTION. By WM. BAXTER, JR.

The business end of any dynamo or motor of the direct current type is the commutator. This book goes into the designing, building, and maintenance of commutators, shows how to locate troubles and how to remedy them; everyone who fusses with dynamos needs this. 25 cents

DYNAMO BUILDING FOR AMATEURS, OR HOW TO CONSTRUCT A FIFTY-WATT DYNAMO. By ARTHUR J. WEED, Member of N. Y. Electrical Society.

A practical treatise showing in detail the construction of a small dynamo or motor, the entire machine work of which can be done on a small foot lathe. Dimensioned working drawings are given for each piece of machine work and each operation is clearly described. This machine, when used as a dynamo, has an output of fifty watts; when used as a motor it will drive a small drill press or lathe. It can be used to drive a sewing machine on any and all ordinary work. The book is illustrated with more than sixty original engravings showing the actual construction of the different parts. Among the contents are chapters on 1. Fifty Watt Dynamo. 2. Side Bearing Rods. 3. Field Punchings. 4. Bearings. 5. Commutator. 6. Pulley. 7. Brush Holders. 8. Connection Board. 9. Armature Shaft. 10. Armature. 11. Armature Winding. 12. Field Winding. 13. Connecting and Starting. Price, paper, 50 cents. Cloth. \$1.00

ELECTRIC FURNACES AND THEIR INDUSTRIAL APPLICATIONS. By J. WRIGHT

This is a book which will prove of interest to many classes of people; the manufacturer who desires to know what product can be manufactured successfully in the electric furnace, the chemist who wishes to post himself on the electro-chemistry, and the student of science who merely looks into the subject from curiosity. The book is not so scientific as to be of use only to the technologist, nor so unscientific as to suit only the tyro in electro-chemistry; it is a practical treatise of what has been done, and of what is being done, both experimentally and commercially with the electric furnace.

In important processes not only are the chemical equations given, but complete thermal data are set forth and both the efficiency of the furnace and the cost of the product are worked out, thus giving the work a solid commercial value aside from its efficacy as a work of reference. The practical features of furnace building are given the space that the subject deserves. The forms and refractory materials used in the linings, the arrangement of the connections to the electrodes, and other important details are explained. 288 pages. New Revised Edition. Fully illustrated. Price \$3.00

ELECTRIC LIGHTING AND HEATING POCKET BOOK. By SYDNEY F. WALKER.

This book puts in convenient form useful information regarding the apparatus which is likely to be attached to the mains of an electrical company. Tables of units and equivalents are included and useful electrical laws and formulas are stated.

One section is devoted to dynamos, motors, transformers and accessory apparatus; another to accumulators, another to switchboards and related equipment, a fourth to a description of various systems of distribution, a fifth section to a discussion of instruments, both for portable use and switchboards; another section deals with electric lamps of various types and accessory appliances, and the concluding section is given up to electric heating apparatus. In each section a large number of commercial types are described, frequent tables of dimensions being included. A great deal of detail information of each line of apparatus is given and the illustrations shown give a good idea of the general appearance of the apparatus under discussion. The book also contains much valuable information for the central station engineer. 438 pages. 300 engravings. Bound in leather pocket book form. Price . \$3.00

ELECTRIC WIRING, DIAGRAMS AND SWITCHBOARDS. By NEWTON HARRISON.

A thoroughly practical treatise covering the subject of Electric Wiring in all its branches, including explanations and diagrams which are thoroughly explicit and greatly simplify the subject. Practical every-day problems in wiring are presented and the method of obtaining intelligent results clearly shown. Only arithmetic is used. Ohm's law is given

CATALOGUE OF GOOD, PRACTICAL BOOKS

a simple explanation with reference to wiring for direct and alternating currents. The fundamental principle of drop of potential in circuits is shown with its various applications. The simple circuit is developed with the position of mains, feeders and branches; their treatment as a part of a wiring plan and their employment in house-wiring clearly illustrated. Some simple facts about testing are included in connection with the wiring. Molding and conduit work are given careful consideration; and switchboards are systematically treated, built up and illustrated, showing the purpose they serve, for connection with the circuits, and to shunt and compound wound machines. The simple principles of switchboard construction, the development of the switchboard, the connections of the various instruments including the lightning arrester, are also plainly set forth.

Alternating current wiring is treated, with explanations of the power factor, conditions calling for various sizes of wire and a simple way of obtaining the sizes for single-phase, two-phase and three-phase circuits. This is the only complete work issued showing and telling you what you should know about direct and alternating current wiring. It is a ready reference. The work is free from advanced technicalities and mathematics, arithmetic being used throughout. It is in every respect a handy, well-written, instructive, comprehensive volume on wiring for the wireman, foreman, contractor, or electrician. 272 pages; 105 illustrations. Price \$1.50

ELECTRIC TOY MAKING, DYNAMO BUILDING, AND ELECTRIC MOTOR CONSTRUCTION. By Prof. T. O'CONNOR SLOANE.

This work treats of the making at home of electrical toys, electrical apparatus, motors, dynamos and instruments in general, and is designed to bring within the reach of young and old the manufacture of genuine and useful electrical appliances. The work is especially designed for amateurs and young folks.

Thousands of our young people are daily experimenting, and busily engaged in making electrical toys and apparatus of various kinds. The present work is just what is wanted to give the much needed information in a plain, practical manner, with illustrations to make easy the carrying out of the work. 19th Edition. Price \$1.00

ELECTRICIAN'S HANDY BOOK. By Prof. T. O'CONNOR SLOANE.

This work of 768 pages is intended for the practical electrician who has to make things go. The entire field of electricity is covered within its pages. Among some of the subjects treated are: The Theory of the Electric Current and Circuit, Electro-Chemistry, Primary Batteries, Storage Batteries, Generation and Utilization of Electric Powers, Alternating Current, Armature Winding, Dynamos and Motors, Motor Generators, Operation of the Central Station Switchboards, Safety Appliances, Distribution of Electric Light and Power, Street Mains, Transformers, Arc and Incandescent Lighting, Electric Measurements, Photometry, Electric Railways, Telephony, Bell-Wiring, Electro-Plating, Electric Heating, Wireless Telegraphy, etc. It contains no useless theory; everything is to the point. It teaches you just what you want to know about electricity. It is the standard work published on the subject. Forty-one chapters, 610 engravings, handsomely bound in red leather with title and edges in gold. Price: \$3.50

ELECTRICITY IN FACTORIES AND WORKSHOPS, ITS COST AND CONVENIENCE.

By ARTHUR P. HASLAM.

A practical book for power producers and power users showing what a convenience the electric motor, in its various forms, has become to the modern manufacturer. It also deals with the conditions which determine the cost of electric driving, and compares this with other methods of producing and utilizing power.

Among the chapters contained in the book are: The Direct Current Motor; The Alternating Current Motor; The Starting and Speed Regulation of Electric Motors; The Rating and Efficiency of Electric Motors; The Cost of Energy as Affected by Conditions of Working, The Question for the Small Power User; Independent Generating Plants; Oil and Gas Engine Plants; Steam Plants; Power Station Tariffs; The Use of Electric Power in Textile Factories; Electric Power in Printing Works; The Use of Electric Power in Engineering Workshops Miscellaneous Application of Electric Power; The Installation of Electric Motors; The Lighting of Industrial Establishments. 312 pages. Very fully illustrated. Price \$2.50

ELECTRICITY SIMPLIFIED. By Prof. T. O'CONNOR SLOANE.

The object of "Electricity Simplified" is to make the subject as plain as possible and to show what the modern conception of electricity is; to show how two plates of different metals immersed in acid can send a message around the globe; to explain how a bundle of copper wire rotated by a steam engine can be the agent in lighting our streets, to tell what the volt, ohm and ampere are, and what high and low tension mean; and to answer the questions that perpetually arise in the mind in this age of electricity. 172 pages. Illustrated. Price \$1.00

CATALOGUE OF GOOD, PRACTICAL BOOKS

HOUSE WIRING. By THOMAS W. POPPE.

This work describes and illustrates the actual installation of Electric Light Wiring, the manner in which the work should be done, and the method of doing it. The book can be conveniently carried in the pocket. It is intended for the Electrician, Helper and Apprentice. It solves all Wiring Problems, and contains nothing that conflicts with the rulings of the National Board of Fire Underwriters. It gives just the information essential to the Successful Wiring of a Building. Among the subjects treated are: Locating the Meter. Panel Boards. Switches. Plug Receptacles. Brackets. Ceiling Fixtures. The Meter Connections. The Feed Wires. The Steel Armored Cable System. The Flexible Steel Conduit System. The Ridg Conduit System. A digest of the National Board of Fire Underwriters' rules relating to metallic wiring systems. Various switching arrangements explained and diagrammed. The easiest method of testing the Three and Four-way circuits explained. The grounding of all metallic wiring systems and the reason for doing so shown and explained. The insulation of the metal parts of lamp fixtures and the reason for the same described and illustrated. 125 pages. Fully illustrated. Flexible cloth. Price 50 cents

HOW TO BECOME A SUCCESSFUL ELECTRICIAN. By Prof. T. O'CONNOR SLOANE.

Every young man who wishes to become a successful electrician should read this book. It tells in simple language the surest and easiest way to become a successful electrician. The studies to be followed, methods of work, field of operation and the requirements of the successful electrician are pointed out and fully explained. Every young engineer will find this an excellent stepping-stone to more advanced works on electricity which he must master before success can be attained. Many young men become discouraged at the very outstart by attempting to read and study books that are far beyond their comprehension. This book serves as the connecting link between the rudiments taught in the public schools and the real study of electricity. It is interesting from cover to cover. Fifteenth edition. 202 pages. Illustrated. Price \$1.00

MANAGEMENT OF DYNAMOS. By LUMMIS-PATERSON.

A handbook of theory and practice. This work is arranged in three parts. The first part covers the elementary theory of the dynamo. The second part, the construction and action of the different classes of dynamos in common use are described; while the third part relates to such matters as affect the practical management and working of dynamos and motors. The following chapters are contained in the book: Electrical Units; Magnetic Principles; Theory of the Dynamo; Armature; Armature in Practice; Field Magnets; Field Magnets in Practice; Regulating Dynamos; Coupling Dynamos; Installation, Running, and Maintenance of Dynamos; Faults in Dynamos; Faults in Armatures; Motors. 292 pages. 117 illustrations. Price \$1.50

STANDARD ELECTRICAL DICTIONARY. By T. O'CONNOR SLOANE.

An indispensable work to all interested in electrical science. Suitable alike for the student and professional. A practical hand-book of reference containing definitions of about 5,000 distinct words, terms and phrases. The definitions are terse and concise and include every term used in electrical science. Recently issued. An entirely new edition. Should be in the possession of all who desire to keep abreast with the progress of this branch of science. In its arrangement and typography the book is very convenient. The word or term defined is printed in black-faced type which readily catches the eye, while the body of the page is in smaller but distinct type. The definitions are well worded, and so as to be understood by the non-technical reader. The general plan seems to be to give an exact, concise definition, and then amplify and explain in a more popular way. Synonyms are also given, and references to other words and phrases are made. A very complete and accurate index of fifty pages is at the end of the volume; and as this index contains all synonyms, and as all phrases are indexed in every reasonable combination of words, reference to the proper place in the body of the book is readily made. It is difficult to decide how far a book of this character is to keep the dictionary form, and to what extent it may assume the encyclopedic form. For some purposes, concise, exactly worded definitions are needed; for other purposes, more extended descriptions are required. This book seeks to satisfy both demands, and does it with considerable success. Complete, concise, and convenient. 682 pages. 393 illustrations. Twelfth edition. Price \$3.00

SWITCHBOARDS. By WILLIAM BAXTER, JR.

This book appeals to every engineer and electrician who wants to know the practical side of things. It takes up all sorts and conditions of dynamos, connections and circuits and shows by diagram and illustration just how the switchboard should be connected. Includes direct and alternating current boards, also those for arc lighting, incandescent, and power circuits. Special treatment on high voltage boards for power transmission. 2d Edition. 190 pages. Illustrated. Price \$1.50

CATALOGUE OF GOOD, PRACTICAL BOOKS

TELEPHONE CONSTRUCTION, INSTALLATION, WIRING, OPERATION AND MAINTENANCE. By W. H. RADCLIFFE and H. C. CUSHING.

This book gives the principles of construction and operation of both the Bell and Independent instruments; approved methods of installing and wiring them; the means of protecting them from lightning and abnormal currents; their connection together for operation as series or bridging stations; and rules for their inspection and maintenance. Line wiring and the wiring and operation of special telephone systems are also treated.

Intricate mathematics are avoided, and all apparatus, circuits and systems are thoroughly described. The appendix contains definitions of units and terms used in the text. Selected wiring tables, which are very helpful, are also included. Among the subjects treated are Construction, Operation, and installation of Telephone Instruments, Inspection and Maintenance of Telephone Instruments; Telephone Line Wiring; Testing Telephone Line Wires and Cables; Wiring and Operation of Special Telephone Systems. etc. 100 pages, 125 illustrations. \$1.00

WIRELESS TELEGRAPHY AND TELEPHONY SIMPLY EXPLAINED.

By ALFRED P. MORGAN.

This is undoubtedly one of the most complete and comprehensible treatises on the subject ever published, and a close study of its pages will enable one to master all the details of the wireless transmission of messages. The author has filled a long felt want and has succeeded in furnishing a lucid, comprehensible explanation in simple language of the theory and practice of wireless telegraphy and telephony.

Among the contents are: Introductory; Wireless Transmission and Reception—The Aerial System, Earth Connections—The Transmitting Apparatus, Spark Coils and Transformers, Condensers, Helixes, Spark Gaps, Anchor Gaps, Aerial Switches—The Receiving Apparatus, Detectors, etc.—Tuning and Coupling, Tuning Coils, Loose Couplers, Variable Condensers, Directive Wave Systems—Miscellaneous Apparatus, Telephone Receivers, Range of Stations, Static, Interference—Wireless Telephones, Sound and Sound Waves, The Vocal Cords and Ear—Wireless Telephones, How Sounds are changed into Electric Waves—Wireless Telephones, The Apparatus—Summary. 200 pages. 150 engravings. Price \$1.00

WIRELESS TELEPHONES AND HOW THEY WORK. By JAMES ERSKINE-MURRAY.

This work is free from elaborate details and aims at giving a clear survey of the way in which Wireless Telephones work. It is intended for amateur workers and for those whose knowledge of electricity is slight. Chapters contained: How We Hear; Historical; The Conversion of Sound into Electric Waves; Wireless Transmission; The Production of Alternating Currents of High Frequency; How the Electric Waves are Radiated and Received; The Receiving Instruments; Detectors; Achievements and Expectations; Glossary of Technical Words, Cloth. Price \$1.00

WIRING A HOUSE. By HERBERT PRATT.

Shows a house already built; tells just how to start about wiring it; where to begin; what wire to use; how to run it according to Insurance Rules; in fact just the information you need. Directions apply equally to a shop. Fourth edition. 25 cents

FACTORY MANAGEMENT, ETC.

MODERN MACHINE SHOP CONSTRUCTION, EQUIPMENT AND MANAGEMENT.

By O. E. PERRIGO, M.E.

The only work published that describes the modern machine shop or manufacturing plant from the time the grass is growing on the site intended for it until the finished product is shipped. By a careful study of its thirty-two chapters the practical man may economically build, efficiently equip, and successfully manage the modern machine shop or manufacturing establishment. Just the book needed by those contemplating the erection of modern shop buildings, the re-building and re-organization of old ones, or the introduction of modern shop methods, time and cost system. It is a book written and illustrated by a practical shop man for practical shop men who are too busy to read theories and want facts. It is the most complete all around book of its kind ever published. It is a practical book for practical men, from the apprentice in the shop to the president in the office. It minutely describes and illustrates the most simple and yet the most efficient time and cost system yet devised. Price \$5.00

CATALOGUE OF GOOD, PRACTICAL BOOKS

FUEL

COMBUSTION OF COAL AND THE PREVENTION OF SMOKE. By Wm. M. BARR.

This book has been prepared with special reference to the generation of heat by the combustion of the common fuels found in the United States, and deals particularly with the conditions necessary to the economic and smokeless combustion of bituminous coals in Stationary and Locomotive Steam Boilers.

The presentation of this important subject is systematic and progressive. The arrangement of the book is in a series of practical questions to which are appended accurate answers, which describe in language, free from technicalities, the several processes involved in the furnace combustion of American fuels; it clearly states the essential requisites for perfect combustion, and points out the best methods for furnace construction for obtaining the greatest quantity of heat from any given quality of coal. Nearly 350 pages, fully illustrated. Price \$1.00

SMOKE PREVENTION AND FUEL ECONOMY. By BOOTH and KERSHAW.

A complete treatise for all interested in smoke prevention and combustion, being based on the German work of Ernst Schmatolla, but it is more than a mere translation of the German treatise, much being added. The authors show as briefly as possible the principles of fuel combustion, the methods which have been and are at present in use, as well as the proper scientific methods for obtaining all the energy in the coal and burning it without smoke. Considerable space is also given to the examination of the waste gases, and several of the representative English and American mechanical stoker and similar appliances are described. The losses carried away in the waste gases are thoroughly analyzed and discussed in the Appendix, and abstracts are also here given of various patents on combustion apparatus. The book is complete and contains much of value to all who have charge of large plants. 194 pages. Illustrated. Price \$2.50

GAS ENGINES AND GAS

GASOLINE ENGINES: THEIR OPERATION, USE AND CARE. By A. HYATT VERRILL.

The Simplest, Latest and Most Comprehensive popular work published on Gasoline Engines describing what the Gasoline engine is; its construction and operation; how to install it; how to select it; how to use it and how to remedy troubles encountered. Intended for owners, Operators and Users of Gasoline Motors of all kinds. This work fully describes and illustrates the various types of Gasoline engines used in Motor Boats, Motor Vehicles and Stationary Work. The parts, accessories and Appliances are described, with chapters on Ignition, fuel, lubrication, operation and engine troubles. Special attention is given to the care, operation and repair of motors with useful hints and suggestions on emergency repairs and make-shifts. A complete glossary of technical terms and an alphabetically arranged table of troubles and their symptoms form most valuable and unique features of this manual. Nearly every illustration in the book is original, having been made by the author. Every page is full of interest and value. A book which you cannot afford to be without. 320 pages. Nearly 150 specially made engravings. Price \$1.50

GAS, GASOLINE, AND OIL ENGINES. By GARDNER D. HISCOX.

Just issued, 20th revised and enlarged edition. Every user of a gas engine needs this book. Simple, instructive, and right up-to-date. The only complete work on the subject. Tells all about the running and management of gas, gasoline and oil engines, as designed and manufactured in the United States. Explosive motors for stationary, marine and vehicle power are fully treated, together with illustrations of their parts and tabulated sizes, also their care and running are included. Electric ignition by induction coil and jump spark are fully explained and illustrated, including valuable information on the testing for economy and power and the erection of power plants.

The rules and regulations of the Board of Fire Underwriters in regard to the installation and management of gasoline motors is given in full, suggesting the safe installation of explosive motor power. A list of United States Patents issued on gas, gasoline, and oil engines and their adjuncts from 1875 to date is included. 484 pages. 410 engravings. Price \$2.50

MODERN GAS ENGINES AND PRODUCER GAS PLANTS. By R. E. MATHOT, M.E.

A guide for the gas engine designer, user, and engineer in the construction, selection, purchase installation, operation, and maintenance of gas engines. More than one book on gas engines has been written, but not one has thus far even encroached on the field covered by this book. Above all Mr. Mathot's work is a practical guide. Recognizing the need of a volume that

CATALOGUE OF GOOD, PRACTICAL BOOKS

would assist the gas engine user in understanding thoroughly the motor upon which he depends for power, the author has discussed his subject without the help of any mathematics and without elaborate theoretical explanations. Every part of the gas engine is described in detail, tersely, clearly, with a thorough understanding of the requirements of the mechanic. Helpful suggestions as to the purchase of an engine, its installation, care, and operation form a most valuable feature of the work. 320 pages. 175 detailed illustrations. Price . . . \$2.50

GAS ENGINE CONSTRUCTION, OR HOW TO BUILD A HALF-HORSE-POWER GAS ENGINE. By PARSELL and WEED.

A practical treatise of 300 pages describing the theory and principles of the action of Gas Engines of various types and the design and construction of a half-horse power Gas Engine, with illustrations of the work in actual progress, together with the dimensioned working drawings giving clearly the sizes of the various details; for the student, the scientific investigator and the amateur mechanic.

This book treats of the subject more from the standpoint of practice than that of theory. The principles of operation of Gas Engines are clearly and simply described and then the actual construction of a half-horse power engine is taken up, step by step, showing in detail the making of the Gas Engine. 3d Edition. 300 pages. Price . . . \$2.50

THE GASOLINE ENGINE ON THE FARM: ITS OPERATION, REPAIR AND USES. By XENO W. PUTNAM.

This is a practical treatise on the Gasoline and Kerosene engine intended for the man who wants to know just how to manage his engine and how to apply it to all kinds of farm work to the best advantage.

The book includes selecting the most suitable engine for farm work, its most convenient and efficient installation, with chapters on troubles, their remedies and how to avoid them. The care and management of the farm tractor in plowing, harrowing, harvesting and road grading are fully covered; also plain directions are given for handling the tractor on the road. Special attention is given to relieving farm life of its drudgery by applying power to the disagreeable small tasks which must otherwise be done by hand. Many homemade contrivances for cutting wood, supplying kitchen, garden and barn with water, loading, hauling and unloading hay, delivering grain to the bins or the feed trough are included; also full directions for making the engine milk the cows, churn, wash, sweep the house and clean the windows, etc. Very fully illustrated with drawings of working parts and cuts showing Stationary, Portable and Tractor Engines doing all kinds of farm work. 300 pages. Nearly 150 engravings. 12mo. Price . . . \$1.50

CHEMISTRY OF GAS MANUFACTURE. By H. M. ROYLES.

This book covers points likely to arise in the ordinary course of the duties of the engineer or manager of a gas works not large enough to necessitate the employment of a separate chemical staff. It treats of the testing of the raw materials employed in the manufacture of illuminating coal gas, and of the gas produced. The preparation of standard solutions is given as well as the chemical and physical examination of gas coal including among its contents—Preparations of Standard Solutions, Coal, Furnaces, Testing and Regulation, Products of Carbonization, Analysis of Crude Coal Gas, Analysis of Lime, Ammonia, Analysis of Oxide of Iron, Naphthalene, Analysis of Fire-Bricks and Fire-Clay, Welding and Spent Oxide, Photometry and Gas Testing, Carburetted Water Gas, Metropolis Gas, Miscellaneous Extracts. Useful Tables. . . . \$4.50

GEARING AND CAMS

BEVEL GEAR TABLES. By D. AG. ENGSTROM.

A book that will at once commend itself to mechanics and draftsmen. Does away with all the trigonometry and fancy figuring on bevel gears and makes it easy for anyone to lay them out or make them just right. There are 36 full-page tables that show every necessary dimension for all sizes or combinations you're apt to need. No puzzling figuring or guessing. Gives placing distance, all the angles (including cutting angles), and the correct cutter to use. A copy of this prepares you for anything in the bevel gear line. 66 pages. . \$1.00

CHANGE GEAR DEVICES. By OSCAR E. PERRIGO.

A practical book for every designer, draftsman, and mechanic interested in the invention and development of the devices for feed changes on the different machines requiring such mechanism. All the necessary information on this subject is taken up, analyzed, classified, sifted, and concentrated for the use of busy men who have not the time to go through the masses of irrelevant matter with which such a subject is usually encumbered and select such information as will be useful to them.

It shows just what has been done, how it has been done, when it was done, and who did it. It saves time in hunting up patent records and re-inventing old ideas. 88 pages. \$1.00

CATALOGUE OF GOOD, PRACTICAL BOOKS

DRAFTING OF CAMS. By LOUIS ROUILLION.

The laying out of cams is a serious problem unless you know how to go at it right. This puts you on the right road for practically any kind of cam you are likely to run up against. 25 cents

HYDRAULICS

HYDRAULIC ENGINEERING. By GARDNER D. HISCOX.

A treatise on the properties, power, and resources of water for all purposes. Including the measurement of streams, the flow of water in pipes or conduits; the horse-power of falling water; turbine and impact water-wheels, wave motors, centrifugal, reciprocating, and air-lift pumps. With 300 figures and diagrams and 36 practical tables.

All who are interested in water-works development will find this book a useful one, because it is an entirely practical treatise upon a subject of present importance, and cannot fail in having a far-reaching influence, and for this reason should have a place in the working library of every engineer. Among the subjects treated are: Historical—Hydraulics, Properties of Water; Measurement of the flow of Streams; Flow from Subsurface orifices and nozzles; Flow of water in Pipes; Siphons of various kinds; Dams and Great Storage Reservoirs; City and Town Water Supply; Wells and their reinforcement; Air lift methods of raising water; artesian wells; Irrigation of Arid districts; Water Power, Water Wheels; Pumps and Pumping Machinery; Reciprocating Pumps; Hydraulic Power Transmission; Hydraulic Mining; Canals; Ditches; Conduits and Pipe Lines; Marine Hydraulics; Tidal and Sea Wave power, etc. 320 pages. Price \$4.00

ICE AND REFRIGERATION

POCKET BOOK OF REFRIGERATION AND ICE MAKING. By A. J. WALLIS-TAYLOR.

This is one of the latest and most comprehensive reference books published on the subject of refrigeration and cold storage. It explains the properties and refrigerating effect of the different fluids in use, the management of refrigerating machinery and the construction and insulation of cold rooms with their required pipe surface for different degrees of cold; freezing mixtures and non-freezing brines, temperatures of cold rooms for all kinds of provisions, cold storage charges for all classes of goods, ice making and storage of ice, data and memoranda for constant reference by refrigerating engineers, with nearly one hundred tables containing valuable references to every fact and condition required in the installment and operation of a refrigerating plant. Illustrated. (5th Edition, revised.) Price \$1.50

INVENTIONS—PATENTS

INVENTOR'S MANUAL, HOW TO MAKE A PATENT PAY.

This is a book designed as a guide to inventors in perfecting their inventions, taking out their patents and disposing of them. It is not in any sense a Patent Solicitor's Circular, nor a Patent Broker's Advertisement. No advertisements of any description appear in the work. It is a book containing a quarter of a century's experience of a successful inventor, together with notes based upon the experience of many other inventors.

Among the subjects treated in this work are: How to Invent. How to Secure a Good Patent. Value of Good Invention. How to exhibit an Invention. How to Interest Capital. How to Estimate the Value of a Patent. Value of Design Patents. Value of Foreign Patents. Value of Small Inventions. Advice on Selling Patents. Advice on the Formation of Stock Companies. Advice on the Formation of Limited Liability Companies. Advice on Disposing of Old Patents. Advice as to Patent Attorneys. Advice as to Selling Agents. Forms of Assignments. License and Contracts. State Laws Concerning Patent Rights. 1900 Census of the United States by counties of over 10,000 population. Revised edition. 120 pages. Price \$1.00

KNOTS

KNOTS, SPLICES AND ROPE WORK. By A. HYATT VERRILL.

This is a practical book giving complete and simple directions for making all the most useful and ornamental knots in common use, with chapters on Splicing, Pointing, Seizing,

CATALOGUE OF GOOD, PRACTICAL BOOKS

Servings, etc. This book is fully illustrated with one hundred and fifty original engravings, which show how each knot, tie or splice is formed and its appearance when finished. The book will be found of the greatest value to Campers, Yachtsmen, Travelers, Boy Scouts, in fact to anyone having occasion to use or handle rope or knots for any purpose. The book is thoroughly reliable and practical and is not only a guide but a teacher. It is the standard work on the subject. Among the contents are: 1. Cordage, Kinds of Rope. Construction of Rope, Parts of Rope Cable and Bolt Rope. Strength of Rope, Weight of Rope. 2. Simple knots and Bends. Terms used in Handling Rope. Seizing Rope. 3. Ties and Hitches. 4. Noose, Loops and Mooring Knots. 5. Shortenings, Grommets and Selvages. 6. Lashings. Seizings and Splices. 7. Fancy Knots and Rope Work. 128 pages. 150 original engravings. Price 60 cents

LATHE WORK

MODERN AMERICAN LATHE PRACTICE. By OSCAR E. PERRIGO.

This is a new book from cover to cover, and the only complete American work on the subject written by a man who knows not only how work ought to be done, but who also knows how to do it, and how to convey this knowledge to others. It is strictly up-to-date in its descriptions and illustrations, which represent the very latest practice in lathe and boring mill operations as well as the construction of and latest developments in the manufacture of these important classes of machine tools.

Lathe history and the relations of the Lathe to manufacturing are given; also a description of the various devices for Feeds and Thread Cutting mechanisms from early efforts in this direction to the present time. Lathe design is thoroughly discussed, including Back Gearing, Driving Cones, Thread Cutting Gears, and all the essential elements of the modern Lathe. The classification of Lathes is taken up, giving the essential differences of the several types of Lathes, including, as is usually understood, Engine Lathes, Bench Lathes, Speed Lathes, Forge Lathes, Gap Lathes, Pulley Lathes, Forming Lathes, Multiple Spindle Lathes, Rapid Reduction Lathes, Precision Lathes, Turret Lathes, Special Lathes, Electrically Driven Lathes, etc. 424 pages. 314 illustrations. Price \$2.50

PRACTICAL METAL TURNING. By JOSEPH G. HORNER.

This important and practical subject is treated in a full and exhaustive manner and nothing of importance is omitted. The principles and practice and all the different branches of Turning are considered and well illustrated. All the different kinds of Chucks of usual forms, as well as some unusual kinds, are shown. A feature of the book is the important section devoted to modern Turret practice; Boring is another subject which is treated fully; and the chapter on Tool Holders illustrates a large number of representative types. Thread Cutting is treated at reasonable length; and the last chapter contains a good deal of information relating to the High-Speed Steels and their work. The numerous tools used by machinists are illustrated, and also the adjuncts of the lathe. In fact, the entire subject is treated in such a thorough manner as to make this book the standard one on the subject. It is indispensable to the manager, engineer, and machinist as well as to the student, amateur, and experimental man who desires to keep up-to-date. 400 pages, fully illustrated. Price \$3.50

TURNING AND BORING TAPERS. By FRED H. COLVIN.

There are two ways to turn tapers; the right way and one other. This treatise has to do with the right way; it tells you how to start the work properly, how to set the lathe, what tools to use and how to use them, and forty and one other little things that you should know. Fourth edition. 25 cents

LIQUID AIR

LIQUID AIR AND THE LIQUEFACTION OF GASES. By T. O'CONNOR SLOANE.

This book gives the history of the theory, discovery, and manufacture of Liquid Air, and contains an illustrated description of all the experiments that have excited the wonder of audiences all over the country. It shows how liquid air, like water, is carried hundreds of miles and is handled in open buckets. It tells what may be expected from it in the near future.

A book that renders simple one of the most perplexing chemical problems of the century. Startling developments illustrated by actual experiments.

It is not only a work of scientific interest and authority, but is intended for the general reader, being written in a popular style—easily understood by every one. Second edition. 365 pages. Price \$2.00

CATALOGUE OF GOOD, PRACTICAL BOOKS

LOCOMOTIVE ENGINEERING

AIR-BRAKE CATECHISM. By ROBERT H. BLACKALL.

This book is a standard text book. It covers the Westinghouse Air-Brake Equipment, including the No. 5 and the No. 6 E. T Locomotive Brake Equipment; the K (Quick-Service) Triple Valve for Freight Service; and the Cross-Compound Pump. The operation of all parts of the apparatus is explained in detail, and a practical way of finding their peculiarities and defects, with a proper remedy, is given. It contains 2,000 questions with their answers, which will enable any railroad man to pass any examination on the subject of Air Brakes. Endorsed and used by air-brake instructors and examiners on nearly every railroad in the United States. 25th Edition. 350 pages, fully illustrated with folding plates and diagrams. **\$2.00**

AMERICAN COMPOUND LOCOMOTIVES. By FRED. H. COLVIN.

The only book on compounds for the engineman or shopman that shows in a plain, practical way the various features of compound locomotives in use. Shows how they are made, what to do when they break down or balk. Contains sections as follows:—A Bit of History. Theory of Compounding Steam Cylinders. Baldwin Two-Cylinder Compound. Pittsburg Two-Cylinder Compound. Rhode Island Compound. Richmond Compound. Rogers Compound. Schenectady Two-Cylinder Compound. Vauclain Compound. Tandem Compounds. Baldwin Tandem. The Colvin-Wightman Tandem. Schenectady Tandem. Balanced Locomotives. Baldwin Balanced Compound. Plans for Balancing. Locating Blows. Break-downs. Reducing Valves. Drifting. Valve Motion. Disconnecting. Power of Compound Locomotives. Practical Notes.

Fully illustrated [and containing ten special "Duotone" inserts on heavy Plate Paper, showing different types of Compounds. 142 pages. Price **\$1.00**

APPLICATION OF HIGHLY SUPERHEATED STEAM TO LOCOMOTIVES. By ROBERT GARBE.

A practical book. Contains special chapters on Generation of Highly Superheated Steam; Superheated Steam and the Two-Cylinder Simple Engine; Compounding and Superheating; Designs of Locomotive Superheaters; Constructive Details of Locomotives using Highly Superheated Steam; Experimental and Working Results. Illustrated with folding plates and tables. Price **\$2.50**

COMBUSTION OF COAL AND THE PREVENTION OF SMOKE.

By WM. M. BARR.

This book has been prepared with special reference to the generation of heat by the combustion of the common fuels found in the United States, and deals particularly with the conditions necessary to the economic and smokeless combustion of bituminous coal in Stationary and Locomotive Steam Boilers.

The presentation of this important subject is systematic and progressive. The arrangement of the book is in a series of practical questions to which are appended accurate answers, which describe in language, free from technicalities, the several processes involved in the furnace combustion of American fuels; it clearly states the essential requisites for perfect combustion, and points out the best methods of furnace construction for obtaining the greatest quantity of heat from any given quality of coal. Nearly 350 pages, fully illustrated. Price **\$1.00**

DIARY OF A ROUND HOUSE FOREMAN. By T. S. REILLY .

This is the greatest book of railroad experiences ever published. Containing a fund of information and suggestions along the line of handling men, organizing, etc., that one cannot afford to miss. 176 pages. Price **\$1.00**

LINK MOTIONS, VALVES AND VALVE SETTING. By FRED H. COLVIN, Associate Editor of "American Machinist."

A handy book for the engineer or machinist that clears up the mysteries of valve setting. Shows the different valve gears in use, how they work, and why. Piston and slide valves of different types are illustrated and explained. A book that every railroad man in the motive power department ought to have. Contains chapters on Locomotive Link Motion, Valve Movements, Setting Slide Valves, Analysis by Diagrams, Modern Practice, Slip of Block, Slide Valves, Piston Valves, Setting Piston Valves, Joy-Allen Valve Gear, Walschaert Valve Gear, Gooch Valve Gear, Alfree-Hubbell Valve Gear, etc., etc. Fully illustrated. Price **50 cents**

CATALOGUE OF GOOD, PRACTICAL BOOKS

LOCOMOTIVE BOILER CONSTRUCTION. By FRANK A. KLEINHANS.

The construction of boilers in general is treated, and following this, the locomotive boiler is taken up in the order in which its various parts go through the shop. Shows all types of boilers used; gives details of construction; practical facts, such as life of riveting, punches and dies; work done per day, allowance for bending and flanging sheets, and other data. Locomotive boilers present more difficulty in laying out and building than any other type, and for this reason the author uses them as examples. Anyone who can handle them can tackle anything.

Contains chapters on Laying Out Work; Flanging and Forging; Punching; Shearing; Plate Planing; General Tables; Finishing Parts; Bending; Machinery Parts; Riveting; Boiler Details; Smoke Box Details; Assembling and Calking; Boiler Shop Machinery, etc., etc.

There isn't a man who has anything to do with boiler work, either new or repair work, who doesn't need this book. The manufacturer, superintendent, foreman, and boiler worker—all need it. No matter what the type of boiler, you'll find a mint of information that you wouldn't be without. Over 400 pages, five large folding plates. Price \$3.00

LOCOMOTIVE BREAKDOWNS AND THEIR REMEDIES. By GEO. L. FOWLER. Revised by Wm. W. Wood, Air-Brake Instructor. Just issued. Revised pocket edition.

It is out of the question to try and tell you about every subject that is covered in this pocket edition of Locomotive Breakdowns. Just imagine all the common troubles that an engineer may expect to happen some time, and then add all of the unexpected ones, troubles that could occur, but that you had never thought about, and you will find that they are all treated with the very best methods of repair. Walschaert Locomotive Valve Gear Troubles, Electric Headlight Troubles, as well as Questions and Answers on the Air Brake are all included. 294 pages. 7th Revised Edition. Fully illustrated. \$1.00

LOCOMOTIVE CATECHISM. By ROBERT GRIMSHAW.

The revised edition of "Locomotive Catechism," by Robert Grimshaw, is a New Book from Cover to Cover. It contains twice as many pages and double the number of illustrations of previous editions. Includes the greatest amount of practical information ever published on the construction and management of modern locomotives. Specially Prepared Chapters on the Walschaert Locomotive Valve Gear, the Air Brake Equipment and the Electric Head Light are given.

It commends itself at once to every Engineer and Fireman, and to all who are going in for examination or promotion. In plain language, with full complete answers, not only all the questions asked by the examining engineer are given, but those which the young and less experienced would ask the veteran, and which old hands ask as "stickers." It is a veritable Encyclopedia of the Locomotive, is entirely free from mathematics, easily understood and thoroughly up-to-date. Contains over 4,000 Examination Questions with their Answers. 825 pages, 437 illustrations and three folding plates. 28th Revised Edition. . . \$2.50

PRACTICAL INSTRUCTOR AND REFERENCE BOOK FOR LOCOMOTIVE FIREMEN AND ENGINEERS. By CHAS. F. LOCKHART.

An entirely new book on the Locomotive. It appeals to every railroad man, as it tells him how things are done and the right way to do them. Written by a man who has had years of practical experience in locomotive shops and on the road firing and running. The information given in this book cannot be found in any other similar treatise. Eight hundred and fifty-one questions with their answers are included, which will prove specially helpful to those preparing for examination. Practical information on: The Construction and Operation of Locomotives. Breakdowns and their Remedies; Air Brakes and Valve Gears. Rules and Signals are handled in a thorough manner. As a book of reference it cannot be excelled. The book is divided into six parts, as follows: 1. The Fireman's Duties. 2. General description of the Locomotive. 3. Breakdowns and their Remedies. 4. Air Brakes. 5. Extracts from Standard Rules. 6. Questions for examination. The 851 questions have been carefully selected and arranged. These cover the examinations required by the different railroads. 368 pages. 88 illustrations. Price \$1.50

PREVENTION OF RAILROAD ACCIDENTS, OR SAFETY IN RAILROADING.

By GEORGE BRADSHAW.

This book is a heart-to-heart talk with Railroad Employees, dealing with facts, not theories, and showing the men in the ranks, from every-day experience, how accidents occur and how they may be avoided. The book is illustrated with seventy original photographs and drawings showing the safe and unsafe methods of work. No visionary schemes, no ideal pictures. Just plain facts and Practical Suggestions are given. Every railroad employee who reads the

CATALOGUE OF GOOD, PRACTICAL BOOKS

book is a better and safer man to have in railroad service. It gives just the information which will be the means of preventing many injuries and deaths. All railroad employees should procure a copy, read it, and do your part in preventing accidents. 169 pages. Pocket Size. Fully illustrated. Price 50 cents

TRAIN RULE EXAMINATIONS MADE EASY. By G. E. COLLINGWOOD.

This is the only practical work on train-rules in print. Every detail is covered, and puzzling points are explained in simple, comprehensive language, making it a practical treatise for the Train Dispatcher, Engineman, Trainman, and all others who have to do with the movements of trains. Contains complete and reliable information of the Standard Code of Train Rules for single track. Shows Signals in Colors, as used on the different roads. Explains fully the practical application of train orders, giving a clear and definite understanding of all orders which may be used. The meaning and necessity for certain rules are explained in such a manner that the student may know beyond a doubt the rights conferred under any orders he may receive or the action required by certain rules.

As nearly all roads require trainmen to pass regular examinations, a complete set of examination questions, with their answers, are included. These will enable the student to pass the required examinations with credit to himself and the road for which he works. 256 pages. Fully illustrated with Train Signals in colors. Price \$1.25

TRAIN RULES AND DESPATCHING. By H. A. DALBY.

Every railroad man, no matter what department he's in, needs a copy of this book. It gives the standard rules for both single and double track, shows all the signals, with colors wherever necessary, and has a list of towns where time changes, with a map showing the whole country. The rules are explained wherever there is any doubt about their meaning or where they are modified by different railroads. It's the only practical book on train rules in print. Over 220 pages. Leather cover. Price \$1.50

THE WALSCHAERT AND OTHER MODERN RADIAL VALVE GEARS FOR LOCOMOTIVES. By Wm. W. Wood.

If you would thoroughly understand the Walschaert Valve Gear you should possess a copy of this book, as the author takes the plainest form of a steam engine—a stationary engine in the rough, that will only turn its crank in one direction—and from it builds up—with the reader's help—a modern locomotive equipped with the Walschaert Valve Gear, complete. The points discussed are clearly illustrated; two large folding plates that show the positions of the valves of both inside or outside admission type, as well as the links and other parts of the gear when the crank is at nine different points in its revolution, are especially valuable in making the movement clear. These employ sliding cardboard models which are contained in a pocket in the cover.

The book is divided into five general divisions, as follows: I. Analysis of the gear. II. Designing and erecting the gear. III. Advantages of the gear. IV. Questions and answers relating to the Walschaert Valve Gear. V. Setting valves with the Walschaert Valve Gear; the three primary types of locomotive valve motion; modern radial valve gears other than the Walschaert; the Hobart All-free valve and valve gear, with questions and answers on breakdowns; the Baker-Pilliod valve gear; the Improved Baker-Pilliod Valve Gear, with questions and answers on breakdowns.

The questions with full answers given will be especially valuable to firemen and engineers in preparing for an examination for promotion. 245 pages. Third Revised Edition. Price \$1.50

WESTINGHOUSE E-T AIR-BRAKE INSTRUCTION POCKET BOOK. By Wm. W. Wood, Air-Brake Instructor.

Here is a book for the railroad man, and the man who aims to be one. It is without doubt the only complete work published on the Westinghouse E-T Locomotive Brake Equipment. Written by an Air Brake Instructor who knows just what is needed. It covers the subject thoroughly. Everything about the New Westinghouse Engine and Tender Brake Equipment, including the Standard No. 5 and the Perfected No. 6 Style of brake, is treated in detail. Written in plain English and profusely illustrated with Colored Plates, which enable one to trace the flow of pressures throughout the entire equipment. The best book ever published on the Air Brake. Equally good for the beginner and the advanced engineer. Will pass any one through any examination. It informs and enlightens you on every point. Indispensable to every engineman and trainman.

Contains examination questions and answers on the E-T equipment. Covering what the E-T Brake is. How it should be operated. What to do when defective. Not a question can be asked of the engineman up for promotion on either the No. 5 or the No. 6 E-T equipment that is not asked and answered in the book. If you want to thoroughly understand the E-T equipment get a copy of this book. It covers every detail. Makes Air Brake troubles and examinations easy. Price \$1.50

CATALOGUE OF GOOD, PRACTICAL BOOKS

MACHINE SHOP PRACTICE

AMERICAN TOOL MAKING AND INTERCHANGEABLE MANUFACTURING. By J. V. WOODWORTH.

A "shoppy" book, containing no theorizing, no problematical or experimental devices, there are no badly proportioned and impossible diagrams, no catalogue cuts, but a valuable collection of drawings and descriptions of devices, the rich fruits of the author's own experience. In its 500-odd pages the one subject only, Tool Making, and whatever relates thereto, is dealt with. The work stands without a rival. It is a complete practical treatise on the art of American Tool Making and system of interchangeable manufacturing as carried on to-day in the United States. In it are described and illustrated all of the different types and classes of small tools, fixtures, devices, and special appliances which are in general use in all machine manufacturing and metal working establishments where economy, capacity, and interchangeability in the production of machined metal parts are imperative. The science of jig making is exhaustively discussed, and particular attention is paid to drill jigs, boring, profiling and milling fixtures and other devices in which the parts to be machined are located and fastened within the contrivances. All of the tools, fixtures, and devices illustrated and described have been or are used for the actual production of work, such as parts of drill presses, lathes, patented machinery, typewriters, electrical apparatus, mechanical appliances, brass goods, composition parts, mould products, sheet metal articles, drop forgings, jewelry, watches, medals, coins, etc. 531 pages. Price \$4.00

HENLEY'S ENCYCLOPEDIA OF PRACTICAL ENGINEERING AND ALLIED TRADES. Edited by JOSEPH G. HORNER, A.M.I., M.E.

This set of five volumes contains about 2,500 pages with thousands of illustrations, including diagrammatic and sectional drawings with full explanatory details. This work covers the entire practice of Civil and Mechanical Engineering. The best known expert in all branches of engineering have contributed to these volumes. The Cyclopaedia is admirably well adapted to the needs of the beginner and the self-taught practical man, as well as the mechanical engineer, designer, draftsman, shop superintendent, foreman, and machinist. The work will be found a means of advancement to any progressive man. It is encyclopedic in scope, thorough and practical in its treatment of technical subjects, simple and clear in its descriptive matter, and without unnecessary technicalities or formulae. The articles are as brief as may be and yet give a reasonably clear and explicit statement of the subject, and are written by men who have had ample practical experience in the matters of which they write. It tells you all you want to know about engineering and tells it so simply, so clearly, so concisely, that one cannot help but understand. As a work of reference it is without a peer. \$6.00 per volume. For complete set of five volumes, price \$25.00

MACHINE SHOP ARITHMETIC. By COLVIN-CHENEY.

This is an arithmetic of the things you have to do with daily. It tells you plainly about: how to find areas of figures; how to find surface or volume of balls or spheres; handy ways for calculating; about compound gearing; cutting screw threads on any lathe; drilling for taps; speeds of drills, taps, emery wheels, grindstones, milling cutters, etc.; all about the Metric system with conversion tables; properties of metals; strength of bolts and nuts; decimal equivalent of an inch. All sorts of machine shop figuring and 1,001 other things, any one of which ought to be worth more than the price of this book to you, and it saves you the trouble of bothering the boss. 6th Edition. 131 pages. Price 50 cents

MODERN MACHINE SHOP CONSTRUCTION, EQUIPMENT AND MANAGEMENT.

By OSCAR E. PERRIGO.

The only work published that describes the Modern Machine Shop or Manufacturing Plant from the time the grass is growing on the site intended for it until the finished product is shipped. Just the book needed by those contemplating the erection of modern shop buildings, the rebuilding and reorganization of old ones, or the introduction of Modern Shop Methods, time and cost systems. It is a book written and illustrated by a practical shop man for practical shop men who are too busy to read theories and want facts. It is the most complete all-around book of its kind ever published. 400 large quarto pages. 225 original and specially-made illustrations. Price \$5.00

MECHANICAL APPLIANCES, MECHANICAL MOVEMENTS AND NOVELTIES OF CONSTRUCTION. By GARDNER D. HISCOX.

This is a supplementary volume to the one upon mechanical movements. Unlike the first volume, which is more elementary in character, this volume contains illustrations and descriptions of many combinations of motions and of mechanical devices and appliances found in different lines of machinery. Each device being shown by a line drawing with a description

CATALOGUE OF GOOD, PRACTICAL BOOKS

showing its working parts and the method of operation. From the multitude of devices described, and illustrated, might be mentioned, in passing, such items as conveyors and elevators, Prony brakes, thermometers, various types of boilers, solar engines, oil-fuel burners, condensers, evaporators, Corliss and other valve gears, governors, gas engines, water motors of various descriptions, air ships, motors and dynamos, automobile and motor bicycles, railway block signals, car couplers, link and gear motions, ball bearings, breech block mechanism for heavy guns, and a large accumulation of others of equal importance. 1,000 specially made engravings. 396 octavo pages. Price \$2.50

MECHANICAL MOVEMENTS, POWERS, AND DEVICES. By GARDNER D. HISCOX.

This is a collection of 1,890 engravings of different mechanical motions and appliances, accompanied by appropriate text, making it a book of great value to the inventor, the draftsman, and to all readers with mechanical tastes. The book is divided into eighteen sections or chapters in which the subject matter is classified under the following heads: Mechanical Powers; Transmission of Power; Measurement of Power, Steam Power; Air Power Appliances; Electric Power and Construction, Navigation and Roads; Gearing; Motion and Devices; Controlling Motion; Horological; Mining; Mill and Factory Appliances; Construction and Devices; Drafting Devices; Miscellaneous Devices, etc. 12th edition, 400 octavo pages. Price \$2.50

MACHINE SHOP TOOLS AND SHOP PRACTICE. By W. H. VANDERVOORT.

A work of 555 pages and 673 illustrations, describing in every detail the construction, operation, and manipulation of both hand and machine tools. Includes chapters on filing, fitting, and scraping surfaces; on drills, reamers, taps, and dies; the lathe and its tools; planers, shapers, and their tools; milling machines and cutters; gear cutters and gear cutting; drilling machines and drill work; grinding machines and their work; hardening and tempering; gearing, belting and transmission machinery: useful data and tables. 6th edition. Price \$3.00

THE MODERN MACHINIST. By JOHN T. USHER.

This is a book showing, by plain description and by profuse engravings, made expressly for the work, all that is best, most advanced, and of the highest efficiency in modern machine shop practice, tools, and implements, showing the way by which and through which, as Mr. Maxim says, "American machinists have become and are the finest mechanics in the world." Indicating as it does, in every line, the familiarity of the author with every detail of daily experience in the shop, it cannot fail to be of service to any man practically connected with the shaping or finishing of metals.

There is nothing experimental or visionary about the book, all devices being in actual use and giving good results. It might be called a compendium of shop methods, showing a variety of special tools and appliances which will give new ideas to many mechanics, from the superintendent down to the man at the bench. It will be found a valuable addition to any machinist's library, and should be consulted whenever a new or difficult job is to be done, whether it is boring, milling, turning, or planing, as they are all treated in a practical manner. Fifth Edition. 320 pages. 250 illustrations. Price \$2.50

MODERN MILLING MACHINES: THEIR DESIGN, CONSTRUCTION AND OPERATION. By JOSEPH G. HORNER.

This book describes and illustrates the Milling Machine and its work in such a plain, clear, and forceful manner, and illustrates the subject so clearly and completely, that the up-to-date machinist, student, or mechanical engineer cannot afford to do without the valuable information which it contains. It describes not only the early machines of this class, but notes their gradual development into the splendid machines of the present day, giving the design and construction of the various types, forms, and special features produced by prominent manufacturers, American and foreign.

Milling cutters in all their development and modernized forms are illustrated and described, and the operations they are capable of producing upon different classes of work are carefully described in detail, and the speeds and feeds necessary are discussed, and valuable and useful data given for determining these usually perplexing problems. The book is the most comprehensive work published on the subject. 304 pages. 300 illustrations. Price . . . \$4.00

"SHOP KINKS." By ROBERT GRIMSHAW.

A book of 400 pages and 222 illustrations, being entirely different from any other book on machine shop practice. Departing from conventional style, the author avoids universal or common shop usage and limits his work to showing special ways of doing things better, more cheaply and more rapidly than usual. As a result the advanced methods of representative establishments of the world are placed at the disposal of the reader. This book shows the proprietor where large savings are possible, and how products may be improved. To the employee it holds out suggestions that, properly applied, will hasten his advancement. No shop can afford to be without it. It bristles with valuable wrinkles and helpful suggestions. It will benefit all, from apprentice to proprietor. Every machinist, at any age, should study its pages. Fifth Edition. Price \$2.50

CATALOGUE OF GOOD, PRACTICAL BOOKS

THREADS AND THREAD CUTTING. By COLVIN and STABEL.

This clears up many of the mysteries of thread-cutting, such as double and triple threads, internal threads, catching threads, use of hobs, etc. Contains a lot of useful hints and several tables. 3rd Edition. Price **25 cents**

TOOLS FOR MACHINISTS AND WOOD WORKERS, INCLUDING INSTRUMENTS OF MEASUREMENT. By JOSEPH G. HORNER.

The principles upon which cutting tools for wood, metal, and other substances are made are identical, whether used by the machinist, the carpenter, or by any other skilled mechanic in their daily work, and the object of this book is to give a correct and practical description of these tools as they are commonly designed, constructed, and used. 340 pages, fully illustrated. Price **\$3.50**

MANUAL TRAINING

ECONOMICS OF MANUAL TRAINING. By LOUIS ROUILLION.

The only book published that gives just the information needed by all interested in Manual Training, regarding Buildings, Equipment, and Supplies. Shows exactly what is needed for all grades of the work from the Kindergarten to the High and Normal School. Gives itemized lists of everything used in Manual Training Work and tells just what it ought to cost. Also shows where to buy supplies, etc. Contains 174 pages, and is fully illustrated. 2nd Edition. Price **\$1.50**

MARINE ENGINEERING

MARINE ENGINES AND BOILERS, THEIR DESIGN AND CONSTRUCTION. By DR. G. BAUER, LESLIE S. ROBERTSON, and S. BRYAN DONKIN.

In the words of Dr. Bauer, the present work owes its origin to an oft felt want of a Condensed Treatise, embodying the Theoretical and Practical Rules used in Designing Marine Engines and Boilers. The need for such a work has been felt by most engineers engaged in the construction and working of Marine Engines, not only by the younger men, but also by those of greater experience. The fact that the original German work was written by the chief engineer of the famous Vulcan Works, Stettin, is in itself a guarantee that this book is in all respects thoroughly up-to-date, and that it embodies all the information which is necessary for the design and construction of the highest types of marine engines and boilers. It may be said, that the motive power which Dr. Bauer has placed in the fast German liners that have been turned out of late years from the Stettin Works, represent the very best practice in marine engineering of the present day.

This work is clearly written, thoroughly systematic, theoretically sound; while the character of its plans, drawings, tables, and statistics is without reproach. The illustrations are careful reproductions from actual working drawings, with some well-executed photographic views of completed engines and boilers. 744 pages. 550 illustrations and numerous tables. **\$9.00 net**

MODERN SUBMARINE CHART.

A cross-section view, showing clearly and distinctly all the interior of a Submarine of the latest type. You get more information from this chart, about the construction and operation of a Submarine, than in any other way. No Details omitted—everything is accurate and to scale. It is absolutely correct in every detail, having been approved by Naval Engineers. All the machinery and devices fitted in a modern Submarine Boat are shown and to make the engraving more readily understood all the features are shown in operative form with Officers and Men in the act of performing the duties assigned to them in service conditions. This CHART IS REALLY AN ENCYCLOPEDIA OF A SUBMARINE. It is educational and worth many times its cost. Mailed in a Tube for **25 cents**

MINING

ORE DEPOSITS, WITH A CHAPTER ON HINTS TO PROSPECTORS. By J. P. JOHNSON

This book gives a condensed account of the ore-deposits at present known in South Africa. It is also intended as a guide to the prospector. Only an elementary knowledge of geology and some mining experience are necessary in order to understand this work. With these qualifications, it will materially assist one in his search for metalliferous mineral occurrences

CATALOGUE OF GOOD, PRACTICAL BOOKS

and, so far as simple ores are concerned, should enable one to form some idea of the possibilities of any he may find.

Among the chapters given are: Titaniferous and Chromiferous Iron Oxides—Nickel—Copper—Cobalt—Tin—Molybdenum—Tungsten—Lead—Mercury—Antimony—Iron—Hints to Prospectors. \$2.00

PHYSICS AND CHEMISTRY OF MINING. By T. H. BYROM.

A practical work for the use of all preparing for examinations in mining or qualifying for colliery managers' certificates. The aim of the author in this excellent book is to place clearly before the reader useful and authoritative data which will render him valuable assistance in his studies. The only work of its kind published. The information incorporated in it will prove of the greatest practical utility to students, mining engineers, colliery managers, and all others who are specially interested in the present-day treatment of mining problems. Among its contents are chapters on: The Atmosphere; Laws Relating to the Behavior of Gases; The Diffusion of Gases; Composition of the Atmosphere; Sundry Constituents of the Atmosphere; Water; Carbon; Fire-Damp; Combustion; Coal Dust and its Action; Explosives; Composition of Various Coals and Fuels; Methods of Analysis of Coal; Strata Adjoining the Coal Measures; Magnetism and Electricity; Appendix; Useful Tables, etc.; Miscellaneous Questions. 160 pages. Illustrated. \$2.00

PRACTICAL COAL MINING. By T. H. COCKIN.

An important work, containing 428 pages and 213 illustrations, complete with practical details, which will intuitively impart to the reader, not only a general knowledge of the principles of coal mining, but also considerable insight into allied subjects. This treatise is positively up to date in every instance, and should be in the hands of every colliery engineer, geologist, mine operator, superintendent, foreman, and all others who are interested in or connected with the industry. 2nd Edition. \$2.50

PATTERN MAKING

PRACTICAL PATTERN MAKING. By F. W. BARROWS.

This is a very complete and entirely practical treatise on the subject of pattern making, illustrating pattern work in wood and metal. From its pages you are taught just what you should know about pattern making. It contains a detailed description of the materials used by pattern makers, also the tools, both those for hand use, and the more interesting machine tools; having complete chapters on the band saw, The Buzz Saw, and the Lathe. Individual patterns of many different kinds are fully illustrated and described, and the mounting of metal patterns on plates for molding machines is included.

Rules, Formulas and Tables are included, containing simple and original methods for finding the weight of castings, both from the pattern itself and from the drawings. This section contains some new and practical formulas, which will be found very useful in estimating weights, with the accuracy required for quotations to prospective customers. All of these rules are simple, and can be put to practical use by the ordinary, every-day man, and they have been proved by years of actual use.

Plain rules for keeping down the cost of patterns, with a complete system for checking the cost of and marking the patterns, and a card record showing what the pattern is, material used, where located in safe, with its cost and date of production, is included. The book closes with an original and practical method for the inventory and valuation of patterns. Containing 326 pages and 150 detailed illustrations. Price \$2.00

PERFUMERY

HENLEY'S TWENTIETH CENTURY BOOK OF RECEIPTS, FORMULAS AND PROCESSES. Edited by G. D. HISCOX.

The most valuable Techno-chemical Receipt Book published. Contains over 10,000 practical receipts, many of which will prove of special value to the perfumer, a mine of information, up-to-date in every respect. Price, Cloth, \$3.00; half morocco \$4.00

PERFUMES AND THEIR PREPARATION. By G. W. ASKINSON, Perfumer.

A comprehensive treatise, in which there has been nothing omitted that could be of value to the Perfumer. Complete directions for making handkerchief perfumes, smelling-salts, sachets, fumigating pastilles; preparations for the care of the skin, the mouth, the hair, cosmetics, hair dyes and other toilet articles are given, also a detailed description of aromatic substances: their nature, tests of purity, and wholesale manufacture. A book of general, as well as professional interest, meeting the wants not only of the druggist and perfume manufacturer, but also of the general public. Third edition. 312 pages. Illustrated. . \$3.00

CATALOGUE OF GOOD, PRACTICAL BOOKS

PLUMBING

MECHANICAL DRAWING FOR PLUMBERS. By R. M. STARBUCK.

A concise, comprehensive and practical treatise on the subject of mechanical drawing in its various modern applications to the work of all who are in any way connected with the plumbing trade. Nothing will so help the plumber in estimating and in explaining work to customers and workmen as a knowledge of drawing, and to the workman it is of inestimable value if he is to rise above his position to positions of greater responsibility. Among the chapters contained are: 1. Value to plumber of knowledge of drawing; tools required and their use; common views needed in mechanical drawing. 2. Perspective versus mechanical drawing in showing plumbing construction. 3. Correct and incorrect methods in plumbing drawing; plan and elevation explained. 4. Floor and cellar plans and elevation; scale drawings; use of triangles. 5. Use of triangles; drawing of fittings, traps, etc. 6. Drawing plumbing elevations and fittings. 7. Instructions in drawing plumbing elevations. 8. The drawing of plumbing fixtures; scale drawings. 9. Drawing of fixtures and fittings. 10. Inking of drawings. 11. Shading of drawings. 12. Shading of drawings. 13. Sectional drawings; drawing of threads. 14. Plumbing elevations from architect's plan. 15. Elevations of separate parts of the plumbing system. 16. Elevations from architect's plans. 17. Drawing of detail plumbing connections. 18. Architect's plans and plumbing elevations of residence. 19. Plumbing elevations of residence (continued); plumbing plans for cottage. 20. Plumbing elevations; roof connections. 21. Plans and plumbing elevations for six-flat building. 22. Drawing of various parts of the plumbing system; use of scales. 23. Use of architect's scales. 24. Special features in the illustrations of country plumbing. 25. Drawing of wrought iron piping, valves, radiators, coils, etc. 26. Drawing of piping to illustrate heating systems. 150 illustrations. Price \$1.50

MODERN PLUMBING ILLUSTRATED. By R. M. STARBUCK.

This book represents the highest standard of plumbing work. It has been adopted and used as a reference book by the United States Government, in its sanitary work in Cuba, Porto Rico, and the Philippines, and by the principal Boards of Health of the United States and Canada.

It gives connections, sizes and working data for all fixtures and groups of fixtures. It is helpful to the master plumber in demonstrating to his customers and in figuring work. It gives the mechanic and student quick and easy access to the best modern plumbing practice. Suggestions for estimating plumbing construction are contained in its pages. This book represents, in a word, the latest and best up-to-date practice, and should be in the hands of every architect, sanitary engineer and plumber who wishes to keep himself up to the minute on this important feature of construction. Contains following chapters, each illustrated with a full-page plate: Kitchen sink, laundry tubs, vegetable wash sink; lavatories, pantry sinks, contents of marble slabs; bath tub, foot and sitz bath, shower bath; water closets, venting of water closets; low-down water closets, water closets operated by flush valves, water closet range; slop sink, urinals, the bidet; hotel and restaurant sink, grease trap; refrigerators, safe wastes, laundry waste; lines of refrigerators, bar sinks, soda fountain sinks; horse stall, frost-proof water closets; connections for S traps, venting; connections for drum traps; soil pipe connections; supporting of soil pipe; main trap and fresh air inlet; floor drains and cellar drains, subsoil drainage; water closets and floor connections; local venting; connections for bath rooms; connections for bath rooms, continued; connections for bath rooms, continued; connections for bath rooms, continued; examples of poor practice; roughing-work ready for test; testing of plumbing system; method of continuous venting; continuous venting for two-floor work; continuous venting for two lines of fixtures on three or more floors; continuous venting of water closets; plumbing for cottage house; construction for cellar piping; plumbing for residence, use of special fittings; plumbing for two-flat house; plumbing for apartment building; plumbing for double apartment building; plumbing for office building; plumbing for public toilet rooms; plumbing for public toilet rooms, continued; plumbing for bath establishment; plumbing for engine house, factory plumbing; automatic flushing for schools, factories, etc.; use of flushing valves; urinals for public toilet rooms; the Durham system, the destruction of pipes by electrolysis; construction of work without use of lead; Automatic sewage lift, automatic sump tank; country plumbing; construction of cesspools; septic tank and automatic sewage siphon; country plumbing; water supply for country house; thawing of water mains and service by electricity; double boilers; hot water supply of large buildings; automatic control of hot water tank; suggestions for estimating plumbing construction. 400 octavo pages, fully illustrated by 55 full-page engravings. Price . \$4.00

STANDARD PRACTICAL PLUMBING. By R. M. STARBUCK.

A complete practical treatise of 450 pages covering the subject of Modern Plumbing in all its branches, a large amount of space being devoted to a very complete and practical treatment of the subject of Hot Water Supply and Circulation and Range Boiler Work. Its thirty chapters include about every phase of the subject one can think of, making it

CATALOGUE OF GOOD, PRACTICAL BOOKS

an indispensable work to the master plumber, the journeyman plumber, and the apprentice plumber, containing chapters on: the plumber's tools; wiping solder, composition and use; joint wiping; lead work; traps; siphonage of traps; venting; continuous venting; house sewer and sewer connections; house drain; soil piping, roughing; main trap and fresh air inlet; floor, yard, cellar drains, rain leaders, etc.; fixture wastes; water closets; ventilation; improved plumbing connections; residence plumbing; plumbing for hotels, schools, factories, stables, etc.; modern country plumbing; filtration of sewage and water supply; hot and cold supply; range boilers; circulation; circulating pipes; range boiler problems; hot water for large buildings; water lift and its use; multiple connections for hot water boilers; heating of radiation by supply system; theory for the plumber; drawing for the plumber. Fully illustrated by 347 engravings. Price \$3.00

RECEIPT BOOK

HENLEY'S TWENTIETH CENTURY BOOK OF RECEIPTS, FORMULAS AND PROCESSES. Edited by GARDNER D. HISCOX.

The most valuable Techno-chemical Receipt Book published, including over 10,000 selected scientific, chemical, technological, and practical receipts and processes.

This is the most complete Book of Receipts ever published, giving thousands of receipts for the manufacturer of valuable articles for everyday use. Hints, Helps, Practical Ideas, and Secret Processes are revealed within its pages. It covers every branch of the useful arts and tells thousands of ways of making money and is just the book everyone should have at his command.

Modern in its treatment of every subject that properly falls within its scope, the book may truthfully be said to present the very latest formulas to be found in the arts and industries and to retain those processes which long experience has proven worthy of a permanent record. To present here even a limited number of the subjects which find a place in this valuable work would be difficult. Suffice to say that in its pages will be found matter of intense interest and immeasurable practical value to the scientific amateur and to him who wishes to obtain a knowledge of the many processes used in the arts, trades and manufactures, a knowledge which will render his pursuits more instructive and remunerative. Serving as a reference book to the small and large manufacturer and supplying intelligent seekers with the information necessary to conduct a process, the work will be found of inestimable worth to the Metallurgist, the Photographer, the Perfumer, the Painter, the Manufacturer of Glues, Pastes, Cements, and Mucilages, the Compounder of Alloys, the Cook, the Physician, the Druggist, the Electrician, the Brewer, the Engineer, the Foundryman, the Machinist, the Potter, the Tanner, the Confectioner, the Chiropodist, the Manicure, the Manufacturer of Chemical Novelties and Toilet Preparations, the Dyer, the Electroplater, the Enameler, the Engraver, the Provisioner, the Glass Worker, the Goldbeater, the Watchmaker, the Jeweler, the Hat Maker, the Ink Manufacturer, the Optician, the Farmer, the Dairyman, the Paper Maker, the Wood and Metal Worker, the Chandler and Soap Maker, the Veterinary Surgeon, and the Technologist in general.

A mine of information, and up-to-date in every respect. A book which will prove of value to EVERYONE, as it covers every branch of the Useful Arts. 800 pages. Price \$3.00

WHAT IS SAID OF THIS BOOK:

"Your Twentieth Century Book of Receipts, Formulas and Processes duly received. I am glad to have a copy of it, and if I could not replace it money couldn't buy it. It is the best thing of the sort I ever saw." (Signed) M. E. TRUX,
Sparta, Wis.

"There are few persons who would not be able to find in the book some single formula that would repay several times the cost of the book."—*Merchant's Record and Show Window.*

RUBBER

RUBBER HAND STAMPS AND THE MANIPULATION OF INDIA RUBBER. By T. O'CONNOR SLOANE.

This book gives full details on all points, treating in a concise and simple manner the elements of nearly everything it is necessary to understand for a commencement in any branch of the India Rubber Manufacture. The making of all kinds of Rubber Hand Stamps, Small Articles of India Rubber, U. S. Government Composition, Dating Hand Stamps, the Manipulation of Sheet Rubber, Toy Balloons, India Rubber Solutions, Cements, Blackings, Renovating

CATALOGUE OF GOOD, PRACTICAL BOOKS

Varnish, and Treatment for India Rubber Shoes, etc.; the Hektograph Stamp Inks, and Miscellaneous Notes, with a Short Account of the Discovery, Collection, and Manufacture of India Rubber are set forth in a manner designed to be readily understood, the explanations being plain and simple. Including a chapter on Rubber Tire Making and Vulcanizing; also a chapter on the uses of rubber in Surgery and Dentistry. Third revised and enlarged edition. 175 pages. Illustrated. \$1.00

SAWS

SAW FILINGS AND MANAGEMENT OF SAWS. By ROBERT GRIMSHAW.

A practical hand book on filing, gumming, swaging, hammering, and the brazing of band saws, the speed, work, and power to run circular saws, etc. A handy book for those who have charge of saws, or for those mechanics who do their own filing, as it deals with the proper shape and pitches of saw teeth of all kinds and gives many useful hints and rules for gumming, setting, and filing, and is a practical aid to those who use saws for any purpose. New edition, revised and enlarged. Illustrated. Price \$1.00

STEAM ENGINEERING

AMERICAN STATIONARY ENGINEERING. By W. E. CRANE.

This book begins at the boiler room and takes in the whole power plant. A plain talk on every-day work about engines, boilers, and their accessories. It is not intended to be scientific or mathematical. All formulas are in simple form so that any one understanding plain arithmetic can readily understand any of them. The author has made this the most practical book in print; has given the results of his years of experience, and has included about all that has to do with an engine room or a power plant. You are not left to guess at a single point. You are shown clearly what to expect under the various conditions; how to secure the best results; ways of preventing "shut downs" and repairs; in short, all that goes to make up the requirements of a good engineer, capable of taking charge of a plant. It's plain enough for practical men and yet of value to those high in the profession.

A partial list of contents is: The boiler room, cleaning boilers, firing, feeding; pumps; inspection and repair; chimneys, sizes and cost; piping; mason work; foundations; testing cement; pile driving; engines, slow and high speed; valves; valve setting; Corliss engines, setting valves, single and double eccentric; air pumps and condensers; different types of condensers; water needed; lining up; pounds; pins not square in crosshead or crank; engineers' tools; pistons and piston rings; bearing metal; hardened copper; drip pipes from cylinder jackets; belts, how made, care of; oils; greases; testing lubricants; rules and tables, including steam tables; areas of segments; squares and square root; cubes and cube root; areas and circumferences of circles. Notes on: Brick work; explosions; pumps; pump valves; heaters, economizers; safety valves; lap, lead, and clearance. Has a complete examination for a license, etc., etc. Second edition. 285 pages. Illustrated. Price . \$2.00

EMINENT ENGINEERS. By DWIGHT GODDARD.

Everyone who appreciates the effect of such great inventions as the Steam Engine, Steamboat, Locomotive, Sewing Machine, Steel Working, and other fundamental discoveries, is interested in knowing a little about the men who made them and their achievements.

Mr. Goddard has selected thirty-two of the world's engineers who have contributed most largely to the advancement of our civilization by mechanical means, giving only such facts as are of general interest and in a way which appeals to all, whether mechanics or not. 280 pages. 35 illustrations. Price \$1.50

ENGINE RUNNER'S CATECHISM. By ROBERT GRIMSHAW.

A practical treatise for the stationary engineer, telling how to erect, adjust and run the principal steam engines in use in the United States. Describing the principal features of various special and well-known makes of engines: Temper Cut-off, Shipping and Receiving Foundations, Erecting and Starting, Valve Setting, Care and Use, Emergencies, Erecting and Adjusting Special Engines.

The questions asked throughout the catechism are plain and to the point, and the answers are given in such simple language as to be readily understood by anyone. All the instructions given are complete and up-to-date; and they are written in a popular style, without any technicalities or mathematical formulae. The work is of a handy size for the pocket, clearly and well printed, nicely bound, and profusely illustrated. To young engineers this catechism

CATALOGUE OF GOOD, PRACTICAL BOOKS

will be of great value, especially to those who may be preparing to go forward to be examined for certificates of competency; and to engineers generally it will be of no little service, as they will find in this volume more really practical and useful information than is to be found anywhere else within a like compass. 387 pages. Seventh edition. Price \$2.00

ENGINE TESTS AND BOILER EFFICIENCIES. By J. BUCHETTI.

This work fully describes and illustrates the method of testing the power of steam engines, turbines and explosive motors. The properties of steam and the evaporative power of fuels. Combustion of fuel and chimney draft; with formulas explained or practically computed. 255 pages, 179 illustrations. \$3.00

HORSEPOWER CHART.

Shows the horsepower of any stationary engine without calculation. No matter what the cylinder diameter of stroke; the steam pressure or cut off; the revolutions, or whether condensing or non-condensing, it's all there. Easy to use, accurate, and saves time and calculations. Especially useful to engineers and designers. 50 cents

MODERN STEAM ENGINEERING IN THEORY AND PRACTICE. By GARDNER D. HISCOX.

This is a complete and practical work issued for Stationary Engineers and firemen dealing with the care and management of boilers, engines, pumps, superheated steam, refrigerating machinery, dynamos, motors, elevators, air compressors, and all other branches with which the modern engineer must be familiar. Nearly 200 questions with their answers on steam and electrical engineering, likely to be asked by the Examining Board, are included.

Among the chapters are: Historical; steam and its properties; appliances for the generation of steam; types of boilers; chimney and its work; heat economy of the feed water; steam pumps and their work; incrustation and its work; steam above atmospheric pressure; flow of steam from nozzles; superheated steam and its work; adiabatic expansion of steam; indicator and its work; steam engine proportions; slide valve engines and valve motion; Corliss engine and its valve gear; compound engine and its theory; triple and multiple expansion engine. steam turbine; refrigeration; elevators and their management; cost of power; steam engine troubles; electric power and electric plants. 487 pages. 405 engravings. Price \$3.00

STEAM ENGINE CATECHISM. By ROBERT GRIMSHAW.

This unique volume of 413 pages is not only a catechism on the question and answer principle; but it contains formulas and worked-out answers for all the Steam problems that appertain to the operation and management of the Steam Engine. Illustrations of various valves and valve gear with their principles of operation are given. Thirty-four Tables that are indispensable to every engineer and fireman that wishes to be progressive and is ambitious to become master of his calling are within its pages. It is a most valuable instructor in the service of Steam Engineering. Leading engineers have recommended it as a valuable educator for the beginner as well as a reference book for the engineer. It is thoroughly indexed for every detail. Every essential question on the Steam Engine with its answer is contained in this valuable work. Sixteenth edition. Price \$2.00

STEAM ENGINEER'S ARITHMETIC. By COLVIN-CHENEY.

A practical pocket book for the steam engineer. Shows how to work the problems of the engine room and shows "why." Tells how to figure horse-power of engines and boilers; area of boilers; has tables of areas and circumferences; steam tables; has a dictionary of engineering terms. Puts you on to all all of the little kinks in figuring whatever there is to figure around a power plant. Tells you about the heat unit; absolute zero; adiabatic expansion; duty of engines; factor of safety; and 1,001 other things; and everything is plain and simple—not the hardest way to figure, but the easiest. 2nd Edition. 50 cents

STEAM HEATING AND VENTILATION

PRACTICAL STEAM, HOT-WATER HEATING AND VENTILATION. By A. G. KING.

This book is the standard and latest work published on the subject and has been prepared for the use of all engaged in the business of steam, hot water heating, and ventilation. It is an original and exhaustive work. Tells how to get heating contracts, how to install heating and ventilating apparatus, the best business methods to be used, with "Tricks of the Trade" for

CATALOGUE OF GOOD, PRACTICAL BOOKS

shop use. Rules and data for estimating radiation and cost and such tables and information as make it an indispensable work for everyone interested in steam, hot water heating, and ventilation. It describes all the principal systems of steam, hot water, vacuum, vapor, and vacuum-vapor heating, together with the new accelerated systems of hot water circulation, including chapters on up-to-date methods of ventilation and the fan or blower system of heating and ventilation. Containing chapters on: I. Introduction. II. Heat. III. Evolution of artificial heating apparatus. IV. Boiler surface and settings. V. The chimney flue. VI. Pipe and fittings. VII. Valves, various kinds. VIII. Forms of radiating surfaces. IX. Locating of radiating surfaces. X. Estimating radiation. XI. Steam-heating apparatus. XII. Exhaust-steam heating. XIII. Hot-water heating. XIV. Pressure systems of hot-water work. XV. Hot-water appliances. XVI. Greenhouse heating. XVII. Vacuum vapor and vacuum exhaust heating. XVIII. Miscellaneous heating. XIX. Radiator and pipe connections. XX. Ventilation. XXI. Mechanical ventilation and hot-blast heating. XXII. Steam appliances. XXIII. District heating. XXIV. Pipe and boiler covering. XXV. Temperature regulation and heat control. XXVI. Business methods. XXVII. Miscellaneous. XXVIII. Rules, tables and useful information. 367 pages. 300 detailed engravings. Price \$8.00

STEAM PIPES

STEAM PIPES: THEIR DESIGN AND CONSTRUCTION. By Wm. H. BOOTH.

The work is well illustrated in regard to pipe joints, expansion offsets, flexible joints, and self-contained sliding joints for taking up the expansion of long pipes. In fact, the chapters on the flow of steam and expansion of pipes are most valuable to all steam fitters and users. The pressure strength of pipes and method of hanging them are well treated and illustrated. Valves and by-passes are fully illustrated and described, as are also flange joints and their proper proportions, exhaust heads and separators. One of the most valuable chapters is that on superheated steam and the saving of steam by insulation with the various kinds of felted and other materials with comparison tables of the loss of heat in thermal units from naked and felted steam pipes. Contains 187 pages. Price \$2.00

STEEL

AMERICAN STEEL WORKER. By E. R. MARKHAM.

This book tells how to select, and how to work, temper, harden, and anneal steel for everything on earth. It doesn't tell how to temper one class of tools and then leave the treatment of another kind of tool to your imagination and judgment, but it gives careful instructions for every detail of every tool, whether it be a tap, a reamer or just a screw-driver. It tells about the tempering of small watch springs, the hardening of cutlery, and the annealing of dies. In fact there isn't a thing that a steel worker would want to know that isn't included. It is the standard book on selecting, hardening, and tempering all grades of steel. Among the chapter headings might be mentioned the following subjects: Introduction; the workman; steel; methods of heating; heating tool steel; forging; annealing; hardening baths; baths for hardening; hardening steel; drawing the temper after hardening; examples of hardening; pack hardening; case hardening; spring tempering; making tools of machine steel; special steels; steel for various tools; causes of trouble; high speed steels, etc. 366 pages. Very fully illustrated. 3rd Edition. Price \$2.50

HARDENING, TEMPERING, ANNEALING, AND FORGING OF STEEL. By J. V. WOODWORTH.

A new work treating in a clear, concise manner all modern processes for the heating, annealing, forging, welding, hardening, and tempering of steel, making it a book of great practical value to the metal-working mechanic in general, with special directions for the successful hardening and tempering of all steel tools used in the arts, including milling cutters, taps, thread dies, reamers, both solid and shell, hollow mills, punches and dies, and all kinds of sheet metal working tools, shear blades, saws, fine cutlery, and metal cutting tools of all description, as well as for all implements of steel both large and small. In this work the simplest and most satisfactory hardening and tempering processes are given.

The uses to which the leading brands of steel may be adapted are concisely presented, and their treatment for working under different conditions explained, also the special methods for the hardening and tempering of special brands.

A chapter devoted to the different processes for Case-hardening is also included, and special reference made to the adoption of machinery steel for tools of various kinds. 4th Edition. 288 pages. 201 Illustrations. Price \$2.50

CATALOGUE OF GOOD, PRACTICAL BOOKS

TURBINES

MARINE STEAM TURBINES. By DR. G. BAUER and O. LASCHE. Assisted by E. Ludwig and H. Vogel. Translated from the German and edited by M. G. S. Swallow.

This work forms a supplementary volume to the book entitled "Marine Engines and Boilers." The authors of this book, Dr. G. Bauer and O. Lasche, may be regarded as the leading authorities on turbine construction.

The book is essentially practical and discusses turbines in which the full expansion of steam passes through a number of separate turbines arranged for driving two or more shafts, as in the Parsons system, and turbines in which the complete expansion of steam from inlet to exhaust pressure occurs in a turbine on one shaft, as in the case of the Curtis machines. It will enable a designer to carry out all the ordinary calculations necessary for the construction of steam turbines, hence it fills a want which is hardly met by larger and more theoretical works.

Numerous tables, curves and diagrams will be found, which explain with remarkable lucidity the reason why turbine blades are designed as they are, the course which steam takes through turbines of various types, the thermodynamics of steam turbine calculation, the influence of vacuum on steam consumption of steam turbines, etc. In a word, the very information which a designer and builder of steam turbines most requires. The book is divided into parts as follows: 1. Introduction. 2. General remarks on the design of a turbine installation. 3. The calculation of steam turbines. 4. Turbine design. 5. Shafting and propellers. 6. Condensing plant. 7. Arrangement of turbines. 8. General remarks on the arrangement of steam turbines in steamers. 9. Turbine-driven auxiliaries. 10. Tables. Large octavo. 214 pages. Fully illustrated and containing 18 tables. Including an entropy chart. Price, net, **\$3.50**

WATCH MAKING

WATCHMAKER'S HANDBOOK. By CLAUDIUS SAUNIER.

This famous work has now reached its seventh edition and there is no work issued that can compare to it for clearness and completeness. It contains 498 pages and is intended as a workshop companion for those engaged in Watch-making and allied Mechanical Arts. Nearly 250 engravings and fourteen plates are included. Price **\$3.00**

89081505265



b89081505265a

2

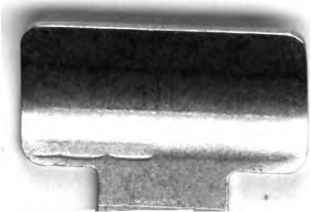
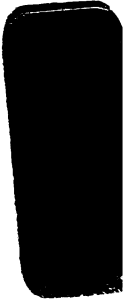
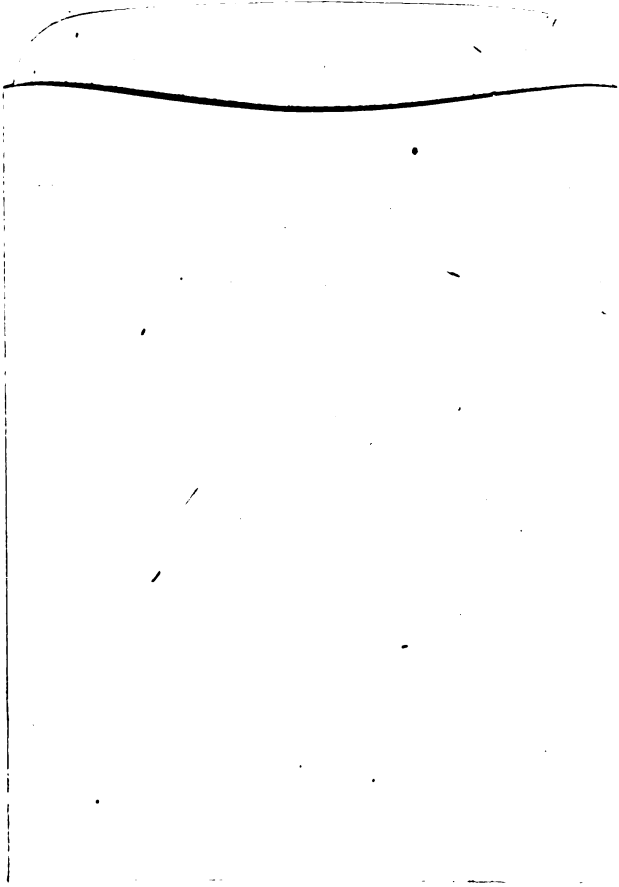

89081505265



B8908 1505265A