

THE THOUGHT IS IN THE QUESTION THE INFORMATION IS IN THE ANSWER

HAWKINS

ELECTRICAL GUIDE

NUMBER
ONE

1921
QUESTIONS
ANSWERS
&

ILLUSTRATIONS

A PROGRESSIVE COURSE OF STUDY
FOR ENGINEERS, ELECTRICIANS, STUDENTS
AND THOSE DESIRING TO ACQUIRE A
WORKING KNOWLEDGE OF

ELECTRICITY AND ITS APPLICATIONS

A PRACTICAL TREATISE

HAWKINS  AND STAFF

THEO. AUDEL & CO.  72 FIFTH AVE. NEW YORK.

COPYRIGHTED, 1917,
BY
THEO. AUDEL & CO.,
NEW YORK.

Printed in the United States.



Thomas A. Edison

1921

PREFACE

The word "guide" is defined as :

One who leads another in any path or direction; a person who shows or points out the way, especially by accompanying or going before; more particularly, one who shows strangers or tourists about; a conductor; leader, as "let us follow our guide."

This book, or "Guide," is so called because it leads or points out the way to the acquirement of a theoretical and practical knowledge of Electricity.

There are several guides, each covering in detail a certain phase of the broad subject of Electricity and leading the reader progressively, and in such a way, that he easily grasps, not only the simple fundamental facts, but the more complex problems, encountered in the study of Electricity. This is accomplished by the aid of a very large number of illustrations, together with specific explanations, worded in concise and simple language.

The Guides are written partly in the question and answer form, as this style of presentation has met with hearty approval, not only from those of limited education, but also from the better informed.

Where recourse is had to the question and answer form, the special aim of the author has been to give short and direct answers, in such

plain language as to preclude a misconception of the meaning. With this in view, **the answer gives simply the information sought by the question.**

The answer is limited to one paragraph so that the reader may concentrate upon the fact or facts demanded by the question.

Any enlargement of the answer or specific explanations of items contained therein, are presented in separate paragraphs printed in smaller type.

With this plan of **separating the answer**, as it were, from items of secondary importance, and making it short and simple, its content is more forcibly impressed upon the mind of the reader.

In a text book, it is necessary to illustrate and explain the various species of commercial apparatus met with in practice, and in this connection the Publishers desire to call attention to the manner in which the author has treated what may be classed as the "**descriptive matter.**" Contrary to the usual custom of giving descriptions of commercial machines in the main text, where they would occupy considerable space, to the exclusion of the more important matter, all such descriptions are placed in small type directly under the illustrations, leaving space for an adequate presentation of the underlying **principles, theories**, and for the large amount of **practical information** that is essential to obtain a general knowledge of Electricity and its numerous applications.

Credit is largely due to Frank D. Graham, B.S., M.S. (Princeton University), and M.E. (Stevens Institute), practical engineer, for the authorship of the **Guides**, and for original sketches illustrating electrical principles and construction.

TABLE OF CONTENTS

GUIDE NO. 1.

ELECTRICITY - - - - - 1 to 4

Nature and source—kinds of electricity: static, current, dynamic, radiated, positive, negative, atmospheric, frictional, resinous, vitreous.

STATIC ELECTRICITY - - - - - 5 to 26

Electrical attraction and repulsion—the charge—distribution of the charge—free and bound electricity—conductors and insulators—electroscopes—gold leaf electroscope—electric screens—electrification by induction—nature of the induced charge—the electrophorus—condensers; Leyden jar—electric machines—action of Toepler-Holz machine—Wimshurst machines.

THE ELECTRIC CURRENT - - - - - 27 to 34

Volt — ampere — ohm — Ohm's law — production of the electric current—current strength—voltage drop in an electric current.

PRIMARY CELLS - - - - - 35 to 67

The word "battery"—action of cell—chemical changes; polarization—effects of polarization—methods of depolarization — depolarizers — depolarizer bag—Volta's contact law — contact series of metals — laws of chemical action in cell—requirements of a good cell—single and two fluid cells—the Leclanche cell—Fuller bichromate cell—the Edison cell—Grenet bichromate cell—Daniell cell—directions for making a Daniell cell—gravity cells—Daniell gravity cell—so called "dry" cells—points relating to dry cells—care of cells—cleanliness—separating the elements — creeping — amalgamated zinc — battery connections.

CONDUCTORS AND INSULATORS - - 68 to 74

The so called "non-conductors"—**table of conductors and insulators**—mode of transmission—effect of heat—**heating effect of the current—insulators**—impregnating compounds—water as a conductor.

RESISTANCE AND CONDUCTIVITY - 75 to 82

Standard of resistance—conductivity of metals and liquids—effect of heat—**laws of electrical resistance**—conductivity—specific conductivity—**divided circuits**.

ELECTRICAL AND MECHANICAL ENERGY - - - - - 83 to 92

Definitions: energy, matter, molecule, work, foot pound volt coulomb, ampere hour, power, horse power, **watt**, kilowatt, watt hour—mechanical equivalent of heat—**British thermal unit—electrical horse power**—the farad.

EFFECTS OF THE CURRENT - - - - 93 to 104

Thermal effect—use of heat from the current—magnetic effect—chemical effect—**electrolysis**—electrochemical series—electric osmose—electric distillation—muscular contractions—**electroplating**—electrotyping.

MAGNETISM - - - - - 105 to 124

Two kinds of magnetism—nature of each—**poles**—magnetic field—magnetic force—**magnetic circuit**—magnetic flux—the Maxwell—the Gauss—**magnetic effect of the current**—corkscrew rule—solenoids—permeability—magnetic saturation—magnetomotive force—**reluctance**—analogy between electric and magnetic circuits—**hystereses**—residual magnetism.

ELECTROMAGNETIC INDUCTION - - 125 to 136

Faraday's discovery—Faraday's machine—Faraday's principle—line of force—induction of current—laws of electromagnetic induction—rules for direction of induced current—Fleming's rule—Ampere's rule—the palm rule—self-induction.

INDUCTION COILS - - - - - 137 to 154

Self-induction — mutual induction — **primary induction coils — secondary induction coils** — plain secondary induction coils — secondary induction coils with vibrator and condenser; **cycle of action** — magnetic vibrators — vibrator adjustment — table of induction coil dimensions — table of sparking distances in air — **points relating to induction coils** — wiring diagram.

THE DYNAMO - - - - - 155 to 160

Operation — **essential parts** — field magnets — armature — **construction of dynamos** — parts; bed plate, field magnets, armature, commutator, brushes.

THE DYNAMO: BASIC PRINCIPLES - 161 to 170

Definitions — essential parts — **elementary alternator** — operation — direction of induced current — application of Fleming's rule — cycle of operation — **the sine curve**; its construction and application.

THE DYNAMO: CURRENT COMMUTATION - - - - - 171 to 180

How the current is produced — **how direct current is obtained** — the commutator — inductors — "continuous current" — action of four coil elementary dynamo — **conditions for steadiness of the current.**

CLASSES OF DYNAMO - - - - - 181 to 198

Classification — bipolar and multipolar dynamos — difference between dynamo and magneto — self exciting dynamo — **the series dynamo** — regulation of series dynamo; difficulties experienced — **the shunt dynamo** — adaptation — operation — characteristic — regulation — **the compound dynamo** — service intended for — regulation — over compounding — usual degree of over compounding — short shunt — long shunt — voltage of short and long shunt machines — separately excited dynamos — **Dobrowski three wire dynamo.**

FIELD MAGNETS - - - - - 199 to 220

Object—essential parts—classes of field magnet—multipolar field magnets—construction—choice of materials—design—pole pieces—eddy current—laminated fields—construction to reduce reluctance of the magnetic circuit—magnetizing coils—methods of winding—coil ends—insulation—attachment of coils—coil connections—**heating—ventilation.**

THE ARMATURE - - - - - 221 to 228

Definition—how continuous current is obtained—type of armature—comparison ring and drum armatures—**why drum armature is the prevailing type**—disc armatures—why disc armatures were abandoned.

ARMATURE WINDINGS - - - - - 229 to 256

Preliminary considerations—winding diagrams and winding tables—lap and wave winding—angular pitch or spread of drum coils—parallel or lap winding—series or wave winding—double windings—Siemens winding—objection to Siemens winding—chord winding—multiplex windings—number of brushes required—number of armature circuits—**equalizer rings—drum winding requirements.**

THEORY OF THE ARMATURE - - - 257 to 282

Current distribution in ring and drum armatures—**connection of brushes**—variation of voltage around the commutator—**cross magnetization**; field distortion—remedies for field distortion—angle of lead—demagnetizing effect of armature reaction—**effect of lead—eddy currents**; lamination—remedy for eddy currents—magnetic drag on the armature—smooth and slotted armatures—comparison of smooth and slotted armatures—magnetic hysteresis in armature cores—**core loss or iron loss—dead turns—friction.**

**COMMUTATION AND THE
COMMUTATOR - - - - - 283 to 302**

Period of commutation—commutating plane—normal neutral plane—neutral plane—plane of maximum induction—commutation—position of the brushes—**sparking**—effect of self-induction—construction of commutators—**points relating to commutators**—types of commutator.

BRUSHES AND THE BRUSH GEAR - - - 303 to 320

Classification — gauze brushes — wire brushes — strip brushes—**carbon brushes**—adjustment—comparison of copper and carbon brushes—size of brushes—number—**contact angle of brush**—brush contact—drop in voltage at brushes—**brush holders**—brush rigging—multipolar brush gear.

ARMATURE CONSTRUCTION - - - 321 to 348

Parts—shaft—core—slotted core—**core laminations**—core bolts—attachment to shaft—insulation of core discs—teeth—advantages and defects of slotted armatures—slotted cores; built up construction—**ventilation**—**insulation of core**—armature windings—construction of inductors—objection to copper bars—**various windings**: hand winding—evolute or butterfly winding—connectors—barrel winding—bastard winding—former winding—former coils—peculiarity of evolute coil—"straight out" coil—**coil retaining devices**—driving horns.

INTRODUCTORY CHAPTER

The subject matter of this work relates to one of the secrets of creation which appears to have been intended at the very beginning to be "sought out." This idea is expressed in a certain saying copied three or four thousand years ago by the men of Hezekiah, King of Judah: from Solomon's proverbs: "*It is the glory of God to conceal a thing: But the glory of Kings (i.e., wise men), to search out a matter.*"

In all that may be said hereafter through the work, it is admitted that the results recorded are the determinations of experiments performed by an incredible number of searchers extending through many ages. These inquiries have been pursued with a generous rivalry which has permitted discovery to be added to discovery, until the sum total has been wrought into such exactness that it has been thoughtlessly stated that there is nothing more, save its application.

It may be well, however, to state a few fundamental facts relating to electricity: 1, Electricity and magnetism are one and the same thing; 2, what is really known about it has come as a discovery and not as an invention. Thus, we say the intrepid explorer discovered the pole, not that he invented it.

So with electricity it has been a subject of discovery while its many applications to useful purposes have been veritable inventions; 3, the earth itself is a magnet.

This last is shown by the fact that the earth affects a magnet just as one magnet affects another. Magnets are bodies, either natural or artificial, which have the property of attracting iron, and the power, when freely suspended, of taking a direction toward the poles of the earth. The natural magnet is sometimes called the *loadstone*. This word is said to be derived from *loedan*, a Saxon word which signifies to guide. It is an oxide of iron of a peculiar character, found occasionally in beds of iron ore. Though commonly met with in irregular masses only a few inches in diameter, however, loadstones of larger sizes are sometimes found.

By means of simple experiments it may be ascertained that the magnet has the following general properties, viz: 1, power of attraction; 2, power of repulsion; 3, power of communicating magnetism to iron or steel; 4, polarity, or the power of taking a direction toward the poles of the earth; 5, power of inclining itself toward a point below the horizon.

Speaking generally we may say, that magnetism is a department of electrical science which treats of the properties and effects of the magnet. The same terms are also used to denote the unknown cause of magnetic phenomena, as when we speak of magnetism as excited, imparted, and so on.

Lightning and the Northern Lights are displays of electricity on a grand scale. Electricity is a term derived from the Greek word for *amber*, that being the substance in which a property of the agent now denominated electricity was first observed.

The ancient Greek philosophers were acquainted with the fact that amber, when rubbed, acquired the property of attracting light bodies; hence the effect was denominated electrical and in later times, the term electricity has been used to denote the unknown cause of electrical phenomena, and broadly the science which treats of electrical phenomena and their causes.

Electricity, whatever it may prove to be, is not *matter* nor is it *energy*; it is however a means or medium of transmitting energy.

If electricity is to transmit or convey energy along a wire, this energy must be imparted to the electricity from some external source, that is to say, before electricity can perform any work it must be set in motion, against more or less resistance. This involves that pressure must be applied, and to obtain this pressure, energy must be expended from some external source.

Accordingly, in electrical engineering, the first principle to be grasped is that of *energy*. Without the expenditure of energy no useful work can be accomplished.

Energy may be defined as *the capacity for performing work*.

Although electricity is not energy, electricity under pressure is a form of energy spoken of as electrical energy.

In an expenditure of energy in this form, the electricity acts simply as a transmission agent or medium to transmit the energy imparted to it in causing it to flow.

In a similar manner, steam acts as a transmission agent or medium to transmit the heat energy of the coal to the steam engine, where it is converted into mechanical energy.

As just stated, electricity under pressure is a form of energy, and its generation is simply a transformation of energy from one form into another. Usually, mechanical energy is converted into electrical energy. and a dynamo is employed for effecting the transformation.

In transforming the mechanical energy of waterfalls into electric energy, this natural power of water due to its weight and motion is first converted into rotary motion by a turbine or water wheel, and then converted into electric energy by a dynamo, or an alternator.

All dynamos are but machines for converting into electric energy the energy which is given to them by some prime mover, as a steam engine, a gas engine, by hydraulic or even by wind power.

All electric motors are merely machines for reconverting the electric energy which they receive by means of the conducting wires or mains, into mechanical energy.

All electric lamps are contrivances for converting into luminous energy a percentage of the electric energy that is supplied through the mains.

Potential and Kinetic Energy.—*Potential energy* is the capacity for performing work which a body possesses *by virtue of its position*. *Kinetic energy* is the capacity for performing work which a body possesses *by virtue of its motion*.

It must be evident that position or motion given to a body enables it to perform work. In the first instance, for example, a heavy weight at the top of a high tower possesses potential energy. A ten pound weight supported one foot above a plane has ten foot pounds of potential energy.

The flywheel of a steam engine in motion is an example of a body possessing kinetic energy. Some of this kinetic energy which was stored up in the fly wheel during the working stroke is expended in moving the engine over the "dead center," and any other point where no torque is produced by the pressure on the piston.

Chemical Energy can be converted into electric energy to a limited extent by means of the electric battery, but the cost of this energy is so high that it is commercially feasible only where small quantities are required, and the cost of production is secondary to the convenience of generation, as for signalling purposes, the operation of bells and annunciators, etc.

The chemical energy of coal and other fuels cannot be directly converted into electric energy. For power producing purposes, the

chemical energy of a fuel is first converted into heat by combustion, and the heat thus obtained converted into mechanical energy by some form of heat engine, and the mechanical energy subsequently transformed into electric energy in an electric generator.

Energy cannot be created or destroyed. This is the law known as the **conservation of energy** which has been built up by Helmholtz, Thomson, Joule and others. It teaches further, that energy can be transmitted from one body to another or transformed in its manifestations.

Energy may be dissipated, that is, converted into a form from which it cannot be recovered, as is the case with the great percentage of heat escaping from the exhaust nozzle of a locomotive or in the circulating water of a steamship, but the total amount of energy in the universe, it is argued remains constant and invariable.

Following this law comes the doctrine of the **conservation of electricity** as announced by Lippman, being undoubtedly the outcome of the ideas of Maxwell and of Faraday as to the nature of electricity. According to their doctrine, electricity *cannot be created or destroyed, although its distribution may be altered.*

Lippman states that every charge of electricity has an opposite and equal charge somewhere in the universe more or less distributed; that is, the sum of positive charges is always equal to the sum of negative charges.

In *altering the distribution of electricity*, we may cause **more** to appear at one place and **less** at another, or may change it from the condition of rest to that of motion, or may cause it to spin round in whirlpools or vortices, which themselves can attract or repel other vortices. According to this view all our electrical machines and batteries are merely instruments for altering the *distribution* of electricity by moving some of it from one place to another, or for causing electricity, when accumulated

or heaped together in one place, to do work in returning to its former distribution.

Electrical engineering has developed largely and widely within a very short time and its many applications has created so great a demand for various kinds of electrical apparatus, that their manufacture forms one of the leading industries.

Electricity is very valuable as a medium for the transmission of energy, especially to long distances; it is also used to great advantage in lighting, being free from the disagreeable properties of gas or oil.

Again, electricity finds various applications, in extracting gold from the ore, pumping and ventilation of mines, traction, telephone, telegraph, electroplating, therapeutics, etc.

These few, of its many applications will perhaps serve to indicate the far reaching interest and importance of electricity, and possibly help to kindle in the student something of the eagerness in his work and enthusiasm without which he will fail to do justice either to his calling or to himself.

SIGNS AND SYMBOLS

The following signs, symbols and abbreviations are almost universally employed in descriptive and technical works on electrical subjects.

Although, in the arrangement of the Guides, the direct current and alternating current matter has been kept separate, it is perhaps advisable in the case of signs and symbols, to combine those relating to the alternating current with the direct current and other symbols, making a single table, rather than have them scattered throughout the work.

1. Fundamental.

- l*, Length. cm. = centimeter;
in., or " = inch, ft. or ' =
foot.
- M*, Mass. gr. = mass of 1 gramme;
kg. = 1 kilogramme.
- T, t*, Time. *s* = second.

2. Derived Geometric.

- S, s*, Surface.
- E*, Volume.
- α, β*, Angle.

3. Derived Mechanical.

- v*, Velocity.
- ω*, Angular velocity.
- m*, Momentum.
- a*, Acceleration.
- g*, Acceleration due to gravity =
32.2 feet per second.
- F, f*, Force.
- W*, Work.
- P*, Power.
- δ*, Dyne.
- e*, Ergs.
- ft. lb., Foot pound.
- H.P., h.p.; horse power.
- I.H.P., Indicated horse power.
- B.H.P., Brake horse power.
- E.H.P., Electrical horse power.

- J*, Joule's equivalent.
- p*, Pressure.
- K*, Moment of inertia.

4. Derived Electrostatic.

- e*, Pressure difference.
- i*, Current.
- r*, Resistance.
- q*, Quantity.
- c*, Capacity.
- sc*, Specific inductive capacity.

5. Derived Magnetic.

- m*, Strength of pole.
- J*, Intensity of magnetization.
- M*, Magnetic moment.
- H*, Horizontal intensity of earth's
magnetism.
- H*, Field intensity.
- Φ*, Magnetic flux.
- EB*, Magnetic flux density or mag-
netic induction.
- H*, Magnetizing force.
- F*, Magnetomotive force.
- R*, Reluctance, magnetic resist-
ance.
- μ*, Magnetic permeability.
- κ*, Magnetic susceptibility.
- p*, Reluctivity (specific magnetic
resistance).

6. Derived Electromagnetic.

- R,** Resistance, ohm.
O, do, megohm.
E, Volt, pressure.
E_{im} Impressed pressure.
E_a, E_o Active pressure; ohmic drop.
E_v Virtual pressure.
E_{max} Maximum pressure.
E_{av} Average pressure.
E_{ef} Effective pressure.
E_t Inductance pressure.
E_c Capacity pressure.
U, Difference of pressure, volt.
I, Intensity of current, ampere.
I_{im} Impressed current.
I_a Active current.
I_v Virtual current.
I_{max} Maximum current.
I_{av} Average current.
I_{ef} Effective current.
Q, Quantity of electricity, ampere hour; coulomb.
C, Capacity, farad.
W, Electric energy, watt hour; Joule.
P, Electric power, watt; kilowatt.
ρ, Resistivity (specific resistance) ohm centimeter.
G, Conductance, mho.
γ, Conductivity (specific conductivity).
Y, Admittance, mho.
Z, Impedance, ohm.
X, Reactance, ohm.
X_l Inductance reactance.
X_c Capacity reactance.
B, Susceptance, mho.
L, Inductance (coefficient of Induction), henry.
v, Ratio of electro-magnetic to electrostatic unit of quantity = 3×10^{10} centimeters per second approximately.

7. Symbols in general use.

- D,** Diameter.
r, Radius.

- t,* Temperature.
θ, Deflection of galvanometer needle.
N, n, Number of anything.
π, Circumference ÷ diameter = 3.141592.
ω, $2\pi f = 6.2831 \times$ frequency, in alternating current.
 $\sim f,$ Frequency, periodicity, cycles per second.
φ Phase angle.
G, Galvanometer.
S, Shunt.
N, n, North pole of a magnet.
S, s, South pole of a magnet.
A.C. Alternating current.
D.C. Direct current.
P.D. Pressure difference.
P.F. Power factor.
C.G.S. Centimeter, gramme, Second system.

- B.&S.** Brown & Sharpe wire gauge.
B.W.G. Birmingham wire gauge.
R.p.m. Revolutions per minute.
C.P. Candle power.
 $\text{—} \circ \text{—}$ Incandescent lamp.
 $\text{—} \times \text{—}$ Arc lamp.

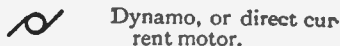
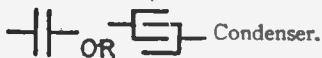

CHAPTER I

ELECTRICITY

Nature and Source of Electricity.—What is electricity? This is a question that is frequently asked, but has not yet been satisfactorily answered. It is a force, subject to control under well known laws.

While the nature and source of electricity still remain a mystery, many things about it have become known, thus, it is positively assured that electricity never manifests itself except when there is some mechanical disturbance in ordinary matter.

The true nature of electricity has not yet been discovered. Many think it a quality inherent in nearly all the substances, and accompanied by a peculiar movement or arrangement of the molecules. Some assume that the phenomena of electricity are due to a peculiar state of strain or tension in the ether which is present everywhere, even in and between the atoms of the most solid bodies. If the latter theory be the true one, and if the atmosphere of the earth be surrounded by the same ether, it may be possible to establish these assumptions as facts.

The most modern supposition regarding this matter, by Maxwell, is that light itself is founded on electricity, and that *light waves* are merely *electro-magnetic waves*. The theory "that

electricity is related to, or identical with, the luminiferous ether," has been accepted by the most prominent scientists.

But while electricity is still a mystery, much is known about the laws governing its phenomena. Man has mastered this mighty force and made it his powerful servant; he can produce it and use it.

Electricity, it is also conceded, is without weight, and, while it is without doubt, one and the same, it is for convenience sometimes classified according to its motion, as:

1. Static electricity, or electricity *at rest*;
2. Current electricity, or electricity *in motion*;
3. Magnetism, or electricity *in rotation*;
4. Electricity *in vibration* (radiation).

Other useful divisions are:

1. Positive;
2. Negative electricity;
3. Static;
4. Dynamic electricity.

Static Electricity.—This is a term employed to define electricity produced by friction. It is properly employed in the sense of a static charge which shows itself by the attraction or repulsion between charged bodies.

When static electricity is discharged, it causes more or less of a current, which shows itself by the passage of sparks or a brush discharge; by a peculiar prickling sensation; by a peculiar smell due to its chemical effects; by heating the air or other substances in its path; and sometimes in other ways.

Current Electricity.—This may be defined as the quantity of electricity which passes through a conductor in a given time—or, electricity in the act of being discharged, or electricity in motion.

An electric current manifests itself by heating the wire or conductor; by causing a magnetic field around the conductor and by causing chemical changes in a liquid through which it may pass.

Dynamic Electricity.—This term is used to define current electricity to distinguish it from static electricity.

Radiated Electricity.—Electricity in vibration. Where the current oscillates or vibrates back and forth with extreme rapidity, it takes the form of waves which are similar to waves of light.

Positive electricity.—This term expresses the condition of the point of an electrified body having the higher energy from which it flows to a lower level. The sign which denotes this phase of electric excitement is +; all electricity is either positive or negative.

Negative Electricity.—This is the reverse condition to the above and is expressed by the sign or symbol—. These two terms are used in the same sense as *hot* and *cold*.

NOTE.—In 1749, Benjamin Franklin, observing lightning to possess almost all the properties observable in electric sparks, suggested that the electric action of points, which was discovered by him, might be tried on thunderclouds, and so draw from them a charge of electricity. He proposed, therefore, to fix a pointed iron rod to a high tower, but shortly after succeeded in another way. He sent up a kite during the passing of a storm, and found the wetted string to conduct the electricity to the earth, and to yield abundance of sparks. These he drew from a key tied to the string, a silk ribbon being interposed between his hand and the key for safety. Leyden jars could be charged, and all other electrical effects produced, by the sparks furnished from the clouds. The proof of the identity was complete. The kite experiment was repeated by Romas, who drew from a metallic string sparks 9 feet long. In 1753, Richmann, of St. Petersburg, who was experimenting with a similar apparatus, was struck by a sudden discharge and killed.

Atmospheric Electricity is the free electricity of the air which is almost always present in the atmosphere. Its exact cause is unknown.

The phenomena of atmospheric electricity are of two kinds; there are the well known manifestations of thunderstorms; and there are the phenomena of continual slight electrification in the air, best observed when the weather is fine; the Aurora constitutes a third branch of the subject.



Fig. 1.—The electric eel. There are several species inhabiting the water, and which have the power of producing electric discharges by certain portions of their organism. The best known of these are the *Torpedo*, the *Gymnotus*, and the *Silurus*, found in the Nile and the Tiger. The Electric Ray, of which there are three species inhabiting the Mediterranean and Atlantic is provided with an electric organ on the back of its head, as shown in the illustration. This organ consists of laminæ composed of polygonal cells to the number of 800 or 1000, or more, supplied with four large bundles of nerve fibres; the under surface of the fish is -, the upper +. In the Surinam eel, the electric organ goes the whole length of the body along both sides. It is able to give a very severe shock, and is a formidable antagonist when it has attained its full length of 5 or 6 feet.

Frictional Electricity is that produced by the friction of one substance against another.

Resinous Electricity.—The kind of electricity produced upon a resinous substances such as sealing wax, resin, shellac, rubber or amber when rubbed with wool or fur. Resinous electricity is *negative electricity*.

Vitreous Electricity.—A term applied to the positive electricity developed in a glass rod by rubbing it with silk. This electric charge will attract to itself bits of pith or paper which have been repelled from a rod of sealing wax or other resinous substance which had been rubbed with wool or fur.

CHAPTER II

STATIC ELECTRICITY

Static electricity may be defined simply as *electricity at rest*; the term properly applies to an isolated charge of electricity produced by friction. The presence of static electricity manifests itself by *attraction* or *repulsion*.

Electrical Attraction and Repulsion.—When a glass rod, or a stick of sealing wax or shellac is held in the hand and rubbed with a piece of flannel or cat skin, the parts will be found to have the property of attracting bodies, such as pieces of silk, wool, feathers, gold leaf, etc.; they are then said to be *electrified*. In order to ascertain whether bodies are electrified or not, instruments called *electroscopes* are used.

There are two opposite kinds of electrification:

1. Positive;
2. Negative.

Franklin called the electricity excited upon glass by rubbing it with silk *positive* electricity, and that produced on resinous bodies by friction with wool or fur, *negative* electricity.

The electricity developed on a body by friction depends on the rubber as well as the body rubbed. Thus glass becomes

negatively electrified when rubbed with catskin, but positively electrified when rubbed with silk.

The nature of the electricity set free by friction depends on the degree of polish, the direction of the friction, and the temperature. If two glass discs of different degrees of polish be rubbed against each other, that which is most polished is positively, and that which is least polished is negatively electrified. If two silk ribbons of the same kind be rubbed across each

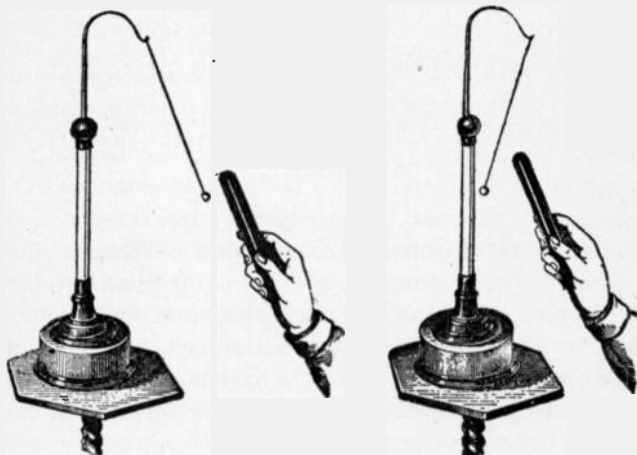

FIGS. 2 and 3.—Pith ball pendulum or electroscope; the figures illustrate also electrical attraction and repulsion.

other, that which is transversely rubbed is negatively and the other positively electrified. If two bodies of the same substance, of the same polish, but of different temperatures, be rubbed together, that which is most heated is negatively electrified. Generally speaking, the particles which are most readily displaced are negatively electrified.

In the following list, which is mainly due to Faraday, the substances are arranged in such order that each becomes

positively electrified when rubbed with any of the bodies following but negatively when rubbed with any of those which precede it.

- | | |
|------------------|------------------|
| 1. Catskin. | 9. Wood. |
| 2. Flannel. | 10. Metals. |
| 3. Ivory. | 11. Caoutchouc. |
| 4. Rock crystal. | 12. Sealing wax. |
| 5. Glass. | 13. Resin. |
| 6. Cotton. | 14. Sulphur. |
| 7. Silk. | 15. Guttapercha. |
| 8. The hand. | 16. Gun cotton. |

The Charge.—The quantity of electrification of either kind produced by friction or other means upon the surface of a body is spoken of as a charge, and a body when electrified is said to be *charged*. It is clear that there may be charges of different values as well as of either kind. When the charge of electricity is removed from a charged body it is said to be *discharged*. Good conductors of electricity are instantaneously discharged if touched by the hand or by any conductor in contact with the ground, the charge thus finding a means of escaping to earth. A body that is not a good conductor may be readily discharged by passing it rapidly through the flame of a lamp or candle; for the flame instantly carries off the electricity and dissipates it in the air.

Distribution of the Charge.—When an insulated sphere of conducting material is charged with electricity, the latter passes to the surface of the sphere, and forms there an extremely thin layer. The distribution of the charge then, depends on the *extent* of the surface and not on the mass.

Boit proved that the charge resides on the surface by the following experiment:

A copper ball was electrified and insulated. Two hollow hemispheres of copper of a larger size, provided with glass handles, were then placed near the sphere, as in fig. 4. So long as they did not touch the sphere, the charge remained on the latter, but if the hemispheres touched the inner sphere, the whole of the electricity passed to the exterior, and when the hemispheres were separated and removed the inner globe was found to be completely discharged.

The distribution of a charge over an insulated sphere of conducting material is uniform, provided the sphere is remote from all other conductors and electrified bodies.

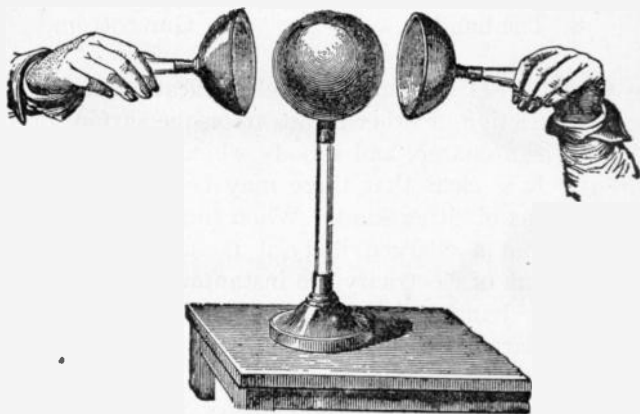
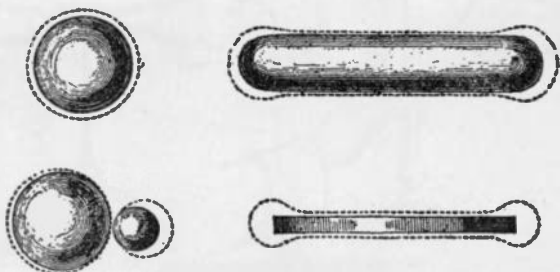

FIG. 4.—Boits experiment which proved that the *charge resides on the surface.*

Figs. 5 to 8 show, by the dotted lines, the distribution of a charge for bodies of various shapes. Fig. 6 shows that for elongated bodies, the charge collects at the ends.

The effects of points is illustrated in fig. 9; when a charged body is provided with a point as here shown, the current accumulates at the point to such a high degree of density that it passes off into the air, and if a lighted candle be held in front of the point, the flame will be visibly blown aside.

Fig. 10 shows an *electric windmill* or experimental device for illustrating the escape of electricity from points. It consists of a vane of several pointed wires bent at the tips in the same direction, radiating from a center which rests upon a pivot. When mounted upon the conductor of an electrostatic machine, the vane rotates in a direction opposite that of the points. The movement of the vane is due to the repulsion of the electrified air particles near the points and the electricity on the points themselves. The motion of the air is called *electric wind*. This device is also called *electric flyer*, and *electric whirl*.



FIGS. 5 to 8.—Illustrating the distribution of the charge on conductors of various shapes.

“Free” and “Bound” Electricity.—These terms may be defined as follows:

The expression *free electricity* relates to the ordinary state of electricity upon a charged conductor, not in the presence of a charge of the opposite kind. A free charge will flow away to the earth if a conducting path be provided.

A charge of electricity upon a conductor is said to be *bound*, when it is attracted by the presence of a neighboring charge of the opposite kind.

Conductors and Insulators.—The term *conductors* is applied to those bodies which readily allow electricity to flow through them, in distinction from *insulators* or so called *non-conductors*, which practically allow no flow of electricity.

Strictly speaking, there is no substance which will prevent the passage of electricity, hence, the term non-conductors, though extensively used, is not correct.

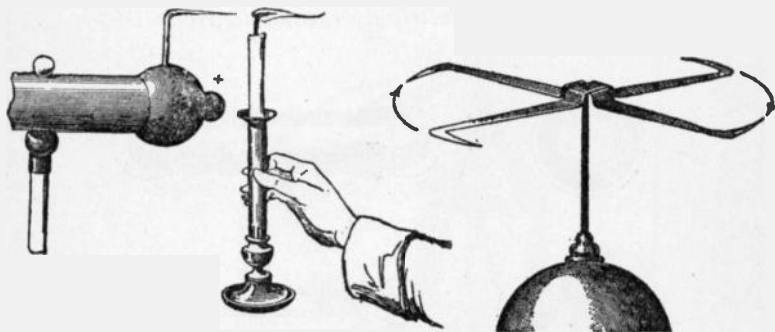

FIG. 9.—Experiment to illustrate the effect of pointed conductors.

FIG. 10.—Electric windmill which operates by the reaction due to the escape of the electric charge from the points.

Electroscopes.—These are instruments for detecting whether a body be electrified or not, and indicating also whether the electrification be positive or negative. The earliest electroscope devised consisted of a stiff straw balanced lightly upon a sharp point; a thin strip of brass or wood, or even a goose quill, balanced upon a sewing needle will serve equally well. Another form of electroscope is the pith ball pendulum, shown in figs. 2 and 3. When an electrified body is held near the electroscope it is attracted or repelled thus indicating the presence and nature of the charge.

Gold Leaf Electroscope.—This form of electroscope, which is very sensitive, was invented by Bennet. Its operation depends on the fact that *like charges repel each other*.

The gold leaf electroscope as shown in fig. 11, is conveniently made by suspending the two narrow strips of gold leaf within a wide mouthed glass jar, which both serves to protect them from draughts of air and to support them from contact with the ground. A piece of varnished glass tube is pushed through the



FIG. 11.—Gold leaf electroscope; it consists of two strips of gold foil suspended from a brass rod within a glass jar. Used to detect the presence and sign of an electric charge.

cork, which should be varnished with shellac or with paraffin wax. Through this passes a stiff brass wire, the lower end of which is bent at a right angle to receive the two strips of gold leaf, while the upper end is attached to a flat plate of metal, or may be furnished with a brass knob.

When kept dry and free from dust it will indicate excessively small quantities of electricity. A rubbed glass rod, even while two or three feet from the instrument, will cause the leaves to repel one another. If the knob be brushed with only a small

camel's hair brush, the slight friction produces a perceptible effect. With this instrument all kinds of friction can be shown to produce electrification.

The gold leaf electroscope can be further used to indicate the *kind* of electricity on an excited body. Thus, if a piece of brown paper be rubbed with a piece of india rubber, the nature of the charge is determined as follows:

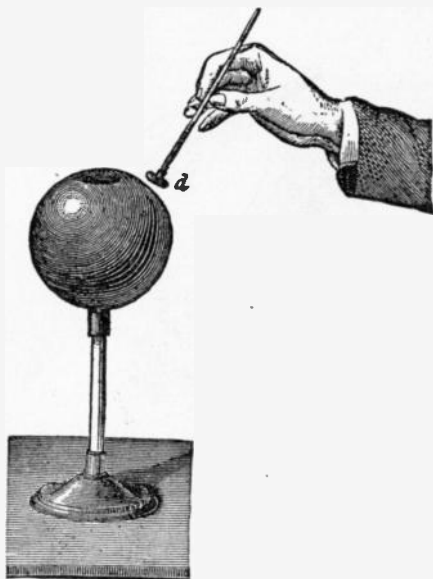
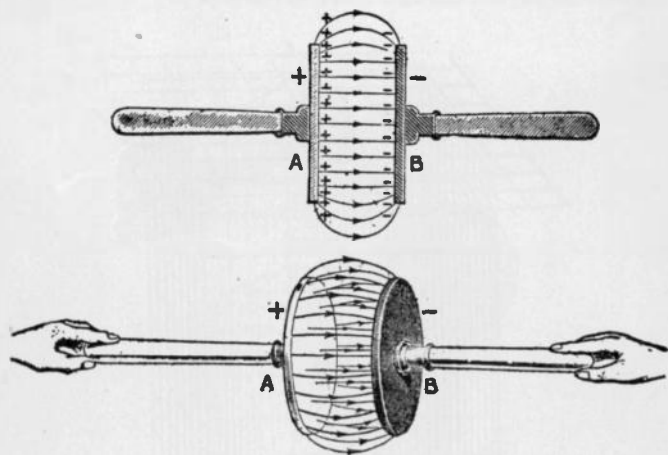

FIG. 12.—Distribution of electrification on a charged hollow sphere. If an insulated conductor *d* be inserted through the opening in the sphere and brought in contact with the interior surface and afterwards carefully removed, it will be found, by testing with the gold leaf electroscope, that it has received no charge. If touched to the outside, however, the conductor will receive part of the charge.

First charge the gold leaves of the electroscope by touching the knob with a glass rod rubbed on silk. The leaves diverge, being electrified with positive electrification. When they are thus charged the approach of a body which is positively electrified will cause them to diverge still

more widely; while, on the approach of one negatively electrified, they will tend to close together. If now the brown paper be brought near the electroscope, the leaves will be seen to diverge more, proving the electrification of the paper to be of the same kind as that with which the electroscope is charged.

The gold leaf electroscope will also indicate roughly the amount of electricity on a body placed in contact with it, for the gold leaves open out more widely when the quantity of electricity thus imparted to them is greater.



FIGS. 13 and 14.—Electrification produced by rubbing dissimilar bodies together and then separating them. If the insulated glass and leather discs A and B be rubbed together, *but not separated*, no signs of electrification can be detected; but if the discs be drawn apart a little distance the space between them is found to be an electric field, and as they separate farther and farther, electric forces will be found to exist in more and more of the surrounding space, the electrification being indicated by "lines of force." It should be noted that *work has to be done* in separating the charged discs to overcome the attraction which tends to hold them together. The stress indicated by the lines of force consists of a tension or pull in the direction of their length and a pressure or thrust at right angles to that direction.

Electric Screens.—That the charge on the outside of a conductor always distributes itself in such a way that there is no electric force within the conductor was first proved experimentally by Faraday. He covered a large box with tin foil

and went inside with the most delicate electroscopes obtainable. Faraday found that the outside of the box could be charged so strongly that long sparks would fly from it without any electrical effects being observable anywhere inside the box.

To repeat the experiment in modified form, let an electroscope be placed beneath a bird cage or wire netting, as in fig. 15. Let charged rods or other powerfully charged bodies be brought near the electroscope outside the cage. The leaves will be found to remain undisturbed.

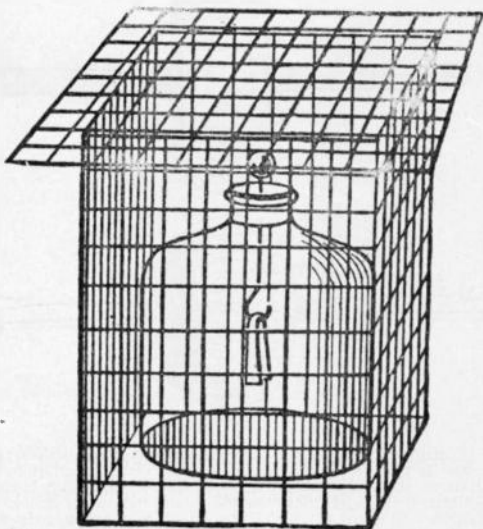

FIG. 15.—The electric screen. A screen of wire gauze surrounding a delicate electrical instrument will protect it from external electrostatic induction.

Electrification by Induction.—An insulated conductor, charged with either kind of electricity, acts on bodies in a neutral state placed near it in a manner analogous to that of the action of a magnet on soft iron; that is, it decomposes the neutral electricity, attracting the opposite and repelling the

like kind of electricity. The action thus exerted is said to take place by *influence* or *induction*.

The phenomenon of electrification by induction may be demonstrated by the following experiment:

In fig. 16, let the ebonite rod be electrified by friction and slowly brought toward the knob of the gold leaf electroscope. The leaves will be seen to diverge, even though the rod does not approach to within a foot of the electroscope.

This experiment shows that the mere *influence* which an electric charge exerts upon a conductor placed in its vicinity

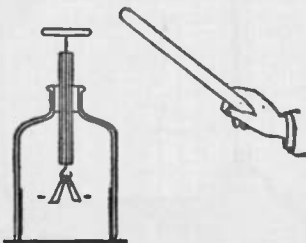

FIG. 16.—Experiment to illustrate electrostatic induction. The leaves will diverge, even though the charged ebonite rod does not approach to within a foot of the electroscope.

is able to produce electrification in that conductor. This method of producing electrification is called *electrostatic induction*.

As soon as the charged rod is removed the leaves will collapse, indicating that this form of electrification is only a temporary phenomenon which is due simply to the presence of the charged body in the neighborhood.

Nature of the Induced Charge.—This is shown by the experiment illustrated in fig. 17.

Let a metal ball A be charged by rubbing it with a charged rod, and let it then be brought near an insulated metal cylinder B which is provided with pith balls or strips of paper C, D, E, as shown.

The divergence of C and E will show that the ends of B have received electrical charges because of the presence of A, while the failure of D to diverge will show that the middle of B is uncharged. Further, the rod which charged A will be found to repel C but to attract E.

From these experiments, the conclusion is that when a conductor is brought near a charged body, the end away from the

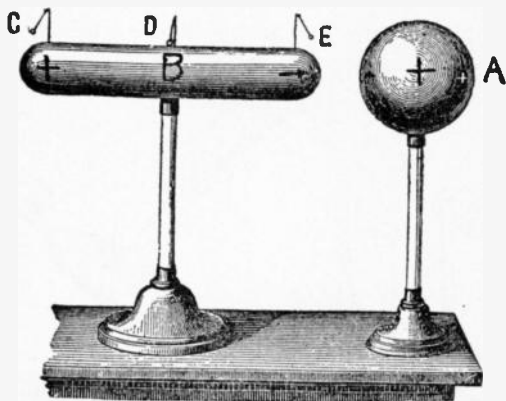
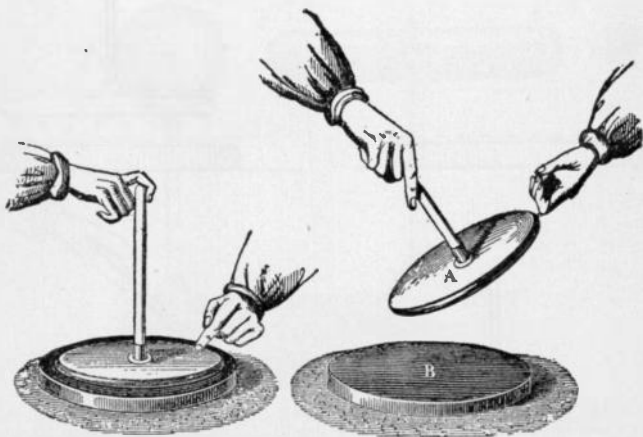

FIG. 17.—Experiment illustrating the nature of an induced charge. The apparatus consists of a metal ball and cylinder, both mounted on insulated stands, pith balls being placed on the cylinder at points C, D, and E.

inducing charge is electrified with the same kind of electricity as that on the inducing body, while the end toward the inducing body receives electricity of opposite sign.

The Electrophorus.—This is a simple and ingenious instrument, invented by Volta in 1775 for the purpose of procuring, by the principle of induction, *an unlimited number of charges of electricity from one single charge.*

It consists of two parts, as shown in fig. 19, a round cake of resinous material B, cast in a metal dish or "sole" about one foot in diameter, and a round disc A, of slightly smaller diameter made of metal or of wood covered with tinfoil, and provided with a glass handle. Shellac, or sealing wax, or a mixture of resin shellac and Venice turpentine, may be used to make the cake.



Figs. 18 and 19.—The electrophorus and method of using. Charge B; place A in contact with B, and touch A (fig. 18). The disc is now charged by *induction* and will yield a spark when touched by the hand, as in fig. 19.

To use the electrophorus, the resinous cake B must be first beaten or rubbed with fur or a woolen cloth, the disc A is then placed on the cake, touched with the finger and then lifted by the handle. The disc will now be found to be charged and will yield a spark when touched with the hand, as in fig. 19.

The "cover" may be replaced, touched, and once more removed, and will thus yield any number of sparks, the original

charge on the resinous plate meanwhile remaining practically as strong as before.

The theory of the electrophorus is very simple, provided the student has clearly grasped the principle of induction.

When the resinous cake is first beaten with the cat's skin its surface is negatively electrified, as indicated in fig. 20. Again,

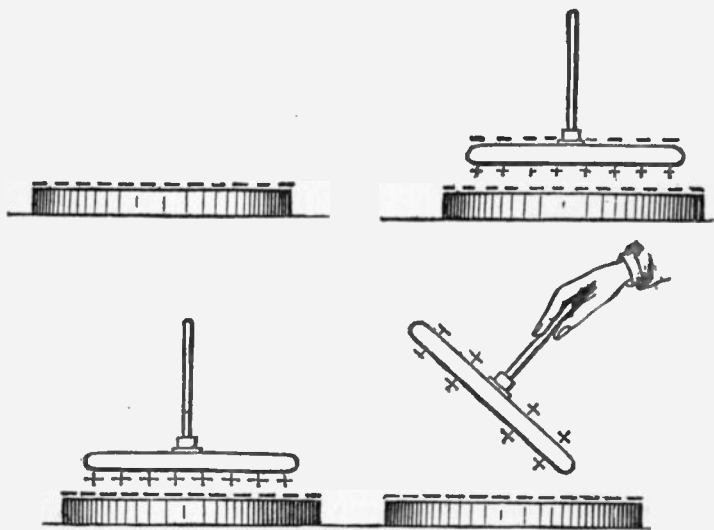

Figs. 20 to 23.—Illustrating "how the electrophorus works."

when the metal disc is placed down upon it, it rests really only on three or four points of the surface, and may be regarded as an insulated conductor in the presence of an electrified body. The negative electrification of the cake therefore acts inductively on the metallic disc or "cover," attracting a positive charge to its under side, and repelling a negative charge to its upper surface, as shown in fig. 21.

If, now, the cover be touched for an instant with the finger, the negative charge of the upper surface (which is upon the upper surface being repelled by the negative charge on the cake) will be neutralized by electricity flowing in from the earth through the hand and body of the experimenter. The attracted positive charge will, however remain being bound as it were

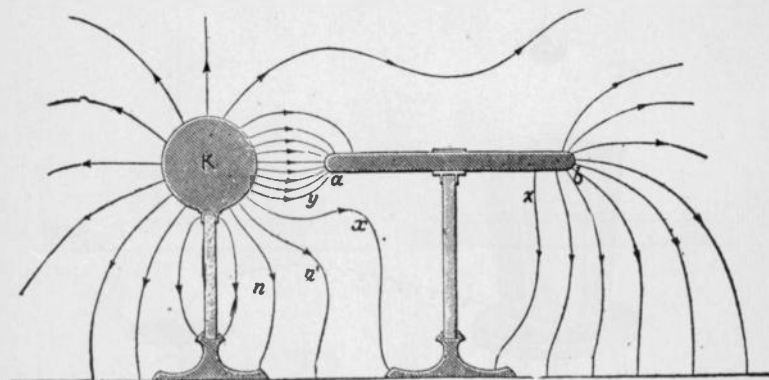

FIG. 24.—Lines of force of a charged sphere and a conductor under induction. The negative electrification on the end *a* of the cylinder indicates that a certain number of lines end there, while the positive electrification on the end *b* similarly indicates that an equal number of lines set out from that end. It is one of the fundamental properties of a conductor that it yields instantly to the smallest electric force, and that no electric force can be permanently maintained within the substance of a conductor in which no current is passing. There can, therefore, be no electrostatic strain and no lines of force within the material of a conductor where the electric field has become steady. Hence the lines starting from *b* are entirely distinct from those ending at *a*. The two sets are equal in number because no charge has been given to the cylinder, either positive or negative, and therefore the sum of all the positive electrifications (or lines starting from *b*) must be equal to the sum of all the negative electrifications (or the lines ending at *a*). In all nine lines have been drawn at each end of the cylinder, leaving the thirteen lines emanating from the sphere which do not run on to the cylinder. If the cylinder be withdrawn to a distance from *K*, it (the cylinder) will be found to show no signs of electrification.

by its attraction towards the negative charge on the cake.

Fig. 22 shows the result after the cover has been touched. If, finally, the cover be lifted by its handle, the remaining positive charge will no longer be "bound" on the lower surface by attraction, but will distribute itself on both sides of the cover, and may be used to give a spark. It is clear that no

part of the original charge has been consumed in the process, which may be repeated as often as desired. As a matter of fact, the charge on the cake slowly dissipates—especially if the air be damp. Hence it is needful sometimes to renew the original charge by again beating the cake with the cat's skin.

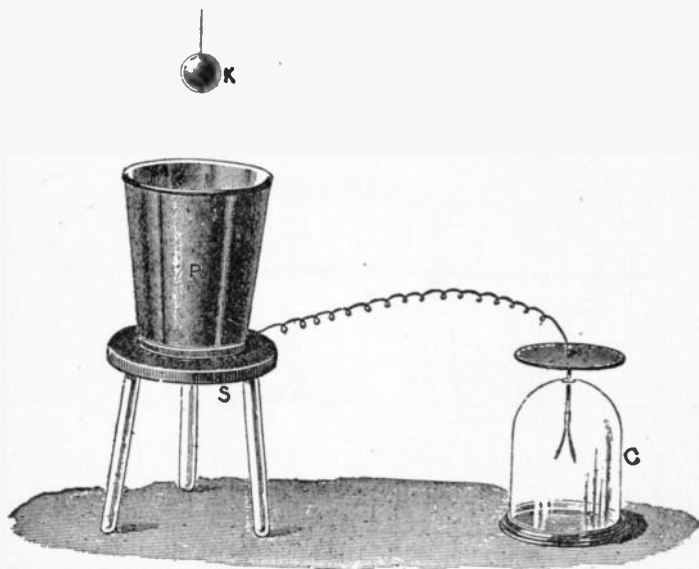
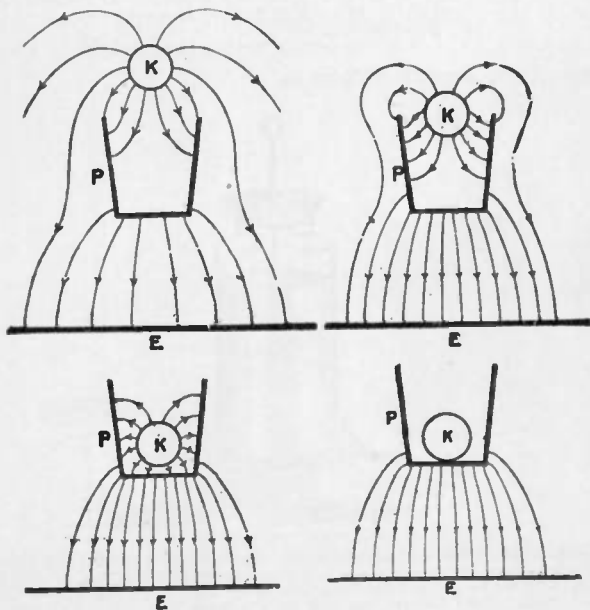

FIG. 25.—Paraday's ice pail experiment. An ice pail *P* connected with the gold leaves of an electroscope *C*, is placed on an insulating stand *S*. A charged conductor *K*, carried by a silk thread, is lowered into the pail, and finally touches it at the bottom. While it is being lowered the leaves of the electroscope diverge farther and farther, until *K* is well within the pail, after which they diverge no more, even when *K* touches the pail or is afterwards withdrawn by the insulating thread. After withdrawal, *K* is found to be completely discharged.

The labor of touching the cover with the finger at each operation may be saved by having a pin of brass or a strip of tinfoil projecting from the metallic "sole" on to the top of the cake, so that it touches the plate each time, and thus neutralizes the negative charge by allowing electricity to flow in from the earth.

Since the electricity thus yielded by the electrophorus is not obtained at the expense of any part of the original charge, it is a matter of some interest to inquire whence is the source from which the energy of this apparently unlimited supply is drawn;



FIGS. 26 to 29.—Explanation of Faraday's ice pail experiment. For simplicity the electroscope, insulating stand and silk thread have been omitted. Only the three principal conductors K, P, and the earth E are shown. In fig. 26 the ball K is sufficiently close to P to act inductively on it; six lines are shown as falling on P, and the other six as passing to E by different paths. Corresponding to the six lines falling on P from K, six others pass to E from the lower surfaces. In fig. 27 where K is just entering the pail, two lines only pass from K to E through the dielectric; the remaining ten fall on P, and ten others starting from the distant parts of P pass to E. In fig. 28, K is so far within P that none of its lines can reach E through the dielectric; they all fall on P and from the outside of P an equal number start and pass through the dielectric to E. It is evident that in this position K can be moved about within P, without affecting the outside distribution in the slightest, and that even when K touches P as shown in fig. 29, and when, therefore, all lines between them disappear, the lines in the dielectric outside remain just as they are in fig. 28. K is now completely discharged, since lines no longer emanate from it, hence it can be removed by the silk cord without disturbing the electrification of P. If K be again charged and introduced into P it will be again discharged, for the fact that P is already charged will have no effect on the final result, provided when K touches P it is well under cover.

for it cannot be called into existence without the expenditure of some other form of energy. The fact is, *more work is done in lifting the cover when it is charged with the positive electricity than when it is not charged*; for when charged, there is the force of the electric attraction to be overcome as well as the force of gravity; this excess force is the real origin of the energy stored up in the separate charges.

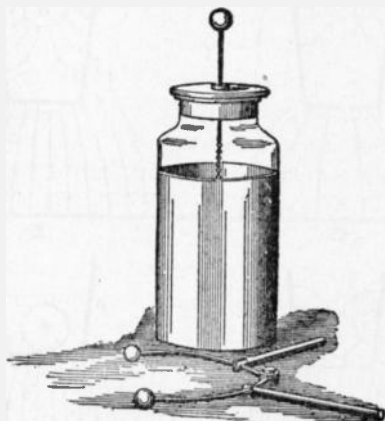

FIGS. 30 and 31.—The Leyden jar and discharger. Its discovery is attributed to the attempt of Musschenbrock and his pupil Cuneus to collect the supposed electric "fluid" in a bottle half filled with water. The bottle was held in the hand and was provided with a nail to lead the "fluid" down through the cork to the water from the electric machine. The invention of the Leyden jar is also claimed by Kleist, Bishop of Pomerania.

Condensers; Leyden Jar.—A *condenser* is an apparatus for condensing a large quantity of electricity on a comparatively small surface. The form may vary considerably, but in all cases it *consists essentially of two insulated conductors, separated by an insulator and the working depends on the action of induction.*

A form of condenser generally used in making experiments on static electricity is the Leyden jar, so named from the town

of Leyden where it was invented. It consists of a glass jar coated inside and out to a certain height with tinfoil, having a brass rod terminating in a knob passed through a wooden stopper, and connected to the inner coat by a loose chain, as shown in fig. 30.

The jar may be charged by repeatedly touching the knob with the charged plate of the electrophorus or by connecting the inner coating to one knob of an electrical machine and the outer coating to the other knob.

The discharge of a condenser is effected by connecting the plates having an opposite charge. This may be done by use of a wire or a discharger, as shown in fig. 31; the connection is made between the outer coat and the knob.

When the knob of the discharger is sufficiently close to the knob of the jar, a bright spark will be observed between the knobs. This discharge occurs whenever the difference of potential between the coats is great enough to overcome the resistance of the air between the knobs.

Let a charged jar be placed on a glass plate so as to insulate the outer coat. Let the knob be touched with the finger. No appreciable discharge will be noticed. Let the outer coat be in turn touched with the finger. Again no appreciable discharge will appear. But if the inner and outer coatings be connected with the discharger, a powerful spark will pass.

Electric Machines.—Various machines have been devised for producing electric charges such as have been described. The ordinary "static" or electric machine, is nothing but a continuously acting electrophorus.

Fig. 32 represents the so called Toepler-Holtz machine. Upon the back of the stationary plate E, are pasted paper sectors, beneath which are strips of tinfoil AB and CD called *inductors*.

In front of E is a revolving glass plate carrying discs *l, m, n, o, p* and *q*, called *carriers*.

To the inductors AB and CD are fastened metal arms t and u , which bring B and C into electrical contact with the discs l , m , n , o , p and q , when these discs pass beneath the tinsel brushes carried by t and u .

A stationary metallic rod rs carries at its ends stationary brushes as well as sharp pointed metallic combs.

The two knobs R and S have their capacity increased by the Leyden jars L and L' .

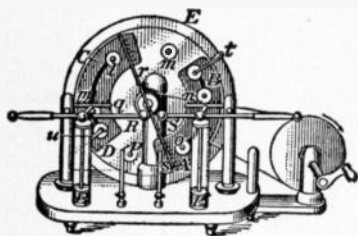

FIG. 32.—The Toeppler-Holtz electric machine.

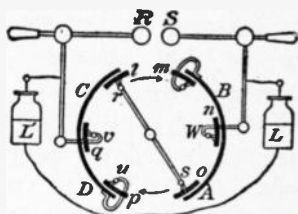

FIG. 33.—Principle of Toeppler-Holtz electric machine.

Action of the Toeppler-Holtz Machine.—The action of the machine described above is best understood from the diagram of fig. 33. Suppose that a small $+$ charge is originally placed on the inductor CD . Induction takes place in the metallic system consisting of the discs l and o and the rod rs , l becoming negatively charged and o positively charged. As the plate carrying l , m , n , o , p , q rotates in the direction of the arrow the negative charge on l is carried over to the position m , where a part of it passes over to the inductor AB , thus charging it negatively.

When l reaches the position n the remainder of its charge, being repelled by the negative electricity which is now on AB , passes over into the Leyden jar L .

When l reaches the position o it again becomes charged by induction, this time positively, and more strongly than at first, since now the negative charge on AB , as well as the positive charge on CD , is acting inductively upon the rod rs .

When l reaches the position u , a part of its now strong positive charge passes to CD , thus increasing the positive charge upon this inductor.

In the position v the remainder of the positive charge on l passes over to L' . This completes the cycle for l . Thus as the rotation continues AB and CD acquire stronger and stronger charges, the inductive action upon rs becomes more and more intense, and positive and negative charges are continuously imparted to L' and L until a discharge takes place between the knobs R and S .

There is usually sufficient charge on one of the inductors to start the machine, but in damp weather it will often be found necessary to apply a charge to one of the inductors by means of the ebonite or glass rod before the machine will work.

The Wimshurst Machine.—The essential parts of an ordinary Wimshurst machine, as shown in fig. 34, are two insulating plates or drums. On each plate are fixed a large number of strips of conducting material, which are equal in size and are equally spaced—radially if on a plate, and circumferentially if on a drum. The plates, or drums, are made to rotate in opposite directions. The capacity of the inductors therefore varies from a maximum when each strip on one plate is facing a strip on the other, to a minimum when the conducting strips on each plate are facing blank or insulating portions of the other plate.

There are three pairs of contact brushes, the members of two of the pairs being at opposite ends of diametrical conducting rods placed at right angles to one another; the third pair are insulated from one another and form the principal collectors, the one giving positive and the other negative electricity.

The plates are revolving in opposite directions; thus if there be a charge on one of the conducting segments of one plate and an opposite charge on one of the conducting segments on the other plate near it, their potential will be raised as the rotation of the plates separates them.

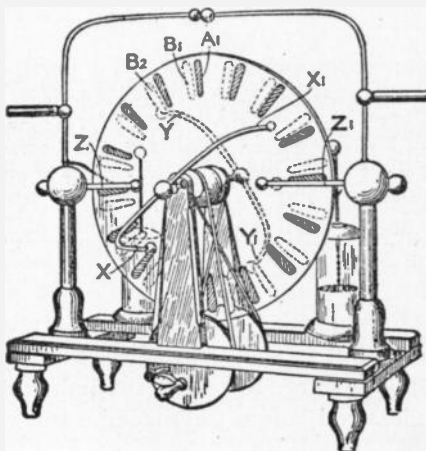

FIG 34.—The Wimshurst Electric Machine.

NOTE.—Suppose that the conditions are as in the fig. 34, that is, the segment A_1 is positive and the segment B_1 negative. Now, as A_1 moves to the left and B_1 to the right, their potentials will rise on account of the work done in separating them against attraction. When A_1 comes opposite the segment B_2 of the B plate, which is now in contact with the brush Y , it will be at a high positive potential, and will therefore cause a displacement of electricity along the conductor between Y and Y_1 , bringing a large negative charge on B_2 and sending a positive charge to the segment touching Y_1 .

As A_1 moves on, it passes near the brush Z and is partially discharged into the external circuit. It then passes on until, on touching the brush X , it is put in connection with X , and has a new charge, this time negative, driven into it by induction from B_2 . Positive electricity, then, being carried by the conducting patches from right to left on the upper half of the A plate, and negative from left to right on its lower half.

A similar process is taking place on the B plate, but in this case the negative electricity is going from left to right above, and the positive from right to left below. On the whole, therefore, positive electricity is being supplied to the left hand main conductor Z by both upper and lower plates, and negative to Z_1 .

CHAPTER III

THE ELECTRIC CURRENT

The ordinary statement that an electric current is flowing along a wire is only a conventional way of expressing the fact that the wire and the space around the wire are in a different state from that in which they are when no electric current is said to be flowing.

In order to make laymen understand the action of this so called current, it is generally compared with the flow of water.

In comparing hydraulics and electricity, it must be borne in mind, however, that there is really no such thing as an "electric fluid," and that water in pipes has mass and weight, while electricity has none. It should be noted, however, that electricity is conveniently spoken of as having weight in explaining some of the ways in which it manifests itself.

All electrical machines and batteries are merely instruments for moving electricity from one place to another, or for causing electricity, when accumulated in one place, to do work in returning to its former level of distribution.

The *head* or *pressure* in a standpipe is what causes water to move through the pipes which offer *resistance* to the flow.

Similarly, the conductors, along with the electric current is said to flow, offer more or less *resistance* to the flow, depending

on the material. Copper wire is generally used as it offers little resistance.

The current must have pressure to overcome the resistance of the conductor. This pressure is called *voltage* caused by what is known as *difference of potential* between the source and terminal.

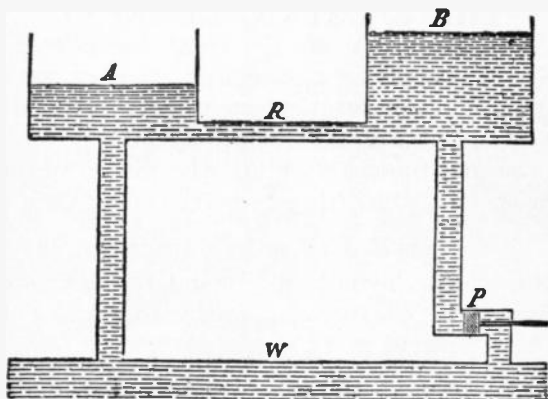

FIG. 35.—Analogy of the flow of water to the electric current. The water in the reservoirs A and B stands at different heights. As long as this difference of level is maintained, water from B will flow through the pipe R to A. If by means of a pump P the level in B be kept constant, flow through R will also be maintained. Here, by means of the work expended on the pump, the level in the reservoir is kept constant; and in the corresponding case of the electric current, by the conversion of chemical energy a constant difference of potential is maintained.

The pressure under which a current flows is measured in *volts* and the quantity that passes in *amperes*. The resistance with which the current meets in flowing along a conductor is measured in *ohms*.

Ques. What is a volt?

Ans. A volt is that electromotive force (E. M. F.) which produces a current of one ampere against a resistance of one ohm.

Ques. What is an ampere?

Ans. An ampere is the current produced by an E.M.F. of one volt in a circuit having a resistance of one ohm. It is that quantity of electricity which will deposit .005084 grain of copper per second.

Ques. What is an ohm?

Ans. An ohm is equal to the resistance offered to an unvarying electric current by a column of mercury at 32° Fahr., 14.4521 grams in mass, of a constant cross sectional area, and of the length of 106.3 centimeters.

Ohm's Law.—*In a given circuit, the amount of current in amperes is equal to the E. M. F. in volts divided by the resistance in ohms; that is:*

$$\text{current} = \frac{\text{pressure}}{\text{resistance}} = \frac{\text{volts}}{\text{ohms}}$$

expressed as a formula:

$$I = \frac{E}{R} \dots\dots\dots (1)$$

in which

- I = current strength in amperes;
- E = electromotive force in volts;
- R = resistance in ohms.

From (1) is derived the following:

$$E = I R \dots\dots\dots (2)$$

$$R = \frac{E}{I} \dots\dots\dots (3)$$

From (1) it is seen that the flow of the current is proportional to the voltage and inversely proportional to the resistance; the latter depends upon the material, length and diameter of the conductor.

Since the current will always flow along the path of least resistance, it must be so guarded that there will be no leakage. Hence, to prevent leakage, wires are *insulated*, that is, covered by wrapping them with cotton or silk thread or other insulating material. If the insulation be not effective, the current may leak, and so return to the source without doing its work. This is known as a *short circuit*.

The conductor which receives the current from the source is called the *lead*, and the one by which it flows back, the *return*.

When wires are used for both lead and return, it is called a *metallic circuit*: when the ground is used for the return, it is called a *ground circuit*. An electric current is said to be:

1. *Direct*, when it is of unvarying direction;
2. *Alternating*, when it flows rapidly to and fro in opposite directions;
3. *Primary*, when it comes directly from the source;
4. *Secondary*, when the voltage and amperage of a primary current have been changed by an *induction coil*;
5. *Low tension*, when its voltage is low;
6. *High tension*, when its voltage is high.

A high tension current is capable of forcing its way against considerable resistance, whereas, a low tension current must have its path made easy.

Production of the Electric Current.—To produce a steady flow of water in a pipe two conditions are necessary. There must first be available a hydraulic pressure, or, as it is

technically called, a "head" of water produced by a pump, or a difference of level or otherwise.

In addition to the pressure there must also be a suitable path or channel provided for the water to flow through, or there will be no flow, however great the "head," until something breaks down under the strain. In the case just cited, although there is full pressure in the water in the pipe, there is no current of water as long as the tap remains closed. The opening of the tap completes the necessary *path* (the greater part of which was already in existence) and the water flows.

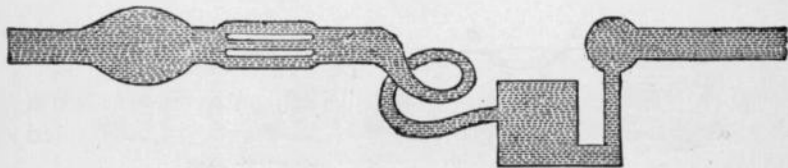

FIG. 36.—Hydraulic analogy of the electric current. If, say 10 gallons of water flow in every second into a system of vessels and pipes of any shape, whether simple or more complicated as shown in the figure, and 10 gallons flow out again per second, it is evident that through every cross section of any vessel or pipe of the system 10 gallons of water pass every second. This follows from the fact that water is an incompressible liquid and must be practically of the same density throughout the system. The water moves slowly where the section is large and quickly where it is small, and thus the quantity of water that flows through any part of the system is independent of the cross section of that part. The same condition holds good for the electric current; if in a closed circuit a constant current circulates, the same amount of electricity will pass every cross section per second. Hence the following law: *The magnitude of a constant current in any circuit is equal in all parts of the circuit.*

For the production of a steady electric current two very similar conditions are necessary. There must be a steadily maintained electric pressure, known under different aspects as "electromotive force," "potential difference," or "voltage." This alone, however, is not sufficient. In addition, a suitable conducting path is necessary. Any break in this path occupied by unsuitable material acts like the closed tap in the analogous case above mentioned, and it is only when all such breaks have

been properly bridged by suitable material, that is, by conductors, that the effects which denote the flow of the current will begin to be manifested.

The necessary electromotive force or voltage required to cause the current to flow may be obtained:

1. Chemically;
2. Mechanically;
3. Thermally.

In the first method, two dissimilar metals such as copper and zinc called *elements*, are immersed in an exciting fluid or *electrolyte*.

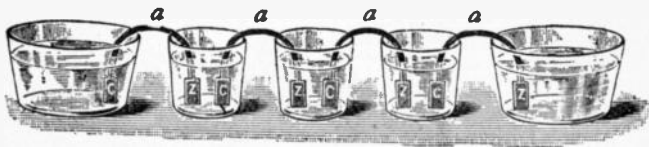

FIG. 37.—Volta's "Crown of Cups." The metallic elements C and Z each consisted of two metals, the plate C being of copper and the plate Z of zinc. They were placed, as shown, in the glass vessels, which contained salt water and ordinary water or lye. Into each vessel, except the two end ones, the copper end of one arc and the zinc end of the next were introduced, the series, however long, ending with copper dipping into the terminal vessel at one end and zinc into that at the other. The arrangement is almost exactly that of a modern one fluid primary battery.

When the elements are connected at their terminals by a wire or conductor a chemical action takes place, producing a current which flows from the copper to the zinc. This device is called a *cell*, and the combination of two or more of them connected so as to form a unit is known as a *battery*. The word *battery* is frequently used incorrectly for a single cell. That terminal of the element from which the current flows is called the *plus* or *positive pole*, and the terminal of the other element the *negative pole*.

Cells are said to be *primary* or *secondary* according as they generate a current of themselves, or first require to be charged from an external

source, storing up a current supply which is afterwards yielded in the reverse direction to that of the charging current.

An electric current is generated mechanically by a *dynamo*. In either case *no electricity is produced, but part of the supply already existing is simply set in motion by creating an electric pressure.*

An electric current, according to the third method, is generated directly from heat energy, as will be later explained; the current thus obtained is very feeble.

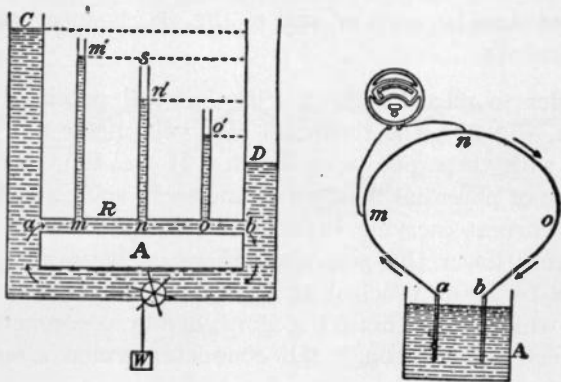

FIG. 38.—Hydrostatic analogy of fall of potential in an electrical circuit.

FIG. 39.—Showing method of connecting voltmeter to find potential difference between any two points as *m* and *n* on an electrical circuit.

Strength of Current.—It is important that the reader have a clear conception of this term, which is so often used. The exact definition of the strength of a current is as follows:

The strength of a current is the quantity of electricity which flows past any point of the circuit in one second.

Example.—If, during 10 seconds, 25 coulombs of electricity flow through a circuit, then the average strength of the current during that time is $2\frac{1}{2}$ coulombs per second, or $2\frac{1}{2}$ amperes.

Voltage Drop in an Electric Circuit.—A difference of potential exists between any two points on a conductor through which a current is flowing on account of the resistance offered to the current by the conductor.

For instance, in the electrical circuit shown in fig. 39, the potential at the point *a* is higher than that at *m*, that at *m* higher than that at *n*, etc., just as in the water circuit, shown in fig. 38, the hydrostatic pressure at *a* is greater than that at *m'*, that at *m'* greater than that at *n'*, etc. The fall in the water pressure between *m'* and *n'* (fig. 38) is measured by the water head *n's*.

In order to measure the fall in electrical potential between *m* and *n*, (fig. 39), the terminals of a volt meter are placed in contact with these points as shown. Its reading will give the difference of potential between *m* and *n*, in volts, provided that its own current carrying capacity is so small that it does not appreciably lower the potential difference between the points *m* and *n* by being touched across them; that is, provided the current which flows through it is negligible in comparison with that which flows through the conductor which already joins the points *m* and *n*.

CHAPTER IV

PRIMARY CELLS

The word "battery" is a much abused word, being often used incorrectly for "cell," as in fig. 40. Hence, careful distinction should be made between the two terms.

A battery consists of two or more cells joined together so as to form a single unit.

There are numerous forms of primary cell; they may be classified as follows:

1. According to the service for which they are designed;
2. According to the chemical features.

With respect to the first method cells are classified as:

1. Open circuit cells;

Used for *intermittent work*, where the cell is in service for short periods of time, such as in electric bells, signaling work, and electric gas lighting. If kept in continuous service for any length of time the cell soon polarizes or "runs down," but will recuperate after remaining on open circuit for some little time.

2. Closed circuit cells.

This type of cell is adapted to furnishing current continuously, as in telegraphy, etc.

With respect to the second method, cells are classified as:

1. One fluid;
2. Two fluid:

Ques. Describe a primary cell.

Ans. A primary cell consists of a vessel containing a liquid in which two dissimilar metal plates are immersed.

In *one fluid* cells both metal plates are immersed in the same solution. In *two fluid* cells each metal plate is immersed in a separate solution, one of which is contained in a porous cup which is immersed in the other liquid.

Ques. What name is given to the metal plates?

Ans. They are called *elements*.

Ques. What is the fluid called?

Ans. The *electrolyte* or *exciting fluid*.

The term "electropoion" is a trade name for the electrolyte employed in the Fuller cell.

Action of a Primary Cell.—The fundamental fact on which the electro-chemical generation of current depends is, that if a plate of metal be placed in a liquid there is a difference of electrical condition produced between them of such sort that the metal either takes a lower or higher electrical potential than the liquid, according to the nature of the metal and the liquid. If two different metals be placed in one electrolytic liquid, then there is a difference of state produced between them, so that, if joined by wire outside the liquid, a current of electricity will traverse the wire. This current proceeds in the liquid from the metal which is most acted upon chemically to that which is least acted upon.

Referring to fig. 41, the construction and action of a simple primary cell may be briefly described as follows:

Place in a glass jar some water having a little sulphuric or other acid added to it. Place in it separately two clean strips, one of zinc, Z, and one of copper, C. This cell is capable of supplying a continuous flow of electricity through a wire whose

ends are brought into connection with the two strips. When the current flows, the zinc strip is observed to waste away, its consumption in fact furnishing the energy or electromotive force required to drive the current through the cell and the connecting wire. The cell may therefore be regarded as a kind of chemical furnace in which the fuel is the zinc.

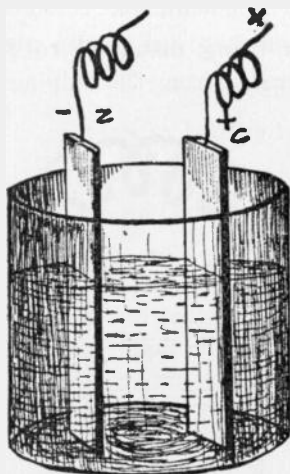

FIG. 40.—Simple primary cell. It consists of two dissimilar metal plates (such as copper and zinc which are called the *elements*), immersed in the *electrolyte* or exciting fluid contained in the glass jar.

Ques. How are the positive and negative elements of a primary cell distinguished?

Ans. The plate attacked by the electrolyte is the positive element, and the one unattacked the negative element.

Chemical Changes; Polarization.—The chemical changes which take place in a simple cell, consisting of zinc and copper elements in an electrolyte of dilute sulphuric acid, may be briefly

described as follows: When the two elements are connected and the current commences to flow, the sulphuric acid acts on the surface of the zinc plate and forms sulphate of zinc. The formation of this new substance necessitates the liberation of some of the hydrogen contained in the sulphuric acid, and it will be found that bubbles of free hydrogen gas speedily appear on the surface of the negative element, that is, on the copper plate.

While the zinc is being dissolved to form zinc sulphate, hydrogen gas is liberated from the sulphuric acid.

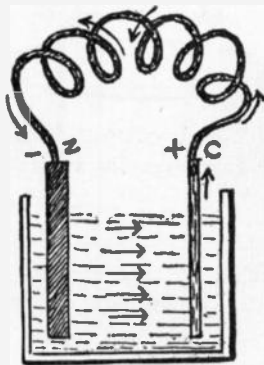

FIG. 41.—Simple primary cell with circuit closed, showing direction of the current.

Some bubbles of the gas rise to the surface of the electrolyte and so escape into the air, *but much of it clings to the surface of the copper element which thus gradually becomes covered with a thin film of hydrogen.*

Partly on account of the decreased area of copper plate in contact with the electrolyte, and partly because the hydrogen tends to produce a current in the opposite direction, the useful electrical output becomes considerably diminished and the cell is said to be *polarized*. This state of affairs may be rectified

by stirring up the electrolyte, or by shaking the cell, so as to assist the hydrogen bubbles to detach themselves from the surface of the copper plate and make their way to the atmosphere through the electrolyte. This, however, is only a temporary remedy, as the polarized condition will soon be reached again, and a further agitation of the cell will be necessary. Hence, a simple cell of this kind is not desirable for practical work, and it must be modified to adapt it to constant use.

When the sulphuric acid in a cell acts in the zinc element and produces sulphate of zinc, a certain amount of work is done which is manifested partly in the form of useful electric energy, and partly as heat which warms the electrolyte and which is thereby lost for all practical purposes.

Ques. If the zinc and copper electrodes of a simple cell be not connected externally what changes take place within the cell?

Ans. The zinc plate immediately becomes strongly charged with negative electricity, and the copper plate weakly so. As long as the plates remain unconnected, and the zinc is pure, no further action takes place.

Ques. If the electrodes be connected externally what happens?

Ans. If the plates be connected by a wire outside the electrolyte, the tendency which dissimilar electrical charges have to neutralize one another causes a flow of negative electricity through the wire from zinc to copper, and a positive flow in the opposite direction. The "static" charge being thus disposed of, a fresh charge is given to the plates by the action of the acid, which commences to dissolve the zinc. As long as the wire connects the copper and zinc plates, the acid will continue its action on the zinc until either acid or zinc is exhausted.

The reader may ask: how can there be a positive flow when both plates are negatively electrified?

An analogy is the best way to make this point clear: Imagine two equal vessels, from each of which the air has been partially exhausted, but from one (A) 10 times as much air has been taken as from the other (B). Connect A and B by a tube. Now, although both vessels have less than the atmospheric pressure, that is, both have "negative" pressures, yet a current of air will flow from B to A until the pressures in each are equalized; that is, until both have equal "negative charges" of air.

There is a second important effect of the acid solution or electrolyte in a cell. If pure sulphuric acid were used, the first action or production of an electrical charge on the zinc plate would be the same, but when the plates were joined by the wire the current would soon cease. The reason for this lies in the fact that the sulphate of zinc, which is the compound produced by the acid plus the zinc, being insoluble in pure undiluted sulphuric acid, remains on the surface of the zinc plate. The coating of sulphate of zinc thus formed also operates as a protective agent, and no further electrical charge can be induced until it is removed. The addition of water to the acid has the effect of allowing the sulphate of zinc to dissolve, and the zinc plate is left free for further action.

Ques. What governs the rate of current flow of a primary cell?

Ans. The size of the elements and their proximity.

Effects of Polarization.—The film of hydrogen bubbles affects the strength of the current of the cell in two ways:

1. It weakens the current by the increased *resistance* which it offers to the flow, for bubbles of gas are bad conductors;
2. It weakens the current by setting up an opposing *electromotive force*.

Hydrogen is almost as oxidizable a substance as zinc, especially when freshly deposited (in the "nascent" state), and is electropositive; hence, the hydrogen itself produces a difference of potential, which would tend to start a current in the opposite direction to the true zinc-to-copper current. It is therefore an important matter to abolish this polarization, otherwise the currents furnished by batteries would not be constant.

Methods of Depolarizing.—One of the chief aims in the arrangement of the numerous cells which have been devised is to avoid polarization. The following are the methods usually employed:

1. Chemical methods;

- a. Oxidation of the hydrogen by potassium bichromate and by nitric acid.
- b. Substitution of the hydrogen by some other substance which does not give a counter electromotive force of polarization; for instance, in the Daniell cell by replacement of the copper in copper sulphate by the hydrogen, the copper being deposited on the positive pole.

2. Electro-chemical means;

It is possible by employing double cells, to secure such action that some solid metal, such as copper, shall be liberated instead of hydrogen bubbles, at the point where the current leaves the liquid. This electro-chemical exchange obviates polarization.

3. Mechanical methods.

- a. Agitation of the liquid or of the positive electrode, in order to prevent the accumulation of hydrogen thereon.
- b. Corrugating or roughing the positive electrode, as in the Smee cell. This causes the hydrogen gas to form in large bubbles which rise to the surface more rapidly than the small bubbles which form on a smooth electrode.

In the simplest form of cell, as zinc, copper, and dilute sulphuric acid, no attempt has been made to prevent the evil of polarization, hence, it will quickly polarize when the current is closed for any length of time, and may be classified as an open circuit cell.

When polarization is remedied by chemical means, the chemical added is one that has a strong affinity for hydrogen and will combine with it, thus preventing the covering of the negative plate with the hydrogen gas.

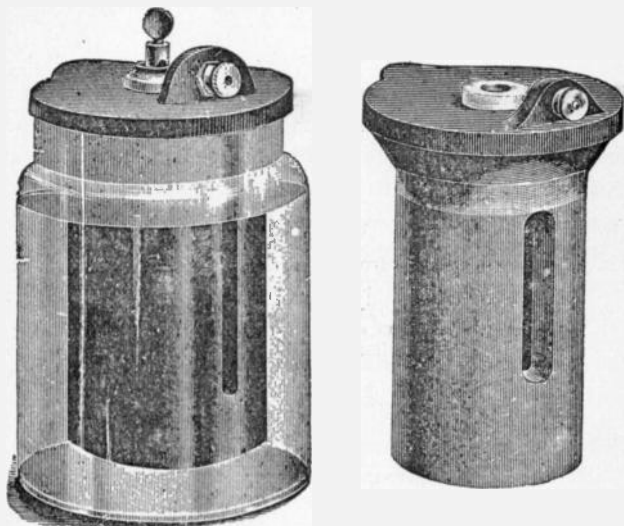

FIGS. 42 and 43.—Carbon cell and carbon cylinder. Carbon possesses a natural power to prevent a limited amount of polarization by absorbing the hydrogen gas coming from the zinc rod; hence it is used in various shapes for open circuit cells, which gives rise to as many different names, such as *Samson*, *Hercules*, *Law*, *National*, *Standard*, etc. In all these types of cell, sal-ammoniac and zinc are used, and by corrugating the carbon, fluting it, or making concentric cylinders, special merits are obtained in each case. The carbon element is usually made in the form of a porous cup, filled with oxide of manganese to prevent polarization, and then sealed. The zinc rod is inserted through a porcelain insulator. About 4 to 6 ounces of sal-ammoniac are generally used for cells of ordinary size. The salt is placed in the jar, water poured in until it is about two-thirds full, and then stirred till all the salt is dissolved. When the carbon cylinder is inserted, the solution should be within $1\frac{1}{2}$ inches of the top of the jar. The electromotive force is from 1.0 to 1.4 volts for the different forms of carbon cell.

Ques. What is a depolarizer?

Ans. A substance employed in some types of cell to combine with the hydrogen which would otherwise be set free at the positive electrode and cause polarization.

The chemical used for this purpose may be either in a *solid* or *liquid* form, which gives rise to several types of cell, such as cells with a single fluid, containing both the acid and the depolarizer, cells with a single exciting fluid and a solid depolarizer, and cells with two separate fluids.

In the two fluid cell, the zinc is immersed in the liquid (frequently dilute sulphuric acid) to be decomposed by the action upon it, and the negative plate is surrounded by the liquid depolarizer, which will be decomposed by the hydrogen gas it arrests, thereby preventing polarization.

In *open circuit cells* polarization does not have much opportunity to occur, since the circuit is closed for such a short period of time; hence, these cells are always ready to deliver a strong current when used intermittently.

In *closed circuit cells* polarization is prevented by chemical action, so that the current will be constant and steady till the energy of the chemicals is expended.

Ques. What is a depolarizer bag?

Ans. A cylinder of hemp or other fabric used in place of a porous pot in some forms of Leclanche cell, and also as a support for the depolarizing mass in some forms of dry cell where the electrolyte is of a thin gelatinous nature.

Volta's Contact Law.—When metals differing from each other are brought into contact, different results are obtained, both as to the kind of electrification as well as the difference of potentials.

Volta found that iron, when in contact with zinc, becomes negatively electrified; the same takes place, but somewhat weaker, when iron is touched with lead or tin. When, however, iron is touched by copper or silver, it becomes positively electrified. Volta, Seebeck, Pfaff, and others have investigated the behavior of many metals and alloys when in contact with each other.

The following lists are so arranged that those metals first in each list become positively electrified when touched by any taking rank after them:

CONTACT SERIES OF METALS

According to Volta.

+ zinc
 lead
 tin
 iron
 copper
 silver
 gold
 graphite
 — manganese ore

According to Pfaff.

+ zinc	copper
cadmium	silver
tin	gold
lead	uranium
tungsten	tellurium
iron	platinum
bismuth	— palladium
antimony	

Volta laid down a law regarding the position of the metals in his table which may be stated as follows:

The difference of potential between any two metals is equal to the sum of the differences of potentials of all the intermediate members of the series.

Hence, it is immaterial for the total effect whether the first and the last are brought into contact directly, or whether the contact is brought about by means of all or any of the intermediate metals.

Volta's law further asserts that when any number of metals are brought into contact with each other, but so that the chain closes with the metal with which it was begun, the total difference must be zero.

Laws of Chemical Action in the Cell.—There are two simple laws of chemical action in the cell:

1. *The amount of chemical action in a cell is proportional to the quantity of electricity that passes through it.*

One coulomb of electricity in passing through the cell liberates .000010352 of a gramme of hydrogen, and causes .00063344 of a gramme of zinc to dissolve in the acid.

2. *The amount of chemical action is equal in each cell of a battery connected in series.*

Requirements of a Good Cell.—The several conditions which should be fulfilled by a good cell are as follows:

1. Its electromotive force should be high and constant;
2. Its internal resistance should be small;
3. It should be perfectly quiescent when the circuit is open;
4. It should give a constant current, and therefore must be free from polarization, and not liable to rapid exhaustion;
5. It should be easily cared for, and if possible, should not emit corrosive fumes;
6. It should be cheap and of durable materials.

Single and Two Fluid Cells.—The distinction between a single and a two fluid cell has already been given. The single fluid cell of Volta with its zinc and copper plates represents the simplest form of primary cell.

In the *two fluid cell*, the positive (zinc) plate is immersed in the exciting liquid (usually dilute sulphuric acid) and is decomposed by the action upon it, while the negative plate is placed in the liquid depolarizer which is decomposed by the hydrogen arrested by it, thus preventing polarization.

In some forms of cell, the two liquids are separated by a porous partition of unglazed earthenware, which, while it prevents

the liquids mixing except very slowly, does not prevent the passage of hydrogen and electricity.

Complete depolarization is usually obtained also in single fluid cells, having in addition a depolarizing solid body, such as oxide of manganese, oxide of copper, or peroxide of lead, in contact with the carbon pole. Such cells really do not belong

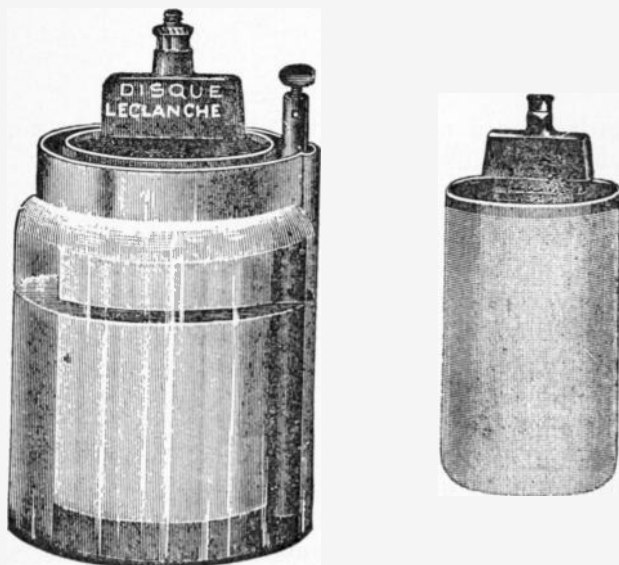

FIGS. 44 and 45.—Leclanche cell and porous cup. This very common form of cell is an example of the single fluid type, with a solid depolarizer surrounding the negative element; the latter is generally carbon, the positive element being zinc. The liquid used is a strong solution of ammonium chloride, commonly known as sal-ammoniac, and which resembles table salt. In the porous cup type of cell, a carbon slab is placed in the porous cup, and is surrounded by a mixture of small pieces of carbon and manganese dioxide, the top being covered by means of pitch, leaving one or two small holes for air and gas to pass through. The depolarizer will take care of a limited amount of the hydrogen produced when the cell is on closed circuit, but if the circuit be closed for any length of time polarization occurs. The cell is thus of the open circuit class, and will furnish a good current where it is required only intermittently. Zinc is dissolved only when the cell is being used. This type of cell, or its modification, is used for gas lighting and bell work. The cell requires very little attention. Water must be added as the solution evaporates, and the zinc rod replenished when necessary. The electromotive force is about 1.48 volts and the internal resistance about 4 ohms.

to the single fluid cells, and are considered in the two fluid class.

A few examples of single and double fluid primary cells will now be described.

The Leclanche Cell.—This cell was invented by Leclanche, a French electrician, and was the first cell in which sal-ammoniac was used. This form of cell, as shown in fig. 45, is in general use for electric bells, its great recommendation being that, once charged, it retains its power without attention for considerable time.

Two jars are employed in its construction; the outer one is of glass, contains a zinc rod, and is charged with a solution of ammonium chloride, called sal-ammoniac.

The inner jar is of porous earthenware, containing a carbon plate, and is filled with a mixture of manganese peroxide and broken gas carbon. When the carbon plate and the zinc rod are connected, a steady current of electricity is set up, the chemical action which takes place being as follows: *the zinc becomes oxidized by the oxygen from the manganese peroxide, and is subsequently converted into zinc chloride by the action of the sal-ammoniac.*

After the battery has been in continuous use for some hours, the manganese becomes exhausted of oxygen, and the force of the electrical current is greatly diminished; but if the battery be allowed to rest for a short time, the manganese obtains a fresh supply of oxygen from the atmosphere, and is again fit for use.

After about 18 months work, the glass cell will probably require recharging with sal-ammoniac, and the zinc rod may also need renewing; but should the porous cell get out of order, it is better to get a new one than to attempt to recharge it.

The directions for setting up a Leclanche cell are as follows:

1. Place in the glass jar six ounces of sal-ammoniac, and pour in water until the jar is one-third full, then stir thoroughly.
2. Place the porous cup in the solution, and if necessary add water until it rises to within $1\frac{1}{2}$ inches of the top of the porous cup.
3. Put the zinc rod in place and set the cell away (not connected up), for about 12 hours, so as to allow the liquid to thoroughly soak into the porous cup. This will lower the level of the liquid to about one-third the height of the jar. The cell will then be ready for use. As the level of the liquid is lowered by evaporation, it should be maintained at the stated height by adding water.

The Leclanche cell is adapted to open circuit work, being extensively used for ringing electric bells.

The objections to the Leclanche cell are:

1. Rapid polarization;
2. High internal resistance due to porous pot;
3. Restricted space for electrolyte causing rapid lowering of level of liquid by evaporation;
4. Eating away of the zinc rod at the surface of the liquid, rendering the rod useless before the lower part is consumed.

Fuller Bichromate Cell.—In the bichromate cells or the chromic acid cells, bichromate of soda, or bichromate of potassium, is used for the depolarizer, water and sulphuric acid being added for attacking the zinc.

The Fuller cell is of the two fluid type. A pyramidal block of zinc at the end of a metallic rod covered with guttapercha is placed in the bottom of a porous cup containing an ounce of mercury. The cup is then filled with a very dilute solution of sulphuric acid or water and placed in a jar of glass or earthenware containing the bichromate solution and the carbon plate. The diffusion of the acid through the porous cup is sufficiently rapid to attack the zinc, which being well amalgamated, prevents local action; while the hydrogen passes through the porous cup and combines with the oxygen in the bichromate of potassium.

This type of cell has an electromotive force of 2.14 volts, and is suited to open circuit, or semi-closed circuit work. The directions for setting up a Fuller cell are as follows:

1. To make the "electropoion" fluid, mix together one gallon of sulphuric acid and three gallons of water, and in a separate vessel, dissolve six pounds of bichromate of potash in two gallons of boiling water; then thoroughly mix together the two solutions.
2. Immerse the zinc in a solution of dilute sulphuric acid, and then in a bath of mercury, and rub it with a brush or cloth so as to reach all parts of the surface.
3. Pour into the porous cell one ounce (a tablespoonful) of mercury, and fill the porous cell with water up to within two inches of the top.
4. Place the porous cell and the carbon plate in the glass jar, as in fig. 46, and fill glass jar to within about three inches of the top with a mixture of three parts of electropoion fluid to two parts of water.

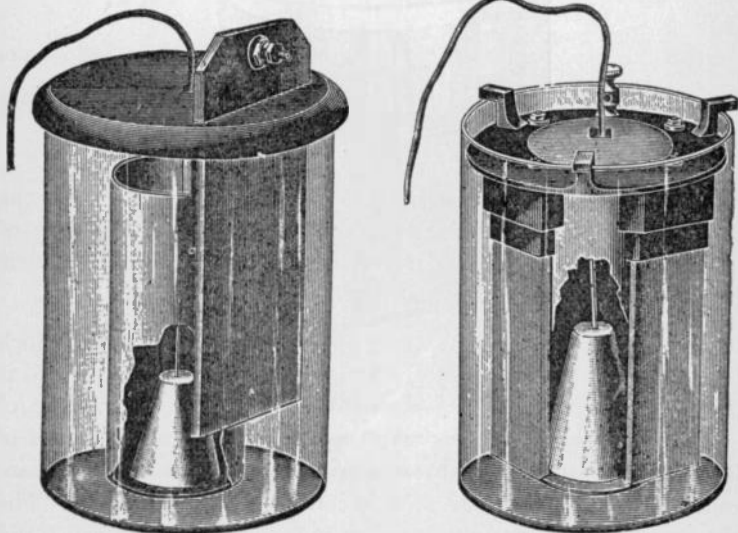

FIGS. 46 and 47.—The telephone standard and compound forms of Fuller cell. The type shown in fig. 46 is especially adapted to long distance telephoning, and that shown in fig. 47 to incandescent lamps, motors, nickel and other electroplating. The Fuller cell is of the double fluid variety and has the advantage over the Grenet type, in that the zinc is always kept well amalgamated and does not require removal from the solution. The Fuller cell is suitable for open and semi-closed circuit work; its electromotive force is about 2.14 volts.

5. The zinc should be lifted out occasionally and the sulphate washed off.
6. The supply of mercury in the porous cell should be maintained, so as to have the zinc always well amalgamated.
7. To renew, clean all deposits from carbon plate and zinc, and set up with fresh solution.

The Edison Cell.—This is a single fluid cell with a solid depolarizer, as shown in fig. 48, and is well adapted for use on closed circuits.

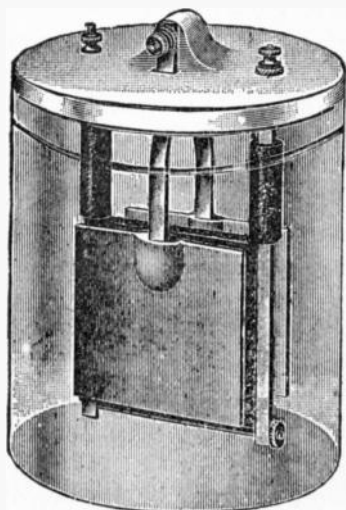

FIG. 48.—Edison cell, type R R. The electrolyte used is caustic soda, the positive element zinc, and the negative element copper oxide. The Edison cell is suitable for large stationary gas engine ignition, railroad crossing signals, electroplating, fire alarms, telephone circuits, etc.

The positive element is zinc, and the negative element black oxide of copper. The exciting fluid is a solution of caustic potash. The black oxide of copper plates are suspended from the cover of the jar by a light framework of copper, one end of

which forms the positive pole of the battery. A zinc plate is suspended on each side of the copper oxide element and kept from coming in contact with the latter by means of vulcanite buttons.

When the cell is in action, the water is decomposed, and the oxygen thus liberated combines with the zinc and forms oxide of zinc, which combines with the potash to form a double salt of zinc and potash. The last combination dissolves as rapidly as it is formed. The hydrogen liberated by the decomposition of the water reduces the copper oxide to pure metallic copper. It is highly important that the copper oxide plates be completely submerged in the solution of caustic potash, and that heavy paraffin oil be poured on top of the solution to the depth of about $\frac{1}{4}$ of an inch to exclude the air. If oil be not used, the formation of creeping salts will reduce the life of the battery fully two-thirds. The battery has a low electromotive force, about 0.7 of a volt, but as the internal resistance is also very low, quite a large current can be drawn from the cell.

The *Bunsen Cell*, shown in fig. 51, is a two fluid cell constructed with zinc and carbon electrodes. The negative plate is carbon, the positive plate amalgamated zinc. The excitant is a dilute solution of sulphuric acid. The top part of the carbon is sometimes impregnated with paraffin (to keep the acid from creeping up).

The force of the Bunsen cell increases after setting up for about an hour, and the full effect is not attained until the acid soaks through the porous cell. Carbons are not affected and last any length of time. The zinc is slowly consumed through the mercury coating.

Grenet Bichromate Cell.—In this cell, as shown in figs. 49 and 50, the positive element is zinc and the negative element carbon.

The electrolyte is a solution of bichromate of potash in a mixture of sulphuric acid and water.

The cell consists of a glass bottle containing the electrolyte and fitted with a lid from which the elements are supported. There is a zinc plate in the center and a carbon plate on each

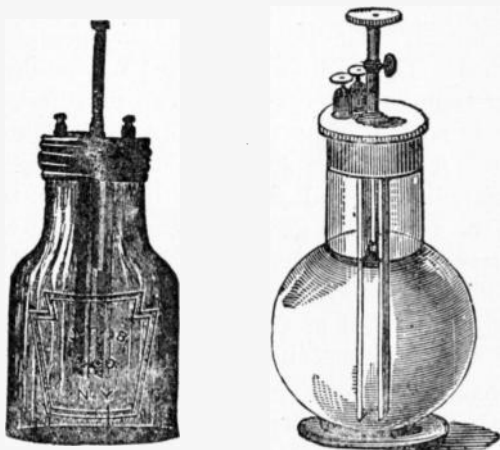

Figs. 49 and 50.—American and French forms of Grenet cell. The elements are zinc and carbon. In the Grenet cell, a zinc plate is suspended by a rod between two carbon plates, so that it does not touch them, and when the cell is not in use the zinc is withdrawn from the solution by raising and fastening the rod by means of a set screw, as the acid attacks the zinc when the cell is on open circuit. This cell has an electromotive force of over 2 volts at first, and gives a strong current for a short time, but the liquid soon becomes exhausted, as will be noted by the change in the color of the solution from an orange to a dark red, and must be replenished. The zinc should be kept well amalgamated and out of the solution except when in use. It is a good type of cell for experimental work. To make the electrolyte take 3 ounces of finely powdered bichromate of potash and 1 pint of boiling water; stir with a glass rod and after it is cool, add slowly, stirring all the time, 3 ounces of sulphuric acid. The electrolyte may also be prepared as follows: take 4 ounces of bichromate of soda, $1\frac{1}{4}$ pints of boiling water, and 3 ounces of sulphuric acid.

side. The two carbon plates are connected to the same terminal, thus forming a large positive surface, and the zinc plate to a terminal on the top of the brass rod to which it is attached.

This rod slides through a hole in the lid so that the zinc plate can be lifted out of the electrolyte when the cell is not at work, thus preventing wasteful consumption of zinc and of the electrolyte. Bichromate cells give a strong current, the electromotive force of a single cell being 2 volts.

Daniell Cell.—This is one of the best known and most widely used forms of primary cell. It is a double fluid cell, composed of an inner porous vessel containing an electrolyte of either



FIG. 51.—The Bunsen cell. This is a two fluid cell and has a bar of carbon immersed in strong nitric acid contained in a porous cup. This cup is then placed in another vessel, containing dilute sulphuric acid, and immersed in the same liquid, is a hollow cylindrical plate of zinc, which nearly surrounds the porous cup. The hydrogen, starting at the zinc, traverses by composition and recombination, the sulphuric acid; it then passes through the porous partition, and enters into chemical action with the nitric acid, so that none of it reaches the carbon. Water is produced by this action, which in time dilutes the acid, and orange colored poisonous fumes of nitric oxide rise from the battery. If the nitric acid first be saturated with nitrate of ammonia, the acid will last longer and the fumes be prevented. Strong sulphuric acid cannot be used in any battery; one part of sulphuric acid is generally added to 12 parts by weight, or 20 by volume, of water. Grove used a strip of platinum instead of carbon in his cell. A solution of bichromate of potassium is frequently substituted for the nitric acid in the porous cup, thereby avoiding disagreeable fumes. Bunsen's and Grove's cells produce powerful and constant currents, and are well adapted for experiments, but they require frequent attention, and are expensive, so that they are little used for work of long duration. The electromotive force of these cells is from 1.75 to 9.51 volts.

dilute sulphuric acid or dilute zinc sulphate solution, and an outer vessel containing a saturated solution of copper sulphate.

A zinc rod is placed in the inner electrolyte, and a thin plate of sheet copper in the outer electrolyte. Sometimes this arrangement of the elements is modified, the outer vessel being made of copper and serving as the copper plate. This would then contain the copper sulphate solution, while the zinc sulphate and the zinc rod would be contained in the porous pot as before.

The chemical reactions which take place in a Daniell cell are as follows:

The zinc dissolves in the dilute acid, thus producing zinc sulphate, and liberating hydrogen gas. The free hydrogen passes through the walls of the porous pot, but when it reaches the copper sulphate solution it displaces some of the copper therefrom, and combines with this solution, forming sulphuric acid. The copper, which is thus set free, is deposited on the surface of the copper plate. In this way polarization is avoided, and a practically constant current is obtained.

When the zinc sulphate solution is employed in place of dilute acid, a similar series of chemical reactions occur, except that the zinc is liberated instead of hydrogen.

Daniell cells are used especially for electroplating, electrotyping and telegraphic work. The electromotive force of a single cell is 1.079 volts.

Directions for Making a Daniell Cell.—The simple Daniell cell shown in fig. 52 may be easily made as follows: The outer vessel A, consists of a glass jar (an ordinary glass jam jar will do) containing a solution of sulphuric acid (1 part in 12 to 20 parts of water), and a zinc rod B.

Inside the jar is placed a porous pot C containing a strip of thin sheet copper D, and a saturated solution of sulphate of copper (also called "blue stone" and "blue vitrol").

The zinc is preferably of the Leclanche form, which will be

found to be cleaner, more durable, and cheaper than a zinc sheet. The porous pot should be dipped in melted paraffin wax, both top and bottom, to prevent the solution mingling too freely and "creeping." A few crystals of copper sulphate are placed in the pot as shown.

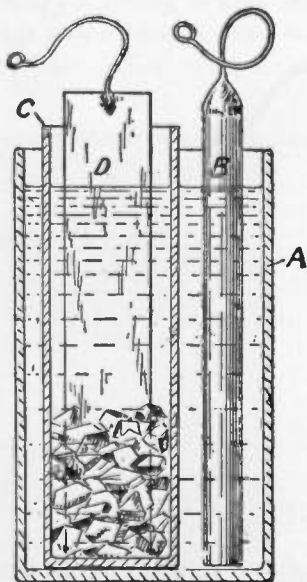

FIG. 52.—Simple Daniell cell for closed circuit work. To maintain a constant current for an indefinite time, it is only necessary to maintain the supply of copper crystals and zinc. The cell as shown in the figure is easily made by following the direction given in the accompanying text.

In mixing the sulphuric acid and water, *the acid should be added to the water—never the reverse*. Zinc sulphate is sometimes used instead, as it reduces the wasteful consumption of the zinc, but it should be pure.

With care the cell will last for weeks. When it weakens or "runs down," an addition of sulphuric acid to the outer jar and

a few more crystals placed in the porous pot will put the cell in good condition.

Gravity Cells.—In a two liquid cell, instead of employing a porous cell to keep the two liquids separate, it is possible, where one of the liquids is heavier than the other, to arrange that the heavier liquid shall form a stratum at the bottom of the cell,



FIG. 53.—Daniell gravity cell, "crowfoot" pattern. This is a two fluid cell in which gravity instead of a porous cup is depended upon to keep the liquids separate. The two solutions consist of copper sulphate and dilute sulphuric acid, the elements being made of zinc and copper.

the lighter floating upon it. Such arrangements are called *gravity cells*; but the separation is never perfect, the heavy liquid slowly diffusing upwards.

Daniell Gravity Cell.—In this cell, shown in fig. 53, the same elements are used as in the ordinary Daniell cell, but the porous pot is dispensed with, the two solutions being separated by the action of gravity as explained in the preceding paragraph.

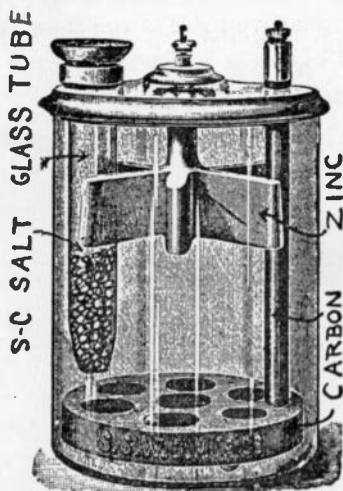

FIG. 54.—Partz acid gravity cell. In this form of cell, the electrolyte which surrounds the zinc is either magnesium sulphate or common salt. The depolarizer is a bichromate solution which surrounds the perforated carbon plate located in the bottom of the jar. A vertical carbon rod fits snugly into the tapered hole in the carbon plate, and extends through the cover forming the positive pole. The depolarizer, being heavier than the electrolyte, remains at the bottom of the jar, and the two liquids are thus kept separate. This depolarizer is placed on the market in the form of crystals, known as sulpho-chromic salt, made by the action of sulphuric acid upon chromic acid. When dissolved, its action is similar to that of the chromic acid solution. After the cell has been set up with everything else in place, the crystals are introduced into the solution, near the bottom of the jar, through the vertical glass tube shown, and slowly dissolve and diffuse over the surface of the carbon plate. When the cell current weakens a few tablespoonfuls of the salt introduced through the tube will restore the current to its normal value. The cell should remain undisturbed to prevent the solution from mixing. Its electromotive force is from 1.9 to 2 volts, and the 6 in. x 8 in. size has an internal resistance of about .5 ohm. Since the depolarizer is quite effective, the cell may be used on open or closed circuit work.

The copper sulphate solution, being the heavier of the two, rests at the bottom of the battery jar, while the dilute sulphuric acid remains at the top. To suit this arrangement the copper and zinc elements are located as shown, the copper elements

being at the bottom, and the zinc element, shaped like a crow's foot (hence the name "crowfoot cell") is suspended at the top.

The absence of the porous pot decreases the internal resistance, but the electromotive force is the same as in the ordinary type of Daniell cell.

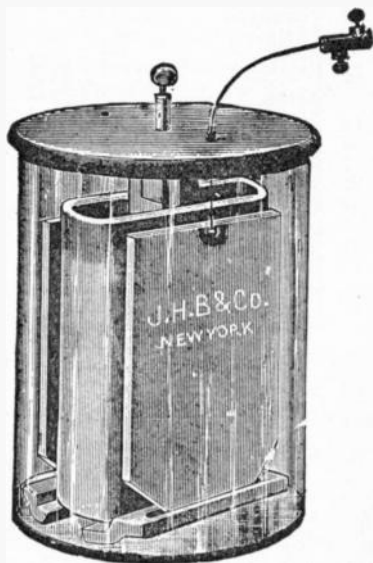

FIG. 55.—Wheelock cell; the elements are carbon and zinc. To set up, place the grid in the bottom of the jar and fill its two troughs each about half full of mercury. Place the porous cell in position on the grid so that it sits perfectly upright, resting in the recess of the latter. The zincs stand with lower ends resting in mercury in the troughs of the grid. Into the porous cell, to a height of *only two thirds* full, pour solution consisting of equal parts water and sulphuric acid, by measure. Add to this $\frac{1}{2}$ pound nitrate soda, 1 ounce chromic acid. This solution may be made up in the above proportion and kept in covered receptacle in any desired quantity, ready for use. In the outer jar for 6 x 8 size, $2\frac{1}{2}$ pints of water, and $\frac{1}{2}$ gill sulphuric acid, 1 part sulphuric acid to 20 parts water, or as much sulphuric acid as it will take without boiling. When a charge becomes exhausted it may be renewed by adding sulphuric acid and salts in the proportions given above, after drawing out with syringe enough of the old solutions to make room for the additions, but the best action is obtained with entirely new solutions. Zincs must be kept thoroughly amalgamated by keeping a good supply of mercury in the troughs.

When a current is produced by a Daniell cell:

1. Copper is deposited on the copper plate;
2. Copper sulphate is consumed;
3. The sulphuric acid remains unchanged in quantity;
4. Zinc sulphate is formed;
5. Zinc is consumed.

If, however, the copper sulphate solution be too weak, the water is decomposed instead of the copper sulphate, and hydrogen is deposited on the copper plate. This deposit of hydrogen lowers the voltage, hence care should be taken to maintain an adequate supply of copper sulphate.

The voltage of a Daniell cell varies from about 1.07 volt to 1.14 volt, according to the density of the copper sulphate solution and the amount of zinc sulphate present in the dilute sulphuric acid.

“Dry” Cells.—It is often necessary to use cells in places where there is considerable jarring or motion, as for automobile or marine ignition. The ordinary cell is not well adapted to this service on account of the liability of spilling the electrolyte, hence, the introduction of the so called dry cell.

A dry cell is composed of two elements, usually zinc and carbon, and a liquid electrolyte. A zinc cup closed at the bottom and open at the top forms the negative electrode; this is lined with several layers of blotting paper or other absorbing material.

The positive electrode consists of a carbon rod placed in the center of the cup; the space between is filled with carbon—ground coke and dioxide of manganese mixed with an absorbent material. This filling is moistened with a liquid, generally sal-ammoniac. The top of the cell is closed with pitch to prevent leakage and evaporation. A binding post for holding the wire connections is attached to each electrode and each cell is placed in a paper box to protect the zincs of adjacent cells from coming into contact with each other when finally connected together to form a battery.

Points Relating to Dry Cells.—The following instructions on the care and operation of dry cells should be carefully noted and followed to get the best results:

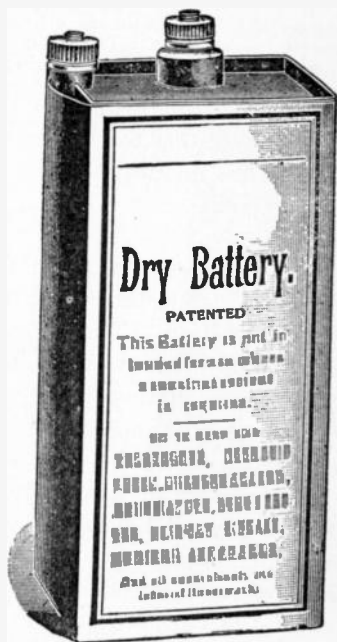
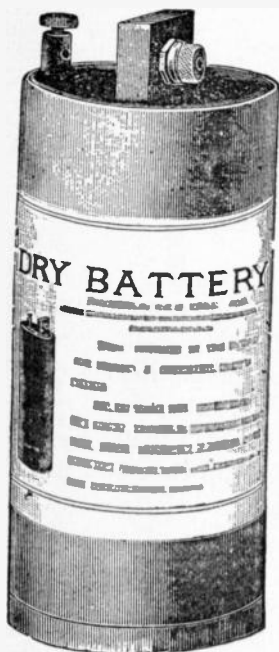

FIGS. 56 and 57.—Round and rectangular types of the so called "dry" cell.

1. In renewing dry cells (or any other kind of cell), a greater number should never be put in series than was originally required to do the work, because the additional cells increase the voltage beyond that required, which causes more current than is necessary to flow through the coil. This increased current flow shortens the life of the battery.
2. In connecting dry cells in places where there is vibration, heavy copper wire should not be used, because vibration will cause it to break.
3. Water should not be allowed to come in contact with the paper covers of the cells because they form the insulation, hence, when moist.

current will leak across from one cell to another, resulting in running down the battery.

4. Dry cells will deteriorate when not in use, making it necessary to renew them about every sixty days. The reason dry cells deteriorate is because the moisture evaporates. Freezing, exposure to heat, and vibration which loosens the sealing, causes the evaporation.

5. Weak cells can be strengthened somewhat by removing the paper jacket, punching the metal cup full of small holes, and then placing in a weak solution of sal-ammoniac, allowing the cells to absorb all they will take up. This is only to be recommended in cases of emergency when they are hard to get.

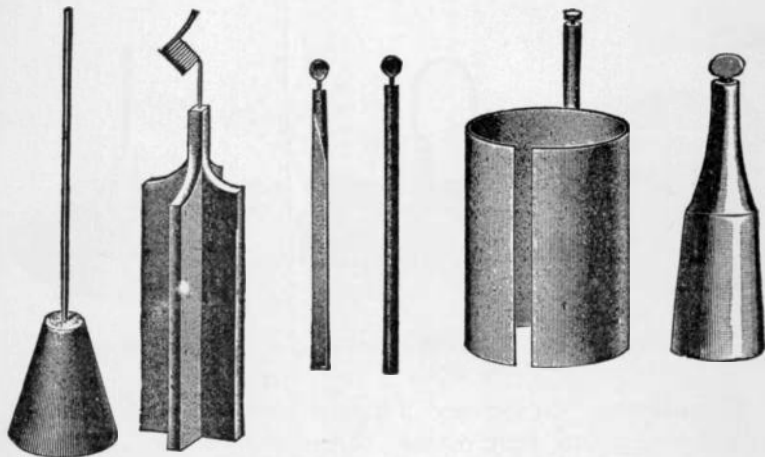

FIGS. 58 to 63.—Various zincs; fig. 58 Fuller; fig. 59 Daniel; fig. 60 Leclanche square; fig. 61 Leclanche round; fig. 62 Sampson; fig. 63, bottle.

6. The average voltage of a dry cell when new is one and one-half volts, while the amperage ranges from about twenty-five to fifty amperes according to size.

7. A dry cell when fresh should show from 20 to 25 amperes when tested; the date of manufacture should also be noted as fresh cells are most efficient.

8. Dry cells should be tested with an ammeter, care being taken to do it quickly as the ammeter being of a very low resistance short circuits

the cell. A volt meter is not used in testing because, while the cells are not giving out current, their voltage remains practically the same, and a cell that is very weak will show nearly full voltage. When no ammeter is at hand, the battery current may be tested by disconnecting the end of one of the terminal wires and snapping it across the binding post of the other terminal; the intensity of the spark produced will indicate the condition of the battery.

Points Relating to the Care of Cells.—To get the best results from primary cells, they should receive proper attention and be maintained in good condition. The instructions here given should be carefully followed.



FIGS. 64 to 66: Various carbons; fig. 64 Cylindrical form, fig. 65 Calland star; fig. 66, wheel.

Cleanliness.—In the care of batteries, cleanliness is essential in order to secure best results. Zincs and coppers should be thoroughly cleaned every time a cell is taken out of use. The zinc, after being thoroughly cleaned, should be rubbed with a little mercury. This prevents local action. Porous cups should be soaked in clean water four or five hours and then wiped dry.

The terminals of each cell should be thoroughly cleansed and scraped bright so as to get good contact of the connecting wires and thus avoid extra resistance in the circuit.

Separating the Elements.—Obviously the positive and negative elements of a cell must not be in contact within the exciting fluid; they should be separated by a space of $\frac{3}{8}$ to $\frac{1}{2}$ inch. In the case of cells without porous cups, periodic attention must be given to ensure this condition being maintained.

Creeping.—As evaporation of the electrolyte takes place in a cell, it increases in strength, and crystals are left on the sides of the jar previously wetted by the solution, the action

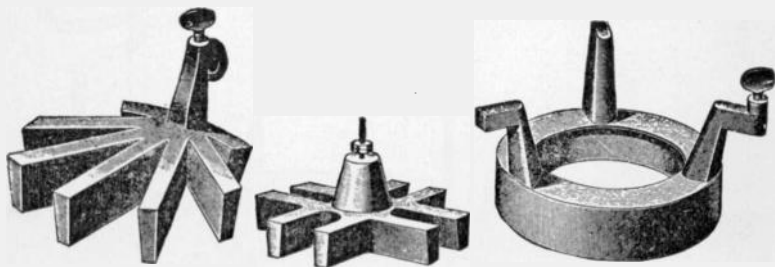

FIGS. 67 to 69.—Various zincs: fig. 67 Crowfoot; fig. 68 Lockwood; fig. 69 fire alarm.

being very marked when the solution is a saturated one. The space between these crystals and the side of the jar acts as a number of capillary tubes, and draws up more liquid, which itself evaporates and deposits crystals above the former ones. So that finally the film of crystals passes over the edge of the jar and forms on the outside, thus making a kind of syphon which draws off the liquid. This action may, to a great extent, be prevented by warming the edges of the glass, or stoneware, jars, and of the porous pots, before the cells are made up, and dipping them while warm into some paraffin wax melted in

warm oil, a precaution that should always be carried out when a dense solution of zinc sulphate is employed in the cell.

Amalgamated Zinc.—To “amalgamate” a piece of zinc, dip it into dilute sulphuric acid to clean its surface, then rub a little mercury over it by means of a piece of rag tied on to the end of a stick, and lastly, leave the zinc standing for a short time in a dish to catch the surplus mercury as it drains off.

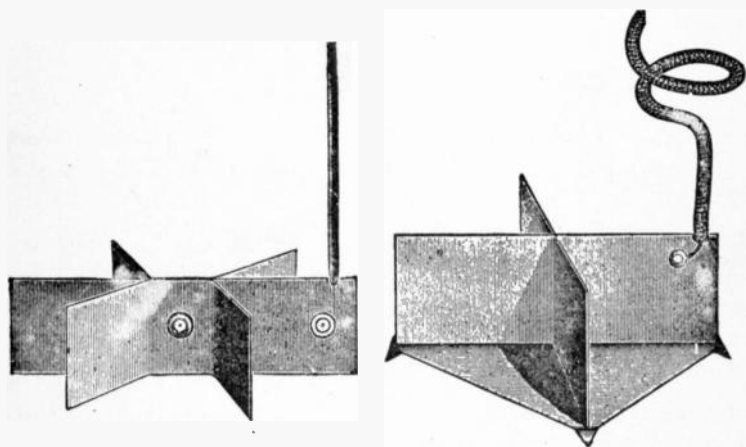

FIGS. 70 and 71.—Two forms of copper element: fig. 70, regular form for crowfoot cell; fig. 71, signal pan bottom copper.

The action of the amalgamated zinc is not well understood; by some it is considered that amalgamating the zinc prevents local currents by the amalgam *mechanically* covering up the impurities on the surface of the zinc and preventing their coming into contact with the liquid. By others it is thought that amalgamating the zinc protects it from local action by causing a film of hydrogen gas to adhere to it. This theory is based on

the fact that while no action takes place when amalgamated zinc is placed in dilute sulphuric acid at ordinary atmospheric pressure, the creation of a vacuum above the liquid causes a rapid evolution of hydrogen, which, however, stops on the re-admission of the air.

Amalgamating a zinc causes it to act as a somewhat more positive substance than before, therefore the voltage of a cell containing amalgamated zinc is slightly higher than that of a cell constructed with unamalgamated zinc.

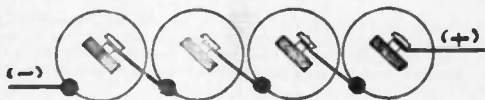

FIG. 72.—Diagram of a series battery connection: four cells are shown connected by this method. If the cell voltage be one and one-half volts, the pressure between the (+) and (-) terminals of the battery is equal to the product of the voltage of a single cell multiplied by the number of cells. For four cells it is equal to six volts.

The addition of a very small amount of zinc to mercury causes the mercury to act as if it were zinc alone, arising perhaps from the amalgam having the effect of bringing the zinc to the surface.

Battery Connections.—There are three methods of connecting cells to form a battery; they may be connected:

1. In series;
2. In parallel;
3. In series multiple.

A series connection consists in joining the positive pole of one cell to the negative pole of the other, as shown in fig. 72; this adds the voltage of each cell.

Thus, connecting in series four cells of one and one-half volts each will give a total of six volts.

Fig 73 illustrates a parallel or multiple connection; this is made by connecting the positive terminal of one cell with the positive terminal of another cell and the negative terminal of the first cell with the negative terminal of the second cell.



FIG. 73.—Diagram of a multiple or parallel connection. When connected in this manner the voltage of the battery is the same as that of a single cell, but the current is equal to the amperage of a single cell multiplied by the number of cells. Thus with $1\frac{1}{2}$ volt 15 ampere dry cells, the combination or battery connected as shown would give $4 \times 15 = 60$ amperes at a pressure of $1\frac{1}{2}$ volts.

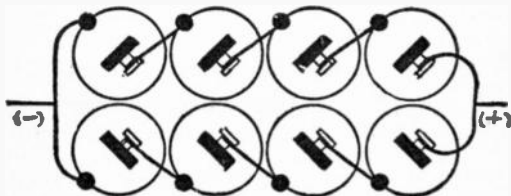

FIG. 74.—Diagram of a series multiple connection. Two sets of cells are connected in series, and the two batteries thus formed, connected in parallel. The pressure equals the voltage of one cell, multiplied by the number of cells in one battery, and the amperage, that of one cell multiplied by the number of batteries. This form of connection is objectionable unless all the cells be of equal strength. If old cells be placed on one side and new cells on the other, current will flow (as in fig. 75) from the stronger through the weaker until the pressure of all the cells thus becomes equal. This process therefore wastes some of the energy of the strong cells.

A parallel or multiple connection adds the amperage of each cell; that is, the amperage of the battery will equal the sum of the amperage of each cell.

For instance, four cells of twenty-five amperes each would give a total of one hundred amperes when connected in parallel.

A series multiple connection, fig. 74, consists of two series sets of cells connected in parallel. In series multiple connections the voltage of each set of cells or battery must be equal, or the batteries will be weakened, hence each battery of a series multiple connection should contain the same number of cells.

The voltage of a series multiple connection is equal to the voltage of one cell multiplied by the number of cells in one battery, and the amperage is equal to the amperage of one cell multiplied by the number of batteries.

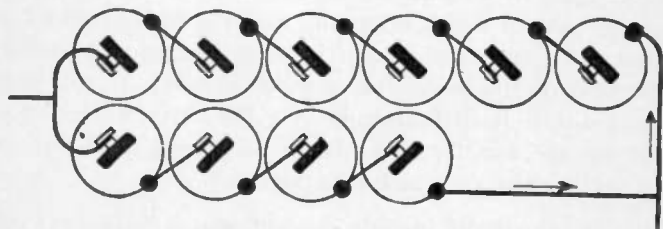

FIG. 75.—Diagram to illustrate incorrect wiring. The current pressure of the six cell battery being greater than that of the smaller unit, current will flow from the former through the latter until the pressure of the six cells is equal to that of the four cells.

Fig. 75 shows an incorrect method of wiring in series multiple connection. If the circuit be open, the six cells, on account of having more electromotive force than the four cells, will overpower them and cause a current to flow in the direction indicated by the arrows until the pressure of the six cells has dropped to that of the four. This will use up the energy of the six cells, but will not weaken the four cell battery. This action can be corrected by placing a two-way switch in the circuit at the junction of the two negative terminals so that only one battery can be used at a time

CHAPTER V

CONDUCTORS AND INSULATORS

Bodies differ from each other in a striking manner in the freedom with which the electric current moves upon them. If the electric current be imparted to a certain portion of the surface of glass or wax, it will be confined strictly to that portion of the surface which originally receives it, by contact with the source of electricity; but if it be in like manner imparted to a portion of the surface of a metallic body, it will instantaneously diffuse itself uniformly over the entire extent of such metallic surface, exactly as water would spread itself uniformly over a level surface on which it is poured.*

Bodies in which the electric current moves freely are called *conductors*, and those in which it does not move freely are called *insulators*. There is, however, no substance so good a conductor as to be devoid of resistance, and no substance of such high resistance as to be a *non-conductor*.

Mention should be made here of the misuse of the word non-conductor; the so called "non-conductors" are properly termed insulators.

*NOTE.—The discovery of this property of matter is due to Stephen Gray, who, in 1729, found that a cork, inserted into the end of a rubbed glass tube, and even a rod of wood stuck into the cork, possessed the power of attracting light bodies. He found, similarly, that metallic wire and pack thread conducted electricity, while silk did not.

Gray even succeeded in transmitting a charge of electricity through a hempen thread over 700 feet long, suspended on silken loops. A little later, Du Fay succeeded in sending electricity to no less a distance than 1,256 feet through a moistened thread, thus proving the conducting power of moisture. From that time the classification of bodies into conductors and insulators has been observed.

The bodies named in the following series possess conducting power in different degrees in the order in which they stand, the most efficient conductor being first, and the most efficient insulator being last in the list.

TABLE OF CONDUCTORS AND INSULATORS

Good conductors..... (metals and alloys)	{ Silver Copper Aluminum Zinc Brass (according to composition) Platinum Iron Nickel Tin Lead German silver (copper 2 parts, zinc 1, nickel 1) Platinoid (German silver 49 parts, tungsten 1 part) Antimony Mercury Bismuth.	
Fair conductors.....	{ Charcoal and coke Carbon Plumbago Acid solutions Sea water Saline solutions Metallic ores Living vegetable substances Moist earth.	
Partial conductors.....	{ Water The body Flame Linen Cotton Mahogany Pine Rosewood Lignum Vitæ Teak Marble.	} Dry woods

Insulators, or so-called
non-conductors.

Slate
Oils
Porcelain
Dry leather
Dry paper
Wool
Silk
Sealing wax
Sulphur
Resin
Gutta percha
Shellac
Ebonite
Mica
Jet
Amber
Paraffin wax
Glass (varies with quality)
Dry air.

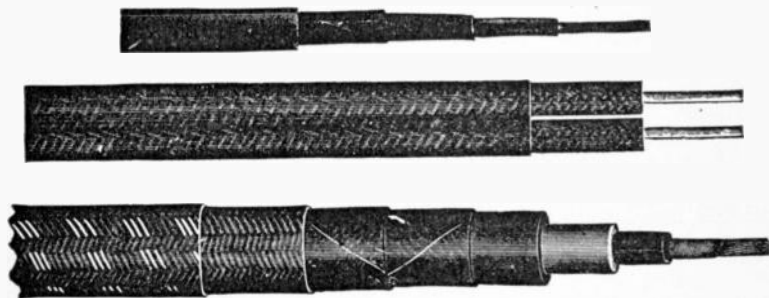

FIGS. 76 to 78.—Various covered wires. fig. 76, single; fig. 77, duplex; fig. 78, automobile high tension cable.

The earth is a good conductor; much difficulty is frequently experienced by the wires making contact with some substance that will conduct the electricity to the earth. This is called "grounding."

NOTE.—Copper is pre-eminently the metal used for electric conduction, being among the best conductors, it is excelled by one or more of the other metals, but no other approaches it in the average of all qualities.

Mode of Transmission.—The exact nature of electricity is not known, yet the laws governing its action, under various conditions are well understood, just as the laws of gravitation are known, although the constitution of gravity cannot be defined. Electricity, though not a substance, can be associated

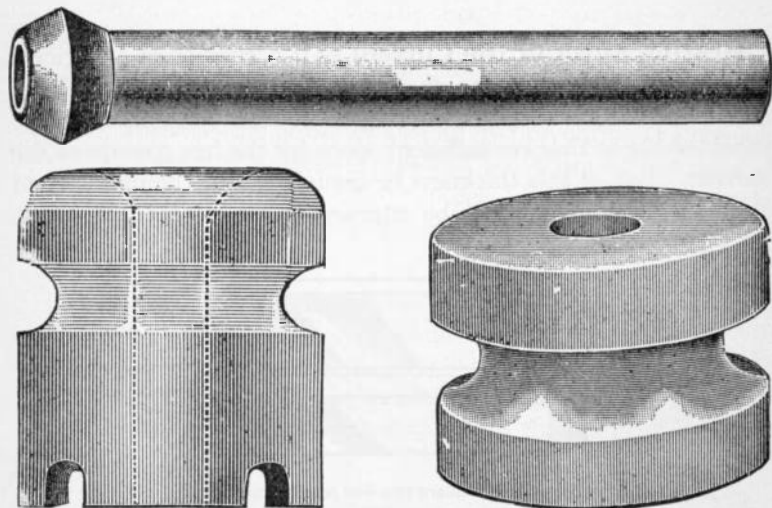

FIGS. 79 TO 81.—Standard porcelain insulators. Fig. 79, tube type; figs. 80 and 81, grooved insulators.

with matter, and its transmission requires energy. While it is neither a gas nor a liquid, its behavior sometimes is similar to that of a fluid so that it is said to “flow” through a conductor. This expression of flowing does not really mean that there is an actual movement in the wire, similar to the flow of water in a pipe, but is a convenient expression for the phenomena involved.

Effect of Heat.—The conducting power of bodies is affected in different ways by their temperature. In the metals it is diminished by elevation of temperature; but in all other bodies,

When wires or cables are to be used under water, they must be made impervious, and great care must be taken to prevent the water penetrating and thus injuring the insulation.

Water as a Conductor.—Water, whether in the liquid or vaporous form, is a conductor, though of an order greatly inferior to the metals. This fact is of great importance in electrical phenomena. The atmosphere contains, suspended in it, always more or less aqueous vapor, the presence of which impairs its insulating property.

The best insulators become less efficient if their surface be moist, the electricity passing by the conducting power of the moisture. This circumstance also shows why it is necessary to dry previously the bodies on which it is desired to develop electricity by friction

CHAPTER VI

RESISTANCE AND CONDUCTIVITY

Resistance is that property of a substance that opposes the flow of an electric current through it.

The practical electrician has to measure electrical resistance, electromotive forces, and the capacities of condensers. Each of these several quantities is measured by comparison with ascertained standards, the particular methods of comparison varying, however, to meet the circumstances of the case.

Ohm's law states that the strength of a current due to an electromotive force falls off in proportion as the resistance in the circuit increases. It is therefore possible to compare two resistances with one another by finding out in what proportion each will cause the current of a constant battery to fall off.

Silver is taken as the standard, with the percentage of 100, and the conductivity of all other metals is expressed in hundredths of the conductivity of silver.

NOTE.—A current of electricity always flows in a conducting circuit when its ends are kept at different potentials, in the same way that a current of water flows in a pipe when a certain pressure is supplied. The same electrical pressure does not, however, always produce a current of electricity of the same strength, nor does a certain pressure of water always produce a current of water of the same volume or quantity. In both cases the strength or volume of the currents is dependent not only upon the pressure applied, but also upon the *resistance* which the conducting circuit offers to the flow in the case of electricity, and on the friction (which may be expressed as resistance) which the pipe offers to the flow in the case of water.

Conductivity of Metals and Liquids.—The metals in general, conduct well, hence their resistance is small, but metal wires must not be too thin or too long, or they will resist too much, and permit only a feeble current to pass through them. The liquids in the battery do not conduct nearly so well as the metals, and different liquids have different resistances. Pure water will hardly conduct at all, unless the voltage be very high.

Salt and saltpetre dissolved in water are good conductors, and so are dilute acids, though strong sulphuric acid is a bad conductor. Gases are bad conductors.

Effect of Heat.—Another very important fact concerning the resistance of conductors is that the resistance in general increases with the temperature. While this fact is true regarding metals, it does not apply to non-metals. The resistance of different metals does not increase in the same proportion. Iron at 100 degrees C, has lost 39 per cent. of the conducting power it possessed at zero, while silver loses but 23 per cent.

Laws of Electrical Resistance.—Resistances in a circuit may be of two kinds:

1. Resistance of the conductors;
2. Resistance due to imperfect contact.

The latter kind of resistance is affected by pressure, for when the surfaces of two conductors are brought into more intimate contact the current passes more freely from one conductor to the other.

The following are the laws of the resistance of conductors:

1. *The resistance of a conducting wire is proportional to its length.*

If the resistance of a mile of telegraph wire be 13 ohms, that of fifty miles will be $50 \times 13 = 650$ ohms.

2. *The resistance of a conducting wire is inversely proportional to the area of its cross section, and therefore in the usual round wires is inversely proportional to the square of its diameter.*

Ordinary telegraph wire is about $\frac{1}{6}$ th of an inch thick; a wire twice as thick would conduct four times as well, having four times the area of cross section; hence an equal length of it would have only $\frac{1}{4}$ th the resistance.

3. *The resistance of a conducting wire of given length and thickness depends upon the material of which it is made—that is, upon the specific resistance of the material.*

Conductance and Conductivity.—It is sometimes convenient, if not necessary, to make use of the *conductance*, of a circuit, and the *conductivity* of a material.

The conductance of a circuit is the reciprocal of its resistance. The conductivity of a material is the ratio, expressed in per cent, of its conducting power to the conducting power of a standard, often *pure copper*, whose conductivity is called 1, or 100 per cent.

Example.—A circuit consists of a battery whose resistance is 2 ohms in series with two resistances of 10 ohms and 15 ohms respectively. Find the conductance of the circuit.

Solution.—Since all parts are in series the total resistance is the sum of all parts, hence

$$\text{resistance} = 2 + 10 + 15 = 27 \text{ ohms.}$$

$$\text{Therefore conductance} = \frac{1}{27} = .037.$$

Specific Conductivity.—The figure which indicates the relation between one substance and another as to their capacity to conduct electricity is called *specific* or *relative conductivity*.

Taking the specific conductivity of silver as 100, that of pure copper is 96.

The specific resistance of a substance is the reverse of its relative conductivity. The specific resistance of a metal is generally expressed in millionths of an ohm as the resistance of a centimeter cube of that metal between opposite sides.

The following table gives the data for a few metals:

Substance.	Specific Resistance in Microhms.	Specific Conductivity.
Silver	1.609	100.
Copper	1.642	96.
Gold	2.154	74.
Iron (soft)	9.827	16.
Lead	19.847	8.
German Silver	21.470	7.5
Mercury (liquid)	96.146	1.6

The specific resistance of copper is therefore:

$$\frac{1.642}{1,000,000} \text{ ohms, or } 1.642 \text{ microhms.}^*$$

Divided Circuits.—If a circuit be divided, as in fig. 83, into two branches at A, uniting again at B, the current will also be divided, part flowing through one branch and part through the other.

The relative strength of current in the two branches will be proportional to their conductivities.

This law will hold good for any number of branch resistances connected between A and B. Conductivity is, as shown before, the reciprocal of resistance.

*NOTE.—The prefixes "meg" and "micro" denote million and millionth. For example, a megohm equals 1,000,000 ohms, a microhm equals $\frac{1}{1,000,000}$ of an ohm.

EXAMPLE.—If, in fig 83, the resistance of $R=10$ ohms, and $R'=20$ ohms, the current through R will be to the current through R' as $\frac{1}{10}$ to $\frac{1}{20}$: or, as 2:1, or, in other words, $\frac{2}{3}$ of the total current will pass through R and $\frac{1}{3}$ through R' . The joint resistance of the two branches between A and B will be less than the resistance of either branch singly, because the current has increased facilities for travel. In fact, the joint conductivity will be the sum of the two separate conductivities.

Taking again the resistance of $R=10$ ohms and $R'=20$ ohms, the joint conductivity is

$$\frac{1}{10} + \frac{1}{20} = \frac{3}{20}$$

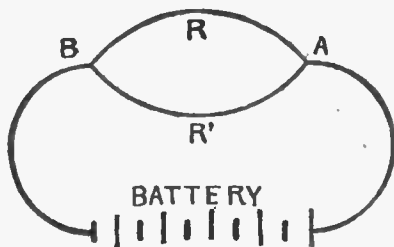

FIG. 83.—Divided circuit with two conductors in parallel.

and the joint resistance is equal to the reciprocal* of $\frac{3}{20}$

or $6\frac{2}{3}$

In most cases the resistance of the different branches will be alike. This simplifies the calculations considerably. Take, for instance, two branches of 100 ohms resistance each and find the joint resistance.

*NOTE.—The reciprocal of a number is equal to 1 ÷ the number; for instance, the reciprocal of $\frac{3}{20} = 1 \div \frac{3}{20} = \frac{20}{3} = 6\frac{2}{3}$

SOLUTION: $\frac{1}{100} + \frac{1}{100} = \frac{2}{100}$; the reciprocal is $\frac{100}{2} = 50$ ohms, or, in other words, the joint resistance is one-half of the resistance of a single branch, and each branch, of course, will carry one-half of the total current in amperes.

With three branches of equal resistance, the joint resistance will be $\frac{1}{3}$; with four branches $\frac{1}{4}$; with 100 branches $\frac{1}{100}$ of the resistance of a single branch.

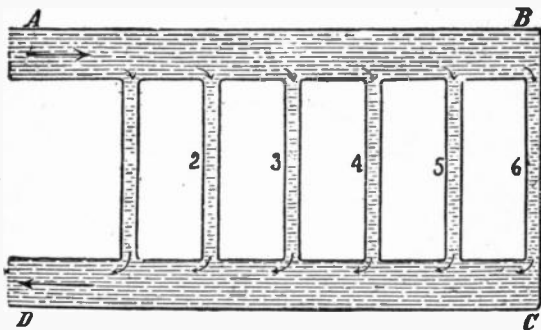

FIG. 84.—Hydraulic analogy for divided circuits. In the system of pipes shown, water flows from A B to C D through the six vertical pipes 1 to 6, the greatest amount going through the one which offers the least resistance. If pipes 1 to 6 all have the same dimensions, equal quantities of water will flow through them. It follows that the resistance which the water encounters diminishes with the increase in the number of pipes between A B and C D. The electrical circuit presents the same conditions: the greater the number of parallel connections (corresponding to the pipes 1 to 6) the less is the resistance encountered by the current.

If, for instance, the resistance of an incandescent lamp hot be 180 ohms, the joint resistance of 100 such lamps connected in multiple is

$$\frac{180}{100} = 1.8 \text{ ohms.}$$

If the electromotive force of the system is to be, say 110 volts, then, according to Ohm's law, the current for 100 lamps is:

$$\frac{110}{1.8} = 61.11 \text{ amperes.}$$

giving for each lamp a current of

$$\frac{110}{180} = .61 \text{ ampere.}$$

In the case of two branches only, the following rule may be applied also:

Multiply the two resistances and divide the product by their sum.

Written as a formula:

$$\text{Joint resistance} = \frac{R \times R'}{R + R'}$$

Again, assuming that $R = 10$ ohms and $R' = 20$ ohms:

$$\text{Joint resistance} = \frac{10 \times 20}{10 + 20} = \frac{200}{30} = 6\frac{2}{3} \text{ ohms.}$$

This rule *cannot* be employed for more than two branches at a time.

EXAMPLE—A current of 42 amperes flows through three conductors in *parallel* of 5, 10 and 20 ohms resistance respectively. Find the current in each conductor.

$$\text{SOLUTION: Joint Conductance} = \frac{1}{5} + \frac{1}{10} + \frac{1}{20} = \frac{7}{20}$$

Supposing the current to be divided into 7 parts, 4 of these parts would flow in the first conductor 2 in the second and 1 in the third.

The whole current is 42 amperes.

$$\frac{2}{3} \text{ of } 42 = 24.$$

$$\frac{1}{3} \text{ of } 42 = 12.$$

$$\frac{1}{6} \text{ of } 42 = 6.$$

Current in first conductor = 24 amperes.

“ “ second “ = 12 “

“ third “ = 6 “

} Ans.

CHAPTER VII

ELECTRICAL AND MECHANICAL ENERGY

The production of electricity is simply a transformation of energy from one form into another, usually mechanical energy is changed into electrical energy and a dynamo is simply a device for effecting the transformation.

Prof. Fessenden truly remarks there are two independent properties of matter—gravity and inertia—and these give two ways of defining force and energy.

It should always be remembered that electricity is something real, although not easily defined. And then, too, while it is not matter and not energy, yet under proper conditions (it having the power of doing work) it is convenient to speak of its performances as electric energy. The following questions and answers, although few in number, may present the subject with clearness.

Ques. What is energy?

Ans. Energy is the capacity for doing work.

Steam under pressure is an example, a spring bent ready to be released is another form, again, water stored in an elevated tank has capacity for doing work. These examples illustrate *potential energy*, as distinguished from *kinetic energy*. Potential energy may be defined as *energy due to position*, and kinetic energy, as *energy due to momentum*.

Ques. What is matter?

Ans. Matter is anything occupying space, and which prevents other matter occupying the same space at the same time.

Ques. What name is given the smallest quantity of matter which can exist?

Ans. The atom.

An atom means that which cannot be cut, scratched, or changed in form and that cannot be affected by heat or cold or any known force; although inconceivably small, atoms possess a definite size and mass.

Ques. What is a molecule?

Ans. A molecule is composed of two or more atoms.

Ques. What is the behaviour of these minute bodies?

Ans. They are perpetually in motion, vibrating with incredible velocities.

Ques. Why at this point are definitions of energy and of matter most useful?

Ans. Because, as stated, all electric action is an exhibition of energy, and energy must act through matter as its medium.

NOTE.—A writer in the *New Science Review* undertakes to answer the question: "What is electricity?" In order to lead the reader up to the main question, he first considers the natural forces, gravitation and heat. Examples are given of how these forces are manifested and how energy is changed from one form to another. Every form of force, the author says, should be regarded as a different method in which energy makes itself known to the senses. He calls particular attention to the important fact that the "resistance of one kind or another is always the agent that acts to alter energy from one form to another," and suggests that electricity is simply a form or manifestation that energy may assume under given conditions, and generally is a mere transitory stage between the mechanical form and the heat form. "In most operations," he continues, "mechanical force passes to the heat form without passing through the electric form; but whenever magnetism is brought into play as a resistance that must be overcome, then mechanical power applied to overcome this resistance always becomes electricity, if only momentarily in its passage from the mechanical to the heat form." In conclusion, he asks if the question: "What is electricity?" cannot be answered in a fairly satisfactory way by saying that it is simply a form that energy may assume while undergoing transformation from the mechanical or the chemical form to the heat form or the reverse.

Ques. What is the difference between electricity and magnetism?

Ans. The ultimate nature of neither is known. There are, however, some differences. To sustain a current of electricity requires energy. To sustain magnetism requires no energy. A current of electricity is always accompanied by a magnetic field of peculiar form. Magnetism alone cannot produce electricity. Electricity can do work; but magnetism cannot in the same sense—and alike with electricity, neither can it exist without contact with matter.

Ques. How is energy transmitted from one part of a material substance to another?

Ans. Gradually and successively. It requires a medium and also time.

Ques. What is the principal use or function in mechanics of electricity?

Ans. It is purely that of transmission. It corresponds to ropes, shafts and fluids as a medium of conveying and translating power or work.

Ques. What is work?

Ans. Work is the overcoming of resistance through a certain distance.

As a quantity of water moving from a higher to a lower level will do work, so also will a quantity of electricity falling through a difference of potential.

Ques. How is work measured?

Ans. In foot pounds.

Ques. What is a foot pound?

Ans. The amount of work done in raising a weight of one pound one foot or the equivalent, overcoming a pressure of one pound through a distance of one foot.

Ques. What is the electrical unit of work?

Ans. The *volt-coulomb*.

A volt-coulomb of work is performed when one ampere of current flows for one second in a circuit whose resistance is one ohm, when the pressure is one volt.

The Ampere-Hour.—A gallon of water may be drawn from a hydrant in a minute, or in an hour; it is still one gallon. So in electricity, a given amount of the current, say one *coulomb*, may be obtained in a second or in an hour.

The ampere is the unit rate of flow.

What is called the electric current is simply the relation of any quantity of electricity passed to the time it is passing; that is

quantity in coulombs = current in amperes \times time in seconds,
or simply

$$\text{coulomb} = \text{ampere} \times \text{second}.$$

Again:

$$\begin{aligned} 10 \text{ coulombs} &= 2 \text{ amperes} \times 5 \text{ seconds} \\ &= 10 \text{ amperes} \times 1 \text{ second} \\ &= 1 \text{ ampere} \times 10 \text{ seconds, etc.} \end{aligned}$$

One *ampere hour* is simply another way of saying 3,600 coulombs. Of course 3,600 coulombs of electricity may be obtained in any desired time. It all depends on the rate of flow or the current strength in amperes.

For instance, 2 amperes in $\frac{1}{2}$ hour, or 4 amperes in $\frac{1}{4}$ hour will also give one ampere-hour of 3,600 coulombs.

It is well to keep the distinction between coulombs and amperes in mind, as even in text books very lately published these units are confounded. To illustrate further the difference between coulombs and amperes, the following example is given.

It is sometimes estimated that the quantity of electricity in a flash of lightning is 10 coulomb, and the duration of the discharge $\frac{1}{2000}$ part of a second. What is the current in amperes?

Now since

$$\text{coulombs} = \text{amperes} \times \text{seconds} \quad (1)$$

solving (1) for the current,

$$\text{amperes} = \frac{\text{coulombs}}{\text{seconds}} \quad (2)$$

substituting the given values in (2),

$$\text{amperes} = \frac{10}{\frac{1}{2000}} = 2000$$

Power.—The term power means *the rate at which work is done*; it is usually expressed as *the number of foot pounds done in one minute*, that is

$$\text{power} = \frac{\text{foot pounds}}{\text{minutes}}$$

Power exerted for a certain time produces work.

Ques. What is the mechanical unit of power?

Ans. The horse power.

Ques. What is one horse power?

Ans. 33,000 foot pounds per minute.

discovered the law, known as Joule's law, for determining the relation between the heat, current pressure, and time in an electric circuit.

Ques. What is heat?

Ans. A form of energy.

Heat is produced in the agitation of the molecules of matter—the energy expended in agitating these molecules is transformed into heat.

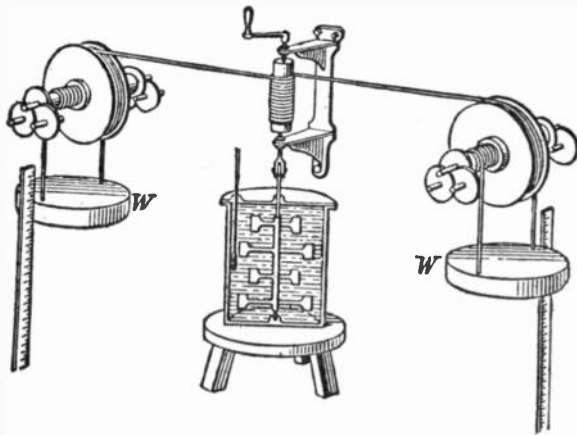

FIG. 86. — Joule's experiment on the mechanical equivalent of heat, in which he caused paddle-wheels to rotate in a vessel of water by means of falling weights W . The amount of work done by gravity upon the weights in causing them to descend through any distance d was equal to their weight W times the distance. If the weights descended slowly and uniformly, this work was all expended in overcoming the resistance of the water to the motion of the paddle wheels through it; that is, it was wasted in eddy currents in the water. Joule measured the rise in the temperature of the water and found that the mean of his three best trials gave 427 gram meters as the amount of work required to develop enough heat to raise a gram of water one degree. He then repeated the experiment, substituting mercury for water, and obtained 425 gram meters as the work necessary to produce a calorie of heat. The difference between these numbers is less than was to have been expected from the unavoidable errors in the observations. He then devised an arrangement in which the heat was developed by the friction of iron on iron, and again obtained 425. This corresponds to 772 foot pounds, but later experiments show that the correct value is 778 foot pounds.

Ques. How is heat measured?

Ans. In British thermal units (B.t.u.).

Ques. What is the British thermal unit?

Ans. The quantity of heat required to raise the temperature of 1 lb. of pure water 1° Fahr., at or near 39.1° F., the temperature of maximum density.

Ques. What is the mechanical equivalent of heat?

Ans. The number of foot pounds of mechanical energy equivalent to one British thermal unit.

Joule's experiments 1843-50 gave the figure 772 ft. lbs. which is known as Joule's equivalent. Later experiments gave higher figures, and the present accepted value is 778 ft. lbs., that is: 1 B. t. u. = 778 ft. lbs.

Electrical Horse Power.—It is desirable to establish the relation between *watts* and *foot pounds* in order to determine the *capacity* of an electric generator or motor in terms of *horse power*.

One watt is equivalent to one joule per second or 60 joules per minute. One joule in turn, is equivalent to .7374 ft. lbs., hence 60 joules equal:

$$60 \times .7374 = 44.244 \text{ ft. lbs.}$$

Since one horse power = 33000 ft. lbs. per minute, the electrical equivalent of one horse power is

$$33000 \div 44.244 = 746 \text{ watts.}$$

or,

$$\frac{746}{1000} = .746 \text{ kilowatts (K.W.)}$$

Again, one kilowatt or 1000 watts is equivalent to

$$1000 \div 746 = 1.34 \text{ horse power.}$$

The Farad.—The measure constructed to hold a gallon of water may be called the gallon measure. The capacity of a condenser which would contain a charge of one coulomb under one volt pressure is the *farad*. It may seem strange that there is a unit of quantity and another of capacity to hold that quantity, when in the case of water the term "gallon" may suffice for the measure and the liquid it can hold. Electricity in this respect, however, corresponds to a *compressible fluid* or a *gas*.

A gallon measure may hold a gallon of gas or ten; it depends entirely upon the pressure. So a condenser of a certain size may hold any number of coulombs, according to the electrical pressure.

The farad being inconveniently large for practical use, one-millionth of a farad, called a *microfarad*, is generally adopted.

CHAPTER VIII

EFFECTS OF THE CURRENT

The term "electric current," in the present state of our knowledge, should be regarded as denoting the existence of a state of things in which certain definite experimental effects are produced, for some of which there certainly is no analogy exhibited in ordinary hydraulic currents. The following are the most important of these effects:

1. Thermal effect;
2. Magnetic effect;
3. Chemical effect.

It is rather to these effects than to any imaginary current flow in the conductor that the mind of the reader should be directed.

With this preliminary caution, which should never be lost sight of, the use of familiar words and expressions connected with the flow of water in pipes is justified in order to avoid roundabout and cumbrous phrases which, though perhaps more nearly in accord with present knowledge of the facts, would not tend to clearness or conciseness.

The three most important effects of the current just mentioned, may be presented in more detail as follows:

1. The *Thermal effect*:—

The conductor along which the current flows becomes heated. The rise of temperature may be small or great according to circumstances, but some heat is always produced.

2. The *Magnetic effect*;

The space both outside and inside the substance of the conductor, but more especially the former, becomes a "magnetic field" in which delicately pivoted or suspended magnetic needles will take up definite positions and magnetic materials will become magnetized.

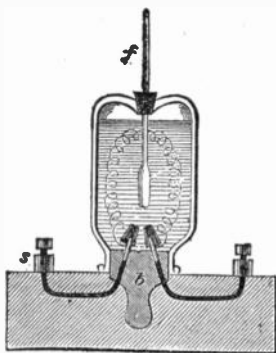

FIG. 87.—Lenz's apparatus for measuring the heat given off by an electric current. It consisted of a wide mouthed stoppered bottle fixed upside down, with its stopper, *b* in a wooden box; the stopper was perforated so as to give passage to two thick platinum wires, connected at one end with binding screws, *s*, while their free ends were provided with platinum cones by which the wires under investigation could be readily affixed; the vessel contained alcohol, the temperature of which was indicated by a thermometer fitted in a cork inserted in a hole made in the bottom of the vessel. The current is passed through the platinum wires, and its strength measured by means of a galvanometer interposed in the circuit. By observing the increase of temperature in the thermometer in a given time and knowing the weight of the alcohol, the mass of the wire, the specific heat, and the calorimetric values of the vessel, and of the thermometer, compared with alcohol, the heating effect which is produced by the current in a given time can be calculated.

3. The *Chemical effect*;—

If the conductor be a liquid which is a chemical compound of a certain class called *electrolytes*, the liquid will be decomposed at the places where the current enters and leaves it.

Thermal Effect.—If a quantity of electricity were set flowing in a closed circuit and the latter offered no *resistance*, it would flow forever, just as a wagon set rolling along a circular railway would never stop if there were no *friction*.

When matter in motion is stopped by friction, the energy of its motion is converted into heat by the friction thus causing

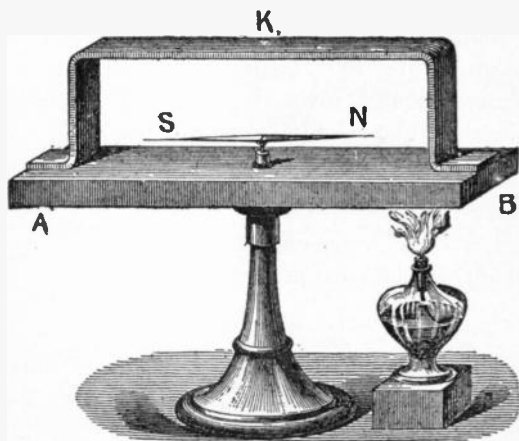

FIG. 88. — The Seebeck effect: If in a complete metallic circuit having junctions of dissimilar metals, the junctions are at different temperatures, then generally a steady current will flow in the circuit as long as the differences of the temperatures of the junction is maintained. To demonstrate this, a piece of copper K bent in the shape seen in the figure, was placed on a block of bismuth A B, carrying a pivoted magnetic needle N S; as soon as the equality of temperatures was altered by either heating or cooling one of the junctions of the two metals, the needle indicated a current which continued to flow as long as the difference of temperature was maintained at the junctions. The movement of the needle indicated the direction in which the current flowed. If, for instance, the north junction B were heated, the N pole moved eastwards, showing that at the heated junction the current flows from the bismuth to the copper, at the cold junction from the copper to the bismuth.

the matter to come to rest. Similarly, when electricity in motion, that is, an electric current is stopped by resistance, the energy of its flow is transformed into heat by the resistance of the circuit.

If the terminals of a battery be joined by a short thick wire of low resistance, most of the heat will be developed in the battery, whereas, if a thin wire of high resistance be used it will become hot, while the battery itself will remain comparatively cool.

To investigate the development of heat by a current, Joule and Lenz used instruments on the principle of fig. 87, in which a thin wire joined to two stout conductors is enclosed within a glass vessel containing alcohol, into which is placed a thermometer. The resistance of the wire being known, its relation to the other resistances can be calculated. Joule found that the number of heat units developed in a conductor is proportional to:

1. The resistance;
2. The square of the current strength;
3. The time that the current lasts.

Joules' law may be stated as follows:

The heat generated in a conductor by an electric current is proportional to the resistance of the conductor, the time during which the current flows, and the square of the strength of the current.

The quantity of heat in calories may be calculated by use of the equation,

$$\text{calories per second} = \text{volts} \times \text{amperes} \times .24. \quad (1)$$

The total number of calories H developed in t seconds will be given by

$$H = P. D. \times C \times t \times .24. \quad (2)$$

EXAMPLE:—If a current of 10 amperes flow in a wire whose terminals are at a potential difference of 12 volts, how much heat will be developed in 5 minutes?

Substituting in equation (2):

$$10 \times 12 \times (60 \times 5) \times .24 = 8640 \text{ calories.}$$

Since by Ohm's Law potential = I × R

substituting I R for P. D. in 2)

$$H = I^2 R \times t \times .24$$

Use of Heat from Electric Current.—In the transmission of electricity from place to place, it is very desirable that none of the energy be expended in heating the conductor. Hence copper wires of the proper size must be used.

In wiring a building for electric lights, the insurance rules require that the wires be of a certain size and that they be put up in a certain manner. Otherwise they will not insure a building against fire.

It is often desirable, however, to use the electric current for the purpose of producing heat. The carbons of the arc and incandescent lamps are intensely heated that they may produce light. Coils of German silver wire or other high resistance wire are heated by the passage of a current through them. In this manner the electric stove is made.

Soldering coppers, smoothing irons, and baking ovens are heated in a similar manner.

Magnetic Effect.—An electric current flowing in a wire causes it to be surrounded by a *magnetic field*, which consists of *lines of force* encircling the wire. The field is strongest near the wire and diminishes gradually in strength at increasing distances therefrom. The presence of this magnetic field is shown by various experiments and the subject is fully explained in chapter IX on *magnetism*.

Chemical Effect.—Pats van Trostwyk (1789) pointed out that an electric discharge was capable of decomposing water; to show this he used gold wires, which he allowed to dip in water, connecting one of them with the inner, and another with the outer coating of a Leyden jar, and passing the discharge through the water. The gas bubbles collected proved to consist of oxygen and hydrogen gas.

Nicholson and Carlisle (1800) dipped a copper wire which was connected with one of the poles of a voltaic pile into a drop of water, which happened to be on the plate connected with the other pole; gas bubbles appeared, and the drop of water became smaller and smaller.

This experiment was repeated in a somewhat different manner, the brass wires from a pile being brought under a tube filled with water and closed at the top. Gas bubbles were produced by the wire in connection with the negative pole of the pile, and the water was observed to diminish gradually. At the positive wire, on the contrary, no gas came off, but the

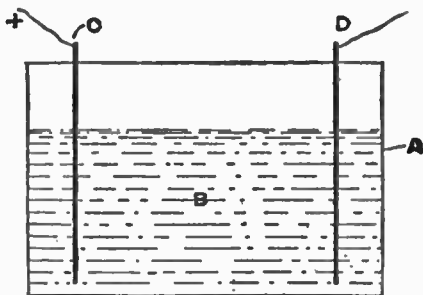

FIG. 89. — An electrolytic cell. The parts are: A, cell; B, electrolyte; C, positive electrode or anode; D, negative electrode or cathode.*

metal lost its metallic lustre, became dark, and finally crumbled away. The gas which had collected in the tube proved to be hydrogen; while on examining the black mass it was found that the constituents of brass, viz., copper and zinc, had become oxidized.

Electrolysis.—*Electric analysis* or more briefly *electrolysis* was the term applied by Faraday to the process of decomposing a liquid by the passage of a current of electricity through it.

The vessel containing the liquid is known as an *electrolytic cell*. In fig. 89, A is the cell, which may be of glass or of any other

*NOTE.—The cathode is the conductor by which current flows away as distinguished from the *anode* or conductor through which the current enters. The terms usually apply to conductors leading the current through a liquid or gas, as an electrolytic cell, or vacuum tube

suitable material, and B is the liquid which is to be electrolyzed. Current enters by the *positive electrode* C, also known as the *anode*, traverses the liquid, and leaves by the *negative electrode*, or *cathode*, D.

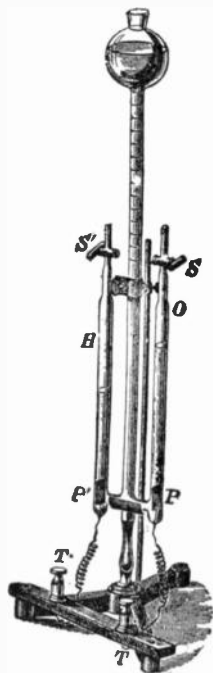

FIG. 90. — Modern apparatus for decomposing water by electrolysis. Platinum electrodes P and P' are placed at the bottom of two upright tubes O and H, and are connected to the terminals T and T' by platinum wires, which are fused through the glass of the tubes. These tubes have glass stopcocks S and S' at their upper ends, and at their lower ends are connected by a short glass tube, from the center of which rises the large central tube which expands with a bulb at its upper end, which is open at the top. The three tubes can be filled with acidulated water from the central tube, the previously contained air being allowed to escape through the stopcocks, which are afterwards closed. If it be so filled, and the terminal T be attached to the positive and T' to the negative pole of a suitable battery, bubbles of gas will be observed to rise from the plates P and P', and finding their way to the top of the respective tubes, will displace the liquid, which will be driven into the open central tube. The gas rising from the anode P is oxygen (O), and that rising from the cathode P' is hydrogen (H). If the tubes are graduated, the latter will be found to occupy about twice the volume of the former. The proportion is theoretically 2 to 1; however, on account of the different solubilities of the two gases in water, oxygen being the more soluble of the two, is deficient in quantity.

The passage of current through the water splits up its molecules into their constituent atoms of oxygen and hydrogen, the former being given off in bubbles at the anode, and the latter at the cathode.

When current is passed through a solution of copper sulphate between platinum electrodes, the liquid is decomposed, atoms

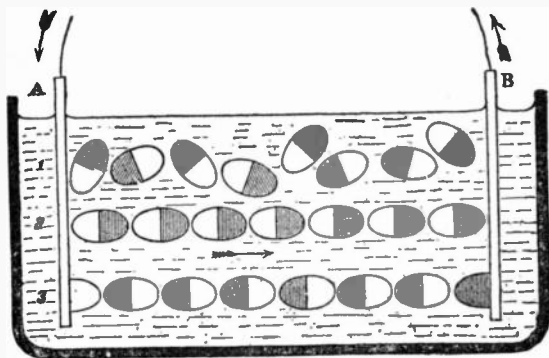

FIG. 91.—Grotthuss' theory of electrolysis. Grotthuss in (1806), announced his theory that the molecules in an electrolyte have their individual electro-positive and electro-negative atoms charged positively and negatively respectively. In an ordinary liquid, for instance in water, the molecules are arranged indifferently, like row 1, with their positive and negative ends pointing in all directions. When the charged plates A and B connected to the + and - poles of a battery are inserted in the water, the molecules under the action of the laws of electrostatic action turn as shown in row 2, so that all the hydrogen or shaded ends (+) are turned towards the (-) plate B and all the oxygen or unshaded ends (-) towards the (+) plate A. All along the row the electrical forces are supposed to tear the molecules asunder, depositing H on B and O on A. The atoms in the middle of the liquid, however, recombine, for the hydrogen atoms in their journey towards B meet the oxygen atoms travelling in the opposite direction, and we get the state of affairs represented in row 3. The next step is to rotate once more the atoms into the positions shown in row 2, and so on. In this way the theory accounts for the products only appearing at the electrodes and not in the body of the liquid.

of copper being deposited at the cathode, bubbles of oxygen being given off at the anode, and sulphuric acid being formed in the liquid, which latter becomes more and more acid as the copper is withdrawn.

If, however, the anode be of copper instead of platinum, no sulphuric acid will be formed, neither will oxygen be given off at the anode. As copper is deposited at the cathode, an equal quantity will be dissolved at the anode, so that the original constitution of the liquid is maintained.

The atoms separated from each other by the electric current were called *ions* by Faraday; those going to the anode being *anions*, and those going to the cathode being *kathions*.

Anions are generally regarded as *electro-negative*, because they move as if attracted to the positive electrode, while kathions are regarded as *electro-positive*.

In order to explain the transfer of electricity and the transfer of matter through the electrolyte, Grotthuss put forward the hypothesis that when two metal plates at different potentials are placed in a cell, the effect produced in the liquid is that the molecules of the liquid arrange themselves in innumerable chains, as shown in fig. 91, in which every molecule has its atoms pointing in a certain direction, the electro-positive atom being attracted towards the cathode and the electro-negative towards the anode. An interchange then takes place all along the line, the free atoms appearing at the electrodes, and every atom discharging a minute charge of electricity upon the electrode at which it is liberated.

Electro-chemical Series.—This is an arrangement of the metals in a series in such a manner that the most electro-positive is at one end and the most electro-negative at the other.

The order of the metals varies with the electrolyte in which the metals are tested.

The following table shows such series for the most common metals, in three different solutions.

<i>Sulphuric acid.</i>	<i>Hydrochloric acid.</i>	<i>Caustic potash.</i>
Zinc	Zinc	Zinc
Cadmium	Cadmium	Tin
Tin	Tin	Cadmium
Lead	Lead	Antimony
Iron	Iron	Lead
Nickel	Copper	Bismuth
Bismuth	Bismuth	Iron
Antimony	Nickel	Copper
Copper	Silver	Nickel
Silver	Antimony	Silver
Gold		
Platinum		

Faraday stated several laws of electrolysis, as follows:

1. *The quantity of an ion liberated in a given time is proportional to the quantity of electricity that has passed through the voltameter* in that time.*

2. *The quantity of an ion liberated in a voltameter is proportional to the electro-chemical equivalent of the ion.*

3. *The quantity of an ion liberated is equal to the electro-chemical equivalent of the ion multiplied by the total quantity of electricity that has passed.*

Electric Osmose.—Porret observed that if a strong current be led into certain liquids as if to electrolyze them, a porous partition being placed between the electrodes, the current mechanically carries part of the liquid through the porous diaphragm, so that the liquid is forced to a higher level on one side than on the other. This phenomenon is known as *electric osmose*.

Electric Distillation.—Closely connected with the preceding phenomenon is that of the *electric distillation of liquids*. It was noticed by Beccaria that *an electrified liquid evaporates more rapidly than one not electrified*.

*NOTE.—The name *voltameter* was given by Faraday to an electrolytic cell employed as a means of measuring an electric current by the amount of chemical decomposition the current effects in passing through the cell.

Gernez has recently shown that in a bent closed tube, containing two portions of liquid, one of which is made highly + and the other highly -, the liquid passes over from + to -. This apparent distillation is not due to difference of temperature, nor does it depend on the extent of surface exposed, but is effected by a slow creeping of the liquid along the interior surface of the glass tubes. Bad conductors, such as turpentine, do not thus pass over.

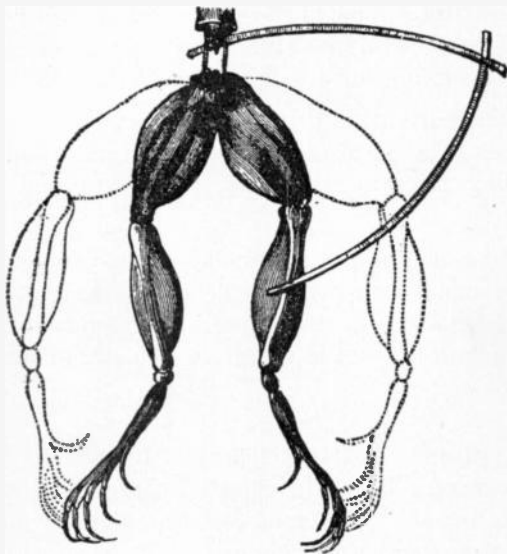

FIG. 92.—Effect of the electric current on a frog's legs; discovered in 1678 by Galvani.

Muscular Contractions.—It was discovered in 1678 that when a portion of muscle of a frog's leg, hanging by a thread of nerve bound with a silver wire, was held over a copper support so that both nerve and wire touched the copper, the muscle immediately contracted.

More than a century later Galvani's attention was drawn to the subject by his observation of spasmodic contractions in the legs of freshly killed frogs under the influence of the "return shock" experienced every time a neighboring electric machine was discharged.

The limbs of the frog, prepared as directed by Galvani, are shown in fig. 92. After the animal has been killed the hind limbs are detached and skinned; the crural nerves and their attachments to the lumbar vertebrae remaining. For some hours after death the limbs retain their contractile power. The frog's limbs thus prepared form an excessively delicate galvanoscope.

Electroplating.—This is the process of depositing a layer or coating of a rarer metal upon the surface of a baser, or of a metal upon any conducting surface, by electrolysis.

The electric current used may be obtained from a battery or other source. The battery has its positive plate connected to a rod extending across a trough or tank containing the plating bath.

Suspended from the rod are anodes of gold, silver, or copper or whatever metal from which a deposit is desired. The other plates of the battery or the negative elements, are connected with another rod across the trough, to which are suspended the articles to be plated.

Electrotyping.—This is the process by which, type, wood cuts, etc., are reproduced in copper by the process of electroplating. A mould is first made of the set type in wax; this mould is next coated with black lead to give it a metallic surface, as the wax is an insulator; the mould is then subjected to the process of electro deposition, resulting in the formation of a film of copper on the prepared surface.

The copper shell is removed from the mould by applying hot water; the shell is then backed up with electrotype metal to render it strong enough for use.

Almost all the illustrations in this book, for example, are printed from electrotype copies, and not from the original wood blocks, which would not wear so well.

CHAPTER IX

MAGNETISM

Magnetism.—The ancients applied the word “magnet,” *magnes lapes*, to certain hard black stones which possess the property of attracting small pieces of iron, and as discovered later, to have the still more remarkable property of pointing

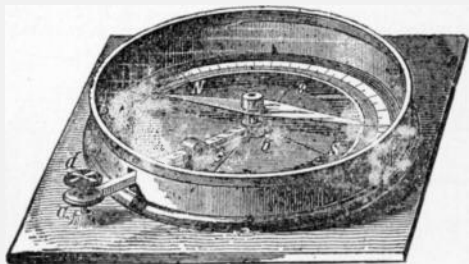

FIG. 93. — Simple compass. It consists of a magnetic needle resting on a steel pivot, protected by a brass case covered with glass, and a graduated circle marked with the letters N, E, S, W, to indicate the cardinal points; *a b* is a lever which arrests the needle by pushing it against the glass when the button *d* is pressed.

north and south when hung up by a string. At this time the magnet received the name of *lodestone* or “leading stone.” It is commonly, though incorrectly, spelled *loadstone*.

Ques. Describe two kinds of magnetism.

Ans. Magnets have two opposite kinds of magnetism or magnetic poles, which attract or repel each other in much the same way as would two opposite kinds of electrification.

Ques. What is the nature of each kind of magnetism?

Ans. One has a tendency to move toward the north and the other toward the south.

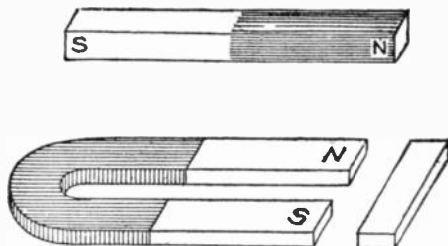

FIGS. 94 to 96.—Simple bar magnet and horse shoe magnet with keeper. These are known as *permanent magnets* in distinction from *electro-magnets*. The horse shoe magnet will attract more than the bar magnet because both poles act together. A piece of soft iron, or keeper is placed across the ends of a horse shoe magnet to assist in preventing the loss of magnetism.

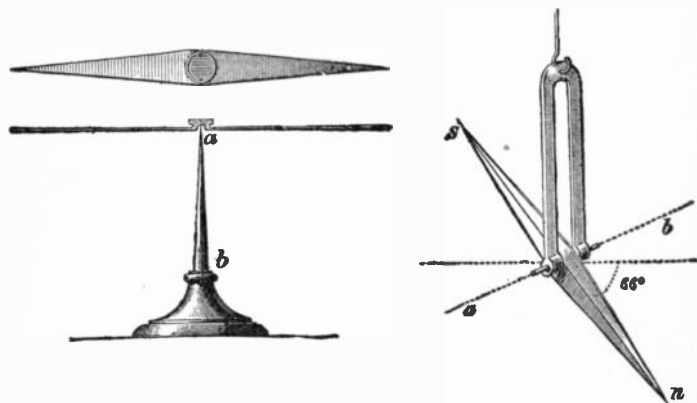

FIGS. 97 and 98.—Horizontal magnetic needle, and magnetic "dip" needle. A magnetic needle consists of a small bar magnet, supported upon a pivot or suspended so that it is free to turn in a horizontal or vertical plane. The form of magnetic needle illustrated in fig. 97 is arranged to show the magnetic meridian; the needle moves upon a perpendicular axis or pivot *ab*. In fig. 98, the needle *sn* turns upon a horizontal axis *ab*. This needle indicates the dip or inclination, that is, the angle which it makes with the horizontal plane, due to the fact that in most places the lines of force are not horizontal. In the northern hemisphere the N pole of the needle is depressed, in the southern hemisphere the S pole is similarly affected. When used, the dip needle must be set so that the plane in which the needle swings contains the magnetic meridian, as indicated by the horizontal needle.

Ques. Where is the magnetism the strongest?

Ans. In two regions called the *poles*.

Ques. Describe the distribution of magnetism in a long shaped magnet.

Ans. The strongest magnetism resides in the ends, while all around the magnet half way between the poles there is no attraction at all.

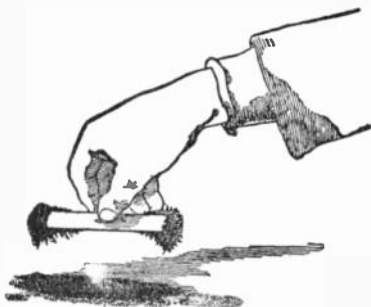

FIG. 99.—Magnetic poles. If a bar magnet be plunged into iron filings and then lifted, as illustrated in the figure, a mass of filings will cling to the ends of the magnet but not to the middle. The ends are called the *poles* of the magnet.

Ques. How are the poles designated?

Ans. They are called the *north pole* and the *south pole*.

Ques. What is the distinguishing feature of each?

Ans. The north pole points approximately to the earth's geographical north, while the south pole of a magnet points approximately to the earth's geographical south.

The north pole is the positive (+) pole and the south pole is the negative. The north and south poles were formerly called in France, the austral and boreal poles respectively.

Magnetic Field.—When a straight bar magnet is held under a piece of card board upon which iron filings are sprinkled, the filings will arrange themselves in curved lines radiating from the poles. If a horse shoe magnet be held at right angles to the plane of the card board, the filings will arrange themselves in curved lines, as shown in fig. 108. These lines are called *magnetic lines of force* or simply *lines of force*; they show that the medium surrounding a magnet is in a state of stress, the space so affected being called the *magnetic field*

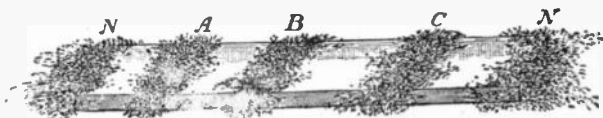
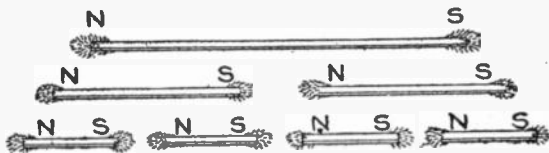

FIG. 100.—Badly magnetized bar. Properly magnetized magnets have only two poles; if it is possible, however, by special or careless magnetization, to produce magnets with more than two poles, but no process will produce a magnet with a single pole. If an abnormal magnet with more than two poles be dipped into iron filings, the latter will adhere at places other than the two ends, as shown in the illustration. The polarities are alternately N and S; that is, the regions N, B, N', have north polarity, while A and C have south polarity. These are known as *consequent poles*.



FIGS. 101 to 107.—Effect of breaking a magnet into several parts. If a magnetized needle be broken, each part will be found to be a complete magnet having a N and S pole. The sub-division may be continued indefinitely, but always with the same result as indicated in the figure. This is evidence of the correctness of the molecular theory of magnetism, which states that the molecules of a magnet are themselves minute magnets arranged in rows with their opposite poles in contact.

Ques. What is the extent and character of the magnetic field?

Ans. The influence of a magnet is supposed to extend in all directions indefinitely, however, the effect is very slight beyond a comparatively limited area.

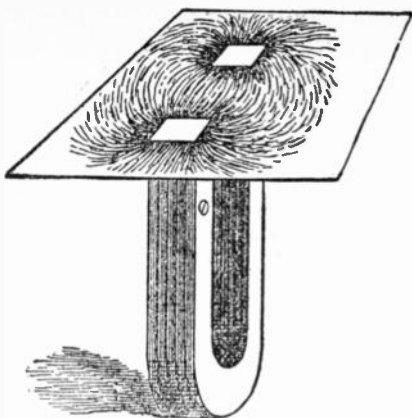

FIG. 108.—The region about a magnet in which its magnetic forces can be detected is called the *magnetic field*. This can be represented graphically by placing a piece of cardboard over the magnet and sprinkling iron filings on the paper, gently tapping at the same time. Each filing becomes a temporary magnet by *induction*, and sets itself, like the compass needle, in the direction of the *line of force* of the magnetic field.

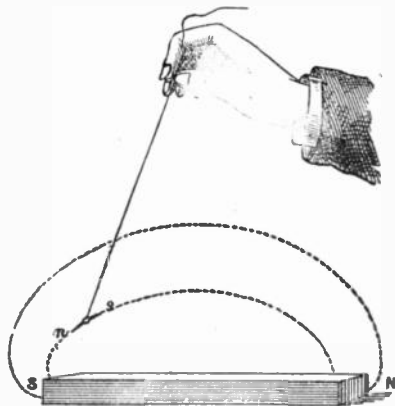

FIG. 109.—Tracing lines of force with a suspended magnet. If a small magnetic needle, suspended by a thread, be held near a magnet, it will point in some fixed direction depending on the proximity of the poles of the magnet. The direction taken by the magnet is called the *direction of the force at the point*, and if the suspended needle be moved forward in the direction of the pole, it will trace out a curved line which will be found to start from one of the poles, and end at the other. Any number of such lines can be traced; the space filled by these lines of force is called the *magnetic field*.

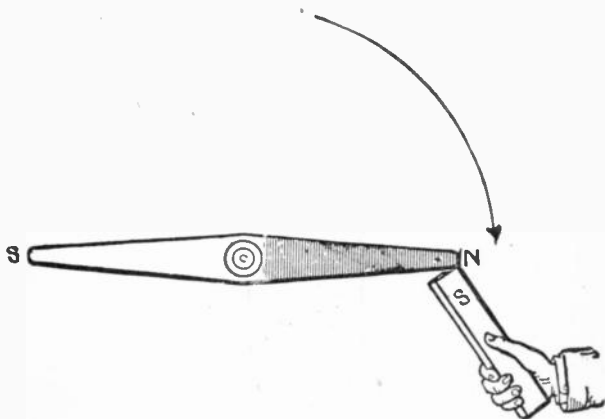

FIG. 110.—Magnetic action: *Unlike poles of magnets attract each other.*

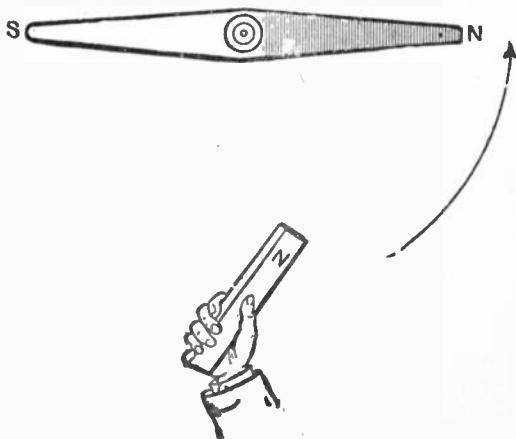

FIG. 111.—Magnetic action: *Like poles of magnets repel each other.*

Magnetic Force.—This is the force with which a magnet attracts or repels another magnet or any piece of iron or steel. The force varies with the distance, being greater when the magnet is nearer and less when the magnet is farther off. The following are the laws relating to magnetic force:

1. *Like magnetic poles repel one another; unlike magnetic poles attract one another.*

2. *The force exerted between two magnetic poles varies inversely as the square of the distance between them.*

Magnetic Circuit.—The path taken by magnetic lines of force is called a magnetic circuit; the greater part of such a circuit is usually in magnetic material, but there are often one or more air gaps included. The total number of lines of force in the circuit is known as the *magnetic flux*.

Ques. How is magnetic flux measured?

Ans. By a unit called the maxwell.

Named after James Clerk Maxwell the Scottish physicist.

Ques. What is the maxwell?

Ans. *The amount of magnetism passing through every square centimetre of a field of unit density.*

Ques. What is the unit of field strength?

Ans. The gauss.

Ques. What is a gauss?

Ans. *The intensity of field which acts on a unit pole with a force of one dyne. It is equal to one line of force per square*

centimetre. Named after Karl Friedrich Gauss, the German mathematician.

The Magnetic Effect of the Current.—Hans Christian Oersted, the Danish scientist, discovered in 1819 that a magnet tends to set itself at right angles to a wire carrying an electric current. He also found that the way in which the needle turns, whether to the right or left of its usual position, depends: 1, upon the position of the wire that carries the current, whether

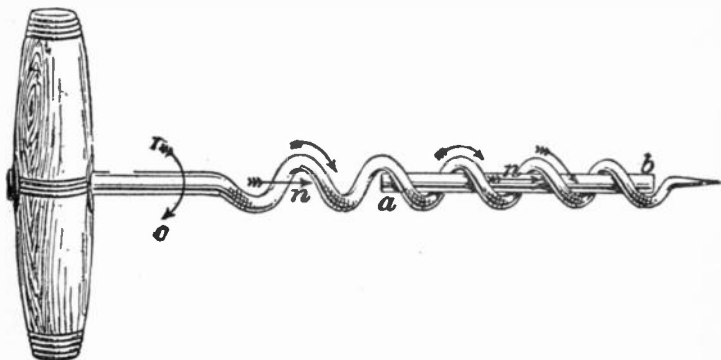

FIG. 112.—Illustrating Maxwell's "corkscrew rule" for relative directions of current and lines of force. According to the rule: *the direction of the current and that of the resulting magnetic force are in the same relation to each other as is the forward travel and rotation of an ordinary corkscrew.* Thus, in the figure, if a current flow through the wire *ab* in the direction from *a* to *b*, the magnetic lines will encircle the wire in the direction of the curved arrow *o* which shows the direction in which the corkscrew must be turned to advance in the direction of the arrow *n*.

it be above or below the needle, and 2, on the direction in which the current flows through the wire.

To keep these movements in mind numerous rules have been suggested, of which the following will be found convenient:

Corkscrew Rule.—*If the direction of travel of a right handed corkscrew represent the direction of the current in a straight conductor, the direction of rotation of the corkscrew will represent the direction of the magnetic lines of force.*

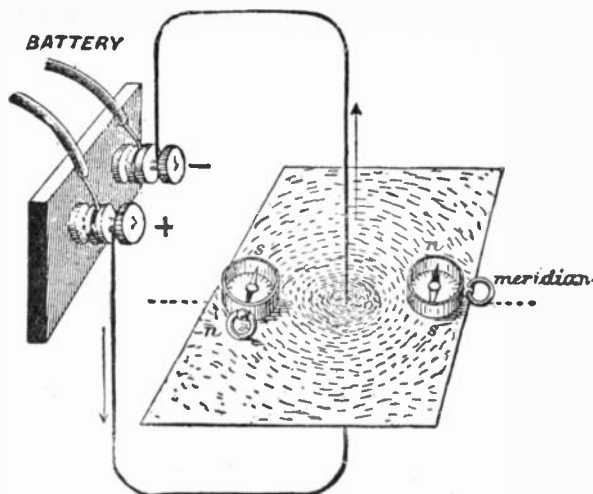

FIG. 113.—Experiment showing direction of lines of force in the magnetic field surrounding a conductor carrying an electric current. A piece of copper wire is pierced through the center of a sheet of cardboard, and carried vertically for two or three feet then bent around to the terminals of a battery or other source of current. If iron filings be sprinkled over the card while the current is passing, they will arrange themselves in circles around the wire, thus indicating the form of the magnetic field surrounding the conductor. Compass needles may also be used to show the direction of the lines of force at any point.

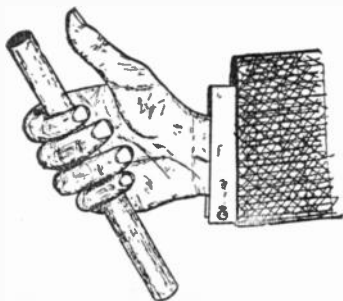

FIG. 114.—Right hand rule to determine the direction of magnetic field around a conductor carrying a current. The thumb of the right hand is placed along the conductor, pointing in the direction in which the current is flowing, then, if the fingers be partly closed, as shown in the illustration, the finger tips will point in the direction of the magnetic whirls.

Ques. What is the effect of a current flowing in a loop of wire?

Ans. If, in figs. 116 and 117, the current flow in the direction indicated by the arrow, the lines for magnetic force are found to surround the loop as shown; all the lines leave on one side of the loop and return on the other; accordingly, a north pole is formed on one side, and a south pole on the other.

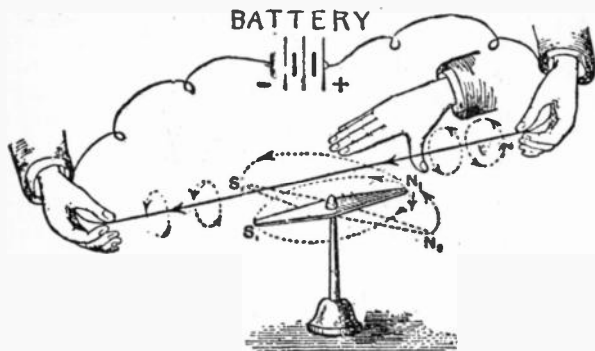

FIG. 115.—Right hand palm rule to determine the direction of the magnetic field around a conductor carrying a current: Place the palm of the outstretched right hand above and to the right side of the wire with the fingers pointing in the direction of the current, and the thumb extended at right angles, that is, pointing downward. The direction in which the thumb points will indicate the direction of the magnetic whirls.

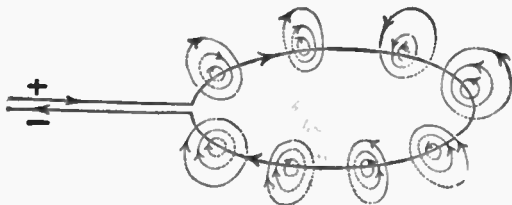

FIG. 116.—Lines of force of a circular loop. If a current flow through the loop in the direction indicated, the lines of force both inside and outside the loop, will cross the plane of the loop at right angles, and all those which cross the loop on the inside will pass through the plane in one direction (downwards in the figure), while all on the outside will return through the plane in the opposite direction.

Solenoids.—A solenoid consists of a spiral of conducting wire wound cylindrically so that, when an electric current passes through it, its turns are nearly equivalent to a succession of parallel circular circuits, and it acquires magnetic properties similar to those of a bar magnet.

Ques. What is the character of the lines of force of a solenoid in which a current is flowing?

Ans. The lines of force must be thought of as closed loops linked with the current. The conductor conveying the current

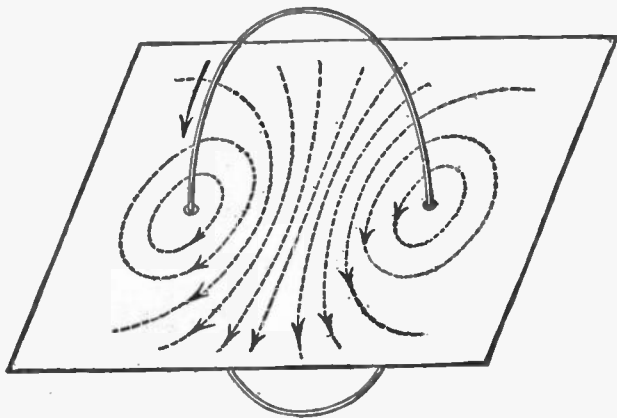

FIG. 117.—Lines of force of a circular loop. If the loop pass through a piece of cardboard at right angles to its plane, and the current flow as indicated, the dotted lines on the cardboard will represent the direction of the lines of force in the plane of the cardboard. The student should verify the lines of force as here given by applying the corkscrew rule.

passes through all the loops of force, and these are, so to speak, threaded or slung on the current line of flow, as in fig. 116.

Ques. What is the distribution of the lines of force?

Ans. The lines of force form continuous closed curves running through the interior of the coil; they issue from one end and enter into the other end of the coil, as shown in fig. 117.

Ques. What are the properties of a solenoid?

Ans. A solenoid has north and south poles, and in fact possesses all the properties of an ordinary permanent magnet, with the important difference that the magnetism is entirely under control.

Since a solenoid carrying a current attracts and repels by its extremities the poles of a magnet, two such solenoids will attract and repel each other.

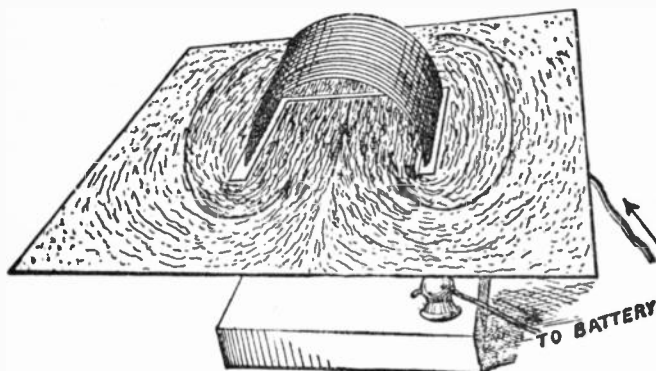

FIG. 118.—Magnetic field of a solenoid. This is best observed by cutting a piece of cardboard and fitting it around the solenoid, as shown. If iron filings be sprinkled on the cardboard and a current passed through the solenoid, the character of the field is indicated. With the current in the direction shown, it will be found that wherever small compass needles are placed, the direction in which their north poles turn is along arrows marked on the card. The card only exhibits the field in one of the sectional planes of the coil, but it is obvious that the field is the same for all sectional planes.

Ques. How does the magnetic strength of a solenoid vary?

Ans. It is proportional to the strength of the electric current passing through it.

Ques. On what, besides the current strength, does the magnetizing power of a solenoid depend?

Ans. The magnetic effect or the magnetizing power is proportional to the number of turns of wire composing the coil.

Ques. How may the magnetizing power of a solenoid be increased?

Ans. By inserting in the solenoid an *iron core* or round bar of soft iron.

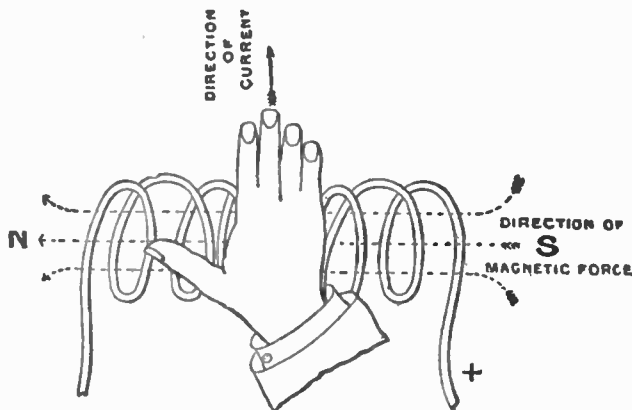
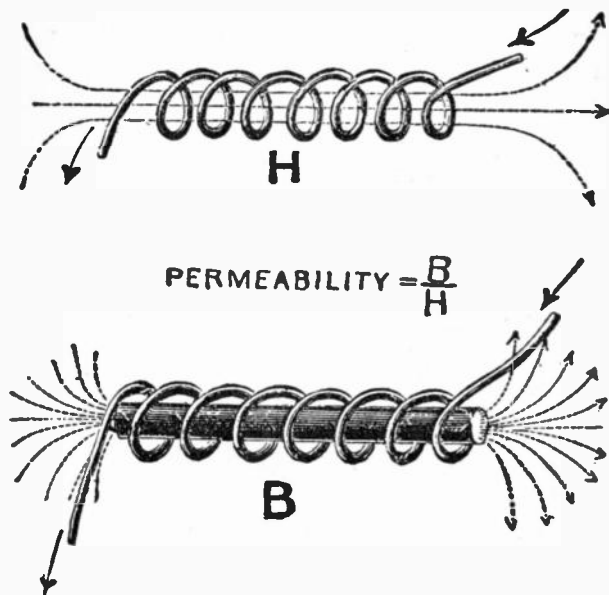

FIG. 119.—Right hand rule for polarity of a solenoid: If the solenoid be grasped in the right hand, so that the fingers point in the direction in which the current is flowing in the wires, the thumb extended will point in the direction of the north pole.

Ques. Describe the action of an iron core.

Ans. At first, the presence of an iron core greatly increases the strength of the field; after a time, however, as the strength of the current flowing in the exciting coils is increased, the *conductibility* of the iron for the lines of force appears to decrease, until a point is eventually reached when the presence of the iron core appears to have no effect in increasing the strength of the field.

Permeability.—Permeability is a measure of the ease with which magnetism passes through any substance. It is defined as: *the ratio between the number of lines of force per unit area passing through a magnetizable substance, and the magnetizing force which produces them.*



Figs. 120 and 121.—Illustrating the effect of introducing an iron core into a solenoid. In the upper figure, the air space or "air core" surrounded by the solenoid offers considerable resistance to the passage of magnetic lines, allowing only a small number to pass through. If a piece of iron be introduced, as in the lower figure, the number of lines will be greatly increased. The number of lines B passing through a unit cross section of the iron core divided by the number of lines H, passing through a unit cross section of the air core is called the *permeability* and designated by the Greek letter μ .

In other words, it is the ratio of flux density to magnetizing force. Permeability is a measure of the ease with which magnetism passes through any substance. The permeability of good soft wrought iron is sometimes 3000 times that of air, varying with the quality of the iron.

Ques. What is the effect of increasing the magnetization?

Ans. The magnetic permeability decreases as the magnetization increases.

Ques. What is magnetic saturation?

Ans. The state of a magnet which has reached the highest degree of magnetization.

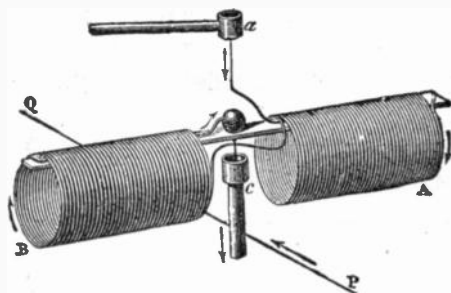

FIG. 122.—Action of currents on solenoids. To demonstrate this fact experimentally, a solenoid is constructed as shown, so that it can be suspended by two pivots in the cups *a* and *c*. The solenoid is then movable about a vertical axis, and if a rectilinear current *QP* be passed beneath it, which at the same time traverses the wires of the solenoid, the latter is seen to turn and set at right angles to the lower current; that is, in such a position that its circuits are parallel to the fixed current; moreover, the current in the lower part of each of the circuits is in the same direction as in the rectilinear wire. If, instead of passing a rectilinear current below the solenoid, it be passed vertically on the side, an attraction or repulsion will take place, according as the two currents in the vertical wire, and in the nearest part of the solenoid, are in the same or in contrary directions.

A magnet, just after being magnetized, will appear to have a higher degree of magnetism than it is able to retain permanently; that is, it will appear to be super-saturated, since it will support a greater weight immediately after being magnetized than it will after its armature has been once removed.

For all practical purposes, magnetic saturation may be defined as: That point of magnetization where *a very large increase in the magnetizing force does not produce any perceptible increase in the magnetization.*

From tests it has been shown that permeability increases with the flux density up to a certain point and then decreases, indicating that the iron is approaching a state of saturation.

Magnetomotive Force.—This is a force similar to electromotive force, that is, magnetic pressure. When a coil passes around a core several times, its magnetizing power, or magnetomotive force, (m.m.f.) is proportional both to the strength of the current and to the number of turns in the coil. The product of the current passing through the coil multiplied by the number of turns composing the coil is called the *ampere turns*.

It is known by experiment that one ampere turn produces 1.2566 units of magnetic pressure, hence:

$$\text{magnetic pressure} = 1.2566 \times \text{turns} \times \text{amperes}$$

that is,

$$\text{magnetomotive force (m.m.f.)} = 1.2566 \times n \times I.$$

The unit of magnetic pressure is the *gilbert* (named after William Gilbert, the English physicist) and is equal to

$$1 \div 1.2566 \text{ ampere turn} = .7958 \text{ ampere turn.}$$

Reluctance.—The magnetic pressure (magnetomotive force) acting in a magnetic circuit encounters a certain opposition to the production of a magnetic field, just as electromotive force in an electric circuit encounters opposition to the production of a current. In the magnetic circuit this opposition is called the *reluctance*; it is simply *magnetic resistance* and may be defined as: *the resistance offered to the magnetic flux by the substance magnetized, being the ratio of the magnetomotive force to the magnetic flux.*

The unit of reluctance or magnetic resistance is the *oersted* (named after Hans Christian Oersted, the Danish physicist) and is defined as: *the reluctance offered by a cubic centimetre of vacuum.*

Analogy Between Electric and Magnetic Circuits.—The total number of magnetic lines of force, or magnetic flux, produced in any magnetic circuit will depend on the magnetic

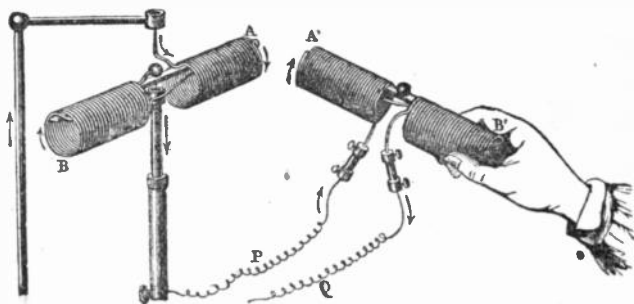

FIG. 123.—Mutual action of solenoids. When two solenoids traversed by a current are allowed to act on each other, one of them being held in the hand and the other being movable about a vertical axis, as shown in the figure, attraction and repulsion will take place just as in the case of two magnets (see figs. 110 and 111).

pressure (m.m.f.) acting on the circuit and the total reluctance of the circuit, just as the current in the electrical circuit depends upon the electrical pressure and the resistance of the circuit.

To make this plain, Ohm's law states that

$$\text{electric current} = \frac{\text{electromotive force}}{\text{resistance}} \text{ or } I = \frac{E}{R}$$

expressed in units

$$\text{amperes} = \frac{\text{volts}}{\text{ohms}}$$

The resistance, as already explained, depends on the materials of which the circuit is composed, and their geometrical shape and size.

Similarly, in the magnetic circuit, the total number of magnetic lines produced by a given magnetizing solenoid depends on the magnetic pressure, the material composing the circuit, and its shape and size.

That is,

$$\text{magnetic flux} = \frac{\text{magnetomotive force}}{\text{reluctance}}$$

expressed in units, the equation becomes:

$$\text{maxwells} = \frac{\text{gilberts}}{\text{oersteds}}$$

The gilbert is the unit of magnetomotive force, equivalent to the magnetomotive force of .7958 ampere turn.

It should be noted that in the electric circuit resistance causes heat to be generated and therefore energy to be wasted, but in the magnetic circuit reluctance does not involve any similar waste of energy.

Ques. Upon what does the reluctance of a magnetic circuit depend?

Ans. The reluctance is directly proportional to the length of the circuit, and inversely proportional to its cross sectional area.

The reluctance of a magnetic circuit is calculated according to the following equation:

$$\text{reluctance} = \frac{\text{length in centimetres}}{\text{permeability} \times \text{cross section in square centimetres}}$$

Hysteresis.—The term hysteresis has been given by Ewing to the subject of *lag of magnetic effects behind their causes*. Hysteresis means to “lag behind,” hence its application to denote the *lagging of magnetism, in a magnetic metal, behind the magnetizing flux which produces it*.

Ques. What is the cause of hysteresis?

Ans. It is due to the friction between the molecules of iron or other magnetic substance which requires an expenditure of energy to change their positions.

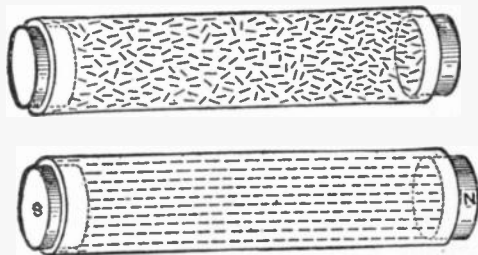

FIGS. 124 and 125.—Experiment illustrating the molecular theory of magnetism. Coarse steel filings are placed inside a small glass tube and the contents magnetized. It will be found that filings which at first had no definite arrangement will rearrange themselves under the influence of magnetic force, and assume symmetrical positions, each one lying in line with, or parallel to its neighbor, as shown in the lower figure.

Ques. When do the molecules change their positions?

Ans. Both in the process of magnetization and demagnetization.

Ques. What becomes of the loss of energy due to hysteresis?

Ans. It is converted into heat in changing the positions of the molecules during magnetization and demagnetization.

Ewing gives the value for the energy in ergs dissipated per cubic centimetre, for a complete cycle of doubly reversed strong magnetization for a number of substances as follows:

Substance	Energy dissipated (ergs)
Very soft annealed iron.....	9,300
Less " " ".....	16,300
Hard drawn steel wire.....	60,000
Annealed " ".....	70,000
Same steel glass hard.....	76,000
Piano steel wire annealed.....	94,000
" " " normal temper.....	116,000
" " " glass hard.....	117,000

Approximately 28 foot pounds of energy are converted into heat in making a double reversal of strong magnetization in a cubic foot of iron.

Residual Magnetism.—When a mass of iron has once been magnetized, it becomes a difficult matter to entirely remove all traces when the magnetizing agent has been removed, and, as a general rule, a small amount of magnetism is permanently retained by the iron. This is known as *residual magnetism*, and it varies in amount with the quality of the iron.

Well annealed, pure wrought iron, as a rule, possesses very little residual magnetism, while, on the other hand, wrought iron, which contains a large percentage of impurities, or which has been subjected to some hardening process, such as hammering, rolling, stamping, etc., and cast iron, possess a very large amount of residual magnetism.

Residual magnetism in iron is of great importance in the working of the *self-exciting* dynamo, and is, indeed, the essential principle of this class of machine.

That is, without residual magnetism in the field magnet core, the dynamo when started would not generate any current unless it received an initial excitation from an external source.

CHAPTER X

ELECTRO-MAGNETIC INDUCTION

The word *induction*, introduced by Faraday, has various meanings so far as it relates to electricity. It signifies, in general, phenomena produced in bodies by the influence of other bodies, having no necessary material connection with them.

A body charged with electricity causes or "induces" charges on neighboring bodies. The process in this case is called *electrostatic induction*.

A magnet induces magnetism in neighboring masses of iron or other magnetic materials by the process of *magnetic induction*.

Again, a moving magnet induces electric currents in neighboring conductors by the process of *electromagnetic induction*.

Faraday's Discovery.—All dynamos of whatever form, are based upon the discovery made by Faraday in 1831, which may be stated as follows:

Electric currents are generated in conductors by moving them in a magnetic field, so as to cut magnetic lines of force.

NOTE.—Faraday's own description of his discovery is as follows: "Two hundred and three feet of copper wire in one length were coiled round a large block of wood; another two hundred and three feet of similar wire were introposed as a spiral between the turns of the first coil, and metallic contact everywhere prevented by twine. One of these helices was connected with a galvanometer, and the other with a battery of one hundred pairs of plates, four inches square, with double coppers, and well charged. When the contact was made there was a sudden and very slight effect at the galvanometer, and there was also a similar slight effect when the contact with the battery was broken."

Ques. What does the expression "cut lines of force" mean?

Ans. A conductor, forming part of an electric circuit, *cuts lines of force* when it moves across a magnetic field in such manner as to *alter* the number of magnetic lines of force which are embraced by the circuit.

It is important to clearly understand the meaning of this expression, which will be later explained in more detail.

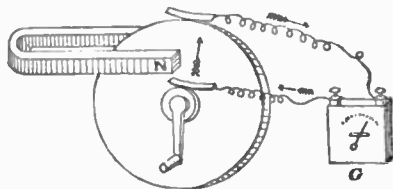

FIG. 126.—Faraday's dynamo which embodies his discovery in 1831 of *electromagnetic induction*, the principle upon which all dynamos work, as well as induction coils, transformers, and other electrical apparatus.

Faraday's Machine.—After various experiments, Faraday made his "new electrical machine" as shown in fig. 126. This piece of apparatus is preserved and was shown in perfect action by Prof. S. P. Thompson in a lecture delivered April 11th, 1891, after an interval of sixty years.

It consists of a horse shoe magnet and a copper disc attached to a shaft and supported so as to turn freely. The magnet is so placed that its inter-polar lines of force traverse the disc from side to side. There are two copper brushes, one bears against the shaft, and the other against the circumference of the disc. A handle serves to rotate the disc in the magnetic field.

Now, if the north pole of the magnet be nearest the observer and the disc be rotated clockwise, the current *induced* in the circuit will flow out at the brush which touches the circumference, and return through the brush at the shaft.

Faraday's Principle.—The principle deduced from Faraday's experiment may be stated as follows:

When a conducting circuit is moved in a magnetic field so as to alter the number of lines of force passing through it, a current is induced therein, in a direction at right angles to the direction of the motion, and at right angles also to the direction of the lines of force, and to the right of the lines of force, as viewed from the point from which the motion originated.

Faraday's principle may be extended as follows to cover all cases of electromagnetic induction:

When a conducting circuit is moved in a magnetic field, so as to alter the number of lines of force passing through it, or when the strength of the field is varied so as to either increase or decrease the number of lines of force passing through the circuit, a current is induced therein which lasts only during the interval of change in the number of lines of force embraced by the circuit.

Ques. Explain just what happens when a current is induced by electromagnetic induction.

Ans. In order to induce an electromotive force by moving a conductor across a uniform magnetic field, it is necessary that the conductor, in its motion, should so cut the magnetic lines as to alter the number of lines of force that pass through the circuit of which the moving conductor forms a part.

Ques. What is the proper name for a "conductor" which moves across the magnetic field?

Ans. An *inductor*, because it is that part of the electric circuit in which induction takes place.

In the case of a dynamo, an inductor may be either a copper wire or copper bar.

Ques. How may a conducting circuit be moved across a magnetic field without having a current induced therein?

Ans. If a conducting circuit—a wire ring or single coil, for example—be moved in a uniform magnetic field, as shown in fig. 127, so that only the same number of lines of force pass through it, no current will be generated, for since the coil is moved by a motion of translation to another part of the field, as many lines of force will be left behind as are gained in advancing from its first to its second position.

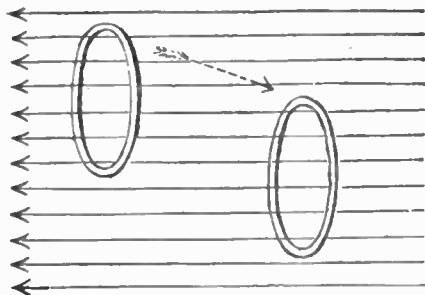

FIG. 127.—Electromagnetic induction: In order to induce a current by electromagnetic induction, a conductor must be so moved through a magnetic field that the number of lines of force passing through it (that is, embraced) are altered. If a coil be given a simple motion of translation in a uniform magnetic field as indicated in the figure, no current will be induced because the number of lines of force passing through it are not changed, that is, during the movement as many lines are lost as are gained.

Ques. Describe another movement by which no current will be induced.

Ans. If the coil be merely rotated on itself around a central axis, that is, like a fly wheel rotating around a shaft, the number of lines of force passing through the coil will not be altered, hence no current will be generated.

Ques. State the essential condition for current induction in a uniform field.

Ans. The coil in which a current is to be induced, must be tilted in its motion across the uniform field, or rotated around any axis in its plane as in fig. 128, so as to alter the number of lines of force which pass through it.

Ques. In what direction will the current flow in the coil, fig. 128?

Ans. The current induced in the coil will flow around it in a clockwise direction (as observed by looking along the magnetic

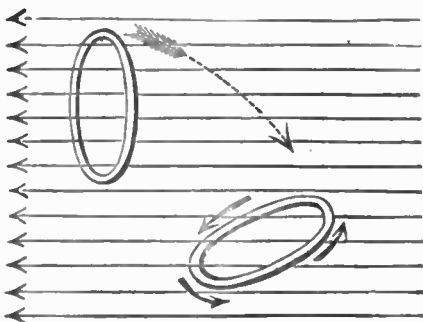

FIG. 128.—Electromagnetic induction: If a coil be given a motion of rotation from any point within its own plane so that it passes through a uniform magnetic field, a current will be induced in the coil because the number of lines of force passing through it is altered.

field in the direction in which the magnetic lines run) if the effect of the movement be to diminish the number of lines of force that pass through the coil. The current will flow in the opposite direction, (counter-clockwise) if the movement be such as to increase the number of intercepted lines of force.

Ques. If the magnetic field be not uniform, as in fig. 129, what will be the result?

Ans. The effect of moving the coil by a simple motion of translation from a dense region of the field to one less dense, or

vice versa, will be to induce a current because in either case, the number of lines of force passing through the coil is altered.*

Laws of Electro-magnetic Induction.—There are certain laws of electro-magnetic induction which, on account of the importance of the subject, it is well to carefully consider. The facts presented in the preceding paragraphs are embodied in the following fundamental laws:

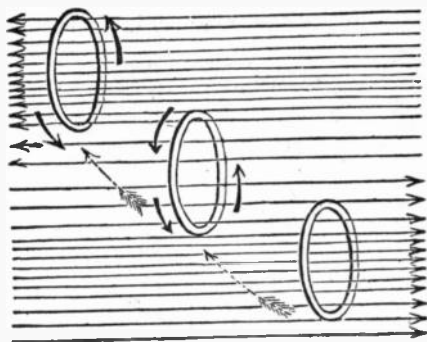

FIG. 129.—Electromagnetic Induction: If a coil be given a simple motion of translation in a non-uniform or variable magnetic field, a current will be induced in the coil, whether the motion be from the dense to the less dense region of the field or the reverse, because the number of lines of force passing through the coil is altered.

1. To induce a current in a circuit, there must be a relative motion between the circuit and a magnetic field, of such a kind as to alter the number of magnetic lines embraced in the circuit.

2. The electromotive force induced in a circuit is proportional to the rate of increase or decrease in the number of magnetic lines embraced by the circuit.

* NOTE.—In reality it would be impossible to have a magnetic field exactly like fig. 129, for in the less dense part, the magnetic lines would be of curved complex form.

For instance, if n equal the number of magnetic lines embraced by the circuit at the beginning of the movement, and n' the number embraced after a very short interval of time t , then

$$\text{the average induced electromotive force} = \frac{n - n'}{t}$$

It would require the cutting of 100,000,000 lines per second to produce an electromotive force equal to that of one Daniell cell.

The unit of electromotive force, called the *volt*, is the electric pressure produced by cutting 100,000,000 lines per second, usually expressed 10^8 .

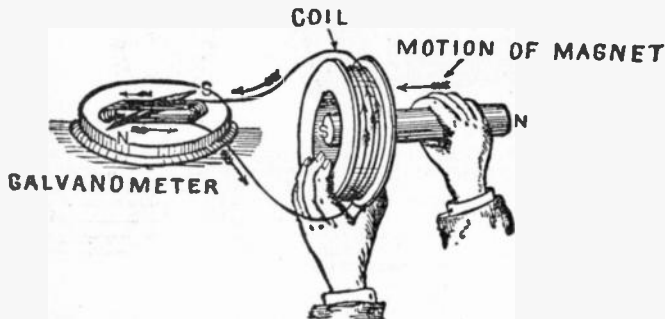

FIG. 130.—Experiment illustrating Lenz's law which states that in all cases of electromagnetic induction, the direction of the induced current is such as to tend to stop the motion producing it. In the experiment, in order to produce the induced current, energy must be expended in bringing the magnet to the coil and in taking it away, which is in accordance with the law of conservation of energy.

3. By joining in series a number of conductors or coils moving in a magnetic field, the electromotive forces in the separate parts are added together.

The reason for this is apparent by considering a coil of wire having several turns and moving in a magnetic field so as to cut magnetic lines. During the movement, the lines cut by the first turn are successively cut by all the other turns of the coil, hence, the total number of lines cut is equal to the number cut by a single turn multiplied by the number of turns. The electromotive forces therefore of the separate turns are added.

EXAMPLE:—If a coil of wire of 50 turns cut 100,000 lines in $\frac{1}{10}$ of a second, what will be the induced voltage?

The number of lines cut per second per turn of the coil is
 $100,000 \times 100 = 10,000,000.$

The total number of lines cut by the coil of 50 turns is
 $10,000,000 \times 50 = 500,000,000.$

which will induce a pressure of

$$500,000,000 \div 10^8 = 5 \text{ volts.}$$

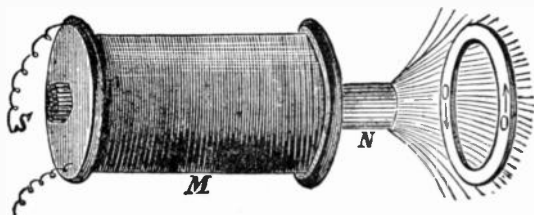

FIG. 131.—Experiment illustrating Lenz's law. If a copper ring be held in front of an ordinary electromagnet, and the current circulating through the coil of the magnet be in such a direction as to magnetize the core as indicated by the letters S N, then as the current increases in the coil more and more of the lines of force proceeding from N pass through the ring O O from left to right. While the field is thus increasing currents will be induced in the copper ring in the direction indicated by the arrows, such currents tending to set up a field that would pass through the ring from right to left, and would therefore *retard* the growth of the field due to the electromagnet M.

4. *A decrease in the number of magnetic lines which pass through a circuit induces a current around the circuit in the positive direction.*

The term positive direction is understood to be the direction along which a free N pole would tend to move.

5. *An increase in the number of magnetic lines which pass through a circuit induces a current in the negative direction around the circuit.*

The reason for the change of direction of the current for decrease or increase in the number of lines cut, as stated in the fourth and fifth laws, will be seen by aid of the formula given under the second law, viz:

$$\text{electromotive force} = \frac{n - n'}{\dots\dots\dots} \dots\dots\dots (1)$$

but by Ohm's law

$$\text{current} = \frac{\text{electromotive force}}{\text{resistance}} \text{ or, } I = \frac{E}{R} \dots\dots\dots(2)$$

Substituting (1) in (2)

$$\text{current} = \frac{\frac{n - n'}{t}}{R} \text{ or, } \frac{n - n'}{Rt} \dots\dots\dots(3)$$

RIGHT HAND

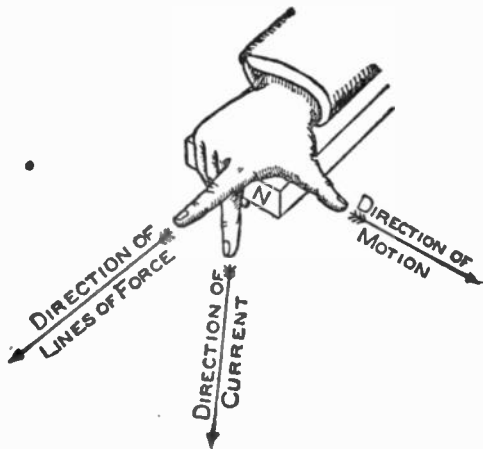

FIG. 132.—Fleming's rule for direction of induced current. Extend the thumb, forefinger and middle finger of the right hand so that each will be at right angles to the other two. Place the hand in such position that the thumb will point in the direction in which the conductor moves, the forefinger in the direction of the lines of force (N to S), then will the middle finger point in the direction in which the induced current flows.

Now in equation (3) if there be a *decrease* in the number of lines cut n' will be less than n hence the current will be positive (+); again, if the lines *increase* n' will be greater than n , which will give a minus value, that is, the current will be negative or in a reverse direction.

VI. *The approach and recession of a conductor from a magnet pole will yield currents alternating in direction.*

Since the strength of the field depends on the proximity to the pole, the approach and recession of a conductor involve an *increase* and *decrease* in the rate of cutting of magnetic lines, hence a reversal of current.

7. *The more rapid the motion, the higher will be the induced electromotive force.*

In other words, the greater the number of lines cut per unit of time, the higher will be the voltage.

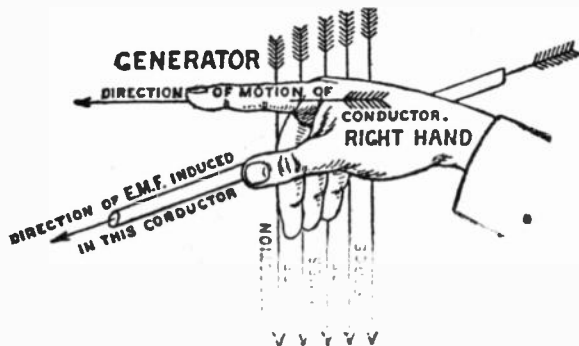

FIG. 133.—A rule for direction of induced current which, in some cases, is more conveniently applied than Fleming's rule: Hold the thumb, forefinger and remaining fingers of the right hand at right angles to each other; place the hand in such position that the forefinger points in the direction of motion of the conductor, the three fingers in the direction of the lines of force, then will the thumb point in the direction of the induced current.

8. *Lenz's law. The direction of the induced current is always such that its magnetic field opposes the motion which produces it.*

This is illustrated in figs. 130 and 131.

Rules for Direction of Induced Current.—There are a number of rules to quickly determine the direction of an induced current when the direction of the lines of force, and motion of the conductor are known. The first rule here given was devised by Fleming and is very useful. It is sometimes called the "dynamo rule."

Fleming's Rule.—*If the forefinger of the right hand be pointed in the direction of the magnetic lines, and the thumb (at right angles to the forefinger) be turned in the direction of the motion of the conductor, then will the middle finger, bent at right angles to both thumb and forefinger, show the direction of the induced current.*

The application of this rule is shown in fig. 132. Here the right hand is so placed at the north pole of a magnet, that the forefinger points in the direction of the magnetic lines; the thumb in the direction of motion of the conductor; the middle finger pointed at right angles to the thumb and forefinger indicates the direction of the current induced in the conductor.

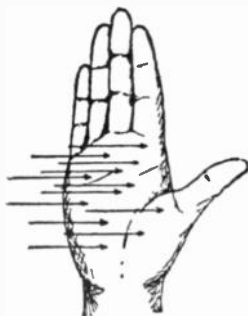

FIG. 134.—The palm rule for direction of induced current: If the palm of the right hand be held against the direction of the lines of force, the thumb in the direction of the motion, then the fingers will point in the direction of the induced current.

Ampere's Rule.—*If a man could swim in a conductor with the current, then the north seeking (+) pole of a magnetic needle placed directly ahead of him, will be deflected to the left, while the south seeking (−) pole will be urged to the right.*

For certain particular cases in which a fixed magnet pole acts on a movable circuit, the following converse to Ampere's rule will be found useful: If a man swim in the wire with the current, and turn so as to look along the direction of the lines of force of the pole (that is, as the lines of force run, from the pole if it be north seeking, toward the pole if it be south seeking), then he and the conducting wire with him will be urged toward his left.

The palm rule.—*If the palm of the right hand be held facing or against the lines of force, and the thumb in the direction of the motion, then will the fingers point in the direction of the induced current.*

Self-induction.—This term signifies *the property of an electric current by virtue of which it tends to resist any change of value.* Self-induction is sometimes spoken of as *electromagnetic inertia*, and is analogous to the mechanical inertia of matter.

It is on account of self-induction of the induced currents in the armature winding of a dynamo, that sparks appear at the brushes when the latter are not properly adjusted, hence the importance of clearly understanding the nature of this peculiar property of the current.

Self-induction is fully explained in the chapter following.

CHAPTER XI

INDUCTION COILS

The induction coil has always been a popular piece of apparatus with those interested in electrical science; the experiments which can be performed with its aid are very numerous. It is of considerable importance, especially in its application to such useful purposes as X ray work, wireless telegraphy and *ignition* for gas engines. The latter has caused manufacturers to give much attention to the development of the induction coil, resulting in many refinements of design and construction.

Induction coils may be divided into two general classes:

1. Primary coils;
2. Secondary coils.

The subject of electromagnetic induction has been fully explained in chapter X, but it may be said, with special reference to induction coils, that the operation of the two classes just mentioned is respectively due to:

1. Self-induction;
2. Mutual induction.

Self-induction.—This is the property of an electric current by virtue of which *it tends to resist any change in its rate of flow*. It is sometimes spoken of as *electromagnetic inertia* and is analogous to the mechanical inertia of matter.

Self-induction is due to the action of the current upon itself during variations in strength. It becomes especially marked in a coil of wire, in which the adjacent turns act inductively upon each other upon the principle of *mutual induction* arising between two separate adjacent circuits. Self-induction manifests itself by giving "momentum" to the current so that *it cannot be instantly stopped when the circuit is broken*, the result being a bright

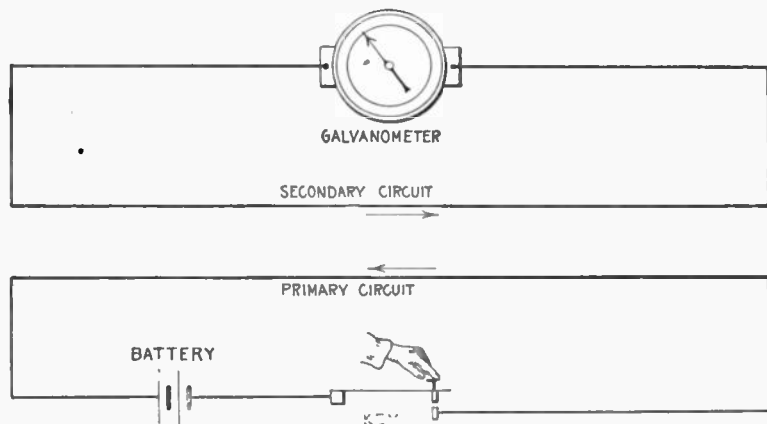

FIG. 135.—Diagram illustrating the action of mutual induction between two circuits; the one including a source of electrical energy and a switch; the other including a galvanometer, but having no cell or other electrical source. During the increase or decrease in the strength of the current as on closing or opening the key a current is *induced* in the secondary circuit in a direction opposite to that of the primary current as indicated by the arrows.

spark at the moment of breaking the circuit. On account of this spark a primary induction coil is used in low tension or "make and break" ignition systems.

In a single circuit, consisting of a straight wire and a parallel return wire there is little or no self-induction. When a circuit containing a primary induction coil and a battery is closed there is no spark because at the instant of closing the circuit the current is at rest and on account of self-induction *the current cannot at once rise to its full value.*

Mutual Induction.—This is a particular case of electromagnetic induction in which the magnetic field producing an electromotive force in a circuit is due to the current in a neighboring circuit.

The effect of mutual induction may be explained with the aid of fig. 135. If, as illustrated, a circuit including a battery and a switch, be placed near another circuit, formed by connecting the two terminals of a galvanometer by a wire, it will be found that whenever the first circuit, 1, is closed by the switch, allowing a current to pass in a given direction, a momentary current will be induced in the second circuit, 2, as shown by the galvanometer. A similar result will follow on the opening of the battery circuit, the difference being that the momentary induced current occurring at closure moves in a direction opposite to that in the battery circuit, while the momentary current at opening moves in the same direction.

Currents, besides being induced in circuit 2 at *make* or *break* of circuit 1, are also induced when the current in 1 is fluctuating in intensity.

The most marked results are observed when the make or break is sudden, *the action being strongest at the break of the current in 1.*

The inductive effect of the current in the arrangement shown in fig. 135 is very weak.

Ques. What name is given to circuit 1?

Ans. The *primary circuit.*

Ques. What name is given to circuit 2?

Ans. The *secondary circuit.*

Ques. What names are given respectively to the currents in circuits 1 and 2?

Ans. The *primary* and *secondary* or *induced currents*

Primary Induction Coils.—These represent the simplest form of coil, and are used chiefly in low tension ignition to intensify the spark when a battery forms the current source.

A primary coil consists of a long iron core wound with a considerable length of low resistance insulated copper wire, the length of the core and the number of turns of the insulated wire winding determining the efficiency. The effect of the iron core is to increase the self-induction.

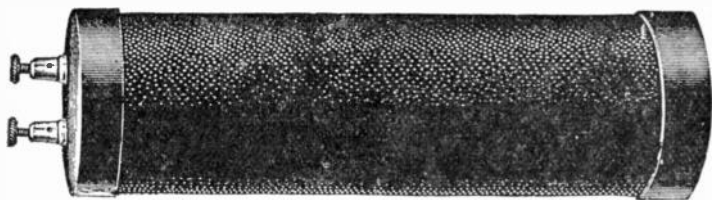

FIG. 136.—Primary induction coil as used for low tension ignition. Coils of this type are made in a great variety of form and size. Ordinarily the winding consists of about six convolutions of No. 14 copper wire. The winding is usually covered and the ends capped with ebonite heads so that the core wires are not exposed.

The spark produced, as previously explained, is due to self-induction, and it should be remembered that in the operation of the coil, the *spark occurs at the instant of breaking the circuit, not at the instant of making.*

Secondary Induction Coils.—The arrangement shown in fig. 137, may be considered as a very simple or rudimentary form of secondary induction coil. In the actual coil, the primary and secondary circuits (corresponding to 1 and 2 in fig. 135) are made up of coils of insulated wire, as shown in fig. 143, the primary coil P, being wound over a core C and the secondary coil S being wound over the primary.

The one property of such an arrangement that makes it of great value for most purposes is that *the voltage of the induced*

currents may be increased or diminished to any extent depending on the relation between the number of turns in the primary and secondary winding.

This relation may be expressed in the following rule:

The voltage of the secondary current is (approximately) to the voltage of the primary current as the number of turns of the secondary winding is to the number of turns of the primary winding.

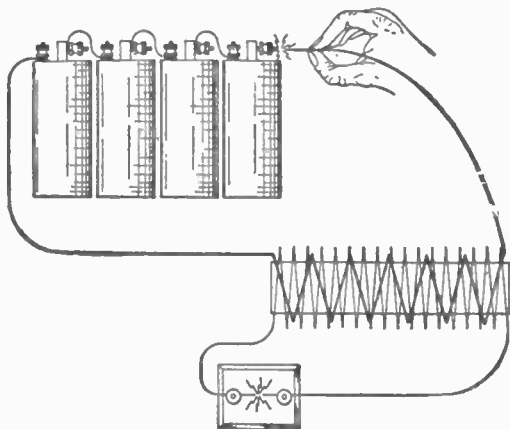

FIG. 137.—Production of spark with plain coil. Connect the ends or leads of the secondary winding to fixed insulators and bend the ends so they are from one-sixteenth to one-eighth inch apart. Connect one end of the primary winding to an electric battery, and with the other lead of the primary winding brush against the other terminal of the battery, as indicated. When the contact is broken there will be a spark both at the point of rupture in the primary circuit and at the gap. An electric impulse is also induced in the secondary circuit when the primary circuit is closed and the current flowing in it gradually rises to its maximum value, but this impulse is too feeble to cause a spark to jump across the gap. Only the impulse induced in the secondary during the dying out of the current in the primary is utilized.

For instance, if the voltage of the primary current be 5 volts, the primary winding have 10 turns and the secondary 100 turns, then

Secondary voltage: 5 :: 100 : 10
from which

Secondary voltage = 50 volts (approximately)

The watts in each circuit are approximately the same; hence: it, for instance, the current strength in the primary circuit be 5 amperes, the watts in primary circuit are $5 \times 5 = 25$. Accordingly, for the secondary circuit the current strength is:

$$25 \text{ watts} \div 50 \text{ volts} = \frac{1}{2} \text{ ampere (approximately)}$$

From this, it is seen that where the voltage is raised in the secondary circuit, the current flow is small as compared to that in the primary circuit; therefore, heavy wire is used in the primary winding and fine wire in the secondary, as indicated in figs. 137 and 143.

For most purposes a very much higher secondary voltage is required than in the example just given.

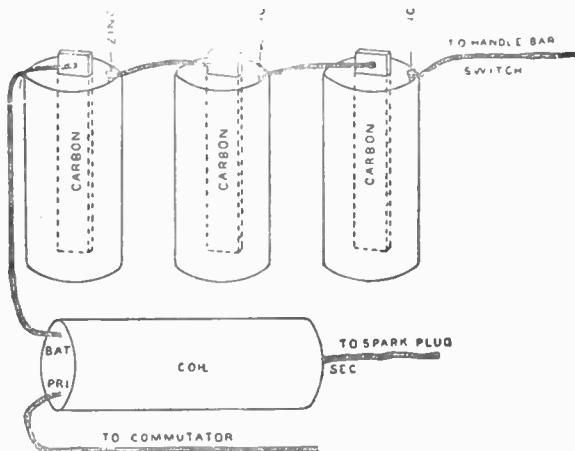

FIG. 138.—Diagram of battery and coil connections for jump spark ignition as applied to a motor cycle. Coils are usually plainly labeled with the abbreviations: "Bat.," "Pri.," "Sec.," indicating that the wires are to be connected to the battery, the primary circuit or contact maker, and the spark plug. The battery and primary wires being for the low tension circuit are easily distinguished from the secondary wire by the small amount of insulation surrounding them.

Secondary induction coils may be divided into three general classes:

1. Plain coils;
2. Condenser coils.
3. Vibrator coils;

The plain coil gives but one spark when the primary circuit is made and broken, while the vibrator coil gives a series of sparks following each other in rapid succession.

Plain Secondary Induction Coils.—Coils of this class are very simple and consist of:

1. Core;
2. Primary winding;
3. Secondary winding.

The construction of a plain coil, such as would be suitable for ignition service, is about as follows:

The core is made of soft annealed iron wires (No. 20 B and S gauge) from one-half to three-quarters of an inch in diameter and about six inches long. Over this core is slipped a spool of insulating material (hard rubber or composition), on which is wound first the primary winding of the coil, which consists of several layers of about No. 18 B and S gauge silk insulated magnet wire.

After the *primary winding* has been wound over the insulated core, and the ends have been properly brought out through the heads of the spool to be connected to binding posts thereon, a layer of insulating material is applied over the primary wire, and the secondary winding is then wound on.

The wire for the secondary winding consists of about No. 36 B and S gauge silk covered magnet wire, the amount used varying considerably, depending on the desired voltage of the secondary current.

When all the wire has been wound on, the ends are brought out to the binding posts, the coil is soaked in shellac dissolved in alcohol and baked, or in melted paraffin or a paraffin compound, and allowed to cool. It is then placed in either a cylindrical hard rubber shell or in a hard wood box.

The proportions of such coils vary greatly; for motor cycle use they are made long and of small diameter (10x2½ inches for instance), while for some other purposes short and thick coils are found more convenient,

Ques. How may the coil just described be connected for demonstrating purposes?

Ans. Connect the ends of the secondary winding to fixed insulators and bend the ends so they are about ⅛ inch or less

apart. Connect one end of the primary winding to a battery and brush the other end of the primary winding against the other terminal of the battery as indicated in fig. 137.

Ques. What happens when the primary circuit is made?

Ans. An electric pressure is induced in the secondary circuit, but of not enough intensity to cause a spark to jump across the air gap.

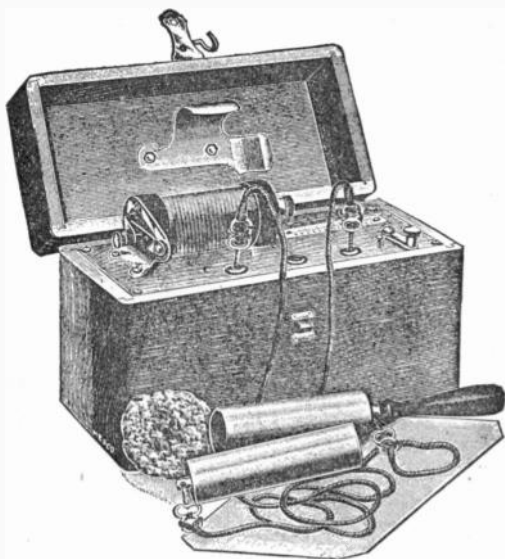

FIG. 139.—A Medical coil with armature and attachments consisting of electrodes, foot place, sponge, induction coil etc. A current of any degree of intensity may be obtained. The currents furnished are: 1, primary, 2, secondary; and 3, primary and secondary combined.

Ques. What happens when the primary circuit is suddenly broken?

Ans. A spark is produced both at the point of break in the primary circuit and at the air gap in the secondary circuit.

Ques. Why is a spark produced at the air gap at break and not at make of the primary current?

Ans. Because when the current is flowing it cannot be stopped instantly on account of self induction, that is, it acts as though it possessed weight.

If the reader has charge of a gas engine with a make and break ignition system, he will often avoid vexatious delays in locating ignition troubles, if he remember that one of the most important conditions for obtaining a good spark is that the *break take place with great rapidity*. This, of course, involves that the ignition spring be adjusted to the proper tension.

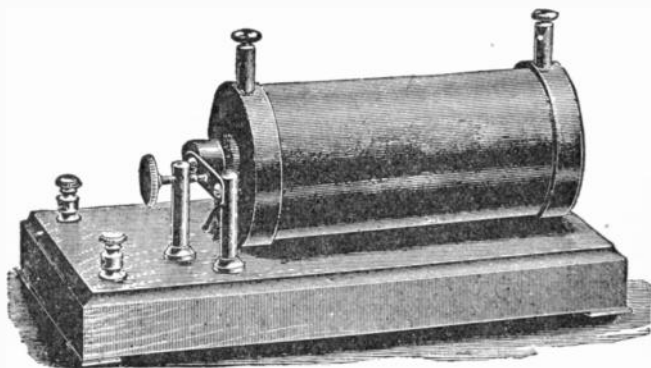

FIG. 140.—Rhumkorff induction coil. A secondary coil with vibrator and condenser; a type generally used in the laboratory. The name Rhumkorff was formerly very widely applied to induction coils for the reason that some of the earliest coils were constructed by Rhumkorff.

Secondary Induction Coils with Vibrator and Condenser.—A plain secondary coil, such as just described, will only give feeble sparks for its size for the following reasons: The inductive effect of the primary winding in the secondary depends as previously explained on the rate at which the current in the primary winding decreases or dies out.

If a strong inductive effect is to be produced in the secondary, the current in the primary must stop suddenly. This is prevented by self-induction in the primary winding, which opposes any change in the current strength. The direct result is that, as the primary circuit is broken, a spark appears at the break, which means that the current continues to flow after the break has occurred, dying down comparatively slowly, hence, the inductive effect on the secondary winding is small.

The spark at the break in the primary circuit is even larger than that in the secondary circuit, and as this primary spark



FIG. 141.—Conventional diagram of a condenser. A condenser is a device designed to absorb or hold an electric charge in about the same manner as a vessel will hold a liquid. Every conductor of electricity forms a condenser and its capacity for holding a charge depends upon the extent of its surface. A condenser is therefore made of conductive material formed into such shape as to present the maximum surface for a given amount of material.

serves no useful purpose, but, on the contrary, quickly burns away the contact points, such an arrangement is obviously defective.

The vibrator-condenser coil is designed to overcome this trouble and also to give a series of sparks following in rapid succession instead of one.

It should be noted that a series of sparks following each other with considerable rapidity may be obtained with a plain coil by placing a *mechanical vibrator* in the primary circuit, as used on some motor cycle ignition circuits.

The object of the vibrator, of a vibrator-condenser coil, is to rapidly make and break the primary circuit during the time the

primary circuit is closed externally. It consists of a flat steel spring secured at one end, with the other free to vibrate. At a point about midway between its ends, contact is made with the point of an adjusting screw, from which it springs away and returns in vibrating. The points of contact of blade and screw are tipped with platinum. One wire of the primary circuit is connected to the blade and the other to the screw, hence, the circuit is made when the blade is in contact with the screw and broken when it springs away.

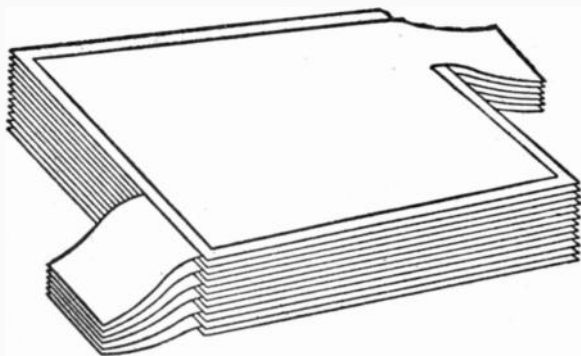

FIG. 142.—Construction of condenser for an induction coil. The conducting material used is tinfoil, of which a large number of sheets are prepared, all cut to the same size. These are placed, one on top of the other, like the pages of a book, with a thin layer of insulating material between, usually two sheets of paraffined paper. Numbering the successive sheets of tinfoil serially, all sheets of even number are connected together and all sheets of odd number are connected together, these connections forming the terminals of the condenser. The condenser is then connected across the break in the primary circuit.

A condenser is used to absorb the self-induced current of the primary winding and thus prevent it opposing the rapid fall of the primary current.

Every conductor of electricity forms a condenser and its capacity for absorbing a charge depends upon the extent of its surface. Hence, a condenser is constructed of conductive material so arranged as to present the greatest surface for a given amount of material.

The usual form of condenser for induction coils as shown in figs. 141 and 142 is composed of a number of layers of tin foil separated by paraffin paper, each alternate layer being connected at the ends.

Fig. 143 is a diagram of a vibrator coil, CC represents the core composed of soft iron wires. PP is the primary winding and SS the secondary. There is no connection between these

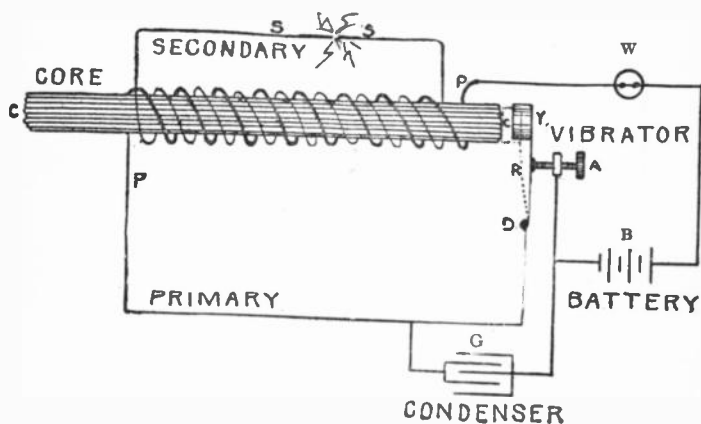

FIG. 143.—Diagram of a vibrator coil. The parts are as follows: A, contact screw; B, battery; C, core; D, vibrator terminal; G, condenser; P, primary winding; S, secondary winding; W, switch; Y, vibrator. When the switch is closed, the following cycle of actions take place: 1, the primary current flows and magnetizes core; 2, magnetized core attracts the vibrator and breaks primary circuit; 3, the magnetism vanishes, including a momentary high tension current in the secondary winding; 4, magnetic attraction of the core having ceased, vibrator spring renews contact; 5, primary circuit is again completed and the cycle begins anew.

windings and they are carefully insulated. Y is the vibrator or *trembler* and D the center about which it vibrates. W is a switch used for opening and closing the primary circuit; B, a battery of five cells. The point of adjusting screw A rests against a platinum point R soldered upon the vibrator.

If the switch *W* be closed, the electric current generated by the battery *B* will flow through the primary winding. This will cause the core *CC* to become magnetized, and the vibrator *Y* will at once be drawn toward it. This will break the connection at *R*. The core, being made of soft iron, immediately upon the interruption of the current, will again lose its magnetism, and

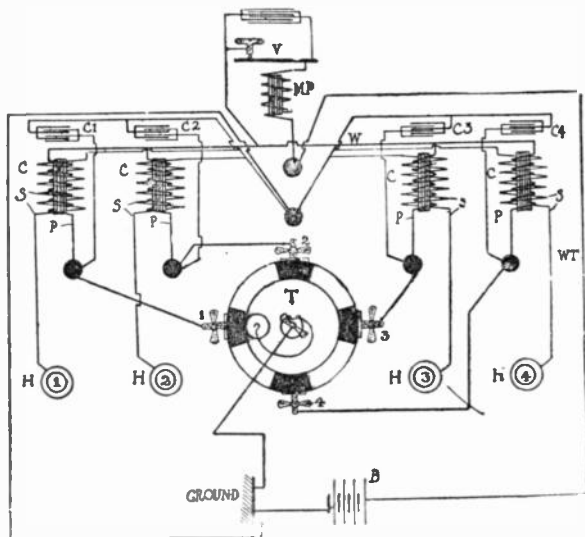

FIG. 144.—Circuit diagram of a master vibrator coil. *B*, is the battery; *C*, the unit coils; *C*1, *C*2, etc., the condensers; *P*, the primary windings and *S*, the secondary windings; *H*1, *H*2, etc., the spark plugs; *T*, the timer; *MP*, the master primary; *V*, the vibrator; *W*, the common primary connection; 1, 2, etc., the stationary contacts of the timer.

the vibrator will return to its original position. This again closes the circuit, after which the operation of opening and closing it is repeated with great rapidity so long as the switch *W* remains closed.

The cycle of actions may be briefly stated as follows:

1. A primary current flows and magnetizes the core;
2. The magnetized core attracts the vibrator which breaks the primary circuit;
3. The core loses its magnetism and the vibrator springs back to its original position;
4. The vibrator, by returning to its original position, closes the primary circuit and the cycle begins again.

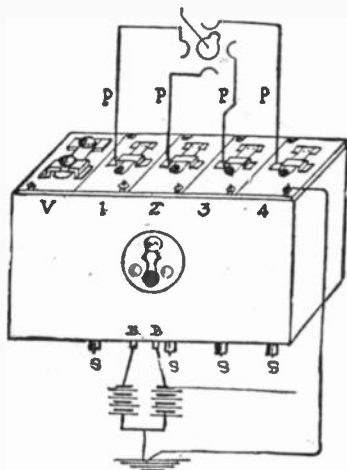

FIG. 145.—The Splittdorf master vibrator coil. As shown in the illustration the several unit coils are indicated by the figures 1, 2, 3, and 4. A fifth unit V at the left contains the master vibrator. The primary wires P connect with the timer and the secondary wires S with the plugs. B B shows the battery connections.

Magnetic Vibrators.—Many types of vibrator are used on induction coils, the most important requirement being that *the break occur with great rapidity*. In order to render the break as sudden as possible, different expedients have been resorted to, all tending to make the mechanism more complicated, yet having sufficient merit in some cases to warrant their adoption.

In the plain vibrator, the circuit is broken at the instant the spring begins to move, hence, the operation must be comparatively slow.

In order to render the break more abrupt some vibrators have two moving parts, one of which is attracted by the magnetic core of the coil and moved a certain distance before the break is effected. A vibrator of this type is shown in fig. 146 and described under the illustration.

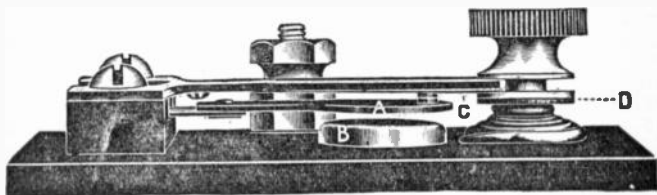

FIG. 146.—A hammer vibrator. When at rest, the upward tension of the spring, which carries the armature A, holds the platinum points in contact and causes the upper spring C, to leave shoulder of adjusting screw D, and rest against the heavy brass plate above it. When the iron core B, attracts the armature A, the downward tension on the upper spring, C, causes the latter to follow the armature down, holding the platinum point in contact, until the end of the upper spring C, strikes the lower shoulder of the adjusting screw, D, which gives it a "hammer break." The adjusting screw is held firmly in position by a bronze spiral spring under shoulder D.

Vibrator Adjustment.—When a vibrator coil is used, the quality of the spark depends largely upon the proper adjustment of the vibrator. The following general instructions for adjusting a plain vibrator should be carefully noted:

1. Remove entirely the contact adjusting screw.
2. See that the surfaces of the contact points are flat, clean and bright.
3. Adjust the vibrator spring so that the hammer or piece of iron on the end of the vibrator spring stands normally about one-sixteenth of an inch from the end of the coil.

4. Adjust the contact screw until it just touches the platinum contact on the vibrator spring—be sure that it touches, but very lightly. Now start the engine; if it miss at all, tighten up, or screw in the contact screw a trifle further—just a trifle at a time, until the engine will run without missing explosions.

TABLE OF INDUCTION COIL DIMENSIONS.

Length of spark.....	$\frac{3}{4}$ inch	$\frac{1}{2}$ inch	1 inch	2 inches
Size of bobbin ends...	$2\frac{1}{4} \times 1\frac{1}{4}$	$2\frac{1}{2} \times \frac{7}{8}$	$3 \times \frac{3}{4}$	$4 \times 2\frac{1}{4} \times \frac{3}{4}$
Length of bobbin.....	4	$5\frac{1}{2}$	$6\frac{1}{2}$	$6\frac{1}{2}$
Length and diameter of core.....	$4\frac{1}{2} \times \frac{7}{8}$	$6 \times \frac{3}{4}$	$6\frac{1}{2} \times \frac{3}{4}$	—
Size of base.....	$7\frac{1}{2} \times 3\frac{1}{2} \times 1\frac{1}{2}$	$9 \times 5 \times 2$	$14\frac{1}{2} \times 6 \times 1\frac{1}{2}$	$12 \times 7\frac{1}{2} \times 3\frac{1}{2}$
Size of tinfoil sheets...	4×2	$5\frac{1}{2} \times 3\frac{1}{4}$	6×4	6×6
Number of tinfoil sheets.....	36	40	40	60
Size of paper sheets...	5×3	$6\frac{1}{2} \times 4\frac{1}{2}$	9×5	—
Primary coil.....	No. 18	No. 18	2 layers No. 16, silk covered.	2 layers 14B. W. G. silk covered.
Secondary coil.....	$\frac{3}{4}$ lb. No. 40	1 lb. No. 40	$1\frac{1}{2}$ lbs. No. 38	$2\frac{1}{2}$ lbs. No. 36.

TABLE OF SPARKING DISTANCES IN AIR.*

Volts.	Distance. (Inches.)	Volts.	Distance. (Inches.)
5000.....	.225	60000.....	4.65
10000.....	.47	70000.....	4.85
20000.....	1.00	80000.....	7.1
30000.....	1.625	100000.....	9.6
35000.....	2.00	130000.....	12.95
45000.....	2.95	150000.....	15.00

Points Relating to Ignition Coils.—1. Most ignition induction coils or "spark coils" as they are called, have terminals marked "battery," "ground," etc., and to short circuit the timer

*NOTE.—These values are correct for effective sinusoidal voltages.

CHAPTER XII

THE DYNAMO

The dynamo is a machine which converts mechanical energy into electrical energy by electromagnetic induction.

The word dynamo is used to designate a machine which produces *direct current* as distinguished from the *alternator* or machine generating an *alternating current*. In a broader sense, the word *generator* is used to denote any machine generating electric current by electromagnetic induction; the term therefore includes both dynamos and alternators.

Operation of a Dynamo.—A dynamo does not create electricity, but generates or produces an *induced electromotive force* which causes a current of electricity to flow through a circuit of conductors in much the same way as a force pump causes a current of water to flow in pipes. The electromotive force generated in the dynamo causes the current of electricity to pass from a lower to a higher potential in the machine, and from the higher back to the lower potential in the external circuit; that is, the dynamo generates electrical pressure which overcomes the *resistance* or opposition to the current flow in the circuit. The pump produces a mechanical pressure which, for instance, may be used to force water into an elevated reservoir against the back pressure due to its weight.

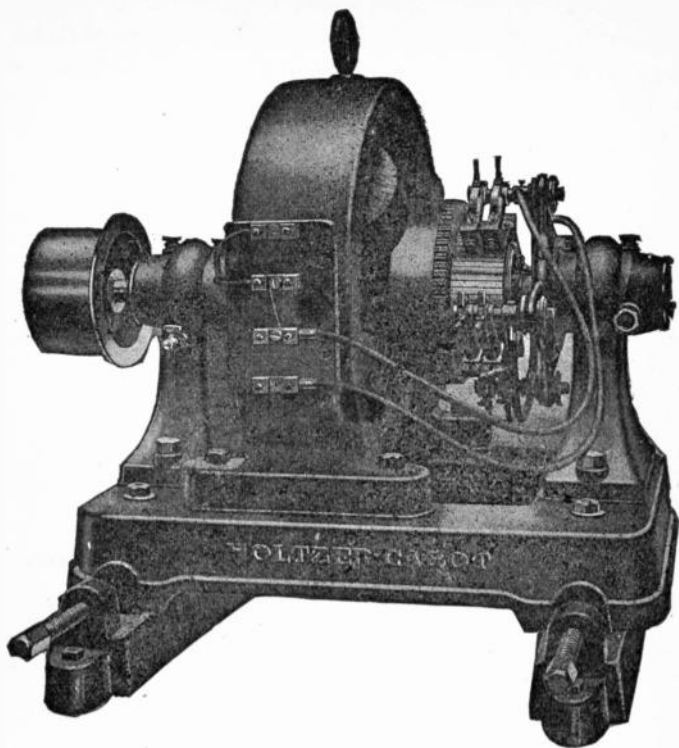

FIG. 162.—Holzer Cabot type "M" dynamo. The design of the base is such that it allows the field ring or frame to drop down, lowering the center of gravity, which gives increased stability. The pedestals are bolted directly to the base. Both front and rear pedestals are removable, so that the armature may be taken out from either end without disturbing the brushes or connections. The journals are provided with oil rings which keep the oil in continual circulation around the shaft by means of oil grooves in the journal. The pole pieces are cylindrical in shape and are fitted with shoes which retain the field coils in place and assist commutation. The field coils are former wound, the insulation being reinforced with mica. They are soaked in varnish and baked for 24 hours at 225° Fahr. The armature is wound as desired, series, shunt or compound. The armature core is of the drum type and is laminated, the discs being held by end plates locked without through bolts. The armature coils are formed of round, ribbon or bar copper, and are without joint except at the commutator; they lie in troughs of insulating material, the upper layers being insulated from the lower layers; they are retained in place by maple wedges secured by binding wires, soldered throughout their length. The commutator segments are drop forged in the smaller, and hard drawn in the larger sizes. Radial brushes are used. The efficiency of this type machine is stated by the maker at from 80% to 90%, according to size.

The point to be emphasized is that *the dynamo does not create electricity (nor the pump water) but sets into motion something already existing by generating sufficient pressure to overcome the opposition to its movement.*

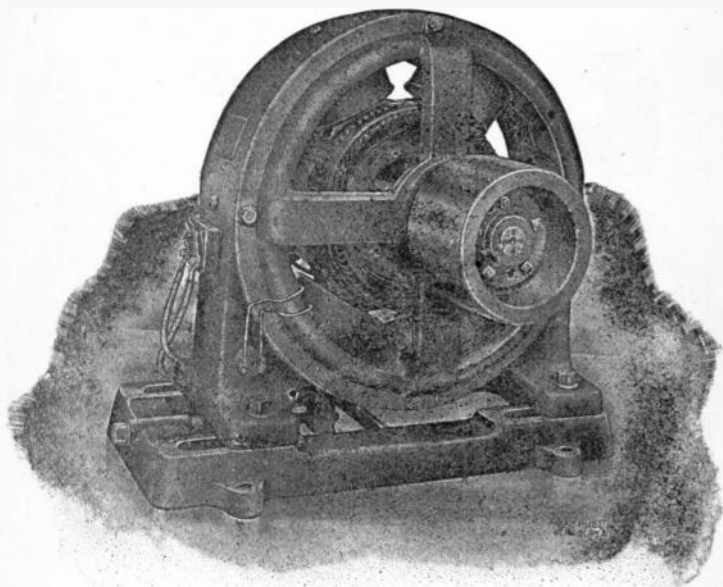

FIG. 163.—General Electric 16 K W multipolar dynamo designed to operate at moderate and slow speeds. The outer structure of the machine consists of a magnet frame having feet in one casting. Adjustment is provided for moving the machine on its bed plate to tighten the belt. The field coils are former wound and the series windings permit of any degree of compounding up to 10% by the use of suitable German silver shunts connected across the series field.

Essential Parts of a Dynamo.—The dynamo in its simplest form consists of two principal parts:

1. The field magnet;
2. The armature.

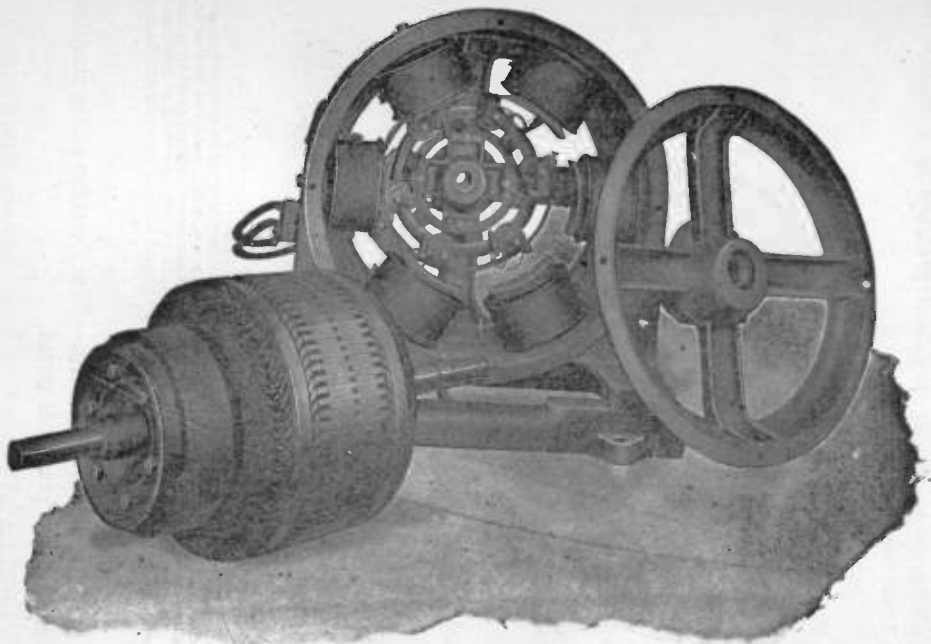

FIG. 164.—General Electric dynamo with end shield and armature removed showing construction. The core of the armature consists of laminations keyed to spider with space blocks inserted at intervals to provide ventilating ducts for cooling the core and windings. The armature is *former wound*—that is, the inductors are bent to the proper shape on a form; they are, therefore, interchangeable.

Ques. What is the object of the field magnet?

Ans. To provide a field of magnetic lines or lines of force to be *cut* by the armature inductors as they revolve in the field.

Ques. What is an armature?

Ans. A collection of *inductors* mounted on a shaft and arranged to rotate in a magnetic field with provision for collecting the currents induced in the inductors.

A simple loop or turn of wire may be considered as the simplest form of armature.

Ques. How do armatures and field magnets differ in dynamos and alternators?

Ans. A characteristic feature is that in the dynamo the field magnet is the stationary part and the armature the rotating part, while in the alternator the reverse conditions usually obtain.

Ques. With respect to this feature, what names are sometimes given to the armature and field magnet?

Ans. The *stator* and the *rotor* depending on which moves.

Ques. What is the real distinction between an armature and a field magnet?

Ans. The name field magnet is properly given to that part which, whether stationary or revolving, *maintains its magnetism steady during operation*; the name armature is properly given to that part which, whether revolving or fixed, *has its magnetism changed in a regularly repeated fashion when the machine is in motion*.

Construction of Dynamos.—In the make up of a dynamo, as actually constructed, there are five principal parts, as follows:

1. Bed plate;
2. Field magnets;
3. Armature;
4. Commutator;
5. Brushes.

CHAPTER XIII

THE DYNAMO: BASIC PRINCIPLES

A dynamo is a machine for converting mechanical energy into electrical energy, by means of electromagnetic induction, the amount of electric energy thus obtained depending upon the mechanical energy originally supplied.

The word dynamo is properly applied to a machine which generates* direct current, as distinguished from the alternator, which generates alternating current.

Ques. Define a dynamo with respect to its principle of operation.

Ans. A dynamo is a machine for filling and emptying conducting loops with magnetic flux, and utilizing the electromotive force thus induced in them for the production of current in the external circuit.

The fitness of this definition is apparent, having in mind the principles of electromagnetic induction.

Ques. What are the three essential parts of a dynamo?

Ans. The field magnet, armature, and commutator.

*NOTE.—It should be understood that a dynamo does not generate electricity, for if it were only the quantity of electricity that is desired, it would be of no use, as the earth may be regarded as a vast reservoir of electricity. However, electricity without pressure is incapable of doing work, hence a dynamo, or so called "generator," is necessary to create an electromotive force by electromagnetic induction in order to cause the current to flow against the resistance of the circuit and do useful work.

Ques. What is the object of the field magnet?

Ans. To provide a magnetic field, through which the conducting loops arranged on a central hub and forming the *armature* are carried, or the flux carried through them, so that they are successively filled and emptied of magnetic lines.

Ques. What is a commutator?

Ans. A device for causing the alternating currents generated in the armature to flow in the same direction in the external circuit.

Ques. Upon what does the voltage depend?

Ans. Upon the *rate* at which each conducting loop is filled and emptied of lines of force and the number of such loops with their grouping or connection.

Ques. How is the operation of a dynamo best explained?

Ans. By considering first the action of the simplest form of current generator, or elementary alternator.

Ques. Describe an elementary alternator.

Ans. It consists, as shown in fig. 165, of a single rectangular loop of wire A B C D, one end being attached to a ring F and the other to the shaft G, and arranged so as to revolve around the axis X X', which is located midway between the two poles of the magnet. Two metallic strips or *brushes* M and S connected with the external circuit, bear on the ring F and shaft G, respectively, in order to "collect" the current generated in the armature when the machine is in operation. The long, straight, horizontal arrows joining the two poles of the magnet, represent

the *lines of force* which make up the magnetic field between the poles. The field is here assumed to be uniform, as indicated by the equal spacing of the arrows.

Ques. What happens when the loop is rotated?

Ans. According to the law of electromagnetic induction, when the loop is rotated around its horizontal axis in the direc-

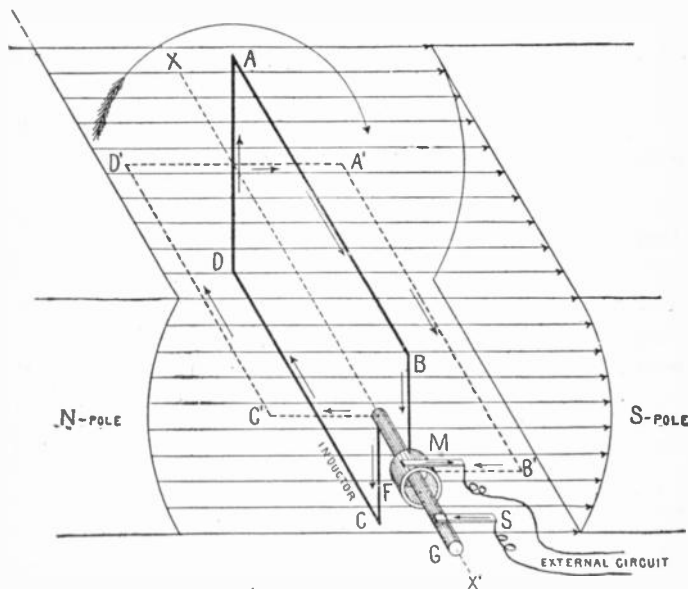

FIG. 165.—Simple elementary alternator. Its parts are a single conducting loop, A B C D, placed between the poles of a permanent magnet, and having its ends connected with a ring, F, and shaft, G, upon which bear brushes M and S, connected with the external circuit. When the loop is rotated clockwise the induced current will flow in the direction indicated by the arrows during the first half of the revolution.

tion indicated by the curved arrow, an electromotive force will be induced in the loop, the magnitude of which depends on the *rate* of change of the number of lines of force threading through, or embraced by the loop.

That is, if the number of lines embraced by the loop be increased from, say, 0 to 1000, or decreased from 1000 to 0, in one second, the electromotive force generated will be two times as great as if the increase or decrease were only 500 lines per second.

Ques. Upon what does the direction of the induced current depend?

Ans. Upon the direction of the lines of force and direction of rotation of the loop.

Ques. How is Fleming's rule applied to determine the direction of current?

Ans. In applying this rule, the horizontal portion of the loop, such as A B or C D (fig. 165), is to be considered as moving up or down; that is, the component of its motion at right angles to the lines of force is taken as the direction of motion. When the loop is in the position A B C D, such that its plane is vertical or perpendicular to the lines of force, the maximum number of magnetic lines thread through it, but when it is in a horizontal position, A' B' C' D', so that its plane is parallel to the lines of force, no lines pass through the loop. During the rotation from position A B C D to A' B' C' D', the number of lines passing through the loop is *reduced* from the maximum to zero, the reduction taking place with *increasing rapidity* as the loop approaches the horizontal position, the electromotive force thus induced *increasing in like proportion*. Continuing the rotation from the horizontal position A' B' C' D' to the inverted vertical position A B C D (fig. 166), the number of lines passing through the loop is increased from zero to the maximum, the increase taking place with *decreasing rapidity* as the loop approaches the inverted vertical position, the electromotive force thus induced *decreasing in like proportion*.

Ques. What occurs during the second half of the revolution?

Ans. The wire A B (fig. 166), which before was moving in a downward direction, moves in an upward direction; hence, the current is reversed and flows around the loop in the direction A D C B (fig. 166), going out through brush S and returning through brush M. This makes M negative and S positive.

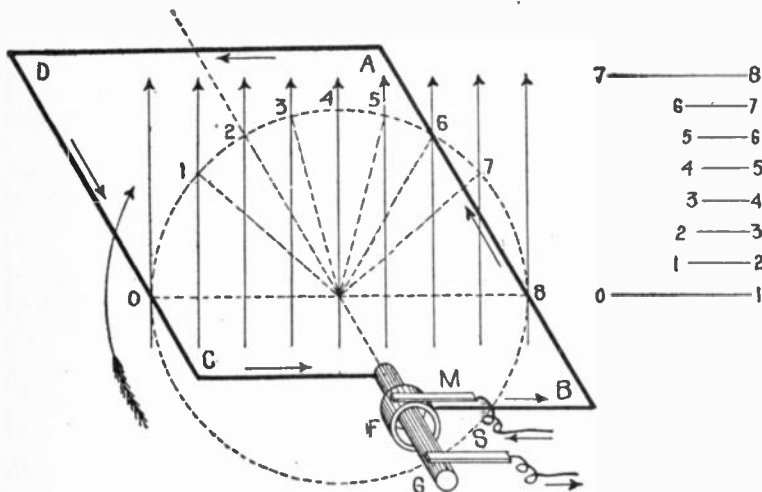

FIG. 167.—Illustrating the increase and decrease in the rate magnetic lines are cut by a revolving loop. The initial position of the loop is taken at right angles to the direction of the lines of force. Since the loop rotates at a constant speed, it is evident that it does not cut the magnetic lines at uniform rate, because the intercepted arcs 0-1, 1-2, etc., are unequal. These arcs, rectified at the right by the horizontal lines 0-1, 1-2, etc., show more clearly the increase and decrease in the rate at which the magnetic lines are cut.

Ques. What may be said of the electromotive force during the second half of the revolution?

Ans. It varies in a similar manner as in the first half of the revolution; that is, the magnetic lines are cut *with increasing rapidity* during the third quarter, and *with decreasing rapidity*

during the fourth quarter of the revolution, which causes the electromotive force to increase and decrease during these intervals.

The cycle of events just described may be summed up as follows: During the revolution of the loop:

1. From 0° to 90° , the electromotive force increases from 0 to maximum;
2. From 90° to 180° , the electromotive force decreases from maximum to zero;
3. From 180° to 270° , current reverses and the electromotive force increases from zero to maximum;
4. From 270° to 360° , the electromotive force decreases from maximum to zero.

It was stated that, during the revolution of the loop, the magnetic lines were cut "with increasing or decreasing rapidity," causing the electromotive force to rise or fall. The reason for this is illustrated in fig. 167. The loop is here shown in a horizontal position at right angles to the direction of the magnetic field; the latter, as indicated by the even spacing of the vertical arrows representing the magnetic lines, is assumed to be uniform.

The wire C D of the loop, as it rotates at *constant speed*, cuts the magnetic lines at the points 0, 1, 2, 3, etc., but the distances 0-1, 1-2, 2-3, etc., between these points, are unequal; that is, the wire C D travels farther in cutting the lines 0 and 1, than it does in cutting 1 and 2, and still less in cutting the lines 2 and 3. After cutting the line 4, which passes through the axis of revolution, the opposite conditions obtain.

If the arcs 0-1, 1-2, etc., of the dotted circle, which are intercepted by the magnetic lines and passed through by the wire, be rectified and laid down under each other, as lines 0-1, 1-2, etc., the time of passage of the wire between successive magnetic lines will vary as the length, since the speed is uniform. Thus the wire in passing from line 0 to line 1, takes much more time than in passing from 1 to 2, as indicated at the left of the figure by 0-1 and 1-2, and still less in passing from 2 to 3; that is, the rate of cutting the lines increases as C D rotates from 0 to 4 and decreases from 4 to 8.

Since similar conditions prevail with respect to A B, for its corresponding movement, it is evident that the number of lines which thread through the loop are *decreased with increasing rapidity* as the loop rotates through the first quarter of a revolution, and *increased with decreasing rapidity* during the second quarter of the revolution. Moreover, it must be evident that the reverse conditions obtain for the third and fourth quarters of the revolution.

The Sine Curve.—In the preceding paragraph it was shown that an alternating current is induced in the armature of either an alternator or dynamo; that is, the current: 1, begins with zero electromotive force, 2, rises to a maximum, 3, decreases again to zero, 4, increases to a maximum in the opposite direction, and 5, decreases to zero.

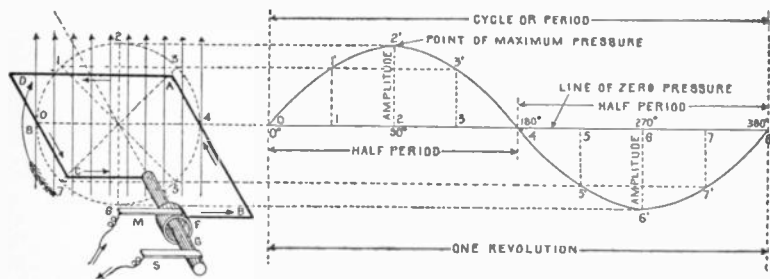

FIG. 168.—Application and construction of the sine curve. The sine curve is a wave-like curve used to represent the changes in strength and direction of an alternating current. An elementary alternator is shown at the left to illustrate the application of the sine curve to the alternating current cycle. It consists of a loop of wire A B C D, whose ends are attached to the ring F and shaft G, being arranged to revolve in a uniform magnetic field indicated by the vertical arrows which represent magnetic lines at equidistances. The alternating current induced in the loop is carried to the external circuit through the brushes M and S. Now, as the loop rotates, the induced electromotive force will vary in such a manner that its intensity at any point of the rotation is proportional to the sine of the angle corresponding to that point, this is represented by the wave-like curve. The mean value of the sine curve, or average electromotive force developed during the revolution, or period, is equal to $2 \div \pi$, or .637 of that of the maximum ordinate, that is, average electromotive force = .637 \times amplitude. The sine curve lies above the horizontal axis during the first half of the revolution and below it during the second half, which indicates that the current flows in one direction for a half revolution and in the opposite direction during the remainder of the revolution.

A wave-like curve, as shown in fig. 168, is used to represent these several changes, in which the horizontal distances represent time, and the vertical distances, the varying values of the electromotive force. It is called the sine curve because a perpendicular at any point to its axis is proportional to the sine of the angle corresponding to that point.

Ques. Describe the construction and application of the sine curve.

Ans. In fig. 168, at the left, is shown an elementary armature in the horizontal position, but at right angles to the magnetic field. The dotted circle indicates the circular path described by A B or C D during the revolution of the loop. Now, as the loop rotates, the induced electromotive force will vary in such a manner that *its intensity at any point of the rotation is proportional to the sine of the angle corresponding to that point.* Hence, on the horizontal line which passes through the center of the dotted circle, take any length, as O8, and divide it into any number of parts representing fractions of a revolution, as 0° , 90° , 180° , etc. Erect perpendiculars at these points, and from the corresponding points on the dotted circle project lines parallel to O8; the intersections with the perpendiculars give points on the sine curve. Thus the loop passes through 2 at the 90° point of its revolution, hence, projecting over to the corresponding perpendicular gives 2 2', a point whose elevation from the axis is proportional to the electromotive force at that point. In like manner other points are obtained, and the curved line through them will represent the variation in the electromotive force for all points of the revolution.

At 90° , the electromotive force is at a maximum; hence, by using a pressure scale such that the length of the perpendicular 2 2' for 90° will measure the maximum voltage the length of the perpendicular at any other point will represent the actual pressure at that point.

The curve lies above the horizontal axis during the first half of the revolution, and below it during the second half, which indicates that the current flows in one direction for a half revolution and in the opposite direction during the remainder of the revolution.

The application of the sine curve to represent the alternating cycle, is further illustrated in figs. 169 to 173, which show the position of the armature at each quarter of the revolution.

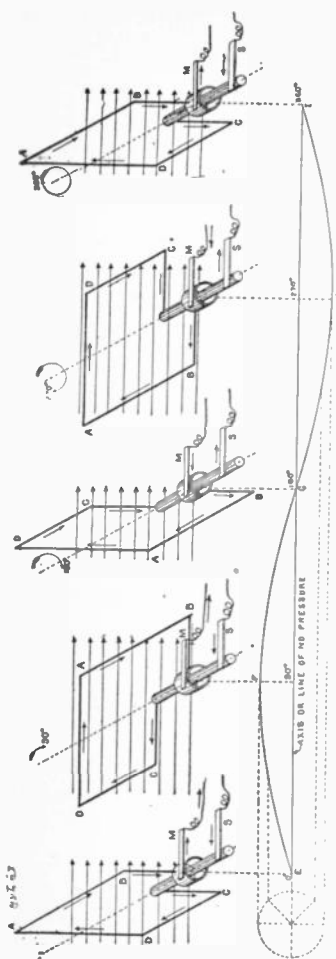

FIG. 169 to 173.—The sine curve, with view of armature for each 90° of the revolution, showing progressively the application of the sine curve to the alternating current cycle.

In fig. 179, the loop A B C D is in the vertical position at the beginning of the revolution. At this instant the electromotive force is zero, hence the sine curve as shown begins at E, the zero point—that is, on the axis or line of no pressure.

As soon as the loop rotates out of the vertical plane, the electromotive force rises and the current begins to flow in the direction indicated by the arrows, going out to the external circuit through brush M, and returning through brush S.

Continuing the rotation, the electromotive force increases in proportion to the sine of the angle made by the plane of the loop with the horizontal, until the loop comes into the horizontal position illustrated in fig. 170. This increase is indicated by the gradual rise of the sine curve from E to F. The loop has now made one quarter of a revolution and the electromotive force reached its maximum value.

As the loop rotates past the horizontal position of fig. 170, the electromotive force gradually decreases in intensity, reaching the zero point at the end of the second quarter—that is, when the loop has turned one half revolution. This is indicated by the gradual fall of the curve from F to G.

When the loop turns out of the vertical position shown in fig. 171 the current reverses, because the movement of A B and C D is reversed; at this instant the brush M becomes negative, and S positive. This reversal of current is indicated by the curve falling below the axis from G to I.

During the second half of the revolution, figs. 171 to 173, the changes that occur are the same as in the first half, with the exception that the current is in the reverse direction; these changes are as shown by the curve from G to I.

CHAPTER XIV

THE DYNAMO: CURRENT COMMUTATION

How the Dynamo Produces Direct Current: The Commutator.—The essential difference between an alternator and a dynamo is that the alternator delivers alternating current to the external circuit while the dynamo delivers direct current. In both machines, as before stated, alternating currents are induced in the armature, but the kind of current delivered to the external circuit depends on the manner in which the armature currents are collected.

In the case of an alternator, the method is quite simple. As previously explained, each end of the loop is connected with an insulated collector ring carried by the shaft, the current being collected by means of brushes which bear against the rings. This principle, rather than the actual construction, is shown in the preceding illustrations. Its important point, as distinguished from other methods of collecting the current, is that *each end of the loop is always in connection with the same brush.*

Ques. How is direct current obtained in a dynamo?

Ans. A form of switch called the *commutator* is placed between the armature and the external circuit and so arranged that it will reverse the connections with the external circuit at the instant of each reversal of current in the armature.

Ques. How is a commutator constructed?

Ans. It consists of a series of copper bars or segments arranged side by side forming a cylinder, and insulated from each other by sheets of mica or other insulating material.

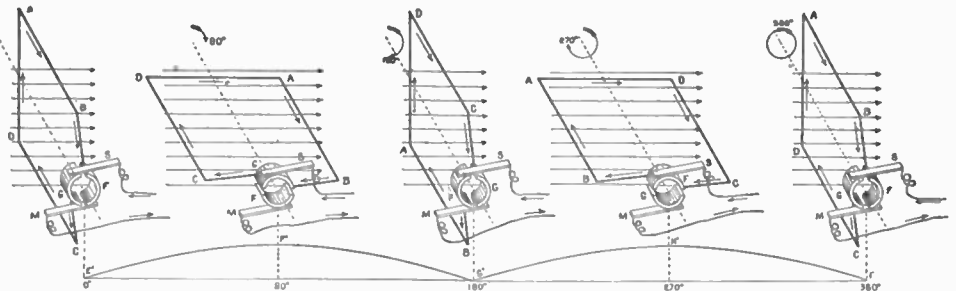

Figs. 174 to 178.—Commutation of the current. These figures show how a dynamo transforms alternating into the so called direct current. During the first half of the revolution the current flows in the direction A B, out through segment F of the commutator and brush M, returning through brush S and segment G, figs. 174 and 175. At the beginning of the second half of the revolution, fig. 176, the current in the armature reverses and flows around the loop in the direction B A. At this instant the brushes M and S pass the gaps between the commutator segments, thus reversing contact with the segments, and causing the current in the external circuit to remain in the same direction.

Ques. Where is the commutator placed?

Ans. It is attached to the shaft at the front end of the armature.

Ques. What are inductors?

Ans. The insulated wires wound on the armature core, and in which the electric current is induced.

Ques. How are the inductors connected to the commutator?

Ans. The ends of each conducting loop or coil must be connected with the commutator segments in a certain order to correspond with the type of winding.

Ques. Explain in detail how direct current is obtained in a dynamo.

Ans. It will be easily seen by the aid of a series of illustrations just how the alternating armature currents are transformed into direct current. Figs. 174 to 178 show, in several positions, a single loop of wire with its ends joined to a commutator; the latter has only two segments, one for each end of the loop. In fig. 174 the loop is shown in the vertical position, and it should be noted that the division between the two segments forming the commutator is in the same plane as the

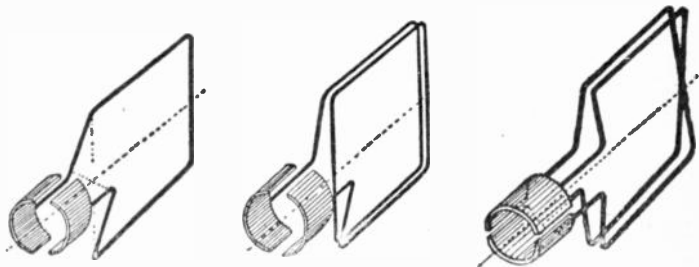

Figs. 179 to 181. Elementary dynamo armatures. Fig. 1, single turn loop; fig. 2, coil of two turns *in series*; fig. 3, coil of two turns *in parallel*. In operation the amplitude or maximum pressure induced with the two turn coil, fig. 180, is double that of a single turn loop, fig. 179. In fig. 180, the pressure is double that induced in fig. 181, while the amount of current generated with series turns, fig. 180, is only half that generated with turns in parallel fig. 181.

loop. When the loop is in the vertical position, as shown in fig. 174, brush M is in contact with segment F, and S with G. As the armature rotates, the current flows for one half revolution in the direction A B, through segment F and out to the external circuit through brush M as shown in figs. 174 and 175, returning through brush S and segment G. At the beginning of the second half of the revolution, fig. 176, the current in the loop reverses and flows in the opposite direction B A as indicated by the arrows. At this instant, however, the brushes M and S

pass out of contact with segments F and G, and come into contact with G and F respectively; that is, M leaves F and contacts with G, while S leaves G and contacts with F. The effect of this is to reverse the connections with the external circuit at the instant the alternation or reversal of current in the armature takes place, thus keeping the current in the external circuit in the same direction.

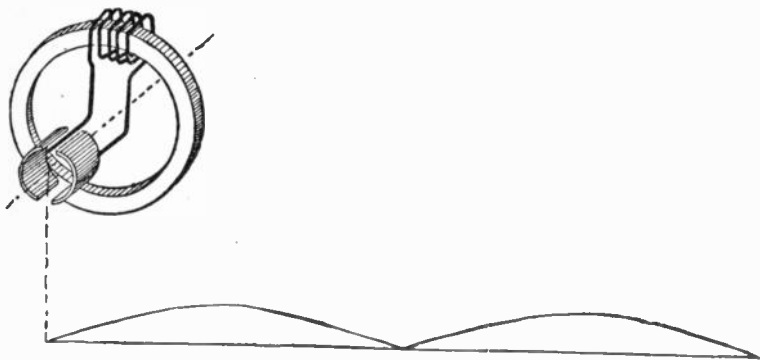

FIG. 182.—Gramme ring armature with one coil, and characteristic sine curve below. With one coil as shown, there are two pulsations of the current per revolution of the armature.

Ques. How is this indicated by the sine curve?

Ans. The sine curve, instead of falling below the axis, as in figs. 169 to 173, again rises as in the first half of the period, that is $G'H'I'$ is identical with $E'F'G'$.

Ques. Is the direct current indicated by the sine curve in figs. 174 to 178 continuous?

Ans. No; it is properly described as a *pulsating current*, or one, constant in direction, but periodically varying in intensity so as to progress in a series of throbbings or pulsations instead of with uniform strength.

Ques. What is generally understood by the word "continuous" as applied to the current obtained from a dynamo?

Ans. It is usually accepted as meaning a steady or non-pulsating direct current; one that has a uniform pressure and constant direction of flow as opposed to an alternating current.

Ques. Is a continuous current ever obtained with a dynamo?

Ans. *No.*

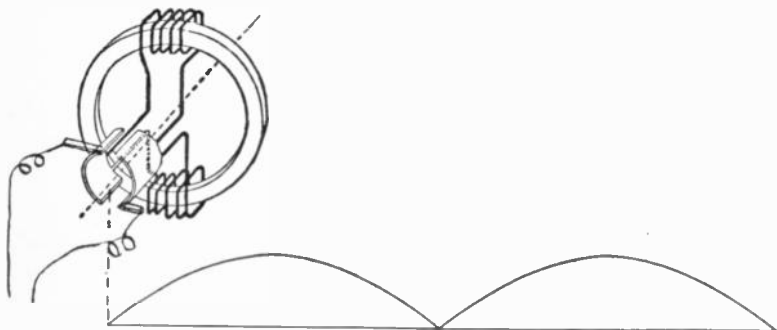

FIG. 183.—Gramme ring armature with two coils placed 180° apart. This arrangement gives double the pressure of the one coil armature, fig. 182.

It should be clearly understood at the outset that it is impossible to obtain a continuous current with a dynamo. The so called continuous current which it is said to produce is in reality a pulsating current, but with pulsations so minute and following each other with such rapidity that the current is practically continuous, and as such is generally called continuous.

Ques. How is the so called continuous current produced by a dynamo?

Ans. In order to obtain a large number of small pulsations per revolution of the armature instead of two large pulsations,

as with the single loop armature, the latter must be replaced by one having a great number of loops properly connected to commutator segments and so arranged that the successive loops begin the cycle progressively.

The difficulties encountered in connecting up numerous loops were overcome by Gramme, who, in 1871 invented a "ring" armature. His method consists in winding a ring with a continuous coil of wire, connections being made at suitable intervals with the commutator.

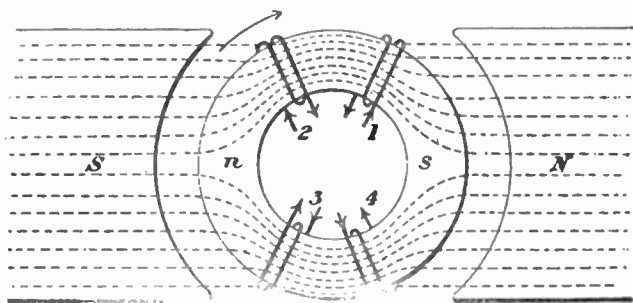

FIG. 184.—Four separate coils wound on ring to illustrate the action of a Gramme ring armature. If the ring be rotated the electromotive forces induced in adjacent coils will be equal and tend to produce currents in opposite directions; hence, if the inner ends be joined, the junctions would be at a higher potential (+ or -) than the loose ends. With proper connections current may be collected at the junctions.

In order to understand the action of such an arrangement, it will be well to first consider four separate coils wound on a ring as shown in fig. 184. These coils are all similar, but at the moment occupy different magnetic positions on the ring. The rotation being clockwise, 1 is about to enter the field adjacent to the north pole, while 2 is emerging from the field in the region of the south pole. Again, 3 is approaching the south pole and 4 receding from the north pole.

Ques. Describe in detail the action of the four coils wound around the ring as in fig. 184.

Ans. According to the laws of electromagnetic induction, pressures are set up at the ends of the coils such as tend to produce currents in the directions indicated by the arrows. Now, assuming the electromotive forces in coils 1 and 2 to be equal, if the adjacent ends be joined, no flow of current will take place, but the junction will be at a higher pressure

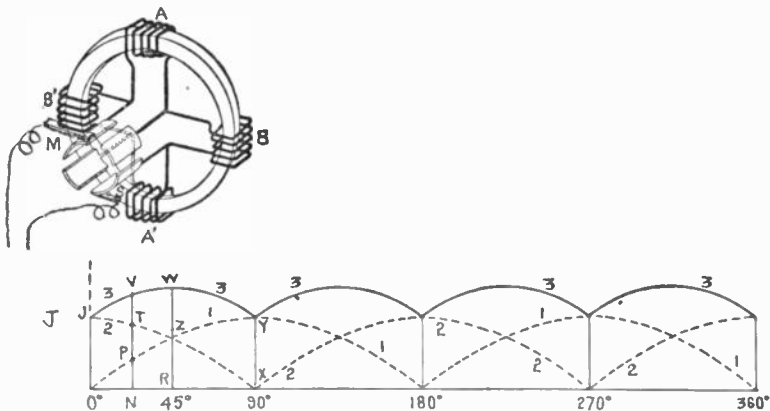

FIG. 185.—Gramme ring armature with four coils. The electromotive force induced in coils A, A' reaches the zero point at the instant that of coils B, B' is at a maximum; hence, sine curve No. 1, beginning at zero, and No. 2, at the maximum, show the pressure changes for A, A' and B, B', respectively. The summation of these curves gives the resultant curve No. 3, showing changes in pressure of current delivered to the external circuit.

than the loose ends of the coils and if a wire be attached to this junction, and the necessary circuits completed, a current will flow along the wire outward from the junction. Similarly, if the adjacent ends of coils 3 and 4 be joined, there will be no flow of current, but the junction will be at a lower pressure than the loose ends, and if a wire be attached to the junction and the necessary circuits completed, current will flow from the junction around the coils.

Ques. What may be said with respect to the four coil Gramme ring armature shown in fig. 185?

Ans. According to the laws of electromagnetic induction, with the north pole of the field at the left and clockwise rotation, the induced currents flow *upward* on both sides of the ring, hence, *the electromotive forces oppose each other at only two of the junctions, namely: at the one connected to brush M where the pressures on*

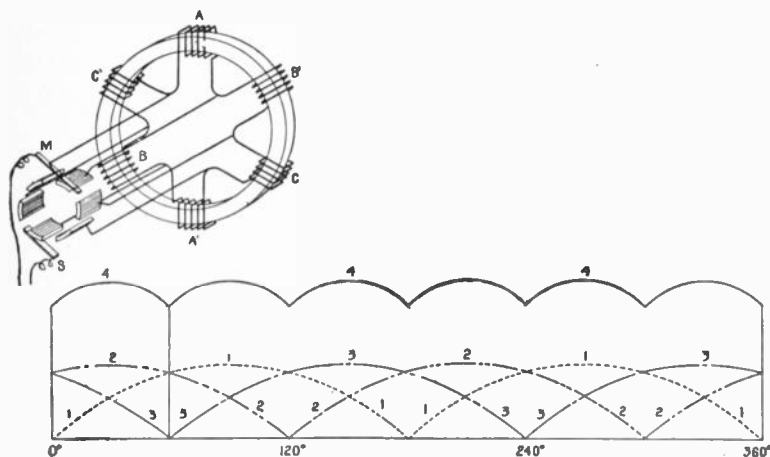

FIG. 186.—Gramme ring armature with six coils. The sine curves 1, 2 and 3, represent the conditions due to coils AA', BB' and CC', respectively, and 4, the resultant pulsations.

either side are both directed toward the junction and the other at the junction connected to brush S, at which the pressures are both directed from the junction.

It is evident, then, that the pressure at M is higher than at S; that is, M is positive and S negative; consequently, the current flows from M to the external circuit and returns through S.

Ques. In what other way may the four coils of the armature in fig. 185 be regarded?

Ans. They may be considered as two pairs A A' and B B', the action of either pair being identical with the two coil armature shown in fig. 183; this, in turn, produces the same effect as the one coil armature of fig. 182, with the exception that the amplitude of the current generated with two coils is twice as great as that with one coil of the same number of turns.

Again considering the action of the four ring coil shown in fig. 185, and starting at the beginning of the revolution, the variation of electromotive force induced in coils AA' is indicated

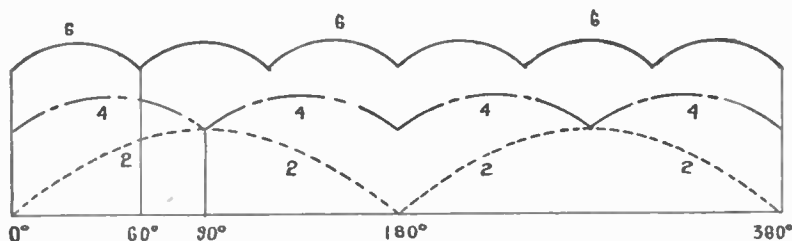

FIG. 187.—The resultant curves of figs. 183, 185 and 186 are here shown for comparison to illustrate the approach to uniform pressure as the number of coils are increased. It should be noted that the number of pulsations per cycle depends on the number of coils, and that as the pulsations increase in number, the variation in pressure decreases.

by the dotted sine curve 1, and of BB' by dotted curve 2. It will be seen that 1 begins at the axis or line of no pressure, and 2 at maximum pressure.

The two curves overlap each other, and in order to determine the effect of this it is necessary to trace the resultant curve, 3. This is easily done, as the resultant electromotive force induced at any point in the revolution of the armature is equal to the sum of the pressures induced in AA' and BB'. Thus, at the beginning of the revolution the pressure induced in AA' is at zero point, and in BB' at its maximum J, hence, the resultant curve begins at the point J. Again, for any point

in the revolution, as N , the height of the resultant curve is equal to $N P + N T = N V$. For 45° or $\frac{1}{8}$ revolution, the resultant curve reaches its amplitude, which is equal to $2 \times R Z = R W$, and at 90° it again reaches its minimum, $X Y$.

Ques. State the conditions upon which the steadiness of the current depends.

Ans. It depends on the number of coils and the manner in which they are connected.

Comparing curves 1 and 3, in fig. 185, it will be noted that with four coils the variation of pressure or amplitude of the pulsations is less than half that obtained with two; moreover, with four coils the number of pulsations per cycle is doubled.

In order to further observe the approach to continuous current obtained by increasing the number of coils, the effect of a six coil armature is shown in fig. 186, the resultant curve being obtained in the same manner as just explained. For comparison, the curves for the three cases of two, four, and six coils are reproduced under each other in fig. 187.

As the number of coils is further increased, the amplitude of the pulsations decreases so that the resultant curve approaches nearer the form of a straight line.

In the actual dynamo there are a great many coils, hence the amplitude of the pulsations is exceedingly small; accordingly, it is customary to speak of the current as "continuous," although as previously mentioned such is not the case.

CHAPTER XV

CLASSES OF DYNAMO

In order to adapt the dynamo to the varied conditions of service, its design is modified in numerous ways, giving rise to the different "types." These may be classified with respect to:

1. Field magnets;
2. Field excitation;
3. Field winding.

The first division relates to the number of magnetic poles as unipolar, bipolar, and multipolar dynamos; also interpolar dynamos. Under the second division are included the following:

1. *Self-exciting machines* of which the magneto is the simplest. Its magnetic field is obtained from permanent magnets, hence the electromotive force generated is comparatively small. The more important type of self-exciting machine is provided with electro-magnets in which the field of force is "built up" from the residual magnetism of the soft iron or steel cores of the field magnets of the dynamo itself. Nearly all commercial types of dynamo are of this class.

2. *Separately excited machines* in which the field magnets are magnetized when the machine is in operation by current supplied from a separate source such as a battery or magneto generator.

Ques. What is a self-exciting dynamo?

Ans. A machine in which the initial excitation of the field is due to the residual magnetism retained by the cores.

Ques. What may be said of the field due to this residual magnetism?

Ans. It presents a very weak field, and the voltage that could be generated by the armature revolving in such a field would be only about two to ten volts.

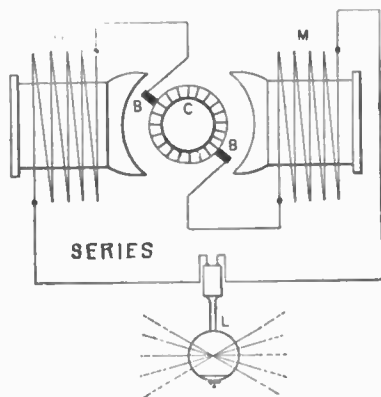

FIG. 190.—Series wound dynamo, used for series arc lighting, and as a booster for increasing the pressure on a feeder carrying current furnished by some other generator. The coils of the field magnet are in series with those of the armature and external circuit, and consists of a few turns of heavy wire. The characteristic of the series dynamo is to furnish current with increasing voltage as the load increases. If overloaded, the voltage will drop.

Ques. How then can commercial voltages such as 100 or more volts be obtained with a self-exciting dynamo?

Ans. Part or all of the current induced in the armature is passed through the windings of the field magnets, thus strengthening the field. The voltage, therefore, will "build up," increasing until the maximum has been reached.

The maximum voltage will depend upon the capacity of the field magnets as determined by the construction, and upon the strength of current used to excite them.

Ques. How long does the process of "building up" require?

Ans. The time required to fully excite the field magnets is from ten to twenty seconds, the rise in field strength being indicated on the voltmeter or by the gradual increase in the brilliancy of the *pilot lamp*.

Ques. Name three important classes of dynamo.

Ans. Series wound, shunt wound, and compound wound.

Ques. Describe the winding of a series dynamo.

Ans. In this machine, the field magnets are wound with a few turns of thick wire joined in series with the armature brushes as shown in fig. 190.

Ques. What is the effect of this arrangement?

Ans. All of the current generated by the machine passes through the coils of the field magnets to the external circuit. The current in passing through the field magnets, energizes them and strengthens the weak field due to the residual magnetism of the magnet cores, resulting in the gradual building up of the field.

Ques. For what service is the series dynamo adapted?

Ans. It may be used for series arc lighting, series incandescent lighting, and as a *booster* for increasing the pressure on a feeder carrying current furnished by some other generator.

Ques. What is the effect of the series winding in the operation of the machine?

Ans. Its characteristic is to furnish current at an increased voltage as the load increases. If sufficient current be drawn to overload the machine, the voltage will drop.

Since the armature coils, field magnets and external circuits are in series, any increase in the resistance of the external circuit lessens the power of the machine to supply current, because it diminishes the current in the coils of the field magnets and therefore diminishes the effective magnetism. Again, a decrease in the resistance of the external circuit will increase the voltage because more current will flow through the field magnets. Accordingly, when the external circuit has lamps in series (as is common in an arc light circuit) the switching on of an additional lamp both adds to the resistance of the circuit and diminishes the power of the machine to supply current. When the lamps are in parallel, the switching on of additional lamps not only diminishes the resistance of the circuit, but causes the field magnets to be further excited by the increased current, so that the greater the number of lamps put on, the greater becomes the risk of inducing too much current.

The series dynamo has also the disadvantage of not starting action until a certain speed has been attained, or unless the resistance of the external circuit be below a certain limit.

Regulation of Series Dynamos.—The series dynamo is ordinarily used for operating arc lamps connected in series. The current generally consumed is about 10 amperes, and it is necessary that it should remain at this strength to keep the lights burning steadily. If it increase, the lights will be too bright, and if it decrease, they will be too dim or flicker.

With all the lamps connected in series it is evident that the resistance of the circuit will vary widely as they are turned on or off, the resistance increasing as the lamps are turned on, and decreasing as they are turned off. It is necessary, therefore, that some means of regulation be provided to enable the dynamo to increase or decrease the voltage in proportion to the load. There are several methods of regulation, as by:

1. Variation of armature speed;
2. Variation of position of brushes;
3. Variation of field strength.

Whatever method be used the necessary regulation should be accomplished by automatic devices, as it would not be practical to station a man in constant attendance to regulate

the voltage every time one or more lamps were thrown on or off.

Ques. When is the first method of regulation used?

Ans. It is only used in special cases, as for constant load; if the voltage be not just right to give the required current, it may be adjusted by changing the speed of the engine.

Ques. What may be said of the second method?

Ans. In both the "ring" and "drum" types of armature, rotating in a bipolar field, there are two points situated at opposite extremities of a diameter of the commutator, at one of which the potential is a maximum and at the other a minimum, and it is at these points that the brushes must be placed in order to obtain the greatest difference of pressure, the difference being less at other points. Hence, by rocking the brushes around the commutator the pressure at the terminals of the machine may be varied and regulated as required.

Ques. What difficulty is experienced in rocking the brushes to regulate the voltage?

Ans. Sparking takes place at the brushes when they are moved any considerable distance from the neutral position.

Special dynamos have been designed to overcome this objectionable feature, still this method of regulation is not extensively used.

Ques. What may be said of the third method of regulation?

Ans. The third method, that of variation of field strength is the one in general use.

Ques. How is the field strength varied?

Ans. This may be done by the *two path method*, or by the *variable field coil method*.

Ques. Describe the two path method of field regulation.

Ans. An adjustable resistance or *rheostat* is connected in parallel with the field winding as shown in fig. 191. This shunts more or less of the current from the field winding according to the amount of resistance made active by the lever, *L*.

Thus, if the current in the armature and main circuit be 10 amperes and the resistance of the field winding 10 ohms, a resistance of 40 ohms in parallel with the winding would cause the current to split in the ratio of 40 to 10, or 4 to 1; 2 amperes would pass through the resistance and 8 amperes through the field.

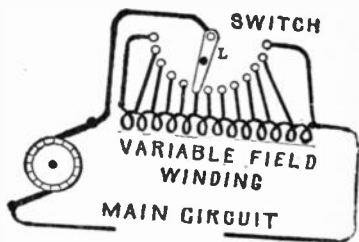
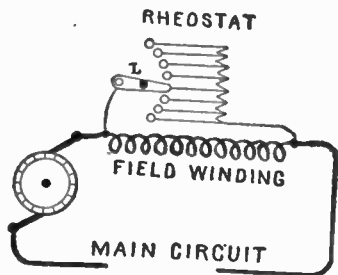

FIG. 191.—The two path method of regulating a series dynamo. The ends of the series winding are connected by a shunt containing a rheostat. The current induced in the armature divides and flows through the two paths thus offered, the amount flowing through the shunt being regulated by the rheostat. In this way the field strength is easily regulated.

FIG. 192.—Regulation of series dynamo by variable field. A multipoint switch is provided with connections to the field winding at various sections, thus permitting more or less of the field winding to be cut out to regulate its strength.

Ques. Describe the variable field coil method of field regulation.

Ans. This consists in dividing the field winding into a number of sections and throwing the sections in and out of circuit as shown in fig. 192.

Since the strength of any magnet depends on the number of ampere turns in its field winding, reducing or increasing the number of turns will respectively reduce or increase the field strength, the current being kept constant.

Ques. What is the objection to this method?

Ans. This arrangement is undesirable for magnets of large size, because of the tendency to flashing at the contacts of the regulating switch.

The Shunt Dynamo.—The shunt wound dynamo differs from the series wound machine, in that an independent circuit is used for exciting its field magnet. This circuit is composed of a large number of turns of fine insulated copper wire, which

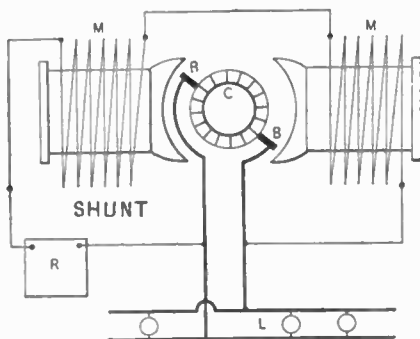

FIG. 193.—Shunt wound dynamo for parallel circuit incandescent lighting, and for mill and factory power. The coils of the field magnet form a shunt to the main circuit; they consist of many turns of fine wire and consequently absorb only a small fraction of the current induced in the armature. The characteristic of the shunt dynamo is that it gives practically constant voltage for all loads within its range. If overloaded the pressure will drop and the machine cease to generate current.

is wound round the field magnets and connected to the brushes, so as to form a shunt or "by pass" to the brushes and external circuit, as shown in fig. 193. Two paths are thus presented to the current as it leaves the armature, between which it divides in the inverse ratio of the resistance. One part of the current flows through the magnetizing coils, and the other portion through the external circuit.

In all well designed shunt dynamos, the resistance of the shunt circuit is always very great, as compared with the resistance of the armature and external circuit, the strength of the current flowing in the shunt coils being very small even in the largest machines.

Ques. For what service is the shunt dynamo adapted?

Ans. It is used for constant voltage circuits, as in incandescent lighting.

Ques. In the operation of a shunt dynamo what is its characteristic feature?

Ans. The voltage at the dynamo remains practically unchanged, and the current varies according to the load.

Ques. Does the voltage remain constant for all loads?

Ans. There is a certain maximum load current that the shunt dynamo is capable of supplying at constant voltage; beyond this, the voltage will decrease, the machine finally demagnetizing itself, and ceasing to generate current.

Ques. Why does the voltage not remain constant for all loads?

Ans. Because there is a drop in the voltage in forcing the current through the armature windings which increases with the load.

Ques. What is the usual method of regulation for shunt dynamos?

Ans. The method of varying the current through the field coils by means of a rheostat inserted in series with the field winding as shown in fig. 194.

Moving the lever *L* of the rheostat to the right increases the resistance in series with the field winding, and this reduces the amount of current in that winding, thus reducing the strength of the magnet and consequently the voltage at the brushes. The contrary movement of the lever, by cutting out the resistance, produces the opposite effect.

The Compound Dynamo.—This class of generator is designed to automatically give a better regulation of voltage on constant pressure circuits than is possible with a shunt machine. It possesses the characteristics of both the series and shunt machines, of which it is in fact a combination.

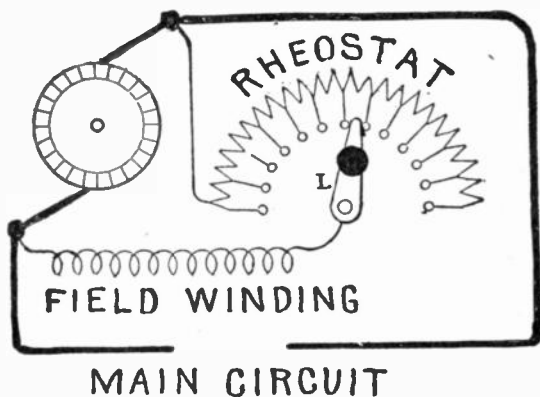

FIG. 194.—Regulation of shunt dynamo by method of varying the field strength. A rheostat is placed in series with the field coils, and by varying the resistance, more or less current will flow through the coils, thus regulating the field strength.

The field magnets of the compound dynamo, as shown in fig. 195, are wound with two sets of coils, one set being connected in series, and the other set in parallel, with the armature and external circuit. The purpose of the series winding is to strengthen the magnets by the current supplied from the armature to the circuit, and thus automatically sustain the pressure. If the series winding were not present, the pressure at the

terminals would fall as the load increased. This fall of pressure is counteracted by the excitation of the series winding, which increases with the load and causes the pressure to rise. The number of turns and relative current strengths of the series and shunt windings are so adjusted that the pressure at the terminals is maintained practically constant under varying loads.

With respect to the ratio between the number of turns of the two field windings, the dynamo is spoken of as:

- 1 Compound;
2. Over compounded.

Ques. What is the difference between a compound and an over compounded dynamo?

Ans. In the first instance, there are just enough turns in the series winding to maintain the voltage constant at the brushes for variable load. If a greater number of turns be used in the series winding than is required for constant voltage at the brushes for all loads, the voltage will rise as the load is increased, and thus make up for the loss or drop in the transmission lines, so that a constant voltage will be maintained at some distant point from the generator. The machine is then said to be *over compounded*.

Ques. For what service is over compounding desirable?

Ans. For incandescent lighting where there is considerable length of transmission lines.

Ques. What is the usual degree of over compounding?

Ans. Generally for a rise of voltage of from five to ten per cent.

In construction, the field coils are wound with a greater number of turns than actually required, the machine being accurately adjusted by a running load test after completion.

Ques. How is the degree of over compounding varied?

Ans. A rheostat is placed in shunt with the series winding so that the current passing through the winding may be regulated to control the voltage of the machine.

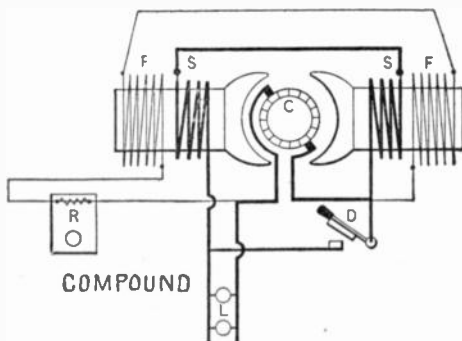

FIG. 195.—Compound wound dynamo, used when better automatic regulation of voltage on constant pressure circuits is desired than is possible with the shunt machine. The compound dynamo is a combination of the series and shunt types, that is, the field magnet is excited by both series and shunt windings. With a proper selection of the number of turns in the series coils, the voltage may be kept automatically constant for wide fluctuations in the load. When the machine is *over compounded* its characteristic is to slightly increase the voltage with increase of load, a desirable feature for long transmission lines in order to compensate for the line drop.

Ques. How are the ends of the shunt winding of a compound dynamo connected?

Ans. There are two methods of connection, being known as the short shunt and the long shunt.

Ques. Describe the short shunt.

Ans. In the short shunt, the ends of the shunt winding are connected directly to the brushes as in fig. 196.

Ques. Describe the long shunt.

Ans. In the long shunt, one end of the shunt winding is connected to one of the brushes and the other end to the terminal connecting the series winding with the external circuit as in fig. 197.

Ques. Which is the more desirable?

Ans. Theoretically, the long shunt is preferable as being the more efficient; however, in practice, the gain is not very appreciable and the short shunt is generally used.

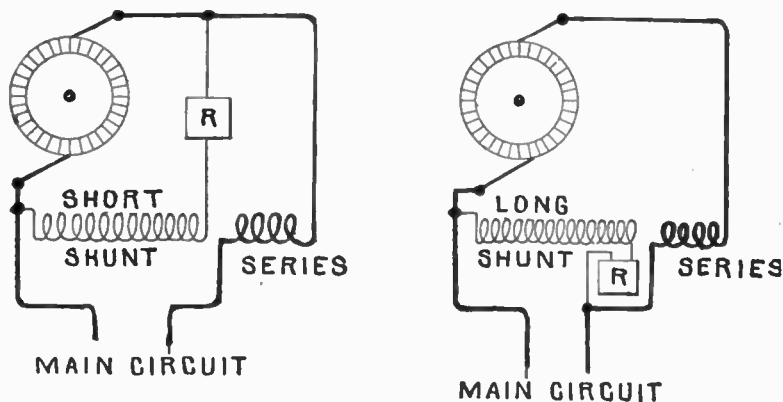

FIGS. 196 and 197.—Short and long shunt types of compound wound dynamos. The distinction between the two is that the ends of the short shunt connect direct with the brush terminals, while in the long shunt type, fig. 197, one end of the shunt connects with one brush terminal and the other with the terminal connecting the series winding with the external circuit. R is the shunt field rheostat for regulating the current through the shunt.

Ques. What may be said regarding the voltage in short, and long shunt machines?

Ans. In a short shunt machine, the shunt winding is subjected to a higher voltage than with a long shunt. The pressure applied through a shunt winding with a long shunt, for any

particular load, is equal to the voltage at the brushes plus the drop in the series winding.

Ques. For what other service besides incandescent lighting are compound dynamos adapted?

Ans. They are employed in electric railway power stations where the load is very fluctuating.

Ques. What is the effect of a short circuit on a compound dynamo?

Ans. It overloads the machine, since the excessive current flowing through the series field tends to keep the voltage at its normal value.

Unless the line be automatically opened under such a condition either by a fuse or circuit breaker, the machine and its driving engine may be damaged. To avoid this danger fuses or automatic circuit breakers are employed.

Ques. Mention another service for which the compound dynamo is used.

Ans. In some isolated plants, as small country residences where it is frequently necessary to have a dynamo capable of charging a storage battery during the day, and of furnishing current for lighting during a certain portion of the evening.

Under such conditions the compound machine with slight modification is used, the ordinary shunt dynamo not being capable of maintaining the necessary consistency of voltage, without attention to the shunt regulator in driving the lamps direct, the ordinary compound dynamo on the other hand, being unsatisfactory for charging storage batteries.

Ques. How is the compound dynamo modified to adapt it to the dual service of lighting and battery charging?

Ans. It is furnished with *alternative compound winding*, in which the series winding is provided with a switch, which

may be fixed either upon the machine itself or upon the switch-board. This switch permits the series coils to be either short circuited in part or cut out of the circuit entirely while the machine is charging the storage battery, being again cut into circuit when the machine is required to furnish current for the lamps.

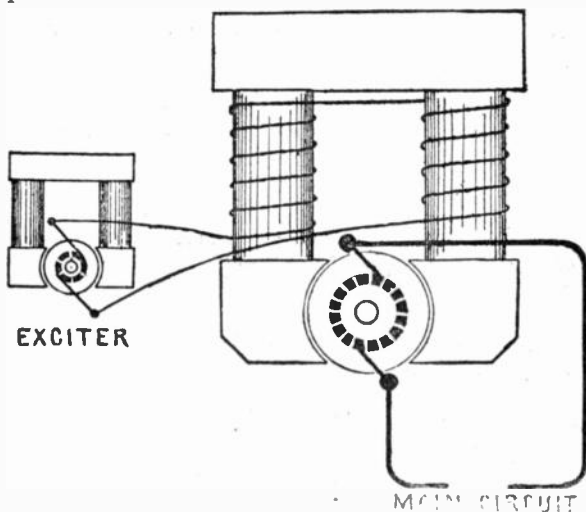

FIG. 198.—Separately excited dynamo. Current for field excitation is supplied by a second and smaller generator.

Separately Excited Dynamos.—In this class of machine the current required to excite the field magnets is obtained from some independent external source. Though used by Faraday, the separately excited dynamo did not come into favor until, in 1866, Wilde employed a small auxiliary magneto machine to furnish currents to excite the field magnets of a larger dynamo.

A separately excited dynamo is shown in fig. 198. This

method of field excitation is seldom used except for alternators; it is, however, to be found occasionally in street railway power houses, the shunt fields of all the dynamos being separately excited by one dynamo.

In common with the magneto, the separately excited machine possesses the property that, with the exception of armature reactions, the magnetism in its field and therefore the total voltage of the machine is independent of variations in the load.

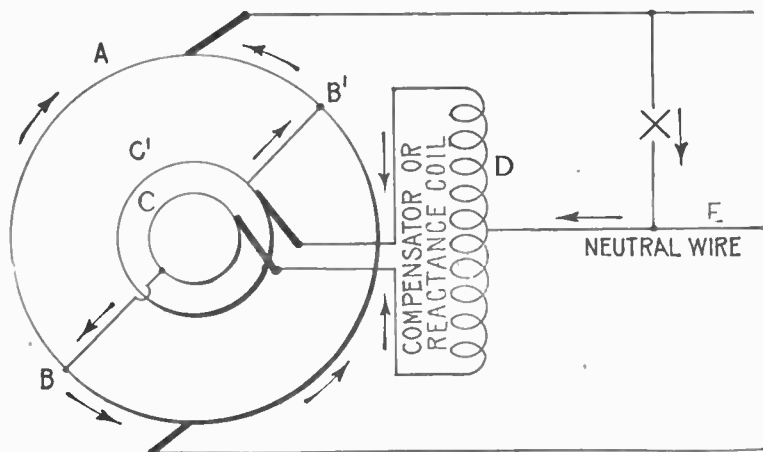

FIG. 199.—Diagram showing principle of Dobrowolski three wire dynamo. This type of machine is shown in more detail in fig. 795 on page 708.

Dobrowolski Three Wire Dynamo.—This type of dynamo was designed to operate a three wire system of distribution without a balancer. The armature is provided with insulated slip rings connected to suitable points in the armature winding and (by means of brushes) with choking coils meeting at a common point, to which the neutral wire of the system is connected, the main terminals being connected with the outside wires.

The machine is capable of feeding unbalanced loads without serious disturbance of the pressure on either side of the system.

The principle of the Dobrowolski three wire dynamo is illustrated in fig. 199. The armature A is tapped at two points, B and B', and connected to slip rings C C'. A compensator or reactance coil D, between the two halves of which there is minimum magnetic leakage, is connected to C and C' by brushes, and has its middle point tapped and connected to the neutral wire E.

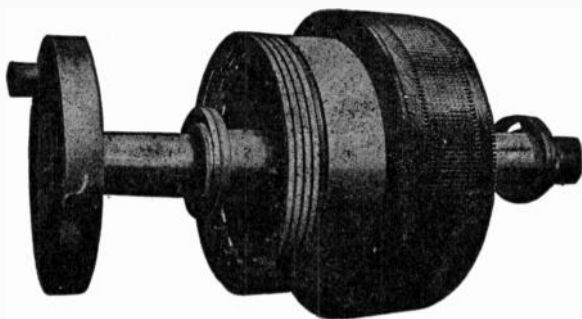

FIG. 200.—Armature of Westinghouse three wire dynamo. Collector rings are mounted at one end of the armature as shown, and the leads to them with the armature winding are similar to those employed on the alternating current side of a rotary converter armature. The connections from the armature to collector rings may be either single phase, two phase, or three phase. The two phase connection with four collector rings and two balance coils is used in the Westinghouse three wire dynamo.

It is clear, from the symmetry of the arrangement, that the center point of the coil must always be approximately midway in pressure between that of the brushes, and hence any unbalanced current will return into the armature, dividing equally between the two halves of the coil.

The arrangement forms a cheap and effective substitute for a balancer set, but lacks the adjustable properties of the latter.

There are various modifications of the arrangement. Thus more than two slip rings may be used. The compensator windings, however, should always be arranged so that the magnetizing effect of the neutral current is self-neutralized in the windings, as otherwise saturation occurs causing a very heavy alternating magnetizing component.

CHAPTER XVI

FIELD MAGNETS

The object of the field magnet is to produce an intense magnetic field within which the armature revolves. It is constructed in various forms, due in a large measure to considerations of economy, and also to the special conditions under which the machine is required to work.

Electromagnets are generally used in place of permanent magnets on account of: 1, the greater magnetic effect obtained, and 2, the ability to regulate the strength of the magnetic field by suitably adjusting the strength of the magnetizing current flowing through the magnet coils.

The field magnet, in addition to furnishing the magnetic field, has to do duty as a framework which often involves considerations other than those respecting maximum economy.

The Make Up of a Field Magnet.—In construction, the electromagnet, used for creating a field in which the armature of a dynamo revolves, consists of four parts:

1. Yoke;
2. Cores;
3. Pole pieces;
4. Coils.

These are shown assembled in figs. 201 to 204.

Ques. What is the object of the yoke?

Ans. The yoke serves to connect the two "limbs," that is, the cores and pole pieces, and thus provide a continuous metallic circuit up to the faces of the pole pieces.

Ques. How is the yoke constructed?

Ans. It usually forms the frame of the dynamo as shown in figs. 205 and 206.

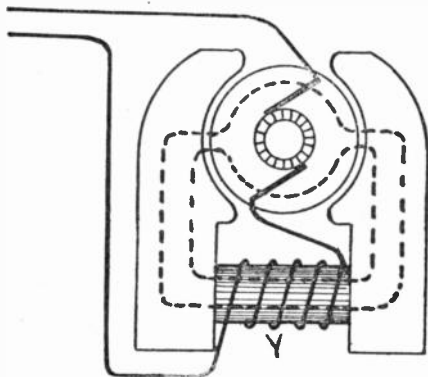

FIG. 201.—Salient pole, bipolar field magnet with single coil wound around the yoke.

Ques. What may be said of the cores?

Ans. The cores, which are usually of circular form, carry the coils of insulated wire used to excite the magnets.

Classes of Field Magnet.—Although numerous forms of field magnet have been devised, they can be classed into two groups according to the type of pole, as:

1. Salient pole;
2. Consequent pole.

The distinction between these two types of pole is shown in figs. 201 to 203. By inspection of the figures, it will be seen that the term *salient* applies to poles produced when the pole pieces form the *ends* of the magnet, as distinguished from *consequent* poles, or those formed by coils wound on a continuous metal ring or equivalent.

In the salient pole bipolar magnet, the winding may be either upon the limbs, M M fig. 202, or upon the yoke, Y as shown in fig. 201. The magnetic circuit of salient and consequent poles is indicated in the figures by the dotted lines.

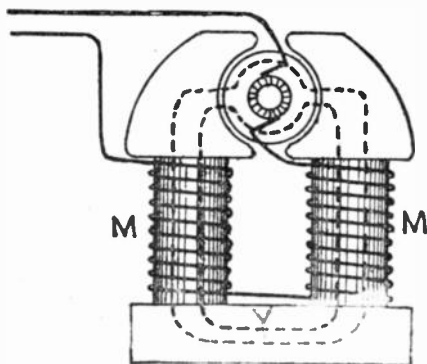

FIG. 202.—Salient pole, bipolar field magnet with two coils wound around the cores.

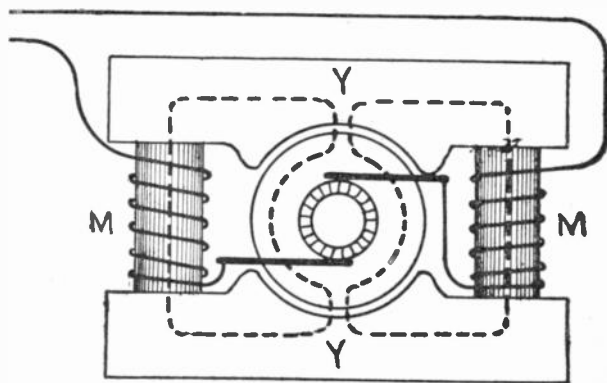

FIG. 203.—Consequent pole bipolar field magnet with two coils on the cores. This is known as the "Manchester" type in which the cores are connected at the ends by two yokes—so named from its original place of manufacture at Manchester, England.

Multi-Polar Field Magnets.—In the multi-polar machine, the subdivision of the magnetic flux reduces the amount of material of both magnet and armature. Moreover, there is less heating on account of the greater capability of dissipating the heat, offered by the increased area of surface per unit of volume in each magnet pole and winding.

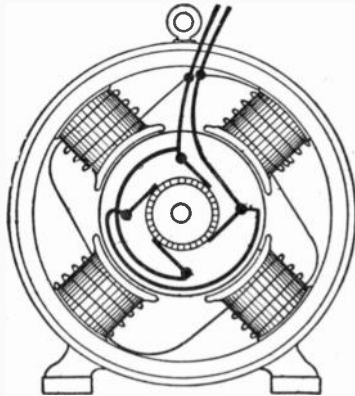

FIG. 204.—Modern dynamo with four consequent pole field magnets. In this construction the ring shaped yoke also serves as a frame; the circular form of yoke gives the least chance for magnetic leakage.

There may be four, six, eight, or more poles, arranged in alternate order around the armature. Fig. 204 shows a four pole field magnet having a common yoke or iron ring, with four pole pieces projecting inwardly, and over which the exciting coils are slipped.

In the larger machines the yoke is made in two parts bolted together as shown in fig. 206, so that the upper portion may be lifted off for examination of the armature.

Ques. Can the number of poles in a multi-polar machine be advantageously increased to 16, 32, or more?

Ans. A large number of poles is not advisable except in very large machines, since it involves an increase in the expense

of machine work, fittings, etc., somewhat out of proportion to the reduction in cost of material and increase in efficiency.

Ques. What materials are generally used for field magnets?

Ans. Wrought iron, steel and copper.

There are a number of considerations which govern the selection of the materials to be used in a particular machine, such as initial cost, weight, efficiency, etc.

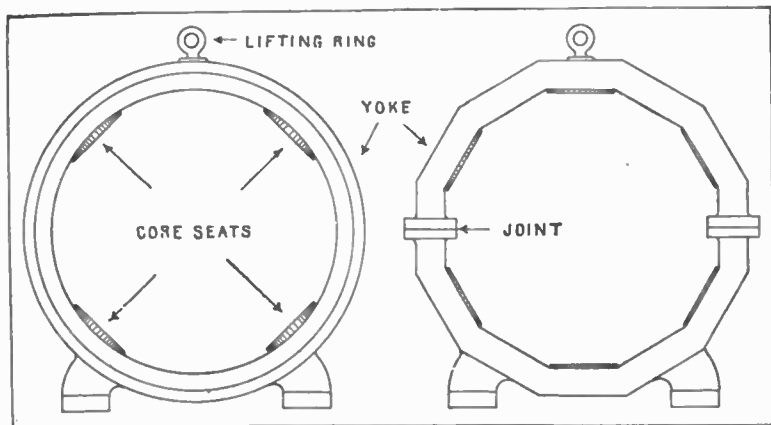

FIGS. 205 and 206.—Solid and split construction of yoke for multi-polar dynamos. In the latter type the yoke is in two halves joined along a horizontal diameter; while the upper half may be conveniently removed to give access to the armature, it has the disadvantage of the joint, which, no matter how well made, will add to the reluctance of the magnetic circuit. The figures also illustrate the circular and segmental forms of yoke construction.

Ques. In the construction of field magnets, what governs the choice of materials?

Ans. For cores, wrought iron is most desirable, as requiring the smallest amount of material for a given flux. There is a saving in copper due to using wrought iron for the core since, on account of its small size, the length of each turn of the

magnetizing coil is reduced. For heavy yokes, where lightness is not essential, but very often the reverse, cast iron is used, as its cross section can be made larger than that of the cores, this increase in area serving to give strength and rigidity to the machine. Cast steel occupies a place intermediate between cast iron and wrought iron both in cost and magnetic properties.

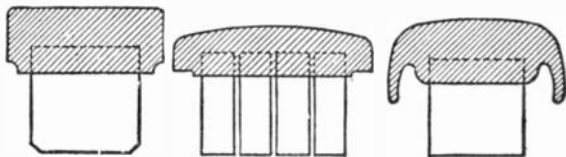

FIGS. 207 to 209.—Various sections of cast iron yoke. In form, these yokes may be either circular or segmental as shown in figs. 205 and 206.

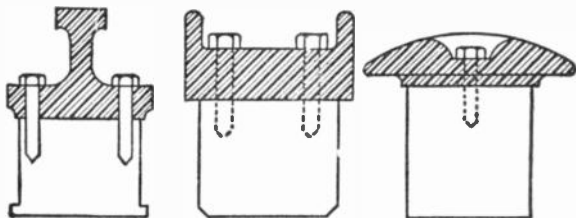

FIGS. 210 to 212.—Various sections of cast steel yoke. The ribs shown in figs. 210 and 211 are provided to secure stiffness.

Ques. Name two forms of yoke in general use.

Ans. The solid, and divided types as shown in figs. 205 and 206.

Ques. What is the object of dividing a yoke?

Ans. To permit access to the armature, where the construction does not admit of removal of the latter from the side.

Ques. How is the yoke usually divided?

Ans. Across its horizontal diameter into an upper and lower half, as shown in fig. 206, the lower half being seated on, or more frequently cast in one piece with the bed plate.

Ques. What is the objection to dividing a yoke?

Ans. The joints introduced, even if carefully faced and well bolted together, add a little reluctance to the magnetic circuit.

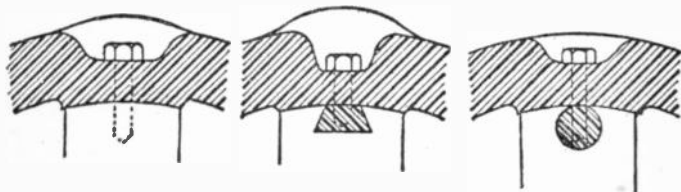

FIGS. 213 to 215.—Some methods of attaching detachable cores. The core seat is machined to receive the core, it being necessary to secure good contact in order to avoid a large increase in the reluctance of the magnetic circuit.

Ques. How does this affect the poles adjacent to the points, and what provision is made?

Ans. It weakens them, and in order to overcome this, the coils of these poles are given a few extra turns.

Ques. How is the reluctance of a yoke joint reduced?

Ans. By enlarging the area of contact; the flange for the bolts furnishes the necessary increase.

Ques. What determines chiefly the cost of field magnets?

Ans. The material used in making the cores and their shape.

Ques. How does this affect the cost?

Ans. Since considerable cross sectional area of core is required, the problem confronting the designer is to design the core by judicious selection of material and shape, that the required number of turns in the magnetizing coil is obtained with the shortest length of wire.

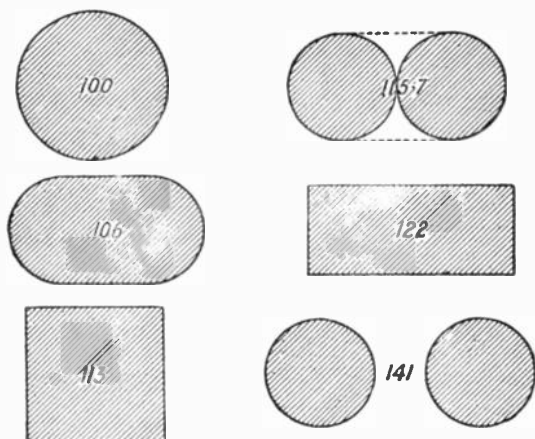

FIGS. 216 to 221.—Comparison of field magnet core sections. The shorter the perimeter or outside boundary of the core for a given cross sectional area, the less will be the amount of copper required for the magnetizing coils. All the above sections are of equal area, and the figures marked on each represent relative values for the perimeters, the circle for convenience being taken at 100.

Ques. What is the principal objection to the use of cast iron for core construction?

Ans. Since its sectional area must be considerably more than wrought iron, a much greater quantity of copper is required for the magnetizing coils.

Copper is expensive, while cast iron cores are less expensive than equivalent ones of wrought iron; in this connection, it is interesting to observe how different designers aim at true economy in construction.

Steel is sometimes used in place of wrought iron, and though less efficient magnetically, it can be cast into the desired shape, thus avoiding the somewhat expensive processes of forging and machining, which are necessary in the case of wrought iron.

Ques. What form of core requires the least amount of copper for the magnetizing coils, and why?

Ans. The cylindrical core, because it has the shortest periphery or boundary for a given area enclosed.

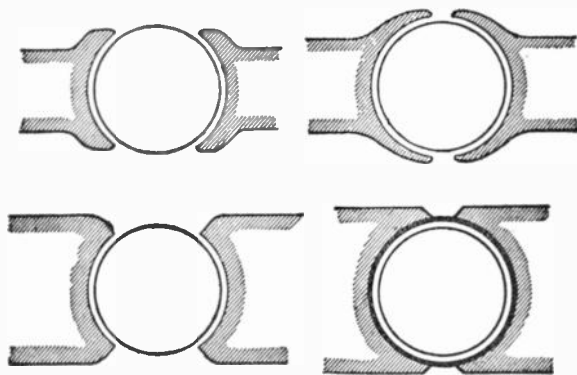

FIGS. 222 to 225.—Several forms of pole piece. Where the extremities project as in figs. 222 and 223, they are called *horns*. The object of these is to reduce the reluctance of the air gap. The width of "fringe" of the magnetic field is influenced by the shape of the pole piece; the margin of fringe should be such that the flux density will vary from zero to a high value where the inductors enter.

Figs. 216 to 221, show a series of cross sections, all of the same area. The number marked on each section indicates the length of the boundary line, that of the circle being taken for convenience as 100.

Ques. What are the pole pieces?

Ans. These are the end portions of the field magnets, joined to, or cast together with the core and placed adjacent to the armature.

The faces of the pole pieces are of circular shape, thus forming the sides of the so-called armature chamber within which the armature rotates.

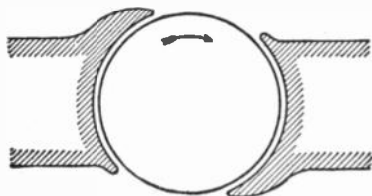

FIG. 226.—Unsymmetrical pole piece introduced by Gravier to concentrate the magnetic field. When the dynamo is working at small loads, the flux in the gap is nearly uniform, but at heavy loads, the distortion due to the armature current forces the flux forward and saturates the forward horn, thus preventing much change in its flux density, on account of the saturation, and the diminishing area. Lundell combined the unsymmetrical and slotted forms of pole piece as shown in fig. 237.

Ques. Why are the pole faces made larger than the coils?

Ans. In order to reduce the reluctance of the air gap between the face and the armature, thus enabling fewer magnetizing coils to be used.

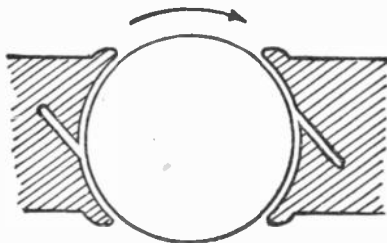

FIG. 227.—Pole piece with oblique slots; a modification of Lundell's form of pole piece as suggested by Thompson. In operation, the neck of the casting becomes saturated and offers considerable reluctance, which tends to prevent distortion of the magnetic field.

It is important that the field should be magnetically rigid, that is, not easily distorted. This stiffness of field can be partially secured by judicious shaping of the pole pieces. A few forms of pole piece are shown in figs. 222 to 231.

If the projecting tips of the pole pieces, or *horns* as they are called, be widely separated, as in fig. 222, they are not always good, even though thin. It is better that they should be extended as in fig. 223 so that they may be saturated by the leakage field or else cut off as in fig. 224.

An extreme design, suggested by Dobrowolsky, as shown in fig. 225, surrounds the armature with iron.

Another scheme, proposed by Gravier, employed the unsymmetrical form shown in fig. 226. In this pole piece the forward horn is elongated. The action due to this arrangement is such that when the machine is

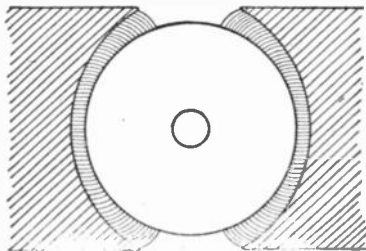
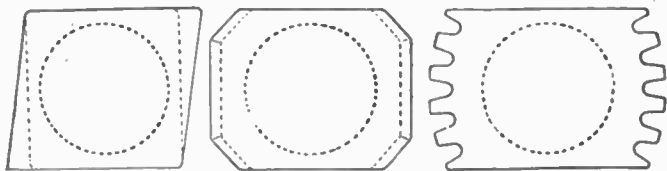

FIG. 228.—Non-concentric pole faces; one method of securing suitable magnetic "fringe" with fair magnetic rigidity of field.



FIGS. 229 to 231.—Various shapes of pole piece for securing a gradual entrance of the armature inductors into the magnetic field.

working at small loads, the field in the gap is nearly uniform, but at heavy loads with distorting reactions which have a tendency to drive the flux into the forward horn, the small section of the latter causes it to become saturated, thus reducing the distortion to a minimum.

Eddy Currents; Laminated Fields.—The field magnet cores and pole pieces, as well as the armature of a dynamo are specially subject to *eddy currents*, that is, induced electric

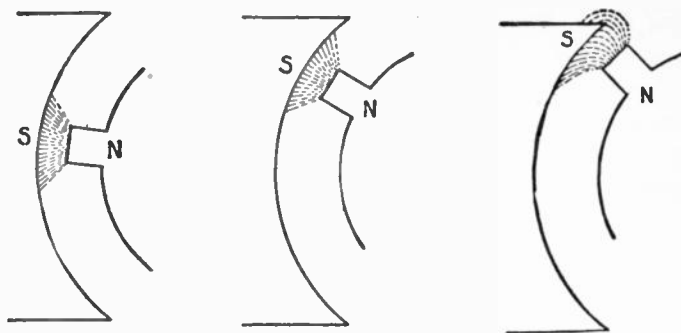

FIG. 232.—Illustrating the alteration of magnetic field due to movement of mass of iron in the armature. If the masses of iron in the armature are so disposed that as it rotates, the distribution of the lines of force in the narrow field between the armature and the pole piece is being continually altered, then, even though the total amount of magnetism of the field magnet remain unchanged, eddy currents will be set up in the pole piece and will heat it. This is shown in the above figures, which represent the effect of a projecting tooth, such as that of a Pacinotti ring, in changing the distribution of magnetism in the pole piece.

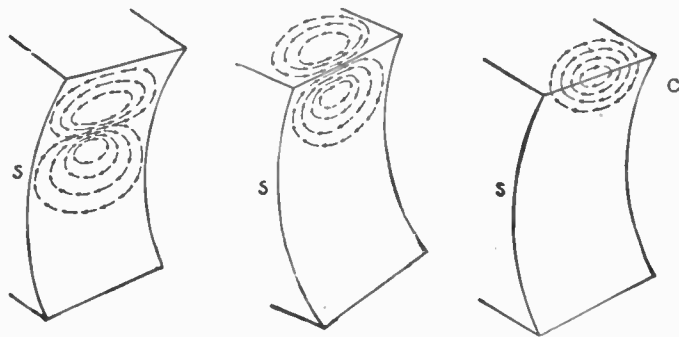

FIG. 233 — Eddy currents induced in pole pieces by movement of masses of iron. These diagrams, which correspond to those of fig. 232, show the eddy currents grouped in pairs of vortices. The strongest current flows between the vortices and is situated just below the projecting tooth, where the magnetism is most intense; it moves onward following the pole piece. At C is shown what occurs during the final retreat of the tooth from the pole piece. These eddy currents penetrate into the interior of the iron, although to no great depth. Clearly the greatest amount of such eddy currents will be generated at that part of the pole piece where the magnetic perturbations are greatest and most sudden. A glance at the figures shows that this should be at the forward horn of the pole piece. However, when a dynamo, with horned pole pieces, has been running for some time as a motor the forward horns are cool and the hindward horns hot.

currents occurring when a solid metallic mass is rotated in a magnetic field. These currents consume a large amount of energy and often occasion harmful rise in temperature. This loss may be almost entirely avoided by laminating the pole piece, or both pole piece and core; in the latter case, both form one part without any joint.

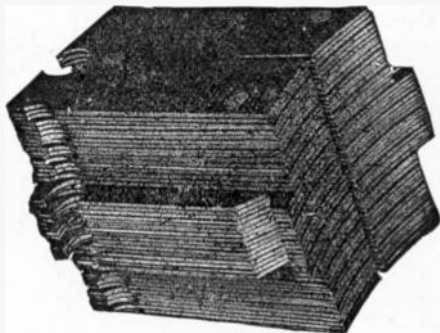

FIG. 234.—Port Wayne laminated pole piece before being cast welded into frame. In the faces of solid pole pieces there exist minute electric currents called *eddy currents* which cause heating of the iron and increase the energy required to maintain a magnetic circuit in much the same manner as does reluctance. This loss is reduced by dividing the magnetic circuit in the line of flux into numerous parallel paths separated by some material of relatively high resistance. In construction, the above core and pole piece is made up of sheets of annealed steel of two different widths assembled together to form proper size and shape. The minute spacing between these laminations and the slight oxidizing on each surface is sufficient to reduce considerably the eddy currents. By cast welding the pole piece into the frame, a low reluctance is secured.

Ques. What is a laminated pole?

Ans. One built up of layers of iron sheets, stamped from sheet metal and insulated, as shown in fig. 234.

Ques. What may be said of this construction?

Ans. It is a most approved method, and one frequently employed in the construction of cores and pole pieces.

Fig. 234 shows a combined core and pole piece made entirely of sheet iron punchings assembled and riveted together, and fig. 235, a core to be used with separate pole piece. It should be noted that in both cases there is a longitudinal slot extending from the end into the core. This was first suggested by Lundell, the object being to prevent, as far as possible, the distortion of the magnetic field due to armature reaction especially on heavy overloads.

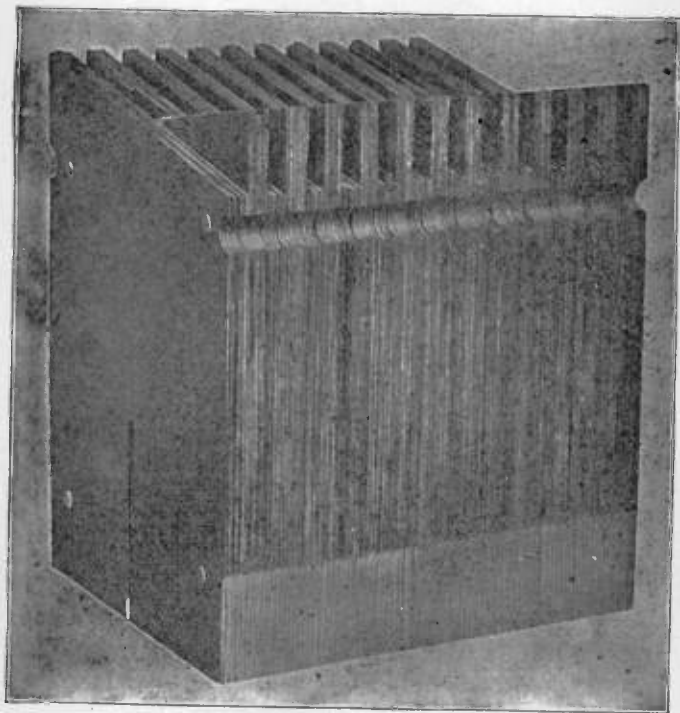

FIG. 235.—Fort Wayne laminated core without pole piece, as used on large dynamos. It is constructed of punchings from sheet iron, and riveted under pressure. The alternate end projections and grooved base insure good mechanical union of metal in cast welding to magnet frame. Reluctance between core and yoke is reduced to a minimum by cast welding. The core is slotted parallel with the shaft to prevent, as far as possible, the distortion of the magnetic field, especially on heavy overloads.

Ques. What mode of construction is adopted to reduce the reluctance of the magnetic circuit when laminated poles are used?

Ans. They are cast welded into the frame.

The frame end of the core as shown in the illustrations has irregularities in the heights of the different sheets, as well as grooved undercut



FIG. 236.—Fort Wayne one piece frame with cast welded combined cores and pole pieces. In any electrical apparatus a magnetic circuit of low reluctance requires less energy to maintain a given flux than one having a comparatively high reluctance. To reduce this to a minimum the pole pieces and cores are combined into one part and then cast welded into the yoke or frame. Thus the continuity of the magnetic circuit is practically unbroken save for the air gap.

surfaces, in order to enable the molten metal of the frame to key well into the laminations of the core, making a good joint, both mechanically and electrically. By this construction, the continuity of the magnetic circuit is practically unbroken save for the air gap between the pole piece and armature.

Fig. 236 shows a one piece frame of a six pole dynamo having cast welded into it, combined cores and pole pieces.

Ques. What is the disadvantage of laminating a core?

Ans. It necessitates a nearly square or rectangular section, which requires more copper for the winding than the cylindrical form.

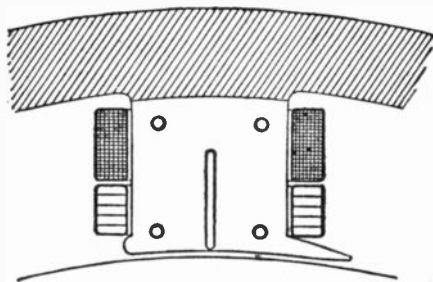

FIG. 237.—Lundell type of combined core and pole piece; a combination of Gravier's un-symmetrical horns and longitudinal slot designed to prevent distortion of field.

The Magnetizing Coils.—The object of the magnetizing coils, is to provide, under the various conditions of operation, the number of *ampere turns* of excitation required to give the proper flux through the armature to produce the desired electromotive force.

With respect to the manner in which magnetizing coils are wound they are said to be:

1. Spool wound;
2. Former wound.

Ques. Describe the methods of constructing spool wound coils.

Ans. The spool is made in various ways, sometimes entirely of brass, or of sheet iron with brass flanges, or of very thin cast iron. Some builders use sheet metal with a flange of hardwood, such as teak. If a spool be simply put upon a lathe to be wound, the inner end of the wire, which must be properly secured, should be brought out in such a way that it cannot possibly make a short circuit with any of the wires in the upper

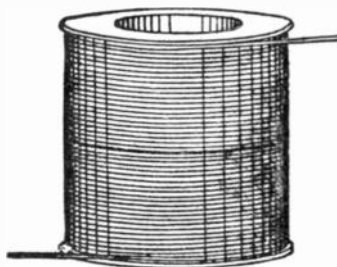

FIG. 238.—Method of winding magnet spool so that the two ends of the coil will come to the outside. This method has also been used for induction coils, where it is desirable to keep the ends of the wire away from the core and primary coil.

layers. To avoid this difficulty, the wire is sometimes wound on the spool in two separate halves, the two inner ends of which are united, so that both the working ends of the coil come to the outside as shown in fig. 238.

Ques. Describe the construction of former wound coils.

Ans. Former wound coils are wound upon a block of wood having temporary flanges to hold the wire together during the winding. Such coils have pieces of strong tape inserted between

the layers and lapped at intervals over the windings to bind them together. Coils are usually soaked with insulating varnish and stove dried.

Ques. What may be said with respect to the coil ends?

Ans. Several methods of bringing out the ends of coils are shown in figs. 238 to 241. In fig. 239 copper strip, laid in behind an end sheet of insulating material, makes connection to the inner end, as shown in the right side of the figure, while

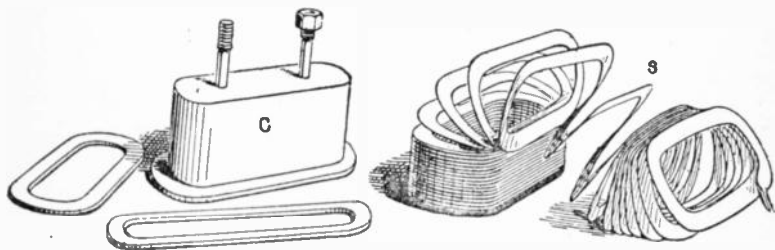

FIG. 239.—Core and edge strip winding for shunt field coils of large multipolar dynamo. The winding consists of a copper strap S carefully insulated and placed edgewise on the core C in a single layer of winding. With this arrangement, the space occupied by insulation is reduced to a minimum, and, although the cooling surface is small, each turn of the winding has one edge on the outer surface, being ample for adequate cooling.

another strip, shown on the left side similarly inlaid, serves as a mechanical and electrical attachment for the outer end of the winding.

Two other methods are shown in figs. 240 and 241. A simple device for securing the outer end is to fashion a terminal piece so that it can be laid upon the winding, the last three or four turns of which are wound over its base, and after winding, are bared at the place and securely soldered.

Ques. How are the coils insulated?

Ans. The spools upon which the coils are wound are usually insulated with several layers of paper preparations; a thickness

of one-tenth of an inch made up of several superposed layers is generally sufficient. Varnished canvas is useful as an underlay, and vulcanized fibre for lining the flanges. It is important to protect the joint between the cylindrical part and the flanges. A core paper may be laid upon every four layers of winding. Between series and shunt coils, in compound wound machines there should be an insulation as efficient as that on the cores.

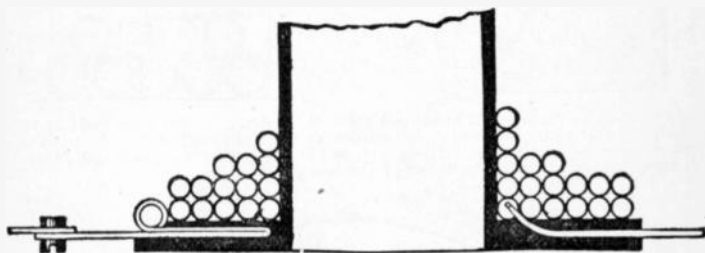

FIG. 240.—One mode of bringing out the coil ends, in which copper strip is laid in behind an end sheet of insulating material.

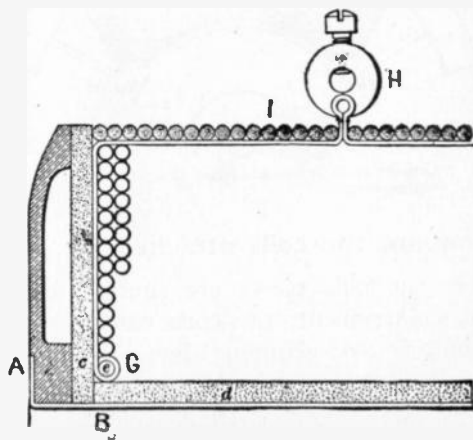

FIG. 241.—Another mode of bringing out the coil ends. A narrow insulated strip of thin copper G, leading to terminal H, is connected with the end *c* of the coil before winding.

When the winding is completed, two layers of pressed board or equivalent are laid over and bound with an external winding of hard rope or tape. This protective external lagging covering the outer surface of the completed coils is not altogether a benefit for it tends to prevent dissipation of heat.



FIGS. 242 and 243.—Square and hexagonal order of "bedding." The term bedding is an expression used to indicate the relation between the cross sectional area of the winding when wound square, as in fig. 242, and where wound in some other way, as in fig. 243. In the square order of bedding, the degree of bedding equals zero.

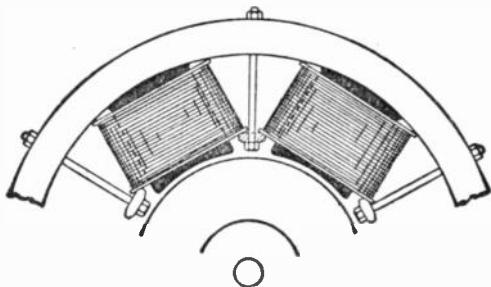

FIG. 244.—Method of securing coils in position when the pole pieces are simply extensions of the core without enlargement.

Ques. How are the coils attached?

Ans. Where the pole pieces are simply extensions of the cores without enlargement, the coils can be slipped over the ends, but some kind of clamping device is necessary to hold them in place, as for instance, the method shown in fig. 244.

In case the pole piece be made larger than the core and separate therefrom, it is put into position after the coils are in place, thus serving the double purpose of pole piece and clamp.

Ques. Describe the coil connections.

Ans. Coils are generally united in series so that the same magnetizing current may flow through all of them. The coils should be so connected that they produce alternate north and south poles.

If all the coils be similarly wound with respect to the terminals, and similarly placed; that is, so placed that the winding, considered from the coil terminal nearest the pole face, starts in all the coils in the same direction, then the connections will come at the north end and at the south end of the spools.

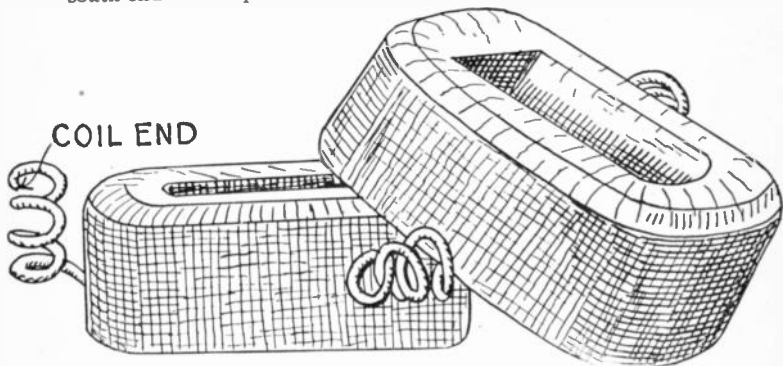

FIG. 245.—Western Electric set of former wound field coils for four pole dynamo. These coils are wound around a former or template, and are then slipped over the cores before the latter are bolted to the yokes or frame.

Heating.—The heat generated in the magnetizing coils is dissipated in three ways; by:

1. Induction;
2. Radiation;
3. Convection.

In the first instance, it passes through the copper and the insulation, either to the external surface, whence it passes off by radiation and convection into the air, or to the magnet

core and yoke, which in turn conduct it away. In large multipolar machines the masses of metal in the pole cores and frame are more efficient in dissipating heat than the external surface of the coil.



FIG. 246.—Fort Wayne compound wound rectangular ventilated spool field coil. The series and shunt coils are wound side by side, ventilating passages being provided lengthwise through each coil and between the shunt and series coils as shown.

Ventilation.—Sometimes provision is made for ventilation of the field magnet coils as shown in fig. 246. Here the series and shunt coils are wound side by side, ample ventilation being provided lengthwise through and between the coils.

CHAPTER XVII

THE ARMATURE

The armature of a dynamo consists of coils of insulated wire wound around an iron core, and so arranged that electric currents are induced in the wire when the armature is rotated in a magnetic field or the field magnets rotated and armature held stationary.

The commutator is in fact a part of the armature, but is of sufficient importance to be considered in a separate chapter.

Ques. What are the practical objections to the elementary armature, described in fig. 165?

Ans. It induces a very feeble current, which is not of constant pressure, but pulsating; that is, it consists of two pronounced impulses in each revolution as shown in fig. 168.

Ques. Why does the elementary armature produce a pulsating current?

Ans. The pulsations are due to the coil moving alternately into, and out of, the positions of best and least action in the magnetic field.

Ques. How is a continuous current, or one of uniform pressure obtained?

Ans. If an additional coil be added to the elementary armature, at right angles to the existing coil, and its ends suitably connected to a four part commutator, as in fig. 185, so that

one coil is in the position of best action, while the other is in the position of least action, the pulsations of the resulting current will be of less magnitude. By increasing the coils and suitably altering the construction of the commutator to accommodate the ends of these coils, the resultant current may

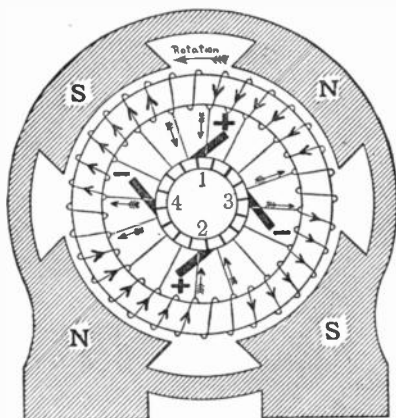

FIG. 247.—Ring armature of four pole dynamo; diagram of winding and connections, showing direction of the induced currents. The currents in the windings under the upper N and S poles are opposed to each other and flow to the external circuit by the positive brush 1, and back to this half of the armature by the negative brushes 3 and 4. At the same instant the opposed currents in the lower windings flow to the external circuit by positive brush 2 and return to the armature through negative brushes 3 and 4. The armature is thus divided into four circuits and four brushes are required which must be placed between the poles so as to short circuit the coils as they pass through the neutral space. In this form of winding there is no difference of potential between the + brushes, so that they are connected in parallel, as are also the negative brushes, and then to the external circuit. In multipolar machines there are as many brushes as pole pieces. Since opposite commutator bars are of the same potential on this four pole dynamo they may be joined by a cross connecting wire and two brushes, as 2 and 4, dispensed with. This can only be done when there is an even number of coils. The armature is said to be "cross connected."

be represented by practically a straight line, indicating the so called *continuous current*, instead of the wavy resultant curve No. 6, as illustrated in fig. 187.

An armature for practical use has a large number of coils, suitably arranged upon an iron core, so that a large proportion of them are always actively cutting the lines of force, or moving into the positions of best action in the magnetic field.

Types of Armature.—Although there are many forms of armature, all may be divided into three classes, according to the arrangement of the coils or winding on the core, as:

1. Ring armatures;
2. Drum armatures;
3. Disc armatures.

Each of these forms of armature has its own special advantages for particular purposes, the disc type being least in favor and not having had any extensive application in this country.

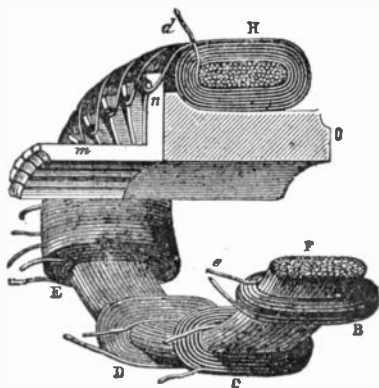

FIG. 248.—Early form of Gramme ring armature, the core being shown cut through, and some of the coils displaced to make it clearer. The core, *F*, consists of a quantity of iron wire wound continuously to form a ring of the shape shown by the section. Over this is wound about thirty coils of insulated copper wire, *B C D*, etc., the direction of the winding of each being the same, and their adjacent ends connected together. The commutator segments consist of a corresponding number of brass angle pieces, *m, n*, which are fixed against the wooden boss, *o*, carried on the driving shaft. The junction of every two adjacent coils is connected to one of the commutator segments, as shown at *n*.

Ques. What is the comparison between ring and drum armatures?

Ans. The drum armature is electrically and mechanically the more efficient, possessing, as it does, possibilities in the way of better mechanical construction of the core, and in the

arrangement and fixing of the inductors thereon not to be found in the ring form. Less wire and magnetizing current are required for the field magnets for a given output than with the ring armature. Drum winding is not so simple as ring winding, and it is more difficult to ventilate a drum than a ring armature, it being necessary to provide special ventilating ducts.

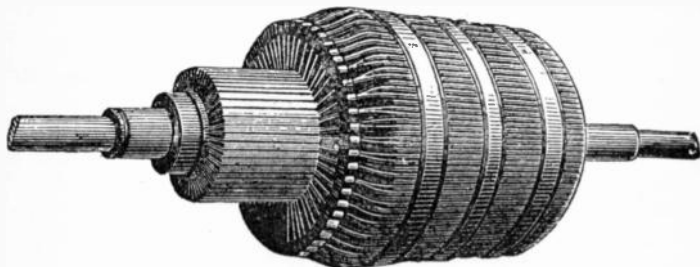

FIG. 249.—Modern form of Gramme ring armature. The core consists of a number of thin flat rings of well annealed charcoal iron, the outer diameter of each ring or disc being $11\frac{1}{2}$ inches, and its inner diameter $9\frac{1}{4}$ inches. Sheets of thin paper insulate each disc from its neighbors to prevent the flow of eddy currents. The armature is mounted on a steel shaft to which is keyed a four armed metal "spider," the extremities of whose arms fit into notches cut in the inner edges of the soft iron core rings, so that a good mechanical connection is obtained between the core and the shaft. The spider is made of a non-magnetic metal, to reduce the tendency to leakage of lines of force across the interior of the armature. The armature inductors consist of cotton covered copper wire of No. 9 standard wire gauge, wound around the core in one layer, and offering a resistance, from brush to brush, of 0.048 ohm. There are two convolutions in each section, the adjacent ends of neighboring sections being soldered to radial lugs projecting from the commutator bars.

Ques. Describe a ring armature.

Ans. It consists essentially of an iron ring, around which is wound a number of coils. These various coils are wound on separately, the wire being carried over the outside of the ring, then through the center opening and again around the outside, this operation being repeated until the winding for that individual section is completed. The adjacent coil is then wound in the same way, the ends of each being brought out to the commutator side of the armature. the arrangement of

the coils on the ring and connections with the commutator being shown in fig. 247, examples of actual construction being shown in figs. 248 and 249.

Ques. For what conditions of operation is the ring armature specially adapted, and why?

Ans. It is well suited to the generation of small currents at high voltage, as for series arc lighting, because the numerous coils can be very well insulated.

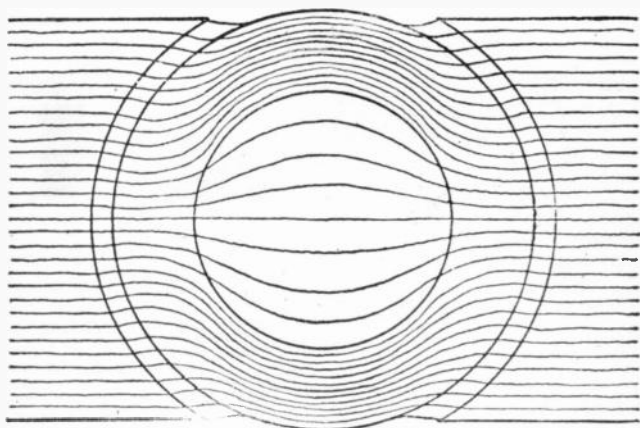

Fig. 250.—Distribution of magnetic lines of force through a Gramme ring. Since the metal of the ring furnishes a path of least reluctance, most of the magnetic lines will follow the metal of the ring and very few will penetrate into the aperture of the interior. This condition causes a serious defect in the action of ring armatures rendering the winding around the interior useless for the production of electromotive force. Hence, in ring armatures only about half of the winding is effective, the rest or "dead wire," adding its resistance to the circuit, thus decreasing the efficiency of the machine.

Ques. Why does a ring armature require more copper in the winding than a drum armature?

Ans. For the reason that those inductors which lie on the inner side of the iron ring, being screened from practically all the lines of force, as shown in fig. 250, do not generate any current.

Numerous attempts have been made to utilize this part of the winding by making the pole pieces extend around the ring in such a manner that lines of force will pass to the inside of the ring, also by arranging an additional pole piece on the inside of the armature, but mechanical considerations have shown these methods to be impractical.

Ques. Is any portion of the winding of a drum armature inactive?

Ans. Yes; the end connectors do not generate any current.

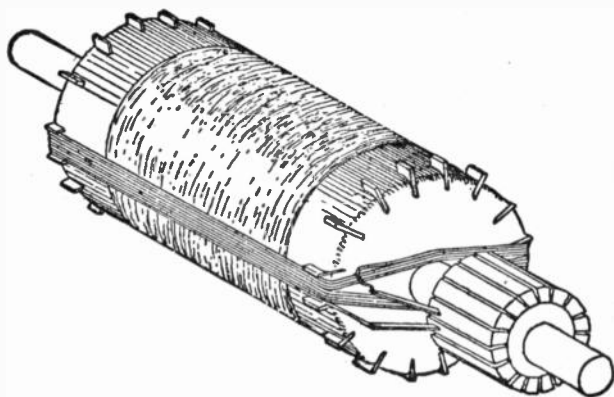

FIG. 251.—Illustrating the principle of Siemens' drum winding. In order to make the winding and connections clear, one coil and the commutator is shown assembled, although the latter is not put in place until after all the sections have been wound, the ends of the wires being temporarily twisted together until all can be soldered to the risers. The cores of these early machines were of wood overspun circumferentially with iron wire before receiving the longitudinal copper windings.

Ques. What is the chief advantage of the drum armature?

Ans. It reduces considerably the large amount of dead wire necessary with the ring type.

Ques. How is this accomplished?

Ans. By winding the wire entirely on the outer surface of a cylinder or *drum*, as it is called, as shown in fig. 251, thus none of the wire is screened by the metal of the core.

Fig. 252 shows an elementary four coil drum armature. Starting from the point *a* and following the winding around without reference at

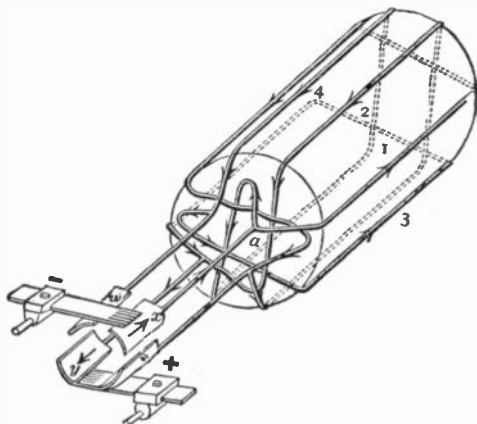

FIG. 252.—Elementary four coil drum winding, showing the connections with the commutator segments, and directions of currents in the several coils. The action of this type of armature is fully explained in the text.

first to the commutator, it will be found that the rectangular turns of the wire form a closed circuit, and are electrically in series with one another in the order of the numbers marked on them.

With respect to the connections to the four segments *w*, *x*, *y*, *z*, of the commutator it will be found that at two of these, *x* and *y*, the pressures in the windings are both directed *from*, or both directed *toward* the junction with the connecting wire. At the other two segments, *z* and *w*, one pressure is toward the junction and the other directed from it. If, therefore, the brushes be placed on *x* and *y* they will supply current to an external circuit, *z* and *w*, for the moment being idle segments.

Disc Armatures.—The inductors of a disc armature move in a plane, perpendicular to the direction of the lines of force, about an axis parallel to them as shown in fig. 253. The main difficulty with this type has been in constructing it so that it will be strong and capable of resisting wear and tear. It was introduced in an effort to avoid the losses due to eddy currents and hysteresis present in the other types of armature.

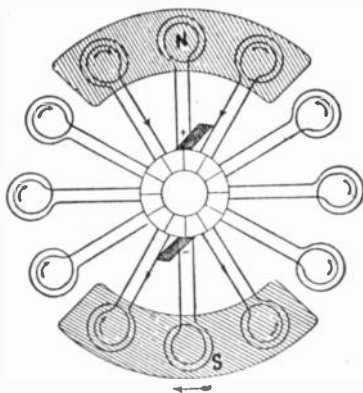

FIG. 253.—Disc armature of Niaudet. It is equivalent to a ring armature, having the coils turned through an angle of 90° , so that all the coils lie in a plane perpendicular to the axis of rotation. The connections of the coils with each other and with the commutator remain the same, the beginning and the end of adjacent coils leading to a common commutator bar as shown. The magnetic field is arranged by the use of two magnets, so arranged as to present the north pole of one to the south pole of the other, and *vice versa*. In the figure one of these magnets is considered as above the paper, and the other below. If this armature be rotated through the magnetic field as shown, a reversal of current takes place in each coil, when it is in such a position that one of its diameters coincides with the pole line, *NS*. If the brushes be set so as to short circuit the coils that are in this position, the armature will be divided into two branchings, the current flowing in an opposite direction in each, and a direct current will flow in the exterior circuit.

On account of the nature of the construction of a disc armature, it is necessary that the coils subject to induction occupy as small a space as possible in the direction of their axes. This requirement, as well as the connection of the inductors with each other and with the commutator, prevented the general adoption of this form of armature, and subsequent experience failed to justify the existence of the type.

CHAPTER XVIII

ARMATURE WINDINGS

To connect up rightly the inductors on an armature so as to produce a desired result is a simple matter in the case of ring winding, for bipolar or multipolar machines. It is a less easy matter in the case of drum winding, especially for multipolar machines. Often there are several different ways of arriving at the same result, and the fact that methods which are electrically equivalent may be geometrically and mechanically different makes it desirable to have a systematic method of treating the subject.

The elementary arrangement of drum and disc armatures has already been considered, which is sufficient explanation for small armature coils of only a few turns of wire, but in the case of larger machines which require many coils, further treatment of the subject is necessary.

For example, in order to direct the winder how to make the connections for, say a four pole machine having 100 bars spaced around its armature, some plain method of representing all the connections so that they may be easily understood is necessary. From this the workman finds out whether he is to connect the *front** end of bar No. 1 across to 50 or across a quarter of the circumference to 24, or across three quarters of it to bar 75. Again, he ascertains to which bar he is to connect the *back** end of the bar, and how the bars are to be connected to the commutator.

*NOTE.—The "front" end means the end at which the commutator is located. Armatures are most conveniently regarded from this end, the opposite end being known as the "back" end.

Winding Diagrams and Winding Tables.—In the construction of armatures, instructions to winders are given in the form of diagrams and tables. In the tables the letters F and B stand for *front* and *back*, meaning *toward* the front end, and *from* the front end respectively. The letters U and D stand for *up* and *down*.

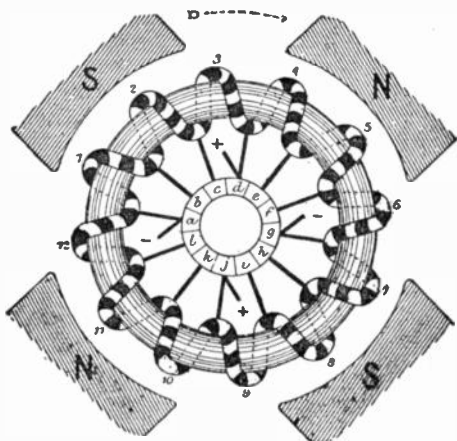

FIG. 254.—End of ring winding for a four pole machine. An end view is simply a view showing the arrangement of the armature inductors and connections looking from the front or commutator end. A developed view of the above winding is shown in fig. 257.

There are three kinds of winding diagram:

1. End view diagram;
2. Radial diagram;
3. Developed diagram.

The end view is simply a view showing the arrangement of the armature inductors and connections looking from the front or commutator end, such as shown in fig. 254.

In the radial diagram the inductors of the armature are represented by short radial lines, while the end connectors are represented by curves or zigzags, those at one end of the armature being drawn within, those at the other end, without the circumference of the armature. With the radial diagram it is easier to follow the circuits and to distinguish the back and front pitch of the winding.

The developed diagram is a mode of representation, originally suggested by Fritsche of Berlin, in which the armature winding

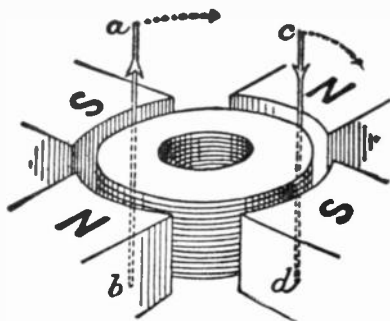

FIG. 255.—Partial sketch of a four pole machine laid on its side. If the observer imagine himself placed at the center, and the panorama of the four poles to be then laid out flat, the developed view thus obtained would appear as in fig. 256.

is considered as though the entire structure had been developed out of a flat surface. This is best explained by aid of figs. 255 and 256.

If in fig. 255, which represents an armature core and a four pole field, wires *a* and *c* be placed parallel to the axis of the armature to represent two of the armature inductors, and moved along the air gap space clockwise past the S poles, they will cut magnetic lines inducing electromotive forces in the directions indicated. To attempt to show a large number of inductors in a drawing of this kind would be unintelligible. Accordingly, the observer is considered as being placed at the center of the armature, and the panorama of the four poles surrounding him to be then laid out flat or "developed" as in fig. 256.

The faces of the N and S poles are shaded obliquely for distinction. By choosing the proper directions for these oblique lines, a piece of paper having a narrow slit to represent the wire may be laid over the drawing of the pole and when moved, as indicated by the dotted arrows to the right, the slit in passing over the oblique lines will cause an apparent motion in the direction in which the current in reality tends to flow. It is easily remembered which way the oblique lines must slope, for those on the N pole slope parallel to the oblique part of the letter N.

Lap Winding and Wave Winding.—In winding armatures there are two distinct methods employed, known respectively as *lap* and *wave winding*. The distinction arises in the following

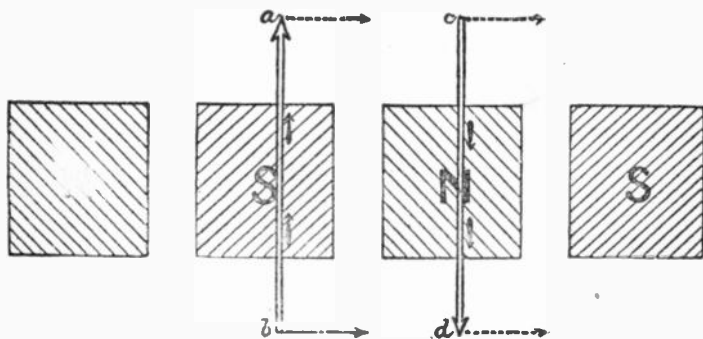

FIG. 256.—Developed view of the four pole field shown in perspective in fig. 255.

manner: Since the inductors, in passing a north pole generate electromotive forces in one direction, and in passing a south pole generate electromotive forces in the opposite direction, it is evident that an inductor in one of these groups ought to be connected to one in nearly a corresponding position in the other group, so that the current may flow down one and up the other in agreement with the directions of the electromotive forces. The order followed in making these connections gives rise to lap and wave windings.

Ques. What is lap winding?

Ans. *One in which the ends of the coils come back to adjacent segments of the commutator; the coils of such a winding lap over each other.*

Ques. What is a wave winding?

Ans. *One in which the coil ends diverge and go to segments widely separated, the winding to a certain extent resembling a wave.*

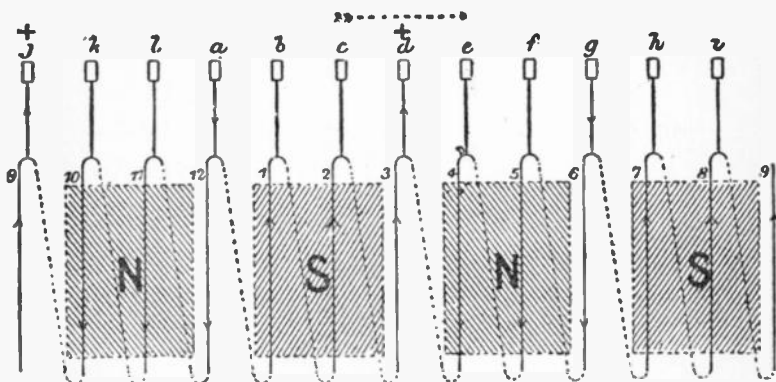
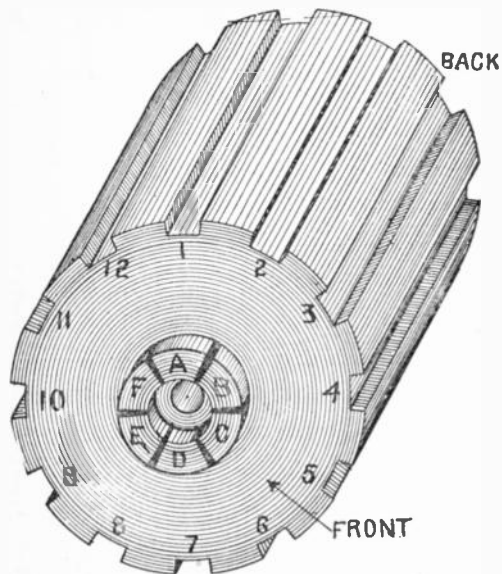







FIG. 257.—Development of ring winding of four pole machine shown in fig. 254. The dead wire or inactive inductors on the inside of the ring are shown in dotted lines, the full lines representing the active portion of the winding.

Angular Pitch or Spread of Drum Coils.—Before taking up the winding as a whole, the form of the individual coil should be considered. Fig. 260 shows an end view of one coil in position on a drum armature of a multipolar machine. The two slots *a* and *b* contain the sides of the coil and the distance between them on the surface of the drum is called the *angular pitch* or *spread of the coil*. Theoretically this is equal to the



WINDING TABLE.

	A	1	6	B
	B	3	8	C
	C	5	10	D
	D	7	12	E
	E	9	2	F
	F	11	4	A

FIGS. 258 and 259.—Wooden armature core and winding table for practice in armature winding. By using strings of different colors to represent the various coils, the path of each coil is easily traced when the winding is completed, as in fig. 263.

pitch of the poles, represented by the angle M , which is the angle between the pole centres.

For instance, on a four pole machine the pitch would be 90° , on a six pole machine, 60° , etc. Usually the angular pitch of the coil is made just a little less than the pole pitch of the machine, in order to shorten the end connections of the coils from slot to slot. However, if the angular pitch be made too small trouble will be encountered in commutation.

In addition to the angular pitch there is the *commutator pitch* which relates to the distance around the commutator bridged by the ends of the coil. Thus, if the commutator segments were numbered consecutively 1, 2, 3, etc., and the *commutator pitch* say is 10, it would signify that one end of the coil was connected to segment 1 and the other end to segment 11; the ends of the next coil in order then would be connected to segments 2 and 12, in each case there would be ten segments between the two segments connecting with the coil ends.

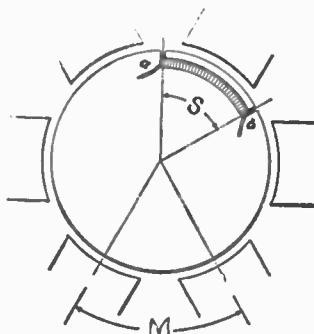

FIG. 260.—End view of drum armature of a multipolar machine showing one coil in position to illustrate the *angular pitch* or spread of drum coils.

Parallel or Lap Drum Winding.—In order to avoid much of the difficulty usually experienced by students of drum winding, the beginner should construct for himself a wooden armature core upon which he can wind strings of various colors, or wires with distinctive insulation, to represent the numerous coils that are used on real armatures. A few windings attempted in this way will make clear many points that cannot be so easily grasped from a written description.

The type of drum core best adapted for this work is the slotted variety as shown in fig. 258, as it will facilitate the winding. The core as shown in the illustration has twelve slots and six commutator segments, the number of each required for the example of lap winding indicated in the winding table fig. 259.

In making the wooden core, the slots may be formed by nailing a series of thin strips around a cylindrical piece of wood, thus avoiding the trouble of cutting grooves. In the illustrations the commutator segments are shortened (leaving no room for brushes) in order to show the connections as clearly as possible.

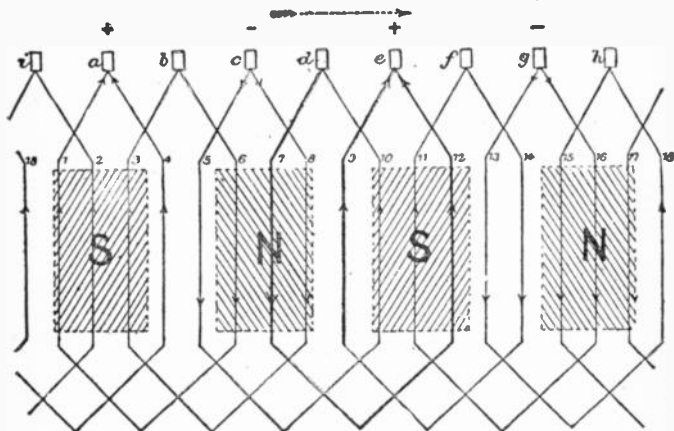

FIG. 261.—Developed view of a typical lap winding. From the figure it is seen that at the back of the armature each inductor is united to one five places further on, that is, 1 to 6, 3 to 8, etc., and at the front end of the winding, after having made one "element," as for example $d-7-12-e$, then forms a second element $e-9-14-f$ which "laps" over the first, and so on all around until the winding returns on itself.

Ques. Describe the simple lap winding fig. 259.

Ans. As given in the table, it consists of six loops of wire presenting twelve inductors on the cylindrical surface of the core or drum. In the table, six wires are shown, having

distinctive and varied insulation so as to readily distinguish the different coils. Opposite these are letters and figures designating the path and connections of each coil.

Ques. What is the path of the first coil?

Ans. According to the table it is:

A—1—6—B

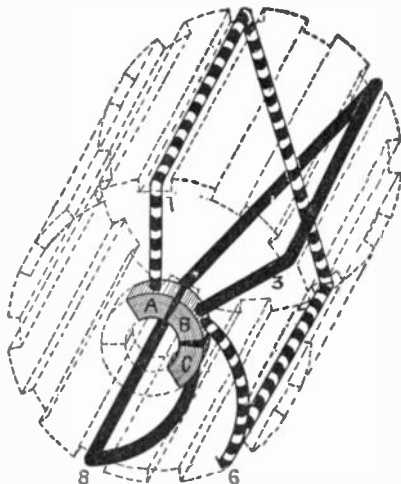

FIG. 262.—Skeleton view of wooden armature core showing in position the first two coils of the winding indicated in the table fig. 259.

that is, one end of the wire is connected to commutator segment A (fig. 262) and then wound to the back of the drum through slot 1, across the back of the drum to slot 6, returning through this slot, and then connected with commutator segment B.

Ques. Describe the path of the second coil.

Ans. The second coil, having the block insulation, is wound according to the table, in the order:

B—3—8—C

that is, beginning at segment B, thence to back of drum through slot 3, across the back to slot 8, returning through this slot and ending at segment C.

The completed winding of the first two coils are shown in fig. 262, the drum being shown in dotted lines so that all of each coil may be visible.

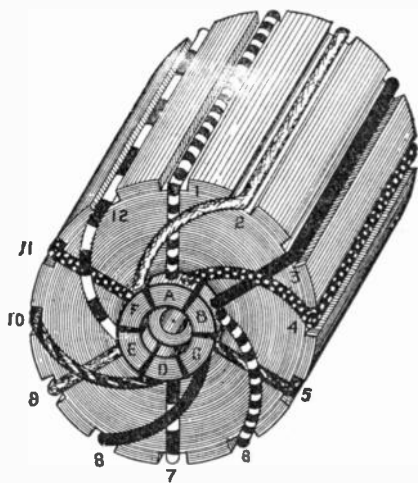

FIG. 263.—View of completed winding as indicated in the table fig. 259. Thus the path of the first coil, according to the table is A-1-6-B which means that the coil begins at segment A of the commutator, rises to slot 1, and proceeds through the slot to the back of the drum; thence across the back to slot 6, through the slot and ending at segment B. The other coils are wound in similar order as indicated in the table.

Ques. How are the remaining coils wound on the drum?

Ans. Each of the succeeding coils are wound as indicated in the table, the last connection being made to segment A, the one from which the winding started.

Ques. What is the general form of the completed winding?

Ans. It may be considered simply as a wire wound spirally around the drum, with loops brought down to the commutator segments, and ending at the segment from which the start was made.

The completed winding as indicated by the table is shown in fig. 263. Here the path of each coil is easily distinguished by means of the varied insulations although in part hidden by the drum. Fig. 264 shows a developed view of the winding.

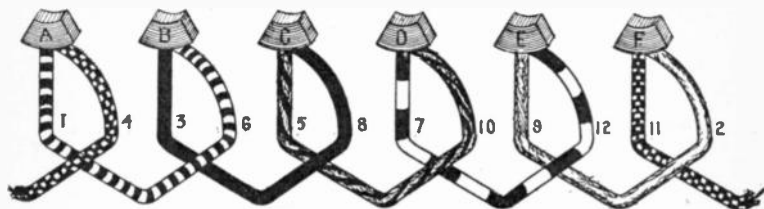

FIG. 264.—Developed view of the winding shown in perspective in fig. 263.

Ques. What condition must obtain in winding an even number of coils?

Ans. The wire must not be wound around the drum to diametrically opposite positions, as for instance 1 to 7 in fig. 265.

Ques. Why is this?

Ans. The reason will be clearly seen by attempting the winding on the wooden core. A winding of this kind on the drum fig. 258, would proceed as follows:

A—1—7—B
 B—3—9—C
 C—5—11—D

In order now to continue winding in a regular way, the wire from segment *d* should pass to the rear of the armature along space 7, but this space is already occupied by the return of the first coil. Continuing the winding from this point, it would be necessary to carry the wire from segment *d* to 6 or 8, resulting in an unbalanced winding.

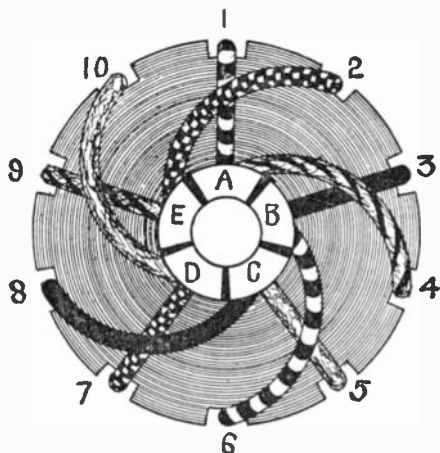

FIG. 265.—Lap winding for bipolar machine, with uneven number of coils; in this case the rear connectors may be made directly across a diameter as shown.

Ques. How is a symmetrical winding obtained having an even number of coils?

Ans. The inductors, in passing from the front to the rear of the armature, fig. 263, must occupy positions 1, 3, 5, 7, 9, 11, and the even numbered positions will then serve as the returns for these wires.

In the example here shown there are six coils, comprising twelve inductors and six commutator segments; it should be noted, however, that if there were an uneven number of coils, the rear connections

is, the coil ends instead of connecting with adjacent segments of the commutator, are attached to segments more or less remote.

Ques. Describe the circuits of a simple or simplex wave winding.

Ans. Only two sets of brushes are required for such a winding, but as many brushes as there are poles can be used.

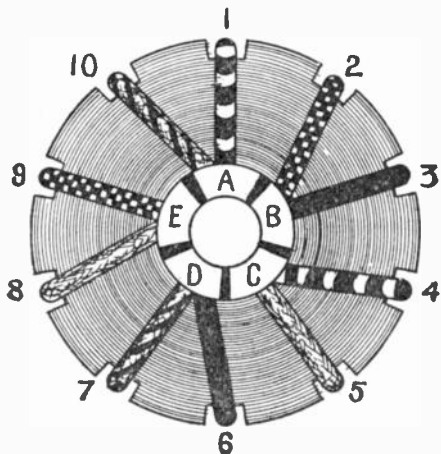

FIG. 267.—Five coil wave winding for a four pole machine. In this winding only two brushes are used, there being only two paths through the armature.

Ques. For what service are wave windings adapted?

Ans. They are generally used on armatures designed to furnish a current of high voltage and low amperage.

An example of wave drum winding for a four pole machine is shown in fig. 267. For simplicity, very few coils are taken, there being only five as shown in the illustration. To make the winding, one strip should be removed from the wooden core and the others spaced equally around the cylindrical surface. This will give ten slots, the number required for the five coils. The winding is indicated in the following table:

A — 1 — 4 — C
 B — 3 — 6 — D
 C — 5 — 8 — E
 D — 7 — 10 — A
 E — 9 — 2 — B

Accordingly the first coil starting at segment A, is carried to the back of the drum through slot 1, thence across the back and returning through slot 4, ending at segment C the starting point of the second coil. Each coil is wound on in similar manner, the last coil ending at segment A, the starting point of the first coil. A developed view of the winding is shown in fig. 268.

Double Windings.—In the various drum windings thus far considered, each coil had its individual slots, that is, no two occupied the same two slots. This arrangement gave twice the number of slots as commutator segments.

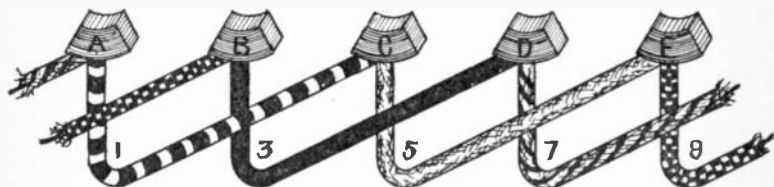

FIG. 268.—Developed view of the five coil wave winding shown in fig. 267.

In a double winding there are as many segments as slots, each of the latter containing two inductors, comprising part of two coils.

The Siemens Winding.—In winding drum armatures for bipolar dynamos of two horse power or less, and especially for very small machines as used in fan or sewing machine motors, a form of winding, known as the Siemens winding, which is shown in fig. 271, is largely used. It consists in dividing the surface of the armature core in one equal number of slots, say 16, and using a 16 part commutator.

In the Siemens winding, the end of the wire used at the start is to be connected to the first commutator bar, but must be fastened to the armature core out of the way so as not to interfere with the winding of the coils.

If eight turns of wire be required to fill a slot with one layer, then the wire is carried from front to back and bent aside so as to clear the shaft; after passing across the back or pulley end of the armature, it is wound in the diametrically opposite section and brought to the front, then across the commutator end and up close to the beginning of the coil.

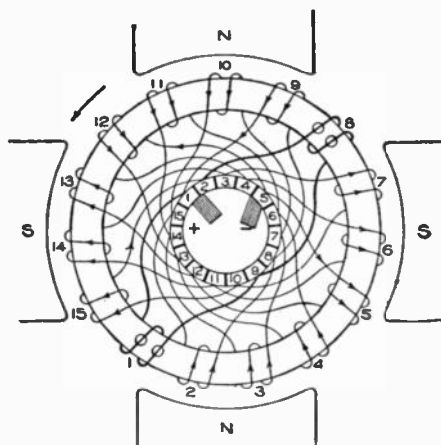

FIG. 269.—Series connected wave wound ring armature for a four pole machine. The coils are so connected that only two brushes are necessary.

Since eight turns are to be used, the process of winding is continued until the section is full and the end of the coil will lie in a position ready to begin the next section. Sometimes the wire is cut at this part of the coil leaving 3 or 4 inches projecting for connecting to the commutator bar 2, or next to the first bar where the winding was started.

The usual practice is, however, to make a loop of the wire of sufficient length to make the connection to the commutator and it has the advantage that since all of the coils on the armature are joined in series, the ending of one coil is joined to the beginning of the next which avoids making mistakes in making the commutator connections.

If the ends be cut they should be marked "beginning" and "end" to avoid trouble, because if they get mixed, it will be necessary to test each coil with a battery and compass needle in order to determine the polarity produced and find which is the beginning of the coil and which the end.

With 32 ends of the wire projecting from the end of the armature, it is confusing and mistakes are often made in the connections, so that one or more coils may oppose each other which would reduce the voltage.

After the surface of the armature is covered with one layer it will be noticed that the number of leads from the coils to the commutator bars is only one-half the number of bars and that they lie on one-half of the armature.

In order to complete the winding the first layer should be insulated and the second layer wound on. The beginning of the new coil will be directly over the first coil put on, but the beginning of the new coil will be diametrically opposite the beginning of the first coil wound.

The winding is now continued section by section and as each coil is finished a loop or pair of leads is left to connect to each bar. When the

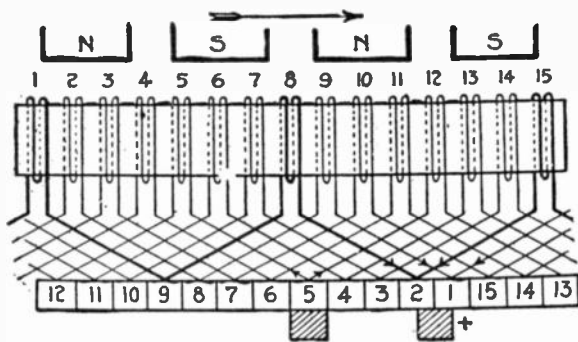

FIG. 270.—Developed view of the series connected wave wound ring armature shown in fig. 269

last coil is wound, its end will be found lying next to the wire used in starting and should be joined to it and finally connected to bar number one where the start was made.

With the winding and commutator connected, all of the coils are in series and the beginning of the first coil joins the end of the last coil.

If a pair of brushes be now placed on the commutator at opposite points the current will flow into the bar and then divide between the two leads connected to it, half of the current flowing around one side and the other half flowing around the other half of the armature or in other words, the two halves of the armature are joined in parallel.

Ques. What is the objection to the Siemens winding just described?

Ans. It produces an unsightly head where the wires pass

The brush then must be large enough to overlap at least two segments, so as to collect current from both windings simultaneously. Both windings then are always in the circuit in parallel.

Ques. What is the effect of a multiplex winding?

Ans. It reduces the tendency to sparking, because only half of the current is commutated at a time, and also because adjacent commutator bars belong to different windings.

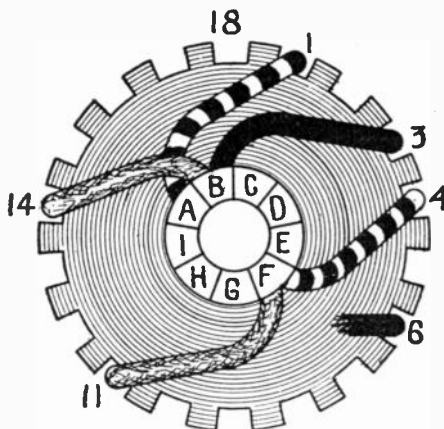

FIG. 272.—A progressive wave winding. If the front and back pitches of a wave winding be such that in tracing the course of the winding through as many coils as there are pairs of poles, a segment is reached in advance of the one from which the start was made, the winding is said to be progressive. The figure shows three coils of a winding having 18 inductors. From the definition, the number of coils to consider to determine if the winding be progressive is equal to the number of poles divided by 2, which in this case is equal to 2. These coils are shown in the figure as follows: A-1-4-F and F-11-14-B. The second coil ends at segment B which is in advance of segment A from which the winding began, indicating that the winding is progressive. Fig. 272 is given simply to illustrate the definition of a progressive winding, and not to represent a practical winding.

Ques. Does an accident to one winding disable the machine?

Ans. No, it simply reduces its current capacity.

Ques. Can multiplex windings have more than two windings?

Ans. Yes, there may be three or four windings.

Ques. What is the objection to increasing the number of windings?

Ans. It involves an increased number of inductors and

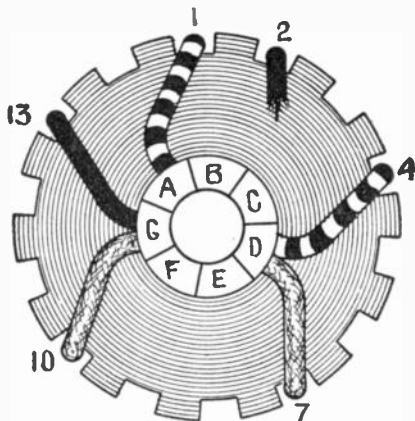

FIG. 273.—A retrogressive wave winding. If the pitches be such that in tracing the winding through as many coils as there are pairs of poles, the first segment of the commutator is not encountered or passed over, the winding is said to be retrogressive. The number of coils to consider is two, as follows: A-1-4-D and D-7-10-G. The second coil ends at G, hence, since the segment A where the start was made has not been reached or passed over the winding is retrogressive. Fig. 273 is given simply to illustrate the definition of retrogressive winding, and not to represent a practical winding.

commutator segments, which is undesirable in small machines, but for large ones might be allowable.

When there are two independent windings the arrangement is called *duplex*, with three windings, *triplex*, and with four, *quadruplex*.

Ques. What loss is reduced with multiplex windings?

Ans. In these windings, the division of what otherwise would be very stout inductors into several smaller ones, has the effect of reducing eddy current loss.

Ques. For what service are machines with multiplex windings specially adapted?

Ans. Multiplex windings are used in machines intended to supply large currents at low voltages, such as is required in electrolytic work.

Number of Brushes Required.—The number of places on the commutator at which it is necessary or advisable to place a set of collecting brushes can be ascertained from the winding diagrams. All that is necessary is to draw arrows marking the directions of the induced electromotive forces. Wherever two arrow heads meet at any segment of the commutator, a positive brush is to be placed, and at every point from which two arrows start in opposed directions along the winding, a negative brush should be placed.

Ques. How many brushes are required for lap windings and ordinary parallel ring windings?

Ans. There will be as many brushes as poles, and they will be situated symmetrically around the commutator in regular order and at angular distances apart equal to the pole pitch.

It should be noted that the number of brush sets does not necessarily show the number of circuits through the armature.

Ques. How many brushes are required for wave windings?

Ans. If arrows be drawn marking the direction of the induced electromotive forces to determine the number of brushes, it will be found that only two brushes are required for any number of poles.

Ques. What is the angle between these two brushes?

Ans. It is the same as the angle between any north and south pole.

For instance, in a ten pole machine with wave winding the pitch between the brushes may be any of the following angles:

$$360 \div 10 = 36^\circ$$

$$3 \times 36^\circ = 108^\circ$$

$$5 \times 36^\circ = 180^\circ$$

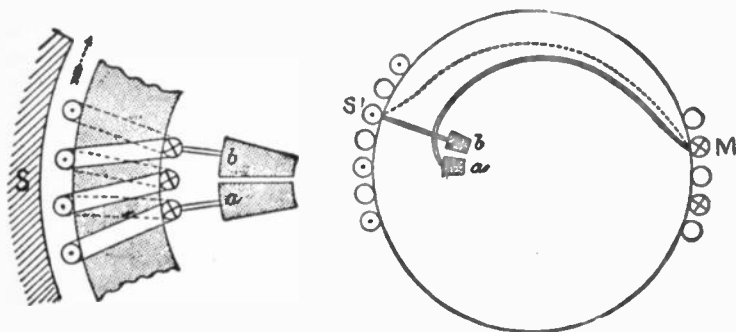

Figs. 274 and 275.—Right and left hand windings. These consist respectively of turns which pass around the core in a right or left handed fashion. Thus in fig. 274, in passing around the circle clockwise from *a* to *b*, the path of the winding is a right handed spiral. In fig. 275, which shows one coil of a drum armature, if *a* be taken as the starting point, in going to *b*, *a* must be connected by a spiral connector across the front end of the drum to one of the descending inductors such as *M*, from which at the back end another connector must join it to one of the ascending inductors, such as *S*, where it is led to *b*, thus making one right handed turn.

Sometimes with lap winding it is desirable to reduce the number of brushes. In fig. 276, is shown the distribution of currents in a four pole lap wound machine having four brushes and generating 120 amperes. In each of the four circuits the flow is 30 amperes, and the current delivered to each brush is 60 amperes. If now two of the brushes be removed, the current through each of the remaining two will be 120 amperes, while

internally there will be only two circuits as shown in fig. 277. It should be noted, however, that these two circuits do not take equal shares of the current since, though the sum of the electromotive forces in each circuit is the same, the resistance of one is three times that of the other, giving 90 amperes in one and 30 amperes in the other, as indicated in the figure. If no spark difficulties occur in collecting all the current with only two brushes, the arrangement will work satisfactorily, but the heat losses will be greater than with four brushes.

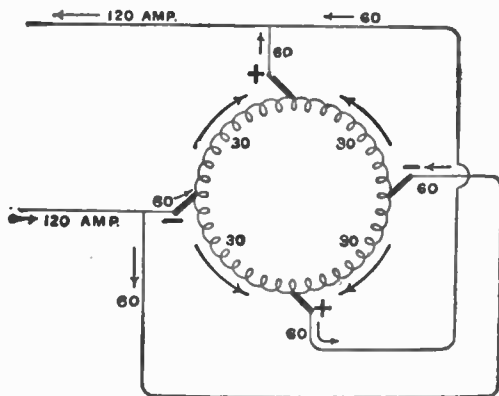

FIG. 276.—Distribution of armature currents in a four pole lap wound dynamo having four brushes and generating 120 amperes.

Ques. Are more than two brushes ever used with wave winding?

Ans. It is sometimes advisable to use more than two brushes with wave windings, especially when the current is very large.

For instance, in the case of a singly re-entrant* simplex wave winding for an eight pole machine, whenever any brush bridges adjacent bars

*NOTE.—A re-entrant winding is one in which both ends re-enter or lead back to the starting point; a closed winding.

of the commutator, it short circuits one round of the wave winding and this round is connected at three intermediate points to other bars of the commutator. Hence, if the short circuiting brush be a positive brush, no harm will be done by three other positive brushes touching at the other points. If these other brushes be broad enough to bridge across two commutator bars, they may effect commutation, that is, three rounds instead of one undergoing commutation together.

Number of Armature Circuits.—It is possible to have windings that give any desired even number of circuits in machines having any number of poles.

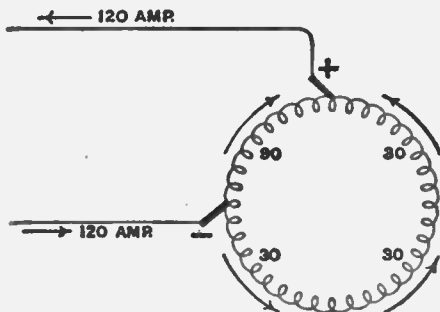

FIG. 277.—Showing effect of removing two of the brushes in fig. 275. If no spark difficulties occur in collecting the current with only two brushes, the arrangement will work satisfactorily, but the heat losses will be greater than with four brushes.

Ques. How many paths are possible in parallel?

Ans. For a simplex spirally wound ring, *the number of paths in parallel is equal to the number of poles*, and for a simplex series wound ring, *there will be two paths*. In the case of multiplex windings *the number of paths is equal to that of the simplex winding multiplied by the number of independent windings*.

In large multipolar dynamos it is, as a rule, inadvisable to have more than 100 or 150 amperes in any one circuit, except in the case of special machines for electro-chemical work. Such considerations are factors which govern the choice of number of circuits.

Equalizer Rings.—These are rings resembling a series of hoops provided in a parallel wound armature to eliminate the effects of “unbalancing,” by which the current divides unequally among the several paths through the armature. By means of leads, equalizer rings connect points of equal potential in the winding and so preserve an equalization of current.



FIG. 278.—Rear view of armature of a large dynamo built by the General Electric Co., showing equalizer rings.

Ques. In multipolar machines what points are connected by equalizer rings?

Ans. Any two or more points in the winding, that during the rotation, are at nearly equal potentials.

If there were perfect symmetry in the field system, no currents would flow along such connectors; however, owing to imperfect symmetry, the induction in the various sections of the winding may be unequal and the currents not equally distributed.

Drum Winding Requirements.—There are several conditions that must be satisfied by a closed coil drum winding:

1. There cannot be an odd number of inductors;

An odd number of inductors would be equivalent to not having a whole number of coils. The even numbered inductors may be regarded as the returns for the odd numbered inductors.

2. Both the front and back pitches must be odd in simplex windings.
3. The average pitch should be approximately equal to the number of inductors divided by the number of poles.

This condition must obtain in order that the electric pressures induced in inductors moving simultaneously under poles of opposite sign, will be added. The smallest pitch meeting this condition would stretch completely across a pole face, while the largest would stretch from the given pole tip to the next pole tip of like polarity.

The choice of front and back pitch for a given number of inductors should, with lap and wave windings in general, comply with the following conditions:

1. All the coils composing the winding must be similar, both mechanically and electrically, and must be arranged symmetrically upon the armature.
2. Each inductor of a simplex winding must be encountered once only, and the winding must be re-entrant.
3. Each simplex winding composing a multiplex winding must fulfill the requirement for a simplex winding.
4. A singly re-entrant multiplex winding must as a whole satisfy the requirement for a simplex winding.

In addition to the above requirements for lap and wave windings in general, lap windings must comply with the following conditions:

1. The front and back pitches must be opposite in sign;
2. The front and back pitches must be unequal;
If they be equal, the coil would be short circuited upon itself.
3. The front and back pitches must differ by two;
4. In multiplex windings, the front and back pitches must differ by two multiplied by the number of independent simplex windings composing the multiplex winding;
5. The number of slots on a slotted armature may be even or odd;
6. The number of inductors must be an even number; it may be a multiple of the number of slots;

In the case of wave windings the several conditions to be fulfilled may be stated as follows:

1. The front and back pitches must be alike in sign;
2. The front and back pitches may be equal or they may differ by any multiple of two.

They are usually made nearly equal to the number of inductors divided by the number of poles.

CHAPTER XIX

THEORY OF THE ARMATURE

Current Distribution in Ring and Drum Armatures.—

In studying the actions and reactions which take place in the armature, the student should be able to determine the directions of the induced currents. The basic principles of electromagnetic induction were given in chapter X, from which, for instance, the distribution of current in the gramme ring armature, shown in fig. 279, is easily determined by the application of Fleming's rule.

Tracing the current from the negative to the positive brush, it will be seen that it divides, half going through coils 1, 2, 3, and half through coils I, II, III, these two currents ascend to the top of the ring, uniting at the positive brush.

Ques. In the Gramme ring armature (fig. 279) what is the distribution of armature currents?

Ans. There are two paths in parallel as indicated in fig. 279.

Ques. How does the voltage vary in the coils?

Ans. It varies according to the position of the coils, being least when vertical and greatest when horizontal in a two pole machine arranged as in fig. 279.

The upper and lower coils in the right hand half of the ring armature, fig. 279, will have about the same electromotive force induced in them, say 2 volts each, while the two coils between them will have a higher electromotive force, at the same instant, say 4 volts each, since they occupy

nearly the positions of the maximum rate of change of the magnetic lines threading through them. These eight coils may be represented by two batteries connected in parallel, each battery consisting of two 2 volts cells and two 4 volt cells as shown in fig. 280. The voltage of each battery then will be

$$+ 4 + 4 + 2 = 12 \text{ volts}$$

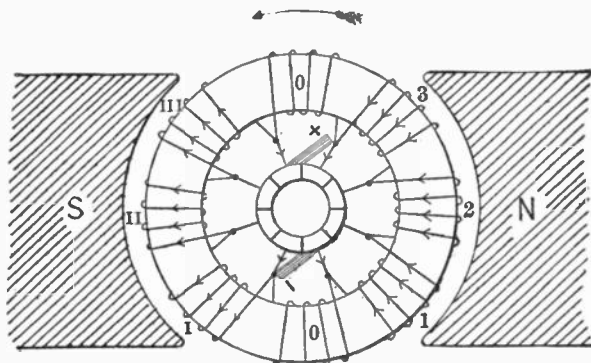

FIG. 279.—Current distribution in a gramme ring armature. There are two paths for the current between the brushes, half going up each side of the ring as indicated by the arrows, thus giving two paths in parallel as indicated in fig. 281.

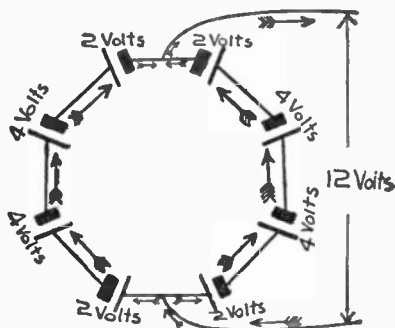

FIG. 280.—Battery analogy illustrating current distribution in a ring armature. The eight coils of the armature, fig. 279, are represented by two batteries of four cells each. The action of the two units thus connected is indicated by the arrows. In the external circuit the voltage is equal to that of one battery and the current is equal to the sum of the currents in each battery.

The two batteries being connected in parallel, the voltage at the terminals will be the same, but the current will be the sum of the currents in each battery.

Ques. How may the number of paths in parallel be increased?

Ans. By increasing the number of poles.

For instance, in a four pole machine, as in fig. 283, there are four paths in parallel. In this case the armature may be used to furnish two separate currents, though this is not desirable.

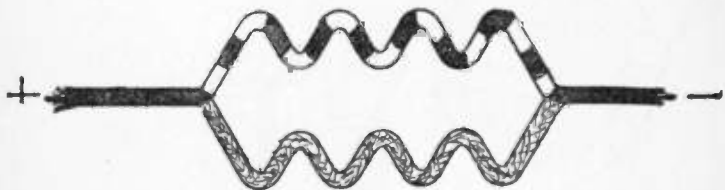

FIG. 281.—Diagram showing distribution of current in the gramme ring armature of fig. 279. The current flows in two parallel paths as indicated.

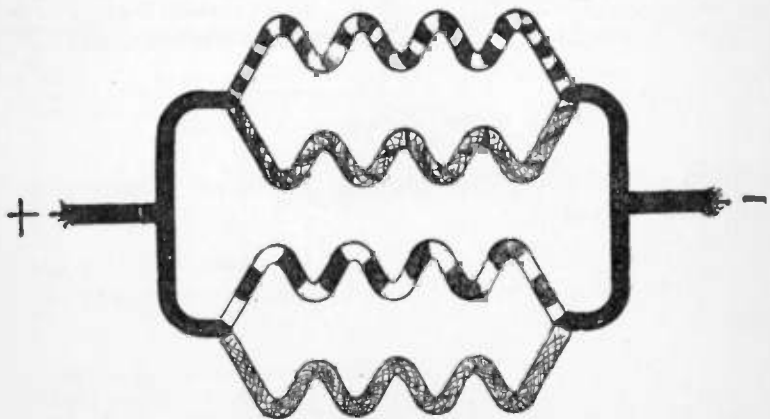

FIG. 282.—Diagram showing current distribution through armature of a four pole machine with like brushes connected. There are four paths in parallel, hence the induced voltage will equal that of one set of coils, and the current will be four times that flowing in one set of coils.

Ques. How are the brushes connected?

Ans. Usually all the positive brushes are connected together, and all the negative brushes as in fig. 283, giving four paths in parallel through the armature as indicated in fig. 282.

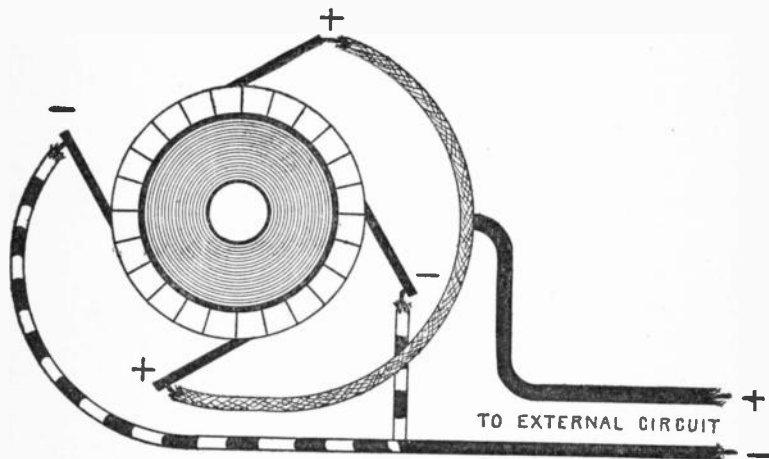

FIG. 283.—Brush connections for four pole dynamo. It is usual to connect all the positive brushes to one terminal and all the negative brushes to the other which gives four parallel paths as shown in the diagram, fig. 282. In a four pole machine, two separate currents can be obtained by omitting the parallel brush connections.

Ques. How does this method of brush connection affect the voltage?

Ans. The voltage at the terminals is equal to that of any of the sets of coils between one positive brush and the adjacent negative brush.

Thus in the four pole machine, fig. 283, the coils of the four quadrants are in four parallels, which gives an internal resistance equal to one-sixteenth that of the total resistance of the entire ring.

When the coils are connected in two circuits or series parallel, it requires only two brushes at two neutral points on the commutator, for any number of poles; this arrangement is shown in fig. 269.

Ques. In general what may be said about the current paths through an armature?

Ans. The paths may be in parallel or series parallel according as the winding is of the lap or wave type.

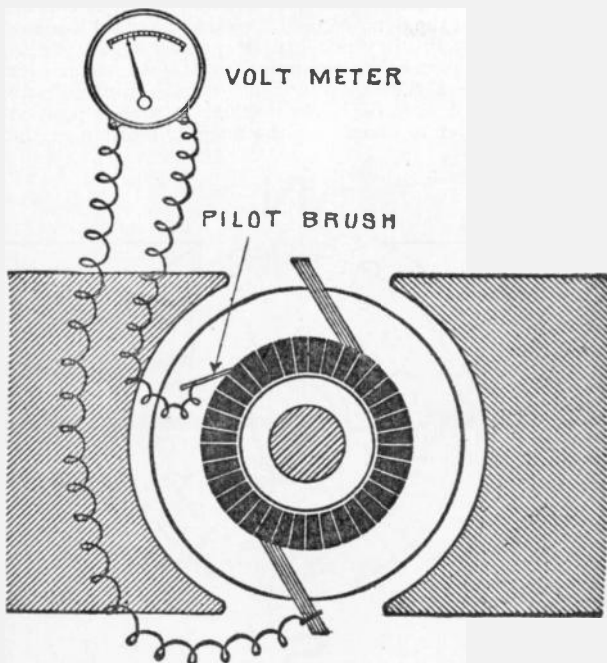

FIG. 284.—Morday's method of measuring the variation of voltage around the commutator by use of a single exploring brush and voltmeter. It consists in connecting one terminal of the voltmeter (preferably an electrostatic one) to one brush of the machine, and the other terminal to the exploring brush, which can be moved from point to point, readings being taken at each point.

Variation of Voltage Around the Commutator.—There are numerous ways of determining the value of the induced voltage in an armature at various points around the

commutator. In the method suggested by Morday, it can be measured by the use of a single exploring brush and a volt meter as shown in fig. 284.

In this method, one terminal of the volt meter is connected to one of the brushes of the dynamo, and the other terminal is joined by a wire to a small pilot brush which can be pressed against the commutator at any desired part of its circumference. With the machine running at its rated speed, the exploring brush is placed in successive positions between the two brushes of the machine. In each position a reading of the volt meter is taken and the angular position of the exploring brush noted.

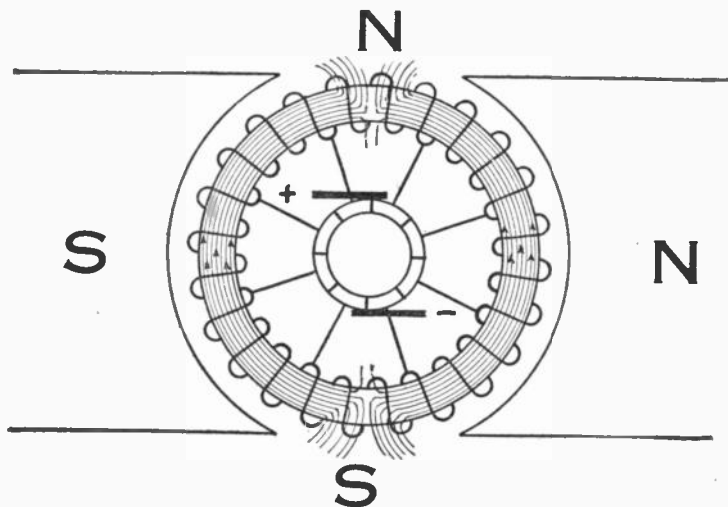

FIG. 285.—Cross magnetization. This is defined as lines of magnetic force set up in the windings of a dynamo armature which oppose at right angles the lines of force created between the poles of the field magnet. The figure shows this cross flux which is due to the armature current alone.

Ques. How does the voltage vary between successive pairs of commutator segments?

Ans. The variation is not constant.

Cross Magnetization; Field Distortion.—In the operation of a dynamo with load, the induced current flowing in the armature winding, converts the armature into an electro-magnet setting up a field across or at right angles to the field of the machine. This cross magnetization of the armature tends to distort the field produced by the field magnets, the effect being known as *armature reaction*. To understand the nature of this reaction it is best to first consider the effect of the field current and the armature current separately.

Fig. 285 represents the magnetic flux through an armature at rest, where the field magnets are separately excited. If the armature be rotated clockwise, induced currents will flow upward through the two halves of the winding between the brushes, making the lower brush negative and the upper brush positive

Ques. If, in fig. 285, the current in the field magnet be shut off, and a current be passed through the armature entering at the lower brush, what is the effect?

Ans. The current will divide at the lower brush, flowing up each side to the top brush. These currents tend to produce north and south poles on each half of the core at the points where the current enters and leaves the armature. Hence, there will be two north poles at the top of the ring and two south poles at the bottom.

Ques. What effect is produced by the like poles at the top and bottom of the ring?

Ans. The external effect will be the same as though there were a single north and south pole situated respectively at the top and bottom of the ring.

Ques. In the operation of a dynamo, how do the poles induced in the armature affect the magnetic field of the machine?

Ans. They distort the lines of force into an oblique direction as shown exaggerated in the diagram fig. 286.

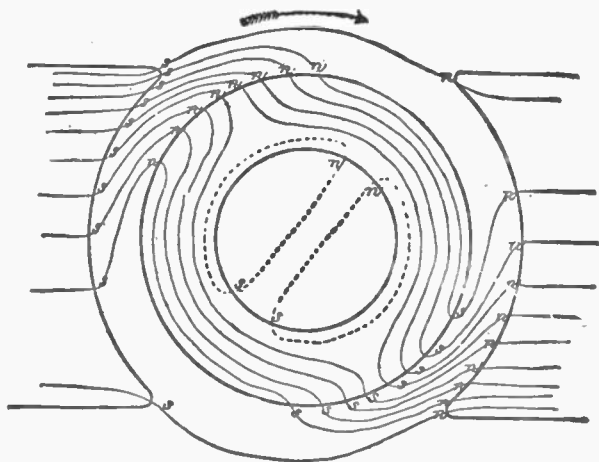

FIG. 286.—Distortion of magnetic field due to cross magnetization. For clearness, the effect is shown somewhat exaggerated. A drag or resistance to the movement of the armature is caused by the attraction of the north and south poles on the armature and pole pieces respectively.

Ques. What effect has the presence of poles in the armature on the operation of the machine?

Ans. In fig. 286, the resultant north pole n, n, n , where the lines emerge from the ring, attracts the south pole, s, s, s , where the lines enter the field magnet, hence a load is brought upon the engine, which drives the dynamo, in dragging the armature around against these attractions. The stronger the current induced in the armature, the greater will be the power necessary to turn it.

Ques. Why does this reaction in the armature require more power to drive the machine?

Ans. The effect produced by the armature reaction is in accordance with Lenz's law which states that: *In electro-magnetic induction, the direction of the induced current is such as to oppose the motion producing it.*

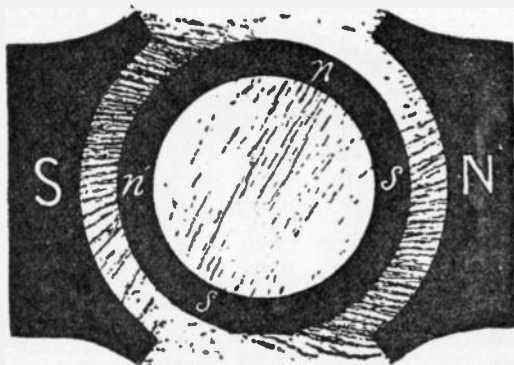

FIG. 287.—Actual distortion of field resulting from cross magnetization, as shown by iron filings.

Remedies for Field Distortion.—Since the distortion of the magnetic field of a dynamo causes unsatisfactory operation, numerous attempts have been made to overcome this defect, as for instance, by:

1. Experimenting with different forms of pole piece;

The reluctance of the pole piece should be increased in the region where the magnetic flux tends to become most dense. The trailing horn of the pole piece may be made longer than the advancing horn and cut farther from the surface of the armature, so as to equalize the distribution of the magnetic flux.

2. Lengthening the air gap;

This increases the reluctance, and also necessitates more ampere turns in the field winding. The field distortion, however, will not be so great, as it would be if the magnetic field of the machine were weaker.

3. Slotting the pole pieces;

Both longitudinal gaps and oblique slots have been tried. The reduction of cross section of the pole piece causes it to become highly saturated and to offer large reluctance to the cross field.

4. The use of auxiliary poles.

These are small poles placed between the main poles and so wound and connected that their action opposes that of the cross field.

Normal Neutral Plane.—This may be defined as a *plane passing through the axis of the armature perpendicular to the magnetic field of the machine when there is no flow of current in the armature*, as shown in fig. 288. It is the plane in which the brushes would be placed to prevent sparking when the machine is in operation were the field not distorted by armature reaction, and there were no self-induction in the coils.

Commutating Plane; Lead of the Brushes.—It has been found that in order to reduce sparking to a minimum, the brushes must be placed in certain positions found by trial and designated as being located in the *neutral plane*.

When the brushes are in the neutral plane, they are in contact with commutator segments connecting with coils that are cutting the lines of force at the minimum rate.

Ques. Define the term “commutating plane.”

Ans. This is a plane passing through the axis of the armature and through the center of contact of the brushes as shown in figs. 289 and 300.

Ques. What is the angle of lead?

Ans. The angle between the normal neutral plane and the commutating plane.

In the operation of a dynamo since the field, on account of armature reaction, is twisted around in the direction of rotation, the proper position for the brushes is no longer in the normal neutral plane, but lies

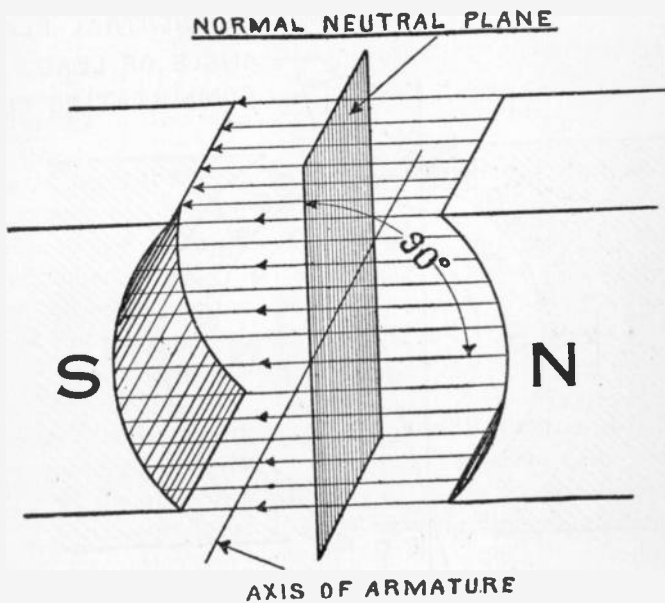

FIG. 288.—Normal neutral plane. This is a reference plane from which the lead is measured. As shown, the normal neutral plane lies at right angles to the lines of force of an undistorted field.

obliquely across, a few degrees in advance. Hence, for sparkless commutation, the commutating plane is a little in advance of the normal neutral plane, the lead being measured by the angle between these planes, as stated in the definition.

Ques. What may be said with respect to the angle of lead?

Ans. For sparkless commutation, the angle of lead varies with the load.

If the field be much altered at full load, it is evident that at half or quarter load it will not be nearly so much twisted, hence the necessity for mounting the brushes on some kind of rocking device which will

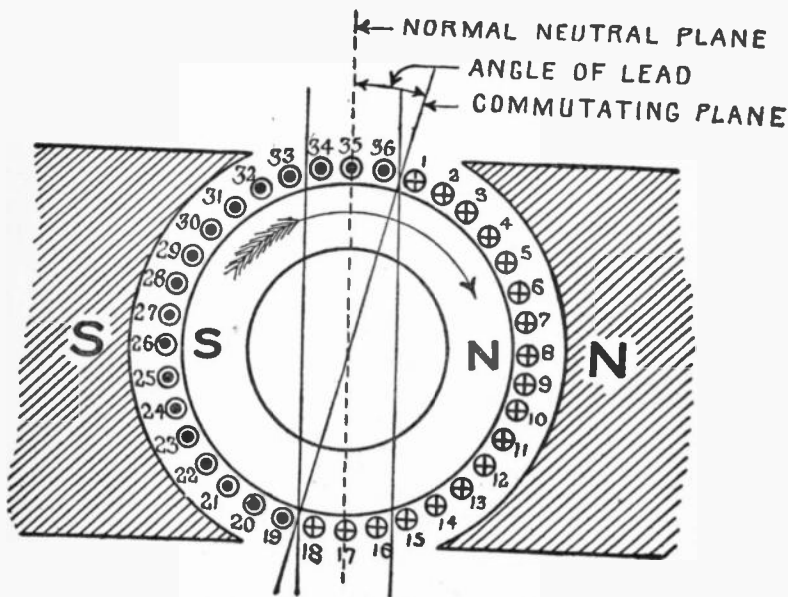

FIG. 289.—Diagram illustrating the demagnetizing effect of armature reaction. This results from the forward lead given the brushes in order to secure sparkless commutation.

allow them to be shifted in different positions for different loads. A desirable point, then, in dynamo design is to make the angle of lead at full load so small that it will not be necessary to shift the brushes much for variation of load. This can be accomplished by making the field magnet field considerably more powerful than the armature field.

Demagnetizing Effect of Armature Reaction.—In the operation of a dynamo, as previously explained, the position of the brushes for sparkless commutation must be varied with the load; that is, for light load they should occupy a position practically midway between the poles and for a heavy load they must be moved a few degrees in the direction of rotation. In other words, the commutating plane must be more or less in advance of the normal neutral plane as shown in fig. 289.

Ques. What is the effect of lead?

Ans. It produces a demagnetizing effect which tends to weaken the field magnets.

Ques. Describe this demagnetizing effect in detail.

Ans. Tracing the armature currents, in fig. 289 according to Fleming's rule, it will be seen that current in inductors 1 to 18 flow *from* the observer indicated by crosses representing the tails of retreating arrows and in inductors 19 to 36, *toward* the observer from the back of armature, indicated by dots representing the points of approaching arrows. In determining these current directions the inductors to the right of the neutral line are considered as moving downward, and those to the left as moving upward. The current in inductors 1 to 15 and 19 to 33, tends to cross magnetize the magnetic field of the machine, but the current in inductors 34 to 36 and 16 to 18 tends to produce north and south poles as indicated. These poles are in opposition to the field poles and tend to demagnetize them. Hence, the inductors lying outside the two upright lines are known as *cross magnetizing turns*, and those lying inside, as *demagnetizing turns*.

The breadth of the belt of demagnetizing turns included between the two upright lines is clearly proportional to the angle of lead; therefore, the demagnetizing effect increases with the lead.

Eddy Currents; Lamination.—Induced electric currents, known as eddy currents, occur when a solid metallic mass is rotated in a magnetic field. They consume considerable energy

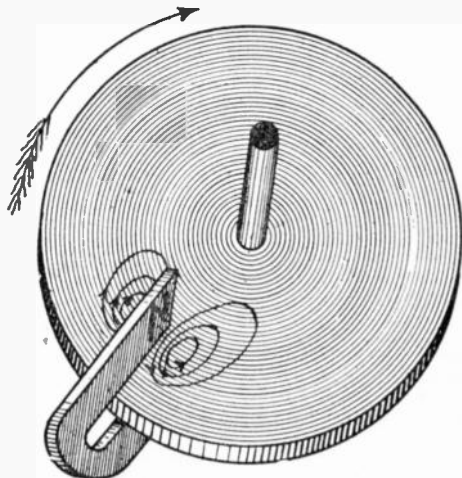

FIG. 290.—Arago's experiment illustrating eddy currents. Arago found that if a copper disc be rotated in its own plane underneath a compass needle, the needle was dragged around as by some invisible friction. The explanation of this phenomenon, known as *Arago's rotations*, is due to Faraday, who discovered that it was caused by induction. That is, a magnet moved near a solid mass of metal, induces in it currents, which, in flowing from one point to another, have their energy converted into heat, and which, while they last, produce (in accordance with Lenz's law) electromotive forces tending to stop the motion. Thus, in the figure, there are a pair of eddies in the part passing between the poles, and these currents oppose the motion of the disc. Foucault showed by experiment the heating effect of eddy currents, but such currents were known years before Foucault's experiments, hence they are incorrectly called Foucault currents.

and often occasion harmful rise in temperature. Armature cores, pole pieces, and field magnet cores are specially subject to these currents.

Ques. Describe the formation of eddy currents.

Ans. In fig. 291, a bar inductor is seen just passing from under the tip of the pole piece N of the field magnet. Noting the distribution of the lines of force, it will be seen that the edge cd is in a weaker field than the edge ab , hence, since the two edges move with the same velocity, the electromotive force

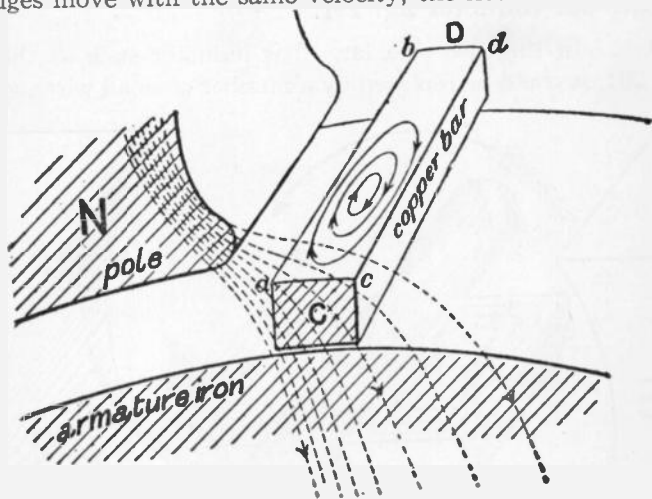

FIG. 291.—Formation of eddy currents in a solid bar inductor. On account of its appreciable size, the field is sometimes weaker at one point than another, hence the unequal electromotive forces thus produced will induce eddy currents.

induced along cd will be less than that induced along ab . This gives rise to whirls or current eddies in the copper bar as shown.

Ques. What should be noted in seeking a remedy for eddy currents?

Ans. It should be noted that eddy currents are due to very small differences of pressure and that the currents are large only because of the very low resistance of their circuits.

Ques. What is the best means of reducing eddy currents?

Ans. Lamination.

Ques. Explain this mode of construction with respect to the bar inductor fig. 291.

Ans. In the case of a large bar inductor such as shown in fig. 291, it could be replaced by a number of small wires soldered

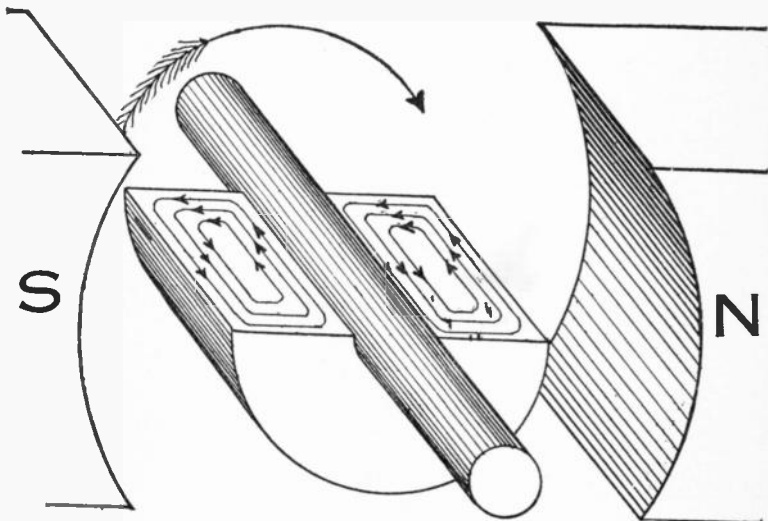

FIG. 292.—Eddy currents induced in a solid armature core. Eddy currents always occur when a solid metallic mass is rotated in a magnetic field, because the outer portion of the metal cuts more lines of force than the inner portion, hence the induced electromotive force not being uniform, tends to set up currents between the points of greatest and least potential. Eddy currents consume a considerable amount of energy and often occasion harmful rise in temperature.

together only at the ends. The layer of dirt or oxide on the outside of the wires will furnish sufficient resistance to practically prevent the eddy currents passing from wire to wire.

Ques. How should an armature core be laminated to avoid eddy currents?

Ans. It should be laminated at right angles to its axis.

Fig. 292 shows the induced eddy currents in a solid armature core, and fig. 293 shows the manner in which the paths of these currents are interrupted and the losses due to their effect diminished by the use of laminated cores.

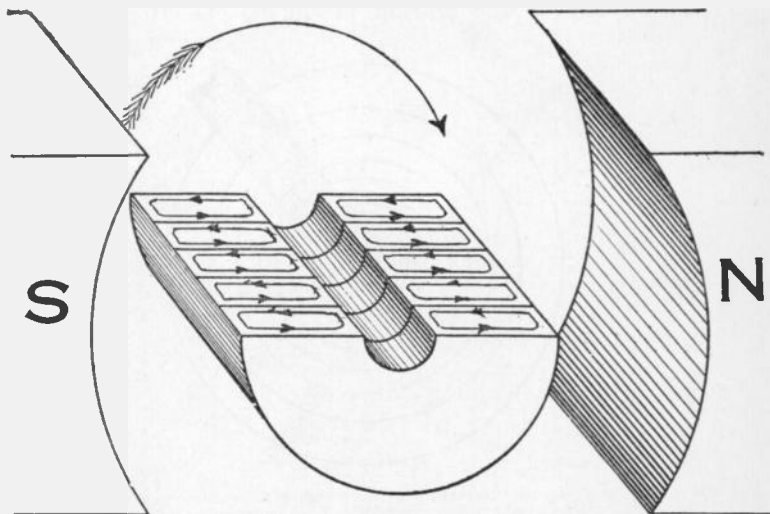

FIG. 293.—Armature core with a few laminations showing effect on eddy currents. In practice the core is made up of a great number of thin sheet metal discs, about 18 gauge, which introduces so much resistance between the discs that the formation of eddy currents is almost entirely prevented.

In fig. 293, only five laminations or plates are indicated, so as to show the sub-division of the eddy currents, but in practical armatures, the number of laminations or punchings ranges from 40 to 66 to an inch, and brings the eddy current loss down to about one per cent. A greater increase in the number of laminations per inch is not economical, however, owing to the difficulties encountered in the punching and handling of extremely thin sheets of iron, and the loss of space between the plates.

Armature cores constructed of the number of plates stated, and forced together by means of screws and heavy hydraulic pressure, contain from 80 to 90 per cent. of iron, and have a magnetic flux carrying capacity only from 5 to 15 per cent. less than when they are made of an equal volume of solid iron.

Magnetic Drag on the Armature.—Whenever a current is induced in an armature coil by moving it in the magnetic field so as to cut lines of force, the direction of the induced current is such as to oppose the motion producing it. Hence, in the

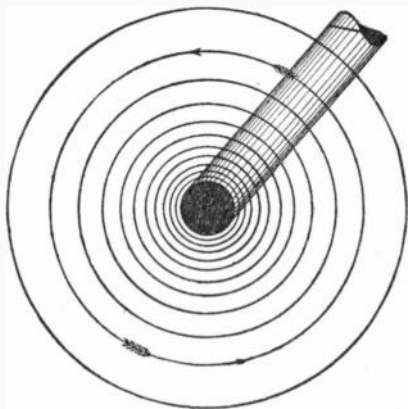

FIG. 294.—Circular concentric magnetic field surrounding a conductor carrying a current. If this conductor be moved across a magnetic field, as between the poles of a magnet, the lines of force will be distorted as in fig. 295, which will oppose the motion of the conductor.

operation of a dynamo, considerable driving power is required to overcome this magnetic drag on the armature.

A conductor carrying a current is surrounded by a circular concentric magnetic field. If now such a conductor, with current flowing toward the observer as in fig. 294, be placed in a uniform magnetic field, a distortion of the magnetic lines will occur as shown in fig. 295. The resulting mechanical

actions are easily determined by remembering that *the magnetic lines act like elastic cords tending to shorten themselves*. There is in fact a tension along the magnetic lines and a pressure at right angles to both, proportional at every point to the square of their density.

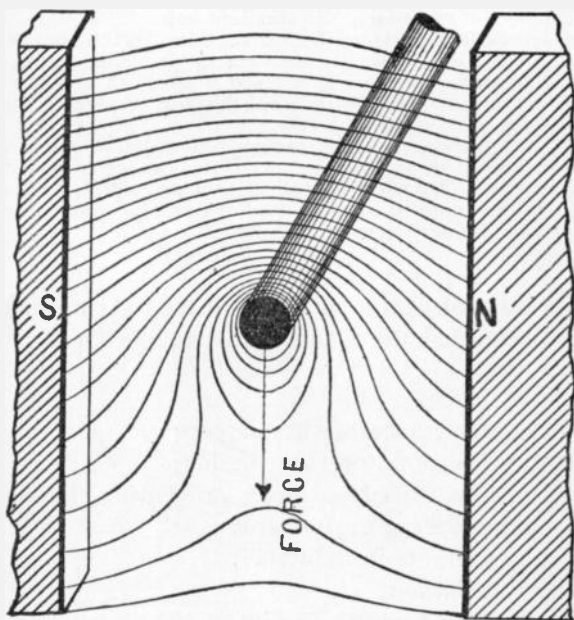

FIG. 295.—Illustrating drag on armature inductors. In moving a wire carrying a current through a magnetic field, the lines of force are distorted, and the effect on the wire is the same as though the magnetic lines were elastic cords tending to shorten themselves. They, therefore, oppose the motion of the wire; hence, in dynamo operation, more or less power is absorbed in overcoming this drag on the numerous inductors. In the figure the inductor is being moved upward against the "drag" due to the magnetic field.

It is evident by inspection of the lines in fig. 295, that there is a drag upon the conductor in the direction shown by the arrow.

Smooth and Slotted Armatures.—The inductors of an armature may be placed on a smooth drum or in slots cut in the surface parallel to the axis.

In the first instance, the magnetic drag comes on the inductors, and in the case of slots, upon the teeth.

The effect of embedding the armature inductors in slots is to distort the magnetic field as shown in fig. 296. Most of the lines of force pass through the teeth, thus, not only are the inductors better placed for driving purposes, but, being screened magnetically by the teeth, the forces acting on them are reduced. the greater part of the magnetic drag being taken up by the core.

It should be noted that, although screened from the field, the inductors in a slotted armature cut magnetic lines precisely as if they were not protected. The effect is as though the magnetic lines flashed across the slots from tooth to tooth, instead of passing across the intermediate slot at the ordinary angular velocity.

Comparison of Smooth and Slotted Armatures.—The slotted armature has the following advantages over the smooth type:

1. Reduced reluctance of the air gap;
2. Better protection for the winding;
3. Inductors held firmly in place preventing slippage;
4. No magnetic drag on inductors;
5. No eddy currents in inductors;
6. Better ventilation;
7. Opposition to armature reaction.

Due to increased density of flux through the teeth.

The disadvantages of slotted armatures may be stated as follows:

1. Tendency of the teeth to induce eddy currents in the pole pieces;
2. Increased self-induction of the armature coils;

3. Greater hysteresis loss on account of denser flux in the teeth;
4. Leakage of lines of force through the core, especially in the case of partially enclosed slots.

Magnetic Hysteresis in Armature Cores.—When the direction or density of magnetic flux in a mass of iron is rapidly changed a considerable expenditure of energy is required which

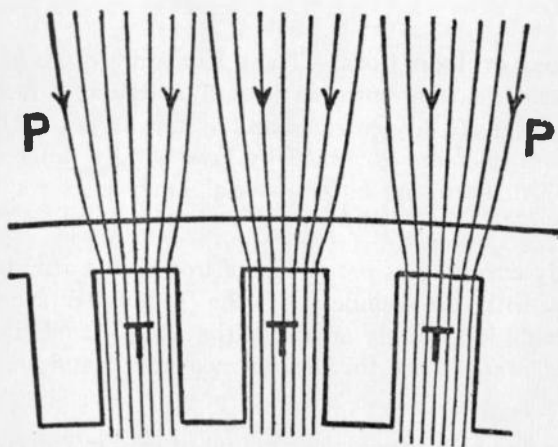

FIG. 296.—Effect of slotted armature. The teeth, as they sweep past the pole face, cause oscillations of the magnetic flux in the iron near the surface because the lines in the pole piece PP tend to crowd toward the nearest teeth, and will be less dense opposite the slots. This fluctuation of the magnetic lines produce eddy currents in the pole faces unless laminated. The armature inductors, being screened from the field, are relieved of the drag which is taken by the teeth.

does not appear as useful work. For instance, when an armature rotates in a bipolar field, the armature core is subjected to two opposite magnetic inductions in each revolution; that is, at any one instant a north pole is induced in the core opposite the south pole of the magnet, and a south pole in the core opposite

the north pole of the magnet as indicated in fig. 297 by *n* and *s*. Accordingly, if the armature rotate at a speed of 1,000 revolutions per minute, the polarity of the armature will be changed 2,000 times per minute, and result in the generation of heat at the expense of a portion of the energy required to drive the armature. This loss of energy is due to the work required to change the position of the molecules of the iron, and takes place both in the process of magnetizing and demagnetizing; the magnetism in each case lagging behind the force.

Core Loss or Iron Loss.—These terms are often employed to designate the total internal loss of a dynamo due to the combined effect of eddy currents and hysteresis, but as the losses due to the former are governed by laws totally different from those applicable to the latter, special analysis is required to separate them.

The eddy current loss per pound of iron in the armature core diminishes with the thinness of the laminated sheets, and may be made indefinitely small by the use of indefinitely thin iron plates, were it not for certain mechanical and economical reasons.

The loss due to hysteresis per pound of iron in the core, does not vary with the thinness of the core plates; it can be reduced only by the use of a material having a low hysteretic coefficient.

Dead Turns.—The voltage generated in a dynamo with a given degree of field excitation is not strictly proportional to the speed, but somewhat below on account of the various reactions. That is, the machine acts as though some of its revolutions were not effective in inducing electromotive force.

The name *dead turns* is given to the number of revolutions by which the actual speed exceeds the theoretical speed for any output.

Again, this term is sometimes used to denote that portion of the wire on an armature which comes outside the magnetic field and is therefore rendered ineffective in inducing electromotive force. The number of dead turns is about 20% of the total number of turns.

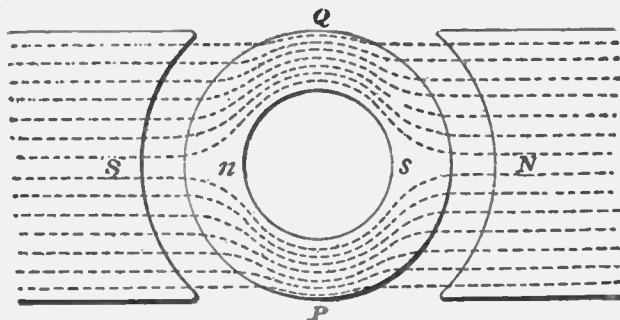

FIG. 297.—Magnetic hysteresis in armature core. Unlike poles are induced in the core opposite the poles of the field magnet. Since on account of the rotation of the core the induced poles are reversed a thousand or more times a minute, considerable energy is required to change the positions of the molecules of the iron for each reversal, resulting in the generation of heat at the expense of a portion of the energy required to drive the armature.

Self-Induction in the Coils; Spurious Resistance.—

Self-induction opposes a rapid rise or fall of an electric current in just the same way that the inertia of matter prevents any instantaneous change in its motion. This effect is produced by the action of the current upon itself during variations in its strength.

In the case of a simple straight wire, the phenomenon is almost imperceptible, but if the wire be in the form of a coil, the adjacent turns act inductively upon each other upon the principle of the mutual induction arising between two separate adjacent circuits.

Ques. What effect has self-induction on the operation of a dynamo?

Ans. It prevents the instantaneous reversal of the current in the armature coils. That is, the current tends to go on, and in fact does actually continue for a brief time after the brush has been reached.

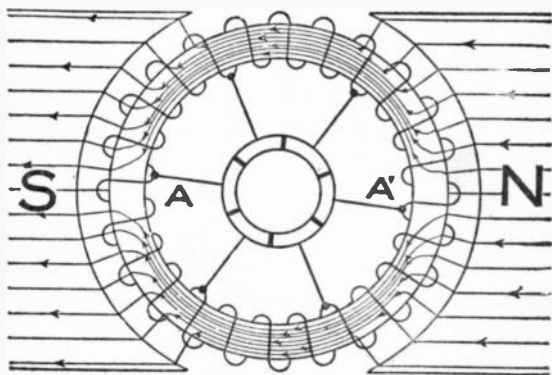

FIG. 298.—Distribution of magnetic lines through a ring armature. Since the lines follow the metal of the ring instead of penetrating the interior, no electromotive force is induced in that portion of the winding lying on the interior surface of the ring. There is, therefore, a large amount of dead wire or wire that is ineffective in inducing electromotive force; this is the chief objection to the ring type of armature.

Ques. What becomes of the energy of the current at reversal?

Ans. The energy of the current in the section of the winding undergoing commutation is wasted in heating the wire during the interval when it is short circuited, and as it passes on, energy must again be spent in starting a current in it in the reverse direction. There is, then, a lagging of the current in the armature coils due to self-induction.

Ques. What is spurious resistance?

Ans. This is an apparent increase of resistance in the armature winding, which is proportional to the speed of the armature, and due to the lagging of the current.

Armature Losses.—The mechanical power delivered to the pulley of a dynamo is always in excess of its electrical output on account of numerous mechanical and electrical losses. Mechanical losses result from:

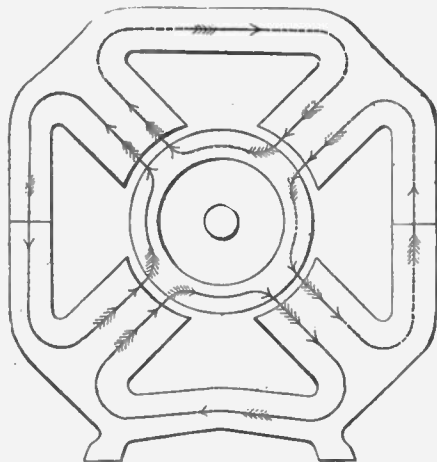

FIG. 299.—Distribution of magnetic lines through solid drum armature of a four pole machine.

1. Friction of bearings;
2. Friction of commutator brushes;
3. Air friction.

The electrical losses may be classified as those due to:

1. Armature resistance;
2. Hysteresis;
3. Eddy currents.

Ques. How do the mechanical and electrical losses compare?

Ans. The mechanical losses are small in comparison with the electrical losses.

Ques. What may be said with respect to friction?

Ans. The bearing friction varies with the load. In calculating this loss not only must the weight of the armature be considered but also the belt tension and magnetic attraction in order to get the resultant thrust on the bearing. Friction of the brushes is very small and may be neglected. A small loss of power is caused by the friction of the air on the armature. The latter, since it revolves rapidly, acts to some extent as a fan, and in some machines this fan action is made use of for ventilation and cooling.

Ques. How are the other losses determined?

Ans. The loss of power due to armature resistance is easily found by Ohm's law, but the hysteresis and eddy current losses, known collectively as *iron losses*, are not so easily determined. If the magnetization curve of the particular quality of iron used for armature plates be known, the hysteresis loss may be calculated approximately. Eddy current losses are the most important, especially in large machines. As previously explained, in all the moving metal masses unless laminated, there will be eddy currents set up if they cut magnetic lines. Power may be lost from this cause even in the metal of the shaft if there be leakage of magnetic lines into it.

CHAPTER XX

COMMUTATION AND THE COMMUTATOR

The act of commutation needs special study. If it be incorrectly performed, the imperfection at once manifests itself by sparks which appear at the brushes. In the study of this chapter on commutation it would be advisable for the student to first review the basic principles of commutation as given in chapter XIV, which contains a brief and simple explanation of how the alternating current in the armature is converted into direct current by the action of the commutator.

Ques. What is the period of commutation?

Ans. The time required for commutation, or the angle through which the armature must turn to commute the current in one coil.

Ques. Upon what does the period of commutation depend?

Ans. Upon the width of the brushes as shown in fig. 300.

This fixes the angle through which the armature must revolve to commute the current in one coil. This angle is formed, as shown in the figure, by two intersecting planes, M and S, which pass through the axis of the armature and the two edges of the brush. Commutation then, begins at M and ends at S.

Ques. What is the position of the commutating plane with respect to M and S, in fig. 300?

Ans. It bisects the angle formed by the planes M and S.

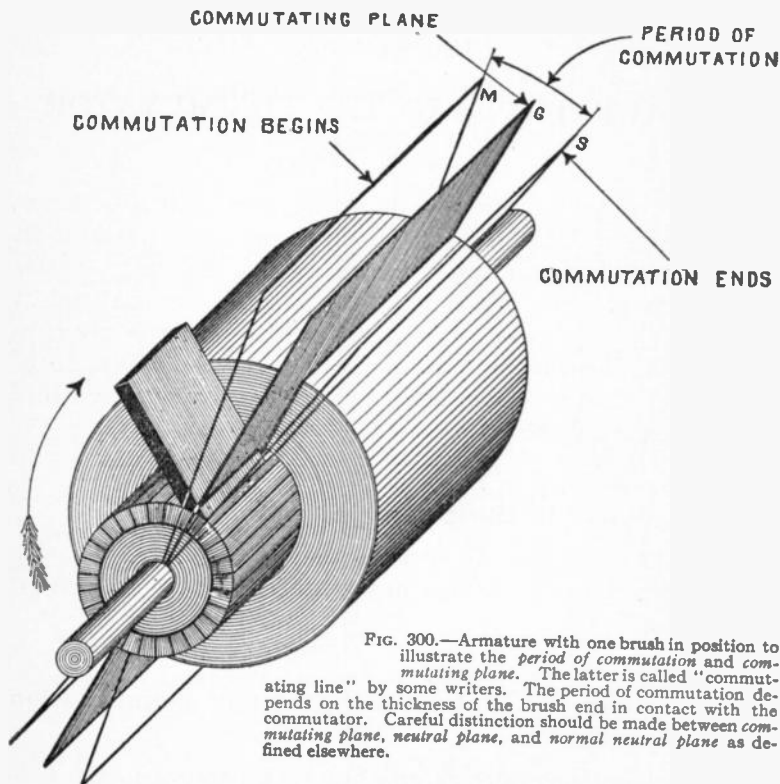

FIG. 300.—Armature with one brush in position to illustrate the *period of commutation* and *commutating plane*. The latter is called "commutating line" by some writers. The period of commutation depends on the thickness of the brush end in contact with the commutator. Careful distinction should be made between *commutating plane*, *neutral plane*, and *normal neutral plane* as defined elsewhere.

Ques. What is the the commutating plane?

Ans. An imaginary plane passing through the axis of the armature and the center of contact of the brush.

Ques. What two planes are referred to in stating the position of the brushes?

Ans. The normal neutral plane and the commutating plane.

The angle intercepted by these two planes represents the *lead*, thus in stating that the brushes have a lead of 6° , means that the angle intercepted by the normal neutral plane and the commutating plane is 6° .

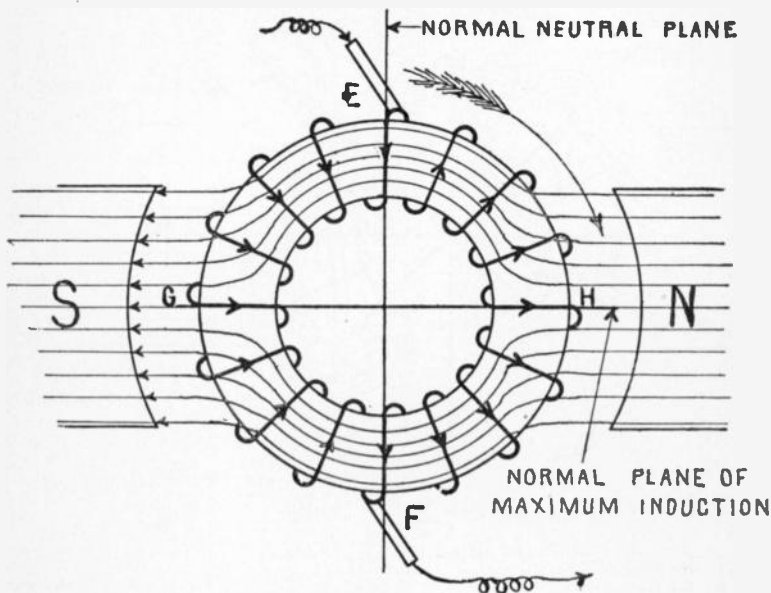

FIG. 301.—The proper position of the brushes, if there were no field distortion and self-induction in the armature coils, would be in the normal neutral plane. In the actual dynamo these two disturbing effects are present which makes it necessary to advance the brushes as shown in figs. 302 and 303 to secure sparkless commutation.

Ques. What is the difference between the normal neutral plane and the neutral plane?

Ans. This is illustrated in figs. 301 and 302. *The normal neutral plane is the position of zero induction assuming no*

distortion of the field as in fig. 301. The neutral plane is the position of zero induction with distorted field as in fig. 302 and as is found in the actual machine; the distortion is exaggerated in the figure for clearness.

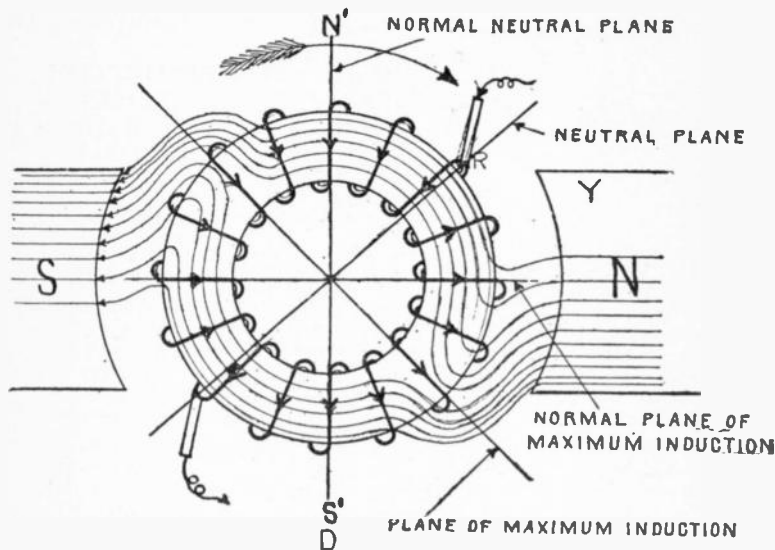

FIG. 302.—Brush adjustment for field distortion. The effect of the latter is to twist the lines of force around in the direction of rotation, thus maximum induction takes place in an inclined plane. The brushes then must be advanced to the neutral plane which is at right angles to the plane of maximum induction. This gives the proper position of the brushes neglecting self-induction.

Ques. What is the normal plane of maximum induction?

Ans. A plane, 90° in advance of the normal neutral plane, being the position of maximum induction with no distortion of field, as in fig. 301.

Ques. What is the plane of maximum induction?

Ans. A plane 90° in advance of the neutral plane, being the position of maximum induction in a distorted field as in fig. 302.

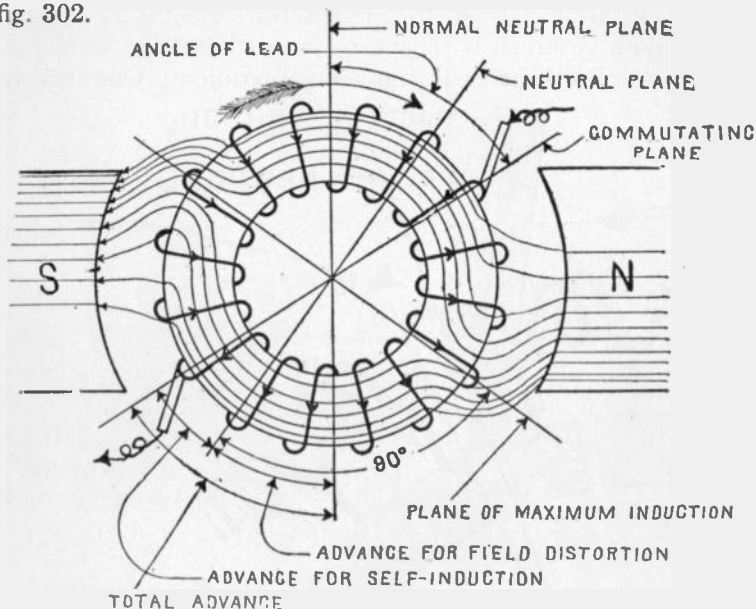

FIG. 303.—Brush adjustment for self-induction. For convenience an electric current is regarded as having weight and hence possessing the property of inertia. The current then during commutation cannot be instantly brought to rest and started in the reverse direction but these changes must be brought about gradually by an opposing force. Hence by advancing the brushes beyond the neutral plane as illustrated, commutation takes place with the short circuited coil cutting the lines of force so as to induce a current in the opposite direction; this opposes the motion of the current in the short circuited coil, brings it to rest and starts it in the opposite direction, thus preventing sparks. Figs. 301 to 303 should be carefully compared and thoroughly understood.

Ques. What should be noted with respect to the different planes?

Ans. The commutating plane should be carefully distinguished from the normal neutral plane and from the neutral plane, as shown in fig. 303.

Commutation.—In order to understand just what happens during commutation, a section of a ring armature may be used for illustration, such as shown in fig. 304. Here the coils A, B, C, D, E, are connected to commutator segments 1, 2, 3, 4, and the positive brush is shown in contact with two segments 2 and 3, the brush being in the neutral position. Currents in

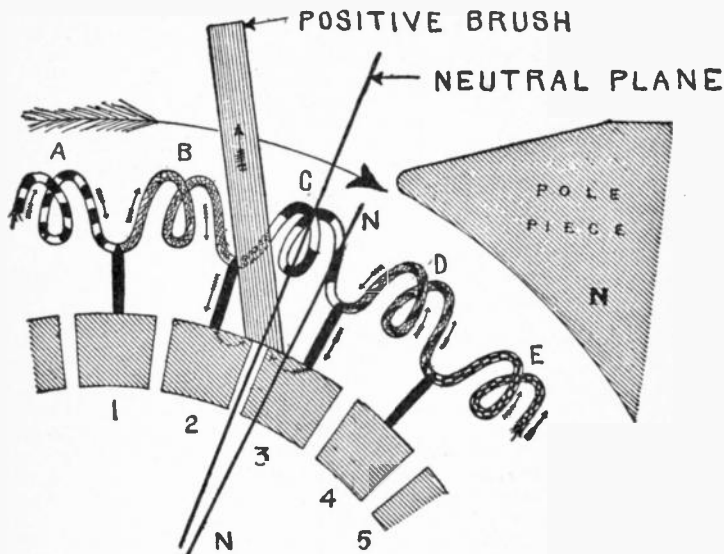

FIG. 304.—Commutation. This takes place during the brief interval in which any two segments of the commutator are bridged by the brush. The coil connecting with the two segments under the brush is thus short circuited. During commutation the current in the short circuited coil is brought to rest and started again in the reverse direction against the opposition offered by its so called inertia, or effect produced by self-induction.

the coils on each side of the neutral line flow to the brush through segments 2 and 3; the brush then is positive.

Now, as the armature turns, the commutator segments come successively into contact with the brush. In the figure, segment 3 is just leaving the brush and 2 is beginning to pass under it, hence, for an instant the coil C is short circuited.

Ques. In fig. 304, what are the current conditions?

Ans. Previous to contact with segment 2, current flowed in coil C in the same direction as in coil B.

Ques. What occurs while the brush is in contact with segments 2 and 3?

Ans. During this brief interval, the current in C is stopped and started again in the opposite direction.

Similarly each coil of the armature as it passes the brush will be short circuited and have its current reversed. This is known as *commutation*.

Ques. What is the effect of field distortion with respect to commutation?

Ans. The neutral plane no longer coincides with the normal neutral plane but is advanced in the direction of rotation of the armature as shown in fig. 302.

The reaction of the poles N' and S' of the armature field on the poles S and N of the main magnetic field tends to crowd the lines of force into the upper pole face of the south pole of the magnet, and into the lower pole face of the north pole. This effect is due to the strong magnetic attraction between the opposite poles S and N' and N and S' , and the equally strong repulsion between like poles N and N' and S and S' . Hence, the plane of maximum induction no longer coincides with the normal plane of maximum induction, but is advanced in the direction of rotation, depending upon the strength of the armature current, being shifted forward for an increase of current, and backward for a decrease of current. This distortion of the field and the consequent shifting of the plane of maximum induction naturally results in the shifting of the neutral plane from the vertical position to the inclined position as shown.

Position of the Brushes; Sparking.—In accordance with the laws of electromagnetic induction, if the bipolar ring armature shown in fig. 301 be rotated in the direction indicated by the arrow the armature current entering at the brush E will

divide, one part passing through the coils on the right half of the ring, and the other part through the coils on the left half of the ring, to the brush F, from which the total current will pass out, urged by the full value of the electromotive force induced in all the coils on both halves of the ring.

Again, if the brushes be placed at the points G and H, each half of a current entering at G, will pass through one-half of

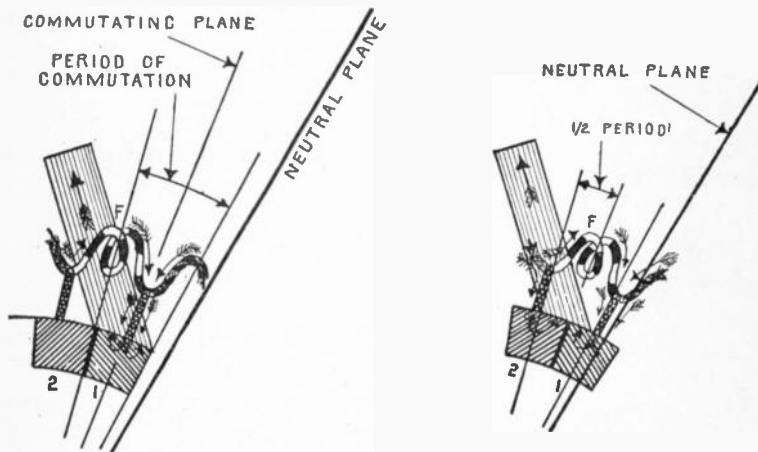

COMMUTATION BEGINS

FIGS. 305 to 308.—Improper brush adjustment resulting in excessive sparking. When the brushes are not advanced far enough, commutation takes place before the short-circuited coil reaches the neutral plane, hence, its motion is not changed with respect to the magnetic field so as to induce a reverse current till after commutation. There is

the coils on the left side and one-half of the coils on the right side of the ring, so that each half of the current will be urged forward by an electromotive force equal to the electromotive force tending to force it back, and therefore, no current will pass in or out through the brushes. From these considerations it is obvious that the proper position for the brushes would be

in the normal neutral plane, were it not for the disturbing effects of armature reaction and self induction of the current.

Ques. Should the brushes of a dynamo be placed in the neutral plane?

Ans. No.

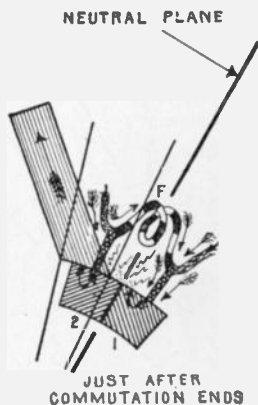
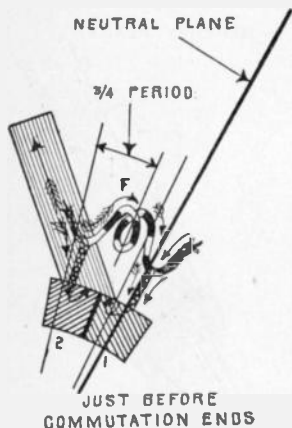

then no opposing force, during commutation, to stop and reverse the current in the short circuited coil, and when the brush breaks contact with segment 1, as in fig. 308, the "momentum" of the current in coil F causes it to jump the air gap from segment 1 to segment 2 and the brush, against the enormous resistance of the air, thus producing a spark whose intensity depends on the momentum of the current in coil F. Sparking, if allowed to continue, will injure the brushes and commutator segments.

Ques. Why not?

Ans. The brushes must be advanced beyond the neutral plane to prevent sparking.

Ques. What is the cause of sparking at the brushes?

Ans. It is due to *self-induction* in the coil undergoing commutation.

Ques. Explain the effect of self-induction in detail.

Ans. When commutation takes place with the brushes in the neutral plane as in fig. 304, there will be no voltage induced in the short circuited coil C. The current, therefore, which flowed in coil C before it was short circuited will cease, and as segment 3 breaks contact with the brush, it will be thrown as a

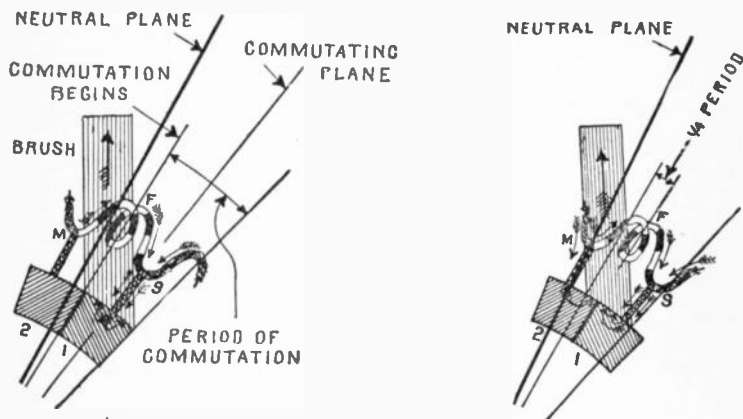

Figs. 309 to 313.—How sparkless commutation is obtained by advancing the brushes beyond the neutral plane; commutation progressively shown.

FIG. 309.—Commutation begins; current flows up both sides of the armature, uniting at S and flowing to the brush through commutator segment 1 as indicated by the arrow.

FIG. 310.—Segment 2 has come into contact with the brush and coil F, in which commutation is taking place, is now short circuited. The current now divides at M, part passing to the brush through segment 2, and part through coil F and segment 1. Although coil F is short circuited and having passed the neutral plane, is cutting the lines of force so as to induce a current in the opposite direction, it still continues to flow with unchanged direction against these opposing conditions. This is due to *self-induction* in the coil which resists any change just as the momentum of a heavy moving body, such as a train of cars, offers resistance to the action of the brakes in retarding and stopping its motion.

perfectly idle coil upon the right hand half of the ring in which a current is flowing toward the brush. Moreover, the current which was flowing through D and 3 directly to the brush, must suddenly traverse the longer path through the idle coil C. Now,

on account of self-induction, *the current acts in precisely the same manner as though it had weight*; that is:

It cannot be instantly stopped or started.

Therefore, when segment 3 leaves the brush, the current will not instantly change its path and flow through C, but will be urged by its "momentum," and jump the air gap between the brush and segment 3, thus producing a spark.

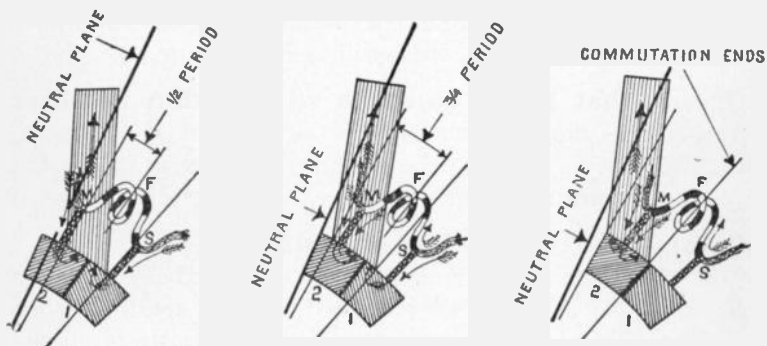

FIG. 311.—Segment 2 has moved further under the brush, and the opposition offered to the forward flow of the current in the short circuited coil F by the reverse induction in the magnetic field to the right of the neutral plane has finally brought the current in F to rest. The currents from each side of the armature now flow direct to the brush through their respective end segments 1 and 2.

FIG. 312.—Segment 1 is now almost out of contact with the brush. A current has now been started in the coil F in the reverse direction due to induction in the magnetic field to the right of the neutral plane; it flows to the brush through segment 2. The current has not yet reached its full strength in F, accordingly, part of the current coming up from the right divides at S and flows to the brush through segment 1.

FIG. 313.—Completion of commutation in segments 1 and 2; the brush is now in full contact with segment 2, the current in coil F has now reached its full value, hence the current flowing up from the right no longer divides at S but flows through F and segment 2 to the brush. If the current in F had not reached its full value, at the instant segment 1 left contact with the brush, it could not immediately be made to flow at full speed any more than could a locomotive have its speed instantly changed. This, as previously explained, is due to self-induction in the coil or the so called "inertia" of the current which opposes any sudden change in its rate of flow or direction. Accordingly that portion of the current which was flowing up from the right and passing off at S to the brush through segment 1 as in fig. 312, would, when this path is suddenly cut off as in fig. 313, encounter enormous opposition in coil F. Hence, it would momentarily continue to flow through segment 1 and jump the air gap between this segment and the brush, resulting in a more or less intense spark depending on the current conditions in coil F.

Ques. How may this sparking be prevented?

Ans. If the brushes be given additional lead, that is shifted further to the right to some position as N N, fig. 304, coil C will not remain idle during the interval it is short circuited, *but will cut the magnetic lines in such a way as to induce a current in the reverse direction through it.* Under these conditions, when segment 3 breaks contact with the brush, the current flowing through D does not encounter an idle coil, but one in which a current is flowing in the same direction, hence, the tendency to jump the air gap and produce a spark is reduced; with proper adjustment of the brushes, there will be no sparking.

Ques. What is the objection to very thin brushes?

Ans. Time must be allowed for reversal of the current, hence the brushes must not be so thin as merely to bridge the insulation between segments.

Ques. What is the effect of lead?

Ans. There is usually much sparking when the lead is too small; a little sparking when too great, and no sparking when just right. If the lead be excessive, there is a waste of energy due to the generation of a larger reverse current in the short circuited coil than is necessary.

Fixed Position of Brushes.—The condition for sparkless commutation is that the current in the short circuited coil be reduced to zero, and increased in the opposite direction up to the same value as that in the next coil leading. If the brushes are to remain in a fixed position, this condition will only be realized at the particular load for which the brushes are set. Thus, if the brushes be set for the average load, the reversing field will not be correct for either a weaker or stronger load. Hence, sparkless commutation with fixed brushes must be due to some other factor.

Ques. What may be said with respect to carbon brushes?

Ans. Since carbon possesses a high resistance, the drop will vary greatly with the contact area, thus affecting a difference of potential in the two segments passing under the brush and it is largely to this that sparkless commutation is due.

Ques. What is the effect of resistance on commutation?

Ans. In fig. 304 during commutation, that is, while the brush contacts with any two segments, as 2 and 3, the currents coming up through the winding on either side of the neutral plane are offered two paths to the brush: 1, direct to brush through the connecting segment, or 2, across the short circuited coil and adjacent segment. Thus, on the right side: to brush through segment 3, or across coil C and adjacent segment 2.

The current will take the path of least resistance.

At the beginning of commutation, almost the entire brush area being in contact with segment 3, the contact resistance of this segment will be much less than for segment 2; hence, not only will the current at the right flow through 3, but also the current at the left after first traversing the short circuited coil. As commutation progresses, the area of contact of 3 decreases while that of 2 increases, and the respective resistances vary in inverse proportion. Likewise the tendency of the current in the left half of the winding to take the longer path through coil C and segment 3 to the brush gradually decreases, becoming zero when the two contact areas become equal. During the second half of the period of commutation, the contact area of segment 2 becomes greater and of 3, less; thus the resistance of 2 is lowered, and that of 3 increased. Accordingly, all of the current at the left will flow through segment 2, and the current at the right will flow through C and 2 rather than through

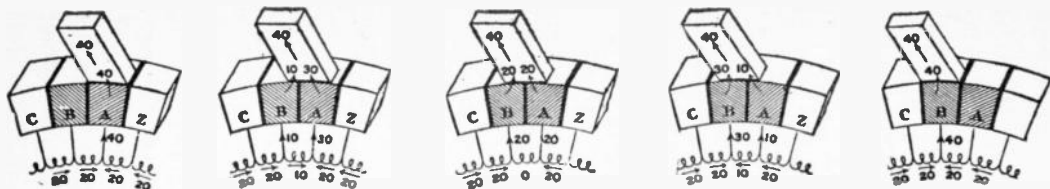

FIGS. 314 to 318.—Brush contact resistance theory of commutation, neglecting self-induction and resistance in the coils. The total current is assumed to be 40 amperes made up of 20 amperes flowing toward the brush from the coils on the right and 20 amperes from the coils on the left. During commutation, that is, the interval during which the brush contacts with any two adjacent segments of the commutator, the current is assumed to vary directly as the contact area.

FIG. 314.—Beginning of commutation; segment A is entirely under the brush, and B is at the initial point of contact. For this position the currents from both sides flow to the brush through segment A.

FIG. 315.—One-quarter period of commutation. One quarter of the brush area is in contact with B and three quarters in contact with A; hence, 10 amperes will flow through B and 30 amperes through A.

FIG. 316.—Second quarter of commutation period. The brush now contacts equally with both segments, hence 20 amperes will flow through each segment.

FIG. 317.—Third quarter of commutation period. Three quarters of the brush area is in contact with segment B and one quarter with segment A; accordingly, 30 amperes will flow through B and 10 amperes through A.

FIG. 318.—Completion of commutation. The brush is in full contact with segment B and at the point of breaking contact with A, hence the entire current from both sides or 40 amperes will flow through B.

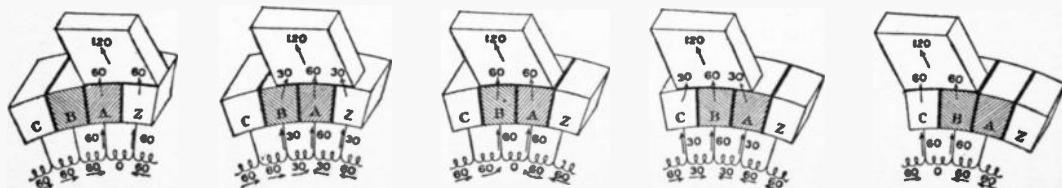

FIGS. 319 to 323.—Brush contact theory of commutation for case in which the brush covers two segments of the commutator. Fig. 319 beginning of commutation; fig. 320 one-quarter period; fig. 321, one-half period; fig. 322, three-quarter period; fig. 323 completion of commutation.

3. In this way the current is reversed in C, and, if the brush be broad enough to allow a sufficient time interval, the current in C is built up to its full value before segment 3 leaves the brush, thus securing sparkless commutation.

This contact resistance factor in sparkless commutation is illustrated in figs. 314 to 318, it being assumed that during commutation, the brush contact resistance is inversely proportional to the area of contact, and that the winding is free of resistance and inductance. The current is taken as 40 amperes, in which case 20 amperes will flow from each side of the winding to the brush.

In fig. 314 the instant before commutation begins all the current will flow through segment A. At the end of the first quarter of the period of commutation, fig. 315, 30 amperes will flow from the right to brush through A, and from the left, 10 amperes through the short circuited coil via A and 10 amperes through B.

At the end of the second quarter or half period, fig. 316, the current through each half of the winding will flow to the brush through these respective segments.

At the end of the third quarter, fig. 317, the current from the right will divide, 10 amperes going through A, and 30 amperes traversing the short circuited coil and out through B. The entire current from the left will flow through segment B.

At the end of the fourth quarter, fig. 318, or completion of the period the current from each half of the winding will flow to the brush through B.

Ques. What is the effect of increasing the degree of contact of the brushes?

Ans. It lengthens the period of commutation, and permits it to start in one coil before the preceding coil has entirely passed through this stage.

The effect of changing the degree of contact is shown in figs. 319 to 323, in which the width of the brush is made equal to that of two segments.

Construction of Commutators.—The commutator for a closed coil armature consists of a number of segments or L-shaped bars C of drop forged hard drawn copper assembled around a tubular iron hub as shown in figs. 324 and 325. The bars are

held in position by the nuts E, and washers F, screwed on the ends of the tube D. The bars are insulated from each other and from the washers by mica as shown by the heavy lines G, and they are also insulated from the tube either by a tube of mica H, or by a sufficient air space. The ends of the sections of winding are connected to the vertical portions of the bars K, by insertion in the slots L, where they are securely held in place by means of the binding screws, which for greater security

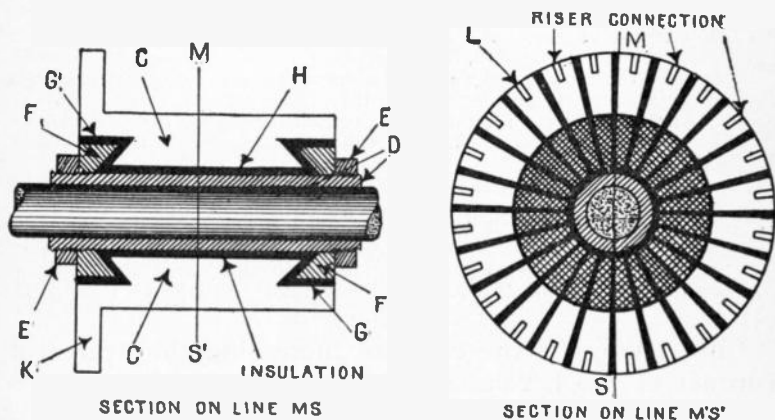

FIGS. 324 and 325.—Side and end sectional views of commutator showing construction. The parts are: C, segments; D, tubular iron hub; E, end nuts; F, clamps; G, insulation; L, riser connection.

are soldered together, and may be released from the slots, whenever necessary, by the application of a hot soldering iron.

It is very important that all the parts of the commutator should be fitted together perfectly and screwed up tightly, in order to prevent looseness. Commutator segments are often made with the washers E, projecting beyond the ends, but such construction reduces the effective length of the commutator, therefore the under cut form of bar is preferable.

In the construction of commutators, the conditions of operation require that there be:

1. Adequate insulation;

It is necessary to have good insulation between each segment, and a specially good insulation between the segments and the hub or sleeve on which they are mounted; also between the segments and end clamps. The insulating material must not absorb moisture, hence asbestos, plaster, or vulcanized fibre are not used. The end insulating rings are usually built up of mica and shellac, moulded while hot under pressure to the correct shape.

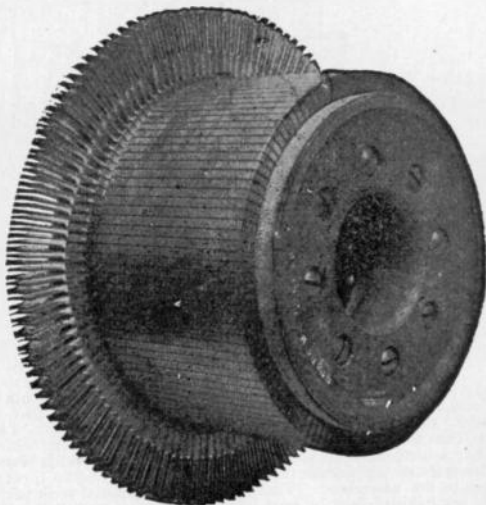

FIG. 326—Front view of Western Electric Commutator for bar wound armature. This commutator is made of hard drawn copper and insulated throughout, ventilating spaces being provided near the shaft.

2. Rigidity against centrifugal force;

Since the segments are subject to centrifugal force, they must be securely clamped in place. Screws cannot be used, for that would destroy the insulation. They are therefore held in place by insulated clamps as shown in fig. 324. These clamps should be strong and capable of holding the segments firmly in position, for if a segment should rise out of its place through centrifugal force, it would disturb the action of the brush and cause sparking.

3. Provision for wear.

The segments should be of considerable radial depth, so that the commutator may be turned down from time to time to preserve its circular form.

Points Relating to Commutators.—1. The number of commutator segments depends on the scheme of winding and on the number of sections in the armature winding.

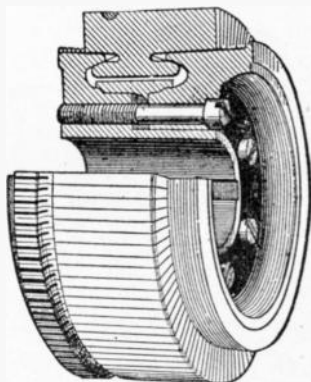

FIG. 327—Sectional view of a General Electric commutator. The segments are of rolled or forged copper and are separated by soft mica insulating sheets. This mica must wear down evenly with the copper, hence its consistency is important. The segments are wedge shaped so that when drawn radially inward they support each other like the stones of an arch. They are drawn together by hollow cone collars which bear upon lugs projecting from the ends of the segments. These lugs are turned to form a smooth cone after the segments are assembled. The collars are insulated with mica from the segments and they are held in place by nuts upon the commutator shell or by bolts passing from end to end under the segments. The segments are also provided with lugs for connection to the windings.

2. Increasing the number of bars diminishes the tendency to spark, and lessens the fluctuations of the current.

There are two practical reasons for not using a very great number of segments: it increases the cost, and in small machines the segments would be so thin that a brush of the proper thickness to collect the current would lap over, or bridge several segments.

Types of Commutator.—Commutators are made in various forms, but they may be grouped into two general types:

1. Commutators for closed coil armatures;

These consist of a large number of segments or bars, insulated from each other and varying in number according to the scheme of armature winding, and on the number of sections into which that winding is grouped.

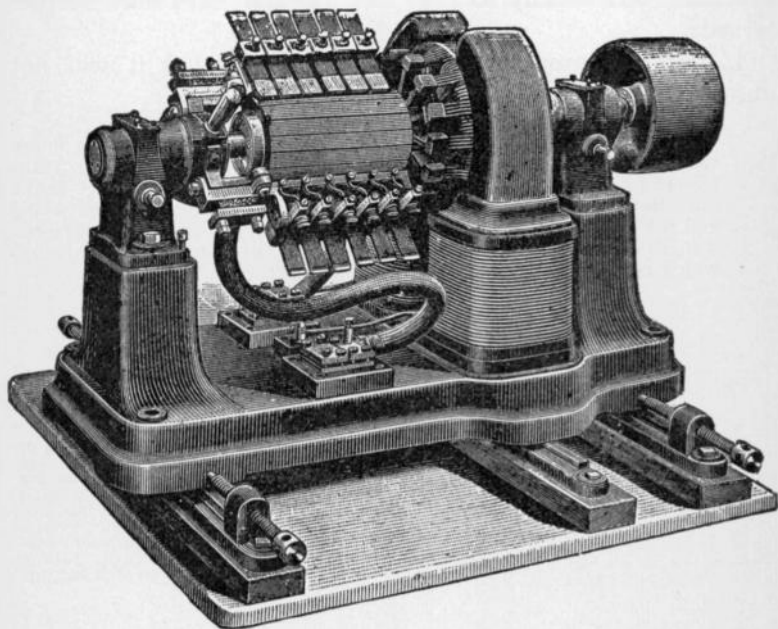

FIG. 328.—A large current low voltage bipolar dynamo built for electrolytic work and here shown to illustrate the large size commutator and brushes necessary to collect the large current. Carbon brushes would not be suitable for this class of machine because even with copper brushes, whose conductivity is much higher than carbon, the commutator must be of considerable size to give the required brush contact area. The contrast between the axial lengths of the armature and the commutator is very marked. The rocker construction is of the ordinary type, and heavy flexible cables conduct the current from the brush holders to the fixed terminals. The machine here illustrated gives 310 amperes at 7 volts when running at a speed of 1400 R. P. M., corresponding to an output of 2.17 kilowatts.

2. Commutators for open coil armatures;

This form of commutator is used on some machines designed especially for arc lighting, such as the Brush and Thompson-Houston machines. They consist of a comparatively small number of segments each of which covers a wide angle, and are separated from each other by air gaps.

3. The segments should be of considerable depth to permit returning occasionally so that their circular form may be preserved;

4. The insulating material must be such that it will not absorb oil or moisture;

Mica is best adapted for insulation, but as there are a great many varieties, differing greatly in hardness and other equalities, it is important to select the kind that wears at the same rate as the segments. If the mica be too hard, the wearing of the segments will leave it projecting and prevent proper contact with the brushes; again, if the mica be too soft, it will result in furrows or depressions between the segments into which copper dust will collect, causing short circuits.

CHAPTER XXI

BRUSHES AND THE BRUSH GEAR

With respect to construction, brushes may be broadly classified as: 1, those made of metal, and; 2, those made of carbon. There are several varieties of metal brush, such as:

1. Gauze brushes;
2. Wire brushes;
3. Laminated or strip brushes.

Gauze Brushes.—These are very flexible and yielding, their use being attended with little wear of the commutator.

Ques. What is the construction of a gauze brush?

Ans. A gauze brush is made up of a sheet of copper gauze, folded several times, with the wires running in an oblique direction, so as to form a solid flat strip of from $\frac{1}{4}$ to $\frac{1}{2}$ inch in thickness, increasing with the volume of the current to be collected.

Ques. What is the object of folding the gauze with the wires running in oblique directions?

Ans. It is to prevent the ends of the brush fraying or threading out, which would be the case if the gauze were folded up in any other manner.

Ques. What are the features of gauze brushes?

Ans. They make good contact, but are quite expensive. They may be set either tangentially or radially, the latter preferably, since the point of contact remains the same as the brushes wear away.

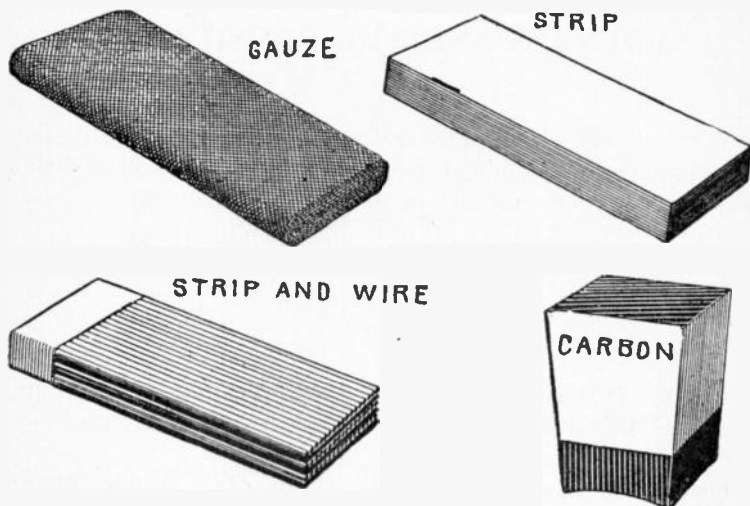

Figs. 329 to 332.—Various forms of brush. Fig. 329 gauze brush; fig. 330 laminated or strip brush; fig. 331 strip and wire brush as used on the early Edison machines; fig. 332 carbon brush. Carbon is preferred to copper for brushes on account of the reduction of sparking secured by its use.

Wire Brushes.—This class of brush, which was extensively used before the invention of the gauze brush, is made up of a bundle of brass or copper wires, laid side by side and soldered together at one end. Since wire brushes are harder than the gauze brush, they are more liable to cut or score the commutator, and are also more troublesome to trim.

Laminated or Strip Brushes.—These probably represent the simplest form of brush, but are not extensively used owing to the lack of flexibility. They consist of a number of strips of copper or brass, laid one upon the other and soldered at one end, as in fig. 330.

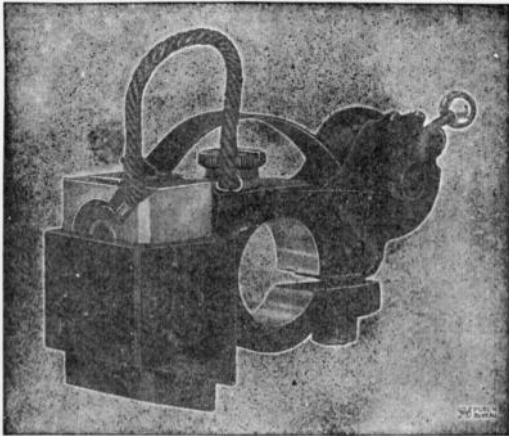

FIG. 333.—General Electric brush holder. The brush holder yoke consists of a cast iron ring of elliptical section, supported from the bracket of the end shield in such a manner as to facilitate the shifting of the brushes. It is provided with a suitable handle, and may be fastened in any position by means of a thumb nut on the outside of the bracket. It is so constructed that the tension on the individual brush can be adjusted without lifting the brush from the commutator and without the use of tools. The brush can be removed while the machine is running, without moving the holder on the stud and without disturbing any other brush. Removal of the brushes for inspection can be accomplished without permanent change in the adjustment of the tension of the brush holder spring. The connection between the brush and stud is made through a flexible copper connection.

Ques. What name is generally given to strip brushes?

Ans. They are commonly and erroneously called *tangential brushes*, but they are really beveled at the end and set inclined to the line of tangency so that the ends of all the sheets will make contact.

In the Brush and Thomson-Houston arc dynamos, in which the current is limited to ten amperes, the brushes consist of a simple strip of flexible sheet copper, the ends of which are slit in a number of places so as to insure contact at several points.

Carbon Brushes.—When metallic brushes are used upon the commutators of high tension machines, they frequently

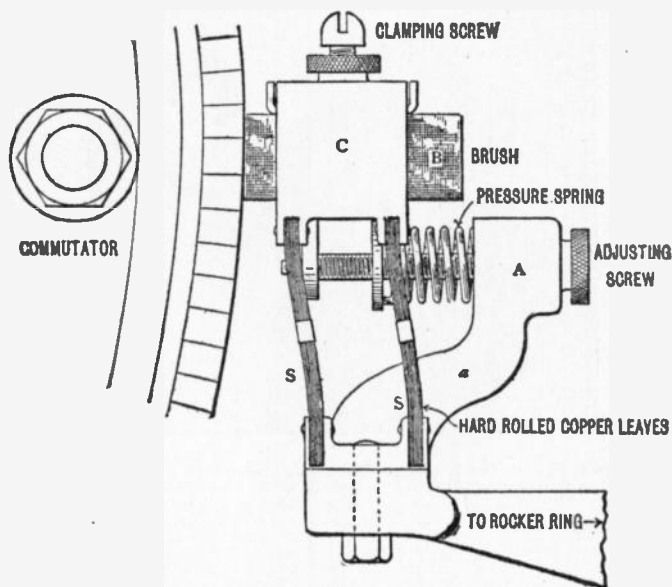

FIG. 334.—Crocker-Wheeler brush holder. The carbon brush B is firmly clamped in the "box" C by two screws which bear on a sheet of brass to protect the carbon from being broken by the ends of the screws. The box C is carried by four flexible springs SS, one at each corner and formed of hard copper leaves. These are fixed at one end to the box and at the other to the solid base which is in one piece with the spoke attached to the rocker ring. An adjusting screw passes through appropriate lugs on the box C and loosely through the head A of a fixed arm a. Between the lower surface of a and the upper lug on the box C is placed the pressure spring.

give rise to excessive sparking and also heating of the armature, the metallic dust given off appearing to lodge between the segments of the commutator, thus partially short circuiting the

armature. To obviate this, carbon brushes are extensively used on such dynamos, this material being found very effectual in the prevention of sparking.

Ques. What is the usual form of carbon brushes?

Ans. They are usually in the form of oblong blocks.

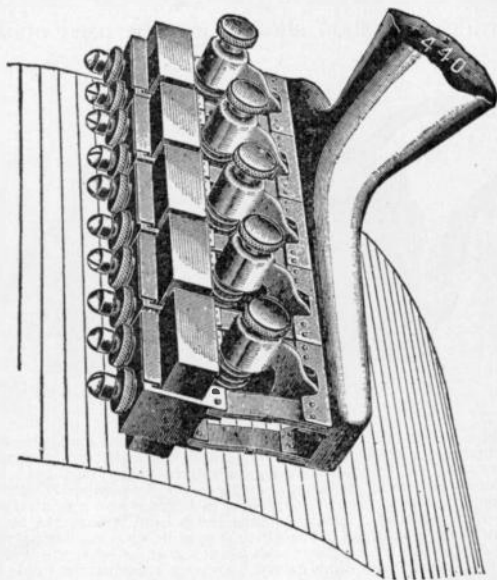

FIG. 335—Perspective views of Crocker Wheeler brush holder. This holder is of the parallel type in which the brushes may be adjusted without affecting the lead. Each brush is held rigidly in its box and there are no sliding contacts in the path of the current. The holder is further described under fig. 334.

Ques. How are they adjusted on the commutator?

Ans. They are set "butt" end on the commutator, and fed forward as they wear away by means of a spring holder.

Ques. Why are carbon brushes so extensively used?

Ans. Because they are the only form of brush that will give good commutation with fixed lead.

Ques. What may be said of the different grades of carbon in use for brushes?

Ans. The very soft carbon leaves a layer of graphitic matter on the commutator, and at high voltages, this may cause sparking; such grade of carbon should only be used on low voltage machines.

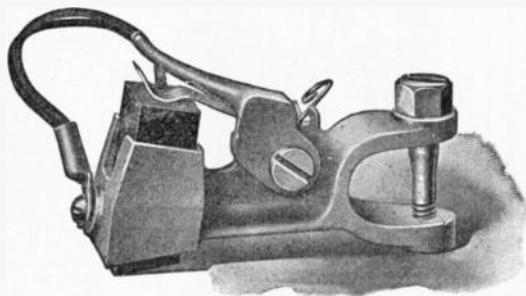

FIG. 336.—Western Electric box type brush holder. The box which holds the brush is broached to allow the brush to slide freely, but not loosely, to and from the commutator against which it is normally held by a lever acting directly upon the brush head. This avoids the possibility of uneven bearing on the commutator, as the brushes are allowed very slight lateral or angular motion. The adjustment of a brush is also simplified after it has been removed and then replaced. Tension on the brush head is obtained by a special spring which maintains any given tension for which it may be set. An auxiliary flat steel spring on the lower side of the lever acts as a shock absorber between the lever and the brush head, absorbing all minor vibrations caused by a worn commutator. Side contact between brush and brush holder is not relied upon to carry the current, flexible copper pigtails performing this function to the exclusion of sliding contacts or tension springs, in order to reduce the brush loss. It is not necessary to take the brush rigging apart or loosen cable connections when it is desired either to remove or reverse the brushes to change the direction of armature rotation.

Ques. How are the ends of carbon brushes treated and why?

Ans. They are usually covered at their upper part with a coating of electro-deposited copper to insure good contact with the holder.

Comparison of Copper and Carbon Brushes.—Copper brushes tend to tear and roughen the surface of the commutator, while carbon brushes tend to keep the surface smooth. Copper causes more wear of the commutator than carbon. With carbon brushes, the armature may be run in either direction. The resistance of carbon being greater than copper, there is less short circuiting caused by carbon particles than by those of copper.

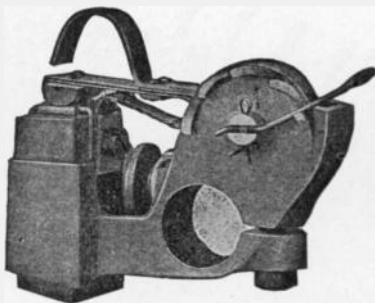

FIG. 337 —Westinghouse brush holder. It is made of brass, cast in one piece, and of standard sliding type with a shunt of braided copper wire directly connected to a clamp on each brush and to the solid portion of the holder, where it is held by a screw. This shunt relieves the spring of heavy currents. The holder is so arranged as to be easily accessible for adjustment, cleaning and renewal of carbons. Proper tension is provided by spiral strap springs so mounted as to eliminate friction and give uniform pressure over a wide working range. The spring tension is readily adjusted by a simple ratchet arrangement.

Ques. What is the chief merit of carbon brushes?

Ans. They give less sparking than other types.

Ques. How has the construction of carbon brushes been varied?

Ans. Since, for minimum sparking, it is only necessary that the brush have high resistance in the region rear its edge,

attempts have been made to increase the conductivity of the other portions by combining with the carbon, copper sheets or wires.

Ques. What are the objections to carbon brushes?

Ans. They are easily broken and not being flexible, vibration, or any roughness of the commutator will cause bad contact.

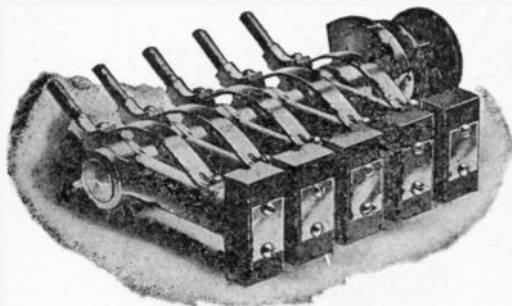

FIG. 338.—Holzer Cabot multiple brush holder. Each brush is fastened securely to a machined surface by one or two machine screws, making a positive contact. Several strips of flexible copper of ample section to carry the current are interposed between the part of the holder carrying the brush and the portion clamping the stud, no sliding contact or spring being therefore required to carry any current. The brushes are proportioned for a carrying capacity of not more than 25 amperes per square inch of brush surface. The brush can be adjusted to any degree of tension during the operation of the machine if necessary. Each holder is insulated in such a manner that no short circuit can occur if the holder be accidentally tipped backward while the operator is changing a brush or cleaning the commutator during a run.

Ques. For what class of machine are carbon brushes specially adapted?

Ans. For machines furnishing a small current at high pressure.

When carbon brushes are used, it is desirable that the current be small, because, on account of the low conductivity of the carbon, more contact area is necessary than with copper for equal current transmission. For fixed lead and fluctuating currents, carbon brushes should be used.

Ques. For what class of machine are copper brushes specially adapted?

Ans. For machines furnishing large current at low pressure, as in fig. 328.

Size of Brushes.—The number of brush sets depends upon the number of poles of the machine, but there may be several brushes in each set. It is usual, except in the smallest machines, to place at least two brushes exactly similar side by side instead of one broad brush, thus allowing one brush to be removed for trimming or renewal while the machine is running. Moreover, better contact is secured by this sub-division, because a slight elevation in the commutator surface at one point may slightly raise one brush of a set at each revolution without much harm, while with one broad brush, the entire brush would be lifted, causing bad sparking.

Ques. What determines the number of brushes in each set?

Ans. It depends upon the current capacity, size of machine, and judgment of the designer.

Ques. What may be said with respect to the dimensions of the brushes?

Ans. No general rule can be given for breadth and thickness of brush. The contact face must clearly be wider than the thickness of the insulation between commutator segments, since the period of commutation must last an appreciable interval of time on account of self-induction.

Ques. What should be the minimum width of the brush contact face?

Ans. It may be taken as one and one-half times the thickness of the commutator segments.

Ques. How wide should a carbon brush contact be?

Ans. The brush should be thick enough to cover two and one-half commutator segments. The thickness should in no case be excessive on account of the loss due to heating, which results from the difference of potential at the forward and rear edge of the brush.

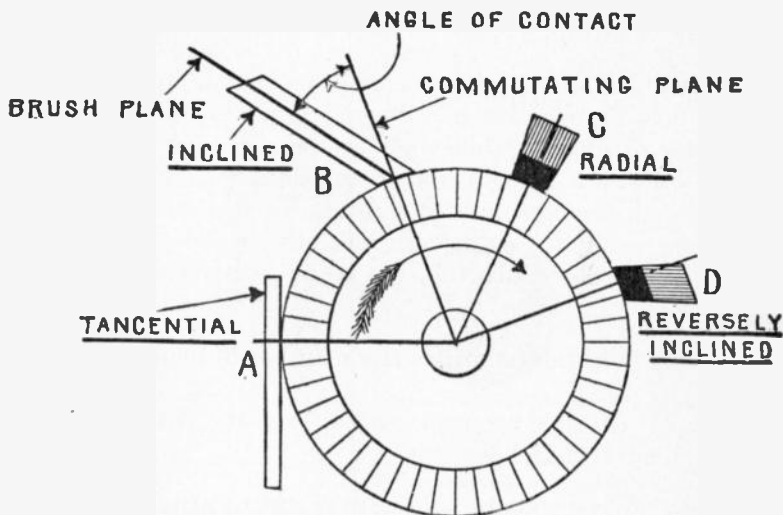

FIG. 339.—Contact angle for the different types of brush. At A is shown a brush with tangential contact, and at B, a so called tangent brush; the latter is properly called an inclined brush. Sheet copper brushes are set tangentially as at A, and gauze brushes inclined as at B. Carbon brushes are placed radially as at C when mounted in box holders, and inclined opposite to the direction of rotation when used with reaction holders.

Contact Angle of Brush.—This may be defined as the angle which the brushes make with the commutating plane as shown in fig. 339. The several kinds of brush, together with the varied conditions of operation require different contact angles ranging from zero to 90° .

Thus in the figure, a copper strip brush may lie at 90° or tangentially as at A.

Wire or gauze brushes should make a more or less acute angle as at B, in order to present the end and not the side of the brush to the commutator.

Carbon brushes may be placed end on or radially as at C, which is the position almost universally used in the case of traction or other reversing motors.

Sometimes the carbon brush is inclined as at D, in order that the revolving commutator may tend to push the brush against its supports and thus ensure better contact.

Brush Contact.—The relation between *contact pressure*, *contact resistance*, and *friction* of brushes varies greatly for different kinds of brush. Copper brushes will carry from 150

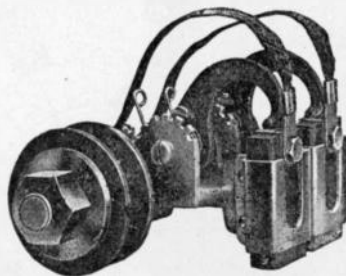

FIG. 340.—Bissell double brush holder. Flexible cables carry the current between the brushes and holders. This holder works equally well for forward or reverse rotation. Two or more holders are used on each stud except for the two smallest frames. The construction permits of adjustment or renewal of brush while the machine is in operation. Sufficient contact area of brush is provided to permit running on one carbon at ordinary loads in case the other become worn or inoperative.

to 200 amperes per square inch of contact surface; and carbon brushes from 40 to 70 amperes per square inch. The usual contact pressure is 1.25 to 1.5 pounds per square inch for copper brushes, and 1.5 to 2 pounds per square inch for carbon brushes. The rim velocities of commutators vary from 1,500 to 2,500 feet per minute, the velocity usually increasing with the size of the machine.

Ques. What is the drop in voltage at the brushes?

Ans. For carbon brushes it is about 0.8 to 1.0 volt at each contact, or 1.6 to 2.0 volts for the two, positive and negative, contacts of a machine.

This value is not materially affected by placing a number of brushes in parallel or by using several sets, as in the case of multipolar machines, as such arrangement merely reduces the current density, and since the contact resistance varies in the inverse ratio, their product remains nearly constant.

Ques. What may be said of the friction of the brushes?

Ans. The coefficient of friction of brushes is about .2 to .25 for copper and .3 for carbon.

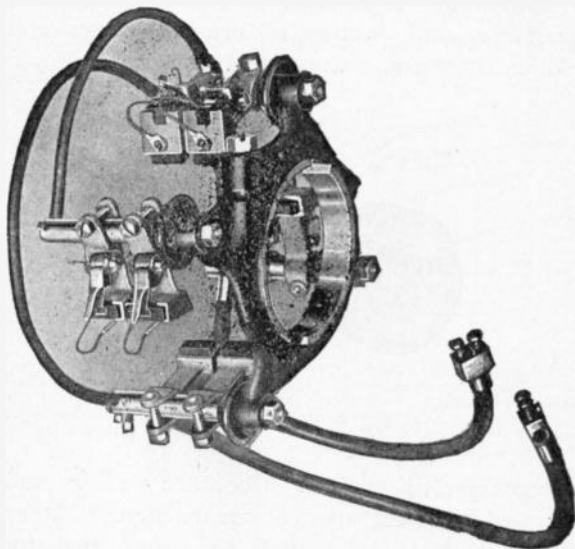

FIG. 341—Western Electric brush gear. The brush holders carry carbon brushes and are so designed that the brushes may be firmly clamped in position and also be capable of independent adjustment. Any brush can be removed while the machine is in operation without disturbing the others and without moving the holder on the stud.

Ques. How many watts are lost at the brushes?

Ans. The watt loss is equal to 1.6 to 2. volts for carbon multiplied by the total current carried.

The watt lost on account of friction may be calculated by the formula:

$$\frac{.3 \times 746}{33000} (P \times S) = \text{watts lost by carbon friction, in which } P$$

is the total pressure in pounds on the commutator, and S , the rim velocity of the commutator in feet per minute.

The losses due to contact resistance and brush friction are very liable to be greatly increased above the values that may be obtained by the preceding methods, if the commutator and brushes are dirty and rough, or not in good condition.

Brush Holders.—These are devices employed to hold the brushes against the commutator with the proper pressure. They differ considerably in various types of machine, hence, no

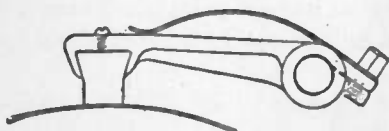

ARM OR LEVER TYPE

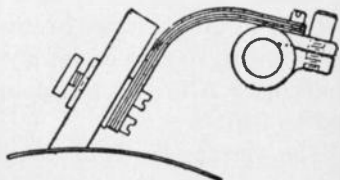

SPRING ARM TYPE

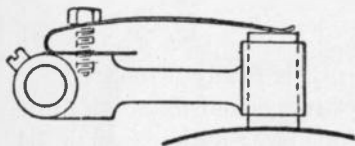

BOX TYPE

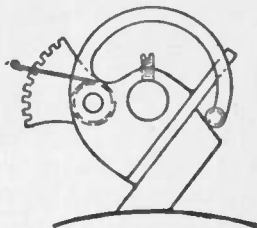

REACTION TYPE

FIGS. 342 to 345.—Various types of brush holder. Fig. 342, arm or lever type; fig. 343, spring arm type; fig. 344, box type; fig. 345, reaction type.

general rules can be given with respect to their construction or use, but any brush holder must fulfill the following requirements:

1. It must hold the brush securely and at the same time feed it forward as it wears away so as to maintain a proper contact;
2. It must hold the brush at the proper contact angle:

3. It must be capable of being raised from the commutator, and held out of contact by some form of catch;
4. It must be so constructed that the brush can be easily removed for cleaning or renewal;
5. The spring pressure must be adjustable;
6. The brush holders themselves must be carried on a rocker arm, or rocker ring.

It is desirable that brush holders be capable of individual adjustment, so that each may be set at its own point of minimum sparking. A few forms of brush holder are illustrated in figs. 342 to 345.

The various kinds of brush holder may be divided into four types:

1. Arm or lever type;
2. Spring arm type;
3. Box type;
4. Reaction type.

In the arm or lever type the brush is firmly attached to the extremity of a rigid arm capable of movement about the brush spindle, except in so far as it is restrained by a spring as in fig. 342.

Fig. 343 shows a brush holder of the spring arm type. The brush is firmly attached to the extremity of a spring arm, the other end of which is secured to the brush spindle, and when once adjusted is not capable of movement about the brush spindle.

In the box type of brush holder as illustrated in fig. 344, the brush is free to move up and down in the brush box, so far as it is not restrained by a spring rigidly secured to the arm which carries the brush box at its extremity.

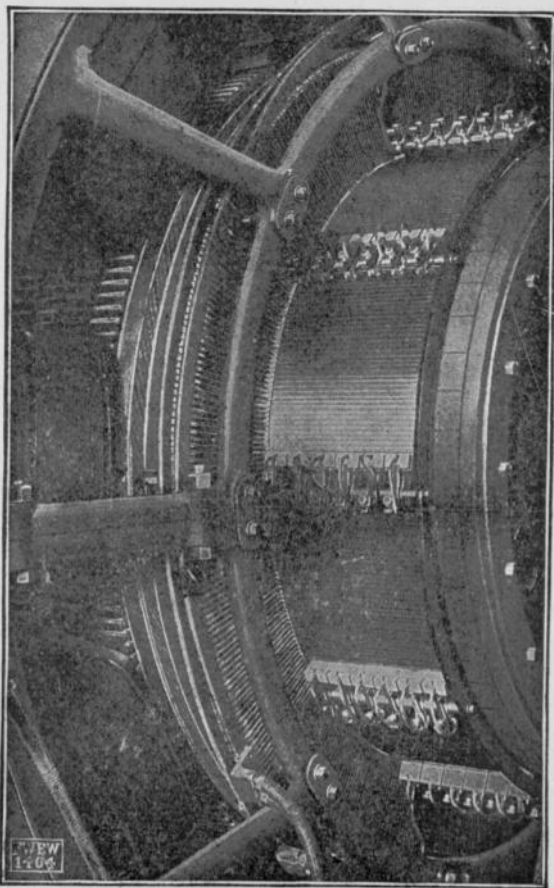

FIG. 346.—Fort Wayne type MPL dynamo; view showing details of armature, commutator and brush rigging of large machine. The laminations of the armature core are punched from thin sheet steel, annealed and japanned. Spacing ribs are built into the core at proper intervals forming air passages for ventilation. In addition, there are recesses in the inside of the flanges which permit the passage of air from the interior around the ends of the core to the openings in the end flanges. The armature coils are constructed of round or bar copper on standard forms. The coils are laid in slots in the surface of the core. The commutator is constructed of bars of hard drawn copper of uniform size and shape, supported and clamped at either end between beveled rings and securely seated on the commutator drum. The drum is connected by radial arms to the commutator sleeve which is mounted and keyed on the armature hub extension.

Fig. 345 shows the reaction type of brush holder, in which the movement of the brush is constrained in one direction by the surface of a part rigidly secured to the brush spindle, and is further constrained by a spring controlled arm, the pressure of which is capable of ready adjustment.

Among the special forms of brush holder may be mentioned:

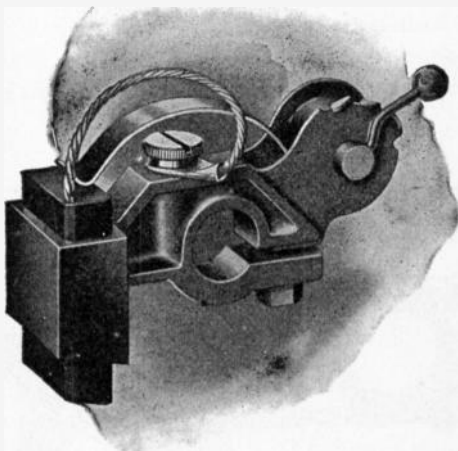

FIG. 347.—Western Electric brush holder. This holder consists of a rugged iron casting, elliptical in section, and supported from the commutator end bearing bracket in such a manner as to provide for the shifting of the brushes. A handle attached to the yoke aids in this shifting and a thumb nut on the outside holds the whole brush gear in the desired position. The brush is fed through an accurately broached slot by a spring which maintains uniform pressure against the commutator throughout the wearing length of the brush. The long lever arm of the spring is sufficiently flexible to take up any minor vibrations of the brush. The tension of the brush may be adjusted without lifting it from the commutator or disturbing any of the other holders. The brush may be removed for inspection by throwing the spring out of notch. The brush is connected to the holder by flexible copper pig tails of ample current carrying capacity.

1. Scissor type of brush holder, used for slip rings, and consisting of two arms pivoted together like a pair of scissors. The lower ends of the arms carry the brushes, suitably mounted, and the upper ends are drawn together by a spring, which thus exerts pressure on the brushes.
2. Clock spring type of brush holder in which the necessary contact pressure is applied to the brush by means of a clock spring, which, with the aid of a ratchet may be wound up and adjusted to any desired pressure.

Ques. How are brush holders carried?

Ans. They are carried by a *rocker arm* for bipolar, and by a *rocker ring* for multipolar machines, which is mounted upon one of the main bearings, or upon a support specially provided for it, being pivoted to revolve from the same center as the shaft, to permit shifting the brushes.

Ques. Mention one trouble sometimes encountered with brush holders.

Ans. There is sometimes trouble resulting from the current passing through the spring which heats it and destroys its elasticity.

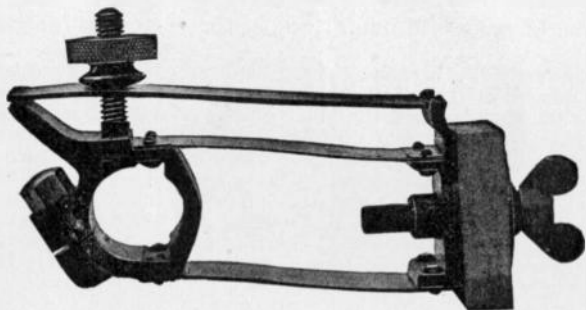

FIG. 348.—Western Electric parallel spring brush holder as used on the larger machines.

Ques. How may this be avoided?

Ans. By insulating one end of the spring, and carrying the entire current directly from the brush itself to the main conductors by a flexible copper strip or cable firmly connected to both.

Ques. What may be said with respect to brush construction on machines for electrolytic work?

Ans. The collection of large currents at low voltage, generated by comparatively small machines, requires careful design of brushes and brush holders. The commutator is longer than the

commutators on machines of equal capacity at higher voltages, and as a rule the commutator segments are thicker and fewer in number. Each brush set is made up of numerous narrow brushes rather than two abnormally wide ones.

An example of brush and brush gear designed to meet such conditions is shown in fig. 328.

• In large machines for electrolytic work, it is not unusual to find the current divided between two wide commutators, one at each end of the armature, thus giving a longer axial bearing surface for the brushes without inconveniently lengthening the pins upon which the separate brushes are threaded.

Multipolar Brush Gear.—The brush gear which includes the holders and carrier arm or ring, becomes more complicated as the number of poles and magnitude of the current is increased.

In the early days of multipolar machines, schemes of armature winding were devised such that all the necessary cross connections were made inside the machine, and the number of brush holders reduced to two and placed at an angular distance apart depending upon the number of poles. Such windings, though possible, are not used much, chiefly on account of their complexity, which not only increases the danger of error in construction, but also makes repairs costly. In modern multipolar machines, such complicated windings are avoided, and the several sets of brushes are connected together in two groups, positive and negative. These connections are carefully designed as part of the brush gear.

Ques. How are the brushes held in large multipolar dynamos?

Ans. They are held at the proper points of commutation by arms offset from a cast iron rocker ring, which is itself supported by brackets projecting from the magnet yoke as shown in fig. 346.

Ques. What provision is made for shifting the ring to adjust the lead?

Ans. The ring is rotated by means of a worm gear and hand wheel.

CHAPTER XXII

ARMATURE CONSTRUCTION

The armature of a dynamo has been defined as: *a collection of coils of wire wound around an iron core, and so arranged that electric currents are induced in the wire when the armature is rotated in a magnetic field.*

From the mechanical point of view the armature may be said to be made up of the following parts:

1. Shaft;
2. Core;
3. Spider
(in large machines);
4. Winding;
5. Commutator.
(broadly speaking).

Of the two types of armature, ring and drum, the latter is almost universally used, hence the examples of construction which follow will be confined chiefly to this type.

Shaft.—A typical armature shaft is shown in fig. 349. It is made of steel and, except in the smaller machines, is thicker in the middle than at the ends for stiffness to withstand the

strong magnetic side pull on the core when the latter is, slightly, nearer one pole piece than the other.

Ques. What is the object of providing shoulders on the shaft as in fig. 349?

Ans. They serve to keep the armature in the proper position with respect to the bearings.

Ques. How is the shaft proportioned?

Ans. If it be proportioned to secure the proper stiffness, it will be found of ample size to resist the twisting strain.

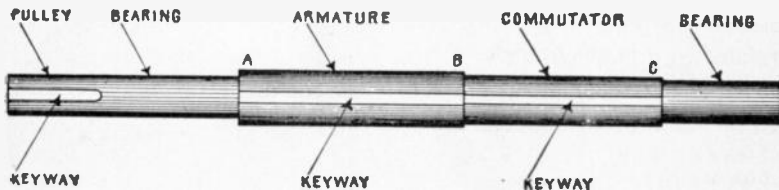

FIG. 349.—Typical shaft for an armature. The illustration shows the keyways for pulley, armature and commutator. In the smaller sizes, there is usually a flange at A, and threads at B and C for retaining nuts.

The shaft is subject also to bending by the weight of the armature, by the magnetic drag on its core, and in belt driven machines, by the lateral drag of the pulley. When running, it is also subjected to bending stresses if the armature be not properly balanced. If the bearings do not give, it is evident that all such actions tend to bend the shaft at definite points.

Core.—In the small and medium size dynamos, the core is attached direct to the shaft. There are two kinds of core:

1. Smooth;
2. Slotted.

Ques. What may be said of the smooth type of core?

Ans. It has become obsolete, except in special cases, as for machines used for electrolytic work where a large current at low voltage is required.

Ques. What is necessary with a smooth core?

Ans. Driving horns as later described.

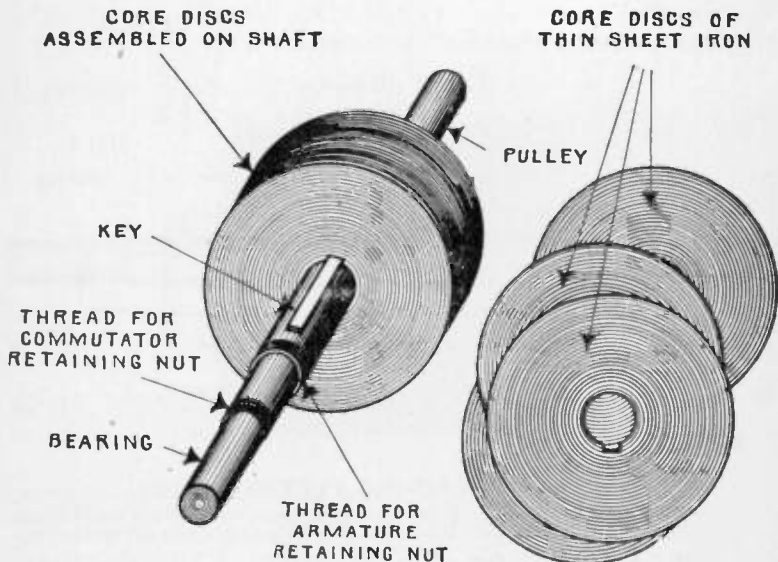

FIG. 350.—Laminated smooth core armature partly assembled. It consists of numerous discs of thin sheet iron threaded on the shaft and pressed together by end plates. The object of this construction is to prevent eddy currents.

Ques. What is a slotted core?

Ans. One having a series of parallel slots, similar to the spaces between the teeth of a gear wheel, and in which the inductors are laid.

Ques. What provision is made to avoid eddy currents in cores?

Ans. They are laminated.

Ques. Describe this method of construction.

Ans. The core is made of stampings of thin wrought iron or mild steel. The numerous discs stamped from the sheet metal are threaded on the shaft as in fig. 350, forming a practically solid metal mass.

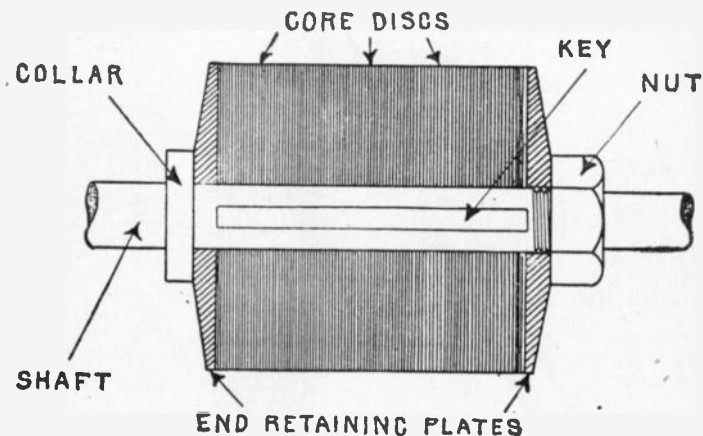

FIG. 351.—Sectional view of laminated smooth core armature showing end plates, flange and retaining nut. A key is provided to prevent rotation of the core with respect to the shaft.

Ques. How thick are the discs?

Ans. The thickness ranges from .014 inch to .025 inch, corresponding to 27 and 22 B and S gauge respectively, 27 gauge being mostly used.

Ques. How are the discs held in place?

Ans. By two end plates pressed together either by large nuts screwed directly on the shaft as in fig. 351, or by bolts

passing through the core from end to end, as in fig. 352, holes being punched in the discs for the purpose.

Ques. What precaution is taken with respect to the core bolts?

Ans. They are insulated from the core by tubes and washers of mica or other insulating material.

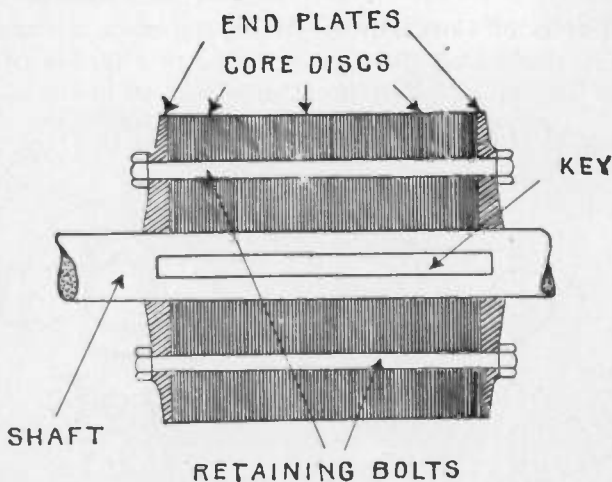

FIG. 352.—Laminated armature core with through retaining bolts. In the larger sizes, these bolts are used instead of a nut threaded on the shaft on account of the large size of the latter.

Ques. What is the construction of the core end plates, and why?

Ans. The rims are beveled quite thin to avoid eddy currents.

Ques. How is the core connected to the shaft?

Ans. Since the core has the full torque exerted upon it by the drag of the inductors, it must be firmly connected to the shaft by means of a key, as shown, so that it may be positively driven.

Core discs are stamped in one piece up to about 30 inches in diameter, and for larger sizes they are built up from sections as later described.

Figs. 353 and 354 show two forms of disc stamped in one piece. The first illustrates a solid disc, and the second a *ventilated* disc in which more or less of the metal is cut away near the center, thus providing passages for the circulation of air which carries away some of the heat generated in the armature.

Insulation of Core Discs.—When the discs are stamped from very thin metal, the mere existence of a film of oxide is sufficient insulation. It is usual, however, to apply a quick

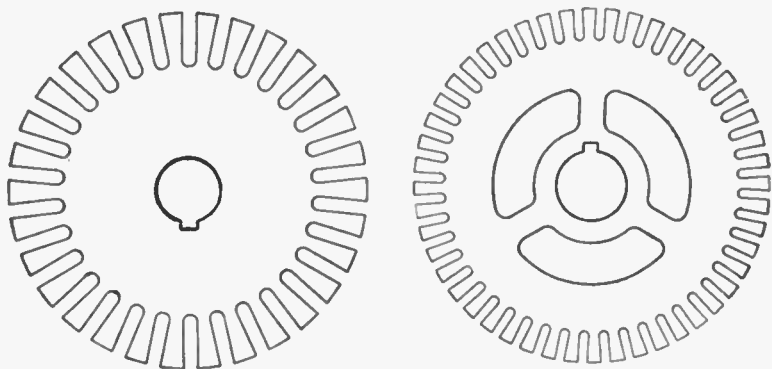

FIGS. 353 and 354.—Solid and ventilated core discs. In fig. 353, the metal cut away near the center reduces the weight and provides passages for air circulation. In some instances a forced circulation is secured by means of a fan attached to the armature, as shown in fig. 366.

drying varnish that will give a hard tough coat and not soften with heat or become brittle and crumble under vibration. The varnish may be applied either by dipping or with a japanning machine; it must be very thin, and the solvent employed should be a very volatile spirit.

Forms of Armature Teeth.—The teeth stamped in the core discs are made in various shapes, depending largely on the

method of securing the inductors in the slots against electromagnetic drag and centrifugal force. The teeth may be cut with their sides:

1. Inclined;
2. Projecting;
3. Notched.

Ques. What may be said of teeth with inclined sides?

Ans. A tooth of this type is shown in fig. 356, being slightly narrower at the root than at the top, the resulting slot having parallel sides.

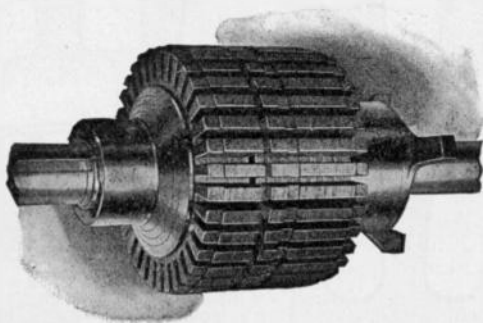

FIG. 355.—Western Electric slotted armature core. The laminations are of sheet steel, annealed and japanned. They are mounted directly on the shaft, (except in the large sizes) and held in place by substantial end plates.

Ques. What are the features of the projecting type of tooth?

Ans. The projecting type is shown in figs. 357 and 358 in which the tops project; this gives a larger core area around the circumference of the armature which reduces the reluctance of the air gap, and provides projecting surfaces for retaining the inductors in the slots by the insertion of wedges.

Ques. What is the object of cutting notches in teeth?

Ans. They are provided for the insertion of retaining wedges, as in fig. 361; this results in less area at the top of the teeth.

Ques. How should teeth be proportioned to secure most efficient operation?

Ans. The width of the tooth should be about equal to the width of the slot minus twice the thickness of the slot insulation;

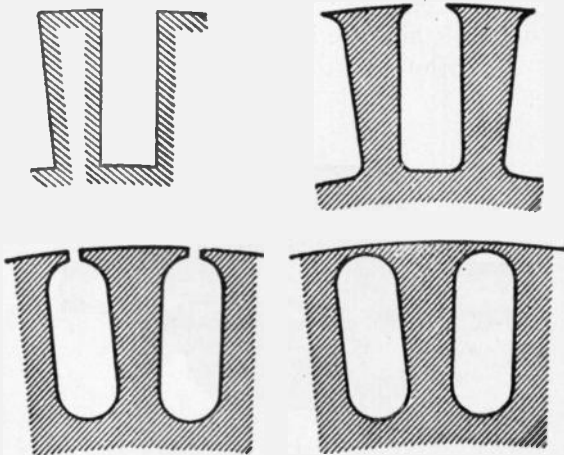

FIGS. 356 to 359.—Various forms of armature teeth; fig. 356 inclined type forming a slot with parallel sides; figs. 357 and 358 projecting type which provides a support for the retaining wedges; fig. 359 enclosed type which forms "tunnels" for the inductors.

that is, the cross sectional area of the teeth should be equal to that of the slots.

Advantages and Defects of Slotted Armatures.—The slotted armature, sometimes called the Pacinotti armature, after its inventor, has the following advantages over the smooth type:

1. The inductors are held more firmly in place to resist stresses due to electromagnetic drag and centrifugal force;
2. The inductors are protected by the teeth against mechanical injury;
3. Less reluctance of the air gap;
4. The intermittent induction due to the presence of the teeth prevents the formation of eddy currents.
5. When the teeth are saturated they oppose the shifting of the lines due to armature reaction.

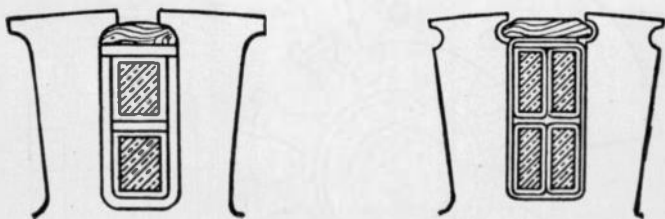

FIGS. 360 and 361.—Projecting and notched teeth; cross sections showing inductors and retaining wedges in place.

The disadvantages of slotted armatures compared with the smooth type are:

1. Greater hysteresis loss, caused by denser flux in the teeth;
2. Generation of eddy currents in the polar faces when the latter are not of laminated construction;
3. Greater self-induction in the armature coils;
4. Construction more expensive;
5. Leakage of magnetic lines through core, exterior to winding.

The generation of eddy currents in the polar faces may be overcome by making the air gap at least 50 per cent. of the distance between the teeth, so that the magnetic lines can spread from the corners of the teeth, and become nearly uniformly distributed over the polar faces. Magnetic leakage through the core may be reduced by making the amount of metal above the inductors very small.

Slotted Cores; Built Up Construction.—In the case of large dynamos, the core discs are built up in order to reduce the cost of construction; the following parts are used:

1. Spider;
2. Core rings split into sections.

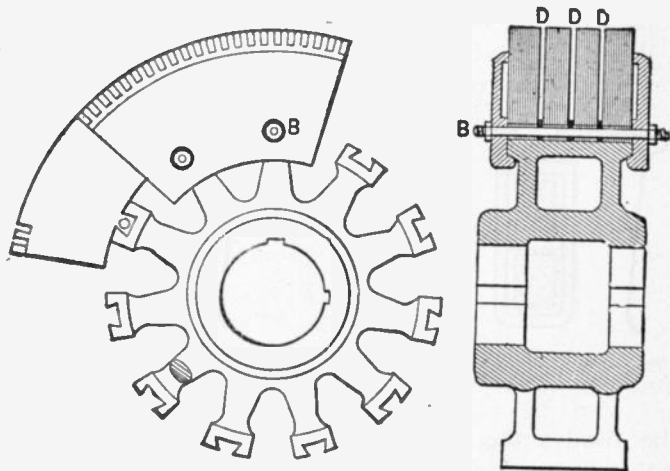

FIGS. 362 and 363.—Side and end view of built up armature core. The sheet metal ring sections containing the teeth are fastened into dovetail notches in the spider as shown. The layers of ring sections are placed so as to break joints and are held by end clamps and through bolts B. Distance pieces are inserted at intervals to provide ventilating spaces D, D, D.

Ques. What is the approved method of core construction in large armatures?

Ans. The core should be of the built up construction to avoid waste of material in the stampings.

Ques. Describe the construction of a built up core.

Ans. Ring sections stamped from sheet metal are fastened to a central support or *spider*, which consists of an iron hub

with radiating spokes and a rim with provision for fastening the rings. The rim of the spider is provided with dovetail notches into which fit similarly shaped internal projections on the core segments. These features are shown in figs. 362 to 364. Each layer of core sections is placed on the spider so as to break joints and the core thus formed is firmly held in place by end clamps as shown. The manner of fastening the rings to the

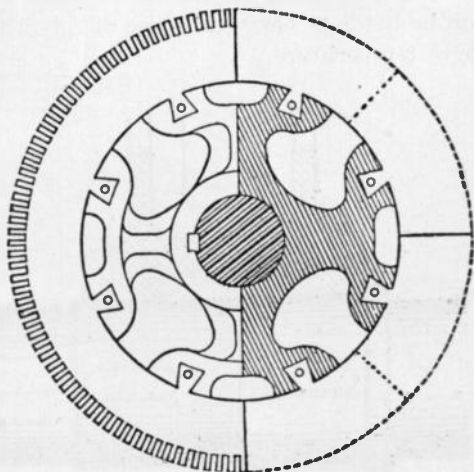

FIG. 364.—Built up core with four spoke spider, each spoke carrying two dovetail notches. In this construction a little more air space is obtained for ventilation than where a separate spoke is provided for each notch.

spider is an important point, for it must be done without reducing the effective cross section of the core in order not to choke the magnetic flux.

In order to secure a better fit and reduce the machine work, the spider hub in large machines is sometimes cored with enlarged section between the outer bearing surfaces, and it is not unusual to find these surfaces turned to two different sizes as in fig. 365, to admit of easier erecting.

To avoid any trouble that may arise by unequal expansion, the rim of the spider is not made continuous, but in several sections as shown in fig. 364. The rim here consists of four sections each of which has two dovetail notches. By thus dividing the rim into sections, its weight is somewhat reduced and the ventilating spaces between the sections increased.

Ventilation.—In the operation of a dynamo more or less heat is generated, depending on the load; hence it is desirable that provision be made to carry off some of this heat to prevent excessive rise of temperature.

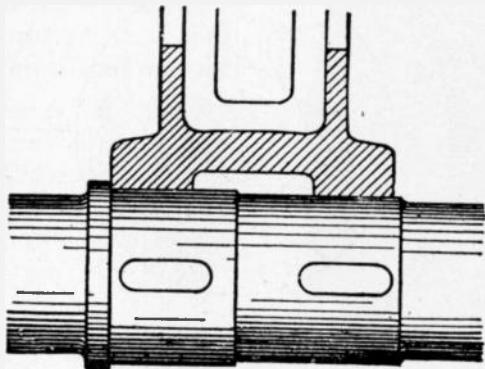

FIG. 365.—Hub and shaft design on large machines to reduce the machine work and facilitate erecting.

Ques. Why do armature cores heat?

Ans. They heat from these causes: eddy currents, hysteresis, and heat generated in the inductors.

Ques. How is adequate ventilation secured?

Ans. The spider is constructed with as much open space as possible through which air currents may circulate. The core



FIG. 366.—Western Electric barrel wound armature, having a fan attached at one end to induce a circulation of air for ventilation.

is divided into several sections with intervening air spaces D as shown in fig. 363, the discs being kept apart at these points by distance pieces. These openings between the discs are called *ventilating ducts*; they are usually spaced from 2 to 4 inches apart.

Ques. What other provision is sometimes made to secure ventilation?

Ans. In some machines a forced circulation of air is secured by means of a fan attached to one end of the armature as shown in fig. 366.

Insulation of Core.—Before the winding is assembled on the core, the latter should be thoroughly insulated. Japan or enamel insulation is not sufficient because it is liable to have bubbles or minute holes in it, or be pierced by particles of metal or by the rough edges of the core discs. Two or more layers of strong paper, fibre, canvas or mica, should be applied to the

core before placing the inductors in position. The ends of the core should be insulated with thicker material, since the strain upon it is greater, especially at the edges.

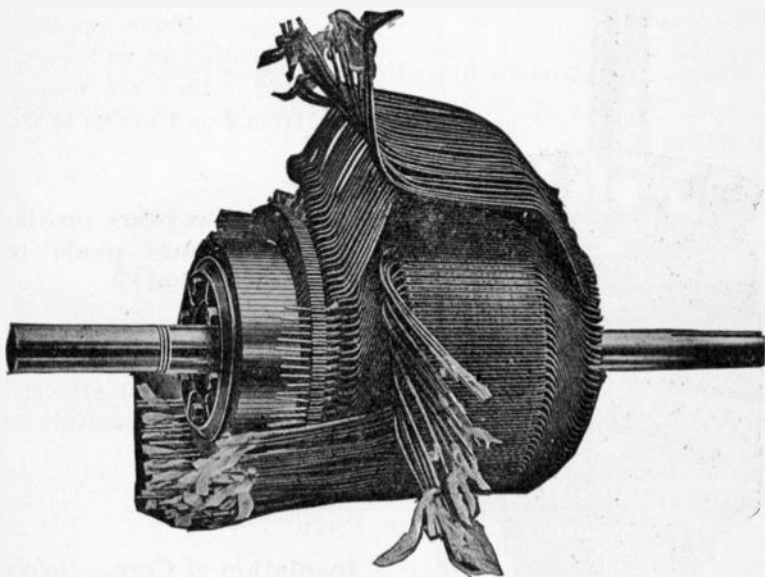

FIG. 367.—Holzer Cabot partially wound barrel wound armature, showing arrangement of coils. The core is built up of thin discs of soft annealed steel, which are slotted to allow the wire to sink below the surface, this being sometimes called *iron clad construction*. The discs are held by end plates, clamped without through bolts. The coils are machine formed of round ribbon or bar copper depending on the size and purpose of the machine, being without joint except at the commutator. They lie in insulated troughs, the upper layers being insulated from the lower layers by fibre.

Armature Windings.—The subject of windings has been fully treated from the theoretical point of view in chapter XVIII. It remains then to explain the different methods employed in the shop and the mechanical devices used to construct the scheme of winding adopted.

Ques. What is the construction of the inductors?

Ans. They are made of copper; the ordinary form consists of simple copper wire, insulated with a double or triple covering of cotton, and in some cases copper bars are used for large current machines.

Ques. What is the objection to copper bars?

Ans. They are liable to have eddy currents set up in them as illustrated in fig. 291.

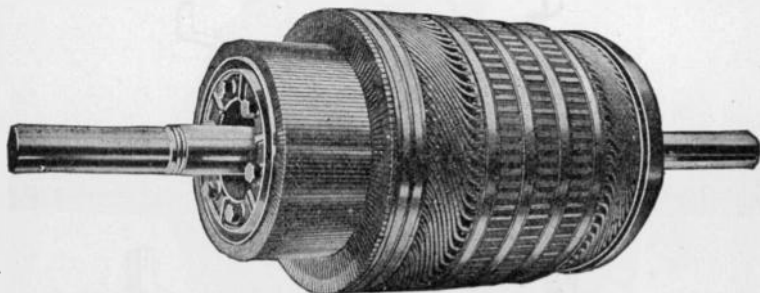

FIG. 368.—Holzer Cabot iron clad band wound armature complete; view showing openings for ventilation. The advantage of the form of winding adopted, is the ease with which a coil may be replaced in case of injury and the additional cooling surface. The coils are held in place by maple wedges secured by binding wires which are soldered throughout their length.

Ques. What may be said with respect to the sizes of wire used for inductors?

Ans. Wire larger than about number 8 B and S gauge (.1285 inch diameter) is not easily handled, hence for large inductors, two or more wires may be wound together in parallel.

According to the mechanical features and manner of assembling on the core, drum windings may be divided into several classes, as follows:

1. Hand winding;
2. Evolute or butterfly winding;

3. Barrel winding;
4. Bastard winding;
5. Former winding.

Hand Winding.—The first windings were put on by hand, and proved objectionable on account of the clumsy overlapping of the wires at the ends of the armature, which stops ventilation

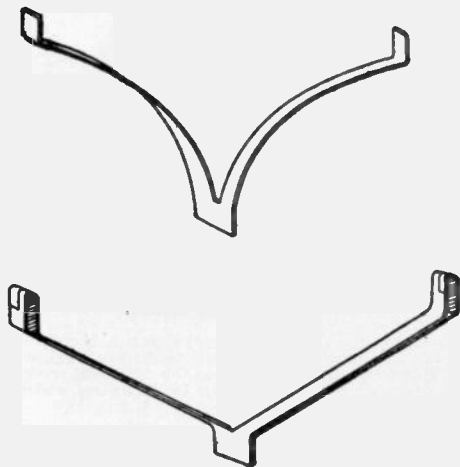

FIGS. 369 and 370.—Evolute and "straight out" connectors. In small machines the connectors must be curved as in fig. 369, but in large machines, especially where the teeth are wide, they may be straight as in fig. 370. These connectors may take either of the following forms: 1. *involute or evolute connectors*—An involute is the curve drawn by the extremity of a piece of string which is unwound from a cylinder; 2. *spiral connectors*—These consist of double spirals, the commutator being usually connected to the junction of the two spirals. These connectors are also known as "butterfly" connectors.

and hinders repairs, while the outer layers overlying those first wound, bring into close proximity inductors of widely varying voltage. The method is still used in special cases and for small machines. Such a winding has rarely, if ever, been made with one continuous wire.

Evolute or Butterfly Winding.—This mode of winding, was introduced by Siemens for electroplating dynamos to overcome the objections to hand winding. It takes its name from the method of uniting the inductors by means of spiral end connectors as shown in fig. 374, also in figs. 369 and 370, which show more modern forms.

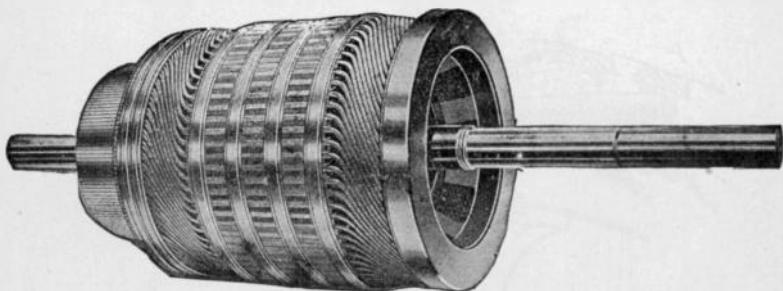

FIG. 371.—Holzer Cabot armature; rear view showing back head and coil guard. The construction of core and winding is described in fig. 367. The shaft is of crucible steel ground to gauge. The commutator segments are of drop forged copper in the smaller and hard-drawn copper in the larger sizes. The insulating material between the segments is mica. On the larger sizes, the commutator shell is fitted with a thread and mounted on a spider. This construction provides openings between the commutator and shaft for ventilation.

Ques. What are evolute connectors ?

Ans. The fork shaped strips used to connect bars at different positions on the armature, as shown in fig. 369.

In large machines, especially where the teeth are wide, these connections may be straight, but in small cc machines they must be curved in the manner shown in the upper part of the figure, as the room available may diminish by as much as half, as the lowest point is reached, and the room occupied by the strip is the width of a horizontal section at various points. This width, in the case of the straight connections, is constant.

In place of the wooden block, used in early machines, for fastening the middle part of the connectors, they may be anchored to an insulated clamping device built up like a commutator and for that reason called a *false commutator*.

Ques. How are the inductors arranged in evolute winding?

Ans. In fig. 373, it will be seen that the ends of the evolute connectors lie in two planes, hence the inductors must project to different distances beyond the core. Accordingly, one long and one short bar may be conveniently placed in each slot, side by side. In large machines, especially where the teeth are wide,

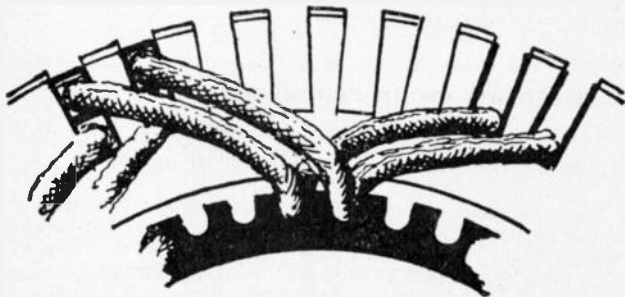
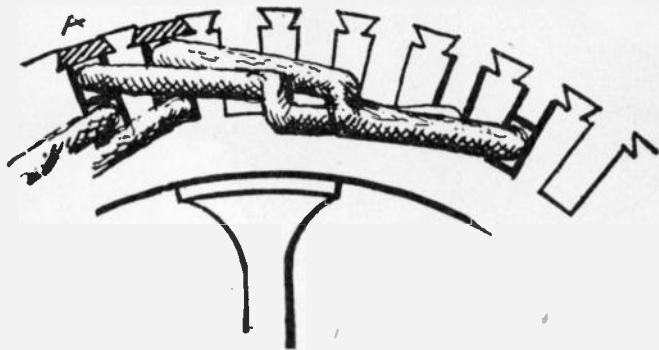

FIGS. 372 and 373.—*Barrel and evolute windings; end views showing placement of coils.* When all the coils are wound on the former, the placing of them on the armature is a simple matter. After insulating the slots, the winder begins at any convenient slot, and inserts the coils as shown. Before he can fill all the slots, some of the first coils must be raised and the last ones inserted underneath. There is not much difference between barrel and evolute winding and one style may be used at one end of the armature and the other at the opposite end.

the connectors may be straight as in fig. 370. Evolute connectors may be used for either lap or wave windings.



FIG. 374.—Siemens' bar armature; end view. Each inductor in the form of a bar is connected to the next by means of two evolute spiral copper strips, one bending inwardly, the other outwardly, their junction being in some cases secured to a block of wood upon the shaft. Their outer ends are attached to the bars by rivets or silver solder.

Barrel Winding.—This is a form of drum winding in which the inductors are arranged in two layers and carried out obliquely on an extension of the cylindrical surface of the drum to meet and connect with radial risers.

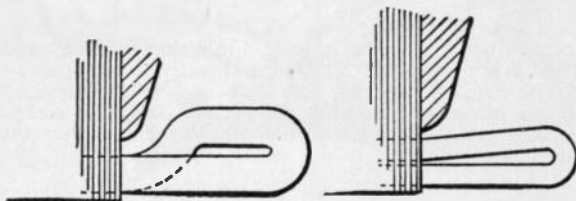

FIGS. 375 and 376.—Single layer and double layer barrel winding. Barrel winding is a method of arranging the ends of armature coils as they pass from one pole to the next, in which, instead of using *involute* or *butterfly* connections, V-shaped end connections are used which lie on a cylindrical surface, which is a continuation of the armature surface. The coil ends must of necessity be arranged in two layers, but the method may be used for either one or two coils per slot, the difference in arrangement for these is here illustrated.

Barrel winding has been very widely adopted. Although it involves an increased length of armature, this gives additional cooling surface and provides for good ventilation.

In barrel winding, the coil ends must of necessity be arranged in two layers but the method may be used for either one or two coils per slot, the difference in arrangement for these two cases being shown in figs.

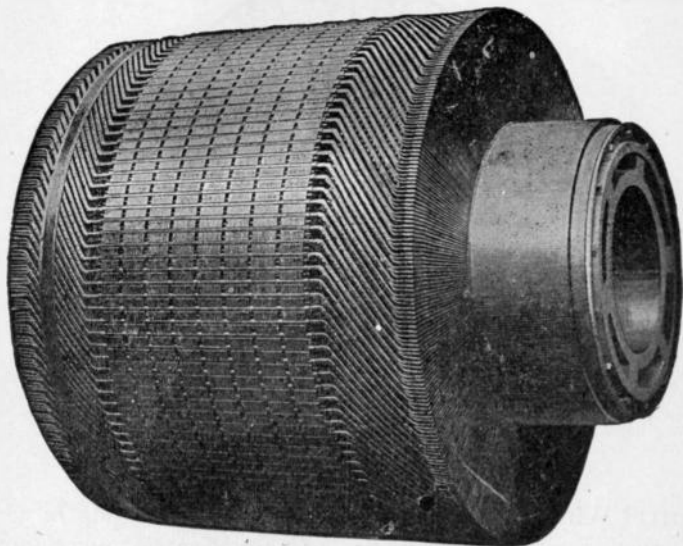

FIG. 377.—Westinghouse barrel wound armature. The coils are former wound from copper strap and are interchangeable. In the larger size machine they are of the single type. The illustration shows plainly the characteristic feature of barrel winding, namely the oblique end connectors carried out on the extended drum.

375 and 376. In the single layer barrel winding, fig. 375, each slot is occupied by but one side of one coil. In the double layer barrel winding, fig. 376, the opposite sides of two separate coils occupy space in the same slot. The coils, on emerging from the slots bend in opposite directions, and if one side of a coil occupy the bottom portion of a slot, its other side usually occupies the top portion of a slot distant from the first slot by the polar pitch.

Bastard Winding.—In this type of winding, the end connectors project from the inductors in straight lines parallel to the shaft and then are bent inward. It has the

effect of being somewhat shorter than the barrel winding. In order to secure better ventilation, it is usual to combine a bastard winding at the rear end of the armature with a barrel

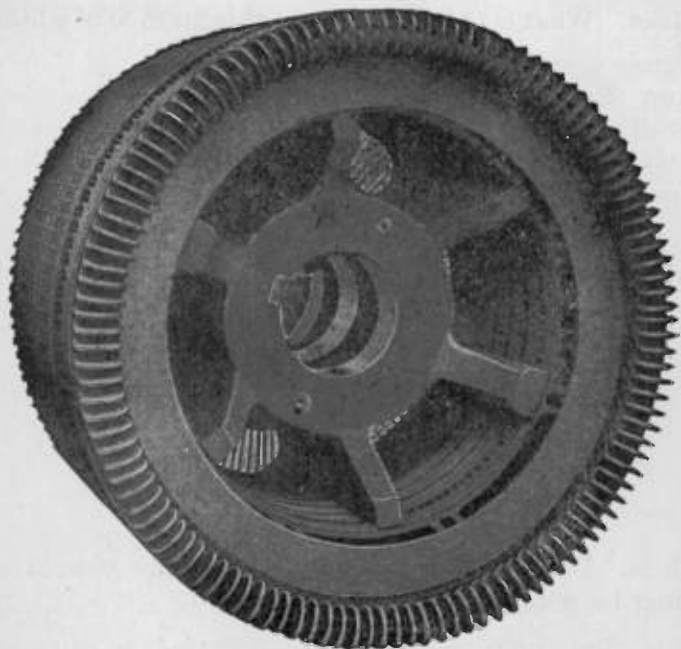

FIG. 378.—Rear end of Westinghouse wave-barrel wound armature; view showing ventilation.

winding at the commutator end. This class of winding is used only with bar armatures.

Former Winding.—This relates to a method of winding coils, and not to any particular type; that is, mechanical winding as distinguished from hand winding. While hand winding is necessary for ring armatures, a drum armature is wound better and more easily by the aid of machinery.

Ques. What is a "former" coil?

Ans. A former coil, as its name suggests, is one that is wound complete upon a former before being placed upon the armature.

Ques. What is the advantage of this method of winding coils?

Ans. By the use of formers much time is saved, thus reducing the cost, and also by their use all the coils are symmetrical which improves the appearance of the finished winding.

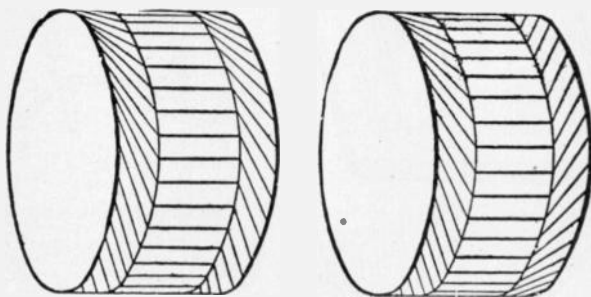

FIGS. 379 and 380.—Diagrams illustrating lap and wave barrel windings.

Ques. How is the required shape of the template or former for winding the coils determined?

Ans. By winding one coil on the armature in order to ascertain its dimensions and shape; it is then removed from the armature and used as a pattern in constructing the former.

Types of Former Coil.—Of the numerous shapes of former coil, mention should be made of:

1. Evolute coils;
2. Straight out coil

Ques. Describe the evolute type of former coil.

Ans. The evolute coil is wound around eight pins inserted in a board as shown in fig. 381. The required number of turns are taken around these pins and their ends G and H left projecting. The coil thus formed is now covered with tape and after removal from the board, is put into a clamp at C and F, and opened up as shown in fig. 382, which is the form required for insertion in the proper slots of the armature.

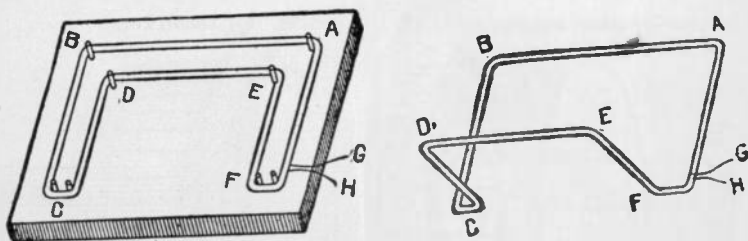

Fig. 381.—Method of winding evolute coils. In preparing the former, it is necessary to know the dimensions of the coil, hence, a pattern coil must first be made, from which the spacing of the pins can be taken so that the completed coil will fit into the slots for which it is intended. After the pins have been properly spaced on the board, the wire is wound around them as indicated, as many turns being taken as decided on for each coil. When the coil is thus completely wound, it is taken from the pins, and the lower ends, C and F, placed in a suitable clamp. The two halves of the coil are then spread apart, the coil assuming the shape illustrated in fig. 382.

Fig. 382.—Appearance of an evolute former wound coil opened out. The points A, B, C, etc. correspond to similar points in fig. 381.

Ques. What is the peculiarity of the evolute coil?

Ans. The two sides of the evolute coil have unequal dimensions. The part marked AB, in fig. 381 which is an upper layer inductor is longer than the part DE, which constitutes a lower layer inductor. The portions DC and EF act as parts of an inner layer of evolutes, and the portions AF and BC as parts of an outer layer of evolutes. These features are shown in fig. 382.

Ques. How are evolute coils placed on the core?

Ans. They are placed in position as shown in figs. 372 and 373, continuing around the core until all the slots are filled. To complete the operation it is necessary to raise some of the first laid coils and insert the last ones below them. The winding is thus completed and is symmetrical.

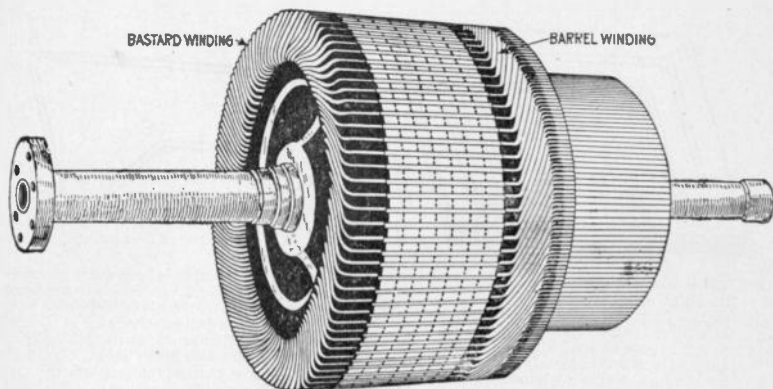

FIG. 383.—Westinghouse combination bastard and barrel winding. A bastard winding at the rear end is combined with a barrel winding at the commutator end, as shown in the illustration, to secure better ventilation.

Ques. Describe the method of winding the “straight out” type of former coil.

Ans. The straight out coil may be wound on a former such as shown in fig. 384. This consists of a board having four upright pins, A, B, D, E, properly spaced and two horizontal pins C, F, attached to extensions at each end of the board. A coil of the required number of turns is wound around these pins and then opened out as in fig. 385. After varnishing and baking it is ready to be placed on the armature.

Ques. For what class of winding are straight out former coils suitable?

Ans. For barrel winding.

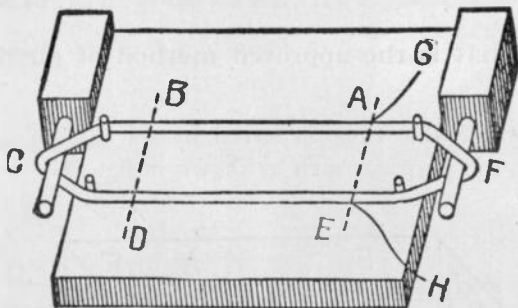

FIG. 384.—Method of winding "straight out" coils. There are several ways of making these coils. A former may be prepared, as shown in the figure, with a board having inserted four pins, and having attached two blocks at the ends carrying horizontal pins as shown. Around the several pins, the coil is wound to the required number of turns and taped. This coil differs from the evolute coil in that the two halves are of equal size, the parts which act respectively as upper and under inductor being of equal length. The coil as shown is suitable for wave winding.

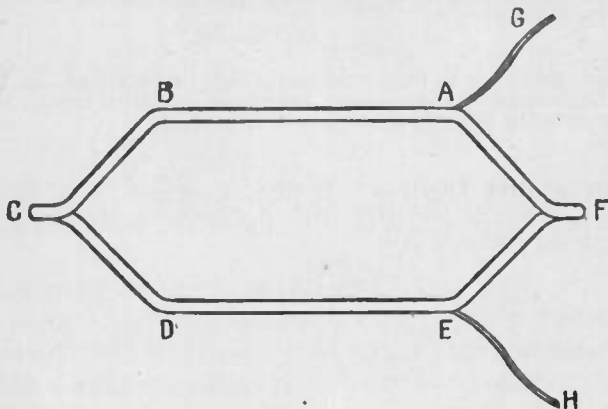

FIG. 385.—Appearance of straight out coil after being opened out. In opening out the coil, the ends C and F are put into a clamp and twisted at right angles to the plane of the coil. The letters correspond to the points indicated in fig. 384.

Ques. How are straight out coils placed on the core?

Ans. In the same manner as described for evolute coils; when in position straight out coils appear as in fig. 372.

Ques. What is the approved method of putting tape on a coil?

Ans. Considerable time is saved by the use of a machine designed for the purpose, such as shown in fig. 387.

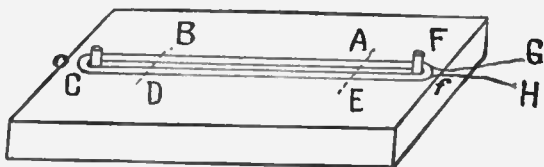

FIG. 386.—Another and simpler method of winding a "straight out" coil. A board with only two pins is employed as shown; this plan, however, gives more trouble in the subsequent opening out of the coil.

The construction of these machines is such that a roll of tape placed on a split metal ring is revolved around the coil to be taped, the coil being gradually moved until it is entirely covered.

Coil Retaining Devices.—In the operation of a dynamo there are two forces which tend to throw the inductors out of position:

1. Armature drag;
2. Centrifugal force.

Both of these forces are present with smooth core armatures, but only centrifugal force with slotted armatures. The devices used to hold the inductors in position against these forces are:

1. Driving horns;
2. Binding ribbons;
3. Retaining wedges.

Ques. What are driving horns?

Ans. They are simply pins or strips projecting from the surface of a smooth core as shown in fig. 251.

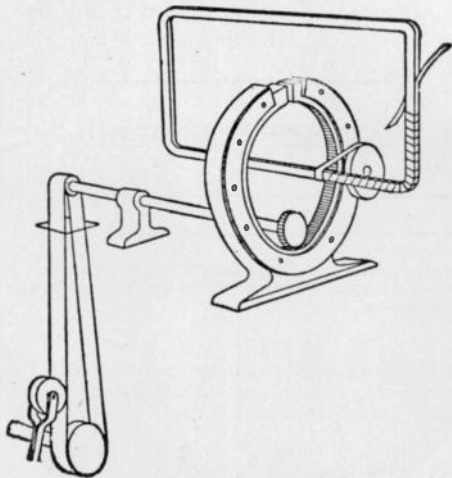

FIG. 387.—Armature coil taping machine. Numerous machines have been invented for taping armature coils. They consist essentially of a device which revolves a roll of tape around the coil, in such a direction that the tape is unwound from the roll and rewound on the coil. The speed at which the coil is fed through the machine will determine the overlapping of the tape.

Ques. What other kinds of retainer are used on smooth core armatures?

Ans. They require several binding ribbons or brass bands placed around the winding to prevent the inductors being thrown off the core by centrifugal force.

Ques. With slotted armatures what provision must be made for retaining the inductors in position?

Ans. Retaining wedges must be inserted into the notches or between the projecting tops of the teeth.

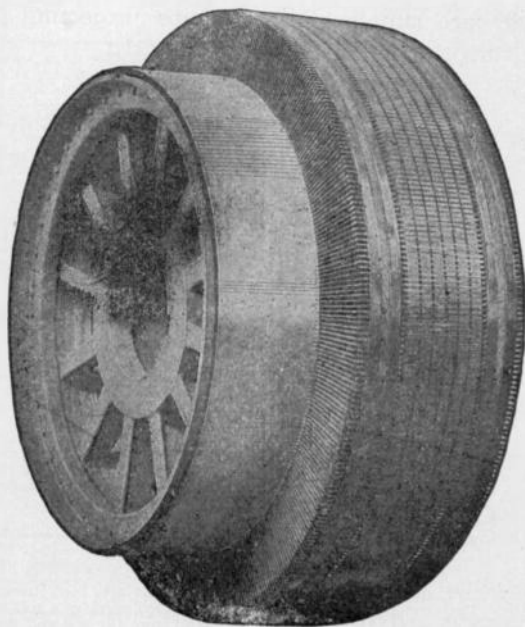

FIG. 388.—Front view of large armature for direct connected dynamo, built by the General Electric Co.

Ques. How are the wedges made?

Ans. They are usually made of well baked hard wood, such as hornbeam, or hard white vulcanized fibre. Sometimes a springy strip of German silver is used.

HAWKINS PRACTICAL LIBRARY OF ELECTRICITY

IN HANDY POCKET FORM

PRICE, \$1 EACH

They are not only the best, but the cheapest work published on Electricity. Each number being complete in itself. Separate numbers sent postpaid to any address on receipt of price. Catalog of series will be mailed free.

GUIDE No. 1 Treating on electrical signs and symbols—static and current electricity—primary cells—conductors and insulators—resistance and conductivity—effects of the current—magnetism—electro-magnetic induction—induction coils—dynamo principles—classes of dynamo—field magnets—Armatures—armature windings—armature theory—commutation and the commutator—brushes and the brush gear—armature construction.

GUIDE No. 2 Motor principles—armature reaction in motors—starting a motor—motor calculations—brake horse power—selection and installation of dynamos and motors—performance curves—location—foundation—belts—auxiliary machines—Galvanometer—standard cells—current measurement—resistance measurement—Christie bridge—testing sets—loop tests—potentiometer—armature voltmeter and wattmeter—multipliers—electro-dynamometers—demand indicators—watt hour meters—operation of dynamos—lubrication—troubles—coupling of dynamos—armature troubles—care of commutator and brushes—heating—operating of motors—starters—speed regulators.

GUIDE No. 3 Distribution systems—boosters—wires and wire calculations—inside, outside, and underground wiring—wiring of buildings—sign flashers—lightning protection—storage battery—rectifiers—storage battery systems.

GUIDE No. 4 Alternating current principles—alternating current diagrams—the power factor—alternator principles—alternator construction—alternator windings.

GUIDE No. 5 Alternating current motors—synchronous and induction motor principles—construction of alternating current motors—A. C. commutator motors—power factor of induction motors—transformers—transformer losses—transformer construction—transformer connections—transformer tests—converters—rectifiers—alternating current systems.

GUIDE No. 6 Transformation of phases—switching devices—circuit breakers—relays—lightning projector apparatus—regulating devices—synchronous condensers—indicating devices—meters—power factor indicators—Wave form measurement—switchboards.

GUIDE No. 7 Alternating current wiring—properties of copper wire power stations—power station calculations—turbine practice—management—embracing: selection, location, erection, testing, running, care and repair—telephones.

GUIDE No. 8 Telegraph—simultaneous telegraphy and telephony—wireless—electric bells—electric lighting—photometry.

GUIDE No. 9 Electric railways—electric locomotives—car lighting—trolley car operation—miscellaneous applications—motion pictures—gas engine ignition—automobile self-starters—and lighting systems—electric vehicles.

GUIDE No. 10 Elevators—cranes—pumps—air compressors—electric heating—electric welding—soldering and brazing—industrial electrolysis—electro-plating—electro-therapeutics, X-rays, etc. This number contains a complete ready reference index of the complete library.

Theo. Audel & Co., Publishers.

72 FIFTH AVENUE,
NEW YORK

