

AN INTRODUCTION TO

TELEVISION



C·J·HYLANDER

R·HARDING, JR

100

200

500

AN INTRODUCTION TO TELEVISION

By Clarence J. Hylander and Robert Harding, Jr.

EVEN in these days when we may take many a scientific miracle for granted, none of us can but thrill to television. When the opening of the New York World's Fair in 1939 was telecast, another great science passed beyond the experimental stage.

This accomplished fact was a milestone in a comparatively rapid sequence of events. It was only sixteen years ago that a Scotch inventor projected televised shadows on a screen. Between that era and ours today, spans a bridge of fascinating facts, discoveries, adjustments, trials, exciting experiments and dismal failures; all of them contributing to a steady progress in extending the range of human vision to distant places.

Television is still a science in progress. To know its story converts a mysterious and sometimes incomprehensible invention into a lively story of applied science, and gives everyone, young and old, a background of understanding that will clarify and dramatize future developments that are sure to come.

SHIP & AIRCRAFT BEACONS
GOVERNMENT
RADIO COMPASS
COASTAL TELEG.

← ← ←
10

INTERNATIONAL B.C.
AVIATION
GOVERNMENT

← ← ←
100 (ME)

TELEVISION 4-5
TELEVISION 6-7

ether highway".

1000

2000

3000

4000

WEAF
WLW
WJZ
WABC
KOMO
KDKA
KEX
WCAE
KIDO
WQXR

BROADCAST

AMATEUR

POLICE & GOVERNMENT
COASTAL TELEG.
AVIATION
SHIPS

AMATEUR

From the collection of the

z n m
o Prelinger
v a
t p
Library

San Francisco, California
2006

20

25

FIXED
VERNMENT
IP, COASTAL
TELEG.

INTERNATIONAL B.C.

AVIATION
GOVERNMENT
SHIP, COASTAL
TELEG.

AMATEUR

300

500

LICE
RNMENT

TELEVISION

TELEVISION

TELEVISION

TELEVISION

TELEVISION

EXPERIMENT
AND
RESEARCH

Adapted, with consent, from a chart
copyrighted by "Radio Today",

AN INTRODUCTION TO TELEVISION

by C. J. Hylander

CRUISERS OF THE AIR

AMERICAN INVENTORS

AMERICAN SCIENTISTS

THE BOYS' OWN BOOK OF GREAT
INVENTIONS (with Darrow)

THE WORLD OF PLANT LIFE

THE YEAR ROUND (Putnam)



Courtesy National Broadcasting Company

Television mobile field unit of National Broadcasting Company in operation. The crew is in action on top of the camera truck, the television camera (left) picking up the scene while the microphone with its sound-reflector (right) is picking up the accompanying sounds.

An Introduction to

TELEVISION

BY C. J. HYLANDER

and ROBERT HARDING, Jr.

New York · 1941 · The Macmillan Company

COPYRIGHT, 1941, BY THE MACMILLAN COMPANY

All rights reserved—no part of this book may be reproduced in any form without permission in writing from the publisher, except by a reviewer who wishes to quote brief passages in connection with a review written for inclusion in magazine or newspaper.

Published September 1941.

PRINTED IN THE UNITED STATES OF AMERICA
BY J. J. LITTLE & IVES COMPANY, NEW YORK

INTRODUCTION

IN 1923 a Scotch inventor projected televised shadows on a screen. Two years later a Washington, D. C., inventor broadcast television silhouette pictures. Five years later American Telephone and Telegraph Company, Bell Telephone Laboratories, and Radio Corporation of America seriously set research workers to tackle the problem of television. In that same year a television drama was broadcast from station WGY. And then, as dozens of trained technicians, with the resources of well-equipped laboratories at their disposal, wrestled with the obstacles which lay in the path of this infant in the family of electrical communication, a surprised world suddenly became aware of television. In 1939—only sixteen years after the first practical demonstration that television was possible—Radio Corporation of America telecast the opening of the New York World's Fair, the first American broadcast by television of a moving outdoor scene which was truly beyond the experimental stage. Coincident with this

perfection of transmission came the manufacture of television receivers by several electrical manufacturers, including General Electric Company, RCA Manufacturing Company, Westinghouse, and others. The climax came when the Federal Communications Commission approved sponsored television programs on July 1, 1941, which permitted television to begin in earnest as a business enterprise.

Television has been characterized by an unusually rapid progress since the first public demonstration, as has been suggested by some of the milestones mentioned above. This has brought about an inability on the part of the public to appreciate the basic principles involved in television transmission and reception. This progress of television has also been marked, unfortunately, by an undue optimism, furthered by a great deal of press publicity, that television is now an accomplished fact; that all one has to do is to buy a receiver and he will become a satisfied "televviewer." As the last few years have passed by, and these television prophecies are unfulfilled, a good share of the public has become skeptical, perhaps feeling that nothing is being done, since television is not in wider use.

It is the main purpose of this *Introduction to Television* to throw light upon both of these aspects of television. By explaining the most pertinent funda-

mental principles, the authors hope to illuminate the progress of television to date. By explaining also the problems yet to be solved, the authors hope that the expectant public will realize more fully the limitations of television in its present state and appreciate more intelligently whatever progress is described in the news.

There was a time when one man could communicate with another only if he was within hearing distance of his voice or seeing distance of his signals. The development of transportation devices during the seventeenth and eighteenth centuries improved means of communication by making possible the transmission of messages by post wherever coach or ship could go. It increased the range of human communication by means of written or printed words, but the time required was often months. Two individuals separated by the width of a continent or an ocean could communicate with each other only infrequently.

The limits of human communication by means of sound vibrations passing through the air, recognizable as words, is several miles at the most. Attempts to increase this range, for providing a means to supplant written messages, were failures until the nineteenth century ushered in the age of electricity.

Then the range of human communication, and the

time element required for it, changed tremendously. More than one experimenter reasoned thus: since an electric current traveled through a wire almost instantaneously, why not use this current as a means of sending signals between stations, each signal representing a letter or word? Thus the telegraph came into existence. It was but a matter of a few decades before other inventors, spurred on by the success of telegraphy, were able to transmit sounds as well as signals. Soon dots and dashes gave way to a sound-modulated electric current which was reconverted into sound waves at the other end of the wire. The telephone took its place beside the telegraph as another means of rapid communication.

Then came the discovery of radio waves—those electromagnetic vibrations speeding through space with the velocity of light. They opened up new vistas to experimenters in the field of electrical communication. If signals and sounds could be transmitted as electric currents in wires, why couldn't they likewise be converted into electromagnetic waves and sent through the atmosphere without wires? As with wire communication, at first only signals were transmitted by wireless; intermittent electrical waves miraculously clicked receivers thousands of miles away. Hardly had the world accustomed itself to this new method of communication when other inventors dis-

covered how to send sounds through the air as radio waves. Instead of clicking receivers, these electrical impulses set in motion diaphragms in earphones and loud-speakers, reconverting the radio waves into sounds similar to those produced at the sending station. Radio became a lusty member of the quartette of electrical means of communicating spoken or written words.

Thus through the twentieth century man marched on in his quest for better and speedier means of sending his messages from one place to another. Yet during all this time little progress was made in extending the range of human vision. Man could see a little farther as he invented telescopes; but even with these, as far as earthly scenes were concerned, he was handicapped by the fact that light rays travel in straight lines and that the curvature of the earth prevents seeing beyond a fairly limited horizon. Man had discovered how to hear at a distance, but not how to see at a distance.

It was inevitable, however, that some inventors should be attracted by the latter, attempting to satisfy the universal human urge to see something happening far away. In recent years (about 1916) the term *television* has been applied to the process of transmitting visual stimuli to a distant place via the medium

of electric impulses. It is a word compounded from two classical roots: *tele* a Greek term for "far off," and *visio* a Latin word meaning "to see." Thus television means "seeing at a distance."

Many books have been written with the purpose of explaining in everyday language just how the telegraph, telephone, wireless, and radio operate. For very obvious reasons, few books have appeared which attempt to explain in simple language the fundamental principles of television. Television, therefore, is to the majority of Americans a mysterious and incomprehensible invention.

But television can be made less mysterious and more comprehensible. Since it has now reached the stage where mechanically it is successful, it can be described in the form in which it most probably will remain for a considerable number of years to come.

There are several ways in which a complex subject such as television can be approached. The reader could be introduced at once to the modern device, studying it piecemeal so that the function of each unit of the apparatus becomes clear and then interrelating all the parts. This, however, has a serious drawback. A television receiver or transmitter is a complicated mechanism made up of many separate inventions, each embodying its own scientific principles. It would be almost impossible for the average reader, without

any previous electrical knowledge, to keep in mind all of these separately and then associate them into a composite picture of what a television apparatus is.

Another approach is by the historical method; it is such which forms the method of presentation in this book. The reader is introduced to the various stages in the development of television knowledge in the same fashion that these stages became known to inventors engaged in perfecting the process. The reader will therefore learn about television as a great number of successive workers learned about it—one principle and its application at a time. In this way the simplest aspects are introduced first, and these used as foundation knowledge for the succeeding concepts. The growth of television as an *idea* is traced, step by step, until it logically culminates in the *apparatus* used today. When the reader finally does find himself face to face with the complex television mechanism, he can comprehend it because the various elements comprising it, and the principles on which they work, have been described in the sequence in which they occurred as ideas to members of the human race.

The historical approach, in addition to being an easier one, becomes far more interesting because it suffuses mechanical devices with the human element; the television set becomes, not only an understand-

able machine, but also tangible evidence of the labors and cooperative endeavors of many inventive minds.

It is thrilling to be living during an important period in human history. And not always is it one's privilege to witness the final chapters in the development of a great invention. It was exciting for many of us to live through the days when radio was growing up, when movies became a full-fledged means of entertainment, when aircraft began competing with railroads and steamships as reliable and ordinary means of transportation.

This is all being repeated in the case of television. Boys of today will remember tomorrow when they are men that they witnessed the successful premières of television as a new means of communication and entertainment. Everyone can follow this growth of television more intelligently if he understands what has gone before to make it possible, and the basic principles upon which it operates.

In addition, since television is such a newcomer, it still is a continuous subject for news. As news, prophecies and optimistic statements mingle with the wealth of technical data in electrical journals. Many who are by nature scientifically minded will want to have a background so that they can evaluate these current statements, many of which are enthusiastic

but uncritical. Anyone who understands the principles of television, their application, and the obstacles to their further development can appraise this flow of printed material; he will know what to believe and what to be skeptical of until more adequate proofs are presented.

Television is still an invention in a fluid state; it has by no means reached its culmination. Many of the problems which have not been solved by inventors of yesterday are still waiting to be solved by young inventors with the added knowledge and equipment of the present time. In the development of radio the contributions of amateur experimenters aided radio progress tremendously. In like fashion it may well be that some boy, introduced to the fundamental problems of television and to the methods used in the past in solving these problems, will be able to contribute his share to the growth of this as yet imperfect device.

It is certain that someday—perhaps in the not too distant future—television will be a universal household device. It may supplant newsreels, become an important adjunct of educational institutions, and bring sports events to large theater audiences. When this does happen, every mechanically minded individual will want to know how a television apparatus works. Those boys living today who have been able to comprehend the basic principles of television, and

to follow the growth of television to its present stage, will have little difficulty in keeping abreast of future developments.

The arrangement of the chapters is such that the reader can choose to what extent he wishes to penetrate into the complexities of television. For one who desires to know the historical development of television, Chapters One and Two will be particularly helpful. For one who wishes merely to understand the present type of television camera, television broadcast, and television receiver, Chapters Five, Six, and Seven will be found useful. And for the more serious-minded reader, who desires a more complete treatment of the electrical principles involved in television, Chapters Three and Four have been included.

If but one of the many purposes suggested in preceding paragraphs as a reason for publication of such a book as this is fulfilled, the authors will feel amply repaid for whatever efforts have entered into presenting as lucid and nontechnical an account as possible which can serve as *An Introduction to Television*.

CLARENCE J. HYLANDER
ROBERT HARDING, JR.

April 25, 1941

Table of Contents

INTRODUCTION	vii
--------------	-----

Chapter One

WHAT IS TELEVISION?	1
---------------------	---

Vision and the object field—picture elements—conversion of light into electricity—translation of a visual image into electric impulses—simultaneous transmission—persistence of vision—scanning—transmission of scanned units—the television picture.

Chapter Two

THE BIRTH OF TELEVISION	21
-------------------------	----

Paul Nipkow and the scanning disk—John L. Baird, English pioneer—C. Francis Jenkins, pioneer in the United States—scanning by mirrors—the Scophony system—pioneers in electric scanning: Braun, Swinton, Rosing—Zworykin—Farnsworth.

Chapter Three

THE RADIO TUBE TO THE RESCUE	56
------------------------------	----

Importance of the vacuum tube—the invention of the vacuum tube: Thomas A. Edison, J. J. Thomson, J. A. Fleming, Lee De Forest—the vacuum tube as an amplifier—the vacuum tube as a generator—the vacuum tube as a modulator and detector.

Chapter Four**THE ETHER HIGHWAY** 87

The electromagnetic wave—modulation of the electromagnetic wave—channels in the ether spectrum—television channels in the ether highway.

Chapter Five**THE TELEVISION CAMERA** 101

The iconoscope type of camera tube: electron gun, mosaic plate, grid, deflecting coils, sweep circuits, synchronizing mechanism—coaxial cable—the orthiconoscope—the image-dissector type of camera tube: photoelectric cathode, electron image, scanning anode—motion-picture film scanners.

Chapter Six**THE PICTURE GOES ON THE AIR** 138

The television studio: camera equipment, monitor control room—the television transmitter: studio connection, transmitting antenna—television with field equipment—television by relays.

Chapter Seven**THE TELEVISION RECEIVER** 158

The receiving antenna—general plan of the television receiver—the picture tube and its operation—other elements in the receiver—television receiver controls—the projection receiver.

Chapter Eight**THE FUTURE OF TELEVISION** 182

Television transmission of tomorrow—television receiver of tomorrow—television in color—probable uses of television in entertainment and education.

AN INTRODUCTION TO TELEVISION

Chapter One

WHAT IS TELEVISION?

TELEVISION is seeing something which, though invisible because of its distance from the observer, has been recreated as a visual image after it has been transmitted electrically from its source (figure 1). Before this achievement of science can be explained in detail, it will be advisable to consider a few of the most important steps in the television process.

Let us first see what takes place during ordinary vision, when we become conscious of the characteristics of an object or a scene directly, without electrical intervention. For the sake of convenience, the term *object field* will be used to refer to that which is within range of vision at any particular moment. It is essential that we understand the character of this object field, and how it is brought to our consciousness by ordinary vision, before we can discuss image formation by television.



Courtesy General Electric Company

FIG. 1—An artist's conception of a radio television system. At extreme left the camera "sees" the televised scene, sends image, now transformed into a series of electric impulses, to control panel where engineer watches to assure that equipment produces a satisfactory picture. The signals are then transmitted to the broadcast station (top of hill) and from here the electromagnetic waves are sent out in space, to be picked up by the receiving antenna (right) and reconverted into a visual image in the viewer's home.

The Object Field

The eye is a nearly spherical, hollow organ with a transparent covering over its exposed surface, protecting two important underlying structures—the iris and the lens. On the inside surface of the back of the eyeball is another important visual structure, the retina. The eye, in its general design, is thus much like a camera; it possesses structures comparable to the iris, the lens, and the sensitive film (retina). It is also like a camera in that it transforms light rays reflected from an object field into a photo-chemical image.

Every scene reflects thousands of rays of light from various portions of itself; the point of origin of any given light ray can be called one *picture element* of the object field. Brightly lighted portions of the object field, reflecting considerable light, consist of light picture elements; conversely, darker portions reflect less light and constitute dark picture elements. This conception of an object field as points of light and dark can be demonstrated by looking at a newspaper photograph under a magnifying glass. The light and dark areas of the picture now appear as rows of minute dots of white and black. Each dot is comparable to a picture element of the photograph. The more picture elements (dots) there are in any image

or photograph, the finer will be the detail. In each frame of a 35 mm. movie film there are about 500,000 picture elements.

In ordinary vision the countless light rays coming from the picture elements of the object field are brought into focus, by means of the lens of the eye, upon a relatively small portion of the retina, there forming a miniature image of the object field. The retina is made up of millions of microscopic nerve endings, each sensitive to light; the retina can thus be considered a mosaic of light-sensitive cells. A ray of light coming from one picture element stimulates one of these light-sensitive units, producing a photochemical reaction. Theoretically there is one such light-sensitive unit for every picture element of the object field. This mosaic of nerve endings, stimulated by the light rays, initiates nervous impulses which travel to the brain, bringing about consciousness of the character of the object field. We are not conscious of any single picture element but rather of the combined effect of millions of them, since they strike the retina simultaneously and, although each stimulates a separate light-sensitive unit, the nerve impulses from all these units in the retina reach the brain simultaneously via the optic nerve.

A comparable process occurs in producing a photographic image. The negative film in the camera

records the object field by receiving simultaneously the light rays reflected from all of the picture elements, each brought to focus upon a different spot on the sensitive emulsion. If the original picture element is brightly lighted, the corresponding portion of the film receives intense light stimulation and forms a proportionately darkened spot. Thus point by point the entire negative image reproduces the photochemical equivalents of every picture element of the object field. This image of the object field, unlike that upon the retina of the eye, can be rendered permanent by suitable chemical means.

Thus the basis of photography, as well as of vision, lies in the fact that many tiny picture elements, differing in their light values, constitute an object field, whether it be a minute insect close at hand or the broad sweep of a distant landscape. We are not conscious of these individual picture elements because of their small size—except in coarse newspaper reproductions—and, in vision, because of their simultaneous reception and interpretation.

The Transformation of Light into Electricity

A second important consideration in television is the conversion of light impulses into electrical ones. Every television process depends upon the trans-

formation of light rays reflected from an object field not into a photochemical image, such as previously described, but into an electric one. For it is only as electric currents that picture elements can be transmitted by wire or radio. Thus the knowledge of how

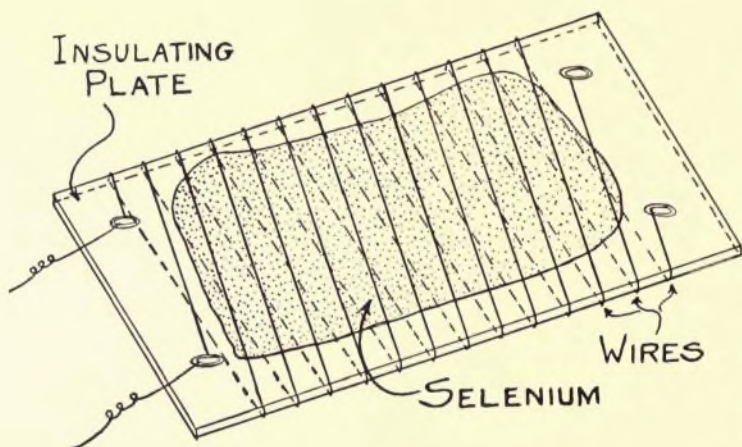

FIG. 2—Construction of an early type of selenium cell.

to transform light into electricity had to be gained before any progress in television could be made.

The photoelectric properties of certain substances were first noticed about 1873 when several experimenters (Sale, Willoughby, Smith) discovered that the conductivity of the metal selenium varied under the influence of light. It was discovered that selenium and other related light-sensitive metals possess a

unique property. When light strikes them, their electric resistance is lowered and thus a greater current of electricity can flow through them.

In a typical selenium cell (figure 2) of the early days of television, a rectangular sheet of some insulating material, such as mica, had two coils of bare wire wound around it, the wire of each coil being separated from that of the other. Metallic selenium was then pressed over the face of the sheet and the wire coils. Since the ordinary conductivity of selenium is very low, only a slight current could flow from one coil to the other when they were connected in an electrical circuit. However, when the cell was exposed to the light, the conductivity increased proportionately with the light intensity, permitting an electric current to flow from one wire to the other, which was in direct ratio to the strength of the light striking the cell.

This change in the conductivity of selenium is practically instantaneous when light falls upon it, but the change back to normal when the light is removed is more gradual. Thus if two light impulses come in rapid succession the first will be accurately translated into an electric current, but the cell will not recover sufficiently to translate accurately the second. This was a serious drawback, since in televising moving object fields the succeeding light stimuli which have

to be changed into electrical equivalents come at exceedingly high rates—a million per second or more.

Other light-sensitive materials have since been found which are more satisfactory in this respect. The photoelectric cell of today (figure 3) is an evacuated glass bulb in which is mounted a curved metal plate upon the concave surface of which is deposited a thin

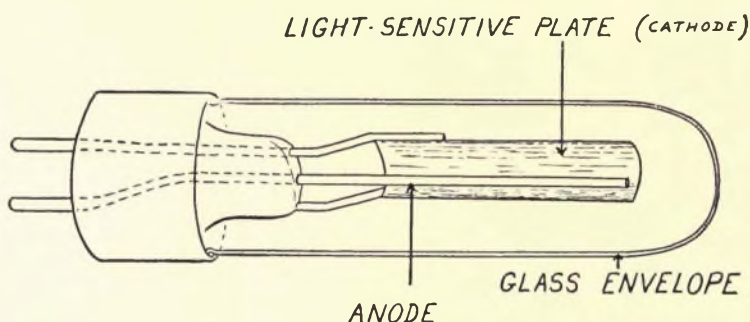

FIG. 3—Construction of a photoelectric cell.

coating of light-sensitive potassium, connected with an external terminal. In the center of the bulb is a collecting electrode, also connected with a terminal outside of the bulb. When a light ray strikes the potassium coating the latter releases a stream of electrons and thus becomes positively charged. The number of electrons—or flow of current—is proportional to the light intensity; thus when a bright light strikes the cell considerable current flows in the outside

circuit which connects the electrode with the potassium coating. When the light is weak, very little current flows in the circuit.

Through the action of such light-sensitive devices, varying light intensities can be made to produce electric currents of varying strength. The photoelectric principle is therefore capitalized so that the amount of light reflected from an object field is converted into an electric-current equivalent, a bright light producing a strong current and a weak light a faint current.

The Conversion of a Light Image into an Electric Image

Thus the first television experimenters, equipped with photoelectric cells, found it easy to solve this preliminary step in television: the translation of light values into electric currents. But immediately there appeared a stumbling block to further progress. The light reflected from a scene or a picture, when received and converted into electricity, did not reproduce the various portions of that field but, instead, interpreted the average light intensity of the entire object field. In order to reproduce the detail of an object field, small parts of it with their differing light values had to be converted into electrical equivalents independently of each other. In fact, it was found that

the light value of only one small portion, or picture element, could be transmitted at a time, as an electric impulse. Since no object field consists of but one picture element, this means that even in reproducing small images, such as a 16 mm. movie image, an object field must be electrically reproduced as a mosaic of hundreds of thousands of picture elements.

Many early experimenters, perhaps attempting to duplicate the process as it occurs in the retina of the eye, tried to transmit the electrical equivalents of each and every picture element *simultaneously*. But electrical impulses can be sent only one at a time over a single wire. Therefore the electric-current variations corresponding to the light intensities of a thousand picture elements, stimulating a thousand photoelectric cells, have to be transmitted over a thousand different wires! In other words, one transmission unit can correspond to only one picture element at a time.

Those who believed in the possibility of simultaneous transmission of all the picture elements therefore had to resort to the use of a photoelectric cell and a transmission channel (wire or radio frequency) for each picture element. An inventor named Carey tried this in 1880. As a transmitter he used a disk drilled with holes, each containing selenium and connected with a transmission wire. As the image was focused upon the disk, it was resolved into as many picture

elements as holes in the disk (figure 4). In this way a very crude counterpart of the image was converted into simultaneous electric impulses.

In 1893 another inventor named Morse (not the famous inventor of the telegraph) proposed a similar method of simultaneous picture transmission by using

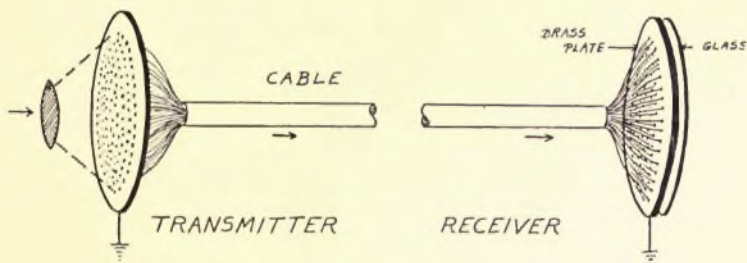

FIG. 4—Representation of the Carey system for simultaneous transmission of picture elements of a television image. 1880.

a cable made up of wires, each of which terminated in a selenium tip and therefore acted as a light-sensitive cell (figure 5). The diameter of the cable necessarily determined the size of the image. Several more recent inventors have continued work along this line of simultaneous transmission, with little results of a practical nature.

Other television workers realized that all of the picture elements need not be transmitted simultaneously provided they were received rapidly enough for the eye to assemble them into as complete an

image as if they had been transmitted simultaneously. Motion-picture inventors had already proved that this was possible, by capitalizing upon a peculiar characteristic of the human retina known as *persistence of*

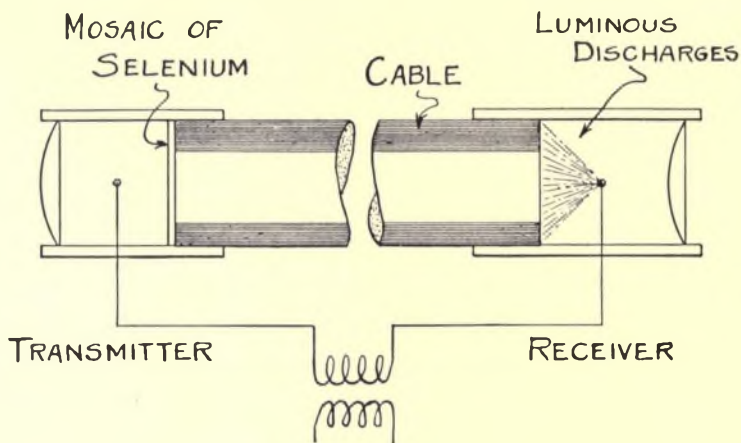

FIG. 5—Representation of the Morse system for simultaneous transmission of picture elements of a television image. 1893.

vision. When the light-sensitive nerve cells are stimulated, they retain the effect of the stimulation for a short period (varying from one-fifth to one-fiftieth of a second). This time lag in the return of the retinal elements to the unstimulated condition means that we see an object field for a fraction of a second after the light rays coming from it have ceased reaching the retina. Thus if two pictures are presented to the eye

in rapid succession, the eye receives the image of the second one before that of the first has faded away. The result may be the creation of an illusion of movement, as in the motion-picture phenomenon where a series of still photographs are intermittently projected in rapid sequence.

Being familiar with the effect of persistence of vision in the movies, some television pioneers reasoned that if the picture elements could be transmitted one at a time—over a single wire or radio frequency—but at such a speed that the eye of the observer at the receiver retained the impression of the first picture element of an object field until the last one arrived, then the illusion of simultaneous transmission would have been achieved. This led to a line of experimentation which has resulted in the type of television transmission and reception in use today.

Thus a third important stage in the television process involves the analysis of an object field into its individual picture elements so that these can be transmitted electrically, one at a time and in a predetermined sequence. Such analysis of an object field into its constituent picture elements is known as *scanning*; this is considered at greater length in the following chapter, since the early history of television is largely the story of attempts to find the most adequate method of scanning.

Scanning in television is very similar to scanning as the term is applied to reading a page of print. The eye begins at the upper left-hand corner of the page and, moving to the right, scans the printed matter to the end of a line; moving across the page in this fashion, line by line, the eye eventually reaches the lower right-hand corner of the page. If each word is considered a picture element, then we can say that our knowledge of the content of that page is the result of scanning successively all of the picture elements one by one. In television scanning the picture or object field is analyzed into successive points of light and dark, or picture elements, scanning first those which make up a horizontal line at the top of the picture. When one line is completed, the next line is scanned beginning slightly beneath the starting point of the first line. Thus the object field is resolved into a series of parallel horizontal lines, each made up of numerous picture elements side by side and of varying light value (figure 6). Obviously the closer together the lines are, and the greater the number of picture elements in each line, the finer will be the detail of the television image.

Scanning therefore decomposes the object field into an orderly sequence of picture elements arranged in lines, each picture element being translated by a light-sensitive device into an electric-current equiva-

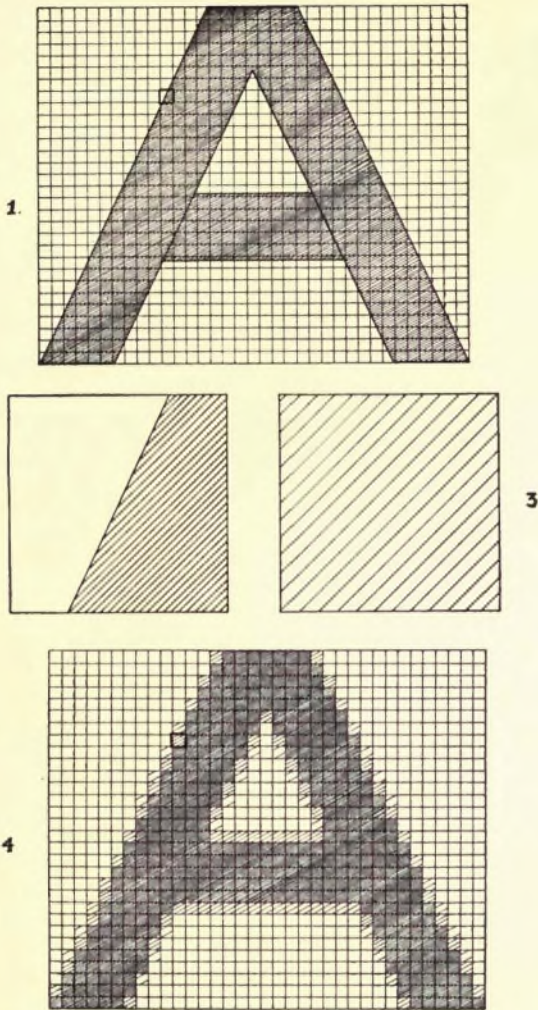

FIG. 6—The upper figure represents a letter “A” analyzed into 30 lines of 35 picture elements each. Some picture elements will be white, some black; but some—as in small square—will be partly white and black. An enlargement of this small square is shown at 2, while 3 shows the same square as it would appear on a television receiver. The complete letter “A” as it would appear on a television receiver is shown in 4.

lent. This varying current can then be transmitted to a receiver by wire or wireless and there recorded before the succeeding picture element is converted into the next electric signal. Naturally, these current equivalents of the picture elements have to be reconverted at the television receiver into light values in the same sequence, line by line and picture element by picture element, in which they were transmitted. This is brought about by a synchronizing device which keeps the transmitting and receiving apparatus in step.

The Transmission of the Electric Image

Television therefore must begin with some means of analyzing an object field by scanning, and translating the light values of each scanned picture element into an electric current. When this electric current has been produced it must be transmitted to the place where the picture is to be reconstructed. The early experimenters, before the time of radio, transmitted their images over wires, but with little success; the weak signals produced by the light-sensitive cell almost disappeared by the time they were carried any great distance. Since this was before the perfection of the vacuum tube, there was no way known of amplifying these weak currents. Another difficulty of wire transmission lay in the fact that the extreme

rapidity of the sequence of the electric impulses caused a distortion or a complete loss of some of the signals. In recent years a special wire, known as a coaxial cable, has been developed to overcome this difficulty.

We think of television today as the transmission of light-modulated electric signals through the air, by radio. Such a transmission involves the production of an electromagnetic radio wave called a *carrier wave*, similar to that which transmits radio programs, and the modification of this carrier wave by the sequence of electrical impulses comprising the television signal. The carrier wave is then said to be modulated by the television signal, which can be taken off the carrier wave by a proper receiving device. The nature of this wave will be explained in later chapters.

The Conversion of the Electric Signals into a Visual Image

The final step in television, after the analysis of the object field by scanning, the translation of the picture-element light values into electrical equivalents, and the transmission of these signals as electromagnetic waves to the receiving apparatus, consists in intercepting these waves and reconvertng them into the television image. As has already been suggested, in order to do this the receiver and the transmitter must

be carefully synchronized. For unless the television receiver is building up the image, picture element for picture element, in exactly the same sequence and at the same speed as the image is being scanned at the transmitter, a completely scrambled and unrecognizable picture will result.

There must also be a controlled light source which can build up the image, following the scanning process, with each spot of light corresponding in intensity exactly to the light value of the original picture element. This must also be brought about so rapidly that the image appears as a continuously lighted area instead of what it really is—a series of intermittent points of light, composing the picture line by line. In the picture tube of the television receivers as they are designed today, this light source is usually a fluorescent surface which is activated by a moving electron beam which is controlled by the television signal coming through the air.

In summing up the stages in the television process, we can see that it consists of: (1) a method of reducing all of the complex light values which make up a picture or a scene into a definite series of picture elements, by scanning; (2) a conversion of each picture element into an electric-current equivalent, utilizing the principle of photoelectric cells; (3) the

superimposing of these picture-element signals upon a carrier electromagnetic wave which is transmitted through the air; and (4) the reconversion of these television signals into the image reproduced in the receiver (figure 7).

The following chapter relates the search for a satisfactory scanning device up to the discovery of the electronic method, which is elaborated in Chapter Five. In this latter chapter is also described the conversion of light values into electric currents. The importance of the vacuum tube in getting the television signals "on the air" as well as in receiving them is taken up in Chapter Three. The actual preparation of the scene for telecasting, the use of the television camera, and the transmission of the telecast occupy Chapters Five and Six. In Chapter Seven the final step in the process is described, with the functions of the television receiver.

If the reader can keep in mind these rather distinct phases in the television process before absorbing the details of any one portion of it, comprehension of television will be a relatively easy matter.

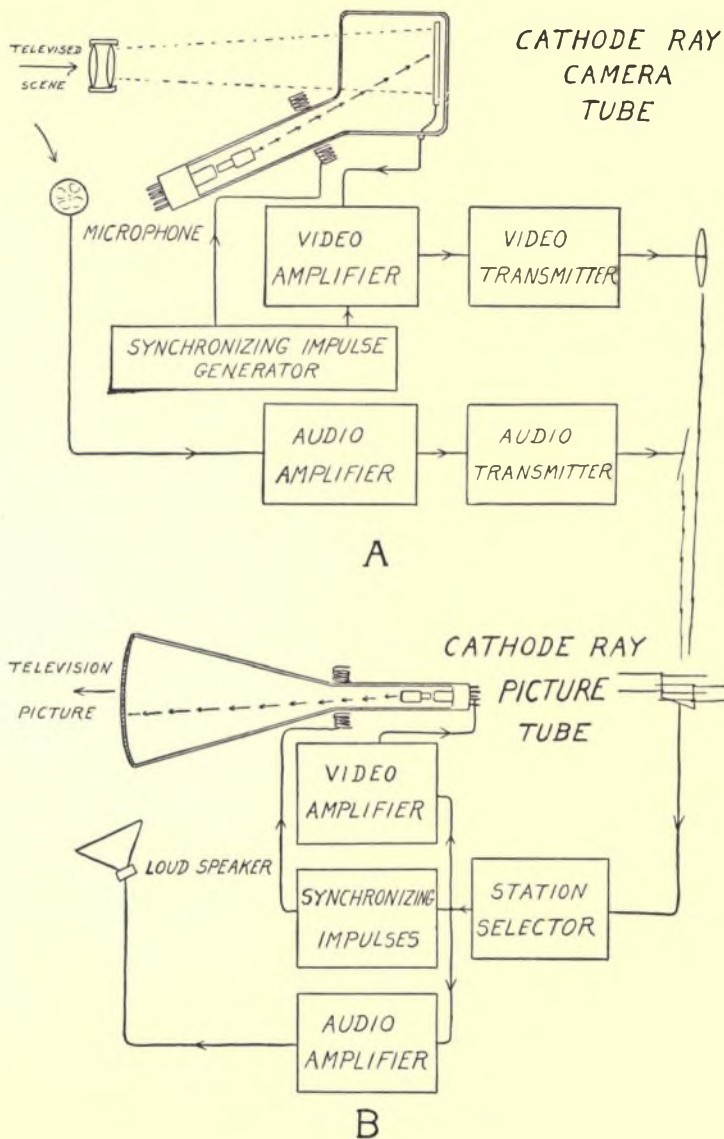

FIG. 7—Diagram of the various elements which are involved in a complete television system of the electronic type. A, transmitting apparatus; B, receiving apparatus.

Chapter Two

THE BIRTH OF TELEVISION

A LONG period of countless experiments, many of them disappointing, intervened between the discovery that light could be converted into electrical impulses by means of photoelectric substances and the first public demonstrations of television, crude though they were.

The major problem was to find a suitable scanning device by which the entire object field could be broken down into a sequence of picture elements. Thus the majority of television inventors centered their attentions upon the construction of scanning machines. Many were content to send their picture signals two or three feet over wires to the receiving equipment, and even to operate the receiving and transmitting scanning devices on the same shaft so as to avoid problems of synchronization. The earliest of these scanning devices were all mechanical in nature, and

of these the Nipkow scanning disk was the most widely adopted by following experimenters.

Paul Nipkow

Paul Nipkow of Berlin invented a scanning device in 1883, for use in a television system, which he termed an *electrical telescope*. The important part of both the transmitting and the receiving portions of his system was a metal disk provided with a single series of perforations spirally arranged around the margin (figure 8 A). Each succeeding perforation was slightly nearer the margin than the preceding one, and spaced from it by a distance equal to the size of the image being scanned. A picture aperture, or frame, was so arranged that as the disk revolved each perforation passed successively from side to side in front of it.

At the transmitter an image of the object field to be televised was projected by means of a lens upon the scanning disk at the picture aperture (figure 8 B). Immediately behind the disk, at the picture-aperture region, was a photoelectric cell upon which a beam of light could fall after passing through a perforation in the disk. As the first perforation moved across the picture aperture, with its projected image, it permitted light rays from a single line of picture elements to pass through in succession to the photoelectric cell. The next perforation, being slightly

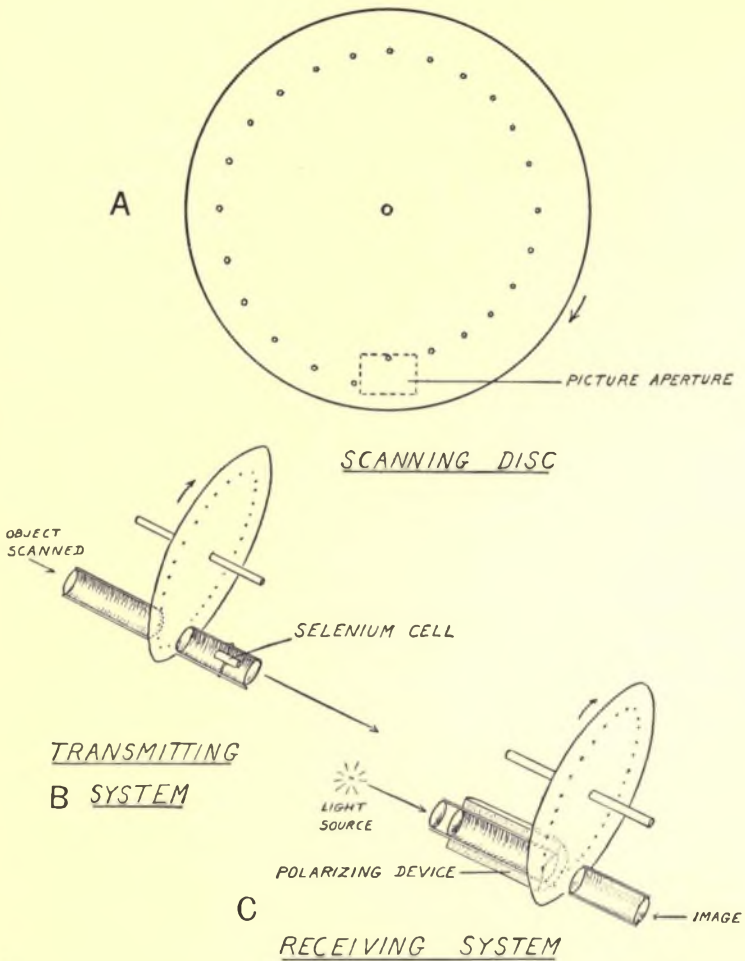

FIG. 8—The Nipkow television system, 1883. The scanning disc is illustrated in the upper figure; the transmitting disc with the light-sensitive cell for transforming light values into electric impulses is illustrated at the lower left; the receiving disc at the lower right.

nearer the margin than the first one, then swept across an adjacent line of the image, with its picture elements. In this way, as the disk revolved, the image was broken down into as many lines as there were holes in the disk. Each line, in turn, was made up of a sequence of picture elements as the perforation moved across the image. Each perforation was small enough to admit only a tiny light beam from a small portion of the image, whose light value was thus translated by the photoelectric cell.

Nipkow began the scanning of the image with the innermost perforation, which, as the disk rotated, permitted in this fashion a series of varying light impulses to strike the photoelectric cell as a line of picture elements was scanned. As soon as the first perforation passed out of the picture aperture the second perforation began its scanning of the second line, translating the light values of this row of picture elements into electric impulses. When the disk had completed its rotation once, the image had been completely scanned; and its light values—picture element for picture element—had been changed by the photoelectric cell into a wire current whose strength varied with the light intensity of the particular spot in the line being transmitted at any given moment.

The wire carrying this current which had been thus affected by the light values of the image was led to a

receiver which was basically like the transmitter, with the scanning process reversed. Here, instead of an image being resolved into a series of lines of picture elements, picture elements were built up, line by line, to form an image. In the receiver the disk was made to revolve at exactly the same speed as that of the scanning disk of the transmitter, so that when the first perforation of the latter started across the picture aperture the first perforation of the receiver disk was at a corresponding position. Between the disk and the light source (figure 8 C) was a polarizing device connected to the photoelectric cell of the transmitter, in an electrical circuit. This device was capable of modifying the strength of the light from the light source falling upon the disk, in accordance with the strength of the electric current sent out by the photoelectric cell behind the transmitting scanning disk. Such modification of the strength of a current is known as *modulation*. In this case the modulation of the current in the receiver was brought about by the variations in the light intensities striking the transmitter photoelectric cell; thus it can be called a light-modulated current.

The observer looked at the picture aperture on the receiving disk, behind which was the lens focusing the light from the light source, as it passed through the polarizing device, to completely cover the aper-

ture. The light spot he saw through the first moving perforation was an exact duplicate in its intensity of the picture elements in the first line of the image being projected upon the transmitting disk. Because of the persistence-of-vision phenomenon, the observer still retained the memory of this line of the image as the second perforation allowed a new moving spot of light to reproduce the second line of the image. Another and another spot of varying light intensity appeared as successive lines were scanned in the transmitter, until finally the last opening allowed the light values of the last line of picture elements to strike the observer's eye while it still retained the impression of the picture elements in the first line. If such an apparatus were driven at sufficient speed, presenting a second image for complete scanning while the memory of the first remained with the observer, and then a third, fourth, and so on until fifteen or sixteen complete images had been scanned in one second, then the transmission and reception of object fields in motion would be possible.

Nipkow never built the apparatus thus described; and although he filed an application for a patent in Germany, his application was allowed to lapse for lack of funds. Nevertheless, Nipkow's disclosure of the scanning-disk principle was a great step toward realizing practical television by transmission of suc-

cessive electrical picture-element values. It spurred numerous other workers to further successes—experimenters who used such a scanning disk with various modifications.

It was soon realized that there were many minor details which had to be improved. The holes in such a disk, for example, had to be exceedingly minute if any satisfactory detail were to be in the television picture, since the size of the perforation was the size of the picture element transmitted. And it was found difficult to make very small holes in the disks. Likewise, the use of round holes—which were the easiest to make—had a tendency to form dark lines or streaks between adjacent scanned lines. The reason for this was that near the edge of the scanning holes the corresponding area scanned was illuminated for a much shorter period than the portion of the line directly in the center of the perforation, where the full diameter of the opening admitted more light. For this reason some inventors tried using square holes, but with little success. The spacing of these tiny holes was also of utmost importance; if two holes were farther apart than another pair of openings, a dark line appeared in the television picture.

The early Nipkow disks had a series of perforations in a single spiral, with the received image viewed directly upon the surface of the disk. The size of the

perforation, as has been pointed out, determined the size of the picture element; and its brightness could not be any greater than the brightness of one correspondingly tiny portion of the light source behind the disk, which was not at all bright. There was, as a result, not enough illumination to permit projection of the image upon a screen, by means of lenses. In addition, when looking directly at the disk, the observer saw a very small image, whose size was determined by the distance between the perforations; this image was an inch or two in size at most, and necessarily had to be smaller if the number of lines was to be increased. Thus at this stage in the progress of television, inventors had two objectives in view: to enlarge the size of the television picture and to increase its brightness.

John L. Baird

Adding some of these improvements to the Nipkow disk, with its natural modification by intervening inventors, John L. Baird, a Scotch inventor, was able to demonstrate television in public by January of 1926. The original Baird apparatus (figure 9) included a scanning disk with a series of lenses arranged spirally upon it, in place of the simple perforations used by previous experimenters. Each lens intercepted a greater amount of light from the object field

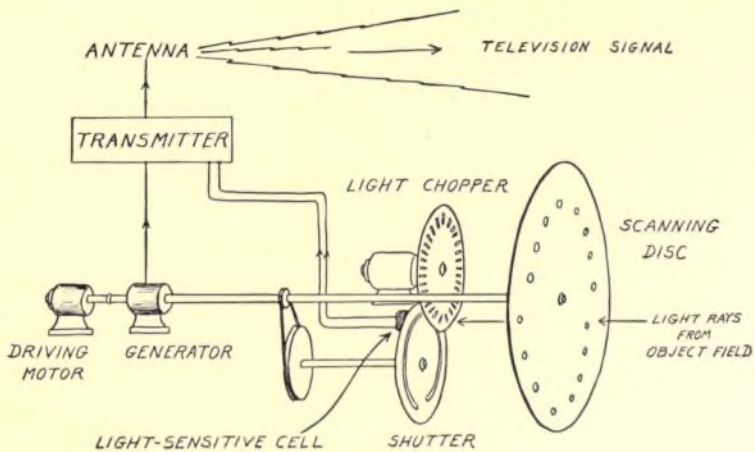

A

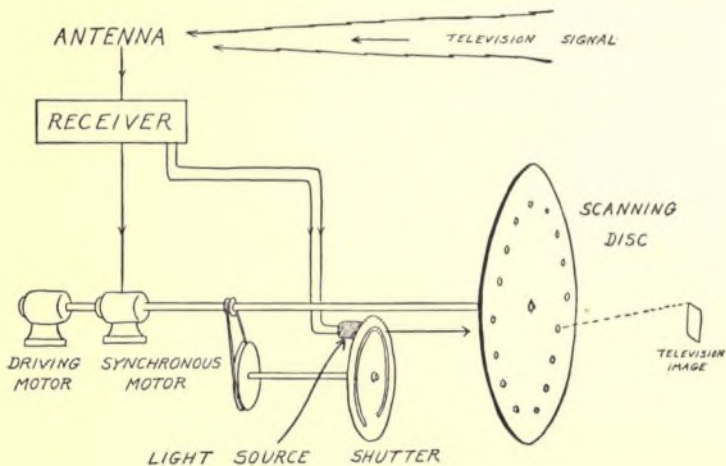

B

FIG. 9—An early Baird television apparatus.

than could pass through the small holes of a Nipkow disk and consequently the photoelectric cell received more light. These lenses had to be anchored firmly in the disk to prevent their flying out while the disk was rotating at high speeds; they also had to be set very accurately so that the projected light fell upon the correct spot. In the early Baird disk there were seventeen such lenses, making seventeen lines in the picture.

The object being televised was strongly illuminated and placed on one side of the scanning disk, with a lens to assist the lenses in the disk in focusing the image of the object upon the light-sensitive cell. As the disk rotated, this image swept across the cell—which was provided with a small opening to permit light from only one picture element to reach the cell at one time. Each lens swept a new image across the cell, spaced a little from the preceding one, resulting in a scanning of the image line by line.

Between the object field and the scanning disk Baird placed another disk (known as a light-chopping disk) which had a saw-tooth edge; this broke up the light beam coming from the object field into a pre-determined on-and-off light frequency. This, in turn, was modulated by the light values of the picture elements. The on-and-off light frequency produced an alternating current in the photoelectric cell, which

was easier to amplify than a direct current would have been. The image was scanned vertically by using the side edge of the disk instead of the top or bottom. The intermittent beam, falling upon the photoelectric cell on the other side of the disk, produced a modulated electric current as in the original Nipkow system. The weak current from the photoelectric cell was amplified by vacuum tubes which by that time were becoming available to experimenters; the role played by the vacuum tube at this stage in television progress is considered in greater detail in the following chapter. The amplified signal was caused to modulate a carrier wave (also described in later chapters) which was sent through the air to the receiver.

The Baird receiver included a scanning device like that at the transmitter, with lenses in the perforations; each lens projected a tiny beam of light from behind the disk onto a screen, one spot of light striking the screen at a time. As each lens perforation swept across the picture aperture, a beam of light with varying intensity reproduced a line of the television picture. The next lens perforation similarly built up the second line of the picture, and at the close of the seventeenth line the entire image had been reproduced as the scanning disk completed its rotation. Owing to persistence of vision, the observers did not see a moving spot of light but, instead, a

screen image which appeared to be continuously illuminated.

Baird synchronized his transmitting disk with his receiving disk by using an alternating-current generator which was attached to the transmitter motor, and a synchronous motor attached to the receiving set. A synchronous motor is one whose exact speed is determined by the alternations of the current operating it. A separate radio signal transmitted the alternations of the generator to the motor, thus keeping the two disks rotating synchronously.

With this apparatus Baird was able to give some of the first television demonstrations for public viewing, though it was only a shadow picture which was projected upon the screen. His original apparatus is now in South Kensington Museum, London. Describing his own device, Baird said: "The letter 'H' for example can be clearly transmitted, but the hand, moved in front of the transmitter, is reproduced only as a blurred outline. A face is exceptionally difficult to send with the experimental apparatus, but with careful focusing, a white oval, with dark patches for the eyes and mouth, appears at the receiving end, and the mouth can be clearly seen opening and closing."

Thus Baird himself realized the defects of his apparatus. But, even so, it naturally created quite a

sensation in Great Britain, and secured for the inventor a subsidy from the British government for further experimentation. In a later apparatus Baird used thirty lines instead of seventeen, but the projected pictures still were very crude in their detail. Later inventors were to find that hundreds of lines per image were necessary if any satisfactory detail was to be expected in the television picture.

In much of Baird's later work with mechanical scanning systems he used what has been termed the *flying spot* at the transmitting end of the television apparatus. The subject being televised was placed in relative darkness, in front of a scanning disk. Behind the disk was a bright arc light, and a lens in front of the disk focused an image of the perforation in the disk upon the subject. When the disk rotated, the subject was scanned by the bright spots of light coming from the holes in the scanning disk. Around the lens opening through which this flying spot of light was being projected there were placed several photoelectric cells facing the subject. These received light reflected from the subject, and the amount of light thus received was dependent upon whether the moving spot of light touched a dark portion of the subject's hair or his white shirt front. There were two marked advantages to this system: one was that the subject did not have to sit in the glare of bright lights

—a very trying experience—and the other was that several cells could be coupled so that a greater electrical response could be obtained. This flying-spot method of scanning was used by many other television experimenters also.

Baird carried on many television experiments. By the latter part of 1928 he had produced television pictures in color, he had televised subjects in daylight out of doors, and he had produced a stereoscopic television picture. Later he televised objects in total darkness by means of heat rays. He also televised motion-picture films and recorded a picture signal on a phonograph record. From this brief survey of his contributions to television, it is evident that Baird has filled an important place in the development of this form of electrical communication.

C. Francis Jenkins

In the meantime an American inventor by the name of C. Francis Jenkins, who had made notable contributions to the development of motion-picture projection, had become interested in television. This interest was a logical outgrowth of some of Jenkins' experiments upon transmission of photographs by telegraph and radio. In 1925—a few years after the first Baird experiments—Jenkins broadcast silhouette pictures from his Washington, D. C., studio. He tried

many types of scanning devices, including the Nipkow disk and a special type of glass-prism disk.

The Jenkins prism disk was made of glass instead of metal; the faces of this disk at the circumference were ground at an angle which varied progressively around the disk. At one point the edge of the glass was very thin, but as one progressed around the circumference he could note that the glass edge became thicker and thicker as the prism angle of the disk inclined more and more toward the surface of the disk. A decided and abrupt falling away of the glass marked the juncture of the thin edge with the thick. The same gradual change occurred at the inner edge of the prism circle, except that this change was the opposite from that described for the edge. Where the extreme edge of the scanning disk was thinnest, the inner prism border was thickest—and vice versa.

A light beam focused through the prism edge of such a rotating disk was deflected farther and farther toward the center of the disk (or farther from the center, depending upon direction of rotation) until the juncture of the thick and thin edges reached the beam. Then the beam jumped back to its original position, repeating the movement as the disk made a second rotation. By mounting two such disks in overlapping relation to each other so that the light beam passed through the prism edges where they crossed

each other at right angles, Jenkins scanned his image with a moving light beam (figure 10). One disk made the horizontal movement necessary in scanning one line of picture elements, and the other disk, rotating much more slowly, brought about the vertical movement needed in bringing the scanning beam from line to line. The light beam, after passing through the two glass scanning disks, actuated a photoelectric cell which converted the picture-element light values into electric impulses. Using the same types of prism disks in his receiver, Jenkins projected a light beam from a neon glow lamp whose brightness was modulated by the light impulses sent through the air from the photoelectric cell of the transmitter as electromagnetic waves.

Jenkins experimented with all sorts of light sources and scanning devices. He also used the lens disk and combinations of disks and prisms. A great part of his work involved the development of televising motion-picture films; as a result, Jenkins secured many patents relating to this aspect of television.

Scanning by Mirrors

Another method of mechanical scanning was developed by television experimenters which eliminated the use of a scanning disk. As long ago as 1889 a man named Weiller had invented a wheel or drum

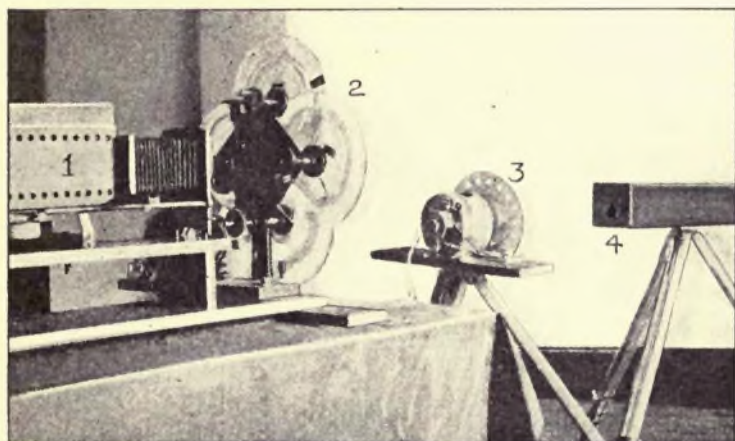
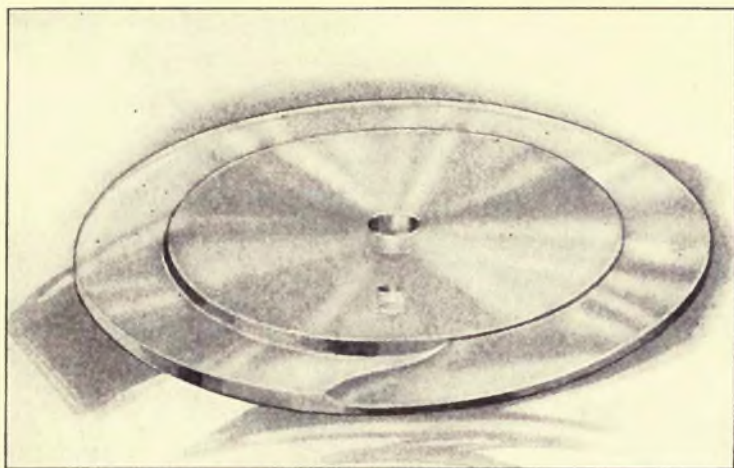

From Jenkins: Boyhood of an Inventor

FIG. 10—The Jenkins television system, showing the prism ring in the upper photograph and the radio picture transmitter in the lower photograph, as it was set up in Navy Station NOF.

upon whose circumference was arranged a series of mirrors, each set at a different angle so that when the mirrors were revolving a light beam could be projected by reflection in a series of lines sweeping over the object field. Weiller used a selenium cell at the transmitter and the same type of drum to reconstruct the picture, ingeniously using a gas flame as the source of light—causing it to glow brightly or dimly as a result of a magnetically operated diaphragm which controlled the pressure of the gas.

The mirror idea was improved upon by numerous inventors in England, Germany, France, and the United States. A drawback to the use of the Weiller wheel was the difficulty of setting the mirrors accurately. To avoid this some experimenters separated the two scanning movements, providing one moving mirror member to make the picture elements of a line and another mirror device to build up the sequence of lines of the image. Thus two mirror drums are made with reflecting surfaces parallel to the axis, and these are mounted at right angles to each other. The light beam is reflected from one drum to the other. In a horizontal scanning of the image, the mirror drum on a vertical axis is rotated at high speed while the other horizontal drum turns comparatively slowly. The light beam, striking one reflecting surface of the fast-moving drum, is swept quickly sidewise

across the other drum, which directs it to the screen—causing it to move across the screen. By the time the next mirror surface of the fast-moving drum cuts the light beam, the other drum has moved slightly so that when the beam is moved across the screen by this next mirror surface it forms the next line of the picture. When the slower-moving mirror has traveled far enough, the last line of the picture is completed and a second mirror on the slower drum directs the pencil of light to the top again to start the second picture.

With such a mirror system the vertically rotating drum must revolve at a very fast rate. If, for example, there are to be sixty lines in the picture, sixty mirror faces must intercept the light beam while one face of the other drum is crossing it. If the drum has twelve faces, it requires five complete rotations to produce sixty lines; and if there are to be twenty pictures a second (to reproduce moving scenes), the drum must rotate one hundred times a second—or six thousand times a minute. This is a much greater speed than that developed by ordinary motors, and raises somewhat the same problem as that confronting inventors using scanning disks. We shall see later that Sco-phony Ltd. of England has solved this problem of a high-speed motor.

In 1922 C. Francis Jenkins tried using a two-way

vibrating mirror. In his device a mirror was so mounted on a frame, attached to a motor-driven shaft, that its inclination to the light beam could be gradually increased up to a certain point and then returned to the original position. A cam arrangement brought about oscillation of the mirror in a plane at right angles to the other movement of the mirror. Thus a light beam could be reflected from this single oscillating mirror to a screen, producing the line-for-line effect as in the Nipkow-disk system.

Another modification of the mirror-scanning method was developed by Dr. E. F. W. Alexanderson of Schenectady, New York, in 1927. This system consisted of a drum with many mirrors arranged side by side around the circumference (the Weiller-wheel design), each mirror having a different inclination to the drum axis. This drum was mounted on a horizontal shaft, and the image of the object being televised was projected upon the mirrors and thence by reflection upon a cluster of seven light-sensitive cells. Seven arc lights, each one of which was modulated in intensity by a separate incoming television signal, furnished the light source at the receiver (figure 11). Thus Alexanderson used seven transmitting channels, each provided with a photoelectric cell at the transmitting end and a light modulator at the receiving end of the system.

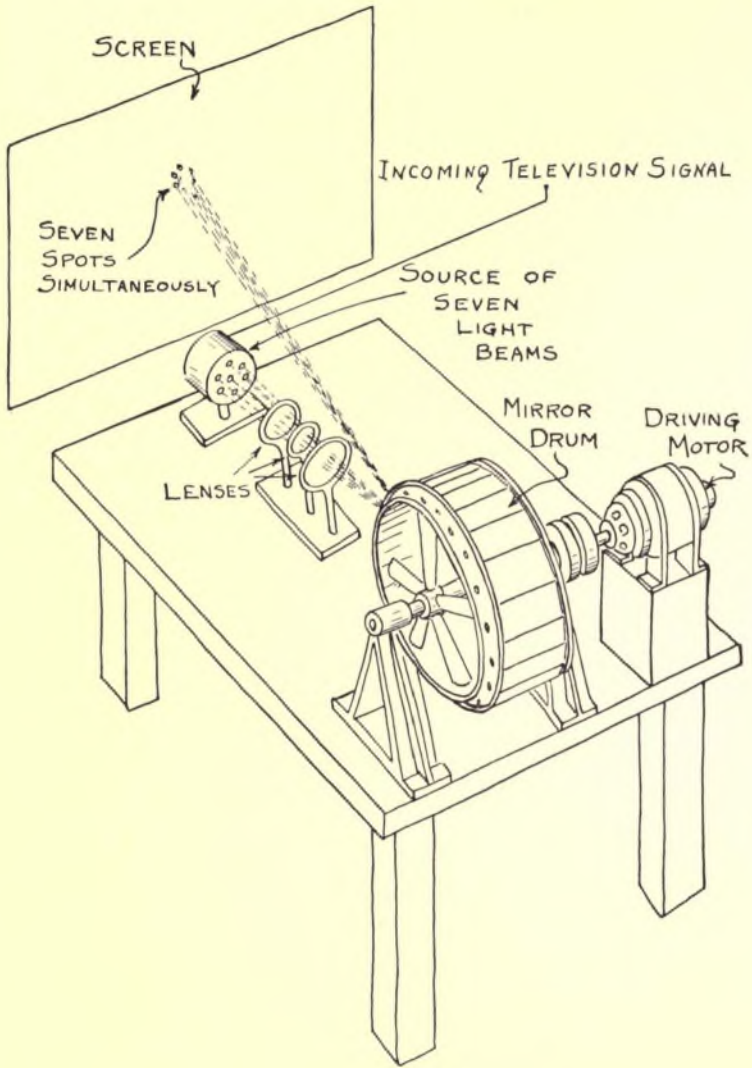

FIG. 11—The mechanical television system developed by Alexander, which used a mirror drum for scanning.

One of the television systems in operation today, Scophony Ltd. of England, makes use of mirror drums in scanning (figure 12), including a novel method

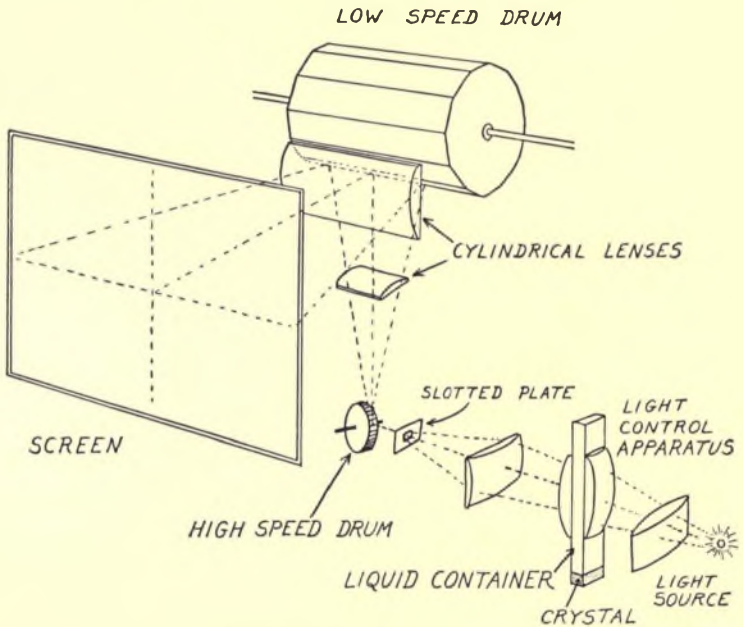

FIG. 12—The mechanical television system in use by Scophony Ltd. A high speed and a low speed mirror drum scan the image into lines and picture elements.

of increasing the brilliancy of the projected picture. Instead of projecting a single spot of light at a time on the viewing screen, the Scophony receiver stores up the incoming signal impulses and, keeping a num-

ber of them in a row, projects that row upon the screen to form a large part of one line of the picture. These picture elements remain stationary on the screen as the scanning proceeds. The beam of light from the light source is focused upon a transparent container filled with a liquid and a quartz crystal at the bottom. This functions as a light control, the incoming television signal setting up vibrations in the quartz crystal which travel upwards through the liquid. This produces regions of different densities in the liquid, each region corresponding to the light value of a picture element; all these regions travel upwards at the same speed, which corresponds to the rate of horizontal scanning. An image of the liquid container is projected upon the television screen horizontally after being reflected from two mirror drums, one rotating at a much slower speed than the other.

If the drums were stationary the image of the liquid container would fall along one line of the picture, with the light and dark regions in the image traveling toward the left because of the vibrations traveling upwards in the container. With the drums rotating, however, this movement of the light and dark regions of the image to the left is counteracted, and these appear to stand still while each new impulse received creates a vibration at the bottom of the container.

This adds on to the right side of the group of picture elements on the screen until the line is completed. The effect is the same as if a large part of a line of the picture were being produced at the same time, thus greatly increasing the brightness of the image. This is one reason why Scophony Ltd. has produced larger images than many other television companies.

Such scanning devices as we have just considered necessitate a movement of some part of the apparatus along with the spot of light as the line is scanned. In the scanning disk the perforation through which the light beam passes must move completely across the picture, or a proportional part of it if the picture is projected. If a great number of lines are used, this means a tremendously high speed for the scanning apparatus. The horizontal scanning drum of the Scophony system—a tiny affair which, with the motor, is only a few inches in length—rotates at a very high speed on specially constructed bearings.

One ingenious method of overcoming this difficulty and causing a light spot to move over the field of view with a minimum of movement of the scanning device has been developed (1928) by an inventor named Gardner of Los Angeles. This scanning drum is made of a great number of long flat mirrors arranged side by side in a helix around an axis, so that they look like a winding stairway of mirrors, making

one complete turn from top to bottom of the drum (figure 13). The image is observed directly on this drum. As the observer looks at it, he sees the reflection of a linear light source which is set up at some

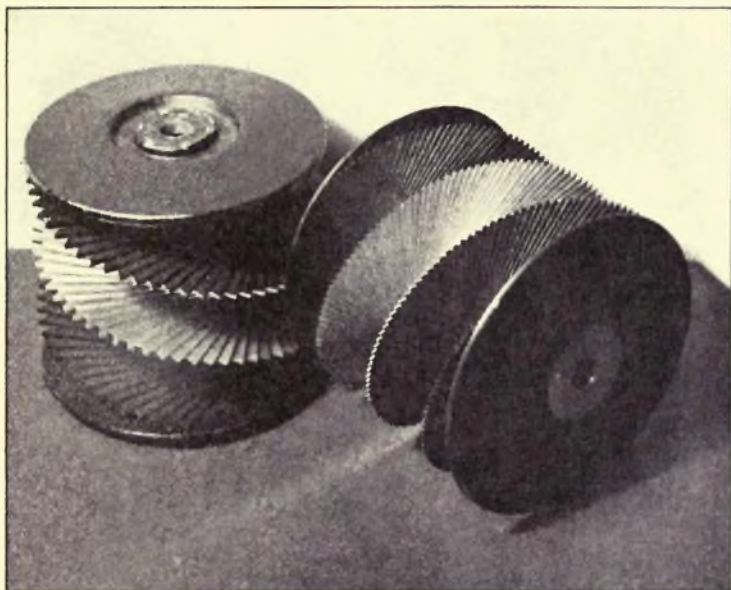

Courtesy National Television Corporation

FIG. 13—Spiral mirror drum used in a mechanical scanning system.

distance from the drum itself, as a spot of light on one of the mirrors. As the drum rotates, this spot of light appears to move very rapidly from one side of the drum to the other, although a point on the circumference of the drum has moved through only a

short distance. When the spot of light leaves the right side of the drum, another appears on the next mirror and moves across to form the second line of the picture, and so on.

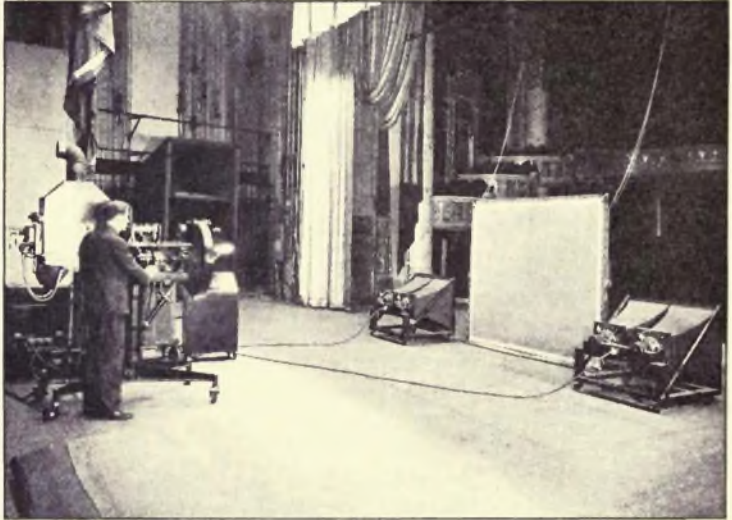

Courtesy General Electric Company

FIG. 14—The apparatus used by General Electric Company in their first theater-projection of television screen pictures, Schenectady, New York, May, 1930.

But the practical solution of television was not to come about by the use of mechanical scanning devices, even though they have been, and—as in the case of Scophony Ltd.—in some countries still are, widely used. Television came into existence in Germany, England, and the United States, with the use

of mechanical scanning systems, in the late twenties. A television drama was broadcast from station WGY in Schenectady, New York, in 1928. Two years later the first television images were screen-projected at a theater in Schenectady, New York, using the scanning system devised by Dr. Alexanderson (figure 14). It was realized, however, that such mechanical systems had inherent disadvantages which made television of moving scenes impractical. In reproducing a reasonably good image, a few inches square, if scanning included two hundred lines of two hundred picture elements each, there would have to be a spot of light moving over 40,000 picture elements. To produce a picture without noticeable flicker thirty of these would have to be transmitted per second, requiring 1,200,000 transmission units a second. Almost insurmountable obstacles resulted when mechanical scanning devices were expected to rotate at speeds demanded by such a scanning rate.

The solution of the problem came rather unexpectedly when mechanical methods, upon which television experimenters had been working for half a century, were discarded in favor of electric scanning. Electron beams have no weight and no inertia; they can be moved about at incredible rates of speed—millions of movements per second. The invention of the vacuum tube led the way to this new method of

scanning, with the development of that type known as the cathode-ray tube.

Pioneers in Electric Scanning

At the beginning of the present century many inventors, working in different countries, had begun to experiment with electric discharges in vacuum tubes. Lee De Forest, of whom we shall hear more in the following chapter, was working on a vacuum tube which could be used as a detector of radio signals. In Europe, Professor Braun was experimenting with cathode-ray tubes. Cathode rays are streams of negatively charged particles, called electrons, given off by a cathode in a tube which has been evacuated, or filled with a gas at low pressure.

It was in 1906 that Professor Braun discovered that when he produced a magnetic field cutting across the path of the electrons in the cathode-ray tube it changed the course of the electrons. His tube was narrow at one end, where the electron-emitting cathode was situated, and flared at the opposite end (figure 15). The flared, flattened end of the tube had the inner surface coated with a substance which became fluorescent (that is, emitted light) when struck by electrons. Braun used an alternating current to produce an alternating magnetic field, so that this deflected the electron beam first in one direction

and then in another—as was evident from the change in the fluorescent spot of light on the flared end of

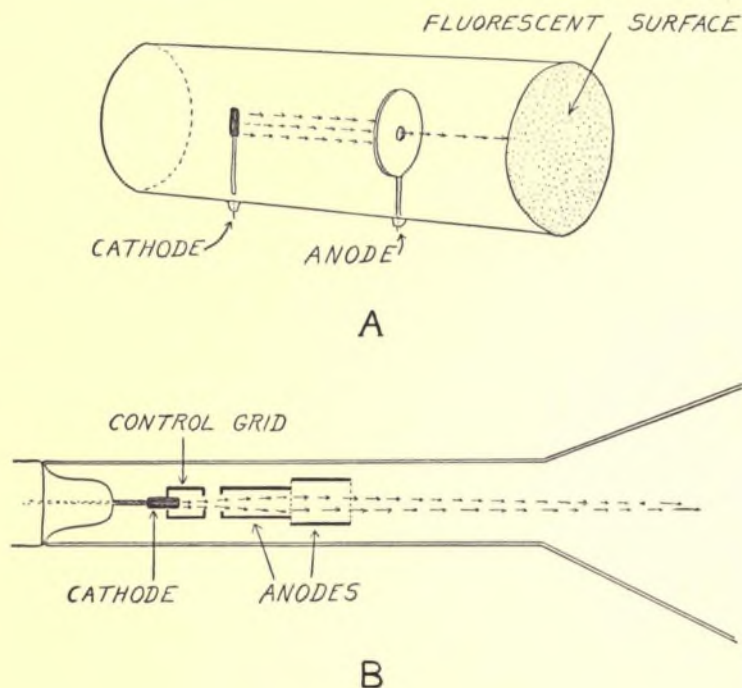

FIG. 15—A, Braun's cathode ray tube, with arrows indicating electron stream; B, portion of modern cathode ray tube used in television, showing the units of the electron gun, or electron-emitting and control apparatus. Arrows indicate electron beam.

the tube. Braun called such a tube a cathode-ray oscillograph, since it produced an oscillating electron beam whose vibration to and fro was determined by

the frequency of the alternating current producing the magnetic field. Today oscillograph tubes of this nature are used widely in electrical experimental work.

In that same year (1906) an Englishman named Swinton saw the television value of the cathode-ray oscillograph. He suggested that two magnetic fields be introduced into the tube, at right angles to each other; thus one field deflected the electron stream leaving the cathode from right to left (horizontally) while the other field deflected the electrons up and down (vertically). This was the same movement used in scanning by mechanical means.

Although Swinton did not build a television apparatus, a few years later he gave very definite suggestions as to how the cathode-ray tube could combine in one unit both the scanner and the photoelectric cell (figure 16); as we have seen, up to this time two different mechanisms had to be used for these purposes. In the Swinton cathode-ray tube which acted as the transmitter—now known as the camera tube—the image to be televised was focused upon a light-sensitive plate inside the tube; this plate was made up of rubidium cubes, insulated from each other and each corresponding to a picture element. The electron beam, its course directed by the two magnetic fields, was made to scan this image

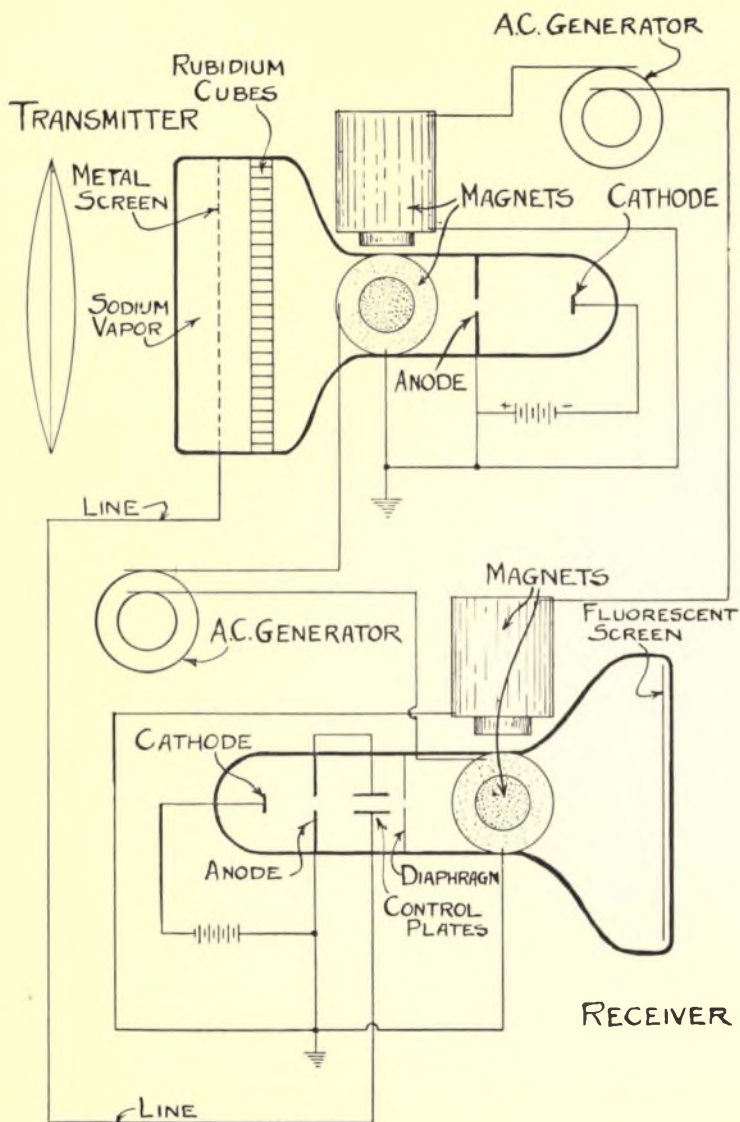

FIG. 16—Suggestion for an electronic television system devised by Swinton, 1906-1908, in which cathode ray tubes were used in both receiver and transmitter as scanning device and light-sensitive cells combined.

upon the rubidium plate; the scanned spot sent a discharge to a wire mesh behind the plate. This electric impulse varied in strength with the light striking the rubidium cubes. The impulse became the television signal, representing the electrical equivalent of the light value of the picture element, and was conveyed to another cathode-ray tube which was to be used as a receiver. In the latter there was no mesh screen or plate but, instead, a fluorescent surface on the inner side of the flared end of the tube. The incoming signal determined the strength of the electron beam leaving the cathode, while two magnetic fields moved the electron beam in scanning sequence over the fluorescent surface. Thus an image was reproduced on the surface of the receiving cathode-ray tube, as a result of a fast-moving electron beam activating spots on the fluorescent surface.

In 1907 Rosing, a Russian inventor, translated some of the Swinton suggestions into reality (figure 17). He used a mechanical scanning device as a transmitter—two mirror drums mounted at right angles. From this transmitter the modulated electric impulses were sent to a cathode-ray oscillograph which was used as a television receiver. The electron beam in this tube passed between two magnetic fields which deflected the electrons to bring about the scanning. The speed and regularity of scanning in

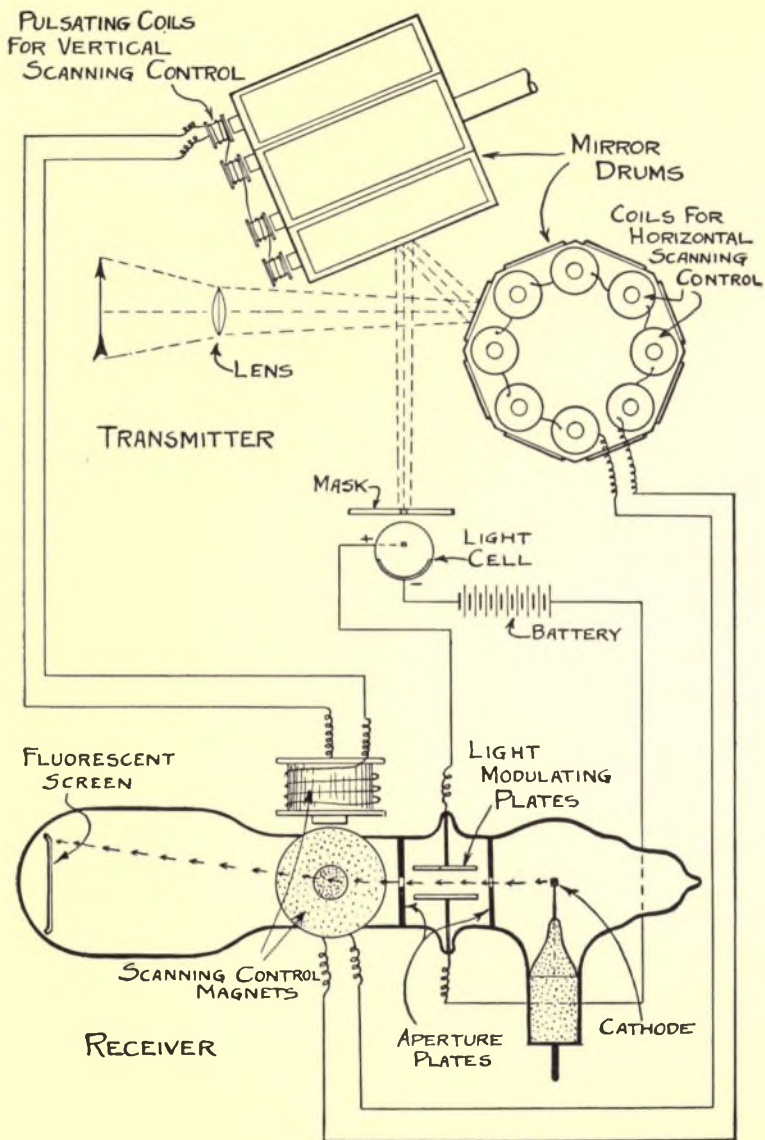

FIG. 17—An actual television system developed by Rosing, 1907, involving a mechanical scanning device in the transmitter and an electronic one in the receiver.

one direction was controlled by impulses induced in coils placed at the side of one mirror drum; impulses for controlling the scanning beam in another direction were induced in coils associated with the other drum.

Since 1925 the use of the cathode-ray tube as both transmitter and receiver has been found a very satisfactory method of scanning, translating light values into exceedingly rapid electrical modulations, and building up the television picture from the electric signals. This has resulted largely from the individual work of two inventors working in the United States—Zworykin and Farnsworth—and from the work of the research staff of several large American organizations, notably Radio Corporation of America. The details of their cathode-ray tubes will be explained in later chapters.

The introduction of the electronic system of scanning gave a great impetus to public television demonstrations. It was first used publicly by the Don Lee Broadcasting Company of Los Angeles in 1933. At about the same time the National Broadcasting Company of New York and the General Electric Company in Schenectady introduced the cathode-ray camera tube and picture tube. Research work is going on to perfect the electronic method of television at numerous laboratories, among them the Farnsworth Television and Radio Corporation of Fort Wayne,

Indiana; the Allen B. Dumont Laboratories in Passaic, New Jersey; Radio Corporation of America; Philco Radio and Television Company of Philadelphia; and numerous others.

Television has truly come of age, and in succeeding chapters we shall consider in greater detail just what takes place in the present-day television camera, transmitting apparatus, and television receiver.

Chapter Three

THE RADIO TUBE TO THE RESCUE

IN THE early years of the present century television had reached a stalemate. Many had suggested how pictures might be transmitted electrically, and a few had actually produced such pictures. But the detail in the images was so poor that they were hardly recognizable as pictures, and their illumination so weak that it was only in a perfectly dark room that they could be seen at all. The signals produced by the light-sensitive cells were so weak that they could barely be detected at short distances. And, what was most discouraging, there didn't seem to be any possible way of improving these conditions. Inventors had learned how to turn light into electricity, but the electric currents produced were extremely feeble; there was no means of amplifying them or sending them any appreciable distance.

What a Vacuum Tube Can Do

Then came the vacuum tube, more popularly known as the radio tube. Among all the inventions contributing to the success of television the vacuum tube probably stands out as the greatest, because it solved so many of the problems with which television experimenters were confronted. It was the vacuum tube that solved the problem of amplification of the weak signals produced by the light-sensitive devices used in the television transmitter. It was the vacuum tube which led to present-day methods of transmitting electrical signals to distant points over wires or through the air. And it was the vacuum tube which pointed the way for the development of the cathode-ray tube used in modern television systems, in one form as the camera tube in the television camera and in another form as the picture tube in the television receiver.

Before the invention of the vacuum tube the phenomena of electricity flowing through wires was well understood. For those readers unfamiliar with electrical terms, it might be well to define a few of these which will be used in discussing electrical phenomena associated with the functions of vacuum tubes. The amount of electricity flowing in a wire is called the *current*, and the pressure which produces

that electric current is known as the *voltage*. All conductors of electricity offer some resistance to the flow of current, some much more so than others. It was known that by increasing the resistance of a part of the circuit through which the current is flowing the current (or amount of electricity) would be decreased; likewise, by decreasing the resistance of the circuit the current would be increased. It was also known that if the voltage is increased the current will be increased, and vice versa. These fundamental principles were understood, but no one knew how to control a large current flowing in one circuit by a very small electrical change in another circuit.

The function of a vacuum tube will be understood better if it is thought of as a device which primarily relates two circuits to each other, the first circuit having a very weak current, or none at all, and the second circuit possessing a large current. By means of this device any slight changes in the weak current of the first circuit will produce corresponding changes instantaneously in the more powerful current of the second circuit.

Thus the vacuum tube supplied the television experimenters with a means by which the weak light-produced currents of the television camera might be amplified; for these weak currents could be forced to flow in the first circuit, controlling the stronger

current in the second circuit. This latter current could then be used to modulate the lighting device of the receiver, producing the picture.

But amplification was not the only function that this remarkable device could carry out. By means of

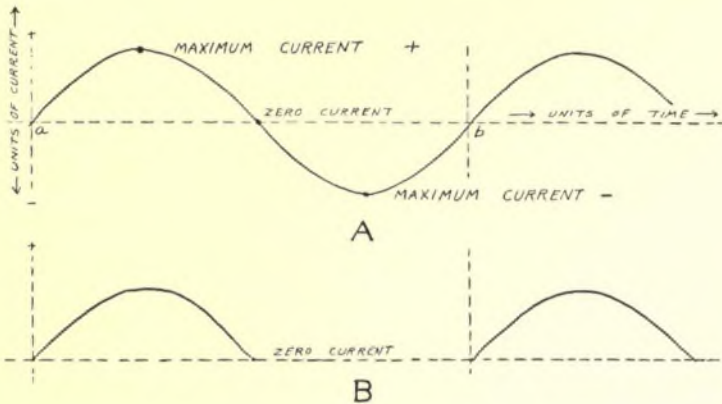

FIG. 18—Representation of an alternating current wave. A, reversing its direction at regular time intervals; and B, the same current wave transformed into direct current with the rise from zero flow to maximum in one direction only.

the vacuum tube engineers were able to produce the carrier currents which today bear radio and television signals through the air.

There are two kinds of electric current. One type flows in a circuit, always in one direction; such is called a *direct current* (sometimes written D.C.). But a current can also flow first in one direction and then

in the opposite direction, repeating this reversal at regular intervals; this type is known as *alternating current* (written A.C.). The usual house current is alternating current, and the reversals in most localities occur sixty times a second. The carrier currents used in radio and television are alternating currents, but the reversals of these currents occur at a much higher rate—10,000 to 100,000,000 times a second. The number of reversals per second is known as *frequency*. Each time the current changes from one direction to the other and returns to the first direction again we say that it has passed through one cycle, and so we refer to a radio frequency current as being of 10,000 cycles per second, of 1,000,000 cycles per second, and so on. Such an alternating current can be represented as shown in figure 18.

The vacuum tube is used to produce these high-frequency currents by an ingenious circuit arrangement in which the tube is connected between a first and a second circuit so that these react on each other in a manner which will be described later in the chapter. Operating in this fashion, the tube is said to *oscillate* and is called an *oscillator*. An oscillator is used at all radio and television stations to produce the carrier frequencies which convey the signal to the receivers.

This versatile tube is also used to put the signal

on the carrier wave at the transmitting station and again to take it off the carrier wave at the receiver. The process of putting the signal on the carrier is called *modulation*, while taking it off at the receiver is known as *demodulation* or *detection*.

The Invention of the Vacuum Tube

The vacuum tube as we know it today grew out of a great number of discoveries and inventions. Prior to 1883 two men (Elster and Geitel) were experimenting with electrical phenomena. They discovered during their experiments that if a wire filament, like the filament in an electric-light bulb, was heated red-hot by connecting it with a battery and passing a current through it, and if a metal plate was held near it, the plate became electrically charged. If the plate was connected to the filament by a wire, a current flowed in that wire. They also found that this charge was more pronounced if the filament and the plate were in a bulb from which the air was removed, or, in other words, if the filament and plate were in a vacuum.

If a battery or other source of electrical energy is connected in a circuit, any point near the positive terminal of the battery is said to have a positive *potential* (the pressure or voltage at a particular point in a circuit) and any point near the negative terminal

is said to have a negative potential. In the same year (1883) Thomas A. Edison discovered that if the plate of an evacuated bulb, such as has been described in the previous paragraph, was connected to the positive end of the filament—the end connected to the positive terminal of the battery—a current flowed between the plate and the filament. But if the plate was connected to the negative end of the filament, no current occurred. Therefore Edison really discovered that if the plate is given a positive potential with respect to the filament a current will flow through the space between the plate and the filament, and that if the plate is given a negative potential with respect to the filament no current will flow. This flow of current through space is today known to be a discharge of electrons, or negative charges of electricity. This phenomenon is called the *Edison effect*.

In 1889 Sir J. J. Thomson explained that this effect was caused by small particles of electricity passing from the filament to the plate. These particles of electricity, or *electrons*, are negatively charged. Since they are attracted to anything which is positively charged, if the plate is connected outside of the tube to the positive end of the filament, and is maintained at the positive potential of that end of the filament, these electrons will be attracted to the plate. This flow of electrons through space between the

filament and the plate is an electric current, and it causes a current to flow in the wire connecting the plate and the filament outside the tube. From this it can be seen that if the plate is made more positive

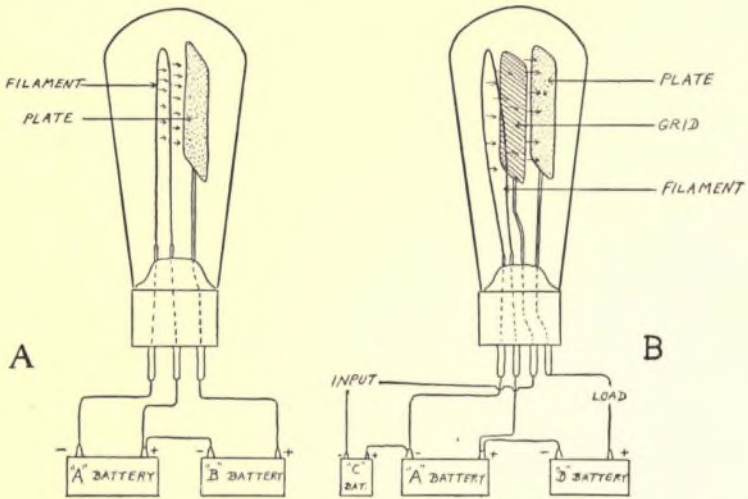

FIG. 19—A two-element vacuum tube: A, with only filament and plate; and a three-element vacuum tube: B, with a grid inserted between the filament and plate.

by placing a battery in the circuit between the plate and the filament, with the positive terminal of the battery connected to the plate and the negative terminal connected to the filament, a greater current flows in this circuit.

As illustrated in figure 19 A, the filament, or

cathode as it is sometimes called, is heated by current from the battery A, the electrons moving in the direction of the arrows from the filament to the plate (also referred to as the *anode*) which is connected outside of the tube to the filament through battery B. Current will flow only in one direction between the filament and plate, as indicated by the arrows in the figure, and will flow only when the battery is connected in the manner shown, with the positive terminal connected to the plate. It was because of this fact that J. A. Fleming in 1905 suggested the use of this simple form of vacuum tube for the detection of electromagnetic waves, or wireless waves as they were known at that time. This simple tube with the filament and plate is known as the two-element tube or *diode*; its use as a detector will be explained in later paragraphs.

However, in the diode there was no way in which the stream of electrons flowing between the filament and plate could be controlled within the tube itself, and therefore the one factor which was to accomplish so much for radio and television was not present in Fleming's diode. It remained for Lee De Forest to add this very important part to the vacuum tube when, in 1907, he inserted another element between the filament and the plate. This element was a screen of fine wires, later to be known as a *grid*.

When such a grid is placed between the filament and plate (figure 19 B) it does not normally interfere with the passage of electrons because of the fineness of the wires of which it is made. The electrons leave the filament like bullets from a machine gun, and most of them pass between the wires. However, they do not all leave with the same force; and some of them cannot reach the plate, but turn around and return to the filament. If this grid is given a negative potential with respect to the filament, it repels the electrons since these are negative particles of electricity. This means that large numbers of electrons which might have had just enough energy to reach the plate do not pass through the grid but, instead, are returned to the filament. If, however, the grid is given a positive charge with respect to the filament, then some of these same electrons are pulled a little harder away from the filament and go on through the grid to reach the plate. In addition, the pull on all the electrons is greater and a larger number of them reach the plate.

By inserting this important grid, De Forest showed the way to vary the number of electrons striking the plate merely by changing the potential on the control grid. The use of a tube with these three elements led to startling results. Since the current flowing in the plate circuit is dependent on the number of electrons

striking the plate, this current can be changed by the action of the grid. It may be started or stopped instantaneously, or it may be raised or lowered slowly, as desired. In addition, the potential of the grid can be controlled by the grid circuit which is connected between the grid and the filament. The slightest ripple of current in this grid circuit affects the potential of the grid, and that in turn determines the current flowing in the plate circuit.

It is possible to give the grid such a strong negative potential that no current at all can flow in the plate circuit. Except in such a case, regardless of the potential maintained on the grid, if that potential is varied the plate current is also varied. It was found, however, that if the increase and decrease of the plate current was to correspond exactly to the increase and decrease of the grid potential the grid must never be positive with respect to the filament. This is because the grid, when more positive than the filament, steals some of the electrons which normally would go to the plate and therefore lessens the plate current, which under these conditions does not increase proportionately with the increase of the potential of the grid. It is therefore customary to keep the grid always negative, either by means of a very high resistance or by means of a C battery connected between the filament and the grid, with the negative pole of the

battery connected to the grid and the positive to the filament. The grid is then always negative, but it becomes more or less negative as it is varied to control the plate circuit.

These, then, are the three important elements of the vacuum tube in use today: the electron-emitting filament or cathode, the plate or anode, and the control grid between the two which determines the flow of electrons from filament to plate. As soon as the functions of these three elements began to be understood numerous improvements developed. It was found that certain metals or oxides of metals were better electron emitters than others; it was found that the electron emitter could be a separate element, usually a slim cylinder capable of being heated to the proper temperature by placing a heating filament inside it. Additional grids were added to help control the electrons, until today some of the tubes in use have three or four grids besides the plate, the cathode, and the heater for the cathode. Every tube has at least two circuits, one of which is the grid or control circuit and another the plate circuit—the current in the latter being under the control of the former. Some types of tubes have been found better suited for certain purposes than others, and so each tube has its particular function in the circuit in which it is used.

The Vacuum Tube as an Amplifier

As has been stated before, early television experimenters had found the means of translating light into electrical impulses, but the impulses produced were extremely weak. The vacuum tube offered a means

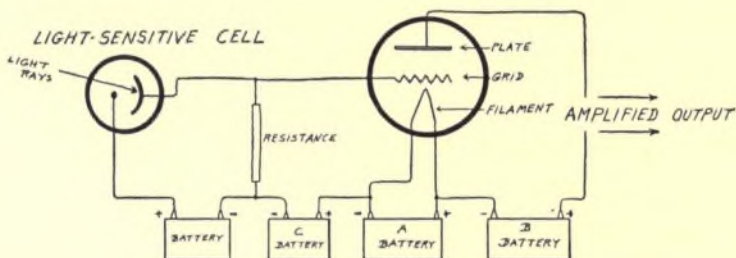

FIG. 20—A vacuum tube (represented by the larger circle) used as an amplifier of the light modulated current produced in a light-sensitive cell (represented by the smaller circle).

of amplifying these impulses. One way in which the vacuum tube is used as an amplifier is illustrated in figure 20. The light-sensitive cell or “electric eye” of the television camera can be connected in the grid control circuit, whereupon the current changes in the plate circuit will be much greater than the electric changes produced by the light-sensitive cell.

It is important to be able to couple two circuits together so that current variation in the first circuit will cause a similar variation in the second. One

method of doing this is by means of a transformer. A *transformer* consists of two coils of wire not connected to each other but wound closely together (figure 21). For low-frequency currents the coils are

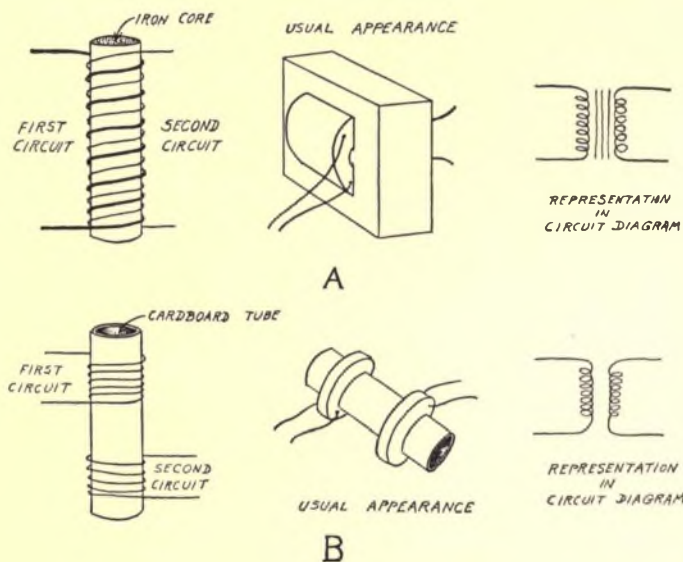

FIG. 21—Types of transformers: A, those used in low frequency transformation; B, those used at high frequencies.

wound on an iron core; for high-frequency currents the coils are usually wound on a tube of cardboard or other insulating material. One coil is part of one circuit, and the other coil is connected with the other circuit. If an alternating current, or a variable direct current, is flowing through the first circuit

it will produce a variable magnetic field around the coil, which will produce in turn a similar variable current in the coil of the second circuit. This principle of the transfer of current from one coil of wire to another is called *induction*, and an induced

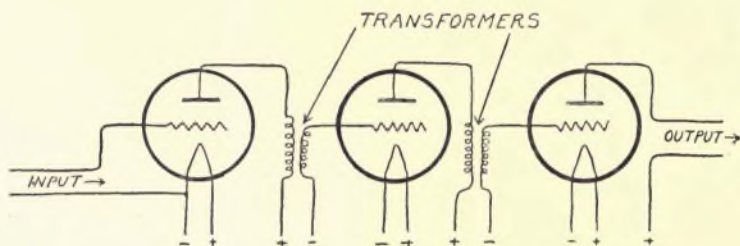

FIG. 22—Use of a series of three vacuum tubes (represented by circles) with transformers in a circuit to amplify television signals.

current is said to be produced in the second circuit. The voltage in the second circuit will be determined by the number of turns of wire in the two coils. If the coil of the second circuit has more turns than the coil of the first circuit, the voltage in it will be greater than the voltage in the first circuit.

By using this principle several tubes can be coupled together in a chain as shown in figure 22; as each one multiplies the current, the amplification of the last tube can be enormous. If, for instance, a vacuum tube amplifies ten times, then when four such tubes

are connected the total amplification will be ten thousand times! The number of tubes which can be used in this manner is limited only by the attendant amplification of noises which accompany the signal or which are caused by the tubes themselves. Such noises or undesirable signals are amplified together with the signal and, if too many tubes are used, sometimes become so great that they obscure the signal.

In a television system where the signal is transmitted to a distant point, vacuum tubes are used in this arrangement at both the transmitting and the receiving ends. Such amplifier tubes are used to amplify not only the signal but also the currents used to control the television equipment.

The Vacuum Tube as a Generator

It has been pointed out that another important function of the vacuum tube is to generate the very high frequency alternating currents which are used as carriers to transmit sound or picture signals through space. Before explaining the action of the vacuum tube in this respect, a few words might be said concerning the action of alternating currents in circuits and the importance of certain characteristics of these circuits.

Every electrical circuit has certain characteristics of resistance, inductance, and capacity; these can be

adjusted so that almost any desired relationship between the three can be obtained. *Resistance*, as we have already noted, is just what the name implies: something which resists the flow of electricity in the circuit. *Inductance* is brought about by the effect of a coil of wire connected in the circuit. We have seen that when a current flows through a coil of wire a magnetic field is set up around the coil, and that when the current is varied (as in an alternating current) the magnetic field also varies. Another coil of wire near the first will have a current *induced* in it similar to the current in the first coil. That is one way to indirectly couple two circuits together. However, each turn of wire in a coil tries to induce a current in the turn next to it; and the total effect of each turn upon the other turns of the coil is to give the coil itself a certain value of inductance. This value of inductance has an important effect upon the current flowing in the circuit. Any stopping and starting of the current in the coil causes the induced current to oppose these actions. Induction tends to keep the current flowing for a short time after it has stopped, and to require a little time for it to build up to full strength after it has started. Because of this, if a coil has a low inductance a current of high frequency can easily flow through it. If the inductance is high enough the same high frequency will be prevented from flowing

through it, and the coil will permit only a current of low frequency to pass through it.

Capacity likewise has an important effect on the current flowing in the circuit. If two plates are held close to each other, a positive electrical charge on one plate will produce a negative charge on the other and vice versa. If no wire connection is provided between the plates, these charges will remain for some time; but if a wire connects one plate with the other, the charge will be dissipated immediately with a resulting surge of current through the wire. Two such separated plates are called a *condenser*, and their ability to store up a charge is known as their *capacity*.

If the plates of a condenser are connected in a circuit, they will not stop the flow of alternating current in that circuit. This is because alternating current, flowing first in one direction and then in the other, has the effect of first charging one plate positively and the other negatively and then reversing the process. Thus a condenser does not stop alternating current, but the capacity of the condenser will determine how easily an alternating current can flow through the circuit. A high-capacity condenser will pass low frequencies easily, but high frequencies will have difficulty in passing through it. On the other hand, a low-capacity condenser will pass high-

frequency current but will impede the passage of low-frequency current.

Let us imagine a closed circuit containing a coil and a condenser. To make it as easy as possible for current at a certain frequency to flow in that circuit the value of inductance of the coil and the value of the capacity of the condenser must be chosen according to a definite law. When these values are properly chosen and the resistance in this circuit is low, the circuit is said to be *tuned* to that particular frequency, and an alternating current of that frequency not only will flow in that circuit but will flow so easily that it will tend to keep on flowing after it has once started. It is similar to the action of a violin string: pluck the string and it vibrates at a certain frequency, depending on how it is tuned, and continues to vibrate for some time. Similarly if you give the tuned circuit one little impulse of alternating current at the particular frequency to which it is tuned, alternating current at that frequency will flow in the circuit for a short time after the impulse has entirely stopped. To tune the circuit to a higher frequency either the capacity or the inductance must be decreased.

It is from such a tuning of a circuit that we get the expression *tuning a radio set*; when one tunes a radio set, he actually makes adjustments in the circuits so that they will respond to an alternating current of a

particular frequency which happens to be the frequency of the carrier wave of the radio station to which he is tuning.

Tuned circuits play an important part in radio and television. They are necessary when a vacuum tube

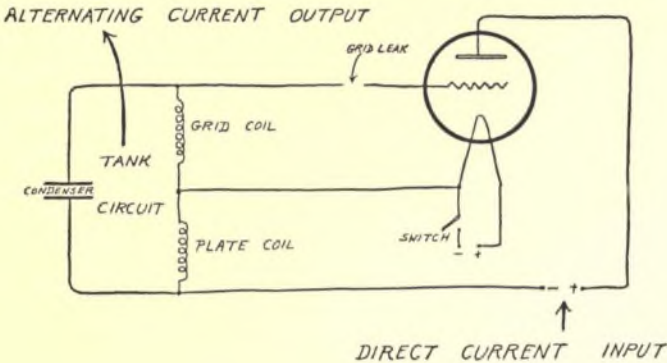

FIG. 23—Use of a vacuum tube as an oscillator, converting direct current into alternating current.

is used to generate alternating currents of a given frequency. In figure 23 a vacuum tube is shown introduced into a circuit for this purpose; thus connected it is said to be an *oscillator*. There are really several circuits connected to this vacuum tube. There is one tuned circuit containing the two coils and the plates of the condenser, and the capacity of the condenser and the inductance of the coils are adjusted so that the circuit is tuned to the desired frequency,

which we will assume to be 10,000 cycles a second. Between the plate of the tube and the filament there is also another circuit which includes one of the coils; the other coil is also included in a circuit between the grid and the filament.

Unless the filament is heated so that it can emit its stream of electrons to the plate, no current will flow in any of the circuits. Now suppose we close the switch which connects the A battery to the filament so that current flows through the filament and heats it. Electrons will immediately begin to travel to the plate and current will flow in the plate circuit and through the coil and will set up a similar impulse through the other coil by induction. Although no current can flow in the grid circuit, current through the coil in that circuit will cause the potential of the grid to swing in a negative direction which will reduce the current in the plate circuit. Reduction of the current through the coil in the plate circuit will cause the coil in the grid circuit to swing the grid back to a more positive potential which will cause the plate current to start up again, and the cycle is repeated over and over. Since the circuit containing the two coils is tuned to 10,000 cycles, the strongest current in the circuit will be one at that frequency and therefore the periodic action of the tube just described will take place at that frequency, with the result that a

strong alternating current at 10,000 cycles a second will be produced in the circuit containing the coils and condenser (called the *tank circuit*).

There are several other circuits which are used to make vacuum tubes act as oscillators to produce a high-frequency alternating current. However, they all work on much the same principle: the action in the plate circuit affects the grid circuit in such a way that the grid tends to reverse the action in the plate circuit. The action is like that of a tennis ball being batted continuously back and forth across the net.

It is sometimes difficult to keep the oscillator going at exactly the desired frequency. Changes in temperature and the moisture content of the air may cause the action to speed up or slow down. To avoid this, most radio stations today control their frequency generators by means of a crystal which is connected in the grid circuit. Certain rock crystals as, for instance, quartz, if ground a certain way will vibrate at a particular frequency when an electric current is run through them. Such a crystal, ground so that it will vibrate at 10,000 vibrations a second, if connected in the grid circuit of the oscillator tube will hold the oscillation of the tube very closely to 10,000 cycles a second.

The Vacuum Tube as Modulator and Detector

One of the earliest uses of the vacuum tube in radio reception was to separate the radio signal from the carrier wave. Today the vacuum tube is used in both radio and television, not only to take the signal off the carrier wave at the receiver but also to put the signal onto the carrier wave at the broadcasting station. We have seen that the early Fleming valve had only two elements: a filament and a plate. Since current will flow only in one direction between the filament and plate, if alternating current is applied to the plate circuit current will flow through the tube when its flow is in the proper direction. When the current tries to flow in the opposite direction for the regular reversal of the alternating-current cycle, no current can flow through the tube. Thus the alternating-current wave is changed into a series of half waves or impulses of direct current.

When a current flows through a telephone receiver or loud-speaker, an electromagnetic field is created which exerts a pulling force on a diaphragm. If that current is caused to alternate at, say, 1,000 cycles a second, the diaphragm will vibrate at 1,000 times a second and set up vibrations in the air which in turn will cause our eardrums to vibrate at that frequency.

We then hear a high-pitched note. The diaphragm of the telephone receiver as well as our eardrum can move at that rate.

Now suppose this note is the signal with which a million-cycle radio carrier wave is modulated (figure

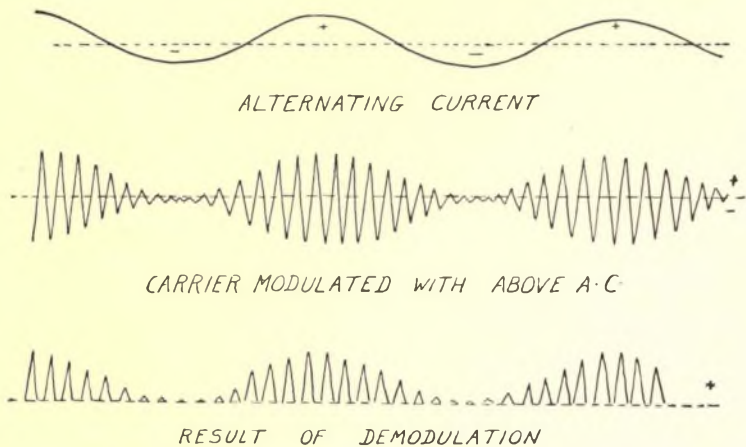

FIG. 24—Amplitude modulation of a carrier current.

24). The diaphragm of the telephone receiver is too heavy to vibrate a million times a second, and so are our eardrums. If we caused this modulated radio frequency current to flow through the telephone receiver, we would therefore hear nothing.

But suppose we let this modulated high-frequency current flow through a circuit connected between the filament and plate of a Fleming valve or diode. Since

the current can flow in only one direction through the tube, we get the series of little half-wave impulses. These tend to push the diaphragm of the telephone in only one direction; and as the strength of these impulses varies in accordance with the thousand-cycle note, the diaphragm will start to vibrate a thousand times a second and we will again hear the note. In this way the diode tube *detects* the signal, removing it from the carrier wave.

What has been said with respect to the effect of carrier frequency currents on the diaphragms of telephone receivers and loud-speakers applies also to the light sources used in television. The signal must be removed from the carrier before it can be used.

After De Forest put the grid in the tube, it began to be used in another manner for this same purpose. The signal was applied to the grid of the tube to cause its potential to rise and fall in correspondence to the alternating-current wave picked up from the air. You would expect this to cause a similar rise and fall of plate current, but the potential of the grid is, in this case, adjusted so that when it swings in the negative direction the plate current is stopped. The result is that the plate current is reduced to a series of impulses corresponding to half the alternating-current wave.

Vacuum tubes are used to put the signal on the

carrier wave in a number of ways. One way which has proved very popular is to use a tube with two grids, separated from each other and mounted in the space between the plate and cathode. The high-frequency alternating current from the oscillator is applied between one grid and the cathode. This would normally cause a varying current in the plate circuit of the tube producing an alternating current of the same frequency in another circuit coupled to the plate. The signal is applied between the other grid and the cathode; this second grid causes the plate current to rise and fall in accordance with its changes in potential, and so we have a plate current which rises and falls not only at the frequency of the carrier current but also in accordance with the signal. This produces a high-frequency current the amplitude of which is changed in accordance with the signal.

The process of putting the signal on the carrier, whether for a radio program or for a television picture, is called *modulation* and the process of taking it off of the carrier is called *demodulation* or *detection*.

The process of modulation described above is known as *amplitude modulation*; the carrier frequency is fixed, but its amplitude or strength rises and falls in accordance with the variations in the signal. There are other forms of modulation by which a signal may be impressed upon a carrier wave. One

which is now coming into use for radio, and is used for the sound portion of television, is known as *frequency modulation* (F.M.). In this the amplitude of the carrier is kept constant, but the frequency of the carrier wave is caused to vary in accordance

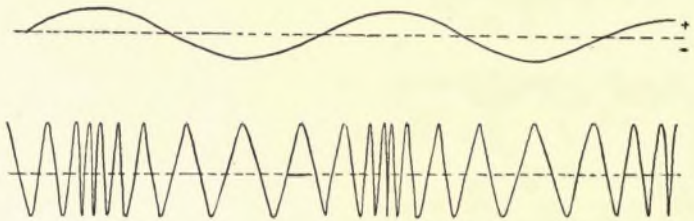

FIG. 25—Frequency modulation of a carrier current, using the same alternating current wave as that in figure 24.

with the signal (figure 25). The usual method of operating with this form of modulation is somewhat complicated. The simplest method is to make the signal vary the tuning of the tuned circuit of the oscillator tube. When this is done, the frequency at which the tube oscillates will shift up and down with the variations of the signal.

In demodulating this signal the incoming carrier wave is used to induce a current in two separate tuned circuits. One circuit is tuned to a frequency below the average frequency of the signal, and the other is tuned to a frequency above the average frequency.

Each tuned circuit is connected to a separate diode detector tube and these diode tubes are connected in a single circuit in such a manner that the direction of the current flowing in that single circuit will be determined by the diode which has the most current flowing through it. When the frequency shifts in the slower direction, the circuit tuned to the lower frequency will have an increase of current flowing in it and, through its diode tube, will cause current to flow in a certain direction in the last signal circuit. When the frequency of the carrier shifts to a higher frequency, the current in the other tuned circuit will increase while that in the first tuned circuit will decrease. Thus the current in the last circuit will reverse whenever the frequency shifts, and these reversals will therefore be at the signal frequency and not at the carrier frequency. Current from this last circuit can then be led to loud-speakers or television light sources.

The Vacuum Tube as the Basis of the Cathode-ray Tube

The principles upon which the vacuum tube operates have contributed to television in another way; they are the same principles that govern the operation of the cathode-ray tube, about which we shall read more in detail in Chapter Four. When electrons move

through a vacuum they can be controlled in their direction of movement similarly to the way in which light rays can be controlled. The stream of moving electrons can be focused so that they all converge at a point just as light rays from the sun can be focused by a magnifying glass on a small spot. In addition, their direction of movement can be changed instantaneously. The cathode-ray tube has an electron emitter, a plate, and a grid, like the ordinary vacuum tube, although these elements have different shapes and positions in the tube. The cathode-ray tube also has the means to focus the electrons in a beam and the means to steer the beam around in a certain predetermined manner.

We have seen that the vacuum tube plays an important part in radio and television. It solved many of the important problems connected with the development of television and opened the way toward perfection in television pictures and the smooth transmission of television signals through the air as a television-broadcast program. Vacuum tubes are now made in many different sizes and for many different uses, in both radio and television circuits (figure 26). Most tubes are made of glass, although some have a metal shell; but all use glass to separate and insulate the various parts. The tubes range in size from the "acorn" tube, which is about the size of a small acorn,

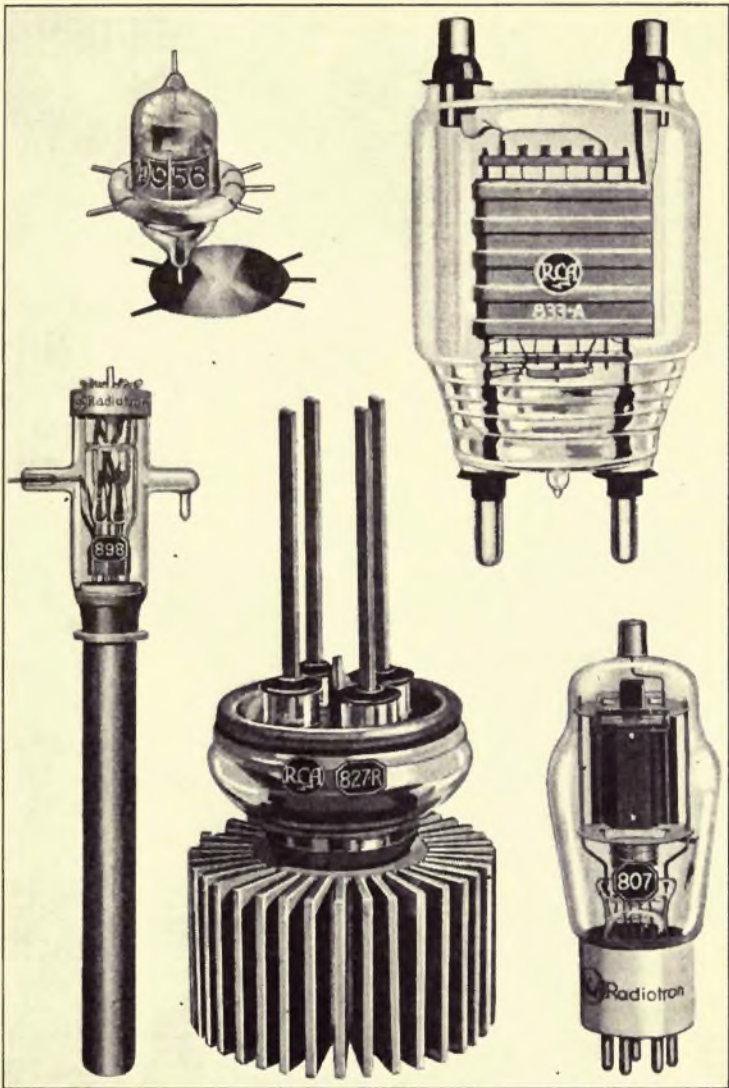

Courtesy Radio Corporation of America

FIG. 26—A few of the numerous types of vacuum tubes in use today in radio and television apparatus.

to the large transmitting tubes which are as big as a man and are kept from overheating by a continuous flow of water through pipes associated with the plates of the tubes.

The tubes have been described as operated by batteries. However most vacuum tube circuits have *power supplies* which transform the ordinary house lighting current into the equivalent energy supplied by batteries.

Chapter Four

THE ETHER HIGHWAY

IN DISCUSSING radio and television transmission the terms *carrier wave*, *channel*, *wave band*, *frequency*, and *wave length* are used continuously; it may be that many laymen do not really understand their meaning and their relation to one another. We have learned that a carrier wave is an electromagnetic wave produced by an alternating current, and that this wave can have its amplitude varied in accordance with the vibrations of some kind of signal when amplitude modulation is used, and its frequency varied in accordance with the signal when frequency modulation is used.

The Electromagnetic Wave

If one throws a stone into the water of a quiet pond he can watch the ripples travel outward from the place where the stone entered the water, in ever-widening

circles. These ripples are little waves which diminish in height as they get farther away from the starting point. The larger the stone, the higher the waves become and the farther they will travel across the water. The water itself does not actually move along the surface of the pond, each particle merely rising and falling under the influence of the waves set up by the stone. A cork floating on the surface will rise and fall as the waves pass it, first moving down into the trough as the lowest part of the wave passes it and then moving up in the opposite direction as the crest of the wave reaches it.

If, instead of throwing the stone into the water, we fasten it at the end of a long pole, raising and lowering it at a uniform rate, the result is the continuous formation of new waves which keep on traveling in widening circles. As long as this procedure is kept up, the cork continues to bob up and down at the same rate that the stone is being raised and lowered into the water.

Electromagnetic waves act in a somewhat similar fashion to the waves set up in the water. The radio aerial at a broadcasting station extends up in the air, away from buildings and other obstructions. As an alternating current at high frequency flows in the aerial (antenna) circuit, it causes electromagnetic waves which spread out in widening circles from the

aerial. The stronger the current in the antenna circuit, the greater is the amplitude of these electromagnetic waves and the farther the waves travel out into space. If a wire is raised into the air at some point distant from the broadcasting aerial, it corresponds to the cork floating in the water; although the wire does not move physically, it will contain an induced current which rises and falls as the magnetic waves pass by. Current will flow in one direction as the valley of the electromagnetic wave approaches, and then will be reversed and flow in the other direction as the peak of the wave approaches. Thus there is created an alternating induced current which has the same frequency as the current in the broadcasting antenna circuit—just as the cork bobbed up and down at the same frequency as the movement of the stone in and out of the water.

In figure 27 A there is illustrated diagrammatically an electromagnetic carrier wave leaving a broadcasting station. The distance between points A and B on the wave is considered the length of the wave. All waves travel through space at the same speed; if a wave is said to have a frequency of 10,000 cycles a second, it means that 10,000 of these waves will pass a given point in each second. In figure 27 B wave C is represented as having a frequency of 10,000 cycles a second, and wave D a frequency of 20,000 cycles

a second. This means that 20,000 waves of D pass a given point in the same time that 10,000 waves of C pass the same point. In order that D may have *twice*

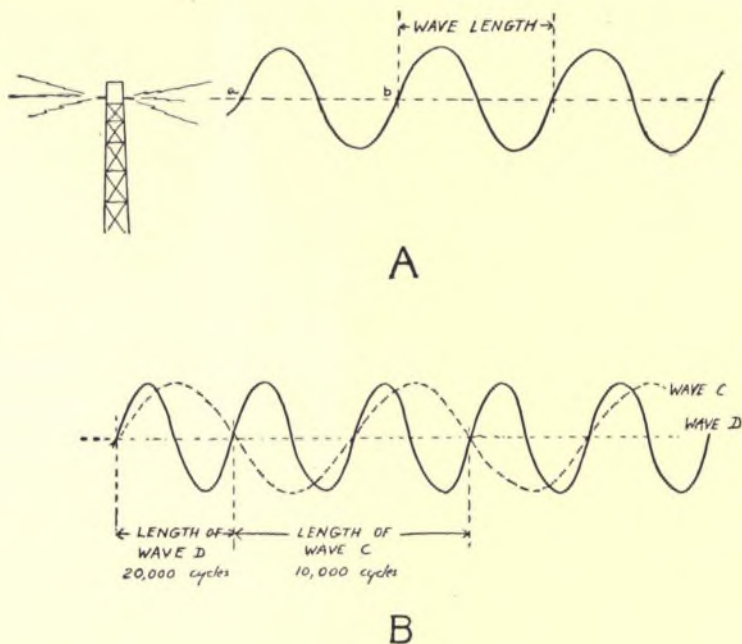

FIG. 27—A, an electromagnetic wave leaving the transmitting antenna; B, two electromagnetic waves with one having twice the frequency of the other.

the number of waves as C in the same time interval, the wave length of D must obviously be *half* that of C. From this it can be seen that as the frequency of a wave increases the wave length must be decreased.

Wave lengths are measured in meters instead of feet and inches; and although carrier waves are identified by both wave length and frequency, the latter method is used throughout this book to avoid confusion. If the frequency is known the wave length can easily be computed, and vice versa.

The Modulation of the Electromagnetic Wave

The appearance of a carrier wave, modulated by a signal wave with amplitude modulation, has been illustrated diagrammatically in figure 24, Chapter Three; in the same chapter the appearance of a carrier wave under the influence of frequency modulation has been described. An important fact to remember is that if a signal is to bring about a variation of the carrier wave the latter must have a higher frequency than that of the signal.

The highest sound vibration which the most sensitive human ear can detect is about 16,000 cycles a second; most radio receivers come much nearer to a maximum of 5,000 cycles a second. Such signals can be transmitted over the lowest frequency of the broadcast band since this is 550,000 cycles a second (often written as 550 kilocycles); the carrier wave in this case has a much higher frequency than the maximum sound-vibration rate. A television signal, however,

because of the large number of individual picture elements and the high speed of scanning, may have frequencies as great as several million a second—which requires a carrier wave of a greater frequency. For this reason the television signal is transmitted on a carrier wave of from 40,000,000 cycles (40,000 kilocycles or 40 megacycles) to 108,000,000 cycles (108 megacycles) a second.

Channels in the Ether Spectrum

The ordinary electric current used in homes alternates its direction of flow in the wires sixty times a second. Such a current produces, therefore, an electromagnetic wave of 60 cycles a second; this is too low a frequency for use in radio or television since—as has been pointed out previously—the carrier wave must have a higher frequency than the superimposed signal. Such a low frequency has another drawback: the electromagnetic waves produced can travel but a few feet. As the frequency is increased, many startling phenomena accompany the change; if the frequency is increased as far as is possible, the range will include all of the frequencies which constitute the *ether spectrum* (figure 28). Much of what we do and enjoy in our everyday lives depends upon what happens to electromagnetic waves as their frequency increases.

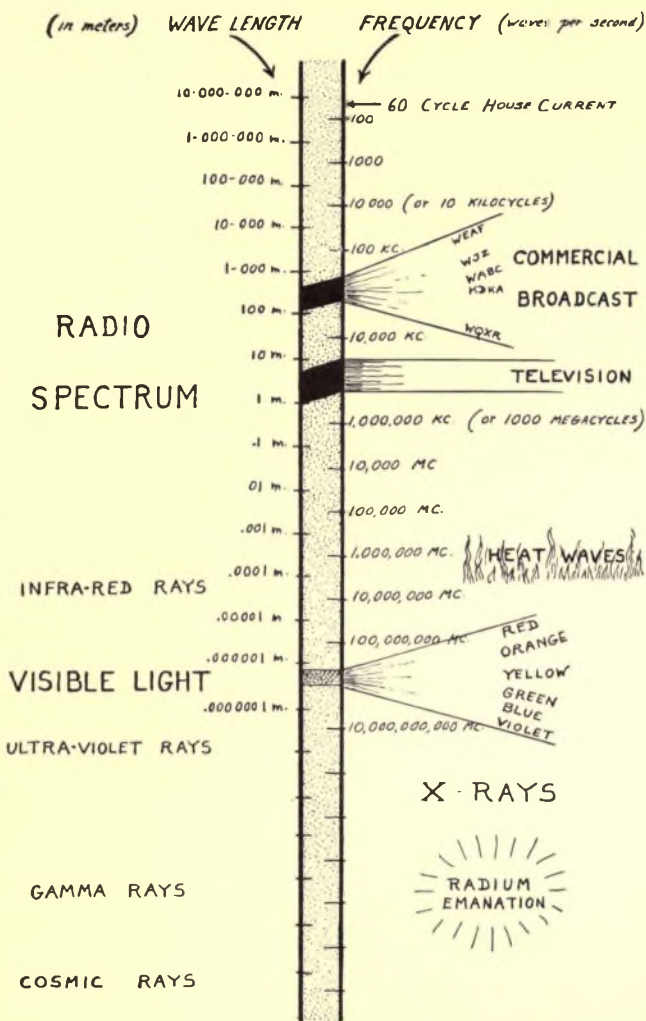

FIG. 28—The complete range of the ether highway; at the upper end are the lowest frequencies and greatest wave lengths while at the lower end are the highest frequencies and shortest wave lengths. The portion known as the Radio Spectrum is elaborated in greater detail in the endpaper illustration.

With an increase in frequency the first noticeable change is that the electromagnetic wave travels farther. By the time the frequency reaches 10,000 cycles a second, we find the wave suitable for communication purposes. Up to about 300,000,000 cycles the wave can be used for transmission of sound or pictures. While we have not, as yet, learned to use the highest frequencies just mentioned with much success, the probability is that in the future we will be able to do so with increasing value for communication purposes.

When the frequencies reach 100 billion cycles, the electromagnetic waves have a heating effect upon anything in their path; in this way heat is transmitted and the waves are known as infrared rays. As the frequencies reach 375 trillion cycles, the electromagnetic waves begin to affect the human eye and appear as red light. This is the beginning of the visible portion of the ether spectrum where the electromagnetic waves are known as light rays. If the frequency is increased even more, the red color changes to orange; the orange to yellow; the yellow to green; the green to blue, indigo, and violet. We have now reached a frequency of 750 trillion cycles. Beyond this point there is no longer any effect upon the eye, the succeeding wave lengths now becoming ultra-

violet rays—which are exceedingly penetrating, as is demonstrated when one sunburns.

Further speeding up of the frequency of these electromagnetic waves produces X-rays, which can penetrate even metals as well as the human body. The X-rays, upon further increase in frequency, give way to the gamma rays (produced by radium) and to cosmic rays; the latter have such incredible frequencies as 10 septillion cycles.

This discussion of the ether spectrum shows the relation of the electromagnetic waves used in radio and television transmission to waves of other frequencies; such radio and television waves are only a small part of a great system of electromagnetic waves which produce such phenomena as heat, light, color, and X-rays. The small portion of this ether spectrum used for radio communication is the *radio spectrum*—an ether highway thronged with invisible electromagnetic waves, of which there can be as many as there are differences in frequency.

It is obvious that there is a definite limit to the number of broadcasting stations (radio and television) that can be accommodated on this ether highway. It has been found that every time a carrier wave is modulated with a signal certain disturbances known as *side bands* occur at frequencies just above and below the frequency of the carrier. For this rea-

son it is necessary to keep the carrier waves for sound separated from each other by about 10,000 cycles. For television, carrier waves must be about 6,000,000 cycles apart. We can therefore consider this highway of communication in the ether as being made up of lanes or channels, each separated from every other by a band of a certain number of cycles—depending upon what signal the channel is to carry.

These channels are naturally in great demand; many broadcasters are clamoring to use them for all sorts of purposes. To keep order in the ether highway, the Federal Communications Commission has been empowered to control the use of these channels. Some carrier frequencies are allotted to particular broadcasting stations, as is the case in the broadcast band which includes the regular entertainment broadcasting stations. Other bands of frequencies are allocated to certain licensed operators such as amateurs, who may use any frequency within that band.

The chart used as end-paper illustrations, inside the front and back covers of this book, shows the allocation of frequencies and the purposes for which they are used. The television channels are near the end, having the highest frequencies. This is chiefly because the very high frequencies in the television signal require a carrier of higher frequency, as we have already discovered. Also when the demand for

television carrier waves began there was no available space for them except at the higher end of the spectrum. The necessary great width of the television band is another factor to be considered; if it were possible to locate a modern high-frequency television station at the center of the sound-broadcast band, one could hear the picture signal as a whirring noise in the radio receiver from one end of the dial to the other. There is more room for these wide television channels at the upper end of the radio spectrum.

A television picture could be sent out as just a picture, without any sound accompaniment; but the sound adds considerably to the enjoyment of the picture. Just as movies were greatly improved by the addition of sound, television would be immeasurably handicapped by the elimination of the attendant sound and voice accompaniment. In television the sound has really nothing to do with the scene being transmitted; it is an ordinary radio program synchronized with the television picture. It might therefore be given a carrier frequency almost anywhere in the spectrum. It is convenient, however, to have it near the carrier wave of the picture it accompanies. The Federal Communications Commission has therefore allotted a band of 6,000,000 cycles for each television picture which is to include the sound accompaniment. The picture itself is to take up a certain

space in this channel; above this for a few higher frequencies there is nothing at all, and then (among the highest frequencies in the channel) there is a band of frequencies including the carrier for the sound signals. The space between the picture signal and the sound is sufficient so that the picture and the sound will not interfere with each other. In poorly constructed television receivers, however, some interference may take place—through no fault of the broadcast station. In such cases the sound signal shows as dark streaks flashing in patterns across the picture, and the picture signal may cause a whirring noise heard as a background above the sound accompaniment. In order to make doubly sure that there will be no interference between the picture and the sound signals, the Federal Communications Commission has decided that amplitude modulation be used for the picture and frequency modulation for the sound portion of the program.

It has already been pointed out that in general the higher the frequency the greater the carrying distance of the electromagnetic waves. However, the carrying distance of the waves in the radio spectrum does not seem to depend upon the frequency. Some of the lower-frequency carriers reach great distances as do also some of those of higher frequencies, while some carrier waves in between the two extremes do not travel

so far. Atmospheric conditions, night or day (radio waves seem to travel greater distances at night), and presence or absence of sunspots affect the distance these waves will travel; the distance changes also over a period of years. At present those frequencies assigned to television broadcasts travel comparatively short distances—the waves going off at a tangent to the earth's surface rather than following the earth's curvature as do the longer waves of the commercial sound-broadcast band. Thus the distance of transmission of these television carrier waves is approximately equal to that of the visible horizon. The National Broadcasting Company's aerial on top of the Empire State Building in New York City sends out television signals capable of reception fifty miles away. The average-height transmitting aerial will have a range of twenty-five miles or less. While this is a drawback in some respects, it means that several television stations can operate on the same frequency at localities several hundreds of miles apart, without having any interference between their signals.

The ether highway which is used for transmission of sound and television programs is therefore but a small part of a great spectrum of electromagnetic waves which include light, heat, and many other forms of radiation. The electromagnetic carrier waves

radiate outwards in space from the antenna of the transmitter, like ripples caused by a stone thrown into the water; as these electromagnetic waves speed invisibly through space they are capable (within certain limits of distance) of inducing a current of similar frequency in the receiver. Each carrier wave has its own particular frequency which functions as a lane or channel in the ether highway; one might think that there could be as many lanes as there are frequencies in the portion of the spectrum used. But we have already pointed out that this is impossible because of side-band interference. Even so, there are several channels available in the present allotted portion of the television band. Before each carrier wave is sent out into space along its predetermined lane, it has been modulated by a sound or picture signal and thus is carrying with it an electrical equivalent of the sounds or scenes which are present in front of the microphone or television camera.

The manner in which these modulated carrier waves are picked up and the television picture reconstructed will be explained in following chapters.

Chapter Five

THE TELEVISION CAMERA

IN THE preceding chapters we have become acquainted with the fundamentals of television, and the stages through which experimentation passed until it culminated in the equipment in use today. In these chapters we have also considered such basic knowledge in electricity as is necessary for an understanding of the present-day television transmitter and receiver; this included a digression upon the importance of the vacuum tube and its contribution to television progress, as well as a brief outline of the channels through which sound and picture signals travel between the transmitter and the receiver. Now we can consider the finished product with which many of us may soon become familiar: the television camera, the sending of the picture "on the air" from studio or field, and the reception of that picture in our home or on our theater screen.

The television camera and the ordinary photographic camera both use lenses as a means of producing a miniature image of the object field. As was discovered during the early history of television, one

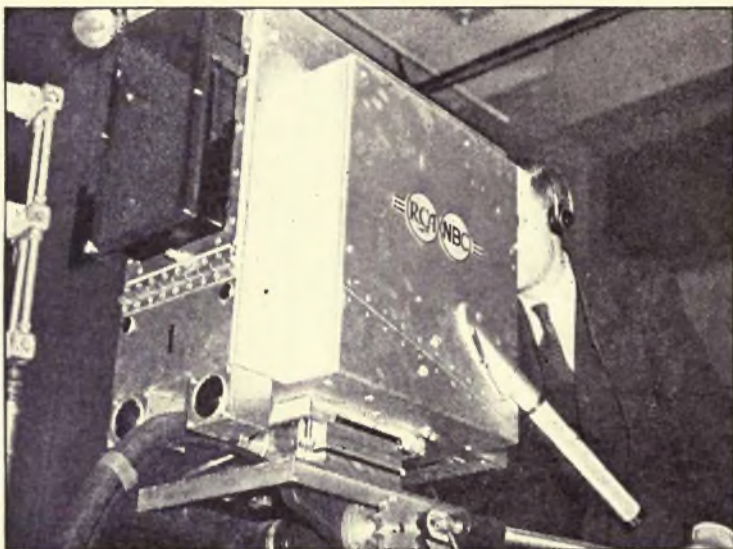

Courtesy Radio Corporation of America

FIG. 29—The television Camera, front and side view, showing opening (the lenses are not visible) through which the light reaches the camera tube.

of the first essentials for translating an actual scene into a succession of electrical impulses is an optical system which produces the image in a size that it is capable of being scanned. The television camera therefore, with its lenses, looks externally much like

an ordinary camera of considerable size (figure 29). It is usually mounted on a tripod by means of a swivel connection so that it can be easily swung from side to side, or tilted up and down. The resemblance to a



Courtesy National Broadcasting Company

FIG. 29a—Camera in field operation, with use of telephoto lenses.

photographic camera ceases, however, when the interior construction is revealed (figure 30).

The function of the television camera is to transform the light values of the scene being “photographed” into electric equivalents, and not into a

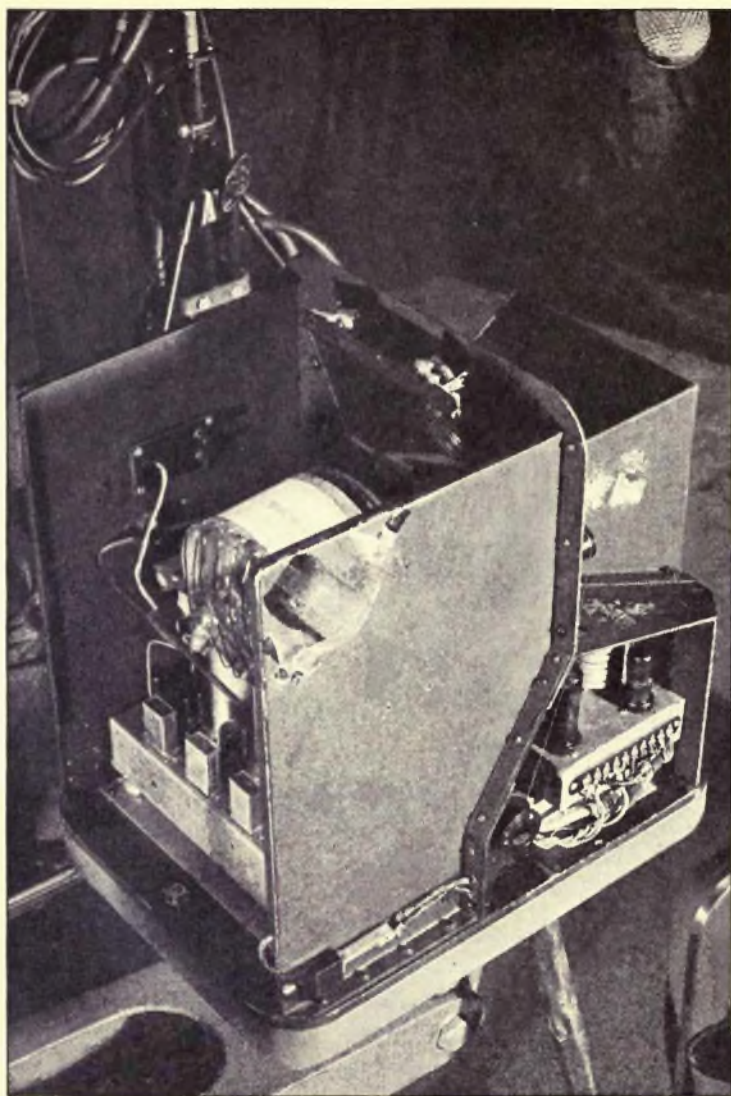

Courtesy General Electric Company

FIG. 30—Television Camera with cover removed. A portion of the camera tube is visible, with the amplifying circuits beneath it; front of camera at the right.

permanent photochemical image on a sensitive film. To bring this about, the television camera contains a *scanning device* which analyzes the image of the object field into a great number of picture elements, in a predetermined sequence, and a *light-sensitive*

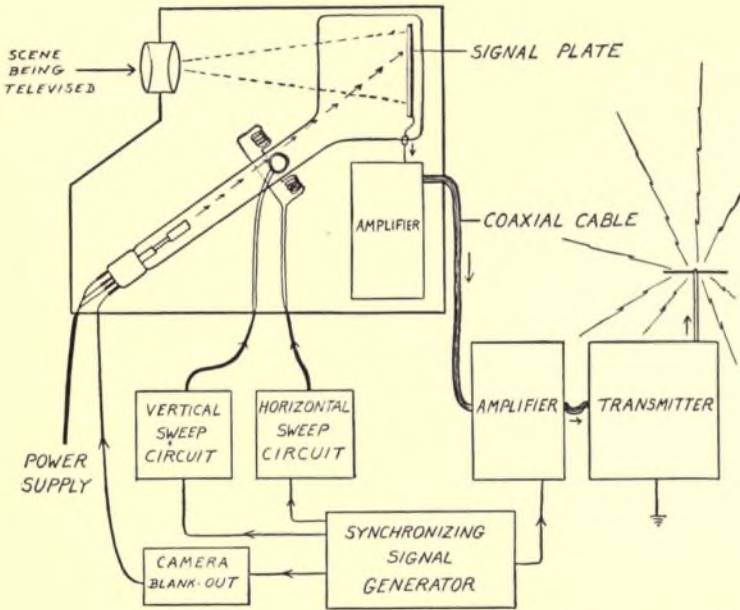

FIG. 31—Diagram of the units involved in a television transmission apparatus; the television camera (upper left) converts the light values into electric impulses which leave the signal plate of the camera cathode ray tube, pass through a first stage of amplification, and then (by means of coaxial cable) to the other amplifiers and the transmitting mechanism, located outside the television camera, and usually also some distance from the television studio.

device for translating the light intensity of each of these picture elements into electric impulses of corresponding value. Both of these devices are a part of the cathode-ray camera tube, which is the most important part of the television camera (figure 31). The most satisfactory scanning device at the present time appears to be that which uses an electron beam, as is done in the cathode-ray tube. Having no moving mechanical parts, this can scan electrically with almost unlimited speed—thus eliminating most of the defects found in mechanical scanning devices.

There are two types of cathode-ray tube used in television cameras of the present time. The one developed by Zworykin is the heart of the television camera in use by the National Broadcasting Company and Radio Corporation of America; as we have already seen, this type of camera tube is known as an *iconoscope*. A recent modification of it has been called an *orthiconoscope*. The other type of tube, developed by Farnsworth, and Farnsworth Television and Radio Corporation, is called an *image dissector*. This is an instantaneous tube, while the Zworykin iconoscope is a storage type of tube.

The Iconoscope

The iconoscope is a large glass tube shaped like a dipper (figure 32), from which the air has been

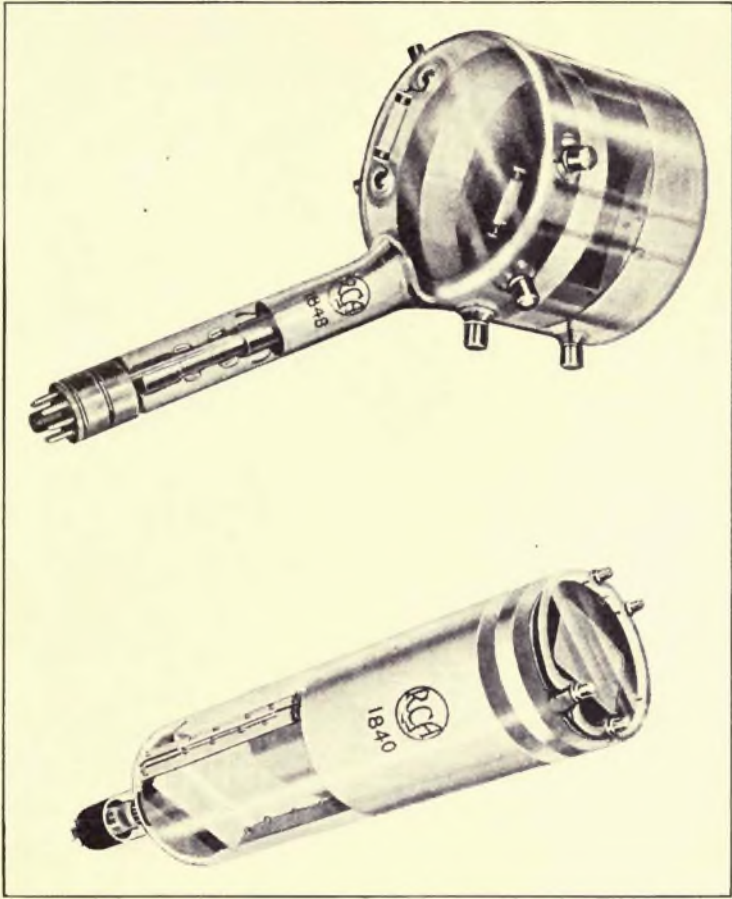

Courtesy Radio Corporation of America

FIG. 32—The Camera Tube. Upper photograph illustrates the iconoscope type, with the mosaic plate visible at the right, electron gun at the left. Lower photograph illustrates the orthiconoscope.

evacuated. In the portion of the tube corresponding to the handle of the dipper is the *electron gun*, an arrangement of cathode and anode which directs a stream of electrons toward the wider end of the tube; in this enlarged portion, opposite the electron gun, is the *light-sensitive mosaic*, a plate about four inches square upon which the image of the scene being televised is focused by the television-camera lens.

The electron gun has some of the same elements as the vacuum tube, as was pointed out in Chapter Three. There is an electron emitter or cathode, a grid, and several anodes (figure 33). Whereas in the vacuum tube the electrons leave the cathode and move in any direction toward the anode, in the cathode-ray camera tube the direction of the electron stream is controlled so that all of the electrons pass through the narrow neck of the tube toward the main body of the dipper. Not only do they pass up the neck of the tube, but they are made to converge at any one point on the mosaic plate which is placed so as to intercept them. This focusing of the electron stream is brought about by the arrangement of the anodes, which are rings or cylinders given different potentials. The electrons, leaving the cathode at tremendous speed, pass right through the anode rings, which change their course sufficiently so that all the electrons strike the same spot on the mosaic. The

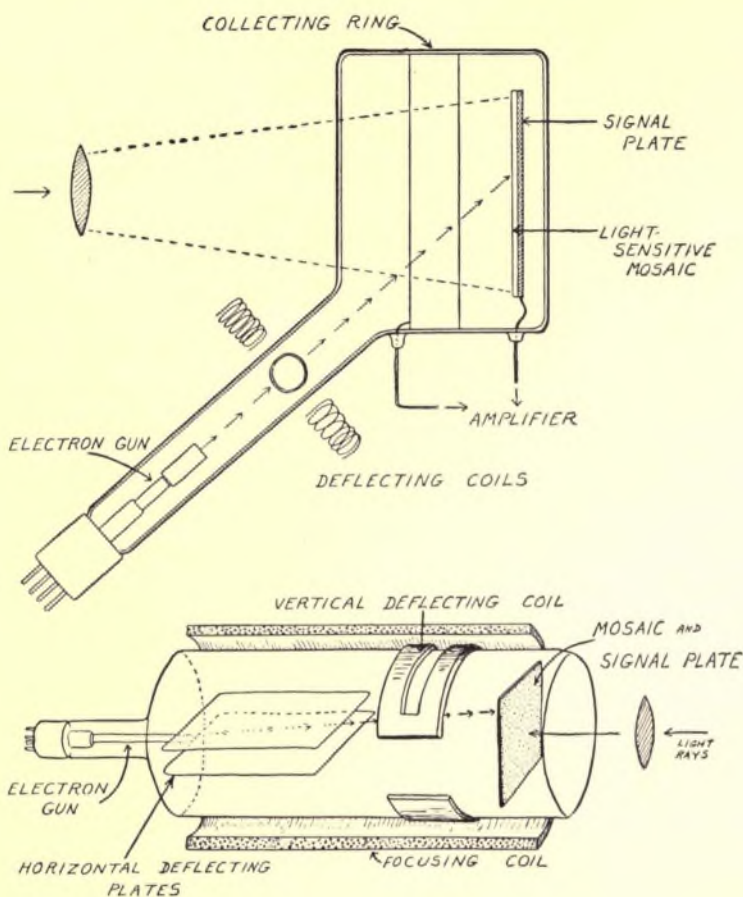

FIG. 33—Cathode ray tubes used in television cameras. Upper figure the iconoscope type, lower figure the orthiconoscope type. In both, a moving electron beam, guided by deflecting coils, scans the electron image produced upon the light-sensitive mosaic; this creates a sequence of electric impulses upon the signal plate behind the mosaic, which leave the tube as the television signals.

anodes can be likened to an electrical lens system which converges the electron stream so that the individual electrons strike the same spot on the mosaic plate, much as a lens brings light rays to focus on a single spot.

The grid in the iconoscope has the same function as the grid in the vacuum tube: it controls the number of electrons which eventually reach the mosaic plate. Making the grid more positive in potential increases the number of electrons striking the mosaic, while changing the potential of the grid in a negative direction reduces the number of electrons reaching the mosaic.

The mosaic is composed of a very large number of minute globules of silver and caesium which are deposited upon a sheet of mica; each globule functions as a minute photoelectric cell, separated from every other globule and capable of reacting independently. The sensitized globules are so tiny and so close together that they form a smooth, uniform surface. The mica plate is backed by a metal plate, which is connected to the external circuit by means of a terminal on the outside of the tube. It is from this *signal plate* that the electrical impulses constituting the television picture signal are obtained.

Each of the light-sensitive silver globules forms one plate of a condenser, with the metal signal plate

behind the mica insulation forming the other condenser plate. If the potential on any one silver globule changes suddenly, the result is a change in the potential of the signal plate—just as changing the potential of one plate of an ordinary condenser will affect the potential of the other. How these minute light-sensitive cells operate to produce the television picture will be explained later in the chapter; at this time let us return to see what happens to the electrons produced by the electron gun.

In order to scan the mosaic—upon which there is a reduced image of the object field, produced by the lenses in the television camera—the electron beam must move across the mosaic from side to side and, during every line scan, must move downwards slightly so that the next sweep of the electron beam can scan a new line.

To bring this about the iconoscope makes use of a well-known principle of electricity: when an electric current flows in a wire, a magnetic field exerts a force upon such a wire tending to move it in a direction at right angles to the lines of force of the field. The stronger the magnetic field, the more powerful is the force exerted against the wire. In the case of the electron beam there is no wire, but the beam is a current which, if surrounded by a magnetic field, will be moved to one side or the other depending upon the

direction and strength of the magnetic field. This is the basis of the method used in controlling the direction of the electrons leaving the electron gun.

Placed around the narrow neck of the camera tube (figure 33) are two sets of coils. In one set a coil is placed above the neck of the tube and another below it, so that the magnetic field produced by the two coils extends right through the tube when a current flows in the coils. Let us suppose that the electron gun is so placed that a stream of electrons is focused on a point of the mosaic at the upper left side of the image. As the current in the coils is gradually increased, the beam of electrons moves across the mosaic toward the right—in so doing passing along a narrow line of silver globules. The distance it moves depends upon the strength of the current flowing in the coils. When this current has reached a sufficient strength, the beam will have reached the opposite edge of the image. In order to get it back to the first side again, to start the scanning of another line, the current in the coils is suddenly reduced; this brings about a reduction of the magnetic field and a backward sweep of the beam to its starting point. But if this were all that happened, the beam would sweep back and forth over the same line of silver globules on the mosaic. To complete a scanning of the remainder of the image, the successive sweeps of the

beam across the mosaic must each be one line below the previous one. Another pair of coils is attached to the neck of the camera tube to bring this about. This second set of coils is so placed that its magnetic field extends through the tube at right angles to the field created by the first set of coils. By gradually increasing the current in these coils the electron beam can be moved down over the mosaic, just as the first set of coils brought about a horizontal sweep of the image. By suddenly reducing the current in this second set of coils to zero, the electron beam returns to its starting point at the first line.

These two sets of coils are connected with two independent circuits known as the *sweep circuits*. The first set controls the movement of the electron beam from left to right, while the second set controls the movement of the beam vertically over the image. As the sweep circuits operate, the current in the first set of coils rises—causing the beam to move horizontally across the mosaic image. At the same time the current in the other set of coils is increasing at a much slower rate, so that actually the beam of electrons does not sweep across in a perfectly horizontal line but follows a slightly downward-slanting course. When the beam reaches the right side of the image, the current in the first set of coils stops and the beam swings suddenly back to the left side again. But at the same time the

current in the second set of coils is still increasing at a slow enough rate to cause the beam to be directed at a point one line lower on the image. The current in the first set of coils now repeats the operation of increasing and suddenly decreasing, which sends the beam to the right and then returns it to the left side of the image again.

This action of the first set of coils is repeated again and again while the current in the second set is still gradually increasing. Thus each time the beam returns to the left side of the image, it is one line lower down than it was before. Finally the beam sweeps across the lowermost line of the image on the mosaic and is returned as before to the left side. But now the current in the second set of coils has reached its maximum and is suddenly decreased, thus sending the beam up again toward the top of the image. During the time it is traveling from the bottom to the top, the current in the first set of coils is still rapidly increasing and decreasing, and may cause the beam to sweep from right to left several times. But eventually it reaches the upper left-hand corner of the image again, ready to start the second complete scanning process. This entire line-by-line scan takes only one-thirtieth of a second; the rapidity of the movement of the scanning electron beam is hard to visualize, when one realizes that in modern scanning five hundred and

twenty-five lines are covered in that fraction of a second.

The deflecting coils which control this important course of the electron beam are very carefully and accurately wound and usually compressed into a sleeve, about half an inch thick and several inches long, which slips over the neck of the tube, being held in position near the enlarged end of the dipper.

We now have a controlled electron beam which can scan, picture element for picture element, a mosaic plate upon which is an image of the scene to be televised. Before considering what happens to the mosaic when the electron beam strikes it, let us see what is taking place on the surface of the mosaic as a result of the image being projected upon it. The light-sensitive globules are individually exposed to different light intensities, depending upon their position in the lights and darks of the image. Those globules which are brightly lighted (corresponding to picture elements of considerable light intensity) emit electrons as in any photoelectric cell exposed to light. When these electrons, which are negative charges of electricity, leave a particular globule, it naturally becomes positively charged. Those globules which are less brightly illuminated do not emit as many electrons and hence become less positively charged. Those which correspond to black picture elements emit no

electrons at all and do not become charged. Throughout the entire surface of the mosaic the globules—each corresponding to a picture element—are either charged or not charged; if charged, the amount of the charge is conditioned by the amount of light falling upon a particular globule. The result is an electrical image, produced spot for spot by the visible image focused upon the mosaic by the camera lens.

The electron beam now begins to scan the invisible electric image, starting at the first line. When it reaches one of the globules having a positive charge, the electrons, given up by the globule through the influence of the light upon it, are replaced by the electrons of the scanning beam. In other words, the positive charge is replaced by a negative one. As we have already pointed out, the globule and the signal plate form a condenser; so when the replacement of the electrons upon the globule takes place, the other plate of the condenser is affected exactly as if the globule and the signal plate were touched by the ends of a wire. There is a slight surge of current which changes the potential of the signal plate, corresponding to the strength of the charge replaced upon the globule by the scanning beam. It is this change in potential of the signal plate which becomes the television picture signal, forming an electrical impulse

which can recreate the light value of that particular picture element in the television receiver.

The electron beam now moves on to the next globule of the mosaic, corresponding to the next picture element in the line being scanned. If that globule has the same amount of charge upon it as the last one, the impulse that the signal plate receives is the same as the preceding one. If it has a smaller charge because there is a picture element of less light intensity, the signal plate receives a proportionally smaller impulse. If the globule has no charge upon it at all, there will be no impulse produced by the signal plate. Thus the electric image is broken down into a series of electric impulses; each time the electron beam strikes a globule on the surface of the mosaic an impulse is produced on the signal plate which corresponds to the light value of one picture element of the image. When the mosaic has been completely scanned, the process begins all over again on the next image. In the television system used by the National Broadcasting Company the image is scanned into 525 lines, thirty such images being scanned completely in a second (figure 34).

It has been found that the picture is produced with less flicker if it is not scanned in regular sequence from line 1 to line 525. Instead, the scanning sequence is so arranged that alternate lines are

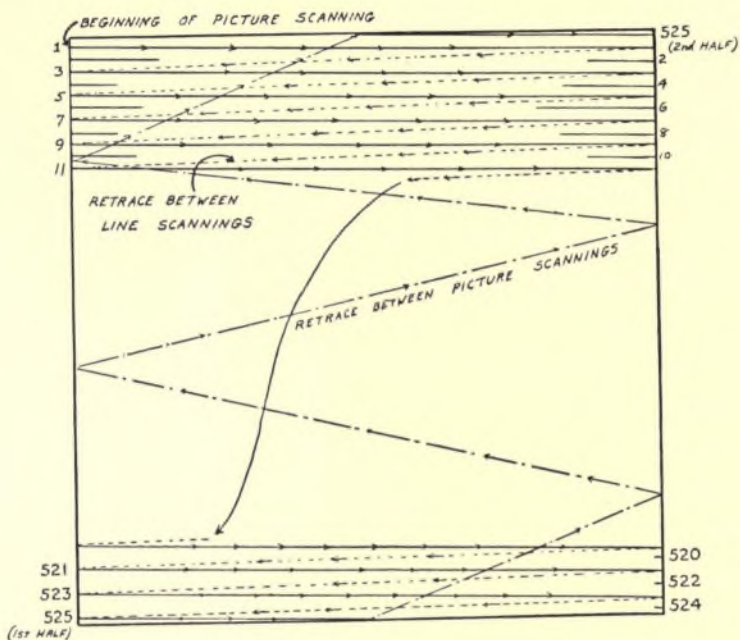

FIG. 34—Diagram of the path followed by the electron beam in interlace scanings of the television image. Scanning begins at line 1, upper left hand edge of image, proceeds to right (solid line) at a slightly slanting angle to end of first line; then the beam retraces its path (dotted line) to left hand edge of picture and begins the scanning of the 3rd line; after every retrace, a new odd-numbered line being scanned. At the bottom of the picture, the beam (while still scanning horizontally) retraces to the top of the picture, and now scans every even-numbered line.

scanned. Thus, beginning with the first line, odd-numbered lines are scanned until half of the last line has been covered; then the spot of light jumps up to the top of the picture, finishes the half line there, and then starts scanning line 2—proceeding to scan all the even-numbered lines. This scanning sequence is known as *interlacing*, and to bring it about, so that the lines come in their proper places, there must be an odd number of lines (such as 441 or 525) for the total of the picture.

The reason for choosing 525 lines, instead of some other number which would give sufficient definition, is that by so doing a definite relationship is maintained between the line frequency (525) and the picture frequency (30). One of these frequencies is created from the other by electrical circuits, so that there must be a certain relation between the two. Thirty pictures a second are chosen, not only to give a flickerless picture, but to prevent the formation of shadows moving up and down over the picture, resulting from interference with the 60 cycle house current.

A camera tube such as the iconoscope is known as a *storage* type tube, because each of the tiny condensers forming the mosaic can retain the charge given it by the light, even after the light has been removed, until the electron beam discharges it. If the light is cut off after an image has been focused upon

the mosaic, although no visible image is there when the scanning takes place, the electric image remains, so that one complete picture can be taken off from the charges on the mosaic plate. For this reason the iconoscope is often said to have a "memory"; an instance where the memory of an iconoscope serves a useful purpose will be explained when motion-picture scanning is discussed.

One decided advantage of the iconoscope is that each light-sensitive cell does not have to change instantaneously from one light intensity to another. In the old scanning-disk systems one light-sensitive cell had to bring about the translation from light to electricity of each and every picture element, and thus had to change instantaneously from one light value to another. Any light-sensitive cell works better if it does not have to change too quickly. With the iconoscope, therefore, a more accurate reproduction of the picture can be made.

Electrons are invisible and have no effect upon the light rays passing through the wall of the camera tube to form the visible image on the mosaic. If one were to look through a hole in the side of the television camera while the scanning is taking place, he would see only an image on the mosaic plate which would look like the image seen on the ground glass of a photographic camera.

Since the electrons which are thrown off from the light-sensitive globules have nowhere to go, a ring is placed inside of the main portion of the tube connected to a terminal outside of the tube. This ring is

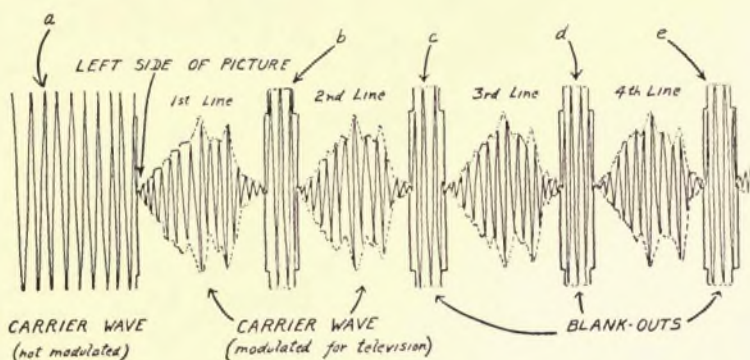

FIG. 35—Representation of the carrier wave and television signal modulation. At the left (a) is the unmodulated carrier wave, as it is during the absence of television signal modulation; during this time the vertical synchronizing impulses are applied. The modulation corresponding to four lines of the picture is indicated. Horizontal synchronizing impulses are applied at (b), (c), (d) and (e) while there is a pause between lines being transmitted.

given a high positive potential, attracting these wandering electrons and preventing their interference with the operation of the camera tube.

When the electron beam retraces its steps across the mosaic, no impulse should be produced; only the regular sequence of impulses from successive scanned

picture elements is desired in reproduction of the television picture. Therefore, during the time that the beam is retracing its path across the mosaic, a negative potential is applied to the grid, sufficient to stop the flow of electrons to the mosaic. This leaves a blank period in the signal coming from the signal plate. There is a succession of impulses for the first line of the image, then a blank period, followed by a succession of impulses for the second line of the image, another blank period, and so on. A longer blank period occurs after the last line is completed, giving the beam time to retrace its steps from the bottom of the image to the top of the next image (figure 35). Since these blank periods are not needed for anything else, they make convenient times for sending out the synchronizing impulses. These are produced, as explained before, to keep the scanning device of the television receiver in step with that of the television camera. Accordingly, every time one of these *blankouts*, as they are termed, occurs, a synchronizing impulse is added to the signal coming from the signal plate. These synchronizing impulses are created by a special signal generator which also controls the production of the currents for the sweep circuits and the negative impulses applied to the grid.

The television camera also includes amplifying circuits which act upon the picture signal coming

from the camera tube. A number of amplifying tubes are used to increase the signal; two or three such tubes are mounted in a metal box located inside the camera. They are so arranged that the connection from the signal plate to the grid terminal of the first tube can be very short. The signal leaves this first amplifier circuit through a special wire, which will be described later, and is led to other amplifiers where the strength of the signal is still further increased. The synchronizing impulse is added to the signal by causing this impulse to affect one of the grid circuits in the amplifier before the signal is completely amplified, preparatory to using it to modulate the carrier wave for transmission through the television channels.

In a well-equipped studio the television camera is set up on a *dolly* (figure 36), which is a support on wheels, so that the camera can easily be moved around the studio. The dolly carries a seat for the operator, who must continually watch the focus of the image in the camera and keep the lens pointed at the scene being televised.

In photographing the scene for television by a camera containing the iconoscope type of camera tube, the object field is projected upon the light-sensitive mosaic—creating there a corresponding electric image which is scanned by the electron beam



Courtesy General Electric Company

FIG. 36—Television Camera mounted on a dolly. A studio crew in action at the General Electric Company.

emitted by the electron gun in the camera tube. Variation of the currents in two sets of deflecting coils controls the horizontal sweep of the electron beam as well as its vertical movement, resulting in a line-by-line scanning of the entire image. As this scanning is taking place, varying discharges between the light-sensitive globules and the signal plate produce a series of electric impulses, each corresponding to the light value of one picture element. These impulses leave the signal plate and pass out of the camera tube and through the first amplifier which is inside of the camera.

Coaxial Cable

The electric impulses produced in the television camera and amplified in this first amplifying circuit leave the camera by a special wire known as a *coaxial cable* (figure 37). A special kind of wire is needed for transmitting television signals since, because of their high frequencies, they tend to radiate from an ordinary wire just as a carrier wave radiates from the broadcasting antenna. A coaxial cable consists of a central wire, or conductor, through which the television signals travel, and an outer tubular shield which is kept equidistant from the conductor in the center. This shield, or hollow metal tube, prevents the loss of the signal by radiation and at the same

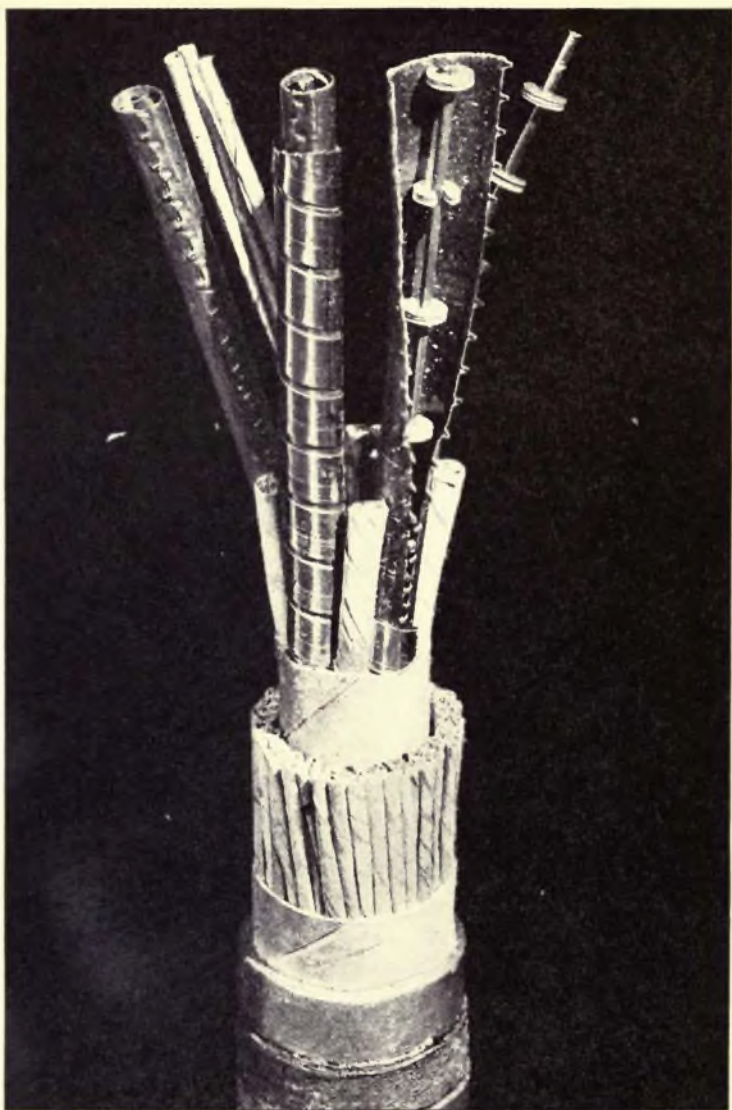

Courtesy Bell Telephone Laboratories

FIG. 37—Television by wire. A cable dissected to show three coaxial cables, used in television signal transmission; also internal construction.

time prevents outside interference from affecting the signal.

Wherever a television signal has to be sent through a wire (as from the camera to the transmitter, or in telephone-television) coaxial cable gives the best results. At present, since it is expensive to manufacture, this fact has limited the transmission of television to any great distance by wire.

Television over an all-wire circuit had its longest-distance public demonstration in January, 1941, when a program taken from motion-picture films was transmitted from Bell Telephone Laboratories in New York over a coaxial cable to Philadelphia and back to the Hotel Pennsylvania in New York. The demonstration allowed observers to compare the scene transmitted over a 190 mile loop of coaxial cable with the same scene locally transmitted across a few miles in New York City. The scenes were reproduced on a special television receiver tube developed in the Bell Telephone Laboratories; when viewed from the usual distance, the difference between local and long-distance cable transmission was imperceptible.

Between Philadelphia and New York there are two coaxial cables inside a single lead sheath. This was installed in 1936 by the Bell Telephone System for use in its experiments primarily on the transmission

of speech but also on the long-distance transmission of television signals. One of these coaxial cables was used to transmit television views of the Republican Convention of 1940 from Philadelphia to New York. Each of the coaxial cables consists of a copper tube about the size of a lead pencil with a copper wire running through it and held centrally in it by disk insulators less than an inch apart. As the signal travels along the coaxial cable it becomes weaker and weaker, so that every five miles along the line there is a three-stage vacuum-tube amplifier. These are required because the loss of signal strength is so great for these high frequency television signals.

Even with these difficulties, the use of coaxial cable may make possible wire-television hookups between studios and locations in the field or between transmitting stations and theaters within a few-hundred-mile radius, as was proved to be feasible in the Bell Telephone demonstrations described in the preceding paragraphs.

The Orthiconoscope

A more recent improvement of the iconoscope is the orthiconoscope, sometimes called simply an *orthicon* (figure 32 B). In this tube the image is projected

upon one side of the light-sensitive mosaic while the electron beam scans the other side. Because of this arrangement the odd shape of the iconoscope has given way to a simple straight cylindrical tube four or five inches in diameter. At one end of the tube is the electron gun, while at the other end is the mosaic; the latter is translucent so that light projected against the outer side shines through the mosaic and affects the light-sensitive globules on the other side. Unlike the iconoscope, the electron beam is focused to a point by means of a magnetic field produced by a coil surrounding the tube. The vertical movement of the beam is controlled by a set of coils on the outside of the tube which produces a magnetic field under control of the vertical-sweep circuit. Horizontal deflection is brought about by a pair of horizontal plates which are mounted inside the tube and are given certain potentials which are controlled by the horizontal-sweep circuit. These plates and coils, acting upon the electrons simultaneously with the focusing coil on the outside of the tube, bring about horizontal sweeps across the mosaic accompanied by a slight vertical movement between lines. The orthicon is more sensitive than the iconoscope, and therefore requires less light upon the subject being televised.

The Image Dissector

The instantaneous type of camera tube, as represented by the Farnsworth image dissector (figure 38), operates on a slightly different principle than that of the iconoscope or orthicon. At one end of a cylindrical glass tube is a photoelectric cathode upon the inner side of which an image of the object field is projected by means of the usual lens system. This image is projected through the other end of the tube. The cathode is a metal plate with a light-sensitive surface, much the same as the photoelectric cathode in an ordinary photoelectric cell. It is given a negative potential, and electrons are emitted from it in response to various light intensities projected upon it. The number of electrons leaving any point on this cathode is dependent upon the amount of light associated with any one picture element at that particular spot.

A coil is placed around the tube to produce a constant magnetic field within it. This coil is designed so that the electrons leaving the cathode are not focused to a point, as they are in the iconoscope, but are projected in such a way that, at an imaginary plane in the other end of the tube, there is an invisible electron image of the scene being projected upon the photoelectric cathode (figure 39). The number of electrons

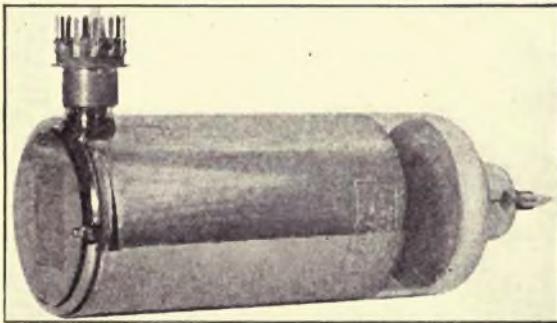
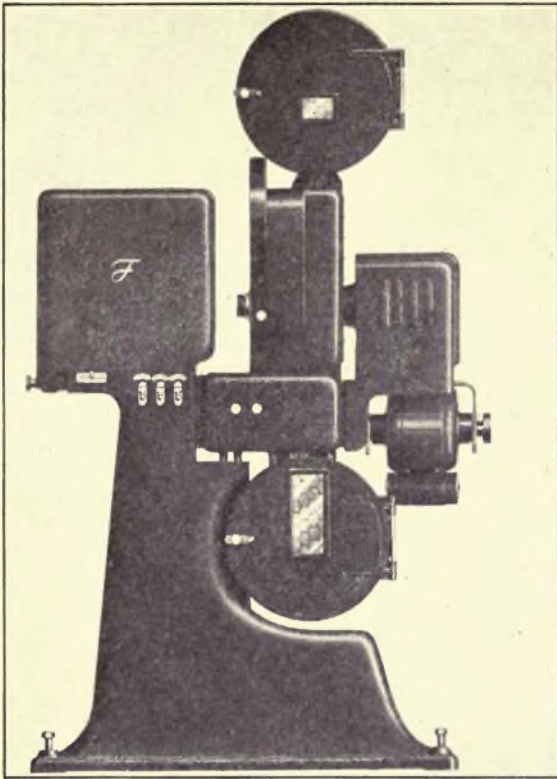

Courtesy Farnsworth Radio and Television Corporation

FIG. 38—(Top) motion picture scanner developed by Farnsworth. (Below) the image dissector type of camera tube.

passing through any point of that plane is proportional to the light falling on a corresponding point of the cathode. In this plane, with its invisible electron image, is a small fingerlike structure with a tiny hole

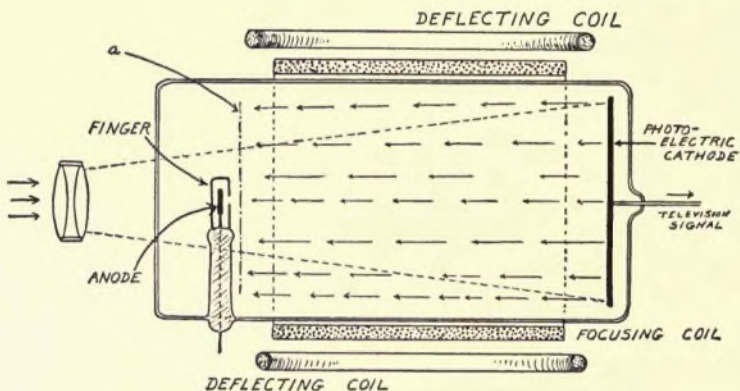

FIG. 39—Diagram of the Image-dissector type of camera tube. At (a) is the invisible electron image plane, formed by the electrons leaving the light-sensitive cathode at the right-hand end of the tube. The focusing and deflecting coils are outside of the tube.

in it, facing the cathode. Within the finger is an anode which is given a positive potential. Electrons do not stop at the plane, but go racing by—unless they are intercepted by some obstruction in their path. The finger forms such an obstruction, stopping some of them; but electrons from only one point on the cathode can pass through the hole in the finger and reach the anode within it.

On the outside of the tube are arranged other sets of coils similar to those around the neck of the iconoscope. One set, when supplied with certain current impulses, causes the entire electron beam and the complete electron image at the plane of the finger to sweep back and forth across the finger. This permits the electrons coming from one line of the image to pass through the hole in succession, striking the small anode inside. This anode acts like the plate of a vacuum tube, and in the plate circuit a series of impulses, corresponding to the light values of the particular line of the image, is produced. The other set of coils causes the electron image to move up and down at a slower rate—with the result that, each time the entire beam sweeps across the finger, electrons from a different line of the image pass through the hole, so that the lines of the image are scanned in sequence.

In the iconoscope an electron beam which is focused to a fine point sweeps across the light-sensitive mosaic to scan the image which is temporarily stationary upon it. In the image dissector just the opposite takes place: an electron image is caused to sweep across the hole in the finger with its stationary anode. The result is the same in either case, since an electric image—the invisible counterpart of the visual image—is translated into a sequence of electric im-

pulses whose strength varies with the light value of the picture elements. Either type of tube may be used in a television camera, although the iconoscope seems to be more sensitive in picking up actual scenes.

Film Scanners

So far we have considered only the televising of actual scenes and object fields, but these are not the only subjects suitable for television. Motion-picture film offers a rich and convenient source of material for television programs; for this reason, *film scanners* are important forms of television cameras.

In using the television cameras previously described, the amount of light on the scene is a vitally important factor. Outdoor scenes require good daylight conditions, while indoor scenes must be brightly illuminated by powerful lamps. This problem does not arise when film scanners are used, because any amount of light can be provided to shine through the film into the television camera.

One obstacle which had to be overcome before standard motion-picture film could be broadcast by television involved the different rates of projection. In commercial motion pictures the film is run through the projectors so that twenty-four different images are projected upon the screen in a second. The present television system, on the other hand, scans at the rate

of thirty complete images per second. It is not practicable to run the film faster, thus giving thirty pictures a second, because that would make the action too fast and would also make the sound which accompanies the picture high-pitched and strange. This problem has been solved by scanning one frame of the picture twice, the next one three times, the next one twice, the next one three times, and so on. With this arrangement, although the film is moving through the machine at the rate of twenty-four pictures a second, the scanning rate is thirty interlaced pictures a second.

An ordinary motion-picture projector is used for this purpose (figure 40), but the shutter which cuts off the picture from the screen when the film is being moved is replaced by a different one. This new shutter shortens the time during which each picture is projected to a very brief interval, and then provides a much longer period of darkness. This film scanner is used in conjunction with an iconoscope which, as we have discovered, has an ability to retain the impression of the picture. The picture is projected from the motion-picture machine directly into the television camera and upon the light-sensitive mosaic. An image is flashed upon the mosaic, and this is followed by the interval of total darkness when the shutter cuts off the light. During this dark period the electron beam

scans the mosaic. Before the film has moved in the projector, the same picture is flashed on the mosaic again and the scanning repeated during the dark period. During this second interval, however, the film

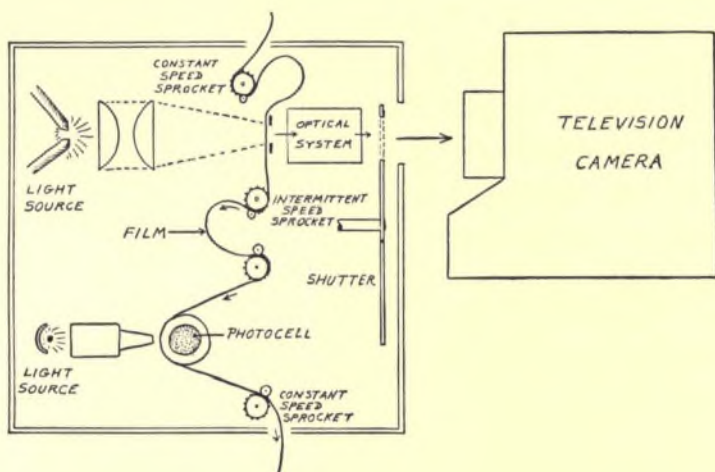

FIG. 40—Use of a film-scanner in converting motion picture scenes into television images. The motion picture projector is outlined in section view at the left.

is moved into position to project the next picture. This next picture is then flashed onto the mosaic and the mosaic scanned while the shutter cuts off the light. This happens twice more before the film is again moved to bring the following picture into position for projection. Thus the film is moving no faster than in ordinary motion-picture projection, but the scanning

is going on at the usual television rate of thirty interlaced images per second.

There is another type of film scanner in which the film moves continuously through the machine, instead of intermittently as in the customary motion-picture projector. In this special machine, disks with moving lenses compensate for the continuous movement of the film; so, even though the film is moving, an image of one picture remains stationary on the light-sensitive element of the camera tube long enough to be scanned twice—after which the second picture remains stationary so that it can be scanned three times. This type of film scanner can be used with an instantaneous type of tube such as that designed by Farnsworth (figure 38). The resulting television picture produced by either machine is practically the same, although the latter uses a special machine for handling the film while the former makes use of a standard projector.

Film scanners are standard equipment in television studios, in addition to the usual direct pickup cameras. With their use television programs can be shifted from living entertainers and actual scenes to motion-picture features, as the studio director sees fit.

Chapter Six

THE PICTURE GOES ON THE AIR

IN THE preceding chapters we have considered what happens during the process of translating the light values of a scene into a sequence of electrical impulses or television signals. At this time we shall see what other details there are which ensure the sending of a television program through the air.

The Television Studio

The well-equipped television studio is a large room, preferably with a high ceiling and plenty of space for placing the necessary scenery and props used in creating the various television scenes (figure 41). The central part of the floor is kept as clear as possible to permit the ready shifting around of the television cameras on their easily rolling dollies. Various lighting fixtures are suspended from the ceiling,

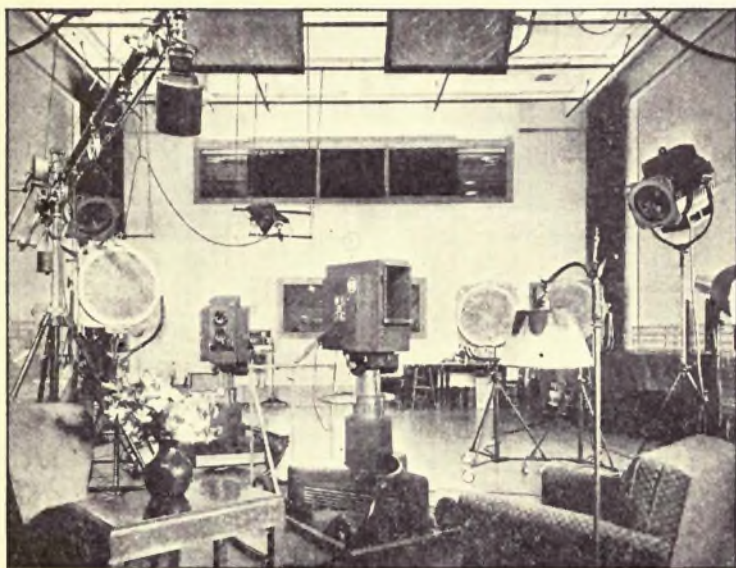
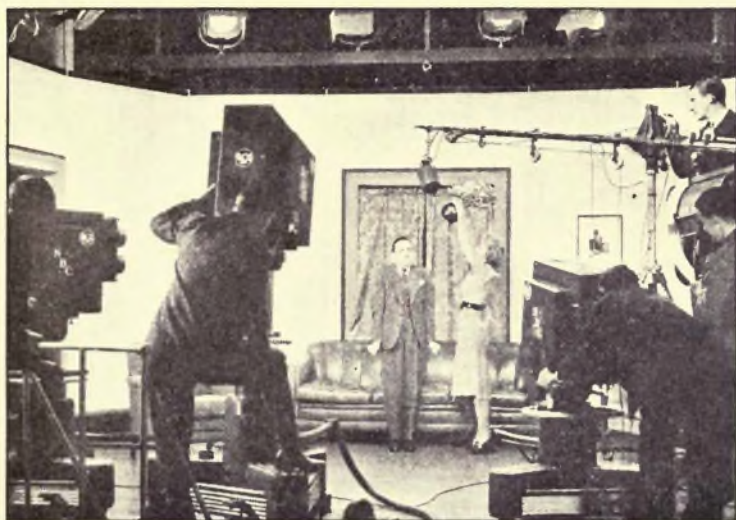

Courtesy National Broadcasting Company

FIG. 41—Television Studio at National Broadcasting Company, New York.

capable of lighting up brilliantly the different sets in any desired manner; they are so arranged that the set may be lighted from any direction, according to the effects desired in the picture. In early studio lighting, lamps which produced intense and uncomfortable heat had to be used. Recent improvements have included fluorescent lighting and mercury vapor lights, the latter having been developed by General Electric Company (figure 42). The newer types of studio lights improve the character of the television picture, and make televising more comfortable for the actors.

At the end of the room a balcony, where the control apparatus is located, is separated from the studio proper by plate-glass partitions which prevent noises from interfering with the sound accompanying the scene being televised. The walls and ceiling of the studio are soundproofed to prevent the echoing of the sound accompaniment and to deaden the sounds of other activity in the studio when the picture is being televised.

There are usually about three television cameras in the studio—for convenience numbered 1, 2, and 3. These cameras are connected by flexible coaxial cables to the apparatus in the control room; this apparatus includes at least one small receiver which is built into the panels of the apparatus and is called

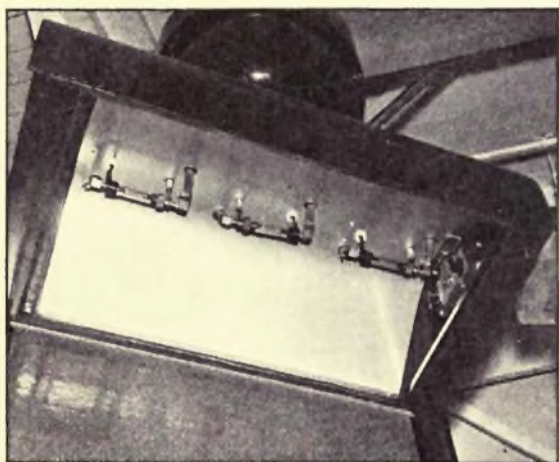

Courtesy General Electric Company

FIG. 42—Television Floodlights. New type developed by General Electric Company engineers (one held by girl) is tiny water-cooled mercury lamp producing a 1000-watt light; a marked contrast to the older type of giant studio lamps. Lower photograph shows three of these small mercury lamps in a studio floodlight, capable of producing daylight photographic conditions.

the *monitor receiver* (figure 43). The picture which appears on the television screen of this monitor receiver is the picture which is going out on the air when the circuits are closed connecting the studio

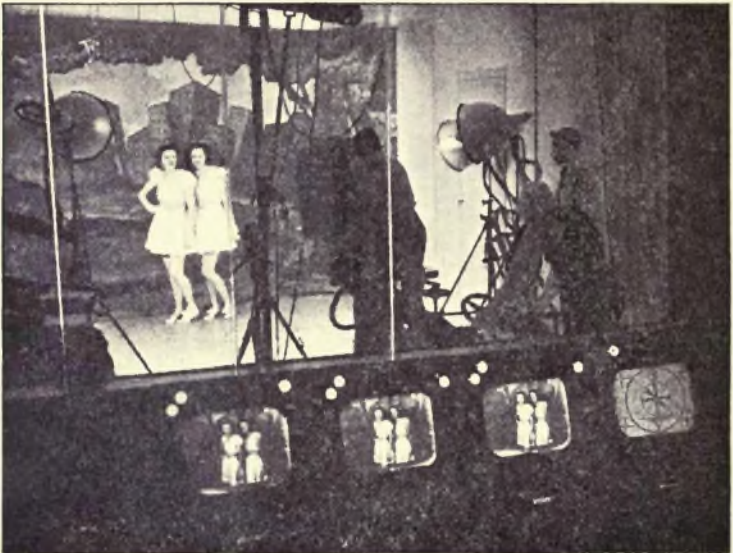

Courtesy General Electric Company

FIG. 43—Monitor receivers in the control room show the television scene as it is being transmitted, while the actual scene is visible through the glass partition.

with the transmitter. On the control board are a series of switches and rheostats by means of which any one of the three cameras can be connected to the control room and the television signal sent out. By adjusting the controls, the operator in this important room can

make the picture coming from one camera fade out while the picture from another camera is gradually brought into view.

In an adjoining room is the moving-picture scan-

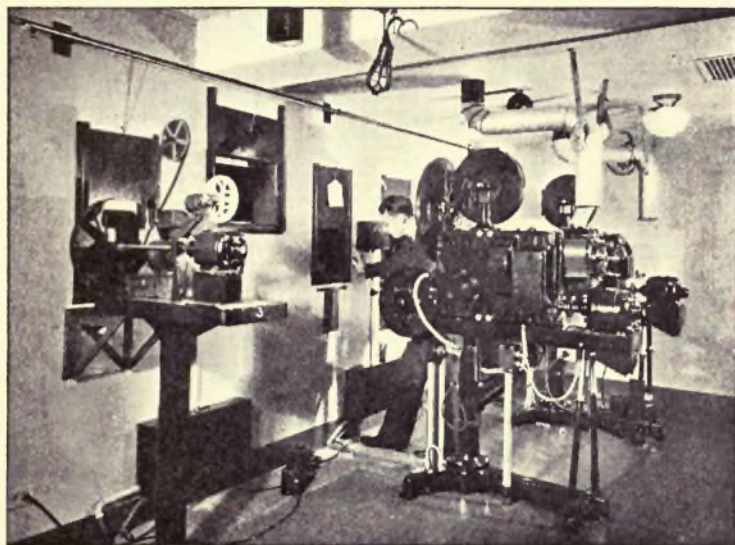

Courtesy Radio Corporation of America

FIG. 43a—A motion picture scanner (right) is an important part of a studio equipment.

ning equipment (figure 43a). This usually consists of at least two film scanners, each provided with its own television camera; these are also connected with the control room, so that they can be cut into and out of the circuit leading to the transmitter as desired.

There are, in addition, the usual microphones in

the studio for picking up the sound which is to accompany the picture; these may be suspended from the ceiling, or attached to long swinging booms so that they will not be visible in the picture. These microphones are connected to the sound-control apparatus in the control room—to enable the sound from one microphone to be faded out and that from another microphone brought in, and the strength of the sound to be adjusted to get the desired effects.

Let us imagine that a play is about to be televised. Several different sets have been arranged with appropriate scenery for the different scenes in the play, and the cameras have been rolled into position in front of the first set. Each camera has at least one operator, who keeps it pointed at the scene so that the latter is in focus upon the mosaic plate of the camera tube. Up in the control room one engineer listens to the sound with earphones, and he is ready to control the volume of the sound and cut the different microphones into and out of the circuit. Another engineer sits in front of the monitor television receiver, ready to control the intensity of the picture as well as to fade the different cameras in and out.

All of the cameras are operating, as far as the scanning operation is concerned; that is, the cathode-ray beam in each camera is sweeping across the mosaic of that camera to scan the image projected

on the mosaic. At any given instant the electron beams in the different cameras are striking corresponding points on their respective mosaics, because the sweep circuits of all are supplied with energy from a single signal generator. But the image in each camera on the studio floor will naturally be different because of the different positions of the cameras. One of the film scanners is also operating and is provided with the introductory film.

When the signal is given to commence the program, the film is started through the film scanner and the engineer in the control room switches that particular camera into the transmitter circuit. The picture on the film is now picked up by the film scanner and its camera tube, and thus converted into the television signals sent out on the air. This film usually includes some kind of signature designating the station and is accompanied by the voice of an announcer describing what the program is going to be. After this announcement has been made, the engineer at the controls gradually fades the film scanner out and at the same time connects camera number 1 in the studio and gradually increases the strength of the picture being scanned in that camera. He gets the desired effect by watching the screen of the monitor receiver. The setting of the first scene now appears in the picture with the actors, who are

at their positions on the set. They begin the action, and the microphones suspended over them pick up the sounds of their voices; this sound signal is sent out via the control room to the radio transmitter.

As the play progresses, the engineer may switch from camera 1 to camera 2, to get a different "shot" of the scene, and later may switch to camera number 3 in order to get a close-up of some actor or action. This "fading" is done so gradually that the picture changes from one point of view to another without sudden jumps or jerks.

When the action on the first set is reaching its close, one of the television cameras then not in use is rolled over to the second set and focused on that in preparation for the next scene of the play. The same procedure may then be followed as the second scene is televised, one camera being faded in and another faded out and different microphones coming into use—all controlled by the engineers in the control room.

Some such procedure as this may take place throughout the production of the television play; when it is over, one of the cameras used as a film scanner may sign off the station. Or the program may be switched to a fashion show picked up by another television camera, or to a comedy or musical "short feature"; or a moving picture may be run. Thus a

continuous program is provided as long as the television station is on the air.

The Television Transmitter

In another part of the building, or perhaps in an entirely different building, is the television transmitting apparatus. As has been explained in previous chapters, because of the very high frequencies, and therefore short wave lengths, of the television carrier waves they can be satisfactorily intercepted only at short distances from the transmitting station. Therefore the television transmitting antenna should be at the highest possible point in the region which the television station is to serve. Having placed the antenna at such a high point—for example, on the roof of a tall building—it is convenient to have the other transmitting apparatus as near it as possible. The television antenna of the National Broadcasting Company in New York City is therefore on top of the tower of the Empire State Building (figure 44) and the apparatus is on one of the floors immediately below it. The studios where the televising is done, however, are in the RCA building about a mile away. The signals are sent from the studios to the transmitting room by coaxial cable. Likewise, the studios of Columbia Broadcasting Company in New York City are in the Grand Central Station building, but

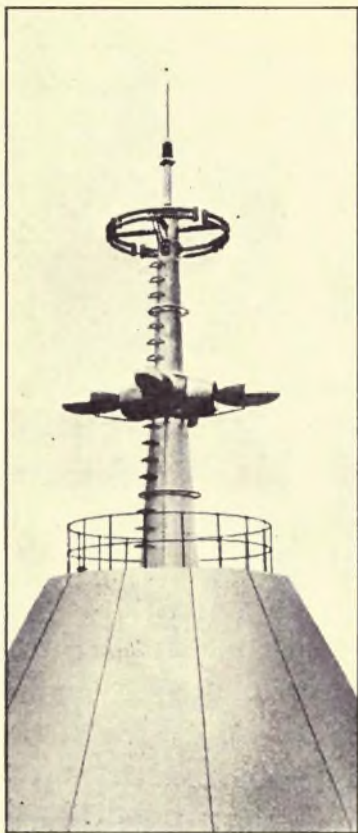

*Courtesy Radio Corporation of
America*

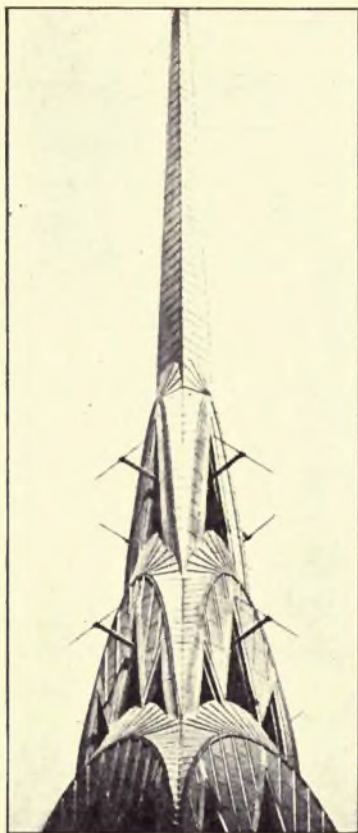

*Courtesy Columbia Broadcasting
Company*

FIG. 44—Television Transmitting Antennas. Left, that of National Broadcasting Company on top of the Empire State Building; right, that of the Columbia Broadcasting Company on top of the Chrysler Building. Audio transmitter above, video transmitter below.

the transmitting equipment and antennas are in the Chrysler Building a block away.

All of the circuits containing the transmitting apparatus are set up in racks with meters on the front

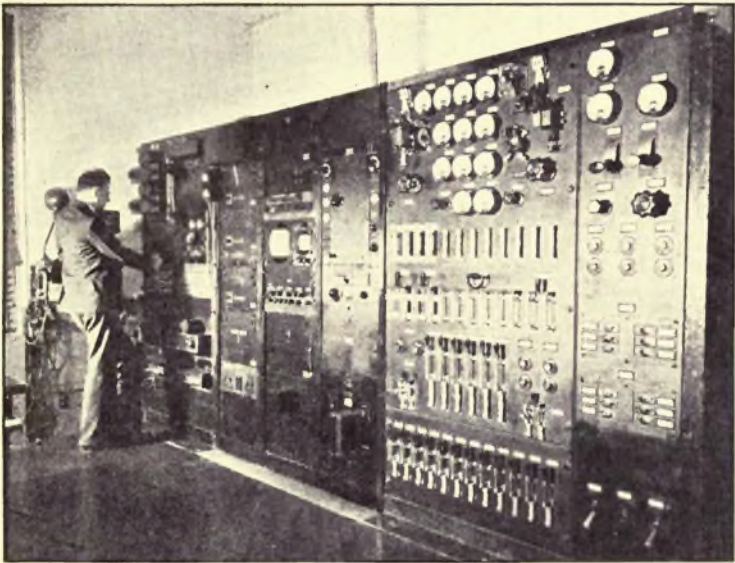

Courtesy Radio Corporation of America

FIG. 45—Television Transmitting Apparatus. Control panel in RCA's television transmitting station in the Empire State Building; the engineer is in front of the audio rack, while the third section from him is the video signal amplifier, with controlling buttons.

for indicating the voltages and currents of the various circuits, and with controls for adjusting these as well as tuning the circuits (figure 45). At the rear of the racks are doors to enable the operators to gain access

to the various circuits, change tubes when necessary, and keep the apparatus in running order generally.

The reason that the television transmitting antenna is quite different in appearance from the antennas of ordinary radio stations is because of the very high frequency of the television carrier wave. The best results are obtained when the antenna is the same length as the carrier wave. Therefore the effective parts of the antenna represent the actual length of the carrier wave. There is also a tendency for these short waves to radiate stronger in one direction than in another. For this reason there may be as many as four antennas, each sending out a wave in a different direction. With such a directional antenna, signals of considerable strength can be sent to receivers in outlying districts.

The sound accompanying the television signal is transmitted on a carrier wave of higher frequency, as will be explained in the next chapter; sometimes an entirely different antenna is used for the sound. In the transmitting antennas on top of the Empire State Building the upper structures in figure 44 are the sound-transmitting portion, while the torpedo-shaped lower structures are the television-transmitting ones. In some cases the sound and television carrier waves are radiated from the same antenna.

The television signal, as has already been stated, is

sent from the studio control room to the transmitting room by coaxial cable. After being received in the transmitting apparatus, the television impulses are put on the carrier wave and sent out into space from the antenna. At the same time the sound is sent to a separate sound transmitter, where a separate carrier wave is also radiated by the antenna system.

Television in the Field

We have thus far considered the production of a television program only from an indoor or studio location. But the program need not be confined to such scenes alone. The completely equipped television broadcasting station has mobile field units which are designed to pick up pictures of outdoor scenes, provided they are sufficiently well illuminated to be scanned by the camera tube. The Radio Corporation of America has developed and used such mobile field equipment (figure 46), housed in two large trucks which look like buses without the customary windows.

One of these mobile units carries the television cameras, of which there are at least two. One of the television cameras may be mounted on top of the truck when scenes are to be televised, and the other is connected to the truck by a long flexible cable so that it can be taken some distance from the truck. This portable portion of the field unit is of use in

picking up scenes from football and baseball fields, and various outdoor public affairs. The microphones are mounted in big sound reflectors which look somewhat like huge searchlights; these concentrate the sound waves upon the microphone which is placed at the center of the device. With such an apparatus the microphones may be some distance from the scene



Courtesy Radio Corporation of America

FIG. 46—Mobile Television Pick-up Units. The camera and transmitter trucks of RCA-NBC.

of the sound production and still pick up the sounds accurately.

In this truck are control panels similar to those in the control room of the television broadcasting

studio; through them the signals coming from the cameras and the microphones are monitored in the

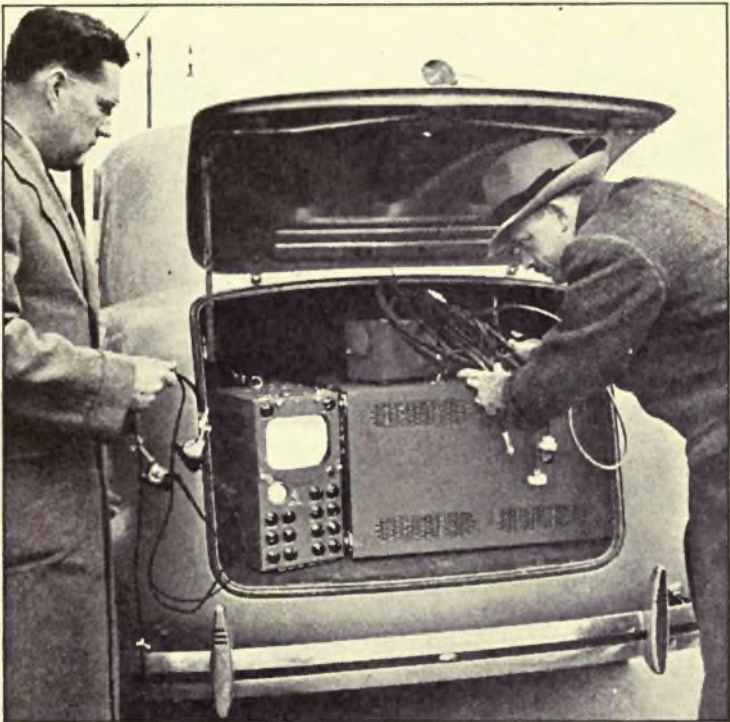

Courtesy Radio Corporation of America

FIG. 46a—Portable field unit being packed into an ordinary car compartment.

same fashion as in the studio itself. This truck also carries spare parts for all of the apparatus, as well as repair kits to enable the engineers to keep the equipment in operation under all sorts of conditions.

The other truck contains the transmitting apparatus. This consists of a portable transmitter operating at a high frequency, usually different from that of

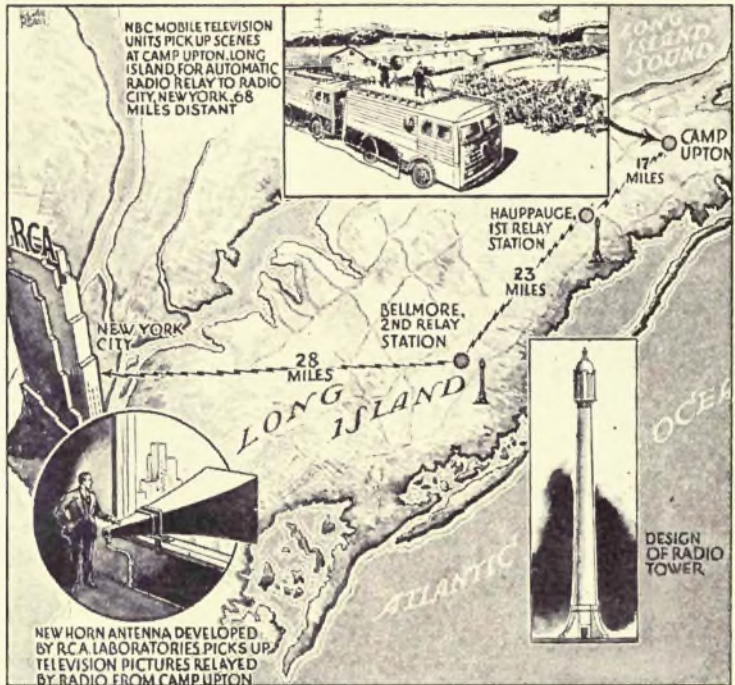

Courtesy Radio Corporation of America

FIG. 47a—Television Transmission by Relay. The relay transmission from Camp Upton, New York, to New York City.

the broadcasting station. When the truck is driven to the location where the televising is to be done, a mechanism is operated inside the truck which raises a folding antenna on the roof. After the cables from

the camera truck are connected to the transmitter, actual televising can begin. The truck carries its own generator for producing the electric energy needed

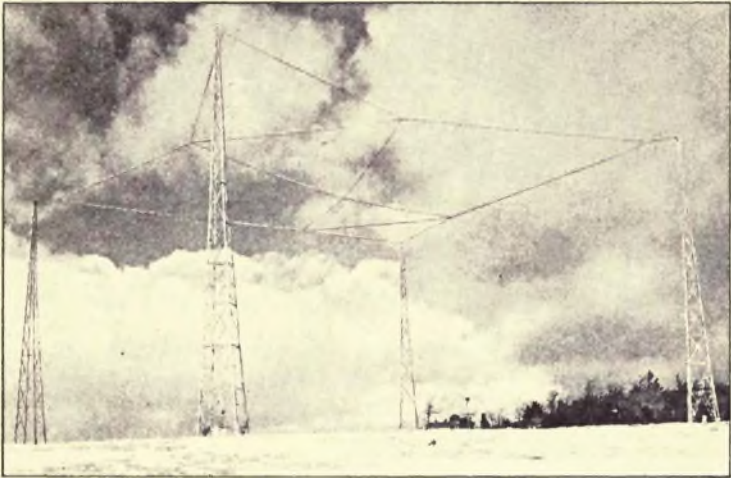

Courtesy General Electric Company

FIG. 47b—Relay installation erected by General Electric Company in the Helderberg Mountains near Schenectady, New York, capable of picking up television signals from New York City, 129 miles away.

in operating the transmitter and television apparatus. In some cases provision is made for connecting the two trucks to the city power lines, if these are conveniently located.

When an outdoor scene is being televised the cameras pick up the picture and the microphone the sound; these signals are passed through the monitor

panels in the first truck, where both are under control of the engineers; then they are sent on to the transmitter truck, where the signals are converted into electromagnetic waves and sent through the air to the main broadcasting station. This second carrier wave is then broadcast with much greater power, and can be picked up by the "televviewer" in the area served by the broadcasting station.

Television by Relay

It is obvious that the transmitter in the field unit cannot be a very powerful one, and therefore cannot be used to transmit the signal to any great distance. Its antenna, also, is not very high; this fact also accounts for the short range of the mobile transmission unit. This difficulty is overcome, however, by a relay system, which makes it possible for the field units to reproduce scenes a considerable distance from the main broadcasting station. Relay stations can be provided between the two, spaced about twenty-five miles apart. The illustration (figure 47 A) shows the arrangement of relays used for a test television transmission between Camp Upton on Long Island, New York, and the RCA building which was demonstrated to members of the Federal Communications Commission in January, 1941. The relays mounted on their towers look like lighthouses and are

entirely automatic. These pick up the signal on one carrier frequency and rebroadcast it on another frequency. During the demonstration the television signal was picked up by a special horn antenna in the RCA building and was then projected onto a screen. The normal procedure would be to pick up the signal from the last relay at the broadcasting station, which would then rebroadcast it on the regular carrier wave of that station. With such an arrangement of relays television signals could be sent from city to city, so that the whole nation could conceivably be connected for the interchange of television programs.

Chapter Seven

THE TELEVISION RECEIVER

WE HAVE now reached the final step in the television process, a step which comes closest to the experience of the owner of a television set: the recreation of the television picture in the apparatus which can detect the invisible television signals and reproduce through them the image on a screen.

The Receiving Antenna

Since the carrier waves used for television have such a high frequency, they act differently from the familiar radio waves of the broadcast band. Because the television carrier waves are reflected from hills, buildings, and other obstructions, care must be taken in the placing of the antenna if satisfactory reception is to result.

In figure 48 there is shown the relation of the position of a television antenna to the signal it is

supposed to pick up. The antenna receives the signal direct from the broadcasting station because there is nothing to obstruct the signal coming from it to the antenna. But a signal is also received from the opposite direction, this signal having been reflected from

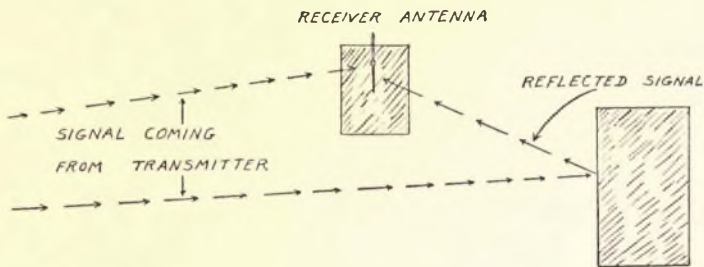

FIG. 48—Diagram showing double signal reception by an antenna; one signal coming direct from the transmitter, the other being reflected from a tall building behind the home of the viewer.

a high building located in the rear of the television receiver. The antenna will therefore pick up two signals which may be equally strong. However, it takes less time for the signal to come directly from the broadcasting antenna than for it to travel first to the tall building and then be reflected back. Therefore a line of the picture, as received directly, will be slightly ahead of the same line produced by the reflected signal. This produces two pictures spaced a little from each other, from left to right on the

television screen. Sometimes several of these “ghost” pictures can be counted on the screen, depending upon the number and strength of these reflected signals which are picked up.

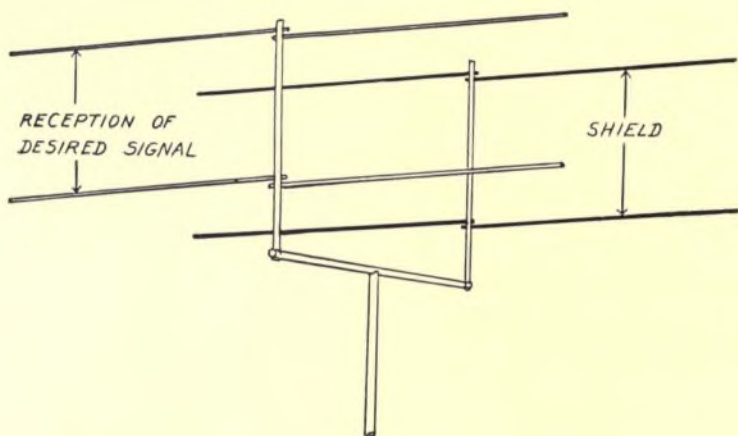

FIG. 49—A dipole television antenna, with a shield (looking like the receiving portion) to absorb unwanted signals.

In order to eliminate the unwanted signals the antenna is provided with a shield which looks exactly like the antenna and is spaced a short distance from it. The antenna itself usually consists of two rods which are mounted at the top of a pole and extend in opposite directions like the letter T (figure 49). This is called a *dipole antenna*; in use it is turned so that the rods are at right angles to the direction of

the electromagnetic waves emanating from the broadcasting station. The lead-in to the receiver consists of two wires, one connected to each rod. The two rods forming the shield are mounted in a similar fashion in back of the antenna proper. They intercept the extra signals and prevent them from interfering with the picture.

This type of antenna is not limited in its use to television alone, but is used advantageously for the reception of any carrier waves of these particular high frequencies—whether they carry picture, sound, or telegraph-code signals.

It often happens that there is some obstruction between the antenna of the receiver and that of the transmitting station, which prevents a good strong signal from being received in a direct line. In such a case the reflected signal, coming from a building or other obstruction at the rear or at one side of the antenna, may be the strongest. Then the antenna can be adjusted so that it is at right angles to the direction of the strongest signal, and the shield prevents other signals from interfering. When the signal is weak, it is often necessary to have several sets of dipole antennas mounted on the same mast; these intercept more of the carrier-wave energy and therefore deliver a signal of greater strength to the receiver.



Courtesy Radio Corporation of America

FIG. 50—Here the image is seen reflected in a mirror.

Where the signal is strong a twisted pair of wires, one connected to each rod of the dipole, may prove sufficient in connecting the antenna to the receiver. Where the signal is very weak a coaxial cable may be necessary, the inner wire being connected to one rod of the dipole and the shield to the other. The Philco Radio and Television Corporation has developed a receiver with a built-in antenna which is claimed to give good results.



Courtesy General Electric Company

FIG. 50a—Home Television Receivers of the Direct-viewing type. Here the picture is actually being seen on the fluorescent surface of the cathode ray tube.

General Plan of the Receiver

It is important that the transmitter at the television broadcasting station send out as perfect a picture as

possible, because the receiver can pick up no picture better than the transmitter sends out upon the air waves. To do so, the broadcasting station spares no expense in the manufacture of the transmitting and televising equipment, since one transmitter can be owned by a large company serving a great number of receivers.

On the other hand, the success of television from the viewers' angle will depend upon the manufacture of a receiver which will be reasonably inexpensive, so that it will be within the means of the average person. In addition the receiver will have to be simple to operate, because the majority of users will know little about the various circuits involved and the function of the various parts. The ideal television receiver will be one that is both inexpensive and foolproof (figure 50).

The Picture Tube

The receiver which at present seems likely to meet the requirements stated in the previous paragraphs is one which contains a cathode-ray tube as the device for reconstructing the television picture. There are no moving parts in a cathode-ray picture tube, and consequently there is nothing to produce mechanical wear and nothing to oil and clean. At the same time the cathode-ray tubes are simple in construction and

can, in the future, be manufactured cheaply in large numbers.

This picture tube—termed a *kinescope* by the engineers at Radio Corporation of America—is a funnel-shaped glass bulb from which the air has been exhausted (figures 51 and 52). One end has a narrow neck, while the other end is flared and flattened. In the neck of the picture tube is the electron gun. The inner surface of the flared end is coated with a fluorescent material which gives the effect of a grayish-white screen. It is on this screen, in the direct-viewing type of home television receivers, that the picture is observed.

The electron gun of the picture tube is much the same as that in the camera tube (see page 108). It has an electron-emitting cathode with a series of anode rings which are given positive potentials and have the power to focus the electron beam down to a pin point on the fluorescent screen. A grid is placed between the cathode and the anodes, to control the intensity of the electron stream. When this grid is made sufficiently negative, no electrons strike the fluorescent surface of the tube; but when the potential of the grid is changed to the positive, a large number of electrons strike the surface.

This fluorescent coating has the property of emitting light when struck by electrons. Thus when a

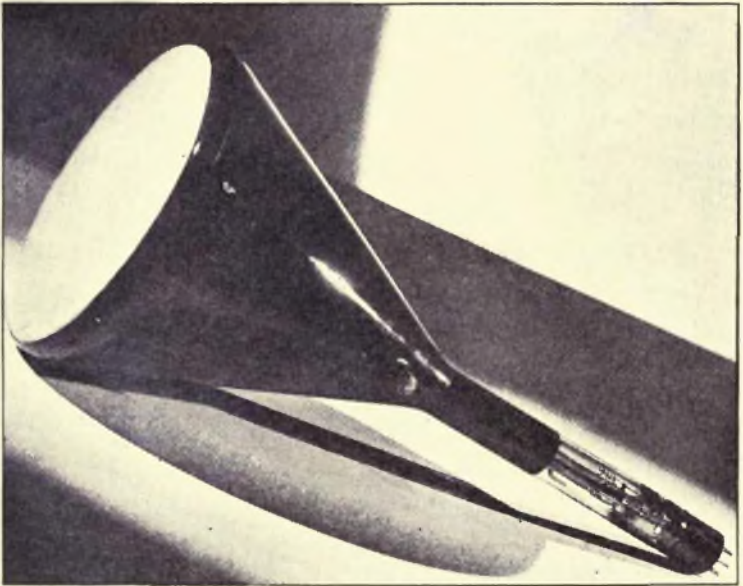

Courtesy Radio Corporation of America

FIG. 51—The heart of the television receiver is the kinescope or picture tube, two types are illustrated.

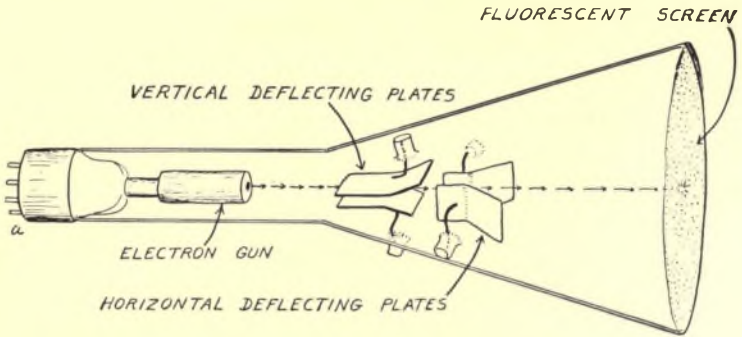

A

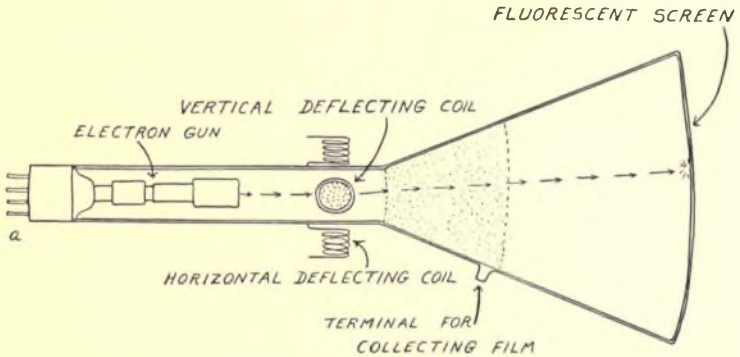

B

FIG. 52—Cathode ray tube used to produce television picture in the receiver. A, represents the type using electrostatic deflection; B, the type using electromagnetic deflection. The electron beam, produced in the electron gun at the left of the tube, creates a rapidly moving spot of light upon the fluorescent surface at the opposite end of the tube, thus building up the television picture. At (a) are the connections for the anode, cathode and grid.

stream of electrons strikes the surface, a spot of light appears whose intensity depends upon the number of electrons in the beam. The number of electrons, or strength of the electric current, is in turn dependent upon the potential of the grid. And, as we have just said, when the grid is very negative the electrons are prevented from reaching the screen; the result is little or no light on the fluorescent surface, which therefore appears dark. When, on the other hand, the grid swings toward the positive, the number of electrons reaching the screen increases and a spot of light appears which increases in brightness as the grid becomes more and more positive. The electron beam therefore has the power of creating a spot of light which can vary in brightness from black to white.

This electron beam is made to scan the fluorescent screen in the same manner as that used in the camera tube. A vertical magnetic field and a horizontal magnetic field, extending through the neck of the tube, are produced at right angles to each other by means of coils of wire which are connected with the sweep circuits. The vertical field is caused to increase at a definite and uniform rate, and then to suddenly decrease; this brings about a movement of the beam across the screen and then a rapid return to the starting point, thus completing the scanning of one

line of the picture. This increasing and decreasing of the current is repeated at an exceedingly rapid rate, so that there will be a definite number (at present, as we have seen, 525) of horizontal scanned lines in one-thirtieth of a second. While this is happening, the horizontal magnetic field goes through the same increasing and decreasing process but at a much slower rate, controlled by the current from the vertical-deflection circuit. This brings about a vertical movement of the electron beam so that the horizontal lines of the picture appear one below the other in regular sequence.

The control of the electron beam in this type of receiver tube is accomplished in the same fashion as it is in the camera tube, by means of magnetic fields controlled by sweep circuits. Some cathode-ray picture tubes, however, have a different arrangement for controlling the scanning beam. The control previously described is known as *electromagnetic deflection*, while the other method is called *electrostatic deflection*.

If a plate, placed in the neck of the tube, is parallel to the wall of the tube and the path of the electrons, as the latter shoot by it they can be made to swing toward the plate or away from it by varying the potential on that plate. If the potential is negative the beam of electrons will be repelled from the plate,

while if it is positive the electrons will be attracted toward it. Two parallel plates are therefore inserted in the tube, arranged vertically one at each side of the neck, so that the electrons must pass between them. By varying the potential of these plates, the beam of electrons can be made to sweep horizontally across the fluorescent screen. In like manner a pair of horizontal plates are placed in the neck of the tube, one above the other so that the electron stream must pass between them also. By controlling the potentials of this second pair of plates, the electron beam may be made to swing up or down—bringing about a vertical movement of the scanning beam.

With the electrostatic method of beam control, the deflecting plates must be built into the cathode-ray tube. This makes the tube more difficult to manufacture, as well as more expensive. This method also increases the cost of the electrical operation of the receiver, since it requires higher voltages for the plates.

Other Elements in the Receiver

The various elements in a cathode-ray television receiver are illustrated in figure 53. First there must be a station selector to pick up the signal being transmitted through the air. This is so arranged that it can pick up both the television carrier wave, with its

signal, and the sound carrier wave with its modulations; the latter, as we have seen, is higher in frequency than the television carrier. This first unit of the receiver separates the television and sound

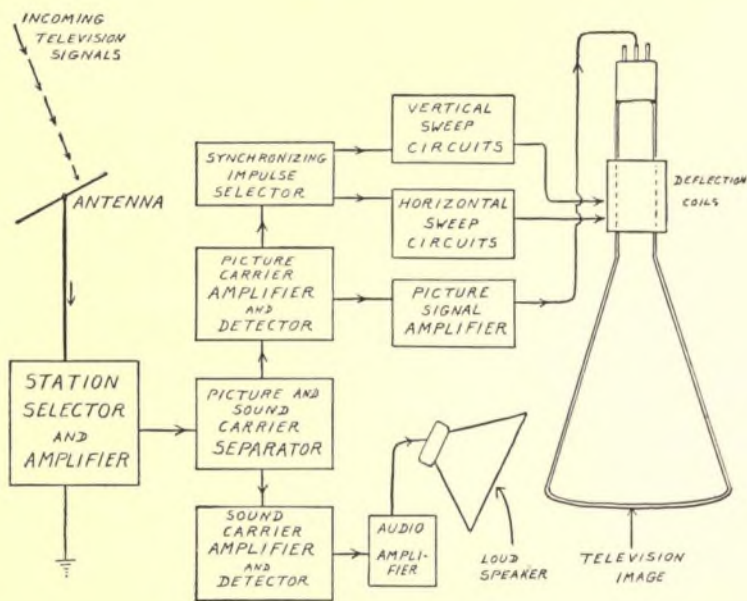

FIG. 53—Plan of a television receiver.

signals from their respective carrier waves. The picture signal passes through amplifying tubes and eventually reaches the grid of the cathode-ray tube. As the impulses come in, each corresponding in intensity to the light value of a picture element, the grid

of the picture tube is changed in potential accordingly, increasing or decreasing the brightness of a spot of light on the fluorescent screen.

The horizontal synchronizing impulses and the vertical synchronizing ones are separated from the picture signal, and pass into separate circuits where they are amplified and transformed into the currents which are fed to the magnetic deflecting coils around the neck of the picture tube. Through them these synchronizing currents control the magnetic fields, which in turn direct the movement of the beam of electrons as it moves over the fluorescent end of the picture tube.

The deflecting circuits under control of the synchronizing impulses keep the electron beam of the receiver exactly in step with the beam in the tube of the television camera at the broadcasting station. At the same time the picture signal, acting upon the grid of the tube, makes each spot of light on the fluorescent screen correspond with the amount of light on the corresponding spot of the camera-tube mosaic. Thus the picture is reconstructed before the observer's eyes on the exposed front of the tube. The moving spot of light travels so quickly that there appears to be a continuously lighted image on the picture tube.

The sound signal, in the meantime, after having been separated from its carrier wave, is amplified in a separate circuit. From it the impulses are delivered to a loud-speaker in the same manner that this is done in an ordinary radio set.

The largest piece of apparatus in a cathode-ray television receiver of the direct-viewing type is the picture tube itself. Thus the receiver cabinet has to be constructed to conform to the size and shape of the tube. A picture tube which has a fluorescent surface about nine inches in diameter has a length of about twenty-four inches. If such a tube is mounted horizontally in the cabinet, so that the observer looks directly at the large end of the tube, the cabinet has to be so deep that it makes an awkward piece of furniture. Some manufacturers solved this problem by mounting the tube in an upright position and providing a hinged top for the cabinet which can be raised at an angle of forty-five degrees; on the inside of the top is a mirror in which the observer sees a reflection of the image on the fluorescent surface of the tube. This gives the same effect as having the picture screen directly in front of the viewer. On the other hand, a smaller picture tube can be placed horizontally in the television set without detracting from the appearance of the cabinet.

Attempts of cathode-ray-tube manufacturers to increase the size of the screen end of the tube without increasing the length have met with some success. The Allen B. Dumont Laboratories, for instance, have produced a tube twenty inches in diameter, which is no longer than the nine inch tube referred to above and on which may be seen a picture eleven by fifteen inches (figure 54).

The loud-speaker is usually placed below or at one side of the image screen, and the other electrical circuits are built into units disposed in the most advantageous positions around these two larger pieces of television apparatus.

Television Receiver Controls

There are a number of necessary controls on the front of the present type of television receiver. Most important of these is the tuning control. The picture is tuned in just as a sound program is tuned in, on the familiar radio. As the dial is turned the picture gradually appears on the screen, increases in brightness, and then fades away again as the tuning dial passes by the station's channel. The receiver is properly tuned when the picture appears the brightest. Since the sound carrier is always spaced the same distance from the picture carrier wave, the tuning for both may be controlled by a single dial. Thus as the

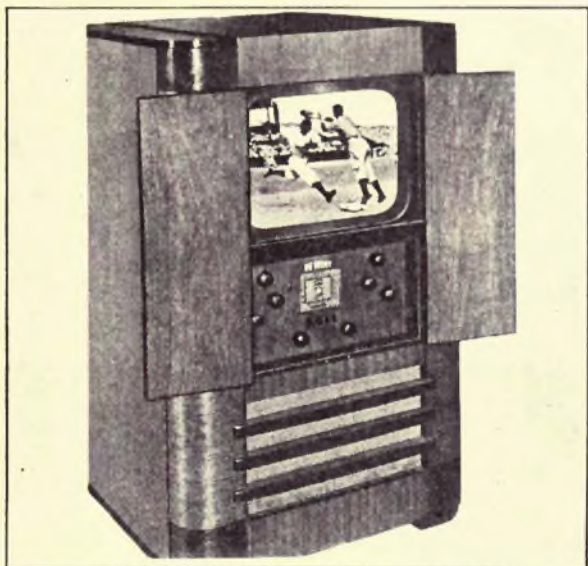

Courtesy Allen B. Du Mont Laboratories

FIG. 54—(Top) two giant cathode ray picture tubes, producing a 15-inch and a 12-inch picture, respectively. (Below) home receiver with one of the large tubes.

picture gradually appears, the sound also becomes louder and louder; in fact, it may be used as a gauge to determine when the receiver is properly tuned.

Another control regulates the brightness of the picture. A receiver very near the television broadcasting station has to keep the brightness control at its lowest point, while a receiver some distance from the station has to keep the brightness control at its maximum. This control corresponds to the volume control in the usual radio set. There is, of course, a control for the volume of sound also.

Another control takes care of the framing of the picture, so that it can be adjusted to fit the fluorescent screen. This adjustment ordinarily does not have to be made very often.

Two additional controls are those which determine the horizontal and vertical synchronization. While the television industry has adopted certain standards for television, there may well be several stations broadcasting on slightly different standards of scanning. In other words, the number of scanned lines in the picture and the number of pictures scanned a second may vary for different stations. As it is, if these standards of scanning do not differ too much, it is possible to adjust the synchronization controls to agree with the standards of a particular station. This

is done by tuning the synchronization controls to the proper synchronizing frequencies.

From this it can be seen that the operation of a television receiver will not differ greatly from that of the customary radio receiver. A front panel with the various controls centrally located will offer a minimum of difficulty to the inexperienced televiewer. Anyone in the home can sit down in front of the television receiver and in a few seconds have the picture and the sound "tuned in," bringing the latest in electrical communication into the family circle with little need for special skill in operating the receiver.

The Projection Receiver

With the direct-viewing type of television receiver just described, there are certain limitations. Only a few people can see the picture at the same time, and the picture itself can be of only relatively small size. This is no handicap for a home television set, but for larger groups and for theaters a larger, brighter image is essential. Screen-projected television images have been attempted by many different methods, as was pointed out in Chapter Two. Very recently the cathode-ray tube has been developed so that it can be used for screen projection.

The cathode-ray projection tube is quite like the

tube already described, except that it is smaller and requires more power to operate it. With this tube an optical system is used to project the image which appears on the fluorescent portion of the tube, onto a large screen. In order to make this possible, the image as it appears on the tube itself must be very much brighter than the image on the ordinary picture tube. For this reason much more power is required to operate a projection tube. The illustration (figure 55) shows one of the RCA experimental tubes which has not yet been placed on the market, and also a home receiver arranged to use one of these projection tubes. The lid of the receiver is raised at an angle of forty-five degrees, which also raises the screen; and a mirror on the underside of the lid reflects the projected image to the screen from the vertically mounted projection tube.

While many television engineers favor the cathode-ray receiver, there are also those who are as enthusiastic over mechanical systems. The only mechanical receiver which appears able to compete with the cathode-ray type in quality and brightness of picture is the Scophony receiver, described in Chapter Two. These were in operation in England for several years before the outbreak of the Second World War, and during that time produced a much larger picture than the cathode-ray picture tubes. The Scophony company

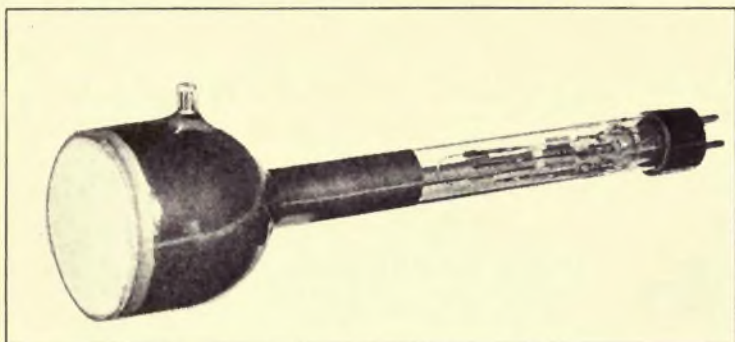

Courtesy Radio Corporation of America

FIG. 55—(Top) a television projection tube. (Below) television picture produced by a projection tube upon a 13x18 inch screen, after magnification by means of a lens system.

demonstrated excellent pictures on a full-size theater screen before members of the Federal Communications Commission in January, 1941. The same apparatus was used which had previously been in

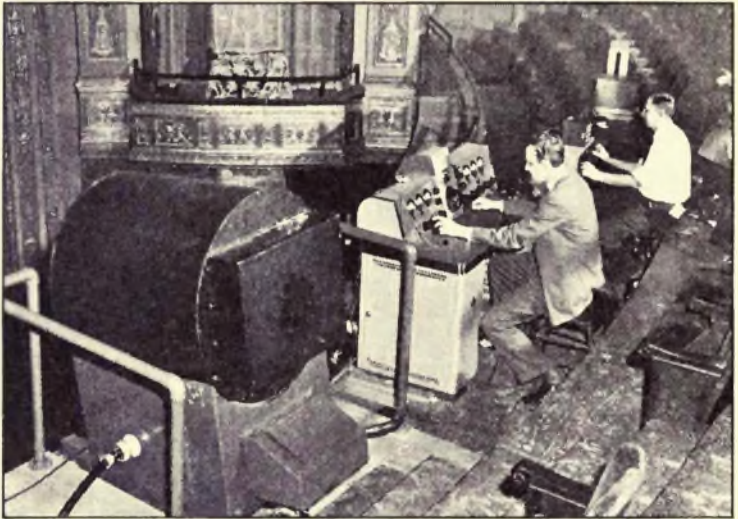

Courtesy Radio Corporation of America

FIG. 56—Television projection equipment installed in the balcony of the New Yorker Theatre, the steel-jacketed projector in the foreground, the control desk to the right.

operation in England, to project theater-size screen pictures.

However, the projection-type cathode-ray tube has also been used to demonstrate television pictures on a theater screen. Radio Corporation of America made such a demonstration before the same Commission

in the same month, at the New Yorker Theater in New York City. Figure 56 shows the projection apparatus set up in the balcony of the theater, and figure 56a an artist's conception of the television program.

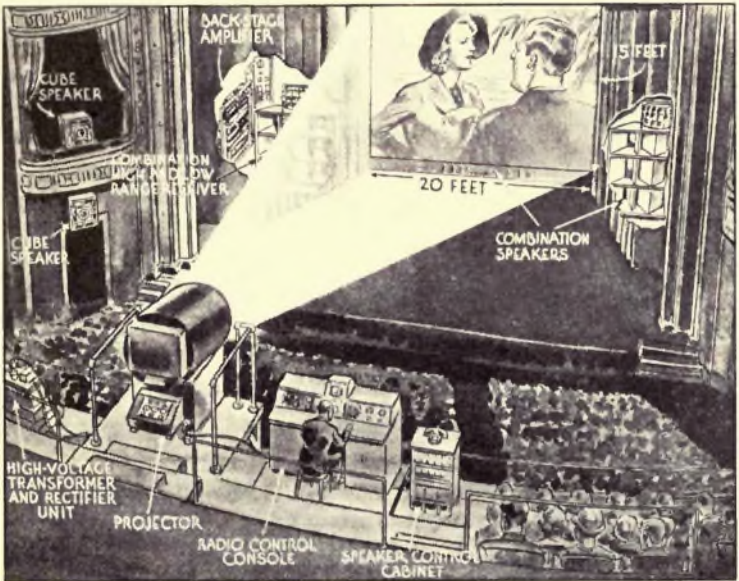

Courtesy Radio Corporation of America

FIG. 56a—Theater television projection becomes a reality with the equipment developed by RCA Laboratories, producing a 15x20 foot screen picture.

Chapter Eight

THE FUTURE OF TELEVISION

WHAT will television be like in the near future? How widespread will be its use? When will a television set become commonplace in every home? These and many other questions come to our mind when we consider the probable development of this as yet youthful invention. These are questions which no one can answer definitely, for it is impossible to foretell what unexpected discoveries may appear to alter the present trend in television practice.

It would have been a wise man, indeed, who, watching Ford and Haynes and Duryea noisily creeping about in their awkward horseless carriages, could have predicted that less than fifty years later there would be several million automobiles on the highways of this country alone and that such automobiles would be made in quantity cheaply enough for almost every family to own one.

No one could imagine, in the days when Bell, Berliner, Edison, and others were struggling with the first crude telephones, that seventy-five years later almost every home would have its telephone and that telephone conversations between distant cities, and from continent to continent, would be within the reach of everyone.

And in the early days of radio—not so many years ago—when one had to wear earphones to listen in on crude programs, with homemade receivers, who could have predicted what radio was to become within a decade? Many competent persons considered it a fad and were sure that the public would soon tire of its novelty. It would have taken a person with unusual imagination and foresight to look ahead and see not one, but several, factory-built receivers in every home and a radio in almost every automobile and to visualize millions of men, women, and children spending hours each day listening to every conceivable kind of program.

This list of inventions could go on and on: airplanes, Diesel engines, motion pictures. As each was in its infancy, who dared predict the importance of the invention before it became perfected for public use?

Perhaps because television is the little brother of radio, and the first cousin of motion pictures, we can

with a little clearer insight predict what will happen to it in the immediate future. At any rate, we know of some of the plans and hopes that its many parents have for it and we can estimate the worth of the trends in the great research laboratories where experimentation is constantly going on. The result will be a guess as to what improvements are likely to take place mechanically in the design of television cameras, transmitters, and receivers. But in addition to such technical advances associated with the television apparatus itself there will be improved techniques of broadcasting, the ever-widening field of potential television material, and the ever-increasing uses to which television will be put.

Television Transmission of Tomorrow

It seems probable that television scanning will continue to be of the electronic type; its superiority to the mechanical disks and mirror drums of the earlier period of television development has been quite definitely established. This means that constant research in electronics will give us better and cheaper camera tubes. Improvements will be made in increasing the sensitivity of the light-sensitive mosaic. At the same time better amplifier tubes are being developed constantly which will strengthen the signal as it comes from the camera tube. We can expect

therefore that the television camera of the future will be able to pick up outdoor scenes even on a dark day or in the rain. This will also mean that indoor scenes will not need the great amount of light used at the present time, opening up the possibility of televising plays directly from the stages of the theaters.

At present great care has to be exercised in the construction and operation of amplifiers so that the signal which comes from the camera tube will not be altered materially, or distorted, by the time it reaches the transmitter. Improvements in the accuracy of the amplifying tubes and circuits are constantly being made which will undoubtedly improve the detail of the picture in the future.

The limited range of the television-broadcast carrier wave, because of its position in the short-wave end of the radio spectrum, has been considered one of the major drawbacks to television acceptance by the public. It has been argued that only the residents of a few of our largest cities, where the expensive television transmitting stations would be located, could take advantage of television programs. One method has already been suggested (see page 156)—by using relays to increase the range of the television signal, whereby the size of the television audience could be greatly increased. Other methods will also be found in the near future, so that the

region served by a central station will be greatly increased. The use of coaxial cable in the Bell Telephone experiments between Philadelphia and New York (see page 125) offers other possibilities.



FIG. 57—Television brings a football game to the home.

The present handicaps of getting the television equipment to the places where television material exists will undoubtedly soon be overcome. Every big convention hall, opera house, and athletic field (figure 57) could be permanently connected with a central television broadcasting station by coaxial

cable or relays. Thus programs from such sources could be broadcast easily and at short notice. We can also expect that great improvements will take place in the mobile field units (figure 57 A) and various



Courtesy Allen B. Du Mont Laboratories

FIG. 57a—Televising army maneuvers at Canton, New York.

portable pickup cameras, so that tomorrow's television programs will be of a most flexible nature. Scenes from fires and floods, parades and public gatherings, will then be easily televised. We can expect that all of the principal cities in the country may some day be connected by a system of relays or

cables, so that the majority of Americans may see at the same time, as well as hear at the same time, any event of national importance.

The Television Receiver of Tomorrow

Changes can also be predicted in the receiver, which, after all, is the most familiar part of the television apparatus to the average citizen. There has already been a steady trend toward larger viewing screens and larger images. At first these screens were but a few inches square, and the pictures had to be viewed in comparative darkness. Today they vary from four by six inches to eighteen by twenty-four inches. The size of the picture in the direct-viewing type of receiver, as we have seen, is dependent upon the maximum practical size of the picture tube. Such tubes are today quite expensive (as compared with ordinary radio tubes), but no doubt constant research and quantity production will make them less so every year.

But the public will want larger pictures, somewhat like the size of home movies; they will eventually get them as television research moves forward. Already, with both mechanical systems and cathode-ray projection tubes, pictures have been projected to the size of theater screens, with excellent reproduction of detail (comparable to that of movie newsreels),

although at present the projection machines for such large television pictures are quite elaborate and as yet in the experimental stage. We can expect that it will be easier to produce larger and better screen television pictures with simpler apparatus. In the meantime the home receiver, with its directly viewed television image (figure 50), will naturally become cheaper in price as more concerns manufacture it in greater quantities.

The receiver circuits are being constantly improved so that the accuracy and detail of the picture will be more satisfactory (figure 58 and figure 58 A). The receivers will also be more simply and easily synchronized with the television transmitter, producing a steadier and smoother picture without the necessity for constant individual adjustment. It is probable that better antenna systems for home television receivers will make installation of the receiver easier, especially in crowded city areas where at present it is difficult to erect an adequate receiving antenna.

Television in Color

As soon as it became possible to transmit scenes by television, experimenters began to devise ways and means of transmitting the pictures in natural colors. Numerous methods of doing this have been suggested since the pioneer work of Baird; Zworykin of Radio

Corporation of America, Dr. Ives of Bell Telephone Laboratories, the General Electric Company, Colum-



Courtesy National Broadcasting Company

FIG. 58

bia Broadcasting Company, and others have devised color-television apparatus. However, the English inventor Baird was among the first to demonstrate that

color television was possible (1928), and the first to give a color-television broadcast (ten years later).



Courtesy National Broadcasting Company

FIG. 58a—Improvement in picture detail of the television image is realized when a comparison is made of the early 60-line image on opposite page with the modern 441-line picture above.

The Baird system made use of the principle of persistence of vision to produce the complete colored effect. His first apparatus included a scanning disk which had three sequences of scanning holes instead of the usual single sequence. In other words, the

picture was completely scanned when the disk had made one-third of a rotation, then was scanned again by the next third of the disk, and a third time by the remaining perforations in the disk.

A photoelectric cell does not know the difference between lights of different colors. The current produced is the same, although some colors do have a greater effect on the cell than others. Baird covered the first set of holes in his disk with a red transparent material, and therefore only the light from portions of the object field which were red reached the light-sensitive cell. He covered the next set of holes in the disk with blue transparent material, and thus the light which reached the cell came only from the blue parts of the object field. The third set of holes was covered with a green filter, permitting only light from green portions of the object field to pass through to the photoelectric cell.

Thus, of the rapid sequence of pictures produced, the first picture reproduced before the observer had only those parts of the image which were red; the second had only those parts which were colored blue; the third had only those which were green.

Baird used two light sources at the receiver; one was a neon gas lamp which produced a red light, while the other was a helium-mercury lamp producing both blue and green light. The holes in the receiving

disk were provided with color filters similar to those in the transmitting disk. A commutator or switch attached to the disk was so arranged that the neon lamp was connected to the circuit during the time that the first set of holes was passing in front of the picture aperture, and the helium-mercury lamp was connected while the other two sets of perforations were passing in front of the aperture. The observer therefore saw the red parts of the object field colored red, during the first scanning, then the blue and, finally, the green. Of course this sequence of pictures (red, blue, green) was repeated over and over again during the scanning procedure. Persistence of vision assembled the separately colored images into a completely colored one.

More recently Columbia Broadcasting Company has given successful demonstrations of color television, using this system of successively colored pictures but with a cathode-ray camera and picture tube. In front of the iconoscope type of camera tube is placed a rotating cylinder whose walls are made of three different-colored transparencies. Figure 59 illustrates this rotating color cylinder. A mirror inside the cylinder directs the light rays through the colored wall to the camera-tube mosaic, which thus receives in succession light rays from different-colored parts of the object field.

The receiver consists of a cathode-ray tube in front of which a transparent disk with the three different colors is rotated. The observer views the picture on the usual television screen through this disk. An

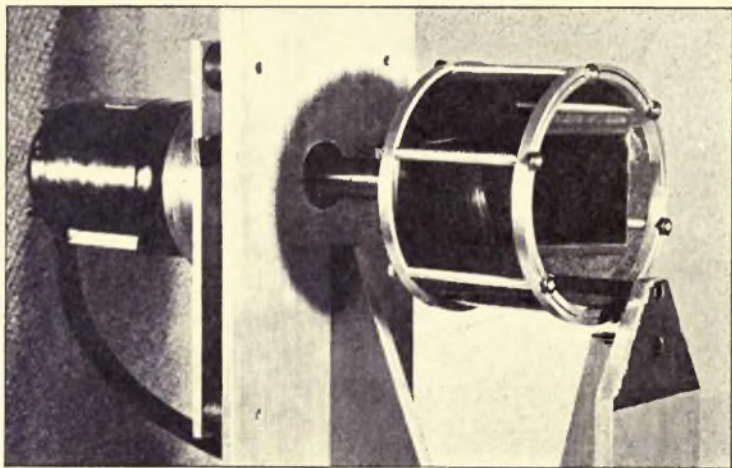

Courtesy Columbia Broadcasting Company

FIG. 59—Color Television. Filter drum and mirror used in the Columbia Broadcasting Company system.

experimental color-television receiver is illustrated in figure 59a. The colored disk is driven by a motor synchronized with the motor at the transmitter by means of the synchronizing impulses.

In this type of color television it is preferable to speed up the number of pictures scanned per second to sixty, instead of the customary thirty; this avoids the appearance of color fringes when rapidly moving

objects are being televised. If the rate is too slow, the colored images of moving objects will appear to have a vague color-fringe outline because the images in the different colors are not exactly superimposed.



Courtesy General Electric Company

FIG. 59a—Dr. Alexanderson (left) with the General Electric color system.

Thus color television does not involve any great obstacles or fundamental change in the existing black-and-white apparatus. It is possible that color television may soon become available to the public.

Television in Use

The perfection of television cameras, pickup units, and receivers will open up many new fields for entertainment and education. As an entertainment factor, television will make possible public viewing of plays, operas, concerts, and sports events hitherto limited to relatively few people in certain metropolitan areas.

It may be possible, for example, to televise special performances of stage plays with the original casts or to reproduce for the televiewer complete productions of the Metropolitan Opera or nationally known symphony orchestras. Football games, baseball games, horse races, yacht races, prize fights, and the whole gamut of the sports events that thrill millions of Americans with their seasonal appeal could conceivably be covered by the mobile field units of a television studio.

This may all become a reality long before television sets become practicable or cheap enough for universal home use. In April, 1941, a boxing match at the Madison Square Garden, witnessed by a few spectators, was picked up by a television camera; the televised bout was carried by wire to the New Yorker Theater and there projected onto a screen. The audience in the theater felt that they had ringside seats at the real bout, so far has television gone in repro-

ducing scenes outside of the studio. Such a procedure as this may open new vistas for sports fans. Certain theaters, equipped with television receivers suited for screen projection and connected with sports arenas such as the Madison Square Garden or the Polo Grounds in New York City, may regularly schedule television programs of current sports events. Not only will this increase the actual number of observers who can see a boxing match or a horserace, but every observer will have the advantage of a seat as close to the action as the television camera can come. Suburban dwellers can drop into their local theaters, which are connected by wire with the television studios, and witness their favorite sports in comfort and at much less expense. Competent witnesses of the boxing match televised at the Madison Square Garden and transmitted to the theater considered it probable that chains of televised-sport theaters might come into existence.

T. R. Kennedy, Jr., in the *New York Times* (April 6, 1941), wrote of this event: "Observers in the New Yorker Theater saw, perhaps, the clearest television show ever staged, as images flashed from a barrel-like projector in the balcony to a fifteen by twenty foot screen on the stage. The Garden fighters bobbed and weaved. They punched and slugged. None of the action appeared lost in the television transmission.

There was a feeling of reality about the show; it was not like a picture, it appeared to be an actual fight, even though nearly half a mile of wire intervened between the electric eye in the Garden and the theatrical image projector. The test was conducted by engineers of the National Broadcasting Company, using a new RCA image projector.”

In like fashion the thousands of alumni of Yale and Harvard may soon be able to attend television-equipped theaters and watch a play-by-play reproduction of their annual football classic. Roving field units of the television pickup, telephoto lenses, more sensitive mosaic plates—all will make it possible for the viewer to see close-ups of plays as well as broad sweeps of the entire grandstand impossible for the average attending fan.

Another probable use of television will involve covering of current news events. Within the range of the television broadcasting station and its relays, the field units can televise visiting celebrities as their ships enter New York harbor; can cover the unexpected local events, such as fires, strikes, floods, and similar tragic but newsworthy human situations. Perhaps most important of all, political campaigns will be fought on the television screens of the nation, where American citizens will be able to see as well as hear all of the political speakers. And when the Presi-

dent of the United States is inaugurated, we shall all have the benefit of a grandstand seat in Washington, D.C.—even though we may live hundreds of miles away.

Television also will have a tremendous educational value—far more than radio, for the information presented to the eye registers upon our memory much more indelibly than that presented to our ears alone. The combination of seeing and hearing will make television education programs of far-reaching value. A thousand medical students can sit in suitably equipped projection rooms connected with some large city hospital where a world-famous specialist conducts an important operation (figure 60). Everyone can follow the steps of the surgeon as the television camera poised over the operating table gives a view that few students could get if they were sitting in the amphitheater surrounding the operating table. Famous scientists in their laboratories, world-renowned craftsmen and artists conducting their work—a new world of intimate revelations of how things are created and carried out in the world of science may possibly be witnessed by college and school audiences in their own theaters, equipped for television projection.

In practically every field of human knowledge, first-hand information can thus be presented to

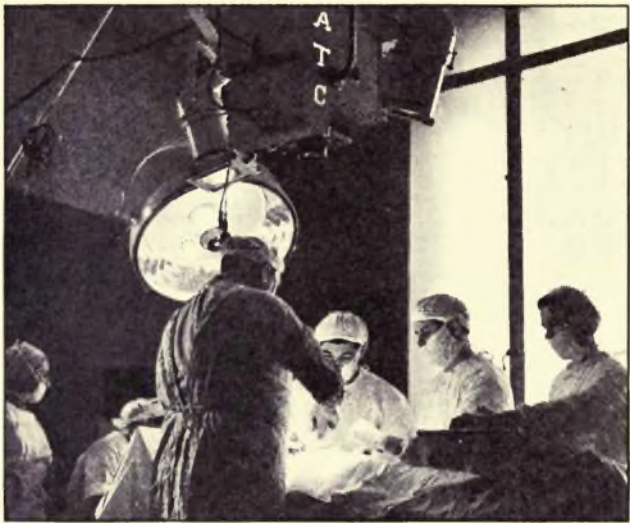

FIG. 60—Television in Education. Upper photograph shows camera picking up an operation at Israel Zion Hospital in Brooklyn, New York. This was transmitted to a neighboring auditorium in the hospital where several hundred medical students watched the progress of the operation on the screen (lower photograph).

students and laymen alike. Science, politics, history, social studies, travel—these and many other aspects of modern education will lend themselves well to the use of televised programs.

The probable relation between the motion-picture industry and television is difficult to predict. There will be little competition between the two in so far as the traditional long motion-picture play is concerned. The average home televiewer will not be content to sit for several hours in the quiet of his own home to witness a usual movie. Moving-picture short features, however, will have to be used in great quantities, to fill up the time on television programs; of these, the existing supply would be exhausted in a few months. It may be, therefore, that television will create a great demand for new short features which will give the motion-picture industry a new outlet for its product.

There is also the probable relation between television and advertising sponsors. If television is developed as radio has been by independent competition and support of advertisers, the televiewers will have to watch a great amount of visual advertising. From the seller's viewpoint this will be a great advantage, for the home televiewers will be able to see the advertised products—and the housewife will be much more likely to be influenced to purchase something she can see as well as hear about.

With all of these possibilities in television apparatus and technique, let us summarize briefly what television may have in store for us. In the immediate future we shall be able to see television programs regularly at certain theaters, especially in the urban and suburban areas. Perhaps in the not too distant future, we shall be able to have reasonably priced and easily adjusted television sets in our own homes. These home receivers will probably be as large as a good-sized radio, and will produce small pictures to be directly viewed (perhaps eight by ten inches) or larger pictures on a projection screen. We shall turn on our receivers and watch our favorite radio comedians on their customary programs. We shall see orchestras as well as hear them play, and the program will be interspersed with close-ups of the various musicians as they carry a particular part in the music. As has already been mentioned, we shall undoubtedly see basketball games, football games, boxing matches, and other sports events.

In the midst of a program the announcer may suddenly appear on the screen and explain that there will be an interruption to bring us a picture of a sudden fire which has broken out; we shall watch the firemen as they fight the blaze, and then shall return to the regular program again. This may be followed by some motion-picture feature, or motion pictures

of outdoor scenes accompanying the play being enacted in the television studio. Motion-picture scanners will also be used at night to bring us news events which happened during the daytime, so that members of the family who have been busy during the day can watch in the evening a review of the day's news.

At present there are not many television broadcasting stations, and few manufacturers of television sets and equipment. But with the process mechanically in such stages of development that extensive commercial production is possible, and with the settlement of whatever standards may be necessary in stabilizing the television industry, more television stations will go on the air and the public will soon have a wide choice of receivers.

Twenty years ago mechanical scanning devices were recreating crude shadow pictures with less than twenty lines per picture; the only receivers were experimental ones in the research laboratories. Ten years ago the electronic scanners gave television a renewed lease on life; millions of dollars were invested in research equipment, and a few private receivers could be found here and there. At present, images are recreated with fairly satisfactory detail upon larger home-viewing screens as well as full-size theater screens. In the New York City area it is estimated that there are 3,225 television sets in homes;

several commercial broadcasts are regularly on the air. The National Broadcasting Company, in the year ending March 31, 1941, completed seventy-six pick-ups of field events and various outdoor spectacles.

Ten years from now we may expect to have 32,000 or even 320,000 television sets in operation; the broadcasting stations will be increased in number, as will be their hours on the air; and, at least in the majority of city homes, television will have become a reality.

Television marches on!

INDEX

- Alexanderson, 40, 41, 47
Allen B. DuMont Laboratories,
55, 174
alternating current, 60
amplifier, 68-71, 123
amplitude modulation, 81, 87
anode, 64, 67
antenna, 147, 148, 150, 158-160

Baird, 28-34, 191-192
Bell Telephone Laboratories,
127
blankout, 122
Braun, 48

camera tube, 50, 54, 57
capacity, 73
Carey, 10
carrier, 19, 79, 80, 87-90
carrier wave, 17, 87
cathode, 48, 50, 64, 67
cathode ray oscillograph, 49,
52-54
cathode ray tube, 48, 52-54, 83
cathode rays, 48
channel, 87
coaxial cable, 17, 125
color television, 180-191
Columbia Broadcasting Com-
pany, 147, 190, 193
condenser, 73
cosmic rays, 95
crystal, 43, 77
current, 57
current, alternating, 60
current, direct, 59
cycle, 60, 89

deflecting circuits, 168, 169,
172
deflecting coils, 112-115
deflection, 169
DeForest, 48, 64, 65
demodulation, 61, 79, 81
detection, 61
detector, 48, 78, 80-83
diode, 64
dipole, 160
direct current, 59
dolly, 123
Don Lee Broadcasting Com-
pany, 54
DuMont, Allen B, Laboratories,
55, 174

Edison, 62
Edison Effect, 62
electrical telescope, 22
electromagnetic deflection, 169
electromagnetic wave, 17, 87-90
electron, 48, 50, 62, 65-67
electron beam, 18, 47-50, 106,
165
electron gun, 108
electrostatic deflection, 169, 170
Elster, 61
ether spectrum, 92-95
eye, 3, 4

- Farnsworth, 54
 Federal Communications Commission, 96-98, 180
 filament, 61-63
 film scanner, 131, 134-137
 Fleming, 64
 fluorescent surface, 18, 48, 52, 165
 flying spot, 33, 34
 frequency, 60, 87
 frequency modulation, 82, 87

 gamma rays, 95
 Gardner drum, 41
 Geitel, 61
 General Electric Company, 54, 140, 190
 generator, 71-77
 glow lamp, 36
 grid, 64-67

 iconoscope, 106-117
 image dissector, 106, 130-134
 inductance, 72
 induction, 70
 infrared rays, 94
 interlacing, 119
 iris, 3
 Ives, 190

 Jenkins, 34-36, 39

 kinescope, 165

 light rays, 94
 light sensitive cell, 6-8, 11, 68
 light sensitive mosaic, 108, 110, 111
 light source, 18, 38, 48, 165
 lines, 14-16, 117-119
 loud speaker, 174

 mobile units, 151-153
 modulation, 17, 25, 61, 81, 91
 modulation, amplitude, 79-81
 modulation, frequency, 82
 modulator, 78-81
 monitor receiver, 142
 Morse, 11
 mosaic, 4

 National Broadcasting Company, 54, 106, 147, 198, 204
 neon lamp, 36, 192
 Nipkow, 22-28

 object field, 1, 3
 orthicon, 106, 128, 129
 orthiconoscope, 106, 128, 129
 oscillator, 60, 75
 oscillograph, 50, 52

 persistence of vision, 12, 26
 Philco Radio and Television Corp., 55, 162
 photoelectric cell, 6-8
 picture aperture, 22, 23, 25
 picture element, 3, 4
 picture tube, 18, 54, 57, 164-170, 173
 plate, 62-67
 polarizing device, 23, 25
 potential, 61
 power supply, 86
 prism disk, 35-37
 projection receiver, 177-181

 quartz crystal, 43, 77

 Radio Corporation of America, 55, 106, 151, 156, 157, 178, 180, 198
 radio spectrum, 95
 radio tube, 57-67
 relay, television, 156, 157
 resistance, 58, 72
 retina, 3, 4, 12
 Rosing, 52

- scanning, 13, 14, 15, 18, 21, 36-42, 47, 48, 54, 105, 115-118, 168-169
- scanning disk, 22, 27
- scanning drum, 38-46, 52, 53
- Scophony, 42-44
- selenium cell, 6-7
- side bands, 95
- signal plate, 110
- simultaneous reproduction, 4, 5, 10-12
- spectrum, ether, 92-93
- spectrum, radio, 95
- station selector, 170
- storage type tube, 119
- sweep circuits, 113
- Swinton, 50-52
- synchronization, 16, 18, 122, 172

- tank circuit, 77
- television broadcast, 144-147
- television camera, 101-122
- television flood lights, 141
- television receiver, 16, 20, 23, 158
- television receiver controls, 174-177

- television relay, 156
- television signal modulation, 121, 122
- television studio, 138-147
- television transmitter, 20, 147
- television tuning, 74, 174-177
- theatre television, 46, 180, 181
- Thomson, 62
- transformer, 69
- transmitter, 10, 20, 147
- tuned circuit, 74, 75

- ultra violet rays, 95

- vacuum tube, 16, 31, 47, 48, 57, 68
- vibrating mirror, 40
- voltage, 58

- wave band, 87
- wave formation, 87, 88
- wave length, 87
- Weiller, 36

- X-rays, 95

- Zworykin, 54, 106, 189

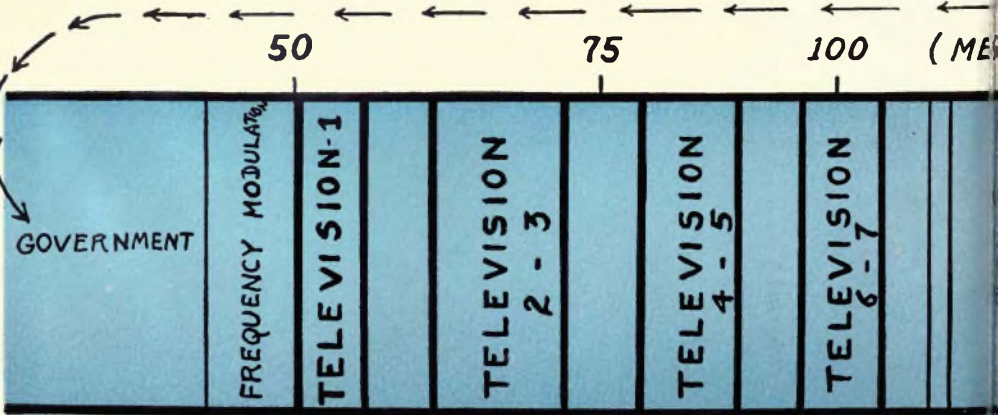
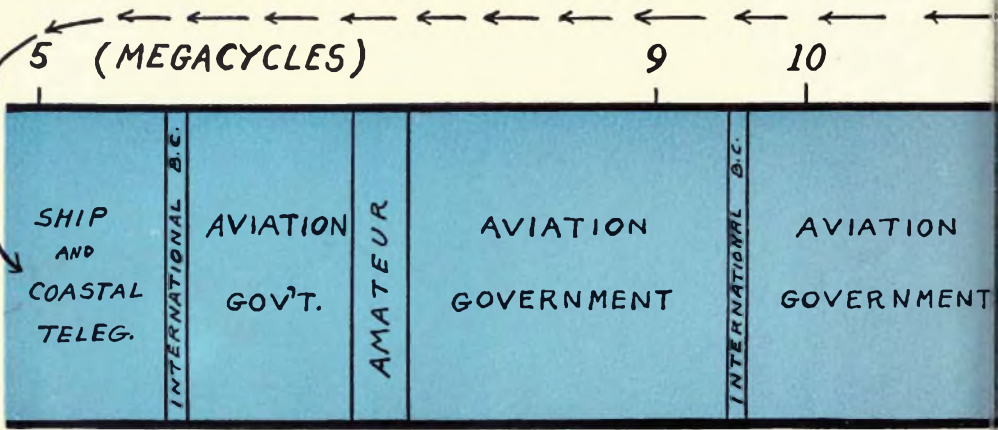
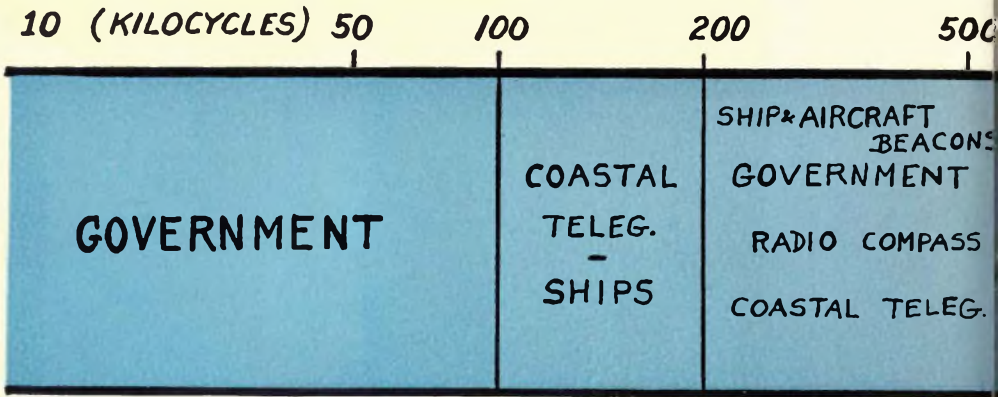

The Radio Spectrum: the "ether highway".

1000

2000

3000

4000

KFI
WEAF
WFLY
WJZ
WABC
KOMO
KDKA
KEX
WCAE
KIDO
WQXR

ROADCAST

AMATEUR

POLICE & GOVERNMENT
COASTAL TELEG.
AVIATION
SHIPS

AMATEUR

15

20

25

SHIP
AND
COASTAL
TELEG.

AMATEUR

GOV'T.

INTERNATIONAL B.C.

GOV'T.

INTERNATIONAL B.C.

FIXED
GOVERNMENT
SHIP, COASTAL
TELEG.

INTERNATIONAL B.C.

AVIATION
GOVERNMENT
SHIP, COASTAL
TELEG.

AMATEUR

(CYCLES)

200

300

500

ATION
LICE
RNMENT

TELEVISION

TELEVISION

TELEVISION

TELEVISION

TELEVISION

EXPERIMENT
AND
RESEARCH

