

high

*Fidelity*

circuit  
design

---

norman h. crowhurst and  
george fletcher cooper





*high-  
fidelity  
circuit design*

**norman h.crowhurst**

and

**george fletcher cooper**

published by gernsback library, inc.

First Printing — April, 1956.  
Second Printing — April, 1957.



© 1956 Gernsback Library, Inc.  
*All rights reserved under Universal,  
International, and Pan-American  
Copyright Conventions.*

*Library of Congress Catalog Card No. 55-11190*  
*jacket design by muneef alwan*

# contents

chapter

page

## Part 1 — Feedback

1

### Feedback effects

Feedback improves response. Basic mathematics. Effects of phase shift. Feedback design. Sample problems. Gain without feedback. Where to apply feedback. Safety margins. Calculated response. Interpreting the phase-shift curve. **7**

2

### Analysis and design

Response curves. High-frequency response. Increasing stability. The feedback circuit. Amplifier design. The output stage. The phase splitter. Low-frequency response. The feedback resistor. The preamplifier stage. **31**

3

### Response and stability

Circuit refinements. Cathode and screen circuits. Coupling networks. The feedback network. Nyquist testing. Polar response curves. Stability margin. Phase margin. Degree of stability. Component tolerances. **47**

4

### Distortion

Using positive feedback. Reducing intermodulation and harmonic distortion. Limitations of positive feedback. Input and output impedance control. Passive networks. Optimum load. Load lines. Sensitivity. Positive grid swing boundary. **65**

5

### Extending design factors

Alpha-beta vs. mu-beta effect. The alpha-beta evaluator and its use. Stability margin. Design comparisons and procedures. Narrow-pass band-pass amplifiers. Feedback considerations. Series and shunt feedback injection. Internal noise. **87**

## Part 2 — Design and Testing Techniques

6

### Drivers and inverters

Two good phase splitters. Some circuits from life. Methods of preserving balance. Practical applications. Some important problems. The seesaw circuit. Noncritical circuits. Choosing the best circuit. The "long-tailed pair." **111**

7

### Power supplies

The full-wave rectifier. Regulation. Capacitor-input filters. Choke-input filters. Swinging-choke filters. Filter ripple. Choke current saturation. Regions of constant voltage output. Swinging-choke design chart. Eliminating filter hum. **143**



8

**Attenuators**

Calibrated attenuators. Basic configurations. Balanced and single-ended networks. Constant impedance. Attenuator design. Attenuation losses resulting from impedance mismatching. Mismatch reflections. Correcting for impedance changes.

**151**

9

**Filters and equalizers**

Derivation from transmission line. Characteristic impedance. Artificial lines. Significance of image impedance. M-derived filters. Constant resistance networks. Equalizers. Terminal impedance. Bass-boost circuits.

**175**

10

**Scope test procedures**

Detecting amplifier distortion. Phase-shift pattern. Determining the phase angle. Sine of phase angle. Cosine of phase angle. Common distortion patterns. Clipping. Transformer-core magnetizing current distortion. Ringing.

**195**

11

**Speaker systems**

Source of sound. Realism. Constant-resistance networks. Impedance variations. Dissociation effect. Directional sensitivity. Speaker phasing in sound reinforcement work. Phase difference. Crossover network design chart.

**205**

12

**Advanced techniques**

Remote control amplifier. Bass control circuit. Vari-slope technique. The grounded-grid amplifier. The inverted amplifier. Grounded-cathode amplifier. Interstage transformers. Negative resistance. The cathode follower.

**219**

13

**High-power amplifiers**

Hookup problems. 500-ohm bus system. Ground potentials. Line impedance. Improving outputs. Multiple signal sources. Isolating grounds. Remote microphone control. The story of an amplifier. High-frequency problems.

**241**

14

**Test equipment design**

Single-frequency generator. Oscillator circuits. Modulators. Detectors. Circuit problems. Tuning modulator plate. Self-balancing push-pull oscilloscope amplifier. Basic rules for calibrating audio oscillators.

**269**

15

**Improving old amplifiers**

Cost limitations. Modification procedures. Gain problems. Output transformer saturation. Phase characteristics. Amplitude response. Feedback applications. Interstage coupling. Low-frequency considerations. Compromise solutions.

**289**

# introduction

**M**any books have been published on the various aspects of audio that can broadly be divided into two groups: the "theoretical" group, which undoubtedly give all the theory anyone needs, *provided* he has sufficient knowledge of advanced mathematics to be able to apply it; and the "practical" group, which tell the reader, step by step, how to make some particular piece of equipment. What has been lacking in the literature is some information in a form that will enable the man with only the most elementary knowledge of mathematics to produce his own design and make it work.

With the objective of filling in this gap, we have written various articles that have appeared in RADIO-ELECTRONICS magazine. And the correspondence we have received assures us that we have achieved our objective in this. In fact, many people find the only complaint is the inconvenience of having numerous copies of RADIO-ELECTRONICS strewn about the place for easy reference!

For this reason the Gernsback Library undertook the assembly of this material into book form. But a number of separate magazine articles do not too readily go together to make the best book, just like that. The result is apt to be rather a mass of bits and pieces. So the authors' help was called upon, and the original articles have been considerably edited and rewritten. In several places additional material has been added, in the interest of overall clarity, and to fill in some gaps that naturally result from preparing a book in this way. But now that we have finished the work we feel confident in offering it to the reader as a real primer on designing the best in audio.

Often people ask where we get the ideas for articles. We feel this introduction is a good opportunity to give the answer to this question, as credit to whom credit is due. Practically all the subjects for our articles arise from questions various people have asked, and the discussions that have followed. To be able to explain a



subject successfully, it is necessary not only to understand it properly one's self, but also to understand the obstacles that make it difficult for others to grasp. It is odd how obstacles in the attainment of knowledge seem insurmountable as we approach them, but having passed them, they seem to vanish, and we find it difficult to realize the obstacle ever existed. This is why questions from people seeking knowledge, and the discussions that ensue, are invaluable in providing material for this kind of presentation.

Knowing that many look in the introduction of a book to find out for whom it is written, we should answer that. While we have avoided using expressions that would put it over the heads of the many enthusiasts who do not possess very much theoretical knowledge, we are also confident that much of its contents will prove helpful to many who have more advanced training, but who have failed to visualize adequately some of the problems they encounter, largely due to the vagueness of the "classical" approach. As a "primer" to read, it will give a sound basic knowledge of the subject, after which it will serve for years as an invaluable reference book. We make no apology for such a claim — we use our own writings for reference. It's so much easier than trying to memorize it all!

NORMAN H. CROWHURST

GEORGE FLETCHER COOPER

# feedback effects

**B**oil water and butter together. Add flavor. Cook till it forms a ball. Season, and beat in an egg.

This is not a book on cookery, nor is it one of those with a cook-book approach on how to build the perfect amplifier. "Take a ripe output transformer, about four pounds," he says; "two large well-matched tubes and an assortment of smaller tubes, capacitors and resistors. Connect as shown. Add feedback to taste." The trouble is, that the amplifier described this way is never just what you want, and nothing in the book tells how you can alter it without ruining the performance completely. Consequently, when you or your employer needs an amplifier, it has to be designed from scratch. Amplifiers without feedback are no problem, but the addition of a reasonable amount of feedback to an amplifier with more than two stages usually leads to instability unless the circuit is carefully designed.

To begin with, why do we want to use negative feedback in amplifiers at all? There are four reasons which assume different orders of importance, depending upon the function of the amplifier. If the amplifier is part of an a.c. voltmeter, the gain must be constant in spite of changes in supply voltages and aging of tubes. A voltmeter with a drift of 10% would be a thorough nuisance in any laboratory. After all, unless you are a magician, you must trust something. By using negative feedback, the overall gain can be made almost independent of the internal gain of the amplifier; once it is adjusted, the gain will be the same even if the tubes



are changed or the line voltage drops 5%. If the gain is independent of the plate supply voltage, ripple caused by inadequate filtering will not modulate the signal. This aspect is especially important for ordinary program amplifiers.

The reasons for using feedback are also important in audio. By using negative feedback we can flatten the frequency response, and reduce the harmonic and intermodulation distortion. It can also be used to modify effective input or output impedances.

## Feedback improves response

Let us first consider how negative feedback helps keep the gain of an amplifier constant. A particular amplifier has a gain of 80 db<sup>1</sup>; an input of 1 mv between the first grid and cathode gives an output of 10 volts. When the input and output impedances of an amplifier are not equal:

$$\text{db gain (or loss)} = 20 \log \frac{E_2}{E_1} + 10 \log \frac{Z_1}{Z_2} + 10 \log \frac{k_2}{k_1} \quad (1)$$

where  $E_1$  and  $E_2$  are the input and output voltages;  $Z_1$  and  $Z_2$  represent the input and output impedances respectively;  $k_1$  and  $k_2$  are the power factors of the input and output impedances. However, if input and output impedances are identical (as in our example), the formula for db gain or loss of an amplifier is simplified to<sup>2</sup>:

$$\text{db gain (or loss)} = 20 \log \frac{E_2}{E_1} \quad (2)$$

With an input of 1 mv (.001 volt) and an output of 10 volts,

$$\text{db gain} = 20 \log \frac{10}{.001} = 20 \log 10,000 = 20 \times 4 = 80 \text{ db}$$

We now connect across the output a network which gives exactly 1/1,000 of the output voltage. We can readily calculate the loss in this network. Since the output voltage is 10 volts, the voltage across the output will be 10 millivolts. Using formula (2):

$$\text{db loss} = 20 \log \frac{E_2}{E_1} = 20 \log \frac{10}{.01} = 20 \log 1,000 = 20 \times 3 = 60 \text{ db}$$

<sup>1</sup> These are not true decibels, as the impedances are not necessarily the same. "The question is," said Alice, "whether you *can* make words mean different things."

"The question is," said Humpty Dumpty, "which is to be master—that's all."  
(*Through the Looking Glass*—Lewis Carroll.)

<sup>2</sup> Throughout this work, all log formulas are to the base 10.

Thus our network has a loss of 60 db. When the input to the amplifier is 1 mv, the amplifier output is 10 volts and the network output is 10 mv.

The output of this network is now connected in series with the input, so that the voltage appearing between grid and cathode of the first tube is the difference between the applied input between grid and ground and the voltage fed back through the network. Working backward, we see that if the output is to remain at 10 volts with a feedback voltage of 10 mv, then we must increase our input to 11 mv (1 mv for input signal and 10 mv to overcome the effect of the feedback voltage on the input voltage). The overall gain is now 10 v/11 mv, which equals 59.17 db, since:

$$\begin{aligned}\text{db gain} &= 20 \log \frac{E_2}{E_1} \\ &= 20 \log \frac{10}{.011} = 20 \log 909 \\ \log 909 &= 2.9586 \\ \text{db gain} &= 20 \times 2.9586 = 59.17 \text{ db}\end{aligned}$$

Since our amplifier, without feedback, originally had a gain of 80 db and with feedback has had its gain reduced by a little more than 20 db, let us see what advantage we secure by this sacrifice of gain.

Suppose now that we make some change in the amplifier, so that for 1 mv between grid and cathode we obtain 20 volts out. The voltage feedback will be 20 mv, so that this 20-volt output requires an input of 21 mv and the gain is 20 v/21 mv=59.58 db. Although the internal gain has been doubled (6-db increase), the overall gain has increased only by about 5%, or 0.41 db.

This example shows immediately how negative feedback improves the performance of a voltmeter amplifier. By using more feedback, even greater constancy of gain can be obtained. A little thought will show that the other properties of negative feedback can also be obtained in this example. Suppose that the change of gain was the result of changing the test frequency. For example, the gain might increase by 6 db when the frequency is increased from 50 to 400 c.p.s. The feedback keeps the gain the same within 0.4 db for this change of frequency.

The reduction in distortion is not as simple. In the normal working range of the amplifier the gain is not quite constant at all points in the voltage wave. This can be seen by looking at a graph



showing mutual conductance plotted against grid bias. These variations in gain *during a single cycle* cause distortion; but obviously since negative feedback keeps the gain nearly constant, the distortion must also be reduced.

At this point the reader is warned not to open his amplifier to connect a simple potential divider from loudspeaker terminals to input grid. By a well-known law of Nature (the *law of the cursedness of inanimate things*) you will be certain to add positive feedback and will produce an excellent oscillator. Relax in your armchair and continue to read this book.

## Oscillation troubles

The problem which really causes trouble in negative-feedback amplifiers is oscillation of the extremes of the frequency range. When feedback is applied to an amplifier with more than one

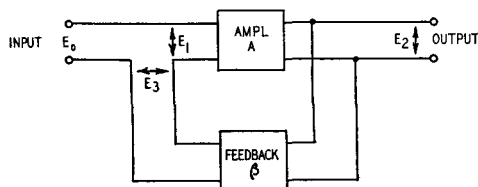

*Fig. 101. Basic feedback-amplifier circuit. The feedback network feeds part of the output signal back to the input. When the feedback is negative, the voltage fed back to the input is out of phase with the original input signal.*

stage, oscillations may occur either at very low or very high frequencies. Fairly typical values would be 2 c.p.s. and 30 kc. It is difficult to detect the high-frequency oscillations just by looking. The amplifier appears to have no gain but lots of distortion. With an oscilloscope, of course, the trouble is easily found. There are no certain cures which can be applied to all amplifiers: one man's meat is another's poison. In our view, the only safe way to proceed is to draw the amplitude and phase responses (later in this book, it will be shown how this can be done easily).

## A little mathematics

Before discussing the specific problems of design, let us look at some of the basic mathematics. The generalized circuit of a feedback amplifier is shown in Fig. 101. It consists of an amplifier having a gain of  $A$  and a feedback network having a gain (actually a small fraction) of  $\beta$ . The two equations are:

$$\frac{E_2}{E_1} = A \text{ and } \frac{E_3}{E_2} = \beta \quad (3)$$

Suppose we call the gain of the amplifier including feedback  $A'$

to distinguish it from the gain  $A$  of the amplifier without feedback. The overall gain is:

$$A' = \frac{E_2}{E_0} \quad (4)$$

Since the feedback is negative the feedback voltage must subtract from the input voltage to give the voltage  $E_1$  actually applied to the grid, or:

$$E_1 = E_0 - E_3 \quad (5)$$

For convenience we can rearrange this equation to read:

$$E_0 = E_1 + E_3 \quad (6)$$

Suppose we substitute  $(E_1 + E_3)$  for  $E_0$  in equation (4) (which we can easily do because the two quantities are equal to each other). We then get:

$$A' = \frac{E_2}{E_1 + E_3} \quad (7)$$

So far we see that nothing spectacular has happened, but from equation (3) we know:

$$E_1 = \frac{E_2}{A}$$

We can now put this value for  $E_1$  into equation (7) and we will get

$$A' = \frac{E_2}{\frac{E_2}{A} + E_3} \quad (8)$$

Combining the denominator terms on the right-hand side, we have:

$$A' = \frac{E_2}{\frac{E_2 + E_3A}{A}}$$

Clearing the division of fractions, we get

$$A' = \frac{E_2A}{E_2 + E_3A}$$

We know from equation (3) that  $E_3 = \beta E_2$ . We can substitute this value for  $E_3$  and arrive at a gain value of:

$$A' = \frac{E_2A}{E_2 + \beta E_2A} \quad (9)$$



We can now factor the denominator:

$$A' = \frac{E_2 A}{E_2(1 + A\beta)}$$

Cancelling  $E_2$  in numerator and denominator, the gain of an amplifier with feedback is seen to be:

$$A' = \frac{A}{1 + A\beta} \quad (10)$$

The term  $A\beta$  in this equation will be called *loop gain* although some other authors have referred to it as the *feedback factor* or *feedback ratio*. One additional point to note here is our usage of  $A/(1 + A\beta)$  as representing negative feedback gain. This form is based on the *algebraic* rather than on the magnitude value of  $\beta$ . In some engineering texts, the form  $A/(1 - A\beta)$  is used, assuming of course that  $\beta$  itself is negative for negative feedback. This form resolves itself algebraically to:

$$A' = \frac{A}{1 - (-\beta)A} = \frac{A}{1 + A\beta}$$

In terms of numbers we can make this factor have practically any value we want by adjusting the gain of the amplifier and the amount of feedback voltage. Suppose we make  $A\beta$  much larger than 1. In this case, the quantity  $(1 + A\beta)$  in equation (10) is very nearly equal to just  $A\beta$ , and for all practical purposes we can write equation (10) as:

$$A' = \frac{A}{A\beta} \quad (11)$$

and the gain of the amplifier with feedback is:

$$A' = \frac{1}{\beta} \quad (12)$$

Since the  $A$  drops out, the gain  $A'$  of the amplifier with feedback is independent of the gain without feedback as long as the loop gain  $A\beta$  is fairly large as compared to 1. To meet this condition,  $A\beta$  would usually have to have a value of at least 10.

Equation (12) is of interest in that it shows directly that the gain of an amplifier is inversely proportional to the amount of feedback and, as the amount of feedback is increased, the gain of the amplifier is reduced.

Earlier in this chapter the formula for the gain of an amplifier in db was given as:

$$\text{db gain (or loss)} = 20 \log \frac{E_2}{E_1}$$

Using this formula, we can obtain an expression for a feedback amplifier in decibels, making use of formula (10);

$$20 \log A' = 20 \log A - 20 \log (1 + A\beta) \quad (13)$$

Without feedback the gain in decibels is  $20 \log A$ . The effect of the feedback is to reduce the gain by  $20 \log (1 + A\beta)$  decibels. This latter term is correctly called the *feedback factor*.

### Effects of phase shift

So far we have assumed that  $\beta$  and  $A$  are just ordinary numbers. If the feedback network is just a couple of resistors, this is all right as far as  $\beta$  is concerned. However, amplifier gain  $A$  has a phase angle which depends on the interstage coupling networks and transformers if any are used.

*Fig. 102. A typical R-C network. Since the capacitor (C) blocks the passage of the B-supply voltage into the grid circuit of the second stage, only the a.c. signal component from the first stage is coupled into the grid circuit, and appears across resistor R.*

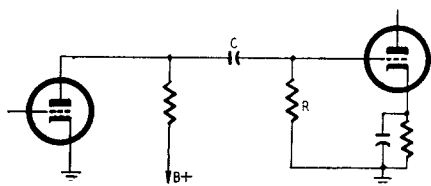

Fig. 102 shows a typical resistance-capacitance coupling circuit. At some frequency the reactance of  $C$  will be equal to the resistance  $R$ . At this frequency the phase shift between the plate of the first tube and the grid of the second tube is  $45^\circ$  and the response has fallen by 3 db. At still lower frequencies the phase shift gets larger until it approaches  $90^\circ$ .

To understand this, let us assume a condition such that  $R = X_c$ . However,

$$X_c = \frac{1}{2\pi fC} \quad (14)$$

and since (at a particular frequency),  $R = X_c$ , then

$$R = \frac{1}{2\pi fC} \quad (15)$$

An elementary rule in arithmetic is that a number multiplied by its reciprocal is equal to 1. Although this sounds formidable, it simply means that a number such as 6, when multiplied by its reciprocal,  $1/6$ , is equal to 1 ( $6 \times 1/6 = 1$ ). We can apply the same reasoning to  $X_c$  and  $R$  since we have deliberately chosen a frequency at which these two are equal. Thus we have:

$$\frac{1}{X_c} R = 1 \quad (16)$$

Another basic rule in arithmetic states that if numbers are equal, then their reciprocals are also equal. This simply means that if  $6 = 6$ , then  $1/6 = 1/6$ . Using this principle we can change formula (16) to read:

$$\frac{1}{X_c} = \frac{1}{\frac{1}{2\pi fC}} = 2\pi fC \quad (17)$$

Now by substituting the right-hand member of this equation in place of  $1/X_c$  in equation (17), we will have:

$$2\pi fCR = 1 \quad (18)$$

When the frequency makes  $R = X_c$ , then the voltage across the capacitor and across the resistor will be equal since the ohmic values of the two components are identical.

Now let us take a condition in which

$$2\pi fCR > 1 \text{ or } f > \frac{1}{2\pi CR}$$

Since the frequency has increased, the capacitive reactance has gone down accordingly; the signal voltage across the capacitor is smaller, while the signal voltage appearing at the input of the amplifier stage (across  $R$ ) has become larger.

The final condition, of course, is one in which

$$2\pi fCR < 1 \text{ or } f < \frac{1}{2\pi CR}$$

Since this represents a decrease in frequency, the capacitive reactance is increased; and the signal voltage across the capacitor is also increased, while the useful driving voltage (signal voltage across  $R$ ) is cut down. Under these conditions, the phase angle approaches  $90^\circ$  and the volume decreases.

In a three-stage amplifier there will be two coupling circuits of this kind plus a third to keep the plate d.c. from the feedback network. If the C-R products of these three networks are equal, each will have a phase shift of  $60^\circ$  at some frequency and the total phase shift will be  $180^\circ$ . Where a C-R circuit has a phase shift of  $60^\circ$ , it also attenuates the amplitude to one-half, or 6 db. Thus, three such circuits will attenuate to  $\frac{1}{2} \times \frac{1}{2} \times \frac{1}{2} = \frac{1}{8}$  or 18 db. The correct value for the gain at this frequency is then not  $A$  but  $\frac{1}{8}A$ . The gain with feedback is then equal to:

$$A' = \frac{\frac{1}{8}A}{1 - \frac{1}{8}A\beta} \quad (19)$$

$A$  but  $\frac{1}{8}A$ . The gain with feedback is then equal to:

this equation is equal to 0 and the gain is infinite. Obviously this will not do because we want an amplifier, not an oscillator, so we must arrange for  $\frac{1}{8}A\beta$  to be less than 1 at the frequency where the phase shift is  $180^\circ$ . For  $\frac{1}{8}A\beta$  to be less than 1,  $A\beta$  must be less than 8, or  $1 + A\beta$  less than 9. This means that a three-stage amplifier using equal C-R couplings must use less than  $20 \log 9 = 19.08$  db feedback or it will oscillate. By using unequal values of C-R, this limit can be raised as we shall learn later.

Up to this point we have just considered two very special conditions in which the output voltage of an amplifier is either directly in phase with the input signal or completely out of phase with it. The phase of the output voltage of an amplifier without feedback (compared to the incoming signal) will vary between these two extremes at different frequencies, depending upon the value and type of the coupling components. If we have an amplifier using negative feedback with large phase shift at some frequency, then there will be an equally large shift in the phase of the feedback voltage, thus reducing the effectiveness of the feedback at this frequency. For this reason the gain can increase, producing a bump in the frequency response at one end or the other or perhaps at both ends. If the amplifier is well designed—that is to say, if the amount of feedback is properly controlled—these bumps will not appear. A low-frequency bump at 60 c.p.s. is obviously not desirable; and if the amplifier is used with a phono pickup, a low-frequency bump can be a nuisance. High-frequency bumps are equally bad since they increase the noise level.

## Feedback design

The designer of an amplifier may often be confronted with the problem of knowing how much the gain of his amplifier *could change* for a given amount of feedback. Alternatively, he may wish to keep the *change of gain* of his amplifier within prescribed limits and will want to know just how much feedback is necessary to achieve this. Actually, these two problems are identical. In each case the designer has a problem involving small changes.

Since differentiation is the technique by which we can solve problems dealing with rate of change, we can differentiate equation (10) and arrive at an important and useful tool. First, let us repeat equation (10):

$$A' = \frac{A}{1 + A\beta}$$

We can rearrange this equation to read:

$$A' = A \left( \frac{1}{1 + A\beta} \right) \quad (20)$$

By differentiating this equation we then get:

$$\frac{dA'}{A'} = \frac{dA}{A} \times \frac{1}{1 + A\beta} \quad (21)$$

In this form the terms  $dA'$  and  $dA$  represent moderate changes of gain in an amplifier with and without feedback. Rate in this case *does not* involve the idea of time. If variations of supply voltages or circuit components produce a change in the gain of the amplifier without feedback ( $dA$ ), then this change will be a fraction ( $dA/A$ ) of the total gain  $A$ . The change of gain with feedback is  $dA'/A'$ . In other words, any variations in gain of the amplifier will be *reduced* by the fraction  $1/(1 + A\beta)$  when the circuit has a feedback factor of  $A\beta$ .

### Solution of a sample problem

Equation (21) is very useful for designing amplifiers to rigid specifications. Let us assume that we want an amplifier with feedback to have a gain of 1,000, with a maximum possible tolerance of gain not to exceed  $\pm 2\%$ . A deviation of  $2\%$  means that 1 volt could change to 1.02 volt. To numerically express this change in db, we take:

$$20 \log \frac{1.02}{1} = 20 \log 1.02 = 0.17 \text{ db}$$

The gain of the amplifier in db is then:

$$\text{db gain} = 20 \log \frac{1,000}{1} = 20 \log 1,000 = 20 \times 3 = 60 \text{ db } (\pm 0.17 \text{ db})$$

Suppose that this particular amplifier, without feedback, can increase its gain by  $50\%$ . In terms of db, this would be a change in gain of 3.52 db. To a person listening to such an amplifier, this change would be barely noticeable. However, for voltmeter amplifiers, modulators and high-fidelity amplifiers this change might very well be considered intolerable.

In this problem, the change of gain with feedback is  $2\%$ , or  $.02$ . Thus we get:

$$\frac{dA'}{A'} = .02$$

The change of gain without feedback is 50%, or 0.5, and so we have:

$$\frac{dA}{A} = 0.5$$

If we now substitute these values in equation (21), we will have:

$$.02 = (0.5) \frac{1}{1 + A\beta}$$

$$.02 = \frac{0.5}{1 + A\beta}$$

Transposing, we get

$$1 + A\beta = \frac{0.5}{.02} = 25$$

Now  $A' = 1,000$  and we can find the value of  $A$  from the equation:

$$A' = \frac{A}{1 + A\beta}$$

or

$$A = A'(1 + A\beta)$$

Substituting our values in this equation, we have:

$$A = 1,000 \times 25 = 25,000, \text{ or } 87.96 \text{ db}$$

Our amplifier would require an initial gain (without feedback) of 25,000, or 87.96 db. Our feedback factor would be 25. Because of this feedback, the gain of the amplifier would be reduced to 1,000 (60 db) while the change in gain of the amplifier would be down to  $\pm 0.17$  db.

Most people use negative feedback, not to provide constant gain, but to reduce the distortion. Usually most of the distortion originates in the output stage. For this reason, the feedback is sometimes applied only to the output stage. This is not as useful as it appears, for the previous stage must now provide much more drive and usually begins to make a substantial contribution to the distortion.

In subsequent chapters, charts will be given so that you can calculate easily the phase and amplitude response and, hence, the stability conditions of amplifier circuits.

## **Gain without feedback**

Now that we have examined the basic principles of negative-feedback amplifier design, we can readily see that the quantity of



key importance is the feedback factor  $(1 + A\beta)$ . Expressing the feedback factor in db, it becomes:

$$F = 20 \log (1 + A\beta) \quad (22)$$

If  $A\beta$  is fairly large, this is almost identical to the condition where there is no phase to consider with the loop gain. Thus:

$$F = 20 \log A\beta \quad (23)$$

This of course can be factored to:

$$F = 20 \log A + 20 \log \beta$$

Most of our attention has to be focused upon the first term ( $20 \log A$ ), which is the gain of our amplifier without feedback, since  $\beta$  is relatively simple to handle.

The first thing to do is decide what you want. This may sound platitudinous, but even professional designers sometimes try to produce amplifiers which are not possible. We have discussed some of these basic design problems. For example, if a 6AQ5 beam power output tube is to give 4.5 watts, the distortion without feedback will be, according to the maker's specifications, 8%. To get only 1%, it is necessary to use about 20 db of feedback. The mutual conductance is 4,100  $\mu$ mhos, the optimum load 5,000 ohms. Therefore the gain will be about 20, or 26 db. The input stages of the amplifier must therefore provide most of the total gain we need.

If we want, say, 50 db all together, the gain without feedback must be 70 db. Since the 6AQ5 will supply 26 db, the earlier stages must have 44-db gain. This is an awkward example because 44 db is just about on the limit for a single high-gain pentode. We should have to look closely to decide whether to use two stages before the 6AQ5 and have the advantage of the extra feedback or risk the distortion rising to perhaps 2% at full output.

## Where to apply feedback

In this preliminary design, we must decide where the negative feedback is to be applied. Voltage feedback can be applied either to the grid or the cathode of the input stage in the ways shown in Fig. 103. The second way (Fig. 103-b) is useful only for feedback around a single stage because the resistances in the feedback connection must be very high and stray capacitances then become important. The method of Fig. 103-a has the disadvantage that the secondary of the transformer is not directly grounded; but as the resistance  $R$  is usually only about 100 ohms, this is not serious.

This method allows the cathode to be bypassed, thus increasing  $A$  and therefore  $A\beta$ , the feedback factor. The cathode R-C circuit is sometimes useful for increasing the stability margin. The method of 103-c is simple if the loss of gain due to the unbypassed cathode can be allowed.

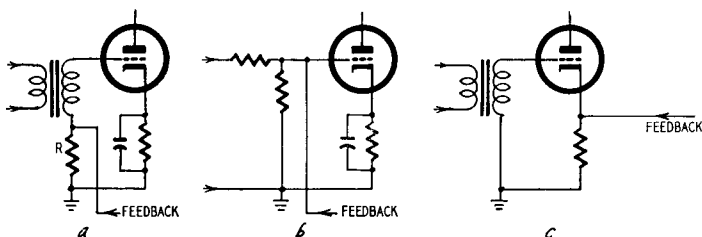

Fig. 103. Three common ways of applying voltage feedback to an amplifier input.

If the feedback voltage cannot be taken from a transformer, there is no way to reverse its polarity. In that case Fig. 103-a or-b must be used with an odd number of tubes and 103-c with an even number. Otherwise the feedback will be positive. This assumes that the output is taken from the plate and not from a cathode load. When the feedback is taken from the output side of an output transformer, circuit 103-a is the best because there is no d.c. in the feedback circuit and no capacitors are needed. If 103-c is used, a blocking capacitor must be used to keep the cathode voltage off the output line. This capacitor usually must be very large because of the low impedances normally used in this type of circuit. Some output transformers have separate windings for feedback.

## Safety margins

An amplifier will be unstable if the total or sum of the phase shifts through it reaches  $180^\circ$ , while at the same time the value of the loop gain ( $A\beta$ ) is equal to 1. Let us look at the typical amplifier response shown in Fig. 104, and analyze it in terms of amplitude characteristics and phase response before continuing our discussions of phase shift.

At frequencies between 256 and 2,048 c.p.s., the amplitude characteristic is very close to flat and the phase response is practically zero. This means that the coupling capacitors and transformer inductance (if a transformer is used) have negligible effects, the

coupling capacitor reactance is very small compared with the grid resistor and the primary inductance of the transformer has a reactance very high compared to the plate load impedance. It also means that the various stray capacitances that cause loss at the high frequencies still have reactances that do not appreciably shunt the circuit impedances.

At frequencies from 128 c.p.s. downward, the amplitude response drops off and the phase response shows advance angle. This is due to the rising series reactance of the coupling capacitors. In the interstage couplings a progressively larger proportion of the voltage developed at the plate of the previous stage gets dropped across the reactance of the capacitor and a progressively smaller proportion reaches the grid resistor of the following stage. At the same time, there is a  $90^\circ$  phase difference between the voltage dropped across the coupling capacitor reactance and that across the grid resistor. The voltage across the capacitor lags behind that across the resistor. When most of the voltage developed is dropped across the capacitor, the two will then be almost in phase, and the voltage across the grid resistor must be almost  $90^\circ$  out of phase with the input voltage. It is the grid resistor voltage which is passed on for further amplification. If the voltage across the capacitor lags behind the voltage across the resistor, then, conversely, the voltage across the resistor must lead, or be ahead of, the voltage across the capacitor. This means that the output voltage is actually ahead of the input voltage under this condition. It is indicated in Fig. 104 by showing the angles in negative degrees. The "waviness" of the characteristic is a result of the irregularity with which the different R-C values of the coupling circuits take effect.

At frequencies above about 4,096 c.p.s., the amplitude response again departs from level and eventually rolls off, and the phase curve goes into positive angles, representing phase lag or delay. At these frequencies the output is behind the input. This deviation is caused by the various stray capacitance effects. Grid to ground, plate to ground and stray wiring capacitance all contribute to this effect. The slight rise before falling off may be caused by interaction between the leakage inductance of the output transformer and its capacitance, forming a tendency to resonate. (Leakage inductance should not be confused with primary inductance. It is like an inductance in series between source and load, causes a loss of high frequencies rather than low, except where it resonates with some capacitance elsewhere in the circuit).

Instead of using  $180^\circ$  as the phase limit, we shall use  $150^\circ$  to give us a safety or phase margin of  $30^\circ$ . At some low frequency the phase shift between the input signal voltage and the output signal voltage will reach  $150^\circ$  and the gain will be less. If, as before, we represent the gain of an amplifier without feedback as  $A$ , then the gain of the amplifier at the low-frequency end will be less than  $A$ .

To meet the conditions of stability at the low-frequency end the loop gain ( $A\beta$ ) should be no greater than the amount by which the midband gain (without feedback) is reduced at the

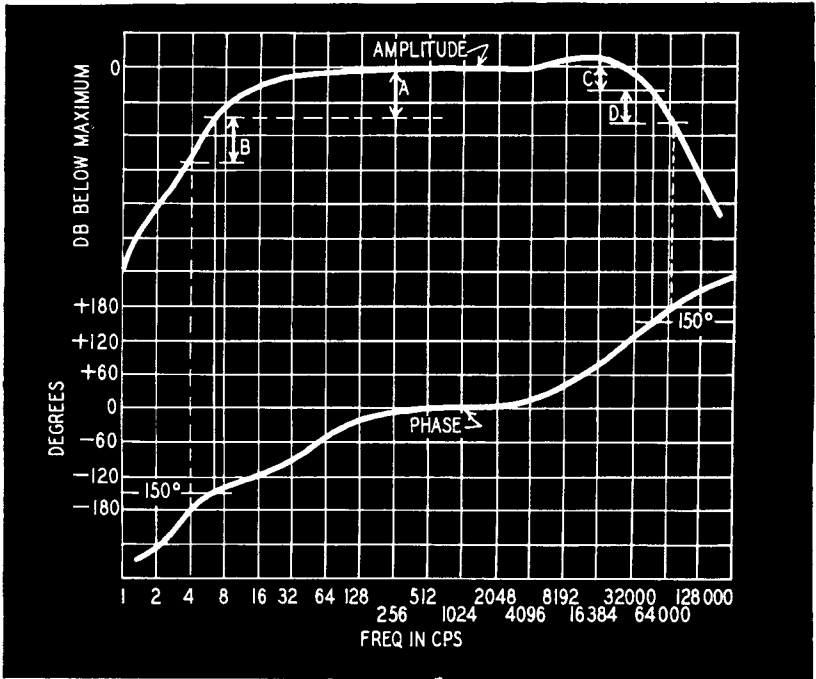

Fig. 104. Typical amplitude and phase characteristics of an audio amplifier.

frequency where the phase shift is  $150^\circ$ . In turn, the limit on the size of the feedback factor is determined by the amount of amplification decrease at the low-frequency end (using mid-frequency as a reference) in an amplifier without feedback. To understand this more clearly, refer to Fig. 104 in which the amount of drop in gain at the  $150^\circ$  point is shown by the length of vertical line  $A$ . We can reduce the gain by this amount when we apply feedback. If we use more feedback than this,  $A\beta$  becomes greater than unity at the  $150^\circ$  point and the circuit has insufficient margin of stability.

Exactly the same conditions apply to the high-frequency end. Here we also use the  $30^\circ$  phase margin. In Fig. 104, the length of vertical line C is the limit we should observe to keep the amplifier stable at the high-frequency end.

At more extreme high and low frequencies, the phase shift will reach  $180^\circ$ . At these points the difference between the actual feedback and the amount the response without feedback has fallen is called the *gain margin*. These are indicated by B and D in the response curve. The phase and gain margins are merely safety factors chosen so that the amplifier will not be running too close to its instability limits. A typical value for the gain margin is 10 db.

The phase shift can be allowed to be more than  $150^\circ$  as long as it dips back to that value. This is shown in Fig. 105. Point B on that curve is the one to use, and not A. This is true even if the

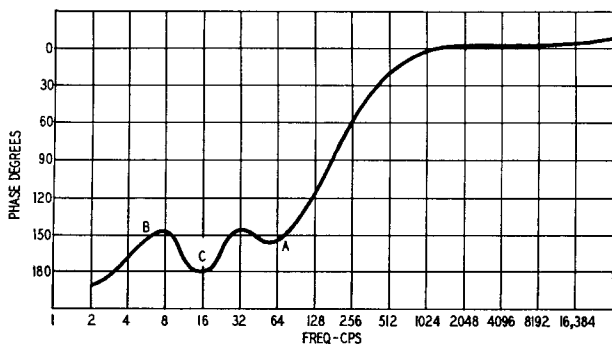

Fig. 105. Curve showing how the phase shift may go beyond the phase margin.

curve dips below the  $180^\circ$  line at C. In this case, however, the amplifier is only conditionally stable and might oscillate when first turned on. It is best to avoid such a condition because it is hard to handle. We will return to this question of margins later.

## Calculated response

We are now faced with the problem of calculating the response of the amplifier. Let us first concentrate on the low-frequency end. Two things cause the low-frequency response to drop off. One is the reactance of plate, screen and cathode decoupling capacitors; the other is the reactance of the interstage coupling circuits. The effect of decoupling is usually considered a refinement and will be considered separately.

At low frequencies an interstage coupling can be reduced to an equivalent as shown in the series of diagrams of Fig. 106-a. First the plate resistance of the tube is considered in parallel with the plate coupling resistor. Then, because the capacitor is the only frequency discriminating part of the circuit and the resistance parts can be considered a simple potentiometer following

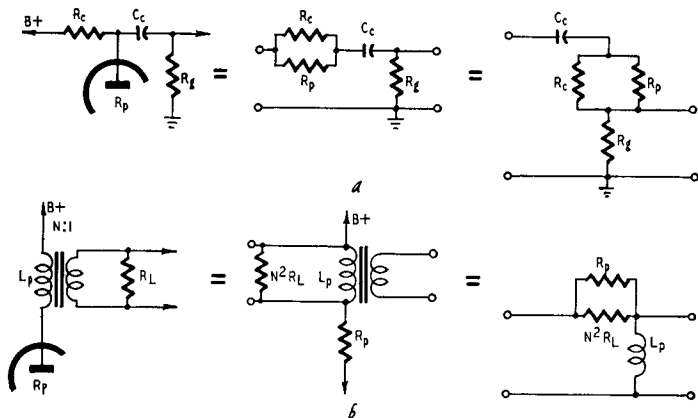

Fig. 106. At (a) is shown an interstage coupling reduced to its equivalent circuit where capacitor  $C$  is the only frequency discriminating part of the circuit. At (b) is the equivalent circuit when a transformer or choke is used where its inductance contributes to the low frequency response.

the capacitor, which has no effect on low frequencies, it appears that the turnover frequency ( $\omega_0$ ) occurs where the reactance of the coupling capacitor is equal to the parallel combination of  $R_p$  and  $R_c$  in series with  $R_g$ , or

$$\omega_0 = \frac{1}{C_c \left( R_g + \frac{R_p R_c}{R_p + R_c} \right)} \quad (24)$$

Where a transformer or choke is used, its inductance also contributes to the low-frequency response, and the equivalent can be reduced as shown in the series of diagrams at Fig. 106-b. First, the load impedance connected to the secondary of the transformer is multiplied by the square of transformer *stepdown* ratio. (If the transformer is an interstage *stepup*, the secondary resistance is divided by the square of the ratio). The resultant primary load is combined in parallel with the plate resistance of the tube, and



the turnover point occurs where the reactance of the inductance is equal to this resistance combination, or:

$$\omega_0 = \frac{R_p N^2 R_L}{R_p + N^2 R_L} = \frac{R_p N^2 R_L L_p}{R_p + N^2 R_L} \quad (25)$$

Fig. 107 shows the curve produced by any single reactance causing a low-frequency rolloff. This curve is normalized, by which

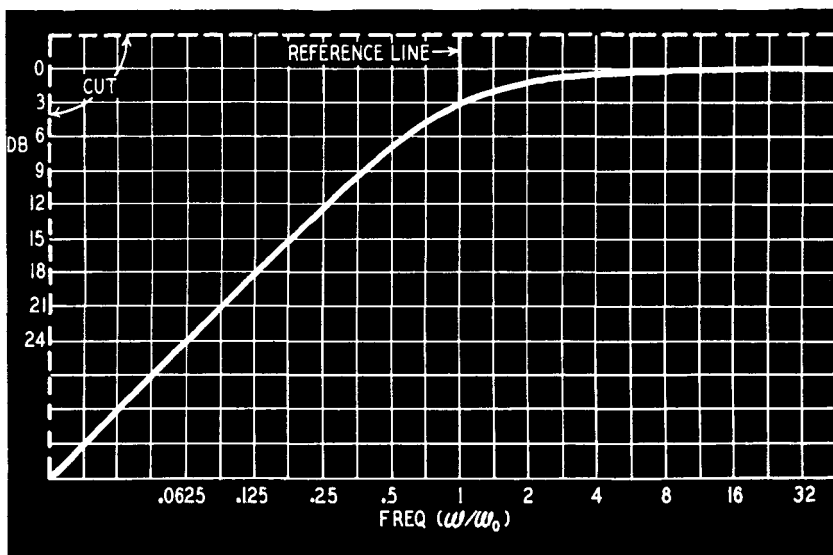

Fig. 107. The amplitude characteristic of amplifier coupling circuits. This curve is used to make the template discussed in the text.

we mean that a reference frequency has been chosen to make it universally applicable. In this case, the frequency marked as 1 is the frequency at which the reactance of C or L is equal to the appropriate resistance value, or  $\omega_0$  of equations (24) and (25).

The numbers on the frequency axis of Fig. 107 are the ratio of the frequency at that point to the normalized frequency, or  $\omega/\omega_0$  where  $\omega = 2\pi f$  and  $\omega_0$  is the turnover frequency.

You will notice that this curve is drawn on linear scales rather than the logarithmic one usually used for frequency response curves. Various makers use different spacing for their logarithmic paper, and, since we are going to make a template from this curve, we could use the template only with the same make of paper if

we use log paper. If you transfer this curve to centimeter-square or inch-square paper, you won't have this trouble. Besides, linear paper is much cheaper than log paper and an amplifier design may use up quite a lot of paper.

To make the template (Fig. 107), trace and then paste the curve to a stiff sheet of paper. Draw in the numbers indicating frequency on the template, which is now the upper part of the normalized response curve cut out.

An alternative method of making the template is to copy the curve onto centimeter or half-inch square paper. Paste this to a sheet of  $\frac{1}{16}$ -inch celluloid and scratch through the 0 db,  $\omega/\omega_0 = 1$  line, and the curve itself. Now fill the scratches with black wax (boot blacking) and cut out. You can now wash off the paper, since the template has now been etched into the celluloid.

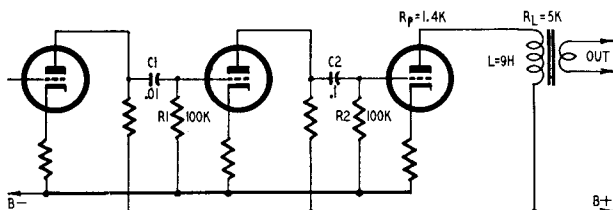

Fig. 108. A simplified amplifier circuit to illustrate the interstage coupling.

## A sample problem

Suppose we wish to draw the response curve of the amplifier shown in Fig. 108. The first step is to prepare a sheet of graph paper with the same size squares as are used on the template. Draw in the decibel scale the same as in Fig. 107 and put in a frequency ( $\omega$ ) scale. Notice that equal intervals on the frequency scale represent a doubling of frequency.

Now we determine the three values of  $\omega_0$  for the three coupling circuits.  $R_p + R_L$  is the resistive load on the plate of the output stage. For the first coupling circuit:

$$\omega_1 = \frac{1}{(R_1)(C_1)}$$

$$\omega_1 = \frac{1}{(10^5)(.01 \times 10^{-6})} = \frac{1}{10^{-3}} = 1,000$$

In this case the coupling resistor and plate resistance in parallel will be less than 10,000 ohms, so the error incurred in leaving

them out of the calculation will be less than the tolerance on resistor or capacitor values.

Since  $\omega = 2\pi f$ , we can easily divide 1,000 by  $2\pi$  and arrive at a frequency of 160 c.p.s. At this frequency, the signal voltage across C1 is equal to the signal voltage across R1, and the gain

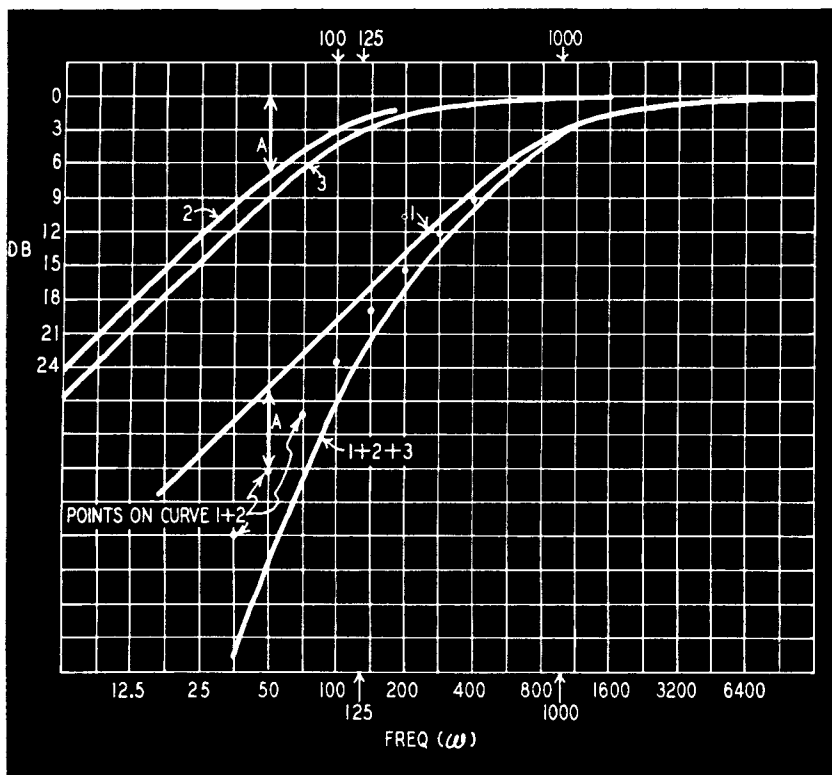

Fig. 109. Graph showing the amplitude response of each of three coupling circuits and the final curve (1 + 2 + 3) which results when the three are added.

is down by 3 db, for this particular circuit. We must now take into consideration the effect on the response curve of the remaining coupling circuits:

$$\omega_2 = \frac{1}{(R_2)(C_2)} = 100 \text{ (16 c.p.s.)}$$

and using the same approximation we will find:

$$\omega_3 = \frac{1.4 \times 5 \times 10^6}{(1.4 + 5) \times 10^3 \times 9} = \frac{7 \times 10^3}{6.4 \times 9} \cong 125 \text{ (19.9 c.p.s.)}$$

First place the template on the paper so that the reference line is at  $\omega_1 = 1,000$  and trace the curve. Move the template sideways so the reference line is opposite  $\omega_2 = 100$ , and trace another curve. Then place the reference line opposite  $\omega_3 = 125$  and trace the third curve. Now you should have three curves like 1, 2 and 3 on a graph that looks like Fig. 109. Each of these curves shows the low-frequency attenuation of the coupling circuit in question.

To get the overall response add the attenuation of these three curves. At some frequency, measure the distance from the 0-db line to curve 2 (a pair of dividers or a compass is handy for this).

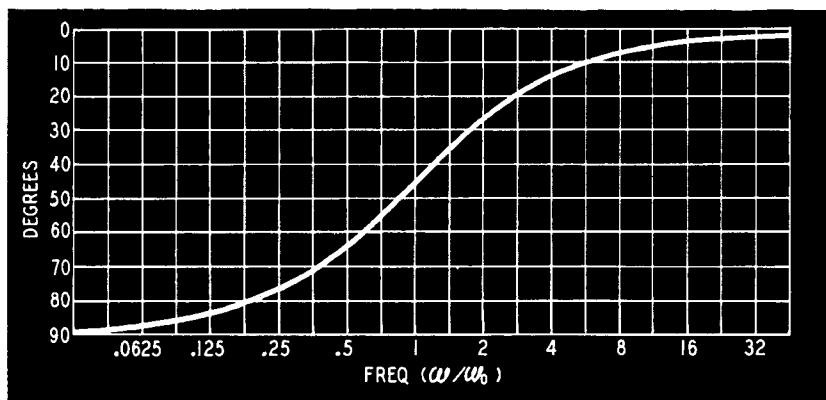

Fig. 110. The phase curve of the coupling circuits (Fig. 109). This curve is also normalized.

Then, below curve 1 mark a point equal to this distance. On our curves for example, at 50 cycles we mark off distance A to curve 2, then mark off this same distance A below curve 1. If you do this for a number of points, you will have points on curve 1 plus curve 2. In exactly the same way measure the distance from the zero line to curve 3 at the same frequency points used for curves 1 and 2 and mark off this distance below the new curve (1 + 2). Draw a continuous line between these points and you have the sum of the three curves—the overall response curve of the amplifier. Or, you can put a straight edge against the left hand margin of the template, and ride its parallel to the db axis.

### Interpreting the phase-shift curve

We can glean a few bits of interesting information from Fig. 110. The maximum transfer of signal voltage through a coupling circuit takes place when the circuit is purely resistive and has a  $0^\circ$  phase shift. The introduction of a phase shift means a loss in

gain since *less* useful signal voltage is developed across the grid resistor. The greater the phase shift, the greater the voltage decrease across the grid resistor until at  $90^\circ$  we should theoretically get no transfer of signal through the coupling circuit from one stage to the next so that the attenuation of the signal across the grid resistor should be infinite, resulting in zero output from the speaker. Each coupling circuit conspires to give us a phase shift as well as a signal loss. The effect of successive stages is cumulative

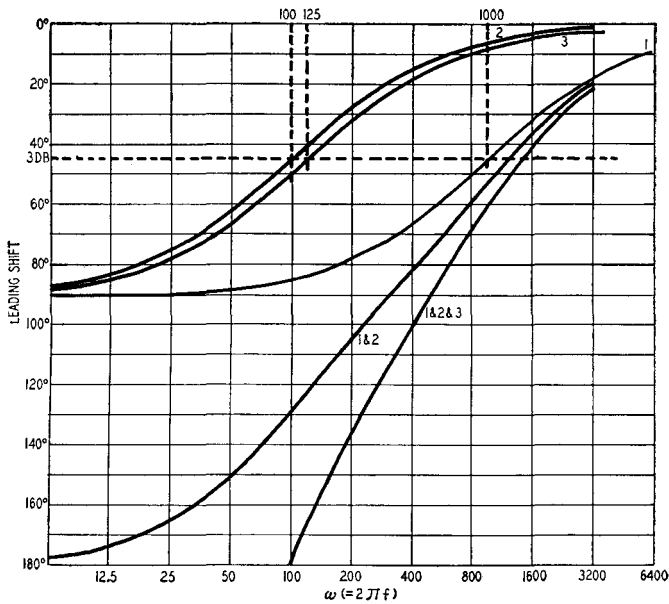

Fig. 111. Phase shift curve of the amplifier of Fig. 108. Curve 2 represents the shift of the circuit if the amplifier had contained only a single coupling stage consisting of R2 and C2.

and may be added, using db for response and degrees for phase shift. If, for example, our amplifier in Fig. 108 had contained simply a single coupling stage consisting of C2 and R2, the gain would have been down only 3 db at an angular frequency of 100. You can verify this by examining the attenuation curve (curve 2) of Fig. 111. However, with the addition of the other coupling circuits, the output at an angular frequency of 100 is much lower. Curve 1 in Fig. 111 differs considerably from curves 2 and 3. When  $\omega$  is 50, this curve is almost on the  $90^\circ$  line and the output of this coupling circuit is considerably reduced. This difference between constants of consecutive coupling stages has advantages. The point

where the overall phase curve cuts the  $150^\circ$  line is the critical point; the amplitude at this point should have fallen by an amount greater than  $A\beta$ . If this condition is not met, we will have insufficient margin of stability at the low-frequency end and must make some changes in the interstage coupling circuits.

## The high-frequency response

At the high-frequency end we must repeat this process. The two basic circuits are shown in Fig. 112. The resistance-coupled stage has plate coupling resistor  $R_c$ , plate resistance and the grid re-

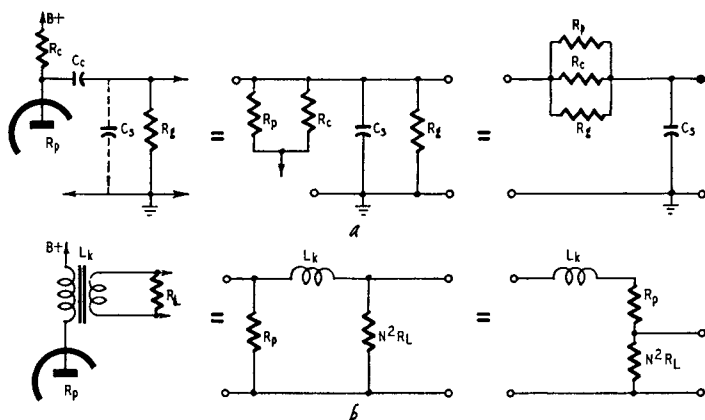

Fig. 112. Equivalent circuit (a) of an interstage coupling circuit at the high-frequency end showing the effect of stray capacitance. At (b), the reduction of the circuit when a transformer or choke is used, showing the effect of leakage inductance.

sistor and stray capacitance  $C_s$ , made up of the tube output capacitance, the input capacitance of the following stage and other strays. Of these, the capacitance to ground of the coupling capacitor can be the most important. In one compact amplifier the stray capacitance to ground of a  $0.1\text{-}\mu\text{f}$  capacitor in a rectangular metal can was  $40\ \mu\text{f}$ .

The inductance of the circuit in Fig. 112-b is the leakage inductance  $L_k$  of the output transformer. Both these circuits can be represented by the curves of Fig. 107 except that they are backward. All we have to do is turn the template over. Now the normalized frequency is given by  $\omega_0/\omega$ . Thus if  $\omega_0$  is 10 kc, the frequency 20 kc corresponds to  $1/2$ . The response characteristic is constructed in the same way as for the low frequencies and the stability is checked by observing where the curve crosses the  $150^\circ$  line.



The calculated response curve may not match exactly the actual response curves of the completed amplifier; but if all steps in drawing it are carefully carried out, it will be so close that the amplifier's performance can be predicted with as much accuracy as is possible in view of component tolerance. The effort of making the curves is rewarded with a good amplifier.

# analysis and design

In the first chapter the general principles of design of amplifiers with negative feedback were discussed. The procedure essentially is to design the amplifier; test it, not in the solid but on paper, and then modify the design if necessary to obtain the final circuit.

In this chapter we shall consider a concrete design, and we shall try to emulate the Butcher, who—

... wrote with a pen in each hand  
And explained all the while in a popular style  
Which the Beaver could well understand.  
“The method employed I would gladly explain,  
While I have it so clear in my head,  
If I had but the time and you had but the brain—  
But much yet remains to be said.”<sup>1</sup>

The Butcher took three as the subject to reason about but we are going to use instead a high-quality amplifier which has received much attention in Europe and which is fairly well known in the United States. Before going any further we must state that this is a jolly good amplifier and any criticism which may appear is only a reflection of the fact that one designer's meat is another designer's *poisson*.

The circuit is shown in Fig. 201. The output tubes, type KT66, are closely equivalent to the 6L6, although, being British, they are rather more powerful or are more conservatively rated. If we neglect the feedback for the moment, we can consider this circuit as our

---

<sup>1</sup> *The Hunting of the Snark, Fit the Fifth*, Lewis Carroll.

preliminary design and we can calculate how much feedback is permissible if the amplifier is to remain stable. The original designer has given us all the stage gains, except for the last stage. Here the total load, plate to plate, is 10,000 ohms, so that the peak voltage across the transformer primary must be 173 volts for 1.5 watts output.

Since we know

$$\frac{E^2}{R} = W \text{ or } \frac{E_{\text{EFF}}^2}{10^4} = 1.5$$

By transposing to solve for E (*effective*) we get:

$$E_{\text{EFF}}^2 = 1.5 \times 10^4$$

$$E_{\text{EFF}} = \sqrt{1.5 \times 10^4}$$

However, since we are concerned with finding the *peak* value of this voltage, (which is equal to  $\sqrt{2}$  times the effective value), we can now say:

$$E_{\text{PEAK}} = \sqrt{1.5 \times 10^4} \times \sqrt{2}$$

By combining this we then get:

$$E_{\text{PEAK}} = \sqrt{1.5 \times 10^4 \times 2}$$

$$E_{\text{PEAK}} = \sqrt{30,000} = 173 \text{ volts}$$

## Low-frequency response

There are three primary and two secondary factors governing the low-frequency response. The three primary ones are the two resistance-capacitance interstage couplings and the output transformer. At low frequencies the circuit is completely symmetrical, which makes things rather easier. At high frequencies this is not true, because the stray capacitance at the plate of V2 is in parallel with R7 and the impedance of V2, which is high due to the feedback in the cathode resistor R5.

The stray capacitance at the cathode of V2, a different capacitance, is in parallel with the impedance of V2 acting as a cathode follower. This difference could be quite important if the output stage were operating in class B. It is mentioned here merely as an indication of the special difficulties which the high-frequency response presents when compared with the low-frequency response.

Assuming complete symmetry, the primary factors in the low-frequency response are:

$$(C3)(R8) = (C4)(R9) = .05 \mu\text{f} \times 0.47 \text{ megohm or} \\ .05 \times 10^{-6} \times .47 \times 10^6 = .0235 = 1/43$$

$$(C6)(R10) = (C7)(R11) = 0.25 \mu\text{f} \times 0.15 \text{ megohm} \\ = .0375 = 1/27$$

L/R (in the output transformer circuit).

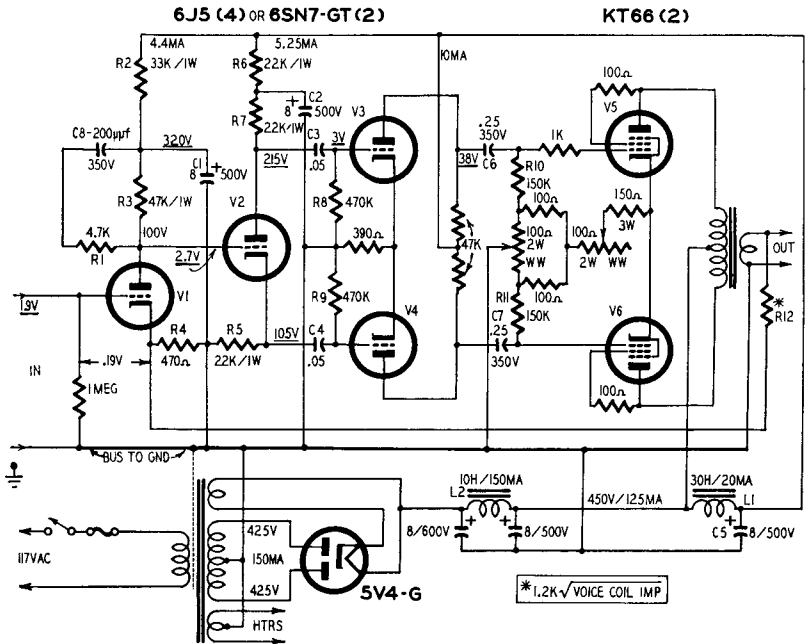

Fig. 201. The complete circuit of a Williamson amplifier. The underlined voltages are the peak signal voltages required for full output of 15 watts.

In the last case R is the resistance produced by the load in parallel with the tube impedance. The load, at the primary side, is 10,000 ohms: reference to data sheets shows that the KT66 has an impedance of 1,250 ohms when connected as a triode. The 6L6 is rather higher, 1,700 ohms; but it has a lower transconductance, so that the main effect of replacing the KT66 with the 6L6 is to reduce the gain without feedback and leave the stability about the same as a lower feedback factor.

Two KT66 tubes in series give 2,500 ohms, and this in par-

allel with 10,000 ohms gives R a value of 2,000 ohms. With formula, this is shown by:

$$R = \frac{R_1 R_2}{R_1 + R_2} = \frac{(25 \times 10^2) \times (10 \times 10^3)}{(25 \times 10^2) + (100 \times 10^2)} = \frac{250 \times 10^5}{125 \times 10^2} = 2,000 \text{ ohms}$$

Using 6L6's, we should have  $R = 2,500$  ohms.

We assume that  $L = 100$  henries, which gives:

$$\frac{L}{R} = \frac{100}{2,000} = \frac{20}{1} = .05$$

The choice of 100 henries may be because this is the largest inductance obtainable with a reasonable size of transformer, or because we want to keep a very good low-frequency characteristic. In this particular amplifier it was chosen because the designer is doing without an air gap and must allow for the increasing permeability at high flux densities.

When the value of L increases,  $L/R$  will increase, giving an improved margin of safety, since it moves further in value from that of the first two factors.

The secondary factors are:

$$(C1)(R2) = 8 \mu\text{f} \times 33,000 \text{ ohms} = 0.264 \cong 1/4$$

The relationship between R2 and R3 is then  $R2/R3$  is equal to  $33 \times 10^3 / 47 \times 10^3 = 0.7$ .

$$(C2)(R6) = 8 \mu\text{f} \times 22,000 \text{ ohms} = 0.176 = 1/5.7$$

The relationship then between R6 and R7 is  $R6/R7$  is equal to  $22 \times 10^3 / 22 \times 10^3 = 1.0$ .

These secondary factors cause the response to rise at low frequencies, and thus provide a small amount of phase correction. In the critical region this amounts to  $30^\circ$  and is, in fact, the feature which keeps the amplifier stable at low frequencies.

### The response curves

The individual responses are drawn in Figs. 202 and 203, and the total responses are plotted for the critical region. These responses were plotted by the method described in the previous chapter and even drawing them rather carefully took only about ten minutes. If the figures are examined, we see that we have a  $180^\circ$  phase shift at  $\omega = 10.5$ , at which point (A on both curves) the amplitude response has dropped by 24 db.

If we wish to have 20 db of feedback, we must also consider the

phase at the point B,  $\omega = 13$ . This is  $170^\circ$ . Remembering the definition of margins, we see that the phase margin is  $10^\circ$ , and the amplitude margin is 4 db ( $24 - 20$ ). The reader will realize that these margins are rather narrow.

One other factor must be taken into account in deciding whether they are safe margins. It is the increase in inductance produced by any signal in the output transformer. The maximum permeability of the core may be five times the initial permeability, and this will shift curve 3 to the left. The reader can confirm, if he wishes, that this does improve the margins. He can also confirm

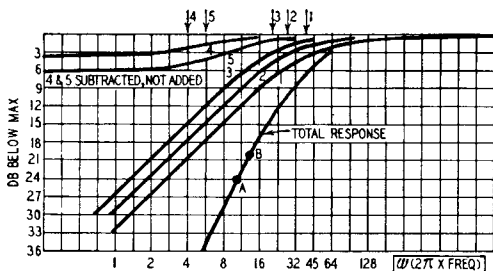

Fig. 202. Calculated response curves at the low-frequencies of the amplifier circuit of Fig. 201.

that improved margins can also be obtained by moving curve 1 to the right, that is by reducing C3 and C4. In general, stability can always be increased by moving the curves apart. In particular it is advantageous to move one curve from the remainder in either direction.

One more factor should be noted. At 10 cycles the response without feedback is only 3 db down. This means that we still have 17 db of feedback at 10 cycles, so that the full distortion-reducing effect of the feedback is in force.

## High-frequency response

The calculation of the high-frequency response is never very easy because of the lack of essential data. We shall ignore in the first calculation the circuit C8-R1 connected to the plate of V1. The response is then settled by the shunt capacitances of each stage and by the output transformer. Unfortunately the capacitances depend on the way in which the components are arranged, while the transformer's response may be complicated by resonance between the winding capacitance and the leakage inductance.

Let us plunge in boldly, however, and assume for each stage a

plate-ground capacitance (C) of  $20 \mu\text{mf}$  ( $20 \times 10^{-12}$  farads). We also have the designer's figure of 30 millihenries as the maximum leakage inductance, measured at the primary side of the output transformer. The factors controlling the high frequency response will be:

$$CR_{V1} = 20 \times 10^{-12} \times 10 \times 10^3 = 200 \times 10^{-9} = 1/5 \times 10^{-6}$$

Here an allowance of 10,000 ohms is made as the plate resistance of tube V1, taking into account local cathode feedback.

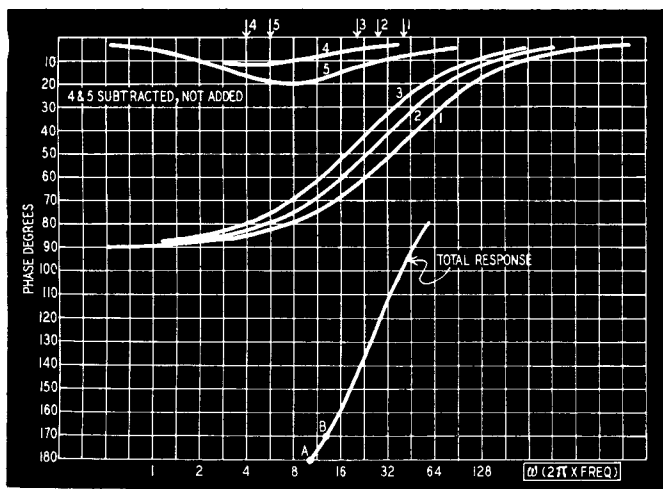

Fig. 203. The calculated phase characteristics of the amplifier (Fig. 201) at low frequencies. These curves were plotted by methods described in Chapter 1.

$$CR_7 = 20 \times 10^{-12} \times 22 \times 10^3 = 440 \times 10^{-9} \cong 1/2 \times 10^{-6}$$

In this case the impedance of V2 is made very high by the feedback due to the 22,000-ohm resistor (R5) in the cathode of V2; so the effective resistance is mainly that of R7.

$$CR_{V3} = 20 \times 10^{-12} \times 75 \times 10^2 = 1500 \times 10^{-10} = 1/6.7 \times 10^{-6}$$

The plate resistance of V3 is taken as 7,500 ohms from figures obtained in a tube manual.

$$\frac{L_k}{R} = \frac{30 \times 10^{-3}}{125 \times 10^2} = 2.4 \times 10^{-6} = 1/0.4 \times 10^{-6}$$

$L_k$  is the leakage inductance (in henries) of the output transformer. The resistance is the series combination of tube impedance (2,500 ohms for two KT66's) with the plate-to-plate load of 10,000 ohms.

These factors give the curves which are shown in Figs. 204 and



205. These were drawn in just the same way as before, using the simple templates, and only the important part of the total response characteristic has been drawn. The phase shift reaches  $180^\circ$  at  $\omega$

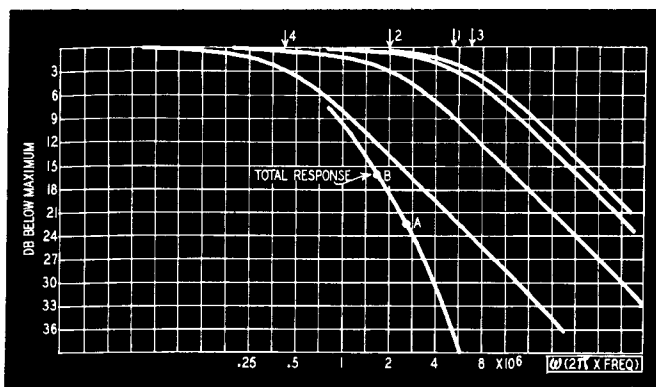

Fig. 204. The calculated high-frequency response of the amplifier. At point B, the amplitude margin is 6 db.

$= 2.6 \times 10^6$  ( $f = 300$  kc). At this point the amplitude characteristic has fallen by 22.5 db, indicated by the point A in Fig. 204. If we take  $150^\circ$  as the safe limit, we have B and a maximum feedback

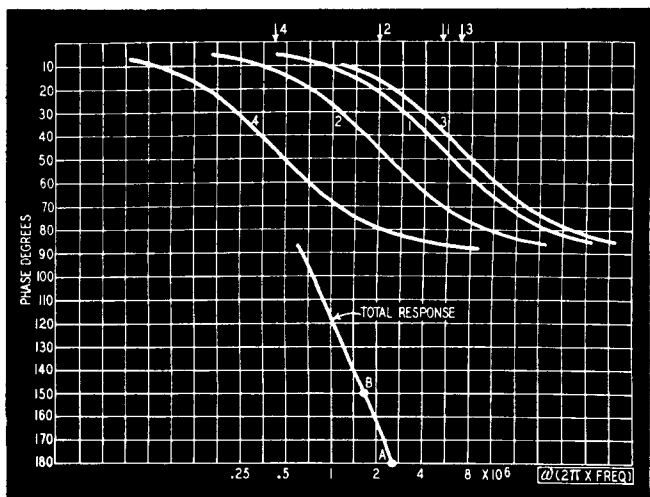

Fig. 205. The high-frequency phase characteristic. Maximum feedback for a phase margin of  $30^\circ$  is 16.5 db.

of 16.5 db. Using this amount of feedback, the amplitude margin is 6 db and the phase margin  $30^\circ$ .

## Increasing stability

One way of increasing the margin of stability is to increase the leakage inductance; another is to reduce the stray capacitances, especially that of the first stage. The reader will do well to recalculate these curves for, say, 50-mh leakage inductance and 15- $\mu\text{mf}$  capacitance. In the original version of this amplifier it is clear that the margins were rather small for the use of production transformers, for the circuit C8-R1 has been added. Let us see what this does.

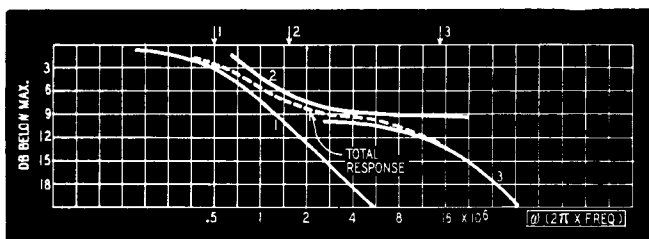

Fig. 206. The high-frequency response of the amplifier including the R1-C8 network (Fig. 201). This circuit is added to the amplifier to increase stability at the high frequencies.

The capacitance C8 is 200  $\mu\text{mf}$ . At a frequency  $\omega = 1/C8 \times R_{V1}$ , the response of the first stage will start to drop, and it will run down to meet a curve defined by C8 and R1. At still higher frequencies the response will drop owing to the 20- $\mu\text{mf}$  plate capacitance in parallel with  $R_{V1}$  and R1. Instead of the curves 1 in Figs. 204 and 205, we will have the curves shown in Figs. 206 and 207. We need the characteristic factors:

$$\begin{aligned} \frac{1}{\omega_1} &= C8R_{V1} = 200 \times 10^{-12} \times 10 \times 10^3 = 2 \times 10^{-6} \\ &= 1/0.5 \times 10^{-6} \end{aligned}$$

$$\begin{aligned} \frac{1}{\omega_2} &= C8 \frac{R1R_{V1}}{R1 + R_{V1}} = 200 \times 10^{-12} \times 3 \times 10^3 \\ &= 6 \times 10^{-7} = 1/0.17 \times 10^{-6} \end{aligned}$$

$$\begin{aligned} \frac{1}{\omega_3} &= C \frac{R1R_{V1}}{R1 + R_{V1}} = 20 \times 10^{-12} \times 3 \times 10^3 \\ &= 60 \times 10^{-9} = 1/17 \times 10^{-6} \end{aligned}$$

We could now redraw Figs. 204 and 205 but it is sufficient if

we simply compare the curves 1 of Figs 204 and 205 with the total response curves of Figs. 206 and 207. At  $\omega = 2 \times 10^6$ , for example, we had a contribution of about 1 db and  $20^\circ$  from the simple circuit, and the addition of C8-R1 has increased the attenuation to 7.5 db and the phase to  $32^\circ$ .

This means that the phase is now just over  $180^\circ$  at this point, and the attenuation is about 26 db. The amplitude margin of 6 db will then allow us to use 20 db of feedback. At  $\omega = 1.4 \times 10^6$ , the C8-R1 circuit gives us 6 db and  $35^\circ$  instead of 0.5 db and  $15^\circ$ ,

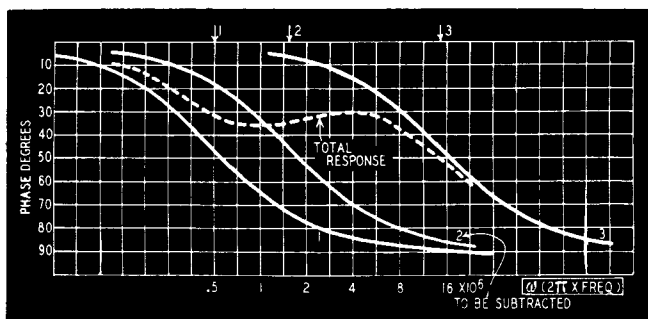

Fig. 207. High-frequency phase characteristic with R1-C8.

so that the total response at this point will have a phase shift of  $160^\circ$  and will be 19 db down.

By examining a few more points we can determine the phase margin exactly, but it is a little under  $20^\circ$ . These margins are rather tight; but, as we are making no allowance for the output transformer capacitance and as any assumed capacitance can be in error by  $\pm 25\%$  or more, we must not be too critical. In a later chapter we shall see how to deal with high-frequency instability.

At this point let us look back. We have taken as a design basis the circuit shown in Fig. 201 and have made certain assumptions which have enabled us to draw the amplitude and phase characteristics. These, in turn, showed us that we could apply 20 db of feedback without low-frequency instability, but that we require the stabilizing circuit C8-R1 if the amplifier is not to be unstable at high frequencies. We can also see that, without feedback the response being only 3 db down at 10 cycles, we get the full feedback over this range for the reduction of distortion and intermodulation.

## The feedback circuit

One more thing remains to be determined. In the actual design

process we must calculate the value of R12 which will give 20-db feedback. The designer tells us, or your own calculations will tell, that the input voltage between grid and cathode for 15 watts output must be 0.19.

We shall ignore the local feedback produced by R4 and assume that with R12 connected we want the gain to drop 20 db, making the new input for 15 watts output 1.9. Then we have 1.9 volts from grid to ground, 1.71 volts from cathode to ground and the necessary 0.19 volt from grid to cathode.

Let us assume that the transformer is designed for a 3.6-ohm secondary load. The 15 watts output then corresponds to  $\sqrt{3.6 \times 15}$  volts across the load, or 7.4 volts. Calculations give  $R12 = 1,570$  ohms to produce this required 1.71 volts at the cathode, while the original designer gives 2,200 ohms.

The reason for this discrepancy is the difference in what is meant by 20-db feedback when the main feedback loop also involves a local feedback of 6 db. When the resistor R12 is disconnected, 20-db feedback implies the gain rises 20 db. This could be attained by leaving the 6-db local feedback operative due to R4 or by removing it with a large electrolytic capacitor across R4. We used the former condition, whereas the designer used the latter.

In commercial design one more factor needs to be considered. Is the amplifier open-circuit stable? Often we need to have an amplifier switched on, but idle, and, if it operates from a common supply system with other amplifiers, it cannot be allowed to be unstable even when not in use. To test this we must redraw the characteristics for the amplifier with no load on the output transformer. The general question of load impedance will be discussed in a later chapter.

These calculated response curves are, of course, not the same as the actual measured response curves of the amplifier. We cannot, without a great deal of cumbersome mathematics, account for such things as tolerances of the components, stray wiring capacitance and a number of other factors. However, most of these items are rather small in value, and they also tend to average each other out.

What we do get from these curves is a very substantial idea of how the amplifier will behave once it is constructed. We immediately see any important flaws in the basic design so that the necessary corrections can be made at no cost of time or parts.

## Amplifier design

Now we shall consider a new design from the beginning.

We shall start off with the assumptions that the output power is to be 10 watts and that the distortion is to be below 1%. It really is not worth while pressing the distortion below  $\frac{1}{2}$  to 1%, because the transmitter distortion is more than this if we take a broadcast signal, while disc distortion is a good deal more than 1%. The response should be uniform from 30 to 15,000 cycles.

To obtain 10 watts output we may use type 6L6 or type KT66 tubes, but we shall use them as tetrodes with a lower plate voltage. This will save quite a lot in smoothing capacitor costs. We will use figures for the KT66, but the 6L6 values will not be significantly different. The distortion requirement suggests that we aim at 20 db of feedback. We would like to have the amplifier give its 10 watts for less than 0.5-volt input.

A 10:1 input transformer gives 5 volts on the secondary; but if 20-db feedback is used, only 0.5 volt will be available at the first tube grid. The 6L6 tubes require about 11 volts on each grid to swing them to 10 watts output. So a voltage gain of about 22 from first grid to each 6L6 grid is required. A 12AT7 in the so called seesaw circuit, will just about do this.

## The output stage

Our main difference in approach from the Williamson is in the design of the output transformer. It keeps the direct current balanced and uses a large inductance. We shall use the smallest possible inductance and then allow an air gap to avoid dependence on the d.c. balance. It seems easier that way. We begin with the design of the output transformer.

To make life easy, assume that the load impedance is 10 ohms. The lowest frequency is to be 30 cycles, and we want the output transformer to be as small as possible. If the inductance is made too low, however, we shall get distortion in the transformer and the load as seen by the tubes becomes reactive. A good reference point is where the response drops by 3 db. This makes calculation easy.

The inductance must therefore have on its low-impedance side a reactance of 10 ohms at 30 cycles, or  $2\pi \times 30 L = 10$ , or  $L = 50$  mh.

The optimum load for each tube is 2,200 ohms (2,500 ohms for 6L6), so that the transformer must have an impedance ratio of 440

to 1 ( $2 \times 2200/10 = 440/1$ ) center-tapped, or a turns ratio of 21 to 1. The formula for turns ratio of a transformer is given as:

$$\frac{N_p}{N_s} = \sqrt{\frac{Z_p}{Z_s}} \quad (26)$$

From this we get:

$$\frac{N_p}{N_s} = \sqrt{\frac{440}{1}} = 21:1$$

The high-side inductance is equal to  $440 \times 50 \text{ mh} = 22 \text{ h}$  (25 h for 6L6). The air gap must be chosen so that the inductance is not altered appreciably by a current of 20 ma. This is the unbalance current which may be obtained if the two tubes are at opposite ends of the tolerance range.

### The circuit

Before going any further we need to draw the circuit diagram, as far as we know it. This is shown in Fig. 208. Since we have only two stages, there is theoretically no possibility of low-frequency instability: if we want to add another stage to obtain a high-impedance input, we must watch this in the design. The first step is to decide on the values of C2 and C3.

For class A operation, R9 and R10 can be made 470,000 ohms. This value will be chosen, because the larger R9 and R10, the smaller C2 and C3 for the same C-R product. The output transformer is designed to have a characteristic frequency R/L of 30 cycles which brings its response 20 db down at 3 cycles. It is exactly the same as saying that the response falls 6 db per octave.

To provide 20-db feedback, the response must be down at least 26 db. If we take the frequency at which  $\omega CR = 1$ , we have  $45^\circ$  of phase shift, so that for two similar C-R terms (one from the preamplifier stage which we may add), there is a  $90^\circ$  phase shift at  $\omega = 1/CR$ . The transformer gives  $90^\circ$ , too, so that we must make  $1/CR$  less than  $2\pi \times 3$  cycles, to allow 26-db feedback at the  $180^\circ$  point. This means a capacitance of at least 0.1  $\mu\text{f}$  must be used. Let us go ahead with this value and, if necessary, use a slightly more sophisticated preamplifier stage.

### The phase splitter

This reservation has been made because we have not yet considered what happens in the phase splitter V1. This circuit is a rather attractive one and seems to work very well. The first half

of the double triode acts as an ordinary amplifier, with a plate load R4. The second triode is driven by the difference in plate voltages between V1-a and V1-b.

The two tubes seesaw<sup>2</sup> about the fulcrum P. That, at least, is the usual way of describing the operation of the circuit. There is, however, another way of looking at it. The output from V1-a is applied, through the voltage divider R6-C1-R8, to the grid of V1-b. R7 provides feedback to make the gain in V1-b sufficient for push-pull operation.

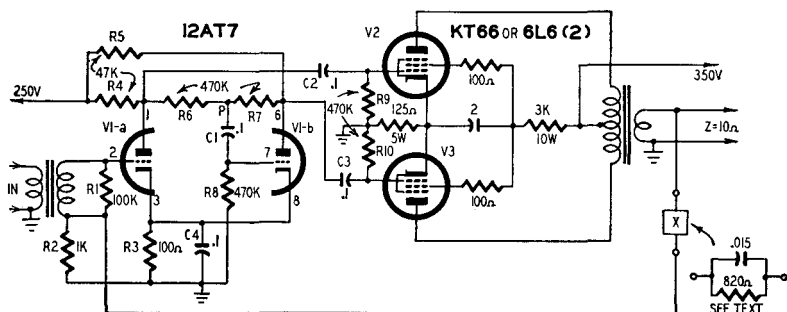

Fig. 208. Circuit of the amplifier whose design is described in the text.

Looked at like this it is easy to see that the phase shift produced by C1-R8 is greatly reduced by the feedback, which is of the order of 20 db. We shall go into this more fully, because the usual analysis of this circuit tends to conceal this rather important fact.

The suspicious reader may have noted that we have not yet mentioned C4. If the two triodes are really operating in pushpull, the current in R3 should not contain any alternating component, and C4 has no decoupling function. It is indeed a safety term, put in to deal with any tendency of the stage to act as a cathode-coupled multivibrator at very high frequencies. It has not been found necessary, but if there is excessive capacitance across R6, C4 might save the situation.

## High and low response

The overall response curves are shown as Figs. 209 and 210. It will be seen that with two C-R circuits there is 21 db of feedback for the 30° phase margin, and that under these conditions the gain margin is just over 6 db. Because these margins can be easily increased by increasing the capacitances, we need not worry about the low-frequency response.

<sup>2</sup>The seesaw phase inverter is discussed in Chapter 6, page 127.

The high-frequency stability is, as always, a problem. The values chosen for R4 and R5, with the total interstage stray capacitance and the tube impedance—about 10,000 ohms—give  $C \times R = 40 \times 10^{-12} \times 10,000$ , a characteristic frequency  $1/C \times R$ , where  $\omega_0 = 2\pi f_0 = 2,500,000$ . The interstage circuit should therefore be flat up to about 400,000 cycles.

The exact design of the output transformer now comes under consideration. The reader will probably prefer to buy one ready made or at least use the parts he already possesses. The only thing to avoid is the influence of the output transformer at high frequencies. To do this we shall add a few small components and then determine the limits to be imposed on the transformer.

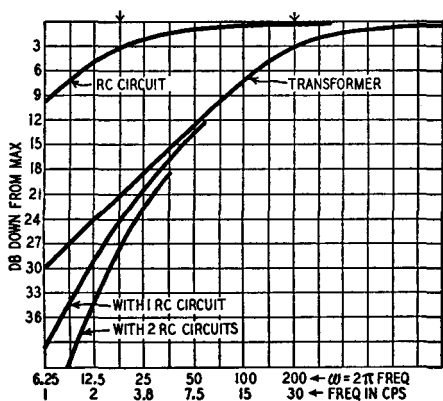

Fig. 209. The low frequency response of the feedback amplifier.

## Feedback resistor

Let us assume that we do not want any frequencies above 14,000 cycles, or at least that the response can roll off there. We shall begin by calculating the feedback resistance, which is in the little box marked X in Fig. 208. Our gain requirements are that 0.5 volt at 600 ohms at the input must give 10 volts across the 10-ohm output.

Assuming a 1:10 stepup in the input transformer, we have 5 volts across R1. Since we need only 0.5 volt from grid to cathode, across R2 we must have 4.5 volts. Immediately, therefore,  $R2/R_x = 4.5/(10 - 4.5) = 4.5/5.5 = 0.82$ . Let us take  $R2 = 1000$  ohms, thus from this ratio  $R_x = 820$  ohms. To produce the required roll-off at 14,000 cycles, connect a capacitor in parallel with this resistor. The capacitor must have a reactance of 820 ohms at this



frequency, so that the capacitance will be .015  $\mu\text{f}$ . The value of  $R_x$  is a standard and easily obtained from a stock.

The calculation of the capacitor is shown by;

$$X_c = \frac{1}{2\pi fC} \quad (27)$$

Rearranging equation (27) to solve for C, we get:

$$C = \frac{1}{2\pi fX_c} = \frac{1}{6.28 \times 14 \times 10^3 \times 820} = .014 \mu\text{f}$$

This calculated value is not a convenient standard. The nearest value, as previously stated, would be .015  $\mu\text{f}$ .

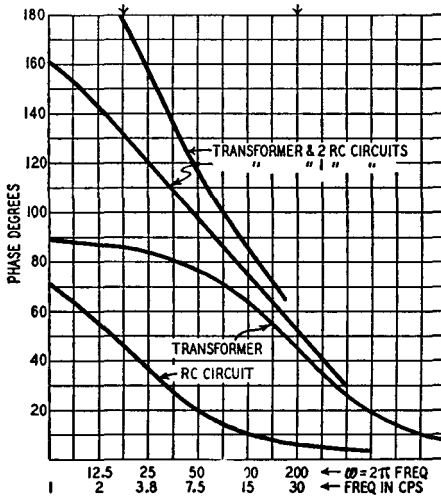

Fig. 210. The low-frequency response curves of the amplifier in Fig. 208.

This capacitor is very important, because it produces a phase shift rising to  $90^\circ$  and in the opposite sense to the phase shift produced by the transformer. The result is that, without the pre-amplifier stage, the system must be stable so long as the transformer has no awkward resonances. The practical implications are that we design the transformer for the right low-frequency inductance and use the simplest possible balanced structure. This is necessary if we are to avoid these odd resonances due to partial leakage inductance. Having done this, we can very profitably load down the two halves of the primary with capacitance to make the frequency response drop off above 14,000 cycles. Something of the

order of  $.003$  to  $.005 \mu\text{f}$  is indicated here, but we have not shown these components.

The most important thing in this work seems to be to acquire the "feedback finger." The important thing is to be able to make a sketch of the phase characteristic and then correct it as may be required.

The author's amplifier, built to this general design, gives about 0.3% distortion at 1,000 cycles at 10 watts output and 0.5% at 30 cycles and 6 watts output.

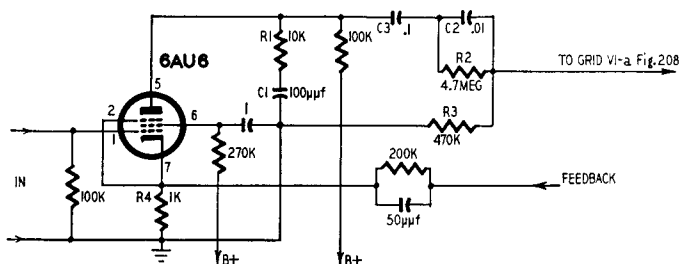

Fig. 211. The preamplifier that may be used in place of the input transformer.

## A preamplifier stage

The circuit diagram of a possible preamplifier stage is shown in Fig. 211. The interstage network is made up of two parts: R1 and C1, for high frequencies; C2, C3, R2, R3 for low frequencies.

We will discuss this type of interstage circuit in some detail a little further along. The basic idea is to provide a *step* in the amplitude response, and this enables more feedback to be used. We saw this, in a simple way, in connection with the cathode and plate decoupling circuits.

# response and stability

**T**he design method described in Chapter 1, to construct the amplitude and phase responses using simple templates, assumed that there were always sufficient margins to permit stability to be obtained. For example, if the amplifier was in danger of low-frequency instability, a coupling capacitance could be increased or decreased to get the extra stability. This was not stated explicitly, but, as no alternative was given, the reader was confronted with this single solution.

This brute-force method is applicable only up to a point which is reached rather early. When you find that you need a 4- $\mu\text{f}$  coupling capacitor somewhere in the circuit further thought is required, because the stray capacitance to ground is going to produce some headaches at high frequencies. We must call up some design reserves. It is probably worth while using two small capacitors instead of one big one, because the small ones are much easier to mount.

The design refinements considered here include the use of extra capacitors to permit the use of smaller ones. For portable equipment the weight saving is often important; however, this chapter stresses the increased amount of feedback which can be applied with the more thorough design.

## **Circuit refinements**

In the simple design a number of components were not made to earn their livings fully. These components were the decoupling

capacitors and resistors. Using pentodes, there will be either two or three of each to each tube, and we can make them contribute to the stability as well as carry out their fundamental decoupling job. The basic circuit diagram which we need is shown in Fig. 301. At moderate frequencies, say 1,000 cycles, the gain of this simple amplifier stage is:

$$A = g_m R_1 \quad (28)$$

where  $g_m$  is the transconductance of the tube and  $R_1$  is the plate resistor.

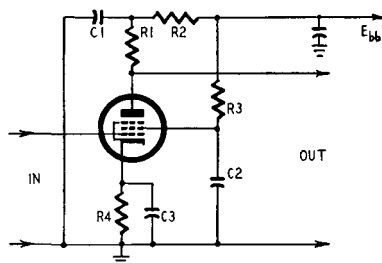

Fig. 301. Basic pentode amplifier hookup.

Forget for the moment the screen and cathode circuits: the plate load is made up of  $R_1$  in series with the parallel combination of  $R_2$  and  $C_1$  ( $E_{bb}$  is grounded to a.c.), so that the gain at any frequency is:

$$A\omega = g_m R_1 + \frac{\frac{R_2}{j\omega C}}{R_2 + \frac{1}{j\omega C}}$$

$$A\omega = g_m R_1 + \frac{R_2}{1 + j\omega C_1 R_2}$$

$$A\omega = g_m \left( \frac{R_1 + R_2 + j\omega C_1 R_1 R_2}{1 + j\omega C_1 R_2} \right)$$

$$A\omega = g_m (R_1 + R_2) \frac{1 + j\omega C_1 \frac{R_1 R_2}{R_1 + R_2}}{1 + j\omega C_1 R_2} \quad (29)$$

Using logarithms to express the gain in decibels, we have:

$$\begin{aligned} \text{db gain} = & 20 \log g_m (R_1 + R_2) + 20 \log \left( 1 + j\omega C_1 \frac{R_1 R_2}{R_1 + R_2} \right) \\ & - 20 \log (1 + j\omega C_1 R_2) \end{aligned} \quad (30)$$

The first term is the maximum gain, at zero frequency. The second and third terms give the frequency response, and the point to notice is that they have the same general form  $(1 + j\omega CR)$ . We

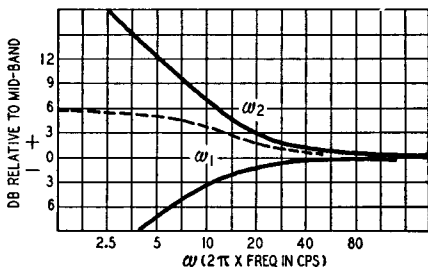

Fig. 302. The plate circuit frequency response of the amplifier of Fig. 301.

can therefore use our standard curves for working out the frequency response. All we need is the pair of *characteristic frequencies*:

$$\omega_1 = \frac{1}{C1R2}$$

$$\omega_2 = \frac{1}{C1 \frac{R1R2}{R1 + R2}}$$

$\omega_2$  is the frequency at which the response begins to rise: if R2 were big enough, the response would rise by 3 db at  $\omega_2$ .  $\omega_1$  is the frequency at which it begins to flatten out again. Fig. 302 shows how we construct the response. We take  $R1 = R2 = 100,000$  ohms,  $C1 = 1 \mu f$  giving for  $\omega_1$ :

$$\omega_1 = \frac{1}{10 \times 10^{-6} \times 10^4} = \frac{1}{10 \times 10^{-2}} = \frac{1}{0.1} = 10$$

and for  $\omega_2$ .

$$\omega_2 = \frac{1}{1 \times 10^{-6} \times \frac{10 \times 10^4 \times 10 \times 10^4}{10 \times 10^4 + 10 \times 10^4}}$$

$$\omega_2 = \frac{1}{1 \times 10^{-6} \times \frac{100 \times 10^8}{20 \times 10^4}}$$

$$\omega_2 = \frac{1}{1 \times 10^{-6} \times 5 \times 10^4} = \frac{1}{5 \times 10^{-2}} = \frac{1}{.05} = 20$$

The curve marked  $\omega_2$  is drawn with the aid of the template described in the first chapter, the 3-db line being set at  $\omega = 20$ . The template is then moved across the paper to  $\omega = 10$  and turned over. It is not really necessary to draw the curve marked  $\omega_1$ , but the dotted curve can be obtained by sliding the template parallel to the  $\omega = \text{constant}$  lines to add the two curves. The minus sign has been accounted for in turning the template over. The phase curves are shown in Fig. 303. The template has not been turned over in drawing the  $\omega_1$  curve, because it makes the diagram too big. It was turned over to get the difference curve shown by the dashed line. The reader will see that this 6-db rise in response gives a "phase bump" of  $18^\circ$ , midway on a log scale between the two characteristic frequencies. Adopting the principle of determining signs by common sense, it is clear that the phase shift produced by this circuit is such that it opposes the phase shift produced by a coupling capacitor, since the amplitude response *rises* instead of falls as we go down in frequency. This circuit therefore tends to make the phase margin bigger, although it does so at the cost of the gain margin. At  $\omega = 20$ , however, we have gained  $18^\circ$  in exchange for 1.9 db. This seems a worth-while trade, since we can always get more gain if necessary.

### Cathode and screen circuits

Now let us turn to the cathode circuit. At very low frequencies C3 has no effect, so R4 produces some feedback: usually R4 produces about 6 db of feedback in a pentode circuit. The gain of the stage, considering only the effects of R1, R4 and C3, will be approximately:

$$A_\omega = \frac{g_m R_1}{1 + g_m \left[ \frac{\frac{R_4}{j\omega C_3}}{R_4 + \frac{1}{j\omega C_3}} \right]}$$

Multiplying numerator and denominator in the square bracket by  $j\omega C_3$  we get:

$$A_\omega = \frac{g_m R_1}{1 + \frac{g_m R_4}{1 + j\omega C_3 R_4}} \quad (31)$$

This is not the exact expression, as the  $g_m$  in the bottom line

should include various screen conductance and transconductance terms, but the expression given is as accurate as the normal tube tolerances justify. At high frequencies, the gain reduces to simply  $g_m R_1$ , and the response therefore is:

$$\begin{aligned} \frac{A_0}{A_\omega} &= 1 + \frac{g_m R_4}{1 + j\omega C_3 R_4} = \frac{1 + g_m R_4 + j\omega C_3 R_4}{1 + j\omega C_3 R_4} \\ &= (1 + g_m R_4) \frac{1 + \frac{j\omega C_3 R_4}{1 + g_m R_4}}{1 + j\omega C_3 R_4} \end{aligned} \quad (32)$$

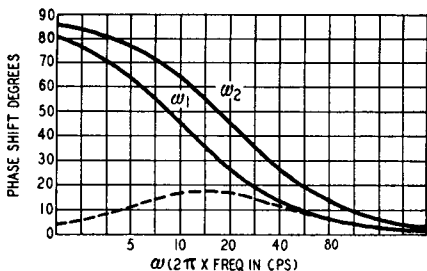

Fig. 303. The phase shift curves corresponding to the curves shown in Fig. 302.

The two characteristic frequencies, by comparison with the equations we had for the plate circuit, are:

$$\omega_1 = \frac{1}{C_3 R_4}$$

$$\omega_2 = \frac{1 + g_m R_4}{C_3 R_4}$$

We can draw the responses in just the same way as before, noticing that the response starts to *drop* at  $\omega_2$  and then starts to flatten out at  $\omega_1$ . The resulting curves will be similar to reflections of the curves of Figs. 302 and 303 in the horizontal axis. By choosing  $\omega_1$  and  $\omega_2$  for the cathode circuit to equal the plate circuit values, the overall response will be flat.

Finally, the screen circuit. For this, if we have only  $R_1$ ,  $R_3$  and  $C_2$  to consider, the gain is:

$$A_\omega = \frac{g_m R_1}{1 + \frac{\sigma_s R_3}{1 + j\omega C_2 R_3}} \quad (33)$$

where  $\sigma_s$  is the screen conductance. This effect is caused by feed-

back from the screen when it is not decoupled. Again the response drops at low frequencies, just as before, with the turnover frequencies given by:

$$\omega_1 = \frac{1}{C_2 R_3}$$

and

$$\omega_2 = \frac{1 + \sigma_s R_3}{C_2 R_3}$$

The only disadvantage of the latter expression for the screen circuit is that you don't know the value of  $\sigma_s$ . The tube maker never tells you that, not even in Europe. A rough value is quite easily found, however. When the working conditions for the tube have been settled, disconnect  $C_2$  and note how much the gain decreases at 1,000 cycles. Suppose that it is by a factor  $n$ . Then  $n = 1 + \sigma_s R_3$  and  $\sigma_s = (n - 1) / R_3$ . Then you can calculate the response.

Using the three sets of curves we have considered, we have the exact stage response, except for some interaction terms which may be neglected. We can choose the component values to help us to get a higher feedback factor. One word of warning, however: When the screen decoupling is affecting the response, the distortion starts to rise in a high-level stage. Hold that screen down, if you can.

## Coupling networks

There is nothing more to be gained from the tube circuits: we must use more complicated coupling circuits if we want more feedback than the design seems to permit. Let us look at Fig. 304. Take no notice of  $C_2$ , and assume that  $R_2$  is very large, about ten times  $R_1$ . As the frequency is reduced, the response depends initially on  $C_1$  and  $R_1$ , but when the impedance of  $C_1$  exceeds  $R_2$  the circuit degenerates into a simple resistance divider. This circuit has three characteristic frequencies which are:

$$\omega_1 = \frac{1}{C_2(R_1 + R_2)}$$

$$\omega_2 = \frac{1}{C_1 R_2}$$

$$\omega_3 = \frac{R_1 + R_2}{C_1 R_1 R_2}$$



The last frequency, if  $R_2$  is much larger than  $R_1$ , can be written approximately as  $\omega_3 \cong 1/C_1R_1$ .

At  $\omega_3$  the response starts to drop; at  $\omega_2$  it flattens out, and at  $\omega_1$  it starts to drop again. The sort of curve we get is shown in Fig. 305, which was drawn using a linear cutoff template, not the exact one. It will be seen that the phase is about  $60^\circ$ , or less, down to a frequency at which the response has fallen by 17 db. With only the conventional coupling circuit the response has fallen only 6 db at the  $60^\circ$  point. This circuit therefore gives an extra 11 db of possible feedback.

Fig. 304. A useful coupling circuit that makes possible more negative feedback. This circuit actually allows an extra 11 db of feedback.

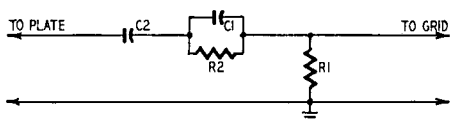

When we neglect the  $\omega_1$  term, so that we have an elongated S characteristic, the phase is just the dotted hump. The size of this hump depends on the ratio of  $\omega_3$  to  $\omega_2$ , and the top of the hump is halfway, on a logarithmic scale, between  $\omega_2$  and  $\omega_3$ . Fig. 306 plots the hump height angle in terms of the step in decibels. This curve is very useful in early design calculations. Suppose we have a five-stage amplifier. We can allow  $30^\circ$  per stage and still have  $30^\circ$  margin. Then the step is just over 9 db, and we are free to apply  $9 \times 5 = 45$  db of feedback by using this same step in each interstage coupling. From this beginning we go on to calculate in more detail. A practical point is that  $C_1$  has no steady voltage applied, so that it can be a low working voltage type.

At high frequencies, as we saw earlier, the tube capacitances and strays begin to cause trouble. Fig. 307 shows the bare bones of a circuit which does for high frequencies what the circuit of Fig. 304 did for low frequencies. Here  $R_1$  is the normal plate load,  $C_2$  the normal plate capacitance, including strays and the input capacitance of the next grid.  $C_1$ - $R_2$  are the additional components. For this circuit, as the reader can check for himself, the characteristic frequencies are:

$$\omega_1 = \frac{1}{C_1 \left( R_2 + \frac{R_p R_1}{R_p + R_1} \right)}$$

$$\omega_2 = \frac{1}{C_1 R_2}$$

$$\omega_3 = \frac{R_1 R_2 + R_p R_1 + R_p R_2}{C_2 R_1 R_2 R_p}$$

where  $R_p$  is the plate resistance of the tube.

At  $\omega_1$  the response begins to drop as the first part of the step. At  $\omega_2$  it flattens off as the completion of the step. At  $\omega_3$  it goes into its final rolloff. If the step height is 20 db, then the phase hump rises to  $55^\circ$ . These factors are important considerations in the design of coupling networks and should not be overlooked.

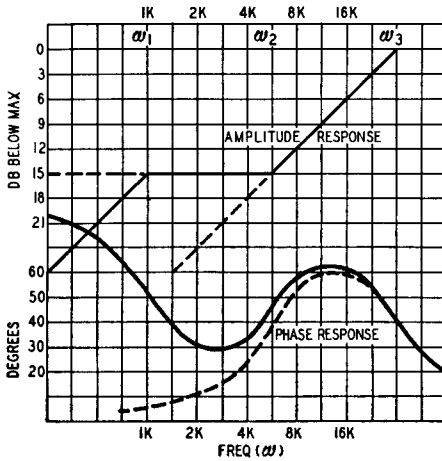

Fig. 305. Simplified phase and amplitude response of the network shown in Fig. 304.

The curve of Fig. 306 applies to this circuit, too, except that the ratio scale is now  $\omega_2/\omega_1$ . The result obtained by using this stabilizing circuit is well worth the effort expended in its development. It has proved to be the salvation of a good many amplifiers.

## The feedback network

Finally, there is a network which we can put in the feedback path itself. Why are we troubled by instability? Because the  $A\beta$  falls too quickly, almost invariably at the top end. The low end we can handle by ordinary component changes, if necessary, using circuits of the type shown in Fig. 304. At the top, if we cannot prevent  $A$  falling rapidly, let us make  $\beta$  rise. Fig. 308 shows a way of doing this. At frequencies in the working band the feedback resistor is made up of  $(R_1 + R_2)$ . At high frequencies it is just  $R_1$ .

This makes the factor  $A\beta$  more nearly constant. Therefore, the characteristic frequencies of this network are:

$$\omega_1 = \frac{1}{CR^2}$$

$$\omega_2 = \frac{1}{C \left( \frac{R1 \times R2}{R1 + R2} \right)}$$

and all our template tricks, and the curve in Fig. 306, can be used again. Here the loop gain begins to rise at  $\omega_1$  and flattens off at  $\omega_2$ . Use this circuit for final equalization of the response characteristic at high frequencies as well as for stabilization.

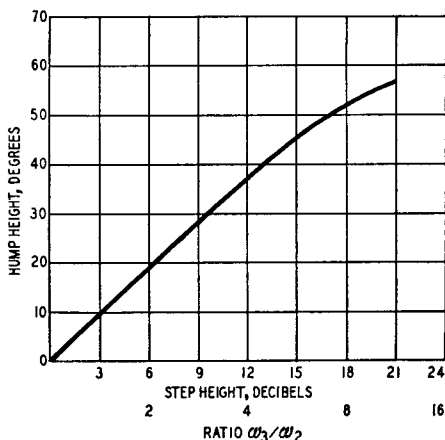

Fig. 306. The hump height in the phase characteristic of the Fig. 304 network.

Of course it is simpler to omit these circuits from an amplifier and allow plenty of phase and amplitude margin in the interstage coupling circuits, but these refinements are needed for large amounts of feedback.

All the circuit methods described here are easy to use once you get a grasp of them. The first time is sweat and tears, but by the fifty-first time it has become second nature. The real problems arise with positive feedback.

## Nyquist testing

We have already discussed the stability of the amplifier in terms of phase margin and gain margin. This method, which is very widely accepted, is extremely useful in designing an amplifier but

it is rather difficult to apply for testing the unit. Even if you make only one amplifier, it is worth while to test it properly, because it may go unstable owing to tube aging or supply variations just when you are showing it off to an admiring aunt. And, of course, if you make amplifiers for money you will not find many customers who want unstable ones, since their basic concern is to obtain optimum performance from the unit.

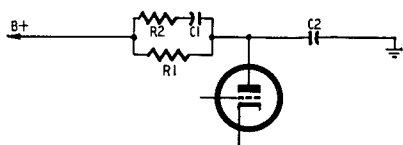

Fig. 307. A modified plate circuit that does for the high frequencies what the circuit of Fig. 304 does for the low frequencies. Its application has, in many instances, been the salvation of a good many amplifiers.

Measuring the phase and gain margins is a difficult job, because the measurements have to be extended to a very high frequency where the gain has fallen 20-30 db. Phase meters are available commercially. However, since they are ordinarily very expensive, you will generally find that only the very best equipped industrial laboratories have them. An oscillograph can be used, but it is a tedious and inexact method of measurement. An elegant way out has been described by W. T. Duerdoth, of the British Post Office. He has introduced a new quantity, the stability margin, which is

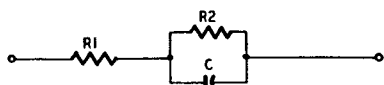

Fig. 308. This feedback network affords high-frequency stability. The feedback resistor consists of  $R1 + R2$  in the working band, and of  $R1$  alone, at high frequencies.

easy to measure and which gives a clear indication of the stability conditions. This quantity is related to the shape of the Nyquist diagram. Although it cannot be used in the design stage so easily as the gain and phase margins, it does seem to be the answer to the testing problem.

To have something tangible to talk about, a typical high-end response characteristic has been constructed and is shown as Figs. 309 and 310. According to what we have seen earlier, the permissible feedback for an amplifier with this characteristic would be about 18 db, giving a phase margin of  $25^\circ$  and a gain margin of 6 db. The important part of the Nyquist diagram is plotted as Fig. 311.

To plot this we start by drawing a circle with center O, and a radius of, say, 20 cm. We also draw a line OX, to the left. This

first circle is the zero circle, and we next draw a number of smaller circles, with the same center O. The circle with a radius of 10 cm, half the radius of the zero circle corresponds to a drop of 6 db; then one of radius 5 cm represents a drop of 12 db; the next, radius 2.5 cm, a drop of 18 db, and so on. We can also draw the circle of radius 2 cm ( $=20/10$ ), corresponding to a drop of 20 db.

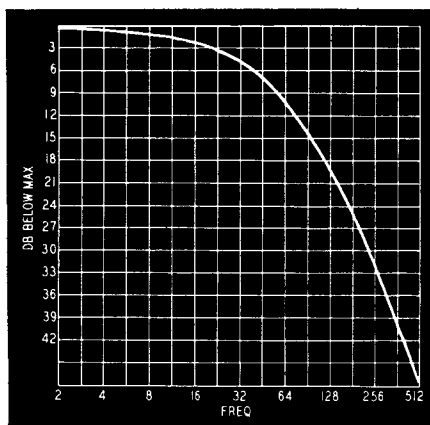

Fig. 309. The high-frequency response of a typical amplifier.

The figure actually does not include the zero circle, because the region located outside the 12-db circle is not particularly significant. As a result, it does not hold much interest for us.

### Polar response curve

We must now plot the amplitude-phase-frequency response as a polar diagram. For each value of amplitude we can determine a frequency from Fig. 309, and the corresponding phase from Fig. 310. Thus in Fig. 309, 4.5 db gives us a frequency of 32, and in Fig. 310 a frequency of 32 gives us  $72^\circ$ . In tabular form:

Fig. 309	Fig. 310
4.5 db $\rightarrow$ 32 (f)	$\rightarrow$ (f) 32 $\rightarrow$ $72^\circ$
7.5 db $\rightarrow$ 50	$\rightarrow$ 50 $\rightarrow$ $100^\circ$

Now draw a line OP, such that angle XOP =  $100^\circ$ , and fix P on this line at the 7.5-db level. This is actually at a radius of  $0.422 \times 20$  cm (the 0.422 comes from the voltage ratio-decibel table to

be found in most reference books). The point P therefore corresponds to the amplitude and phase given in Figs. 309 and 310 at a frequency of 50. This we plot in Fig. 311. Repeating the process at 6, 12, 18 and 24 db, we have enough points to plot the solid line. On a larger scale we can draw the dashed line, for which the original zero circle, if drawn, would have had a radius of 160 cm. Going back to the full line, which is part of the Nyquist diagram—the rest, over on the left, does not concern us—we see that it crosses

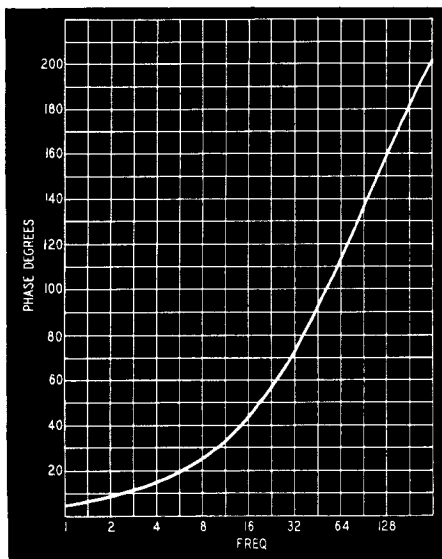

Fig. 310. The phase characteristic corresponding to the response curve shown in Fig. 309.

the  $180^\circ$  axis OY at the point L where the response of the audio amplifier has been reduced by the sum total of 24 db.

As we have already seen, the condition for stability is that we should have less feedback than the drop of response at  $180^\circ$  so here we must have less than 24-db feedback. This illustrates a rule which is known as *Nyquist's criterion*. This is usually expressed as follows: We define a point N as the point, lying on the line OY, at which the response has dropped F db, where F is the feedback. Then the curve must not encircle N. Usually this just means a smooth run-in above N, like the curve we have shown, but the Nyquist diagram may take the form shown in Fig. 312-a without the amplifier being unstable. This particular form is called "con-

ditionally stable” and it is a rather difficult form to use, because the amplifier becomes unstable if the gain falls (Figs. 312-b and c).

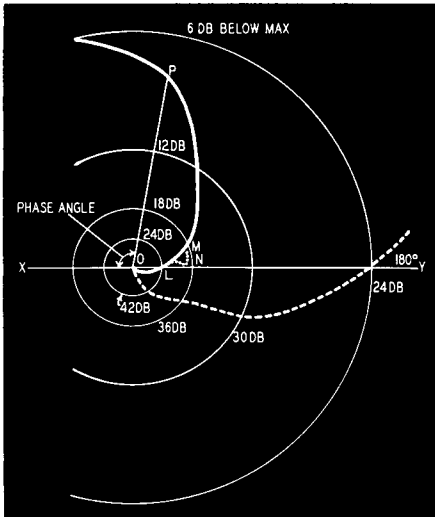

Fig. 311. This Nyquist diagram is a phase-amplitude curve on polar coordinates. The significant portion of the curve only is shown.

As a result, when first switched on, with the heaters warming up, the circuit will sing, and the resulting grid current may keep the

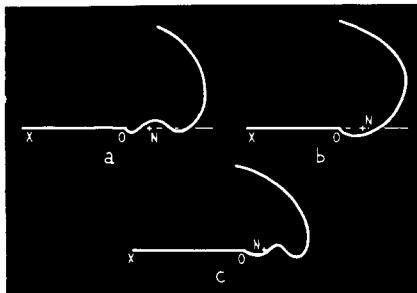

Fig. 312. Nyquist curves may cross the  $180^\circ$  line several times. The curve at (a) is stable, but those at (b) and (c) are unstable.

amplifier in the unstable low-gain condition. These “conditionally stable” circuits are therefore used only rarely and in applications where they are kept switched on permanently.

## Stability margin

The important idea which Duerdoth has introduced is this: It is not just the pair of points L and M (Fig. 311), corresponding to gain and phase margin respectively which matter, but how close the curve gets to N. The same values of these quantities would be given by a curve with the little dotted pimple shown on it; yet an

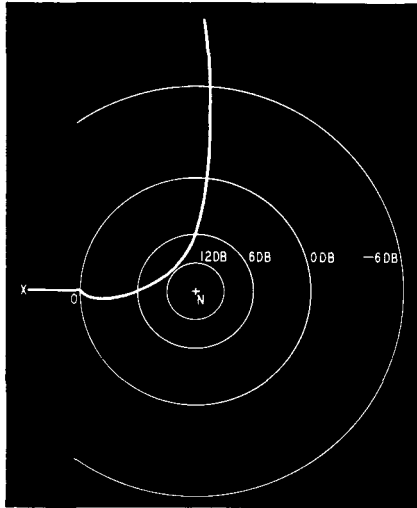

Fig. 313. The curve of Fig. 311 replotted to show the stability margin circles.

increase of gain of 0.1 db and  $1^\circ$  of phase would then make the dotted loop encircle N.

Looking back to the first chapter, we had an equation for the gain with feedback  $A'$  in terms of the gain without feedback  $A$  and the feedback network attenuation  $\beta$  (equation 10) given as:

$$A' = \frac{A}{1 + A\beta}$$

or

$$\frac{A}{A'} = 1 + A\beta$$

In Fig. 311, the distance  $OP$  is  $A\beta$  and  $OP$  is actually a vector, which includes the phase of  $A$  (and of  $\beta$ , if the feedback path is not a pure resistance network). By taking the right account of the



signs and doing a little vector mathematics, we can show that  $NP = 1 + A\beta$  so that the *length* NP is the ratio of the gain without feedback to the gain with feedback. In Fig. 313 the circles of constant NP are drawn for the same Nyquist diagram. The 0-db circle passes through O, the 6-db circle bisects the line NO and the

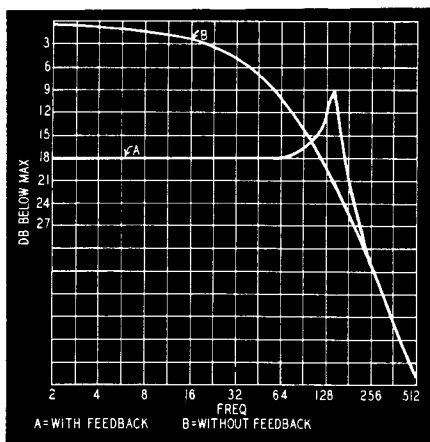

Fig. 314. Feedback reduces gain in the working band, but may actually cause an increase at the outside of the band, as these two response curves indicate.

12-db circle has a radius equal to  $\frac{1}{4} \times NO$ . It will be seen that the  $A\beta$  curve almost touches the 12-db circle, so that the stability margin is 12 db.

By now the reader may be getting a bit impatient wondering how all this indicates in any way a simplified procedure. Careful observation will show the answer was hidden in the last paragraph. To illustrate: we have calculated the effect of applying 18 db of feedback to the characteristics of Figs. 309 and 310. Fig. 314 shows the result. With feedback the response peaks up to 12 db above the response without feedback. (With feedback it is only 9 db below the maximum level without feedback, but without feedback it is 21 db below the maximum at this frequency). With less feedback the peak would be flatter; with more feedback it would get higher until it shot right up off the paper—*instability*. To find the stability margin all we need to do, therefore, is to measure the effect of connecting a variable amount of feedback in this range of frequencies until we find the point where oscillation occurs. The margin between operating gain chosen and the point where oscillation starts is then the stability margin.

It would be wise for the reader to review these points once again to ensure a thorough understanding of the problems discussed. Familiarization will afford a minimum of wasted effort.

## Degree of stability

We must have a criterion for a satisfactory value of stability margin. A figure of 6 db is quite a good working limit for test purposes. For design work, however, it is desirable to adopt a figure of about 4.5 db to allow for errors in component values and high transconductance tubes. Very often a still lower figure is forced on the designer by another consideration. Looking at Fig. 314 we see that with feedback we get a 9-db peak at the top end. Usually

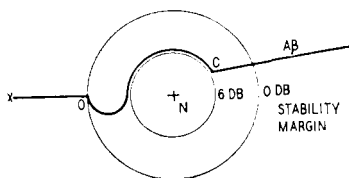

Fig. 315. An enlarged view of the center of the Nyquist diagram showing how to get a 6-db stability margin economically without an excessive phase margin. This represents an ideal condition, but has several disadvantages (see text), since the response is not easily controlled in actual practice.

we should add a small capacitance across the feedback resistor to round off this peak. Automatically we should improve the stability margin, and without calculation we can estimate that in this circuit we could easily make it 2 db. Stability margin is thus closely associated with response: a flat response with a smooth rolloff will usually have a very good stability margin.

Looking only at the stability margin, a Nyquist diagram like the one shown in Fig. 315 would be ideal. The amplitude response here would be flat up to the edge of the band, where it would drop sharply about 8 db and then follow a slope of 11 db per octave. When the feedback factor was reached, there would be a small flat step, giving the arc of a circle round  $N$ , and then down the response would plunge. By the phase area theorem this response is very efficient.<sup>1</sup> It is not easy to control the response as exactly as this. There is another disadvantage, too. Suppose the forward gain changes: it may rise or fall as the supply voltage changes or with tube aging. The effect is equivalent to moving  $N$  to the left or to the right. Decreasing the gain by 6 db will bring the corner  $C$  very close to  $N$ ; and although the amplifier is still stable, this does mean a high peak in the response. Increasing the gain by 6 db will make the amplifier unstable.

<sup>1</sup>Radio Engineers' Handbook, Terman, pp. 218-224.

A more sophisticated diagram is that shown in Fig. 316. This allows more room for maneuvering when the gain increases. Any reader who has reached the point of using circuits giving complicated diagrams of this sort can refer to Duerdoth's paper and the discussion on it.<sup>2</sup>

### Component tolerances

It is appropriate to point out here what the effect of component tolerances will be. If you use commercial capacitors and resistors,

*Fig. 316. Since the working conditions of an amplifier tend to change, the stability margin represented in this Nyquist diagram can be maneuvered as the gain increases, without causing the amplifier to become unstable. For the condition of Fig. 315, a 6-db gain increase causes instability.*

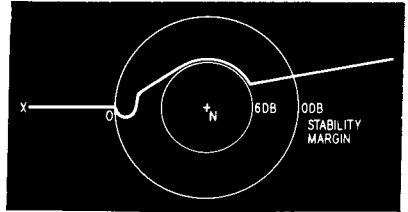

you cannot, with economy, get values better than 10%. The effect of a 10% change in either capacitance or resistance will cause a difference in phase shift of 3° at the characteristic frequency, where the phase shift is nominally 45°. In a three-stage amplifier, if all resistors and capacitors are 10% wrong in the most harmful direction, the phase will be in error by 18°. On top of this there may be a small error due to the decoupling circuits, so that at the worst we may expect 20°. Of course, it is not likely that we shall have all components at the limit values. If we do, we must either use others or else select sets of upper-and lower-limit resistors, using upper-limit resistors in one stage and lower-limit resistors in another. Alternatively, R-C sets can be chosen to give the right characteristic frequencies. This problem arises only if you are making a number of amplifiers which have rather tight specifications.

An important practical case of component tolerances arises in push-pull transformer design at low frequencies. Always allow for an unbalanced d.c. component in the plate windings due to differences between the tubes.

All the discussion of the stability margin has been devoted to the high-frequency stability. At low frequencies, where the region around 1 cycle is usually the important one, there seems to be no

<sup>2</sup>*Proceedings of the IEE*, Vol. 97, Part III.

really satisfactory solution. Our method is to increase the feedback until the amplifier becomes unstable. If the instability is at high frequencies, the stability margin is used as the test criterion; if the instability is at low frequencies, working feedback is used as the criterion. There is now available a range of very-low-frequency test equipment, mainly intended for servomechanisms (which are feedback amplifiers built around machinery), but not many are readily available. Most amplifiers do seem to rest against the high-frequency limit.

# distortion

**S**o far we have discussed the method of designing a conventional negative-feedback amplifier for audio-frequency use. The control of output impedance has not yet been discussed, but this will be considered later. Now we shall discuss one of the refinements of design which can give a considerable improvement in performance at very low material cost. Low material cost we consider a factor because the use of positive feedback can involve quite a lot of time and trouble.

## Using positive feedback

By using negative feedback we can flatten the frequency response, and we can reduce the harmonic and intermodulation distortion. Is there any reason why we should not apply common-sense arguments and say that by using positive feedback we shall make the frequency response less flat and shall increase the harmonic and intermodulation distortion?

There are two separate reasons for using positive feedback. One is to help control the impedance of an amplifier, and this we shall leave until we come to discuss the effects of feedback, positive and negative, on the impedance. The other reason is that we can improve the performance by the use of positive feedback, if—. And that *if* is our subject for the present.

Mathematical equations you either understand or you don't. Words, as you know, can mean just what you want them to. First let us look at Fig. 401-a, the basic circuit we used in Chapter 1. In

this, as you will remember,  $A$  is the gain of the amplifier itself and  $\beta$  is the attenuation of the feedback network. Instead of taking a simple amplifier in the box  $A$ , we can split this amplifier into two parts,  $A_1$  and  $A_2$ , with feedback  $\beta_1$  around  $A_1$  and  $\beta_2$  around both  $A_1$  and  $A_2$  (Fig. 401-b). Thus  $\beta_2$  is the negative feedback around  $A$  which we have in Fig. 401-a. Now the combination of  $A_1$  and  $\beta_1$  is a normal amplifier with feedback, having a gain of:

$$A' = \frac{A_1}{1 + A_1\beta_1}$$

This is in tandem with  $A_2$ , giving a gain, without allowing for  $\beta_2$ , of  $A_3 = A' \times A_2$ . We can write this in full as:

$$A_3 = \frac{A_1A_2}{1 + A_1\beta_1} \quad (34)$$

When we apply the extra feedback  $\beta_2$ , the overall gain becomes:

$$\begin{aligned} A'' &= \frac{A_3}{1 + A_3\beta_2} = \frac{A_1A_2}{1 + A_1\beta_1} \times \frac{1}{1 + \frac{A_1A_2\beta_2}{1 + A_1\beta_1}} \\ &= \frac{A_1A_2}{1 + A_1\beta_1 + A_1A_2\beta_2} \end{aligned} \quad (35)$$

If we have a fair amount of gain and feedback, ignoring phase shift effects, we can simplify this approximately to:

$$A'' = \frac{A_1A_2}{A_1\beta_1 + A_1A_2\beta_2} = \frac{A_2}{\beta_1 + A_2\beta_2} \quad (36)$$

or more simply it reduces approximately to

$$A'' = \frac{1}{\beta_2} \quad (37)$$

This, of course, is the standard feedback formula. But let us look at this basic two-path feedback equation more closely. We have:

$$A'' = \frac{A_1A_2}{1 + A_1\beta_1 + A_1A_2\beta_2}$$

When  $\beta$  is *negative* feedback,  $A\beta$  is a positive quantity, so that  $1 + A\beta > 1$ . Therefore, if the network  $\beta_1$  provides *positive* feedback,  $A_1\beta_1$  will be a negative quantity. Let us take  $1 + A_1\beta_1 = 0$ , which means that the loss in  $\beta_1$  equals the gain in  $A_1$ , and the feedback is connected as positive feedback. This, by the way, is the amount of feedback which when connected as negative feed-

back would reduce the gain by 6 db. With  $1 + A_1\beta_1 = 0$ , we then have:

$$A'' = \frac{A_1A_2}{A_1A_2\beta_2} = \frac{1}{\beta_2}$$

Notice that now there is no approximation: we haven't left out any small quantities. We actually have an overall gain which is settled only by the feedback network. Since the feedback network is assumed to be made up only of resistors, it must be absolutely linear and the distortion will be zero.

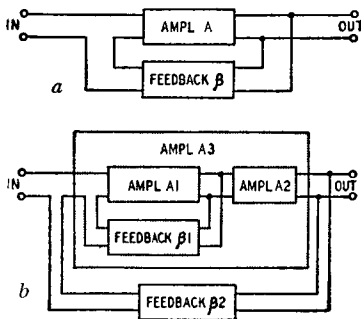

Fig. 401. The basic feedback circuit is shown at (a), while (b) shows a second feedback loop within the overall feedback loop.

## Limitations of this result

More careful examination shows that our mathematics has not told us the whole story. Let us look again at our first equation:  $A' = A_1/(1 + A_1\beta_1)$ . We took  $1 + A_1\beta_1 = 0$ , to achieve our final distortion-free amplifier. This means that  $A' = A_1/0 = \infty$ . That's fine, we have infinite gain, so that any input at all will overload the first amplifier unit. Anyway,  $A_1$  is not exactly constant. If it were, we should have no distortion, so why worry about using any feedback! Obviously we are pushing things too hard if we take  $1 + A_1\beta_1 = 0$ . Let us try something a little milder. Assume that  $A_1 = 100$  (40 db) at maximum tube transconductance and 50 (34 db) with low-limit tubes. A twin triode would give about this much gain. Take  $\beta_1 = -1/200$ , so that  $-A_1\beta_1 = 1/2$  to  $1/4$ . Then  $A' = 2A_1$ , in the maximum-transconductance case, which gives  $A' = 200$ . Thus there is an increase in the forward gain of 6 db. If the positive feedback has not introduced any extra distortion, the overall distortion, with  $A_2$  and  $\beta_2$  in the circuit, will be reduced

to one-half its value in the absence of the addition of positive feedback.

Even now, of course, the reader may be suspicious—if negative feedback reduces distortion, positive feedback must increase it. Let us assume that A1 consists of two single-ended stages, while A2 is a push-pull stage. The second single-ended stage will produce some second-harmonic distortion, say 3%, while the push-pull stage produces mainly third-harmonic distortion, say 8%. The

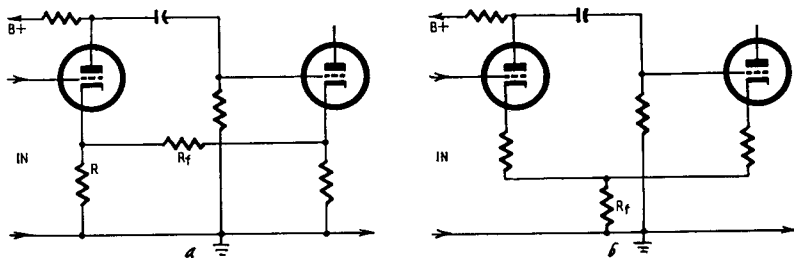

Fig. 402. Two simple circuits for applying positive feedback to an amplifier.

total distortion in the two circuits will be  $\sqrt{(3^2 + 8^2)}\% = 8.54\%$ . If  $\beta_2$  produces 20-db feedback the overall distortion will be 0.854%. Now we add the positive feedback to the first two stages: we get 6 db more gain, but we get  $2 \times 3\% = 6\%$  distortion here. The total distortion is now  $\sqrt{(6^2 + 8^2)}\% = 10\%$ . As we have the same  $\beta_2$  with 6-db extra gain in the forward direction, the overall distortion is reduced to 0.5%.

Maybe that improvement doesn't seem worth while. We can look at some other numbers. The first stage, A1, might be kept to 1% distortion by careful design and, if you don't mind trimming it when the tubes are replaced, it would be possible to add as much as 20-db of positive feedback. Without positive feedback, but with 20-db negative feedback, the overall distortion would be 1.01%. With positive feedback this is brought down to 0.2%. An improvement of five times is really something, because it would cost 14-db gain to get this improvement using negative feedback only.

Here, then, is the background of the positive feedback story. The questions that remain are how to produce the feedback, what it costs in components and what it costs in design effort. First of all, how should we produce the positive feedback? We should always put positive feedback around the shortest possible loop. The simplest possible circuit is that shown in Fig. 402-a, a circuit



which is equivalent to Fig. 402-b. If we replace  $R_f$  in Fig. 402-a by a capacitor, we have a fairly familiar circuit, the cathode-coupled multivibrator. This multivibrator is a circuit with much more positive feedback than we need.

Fig. 403. A modified version of Fig. 402-a that will provide positive feedback only in the middle of the audio range. At high frequencies,  $C1$  short-circuits  $R$ ; at low frequencies, the feedback path through  $R_f$  becomes an open circuit because of  $C2$ .

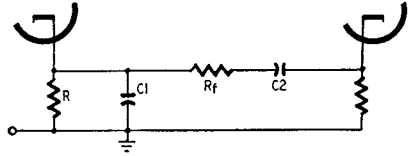

Looking at Fig. 402, we see that we have gotten rid of two cathode bypass capacitors and substituted one resistor. That doesn't seem too expensive, especially when you remember that performance is improved. In Fig. 402-a, the extra resistor will be a fairly large one; we shall see the sort of value needed later. In the circuit of Fig. 402-b, the common resistor is a small one, a few tens of ohms. As the two cathodes in Fig. 402-a will usually be at about the same potential, there will not be much d.c. in the feedback resistor  $R_f$ , so that it will only be a minimum-wattage component. Also, the value does not have much effect on the bias.

Fig. 404. Feedback circuit for a broadcast receiver to get high gain on weak signals, low gain with strong signals.

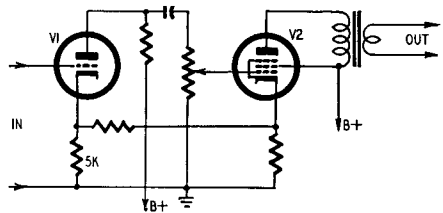

We can calculate the size of  $R_f$  approximately by the following method. Assume that the two tubes are the two halves of a 12AT7 double triode. With 1 mv applied to the input, the cathode-ground voltage for the first tube, without positive feedback, will be about  $\frac{1}{2}$  mv, and the plate-ground voltage about 20 mv. This is the grid-ground voltage for the second tube, and will produce a cathode-ground voltage of about 10 mv. By producing a cathode-ground voltage of 1 mv at the first tube we could keep this condition steady even without an input, so that we need  $R_f = 9R$ . For a 12AT7  $R$  will be about 200 ohms, and we get a value of  $R_f = 1,800$  ohms for infinite gain. For 6-db feedback the value will be about 4,000 ohms. This calculation is only a very rough one, to find out what size of resistor to try in the circuit, because the exact

expression is rather long and its practical value too limited to warrant giving it space here. It is always much easier to connect in a variable resistor and to adjust it.

There are two ways of approaching the design aspects of positive feedback. We can calculate the phase and amplitude response of A1 and then calculate what happens with positive feedback. When we describe the "A $\beta$  evaluator" in Chapter 5, you will see an easy way of carrying out the calculation. The alternative is to make A2 responsible for controlling the phase and amplitude out in the critical regions where the negative feedback can cause instability. We do this at low frequencies very often by keeping the

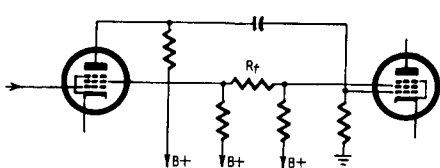

*Fig. 405. Another practical application of positive feedback can be utilized in pentode-tube circuits. Feedback from screen to screen will eliminate the need for the decoupling capacitor. Extreme high-gain input to the second stage should be avoided.*

output transformer inductance as the limiting factor. At high frequencies a small capacitor, or a pair for push-pull, can be used to have the same effect.

There is possible a modification of this second approach. If you look back to Chapter 2, you will see the responses calculated for the amplifier (Fig. 201). At  $\omega = 64$  (about 10 c.p.s. and  $\omega = 0.5 \times 10^6$  (about 90 kc), the phase shift is only 75 to 80°. So long as the positive feedback is out of action outside the frequency band 10 to 90,000 cycles, which isn't a bad working band, the overall stability should not be affected. Fig. 403 shows how the basic circuit of Fig. 402-a can be modified to make this happen. The shunt capacitor C1 short-circuits R at high frequencies, and we must have  $\omega C1R \gg 1$  at the upper end, which we saw might be as high as 90 kc. The other capacitor, C2, open-circuits the feedback path through  $R_f$  at low frequencies, so that  $\omega C2R \ll 1$  at the lower end, which might be at 10 cycles. Thus, typical values could be  $R = 200$  ohms,  $C1 = .01 \mu\text{f}$ ,  $C2 = 1 \mu\text{f}$ . With these values we would have positive feedback over the range from 100 cycles to 10 kc, which is the most important region unless you are a super-extra-ultra-high-fidelity fan. Most orchestral power comes up in the middle of the band, and that is where we need low distortion most of the time.

There is a rather interesting modification of this circuit which has been published. This is shown in Fig. 404. V1 has a high value

of cathode resistor, about 5K, which will produce a lot of local negative feedback. With the gain control potentiometer at maximum the positive feedback resistor is adjusted to compensate for this negative feedback. When the gain control is turned down to deal with a strong signal, the value of  $A_1$  is reduced, so that  $A_1\beta_1$  gets less, the positive feedback has less effect and  $V_1$  is linearized by the local negative feedback.

We have discussed only the cathode-cathode feedback circuit, because we haven't found any use for any other possible positive

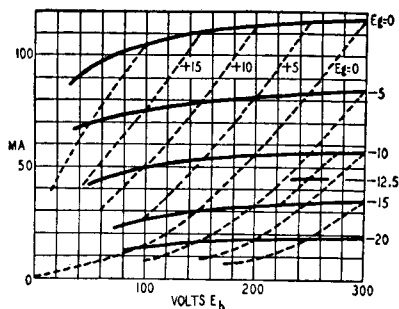

Fig. 406. Negative feedback from plate to grid makes the 6AQ5's characteristic (shown in solid lines) look like those of a triode (broken lines).

feedback circuit. As soon as you get away from this relatively low-impedance feedback path, stray capacitances start to be important, and these bring phase problems in their train.

Another application of positive feedback which is useful if you can make it work is in pentode circuits. The screen of a pentode can be regarded as either a grid, controlling the plate current or a plate, having a current controlled by the first grid. Usually the input is zero, and its contribution to the plate load is also zero, because of the decoupling capacitor. Suppose, however, that we leave out the decoupling capacitor, as we do in the tritnet circuit. Then we have a signal at the screen. By feeding back this signal to the screen of the preceding stage, where the screen now acts as a control grid, we can introduce enough positive feedback. Fig. 405 shows the sort of circuit we finish up with, and again we have saved the price of two capacitors by the use of only one resistor. The important thing in using this circuit is to avoid too much gain to the screen in the second stage; and, although we have drawn only a dropping resistor, it is essential to feed the second

screen from a relatively low resistance voltage divider.

At the start of this book we said that this was not to be an amplifier cookbook. To take positive feedback out of the jam-making class, you must have the means for calculating the phase and amplitude characteristics. The "A $\beta$  evaluator" discussed in Chapter 5 is a sort of slide rule for this job, and designing amplifiers with multiple feedback loops without it is like cooking without measures: ask the dairyman for five tablespoons of milk! But it is so easy to vary the feedback that we have no apologies.

## Impedance control

We have seen how the use of negative feedback makes the properties of an amplifier depend more on the behavior of a passive network than on the behavior of the amplifier itself. Since the "passive network" is usually just a couple of resistors, with no distortion and no frequency dependence, the overall circuit gives a flat distortion-free response. Very often, though, that in itself is not enough. For most readers, though not for most amplifiers, the probable load is a loudspeaker: If you get the cone vibrating nicely and then cut off the input, you have a coil moving in a magnetic field and thus acting as a generator, so that the impedance seen by the coil looking back into the amplifier is important.

Output impedance control is usually considered part of the job of a feedback amplifier. In quite a different connection, so is input impedance control. The commonest example of this is in voltmeter and scope amplifiers, when we wish to avoid loading down the circuit to which the amplifier is connected. Nine times out of ten a cathode follower, which is just a stage with a feedback  $\beta$  of 1, is used.

Before we consider the amplifier as a whole, it is rather instructive to see what happens to a single tube with feedback. For an example which is reasonably typical, we have drawn in Fig. 406, the characteristics of a 6AQ5 tube: a miniature which will give you 3–4 watts. It is a pentode, and at the standard working point,  $E_b = E_s = 250$  volts,  $E_g = -12.5$  volts,  $I_b = 45$  ma, the transconductance is about 4,000  $\mu$ mhos and the impedance about 50,000 ohms. This last figure is the real problem. The optimum load is 5,000 ohms, so that if you transform down to use a 15-ohm loudspeaker, the speaker will be looking back at 150 ohms. It might as well be an open circuit, as far as damping down speaker resonances goes.

Let us see what happens to the tube characteristics if we apply negative feedback. To make the calculations easy, let us apply feedback of one tenth of the plate voltage to the grid. Starting at the point  $E_g = 10$ ,  $E_b = 300$ , let us reduce  $E_g$  to  $-5$  volts. Then if  $E_b$  drops by 50 volts we shall feed back  $+5$  volts to the grid, and we shall be on the same  $E_g$  line as the starting point. Similarly, the point  $E_g = -10$ ,  $E_b = 300 - 100$  is on this  $E_g = 0$  line.

The resulting characteristic is drawn in Fig. 406. The feedback tube curves are indicated as broken lines. If you will forget we had a pentode, you will see that the new characteristics are those

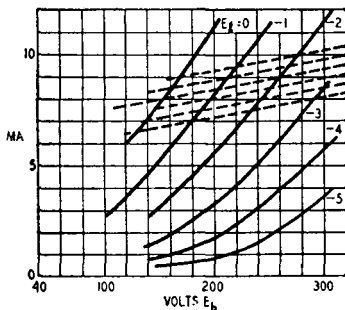

*Fig. 407. Negative current feedback will alter the curves of a triode so they will take on the high-impedance characteristic of a pentode (broken line).*

of a triode, with an impedance of 2,100 ohms at the original working point. If you connect this plate-grid feedback around a pentode and put it in a black box, anyone measuring the characteristics will think they have a triode. There is only one difference. You can swing this 'triode' down to a plate voltage of 50 without running into grid current; the corresponding limit when the screen and plate are joined together is about 170 volts.

The results of Fig. 406 are well worth a closer study. In the area below  $E_g = 0$  there is no grid current, because the feedback circuit will be an a.c. coupling. A pentode with negative feedback of this kind has the same characteristics as a triode, including the triode positive grid region, but you can work over the whole set of characteristics without grid current trouble. This is stressed because there are audio men who disbelieve that tetrodes can sound as good as triodes. Cast your eye over those curves, and you can see they are better than triode curves!

We can, to some extent, reverse this effect. A typical triode

characteristic is shown in Fig. 407. This triode has a  $\mu$  of about 50 and an impedance of about 20,000 ohms. By putting in a cathode resistor of 2,000 ohms we can make a change of 1 ma in the plate current feed back 2 volts to the grid. The effect of this is shown in part by the broken lines on Fig. 407. These are part of the characteristics of a "black box" tube having an impedance of about 105,000 ohms, which is getting on toward the pentode class. If you need a pentode and have only a triode handy, this is one way of making the circuit think it sees a pentode.

These two examples of modified tube characteristics have been considered because they provide a useful background to the general discussion of amplifier impedances. Ultimately any amplifier can be considered as a 4-terminal network in a box, and if you don't look inside you cannot be certain that it is not just one tube, with a transconductance of 1 amp/volt, perhaps! Now we can turn to the general amplifier circuit. Fig. 408 shows the general voltage feedback amplifier, with input short-circuited and output connected to a generator. This generator produces a voltage  $E_0$  at the output terminals, and the current flowing into the amplifier is  $I_0$ . The amplifier itself has an impedance of  $R_0$  and an *open-circuit* gain,  $E_2/E_1$  of  $A_0$ . Notice that we are using now the open-circuit gain, which can be quite a lot higher than the usual loaded gain. For a triode the difference is less than 6 db, but for a pentode or tetrode it may be much more. The feedback network  $\beta$  is assumed to be of such high impedance that it does not affect the impedances.

In the output mesh, we have this equation:

$$E_0 - E_2 = I_0 R_0$$

Now  $E_2 = A_0 E_1$  and since the only input is that provided by the feedback network  $E_1 = \beta E_3$  or, indeed,  $-\beta E_0$  since  $E_3$  and  $E_0$  are the same here.

Arranging the equations in order, we have

$$E_2 = A_0 E_1$$

$$E_1 = -\beta E_0$$

$$E_2 = -A_0 \beta E_0$$

Thus,  $-E_2 = A_0 \beta E_0$ , and we can substitute in the previous equation,

$$E_0 + A_0 \beta E_0 = I_0 R_0 \tag{38}$$

$$E_0(1 + A_0 \beta) = I_0 R_0 \tag{39}$$

Dividing through by  $I_0(1 + A_0\beta)$ , we get:

$$\frac{E_0(1 + A_0\beta)}{I_0(1 + A_0\beta)} = \frac{I_0 R_0}{I_0(1 + A_0\beta)} \quad (40)$$

which cancels to:

$$\frac{E_0}{I_0} = \frac{R_0}{1 + A_0\beta} \quad (41)$$

Of course  $E_0/I_0$  is the impedance seen by the generator connected to the output, and if the feedback were absent,  $\beta = 0$ , the impedance would be  $R_0$ . With negative feedback the impedance is reduced by the factor  $(1 + A_0\beta)$ .

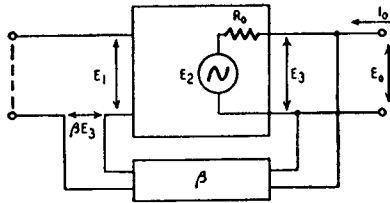

Fig. 408. Voltage feedback network used for calculating the output impedance.

This feedback was voltage feedback. We could use a circuit like that of Fig. 409, in which the feedback voltage depends on the *current* in the output circuit. To keep the formulas very simple, the resistance across which the feedback is picked off will be assumed to be small, just as before we assumed that the  $\beta$  network was of infinite impedance. In calculating this circuit we work in terms of current: the amplifier is assumed to have a transconductance of  $g_{m0}$  under short-circuit conditions, so that it produces an output current of  $g_{m0}E_1$  for an input of  $E_1$ . When we apply an additional current of  $I_0$  we have a current of  $I_0 + g_{m0}E_1$  through  $R_0$ , so that the voltage across the output terminals is:

$$E_2 = (I_0 + g_{m0}E_1)R_0 \quad (42)$$

The feedback network including the small resistor across which  $E_3$  is produced) delivers a voltage  $\beta I_0$  to the input terminals, and since the input has no other supply  $E_1 = \beta I_0$ . Thus:

$$E_2 = (I_0 + g_{m0}\beta I_0) R_0 \quad (43)$$

The admittance seen at the output is  $I_0/E_2$  and is:

$$\frac{I_0}{E_2} = \frac{1}{R_0} \times \frac{1}{1 + \beta g_{m0}} \quad (44)$$

If there were no feedback ( $\beta = 0$ ), this would be just  $1/R_0$ . With current negative feedback, therefore, the output *admittance* is reduced by the factor  $(1 + \beta g_{m0})$ . This means, of course, that the impedance is *increased* by this factor.

It must be noted that the factor  $g_{m0}$  is not the same as the  $A_0$  we have discussed, and it is not the same as the factor  $A$  in the term  $(1 + A\beta)$  we used in the distortion and gain effects earlier. This

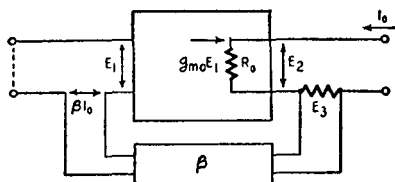

Fig. 409. Basic feedback network employing current feedback. In this arrangement, the current in the output circuit determines the feedback voltage. Formulae derived from this network are discussed in detail in the text.

means that we must make a separate calculation when determining the output impedance. When using voltage feedback we must use the equation

$$M = \frac{\mu R}{R + R_0} \quad (45)$$

for the gain of the last stage in determining the gain factor  $A$  (here  $R$  is the load impedance and  $R_0$  the plate resistance, both measured in the same part of the circuit); but  $M_0 = \mu$  for the impedance factor  $A_0$ . If, however, the feedback network uses resistors of values low enough to cause appreciable loading of the output stage, we may find it more accurate to write

$$M_0 = \frac{\mu R'}{R' + R_0} \quad (46)$$

where  $R'$  is the input impedance of the feedback network. We also ought to bring the output transformer losses into  $R'$ . In a pentode circuit, this means that  $A_0$  is from 3 to 10 times the corresponding value of  $A$ .

When using positive feedback, the term  $(1 + A_0\beta)$  becomes less than unity. Thus, positive voltage feedback increases the output impedance, and positive current feedback reduces the output impedance. We can combine positive voltage feedback and negative current feedback to give a very high impedance, for example, without losing too much gain. As an example of what can be done, a small amplifier, using a 12AT7, achieved an impedance, at the high side of the output transformer, of something around 5 megohms. This is better than pentode performance. In the opposite direction, another amplifier gives an impedance of 0.1 ohm when



designed to work into a 25-ohm load: this uses positive current and negative voltage feedbacks. There are good reasons for these designs: the pentode is needed to get power at low supply voltage, the 12AT7 to get gain from a single bottle and the extreme impedances are "musts" in their particular applications.

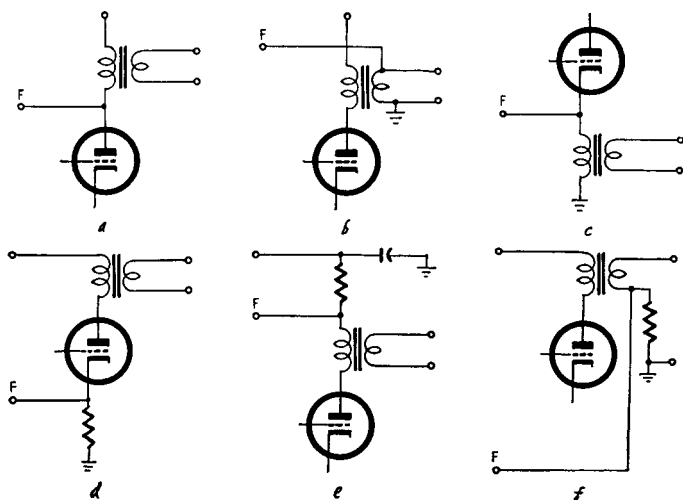

Fig. 410. Skeleton circuits showing six ways to pick off feedback  $F$ . The first three (*a*, *b* and *c*) are voltage feedback, the others (*d*, *e* and *f*) are current feedback.

The circuits for giving voltage and current feedbacks are summarized in Fig. 410.  $F$  is the feedback voltage in each case; *a*, *b*, *c*

TABLE FOR FEEDBACK CONNECTIONS				
No. of stages	Circuit of Fig. 410			
	a	c	d	e
1	g—			g—
2	k— g+	g— k+	g— k+	k— g+
3	g— k+	k— g+	k— g+	g— k+
4	k— g+	g— k+	g— k+	k— g+

Circuits *b* and *f* depend on transformer sense.

are voltage feedback and *d*, *e*, *f* are current feedback. The table is a summary showing whether the feedback should go to cathode

(k) or grid (g) of an earlier stage to be negative or positive. The plus signs show positive feedback, the minus signs negative feedback. Thus in a three-stage circuit you must feed back from cathode to cathode (circuit d) or from anode to grid (circuit e) to get negative current feedback.

For the sake of completeness we should mention the bridge feedback circuit. This can be used to effect a compromise value in output impedance.

Now let us consider the input impedance. A typical input circuit is shown in Fig. 411; and, although we have shown a resistor

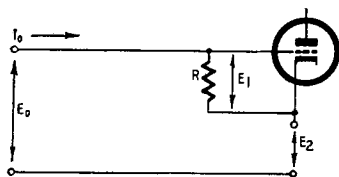

Fig. 411. The input circuit of an amplifier having series connected feedback at the cathode. Use of this circuit with a crystal pickup is practical, since this arrangement effectively reduces the input capacitance.

between grid and cathode, this could be a more complicated impedance. The biasing arrangements are also neglected. In this circuit, the input to the amplifier section of gain  $A$  is  $E_1$ , and the voltage developed by the feedback circuit is:

$$E_2 = A\beta E_1 \quad (47)$$

By simple addition,  $E_0 = E_1 + E_2 = (1 + A\beta)E_1$ , and from this we could deduce that the gain would fall by a factor of  $(1 + A\beta)$  when feedback was added, because we now need an input of  $E_0$  to produce  $E_1$  at the grid.

The current which flows through  $R$  is given by:

$$I_0 = \frac{E_1}{R} = \frac{E_0}{R(1 + A\beta)} \quad (48)$$

So far as any circuit connected to the input can tell, this current is produced by  $E_0$ , so that the input impedance is:

$$\frac{E_0}{I_0} = R(1 + A\beta) \quad (49)$$

The impedance has thus been increased by a factor  $(1 + A\beta)$ . This may be 10 to 100, so a resistance of 1 megohm, which is all we can normally use because of gas current in the tube, looks like 10–100 megohms to the external circuit. The input capacitance is reduced, too, which is important if you are using a crystal pickup. Notice, however, that positive feedback in this connection will reduce the input impedance, since then the quantity  $(1 + A\beta)$  is less than unity.

An alternate way of connecting the feedback is shown in Fig. 412. The current which flows into this circuit is:

$$I_0 = \frac{E_0 - E_2}{R_1 + R_2} \quad (50)$$

Now,  $E_2 = -A\beta E_1$  and  $E_1 = E_0 - I_0 R_1$ . We therefore have:

$$E_2 = -A\beta E_0 + A\beta I_0 R_1 \quad (51)$$

and

$$I_0(R_1 + R_2) = E_0 + A\beta E_0 - A\beta I_0 R_1 \quad (52)$$

By rearranging terms we get:

$$I_0(R_1 + R_2 + A\beta R_1) = E_0(1 + A\beta) \quad (53)$$

and

$$\frac{E_0}{I_0} = R_1 + \frac{R_2}{1 + A\beta} \quad (54)$$

Fig. 412. An alternate arrangement for connecting the feedback of Fig. 411. The circuit utilizes a parallel hookup for the feedback at the cathode. It is possible to employ negative feedback to the cathode and positive feedback to the grid to produce an extremely high input impedance.

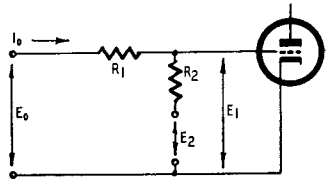

The  $R_1$  term is the impedance of the external generator, so that the input impedance  $R_2$ , without feedback, is reduced by the factor  $(1 + A\beta)$  with negative feedback. As before, if the feedback is positive, this gives an increase in input impedance. It would seem to be quite possible to apply negative feedback to the cathode and positive feedback to the grid to produce an extraordinarily high input impedance. The negative feedback would stabilize the gain so that the term  $(1 - A\beta)$  in the positive feedback equation could be made quite small.

In many applications it is necessary to provide a controlled value of input impedance, which involves the use of the circuit of Fig. 411 with an additional shunt resistor across the input. Often, too, we need a good 600-ohm output impedance, and then a high impedance shunted by 600 ohms is used.

This has been only a general survey of the problems of impedance control. If an amplifier is needed with some special impedance properties, a closer study may be required, but for almost all jobs the discussion here will be sufficient. Always the effect of feedback is to modify the apparent tube characteristics. It is prob-

ably wise to point out one important thing: If you turn a tetrode into a triode by means of feedback, the *optimum load* is unchanged: you should not try to match this “triode.” You can check this statement very carefully, both with modified characteristics and by actual experiment. This is specially important if you are using a high degree of feedback to get a low impedance for damping a loudspeaker or to get a high impedance for some other purpose. And don’t forget, if you want a low impedance, to allow for the resistance of the output transformer windings. This is also important.

## Optimum load

We have previously introduced the term *optimum load* without clarification on the assumption that all our readers are familiar with its meaning. However, our assumption may have been incorrect, so that perhaps it is best to define it clearly.

The word “optimum” means “best,” but it should be qualified. If someone asked you what is the best tube type on the market, you would need to know what he wanted it for; a low-noise-level input stage, a high-gain preamplifier stage, a driver stage, or a power-output stage—to name just a few. The same thing is true about the plate load for any given tube. What do you want the plate load to do?

Probably the most common use of the term *optimum load* is in connection with output tubes, where we are interested in getting the maximum power output from a tube without exceeding its plate dissipation rating. In such a case, optimum means the load for giving maximum output without overdriving the tube. But it may not be as simple as that. What kind of output do you want: square wave or something similar to the input wave? Or do you want it to have the lowest possible distortion while still giving close to its maximum output? Another application of output tubes is when a specific output power is required with a minimum of input grid swing. This can be called optimum load for maximum sensitivity. All these objectives cannot be obtained with the same optimum load value for the same tube.

Leaving tubes behind for the moment, let’s assume we have a battery from which we want to operate a heating element. The element can be wound to any specified resistance, but we want all the heat in the element that we can get from the battery. If we make the resistance too high, the battery voltage remains high,

there is a small current flow and little heat is created. If the resistance is too low, the battery voltage drops and, although the battery may get warm, the resistance element will not get enough voltage to warm it appreciably. The optimum resistance for the heater is the one that will draw the maximum wattage from the battery—somewhere between these two extremes.

To simplify this problem, the battery is regarded as being made up of two separate components: a perfect battery that gives constant voltage regardless of what is connected to it and an internal resistance which accounts for the drop in the terminal voltage

Fig. 413. The equivalent circuit of a battery. Maximum power dissipation from the battery through its externally connected load will occur when the load resistance  $R_L$  is equal to the internal resistance of the battery.

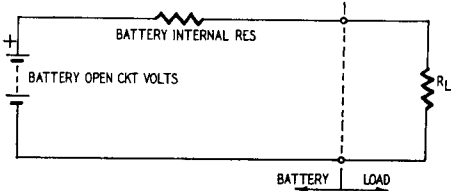

when current is drawn from the battery. Fig. 413 shows this idea. Let's put in some figures. Suppose the battery is a group of small cells giving 24 volts and having an internal resistance of 12 ohms. The total resistance which determines the current is the internal plus the external heater resistance. The voltage across the heater can be obtained by Ohm's law and the wattage dissipated by the heater is terminal voltage times current. We can tabulate this for different values of heater resistance. (See wattage table.)

Fig. 414 shows heater dissipation plotted against heater resist-

WATTAGE TABLE				
Heater resistance (ohms)	Total resistance (ohms)	Current (amperes)	Terminal volts	Heater watts
3	15	1.6	4.8	7.68
4	16	1.5	6	9
6	18	1.33	8	10.67
8	20	1.2	9.6	11.52
12	24	1.0	12	12
18	30	0.8	14.4	11.52
24	36	0.67	16	10.67
36	48	0.5	18	9
48	60	0.4	19.2	7.68

ance. It appears that a 12-ohm heater gives the maximum wattage—12. This is the same resistance as the internal resistance of the battery. This numerical example illustrates an important principle: The *maximum wattage* in the external circuit is obtained by making the external circuit resistance equal to the internal resistance.

### Maximum sensitivity

Assume we have a tube connected to the necessary voltages (Fig. 415), and the plate choke-coupled to the plate load, so we

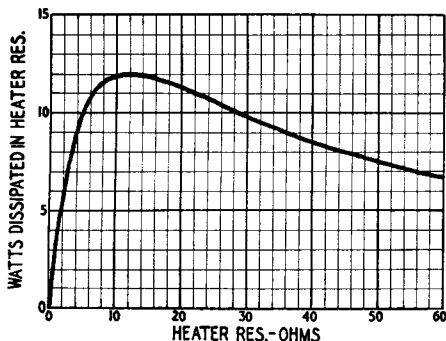

Fig. 414. Graph showing the effect of varying the load resistance across the battery.

can change the plate load without altering the plate voltage. Now apply an audio signal to the grid, well within the maximum swing allowed for the bias used, so that the distortion is small no matter what load we use. If we leave the plate load unconnected and assume that the choke does not itself constitute a load, the audio voltage at the output will be the audio voltage at the grid multiplied by the amplification factor of the tube. If we short the output terminals, the voltage disappears, the same as it did with the simple battery. Any amount of plate load we connect will *reduce* the audio voltage at the terminals, according to the load value. This can be explained by regarding the tube as an audio-voltage generator combined with an internal resistance. The so-called internal resistance is the plate resistance of the tube. For the case we are now considering, the maximum wattage in the load occurs when the plate load is equal to plate resistance.

This result is expected, but it doesn't seem to line up with practice, you will be thinking. All the same, it is true for the

particular case dealt with. The conditions should be emphasized: Audio signal level at the grid is well inside the maximum swing allowable for the grid bias used and is restricted to this level; the output variation considered is the power in the plate load as plate load value is varied, using the fixed grid input.

If we wanted an output tube to provide its maximum gain in terms of power in the load, we should use an optimum load equal to the plate resistance of the tube. But gain is usually easy to obtain elsewhere. The more difficult thing with power tubes is to get a large audio output with reasonable plate dissipation. So we start at a different place. We assume that whatever grid swing is needed will be found somehow, although it will generally be

*Fig. 415. A basic type of output circuit. If we consider the tube as an audio generator, and disregard the presence of the audio choke, maximum energy transfer from the tube will occur across an actual load when its value is equal to the internal resistance (plate resistance) of the tube.*

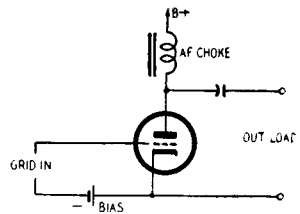

advantageous to use a tube with a small grid swing. The problem is to get the biggest possible swing in plate voltage and current at the same time, so the output watts are as high as possible with little distortion.

Matters are complicated because tube characteristics have boundaries. We have assumed we were well enough within these boundaries so we could ignore their existence, but in each kind of tube there are at least three boundaries that have to be considered. Fig. 416 shows the case for triode types and Fig. 417 for tetrode or pentode types. In each case dashed lines are used to show how the curves would go in theory if there were no boundaries at all.

The first boundary for a power tube, and for any tube when it is to be operated close to maximum conditions, is the wattage-dissipation curve, a line of points showing maximum plate dissipation (volts  $\times$  current).

The secondary boundary can be called the positive grid-swing boundary. For the triode tubes, this will usually be the zero grid-voltage curve, unless power is available to supply the grid current that flows when the grid runs positive. In such a case, some specific value of positive grid-voltage curve will determine

this boundary. For pentode and tetrodes the zero grid curve applies as a boundary above the *knee*, but in the vertical part it is advisable to set the boundary over, as the curves merge here, so that use of the zero grid curve would cause severe distortion.

The third boundary is the line representing zero plate current. Plate current does not normally go into reverse, and before it reaches zero there is a converging of the characteristics that will cause distortion, so the boundary should be set at some minimum value of plate current. This can be called the minimum plate-current boundary.

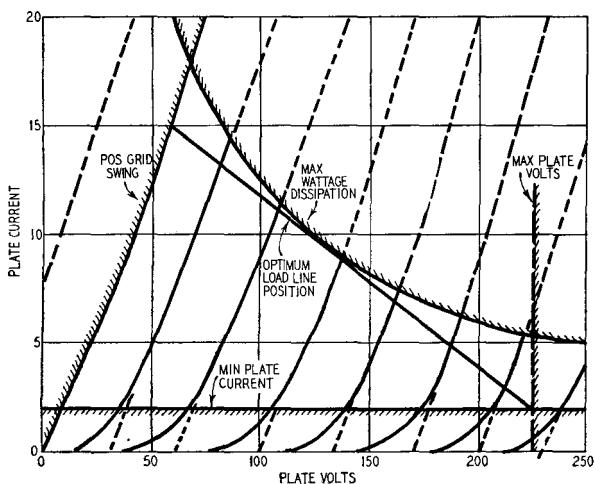

Fig. 416. Tube characteristics of a typical triode, showing boundaries controlling optimum load.

In addition to these three boundaries that apply every time, there is another that sometimes chips in, while in other cases the three regular boundaries take care of it automatically. This is: maximum permissible plate voltage.

For any given tube the optimum plate load is found by varying the slope of the load line (varying the plate-load resistance) until the product of plate-voltage and plate-current swings is a maximum. The slope of this line gives a value of optimum load.<sup>1</sup>

Load values for triodes are not usually too critical. A value two or three times greater than the rated optimum will not introduce

<sup>1</sup>Calculation procedures for determining the power output of tubes are given in the *RCA Receiving Tube Manual*, Technical Series RC-16 and -17 pp. 17-21.



distortion, but the power will be reduced somewhat. In triode output tubes the optimum load is several times the plate resistance—usually three, and often five or more times. Further increase of plate load improves waveform slightly and increases output voltage swing slightly, but reduces output power, because the current swing is cut down more than the voltage swing is increased. Use of a plate load less than about three times the plate resistance results in distortion, unless the grid input swing is restricted, which limits the output.

For pentode and tetrode tubes, the term optimum load can

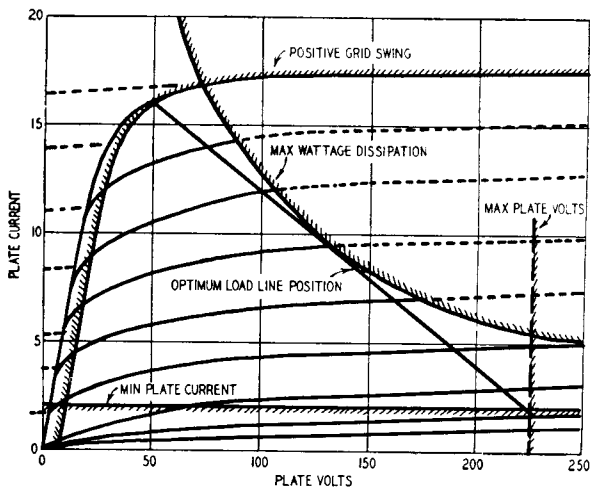
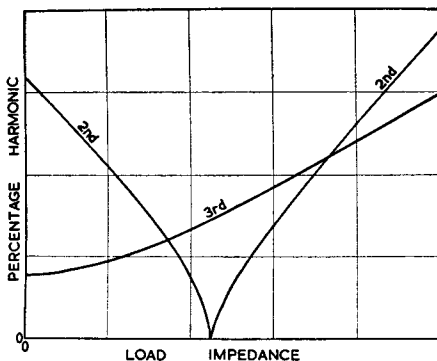

Fig. 417. Tube characteristics of a typical tetrode or pentode, showing boundaries controlling optimum load.

have a stricter meaning. Working at a level a little below maximum output, variation of the load changes the nature of the distortion. In triodes, all the curvature is in the region of the minimum plate current boundary, which results in second harmonic distortion. In tetrodes and pentodes, curvature is also introduced at the positive grid-swing boundary when the top end of the load line swings below the knee of the curves, representing load values higher than optimum. The higher-order harmonics are introduced, and the amount of second harmonic depends on how the two sources of curvature balance one another. It is possible, by selection of load value, to eliminate second harmonics altogether. An analysis of distortion from typical tetrode or pentode tubes is shown in Fig. 418. For some purposes the point where the sec-

ond harmonic disappears, or the total harmonic is a minimum, is considered the optimum load.

We have assumed that the object is to get the maximum output with minimum distortion. But since in audio work the maximum output is somewhat of an unused figure, reached at only fairly rare peaks, it can be said that distortion is more important at lower output levels. The exact curvature of the characteristic along any given load line follows a rather complicated law. The result can lead to the following kind of experience: Assume the



*Fig. 418. Graph showing harmonic distortion analysis from typical tetrode or pentode tubes.*

plate load is made adjustable, so that it can be varied. With a harmonic analyzer connected to give minimum distortion at or near full output, turn the level down 10 or 20 db. Readjustment of the plate load will probably reduce distortion at this reduced level. Consequently it is probably better to choose a load value that gives minimum distortion at low levels, even though the distortion at maximum level may be up slightly.

# extending design factors

Every book on feedback opens with a light barrage of mathematics, in which the gain of an amplifier with feedback is shown to be:

$$A' = \frac{A}{1 + A\beta}$$

where  $A$  is the gain without feedback and  $\beta$  is the attenuation of the feedback path. Then there is a discussion of this, and out of the hat comes  $A = 1/\beta$ . (Gain without feedback is described in Chapter 1.) Blinded with science, the reader rubs his hands and reaches for a soldering iron. *However, the gain without feedback is not always large.* If we are concerned with low-gain amplifiers or with effects at the edge of the band, we must go back to the basic equation. We can write this in the form:

$$A' = \frac{1}{\beta} \times \frac{A\beta}{1 + A\beta} \quad (55)$$

When we work in decibels, we have:

$$\text{db gain} = 20 \log \frac{1}{\beta} + 20 \log \left( \frac{A\beta}{1 + A\beta} \right) \quad (56)$$

You will notice an interesting term enclosed in the parentheses. This is what we have been looking for, because the first term on the righthand side is just the traditional approximation; the second term is the gain component of what has been called the “*mu-beta effect*.” This unexpected name was provided by Dr. H. W.

Bode.<sup>1</sup> In classical engineering papers you will find the fundamental equation written as:

$$G = \frac{\mu}{1 - \mu\beta} \quad (57)$$

Notice here that as well as using  $G$  in place of  $A'$  and  $\mu$  in place of  $A$ , the sign used in the denominator (by Dr. Bode) represents the magnitude value of  $\beta$ . *Our form is based on the algebraic value of  $\beta$ , which is itself negative in the case of negative-feedback and positive in the case of positive feedback gain.* (This was discussed fully in Chapter 4.) Algebraically, both forms are essentially the same in the following manner:

$$G = A' = \frac{\mu}{1 - \mu\beta} = \frac{A}{1 - (-\beta A)} = \frac{A}{1 + A\beta}$$

Before going on to discuss the refinements in calculation which are provided by the exact formula, let us look at the reasons for using it. Some of them will probably never affect some readers, but in special circuit designs this technique is invaluable. For one thing, it takes the use of positive feedback out of the cut-and-come-again class, and there's a big future in positive feedback if only to help out in a component shortage.

The first use of the exact equation is to check what happens at the edges of the band when the gain of the amplifier varies. If you look up the government specifications for the tubes you are using, you will see that when the maker says boldly  $g_m = 5,000$  micromhos, he really means something between 4,000 and 6,000 or, if you are not a military customer, even wider limits. Roughly speaking, that means that the gain per stage can vary over a range of about 4 db: in three stages, 12 db will be the range for a typical audio amplifier.

Actual stability, under these conditions, may be a headache in its own right, but the maintenance of a specified frequency response often may cause a lot of trouble. A batch of tubes on the high side may result in the measured frequency response falling outside the customer's limits. Try telling him his tubes are too good!

The second major use for the exact equation is in one of these multiple feedback loop amplifiers we discussed in Chapter 4. If we want to design this right to the bitter end, we must determine

---

<sup>1</sup>"*Network Analysis and Feedback Amplifier Design*"; H. W. Bode, D. Van Nostrand Co., Inc., New York, N. Y., 1945; p. 33.

the gain and phase characteristics of the first subamplifier with its positive feedback to draw the phase and amplitude responses for the complete amplifier, to which the main negative feedback is applied.

### The "alpha-beta" evaluator

These more refined calculations became really practicable in October, 1949, when Jean Felker of the Bell Laboratories published a paper on the subject.<sup>2</sup> To avoid confusion, since the original calculator (called the "mu-beta effect" calculator) was designed from Dr. Bode's equation, we have modified it to conform to our application of the form  $A/(1 + A\beta)$  as representative of negative feedback gain. The original design<sup>3</sup> presents  $\mu\beta$  where we have used  $A\beta$ , and all angular measurement scales are the supplements of those in the  $A\beta$  evaluator. (Where we use  $70^\circ$ , Mr. Felker uses  $110^\circ$ , etc.) The evaluator is a sort of circular slide rule for performing the necessary phase and amplitude calculations.

Let us go back to our mathematics again and see what confronts us. The alpha-beta (mu-beta) effect is:

$$\frac{A\beta}{1 + A\beta} \tag{58}$$

In general, both  $A$  and  $\beta$  include a phase shift. Let us take the total phase shift in the amplifier and feedback network at a particular frequency to be  $\theta$ . This is the phase which we use when we draw the Nyquist diagram. Since we now have to watch our signs, we must notice that in the middle of the working range  $\theta = 0^\circ$ , while at the danger point for stability,  $\theta = 180^\circ$ . We can write the alpha-beta effect as:

$$\gamma/\phi = \frac{|A\beta| \ / \underline{\theta}}{1 + |A\beta| \ / \underline{\theta}} \tag{59}$$

where  $\gamma$  (gamma) is the magnitude of the alpha-beta effect and  $\phi$  (phi) is the phase. We know the phase shift in the feedback network, because we can calculate it using the templates: call this  $\psi$  (psi). The effective phase shift through the amplifier with feedback connected is then  $\phi - \psi$ . When  $\psi$  is zero, this is just

<sup>2</sup> "Calculator and Chart for Feedback Problems," Jean Felker; *Proceedings of the IRE*, Vol. 37, p. 1204.

<sup>3</sup> The original "mu-beta effect" calculator is available from Graphimatics, 201 N. Taylor Ave., Kirkwood 22, Mo.

$\phi$  instead of the value without feedback, as given by  $\theta$ .

The gain of the amplifier is  $\gamma$  db plus the ideal gain,  $20 \log 1/\beta$  db. The Greek letters  $\gamma$ ,  $\theta$ ,  $\phi$  and  $\psi$  have been used because they are the same as those in the Felker paper.

For some purposes it is rather useful to turn the mu-beta effect upside down. Let us write  $v$  (upsilon) =  $1/\gamma$ . Then

$$v/\underline{\phi} = \frac{1 + |A\beta|/\underline{\theta}}{|A\beta|/\underline{\theta}} = 1 + \frac{1}{|A\beta|/\underline{\theta}} \quad (60)$$

We did not do this bit of mathematics just to show how clever we are: this particular form is rather a useful one. Consider the impedance shown in Fig. 501-a.  $Z$  is any impedance, and  $R$  is a resistance. Taken together the impedance is  $R + Z$ , and this can be written  $R(1 + Z/R)$ .

Remembering that  $Z$  is a general impedance, we can write this as

$$R\left(1 + \left|\frac{R}{Z}\right|/\underline{\theta'}\right) \quad (61)$$

If we put  $\theta = -\theta'$  and  $A\beta = R/Z$  the impedance of the two-terminal network is thus  $Rv/\underline{\phi}$ .

In much the same way, the admittance of the circuit in Fig. 501-b is

$$\frac{1}{R}\left(1 + \frac{R/\theta'}{Z}\right) \quad (62)$$

Now we put  $A\beta = Z/R$  and also put  $\theta = \theta'$ , to make the admittance equal

$$\frac{1}{R} v/\underline{\phi} \quad (63)$$

We can go even further and apply this expression to the networks of Fig. 502. If we take the ratio  $E_1/E_2$ , which is the most useful when we want to convert to decibels, we have for this ratio:

$$\frac{E_1}{E_2} = 1 + \left|\frac{R}{Z}\right|/\underline{\theta'} \quad (\text{Fig. 502-a})$$

$$\frac{E_1}{E_2} = 1 + \left|\frac{Z}{R}\right|/\underline{\theta'} \quad (\text{Fig. 502-b})$$

$$\frac{E_1}{E_2} = 1 + \left(1 + \left|\frac{R}{Z_2}\right|/\underline{\theta'_1}\right) \frac{Z_1}{R} / \underline{\theta'_1} \quad (\text{Fig. 502-c})$$

Even the impedance forms are useful in decibels, because when

we connect an impedance as the plate load of a pentode, the gain is  $g_m Z$ , or  $(20 \log g_m + 20 \log Z)$  decibels. For that reason the curve of  $v$  given as Fig. 503 shows  $v$  in decibels.

We could, of course, proceed to use those curves to determine the alpha-beta effect, but the Felker calculator is much more convenient. This chart (in modified form) is reproduced in Fig. 504. When the rotatable arm is fastened to a suitable backing of thin card or plastic and attached to the center of the circular chart, the longer end of the moving arm moves over the upper semicircle. The readings obtained on this scale represent the alpha-beta effect as measured in degrees.

Fig. 501. Some typical circuits employed in solving two-terminal network problems. In (a) the impedance ( $Z$ ) is in series with the resistance. In (b), the impedance is in parallel with the resistance.

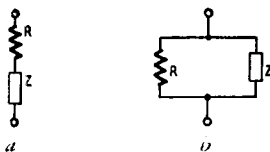

Figs. 505 and 506 have been constructed to enable us to work out an example. Three circuits of 6 db per octave are assumed, with characteristic frequencies at 1, 2 and  $4\sqrt{2}$ . The most feedback which could be applied without instability is 21 db and for this example we shall assume that we are applying 15 db of feedback. We can now therefore construct the second scale, marked  $A\beta$ , with its zero at the 15 db down level on the GAIN BELOW MAXIMUM scale.

## Using the evaluator

Now take the evaluator. At  $\omega = 2$ , we have alpha-beta = +4 db and  $\theta = 130^\circ$ . Find the point where alpha-beta = +4 and alpha-beta phase =  $130^\circ$ . It is up near the top left-hand side of the chart. Turn the rotating arm until it passes through this point, and read off the alpha-beta effect magnitude on the arm itself and the phase on the semicircular scale. We find +2.3 db,  $140^\circ$ . Repeating the calculation at other points, we get +6.2 db,  $88^\circ$  at  $\omega = 2\sqrt{2}$ , and so on. All these values have been plotted in on Figs. 505 and 506. In Fig. 505, you will remember, this alpha-beta effect is the deviation of gain from what we expect in the simple theory. We use the alpha-beta scale for plotting the response. As you can see, the "flat" gain is about 1.5 db below the zero determined by the simplified theory. The phase shift is, at most frequencies, much less with feedback, but at the edge of

the working band it rushes sharply upward. You can see how dangerous this can be in a multiple-loop amplifier, by considering the values at  $\omega = 4$ : with feedback the gain is 1.5 db above the "flat" region, but the phase shift has practically hit the  $180^\circ$  mark.

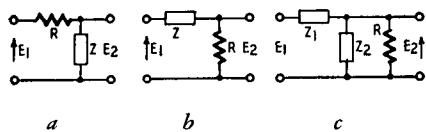

Fig. 502. Some typical impedance problems in four-terminal network analysis are represented by the circuits of (a), (b) and (c).

As a subamplifier in a complicated multiloop system this particular system could give you enough headaches for a lifetime.

Suppose that, in place of the gain we planned, the amplifier has in it rather old or low-limit tubes. The gain without feedback  $A$  may have dropped 6 db. The feedback term  $\beta$  remains the same, however, so the product  $A\beta$  (alpha-beta) is down 6 db. The alpha-beta scale zero, on the left of Fig. 505, should now be set at 9 db on the GAIN BELOW MAXIMUM scale. At  $\omega = 2$  we have  $A\beta = -2$  db,  $\theta = 130^\circ$ , so that the  $A\beta$  effect is  $+0.2$  db instead of  $+1.6$  db. As  $\omega \rightarrow 0$ , the response for  $A\beta = 9$  db and  $\theta = 0^\circ$  is 2.6 db. The response therefore has risen 2.8 db at  $\omega = 2$  for this low-gain case, instead of 3.1 db for the normal gain case. The mid-band gain has dropped 1.1 db.

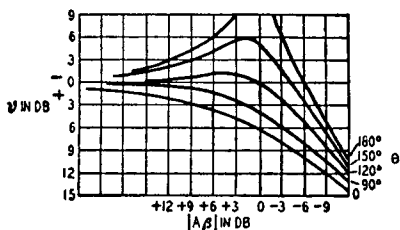

Fig. 503. Graph showing the impedance forms of Fig. 502 plotted in db. The formulas used to derive these curves (see text) are based on the relationship of  $E_1/E_2$ . In the case of a pentode tube, when the plate load is an impedance, the gain is  $g_m Z$  or  $(20 \log g_m + 20 \log Z)$  decibels. Thus, these forms are quite useful in practical work.

We are not inclined to discuss this application of the alpha-beta evaluator any further, since the time that would be spent on additional discussion can be spent more profitably in working out the solution to some of the many typical problems you are likely to encounter in audio amplifier design work. However, here is an important item: When the feedback network itself contains reactances, which usually will be capacitors, the response calculated is that which appears at the output of the feedback network. Therefore it is necessary to subtract the response of the feedback network from the calculated response given by the alpha-beta



evaluator to get the response for the overall system. This is shown in the basic equation:

$$\text{gain} = 20 \log \frac{1}{\beta} + \text{alpha-beta effect.}$$

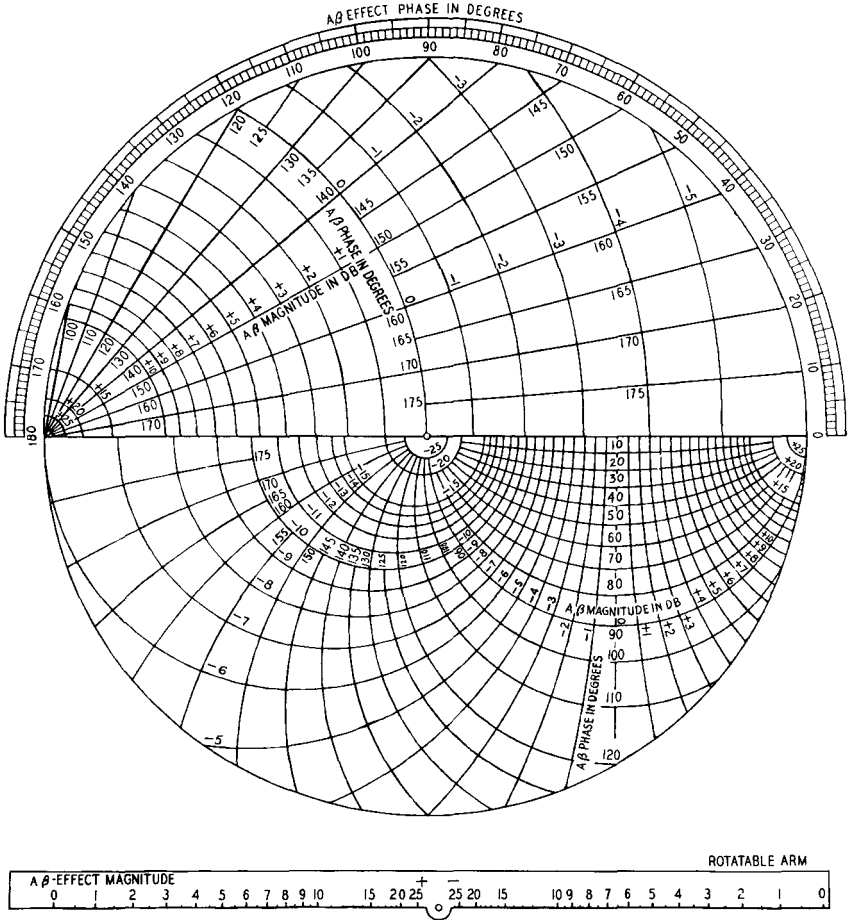

Fig. 504. The Alpha-Beta evaluator. This chart is a modified version of the Felker "mu-beta effect" calculator discussed in the text. Familiarity with its operation will aid considerably in amplifier design work.

Here is another use for the alpha-beta evaluator. It can be used for determining the stability margin directly. As you may remember, we showed in Chapter 3 that a quantity called the stability margin was a very useful measure for the safety of a

design. This quantity is in our notation:

$$\frac{A'}{A} = \frac{1}{1 + A\beta} \quad (64)$$

The alpha-beta effect, you will remember, is

$$\gamma = \frac{A\beta}{1 + A\beta} = \frac{1}{1 + \frac{1}{A\beta}}$$

If we have a value of, say, 6 db for  $A\beta$ , and we calculate the  $A\beta$  effect corresponding to -6 db, the quantity we obtain is the stability margin. Let us draw up a table from Figs. 505 and 506 as follows:

$\omega$	=	<b>1</b>	<b>1.4</b>	<b>2</b>	<b>2.8</b>	<b>4</b>
$A\beta$	=	<b>+10 db</b>	<b>+7.5 db</b>	<b>+4.2 db</b>	<b>-1 db</b>	<b>-6.3 db</b>
$\theta$	=	<b>83°</b>	<b>105°</b>	<b>130°</b>	<b>154°</b>	<b>176°</b>
<b><math>A\beta</math> effect</b>	=	<b>-0.8 db</b>	<b>+0.3 db</b>	<b>+2.3 db</b>	<b>+6.2 db</b>	<b>-0.5 db</b>
<b>Stability Margins</b>	=	<b>-10.8 db</b>	<b>-7.3 db</b>	<b>-1.8 db</b>	<b>+7.2 db</b>	<b>+5.8 db</b>

The last line was calculated directly, taking the -10 db, 83°, -7.5 db, 105°, etc. points on the chart. This means that it is not necessary to pass through the response, alpha-beta effect or overall response system in order to check the stability margin. When the feedback path has a nonuniform response this can be very helpful, because all that need be done is to plot the two pairs of curves, for alpha-beta and for beta, and then determine the stability directly.

There is a very attractive phrase which you can find in British patents: "Having now particularly described and ascertained the nature of the invention . . ." Well, we've done that, but just in case the explanation has not been sufficiently certain, Fig. 507 shows how the evaluator is actually set to fish out the results at  $\omega = 2$ . The point marked A is at alpha-beta = +4.2 db, alpha-beta phase = 130°. The rotating arm OA has been turned until the edge passes through this point, and the alpha-beta effect is read off at A on the scale printed on the arm. The phase of the alpha-beta effect is read off on the circular scale. For the stability margin we hunt out point B, -4.2 db, 130°, and twist the arm to pass through this point. The stability margin is read off the arm.

Wary readers may have noticed that almost everything we have discussed in this book deals with the analysis of feedback circuits and not the synthesis. We guess a circuit and test it, on paper, to see if it will work. Nearly everything in the field of circuit design boils down to this in the end. The main differences appear in the methods of testing. At one extreme you wire up the circuit

Fig. 505. Graph showing three design curves of an amplifier. Curve A is the ideal response, curve B is the response calculated with the  $A\beta$  effect, and curve C is the response calculated without feedback.

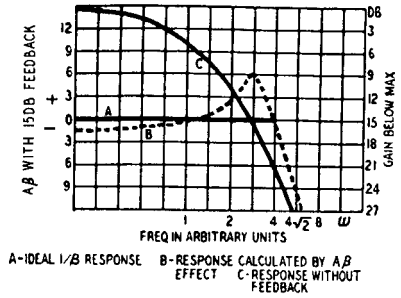

and pray; at the other extreme you test on paper in such a general way that you never come to a practical answer. This work aims at a reasonable compromise. While providing all the information

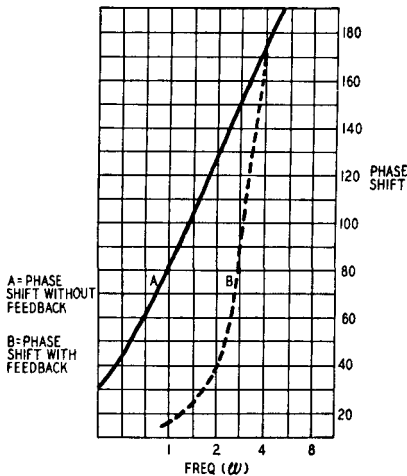

Fig. 506. This graph shows two curves representing amplifier phase shift characteristics. Curve A is the shift without feedback; curve B is the shift with feedback.

needed by the average professional designer, we hope also it is not too forbiddingly mathematical for the man who wants to

build just one amplifier, but wants to build it right. The important thing to learn here is: alpha-beta simplifies design work.

## Design comparisons

Having been associated with a group of network engineers, it was unavoidable that we run across a concept of theirs which stated simply: All problems are network problems, and all network problems are low-pass problems. You may wonder what this has to do with the problems of designing feedback amplifiers, but you will find it a valuable approach to keep in mind.

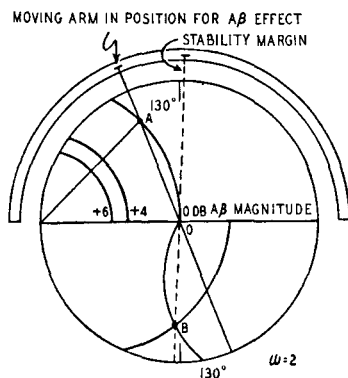

*Fig. 507. The Alpha-Beta evaluator set up for solving a problem. Details of problem and its solution are discussed in the text.*

This preamble is intended to introduce a design procedure for narrow-pass bandpass amplifiers (which are more commonly known as i.f. amplifiers) and to show that they may be designed in complete accordance with the rules we have already discussed, just as though they were audio amplifiers. This is not to say that you can build a radar i.f. amplifier for 60 mc in the same way you build an audio amplifier. But you can design a three-stage amplifier with 20-db feedback for use at, say, 1 mc without any design curves other than those which we have already used. Although it will appear that this type of amplifier is limited to special applications, it is in itself noteworthy as a source of design comparisons, particularly when approached through the network concept.

## Procedures

The basic unit we shall consider is that which is sometimes

known as the center-tuned, resistance-loaded amplifier. The plate circuit of each tube contains a parallel network of resistance, inductance and capacitance. Each circuit is tuned to the center frequency. This type of amplifier is easier to design as a feedback amplifier than the stagger-tuned type, in which the plate circuits are tuned to different frequencies. The center-tuned

Fig. 508. The basic parallel reactance circuit is equivalent to a capacitance under certain conditions. Since in theoretical circuit design development, mathematical calculations are more easily obtained using admittance than with reactance, in this circuit the admittance ( $Y$ ) is equal to  $j\omega C + 1/j\omega L$ .

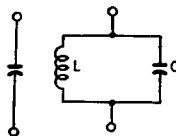

type is also easier to line up, because three or more reference frequencies are needed in the stagger-tuned variety. In the latter case the spacing of these frequencies governs the pass characteristic and a good signal generator must be used.

Let us look at the basic element of the circuit. This is shown in Fig. 508 and consists of inductance  $L$  in parallel with capacitance  $C$ . The admittance of this circuit is  $j\omega C + 1/j\omega L$ .

Notice that it is easier to use admittance (than reactance) when you deal with parallel circuits. In theoretical work admittances make mathematical manipulations easier.

Fig. 509.  $L$  and  $C$  replace the inductance in the series bandpass circuit with lowpass equivalence. In this arrangement, the circuit impedance ( $Z$ ) is equal to  $j\omega L + 1/j\omega C$ . Characteristics of the circuit and related mathematical derivations are covered in the text.

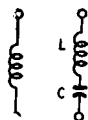

We will do some manipulations and see what we can make of this admittance:

$$Y = j\omega C + \frac{1}{j\omega L} \quad (65)$$

Adding the two over the common denominator  $j\omega L$ , we have:

$$Y = \frac{(j\omega C)(j\omega L) + 1}{j\omega L}$$

Multiplying the numerator we get:

$$Y = \frac{j^2\omega^2 LC + 1}{j\omega L}$$

Since  $j = \sqrt{-1}$ , then  $j^2 = -1$ . We then get:

$$Y = \frac{-\omega^2 LC + 1}{j\omega L}$$

Rearranging this equation gives us:

$$Y = \frac{1 - \omega^2 LC}{j\omega L} \quad (66)$$

Now let  $\omega^2 LC = 1$ . This will be the case at the antiresonant frequency  $\omega_0$ :

$$\omega_0 = 2\pi f_0 = \frac{1}{\sqrt{LC}} \quad (67)$$

At this frequency the admittance  $Y$  is zero and the circuit of Fig. 508 is at resonance:

At this frequency  $1/\omega_0 L = \omega_0 C$  (the reactance of the coil is equal to that of the capacitor). We can write the coil reactance as

$$\omega L = \frac{\omega}{\omega_0} \omega_0 L$$

and

$$\omega^2 LC = \frac{\omega^2}{\omega_0^2} \omega_0^2 LC = \frac{\omega^2}{\omega_0^2}$$

because  $\omega_0^2 LC = 1$  and  $1/j\omega_0 L = j\omega_0 C$ .

The expression for admittance can be changed to:

$$Y = \frac{j\omega_0 C \left( \frac{\omega^2}{\omega_0^2} - 1 \right)}{\frac{\omega}{\omega_0}} \quad (68)$$

Suppose to save space and trouble, we let  $\Omega$  (capital omega) represent

$$\frac{\omega_0 \left( \frac{\omega^2}{\omega_0^2} - 1 \right)}{\frac{\omega}{\omega_0}}$$

in our further calculations. The admittance is then simply:

$$Y = j\Omega C \quad (69)$$

For a single capacitor, the admittance at a frequency  $\omega$  is just  $Y = j\omega C$ .

The reader will be well advised to think about these two equations very carefully. He will see that anything which can be said about a capacitance at a frequency  $\omega$  can be said about an antiresonant (parallel) circuit at a "normalized frequency"  $\Omega$ . For example, 1,000  $\mu\text{f}$  has an admittance of 1/16,000 ohms at 10 kc.

Put 100  $\mu\text{h}$  in parallel, and the antiresonant frequency is 500 kc. This means that  $\omega_0 = 2\pi \times 500,000$  and at this frequency  $\omega = \omega_0$

$$\Omega = \omega_0 \frac{1^2 - 1}{1} = 0 \quad (70)$$

The admittance is zero, just as the admittance of a capacitor alone is zero at zero frequency. Raising the frequency slightly to 505 kc:

$$\Omega = 2\pi \times 500,000 \frac{\left(\frac{505}{500}\right)^2 - 1}{\frac{505}{500}}$$

$$\Omega = 2\pi \times 500,000 \frac{[ (1.01)^2 - 1 ]}{1.01}$$

$$\Omega = 2\pi \times 500,000 \times .02$$

$$\Omega = 2\pi \times 10,000$$

and the admittance  $j\Omega C$  is .0000628 mhos, corresponding to an impedance of 16,000 ohms. The admittance at 5 kc from the center frequency is equal to that of the capacitor alone at twice 5 kc from zero. We shall get the same number if we examine the admittance at 495 kc, but the sign will be negative because it represents a negative or inductive susceptance instead of a positive or capacitive one.

The admittance of an antiresonant circuit  $f$  cycles away from the tuning point is equal to that of the capacitor alone at  $2 \times f$  cycles away from zero. To help the reader who wants to check this, the approximation used is  $(1 + \lambda)^2 = 1 + 2\lambda$ , where  $\lambda$  (lambda) is a small fraction of 1.

We can do the same thing for the series circuit of Fig. 509. Here the impedance is:

$$j\Omega L = j\omega L + \frac{i}{j\omega C} = \frac{(1 - \omega^2 LC)}{j\omega C} = \frac{j\omega_0 L \left( \frac{\omega^2}{\omega_0^2} - 1 \right)}{\frac{\omega}{\omega_0}} \quad (71)$$

with  $\Omega$  having the same meaning as before.

Let us look at a very simple application of this result. A low-pass filter has been designed in the form shown in Fig. 510. It may have been designed by a purely arithmetical process to give a special response. Now we want a bandpass filter to give the cor-

responding performance symmetrically centered on a “carrier” frequency.

First of all, remember that there is a factor “2” in the low-pass to bandpass transformation. If we want the bandpass filter to work up to  $f$  cycles on each side of the center frequency, we must make the low-pass filter have a design cutoff of  $2f$  cycles. We have seen that we can replace a capacitance by an antiresonant cir-

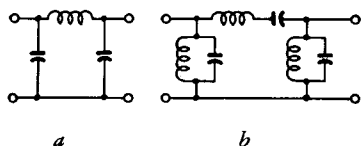

Fig. 510. Substituting Figs. 508 and 509, low-pass filter circuit (a) becomes bandpass circuit (b). Added elements tune the circuit to center frequency.

cuit with the same capacitance (allowing for the factor “2”) and that we can replace an inductance by a resonant circuit with the same inductance. The bandpass filter is thus obtained by using the circuit shown in Fig. 510. The added elements are those which tune the low-pass components to the center frequency. The bandpass problem is just a variant on the low-pass problem.

Now we may look back to the circuit we need for our amplifiers. This is shown in Fig. 511. We can write the admittance of this as  $1/R + j\omega C$  and remembering the equations we used in setting up our templates (Chapter 1), we can say that the circuit has a characteristic frequency  $\Omega$  given by  $\Omega CR = 1$ . At this frequency, which is most conveniently written  $\Omega_0 = 1/CR$ , the response is 3 db down. It is at a distance  $\omega_a$  from the center frequency, and  $\omega_a = 1/2CR$ .

The low frequency and bandpass circuit responses are shown together in Fig. 512. This is drawn in the usual “response” form

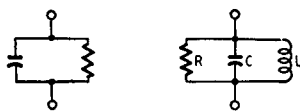

Fig. 511. Plate loads of a typical bandpass amplifier. At the left the load consists of merely a resistance and capacitance in parallel. At the right, an inductance ( $L$ ) has been added to this combination as another shunt element.

without decibel and logarithmic scales, so that the relationship between the two curves and the usual universal “resonance curve” of the textbooks is made more obvious.

The way in which the factor “2” appears can also be remembered by considering these two curves. It will be seen that for any  $C$ - $R$  the total bandwidth is the same. In the low-pass case this means that the band extends from 0 to  $f$ ; in the bandpass



case it extends from  $f_0 - f/2$  to  $f_0 + f/2$ . There are a number of ways of interpreting this mathematically, but they are all beyond our scope. Perhaps the only thing we need to mention is that the noise energy is the same wherever you put the band.

Notice also that the low-pass case is not simply a bandpass extending from  $-f$  to  $f$ , centered on zero. This produces an error of 2. The bandwidth 3 db down is the same for low-pass and bandpass, but because there are two sidebands, the audio width is halved in the bandpass case.

One more point to observe: For our purposes, the bandwidth is taken at the 3 db down level. You will find very often in textbooks that the 6-db point is used, but this has no significance for our design technique.

Fig. 512. Lowpass and bandpass circuit responses. These curves are shown together so that their relationship as compared to the universal resonance curve of textbooks becomes more obvious. The lowpass response is shown at the left; the bandpass response at the right. The range of the curves extend from  $f_0 - f_2$  to  $f_0 + f_2$  (see text).

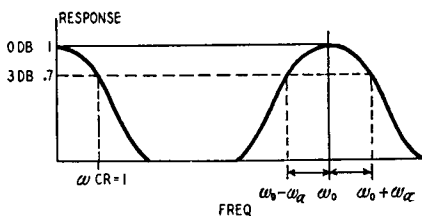

Let us now turn to our specific task, the design of a bandpass amplifier with feedback. We shall take the center frequency to be 1.6 mc, so that  $\omega_0 = 2\pi \times 1.6 \times 10^6 \cong 10^7$ , and the bandwidth to be 16 kc (8 kc on either side of the center frequency). From what we have just said, *this is really equivalent to designing an audio amplifier to work up to 16 kc*. We shall use two 6AK5's and a 6AQ5, since this is a paper design. Let us see what we can do with a three-stage amplifier.

For the 6AK5 we can rely on having a transconductance of 4,000  $\mu$ mhos, and we shall be safe in taking an input capacitance of 7  $\mu$ mf and an output capacitance of 5  $\mu$ mf. The capacitances of the 6AQ5 are higher, and we must assume about 10 and 15  $\mu$ mf. The book values are lower than this, but the socket must be taken into account. The optimum load for the 6AQ5 is 5,000 ohms, so that with decoupling the stage gain in the output stage is 20 times. Since in this sort of amplifier we usually apply the feedback from cathode to cathode, the first and third stage cathodes will not be decoupled, and the output stage gain is only 10 times.

It is important to notice that the plate circuit of the 6AQ5 should not affect the behavior (from the stability point of view) of the amplifier since the feedback comes from the cathode.

Theoretically we have only two circuits in the feedback loop, and therefore it must be stable, whatever we do. But let us look at the first plate circuit. The total capacitance is made up of the output capacitance of the first tube and the input capacitance of the second tube: this gives us 12  $\mu\text{f}$ . With wiring, coil capacitance and an allowance for trimming let us increase this to 25  $\mu\text{f}$ . The bandwidth is 16 kc, so that we can be 3 db down at the band edges if we have,

$$2\pi \times 16,000 \times 25 \times 10^{-12} \times R = 1$$

and

$$R = 400,000.$$

This implies that the  $Q$  of the coil must be 100, which is a moderately good coil. Let us take this as one circuit. The stage gain, without decoupling, will be about 800 times. Using the templates of Chapter 1, we draw the sideband responses, putting  $\omega_a$  at 50,000 ( $2\pi \times 8,000$ ). Adding another circuit with  $\omega_a$  at 200,000, we get overall curves which show that the phase margin for 20-db feedback is  $45^\circ$ , which is a fairly safe value.

At first sight this looks like a reasonable design. The second circuit, for which  $\omega_a = 200,000$ , has a capacitance of the same order as the first, if we make slightly less generous allowance. It is easy to see that for this circuit  $R = 100,000$ , and without decoupling the stage gain will be 200 times. This means that the total gain is  $800 \times 200 \times 10 = 1,600,000$ , or over 120 db.

In theory, all we do now is calculate the inductances and connect a feedback resistor, cathode-to-cathode. In practice we have left out a very important factor, the plate-grid capacitance of the tube. Consider the second tube. The impedance in the grid circuit is 400,000 ohms; the plate-grid capacitance is at least .02  $\mu\text{f}$  even without strays. This capacitance has an impedance—at 1.6 mc—of 5 megohms. As a rough approximation of the plate swing

$$\frac{0.4 \text{ meg}}{5 \text{ meg} + 0.4 \text{ meg}} = \frac{.4}{5.4} = \frac{1}{13.5}$$

will be fed back to the grid.

We have ignored the phases, because we want only a rough figure for the moment. Thus, with almost one-tenth of the plate swing reappearing at the grid, we cannot use a gain of 200 times. Our design procedure breaks down because it leads us to values which are not practical in this case.

We get around this problem by checking on the grid-plate

capacitance first. We know it is 5 megohms, so we can construct a table:

Plate load	Plate-grid feedback ratio	Gain for $g_m=4,000$ and no decoupling
100,000	50	200
50,000	100	100
25,000	200	50
20,000	250	40
10,000	500	20

This table is used in conjunction with the required gain, which we haven't mentioned so far. Let us take a figure of 50 db, with 20-db feedback. Without feedback we need 70 db, and the output stage will give us 20 db. By using plate loads of 10,000 ohms in each of the first two stages, giving 26-db gain in each (20 times), we get a gain without feedback of 72 db, which is near enough.

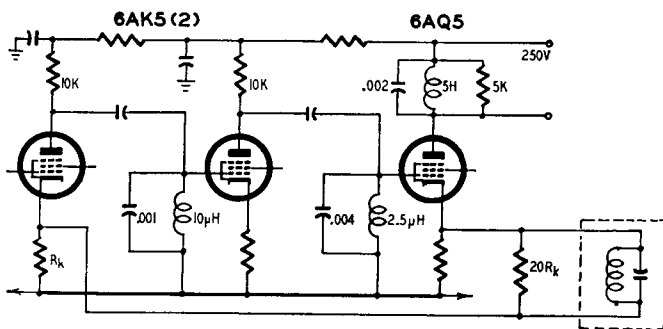

Fig. 513. The essential structure of a three stage amplifier with a bandpass of 1.6 mc.

Having fixed  $R$ , we can go back and calculate the capacitances. We have, for one stage,

$$2\pi \times 16,000 \times 10,000 C = 1$$

$$C = \frac{1}{1,000 \mu f} = 1,000 \mu\mu f$$

For the other stage, with four times the bandwidth, we find that  $C = 4,000 \mu\mu f$ .

The output stage, which has a resistive load of 5,000 ohms, will give a response 3 db down at the band edges if we should now make the total capacitance 2,000  $\mu\text{mf}$ .

We now calculate the inductances which must tune these capacitances to 1.6 mc. They are:

1. 1,000 $\mu\text{mf}$	10.0 $\mu\text{h}$
2. 2,000 $\mu\text{mf}$	5.0 $\mu\text{h}$
3. 4,000 $\mu\text{mf}$	2.5 $\mu\text{h}$

Calculation of these values were obtained by using the formula:

$$f_0 = \frac{1}{2\pi \sqrt{LC}} \quad (72)$$

Rearranging the formula to solve for L:

$$\sqrt{L} = \frac{1}{2\pi f \sqrt{C}}$$

$$L = \frac{1}{(2\pi f)^2 C}$$

Substituting values in this equation we have, when  $C = 2,000 \mu\text{mf}$ :

$$L = \frac{1}{40(1.6 \times 10^6)^2 \times 2 \times 10^{-9}} = \frac{1}{204.8 \times 10^3} = 5 \mu\text{h}$$

With this information, the amplifier design is almost complete. The 6AK5 does not like more than 180 volts on the plate, at 7.7 ma. We can put the 10,000-ohm resistors in the plate-supply leads to drop the voltage and use the 250-volt line for the 6AQ5. The coils are then connected in the grid circuit, as shown in Fig. 513. The gain from the first grid to the third cathode will be about 200 times, which we propose to reduce by a factor of 10. The feedback resistor therefore must be approximately 20 times the cathode resistance,  $R_k$ .

What more remains to be done? This depends on the design specification.

We can compute the stability margin in the manner described in Chapter 3. We can calculate the exact response, using the alpha-beta evaluator described earlier in this chapter. We can, if needed, put a network in the feedback path to make the response drop more rapidly outside the working band. This network, which corresponds to a capacitance in the ordinary audio amplifier, has been shown dotted in Fig. 513.

The example we have chosen is a very simple one, because the use of feedback in high-frequency amplifiers seems to afflict a lot of people with quite unnecessary feelings of nervousness. As you can see, it is just the same sort of problem you encounter at audio frequencies, except that the screen decoupling, plate decoupling and band-center (or low end at audio) effects can be neglected. In fact, audio amplifiers are really more difficult to design!

## Why feedback so far?

At first glance, the general idea behind feedback seems sound enough: Plenty of feedback improves amplifier performance, and

Fig. 514. The two standard feedback systems as considered from the output end. At (a) is an example of voltage feedback; at (b) is an example of current feedback.

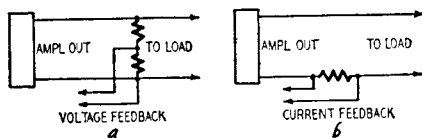

to get a large amount of feedback we must feed back a voltage from the output to a stage where the signal voltage is quite small. Blind acceptance of this fact as the only requirement has encouraged the design of a number of amplifiers in which feedback is applied from the output stage back almost, if not quite, to the input stage.

The owner of such an amplifier will probably be all too familiar with some of the problems attending overall feedback, but there are others that are perhaps less obvious.

Many proud possessors of high-fidelity equipment have been puzzled by experiences like this: The complete chain sounds horrible—shrill resonances, intermodulation and other forms of distortion. A check of the amplifier with dummy load shows everything all right in that part of the system; the speaker sounds fine on another amplifier; all impedances match correctly. The chain works nicely on phono input but not on radio (or maybe *vice versa*), but everything is all right when a different speaker is used. Where does the trouble lie? To see how such snags arise let's consider first how feedback is obtained.

From the viewpoint of the output end there are two kinds of feedback: voltage and current. See Fig. 514. In the first (Fig. 514-a) the signal fed back is proportional to the voltage developed across the output load; in the second (Fig. 514-b) it is propor-

tional to the amount of current drawn by the output load.

From the viewpoint of the *input* end there are two methods of applying the feedback: series injection and shunt injection. See Fig. 515. In the former the signal feed back is injected *in series* with the original input signal (Fig. 515-a), while in the latter (Fig. 515-b) it is injected *in shunt* with it.

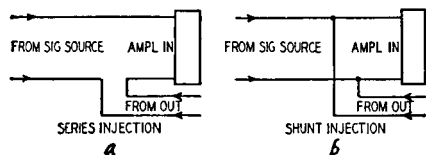

Fig. 515. Examples of two methods employed for feedback injection as they are viewed from the input end. Series injection is shown in (a); shunt injection is shown in (b).

A point that is often overlooked is that when the feedback loop includes both the input and output circuits of an amplifier, the impedance of the input-signal source and of the output load affect the amount of feedback.

For example, with voltage feedback, if the load impedance is reduced to zero there will be no feedback at all. Similarly, when current feedback is used, there will be no feedback at all if the load impedance is an open circuit.

At the input end of the amplifier the method used to inject the feedback depends on the impedance of the signal source. With series injection the source impedance connected to the input must be low compared to the grid-circuit impedance of the first stage or it will reduce the amount of feedback. If the input source impedance becomes an open circuit there is no feedback.

In practice the input circuit is closed either by the secondary of an input transformer or by a grid resistor so that there is always a complete feedback path, although the impedance connected to the input will still modify the feedback characteristic somewhat.

Shunt feedback injection depends on the source impedance connected to the input being high, since a short circuit across the input will reduce the feedback to zero.

The reader is probably quite familiar now, with the properties of inverse feedback in improving frequency response, reducing distortion and modifying input and output impedances. For example, the internal output impedance of the amplifier, which serves as loudspeaker damping, can be reduced considerably by the liberal use of inverse feedback. Similarly, the input impedance can be modified—made either higher or lower—according to

whether series or shunt injection, respectively, is used.

Where an input transformer introduces an undesirable resonance peak, appropriate connection of the feedback circuit may damp out this resonance and produce a satisfactory overall response. But a change in the load impedance connected across the output will alter the actual amount of feedback reaching the input, and thus change the effective response of the input transformer again. Similarly, changing the input impedance can sometimes affect the damping at the output.

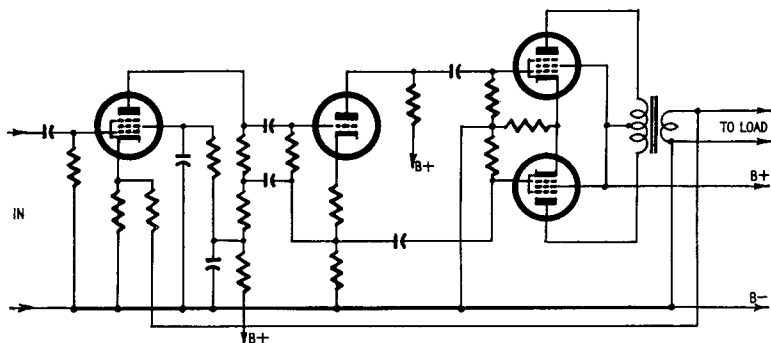

Fig. 516. Circuit of a typical amplifier employing overall voltage feedback.

With overall feedback this interaction is always present, even though it may pass unnoticed. An effect that *does not* pass unnoticed, however, is that the stability of the amplifier depends on the impedances connected to it. For example, an amplifier with overall feedback like the one in Fig. 516 may be perfectly stable with a 3-ohm loudspeaker of one particular make; but some form of instability may show up when another speaker of slightly different impedance is connected. In addition, many amplifiers with overall feedback are not stable when the output load is disconnected or if a 15-ohm loudspeaker is used in place of a 3-ohm type.

Various arguments in their favor have been used by designers and manufacturers of such amplifiers, but with a really good amplifier we should not need to be so fussy about the impedances connected to it. Correct matching is obviously desirable, but one cannot prevent the loudspeaker impedance from having a frequency characteristic (Fig. 517) and affecting the feedback.

### Internal noise

Another feature detracting from the advantages of overall

feedback is its effect on output hiss and other noises generated in all high-gain amplifiers. It has generally been preached that inverse feedback, however used, reduces distortion and noise, but this is not quite true. Harmonic and intermodulation distortion are periodic signals added to the original signal. With inverse feedback we can build up an out-of-phase component of the distortion signal and combine the two so as to reduce it. But noise, especially output hiss, *is not a periodic signal*. Rather, it is a ran-

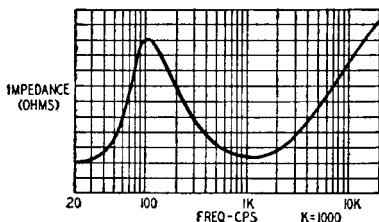

Fig. 517. Graph showing effect of voice-coil impedance variation.

dom movement of charges or currents occurring over an infinitely wide range of time intervals so that it contains frequency components effectively from zero to infinity. It is true that the frequency response of the amplifier restricts the range of noise frequencies that reach the output, but the foregoing statement is true *at the point where noise is generated*. This means that to neutralize noise completely an out-of-phase signal of the same amplitude must be fed back absolutely instantaneously coincident with each "happening." The fact that every amplifier has a restricted frequency response makes this impossible, so it is obviously impossible for feedback to produce the same cancellation for noise that it does with distortion.

Taking the overall result when inverse feedback is used, extra gain is required to offset that used up by the feedback. This means that in a feedback amplifier, noise will receive far more amplification in the output than in the same amplifier without feedback. If feedback could cancel noise to the same extent that it can cancel harmonic distortion, the noise would finish up at about the same level as in the amplifier without feedback, provided the overall gain remained the same. But because the inverse feedback is unable to cancel the noise as completely as it does the periodic distortion waveforms, the resulting noise in the output of the feedback amplifier is actually higher. This explains



what some workers have noted: that a feedback amplifier seems to have more hiss than a nonfeedback amplifier with the same gain but without feedback.

### The alternative

All these disadvantages of overall feedback can be overcome by restricting the number of amplifier stages over which feedback is applied.

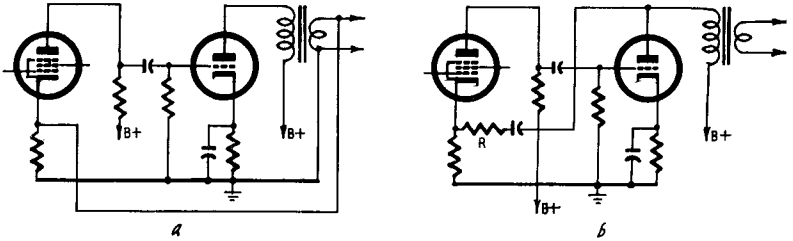

Fig. 518. Two types of short loop feedback. In (a) the voltage is often insufficient for employing large amounts of feedback. In (b), the resistor ( $R$ ) absorbs too much of the available power.

Fortunately, coupling impedances between stages are not subject to variation as source and load impedances are, so the possibility of impedance changes at both ends of the loop no longer arises. It is generally unnecessary to apply feedback to reduce distortion in the early stages of an amplifier where signal level is so small that curvature distortion cannot arise anyway; in fact, it is better to operate the low-level stages at maximum gain to maintain a good signal-to-noise ratio. Sometimes single-stage feedback may be used in a low-level stage for tone control, but this can still be applied *after* sufficient amplification has been provided to overcome output-hiss troubles.

Applying inverse feedback from the output *over not more than two stages*—and preferably only as far back as the driver stage—will prevent instability troubles with changes in the output load. It can even improve amplifiers that are perfectly stable *with* overall feedback, but whose performance may be affected in other ways by changes in the output load.

The next question is: Why hasn't this short-loop feedback arrangement been used more before this?

### The difficulty

When it comes to applying feedback from the output of an amplifier to the driver stage, the difficulty that arises is that the

signal at the point to which feedback is applied is not very much smaller than at the point from which it is obtained. If the feedback is taken from the low-impedance secondary of an output transformer (Fig. 518-a), the voltage may not be high enough to give as much feedback as you want. On the other hand, if feedback is taken from the *primary* of the output transformers (Fig.

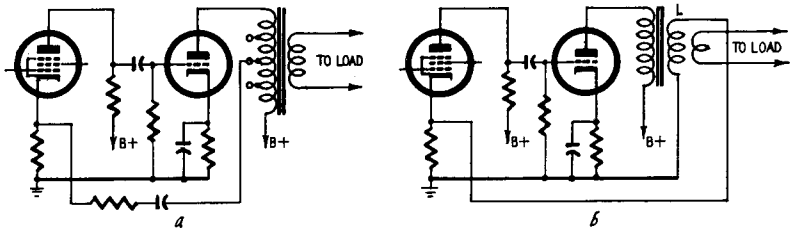

Fig. 519. Two better types of feedback circuit. The results obtained with the use of these circuits is considerably better than with the circuits of Fig. 518. In (b), L is a tertiary winding.

518-b), there is plenty of voltage available, but the voltage-divider resistors required to produce sufficient feedback at the cathode of the preceding stage are so low that they absorb an appreciable proportion of the available output power, which is clearly undesirable.

### The solution

Basically, the solution is fairly simple, but (as usual) there is a practical snag which explains why it has not yet been more widely applied. As we have explained, the impedance on the primary side of the output transformer is high, so that, although more than adequate voltage for feedback purposes is available, the feedback resistor chain will absorb more current than can be spared. On the transformer secondary the resistance of the feedback arrangement absorbs negligible energy because plenty of current is available, but the voltage is insufficient. What we need is an impedance between these extremes.

The output transformer can still provide for direct connection to the voice coil, if it has taps on the primary (Fig. 519-a) or an *additional winding* (Fig. 519-b) so that a suitable intermediate impedance point is available for feedback purposes. The separate-feedback-winding (tertiary) method is preferable because it eliminates the blocking capacitors needed when taps on the primary are used. Because the feedback circuit consumes negligible power, the tertiary can be wound with fine-gauge wire and need occupy only negligible space.

# drivers and inverters

The majority of amplifiers in the 5-watt class and higher now use push-pull output stages. The properly balanced push-pull stage produces no even harmonics, though that is not so important, now that we use so much negative feedback. The output transformer has no d.c. polarization, which makes it a lot easier to design (though we must allow for at least 10% unbalance in any practical circuit) and the signal does not appear in the plate supply lead, which makes decoupling much less of a headache. There are other aspects, too, such as the possibility of pushing down toward class B working. If the tube cuts off in a single-sided stage, no amount of negative feedback will help the situation, because just at the instant of cutoff there is no gain, and thus no  $A\beta$ . In a push-pull stage one tube is working away to keep the gain up even when the other grid is far negative, and the feedback can do its work in keeping down the distortion.

There is not much point in using push-pull in the early stages of an amplifier, unless you want to go down to zero frequency and keep a balanced input. The electroencephalograph designers, who want to watch your brain ticking before they try to find what makes it tick, use these all-push-pull amplifiers so that they can record the push-pull signals from electrodes on your head. This in itself is a special problem. For most of us, single-sided stages at low levels, then a phase splitter and a push-pull stage, are the answer.

While writing this book, we skimmed through a collection of

commercial circuit diagrams to see what other designers thought about phase splitters. Right then we decided that phase-splitting techniques were not as familiar as we had believed, because the most commonly used circuit was a pretty poor one, with plenty of disadvantages and practically no advantages. It does seem worthwhile to make a survey of the known phase splitters and to indicate how good or bad they are.

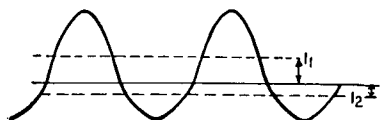

Fig. 601. The effect on the signal output waveform from a class-B push-pull amplifier stage if one half of the stage is driven twice as hard as the other half.

First of all, why should we concern ourselves with making the phase splitter good? We can see the answer most clearly if we consider a class B output stage. Fig. 601 shows in a very exaggerated way the appearance of the output from a push-pull class-B stage if one-half is driven twice as hard as the other. As you can see, there is quite a lot of distortion.

More serious, perhaps, is the fact that if the upper half is at maximum drive, the output power is down to  $(\frac{3}{4})^2$ , or little more than one-half, of the true maximum. The negative feedback could help the distortion, but it will not get back that extra power.

Another point comes out of this figure. The hard-working tube will take an additional plate current of  $I_1$ , while the idler takes only  $I_2$ , so that the output transformer will be subjected to a substantial polarized magnetic flux which may (if it is not overgen-

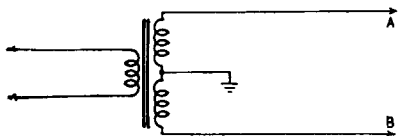

Fig. 602. An ideal phase splitter. This consists of a transformer, capable of producing equal voltages across the two halves of the secondary at all times during which the rated voltage is applied across the primary.

erously designed) cause stability trouble at low frequencies, trouble which can be caused also by the unbalanced signal back in the plate-supply unit.

There may be some more reasons for making sure that the push and pull are equal, but certainly there are no reasons for allowing them to be unequal. One of the main problems of push-pull design is therefore to make sure that the two drive halves are equal, retaining this ratio at all frequencies, and that

they do not change with age. As we shall see, the difficulties arise when we demand equality *at all frequencies*, and when we demand that the drives shall stay equal as tubes age and supplies vary.

## Two good phase splitters

The best of all phase splitters is the transformer, shown in Fig. 602. A well-designed balanced transformer will produce equal voltages across the two halves with an accuracy of 1 part in 1,000

Fig. 603. Another type of phase splitter. This circuit has limited use, but is of considerable interest when the input source has no ground. The values of the two resistors ( $R$ ) should be equal.

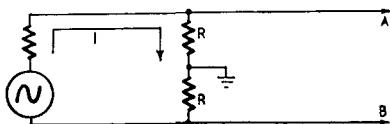

and will certainly stay like that. The main objections to the transformer are that its frequency response is not too good and that it makes the use of negative feedback a lot more difficult. Transformers are mainly used, indeed, when other circuit demands must be met. One example is in operating a push-pull rectifier, for which the low direct-current resistance of the transformer is important; another is in driving a push-pull variable stage in a limiter or compressor, when the gain control bias must have a low-impedance path with no time-constant to the grid. Apart from these special circuits, the interstage transformer is rare nowadays, although it was standard practice in the early days of push-pull.

Another excellent phase splitter of limited use is made up of

Fig. 604. A typical application of the circuit of Fig. 603. The ground on the tuned circuit does not affect its balance. This circuit was first developed in the year 1934.

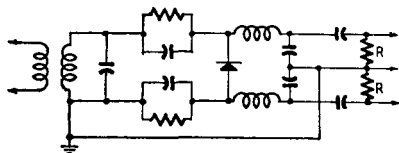

two resistors (Fig. 603). This is of interest when the input source has no ground; for example, if a phonograph pickup or magnetic reproducing head is to work straight into a push-pull circuit. Since the same current flows in series in the two resistors they must be equal in order to give the same voltage at the two push-pull terminals, and any stray capacitances must also be equal. An application of this idea has been allied to the diode detector, which gives the circuit shown in Fig. 604. The ground on

the tuned circuit does not affect the balance of the circuit, because to audio frequencies the tuned circuit is a very low impedance. Now that crystal diodes are so cheap, we consider that a more economical solution would be obtained by putting a tap on the center of the coil and rectifying the two halves with separate diodes. (The circuit of Fig. 604 dates back to 1934).

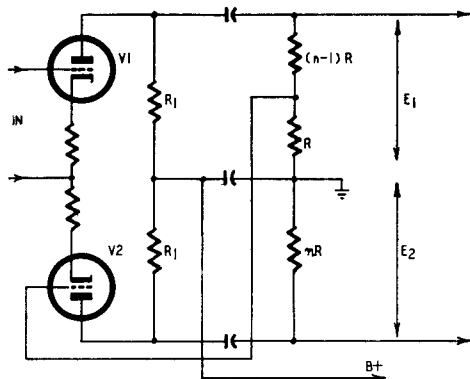

Fig. 605. One of the more common types of inverter circuit used today. V1 is driven by the unbalanced input, while V2 receives its drive from the voltage divider. Although practical, this circuit does not receive too wide a usage by the critical design engineer.

### Some circuits from life

These circuits are, of course, the textbook type, well suited to the student and ignored by the engineer. Let us turn to a more practical circuit, which, though very widely used, is not very satisfactory to a critical designer. It is the circuit given in Fig. 605. In this circuit V1 is driven by the unbalanced input, while V2 receives its drive from the voltage divider made up of R and  $(n - 1)R$ . These values provide a drive voltage for V2 of  $E_1/n$ . We can assume that R is very large indeed and that we are using pentodes. These assumptions have no influence on the final conclusions, but they make the mathematics very easy, with  $A = g_m R_1$  instead of

$$A = \frac{\mu \left( \frac{nRR_1}{nR + R_1} \right)}{\frac{nRR_1}{nR + R_1} + R_p} \quad (73)$$

V2 has a gain of  $g_m R_1$  (where  $g_m$  is the transconductance), so

that the voltage applied to its grid is  $E_1/n$ . Thus we have

$$E_2 = \frac{g_m R_1 E_1}{n} \quad (74)$$

We want this voltage to be equal to  $E_1$ , and therefore:

$$E_1 = \frac{g_m R_1 E_1}{n} \quad (75)$$

$$n = g_m R_1 \quad (76)$$

What could be more pleasant: just look up  $g_m$  in the tube handbook, choose  $R_1$  to suit the tube and you know  $n$  right away.

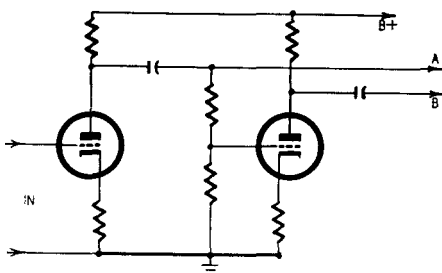

Fig. 606. This diagram shows how the circuit of Fig. 605 operates.

The total grid resistor  $nR = R + (n - 1)R$  will be 100,000 ohms perhaps, so that  $R$  is known too.

The only trouble is that although the tube manual may give  $g_m = 7,650 \mu\text{mhos}$ —and we have seen this exactness used—a look in the MIL specifications will leave you slightly worried. Most tubes have a tolerance of about 20% on transconductance. If you set the circuit up with a high  $g_m$  tube, it will be more than 30% out of balance with a low- $g_m$  tube. Of course, there are the tolerances on the resistors too; although you can always adjust the circuit to take account of these, you cannot prevent the balance drifting away as the tube gets old.

### Another weakness

If we redraw the circuit as shown in Fig. 606, we see a new disadvantage, which we shall find is common in phase splitters. The output voltage to the push-pull stage which appears at A has passed through one tube (V1 of Fig. 605), while that which appears at B has passed through tubes V1 and V2. Thinking again of a class-B output we can see that, if we feed back to the

grid (or cathode) of V1 we shall be feeding back around two stages for one half-cycle and around three stages for the other half-cycle. The plate capacitance of V2 provides at high frequencies an additional phase shift which may make the amplifier unstable. It is not uncommon with circuits of this kind to observe a short buzz of h.f. oscillations on one peak of a low-frequency signal. This effect usually is to be detected only with an oscilloscope, and its cure involves the addition of as many components as would be needed for a more sophisticated phase splitter.

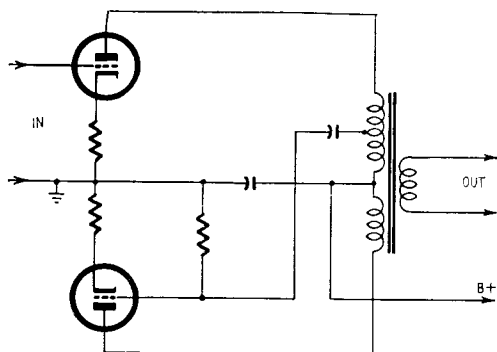

*Fig. 607. Another little used circuit. The main disadvantage here is if the tap on the output transformer is chosen at a point that will give good low-level balance with a poor tube, when a high  $g_m$  tube is used as a replacement, it will oscillate, since its normal level lies within 6 db of this unstable condition.*

Another circuit is shown in Fig. 607. The drive for the lower tube is taken from a tapping point on the output transformer. Perhaps the worst feature of this circuit is the fact that if the tap is selected to give a good low-level balance with a poor tube, a high- $g_m$  sample driven vigorously will oscillate in the Hartley oscillator circuit shown in Fig. 608, its normal operation being within 6 db of this unstable condition.

It is not impossible to find other disadvantages to this circuit in its practical applications, but it is so rarely used it doesn't seem necessary to do more than indicate it as an undesirable form.

### **A "simple" compromise**

A third circuit belonging to this condemned class is sometimes seen. One example of it was found in a fairly recent car-radio design, though we must admit that it contained a mitigating fea-



ture. This circuit is shown in Fig. 609. The drive is applied to V1, and the grid of V2 is fed from the screen of V1. As you remember, the signal at the screen of a tube is in the opposite phase to that at the control grid, so that, if the grid-screen transconductance is  $g_{mgs}$  and we connect a load resistor of  $1/g_{mgs}$  in the screen lead, we obtain a voltage equal to the grid voltage but with reversed phase. This voltage is used to drive the grid of the other tube of the push-pull pair.

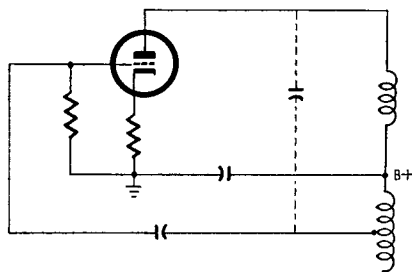

Fig. 608. Circuit of the Hartley oscillator hidden in Fig. 607.

The circuit shown in Fig. 609 includes a decoupling capacitor in the common screen lead connected above the screen load mentioned in the last paragraph. When this capacitor is used, the circuit suffers from the basic defect of the three circuits discussed; if the tube characteristics change, the balance is destroyed. As we saw at the beginning, a good balance is necessary if the distortion and power output are to be satisfactory. The designer of the car radio which incorporated this screen coupling avoided this difficulty by an ingenious and economical trick. He left out the dotted capacitor! When the circuit is balanced, the capacitor is not needed, because when the grid of V1 goes negative the screen current drops, driving the grid of V2 positive and increasing the screen current in V2 by exactly the same amount. Since the total screen current is constant, the voltage drop in the common screen resistor is constant, and the capacitor would have no alternating voltage across it. Consequently it is doing no work and can be omitted.

Suppose, however, that through wrong choice of the resistor  $R_1$ , the grid of V2 is driven too hard. The voltage appearing at the screen of V2 will be greater than that produced by V1 at the top of  $R_1$ . When the grid of V2 goes plus, the top of  $R_1$  will go negative. This negative voltage will be communicated back to the

grid of V2 to help restore the balance. We have, in fact, negative voltage feedback in the screen-grid circuit of V2, which helps to preserve the balance.

Unfortunately, the grid-screen transconductance is too low to be of very much help in such a simple circuit. A typical value of  $g_{mgs}$  would be  $500 \mu\text{mhos}$ , and the "stage gain" will only be a few decibels, which is not much to use for feedback. So this elegant balancing—although helped by a common cathode resistor—isn't

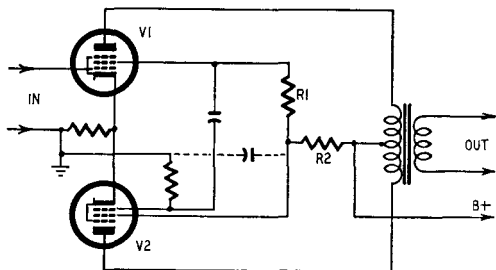

*Fig. 609. This inverter circuit contains the basic defect found in the three circuits of Figs. 605, 607 and 608. When a decoupling capacitor is included in the common screen lead connected above the screen load, the circuit balance is destroyed if tube operating characteristics change.*

really so good. Of course, if  $R_2$  is made very large, the effect can be increased, but usually you cannot make  $R_2$  large or you will not get any power out of the tubes. Some of you will have no doubt seen that we could put in a choke instead of  $R_2$ , thus providing the balancing forcing action at no cost in d.c. volts. Here, however, we run into a new difficulty. The screen of a normal output tube is not a well-behaved electrode. If you drive the grid hard, you get a distorted sort of wave at the screen as soon as you have any substantial screen load. This you would expect, because after all you have a pentode drive applied to a triode. The result is that as you increase the balancing load  $R_2$  you increase the distortion fed back from the screen circuit into the grids, and the result can be quite unpleasant. Our experience is that all these trick circuits which save two components or so usually degrade the system down to the "all right for the price" class.

The tube circuits which we have considered can be seen to have one feature in common: the drive for the pull section is derived from the push section in a way which depends on a

knowledge of the gain of a tube stage. As a tube transconductance can vary over a 2:1 range, there is not much hope that the push and the pull will be equal, or if they start equal there is not much hope that they will stay that way. Obviously the designer who wants to get the best performance must think up some better method. Two basic types of solution have been found. One is to use the same current passing through two separate load resistors; the other is to use very large amounts of negative feedback.

*Fig. 610. This is an excellent type of phase splitter. It consists of simply two resistors with their junction point grounded. As long as the resistors maintain their equal values, the voltages appearing across them must be equal and opposite. This circuit also has some practical applications.*

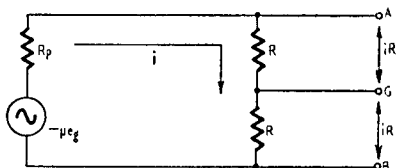

It is only fair to add that in condemning these widely used circuits, we are not suggesting that the designer who uses them does not know his job. It is merely that while their job is to produce plenty of output which does not sound too bad, our main job always seems to be to produce plenty of output which gives less than 1% or 0.5%, or whatever the specification says, of distortion. What is worse, there is no tube selection or trimming allowed, though we can always afford an extra tube if we want to apply more feedback. Pity the poor designer who is trying to save two cents; but if you can afford it, make it good!

## A method of preserving balance

The best way to produce two equal voltages with opposite phases is to pass a current through two equal resistors in series. If we use the simple equivalent for a tube, we have the arrangement shown in Fig. 610. We can match the resistances as closely as we like and obtain virtually perfect balance. Most of our problems will arise from the difficulty of achieving this ideal circuit when we must add the supply voltages and input for the tube. So long as we are concerned only with the ideal case we can see that the tube load is  $2R$ , which should be equal to the optimum load given in the tube characteristics, and the gain of the stage to *each* push-pull grid is:

$$A_s = \frac{\mu R}{R_p + 2R} \quad (77)$$

or half the gain for a single-ended load of  $2R$ .

Now let us consider the practical applications of the circuit. Terminal G must be grounded, because that is what the push-pull stage demands. The practical circuit must therefore look something like Fig. 611-a. This, of course, is still a rather theoretical circuit, because the grid of the tube is floating about in mid-air. We proceed to fix the working point of the tube by adding the components  $R_g$ ,  $R_k$  and  $C_k$  (Fig. 611-b). These are the standard components for the tube.  $R_k$  sets the tube to its correct bias,  $C_k$

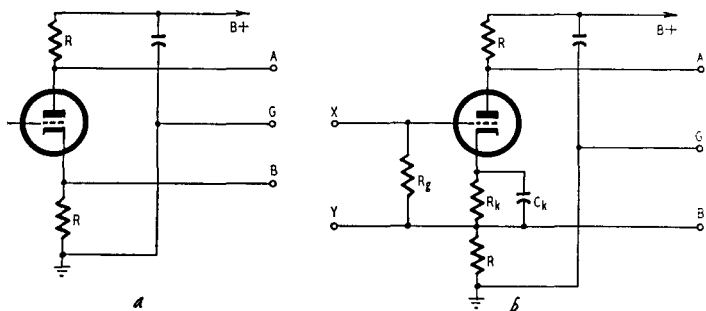

Fig. 611. Two steps towards making a more practical circuit from the one shown in Fig. 610. A tube is inserted between the two resistors to supply the necessary current through them and to modulate that current as desired.

eliminates the negative feedback caused by  $R_k$  at all frequencies for which  $2\pi fC_kR_k \gg 1$  and  $R_g$  is the usual grid resistor, which normally must not exceed about 500,000 ohms for tubes operated with cathode bias.

We can apply the input signal between X and Y, provided that the source has no ground on it. For practical purposes this implies the use of an input transformer, giving the circuit shown in Fig. 612, which now includes a decoupling resistor  $R_s$  in the supply lead. We can draw the exact equivalent circuit for this arrangement in two different ways, depending on whether we are interested in the low-frequency or the high-frequency end of the response. For the low-frequency end we have Fig. 613.

## What happens in the circuit

The general form of Ohm's law ( $I = E/Z$ ) can be applied to this circuit fairly easily, though the expressions are rather long because they contain nine variables. We can see by straightforward reasoning what will happen however. At low frequencies  $C_k$  will no longer act to decouple the cathode resistor  $R_k$ , so that

the gain will fall by a small amount. As we usually take a cathode resistor approximately equal to  $R_p/\mu$  the gain will fall by about 4–6 db if we use a triode, or maybe a little more than 6 db if we use a pentode. This drop applies to the current around the loop and affects both the push-pull outputs equally: it does not affect

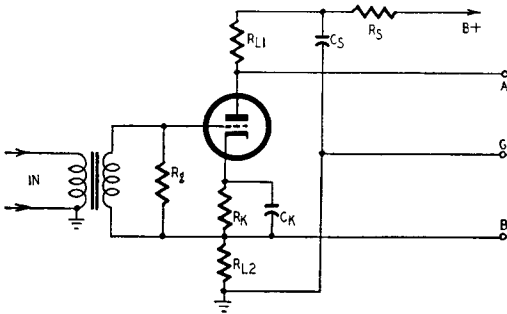

Fig. 612. A practical form of the circuit of Fig. 610. Here, transformer input solves the problem of providing a grid return path and of isolating the input from ground.

the balance of the outputs at all. Notice, however, that this is because we took output B from the top of  $R_{L2}$ , not directly from the cathode of the tube. By taking output B from the cathode we will add a new effect, because as the current drops, due to the feedback, the impedance across which the voltage is taken rises,

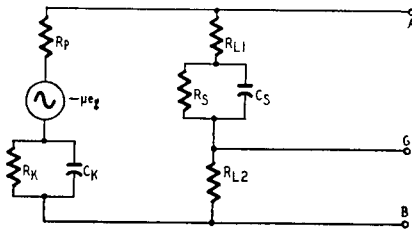

Fig. 613. This shows in equivalent form, how the circuit in Fig. 612 appears to low audio-frequency signals.

so that the output voltage at B will not drop as much as it does at A.

In the other half of the push-pull drive, the current flows through  $R_{L1}$  and the parallel combination of  $R_s$  and  $C_s$ . The impedance at very low frequencies thus rises from  $R_{L1}$  to  $(R_{L1} + R_s)$ , giving, if the current were constant, a rise in response of 20

$\log (1 + R_s/R_{L1})$  db. This rise in response is not balanced by anything which happens in the  $R_{L2}$  circuit, so that at very low frequencies we have an unbalance of about  $R_s/R_{L1}$ .

It is attractive to suggest that we should take  $R_k = R_s$  and  $C_k = C_s$  and derive output B from the cathode. Then the circuit would stay balanced right down to the lowest frequencies. Can we do this? The answer is no. A typical value of  $R_k$  will be around 500 ohms and  $C_k$  can be 100. This give us  $\omega C_k R_k = 1$  if

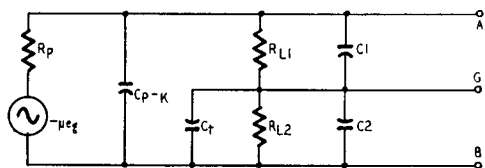

Fig. 614. This is the equivalent circuit of Fig. 612 for signals at the high end.

$\omega = 20$  (using  $\omega$  to denote  $2\pi f$ ). The characteristic frequency is about 3 cycles per second. We could also use an electrolytic capacitor of 100  $\mu f$  for  $C_s$ , but it is bulky and expensive because of the difference in working voltage:  $C_k$  has only a few volts across it, while  $C_s$  has almost full B+. Remember why we insert this decoupling circuit. We decouple tubes because the plate supply unit has a measurable impedance, and the current drawn by one tube affects the voltage supplied to another. This finite supply-unit impedance is in series with  $R_s$ , so because of the current fluctuations, our elegant calculations on this single stage are vitiated. We must just decouple cathode and plate efficiently.

At high frequencies the circuit takes the form shown in Fig. 614.  $C_1$  and  $C_2$  are the capacitances of the following push-pull stage, and will be equal;  $C_t$  is the capacitance from input-transformer secondary to ground, together with the cathode-heater capacitance of the tube. In addition to these there is the important plate-grid capacitance, which provides a "Miller" capacitance in parallel with that of the grid and cathode and affects the overall frequency response. It does not have any effect on the balance, however, so we need not discuss it here. We can concentrate our attention on the unbalance effect produced by the capacitor  $C_t$ .

We can get an idea of what this capacitance will do by putting in some numbers. Typical values of  $R_{L1}$  and  $R_{L2}$  will be 50 kil-ohms, so that for a top frequency of 16,000 cycles a capacitance of

200  $\mu\text{f}$  will be tolerable, from the frequency-response point of view. If feedback is being applied round this stage, the phase shift will be an embarrassment, but in any event we shall be using a modification which eliminates some of this capacitance.

## The practical applications

We very rarely want to use an input transformer, and the reader may ask why we have spent so long considering this circuit which

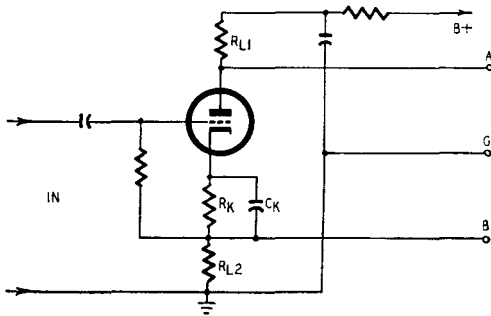

*Fig. 615. In this circuit, by grounding one side of the input and using a blocking capacitor, we can abandon the unpopular transformer input. This reduces the gain because of degenerative cathode feedback.*

in spite of its very good balance presents difficulties in connecting the input. The answer is that we can apply our analysis to other arrangements which have a grounded input. Knowing that we have a good arrangement so far as the push-pull character is concerned, we can press on to an examination of other input circuits, without having to worry about the output circuit.

Fig. 615 is a conventional arrangement in which a blocking capacitor has been added in series with the grid circuit. So far as B is concerned, this stage is just a cathode follower and since  $R_{L2}$  is large there will be slightly less than unity gain from the input to output B. As we have already shown, the phase splitter is well balanced, so that in this form we need to apply to the input just about the same voltage as each of our final push-pull tubes will require. We can omit  $C_K$  because we have already so much feedback from  $R_{L2}$  that a little extra will not make any difference.

## Two important problems

Before adding some notes on the design of this circuit, two

matters have to be discussed. The cathode of the tube is suspended, like Mahomet's coffin, between heaven and earth. Usually it will be at least 50 volts above ground, and we must take care not to let it exceed the maximum voltage given by the tube maker, which is often 90 volts. When a separate heater winding can be provided for this tube, there is no problem at all. Some may prefer to moor the heater center point to a +20-volt point obtained by tapping with high resistors across the plate supply. This not only helps to reduce the heater-cathode voltage in this phase-splitter stage, but also reduces the hum in earlier stages of the amplifier.

The second point becomes important only in advanced feedback circuits, or if the following tubes draw grid current. At B, the apparent generator impedance is that of a cathode follower and is low; at A, the impedance is that of a tube with a great deal of current feedback and is very high.

The design conditions are fairly easily studied. We take our selected tube, say one half of a 12AT7, and choose the bias resistor, 500 ohms, and the plate load, say 50,000 ohms. This 50,000 ohms we split in two, giving 25,000 ohms for each of the resistors  $R_{L1}$  and  $R_{L2}$ .

Applying this load line to the tube characteristics with a supply of 250 volts we get a current of 3–4 ma, and a bias of 1.5–2 volts. The cathode is then between +75 and +100 volts, and the stage gain will be

$$A_s = \frac{\mu R_{L1}}{R_p + (\mu + 1)R_{L2}} \quad (78)$$

$$\cong \frac{40 \times 25,000}{15,000 + (41 \times 25,000)} \cong 0.98$$

The input impedance (by virtue of the negative feedback caused by the cathode resistor) is very high indeed. This fact enables us to get adequate gain in a complete amplifier in spite of the wastage in the phase splitter. Let us see why we have such a high input impedance. Suppose that we apply 1 volt positive to the input terminal: the cathode will rise to 0.98 volt, leaving only 0.02 volt across the grid leak. If this is 100,000 ohms, the current through it, due to grid-cathode signal voltage, will be 0.2  $\mu$ a. At the input it will appear as though 1 volt has produced 0.2- $\mu$ a current, so the apparent input impedance will be 5 megohms. We can use this very high resistance as the load for a pentode



amplifier stage and obtain a corresponding high increase in its voltage gain. This will make up the loss of gain in the triode phase splitter, because the two stages together would hardly have shown such a high gain normally anyway.

### A more refined circuit

Fig. 616 shows the way in which the circuit is arranged. The supply to V1 passes through R<sub>7</sub>, R<sub>2</sub> and R<sub>1</sub> in series, with R<sub>1</sub> as

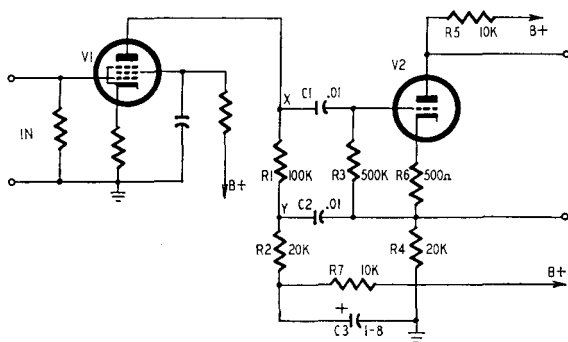

*Fig. 616. This more refined circuit overcomes the reduced gain by taking advantage of the cathode-follower circuit's high input impedance. By using a pentode in the first stage, the combined gain of the two stages is excellent.*

the useful part of the load. The load on V1 is the combination of R<sub>1</sub> in parallel with R<sub>3</sub> multiplied by the feedback effect in V2. The effective impedance in parallel from X to ground is of the order of megohms, so that V1 has a very high gain. R<sub>2</sub> is needed to prevent point Y from being grounded by the decoupling capacitor C<sub>3</sub>, and R<sub>2</sub> is, for a.c., in parallel with R<sub>4</sub>, the cathode load resistor of V2. Since R<sub>4</sub> settles the voltage at which the cathode is set and the steady current conditions in V2, it cannot be made too large. We must therefore reduce the value of the plate load of V2 (R<sub>5</sub>) and V2 will not be operating under ideal conditions. The values shown in Fig. 616 represent a reasonable compromise, however. (The values are all even numbers—the nearest preferred values will work in a practical circuit.)

Perhaps the most serious disadvantage of this circuit is the fact that the gain depends on the amplification factor of a pentode, a number which you never see in the books. This is because the quantity is far from constant.

We can, of course, stabilize the gain of the complete amplifier by using overall negative feedback, but here we meet another difficulty. The plate capacitance of V1, together with the capacitance of the unit to ground, will be in parallel with the very high pentode plate load. Perhaps with care these can be kept down to 20  $\mu\text{f}$  or less. The average small pentode has a plate impedance of about 1 megohm, which is in parallel with the load of about 5 megohms effective, resulting in a roll off, using 20  $\mu\text{f}$ , at about 9 kc. Using the same combination of about 0.8 megohm with a  $g_m$  of about 1,250  $\mu\text{mhos}$ , we obtain a gain of about 60 db from our two tubes. Thus, if the final stages need 20 volts drive, we can operate with 20-mv input to V1.

The circuits shown in Figs 615 and 616 are two of the most important phase-splitter circuits. They provide a very well balanced output, are almost independent of the characteristics of the phase-splitter tube over the range of commercial tolerances and involve no trick circuitry. The only disadvantages are that the tube must have good heater-cathode insulation (both to prevent breakdown under the voltage stress and to prevent the leakage of 60-cycle hum into the cathode resistor) and that one tube must provide sufficient swing to drive both the push-pull grids.

Thus if each grid requires 20 volts, the tube must be capable of giving 40 volts under normal amplifier conditions. When driving a class-B amplifier, which needs say 40 volts peak for *each* grid, this demand for 80 volts peak is too much for a small tube. Some designers have therefore followed a phase splitter of this type with a push-pull intermediate driver. We are not enamored of this solution, which puts in an additional double triode to do work which could be done better by a single tube elsewhere in the circuit.

## Phase splitters

For output stages requiring a reasonable swing, tubes such as the 6J7 or European EF37 make excellent drivers, because they have higher impedances than newer miniature pentodes such as the 6AK5 and stage gains of over 1,000 are referred to in the literature.

The disadvantage of this phase splitter is that the cathode is away above ground, at a steady potential of perhaps +100 volts. If you use it to drive a pair of 6L6's, the cathode will swing up to +130 volts on positive half-cycles. This isn't too favorable a con-

dition, as most tube makers specify a limit on heater cathode potential difference of about 90 volts maximum. A solution to this problem is to return the heater center point to a +50-volt tap on the plate-supply bleeder, so that the phase-splitter cathode swings up to only +80 volts relative to the heater, while all other cathodes are at about -50 volts relative to their heaters. This is, in any case, a better approach, as you will find it reduces

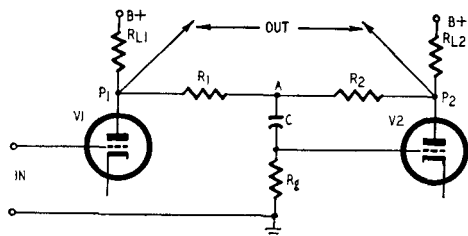

Fig. 617. Basic seesaw phase-inverter circuit. This circuit is also known as an anode follower.

the hum caused by leakage current from heater to cathode flowing back to ground through the cathode-bias resistor. By saturating this leakage path with d.c., the 60-cycle leakage current becomes a minor fraction of the total, and the hum from the heater disappears.

A second very important push-pull driver is rapidly becoming popular. It is not a new circuit; it seems to be more than 20 years old, but it has come to the fore with the growing demand for quality at high signal levels and the introduction of good small double triodes. This circuit is known variously as *anode follower* or *seesaw*. The basic circuit is shown in Fig. 617. Each triode has its usual cathode-biasing resistor (not shown) and its basic plate-load resistor ( $R_{L1}$  and  $R_{L2}$ ).  $R_{L1}$  is equal to  $R_{L2}$ , of course. The input is applied to the grid of V1. Two resistors,  $R_1$  and  $R_2$  are connected in series between the plates, and the grid of V2 is driven by the mid-point of these two resistors through the C- $R_g$  coupling circuit.  $R_1$  is slightly smaller than  $R_2$ , but both are large compared with  $R_L$ , so that they do not cause appreciable additional loading effect. Similarly we can forget C- $R_g$  in our first discussion.

## The seesaw circuit

This circuit is traditionally explained by drawing the seesaw

Fig. 208 (page 43) shows an amplifier utilizing the seesaw circuit.

of Fig. 618. Suppose the circuit is working as a perfect push-pull system balanced symmetrically at O, and  $P_1$  swings down to X as  $P_2$  swings up to Y, with  $P_1X = P_2Y$ . Divide the line  $P_1P_2$  at A so that  $P_1A/AP_2 = R_1R_2$ . Draw AG parallel to  $P_1X$  (and  $P_2Y$ ) to meet the line XY at G. Then AG, the voltage at A, is the grid drive to V2. It does not take much recollection of school geometry to see that  $P_2Y/AG = P_2O/OA$  (corresponding sides of similar triangles). Now  $P_2Y/AG$  is the gain of stage 2, which we can

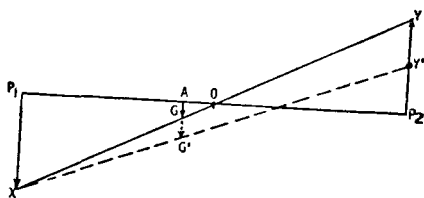

Fig. 618. Operating diagram of the voltage relationships in the seesaw phase-inverter circuit.

call  $A_T$ . If we remember that O is the mid-point of  $P_1P_2$ , we see that  $OP_1 = OP_2 = P_1P_2/2 = R_1 + R_2/2$ , and also,  $OA = OP_1 - AP_1 = R_1 + R_2/2 - R_1$ . Therefore:

$$A_T = \frac{R_1 + R_2}{R_2 - R_1} \quad (79)$$

This result can be rearranged to give

$$\frac{R_1}{R_2} = \frac{A_T - 1}{A_T + 1} \quad (80)$$

That last paragraph is very easy to follow if you take a really big sheet of graph paper and draw the figure yourself. Make  $P_1P_2$  equal 10 inches and put A  $1/8$  inch to the left of the center point O. This corresponds to a stage gain of 40, which is a bit high. With a scale drawing you will see how the line XY pivots about O, which means it pivots almost about the grid of V2, just like the plank of a seesaw or "teeter-board."

Now suppose that for some reason V2 gives an unbalanced output, say  $PY'$ . Joining  $XY'$  and prolonging the line AG, we get the new grid drive  $AG'$ . On your big diagram you will see that for a small movement in Y you get a very large increase in grid drive, so that a very large change of gain does not unbalance the circuit much. This is merely clearing away the standard explanation, but before we go on we might just look at our one useful

formula,  $R_1/R_2 = (A_T - 1)/(A_T + 1)$ . We know that  $A_T$  will be about 40 for a 12AT7, so  $R_1/R_2$  is about 0.95. If you are using ordinary commercial-tolerance resistors for  $R_1$  and  $R_2$ , all you need do is pick the larger of a nominally equal pair for  $R_2$  and use the other for  $R_1$ .

### A more advanced explanation

This way of explaining the circuit is unsatisfactory, because it

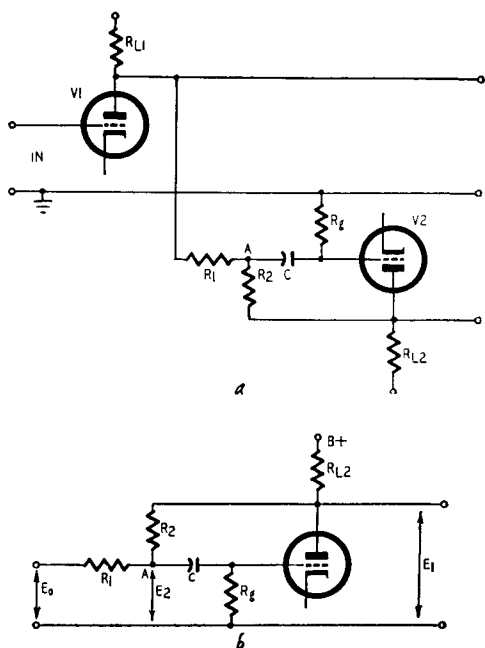

Fig. 619. Seesaw circuit redrawn (a) to show phase inverting action of V2. The input- and output-voltage relationships in the phase inverting circuit (b) are discussed in the text.

does not lend itself to more detailed study. At this point we shall consider the circuit in a more formal way, regarding the second tube as a separate phase-reversing amplifier. To show this nicely, the circuit is redrawn in Fig. 619-a, and the second tube circuit is turned the usual way in Fig. 619-b. V2 has a feedback connection from plate to grid through  $R_2$ . We will forget about C and  $R_g$  and will make  $R_1$  and  $R_2$  very much larger than  $R_{L2}$ , to keep the mathematics simple. First,  $E_1/E_2 = A_T$ , the gain of the

tube itself, and  $A_T$  is given by the well-known formulas:

$$A_T(\text{triode}) = \frac{\mu R_{L2}}{R_p + R_{L2}} \quad (81)$$

$$A_T(\text{pentode}) = g_m R_{L2} \quad (82)$$

Also, as you know, if the grid goes negative, the plate voltage rises. If we drive the grid *down* 1 volt, the plate voltage *rises* and across  $R_2$  we get  $(A_T + 1)$  volts. The current through  $R_2$  produced by a 1-volt signal at  $E_2$  is therefore  $(1 + A_T)/R_2$  and to a man who has connected a voltmeter at point A and an ammeter in series with  $R_2$  it seems as though the resistance value must be  $R_2/(1 + A_T)$ .

You may have met this expression before in another connection. Suppose that  $R_2$  is replaced by a capacitor  $C_2$  with a reactance of  $1/\omega C_2$  ( $\omega = 2\pi f$ ). The man with a meter will see a reactance of  $1/\omega C_2(1 + A_T)$  and will think there is a capacitor of  $(1 + A_T)C_2$ . This is our old friend the Miller effect, a curse to all high-frequency designers and the bread and butter of the designers of time bases.

For a voltage  $E_2$  at point A, the current flowing through  $R_2$  must be  $E_2(1 + A_T)/R_2$  remembering that the effect of  $R_g$  is to be neglected. This current is produced ultimately, of course, by the applied signal  $E_0$ , so it must also flow through  $R_1$ . The voltage across  $R_1$  is  $(E_0 - E_2)$ , and we must have the same current flowing through  $R_1$  and  $R_2$ . From this we get:

$$\frac{E_0 - E_2}{R_1} = \frac{(1 + A_T)E_2}{R_2}$$

Rearranging this form, we now have

$$\frac{R_2}{R_1} = \frac{A_T + 1}{A_T \left( \frac{E_0}{E_1} \right) - 1} \quad (83)$$

Since we want  $E_0 = E_1$ , a unity ratio phase reverser, we must have

$$\frac{R_2}{R_1} = \frac{A_T + 1}{A_T - 1} \quad (84)$$

This is the result we had previously obtained by the simple geometrical method. We can now study more closely what happens if

the value of  $A_T$  changes, through tube aging or for any other reason, including the tolerances of  $R_{L2}$ . We have

$$\frac{E_0}{E_1} = \frac{1}{A_T} \left[ 1 + \frac{(1 + A_T)R_1}{R_2} \right] \quad (85)$$

which is normally 1.

Let us start with  $A_T = 40$ , so that  $(A_T + 1)/(A_T - 1) = 41/39$  and  $R_1/R_2 = 39/41$ ;  $E_0/E_1 = 1$ . By setting  $A_T$  to 30, we have:

$$\begin{aligned} \frac{E_0}{E_1} &= \frac{1}{30} \left[ 1 + \frac{(1 + 30) \times 39}{41} \right] \\ &= \frac{30.48}{30} = 1.016 \end{aligned}$$

This change in tube gain has thus produced an unbalance of 1.6%, while in the circuits given earlier a gain change of this order would have caused an unbalance of 33%. There is, you see, a considerable improvement.

### A noncritical circuit

What we like most about this circuit is its simplicity, as it does not seem to use any more components than the circuits we dislike so much. The cathodes are grounded, except for the ordinary self-bias drop, so there is no problem of heater-cathode voltage. The plate loads need not be matched carefully, because the feedback takes care of normal differences, though you should make them nominally equal since both tubes need to develop the same output. The splitting resistors  $R_1$  and  $R_2$  are the only critical components, and a quick check with an ohmmeter is enough to select a pair in which  $R_2$  is about 5% higher than  $R_1$ , the actual value not being critical. Since we have full feedback around V2, there is no extra distortion here.

Before we look at some variations on this simple theme, we must consider what stray capacitance does to unbalance the circuit at high frequencies, and what our neglected components C and  $R_g$  do, especially at low frequencies. This is where we reap the benefit of our more formal approach, since the effect of the strays cannot be fitted into the geometrical treatment.

First, we see that any strays across tube V1 have no effect on the balance at all because they affect the response before we go into the circuit of V2, and if the response drops there is less drive to

V2. The strays across V2 are the main problem because the *push* signal from V1 is not affected by them. Now any capacitance to ground at the plate of V2 is in parallel with  $R_{L2}$  and will pull down the stage gain at high frequencies; but, as we have just seen, the effect of changes in stage gain is very small indeed, so that we are not too worried by these strays.

At low frequencies the blocking capacitor C begins to have some effect. Between point A (Fig. 619-b) and the tube grid there will be a 3-db drop at the frequency where  $\frac{1}{2}\pi fC = R_g + R_1R_2/R_1 + R_2$ . But all our calculations so far have been referred back to point A, so that this 3-db drop is included among changes in  $A_T$ , and we have just seen that a 25% drop in  $A_T$  produces an unbalance of only 1.6%. If we intend to work down as low as 30 cycles we can take  $C = .01 \mu\text{f}$  and  $R_g = 500,000$  ohms, and have only this 1.6% unbalance. In a very complex feedback amplifier we might need a larger capacitor because at frequencies of a few cycles we should get a small *increase* of phase shift owing to the feedback. However, this effect is almost always considered unimportant.

### A numerical example

This circuit is balanced and stays balanced in spite of strays, blocking capacitors and tube variations. Let us now put in some numbers. A 12AT7 operating at 6 ma with a bias of -1.5 volts has a  $\mu$  of 50 and a plate resistance  $R_p$  of 12,000 ohms. The voltage at the plate will be about 160 and the maximum swing perhaps 60 peak or 42 r.m.s. Using 48,000 ohms for plate-load resistors  $R_{L1}$  and  $R_{L2}$ , the gain  $A_T$  is exactly 40 and a preferred resistance value 47,000 ohms fits conveniently. The total supply voltage must then be  $160 + (47,000 \times .006)$  or 442 volts, which is quite a practical value if you are using output tubes which take 40 volts drive. The cathode resistors are nominally 250 ohms (270 is a preferred value). For smaller drives use the same 47,000 ohms in the plate but drop the supply voltage and increase the cathode resistance.

We must now choose  $R_1$  and  $R_2$ , which are to be much bigger than  $R_{L1}$  and  $R_{L2}$ . A suitable value might be 470,000 ohms, but we run into trouble at once because we want  $R_g$  to be much bigger than this and the tube maker tells us not to make  $R_g$  more than 470,000 ohms. Things are not too bad, however. We saw that the apparent impedance at point A in Fig. 619-b due to  $R_2$  is  $R_2/(1 + A_T)$  or  $470,000/41$ . Connecting  $R_g$  in parallel with



this produces only a  $2\frac{1}{2}\%$  error, and we make up for this by making  $R_2$  about 5% larger than  $R_1$ .

When we lightly wrote down the cathode resistance as 270 ohms in the last paragraph, we did not stop to consider the local feedback effects. As the two tubes are in phase opposition, there will be no audio current in the cathode circuit if the two cathodes are connected together, and we could use a 135-ohm common bias

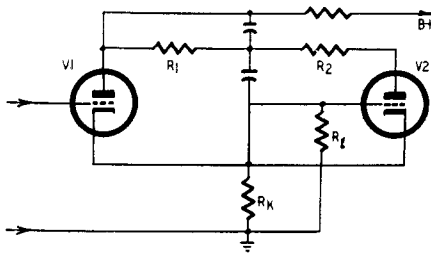

*Fig. 620. When a common cathode resistor is used in the seesaw circuit, stray capacitance across  $R_1$  converts the inverter into a cathode-coupled multivibrator.*

resistor. But suppose there is a small stray capacitance across  $R_1$ ; we shall have the circuit shown in Fig. 620, which you will recognize as a multivibrator. This may oscillate at high frequencies, though we have never encountered the effect in practice. A small bypass capacitor—say .01–0.1  $\mu\text{f}$ , across the cathode resistor will cure this trouble, if you should meet it. It is worth while avoiding the local feedback because it costs about 6 db in the gain of tube V1, which must be paid for in reduced feedback around the complete amplifier. It also reduces the initial balance of the phase-reversing stage, although with local feedback  $A_T$  will not change much and the effect of tube variations is the same with and without local feedback.

It is sometimes stated that a small capacitance should be connected across  $R_1$ . The object is to balance the plate-grid capacitance of V2, which is in parallel with  $R_2$  and which causes an increase in the feedback around V2 at high frequencies. The plate-grid capacitance of a 12AT7 is 1.45  $\mu\text{f}$ , so with socket and wiring it should not total more than 10  $\mu\text{f}$ . The effect will be important at about 30 kc where  $\frac{1}{2}\pi\text{fC} = 470,000$ . Where is the program with enough audio power to make the 30 kc balance important, and where do you get ears to hear it with? This extra

capacitor is, as we have just seen, at a danger spot anyway and it is best omitted.

### Some similar circuits

Three variants of this circuit are worth noting. The first is shown in Fig. 621 and it appears quite attractive until you look at it more closely. It saves one capacitor and one resistor because the grid drive is picked off after the usual plate-coupling capaci-

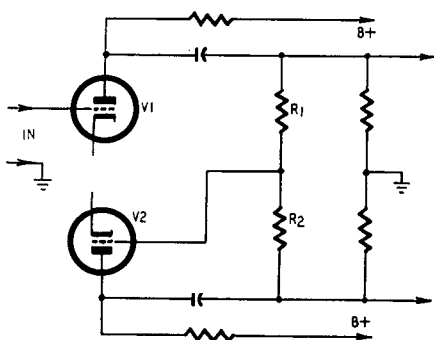
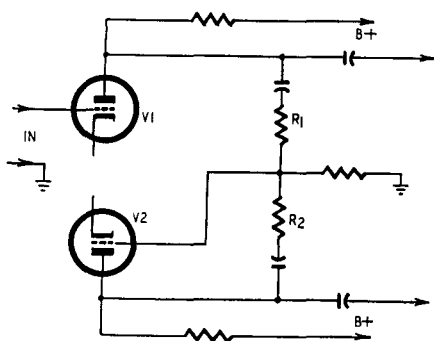

*Fig. 621. This circuit variation excludes a coupling capacitor, but has definite drawbacks.*

tors to the next stage. The theoretical results are practically identical, and the balance is only a fraction of 1% different from the values obtained in our earlier discussion. The objection to this circuit is purely practical: we are using it to drive fairly large tubes. We cannot, of course, use fixed bias on these because the bias would also be applied to the grid of V2. On signal peaks we shall get some grid current; indeed we shall probably always have a little grid current in the output tubes. It does not matter if the 25–40-volt bias on the output tubes is supplemented by 1–2 volts of bias due to grid current, especially as any bias pulses will be in push-push. However, 2 volts of bias on V2 will shift its working point until it can no longer deliver its full output. Any attempt to avoid this involves using such low grid resistances that gain is lost in the driver stage.

The second variant is shown in Fig. 622. There isn't very much value in this, although in theory it gives a slightly better balance at low frequencies at the cost of two capacitors instead of one. If a really good balance is needed at very low frequencies, a bigger blocking capacitor can be used in the basic circuit.

The third variant is shown in Fig. 623. This uses the fewest components of all, but, as you can see, all the grid current for V2 and for the power tubes passes through  $R_g$ . If  $R_g$  is made small to avoid bias trouble, it has a loading effect which complicates the choice of  $R_1$  and  $R_2$ . Theoretically it would be possible to use a large inductance in place of  $R_g$ , but who wants to use hundreds of henries to save a .01- $\mu$ f capacitor?



*Fig. 622. Another modified seesaw inverter circuit offering better balance between the driver output voltages at low frequencies.*

## Choosing the best circuit

The anode-follower circuit is superior to the split-load circuit previously described in output capacity. The first tube delivers no power to the second, so that the drive available for each half of the output stage is the full output from one tube. The split-load circuit gives only half a tube output to each side of the final stage. Using triodes there is no difference in gain, but the impedance increasing trick with the split-load circuit allows you to get a much larger gain if a pentode is used for V1. In both circuits the tube in which phase reversal takes place has so much feedback that distortion can be neglected. From the point of view of supply noise the anode follower is probably slightly better, but at those levels the question is not usually important. Both circuits have the disadvantage that the impedances at the two push-pull output points are not the same. This effect is a little worse with the split-load type than with the anode follower.

When class-B output stages are to be driven into grid current, it is worth while adding an extra feedback path, which in the case of the anode follower should run from the plate of V1, while

in the split load circuit it should run from the plate of the splitter tube. This feedback is taken to a point earlier in the amplifier and is adjusted to give the correct impedance to match the other side of the phase-splitting system. In the example we have considered here, the feedback should reduce the gain 26 db. An extra tube will be needed to make up the loss due to this internal feedback loop, but the response up to the grids of the final stage

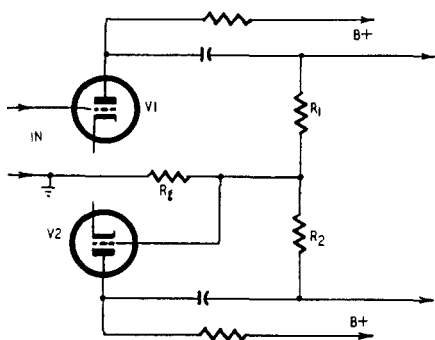

Fig. 623. An ultra-simplified form of the seesaw phase inverter. In this circuit, however, output-tube grid current may over-bias V2 unless  $R_g$  has a low value, or is replaced by an expensive high-inductance audio choke.

should be very flat and free from phase shift over a very wide band. As a result, the feedback loop of the complete amplifier will be affected mainly by the characteristics of the output transformer, and this may help in simplifying the design of this large and awkward element. Unequal drive impedances will cause behavior differences on “push” and “pull”. As we have seen, this circuit uses negative feedback to force the two *output voltages* into equality.

## Comparisons

In discussing the phase-splitting stage which must provide the link between a single-ended amplifier and a push-pull stage we have examined several bad circuits and two classes of good circuits. As we have seen, the single tube with a split load is good if you do not need too much drive, and the anode-follower or *seesaw* circuit gives more output but less gain. For conventional audio work the tubes and supply voltages you plan to use will

determine whether you take the single-tube or two-tube phase-splitting circuit.

There are some special jobs, though, for which these push-pull driver types are not suitable. The most important of these is when you want to go down to extremely low frequencies or even all the way to zero frequency. The anode follower includes one coupling capacitor, so that it will not stay balanced once the

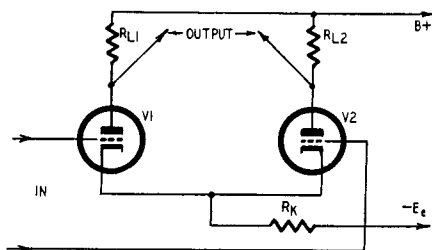

Fig. 624. Circuit of the "long-tailed pair" cathode-coupled phase inverter.

capacitor starts to take control; the split-load circuit has the disadvantage that the two output terminals are at different d.c. potentials. A symmetrical direct-coupled deflection amplifier for a cathode-ray oscilloscope calls for a phase splitter which provides two outputs at the same average d.c. potential, because any unbalanced difference will pull the undeflected spot away from the center of the tube.

### "Long-tailed pair"

One phase-splitting circuit is particularly good for cathode-ray oscilloscope work. It has other uses, too, but we shall come back to those after we have examined its characteristics. The circuit itself is known as the "longtailed pair" or, more prosaically, as the Schmitt cathode-coupled phase inverter. If you look at the basic circuit in Fig. 624, you will see why the name "longtailed pair" was adopted. This circuit is related to the anode follower in a rather interesting way. The anode-follower circuit, you may remember, could be described simply by saying that the second tube is driven by the *difference* in the *plate-voltage* swings of the two tubes. The second tube of the long-tailed pair has its grid grounded, and the effective drive to this tube is applied at the cathode. The driving voltage is equal to the cathode resistance  $R_k$  multiplied by the *difference in plate currents* of the two tubes.

Suppose we raise the potential of grid 1 by 1 volt, causing an extra current  $I_1$  to flow through V1. The current in V2 will *drop* by an amount  $I_2$ , and the cathode potential will change by  $(I_1 - I_2)R_k$ . This *change* is the input to V2 and, if  $R_k$  is very large, we can have  $(I_1 - I_2)$  very small and still get some drive into V2. In fact, we can draw Fig. 625-a for comparison with Fig. 625-b, which is the *seesaw voltage* diagram shown separately in Fig. 618. If you look at Fig. 625-a, you will notice that in order to get any drive at all for V2 it is necessary to have unequal values of  $I_1$  and  $I_2$ ,  $C_1 - R_k$  and  $C_2 - R_k$ . Drive for V2 is Og. The only way to get equal swings at the two plates is to use slightly different plate-load resistances  $R_{L1}$  and  $R_{L2}$ .

We can do some very simple calculations to see the sort of difference.

At plate 1 we have a swing of  $I_1 R_{L1}$ . Thus the input to V2 is  $(I_1 - I_2)R_k$ , which gives a plate current of  $g_m(I_1 - I_2)R_k$  and, therefore, a swing at the plate of V2 equal to  $g_m(I_1 - I_2)R_k R_{L2}$ , which is, of course, also equal to  $I_1 R_{L2}$ . Therefore:

$$g_m I_1 R_k R_{L1} = I_2 (1 + g_m R_k) R_{L2} \quad (86)$$

and

$$\frac{I_1}{I_2} = 1 + \frac{1}{g_m R_k} \quad (87)$$

Since we want  $I_1 R_{L1} = I_2 R_{L2}$ , we have

$$\frac{R_{L2}}{R_{L1}} = \frac{I_1}{I_2} = 1 + \frac{1}{g_m R_k} \quad (88)$$

Typical values used for this circuit are  $R_k = 5,000$  ohms and  $g_m = 5$  ma/v (5,000  $\mu$ mhos), giving a ratio,  $R_{L2}/R_{L1} = 1.04$ . This means that even without unequal load resistors we get a balance correct to 4%, which is quite good.

### The rigorous approach

This result, obtained by very simple reasoning, applies quite well if V1 and V2 are pentodes, though it leaves a rather tricky gap if you wonder how to bypass the screen grids right down to zero frequency. It shows that the circuit looks good, anyway. Now we come up against the main problem of the writer of technical books: do you want it easy, or do you want it right? Sometimes the writer can put in all the mathematics—if he is French he seems to put in nothing but the mathematics—some-

times he collects a dense mass of small-print equations at the end. Usually he must tack between the Scylla of editorial condemnation and the Charybdis of long-haired readers who write and point out the smallest deviation from rigor.

Personal preference is to start off with the exact mathematical solution and then to simplify. Any reader who wants to get more detail can then build up on the sound foundations provided.

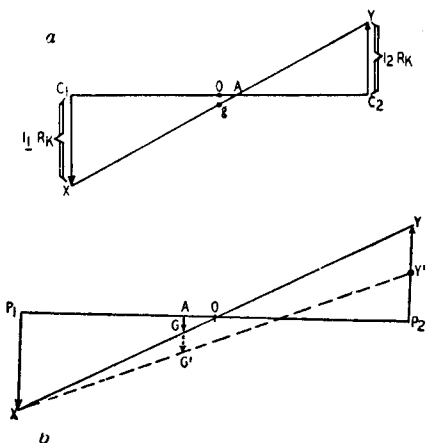

Fig. 625. Seesaw current diagram (a) of the "long-tailed pair", as compared to the seesaw diagram of the balanced-voltage phase inverter (b).

If you try to simplify *first*, you will have nothing to build on later.

It will be much easier to understand the long-tailed pair if we redraw the circuit in the form of Fig. 626. This is not as elegant and symmetrical as Fig. 624, but it is a great deal more useful. V2, you now see, is a grounded grid stage, a subject we will discuss in detail in Chapter 12. A lot of time can be saved here by using some of the results obtained from that chapter. In particular, the input impedance  $R_{in}$  looking in at the cathode is:

$$R_{in} = \frac{R_{L2} + R_{p2}}{1 + \mu_2} \quad (89)$$

The stage gain would then be:

$$A_s = \frac{(1 + \mu_2)(R_{L2})}{R_{L2} + R_{p2}} \quad (90)$$

Let us look at the first stage first. The tube has a plate load of  $R_{L1}$  and there is some negative feedback because of the unby-passed cathode resistor. If we represent the cathode circuit ( $R_k$

in parallel with the input resistance of V2) as  $R_x$ , the stage gain is just:

$$A_s = \frac{\mu_1 R_{L1}}{R_{L1} + R_{p1} + [(1 + \mu_1)R_x]} \quad (91)$$

The voltage across the cathode circuit is  $R_x/R_{L1}$  multiplied by the voltage at the plate. If we have 1 volt at the grid of V1, we get the voltage at plate one as:

$$E_{p1} = \frac{\mu R_{L1}}{R_{L1} + R_{p1} + [(1 + \mu_1)R_x]} \quad (92)$$

and the voltage at the common cathode as:

$$E_{ck} = \frac{\mu_1 R_x}{R_{L1} + R_p + [(1 + \mu_1)R_x]} \quad (93)$$

This we can rewrite as  $E_x$ . Then the voltage at the plate of V2 would be:

$$E_{p2} = \left[ \frac{(1 + \mu_2)R_{L2}}{R_{L2} + R_{p2}} \right] E_x \quad (94)$$

We want the voltage at plate 1 to be the same as that of plate 2, so we put:

$$\frac{\mu R_{L1}}{R_{L1} + R_{p1} + [(1 + \mu_1)R_x]} = \left[ \frac{(1 + \mu_2)R_{L2}}{R_{L2} + R_{p2}} \right] E_x \quad (95)$$

In this form,  $E_x$  is equal to  $E_{ck}$ , as shown in the formula for the common cathode voltage (equation 93).

There is one more equation, because  $R_x$  is made up of  $R_k$  in parallel with  $R_{in} = R_{L2} + R_{p2}/1 + \mu_2$ , so that

$$R_x = \frac{R_k (R_{L2} + R_{p2})}{R_{L2} + R_{p2} + \mu R_k} \quad (96)$$

The last paragraph is tough but true. Assume that the two tubes are equal and, by reducing the last formula, you will come out with the equation for true push-pull balance, which is:

$$\frac{R_{L1}}{R_{L2}} = \frac{(1 + \mu)R_k}{R_{L2} + R_{p2} + \mu R_k} \quad (97)$$



This doesn't look too bad and, if we assume further that we have pentodes, so that  $\mu$  and  $R_p$  are very large: or  $1 + \mu \cong \mu$  and  $\mu/R_p = g_m$ . From this we arrive at the equation:

$$\frac{R_{L1}}{R_{L2}} = \frac{g_m R_k}{1 + (g_m R_k)} \quad (98)$$

This is equivalent to the answer given by our simple treatment.

It is interesting to compare the exact solution with that of the simple one for a typical case. Consider a 12AT7, with its

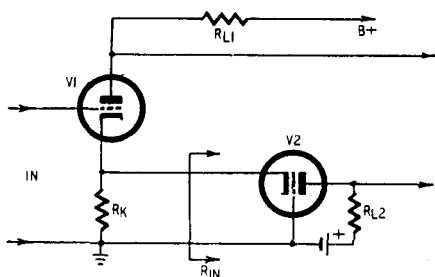

Fig. 626. Circuit diagram of the "long-tailed pair" redrawn to show grounded-grid operation of V2.

$R_p = 10,000$  ohms,  $\mu = 50$ ,  $g_m = 5,000$   $\mu$ hos and  $R_k = 5,000$  ohms. We can choose  $R_{L2} = 50,000$  ohms, and we obtain (using the formula for push-pull balance):

$$\begin{aligned} \frac{R_{L1}}{R_{L2}} &= \frac{(1 + \mu)R_k}{R_{L2} + R_{p2} + \mu R_k} \\ &= \frac{51 \times 5 \times 10^3}{50 \times 10^3 + 10 \times 10^3 + (50 \times 5 \times 10^3)} \\ &= \frac{255 \times 10^3}{310 \times 10^3} = 0.825 \end{aligned}$$

With the simple formula we had:

$$\frac{R_{L1}}{R_{L2}} = \frac{1}{1.04} = 0.96$$

There is quite a difference between a 17% unbalance and a 4% unbalance. Obviously, we are quite justified in adopting a

more rigorous approach as indicated by the results.

Energetic readers may care to consider what happens if  $V_2$  ages and  $R_{p2}$  gets bigger. As  $R_{p2}$  represents only 10,000 in the total 310,000 of the numerator it cannot be a very serious factor. If  $\mu_2$  gets smaller, things are rather more complicated, because  $\mu_2$  appears in both denominator and numerator. In any case,  $\mu_2$  is more nearly constant during the life of the tube.

Some further applications of this type of phase-splitter circuit are described in Chapter 14.

# power supplies

**M**any modern audio output circuits are operated class AB, causing large fluctuations in plate current. Two 6V6 tubes operated under recommended push-pull conditions, for example, swing from a total cathode current of 73 ma at zero signal to 105 ma at full output, a rise of over 40%. In normal power-supply circuits such a rise in load current would result in an appreciable drop in d.c. supply voltage. This drop would reduce the available maximum output, and possibly introduce distortion (the bias becomes incorrect for the changed B voltage). Therefore, it is desirable that the power supply be well regulated.

Some output-stage designs using transmitter type triodes or large output pentodes connected as triodes, biased for class-B operation, demand even greater relative changes in current between zero-signal and full-output conditions.

The voltage drop as the load current is increased is due to two effects: the voltage drop in transformer windings, chokes and across the rectifier, and the inherent characteristic of the filter circuit that follows the rectifier.

The latter factor is not always appreciated. Fig. 701 includes a typical curve for the d.c. output voltage with a capacitor input (reservoir) type filter and an assumed loss, due to the various voltage drops listed above, of zero. However generous are the proportions of the transformer, rectifier and choke, the voltage characteristic of such a circuit cannot be better than this curve.

To offset these various sources of voltage drop as load current

is increased, the swinging-choke type of filter is sometimes used when the current taken by the output tubes varies with signal. Fig. 702 shows a simple rectifier, choke and filter capacitor arrangement for this circuit. Fig. 703 shows how the waveforms change to produce a rising output voltage characteristic in a theoretical resistanceless circuit designed for this purpose.

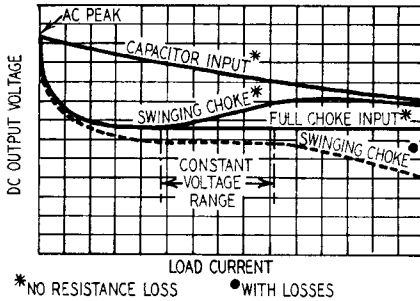

Fig. 701. Graph showing power supply characteristics. Curves show the comparison between capacitor input, choke input and swinging choke type power supplies over their respective constant voltage ranges.

In Fig. 703-a the inductance of the choke is large enough to smooth out fluctuations in the output current from the rectifier to a considerable extent so the choke has a steady value

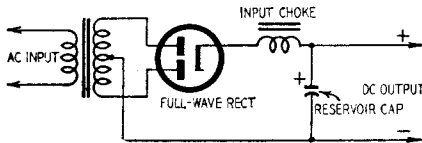

Fig. 702. The circuit arrangement of a choke-input full-wave rectifier. The center tap on the secondary of the transformer is connected to the negative side of the filter capacitor.

with a slight ripple imposed on it. The output voltage from the choke has very little ripple at all due to the further smoothing effect of the filter capacitor. As the rectifier is conducting all the time, the output voltage is the average value of the voltage at the input to the choke, neglecting the effect of resistance drops. So

the output voltage from a choke filter is equal to 0.637 times the peak value of input voltage (or 0.9 times the r.m.s. value of the input voltage).

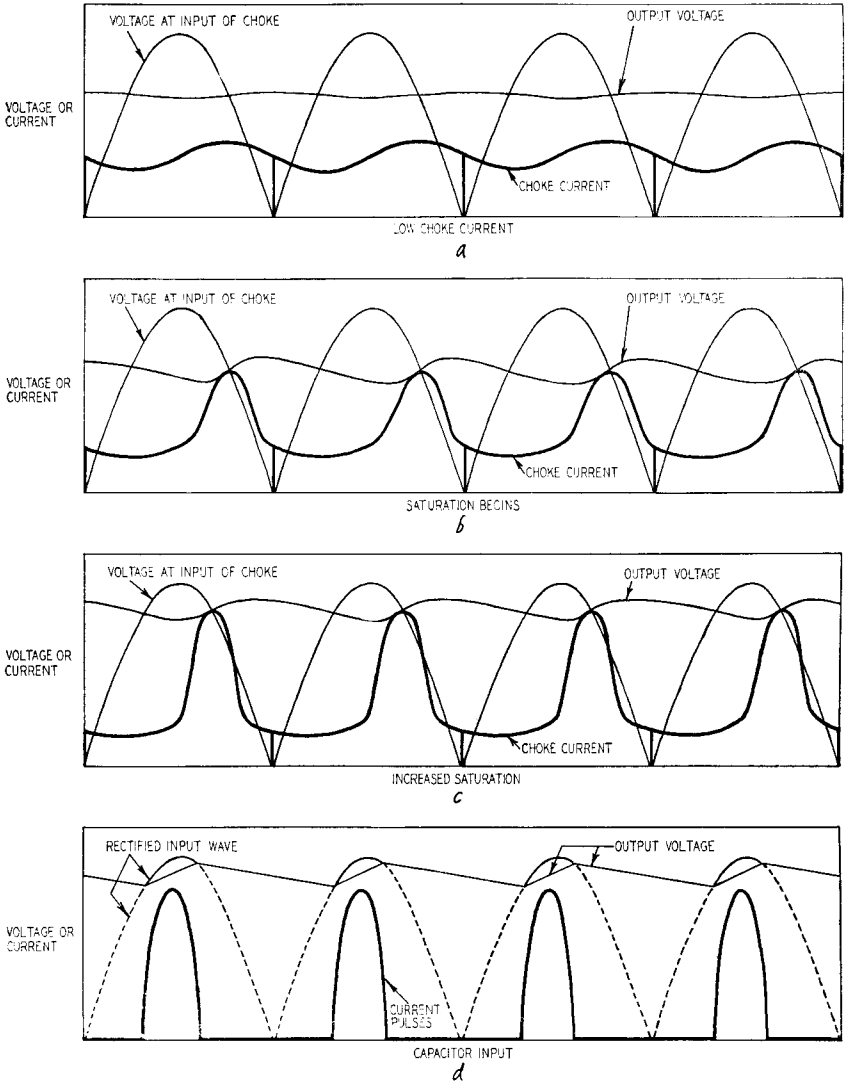

Fig. 703. Waveforms of swinging-choke operation at various load currents: (a) low choke current, (b) the point where saturation begins, and (c) the effect of increased saturation. The similarity between swinging-choke and capacitor input operation at high current can be seen by comparing (c) with (d).

Fig. 703-b shows the waveforms as saturation begins. The positive current swing becomes very peaky due to saturation; the negative excursion becomes flatter, making the waveform asymmetrical. The effect on the output voltage is a tendency to rise to a higher point on the input waveform as the positive-going pulses begin to make the filter capacitor act as a true reservoir. (The vertical lines in the current waveforms indicate the points

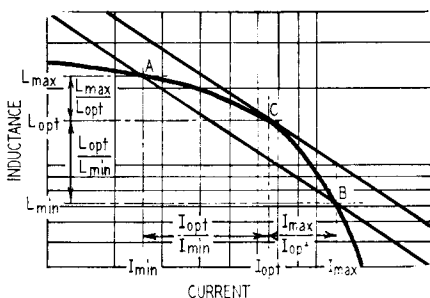

Fig. 704. Graph showing choke inductance-current characteristics, as drawn on a log-log scale.

where the current in the choke changes over from one plate of the rectifier to the other. At no point, however, does the current actually fall to zero during this time—it merely changes rapidly from one plate to the other.)

Fig. 703-c shows the same arrangement with saturation further advanced. The process can be compared to a changeover from choke input at low currents to capacitor input at high currents. The similarity at high current can be seen by comparison with the waveforms of a capacitor-input circuit, shown in Fig. 703-d. From this comparison, Fig. 701 shows how a swinging choke can produce a region of constant voltage output from the power supply. A filter using a nonsaturating, resistanceless choke (assuming no losses elsewhere) would produce a level output at 0.637 of the peak a.c. input, for current values above the point where the inductance is large enough to prevent the filter capacitor from acting partially as a reservoir. (The reservoir action accounts for the upward sweep of the curve toward zero current.)

A swinging choke with no resistance losses would produce a characteristic following the full choke curve up to the point where saturation begins to set in. At this point it will begin to

# Swinging Choke Design Chart

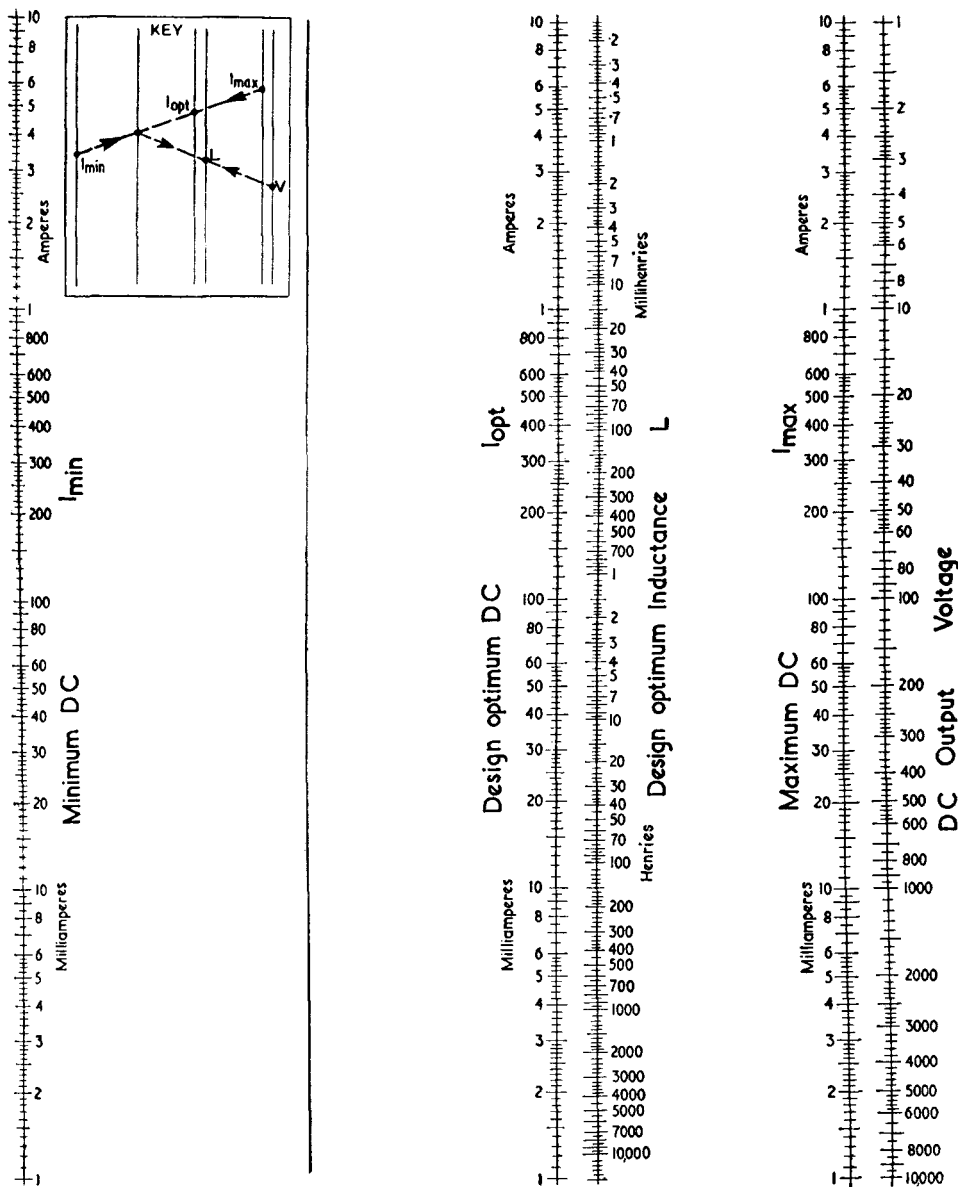

Fig. 705. This chart can be used for calculating the optimum value of a swinging choke for a given range of B-supply current swing. Examples of how the chart is used are given in the text. The reader will find that this chart is a most practical one, and that power supply design data can be obtained with a minimum of effort.

rise toward the capacitor input characteristic (if the same capacitor value is used in both cases). The dotted curve in Fig. 701 shows the final result when the effects of losses due to resistance in the plate transformer, choke and rectifier are taken into account. These losses produce a voltage drop from the ideal curve directly proportional to current, but one in which the d.c. output voltage becomes virtually constant over a certain range, as shown.

The whole action is rather complicated and a completely satisfactory mathematical analysis of its behavior has never been published. At one time it was assumed that the inductance of the choke had a constant value throughout each rectification cycle. The output voltage of such an arrangement was then analyzed as the inductance was varied. The curves of Fig. 704 show that the assumption of constant inductance during a cycle is not strictly true. Using this principle as a basis, an ideal swinging choke would have an inductance that reduced in inverse proportion to increasing load current, as represented by the straight line joining AB in Fig. 704.

Investigation of a variety of iron-cored inductances with direct current flowing showed that the curve of inductance against current, as represented by ACB in Fig. 704, has inherent relations that never depart very far from the proportions shown. A logarithmic scale is used, so the distance between two points on the curve represents the *ratio* between the currents or inductances at those points rather than the *difference* between them.

The inherent ratio of these proportions is incorporated into the design chart (Fig. 705). The optimum inductance value at a current, represented by point C (Fig. 704), bears a definite relationship to the minimum and maximum currents, represented by points A and B, and can always be calculated from knowledge of the circuit requirements.

### How the chart works

In practice, although the theory remains somewhat doubtful, this method of calculation has proved useful in preparing a chart for finding a choke with the right characteristic for a job. The quantities required for the chart are the maximum and minimum currents and the d.c. output voltage, using full-wave rectification at a supply frequency of 50 or 60 cycles. Using a straightedge as shown in the key on the chart (Fig. 705) gives us the inductance



and current rating for a choke, having its optimum value at the current rating specified.

To give an example of the chart's use, suppose that the two 6V6's previously mentioned are used in an amplifier where the total B supply current consumption at zero signal is 100 ma. rising to 135 ma at full output. The chart shows that the design figure should be a little over 120 ma and with a supply voltage

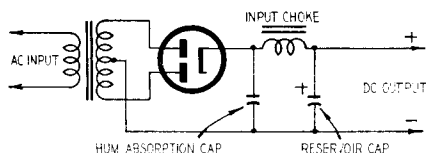

*Fig. 706. In amplifiers using choke input filters, a hum, similar to static hum, is sometimes heard. A simple method of overcoming this problem is to add a small input capacitor at the input end of the swinging choke as shown.*

of 285, as recommended by the tube manufacturers, the inductance required is about 3.8 henries. In practice a 4 henry, 120-ma choke would serve this purpose well since this value is more readily obtainable.

### Eliminating filter hum

A small practical point for amplifiers using choke-input filters: a ticky kind of hum, similar to static hum, is sometimes heard. This is due to the sudden current changeover in the rectifier circuit, referred to earlier, which can produce by induction extremely sharp pulses in various parts of the circuit. To overcome this, a simple method is to use a small capacitor at the input end of the swinging choke (Fig. 706). Its value must be small enough not to interfere with the choke action appreciably at low currents, but large enough to smooth off the sharp negative-going points of the voltage waveform at the input to the choke. This avoids the suddenness of transition from one plate to the other in the rectifier. Suitable values for this input capacitor are from 0.1 to 0.5  $\mu\text{f}$ , depending upon its application. It should have a generous voltage rating because of the relatively large ripple current it will carry.

The foregoing discussion applies only where the output tube

plate current swings when audio signal is applied. For power amplifiers employing class-A amplification, such steps toward providing regulation are not necessary and the well known capacitor input filter can be used with sufficiently large capacitors to take care of hum in each stage of the amplifier.

# attenuators

It is often necessary to calculate the value of resistors in parallel or of capacitors in series. The formula for such calculations is well known but difficult to handle. Various charts and “slide rules” have been designed as aids, but such methods lack the directness desirable for general use.

Compare the difference between calculating the values of resistors in parallel and values of resistors in series. For example: a 33,000-ohm resistor in series with a 47,000-ohm one will total 80,000 ohms. The result is found by simple addition. If we want to know the overall tolerance, using standard 20% resistors: the 33,000-ohm unit can vary between 27,000 and 39,000 ohms, and the 47,000-ohm unit between 39,000 and 56,000. Adding together the highest and lowest pairs of figures, we find the resultant series combinations can be anywhere from 66,000 to 95,000 ohms. All this is calculated by simple arithmetic. But the arithmetic for working out the same information about parallel resistors—or series capacitors—becomes much more involved. The chart presented in Fig. 801 has been designed to simplify this and similar calculations.

A case where such calculations can arise is the R-C coupling circuit of Fig. 802. The actual circuit is shown at 802-a. At 802-b is the equivalent circuit for calculating low-frequency response. It contains plate resistance  $R_p$  and coupling resistor  $R_L$  in parallel. At 802-c is shown the equivalent circuit for high-frequency response. It contains  $R_p$ ,  $R_L$  and  $R_g$  (the grid resistor) in parallel.

To discover whether the tube may cause distortion, the equivalent plate load made up of  $R_L$  and  $R_g$  in parallel (Fig. 802-d) must be known. So, to work out these three details of an R-C coupling stage, we need to know three different parallel combinations of the circuit resistances.

When we apply these principles to the calculation of complete amplifier circuits as described in Chapters 1 through 5, a great many such calculations must be made, and a simple method proves very useful.

Another application is for attenuator circuits where a resistor has to be held to a closer tolerance than usual. A simple method of getting the right resistance is selecting one resistor slightly higher than the required value and shunting it with a much higher value to trim it to the correct resistance. Of course, the best way to do such jobs is to obtain close-tolerance resistors in the first place. If an attenuator is being built to a ready-made design, a kit of resistors with the correct close-tolerance values is probably available. Frequently, however, a simple fixed attenuation pad of some predetermined value is required for some purpose for which the close-tolerance resistors are not available, so the simplest method is to make them up. You can search through a large batch of ordinary resistors with a resistance bridge—a very tedious process—or else use the trimming technique suggested. For a variety of reasons the trimming technique is usually more practical.

When resistors are connected in parallel, it is necessary to add their conductances to find the resultant value. For this reason the scale law used in the chart is a reciprocal one. The operation of the chart is graphically that of simple addition, and the scale calibration changes this graphical addition of conductances into terms of resistances, with which we are more familiar.

The chart automatically tells us the effect of different values of resistors connected in parallel or of capacitors connected in series. For example, when a high-value resistor is connected in shunt with one of lower ohmage, changing the value of the higher resistor makes a smaller movement on the scale than a similar change in the value of the lower resistor. This indicates that the total value is more dependent on the lower one than on the higher.

If the resistors used are of the 20% tolerance type, the first two colors of their color coding designate the numerals 10, 15, 22, 33,

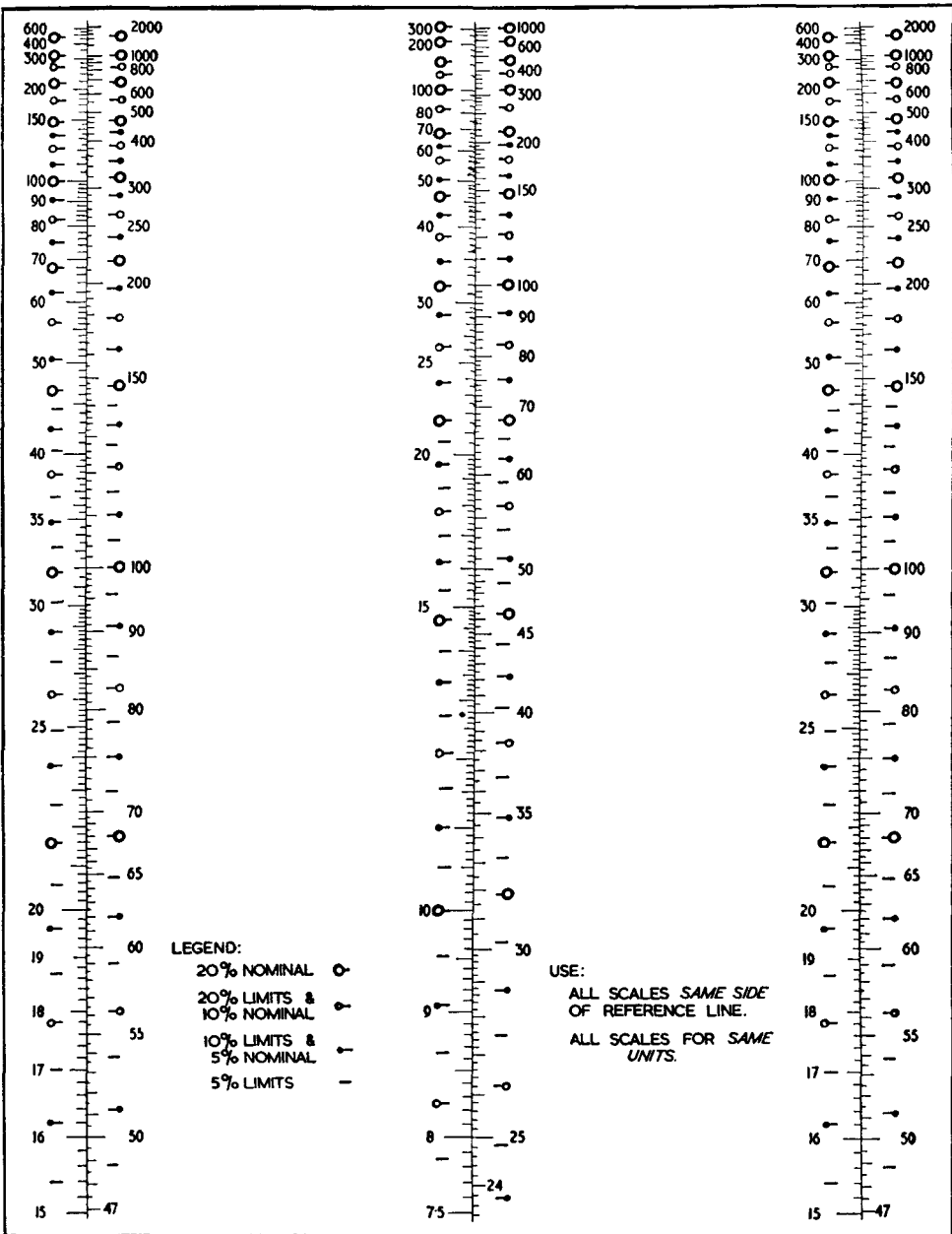

Fig. 801. A new nomogram for finding resistances in parallel and capacitances in series. It contains two complete reference scales. Explanations of the scales are given in the text and examples of their use are shown in Figs. 803, 804, 805 and 806.

47 or 68; the third color indicates the number of zeros that follow. The chart does not take into account the number of zeros but its correct use is dependent upon choosing reference values so that the same number of zeros follow the scale reading for each resistance value in any one calculation. This is what is meant by the comment on the right-hand side, "Use All Scales for Same Units." For example, if the numerals on the chart can be taken to be in thousands, they must be in thousands for every

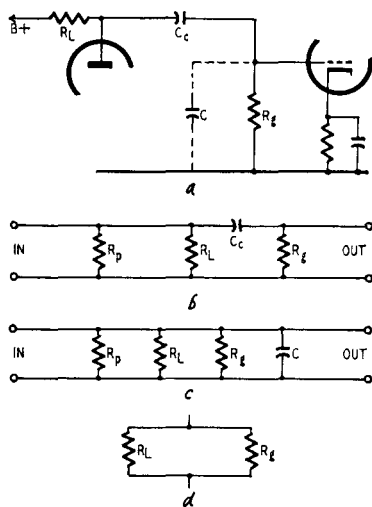

Fig. 802. At (a) is shown a typical R-C coupling circuit. The equivalent circuit for the low-frequency response is shown in (b), for the high-frequency response in (c), and the equivalent plate load circuit is shown in (d).

value in that particular calculation. If the numerals represent hundreds of ohms, they must do so for every value in the calculation.

The 20% nominal (color-coded) values are indicated in the legend by the larger circle with a short horizontal line attached, to indicate the exact position on the reference scale to which each refers. The limits between which such nominal values may actually vary are indicated by the smaller circle with a horizontal line attached.

These smaller circles also represent the intermediate nominal values for 10% tolerance resistors of the preferred value range, designated by the numerals 12, 18, 27, 39, 56 and 82. The limits

of 10% resistors are indicated by the smaller solid circle with line attached. This is true for all the 10% range, whether the numerical value is identical with one of the 20% range or is one of the intermediate values.

The solid circles also indicate the nominal values for the intermediate 5% ratings, the complete range of which is made up also by values identical with the 10% nominals. The limits between 5% ratings are indicated by the intermediate lines without any circles attached.

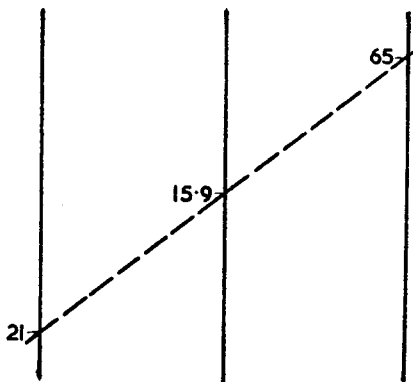

Fig. 803. An example of the use of left-hand scales on the chart of Fig. 801.

The numbers on the chart apply to the scales themselves, and only at the 10, 100 and 1,000 figures do they actually coincide with preferred value markings. All other preferred value markings are spaced logarithmically along the scales, which allow correct percentage overlap. Thus, 39 appears as 38.5; 47 as 46.5, etc. (The precise values are rounded off by the manufacturers in actual production.) It is simple to identify a preferred value by comparison with the numerical scale.

### Using the chart

The chart has been provided with two complete sets of reference scales: one using the left-hand side of all three reference lines, while the other uses the right-hand side. For this reason any individual calculation must use all scales *on the same side* of the reference lines.

#### Example 1

The total value of two resistors in parallel, 21,000 and 65,000,

is to be found: the lower of these values is 21,000. On the outside pair of reference lines, the lowest position at which the number 21 can be used appears on the left-hand side. So the scale marking corresponding to 21 and that corresponding to 65 on the left-hand side of the outside reference lines, are aligned with a straightedge or ruler. The total resistance is read from the left-hand side of the center reference line, in this case 15.9, so the

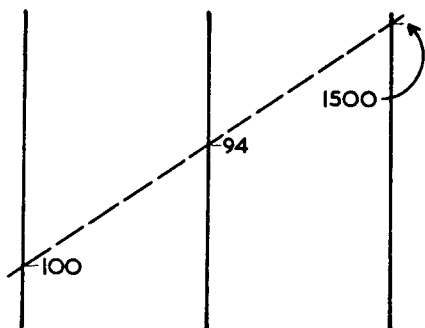

Fig. 804. An example of the use of the right-hand scales on the chart of Fig. 801.

parallel resistance is 15,900 ohms. This is illustrated in Fig. 803.

The same position of the straightedge could represent the parallel resistance of 210 and 650 ohms, giving a total resistance of 159 ohms, by using the scale numerals to represent ohms times 10. The scale numerals could represent any other desired units: ohms, hundreds of ohms, etc.

### Example 2

Fig. 804 illustrates a case requiring use of the right-hand reference scales. The resistors to be connected in parallel have values of 1,000 and 15,000 ohms. For the lower of these values, (1,000), the lowest reference position on the outer reference lines is on the right-hand side, where it can be represented by the figure 100. This means the scale units will be ohms divided by 10, so that the numerals on the right-hand side of the reference lines that represent 1,000 and 15,000 will be 100 and 1,500. Aligning these, the right-hand side of the center reference line reads 94, indicating that the total resistance is 940 ohms.

### Example 3

Fig. 805 shows the use of the chart for lowering the resistance



of a known resistor to another value by connecting a resistor in parallel with it.

The known resistor measures 18,000 ohms and the required total resistance is 12,000. The points on the scale corresponding to 18 and 12, on the left-hand side of the left-hand and center reference lines, respectively, are aligned, reading 36 on the left-hand side of the right-hand reference line. A preferred value

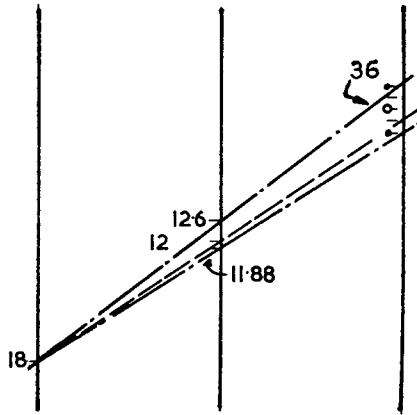

*Fig. 805. An example of how parallel resistances are added to reduce the total resistance of the combination using the chart of Fig. 801.*

resistor should be used to obtain this result. Assuming that 10% resistors are the closest tolerance values available, the nearest nominal value will be a 39,000, whose limits are marked by the solid circles nearest to the small circle representing 39,000, as 34.8 and 42.2. Aligning the scale position on the left-hand side of the left-hand reference line at 18, with each of these points in turn, the readings on the center reference line show that a stock 39,000-ohm 10% resistor in parallel with the resistor already known to be 18,000 ohms can give a total value somewhere between 11,880 and 12,600 ohms. The chart indicates that a 39,000-ohm 10% resistor, a little more than 5% below the nominal value, is required to give the 12,000-ohm resultant exactly. The proper value can then be sorted out comparatively easily with an ohmmeter. Similarly, a 33,000-ohm 20% resistor just under 15% up on its nominal value would do.

#### **Example 4**

Fig. 806 shows the chart used for a purpose similar to the

example mentioned at the beginning of the chapter with series resistors. Suppose a circuit diagram specifies a 62,000-ohm 5% resistor connected in parallel with a 470,000-ohm 20% resistor, and we would like to determine the tolerance on the resultant combination as easily as it was calculated previously where there were two resistors in series.

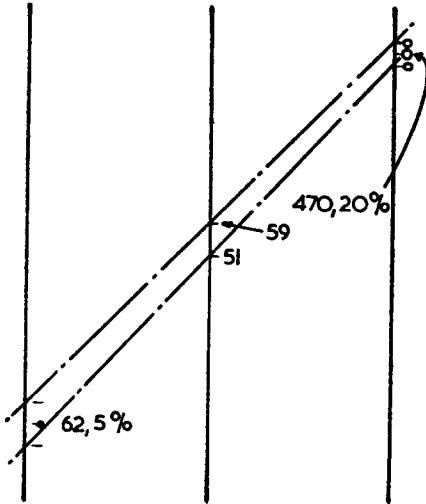

Fig. 806. An example of the use of the chart of Fig. 801 for finding tolerance limitations.

This is found, as indicated in Fig. 806, by aligning the upper and lower limits for these two values, and reading off the resultant values shown as 51 and 59, on the right-hand side of the center scale, since the right-hand side of the other scales is used. This means the combined parallel resistance can vary anywhere between 51,000 and 59,000 ohms.

The 51,000 point has a solid circle with line opposite it, while that for 59,000 has a plain line opposite it; in between are two other markings, making three spaces. At this part of the scale the spaces represent 5% tolerance intervals, so the total range is easily estimated as 15%, meaning that the 51,000 and 59,000 limits represent about  $\pm 7\frac{1}{2}\%$  from the average value of 55,000.

Thus the chart has shown quite clearly that the accuracy of the total resistance depends more on the lower-value close-tolerance resistor than on the high-value wide-tolerance resistor, because the deviation of the parallel combination is only  $7\frac{1}{2}\%$  as compared with 5% and 20% for the individual resistors.

These examples should enable the reader to practice using the chart. Examples have not been given dealing with series capacitors, because the method of calculation is identical with that for parallel resistors.

## Attenuators

Calibrated attenuators, giving any desired degree of attenua-

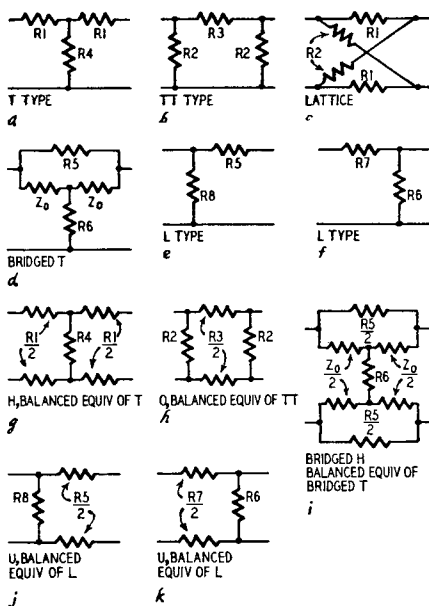

Fig. 807. Some of the most frequently used attenuator circuits. The six basic types are shown in (a) to (f). All but (c) are single ended. These circuits are easily converted to balanced form by the methods shown in (g) to (k). All the resistors are coded, and formulae for determining their values are given in the text.

tion in definite steps can be bought ready-made or assembled from kits supplied complete with the necessary close-tolerance resistors. But often, in both audio and radio work, we need an attenuator pad between the output of one piece of equipment and the input to another to avoid overloading the latter and to operate the gain controls in a normal way instead of at the "bottom end."

An attenuator can be designed with comparatively simple formulas. But even those of us who are mathematically inclined may

feel safer if we get the answer from a ready-made chart.

The six basic types of attenuator network in common use are known—from their configurations—as T,  $\pi$ , lattice, bridged-T and the two types of L (according to whether the shunt arm of the L is at the input or output end). These are illustrated at *a* to *f* in Fig. 807. Only one of these—the lattice—is for balanced circuits. The others are all single-ended in their basic form. However, each of these can be rearranged in balanced form by splitting the series resistor components, giving the corresponding types shown at *g* to *k* in Fig. 807. If the balanced attenuators are to have a grounded center point, the shunt resistor elements will also require center tapping.

Such a variety of circuits can be confusing. Which one should we choose for a particular job? The balanced and single-ended variations need little explaining. If a circuit has one side grounded, then single-ended attenuators are necessary; if both lines of a circuit are above ground (have signal voltages on them), a balanced type must be used. After this selection, the choice depends upon a number of factors, chief of which are the working impedance (high or low) and the amount of attenuation required; also whether constant impedance is needed both ways. The advantage of constant impedance both ways is that it can be inserted in any circuit of the correct impedance without interfering with the existing circuit either before or after the point of insertion. This is particularly advantageous where an attenuator is patched in with equalizers and other components, as between a preamplifier and the main amplifier.

For this purpose, the T,  $\pi$ , lattice and bridged-T types, with their balanced counterparts, are suited. Among these, the T is best suited for medium-impedance circuits (500 or 600 ohms) because it uses the most reasonable values in resistors, while the  $\pi$  networks are better for low-impedance circuits for the same reason. Along with convenience in resistor values, possible stray pickup also dictates a similar choice. The lattice variety is good for small values of attenuation (balanced circuits only) which can be achieved with good accuracy, but is poor for large attenuations because the resistor values become very critical. The bridged-T is more complicated as a straightforward attenuator, but is better suited for a variable attenuator of the constant-resistance type because it requires only two variable elements as against at least three for the others.

Where it is important for constant resistance to be held only one way, the L types will serve. As shown, both are designed to maintain constant resistance at the input end, which is usual. If for any reason the opposite is required, the network may be reversed. The choice of which end the shunt element goes at will be seen better from the examples. As with the choice between T and  $\pi$ , it is a matter of getting convenient resistor values.

The formulas for the various resistors, using the coding given in Fig. 807 are as follows:

$$\text{db attenuation} = 20 \log A$$

where  $A = E_{\text{in}}/E_{\text{out}}$ , and:

$$1. \frac{R1}{Z_0} = \frac{A-1}{A+1}$$

$$5. \frac{R5}{Z_0} = A-1$$

$$2. \frac{R2}{Z_0} = \frac{A+1}{A-1}$$

$$6. \frac{R6}{Z_0} = \frac{1}{A-1}$$

$$3. \frac{R3}{Z_0} = \frac{A^2-1}{2A}$$

$$7. \frac{R7}{Z_0} = \frac{A-1}{A}$$

$$4. \frac{R4}{Z_0} = \frac{2A}{A^2-1}$$

$$8. \frac{R8}{Z_0} = \frac{A}{A-1}$$

A number of different ways of presenting this simple design information have been derived. Probably the first stage was a simple graph giving resistance values against attenuation for some fixed working impedance. This results in curves of the form shown in Fig. 808. Here all the values are given as R divided by the operating impedance. This means the factor obtained from the graph must be multiplied by the working impedance to find the correct resistor values. The popularity of the abac (alignment chart or nomogram) led to applying the same information by means of *contact* curves, producing the arrangement shown in Fig. 809.

This uses the same information as in Fig. 808, but the reading is obtained by laying a straightedge from the required decibel attenuation scale at the left to a point just touching the desired curve. This will give a reading on the right-hand scale that is identical to that given by the graph of Fig. 808. (These charts give factors. A more common practice is to give actual resistor values for just one particular impedance, say 10 ohms.)

Each of these presentations requires eight curves to cover all the possible attenuator configurations. The resistor values are

given either for one working impedance only or as a factor relative to the working impedance (as shown in Figs 808 and 809). We now have only to do some arithmetic (or use a slide rule) to get the resistor values for the actual working impedance.

The decibel scale used has been linear. By adjusting the db scale spacing appropriately, any one of the curves can be converted into a straight line. Further, by plotting working imped-

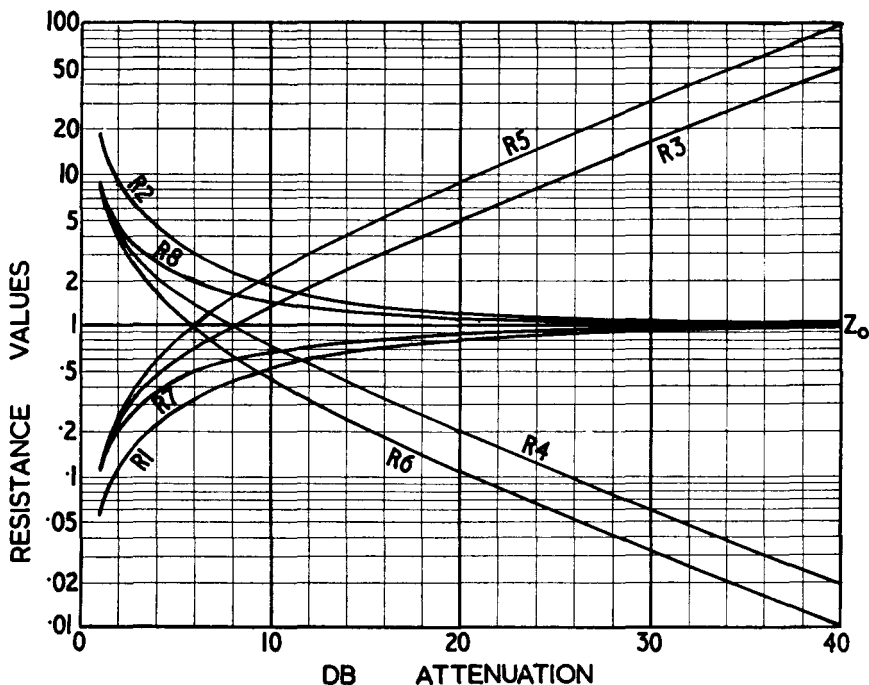

Fig. 808. This graph shows the plots of the formulae used for determining the resistance values ( $R/Z_0$ ) of Fig. 807.

ance horizontally and resistor values vertically, a chart (Fig. 810) using irregularly spaced decibel rulings can give one of the resistor values in an attenuator for the actual working impedance required. Here the chart has been drawn to cover a decade of working impedances from 100 to 1,000 ohms, and the values are read off directly for any impedance in this range. Outside this range the value does not call for a slide rule, but merely the addition or removal of some ciphers.

Fig. 810 is the chart for values of  $R_3$ . The disadvantage of this presentation is that, to cover all the configurations of attenuators, eight charts are required, each with spacing between the db

rulings to correspond with the individual formula. This is cumbersome. By applying the same method to the nomogram construction, the number can be reduced to two because each reference line can be used to carry two different scales, one on each side. Notice that, in the eight formulas for resistor values, four are reciprocals of the other four. This means that the same set of decibel rulings can be used for a pair of resistors using recip-

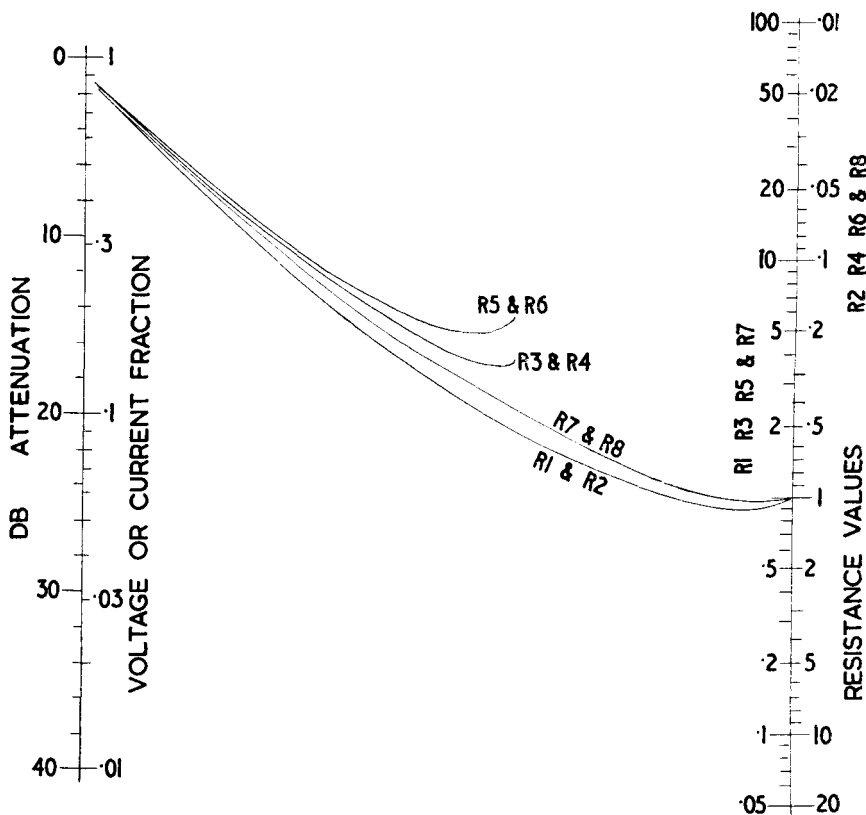

Fig. 809. A method of converting the information of Fig. 808 into an alignment chart. The resistance value scale is based on the calculation of  $R/Z_0$ .

rocal formulas by inverting the R and Z scales on the appropriate reference lines. This was used in the presentation of Fig. 809 to reduce the number of contact curves necessary to four. The decibel reference line can also have a scale on each side, enabling two pairs of reciprocal formulas to be accommodated on one chart. This turns out to be quite convenient because any one configuration uses only two resistor values, selected from one group of

four in the list of formulas. By using a separate chart for each group of four, only one chart is necessary for the design of any particular attenuator.

Chart 1 (Fig. 811) deals with T,  $\pi$  and lattice attenuators and can be used of course for the balanced equivalents of T (H) and  $\pi$  (O) types, while Chart 2 (Fig. 812) deals with bridged-T and L types and their balanced counterparts.

You may wonder why so many types of attenuator networks are used—why not just stick to one? Several factors contribute to the answer to this question. It is largely a matter of relative values and depends partly on the amount of attenuation required and partly on the working impedance. This will be made clearer by some examples:

### Example 1

To design a T type attenuator to give 20-db attenuation at an impedance of 600 ohms:

As shown in the top key for Chart 1 (Fig. 811) the scales for R and Z are both on the left-hand side of the R and Z reference lines; the db scale for R1 is on the left-hand side and that for R4 is on the right-hand side of the db reference line. Using the chart in this way, R1 is 480 ohms and R4 is 120. For an H pad, the series arms each would be half of 480 or 240 ohms.

### Example 2

To design a  $\pi$  type attenuator for the same job as example 1:

The middle key on Chart 1 (Fig. 811) shows that the right-hand scales for resistance and impedance are used, with one db scale on either side of the reference line as for the T pad. Using these positions, R2 is 750 ohms and R3 is 3,000 ohms.

Notice here that R1 and R2, for values of 20-db attenuation and upward, approach the same value as the working impedance. For the T pad R4 goes much lower and for the  $\pi$  pad R3 goes much higher. For smaller degrees of attenuation, the distribution of relative resistance values is bound to be somewhat different.

### Example 3

An attenuator required to give 10-db attenuation at an impedance of 100 ohms: using the  $\pi$  configuration R2 is 190 ohms and R3 is 140 ohms. For the T configuration, opposite sides of the



resistor and impedance scales are used again (for 100 ohms this is the same point on the impedance scale), giving R1 as 52 ohms and R4 as 70 ohms.

Notice here that the resistor values are all somewhere near the working impedance.

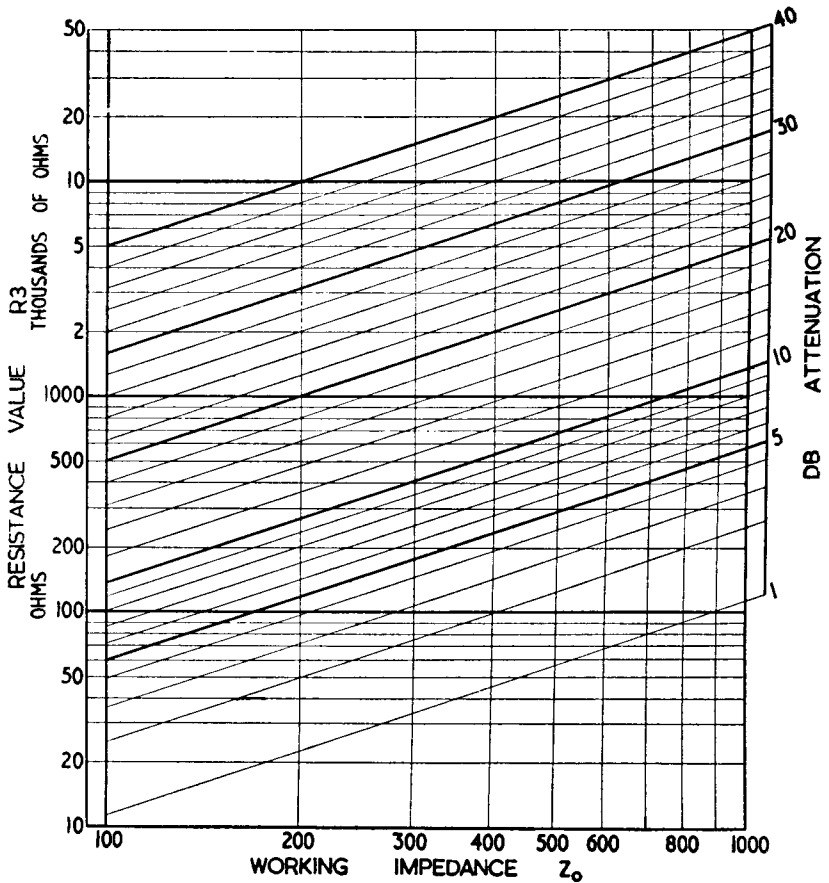

Fig. 810. This graph enables values to be given for a variety of working impedances.

#### Example 4

A lattice attenuator is required for 6 db at a working impedance of 250 ohms.

For lattice type attenuators, as shown in the bottom key on Chart 1 (Fig. 811), the left-hand db scale is used for both values, the left-hand resistance and impedance scales being used for one

# Chart 1—For T, Pi, H, O and lattice type attenuators.

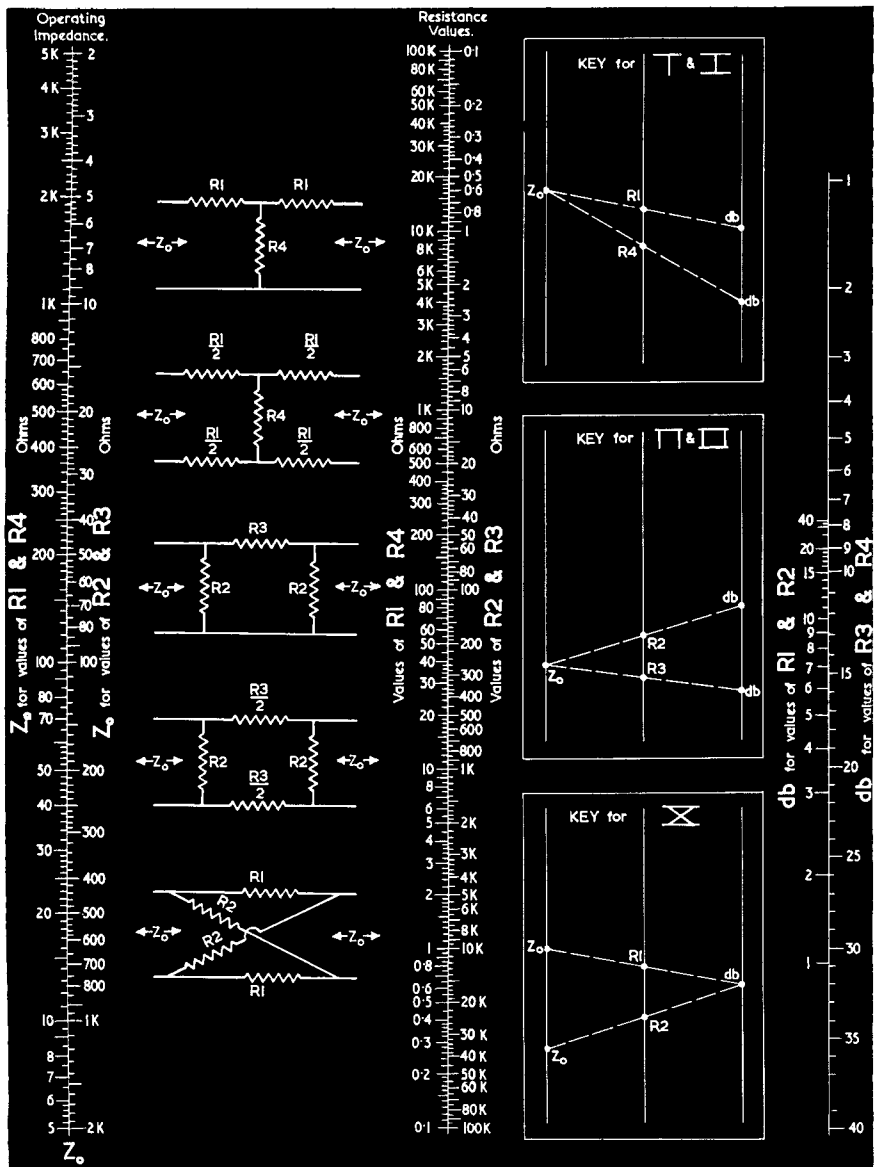

Fig. 811. Design information for the various types of attenuator circuits described at the top of the chart can be obtained by making use of the respective key boxes. The key at the top of the chart is used for the T and its balanced equivalent H. The center key is utilized for the  $\pi$  and its balanced equivalent O. The bottom key is used when designing lattice types. Examples of the key applications are summarized along with the solution of several sample design problems in the text.

## Chart 2—For bridged-T, H, L and U type attenuators.

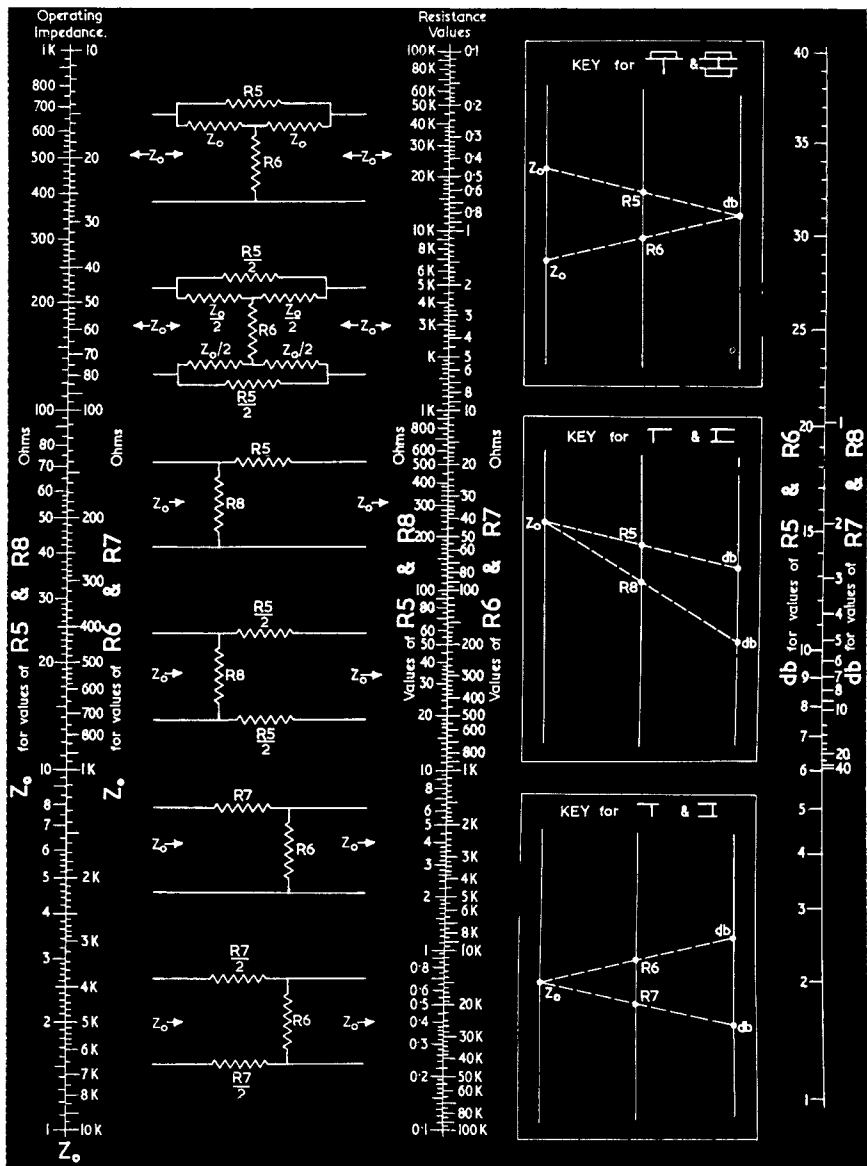

Fig. 812. Another design chart for some additional attenuator circuits not covered by Fig. 811. Here too, the application of the key is of importance towards insuring satisfactory results. Design data for the bridged-T and bridged-H is derived from the uppermost key box. The center and bottom key boxes are utilized for L and U types, according to the circuit configurations found directly opposite. The text covers several sample problems.

resistor and the right-hand scales for the other. Using these positions for a working impedance of 250 ohms, the required resistances are R1, 85 ohms and R2, 760 ohms.

### **Example 5**

A lattice attenuator is required for 20-db attenuation at 500 ohms. This gives R1 as 410 ohms and R2 as 610 ohms.

The point to notice with lattice attenuators is that as attenuation rises both resistors approach the working impedance closely, so that resistance tolerances have a much greater effect on the amount of attenuation. It is obvious from Example 5 that a comparatively small change in any resistor would result in a relatively large change in attenuation. On the other hand, for low degrees of attenuation, the lattice attenuator gives greater precision without necessity for strict tolerance on resistor values.

### **Example 6**

To design a bridged-T attenuator for an attenuation of 26 db at 1,000 ohms:

In the bridged-T type attenuators, two of the resistors have the same value as the working impedance; in the balanced counterpart there are four resistors having half the value of the working impedance. The remaining values, R5 and R6, are found by using Chart 2 (Fig. 812), as Chart 1 is used for lattice attenuators. For this example R5 is 19,000 and R6 is 52.5.

Whatever attenuation is required, the working impedance is a geometric mean between the values of R5 and R6. For small degrees of attenuation R5 is very low and R6 very high. As attenuation increases, the values of R5 and R6 change over, so R5 is high and R6 is low. The widespread decibel scale for R5 and R6 indicates that a strict tolerance on resistor values is not so vital with bridged-T and bridged-H type attenuators as it is with the other types.

### **Example 7**

To design an L type attenuator, with the shunt arm at the output end, for an attenuation of 14 db and an impedance of 50 ohms:

As shown in the middle key on Chart 2 (Fig. 812), the working impedance and resistor values both are on left-hand scales, while the db scales are on opposite sides of the db reference line

# Chart 3—Attenuation losses from impedance mismatching.

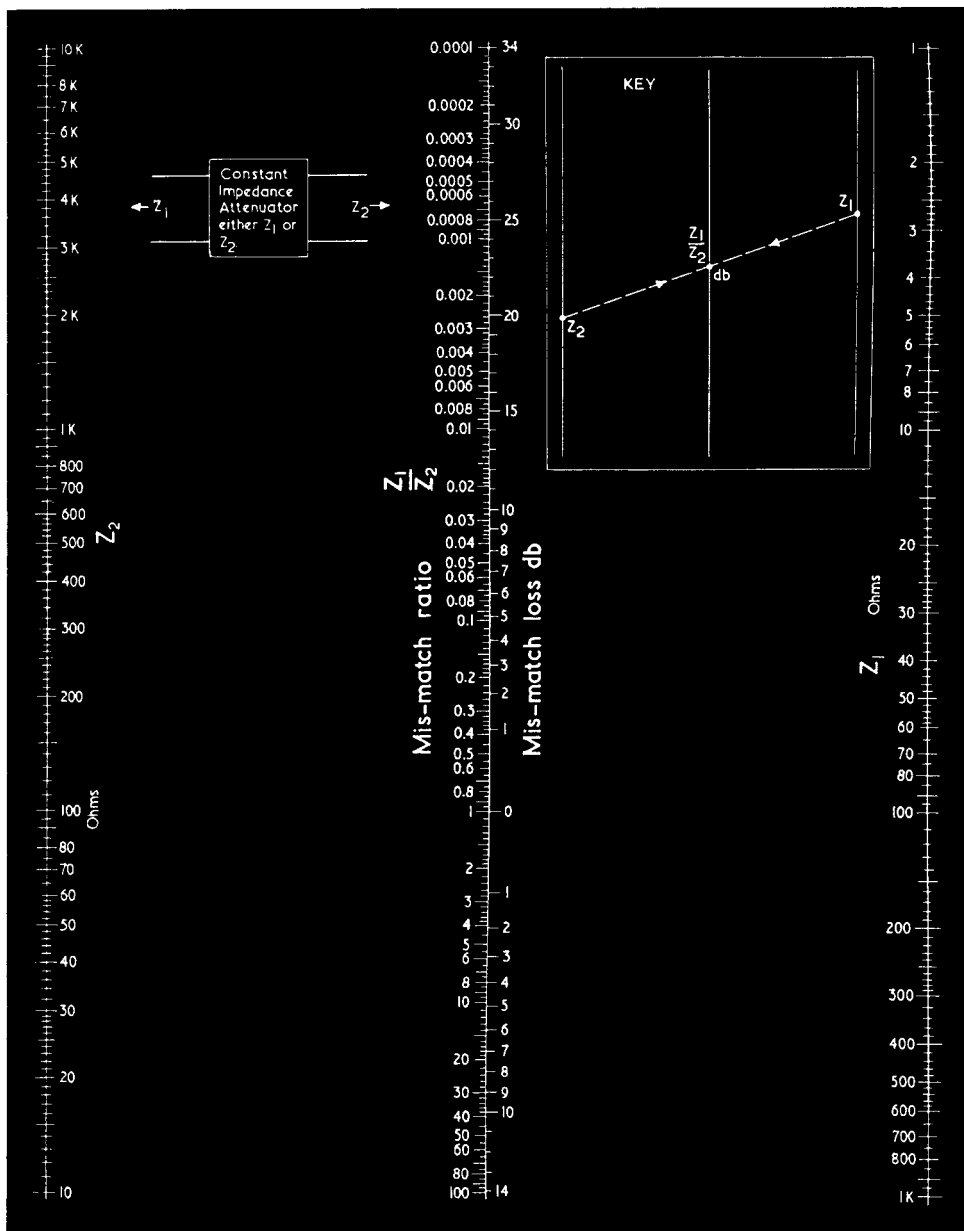

Fig. 813. The reference line in the center of the chart gives the ratio between the impedances and the attenuation resulting from improper impedance matching.

for R5 and R8. For the example specified R5 is 200 ohms and R8 is 62.5 ohms.

### Example 8

For comparison with the previous example we will design an attenuator for the same purpose with the shunt arm at the input end.

As shown in the key at the bottom of Chart 2 (Fig. 812), the references for R and  $Z_0$  are on the right-hand side of their respective scales in this case. R6 is 12.5 ohms and R7 is 40 ohms.

Notice the difference in values for the same operating impedance and attenuation as compared with Example 7.

The foregoing indicate why different attenuator configurations suit different cases.

The L types are much simpler than any of the others. They save one or more resistors but do not have constant resistance in both directions, as indicated in the configuration diagrams on Chart 2 (Fig. 812). When terminated at the right-hand or output end with  $Z_0$ , the resistance measured at the input end is also  $Z_0$ , but this is not true in the opposite direction. For many purposes an attenuator of this simple type is quite adequate. Often the source impedance preceding an attenuator is not the same as the output impedance into which it is working, so two-way matching is unnecessary anyway.

In the other types of attenuators, if the source impedance is  $Z_0$ , the source impedance measured at the output end of the attenuator will also be  $Z_0$  giving two-way matching. An attenuator of this type is always desirable for really high-quality work, but to get the benefit of it the impedances between which it is connected must be true values and not deviate from the nominal working impedance.

Often heard is the opinion expressed about attenuators, similar to that about filters, that when resistances obtained from the required formulas are put into a circuit, the circuit possesses "magical" properties. An impedance of 500 or 600 ohms has been shown to be an ideal line impedance. This has been interpreted to mean that attenuators designed to work at this impedance will smooth out any discrepancies: that, for example, a 20-db 600-ohm attenuator will give an attenuation of 20 db and present terminal impedances of 600 ohms, regardless of what is connected to the other end of it! *This is definitely not true.*

Attenuators do what they are designed to do only when the correct impedances are connected to them.

Sometimes, however, an output of one impedance requires that

### Chart 4 — Determining mismatch reflection.

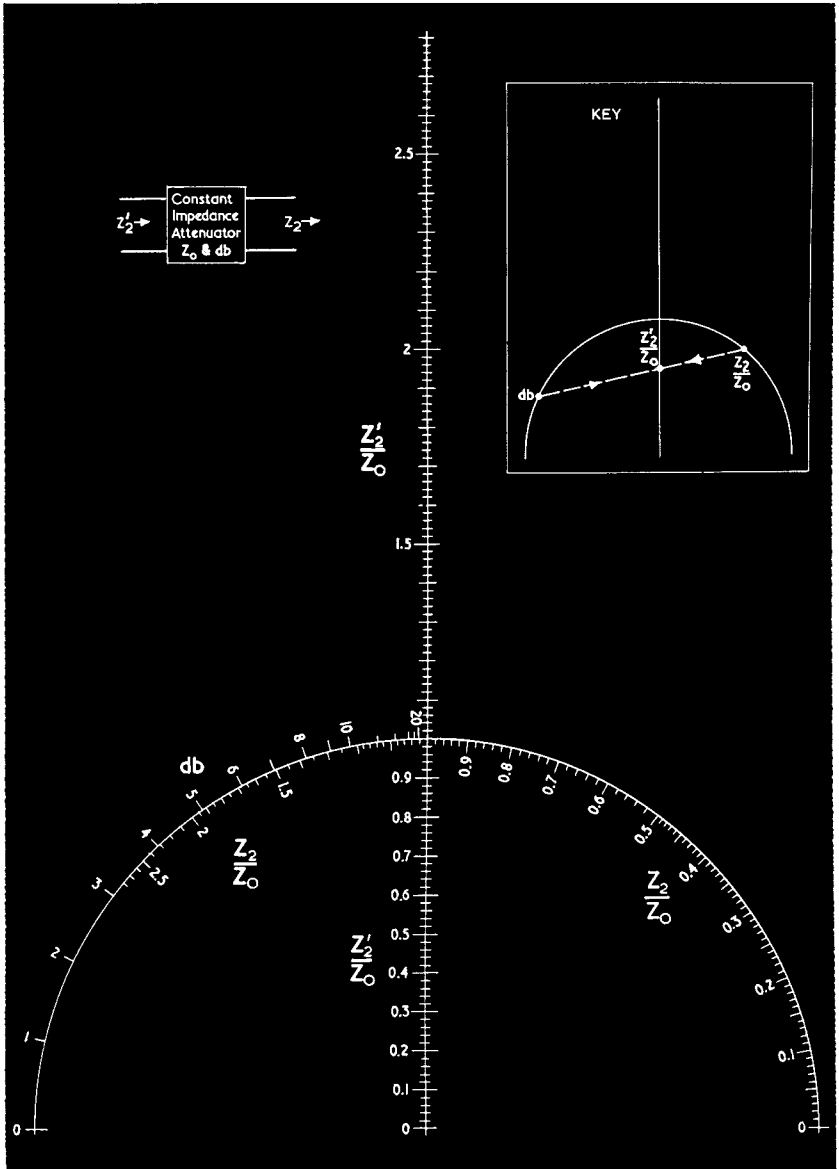

Fig. 814. Chart No. 4: for determining mismatch reflection through the attenuator when the attenuator is improperly terminated.

it be connected, via an attenuator, to an input of a different impedance. Then comes the puzzle of how to correct for this change of impedance.

### Correcting for impedance changes

If a constant-impedance attenuator is connected to one of the working impedances, and is correctly designed for that impedance, the presence of the attenuator will not affect the mismatch loss because the impedance reflected to the opposite terminals will be the same as the correct impedance terminating it. This applies to only those attenuators either where the constant-impedance characteristic applies for both directions or, in the case of L pads, where the attenuator is correctly terminated in the direction for which it is designed to have constant impedance. It would be pointless to extend the chart for other cases using L pads because there seems to be no reason why the correct matching type L pad could not be used.

The mismatch loss, over and above the attenuation of the attenuator, will be quite independent of either the type of attenuator or the amount of attenuation for which it is designed.

Chart 3 (Fig. 813) is a simple alignment abac (alignment chart or nomogram) with two impedance scales on the outside and a reference line in the middle, giving on the left the ratio between the impedances on the outside scales, and on the right the mismatch loss resulting from connecting these impedances together.

Chart 4 (Fig. 814) deals with the mismatch reflection through the attenuator. It shows that the attenuator is designed for a working impedance  $Z_0$  and a specific attenuation in db. It is, however, improperly terminated by the impedance  $Z_2$ . As a result, the chart shows what impedance will appear at the opposite end of the attenuator, represented by the symbol  $Z_2'$ . The type of attenuator is unimportant. What affects the mismatch reflection is the design figure of attenuation for the particular unit.

It is also unimportant whether the designed attenuation is achieved in one stage or in a number of separate stages. For example, the mismatch reflection would be the same through 40 db of constant-impedance attenuation whether this was made up in a single pad or of a number of separate pads of, say, 20 plus 10 plus 5 plus 2 plus 2 plus 1.

#### Example 1

A constant-impedance attenuator designed for 5,000 ohms is



terminated by a resistance load of 5 ohms resulting in a mismatch loss.

To find the mismatch loss: Chart 3 (Fig. 813), using  $Z_2$  5,000

**Chart 5 — Data for L-pads.**

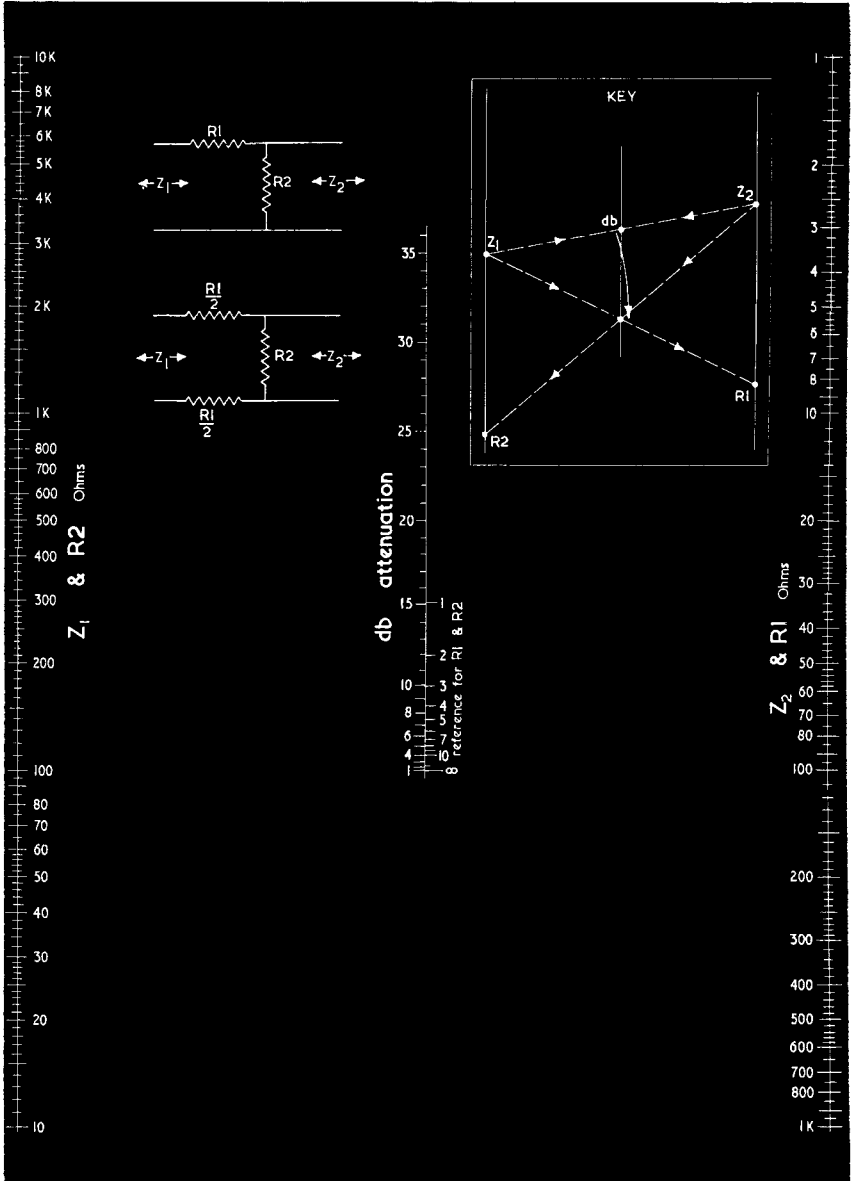

Fig. 815. Chart No. 5: for determining the minimum attenuation necessary for correct matching and resistor values required for L-pads.

ohms and  $Z_1$  5 ohms gives 24 db. Using Chart 4 (Fig. 814) to find the mismatch, reflected impedance  $Z_2/Z_0$  as given from Chart 3 (Fig. 813) is .001, which will be indistinguishable from zero at the right-hand side of Chart 4 (Fig. 814). This means that, to all intents and purposes, a 5-ohm resistance connected to a 5,000-ohm attenuator is a short circuit. Suppose the attenuation is designed for 20 db, then by using the straightedge or ruler, as shown in the key on Chart 4 (Fig. 814),  $Z_2'/Z_0$  is given as 0.98, which means the input impedance is  $0.98 \times 5,000$  ohms or 4,900.

If the attenuation was 10 db,  $Z_2'/Z_0$  becomes 0.82, making the impedance at the input end of the attenuator 4,100 ohms.

### Example 2

An attenuator is designed for 250 ohms and is actually terminated by 600 ohms. Using Chart 3 (Fig. 813) the ratio  $Z_1/Z_2$  is 2.4, and the mismatch loss attenuation is slightly less than 1 db.

Turning to the mismatch impedance transfer, using 2.4,  $Z_2/Z_0$ , which is in the left-hand part of the arc on Chart 4 (Fig. 814), and supposing the attenuator is designed for an attenuation of 6 db, alignment gives a reading of 1.24 for  $Z_2'/Z_0$ . So, the reflected impedance is  $1.24 \times 250$  or 310 ohms.

If the attenuation is 20 db, the mismatch drops to a ratio of 1.01, representing 252.5 ohms.

To avoid any trouble due to mismatch, which in r.f. can result in reflections and their consequent troubles as well as just losses, it is advisable to design a matching pad so that both impedances are correctly matched. This can be done quite easily with Chart 5 (Fig. 815).

The chart gives the minimum attenuation necessary to produce correct matching and the resistor values for an L pad to produce such matching. This pad can of course be combined with further attenuators of the constant-resistance type, designed at either of the working impedances, using either the charts of Fig. 811 or Fig. 812.

To use Chart 5. (Fig. 815), the two impedances to be matched, denoted by  $Z_1$  and  $Z_2$ , are aligned, and the db attenuation can be found on the left-hand side of the center reference line. The figure from this scale is then transferred to the scale on the right-hand side of the same reference line and aligned with  $Z_1$  and  $Z_2$ . This locates the values of  $R_1$  and  $R_2$  as shown in the key on the chart.

# filters and equalizers

**M**any approaches have been offered from time to time, giving various details of filter design, complete with circuits and values or with charts or formulas from which values can be calculated to suit individual applications. This information has included idealized response characteristics, and a general impression seems to exist that filters are special circuits possessed of some magical properties which can be achieved simply by applying the charts or formulas.

Mathematicians may be more fortunate than the rest of us in being able to understand the *derivation* of the wonderful circuits; but whether or not they understand fully the practical implications of their handiwork, they generally fail to convey this information in terms the individual who is not a mathematical genius can understand. The truth is that even to the mathematician complete analysis of circuits containing a number of reactance elements is highly involved. Even our mathematical friends look for short cuts. As anyone who has tried taking a short cut knows, it can be very useful *when the short cut really does lead to the same place* as the regular route.

## Derivation from transmission line

Most filter designs are based on transmission-line theory. To understand this let us first look at the properties of transmission lines. They consist essentially of two conductors spaced apart by

dielectric material. The conductors may be similar or different, concentric or parallel wire—in all cases the conductors possess resistance and inductance distributed uniformly along their length, and the dielectric between them will introduce capacitance and insulation leakage (conductance) also distributed uniformly along the length of the line.

The theory of transmission lines deduces that attenuation along the line is due to conductor resistance and insulation conductance. Time delay and other effects are created by inductance and capacitance. When these four quantities are in a simple proportional relationship, the line is "distortionless". This means uniform attenuation and time delay for all frequencies. As all frequencies suffer the same *time* delay, this means the *phase* delay of individual frequencies will be proportional to frequency. Such a distortionless line does not occur naturally; insulation conductance is usually too low (or insulation resistance too high) to satisfy the proportional relationship required. Increasing insulation conductance by deliberately making the line more leaky is obviously undesirable because this will increase the attenuation along the line.

Long lines are usually loaded to make them distortionless. This consists of artificially increasing inductance so that correct proportional relationship is obtained. There are two kinds of loading: distributed and lumped. Distributed loading is introduced by inserting magnetic material along the conductors to increase the inductance uniformly all along the line. Lumped loading is achieved by inserting chokes—or *loading coils*—at regular intervals along the line, so the average inductance value satisfies the proportional relationship required.

Theoretical analysis of lines with distributed loading is quite simple, but the mathematics for lumped loading becomes formidable and approximations have to be made to obtain workable formulas. These apply only over a limited range of frequencies; beyond this range the approximations are not good enough. It is obvious that a line with lumped loading cannot achieve the distortionless condition in the same way as one using distributed loading, but it does produce an approximation to the distortionless condition nearer than the unloaded line, within the range of frequencies for which it is designed. However, we did not start out to discuss transmission lines—the real subject is *filters*. The transmission line is merely a short cut to conventional filter design.

Enough has been said to show that a distortionless transmission line is somewhat a "castle in the air." Filter design is based on another approximation in transmission-line theory called the *loss-free line*. In this approach, conductor resistance and insulation conductance are both assumed to be zero, so the line possesses only inductance and capacitance.

### **Characteristic impedance**

A loss-free line would be distortionless and would possess what is called a *characteristic impedance*. If the line is terminated with a resistance equal to the characteristic impedance, the voltage and current in this terminating resistance will naturally follow the usual Ohm's law relationship; but the signal voltage and current at any point along the line will be identical in value with that in the terminating resistance. Progressive phase delay takes place along the line, but this will not affect either the values of voltage and current or the phase relationship between them at any one point.

Now suppose the line is terminated, not by a resistance equal to its characteristic impedance, but by some other value—either a different resistance, or a reactance. The usual explanation of what happens states that when the line is terminated by its characteristic resistance all the energy transmitted along the line is dissipated in this termination; but when some different value is used, some of the energy arriving at the termination is reflected back along the line. The varying phase relations between the reflected components of voltage and current and the original **forward-going** components cause the effective impedance of the line measured at different points to vary. The net result: with wrong resistance termination, the impedance varies above and below the characteristic value, having maximum values at half-wave intervals and minimum values also at half-wave intervals but spaced midway between the maximum values; with reactance termination the impedance of the line varies so as to produce alternately positive and negative reactance components at similar half-wave intervals.

This brief consideration shows that even the comparatively simple loss-free line, wholly theoretical as it is, can produce some quite complicated results if the operating conditions are not exactly as planned, especially when it is remembered that the wavelengths of different signals along the same line will vary in

inverse proportion to frequency. The impedance at the sending end of a line mismatched at the receiving end will vary in a very complicated way over a wide frequency band. However, in our short cut to filter theory, lines are always *assumed* to be correctly terminated to avoid these complications.

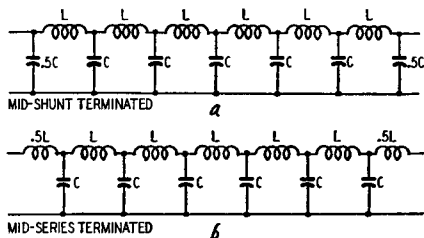

Fig. 901. Examples of artificial lines built up from two types of low-pass filter sections.

The simplest form of filter derived directly from this imaginary loss-free line is the *lowpass* type. A number of sections of this type of filter are called an *artificial line*. Fig. 901 shows such an artificial line. (A high-pass filter merely has the positions of L and C reversed.) The basic difference from the theoretical loss-free line is that the inductance and capacitance of the line are uni-

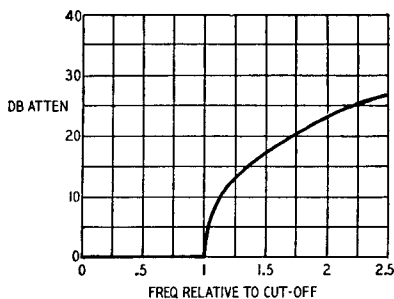

Fig. 902. The attenuation curve of a typical low-pass filter section that is terminated in its image impedance.

formly distributed along its length. Each little bit of inductance is between two little bits of capacitance, so finely divided that a true equivalent would contain an infinite number of both inductances and capacitances. The artificial line has a restricted, or finite, number of elements.

# Image impedance

The practical effect of this fact is that the artificial line has a definite cutoff frequency (it may be high-pass or low-pass). The loss-free line had no cutoff frequency, remember (provided we do not take into consideration the effect of transverse propaga-

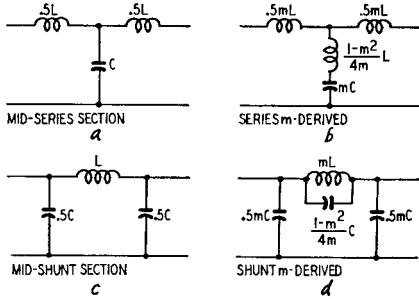

Fig. 903. Some basic low-pass filter sections with corresponding *m*-derived types.

tion between conductors. This enters the picture only when we get to waveguides.) The term *image impedance* replaces what was called *characteristic impedance* for the transmission line. It signifies that if this image impedance is applied as a termination to the output end, the impedance measured at the input will be identical. What is often overlooked about the artificial line is that,

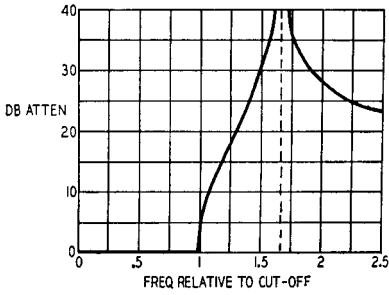

Fig. 904. The attenuation curve of an *m*-derived low-pass filter. For this example,  $m = 0.8$

besides having a cutoff frequency, its image impedance also has a frequency characteristic. *Image impedance* is thus quite different from the *characteristic impedance* of the loss-free transmission line.

If the artificial line is terminated at what are termed mid-shunt points, represented at Fig. 901-a, the theoretical image impedance

rises to infinity (or open circuit) at the cutoff frequency. Below cutoff this image impedance is resistive and starts from a value identical with the characteristic impedance of the equivalent transmission line. Above the cutoff frequency the theoretical image impedance becomes reactive.

If the artificial line is terminated at a mid-series point, as repre-

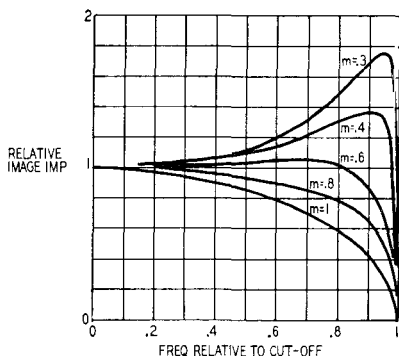

Fig. 905. This graph shows how the image impedance of low-pass filters varies with different  $m$ -values.

sented at Fig. 901-b, the image impedance at cutoff falls to zero (short circuit). Below cutoff the image impedance is always a resistance and likewise starts from the characteristic impedance of the equivalent transmission line. Above cutoff, the image impedance again becomes a reactance.

The usual way of showing the transmission (or attenuation) characteristic of such an artificial line is represented in Fig. 902. Note that the attenuation is zero right up to the cutoff frequency, and from there it suddenly starts to rise steeply. In curves of this kind the filter is assumed to be terminated by its image impedance, something which is not always clearly stated.

Before considering the implications of this fact on practical circuits, let us turn to the next stage in filter derivation. These are called  $m$ -derived filters.

The idea is that one of the elements, series or shunt, in a basic section of the artificial line is modified by a factor  $m$  (modification) and then the other one is also modified and another element (of opposite reactance) is introduced in such a way that the image impedance in the pass range, i.e. well away from cutoff frequency, retains its original value. In practice, the factor  $m$  is a fraction of 1.



Fig. 903 shows basic mid-series and mid-shunt sections of artificial line together with the  $m$ -derived filter obtained from each. Fig. 904 shows the attenuation characteristic for one of these  $m$ -derived filters. Comparing this with Fig. 902, the advantages gained are that the cutoff slope is much steeper, and at one frequency beyond the pass range (indicated by the dotted line) the attenuation becomes theoretically infinite. (In practice this at-

Fig. 906. Low-pass sections of crossover networks based on wave-filter design. The  $m$ -values used for both sections are equal.

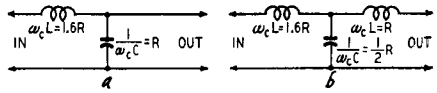

tenuation is limited by losses.) This attenuation characteristic is also plotted on the assumption that the filter is terminated by its image impedance.

### Significance of image impedance

Now to see what this assumption of image impedance termination really means. Fig. 905 shows how mid-series image impedance varies with frequency for a low-pass filter or artificial line of the simple type (given by  $m = 1$ ) and for different values of  $m$  in series  $m$ -derived types. Books on filters recommend using, as termination for a composite filter, an  $m$ -derived section with a value of  $m = 0.6$ , because this value of  $m$  gives an image impedance that adheres most closely to characteristic impedance up to cutoff frequency. However, even then, to get the idealized per-

Fig. 907. These curves show the response of the low-frequency section of Fig. 906-a.  $A$  is the curve usually published for the values shown;  $B$  is the actual curve for the filter;  $C$  is the circuit's response with the constant-resistance filter values of Fig. 909

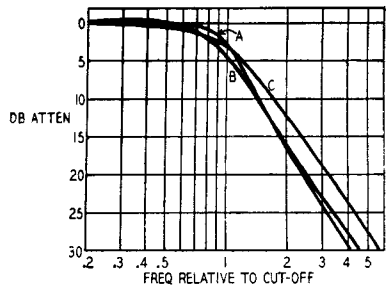

formance characteristic given in Figs. 902 and 904, the output load (loudspeaker) impedance must look like one of the curves of Fig. 905. Even if, and when, the speaker manufacturer obliges, who wants to load the amplifier with such an impedance—since it will also “appear” at the input terminals? Every type of filter has an image impedance that either rises to open circuit or falls to short circuit at cutoff frequency: *but the practical terminating im-*

pedance never does this. Because of this, there are definite limits to the use of approximations in designing filters. Even when all the precautions described are observed, the result often falls far short of what is claimed for it.

For example, take the types of high-and low-pass filters—frequently used for loudspeaker crossovers—which have two or three reactance elements in each feed. The low-pass sections which

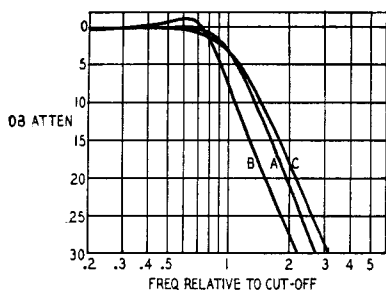

Fig. 908. Response curve of the low-frequency section of the crossover network of Fig. 906-b. Curve A is usually published for the values shown; curve B is the actual curve of the filter feeding load  $R$ , with a source impedance of zero; curve C is the response with values for a constant-resistance filter.

would feed the low-frequency speaker are shown in Fig. 906-a-b. They are a form of  $m$ -derived filter, though they differ from the types already mentioned. Figs 907 and 908 show (at A) the kind of response curves published for these circuits. The curves B are the actual curves for the filter, feeding a load of  $R$  and with zero source impedance. Curves C are for the same circuits, using values derived by a method of computing that avoids approximation.

The difference is not very great, but the phase characteristic or the impedance characteristic may often be more important than the attenuation or transfer characteristic. The phase shift in the vicinity of cutoff using these accentuated slopes is much more rapid than with the types employing constant-resistance derivation; also the impedance at the input terminals fluctuates considerably.

However, it is possible to design “constant-resistance” types which approach very closely to the idealized characteristic.

### Constant-resistance types

The fact that no single high-pass or low-pass filter by itself possesses a constant-resistance characteristic should be emphasized.

Fig. 909. On the facing page is a comparison of wave-filter and constant-resistance derivations for crossover networks using the same circuits. Throughout the tabulation,  $R$  represents the working impedance and  $\omega_c$  stands for  $2\pi$  times the crossover frequency. Thus,  $\omega_c L$  represents the reactance of  $L$  at crossover.

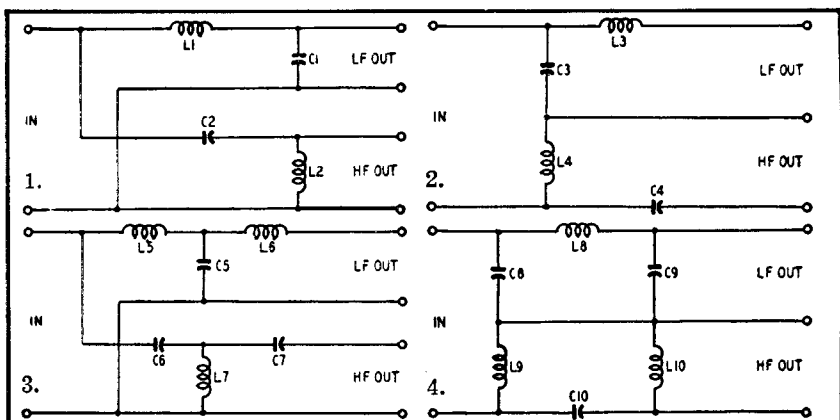

*Wave-Filter Derived Types*

*Constant-Resistance Types*

1.  $\omega_c L_1 = 1.6R$       $\frac{1}{\omega_c C_1} = R$   
 $\frac{1}{\omega_c C_2} = 1.6R$       $\omega_c L_2 = R$   
 Attenuation at  $\omega_c = 4.65$  db  
 Phase difference at  $\omega_c = 219^\circ$   
 Input impedance at  $\omega_c = 1.44R$

2.  $\omega_c L_1 = 1.414R$       $\frac{1}{\omega_c C_1} = 1.414R$   
 $\frac{1}{\omega_c C_2} = 1.414R$       $\omega_c L_2 = 1.414R$   
 Attenuation at  $\omega_c = 3$  db  
 Constant phase difference  $180^\circ$   
 Constant input impedance  $R$

2.  $\omega_c L_3 = R$       $\frac{1}{\omega_c C_3} = .625R$   
 $\frac{1}{\omega_c C_4} = R$       $\omega_c L_4 = .625R$   
 Attenuation at  $\omega_c = 4.65$  db  
 Phase difference at  $\omega_c = 219^\circ$   
 Input impedance at  $\omega_c = .695R$

2.  $\omega_c L_3 = .707R$       $\frac{1}{\omega_c C_3} = .707R$   
 $\frac{1}{\omega_c C_4} = .707R$       $\omega_c L_4 = .707R$   
 Attenuation at  $\omega_c = 3$  db  
 Constant phase difference  $180^\circ$   
 Constant input impedance  $R$

3.  $\frac{1}{\omega_c C_3} = \omega_c L_0 = .625R$   
 $\omega_c L_3 = \frac{1}{\omega_c C_{10}} = 2R$   
 $\frac{1}{\omega_c C_9} = \omega_c L_{10} = R$   
 Attenuation at  $\omega_c = 7.15$  db  
 Phase difference at  $\omega_c = 390\frac{1}{2}^\circ$   
 Input impedance at  $\omega_c = .385R$

3.  $\omega_c L_5 = \frac{1}{\omega_c C_3} = 1.5R$   
 $\frac{1}{\omega_c C_5} = \omega_c L_7 = .75R$   
 $\omega_c L_6 = \frac{1}{\omega_c C_7} = .5R$   
 Attenuation at  $\omega_c = 3$  db  
 Constant phase difference  $270^\circ$   
 Constant input impedance  $R$

4.  $\omega_c L_5 = \frac{1}{\omega_c C_3} = 1.6R$   
 $\frac{1}{\omega_c C_5} = \omega_c L_7 = .5R$   
 $\omega_c L_9 = \frac{1}{\omega_c C_7} = R$   
 Attenuation at  $\omega_c = 7.15$  db  
 Phase difference at  $\omega_c = 390\frac{1}{2}^\circ$   
 Input impedance at  $\omega_c = 2.6R$

4.  $\frac{1}{\omega_c C_3} = \omega_c L_9 = .67R$   
 $\omega_c L_5 = \frac{1}{\omega_c C_{10}} = 1.33R$   
 $\frac{1}{\omega_c C_9} = \omega_c L_{10} = 2R$   
 Attenuation at  $\omega_c = 3$  db  
 Constant phase difference  $270^\circ$   
 Constant input impedance  $R$

Constant resistance is possible only by using complementary filters, such as those discussed in Chapter 11 on loudspeaker cross-over design. Then the impedance at the input terminals to the combined arrangement is a constant resistance.

Mathematically the correct relationship between circuit values for this design can be approached in several ways because the arrangement possesses several unique features simultaneously. Without delving into mathematical details, the important difference from the other types is that no approximations are used, so the result can really achieve all the things claimed for it. These may be summarized as follows:

1. When supplied with a gliding tone of constant voltage at the input terminals, the total energy delivered to the output circuits is constant.
2. The impedance presented at the combined input terminals is constant and resistive.
3. The difference in phase between signals delivered to the two outputs is constant.

Another point to emphasize here is that, for these facts to hold, both circuits must be terminated by the correct *resistance* load.

The mathematical process of finding the correct values consists of developing expressions for the attenuation, phase response or input impedance, using any complementary values of reactance in the two filters and substituting into the algebra the appropriate conditions as stated. This will produce simultaneous equations which solved give the correct values for a constant-resistance filter. It is not necessary to give all the mathematics here, because the results can always be obtained from a source that has already done it all. As is shown in Chapter 11, constant-resistance types can be derived using up to three elements in each wing of the filter.

Fig. 909 shows a comparison of constant-resistance and wave-filter-derived types using the same configuration. For comparison, Figs. 907 and 908 also show the constant-resistance response for the same configurations.

### **Some questions to ask**

Finally, we would like to suggest some questions that the prospective user of a filter should always answer before proceeding. These questions have many times proved a safeguard in personal experience and for this reason they are recommended to others.

First, *what impedances does it work with—both ends?* Usually some characteristic impedance will be stated, but information may not be given as to whether this characteristic impedance is for terminating the filter at the output end or the input end or both.

The next question is *what impedances does the filter itself reflect when correctly terminated?* Usually the most important reflected impedance is that presented by the input of the filter when it is correctly terminated at its output. However, in some circumstances, reflection the other way may be important. For example, if the filter is feeding the input of an amplifier, the frequency response of the amplifier depends on its being correctly terminated at its input end; the circuit connected to the input transformer of the amplifier must have the stated source impedance value. When the input circuit is a filter, it follows that the user should be satisfied that the filter reflects the correct terminating impedance throughout the frequency range.

A third question is: *Am I using the correct impedances throughout the frequency range?* Even the constant resistance types achieve their true properties only when they are terminated by the correct constant-resistance loads. Speakers definitely do not do this, although selection of the right filter configuration may compensate for this shortcoming. (This will be explained in Chapter 11.)

The fourth question is one the user would probably have asked anyway: *What is its attenuation characteristic?* And perhaps this one: *What is its phase characteristic?* Some form of attenuation characteristic is usually published for the filter. We have found by experience that, if the conditions under which they are taken are not precisely specified (if the input and output impedances with which the filter works are not given), such characteristics are usually somewhat less than dependable, to say the least.

This statement is not accusing the manufacturers of misrepresentation in issuing such characteristics, since the characteristic probably does give quite accurate information about the filter under some conditions. The real question is *whether those conditions are the practical ones for the user.* This discussion has shown what a variety of possible conditions could be assumed for the purposes of calculating response or actually used for measuring one. Even if the response is the result of actual measure-

ment, the conditions used for measurement may differ from those which the user is going to apply.

Somewhat similar to filter design is equalizer design, the principal difference being that a filter is basically intended to have pass and no-pass frequencies. Of course, this does not really happen, as we have already explained, but rather the filter produces a definite discrimination between frequencies. Equalizers, on the other hand, are intended to produce a definitely shaped frequency response.

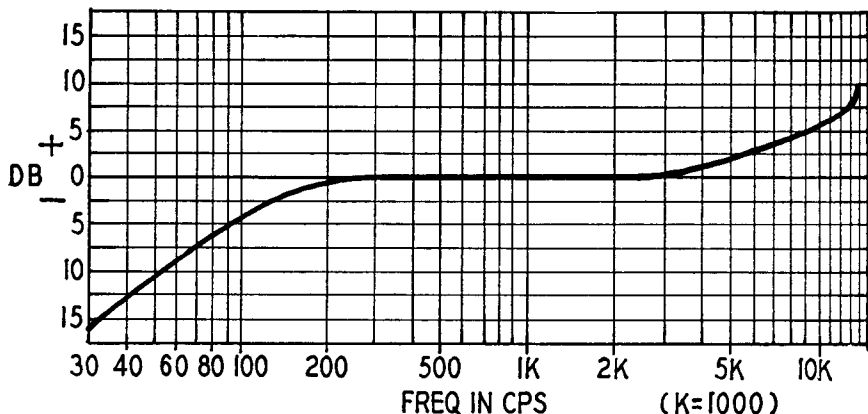

Fig. 910. A typical equalization curve used in making commercial disc recordings. Playback equalizer must have opposite characteristics for ideal reproduction.

## Equalizers

Amplifiers for reproducing various types of recordings—discs, tape, wire or sound-on-film—require some form of equalization to compensate for the special frequency characteristics of each type. For example, in making disc recordings—still the most nearly universal type—the low frequencies are deliberately attenuated to prevent the recording stylus from cutting over between adjacent grooves on strong bass notes. The high frequencies are overemphasized to help them override the disc surface noise and the anticipated losses in the average reproducer.

Fig. 910 shows the general character of a disc recording curve. Practically all recording equalization curves are based on a *maximum rate of boost or drop of 6 db per octave*. (Six db is equivalent to a *voltage ratio of 2 to 1*. An octave is a *frequency ratio of 2 to 1*.) This is the steepest slope obtainable with simple single-section combinations of resistance and capacitance. Each manufacturer uses what he considers to be the right amount of bass reduction

and high boost for the record speed, playing time, groove spacing and disc material.

Equalizer circuits look deceptively simple: a few resistors and a capacitor or two; but even when prescribed values are used they may fail to deliver the expected results. Many articles and books on the subject safeguard against this possibility with a postscript to the effect that "The foregoing method will provide rough values. *Exact values* for any specific application will have

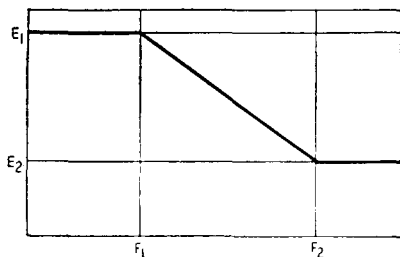

Fig. 911. This curve represents ideal equalizer characteristics.

to be determined by test." In other words. "This gives you a general idea; if you have all the necessary test equipment and enough patience, you *may* eventually get it right. If you haven't—well, just hope for the best."

Fortunately, this rather pessimistic approach to equalizer design is quite unnecessary if you understand and use the right methods. An equalizer has to provide a definite boost (or drop) in the response of a circuit between two specified frequencies. The *amount* of boost or drop may be expressed in decibels or as a voltage ratio. Since the two limit frequencies—called turnover points—are usually fairly far apart (at least in standard recording practice), an ideal equalizer would have the characteristics shown in Fig. 911. The response  $E_1$  of the circuit is perfectly flat to the lower turnover point  $F_1$ ; then it drops *uniformly* to the desired level  $E_2$  at the high-end turnover frequency  $F_2$ ; then flattens out again. It is this idealized shape that gives rise to the name *step* or *shelf*, when applied to the circuits whose function it is to do just this.

Fig. 912 shows two basic resistance-capacitance equalizer circuits. The arrangement at *a* is for high-frequency boost; *b* is for low-frequency boost. (Inductors can be used instead of capacitors—with the opposite characteristics, of course—but capacitors are generally used because they are free from hum pickup troubles

and are usually much less expensive than inductors. Here we will deal only with capacitor type equalizers.)

Both circuits are essentially voltage dividers. In *a* the top resistive element  $R_1$  is short-circuited at the highest frequencies by capacitor  $C_H$ . In *b* the lower resistor  $R_2$  is open-circuited at low frequencies by the capacitor  $C_L$ .

Two mistakes are commonly made in dealing with these circuits:

1. It is assumed that they produce ideal steps with a slope of 6 db per octave (as in Fig. 911), and that the turnover frequencies are exactly at the opposite ends of the step. The actual slopes are invariably less than 6 db, and the turnover points are never exactly at the ends.
2. The effects of the input and output impedances in the circuit where the equalizer is connected are neglected.

The most important actual characteristics of each circuit can be found by checking its response at three frequencies. Two of these are the turnover frequencies  $F_1$  and  $F_2$ ; the third ( $F_3$ ) is the geometric mid-frequency  $F_3 = \sqrt{F_1 \times F_2}$ .  $F_3$  is useful because the actual response curve has its steepest slope at this point.

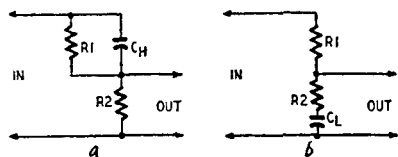

Fig. 912. Two basic R-C equalizer circuits. The configuration employed for high-end boost is shown in (a), while the low-end boost circuit is shown in (b).

The insert in Fig. 913 is a generalized equalization curve showing the important factors. (Although this represents the performance of a high-frequency boost circuit—Fig. 912-a—it can be applied just as well to bass-boost equalizers—912-b—by simply reversing the curve.) The Fig. 913 chart shows how these factors are determined in designing a practical equalizer. Frequencies  $F_1$  and  $F_2$  are the “turnover” points of the curve.

The straight line A gives the relation between the overall height of the step and the ratio  $R_1/R_2$  or the ratio between the reference frequencies  $F_1$  and  $F_2$ , which is simply  $(1 + R_1/R_2)$ . Curve B shows how much the response at the turnover frequencies  $F_1$  and  $F_2$  departs from the nearest level portion of the overall response curve; for big steps this is very nearly 3 db. Curve C shows the difference in response between the turnover frequencies  $F_1$  and  $F_2$ ; curve D gives the *maximum slope* in db per octave (at the mid-frequency  $F_3$ ).



Some typical solutions based on the use of this chart are shown in Fig. 914. In Fig. 914-a, for an overall step height of 3 db, the turnover frequencies have a ratio of 1.4:1 (half an octave). The maximum slope is about 1 db per octave, and there is only about 0.5-db difference in level between  $F_1$  and  $F_2$ . There is a rolloff

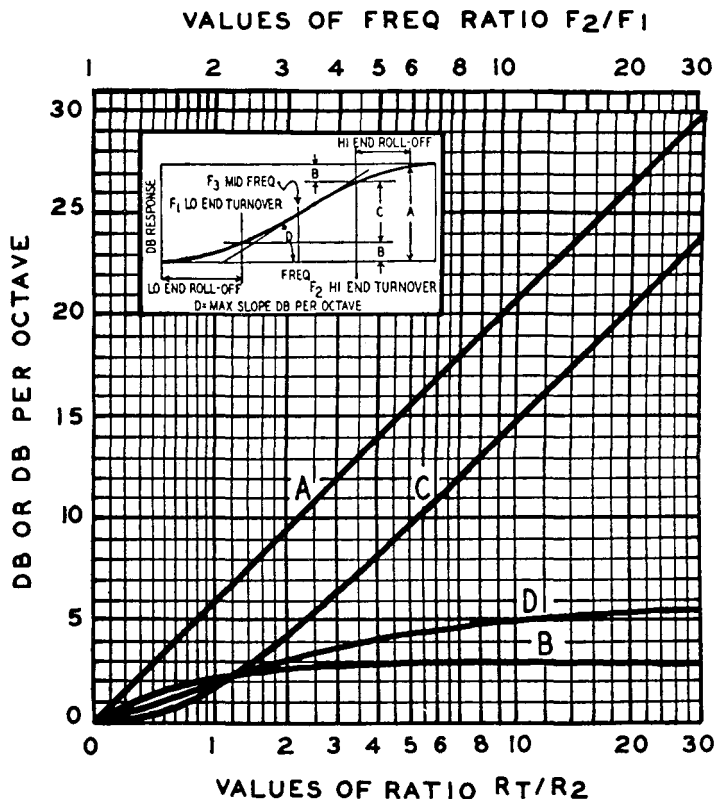

Fig. 913. Generalized equalization curve (insert) and chart for finding essential characteristics with actual circuit combinations. The overall height of the step is shown by A; the height of the roll-off at each end of the step is shown by B; C shows the net boost (or drop) between the turnover frequencies  $F_1$  and  $F_2$ ; the maximum slope at the mid-frequency point  $F_3$  is shown by D.

of 1.25 db between each of the turnover frequencies and the ultimate levels.

In Fig. 914-b,  $F_1$  and  $F_2$  are separated by an octave. The maximum slope is 2 db per octave, and the difference in level between  $F_1$  and  $F_2$  is nearly 2 db. There is a 2-db rolloff at each end.

In Fig. 914-c,  $F_1$  and  $F_2$  are separated by a decade, giving a 20-db overall step and a 14-db difference between  $F_1$  and  $F_2$ . Even in this case the *maximum slope* is still less than 6 db per octave, and

the *average* slope over the 10-to-1 frequency range is only 4.5 db per octave.

### Terminal impedances

Now for the second source of error. If an equalizer designed

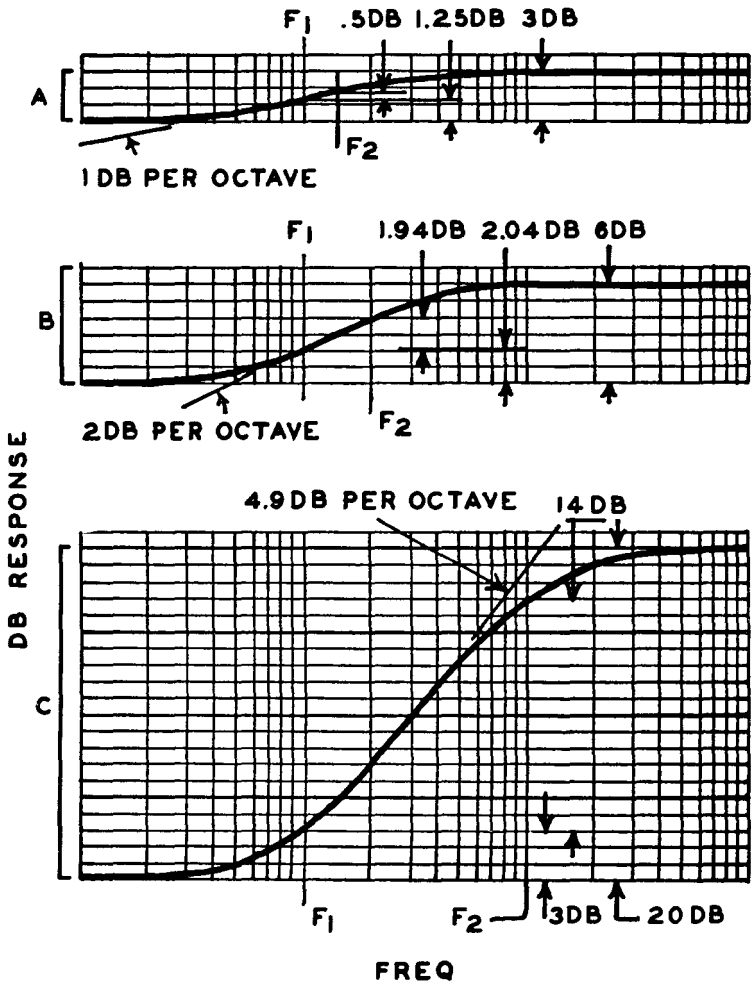
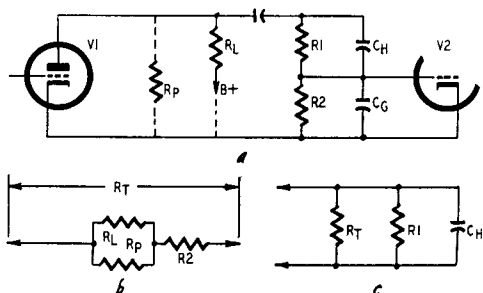

Fig. 914. Some typical curves derived from Fig. 913. Details of the method used are described in the text.

according to the methods in the preceding section is connected between two existing amplifier stages, the results may not conform to expectations. The predicted response would be obtained if the equalizer input voltage was the same at all frequencies.

Unfortunately, the input impedance changes with frequency, and so does the voltage. The grid-circuit impedance of the following stage also changes with frequency and affects the performance.

Fig. 915. The complete high-frequency boost equalizer circuit containing the additional elements affecting its characteristics is shown in (a). In (b) is shown the equivalent circuit of the source impedance used for finding the low-frequency turnover point. The equivalent circuit for finding the high-frequency turnover frequency point is shown in (c).



These plate and grid-circuit impedances must be included in the design calculations for the equalizer.

Fig. 915-a is the basic circuit of Fig. 912-a modified to include these source and output impedances. The low-end turnover frequency is found by making the reactance of  $C_H$  equal to  $R_1$ . The remaining resistance  $R_T$  in the loop is now  $R_2$  in series with the parallel combination of  $R_p$  (the plate resistance of  $V_1$ ) and the load resistance  $R_L$  (Fig. 915-b). As far as frequency discrimination is concerned,  $R_T$  is the equivalent of  $R_2$  in Fig. 912-a. The

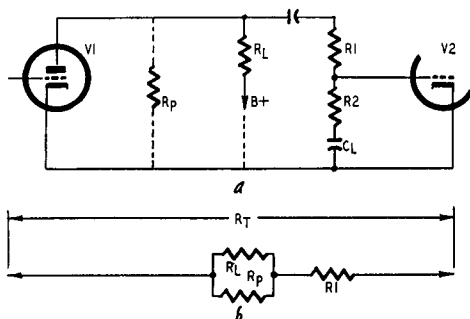

Fig. 916. Low-frequency-boost equalizer (a), and its equivalent input impedance (b).

high-frequency turnover  $F_2$  is found by making the reactance of  $C_H$  equal to the parallel combination of  $R_1$  and  $R_T$  (Fig. 915-c). In practice it will be necessary only to find one of these frequencies.  $F_1$  is the easiest to calculate, and Fig. 913 gives all the other relationships.

As an example, suppose that  $R_p$  is 1.5 megohms,  $R_L$  is 330,000 ohms and  $R_2$  470,000 ohms. A high-frequency-boost step of 15 db

is required, starting at a low-frequency turnover of 2,000 cycles.  $R_p$  in parallel with  $R_L$  gives about 280,000 ohms net plate-circuit resistance; this added to 470,000 ohms ( $R_2$ ) gives 750,000 ohms for  $R_T$ . A 15-db boost calls for a ratio  $R_1/R_T$  of 4.6 (curve A in Fig. 913), so that  $R_1$  works out to about 3.5 megohms. A standard value of 3.3 megohms would be close enough. The circuit will show a boost of 2.9 db (curve B in Fig. 913) when  $C_H$  has a reactance of 3.3 megohms at 2,000 cycles ( $25 \mu\text{f}$ ).

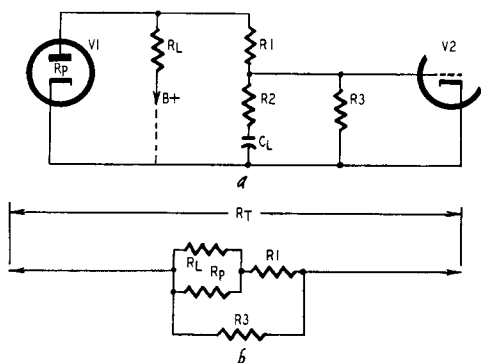

Fig. 917. A workable form of low-frequency-boost equalizer, with the d.c. return to ground (a). Equivalent circuit derivation (b).

Now the grid-circuit impedance of  $V_2$  enters the picture. If the input capacitance  $C_G$  is  $25 \mu\text{f}$ , the total attenuation will be 6 db more than anticipated, because  $C_H$  and  $C_G$  form a 2-to-1 capacitive voltage divider at the highest frequencies. Using a smaller value for  $R_2$  will reduce the effect of  $C_G$ . With  $R_2$  equal to 100,000 ohms,  $R_T$  becomes 380,000 ohms.  $R_1$  then works out to 1.75 megohms (standard value 1.8 megohms).  $C_H$  would then be  $50 \mu\text{f}$  for a 2,000 cycle low-frequency turnover. With  $C_G$  equal to  $25 \mu\text{f}$ , the added loss is only 3.5 db.

Increasing the overall height of the step will offset this loss still further. Using a figure of 20 db, the ratio  $R_1/R_T$  will be 9.  $R_1$  works out to  $9 \times 380,000$ , or about 3.3 megohms, which again calls for  $C_H = 25 \mu\text{f}$  to lift at 2,000 cycles. The loss due to  $C_G$  will be 6 db, leaving a net step height of 20-6, or 14 db.

In any case it pays to reduce the  $V_2$  input capacitance to the smallest possible value. One method is to develop a large amount of inverse feedback in  $V_2$  by using an unbypassed cathode resistor or by operating  $V_2$  as a cathode follower.

## Bass-boost circuit

Let us turn to the bass-boost equalizer following the basic circuit of Fig. 912-b. Input and output impedance factors are shown in Fig. 916. Here  $R_2$  is in series with  $C_L$  (Fig. 916-a) and the balance of the circuit is the series-parallel combination shown in Fig. 916-b. This circuit would not work in practice because

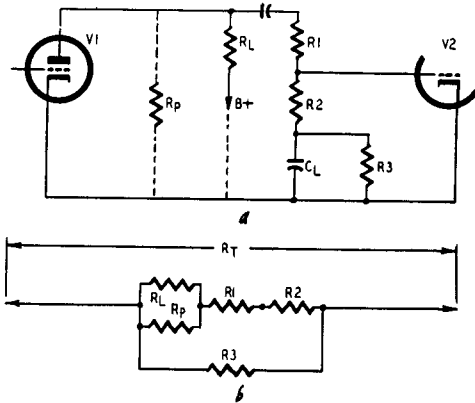

Fig. 918. Another form of low-frequency-boost equalizer (a).  $R_3$  may be a variable resistor for controlling the response. The equivalent circuit is given in (b).

the  $V_2$  grid circuit has no d.c. return to ground. Two workable arrangements are shown in Figs. 917 and 918, and the equivalent basic derivation is given under each. In Fig. 917,  $R_3$  shunts all the other elements ( $R_2$  is effectively open-circuited by  $C_L$ ). This is the simplest circuit to use. Fig. 918 is better where adjustable boost is required.

In this case the simplest reduction to the basic form of Fig. 912-b is by using  $R_T$  of Fig. 918-b as an equivalent for  $(R_1 + R_2)$ , and  $R_2$  and  $R_3$  in parallel as an equivalent for  $R_2$  of Fig. 912-b. The equivalent of  $R_1$  can then be found by subtracting the equivalent of  $R_2$  from that for  $(R_1 + R_2)$ . If  $R_3$  of the practical circuit is nearly zero, both  $(R_1 + R_2)$  and  $R_2$  of the basic circuit are approximately equal to this  $R_3$ , and  $R_1$  is effectively almost zero. This shows that, as  $R_3$  approaches short-circuit, the step vanishes.

Turning back to the question of the errors arising from failure to take circuit impedances into account, take the example shown in Fig. 919. This network is intended to boost both ends of the frequency range. The values of  $R_1$  and  $R_2$  in the basic circuit

of Fig. 919-a should give a lift of about 14 db at each end. If this arrangement is merely inserted between two stages, as in Fig. 919-b (ignoring for the moment the need for a d.c. grid return), the plate-circuit impedance of V1 will reduce the high-frequency boost and increase the bass boost, throwing the whole arrangement off balance. With the values shown, the plate-circuit resistance is about 330,000 ohms.  $R_T$  is 550,000 ohms, so the ratio  $R1/R2$  is only about 2, giving less than 10-db top lift (ignoring possible effects due to input capacitance). For bass lift  $R1/R_T$  is about 6, giving nearly 16-db lift.

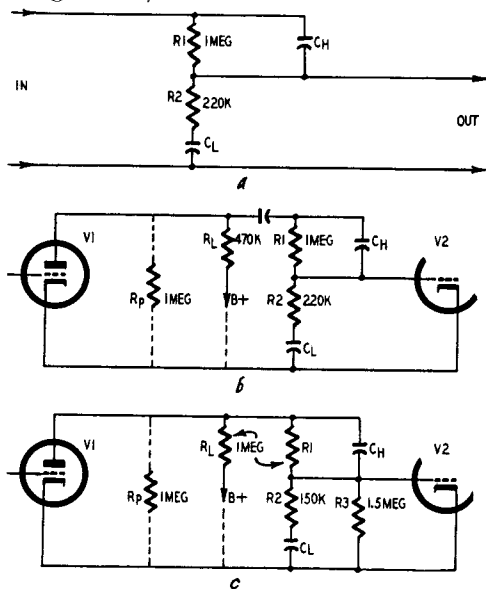

Fig. 919. A combination high-low-boost circuit. The basic network appears in (a); with the input and output circuits added (b). Compensation for equal high- and low-frequency boost is provided by adding resistor  $R3$  (c).

By careful choice of values in the circuit of Fig. 919-c, using the equivalents shown in Figs. 916 and 918,  $R3$  will not affect the top lift materially, but its value can be adjusted to bring the bass boost to the required equal value. The values shown will give 14-db lift at each end. The reactances of capacitors  $C_H$  and  $C_L$  must be equal to  $R1$  and  $R2$ , respectively, at the high and low turnover frequencies. To avoid confusion the effect of grid input capacitance has been ignored; to include it, the procedure for designing the top lift will be as in the earlier example, after which the bass lift can be adjusted by  $R3$  as just stated.

# scope test procedures

**M**agazine articles and textbooks often describe the use of scope patterns to detect or assess amplifier distortion. The method, theoretically, is simple. One merely connects the input of the amplifier to the X plates and the output to the Y plates.

As generally presented in the literature, patterns show the effect of *either* distortion *or* phase shift. In practice, however, distortion *and* phase shift frequently come together, so that an entirely different pattern is produced.

Fig. 1001 shows the general arrangement used for obtaining these patterns. Without doubt, the method itself has advantages over either examining a scope trace of input and output with an ordinary time base (with or without electronic switching) or analyzing input and output with a wave analyzer. For both methods, the input should be almost a perfect sine wave.

For this method perfection of waveform is not so important, although the source should be at least ostensibly a sine wave. Compared with the viewing of waveform with an ordinary time base, small degrees of distortion, particularly lower-order harmonics, are easier to detect and identify.

The use of a wave analyzer identifies precisely the component frequencies produced by distortion but does not indicate how these component frequencies add up to modify the waveform. To diagnose the cause of the distortion, the actual departure of the waveform from its true shape is more helpful than a detailed analysis of the harmonics introduced.

## Phase shift

To make the whole matter quite clear, we will start by discussing phase-shift patterns when no distortion is present. Fig. 1002 shows three families of phase-shift ellipses. In each case zero

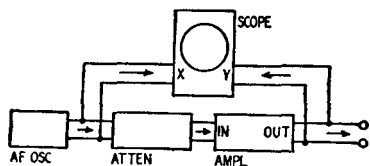

Fig. 1001. The equipment hookup for diagnosing amplifier distortion with oscilloscope patterns. In using this arrangement, lower-order harmonic distortion is easily detected and identified.

phase shift is indicated by a sloping line, which means that the spot traverses to and fro along the same trace. Introduction of phase shift opens the line out into an ellipse and, when  $90^\circ$  is reached, the major and minor axes of the ellipse are horizontal and vertical. Beyond  $90^\circ$  the ellipse would tilt the opposite way, finishing up with a straight line sloping the opposite way for  $180^\circ$  phase shift.

The three groups of Fig. 1002 help clarify the significance or the mathematical properties of various ellipses. In the center

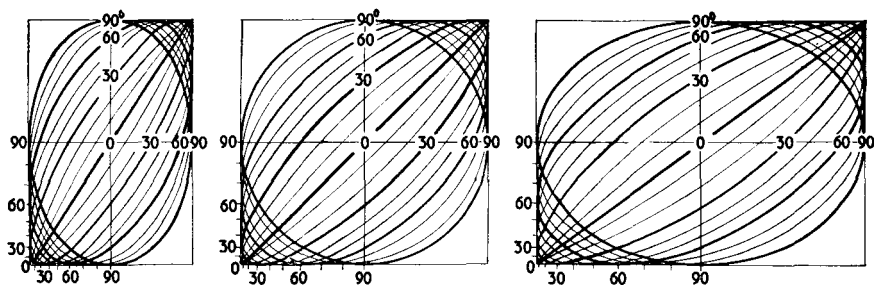

Fig. 1002. Examples of how phase shift appears on an oscilloscope, and how it may be measured.

group the deflection due to the X and Y plates is equal, so the zero phase-shift line is at an angle of  $45^\circ$ , and the  $90^\circ$  phase-shift trace is a circle. The left and right groups of patterns show the resulting pictures when the X deflection is less and greater, respectively than the Y deflection. It is most convenient for diagnosis to use the equal-deflection pattern shown in the center of Fig.



1002 if at all possible. In some instances this may not be easy with the equipment available, so it is necessary to make out a pattern on unequal X and Y deflections. Ellipses are shown for  $10^\circ$  intervals of phase shift from zero to  $90^\circ$ , and the  $30^\circ$  and

Fig. 1003. This setup is used for injecting phase shift into either the X or Y plate feed circuits of the oscilloscope. In practice, phase shift should be introduced only to the undistorted signal fed to the X plates.

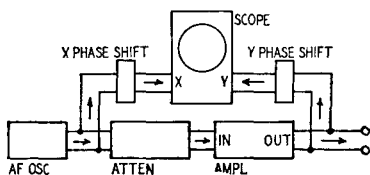

$60^\circ$  phase-shift ellipses are identified and distinguished from the others by being drawn blacker.

Points by which to deduce the phase shift of any given ellipse are marked on the figure. The best way to measure such an

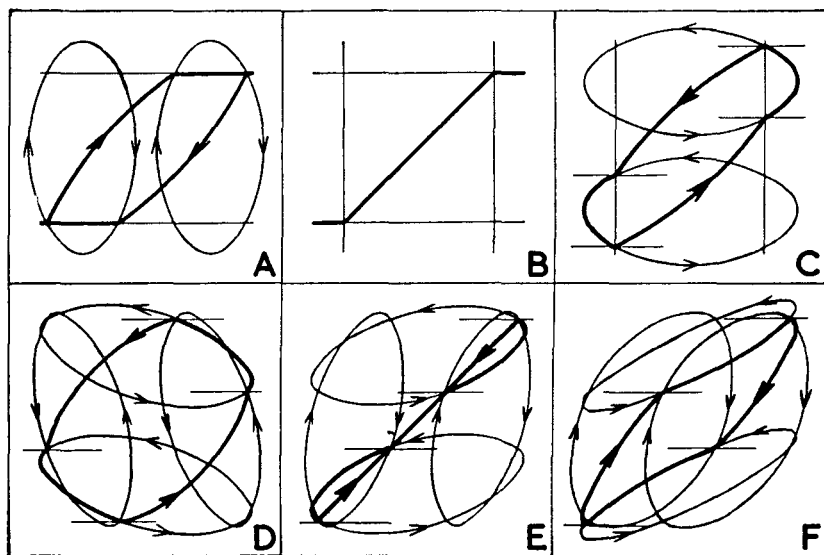

Fig. 1004. Six examples of how a distorted trace's shape varies with phase shift. A full discussion of this is covered in the text.

ellipse is to place a transparent cursor with graph ruling in front of the scope and adjust both deflections so as to fill an even number of squares. This provides a handy reference. Consider

half of one side of the square containing the pattern as equal to the unit "1." Using this graphical unit of distance, the location of the points indicated (along the left and bottom edges) is measured from the center or center line of the pattern.

## Finding the phase angle

The point where the ellipse crosses the vertical or horizontal center line, measured from the center of the pattern, is the *sine* of the phase-shift angle. (For example, the  $30^\circ$  ellipse crosses the line at 0.5 the length of the line.) The point on the boundary square of the pattern where the ellipse touches it, measured along that side from the center line, is the *cosine* of the phase-shift angle. The cosine is measured as a decimal fraction of the line, and the angle can then easily be found by reference to a simple table of sines and cosines.

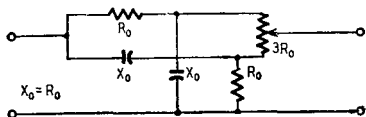

*Fig. 1005. Diagram of a simple phase-shift network. This arrangement affords continual phase shift up to  $30^\circ$  either side of zero position, and it is commonly used in many commercial test instruments.*

It is naturally easier to use the sine reference for angles between zero and  $45^\circ$  and the cosine reference for angles between  $45^\circ$  and  $90^\circ$ , but it is a good idea to measure off both points as a check, particularly where the angle lies between  $30^\circ$  and  $60^\circ$ . It is also a good plan to take an average of all four possible reading points for each value, to eliminate any error due to the ellipse not being quite correctly centered in its boundary square.

## Distortion

If the reader has tried to calibrate an oscillator with Lissajous patterns (as described in Chapter 14), he will notice that when the patterns are not quite locked they appear to be moving around. The direction of movement is somewhat subjective; that is, it depends upon the imagination of the viewer at the moment.

The movement could be imagined as being due to a pattern traced on a transparent cylinder, which is rotated on its axis so the pattern on the far side is viewed as if it were superimposed on the pattern in front. The cylinder could equally well lie on a horizontal or vertical axis, whereupon the movement due to its apparent rotation will appear at right angles. If either of the

patterns has a slight distortion, particularly noticeable at one point in the waveform, the direction of the axis of rotation seems to be identified by the movement of this distortion point. For example, if there is a little kink in the 60-cycle waveform due to rectifier pulse current in a power-supply unit connected to the same power line, this kink will maintain a regular position horizontally, moving up and down along a vertical line in the

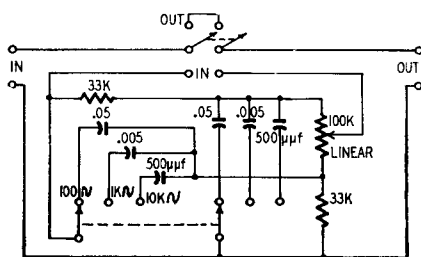

Fig. 1006. A three-frequency shift network arrangement.

trace, and the kink will appear at all points in the pattern where it crosses this vertical line. This will give the impression that the pattern is moving up and down vertically or rotating on a cylinder with a horizontal axis. On the other hand, if the output from the oscillator has a similar definite distortion mark, the apparent movement will be the opposite way, the distortion mark traveling along a definite *horizontal* line in the pattern as if the rotation were due to the pattern being traced on a cylinder with a vertical axis.

All this is perhaps a little easier to visualize with Lissajous patterns where the frequencies applied to the two sets of plates differ. For our purpose the frequency applied to both sets of plates is the same and the pattern does not move because the phase difference remains constant. However, there are ways of making the pattern move by introducing phase shift deliberately, and this can be an aid in recognizing the particular form of distortion.

Fig. 1003 shows that deliberate phase shift can be introduced into the signal fed to the X plates or that to the Y plates. For practical purposes it is best to introduce phase shift only into the undistorted signal fed to the X plates, because a phase-shift network will alter the shape of waveform distortion, making it harder to recognize.

Fig. 1004 shows the effect of phase shift applied in this way, together with construction lines (representing our imaginary cylinder) to help visualize the movement of the trace as phase shift takes place. The pattern at B shows the trace due to simple distortion with no phase shift. This distortion could be due to grid current or similar action producing clipping. The bent thick line can be regarded as an ellipse viewed edge-on, with the ends bent over, rather like what might happen to the rim of a bicycle wheel if it fell into a slot in the paving and the rider fell off the bike sideways. The thin lines are construction lines to identify the position of the sudden bends and can be regarded as intersecting circles viewed edge-on.

The pattern shown at A is due to phase shift in the deflection of the X plates, and C shows the effect of phase shift in the deflection of the Y plates only.

The remaining patterns D, E and F show the effect of combined phase shift on both sets of plates, maintaining the same phase shift in the Y-plate deflection as that shown at C, which means that the points on the actual trace will move along horizontal lines as the X shift is varied. To aid in visualizing this, horizontal lines are drawn for the points where the curve suddenly changes, at C, D, E and F. To allow these points to move on a path similar to a point on the surface of our imaginary vertical cylinder, the original construction lines, becoming ellipses, move in the peculiar manner indicated at D, E and F. The arrows on the ellipses indicate an imaginary direction of rotation consistent with the arrows on the thick line showing direction of spot movement. This direction is arbitrary and might easily be in the opposite sense to the one shown.

At D the phase shift in both deflections is in opposite ways, so the resulting pattern is more opened out. At E the two phase shifts are the same way and the same amount, so, if no distortion were present, the straight line, due to the equivalent ellipse being viewed edge-on, would be restored; but the bent-over portions are now moved round so they appear as loops moving away from this straight line. F shows the way the pattern distorts when the X phase shift is in the same direction as the Y shift, but bigger, so as to turn the pattern inside out.

Some of these variations may occur in practical amplifiers. Phase shift may occur before the distortion sets in and further phase shift may be introduced after the point of distortion. If the

phase shift is due to the fact that the frequency of the signal is either at the high or low end of the spectrum, it will be progressive, all in the same direction, as the signal goes through the amplifier, before and after the point where distortion occurs. But if viewed from the point of distortion, the earlier phase shift will be in the opposite direction from the shift after that point (the signal on the X plates will be in advance of the point of distortion and that on the Y plates behind it in phase).

This combination would produce a pattern somewhat like that shown at D in Fig. 1004. Phase shift only before or after the distortion point would give an effect similar to the trace shown at A or C respectively of Fig. 1004.

To aid in recognizing patterns due to practical amplifier distortion, it may therefore be helpful to inject deliberate phase shift into the signal fed to the X plates. Fig. 1005, shows a simple circuit that will give continuous phase shift variation up to about  $30^\circ$  either way from the zero position. The capacitors are marked in terms of their reactance at the frequency for which the network is used. Of course, it can be used only at one frequency or over a very limited range of frequencies, with any particular set of values, but the arrangement could be modified by switching in different capacitors to provide phase-shift facilities at different preset frequencies. This type of network is used for phase shifting in many test instruments.

Fig. 1006 shows the arrangement applied with switching for frequencies of 100, 1,000 and 10,000 cycles. An extra switch is provided so the phase shift network can be inserted or removed at will. This enables the frequency applied to the amplifier to be swept through the frequency spectrum without deliberate phase shift, switching over to the phase-shift arrangement at the preset frequencies of 100, 1,000 and 10,000 cycles for more detailed investigation of the pattern at these points.

Fig. 1007 gives a complete set of prepared patterns for a variety of typical defects in amplifier performance. The pattern for no phase shift is arranged in the second column from the left-hand side for convenience—that for X phase shift only being to the left and that for Y phase shift only to the right of it. The remaining columns give the effect of equal X and Y phase shift of  $30^\circ$ , the opposite way and the same way. The kind of defect giving rise to the distortion is noted down the left edge of the diagram.

The first four groups of patterns relate to clipping due to grid

current or similar action and curvature due to tube characteristics. The former may be due to inadequate grid bias and the latter to too much grid bias. Wrong plate loading can also cause these troubles. Some of the patterns show little difference between the two kinds of distortion. Notice where the X and Y phase shift are the opposite way. Here the difference between the two kinds of pattern is very small and would be difficult to identify on an actual trace. This means that if some phase shift occurred before distortion, with some more phase shift after it, it would be difficult to determine which of these two kinds of distortion was taking place. Introduction of phase shift in the X plates to neutralize that in the amplifier before distortion occurs would produce a pattern similar to that shown in Fig. 1007, in the column "Y phase shift 30°," where the difference between the two forms of distortion is quite clearly identified.

If sufficient phase shift were introduced in the feed to the X plates to offset all the phase shift in the amplifier, the trace would be similar to that in the last column of Fig. 1007. Here again the patterns are distinctly different. Probably the easiest point to detect the difference is that where the trace divides. In the pattern due to clipping, the curve splits abruptly, but in the pattern due to curvature it forks apart smoothly.

The next line of patterns illustrates the kind of distortion due to magnetizing current in a transformer core. For the previous patterns it would be immaterial which kind of X phase shift were introduced (by itself), because the pattern with no phase shift has a kind of symmetry demonstrated by the fact that the spot retraces its path to produce a single line trace. With this kind of distortion, such symmetry cannot exist, so 30° phase shift produces a different pattern, according to which way the phase is shifted. One direction is indicated in the figure by the solid line, and the opposite kind of phase shift, where it follows a different course, by the dotted line.

Where the phase shift through an amplifier is progressive, as at low frequency, the dotted-line pattern would be the one seen; but where a similar phase shift is inserted in the deflection to the X plates, the solid-line pattern would be produced. The effect of phase shift after the point of distortion is shown in the "Y shift 30°" column and combinations of phase shifts in the remaining two columns.

Another kind of distortion that produces patterns somewhat

DEFECT		X PHASE SHIFT 30°	NO PHASE SHIFT X OR Y	Y PHASE SHIFT 30°	X AND Y PHASE SHIFT 30°	
					OPPOSITE WAY	SAME WAY
CLIPPING DUE TO GRID CURRENT OR SIMILAR ACTION	ASYMMETRICAL					
	SYMMETRICAL					
CURVATURE DUE TO TUBE CHARACTERISTIC	ASYMMETRICAL					
	SYMMETRICAL					
TRANSFORMER MAGNETIZING DISTORTION						
CROSSOVER - BADLY MATCHED CLASS B TUBES						
H.F. RINGING - IN POWER DRIVEN OUTPUT STAGE						

Fig. 1007. Some common forms of distortion resulting from different phase-shift combinations. These are patterns representative of a variety of typical defects to be found in unsatisfactory amplifier operation. The first three vertical columns are for 30° X phase shift, 0° X and Y phase shift and 30° Y phase shift respectively. The last two columns show the effects of combined 30° X and Y phase shift occurring first in opposite directions and then in the same direction.

similar to transformer-core distortion in some phases occurs when tubes in class-B operation are so badly matched that one tube cuts off before the other starts to conduct. A variety of patterns for this case is shown in the next line of the figure.

The last line illustrates the kind of pattern produced when high-frequency ringing occurs in the drive transformer of an output stage where positive excursions of the output tube grids are encountered. The ringing is due to shock excitation of an ultrasonic resonant frequency in the drive transformer circuit each time grid current ceases.



# speaker systems

Some points about the functioning of loudspeaker crossover networks should be clarified. Most classical treatments derive crossover networks from wave-filter theory which in turn is derived from the theory of artificial lines (Chapter 9). The resulting designs may not satisfy all the requirements of a crossover network in the best possible way.

The first and most obvious requirement of a crossover network is to deliver low-frequency energy to one speaker and high-frequency energy to another. This is usually taken care of reasonably well, using a rolloff slope to suit the designer's whim.

A second factor (and one that often receives less attention) is the impedance presented to the amplifier by the combined network. Frequently this varies widely over the audio range and includes sizable reactive components in the vicinity of the crossover frequency. To obtain best performance from the amplifier, a constant resistive impedance should be presented to it as a load.

The third requirement often receives even less attention. This is the *realism* of the acoustic output from the combination. While this is in some respects a matter of individual conditioning and preference, it depends fundamentally on certain electroacoustic requirements. One of the most important, and frequently the one least considered, is the phasing or apparent source of the sound output.

Tests have shown that phase distortion with single speakers is

not normally detectable; but when *two* sources are employed, the phase relations between them influence the character of the radiated sound field. The frequency response as registered by a good pressure microphone may be flat, but what about the wave-shapes? The pressure microphone does not answer that, but a pair of human ears can detect such phase peculiarities. Failure to consider this factor has made many dual-unit combinations sound

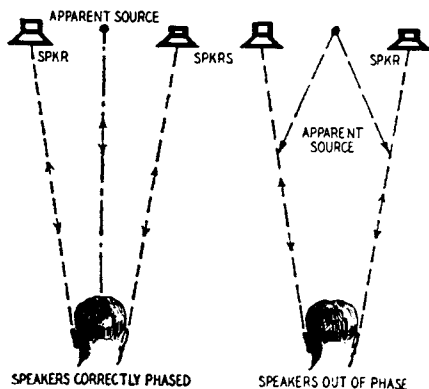

*Fig. 1101. This diagram shows how the apparent sound source shifts when speakers are not in phase with each other as compared to a condition where speaker phasing does exist.*

noticeably unreal, even though their frequency response may look perfect and there may be no measurable distortion.

## Source of the sound

The reader may have checked two speakers for phasing by listening to them while connections to one of them are reversed. Standing some distance in front of them on the center line (as in Fig. 1101) when they are correctly phased, the sound seems to come from a point midway between the two units; but when incorrectly phased, two effects can be noticed. There is a deficiency of low frequencies (due to cancellation effects) and the source of sound at higher frequencies no longer seems to be associated with the units actually radiating it. This is because the air-particle movement caused by the radiated sound is no longer back and forth along a line from the common source, but approximately at right angles to it. The sound field around the listener's head is perpendicular to what it should be, causing, through our binaural

perception, the confused impression which may be called "dissociation effect." Further discussion on this will follow later in this chapter.

A similar dissociation effect will occur with dual units driven by a crossover system at any frequency where the two speakers are out of phase. It is best to keep the two units close together.

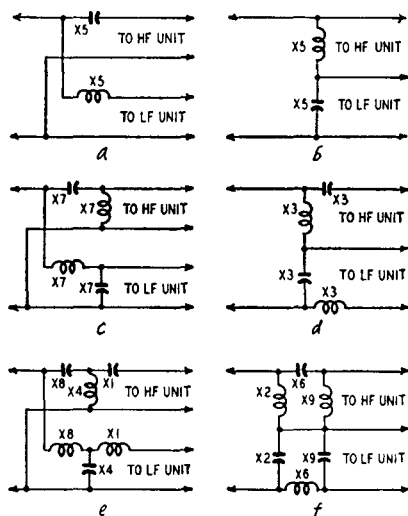

Fig. 1102. Six examples of crossover networks for use with two-way loud-speaker systems.

Some favor putting the smaller unit on the axis of the larger one and immediately in front of it. But, however the units are arranged, the dissociation effect can become noticeable if there is an out-of-phase condition at some frequency near the crossover point. The relative phase at crossover can be adjusted by positioning the diaphragms on their common axis so the wave from the low-frequency unit emerges in phase with that from the high-frequency one. When the units are mounted side by side on the same baffle, the sound should emerge in phase at the baffle surface.

### Constant-resistance networks

How does the crossover network affect the relative phase at frequencies near crossover? This question often seems to be overlooked, and neglecting it can cause the trouble just described. Some networks, of the kind employing two or more reactances

for each unit, have values adjusted to give an accentuated frequency rolloff. For example, the networks shown at Fig. 1102-c-d, using the values given by the chart in Fig. 1103, are of the constant-resistance type, giving a rolloff of 12 db per octave. The phase difference between the outputs is always 180 degrees; but using values designed for a sharper rolloff, the phase difference is not the same. At frequencies near crossover, phase difference changes rapidly. Some out-of-phase effect in the vicinity of the crossover frequency is unavoidable unless a constant-resistance type network is used. It is fortunate that this type takes care of both the second and third requirements already mentioned.

The chart may be used to design any of the six types of crossover network illustrated in Fig. 1102. Those at *a* and *b* give a rolloff of 6 db per octave and a constant phase difference of 90°. For best results the positions of the two diaphragms should be adjusted so the difference in their distances from the face of the baffle is about one-quarter wavelength at the crossover frequency. The phase difference will not be serious within the range where appreciable energy is coming from both units.

The networks at *c* and *d* give a rolloff of 12 db per octave, and a constant phase difference of 180°, which means that reversing connections to one unit will bring the phase right. The units should be mounted so their diaphragms are in the same plane.

For cases where the frequency response of the units used requires a rolloff steeper than 12 db per octave, the networks shown at *e* or *f* are recommended. These give a rolloff of 18 db per octave, and a constant phase difference of 270°. This means that mounting the diaphragms a quarter-wavelength apart at the crossover frequency will give in-phase outputs by appropriate connection.

All these networks are designed to present a constant, resistive impedance to the amplifier over the entire frequency range.

### **Impedance variations**

One more point is often overlooked. The networks are designed on the theory that they are feeding resistance loads of the same value as the nominal voice-coil impedance. The voice-coil impedance is *not* pure resistance, so the performance of the networks is altered. The most serious effect is usually due to the inductance of the low-frequency unit voice coil. By using networks *a*, *d* or *e*, each of which feeds the low-frequency unit through

# Crossover Network Design Chart

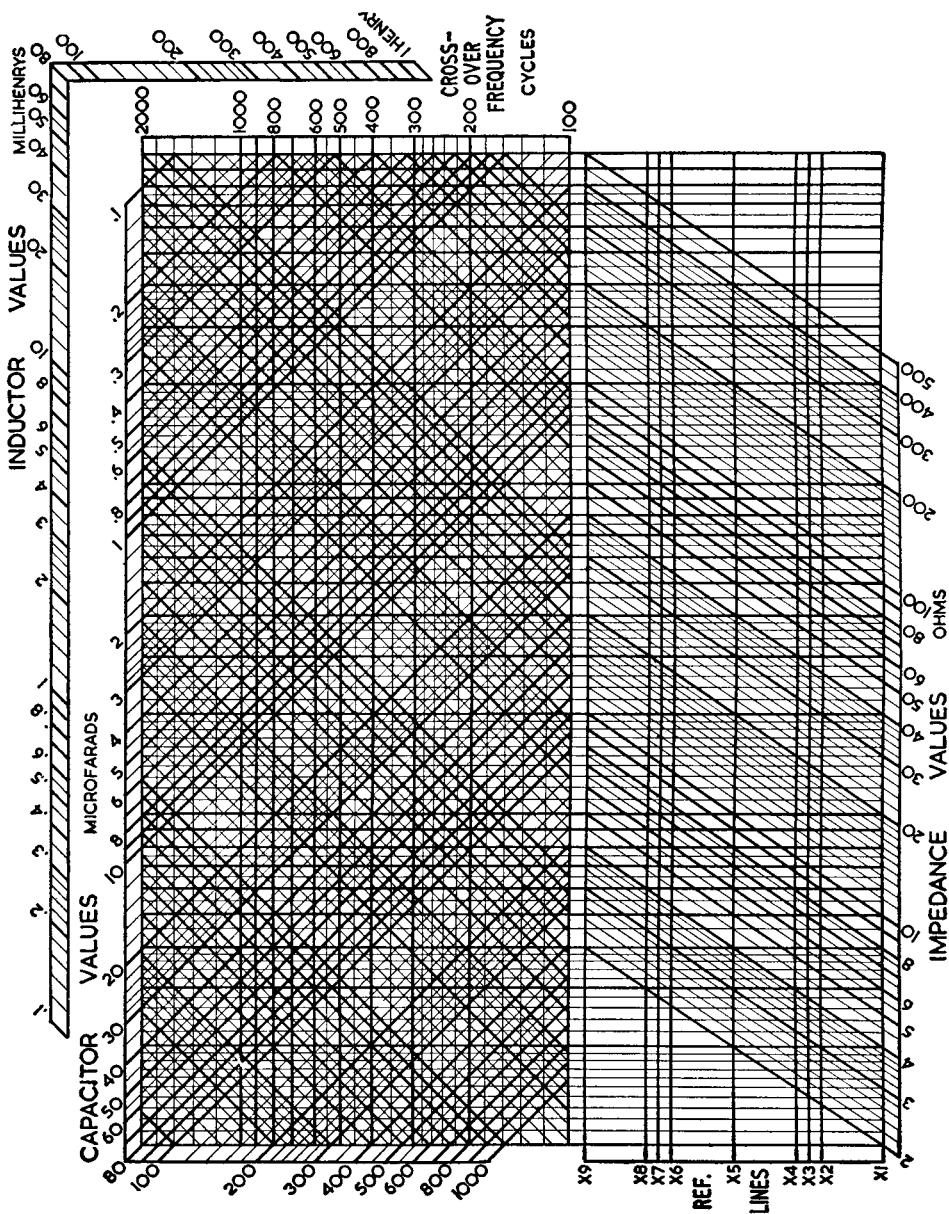

Fig. 1103. This chart is for finding the exact values of inductance and capacitance for any of the networks shown in Fig. 1102. Use of the chart is illustrated in Fig. 1104.

a series inductance, this effect can be overcome by subtracting the voice-coil inductance value from the network inductance value derived from the chart. Even if the available data are insufficient to allow this, these networks will minimize the effect, because the inductance of the voice coil will add very little to the effective inductance of the network. In the other networks the shunt capacitor combined with the voice-coil inductance will cause a greater variation in input impedance.

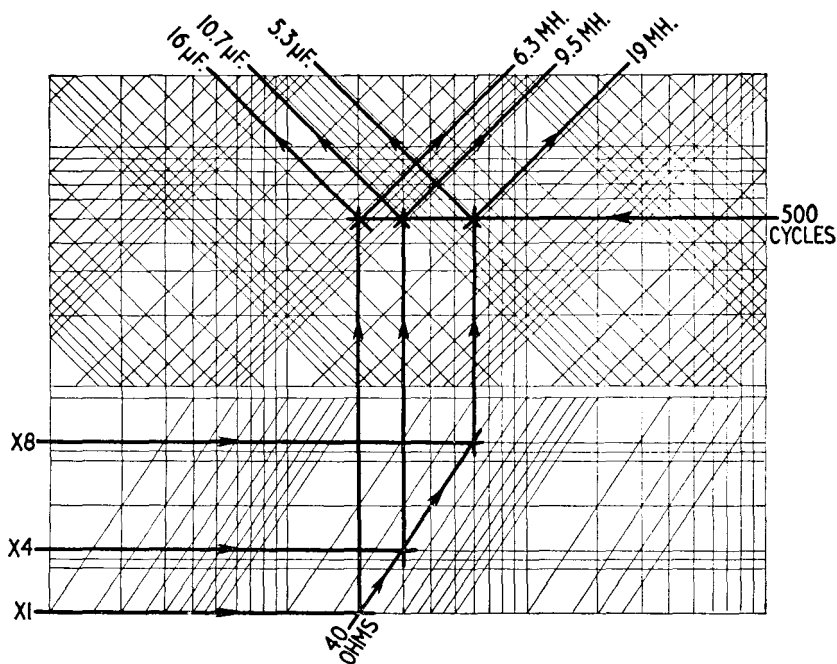

Fig. 1104. How the chart of Fig. 1103 is used to find the inductance and capacitance values for the network of Fig. 1102-e. Each speaker has a 40-ohm voice-coil impedance.

Each diagram in Fig. 1102 has the inductors and capacitors marked with symbols. These identify the reference line (in the bottom part of the design chart) to be used for finding each component's value. Fig. 1104 illustrates the use of the chart to find values for a network of the type in Fig. 1102-e, and Fig. 1105 shows the actual circuit calculated in this way for a crossover frequency of 500 cycles at 40-ohm impedance.

The input impedance is the same as each speaker voice-coil impedance. Some prefer to design the crossover network for 500-

ohm impedance and use matching transformers at the outputs to feed the individual voice coils. This method has two advantages. The two units need not have the same voice-coil impedance and smaller capacitors can be used. The range of impedances covered by the chart extends up to 500 ohms to include such designs.

One modern trend has been to use separate amplifier channels for each unit. In this case the chart can be used for designing an

Fig. 1105. The crossover-network component values for the circuit of Fig. 1102-e as derived by the method shown in Fig. 1104.

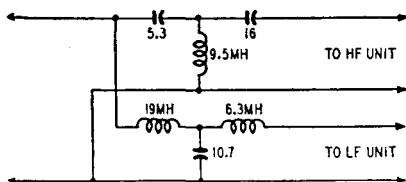

interstage filter to separate the channels by making the following adjustments. 1. Multiply all impedance values by 1,000. (This means the impedance used to terminate each output is a grid shunt). 2. Change inductance values to *henries* instead of millihenries. 3. Divide capacitor values by 1,000. Suitable networks for this application are *a*, *c* or *e*, since these allow the input to each amplifier circuit to be grounded on one side.

### Dissociation effect and directional sensitivity

Undoubtedly many people have recognized the phenomenon called "dissociation effect" without fully understanding its mechanism.

To understand the behavior of sound waves we must have the relative wavelengths of audio frequencies clearly in mind. Acoustic waves travel approximately 1,100 feet per second in free air so the length of one wave at a frequency of 1,000 cycles is a little over 1 foot. Lower frequencies have longer waves, while the wavelengths at higher frequencies are shorter.

Next we must see how it is possible for us, equipped with only two ears, to determine the direction from which a sound originates. A single ear can give only a limited sense of direction because the spiral communicating channel between the outer ear and the mechanism of the inner ear eliminates the external directivity. Directional sensitivity must be a function of the interpreting faculty of the brain derived by comparing the nerve impulses *received from both ears*. This fact was stated at the beginning of this chapter.

Is this ability to discriminate based on the *intensity* relationship or on the *phase* relationship between the two ears? The difference in intensity between sounds reaching the two ears from a given direction in free space depends on the obstructing effect (diffraction) of the head. This effect increases with frequency, so the intensity on one side is greater at high frequencies than at

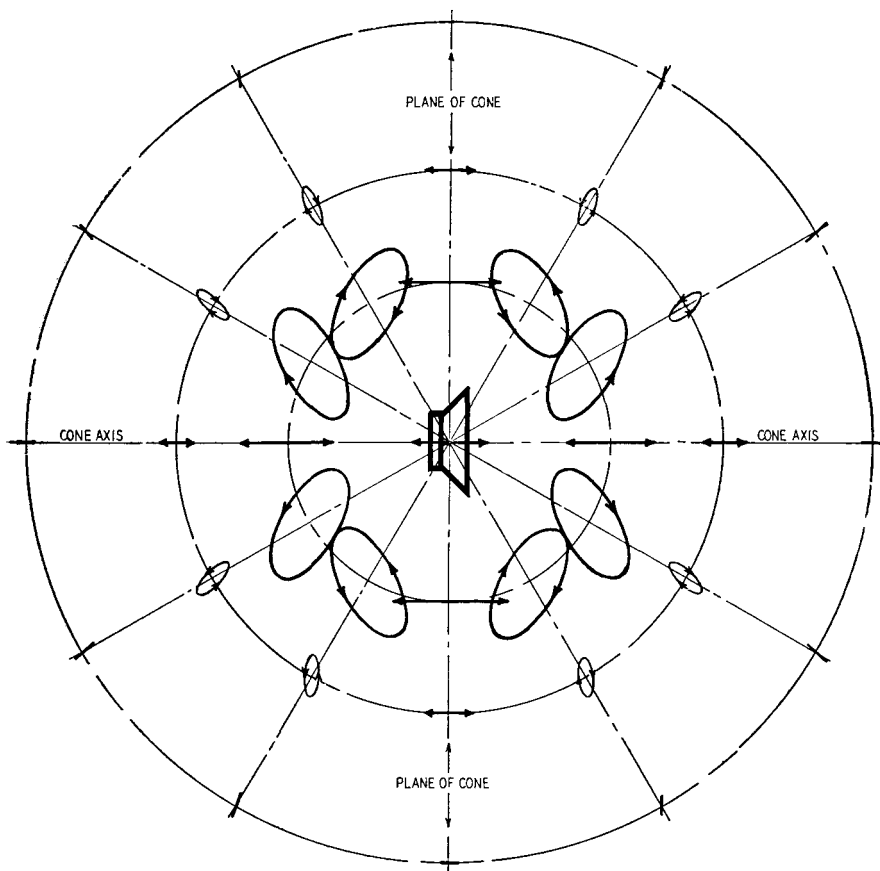

Fig. 1106. A generalized diagram of the movement of the air particles around a speaker.

low. The *phase difference* is also greater at high frequencies, because low-frequency waves are much longer than high-frequency waves and change less in the short interval between their times of arrival at the two ears. The fact that we are more sensitive to the direction of origin of sounds at higher frequencies can be explained by either the intensity-difference or the phase-difference



theory. Our subconscious probably utilizes both effects to some degree, but the *dissociation effect* makes it quite evident that the *phase relationship* between sounds received by our two ears is the more important of the two.

To prove this, we need to understand a little more about sound

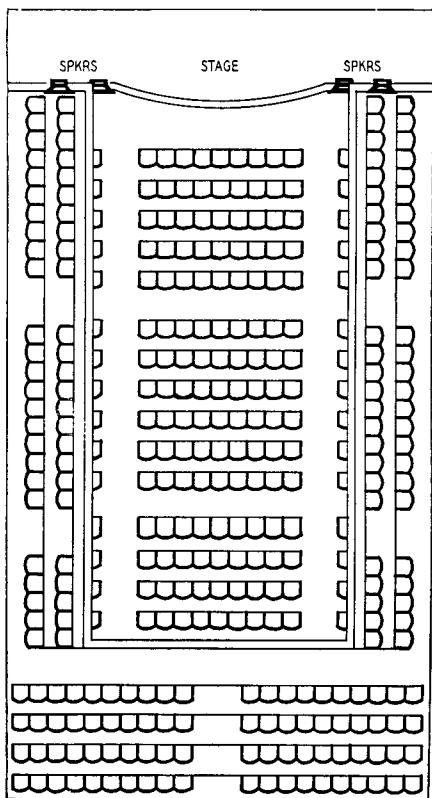

Fig. 1107. The plan of an auditorium that presented a serious problem in acoustics. Proper speaker phasing arrangements was the solution.

waves and their propagation. It is well known that a cone loud-speaker working without any kind of baffle or cabinet loses its effectiveness at low frequencies because air escapes around the edge of the cone. (When the cone is moving *forward*, air particles around the rim rush *backward* into the partial vacuum behind the speaker.) But what happens to other air particles farther away from the speaker?

Fig. 1106 is a diagram of air-particle movement (somewhat

exaggerated) at various points surrounding the speaker. Particles along the *cone axis* move back and forth along straight lines radiating from the source. On either side of the axis the particles spin elliptical paths which grow shorter and narrower as the distance from the speaker increases. At extreme distances these ellipses flatten to straight lines which also radiate from the center of the cone. Note, however, that at points *along the plane of the cone* the particles move *at right angles* to the radius line, so that the sound at these points seems to come from left and right instead of from directly in front of the listener. (Under ideal conditions, the sound waves from left and right would cancel, so that no sound would be heard along the plane of the cone.)

How does this affect our sense of direction? Try listening to a speaker from different positions. You will find that anywhere—except for a small region near the plane of the cone—the source of sound is easily identifiable with the speaker unit. In the plane of the cone, however, the *dissociation effect* becomes noticeable and it is almost impossible to say where the sound comes from. When the dissociation effect is greatest, you get the impression that, instead of having a *single speaker unit in front of you*, there are *two similar units, one on each side*.

### **Phasing in PA work**

Having investigated the matter so far, we can ask the question, “Is speaker phasing important for public address or sound reinforcement work?” The answer is definitely *yes*. One particular job is recalled where phasing played an important part. Fig. 1107 shows the layout of the installation. The auditorium was a long, narrow rectangle, with the stage at one end. The only points where speakers could be mounted were at the sides of the stage and immediately above it, at the ends of the narrow sections of the gallery. An engineer who did not realize the possible consequences had simply connected the four speakers in parallel without regard to phasing. The hall was acoustically poor due to a natural echo, but it *was* symmetrical and he could not understand why it was extra bad at certain spots especially along the right-hand side. We suggested that two of the speakers be disconnected and observations of the type described above be conducted on the center line. Similar tests were then made with the other speaker pair. We found that one speaker on the right-hand side had been connected out of phase with the other three. Re-

versing the offending speaker not only improved the bad spots but made listening considerably better everywhere at the back of the hall. The natural echoes were still evident, but not to such a degree as to render sound almost unintelligible. The incorrectly phased speaker had introduced some echo effects of its own,

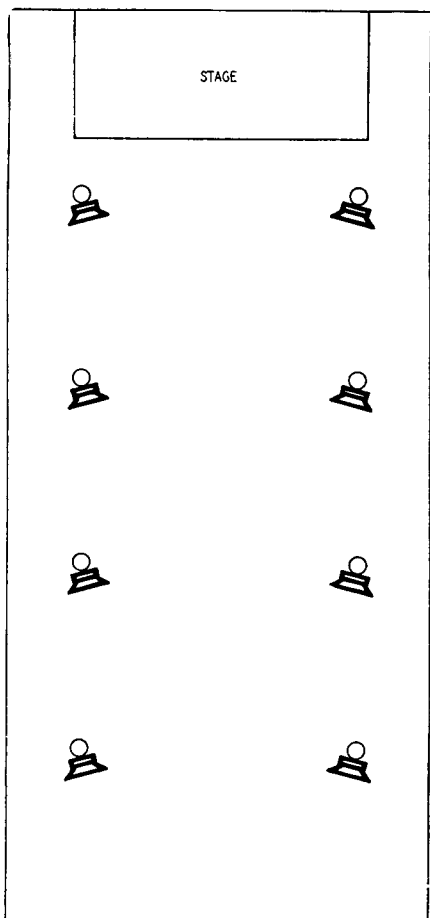

*Fig. 1108. An example of another speaker layout arrangement that requires special phasing techniques.*

which made listening even more difficult except where the listener was comparatively close to one speaker unit.

Extended investigation on other installations has shown that it always pays to check speaker phasing. It may be thought that where speakers are arranged as in Fig. 1108, correct phasing between symmetrical pairs would be important, but not between

other units at different distances from the front of the hall. Tests show that there is one really effective method of connection and this is invariably with correct phasing. The explanation seems to be that when a listener hears sound from two sources, one of which is nearer than the other, as must happen in some positions with an installation of this type, the nearer source gives the im-

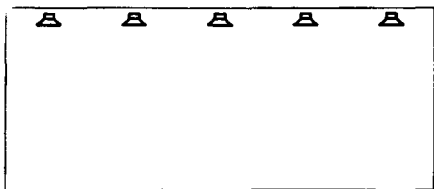

Fig. 1109. Side-by-side speakers can create problems unless they are correctly phased.

pression of a direct sound, while the sound from the more distant source is like an echo. Where the echo arrives long enough after the direct sound to be distinguishable from it, phasing is unimportant; but there are always some positions where the two sounds arrive so close together that the ear cannot distinguish them as separate sounds. At such positions, phasing can make an important difference.

Another type of installation is shown in Fig. 1109. Correct phasing is very important here. Walk around the back of the room while sound is being broadcast: When nearer to one speaker the sound seems to come from the vicinity of this speaker. At a point equidistant from two speakers, if the two are *in phase*, the apparent source of sound seems to pass smoothly from one speaker to the other; but if they are *incorrectly phased*, there will be an area of confused sound where the building echo seems emphasized, often to the point of unintelligibility.

## Crossovers

As previously mentioned, dissociation effect can also occur with dual speaker units fed from an electrical crossover network, but the effect is slightly different from the examples just considered. You get the impression that one part of the frequency spectrum has a source different from the remainder of the spectrum. In large dual-speaker installations, such as in movie theaters, this dissociation effect will be swamped by the natural reverberation of the auditorium. However, the effect can be quite disconcerting

in home equipment, giving the sound an unnatural quality that many listeners have complained of.

Fig. 1110 shows two typical loudspeaker crossover networks, and Fig. 1111 gives their phase characteristics. Although the two networks have identical schematic configurations, the one shown in Fig. 1110-a has values chosen to provide constant resistance, while the network of Fig. 1110-b uses typical wave-filter-derived values.

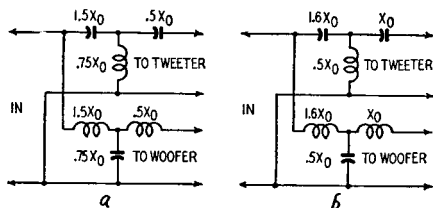

Fig. 1110. Two identical speaker crossover network configurations. The circuit in (a) has values chosen to provide constant resistance, while the circuit in (b) uses typical wave-filter derived values.

To make the distinction between the two types clearer, component values have been marked in terms of their reactances at the crossover frequency,  $X_0$  being a reactance equal to the characteristic impedance at the crossover point.

The top and center A curves in Fig. 1111 show the phase responses of the high- and low-frequency sections of the **constant-resistance** type network. These have a constant phase difference of  $270^\circ$  over the entire frequency range, as indicated by the solid line A at the bottom. On the other hand, the high- and low-frequency sections of the wave-filter-derived network have a phase difference of  $270^\circ$  only at the extreme limits of the frequency range, while the difference between them increases to almost  $450^\circ$  at the crossover frequency (curve B at the bottom).

With this type of crossover network, no matter how the h.f. and l.f. units are connected in an attempt to maintain constant phase difference between them at or near the crossover frequency, there will always be a rapid deviation from the constant-difference condition near the crossover point. As a result, some component frequencies of the reproduced sound will have their apparent sources shifted to one side or the other away from the general apparent source of the speaker combination.

If we are trying to reproduce a musical tone which contains a series of harmonics extending through the crossover frequency,

this type of network will move the apparent sources of some of the harmonics to positions a small distance away from the common source of the others.

It is perhaps well in concluding this chapter to emphasize one point of phase difference that seems to have caused some confusion heretofore. In electrical circuits, phase difference is essentially a *time difference*, measured in degrees over the duration of

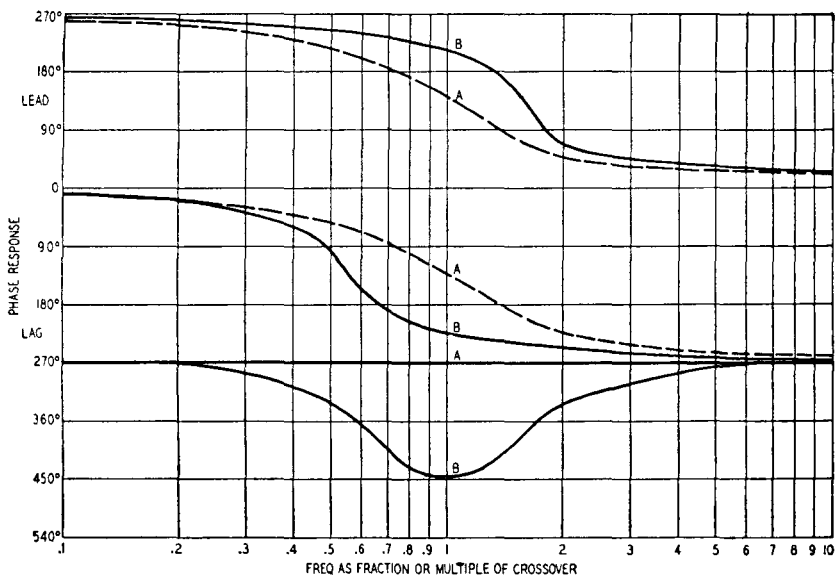

Fig. 1111. Graph showing crossover-network phase relations. Curves A are for constant-resistance networks; curves B are for wave-filter types. Top and center curves show high- and low-frequency shifts, respectively; curves at the bottom show the phase differences between high- and low-frequency units over the entire range.

one cycle at the frequency considered. The acoustic effect on which our ears base their directional deductions is better understood as the *slope* of the wave in space at any particular instant in time, and is thus a kind of *spatial* phase difference. This distinction may help some who find it difficult to see why two interacting acoustic fields which differ in phase can produce effects noticeable to the ear, even though *electrical* phase differences of much greater extent are not normally detectable.

# advanced techniques

It has been said, on both sides of the Atlantic, that the British appear to lead the audio field. When asked to gather material on British audio circuit features, we naturally asked ourselves the question: *Why* do the British lead in this field? In what does this leadership consist? Is it more advanced know-how, or is it just doing an ordinary job a little better?

The consensus is that there is nothing particularly clever about their circuitry in most instances. Rather, it is that more time and effort is put into getting the best out of well-tried circuits or their variations. Until recently, there was very little interest in audio. American production-minded concerns did not find it attractively profitable to invest in research for such small volume. However, some British outfits, working on a smaller scale, found the outlay worth while.

The market is growing with the widening interest, and it may be that American concerns who manufacture in large quantities will soon take the lead from the smaller British firms. However, it is probable that the latter will hold their own, for, even with the market bigger, it will remain essentially an individualistic one. Audio enthusiasts are connoisseurs, and ears, like palates, vary. So there should continue to be room for everybody who is prepared to do a really good job.

Probably the connoisseur aspect of the audiophile is best evidenced in the variety of circuits for quality control, tone compensation or whatever name you like to give it. Recently, we ques-

tioned a statement to the effect that bass boost and treble cut have the *same* effect, and vice versa. We were immediately shown higher authority for this opinion. The truth would appear to be that the difference is indistinguishable to some, while to the more

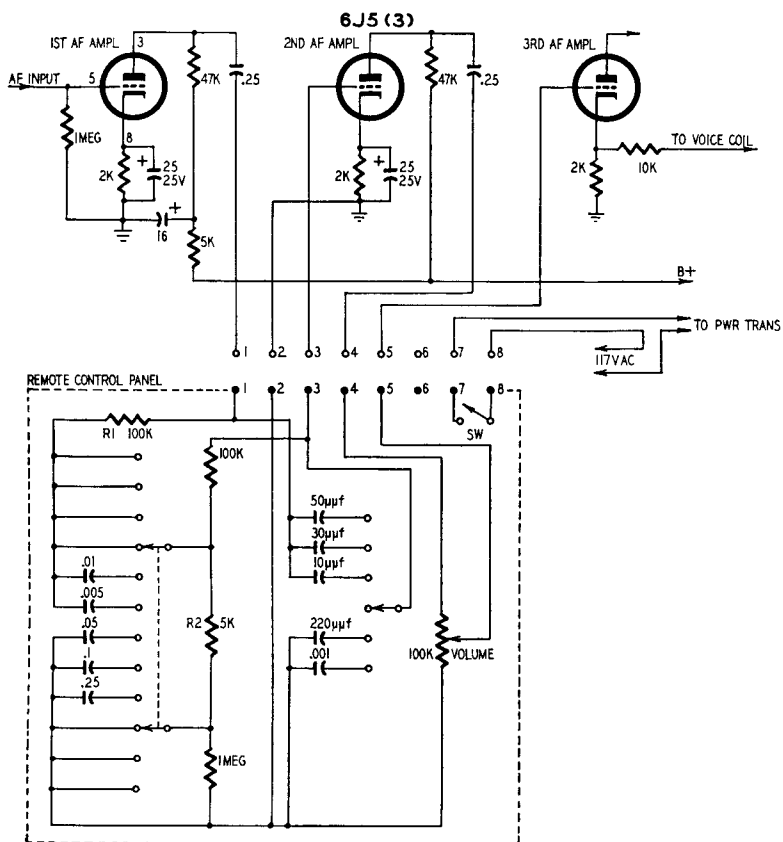

Fig. 1201. The circuit diagram of the Telrad Electronics remote control circuit.

discriminating ear the finer details of frequency response require some control to obtain a satisfying effect.

Most modern audio equipment incorporates the control features in a preamplifier remote from the main amplifier. An exception to this is a unit made by Telrad Electronics — and to produce many of the advantages of more expensive contemporaries the whole amplifier is carried on one chassis. The controls are remote and are connected to the main chassis by a relatively short



length of multiconductor cable, terminated in an octal plug. Fig. 1201 shows the remote panel circuit for this requirement. The tone correction circuit is between the first and second stages, and the volume control between the second and third. The circuit consists

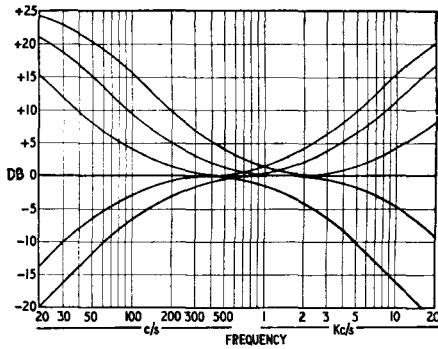

Fig. 1202. Graph shows the curves for six control positions of Fig. 1201.

of a basic voltage divider, R1 and R2, which provides an attenuation of about 26 db. Both bass and treble controls provide a level position (as shown), three lifts and two cuts. The boost gives an ultimate lift at either end of about 26 db. The position of the lift

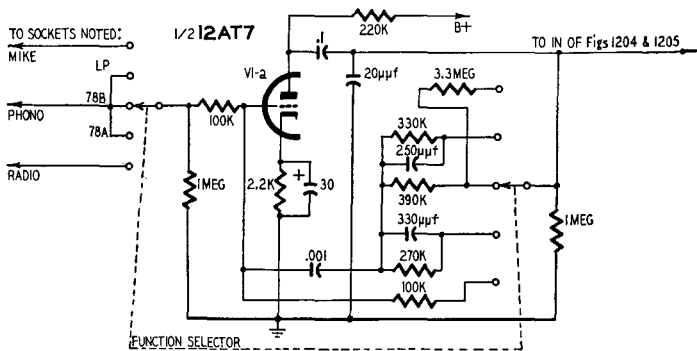

Fig. 1203. Feedback circuit arrangement for input compensation in the Leak "Vari-slope" unit.

is varied by altering the capacitor values. Similar change of values alters the two possible cutoffs provided for each end. The combined range of control provided is shown at Fig. 1202. This arrangement provides sufficient variation to satisfy all practical quality compensation required and has an advantage in that the difference between steps is perceptible.

Preamplifiers of more conventional type generally provide somewhat wider facilities. The Leak *Vari-slope*<sup>1</sup> separates the function of compensating for recording characteristic, etc., from the compensation for studio or room acoustics and noise content, by adjustment of bass and treble controls. The input selector switch has five positions, marked RADIO, 78A, 78B, L.P. and MIC. This compensation is achieved by a feedback arrangement over the first stage of the preamplifier, as shown in Fig. 1203.

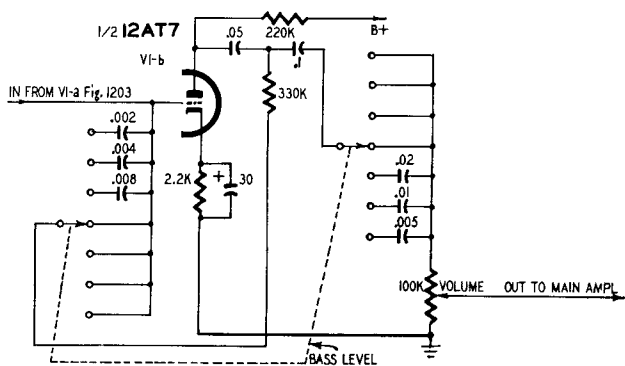

Fig. 1204. Diagram of the Leak bass control circuit.

Over the second stage, the bass boost positions are achieved by different values of series capacitor in the feedback. The cut positions insert different values of series capacitor in the lead to the output volume control. (The combined bass control is shown at Fig. 1204.)

The treble lift is conventional, but the cut positions employ the *Vari-slope* technique from which the unit gets its name. Three turnover frequencies are provided by the switch. At each, a conventional two-stage rolloff response is provided between the first and second amplifier stages. Combined with this is a further correction introduced into the feedback over the second stage, using a form of adjustable twin-T network. Capacitor values are selected by switch to suit the turnover frequency chosen. Variation of the slope control shunts the T to varying degree, thereby changing the shape of correction applied at the rolloff frequency. Thus turnover frequencies are selected in steps, but the rate of cutoff can be adjusted continuously. Fig. 1206 shows a range of possible slopes for the lowest cutoff, 5 kc. Fig. 1205 shows the basic circuit for

<sup>1</sup> Manufactured by H. J. Leak & Co. Ltd.

treble control, leaving out the components that affect only bass response and the muting arrangements. Muting consists, quite simply, of shunting the switch contacts with suitable high-value resistors to prevent residual charges being left on capacitors not in use, so that switching them into use would produce a click.

Finally, one other circuit is that of the QUAD quality-control unit<sup>2</sup>. A particular feature of this unit is the mechanical arrangement of the panel facilitating touch control. The volume

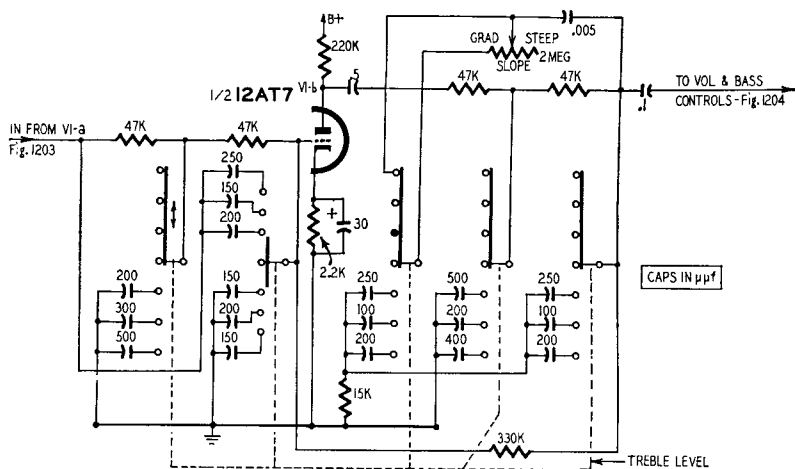

Fig. 1205. Schematic diagram of the Leak "Vari-slope" treble control.

control employs negative feedback over the second stage, using the circuit shown in Fig. 1207. At minimum volume, the second stage operates at unity gain with 100% feedback, or nearly so, while at maximum volume the feedback is considerably reduced.

Tone compensation is again divided into two parts, but the functions are not separated in quite the same way as in the Leak unit. Two different input sockets arrange for flat response or correction for velocity type pickups. The main compensation is in the output circuit. This consists first of a filter with variable slope characteristics, but using a conventional filter circuit modified for this purpose, as shown in Fig. 1208. Two turnover frequencies are available by switching capacitor values, at each of which the slope can be varied very much like the "cut" part of the Leak treble control. Following the filter in the circuit arrangement are the fairly conventional treble and bass controls, as in Fig. 1209,

<sup>2</sup> Manufactured by Acoustical Manufacturing Co. Ltd.

giving the response variation of Fig. 1210. In the panel arrangement the physical position of the controls is reversed, as this is considered more logical from the psychological viewpoint.

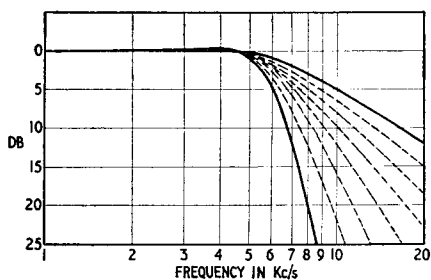

Fig. 1206. Graph of the curves representing the possible slopes for 5-kc cutoff.

The filter switch has four positions:

1. Flat, cutting out filter and top and bass circuits, so that a check can quickly be made against level response at any time.
2. Bringing in treble and bass controls only.
- 3-4. Different filter turnovers.

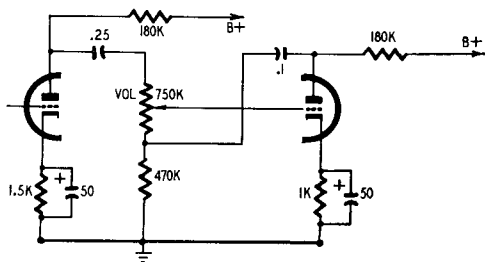

Fig. 1207. Arrangement showing how feedback is employed in the QUAD volume control circuit.

There you are. Three completely different ways of doing virtually the same thing. Each does its job well because of the work that has gone into getting the right circuit values for the purpose, rather than because its circuit is so much better than its competitors.

## The grounded grid

Turning from circuit practices in audio to future possible de-

velopments, let us look at the grounded-grid amplifier which is familiar to designers who work at very high frequencies where it is used for the final stages of transmitters in the kilowatt class and in some wideband low-noise-level amplifiers. The audio designers

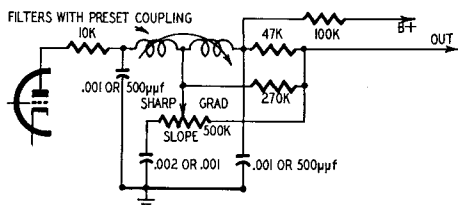

Fig. 1208. Circuit of the basic filter used in the QUAD unit.

have ignored its potentialities, both in America, where they call it grounded grid, and in Britain, where they call it the inverted amplifier. A while ago we began to wonder about using grounded-grid stages in audio amplifiers. Setting their assistant to work, the authors settled down and

“... wrote with a pen in each hand,  
And explained all the while in a popular style  
Which the reader could well understand.”

The experimental work which we completed had been carried out with a 12AT7 double triode. This is not exactly a power tube:

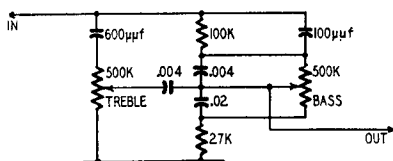

Fig. 1209. The QUAD unit bass and treble control circuits.

with plate supplies of 150 volts and a normal circuit you would not expect to get 100 milliwatts of power from one triode section. However, this happens to be just the sort of power needed for a particular amplifier and offers the opportunity to try out the grounded-grid stage with some feedback circuits which do not seem to be in the books. The interested reader can apply the theory to power amplifiers with the knowledge that he is on fairly new ground.

First of all, what is the grounded-grid amplifier? The basic cir-

circuit is shown in Fig. 1211, where, as you can see, the input is applied between cathode and ground and the output is taken between plate and ground; the grid itself is connected directly to ground. Bias is provided in the usual way by the voltage drop in

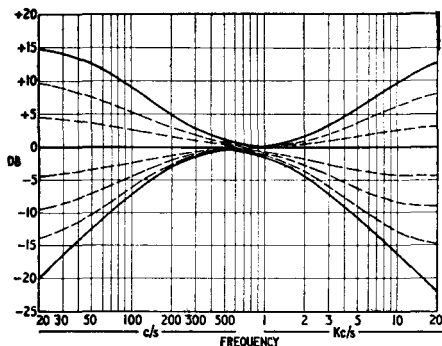

Fig. 1210. Graph of the response curves of the control circuits of Fig. 1209.

the cathode lead, and the input transformer can be dimensioned to provide the necessary secondary resistance. It is instructive to compare the three ordinary ways of connecting a triode amplifier: grounded cathode, grounded grid and grounded plate. These are drawn in Fig. 1212. They are three of the six possible ways of using the triode. The complete set of six connections is shown symbolically in Fig. 1213.

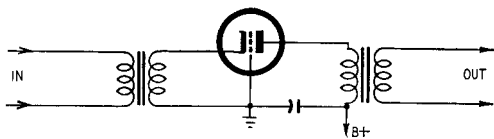

Fig. 1211. The grounded-grid amplifier. This circuit is better known in the u.h.f. spectrum than in audio frequencies.

The three elements of the tube are shown as terminals, with signal being applied and output taken as indicated by the arrows. An inward pointing arrow is input, and one pointing out is output. Thus, at *a* the signal is applied between grid and cathode and the output taken off between plate and cathode, as at *a* in Fig. 1212. Of these, *a*, *b* and *c* are already shown in Fig. 1212; *d* and *e* appear to be quite useless and *f* has been used for measuring high voltages. Negative plate voltages control the grid current with the

grid held positive, the tube having an amplification factor of  $1/\mu$ .

### Circuit features

The particular features of the grounded-grid amplifier, as we shall see, are low input impedance, normal output impedance and the fact that the power which must be applied to the input is

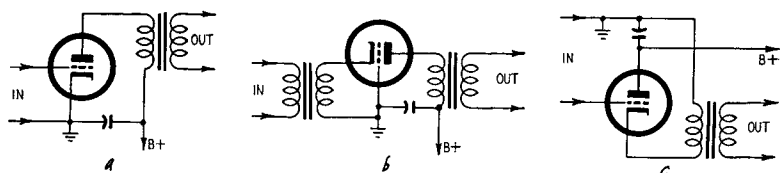
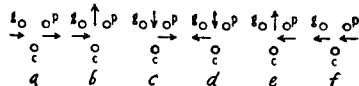

Fig. 1212. The three practical ways in which an amplifier can be hooked up; (a) with cathode grounded, (b) with grid grounded and (c) with plate grounded.

passed through the tube and mostly appears in the load. Let us see how these features are produced. The equivalent circuit is shown in Fig. 1214:  $e$  is the input generator voltage, acting through an impedance  $R_1$ , which includes any cathode resistor;  $\mu$  and  $R_P$  are the usual tube parameters and  $R_2$  is the load resistance.

Fig. 1213. Six ways of hooking up a triode shown symbolically. Setups (d) and (e) are impractical; (f) is used only in special circuits. Fig. 1212 shows (a), (b) and (c).



The current  $i$  through the circuit is given by the equation:

$$i = \frac{e - \mu e_g}{R_1 + R_P + R_2} \quad (100)$$

Now  $e_g$  is the grid-cathode voltage, which is equal to  $iR_1 - e$ . Therefore, by substituting for  $e_g$  in equation (100), we get:

$$i = \frac{e - \mu i R_1 + \mu e}{R_1 + R_P + R_2} \quad (101)$$

Rearranging this form gives

$$e(1 + \mu) = i[(1 + \mu)R_1 + R_P + R_2] \quad (102)$$

The output voltage is, of course,  $iR_2$ , so that the voltage gain is

$$A = \frac{i}{e} \times R_2 = \frac{1 + \mu}{(1 + \mu)R_1 + R_P + R_2} \times R_2 \quad (103)$$

or,

$$A = \frac{i}{e} \times R_2 = \frac{(1 + \mu)R_2}{(1 + \mu)R_1 + R_P + R_2}$$

If you remember the expression for the gain of the ordinary grounded-cathode amplifier as  $A = \mu R_2 / [R_P + R_2 + (\mu + 1) R_1]$ , you will see that, when there is no cathode impedance, the grounded-grid stage gives the same voltage gain for a tube with an amplification factor  $\mu$  as a grounded cathode stage with a tube of amplification factor  $1 + \mu$ . Using a cathode resistor the term  $(1 + \mu)R_1$  appears in both cases.

The input impedance of the grounded-grid stage is quite easy to calculate. It is

$$R_{in} = \frac{e}{i} = R_1 + \frac{R_P + R_2}{1 + \mu} \quad (104)$$

For the grounded cathode stage, as you know, the input impedance is theoretically infinite. This input impedance may be simplified a bit to give an approximate value which is easier to remember. Since we always use triodes in the grounded-grid stages,  $R_2 \cong R_P$ . We have then:

$$R_{in} = R_1 + \frac{2R_P}{1 + \mu} \cong R_1 + 2\frac{R_P}{\mu} \cong R_1 + \frac{2}{g_m} \quad (105)$$

where  $g_m$  is the tube transconductance. For most of the tubes we are using nowadays  $g_m = 2,000\text{--}10,000 \mu\text{mhos}$ , so that  $1/g_m$  may be of the order of 250 ohms and  $R_{in} = R_1 + 500$  ohms. Let us take  $R_1 = 500$  ohms, and we have  $R_{in} = 1,000$  ohms.

For a small tube, a drive of 4 volts may be needed: the resulting power input is 16 milliwatts. This drives a current of 4 ma through the circuit, producing a power output in 10,000 ohms, again a typical value, of 160 milliwatts. If we scale up these figures, you see that a driver stage for a 16-watt grounded-grid amplifier must deliver 1.6 watts: this is quite a contrast with the ordinary power stage which needs only a few milliwatts.

The output impedance is most easily calculated by remembering that if the output is matched it will produce one-half the open-circuit voltage. Since the open-circuit gain, obtained by letting  $R_2 \rightarrow \infty$ , is  $1 + \mu$ , the output impedance equals the value of  $R_2$  for which the gain is:

$$A = \frac{(1 + \mu)R_2}{R_2 + R_P + (1 + \mu)R_1} = \frac{1 + \mu}{2}$$

This gives for the output impedance the not unexpected value  $R_2 = R_P + (1 + \mu)R_1$ . Since the  $(1 + \mu)R_1$  term is of the nature of a negative feedback, the optimum load is, not the matching



load, but the load settled by the tube characteristics and is about  $R_p$ .

Before we go any further, let us summarize the results:

1. Gain:

$$A = \frac{(1 + \mu)R_2}{R_2 + R_p + (1 + \mu)R_1}$$

2. Input impedance:

$$R_{in} = R_1 + \frac{R_p + R_2}{1 + \mu}$$

3. Output impedance:

$$R_{out} = R_p + (1 + \mu)R_1$$

Notice also that the output is in phase with the input: the  $180^\circ$  phase shift of the grounded-cathode stage is not obtained with grounded grid or grounded plate (cathode follower).

## Applications

At this point you may ask why the grounded-grid stage should be used at all: the only important feature seems to be that it needs a lot of power to drive it. The answer is that it is very easy to drive it into grid current because of the low-impedance grid path, and in consequence a triode can be driven over a much bigger plate swing. A 12AT7 may operate linearly up to  $e_g = +3$  volts, instead of being limited to the negative grid voltage region. Just what this means can be seen by looking at the tube characteristics shown in Fig. 1215: the positive grid characteristics were taken on a cathode-ray oscilloscope and are thus not very exact, but in view of the large tolerances which are normal for tube characteristics this is not particularly important.

If we consider the probable working range of the 12AT7 with positive grid drive, we see that, instead of working through the point A (Fig. 1215) with a load of 15,000 ohms, we can work through B with a load of 5,000 ohms. For the first case we get a peak voltage of about 401 and the maximum power will then be  $(40)^2/2 \times 15,000 = 53$  milliwatts. For the second, peak voltage is 50 and maximum power is about  $(50)^2/2 \times 5,000 = 250$  mw. The actual power drawn from the plate supply increases, in this example, from  $120 \text{ v} \times 4 \text{ ma} = 0.48$  watt to  $120 \text{ v} \times 10 \text{ ma} = 1.2$  watt, but the efficiency is doubled. The audio designer who believes in triodes at all costs (and there are still quite a lot of peo-

ple who distrust the pentode and tetrode) thus has a chance of getting more reasonable efficiency from his triodes.

The input impedance is made up of the cathode resistance and a term  $(R_P + R_2)/(1 + \mu)$  which, when the tube is matched, is simply equal to  $2/g_m$ . It is easy to see from Fig. 1215 that  $g_m$  in the working region is about 6,000  $\mu\text{mhos}$ , so that  $2/g_m = 330$  ohms. To obtain an output of 50 volts peak with a gain of  $1 + (\mu/2) = 31/2$  requires a drive of  $50 \div 31/2 = 3.2$  volts. The input power

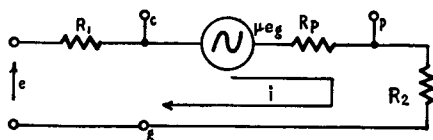

Fig. 1214. The equivalent circuit of the grounded-grid amplifier.

needed to give our theoretical 250 mw is thus, neglecting grid current,  $3.2^2/2 \times 330 = 15.4$  mw. Grid current will amount to about 2-ma extra current to be provided at the peak cathode current, and this will bring the input power needed by the grounded-grid stage appreciably above the maximum power we can get from a conventional grounded-cathode circuit.

In practice we have found the limitations of the driver result in a maximum output power of about 200 milliwatts. The power gain obtained from a complete 12AT7, with transformers designed for the same input and output impedance and covering the usual audio band, is about 50 db.

## Positive feedback

Since the first half of a 12AT7 will not give enough power to drive the second half fully, we are in rather a spot. The solution is to make the second half, the grounded-grid stage, help drive itself. This we can do by means of our old friend positive feedback. What happens if we apply feedback to the grid of a grounded-grid stage? You will not, we think, find the answer in the textbooks, and so you must bear with just a little more mathematics. We go to our first equation,  $e - \mu e_g = i(R_1 + R_P + R_2)$ , and now we say that to  $e_g$  we will add a fraction of the plate voltage  $\beta i R_2$  so that:

$$e_g = iR_1 - e + \beta i R_2 \quad (106)$$

Substituting this in the original formula (equation 100), we now have:

$$e(1 + \mu) = i[(1 + \mu)R_1 + R_P + (1 + \mu\beta)R_2] \quad (107)$$

From this we can see the following relationships;

1. Voltage amplification:

$$A' = \frac{i}{e} R_2 = \frac{(1 + \mu)R_2}{(1 + \mu)R_1 + R_P + (1 + \mu\beta)R_2} \quad (108)$$

2. Input impedance:

$$R_{in} = \frac{e}{i} = R_1 + \frac{R_P}{1 + \mu} + \frac{1 + \mu\beta}{1 + \mu} R_2 \quad (109)$$

3. Output impedance:

$$R_{out} = \frac{(1 + \mu)R_1 + R_P}{1 + \mu\beta} \quad (110)$$

The amount of feedback is defined by the factor  $\beta$ . If  $\beta$  is positive, the feedback is negative, while a negative value of  $\beta$  cor-

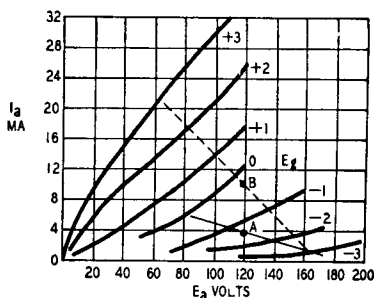

Fig. 1215. This graph shows how the grounded-grid circuit can be run into the positive grid region.

responds to positive feedback. For use in our amplifier the choice of  $\beta = -1/\mu$  is of special interest. This value of positive feedback gives

$$A' = \frac{(1 + \mu)R_2}{(1 + \mu)R_1 + R_P} \quad (111)$$

where the input impedance =  $R_1 + (R_P/1 + \mu)$ , and output impedance =  $\infty$  (infinity).

If we leave out the cathode resistor  $R_1$  we see that the voltage gain is doubled by using this amount of positive feedback and taking a load resistance  $R_2$  equal to  $R_P$ . At the same time the input impedance is reduced to  $1/g_m$  instead of  $2/g_m$ . Consequently we

need only one-half of the previous driving power. This brings us very nicely into the range of the grounded-cathode driver stage. The way is thus cleared for the design of a simple audio amplifier. The circuit diagram appears in Fig. 1216.

The output transformer T3 has three windings: the main windings are designed to suit the load, which we shall take to be a 500-ohm line for design purposes. The optimum plate load is 5,000

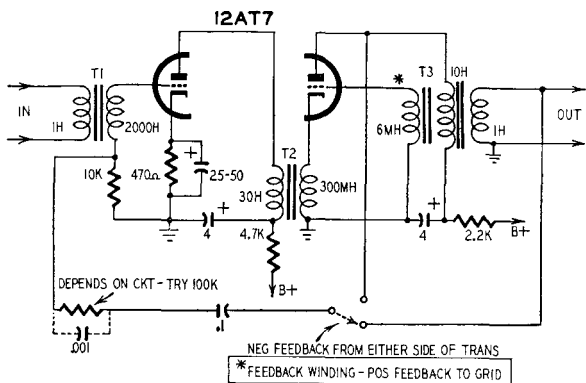

Fig. 1216. A practical grounded-grid amplifier circuit, with both positive and negative feedback. Special transformers are required in the circuit.

ohms, from Fig. 1215, so that the turns ratio will be  $\sqrt{5,000/500} = 3.16:1$ . The stepdown from the plate winding to the grid is to be  $1/\mu$ , which is 40:1. If we want the amplifier to have a response extending below 100 cycles, we can take a line inductance of 1 henry, which would give a 3-db drop at 80 cycles. The other inductances are then 10 henries for the plate winding and  $10/(40)^2 = 6$  mh for the grid winding. This last winding must have low resistance, so as not to cause a voltage drop when grid current flows, but there will not be much trouble with such a low inductance. The interstage transformer must match the ordinary class-A stage to the cathode circuit, and must therefore have a ratio of  $\sqrt{15,000/160}$  or about 10:1.

Including an interstage transformer makes it fairly straightforward to add negative feedback either from the output plate itself or from the line side of the output transformer. There are difficulties in practice, of course, especially if you want to take the feedback from the line winding, because then there are two transformers in the loop, and the resulting 24 db/octave slope of the

total ultimate cutoff means you must stagger the cutoffs rather well. If the feedback is taken from the plate, the shunt capacitor shown in Fig. 1216 will help supply the needed stability.

The outline of the simple 12AT7 amplifier will, we hope, help you to design something more powerful. The sort of amplifier most readers will find interesting is probably a booster unit to tack on behind an existing power amplifier. This is how the radio-

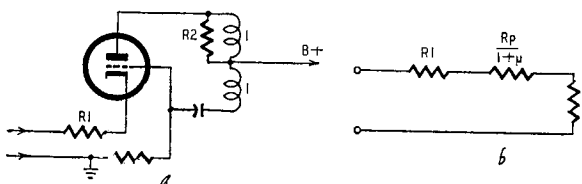

Fig. 1217. The negative-resistance circuit (a) and its equivalent form (b).

frequency designers use the grounded grid: They take a 300-watt transmitter and add a 1-kw stage, and then a 3-kw stage, and so on. If you have a 3-watt audio amplifier, you can use this as a driver for a 10-watt grounded-grid stage: the low impedance output of your present 3-watt amplifier will probably give enough volts to drive the grounded grid input, and it is easy to check this in the tube characteristics.

## Negative resistance

We bypassed this aspect of grounded-grid use temporarily, in order to have space to look at some other consequences of the equations. As we saw earlier, with positive feedback of  $\beta = -1/\mu$  the output impedance is infinite. The general equation for the input impedance (equation 109), reduces, if  $R_1 = 0$  and  $R_2 = R_P$ , to:

$$R_{in} = \frac{2 + \mu\beta}{1 + \mu} R_2 \quad (112)$$

By taking  $\beta = -2/\mu$  we make the input impedance zero. At the same time the gain becomes infinite. This is therefore another important value of positive feedback: any more feedback will make the input impedance negative.

A further interesting value of  $\beta$  is  $\beta = -1$ . This makes the input impedance:

$$R_{in} = R_1 + \frac{R_P}{1 + \mu} + \frac{1 - \mu}{1 + \mu} R_2 \quad (113)$$

Since  $\mu$  is usually fairly large — for the 12AT7 it is about 40–60 — consequently  $(1 - \mu)/(1 + \mu) \cong -1$  and the input impedance is:

$$R_{in} = R_1 + \frac{R_P}{1 + \mu} - R_2$$

As  $R_2$  is about the same order as  $R_P$ , the term  $R_P/1 + \mu$  does not have much effect on the negative impedance. It is not very difficult

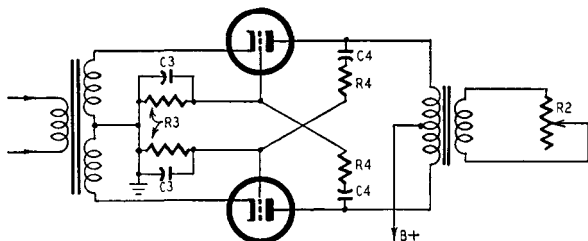

Fig. 1218. This push-pull negative-resistance circuit can be used as an oscillator or a high-gain amplifier.

to show that if  $\mu$  changes by 10%, the term  $(1 - \mu)/(1 + \mu)$  changes by 2/1600 of 10%. The circuit thus provides a very stable sort of negative resistance. Before explaining how to use this, we shall show how we actually obtain it. The essence of the circuit is shown in Fig. 1217-a, in which a 1:1 transformer (a center-tapped choke) provides the phase reversal to make  $\beta = -1$ . The R-C circuit in the grid is just to keep the plate-supply voltage away from the grid. The equivalent circuit is shown in Fig. 1217-b. Nowadays we usually seem to get two small triodes in every bottle, so we can elaborate Fig. 1217 into Fig. 1218, a push-pull version of the same circuit. For audio work, we can have  $R_4 = 10,000$  ohms and  $R_3 = 1$  megohm.  $C_4$  is chosen to produce a cutoff in the region of 200 cycles, say .001  $\mu\text{f}$ , while  $C_3$  provides a top cutoff, which may be at 5 kc, and then  $C_3$  will be .003  $\mu\text{f}$ . At frequencies in the middle of the band, when  $C_4$  can be taken as a short circuit and  $C_3$  as an open circuit,  $\beta = -0.99$ . The input impedance then has a value of  $2R_P/(1 + \mu) - (R_2/n^2)$ .

Without going into too many details, it is sufficient to say that the value of  $n$  is chosen in the same way as if the transformer was to work into a resistance of  $R_2$ , and  $R_2$  should be about 10,000–15,000 ohms for a 12AT7 tube.

What is the object of producing this negative resistance? There are three sorts of job for which negative resistance is useful. It can be used with a tank circuit to provide an oscillator; in a filter to

improve the  $Q$  of a coil or in a special type of amplifier circuit. This last reference is the application for which the circuit of Fig. 1218 is of special value. Consider the very simple circuit of Fig. 1219. A generator of impedance  $R_0$  is connected to a load  $R_0$  through a negative resistance  $-R$ . The current is;

$$i = \frac{e}{2R_0(-R)}$$

and the voltage across the load will be:

$$e_0 = \frac{eR_0}{2R_0(-R)}$$

The voltage without  $-R$  in the circuit would be  $e/2$ , so that the negative resistance produces a gain of  $2R_0/2R_0(-R)$ . This can

Fig. 1219. The equivalent diagram for the derivation of the negative-resistance circuit used in a special type of amplifier circuit (see text).

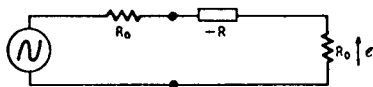

be rearranged as  $1/(1-R_0/2R_0)$ . Suppose we adjust  $R_2$  in Fig. 1218 to make  $R = 3/2R_0$ . The gain will then be 4 times or 12 db.

Fig. 1219 is completely symmetrical and, if the voltage  $e$  acted in series with the  $R_0$  on the right, there would be a gain of 12 db in transmitting from right to left. A negative resistance amplifier can thus be inserted in a line to give a gain in both directions.

An amplifier of this kind<sup>3</sup> is an ideal form of amplifier to add to an intercommunication system when a gain of about 6–12 db will make all the difference between comfort and strain to the user.

Finally, there is a much used device that requires some particular attention. The following discussion will aid the reader in obtaining a better basic understanding of its practical theory.

## The cathode follower

The well-known cathode follower is a very useful but frequently misunderstood circuit. The most common misconception concerns its use to produce a low output impedance. It is true the follower circuit *does* produce a low output impedance, but the kind of misunderstanding referred to can be seen in a recent case where the circuit was used as a buffer stage to isolate an oscillator tube. The essential requirements were high stability and good wave-

<sup>3</sup> *Bell System Technical Journal*; Merrill, Vol. XXX; January 1951, p. 88.

form. The circuit designer assured us that the follower would feed satisfactorily into a 600-ohm line. We had our doubts, which proved well founded.

To avoid getting involved in formulas at this stage, let us instead take a diagram of a cathode follower and put some figures in. A cathode follower is essentially a tube in which the *plate* load is connected between cathode and ground instead of its usual place between plate and B plus. This is shown in Fig. 1220.

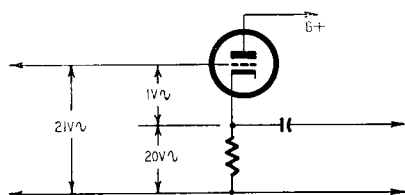

Fig. 1220. Arrangement of the basic cathode follower circuit.

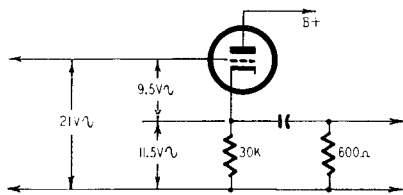

Fig. 1221. Adding a 600-ohm load to the circuit of Fig. 1220.

We can start by assuming that the signal voltage from grid to cathode is, say, 1 volt. This is the tube's viewpoint. It can have no way of knowing what the voltage is from grid to ground, although *we* may prefer that starting point, and it will control the plate-cathode voltage and current. Suppose, that with the plate load chosen (connected in the cathode), the tube has a gain of 20. There will be a signal voltage of 20 across the plate load resistor, in this case from cathode to ground. We find the grid to ground signal voltage by adding these two, giving 21 volts. Not sure of the phase? Well, a positive swing of grid-cathode voltage increases plate current, increasing the drop across the load to produce a positive swing at the cathode. So the two are additive.

Thus, 21 volts input, from grid to ground, will give an output, from cathode to ground, of 20 volts.

What happens when we connect a 600-ohm load (Fig. 1221)? Let's take the figuring further. Suppose the tube has an amplification factor of 30, a plate resistance of 15,000, and the cathode load resistor is 30,000 ohms. This works out to give a gain of 20 without feedback. To complete the tube values, its transconductance would be 2,000  $\mu$ mhos. From the tube's viewpoint, for signal voltages, its load is effectively 30,000 ohms placed in parallel with 600 ohms, which is not much less than 600-ohms. The gain of this tube with a 600-ohm load will be  $30 \times 600/15,000 = 1.2$ .

If the input is still 21 volts, this voltage will divide so that the



voltage across the cathode load (11.5) is 1.2 times the voltage from grid to cathode (9.5). Connection of the 600-ohm load has dropped the output voltage from 20 to 11.5.

This drop can be regarded as due to the effective source impedance of the cathode follower. As the drop is  $20 - 11.5 = 8.5$  volts, the effective source impedance ( $Z_s$ ), calculated by ratio with the load impedance is  $600 \times 8.5/11.5 = 440$  ohms.

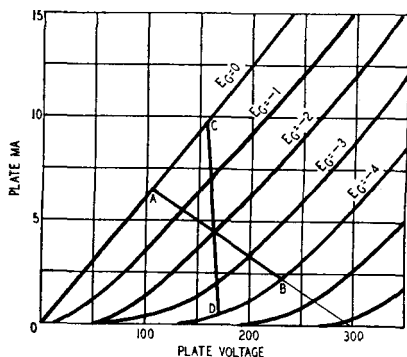

Fig. 1222. Graph showing the load lines for the cathode-follower circuit.

The accurate value of the cathode-follower impedance could be calculated directly from the formula:

$$Z = \frac{R_P R_L}{\mu R_L + R_P + R_L} \quad (114)$$

Take a look at what has happened to the grid voltage. Before the 600-ohm resistor was connected, the grid to cathode signal voltage was only 1; when the 600-ohm resistor is connected, this signal voltage rises to 9.5. Think a moment and you will realize what the arithmetic failed to tell us. Do you know of a tube with 15,000-ohm plate resistance, 2,000-micromho transconductance, that will handle 9.5 volts signal on its grid, requiring a grid bias of at least 25 volts? But one to handle 1 volt would be feasible, wouldn't it? So adding the 600-ohm resistor would obviously produce distortion.

At this stage, many people will come up with the argument: "But what about the feedback? Won't that take care of the distortion?" To which we can imagine our poor little overworked tube squeaking up: "*What feedback?*" Look again. When the tube works into the changed plate load of 600 ohms, its gain is knocked

down to 1.2. Before the load was connected, the tube gain was 20, reduced by feedback to 0.95, a reduction of a little over 26 db. With the load connected the gain is 1.2, reduced by feedback to 0.575, a reduction of a little over 6 db. A mere 6 db will not do much toward cleaning up a waveform produced by giving an input of 9.5 volts to a tube intended to accept not much more than 1 volt!

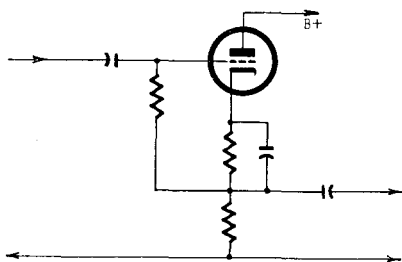

*Fig. 1223. Circuit arrangement of a practical cathode follower.*

All right, someone says, but all you're pointing out is that using a low load on a cathode follower restricts the signal it can handle. Keep within a smaller signal and the cathode follower will still produce lower distortion than other circuits, won't it? To satisfy you, let's go into this a bit further.

Suppose we do turn the input down from 21 volts grid-to-ground to about 2 or 3 volts, so as to keep within the grid-handling capability of the tube. Take a look at the tube characteristics shown at Fig. 1222. The load line AB represents a plate load resistance of 30,000 ohms. Assuming the circuit in Fig. 1223 provides a bias of 2 volts, the load line CD represents the result of connecting 600 ohms in parallel by a.c. coupling through the capacitor. Notice that the line AB crosses the curves representing successive grid voltages at uniform intervals, while CD cuts at an angle so the spacings taper off noticeably at the bottom end, while the top end extends into high plate current. This means serious distortion, even before full grid swing is reached, and with only 6-db feedback the distortion left will be much more than is expected of a respectable amplifier.

Otherwise expressed, the feedback has been "used up" to provide impedance matching and not enough remains to take care of distortion or for other purposes.

It is surprising how resentful people can get when they think

an old favorite is being attacked. So some, to whom the cathode follower has seemed to be a valiant knight slaying all the electronic bugs, take a fighting stand. When triodes aren't "good enough" in other circuits we turn to better tubes, such as pentodes. They have been used successfully as cathode followers, the circuit of Fig. 1224, being typical. Doesn't this arrangement enable low distortion to be obtained into a low load value, since pentodes "like" working into low impedances better than triodes?

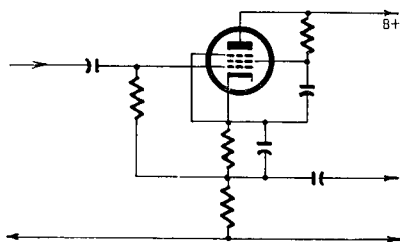

Fig. 1224. The cathode-follower circuit of Fig. 1223, redrawn to show pentode tube operation.

It's not as easy as that. Continuing with the example figures used: With a triode, reduction of the plate load from 30,000 to 600 ohms—a ratio of 50:1—only reduced the gain from 20 to 1.2 because of the triode's relatively low plate resistance. Because of the very high plate resistance of a pentode, the corresponding reduction would be almost in the same ratio as the change in plate load resistance. Even if the pentode had a high gain to start with, loading it down with 600 ohms would reduce the gain as with the triode, so again the effect of feedback in cleaning up waveform would be negligible. In the end, the pentode does no better under these conditions than the same tube used as a triode.

Now don't start throwing out cathode followers. Let's get things really straight by recounting what they *can* do.

1. It is true that they reduce output *source* impedance. Their limitation is that this feature must not be imposed upon by assuming that we can go ahead and use a load impedance much lower than the regular load impedance for the tube used. If we try that, we run into trouble.
2. Another good use for cathode followers is to obtain a very high input impedance. This they also do very well, *provided the plate load (connected in the cathode) is kept high enough to preserve the normal gain of the tube.*

Now let's look around to see how all this affects the circuits commonly used. Probably the most frequent everyday application of the cathode follower is in the output of preamplifiers to provide a low source impedance suitable for line-impedance connection between the preamplifier and the main amplifier. Before throwing that poorly operating preamplifier out, check what the main amplifier input impedance does to it. If it has a line-to-grid transformer, the cathode follower is undoubtedly being loaded down too much, and distortion occurs. If the main amplifier is arranged for input direct to grid, the cathode follower will be quite happy, and its low impedance will give the advantage of line impedance coupling between amplifiers, i.e. freedom from loss of "highs" and from "static" pickup.

Summarizing the foregoing further, the right answer works out this way: If the main amplifier uses transformer input, either for phase splitting or to save gain or both, then the preamplifier output should be properly matched down through a transformer, whether plate *or* cathode coupled. On the other hand, if the input end of the amplifier is all resistance-loaded, with nice high-value resistors, the cathode follower direct is O.K. in the preamplifier output.

So take another look at these circuits: you may rid yourself of an unsuspected source of distortion.

# high-power amplifiers

**F**eeding a number of speakers from a single amplifier has caused the public-address man many a headache. It can also be quite a problem to the hi-fi man who plans a distribution system for his audio. It's not always easy even when all the units have the same impedance and require equal proportions of the total power, though the problem is then theoretically simple. When the problem includes units of different impedances requiring different proportions of the power, it can become a real headache.

The *constant-voltage* system of distribution eases the situation considerably, and generally does a much better job than the older methods. Such systems have become very common in Europe and are fast gaining ground in America. They are usually designated by the nominal voltage used. The American standard is a *70-volt line*; the European, a *100-volt line*.

The constant-voltage system has one apparent disadvantage—a separate output transformer is required for each speaker. However, this disadvantage is more apparent than real. True, when an amplifier is working only one speaker, located close to it, there is no point in using more than one transformer for matching the output to the speaker. Doing the matching in two steps adds to the cost by one transformer, and also adds slightly to the audio losses. **But when the amplifier is feeding a number of speakers, matching problems may well make separate transformers worth while.**

Voice-coil impedances range from 2 to about 16 ohms. (Some-

times values outside this range are met, but they are not common.) Let us take 12 ohms for some examples because it makes calculating easier. Suppose eight such speakers are connected, all to receive the same power. The arrangements shown in Fig. 1301 give over-all impedances of 1.5, 6, 24 and 96 ohms. It is probable that even a multi-ratio output transformer will not provide most of these matchings, so some other arrangement must be figured

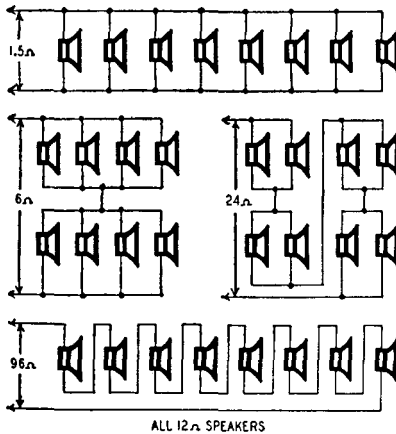

Fig. 1301. Four ways of connecting 12-ohm speakers to receive equal power.

out, including one or more resistors as “dummies” to pad out the values. The number of speakers in an actual installation may not be so convenient for series-parallel connection as our example of eight.

Suppose next that all speakers still have the same coil impedance, but it is desired to feed them at different levels. Fig. 1302 shows two arrangements. Both give LS1 four times the power received by LS2 or LS3. These arrangements are fairly simple, but the evolution of a suitable circuit for larger numbers becomes difficult.

The constant-voltage line simplifies all these problems, makes a far more versatile system and is well worth the extra cost of a transformer for each speaker. There is another advantage. It is always best to operate dynamic type speakers in parallel, otherwise electrical damping is lost and peculiar effects due to interaction between speaker impedances are noticed. In constant-voltage operation, all units are always parallel-connected, even when the power delivered to different units is varied. If numbers of speakers are

operated in parallel by direct connection, the resulting impedance is so low that much of the output power is lost in connecting lines unless very large cable is used. In the constant-voltage system, impedances can be kept up to a reasonable figure.

A nominal line voltage is chosen, usually 70 or 100. This forms the basis of all the calculations. This does not mean that there is *always* a signal of 70 or 100 volts, because it naturally fluctuates as audio signals always do. The stated voltage represents a nominal

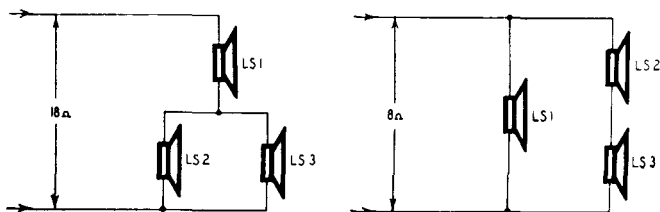

Fig. 1302. These hookups give four times as much power to LS1 as they do to LS2 or LS3.

*maximum output level.* Perhaps the easiest way to get the idea is to think in terms of a sine-wave signal, fully loading the amplifier. The amplifier then can be regarded as providing a constant voltage for all the speakers connected to the line, just as an electric line does for all the appliances connected to it. The generator at the power station has a certain maximum load capacity, and consumers' loads may be connected until that capacity is reached, the power taken by each depending on its load impedance and the line voltage. We are quite used to referring to electric lamps and other appliances as "110-volt 40-watt," but the same method of rating speakers may seem strange at first.

Each speaker is fitted with a transformer to match its voice-coil impedance up to an impedance which accepts the desired wattage when the nominal voltage is applied. Some speakers may be fitted with multi-ratio transformers so their power rating can be adjusted. This makes an installation very versatile and avoids the loss of power caused when an individual volume control is used on each speaker. You simply vary the number of watts accepted by the speaker. Different voice-coil impedances are also taken care of by the speaker-matching transformer.

Fig. 1303 illustrates an ideal calculation. LS1 and LS2 each have an impedance of 5,000 ohms, so they will accept 2 watts each at 100 volts. (Use Ohm's law or the chart of Fig. 1304.) LS3 has a voice-coil impedance of 2 ohms, and uses a transformer of ratio 70

to 1. From the chart of Fig. 1305, this gives an impedance of almost 10,000 ohms, which from the other chart rates at 1 watt for 100 volts. The total wattage load is  $2 + 2 + 1 = 5$ . Using the chart again, this corresponds to an impedance of 2,000 ohms (still for 100 volts). So an amplifier to supply just this load would need to supply 5 watts matched into 2,000 ohms.

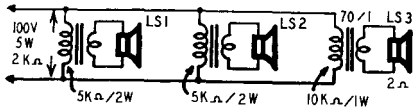

Fig. 1303. A constant voltage line, with the speakers receiving unequal power. The amplifier unit would have to supply 5 watts matched to 2000 ohms for this load (see text).

A large amplifier may be used to supply a load smaller than its own output. For example, suppose a 60-watt amplifier is used to feed the foregoing case requiring only 5 watts. The nominal voltage is used to calculate both LS and amplifier output impedances. A 60-watt output for 100-volt operation should be matched into 170 ohms. The load actually connected is 2,000 ohms. Some amplifiers working into a light load like this will be unstable. To prevent this, a resistance load may be added to absorb the surplus power. In the example suggested, a resistance load to absorb 50 watts would be adequate, and from the chart the value required is 200 ohms. If the amplifier were to be operated continuously at maximum output, this resistor should have a dissipation rating of 50 watts, but in practice a much smaller (10- or 20-watt) resistor could be used.

Sometimes the reverse of the previous problem arises. The nominal load connected *exceeds* the power output of the amplifier. Here matters are adjusted by a different method. Suppose the load is made up of a number of speakers rated at 2 and 5 watts for 100-volt line, adding up to a total load of 80 watts. The load impedance of 80 watts' worth of speakers will be 125 ohms. The load for a 20-watt amplifier, 100-volt working, would be 500 ohms. Applying a 125-ohm load to the output of an amplifier designed for 500 ohms would probably cut the output down to about 5 watts, and as well likely cause distortion. So the output must be matched to the actual speaker load of 125 ohms, which, according to the chart of Fig. 1304, will give 20 watts at 50 volts, instead of the original basis of calculation, 100 volts. This means the nominal 2-watt speakers, of 5,000 ohms impedance, will get  $1\frac{1}{2}$  watt, and the nominal 5-watt speakers, of 2,000 ohms impedance, will get  $1\frac{1}{4}$  watts. Note that this is a reduction of only 6 db, so quite a useful volume



will be available, although the amplifier is smaller than one planned for 100 volts. Anyway, if the 4-to-1 mismatch were used, giving only 5 watts or so, there would be loss of another 6 db and probably considerable distortion.

Use of the constant-voltage system does not necessarily mean special speaker transformers must be used, so a word about picking suitable transformers from stock lines is needed. Makers of speaker

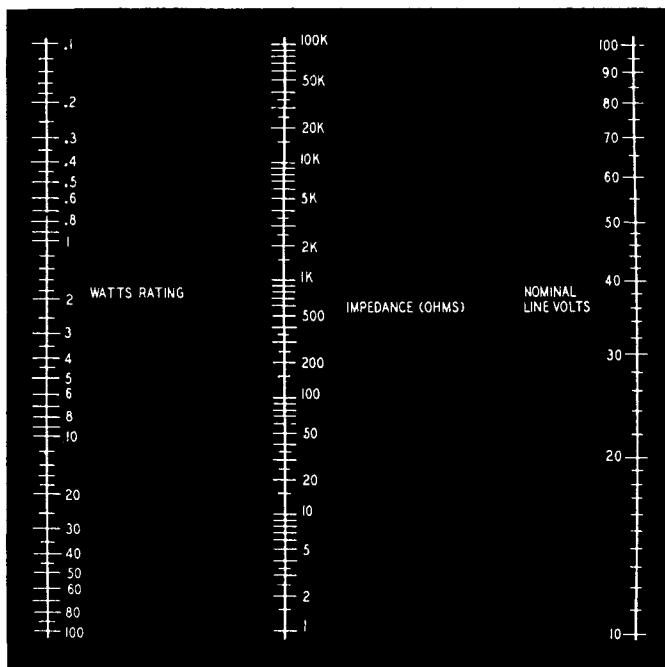

Fig. 1304. A constant-voltage chart showing the relationship of impedance vs. voltage.

transformers mark them variously in turns or impedance ratio. In the former case the chart of Fig. 1305 enables the correct *turns ratio* to be found, but the *actual turns* on each winding must suit the job too. A mike-to-line transformer for a ribbon microphone may have the same ratio of turns as a speaker transformer, but this does not mean that either would do the other's job successfully. A good rule for checking the suitability of speaker transformers with an ordinary ohmmeter is that the winding resistance should be between 2% and 20% of the impedance for which it is to be used. Less than 2% means its inductance will most likely be

inadequate, and 20% or more means the windings will absorb an appreciable portion of the available audio power. If the resistance of the voice-coil winding is too low to register on the ohmmeter scale, the resistance of the high side should be compared with its working impedance. Thus, for example, a winding intended to work at 5,000 ohms should have a resistance that lies somewhere between 100 and 1,000 ohms.

Where transformers are specified by impedance ratio—for example, 7,000 ohms to 3.5 ohms—the maker has stated the *best* impedance at which to work the transformer. Using these impedances, it may be expected to be well over 90% efficient and have a good response at low frequencies. But these are not the only impedances at which the transformer can work. The important thing, of course, is that the *ratio* of impedances hold true, so the same transformer could be used for 4,000 to 2, 10,000 to 5 ohms, etc. As stated in the previous paragraph, the losses and response must be kept within bounds. If impedances more than two or three times the rated values are used, the transformer's inductance may prove inadequate. If it is used with impedances less than one-third to one-half the rated values it will become quite inefficient.

A few years ago we built an amplifier with 50 watts output. Using a special multi-ratio output transformer of personal design provided matching for load impedances of 8, 12.5, 20, 32, 50, 80, 125 and 200 ohms. It can feed a few high-power units direct, using appropriate matching, but more often it is used for 100-volt line distribution, feeding various numbers of speakers. Up to 50 watts nominal loading, the 200-ohm matching is used. If a greater load has to be fed, a lower impedance matching is selected. The outfit is extremely compact, and on various big sound reinforcement jobs where it has been used, many engineers have been amazed that so small an amplifier, with only 50 watts output, can provide such large coverage. The secret lies in making the best use of the watts available. This is just what correct use of the constant-voltage technique enables the public-address man to do.

It is only a matter of a little arithmetic to expand power distribution systems, once the basic principles are grasped. When other multiple connections are to be made, more complicated problems arise.

## **Hookup problems**

Occasions frequently arise where the audio man has to feed two

or more independent sound systems from the same program source. Electrical hookup between separate systems is often fraught with difficulties. The most common solution is to run out a separate microphone for each system to be tied in, resulting in the veritable battery of microphones often seen when a celebrity speaks on an important occasion. This method has serious disadvantages, the greatest of which is the variation of level, whenever the speaker moves or turns his head, on some of the systems whose microphones are not so well placed as others.

The best approach to the problem would be to use only one high-quality microphone (with an extra one as a standby) to supply all the systems. This would simplify program pickup as well as monitoring problems on each of the systems hooked together. There would still be problems, but they need not be insurmountable once they are understood.

The chief problems may be listed under four headings:

1. When two systems are coupled together, a severe line hum often develops in one or both that was not present in either before the connection was made.
2. It may be difficult to provide the right impedance match between the two systems without affecting the volume level in one or both.
3. Where several systems are fed from a common source there may be interaction between controls on the different systems. One operator altering his volume or tone-control settings may affect the volume and quality of the signals delivered to other parts of the hookup.
4. One or more systems in the hookup . . . recording units for example . . . may not require the entire program; and may adopt different methods of cutting in and out of the network. Precautions must be taken to see that any such circuit modifications in one part of the system do not interfere with the rest of the hookup.

### **500-ohm bus system**

By far the most versatile method is to set up a 500- or 600-ohm balanced line that serves as a basic interconnecting bus. The best arrangement is to have a microphone amplifier that will deliver an output level of about 1 volt into a balanced 600-ohm line (0 VU), but this is by no means essential. Any good amplifier with the necessary microphone-control facilities can generally be made

to serve this purpose by padding the output to 500 ohms.

With this system not only can a program from a single source be fed into a number of systems, but also various program sources can be brought into the hookup by using separate local amplifiers to feed into the 500-ohm bus at the desired points. Much of the hum trouble can be eliminated by careful attention to impedance and level matching. However, an important cause of hum that cannot be taken care of in this way is that due to differences in potential between the ground connections of the individual systems.

## **Ground potentials**

In the interests of public safety, all power circuits are connected to ground somewhere, and a ground connection also is provided on some power-supply outlets as a safety precaution. The association between the ground connections of the various supply circuits in the building sets up small currents at the line frequency in the grounded framework. These currents in turn set up slight potential differences, usually only a small fraction of a volt, but even such a minute potential can create a serious hum if it gets into any high-gain amplifier. This often happens when two systems are coupled together, so the solution rests in careful selection of ground-connection points.

While on this subject, it is well to mention that a good-quality power amplifier should operate well *with* or *without* a ground connection, and the effect of breaking or making this connection should be almost inaudible—even with the volume turned to maximum and the ear close to the loudspeaker. If an amplifier does not satisfy these requirements, it is wiser to leave it out of any hookup system and look for a better one. If no better amplifier is available, then careful treatment may produce passable results, as we will later explain.

## **Getting on the bus**

Assume that we have a microphone amplifier delivering an output of 1 volt into a 500-ohm balanced line, and we are going to feed a number of sound systems from this line. Most amplifiers designed for PA use are provided with separate microphone and phono inputs. The microphone input is generally the best one to match the 500-ohm line to, because it will have adequate reserve

of gain, whereas the phono input may not. Microphone inputs are usually low-impedance, between 10 and 50 ohms in which some are balanced to ground; some may be floating and some may have one side connected to chassis.

Fig. 1306 shows the simplest method of connecting the line to a balanced microphone input. For a single-ended input it may be possible to unhook the ground connection inside the amplifier,

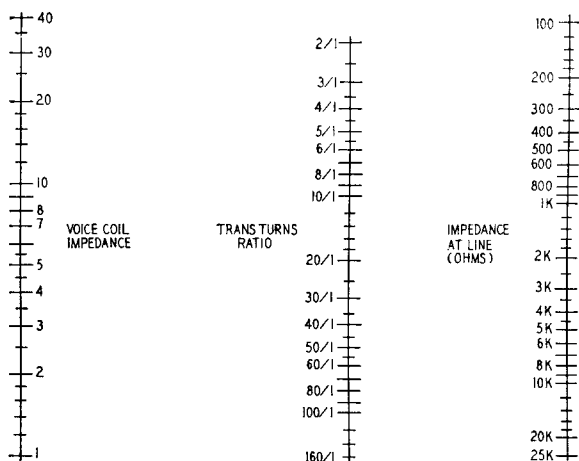

Fig. 1305. A chart for obtaining the line impedance from the turns ratio.

but this may give rise to trouble because the ground connection is probably included to maintain stability in the amplifier. If this is removed, and the input circuit is grounded only at some remote point, hum trouble will probably appear.

Fig. 1307 shows one method of connection where one side of the amplifier input is grounded. This may give trouble for two reasons: The unbalanced line is likely to pick up hum or crosstalk from telephone lines or other speech circuits that may run near it, and the small potential difference between the two ground connections may inject a line-frequency hum.

Fig. 1308 shows an alternative method of connection that avoids strapping the two ground connections together as in Fig. 1307, and also provides a balanced connecting line. One of these two methods of connection should prove satisfactory. When going into low-level low-impedance inputs, the resistor values should be adjusted so the resistance from both lines to ground is equal at the distributing center. If this is checked by d.c.-resistance measure-

ment, all amplifier inputs and outputs should be disconnected, or the winding resistance of their input and output transformers will invalidate the result.

Most high-impedance phono or crystal-microphone inputs are *unbalanced*. Fig. 1309 shows the simpler method of connection here corresponding to Fig. 1307 for low impedance, while Fig.

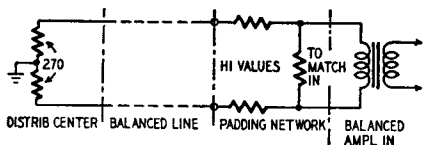

Fig. 1306. Method of connecting a balanced-input amplifier to a balanced 500-ohm line. Series resistors in the padding network reduce loading and allow several amplifiers to be fed from one line.

1310 shows the method to adopt where a balanced line is necessary.

## Line impedance

An important feature to realize about these circuits is that the impedance of the connecting lines must be in the vicinity of 500 ohms. This is achieved in each of the circuits shown by inserting padding resistors at the receiving end of the line. Two factors feature in the reason for this precaution: (a) transmission losses; (b) pickup of hum or crosstalk.

Lines run at low impedance—that is, by putting the resistor networks at the output end of the line as in Figs. 1306, 1307 and

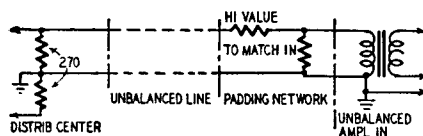

Fig. 1307. Method of feeding on unbalanced-input amplifier from a balanced line. Potential differences between the two grounds may introduce hum at the power frequency.

1308—introduce line loss due to the fact that the line-conductor resistance may be an appreciable fraction of the operating impedance. Such low-impedance circuits are also more susceptible to inductive pickup from magnetic hum fields through which the line may pass. The currents induced in the line will be of the same magnitude whether the line is 500 ohms or low impedance, but in the case of the 500-ohm line they will be attenuated by the padding network at the receiving end.

Lines run at high impedance—that is, by placing the padding resistors of Figs. 1309 and 1310 at the opposite end of the line—cause excessive loss of high frequencies due to line capacitance. The line is also prone to pick up noise from electrostatic fields. Of the two extremes a low-impedance line is preferable because the

inductive components it picks up predominate at very low audio frequencies, which may not get through the average PA amplifier-speaker combination, while the static pickup in a high-impedance line contains high-frequency components with a greater annoyance potential. Loss of high-frequency signal components in the high-impedance line interferes with program quality.

Physically a balanced 500-ohm line is generally made up of a twisted pair run inside flexible shielding. High-impedance lines

Fig. 1308. One method of reducing hum is by the insertion of an isolating resistance between the two ground points. This arrangement also provides a balanced connecting line.

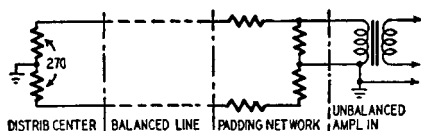

are usually single-conductor shielded wire, coaxial line or an unshielded twisted pair with one of the conductors grounded.

Besides providing good program quality with freedom from spurious pickup, the correct padding network, properly placed, will usually take care of problems 3 and 4 listed at the beginning. The values of the padding network should be chosen so that whatever happens at the outlet end will not materially affect signal voltages at the input end.

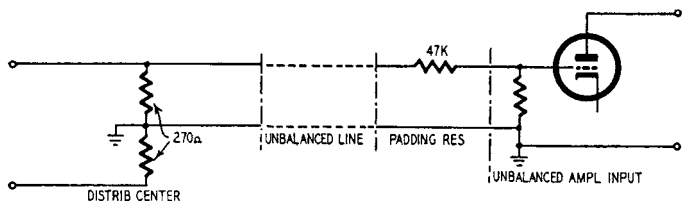

Fig. 1309. A simple method of feeding an unbalanced high-impedance input from a low-impedance unbalanced audio line.

For example, phone plugs and jacks are sometimes used as input connections to an amplifier. When a plug of this type is inserted into its jack, the line connected to the plug is shorted momentarily. If the main 500-ohm line is connected to the plug, then insertion or removal of the plug would momentarily short-circuit the whole program. Inserting a padding network between the line and the plug avoids this. In some tape recorders inserting the input plug disconnects the playback head, so that if an operator wishes to listen to a section of recording on his tape he has to remove the

input plug. Unless the foregoing precaution is observed this operation could involve interference with the program.

Another wise precaution is to see that all padding resistors are soldered securely to the lines (once the values have been satisfactorily determined by experiment) and are suitably covered with

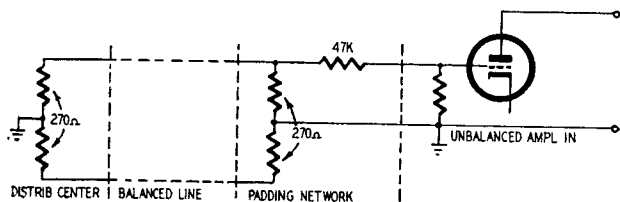

Fig. 1310. The method for connecting a balanced low-impedance line to a high-impedance single-ended amplifier input. If additional units are fed from the same line, the value of the shunt resistors in the padding network should be increased.

insulating tape or otherwise protected against any possibility of accidental short circuit or contact that might interfere with the program in any way.

## Improving outputs

The foregoing assumes that a suitable microphone amplifier with a balanced 500-ohm output is the signal source for the entire network. If such an amplifier is not available, additional padding will be necessary to match the output of the microphone amplifier to the 500-ohm bus. If the amplifier has the usual low-impedance

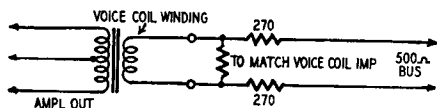

Fig. 1311. Padding out a low-impedance output winding to feed a 500-ohm line. The 270-ohm resistors should be connected in series with each end as shown (see text).

voice-coil output, a dummy load equal to the proper voice-coil impedance should be connected across the output, after which resistors of 270 ohms should be connected in series with each side of the line as shown in Fig. 1311.

The voice-coil winding should not be connected to ground on either side, or the line will not be balanced. If the amplifier requires a ground connection to the voice-coil winding for satisfactory operation, the dummy load resistor should be center-tapped or made up of two equal resistors and the ground connection made



to the center tap as in Fig. 1312. If the secondary of the output transformer is used for feedback purposes, one side will be connected to the internal amplifier ground and the other side through a suitable resistor to the appropriate feedback point. In this case the modification of Fig. 1312 would cut the feedback in half. To rectify this, the feedback resistor also should be halved. The sim-

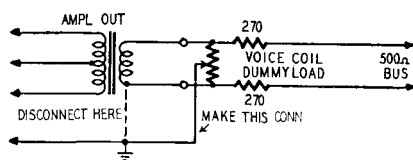

Fig. 1312. The changes required when one side of the voice-coil winding is grounded.

plest procedure in this case, involving minimum alteration to the amplifier (this is something that must always be borne in mind because the amplifier must be put back to normal after the hook-up), is to disconnect the ground connection from one side of the transformer secondary and connect it to the center tap of the dummy-load resistor. Then shunt the feedback resistor with another resistor of the same value. These changes are shown in Fig. 1313.

Most amplifiers can be treated in this way to supply the necessary 500-ohm output, but you may find one that has high-imped-

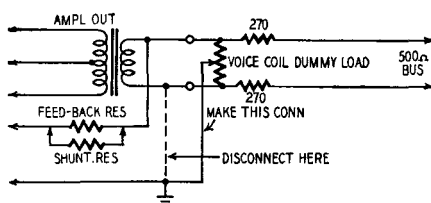

Fig. 1313. Circuit modifications required when the output-transformer secondary is part of the feedback network (see text).

ance output above 500 ohms. We have frequently used an amplifier with 2,000-ohm output (intended for constant-voltage-line work) for this purpose. The procedure is similar in this case, but the series resistors will have to be much higher than the line impedance. This type of network is shown in Fig. 1314.

## Multiple signal sources

Where programs are to be taken from more than one source in the system, it will be advantageous to feed the 500-ohm bus from a local microphone amplifier or phone preamplifier at each point of origin. If the amplifier is one specially designed to feed a 500-

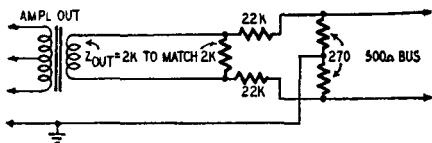

Fig. 1314. Padding a network for matching a high-impedance output transformer to feed a balanced 500-ohm line. In this case, the series resistors must have a much greater value than the line impedance.

ohm balanced line, additional precautions are necessary to see that its operation will not interfere with programs originating from other amplifiers. The plate resistance of the output stage is usually much lower than its load resistance, which means that, even though it is connected to a 500-ohm output circuit, when the amplifier is warmed up, a signal from another source will "see" this output circuit as 500 ohms shunted by the plate resistance, or much less than 500 ohms. Now suppose the amplifier is switched

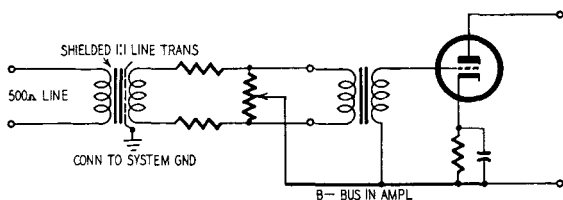

Fig. 1315. An isolation transformer may be needed to reduce hum when feeding an a.c.-d.c. amplifier with a floating B-minus return from an audio line.

off. The shunting effect of the plate resistance disappears and the other amplifier will be feeding into a circuit that has now risen to its true 500 ohms. Thus, switching the first amplifier on and off, although it may not be carrying any program, will affect the output from a second amplifier, changing its volume level by from 10 to 20 db.

From this viewpoint, amplifiers with padding networks may be better than those specifically designed for 500-ohm output. For the correctly designed amplifier, the best plan is to insert a resistor of 150 ohms in series with each side of the line at the output to limit the reduction in shunt impedance when the amplifier is on,

as viewed from another amplifier feeding the 500-ohm bus. This will take care of impedance matching, but may still leave a possible change of level of about 6 db should the amplifier be switched on and off while the program is coming from the other source. A wise precaution is to establish a recognized rule that the amplifier must

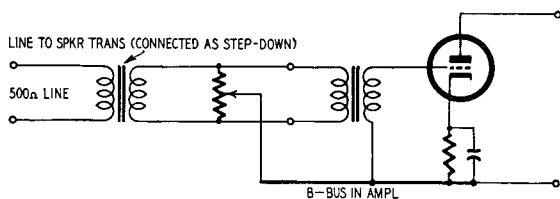

Fig. 1316. Another method of connecting an a.c.-d.c. amplifier to a 500-ohm line. The potentiometer across the input terminals is for balancing out line hum.

be kept running throughout the whole program whenever any part of the system is being used. This rule may not be necessary with amplifiers padded out from lower or higher impedance to 500 ohms.

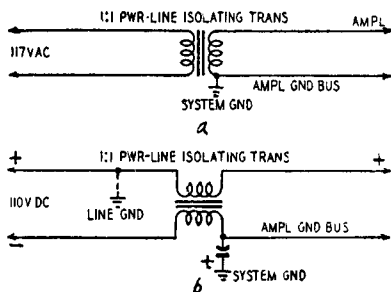

Fig. 1317. Isolating the a.c.-d.c. amplifier from the power line. A 1:1 power transformer for a.c. operation is shown in (a). The same transformer connected as a dual choke for operation from d.c. power lines is shown in (b).

## Isolating grounds

The padding arrangements shown in Figs. 1306 through 1310, usually prove perfectly adequate with good amplifiers. Sometimes, however, an amplifier must be pressed into service which does not meet the conditions specified earlier of satisfactory operation with or without a ground connection. Many amplifiers designed for universal operation come in this category. Complete isolation

must be provided between the system ground and the chassis (or ground bus) of this particular amplifier.

Several methods of attack can be tried, and the choice will be controlled by the equipment available. If a shielded line-to-line transformer is available, the method shown in Fig. 1315 should be satisfactory. If only a line-to-speaker matching transformer or some such component is available, the circuit of Fig. 1316 can be used. The potentiometer may be almost any value, as long as it is higher than the other components in the circuit. It is used to balance out hum pickup.

An alternative approach is to use an isolating transformer between the power line and the amplifier in question. An example of this is shown in Fig. 1317-a. An isolating transformer also can be used as shown in Fig. 1317-b when the supply is d.c. with the wrong side grounded.

### **Remote microphone control**

This application in public-address and sound-reinforcement work has obvious advantages, and once you try it you'll find it indispensable. The control panel can be moved to any convenient point where the operator can hear what the audience hears and can watch the stage for cues. The simplest method of remote control is *electronic mixing*, using d.c. bias on the control or suppressor grids of the individual microphone-input stages. The chief advantages of this method are that low-level audio signals go *direct to the amplifier inputs* instead of first passing through noisy switching circuits, and the control lines carry only hum-free d.c.

The d.c. bias supply can be a dropping resistor in the common negative return, or a well filtered d.c. heater supply for the first stages can be used. Either way there must be sufficient decoupling and filtering to keep hum or noise off the grid used for gain control. Simple resistor-capacitor filters are sufficient.

On jobs where two or more microphones are required there will be less danger of acoustic feedback if only one microphone is alive at any time, or at least if only those microphones actually needed at the moment are alive. This is no problem with direct microphone switching, but a *remote-control switching circuit* is not easy to design. If bias voltage is switched, loud clicks or plops come from the system. One alternative is to change the bias quickly with fader type controls, but this can cause peculiar effects until a great deal of skill is acquired; and with nice fat decoupling capacitors

in the circuit, there can be a disconcerting delay in the microphone changeover action.

The problem is to provide the quickest possible change of bias without any audible effect. The solution is an *automatic* switching circuit (Fig. 1318).

Various arrangements were tried for smoothing out the switching clicks, from a single R-C combination to a multisection low-

Fig. 1318. The circuit of the basic bias-control unit for one microphone. The three-section filter eliminates audible switching transients without any noticeable delay.

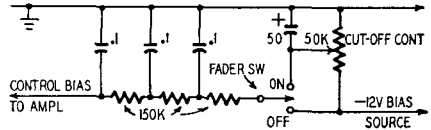

pass filter. A single resistor-capacitor section produced a loud click unless the values were made so large that the time delay became unbearably long. With multisection filters the click was transformed into a *plop*; the filters changed the proportions of the component frequencies in the switching voltage transient.

High-speed switching means that some disturbance (in the form of a simple step transient) is bound to get into the amplifier. The problem is to make this transient inaudible, while still attaining satisfactory operating speed. To do this, all the component frequencies in the step must be inaudible. We dug out an old copy of Fletcher-Munson loudness contours, from which we found that the slope of the curves at the low-frequency end is approximately 18 db per octave near the threshold of audibility. The answer was to use three R-C stages, *each with a slope of 6 db per octave*, to produce an inverse modification of the step response. This should give the highest possible speed of action without producing any audible effect. It worked! When this system is in use, there is not the slightest indication that at one instant a certain mike is dead and a second later it is alive.

Two systems were modified to incorporate this method of switching. The first was simply a twin version of Fig. 1318 for switching two microphone circuits. The second is far more versatile and is shown in block form in Fig. 1319. There are three remote-control microphone inputs with universal input transformers so that microphones of any impedance can be used. After mixing, the frequency spectrum is divided into three channels, with individual low- medium- and high-frequency amplifiers. Two of the channels have remote gain control (operating the middle channel at fixed gain eliminates an extra control).

6J7's are used in the input and tone-control stages. Tubes were scarce in England when the original amplifier was built, and the 6J7 and the Z63 (a British type) can be used interchangeably. With the control bias applied to grid 1, 12 volts provides complete cutoff. This is much less than would be needed with remote-cut-off tubes, and no microphone has large enough output to produce appreciable distortion due to the curvature of the tube characteristic even in the second stages.

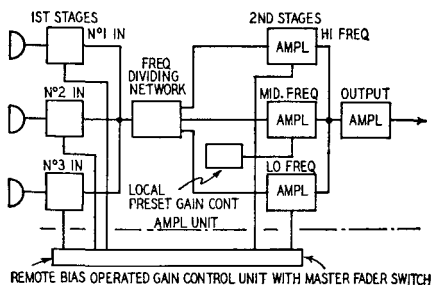

Fig. 1319. Block diagram of the deluxe remote-control amplifier described in the text. One or more microphone inputs may be selected, mixed and divided into low-, medium- and high-frequency amplifier channels with independent gain controls.

Grid 1 control was chosen in preference to suppressor control because the earlier KTZ63, for which the Z63 is now a replacement, was a tetrode. Use care in selecting tubes to find suitable nonmicrophonic samples. Special low-noise pentodes such as the 1620, 5879 and British EF37A might be better for this application, but this does not invalidate the method. Fig. 1320 is the complete amplifier circuit.

The control-panel circuit is shown in Fig. 1321, and the remote-control connection is through an octal plug and socket on a 7-wire cable.

There are two switches with each microphone gain control. The lower one (S1, S2 or S3 in Fig. 1321) is a simple on-off toggle switch: when it is OFF, that mike circuit is definitely off. When it is ON, the mike is controlled by the remaining switches and controls. The additional switch above each gain control (S4, S5 or S6) has three positions, marked A, ON, B; in the center (ON) position, the mike circuit is on, subject to control only by gain controls

R1, R2, or R3. But in either side position A or B it is further subject to control by the tone-control switch S7.

Two pairs of tone-compensation controls—one pair shown as R4 and R5, and the other pair shown as R6 and R7—are provided for low-and high-frequency gain. (The mid-frequency gain is pre-

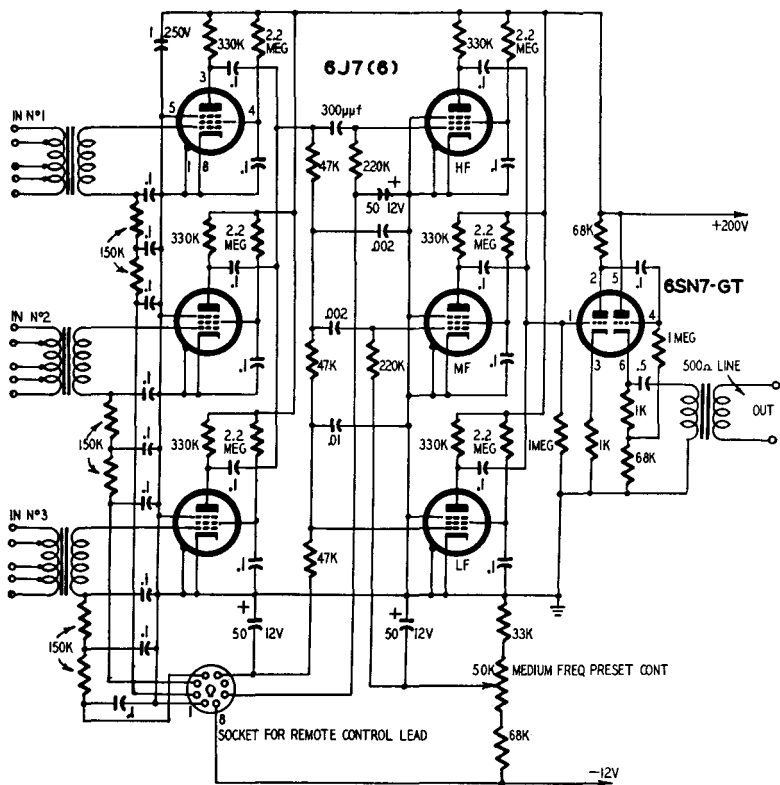

Fig. 1320. Schematic diagram of the deluxe remote-controlled amplifier described in Fig. 1319.

set in the amplifier.) Between these pairs is a two-way switch S7 whose positions have been marked A and B. When this switch is in the A position R4 and R5 control tone, while in B position R6 and R7 control tone. Besides selecting tone-control settings, this switch will also select mike circuits set to position A or B on the individual mike-circuit switches.

This layout may seem complicated, but a little thought will show that it provides extremely versatile control. Suppose two individuals are talking alternately into two different mikes. Using

S4 and S5, one mike can be set to A position and the other to B, and the master tone-control switch S7 can be used to switch from one to the other as each speaks in turn. Tone control group A can be set to give the most pleasing result with mike and voice A, independent of the B position setting. S7 changes the tone setting automatically every time the mikes are switched. If desired, a third mike can cut in on either A or B position by having its three-way circuit switch S6 in the ON position and just bringing it in with its ON-OFF switch S3. It is best to keep any circuit not in use with its ON-OFF switch ON OFF and its selector switch in the middle ON position. Then it can be cut into the circuit instantly, simply by throwing the ON-OFF switch. The high- and low-frequency tone controls can be used to create special effects such as artificial distance by accenting or attenuating extreme frequencies.

One feature of the panel's versatility is that a new tone-control setup can be prepared while one or two mike circuits are being used. At the right moment the changeover between the tone controls is made with a flick of the A-B switch S7. If for any reason the new arrangement would be better on B circuit, and the present arrangement is already on it, then the present setup can be transferred to A circuit first. Set the *live* mike-selector switches to the middle ON position set both tone controls in the same position and change over from B to A with S7. Then switch the live mike selectors to A. Now preparation can proceed on the B circuit. This does not interfere with the program. A little thought is needed to master the principle of operation, but once understood its extreme versatility is ample reward.

Two more points should be made clear before concluding. The values used for the switching-filter circuits, three 150,000-ohm resistors and three 0.1- $\mu$ f capacitors, proved adequate for practically all jobs. If more than usual gain is required, due to using a low-sensitivity microphone at long range, switching clicks may come through, particularly when switching *off*. One method of preventing this without modifying the circuit, is to turn the gain control down first; then switch *off* and then reset the gain control to the desired level ready for the next switching *on*. If the operator finds this difficult, further controls could be added to reduce the gain by a fixed amount in the OFF position (just enough to render the microphone insensitive), instead of cutting the tube off completely. Less switching voltage will be needed with this method, but the first method has been found satisfactory for the comparatively few



occasions where these particular clicks are effectively audible.

Some readers may feel that 6J7's will not give much range of control, but will act like on-off switches. Try it. You will find that any tube can be used as a variable-mu tube, provided the signal level is small enough so the tube curvature does not cause distortion. The range of gain variation is as great as can be obtained with a remote-cutoff tube.

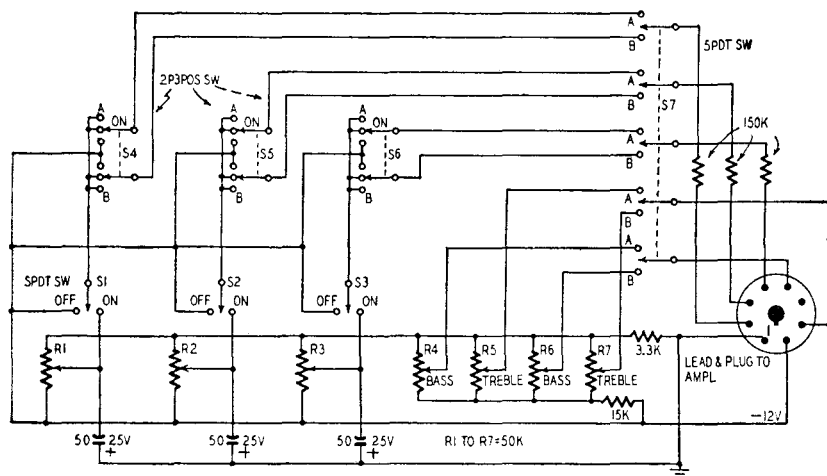

Fig. 1321. Schematic diagram of the remote control unit for use with the amplifier of Fig. 1320.

## The story of an amplifier

We shall now complete the cycle of discussion on high power amplifiers. This section deals with an amplifier which has been designed to act as a general-purpose public-address or sound-reinforcement unit. This is not an amplifier for the home, at least not for our idea of a home. It was designed for use in a sound-distribution network, feeding from 5 to 50 loudspeakers in parallel. The particular merit of the design is its flexibility.

For distribution work in which a number of loudspeakers are to be driven from a common audio line we are in rather the same position as the power engineer who provides 60-cycle supply at a number of outlets to drive the radio and the lamps, the vacuum cleaner and the electric heater. He provides us with a fixed voltage from a low-impedance source, so that the level at one outlet does not depend on the load at another. The nominal level of the 60-cycle supply is 117 volts r.m.s. In distributing speech and music

to a number of outlets it is very convenient to follow this example, but to use 50 volts r.m.s. as the nominal level. Loads of down to 50 ohms then can be connected to a 50-watt supply, and loads down to 5 ohms to a 500-watt supply. If 10-watt speakers are used, each is bridged across the line, with a transformer giving a primary impedance of 250 ohms.

The power supply engineer provides a low-impedance source, then monitors the output so that the voltage does not vary more than about 5% as the load is changed. We shall use negative feedback to keep the audio level from varying more than about 20% as the load changes from one loudspeaker to the maximum system load.

Recently, we had to design a number of such systems of different sizes. For practical reasons, we decided to design one basic amplifier which could be used as a standard "brick," in building any size system. The standard unit which best fitted into the scheme turned out to be a 100-watt amplifier, using four tubes in the output stage. When operated with only two tubes it is a 50-watt amplifier, the power consumption being halved. When more power is needed, several amplifiers can be connected in parallel without any more precaution than the obvious check of keeping the polarities the same. So far only five have been run in parallel, but there will be very few jobs for which more than 500 watts of audio is needed.

This sort of installation is ideal for the ordinary operator. With 500 watts of amplifier power he either can use it all at the one big show, such as the county fair, or he can put in 200 watts for one job, 100 watts for another, 50 watts in some small hall, and still hold one unit in reserve. The equipment load factor can be kept high, and he never has to use a big amplifier for a small job where tube wear would eat away his profit.

## **The circuit**

The amplifier circuit is a very simple one, consisting merely of a seesaw phase splitter driving a class-B push-pull output stage. In consequence, the grid input voltage is high, by the usual standards of power amplifiers (we need 15 volts to drive the amplifiers to full power). This is only a few milliwatts, however, and is easily obtained from a normal three-stage microphone amplifier. The voltage deliberately was made high so that the long connections used in paralleling amplifiers would not pick up serious

amounts of hum and noise. Class-B operation hasn't been too well accepted because of its so-called resultant *notch effect*. *This is the small step at the crossover point where both sides of the push-pull circuit seem to be cut off*. With a bad transformer all sorts of curious effects can occur in the gap, and if the transformer is included in the feedback path, trouble is in store for the designer. A good transformer, which must be symmetrical, seems to prevent all this sort of trouble, and in this amplifier, at any rate, the waveform looks pretty good until the level is high enough for the peaks to start limiting. The notch effect, it is true, can be caused by wrong bias; but so long as the values given by the tube manufacturer are used, there is no trouble. Anyone who is suspicious about this might ponder on the number of AM broadcast transmitters which use high-power class-B modulators. They do this in Europe, too, where state-controlled broadcasting means that low distortion is demanded with all the vigor that any taxpayer puts behind what he considers his rights.

The output tube, which is the key to the amplifier design, is a European type, the Mullard EL34. There just does not appear to be any other tube which will do all that this excellent tube will. It is a 6.3-volt indirectly heated tube, on an octal base, with a transconductance of 10,000  $\mu$ mos and can be run in class B with 0.5 megohm in the grid circuit. The full details are listed separately<sup>1</sup>. Four of these tubes give a rated power output of 116 watts at 425 volts plate supply, and they can be driven by a single 12AT7. Every other tube seems to need a low-impedance driver stage or an extravagantly high plate voltage.

What sort of a performance will this amplifier give? Measured at 10 volts output into a 25-ohm load, the frequency response is flat within  $\pm 1$  db from 20 to over 10,000 cycles. At 100 watts the distortion is less than 2% at frequencies between 300 and 1,000 cycles. It is not much more even at 75 cycles, but this is not important, because we do not expect high levels at extreme frequencies.

<sup>1</sup> Mullard EL34 tube: Heater: 6.3 volts, 1.5 amps. a.c. or d.c. Class B operation, 2 tubes: Common screen resistor 800 ohms

Bias	-42 v	-42 v
Grid drive	0	29.5 v
Supply voltage	425 v	425 v
Optimum load	4,400 $\Omega$	4,400 $\Omega$
$I_p$	2 $\times$ 20 ma	2 $\times$ 106 ma
$I_{g2}$	2 $\times$ 2.4 ma	2 $\times$ 28 ma
Power	0	58 watts
Distortion	--	4.5%

Negative feedback keeps the output impedance low, so that when the load is disconnected the output line voltage rises less than 20%, hardly noticeable by a listener.

The circuit diagram is shown in Fig. 1322. The input tube, a 12AT7 double triode, operates as a seesaw type phase splitter. The first triode is a normal amplifier with 47,000-ohm plate load. Cathode bias is provided by a 2,000-ohm cathode resistor together with the 2,200-ohm feedback resistor, making 1,047 ohms. This tube is used to drive the lower half of the push-pull stage. The second triode is a unity gain amplifier with a large amount of feedback from plate to grid, which gets its input through the first 470,000-ohm resistor. That, at least, is one way of looking at it. Another way of thinking of the circuit is that the grid drive of the second tube is the difference in the plate swings of the two triodes, so that the center point of the two 470,000-ohm resistors acts as the fulcrum of a seesaw. An exact balance of the plate swings is obtained by reducing the left-hand 470,000-ohm resistor slightly. If you want to balance the stage closely, you can try something of the order of 5 megohms in parallel with this resistor or some tens of kilohms in series with the right-hand resistor. The second triode drives the upper half of the push-pull stage. The plate-supply voltage, about 250, for the twin triode is derived from the main high-voltage supply of 425-475 by a potential divider and decoupling capacitor.

In the power stage all cathodes are grounded. Plate stoppers of 22 to 25 ohms, mounted close to each tube, kill any parasitic oscillations which may otherwise be produced in the wiring. Each push-pull pair has its own 800-ohm common screen resistor, which is not decoupled. The screen voltage comes straight from the high-voltage supply. Feedback is taken from the special winding on the output transformer. With 42 volts bias on the output stage, a drive of 29.5 volts r.m.s. is needed to give full output.

### **The output transformer**

The design of the output transformer is the first and most important stage in the detailed design of the amplifier, once the framework of the amplifier is fixed. In designing this transformer for class B it is imperative to keep the leakage inductances low and the balance between the two sides good. Balanced direct-current polarization cannot be assumed, because we do not want to run into instability if a tube fails. We can make the assumption that

we do not want high levels at low frequencies, and in designing the transformer we have allowed the rolloff at low frequencies to begin at 125 cycles, so that the plate load is almost purely resistive down to 300 cycles, while the response is 6 db down at 60 cycles. In these circumstances the high-frequency response of the transformer alone is good up to beyond 30 kc. The inductance is easily calculated. The optimum plate-to-plate load for two tubes is 4,000

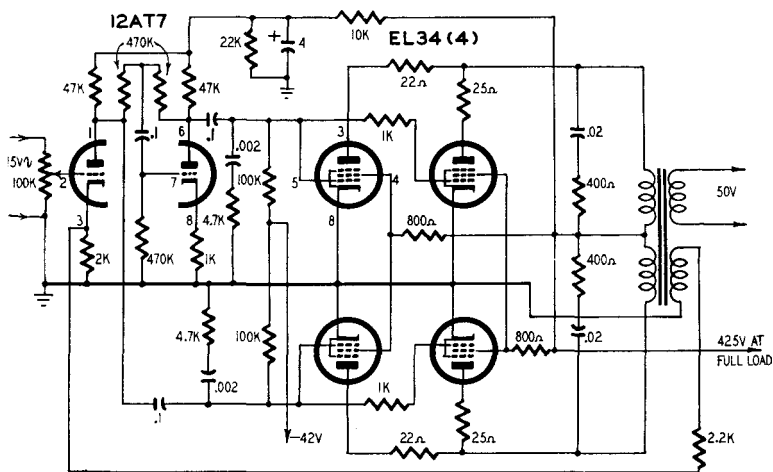

Fig. 1322. The amplifier schematic. Feedback is obtained from a special output winding.

ohms, so that for four tubes it will be 2,000 ohms. The inductance is  $2,000 \times 2\pi \times 125 = 2.54$  henries. With the core size shown in Fig. 1323, and an air gap of .040 inch, ordinary 14-mil silicon steel laminations, we need 1,200 turns to give an inductance of 2.5 h. The exact core size is not critical, of course, and any core of about the same size may be used. Fig. 1323-a is a rough drawing of the core.

The plate windings are put on as four separate windings of 300 turns each, two in each section of a twin former. They are cross-connected as shown in Fig. 1323-b. A layer of insulation, rated at 2,000 volts, is then applied. This can be supplemented with an ordinary split screen of copper foil.

Over the plate windings three additional windings are added on each half of the former. These are output, feedback and output in that order. No. 18 AWG wire is used for the output windings, while 30 AWG is used for the feedback winding. Each of these six coils contain 65 turns. A series-parallel connection of the output

windings and series-feedback windings provide very close and balanced coupling between the output circuit and the feedback winding. The wire turns and size appear in Fig. 1323-c.

Although this sort of amplifier is usually considered to be a two-stage circuit, which must be stable at low frequencies, it must not be forgotten that the signal in one half of the push-pull stage passes through three stages. Adequate low-frequency stability is obtained by choosing the coupling capacitors so that the response is flat to well below the 125 cycles used in the output transformer design. We have used 0.1  $\mu\text{f}$ , which with the 100,000-ohm grid resistors gives a characteristic frequency below 16 cycles per second. This value of capacitance can be reduced to .05  $\mu\text{f}$  without danger, and could probably be reduced even more.

### High-frequency problems

At the high-frequency end the design presented a lot of difficulties, mainly because of the need for flexibility. An amplifier to work into a normal load is quite straightforward; but if you want to be able to remove the load or to attach a long capacitive cable with no termination, the problems of design become much more complicated. Separate responses must be plotted for each possible load condition, and any circuit change must be checked in at least three different plots. To add to the difficulty a really good safety margin seemed to be desirable to meet the special conditions of parallel operation. Two shunt R-C circuits, one in each stage, and duplicated because of the push-pull operation, were found to give satisfactory results. Across each half of the transformer primary a .02- $\mu\text{f}$  capacitor (1,000-volt d.c. working paper tubular) is connected to prevent the load on the output side affecting the high-frequency response. The phase shift produced by this capacitance is brought back to zero in the dangerous region above 25 kc by connecting 400-ohm resistors in series with each capacitor.

An additional pair of high-frequency response control circuits across the interstage circuits of the amplifier, consisting each of a 4,700-ohm resistor in series with .002  $\mu\text{f}$ , was found to be necessary. It would probably be sufficient to combine these into a single 10,000-ohm resistor and .001  $\mu\text{f}$ , leaving out the ground point at the center.

One disadvantage of the stabilizing system used must be noted. At high frequencies all the power can pass into the two 400-ohm resistors across the transformer primary. Any attempt to measure

the frequency response at full power will lead to a burn-out here, unless you use unreasonably large resistors. We have used 5-watt wire wound resistors, which do not even get warm under normal working conditions. The only other resistors with any power in them are the 800-ohm screen resistors, which should be 2-watt types.

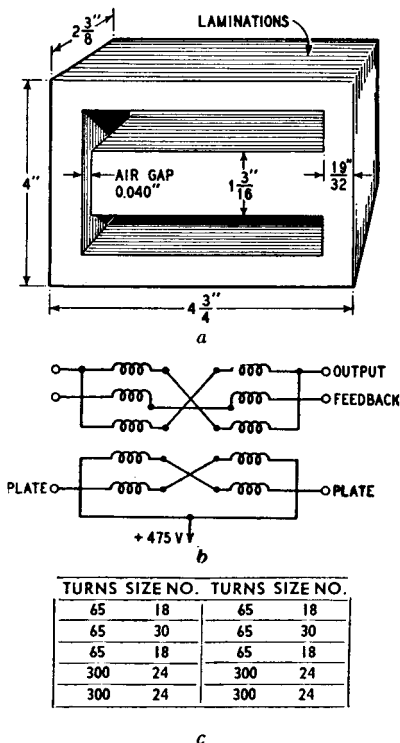

Fig. 1323. The data required for the design of the output transformer. The core specifications are shown in (a); the electrical connections in (b); the wire turns and size are listed in the tabulation box (c).

The physical layout can follow the circuit diagram. The only precautions are to keep the stages separate and to keep the plate stopper resistors in the output stage near the tubes. Do not forget that the output line must carry 2 amperes.

### Some important details

The power supply unit is required to provide 6.3 amp at 6.3

volts for the heaters, a plate supply of about 550 ma at full load, dropping to about 100 ma at no input, with a smoothed voltage of 425 at full load. In addition a smoothed grid supply of 42 volts is needed. For the grid supply a germanium, copper oxide or selenium rectifier may be used, and it is a good idea to take this and the heater supply from one transformer. The grid-bias voltage can be used to operate a relay in the high-voltage supply transformer primary, so that you cannot get plate voltage without bias. More trouble, true, but so is paying for new tubes if the bias supply fails. The bias must be adjusted to 42 volts with a resistor in the bias-rectifier circuit. The high voltage is supplied by a 550-0-550-volt winding and a pair of 5Z3 rectifiers. It is a good idea to make it three 5Z3's to keep the system working through a failure. A choke input filter, using a single 10- $\mu$ f capacitor, provides sufficient smoothing, and the regulation is such that the voltage at no load rises to 475.

An additional *continuity of service* precaution is the connection of a second 12AT7 in parallel with the one shown.

When used as a 100-watt amplifier all tubes should be in place, and the load impedance should be 25 ohms. It is, of course, quite in order to work with higher load impedances, but you will not get 100 watts, but only  $(50)^2/R$  watts, where R is the load impedance. If you need only 50 watts, pull out two of the EL34 tubes and one of the rectifiers, if you are using three. That is all. If you need 200 watts, connect two amplifiers in parallel, after checking that they are set to have the same gain. The load impedance may then be 12.5 ohms; and so on for higher powers.



# test equipment design

**Y**ou will have read dozens of articles on new designs of high-fidelity amplifiers: how often has the designer told you where you can get a correspondingly high-fidelity input? If you have 0.2 volt of input, you get 10 watts of true and faithful copy; but copy of what? The output from a receiver of unknown performance or pickup which seems to sound quite good? In the ground-ray region, of course, there's WWV. Elsewhere, a signal generator must be used, and the average commercial unit is not good enough.

## Single-frequency generator

Faced with this problem, our solution was to build a special signal generator. For our purposes, 0.5% distortion up to 50% modulation was good enough. Mr. Sampson of G-E has described a similar but more elaborate circuit, which has 0.1% distortion at 100% modulation<sup>1</sup>. Here, however, we shall describe our own circuit with emphasis on feedback circuit design because it contains all the basic elements to be considered.

The performance can be improved by elaborating the modulator and detector but these do not involve the feedback loop. The signal generator is a single-frequency unit. The commercial design by Sampson requires six adjustments when changing frequency,

<sup>1</sup> *Electronics*, April, 1949; *Proc. Nat. Elec. Conf.*, 1948.

but for receiver testing it is always possible to tune the receiver to the generator.

To simplify arithmetic, we shall not follow our own design exactly, but will use a design carrier of 800 kc. Any type of modulation may be used, so it is quite easy to run comparative tests on the signal generator and receiver, using a microphone or tape recording as source. A good audio oscillator is used for normal distortion measurements.

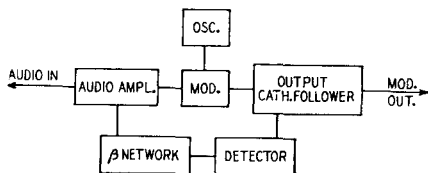

*Fig. 1401. Block diagram of the single-frequency generator showing feedback components and loop. Except for the detector in the feedback path and the modulator within the forward path, this diagram could easily represent a feedback amplifier.*

The block schematic is shown in Fig. 1401. It looks exactly like a feedback amplifier, except that inside the forward path there is a modulator, and in the feedback path there is a detector. Ideally, just as in ordinary audio feedback, the performance depends only on the feedback path, so that instead of needing to design a good modulator, all we must do is produce a good detector.

In practice, just as we make our audio amplifiers as good as possible before we apply feedback, here we try to get a good modulator because we cannot apply unlimited feedback. The problem is to decide what we mean by amplitude and phase characteristics when one part of the circuit works at audio frequencies and another at 800 kc. First, consider the component parts of the system which take the place of the individual stages of an ordinary amplifier.

## The oscillator circuit

The master oscillator circuit (Fig. 1402) is the highly stable Clapp-Gouriet circuit. It was incorporated because we wanted to see whether it was as good as reported. If a new oscillator appears while you are building a signal generator, by all means try it! In case you have forgotten about the Clapp-Gouriet circuit, we have shown the bare bones of this circuit together with the Colpitts circuit in Figs. 1403-a and b. The conversion from one circuit to the other is made by making the tank circuit capacitors of the Colpitts very large, and the necessary small inductance to correspond is obtained by series-tuning a normal-value inductance. The oscillation

frequency is just above the series-resonance frequency of the L-C branch. The main disadvantage of this circuit in some applications is the rather low output, but we need only about 1 volt for the modulator grid.

## The modulator

The modulator uses a 6AS6 tube. This is a rather uncommon application of the tube, but since it has a relatively high sup-

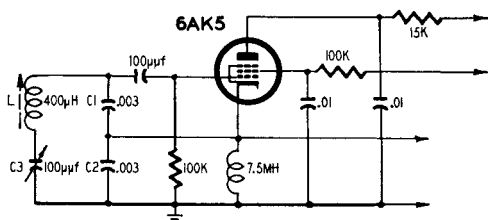
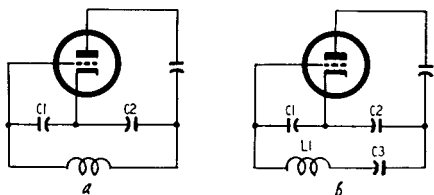

Fig. 1402. Circuit diagram of the master oscillator used in the generator.

pressor mutual conductance, it will work in *phantastron* and other similar circuits. In the 6AS6, 5 volts on the suppressor will cut off the plate current. The exact figure depends on screen and plate voltages. It makes a convenient modulator for this circuit because the oscillator and audio inputs can be completely isolated by applying them to separate grids. The circuit, shown in Fig. 1404, provides cathode degeneration at audio frequencies: the 3,000-ohm resistor is decoupled only to radio frequencies. The result is

Fig. 1403. Two basic oscillator circuits. In (a) is shown a typical Colpitts oscillator; in (b), the Clapp-Gouriet oscillator. The latter circuit's main disadvantage is low output for certain applications.



that the modulator gives fairly low distortion up to about 50% modulation.

The output is taken via a cathode follower, so that the load does not react on the circuit. The external load is tapped down on the cathode-follower resistor, because we require only small outputs and can use the decoupling produced by this resistive attenuator. An external attenuator was used to control the level, but a tapping slider on the 75-ohm resistor could be used. We can neglect the frequency response of the cathode follower, fortunately, so that we need not put in the actual circuit at this point.

## Detector

The key to the feedback loop is the detector. A germanium diode, together with a filter circuit to eliminate the radio-frequency components, provides audio voltages which can be connected back into the audio amplifier. The circuit of this is shown in Fig. 1405. It would be a considerable improvement to add extra carrier at this point to keep the effective depth of modulation very low. The Sampson circuit does this but, unless you expect to be working in the region below 1% with your receivers, it is not worth going to the extra complication involved.

These bare bones must now be assembled into a complete circuit with its feedback loop closed. As we saw in Chapter 5 (design of an amplifier for 1.6 mc), the r.f. stages operate right down to zero-modulation frequency. Therefore, regarding low-frequency audio response, only one R-C circuit has any effect, and we cannot possibly have low-frequency instability. All our attention is concentrated on the problems that are presented by the high-frequency audio response.

## Circuit problems

Three circuits affect circuit behavior for high modulation frequencies:

1. The plate circuit of the audio amplifier.
2. The plate circuit of the modulator.
3. The smoothing circuits in the detector.

Let us consider them separately, and put in numbers which look reasonable. Should the results be unsatisfactory, we must make the changes suggested by the shape of the curves. We are trying to take the reader right along with us in working out the design. Most of the interest lies in the spots where you go wrong!

The audio amplifier is quite conventional and its main purpose is to provide a convenient means of connecting the feedback into the circuit without requiring the use of a very large feedback voltage.

The audio amplifier has a plate resistor of 100,000 ohms and a total capacitance, including wiring, which should not exceed 20  $\mu\text{f}$ . The characteristic frequency is found by

$$\omega = \frac{1}{CR} = \frac{1}{20 \times 10^{-12} \times 10^5} = \frac{1}{10^{-7} \times 20} = 500,000$$

Since  $\omega = 2\pi f = 500,000$ , then:

$$f = \frac{5 \times 10^5}{6.28} = 80 \text{ kc}$$

We can afford to put in a stabilizing circuit here, and a convenient design frequency is 8 kc. The capacitance is therefore 200  $\mu\mu\text{f}$ . If 20  $\mu\mu\text{f}$  gives a frequency of 80 kc, then 8 kc will require (since capacitance is inversely proportional to frequency) a figure

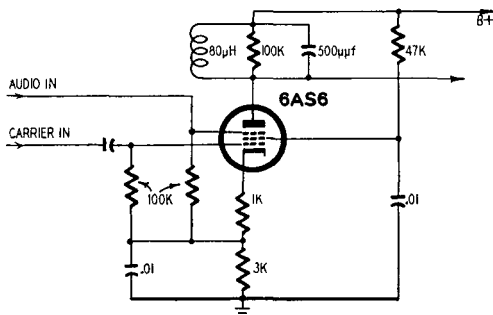

Fig. 1404. The modulator circuit. It provides cathode degeneration at audio frequencies.

of 200  $\mu\mu\text{f}$ . The point at which we flatten out the characteristics settles the amount of phase shift we shall have, and we shall guess the value of resistor to be used as 27,000 ohms. This makes the response of the audio stage flatten out about 14 db down and moves the final cutoff up to 400 kc. These values are the sort of values we have been using in a lot of audio circuits, so this guess has pretty strong inspiration.

For the plate circuit of the 6AS6 we can start from several different assumptions. To get stable tuning without the tube capacitance having too much effect, the capacitance must be at least, say, 100  $\mu\mu\text{f}$ . The corresponding inductance, for a frequency of 800 kc, is 400  $\mu\text{h}$ , as shown in the following calculations:

$$f_0 = \frac{1}{2\pi\sqrt{LC}} \quad (115)$$

$$\sqrt{LC} = \frac{1}{2\pi f_0} = \frac{1}{6.28 \times 800,000}$$

$$\sqrt{L \times 100 \times 10^{-12}} = \frac{1}{50.25 \times 10^5}$$

Squaring, we get

$$L \times 10^{-10} = \frac{1}{2,525 \times 10^{10}}$$

$$L = \frac{1}{2,525} \cong 4 \times 10^{-4} = 400 \text{ } \mu\text{henries}$$

The reactance at 800 kc is

$$\omega L = 2\pi fL = 6.28 \times 8 \times 10^5 \times 4 \times 10^{-4} = 6.28 \times 320$$

$$\omega L = 2,000 \text{ ohms}$$

The plate impedance is  $2,000 \times Q$  ohms:  $Q$  is the figure of merit of the plate-circuit inductance. The coil itself will give us a  $Q$  value in the order of 100, but the tube characteristics suggest that  $Q = 10$ , giving 20,000 ohms plate load, would be more suitable.

Let us look at it another way. You may remember that the bandwidth associated with a given resistance and capacitance is unaltered by moving from audio to bandpass problems. Since we are to work with audio frequencies up to about 8 kc, the bandpass bandwidth must be about 16 kc. Taking 20,000 ohms as the desired resistance value, we have:

$$2\pi fCR = 1 \tag{116}$$

$$C = \frac{1}{2\pi fR} = \frac{1}{6.28 \times 1.6 \times 10^4 \times 2 \times 10^4} = \frac{1}{20 \times 10^8} \\ = 500 \text{ } \mu\mu\text{f}$$

The use of 100  $\mu\mu\text{f}$ , giving five times the bandwidth or 80 kc, would mean that the envelope response was 3 db down at 40-kc modulation frequency, and that the gain was only about 40 db down at audio frequencies. Too much audio would then come straight through to the output. Let us switch designs to the 500- $\mu\mu\text{f}$ , 80- $\mu\text{h}$  basis, and make sure that we get a  $Q$  of 50. (This inductance value can be computed using equation 115 with the value for  $C = 500 \mu\mu\text{f}$ , and  $f = 800 \text{ kc}$ ). An ordinary slug type, dust-core coil will do the job.

In designing the detector circuit we have another problem. We want to keep the radio frequency out of the feedback loop, but yet not produce too much phase shift at audio frequencies. The detector network, of course, is an audio network; it is only in the modulator that we have the bandpass type of circuit. To find what we need we must construct the amplitude and phase response

characteristics for the portions of the circuit already designed. Those are shown in Fig. 1406.

If we assume that we want to put on 20 db of feedback, we can take a 7-db margin and make sure that the phase shift is less than  $180^\circ$  at 45 kc. Looking up low-pass filters in reference tables we see that a full section of constant-K low-pass filter has a phase shift of  $180^\circ$  at cutoff, and a phase characteristic roughly linear with

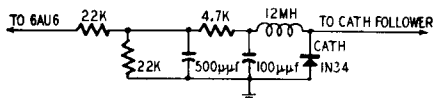

*Fig. 1405. A germanium diode-detector network. In the design of this circuit we are concerned with preventing r.f. from entering into the feedback loop and limiting a.f. phase shift.*

frequency. Usually it is slightly concave downward, so that we get a slight safety margin thrown in if we take the phase as proportional to frequency. By taking a cutoff frequency of  $3 \times 45 \text{ kc} = 135 \text{ kc}$ , we shall have only  $60^\circ$  phase shift at 45 kc, making the total phase shift here  $170^\circ$ . As we have not used a full section, but have replaced one inductance by resistance, the filter is slightly safer than the design suggests. This network will give us 30–40 decibels attenuation at the carrier frequency, so that there is no danger of carrier overloading the audio amplifier.

As a filter design impedance we take 10,000 ohms. The inductance and capacitance are then:

$$L = \frac{R}{2\pi f_c} = \frac{10,000}{6.28 \times 135 \times 10^4} = 11.7\text{mh}$$

$$C = \frac{1}{2\pi f_c R} = \frac{1}{6.28 \times 10 \times 10^3 \times 135 \times 10^3} = 117\mu\mu\text{f}$$

These values are convenient, and the final network is shown in Fig. 1407.

It is necessary to know the total gain round the feedback loop to make sure that one audio stage is enough. The audio amplifier, with a plate load of 100,000 ohms and about 1-ma plate current, where the mutual conductance is low, will have a gain about 40 db. The modulator has a conversion conductance of about 500  $\mu\text{mhos}$ , but the cathode feedback brings the gain down to not

much more than unity. Let us assume a gain of 100 from audio grid to detector. This is just about enough to make the system conform to the standard feedback theory, for we have  $A = 100$ ,  $\beta = 1/10$  and  $A\beta = 10$ . Final adjustment of gains and feedback is done when the model has been built.

### Tuning modulator plate

The most important detail in the construction of this signal generator is the tuning of the modulator-plate circuit. It must be

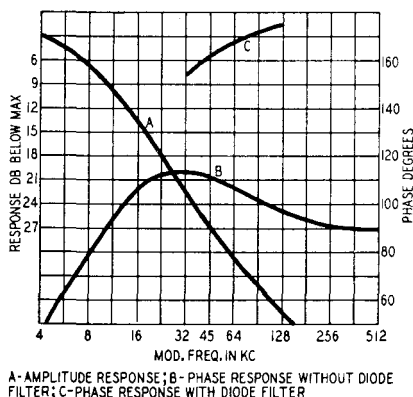

Fig. 1406. Amplifier and phase response found by using the templates of Chapter 1.

tuned exactly to the oscillator frequency. If the modulator is detuned by 8 kc, there will be an extra  $45^\circ$  phase shift on one side or other of the carrier, and the system will be unstable with full feedback. It is not easy to tune on amplitude alone, because the response is only 30% down at  $45^\circ$  phase shift. The phase is very dependent on tuning, so this can be used as a guide: *the tuning is rocked to the unstable point on either side of the center frequency and the mean position used as a final setting.*

In the form in which we have been using it, this signal generator, actually designed for operation at 5 mc, gave a distortion of 0.9% at 90% modulation and less than 0.5% at 50% modulation. The output was about 100 millivolts, which is more than is needed for any normal receiver test. The level required to modulate it fully was less than 0.1 volt on the grid of the audio amplifier. The input voltage depends on your choice of input transformer.



From the feedback aspect the point of interest which this system has illustrated is the way in which audio and modulated radio-frequency systems can be combined in a single feedback loop, using exactly the same ideas of amplitude and phase response as are used in the audio systems alone. Transmitter designers and other high-level engineers use this technique regularly, but most people commonly think of negative feedback for audio only. So long as you remember that the system is intended to pass audio through, and all speech devices are meant for just this, you need keep an eye

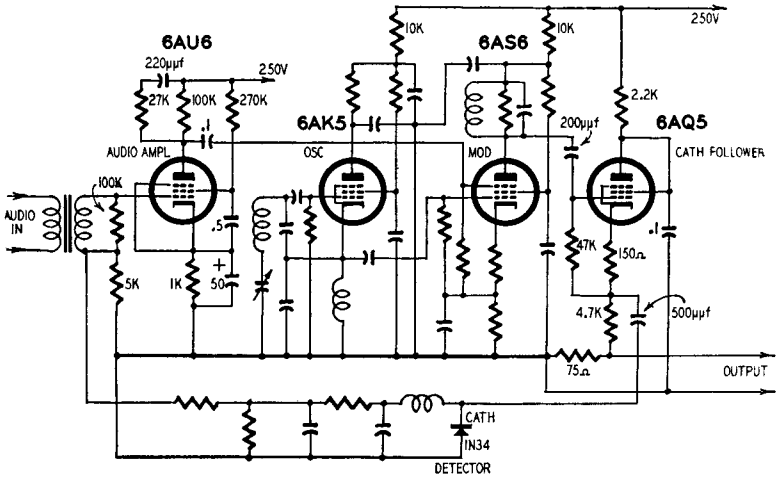

Fig. 1407. This circuit of the feedback signal generator shows values not included in the previous partial circuit diagrams. A regulated power supply is recommended for satisfactory operation of the unit.

only on the audio amplitude and phase response. The carrier, like the d.c. on the telephone local circuit, can be allowed to look after itself.

Before leaving this special mixed system, there is a reversed form of this signal generator which the reader can think about himself. Suppose that you take the audio output from your FM receiver, add a reactance tube in shunt with the local oscillator, and modulate the local oscillator by means of the audio output. The result will be to provide feedback round the discriminator loop. Exactly the same design procedure must be used for this case, provided you can keep the audio in mind. If you think about the problem you will see that trouble arises from the multiple side frequencies (the audio is no longer just one side frequency), and

it is hard to see what the phase means. There is an amplitude-modulated version of this problem too. We do not propose to write anything about these particular devices, but they are mentioned here just to set you thinking, and to encourage you to plan new combinations for yourself.

### Self-balancing push-pull oscilloscope amplifier

Many of the cheaper oscilloscopes have inferior amplifiers, which spoil some of the more critical measurements for which they may be used. To overcome this, quite a simple push-pull circuit can be used, based on the principles introduced in Chapter 6.

For applications in which a good stable balance is needed, a much higher value of  $R_K$  would be used. Referring back to Fig. 626 as an example, we might take  $R_K = 50,000$  ohms. Using equation (97) again, we then get this result:

$$\frac{R_{L1}}{R_{L2}} = \frac{(1 + \mu)R_K}{R_{L2} + R_{P2} + \mu R_K} = \frac{255 \times 10^4}{256 \times 10^4} = 0.996$$

Here the unbalance is only about  $1/2\%$ . Changes in tube characteristics can only unbalance the circuit to the same limited extent, assuming that we start with correctly proportioned load resistors, so that we have a very satisfactory circuit here. But 50,000 ohms is a very long tail.

The reader who has been watching these numbers carefully may be getting a little worried. If each tube draws 5 ma, there will be a total of 10 ma through the cathode resistor. All this talk of 50,000 ohms implies a drop of 500 volts across  $R_K$  and even if we cut  $R_K$  to 20,000 ohms, we need a -200-volt supply if we are to work with the grids around ground potential. This is not a serious matter in oscilloscope circuits, because negative high-voltage supplies are generally used. In some other circuits, where the grid of V1 is connected directly to the plate of a preceding tube, it is an advantage to have the whole tube circuit lifted up above ground. Since 200–500 volts is rather high, when an extra-large cathode impedance is needed for special high-balance jobs, special circuit tricks are usually adopted.

One very important circuit uses a pentode in place of  $R_K$ . A 6AQ5, for example, will pass 10 ma with only 20 volts on the plate, **but the impedance so far as constancy of current is concerned will be very high, certainly above 100,000 ohms.** This means that we

can make  $R_{L1} = R_{L2}$  and still have a virtually perfect balance. The form the circuit takes is shown in Fig. 1408, which also shows a voltage-regulator tube as a screen bypass to insure operation down to zero frequency.

An alternative way of providing the necessary high impedance in the cathode circuit is to use a saturated diode for  $R_K$ . The tungsten-filament diodes used as noise sources in receiver testing give

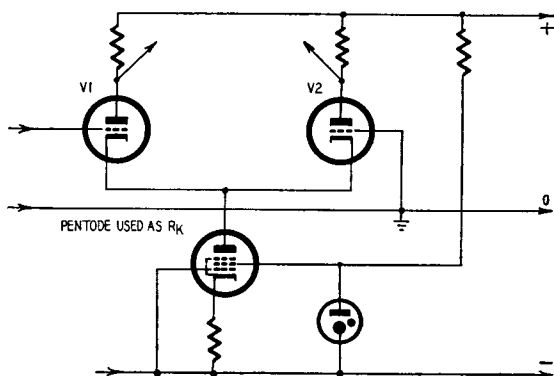

Fig. 1408. A high-impedance pentode used as a common cathode resistor swamps out variations in  $V1$  or  $V2$  that might unbalance the phase-inverter currents.

full emission (saturate) at a relatively low plate voltage, and increases in plate voltage give almost no change in current. The only disadvantage is using them is that the diode current depends on the filament temperature, so that the filament current must be stabilized.

Our purpose in seeking such highly accurate balance is not to get 10.01 watts from an amplifier instead of 10 watts, but to meet the requirements of some special measuring instruments. If you look back at Fig. 624, you will see that apart from the ground connection of the grid of  $V2$ , the circuit is absolutely symmetrical. In fact, this ground connection is there only because we assumed a grounded input: we are really using the voltage  $G_1 - G_2$  as the input, and deriving two equal antiphase outputs from this. Suppose, however, that we connect both grids together, and then apply a signal. There will be an in-phase signal at the plates, but it will be relatively small, since the large cathode resistance  $R_K$  provides a great deal of feedback. We can easily calculate what will happen, because we can assume that each tube has  $2R_K$  in its cathode and

then treat one tube alone. The gain from grid to plate is

$$A_{G-P} = \frac{\mu R_L}{R_L + R_P + [(\mu + 1)2R_K]} \quad (117)$$

With a 12AT7,  $R_L = 50,000$  ohms,  $R_P = 10,000$  ohms,  $\mu = 50$  and  $R_K = 50,000$  ohms.

Working out the formula you will find this gives a gain of about 0.5, so for *push-push* input the gain from grid to plate is less than

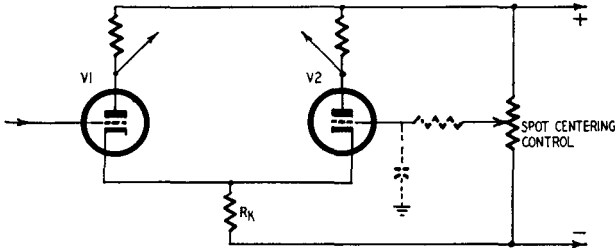

Fig. 1409. When using the "long-tailed pair" to feed the balanced deflecting plates of a cathode-ray oscilloscope, the grid of V2 may be returned to an adjustable d.c. divider to restore the beam to the center of the scope screen.

unity. For *push-pull* input, applied *between* the grids instead of to grids in parallel, the gain is 30, so the balance ratio is 30 to 0.5, or 60 to 1. If a pentode is used for the cathode resistor, this figure can be increased still more.

This circuit is used in electroencephalography: the two grids are connected to electrodes applied to the head of the patient, and the tiny brain currents produce a *push-pull* voltage between the electrodes. Stray 60-cycle fields produce a relatively large *push-push* voltage which must be eliminated, of course, because it would mask the brain signals even if it did not overload the final stages of the recording amplifier.

For use with oscilloscopes there are two possibilities. In the first, the two grids can be regarded as the two input terminals, and we have the feature that *push-push* voltages are discriminated against, while *push-pull* voltages are applied to the deflecting plates of the oscilloscope tube. This is excellent if you wish to work around zero voltage. But if you are interested in the variations of a voltage which is always well away from zero, this push-pull input is not very satisfactory, since the d.c. component of the input will deflect the spot away from the center of the screen. The arrangement of Fig. 1409 is then more useful. The grid of V2 is connected to a

point which provides a positioning voltage to bring the spot near the center of the screen. The grid of V1 takes the input signal, which is converted to push-pull to avoid defocusing and trapezoidal distortion (keystoning). A capacitor (shown in dotted lines) may be added to keep supply hum off the grid of V2, where it would be amplified as an ordinary signal. A resistor (also shown dotted) is sometimes added to improve the smoothing. (In some scopes the

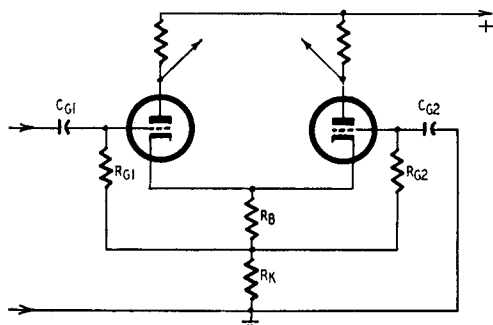

*Fig. 1410. One method of eliminating the negative voltage supply for the cathode return.  $R_B$  is tapped off the total cathode resistance at the desired bias point.*

time constant of this R-C filter is so long that the spot goes on drifting long after you have taken your hand off the positioning control.)

Stages of this kind can be connected in cascade if you have generous power supplies. The subject is slightly outside our present field, but you can see that if the first pair is to operate at about zero grid volt, the plates will be up at about +100, while the cathode resistor is returned to, say, -150 volts. The second stage grids are then at +100, so we have a 250-volt drop in the second cathode resistor (assuming this also goes back to -150 volts). The second-stage plates will be at +200-250 volts, so that the supplies needed will be +400, 0 and -150 volts. You just apply Ohm's law to find the resistance values.

Although this circuit is not used much for audio amplifiers, we should examine how it *can* be used and in particular how we can get away from this negative voltage line. A simple and apparently symmetrical form of circuit is shown in Fig. 1410. Bias is provided by  $R_B$ , which has its usual value for the tubes (about 100-500 ohms) according to the operating conditions, and the grids return

to the bottom of  $R_B$  through  $R_{G1}$  and  $R_{G2}$ . The coupling resistor  $R_K$  lifts the whole group of resistors up to perhaps +100 volts, so that blocking capacitors  $C_{G1}$  and  $C_{G2}$  are needed to connect the input and to provide the a.c. ground on grid 2. This circuit is not as symmetrical as it looks, as you will see if you consider it as redrawn in Fig. 1411. At high frequencies the grid of V2 is grounded, but at low frequencies, when  $C_{G2}$  is no longer a low impedance, the

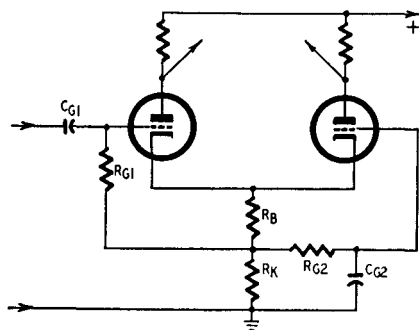

Fig. 1411. The circuit of Fig. 1410 redrawn to show the high-frequency shunting effect of  $C_{G2}$ , the coupling capacitor to V2.

grid is returned to somewhere between ground and the top of  $R_K$ . At zero frequency, the coupling resistance is down to  $R_B$ , which is too small to provide any satisfactory sort of balance. In practice this means that we must make  $2\pi f C_{G2} R_{G2} \gg 1$  at the lowest frequency we intend to use. We also need  $2\pi f C_{G1} R_{G1} > 1$  if we are to get the signal into the circuit at all. At high frequencies the only sources of trouble are tube capacitance, in particular the grid-cathode capacitance which is effectively in parallel with  $R_K$  since grid 2 is grounded.

If you now look back at Fig. 624 you will, no doubt, admire the elegant simplicity of the circuit: just three resistors, a pair of tubes and that little  $-E_c$  sign. Every few years we come back to this point of indecision. It's a good simple circuit, but where will we get that negative supply? For special jobs, with double input, it is possible to elaborate the long-tailed pair to give a really well-balanced system, though the balance is usually not as good as you can get with a transformer. However, the long-tailed pair does stay balanced down to zero frequency.

You can now see that it doesn't cost any more to make your

push-pull circuit really balanced. The shoddy circuits described in Chapter 6 will add to your troubles if you want to use a reasonable amount of negative feedback, and as far as we can see they amount to nothing more than a public avowal that you "couldn't care less." If an amplifier is designed on that basis, we would expect it to be pretty badly constructed, too, and we should stay well clear of it.

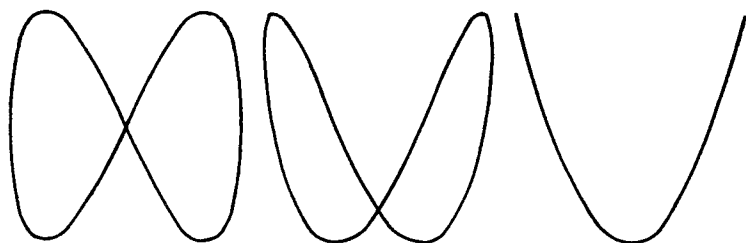

FREQUENCY RATIO 2/1

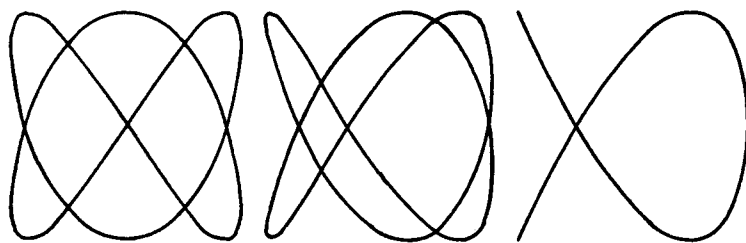

FREQUENCY RATIO 3/2

*Fig. 1412. Lissajous patterns for 120- and 90-cycles in three possible positions of appearance on the oscilloscope screen.*

## Calibrating audio oscillators

Building a good audio oscillator is neither difficult nor particularly expensive, nowadays. There are plenty of good designs to choose from. The difficult job, for most of us, is providing the frequency calibration. So we will concentrate here on that part of the job.

The simplest method by far is to use Lissajous patterns; but most books on the subject give a few samples, state the frequency ratios they represent, and then tell us ". . . With a little practice, more complicated patterns can easily be recognized." This is where many of us get stuck. If you're mathematically inclined, you

can sit down and figure out various ratios for the frequencies you want, work out some idea of what the patterns will look like, then just twiddle the controls until the desired patterns appear. Of course, if you have already located a few frequencies accurately with the aid of the simpler patterns, it is easier to find the right spots for the more complicated ones by *interpolation*. However, many don't get even that far. They're lost in a maze of patterns at the beginning, and don't know where to start.

Fig. 1413. The equipment setup used for the calibrating of frequencies up to 480 cycles with the help of the 60-cycle power line.

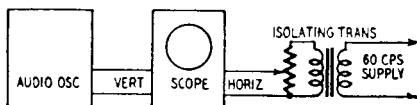

We have calibrated a great many oscillators with Lissajous patterns (mostly on a 50-cycle line standard) and can appreciate the truth of the book statement "with practice . . ."! The difficulty at the beginning is knowing what you are looking for. The patterns are not quite as simple with 60 cycles as with 50, but the job is still fairly easy *when you know what to look for*.

## Basic rules

The calibration depends on the stability of the line frequency. If the line frequency is actually 59.5 or 60.5 instead of 60 cycles, the calibration accuracy can still be held within 1%, which is good enough for most purposes. But if the frequency swings between these two extremes while you are calibrating, the results can be very confusing. It is best to do the job at a time when the line frequency is reasonably stable. Try to avoid transit rush hours, meal-times (when electric stoves and other appliances are being switched on and off) or dusk (when industrial loads are changing and lighting loads are coming on). Normal daytime working hours or mid-evening usually gives the best results. If the supply frequency fluctuates, it is difficult to keep the patterns steady enough to recognize them.

The calibration *must* be based on stationary patterns, because then the frequency is as accurate as the reference standard—in this case the line frequency. The pattern should be moved into the best position for positive identification by first detuning the oscillator

Fig. 1414. The recognition patterns on the facing page are calibrated against 60 cycles for the upper-line frequencies, and against 1000 cycles for the lower-line frequencies.



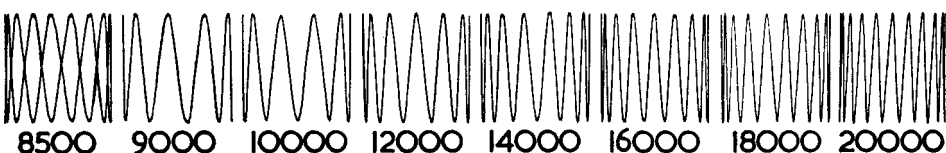
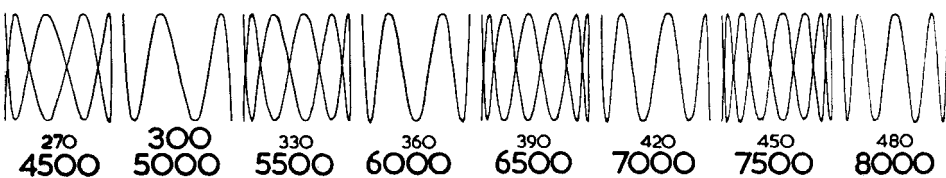
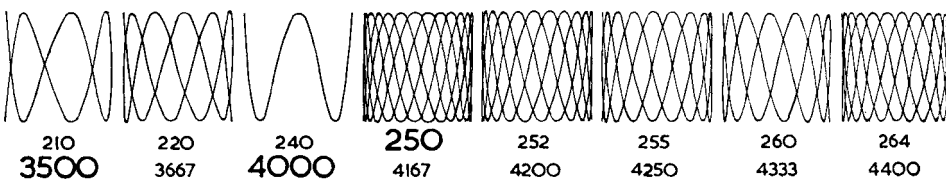
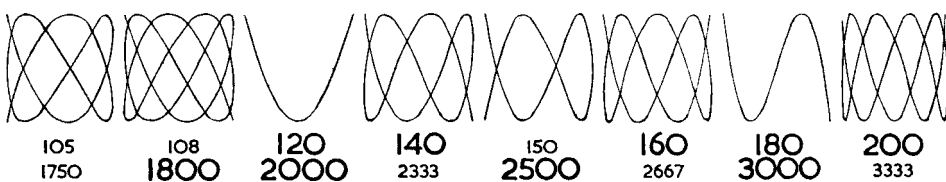
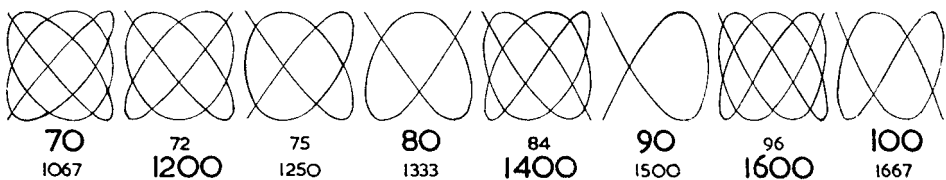
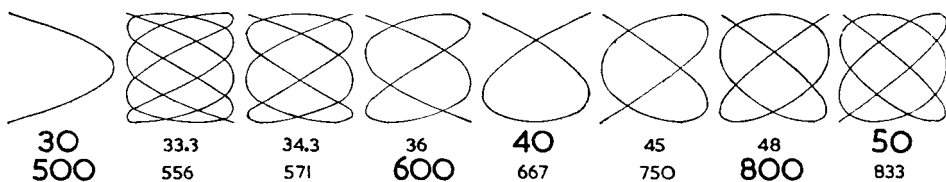
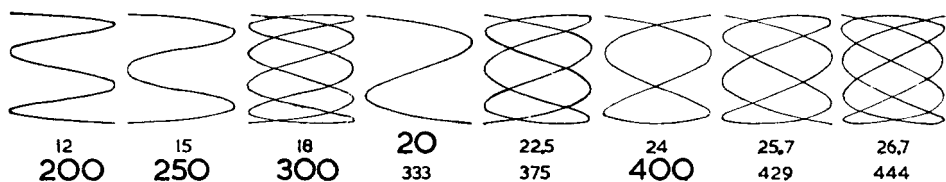

slightly so the pattern drifts slowly, then coming into accurate tune when the pattern is in the right position.

Fig. 1412 shows three possible positions for two patterns, one representing a frequency ratio of 2 to 1 and the other 3 to 2. Using a 60-cycle reference, these patterns represent 120 and 90 cycles, respectively. In both cases the right-hand pattern is the easiest to recognize: the trace folds back on itself, leaving two open ends.

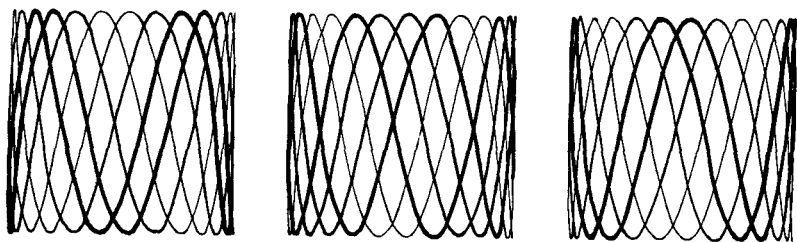

Fig. 1415. The scope patterns for 250 cycles at three different times during its  $1/10$ -second trace.

Complicated patterns appear much simpler, because half the lines on the screen are superimposed on the other half. (This method also provides a valuable check on oscillator waveform. If the waves are not pure sinusoids, the two halves of the pattern will not match perfectly, and it will be impossible to lock them in. All the patterns shown in the recognition chart are in the locked position.)

## Calibration procedure

Fig. 1413 shows the setup for calibrating the lower frequencies (up to 480 cycles) directly from the 60-cycle reference source. The upper figure under each pattern in the main reference chart, Fig. 1414, is the frequency it represents during this stage of the procedure. Mark the simplest patterns (20, 30, 40, 60, 90, 120 and 180 cycles) first. This makes it easy to identify patterns for the principal intermediate frequencies (24, 36, 45, 48, 50, 75, 80, 100 and 150 cycles), and the higher frequencies of 60 cycles (240, 300, 360, 420 and 480). Then go on to the more complicated patterns.

The pattern for 250 cycles is probably the hardest to recognize. It will have considerable flicker, due to the fact that it takes  $1/10$  second for the scope spot to trace out the figure. (This is also true of the 50- and 70-cycle patterns, but they are much less complex.) An accurate guide to identifying the right pattern is to count the

number of crossover points on any part cycle between the top and bottom of the trace. The 250-cycle pattern has five crossovers; 252 and 264 cycles each have four; 255 cycles has three and 260 cycles has only two.

Fig. 1415 is an enlarged view of the 250-cycle pattern in three possible positions on a medium-persistence scope.

### Calibrating higher frequencies

Maintaining the same calibration accuracy for frequencies above 480 cycles requires a second reference oscillator. Since only

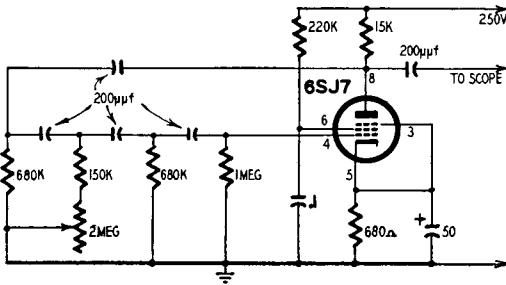

Fig. 1416. Circuit diagram of a simple 1-kc-standard oscillator.

one frequency (1,000 cycles) is required, a breadboard setup will serve the purpose. Fig. 1416 is the circuit of a simple phase-shift oscillator tunable from about 700 cycles to 1,400 cycles. Fig. 1417 is the setup for adjusting this oscillator to exactly 1 kc and using it to calibrate the main oscillator at the higher frequencies.

Note that 200, 250 and 300 cycles appear in both sets of figures on the reference chart (Fig. 1414). These three pairs of patterns are used to find 1 kc in the following manner:

With the switch in the 60-cycle position adjust the *main oscillator* for the original 200-cycle pattern (upper number 200). Now switch to the 1-kc position and adjust the *phase-shift oscillator* for the other 200-cycle pattern (lower figure 200). This should set the phase-shift oscillator to exactly 1 kc. Double-check by repeating these steps with the 250- and 300-cycle patterns. The temporary oscillator can now be used as a reference standard for calibrating the main oscillator to 20 kc, using the patterns for the lower sets of figures. (One kc on the main oscillator should produce a straight diagonal line, ellipse or circle, just as in the original 60-cycle calibration against the line frequency. Check back frequently

against 200, 250 or 300 cycles to see that the phase-shift standard stays on 1 kc.)

You may have a little difficulty at first in recognizing the patterns for the highest frequencies, owing to the large number of waves presented and the convergence at the edges of the pattern, which makes them difficult to count. Notice the patterns for 6, 7, 8, 9 and 10 kc. The *even* ones have both ends either at the top or

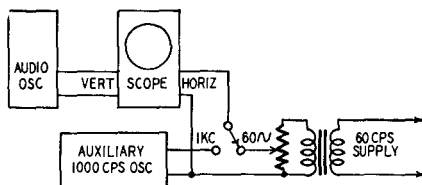

Fig. 1417. The equipment setup necessary for high-frequency calibration.

the bottom; the *odd* ones have one end at the top and one at the bottom. Above 10 kc, only the even-frequency patterns are used, to give 12, 14, 16, 18, and 20 kc.

There will be an odd pattern (not shown) between each pair. The difference between the two types can best be determined by examining both ends of the trace. The even patterns will be symmetrical top and bottom, but not the odd ones.

The great value of the chart (Fig. 1414) is that any pattern obtained can be recognized quickly and its position on the frequency scale known immediately and accurately. This gives a clear indication of *which way and how far* to turn the oscillator dial to find the pattern for the next frequency to be calibrated.

# improving old amplifiers

**W**henever we read in one of the technical journals' articles a description of how to construct something entirely new, we always wonder where the writer thinks the money is to come from. Most of us have some sort of audio amplifier around the house, and even if it isn't perfect, it is still not bad enough to junk completely. So, last but not least, we will consider the problem of the old amplifier and the small bank roll.

Let us assume that you have an old amplifier, without negative feedback, which will give the power you need, and that you want to modernize it by adding feedback. The first step is to decide how much gain you have to spare, since putting on feedback costs gain. Most amplifiers do have gain to spare. If you are unlucky, there are two things you can try. First, get out that circuit diagram and see if there is any gain to be picked up around the stages. Maybe those plate loads in the early stages could be pushed up to scrape another 6 db. If you can't find any more gain, an extra input stage is the only solution. Most power-supply units will provide the extra power you need: 175 ma at 6 volts and about 1 ma at 200–300 volts for a 6AK5, for example. Since you want only about 20 db of gain at low level, practically any small tube will do, and to save money connect it as a triode if you use a pentode.

We shall assume the output transformer is a small one, and it just about passes 50 to 10,000 cycles. Feedback improves the behavior at the low end. Not much can be done at the top or at very low frequencies and high levels, either, once the transformer core

reaches saturation. Feedback does not help then because the forward gain drops to zero during flux maxima, and the feedback vanishes for an instant. However, this just means that where you had intolerable distortion before, the distortion with feedback is unbearable. Any amplifier will overload if the level is too high.

### **Modification procedure**

To begin the reform of the amplifier look back to Chapter 1, and calculate the characteristic frequencies  $1/RC$  for the coupling networks. The chances are that in a three-stage amplifier you will find you have two equal R-C networks giving an  $\omega$  value of about  $1/RC = 300$ , or even higher. Calculate the corresponding characteristic frequencies for the high-frequency end, too, guessing the stray capacitances (a carefully wired interstage will normally be about 20  $\mu\text{f}$ ). This will leave only the transformers as unknown elements. A word of warning here. If there is an interstage transformer, you may as well give up at once. Trying to feed back around two transformers is no way to spend your spare time. Convert the whole circuit to an R-C system at once and save yourself trouble.

Now measure the overall frequency response. Use a resistive load, not a speaker. You ought to take the response from 2 cycles to 200 kc. Take the top end as high as you can, anyway. We can try to find a trick to help out at low frequencies.

If you have a good scope, with wide-band amplifiers for X and Y plates, it is worth while to note the frequencies at which the phase shift is  $90^\circ$  and  $180^\circ$ . Put the input on one pair of plates, the output on the other. Somewhere in the middle of the band you get a nice straight line, which you can arrange at  $45^\circ$  to the horizontal by altering the deflection amplifier gains. As you go up in frequency the figure becomes an ellipse, which twists around and collapses to give a line sloping, when the gains are readjusted,  $45^\circ$  the other way. This is the  $180^\circ$  phase point and is obtained only with some care.

Before you reach this the ellipse will pass through a region in which one axis is horizontal. If you readjust the gains here, you will see a circle. The phase shift here is  $90^\circ$ . These two points (the  $180^\circ$  point is hard to get because of the reduced gain in the amplifier) are useful checks on the graphs we shall draw later. Even though we have a phase meter available we usually adopt this simple checking method.

## Phase characteristics

Let us examine the high-frequency response. Plot the measured response on the same scale you have been using for the amplifier and phase templates (Chapter 1, Figs. 107 and 110). Then plot the amplitude response corresponding to the calculated characteristic frequencies. The difference between these two curves represents the response of the unknown portion of the amplifier. We have done this for a particular example in Fig. 1501.

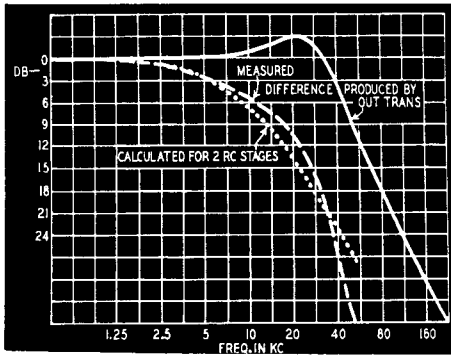

*Fig. 1501. Graph showing the output transformer response obtained from the measured overall response and the calculated effect of the R-C coupling.*

There are now two possible approaches. The classical one is to use the straight-line approximations to the response curve for calculating the phase characteristic. The second is to use a smooth approximation from a set of suitable curves. The straight-line approximation method consists of drawing one or more lines which fit the observed amplitude response and then using the rule that, with a "semi-infinite slope" of 6x db per octave, the phase characteristic is that shown in Fig. 1502. Usually with only an output transformer to worry about,  $x$  will be 2, and the overall phase shift will be  $180^\circ$ . It seems more reliable to make use of some additional curves, however, if it is not too much trouble to find them.

By matching curves of this type to the amplitude response, the way is cleared for a calculation of the phase characteristic. In any normal circuit, the phase is completely determined by the amplitude response, and if you have been following this book, you should be quite at ease with the way in which we combine the basic curves. The reason for splitting off the calculable part was

that it gives us more accurate results and in addition makes it easier to see what happens when we modify the circuit.

This process is sufficient to allow a good guess to be made of the final performance of the system. Suppose that, as is almost certainly the case, the output transformer limits the response. You cannot expect the final response, with feedback, to extend much above the frequency at which the transformer gives  $90^\circ$  phase shift. Is it good enough, in your case? If you decide the answer is yes, or maybe, press on. If it is no, it means a new transformer, and then you can start the design from first principles.

## Feedback

We now have all the facts and have decided to proceed with the design. How much feedback will the circuit accept as it stands? For home use, this is about 6 db less than the drop in amplitude response at the  $180^\circ$  point. Put on feedback and see if this is true. Probably you will not get the 20 db that professional amplifier designers regard as a minimum figure. It is then necessary to process the response curves to permit more feedback to be used. Chapter 3 (especially the extra R-C across the plate load discussed there) contains the material needed to work this out.

It is easier to do the work on graph paper than physically trying all imaginable combinations. We prefer calculating the shunt capacitance to bring the response down 3 db at the highest frequency allowable. This frequency is the  $90^\circ$  phase-shift frequency in the output transformer (the equation  $2\pi fCR = 1$  crops up again). Then put about one-third of the plate load in series with this capacitance. In Fig. 307, Chapter 3, we have  $R2 = R1/3$  and  $C1R2 = 1/2\pi f$ . The step in the response is then about 12 db down, and the phase hump is about  $38^\circ$ . Two circuits of this kind give 24 db and  $76^\circ$  and will normally do the job nicely. You can even make C1 two or three times bigger, because the feedback will flatten the response, and you don't expect high levels above about 1,500 cycles.

A few trial runs will determine the best values of these additional elements to be used. If you haven't been able to measure the response, start by calculating C1 and R2 according to the one-third rule in the last paragraph and add these elements to each interstage coupling. The object of the mathematics in this patching work is to get the right order of magnitude at the beginning.



## Low frequency

At the low-frequency end proceed in the same way: amplitude response, theoretical curves for the R-C networks, resulting transformer response, calculated phase characteristics. If you have any measuring equipment, it is not difficult to find the transformer inductance. The impedance is 377 L ohms at 60 cycles, for example, so that a 60-h primary will pass just over 5 ma if you con-

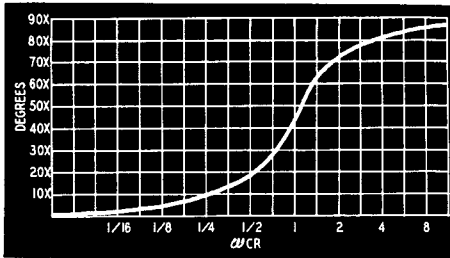

Fig. 1502. The phase characteristic curve for a semi-infinite slope of 6x db (see text).

nect it in series with an a.c. meter across the 117-volt line. A way of getting an approximate idea of what the transformer is doing if the output tube is a pentode is to disconnect the load, working at a low level and remembering, of course, that any feedback should be disconnected before this experiment. If the output voltage rises 40% (3 db), the frequency is the characteristic frequency R/L. This is a quick and reasonably good way to get the answer you need, and you can calculate the phase and amplitude responses directly.

You will probably need to increase the R-C product in the interstage couplings for low-frequency stability. You may do this by increasing the grid resistors, but do not go above 500,000 ohms here; the average tube will not take higher grid resistors. It is possible to increase the coupling capacitors, too, but large size and possibility of motorboating (positive feedback at low frequencies) may make it unfeasible if the coupling R-C products are too big.

It can sometimes save a lot of trouble to jump straight to the use of the step circuit (Fig. 304) with about a 12-db step in each stage. The rolloff can then begin at about 40-50 cycles and you get the protection you need against motorboating. This double R-C circuit has been found to give extremely stable amplifiers, without forcing the use of large capacitors.

All you need to do now is to connect the feedback resistor. In Chapter 4, there is a table of the methods of connection. We favor a straight resistor brought back to the cathode. Provided the resistance is high, as it usually can be, there is no need to put a capacitor in to block the direct current. This helps the low-frequency stability conditions. A variable resistor, such as a  $\frac{1}{2}$ -megohm carbon potentiometer, is conveniently used as the feedback resistor. The value can be reduced until instability occurs. This test is best carried out with a signal applied.

The use of a scope is a great help here because, if instability occurs only during part of the cycle, the resulting fuzz is easily seen. Without the scope you can only listen for distortion. It is better to use a square-wave input with the scope. As feedback increases, ringing on the square waves increases. Feedback can be adjusted to make sure that the amplifier is adequately damped.

### **Compromise solutions**

The above design process has been a general discussion capable of the widest possible solution. Poor output transformers always complicate things, and there are compromise solutions which are easier to apply.

Simplest of them all, in theory, is to feed back from the cathode of the output stage, so that the current through this tube is undistorted. This is a troublesome arrangement in practice, not because it becomes unstable, for the stability is usually very good, but because if the output tube is a tetrode, the cathode current usually includes the screen current. The feedback keeps the *cathode* current undistorted, but as the screen current is usually pretty distorted at high levels, the plate current is not at all what you expect. The distortion may even increase when feedback is applied.

At high frequencies, where this circuit is widely used, in coaxial cable repeaters, for example, it is easy to avoid this trouble by decoupling the screen back to the cathode. At audio this means an extra choke and electrolytic capacitor. Moreover, as we saw in Chapter 4, this increases the output impedance, which we do not want.

The usual compromise is to put on some feedback from the output tube plate and the rest from the actual output winding. The low-frequency problems in this design are exactly the same

as those discussed before. They can be made easier by feeding back only to the cathode of the preceding stage, because we do not expect much distortion in the input stages where the level is usually well within the handling capacity of the tubes.

It is easy to put on about 10–15 db of feedback this way and then add an extra 6–10 db around the whole amplifier. The inner feedback loop reduces the impedance of the amplifier and minimizes the low-frequency distortion behavior of the output transformer. The leakage inductance of the output transformer appears only in the outer feedback loop, so a poor output transformer is much easier to keep under control by this method. The high-frequency response is improved, not by the inner loop feedback, but by the overall feedback.

Instead of considering the final two stages with their feedback loop as a subamplifier, or using the alpha-beta chart of Chapter 5 to work out the response and calculate the overall behavior, the simplest approach seems to be to put in a set of the double R-C circuits to save time in the long run. Add an inner loop feedback resistor to bring the gain down about 12 db. Measure the response to the plate of the output stage and make sure that this response drops gently. If it shows a tendency to bump upward, put a 50–100  $\mu\text{f}$  or other suitable capacitance across the feedback resistor. Then add the main feedback loop and push the feedback to the instability point.

When we began writing this book, we said we would not provide you with a cookbook approach to the negative feedback amplifier. This section has quite consciously avoided the cookbook approach. No quantities, just a hint on how they cook capon around Bayonne. If you are a cook, the rest is up to you. This section is meant to give you the general idea and to set you on the right road. When it comes to adding feedback to your present amplifier, you can add some ahead of the speaker transformer, perhaps even some positive feedback round the first stages, and at least some of the negative feedback from the speaker voice coil itself. The more tendency toward high-frequency resonance the transformer has, the less feedback you can take from the secondary winding.

One final word of warning: do not rush light-heartedly into the addition of feedback to class-B amplifiers! If the output transformer is not completely symmetrical, you can get quite different phase and amplitude characteristics for the two halves

of the cycle with a sine-wave input. Cures are possible, but they take an enormous amount of trouble. It is cheaper to get a new transformer. *Whatever the amplifier, plan carefully what you are going to do before you start working.*

## A

Acoustic Realism .....	205
Adjustable Twin-T Network .....	222
Admittance of Antiresonant Circuit .....	99
Advantage of Output Circuit .....	75
Advanced Techniques .....	219
Air Gap Inductance Balancing .....	41
Alpha-Beta:	
Effect Formula .....	89
Evaluator .....	89
vs. Mu-Beta .....	88
Amplification of Noise .....	108
Amplifier:	
Amplitude Characteristics .....	19, 20
Analysis .....	31
Center-Tuned .....	97
Db Gain or Loss Formula .....	8
Design .....	31
Gain Formula .....	10
Grounded-Cathode .....	228
Grounded-Grid .....	224
High-Frequency Response .....	35
High-Power .....	241
I.f. .....	96
Impedances .....	74
Improvements .....	289
Increasing Stability .....	38
Instability .....	61
Inverted .....	225
Low-Frequency Response .....	293
Low-Gain .....	87
Narrow-Pass Bandpass .....	96
Open-Circuit Stability .....	40
Oscilloscope .....	278
Phase Characteristics .....	291
Phase Response .....	19, 20
Resistance-Loaded .....	97
Self-Balancing .....	278
Unity Gain .....	264
Voltage Feedback .....	74
Voltmeter .....	9
Amplifier Gain:	
Formula .....	12
Grounded-Grid Stage .....	229
Phase Angle .....	13, 14
Amplifier Response:	
Formula .....	51
Low-Frequency .....	32
Problems and Solution .....	25, 26, 27
Amplitude:	
Characteristics of Amplifier .....	19, 20
Margin .....	37
Analysis of Amplifier .....	31
Analyzer, Wave .....	195
Angle of Phase .....	198
Anode Follower Circuit .....	127
Antiresonant Circuit, Admittance of .....	99
Artificial Line .....	178

Attenuation:	
Characteristics .....	185
Losses from Impedance Mis-	
matching .....	169
of Interstage Coupling .....	14
Attenuator:	
Balanced .....	160
Bridged-T .....	160
Constant-Impedance .....	172
H-Type .....	164
Lattice .....	160
L-Type .....	160
Mismatch Reflections Chart .....	171
O-Type .....	164
Pi-Type .....	160
Single-ended .....	160
T-Type .....	160
Attenuator Design:	
Bridged-T .....	168
Lattice Type .....	165, 168
L-Type .....	168
Pi-Type .....	164
T-Type .....	164
Audibility Threshold .....	257
Audio Amplifier Design .....	232
Audio Distribution System .....	241
Audio Oscillator Calibration .....	283
Automatic Switching .....	257
Axis, Cone .....	214

## B

Balanced Attenuator .....	160
Balanced Connecting Line .....	249
Balancing Methods .....	119
Bandpass Filter .....	99
Basic Amplifier, Stage Gain .....	48
Basic Feedback Amplifier	
Mathematics .....	10, 11, 12, 13
Bass Boost:	
Circuit .....	193
Equalizers .....	188
Bass Control Circuit .....	222
Binaural Perception .....	206, 207
Bode's Equation .....	88
Boost, Equalizer .....	187
Boundaries of Tube Characteristics .....	83
Boundary:	
Positive Grid-Swing .....	83
Zero Plate Current .....	84
Bridge Feedback Circuit .....	78
Bridged-T Attenuator .....	160
Bridged-T, H, L and U Attenuator	
Design Chart .....	167
Bump:	
High-Frequency .....	15
Low-Frequency .....	15
Phase .....	50
Bus System, 500-ohm .....	247
Buzz, High-Frequency .....	116

# C

Calculated Response .....	22
Calculating Phase Characteristics .....	291
Calculations:	
Feedback Resistor .....	69
Output Impedance .....	76
Calculator, Mu-Beta Effect .....	89
Calibrating Audio Oscillators .....	283
Calibration, High-Frequency .....	287
Capacitive Reactance Formula .....	13
Capacitor:	
Decoupling .....	48
Input Filter .....	146
Capacitor Type Equalizers .....	188
Cathode-Coupled Multivibrator .....	43, 69
Cathode-Coupled Phase Inverter .....	137
Cathode Follower:	
Functions .....	239
Impedance .....	237
Cathode Local Feedback .....	36
Cathode-to-Cathode Feedback	
Circuit .....	71
Center-Tuned Resistance-Loaded	
Amplifier .....	97
Characteristic Frequencies .....	49
Characteristic Impedance .....	177
Chart:	
Alpha-Beta Evaluator .....	93
Attenuation Losses from Impedance Mismatching .....	169
Attenuator Mismatch Reflections .....	171
Bridged-T, H, L and U Attenuators .....	167
Common Distortion Patterns .....	203
Constant-Resistance vs. Wave-Filter Crossover Networks .....	183
Crossover Networks .....	209
Impedance vs. Constant Voltage .....	245
Impedance vs. Turns Ratio .....	249
Minimum Attenuation and Resistor Values for L-Pads .....	173
Parallel Resistances .....	153
Scope Recognition Patterns .....	284
Series Capacitances .....	153
Swinging-Choke Design .....	147
T, Pi, H and O Attenuator	
Design .....	166
Choke Input Filters .....	146
Circuit:	
Anode Follower .....	127
Bass-Boost .....	193
Bridge Feedback .....	78
Cathode .....	50
Cathode Follower .....	235
Cathode-to-Cathode Feedback .....	71
Equalizer .....	188
Feedback .....	39
Interstage Coupling .....	13, 14
Long-Tailed Pair .....	137
Preamplifier .....	220
Q .....	102
Refinements .....	47
Remote Control, Switching .....	256
Screen Grid .....	50
Seesaw .....	127
Stabilizing .....	39
Tone Correction .....	221
Tritet .....	71
Volume Control .....	224
Clapp-Gouriet Oscillator .....	270
Clipping, Grid Current .....	201
Coil Q .....	102
Coils, Loading .....	176
Colpitts Oscillator .....	270
Conditional Stability .....	59
Common Distortion Patterns .....	203
Component Tolerances .....	63
Conductance:	
Insulation .....	176
Screen Grid .....	51
Conductor Resistance .....	176
Cone Axis .....	214
Connecting Line, Balanced .....	249

Constant Gain .....	7
Constant-Impedance Attenuator 172, .....	173
Constant-k Filter .....	275
Constant-Resistance:	
Filters .....	182
Networks .....	207
vs. Wave-Filter Crossover	
Networks .....	183
Constant-Voltage:	
Lines .....	242
System .....	241
Constant Voltage vs. Impedance,	
Chart .....	245
Control of Impedance .....	72
Control Unit, QUAD .....	223
Controls, Fader .....	256
Cosine of Phase Angle .....	198
Coupling:	
Interstage .....	13, 14
Line Impedance .....	240
Networks .....	52
Crossover:	
Frequency .....	207
Loudspeaker .....	182
Points .....	52
Crossover Networks:	
Design Chart .....	209
Loudspeaker .....	205
Crosstalk .....	249
Current, Unbalancing .....	42
Curvature Distortion .....	109
Curvature, Grid-Swing .....	85
Curve Interpretation, Phase Shift .....	27
Curves:	
Response .....	34
Wattage Dissipation .....	83
Cut, Treble .....	220

# D

Damping Speaker Resonance .....	72
Db Gain of Amplifier Using	
Feedback .....	13
Db Gain or Loss in Amplifier,	
Formula .....	8
Decoupling:	
Capacitors .....	48
Resistors .....	48
Defining Stability Margin .....	60
Degenerative Feedback (see Negative Feedback)	
Degree of Stability .....	62
Design:	
Comparisons .....	96
Considerations .....	16
Factors .....	87
Problems .....	16
Refinements .....	47
Design Chart:	
Attenuation Losses from Impedance Mismatching .....	169
Attenuator Mismatch Reflections .....	171
Bridged-T, H, L and U Attenuators .....	167
Constant-Resistance vs. Wave-Filter Crossover Networks .....	183
Crossover Networks .....	209
Impedance vs. Constant Voltage .....	245
Impedance vs. Turns Ratio .....	249
Minimum Attenuation and Resistor Values for L-Pads .....	173
Parallel Resistances .....	153
Series Capacitances .....	153
Swinging-Choke .....	147
T, Pi, H and O Type Attenuators .....	166
Designing:	
Audio Amplifier .....	232
Bridged-T Attenuator .....	168
Constant-Impedance Attenuator	
172, .....	173
L-Type Attenuator .....	168
Lattice Attenuator .....	165
Output Stage .....	41

Output Transformer .....	41, 264
PA Amplifier .....	261
Pi-Type Attenuator .....	164
Push-Pull Stages .....	112
Sound Reinforcement Amplifier .....	261
T-Type Attenuator .....	164
Test Equipment .....	269
U-Type Attenuator .....	167
Detector, Germanium-Diode .....	272
Directional Sensitivity .....	211
Dissipation of Maximum Wattage .....	82
Dissociation Effect .....	207, 211, 214, 216
Distortion:	
Phase .....	205
Second-Harmonic .....	68
Third-Harmonic .....	68
Transformer Core Magnetizing	
Current .....	202
Trapezoidal .....	281
Distortion Patterns, Chart .....	203
Distortionless Line .....	176
Distributed Loading .....	176
Distribution, Audio System .....	241
Dotted Hump Phase .....	53
Drivers and Inverters .....	111
Dual Speaker Units .....	216
Dynamic Speakers .....	242

## E

Echo, Natural .....	214
Electrical Time Difference .....	218
Electronic Mixing .....	256
Energy, Noise .....	101
Equalizer:	
Bass-Boost .....	187, 188
Capacitor Type .....	188
Drop .....	187
Evaluator, Alpha-Beta .....	89

## F

Factors:	
Feedback .....	12, 18, 231
Gain .....	76
Impedance .....	76
Fader Controls .....	256
Feedback:	
Applications .....	18
Cathode-to-Cathode .....	71
Circuit .....	39
Design .....	15
Factor .....	12, 18, 231
Increasing .....	292
Loop .....	40
Network Gain Formula .....	10
Networks .....	54
Positive .....	65, 230
Positive Current .....	76
Positive Voltage .....	76
Ratio of .....	12
Reasons for Using .....	7, 8
Resistor .....	40, 44
Resistor Calculations .....	69
Series Injection .....	106
Short Loop .....	109
Shunt Injection .....	106
Tertiary Winding .....	110
Uses .....	18
Filters:	
Bandpass .....	99
Capacitor Input .....	146
Choke Input .....	146
Constant-k .....	275
Constant-Resistance .....	182
Highpass .....	178
Low-pass .....	99, 178
M-Derived .....	180, 181
Multisection .....	257
Negative Resistance .....	235
Swinging-Choke .....	144

## Formula:

Admittance .....	98
Alpha-Beta Effect .....	89
Alpha-Beta vs Mu-Beta .....	88
Amplifier Db Gain or Loss .....	8
Amplifier Gain .....	10
Amplifier Gain with Feedback .....	12
Amplifier Response .....	51
Basic Amplifier Stage Gain .....	48
Capacitive Reactance .....	13
Cathode Follower Impedance .....	237
Db Feedback Factor .....	18
Db Gain of Amplifier Using	
Feedback .....	13
Feedback Gain Using Three	
Interstage Coupling Circuits .....	14
Feedback Network Gain .....	10
Gain of Two-Path Feedback	
Network .....	66
Grounded-Cathode Amplifier	
Gain .....	228
Grounded-Grid Amplifier Gain .....	229
Grounded-Grid Amplifier Output	
Impedance .....	228, 229
High Frequency Factors .....	36
Input Impedance of Grounded-	
Grid Amplifier .....	228, 229
Mu-Beta Effect .....	89
Output Circuit Admittance .....	75
Pentode Tube Gain .....	131
Resonant Frequency .....	104
Simple Amplifier Stage Gain .....	48
Transformer Turns Ratio .....	42
Triode Tube Gain .....	131
Turnover Frequency .....	23, 24
Voltage Amplification of	
Grounded-Grid Amplifier .....	231
Frequencies, Characteristic .....	49
Frequency:	
Crossover .....	207
Resonance Formula .....	104
Resonant .....	104
Response Improvement .....	8
Rolloff .....	44
Functions of Cathode Follower .....	239

## G

Gain:	
Changes in .....	10
Constant .....	7
Factor .....	76
Feedback .....	10
Grounded-Cathode Amplifier .....	228
Grounded-Grid Amplifier .....	229
Loaded .....	74
Loop .....	12, 55
Margin .....	22
Maximum .....	49
Negative Feedback .....	12
Open-Circuit .....	74
Peak .....	49
Two-Path Feedback Network .....	66
Variations .....	10
Without Feedback .....	17
Gain Formula:	
Grounded-Cathode Amplifier .....	228
Grounded-Grid Amplifier .....	229
Pentode Tube .....	131
Triode Tube .....	131
Gain Margin Measurements .....	56
Gas Regulator Tube .....	279
Generation of Noise .....	108
Generator, Single-Frequency .....	269
Germanium-Diode Detector .....	272
Grid Current Clipping .....	201
Grid-Swing:	
Curvature .....	85
Positive Boundary .....	83
Ground Potentials .....	248
Grounded-Cathode Amplifier Gain .....	228
Grounded-Grid .....	224

Grounded-Grid Amplifier:	
Input Impedance .....	228, 229
Output Impedance .....	228, 229
Grounds, Isolating .....	255

## H

H, T, Pi and O Attenuator Design	
Chart .....	166
Harmonic Distortion Reduction .....	8
Hartley Oscillator .....	116
High Frequency:	
Bump .....	15
Buzz .....	116
Calibration .....	287
Factors .....	36
Instability .....	39
Problems .....	266
Response .....	29, 35
Stability .....	44
High-Impedance Lines .....	251
Highpass Filter .....	178
High-Power Amplifiers .....	241
Hiss, Output .....	108
Hookup Problems .....	246
H-Type Attenuator .....	164
Hum, Line .....	247
Hum, Static .....	149
Hum Fields, Magnetic .....	250

## I

I.f. Amplifiers .....	96
Image Impedance .....	179
Impedance:	
Amplifier .....	74
Cathode Follower .....	237
Control .....	72
Characteristic .....	177
Factor .....	76
Grounded-Grid Amplifier Input .....	228
Grounded-Grid Amplifier Output .....	228
Image .....	179
Line .....	250
Line Coupling .....	240
Loads .....	244
Practical Terminating .....	182
Terminal .....	190
Transfer Characteristics .....	182
Variations .....	208
Voice-Coil .....	208
Impedance vs. Constant Voltage,	
Chart .....	245
Impedance vs. Turns Ratio, Chart .....	249
Inductance:	
Balancing .....	41
Leakage .....	20, 38
Limiting Factor .....	70
Initial Permeability .....	35
Inner Loop Feedback Resistor .....	295
In-phase Feedback	
(see Positive Feedback)	
Input Impedance:	
Control .....	72
of Grounded-Grid Amplifier,	
Formula .....	228, 229
Input Transformer Resonance .....	107
Instability:	
Amplifier .....	61
High-Frequency .....	61
Insulation Conductance .....	176
Intensity Relationships .....	212
Intermediate Frequency Amplifiers ..	96
Intermodulation Distortion	
Reduction .....	8
Internal Noise .....	107
Interpreting Phase-Shift Curve .....	27
Interstage Coupling:	
Attenuation .....	14
Circuits .....	13, 14
Low-Frequency .....	23

Interstage Transformer .....	113, 290
Inverse Feedback	
(see Negative Feedback)	
Inverted Amplifier .....	225
Inverters and Drivers .....	111
Isolating Grounds .....	255
Isolating Transformer .....	256

## K

K, Constant Derived Filter .....	275
----------------------------------	-----

## L

L, Bridged-T, H and U Attenuator	
Design Chart .....	167
L-Pads .....	172
Lattice Attenuator Design ..	160, 165, 168
Leakage Inductance .....	20, 38
Level Matching .....	248
Level, Volume .....	247
Lift, Treble .....	222
Limiting Factor, Inductance .....	70
Line-to-Line Transformer .....	256
Line-to-Speaker Transformer .....	256
Lines:	
Artificial .....	178
Constant Voltage .....	242
Distortionless .....	176
High-Impedance .....	251
Hum .....	247
Impedance .....	250
Impedance Coupling .....	240
Load .....	84
Loss-Free .....	177
Negative Voltage .....	281
Lissajous Patterns .....	198, 199
Load:	
Dummy .....	253
Lines .....	84
Loudspeaker .....	72
Impedances .....	244
Matching .....	228
Nominal .....	244
Optimum .....	72, 80, 101, 228
Resistive .....	253
Loaded Gain .....	74
Loading:	
Coils .....	176
Distributed .....	176
Impedance .....	244
Lumped .....	176
Local Cathode Feedback .....	36
Long-Tailed Pair .....	137
Loop:	
Feedback .....	40
Gain .....	12, 55
Loss-Free Line .....	177
Losses:	
Output Transformer .....	76
Transmission .....	250
Loudspeaker:	
Correct Phasing .....	216
Crossover Networks .....	182, 205
Dynamic .....	242
Dual Units .....	216
Incorrect Phasing .....	216
Load .....	72
Multiple Connections .....	242
Phasing .....	205
Loudspeaker-to-Line Transformer ..	256
Low-Frequency:	
Bump .....	15
Interstage Couplings .....	23
Response .....	32
Rolloff .....	24
Low-Gain Amplifiers .....	87
Lowpass Filter .....	99, 178
L-Type Attenuator Design .....	160, 168
Lumped Loading .....	176



<b>M</b>	Internal .....	107
	Neutralization .....	108
	Nominal Load .....	244
Magnetic Hum Fields .....	250	
Magnetizing Current Distortion, Transformer Core .....	202	
Margins:		
Amplitude .....	37	
Phase .....	37	
Safety .....	19	
Stability .....	19, 93	
Matching:		
Level .....	248	
Load .....	228	
Mathematics of Basic Feedback		
Amplifier .....	10, 11, 12, 13	
M-Derived Filters .....	180, 181	
Measurements:		
Gain Margin .....	56	
Phase Margin .....	56	
Meter, Phase .....	290	
Microphone Control, Remote .....	256	
Mid-shunt Points .....	179	
Mid-series Points .....	180	
Mike-to-Line Transformer .....	245	
Minimum Attenuation and Resistor Values for L-Pads, Chart .....	173	
Mismatch Reflections Chart Attenuator .....	171	
Mixing, Electronic .....	256	
Modifying Old Amplifiers .....	289, 290	
Modulator, Phantastron .....	270	
Modulator Plate Tuning .....	276	
Monitoring, Program .....	247	
Motorboating .....	293	
Mu-Beta:		
Calculator .....	89	
Effect .....	87	
Effect Formula .....	89	
Mu-Beta Effect vs. Alpha-Beta Effect .....	88	
Multi-Ratio Transformer .....	243	
Multiple:		
Feedback Loops .....	88	
Side Frequencies .....	277	
Signal Sources .....	254	
Speaker Connections .....	242	
Multisection Filters .....	257	
Multivibrator, Cathode-Coupled .....	43, 69	
Muting Arrangements .....	223	
<b>N</b>		
Narrow-Pass Bandpass Amplifiers .....	96	
Natural Echo .....	214	
Natural Reverberation .....	216	
Negative Current and Positive Volt- age Feedback Combined .....	76	
Negative Feedback:		
Effects .....	7	
Gain .....	12	
Negative Resistance:		
Filter .....	235	
Oscillator .....	234	
Negative Voltage Line .....	281	
Networks:		
Constant-Resistance .....	183, 207	
Coupling .....	52	
Feedback .....	54	
Loudspeaker Crossovers .....	205	
Padding .....	250	
Passive .....	72	
Sound-Distribution .....	261	
Twin-T .....	222	
Wave-Filter Crossovers .....	183	
Neutralization of Noise .....	108	
Noise:		
Amplification of .....	108	
Energy .....	101	
Generation .....	108	
Internal .....	107	
Neutralization .....	108	
Nominal Load .....	244	
Nomogram:		
Parallel Resistances .....	153	
Series Capacitances .....	153	
Nonperiodic Signal .....	108	
Normalized Frequency .....	29	
Notch Effect .....	263	
Nyquist Testing .....	55	
Nyquist's Criterion .....	58	
<b>O</b>		
O, T, Pi and H Attenuator Design Chart .....	166	
Octave .....	186	
Open-Circuit:		
Gain .....	74	
Stability .....	40	
Optimum Load .....	72, 80, 101, 228	
Optimum Resistance .....	81	
Oscillation Troubles .....	10	
Oscillators:		
Audio Calibration .....	283	
Clapp-Gouriet .....	270	
Colpitts .....	270	
Hartley .....	116	
Negative Resistance .....	234	
Phase-Shift .....	287	
Oscilloscope:		
Push-Pull Amplifier .....	278	
Recognition Patterns .....	284	
O-Type Attenuator .....	164	
Out-of-Phase Feedback (see Nega- tive Feedback)		
Output:		
Hiss .....	108	
Impedance Calculations .....	76	
Impedance Control .....	72	
Transformer .....	41	
Output Circuit Admittance .....	75	
Output Impedance, Grounded-Grid Amplifier .....	228	
Output Stage Design .....	41	
Output Transformer:		
Design .....	264	
Losses .....	76	
Overall Feedback:		
Disadvantages .....	109	
Problems .....	105	
<b>P</b>		
PA Amplifier Design .....	261	
PA Work, Phasing .....	214	
Padding Networks .....	250	
Pads, L .....	172	
Parallel Resistances, Nomogram .....	153	
Passive Network .....	72	
Patterns:		
Lissajous .....	198, 199	
Oscilloscope .....	284	
Phase Shift .....	196	
Pentode Tube Gain Formula .....	131	
Perception, Binaural .....	206, 207	
Periodic Signal .....	108	
Permeability .....	35	
Phantastron Modulator .....	270	
Phase:		
Bump .....	50	
Delay .....	176	
Distortion .....	205	
Dotted Hump .....	53	
Limits .....	21	
Margin .....	21, 37	
Measurements .....	56	
Meter .....	290	

Response	19, 20
Spatial Difference	218
Splitter	42, 112, 115
Phase Angle:	
Amplifier Gain	13, 14
Cosine	198
Sine	198
Phase Area Theorem	62
Phase Characteristic Calculations	291
Phase Shift:	
Curve Interpretation	27
Effects	13
Oscillator	287
Patterns	196
Phasing:	
PA Work	214
Speaker	205
Pi, T, H and O Attenuator Design Chart	166
Pi-Type Attenuator Design	160, 164
Pickup:	
Spurious	251
Static	240
Plate Current Zero Boundary	84
Plate Tuning, Modulator	276
Polar Response Curve	57
Positive:	
Current Feedback	76
Feedback	65, 230
Grid-swing Boundary	83
Voltage Feedback	76
Positive Current and Negative Voltage Feedback Combined	77
Potentials, Ground	248
Power Supplies	143
Practical Amplifier Design	41
Practical Terminating Impedance	182
Preamplifier, Remote Control	220
Preamplifier Stage	46
Program Monitoring	247
Propagation of Sound Waves	213
Push-Pull:	
Design	112
Scope Amplifier	278
Voltage	280
Push-Push Voltage	280
<b>Q</b>	
Q of Circuit	102
Q of Coil	102
QUAD Control Unit	223
<b>R</b>	
Ratio of Feedback	12
Realism, Acoustic	205
Recognition Patterns, Oscilloscope	284
Regenerative Feedback (see Positive Feedback)	
Reinforcement, Sound	214
Remote Control:	
Microphone	256
Preamplifier	220
Switching	256
Resistance:	
Conductor	176
Negative	233, 234
Optimum	81
Resistance-Loaded Center-Tuned Amplifier	97
Resistor:	
Decoupling	48
Feedback	40, 44
Inner-Loop Feedback	295
Padding	250
Resistor Values and Minimum Attenuation for L-Pads, Chart	173

Resonance Damping, Speaker	72
Resonance of Input Transformer	107
Resonant Frequency Formula	104
Response:	
Calculations	22
Curves	34
High-Frequency	29
Response Curve, Polar	57
Response Improvement, Frequency	8
Reverberation, Natural	216
Rolloff, Low-Frequency	24
<b>S</b>	
Safety Margins	19
Schmitt Cathode Coupled Phase Inverter	137
Scope Amplifier, Push-Pull	278
Scope Test Procedures	195
Screen Grid:	
Circuits	50
Conductance	51
Second Harmonic Distortion	68
Seesaw Circuit	127
Self-Balancing Push-Pull Scope Amplifier	278
Semi-infinite Slope	291
Sensitivity:	
Directional	211
Maximum	82
Series Capacitances, Nomogram	153
Series Injection	106
Shelf Height	187, 188
Shift, Phase	196
Short-Loop Feedback	109
Shunt Injection	106
Side Frequencies, Multiple	277
Signal:	
Nonperiodic	108
Periodic	108
Signal Sources, Multiple	254
Sine of Phase Angle	198
Single-Ended Attenuator	160
Single Frequency Generator	269
Slope, Semi-infinite	291
Sound:	
Distribution Networks	261
Reinforcement of	214
Sound Wave Propagation	213
Sources	206
Speed of	211
Source of Sound	206
Spatial Phase Difference	218
Speaker:	
Correct Phasing	216
Crossover Networks	182, 205
Dual Units	216
Dynamic	242
Incorrect Phasing	216
Multiple Connections	242
Phasing	205
Resonance Damping	72
Systems	205
Transformer Stability	245
Speed of Sound	211
Spurious Pickup	251
Stability:	
Conditional	59
Conditions of	21
Degree of	62
Margin	19, 60, 93
Speaker Transformer	245
Stabilizing Circuit	39
Stage Gain Formula, Basic Amplifier	48
Static Pickup	240
Step Height	54, 187, 188
Step Transient	257
Supplies, Power	143
Swinging Choke:	
Design Chart	147
Filter	144

Switching:	
Automatic .....	257
Remote Control .....	256
Systems:	
Audio Distribution .....	241
Bus, 500-ohm .....	247
Constant-Voltage .....	241

## T

T, Pi, H and O Attenuator Design Chart .....	166
Terminal Impedances .....	190
Tertiary Feedback-Winding .....	110
Test Equipment Design .....	289
Test Procedures, Scope .....	195
Testing, Nyquist Method .....	55
Tetrodes vs. Triodes .....	73
Theorem, Phase Area .....	62
Theory, Transmission Line .....	175
Third Harmonic Distortion .....	68
Threshold of Audibility .....	257
Time Difference, Electrical .....	218
Tolerances, Component .....	63
Tone Correction Circuit .....	221
Transfer Characteristics, Impedance Transformer:	182
Core Magnetizing Current Distortion .....	202
Interstage .....	113, 290
Isolating .....	256
Line-to-Line .....	256
Line-to-Speaker .....	256
Mike-to-Line .....	245
Multi-Ratio .....	243
Output .....	41
Transient, Step .....	257
Transmission Line:	
Properties .....	175, 176
Theory .....	175
Transmission Losses .....	250
Trapezoidal Distortion .....	281
Treble:	
Cut .....	220
Lift .....	222
Triode Tube Gain Formula .....	131
Triodes vs. Tetrodes .....	73
Tritet Circuit .....	71
T-Type Attenuator Design .....	160, 164
Tube, Voltage Regulator .....	279
Tube Characteristics:	
Boundaries .....	83
Load Lines .....	84
Modifications .....	74
Tuning, Modulator Plate .....	276

Turnover Frequency Formulas .. 23,	24
Turnover Points .....	187
Turns Ratio Formula .....	42
Turns Ratio vs. Impedance, Chart .....	249
Twin-T Network .....	222
Two-Path Feedback Network Gain	66

## U

U, Bridged-T, H and L Attenuator Design Chart .....	167
Unbalancing Current .....	42
Unity Gain Amplifier .....	264

## V

Vari-Slope Technique .....	222
Voice-Coil Impedance .....	208
Voltage:	
Push-Pull .....	280
Push-Push .....	280
Voltage Amplification of Grounded-Grid Amplifier .....	231
Voltage Feedback:	
Amplifier .....	74
Input Cathode .....	18
Input Grid .....	18
Voltage Line:	
Constant .....	242
Negative .....	281
Voltage Regulator Tube .....	279
Voltmeter Amplifier .....	9
Volume Control Circuit .....	224
Volume Level .....	247

## W

Wattage .....	82
Wattage Dissipation:	
Curve .....	83
Maximum .....	82
Wave Analyzer .....	195
Wave-Filter vs. Constant-Resistance Crossover Networks .....	183
Wave Propagation, Sound .....	213
WWV .....	269

## Z

Zero Plate Current Boundary .....	84
-----------------------------------	----