

THE

Cat's Whisker

50 YEARS OF WIRELESS DESIGN

JONATHAN HILL

PHOTOGRAPHS BY TREFOR BALL



ORESKO BOOKS LTD · LONDON



W. HEATH
ROBINSON

To Peg and Geoff.

b/c 2142773
~~754645~~

BIE78

ACCESSION No.		117523
CLASS No.		621.39 104 HIL
23 JUN 1978		
O/S	N. CATEGORY	

Acknowledgements

I would like to thank Trefor Ball for taking the photographs and the following for their help and support: Andrew Hill and H. M. Lofthouse; Jeffery Daniels and Richard Sword of the Geffrye Museum, London; Michael and Angela Steyn; the Victoria & Albert Museum (Photo of Murphy A 104), and in particular Dave and Joy for lending me the money to buy my first wireless set.

First published in Great Britain by
Oresko Books Ltd., 30 Notting Hill Gate, London W11

UK ISBN 0 905368 46 0 (cloth)

UK ISBN 0 905368 47 9 (paper)

Copyright © Oresko Books Ltd. 1978

Printed in Great Britain by
Burgess & Son (Abingdon) Ltd., Abingdon, Oxfordshire

Library of Congress Catalogue No: 78 52365

USA ISBN 0 8467 0477 3 (cloth)

USA ISBN 0 8467 0478 1 (paper)

Contents

Introduction	6
The Historical Background	7
Broadcasting Begins	15
The Crystal Set	24
Early Valve Receivers 1922-1927	36
Wireless for the Home 1927-1938	65
War-time Wireless	82
A Short History of the Wireless	91
How to Date a Receiver	94
Bibliography	96

Introduction

During the early days of wireless broadcasting in the 1920s, listeners would often refer to the receiving device more familiarly as the 'cat's whisker'. This tiny coil of wire was an essential part of the crystal set, and much time had to be spent in carefully adjusting the contact between it and the crystal so that the loudest signals could be heard through the headphones. The simplicity of design of these early receivers, which consisted of little more than a few components mounted on a panel and housed in a small wooden box, characterizes this experimental age when every listener was a pioneer.

Over the years the wireless set* has become one of the commonest items to be found in every home, but the exciting visual changes it has gone through during its lifetime have largely been forgotten. In writing this

book I hope to record these changes and show just how important the wireless set has been in people's lives. First, I shall follow the development of wireless from its beginnings as a laboratory experiment in the 1890s, to the foundation of a wireless and broadcasting industry in 1922; then I shall trace the various changes in appearance of the wireless set, the different styles of the cabinet, and the way in which art and social events influenced the design.

*For many years 'wireless' and 'radio' were used to describe the same thing, the difference being that 'radio' was the American version of the British 'wireless'. The receiver was called a 'wireless' because there were no wires linking it to the transmitting station, and was also called a 'radio' because it was a receiver of radiated electrical signals, both terms being equally correct. Gradually, however, the American term was adopted alongside the British version in this country, and came to mean something a little more modern and technical than the slightly old-fashioned 'wireless'. The British Broadcasting Company was one of the first to use the term, publishing the *Radio Times* on 28 September 1923.

The Historical Background



1 Guglielmo Marconi (1866-1937). (by courtesy of the Marconi Company)

In 1894, the man whose name is synonymous with the development of wireless, Guglielmo Marconi (ill. 1), began his first experiments in Italy, using the results of Heinrich Rudolf Hertz's research into the transmission of electromagnetic waves, conducted seven years before. Hertz produced these 'wireless' waves by means of an oscillator (ill. 2), and they were detected at the other end of his laboratory by means of a simple piece of apparatus which he called a resonator (ill. 3). This consisted of no more than a length of thick copper wire about eight feet long, with a small metal sphere soldered at each end. The wire was bent into the shape of a ring with the spheres almost touching each other. When the oscillator was switched on, the discharge of electricity across its spark gap sent out electric waves in all directions. These were intercepted by the resonator, and a corresponding spark immediately appeared across the gap between its two spheres. This simple resonator was the world's first wireless receiver, and proved in practice that Maxwell's electromagnetic theory of the existence of waves, put forward in 1864, was correct.

Marconi took these discoveries and those of Sir Oliver Lodge, who had been working independently in England along the same lines, a stage further. He saw the commercial possibilities of using 'spark transmission' for telegraphy, which until then had relied solely upon cables to link each telegraph station with its neighbour. Lodge had used and improved a sensitive detector of wireless signals first designed by the Frenchman, Edouard Branly, in 1890. Lodge called this improved detector a 'coherer', and in 1894 he used it to send wireless messages in morse code several hundred yards. In so doing, he inaugurated a new system of communication by means of electrical waves, 'wireless telegraphy'.

Marconi's coherer (ill. 4), an improvement upon Lodge's, consisted of a small evacuated glass tube in which were placed two silver plugs attached to platinum wire. The inner ends of the plugs were angled and brought within two millimetres of each other, the space between them being filled with nickel and silver filings (ill. 5). The resistance of the loosely packed

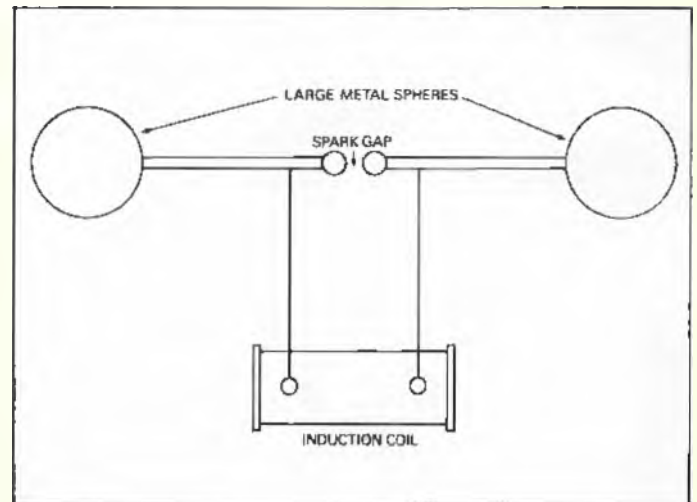

2 The oscillator designed by Hertz.

3 The resonator designed by Hertz.

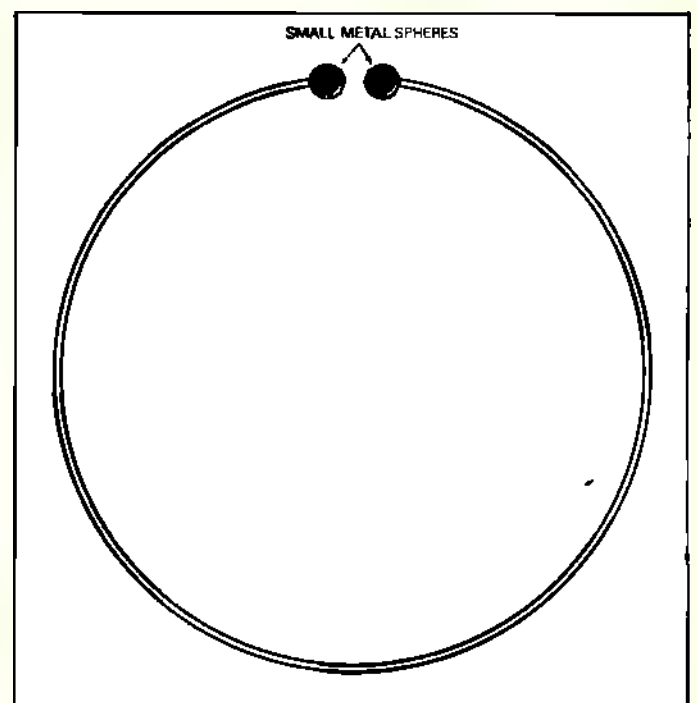

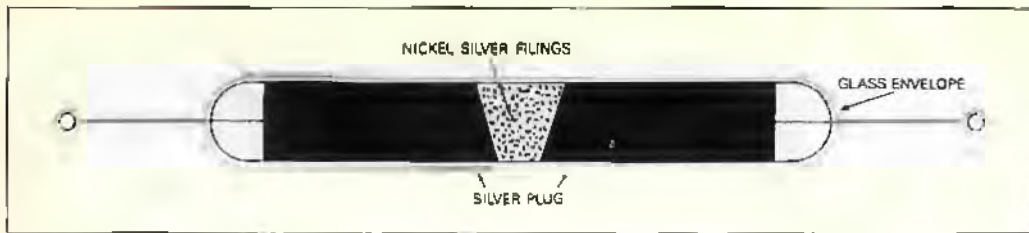

4 The coherer as used by Marconi.

5 Commercial coherer detector manufactured by Gamage. The coherer's glass tube is $\frac{1}{4}$ inch bore, and its two plugs are copper, plated with gold at the ends to form a gap for the filings of silver and nickel (in equal parts).



(below)
6 Circuit employing a coherer.

filings was so great that no current flowed in the circuit shown in ill. 6. However, when wireless waves were picked up by the aerial they caused the filings to cling together and become conductive. An electric current then flowed in the circuit, and was registered on the recording inker.

Marconi used the type of oscillator as designed by Hertz for sending out waves, but now on a much grander scale. He devised an aerial system whereby a large metal plate was suspended vertically in the air and connected by wire to the oscillator. This formed one 'side' of the transmitter. The other 'side' was a similar metal plate which was buried in the ground. Two metal plates were also used at the receiving end, and by burying the earth plate deeper and extending the height of the aerial, Marconi found that he could greatly increase the distance over which he could send signals. With this perfected system of wireless telegraphy, Marconi came to England in 1896 to promote his ideas, and took out a patent for his transmitting and receiving apparatus, the first British patent of its kind.

Although his first experimental signals in 1894 only travelled a short distance, by December 1901 Marconi was receiving in St. John's, Newfoundland a pre-arranged morse signal, the letter 'S', from his experimental wireless transmitting station at Poldhu in Cornwall, some 1800 miles over the horizon. Also by this time the Marconi Wireless Telegraph & Signal Company had been established and was producing commercial transmitting and receiving equipment for the Services and for experimental amateur use (ill. 7).

But this was telegraphy and not telephony, the transmission of sound and speech. Before broadcasting as we know it could develop, a number of major technical problems had to be overcome. Spark transmitters sent out waves in a broken series of hursts or 'trains' which were totally useless for speech transmission as this demanded absolutely steady continuous waves. In 1902 a Dane, Valdemar Poulsen, went some of the way to solving the problem when he produced continuous waves by means of his 'arc' transmitter (ill. 8). The arc (originally thought of, but not exploited, by the Englishman William Duddell in 1899) was formed

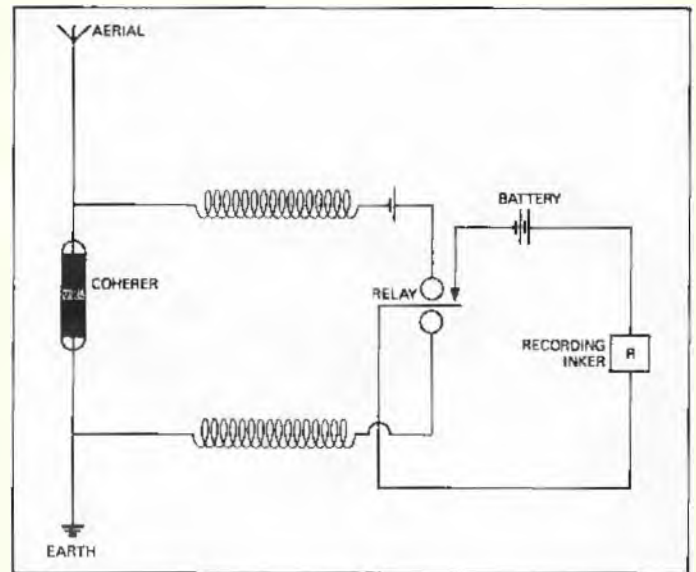

between copper and carbon electrodes enclosed in a gas-tight vessel containing either coal gas or hydrogen, and inserted directly in the aerial-earth circuit. The arc transmitter produced a steady continuous note in the receiver's headphones when the morse key was pressed, and enabled signals to be sent over very much longer ranges than by spark transmission. By connecting a microphone in the direct current supply circuit of the arc, it was seen that this could vary the current flowing through the arc and so be used for the transmission of wireless telephony. The high-frequency continuous wave produced by the arc acted as a carrier wave for the small varying ripples of low-frequency speech current which were superimposed upon it. This 'modulated' or sound-carrying wave was then picked up in the aerial of the receiver, and the low-frequency current was detected and separated from the carrier before being heard through the headphones. The arc method, as well as that of the timed spark-transmitter and the high-frequency alternator, were widely used and developed by experimenters during this period of the early 1900s.

Not long after Poulsen had patented his arc, an American, R. A. Fessenden, working at Pittsburgh University, successfully used wireless waves to carry

B Poulson Arc Continuous-Wave System, as used by the Federal Telegraph Company of America, c. 1910.

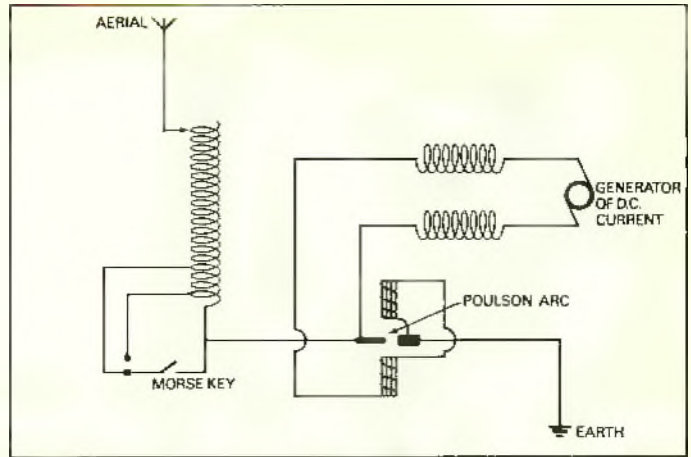

7 Claude Willcox, aged eighteen, with his Marconi Spark Transmitter at Warminster in 1899. He was later to become director of the Warminster Motor Company which made wireless apparatus for the Army in the First World War under the name of the British Telegraph Instrument Company. In the 1920s he was one of the keen band of amateur wireless broadcasters, operating his own station 2FL as soon as the B.B.C. had come off the air at night.

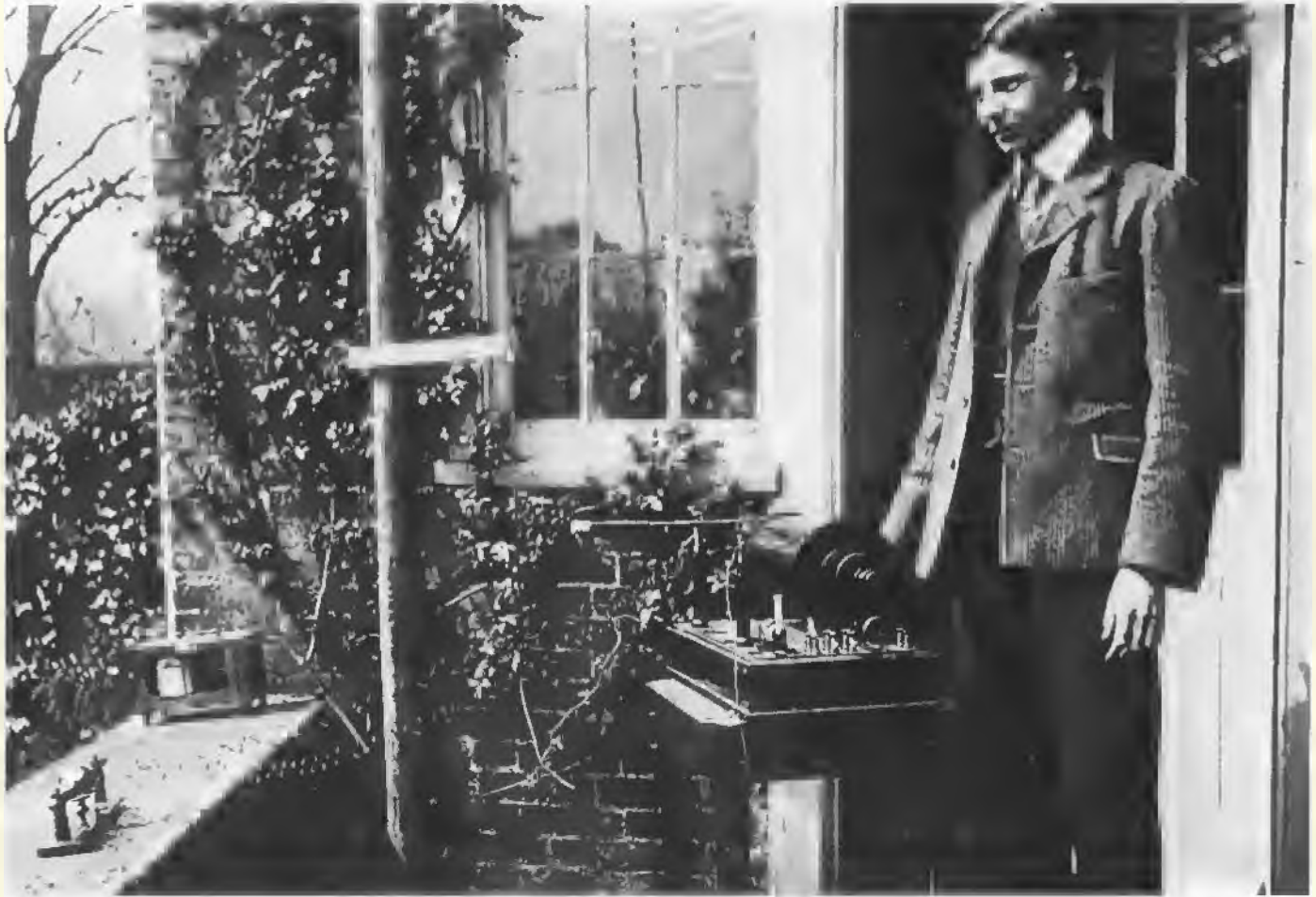

the human voice, even if it was only over a distance of one mile. But his experiments with telephony did not stop there. On Christmas Eve, 1906, he succeeded in transmitting both speech and music over a distance of several hundred miles. By this time, wireless telegraphy equipment (mostly manufactured by Marconi) was a common feature on board ships, and several ships' wireless operators were naturally very surprised to hear instead of the usual morse-code messages not only the sound of a person speaking but also that of a poem being read and of someone playing the violin. When the 'programme' came to an end its listeners were asked to write to Fessenden at Brant Rock, Massachusetts, having heard the 'first broadcast

programme in history' (A. F. Harlow, *Old Wires And New Waves*, 1936).

During the late 1890s, the operator of a receiving station could not select the transmitting station he wanted. If a number of transmitting stations were sending out messages, the receiver would pick them all up at once, there being no successful method of tuning. The only time that a message could be received without interference was when only one of the transmitters was working. In 1897 Lodge first experimented with a tuned circuit, a means of selecting the wavelength of a desired station while keeping the others tuned out. He realized that if the circuit of a receiver could be made to respond to the actual wavelength being transmitted,

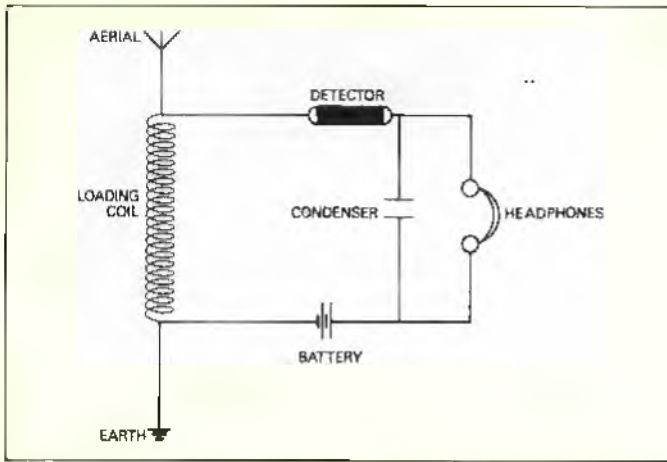

9 Lodge's Tuning Inductance Circuit, introduced in 1897.

10 A later, commercial detector, employing a galena crystal. The crystal is mounted in a cup and the cat's whisker arm, very well designed in this case, allows for minute adjustment. Galena was the most commonly used of all the crystals. Both this and the carborundum steel detector (ill. 18) are from the Marconi Crystal 'A' crystal set of 1922 (ill. 63).



just as one tuning fork is able to respond to another at a distance if they are precisely alike, then the problem of selection would be solved. Ill. 9 shows the arrangement of Lodge's Tuning Inductance Circuit whereby an inductance or 'loading' coil was inserted in the aerial circuit which would respond in sympathy with the wavelength received. For different wavelengths, different loading coils could be inserted, and loading coil circuits based on this method of tuning were still being widely used in domestic receivers until the early 1930s.

Marconi of course was not alone in his success with signalling by means of wireless waves. In 1895, Captain Henry Jackson began to experiment with wireless telegraphy, and in 1896 successfully sent wireless code messages from one British naval vessel to another. Jackson's work was quite independent from that of Lodge or Marconi. In 1897 a German scientist, Slaby, published a book entitled *Spark Telegraphy* in which he described his own success in transmission. At the same time, another German scientist, Karl Ferdi-

nand Braun, was developing a system of wireless telegraphy which enabled him, in 1901, to transmit between Cuxhaven and Heligoland, a distance of forty miles.

Many years earlier, in 1874, Braun had noticed that certain pairs of substances, when placed together so that only a small area was in contact, offered a much greater resistance to an electric current in one direction than in another; acted, in other words, as a rectifier. These substances, of which there are a very large number, include tellurium and aluminium, silicon and copper, and carbon and steel. In 1906 H. H. Dunwoody made the discovery that crystals of carborundum could be used in exactly the same way to rectify high-frequency wireless waves, a process necessary in order for the signal, the varying amplitude of the radio wave, to be heard in the headphones. Since that discovery, it was found that a very large number of other mineral crystals possess the property of rectification when in contact with a small piece of wire or a metal point.



11 Display box of Dr. Cecil's Radio Crystals from the 1920s. Seventy-two individually boxed galena crystals at 1s 6d (7½p) each.

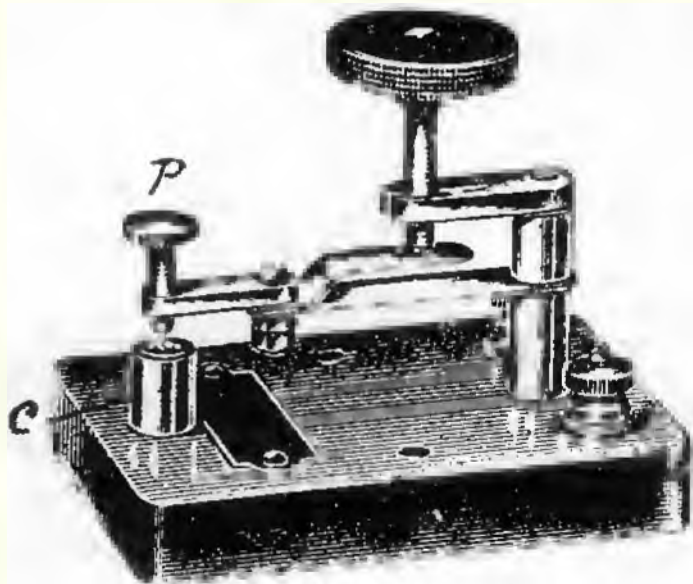

13 Crystal detector. P is a gold pointed screw carried on an adjustable spring. The crystal is held securely in the metal cup C.

12 Mighty Atom and Neutron wireless crystals and cat's whiskers. In tin boxes complete with tweezers and instructions. Mid-1920s.



14 Detector by the Wainwright Manufacturing Company Ltd., c. 1920. The cat's whisker is in fact a steel needle fastened to a flexible brass strip, and is adjusted by turning the screw terminal in the middle of the strip.



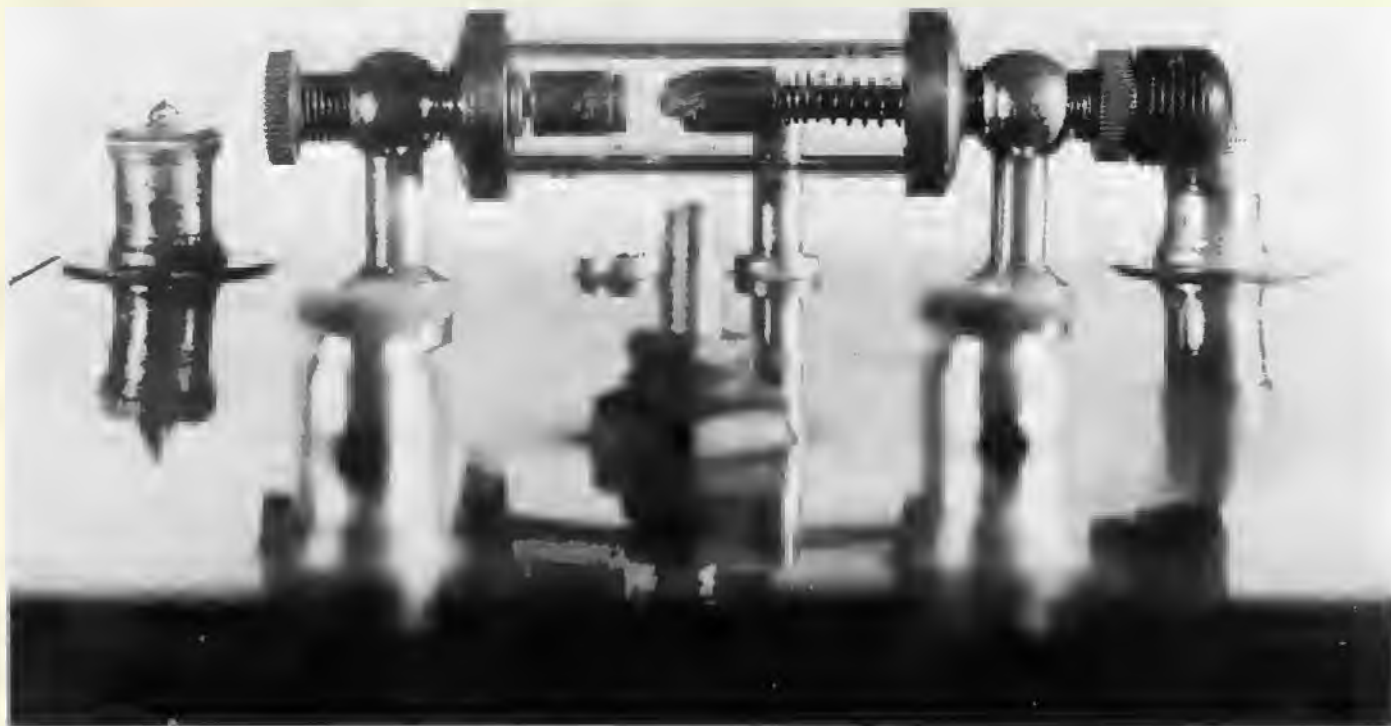
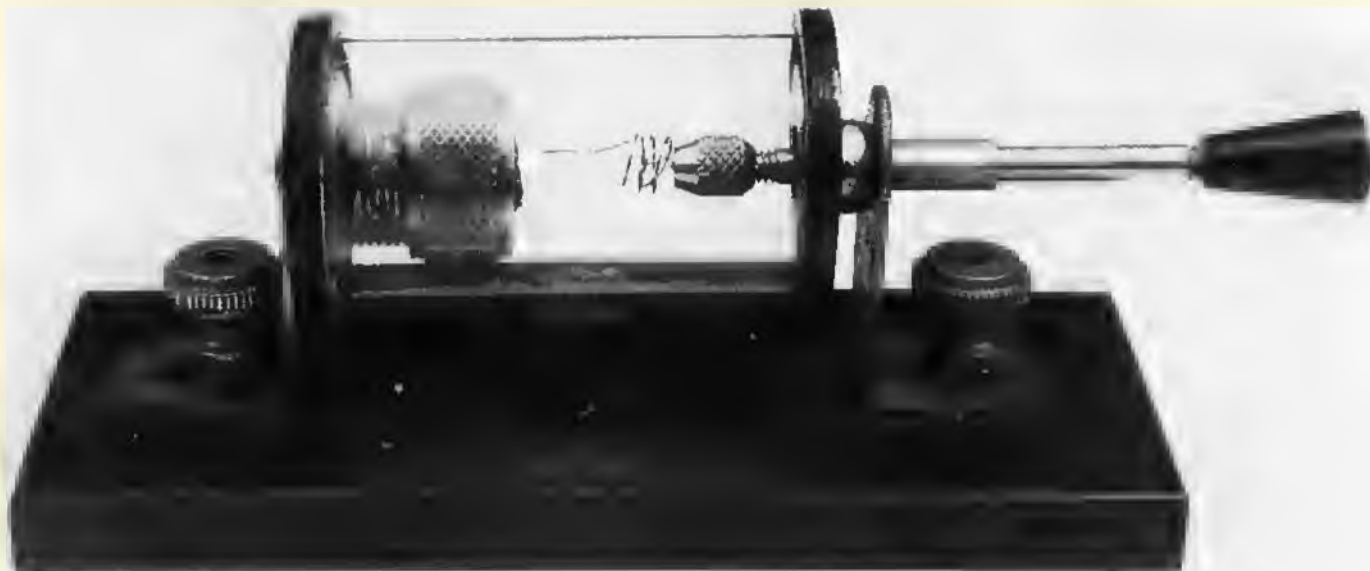

Examples of such crystals are galena, iron pyrites, molybdenite, silicon, zincite and cerusite (ills. 10, 11 and 12). During the 1920s, a simple receiver employing a crystal as the detector was called a crystal set; the fine contact touching the crystal was a tiny piece of coiled wire known as the 'cat's whisker', and was usually made of gold, silver, or copper, fine gauge 32 or 34 s.w.g. The crystal detector (ill. 13) included the crystal, its supports, and connections. There were many different types of crystal detector available, but each had to provide a secure means of holding the crystal, and a controllable method of adjusting the contact between the crystal and wire (ills. 14 and 15).

Sometimes in place of the wire there may be another crystal, and this two-crystal arrangement was known as a 'Perikon Detector'. Patented by the American inventor Greenleaf Pickard, the Perikon Detector's crystals were usually zincite and chalcopyrite (ill. 16). This method of detection was far more stable than the conventional whisker and crystal arrangement, but was uncommon even during the height of the crystal set's popularity in the 1920s (ill. 17). Another variation was the carborundum crystal and steel detector (ill. 18), where instead of the cat's whisker there was a thin steel bar in contact with the crystal. This was perhaps the best of the various crystal detectors, but it would

(opposite top)

15 Enclosed horizontal detector. A ball-and-socket joint on the cat's whisker arm allows easy adjustment, and the whole is protected by means of a tubular glass case held in position by caps at either end. Dirt and dust on the crystal caused loss of signal and this glass case solved the problem.

(opposite bottom)

16 Perikon Detector, c. 1923 (see ill. 17). The two crystals, zincite and chalcopyrite, are held by means of two lightly fitting nickel-plated tubes, one of which is spring-loaded to make it harder for the crystals to be separated should they be accidentally knocked.

17 Home-made crystal set with Perikon Detector and plug-in coil for long-wave reception, c. 1923.



only function if a small local current, obtained from a dry battery, was passed through it.

There were many other experiments going on at the beginning of this century pushing forward the development of wireless telegraphy and telephony. In England, J. A. Fleming patented his two-electrode valve, the diode, in 1904. It consisted of an electric lamp, with a filament made of carbon which was made incandescent by an electric current. The filament was sealed in the glass bulb and all of the air extracted. Around the filament, but not touching it, was a metal cylinder attached to a wire and sealed through the bulb, while the terminals of the filament and the cylinder were

18 Carborundum steel detector. Instead of the usual cat's whisker arm there is a thin strip of steel. Only a small current is required to flow in the crystal circuit in order for the detector to function.



fixed to a base board. Like the crystal, the Fleming Diode acted as a detector and rectifier of the incoming high-frequency alternating currents picked up by the receiver's aerial, and changed these into direct current to which the headphones responded; but it was very much more stable (ill. 19).

Two years later in America, Lee De Forest applied for a patent for a three-electrode valve which he called the 'Audion Triode' (ill. 20). It was very much the same as the Fleming Diode except that a third electrode, the grid, was placed between the filament and the anode of the valve. The varying oscillations picked up by the aerial were fed directly to the grid where they either assisted or resisted the flow of current in the anode circuit. This meant that not only was the Audion a very efficient detector of wireless waves but also it acted as an amplifier. This was a very useful discovery since it made possible the reception of transmissions over far greater distances than had ever been thought possible, and amounted to one of the most important steps in the whole development of communication, many of the earlier problems now being overcome.

The first valve transmitter capable of sending out perfectly steady continuous waves was developed in Germany in 1913 by A. Meissner, working for the Telefunken Company. Soon after, the Marconi Company, as it was now called, adapted the Meissner Valve Generator to wireless telephony, and obtained a range

19 Circuit employing Fleming's Diode.

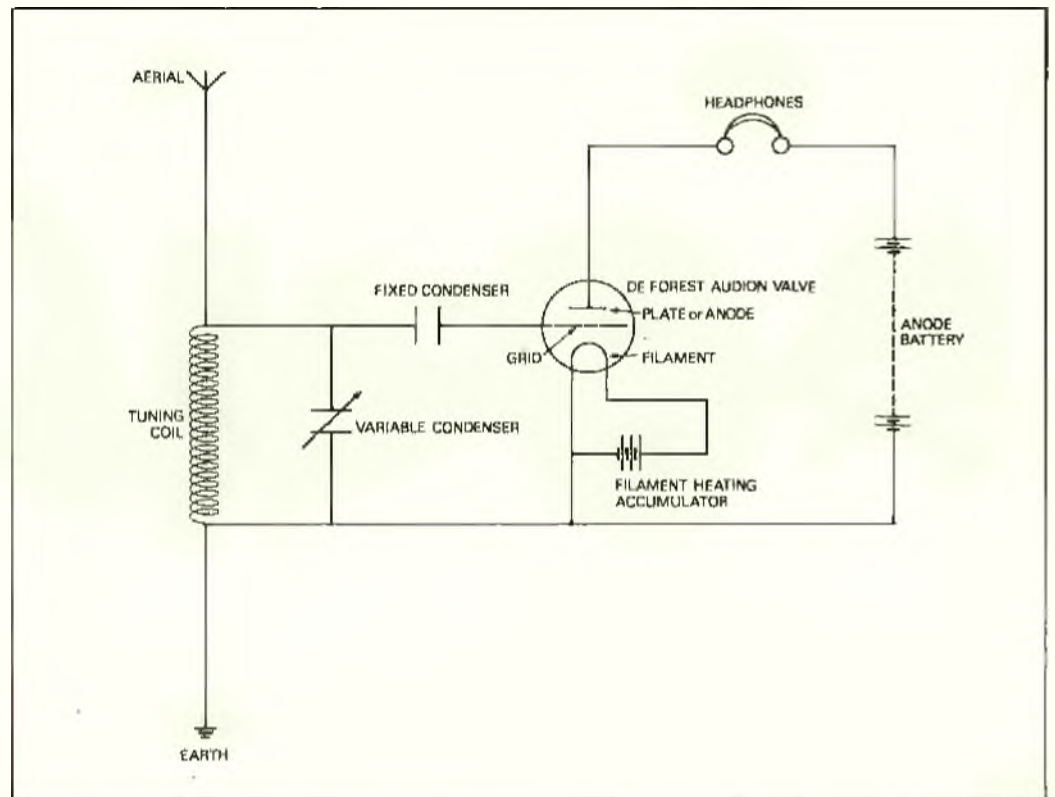
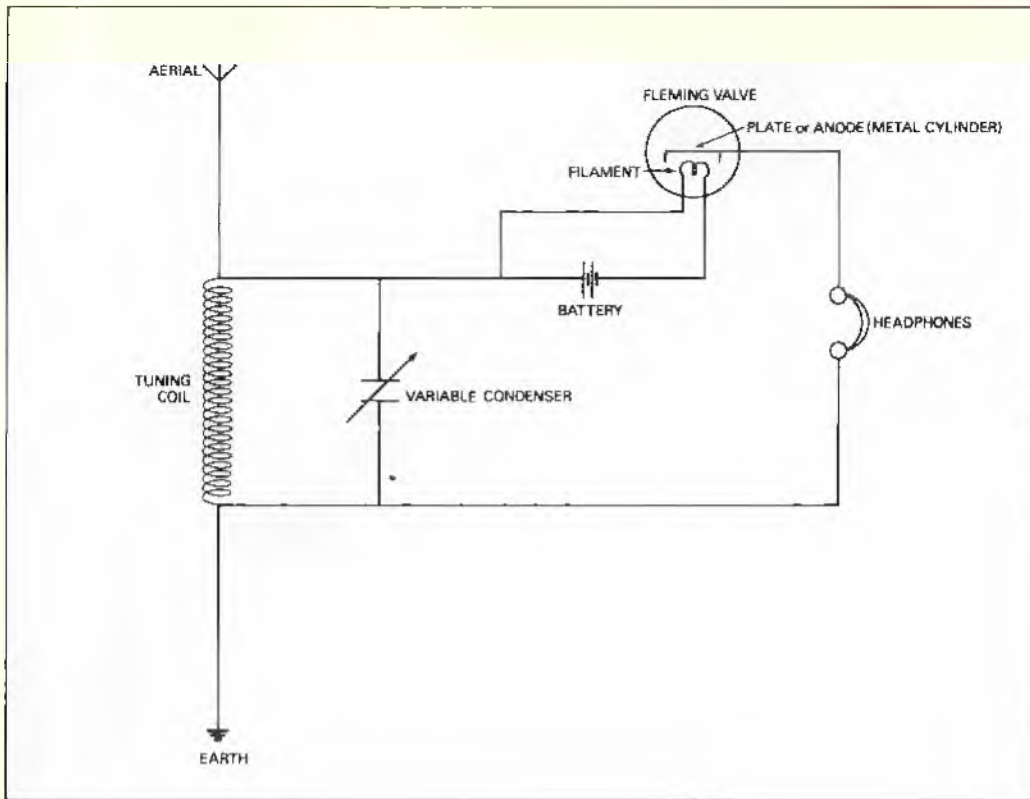

20 Circuit employing De Forest's Audion Triode.

of fifty miles for speech transmission. There were several experimental transmissions of speech from Marconi House in the Strand, London, and at the same time wireless transmitters were being manufactured at the Company's main works at Chelmsford, these

having a working range of thirty miles.

It was this highly successful series of inventions that led to the serious development of broadcasting, and to the foundation of the British Broadcasting Company in 1922.

Broadcasting Begins

Wireless in those days was not thought of in terms of a broadcast entertainment. Indeed people were against the fundamental idea of 'broadcasting' as such, of large numbers of receiving sets all tuned in to one transmitter. Wireless was thought of as merely a device for carrying out certain special tasks, such as communication among ships, between sea and land, and between stations on the mainland (ill. 21). The fact that this 'station-to-station' communication, of an official, sometimes confidential nature, could be picked up by lots of other listeners, was the main impediment to the promotion of broadcasting.

Lodge, however, was one of the first people in this country to realize the advantages to be gained from using broadcasting as a public service. It was only during the First World War that this realization dawned on other people too. In active duty, the conscript was likely to be using wireless equipment (ills. 22 and 23) for the first time, and many found themselves the most enthusiastic wireless amateurs in the immediate post-war years. Courses of wireless instruction were given at Marconi House and also at Crystal Palace. As interest spread, various wireless clubs were formed, and members undertook the building of experimental sets. During the war, all experimentation by wireless amateurs (ills. 24 and 25) was banned, while these new powers of communication were harnessed to the needs of the separate armed and intelligence services. The Admiralty took over the production of equipment at Marconi's Chelmsford works and a wireless interception service was started there. Arthur Burrows, who had the job of collecting, editing and distributing the wireless propaganda of the Central Powers, was to become the first Director of Programmes for the British Broadcasting Company when it was formed in 1922.

H. J. Round, previously engaged in broadcast experiments at Marconi's, was employed to manage wireless direction-finding stations on the east coast, and it was from one of these stations that he reported unusual signals from the German fleet on the eve of the Battle of Jutland. Round is principally known for the invention of his 'soft', or low-vacuum, valve which

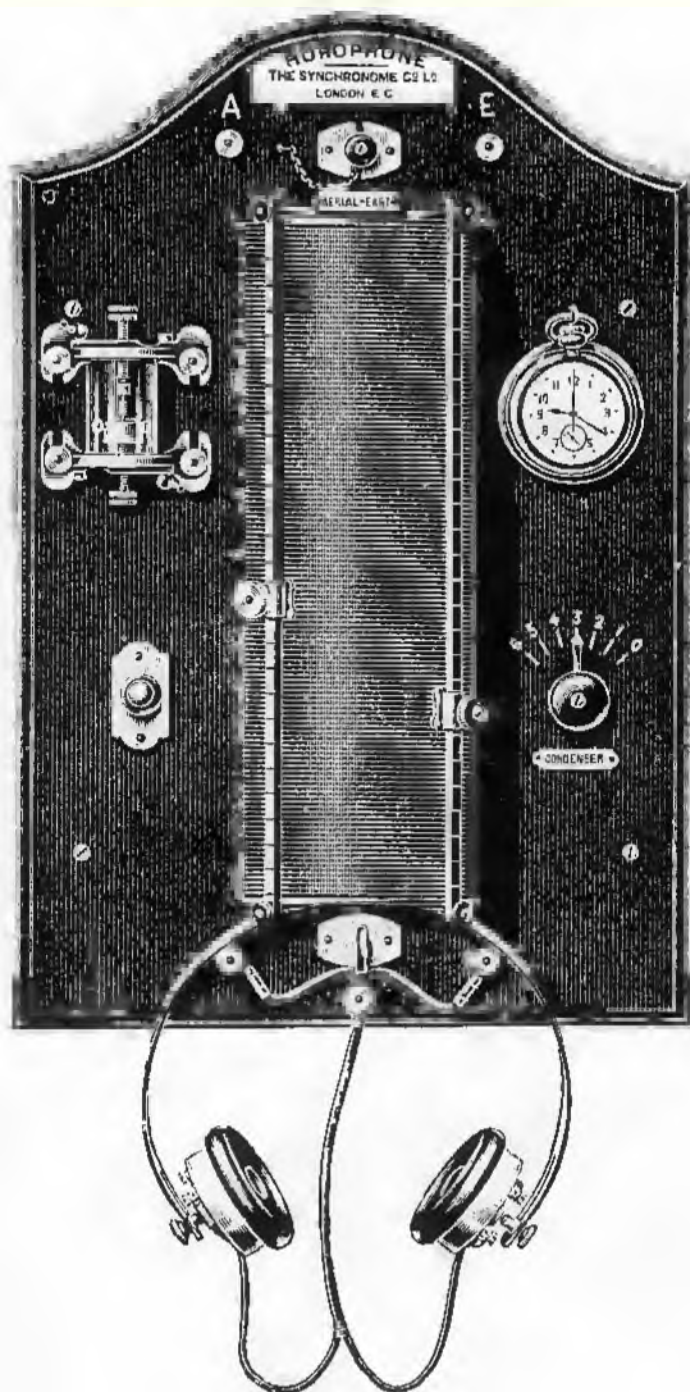

21 The 'Horophone', a receiver of wireless time-signals made by the Synchronome Co. Ltd., London E.C., c. 1914. It could receive weather reports and news

in morse code from Paris, Norddeich and other high power stations within a radius of 800 miles.

22 Sir Henry Norman, Assistant Postmaster-General, testing Willcox's apparatus in 1916. Norman played a leading part in promoting the idea of broadcasting, and sat on many wireless committees including the Sykes Committee, 1923, the first official committee to investigate broadcasting.

(below)
23 Army wireless transmitting and receiving apparatus manufactured by Claude Willcox at Warminster in 1916.

(bottom)
24 Amateur wireless receiver, 1912.



(opposite)
25 Wireless transmitting station operated by Mr. Patrick Harris at Calne in 1913.

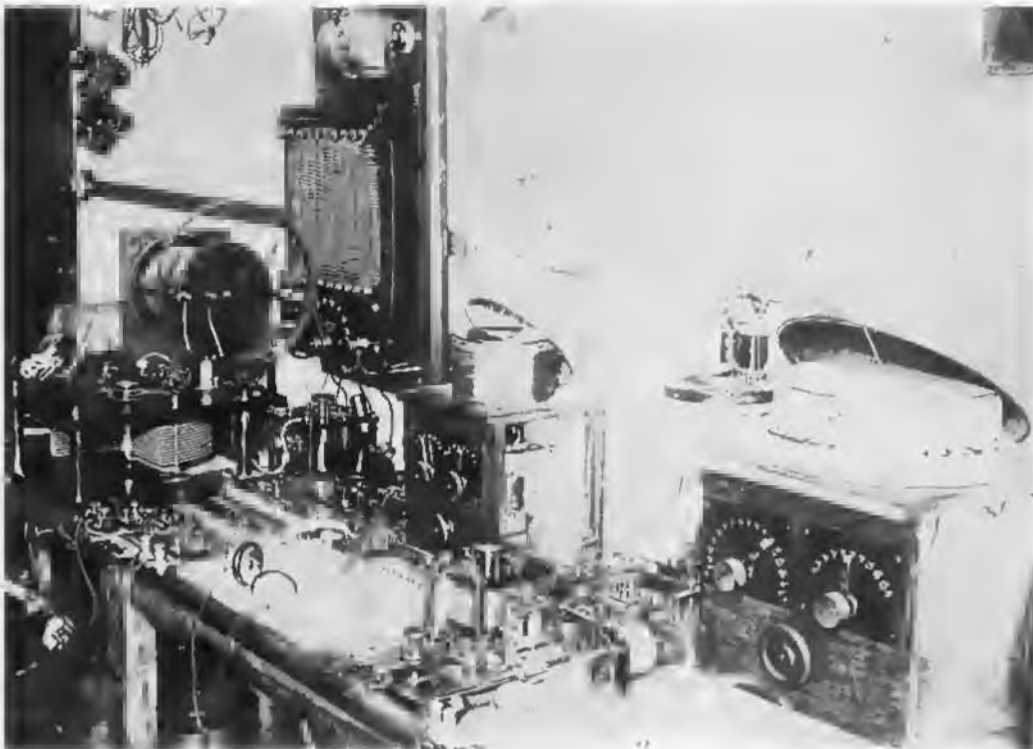
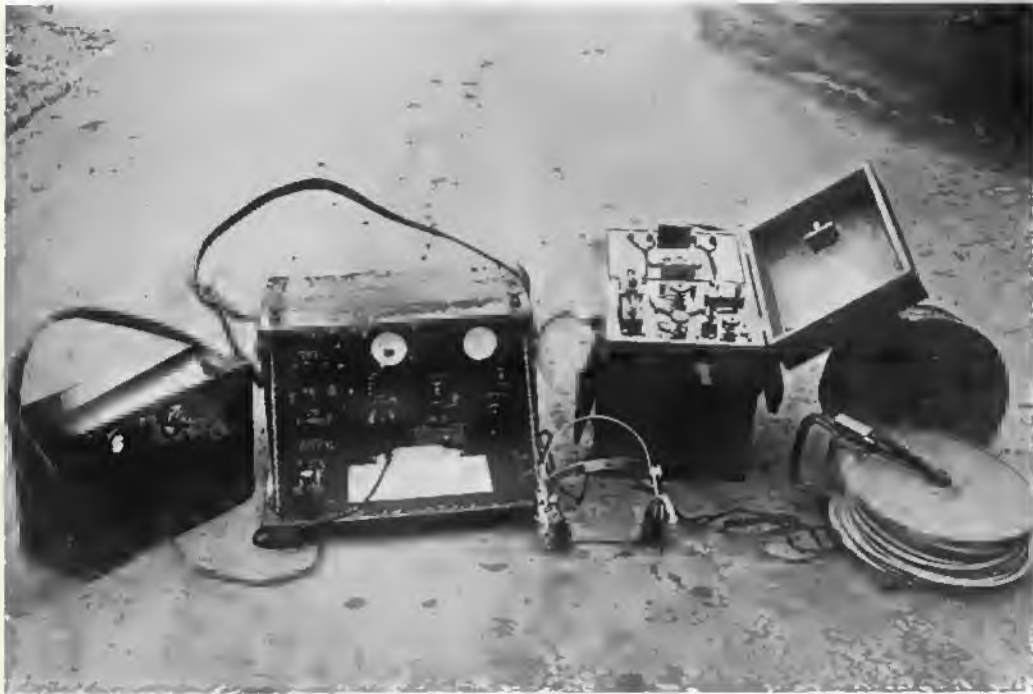

DANGEROUS

NOTICE.
No part of this
instrument must
be touched.
IT IS DANGEROUS.





gave better results than the preceding valves, and depended on the presence of gas in the bulb to work efficiently.

The 'hard', or high-vacuum, valve, the 'Pliotron', was first produced in America by Irving Langmuir in 1915 while working for the General Electric Company. With the aid of specially designed pumps, nearly all the air could be sucked out of the bulb so that the valve would function very well. During the First World War the hard valve was developed rapidly, and by the end of 1915 the 'French' valve made its appearance. This was quickly adopted by the Allied armies, and soon after by the Germans. The British equivalent is known as the 'R' valve (ill. 26) and was still in use until the mid-1920s.

With Europe at war, and wireless engineers absorbed in war effort, it was left to the Americans to develop long-distance wireless telephony. Early in 1915, American engineers built a valve transmitter on Long Island and they succeeded in transmitting speech over a distance of 300 miles. A few months later, this distance was increased to over 800 miles. In October of the same year The American Telephone & Telegraph Company, working with the Western Electric Company, successfully sent speech and music from Arlington, Virginia to the Eiffel Tower receiving station in Paris, a distance of some 3500 miles. For this, the first successful transatlantic telephonic relay, as many as 500 valves were required for the transmitter (E. H. Chapman, *Wireless Today*, 1936). An even greater distance, 5000 miles, was achieved in 1916 when speech was again transmitted from Arlington, this time to Honolulu.

When the war was over, the Marconi Company installed a wireless telephonic transmitter in Ireland, and, under the direction of H. J. Round, began experimental transmissions to North America using a two-valve transmitter. The power of the transmitter was one sixth of the total power of the 500 valves used in the first American transmission of 1915, and a wavelength of 3800 was used to carry the first European voice, that of W. T. Ditcham, a Marconi engineer, across the Atlantic. The success of the

Marconi Company's broadcasts in Ireland led to the building in 1920 of a six-kilowatt transmitter at their Chelmsford works, using a large aerial suspended between two 450-foot masts. Although built chiefly to test long-distance speech transmission, the station occasionally put out a short unofficial musical programme organized by G. W. White, an assistant engineer to Round and Ditcham. These musical items, played by Marconi engineers and assistants on the cornet, oboe, one-string fiddle and piano, and with a Miss W. Sayer singing soprano, had a large following, as was shown by the number of appreciative letters sent in from listeners as far away as Rome.

In anticipation of future broadcasting developments, a wireless industry slowly began to emerge with the idea of making receivers for the domestic market. At first only a few firms, encouraged by the Marconi Company's experiments, produced complete valve or crystal receivers under their own make (ill. 27). But as the number of programmes and interest in them grew, a demand was created. By the time the B.B.C. was in operation at the end of 1922, the domestic wireless industry was an established fact.

From the 23 February 1920, listeners could hear two daily programmes broadcast on the 2500 metre wavelength, each programme lasting half an hour, and consisting mainly of musical items, news and records. At this time, a considerable number of people were building experimental wireless sets, many using the surplus stock left over from the First World War. Inevitably, some unwary constructors were caught out by unscrupulous dealers offloading inefficient or obsolete equipment which was quite unsuitable for the reception of wireless broadcasts.

What has been described as the turning point in the public response to broadcasting took place on 20 June 1920 when Dame Nellie Melba travelled to Chelmsford to sing a special concert sponsored by the *Daily Mail*. Singing in English, Italian and French, Melba's voice was broadcast all over Europe and in parts of North America. 'The renown of the singer,' wrote H. M. Dowsett, 'the world-wide attention which was given to her performance, the great distance at which

27 Advertisement for Wireless Receiving Station No. 1, manufactured by F. L. Mitchell & Co. Ltd. in 1920. Listeners would have been able to hear the two daily programmes put out by Marconi's Company at Chelmsford.

There is only one Wireless Factory in London

that caters for all those Components that are usually so difficult to obtain. If you contemplate buying components or complete sets, if your pocket is limited or well lined, you cannot do better than call upon

MITCHELL'S of PECKHAM, London, S.E.15.

An example of our keen prices is given herewith:—

No. 1.—WIRELESS RECEIVING STATION.

A well-built Receiving Station, in no way stinted in finish or material, that will give wonderful and surprising results on an exceedingly small aerial. All insulation of the highest grade, woodwork of solid mahogany, metal work of lacquered brass. A Single Slide Tuning Coil, Telephone Condenser, Special Crystal Detector comprises the unit, which is well mounted: overall dimensions, 13 ins. high, bases 8 ins. by 8 ins. Price 60s. only. Headgear to suit at popular prices.

WE MANUFACTURE

Tuning Coils, Detectors, Valve Components, Leaks, Condensers, High Tension Components, Resistances, Potentiometers, Loading Coils, Variometers. Complete C/W and Spark Reception Sets from 45s. to £100. Telephone Transformers, H/F & L/F TRANSFORMERS. HEADGEAR, Valve Panels, High Value Non-Inductive Resistances for Valve Couplings. Chokers, etc. etc.

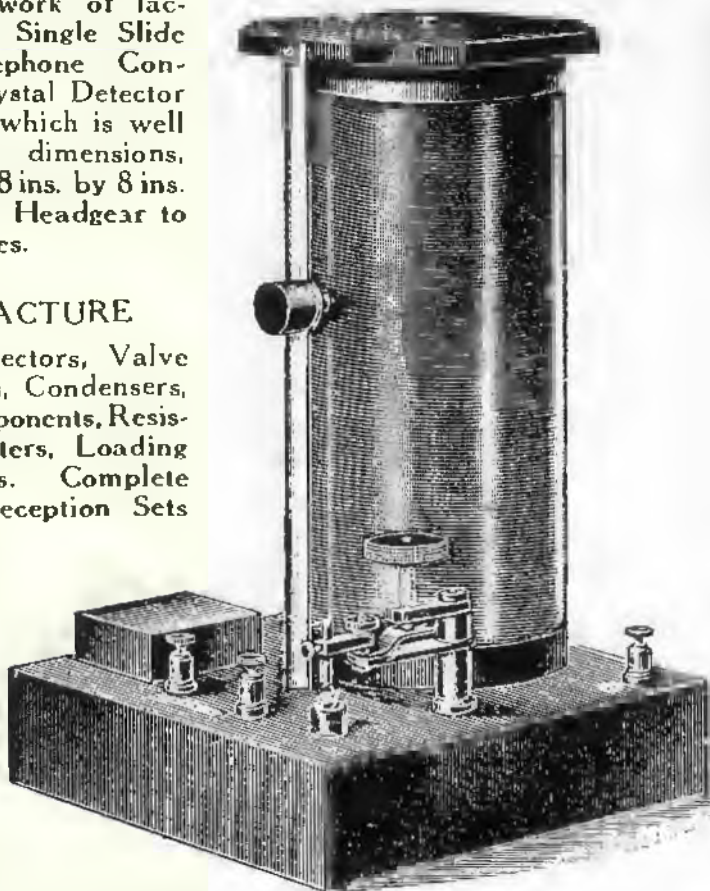

F. L. MITCHELL & CO., Ltd.,

Scientific and Manufacturing Electrician.

Registered Office: 188 RYE LANE, PECKHAM, S.E.15.

Wireless Showroom: 182 Rye Lane, Peckham, S.E.15.

Wholesale Warehouse: McDermott Road, Peckham, S.E.15.

Works: Little South St., London, S.E.5. Tel.: New Cross 1540 & 1541.

PERSONAL INSPECTION INVITED.



28 A recent photograph of the original 2MT hut, from which public wireless programmes were broadcast from 14 February 1922. The hut was acquired from Writtle, and is now being used as a sports pavilion in the grounds of the Kings Road School, Chelmsford.



reception was obtained, all combined to give the Melba Concert the atmosphere of a great initiation ceremony and the era of public amusement of which this was an ideal example may be said to have completed its preliminary trials and to have definitely launched on its meteoric career from this date' (*Wireless Telephony & Broadcasting*, 1923-24).

However it was not long before there was a temporary setback. On the 23 November 1920, the Postmaster-General informed the House of Commons that it had been found that the Chelmsford experiments had caused a lot of interference with other stations, notably those broadcasting official and important communications; and for the time being no more trials would be permitted. On 25 August 1920, *The Financier* had reported to its readers, 'A few days ago the pilot of a Vickers Vimy machine... was crossing the Channel in a thick fog and was trying to obtain weather and landing reports from Lympe, but all he could hear was a musical evening.' With reports like this growing daily, the Post Office, under pressure from the Services to get something done about it, had no alternative but to withdraw the Marconi Company licence. Although Chelmsford went off the air, the number of amateur transmitting and receiving licences continued to grow. By March 1921, the Post Office had

issued over 150 transmitting licences and over 4000 receiving licences, and apart from listening to amateur transmissions, regular concerts from The Hague could be heard.

But this was not enough, and letters started to appear in the press demanding the resumption of telephony. In August 1921, the Marconi Company was allowed to broadcast calibration signals in morse each week for a period of half an hour. This at least allowed the listener to know into which frequency he was tuned; but this could not have been very exciting as it was only the name of the frequency that was being transmitted over and over again! And so, in December a petition signed by sixty-three wireless societies, over 3000 members, was presented to the Post Office demanding the resumption of the Marconi Company's telephonic broadcasts.

The Postmaster-General, sympathizing with these demands, informed the Marconi Company early in 1922 that the Post Office had authorized a programme of speech and music, lasting fifteen minutes, to be included in the weekly half-hour transmission of calibrations. Soon a small transmitter was built in a hut at Writtle (ill. 28), a few miles from Chelmsford-- Station 2MT, whose programmes were to be entirely devoted to broadcasting telephony. Its first broadcast

29 Mr. Norman McKee's wireless stall at a church fête in Weymouth in the summer of 1922. They were probably listening to a tea-time concert broadcast from 2LO, the London station of the Marconi Company, on 360 metres. The single valve set is home-made.



was on 14 February 1922. The programme lasted twenty-five minutes and was broadcast every Tuesday evening at eight, on a wavelength of 400 metres. R. D. Bangay was in charge of the station, and Captain P.P. Eckersley was head of the experimental section. During the First World War, Eckersley had been a wireless equipment officer in the Royal Flying Corps and it was largely due to his great flair for broadcasting that these Writtle transmissions became very popular. The transmitter which fed the aerial slung between two 110-foot high masts, was built by B. N. MacLarty (who was to become Head of the Design & Installation Department at the B.B.C.) and H. L. Kirke (future head of the B.B.C.'s Research Department). It was powered by an Army petrol-driven engine.

Shortly after Writtle went on the air, the Post Office issued a licence to the Marconi Company, granting permission for the building of a telephonic broadcasting station at Marconi House. The first broadcasts from this station, known as 2LO, began on 11 May 1922. These consisted solely of speech, for not more than one hour each day, usually between eleven and midday or from two to three o'clock in the afternoon. At the end of every seven minutes of transmission there was to be a gap of three minutes so that the broadcaster, Arthur Burrows, could listen for any official messages to tell him if for some reason the programme could not continue. This 'three minute silence' also gave the Marconi engineers time to smooth out any technical problems. 'Besides,' as a

writer in the 2 December issue of *Popular Wireless* pointed out, 'these frequent rests are good for the wireless receiver!'

From midsummer 1922, concerts and musical evenings were allowed to be broadcast. The first transmitter had a power of only one hundred watts, so the programmes could only be heard over a distance of about forty miles even if a good valve receiver was used. Crystal sets could only receive up to about fifteen miles from the transmitter. Soon its power was increased to one and a half kilowatts, and it could be heard over most parts of the country (ill. 29). Throughout the life of the pre-B.B.C. 2LO Station, Burrows was its chief influence; and later, when the B.B.C. was formed, not only was he the first Director of Programmes, but also one of its 'Wireless Uncles', Uncle Arthur to thousands of children listening to him on Children's Hour every night at six o'clock.

Apart from Marconi, two other major firms in England were experimenting with wireless broadcasting at this time. They were The Western Electric Company and Metropolitan Vickers, each with American connections. During the First World War, Metropolitan Vickers had produced valves for the Army, and their research department had made a study of the Pittsburgh Station set up by Westinghouse and of factories producing cheap wireless equipment in America, with the idea that they might build their own wireless factory and broadcasting station in England. Having pooled their patents with those of the Radio

Communication Company, who manufactured marine wireless equipment, and deciding on an agreement about the manufacture and sale of their sets, Metropolitan Vickers began experimental broadcasting from their Manchester Station, 2ZY, on 16 May 1922. Later in the autumn at their laboratories at Trafford Park, they began manufacturing their 'Cosmos' crystal set, which had a range of twenty miles, costing £4 10s (£4.50), and a two-valve set with a range of a hundred miles, at £26 10s (£26.50).

In October 1922 the Western Electric Company, which formed part of the Bell Telephone Group of America, set up a 500-watt transmitter, Station 2WP, on the third floor of Oswaldstre House in Norfolk Street, London. In the same month the British Broadcasting Company was formed, comprising companies active in the production of wireless equipment: British Thomson-Houston, General Electric, Marconi, Metropolitan Vickers Electric, Radio Communication and Western Electric.

On 15 November the day after official daily broadcasting began from 2LO, the B.B.C.'s Birmingham Station, 51T, began broadcasting to the Midlands. The components of the Birmingham station had previously been transferred from Station 2WP in London and were now installed in the works of the General Electric Company. B.B.C. Manchester, 2ZY, opened at the same time, closely followed by the Newcastle-Upon-Tyne Station, 5NO, in December.

The Crystal Set

Most people during the pioneering days of wireless broadcasting in the early 1920s listened in on a crystal set. Its popularity was not surprising since it was cheap to buy and simple to operate. Advertisements often showed a child tuning one in to bring the point home and you could buy a crystal set for as little as 10s 6d (52½p) (ill. 30). Maintenance costs were minimal, unlike the valve sets where there were batteries to buy and keep charged and valves to replace when they got burnt out. Except for the rare carborundum-steel detectors no batteries were used on the crystal set, all the power coming directly from the transmitted waves picked up by the aerial. The listener's licence permitted the use of up to a hundred feet of aerial wire, and to obtain a good signal an aerial mast had to be specially constructed in the garden or on the roof. With only the set, an aerial and a good earth wire, the receiver was able to pick up a programme radiating from a station broadcasting up to twenty miles away. As these signals were usually weak, only one person at a time could listen in on the headphones. By attaching a second or third pair of headphones the signal strength was further decreased, and family listening was ruled out since the power was not sufficient to drive a horn loudspeaker.

The operation of the crystal set was a simple matter. Having set it on a table free from vibration, the lead-in wire was attached to the aerial terminal of the set. An earth wire was connected to another terminal on the receiver, and led to a main water pipe or to a metal plate buried in the ground. The area around the plate had to be kept damp, and it was often advised when doing the gardening to use the watering can on the wireless earth too! The headphones were then connected to the headphone terminals. Before any signal could be heard, the cat's whisker had to be adjusted so that it just touched the crystal in the position which produced a loud click in the headphones. The programme was then tuned in by rotating the tuning knob, and when fixed in on a station the cat's whisker was further adjusted to obtain the loudest sound. The four basic tuning circuits were the slide coil circuit, the tapped inductance circuit, the variometer, and the



30 Brownie Tube Type crystal set manufactured by J. W. B. Wireless Ltd. in 1923. Original price: 10s 6d (52½p).

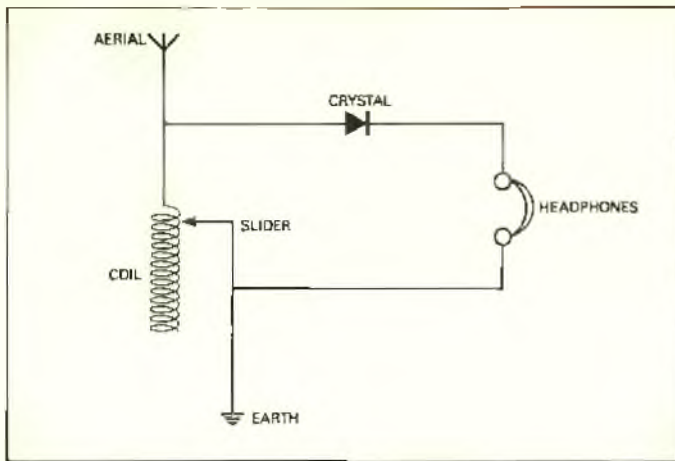

31 Slide coil circuit.

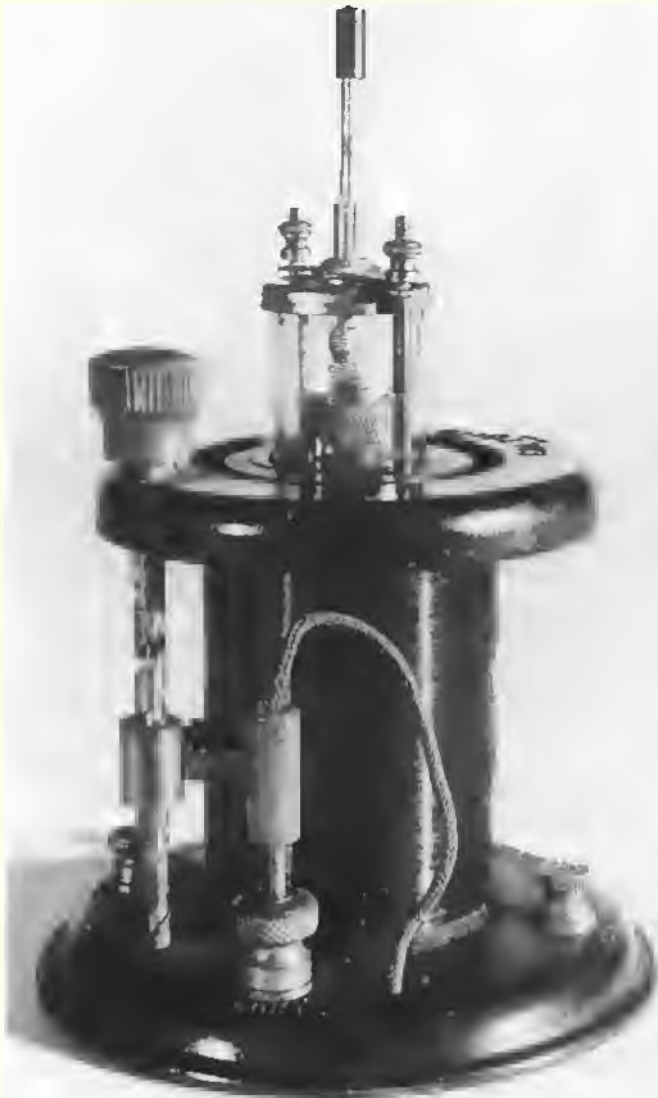

32 Golstone crystal set by Ward & Goldstone Ltd., c. 1925. Moulded ebonite base, and 'archimedean' slide coil tuning. Price 7s 6d (37½p).

loose coupled circuit.

The circuit shown in ill. 31 was one much favoured by many manufacturers in the early 1920s, like J. W. B. Wireless Ltd. and Ward & Goldstone Ltd. (ill. 32). The tuning consists of a slider making contact with the coil which is, in these cases, wound around a cardboard tube which also acts as the body of the crystal set. The coil of the Brownie Tube Type crystal set (ill. 30) consists of eighty turns of twenty-two gauge enamelled copper wire. The diameter of the coil is 3.2 inches and the maximum wavelength which can be received is 530 metres. This simple circuit is however very inefficient due to the so-called 'dead end' effect whereby part of the coil is not being used for reception, with the result that energy is being wasted at the 'dead end'.

Ill. 33 shows a radial tapped inductance crystal receiver circuit used by A. W. Gamage Ltd. for their early-1922 crystal set (ill. 34). The coil consists of a hundred turns of nineteen gauge double cotton-covered copper wire tapped off at various intervals to give a maximum wavelength of approximately 440 metres. For longer wavelengths, a loading coil was put in series with the variable condenser, and when not in use the loading coil terminals were connected together by a short lead, otherwise the set would not function. For 1600 metres, a No. 150 loading coil was used; and for 2000 metres, a No. 200 loading coil was used. To tune the set to the medium wave band, the switch was slowly moved over the studs until the station required was heard. Then for finer tuning the variable condenser was adjusted.

Perhaps the most popular form of crystal tuning circuit was the variometer. A variometer consists of two series-connected coils where one of the coils is capable of rotating within the other. As they are rotated with a current flowing through them, their magnetic fields either assist or resist one another. This variable magnetic field is known as a variable inductance. The standard variometer circuit was employed in the Western Electric Company crystal set (ill. 36); the aerial was connected to terminal A1 to receive stations whose wavelength was under 300 metres, and to the terminal A2 to receive stations

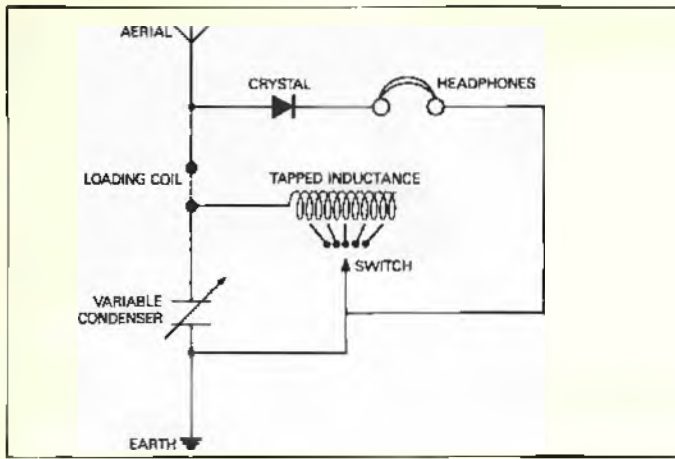

33 Tapped inductance circuit.

34 Crystal set manufactured by A. W. Gamage Ltd. in 1922. The case is not original.



35 Loose coupled circuit.

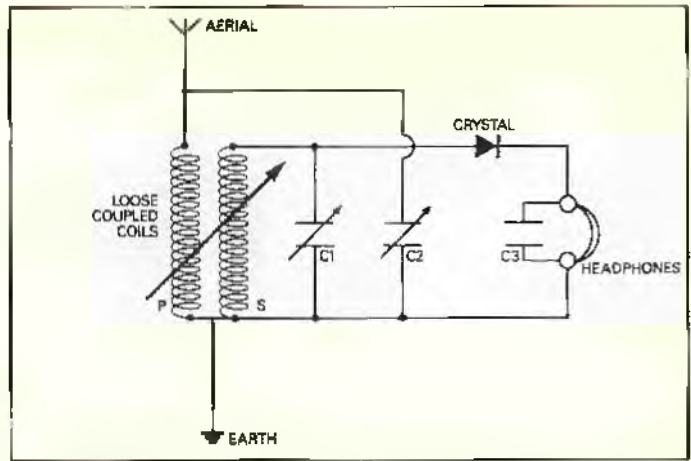

36 Western Electric crystal set, Type 44001, made in 1923.



whose wavelength was between 350 and 500 metres. This passed the aerial current through either of the fixed condensers C1 and C2 before entering the crystal detector circuit. Another fixed condenser C3 was placed across the headphone terminals R, as this usually improved reception by cutting out any sudden pulsations of high frequency current.

In the loose coupled circuit (ill. 35), the two coils P and S are mounted in a twin coil holder, P being fixed and S movable, so that its distance from P could be varied. Just as in the variometer circuit, the movement of the coils towards or away from each other either assisted or resisted the magnetic fields, and acted as the coil's variable inductance. The variable condensers C1 and C2 have a value of 0.0005 microfarads, C3 being a fixed condenser of 0.002 microfarads. For the medium wave band, P may be a No. 35 or No. 50 coil, and S a No. 75; or for long waves P may be a No. 150 or No. 200 and S a No. 200 or No. 250 coil. Tuning was done by varying the distance between P and S and adjusting the condensers C1 and C2. To give it its full title this circuit is known as loose coupled semiaperiodic aerial tuning.

This circuit is employed in the Burne-Jones braille crystal set (ill. 38). On Christmas Day 1929, Winston Churchill launched the first national appeal on the B.B.C. for the British Wireless For The Blind Fund, set up to provide every blind listener with a wireless set. Broadcasting's importance to the visually handicapped had been recognized a few years earlier when, in 1926, the first issue of the *Braille Radio Times* was published, and although a very much abbreviated version of its counterpart, it was popular because it made the blind listener feel more independent. The response to Churchill's appeal was overwhelming, and many manufacturers donated sets. A few even became specialized in designing and producing wireless sets specifically for blind people. One such company was Burne-Jones, who made crystal sets with braille dials and fittings in the early 1930s under their 'Magnum' trade mark.

Most crystal set detectors required very delicate arrangement. Although it was possible to buy a fixed detector so that adjustment was unnecessary, this

37 Variometer circuit (see ill. 36).

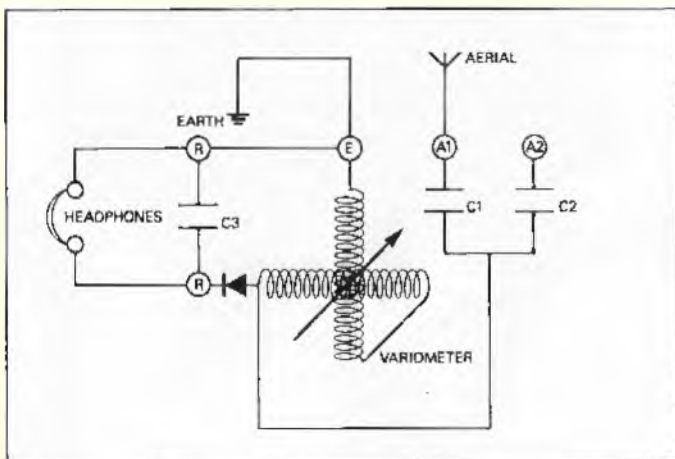



38 Braille crystal set, 'Magnum' trade mark, by Burne-Jones & Company, London, 1930. David Burne-Jones formed his wireless manufacturing company Burne-Jones & Company Ltd. at 309-317 Borough High Street, London E.C.1 in the early 1920s. When he left school he was apprenticed to the Westminster Engineering Company, and later worked for nine years in India as chief engineer of Edward VII's fleet of cars during the Indian tour of 1905-06. From 1913-20 he worked in the kinematograph industry.

method was seldom used by the crystal set manufacturers. This set, however, has a number of interesting features, and has been very thoughtfully designed for the easiest possible use by the blind listener. The cat's whisker, housed beneath the panel with only the end of the arm showing, is spring-loaded and could only be adjusted by lifting the arm up and down. If the arm was accidentally knocked to the side this in no way affected the delicate contact between the cat's whisker and the crystal. The two plug-in coils, which in this particular set are Igranic Triple Honeycombe coils, Nos. 150 and 200 for long wave reception, are mounted in Polar Junior coil holders made by the Radio Communication Company. The two variable condensers were very easily adjusted by means of two large control knobs, and instead of the usual dial numbers there are markings in braille. Furthermore, to avoid confusing the terminals, the aerial and the earth are set far apart and the headphone terminals are close together.

The panel is made of ebonite, a material composed largely of rubber which has been vulcanized (hardened by adding sulphur then heating) at a temperature of 150 degrees Centigrade for several hours. Its normal colour is black, and it is also known as vulcanite. It was

commonly used in the 1920s in sheet form and employed extensively for the panels of wireless receivers and because of its moulding and insulating properties it was used as the basis of many wireless components. It is capable of being highly polished but this reduces its effectiveness as an insulating material and so it is normally found in a matt state. The chassis is housed in a square mahogany base and on the control panel appears the legend THE PROPERTY OF THE BRITISH WIRELESS FOR THE BLIND FUND.

During the first half of the 1920s, when there was a boom in the wireless manufacturing industry, the number of crystal set users outnumbered those who had valve sets by about four to one. As well as the main dealers and suppliers, wireless equipment could be bought from quite unrelated shops such as confectioners, stationers and chemists, and some of the manufacturers were surprising too. For example motor firms like Chase Motors of Newcastle and A. J. Stevens (ill. 89) branched off into producing complete sets, parts and kits for home assembly. In London alone, during the first six months of publication of *Popular Wireless Weekly*, from 3 June 1922, there were sixty different manufacturers advertising their makes of wireless

39 Elwell No. 11 crystal set, 1922. Polished ebonite panel with nickel-plated fittings and Tellite crystal, Mahogany cabinet with lid and compartment for headphones.



40 Elwell crystals. There are four different kinds of crystals housed in the glass tube, and these can be used in place of the Tellite crystal in the Elwell No. 11 set (ill. 39).



41 Claude Willcox transmitting speech from his wireless room at 21 George Street, Warminster.

42 Arcadian ware china cat listening to a crystal set. A seaside souvenir bought at Torquay in 1925.



equipment. However, most of these sets were assembled from other manufacturers parts; few but the large wireless manufacturing firms such as Marconi, C. F. Elwell (ills. 39 and 40), Burndept and the General Electric Company actually designed or built their equipment from scratch. Some of Marconi's sets, including their V2 valve receiver, were built by the Plessey Company in East London.

The cabinets of the crystal sets were often exquisitely made, usually in french-polished mahogany or walnut with intricate joints and decorative moulding. Before the days of mass-production, most orders for wireless cabinets were sent out to cabinet-makers working in the furniture industry and this accounts for the high quality of craftsmanship. Of course this quality was only to be found on the most expensive sets. At the cheaper end of the scale oak and even cardboard, as in the Brownie Tube Type crystal set, served as the cabinet's material.

The main drawback with owning a crystal set was

that it was unselective. It could not separate two or more stations broadcasting on wavelengths which were close together, and it was this failing which ultimately led to the crystal set's downfall. For instance, the broadcasts of Claude Willcox (ill. 41) were very popular, and would attract frequent letters to the press such as this one written to *The Times* in May 1924.

'CRYSTAL USERS COMPLAINT'

Sir, Authorities are generally agreed, I believe, that a great influence is exerted by a good example.

With the hope that this may be proved correct I commend the following to amateur 'broadcasters' in this district—particularly to the owner of station —(his number is known). On two occasions recently I have had the pleasure of listening to the wireless transmissions from a station at Warminster, operated by a gentleman giving his name as Mr. Willcox. Mr. Willcox makes his testing interesting to the casual listener, and intersperses musical items of a high standard. Yet he religiously refrains from experimenting during the hours of broadcasting of the B.B.C. stations.

The owner of—, on the other hand, seems to completely overlook the necessity for such consideration, and conducts his experiments during broadcasting hours, regardless of the fact that reception is utterly ruined for those, who, like myself, rely on a crystal set.

The owner of the station referred to has shown himself aware of the interference caused, but it is hoped that he may yet come to realise that the owners of crystal sets, who according to late official figures are to value users in the proportions of five to one, have some rights, and are entitled to consideration.

R. HOWELL

27 Chesterfield Road, St. Andrew's.

Furthermore, until 1926 the B.B.C. in London had been broadcasting on one wavelength only, namely 360 metres from their 2LO Station. But during that year they began experiments using an alternative wavelength differing from 2LO's by only about 100 metres. The battery-powered valve sets were able to separate these two different wavelengths but the crystal sets could not, and listeners heard the two different programmes simultaneously. However, the results of the wavelength experiments were very successful, and the B.B.C. adopted the plan of alternative wavelength broadcasting, each station offering two separate programmes instead of one, and this led on to the introduction of the Regional Scheme

43 *Microphone Amplifier* by
New Wilson Electrical Company,
patented in 1925. Black ebonite
base.



44 *Brownie No. 2 crystal set*,
1925. Moulded ebonite body.
Price 10s 6d (52½p).

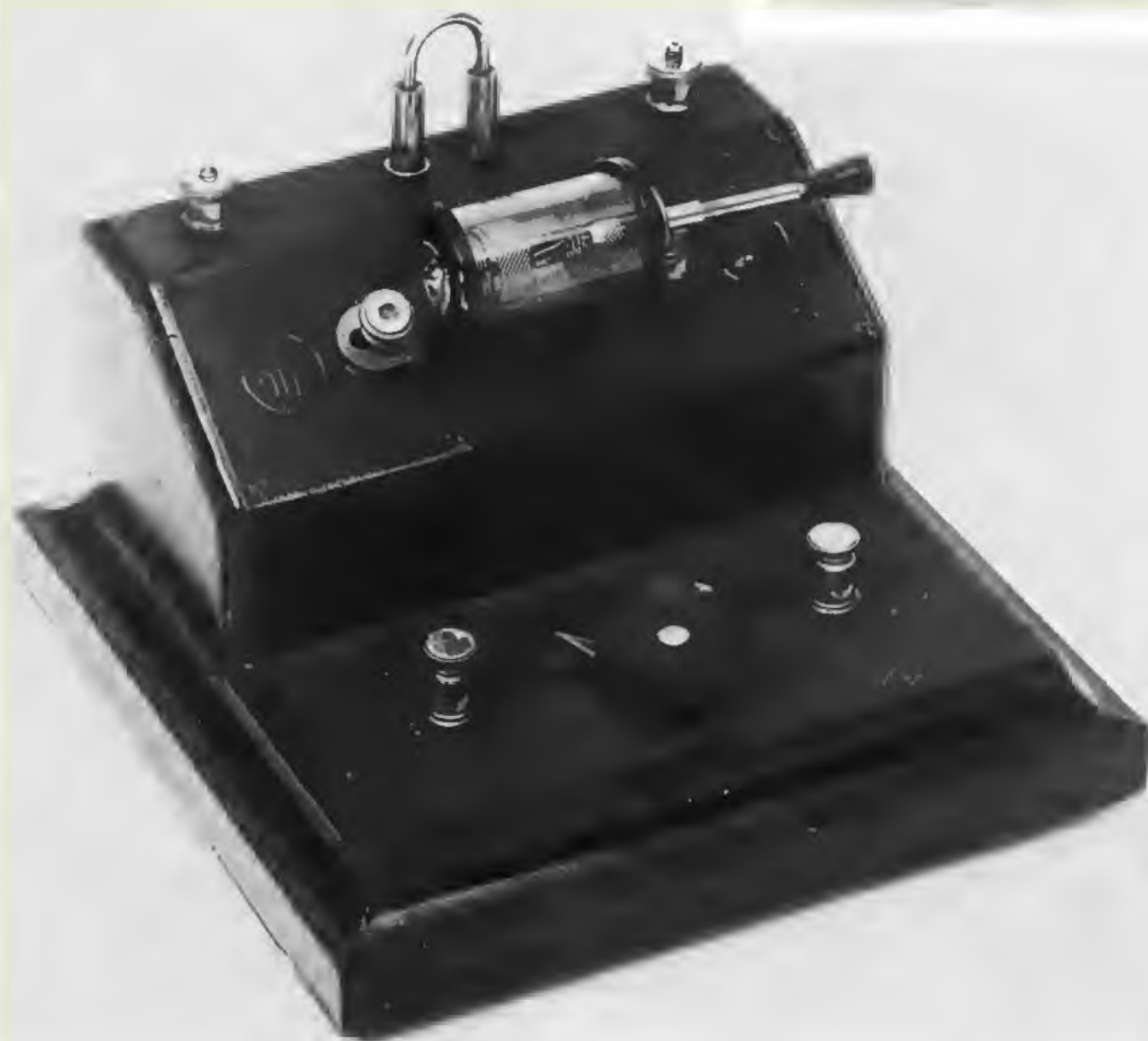

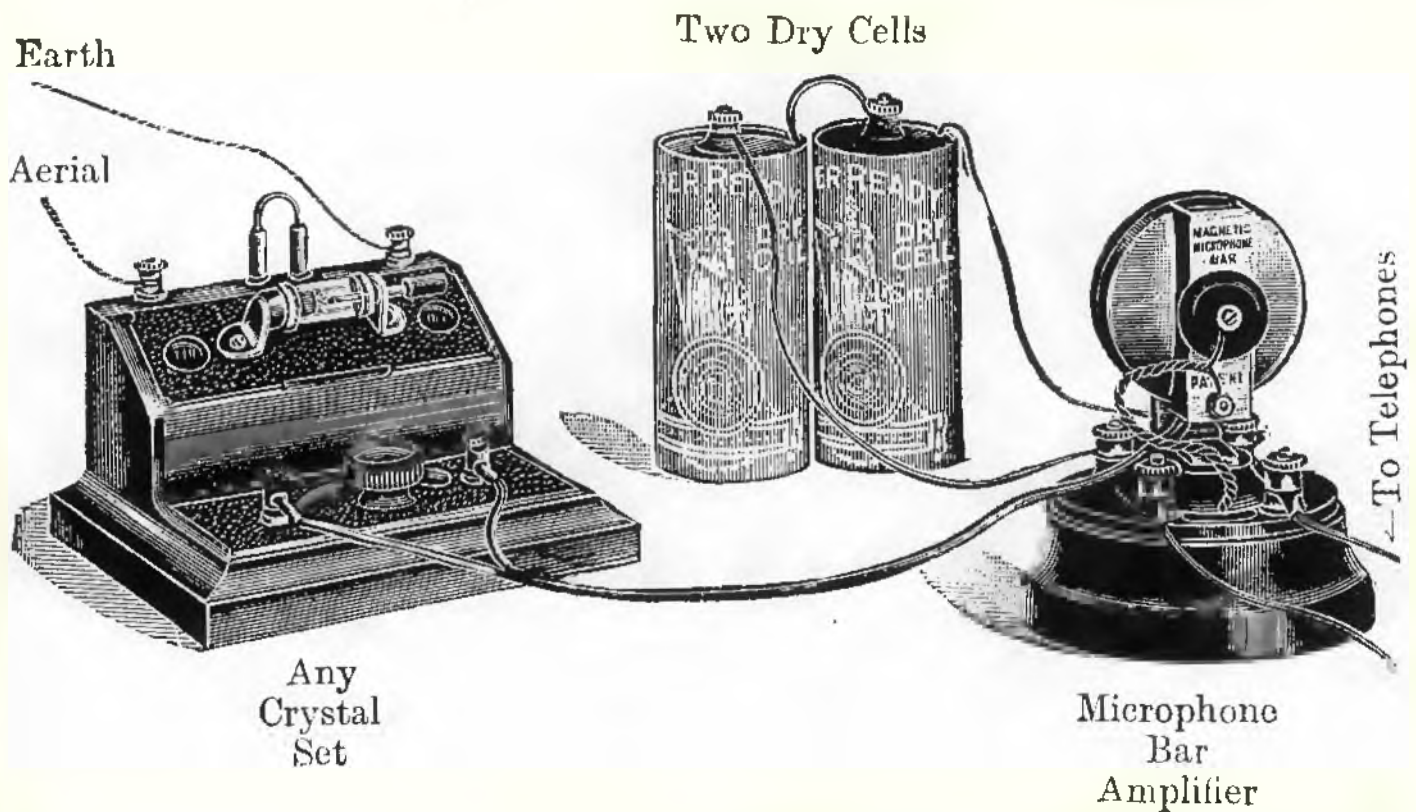

45 This drawing shows the arrangement of the New Wilson Electrical Company Microphone Amplifier connected to a Brownie No. 2 crystal set.

in 1929. The outcome for the crystal set was that very few were made after that date, their seven-year reign having come to an end.

But meanwhile, although the weak signals generated by a crystal set were usually only strong enough to satisfy the lone listener wearing his single pair of headphones, it was possible to buy special crystal set amplifiers, to boost this volume to a point where it was powerful enough to drive a loudspeaker (ills. 43-45).

In the early 1920s S. G. Brown Ltd. introduced three crystal set amplifiers which were designed to produce sufficient power without using amplifying valves. This increased volume was attained by a circuit using a differential microphone, a reed and a magnet. Their Microphone Amplifier, produced in 1921 and the Crystal Amplifier (ill. 46) of 1923, a more powerful version, enabled the listener living within a twelve-mile radius of one of the B.B.C.'s main stations to get

good loudspeaker reproduction, loud enough to make family listening comfortable. These two amplifiers were powered by a six-volt battery which would last for many months due to the very low current consumption. Not only cheap to run, they were simple to operate: their input terminals were connected to the headphone terminals of the crystal set and their output terminals were connected to a loudspeaker. Only an initial adjustment was necessary in order to get them working (ill. 47).

In 1924 S. G. Brown Ltd. brought out their Crystavox loudspeaker (ill. 49) which was designed with a built-in microphone amplifier mounted onto the base. When the new Daventry 5XX high power station opened in 1925 listeners using a Crystavox and living within seventy-five to a hundred miles could obtain 'perfect Loud Speaker reproduction—not just a whisper but real volume'.

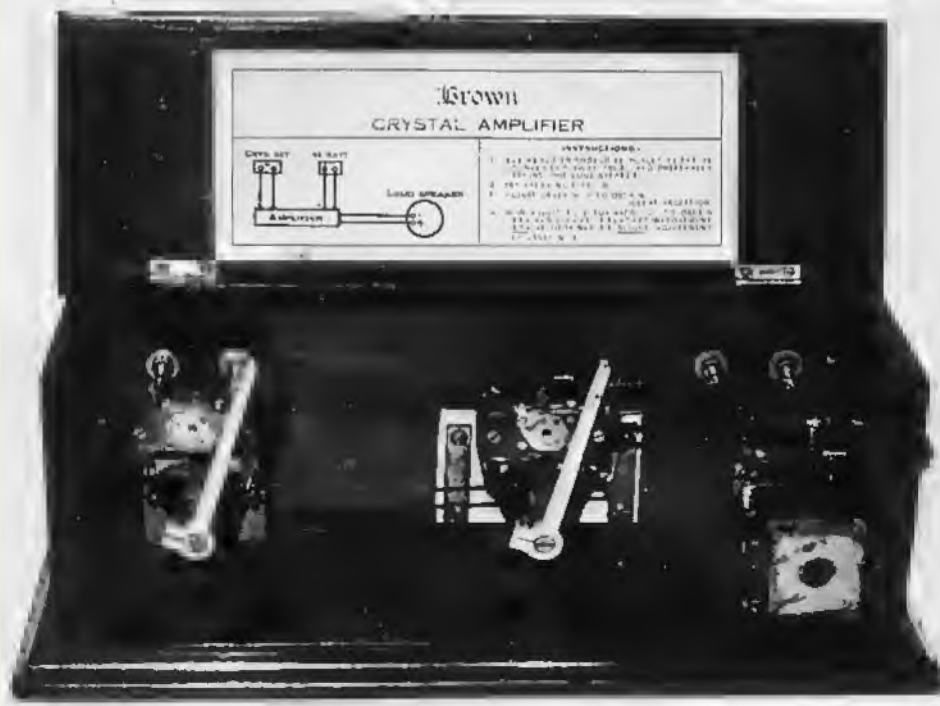

46 Crystal Amplifier by S. G. Brown Ltd., made in 1923. Housed in a lidded mahogany case.



47 Crystal set manufactured by the Service Radio Company, 67 Church Street, Stoke Newington, London N.16, in 1924. Provision is made in the compartment next to the panel for connecting a Service one-valve amplifier which would give the listener greater station selection. Price of the set: £1 10s (£1.50).

48 Home-made crystal set, c. 1923. Constructors could buy the cabinets ready-made and simply build their sets into them.



Brown

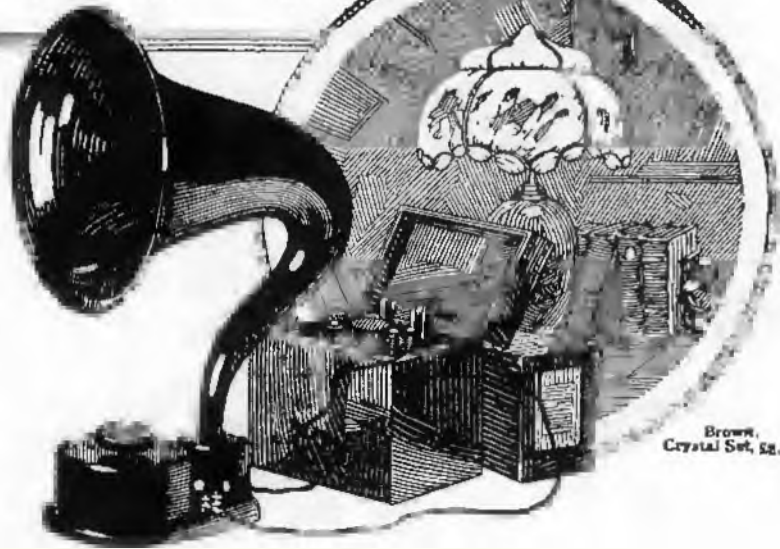

Brown, Crystavox Set, 52.



NO VALVES TO BUY,

Dull Emitter Valves cost 14/- each. It takes a 2-valve Set to operate an ordinary Loud Speaker. Valves need renewal when burnt out. The Crystavox uses no valves—it works straight from your Crystal Set.



NO H.T. BATTERIES

A high tension battery will cost about 15/-. It will last about six to nine months according to the size of your Set and the amount of current it requires. The Crystavox uses no valves and therefore requires no high tension battery.

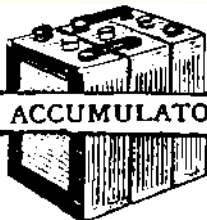

NO ACCUMULATORS

A good Accumulator will cost about 15/- and will require charging at periodical intervals—a constant expense. If you use a simple Crystal Set and a Crystavox you'll save the constant expense of Accumulator charging.

The only Loud Speaker which works direct from a Crystal Set

WITHIN 75 to 100 miles from Daventry thousands of Crystal users are now finding that they can get Loud Speaker results direct from their Sets by means of the wonderful Crystavox. Here is a super-sensitive Loud Speaker, which for purity of tone and economy of upkeep, is absolutely unrivalled. In fact, it requires no valves or accumulators—just attach it to your Crystal Set in place of the headphones and you will obtain a volume of sound sufficient to fill the entire room. No technical skill is required. Think what this

means to you. Just tune in at any time and you can obtain perfect Loud Speaker reproduction—not a whisper but real volume. Any member of the family can use it—its simple mechanism is proof against mishandling.

Try this Test:
Owing to the wide variation of local conditions it is not possible to guarantee that every Crystal set will work a Crystavox. The test is this: Tune in to greatest strength and hold the headphones 12 inches from the ear. If the signals can still be heard your Set is sufficiently powerful to operate a Crystavox.

For those fortunate enough to live within easy reach of a Broadcasting Station, the use of a Crystavox with a Crystal Set is by far the cheapest, most reliable and most economical method of enjoying Wireless.

£6

S. G. Brown, Ltd., N. Acton, London, W.3

Retail Showrooms: 19 Mortimer Street, W.1
14 Moorfields, Liverpool. 67 High Street, Southampton.
Depots (Wholesale only): 15 Bushy Park, Bristol.
Cross House, Westgate Road, Newcastle.

The *A Loud Speaker working from a Crystal Set*
CRYSTAVOX

Gilbert Ad. 4330

Early Valve Receivers 1922-1927

The typical standard type of valve wireless equipment on sale at this early period consisted of a number of separate items, linked to form the wireless 'set', which in many cases was very complicated to operate because of the large number of controls. In order to receive a programme, it was necessary to erect an aerial, usually a hundred feet long, suspended between two masts, either out in the garden or fixed to the roof (ill. 50). It was a common sight to see a sea of aerial masts swaying high above the ground, especially if one was in a town. If the listener had no garden or space to erect his aerial, an indoor frame aerial could be used as an alternative. The aerial connected directly to the receiver whose dials, valves and other components were generally left exposed and mounted on a vertical, horizontal or

sloping panel, an arrangement which gave the set an appearance more of something out of science fiction than of a domestic object (ills. 51-53).

To supply the power, high tension batteries of about ninety volts were needed, and also an accumulator to operate the filaments of the valves. The accumulators had to be kept well charged and this usually meant carting them down to the local garage every two or three months. If a receiver having two or more valves was used, then there was enough power to drive a horn loudspeaker, and this meant that the whole family could gather around and listen. (In those days

50 Advertisement for Simpson & Blythe's Wireless Masts, January 1923.

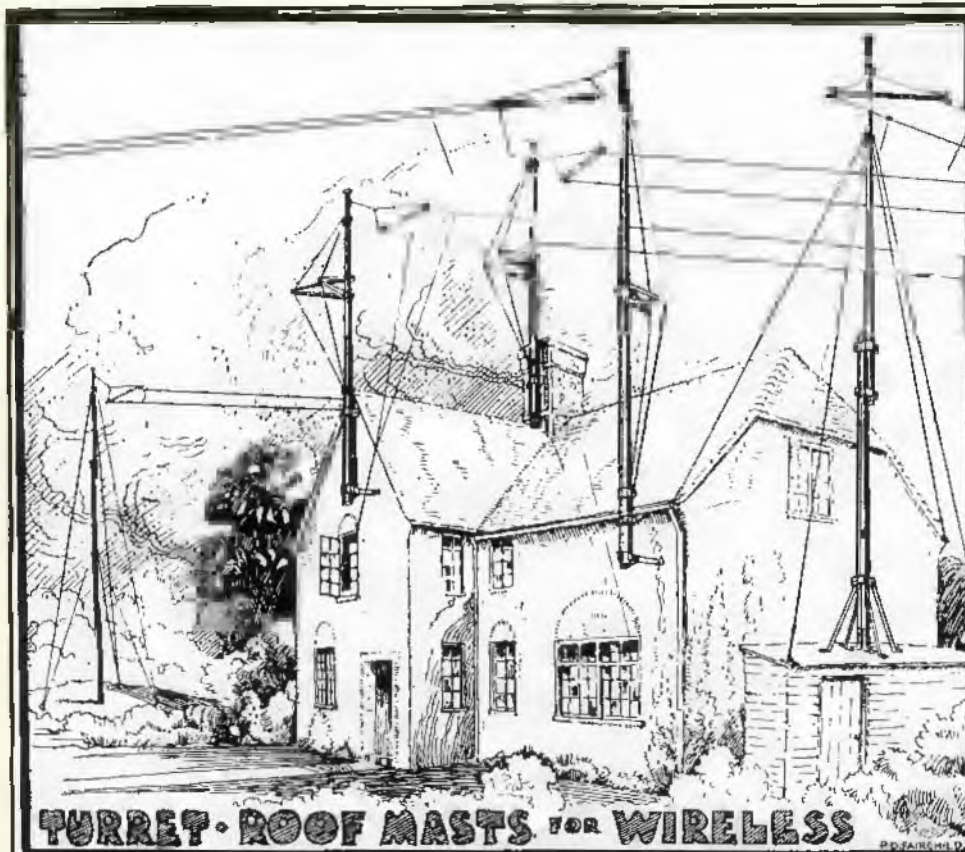

TURRET, WIRELESS GROUND & ROOF MASTS

DESIGNED BY NAVAL EXPERTS

NO CURRENT JUMP OR STEEL TO RUST.

SELECTED COLUMBIAN UNBREAKABLE PINE, 2½-in. BASE (TAPERING).

WEIGHS 66 lbs. EASY TO FIX. (TELESCOPIC TOP MAST.)

SENT IN LIGHT 16-ft. BUNDLE.

PRICES.

Ground Masts.

26-ft. Mast, in 2 sections, complete ... 49/6
36-ft. Mast, in 3 sections, complete ... 65/6
42-ft. Mast, in 3 sections, with Telescopic Top Pole 79/6
(All with Posts.)

FIXINGS FOR ANY ROOF.

Special Wrought Iron Brackets, Supports 1 cwt. on Eaves, Chimneys, or Town Copings. No Damage to Brickwork.

ALUMINIUM SPREADERS AND CANTILEVER STAYS SAVES ROOF WIRES.

ROOF MASTS.

13-ft. Mast (for Light Aerials). Aluminium Spreaders and Cantilever Wires, Brackets for attaching to roof (1 cwt. strength), all fittings ... 45/6
16-17. Mast (for Heavy Aerials) 55/6
28 ft. Mast, in 2 sections, but Guy Wires and Roof Plates (all fittings) 75/6
Masts without wall brackets and plates 28/6, 38/6, 49/6

6 ft. Columbian Pine Spars, 1½-in. Aluminium (Grip Ends). Weight, 2½ lbs. Strain, 1 cwt. (For Aerials) ... 5/6

Pat. and patent applied for.

SIMPSON & BLYTHE,
STANLEY HOUSE, 8 & 9, Sherwood St., PICCADILLY

Send for list to S. & B. or agents.

51 Victory three-valve sloping panel type receiver, c. 1922.



52, 53 Two novelty postcards. The panels of the receivers lift up to reveal snapshots of the seaside towns. c. 1923.





54 Brownie two-valve battery receiver, 1926. It used a loose coupled circuit operating up to 2000 metres and has plug-in coils. Moulded ebonite body. Price: £2 10s (£2.50).

55 Radio ladies headphones by the Sterling Telephone & Electric Company, 1922. Designed to give the listener 'the greatest comfort and convenience when receiving and particularly

desirable for use by ladies, enabling them to "listen-in" without the necessity of wearing overhead straps; thus avoiding disarrangement of the coiffure.'

everybody sat facing the wireless when it was on!) With a less powerful receiver employing only one valve, headphones were connected in place of the loudspeaker (ills. 55 and 56). The valves of this time were known as 'bright emitters' as their filaments lit up like electric lamps (ill. 57). Because of the great heat needed to drive them, they were liable to burn out after only a short life span, and as they cost around £1 1s (£1.05p) each, they had to be treated with special care (it is known that some amateurs used them to see their way into bed and to read by). There was virtually only one type of bright emitter, the 'R' valve, whose function was general purpose, acting as high frequency amplifier, detector or low frequency amplifier.

Even before official broadcasting had started from the B.B.C. stations, wireless manufacturers were so confident in its development that they went ahead and organized the first two wireless exhibitions held in this country to promote the infant radio trade and to introduce wireless to the public. The first was the 'International Radio Exhibition & Convention' held at the Central Hall, Westminster, from 2 September to 8



No. 27. FREE ADVICE FOR THE BEGINNER (SEE PAGE 1).

POPULAR WIRELESS

3d
Weekly



A RADIO TEA.

SPECIAL FEATURE IN THIS ISSUE:

THE ORIGIN OF THE FLEMING VALVE

By Dr. J. A. Fleming, F.R.S.

THE FASCINATING STORY OF THE INVENTION OF THE THERMIONIC VALVE, SPECIALLY WRITTEN FOR "POPULAR WIRELESS" BY THE GREAT INVENTOR.

56 Cover of *Popular Wireless Weekly*. The mums pass round the cups while the kids pass the headphones. The wireless jostles with the jellies and cakes on the table at this 'radio tea' in 1922.



57 Left and Centre: two 'bright emitters' ('R' Type), c. 1923. Right: a Mullard 'Dull Emitter', c. 1925. The silvering which occurred on the inside of valves from the mid-1920s onwards is oxide of magnesium burnt to absorb any traces of gas in the bulb.

(right)

58 Advertisement for *Popular Wireless Weekly*, October 1924.

59 Combined crystal and single valve receiver, Home-made, c. 1922.



POPULAR WIRELESS

EVERY 3rd FRIDAY

FIRST IN POPULARITY, FIRST IN CIRCULATION FIGURES

Every Member of the "P.W." Technical Staff is a wireless expert of proved reliability, and no effort is spared to assist readers. Technical Queries are answered free by post, and a special staff, under the personal supervision of the Technical Editor, Mr. Dowling, devote their time and energies to the work of helping readers who are in difficulties with their sets, etc.

PLACE A REGULAR ORDER WITH YOUR NEWSAGENT AT ONCE, AND SECURE YOUR WEEKLY COPY OF

"POPULAR WIRELESS"
Britain's Leading Wireless Journal

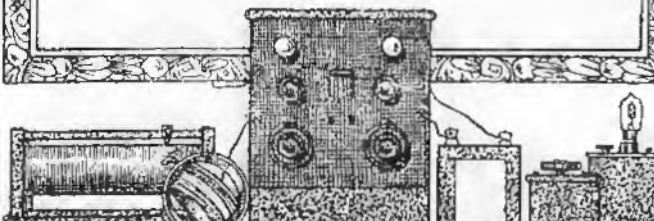

ALL-BRITISH WIRELESS EXHIBITION

HORTICULTURAL HALL, AND CONFERENCE
VINCENT SQ., WESTMINSTER, S.W.1

SEPT. 30th (1922) OCT. 7th ADMISSION **1/3** including tax.
(SATURDAY) (SATURDAY)

SPECIAL TRADE DAY
Oct. 2nd. Admission 1/3 including tax.

SPECIAL PUBLIC DAY
Oct. 3rd. Admission 5/- including tax.
(Public admitted both days after 6 p.m.
at the usual price.)

The CONVENTION will be held under the auspices of THE WIRELESS SOCIETY OF LONDON.

SPECIAL ATTRACTIONS

THE WIRELESS SOCIETY OF LONDON

Have arranged for officers of the Society to be available each day, at the room put at their disposal, to meet officials and members of Affiliated Societies from London and Provinces. A staff of experts will be in attendance to conduct visitors round the Exhibition. The following are among the gentlemen who have kindly promised to give lectures, which will take place every afternoon and evening as announced during the Exhibition.

Admiral of the Fleet Sir HENRY JACKSON,
G.C.B., K.C.V.O., etc.
A. A. CAMPBELL SWINTON, F.R.S., etc.
F. HOPE JONES, M.I.E.E.
MAURICE CHILD

G. P. MAIR, A.M.I.E.E., etc.
G. G. BLAKE, M.I.E.E., A.Inst.P.
E. BLAKE, A.M.I.E.E.
PHILIP R. COURSEY, B.Sc., A.M.I.E.E., F.Inst.P.
W. R. H. TINGEY

R. CLINKER
JOHN SCOTT TAGGART, M.C., A.M.I.E.E., F.Inst.P.,
LI. H. WALKER, A.M.I.E.E.
R. R. RIVERS-MOORE, B.Sc., A.M.I.E.E.
P. D. TYERS

THE DEMONSTRATION STAND

will provide numerous concerts daily, including the reception of Broadcast music, song and speech.

THE EXHIBITS

will include many instruments of entirely new design and novel apparatus never before shown to the Public. At each stand highly experienced representatives will be on duty for the purpose of explaining the various exhibits.

OFFICIAL CATALOGUE

Price 6d. Over 100 pages. Special article by F. Hope Jones, Esq., M.I.E.E., and a Complete List giving the name and address of all affiliated Wireless Societies and Clubs in Great Britain.

ORGANISERS:

BERTRAM DAY & Co., Ltd., 9 and 10, Charing Cross, London, S.W.1.
Wireless Publicity Specialists Gerrard 8063 4

September 1922. The visitor, paying 1s 3d (6p) admission, was able to see a large variety of wireless receivers and accessories from over forty manufacturers as well as components for the home constructor. He could also attend the many lectures given by well-known wireless experts, made famous through the pages of the four main wireless magazines that had begun to be published by this time, *The Wireless World*, *Amateur Wireless*, *Popular Wireless* and *The Broadcaster*.

At the Central Hall Exhibition demonstrations were given emphasizing the usefulness of wireless in tracking down criminals, and the public had the opportunity of controlling a wireless set 'actually causing the arrest of a pseudo criminal'. Prizes of £5

and £3 were offered for the best pieces of amateur-constructed apparatus. The prize-winning sets, a three-valve portable and a two-valve set, were assembled from ready-manufactured components using the constructor's own circuits. It is significant that during this early period of broadcasting history, most enthusiasts at one time or another experimented with home-made receivers (ill. 59). Although they generally compared badly in performance with most manufactured sets, they gave the constructor the feeling of participation in pioneering experimental work, and with, of course, good reason. The also-rans in the competition included a combined crystal set and one-valve receiver, a crystal set made by a seven-year old, and a novelty loud-speaker using a conch shell instead of the usual horn.

Visit Gamages
STAND 31

At the Air Branch
Woolwich E. Exhibition
From Oct. 1st to Oct. 7th

GAMAGES

WIRELESS APPARATUS OF ADVANCED
DESIGN AND GUARANTEED QUALITY

Every Enthusiast
should have a copy
of our

WIRELESS
CATALOGUE

A copy will be sent
post free on request



CRYSTAL RECEIVING SET

This set is the most complete of the type...
It is a simple and efficient design...
The price is £5:5s.

PRICE £5:5s.



WIRELESS APPARATUS FOR
VALVE RECEPTION

This is a complete set for valve reception...
It includes a transformer, valves, and a speaker...
The price is £12:12:0.

£12: 12: 0



"SONUS" MODEL A. COMBINATION

This is a combination set for both crystal and valve reception...
It is a complete and efficient design...
The price is £22:15s.

PRICE £22:15s.

First in 1918 **GAMAGES, HOLBORN, LONDON, E.C.1** Foremost Today

61 A Gamages advertisement in
Popular Wireless Weekly, 30
September 1922.

ARISTOPHONE



For real enjoyment of
wireless music and speech
use the Aristophone
the supreme wireless receiving
set with perfect reproduction

CABINET MODELS

PANELS

ACCESSORIES

Write for a copy of the
Aristophone Brochure

C. F. ELWELL, LTD.

GRAVEN HOUSE
KINGSWAY - - W.C.2



21.



63

ELWELL WIRELESS

62 C. F. Elwell's advertisement
for their Aristophones, 1922.

63 Marconi Crystal 'A' crystal set, 1922. Flexine covered case. Wavelength cards can be plugged in behind the detectors to give different wavebands. Shown at the Agricultural Hall Wireless Exhibition, and priced at £9 10s (£9.50).





Broadcasting Programmes

What you can hear
every evening of the week on your set.

TELEPHONY AND MUSIC TRANSMISSIONS.

Station.	Call sign.	Wave-length in metres.	Remarks.
Croydon	GED	900	.. Throughout day to aeroplanes.
Marconi House, London, Broadcasting Station	2LO	360	.. Every evening, 6 p.m. and 9 p.m. Continuous service to be given shortly.
Writtle, Essex	2MT	400	.. Tuesdays, 8 p.m. (Concert.)
Paris	FL	2,600	.. 7.20 a.m., 11.15 a.m., 5.10 p.m. Also occasional telephony at 10.10 a.m. and 9.20 p.m.
Königswusterhausen ..	LP	2,800	.. Between 6 and 7 a.m., between 11 and 12.30, and between 4 and 5.30 p.m.
The Hague	PCGG	1,085	.. Sundays, 3 to 5 p.m. (Concert.)
Haren	OPVH	900	.. Practically every 20 minutes past each hour from 11.20 to 4.20, giving messages to aeroplanes on the Brussels-Paris, Brussels-London, and Brussels-Amsterdam lines.
Radio-Électrique, Paris	—	1,565	.. Concerts at 9.45 p.m.
Brussels Meteorological Institute	OPO	1,500	.. Slow C.W. and Morse. Easy reading for amateurs.
Messrs. Burnham* (Blackheath)	2FQ	440	.. About 9 o'clock in the evening.
Newcastle*	SBA	440	.. Between 6 and 7.30 p.m.
Manchester Broadcasting Station	2ZY	385	.. Every evening, 6 and 9 p.m.
Birmingham (Witton) Broadcasting Station	2WP	425	.. Every evening, 6 and 9 p.m.

NOTE.—The Bar Lightship, Liverpool, sends telephony at 7 a.m., 9 a.m., 11 a.m., 12 noon, 1 p.m., and every two hours until 9 p.m. Calls "Dock Office." Liverpool answers "Bar Slip."

In addition to the regular transmissions carried on between the British amateur stations, much telephonic conversation may

be heard from St. Inglevert (A M), Le Bourget (Z M), and Brussels (B A V). These stations are quite powerful, but they call for a little extra care in tuning. Wave-length, 900 metres.

All times given are G.M.T.

An asterisk denotes transmissions made purely for experimental purposes.

64 'What you can hear every evening on your set.' Programme times during the first week of operation of the B.B.C. in November 1922.

(opposite)

65 Advertisement by the General Electric Company for their No. 1 and No. 2 crystal sets, December 1922.

From 30 September to 7 October 1922 the second wireless exhibition took place (ill. 60). This was the first all-British event of its kind, and was held in the Agricultural Hall, Westminster. The organizers, Bertram Day & Co. Ltd., managed to secure the wholehearted support of the wireless trade; the exhibition was the most representative gathering of wireless interest held in this country hitherto, and it made clear to the public the advantages of using really high-class British apparatus (ill. 61).

Among the fifty-two manufacturers and suppliers were C. F. Elwell & Co. Ltd., who were offering 'cabinet Aristophones; for drawing room use, having specially designed cabinets which are period reproductions and contain the whole of the wireless apparatus, including batteries and loud-speaker. Standard Aristophones are shown in Cromwellian, Sheraton, Lacquer and Adam styles' (ill. 62). C. F. Elwell also had on display a lacquer-work china cupboard and bureau of 1722 into which wireless apparatus of 1922 had been

built. It was not unusual for very expensive sets such as these to be disguised as other familiar objects which would get them easily accepted into the home. Indeed, the practice of setting wireless receivers in reproduction period furniture still continues today.

Confidence in the belief that official broadcasting was about to begin was demonstrated by the Marconi Company whose advertisements assured the public that 'immediately the official broadcasting scheme is announced a complete range of receivers will be available'. As it was, Marconi were already exhibiting three of their sets at the Agricultural Hall Exhibition: the V2 two-valve model, priced at £25 with a guaranteed range of fifty miles, the Crystal 'A' (ill. 63) priced at £9 10s (£9.50) including accessories, and the Crystal Junior at £5 15s (£5.75). When one considers that in the early 1920s the average take-home pay was about £3 a week, the cost of a good manufactured valve wireless receiver could represent as much as two or three months' wages. With constantly having to

WIRELESS BROADCASTING



*Which Set
Shall I buy?*

IF you want to obtain the best possible reception from Wireless Broadcasting, 'listen in' on a

GECOPHONE

(REGISTERED TRADE MARK)

"GECOPHONE" Receiving Sets are of perfect design and construction, and represent the accumulated knowledge and experience of their makers in many years of telephone and wireless development.

Simplicity is the keynote of all "GECOPHONE" Receiving Sets. They are noticeably devoid of all technical complications and can be installed and operated with the utmost ease.



CRYSTAL SET No. 1.
Approx. range (with standard P.O. Aerial) 25 miles.

Fully approved by H.M. Postmaster-General and comply in all respects with the Regulations affecting Wireless Broadcasting.

Obtainable from all
Principal Electricians
Stores and Ironmongers.



CRYSTAL SET No. 2.
Approx. range (with standard P.O. Aerial) 30 miles.

GECOPHONE

(REGISTERED TRADE MARK)

Manufacturers (Wholesale only) THE GENERAL ELECTRIC CO., LTD., Magnet House, Kingsway, London, W.C. 2.

66 Ediswan crystal set, Model 1924.B. Has a range of twenty miles, receiving wavelengths between 200 and 700 metres, with a plug-in coil attachment in the back. Plug-in coils came in different sizes to enable the receiver to be tuned to the desired waveband by inserting the appropriate coil.

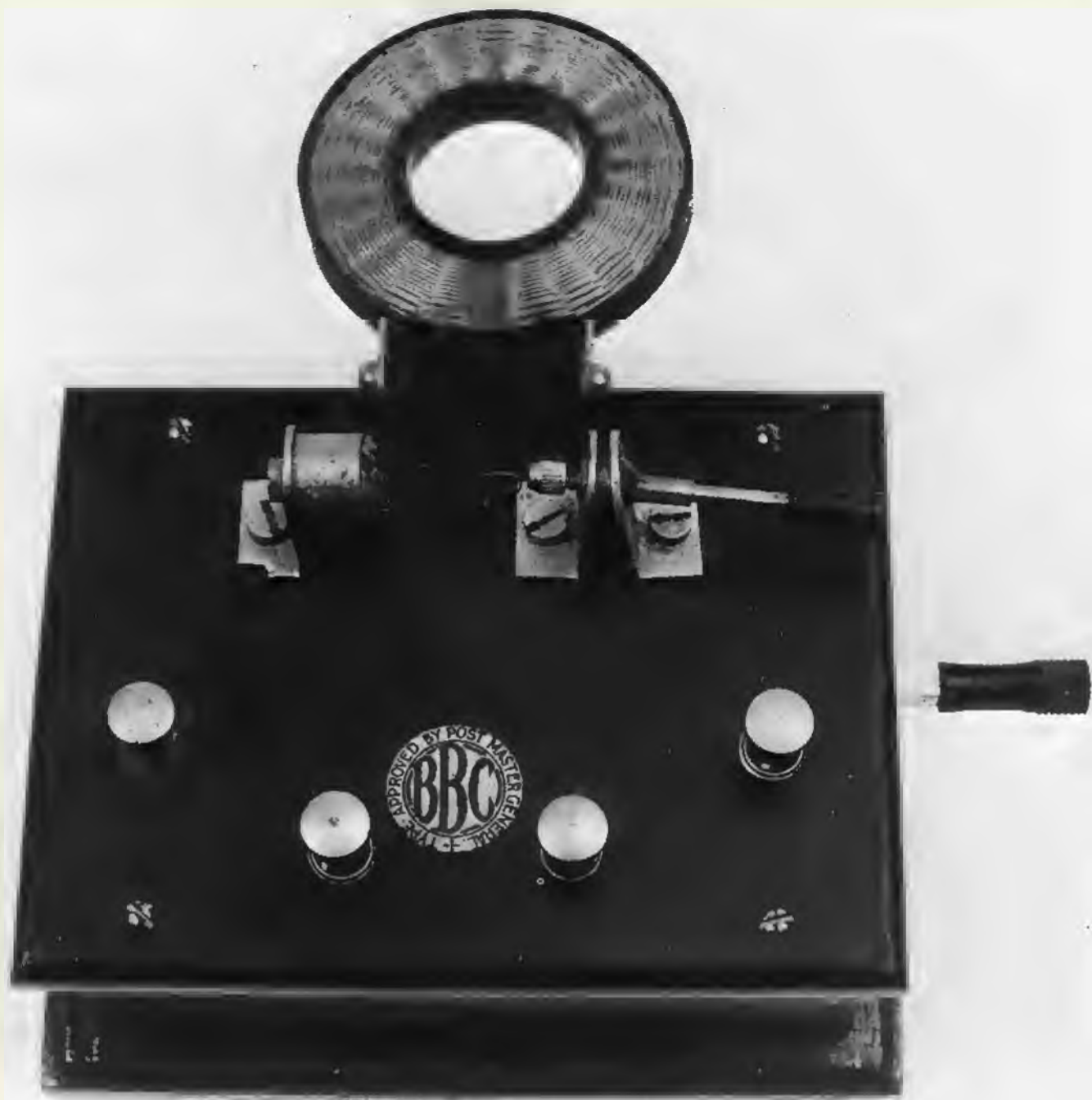

replace worn out batteries and easily damaged valves, as well as the expense of charging accumulators, the cost in many cases was prohibitive. As a result, the cheap crystal sets were much more popular, although they had the much shorter range of around fifteen miles, and possessed no indigenous means of amplifying the signal.

When the British Broadcasting Company finally began their programmes in November 1922 (ill. 64), the large number of manufacturers producing their own sets and components could be protected against foreign competition by becoming a member of the B.B.C. (ill. 65). This protection lasted two years until the end of 1924, and all sets sold in this country had to be of British manufacture. They also had to be tested and approved by the Post Office and stamped with the B.B.C. stamp which bore the words, TYPE APPROVED BY THE POST MASTER GENERAL, (ill. 66).

At this time many firms were manufacturing valve receiver units which could be assembled in a variety of forms. They came in a set of parts or were ready-built, simply needing to be plugged into each other (ill. 67). The K. B. Radio Equipment Company manufactured a series of such units which could be built into anything from a one- to a seven-valve receiver 'in easy stages to suit the pocket' (ill. 69). Buying units No. 2, No. 3 and No. 4 ready assembled would cost the listener £5 11s 6d (£5.57½) and would give him a three-valve set covering all the broadcasting stations within a radius of 250 miles. In addition, H. T. Batteries at 13s 6d (67½p), a four-volt accumulator at 25s (£1.25), an earth wire, a hundred feet of aerial wire and insulators at 7s 6d (37½p), three valves at 22s 6d each (£1.12½) and a horn loudspeaker at £4 15s (£4.75) would all add up to a bill of £16.

Another company specializing in unit type receivers was the Peto-Scott Company, 64 High Holborn, London WC1. Their three-valve kit comprised a tuner, a condenser unit, a high-frequency amplifier, a detector unit and a low-frequency amplifier, for a total cost of £7 15s (£7.75). They also manufactured a one-valve receiver called the Broadcast Baby (ill. 70), fully guaranteed at 50s (£2.50); 'but,' as their advertisements

67 A one-valve receiving set manufactured by Leslie McMichael Ltd., from an advertisement in *Popular Wireless Weekly*, 14 October 1922.

COMPLETE AND EFFICIENT ONE-VALVE RECEIVING SET

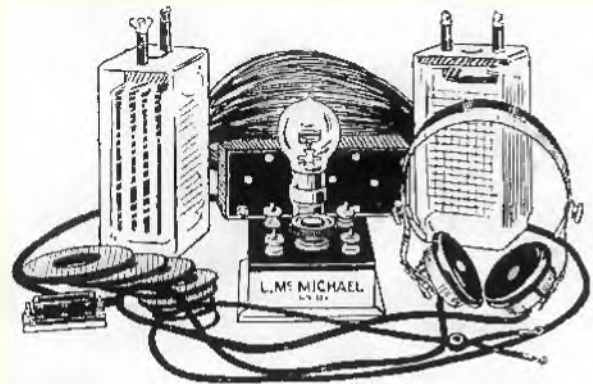

1 Valve Panel, in mahogany box, with circular filament resistance	£.	s.	d.
1 Variable Condenser	1	0	0
Complete set of slab coils for all wave-lengths	15	0	0
1 Valve (Ex-Government, if in stock)	12	0	0
1 Battery, 72 Volts, tapped off every 4 Volts	15	0	0
1 4-Volt Accumulator	1	0	0
100 ft. Aerial Wire, best enamelled, stranded Copper	7	6	0
2 Insulators	2	0	0
1 pair Head Telephones	1	10	0
60 ft. 19/30 Tinned and Rubber-covered Cable, for earth connection and wiring	1	0	0
	£6	17	0

Illustrated Catalogue (P/W) 16 Pages, 100 Illustrations. 6d. Post Free.

When writing please mention this publication.

LESLIE McMICHAEL, Ltd.,
Providence Place, West End Lane, KILBURN, N.W.6

(Bus Services 4, 8, 16, 28, 31 all pass West End Lane.)
 Telephone: HAMPSTEAD 1261. Nearest Tube Station: KILBURN PARK (Bakerloo).

said in January 1923, 'if for use with Broadcast Licence each instrument must be stamped B.B.C. at an extra cost of 32s 6d (£1.62½), being £1 for the Broadcasting Company and 12s 6d (62½p) for the Marconi Company.' All Peto-Scott sets were sold under licence from the Marconi Company and this accounted for the extra 12s 6d (62½p) royalty.

All holders of wireless apparatus had to have a licence of some kind. For the amateur and experimenter, three types of licence were available. The Experimental Licence, which was issued to properly qualified amateurs, enabled them to carry out experimental work. There were strict rules governing this type of licence, among them being that the applicant should

68 One of the 8,127,636
Broadcast Receiving Licences
issued in 1937.

To be produced on demand—NOT TRANSFERABLE. (B.C. Contention & Overload.)

RECEIVING LICENCE. **BV 156678**

WIRELESS TELEGRAPHY ACTS, 1904-1920.

(This Licence is valid on the 31 October 1938 at 1940m to 2015)

Mr. WILLIAM J. BELL
at 1940m to 2015 at 7, Sea View Terrace, Homers

I hereby authorize (subject to all reports in the conditions set forth on the back) for a period ending on the date shown above, to establish a wireless station for the purpose of receiving messages in the frequency occupied by the Licence at the above address.

I have acknowledged the payment of the fee of two shillings is hereby acknowledged.

Signed on behalf of the Postmaster-General, A. Thompson for Postmaster.

(This Licence is valid on the 31 October 1938 at 1940m to 2015)

69 'K. B.' wireless units from an advertisement in *Popular Wireless Weekly*, 19 August 1922.

SIMPLICITY

"K. B." UNITS

EFFICIENCY

ECONOMY

PROMPT DELIVERY

IMMEDIATE SATISFACTION

By means of these units you can build up a complete one to seven valve receiving set in easy stages to suit your pocket; while in the meantime, the units already bought are in themselves a complete receiving set, whatever their number may be. All you have to do is to place the units side by side and connect straight across with the brass links provided.

UNIT No. 1.
CONDENSER PANEL.
No. Repl.: Option 1.



Price.
Complete (as above) 34 - each.
Set of Parts (panel only) 22 6 per set.
Mahogany Cabinet 6 - each.

UNIT No. 2.
DETECTOR PANEL.
No. Repl.: One.



Price.
Complete (as above) 34 6 each.
Set of Parts (panel only) 20 - per set.
Mahogany Cabinet 6 - each.

UNIT No. 3.
I.F. AMPLIFYING PANEL.
No. Repl.: 1, 2, or 3.



Price.
Complete (as above) 43 6 each.
Set of Parts (panel only) 33 - per set.
Mahogany Cabinet 6 - each.

UNIT No. 4.
H.F. AMPLIFYING PANEL.
No. Repl.: 1, 2, or 3.



Price.
Complete (as above) 33 6 each.
Set of Parts (panel only) 18 6 per set.
Mahogany Cabinet 6 - each.

We also hold large stocks of complete Receiving Sets, Cathodes, Coils, Variable Condensers (Assembled and in Parts), Valve Holders, Filament Resistances, H.T. Batteries, Accumulators, Aerial Insulators; in fact ALL AMATEUR REQUIREMENTS.

TRADE ENQUIRIES INVITED. **CATALOGUE P.W. POST FREE 4d.**

COME AND "LISTEN IN" AT OUR SHOWROOMS. OPEN DAILY from 11 a.m. till 7 p.m.

THE "K.B." RADIO EQUIPMENT COMPANY,

Head Offices and Showrooms: 109, High Road, Kilburn, N.W.6.

Bus Services: 4, 15, 28, and 51 pass door. 1 mile, Kilburn Park Stn. (Bakerloo Riv.)

produce written evidence that he was of British nationality and that he would strive to produce something of scientific value or public good from his experiments. A fee of 10s (50p) was payable annually in advance. The Constructors Licence was issued to anyone wishing to construct his own apparatus for receiving wireless broadcasts. The fee was 15s (75p) and allowed the licence-holder to make his set from parts as long as they were not of foreign manufacture.

The 10s (50p) Broadcast Receiving Licence (ill. 68) entitled the holder to receive broadcasts on a receiver bearing the B.B.C. stamp (ill. 66). In addition to receiving that half of the income from the 10s (50p) licences not owing to the Treasury, the B.B.C. received

the following royalties on all apparatus sold by members in order to meet the expenses of broadcasting: crystal sets, 7s 6d (37½p); microphonic amplifiers, without valves, 7s 6d (37½p); crystal sets with one valve, £1 7s 6d (£1.37½); one-valve sets £1; two-valve sets, £1 15s (£1.75); three-valve sets, £2 5s (£2.25); four-valve sets, £2 15s (£2.75). Later only the 10s (50p) licence was retained, the B.B.C. receiving seventy-five per cent of the income.

Until late 1925, and even after, the panel type of receiver, which had the valves and other components mounted on a horizontal, vertical or sloping panel, was the standard kind of instrument (ills. 73 and 74). But during that year there a great

70 The Peto-Scott Broadcast Baby, priced at 50s (£2.50), January 1923.

Every Instrument tested on an Aerial before despatch and a signed Certificate attached to each.

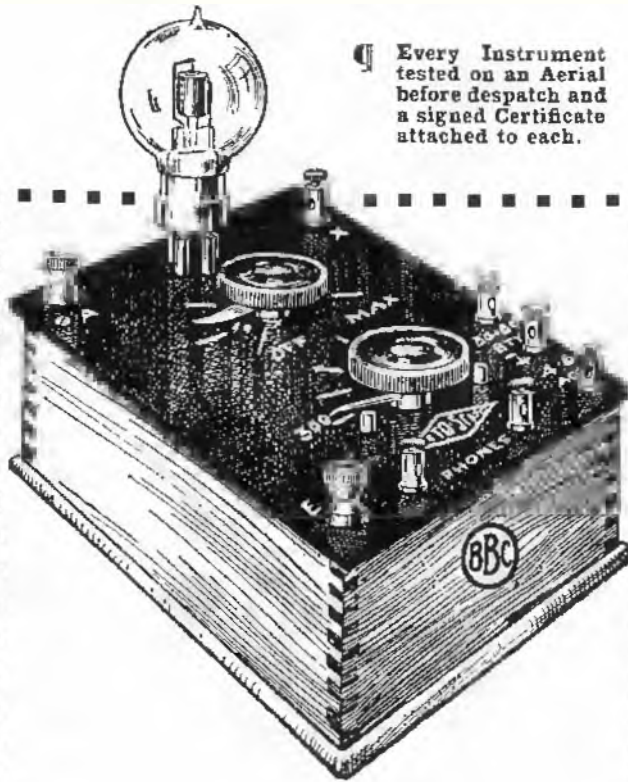

71 Ediswan crystal set Model 1923B. It had a receiving range of twenty-five miles, tuning from 200 to 500 metres. Price: £3 7s 6d (£3.37½).



Registered No. 1045 Passed by PMG
BROADCAST BABY

HERE'S just the Set you want to enable you to enjoy the splendid Concerts now being broadcast from four centres. An excellent Instrument, moderately priced—and simple to operate. One knob controls the whole of the tuning; there are no irritating adjustments to make. Further valves can be added at any time, so that at any future date you can add a Loud Speaker and enable everyone in the room to hear in comfort. In addition, by the aid of a special Loading Panel, to be attached to terminals A and E, its present wave-length limits can be increased to include the Paris, Hague and Berlin Concerts.

Exactly as illustration, but without Valve. Interior Components include superior Variometer, Grid condenser and leak, velvet Rheostat, etc. The whole only needing an accumulator, HT battery and 'phones to make a complete Receiving Station of high efficiency.

For use with Broadcast Licence each instrument must be stamped B.B.C. at an extra cost of 3s.6d. being £1 for the Broadcasting Company, and 12s.6d. for the Marconi Company.

50/-

FULLY GUARANTEED.

The **PETO-SCOTT Co.**,
 Radio Headquarters,
 64, HIGH HOLBORN, W.C.

improvement in the design and quality of the components, and manufacturers began to realize that neater-looking sets were better sellers than those which looked like a scientific collection of knobs and dials (ill. 75).

The bright emitter had by now given way to the four- and six-volt dull emitters, whose filament used less current and glowed a dull red colour. These types of valves were much more efficient and economic than the 'R' type, and they were made for specific functions instead of being just general purpose. Another valve, the tiny American Weco valve, designed to operate on the very low potential of about one volt, found favour for a short time, for it only required a high tension

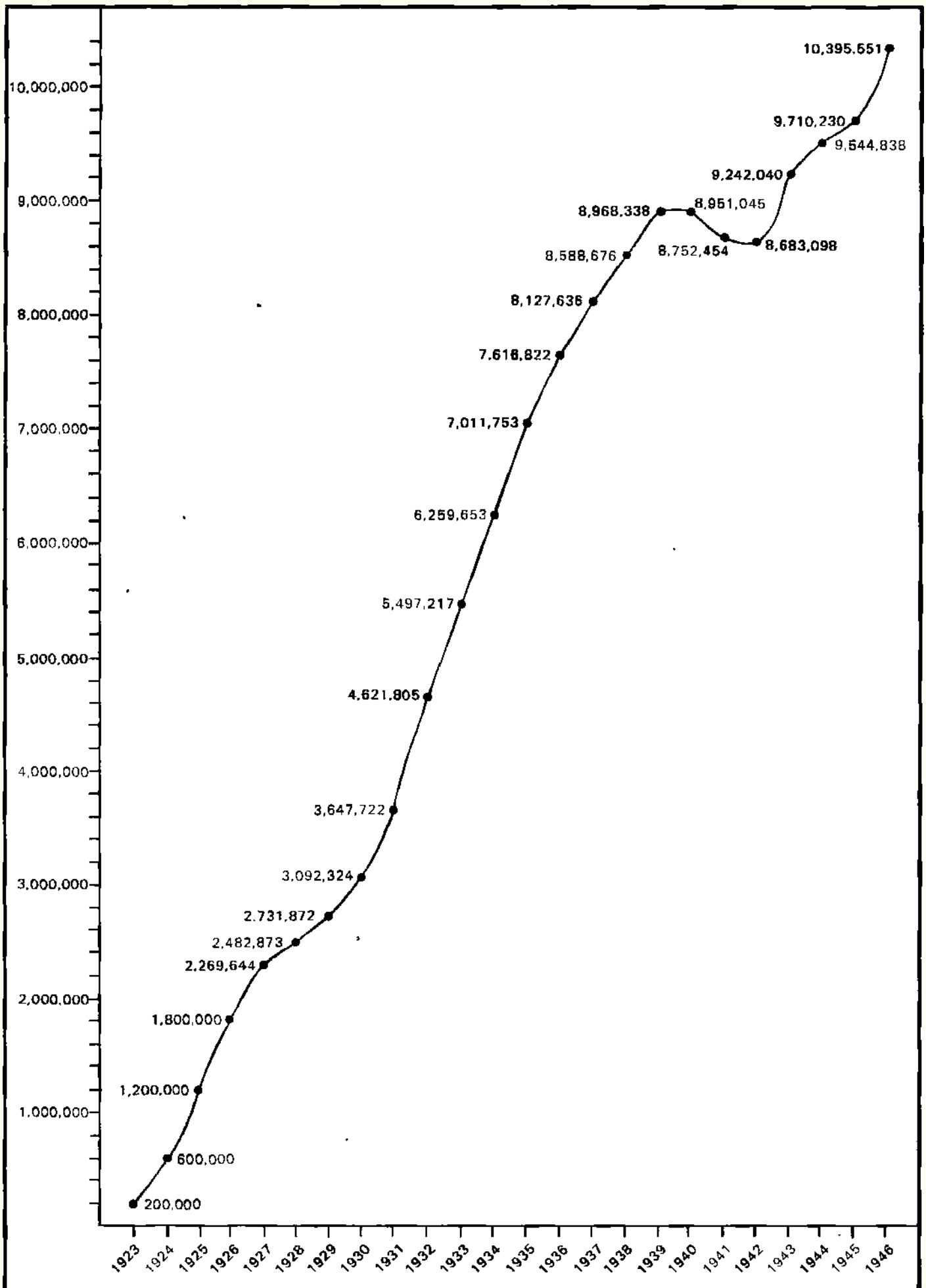

(opposite)
 72 Broadcast Receiving Licence
 figures 1923–1946. Figures
 before 1927 are approximate.



73, 74 Wireless postcards, c. 1923. Cartoons of standard receivers with controls and components mounted on a panel.



supply of between fifteen to fifty volts. It was therefore suitable for portable receivers, but it was not very efficient or robust.

A further advance in design was also demonstrated at an exhibition mounted by the National Association of Radio Manufacturers and Traders at the Albert Hall in September 1925, when decorative and cabinet types of loudspeaker were shown for the first time (ill. 76). Sterling’s Mellovox cone loudspeaker (ill. 77) at £2 5s (£2.25) was one step away from the horn type (ills. 78 and 79). Although still on a stand, it was hornless, using

a paper diaphragm instead, which came in ‘four artistic colour combinations of brown, blue, black or mauve, with gold floral design’. The Mellovox also appeared in the form of a lampshade complete with electric light fittings and an attractively coloured silk shade for £4 4s (£4.20). Cabinet speakers had highly decorative fretwork grilles (ill. 80), usually in a floral or musical motif, a feature which was to be carried on well into the following decade.

The General Strike of 1926 caused a nationwide scramble for sets, since newspapers were not being



(opposite)

75 Three-valve battery receiver made by the General Electric Co., in 1923 'GEC o PHONE' trade mark. Ornamental mahogany case with a drawer beneath to accommodate the battery. Price: £18 5s (£18.25). On top of the receiver is a black enamelled Sterling Baby horn loudspeaker, 1924.

(right)

76 Brown's cabinet type horn speaker. The horn, in cast iron, is curled up inside the mahogany cabinet, c. 1925.



77 Sterling's Mellovox speaker, one of the first hornless types, 1925.

78 Amplion Concert Dragon horn loudspeaker with an oak trumpet, c. 1927. Price: £8 10s (£8.50).

79 British Thomson-Houston horn loudspeaker Type C.2, fitted with a 'swan neck' horn. Price: £3.



80 An early cone loudspeaker by Marconiphone Company. Octagonal in shape with flower design grille. Price: 30s (£1.50).



printed, and did much to show the public the importance of broadcasting, and the value of a wireless set as a conveyor of news and information. In the same year, the first of the self-contained mains sets had appeared on the market (ill. 81). Made by Gambrell Bros. Ltd., they were simply plugged into the electric light socket. It was inevitable that they should attract much public attention since there were no batteries or accumulators to buy, no aerial to erect in the garden. The whole set was enclosed in an attractive wooden case with internal aerial, speaker and components, and with only a few control knobs visible. The set was so



81 Illustration of the first mains-operated set, a receiver by Gambrell Bros. Ltd., 1926.

simplified that no technical knowledge was required to use it.

The type of speaker employed in these mains sets was of the 'moving coil' variety, which had been in limited use for a few years but now came into its own. The moving coil speaker was capable of much better quality than the other types, provided that it was fed with a large input of signal energy, and was at the same time capable of handling much larger volumes of sound without becoming overloaded. It was therefore ideal for use with the comparatively powerful mains receivers. At about the same time, the introduction of battery eliminators meant that battery sets could be successfully worked off the mains, thus cutting down the constant expense of replacing batteries and charging accumulators.

In many ways 1927 was an important year in the history of wireless. The old British Broadcasting Company became the new British Broadcasting Corporation with J. C. W. Reith (ill. 83) its first Director General. The Corporation's licensed listeners now numbered over two million and they were served by ten main stations and ten relay stations all over the country. An industry had been firmly established, so it was inevitable that with this responsibility the smaller Company had to give way to the Corporation.

By this time the crystal set was fast disappearing, as was the horn type of loudspeaker. For outings and picnics (ills. 84 and 85), portable sets using newly introduced two-volt battery triode valves were beginning to take a foothold, and the mains sets with their stylish wooden cabinets were being accepted as something for the home, a piece of furniture, and not just a scientific toy.

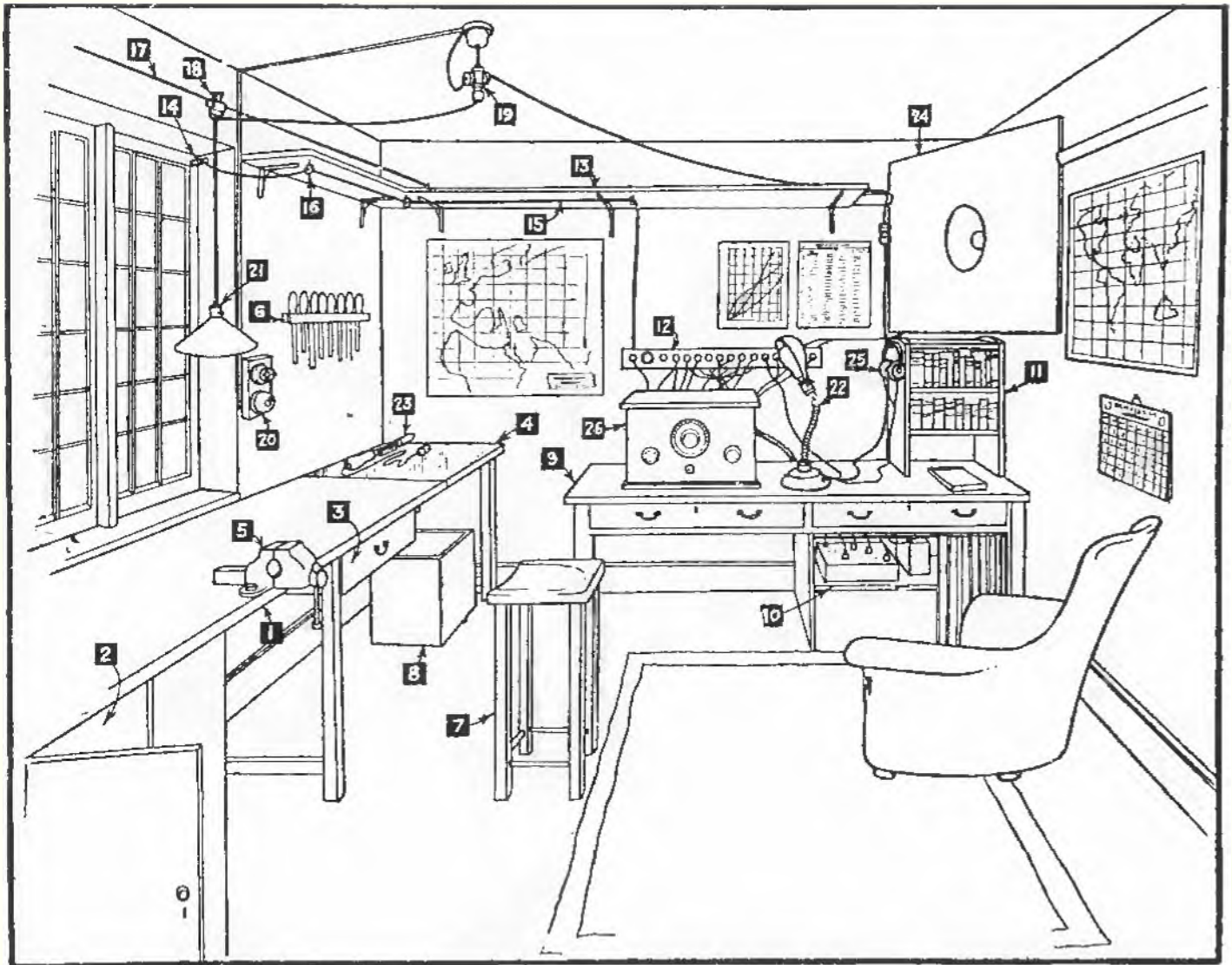

82 Pictorial chart showing the layout of a wireless workshop (from *Practical Wireless*, 11 March 1933).

Key to Chart

- 1 The work bench
- 2 A useful cupboard
- 3 The tool drawer
- 4 Sheet of zinc
- 5 The vice
- 6 The tool rack
- 7 The bench stool
- 8 The scrap box
- 9 The testing bench
- 10 The battery compartment
- 11 Bookshelf
- 12 Universal terminal strip
- 13 Shelf
- 14 Aerial lead-in tube
- 15 Aerial lead-in wire
- 16 Insulated hook
- 17 Stout galvanized wire
- 18 Sliding clip
- 19 Three-way adaptor
- 20 Wall-plug and switch
- 21 Light plug and switch
- 22 Adjustable lamp
- 23 Electric soldering iron
- 24 Baffle board loudspeaker
- 25 Headphones
- 26 Testing a set

The popularity of home-constructed sets did not cease with the introduction of the self-

contained mains type of wireless, but continued well into the 1930s, with many wireless magazines devoted to construction projects and ideas. *Practical Wireless* supposed that a good ninety per cent of the thousands of hobby-made receivers took shape in kitchens, attics, bedrooms, and in almost every conceivable place with the exception of a wireless workshop. In one issue it produced a guide showing the constructor just how easy it was to set one up: 'Why not spring-clean the spare room, clean out the garden shed, or the outhouse, and put up a label on the door, RADIO WORKSHOP—PRIVATE!'

83 J. C. W. Reith, the first General Manager of the British Broadcasting Company in 1922 and the first Director General of the British Broadcasting Corporation in 1927. (by courtesy of the B.B.C.)



84 Halcyon five-valve portable.
1927. Price: £33 1s (£33.05).
Mahogany case with drop-down
door revealing the control panel.





85 The M.P.A. Inclusive Three, a three-valve portable receiver c. 1927. Black Bakelite panel with an oak hinged case opening at the front and back. Variable condenser tuning in conjunction with two Tunewell plug-in coils for all wavelengths between 175 and 840 metres



86 Three-valve home-made set in 'Habilok' cabinet, c. 1927.



Once used—Always used

NEUTRON

Valves & Crystals

Speak for themselves.

British made, fully guaranteed. Full range of 2-volt, 4-volt, and 6-volt Dull Emitter Valves. Highest quality, consistent performance.

NEUTRON (1927) LTD.
8, Laurence Pountney Hill, E.C.4

The Marconiphone

The Triumph of the Master Mind

The outcome of close concentration on the fundamental principles of radio reception by the Marconi Company's Engineers.

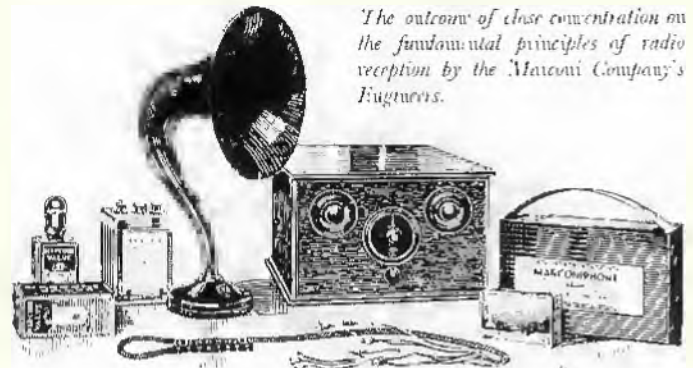

Marconiphone Model 22 (Two Valve) Receiving Set with Sterling "Baby" Loud Speaker

Each type of Marconiphone, from a single valve to an eight valve, instrument represents the highest efficiency in its particular class for simplicity of operation, perfectly pure and natural reproduction of music and speech and above all consistent reliability.

Most of the new models of Marconiphone Receivers are adaptable for operation entirely from A.C. mains, D.C. mains or batteries, thus giving a choice of power supplies unobtainable with any other instruments of their type.

DEFERRED PAYMENTS
Marconiphone Apparatus can be purchased on Deferred Payment Terms

Descriptive literature on Marconiphone Wireless Equipment is obtainable from all responsible Radio dealers or on application to

THE MARCONIPHONE COMPANY, LTD.
210-212 TOTTENHAM COURT ROAD, LONDON, W.1
Registered Office: MARCONI HOUSE STRAND, W.C.2

87 Advertisement by Neutron (1927) Ltd., 1927.

(above right)
88 Advertisement by Marconiphone Company Ltd., 1927.



89 A two-valve battery operated receiver, the Symphony Two manufactured by the motor cycle firm A. J. Stevens & Co. (1914) Ltd., Wolverhampton in 1928.

EDISON BELL RADIO



Cat. No. R 305.

THE EDISON BELL DOUBLE CONE TYPE SPEAKER has no marked resonance point on the musical scale, making the reproduction of music exceptionally sweet. Everything that is broadcast is faithfully reproduced.

Price . . . £2 2s.

SEND for FULL CATALOGUE
of SETS & COMPONENTS FREE.

EDISON BELL REGENT CABINET SPEAKER

EMBODIES all the characteristics of the double cone, with added improvements. In solid mahogany case with mother-o'-pearl grill.

Price . . £5 10s.



Cat. No. R 361.



Edison Bell Ltd., Glengall Rd., London, S.E. 15



INSIST ON EDISON BELL CONDENSERS

THEY ARE BRITISH MADE AND GUARANTEED BY A NAME WITH 30 YEARS REPUTATION BEHIND IT

(opposite)
91 Cartoon by W. Heath Robinson—'Some New Wireless Tests', 1929. (by courtesy of the B.B.C.)

WINDS N.E.
& SOME RAIN
IN SOUTHERN
DISTRICTS

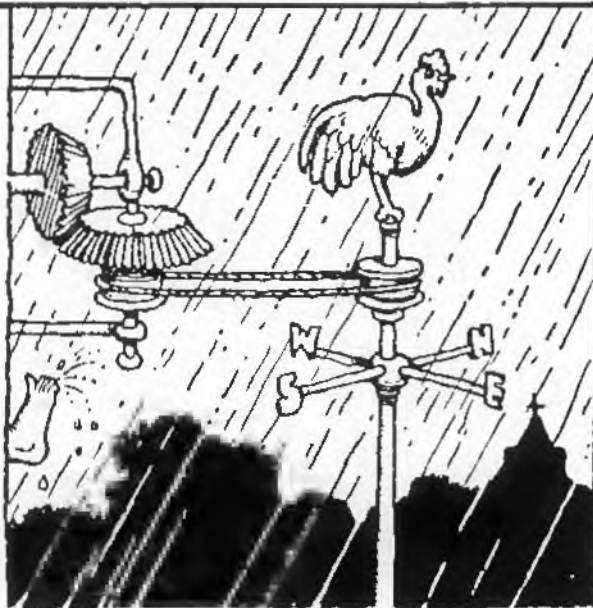
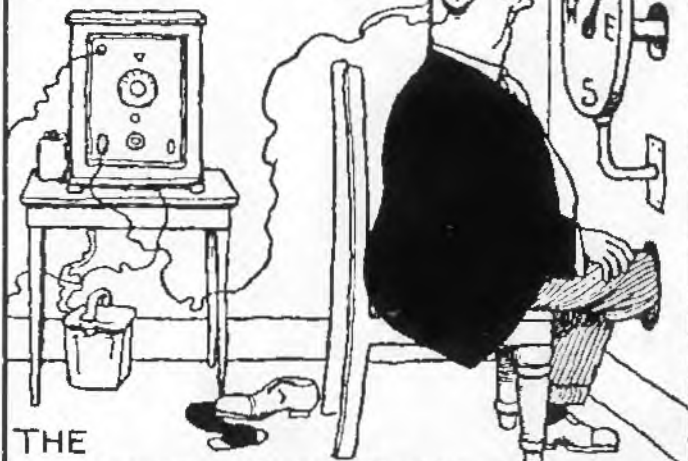

THE METEOROLOGOMETER FOR TESTING THE ACCURACY OF WEATHER REPORTS

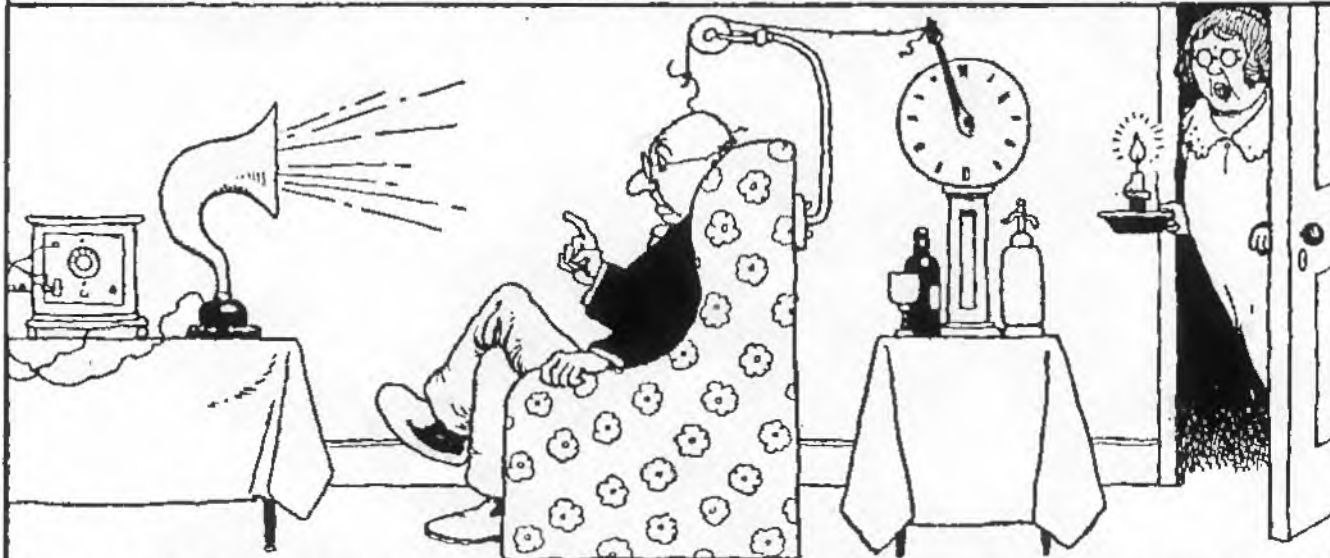

THE EPILOGUEMETER FOR TESTING THE PUNCTUALITY OF THE EPILOGUE

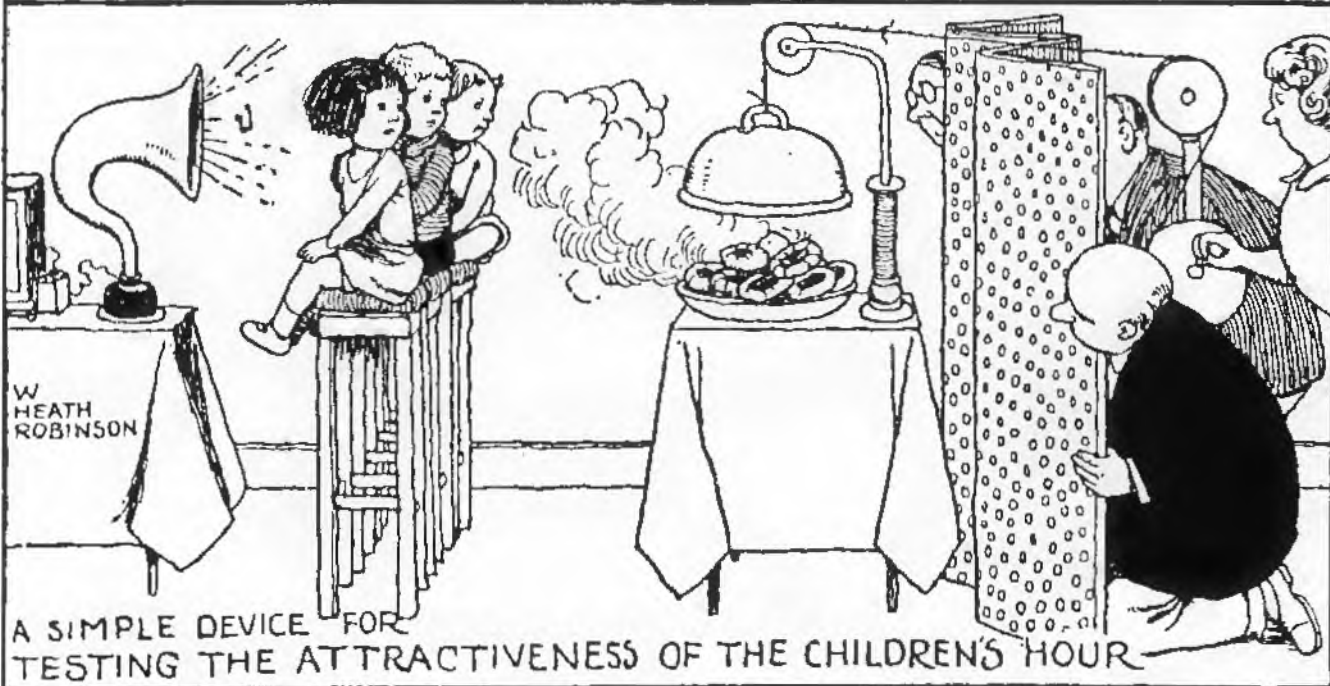

A SIMPLE DEVICE FOR TESTING THE ATTRACTIVENESS OF THE CHILDREN'S HOUR

W
HEATH
ROBINSON

(opposite)
93 Advertisement for Pertrix
Batteries manufactured by
Britannia Batteries Ltd., 233
Shaftesbury Avenue, London
W.C.2, 1932.

92 Osram Music Magnet No. 4
by G.E.C. came in kit form
complete with oak cabinet. The
valves are screened from each
other by metal cans to prevent
local interference. Battery set,
1930.



A
PERTRIX

**BATTERY FOR EVERY
PURPOSE AND PRICE**

High Tension or Low Tension—inexpensive or Super Capacity Batteries—every need for wireless power can be met from the Pertrix range. The extraordinary long life qualities of Pertrix Batteries are the result of over forty years of battery manufacture. Plug into Pertrix and forget all your battery troubles !

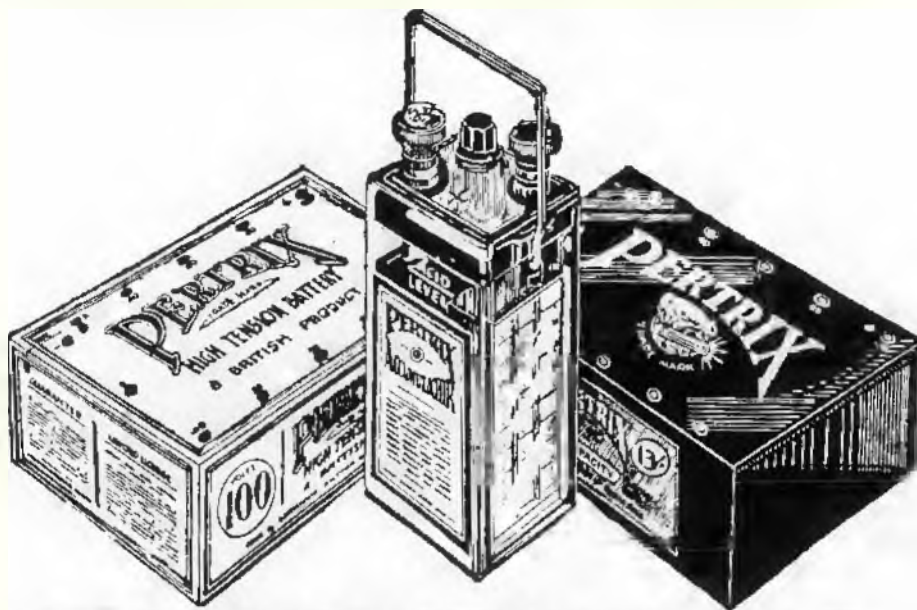

PERTRIX
TRADE MARK
**DRY BATTERIES
& ACCUMULATORS**

H.T. BATTERIES From 5/6 L.T. ACCUMULATORS From 4/6

*Advt. of Britannia Batteries Ltd., 233 Shaftesbury Avenue, London, W.C.2
Telephone : Temple Bar 7971 (5 lines). Works : Redditch (Worcs.)*

Comparison Between a Crystal Set, Battery Valve Set, and Mains Set

	Crystal Set (1924)	Battery Valve Set (1927)	Mains Set (1930)
Equipment needed	Crystal receiver, hundred-foot aerial, earth wire and a pair of headphones.	Valve receiver, hundred-foot aerial (or indoor frame aerial), earth wire, high tension battery, accumulator and a loud-speaker or headphones.	Mains receiver. Home with mains supply.
Cost	Anything from 10s 6d (52½p) to £9 10s (£9.50) including accessories.	Cheap one-valve receiver from £2 10s (£2.50) to around £60 for a five-valve set with accessories.	Around £25.
Advantages	Inexpensive with no running costs. Free from interference and reliable as the crystal never broke down. Simple to use and understand.	Power amplification: could receive stations broadcasting many hundreds of miles away. Produced enough energy to drive a loudspeaker so that many people could listen at the same time. Selective: could separate two stations broadcasting on similar wavelengths.	Self contained: all necessary components within the set and with few controls, very simple to operate. Stylish, easily accepted as 'something for the home'. Power and selection.
Disadvantages	Range limitation: could only receive stations within a fifteen to twenty mile radius. No amplification, could only drive a pair of headphones, not a loud-speaker. Unselective, could not separate programmes broadcast on similar wavelengths.	Expensive to buy and maintain. Subject to interference. Being very sensitive it could easily pick up any electrical interference from other valve sets nearby.	Expensive.

94



*There's always
good reading in*
The Listener
3rd Every Wednesday a BBC Publication

95 Advertisement for The Listener, mid-1930s.

Wireless for the Home 1927-1938

During the 1920s the advance in the technical field of wireless had been too rapid to allow a standard to develop in the form of the wireless cabinet itself. However, after 1927, with the set becoming more of a unit with the introduction of the mains receiver (ills. 96 and 97), the design of the cabinet began to take on a more important rôle. Time had taken its toll of the many small firms who had cashed in on the earlier boom and the large companies, like Marconi, Murphy, Philips, Ekco, McMichael and Pye, now leading the manufacturing field, were left to attract the buyers.

To the majority of the British public, a wireless set was probably the most ultra-modern device that they

had ever seen, and because there was no traditional style to which the manufacturers could turn, they were faced with the problem of deciding the best form in which to present the set to make it most easily acceptable to the home. A story told to me by one of the enthusiastic band of amateur wireless constructors of the 1920s sums up the attitude of some people when

96 Early mains receiver, the GEC o PHONE BC 3130, made in 1930. 'Temple Style' cabinet finished in ebony black with the front panel carried out in a dull gold finish, shading to black. Price: £18.





(opposite)

97 Interior view of the BC 3130. Details of how to operate the set are given on the printed instruction card underneath the lid. A separate loudspeaker is required as well as an aerial and earth, and the power is taken directly from the electric light socket.

98 British Thomson-Houston cone type loudspeaker. Plastic case, price 50s (£2.50). First shown at the 1928 Radiolympia.



99 Wireless postcard, c. 1923. The wireless brought into people's homes a whole world of unfamiliar sounds, and many

listeners found it hard to believe that what was making the sound was not actually in the room with them.



first confronted with a wireless. His mother, listening to a broadcast for the first time was horrified by what she heard, and banished the set to a shed at the bottom of the garden, saying such things were ungodly! It was only after she had recognized the familiar voice of a friend coming over the loudspeaker that she relented.

Wireless created a sense of unreality by enabling the listener, at the flick of a switch, to bring all the sounds of the outside world into the home in a way that had never happened before (ill. 99). To clothe the wireless components in a recognizable form seemed to be the answer; and so the manufacturers adopted the 'Furniture Style', for, it was argued, if the cabinet resembled a piece of furniture in its own right, then the apparent mystery of broadcasting would seem natural and acceptable (ill. 100). Some people, in order to make their wireless sets harmonize with their living room surroundings actually built them into existing pieces of furniture such as cocktail cabinets, armchairs and grandfather clocks.

Once the style of the cabinet was established, the decorative features of the set were subjected to echoing current fashions and interests for a number of years. Dials and knobs were small, sometimes even hidden away behind a small door set into the front, side or top of the receiver. The main features were the polished wood from which the cabinet was constructed and the elaborate loudspeaker grilles, where each company would have its own special motif. Perhaps the most famous is Pye's sunrise motif which reflected the prevalent Art Deco style of design. It first appeared on their Type 25 receiver in 1928 (ill. 101) and was used on successive Pye receivers for another six years (ills. 102 and 103).

At the 'Radiolympia' exhibition of 1929, (Radiolympia always heralded the beginning of the wireless season and was traditionally held in the autumn), A. C. Cossor Ltd. introduced one of their first completely self-contained mains sets (ill. 104). The controls are hidden beneath the lid and consist of a short and long-



100 Grandmother clock receiver made by British Tempovox Ltd., Holly Road, Hampton Hill, Middlesex in 1938. The idea of combining a wireless receiver with an electric clock was more than a novelty, for it was specifically designed for the small modern house where space set a limit on the number of pieces of furniture which could be accommodated in any room. The case stands 4' 8" high with the square grille of the loudspeaker situated in the centre; the receiver chassis is mounted in the space immediately behind the clock face. Price: £15 15s (£15.75).

101 Pye's first 'sunrise' receiver, Type 25, 1928. A five-valve portable, housed in a walnut case with the controls hidden behind a door in the side. Price: £30 12s 6d (£30.62½).



wave switch, volume control and a knob which operated a small tuning scale calibrated from 0 to 100. This method of calibrating was a left-over from previous years when listeners had to write down on a separate card the wavelengths of the stations relative to the numbers on the dial. But in this year there was a notable increase in the tendency to calibrate directly in the metre wavelengths themselves. With the lid closed, its heavy polished oak cabinet looked very much like a Mayan temple and even the grille had a distinct South American feel about it. At about this time the mysteries of Egypt and South America were coming to light, and with public interest surrounding them, a great many receivers were manufactured in forms suggesting ancient Egyptian or Mayan buildings (ills. 105 and 106). This architectural influence lasted until about 1933.

102 Pye Twin Triple Portable battery model of 1930. Walnut cabinet. Price: £23 2s (£23.10).



103 Pye Model 'O' Portable, 1932. Built-in frame aerial and moving coil loudspeaker. Cabinet on turntable base.



By the time of the 1930 Radiolympia, there had been a dramatic increase in the number of mains receivers on show. 'Table' models and 'Mains Transportables', which could be moved about from room to room, were in vogue, and nearly all of these were now marked in wavelengths. The reason why manufacturers did not print the actual names of the stations on the dials was that the allocation of wavelengths for broadcasting had not been finally settled yet. It was no good the manufacturers committing themselves to printing the stations if these were going to become quickly out of date. But also there was an ever increasing number of foreign stations which caused great problems with interference. It was only after several international conferences were held in the early part of the 'thirties to allot each country its wavelengths, that stations were printed on dials, and interference minimized (ill. 107).

Although battery sets were still being bought by the public, a great many homes had by now been provided with electricity. And so, in 1931, there was a push by some manufacturers to get the British people more 'mains-minded'. Many power units appeared on the market enabling the ordinary battery set to be plugged straight into the mains. 'Finish with battery worries forever!' said an advertisement for Ekco in April 1931. 'In three minutes you can put an end to H.T. battery worries forever and enjoy permanent, perfect radio ... just plug the adaptor of the unit into the nearest electric light or power socket and switch on. That's all, you get ample current and high voltage constantly and permanently at a cost of less than 3s (15p) a year.' Next year's model claimed to run for 1s (5p) a year, which was indeed very cheap compared to the cost of batteries.



(opposite)

104 An early mains set by A. C. Cossor Ltd., made in 1929. Price: £14 14s (£14.70).

105 McMichael Duplex Mains Four Transportable, shown at the 1932 Radiolympia, price £23 2s (£23.10). 'Temple Style' cabinet.



(opposite)
107 'Radio-at-a-Glance'
produced by the *Daily Mail* in
1932. By pointing the arrow at
any one of the seventy-six British
and Continental stations named
on the disc, the listener could
read off the station's distance
from London, its frequency,
wavelength, aerial power, call
sign, closing-down signal, and
interval signal, as well as
providing space for his own dial
readings.

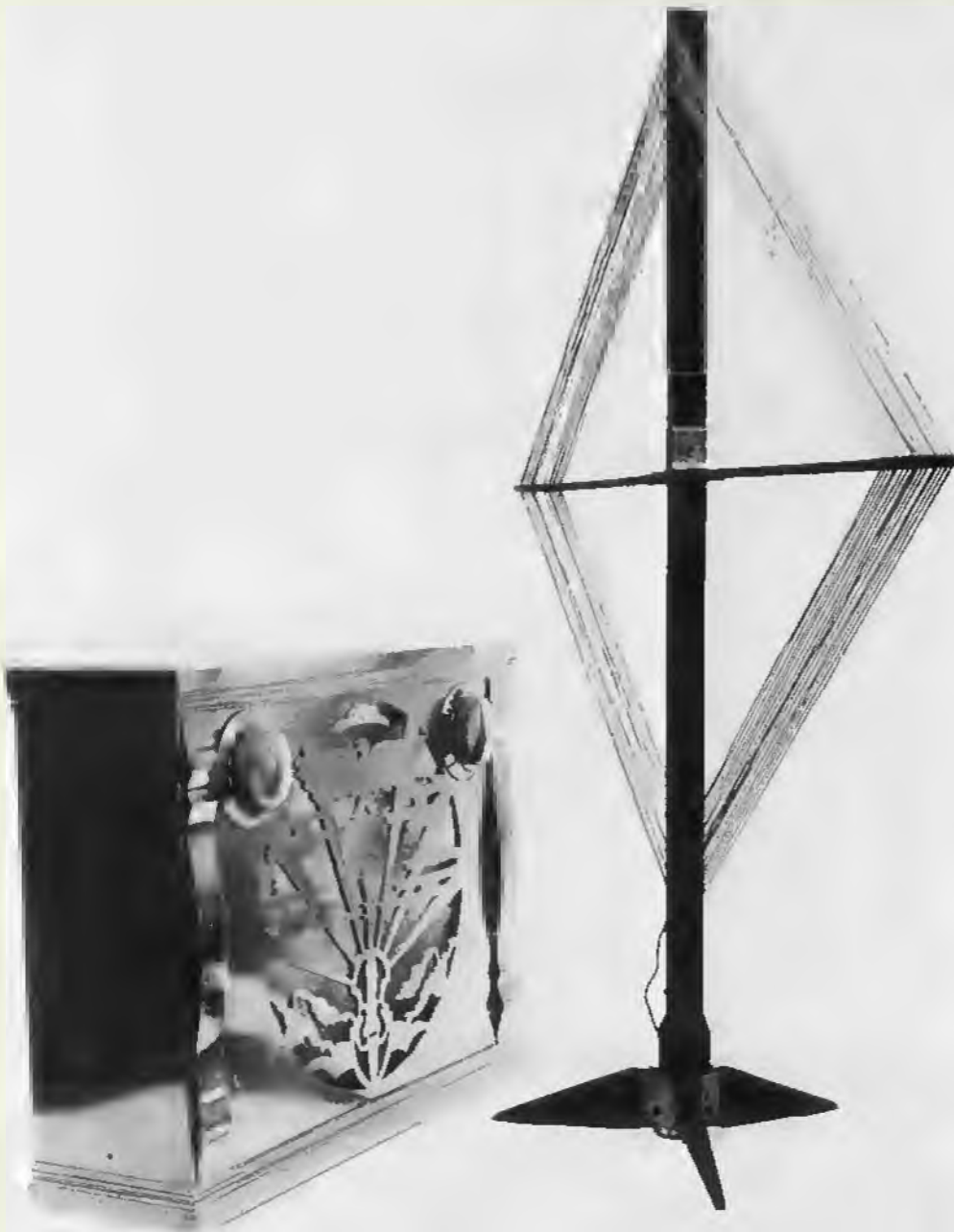

106 Climax 'Chello' Receiver,
battery model, Type 110 and
Climax folding frame aerial with
collapsible stand c. 1928. The
loudspeaker is the cone type and
is situated behind the very
elaborately-cut grille.
'Architecture Style' mahogany
cabinet.

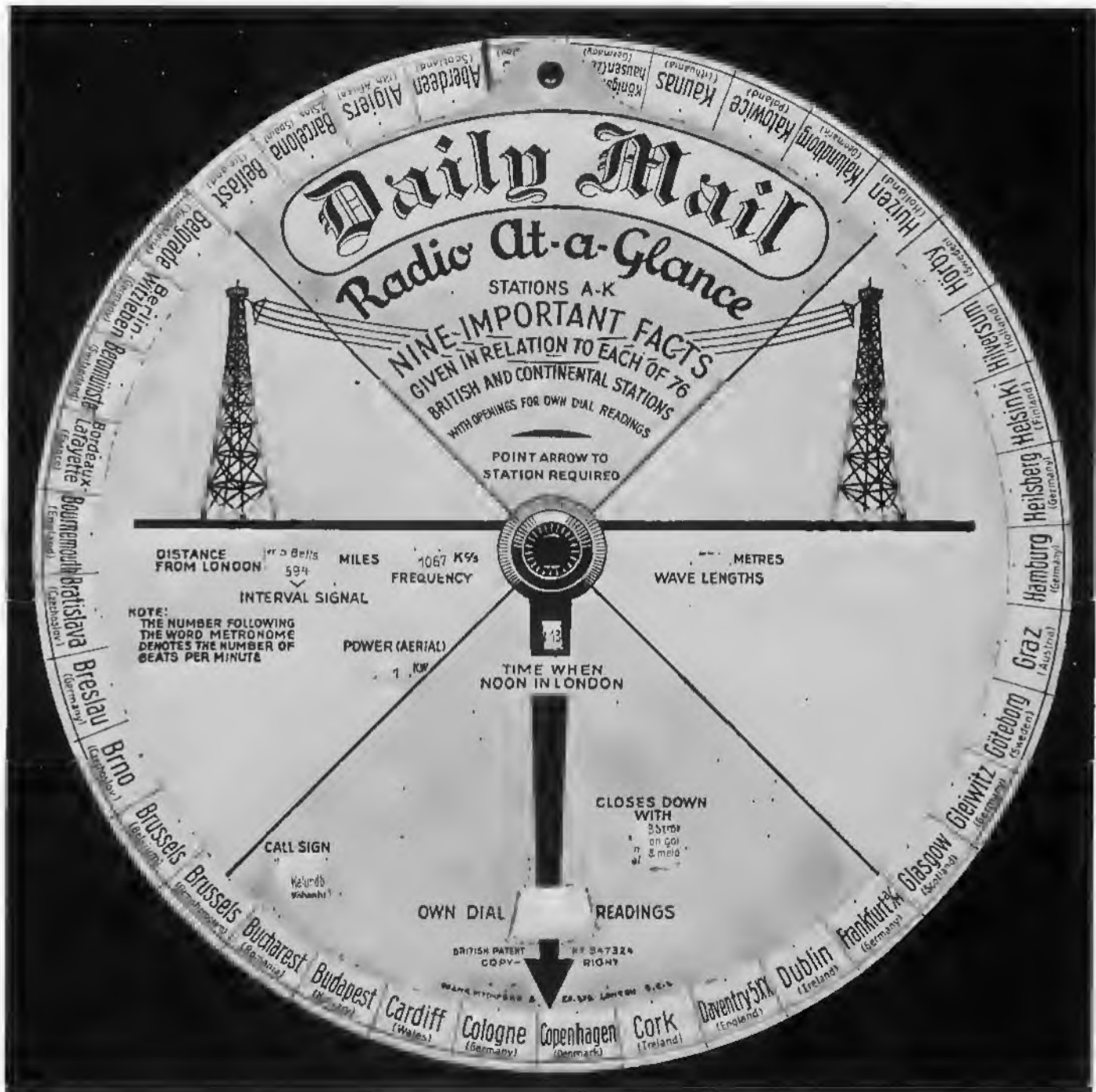

Most sets were by now employing the 'supersonic heterodyne' tuning circuits first proposed by R. A. Fessenden in 1902. In this method of reception, the incoming signals were first amplified by a high-frequency amplifying valve and then combined with the waveform from a local oscillator valve. This resulted in a lower frequency known as the 'beat frequency' which was then detected before being passed to other stages of amplification and to the loudspeaker. There were three main advantages in super-heterodyne reception. Firstly, a very high degree of station selectivity was obtained. Secondly, the method gave a considerable amount of amplification, and thirdly it diminished the interference from spark transmitters and atmospheric disturbance. The work-

ing principle of these receivers, commonly known as 'superhets', has been used in all subsequent designs. So sensitive were they that only a few feet of wire hanging from the back of the set was needed to serve as the aerial, and the sea of masts that dominated the 1920s skyline disappeared forever.

In 1932 Ekco (E. K. Cole) Ltd. brought out one of the first sets which had the actual names of the stations printed on the dial, and by the time of the 1934 Radiolympia, tuning scales marked in both stations and wavelengths were the rule. Ekco's set was the SH 25 model priced at £25 4s (£25.20) and housed in a cabinet whose pattern resembled walnut but was in fact made of a moulded material known as 'Bakelite'. Named after Dr. Baekeland, a Belgian chemist who

(opposite)
109 Ekco AD 65 designed by Wells Coates in 1934. This was the first set to break with the 'Furniture Style' tradition. Standard brown model. Price £10 10s (£10.50). Photographed in the 1930s Room of the Geffrye Museum, London.

108 A page of Ekco receivers from a wireless catalogue, 1932.

RECEIVERS

EKCO

MODEL M.23.
 FOR A.C. or D.C. MAINS.

A combined 3 valve receiver and Moving Coil Speaker provided with an internal aerial, provision being made for an outside aerial. The circuit comprises screened grid H.F., detector and pentode, one knob tuning control, illuminated dial, special volume control and sockets provided for use of a pick-up and external speaker. Complete in a figured Walnut Bakelite case. For A.C. 200/250v. and 100/125v. or D.C. 200/250v.

Price, including Royalties ... £17 17 0
 or 12 monthly payments of £1 12 9.



MODEL S.H.25.
 FOR A.C. or D.C. MAINS.

This is a five valve super-het receiver complete with Moving Coil Speaker. The circuit employs hand-pull tuning, seven tuned circuits with single knob control, and special "Ekco" station dial. A special whistle filter is incorporated to eliminate the annoying whistles, so often experienced. An internal aerial is fitted with provision for external aerial and earth. Sockets for gramophone pick-up and external speakers are also provided. In artistic Walnut shade Bakelite Cabinet. For A.C. 200/250v. and 100/125v. or D.C. 200/250v.

Price, including Royalties ... £25 4 0
 or 12 monthly payments of £2 6 3.



MODEL R.S.2.
 FOR A.C. MAINS ONLY.

A combined 3 valve all electric receiver and speaker in figured Bakelite Cabinet, Walnut shade, similar in appearance to the M.23. Facilities for connecting external aerial.

Price, including Royalties ... £15 15 0
 or 12 monthly payments of £1 11 6.



MODEL R.S.3.
 FOR A.C. MAINS ONLY.

Combined 4 valve all electric receiver with "Ekco" station dial and Moving Coil Speaker in figured Bakelite Case, similar in appearance to the S.H.25. Mahogany and Walnut shades. Facilities for connecting external speaker.

Price, including Royalties ... £21 0 0
 or 12 monthly payments of £1 10 3.



first patented it in 1908, this synthetic is made by mixing carbolic acid with formaldehyde, which results in a material, coarse when powdered, and known as Bakelite A. Mixed with spirits it becomes a resin, and can be used as an insulating varnish in wireless construction. If however the resin is heated, polymerisation occurs, and it becomes permanently solid and insoluble. This new state is known as Bakelite C and was used to some extent in the 1920s in sheet form like ebonite for the insulated panels of receivers.

But it was Ekco who first exploited its fine moulding properties. As a plastic material it possessed the unique property of being able to be formed into any desired shape, something which wood could not claim. Wood by its nature can only be conveniently formed into certain simple basic shapes and it was this limitation which directly retarded the designer's imagination. But since within the wireless trade most manufacturers were happy to treat their sets as pieces of furniture, this limitation did not bother them unduly.

The trouble with the SH 25 was that although the cabinet had a very pleasing shape with a 'willows on a river bank' loudspeaker grille, it could just as easily have been made of wood. Indeed, it was even pretending to be wood with its simulated walnut figured finish. This shape was not getting away from the Furniture Style, nor was it using Bakelite's moulding properties to the full. Compared to wood, Bakelite as a material lacked the interest which is inherent in the grain of wood, and which manufacturers used as a prominent feature in the design of wood cabinet sets. To use Bakelite in a reproduction of a wooden cabinet would therefore make the product inferior. It was only by exploiting its unique plasticity to create superior forms, that the Bakelite cabinet could make up for any surface interest it lacked, and enable it to match the quality of the finest wooden cabinet. In a few years, Ekco was to bring out a set which completely broke with the tradition of the Furniture Style, and which was a milestone in the development of wireless design.

Meanwhile, at the Radiolympia show of 1933 Marconi were showing their own idea of a 'set of the



110 The Ekco AD 65 black and chrome version.



future'. This operated entirely without knobs and was in fact described as a 'robot'. To select the desired station it was only necessary to call out its name. Reports in the wireless press noted that by use of an intricately designed system of relays, the vibrations of the human voice acted upon a microphone causing the instrument to be tuned in automatically without any further operation being called for. Combined with the receiver was a television set which was controlled in the same manner. The idea never caught on.

The only other really non-standard receiver in the show was Ferranti's 'Gloria Companionette', which had all the controls at the top of the cabinet instead of at the front, so that it could be operated while sitting down in an armchair. It also had a bookcase built into the back.

In 1934, larger tuning scales were in evidence, and loudspeaker grilles were getting away from the characteristic symbolic motifs. Instead, they made wide use of geometric designs which were echoed by the harsh lines of square or rectangular cabinets. Components were now standardized and all sets seemed to have the same look about them. Improved superhet circuits had largely cleared the 'ether chaos'; however they needed to be accurately tuned to obtain the best possible quality of reproduction, and any mistuning often resulted in a shrill and distorted quality. Tuning by ear alone was unreliable, and the calibrated dials and station pointers on sets were subject to defects due to mass-production. Therefore manufacturers set about providing some sort of electrical visual tuning indicator to supplement the other methods. The 'fluid light' was a tubular neon indicator, with a cathode in the form of a metal rod. With the arrival of the signal a glow was seen to extend up the rod, the length of the column of light depending upon the signal's strength. When the light was at its longest and brightest the listener could be sure that his programme was accurately tuned in.

Prices in 1934 were lower than ever not only because the industry had successfully mastered the production of receivers through mass-production techniques, but also because of continuing sharp rises in demand (ill.

111 Beethoven 'Midget' set of 1934. A mains long and mediumwave receiver, 9½" x 9½" x 6½".



72). The General Electric Company were using over 1,186,000 square feet of timber a year. Another major manufacturer, His Master's Voice, employed 12,000 workers, using on average 1500 tons of raw materials a week, having their own foundry, generating station, Bakelite moulding plant, timber yard, saw mill and railway siding, in all, a little different to the 'back-room' firms of the early 1920s. In the same year, Ekco brought out the set which was a complete break with traditional wireless design. This was their 'AD 65' model (ills. 109 and 110), designed by the architect Wells Coates who had also designed some of the interiors of the new Broadcasting House for the B.B.C. three years before.

The AD 65 with its Bakelite case came in two

standard versions, one black with chromium fittings and one brown, and a more expensive 'coloured' version. It was quite unique because firstly it was round, and secondly it bore no resemblance to any known piece of furniture. Its shape lent itself perfectly to mass-production techniques, for it reduced the number of tools required for moulding. Not since the days of the panel type of receiver, with the valves and other components left exposed, had the nature of a receiver been so implied by its appearance. Most simply, the round shape of the AD 65 suggested that a variety of sounds could be tuned in at will. This striking and highly expressive shape was to be used by Ekco on successive models as late as the 1950s.

In 1935 all-wave receivers having short, medium and long wavebands were very numerous, and a high quality of sound reproduction had been reached. Most sets were equipped with noise suppression valves which cut down the crackle and interference heard while tuning between stations, variable selectivity which enabled the listener to obtain the highest standard of reception, and improved superheterodyne circuits.

'Midget' sets appeared in large numbers for the first time (ill. 111). One, the Empiric Portable, weighed under two pounds. But apart from neon tuning indicators, there were few other features of technical novelty during this year. Philco produced their famous 'People's Set' Model 444 (ill. 112), so called because it was designed to be afforded by any wage-earner, providing all the standard features of more expensive sets but in a basic form. Its curved black Bakelite case is reminiscent of the German 'People's Car', the Volkswagen, which was produced at this time.

At the Radiolympia of 1936, the new season's receivers exhibited much plainer loudspeaker grilles, often intersected by two or three vertical or horizontal bars. Usually sets were still being constructed of wood, but now more use was being made of Bakelite. Dials continued to grow larger and even more obtrusive, while the cabinets remained square in shape or upright with few embellishments. Sets appeared which seemed to want to cram as much as they could into the

listener's eardrums. The company of Graham-Farish Ltd. produced a kit of parts which, they claimed, could receive more stations than any other set produced, including all stations on the medium, long and short wavebands, as well as trawlers, aircraft, shipping, police and amateurs, good value for just 57s 6d (£2.87½p).

In 1937 the Texaloom Company introduced a range of cabinet receivers which were made from a new woven fibre material. These housed an all-wave chassis, and came in a variety of combined forms such as a sideboard and receiver, a bookcase and receiver and a cocktail-cabinet and receiver. Though the textile was new, the idea of disguising the receiver as something else was not. It was an echo of the late 1920s when, to domesticate their wireless sets, people had hidden them in such pieces of furniture; because of this the Texaloom range never caught on. The old idea of using a sunrise design for the loudspeaker grille also re-appeared at the same show. This was a feature of the McMichael 373 battery set and Aerodyne's 296 portable, but this time the design was very much more simplified and rigid compared to Pye's original of a few years earlier. The most common factor about the 1937 Radiolympia show was the number of sets which appeared with rounded corners and edges, giving them a much gentler line than the harsh edged sets of previous seasons. They also had a wider waveband coverage, used more valves, and gave a greater output of power.

War was becoming daily more likely and although people were waking up to the prospect of leaner times ahead, the wireless industry continued its progress towards bigger, better and more luxurious receivers as though it was a last effort before austerity set in (ill. 113). If one possessed a good strong finger, for instance, then that was all that was needed to work the receiver, for 1938 heralded the dawning of the push-button age. Out of a trade list of 665 new models, 231 employed push-button tuning where in the previous years there were practically none. This method had first appeared in America in sets manufactured by the Zenith Company in 1928. A few years later they introduced it



to Britain in their Zetavox range of sets. But the idea had lain dormant until sufficient technical progress had been made to make full use of its potential.

The Defiant MSH 938 receiver (ill. 114) produced by the Co-op might be described as the 'ultimate luxury in 1938 listening'. Its twenty-two buttons gave the listener instant access to a large assortment of pre-selected

programmes, including television sound, which were automatically obtained with a motorized tuner. There are four bass and treble controls as well as two additional buttons on either side of the tuning knob for driving the tuner either clockwise or anticlockwise around the dial. Should all the mechanisms fail the set could be operated manually.

113 McMurdo Silver Corporation '15-17', 1938. A fifteen-valve console made in England but of American design, introduced in this country in 1937 by McMurdo, whose products had a high place amongst quality receivers. Six wavebands covering 4 to 2200 metres. The whole chassis is chromium-plated and is housed in a solidly built semi-circular walnut cabinet 4' x 3' x 1'9". There is provision for a gramophone underneath the lift-up lid. Price: £40 19s (£40.95), chassis and loudspeaker only.



114 Co-op's Defiant MSH 938,
a push-button receiver with
motorized tuner, 1938.

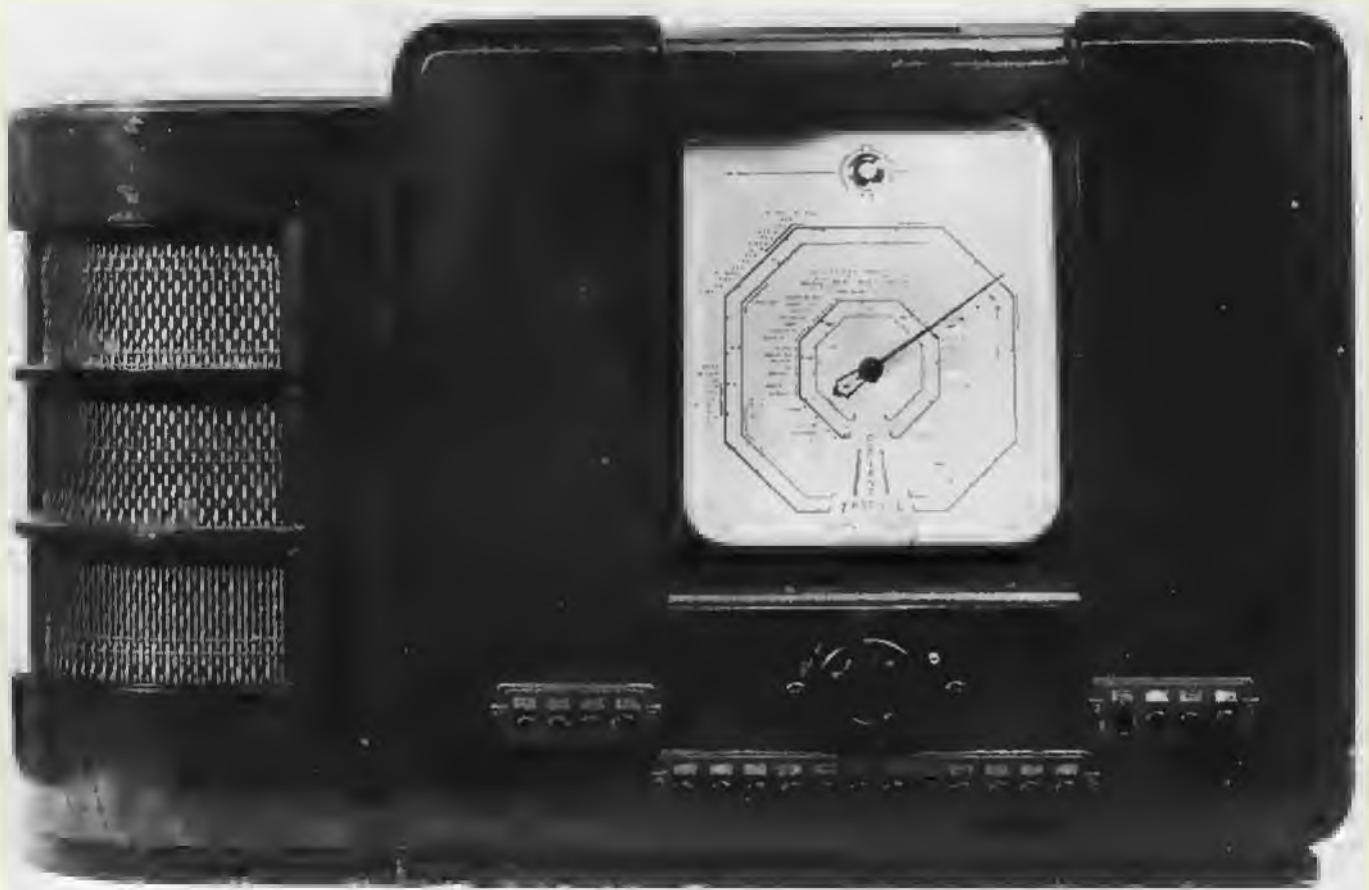

War-time Wireless

With war coming closer all the time, certain measures were put into operation to safeguard the country's security. All Experimental Licences were withdrawn and certain spare parts such as shortwave coils which could be used to construct transmitters were removed from manufacturers' catalogues. But unlike the First World War, people's wireless sets were not confiscated, for the Government realized that they were an essential tool for keeping the public informed of the news which could be broadcast within minutes of being received at the B.B.C. Through this medium the public could be instructed on civil defence matters such as air raid precautions or addressed directly by the country's leaders. But perhaps most important of all, the wireless set could provide the morale-boosting entertainment which was so essential in wartime.

On 1 September 1939 the Home Service was introduced, replacing the National and Regional programmes. The various stations around the country all now carried this single programme which was broadcast on a common frequency. It was thought that if the regional network had remained in operation, each station broadcasting its own programme would have acted as a navigation beacon for approaching enemy aircraft. But with all the stations now broadcasting on the same wavelength at the same strength, the aircraft picking up that frequency would receive no useful guidance.

Because of the possibility of fake broadcasts by the enemy, giving misleading or false information, it was decided to name the B.B.C. announcers so that the public could get to know them, linking name with voice, and be sure that the information given was from a reliable source. Not everybody though thought that this was a good idea. 'Thermion', writing in *Practical Wireless* in December 1939, thought that it would be tragic if announcers were to become famous men (ill. 115). The job of an announcer, he maintained, was an overrated one where little thinking, brains or ability were required; the only qualifications being an 'Empah' voice and a knowledge of the mispronunciations which the B.B.C. prescribed. 'Thermion' got hundreds of letters of complaint from loyal B.B.C.

listeners, already 'fans' of the announcers, but he continued to write his views on the subject for the next three years.

By November 1939, the B.B.C. was maintaining two overseas services: the World Service, operating twenty-two hours a day, and the European Service operating nineteen hours a day, both keeping the rest of the world informed of the war situation. At home there was a great rush to buy all types of receivers, in particular portable models, as the public anticipated a cut in the mains electricity supply; and there was a sharp rise in the number of new applicants for the receiving licence. However, the Wireless Industry now had to devote nearly all of its activities to supplying military, naval and air needs, so that its normal function of meeting civilian requirements had to be severely curtailed. Shortage of valves, batteries and other essential replacement components, so readily available in the pre-war years, brought about a revival of the crystal set which was used mainly as a stand-by in case the valve receiver broke down. The crystal set was particularly suitable, for with only one programme being broadcast there was no need for a highly selective type of receiver.

For listening to the crystal sets, the firm of Ericsson were advertising the same type of headphones which they were selling during the early 1920s. Their advertisements in 1940 even illustrate a pair which are marked with the B.B.C. stamp showing that they must have been made between 1922 and 1924! (for a general method of dating receivers, see page 94). It seems a little odd perhaps that, with wireless technology having come so far since the pioneering days, people should now have had to revert back to methods and equipment first used during those times. But, of course, there were still some new models available, particularly those covering the short wavebands known as 'Communication' receivers. Peto-Scott's Trophy mains set, costing £10 19s 6d (£10.97½), could receive war news from America, Germany, France and Russia, covering wavelengths from 6.5 to 550 metres. *Practical Wireless* were offering to callers at their offices a cheap battery receiver in a partially completed



115 An anonymous photograph of the B.B.C. announcers, c. 1933. The original caption reads, 'This photograph will give many listeners their first glimpse of the Announcers, whose friendly voices are heard daily by millions the world over; a particular request by the B.B.C. prevents us, however, from completing the introduction by publishing their names.'

'Their pronunciation of the King's English must be faultless whilst each must possess an adequate knowledge of the principal European languages—not least of their qualities is an abundance of tact and courtesy which makes artistes feel at home in the atmosphere of a Broadcasting Studio and helps novices to overcome the terrors of the microphone.'

Standing on the right is John Snagge, and next to him in the centre is Freddy Grisewood. The Chief Announcer, A. Stuart Hibberd, is seated on the left. 'One of the tallest men at Broadcasting House', according to the Wills's Cigarette Card Album of Radio Celebrities. (by courtesy of the B.B.C.)

116 Extension loudspeaker in mahogany, c. 1932.



(opposite)
118 War-time Civilian Receiver,
battery model, 1944. Price: £10
19s (£10.95).

117 Murphy AD 94 Receiver,
1940. Bakelite case. Price: £9
10s (£9.50).





form, which in fact only needed a tuning coil to be wound and inserted to make it work. Known as the 'Thirty Shilling Three', it had the appearance of a home-made cabinet set of the late 1920s, and now there was a revival in the number of home-constructed sets, which were much cheaper than the ready-built receivers. Midget sets were popular too, these being listened to on a pair of headphones. Since they were so small, they were very economical. They consumed very little power, only using the new miniature 1.4-volt valves. Most of these receivers were known as 'all dry' sets, since instead of using 'wet' batteries as in previous years they now used small dry cells.

On 7 January 1940 the 'Forces' programme was introduced on the medium waveband to provide the British Expeditionary Force in France with deliberately 'lowbrow' entertainment in order to keep up their morale. Those serving at home in charge of anti-aircraft guns, search-lights and other defence units were given portable receivers donated by the Nuffield Trust. To while away the time spent in the shelters, manufacturers recommended that people should install an extension speaker (ill. 116) there for use during an air-raid. This would also mean that they would not

miss their favourite programme should the raid occur while it was on, for they could simply switch it through to the shelter and continue listening there.

Wireless magazines were full of novelties. In the 11 May issue of *Practical Wireless* there were details of how to construct the 'Gas Mask Handy Two Valve Midget Portable', to be built into an ordinary gas mask box. More expensive was G.E.C.'s new four-valve portable, priced at £8 18s 6d (£8.92½), and built specially to stand the strain of alternate use in A.R.P. shelters, in the train or car, or in the user's own home.

Many retailers were cashing in on the general shortage of receivers and were charging heavily inflated prices. In order to stop this, the Prices of Goods Act made it illegal, from 1 June 1940, to sell receivers at higher prices than those which prevailed on 21 August 1939, while allowing only justifiable war-time increases to be taken into account. Generally, however, manufacturers were directing what efforts they could towards producing simpler sets, so that they could market them without increasing the price.

As the supply for receivers and spares for the Forces increased, the stocks for the home market dwindled, and fewer sets were now appearing. One of those that

119 Planning stages of a new range of receivers, typical of wireless production procedures in the late 1930s.

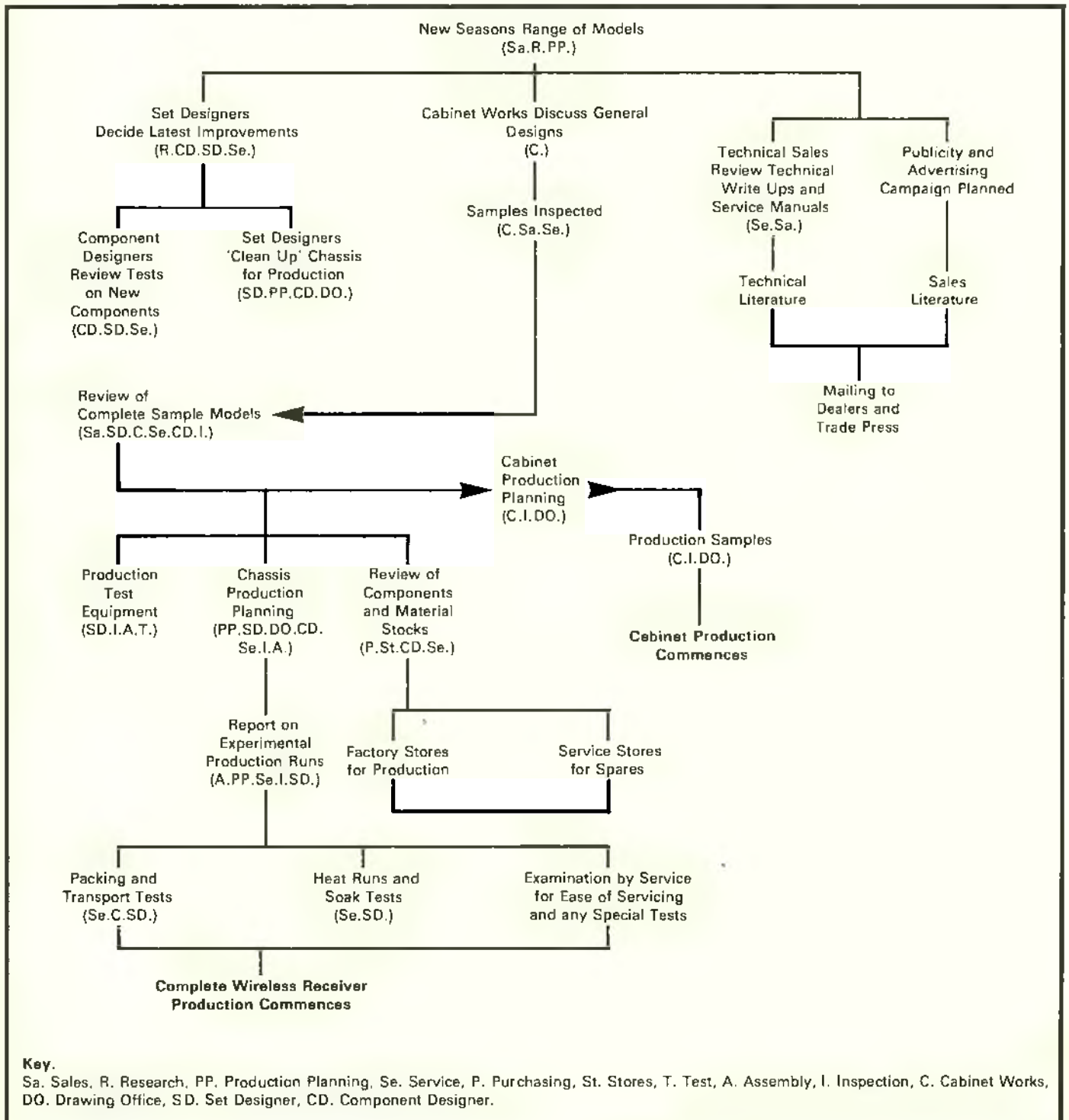

did was the AD 94 by Murphy Radio, which had a black ribbed Bakelite cabinet (ill. 117). Described as 'just the right set to hold the home-front until more liberal times', it was a compact and efficient receiver specially designed to meet war-time requirements. Murphy took into account the restriction in the supply of raw materials and the necessity of keeping within certain price limits; the set cost only £9 10s (£9.50). In size it comes between the midget sets and the table models and covers the medium and short wavebands.

By 1942 it was estimated that there were millions of sets throughout the country which were silent because spare valves and other components were unobtainable. Crystals were now almost impossible to buy, so that even stocks of stand-by sets were decreasing. To help the situation, thousands of valves were imported at the end of the year from the United States, but these were not distributed for some time. The situation was urgent since the wireless set was a highly important factor in keeping the public informed and entertained. The Government therefore decided to ask the wireless industry to produce a large quantity of cheap and basic civilian receivers.

The first ones rolled off the production line in July 1944 (ill. 118). They were made in two versions: an A.C. valve mains set costing £12 3s 4d (£12.16½) complete, and a battery model at £10 19s (£10.95) exclusive of batteries. They were distributed through the normal trade channels but as the sets were produced by the co-operative action of the industry they did not bear the names of the actual manufacturer, only a label saying PRODUCED BY THE RADIO INDUSTRY UNDER GOVERNMENT DIRECTION. Both sets covered the 200 to 560 metre waveband and the dial shows the positions of the Home and Forces programmes only. Their stark appearance gave rise to them being called 'Utility' sets. *Wireless World* of August 1944 did not agree with this description, saying that as the receivers were liable for purchase tax, the popular practice of referring to them as 'Utility' was incorrect; they preferred the term 'War-time Civilian Receiver'. It is interesting to see that the profit margin to the retailer was very high. The retailer bought the

A.C. set for £6 13s 4d (£6.66½) and the battery model for £6. When they reached the public these prices were nearly double.

As the war began to show signs of coming to a close, *Practical Wireless* in October 1944 turned its attention to happier times ahead by launching a competition called 'Your Post-War Receiver'. They invited readers to send in their suggestions so that manufacturers might be accurately guided in the design of post-war wireless receivers, and produce models which would satisfy popular requirements. The prizes offered were £5, £2 2s (£2.10), and six prizes of a loudspeaker. When the results were known in the following January, the most popular type of set was found to be a mains radiogram with short and medium wavebands, as well as television sound, operated by push-button tuning and tone controls, with the dial marked in both wavelengths and station names. However, it is unlikely that any manufacturers took any notice of this guidance, for when the war did come to an end most manufacturers seemed reluctant to push forward any new ideas, many reverting to designs originally scheduled for the 1939-40 season which had never been produced because of the hostilities.

But now, the B.B.C. was ready with a new plan and on 29 July, two months after Victory Day, the Light Programme was introduced to provide entertainment and relaxation for all its listeners. It was intended for a majority audience who would be receptive to its basic ingredients of light drama, comedy, and light music interspersed with regular news summaries.

By December 1945 licences had been granted to some seventy manufacturers for the production of about a million sets over the following twelve months, and with the cancellation of war contracts, supplies of wireless components returned to normal. The manufacture and supply of sets was now controlled under the Musical Instrument and Wireless Receivers Order. Out of the proposed quantity of sets for 1946, 400,000 were intended for export, with fifty per cent of the value of the production for the home market devoted to sets retailed at £15 or less.

On 24 September 1946, King George VI opened the



'Britain Can Make It' exhibition at the Victoria & Albert Museum in London, which was designed to show the British public and the rest of the world that industry was still alive and kicking. The wireless industry was well represented by some twenty-five receivers (ills. 120 and 121). But few, if any, broke with tradition by offering something different to the rectangular box form of cabinet which had prevailed before the war.

Murphy's baffle receiver Type A 104 (ill. 122) was the most unusual design on show. Instead of a cabinet the chassis was mounted directly onto a slightly curved vertical baffle board. The depth of the set was only six and a half inches, the idea being that the flat baffle had better acoustics than a box. Another set on display, the Bush DAC 90 (ill. 120) was a simply designed but very attractive set. Once again, the case was in brown moulded Bakelite, using the old method of imitating woodgrain to add surface interest. These sets were among those which were first to show on their dials the new B.B.C. Third Programme which was inaugurated

on 29 September 1946. This was a wholly new venture by the Corporation, for it was a programme intended for minority audiences which by its content would make demands on their intellectual maturity and cultural curiosity. Serious music, drama, talks and discussions featured widely in its 6000 hours of broadcasts a year.

Listening in became more expensive in 1946, for on 1 June the Broadcast Receiving Licence was increased from 10s (50p) to £1. In the fifty years that had elapsed since Marconi had taken out the first patent for a system of wireless transmission, broadcasting had developed from an experimenter's dream into a vast public service catering for over ten million British licence holders. The wireless set, long accepted as a fixture of every household, was the mouthpiece of the B.B.C. which provided its listeners with thousands of hours of entertainment and news each year from the Home Service, Light Programme, Third Programme and Regional Network.

(opposite)

120 Bush DAC 90. Brown Bakelite case in simulated wood-grained finish. This set appeared in the 'Britain Can Make It' Exhibition of 1946.

121 Ekco Model A22 designed by Wells Coates. Produced in 1945, it was featured in the 'Britain Can Make It' Exhibition of 1946. Black plastic case with chrome detailing. Price: £17 17s 3d (£17.86).

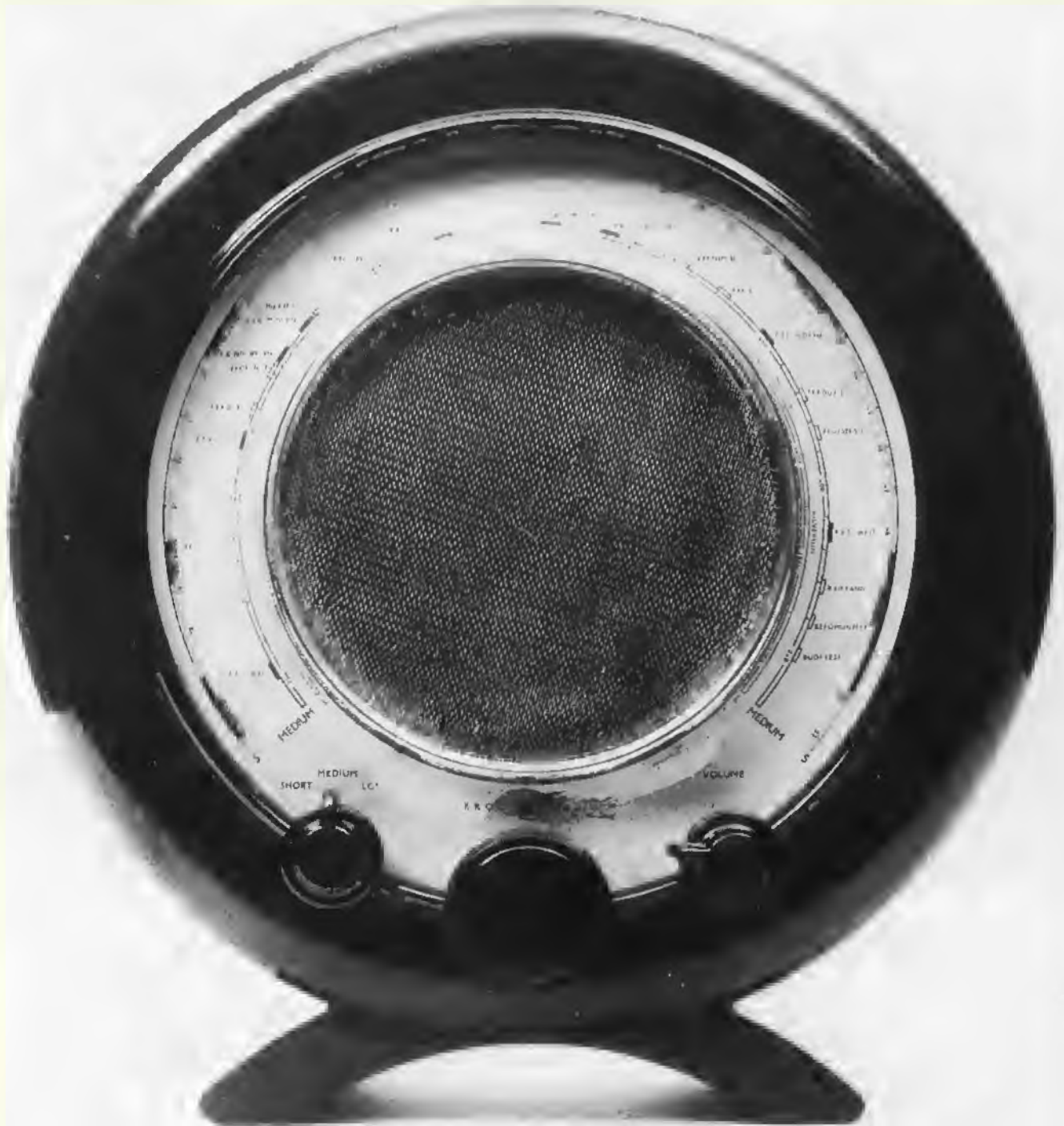

122 Murphy 'Baffle Board'
Receiver Type A104, 1946,
designed by A. F. Thwaites, and
featured in the 'Britain Can Make
It' Exhibition of 1946.
24" x 18"; 6 3/4" deep. Four-
valve (plus rectifier) A.C. mains
superhet.

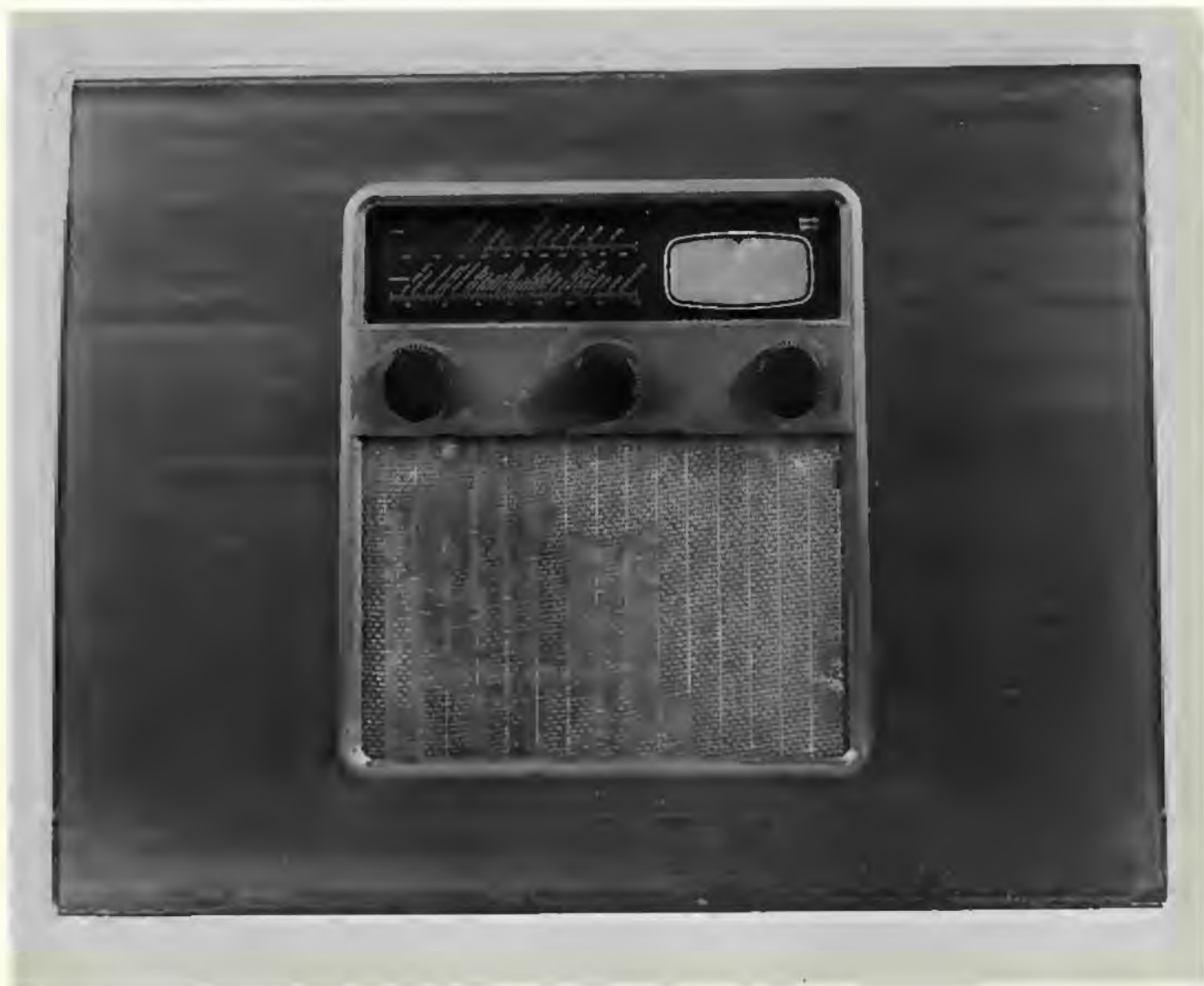

A Short History of the Wireless

- 1864 James Clerk Maxwell presented his theory of the existence of electromagnetic waves.
- 1883 Thomas A. Edison discovered that an electric current could be made to pass through space from the burning filament of an electric light bulb to an adjacent cold metallic plate. This he called the 'Edison Effect', and it was later used in developing the thermionic valve.
- 1887 Heinrich Rudolf Hertz sent and received wireless waves across his laboratory, using a spark transmitter and a receiver called a resonator. These waves were known as 'Hertzian Waves'.
- 1890 Edouard Branly designed a detector of wireless waves, a glass tube filled with metal filings which became conductive when receiving signals.
- 1894 Sir Oliver Lodge improved Branly's detector naming it the 'coherer' and used it when sending messages in morse code, thus inaugurating 'wireless telegraphy'.
- 1895 In Italy, Guglielmo Marconi succeeded in sending morse signals for more than a mile.
- 1896 Marconi came to England to take out a patent covering his system of wireless telegraphy, the first patent of its kind.
- 1897 Marconi formed the Wireless Telegraph & Signal Company.
- 1899 Marconi's system was adopted for ship to shore morse communication.
- 1901 Marconi received a pre-arranged morse code signal (the letter 'S') sent across the Atlantic from Poldhu in Cornwall to St. Johns, Newfoundland, a distance of 1800 miles.
- 1902 Valdemar Poulsen developed his arc transmitter.
- 1904 J. A. Fleming patented his two-electrode valve, the diode, used to detect wireless signals.
- 1906 Lee DeForest patented his three-electrode valve, the triode amplifier; R. A. Fessenden transmitted speech over a distance of several hundred miles.
- 1912 E. H. Armstrong invented the regenerative valve circuit.
- 1913 The German wireless station at Nauen transmitted morse code over a distance of 1550 miles.
- 1914 The Marconi Company began experimental speech transmissions from Marconi House, London.
- 1915 Irving Langmuir produced the first 'hard' valve, the Pliotron; first transatlantic broadcast of speech, from Arlington, Virginia to Paris.
- 1918 Armstrong invented the superheterodyne circuit. The Marconi Company began experimental transmissions of speech from Ireland to North America.
- 1920 *23 February*
Beginning of two daily programmes from the Chelmsford works of the Marconi Company for experimental purposes.
- 20 June*
Famous concert by Dame Nellie Melba from Chelmsford.

- 1922 *14 February*
First broadcast from the Marconi Writtle Station 2MT.
- 11 May*
First broadcast from Marconi's London Station 2LO.
- 16 May*
First broadcast from the Metropolitan Vickers Manchester Station 2ZY.
- 1 November*
The 10s Broadcast Receiving Licence introduced.
- 14 November*
The British Broadcasting Company's first Station 2LO began broadcasting. Head Office set up in Marconi House in the Strand, London.
- December*
B.B.C. stamp applied to apparatus passed by the Postmaster-General, giving the British wireless industry protection from foreign competition. This lasted two years.
- 1923 *8 January*
First outside broadcast, Mozart's *The Magic Flute* from Covent Garden.
- 1 May*
First broadcast from the B.B.C.'s new Savoy Hill Studios.
- 28 September*
First issue of *Radio Times* published.
- 31 December*
First broadcast of Big Ben.
- 1925 Gradual disappearance of the panel type of receiver and introduction of the dull emitter and the cone type of loudspeaker.
- 8 February*
First amateur telegraphy between Australia and England.
- 1926 First types of all enclosed mains receivers introduced.
- 31 December*
British Broadcasting Company dissolved.
- 1927 *1 January*
The British Broadcasting Corporation constituted under Royal Charter for a period of ten years.
- 7 January*
Transatlantic Service introduced; crystal sets gradually disappearing.
- 1929 *16 January*
First issue of *The Listener* published.
- 1930 *30 March*
B.B.C. began television experiments.
- 1932 *2 May*
The new B.B.C. headquarters, Broadcasting House, opened.
- 14 May*
Savoy Hill locked up for the last time.
- 22 August*
First experimental television from Broadcasting House using the thirty-line Baird system.
- 19 December*
Empire Service began from Daventry.
- 25 December*
First Empire Christmas Day message from George V.

- 1936 *2 November*
Inauguration of **high definition television service from Alexandra Palace.**
- 11 December*
Abdication speech of **Edward VIII broadcast.**
- 1937 *1 January*
Renewal of the **B.B.C.'s charter for ten years.**
- 12 May*
First outside television broadcast, the Coronation of George VI.
- 20 July*
Death of Guglielmo Marconi.
- 1938 **Push-button receivers flood the market.**
- 1939 *1 September*
Close down of television broadcasting and replacement of the Regional Service with the Home Service.
- 1941 *June*
'V for Victory' campaign broadcasts introduced into the European Service.
- 1942 *22 March*
Daily news in morse code initiated, for Resistance fighters in Europe.
- 1944 *July*
War-time Civilian Receiver introduced.
- 1945 *29 July*
Light Programme inaugurated and Regional and Home Services resumed.
- 1946 *1 June*
Broadcast Receiving Licence increased from 10s to £1.
- 7 June*
Television service resumed.
- 29 September*
Third Programme introduced.

How to Date a Receiver

By referring to the list of B.B.C. stations and their dates of inauguration given below, it is possible to work out the date of manufacture of a particular set fairly accurately from the names of the stations which appear on the tuning dial.

From the time of the first B.B.C. Station 2LO, until about 1932, no station names appeared on the dial. Instead the dial was calibrated in numbers, usually 1 to 100, or in metre wavelengths. Most listeners in those days kept reference cards by their sets which showed the number on the dial in relation to the name of the station. So unless the original card is still with the set, accurate dating by station reading alone is not possible. However, a few sets, like the Halcyon five-valve portable (ill. 84) included a printed card actually mounted on the set for the listener to fill in the appropriate dial readings in the space provided. The Halcyon station card shows DAVENTRY EXPERIMENTAL (5GB) and LONDON (2LO). By referring to the list of station dates it can be seen that station 5GB was introduced in August 1927, and 2LO changed to

LONDON NATIONAL in 1929; so the set was made between 1927 and 1929.

Receivers with dials clearly marked with the names of the stations are much easier to date, and will be at the very earliest of 1932 vintage.

To take an example of a mains set, say, with DAVENTRY 5XX and WEST REGION on the dial, since Droitwich replaced Daventry in October 1934 the set then must have been made before that date. As the West Region opened in 1933, it follows that the set was manufactured between 1933 and 1934.

To take another example, a dial showing DROITWICH and SCOTTISH NATIONAL but not the HOME, LIGHT or THIRD programmes (one can, of course, also date a set by what does *not* appear on the dial) indicates firstly that it was made after 1934, the date of the introduction of Droitwich, and secondly before 1939 (the Home Service appearing in 1939 and the Light and Third programmes in 1945 and 1946). So the set was made between 1934 and 1939; and so on.

DATE	STATION	WAVELENGTH (Metres)	COMMENTS
1922			
14 November	LONDON (2LO)	361	First B.B.C. station to open, housed at Marconi House in the Strand.
15 November	BIRMINGHAM (5IT)	384	Second B.B.C. station to open.
	MANCHESTER (2ZY)	384	Third B.B.C. station to open.
24 December	NEWCASTLE-UPON-TYNE (5NO)	312	Main station
1923			
13 February	CARDIFF (5WA)	353	Main station
6 March	GLASGOW (5SC)	405	Main station
10 October	ABERDEEN (2BD)	326	Main station
17 October	BOURNEMOUTH (6BM)	326	Main station
16 November	Sheffield (6FL)	272	Relay station
1924			
28 March	Plymouth (5PY)	350	Relay station
1 May	Edinburgh (2EH)	288	Relay station
11 June	Liverpool (6LV)	297	Relay station
8 July	Leeds-Bradford (2LS)	250	Relay station
21 July	CHELMSFORD (5XX)	1600	High-powered station opened for experimental purposes
15 August	Hull (6KH)	294	Relay station
14 September	BELFAST (2BE)	306	Main station
16 September	Nottingham (5NG)	275	Relay station
9 November	Dundee (2DE)	294	Relay station
21 November	Stoke-on-Trent (6ST)	294	Relay station
12 December	Swansea (5SX)	294	Relay station
1925			
27 July	CHELMSFORD (5XX)	(1600)	Transferred to Daventry (B.B.C.'s first longwave transmitter) This marked the experimental beginning of the Regional Scheme
	DAVENTRY (5XX)	1554	

1927				
21 August	DAVENTRY (5GB)	491		New high-powered medium wave station opened for experimental Regional Scheme broadcasts to the Midlands. Because of these transmissions, the Birmingham Station 5IT had to close.
11 November	CHELMSFORD (5SW)	255		Shortwave experimental broadcasts to the British Empire begin.
1929				
21 October	LONDON NATIONAL	261		B.B.C. twin-wave station opened at Brookmans Park launching the Regional Scheme. 2LO now London National. Both broadcast from Daventry transmitter.
	LONDON REGIONAL	356		
	DAVENTRY NATIONAL (5XX)	1554		
	MIDLAND REGIONAL (5GB)	479		
1931				
12 July	NORTH REGIONAL	479		Simultaneous broadcasting of regular programmes from Moorside Edge transmitter near Huddersfield.
	NORTH NATIONAL	301		
1932				
2 May	SCOTTISH REGIONAL	376		Regular programmes began from the transmitter at Westerglen, near Falkirk.
	SCOTTISH NATIONAL	288		
1933				
	WEST REGIONAL	285		Transmitter opened at Washford Cross, near Watchet, Somerset.
	WEST NATIONAL	256		
1934				
7 October	DROITWICH	1554		Superseded Daventry 5XX as national programme transmitter.
1939				
1 September	HOME SERVICE	394		Replaced Regional Scheme.
1940				
7 January	FORCES PROGRAMME	342		Introduced for the British Expeditionary Force fighting in France.
1945				
29 July	LIGHT PROGRAMME	251		With the inauguration of the Light Programme, the Regional Scheme was resumed.
1946				
29 September	THIRD PROGRAMME	460		

Bibliography

Bibliography

Briggs, A., *The History of Broadcasting in the United Kingdom*. London, 1961.

Chapman, E. H., *Wireless Today*. London, 1936.

Dowsett, H. M., *Wireless Telephony & Broadcasting*, 2 vols. London, 1923–24.

Harlow, A. F., *Old Wires & New Waves*. New York, 1936.

Harmsworth's Wireless Encyclopedia, 3 vols (ed. J. A. Hammerton). London, 1923.

Hutchinson, R. W., *Wireless, Its Principles & Practice*. (Fourth Edition.) London, 1937.

Lewis, C. A., *Broadcasting From Within*. London, 1924.

McMahon, M. E. (ed.), *Vintage Radio*. Palos Verdes Peninsula, California, 1973.

Norris, R. C., *Radio Engineering*. London, 1946.

Pevsner, N., *An Enquiry into Industrial Art in England*. Cambridge, 1937.

Reade, L., *Marconi and the Discovery of Wireless*. London, 1963.

Scott-Taggart, J., *The Manual of Modern Radio*. London, 1933.