

SERVICING COLOR TV

ROBERT G. MIDDLETON

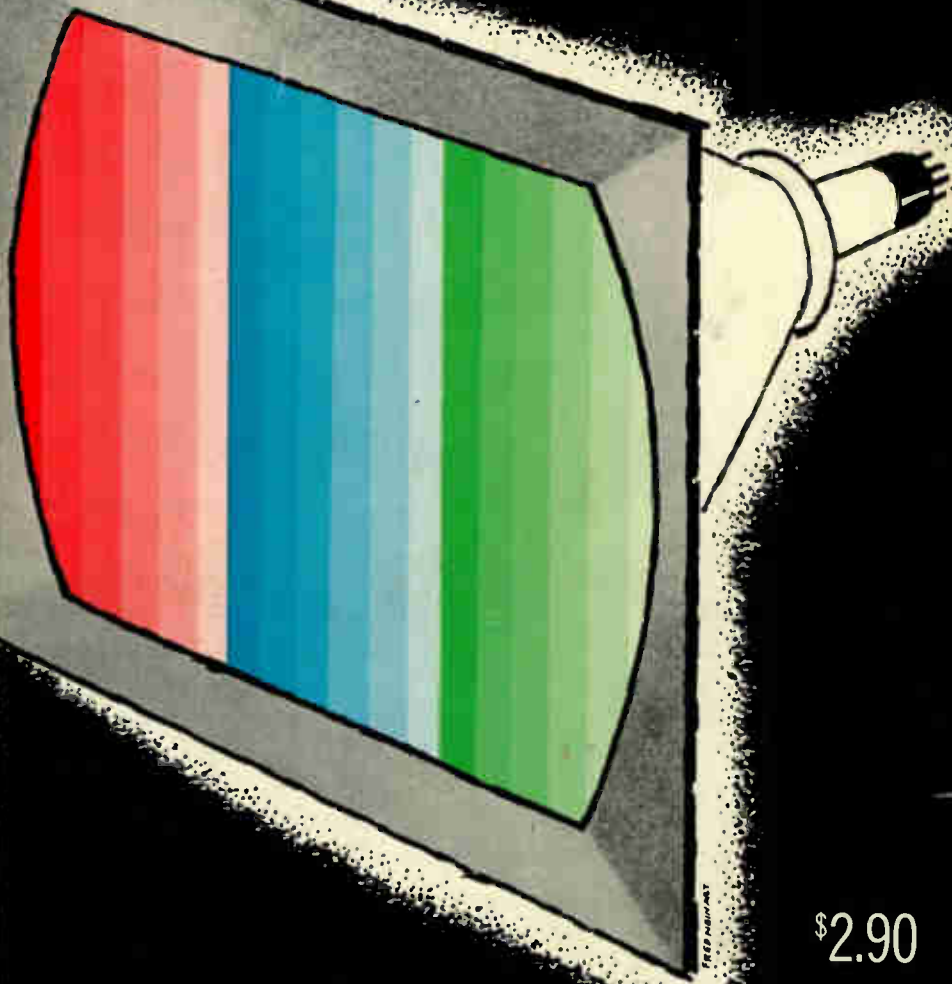

\$2.90

GERNSBACK LIBRARY
NO. 65



SERVICING COLOR TV

robert g. middleton

PUBLISHED BY
GERNSBACK LIBRARY INC.
NEW YORK 11, N. Y.

© 1957 Gernsback Library, Inc.
All rights reserved under Universal,
International, and Pan-American
Copyright Conventions.

Library of Congress Catalog Card No. 57 - 9006

contents

chapter

page

1

Preliminary servicing

Reproduction of improper colors. Check for tube trouble first. Precautions against high-voltage hazards. Trouble chart for color section. Trouble chart for monochrome section. Convergence of the three-gun tube. Tracking the scanning beams. Convergence procedure. Adjustments of phasing and intensity controls. Color reproduction vs. ambient light. Antenna pointers.

7

2

Color sync servicing

Loss of color component. Arrangement of the color sync system. Servicing of color-sync and associated chroma circuits. Crystal-ringing circuits. Subcarrier oscillator and buffer amplifier circuits. Color-sync afc circuits. Video-frequency output and color-sync servicing. Check of color sync lock by variation of burst voltage. Rainbow characteristics produced by loss of color sync. Contamination of burst causes loss of tight chroma lack. Picture symptoms of sync loss. Intermittent operation of the color subcarrier oscillator. Intermittent color sync lock.

33

3

Chroma circuit servicing

Balance between chroma and Y output levels. Video-frequency sweep tests. Video-frequency circuit adjustments. Marking chroma and Y response curves. Converting monochrome to chroma sweepers. Pre-amplifier for demodulator probe. Checking flatness of chroma sweep signal voltages. Test leads. Noise and interference voltages. Marking with dial calibrations. Typical I demodulator sweep test. Generator and scope settings for sweep-frequency check of Q demodulator. Circuit gain. Scope control settings for checking response of Q demodulator circuit, using subcarrier beat signal. Color demodulator as AM detector. Overall response dominated by narrowest-band circuit. Sweep generator as 60-cycle square-wave source. Delay time of video amplifier. Overload of chrominance circuits. Scope control settings for 60-cycle square-wave check of Q demodulator circuit. Chrominance contamination of the white bar signal.

63

4

Servicing chroma demodulators

Demodulator testing with linear phase sweep. Color demodulator testing with keyed linear phase sweep. Checking the demodulator section with an NTSC color bar generator. Characteristics of NTSC color bar signal. Use of NTSC color bar signal and scope to adjust (B - Y) or I gain control. Amplitude or subcarrier oscillator voltage. Weak chroma signals. Picture tinting—causes and cures. Color bar distortion caused by tube failure in receiver.

97

5

Matrix testing

Checking matrix. Matrix checks with a keyed generator. Matrix checks with a signal generator and vtvm. Checking matrix frequency response. Matrix operation. Using probes. Transients. Matrix testing. Matrix servicing. Influence of the Y voltage value in matrix operation. Dc restorers.

121

6

Servicing the IF amplifier

Dynamic range of if amplifier. Stability of if amplifier. Response curve of rf and if amplifier. If alignment characteristics.

143

7

The flyback system

Operation at two frequencies. Heat may soften insulation. Defeat the interlock. Tagging wires. Flyback testers. Disconnect circuits to check loading. Dc drain by branch circuits. Design changes. Corona interference. Variation in replacement flyback transformers. Intermittent arcs in high-voltage system. Horizontal foldover and poor color sync. Conversion of small-screen receiver. Servicing the flyback system. Sweep failure damage to CRT. Potentiometer burnout. Waveform and voltage tests. Using scopes.

157

8

Signal tracing

Suitable test point for burst. Effect of receiver tuning on burst amplitude. Deterioration of waveforms in signal circuits. Demodulator probes in signal tracing. Applications of the color bar signal. Probe loading effects.

179

9

Test equipment

White dot generators. Color bar generators. Color simulators. Composite video crosshatch pattern. Test instruments used to check color circuits. Color bar generator adjustments.

193

Index**217**

introduction

THE television technician, "used to" being thrown upon his own resources, has been put to sterner tests than ever by the advent of color television. Color receivers are more complex in construction and circuit operation is more critical than in black-and-white sets. The practical man, who must keep these receivers operating satisfactorily, is being deluged, unfortunately, with high-flown theory from the research laboratory, and with little translation of theory to practice. This book is planned to meet this real need.

New test equipment has become necessary to install and service color television receivers—instruments such as color bar and white dot generators and scopes with 100% response at 3.58 mc. Conventional test equipment, such as sweep and marker generators, have become obsolete in many cases because of lack of flatness of output from the sweep generator, lack of accuracy of the marker indication, excessive numbers of spurious outputs and insufficient output over the necessary ranges of frequency. Video-frequency sweeping (10 kc to 4.5 mc) becomes an important new requirement in color servicing. These requirements and techniques are carefully discussed and illustrated in this volume. Instructions are provided on how to test the test equipment for the more critical service applications.

Such matters are becoming of increasing importance to the TV technician (relatively inexperienced in color TV) since he may frequently be in doubt as to whether his instruments are all they are supposed to be or whether he may be applying the instruments incorrectly.

This is primarily an applications book. However it has as its central purpose the provision of the clearest possible instructions on how to do the job and how to do it right. It is not a step-by-step book to be followed mechanically and without understanding of why each step is specified; it is the purpose of the book to explain fully *why the* particular method and test setup are utilized and to

show the false conclusions and distortions which result from common errors in making such tests.

The author wishes to take this opportunity of extending his sincere thanks to Mel Buehring, sales manager of Simpson Electric Co., for making available for publication findings of the company's field engineering program, for supplying art work, and making available copyrighted technical data from the company's house organ and instrument instruction book. Bert Williams of Admiral Corp. and Tim Alexander of Motorola likewise deserve credit.

In conclusion, I wish to extend my thanks and appreciation to a host of fellow engineers and TV technicians throughout the country from whose comments and observations I have benefitted enormously. To this group (who for practical reasons cannot be listed individually) I gratefully acknowledge my indebtedness.

ROBERT G. MIDDLETON

preliminary servicing

As in black-and-white reception, most servicing of color receivers requires only replacement of defective tubes. Fig. 101 shows a block diagram of a color set from which it will be evident that the faulty section can often be localized by observing the reproduction (or lack of reproduction) of chrominance, monochrome and audio signals.

A complaint of no sound and no picture may indicate a faulty tube in the front end or in the if stages prior to the sound takeoff point. A complaint of no color picture, but with a black-and-white picture and sound present, points to a faulty tube in the chroma or color-sync sections. For example, if the bandpass amplifier tube is defective, no chroma signal can pass. If the color sync discriminator tube is faulty, the color signal rolls so fast on the screen of the picture tube that it produces gray, and the color signal appears to be missing. If the color picture is satisfactory, but sound is absent, the tubes in the sound channel should be checked, as in a black-and-white receiver. When the complaint is that the color picture has very poor definition with dim and bluish colors, the tubes in the Y channel between the color takeoff point and the picture tube should be checked.

If the color information in the picture appears as horizontal rainbows, the color subcarrier oscillator is out of color sync and is operating slightly off frequency. Sometimes the burst amplifier tube is weak or the color phase-detector tube may be somewhat unbalanced; the reactance or subcarrier oscillator tube can also be responsible. Color hum bars can be seen in the picture if the band-

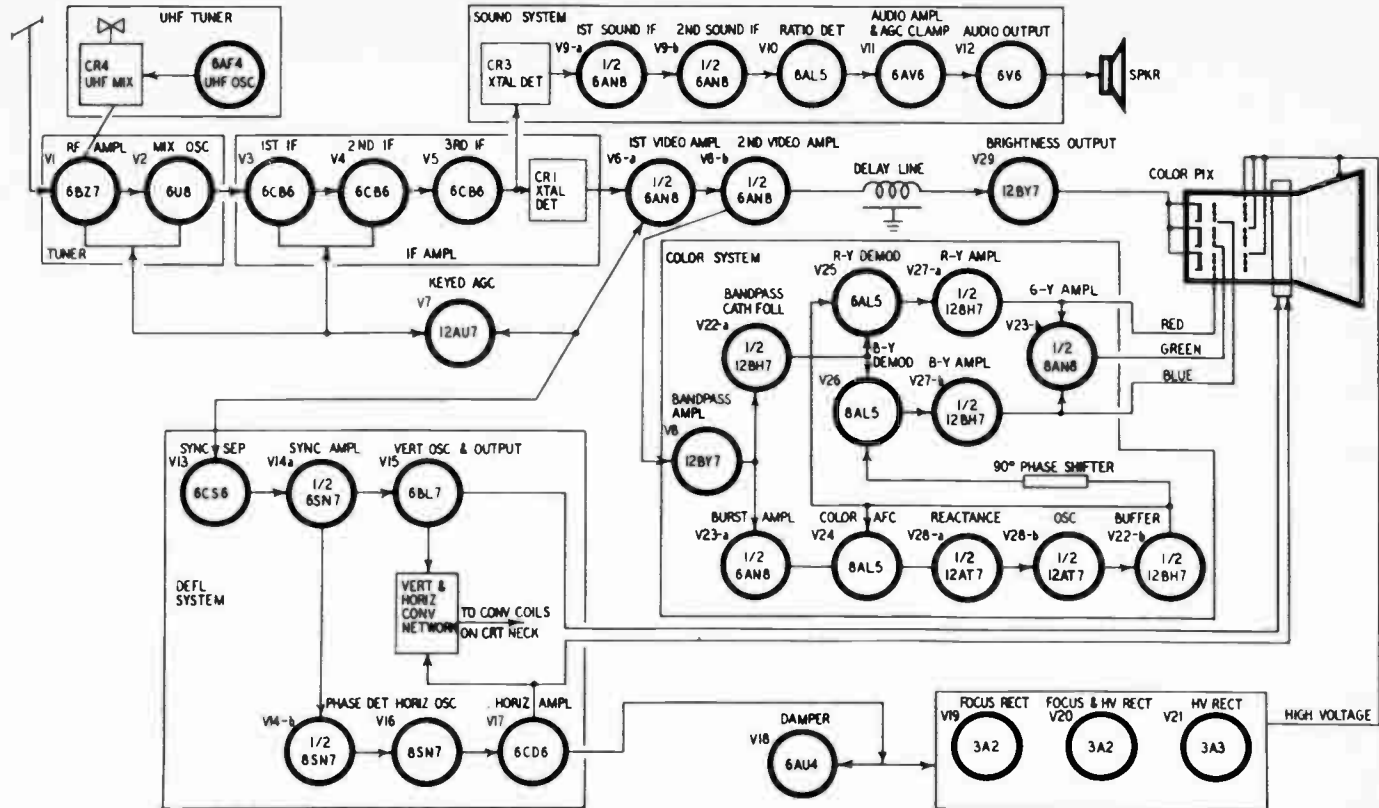

Fig. 101. Block diagram showing the various sections of a color TV receiver. (Courtesy of Motorola, Inc.)

pass amplifier tube, for example, develops heater-to-cathode leakage. They can appear due to heater-to-cathode leakage in the chrominance amplifier tubes or to leakages in the picture tube.

Note that the response of the chroma channel can be rapidly examined by turning the contrast control to minimum and the color intensity control to maximum. Likewise, the response of the Y channel can be checked by turning the intensity control to minimum and the contrast to maximum. These simple tests supplement the conclusions gained by observing the receiver response with the operating controls set for normal reception.

Reproduction of improper colors

When the complaint is improper reproduction of colors, the characteristics of the receiver must be considered before a particular tube is suspected. Fig. 102 shows a popular arrangement of an (R - Y) and a (B - Y) color detector and a (G - Y) matrix. The red color signal is obtained at the output of the (R - Y) detector, the blue color signal from the output of the (B - Y) detector and the green from the output of the (G - Y) matrix. Consider first the situation in which the red, green and blue color signals are ac coupled to the picture tube. If green is missing from the picture, normal yellows appear red because yellow is produced by a mixture of red and green. Lack of green in the picture, and the red appearance of normal yellows, would point to a defective (G - Y) matrix tube.

The color detectors and matrix tubes are often followed by amplifiers, so lack of green would also point to a defective (G - Y) amplifier tube, if utilized in the particular receiver. A defective (R - Y) detector tube (Fig. 102) causes the reds to disappear from the picture and normal magentas will appear blue because magenta is a mixture of red and blue. In the same manner, a defective (B - Y) detector tube causes the blues to disappear from the picture and normal cyans appear green because cyan is a mixture of blue and green.

These considerations are quite straightforward. Now consider the symptoms obtained from the arrangement of Fig. 102 when the circuits are dc coupled to the color picture tube. In this case (quite common in modern receivers), tube failure affects, not only the signal voltage, but also the dc voltages in the channel. The nature of the disturbance in dc distribution will depend upon the particular type of tube failure because the bias on the grids of the picture tube is determined by plate currents and grid biases on the receiving tubes in the channel.

Clear distinction must be made between *raster colors* and *signal colors* on the screen of the color picture tube. The raster colors are present in the complete absence of an incoming signal or in reproduction of a black-and-white signal. Signal colors are developed in response to signal voltages from the chrominance channels and always appear superimposed upon the raster colors.

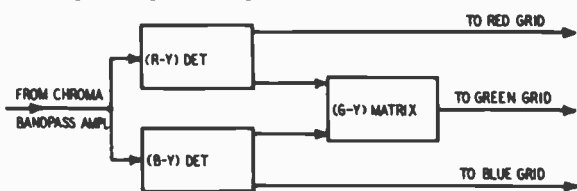

Fig. 102. A common (R - Y) (B - Y) (G - Y) arrangement.

Raster colors are controlled by dc potentials on the cathodes, grids and screen grids of the color picture tube. A higher cathode bias, a higher grid bias or a lower screen voltage causes the associated raster color to decrease in intensity. On the other hand, a lower cathode or grid bias or a higher screen voltage causes the associated raster color to increase in intensity. In normal operation, adjust the grid-cathode bias and the screen voltage for each of the three electron guns in the picture tube to produce a neutral gray or white raster in the absence of a signal.

An inspection of the circuit arrangement of Fig. 103 will show that maintenance of proper bias on the green grid of the picture tube is dependent upon normal plate voltage at the (G - Y) matrix tube. Loss of emission in this tube is equivalent to advancing the green brightness control and causes the entire screen to assume a greenish cast. On the other hand, a defect which causes the grid bias to fall at the (G - Y) matrix tube is equivalent to backing off the green brightness control and causes green to be lacking from the raster. It might be assumed that the green signal was not getting through whereas actually the loss of green is caused by dc bias disturbance.

Hence, when dc coupling is used in the chroma channels, signal and background disturbances go hand-in-hand and picture analysis must be made with this in mind. Dc coupling is used to eliminate the need for dc restorers hence to minimize the tube complement.

Check for tube trouble first

Unless the receiver has been tampered with, it is best to leave all background, screen, gain and balance controls unchanged until a

justifiable reason appears for changing a control setting. If the screen appears dominated by a green hue—actually due to heater failure in the (G — Y) matrix tube (Fig. 103), it would be a time-wasting error to start by backing off on the settings of the green background and screen controls to obtain a neutral raster. After getting a neutral raster in this manner the green signal would be missing from the picture, with only red and blue signals to drive the picture tube.

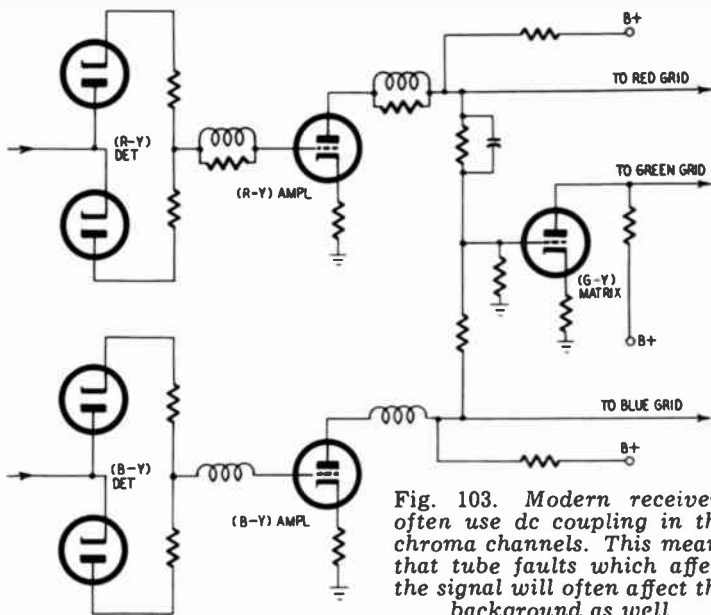

Fig. 103. Modern receivers often use dc coupling in the chroma channels. This means that tube faults which affect the signal will often affect the background as well.

Hence, the (G — Y) matrix tube must be replaced anyhow, and the green background and screen controls must then be readjusted to neutralize the raster on black-and-white reception. Always assume at the start that the receiver is capable of normal operation if a faulty tube or two can be located and replaced. This approach will usually save a great deal of time.

Receiver manufacturers often publish trouble charts which are a valuable guide in localizing faulty tubes. A typical example is given in Chart 1—1, which applies to the Motorola TS-902 series.

Precautions against high-voltage hazards

Color picture tubes operate at approximately 25,000 volts and substantial current requiring much more care than in black-and-white work. Once a person gets "bit" by the high-voltage supply in a color receiver, he does not soon forget it. There is little question

Chart 1-1—Trouble Chart for Color Section

Symptoms	Tubes to Check
Normal raster and black-and-white picture. No color.	Bandpass amplifier and cathode follower; 3.58-mc buffer; (R - Y) and (B - Y) demodulators; (R - Y) and (B - Y) amplifiers; 3.58-mc oscillator and reactance tube; rf amplifier; mixer-oscillator; first, second and third if tubes.
Normal raster, normal black-and-white picture, color out of sync. Color information falls off to side, similar to out-of-horizontal sync.	Bandpass cathode follower; 3.58-mc buffer; burst amplifier; (G - Y) matrix amplifier; color afc tube; 3.58-mc oscillator and reactance tube.
Normal raster and black-and-white picture. Poor color tone and balance on color portion of picture.	Burst amplifier and (G - Y) matrix tube; (R - Y) and (B - Y) demodulators; (R - Y) and (B - Y) amplifiers; picture tube.
Tinted raster (entire raster tinted evenly).	Picture tube—make visual check first to see if all three heaters are glowing; burst amplifier and (G - Y) matrix tube; (R - Y) and (B - Y) demodulators; (R - Y) and (B - Y) amplifiers.
Excessive 920-kc beat interference in picture.	Rf amplifier; oscillator-mixer; first, second and third if amplifiers; sync and video amplifiers; agc detector and amplifier; brightness amplifier.
Picture size changes excessively with adjustment of brightness control.	High-voltage regulator tube.
Tinted raster (one or more sections tinted, usually in the outer areas).	Picture tube.
Color fringing.	Picture tube.
Sound ok; no picture. (Receivers using separate sound detector).	Last if amplifier, picture detector tube.
No sound, no color; black and white picture ok. (Receivers using separate Y detector.)	Chroma-and-sound detector tube.
Picture blooms badly, with varying dynamic convergence as brightness control is advanced.	Regulator tube. (Some receivers utilize a triode regulator—others use a corona bleeder tube). If corona tube is used, weak high-voltage rectifier tubes may reduce the high voltage below the striking level of the regulator.
Color hum bars in picture.	Heater-cathode leakage in color detector tubes, or color amplifier tubes.
Blues and greens only are present in the color picture.	(R - Y) detector, or amplifier.
Reds and greens only are present in color picture.	(B - Y) detector, or amplifier.

Trouble Chart for Monochrome Section

Normal raster. No picture, no sound.	Rf amplifier; oscillator-mixer; first, second and third if amplifiers.
Weak picture (insufficient contrast).	Rf amplifier; oscillator-mixer; first, second and third if amplifiers; sync and video amplifiers; video amplifier; brightness amplifier.
Low brightness or no raster.	Horizontal oscillator and amplifier; damper; focus rectifier; high-voltage rectifier tubes and regulator; picture tube.
Poor vertical linearity and/or size. Horizontal white line (no vertical sweep).	Vertical oscillator, vertical output.
Vertical instability (picture rolls).	Sync separator and noise gate; sync amplifier and horizontal phase detector; horizontal oscillator.
Loss of vertical and horizontal hold.	Sync separator and noise gate; sync amplifier and horizontal phase detector.
No horizontal hold or critical horizontal hold.	Sync separator and noise gate; sync amplifier and horizontal phase detector; horizontal oscillator.
Insufficient horizontal size.	Horizontal oscillator and amplifier; damper.
Picture normal, no sound or weak sound.	Agc detector and amplifier; first and second audio if amplifiers; ratio detector; audio and agc clamps; audio output.
Buzz in sound.	First and second audio if amplifiers; ratio detector; audio amplifier and agc clamp; audio output.
vhf—no uhf.	Uhf oscillator.
Excessive contrast, negative picture.	Rf amplifier oscillator-mixer; first, second and third if amplifiers; sync and video amplifier; agc detector and amplifier; brightness amplifier.
Wide horizontal bar or graduation in shading vertically (set may also have poor vertical sync).	Rf amplifier; oscillator-mixer; first, second and third if amplifiers; sync and video amplifier, brightness amplifier.
Interference in picture.	Horizontal amplifier.
Negative picture.	Agc detector and amplifier, video amplifier, gassy picture tube.
Picture blooms and loses focus as brightness control is advanced.	Regulator tube, high-voltage rectifier tube.

that death could be caused if a person should “freeze” to the high-voltage circuit. The danger of the second-anode voltage is in the heavy current which it can supply. The picture tube is capable of “soaking up” considerable high voltage, which is released after standing a while, although it has been previously discharged. Always discharge a color picture tube before handling, even though it may have been discharged previously.

Measurement of the high voltage is most easily accomplished when the receiver utilizes a high-voltage interlock. This consists of a center pin contacted by one or more flat springs (Fig. 104), to

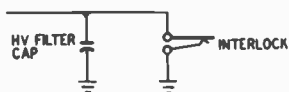

Fig. 104. The high-voltage interlock consists of a center pin at high-voltage potential and one or more flat grounding springs.

short-circuit the high-voltage filter capacitor. When the rear cover is on the set, a polystyrene tube slips over the center pin and separates the spring from the pin so that the high-voltage output is not shorted. During service operations, the rear cover is removed and a tubular cheater (Fig. 105) can be inserted into the interlock. A high-voltage dc probe can then be inserted into the cheater to contact the center pin and measure the voltage on a vom or vtvm.



Fig. 105. A tubular high-voltage cheater. (Courtesy of Walsco.)

It is more difficult to measure the high voltage in a receiver which does not provide an interlock, because corona is a severe problem at 25,000 volts. Sometimes a fine wire can be inserted down the sleeve of the high-voltage connector to bring the high voltage out where it can be measured. But often this expedient is unsuccessful due to corona discharge which ionizes the surrounding air and starts a hot arc to some metallic surface. Indirect methods of measurement are

sometimes suggested in the service manual for the particular receiver. It will often be necessary to check the value of the high voltage as it is much more critical than for a black-and-white picture tube. Proper convergence, for example, cannot be obtained with an incorrect voltage.

Standing waves, due to mismatch between the front end and the lead-in must be minimized in color reception. When ample signal is available, the standing-wave ratio can be improved by a suitable pad between the lead-in and the front end (Fig. 106). The pad imposes a 50% loss of signal but absorbs reflections on the lead-in. It should be connected directly at the receiver input terminals.

Fig. 106. A simple resistive pad which sometimes improves "rainbow" and smear in the picture, due to standing-wave trouble. The pad causes a 50% loss of the incoming signal.

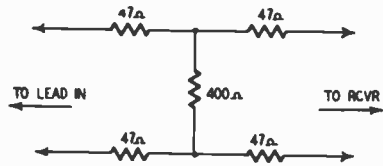

Be careful in the use of brute-force expedients sometimes utilized in black-and-white reception to attenuate the input signal. For example, if one side of the lead-in is disconnected from the receiver, the result is serious standing-wave trouble. This can distort the color signal or eliminate color reproduction entirely. It is poor practice to attenuate the incoming signal or to attempt to "soak up" standing waves by merely connecting series resistors on each side of the lead-in. This oversimplified padding does afford a measure of swr reduction but also offers a mismatch to the lead-in, which again gives rise to more standing waves. Only a suitably designed H-pad will provide the maximum possible attenuation of standing waves in return for the signal loss incurred.

Convergence of the three-gun tube

Convergence is not an easy job and requires considerable practice before it can be satisfactorily completed within a reasonable time. Convergence adjustments are needed when a black-and-white picture exhibits rainbows at the edges of objects. To the experienced eye, the characteristics of the misconverged pattern often give clues for rapid touchup adjustments. The beginner, however, will find it necessary to go through a complete convergence procedure in most cases.

Receiver service manuals always provide explicit instructions for step-by-step convergence adjustments, and these should be carefully followed until experience is gained. It is our purpose to outline general principles rather than to cite the procedure for a given set.

An understanding of these principles facilitates individual jobs and hastens the acquisition of practical experience.

Purity adjustments are preliminary to convergence and, if substantial changes of the convergence voltages and fields are required, the operator must recheck the purity adjustments since these are interdependent to some extent. Purity refers to the uniformity of individual color fields, and hence to the uniformity of the gray or white raster obtained by simultaneous operation of the red, green and blue guns in the color picture tube.

The red field should generally be inspected first. The green and blue guns must be disabled by whatever means available in a particular set. In receivers having plug-in facilities for the three grid leads from the picture tube, a gun can be disabled by unplugging its grid lead from the output of the chrominance circuit and grounding the lead in a nearby jack provided for the purpose on the chassis. Other receivers require shunting a 100,000-ohm resistor from the picture-tube grid to chassis ground. Still others require that the screen control for the gun be turned to minimum. In every case, though, the green and blue guns must be always disabled to make a check of red field purity.

The red field is usually checked first because the beam current of the red gun is higher than that of the blue and green guns. Hence, it is more difficult to obtain red purity. The master brightness control is advanced to obtain suitable screen illumination. (The master brightness control is the customer's brightness control and is located at the front of the receiver.) If the field is not uniformly red, being tinged with blue or green or both, purity adjustments will be required.

Good purity depends upon proper position of the deflection yoke. Unlike a black-and-white picture tube, the yoke is not pushed forward as far as it will go on the neck of the picture tube. Instead, it is positioned at the point which provides best purity. In most cases, the yoke will not require attention, having been properly set at the factory. However, if a new picture tube is installed, this is a point to be kept in mind. The yoke is mounted in slotted brackets, so that it can be exactly centered or slid back and forth along the neck, and secured in position by hex-head machine screws.

Purity is also affected by a magnet mounted on the neck of the picture tube. To the beginner, the purity magnet is suggestive of the centering magnet used on some black-and-white tubes. In most cases, the purity magnet is a pair of adjacent flat rings, with protruding tabs (Fig. 107). When the tabs are rotated to the same position,

the fields of the two rings cancel so that minimum magnetic flux passes through the neck of the picture tube. When the tabs are turned away from each other, correspondingly stronger flux is passed through the tube neck. The general rule is to use the mini-

Fig. 107. A purity magnet consists of a pair of adjacent flat magnetic rings. When the tabs are rotated to the same position, the purity field is minimum. Maximum magnetic flux passes through the picture tube when the tabs are turned away from each other.

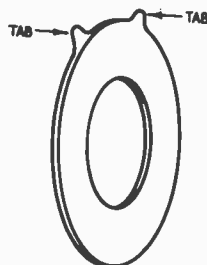

imum strength of field which provides good purity. The rings can also be rotated as a pair. This is another of the essential features of the purity adjustment.

The purity magnet must be located properly about halfway between the convergence magnets and the blue lateral corrector on the tube neck; in case of doubt consult the service notes for the receiver. The purity magnet affects purity chiefly in the center of the screen, while the yoke position has a greater influence on edge purity. The two adjustments should be worked together, in case the yoke requires positioning.

The majority of color receivers also have rim magnets for touching up purity at the edges of the screen. Early sets had a single rim electromagnet, with an adjustment for the amount of dc to be passed through the rim coil. This was a compromise which has been supplanted by approximately eight individual permanent magnets mounted around the periphery of the screen. In some receivers, the rim magnets can be advanced or retracted from the screen and also turned to adjust the polarity of their fields. Other receivers provide only a rotational adjustment. Still others dispense with rim magnets entirely. Some manufacturers believe that rim magnets are not required if the picture tube is properly fabricated.

Since yoke position, neck magnet and rim magnets all interact to some small extent, check back to obtain the most uniform red field possible. In case no adjustments suffice to obtain a satisfactorily pure red field, the most likely trouble is residual magnetism in the picture-tube shield. Regardless of how the shield may have become magnetized, the job is to remove the residual magnetism. This is done by means of a degaussing coil (Fig. 108), consisting of about 500 turns of No. 20 magnet wire, taped into a compact doughnut shape about the diameter of the picture tube. The ends of the coil

connect to a cord which can be plugged into a 117-volt, 60 cycle outlet.

The degaussing coil should not be applied until the rim magnets have been removed from their holders or retracted into their housings, as the case may be. Otherwise, the ac field of the degaussing

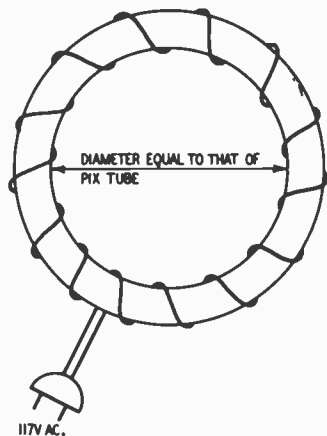

Fig. 108. A degaussing coil has the appearance of a large doughnut. The diameter of the coil is about the same as the rim of the picture tube. It provides an ac field for demagnetizing the picture-tube shield.

coil will weaken the rim magnets and make them ineffective. The coil is held squarely in front of the picture tube for a few seconds and then backed away slowly, so that the ac field is not removed from the tube rapidly. The coil is then unplugged and the rim magnets returned to their positions. If good purity still cannot be obtained in the red field, the yoke or the picture tube is defective. In some special cases, however, trouble may be caused by strong magnetic fields in the neighborhood, such as by subway cables.

After good red purity has been obtained, the green and blue fields are checked in a similar manner. Generally these will fall into satisfactory purity, although slight compromise adjustments may have to be made in some cases. If necessary, it is best to favor the red field since it dominates the flesh tones of which viewers are most critical.

Make certain that the high-voltage value is correct and that any necessary width, height, linearity and drive adjustments have been made. These will affect the accuracy of convergence to a greater or lesser extent and will waste time unless attended to before the convergence procedure.

With preliminaries out of the way, note the three beam magnets on the neck of the picture tube, mounted behind the yoke. Most present-day beam-magnet arrangements have small knobs for making adjustments. In some receivers, the beam magnets slide in and

out of strap brackets. The three beam magnets are supplemented in nearly all cases by a blue lateral corrector magnet, mounted behind the purity magnet. The magnet is a rod which slides in and out of its strap mount. The blue lateral corrector is adjusted in conjunction with the three beam magnets. Adjustment is made upon the basis of indication provided by a pattern generator. A white-dot pattern (Fig. 109) or a white crosshatch pattern (Fig. 110) can

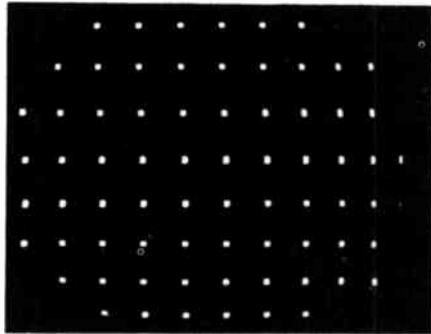

Fig. 109. *Typical white dot pattern.*

be used. Either is satisfactory, but note that random patterns such as program material are quite unsuitable.

When the beams are converged on the screen, the pattern appears white; but where misconvergence exists the dots or lines do

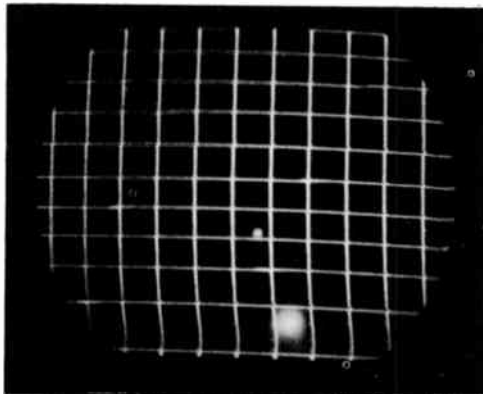

Fig. 110. *Crosshatch pattern (white cross-hatch).*

not appear white—instead they are split up into colored dots or lines (Fig. 111). Convergence is a process of eliminating the color split-up and obtaining a pure white pattern. Here are some useful rules:

1. The red beam magnet will move the red dots diagonally on the screen.

2. The green beam magnet will move the green dots on the opposite diagonal. Hence, there is always a crossover or merging point for the green and red dots.

3. The blue beam magnet moves the blue dots straight up and down.

4. The blue lateral corrector moves the blue dots left and right.

5. Adjustments of the three beam magnets and the blue lateral corrector produce the same motion of the dots at all points.

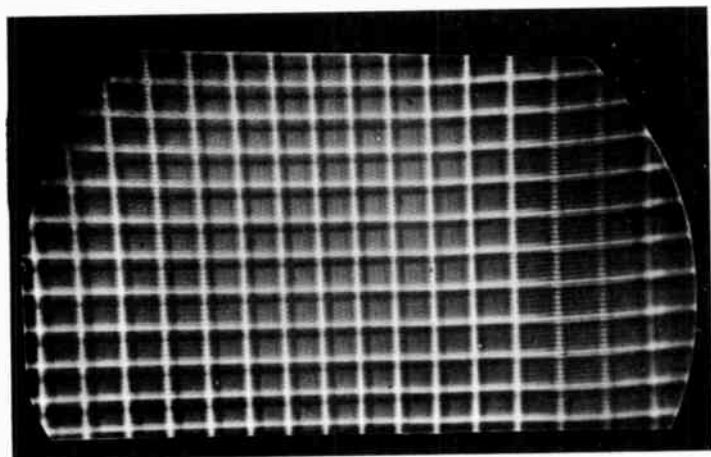

Fig. 111. *Crosshatch pattern displayed on misconverged picture tube.*

At the outset of the convergence procedure, the red and green beam magnets are adjusted to merge the red and green dots or lines at the center of the screen. If convergence is not obtained at the edges or top and bottom, do not concern yourself about it, as other controls are provided for this purpose. Next, the blue beam magnet and the blue lateral corrector are adjusted to merge the blue dots or lines with the (yellow) lines in the center of the screen. The red and green combination produces yellow, and a combination of red, green and blue produces white. At this point, white dots or lines will be obtainable only in the central area of the screen, except in the case where a touchup adjustment may suffice.

If the receiver is considerably out of adjustment, the screen controls may have to be turned to obtain a balance of red, green and blue to make the converged pattern in the center of the screen ap-

pear truly white. In case considerable adjustment of the beam magnets and blue lateral corrector has been required, return to the purity checks at this point and make certain that proper purity is obtained.

Now proceed to the dynamic convergence controls. There are usually 12 of these, and sometimes 13. They are grouped into red, blue, and green controls, into horizontal and vertical controls and into amplitude and phase (or tilt) controls. We are first concerned with the vertical amplitude and tilt controls for red, green and blue. We turn to the vertical center column of dots on the screen (Fig. 112) and disregard the rest of the pattern. And at this point, we

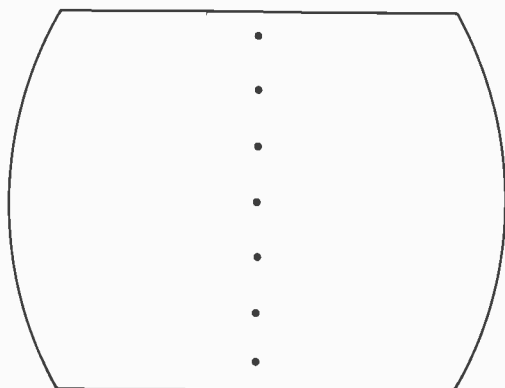

Fig. 112. To make the vertical dynamic convergence adjustments, focus your attention on the vertical column of dots down the center of the screen.

may observe another very useful rule: In this vertical column of dots, the *blue* dots indicate the direction of final convergence. This rule is based on the fact that no adjustment of the vertical amplitude or tilt controls can make the blue dots lean or curve—only the relative spacing between the blue dots can be changed by adjustment of the blue vertical amplitude and tilt controls.

The blue vertical amplitude and tilt controls thus do not require immediate attention and the first job is to bring the red dots and green dots into columns parallel with the blue dots. Fig. 113 shows the dots separated in parallel columns. Now, note this very important fact:

When the red, blue and green dots appear in parallel columns, adjustment of the beam magnets and blue lateral corrector will serve to merge all the dots and obtain final convergence.

The reason for this follows from the principle noted earlier: ad-

justment of the three beam magnets and blue lateral corrector produces the *same* motion of the dots at *all* points on the screen.

Of course, the trick is first to get the color dots lined up in parallel columns. This is accomplished by the vertical dynamic convergence

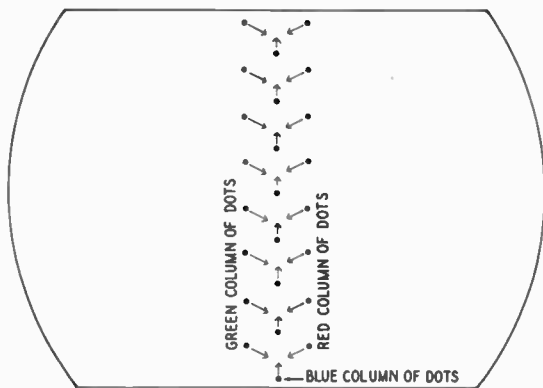

Fig. 113. *Dynamic convergence brings the red, green and blue dots into parallel columns.*

controls. It is often helpful to disable the blue gun at the beginning and to work with the red and green dots only. This simplifies the pattern and, *once the green and red dots have been converged to a column of yellow dots, the blue dots can then be easily merged with the yellow dots.* The vertical tilt controls, as their names indicate, have the effect of tilting or inclining the dot column. The vertical amplitude controls alter the spacing of dots from each other.

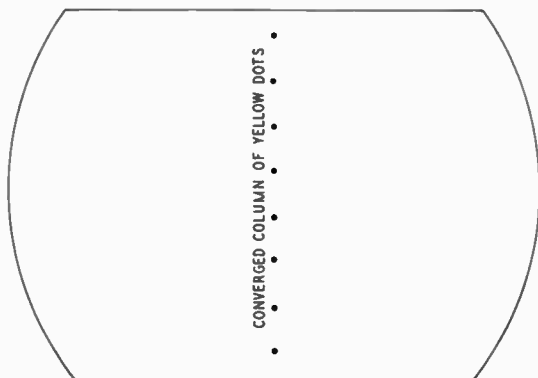

Fig. 114. *The columns of red and green dots converge to a column of yellow dots.*

With the blue gun disabled and paying attention, of course, only to the vertical column of dots in the center of the screen, we adjust

the red and the green vertical amplitude and tilt controls as required to form a column of yellow dots (Fig. 114). As these controls are being adjusted, we usually find that the center convergence begins to go out, so that the yellow dots in the center screen split up into red and green color dots. *Always keep touching up the red and green beam magnets so that center-screen convergence is maintained.*

Eventually, by working back and forth between the vertical tilt and amplitude controls for red and green (with touchup of the magnets as necessary) a converged column of yellow dots will be obtained down the center of the screen. Sometimes it is not possible to obtain perfect convergence at the extreme top and bottom of the column, but the residual misconvergence will not be visible unless the viewer is close to the screen.

Next, the blue gun is started up and the blue beam magnet and lateral corrector are adjusted to produce white dots at the center of the column. Then, the blue vertical tilt and vertical amplitude controls are adjusted to produce white dots all the way up and down the column. While moving the blue vertical tilt and amplitude controls, it is usually necessary to touch up the blue beam magnet and lateral corrector at intervals to maintain white dots at the center of the column.

When the red and green dots have been converged to yellow dots, the column of yellow dots is necessarily straight and parallel to the blue dots—any adjustment of the blue tilt and amplitude controls only changes the relative *spacing* of the blue dots from one another. However, in case very large adjustments are required in the blue dynamic controls, the previous convergence of red and green may have been affected slightly and final convergence will require some touchup adjustment of the red and green dynamic controls. The final result is a column of white dots down the center of the screen, with perhaps a very slight misconvergence at the extreme ends of the column.

We now proceed to horizontal dynamic convergence. The operator focuses his attention on the horizontal line of dots across the center of the screen (Fig. 115). All other dots are disregarded. Note that both horizontal amplitude and phase controls are provided for the red, blue and green beams. We are first concerned with the three phase controls. These are slug-tuned coils, to be tuned or resonated before proceeding further. Start with the red phasing coil. Turn the green and blue horizontal amplitude controls to minimum, turn the red amplitude control to maximum, and observe the red row of dots as the slug is turned in the red phasing

coil. As you approach resonance, the row of red dots starts to move, especially in the center. The slug will go through a peak, in which the dots have a maximum curvature at the center—this is the desired point of adjustment. When the peak is obtained, observe the curve for symmetry—the dots at the ends of the row should fall at the same height on the screen. Of course, a final touchup of phase can be made later, if necessary.

Next, resonate the blue horizontal phasing coil. Turn the blue horizontal amplitude control to maximum, and the red and green

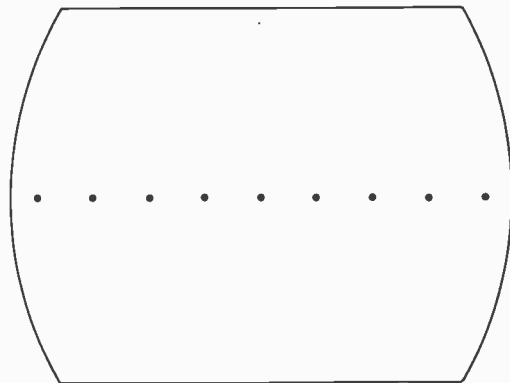

Fig. 115. Horizontal dynamic convergence is made with respect to the horizontal center row of dots across the screen.

horizontal amplitude controls to minimum. Adjust the blue phasing coil to peak the row of blue dots. Resonate the green horizontal phasing coil. Turn the green horizontal amplitude control to maximum and the blue and red horizontal amplitude controls to minimum. Adjust the green phasing coil to peak the row of green dots.

Now turn all three horizontal amplitude controls to minimum. Touch up the beam magnets, if necessary, to obtain convergence at the center of the row. You will observe that the convergence becomes progressively poorer toward the left and right ends of the row. Adjust the blue dynamic amplitude and phase controls as required to form a straight line of horizontal blue dots. At this point use a sheet of paper or a ruler to check the straightness of the blue row of dots. The blue beam magnet and lateral corrector are then touched up again, if required, for convergence at the center of the row.

The next step is to adjust the green horizontal dynamic amplitude and phase controls to obtain equal spacings of green and blue dots. With equal spacing along the row, the green and blue dots can then be converged with the beam magnets. Then, the red horizontal dynamic amplitude and phase controls are adjusted to equal

spacings of the red dots from the blue dots across the horizontal row. The beam magnets will then bring the horizontal row into proper convergence. However, if extensive adjustments have been made on the red controls, it may be necessary to recheck the blue and green controls. Likewise, extensive adjustments of the horizontal controls may require a touchup of the vertical dynamic controls.

It is generally somewhat more difficult to obtain good convergence at the ends of the horizontal row than at the ends of the vertical row. For this reason, some receivers provide a horizontal convergence trimmer coil mounted on top of the yoke. The slug in this trimmer coil can be moved in or out as required to obtain a final horizontal edge correction.

This completes the convergence procedure. A recheck of purity is advisable since convergence adjustments may affect purity. Chart 1-2 gives a resume of the convergence procedure.

Tracking the scanning beams

The picture tube beam currents are not linear functions of the applied voltage. Instead the light output increases faster than the applied voltage. That is, the red, green and blue guns have non-linear characteristics. Furthermore, the characteristic is somewhat different for each gun. If the light output from a gun is plotted against grid or screen voltage, the characteristic curves upward. This curvature is different for red, green and blue guns.

Hence, the screen and brightness controls for each gun are adjusted to make the characteristics *cross over* at two or more points so that the raster maintains a neutral gray hue for all usable settings of the contrast and master brightness control. This is analogous to tracking the rf amplifier and oscillator in a superheterodyne receiver. It is not possible to track the circuits exactly but adjustments can be made for two or more crossover points so that practical uniformity is realized. Similarly, the outputs from the red, green and blue guns are adjusted so that practical uniformity of light radiation from the three screen phosphors is obtained.

To track the picture tube, tune the receiver to a black-and-white program. Set the master brightness and contrast controls for a normal picture. Then, advance the red, blue and green screen controls to maximum, unless blooming and defocusing occur—in such case, keep the screen controls below the bloom point. Then, adjust the blue and green background (sometimes called brightness) controls to obtain white highlights in the brightest portions of the picture. If the green background control is set too high, the high-

Chart 1-2. Convergence Procedure

PRELIMINARY SETUP		
Control	How Adjusted	Remarks
Horizontal drive.	Usually advanced as far as possible without appearance of an overdrive (white vertical) line.	Horizontal drive must be set up at the outset because it affects horizontal dynamic convergence.
Horizontal linearity.	Adjust to obtain uniform horizontal spacing on a white dot or crashtatch pattern.	Horizontal linearity adjustments will affect horizontal dynamic convergence.
Horizontal width.	Usually adjusted for slight overscanning of the color picture tube.	Horizontal width adjustments will affect horizontal dynamic convergence.
Horizontal hold.	Adjust to mid-range of lock on a black-and white program.	Convergence should be made at exactly 15,750 cycles since the horizontal oscillator frequency affects horizontal dynamic convergence.
Picture-tube accelerating voltage.	Usually 25,000 volts, but check manufacturer's service notes.	Incorrect accelerating voltage affects convergence, purity and focus.
Vertical linearity.	Adjust to obtain uniform vertical spacing on a white dot or crashtatch pattern.	Vertical linearity adjustments affect vertical dynamic convergence.
Vertical height.	Adjust for slight overscanning of the picture tube.	Vertical height adjustment affects vertical dynamic convergence.
Yoke position	Yoke must be properly positioned on neck of picture tube to obtain good purity.	Yoke will not need to be moved unless new picture tube is installed.
Purity magnet assembly.	The ring magnets are rotated with respect to each other, and as an assembly, to obtain the best screen purity.	The purity magnet assembly is the most important unit in providing good purity.

CONVERGENCE ADJUSTMENTS

Synchronization of white dot or crasshatch generator.	Sync the generator, if required, at exactly 15,750 cycles.	Incorrect frequency of horizontal operation will affect horizontal dynamic convergence.
Beam magnets and blue lateral corrector.	Adjust for best center-screen convergence.	These static convergence adjustments are touched up as required during the procedure to maintain center-screen convergence.
Red and green vertical dynamic amplitude and tilt controls.	These controls are adjusted to obtain convergence of the red and green beams along the vertical center line of the screen.	The blue gun may be disabled, if desired, to simplify the pattern during this procedure. Touch up static adjustments.
Blue vertical dynamic amplitude and tilt controls.	Adjust these controls to converge the blue dots with yellow along the vertical center line of the screen.	These controls affect only the relative spacings of the blue dots. Touch up the beam-magnet and lateral corrector adjustments as required.
Horizontal dynamic phase coils.	Tune the red, green and blue horizontal dynamic phasing coils for peak.	Horizontal dynamic amplitude control must be turned to maximum during adjustment of the coil. Then return amplitude control to minimum.
Blue dynamic amplitude and phase controls.	Adjust controls to obtain a straight horizontal line of blue dots across the center of the screen.	Use a straightedge across the screen, if necessary, to check on straightness of the line of dots.
Beam magnets and lateral corrector.	Touch up adjustment of these controls for best convergence at the center of the screen.	Dynamic convergence procedures start with good center convergence and progressively work in the dots (or lines) toward the screen edges.
Green horizontal dynamic amplitude and phase controls.	Adjust controls to obtain uniform spacing of the green dots from the blue.	Touch up beam magnets and lateral corrector for best center-screen convergence.
Red horizontal dynamic amplitude and phase controls.	Adjust controls to obtain equal spacings of the red dots from the blue (or cyan).	Touch up adjustments of the beam magnets and lateral corrector.

Note: Corner-screen convergence will automatically fall in when convergence is properly made along the vertical and horizontal lines through the center of the screen. There is no provision for touching up the corner areas of the screen.

lights will appear greenish. If set too low, the highlights will appear magenta. In most cases, only the highlights can be made white at this point in the procedure and the lowlights will very likely appear tinted. However, do not concern yourself with them here.

Now turn the master brightness control down so that the screen is considerably dimmer than before. Inspect the highlights for color tinting. If a red tint appears, adjust the red screen control to restore the white (or gray) highlights. Or, if a blue or green tint is seen, adjust the corresponding screen control to obtain white (or gray) highlights.

Advance the master brightness control again for normal brightness. Readjust the blue and green background controls as required to produce white highlights. Recheck the highlights when the master brightness control is turned down and repeat the steps, if required. When the tracking is acceptable, no tinting of the picture will be visible at any usable setting of the master brightness control.

Color picture tubes have rather wide tolerances and when a picture tube is replaced, the tracking adjustments, like the convergence adjustments, will have to be made "from scratch."

Adjustment of phasing and intensity controls

Adjustment of color phasing and intensity controls is best accomplished with a TV color program. Otherwise a color bar or rainbow generator signal must be used. Viewers of color receivers usually appreciate the opportunity to watch and ask questions about the operating controls; few nontechnical persons ever reach the point where they feel sure they are obtaining the best possible color picture. It is hardly possible to give the layman too much instruction and it is appreciated by most customers. These points should be explained:

1. Selecting the desired channel with the channel-selector switch.
2. Adjustment for best color with the fine-tuning control. Point out the 920-kc beat between sound and chroma signals to the customer and show how the best color is received at the point where the beat is eliminated.
3. Adjustment of the contrast and master brightness controls for best picture.
4. Adjustment of the color-intensity control for the proper proportion of color.
5. Adjustment of the color phasing control for best flesh tones.

The adjustments of the controls are not the same on various channels, due to difference of signal levels, antenna and receiver

characteristics. When height, linearity and hold controls are mounted with the color intensity and phasing controls, caution the customer not to turn these. This point should be made very clear because viewers sometimes feel that "it won't hurt" to see what happens when the service controls are turned. The result is a callback.

A station program is the best signal to use in setup procedures. In the first place, the setting of the color intensity control is seldom the same for both a generator and a given station signal. Further, a station signal takes into account the antenna and lead-in characteristics, which sometimes affect the setting of the color phasing control.

It is sometimes asked whether the color stripe can be used for setup of the operating controls; stripe indication is too indefinite to obtain accurate settings and is generally impractical. Color stripes are transmitted as vertical bars at the left and right-hand edges of a monochrome picture, and appear as "barber poles." Sometimes the color subcarrier oscillator in the receiver will happen to zero-beat with the signal and a single uniform color may appear up and down the stripe. Also, depending upon the setting of the horizontal-hold control, either the left- or right-hand bar may not be visible.

The color stripe is a greenish-yellow signal transmitted to facilitate installation and initial checks of color receivers during the time that a color program may not be on the air. Many factors can impair color reception which would not seriously affect monochrome reception—narrow-band antennas, impedance mismatches, minor misalignment of the signal circuits, some conditions of multipath reception, etc.

The color stripe is a greenish-yellow hue because it has the least visibility on a black-and-white receiver and produces the least interference. On a black-and-white set, the color stripe may be completely invisible, or it may appear as a faint vertical herringbone bar. The herringbone is invisible at normal viewing distance.

When the color intensity control is advanced on a color receiver, the color stripe appears as a barber-pole display of red, green and blue spirals. Adjustment of receiver controls may serve to zero beat the stripe so that it appears as a continuous hue with no color break-up. To obtain normal coloration of the stripe—greenish yellow at the correct setting of the color-phasing control, connect a capacitor into the burst-amplifier keying circuit to delay the keying pulse so that the burst amplifier is gated somewhat later than in normal operation. To insert the capacitor so that the color-stripe can be

locked in color sync, consult the service notes for the receiver.

The following fundamental points of color bar and rainbow generators will be noted here:

1. The simplest rainbow generators provide a pattern such as in Fig. 116. As the color phasing control is turned, the entire spectrum moves horizontally on the screen. Correct adjustment of the phasing control is obtained when the left-hand edge of the screen is a

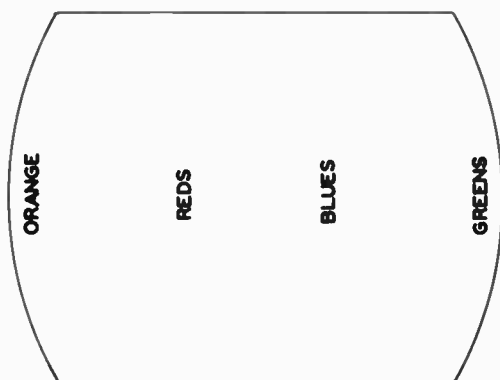

Fig. 116. A simple rainbow pattern is a spectrum of color-difference signals.

dim orange, merging into red; the red merges into blues in the center screen area, and the blues finally merge into greens at the right-hand edge of the screen.

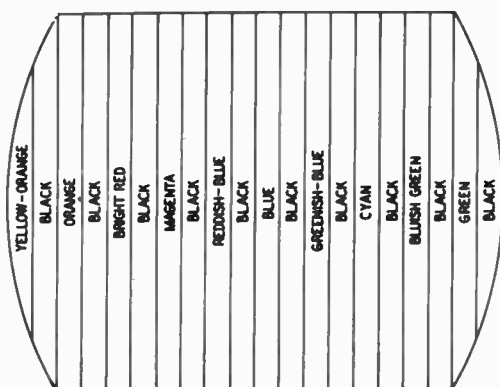

Fig. 117. In a keyed rainbow generator, the spectrum is broken up into stripes by black bars.

2. More elaborate rainbow generators key the rainbow pattern into stripes (Fig. 117). This type of pattern is more accurate since

the individual bars can be localized and compared with a rainbow chart.

3. The most complete color bar generators provide a test signal consisting of bars of true saturated color, as indicated in Fig. 118. The signal is termed an NTSC signal and is equivalent to a color test pattern transmitted from a TV station.

Regardless of the type of color bar generator, there is a definite

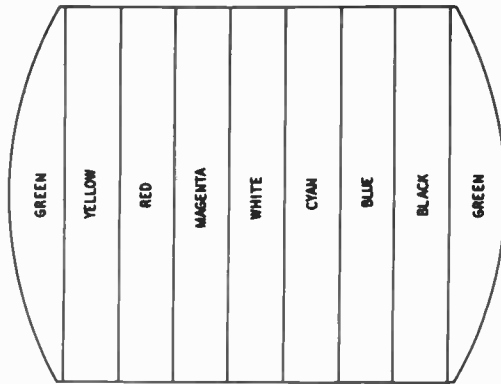

Fig. 118. Typical pattern for an NTSC color bar generator. True colors are displayed, plus black-and-white bars.

sequence of colors obtained from left to right when the color phasing control is properly adjusted. The better generators provide a sound carrier so that the fine-tuning control can be properly adjusted for rejection of the 920-kc beat, at which point the color reproduction is normal.

Color reproduction vs. ambient light

The colors displayed on the screen, whether obtained from a station transmission, NTSC color bar generator or rainbow generator, will undergo a change when the ambient light falling on the screen of the picture tube changes. Thus, if a strong white light is directed on the screen of the tube, all colors will lose saturation. In total darkness, the reproduced colors have maximum saturation but viewing of the screen in total darkness is fatiguing to the eye. A small amount of neutral illumination is desirable.

In case the color picture tube is balanced in tracking during daylight or reduced daylight, the neutral gray raster which is obtained will become tinted with color under various conditions of artificial illumination. The raster which appeared gray or white in

daylight will take on various tints when illuminated by tungsten lamplight, fluorescent light or from various shaded lamps.

It is advisable to explain this in detail to the customer and to balance the raster under the condition of illumination which will exist. The balance adjustments are somewhat complex and it is impractical for the layman to attempt to adjust the color balance for daytime or nighttime viewing. However, by experimenting with the available lamps and shades, a selection can be made which will cause the least change in raster tinting from daylight to artificial lighting.

Antenna Pointers

1. Check the antenna connections at the receiver for corrosion and poor contact.
2. Check the antenna connections at the antenna end for corrosion and poor contact.
3. Is the antenna corroded or covered with soot?
4. Is the lead-in frayed, broken, or touching the building or antenna mast?
5. Has the antenna changed orientation?
6. Has a second receiver been attached to the antenna without the owner's knowledge?
7. Has the antenna been blown away or removed by the landlord without the owner's knowledge?
8. Is the lightning arrester causing trouble due to leakage?
9. Has the owner been sold a replacement antenna lately that might not be suitable for color . . . especially the channel used for color?
10. Have any of the antenna elements been damaged or blown off so that the antenna response could change?

—Courtesy, Motorola, Inc.

color sync servicing

A COLOR receiver has a horizontal and a vertical sync system, just as a black-and-white set. But, in addition, the color receiver also has a color sync system. Servicing of the horizontal and vertical sync sections is nearly the same in a color receiver as in a black-and-white set, but a color sync system has different requirements. Loss of color sync, with maintenance of horizontal and vertical sync, is a common problem.

Loss of color component

When color sync is faulty, the most usual symptom is a display of rainbows. They may be stationary or may move across the screen. The number of rainbows which appear is determined by the amount that the subcarrier oscillator drifts away from 3.58 mc, due to loss of color sync. If the oscillator is running 60 cycles off frequency, one rainbow appears. Its stripes run horizontally across the screen. If the oscillator is 120 cycles off frequency, two rainbows will be displayed horizontally across the screen, etc. When the oscillator pulls out still farther, more rainbows appear and may have a noticeable diagonal slant. If the oscillator is 15,750 cycles off frequency, one rainbow is formed again but now the rainbow stripes are vertically up and down the screen. With the oscillator 31,500 cycles off frequency, two vertical rainbows are formed, etc.

Loss of color sync can also produce apparent disappearance of color when the subcarrier oscillator is much too high or low in frequency. The apparent disappearance of color results from the fact that a very large number of rainbows are produced, which may

move so fast that their colors blend into a gray. Fig. 201 shows details of the horizontal sync pulse and burst.

NOTE: Scanning of the color picture occurs at 525 lines per frame, interlaced 2 to 1. The horizontal scanning frequency is $2/455$ times the color subcarrier frequency, or 15,734.264 cps. The vertical scanning frequency is $2/525$ times the horizontal scanning frequency, or 59.94 cps. The burst frequency is $3.579545 \text{ mc} \pm .0003\%$. The scanning frequencies are quite close to the black-and-white scanning rates of 15,750 and 60 cps. The change in scanning rate of a color picture is required to obtain frequency interleaving and thereby to minimize interference between the chroma and monochrome components of the complete color signal.

Apparent loss of color sync occurs when the color-killer threshold control is set on the "ragged edge." Before making tests of

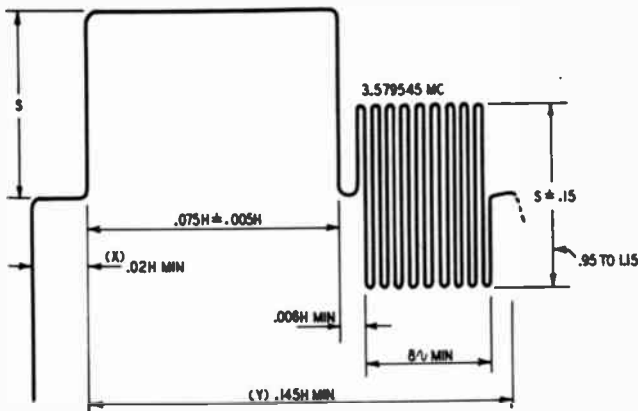

Fig. 201. The color burst follows each horizontal pulse, but is omitted following the equalizing pulses and during the broad vertical pulses. The burst consists of eight cycles of color subcarrier gated into the back porch of the horizontal sync pulse. The average value of the burst is at black level.

color sync circuit operation, the intensity control should be advanced to maximum and the color-killer threshold control to minimum. If loss of color sync is still evident, tests of the color sync circuits are in order. (It is assumed that the possibility of tube trouble has been checked). All receivers do not have color-killer controls; many provide manual control of the chrominance signal only and it is essential to determine the type of receiver at the outset.

Apparent loss of color sync also occurs upon occasion when the agc threshold control is set incorrectly with the result that the complete color signal is unduly attenuated in the high-frequency signal circuits. Most receivers have area-selector switches, and the agc threshold should be checked before assuming that circuit trouble is

present. The switch is usually accessible to the customer and may have been moved to an incorrect position. Children often turn all controls on a receiver, without their parents' knowledge, and nothing should be taken for granted in this regard.

Arrangement of color sync system

Fig. 202 shows a typical color sync system. Loss of color sync can result from the color subcarrier oscillator being forced so far off frequency (by circuit trouble) that the reactance tube cannot control the oscillator and bring it back to 3.58 mc. Likewise, it can result from a defective reactance-tube circuit or a fault in the color sync phase detector.

The color phase detector compares the phase of the burst signal with the phase of the color subcarrier oscillator signal output. If these phases are not the same, a positive or negative control voltage will appear at the output of the phase detector and is applied in turn to the grid of the reactance tube which operates to correct the phase of the color subcarrier oscillator. A reactance tube is an electronic capacitor or inductor (depending upon the particular circuit configuration of the reactance-tube section) and the value of capacitance or inductance which it presents to the oscillating crystal is determined by the value of grid bias applied to the reactance tube. This grid-bias variation must be held within close limits and must not be impaired by leaky capacitors, improper values of resistors in the phase detector circuit or incorrect adjustment of the phase detector balance control, or poor color sync will result.

The reactance tube bias may drift off-value, with the result that the color-subcarrier oscillator drifts and pulls off frequency.

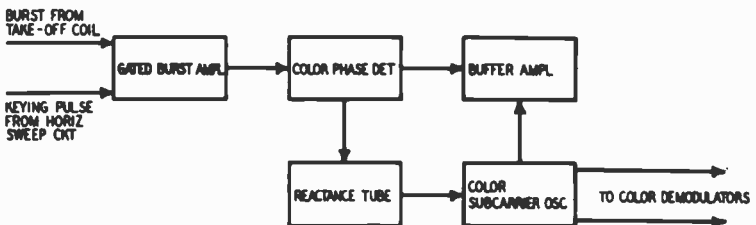

Fig. 202. The color afc detector monitors oscillator frequency drift.

Hence, the grid bias at the reactance tube is one of the key check points in the event of loss of color sync. Confusion sometimes exists between the conceptions of phase and frequency in regard to control of the subcarrier oscillator. Fundamentally, phase and frequency are very closely related and are two aspects of the same thing. If the

color subcarrier oscillator drifts slightly high in frequency, its phase will lead the phase of the burst; if the oscillator drifts slightly low in frequency, its phase will lag the phase of the burst. Hence, the phase detector is also a frequency detector, depending upon the point of view, and the control voltage developed by the phase detector serves to correct the frequency of the subcarrier oscillator via the reactance tube.

To insure that a clean burst voltage is made available to the color sync system, the burst amplifier is keyed by a gate pulse from the horizontal sweep circuit. The burst amplifier passes a signal only during the time that the burst signal is present, and the color picture signal is kept out of the burst amplifier. Attenuation or failure of this keying pulse results in loss of color sync. A typical keying circuit which operates with a gating pulse of approximately 35 peak-to-peak volts is shown in Fig. 203.

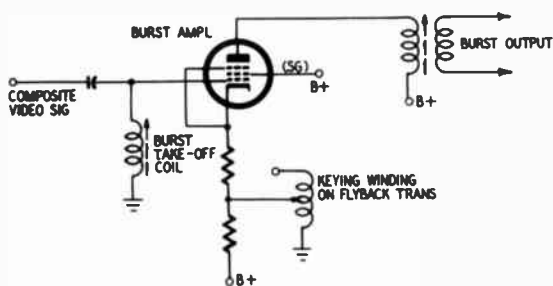

Fig. 203. The burst amplifier is keyed by a gate pulse from the sweep section.

In some receivers the gain of the bandpass amplifier is boosted during the burst interval by application of a keying pulse to the grid of the bandpass amplifier tube. This pulse lowers the bias on the grid during the burst interval. The voltage of the keying pulse is determined by the setting of the color intensity control and its associated circuitry. In this manner, the voltage of the burst signal which is applied to the color afc circuit is maintained essentially constant at different settings of the intensity control.

Best color sync action is obtained when the amplitude of the burst signal is maintained at the optimum operating level (as specified in the receiver service manual). Circuit faults which cause an incorrect burst voltage to arrive at the color afc circuit will contribute to poor color sync. The burst should be traced by means of a wide-band scope and low-capacitance probe to analyze the burst channel for proper operation. Remember that some low-capacitance probes

may have substantial input capacitance and hence load the circuits under test if their impedance is high. Try to obtain a probe with the lowest possible input capacitance.

The color stripe does not normally appear during reception of black-and-white programs on a color receiver having a color-killer tube. The stripe is delayed with respect to the sync pulse and does not disable the color-killer tube. However, if the color-killer threshold control is set too low, the stripe signal will not be rejected and will appear as a barber pole on the screen. This is not a fault of the color sync circuits but of improper setting of the color-killer threshold control.

The burst takeoff coil must be properly tuned to 3.58 mc, or the color sync voltage will suffer proportional attenuation. Improper tuning of the burst takeoff coil also permits spurious signals at other frequencies to get into the color sync system and cause trouble. The coil may be peaked by use of a wide-band scope, color bar generator or accurate signal generator. A vtvm can be used with a high-frequency probe, instead of a scope. A trick sometimes used when a signal generator is not available is to obtain a 3.58-mc test signal by coupling some of the color subcarrier oscillator signal back into the video amplifier. This expedient works only when the oscillator is free-running and fails when a ringing circuit is used for the color subcarrier oscillator.

When the color subcarrier oscillator is used as a source of 3.58-mc test signal, suitable coupling must be employed so that operation of the oscillator circuit is not disturbed. A satisfactory method is to use a test lead terminated by alligator clips. This lead, can be clipped over the insulation of the color subcarrier oscillator plate lead, and the other end clipped over the insulation of the first video amplifier grid lead. If too much signal voltage is obtained, insert a piece of tape under the clip to reduce the coupling.

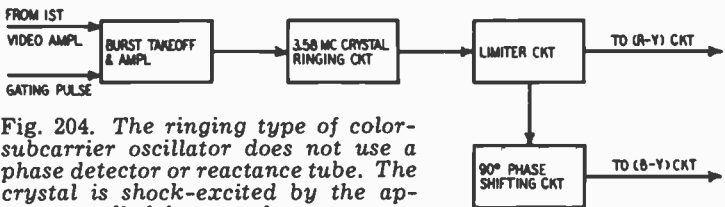

Fig. 204. The ringing type of color-subcarrier oscillator does not use a phase detector or reactance tube. The crystal is shock-excited by the applied burst voltage.

Likewise, application of the wide-band scope must not disturb circuit operation. A low-capacitance probe is useful for this purpose and a low-impedance signal takeoff point should be chosen. The phase detector tube will serve as satisfactory isolation between the

Chart 2-1. Servicing of Color-Sync and Associated Chroma Circuits

Complaint	Instruments Used	Procedure
No color sync. Video and audio ok.	Color-bar generator, vtvm, wide-band scope, heterodyne frequency meter (crystal-calibrated).	Check color phase detector, reactance tube, and color subcarrier oscillator. If grid bias of reactance tube is abnormal, temporarily short its grid to ground; if out-of-sync color appears, check out the color subcarrier oscillator. Check phase detector operation. Check reactance tube circuit. (See text for methods of checking.)
Intermittent color sync. Video and audio ok.	Color-bar generator, vtvm, wide-band scope.	Use same receiver control settings as in operation with antenna. Check the color-sync action, using the signal from the color bar generator. If operation is ok with generator, check the antenna installation. If operation is faulty on generator signal, check color subcarrier oscillator, color afc detector, reactance tube circuit and burst amplifier.
Intermittent or no color sync. Color intensity control must be advanced to maximum; color intensity in picture not up to normal.	Wide-band scope and low-capacitance probe. Color bar generator.	Check at output of picture detector for proper level of burst. If subnormal, check antenna installation. Check burst at picture detector, using color-bar signal. If burst is subnormal, check the picture detector diode. Finally, check if and rf alignment. (If burst is ok at picture detector, check burst levels subsequently through the color sync system with scope and probe.)
Color sync drops into lock with difficulty when receiver is switched from another channel. Lock is ok, once the circuits are caught in sync.	Color bar generator, heterodyne frequency meter, vtvm.	Check color afc output bus for zero volts — adjust balance potentiometer, if necessary. Check color-subcarrier oscillator (with receiver tuned to vacant channel) for off-frequency operation (use crystal-controlled heterodyne frequency meter). Check tuned circuits in color sync section for peak response at 3.58 mc.
Color sync lock uncertain, losing sync at times and then falling back into sync.	Wide-band scope.	Check burst level at picture detector. Trace burst through the subsequent color sync circuits, observing peak-to-peak voltages. Check peak-to-peak voltage of keying pulse at burst amplifier.

tuned burst takeoff coil and the scope input lead. Since the color sync circuits are critical, with close tolerances, use exact replacement parts in any repair work. An error of 5° in phase produces a visible color change. See chart 2-1 for servicing of color sync and associated chroma circuits.

Crystal-ringing circuits

Instead of utilizing a free-running oscillator, with a phase detector and reactance tube control, some color receivers employ a crystal-ringing circuit (Fig. 204). This is basically simpler than afc

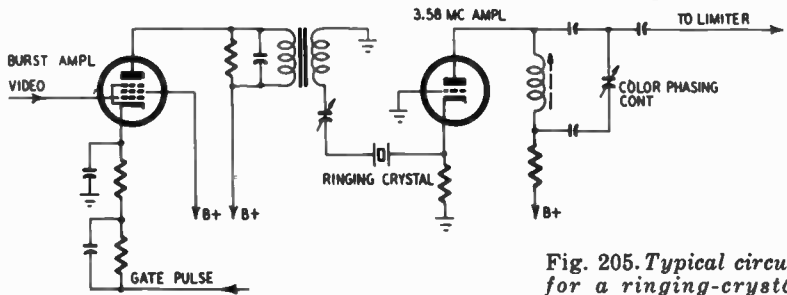

Fig. 205. Typical circuit for a ringing-crystal subcarrier oscillator.

color sync systems. The ringing type of color subcarrier oscillator does not have a phase detector or reactance tube. A limiter stage after the ringing circuit ensures a constant output voltage from the ringing-crystal source. The burst voltage from the signal circuits is applied to the 3.58-mc crystal, which is shock-excited and continues to ring between bursts by its flywheel action. The amplitude of the ringing voltage falls off somewhat between bursts and the limiter clips the output from the crystal so that the output is maintained at a constant voltage. Incorrect bias on the limiter tube can result in poor limiting action, so that color sync is impaired.

A trimmer capacitor is provided in series with the ringing crystal. This allows moving the ringing frequency to exactly 3.579545 mc. A trimmer capacitor is also provided at the output of the 3.58-mc amplifier to permit adjustment of the *phase* of the output subcarrier voltage. This is the color phasing control (a customer control) set to provide the best flesh tones. (See Fig 205.) General relationships of the principal color-difference (chroma) voltages with respect to burst phase are shown in Fig. 206.

A high-frequency crystal probe and a vtvm can be used to check operation of a free-running color subcarrier oscillator. The probe should *not* be applied at the grid or plate of the oscillator, but at a suitable low-impedance point which will not disturb oscillator

operation. Receiver service notes should be consulted or inspect the circuit diagram for a suitable test point. The level of the 3.58-mc voltage can be measured at the cathode of the subcarrier oscillator, with a normal level of 5 peak-to-peak volts present. Of course, a vtvm check of the color subcarrier voltage provides no information concerning frequency. When a frequency check is desired, a heterodyne frequency meter is convenient.

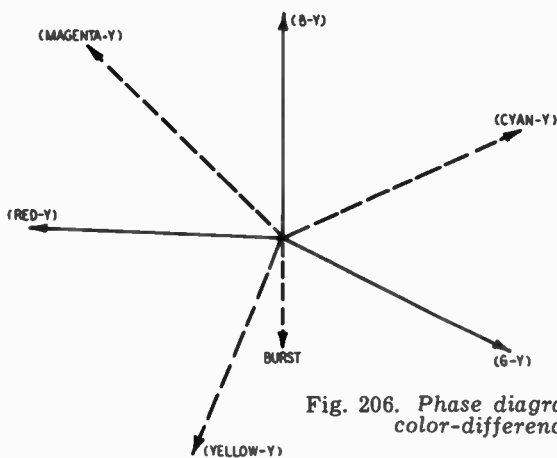

Fig. 206. Phase diagram of the chief color-difference signals.

In some color receivers, a gating pulse is applied to the chroma bandpass amplifier as well as the burst amplifier. The purpose of gating the burst amplifier is to insure that no signal is admitted except during the burst interval. The reason for gating the chroma bandpass amplifier is different inasmuch as the bandpass amplifier passes a signal continuously except when the burst is present. Depending upon the receiver circuits, the bandpass amplifier may be disabled by the gating pulse during passage of the burst or the gain of the bandpass amplifier may be increased during the burst passage if the color sync takeoff follows the bandpass amplifier. The latter type of gain gate is used in some receivers to obtain the desired keying actions and also to insure that adequate burst voltage is passed to maintain color sync lock, even at low settings of the color intensity control. Receivers which have dc restorers at the picture-tube grids must prevent passage of the burst through the bandpass amplifier to avoid disturbance of dc restorer operation.

Subcarrier oscillator and buffer amplifier circuits

A free-running 3.58-mc oscillator is used in most present-day color chassis. The circuit provides its own test signal and the oscil-

lator tank coil and buffer coils can be tuned by utilizing the output from the oscillating 3.58-mc crystal. An external signal source, such as a signal generator, is not required. A wide-band scope or a vtvm can be used as an output indicator at the output of a color demodulator. The color demodulator serves as a conventional detector and a vtvm can be operated on its dc ranges.

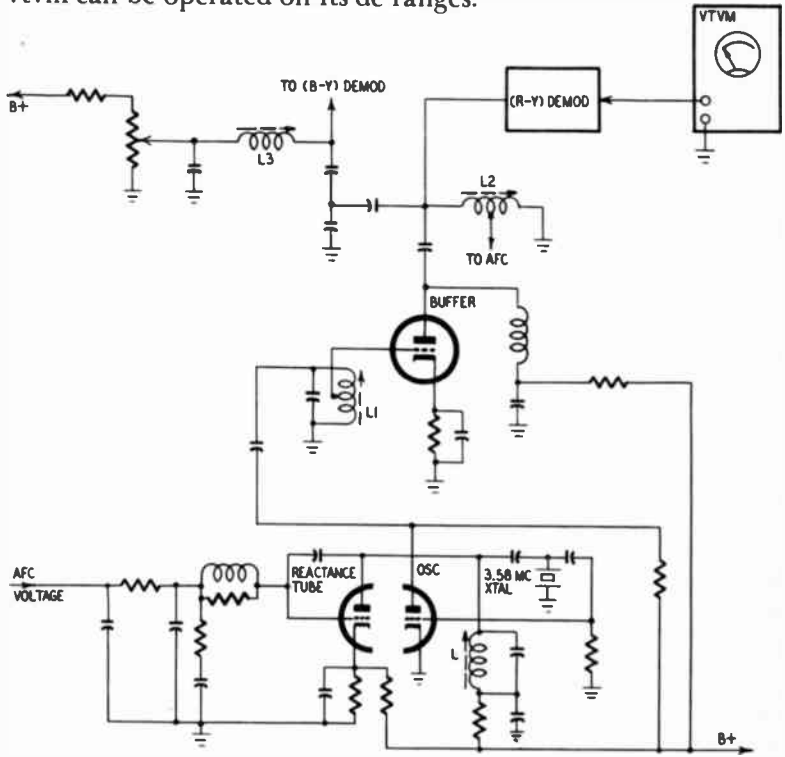

Fig. 207. Typical circuit arrangement for a color subcarrier oscillator, buffer stage and reactance-tube circuit. L_1 is the oscillator plate tank coil; L_2 is the buffer plate coil and L_3 is the quadrature coil. (Courtesy of Motorola, Inc.)

Fig. 207 shows a typical arrangement for a subcarrier oscillator, buffer stage and (R - Y) chroma demodulator. When this section is being checked or adjusted, feedthrough interference voltages should be eliminated by suitable means, such as by biasing the if amplifier. The afc control-voltage bus is also grounded to avoid possible false indication from the afc output variation. If it is necessary to disable the burst amplifier circuit, the burst amplifier tube can be pulled. A dc vtvm may be connected at the output of the (R - Y) demodulator (Fig. 207) to serve as the tuning indicator. The oscillator plate-tank coil L_1 is tuned for maximum in-

dication on the vtvm. Likewise, the oscillator buffer plate coil L2 is tuned for maximum response. However, quadrature coil L3 must be adjusted for minimum response.

Color-sync afc circuits

The burst amplifier tube (Fig. 208) receives the complete color signal but conducts only during the burst interval. A keying voltage

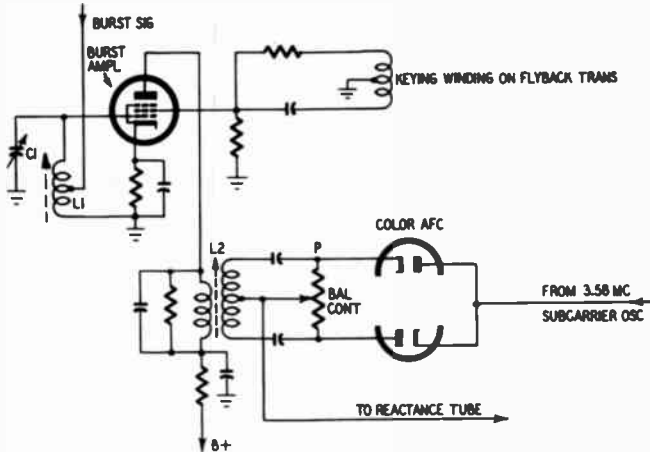

Fig. 208. Burst amplifier and color afc circuits.

is applied to the screen of the tube and the waveform and peak-to-peak voltage of the keying pulse can be checked with a scope and low-capacitance probe at the screen of the burst amplifier. This screen keying voltage is obtained from the flyback transformer, and is the flyback pulse which is suitably delayed through an R-C circuit shown in Fig. 208. The coupling transformer L2 from the burst amplifier to the afc diodes is tuned for maximum output. The balance potentiometer is adjusted for best weak-signal color sync. L1 is tuned slightly off 3.58 mc, if necessary, to obtain a null (zero volt) of burst pulse, as indicated by a scope applied at the (R - Y) detector output. When a color stripe signal is to be locked in color sync, it is the time constant of the R-C circuit which is increased to lock the stripe.

The output from the burst amplifier is applied to the color afc phase detector, which compares the phase (and frequency) of the burst signal with that of the color subcarrier oscillator output. If the oscillator signal leads or lags the burst phase, a positive or negative corrective voltage is developed by the phase detector, which is

applied in turn to the reactance tube for correction of the subcarrier oscillator signal. *In normal operation, the color afc balance is adjusted for zero-volt output from the color afc phase detector.*

The burst amplifier grid tank L1, the coupling transformer L2 to the phase detector and the plate coil in the reactance tube circuit (Fig. 207), are each tuned to 3.58 mc for proper operation. A signal source is required, and a color bar generator providing sync and burst or a color transmission may be utilized. A dc vtvm is convenient for indicating resonance; the vtvm is applied at a suitable point, such as at P in Fig. 208. The meter indication is the sum of the burst and subcarrier oscillator voltages.

When making afc balance adjustments, first determine that the operation of the color subcarrier oscillator is ok; otherwise output voltage and frequency should first be corrected, using a vtvm and heterodyne frequency meter as indicators, respectively. To proceed to afc balance adjustments, set the receiver controls to provide a normal burst signal to the burst amplifier. A color bar generator or a station signal can be used. The color phasing control is set to the midpoint of its range. The burst amplifier grid coil and coupling transformer L2 should be previously peaked for maximum indication on a vtvm.

To check balance, a vtvm is applied at the arm of the afc balance potentiometer. The reactance tube plate coil L in Fig. 207 is tuned to bring the pattern into color sync and to make the vtvm indicate zero volt. The setting of the color afc balance control is then checked by reducing the input signal to the receiver until the picture loses color sync; readjust the afc balance potentiometer for best color sync. A color bar generator is most convenient because the burst voltage is usually adjustable. Attenuators of color bar generators are often inadequate to obtain the desired variation of signal output. If an antenna signal is utilized, pads can be inserted between the lead-in and the receiver to obtain the various reductions of signal level required.

Finally, to check balance, restore the burst voltage to normal, connect the scope at a convenient point in the (R — Y) output circuit and adjust L1 (Fig. 208) to bring the burst pulse to zero as seen on the scope screen.

It is treacherous to try to draw general conclusions in case of color sync trouble without first inspecting the arrangement of the particular receiver. For example, compare the two typical configurations of Fig. 209 and Fig. 210. In Fig. 209, the output from the bandpass amplifier is applied to *both* the burst amplifier and

the color demodulators. However, in Fig. 210 the burst amplifier and the color demodulators are driven from separate sources. In Fig. 210, the output from the bandpass amplifier is applied to the color

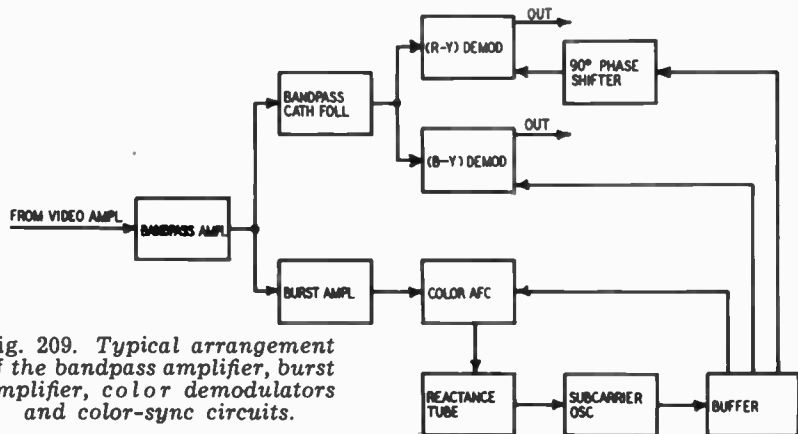

Fig. 209. Typical arrangement of the bandpass amplifier, burst amplifier, color demodulators and color-sync circuits.

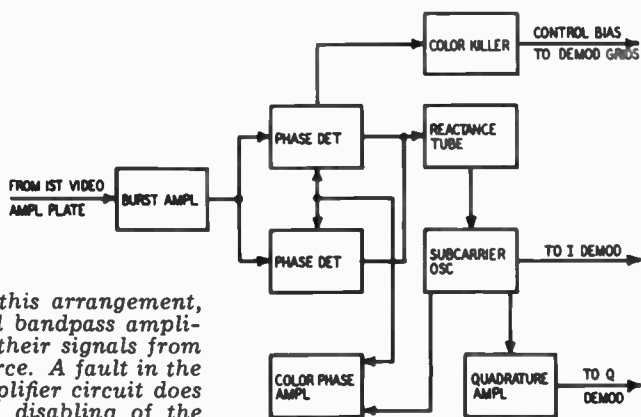
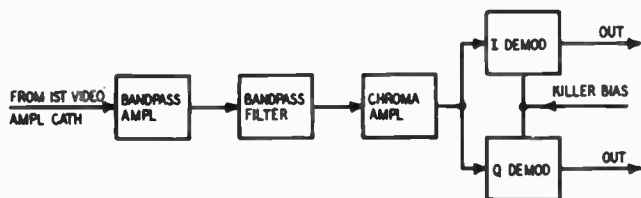

Fig. 210. In this arrangement, the burst and bandpass amplifiers receive their signals from the same source. A fault in the bandpass amplifier circuit does not result in disabling of the color-sync system, as is the case in the arrangement shown in Fig. 209.



demodulators but the burst amplifier derives its signal prior to the bandpass amplifier. Thus, in Fig. 210, a fault in the bandpass amplifier does not affect operation of the color sync circuits but will affect color reproduction. In Fig. 209, a fault in the bandpass

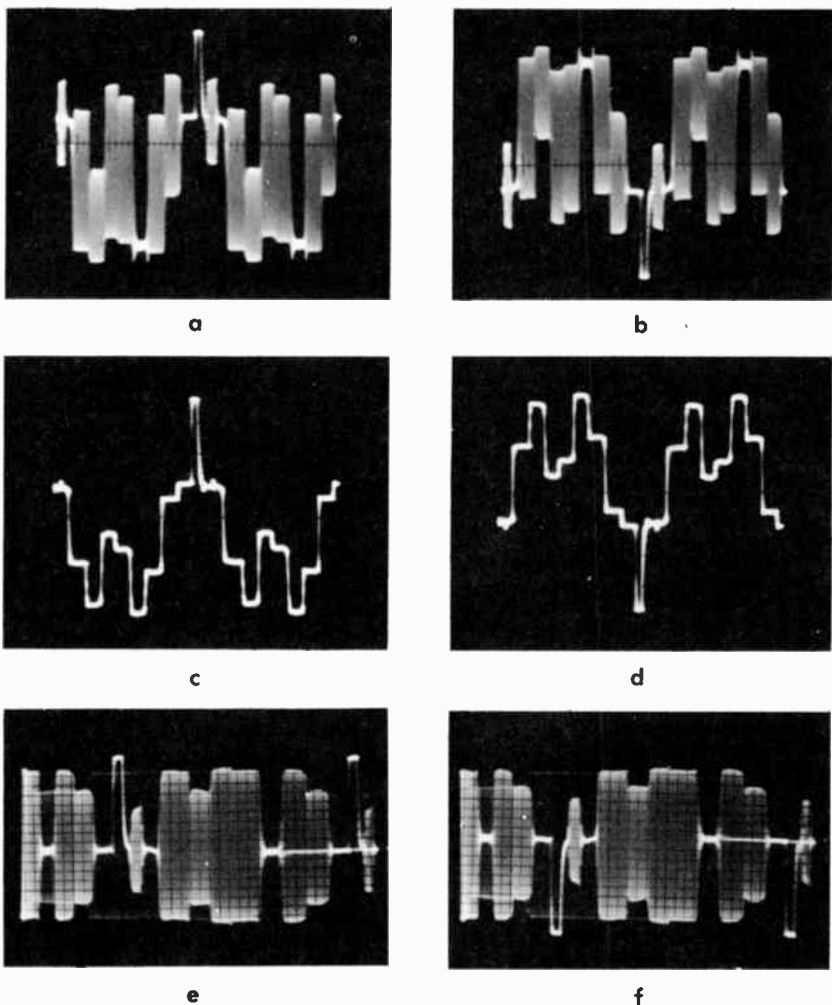
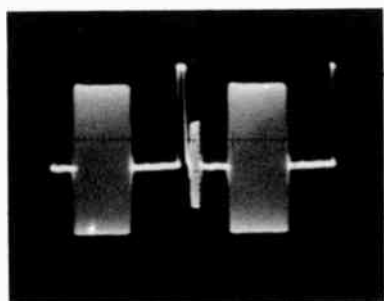

Fig. 211 (a to f). *Typical video-frequency outputs from an NTSC color-bar generator.*

amplifier will be evident in both color sync and picture. Note carefully, too, that in Fig. 210, a fault in the burst amplifier can result in partial or complete disabling of the chrominance circuits by applying excessive bias to the color demodulators.

Video-frequency output and color-sync servicing

Service color bar generators of the NTSC type sometimes provide video-frequency signals with either positive- or negative-going output and a crystal-controlled 3.58-mc output which are often very



g

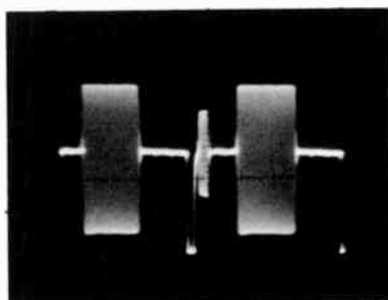

h

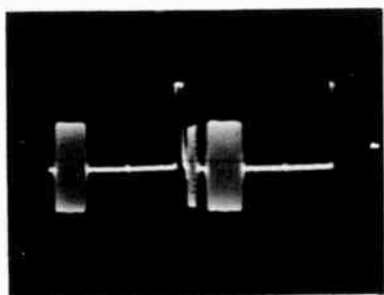

i

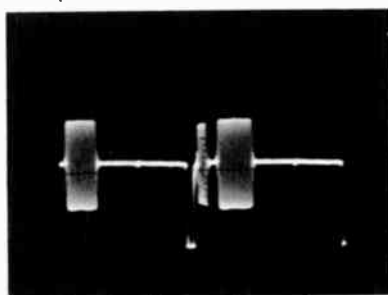

j

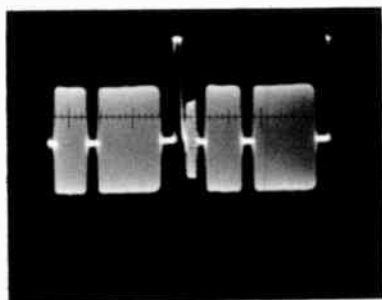

k

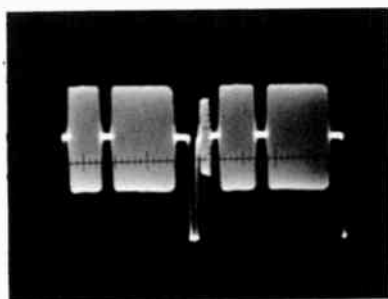

l

Fig. 211 (g to l). Typical video-frequency outputs from an NTSC color-bar generator.

helpful in servicing difficult color sync situations. The video-frequency output from a typical color bar generator is adjustable over a range of 0–2 peak-to-peak volts. Such an output, in suitable polarity, is applicable in signal-substitution tests.

Typical video-frequency outputs from an NTSC type of color bar generator are illustrated in Fig. 211. At (a) is shown a complete color bar signal, in positive polarity; (b) shows the same signal, with the generator reversing switch thrown to obtain an output of

negative polarity. (c) is the Y component of the color bar signal in positive polarity and (d) shows it in negative polarity. (e) is the chrominance component of the color bar signal and is negative polarity (and f is positive polarity). (g) shows an (R - Y) chrominance signal in positive polarity and (h) shows the same signal in negative polarity. (i) shows an I signal in positive polarity and (j) the same signal in negative polarity. (k) illustrates I and Q signals in positive polarity and (l) shows them in negative polarity. Of course, it is impossible for the viewer to distinguish between (R - Y) and (B - Y) and between I and Q signals on the basis of this type of display—such distinction can only be made visible by means of a vectorimeter type of display.

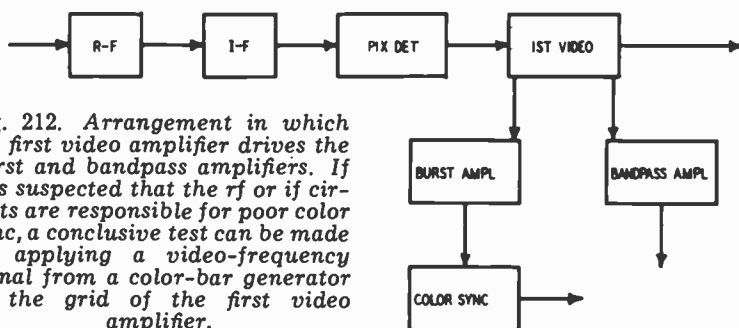

Fig. 212. Arrangement in which the first video amplifier drives the burst and bandpass amplifiers. If it is suspected that the rf or if circuits are responsible for poor color sync, a conclusive test can be made by applying a video-frequency signal from a color-bar generator to the grid of the first video amplifier.

Fig. 212 shows a receiver arrangement in which the first video amplifier drives both the burst and the bandpass amplifiers. In the case of unsatisfactory color sync, the question can arise whether the fault is attributable wholly or partly to faulty operation of the rf and if sections of the receiver. The question develops particularly in situations in which the failure is marginal and permits the receiver to continue full although not normal operation. The question of rf or if trouble is easily answered by driving the first video amplifier with a video-frequency signal from the color bar generator. The output from the generator can be applied to the grid of the first video amplifier, using a blocking capacitor, if necessary, to avoid draining off grid bias.

The output signal from the picture detector may be positive- or negative-going, depending upon the video circuits. Inspect the circuit diagram for the receiver to determine the required polarity of video signal. Fig. 213 shows how to decide whether the color bar signal is positive or negative-going, by means of a scope test. To distinguish between positive- and negative-going pulses or signals, note whether the pulse extends downward or upward on the scope

screen. Some scopes have a polarity-indicating switch to advise the operator whether the beam will deflect upward on a positive, or negative signal. Other scopes have a fixed input arrangement, usually with upward deflection of the beam for a positive-going signal. However, this relation cannot be taken for granted—in case of doubt, apply the scope to a known signal source to determine the direction of beam deflection.

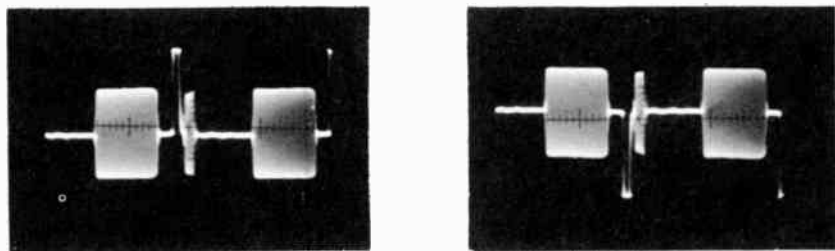

Fig. 213. Scope test shows whether pulse is positive- or negative-going.

The picture detector of a receiver is a good source of reference signals. If the picture detector has cathode output, the sync pulses will extend in the positive direction. If the picture detector has plate output, the sync pulses will extend in the negative direction. In case a germanium diode is utilized in the picture detector circuit, cathode output results in positive-going sync pulses; anode output in negative-going sync pulses.

The picture detector usually provides a peak-to-peak output from 1 to 2 peak-to-peak volts—this value can be determined from the published waveforms in the receiver service manual. The output from the generator should be set to the normal value for the receiver.

Check of color sync lock by variation of burst voltage

Due to antenna characteristics and to misalignment of the rf, if and chrominance circuits, the burst voltage often becomes attenuated while the Y signal is unaffected. The Y signal contains the horizontal sync pulse, which accounts for the fact that loss of color sync can take place independently of loss of horizontal and vertical sync when the antenna or signal circuits are faulty.

Color receivers are designed so that the color sync system, when properly adjusted, will lock in on a burst voltage which is much less than normal. A color bar generator often provides independent control of the burst voltage (Fig. 214), which helps troubleshoot-

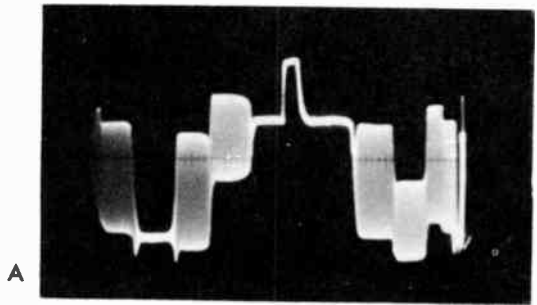

This photo shows no burst signal on the back porch of the blanking signal.

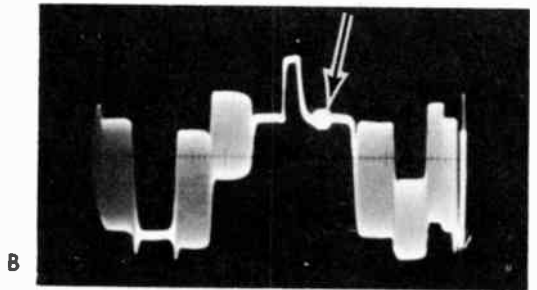

A small amount of burst signal now becomes evident.

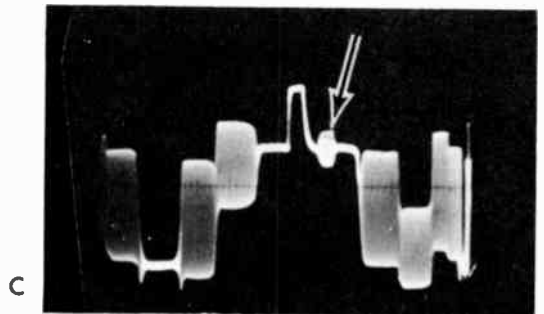

The burst signal shows a definite increase in amplitude.

Fig. 214. *Variable burst voltage (indicated by arrows) from generator assists color sync tests.*

ing. As seen in the photos, the voltage of the burst can be varied while maintaining the same level of horizontal sync and Y signal, independently of the level of the chroma bars. It is also possible in most such instruments to vary the level of the chroma bars independently of the level of the sync information.

To check the range of color sync dropout and dropin, a color bar

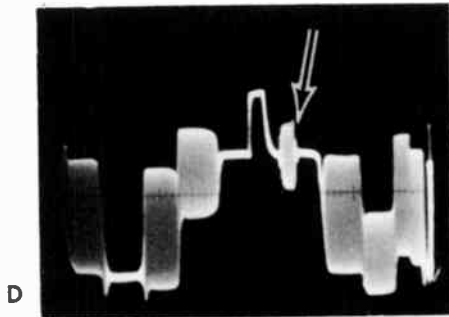

D

Compare the size of the burst signal with the photos in B and C.

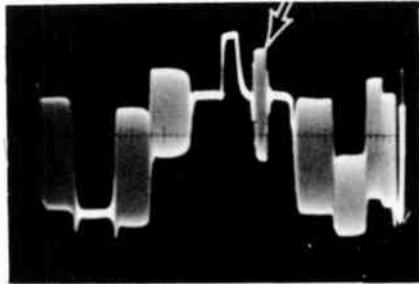

E

The burst now has a greater amplitude than that of the photo marked D.

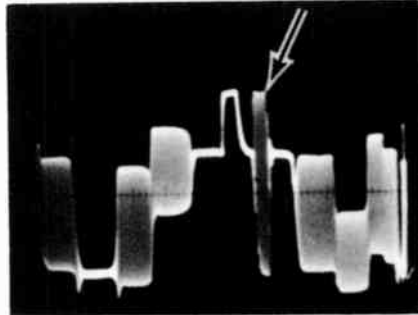

F

Maximum burst signal amplitude.

pattern is displayed on the screen of the picture tube (Fig. 215-a). The video output from the color bar generator is displayed simultaneously on the screen of a wide-band scope (Fig. 214). A normal burst is seen in *d* of Fig. 214. As the burst amplitude control of the generator is varied, the height of the burst changes through the range shown in Fig. 214 a-f. When the burst level reaches a critical lower value, such as Fig. 214-c or -d, the color component of the bars will suddenly lose color sync (Fig. 215-b). Color sync adjustments,

of course, are made to maintain color sync lock at the lowest possible level of burst.

Additional considerations

The color receiver system is such that when the 3.58-mc color subcarrier oscillator ceases operation, no color reproduction is pos-

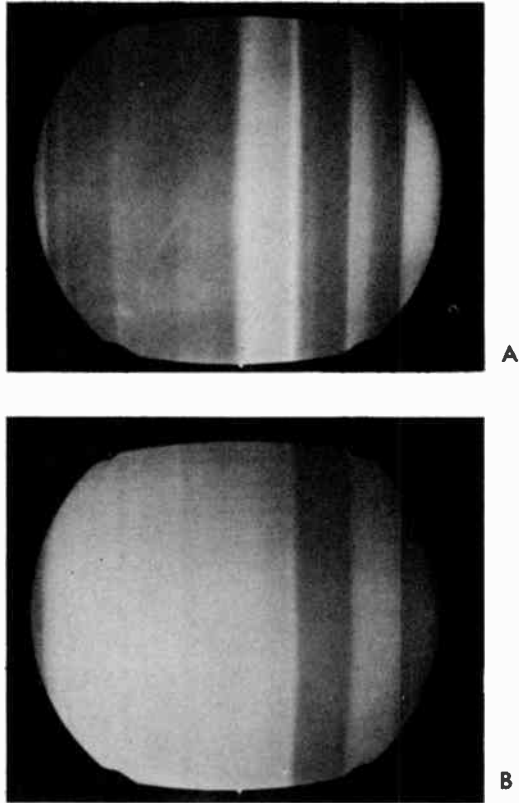

Fig. 215. The photo at the top shows a color-bar pattern with Y and chroma both in sync. The lower photo shows a color-bar pattern with loss of color sync and retention of Y sync.

sible but black-and-white reception is unimpaired. The technician can determine whether the subcarrier oscillator is operating, by observing the detail of background interference during black-and-white reception. When the color intensity control is turned to maximum, there will be an increase in the amount of colored snow (confetti) if the color subcarrier oscillator is operating. If the

oscillator is dead, there is no change in the background noise when the intensity control is advanced.

When making this test with receivers having a color killer, turn the color-killer control to its counterclockwise position so that the chrominance circuits are not biased off. Most receivers utilize full manual control of the chrominance circuits but some have color killers. In making this test the only question is operation of the color subcarrier oscillator; the chroma circuits are otherwise normal.

To troubleshoot the subcarrier oscillator, the dc plate voltage can be measured as an initial test. Normal voltage is usually specified in the service notes for the receiver and is subject to some variation, depending upon the adjustment of the oscillator plate coil (Fig. 216) and also upon the value of the input capacitance to the dc probe of the vtm. Variations of ± 15 or $\pm 20\%$ may be anticipated. However, in case the oscillator is "dead," the indication will be low by 40 or 50%.

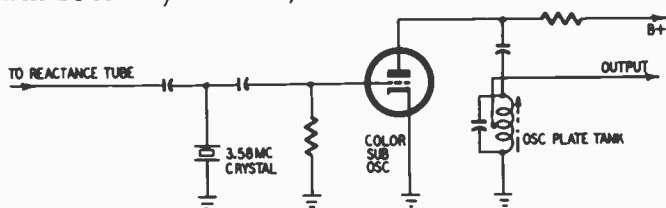

Fig. 216. Typical color-subcarrier oscillator. Low plate voltage indicates a non-oscillating circuit.

A useful expedient is to retune the oscillator slug during the voltage measurement to compensate for the input capacitance of the dc probe to the vtm. If the measured plate voltage should suddenly jump to its normal value as the slug is turned part way out of the coil, the oscillator is normally operative, and was only "killed" by the mistuning imposed by the input capacitance of the probe.

When the grid leak of the color subcarrier oscillator is grounded (Fig. 216), a dc voltage measurement with a vtm will show a small negative voltage at the grid of the tube, even when the circuit is not oscillating. This is only a fraction of a volt caused by the contact potential of the tube. During normal operation of the oscillator, signal-developed bias causes a very substantial negative voltage to appear at the grid—in the order of -5 to -25 volts. Thus, dc grid-voltage checks are a useful cross check with dc plate-voltage checks.

A dead oscillator, with normal plate-supply voltage available, can be caused by a defective crystal or by defective fixed capacitors.

A defective tank coil is a less common source of trouble. The grid and plate resistors are not critical but can "kill" oscillator operation when far off value.

Fig. 217 shows the reactance tube afc diode circuits associated with the color subcarrier oscillator. Defects in these associated circuits can cause the oscillator to become inoperative. To check, open the circuit between the reactance tube and subcarrier oscillator. If the oscillator has been "killed" by abnormal loading from the reactance tube circuit, this expedient will cause the oscillator to resume operation. However, the operating frequency will be several hundred cycles above the burst frequency. If it is desired to restore temporarily the correct operating frequency of the oscillator for tests, a small trimmer capacitor can be shunted between the

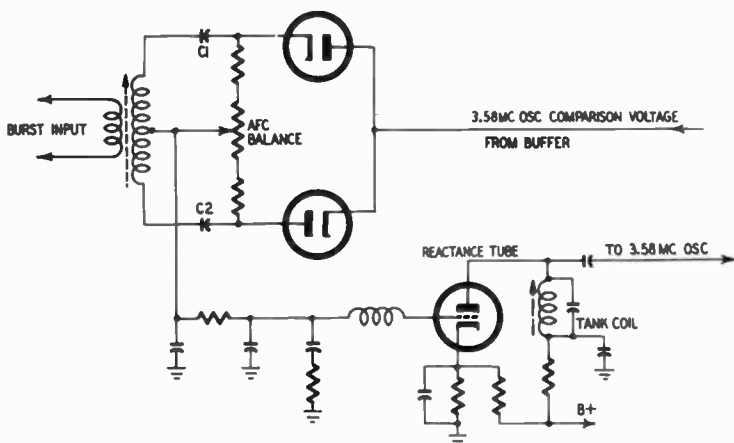

Fig. 217. Defects in the color afc phase detector and in the reactance-tube circuit can cause failure of the 3.58-mc oscillator. Sometimes a defective buffer stage is also responsible.

input lead to the oscillator and chassis ground. About 5 to 10 μf of capacitance serves to zero-beat the subcarrier oscillator at 3.58 mc, although the colors will "roll" in the picture since there is no control of oscillator phase.

The buffer tube, commonly utilized between the subcarrier oscillator and the afc detector can also cause abnormal loading of the subcarrier oscillator in some cases and thereby "kill" oscillator operation. Test by removing the buffer tube from its socket and free-wheeling the subcarrier oscillator. A dummy tube may have to be placed in the buffer socket in case a dual-section tube is utilized. A dummy tube is easily made up by clipping off the pins of the unwanted section.

When shorted turns are suspected in the plate tank of the subcarrier oscillator and a substitute coil is not readily available, a check can be made with a sweep and marker generator and a scope. Service notes for the receiver will usually provide sweep test data for the tank coil but, if notes are not available, an experienced operator can easily devise a suitable test setup. A plate tank coil in good condition will be tunable through 3.58 mc, and have a bandwidth of about 0.5 mc at the 6-db points on the response curve. Even a straight signal generator and vtvm can be used to make the test, although the sweep method is preferred because the technician then obtains a bird's-eye view of overall response as the tuning slug is turned in the coil.

Sometimes the subcarrier oscillator is operative but the tuning slug cannot bring the frequency to 3.58 mc in spite of the fact that the oscillator tank coil is ok. The 3.58-mc crystal determines the general band of frequencies to which the oscillator can be tuned but the crystal can be pulled over a small frequency range in either direction. A heterodyne frequency meter provides the easiest and most certain test of off-frequency operation. A free-wheeling check of the oscillator operation should be made, and if the oscillator free-wheels satisfactorily through 3.58 mc, the fault evidently is located in the reactance tube or afc circuits.

To isolate the trouble the output lead from the afc balance control can be temporarily grounded. This brings the grid of the reactance tube to zero volt, and, if the oscillator tank can now be tuned through 3.58 mc, the trouble is in the afc circuit. However, if the oscillator still cannot be tuned through 3.58 mc, examine the reactance tube circuit.

Faults in this circuit can often be tracked down by dc voltage measurements although an open capacitor or a defective coil for example, has no effect on dc voltage. In most cases, a substitution test should be made if the coil is suspected although the circuit can be checked for correct frequency response with a sweep and marker generator. In some cases, receiver manufacturers provide specified response curves for the stage, with marker points indicated.

Uncertain color sync is caused in some cases by leakage in the afc coupling capacitors, such as at C1 and C2 in Fig. 217. The best check is substitution.

After the subcarrier oscillator has been restored to proper operation, it is then necessary to balance the afc circuit completely to obtain good lock on a weak burst.

Rainbow characteristics produced by loss of color sync

When the subcarrier oscillator is running off-frequency, rainbows are produced in the picture. They are formed by a beating of the color signal with the color subcarrier oscillator in the receiver. The process cannot be properly visualized unless the color and subcarrier oscillator signals are represented by vectors (Fig. 218). When the receiver is in color sync, the oscillator and color signal voltage vectors rotate together. When the oscillator output and the color signals have exactly the same frequency, the two vectors rotate continuously as a single vector—color sync is ok and no rainbows are formed.

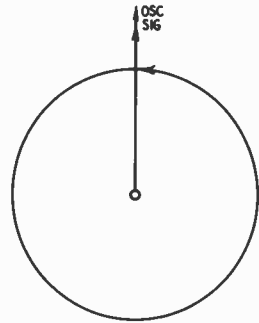

Fig. 218. When the subcarrier oscillator is operating at 3.58 mc, the oscillator vector rotates in sync with the signal vector. Proper colors (no rainbows) appear on the screen of the picture tube.

However, when the receiver is out of color sync and the frequency of the subcarrier oscillator is no longer 3.58 mc, but is slightly higher, the two vectors do not rotate together. Instead, the subcarrier signal falls farther and farther behind the oscillator vector (Fig. 219). This is the nature of the beating of the color signal and the oscillator. The essential point is that while the color signal vector is falling behind the oscillator vector, it is sweeping through the spectrum, since it is *phase* that determines hue in the receiver circuits. Each time a sweep is made through 360° by the lagging signal vector, one complete rainbow appears on the screen of the picture tube.

Consider the situation in which the subcarrier oscillator is running 60 cycles above 3.58 mc. During one vertical scan on the picture tube, one complete sweep will be made through the spectrum (360°) and one complete rainbow is seen on the screen. With the subcarrier oscillator *higher* in frequency than 3.58 mc, the rainbow display appears with red at the top of the pattern and green at the bottom. With the subcarrier oscillator *lower* in frequency than 3.58 mc, the rainbow display appears with green at the top of the pattern and red at the bottom. Hence, it is possible to tell

whether the subcarrier oscillator is running too high or too low in frequency by observing the sequence of colors in the rainbow.

Suppose the subcarrier oscillator is running 1,800 cycles off frequency. In this case, 30 horizontal rainbows appear on the screen

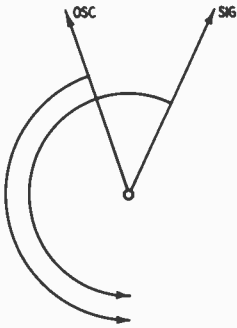

Fig. 219. When the subcarrier oscillator runs at a frequency higher than 3.58 mc, the oscillator vector pulls ahead of the signal vector and forms a rainbow on the screen of the picture tube.

(Fig. 220). Again, if the subcarrier oscillator is running 15,750 cycles off frequency, the oscillator completes one spectrum sweep in the time of one horizontal scan and one vertical rainbow appears on the screen (Fig. 220). If the oscillator is operating above 3.58 mc, the rainbow appears with red on the left and green on the right. But, if the oscillator is operating below 3.58 mc, the rainbow appears with green on the left and red on the right. When the subcarrier oscillator operates 31,500 cycles off frequency, two vertical rainbows appear in the picture, etc.

Since loss of color sync usually does not result in a great discrepancy between the color and oscillator frequencies, the symptoms usually will appear as rainbows running from left to right on the screen. Quite often, only one such rainbow is displayed when color sync is lost. Stationary rainbows appear when the difference between the color-signal and oscillator frequencies is an exact multiple of 60 cycles. Moving rainbows appear when the frequency difference is not an exact multiple of 60 cycles. A moving rainbow can often be made stationary by turning the color phasing or horizontal hold controls slightly.

Rainbow generation must occur whenever there is a frequency difference between the incoming signal and the subcarrier oscillator. If the receiver is operating normally, with the subcarrier oscillator running at 3.58 mc, an incoming signal higher or lower in frequency will likewise produce rainbows. This is the principle of the familiar rainbow generator. This generator is customarily adjusted to provide a signal having a frequency of 3.58 mc minus 15,750 cycles. Hence the standard rainbow generator provides a signal which is lower in frequency than the subcarrier oscillator

by one horizontal scan interval. The standard rainbow signal produces a pattern in which the rainbow stripes appear vertically on the screen of the picture tube and in which reds appear at the left of the screen, blues in the center and greens at the right.

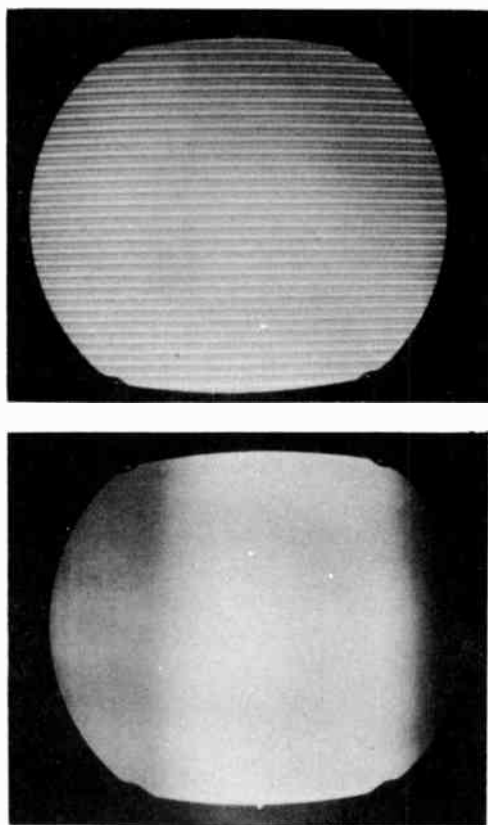

Fig. 220. Color subcarrier oscillator operating off frequency. (Above) Oscillator off frequency by 1,800 cycles. (Below) Oscillator off frequency by 15,750 cycles.

Loss of color sync, accordingly, which causes off-frequency subcarrier operation is a situation which is very closely related to the application of a rainbow signal to a normally operating receiver. Rainbows are produced in either case and the two situations are really two aspects of the same basic principle. Chart 2-2 gives the picture symptoms of sync loss.

Contamination of burst causes loss of tight chroma lock

Tight color lock depends upon a burst frequency of 3.58 mc

Chart 2-2. Picture Symptoms of Sync Loss

Symptom	Cause	Discussion
Black-and-white reception ok; monochrome portion of color picture ok; color appears as rainbow stripes from left to right.	Circuits are holding vertical and horizontal sync but have lost color sync. (Most usual sync problem).	Color sync system operates independently of the vertical and horizontal sync systems. Simultaneous loss of monochrome and color sync is the exception rather than the rule.
Picture rolls vertically on screen — can be stabilized momentarily by free-wheeling the vertical hold control. Colors are all in their right places.	Circuits are holding horizontal and color sync but have lost vertical sync.	Check vertical integrator and associated circuits normally checked for the symptom in black-and-white receiver. Trace vertical sync pulse with scope and low-capacitance probe.
Picture slants diagonally on screen, framed by dark stripes. Colors appear ok in the slanting picture.	Circuits are holding vertical and color sync but have lost horizontal sync. Loss of horizontal sync is regarded as partial, not complete.	Check horizontal phase detector, horizontal oscillator and associated circuits normally checked in black-and-white receiver. Note that if diagonal lines slant downhill to right, horizontal oscillator is running too fast and vice-verso.
Picture slides from one end of screen to other horizontally at varying rate. Colors are reproduced ok. Picture can be stopped momentarily by free-wheeling the horizontal hold control.	Horizontal sync has been completely lost. Vertical and color sync are ok. Loss of horizontal sync is said to be complete because picture moves continuously without being pulled or torn.	Complete loss of horizontal sync can result from a short or open in the differentiating circuit. Trace horizontal sync pulse with scope and low-capacitance probe.
Picture moves continually at varying rate both in horizontal and vertical directions. Colors appear properly. Picture can be stopped momentarily by free-wheeling the vertical and horizontal hold controls.	Vertical and horizontal sync have been completely lost. Color sync is ok.	Complete loss of both vertical and horizontal sync is often traceable to the sync separator. Best approach in difficult cases is usually to trace the sync signals with a scope and low-capacitance probe.
Horizontal and vertical sync ok. Receiver loses color sync at end of color control range.	Characteristics of color phasing control are reflected into reactance tube stage.	Same interaction is present normally in most receivers. If color AFC circuit is balanced properly, the effect of interaction becomes negligible.

arriving at the color afc phase detector. If a false burst of 3.5 or 3.6 mc, for example, should find its way to the phase detector, the frequency of the subcarrier oscillator will be pulled low or high, respectively, with a resulting change in reproduced hues. Likewise, if the output from the burst amplifier is contaminated by some chroma signal voltage, tight color lock cannot be obtained.

To insure that a clean burst signal is obtained from the burst amplifier, a gating pulse is applied to the burst amplifier from the horizontal sweep circuit and in normal operation the burst amplifier tube can conduct only during the burst interval. Suppose, however, that the gating pulse arrives late at the burst amplifier, so that the latter portion of the burst and the starting portion of the chroma signal are both admitted to the burst-amplifier output. The output is then contaminated with a portion of chroma signal, which may have any frequency from 2.1 to 4.1 mc.

Fig. 221. Burst keyer circuit. The resistance and capacitance values must be correct. If not, the timing of the gating pulse to the burst amplifier is "off," resulting in improper burst amplifier operation.

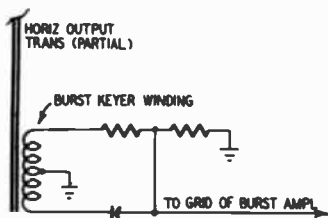

The gating pulse arrives too late, in some cases, due to changed values of resistors in the pulse-delay network, to faulty capacitors (Fig. 221) or, in some receivers, to "pulling" in the horizontal oscillator. The remedy is to check the waveforms in the horizontal oscillator circuit with a scope and low-capacitance probe. The slugs in the tuned coils should be adjusted to provide the waveforms specified in the service manual.

Intermittent operation of the color subcarrier oscillator

Sometimes the color sync is satisfactory for a period of time, following which the subcarrier oscillator abruptly stops operating due to a slight shift of control voltage to the grid of the reactance tube. In some cases, the subcarrier oscillator will resume operation and color sync will be satisfactory if the receiver is switched off channel and then back on. In other cases a few seconds pause between switching on and off is necessary. In still other cases, the subcarrier oscillator drops out of oscillation and later resumes without any discernible correlation to control settings.

When this trouble is encountered, first check the adjustment of the subcarrier oscillator tank coil or coils. One of them will be

found to have a marked effect upon the output voltage from the oscillator—this coil will be in either the plate or the cathode circuit. Apply the dc probe of a vtvm to one of the input electrodes of the color afc phase-detector tube. If the receiver utilizes a color killer, the line to it from the color afc tube is a suitable test point.

As the oscillator tank is tuned through its range, the output from the subcarrier oscillator increases up to a certain point and then drops abruptly to zero. This is a characteristic of all crystal oscillators. Note the maximum output voltage obtained (such as 25 volts) just before the oscillator ceases operation, then back off on the slug adjustment to decrease the output 2 or 3 volts. This adjustment insures that the reactance tube will never cause the subcarrier oscillator to enter the inoperative region of its characteristic.

Intermittent color sync lock

Although the color sync lock may be satisfactory when the receiver is energized by a color bar generator, it can become poor or intermittent when the receiver is operated from an antenna. In such case, check the color sync action with a signal from the generator which has approximately the same level as the antenna signal. This can be done with a vtvm applied to the agc line in the receiver. Equal readings will be obtained on the vtvm when the signals have the same signal strength (microvolts input) to the receiver. Of course, the test must be made on the same channel to be valid, since tuner response often varies considerably from one channel to another.

If the generator cannot be operated on the same channel as the available transmission, the possibility of tuner trouble on the station channel should be investigated with a sweep and marker generator and scope. You may find, for example, that the rf response curve has a severe tilt which unduly attenuates the color burst or the tuner sometimes has greatly subnormal gain on the station channel, which prevents a clean signal from entering the if circuits. If a wide-band scope is available, the burst voltage can be observed at the output of the picture detector as a preliminary quick check. A severe tilt in the tuner response will cause the burst to be reproduced at improper level at the picture detector—but a mismatch of lead-in to the tuner can produce the same result. Hence, the sweep-generator test is the more conclusive insofar as frequency response is concerned.

When the color bar generator can be operated on the same chan-

nel as the station and color sync is satisfactory when the generator output is the same as the antenna's (as checked at the agc bus), the cause of poor color sync on station reception will usually be found to result from a mismatch of the lead-in to the tuner.

A useful quick check can be made by cutting off sections from the lead-in, approximately 1 foot at a time, observing any change in reception. Cutting off a section of lead-in changes its standing-wave pattern of voltage and results in a changed tilt of the overall response of the receiver system. If a substantial mismatch is present, a semicritical length of lead-in will be found which causes the color information to increase greatly in intensity, with a resumption of satisfactory color lock due to buildup of the burst voltage.

For a temporary cure the lead-in can be left cut to the critical length although the color reproduction will not be as accurate as when the lead-in is operated in a reasonably flat condition. The preferred repair is to correct the tuner response or, if the shop does not undertake to repair rf tuners, another possibility is to trade in the tuner for a replacement. As an economical expedient, a resistive H-pad can be added in series with the lead-in to the tuner. Turret type tuners have adequate space available inside the turret to mount an H-pad, if it is desired to switch the pad in on the troublesome channel only.

If adequate signal strength is available on all the operating channels, there is no disadvantage in mounting the H-pad at the input terminals to the tuner, where it is operative on all channels. However, when the signal strength is marginal on one or more channels, install the H-pad inside the turret so that it is operative on the desired channel only.

When checking a receiver on the bench for adequacy of color sync, a color-bar generator should be used. Some generators are better adapted for this purpose than others. For example, some generators have a sequence of color bars in which the series starts with green. The top of the green bar is level with the back porch of the sync pulse. On the other hand, other generators have a sequence of color bars which starts with the red bar. The top of the red bar extends higher than the green bar (up into the blacker-than-black region). For this reason, a sequence starting with the red bar is more useful in color-sync checks than one starting with the green bar.

Just why this is so will become clear from the following considerations: the color-sync circuits operate on a gating principle—in other words, the burst amplifier is keyed open only for the duration of the

color burst. However, trouble is sometimes encountered with the gating circuit—the gating pulse arrives too late or too early, due to incorrect values of R or C in the gating configuration.

If the gating pulse arrives too late, a high chroma signal, such as a red bar, will succeed in gaining partial entry into the burst-amplifier circuit, and thereby disturbing the color sync action. However, a lower-level chroma signal, such as a green bar, will not have nearly as much success in gaining entry into the burst amplifier, and will be less effective as a test of color sync lock (gating action only).

Furthermore, in choosing a color-bar generator for tests of color-sync action, it is helpful to have control of the chroma-level output. For example, some generators provide a chroma-level switch with zero db, -6 db, and -15 db settings. The color sync circuits in the receiver should be capable of holding color sync with the switch in the -15 db position.

chroma circuit servicing

PERHAPS the most unfamiliar section of the color receiver is the video-frequency system comprising the monochrome video amplifier (s), the chrominance bandpass amplifier, color demodulators and matrices. The output from the picture detector divides, energizing the Y and chrominance bandpass amplifiers. These divided signals eventually reunite at the matrices but, prior to merging, the color signal is processed through the color demodulators and phase splitters.

Balance between chroma and Y output levels

Correct color reproduction can be obtained only if the relative gains of the chrominance and luminance channels are correct. Both manual and agc controls are provided in various receivers. Linearity is also important, hence the video-frequency circuits are customarily designed to provide considerably greater reserve output than normally required to handle the luminance and chrominance signals.

The chrominance circuits may operate over a maximum bandwidth of 1.5 mc when the I-Q system of demodulation is used, but are restricted to a bandwidth of 0.5 mc when demodulation is along the (R - Y) and (B - Y) axes. Some receivers utilize semi-wide-band chroma circuits. Unless the bandwidth is restricted to 0.5 mc in most (R - Y) (B - Y) systems, color crosstalk will occur because (R - Y) and (B - Y) signals both have I and Q components. In the I-Q system of demodulation, an I signal produces no output from the Q channel but does produce output from the I channel. Conversely, a Q signal produces no output from the I channel but

does produce output from the Q channel. Fundamentally, transmission of I information is made at extended bandwidth (1.5 mc) to take advantage of the color vision characteristics of the human eye. Physically, I color information past 0.5 mc and out to 1.5 is transmitted in single-sideband form.

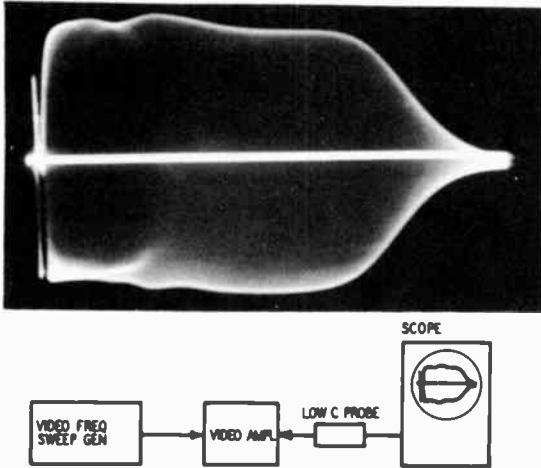

Fig. 301. When a video-frequency circuit is checked with a sweep-frequency signal, the scope displays the outline of the circuit's frequency response.

Color detail between 0.5 and 1.5 mc is resolved on orange-cyan axes in terms of primary colors. Larger color areas, corresponding to frequencies up to 0.5 mc, are resolved in red, green and blue primaries.

In the $(R - Y)$ $(B - Y)$ system of demodulation, the same transmitted signal is used by the receiver but it is demodulated on the $(R - Y)$ $(B - Y)$ axes at reduced bandwidth so that both demodulators operate completely on double-sideband signals. Both the $(R - Y)$ and $(B - Y)$ signals contain I and Q components and the I signal contains single-sideband signals from 0.5 mc to 1.5 mc. For this reason, unless the $(R - Y)$ and $(B - Y)$ demodulator circuits are limited to a 0.5 mc bandwidth, color crosstalk will be caused by the single-sideband I signal (portion of signal above 0.5 mc).

The difference between the two demodulation systems may be summarized:

1. With I-Q demodulation, the color subcarrier is reinserted exactly in phase and quadrature, respectively, with the incoming I-Q signal. The I signal in the I demodulator circuit is then converted

wholly to AM and the Q signal in the I demodulator circuit wholly to FM and hence rejected by the subsequent AM circuits. The Q signal in the Q demodulator circuit is converted wholly to AM and the I signal in the Q demodulator circuit to FM. Thus, the single-sideband information contained in the higher-frequency portion of the I signal can be properly demodulated without noticeable crosstalk.

Fig. 302. Method of sweeping a video amplifier, usually specified by color-receiver manufacturers. A narrow-band scope can be used. (Courtesy of The Technician's Time-saver).

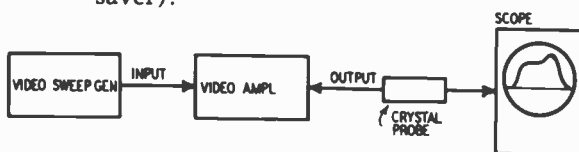
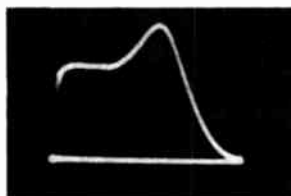

2. When the $(R - Y)$ $(B - Y)$ system of demodulation is used, the color subcarrier is not reinserted exactly in phase and in quadrature with the I and Q signals, respectively. That is, the I-Q trans-

Fig. 303. The response of the Y channel in a typical color-TV receiver shows a sharp dip at the 3.58-mc point (center arrow) caused by a burst take-off trap. The response from 3.58 to 4.5 mc in this case is considerably attenuated with respect to the response from 0 to 3.58 mc. Arrow at right indicates zero frequency point.

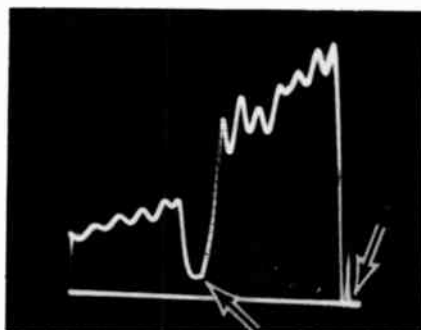

mission is being treated in the demodulation process as if it were an $(R - Y)$ $(B - Y)$ transmission. But since there are both I and Q components along the $(R - Y)$ and $(B - Y)$ axes, the I signal is not converted wholly to FM (or AM) in either the $(R - Y)$ channel or in the $(B - Y)$ channel and color crosstalk can be avoided only by applying double-sideband information to both $(R - Y)$ and $(B - Y)$ demodulators.

Video-frequency sweep tests

The Y amplifier in a color set corresponds to the video amplifier

Chart 3-1. Video-Frequency Circuit Adjustments

Requirement	Reason	Circuit Adjustment
Proper bandwidth of I, Q, R — Y, and B — Y synchronous demodulators.	Loss of color resolution when bandwidth is inadequate; color contamination when bandwidth is excessive.	Coil slug settings; load resistor values. (Make certain that tube shields are in place on demodulator tubes.)
Avoidance of peaks in demodulator response curves.	Excessive peaking causes color signal to ring. Moderate high-frequency peaking of the I circuits may be utilized, however, to compensate for deficiencies in I response.	Damping resistors, load resistors, slug settings. Regenerative peaks can result from open decoupling capacitors or disturbed lead dress.
Proper passband in first chroma amplifiers—2.1 to 4.2 mc.	Admission of color signal from Y amplifier and rejection of all monochrome signals possible.	Slug settings, damping resistor values.
Check of Y amplifier response and 3.58-mc trap adjustment.	Picture resolution is determined primarily by proper response of the Y amplifier. Unless the color subcarrier is trapped, operation of the dc restorers is affected.	Resistor and capacitor network (matrices) terminating delay line; substitution test of delay line.
Gain check of I and Q demodulators (or of R — Y and B — Y demodulators).	Low gain in the Q channel causes the picture to be deficient in magenta and green. Low gain in the I channel causes picture to be deficient in yellow and cyan.	Grid and cathode bias values, 3.58-mc injection voltage, defective filters, faulty bypass capacitors, low plate voltages.
Frequency response of red, green and blue video amplifiers.	Picture resolution depends upon the frequency response of these amplifiers as well as upon the frequency response of the Y amplifier.	Load resistor values, peaking coils, damping resistor values. Check bypass capacitors also, in case of trouble.
Frequency response of I and Q phase splitters, and of I amplifier.	Proper color reproduction depends upon correct frequency response at the output as well as the input end of I and Q channels.	Peaking coils, damping resistor values, coupling capacitors, bias networks, bypass capacitors.
Frequency response of matrices.	Color balance and satisfactory monochrome reproduction require correct matrix operation.	Open capacitors are not indicated in a dc resistance check. Replace, if sweep response is distorted.

in a monochrome receiver. A suitable arrangement for sweeping the Y amplifier is shown in Fig. 301. This is a general method of checking the response of a video-frequency amplifier in either a black-and-white or a color receiver. The scope used must have as good or better frequency response than the amplifier under test. The low-capacitance probe is required to avoid loading and attenuating the high-frequency response of the video circuit under test.

With a narrow-band scope, the arrangement shown in Fig. 302 is used and is the method ordinarily specified by manufacturers. The response of a typical video amplifier (Y amplifier) in a color receiver is shown in Fig. 303. The undulations in the top of the response curve are caused by stray resonances in the 1- μ sec delay line which causes a ringing response. However, unless the ringing is severe (Fig. 304), the variation in color picture shading is not noticeable.

Fig. 304. *Very severe ringing of the Y amplifier caused by a short in the delay-line branch.*

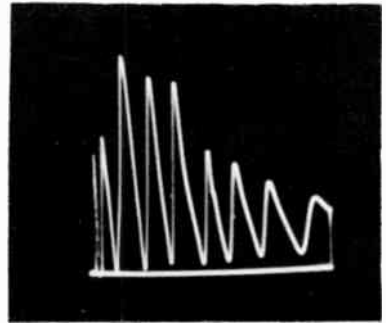

Of course, frequency response tests are misleading unless the output from the sweep generator is free from distortion. The FM output from a color sweep generator has a relatively low output frequency on the first band (video-frequency range) and can be applied directly to the vertical input terminals of a wide-band scope since the sweep frequency is within the frequency-response capability of a 4.5-mc scope (scope with flat response to 4.5 mc). The essential quality of the sweep voltage is its constancy, or flatness over the swept band.

Chart 3-1 lists adjustments that can be made in the video-frequency circuit.

Marking chroma and Y response curves

To check the frequency at a given point along the sweep signal, an absorption marker may be introduced (Fig. 305). If the tuning dial of the sweep generator is adjusted to make the zero-frequency point appear in the center of the display, a dual response is obtained

and the 50-kc marker appears on each half of the pattern.

By choosing suitable values of L-C, the sweep signal may be marked at any desired point. (Peaking coils serve well as inductors and may be obtained in a wide range of inductance values which meet all practical requirements). A 3-30 μf trimmer capacitor in series with the coil permits adjustment of the marker frequency to specific values, which may be checked with a grid dip meter or other suitable arrangement, such as a signal generator, crystal probe and scope.

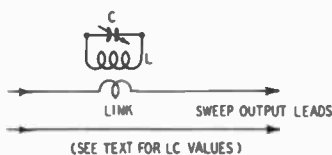
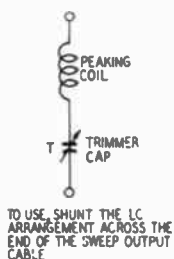
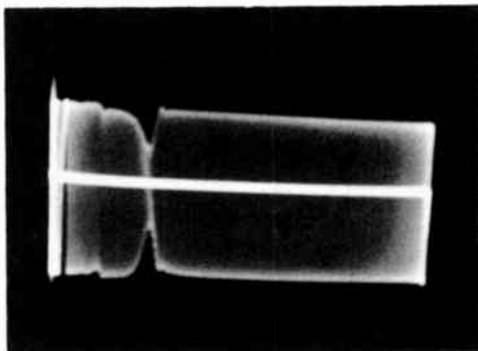

Fig. 305. Typical appearance of a 50-kc absorption marker on the sweep signal. The small spurious marker is caused by the presence of a spurious sweep output voltage from the generator. The drawings below the photo show circuit arrangements for absorption marker indication.

Converting monochrome to chroma sweepers

A problem which arises in many shops is the adaptation of rf or if signal and sweep generators to video-frequency sweep applications. This conversion can be accomplished by heterodyning the output from an if signal generator with the output from an if sweep generator through a nonlinear terminal probe (Fig. 306). Such devices are available commercially.

The probe, shown in Fig 307 and known as a Chromatic Probe, was designed for use with specific equipment, but with slight modifications it can be used with most any sweep and marker generator.

It is essentially a nonlinear mixing device, which generates an upper and a lower sideband when two different frequencies are applied to its input. The lower sideband is a difference-frequency sweep for

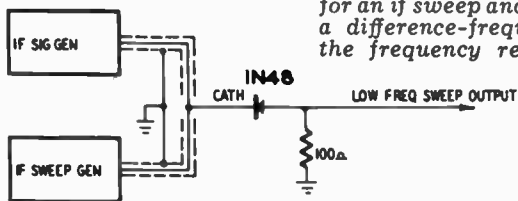
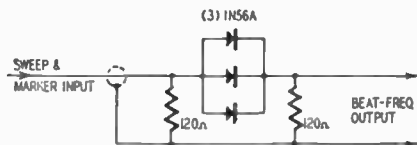

Fig. 306. A heterodyne output arrangement for an if sweep and signal generator to provide a difference-frequency output for checking the frequency response of video-frequency circuits.

testing video-frequency circuits. To understand how the probe operates, consider a typical operating condition in which a 160-mc center-frequency signal from a sweep generator is swept over a 5-mc band, from 157.5 to 162.5 mc, and in which a 157.5-mc signal from

Fig. 307. Circuit arrangement of the Chromatic Probe. The three crystals in parallel work as a nonlinear mixer.



a marker generator is mixed with the swept signal. The signals are applied to the input of the Chromatic Probe. The probe modulates these signals and generates an upper and a lower sideband. The lower sideband sweeps from (nominally) 0 to 5 mc and is the signal that interests the color-TV technician. It is the signal output used to sweep-check the Y amplifier, I, Q, chroma amplifier and chrominance circuits.

The probe has three parallel 1N56A crystal diodes. The reason for using three diodes is that the output impedance of the probe is approximately 100 ohms, and maximum operating efficiency is obtained with a low-impedance modulator. When three crystal diodes are connected in parallel, the internal impedance of the equivalent generator is reduced to one-third, with a corresponding increase in sideband output voltage. A low-impedance output is used because the impedance of color receiver circuits often contains a large capacitive component which attenuates the higher-frequency output signal unless the output impedance is a low value, such as 100 ohms.

The cable of the probe is terminated principally by the first 120-ohm resistor but also in part by the internal impedance of the paralleled crystal diodes plus the output lead resistor. The output

network terminates the cable in its own characteristic impedance so that standing waves are avoided. The probe is preferably operated with an rf instead of an if input. Although the probe can be operated at if, the output is often not as uniform as when operated from rf. Some if sweep generators are provided with a low-pass filter

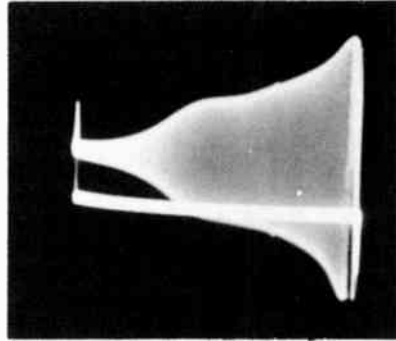
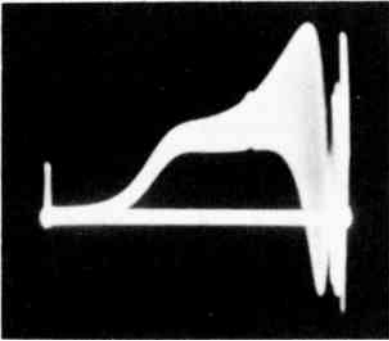
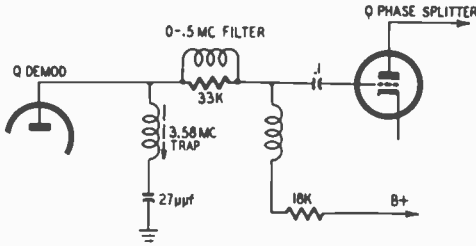

Fig. 308. Typical circuit arrangement of a Q demodulator circuit. The photo at the left shows the response obtained when using a demodulator probe. The photo at the right is the response when using a low-capacitance probe.

in the output circuit so that only the frequency indicated on the generator dial is delivered at the output of the instrument; then, it makes no practical difference whether the probe is operated on rf or on if generator bands.

When used with typical service generators, the probe provides flat sweep output from 8 kc through 4.5 mc (or higher, if desired). This low-frequency limit is remarkable and far exceeds the ability of demodulator probes to handle the low-frequency sweep. Accordingly, a demodulator probe must be avoided in checking out the lower-frequency end of the video amplifier response, and the output from the circuit under test must be applied to the scope via a low-capacitance probe. Insofar as the higher-frequency end of the video amplifier response is concerned, a demodulator probe operates satisfactorily.

If a low-capacitance probe is used instead, low-frequency attenuation is eliminated. However, the technician usually finds that the "modulated carrier wave" type of display is somewhat more difficult to interpret than the conventional response curve. Fig. 308 illustrates the difference between these two types of response.

Two general test setups are shown in Fig. 309. Complete low-frequency information is not obtained in *a* because of the limitations in demodulator-probe response. Complete high-frequency information may not be obtained in *b* unless the vertical amplifier of the scope has a flat response, equal at least to the bandwidth of the chroma circuit under test. Since few service scopes have a flat response to 4.5 mc, the technician will often have to make both tests to obtain complete information.

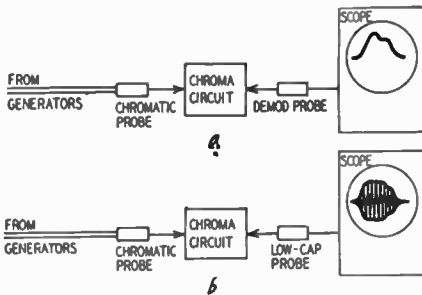

Fig. 309. Chroma channel response using demodulator probe (a) and response displayed when using a low-capacitance probe (b).

When the scope being used does not have as good frequency response as the circuit under test, the result is distortion and attenuation at the high-frequency end in *b*. But if the scope has full frequency response, either test is equally useful to determine the high-frequency response.

It may not be necessary to use a low-capacitance probe and it may be possible in some cases to use a direct probe if the scope is applied across a low-impedance circuit point. But the low-capacitance probe is essential if the scope is applied across a medium- or high-impedance circuit point. Omission of the low-capacitance probe in such case will cause substantial high-frequency attenuation.

Certain precautions are sometimes required in applying the Chromatic Probe at the input of the circuit under test. If a dc voltage component is present, a blocking capacitor must be used in series with the probe output to avoid drainoff of the dc voltage and possible damage to both probe and circuit.

The probe will not work unless *both* sweep and CW output are applied to it. Since many generating units provide separate sweep and marker outputs, a suitable mixing arrangement is necessary before the probe can be used. One practical solution is to remove the

connector provided with the probe and substitute a Y connector to accommodate the two output cables from the sweep and marker generators.

The generator frequencies should also be pure fundamentals (not harmonic or beat frequencies) or unusably low and distorted outputs will probably plague the technician. This point requires careful consideration, since the marker generator may not operate on pure fundamentals above 60 mc, delivering only harmonic output at higher frequencies while the sweep generator may not deliver pure fundamental output below 75 mc.

Preamplifier for demodulator probe

Various of the chroma circuits and, in some cases, the luminance channel (Y amplifier) in the color receiver may have very low gain, and adequate deflection may not be obtained on the scope screen when the amplifier is swept with the output from the Chromatic Probe. The amount of output available depends primarily upon the output from the driving generators. When more deflection is desired on the scope screen, a suitable preamplifier can be utilized. Such an amplifier is a demodulator probe preamplifier and provides an important filter-amplifying function at video frequencies for servicing the signal circuits of color receivers.*

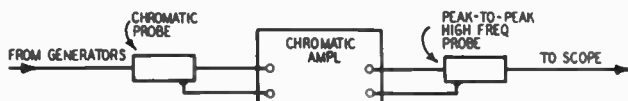

Fig. 310. Test setup for checking flatness of video sweep output from the Chromatic Probe.

Checking flatness of chroma sweep signal voltages

The test setup in Fig. 310 is very useful for checking the flatness of the video sweep from the Chromatic Probe if a wide-band scope is not available. If the swept trace is not flat within $\pm 5\%$, there is some fault in the equipment or arrangement which should be corrected before proceeding with service tests. In this flatness check, the Chromatic Amplifier operates both as an amplifier and as a video-frequency filter. The tuning dials of the sweep and signal generators may be set to any corresponding frequency, subject to the limitations noted.

* The Chromatic Amplifier is a wide-band flat amplifier having a frequency response from 8 kc to 4.5 mc and a gain of approximately 40. It is available from Simpson Electric Company, Chicago, Ill. The unit is described in detail in "Sweep and Marker Generators for Television and Radio" by Robert G. Middleton, Gernsback Library book No. 55.

Fig. 311 shows a somewhat similar test setup used to check the flatness of the swept output from the Chromatic Probe when loaded by the input circuit of the receiver under test. As before, the Chromatic Amplifier operates as a filter as well as an amplifier in this test. There should be no variation from flatness in the swept trace.

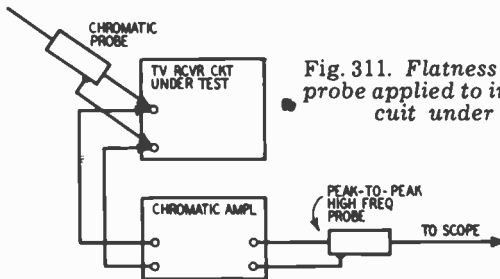

Fig. 311. Flatness check with probe applied to input of circuit under test.

If there is excessive capacitance across the input of the circuit in the receiver under test, high frequencies will be attenuated. Under normal circumstances the circuit capacitance will not be sufficiently large to attenuate the high-frequency response to any appreciable extent. However, if an incorrect test point is selected for application of the sweep voltage, this difficulty may be encountered in a normally operating receiver.

After it has been determined that the swept input voltage to the receiver is flat, the Chromatic Amplifier may be connected (Fig. 312) to observe the response of a video-frequency circuit in the re-

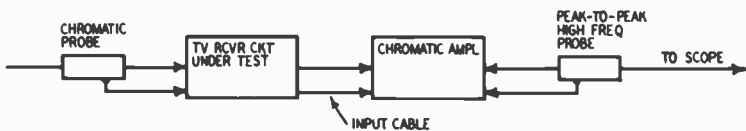

Fig. 312. Typical arrangement of Chromatic Probe, Chromatic Amplifier and peak-to-peak high-frequency probe in testing a low-gain color-TV video-frequency circuit.

ceiver under test. In many tests, its use is not necessary but for some low-gain circuits in color chassis, its use may be required. Typical low-gain circuits are the chroma amplifier and the I demodulator. The Y amplifier is also a low-gain circuit.

When a very-low-resistance load is shunted across the output of the Chromatic Probe, the high-frequency response sometimes tends to rise somewhat during checks of sweep flatness. The reaction of the circuit upon the probe can be corrected by inserting a small series resistance between the output of the probe and the input of the circuit under test. A value of resistor must be used which pro-

vides satisfactory flatness of sweep. The test shown in Fig. 311 will indicate when the right value has been found.

In other cases (Fig. 313) the nature of the load presented to the Chromatic Probe may be such that the low-frequency response tends to rise, as shown in Fig. 314. In such case, a series capacitor

Fig. 313. Partial circuit diagram of a typical I demodulator circuit. This circuit tends to develop a low-frequency boost in an applied video-sweep signal, as shown in Fig. 314.

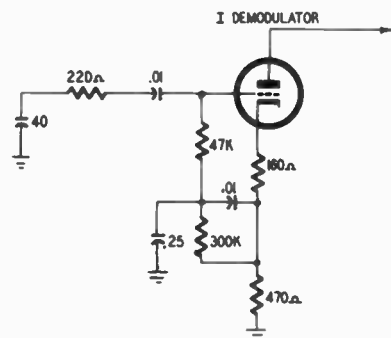

of suitable value between the output of the probe and the input of the circuit under test will provide the desired flatness of sweep voltage. Again, the test in Fig. 311 will indicate when the proper value of series capacitance is utilized.

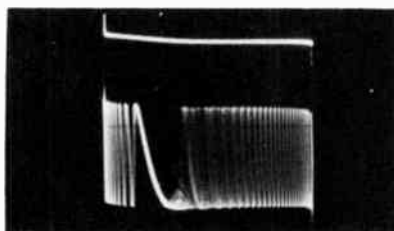
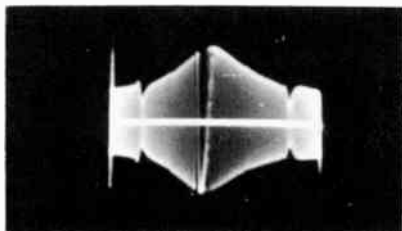

Fig. 314. The photo at the left shows the low-frequency boost imposed on the output from the Chromatic Probe when the circuit of Fig. 313 is under test. The photo at the right shows the correction obtained by the use of a suitable series capacitor.

Test leads

A shielded cable can be used at the input of the Chromatic Amplifier, provided it is connected to a low-impedance circuit in the color receiver. If it is desired to energize the Chromatic Amplifier from a medium- or high-impedance receiver circuit, it is necessary to dispense with the shielded input cable and to use a pair of open test leads to avoid high-frequency attenuation of the video sweep voltage.

Noise and interference voltages

It is essential to eliminate noise and interference voltages from

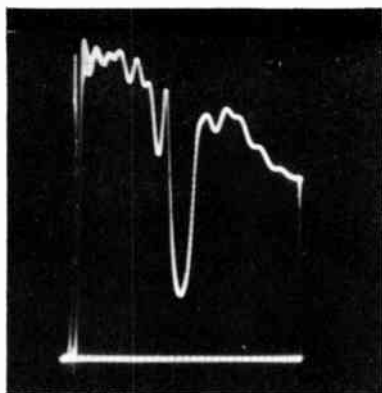
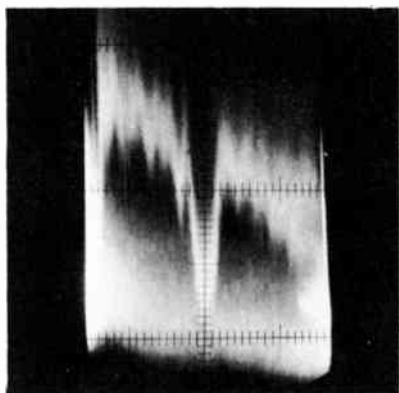

Fig. 315. The photo at the left shows the Y amplifier response curve obscured by entry of noise from the if amplifier. The photo at the right shows the noise eliminated by application of -10 volts of override bias to the agc bus.

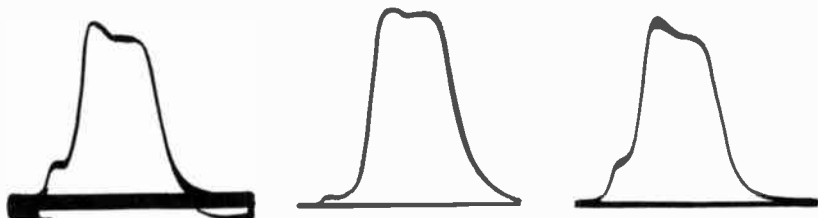

Fig. 316. (Left) Horizontal sweep interference; (center) effect of shunt capacitor at scope; (right) undistorted curve obtained when horizontal-sweep circuit is disabled and no shunt capacitance is added across scope input terminals.

Fig. 317. Power resistor serves as dummy tube. The resistor can have a rating of 5 watts or more.



the color circuits when making frequency-response tests. Fig. 315, for example, shows the serious consequence of permitting noise from the if amplifier to enter the Y channel during sweep-frequency tests. After the if amplifier is biased off by application of -10 volts of agc override bias, the desired curve display is obtained.

Interference from the horizontal-sweep circuit and sometimes

the horizontal oscillator may also be a problem. Fig. 316 shows interference from the horizontal-sweep circuit; the entire display is made fuzzy by superimposition of 525 pulses per scan. Technicians sometimes suppose that a bypass capacitor can be shunted across the input terminals of the scope to eliminate such interference but this

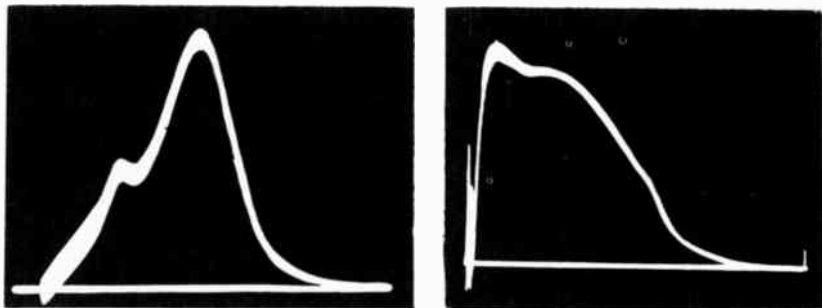

Fig. 318. (Left) Distortion of Q demodulator response when demodulator probe is applied directly at the output of the Q channel, instead of at the low-impedance point in the phase-splitter circuit following the Q channel (right).

leads to curve distortion. The proper procedure is to eliminate the source of the interfering voltage by disabling the horizontal-sweep circuit.

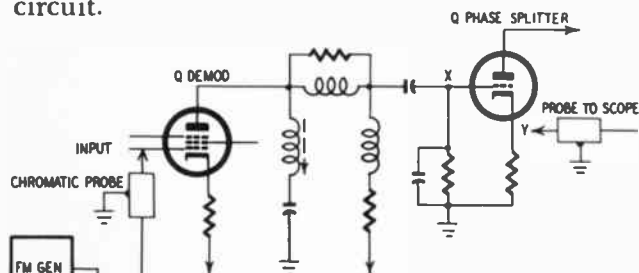
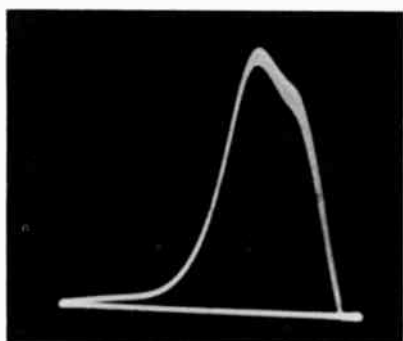
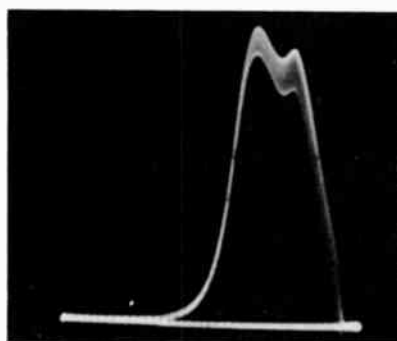

Fig. 319. Test setup for sweep-frequency check of the Q demodulator. The sweep input signal is applied at the grid of the demodulator. The scope is connected through a low-capacitance probe for low-frequency tests, or through a peak-to-peak demodulator probe for high-frequency checks. It is essential to apply the scope probe at point Y in the circuit and not at point X.

Sometimes, when the horizontal-sweep circuit is disabled by removing the horizontal-output tubes, the dc distribution in the receiver circuits is upset because of the decreased load on the power supply. The technician should use dummy horizontal-output tubes (Fig. 317). The dummy tubes are constructed from a pair of wire-



A



B

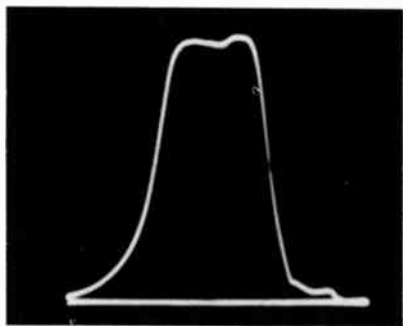

C

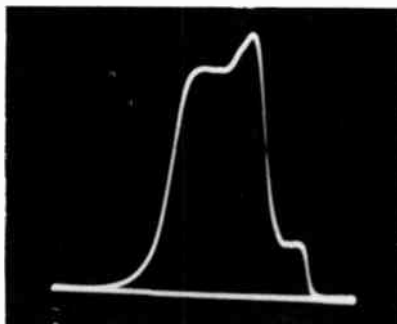

D

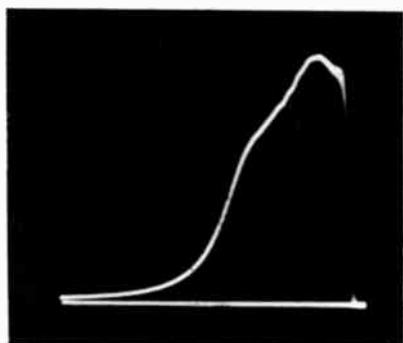

E

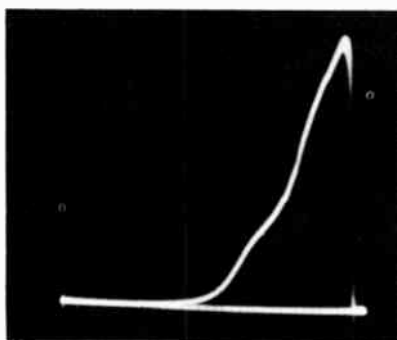

F

Fig. 320. (A) Response of Q demodulator at high signal level. (B) Same response curve at a low signal level. (C) Bandpass amplifier response at high signal level. (D) Same response at low signal level. (E) Green video-amplifier response at high signal level. (F) Same amplifier response at low signal level.

wound power resistors, octal tube bases and tube plate caps. The resistance value used should be equal to the dc plate resistance of the horizontal output tube—20,000 ohms.

Another common source of difficulty in making chroma circuit tests is caused by application of the demodulator probe at an unsuitable point as shown by the photographs of Fig. 318 and the circuit arrangement of Fig. 319.

The level of the applied sweep signal may be increased to override partially the horizontal pulse voltage. However, the applied signal level may also change the shape of the response curve (Fig. 320). The best rule to follow is to use the same voltage level as is present in normal reception of a TV signal.

Control settings will sometimes have an effect upon the circuit response and should be set in accordance with the service data. Fig. 321 shows how the impedance at the input of the Y amplifier (impedance across the contrast control) changes as the power switch is turned on or off. Fig. 322 shows how details of bandpass amplifier response are changed by varying the setting of the color intensity control.

Chart 3-2 lists generator and scope settings for sweep-frequency checks of the Q demodulator.

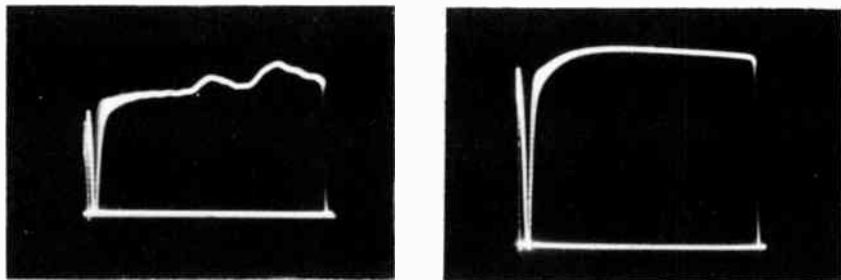

Fig. 321. (Left) With the power switch "on," the Y amplifier reflects into the contrast control, and residual ringing of the delay line is seen. (Right) With the power switch "off," plate resistance of Y amplifier tube becomes infinite, and reflection is no longer seen.

"Marking" with dial calibrations

When the marker or sweep generator used with the Chromatic Probe has closely calibrated dials or when the video-sweep generator has a closely indicated center frequency, the operator does not need any marking equipment other than the instrument dials. Fig. 323 shows how to determine the frequency of various points along a typical Y amplifier response curve. If a Chromatic Probe is being used and the dials of the FM and AM generators are not set to the

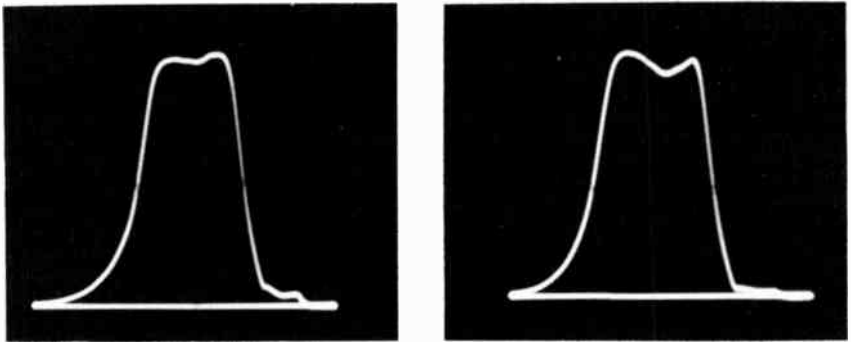

Fig. 322. Influence of the color-intensity control setting on the shape of the bandpass amplifier response. (A) Control at maximum. (B) Control at minimum.

same frequency (such as 160 mc) and the horizontal phasing control of the instrument is properly adjusted, trace and retrace are both visible in the display (Fig. 323-a). The zero-frequency point appears in the center of the twin pattern.

The retrace is next converted into a zero-volt reference line by turning on the blanking control of the sweep generator and phasing the blanking voltage to produce a zero-volt reference line as shown in *b*, which fits the base of the curve and does not clip the display at either end. In the next step, the operator turns the dial of either the FM or AM generator by a suitable amount to bring the zero-frequency point in the display to the right-hand end of the base line, as shown in *c*.

Frequency determinations of any points along the response curve can then be made in *d*, *e* and *f*. In *d*, the dial of the sweep generator has been moved through 2.65 mc to locate the 2.65 mc point on the curve. In *f*, the dial has been moved through 3.58 mc to check the trap frequency.

Of course, this method of marking requires good horizontal linearity in the horizontal sweep generator output. Another related method of marking the video response curve makes use of the ruled graticule over the screen of the cathode-ray tube. A test setup such as in Fig. 324 may be used. The initial display obtained is a twin type (Fig. 325) with the zero-frequency point in the center of the pattern. Next, the tuning dial of the generator is turned to move to zero-frequency point to the left-hand end of the base line (Fig. 326-a). The sweep width control of the generator is then adjusted to 2 mc, which can be checked by turning the sweep generator dial through 2 mc. If the sweep-width setting is exactly 2 mc, then the zero-frequency point will move exactly to the right-hand

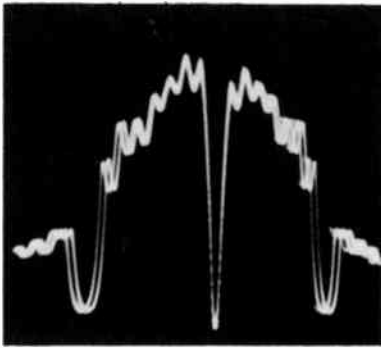

A

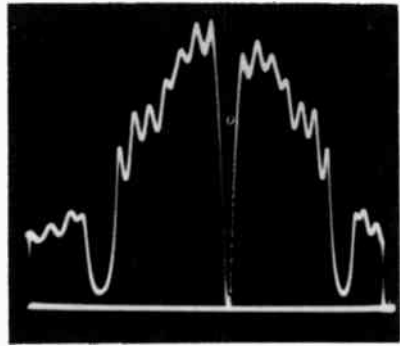

B

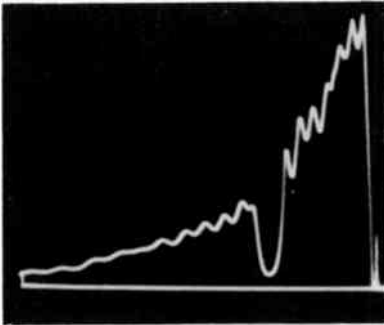

C

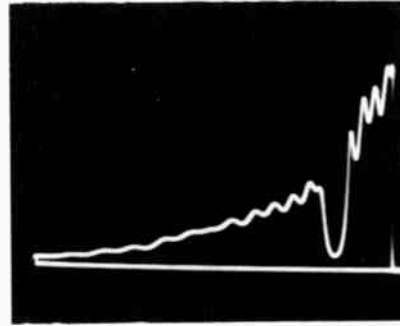

D

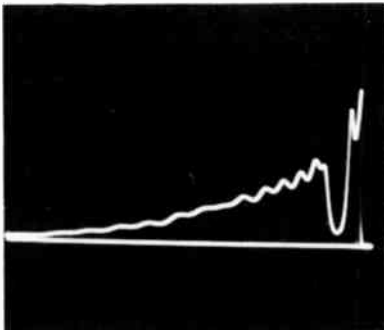

E

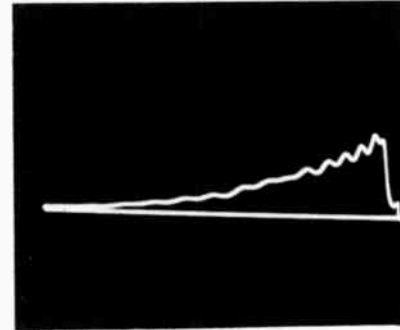

F

Fig. 323. Progressive steps in check of Y amplifier response curve. (A) Response curve with retrace unblanked, but sweep phasing control properly adjusted. (B) Retrace converted to zero-volt reference line. (C) Zero-frequency point tuned to right-hand end of base line. (D) Generator dial moved through 1.65 mc to locate 1.65-mc point on Y response curve. (E) Generator dial moved through 2.65 mc. (F) Generator dial moved through 3.58 mc to check color-subcarrier trap frequency.

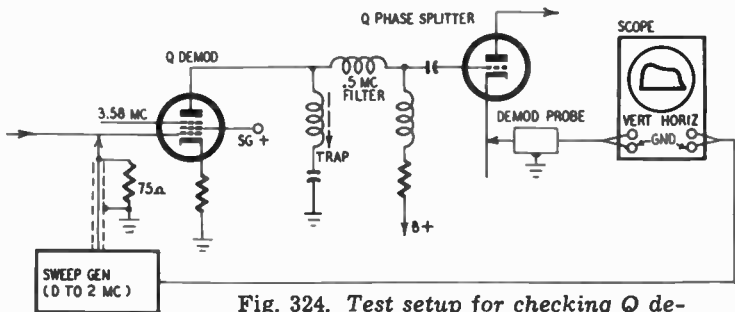
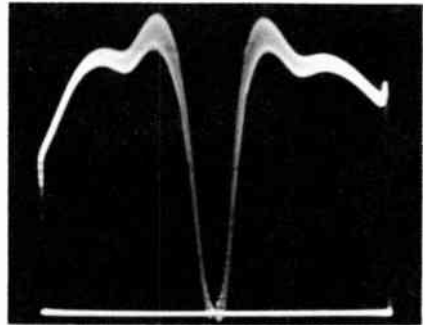

Fig. 324. Test setup for checking Q demodulator response.

end of the base line (Fig. 326-b). Marking may be accomplished with the zero-frequency point at either end of the base line, as desired.

In Fig. 327, the horizontal gain control of the scope has been adjusted to make the display occupy 20 squares on the graticule and

Fig. 325. Q response with the zero-frequency point in the center of the display. This is the waveform obtained (when using a Chromatic Probe) if the sweep and marker generators are tuned to the same frequency.



each square indicates an interval of 0.1 mc. Frequency points are then determined at any desired point along the response curve by counting squares and multiplying by 0.1 mc.

Chart 3-3 lists the scope control settings for checking the response of the Q demodulator circuit.

Typical I demodulator sweep test

In checking the frequency response of the I demodulator channel, the initial twinned response should be entirely symmetrical (Fig. 328). If one of the curves is higher or lower and differently shaped from the other, the video sweep voltage is not flat. A check of sweep flatness should be made (Fig. 311) and the lack of flatness corrected as required. Upon occasion the operator may note spikes at the ends of the display. They are caused by differentiation of the 60-cycle square-wave component in the signal by the series charging capacitor in the crystal probe. The spikes will disappear when the

Chart 3-2. Generator and Scope Settings for Sweep-Frequency Checks of Q Demodulator

Instrument Setting	Discussion
FM generator tuning: set to any convenient frequency on a pure-fundamental band, such as 160-mc center frequency.	Use an FM generator band which has a pure fundamental output to minimize the generation of spurious markers, which often occurs when a beat-frequency band is used.
FM generator attenuator: Advance setting to maximum.	Little or no gain is provided by the Q demodulator circuit and accordingly the test signal should have a high level.
FM generator sweep-width control: Set to 1 or 1.5 mc.	The Q demodulator circuit has a bandwidth of approximately 0.5 mc. A sweep width of 1 or 1.5 mc permits sweeping the response curve down to the base line of the pattern.
AM generator tuning: Set tuning dial initially to the same frequency as the center frequency of the sweep generator, such as 160 mc.	The outputs from the two generators are beat through the Chromatic Probe to obtain a video-frequency difference signal, which will sweep from zero to 1 or 1.5 mc, depending upon the setting of the sweep width control.
AM generator attenuator: Advance setting to maximum. AM generator function control: Set to unmodulated rf output.	Because of the low gain of the Q demodulator circuit, a high-level signal is desirable. A CW voltage must be utilized. If a modulated signal voltage were used, the pattern would "wiggle" violently with the audio modulating voltage.
Scope vertical gain control: Set initially for maximum gain.	Fairly high gain must be used for adequate vertical deflection. If the pattern drives off-screen vertically, reduce the vertical gain setting of the scope as required.
Scope centering and focusing controls: Adjust for properly displayed pattern and sharp focus, as in conventional applications.	If the centering controls are badly misadjusted, the pattern may be initially invisible off-screen. Likewise, if the intensity control is set too low, the pattern will be invisible.
Scope horizontal deflection: Set for 60-cycle sine-wave deflection.	Some scopes have a built-in 60-cycle sine-wave deflection function; others require that this voltage be obtained from the sweep generator and applied to the horizontal input terminals of the scope via an interconnecting cable.
Scope horizontal gain control: Set for appropriate width of pattern on scope screen.	The horizontal gain control is usually adjusted to provide a pattern width of approximately two thirds of the screen diameter.

Horizontal phasing control (provided on either generator or scope). Set to merge trace and retrace together.

Use of 60-cycle sine-wave deflection always produces a trace and a retrace. These must be phased together for proper display.

FM generator blanking control: Turn on to convert the retrace into a zero-volt reference line.

While it is not absolutely necessary to convert the retrace into a zero-volt reference line, this is a convenience in practical work.

Note on probe utilized: Either a demodulator or a low-capacitance probe can be used in this test. If a demodulator probe is used, a conventional envelope type response is displayed on the scope screen. If a low-capacitance probe is used, an undemodulated type of display is obtained. The advantage of using a low-capacitance probe is that the low-frequency response is not attenuated by the probe; the disadvantage is that the technician is usually more familiar with the envelope type of display.

AM generator tuning: Now that the response curve appears on the scope screen, retune the generator to bring the zero-frequency point exactly to the left-hand end of the base line.

The video-frequency sweep which is being used will display two mirror-image curves when the zero-frequency point falls in the center of the pattern; hence, the generator is tuned to run one of the mirror images off the base line, leaving the other fully displayed in conventional form.

Marking the response: Either an absorption marker box can be used between the Chromatic Probe and the grid of the Q demodulator tube or the operator can "step off" 0.1-mc intervals on the generator tuning dial.

An absorption marker box is most convenient and usually provides notches in the curve at 50 kc and 0.5 mc for evaluation of the frequency response. The "stepoff" method is also quite satisfactory.

zero-volt reference line is switched off. In operating with a zero-volt reference line, the spikes are disregarded.

Circuit gain

It often becomes desirable or necessary to measure the gain of video-frequency circuits during servicing. This is easily accomplished by moving the demodulator probe from the input of the circuit under test to the output and noting the increase (or decrease) in pattern height which takes place. Fig. 311 shows how the input signal voltage to the circuit under test can be measured on the scope screen. If, next, the probe is applied at the output of the circuit under test, the relative deflection obtained indicates the circuit gain or loss.

Progressive gain checks may or may not be practical, depending upon the circuit arrangement. For example, it is not possible to

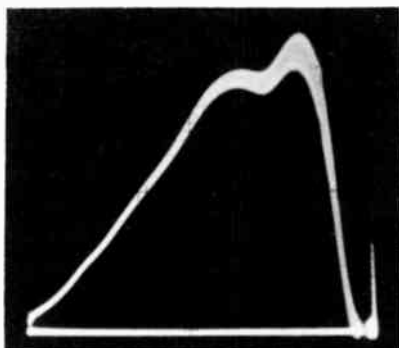
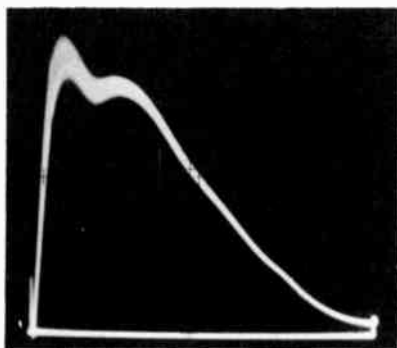
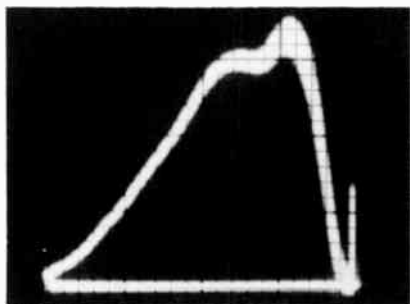

Fig. 326. (Left) Zero-frequency point tuned to left-hand end of base line. (Right) Zero-frequency point appears at right-hand end of base line when sweep-width control is set to 2 mc and the tuning dial of the sweep generator is moved through an interval of 2 mc.

sweep the I and Q demodulators through the chroma bandpass amplifier (at least by the methods so far described). The output from the picture detector passes through the chroma bandpass amplifier, which passes frequencies from 2.1 to 4.2 mc. This filter action serves to remove as much of the monochrome signal as possible, but there

Fig. 327. The horizontal width control of the scope has been adjusted to make the base line extend over an interval of 20 squares on the graticule. Each square indicates an 0.1-mc interval along the curve.



still remains the interleaved monochrome signal in this band from 2.1 to 4.2 mc. The output from the chroma bandpass amplifier accordingly consists principally of the mixed I and Q signal voltages.

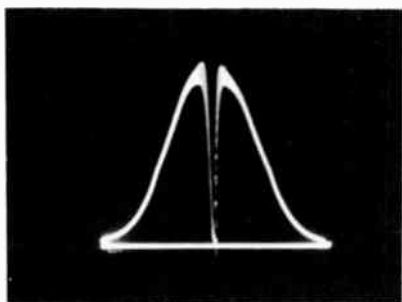

Fig. 328. Response of the I demodulator channel of a color-TV receiver when the sweep voltage is flat. Both curves appear symmetrically at the same height.

Chart 3-3. Scope Control Settings for Checking Response of Q Demodulator Circuit, Using Subcarrier Beat Signal

Control Setting	Discussion
Intensity, focus, and centering controls: Set for normal aspect of pattern.	Beginners unfamiliar with the basic controls of the scope can speed their learning by watching experienced operators whenever possible.
Vertical attenuators: Set to obtain a pattern height approximately two-thirds of full screen.	Some scopes may overload and clip the waveform unless the vertical step attenuator is set to a relatively low position and the vernier attenuator to a relatively high position.
Horizontal function switch: Set to horizontal input position. Connect cable from horizontal input terminals of scope to sweep generator.	The scope is conventionally operated on 60-cycle sine-wave sweep in applications of this type. In most cases, the phasable 60-cycle sine-wave deflection voltage is obtained from the sweep generator via an interconnecting cable.
Horizontal gain control: Set to obtain a pattern width approximately two-thirds of full screen.	The fundamental shape of the waveform is not changed by variation of the gain-control settings; however, the pattern is most convenient for use when adjusted for about two-thirds screen width.
Note: If the scope has a built-in source of phasable 60-cycle sine-wave deflection voltage, set these associated controls as follows:	
Horizontal function switch: Set to 60-cycle sine wave.	In this position of the horizontal function switch, an internal 60-cycle sine-wave deflection voltage is applied to the horizontal deflection plates of the cathode-ray tube.
Phasing control: Adjust to merge the trace and retrace in the pattern.	Correct display of the curve requires that the phases of the FM sweep voltage from the generator and the horizontal deflection voltage in the scope be the same. The phases are the same when trace and retrace lay over in the pattern.
Note on base-line display: the base line in the display is obtained by converting the return trace in the pattern to a zero-volt reference line. This is always accomplished by turning the blanking control of the sweep generator to the ON position.	

In the I and Q demodulators, these signals become separated and demodulated in the suppressor circuits of the demodulators with respect to the injected two-phase 3.58-mc color subcarrier voltage. The output from the I demodulator contains the I signal as AM, and the Q signal as FM (which becomes rejected by the subsequent AM circuits). The output from the Q demodulator contains the Q signal as AM and the I signal as FM. In sweeping these circuits, it

is customary to apply a 0-2-mc sweep signal at the grid of the demodulator circuit under test and to apply a demodulator probe at the output. The color subcarrier demodulator is usually disabled to avoid interference.

Since the passband of the chroma bandpass amplifier is from 2.1 to 4.2 mc, a sweep signal applied at the input of the chroma bandpass amplifier is cut off from the I and Q channels (Fig. 329) since the passbands of the two circuits are staggered. An attempt to sweep the color demodulators from the grid of the chroma bandpass amplifier results in small distorted feedthrough responses (Fig. 330). It should not be inferred, however, that such a test cannot be made.

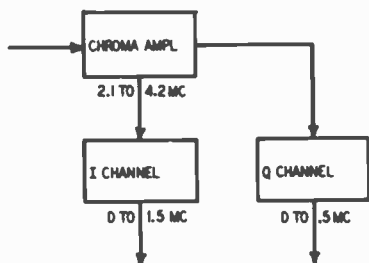

Fig. 329. Since the passband of the chroma bandpass amplifier is from 2.1 to 4.2 mc and the passband of the demodulator circuits from 0 to 1.5 mc and 0 to 0.5 mc, the combined response of the chroma bandpass amplifier and the demodulator circuits cannot be obtained in the conventional manner.

Color demodulator as AM detector

Fig. 331 shows that the color subcarrier is applied at the suppressor grid of the color demodulator tube. AM demodulation occurs in the suppressor circuit during normal operation. It is evident that the frequency response of the color demodulator circuit could

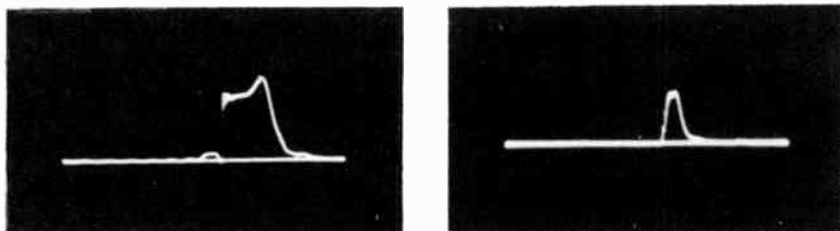

Fig. 330. Small distorted feedthrough obtained when attempting to sweep the Y and Q channels through the chroma bandpass amplifier with a 0-2-mc sweep signal. Since the passbands of the two circuits are staggered, a sweep test cannot be obtained by conventional sweep checks. (A) Feedthrough, I channel, from chroma amplifier. (B) Feedthrough, Q channel, from chroma amplifier.

be obtained by permitting the color subcarrier oscillator to continue in operation and applying a 1.58-3.58-mc sweep signal to the grid of the color demodulator tube. The 3.58-mc color subcarrier then heterodynes with the sweep signal to produce the 0.2-mc sweep

output. However due to the relatively low output of conventional service sweep generators (approximately 0.1 volt), the deflection obtained on the scope screen after losses in the crystal probe is very small. To obtain a satisfactory test, a Chromatic Amplifier must be used between the cathode of the phase splitter and the input of the crystal probe, or the scope must be applied directly at the cathode of the phase splitter.

The result of applying the scope directly at the cathode of the phase splitter is shown in Fig. 332. This is a practical test which makes it possible to view the combined response of the chroma

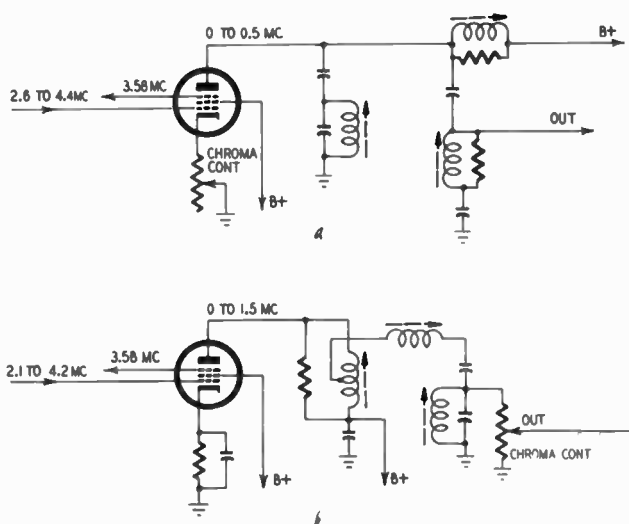

Fig. 331. (A) Typical demodulator bandpass circuit used in the (R - Y) (B - Y) type of receiver. The output from the color subcarrier oscillator is applied to the suppressor grid of the demodulator. (B) Demodulator bandpass circuit used in the I-Q receiver. The incoming signal heterodynes with the 3.58-mc signal applied to the suppressor grid in both types of demodulators.

bandpass amplifier and the color demodulator by applying the 1.58-3.58-mc sweep signal at the grid of the chroma bandpass amplifier and the scope directly at the cathode of the phase splitter. The color subcarrier oscillator is free running in some cases, but is a shock-excited ringing circuit, in other cases. In the case of the shock-excited oscillator, this type of test becomes impractical.

Overall response is dominated by narrowest-band circuit

Fig. 333 shows how the combined response of two circuits is influenced by the characteristics of the narrowest circuit. The pass-

band of the second chroma amplifier is quite wide but when swept through the first (chroma bandpass) amplifier, the combined response becomes dominated by the narrow bandpass of the first circuit.

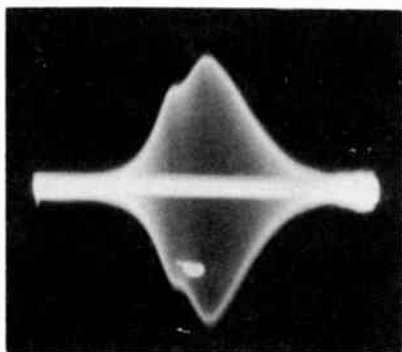
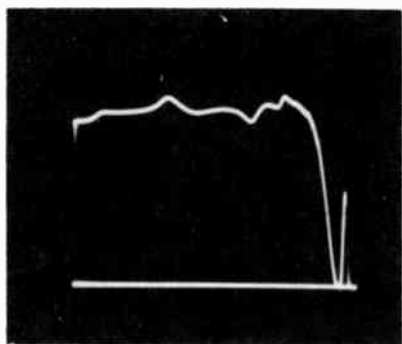
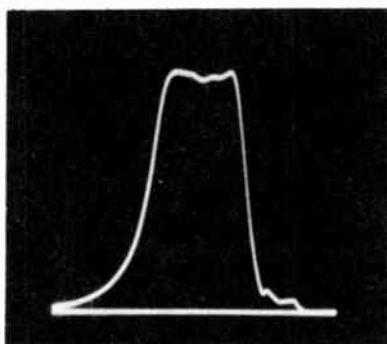

Fig. 332. Response of the (R - Y) demodulator obtained by beating the 2-4.5-mc output from a sweep generator, applied at the grid of the demodulator tube, with the 3.58-mc color subcarrier voltage in the suppressor circuit of the demodulator. The scope is applied directly at the cathode of the phase splitter to avoid loss in the crystal probe. Note that the demodulating action is somewhat unsymmetrical.

Fig. 334-a shows the chroma bandpass circuit on the scope screen with the zero-frequency point in the center of the pattern; the standard form of the curve is with the zero-frequency point tuned to the end of the base line, as shown in *b*. Since the (R-Y) (B - Y) type of receiver utilizes a 0.5-mc bandpass in both color



A



B

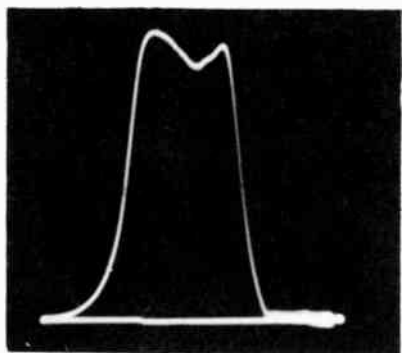

C

Fig. 333. (A) Response of second chroma amplifier. (B) Response of first chroma (bandpass) amplifier. (C) Combined response of first and second chroma amplifiers.

demodulators, the passband of the chroma amplifier is 1 mc to accommodate both upper and lower sidebands and the 3.58-mc point is centered on the response curve. In fact, crosstalk from the color subcarrier oscillator is often useful to mark the center of the chroma bandpass response during alignment procedures. If the ringing type of color subcarrier oscillator is used, the bias on the if amplifier can be reduced somewhat to allow a little noise voltage to

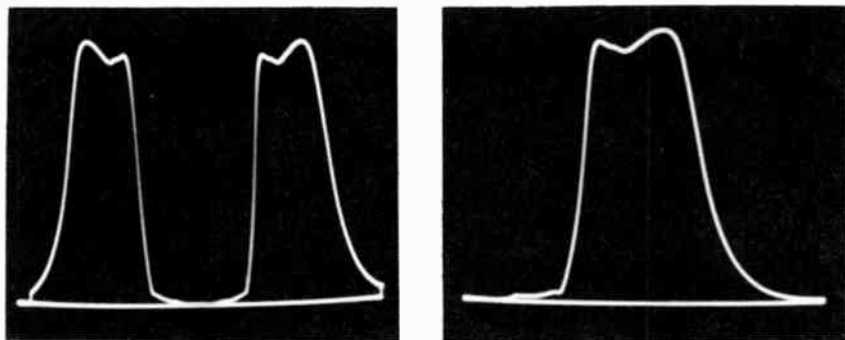

Fig. 334. (A) When the sweep generator is tuned with zero frequency appearing in the center of the display, there is considerable blank space between the twin responses from the chroma bandpass amplifier since the circuits cut off below 2.1 mc. (B) To obtain the standard form of curve, the zero-frequency point is tuned to the left-hand end of the base line.

enter the color sync circuits to excite the 3.58-mc ringing crystal and provide a marker.

In the I-Q type of receiver, the I demodulator utilizes sidebands which extend 1.5 mc below and 0.5 mc above the color subcarrier frequency. Hence, the 3.58-mc point is not centered on the chroma amplifier response curve and the bandpass extends from 2.1 to 4.2 mc.

When making checks without a demodulator probe and with the scope applied directly or through a low-capacitance probe at the output of the circuit under test, the bandwidth of the scope must be adequate. For example, if the output from a video generator is applied directly at the vertical input terminals of a scope and if the sweep width of the generator is set to a value greater than the bandwidth of the vertical amplifier in the scope, the indication is not flat but tapers off. In this type of test it is essential that the bandwidth of the scope be equal to or greater than the bandwidth of the circuit to be tested.

Sweep generator as 60-cycle square-wave source

A sweep generator can be readily utilized as a 60-cycle square-

wave generator by making use of the circuit of Fig. 335 and reducing the sweep width to a small value, such as 0.1 mc. The result of a typical test of a Q demodulator channel is shown in Fig. 336. The

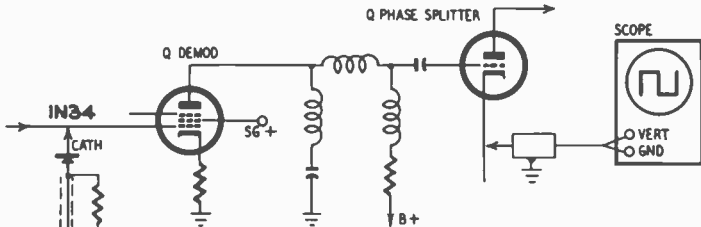

Fig. 335. Test setup using the video-frequency sweep generator as a 60-cps square-wave generator. The scope is connected at the cathode of the phase splitter through a low-capacitance probe, or the scope can be applied directly at this point. The sweep generator is set to some if frequency with a sweep width of 0.1 mc or less.

center frequency of the sweep generator can be set to any convenient value, such as 10 mc or 20 mc.

When running any checks of the color demodulators, it is necessary to bias off the grid of the color killer in case the horizontal-sweep circuit is not disabled. The color killer is actuated by a pulse from the horizontal sweep circuit. Hence, it is not necessary to bias off the color killer. In the case of a manual color killer, the plate voltage to the demodulators is customarily opened when the color

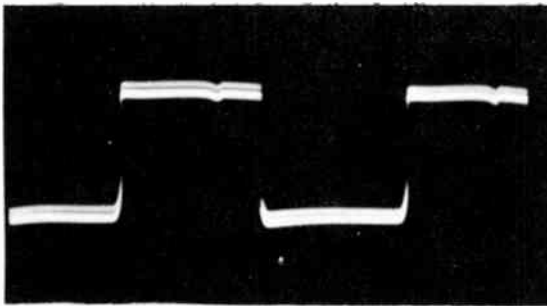

Fig. 336. Typical response of Q channel to 60-cycle square-wave voltage.

killer is turned off. Hence, the control must be turned off in such case, before tests can be made on the color demodulator circuits.

Not only is receiver operation often improved vastly by stabilization of the line voltage, but various circuit tests are sometimes facilitated in the same manner. Consider, for example, a video sweep test

of a chroma circuit in which the scope is applied directly at the cathode of the phase splitter. The output from the generator is usually quite stable, as may be determined by applying the generator signal directly to the scope.

Delay time of video amplifier

Since the chrominance circuits have a narrower bandwidth and a slower rise than the Y amplifier, a 1- μ sec delay line must be interposed in the Y amplifier circuit (Fig. 337) to make color information fit properly on Y information. Fig. 337 shows that a color signal applied to the receiver comprises a 3.58-mc chrominance component and a Y level situated somewhere between black and white, depending upon the particular color signal. If the color signal is alter-

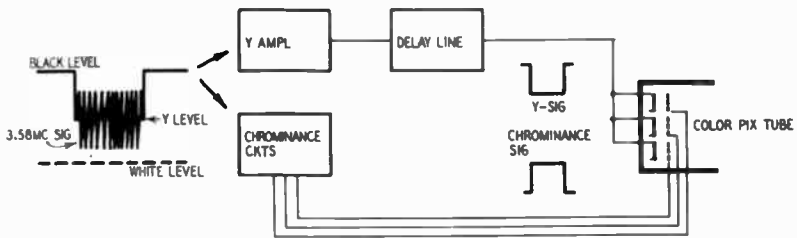

Fig. 337. The operation of the delay line is checked by the signal. The crankshaft signal passes through the Y amplifier and the chrominance signal through the chrominance circuits. If the delay is correct, the edges of color bars and black bars will meet exactly.

nated with a black signal (as often provided by a color bar generator or a test pattern), the operation of the delay line can be readily checked.

The results of such a test, with the two types of delay defects, are depicted in Fig. 338. If the Y signal is delayed too long, a gap will appear between the color bar and the white bar. On the other hand, if the Y signal is not delayed long enough, an overlap will occur between them. Such improper delays are caused by misalignment as well as by faulty delay circuits and even by misadjustment of the fine-tuning control in the receiver.

The transition from color to white bars in the arrangement of Fig. 337 is the resultant of two signals. One component flows through the Y amplifier—this is the crankshaft signal in the waveform. The other component is the demodulated 3.58-mc signal from the chrominance circuits. The crankshaft signal is applied to the cathodes of the picture tube while the chrominance signal is applied to one or more of its grids. Operation of the delay line cannot be checked by a signal which does not pass through the delay

line—i.e., the delay line is not checked by the input signal unless it has a crankshaft component.

Compare the arrangements of Fig. 337 and Fig. 339. In the latter the applied signal contains chrominance information only. The application of such a signal to the receiver causes a flow of energy through the chrominance circuits only; the Y amplifier remains un-

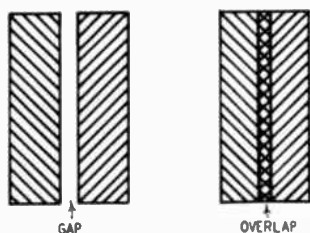

Fig. 338. When the color bar generator energizes both the delay line and the color circuits, bar patterns with a gap or overlap between the color and black bars indicate incorrect delays. Misalignment can also cause delay trouble.

energized. The bars are made readily visible, in this instance, by advancing the brightness control and thereby reducing the bias on the grids of the picture tube. Since no signal is flowing through the Y amplifier, no check of the delay line is obtained although a premature unwarranted conclusion might be drawn in this regard since black bars are displayed beside the color-difference bars.

Chart 3-4 lists the scope control settings for a 60-cycle square-wave check of the Q demodulator circuit.

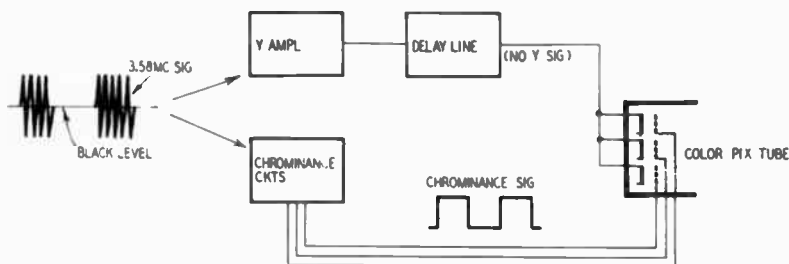

Fig. 339. When the 3.58-mc component of the applied signal has no Y (crankshaft) component, the Y amplifier is not energized. Only the chrominance circuits are energized. The Y component is artificially produced at the picture tube by advancing the brightness control. Under this condition, the color-difference bars always register perfectly with the black bars. A check of the delay line is not obtained.

Overload of chrominance circuits

Chrominance circuits can be overloaded by application of an excessively strong color bar signal. When overload occurs, some of the color bars are affected before others because the chrominance voltage of colors such as red and cyan is higher than for yellow and blue. The relative chrominance voltages for the primary and complementary colors are depicted in Fig. 340.

Overload usually occurs in the bandpass amplifier when the video-frequency output from the color bar generator is applied at the output of the picture detector. The dynamic range of the color detectors is normally much greater than that of the bandpass amplifier. Thus, the color bars first affected by overload are red and cyan. As overload is increased, the green and magenta bars are distorted. Finally, with severe overload, the yellow and blue bars are improperly reproduced. Overload distortion shows up on the screen of the picture tube as a muddying and dirtying of the hue, accom-

Chart 3-4. Scope Control Settings for 60-Cycle Square-Wave Check of Q Demodulator Circuit

Control Setting	Discussion
Vertical attenuators: Adjust for a pattern height about two-thirds of full screen.	Be certain that the waveform is not clipped by the scope amplifier. Set the vertical continuous attenuator to a relatively high position and the vertical step attenuator to a relatively low position.
Horizontal function switch: Set to sawtooth position.	Conventional display of square-wave response is made on a sawtooth sweep.
Horizontal frequency: Set the step switch to a position which includes a 60-cycle sweep rate.	The scope is deflected at a 60-cycle rate to accommodate the 60-cycle square-wave display.
Sync function switch: Set to internal position.	Some scopes provide a choice of INTERNAL + and INTERNAL — sync. Either position is satisfactory for locking a 60-cycle square-wave display.
Sync amplitude control: Advance to lock pattern.	Do not set the sync amplitude control to an excessively high position or the pattern may be distorted.
Vernier sweep control: Set to obtain one complete cycle of the square wave in the display on the screen.	If the vernier sweep control is set for a 60-cycle deflection rate, one complete cycle is displayed. If it is set for a 30-cycle deflection rate, two complete cycles are displayed, etc.
<p>Note: The blanking control of the sweep generator must be ON to provide a suitable test signal to the input of the Q demodulator circuit.</p>	

panied by a darkening of the bars. A scope check shows overloading as clipping of the chrominance waveform and subnormal peak-to-peak voltage with respect to the bars which are not overloading the bandpass amplifier.

Overload usually occurs in the if amplifier when modulated rf output is applied from the generator to the antenna input terminals

of the receiver. In this case, the bars are affected in a slightly different sequence because the signal in the i-f amplifier is a composite signal comprising both Y and chrominance components (Fig. 341). If overload almost always occurs as compression of the signal in the

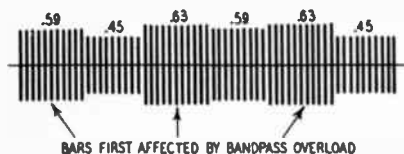

Fig. 340. Chrominance signals with the highest voltage are first affected by bandpass overload.

sync and blanking region. Hence, the colors first affected are red and blue, followed by magenta, green, cyan and yellow.

In most cases, if overload can be avoided in normal operation of the receiver by setting the agc threshold control to a suitable level. However, if the applied signal from the antenna is too strong for

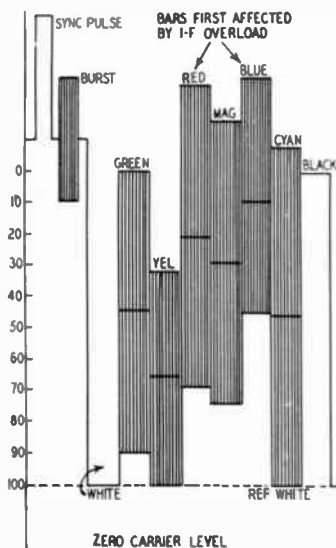

Fig. 341. Overload in i-f amplifier first distorts bar signals extending into black region.

agc control, padding must be used in the lead-in to reduce the signal to a suitable level.

Chrominance contamination of the white bar signal

When checking the chrominance circuits with a color bar generator, color contamination of the white bar (due to improper ad-

justment of the generator) is sometimes encountered. See Fig. 805 in chapter 8. This drawing shows how red, green and blue are overlapped to produce white. Overlapping of color bars corresponds to voltage mixtures of the corresponding signals. The complete color signal which results from mixture of the primary voltages in the generator circuits is also shown.

When the red, green and blue signal voltages are properly mixed, the corresponding chrominance voltages and phases cancel completely, leaving only a horizontal line at the white level. No 3.58-mc signal appears on this white level when the generator is properly adjusted. The adjustment is made by service controls typically identified as red, blue and green saturation.

Consider the case in which the blue and green saturation controls are set to correct relative levels, but in which the red saturation control is too high. Then, the white bar is not a clean horizontal line and displays the presence of 3.58-mc voltage when checked with a wide-band scope (Fig. 342). When viewed on the screen of the picture tube, the white bar will display a tint. With the red saturation control set too high, the white bar displays a red tint. But if it is set too low, the white bar displays a cyan tint.

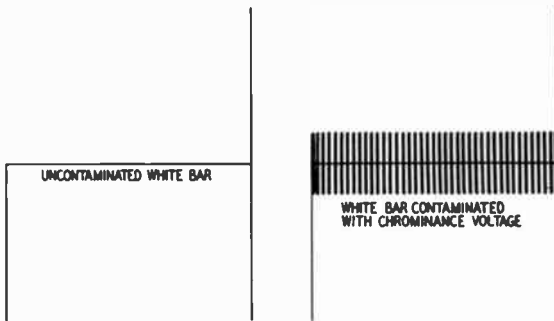

Fig. 342. Result of unbalance of primary signal voltages.

Next, consider the case in which the blue saturation control is set too high, producing another type of unbalance in the white bar signal and again causing it to show the presence of 3.58-mc voltage superimposed upon its Y voltage. The white bar is displayed with a bluish tint. On the other hand, if the blue saturation control is set too low, the white bar displays a yellowish tint. Chrominance voltage will be found upon the white bar display in either case when the generator output is checked with a wide-band scope. When the blue saturation control is set correctly with respect to the red and

green saturation controls (assuming that they are also set to correct relative levels), the chrominance information disappears from the white bar signal and it is displayed without tinting.

Finally, consider the situation in which the green saturation control is set too high. The green bar displays a greenish tint. But, if the green saturation control is set too low, the white bar displays a magenta tint. Of course, the tinting of the white bar due to misadjustment of the generator becomes evident on the screen of the picture tube only when the color intensity control is advanced. If this control is set to minimum, all hues disappear from the screen of the picture tube and the color bars appear only as a series of vertical bars having different values of gray. The white bar will then appear white even if contaminated with chrominance information.

servicing chroma demodulators

SWEEP-FREQUENCY testing of I and Q, and (R — Y) and (B — Y) demodulators was discussed in Chapter 3. The reader is now in a position to consider the more advanced types of chroma demodulator service tests which are unique to color receivers and have no counterpart in black-and-white.

Demodulator testing with linear phase sweep

A linear phase sweep is synonymous with the more familiar term "rainbow signal." Let us take a moment to explain just what is meant by this. A standard linear phase sweep signal is a sine-wave voltage having a frequency of 3.563795 mc. This frequency differs from that of the subcarrier frequency of 3.579545 mc by 15,750 cycles. If we represent the subcarrier oscillator voltage and the phase-sweep voltage by vectors (Fig. 401), it is evident that in the course of one horizontal scan interval the color subcarrier oscillator will pull ahead of the phase sweep signal and, in fact, the two vectors will pass each other once in their rotations for each horizontal scan.

Now, as the linear phase sweep signal is continuously lagging farther and farther behind the color subcarrier oscillator signal, the phase sweep signal sweeps through all (360°) of the color-difference spectrum (Fig. 402). This is why a linear phase sweep signal is a rainbow signal. A linear phase sweep signal is also referred to as a side-lock signal or as an offset color subcarrier signal. For our present purposes, we are chiefly concerned with its application in testing the chroma demodulators in the receiver.

Linear phase sweep generators commonly provide a modulated

rf output which can be applied to the antenna input terminals of the receiver. This method, of course, is most convenient in test work although the same patterns are obtained when a video-frequency phase sweep signal is applied to the circuits following the picture detector in the receiver.

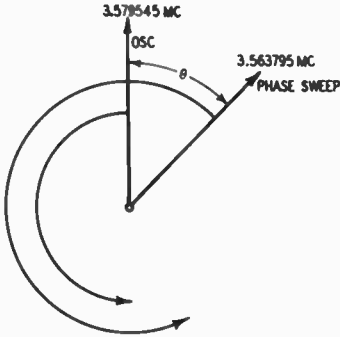

Fig. 401. A linear phase-sweep signal has a frequency which is lower than that of the color-subcarrier oscillator by 15,750 cycles. The phase-sweep vector falls farther and farther behind the oscillator, causing the angle between the two vectors to get larger and larger—thus forming a linear phase sweep.

Fig. 403 shows that, when a linear phase sweep signal is applied to (R - Y) and (B - Y) demodulators and the vertical input terminals of a scope connected to the (R - Y) demodulator output, with the horizontal input terminals of the scope connected to the (B - Y) demodulator output, a circular pattern is obtained on the

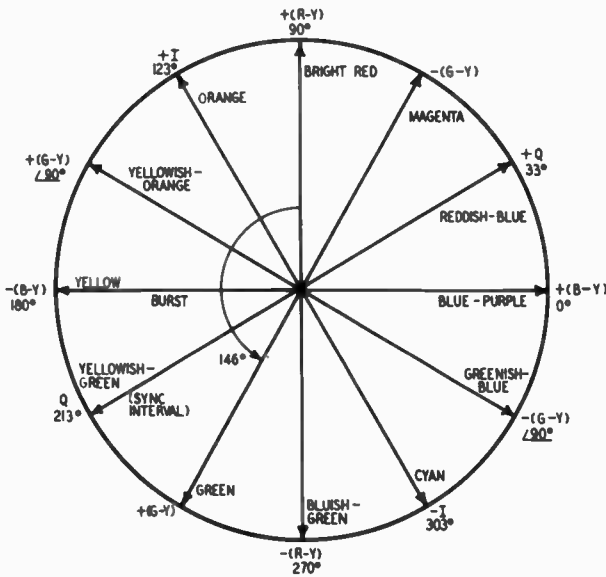

Fig. 402. As the linear phase sweep vector lags farther and farther behind the burst phase, it progressively sweeps through all of the color-difference signals during a horizontal scan interval.

scope screen. The circle has a "pie cut" present, due to the blanking pulse applied to the bandpass amplifier.

The pie cut marks the blanking interval in receiver operation and is an important landmark in checks of chrominance demodulators. Fig. 404 shows how the position of the pie cut falls with respect to the horizontal base line of the scope, when color phasing is correct. If the color phasing control is turned, the pie cut rotates about the scope screen.

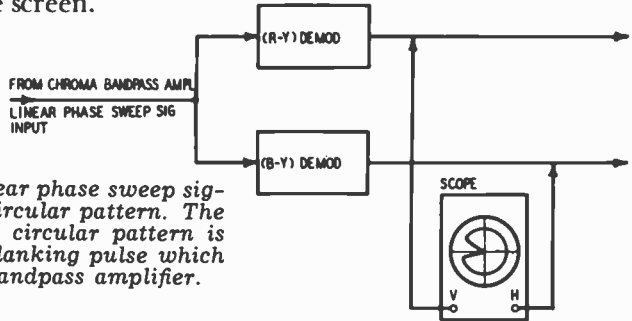

Fig. 403. The linear phase sweep signal produces a circular pattern. The "pie cut" in the circular pattern is formed by the blanking pulse which is fed to the bandpass amplifier.

A circular pattern is obtained on the scope screen because the two color detectors develop a sine-wave output when energized by a linear phase sweep. The sine-wave outputs are separated 90° in phase because the color subcarrier voltage is fed to the two demodulators with a 90° phase difference (Fig. 405). When the sine-wave voltages applied to the horizontal and vertical amplifiers of the scope differ 90° in phase, the scope necessarily develops a circular screen pattern when the gains of the vertical and horizontal amplifiers are equalized with the gain controls.

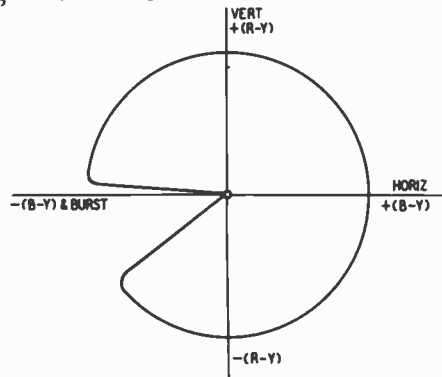

Fig. 404. The "pie cut" appears for the duration of the horizontal blanking interval. The illustration shows the proper relation of the cut to the horizontal base line for an (R - Y) (B - Y) detection system.

Now, consider the situation in which the quadrature transformer is misadjusted in the TV receiver so that the two subcarrier voltages fed to the color demodulators are no longer in quadrature. In such a case, the scope displays an elliptical pattern (Fig. 406), and no

possible adjustment of the scope gain controls can make a circle out of it. This is the basis of the quadrature test with a linear phase sweep.

Of course, I and Q as well as (R - Y) (B - Y) demodulators can

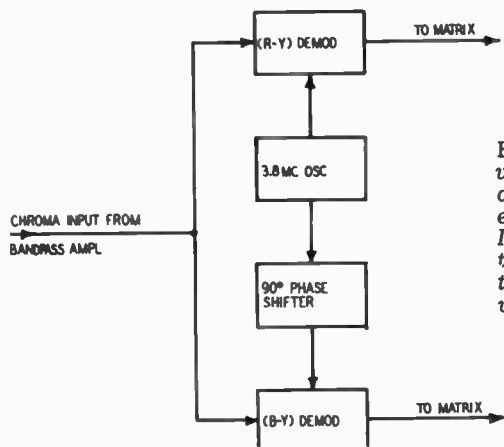

Fig. 405. The subcarrier voltages to the two chroma demodulators should be exactly 90° out of phase. If the phase is more or less than this, a circular pattern cannot be obtained with a linear phase sweep.

be checked with a linear phase sweep. Fig. 407 shows the arrangement utilized in the test setup. The pie cut does not appear in the same position for an I-Q display because the I-Q axes are displaced 33° from the (R - Y) ((B - Y) axes as shown in Fig. 402. The normal pie cut location for I-Q demodulators is shown in Fig. 407. Here again, turning the color phasing control of the receiver causes the pie cut to rotate about the circle. Incorrect adjustment of the quadrature transformer will produce an elliptical pattern on the scope screen.

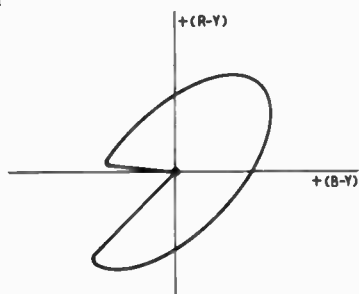

Fig. 406. Misadjustment of quadrature transformer produces elliptical pattern.

Some color receivers demodulate along the (R - Y) and (G - Y) axes (Fig. 408) and matrix the outputs from the demodulators to obtain (B - Y). When checking this demodulation system with a linear phase sweep, the output from the (R - Y) demodulator is applied to the vertical amplifier of the scope and the output

from the $(B - Y)$ matrix to its horizontal amplifier. It is not possible to check quadrature by testing the output from the $(G - Y)$ circuit since $(G - Y)$ is *not* in quadrature with $(R - Y)$ as shown in Fig. 402. The vertical deflection plates are at right angles to the horizontal deflection plates in the scope hence the test requires that the signals be derived from quadrature signal sources.

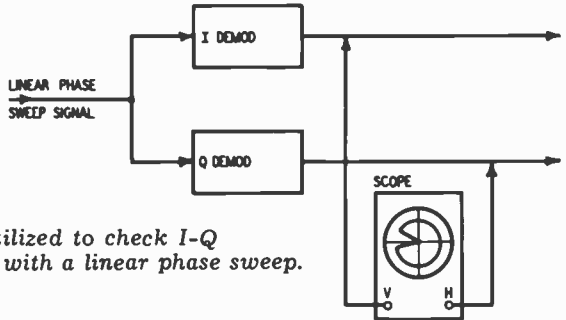

Fig. 407. Test setup utilized to check I-Q demodulators with a linear phase sweep.

When checking an $(R - Y)$ $(G - Y)$ demodulation system with a linear phase sweep (Fig. 408), a circular pattern can be obtained on the scope screen when the phase-shifter circuit (Fig. 409) is adjusted to apply subcarrier signals 146° different in phase to the two color demodulators. The $(R - Y)$ $(G - Y)$ system is used in some receivers to equalize more nearly the dynamic ranges required of the various chrominance stages.

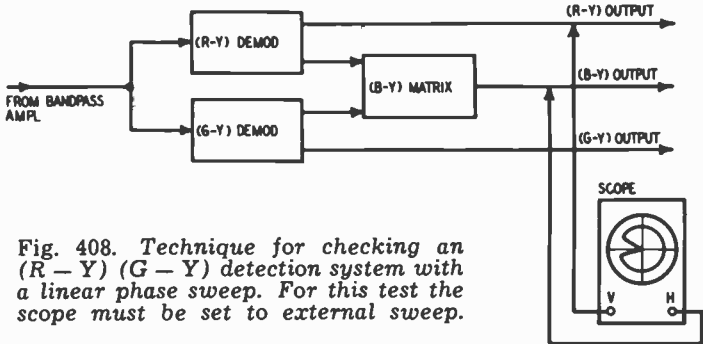

Fig. 408. Technique for checking an $(R - Y)$ $(G - Y)$ detection system with a linear phase sweep. For this test the scope must be set to external sweep.

When the output from a single color demodulator is applied to the vertical amplifier of the scope and the pattern is displayed on sawtooth sweep (Fig. 410), a sine-wave pattern is obtained on the scope screen. The sine-wave is marked with a pulse. This is the blanking pulse applied to the bandpass amplifier and marks the horizontal blanking interval.

Distinction must be made between blanking and boost-gate

pulses which may be applied to the grid of the bandpass amplifier in various receivers. Chrominance circuit arrangements differ. Some receivers obtain the burst signal from the bandpass amplifier output while others obtain it from the video amplifier preceding

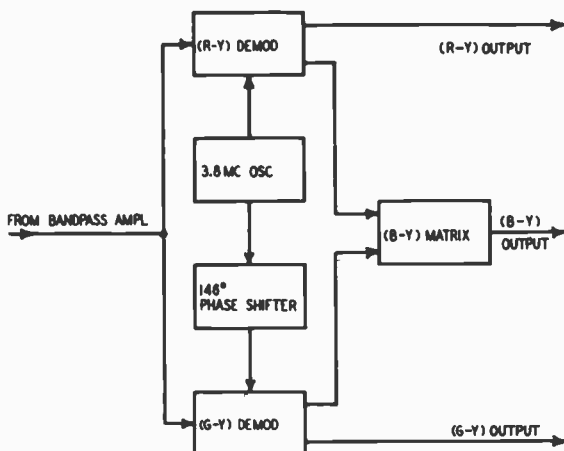

Fig. 409. In the (R - Y) (G - Y) demodulation system, a circular pattern is obtained in the test of Fig. 408 when the two demodulators are fed sub-carrier signals which differ in phase by 146° .

the bandpass amplifier. Likewise, some receivers have dc restorers at the color picture tube while others use dc coupling throughout the chrominance circuits and dispense with the dc restorers.

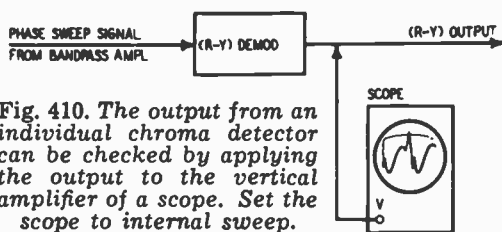

Fig. 410. The output from an individual chroma detector can be checked by applying the output to the vertical amplifier of a scope. Set the scope to internal sweep.

In the first arrangement, the pulse applied to the bandpass amplifier tube is a boost-gate type which increases the gain of the bandpass amplifier during passage of the burst and, in such case, the output from the color demodulator increases for the duration of the pulse. In the second arrangement, the pulse applied to the bandpass amplifier tube is a disabling pulse, which decreases the gain of the bandpass amplifier during passage of the burst. In this case, the output from the color demodulator decreases for the duration of the pulse.

Receivers which utilize dc restorers at the picture tube employ a disabling pulse at the bandpass amplifier during the burst interval

because dc restorers are upset if the burst voltage is permitted to pass through the chrominance circuits. On the other hand, when the color demodulators are dc-coupled to the picture tube, it is of no consequence whether the burst voltage arrives at the picture tube or not. With a boost-gate pulse applied to the bandpass amplifier during the burst interval, the disturbance which reaches the picture tube occurs during the flyback interval and is blanked out.

At the same time that a linear phase sweep is being applied to the antenna input terminals of the receiver, a rainbow pattern appears on the screen of the color picture tube. When the color phasing control is turned, the complete color spectrum shifts left or right on the screen of the picture tube, and the pulse moves correspondingly along the sine wave on the scope screen.

Color demodulator testing with keyed linear phase sweep

The more elaborate type of linear phase sweep generators provide a keyed output (Fig. 411) for easier interpretation of patterns. The pattern is commonly keyed into 11 bursts and contains a horizontal sync pulse. The first burst serves as a sync signal for the color circuits and the following 10 bursts produce 10 color bars on the screen of the picture tube. The pattern is also referred to as a keyed rainbow pattern.

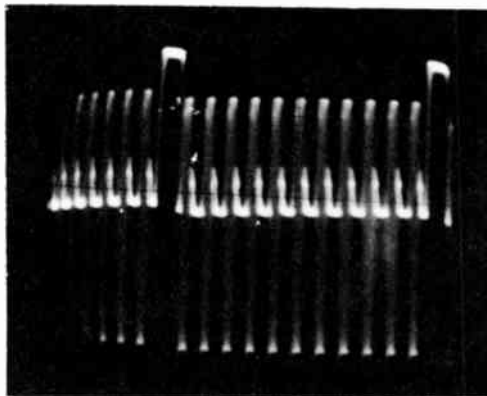

Fig. 411. *Keyed output of linear phase sweep generator.*

The relations between the scope pattern seen at the output of the $(R - Y)$ detector, the bars of color on the screen and the various color-difference signals are depicted in Fig. 412. If the color phasing control is properly set and the quadrature transformer correctly adjusted, the output from the $(R - Y)$ detector will

show a peak at the third bar and a null at the sixth. The reason for this is that the third bar is an $(R - Y)$ signal for which the

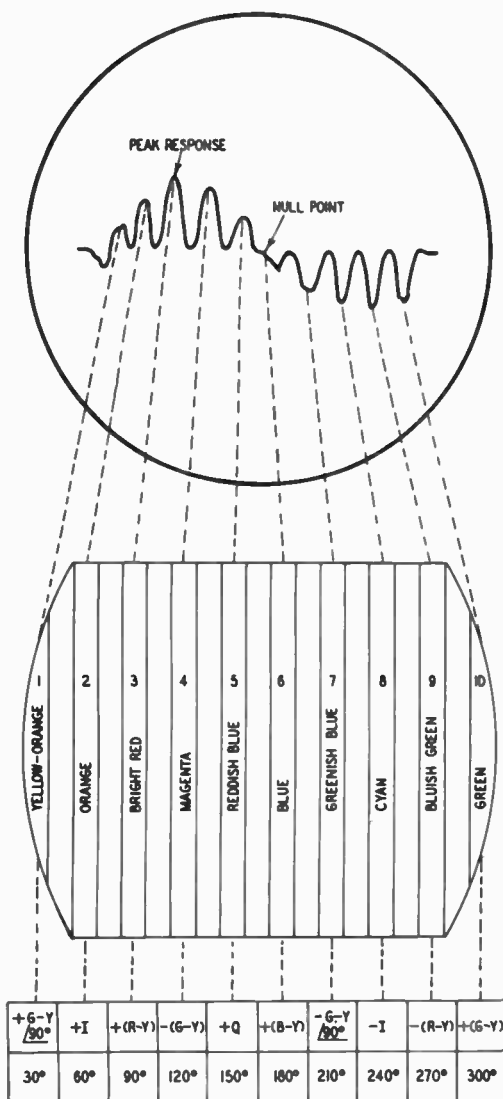

Fig. 412. A keyed linear phase sweep signal has the characteristics shown above. The scope pattern represents the $(R - Y)$ detector output waveform.

$(R - Y)$ detector develops maximum output. The sixth bar is a $(B - Y)$ signal for which the $(R - Y)$ detector develops zero output.

Of course, an I demodulator nulls on a Q signal, a Q demodulator nulls on an I signal and a (B - Y) detector nulls on an (R - Y) signal (Fig. 413). In the same manner, a (G - Y) detector nulls on a (G - Y) $\underline{90^\circ}$ signal.

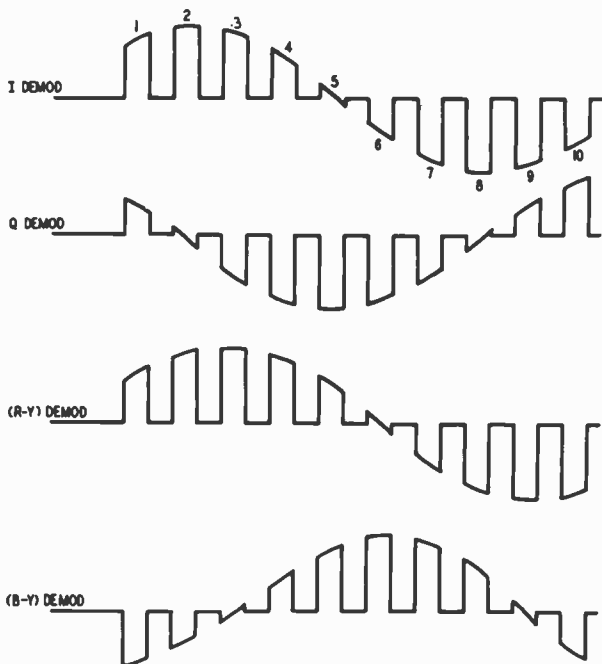

Fig. 413. The output from an I detector nulls on a Q signal. The output from a Q detector nulls on an I signal. Similarly, the (R - Y) detector output nulls on a (B - Y) signal, and vice versa.

When the output from a keyed linear phase sweep is applied to the input of the receiver, the output from the (R - Y) detector applied to the vertical amplifier of a scope and the output from the (B - Y) detector fed into the horizontal amplifier of the scope, a pattern is obtained as in Fig. 414. Patterns of this type are sometimes referred to as vectorscope, or vectorimeter patterns. When a keyed linear phase sweep signal is used in this test, the vector indications obtained in the display are not entirely definite and clear-cut. There are three reasons for this: First, the phase of the sweep voltage is changing from the leading edge of each burst to the lagging edge. Second, color demodulator circuits often develop a certain amount of transient distortion for rapidly varying signals. Third, scope amplifiers may also develop some degree of transient

distortion on a rapidly varying signal. The pulse repetition rate for the pattern in Fig. 414 is in excess of 200,000 pulses per second.

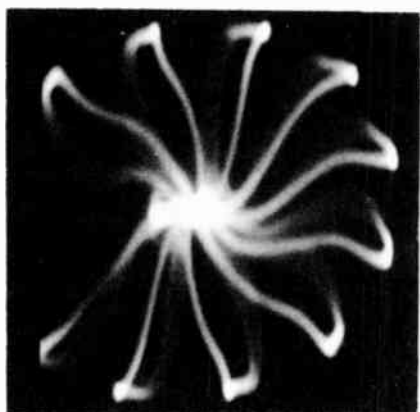

Fig. 414. *Vectorimeter pattern. The vectors will rotate when the color phasing control is turned.*

When the color intensity control is turned, all vectors lengthen or shorten equally. When the color phasing control is turned, all vectors rotate on the scope screen, like the spokes of a wheel. The missing vectors in the pattern are blanked out by the bandpass amplifier blanking pulse. If the quadrature transformer is properly adjusted, the ends of the vectors will lie on a perfect circle when the gain controls of the scope are suitably adjusted. Otherwise, the ends of the vectors will lie on an elliptical locus and the tilt in the ellipse cannot be eliminated by adjustment of the scope gain controls—only adjustment of the quadrature transformer will serve to convert the ellipse into a circle.

Checking the demodulator section with an NTSC color bar generator

Color demodulators and associated chrominance circuits are tested to best advantage by a generator which provides the NTSC type of signal. When the output from such a generator is viewed on the screen of a wide-band scope, the display appears as in (Fig. 415). The Y component of the signal is different for each color and the chrominance voltages have different values. Furthermore, the chrominance voltages have different phases for each color. Fig. 416 shows the $(R - Y)$ output from an NTSC bar generator, as displayed on the screen of a wide-band scope.

When this $(R - Y)$ signal is applied to the $(R - Y)$ $(B - Y)$ demodulators, the output from the $(R - Y)$ detector displays the envelope waveform of the $(R - Y)$ signal (Fig. 417), while the output from the $(B - Y)$ detector shows zero voltage. Of course,

if the quadrature transformer is misadjusted or if the color phasing control is set incorrectly, output will be developed from the

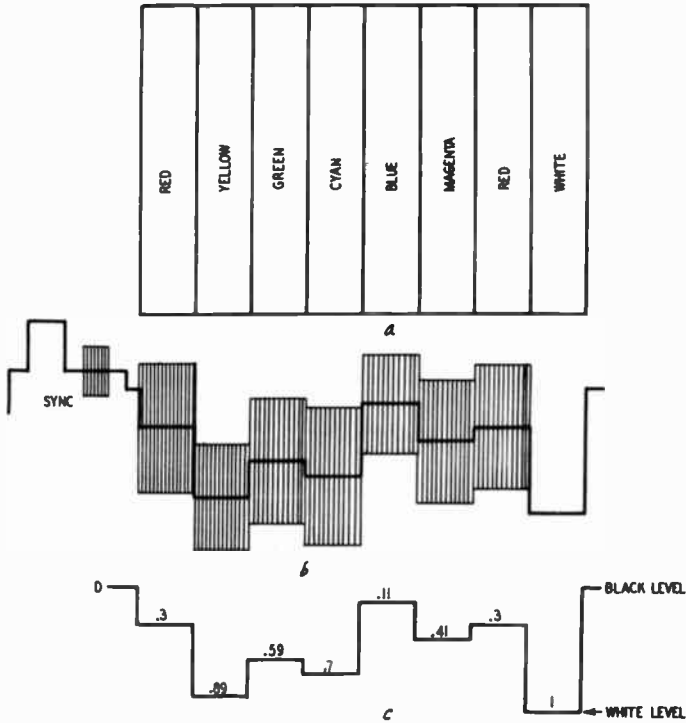
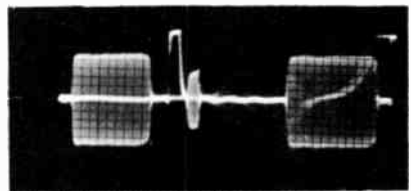

Fig. 415. A typical pattern of true saturated color bars, with white (a). The appearance of the corresponding signal on a wideband scope (b). The relative voltages of the Y or luminance component of each of the colors (c).

(B - Y) detector on an (R - Y) signal. Fig. 418 indicates the three null checks which can be made on the individual color-difference signals usually provided by an NTSC generator.

Now, if the complete color bar signal is applied to the receiver, a wide-band scope connected at the output of one of the color demodu-

Fig. 416. (R - Y) output of an NTSC bar generator as seen on the screen of a wide-band scope.



lators will display a crankshaft pattern (Fig. 419). The various levels of the crankshaft waveform indicate the values of chrominance voltage passed by the detector under test for each of the applied

color signals. Thus, a very accurate and thorough check of color detector operation is provided.

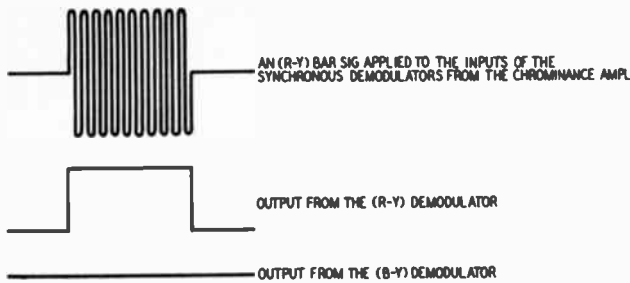

Fig. 417. Application of a wide-band scope at the (R - Y) detector output should indicate that an (R - Y) test signal produces maximum envelope output but that a (B - Y) signal produces zero output.

Returning for a moment to Fig. 418, if the results of the test show that the (R - Y) demodulator nulls on a (B - Y) signal and the (B - Y) demodulator on an (R - Y) signal but the (G - Y) matrix does *not* null on a (G - Y) $\underline{90^\circ}$ signal, matrix trouble is

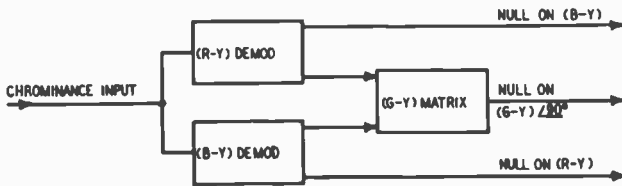

Fig. 418. Illustration shows the null checks that can be made on the three color difference signals.

clearly indicated. The proper operation of the (G - Y) matrix depends upon the ratio of applied (R - Y) and (B - Y) signals (Fig. 420). Hence, a trouble situation such as the foregoing calls

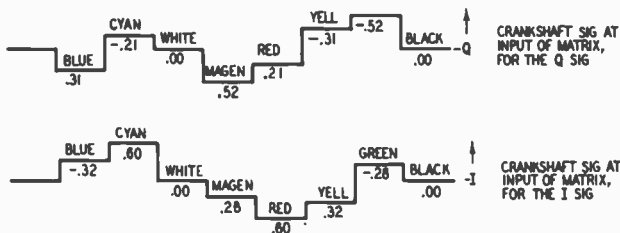

Fig. 419. A typical pair of crankshaft patterns obtained at the outputs of I and Q demodulators when a color bar signal is applied to the receiver.

for measuring the values of the resistors in the matrix network and checking the high-frequency boost capacitor.

The utility of a (G - Y) $\underline{90^\circ}$ test signal is amply apparent, other-

wise, the operation of the $(G - Y)$ matrix would have to be checked by observation of proportional parts of applied $(R - Y)$ and $(B - Y)$ signals. Briefly, the matrix operates by combining 0.19 of the $(B - Y)$ signal with 0.51 of the $(R - Y)$ signal. Although the individual $(R - Y)$ and $(B - Y)$ signals can be applied and

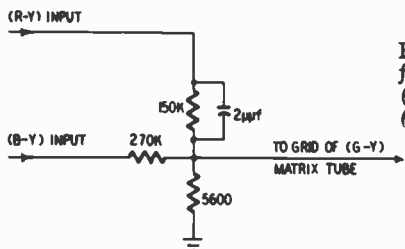
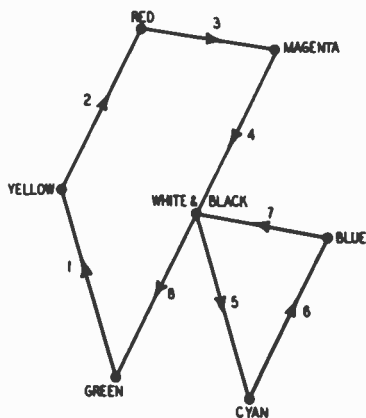

Fig. 420. Typical R-C network for matrixing the $(R - Y)$ and $(B - Y)$ signals to form the $(G - Y)$ signal. (Courtesy of Motorola, Inc.).

the grid of the matrix tube checked with a scope for their required fractions, two tests are required and the proper proportions must either be remembered or looked up in a text. On the other hand, application of a $(G - Y)$ 90° signal to the receiver requires only one check and the result is shown in the form of a simple null (or the lack of it, in the event of trouble).



Fig. 421. Vectorscope diagram for indicated color bar pattern, showing the sequence of motions of the scope beam. Note that this vectorscope diagram is for a receiver using an unkeyed chrominance system. When the chrominance system is keyed, a corresponding "bite" is taken between green and yellow. The phase of the "bite" moves about the pattern, however, as the color phasing control is turned.



A vectorscope check of the color demodulators against a color bar signal is very informative and supplies a large amount of operating data in convenient form. When a color bar signal is applied to the receiver and the color demodulators are connected to a scope with the output from the $(R - Y)$ demodulator energizing the vertical amplifier and the output from the $(B - Y)$ demodulator fed into

the horizontal amplifier, a chrominance phase diagram (Fig. 421) is displayed on the scope screen. If the color demodulators have equal gains, as is usual, the scope amplifiers should also be set for equal gain. The distance of each vector tip from the center spot (white-black) indicates the voltage output for that color and the angle made by each vector with respect to burst (horizontal base line) indicates its phase. The diagram shown in Fig. 421 is drawn to scale and corresponds to correct operating conditions for the $(R - Y)$ and $(B - Y)$ demodulators.

As the color intensity control is turned, the entire pattern expands or contracts on the scope screen but its relative proportions remain constant unless the chrominance circuits are driven into overload and the diagram flattens accordingly on the scope screen. Incorrect adjustment of the quadrature transformer causes both the relative lengths and the angles of the various vectors to be incorrect. Of course, this fault also produces incorrect hues and saturations of the color bars displayed on the screen of the picture tube.

When the video-output signal from the color bar generator is applied to the receiver circuits following the picture detector, any color distortion which might result from mistuning of the rf and if circuits is avoided. In this manner, a more valid test of the color demodulators is made than if the modulated rf output from the generator is applied to the antenna input terminals of the receiver.

Hue reproduction is dependent to some extent upon the setting of the fine-tuning control when modulated rf output is used. For this reason, it is desirable to provide some means in the color bar signal whereby the technician can know when the fine-tuning control of the receiver is properly adjusted. This facility is provided in many color bar generators by a 4.5-mc sound-frequency sideband. When the fine-tuning control is incorrectly set, a 920-kc beat appears in the color bar pattern; the beat is a difference frequency of 3.58 mc and 4.5 mc. But when the fine-tuning control is correctly adjusted, the sound frequency falls in the bottom of the if sound traps and the 920-kc beat does not appear in the color bar pattern.

Characteristics of NTSC color bar signals

A typical pattern of 100% -saturated NTSC color bars, commonly used in service work was illustrated in Fig. 415. Color bar generators, like TV receivers, will require attention; tubes must be changed upon occasion, and minor touchup is required of the generator service controls at times. The only additional equipment needed to adjust the color bar signal output is a wide-band scope having full response at 3.58 mc.

The scope is connected to the video-frequency output cable from the color bar generator and the pattern displayed on the scope screen should conform within $\pm 5\%$. Ruled screens are available for scopes with the reference waveform printed or engraved on the screen, for convenience in checking the color bar signal. The chief check points in the display are: The peak-to-peak voltage of the burst should be adjusted equal to that of the sync pulse. The peak-to-peak voltage of the red bar should be twice that of the burst. The green bar should appear on the same level as the back porch of the sync pulse. The yellow and cyan bars should extend to the same level in the white direction and the red and blue bars should extend to the same level in the black direction. The magenta and white bars reach to the same level. The white bar should be clean, with minimum traces of 3.58-mc signal.

Typical service adjustments provided by the better generators include: burst, sync pulse, red bar, green bar and blue bar width; burst height; Y voltages for red, green and blue bars; overall chrominance and Y levels; sync-pulse height. Bar widths are adjusted for equality by counting horizontal divisions on the scope screen and bar heights by counting vertical divisions. The burst is adjusted for eight (or nine) cycles. The horizontal sync pulse width is set to $4.7 \mu\text{sec}$; this adjustment can be made readily if it is remembered that the time from the leading edge of one sync pulse to the leading edge of the next sync pulse is $63 \mu\text{sec}$. Hence, if the horizontal gain control of the scope is adjusted for a display of 2 inches, or 20 divisions from the leading edge of one pulse to the leading edge of the next, one horizontal division will be equal to approximately $3 \mu\text{sec}$. While the width of the horizontal sync pulse is not critical, it is good practice to adjust the width with reasonable care.

The detailed considerations of NTSC color bar signals are somewhat complex. Most practical service work can be done on the basis of the 100%-saturated NTSC color bar signal which has been described.

Use of NTSC color bar signal and scope to adjust (B - Y) or I gain control

Most color receivers provide a service gain control in the (B - Y) or I channel (depending upon the receiver type) to permit practical adjustment of the relative levels of the color difference signals applied to the picture tube. A (B - Y) gain control (sometimes called a blue gain control) can be adjusted by means of a signal or rainbow generator and a vtm or scope. There is a more comprehensive and

accurate means of checking such chrominance gain controls by means of an NTSC color bar signal and a scope.

Consider first the application of a 100%-saturated NTSC color bar signal to the chrominance circuits of a receiver, with a typical color sequence: green, yellow, red, magenta, blue and cyan. The scope and low-capacitance probe can be applied consecutively to the red and blue grids of the picture tube to determine whether the setting of the (B - Y) gain control is correct.

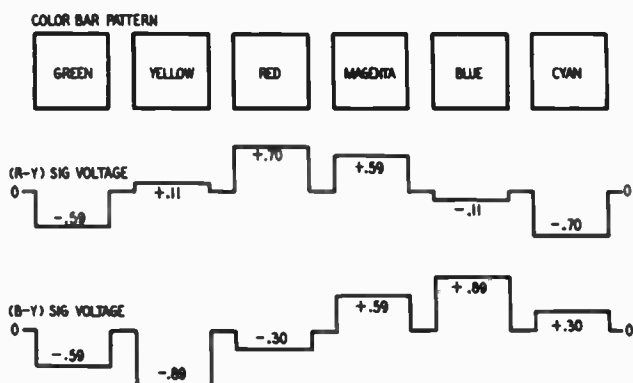

Fig. 422. Relative signal levels when the (B - Y) gain control is set correctly.

First, apply the probe at the red grid and adjust the gain of the scope so that the green bar voltage has a downward excursion of 59% (Fig. 422). Then, if the color-phasing control is properly set, the yellow bar voltage will have an upward excursion of 11% and the red bar voltage an upward excursion of 70%, etc.

Next, apply the probe at the blue grid and adjust the (B - Y) gain control so that the green bar voltage has a downward excursion of 59% (Fig. 422). If the quadrature transformer is properly adjusted, the yellow bar voltage will extend downward 89%, the red bar voltage will be downward by 30%, the magenta bar voltage will have an upward excursion of 59%, etc.

If the setting of an I gain control is to be checked at an I-Q matrix, the relative levels of the I and Q signals at the red, green and blue matrices appear as in Fig. 423 for 100%-saturated bars. The levels of the Y bar voltages are also shown in Fig. 423, but these may be disregarded insofar as a check of the I gain control is concerned. Note that the level of the Y bar voltage is adjusted by the setting of the contrast control.

Technicians sometimes feel that adjustments of the chrominance gain controls can be made by observing the color bar pattern on the

screen of the picture tube and adjusting the controls for the best color display. This is a treacherous procedure and usually leads to quite inaccurate adjustments. Although changes in hue and saturation are readily apparent in the bar display on the screen of the picture tube, the unaided eye is a poor judge of the optimum setting of the gain controls. In consequence, when a color program is reproduced, the viewer will be conscious that the various colors lack fidelity although it will not be possible to explain exactly what is wrong.

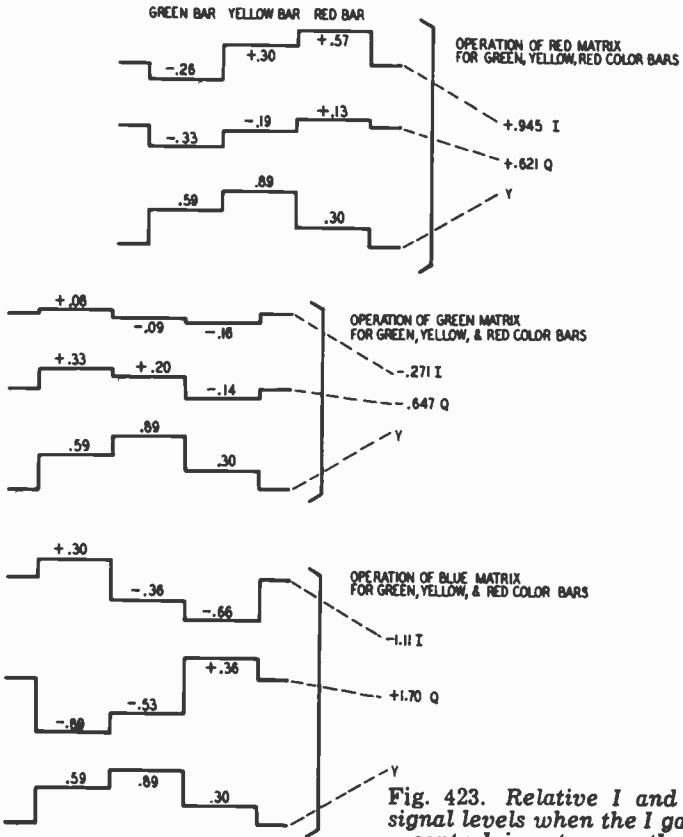

It is possible to adjust the chrominance gain controls upon the basis of color program material but again this is a poor procedure since the fidelity of a color transmission may vary somewhat from time to time and it is not possible to conclude that the gain controls are actually set exactly as they should be. Of course, when a color bar generator and scope are not available, adjustment upon the basis of the screen display is the next best procedure.

Amplitude of subcarrier oscillator voltage

Since the color detectors operate on an incoming signal which has a suppressed carrier, detection cannot take place unless the 3.58-mc injection voltage from the subcarrier oscillator is present. In the absence of subcarrier injection voltage, demodulation does not take place. A check of the subcarrier injection voltage may be essential in the event of color detector trouble.

The value of subcarrier injection voltage applied to the color detectors is different from one receiver to another, depending upon the details of circuitry and tubes utilized. However, an injection voltage of 20 or 25 as measured by vtvm is typical. The receiver service notes usually specify a suitable test point in the detector circuits and indicate the normal value of injection voltage. When the injection voltage is weak, the cause may be due to low plate voltage or other fault in the 3.58-mc oscillator circuit, such as misalignment of the oscillator tank circuit. Low plate voltage or faulty components in a 3.58-mc buffer amplifier circuit can also cause the injection voltage to be low at the detectors. Misalignment of the quadrature transformer can also attenuate the injection voltage.

Weak chroma signals

When a receiver does not reproduce a weak chroma signal, the color detectors are sometimes at fault. Circuit troubles may cause the dc voltages on the tube electrodes to be too high or too low or the injection voltage from the 3.58-mc oscillator may be far off value. However, if these voltages are ok, the possibility of faults in circuits associated with the color detectors should be investigated.

Quite a few receivers provide a color-killer tube, which may or may not be supplemented with a threshold control. If a threshold control is provided, turn it to its lowest position to apply minimum bias to the bandpass amplifier. If a threshold control is not provided, apply a negative bias to the grid of the color-killer tube from a B battery to cut off the killer tube and thereby permit the bandpass amplifier to operate at full gain. If color reception is then obtained, the threshold of the color killer is set too high for the prevailing signal level.

The threshold of the color killer can rise due to a change in resistor values. For example, in one circuit arrangement for a color killer, the grid of the color-killer tube is energized by a positive bias voltage from the B + bus and a negative bias voltage from the burst phase detector. If the resistor to the B + line decreases in value, the threshold of the color killer is raised; likewise, if the resistor to the

phase detector increases in value, the threshold will again be raised. The correct bias voltage at the grid of the color killer is often specified in the receiver service notes but may be difficult to measure accurately unless a vtvm with very high input resistance is used. The circuit itself often has very high resistance and in a typical arrangement the bias resistor to the B + bus has a value of 10 megohms and the bias resistor to the phase detector 4.7 megohms.

When the color killer impairs reception in a weak-signal area, there are at least three courses of action. A better antenna can be installed to provide a higher signal level; this is the best answer to the problem, as the color quality is also improved when the signal is increased to a more nearly normal level. However, in some cases the customer does not wish to incur the expense of such an installation. The color killer can be disabled, if desired, by suitable expedients—for example, a bias resistor to the B+ line can be disconnected so that the color-killer tube is permanently cut off.

When the color killer is thus disabled, the color detectors will respond to noise pulses during black-and-white reception and cause color noise spots in the picture, unless the color intensity control is turned to minimum for black-and-white. This is inconvenient to the viewer and hence it may be preferable to install a threshold control for the color killer so that the threshold can be lowered beyond the point which was intended in the original receiver design.

Inspection of the receiver circuit diagram will show suitable points at which to install a threshold control in the biasing circuits to the color-killer tube. For the arrangement cited, for example, the 10-megohm resistor can be returned to a 1-megohm potentiometer across the B+ bus instead of being connected directly to it. Then, by suitable adjustment of the potentiometer, the amount of positive bias applied into the grid circuit of the color killer can be adjusted to an optimum point for the prevailing level.

Some receivers have noise-gate and agc level controls, which interact with the color-killer threshold control. In other words, if the agc level is reset, it is advisable and often necessary to go back and check the setting of the color-killer control. Likewise, if the setting of the noise-gate control is changed, it may be necessary to recheck the setting of the color-killer control, to obtain proper operation.

When the color killer control is set on the "ragged edge" of operation, the color in the picture is weakened and distorted. It is evident the control should be set sufficiently far above this point so that normal variations of signal strength will not cause reception difficulties.

Chart 4-1. Picture Tinting—Causes and Cures

Symptom	Cause	Cure
All hues in picture are incorrect.	Phase of the color subcarrier voltage is different from phase of burst voltage.	Adjust color-phasing control; check circuit components between color subcarrier oscillator and demodulators.
Reds are accentuated but greens are weakened.	Low gain or no output from the Q channel.	Check the Q-channel circuits for frequency response and voltage gain. Check for proper voltage and phase of color subcarrier at the Q detector.
Greens and blues are accentuated, but reds are weakened.	Low gain or no output from the Y channel.	Check the I-channel circuits for frequency response and voltage gain. Check for proper voltage and phase of color subcarrier at the I detector.
Blues predominant in the picture; yellows weak or invisible. Picture dim and smeary.	Low gain or no output from the Y channel.	Check Y channel for frequency response and voltage gain. Check for signal-handling capability (dynamic range).
Reds appear black in portions of image where reds normally appear alone.	Low gain or no output from red matrix; defective red gun in picture tube.	Use NTSC color bar generator and scope to check matrix output signals. Check picture tube for production of red field.
Greens appear black in portions of image where greens normally appear alone.	Low gain or no output from green matrix; defective green gun in picture tube.	Use NTSC color bar generator and scope to check matrix output signals. Check picture tube for production of green field.
Blues appear black in portions of image where blues normally appear alone.	Low gain or no output from blue matrix; defective blue gun in picture tube.	Use NTSC color bar generator and scope to check matrix output signals. Check picture tube for production of blue field.
Color bars appear correct only at one setting of brightness and contrast controls.	Lack of tracking of guns in picture tube with the various levels of video signal.	Color balance and tracking must be obtained by proper adjustment of the picture-tube screen and brightness controls and of gain controls of color video amplifiers.

Color transmission is reproduced in black and white.	Inoperative color subcarrier oscillator. Faulty chrominance bandpass amplifier or defective color-killer circuit. Defective color sync circuit. Fault in antenna system.	Check output voltage and frequency of color subcarrier oscillator with vtvm and heterodyne frequency meter. Check bandpass amplifier and color killer with scope and vtvm. Check antenna by applying output from color bar generator to input terminals of receiver.
Horizontal rainbows across picture.	Loss of color sync due to incorrect frequency of color subcarrier oscillator, defective color sync circuits or attenuation of color burst.	Adjust color hold control; check burst voltage at output of picture detector with wide-band scope; check waveforms and p-p voltages in color sync circuits. Check operation of receiver with output of NTSC color bar generator applied to receiver input terminals.
Color fringes around edges of objects in picture.	Picture tube not in proper convergence.	Adjust dc convergence control; if picture does not come into convergence, apply signal from white dot generator and make a systematic convergence check of static and dynamic adjustments.
One or more regions on screen of picture tube color-contaminated.	Purity adjustments incorrect.	Check purity of red field with deflection yoke slid to rear of tube neck. Adjust orientation of purity coil, direct current through purity coil and rim-coil magnet(s) as required.
Vertical bars of color at left-hand edge of raster.	Ringling in the horizontal sweep, or foldover, or both. (Do not confuse with color stripe on a monochrome transmission.)	Check adjustment of linearity and width coils; check leakage-inductance bypass capacitor in vertical sweep circuit; check horizontal deflection coils and transformer (substitution test usually best).
Picture tube reproduces only reddish-blue and greenish-yellow hues.	(R — Y) channel output low or zero.	Check gain and frequency response of (R — Y) channel with a video-frequency sweep generator and scope. Check voltage and phase of injected color subcarrier.
Picture tube reproduces only magenta and green hues.	(B — Y) channel output low or zero.	Check the gain and frequency response of (B — Y) channel with a video-frequency sweep generator and scope. Check voltage and phase of injected color subcarrier.

All hues incorrect; correct operation cannot be obtained by adjustment of the color phasing control.	Fault in color subcarrier phase-shifting circuits.	Check color bar signal at output of color demodulators with a vectorscope. Check phase-shifting circuit components by substitution.
Color hum bars in picture.	Heater-cathode leakage in video-frequency signal circuits.	Replace tubes progressively in signal circuits operating in the video-frequency range.
Localized misconvergence in regions of picture having a light or darker gray backgrounds.	Lack of regulation of the high-voltage power supply, usually caused by a fault in high-voltage regulator circuit.	Check regulation of the high-voltage power supply, using an adjustable line-voltage transformer, high-voltage dc probe and vtvm. Correct component responsible for the poor regulation.
Two colors, such as red and blue, interchanged; hues cannot be corrected by adjustment of color phasing control.	Leads for the red and blue guns of the color picture tube transposed at chrominance output jacks.	Check and identify the three chrominance output jacks and plug leads into the correct jacks. Note that the leads to the picture-tube socket are color-coded red, green, blue.
All three guns draw beam current, but one color, such as red, cannot be obtained during purity setup adjustments.	Substantial misconvergence of electron beams, such as caused by considerable misadjustment of blue lateral corrector, resulting in red electron beam completely missing the red phosphor dots.	Obtain reasonably good convergence adjustment before making purity adjustments; then return to making final purity adjustments.
Green matrix tube foils, but green gun continues to deliver output, tinting the picture green.	Normal symptom of loss of plate current in the green matrix tube when receiver utilizes dc coupling between matrix tube and picture tubes. Bias on the green grid is lowered.	Check operation of green gun by grounding the grid lead; green field should disappear. Replace faulty matrix tube and check for normal operation of green gun.
Leads to red, blue and green guns of picture tube are unplugged, but the screen does not become dark.	Exposed leads pick up strong electric and magnetic fields which exist around the chassis, causing spurious drive to the grids of the color picture tube.	Ground the leads of the guns to be disabled, thereby avoiding pickup of stray fields.
Screen has predominant color tinge (red, green or blue, during evening reception). Purity and convergence poor after receiver is moved to a new location.	Incandescent lamps have a different spectral characteristic from daylight. Various locations in a room usually exhibit different magnetic fields, which affect the operation of the color picture tube.	Make the receiver setup adjustments using room lighting preferred for program viewing. Locate receiver permanently before making the purity and convergence adjustments.

Chart 4-2. Color Bar Distortion Caused by Tube Failure in Receiver

Tube	Function	Pattern Distortion	Reason
Burst amplifier.	Steps up level of color burst voltage for locking color sync circuits.	Color bars are broken up into red, green and blue "barber poles." Pattern is sometimes stationary and sometimes drifts.	Color sync is lost. Color subcarrier oscillator operates at incorrect frequency.
Color subcarrier oscillator.	3.58-mc color subcarrier signal for utilization by the color demodulators.	Bars appear without color, in various shades of gray.	Color subcarrier voltage is not applied to suppressor grid of the color-demodulator tubes; passage of the chrominance signal is blocked.
Phase detector (color sync section).	Control voltage for locking color subcarrier oscillator to frequency and phase of the color burst.	Color bars appear as red, green and blue "barber poles." Pattern may be stationary or drifts.	Color sync is lost. Color subcarrier oscillator operates at incorrect frequency.
I amplifier.	Steps up level of the I signal to the color video circuits.	Bars comprised wholly or partially of orange-cyan hues appear in false colors.	The I amplifier supplies the orange-cyan transmission primaries to the color video circuits.
Quadrature amplifier.	Steps up the level of 3.58-mc color subcarrier voltage to the quadrature phase-splitting transformer.	Bars appear without color, in various shades of gray.	Color subcarrier signal is not available to suppressor grids of the color demodulators. Passage of the chrominance signal is blocked.
Dc restorer.	Clamps color signal with reference to the black level.	Color bars affected by the particular restorer failure are not changed in hue, but are reduced in brightness.	The dc component of the bar signal is attenuated during the period of scan.
High-voltage regulator.	Maintains ultor voltage constant.	Bars show some changes in hue, due to loss of spot convergence; horizontal width is reduced.	Proper convergence maintained only at the rated ultor voltage. Picture width decreases when ultor voltage increases.

Tube	Function	Pattern Distortion	Reason
Dynamic convergence amplifier.	Provides correction voltage for edge convergence.	Bars show some change in hue, due to partial misconvergence.	Edge convergence is poor when dynamic convergence voltage fails. Center convergence is also affected to some extent.
Red, green or blue video amplifier.	Steps up level of respective color signal to grid of picture tube.	Bars comprised wholly or partially of respective hues appear black or off-color.	Respective guns of the color picture tube not energized.
Rf or if amplifiers (prior to sound takeoff point).	Steps up level of complete color and sound signals.	Bar pattern disappears completely; sound signal is absent. Raster visible at higher settings of brightness control.	Both video and the audio signals blocked in passage by tube failure.
If amplifier (subsequent to sound takeoff point) or picture detector.	Steps up level of complete color signal. Picture detector demodulates the complete color signal and forms the 4.5-mc intercarrier sound signal.	Some as above, except that sound signal is normal. (Note that the audio signal will appear only in case the color bar generator provides FM modulation of the sound carrier by the audio signal—usually 400 cycles.)	Tube failure results in blocking of complete color signal, but permits passage of the sound signal.
First video amplifier (when tube is located prior to chrominance takeoff point).	Steps up level of complete color signal.	Same as above.	Same as above.
First video amplifier (when chrominance signal takeoff is from picture detector).	Steps up level of the luminance signal.	Color bars appear dim and bluish, similar to bars obtained from a keyed rainbow generator when receiver operates normally.	Chrominance signal is applied to color picture tube, but the luminance signal is not present. Matrix operation is not normal.
Chrominance bandpass amplifier.	Steps up level of chrominance signal, which has been filtered from the high-frequency region of the complete color signal.	Bars displayed without color, in various shades of gray.	Luminance signal is applied to color picture tube, but chrominance signal is not present.

matrix testing

THE matrix is the portion of the color TV receiver which reassembles the color-difference and luminance signals to synthesize the complete color signal. A simple system is shown in Fig. 501. Outputs from the $(R - Y)$ and $(B - Y)$ demodulators are applied to the $(G - Y)$ matrix to synthesize the $(G - Y)$ signal. Final matrixing occurs in the color picture tube, where the Y signal is applied to all three cathodes. The $(R - Y)$ signal is applied to the red grid, $(B - Y)$ to the blue grid and $(G - Y)$ to the green grid.

Checking matrix

The Y , $(R - Y)$, $(B - Y)$ and $(G - Y)$ signals which correspond to a 100%-saturated color bar pattern are shown in Fig. 502. If you apply the video-frequency output from an NTSC color bar generator at the output of the picture detector, a scope check at the cathode and red, blue, and green grids of the picture tube will display the relative voltages shown in Fig. 502, if the matrix system is operating correctly. A low-capacitance probe should be used with the scope to avoid circuit loading.

The Y signal level is determined by the setting of the contrast control, and the levels of the color-difference signals as a group by the setting of the color intensity control. An incorrect setting of the color phasing control causes all the color-difference signals to appear with incorrect values. Hence, these three operating controls must be properly adjusted before a valid check of matrix operation can be made.

Consider a situation in which the signals at the red and blue grids of the picture tube have correct relative values, but in which the signal at the green grid does not. In such case, trouble will be found in the $(G - Y)$ matrix or amplifier stage. Faults in the $(G - Y)$

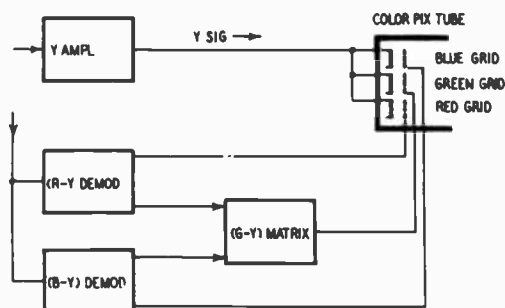

Fig. 501. A common system of matrixing in which $(R - Y)$ and $(B - Y)$ are first matrixed to form $(G - Y)$. Final matrixing of Y , $(R - Y)$ and $(G - Y)$ occurs in the color picture tube.

matrix network cause the various signal levels at the green grid to vary abnormally in both directions—that is, some of the signals will have too high and some will have too low a voltage. Matrix network faults can cause incorrect compounding of $(R - Y)$ and $(B - Y)$ signals to form the $(G - Y)$ signal. Suppose a faulty matrix network is causing the $(G - Y)$ signal to be formed from twice as much $(B - Y)$ signal as is normal. The yellow bar will display too much voltage, but the cyan bar will display too little.

These facts follow from Fig. 502, on the basis that the $(G - Y)$ matrix operates by combining $-0.19 (B - Y)$ with $-0.51 (R - Y)$ to form $(G - Y)$. In practical service work, we are not much concerned with arithmetic, but with end conclusions—in this case, the end conclusion is that: If some of the voltages at the green grid are too high, and others are too low, a fault is indicated in the $(G - Y)$ matrix network.

On the other hand, if all the voltages at the green grid are too high or too low, a fault is indicated in the $(G - Y)$ amplifier. An incorrect value of plate-load resistor in the $(G - Y)$ amplifier output circuit, e.g., is a ready suspect. A typical arrangement for a $(G - Y)$ matrix network amplifier-output circuit is shown in Fig. 503. An incorrect value of cathode resistor affects the gain of the amplifier, hence will cause all values of the green-grid signal to be too high or too low. Many receivers provide a variable cathode resistor in the $(G - Y)$ amplifier circuit as a service control. Hence, in checking

the (G—Y) matrix, this control will be adjusted to obtain the correct level of green-grid signal.

The same values of signal voltages will be found at the electrodes of the picture tube in normal operation whether (R—Y) and (B—Y) are matrixed to form (G—Y), or (R—Y) and (G—Y)

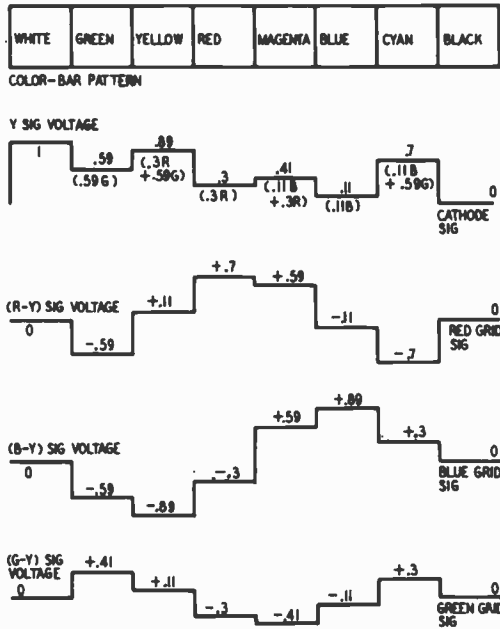

Fig. 502. The relative voltages applied to the electrodes of the picture tube when a 100%-saturated NTSC color bar signal is applied to the luminance and chrominance circuits.

are matrixed to form (B—Y). But in the latter case, trouble in the (B—Y) matrix is indicated by voltages which are too high and too low at the blue grid. This is based on the fact that the amplitudes of the (B—Y) signal depend upon proper proportions of both (R—Y) and (G—Y) signals.

Another arrangement is the twin-triode demodulator matrix (Fig. 504). The matrixing of (R—Y) and (B—Y) to form (G—Y) is accomplished in the common cathode circuit of the triodes. This is a more difficult type of matrix to analyze in the event of trouble, because a circuit fault is usually reflected throughout the system. This causes all signal amplitudes at the picture-tube grids to be incorrect. However, the waveforms of Fig. 502 will be observed if

matrixing is satisfactory; incorrect waveforms require a systematic check of the components in the demodulator matrix network.

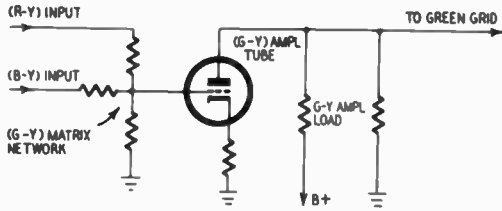

Fig. 503. The $(G - Y)$ matrix network is in the grid circuit of the $(G - Y)$ amplifier. The gain of the amplifier is controlled by values of cathode and plate load resistors.

Still another matrix arrangement is the $I - Q$ system (Fig. 505). This is a more complex setup in which the luminance and the two chrominance signals are separately added in three matrices to form the red, green and blue signals. The picture tube is utilized only as a transducer and serves no matrixing function.

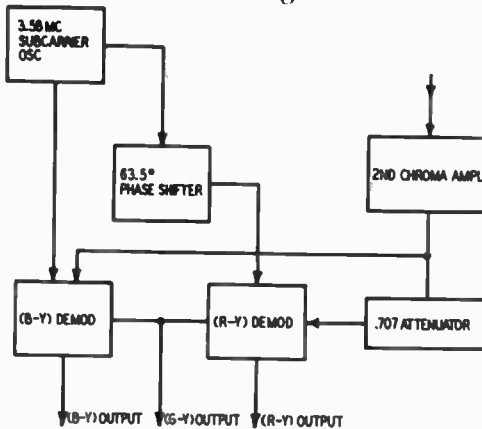

Fig. 504. Arrangement of the $(R - Y)$ $(B - Y)$ demodulation system to accomplish simultaneous $(G - Y)$ matrixing.

As in the $(R - Y)$ $(B - Y)$ system, an NTSC color bar generator and a scope are the most useful instruments for checking matrix operation. The relative levels of Y , I and Q signals arriving at the matrices are shown in Fig. 506 for normal reproduction of 100%-saturated color bars. Correct signal values are dependent upon proper settings of the contrast, intensity and phasing controls and upon proper operation of the I and Q demodulators. When incorrect values of color-difference signals are noted, the demodulators should be individually checked. If the I demodulator nulls on a Q

signal and the Q demodulator on an I signal, examine the values of the various resistors in the matrix network of Fig. 505. These values are critical for proper color reproduction and, since they often carry fairly heavy plate currents, may be subject to eventual drift in resistance values. This check is best made with an ohmmeter.

Fig. 505. The I and Q signals (in suitable polarities) are added to the Y signal in the matrix to synthesize the red, green and blue video signals.

The matrix mixes I and Q signals to form $(G - Y)$; the matrix adds Y to $(G - Y)$ to form the green video signal.

The matrix mixes I and Q signals to form $(B - Y)$; the matrix adds Y to $(B - Y)$ to form the blue video signal.

The matrix mixes I and Q to form $(R - Y)$; the matrix adds Y to $(R - Y)$ to form the red video signal.

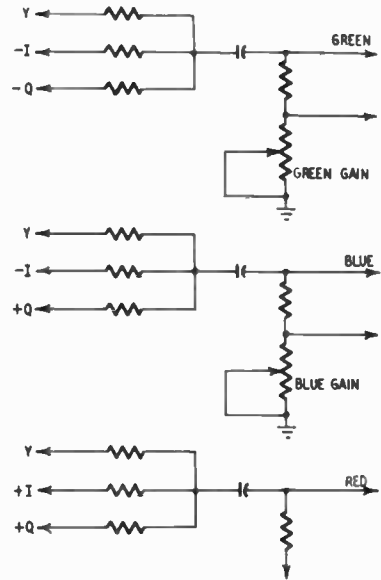

In a small number of sets $(R - Y)$ and $(B - Y)$ detectors are used, with a $(G - Y)$ matrix, but the matrixing of the color-difference signals with the Y signal is not accomplished in the picture tube but in a separate resistive matrix similar to the I-Q matrix. When checked for proper matrix action, the scope is applied at the matrix input terminals instead of at the grids and cathode of the picture tube. The signals found in normal operation are the same as those of Fig. 502.

Matrix checks with a keyed rainbow generator

Matrix checks can easily be made with a keyed rainbow signal, but the procedure is somewhat different from that used for an NTSC signal. The keyed rainbow signal usually has no luminance component, hence the sync pulse in the signal must be utilized as the Y level indicator. When the low-capacitance probe of the scope is applied to the blue grid of the picture tube in an $(R - Y)$ $(B - Y)$ receiver, relative levels of luminance and chrominance signals are displayed on the scope screen (Fig. 507). When contrast and color intensity controls are correctly set, the level of the sync

pulse in the pattern is exactly equal to the peak excursion of the sixth bar in the chrominance signal for correct operation.

This conclusion presupposes that the generator has been adjusted for standard operation with the level of the sync pulse equal to the peak-to-peak voltage of the chrominance bursts. This adjustment is best made and checked by use of a wide-band scope applied at the video output terminals of the keyed rainbow generator.

When the color phasing control is properly set, the third and ninth bars of the keyed rainbow signal will null at the blue grid. When the scope is applied at the red grid, the sixth bar will null in

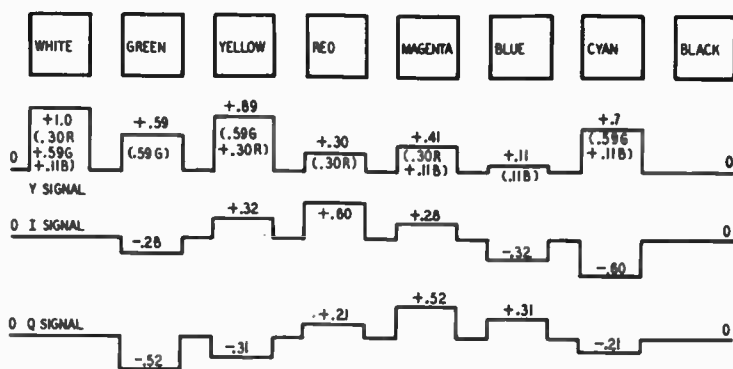

Fig. 506. The Y, I and Q signal voltages developed when scanning a 100%-saturated color bar pattern. The Y signal is the same as in (R - Y) (B - Y) transmission.

normal operation. At the green grid, the first and seventh bars should null. Failure to observe the correct nulls are investigated in the same manner as for (R - Y) (B - Y) matrix checks with an NTSC signal.

Matrix checks with a signal generator and vtm

When a color signal generator is not available, a conventional signal generator and vtm can be used to make checks of signal levels. It is best to apply the generator signal to the grid of the band-pass amplifier. Noise should be prevented from entering the chrominance circuits by biasing the if amplifier or pulling the driver tube to the bandpass amplifier.

The generator is tuned nearly but not quite to 3.58 mc to obtain a rainbow pattern on the screen of the picture tube. It is not necessary to have the pattern locked on the screen and, if several slanting rainbows are displayed, the signal will serve as well as if locked. The generator must not be tuned exactly to 3.58 mc since the outputs

from the color demodulators will not be averaged over a continuing series of cycles, but will depend critically upon the generator tuning. The point to be avoided is that at which a single color field appears on the screen of the picture tube.

The vtvm and detector probes can be applied in turn at the outputs of the $(R - Y)$ and $(B - Y)$ detectors and, if the detectors are developing correct output levels, the voltage readings will be practically the same. This test tells nothing concerning the adjustment of the color phasing control or the quadrature transformer. In other words, voltage levels are indicated but no data concerning phase are obtained.

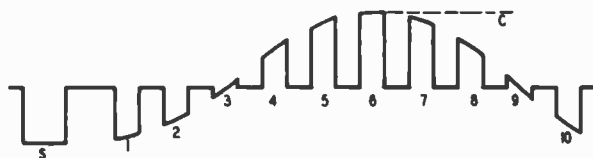

Fig. 507. How to check the ratio of luminance to chrominance voltages, using a rainbow generator. When the p-p voltage of the chrominance output from the generator is set equal to the p-p voltage of the sync pulse, the scope may be applied to the blue grid of the picture tube. The amplitude of the blue (6th) bar (see dotted line marked C) should then equal the amplitude of the horizontal sync pulse.

Overload of the chrominance channels is possible and must be avoided. Overload produces a limiting action beyond which the output voltage does not increase or increases very slowly for substantial advance of input voltage. Check the indication of the vtvm as the signal level is reduced and advanced, to determine that limiting is not occurring. The reading of the vtvm will fall proportionally with reduction of the signal level if the circuits are operating below the overload point.

Although the output voltages from the two color demodulators are equal, the output voltages from the $(R - Y)$ and $(B - Y)$ amplifiers are not. The voltage measured at the plate of the $(B - Y)$ amplifier should be 1.8 times the voltage measured at the plate of the $(R - Y)$ amplifier. We shall not go deeply into the reason for this difference in outputs, except to note here that color transmissions are made via *readjusted chrominance values* which must be converted to *unadjusted chrominance values* in the receiver circuits. This conversion is made by running the gain of the $(B - Y)$ channel 1.8 times the gain of the $(R - Y)$ channel. In many receivers, a gain control is provided for the $(B - Y)$ amplifier so that the proper out-

put level can be obtained. Other sets have no such adjustment and incorrect signal levels must be investigated on the basis of circuit trouble, such as plate load or cathode resistors which may have changed value.

The signal level at the output of the (G - Y) matrix tube is checked next. The detector probe for the vtvm is applied at the plate of the (G - Y) matrix tube, where a voltage equal to one-third of the (B - Y) output should be found. An incorrect voltage reading points to faults in the (G - Y) matrix network or to incorrect values of cathode and plate load resistors in the amplifier plate circuit.

A rainbow or keyed rainbow signal can be used to make the foregoing test, instead of a signal generator. Likewise, a scope can be used instead of a vtvm as an output indicator. It is advisable to use a low-capacitance probe with the scope to avoid the possibility of circuit loading.

Checking matrix frequency response

The color-difference signals are transmitted in I and Q channels, having bandwidths of 1.5 mc and 0.5 mc, respectively. Hence, the I-Q type of matrix requires a bandwidth of 1.5 mc. Most receivers demodulate on the (R - Y) and (B - Y) or on the (R - Y) and (G - Y) axes. These are usually limited to a bandwidth of 0.5 mc in the demodulator output circuits, although some (R - Y) (B - Y) receivers are designed to operate at a 1.5 mc bandwidth in the chrominance circuits. The service notes for the receiver should be consulted to determine the bandwidth utilized.

To make a sweep frequency test of the (G - Y) matrix system, the output from a sweep and marker generator may be applied to the grid of the (R - Y) amplifier (Fig. 508). A demodulator probe and scope are applied at the output of the (G - Y) matrix tube. The curve on the scope screen depicts the frequency response of the matrix *from the (R - Y) amplifier input*. A similar check should also be made, with the output from the sweep and marker generator applied to the grid of (B - Y) amplifier, to obtain the frequency response of the matrix *from the (B - Y) amplifier input*.

Failure to obtain response curves with the required bandwidth is due to faults similar to those which impair the frequency response of video amplifiers—shorted or open peaking coils (partially shorted peaking coils are treacherous trouble makers upon occasion), incorrect values of load resistors, damping resistors, leaky capacitors, etc.

In the test setup of Fig. 508 the 0.25 μf blocking capacitor used in series with the output cable from the generator prevents drainoff of grid bias from the (R - Y) amplifier tube, which could disturb amplifier operation in some cases. This value is adequate for most (R - Y) amplifier grid circuits but, if the grid-circuit impedance is lower than usual, it may be necessary to have a large value of blocking capacitor to avoid attenuation of the low-frequency response. A

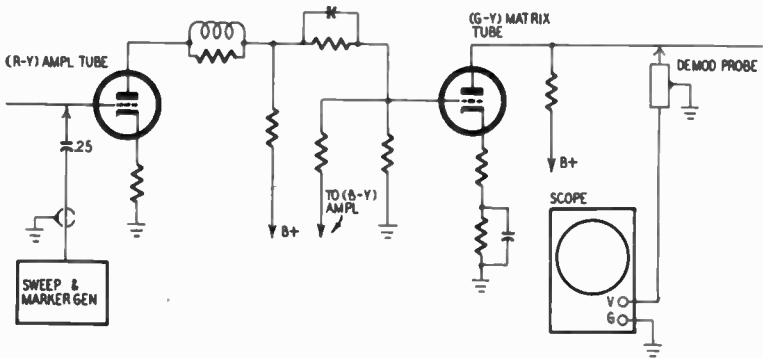

Fig. 508. How to apply a sweep and marker generator and scope with demodulator probe to obtain the frequency response curve for a (G - Y) matrix.

good test is to observe the response curve while another capacitor of the same value is temporarily shunted across the blocking capacitor —if the low-frequency response of the curve rises, a large blocking capacitor is required.

Demodulator probes which have low input capacitance will not attenuate the high-frequency response when applied at the plate of the (G - Y) matrix tube. However, probes with high input capacitance may cause high-frequency attenuation and in such case the probe may be applied at the cathode of the (G - Y) matrix tube. The cathode has low impedance and is less susceptible to capacitance loading. The output signal from the cathode has less voltage than at the plate so that the scope gain must be advanced and perhaps higher output utilized from the generator.

If a square-wave generator is available, a square-wave signal may be applied at the grid of the (R - Y) amplifier and the scope connected at the plate or cathode of the (G - Y) matrix tube via a low-capacitance probe. A square-wave check is an ideal crosscheck of frequency response. Matrices which operate at a bandwidth of 1.5 mc should pass a 40-kc square wave without serious tilt or rounding, and matrices which operate at a bandwidth of 0.5 mc should pass

a 15-kc square wave similarly. The matrices should pass square waves having 10 times these frequencies without substantial attenuation of amplitude but the tops of the reproduced square waves will be greatly rounded.

The color demodulators and matrix system are incapable of reproducing fine detail. This is contributed by the Y amplifier which operates at a bandwidth of 3.5 mc or more. This is why a color picture looks very smeary and blurred when the Y signal is disabled. Although the chrominance circuits are not required to reproduce any high degree of detail in the picture, it is still necessary that chrominance bandwidths be maintained at adequate values—never less than 0.5 mc. Otherwise, the color portion of the picture does not fit the monochrome portion properly and the color drops out of the smaller areas in the picture.

Other matrix arrangements, such as the (B-Y) and I-Q systems are checked for bandwidth and square-wave response in a similar fashion. Technicians sometime feel that an ohmmeter check of the matrix arrangement is adequate, but experience will show that ohmmeter tests alone can be misleading. Such checks usually fail to reveal partially shorted peaking coils, open capacitors and cumulative tolerances which can distort the overall response of the system. In case of doubt, frequency-response and square-wave checks are to be recommended.

Sweep and marker generators require more study and experience than required for an ohmmeter or a voltmeter. However, the servicing of color receivers is handicapped or impossible when suitable generating equipment is not used. The frequency response of *all* the signal circuits is much more critical for color reception than for passable black-and-white. After a "do-it-yourself" fan has turned all the loose screws he can find on a color chassis, the technician will find it almost impossible to restore the receiver to satisfactory operating condition without the use of a good sweep and marker generator and scope.

Matrix operation

While various matrices may differ greatly in superficial appearance, their basic principle of operation is the same. The necessity for the matrix arises from the requirement for compatible reception.

The starting point in visualizing matrix action concerns the nature of the black-and-white signal since the compatible color system starts with the black-and-white signal as a basic building

block. The black-and-white signal is a *brightness* signal and is one of the three defining characteristics of a color signal. Hence, the color signal contains the brightness (Y) signal, which is exactly the same as the familiar black-and-white signal. To this Y signal, the color signal information is added to form the complete color signal.

If we take the complete color signal and subtract the Y signal from it, we have left the color-signal information. This information is appropriately termed the color-difference signal—it is the difference signal contained in the complete color signal, over and above the Y signal. This color-difference signal comprises *hue* and *saturation* signal information. Thus the complete color signal comprises *brightness*, *hue* and *saturation* information.

The complete color signal arrives at the color receiver with the brightness information modulated on the picture carrier and with the color-difference information modulated on the subcarrier. This separate “packaging” of the Y and chrominance signals is required for proper response of a black-and-white receiver to the complete color signal. It makes possible automatic rejection of the chrominance signal by the black-and-white TV receiver.

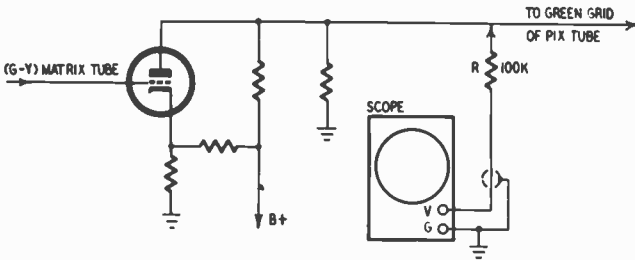

Fig. 509. An isolating resistor is unsuitable for matrix tests; a low-capacitance probe should be used instead.

In color reception, the chrominance signal is *not* rejected but is made available to the matrices. The chrominance signal may be in the form of I and Q color or (R - Y), (B - Y) and (G - Y) color-difference signals. It then becomes the job of the matrices to reassemble these with the Y signal to recover the original red, green and blue primary colors. Thus, the output from the Y channel contains brightness information and the outputs from the chrominance channels contain hue and saturation information. These signals are applied to the matrices and the outputs from the matrix contain all three characteristics: brightness, hue, and saturation.

The end result of the NTSC color system is as if the output from the red camera (at the transmitter) were connected to the red gun in the picture tube (at the receiver), the output from the green camera to the green gun and from the blue camera to the blue gun. The reason for splitting the transmission into brightness and color-difference signals (and hence the requirement for receiver matrices) rests basically upon considerations of compatibility.

Using probes

A low-capacitance probe is the only type suitable for use in matrix checks. An isolating probe or resistor will not serve the same purpose since the use of a 100,000-ohm isolating resistor applied as in Fig. 509, has the effect of "ironing out" the higher-frequency components of the reproduced waveform (Fig. 510).

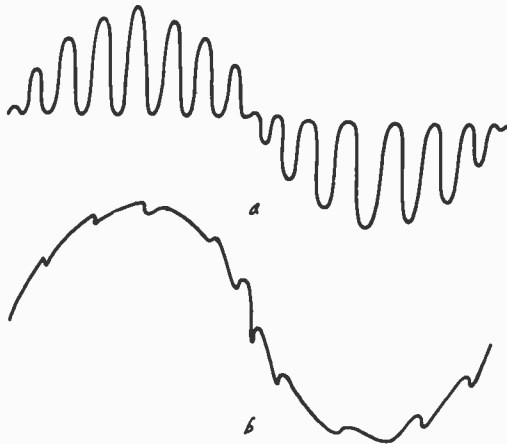

Fig. 510.-a-b. Matrix waveform with low-capacitance probe (above). Matrix waveform with isolating resistor (below).

In case a keyed rainbow signal is used to make a matrix check, the expected output consists of a succession of pulses contained under the envelope of a sine wave. If a low-capacitance probe is used, the pulses are properly displayed, as shown in the upper portion of Fig. 510. However, with a simple isolating resistor the pulses become partially or completely wiped out, as indicated in the lower portion of Fig. 510. Moreover, the use of an isolating resistor causes a time delay, even when the pulses are not completely wiped out, so that the indication of a (G - Y) bar will appear displaced somewhat to the right in the waveform.

The reference point in a keyed rainbow display can sometimes

be puzzling. Although the sync pulse is very greatly attenuated in passage through the bandpass amplifier, a residue does get through and appears as a small transient on the baseline of the display. If this is not immediately apparent, turn the color phasing control back and forth, meanwhile watching the display at the baseline level on the scope screen. All of the chrominance information will move as the color intensity control is turned but the sync-pulse residue will stand still. Hence, the sync-pulse point is easily picked out.

To recapitulate briefly: the pulses which appear following the sync reference point are (from left to right): $-(G - Y) / \sqrt{90^\circ}$, $+I$, $+(R - Y)$, $-(G - Y)$, $+Q$, $+(B - Y)$, $+(G - Y) / \sqrt{90^\circ}$, $-I$, $-(R - Y)$ and $+(G - Y)$.

Transients

Transients or residues sometimes observed in scope checks of an I-Q matrix are caused by the different bandwidths of the Y and chrominance channels. As shown in Fig. 511, a pulse or square wave is passed by the Y channel without appreciable distortion, due to its relatively great bandwidth. However, the same pulse or square wave is rounded and widened in passage through the chrominance section because of its relatively limited bandwidth. The smaller the bandwidth of a channel, the greater is this rounding and widening of a pulse or square wave.



Fig. 511. Waveforms cancel, but have transient residues.

Now, consider a red bar signal arriving at an I-Q matrix. In this type of matrix, the luminance and chrominance signals are added and then the sum of the signals is applied to a grid of the color picture tube. The red bar signal has a luminance component which is cancelled by the chrominance signal at the green and blue matrices, but at the red matrix the luminance signal adds to chrominance signal to produce full output from the red gun in the picture tube.

When a 100%-saturated red signal is applied to the receiver cir-

cuits, the Y voltage at the red matrix is 0.3 of maximum, the I voltage at the green matrix -0.17 of maximum and the Q voltage at the green matrix -0.13 of maximum. Hence, the 0.30 Y voltage is cancelled by the $(-0.17 - 0.13)$ chrominance voltage and the green gun is cut off, as required during reproduction of a red bar signal.

But because the bandwidth of the chrominance channel is less than that of the Y channel, cancellation is incomplete at the leading and trailing edges of the red bar and transient color fringes are produced by the green gun. These can be observed with a scope at the green (or other) matrix and have a minimum amplitude when the chrominance circuits are properly aligned.

Matrix testing

When the output from the color detectors is checked with a scope, using a keyed rainbow test signal, only a chrominance signal is observed and no sync pulse appears in the pattern because the band-pass amplifier blocks passage of the significant frequency components. However, when the signal is checked at the grids of the picture tube, the sync pulse will be observed if Y and chrominance matrixing is accomplished prior to application of the complete color signal to the grids of the picture tube. In case the Y signal is applied to the cathodes of the picture tube and final matrixing is accomplished in the picture tube (the most usual method), the sync pulse will be observed at the cathodes and the chrominance signal at the grids of the tube.

For checks of matrixing action, it is immaterial whether the sync pulse voltage is applied to the grids or the cathodes of the color picture tube. The waveform proportions apply similarly in either case. However, the technician must observe the distinction in signal application from one receiver to another and apply the scope at the necessary electrodes to obtain the desired waveform information. A low-capacitance probe is preferred in matrix checking to avoid possible loading of the circuits which could distort the waveform by attenuation of the higher-frequency components.

It is essential in making these tests to ascertain that the keyed rainbow generator provides an output in which the peak-to-peak voltage of the sync pulse is equal to the peak-to-peak voltage of the bursts—otherwise, it could be falsely assumed that the gain of the Y amplifier was abnormally high or low, as the case may be. The first series of tests concerns the relative levels of the chrominance volt-

ages at the three grids of the picture tube. For the (R - Y) (B - Y) or I-Q type of receiver, correct matrixing action is indicated by the following relative levels of chrominance signals:

1. Check the blue grid first with the scope; the deflection obtained at the blue grid is taken as a reference.
2. The chrominance voltage at the red grid should produce 55% of the deflection obtained in the test at the blue grid.
3. The chrominance voltage at the green grid should produce 33% of the deflection obtained at the blue grid.

If these proportions are not observed, the matrix resistors or capacitors are defective or the outputs from the color detectors are not

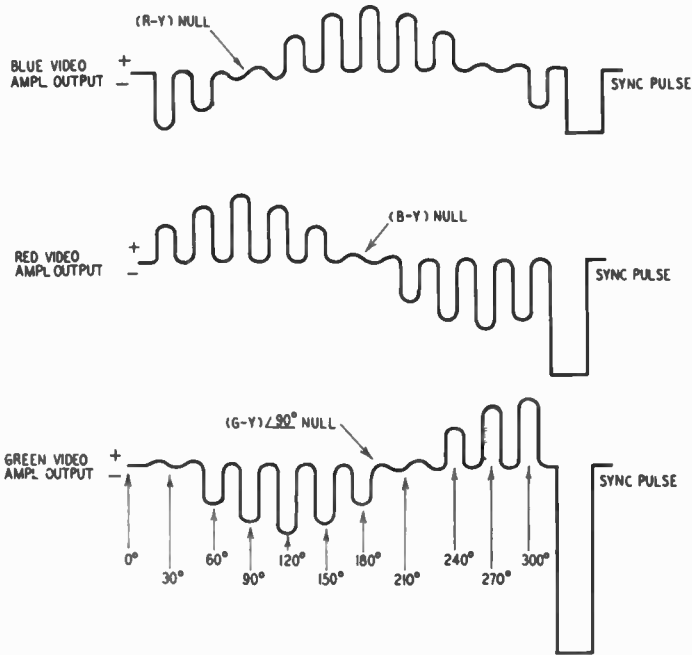

Fig. 512. Signal proportions at the three grids for keyed rainbow signal.

in the proper ratio. In (R - Y) (B - Y) detection, the output from the (B - Y) detector is adjusted to be 1.76 times greater than the output from the (R - Y) detector. The output signal from the (G - Y) matrix will not be correct unless the divider in the grid circuit of the matrix applies 0.51 of (R - Y) and 0.19 of (B - Y) voltages to the grid of the (G - Y) matrix tube. Also, the output circuits of the chrominance amplifiers and matrix must have cor-

Chart 5-1. Matrix Servicing

Type of Test	Indication Obtained	Discussion
Resistance, with ohmmeter.	Resistance values of matrix divider and load resistors; continuity checks of peaking coils.	Matrix resistor values must be held quite closely, particularly in the I-Q matrix system. Resistance test not reliable for shorted turns in peaking coils.
Matrixing, with color bar generator.	Display of signal amplitudes at output of all three chrominance channels.	A color bar generator test is the most conclusive since the ability of the matrix system to operate properly as a whole is accurately indicated. When normal signal level is utilized, overloading also shows up if present.
Relative outputs of color demodulators and matrix, with signal generator and vtm.	Voltage-output ratios of the three chrominance channels.	A relative output test of this type is limited inasmuch as correct voltages may be obtained while incorrect signals may be present when a color signal is applied to the system.
Relative outputs of color demodulators and matrix, with rainbow generator and vtm.	Same as above.	Same as above.
Signal output from matrix, with keyed rainbow generator.	Luminance and chrominance ratios as well as proper matrixing when generator is properly applied.	Indication obtained is not quite as complete as tests of matrixing action on an NTSC signal, but adequate servicing tests are provided.
Frequency response, with sweep and marker generator and scope.	Bandwidth and flatness of response.	A sweep-frequency test is one of the most definitive tests possible, and is second only to color generator tests.
Transient response of matrix to square-wave voltages.	Scope display shows ability of matrix to pass necessary square-wave frequencies without distortion.	The transient response of the chrominance system is highly important because chrominance signals transmitted by a color-TV station are always transient in their characteristics.

rect values of resistance and capacitance to maintain proper signal proportions at the grids of the picture tube. If blue or blue and green gain controls are provided, these must also be adjusted correctly to obtain the specified signal proportions.

Of course, some receivers utilize $(R - Y)$ $(G - Y)$ or $I Q$ detection—however, *this makes no difference in the specified levels at the picture tube*. In other words, the same chrominance voltages must be applied to the grids of the picture tube regardless of the methods of detection and matrixing utilized. The differences to be contended with here concern only the controls and components which must be investigated if the specified signal levels are not obtained at the picture-tube grids.

When Y matrixing is accomplished prior to the application of the signal to the grids of the picture tube, the sync pulse appears with the chrominance signal (Fig. 512). However, when final matrixing is accomplished in the picture tube (Y signal applied to its cathodes) the sync pulse must be checked at the cathodes. In either case, the color intensity control should be advanced to where the peak-to-peak voltage of the sync pulse is equal to the peak voltage of the chrominance signal at the blue grid. In case sufficient chrominance signal cannot be obtained in this manner, when the contrast control is set for normal reproduction of a black-and-white picture, the trouble is due to low gain in the chrominance channel. Improper alignment of the bandpass amplifier or of the if and rf amplifiers or circuit faults in the bandpass amplifier section are common causes of inadequate chrominance voltage with respect to the sync pulse voltage.

Consider also the relative levels of the sync pulse with respect to the chrominance signal at the red and green guns, for a condition of test in which the scope gain has been adjusted in each test to maintain the chrominance deflection constant. If the sync pulse is adjusted to the correct level at the blue gun but has subnormal or zero voltage at the red or blue gun, check for poor connections at the cathodes of the picture tube or for incorrect resistor values (or open capacitors) in the Y matrix, depending upon the matrix configuration.

If leaks or shorts are suspected in the picture tube, the sockets can be unplugged from the tube to check the signal levels at the socket terminals. Remember that improper reproduction of the complete color can result as well from picture tube defects as from matrix defects.

Chart 5-2. Influence of the Y Voltage Value in Matrix Operation

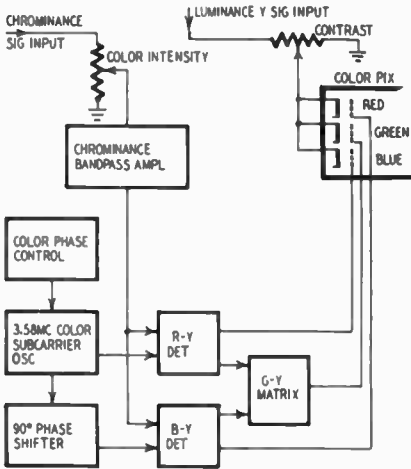

Typical high-level demodulation system utilizing (G - Y) matrix supplemented by matrixing action of the color picture tube. The addition of the Y component to the color-difference signals occurs in the picture tube. Output from the (R - Y) detector is applied to the red grid; from the (B - Y) detector to the blue grid; from the (G - Y) matrix to the green grid; from the Y amplifier to all three cathodes of the color picture tube. The hue which a color-difference signal produces on the screen of the color picture tube is dependent upon the value of the Y voltage.

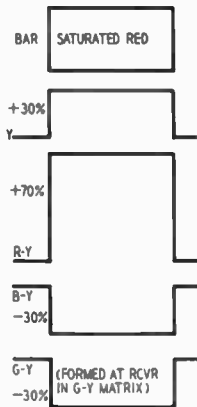

To produce a pure red hue on the screen of the color picture tube, these signal voltages are applied to the grids and cathodes of the picture tube. A 30% Y signal is applied to all cathodes; 70% (R - Y) to the red grid; -30% (B - Y) to the blue grid; the (G - Y) matrix develops a -30% (G - Y) signal voltage, and applies it to the green grid. In consequence, the red gun runs wide open and the outputs from the green and blue guns are zero. A saturated red hue appears on the screen of the color picture tube.

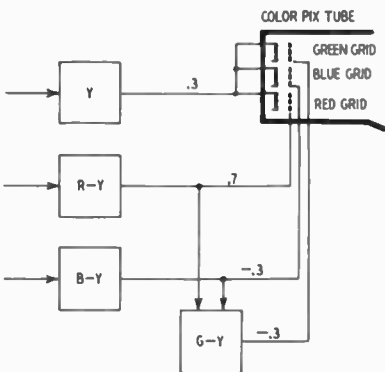

The manner in which the color-difference signal voltages and the Y signal are distributed through the matrix system is shown in the accompanying diagram. Note that the negative outputs from the (B - Y) detector and (G - Y) matrix cancel against the Y signal but that the positive output from the (R - Y) detector adds to the Y signal to produce full output from the red gun. Unless the Y voltage has the correct value, cancellation of the (B - Y) and (G - Y) signals will be incomplete so that noticeable contamination of the red hue with red and blue may become apparent. The relative levels of the luminance and chrominance voltages are controlled by the settings of the contrast and intensity controls.

Influence of the Y Voltage Value in Matrix Operation

To produce a 50% saturated red hue on the screen of the color picture tube, the signal applied to the matrix system is comprised of 65% Y, 35% (R - Y), and -15% (B - Y). The (G - Y) matrix operates on the (R - Y) and (B - Y) signals to develop -15% of (G - Y) output. Now, the red gun is wide open; but, in addition, the blue gun is operating at 50% and the green gun at 50%. Hence, a desaturated red hue is obtained.

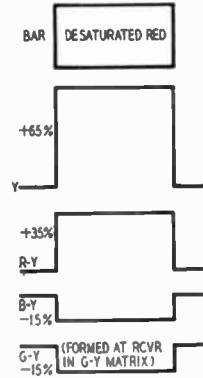

Next, consider the application of a rainbow signal to the matrix arrangement. The rainbow signal is a chrominance voltage (3.58 mc) only and has no Y component. To display the rainbow pattern, advance the master brightness control in order to drop the cathode bias so that the three guns draw beam current even with no signal applied. This is equivalent to providing an equal Y voltage to all three guns from a signal source. The hues depicted in this color circle apply for any one setting of the master brightness control, since the exact hues which are obtained depend upon the value of the Y signal voltage.

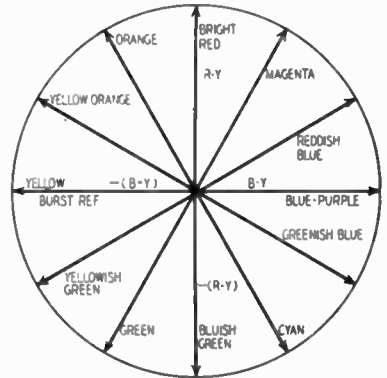

To obtain a pure red hue by application of an (R - Y) signal voltage to the matrix system, run the master brightness control at a level which just brings the screen to darkness in the absence of a signal. The red hue is obtained from application of the output from the (R - Y) detector to the red grid. If the (R - Y) output has a relative level of 1, the output from the (G - Y) matrix is -0.51 and the output from the (B - Y) detector is zero. But if it is attempted to brighten the red display by advancing the master brightness control, the blue gun will start to draw beam current and the red hue will be contaminated with blue. Thus, red becomes magenta as the Y voltage is increased.

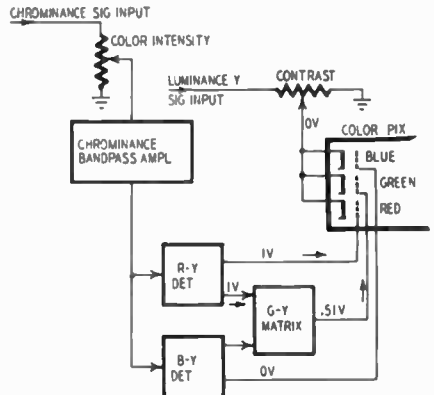

Influence of the Y Voltage Value in Matrix Operation

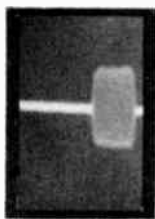

This is the appearance of an $(R - Y)$ signal, as seen on the screen of a wide-band scope. A $(B - Y)$ or a $(G - Y)$ signal appears the same because it is only the phase of the chrominance signal which is varied to cause the matrix to develop various color signal voltages.

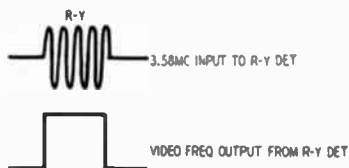

The input signal voltage to the matrix system has a frequency of 3.58 mc, but the output voltage from the $(R - Y)$ and $(B - Y)$ detectors has a square-wave shape, as shown. The output from the detectors has the shape of the envelope of the 3.58 mc signal. The square-wave signal voltages are applied to the input of the $(G - Y)$ matrix.

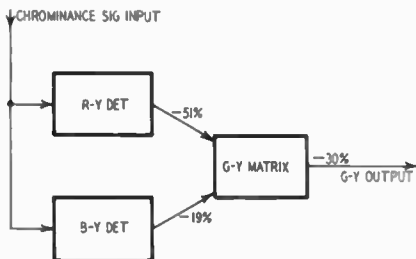

The $(G - Y)$ matrix operates by mixing $-0.51 (R - Y)$ with $-0.19 (B - Y)$ to form $(G - Y)$. Thus, positive output from the $(R - Y)$ or $(B - Y)$ detectors results in negative output from the $(G - Y)$ matrix, or negative output from the $(R - Y)$ and $(B - Y)$ detectors results in positive output from the $(G - Y)$ matrix. Negative output from a detector or matrix results in less beam current from the associated electron gun, while positive output results in increased beam current.

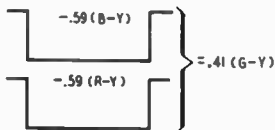

To obtain a saturated green hue on the screen of the color picture tube, the chrominance signal consists of $-0.59 (R - Y)$ and $-0.59 (B - Y)$, from which the green matrix forms $+0.41 (G - Y)$. With a Y signal of $+0.59$, the green gun runs "wide open" while the red and blue guns are cut off.

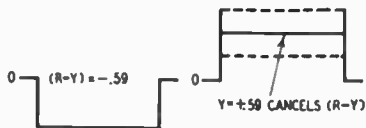

It is apparent that the green gun can operate at 100% output and the red and blue guns can be cut off to produce the saturated green hue only if the Y voltage is correct. If the Y voltage is greater than 0.59, the green hue will be contaminated with red and blue. If the Y voltage is less than 0.59, the green hue will be dimmed, with the green gun producing less than 100% output.

Influence of the Y Voltage Value in Matrix Operation

To realize the required relative values of luminance and chrominance voltages, a standard color bar signal (NTSC) differs from a rainbow signal in that the chrominance voltage is different for each color. The relative chrominance voltages are shown in the accompanying diagram and correspond to associated Y voltages in the next diagram. Note that the relative lengths of the I, Q, etc. color-difference signals are arbitrary, but that the relative lengths of the red, green, and blue, etc. signals must be accurately maintained as they correspond to established and defined saturated colors.

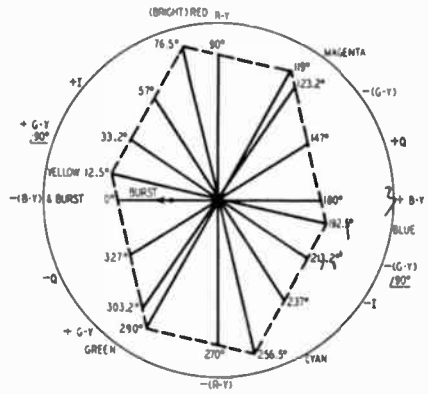

These are the values of Y voltage which are transmitted with the indicated chrominance voltages to obtain the required outputs from the red, green and blue guns to reproduce the colors noted. If the color intensity control is advanced too far, the relative chrominance voltage will be too high. If the contrast control is advanced too far, the relative luminance voltage will be too high. The indicated values of Y voltage on the color bar diagram are realized in the receiver only when the controls are properly adjusted and just as in the case of the rainbow signal discussed, these hues are changed when the value of the Y signal is changed by control misadjustment.

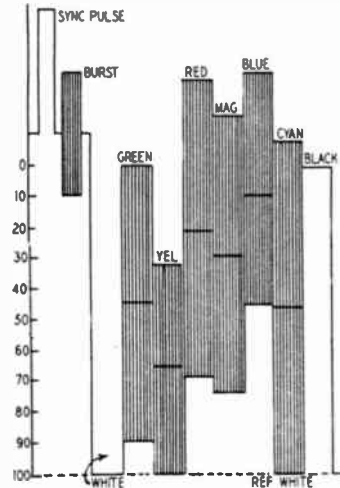

Consider the production of a hue having a high percentage of Y signal, such as yellow: a 100% saturated yellow hue contains 89% Y signal, 11% (R - Y), 11% (G - Y) and - 89% (B - Y). The indicated phase of the rainbow signal produces 11% of (R - Y) and - 89% of (B - Y). If the horizontal hold control (or the color phase control) is suitably adjusted, the yellow signal can be made apparent on the left-hand edge of the color picture tube. Adjustment is required because the yellow phase is usually obscured by the flyback interval. Now, if the master brightness control is set normally, no trace of yellow can be seen; but if it is advanced to provide the equivalent of 89% Y voltage, the yellow hue becomes apparent. Note that this is not a desirable experiment because other portions of the rainbow pattern may bloom excessively.

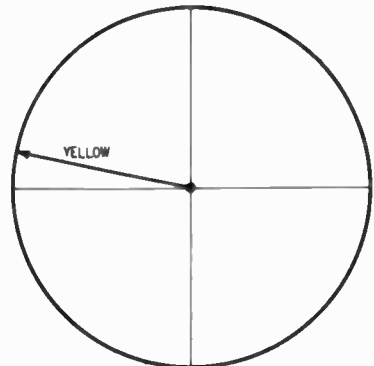

Dc restorers

Although the trend in color receiver design is toward the use of dc-coupled matrices, many of the older receivers and some of the current models are encountered in which the output circuits of the matrices are ac-coupled to the grids of the picture tube. When ac coupling is utilized, a dc restorer is used in each grid circuit of the picture tube to maintain proper background voltages.

Either a keyed rainbow signal or an NTSC color bar signal can be used to check the operation of the dc restorers. Even a color program signal can be used, although the latter does not provide as steady a signal as a generator. To check operation of a dc restorer, the level of the applied signal is increased while the dc voltage at the particular grid is observed with a vtvm. The bias should have the highest value in the absence of chrominance signal and should decrease in value as the signal level is increased. If the dc restorer does not respond properly, the resistors and capacitors in the restorer network must be checked.

Insofar as picture reproduction is concerned when dc restoration is faulty, daytime scenes appear too dim and nighttime scenes appear too bright. Large lettering on a dark background will cause the background to become distorted with smears in various shades of gray. Color reproduction is also affected adversely with incorrect hues and saturations most noticeable in the case of light colors such as yellow and cyan.

servicing the if amplifier

ALTHOUGH the response of the video amplifier in a black-and-white receiver is linked with the response of the if amplifier, this interdependence of the signal circuits is much more extensive in color reception. Thus, the alignment adjustment of the if, video, and bandpass amplifiers are all interrelated. In the wideband type of color receiver it is sometimes necessary to observe a particular form of response in the I demodulator circuit to correlate with the frequency characteristics of earlier signal circuits.

The block diagram of a typical color TV receiver (Fig. 601) indicates that a considerable degree of mutual dependency would be expected to exist between the front end, if, Y and chroma amplifiers, color demodulators and matrix to obtain the required balance of signals applied to the color picture tube.

Fig. 602 shows that the complete color signal is comprised of the black-and-white Y signal, equivalent in all respects to a monochrome signal. The complete color signal also consists of a wide-band color signal having double sidebands out to 0.5 mc on either side of the color subcarrier and of a single sideband from 0.5 mc to 1.5 mc. Also present is the narrow-band color signal which has double sidebands out to 0.5 mc on either side of the color subcarrier. The narrow-band type of color receiver operates only in the double-sideband region of the chrominance signal and rejects the single-sideband color information. The wide-band type of receiver utilizes both single and double-sideband signals. Since the single-sideband signal has only one-half the voltage of the double-sideband signal, alignment of the signal channels must provide double gain in the single-sideband region, at some point in the circuits.

Fig. 603 shows the progress of the complete color signal through a black-and-white receiver. The black-and-white (or Y) signal is sometimes termed the crankshaft signal, and the 3.58-mc color signal is superimposed upon it. Both of these signals pass through the

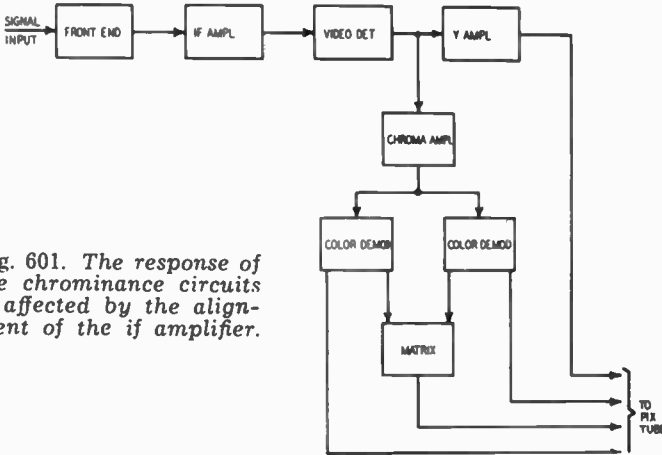

Fig. 601. The response of the chrominance circuits is affected by the alignment of the if amplifier.

rf and mixer stages without attenuation but the relatively narrow bandpass of the if amplifier in a black-and-white receiver attenuates the 3.58-mc signal somewhat, without greatly affecting the Y signal, most of which is lower in frequency. The color signal is further at-

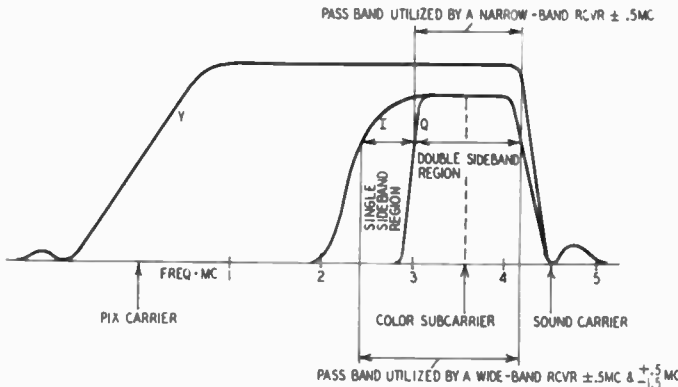

Fig. 602. Complete color signal has double- and single-sideband components within the chrominance region. Wide-band receivers utilizing the single-sideband chrominance signal must be aligned to take the half-voltage level of the single sideband into consideration.

tenuated in the video amplifier of the black-and-white receiver because the response of the video amplifier is usually down considerably at 3.58 mc. Finally, the remaining 3.58-mc signal which finds

its way to the black-and-white picture tube is optically cancelled on the screen (due to frequency interleaving of the chrominance and Y signals). Thus, only the Y signal is effective in producing the image on a black-and-white picture tube.

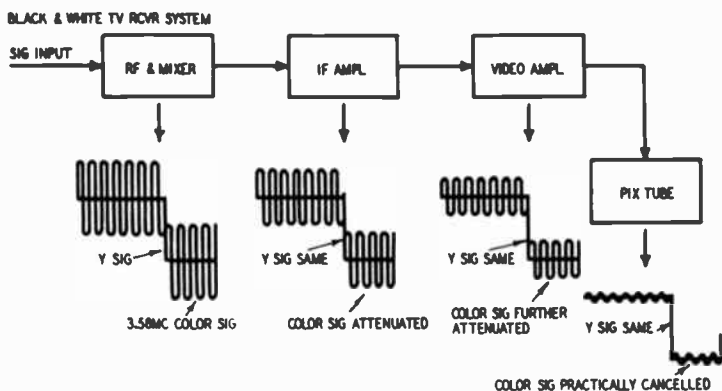

Fig. 603. Progress of the complete color signal through a black-and-white receiver.

On the other hand, the complete color signals can progress through the signal circuits of a color receiver (Fig. 604). The Y signal passes unattenuated through the rf amplifier, mixer, if and video amplifier to the picture tube, the same as in a black-and-white receiver. The 3.58-mc chrominance signal is not attenuated in the if amplifier, but is considerably reduced in the video amplifier to minimize crosstalk between the Y and chrominance signals due to nonlinearity of picture tube operation. What little 3.58-mc signal arrives at the picture tube is practically eliminated by optical cancellation, as in a black-and-white set. The if amplifier passes the 3.58-mc signal in unattenuated level to the color circuits, which develop the wave envelope of the 3.58-mc signal, for application to the grids of the color picture tube. The Y signal is rejected by the color circuits in the bandpass amplifier so that no Y signal is applied to the picture tube grids.

The output from the video detector contains both the chrominance and luminance signals. The complete color signal divides and is applied to the chrominance bandpass amplifier, and to the Y amplifier with its 3.58-mc trap (Fig. 605). The 3.58-mc trap is chiefly effective in eliminating the color signal from the Y channel, although attenuation of the color signal is also imposed by the somewhat limited high-frequency response of the Y amplifier. The frequency response of the chrominance bandpass amplifier usually ex-

tends from 3.1 to 4.1 mc to accept the chrominance signal and to reject a maximum amount of the Y signal. The luminance signal is largely eliminated by the bandpass amplifier because the chrominance signal has high energy in the 3.1 to 4.1 mc region where the

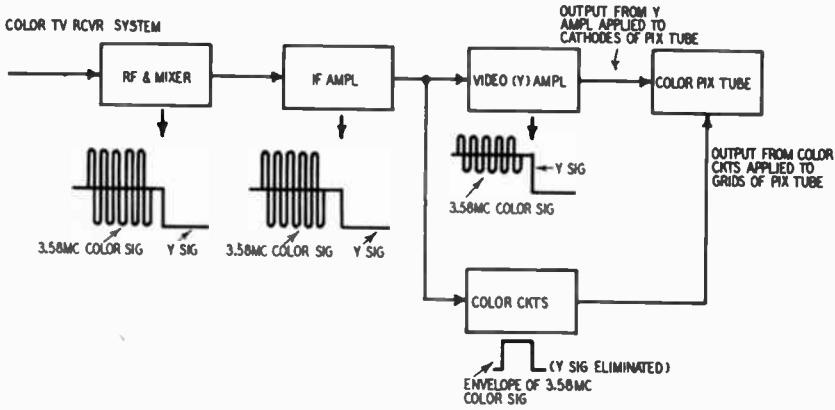

Fig. 604. Progress of the complete color signal through a color TV receiver.

luminance signal has low energy. The sound signal is also present in the if amplifiers but is heavily trapped prior to the video detector to avoid development of a 920-kc beat between the sound carrier and the color signal.

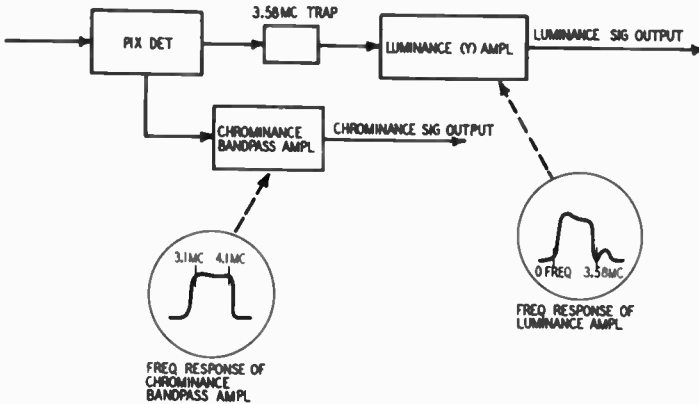
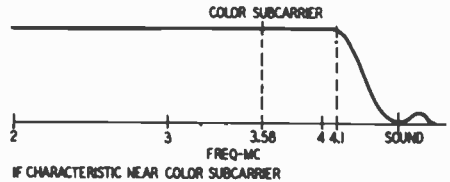

Fig. 605. The passband of the chrominance bandpass amplifier extends typically from 3.1 to 4.1 mc; the Y amplifier is trapped deeply at 3.58 mc, with limited response beyond 3.58 mc.

Consider first the alignment characteristics of an if amplifier which operates in combination with a chrominance bandpass amplifier having a frequency response as in Fig. 605. This is a bandpass amplifier response typical of an (R - Y) (B - Y) receiver

utilizing a ± 0.5 -mc chrominance signal system. The bandpass amplifier response is flat-topped, which requires that the if amplifier provide a uniform output over the 3.1–4.1-mc region. The proper response curve for the if amplifier in this case is shown in Fig. 606. By maintaining the if response flat to 4.1 mc (from the picture car-

Fig. 606. High-frequency end of the if response is maintained flat to 4.1 mc for utilization by a flat-topped band-pass amplifier.



rier frequency), none of the chrominance signal frequencies are attenuated and good fidelity of color reproduction is assured. A flat if response curve also causes less change in color saturation as the fine-tuning control is adjusted and is less perplexing to the unskilled viewer. The phase characteristic in a flat signal system is more linear than in peaked signal systems. Nonlinearities of the overall phase response cause some degree of hue distortion since the color detectors recognize the various hues as phases of the chrominance signal. Thus, a poorly aligned if amplifier not only causes possible attenuation of the color signal but can give rise to unbalanced and incorrect colors.

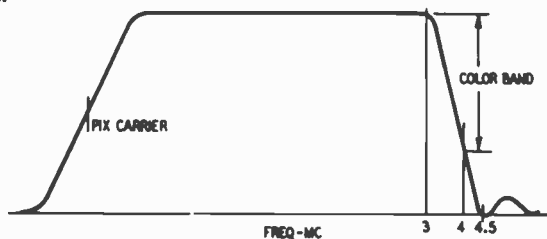

Fig. 607. When the if amplifier is aligned to place the chrominance signal on the slope of the curve, subsequent compensation must be obtained in the chrominance section to obtain equal amplification of all the chrominance frequencies.

Considerable complexity of the if circuitry is required to obtain a flat response out to 4.1 mc, since the sound must be deeply trapped at 4.5 mc and within the span of 0.4 mc the if response must fall abruptly by approximately 60 db. Hence, economy type receivers often employ compromises in the if and chrominance circuitry, which require a lesser number of total components. A typical if response curve of this type is illustrated in Fig. 607. Here, the response starts to fall at 3 mc from the picture carrier and decreases

progressively to sound frequency at 4.5 mc. The span of progressive attenuation occurs through a 1.5-mc interval; fewer components are required in the if strip and if adjustments are less critical.

Because the chrominance signal falls on the sloping side of the if response curve, the signal is unequally amplified through the

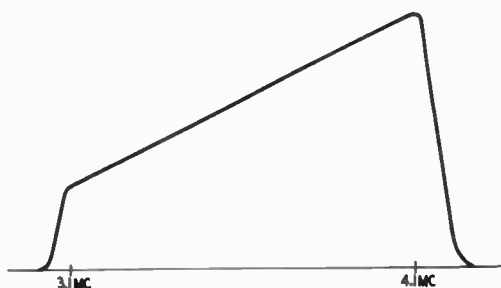

Fig. 608. A rising frequency characteristic in the bandpass amplifier can be used to compensate for a nonuniform if characteristic.

chrominance band. The chrominance frequencies at the high end are relatively attenuated, thus the subsequent circuits must provide suitable compensation to realize an overall response which amplifies all the chrominance frequencies equally. This compensation can be obtained in the chroma bandpass amplifier by utilizing a rising frequency response (Fig. 608). On the other hand, a flat re-

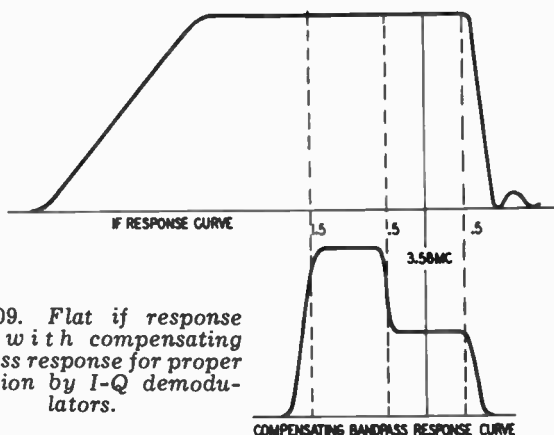

Fig. 609. Flat if response curve, with compensating bandpass response for proper utilization by I-Q demodulators.

sponse curve can be employed in the bandpass amplifier, with subsequent rising responses in the color demodulator circuits. Finally, partial compensation can be obtained in the bandpass amplifier response, with final compensation in the response of the color demodulators.

Next, consider an if amplifier having a flat response curve out to 4.1 mc from the picture carrier. If this amplifier is to be used in an I-Q type of receiver, compensation must be utilized in the chrominance bandpass amplifier (Fig. 609) so that the I demodulator will be energized with equal signal voltages over the entire chrominance band. The chrominance signal contains double sidebands out to 0.5 mc from the color subcarrier frequency but contains only single sidebands in the interval from 0.5 to 1.5 mc from the color subcarrier. For this reason, the if amplifier has only half-voltage color output in the 0.5–1.5-mc interval. This half-voltage output is boosted to full level by providing double gain from 0.5 to 1.5 mc in the bandpass amplifier (Fig. 609).

In the I-Q system the if amplifier may be operated with a portion of the chrominance signal falling on the sloping side of the if curve (Fig. 610). The chrominance signals in this illustration be-

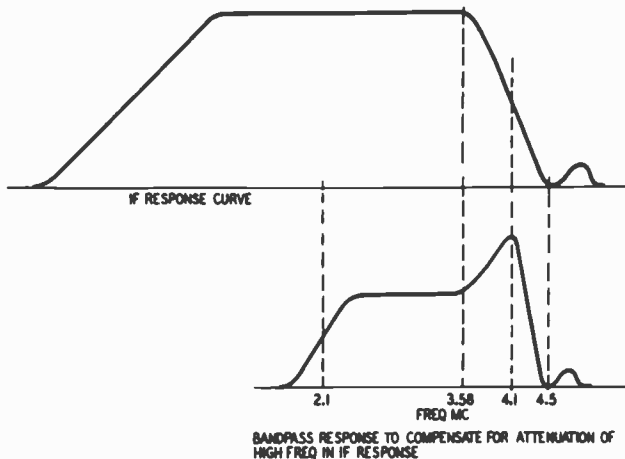

Fig. 610. Bandpass response compensates here only for the high-frequency if attenuation. Single-sideband compensation is subsequently provided in the I demodulator response.

come progressively attenuated in the interval from 3.7 to 4.1 mc. Therefore, the chrominance bandpass amplifier must be aligned to provide a compensating rise in this interval. While this alignment scheme provides flat frequency response through the chrominance channel, no compensation is present to bring up the single-sideband interval to full response. Hence, the subsequent I demodulator requires a stepped response similar to that shown in Fig. 609 for the bandpass response. These more complex alignments are infrequently encountered, but should be recognized.

Dynamic range of if amplifier

The alignment of if amplifiers for color reception is quite similar to black-and-white, except that unusually great bandwidth is required in receivers which employ the flat-topped if type of response. Hence, the alignment adjustments are more critical and the marker frequencies must be determined with considerable accuracy.

There is a further consideration, quite apart from the shape of the if response curve, which is of importance in color reception—the dynamic range of the if amplifier. The dynamic range concerns the ability of the amplifier to pass the complete color signal without overloading, i.e., without limiting or clipping the signal in the blacker-than-black region. The reason for this requirement is evident in the color bar signal (Fig. 611). Note how the 3.58-mc component of the red and blue bars, in particular, extend beyond the black level into the blacker-than-black region.

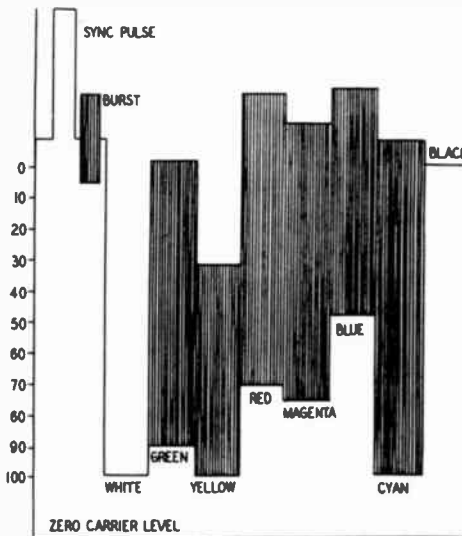

Fig. 611. The color signal places a greater demand on the dynamic range of the if amplifier than a black-and-white signal because the 3.58-mc component extends into the blacker-than-black region.

If limiting or clipping should occur in this region, the red and blue hues will be contaminated and distorted. The best check for overload is to apply a color bar signal to the receiver and to increase the signal from the generator progressively until it somewhat exceeds the level of the prevailing station signals. In case of doubt, a measurement of the dc voltage from the picture detector will serve as an accurate comparative guide. Watch the color bars on the screen of the picture tube as the input signal level is increased. If

noticeable change takes place in hue and saturation, overload exists in the amplifier.

Of course, overload can happen in other signal circuits, such as the video amplifier and chrominance circuits, although it will usually be tracked down to the if amplifier. The most common cause of overload is agc trouble which causes insufficient agc bias to be applied to the grids of the controlled tubes. If overload can also result from low plate or screen voltages. Some receivers have an agc threshold control, which must be suitably adjusted to prevent overload.

Some keyed rainbow generators have a built-in overload check which operates by adding a predetermined amount of 60-cycle hum voltage into the signal when the overload check button is pressed. The color signal rides on top of the hum voltage which causes the signal to rise to a higher peak—again, hue and saturation changes in the pattern during the overload check indicate that the dynamic range of the if amplifier is inadequate for good color reception.

Stability of if amplifier

The final check of an if alignment job in a color receiver should be made at both high and low values of agc override bias. Intermediate-frequency amplifiers which display a good characteristic at high bias sometimes develop a badly distorted response curve when the override bias is reduced. With this fault, reception of weaker color signals will be distorted or perhaps impossible, depending upon the magnitude of curve distortion which takes place.

When the response curve changes in shape and develops less bandwidth at low values of grid bias, the trouble is due to positive feedback in the if circuits. Normally operating receivers have a negligible amount of feedback, but circuit faults or disturbed lead dress can cause it to rise to a noticeable level. Technicians with adequate experience in alignment of black-and-white if amplifiers are familiar with the causes and cures for if regeneration (feedback).

The purpose of this section is to remind the technician of the advisability of always making a feedback check before the receiver leaves the alignment bench since instability of the if amplifier is a much more serious matter in reception of color signals than in black-and-white.

Response curve of rf and if amplifier

It is very important in color reception that the if amplifier and

the front end work well together to provide a good overall response curve. The alignment of front ends in color receivers is quite similar to black-and-white rf alignment procedures, except that closer limits are specified for tolerable tilt and dip. Some inaccuracies are unavoidable in the alignment of both if and rf sections and the question necessarily arises whether the inaccuracies may be cumulative in such manner that the overall response curve is unduly distorted.

The rf amplifier may tend to exhibit a distorted response at low values of grid bias. Although the frequency response of the rf amplifier and mixer stages may appear nearly ideal at medium and high values of override agc bias, it is possible for substantial tilt and bandwidth reduction to show up when the override bias is reduced to a low value. Such feedback variations in tuner response are caused by component failure or by improper placement of components in a repair job. *Most technicians do not undertake to align or troubleshoot rf tuners but replace them when faults occur.* In any event, it is necessary to recognize the basis for rejection of a tuner in a color receiver. Service manuals usually specify the limits on tilt, dip and bandwidth which can be tolerated.

It is good practice to apply rf sweep and marker signals at the antenna input terminals of the receiver and to check the overall response at the output of the picture detector with a scope. The check should be made, of course, at both high and low values of override bias to make certain that amplifier stability is satisfactory for reception of weaker signals.

In case unexpected distortion occurs in the overall response curve, although stability is satisfactory, it is permissible to compromise the alignment adjustments in the front end and the if amplifier to obtain an overall response which is nearest to ideal. Unquestionably, it is better practice to obtain the proper response from both the front end and the if amplifier but, in practice, a measure of compromise is required. Many receiver service manuals illustrate the ideal shape of rf—if response which should be approximated.

It is surely not necessary to stress the necessity for careful alignment of the signal circuits to obtain good quality color reproduction. The serious technician will be interested in advanced types of alignment checks, such as video-frequency modulation checks of the overall performance of the rf, if, and picture detector circuits. The advantage of using a video-frequency modulation check of the signal channel is that the pattern obtained will show up faults in the

picture detector output circuit as well as in rf or if response. Moreover, a "modulated carrier" type of display is obtained which shows up nonlinearities of system response.

The test setup for overall checks of rf, if and picture detector response is shown in Fig. 612. The signal generator is adjusted to the picture carrier frequency of the channel under test and the video-

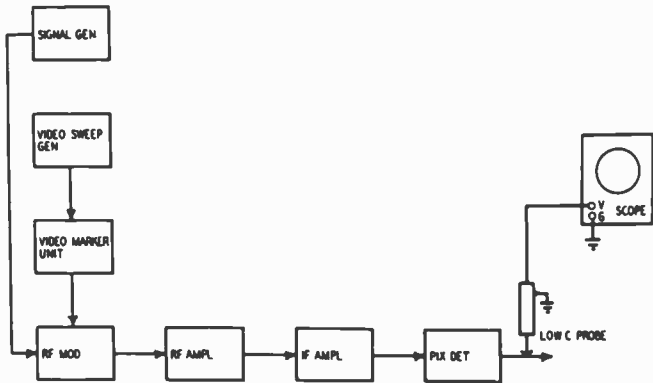

Fig. 612. Test setup to check the overall response with a video-modulated picture carrier.

frequency sweep generator is set to sweep from 0 to 4.5 or 5 mc. The video marker unit should preferably be of the absorption type, with notches at 0.5, 1.5, 3.0, 3.58 and 4.1 mc. The rf modulator unit can be constructed by an experienced technician but is preferably purchased factory-built, since stray resonances on the higher channels can pose treacherous problems in shop-constructed units.

In operation of the system, the video-frequency sweep signal with its markers is modulated upon the picture carrier voltage and impressed upon the antenna input terminals of the receiver. A wide-band scope having flat response to 4.5 mc is applied at the input of the first video amplifier via a low-capacitance probe. It is usually advisable to pull the first video-amplifier tube so that the input capacitance of the probe substitutes for the input capacitance of the tube, thereby maintaining more nearly normal loading on the peaking coils in the detector-output circuit. It is sometimes possible to find a suitable low-impedance point for application of the probe, such as across an unbypassed cathode resistor in the video amplifier circuit. A low-impedance point is best suited for such tests since the capacitance loading imposed in a low-impedance circuit can be neglected. Receiver manufacturers who specify a video-frequency modulation test indicate suitable points for probe application in the receiver service notes.

A typical display of frequency response with this arrangement is shown in Fig. 613. The pattern is in undemodulated form and its envelope is the overall response of the rf amplifier and mixer, if amplifiers and picture-detector circuits. The notches produced by the absorption markers indicate the principal frequencies of interest along the response. Nonlinear operation of the signal channel will cause the positive and negative excursions to be unequal. Thus, this form of test is the most comprehensive alignment check so far discussed. Of course, the test should be made both at low and high values of agc override bias to determine the stability of the signal system and its immunity from feedback distortion.

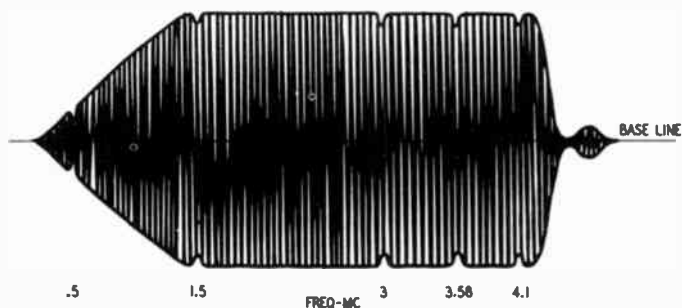

Fig. 613. Typical display obtained in the test shown in Fig. 612.

The reason why the sweep-modulated picture carrier test shows the response of the picture detector output circuit, in addition to rf and if response, is that the output voltage from the picture detector is a video-frequency sweep signal. This sweep signal varies from a low (theoretically zero) frequency to 4.5 mc at a 60-cycle rate. In case the detector peaking coils should have shorted turns, the high-frequency response of the pattern will appear attenuated. If the detector load resistor is too low in value, the low-frequency response of the pattern will appear attenuated. An open detector charging capacitor will cause an excessive rise in the high-frequency end of the pattern.

The sweep-modulated picture carrier type of test is not limited to the situation described but may be extended to check the overall response of the rf, if, picture detector, first video and bandpass amplifier circuits. Receiver manufacturers who list these classes of tests specify suitable test points in their service manuals.

Regeneration is a common difficulty in operation of if amplifiers which is not always clearly recognized. Regeneration also goes by the names of "Miller effect" and "feedback." The latter term is the more descriptive. The effect of regeneration is to produce a sharply

Chart 6-1. IF Alignment Characteristics

Requirement	Reason	Discussion
For wide-band color if amplifiers: Full response at 4.1 mc from the picture carrier.	Attenuation and distortion of the color signal will occur in the wide-band if system if the sidebands fall on the slope of the if response curve.	Circuit adjustment must be such that 100% response at 4.1 mc is abruptly followed by 50 db of sound trapping at 4.5 mc from the picture carrier.
Full 50-db rejection of the sound carrier by the sound traps.	An objectionable 920-kc beat between the color and sound signals occurs unless the sound is extensively trapped.	The sound traps must be accurately tuned to the specified frequency which correlates properly with placement of the color signal on the if curve.
Stability in shape and bandwidth of the if response curve over the normal range of agc bias variation.	When the response curve becomes distorted at low values of if grid bias, color contamination, inconsistent saturation or loss of color results.	Check shape and bandwidth of if curve at the lowest value of agc bias normally anticipated. In case of trouble check if strip for feedback.
Stability in shape of the overall rf-if response curve on all active color channels.	Same as above.	Check shape and bandwidth of the rf-if response on each color channel. In case of trouble, check particularly values of the degenerative stabilizing components in the mixer circuit.
Ample if dynamic range.	If overload distortion is very objectionable in color reception; hues are contaminated in the overload region and saturations are adversely affected.	Test reproduction of color bar signal at the maximum input level anticipated in normal operation. In case of trouble, check particularly the action of the agc circuit.
Proper correlation of if response with rf and picture detector response.	Faults in the picture-detector output circuit can result in poor response to the 3.58-mc color signal although rf and if alignment are ok.	Use a video sweep-modulated picture carrier signal and check the response with a wide-band scope at input to the video amplifier.
Proper correlation of if response with rf, picture detector, first video amplifier and bandpass amplifier response.	The response of the complete system to the color signal must be maintained flat up to the color demodulators for proper reproduction of color.	Use a video sweep-modulated picture carrier signal and check the response with a wide-band scope at the output of the bandpass amplifier.

peaked and narrow-band response, particularly at low bias levels. The lower the a_{gc} bias, the more distorted the response curve becomes. This difficulty has been noted earlier. Now we proceed to view the *causes* for regeneration:

1. Regeneration is usually caused by peaking the grid and plate circuits of a given if stage too closely to the same frequency. Receiver manufacturers specify that stagger tuning be used between grid and plate circuits of any stage, to minimize any tuned—grid-tuned—plate feedback action.

2. Regeneration may also be caused upon occasion by mistuning a cathode trap. The cathode circuit of an if stage is coupled through the tube to both the grid and plate circuits, and reflects reactance into each. Mistuning of the trap can sometimes cause regeneration, or even oscillation of the stage.

3. Missing tube shield, disturbed lead dress, open bypass capacitors, and use of incorrect tube types having too high G_m for the given circuit, are also possible sources of regeneration.

4. A missing shield from the bottom of the tuner can sometimes cause regeneration.

5. Incorrect grounding points (when replacing components such as if transformers or bypass capacitors) will sometimes cause regeneration.

the flyback system

THE flyback system of a color receiver performs several functions aside from providing horizontal-sweep voltage and an accelerating voltage for the picture tube. Marginal faults in the flyback system can cause trouble symptoms which are sometimes difficult to analyze. The flyback transformer in a typical color TV receiver energizes the horizontal deflection and dynamic convergence coils, burst amplifier, keyed agc tube, blanking amplifier, second anode and focus electrode of the color picture tube and supplies B+ boost voltage to various receiver circuits.

Operation at two frequencies

When black-and-white transmission is being reproduced, the flyback system operates at a frequency of 15,750 cycles; when a color transmission is being received, it works at 15,734.264 cycles. The shift in scanning frequency during color transmission is for the purpose of interleaving both the picture and sound carriers with the color subcarrier. Since the flyback transformer drives the horizontal dynamic convergence coils, the dynamic convergence voltages will have slightly different frequencies, depending upon whether a color or black-and-white program is being received.

The dynamic convergence circuits which are driven by the flyback transformer are reactive, not resistive. The horizontal dynamic phasing coils, for example, are tuned either to resonance or slightly to one side or the other of resonance, depending upon convergence requirements. Hence, a change in the frequency of flyback operation causes a change in dynamic convergence. Since a small amount of misconvergence is most evident in black-and-white and is not readily evident in color reception, good practice dictates that

convergence be performed at 15,750 cycles. Receiver service manuals usually provide instructions for insuring that the flyback system is operating exactly at 15,750 cycles during convergence procedures. For example, a sufficient amount of black-and-white program signal may be mixed with the white dot or crosshatch signal to lock the horizontal oscillator at 15,750 cycles.

Heat may soften insulation

The flyback system in a color receiver develops considerable power at 25,000 volts and hence the core of the flyback transformer may run warm. High-voltage wiring in the cage is often insulated with polyethylene, which will soften if permitted to rest against the flyback transformer. Breakdown and arcs can occur, in consequence, and the technician must be on his guard to avoid this source of trouble when making inspections or repairs.

It is not satisfactory to make voltage measurements on flyback wiring by puncturing the insulation of wires with a pin. Corona is a serious problem at 25,000 volts and long hot arcs are easily established which will cause considerable damage before the receiver can be turned off. Suitable points for voltage measurements in the flyback system are noted in receiver service manuals.

Defeat the interlock

A protective fuse is used in the screen or plate (or both) circuits of the horizontal-output tube to protect the primary of the transformer against burnout in the event of shorts or gas in the tube. If the receiver utilizes a high-voltage interlock and receiver operation is attempted with the back removed, but without the use of a cheater to defeat the interlock, a heavy short-circuit current is drawn from the high-voltage rectifier tube. A protective fuse of correct value will also prevent burnout of the flyback transformer. However, if the fuse has been previously replaced with a heavier unit, the flyback transformer will be quickly burned out.

There is never any excuse for replacing a flyback fuse with a higher-than-specified current rating. If a 0.45-amp fuse is specified, a 0.5 amp fuse should not be used—failure to observe this simple rule often leads to expensive and complicated repair jobs. When a rated value of fuse blows in the flyback circuit, the cause of blowing should be investigated. The grid-cathode bias of the horizontal-output tube may be low, permitting the screen to draw too much current. In other cases, arcs from improperly dressed high-voltage

wires cause intermittent surges which blow the fuse or a defective picture tube can draw excessive beam current.

Tagging Wires

Considerable time can be saved when replacing a flyback transformer if each wire is carefully tagged at the time that it is unsoldered from the transformer terminal board. There are numerous leads to contend with and a surprising amount of time can be wasted in identifying them when the new transformer is put in place, if tags have not been used.

Another good working rule is to make a tally of the number of leads removed, making a mark on a card at the time the lead is unsoldered. It is then known exactly how many connections must be made when the new transformer is installed, and eliminates the necessity for a final study of the high-voltage compartment and the underchassis to determine if one or two leads may have been overlooked somewhere.

Flyback testers

Not much satisfaction is obtained from most service flyback testers. There are numerous branch circuits with which the technician is not concerned in black-and-white receivers. Color receivers moreover vary widely among themselves in flyback circuit configurations.

When there is no high voltage—a common problem—it is advisable first to check the drive voltage at the grid of the horizontal-output tube with a scope and low-capacitance probe. A typical value at this point is 175 peak-to-peak volts. In case the drive voltage is normal, turn to the sweep and flyback system but, if the grid drive is weak or zero, the horizontal oscillator is defective. In case of normal drive, the next most helpful check is at the plate of the horizontal-output tube, using a 100-to-1 capacitance-divider high-voltage probe and scope. A waveform of approximately 6,000 p-p volts shows that the plate circuit of the horizontal-output section is ok; the trouble will be found in the high-voltage flyback section. However, low or zero waveform voltage at the plate of the horizontal-output tube shows that there is trouble in the primary circuit or abnormal loading of the output transformer by associated circuits.

Disconnect circuits to check loading

If the waveform at the plate of the horizontal-output tube has low

or zero voltage, it is safe to check the dc plate voltage with a vom or vtvm. Check the screen voltage of the output tube also. One or both of these may be somewhat low due to lack of booster operation. Next, the circuits associated with the output transformer may be disconnected one by one (Fig. 701) to determine whether the high-voltage output may be restored when a source of loading is thus removed.

Inspection of the circuit diagram for the receiver will show the various branch circuits which could develop defects and impose abnormal loading on the output transformer. The width coil may be temporarily disconnected to determine whether it is shorted,

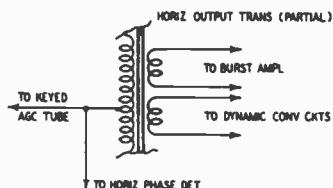

Fig. 701. Typical branch circuits which may load the horizontal-output transformer.

thereby loading the transformer seriously. The possibility of a heavy loading from the high-voltage flyback circuit should not be overlooked before removing the flyback transformer. Pull the high-voltage rectifier tube and check at the plate of the horizontal-output tube with a scope and 100-to-1 probe to determine whether the waveform is restored. However do *not* attempt circuit operation with the high-voltage filter capacitor disconnected.

Check the capacitors and resistors in the sweep circuit. Note that dc voltage tests will not be a guide to faulty components, in most cases, because the dc voltage distribution changes quite substantially in the sweep circuit when ac waveforms are not developed. In case the small components of the sweep system appear to be ok, the flyback transformer and yoke can be checked in turn by substitution. The point to be observed here is that the flyback transformer and yoke should not be replaced too hastily. There are many more circuits and components associated with the horizontal-sweep circuit in a color receiver than in a black-and-white set, hence there is a considerably greater probability of trouble occurring in associated circuits.

Of course, obvious cases of transformer and yoke trouble will also be encountered, such as arcing and burnt windings, open primaries (which show up as no plate voltage at the output tube), etc., but these are not the chief service problems. The difficult problems arise when there is no high voltage, with no obvious faults present.

Dc drain by branch circuits

Situations arise upon occasion in which the operation of the sweep circuit is practically normal, except that too much current is drawn which causes power-supply fuses to blow intermittently. A typical situation is shown in Fig. 702, in which the convergence drive winding on the horizontal-output transformer supplies both ac and dc currents to the dynamic convergence coils. Partial breakdowns and leaks in the convergence controls to ground can cause abnormal dc drains which are sometimes difficult to locate.

Fig. 702. Both alternating and direct currents are often supplied to the convergence circuits.

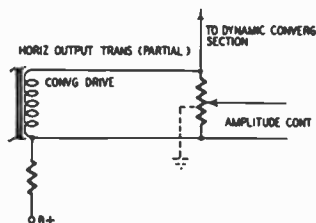

The leakage to ground can be found with an ohmmeter, in some cases, but at times a working-voltage test is required to run down the trouble. Ohmmeters operating at 300 to 400 volts are often provided in capacitor leakage testers and will be found very useful to check convergence (and other branch) circuits for dc leakage to ground. Working-voltage tests are particularly useful for finding faulty electrolytic or paper capacitors in the branch circuits which sometimes leak very little until a critical voltage is reached, after which the current drain suddenly becomes substantial.

In general, sectionalization and appropriate methods of test will serve to lighten the difficult job of flyback-system testing. It is not the complete breakdowns which consume excessive time and effort to locate but, rather, the partial breakdowns and marginal faults which permit sweep operation to continue, although unsatisfactorily. Receivers of a given type are usually prone to develop certain faults and these become catalogued as field experience is gained. Difficult service jobs are sometimes cleared up at once by seeking the advice of others who have worked on similar sets. However, the statistical probabilities do not always apply and the majority of flyback troubleshooting still has to be done on the basis of logic and appropriate test procedures.

Design changes

When a relatively new receiver is being serviced, it is good practice to check the latest data available concerning manufacturer's

design changes. After a new receiver has been sold for a short time, unsuspected weaknesses in design may become apparent, which are subsequently covered in supplementary service notes.

For example, if a replacement focus control is required and a thorough check of this branch circuit gives no clue as to why failure should have occurred, supplementary service data may suggest replacement with a different value of control or the addition of one or two fixed resistors in the circuit. As another example in point, resistors which operate in pulsed circuits are "worked" much harder than in sine-wave or dc circuits. Supplementary service notes sometimes suggest replacement with resistor types better suited to withstand pulse service. Capacitors which appear to be good for a particular application at the time of design sometimes prove unsuitable for use in newly developed circuits; supplementary service notes will suggest a more suitable replacement type.

Corona interference

Any exposed metallic surface in the 25,000-volt flyback section will develop corona and/or arcs unless it is well sealed by good high-voltage insulation, such as polyethylene, or unless the exposed metal is gradually rounded and removed from nearby grounded metal. Corona develops when the electrostatic stress exceeds the ionization potential of the surrounding air. It is accompanied by a bluish glow which can be seen in semidarkness and by a characteristic odor (pungent, sharp) of ozone. A corona discharge often develops at an improperly made connection or due to pin pricks in high-voltage cabling. It not only imposes an extra load on the high-voltage power supply but often leads to arcs and breakdowns as well as disturbance to the receiver circuits. The corona discharge is frequently audible as a rough rushing noise in the speaker.

The high-voltage cable must make a good connection to the picture tube—it must not be assumed that, because high voltage is present, as good a connection as for low-voltage leads is not required. A small arc due to poor contact with the high-voltage anode of the picture tube can cause jittery sync and disturbances in the sound and raster.

Any metal work in the vicinity of the high-voltage anode of the picture tube must be grounded although it may seemingly be well insulated from the source of high voltage. Even glass is slightly conductive at 25 kv and will slowly build up a charge on isolated metal objects which will give the operator or viewer a strong "bite" when touched. Floating metal work in the vicinity of the picture

tube should be grounded to the receiver chassis to avoid such build-up.

Variation in replacement flyback transformers

When replacing a flyback transformer, obtain an exact replacement. This is a much more important consideration in color TV servicing than in black-and-white, because of the numerous subsidiary functions performed by the sweep circuit. Not only must the waveform voltages be correct from the various windings, but the pulse outputs must be positive- or negative-going, as required by the receiver circuits.

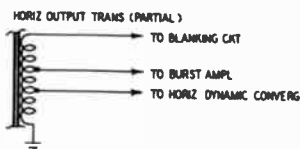

Fig. 703. One end of the winding is grounded. All pulse outputs have the same polarity.

Fig. 703 shows an arrangement for a horizontal-output transformer in which the pulse voltage outputs for the blanking circuit, burst amplifier and horizontal dynamic convergence circuits are all positive-going pulses. When one end of the transformer winding is grounded, all pulse outputs from the winding must have the same polarity. A replacement transformer could be obtained (Fig. 704), which provides all pulse outputs at correct voltages but in which the pulse voltages are positive-going for the blanking circuit and the burst amplifier but with a negative-going pulse for the horizontal dynamic convergence circuits. If such a replacement is made, it will be impossible to obtain horizontal convergence. As the convergence-amplitude controls are advanced, the picture tube will go farther out of convergence due to incorrect pulse polarity.

When an intermediate point of a transformer is grounded, the pulse output on one side of the ground point will have opposite polarity from that on the other side.

The polarity of a pulse can easily be checked with a scope. Most scopes are designed to provide upward deflection on the screen for a positive-going voltage and a downward deflection for a negative-going pulse. When service notes specify a pulse output as +55 volts, for example, it means that the pulse is positive-going and has a peak-to-peak voltage of 55. Such a pulse will extend upward on the screen of a standard scope.

It is easy to become confused by pulse specifications of this type, because there is a tendency to assume that a "+55"-volt rating for a pulse output has reference to a dc voltage measurement. In

matter of fact, a dc voltmeter will indicate zero on such a pulse voltage. Only a scope is suitable for checking pulse voltages. A peak-to-peak indicating vtvm will read the voltage of such a pulse correctly, but it will not indicate whether the pulse is positive or negative-going.

Fig. 704. *Intermediate point of winding is grounded. Pulse outputs have different polarity on either side of the ground point.*

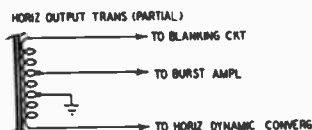

Circuit changes

Improved replacement components, such as deflection yokes, are sometimes available when a color receiver is undergoing repair. This replacement yoke, for example, may permit better convergence at the edges of the picture-tube screen. However, when using improved components, be sure to check the service notes for the receiver, since various circuit modifications and added parts may be required to obtain proper operation of the replacement.

As a practical example of this requirement, a typical improved yoke requires a change of three fixed capacitor values in the sweep circuit, a different value of drive control and change of a half-dozen resistor values, plus several wiring changes. Carelessness in observing the necessary changes results in poorer convergence than with the original yoke.

Intermittent arcs in high-voltage system

When intermittent arcing occurs in the high-voltage cage and the cause is not apparent, it is advisable to check the service notes and supplementary service data for the receiver to determine whether pertinent production changes may have been made. It may be found that revisions in mounting of components or better-insulated components are recommended. The high voltages which are present cause much more rapid deposition of dust than in black-and-white receivers, and for this reason intermittent arcing is sometimes due to breakdown of a thick layer of dust. Compressed air is the best method of cleaning out the dust—but make certain that the air is dry and does not contain condensed water vapor.

Situations have been encountered in which intermittent arcs occur through the glass of the picture tube, into the yoke or convergence coils, thereby causing unexpected and puzzling failures of

these components. The only remedy is to replace the picture tube.

Intermittent arcing is generally aggravated in very humid weather and trouble calls during such periods tend to rise. If the receiver can be installed in an air-conditioned room where the humidity is maintained at a minimum value, costly breakdowns can sometimes be avoided. A color receiver which has been stored for some time in a damp basement should not be turned on until it has had a chance to dry out for a day or two in a room at normal humidity.

Horizontal foldover and poor color sync

When foldover occurs at the left-hand side of the raster, the consequences are more serious in the case of color reception than in black-and-white. Left-side foldover is an indication that the horizontal sweep is starting late, and a late sweep causes late gating of the burst amplifier. Consequently, a clean burst pulse is not admitted to the color AFC phase detector and the burst signal becomes mixed with a portion of the chroma signal.

This admixture of chroma signal with the burst signal results in a pulling of the subcarrier oscillator in a high- or low-frequency direction, depending upon the frequency of the chroma signal at the moment. Poor color sync occurs, with the reproduced hues shifting about in a random manner. When the picture content changes, it is accompanied by a shift in all the reproduced hues.

Horizontal foldover can result from all the causes familiar in black-and-white and should be tackled in the same manner. It is usually advisable to start with an investigation of the horizontal oscillator circuit to make certain that waveforms are correct. Incorrect waveforms usually are due to misadjustment of the tuned coils in the oscillator circuit.

Horizontal foldover can also result from excessive capacitance shunting the flyback transformer or a portion of the total transformer winding. If the high-voltage lead from the transformer is not dressed correctly and is permitted to run beside a metallic surface, the added stray capacitance is sufficient in some cases to cause foldover. Partial breakdowns in the transformer or yoke are also accompanied by foldover in some instances.

Conversion of small-screen receiver

To convert small-screen color receiver for operation with a large-screen picture tube is a difficult job and usually requires more time than it is worth. The circuitry changes required in the flyback sys-

Chart 7-1. Servicing the Flyback System

Fault	Symptom	Discussion
Failure of drive to horizontal output tube.	No raster, high voltage or pulse voltage at bandpass, burst or blanking amplifier; keyed agc tube or afc phase detector. No horizontal parabola in dynamic convergence circuits.	In case of flyback trouble, it is usually advisable to check first for drive voltage at the grid of the horizontal-output tube with a low-capacitance probe and scope.
Leads to flyback transformer not clearly identifiable.	Much time can be wasted when a flyback transformer is replaced, unless each lead is tagged at the time of unsoldering from the defective transformer. Because of the relatively large number of leads, on both sides of the chassis, note the total number of reconnections.	
Convergence circuits do not operate properly with replacement transformer; receiver otherwise ok.	A scope check of the pulse voltage supplied to the dynamic convergence circuits might show that the pulse has incorrect polarity.	Design changes are even more frequent in color receivers than in black-and-white. It is possible for a replacement flyback transformer to appear identical with the faulty unit, but to have a different winding arrangement.
High-voltage filter capacitor suspected of being defective.	Intermittent or no high voltage; flyback fuse blows repeatedly.	Do not attempt receiver operation with filter capacitor disconnected. Substitute replacement capacitor before receiver is turned on.
Intermittent arcing through glass of picture tube neck.	Eventual failure of yoke, convergence coils or electromagnetic purity coil.	Picture tube must be replaced.
High voltage low and sweep width reduced; poor convergence.	Faults in branch circuits may load the flyback transformer excessively.	Most branch circuits can be temporarily disconnected to determine whether high voltage is restored.
Dust or moisture, or bath, in high-voltage cage.	Ozone odor and intermittent arcing in cage.	If receiver has been stored in a damp place, dry out thoroughly before operating. Clean out dust with bellows or compressed air blast.
Corona discharge in high-voltage section.	Ozone odor. Bluish glow can be seen in dark room.	Corona occurs wherever the electrostatic stress is excessive. Poor soldering technique, which leaves points, deteriorated insulation or poor lead dress are the more common causes of corona.

tem are quite extensive, and few of the components utilized in the original horizontal system can be salvaged.

The flyback transformer used in a small-screen receiver is incapable of producing the 25,000 volts (actually slightly higher) required to energize a large-screen tube, and the match required between the transformer and yoke is critical. It is essential that both transformer and yoke be replaced and matching units obtained. A mismatch between the yoke and transformer results in inadequate horizontal width, foldover and ringing in the center of the screen and very poor convergence.

However, conversion can be accomplished satisfactorily if the horizontal system is completely replaced with matched components suitable for use with the large-screen picture tube. The rf, if, Y, color sync, color detector, matrix and horizontal and vertical sync sections of the small-screen chassis will serve their functions properly when a large-screen picture tube is used. The audio system will also remain unchanged, of course.

In some cases, the technician may wish to retain the small-screen receiver but to modify the flyback system for high-voltage regulation. Some of the early small-screen receivers omitted high-voltage regulation, with the result that the raster would bloom easily. Regulation cannot be added to such a receiver unless the flyback system is replaced. Sufficient reserve output is not available to operate a regulator satisfactorily.

Sweep failure damage to CRT

Since the generation of accelerating voltage depends upon the operation of the horizontal sweep circuit, the picture-tube screen becomes dark when a fault of any consequence occurs in the flyback system. However, it is possible for the vertical sweep system to fail while the flyback system remains operative, and in such case damage to the color picture can easily result. The owner of the receiver must be advised to turn the receiver off immediately if the vertical height decreases or if a brilliant horizontal line is observed across the picture tube.

There are three avenues of damage to the color picture tube in the event of vertical sweep failure; burning of the phosphor screen, warping of the shadow mask and gassing of the tube. Phosphor burn causes a dark line to appear through the picture, along the path or area of the burn. Warping of the shadow mask causes errors in purity and convergence which cannot be worked out by adjustment of the service controls. Gassing causes a dim and de-

focused picture, with poor convergence and purity. When the gas release is substantial, internal arcing also occurs, with occasional blowing of the flyback fuse, depending upon the current drawn by the arc.

Due to the high accelerating voltage utilized in a color picture tube, the initial brightness of the raster tends to decrease at a somewhat faster rate than in the case of a black-and-white picture tube, although the tube is not subjected to abuse. Customers sometimes fail to understand this and try to compare the useful life of the black-and-white with that of a color tube. However, the techniques of color tube design and production are being continually im-

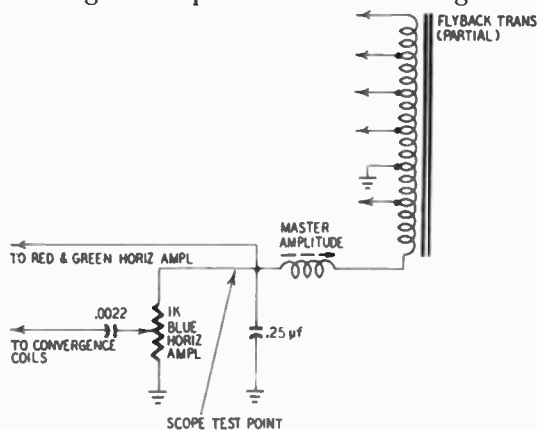

Fig. 705. Misadjustment of the master amplitude control may burn out the 1,000-ohm potentiometer.

proved and eventually color tubes will have as great a life expectancy as black-and-white tubes.

Potentiometer burnout

In the adjustment of horizontal dynamic convergence circuits, the operator must sometimes avoid wide mistuning of the master amplitude control, which may apply an excessive voltage across the individual amplitude controls and cause burnout of the potentiometers. The peak-to-peak voltages specified in the service manuals must be observed. Fig. 705 shows a typical arrangement with the specified peak-to-peak convergence voltage which should be applied from the flyback circuit.

When the master amplitude control is greatly mistuned, it is possible to apply sufficient parabolic voltage across the 1,000-ohm blue horizontal amplitude control so that it will heat up and eventually burn out under continued operation. This is a practical example

of the advisability of using a scope when adjusting drive voltages to or from the horizontal sweep system.

This precaution falls in the same class as avoidance of operation of the flyback system with the high-voltage filter capacitor disconnected or of operating the horizontal-output tube for an appreciable length of time without drive or with the plate cap disconnected. It is the type of servicing knowledge which comes only with experience.

Waveform and voltage tests

A winding on the flyback transformer applies a voltage pulse to the horizontal dynamic convergence system during each retrace interval. When this pulse is checked at the output of the winding with a scope, a typical waveshape is as shown in Fig. 706. Its peak-to-peak voltage is approximately 80. The exact voltage is somewhat different for various receivers, hence the service notes must be consulted. An incorrect value indicates a defective transformer

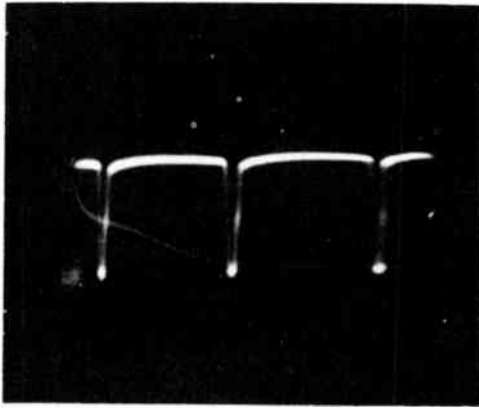

Fig. 706. *Pulse excitation voltage from flyback transformer to convergence circuits.*

winding or abnormally heavy loading of the winding by the convergence circuits. To check for the latter, the lead to the convergence circuits can be temporarily disconnected from the transformer winding—if the pulse voltage is normal, proceed to track down the fault in the convergence circuits. Shorted or broken-down potentiometers and faulty capacitors are common causes of excessive loading.

The equivalent electrical circuit of the horizontal dynamic system of a representative receiver is shown in simplified form in Fig.

707. The configuration comprises the 500-ohm horizontal dynamic amplitude potentiometer, R1; a .01- μf capacitor, C1, a horizontal dynamic phase coil L2 (which forms a series-resonant circuit) and the horizontal dynamic convergence coil, L3. The 70- μf , 100- μf , and .05- μf capacitors may be ignored in the analysis, since their reactance is negligible at the operating frequency of 15,750 cps.

The amplitude of retrace pulse fed to the convergence circuit from the horizontal output transformer is determined by the adjustment of the 500-ohm horizontal dynamic amplitude potentiometer. Its output feeds into the series-resonant circuit composed of

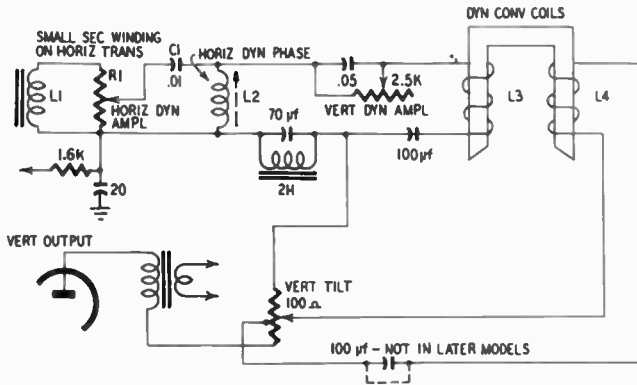

Fig. 707. Configuration of the horizontal dynamic system. (Courtesy of Motorola, Inc.)

the .01- μf capacitor and the horizontal dynamic phase coil. For the sake of simplicity, it may be considered that the series-resonant circuit is excited by the retrace pulse and proceeds to oscillate at its resonant frequency. Since the series circuit must be tuned to 15,750 cps, (the repetition rate of the retrace pulse), it will produce a sine wave having a frequency of 15,750 cps (Fig. 708). When the series-resonant circuit is tuned to this frequency by adjustment of the slug in the phase coil, maximum current flows through the resonant circuit and maximum voltage is developed across the phase coil.

The phase coil accordingly acts as an ac sine-wave generator, driving the horizontal dynamic convergence coil with a 15,750-cps sine-wave voltage. The magnetic field developed by the convergence coil passes through the glass neck of the picture tube and couples the flux lines through the magnetic vanes on either side of the electron beam (Fig. 709). The electron beam is thus caused to change its deflection angle in accordance with the 15,750-cps sine wave and

therefore its convergence point with the other two beams as they move from left to right across the screen during the horizontal scan interval. By this means it is possible to change the point of convergence of the beam at the left and right-hand sides of the screen, as compared to the point of convergence at the center of the screen.

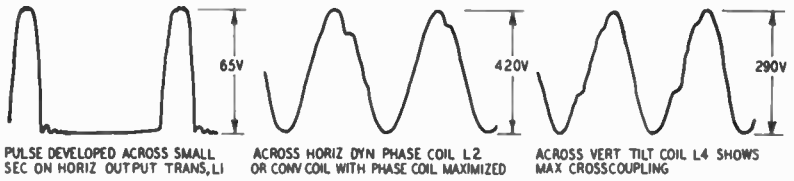

Fig. 708. The series-resonant circuit converts the pulse to a sine-wave voltage. L_1 , L_2 and L_4 correspond to those shown in the circuit diagram of Fig. 707. (Courtesy of Motorola, Inc.)

Correct convergence of the beam can be maintained over the entire horizontal scan line.

The receiver service notes will specify certain test conditions which must be observed to check the horizontal dynamic convergence voltage at the convergence coils. In the first place, crosstalk must be minimized between the vertical and horizontal systems or

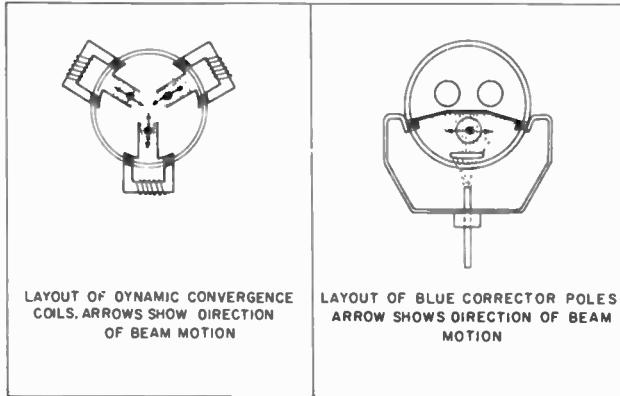

Fig. 709. Layout of dynamic convergence coils and magnetic vanes. (Courtesy of Motorola, Inc.)

the 60-cycle convergence voltages will obscure the horizontal waveform pattern. Hence, dynamic convergence adjustments must be upset to make waveform tests with a scope. In a typical procedure, the vertical dynamic amplitude control is set to its minimum position and the vertical tilt control to mid-range. The horizontal dynamic amplitude control is set to maximum. By this means, the

amount of crosstalk introduced into the horizontal system from the vertical system is minimized and the amplitude of the horizontal convergence waveform is maximized. The peak-to-peak voltage for the waveform specified in the service notes for the receiver will be based upon these control settings.

A typical waveform for normal circuit operation is illustrated in Fig. 710. The specified peak-to-peak voltage is 540. This voltage value might appear "impossible" inasmuch as only 80 peak-to-peak volts are supplied to the convergence circuits from the flyback transformer. However, the horizontal phasing coils are resonant circuits and a voltage stepup occurs across a resonant coil. The higher the Q of the coil, the greater is the voltage stepup. In this typical situation, the coil has a Q value which steps up the applied 65 volts from the potentiometer to 540 at the coil plugs. The irregularity in the sine waveform of Fig. 710 is caused by the application of the

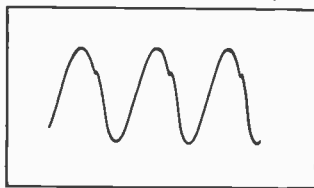

Fig. 710. *Horizontal convergence waveform at coil plug.*
(Courtesy of Motorola, Inc.)

flyback pulse to the convergence coils on each sine-wave cycle. The flywheel effect of the series-resonant circuit maintains the oscillation from one pulse application to the next.

The vertical dynamic convergence system is closely associated with the horizontal system. The same physical coil used for the horizontal dynamic convergence system is also used for the vertical dynamic convergence system in most receivers, as shown in Fig. 707. The coil on the opposite leg of the core is energized by the vertical tilt voltage.

The simplified circuit diagram shown in Fig. 707 shows that the plate current for the vertical output tube flows through the tilt potentiometer, through the 2-henry choke (in parallel with a 70- μ f capacitor) and finally to the B-plus supply line through a 1,500-ohm resistor. The formation of the dynamic parabolic voltage (vertical frequency) is generated across the parallel arrangement of the 70- μ f capacitor and the 2-henry choke. A combination of the charge and discharge time of the capacitor through the choke, as well as the shape of the current curve through the capacitor, con-

placed in theory with a shorting wire. However, in the case of the parallel combination of the .05- μf capacitor and the vertical amplitude potentiometer, this capacitor will not pass an appreciable amount of 60-cycle current and the 2,500-ohm potentiometer is effective in controlling current flow.

The completely simplified circuit is shown in Fig. 711. The parallel circuit of the 70- μf capacitor and the 2-henry choke are supplying vertical dynamic coil with suitable parabolic voltages by way of the dynamic amplitude potentiometer and the 100- μf capacitor. The 60-cycle parabolic voltage fed to the convergence coil generates a magnetic flux which is coupled to the electron beam in the picture tube by the magnetic vanes. A separate coil is provided for each electron gun.

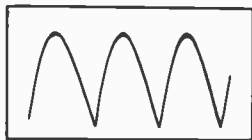

Fig. 712. Typical parabolic voltage across the convergence coil. (Courtesy of Motorola, Inc.)

The parabolic voltage generated by the vertical dynamic convergence circuit as it appears at the convergence coil plugs in a typical receiving system is illustrated in Fig. 712. As in testing the horizontal waveform component, suitable test procedures must be observed. The horizontal oscillator and output tubes are removed and the horizontal dynamic amplitude control is set to minimum. This eliminates crosstalk from the flyback system. The vertical dynamic amplitude control is set to maximum and the specified waveform amplitude of 1.5 peak-to-peak volts is based upon this control setting.*

When scope tests of the convergence waveforms are performed, the normal settings of the convergence controls must be disturbed. To facilitate returning the controls to their previous settings, mark the positions of the controls before they are turned. A scratch on the left control shaft, continued down over the mounting bushing, accurately locates the settings for future reference.

The current waveform through the vertical tilt potentiometer has the form of a sawtooth, due to the characteristics of the current flow through the vertical output tube. A voltage drop can occur across the rotor arm of the potentiometer and the center tap, when the arm is not at the electrical center. If the arm is set at the center-tap junction, there is no voltage drop and no current is fed to the

NOTE: When the scope is connected across the convergence coil in making this test, the scope case becomes "hot" as it is operating above ground. Avoid shock by not touching the scope case and chassis simultaneously.

tilt coils. If we assume that the arm of the potentiometer is set toward the top of the potentiometer, then a sawtooth voltage appears between the rotor arm and the tap. Since the point at which current flows into a resistor will be the negative-voltage end in this arrangement, the top end of the potentiometer will display a negative-polarity sawtooth voltage. A current flow is generated through the tilt coil in a corresponding direction and impresses a sawtooth of magnetic flux upon the electron beam. In other words, a sawtooth of variable amplitude and polarity (positive or negative) may be added to the parabolic waveform and impressed upon the electron beam in the picture tube. A typical vertical tilt waveform observed in a scope test across the convergence coil is shown in Fig. 713. This waveform shows the presence of curvature (nonlinear-

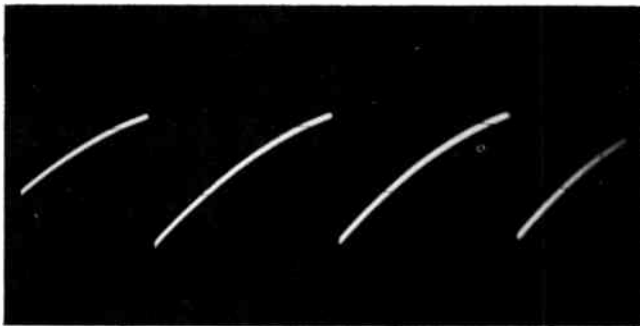

Fig. 713. *Vertical tilt voltage distorted due to capacitor leakage.*

ity) in the sawtooth component, which results in dynamic misconvergence. Such nonlinearity is usually caused by faulty capacitors and is associated with an incorrect peak-to-peak voltage value in most cases.

As in the preceding illustrations, all voltages have been eliminated from the display which otherwise cause interference to the waveform under investigation. During normal operation, of course, three voltages appear simultaneously across each two-section convergence coil. Horizontal and vertical dynamic convergence voltages appear across one section—vertical tilt voltage across the other section. Interference is eliminated by setting the horizontal and vertical dynamic amplitude controls to minimum and the vertical tilt control to maximum.

Using scopes

Many older scopes do not have a response wide enough for satis-

factory reproduction of waveforms having frequency components up to 4.5 mc. Since the product of bandwidth times gain is a constant, modern scopes provide dual-band vertical amplifiers so that high-gain response up to several hundred kilocycles is obtained in the narrow-band position and lower-gain response up to 4 or 5 mc in the wide-band position. The high-gain function is useful in alignment of low-gain circuits while the wide-band function is essential for signal tracing in chrominance circuits. Since the chrominance and video-frequency signal voltages occur at a relatively high level, the lower gain of the scope in wide-band operation is not a handicap and makes for a more economical instrument.

Older scopes which provide only a high-gain narrow-band response are not necessarily obsolete for color signal tracing, if used with a suitable auxiliary amplifier. Such an auxiliary amplifier should have a response flat within 1 db (10%) from 60 cycles to 4 mc when its series peaking coils are properly adjusted. A sensitivity of approximately .04 volt per inch is provided with the usual CRT deflection potential of 1,100 or 1,200 volts. Such amplifiers are available from commercial sources.

The output from the amplifier should be connected to the vertical deflection plates of the scope. This takes the place of the vertical amplifier provided. Otherwise, the sweep and sync sections of the scope operate normally. The sync input should be made to the sweep oscillator in the scope to lock the pattern. If the tubes are unplugged from the vertical amplifier in the scope, the auxiliary amplifier can be powered from the B plus and heater power supply of the scope—otherwise, a small power supply should be incorporated with the auxiliary amplifier.

The auxiliary amplifier should have a step attenuator. This provides essentially constant input impedance on each step so that the auxiliary amplifier can be used satisfactorily with a low-capacitance probe.

Application of scopes in high-voltage circuits

When we come to the application of a general-purpose scope in testing flyback circuits, the first thought that occurs is the fact that the input circuit of the scope is rated for a minimum of 500 or 600 volts, while we may be under the necessity of checking waveforms having peak-to-peak voltages up to 10,000 volts. Hence, a suitable high-voltage accessory probe is a "must."

Briefly, capacitance-divider probes are used in high-voltage appli-

cations. A capacitance-divider probe commonly provides an attenuation ratio of 100-to-1, so that a 10,000-volt waveform, e.g., is reduced by the probe to a level of 100 volts. This is well within the input voltage rating of the scope. The probe comprises a small high-voltage capacitor connected in series with the probe tip. This series capacitor is followed by an adjustable shunt capacitor for calibrating the probe to the desired 100-to-1 attenuation factor.

The use of this 100-to-1 factor is advantageous because once the scope has been calibrated the probe can be used and voltages of waveforms measured merely by adding two zeros to the basic calibrating factor of the scope. For example, if the scope has been adjusted for a sensitivity of 10 volts-per-inch with the probe, the sensitivity becomes 1000 volts-per-inch when the probe is utilized. If a decimal attenuation factor were not used, the operator would have to recalibrate the scope when he plugged in the high-voltage probe.

It is important to observe that the 100-to-1 capacitance-divider probe, which is so useful in testing the flyback circuits, is of no use in testing the vertical circuits. The vertical circuits operate at a frequency of 60 cycles, and the capacitance-divider type of probe will distort such low-frequency waveforms badly. Only a low-capacitance probe should be used in checking vertical circuits. The capacitance-divider type of probe operates properly in horizontal circuits because the frequency of operation is much higher (15,750 cycles), and the capacitance-divider system operates as intended.

Common fallacies in high-voltage testing

Technicians sometimes suppose that a high-voltage probe such as used with a vtvm could be pressed into service for scope application. This is a very elementary error, and will not only lead to severe waveform distortion, but also to incorrect peak-to-peak voltage values.

Even a high-voltage capacitance-divider probe has some definite limitations when testing in flyback circuits of color TV receivers. Commercial probes available on the service market are commonly rated for a peak-to-peak input voltage of 10,000 volts. On the other hand, a number of circuit points in the flyback system operate at still higher voltages. In these cases, it is quite essential to avoid testing such points with a probe and scope, as damage to both instrument and receiver may well result from such misapplication.

When it is not possible to observe a waveform and to measure its peak-to-peak voltage directly, indirect approaches can and must

be used. For example, if we are concerned with the action of a pulse-doubler circuit, it is possible to check dc voltage levels through the circuit with a 30-kv dc probe and a vtvm. From these measurements, we can come to definite conclusions concerning pulse levels. Note that these tests must be made with some care because the high voltages which are encountered will arc over much longer distances than voltages in similar black-and-white flyback circuits. They will also give the unwary technician a much more severe shock, and must be treated with considerable respect.

Examining high-voltage waveshapes

Although no commercial probe is available to check waveforms and voltages in circuits operating in excess of 10,000 peak-to-peak volts, it may be noted that *waveforms alone* can be observed on the scope screen by holding the probe tip against the insulation of the circuit lead. The insulation prevents arcing of the voltage to the probe, and the waveform is passed along into the probe by the stray capacitance which is present. Of course, no information is obtained concerning peak-to-peak voltage values in this type of test, although it does serve to show the operator whether the waveform is present or absent.

signal tracing

THE scope is the preferred instrument for signal tracing in color circuits because of the relatively large amount of information it provides. Signal tracing is basically a simple procedure, although the technician may encounter many puzzling types of patterns which he may not understand until he has gained experience. Technicians who have considerable experience with signal-tracing procedures in black-and-white receivers will find numerous new situations and pattern characteristics to contend with in color servicing.

One of the chief test points is at the output of the picture detector. The color burst and chrominance signals first appear in a frequency range readily adapted to scope checking at the output of the picture detector. It is not practical to attempt to check the color burst and the chrominance signal in the if amplifier because service demodulator probes are incapable of demodulating the 3.58-mc signal and, in fact, will "wipe out" the burst and chrominance signals completely. For this reason, tracing of the burst and chrominance signals must start at the output of the picture detector.

A very important consideration concerns possible loading of the circuit under test and consequent distortion of the waveform. This is a more serious matter in color test work because the chrominance signal has a center frequency of 3.58 mc, with sidebands extending out to 4.1 mc. Circuit loading which could be disregarded in black-and-white receiver servicing may be sufficient to impair the response of color circuits and attenuate the chrominance signals so that the operator reaches quite false conclusions about circuit performance.

Suitable test point for burst

Choice of a suitable test point to make an initial observation of the burst requires a practical understanding of the characteristics of detector and video circuits. It is not the purpose of this book to discuss these in detail, but only to point out the factors which bear upon practical test work. Fig. 801 shows the arrangement of a typical picture detector circuit. This is a video-frequency circuit which has (or should have) essentially flat response out to 4.1 mc. The low-frequency portion of the video signal is developed chiefly across the load resistor and the high-frequency portion chiefly across the peaking coils.

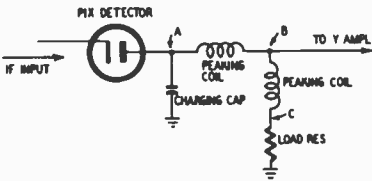

Fig. 801. Three possible test points are shown at A, B and C.

If a test is to be made in the picture detector circuit (Fig. 801), the scope could be applied at points A, B or C. The scope must have as good a frequency response or better than the detector circuit—a vertical amplifier response flat within 10% or better out to 4.5 mc is very desirable. When testing in circuits of this type, it is essential also to make use of a low-capacitance probe to minimize the input capacitance of the scope.

It might be supposed that the scope could be applied satisfactorily at point A in the circuit (Fig. 801) since charging capacitance is already shunted across the circuit. However, the value of the charging capacitor is usually about 5 μf and the input capacitance of the low-capacitance probe may be nearly double this value. If the probe is applied at A, the picture detector tube then works into a capacitance approximately three times as large as in normal operation and the high-frequency characteristics of the circuit will be substantially disturbed.

The scope can be connected to best advantage at B, with the Y amplifier tube pulled. In this manner, the input capacitance of the Y amplifier tube is removed from the circuit and the probe capacitance substituted. From the standpoint of values, the input capacitance to the probe is usually quite a bit greater than the grid capacitance of the Y amplifier tube. However, if the picture detector circuit is to be checked, B is the best test point available.

C is quite unsuitable for checking the color signal, since only the

lower signal frequencies appear across the load resistor and the burst appears to be practically nonexistent at this point. C is useful only for low-frequency tests, such as sweep-alignment procedures.

Fig. 802. Cathode circuit of the video amplifier has low impedance.

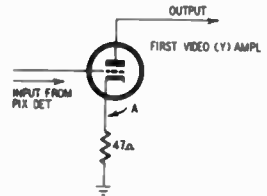

A test point which can be utilized with maximum confidence is shown at A in Fig. 802. The cathode circuit of the first video amplifier is usually unbypassed and also has a low impedance. In consequence, the input capacitance of the probe has a negligible disturbing effect on the circuit and the burst can be observed practically without distortion. Note, however, that the waveform which is observed at the cathode of the first video amplifier is influenced also by the plate load circuit of the amplifier and faults in the plate load circuit will be indicated in the response observed on the scope screen. To eliminate the influence of the plate load circuit in the first video amplifier, a large electrolytic capacitor can be shunted from plate to chassis, thereby grounding the plate of the first video amplifier for ac. The tube then functions as a cathode follower and the waveform observed in the cathode circuit represents the response of the rf and if amplifiers plus the picture detector output circuit.

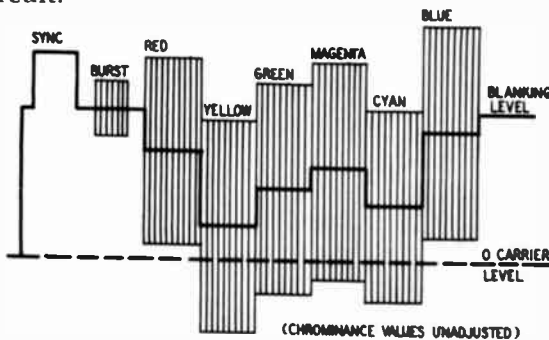

Fig. 803. Color signal corresponding to 100%-saturated color bars.

Effect of receiver tuning on burst amplitude

The luminance and chrominance signals which correspond to the scanning of 100%-saturated color bars (red, yellow, green,

magenta, cyan and blue), are illustrated in Fig. 803. Note that the yellow, green, magenta and cyan bars would extend beyond the zero carrier level and thus overmodulate the color bar generator. This same overmodulation would exist at the color transmitter. Hence, the chrominance values must be readjusted to avoid overmodulation.

In the NTSC system, $(R - Y)$ is reduced to 0.877 and $(B - Y)$ to 0.493, prior to transmission. Likewise, in a color bar generator, the output signal corresponds to a reduction of $(R - Y)$ and $(B - Y)$ by these amounts. This reduction of $(R - Y)$ and $(B - Y)$ values is called the readjustment of chrominance values, and the color bar signal appears as shown in Fig. 804, after readjustment. Note that the

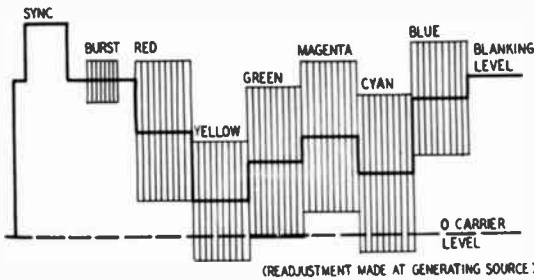

Fig. 804. Readjusted color signal for 100%-saturated color bars.

Y signal is not changed. But now, the overmodulation produced by 100%-saturated color bars is considerably less. This is the signal which is commonly provided by service color bar generators—overmodulation is avoided by arbitrary adjustment of the modulator so that the zero carrier level is slightly below the level of the yellow bar.

At the color transmitter, however, overmodulation is avoided by limiting the saturation of the transmitted colors to a maximum of 75%—this is actually the basic intent of the NTSC system. With color saturation of 75%, the yellow and cyan bars extend down even with the white level (Fig. 805). Note that the station signal provides a margin of carrier between white and zero-carrier level (shown in Fig. 611, Chapter 6) to avoid the possibility of inter-carrier buzz during transmission of white, yellow and cyan signals.

Thus, the color bar signal that is used for service and signal tracing is not entirely equivalent to the color test-pattern signal, and this fact should be recognized when checking the output from the picture detector and comparing the station test-pattern transmission with the signal from a service color bar generator.

When the output from such a generator is applied directly to the

vertical input of a wide-band scope, the signal appears as in Fig. 805. The reader may wonder how this signal can produce bars of saturated color on the screen of the picture tube, inasmuch as the chrominance values have been readjusted. Recall that the chroma demodulators are adjusted for more output from the $(B - Y)$ than from the $(R - Y)$ channel; thus $(R - Y)$ and $(B - Y)$ are brought back to correct relative values and the color intensity control is then advanced to obtain the correct relative level of chroma to Y .

Fig. 805. *Overlapping of the green and red bars produces yellow. The red and blue bars overlap to produce magenta; the green and blue bars overlap to give cyan. The red, green and blue bars are overlapped to produce white. The color subcarrier cancels out on white, leaving only the luminance component.*

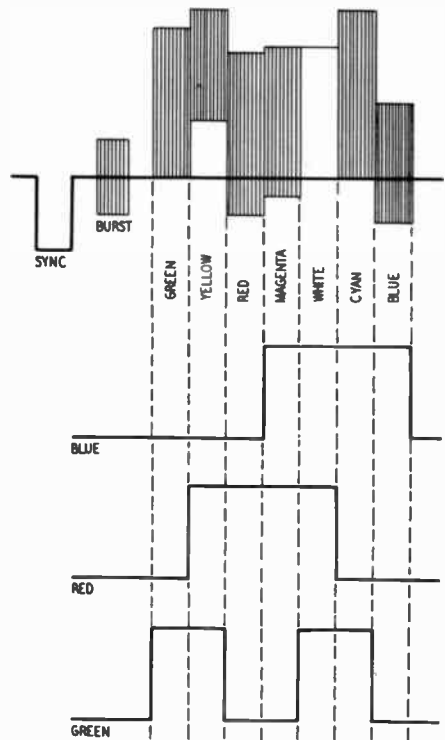

Since the output from the color bar generator appears as in Fig. 805 when applied directly to the scope, it may be a surprise to observe that the color bar signal at the picture detector may appear as in Fig. 806. Here, the chroma signal is considerably attenuated. Reproduction of the chroma signal depends to quite an extent upon the setting of the fine-tuning control. When it is adjusted to run the chroma signal down on the side of the overall response curve, the 3.58-mc component is, of course, attenuated accordingly. When it is adjusted to bring the chroma signal up on

the flat top of the overall response curve, the 3.58-mc component then appears at normal level in the pattern.

Some receivers have if amplifiers in which the chroma signal is intended to fall on the side of the if response curve, with subsequent compensation in the bandpass amplifier characteristic. When a receiver of this type is under test, the burst and chroma will appear attenuated 50% at the output of the picture detector when the fine-tuning control is correctly adjusted.

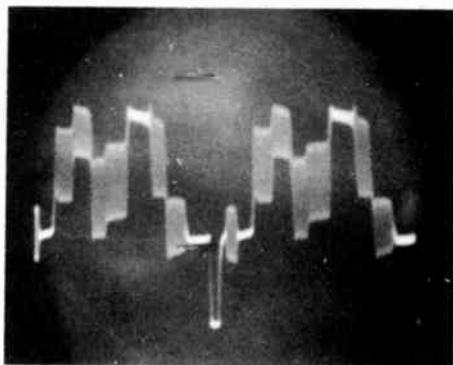

Fig. 806. *Misadjustment of the fine-tuning control attenuates chroma.*

Consider the situation in which the overall response curve is peaked up and rises at the 3.58-mc point. The output signal from the picture detector will then show the chroma component at a higher relative level than is present from the bar generator at the receiver input. Fig. 807 shows how the chroma component appears excessively high in a case of misalignment of this kind.

Another characteristic of the waveform (Fig. 808) deserves attention. Note that the white bar is not clean but shows a noticeable amount of interference; likewise, the blanking level is displaying an interference voltage. However, the top of the sync pulse shows much less interference voltage. If the fine-tuning control is set correctly, this is usually the result of misadjustment of the sound traps in the if amplifier. This permits the 4.5-mc beat between the picture and sound carriers to develop in the picture detector. If the receiver is operating at high gain (with weak signal input) such interference voltages will be partially or almost wholly due to noise. The lesser amount of interference voltage at the tips of the sync pulses shows that limiting is occurring in the if amplifier and that linear reproduction of the sync pulses is not being obtained. The problem of if overload has been discussed earlier.

Everyone is probably familiar with the coarse 920-kc beat between sound and chroma which appears on the screen of the color picture tube when the fine-tuning control is misadjusted. This 920-kc beat is also visible on the scope when checking the output signal from the picture detector. It is a form of pattern interference which appears chiefly in color receivers but which may also appear at times in black-and-white sets if the if and video amplifiers are adjusted for full 4-mc bandpass. This 920-kc beat (as it appears on a scope) is shown in Fig. 808. Note that it appears clearly on the back porch of the sync pulse

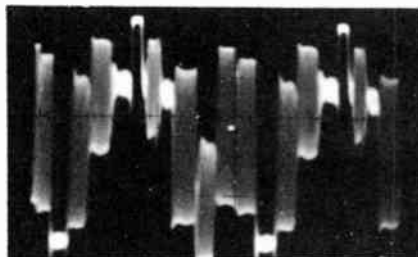

Fig. 807. Rising if response at 3.58 mc produces increase in chroma output.

When the fine-tuning control is properly adjusted, the 920-kc beat will disappear completely from view since the sound carrier is then placed properly at the bottom of the sound-trap dip. The burst will appear at correct amplitude (either 50% or 100% of the sync pulse amplitude, depending on the receiver type) if the overall response curve has proper shape and bandwidth.

Deterioration of waveforms in signal circuits

Waveforms inevitably undergo some amount of deterioration in their passage through the signal circuits. The purpose of circuit

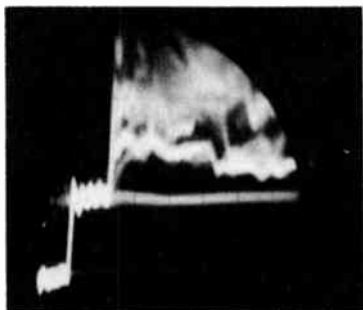

Fig. 808. 920-kc beat visible between sound and chroma signals.

alignment and adjustment is to minimize this deterioration insofar as possible. The technician soon realizes that the burst becomes contaminated with noise and often with noticeable cross-talk from other receiver circuits, so that it is seldom possible to count the number of cycles in the burst at the output of the picture detector—this in spite of the fact that the burst is quite clean at the output of the color bar generator.

The Y channel necessarily contains a 1- μ sec delay line, and distortionless delay lines are very expensive to manufacture. The delay lines in color receivers produce a certain amount of overshoot and ringing which is readily evident in the waveforms observed when signal-tracing through the Y amplifier. The ripples and undulations in frequency response of the Y amplifier have been noted earlier.

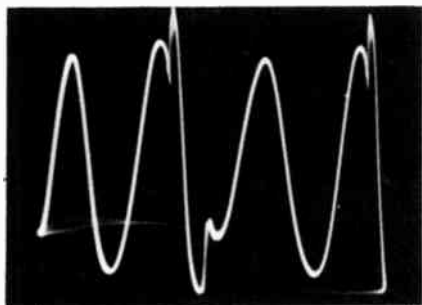

Fig. 809. Boost pulse at bandpass amplifier appears in demodulator output.

The burst amplifier is gated from the horizontal sweep circuit and the gate pulse has a relatively slow rise time and rounded top compared to the envelope of the burst at the output of the picture detector. Accordingly, when the burst is traced through the burst amplifier the output from the burst amplifier changes in shape and assumes an envelope contour similar to the shape of the gating pulse. This change results from the fact that the conduction of the burst amplifier tube is roughly proportional to the voltage of the gating pulse. The fundamental frequency of the burst is not changed, however, hence the color sync is maintained as well as if additional circuitry were utilized to maintain the original envelope shape of the burst.

The bandpass amplifier is gated off during the burst interval in some receivers and gated with a boost pulse in others. In either case, the gating pulse produces a corresponding transient disturbance in the output from the color demodulators, which is observed during signal-tracing procedures through the chrominance circuits. A typical bandpass-boost disturbance in the output signal from an

(R - Y) detector, with a rainbow signal applied at the input to the receiver, is illustrated in Fig. 809.

Waveforms also undergo some deterioration in passage through the bandpass amplifier and chrominance demodulators. Bandpass amplifiers may be aligned with flat response from 3.1 to 4.1 mc or from 2.1 to 4.1 mc and, when the response is flat-topped, or nearly so, waveforms are reproduced with minimum distortion. However, a bandpass amplifier may sometimes be aligned with a rising response to compensate for attenuation in the if amplifier. The amount of rise may be slight or considerable, depending upon the if characteristic. When a sharply rising response is utilized, waveform transitions exhibit considerable overshoot and ringing (Fig. 810).

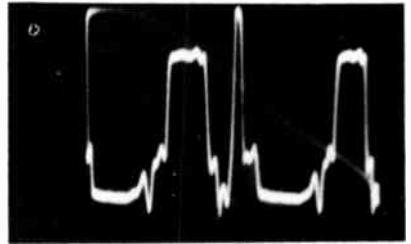

Fig. 810. *Overshoot and ringing of a bar signal in passage through a peaked bandpass amplifier.*

This is the reproduction of an (R - Y) bar through a peaked bandpass amplifier. The (R - Y) demodulator in this case has a gradually rounded characteristic.

Sharply peaked frequency characteristics will introduce maximum transient distortion in the form of overshoot and ringing. A gradually rounded characteristic does not result in appreciable transient distortion, although the bandwidth of a rounded characteristic is, of course, less than that of a flat-topped characteristic.

Demodulator probes in signal tracing

Demodulator probes have an appropriate field of application in color test work, although it is sometimes erroneously supposed that a demodulator probe can be used wherever a high-frequency signal is present. Consider, for example, the tracing of a color burst through the burst amplifier and color afc circuits. A demodulator probe does not operate satisfactorily in this application because the probe has limited demodulating capability. The envelope of the burst has a relatively short duration—approximately the same as that of a horizontal sync pulse. In consequence, a conventional demodulator probe does not have time to respond and develops practically no output when a burst signal is applied.

Chart 8-1. Applications of the Color Bar Signal

Signal Waveform

Analysis

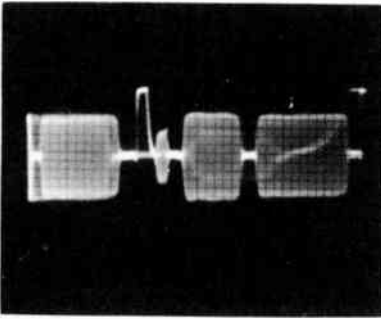

Applied color signal; this output from the color bar generator consists of horizontal sync, burst, I and Q voltages. It is very useful in determining whether the color subcarrier is being applied in exact quadrature and whether the color subcarrier is being applied with I at 57° from burst.

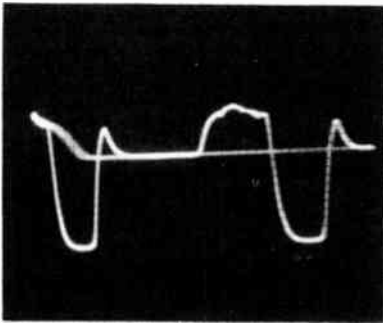

Output from Q detector; considerable contamination of Q bar with voltage from the I bar; I bar extends upward in photo; Q extends downward. Contamination is caused by misadjustment of color phasing control.

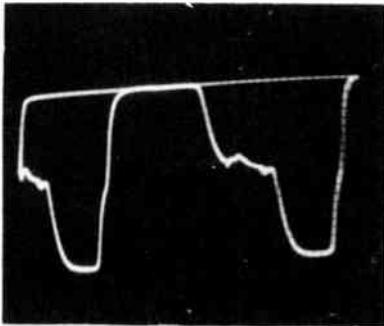

Output from Q detector; again, considerable contamination of Q output with I output. The Q bar is the longer of the two downward excursions. Contamination is caused by misadjustment of the color phasing control.

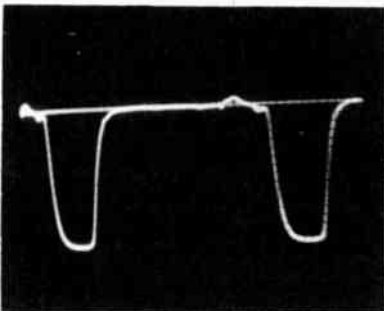

Output from Q detector, I signal nulled satisfactorily. Residual I signal is seen only as a small irregularity in the base line. The corners of the Q bars are rounded because of the relatively narrow bandpass of the Q demodulator circuit.

The output from the I detector is viewed to determine whether the color subcarrier is being applied in quadrature to the two detectors. As shown in the photo, the I bars are displayed with practically no interference from the Q bars. This is the desired condition.

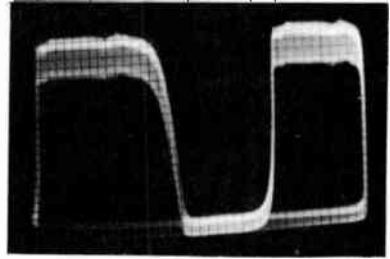

If the output from the I detector appears as shown here, with strong interference from the Q signal, the color subcarrier is not arriving at the I detector in required quadrature relation. Check the 90° phase-shifting network in the output circuit of the color subcarrier oscillator.

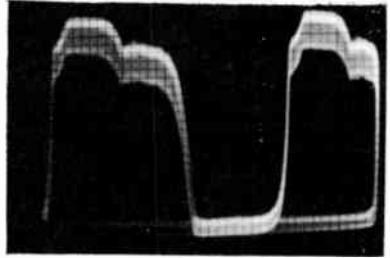

Typical situation in which the output from the I detector is strongly contaminated with interference from the Q signal. There is also interference present in the output from the I detector; residual 3.58-mc color subcarrier voltage. This type of interference is due to the fact that the I detector has a wide-band response which permits some 3.58-mc voltage to feed through. However, this interference is rapidly attenuated in subsequent receiver circuits. If a narrow-band scope is used, the interference will not be reproduced on the scope screen.

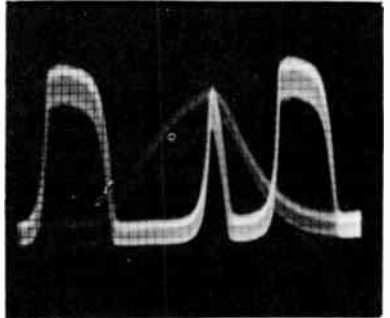

A complete color bar signal as seen when the signal is applied to the antenna input terminals of the receiver and a wide-band scope is applied at the output of the picture detector. This pattern shows some attenuation of 3.58-mc signal (burst should have same peak-to-peak voltage as the sync pulse). Overshoot of bar signals is also evident. These faults can be corrected by careful realignment of rf and if circuits.

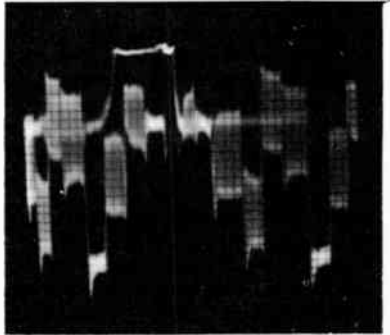

Sync circuits can be checked, if desired, with a horizontal sync pulse and burst signal, in the absence of any chrominance or luminance information. This photo shows the output from a color bar generator with only sync pulse and burst present.

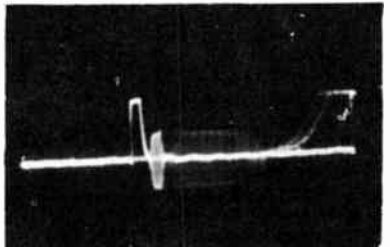

This fact sometimes comes as a surprise to the technician, who often tends to believe that a narrow-band scope can be used with a demodulator probe to trace the color burst. The burst can be traced effectively only with a wide-band scope, to display the burst

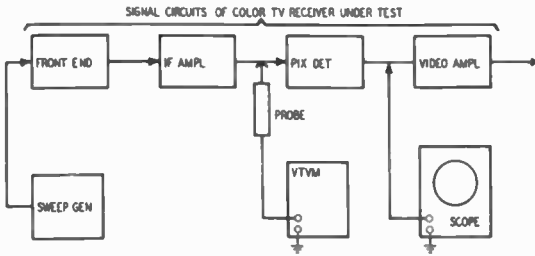

Fig. 811. *Demonstration setup to display probe loading effects.*

directly. A low-capacitance probe is required in most cases to minimize distortion due to circuit loading. The technician should be critical in this regard and should utilize a low-capacitance probe with the minimum value of input capacitance possible. There is quite a variation in this value, depending upon the details of probe design and construction.

Probe loading effects

Signal-tracing probes are available for scopes, vacuum-tube voltmeters and volt-ohm-milliammeters. All have their specific applications in color service. It is perhaps most important for the technician to recognize where such probes should *not* be applied.

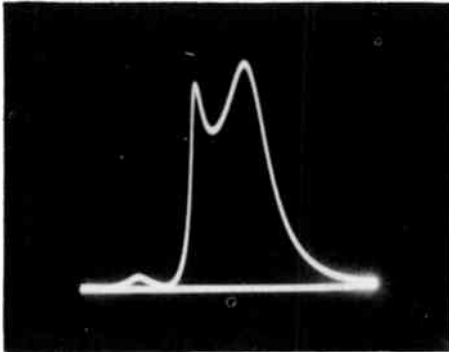

Fig. 812. *Reference response from if amplifier.*

The nature and extent of loading of if amplifier circuits by signal-tracing probes is easily demonstrated by the arrangement shown

in Fig. 811. A sweep generator is utilized to apply a signal voltage to the antenna-input terminals of the color receiver. A scope is connected across the picture detector load resistor to monitor the output from the if amplifier during various tests with different types of signal-tracing probes.

With no probe applied in the if circuits, the reference response of Fig. 812 is obtained on the scope screen. If a signal-tracing probe imposes no loading on the if circuit under test, this reference response would remain unchanged when the probe is applied. First, let us see what happens to the reference response when a vom signal-tracing probe is applied at the grid of the second if amplifier. The

Fig. 813. Attenuation of if signal imposed by vom signal-tracing probe.

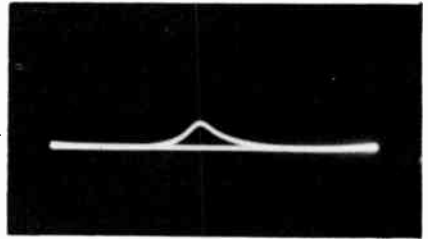
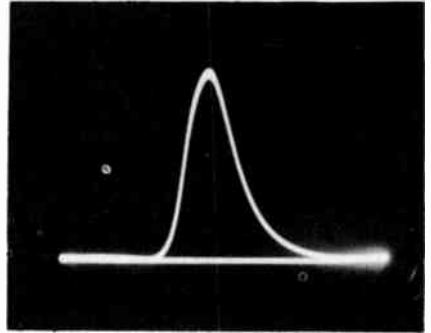

Fig. 814. Lesser attenuation of if signal by vtvm signal-tracing probe.



reference waveform drops to a small fraction of its former value (Fig. 813) and we conclude that, although the test with the signal-tracing probe suffices to show whether the signal is present or absent at this point, the test does *not* serve to show the stage gain.

This is perhaps one of the commonest misconceptions held concerning signal-tracing probes—because a voltmeter indicates the presence of a signal voltage when the probe is applied in the if circuits, some technicians may jump to the conclusion that the indicated values from grid to plate of a stage will reveal the gain of the stage. It should be clear from the foregoing discussion that any such conclusions concerning stage gain will usually be greatly in error.

Some signal-tracing probes have lesser loading effect than others.

For example, Fig. 814 shows the output from the picture detector when a vtvm signal-tracing probe is applied at the grid of the second if amplifier in the same receiver. The if signal is now attenuated to a lesser extent because of the higher impedance of a vtvm probe compared to a vom signal-tracing probe. The possibility of obtaining a more accurate measure of the absolute and relative signal levels with a vtvm probe is amply evident.

A scope signal-tracing probe will be found to have somewhat the same loading effect as a vtvm unit. This approximate equivalence results from the fact that both vtvm and scope have a relatively high input impedance, as compared to the input impedance of a vom.

Chart 8-1 illustrates applications of the color bar signal.

test equipment

It is sometimes assumed that color TV test instruments do not require servicing, but test equipment is heir to all the ailments that afflict the receiver. In addition, it must be capable of better performance than the receiver circuits or test results will be largely meaningless. Hence, the technician must be more critical of the performance of his instruments than he is of the receivers he services.

Most equipment trouble is tube trouble and faulty equipment can often be restored to satisfactory operation by tube replacement. However, there are considerations of accuracy to be observed in regard to frequencies and voltages of the test-signal output, which are quite apart from the question of whether the generator is "live or dead."

Since test-equipment servicing would fill a large book in itself only the chief requirements will be covered.

White dot generators

A white dot generator provides an adjustable number and size of horizontal and vertical dots. The pulse and blanking intervals of the output voltage are generated by triggered multivibrators and gated mixer tubes. Proper operation depends on maintenance of the frequency of the master oscillator, which sets the repetition rates of all subsequent circuits. Fig. 901 shows how the output from the horizontal sync oscillator triggers the horizontal dot multivibrator. This develops an output that becomes clipped and squared in the horizontal dot clipper stage and finally applies a switching pulse to the dot gate tube.

The vertical sync oscillator is also triggered from the horizontal sync oscillator and in turn triggers the vertical dot multivibrator. A branch circuit clips and squares the output from the vertical sync oscillator for utilization as a vertical sync pulse. The output from the vertical dot multivibrator is clipped, squared and then mixed with the output from the horizontal dot clipper in the dot gate tube. The output from the horizontal sync oscillator also is fed to a branch circuit in which the waveform becomes clipped and squared for utilization as a horizontal sync pulse.

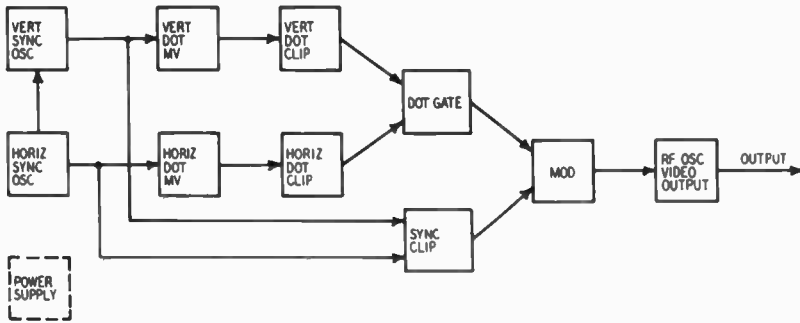

Fig. 901. Block diagram of a white dot generator. (Courtesy of Simpson Electric Co.).

Outputs from the dot gate and sync clipper tubes are impressed upon the modulator, which in turn modulates the output of the rf oscillator. Switching facilities permit the output from the modulator to be used in video-frequency signal-injection tests if desired. With this block diagram in mind, the technician can often decide if a particular tube is faulty. For example, if vertical lines appear on the screen of the picture tube and no vertical blanking bar is visible when the pattern is rolled with the vertical hold control of the receiver, it is evident that the vertical sync oscillator tube is probably defective. On the other hand, if the blanking bar is present but the pattern displays vertical lines only, the vertical dot multivibrator is suspect.

In this type of generator, the frequency of the master oscillator (horizontal sync oscillator) is controllable from the front panel by the hum check control. This control is adjusted to eliminate weaving in the dot pattern—the vertical sync oscillator is then in sync with the power-line frequency so that there is no difference beat between the vertical sync rate and the power frequency. If the hum check control does not have suitable range, a slug adjustment in the horizontal sync oscillator tank coil is varied as required.

Circuit faults can also appear in test instruments. For example, if the fixed capacitor across the sync oscillator tank coil becomes leaky or drifts in value, the slug in the tank coil will not obtain the correct operating frequency or the oscillator may cease operation completely. Thus, the same general trouble analyses apply to receiver and instrument circuitry.

In Fig. 901 the horizontal sync oscillator operates at 15,750 cps. The vertical sync oscillator is adjusted by means of a service control to generate a 60-cycle output. These frequencies may be slightly different if the power-line frequency is not exactly 60 cycles because the operator will normally set the hum check to synchronize the vertical sync oscillator frequency with the power-line frequency. Operation of the horizontal sync oscillator must be close to 15,750 cycles because the horizontal dynamic convergence circuits in the receiver¹ are reactive and distortion of the convergence waveform will occur if the horizontal sync oscillator should operate far off the nominal frequency of 15,750 cycles.

The vertical sync oscillator is synchronized with the horizontal sync oscillator. The vertical and horizontal dot multivibrators are free-running oscillators synchronized from the vertical and horizontal sync oscillators, respectively. The signals from these two multivibrators are differentiated and the sharpened pulses are fed into two clippers: the vertical and horizontal dot clippers, respectively. The pulses from these clippers are next applied to the dot gate, with the result that the horizontal dot pulses are passed through the gate only during the intervals when the vertical pulses are present at the gate input. These gated pulses are then applied to the input of the modulator.

Pulses from the vertical and horizontal sync oscillators are shaped and added in the sync clipper and are also applied to the modulator. The composite output from the modulator is applied to the rf oscillator so that its output is pulse-modulated when the function switch of the instrument is in the rf position. When the function switch is set in the “-” or “+” video position, the modulator is arranged to operate as a phase splitter to provide either polarity of video signal to the output attenuator and cable. Thus the rf oscillator becomes a paraphase inverter instead of an oscillator.

¹ NOTE: The repetition rate of the horizontal sweep system in the receiver is determined only by the sync pulse frequency from the white dot generator—it is *not* determined by the setting of the horizontal hold control in the receiver.

Color bar generators

To produce the color bar sequence (green, yellow, red, magenta, white, cyan and blue) two green, one red, and one blue bar are overlapped. See Fig. 902. It is essential to keep the overlap pattern in mind when adjusting the bar width controls. The names of the width controls (sync width control, burst width control, etc.) are self-explanatory.

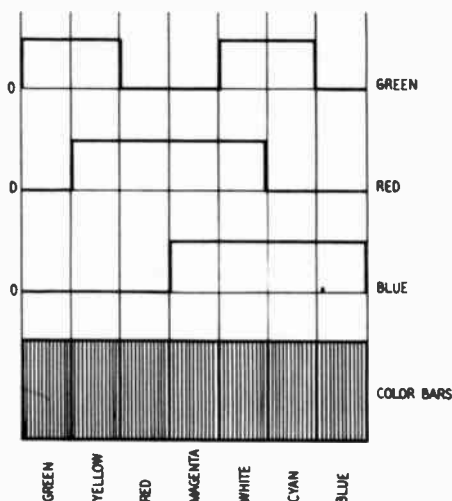

Fig. 902. Complementaries are formed by overlapping the primary colors.

To check the service adjustments of the color bar generator, its video output is applied to the vertical input terminals of a wide-band scope. The composite video waveform should be displayed on the scope screen to within $\pm 5\%$ of the waveform of Fig. 903. The NTSC tolerance on amplitudes is $\pm 20\%$. Some of the important landmarks in the pattern are:

1. The burst peak-to-peak amplitude should be the same as the peak-to-peak amplitude of the sync pulse.
2. The burst peak-to-peak amplitude should equal one-half the peak-to-peak amplitude of the red bar.
3. The lowest portion of the green bar is equal with the blanking level.
4. The yellow and cyan bars have equal peak amplitudes.
5. The red and blue bars have equal lower peaks.
6. The peak amplitude of the magenta bar is level with white.
7. The white bar should be substantially free from subcarrier signal.

Although the NTSC tolerance on amplitudes is $\pm 5\%$, a serious error in receiver adjustments will not result unless the amplitudes are in error by approximately 25%.

To adjust the bar widths, the service width controls are set in the following order: 1) Sync pulse; 2) Burst; 3) Green bar; 4) Red bar;

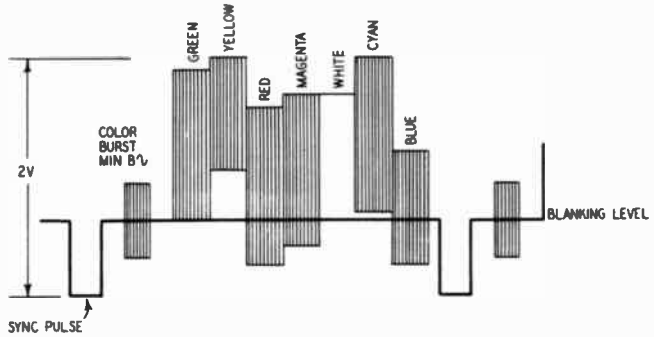

Fig. 903. The complete color signal is adjusted to these proportions.

5) Blue bar. (Chart 9-1 shows the color-bar generator adjustments).

Widths are most conveniently set by adjusting the scope sweep rate to display two complete waveforms. The horizontal gain control may be set to provide an interval of 20 divisions on the scope screen from the leading edge of the first sync pulse to the leading edge of the second. The time over the 20-division interval is 63 microseconds so that each division indicates approximately 3 microseconds. The sync pulse and burst width should each occupy one division or 3 microseconds. This width accommodates 8 cycles of burst—if the scope is provided with triggered sweep or a sweep magnifier, the individual cycles of the burst can be counted.

To make the color bar widths, connect the modulated rf output from the generator to a color receiver; the bar widths can be judged more accurately on a picture-tube screen than on a scope. In making the bar width adjustments, the leading edge of the bar will remain fixed while the trailing edge will vary. Since the color bar pattern is comprised of two green bars, adjustment of the green width control causes the yellow and cyan bars to vary simultaneously.

The width of the white bar is determined by the setting of the red bar width control. Adjustment of the blue bar width affects only the width of the blue bar. With these points in mind, the operator adjusts the red, blue and green bar width controls to obtain the best uniformity of all seven color bars.

The widths of the I, Q, (R - Y) and (B - Y) bars will be de-

terminated by the settings of the green and blue bar widths. Once the width controls are adjusted for the complete color bar pattern, they should not be altered to vary the I, Q, (R - Y) and (B - Y) bar widths.

The amplitudes of the subcarrier voltage for the primary colors (red, green and blue) are determined by the three saturation controls: red, blue and green bar saturation. To produce white, these three primary colors are added together. If the phase and amplitude of each color are correct, the subcarrier voltage will disappear from the white bar and it will appear as a clean line. Since the phases of the primary colors are determined by precision-fixed delay lines, adjustment of the three saturation controls suffices to balance the primaries and to cancel any subcarrier voltage from the white bar. When the subcarrier cancels on the white bar, the amplitudes will be automatically correct for the complementary color bars (yellow, magenta and cyan).

The next step is to adjust the burst amplitude. The amplitude of the burst is approximately one-half that of the red bar. The amplitude of the red bar is measured on the scope screen and the burst gain control is then adjusted to make the burst amplitude half this value.

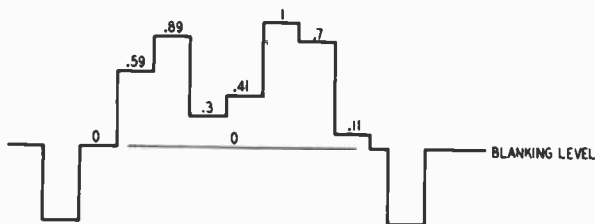

Fig. 904. Y signal voltages for a properly adjusted generator.

The Y signal amplitude is set by turning the green Y gain control to maximum and then backing off on the setting until the overshoot and tilt are eliminated from the green Y bar. (The chroma switch is turned "off" to make this adjustment.) By this means the operator determines the maximum allowable amplitude which can be obtained without distortion.

The vertical gain of the scope is then adjusted to provide 5.9 divisions of deflection from the blanking level to the top of the green bar. Green has a Y component of 0.59. The vertical gain of the scope is then left fixed for the remainder of the Y level adjustments. Next, the red Y gain control is set to provide 3 divisions from the

blanking level to the top of the red bar. (The Y component of red has a relative amplitude of 0.3.)

The operator next adjusts the blue Y gain control so that 1.1 divisions appear from blanking level to the top of the blue bar. This completes the Y level adjustments. The chroma voltage is switched on again and the overall chroma and Y gain controls are adjusted to bring the green bar even with the blanking level.

Finally, the sync pulse level is adjusted by varying the sync pulse gain control. The amplitude of the sync pulse is made equal to the amplitude of the burst. The generator is then in complete adjustment and the output waveform appears as in Fig. 904 with the chroma switch thrown to the OFF position. These voltages are the brightness values of green, yellow, red, magenta, white, cyan and blue (from left to right). With the Y switch in the OFF position and chroma switch ON, the output waveform has the proportions of Fig. 905. These are the readjusted chroma values for the saturated primary and complementary colors (NTSC standard).

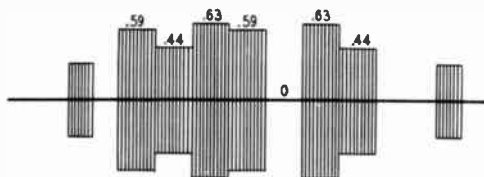

Fig. 905. *Correct proportions of the chroma signal output.*

The I, Q, (B - Y) and (R - Y) displays appear as in Fig. 906. A definite voltage cannot be assigned to these signals since they are defined by certain *phases* and not by hues. No value of Y corresponds to an I test signal, hence there is no definite voltage value to be assigned to I. The I voltage is merely provided at a level which permits convenient tests of receiver circuitry.

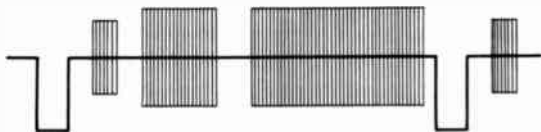

Fig. 906. *I-Q or (R - Y) (B - Y) output from a properly adjusted generator.*

The chroma signal is nulled from the white bar by suitable adjustments of the red, green and blue saturation controls. This null (Fig. 907) is a function of both amplitude and phase of each of the

three chroma signals. The phase of each signal is set by precision delay lines so that, in normal operation, adjustment of amplitudes (saturation) suffices to obtain a correct null. Suppose however, that due to damage of a coil in the delay line or capacitor failure, the phase of the red chroma voltage should be shifted somewhat. It would be possible still to obtain a chroma null on the white bar (by adjustment of the saturation controls) but the amplitudes of the

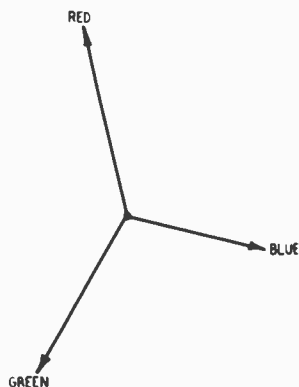

Fig. 907. Phases of primary chroma voltages required for correct white null.

bars containing red will then appear incorrectly. Specifically, the red, yellow and magenta bars would appear at incorrect amplitudes. Hence, a useful cross-check of delay-line accuracy is provided by this knowledge.

Color simulators

The installer usually prefers a color simulator (rainbow generator) to an NTSC type of color bar generator. The simulator is more compact and meets the requirements for installation work adequately.

Fig. 908 shows that the master timing oscillator is crystal-controlled at an operating frequency of 315 kc.² This frequency is divided by blocking oscillators to various lower frequencies which are then gated and mixed together to form the composite video output. Pulses from the 315-kc oscillator are gated by the 900-cycle pulses at the video gate tube to generate the dot signal.

The 15,750-cycle pulses are gated by the 60-cycle pulses in the sync-gate tube to generate the sync signal. Both sync and dot signals

² Maintenance data supplied by courtesy of Hickok Electrical Instrument Co.

are then applied to the adder tubes to generate the composite video signal; the outputs of the adder tubes are connected in parallel. The output from the adder stage is applied to a phase splitter, followed by an output switch which provides a choice of either positive or negative output. The signal from the phase splitter is fed to a cathode follower to obtain a 300-ohm low-impedance output.

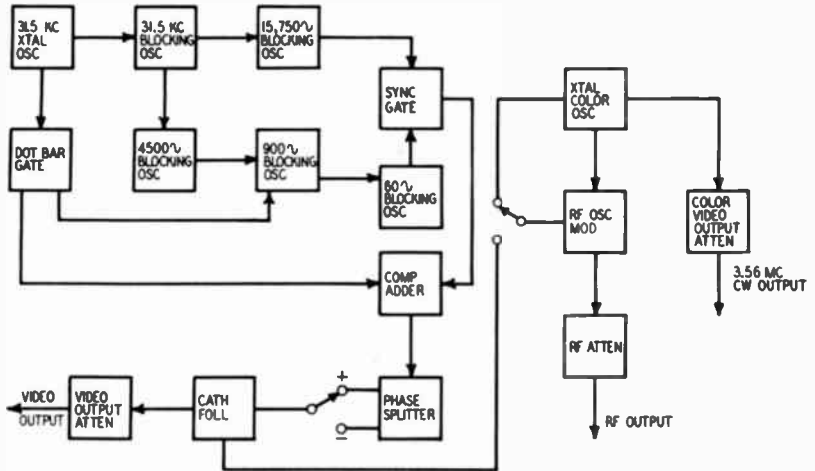

Fig. 908. Block diagram of a rainbow generator. (Courtesy of Hickok Electrical Instrument Co.).

The rf channel oscillator is tunable over channels 2 to 6 by means of a selector switch and the oscillator output is modulated to a depth of 60% by the signal in use—either the composite video or color display signal. The color display signal is a sidelock frequency (linear phase sweep) with sinusoidal waveform. The sidelock signal is crystal-controlled at a frequency of 3.563795 mc. Sidelock output is taken from a cathode follower and fed to an attenuator control.

The timer must operate at the correct frequency or the instrument will become unstable. Due to tube age, component changes resulting from heat, humidity, etc., the timer may eventually go out of sync. In most cases, a simplified calibration procedure will restore normal operating conditions.

To determine whether the timer is out of sync, connect the video output from the instrument to the vertical input terminals of a good scope. The generator should be set for bar-pattern video output and the scope deflected horizontally with 60-cycle sine-wave voltage. If the instrument is timing correctly, a slowly revolving

pattern as shown in Fig. 909 will be observed. However, if the pattern is revolving rapidly or appears jumbled, the timer is out of sync.

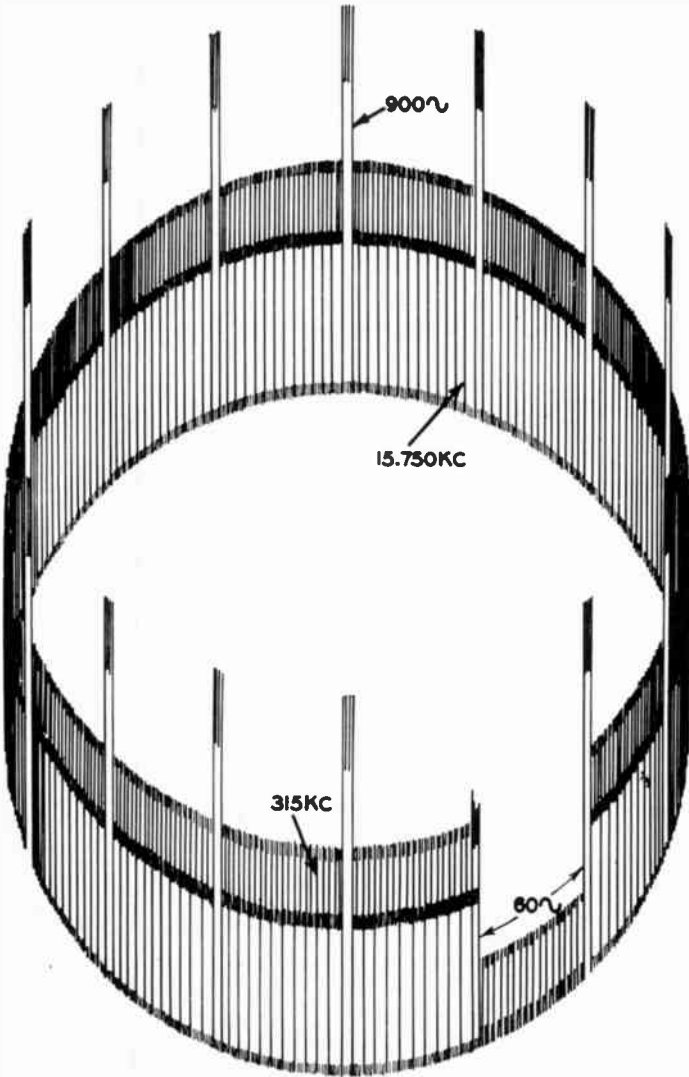

Fig. 909. Composite video crosshatch pattern.

To adjust the timer circuits, tune in a TV station, and lock the pattern normally. Then disconnect the antenna from the receiver. Apply the modulated rf output from the instrument to the antenna

input terminals of the receiver. Allow a 15-minute warmup period for the generator. Connect the video output from the generator to the vertical input terminals of a scope and deflect the scope horizontally with 60-cycle sine-wave voltage. Set the channel selector of the receiver to a vacant channel and set the generator output on the same channel. By viewing both the picture-tube screen and the video pattern on the scope screen, adjustments³ can be conveniently made.

The timer adjustments are split into three operations; (1) 31,500 and 15,750 cps (2) 4,500 and 900 cps (3) 60 cycles. If the 31,500- or 15,750-cycle oscillators are out of sync, the entire timer will be out of sync. This situation is recognized by viewing either the scope or picture tube screens. The scope will show a scrambled, rapidly rotating pattern and the TV screen will show a scrambled pattern that is not locked in vertically or horizontally. In such case, adjust the 31,500-cycle potentiometer. The pattern should lock in so that the vertical lines are displayed properly on the TV screen. If not, return the 31,500-cycle potentiometer to its original position.

Next, adjust the 15,750-cycle potentiometer. The pattern should lock in so that the vertical bars are displayed on the TV screen. If, however, the vertical bars only are locked in, but the horizontal bars are not (indicated by a rapidly revolving pattern on the scope screen), proceed to the next adjustments. If the 4,500- and 900-cycle oscillators are out of sync, the horizontal bars (900 cycles) and the vertical framing frequency (60-cycle pulse) will not be locked in on the TV screen. Also, the scope will display a rapidly revolving pattern. Adjust the 4,500-cycle potentiometer. The horizontal bars should fall into sync on the TV screen. If the pattern does not lock in, return the 4,500-cycle potentiometer to its original position and adjust the 900-cycle potentiometer.

View the revolving pattern on the scope screen. If the 900-cycle oscillator is locked in, the 900-cycle pulse in the revolving composite pattern will be revolving very slowly even though the 60-cycle pulse may be revolving rapidly. This indicates that the 900-cycle oscillator is locked in but that the 60-cycle oscillator may not be. If the 60-cycle oscillator is not in sync, the vertical framing frequency (60-cycle pulse) will not be locked in on the TV screen. Also, the scope will show the 60-cycle pulse revolving rapidly. Adjust the

³ NOTE: Before making adjustments, mark the setting of each potentiometer with pen, ink or crayon. The settings can then be returned to their original positions if the adjustment does not bring the generator into sync. Also, check all three tubes in the timer section one at a time and replace any low-emission tubes with good aged tubes.

Chart 9—1. Test Instruments Used to Check Color Circuits

Section	Instruments Used	Nature of Test
Input system (antenna, lead-in, primary of rf input transformer).	Color bar generator, preferably providing true saturated colors with sync and burst.	Substitution or elimination type of test. If receiver operates satisfactorily, antenna system is at fault.
Front end. Frequency response of rf grid and plate circuits, mixer grid circuit, local oscillator.	Rf sweep and marker generators and scope. Demodulator probe required for some front ends.	Display of frequency response curve for proper shape and correct placement of markers.
If amplifier (mixer plate circuit, if coupling circuits, and sound traps).	If sweep and marker generators, scope and variable agc override bias source.	Display of frequency response curve for proper shape, for adequate sound rejection by traps and for full response at color subcarrier point.
Video detector and Y amplifier. (Luminescence channel.) May include two-stage amplifier and cathode follower.	Video-frequency sweep generator, with output from 15 kc to 4.5 mc (or rf sweep and signal generator with Chromatic Probe).	Display of video-frequency response curves for proper shape and bandwidth, adjustment of sound and color subcarrier traps, and gain.
Chrominance circuits. Bandpass amplifier, I and Q demodulators, phase splitters, matrices and color video amplifiers.	Same as above.	Same as above; determination of low-frequency response below frequency capability of demodulator probe may require a split test.
Color sync circuits (burst take off and amplifier, subcarrier oscillator, color killer, oscillator phase control, and phase-shift network).	Wide-band scope, low capacitance probe, color bar generator with sync and burst, vtm. Generator should provide monochrome as well as color signal.	Waveform checks and measurement of peak-to-peak voltage values. Phase checks with color and monochrome bars. Color sync check with variation of burst voltage.
Tricolor picture-tube and color amplifier output circuits.	White dot generator, color bar generator with gray-range output and high-voltage probe for vtm.	Adjustment for white dots without splitup or fringing; gamma adjustment of output circuits to compensate for nonlinearity of picture tube and to obtain correct highlights and lowlights.
Convergence amplifier circuits.	Wide-band scope and low-capacitance probe.	Check of dynamic convergence waveforms and peak-to-peak voltage values.
Sync separators, agc circuits, deflection and high-voltage circuits.	Wide-band scope, low-capacitance probe, high-voltage capacitance-divider probe, vtm and high-voltage dc probe. Color bar generator with sync and burst.	Waveform checks and measurement of peak-to-peak voltage values. Operation checks over wide range of signal voltages.
Power supply circuits.	Vtm and wattmeter.	Same general tests as in monochrome receivers, except for heavier currents in circuit.

60-cycle potentiometer. The revolving pattern should then lock in. The timer should hold sync over a variation in line voltage from 90 to 125 volts.

If, after going through the simplified timer adjustment, the timer does not lock in properly, troubleshooting must be done in an effort to locate the intermittent or defective component. The timer adjustments must then be rechecked.

Chart 9-1 lists the test instruments used to check various color TV receiver circuit sections.

Oscilloscope requirements for vectorscope tests

An oscilloscope can occasionally be utilized to advantage as a vectorscope. In this application, demodulated chroma signals are applied to both the vertical and horizontal amplifiers of the scope. The horizontal amplifier must have suitable characteristics, which may or may not be provided by a conventional service scope.

The first requirement for the horizontal amplifier is a frequency response which is flat to approximately 1 mc. Some scopes have a horizontal-amplifier response which is flat to only 100 or 200 kc, and such scopes will not reproduce a vector pattern satisfactorily. Of course, if the scope should have a horizontal-amplifier response in excess of 1 mc, it is quite suitable for the application.

In addition to having a sufficiently wide horizontal-amplifier response, it is also necessary that the scope amplifier be able to handle the range of voltages which are encountered in various color TV receivers. Some service scopes can handle only a limited range of input voltages to the horizontal-amplifier terminals. Practical applications require that the horizontal amplifier accommodate input voltages over the range from 1 to 100 peak-to-peak volts, without overload and clipping. This requirement comes about from the fact that some color receivers utilize low-level color detection, while others use high-level color detectors.

Although some service scopes have a step attenuator or step switch provided in the horizontal-input circuit to accommodate a fairly wide range of input voltages, difficulty may be encountered due to the fact that this attenuator is uncompensated. Thus, although good frequency response may be obtained on the high-sensitivity position of the attenuator, it may be found that the frequency response becomes very poor when the attenuator is switched to a lower sensitivity position. This deficiency is caused by use of simple resistive voltage dividers, instead of compensated R-C divider networks in the horizontal-input circuit.

Chart 9—2. Color Bar Generator Adjustments

Observed Pattern

Discussion

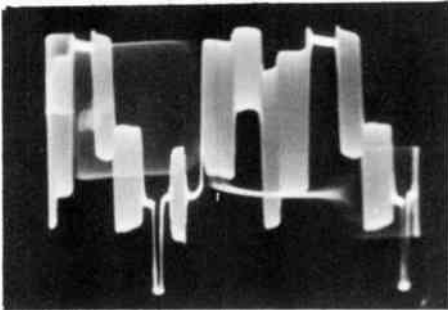

1

The color bar generator usually has a sync-pulse width control. (See photos 1 and 2). This photo shows the pulse adjusted to narrow width.

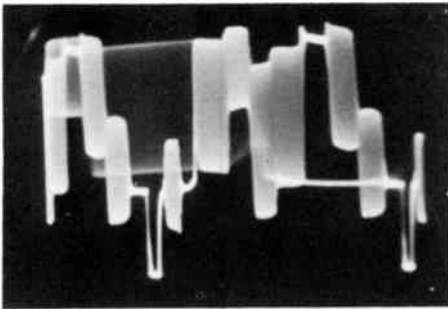

2

This photo shows the pulse adjusted to the correct width. To measure pulse widths, remember that there are 63.3 microseconds from the leading edge of one pulse to the leading edge of the next. By counting squares on the screen graticule, pulse widths may be measured with sufficient accuracy for service work.

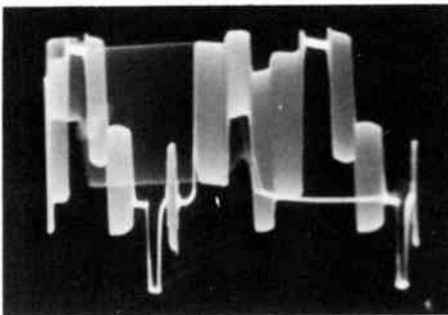

3

The burst width (photos 3, 4 and 5) is also adjustable in most cases. In this photo the burst width is set to minimum.

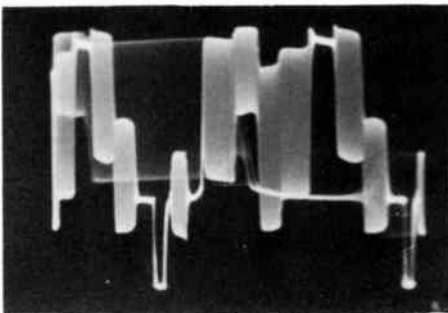

4

Here the burst width is set to maximum. In this photo the burst width is set to the correct value of approximately 3 microseconds. The burst width is measured in the same manner as the horizontal sync-pulse width. If the horizontal gain control on the scope is adjusted to provide 20 divisions from the leading edge of one burst to the next, each division will have a width of approximately 3 microseconds, so that the burst width will be adjusted to occupy one horizontal division on the screen graticule.

Color Bar Generator Adjustments (continued)

Discussion

Observed Pattern

This photo shows the appearance of the pattern when the burst has been set to the correct width.

5

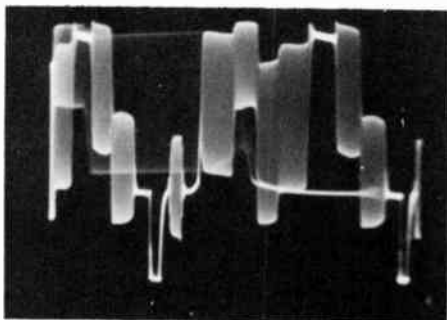

In adjusting bar widths, the controls may be set on the basis of a pattern on the screen of the color picture tube. (See photos 6 and 7).

6

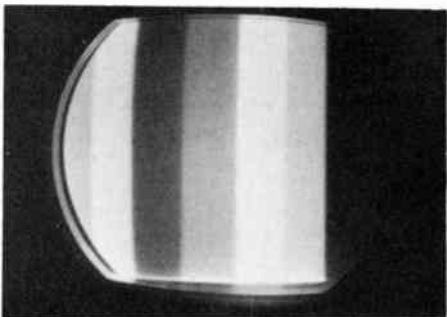

The controls can also be set on the basis of a chrominance signal as observed on the screen of a wide-band scope. However, some service technicians prefer the picture-tube display and believe that it provides a closer check on bar widths than does a scope.

7

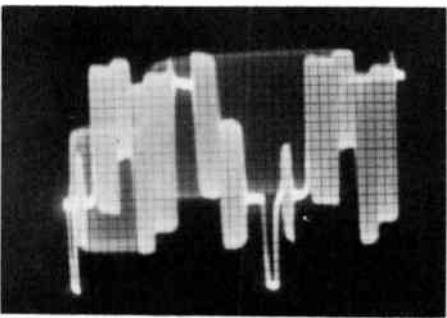

The bar sequence observed here is: green, yellow, red, magenta, white, cyan and blue. The bars have been adjusted to have approximately equal widths. To produce yellow, the green and red bars are overlapped. Magenta is obtained by overlapping red and blue. Cyan is produced by overlapping green and blue. White requires three colors—red, green and blue. (See photos 8, 9 and 10).

8

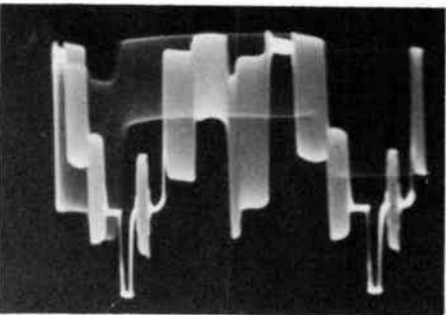

Color Bar Generator Adjustments (continued)

Observed Pattern

Discussion

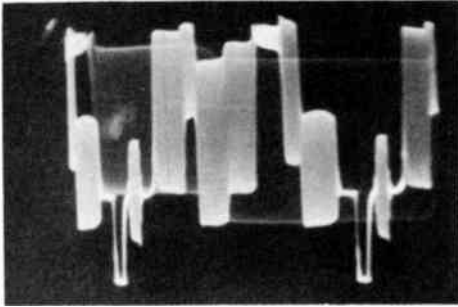

9

Since two green bars are utilized to synthesize the pattern, adjustment of the green bar width varies the widths of the yellow and cyan bars.

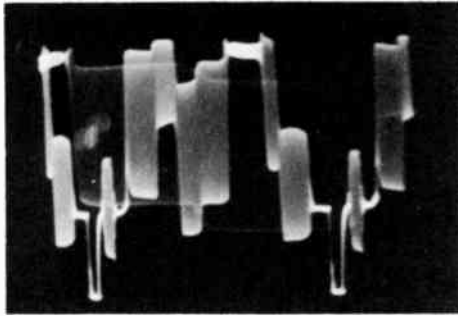

10

Variation of the red bar width changes the width of the white bar. Variation of the blue bar width changes the width of the blue bar only. The photos show the result of varying the width of the green bar.

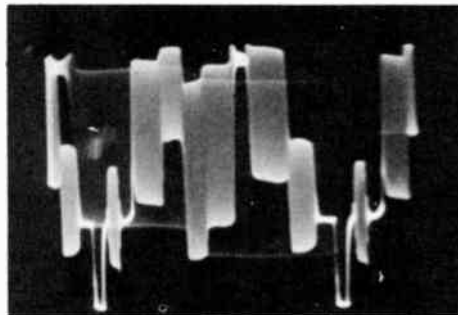

11

These photos (11 and 12) show the result of varying the width of the red bar. The width of the white bar is changed, as well as the width of the cyan bar, due to the overlapping principle utilized to generate the complementaries and white.

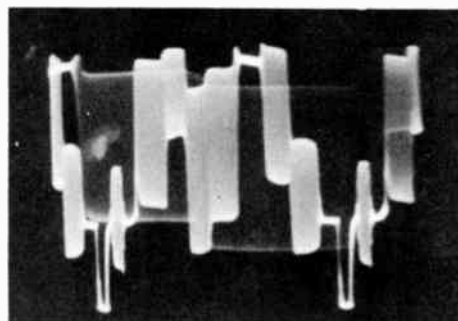

12

Another result of varying the width of the red bar.

Color Bar Generator Adjustments (continued)

Discussion

These photos (13 and 14) show the result of varying the width of the blue bar. In this case, only the width of the blue bar itself is seen to change, the other bar widths remaining unaffected.

13

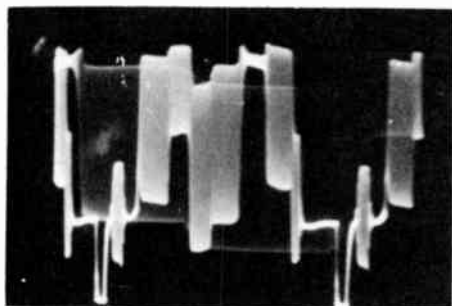

Another result of varying the width of the blue bar.

14

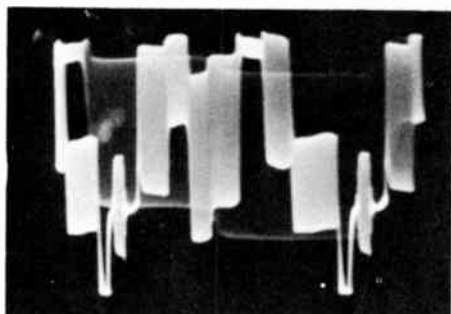

In the better color bar generators, the phase of the primary colors is set accurately with precision delay lines. The amplitude of the subcarrier for each primary color is set by three service controls: green, red and blue bar saturation. To produce white, the three primaries are added. (See photos 15, 16 and 17).

15

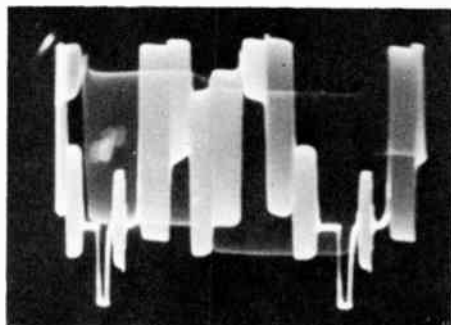

If the phase and amplitude of each of the primaries are correct, the subcarrier of the white bar will disappear. Since the phase is accurately and permanently set (for the example cited) with delay lines, the only other variables are the saturation controls. Hence, to set the amplitude of each of the primary color bars accurately, the technician needs only to vary simultaneously the three color-bar saturation controls and to cancel the subcarrier on the white bar.

16

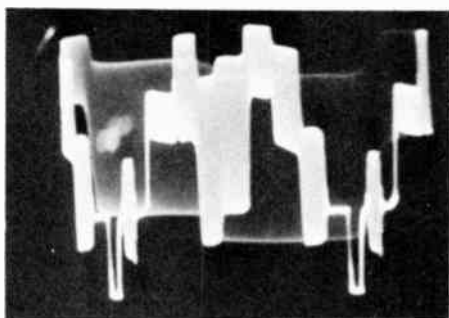

Color Bar Generator Adjustments (continued)

Observed Pattern

Discussion

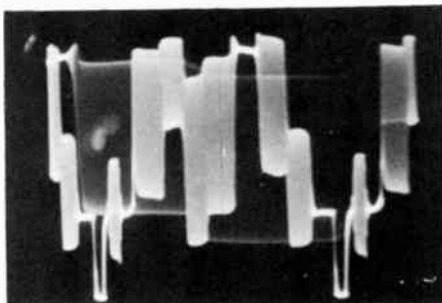

17

This adjustment also automatically sets the complementary color bars: yellow, magenta and cyan to their proper sub-carrier amplitudes, since the comple-mentaries (in this example) are synthe-sized by addition of the primaries. These photos (15, 16 and 17) show the effect on the subcarrier of the white color bar when the green bar saturation control is varied.

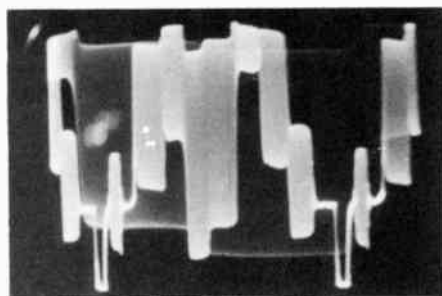

18

These photos (18, 19 and 20) show the effect on the white-bar subcarrier of varying the red-bar saturation control.

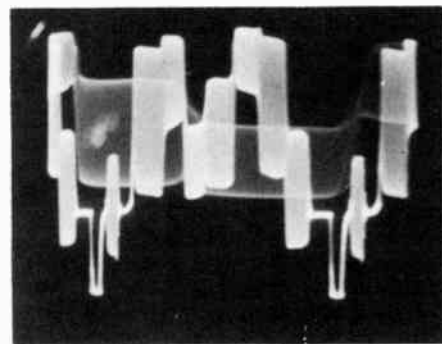

19

Note that when the saturation is varied, only the peak-to-peak voltage of the corresponding chrominance signal varies; the voltage of the Y component does not change.

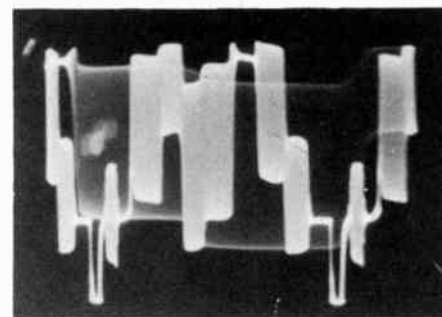

20

This photo also shows the effect on the white-bar subcarrier of varying the red-bar saturation control.

Color Bar Generator Adjustments (continued)

Discussion

Observed Pattern

In these photos (21, 22 and 23) is seen the result of the varying the blue bar saturation control.

21

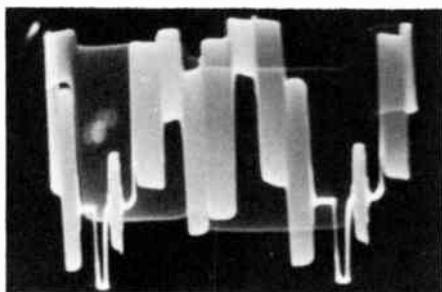

The amplitude of the blue bar chrominance component changes and the extent of subcarrier cancellation in the white bar is also affected.

22

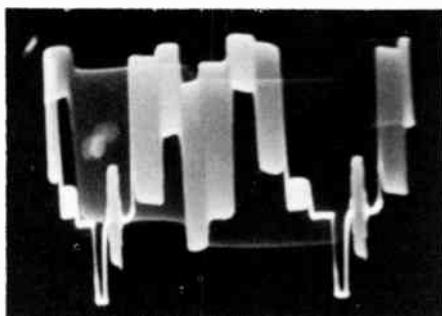

Another photo showing the result of varying the blue bar saturation control.

23

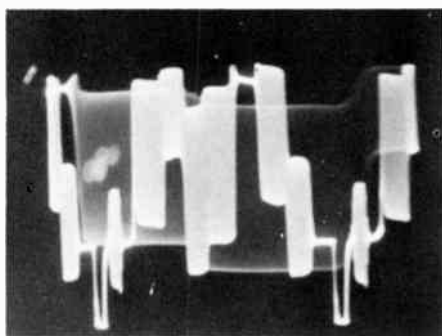

The next step (photos 24, 25 and 26) is to adjust the burst amplitude.

24

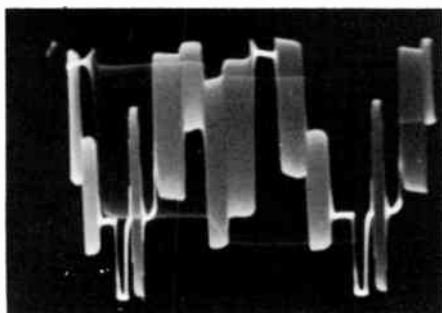

Color Bar Generator Adjustments (continued)

Observed Pattern

Discussion

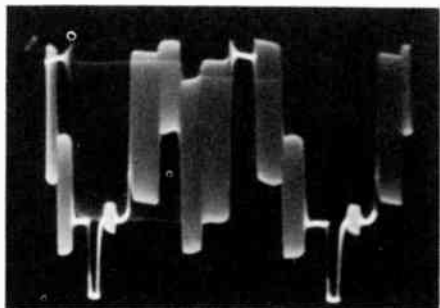

25

The amplitude of burst is approximately equal to one-half that of the red bar.

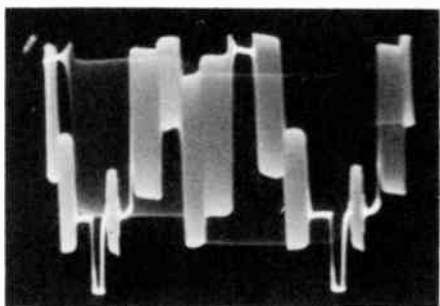

26

Most color bar generators provide a burst gain control. This affects the burst voltage as shown in the photos.

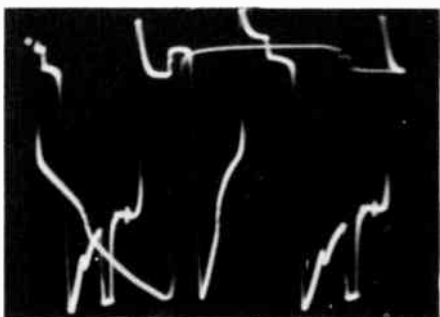

27

To adjust the Y or luminance component the chrominance switch is turned off.

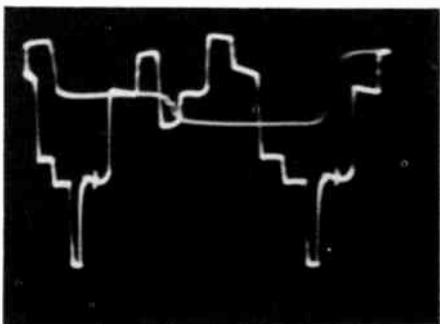

28

The green Y gain control may be adjusted first, and the effect of varying this control is shown in the accompanying photos (27, 28 and 29).

Color Bar Generator Adjustments (continued)

Discussion

Observed Pattern

The correct adjustment is at the point where the overshoot on the green bar is not noticeable.

29

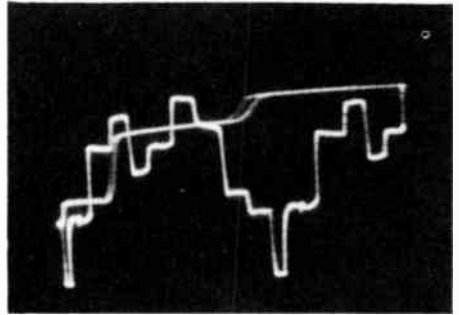

Since the amplitude of the green-bar Y component is 0.59, it is convenient to adjust the vertical gain of the scope so that the green bar occupies 59 squares. See photos 30, 31 and 32.

30

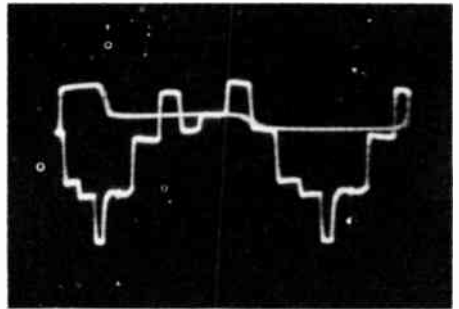

All other Y components may be set against this reference (59 squares).

31

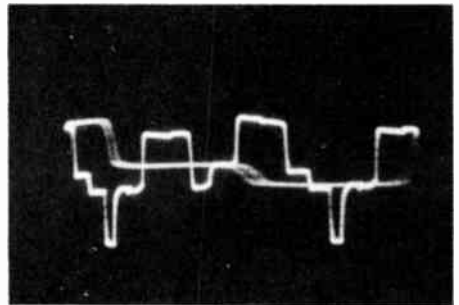

The red-bar Y gain control is conveniently set next to 30 squares.

32

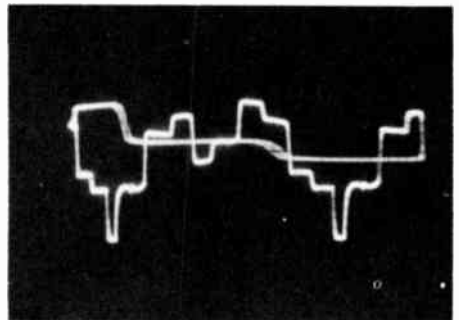

Color Bar Generator Adjustments (continued)

Observed Pattern

Discussion

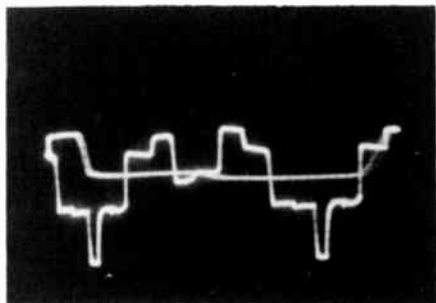

33

The blue Y gain control (photos 33, 34 and 35) is then varied to make the blue bar occupy 11 squares on the graticule, and the relative proportions of the Y signal are then correct.

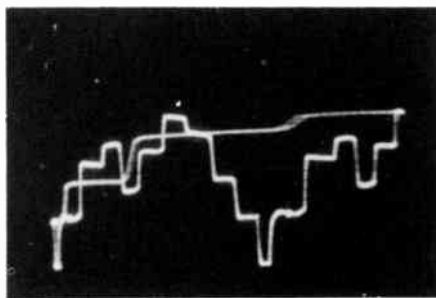

34

The absolute level still remains to be set. The photos show the effect of varying the blue Y gain control.

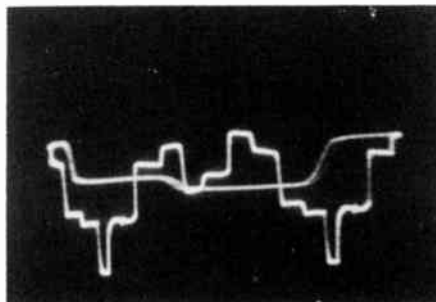

35

Effect of varying the blue Y gain control.

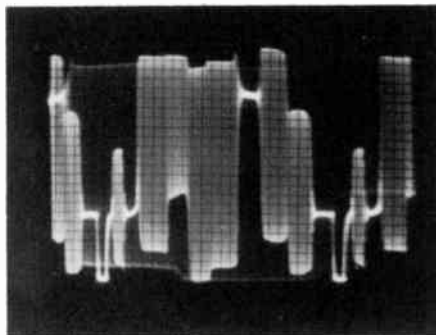

36

Photos 36, 37 and 38. The overall chroma gain control and overall Y gain control are adjusted to bring the peak of the subcarrier in the green bar exactly even with the blanking level.

Color Bar Generator Adjustments (continued)

Discussion

Observed Pattern

The effect on the signal of varying the overall chroma gain control is shown in the accompanying photos.

37

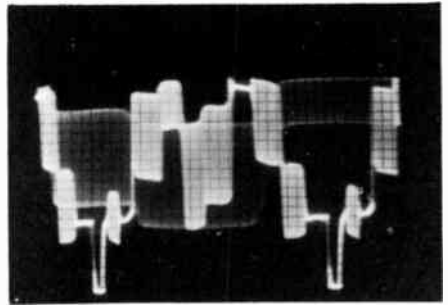

Effect of varying the overall chroma gain control.

38

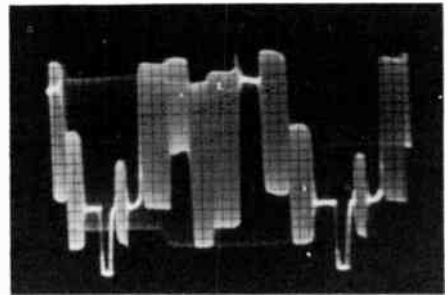

These photos (39, 40 and 41) show the effect on the pattern of adjusting the overall Y gain control.

39

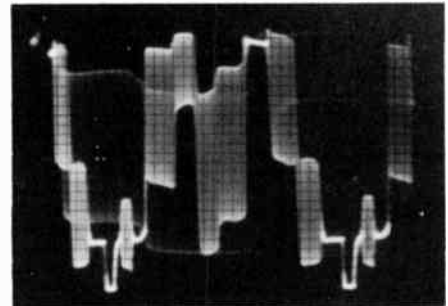

Effect on pattern of adjusting the overall Y gain control.

40

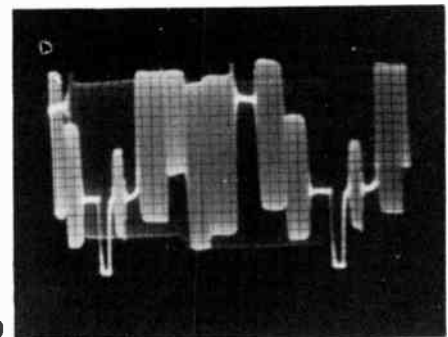

Color Bar Generator Adjustments (continued)

Observed Pattern

Discussion

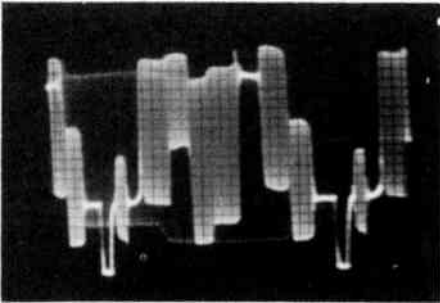

41

This setting (overall Y gain control adjustment) is the correct one.

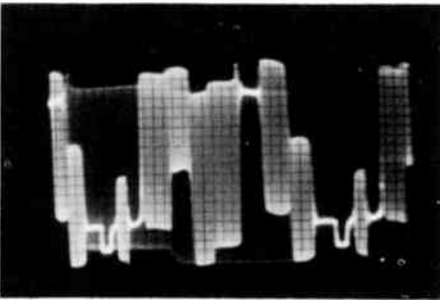

42

Photos 42, 43 and 44. The sync pulse peak-to-peak voltage must next be adjusted as shown.

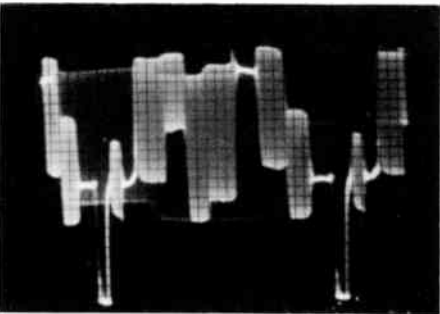

43

This is done by varying the sync-pulse gain control as required.

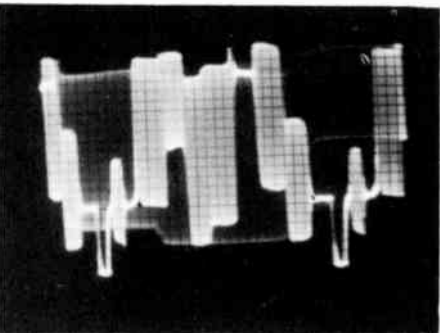

44

The correct height of the sync pulse is the same as the burst height.

index

A

Abnormal Loading of Horizontal Output Transformer	160
Absorption Markers	68
Accelerating Voltage for Picture Tube.....	26
Adjustment:	
of Fine-Tuning Control.....	183
of Horizontal Dynamic Convergence Circuits	168
of Phasing and Intensity Controls.....	28
of Relative Levels of Color Difference Signals	111
Adjustments, Dynamic Convergence.....	171
Adjustments, Purity	16
Afc:	
Balance Adjustments	43
Circuits, Color-Sync	42
Detector, Color	35
Phase Detector, Defects in the Color....	53
Agc Override Bias	151
Agc Threshold Control	34
Alignment:	
Characteristics, IF	155
IF Amplifier	144, 147
Test	154
AM Detector, Color Demodulator as.....	86
Ambient Light vs. Color Reproduction.....	31
Amplifier:	
Alignment of the IF	144
Bandpass	146
Blue	119
Burst	36, 42, 119, 197
Circuits, Buffer	40
Green	119
I	119
IF	120
Quadrature	119
Red	119
RF	120
Servicing the IF	143
Stability of IF	151
Video	120
Amplitude:	
Control, Master	168
Controls, Blue Dynamic	27
Controls, Vertical Dynamic	27
of Subcarrier Oscillator Voltage	114
Analysis of Color Bar Signal	188, 189
Antenna Pointers	32
Applications of the Color Bar Signal....	188, 189
Arcing	158
Arcing, Intermittent	164
Arcing Through Picture Tube	164
Arcs in High-Voltage System, Intermittent	164
Area-Selector Switch	34
Arrangement of Color Sync System.....	35
Attenuation:	
of Chroma Signals	144, 184
of IF Signal	191

B

Balance:	
Adjustments, Afc	43
Between Chroma and Y Output Levels	63
Checking	43
Bandpass Amplifier:	
Bandpass Amplifier	146
Boost Pulse at	186
Overshoot and Ringing in	187

Bandwidth of Chrominance Circuits.....	63
Bar:	
Generator Adjustments, Color	206
Generator Output, NTSC	107
Generators, Color	196
Widths	197
Barber Pole	37
Bars, Overlapping of Color	183
Bars, Saturated Color	107, 181
Beam Magnets	27
Beam Magnets, Mounting of	18
Beams, Tracking the Scanning	25
Beat Interference in Picture	12
Beat, 920-Kc	185
Beats in Picture	177
Bias, Agc Override	151
Bias, Reactance Tube	35
Blanking Interval	99
Block Diagram of White Dot Generator....	194
Blooming	12
Blue:	
Amplifier	119
Distortion	150
Dots, Convergence of	20
Dynamic Amplitude Controls	27
Gain Control Adjustments	111
Hues Contaminated	150
Lateral Corrector	27
Blues Appear Black	116
Boost Pulse at Bandpass Amplifier.....	186
Branch Circuits	160
Branch Circuits, DC Drain by.....	161
Breakdown due to High Voltage.....	158
Breakdowns, Partial	165
Brightness	131
Buffer Amplifier Circuits	40
Buffer Dummy Tube	53
Burning of Screen	167
Burnout, Potentiometer	168
Burst:	
Amplifier	36, 42, 119
Amplitude	197
Amplitude, Effect of Receiver Tuning on	181
Color	34
Contamination of	57
Keyer Circuit	59
Signal	59
Signal, Variable	49, 50
Suitable Test Point for	180
Takeoff Coil	37
Voltage, Attenuation of	48
Buzz in Sound	13
Buzz, Intercarrier	182
(B - Y) Adjustments	111
(B - Y) Demodulation	65

C

Cable, High-Voltage	162
Center of Screen Purity	17
Changes, Circuit	164
Changes, Design	161
Channel Response, Chroma	71
Characteristics, IF Alignment	155
Characteristics of NTSC Color Bar Signals	110
Charging Capacitor, Open Detector.....	154
Cheater, High-Voltage	14
Check List, Tube	12
Check Point, Picture Detector Output as a	179

Checking:		
Balance	43	
Color Sync Lock	48	
Flatness of Chroma Sweep Signal Voltages	72	
Loading	159	
Matrix Frequency Response	128	
Test Equipment	193	
the Demodulator Section with an NTSC Color Bar Generator	106	
the Horizontal Sweep	159	
the Matrix	121	
the Ratio of Luminance to Chrominance Voltages	127	
the Y Amplifier Response Curve	80	
Chroma:		
and Y Output Levels, Balance Between	63	
and Y Response Curves, Marking	67	
Attenuation	184	
Channel Response	71	
Circuit Servicing	38, 63	
DC Coupling in	10	
Demodulators, Servicing	97	
Detector Output	102	
Detector Output Voltages	127	
Detectors, Testing	101	
Response, Overall	87	
Signal Output	199	
Signals, Weak	114	
Chromatic Probe	68	
Chrominance:		
Bandpass Amplifier, Compensation in	149	
Bandpass Amplifier, Passband of	146	
Bandwidths	63	
Circuits, Checking	106	
Circuits Overload of	92	
Circuits, Response of	144	
Contamination of the White Bar Signal	94	
Gain Controls, Adjustment of	112	
Output	133	
Overload	127	
Values, Readjusted	127	
Voltages, Checking	127	
Circuit:		
Adjustments, Video-Frequency	66	
Changes	164	
Gain	83	
Loading	179	
Servicing, Chroma	63	
Circuits, Branch	160	
Clipping	150	
Coil:		
Burst Takeoff	37	
Current, Tilt	175	
Degaussing	17	
Color:		
Afc Balance	43	
Afc Detector	35	
Afc Phase Detector, Defects in the	53	
Bar Distortion Caused by Tube Failure	119, 120	
Bar Generator Adjustments	206	
Bar Generator Output	183	
Bar Generator, Pattern for NTSC	31	
Bar Generator, Video-Frequency Outputs from NTSC	45, 46	
Bar Generators	196	
Bar Pattern	51	
Bar Sequence	196	
Bar Signal, Applications of the	188	
Bar Signals, Characteristics of NTSC	110	
Bar Widths	197	
Bars, Overlapping of	183	
Bars, Saturated	107, 181	
Burst	34	
Circuits, Test Instruments Used to Check	204	
Component, Loss of	33	
Contamination	66	
Crosstalk	65	
Demodulator as AM Detector	86	
Demodulator Testing with Keyed Linear Phase Sweep	103	
Detail	64	
Difference Signals, Adjustment of Relative Levels of	111	
Difference Signals, Phase Diagram of	40	
Disappearance of	33	
Fringing	12	
Hum Bars	7	
Intensity Control Setting, Effects of	79	
Killer	114	
Killer Threshold Control	37	
Lock, Tight	57	
Missing	12	
off to One Side	12	
Phasing Control	39	
Reproduced in Black and White	116	
Reproduction, Correct	63	
Reproduction vs. Ambient Light	31	
Resolution, Loss of	66	
Section, Trouble Chart for	12	
Sidebands	143	
Signal, Attenuation of the	144	
Signal, Complete	143	
Signal, Narrow-Band	143	
Signal, Readjusted	182	
Signals, Gray	7	
Simulators	200	
Stripe	29, 37	
Subcarrier Ceases Operation	51	
Subcarrier Oscillator	119	
Subcarrier Oscillator, Intermittent Operation of	59	
Subcarrier Oscillator, Ringing	39	
Subcarrier Oscillator, Testing the	39, 51	
Sync Afc Circuits	42	
Sync Intermittent	38	
Sync Lock, Checking	48	
Sync Lock, Intermittent	60	
Sync, Loss of	34, 35, 51	
Sync Missing	38	
Sync, Poor	165	
Sync Servicing	33, 38, 45	
Sync System, Arrangement of	35	
Tinge on Screen	118	
Colored Snow	51	
Colors:		
Interchanged	118	
Overlapping of the Primary	196	
Raster	10	
Signal	10	
Compensated IF Bandpass Response	148	
Compensation in Chrominance Bandpass Amplifier	149	
Complete Color Signal	143	
Component, Loss of Color	33	
Composite Video Crosshatch Pattern	202	
Compressed Air, Cleaning with	164	
Confetti	51	
Contaminated Blue Hues	150	
Contaminated Red Hues	150	
Contamination:		
Color	66	
of Burst	57	
of the White Bar Signal, Chrominance	94	
Contrast, Excessive	13	
Control:		
Afc Threshold	34	
Color Phasing	39	
Master Amplitude	168	
Controls:		
Adjustment of Phasing and Intensity	28	
Dynamic Convergence	21	
for Picture Tube, Screen and Background	26	
Green	27	
Purity	27	
Saturation	198	
Tilt	21, 27	
Convergence:		
Adjustments, Dynamic	171	
Amplifier, Dynamic	119	
Coil Magnetic Field	170	

Control Leakage	161	in RF Amplifier	152
Horizontal Dynamic	23	Red	150
of the Three-Gun Tube	15	Transient	187
Procedure	26, 27	Dot Generators, White	193
Vertical Dynamic	21, 172	Dot Spacing	23
Waveforms. Scope Tests of.....	174	Dots, Vertical White	193
Conversion of Small-Screen Receiver.....	165	Double Sidebands	143
Converting Monochrome to Chroma		Dress, Lead	165
Sweepers	68	Drift, Oscillator Frequency	35
Corona Discharge	162	Drift, Subcarrier Oscillator	33
Corona Interference	162	Drive, Horizontal	26
Corrector, Blue Lateral	27	Dummy Tube, Buffer	53
Corrector Magnet, Lateral	119	Dummy Tube, Power Resistor as.....	75
Crankshaft Patterns	108	Dust	164
Crankshaft Signal	91	Dynamic:	
Crosshatch Pattern	19	Phase Coils, Horizontal	27, 170
Crosshatch Pattern, Composite Video.....	202	Range of IF Amplifier	150
Crossover Point, Beam	25	Dynamic Convergence:	
Crosstalk, Color	65	Adjustments	171
CRT, Sweep Failure Damage to.....	167	Amplifier	119
Crystal-Ringing Circuits	39	Circuits, Adjustment of Horizontal....	168
Crystal Trimmer Capacitor, Ringing.....	39	Horizontal	23
Current, Tilt Coil	175	Vertical	21, 172
Current Waveform Through Vertical Tilt		E	
Potentiometer	174	Edge Purity, Poor	118
Cyan Bar Amplitude	197	Effect of Receiver Tuning on Burst	
Cyan Tint	95	Amplitude	181
D		Effects of Color-Intensity Control Setting	79
Damage to CRT, Sweep Failure	167	Equipment, Checking Test	193
DC:		Excessive Contrast	13
Coupling in Chroma	10	F	
Drain by Branch Circuits	161	Failure, Tube	119, 120
Restorers	119, 142	Faulty Matrix	122
Definition, Poor	7	Fine Detail	130
Degaussing Coil	17	Fine-Tuning Control, Adjustment of.....	183
Delay:		Flat IF Response Curve	148
Line	186	Flat Response of IF Amplifier.....	147
Line, Short in	67	Flatness of Chroma Sweep Signal Volt-	
Time of Video Amplifier	91	ages, Checking	72
Demodulation:		Flyback:	
(B - Y)	65	Frequency	157
I-Q	64	Fuse	158
(R - Y)	65	System	157
Systems	64	System, Servicing the	166
Demodulator:		System Testing	161
as AM Detector, Color	86	Testers	159
Circuit, Q	70	Transformer	157
Probe, Pre-amplifier for	72	Transformers, Variation in Replace-	
Probes in Signal Tracing	187	ment	163
Probes, Using	129	Foldover, Horizontal	165
Section, Checking with an NTSC		Free Running Subcarrier Oscillator	40
Color Bar Generator	106	Frequency:	35
Testing with Keyed Linear Phase		Difference between Signal and Sub-	
Sweep, Color	103	carrier Oscillator	56
Testing with Linear Phase Sweep.....	97, 101	Drift Oscillator	35
Tube, Q	120	Flyback	157
Demodulators, Servicing Chroma.....	97	Response, Checking Matrix	128
Demodulators, Testing	101, 108	Scanning	157
Design Changes	161	Fringing, Color	12
Detail, Color	64	Fuse, Flyback	158
Detail, Fine	130	Fuse, Protective	158
Detection, I-Q	64	G	
Detection Systems	64	Gain:	
Detector:		Circuit	88
Circuit, Q	70	Control Adjustment, Blue	111
Load Resistor	154	Control Adjustment, I	111
Output, Chroma	102	Gassing of Picture Tube	167
Output, Video	145	Gate Pulse	36
Output Waveform	104	Generator:	
Phase	35, 119	Adjustments, Color Bar	206
Polarity, Picture	47	and Scope Settings for Sweep-Fre-	
Deterioration of Waveforms in Signal		quency Check of Q Demodulator	82
Circuits	185	Output, NTSC Bar	107
Diagram, Vectorscope	109	Parabolic Voltage	173
Dial Calibrations, Marking with	78	Rainbow	56
Disappearance of Color	33	Using a Square-Wave	129
Discharge, Corona	162	Generators:	
Distortion:		Color Bar	196
Blue	150		
Caused by Tube Failure in Receiver,			
Color Bar	119, 120		

Linear Phase Sweep	97
Rainbow	200
White Dot	193
Gray Color Signals	7
Green:	
Amplifier	119
and Blue Dot Spacing	24
Bar Amplitude	197
Controls	27
Dots, Convergence of	20
Highlights Appear	25
Missing	9
Strong; Reds Weak	116
Tint	96
Weak; Red Strong	116
Greens Appear Black	116
(G — Y) Matrix Network	124
(G — Y) Matrix, Sweep Frequency Test of	129
H	
H Pad	61
Heat, Excessive	158
Height, Vertical	26
High-Frequency End of RF Response.....	147
High-Frequency IF Attenuation	149
High-Voltage:	
Breakdown	158
Cable	162
Hazards, Precautions Against.....	11
Interlock	14
Measurements	158
Measuring	14
Missing	159
Regulator	119
System, Intermittent Arcs in	164
Wiring	158
Highlights Appear Green	25
Highlights Appear Magenta	25
Hold, Horizontal	26
Horizontal:	
Drive	26
Dynamic Convergence	23
Dynamic Convergence Circuits, Adjustment	168
Dynamic Phase Coils	27, 170
Foldover	165
Hold	26
Linearity	26
Output Transformer, Abnormal Loading of	160
Output Transformer, Replacing the....	163
Rainbows	7
Sweep, Checking the	159
Sweep, Interference from	76
White Dots	193
Width	26
Hue	56, 131
Hues:	
Contaminated Blue	150
Contaminated Red	150
in Picture Incorrect	116
Shifting	165
Hum Bars, Color	7
I	
I:	
Amplifier	119
and Q Signal Levels	113
and Q Signals, Matrixing the.....	125
Demodulator Sweep Test	81
Demodulator Tube	120
Gain Control Adjustments	111
Phase Splitter	120
Signal Level	113
IF Alignment Characteristics	155
IF Amplifier:	
Alignment	147
Dynamic Range of	150
Flat Response of	147
Response Curve of	151
Servicing the	143
Stability of	151
IF Amplifiers	120
IF:	
Attenuation, High Frequency	149
Bandpass Response, Compensated.....	148
Overall Check of	153
Response Curve	147
Response Curve, Flat	148
Response, High-Frequency End of.....	147
Signal, Attenuation of	191
Impedance Matching Pad	15
Improper Colors, Reproduction of.....	9
Instruments Used to Check Color Circuits	204
Intensity Controls, Adjustment of.....	28
Intercarrier Buzz	182
Interference:	
Corona	162
from Horizontal Sweep	76
in Picture	13
Voltages	74, 184
Interleaving	157
Interlock	158
Interlock, High-Voltage	14
Intermittent:	
Arcs in High-Voltage System.....	164
Color Sync	38
Color Sync Lock	60
Operation of the Color Subcarrier Oscillator	59
Interval, Blanking	99
I-Q Demodulation	64
I-Q Demodulators, Testing	101
Isolating Resistor, Using an	131
J	
Jittery Sync	162
K	
Keyed:	
Linear Phase Sweep, Color Demodu- lator Testing with	103
Output of Linear Phase Sweep Generator	103
Rainbow Generator, Matrix Checks with a	125
Rainbow Generator, Overload Check in	151
Keyer Circuit, Burst	59
Keying Pulse	36
Killer, Color	114
L	
Lateral Corrector, Blue	27
Lateral Corrector Magnet	19
Lead Dress	165
Leads, Test	74
Leakage	161
Leakage, Convergence Control	161
Leaks in Picture Tube	137
Left-Side Foldover	165
Level, Sync Pulse	137
Level, Zero-Carrier	182
Limiting	150
Line, Delay	186
Linear Phase Sweep:	
Color Demodulator Testing with Keyed	103
Demodulator Testing with	97, 101
Generator, Keyed Output of	103
Generators	97
Quadrature Test with a	100
Signal	98
Vector	98
Linearity, Horizontal	26
Linearity, Vertical	26
Load Resistor, Detector	154
Loading:	
Checking	159
Circuit	179
Effects, Probe	196
Localized Misconvergence	118

Lock, Poor Sync	38
Loss:	
of Color Component	33
of Color Resolution	66
of Color Sync	34, 35
of Color Sync, Rainbow Characteristics Produced by	55
Low-Capacitance Probe, Using	131
Low Gain in Q Channel	66
Low-Impedance Test Points	153
Luminance Voltages, Checking	127

M

Magenta:	
Bar Amplitude	197
Highlights Appear	25
Tint	96
Magnet:	
Assembly, Purity	26
Lateral Corrector	19
Purity	17
Magnets, Beam	27
Magnets, Rim	17, 26
Marker, Spurious	68
Markers, Absorption	68
Marking Chroma and Y Response Curves	67
Marking with Dial Calibrations.....	78
Master Amplitude Control	168
Matching between Transformer and Yoke	167
Matrix:	
Checking with Ohmmeter	130
Checks with a Keyed Rainbow Generator	125
Checks with a Signal Generator and VTVM	126
Frequency Response, Checking	128
Network (G — Y)	124
Network, R-C	109
Operation	130
Operation, Influence of the Y Voltage Value in	138, 139, 140, 141
Output	133
Servicing the	122, 136
Testing	121, 134
Waveform	132
Matrixing:	
I and Q Signals	125
in the Picture Tube	122
System	122
Y	137
Measurements, High-Voltage	158
Measuring High Voltage.....	14
Misadjusted Quadrature Transformer.....	99
Misconvergence	19
Misconvergence, Localized	118
Monochrome:	
Receiver, Progress of Color Signals in	145
Section, Trouble Chart for	13
to Chroma Sweepers, Converting.....	68
Mounting of Beam Magnets	18

N

Narrow-Band Color Signal	143
Narrow-Band Scopes	176
Negative Picture	13
No Color	12
No Color Sync	38
No High Voltage	159
Noise	74
Nonlinearity of Phase Response	147
NTSC:	
Bar Generator Output	107
Color Bar Generator, Checking the Demodulator Section with an.....	106
Color Bar Generator, Pattern for.....	31
Color Bar Generator, Video-Frequency Outputs from	45, 46
Color Bar Signals, Characteristics of	110

O

Ohmmeter Check of Matrix	130
Open Detector Charging Capacitor	154
Operation at Two Frequencies	157
Operation, Matrix	130
Orange-Cyan Axes	64
Oscillator:	
Above 3.58 MC, Subcarrier	55
Below 3.55 MC, Subcarrier	56
Drift, Subcarrier	33
Frequency Drift	35
Pulling, Subcarrier	165
Subcarrier	40
Voltage, Amplitude of Subcarrier.....	114
Output:	
Chroma Detector	102
of Color Bar Generator	183
of Linear Phase Sweep Generator, Keyed	103
Transformer, Replacing the Horizontal	163
Voltages, Chroma Detector	127
Waveform, Detector	104
Overall:	
Check of IF	153
Check of Picture Detector	153
Check of RF	153
Chroma Response	87
Overlapping of Color Bars	183
Overlapping of Primary Colors	196
Overload:	
Check in Keyed Rainbow Generator.....	151
of Chrominance Channel	127
of Chrominance Circuits	92
Overmodulation	182
Override Bias, Agc	151
Overshoot	186, 187
Ozone	162

P

Pad, H	61
Pad, Impedance Matching	15
Parabolic Voltage Generator	173
Partial Breakdowns	165
Partial Compensation in the IF Amplifier	148
Passband of Chrominance Bandpass Amplifier	146
Pattern:	
Color-Bar	51
Crosshatch	19
for NTSC Color Bar Generator.....	31
Rainbow	30
Striped Rainbow	30
Vectorimeter	106
White Crosshatch	19
White-Dot	19
Patterns, Crankshaft	108
Peaked Bandpass Amplifier, Overshoot and Ringing in	187
Peaking	66
Peaking Coils, Shorted Detector.....	154
Phase:	
Detector	35, 55
Detector, Defects in the Color Afc.....	53
Diagram of Color-Difference Signals Response, Nonlinearity of	47
Splitter, I	120
Splitter, Q	120
Sweep Signal, Linear	98
Sweep Vector, Linear	98
Phases of Primary Chroma Voltages.....	200
Phasing:	
Coils, Adjustment of	24
Control, Color	39
Controls, Adjustment of	28
Picture:	
Beat Interference in	12
Beats in	177
Carrier Test, Sweep-Modulated	154
Detector Output as a Check Point.....	179

Detector, Overall Check of	153
Detector Polarity	47
Detector Test Points	180
Interference in	13
Negative	13
Rolls	58
Size Changes Excessively	12
Slants	58
Slides	58
Symptoms of Sync Loss	58
Tinting	116, 117, 118
Tube, Arcing Through	164
Tube, Gassing of	167
Tube, Leaks in the	137
Tube Matrixing	122
Tube Shield	26
Tube, Shorts in the	137
Tube, Signal Levels at the	123
Tube, Tracking the	25
Tube Will Not Track	118
Pie Cut	98
Points, Test	153
Polarity, Picture Detector	47
Polarity, Pulse	163
Pole, Barber	37
Poor Color Sync	165
Poor Definition	7
Position of Yoke	26
Potentiometer Burnout	168
Power Resistor as Dummy Tube	75
Preamplifier for Demodulator Probe.....	72
Precautions Against High Voltage	
Hazards	11
Preliminary Servicing	7
Primary Chroma Voltages, Phases of.....	200
Primary Colors, Overlapping of.....	196
Probe:	
Chromatic	68
Loading Effects	190
Preamplifier for Demodulator	72
Using a Low-Capacitance	131
Probes:	
in Signal Tracing, Demodulator.....	187
Signal Tracing	191
Using	70, 129, 132
Procedure, Convergence	26, 27
Progress of Color Signal in Color TV Set	146
Progress of Color Signals in Monochrome	
Receiver	145
Protective Fuse	158
Pulse:	
at Bandpass Amplifier, Boost	186
Gate	36
Keying	36
Polarity	163
Polarity, Scope Test of	48
Specifications	163
Purity:	
Adjustments	16
Controls	27
Magnet	17
Magnet Assembly	26
Poor	118
Q	
Q Channel, Low Gain in	66
Q Demodulator:	
Circuit	70
Circuit, Scope Control Settings for	
Checking	85
Checking	93
Circuit, Square-Wave Check of	85
Response	77, 85
Response, Checking	81
Sweep-Frequency Check of	76
Tube	12
Q Phase Splitter	120
Q Signal Level	113
Quadrature:	
Amplifier	119
Test with a Linear Phase Sweep.....	100
Transformer Misadjusted	99
Transformer, Misalignment of	114

R

Rainbow:	
Characteristics Produced by Loss of	
Color Sync	55
Generator, Block Diagram of	201
Generator, Matrix Checks with a	
Keyed	125
Generator Spectrum	30
Generators	56, 200
Pattern	30
Signal	97
Stripes in Picture	58
Rainbows	15, 33, 55, 56
Horizontal	7
Number of	33
Vertical	33
Raster Colors	10
Raster, Tinted	12
R-C Matrix Network	109
Reactance Tube Bias	35
Readjusted Chrominance Values	127
Readjusted Color Signal	182
Receiver Tuning, Effect on Burst	
Amplitude	181
Red:	
Amplifier	119
Bar Amplitude	197
Distortion	150
Dots, Convergence of	20
Hues, Contaminated	150
Tint	95
Reds Appear Black	116
Reds Strong; Greens Weak	116
Regulator, High-Voltage	119
Reproduction of Improper Colors	9
Response Curve:	
Flat IF	148
IF	147
of IF Amplifier	151
of RF Amplifier	151
Response Curves, Marking Chroma and Y	
Response, Curves, Y Amplifier	67
Response, IF	75
Response, IF	147
Response of Chrominance Circuits	144
Response, Q Demodulator	77
Restorers, DC	119, 142
RF:	
Amplifier	120
Amplifier, Distortion in	152
Amplifier, Response Curve of.....	151
Overall Check of	153
Tuners	152
Rim Magnets	17, 26
Ringing	186, 187
Circuits, Crystal	39
Crystal Trimmer Capacitor	39
in Y Amplifier	67
Rising IF Response at 3.58 MC.....	185
Rolling Picture	58
(R — Y) Demodulation	65

S

Saturated Color Bars	107, 181
Saturation	131
Saturation Controls	198
Scanning Beams, Tracking the	25
Scanning Frequency	157
Scope:	
Control Settings for Checking Re-	
sponse of Q Demodulation Circuit	85
Control Settings for 60-Cycle Square-	
Wave Check of Q Demodulation	
Circuit	93
Test of Convergence Waveforms	174
Test of Pulse Polarity	48
Using the	111
Scopes, Narrow-Band	176
Scopes, Using	175
Screen:	
and Background Controls for Picture	
Tube	26
Burning of	167

Has Predominant Color Tinge	118	Generator as 60-Cycle Square-Wave	
Selector Switch, Area	34	Source	89
Servicing:		Modulated Picture Carrier Test	154
Chroma Circuits	63	Signal, Linear Phase	98
Chroma Demodulators	97	Testing Video-Frequency Circuit	64
Color Sync	33	Tests, Video-Frequency	65
of Color-Sync and Associated		Symptoms of Sync Loss, Picture	58
Chroma Circuits	38	Synchronization of White Dot Generator ..	27
Preliminary	7	Sync:	
the Flyback System	166	Intermittent Color	38
the IF Amplifier	143	Jittery	162
the Matrix	122, 136	Lock, Intermittent Color	60
Video-Frequency	45	Lock, Poor	38
Shading, Vertical	13	Loss of Color	34
Shadow Mask, Warping of	167	Loss, Picture Symptoms of	58
Shield, Picture-Tube	26	Poor Color	165
Shifting Hues	165	Pulse Amplitude	197
Short in Delay Line	67	Pulse Level	137
Shorted Detector Peaking Coils	154	Servicing, Color	33, 38, 45
Shorts in the Picture Tube	137	System, Arrangement of Color	35
Sidebands	143	System, Flyback	157
Signal:		T	
Burst	59	Tagging Wires	159
Colors	10	Test:	
Complete Color	143	Alignment	154
Crankshaft	91	Equipment, Checking	193
Generator, Checking the Matrix		Instruments Used to Check Color	
with a	126	Circuits	204
Level, Y	121	Leads	74
Levels at Picture Tube	123	Point for Burst, Suitable	180
Levels, I and Q	113	Point, Video Amplifier	181
Output, Chroma	199	Points	153
Rainbow	97	Points, Picture Detector	180
Readjusted Color	182	Setup for Checking Q Demodulator	
Signal Tracing	179	Response	81
Single-Sideband	143	Testers, Flyback	159
Tracing, Demodulator Probes in	187	Testing:	
Tracing Probes	191	Demodulators	108
Variable Burst	49, 50	I-Q Demodulators	101
Vector	55	Matrix	121, 134
Voltages, Y	198	the Color-Subcarrier Oscillator.....	39, 51
Signals, Weak Chroma	114	the Flyback System	161
Simulators, Color	200	with Linear Phase Sweep,	
Single-Sideband Signal	143	Demodulator	97
Slanting Picture	58	Three-Gun Tube, Convergence of	15
Sliding Picture	58	Threshold Control, Agc	34
Small-Screen Receiver, Conversion of	165	Threshold Control, Color-Killer	37
Smear	15	Tight Color Lock	57
Snow, Colored	51	Tilt Coil Current	175
Sound, Buzz in	13	Tilt Controls	21, 27
Sound, Trapping	147	Tint:	
Spacing, Dot	23	Cyan	95
Spacing, Green and Blue Dot	24	Green	96
Specifications, Pulse	163	Magenta	96
Spectrum, Rainbow Generator	30	Red	95
Splitter, Q Phase	120	Yellowish	95
Spurious Marker	68	Tinted Raster	12
Square-Wave:		Tinting, Picture	116, 117, 118
Check of Q Demodulator Circuit	93	Tracing, Signal	79
Generator, Using a	129	Tracking:	
Source, Sweep Generator as 60-Cycle..	89	of Picture Tube, Poor	118
Stability of IF Amplifier	151	the Picture Tube	25
Standing Wave Trouble	15	the Scanning Beams	25
Stripe, Color	29, 37	Transformer:	
Striped Rainbow Pattern	30	and Yoke, Matching Between	167
Stripes in Picture, Rainbow	58	Flyback	157
Subcarrier Oscillator:		Misadjusted, Quadrature	99
Subcarrier Oscillator	40	Transformers, Variation in Replacement	
Above 3.58 MC	55	Flyback	163
Below 3.58 MC	55	Transient Distortion	187
Color	119	Transients	133
Drift	33	Transmission Lead Mismatch	15
Free Running	40	Trap, 3.58-MC	145
Intermittent Operation of the Color....	59	Trapping Sound	147
Pulling	165	Trouble Chart for Color Section	12
Ringing Color	39	Trouble Chart for Monochrome Section	13
Voltage, Amplitude of	114	Troubles, Tube	10
Suitable Test Point for Burst	180	Troubleshooting the Color-Subcarrier	
Sweep:		Oscillator	52
Failure Damage to CRT	167	Tube:	
Frequency Check of Q		Check List	12
Demodulator	76, 82	Failure	119, 120
Frequency Test of (G - Y) Matrix....	129		

Troubles	10
Tuners, RF	152
Two Colors Interchanged	118
Typical I Demodulator Sweep Test	81

U

Using Probes	70, 132
Using Scopes	175

V

Variable Burst Signal	49, 50
Variation in Replacement Flyback Transformers	163
Vector, Linear Phase Sweep	98
Vector, Signal	55
Vectorimeter Pattern	106
Vectorscope Diagram	109
Vertical:	
Dynamic Amplitude Controls	27
Dynamic Convergence	21, 172
Hold, Missing	13
Linearity	26
Rainbows	33
Shading	13
Tilt Potentiometer, Current Waveform	174
White Dots	193

Video:

Amplifier	120
Amplifier, Delay Time of	91
Amplifier Test Point	181
Crosshatch Pattern, Composite	202
Detector Output	145
Video-Frequency	
Circuit Adjustments	66
Circuit Check	64
Outputs from NTSC Color Bar Generator	45, 46
Servicing	45
Sweep Tests	65

Voltage:

and Waveform Tests	169
Generator, Parabolic	173
Hazards, High	11
Interference	74, 184
Voltages, Y Signal	198
VTVM, Checking the Matrix with a	126

W

Warping of Shadow Mask	167
Waveform:	
and Voltage Tests	169
Detector Output	104
Matrix	132
Waveforms in Signal Circuits, Deterioration of	185
Weak Chroma Signals	114

White:

Bar Signal, Chrominance Contamination of the	94
Bar Width	197
Crosshatch Pattern	19
Dot Generator, Block Diagram of	194
Dot Generator, Synchronization of	27
Dot Generators	193
Dot Pattern	19
Dots, Horizontal	193
Dots, Vertical	193
Wide Horizontal Bar in Picture	13
Width, Horizontal	26
Width, White Bar	197
Widths, Bar	197
Wires, Tagging	159
Wiring, High-Voltage	158

Y

Y Amplifier:	
Response Curve, Checking the	80
Response Curves	75
Ringing in	67
Y and Chroma Output Levels, Balance Between	63
Y and Chroma Response Curves, Marking	67
Y Channel Output	133
Y Matrixing	137
Y Signal Level	121
Y Signal Voltages	198
Y Voltage Value in Matrix Operation	138, 139, 140, 141
Yellow Bar Amplitude	197
Yellowish Tint	95
Yoke and Transformer, Matching Between	167
Yoke Position	26

Z

Zéro-Carrier Level	182
--------------------------	-----

Be Sure to Read These Other GERNSBACK LIBRARY Books

- 43—MODEL CONTROL BY RADIO. Remote control of model planes, boats, autos. Theory and construction of coders, transmitting and receiving systems, decoders, power control circuits, servomotors, control systems. 112 pages. \$1.00
- 44—BASIC RADIO COURSE. 26 chapters on radio theory as easy to read as a novel. Describes the action of radio circuits in a quick-to-grasp manner. Supplies a wonderful electronic background. Hard cloth cover. 176 pages. \$2.25
- 45—RADIO TUBE FUNDAMENTALS. The first low-priced book to give a complete understanding of radio tubes. Covers tubes from electron theory to a working analysis of the different types. 96 pages. \$1.00
- 46—TELEVISION TECHNOTES. Case histories of TV troubles based on TV repair information supplied by technicians. Describes and solves over 600 tough TV servicing problems. 128 pages. \$1.50
- 47—RADIO & TV HINTS. Hundreds of shortcuts taken from the experience of service technicians, radio amateurs, audio fans, experimenters, and engineers. The hints and kinks in this book are practical, and can be put to work by you. 112 pages. \$1.00
- 48—HIGH FIDELITY. A three-part book giving the maximum amount of information on modern audio design, construction, and measurement techniques. Has a complete section on building audio amplifiers. 128 pages. \$1.50
- 49—RADIO AND TV TEST INSTRUMENTS. Describes 22 test instruments, including instructions on how to build a Picture Tube Circuit Analyzer, Picture Tube Tester, Three-Inch Scope, Portable Sig Generator, Dynamic Signal Tracer, Practical V.T.V.M., TV Marker Generator, etc. 128 pages. \$1.50
- 50—TV REPAIR TECHNIQUES. Tells how to do signal tracing, service TV in the home, how to overcome high-voltage troubles, picture-tube circuit difficulties, service horizontal locks, cure TVI, intercarrier buzz, brightness troubles, etc. 128 pages. \$1.50
- 51—TRANSISTORS-THEORY AND PRACTICE. This volume describes semi-conductor theory, transistor characteristics, equivalent circuits, transistor amplifiers, oscillators. Gives data on practical transistor circuits, tests and measurements. 144 pages. \$2.00
- 52—THE OSCILLOSCOPE. Get the most out of this test instrument. Chapters on waveforms, the cathode-ray tube, sweep systems, typical scopes, alignment techniques, tests, measurements, experiments. 192 pages. \$2.25
- 53—RADIO-CONTROL HANDBOOK. A how-to-do-it book for all hobbyists interested in radio control for planes, boats, trucks, tractors, etc. Practical construction ideas and suggestions for complete control systems. 192 pages. \$2.25
- 54—PROBES. Explains how probes are designed, constructed, and used. Describes crystal-demodulator probes, voltage-doubler probes, balanced, low capacitance; high-voltage; isolation and direct probes. Covers specialized probes, including a transistorized type. 224 pages. \$2.50
- 55—SWEEP & MARKER GENERATORS for Television and Radio. Completely describes the theory behind the construction of sweep and marker generators. Tells you what you can and cannot do with these generators. 224 pages. \$2.50
- 56—HIGH FIDELITY CIRCUIT DESIGN. Two leading engineers bring you the results of many years' work. Has chapters on negative and positive feedback, drivers, inverters, power supplies, attenuators, filters, equalizers, speaker systems, advanced techniques. Describes practical application of mathematics for audio design. Gold stamped, hard cloth cover. 304 pages. \$5.95
- 57—THE V.T.V.M.—how it works—how to use it. Written by an RCA engineer; supplies full information on the theory and practical operation of the vacuum-tube voltmeter. Explains how to repair your own v.t.v.m. 224 pages. \$2.50
- 58—MAINTAINING HI FI EQUIPMENT. Service hi-fi systems. Chapters include: High-Fidelity Standards; Test Instruments; High-Fidelity Circuits; Preliminary Diagnosis; Distortion; Low-Level Distortion; High-Level Distortion; Bass and Treble Faults; Common Audio Troubles; Phono Pickups and Styli; Turntables and Equalizers; Tuners; Final Adjustments. 224 pages. \$2.90
- 59—SERVICING RECORD CHANGERS. Excellent source of profit for the service technician. Detailed drawings show how to make repairs. Full servicing information. 224 pages. \$2.90
- 60—RAPID TV REPAIR. Alphabetical listing of hundreds of TV troubles. Lists symptoms to look for and gives specific information on what to repair. A practical book with minimum amount of theory. 224 pages. \$2.90
- 61—TRANSISTOR TECHNIQUES. A useful guide for technicians and engineers who want data on how to work with and test transistors. Explains how to make transistor measurements; also supplies practical building projects. 96 pages. \$1.50
- 62—TV—IT'S A CINCH! Learn television this easy, unusual way. Snappy conversational style with hundreds and hundreds of drawings will help you breeze right through TV. 224 pages. \$2.90
- 66—BASIC AUDIO COURSE. The first of a series on audio and high fidelity. Explains fundamental audio concepts, describes theory and operation of microphones, equalizers, amplifiers, speakers, enclosures. Ideal for those who wish to learn audio. 224 pages. \$2.75