

WIRELESS COURSE

in Twenty Lessons by



H. W. SECOR



S. GERNSBACK



A. LESCARBOURA



Published by

THE ELECTRO IMPORTING CO.

NEW YORK

Lesson Number One

THE PRINCIPLES OF ELECTRICITY.

IN the study of wireless telegraphy, many electrical terms and instruments are encountered, making it necessary for the beginners to obtain a working knowledge of electricity before invading the more difficult subject of wireless. We have therefore devoted the first, second and third lessons to a concise and practical course in elementary electricity. We do not claim that it is complete, inasmuch as our course only covers electricity in general to give the student a better understanding of wireless telegraphy. For a better knowledge of

electricity, we recommend the reader to the many excellent text books which cover the subject in a thorough manner.

Electricity in its simplest form was known to the ancients many centuries before the Christian era. Thales, of Miletus, a city of Asia Minor, in the seventh century B. C., described the remarkable property of attraction and repulsion which amber possesses when rubbed. When being thus rubbed he found that it would attract particles of dust, dry leaves, straws, etc. This phenomenon was noted from time to time in the succeeding centuries, but it was not until 1600 A. D., that Dr. Gilbert of Colchester, England, took up the study of this subject. Because of the thoroughness with which he delved into the study of electricity, he is considered as the founder of the science of electricity. He gave the name of electricity to the peculiar force, which he derived from the Greek name "Elektron," meaning Amber.

Electricity is found in two forms, in one it exists as a charge upon a body, and is known as static electricity, while in the other form it consists of a moving current through a wire, known as dynamic electricity. We therefore have:

Electrostatic electricity, that branch of the science which treats with electricity at rest.

Electrodynamical electricity, that branch of the science which treats with electricity in motion.

If a glass rod is rubbed with a silk handkerchief and brought near a small pith ball, (made of dry flowers), which has been suspended by a silk thread, there will be an attraction of the pith ball towards the rod. However, as soon as the pith ball touches the rod, another action takes place: the ball



being repelled from the rod. The explanation is, that the ball originally held a charge opposite to that held by the rod, the charge being neutralized on touching the rod, and the surplus charge of the rod being carried on to the pith ball. Being that both the same charges exist on the ball and the rod, both will repel each other.

Two kinds of electricity are produced by friction, the kind of charge being dependent on the substances rubbed together. Thus if glass is rubbed with silk it becomes charged with positive electricity. On the other hand, sealing wax receives a negative charge if rubbed with flannel. Positive electricity is represented by a plus sign (+), and negative electricity by the minus sign (-). Where the current has been perfectly neutralized so that no polarity exists, a combination of both signs is used (+).

While a charge may be given to a body by contact, it is also possible to charge a body at a distance, and by what is known as induction. If an electrified rod is brought near a glass cylinder, the latter will receive a temporary charge which disappears again when the rod is removed from the vicinity of the cylinder. However, if a permanent charge is desired, the glass cylinder is touched by the hand while the rod is held in the other hand near the end opposite to that being touched. A body touched or grounded while near a charged body is electrified oppositely. A body brought near a charge of electricity is electrified oppositely on the near end and similarly on the far end.

The following table represents electrical conductors and non-conductors in their respective value:

Conductors.	Insulators (or non-conductors)	
Silver	Dry air	
Copper	Shellac	
Other metals	Paraffin	Ebonite
Charcoal	Amber	India Rubber
Plumbago	Rosin	Silk
Damp Earth	Sulphur	Paper
Water containing solids	Glass	Oils
Moist air	Mica	

It must be noted carefully that the conductors do not hold static charges on them, and are therefore known as "non-electrics." The insulators, which do not carry current, hold static charges and are known as "electrics".

The capacity of a body in electricity denotes its ability to retain a charge. The total quantity that can be held depends directly on the (surface) capacity; but if we consider a certain amount of electricity, it will charge a body of small capacity to a higher degree than it would one of a larger capacity, because it can spread out more on the surface of the larger than on the smaller.

One of the most familiar types of capacity is in the form of a glass jar or bottle, coated on its inside and outside with tinfoil, held on to the glass by shellac or other adhesive. This is known as the Leyden jar, Fig. 1, the first



Fig. 1



Fig. 2

one having been produced at Leyden, Holland. A brass rod with a ball at its end is passed through the wooden cover and makes contact either by a chain

or a spring clip to the inner sides of the tin foil. The outer foil may be connected by other means. To charge the Leyden jar, the outside coating is grounded and the inside contact rod ball is touched with some charged body. To discharge the jar, the inner and outer coatings are connected together by means of a discharger, Fig 2, which consists of two connected brass balls mounted on an ebonite handle.

By means of a Leyden jar having brass inner and outer cups for substitutes to the tin foil, it may be noticed that after the jar has been charged and these carefully removed, the charge will not be found in either brass cup, proving that the charge really is held by the glass surface. It will also be noticed that in any Leyden jar, when it is discharged, there is one large spark, and an instant after a weak spark, proving that the electric charge soaks into the glass dielectric, and does not release itself upon the first discharge.

If a heavy charge of current is to be stored, a number of Leyden jars are employed, all the inner coatings being connected together, and all the outsides connected together as shown in the illustration, Fig. 3. These may all be charged or discharged together.

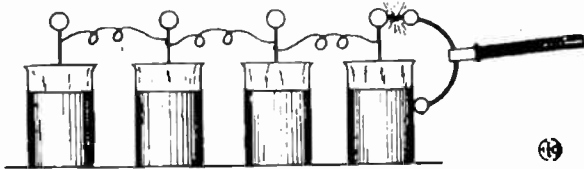

Fig. 3

The capacity of a condenser depends on the size and shape of the plate and the distance between them, as well as the insulating medium (dielectric). The larger the plates, the greater the amount of current required to charge them, hence the greater the capacity. By decreasing the distance between the plates the capacity is also increased, since the nearer a body is brought under the influence of a charged body, the more electricity it will retain.

Specific Inductive Capacity, is the name given to the ratio of the capacity of any condenser, for a given insulating material, to its capacity with air as a dielectric. The table below illustrates the relative dielectric value of various materials. As an example of its use, if a condenser has a certain capacity with air as a dielectric, it will have 2.05 times that capacity if Petroleum is substituted for the air as the dielectric.

Relative Value of Inductive Capacities.

Glass	6.5 to 10	Paraffin	1.9
Shellac	2.9 to 3.7	Carbonic Acid	1.000
Sulphur	2.8 to 3.2	Air	1.
Ebonite	2.7	Hydrogen999
India Rubber	2.34	Vacuum94
Petroleum	2.05		

To produce static electricity in large amounts, a machine employing the principle of friction is often used for experimental purposes. There are various types of these frictional machines, the most popular type being a glass cylinder upon which a silk flap rubs as it is turned. The charge is gathered by appropriate collectors.

The most successful machine of the type illustrated herewith, Fig 4 is the influence static machine, which consists of a number of plates upon which tin foil sectors have been placed. These plates revolve in opposite directions, and the current is gathered by suitable collectors. The small machine shown in the cut generates sufficient current to give a spark 3 inches long, under all conditions, even on a rainy day.



Fig. 4

CURRENT GALVANIC ELECTRICITY.

In the foregoing pages we have only considered static electricity, which is not used extensively in commercial activities, inasmuch as it does not possess such useful characteristics as the current electricity.

We have three kinds of current electricity, as follows:

Continuous or direct current, is current which flows in one direction only.

Alternating current, is current which flows in opposite directions changing its direction periodically.

Pulsating current, is current which flows in one direction, but is interrupted periodically.

In explaining the properties of current electricity and the meaning of its terms, a striking similarity between water and the electric current is made use of to serve as an effective example.

We will therefore consider a tank of water several feet above the surrounding ground, as in the instance of reservoirs of municipal water supplies. If a pipe be connected to this tank, and the pipe be brought to a lower level, there will be considerable pressure exerted in the water coming through the pipe. This pressure may be gauged in pounds per square inch. In electricity, we find a current similar to water, the pressure varying likewise according to the source of supply. This pressure is gauged in volts, and is also referred to as potential. Volts therefore are the units used to denote the pressure of an electrical current. Coming back to the water pipe, we note that if the end of the pipe is left open, the water will flow through the pipe at a certain rate. This may be termed in gallons per minute if necessary, or a smaller unit, if the rate of flow is very slight. The rate of flow of the water will be in proportion to the pressure of the water, and also in ratio with the size of the pipe. If the pipe is larger, and the pressure greater, the rate of flow is likewise higher. In electricity, we measure the flow of current through wires in the term of Amperes, and analogous to the pipe with the water, the greater the voltage (pressure), and the larger the conductor, the more current will pass.

For the resistance the conductors offer to the electric current, as in the instance of the water pipe, the term Ohm is used. Ohm is the unit for denoting the resistance offered to the passage of electric current in a conductor. We therefore note that the lower the number of ohms resistance in a conductor, the greater the number of amperes which will pass for a given voltage. Also, the greater the voltage, the more amperes will be passed through a given resistance.

As every part of the conductor offers resistance to the flow of electricity, a certain amount of pressure or force is necessary to overcome this resistance.

This force is called the **ELECTROMOTIVE FORCE**, or abbreviated **E. M. F.**

The unit in which the **E. M. F.** is measured is the **Volt**.

The **E. M. F.** is the whole electrical pressure existing in a circuit. This force may not be the same at every point in the circuit, and it may vary in pressure between one point and another. This difference is called the **POTENTIAL DIFFERENCE** or abbreviated **P. D.**, and is measured in the same unit as the Electro Motive Force, the **Volt**.

In the early part of this lesson, we have learned that electricity of the static form can be produced by friction and influence, but now as we are considering current electricity, we will consider the chemical means of producing electric current.

If a piece of copper sheet, and another piece of zinc sheet are placed in a weak solution of sulphuric acid and water, an electric current will be generated, which may be noted by ringing a bell. The electric current is formed through the decomposition of the zinc by the powerful action of the acid. The copper sheet is not attacked by the acid, but is used merely to form the complete circuit, which starts from the copper sheet through the conductor, and back to the zinc, after which it goes through the solution and again reaches the starting point, the copper sheet. The two exposed plates are named poles or electrodes, and sometimes elements, Fig. 5. The solu-

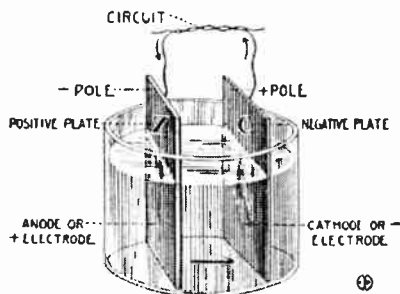

Fig. 5



Fig. 6

tion is termed the electrolyte, the entire apparatus being known as a galvanic cell, or galvanic battery. When a number of cells are combined together in order to obtain a heavy current, this group is called a battery, though battery is often used incorrectly to denote a single cell. The flow of current is always from the inactive element to the active, which in the majority of cells is zinc. The path through which the current is obliged to pass in its journey from one element to the other is termed the circuit.

There are many forms of cell, and a description of each type would require more space than we can grant to the subject. However, the most used type is the dry cell, see fig. 6, which though named a "dry" cell, is not dry, actually speaking. If such a cell is opened, we find a carbon rod passing through the center and surrounded by absorbent material, saturated with the active chemical. The containing case is made of zinc so that the chemical can attack it from the inside and thus generate the current.

Another type largely used in wireless telegraphy by virtue of its excellent constant service is the **Lalande Primary Cell**. The electrolyte is a solution of caustic soda, while the plates are of zinc and cupric oxide. The electrolyte is usually covered with a layer of paraffin oil to prevent evaporation. While the cell furnishes only but .07 volt, it has high amperage and constancy.

After a cell has been used a short interval of time such as the first cell we described with the copper and zinc plates, the voltage is noticed to decrease to a point where it cannot be used further. On investigating, it is discovered that a fine film of gas composed of enumerable bubbles has formed on the copper plate. This is known as the polarization of the cell. This gas being a non-conductor of electricity for such low potentials as are generated in a single cell, causes the voltage to be considerably reduced. But, fortunately there are means of overcoming the formation of the gas, namely Depolarizers as for instance manganese oxide. This compound having a great attraction for free hydrogen, combines with the hydrogen surrounding the copper plate to form other compounds which do not interfere with the passage of the electric current. In dry cells the manganese dioxide is used, while in the Lalande Primary Cell the copper oxide plate serves the purpose. The Gernsback Battery uses copper sulphate for depolarizer. In some wet cells we find nitric acid used, this acid also possessing the characteristic of combining with free hydrogen. In the common wet cell used in bell work we find the manganese oxide mixed in with the carbon cylinder material as depolarizer.

Electric circuits are of many varieties. In instances where the current passes through a number of separate paths on its way back to the starting point, the circuit is known as a multiple circuit, and the individual circuits are said to be connected in multiple, or parallel. Fig. 7. Each small branch

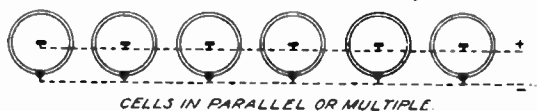

Fig. 7

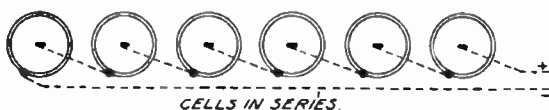

Fig. 8

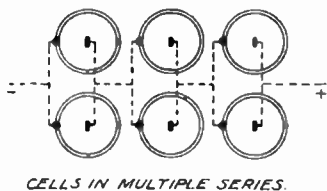

Fig. 9

is known as a shunt or branch. If all the circuits are connected together in such fashion that the current must travel through each in perfect succession, then the circuit is known as a series circuit. Fig. 8.

In connecting cells into batteries, it is important to pay careful attention to how the cells are connected. If all the cells are connected so that the zinc of one cell is connected to the copper or carbon of the next cell, they will be connected in series. The voltage in this instance will be equal to the sum of all the voltages of the individual cells, but the amperage will be equal to that of one average cell. On the other hand, if we connect all the cells in parallel, connecting the zinc elements together, and the carbon or copper elements together, then the potential will be the same as the voltage of one average individual cell; but the current will be equal to the sum of all the individual amperages. Combinations can be made so that the desired amperage and voltage is obtained. Fig. 9



Fig. 10

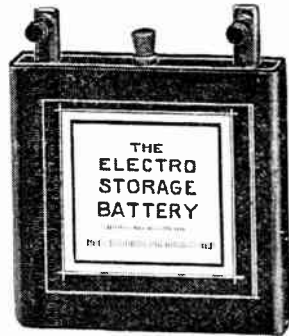

Fig. 11

Electricity may also be stored as in the instance of water. Such an apparatus capable of storing electricity is known as the storage battery, and it operates on the principle of causing certain chemical changes while current is passing into the cell. On the current being disconnected, these chemical changes will begin a reverse action, generating an electric current. See figs. 10, 11.

Coming back to our problem of water and electricity, we find that in water, the resistance, pressure, and quantity of flow in a pipe, bear a mathematical relation to each other. In electricity, an eminent scientist, George Simon Ohm, of Germany, (1827) founded a law showing the definite relations of resistance, voltage, and amperage, this law being known as Ohm's Law, which is the all important factor in electrical calculations.

Ohm's Law states:—

$$\text{Current} = \frac{\text{Electromotive Force}}{\text{Resistance.}}$$

or expressed in an Algebraical equation:

$$C = \frac{E}{R}$$

Let us illustrate the application of this rule in a practical example. We have a winding which has a resistance of 100 ohms, this having been determined by measuring instruments. We want to find the amount of current at 25 volts pressure which will flow through this winding. Looking at Ohm's Law, we have

$$C = \frac{E}{R}$$

substituting the voltage (25) for the E, and the ohmage (100) for the R, we have the equation:

$$C = \frac{25}{100} = \frac{1}{4}$$

$$C = \frac{1}{4}$$

Therefore the winding will allow $\frac{1}{4}$ ampere to pass through it. Ohm's Law may be written in other ways, to allow all factors included in it to be figured. Hence we have:

First: $C = \frac{E}{R}$ for determining the current consumed or passed by an apparatus or conductor.

Second: $E = C \times R$ for determining the voltage required to pass a definite current through a given resistance

Third: $R = \frac{E}{C}$ to determine resistance required for a given current and voltage.

From these three formulas most any simple electrical problem may be figured. The reader will undoubtedly be able to use these without further instructions, and will find these formulas a great help in figuring out daily problems encountered in electrical work of any kind.

The most important electrical units as we have just learned are the ampere, volt, and ohm. These units were originally determined by electrochemical methods, in which the decomposition of water was taken as the means of figuring the exact unit, but to-day both ammeters and voltmeters are used. These instruments consist of small windings mounted on a metal frame-work which is placed between the poles of a permanent magnet. As the current or voltage is increased, the needle which is fitted on to the metal frame-work moves across a scale and indicates the strength of the voltage or current, as the case may be. The only difference between voltmeters and ammeters, figs. 12, 13, is that they have been marked differently, and that one has a suitable winding for the volts, while the other is suited for the amperage. Ammeters are usually connected in series with circuits in which the amperage is to be indicated, and voltmeters are connected across the two wires of the circuit. In measuring resistance, a comparison is made between a known value, and the unknown resistance in the circuit being tried. An instrument indicates when both circuits are evenly balanced, and then by reading the amount of resistance in the known circuit, the ohmage of the unknown circuit is determined. This apparatus is known as the Wheatstone Bridge.

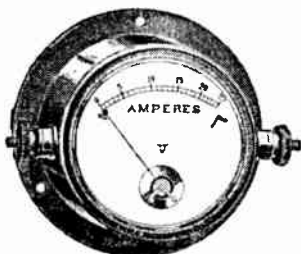

Fig. 12



Fig. 13

Other terms have been derived from the three units we have discussed in the preceding paragraphs. Watt is a term which combines volts and amperes; one watt being equal to a current of one ampere at a pressure of one volt. If we have a current of 10 amperes and 50 volts potential, we have 500 watts. If we have a pressure of 2 volts, and a current of 3 amperes, we have a wattage of 6. All statements of current made in watts are more definite than merely in either volts or amperes, since individually these units are not complete without the other. If we have a current of one watt for one hour, it is known as a watt-hour. If we have a current of 1,000 watts, it is called a kilowatt, this unit being the standard for the calculation of heavy currents. Transformers for wireless telegraphy are rated in kilowatts, as well as dynamos. Electric current is sold by the kilowatt-hour, which means the using of 1,000 watts for one continuous hour. It requires 746 watts to equal one mechanical horse-power when comparing mechanical and electrical energy. Thus it will be noted that a one kilowatt motor is about $1\frac{1}{4}$ H. P. One mechanical horse-power is the force required to raise 33,000 lbs. one foot high in one minute.

Lesson Number Two.

THE PRINCIPLES OF MAGNETISM.

THE name "Magnet" originated from the name of a town, Magnesia, in Asia Minor, where the loadstones, which could attract small particles of iron, were first found. The first discovery is recorded as having been made by the philosopher Plato, who was borne 480 years before the dawn of the Christian Era.

Magnetism is found in nature in the form of ore, commonly known as loadstone, or magnetite by the mineralogists. It is found in many parts of the world, and in the United States there is a fair supply. The compass, fig. 1, a magnetic device, is an invention which rendered navigation over seas possible, and is attributed to the Chinese whom are said to have used it before it became known in Europe.

After 400 years following the invention of the compass, Dr. Gilbert, who will be recalled by the reader as the first active worker in static electricity, published in England his famous work "De Magnete" in the year 1600, which comprised a complete account of the remarkable characteristics of magnetism.



Fig. 1.

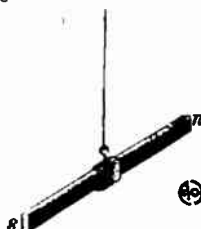

Fig. 1a

If a bar of iron is taken and treated with a loadstone, it will become possessed of magnetism. If suspended on a thread, fig. 1a, it will point north and south, acting as a compass. The end pointing north is the south pole of the compass, while the end pointing south is the north pole. If a needle or other steel object be brought near the bar magnet, it will be attracted at either end, but in the center of the bar there will be found comparatively no magnetism. This illustrates that the magnetism at the center is neutral, increasing in strength toward the ends and in opposite polarity of magnetism at these ends.

Now, if the bar magnet be laid under a piece of white paper and coarse iron filings be scattered over the paper, the filings will arrange themselves in wave-like formation, the lines extending from the magnetic poles, and in faint lines circling to the opposite poles, fig. 2. These lines represent the magnetic lines of force, which extend from

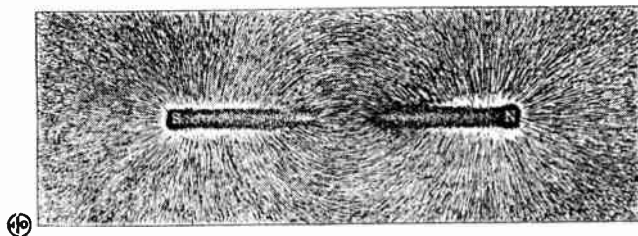

Fig. 2

one pole to the other in all magnets, the strength being less as the distance from the poles increases. These lines of force in passing from one pole to the other are known as the magnetic circuit, fig. 3. A closed magnetic circuit is one where the magnetism is limited to a continuous iron mass, the magnetism having no gaps to cross in order to complete its magnetic circuit from one pole to the other. A closed magnetic circuit is usually employed in watchcase telephonic receivers and possesses many advantages over the open magnetic type. The open magnetic circuit is one in which there are air gaps for the lines of force to bridge in their travel from one pole to the other. This form of magnetic circuit is the one largely employed.

We have learned that a magnet always possesses two poles, the north and the south, represented by N and S respectively.

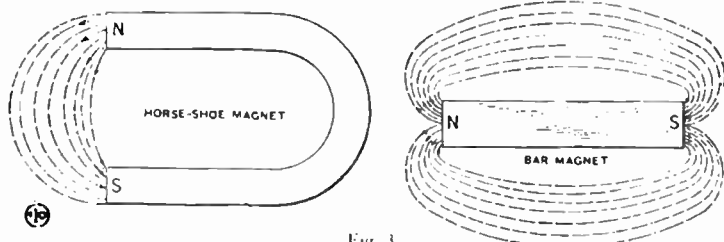

Fig. 3

If we consider the earth as the fundamental magnet, then in comparison with it, we ought to call that pole of any magnet which tends to point north, a south pole, and vice versa. The so-called north pole or end of a compass needle, is thus really a south pole, and its south pole or end, is a north pole. The reason for this inaccuracy is probably due to the mariner's compass being the first general practical application of magnetism. That end of the needle which points always to the north would naturally be called its north end. According to the modern theory of magnetism this is an inaccurate name for it. A more correct designation would be the north-seeking end or pole.

If we take a magnet and suspend it on a thread, it will point north and south, so that we can mark the ends with the polarity they possess. The end pointing north being marked with an "S" and the end pointing south with an "N." If we treat another bar magnet in the same manner, we can then bring the last magnet near to the suspended magnet so that both "S" poles are near together. The suspended magnet will immediately begin to turn away from the other magnet, showing that there is a repulsion. Now, if the "N" poles are treated in the same way the results will be the same, which teaches us that like poles in magnetism repel each other, identically as in static electricity. Then if the "S" pole of one magnet is brought near to the "N" pole of the other magnet, there will be an attraction; the suspended magnet turning and following the one held by the hand. Unlike poles attract each other. It will be noticed that if it were possible to reverse the polarity of the magnets at a critical moment, so that opposite poles would attract each other while the like poles would repel each other, the suspended magnet would assume a rapid rotary motion, depending on the frequency in the reversal of polarity. This is the principle of the electric motor, the magnetism being changed at the critical moment by means of electricity.

Magnetic bodies are those which can acquire and retain magnetism.

Paramagnetic bodies are those which are attracted by magnetism.

Diamagnetic bodies are those which are repelled or on which magnetism has no effect. The following table illustrates common metals and substances in their relative magnetic order.

Paramagnetic.

Iron
Nickel
Cobalt
Manganese
Chromium
Cerium
Titanium
Palladium
Platinum
Oxygen
Ozone

Diamagnetic.

Bismuth
Phosphorus
Antimony
Zinc
Mercury
Lead
Silver
Copper
Gold
Water
Alcohol
Tellurium
Selenium
Sulphur
Thallium



Fig. 5



Fig. 4

(Courtesy "Modern Electrics.")

The best method of forming a bar magnet is to magnetize each end individually. One end is first rubbed from the center to the end by a permanent bar magnet and then

the opposite end is rubbed from the center to the other end, as shown in the sketch, fig. 4 with the opposite pole.

A horse-shoe type of magnet as generally sold by electrical houses, see fig. 5, is nothing more than a bar magnet with its two ends brought near to each other by bending it. While not in use, a small piece of steel is placed across both poles, this piece being known as the "keeper." Its purpose is to form a closed magnetic circuit and thus help to retain the magnetism.

If a magnet be placed in acid so that the outside surface be attacked and dissolved, it will be found that the magnetism is greatly lessened, if not entirely destroyed. This proves that the magnetism is largely confined to the surface. For this reason, it is advisable to use a greater number of smaller magnets, in order that a large surface may be thus formed. In practice this method is employed, a number of permanent magnets with all the "N" poles together and all the "S" poles together, and having one common iron pole for each polarity is used, the magnets so made being known as laminated, built-up, or compound magnets.

Heat has a temporary effect of removing magnetism from bodies, but only while the body is heated, the magnetism again being present when the metal cools. Jarring a magnet will permanently weaken it, the degree of loss being in proportion to the conditions. Inasmuch as many conditions effect permanent magnets, in the electrical industry where magnets are manufactured for accurate purposes, as in measuring instruments, the process is thorough, and the magnets subjected to boiling, jarring, and other tests so that the surplus magnetism may be removed and absolute permanency assured.

A magnetic circuit is similar to an electric circuit, starting from one pole and travelling to the other pole. Magnetism may be produced inductively, by bringing a permanent magnet in the vicinity of a piece of iron or steel, when this object will be found to possess magnetism, but it loses this power as soon as the permanent magnet is removed to a greater distance where the magnetic lines of force become too weak to induce magnetism. It is also possible to locate magnetism in a piece of steel rod, so that the various sections will have north and south poles. This is accomplished by magnetizing the independent sections with a powerful magnet. It is also possible for steel or iron to carry magnetism through it yet only be magnetized as long as in actual contact with the permanent magnet exists. The best grades of steel retain the magnetism the longest time, and display great permanency. The softer the steel, the less efficient it is for use as a permanent magnet. Iron is less efficient; the softer grades being worthless for making permanent magnets. For this reason, soft iron is used in electro-magnets where it must be completely demagnetized after the passage of the electric current.

ELECTRO-MAGNETISM.

Early experimenters suspected that some relation existed between magnetism and electricity, but it was not until 1819 that this was proven by Oersted of Copenhagen, Denmark. He demonstrated that a wire carrying a current would deflect a compass needle. The needle tends to turn at right angles to the direction of the current in the conductor, the degree of the angle being in proportion to the strength of the current. The illustration, fig. 6, represents the direction of the current and the position of the N and S poles of the needle.

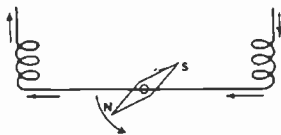

ELECTRIC CURRENTS' EFFECT ON COMPASS NEEDLE

⑧

Fig. 6

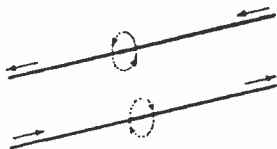

MAGNETIC FLUX OF CURRENT

⑨

Fig. 7

Around a wire carrying an electrical current, a magnetic field is formed, this field extending in concentric lines further and further away from the conductor. Only current electricity produces marked magnetic effects in conductors, static electricity having no appreciable effect.

In the next cut, fig. 7, are represented the lines of force in dotted lines produced by two opposite flowing currents in two wires.

If we take a heavy piece of wire and bend it so as to pass over and under a pivoted compass needle as shown in the cut, fig. 8, it will be found that by connecting both binding posts to a source of current, this current may be detected by the reflection of the compass needle as well as its relative strength. This instrument is known as the galvanometer, and in its more complicated and perfected forms is used for detecting feeble electric currents.

If a wire carrying an electric current is wound into a spiral form, it will exert a powerful magnetic field in the direction of its axis, the polarity being controlled by the flow of current as illustrated by the accompanying cut, fig. 9. This wire coil is called a solenoid.

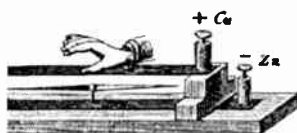

Fig. 8
(Courtesy "Modern Electrics.")

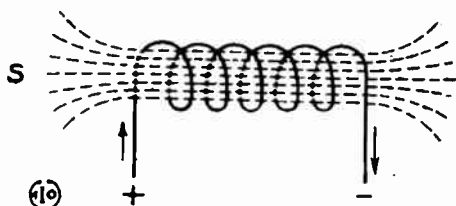

Fig. 9

If a number of turns of wire be wound on a wooden spool and current passed through the winding, a small iron rod will be pulled into the spool. If a spring balance is connected to the rod, the strength of the pull may be gauged. A form of commercial meter formerly used and known as the "plunger" voltmeter employed this principle, the spring being in this case fitted with a pointer which indicated on a scale marked in volts, and if desired the scale could be graduated in amperes instead. If iron is used, it will be pulled into the spool, no matter in what direction the current is flowing, inasmuch as soft iron does not possess permanent magnetism and is therefore attracted by magnetism of either polarity.

To construct an electromagnet, a piece of soft iron is first covered with a thin sheet of paper, in order that the current flowing through the wire will not form a by-path through the iron accidentally, this being called "grounding." Over the paper, the layers of wire are wound, there being two end pieces (coil or spool heads) in order to secure the winding in place, these being either of fibre or hard rubber. The iron rod around which the winding is placed is known as the core. The accompanying diagram, fig. 10, represents the polarity imparted in the core with the direction of current given. In order to obtain the maximum efficiency from electromagnets, usually two are mounted on one steel or iron bar, the N and S poles being connected together. This greatly increases the magnetic force for a given current strength, the gain being derived through the reduction of the magnetic leakage. The electromagnet when subjected to alternating magnetizing currents, produces a heating effect in the iron core which is known as hysteresis.

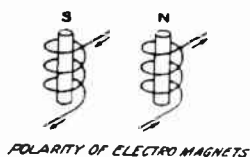

Fig. 10

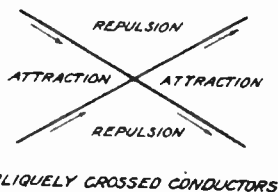

Fig. 11

Hysteresis is that magnetic inertia or resistance to change in polarity of the molecules evidenced whenever the magnetizing power is reversed or changed. The molecules of the iron resist this change in polarity, and this results in molecular friction, (as it is often called), whenever the reversal of magnetism is raised to a certain frequency or number of times per second, the hysteresis effect or friction is soon made evident by the heating of the iron mass.

This phenomenon of electromagnetic induction will be treated upon again in a later chapter, dealing with detectors.

ELECTRODYNAMICS.

Electrodynamics is that branch of electrical study which deals with the action of one current carrying conductor upon another one.

One of the laws relative to electrodynamics is:

Two parallel conductors attract each other when the currents therein flow in the same direction, and repel each other when the currents flow in opposite directions. This rule is applicable whether the wires are of the same or different circuits, and whether the wires are straight or curved.

Another rule applying to the action of conductors states:

Conductors crossing each other obliquely tend to take up a position in which

they are parallel and the currents in them are flowing in opposite directions. This is illustrated in the accompanying fig. 11.

There is no tendency for the wires to be attracted or repulsed lengthwise, the action being entirely sideways. For illustrating the attraction and repulsion of electrical conductors, an apparatus known as "Ampere's Stand" is employed. In the cut, fig. 12, the principle is briefly shown, the instrument consisting of two heavy loops of wire, one being pivoted so as to freely revolve, while the other is fixed. Currents from different circuits may be used on both coils.

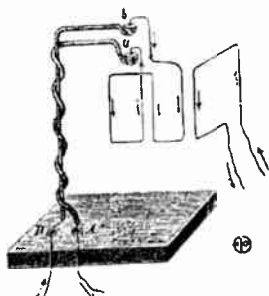

Fig. 12

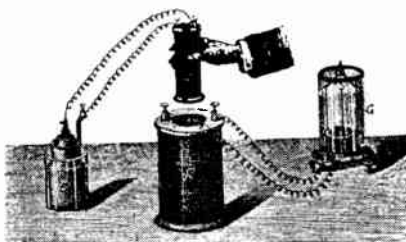

Fig. 13

ELECTROMAGNETIC INDUCTION.

Electromagnetic induction is the production of electric current in a wire, through the action of a magnetic field.

In 1831, Faraday of England, demonstrated that the motion of a magnet near a closed circuit produced an electric current in that circuit. Moving the circuit and keeping the magnet still produces the same result, the essential element being to cut the magnetic lines of force by the moving of the wire or magnet. An apparatus producing this effect consists of a bobbin of wire connected to a galvanometer. When a permanent bar magnet is plunged into the center of the spool, there is a deflection of the needle, proving that a current has been produced. But, as soon as the bar comes to rest against the bottom of the spool there is no further deflection of the galvanometer needle, and it returns to its normal position. However, as soon as the bar is pulled out of the spool, the galvanometer needle swings in the opposite direction demonstrating that a current has been produced, which flows in the opposite direction to that produced when the bar was being plunged into the spool. It is therefore noted that the current induced in the circuit is governed by the movement of the magnet. While either the spool or magnet remains stationary there is no current produced, but upon altering the position of either factor, a current is generated.

If in place of a bar magnet we substitute a small coil of wire which can fit into the larger spool, and in which current has been turned on, we find that upon plunging this spool into the larger spool, a current is again produced. As soon as this spool is removed, a current in the opposite direction is induced, exactly as in the instance of the bar magnet, fig. 13.

In the two preceding methods, the position of the two elements has been altered in order to create the induced current. Now, if we place the smaller coil within the larger one and break the electric current in the exciting spool, a current will be detected in the other circuit. When the current is turned on in the exciting circuit, the galvanometer again detects a current, but in the opposite direction. Thus by making and breaking the circuit of the smaller coil, it is possible to induce a periodic current in the other circuit. The smaller coil may be termed the **primary**, inasmuch as it contains the current which produces the magnetic flux, and the other coil which receives the induced current may be termed the **secondary**. It is by applying this principle that the **induction coils** and **transformers** for wireless telegraphy render it possible to raise a low potential to a high potential, in virtue of the ratio existing between the number of turns in the two coils.

The lines of force of a magnetic field are termed "magnetic flux," and measured by the number of the lines per unit area of the field. Whenever the amount of flux

that passes within a closed electrical circuit is changed for any cause, there is set up an induced current in this circuit. The circuit must always cut the lines of force at right angles, for the maximum effect is then obtained. There is no current induced if the circuit moves in parallel direction to that of the lines of force.

The principle of electro-magnetic induction as applied to telephones and telephone receivers is shown by fig. 14, the permanent bar magnets having two coils of wire

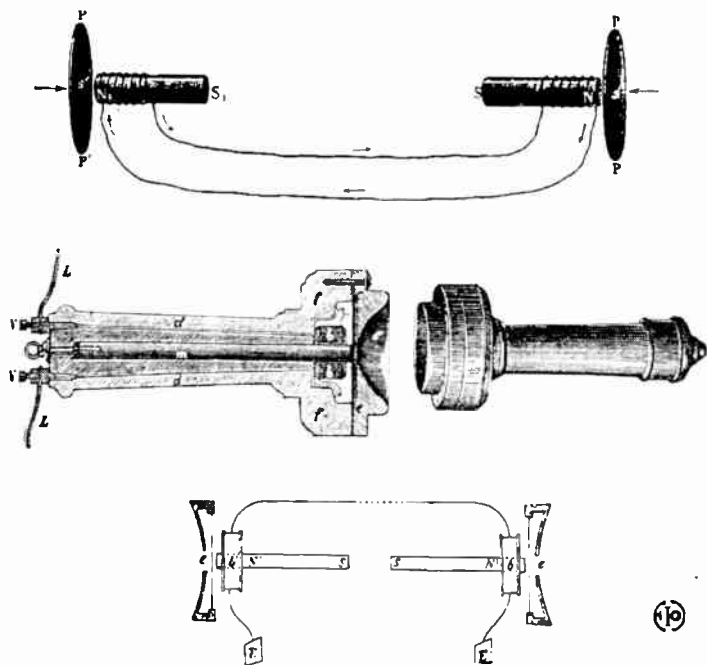

Fig. 14

placed at their ends and any change in the current strength traversing them, results in a change of the magnetic flux, attracting the iron diaphragm. The current in this case is set up and varied by the voice air currents impinging upon one diaphragm, thereby causing a change in the lines of force, and results in the production of the current.

The direction of the induced current will be opposite to that in the exciting circuit when the current is turned on. If the current is turned off, the current in both circuits will be in the same direction.

If a disc of copper or other metal is moved in a magnetic field, there will be induced currents in the metal mass, these currents being known as **Eddy currents**. If the rotation of the disc is continued for a certain length of time, the disc will become heated through the action of these Eddy currents. These currents flow in round circles, and oppose the rotation of the mass through the magnetic field. If the disc be rapidly spun and the driving power removed, it will come to an abrupt stop owing to the drag existing between the Eddy currents and the magnetic field. For this reason, metal discs or masses are employed extensively in electrical instruments where it is desired to secure a damping effect, as well as in electric brakes which have been used for street cars with some success. In motors and dynamos, the rotating portion known as the armature is laminated, the entire mass consisting of a great number of thin iron punchings which have been individually coated with insulating

paint. Thus each punching is insulated from its neighbor, and the Eddy currents thus reduced to a minimum.

When a wire is moved through a magnetic field, a mechanical drag is encountered, due to the opposition of the current generated in the wire. If the ends of the wire be connected the mechanical resistance becomes more pronounced. In all instances of electromagnetic induction, the induced currents have such a direction that their reaction tends to stop the motion producing them.

From the foregoing it has been learned that circuits have inductive effects upon each other, but these circuits also have inductive effects upon themselves, this being termed **self-induction or inductance**.

The unit of inductance is the **Henry**, and inductance is represented by the symbol-letter **L**. The effect of inductance is not as noticeable in short lengths of wire as in long lengths, and the action is considerably augmented by winding the wire in coils. If an iron rod is introduced in the center of the coil, the effects will be greatly increased. By constructing a small coil with an iron core and connecting it to a powerful battery, it will be noticed that upon opening the circuit a heavy spark is caused at the break. If the terminals of the battery alone be connected for an instant and disconnected, the spark will be entirely different and much smaller than the spark caused when the circuit with the coil is broken. This illustrates that there is an extra current produced by the action of the coil upon the circuit. If the hands be placed across the two wires which are disconnected to open the current, a shock will be experienced. If the hands are placed across the battery, no shock will be felt. This proves that the current produced by self-induction is of a higher voltage than that of the battery supplying the current to the coil. This principle of self-induction is used in gas-lighting coils, where many turns of wire are wound upon an iron core. These coils give a heavy spark upon the opening of the circuit. Primary coils for ignition of gas and gasoline engines are made in the same manner.

INDUCTION COILS AND TRANSFORMERS.

It has been learned that if a small coil of wire is placed within a larger coil and interrupted current passed through the smaller coil, there will be a current induced in the larger coil. If an iron core is placed within the smaller coil, the action will be more pronounced. Based upon these facts, an apparatus known as the **Induction coil**, also called **Spark coil**, for the conversion of low voltage currents to high voltage currents has been produced. The induction coil, Fig. 15, consists essentially of a core, usually made of straight lengths of soft iron wire, in order that the magnetism be

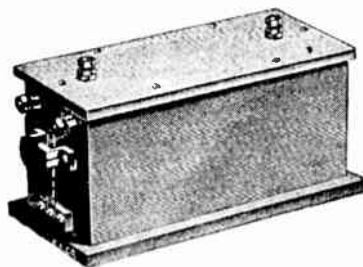

Fig. 15

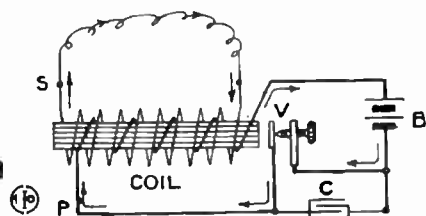
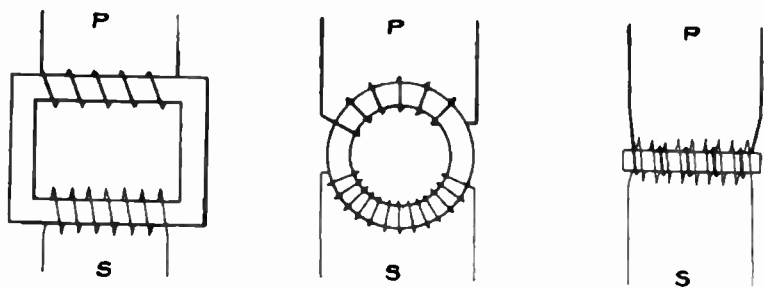

Diagram of Induction Coil.

only present when the current is passing through the surrounding winding. Over this iron core, insulating tape is carefully wound, in order to insulate the currents from the core, and on the tape a number of layers of heavy wire are placed. This is termed the **primary winding**, the core and the winding mentioned together form the **primary**. Over the primary is placed a hard rubber or fibre tube as a precaution against the sparking of the secondary into the primary. Surrounding this tube are the many turns of fine copper wire known as the **secondary winding**. In order to facilitate the construction and future repairing of these secondaries, the windings are placed on small spools or sections, which also increases the insulating value.

These sections are known as "pies." The entire secondary winding when completed is subjected to a thorough soaking in an insulating compound which has been heated to a liquid state. As it cools, it forms a solid mass of the winding which is thus thoroughly insulated. The end wires lead to a pair of binding posts usually located at the top of the coil, and to these binding posts may be connected a pair of spark balls with the rods and insulated handles. On one end of the induction coil is a spring carrying a heavy iron disc at its uppermost portion. The spring is fitted with a platinum point which strikes against a similar point located at the end of a brass adjustment screw. This is known as the vibrator or interrupter, the screw being known as the adjustable contact screw. The interrupter serves the purpose of automatically making and breaking the primary current with which it is connected in series. The magnetism of the core attracts the iron disc which is drawn to it. In so doing it moves the spring which separates the contact points and thus opens the circuit. The current being disconnected, leaves the core without magnetism which allows the disc to return to its former position and again make contact with the adjustment screw, and thus begin the action over again. A large condenser made of paraffined paper and tin foil is bridged across the interrupter contacts to reduce the sparking caused by the self-induction of the primary, this condenser being known as the primary condenser.

A transformer is an apparatus consisting of two windings placed on the same core for the purpose of transferring the current from the one coil to the other by means of electromagnetic induction. There are two main divisions of transformers, the open core and the closed core. The open core is one in which the iron magnetic circuit is open, the core consisting of but a single straight rod with both ends pointing in opposite directions. The closed core transformers is one in which the iron



CLOSED AND OPEN CORE TRANSFORMERS.

Fig. 16

magnetic circuit is continuous, the core being continuously joined. Fig. 16. The most common form of closed core transformer is that in which the core consists of four square cores joined together to form a perfect rectangle. Closed core transformers are preferred to open core types for the reason that the percentage of loss is much less than in the open core type, due to the more efficient magnetic circuit which has the minimum loss of flux. In the open core, there is a certain loss of magnetic flux at both ends. Transformers may be operated by alternating current, and are rated in kilowatts. Open core transformers may also be used on direct currents, as in the instance of the induction coil, but a means of interrupting the current must be provided. A small electric motor carrying a contact which makes and breaks the circuit may be employed. For all open core transformers and induction coils, a type known as the electrolytic interrupter may be used, which is described in a future lesson, but it cannot be used on closed core transformers.

Lesson Number Three.

DYNAMOS, MOTORS, GENERATORS AND WIRING.

UN studying the principles of magnetism the student will remember that the attractor and repulsion was caused by the action of like and unlike magnetic polarities. This principle has been applied in the electric dynamo, which is in reality an electro-magnetic engine, since the electricity must be converted into magnetism before the dynamo can operate.

As we have seen in a previous lesson, it was Faraday, who in 1831 discovered this principle. The electromotive engines are the following:

The Dynamo. The dynamo is a machine converting mechanical energy into electrical energy, or electrical energy into mechanical energy.

The Generator. If the dynamo is used to transform mechanical energy into electrical energy, it is called a generator.

The Motor. If the dynamo is used to transform electrical energy into mechanical energy it is called a motor.

An Alternator is a machine converting mechanical energy into electrical alternating current.

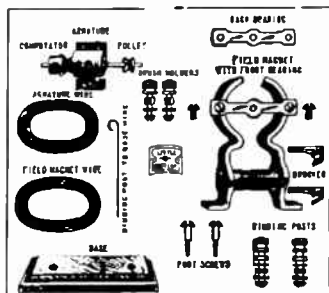

Fig. 1.



Fig. 2.

In the accompanying illustration, fig. 1, will be noticed the parts of a small battery motor, while the complete assembled motor is seen in fig. 2. The armature is the rotating member of the motor, and in this instance contains three iron pole pieces upon which are placed the windings. These windings are connected to three brass or copper segments shown to the left of the armature and mounted on the same shaft which also holds the pulley. These segments are known as the commutator, and its purpose is that of changing the polarity of the magnetism in the three pole-pieces of the armature at the critical instant, so that like and unlike poles will be approaching each other at the correct moment so as to impart a rotary motion to the armature. On this commutator, two copper strips press at opposite sides, and are known as brushes, being held in suitable clamps which are termed brush-holders. These brushes convey the current to the rotating commutator. The field contains a winding and thus produces a powerful magnetic flux in the space in which the armature revolves.

Larger motors employ the same principles and similar parts, though naturally these must be of larger construction and improved in details to perform the heavier work. Instead of three pole-pieces on the armature, a large number are used, which are very small in size, the windings being placed between these small poles or teeth. The field contains perhaps four or more pole-pieces with windings on each. Alternating current motors differ from the direct current type which we have mentioned, and more about their operation will be stated later.

Motors of the direct current type are classified as follows, according to the connections of the field winding:

A **series motor** is one in which the field winding is connected in series with the armature as shown in the illustration. This type is the usual one for small motors, and also the motors for railroad work. A series motor can be started with full load, and will easily gain its full speed under such conditions, though the speed varies considerably with the load, and is never dependable for work requiring constant speed. Fig. 3.

A **shunt motor** is one in which the field winding is connected across the armature, which, in turn, is placed across the power supply wires. This type is the one in general use. It must be slowly started but when it has gained its maximum speed, it maintains this speed fairly constant for varying loads. Fig. 4.

The compound motor is a combination of the two foregoing types, the disadvantages of each being largely overcome, and the advantages retained. The current first passes through the series field, and then to the armature which is connected in series with this field, and has the shunt field connected across its terminals as shown in the diagram. Fig. 5.

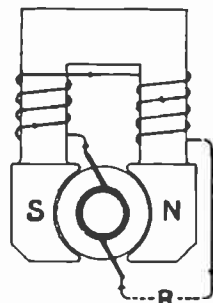

Series Wound Generator.

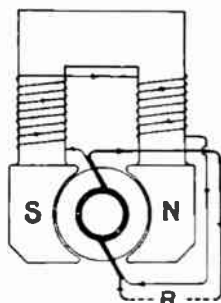

Shunt Wound Generator.

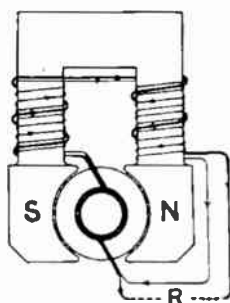

Compound Wound Generator.

Fig. 3

Fig. 4

Fig. 5

In starting motors on high voltage circuits a form of rheostat must be used. Fig. 6. This is termed a "starting box" in the case of a shunt or compound motor, and consists of a number of contacts mounted on a slate base with a handle to touch the contact, and resistance wire mounted on the back of the slate base and connected with the contacts. As the handle is moved over the contacts, the motor gains more and more speed, until the arm has reached the last contact where a stop prevents its further movement. An electromagnet immediately attracts an iron bar on the arm, and holds the arm at the last contact. The electromagnet is connected across the line and holds the arm while current is passing through the motor. Should the current fail or be shut off, the motor will continue to revolve for a few moments, and the current generated in its armature will be sufficient to hold the arm to the electromagnet. However, as the motor slows down, the electromagnet releases the arm which is forced by a spring to return to the first contact and thus cut off the line from the motor. Now should the current be again turned on, the motor will be safe as it has been automatically disconnected. Otherwise if such a device did not release the arm, the motor would come to a stop on the failure of the current, and when current was again turned on, the armature would probably be ruined or badly damaged by the rush of current, due to the fact the motor would not be producing any counter E. M. F. This electromagnet is termed "no-voltage, release" and starting boxes equipped with them are styled "automatic." To start a motor equipped with a starting box, the switch controlling the current is first turned on, and then the arm is moved slowly, waiting till the armature has attained the maximum speed on each contact before the arm is moved to the next contact. When the motor is to be stopped, the switch is opened and the motor will come to a stop. Care should be taken to see that the arm has been released before starting a motor, for the failure of the arm to return may cause damage to the motor. By covering the pole pieces of the electromagnet with thin paper its failure to operate can often be prevented.

To increase the speed of a motor, the field is weakened by inserting resistance. A special form of variable resistance consisting of an iron frame containing many turns of german silver or other resistance wire and having a handle which makes contact with contact buttons connected to different points on the wire is used, and is termed a "rheostat." By turning the handle, more or less resistance is introduced into the shunt field winding, and the speed thus varied, the more resistance inserted, the higher the speed.

A dynamo is built upon the same principles as the motor, and the student will remember that a wire cutting the lines of a powerful magnetic field causes an electromotive force to be generated in that wire and if the wire forms part of a closed circuit a current will flow through it. This is the action of the dynamo. The dynamo also has the armature and commutator, the windings in the armature cutting the magnetic lines of force and generating current. This current is actually alternating current, but is rectified to direct current through the action of the commutator. Most dynamos may be used as motors, and likewise some motors may be used as dynamos, so that the student may readily see that the details are practically the same. An alternating current dynamo embodies the same principles, but has two brass rings on

the end of the armature shaft in place of the commutator, with two brushes pressing on same. These brass rings are termed collector or slip rings.

The voltage of a direct current dynamo at a given speed may be varied by changing the current in the field winding. This is accomplished by means of a rheostat usually mounted on the switchboard. The speed may also be raised with a corresponding increase in the voltage. Dynamos, as in the instance of motors, are made in three types, series, shunt, and compound. A fourth type sometimes employed, is separately excited, which consists in having the current for the field supplied by some external source of current, such as a battery, or generator. A small direct current generator is often mounted on the same shaft as the armature of an alternating current dynamo, and serves the purpose of furnishing the field winding with direct current. Of the various types, the shunt is the most common for charging storage batteries etc., or where the load is constant, while the compound type is used where the voltage must be kept constant with a varying load. In alternating current installations, the generators must be separately excited with direct current inasmuch as the alternating current is not suitable for this purpose.

In changing alternating current to direct current, or direct current to alternating current, a motor directly coupled to a generator on a common base is used and is known as a motor-generator set. The motor is operated on the current which is to be converted. In wireless telegraphy where a transformer is used and only direct current is available, the direct current operates the motor of a motor-generator set, while the generator supplies the alternating current.

A simpler form of this combination is the rotary converter, which consists of a single machine having slip rings at one end of its armature, and the usual commutator at the other end.

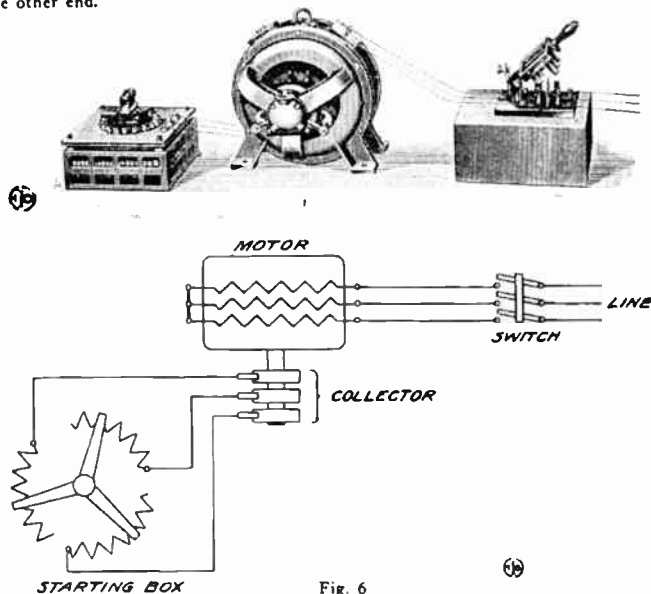

Fig. 6

POWER TRANSMISSION AND WIRING.

From the generator in the power station, the leads are brought to a switchboard, which contains the voltmeters, and ammeters, as well as all the rheostats and other controlling devices. The switchboard is the "brain" of the entire power station, for it is the controlling center for all the machinery and distribution of current. From the switchboard the wires pass out through tubes in the walls of the station and thence to the consumers of the current.

In the country, overhead construction is employed, as it is comparatively inexpensive as compared with the underground distributing systems employed in large cities. The overhead system, however, possesses a number of disadvantages, the damage from storms, and the objectional appearance being among the most important.

From the porcelain or composition tubes through the walls of the power station, Fig. 7, the wires pass to the insulators on the cross arms of the poles. If the current is direct current and of a suitable voltage for power and lighting purposes, the leads to the various buildings are taken off the nearest wires, these leads passing through porcelain tubes or iron pipes and into the house. The leads are then connected to a fuse block, which usually consists of a porcelain base with suitable screw parts mounted on same, fig. 8. Into these screw parts are placed porcelain plugs which have a metal screw portion to fit the thread of the parts in the porcelain base. Each plug contains a fine wire which connects the screw portion with a contact button on the bottom, the wire being protected by a mica window. The porcelain base is known as a fuse cut-out, and the plugs as fuse-plugs.

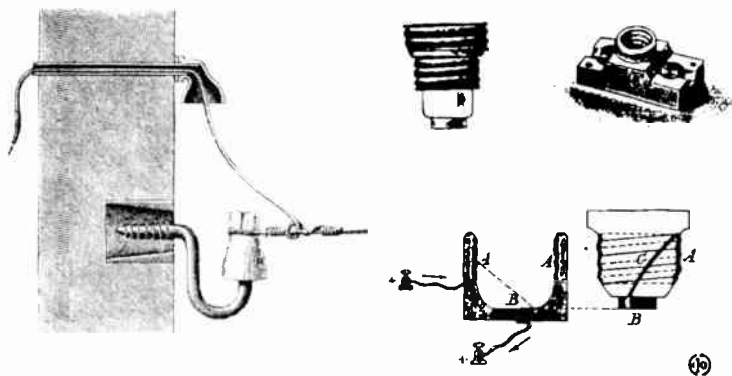

Fig. 7

Fig. 8

The purpose of the fuse wire is to protect the circuit beyond the fuse block from heavy accidental currents. Fuse wire is composed of an alloy, of tin, lead and other metals, which melts at a low temperature. Fuses and fuse wire are rated at the current which will cause the wire to melt. On plug fuses the number of amperes is stamped on

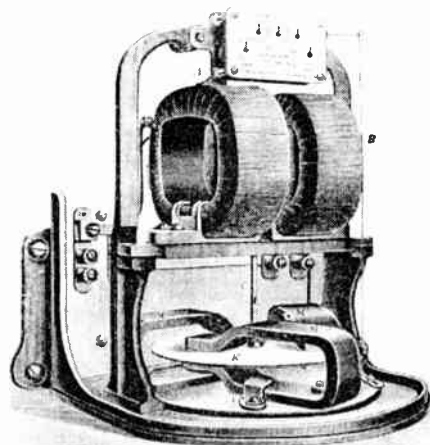

Fig. 9

the bottom contact button, or on the rim, while in fuse wire, the rated ampere capacity is marked on the containing spool. Another type of fuse usually employed for power purposes is the cartridge fuse. This consists of a fibre tube, with metal parts for the connections at both ends and containing fuse wire which connects both metal

parts within the tube and is surrounded by asbestos powder which quickly extinguishes the arc formed and protects the fibre tube from being blown to pieces. In the plug fuses the mica window permits an examination of the fuse wire, so as to determine whether it has been melted or "blown out," while in cartridge fuses the label contains a device to indicate when the fuse has been melted. Fuses should be used in all instances where apparatus is operated on 10 volts or more, or on storage batteries to protect the apparatus and wiring against sudden heavy currents which might cause damage.

From the fuse block the leads are usually brought to the recording watt-hour meter, which records the amount of power used by the consumer. In certain localities, where cheap electric power is available through the use of water supply, the current is charged to customers by the month, based on a fixed number of lamps. An accurate switch automatically shuts off the current or flashes the lights when a single lamp or more are used in excess of the contracted number, controls the current, protecting the company from fraud. However, to return to the watt-hour meter more generally used, we find that it operates on the same principles as the motor, the inside construction, Fig. 9, consisting of a small armature turning on jewelled bearings and with a small silver commutator and brushes. A field winding exerts a magnetic field in which the armature rotates the field flux being in proportion to the current used; the field coils being connected in series with the circuit. The armature, being supplied with current in shunt with the power circuit, rotates in proportion to the voltage used, and is connected through a series of gears to pointers which indicate on dials the number of watt-hours of energy consumed. On the bottom of the armature shaft a copper or aluminum disc is fixed which rotates with the armature and passes between the poles of three powerful permanent magnets. The Eddy currents in the disc retard the rotation of the armature, so that by moving the magnets nearer to the edge of the disc more drag and more retardation can be secured. Thus the speed can be accurately regulated so as to coincide with the readings of a standard watt-hour meter.

There are five dials on the common watt-hour meter, these dials being respectively marked from left to right, 10,000,000, 1,000,000, 100,000, 10,000, and 1,000. These figures represent the number of watt-hours represented by one complete revolution of the individual pointer on each dial. Each dial is marked from 1 to 0 which represent tenth parts of a complete revolution. One complete revolution of the dial on the extreme right marked 1,000, will cause the neighboring dial to the left to indicate 1 on its dial, and so on. The reading is therefore taken by noting the readings from the first dial to the left to the last dial to the right. In order to determine the current consumed during a definite period of time, it is necessary to know the reading of the meter at the beginning of the period, and this figure is subtracted from the last reading at the expiration of the period, thus giving the number of watt-hours for the period between both readings.

From the meter the current is conveyed to the various fixtures and appliances. In dry locations this wiring is often placed in wooden moulding which has suitable grooves to hold the wire. After the wiring is in the grooves, a covering commonly named "capping" is nailed over the moulding. In places where there is considerable moisture such as cellars or porches of houses, cleat wiring is employed, which consists of running the wires between porcelain blocks spaced at every four feet. Two screws pass through the two cleats and the wire is secured between the jaws of both blocks. Knob wiring is also employed, which consists of using porcelain knobs in place of cleats, the both wires being individually supported on a separate row of knobs. In houses where the wiring is concealed iron piping is passed between the floors and walls, this piping being known as conduit. At regular intervals where fixtures are to be placed, an iron box is inserted between the lengths of the piping, these boxes being named outlet boxes. The wires pass through the outlet box and again into the next length of piping, so that the wires must be scraped and the connections for the fixtures soldered on each wire which is carefully covered with tape afterwards. For short stretches or where it is desired to run a line for heavy current, steel armored but flexible tubing containing the wires firmly imbedded, is employed, this being known to the electrical trade as "BX." It is especially recommended for carrying the current from the cellar where the meter and fuse cut-out are located, to the upper floors where a wireless station is to be operated. The BX is fastened to the walls by means of iron strips which firmly clamp it and are usually known as "straps."

In the cities, the electric feeders are placed underground in conduits. At convenient intervals small rooms are placed under the street and can be reached through a hole in the street which is normally covered with an iron lid, the entire structure being termed a "man hole," fig. 10. On the walls of these rooms are the many cables, supported on iron racks, which pass from one section of the conduit to the next section, and thereby allow a workman to examine and test the different cables as well as to allow new cables to be passed through the conduit or old cables removed. From the conduits the leads are brought into the houses through the cellars where connections are made to the cutout and the meter. From the meter the same wiring as previously described is used.

In alternating current transmission, the voltage is often far above that which

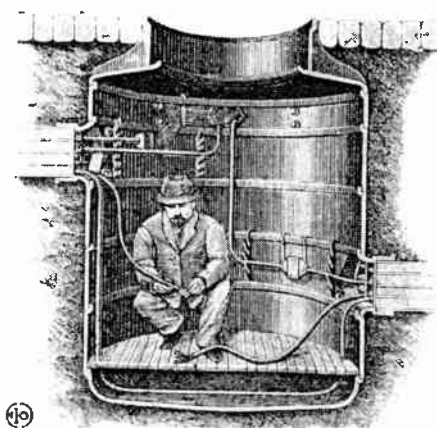

Fig. 10

may be used for lighting and power purposes, the reason being that the lower the amperage and the higher the voltage, the less copper is needed in the conductors and thus a large saving in the construction of the line is accomplished. This is analogous to an instance where water represents electricity and a pipe represents the wire, and a certain quantity of water measured by gallons must be passed through the pipe to be delivered at the other end. Now, if we employ a powerful pressure to force the water through, a small pipe may be used, but if we employ a large quantity of water with little pressure behind it, a large pipe must be employed to obtain a suitable amount of water at the other end. The pressure illustrates the voltage which is applied to force a greater current through a smaller wire. Therefore, in alternating current the voltage is usually as high as possible in order to gain the advantage of using smaller copper conductors. In overhead construction the student has probably noticed iron boxes on the poles at intervals and did not know the purpose of these boxes. These boxes are transformers, fig. 11, and contain two

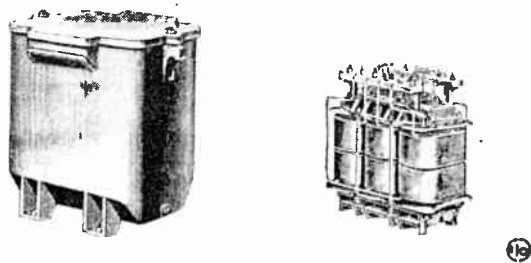

Fig. 11

windings, the primary being connected to the power supply while the secondary is connected to the consumer's wiring. The transformer is of the closed core type, and has very high efficiency, usually ranging between 92 and 98 per cent. It is termed a step-down transformer, since the voltage is stepped down in this instance. The current of the line is thus lowered to a suitable voltage which the consumer can employ, so that the advantage gained in employing high voltage does not cause any inconvenience to the consumer. The transformer can also be used to step up the current. For instance, if for reasons of safety a low voltage can only be sent through the wire, the tension can be increased or stepped up by the use of a transformer to any voltage desired at the place where it is to be used.

If the transformer is to be used to step up a current, the secondary winding has more turns of wire than the primary, and vice versa, if the current has to be stepped down, the primary has more turns of wire than the secondary. Figs. 12 and 13 are hook-ups of transformers connected in series and in parallel.

Alternating current is gaining in favor over direct current for power transmission, and it is probably a matter of only a few years before it will be extensively used and will supercede direct current in all transmissions of any reasonable distance.

Alternating current motors are of various types, which would occupy more space to describe than this course permits, but it is important to know that the most common type in small sizes is the induction motor. This type consists of a number of iron poles with field windings, mounted on the motor frame, the windings being connected to the power supply. The moving member is not named an "armature" but is known as the rotor. The stationary winding is called the stator. It consists of many punched discs which are insulated with varnish and mounted together on a steel shaft. In suitable grooves in these discs are heavy copper wires which are connected together, though they have no connection with the current supply. The action of the motor is therefore based on induction effects in these windings and in the iron discs, causing the rotary movement. There are other types besides the induction, notably the slip ring type which is extensively used.

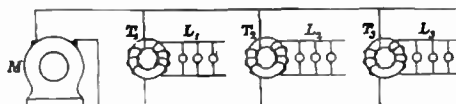

Fig. 12

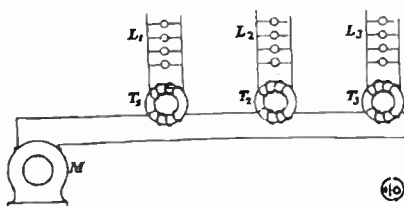

Fig. 13

Alternating current differs from direct current as already stated, by the fact that it changes its polarity at regular intervals. At one instant a wire carrying an alternating current will be the positive pole while at the next instant it will be the negative pole. The current begins at 0 voltage and rises to the maximum positive voltage and then descends to 0, but immediately begins to arise to the maximum negative voltage and then descends to 0, which may be noticed in the diagram,

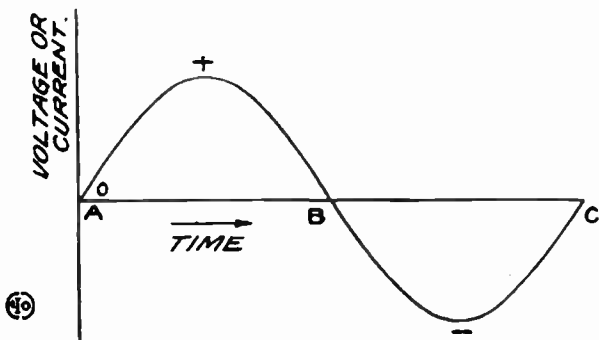

Fig. 14

fig. 14, where the straight center line represents time elapsed, and also 0 potential. One complete period in which the maximum potentials in both polarities have been reached is termed a cycle. Alternating current is always specified in cycles, as this constitutes an important item which is needed in the furnishing of proper apparatus and machinery to operate on this current. Standard power circuits employ either 25

or 60 cycles and lighting circuits 60, 125 and, in some instances, 133 cycles, per second. An alternation is half of a cycle, and represents the rise and fall of one potential cycle. The frequency is the number of cycles per second, and usually is employed in connection with the number of cycles, thus, if a motor is said to operate on a frequency of 60 cycles, it means that the motor will operate on an alternating current having 60 cycles per second. If frequency is not mentioned in connection with cycles, the meaning is lost. In the diagram the relation of the terms may be clearly seen, the alternation being from A to B or from B to C, and the cycle from A to C.

In some power transmissions, a number of cycles may be employed at the same time, and thus when one cycle is rising towards its maximum positive voltage, the next cycle is just beginning, while a third cycle may just have passed through half of its period. Each one of these separate cycles are termed *phases*, a *single phase line* being one in which only one definite cycle exists, while in a *two phase line* there are two cycles at the same instant, and in a *three phase line* there are three cycles at the same instant. The study of these complicated forms of current transmission may be thoroughly covered by referring to text books which cover the electrical engineering field, but this passing word is all that can be mentioned in the limited space of this course.

In direct current transmission, a method of great convenience and representing a 2 $\frac{1}{2}$ % saving in copper is largely used, and known as the Edison three wire system, Fig. 15. Two 110 volt generators are connected in series across two wires so that the voltage on these leads will be 220 volts. From the connection between the two generators, another lead is taken so that by connecting to this lead and one of the other leads a voltage of 110 volts is obtained since the current of only one generator is being used. Thus the consumer may use either 110 or 220 volts according to the work he has. By using 220 volts a considerable saving is effected in the two outside leads and the common return is used for both circuits furnishing 110 volts, saving the cost of a fourth independent wire. The center wire is termed the neutral wire, and usually is grounded so as to give greater protection to consumers. Great care must therefore be taken against accidental contact of either outside wire with the ground connection or with objects which are connected with the ground, such as gas, water, or steam pipes, for there will be a rush of current and a blowing of the fuses. For this reason it will be noticed that all lighting fixtures are connected to the gas pipe, or the fixture hanger, through a small insulating joint which thoroughly insulates the fixture from accidental contact with the ground should one of the wires touch the metal. All motors under $\frac{1}{4}$ H. P. may be used on 110 volts, but those of a higher power must be used on 220 volts. For this reason the student must bear in mind that it is important to examine a motor closely when it is larger than $\frac{1}{4}$ H. P. and is to be used on a three wire transmission system, since a 110 volt motor would be useless in this instance, due to the Underwriter's rules.

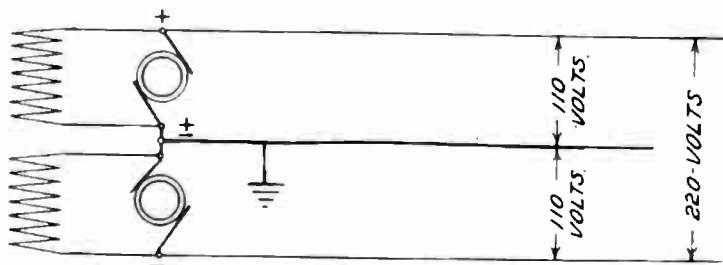

THE EDISON THREE WIRE SYSTEM.

(10)

FIG. 15

After these few lessons, in which the subject of electricity has been but roughly covered, the explanations being only to identify certain facts and points as are necessary to understand the complicated apparatus and operations of the wireless telegraph and telephone, the next lesson begins the principles of wireless telegraphy with the succeeding lessons leading through a complete and thorough study of the subject to which this course is devoted.

Lesson Number Four.

THE PRINCIPLES OF WIRELESS TELEGRAPHY.

THE explanation of the principles of wireless telegraphy to the layman would be a difficult problem if a comparison with the waves of a body of water were not possible. Fortunately, however, we can make an interesting analogy between water and wireless waves as in the previous study of elementary electricity. We will take for instance, a body of water 30 feet in length. At the two opposite banks, small platforms have been built as illustrated in fig. 1. On one of these

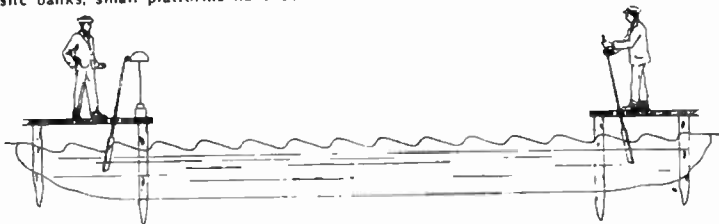

Fig. 1.

platforms, a large paddle has been arranged so that a person may operate its handle. Now, if the paddle is moved back and forth, a series of waves extending in all directions from this source of creation, will be formed. The waves spread further and further away from the paddle in concentric rings until their strength is completely expended. In this instance, the pond is small and the waves are sufficiently powerful to reach the opposite bank whereon the other platform is built.

On the other platform, located on the opposite shore, we have a smaller paddle, on the handle of which a hammer hitting against a gong, has been arranged. It is obvious that the waves moving the paddle will cause the gong to ring, informing the operator on that platform that the operator on the other platform is moving the paddle and creating waves on the surface of the water. By skillful manipulations of the larger paddle, it is possible to cause the smaller paddle to ring the bell periodically as desired, and if a series of signals have been prearranged, the operator with the larger paddle may communicate certain information by properly operating its handle. This represents both the transmitting and receiving stations of the wireless telegraph, the larger paddle being the transmitter, and the conducting medium being the water, while the smaller paddle is the receiver.

In the actual wireless telegraph system, we find the same essentials. The ether is the conducting medium, the Hertzian waves are the means of communication, and the codes are the prearranged signals. The paddles correspond to the "aerials" in the actual wireless system, since aerials both impart and intercept the waves traveling through the ether.

The ether or conducting medium in wireless telegraphy, is little understood at the present time. It is a substance which fills all spaces not already occupied by other substances. It exists everywhere; between planets, suns, in nature, and even in the pores of metals, wood, and other substances. It is comparable to water soaking into a sponge, since it occupies every pore in the universe not occupied by another substance.

After the theory of Maxwell, ether is also the medium of the electrical phenomenon, since each particle of ether assumes a peculiar state of electricity, in which one end of the particle assumes a negative electric charge while the other end assumes a positive charge, the two charges being seemingly separated by an exterior influence. The difference in polarity between adjoining particles causes them to group together firmly, so that a foreign disturbance can force them slightly apart, but after removing this force the particles again come together. The action of the exterior electrical force is to cause the adjoining particles to become charged with the same polarity, which causes the particles to draw apart. When the electrical force is removed the particles are again in the same electrical state as before, with the result that they come together again.

In 1888, a young German scientist, Heinrich Rudolf Hertz, set forth in a written statement, a series of interesting experiments in which remarkable characteristics of electro-magnetic waves were discussed. These waves have since been named Hertzian waves, in honor of the researches performed by Hertz. The waves were produced by connecting to the terminals of a spark coil two brass balls mounted on rods, these rods having little metal squares at the extremities, or if desired, the ends of the rods may be bent, serving the same purpose. This arrangement is known

as the Hertz radiator or oscillator, and is illustrated in fig. 2. When the current was supplied to the spark coil, a discharge passed between the brass balls. When a loop of heavy wire with a small gap left between the ends of the spiral was brought in the neighborhood of the oscillator, small sparks were noticed to jump across the gap of this spiral, proving that the electro-magnetic waves had been generated and propagated through the intervening space or ether. This loop is known as the Hertz resonator or receiver and is shown in fig. 3. Those electro-magnetic waves, caused by the discharge of a high tension electric current, are similar to light rays in certain characteristics, and they may be reflected, deflected, gathered, and dispersed by metal screens. Differing from light rays in other respects, they will penetrate without difficulty stone, wood, earth, and other non-metallic material, which are unpenetrable by light rays.

Thus the principle of wireless telegraphy is based on the fact that an electrical discharge may be employed for generating electro-magnetic waves which travel through space in all directions from the source of production. It is also known that these electro-magnetic waves can produce effects in conductors placed within the range of the waves. The problem therefore consisted of perfecting means of detecting these waves, and to increase the efficiency and distance possible to create these results with a reasonable amount of electrical energy in the spark coil.

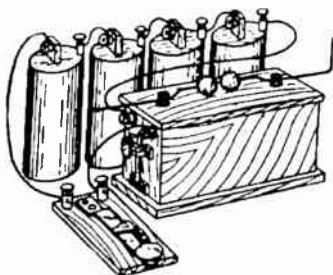

Fig. 2

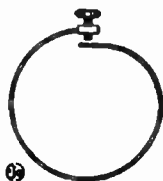

Fig. 3

In 1894, Professor A. Righi of Italy, made interesting experiments along the same lines as his predecessor Hertz, but used perfected apparatus of his own. His resonator consisted of a glass sheet upon which copper had been deposited in a strip. This strip was scratched with a sharp razor blade, so that a minute spark gap was formed between the two separated halves of the copper strip. By placing the gap under a powerful microscope, the almost invisible sparks could be seen. This resonator, of course, proved to be far more practical than the Hertz resonator, and much greater distances were covered.

The early experimenters perceived the possibility of using these waves for transmitting energy across space without connecting wires, and steady progress was made towards perfecting the apparatus. In 1866, S. A. Varley had discovered that the high electrical resistance of metal filings might be greatly decreased by the passing of an electrical discharge through them, and on being shaken, the original high resistance was regained. In 1884, Calzecchi-Onesti also discovered that the high electrical resistance of filings could be thus effected, and wrote on his experiments and discoveries.

In 1890, Professor E. Branly of the University of Paris, rediscovered the interesting action of filings, but placed these in a glass tube with metal plugs fitting in on both sides, thereby making electrical connections with the filings. He discovered that: even discharges at a distance from the filings created the same effect, though the actual discharge did not pass through the filings. To the tube he gave the name of "radio-conductor."

The following information describes the principle upon which the Branly coherer operates. As the resistance between the filings in such a coherer is extraordinarily high, amounting to several hundred ohms, the current from a battery cannot possibly flow through the filings. But, upon the receipt of a high frequency current wave, minute sparks jump between the filings and cause the neighboring filings to be slightly fused together. The electrical contact between the filings is immediately improved, and the resistance decreases to about 5 to 10 ohms. The same battery as previously mentioned which was unable to pass a suitable current strength through the coherer, can now send a very powerful current through the cohered filings and operate the relay.

In 1893 and 1894, Sir Oliver Lodge applied the Branly tube in place of a micro-meter spark gap on the Hertz resonator, and gave the name of "coherer" to the filings tube. The terminals of the coherer were connected to a galvanometer and

powerful battery, and the tube could be shaken or tapped by means of a clockwork mechanism or an electrical bell. With the reception of the Hertzian waves the coherer operated and allowed the battery current to deflect the galvanometer. The clockwork or electrical bell was then employed to decohere the filings and to return them to the original high resistance state. The maximum distance obtained with this apparatus was 55 yards from the transmitter.

In 1895, Professor Popoff employed the nearest approach to the present day receiving outfit. To each terminal of a coherer, he connected respectively a wire leading to the ground, and a wire supported on a high pole outside the building, and corresponding to the aeriols of the present day systems. Shunted across the coherer was a relay and battery, while the relay contacts operated an electric bell which tapped against the coherer tube. The apparatus was used with success to register the discharges of lightning at great distances.

In 1896, G. Marconi began his early experiments which finally led to the perfection of the present day commercial systems. At the transmitting end a spark coil with the Hertz oscillator as shown in fig. 2 was employed, while the receiving end contained a coherer and decoherer similar to that shown in fig. 4. At each

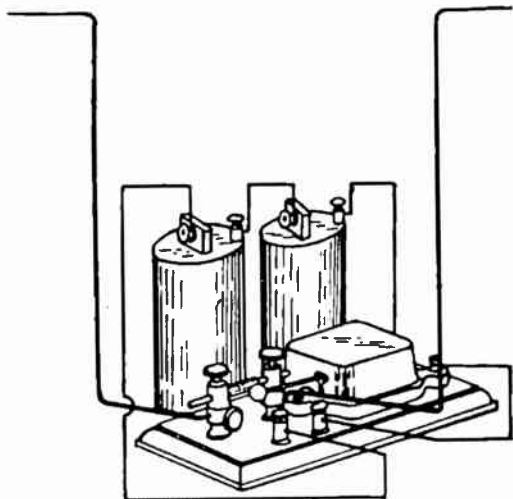

Fig. 4



Fig. 5



discharge of the transmitter the coherer causes the bell to ring, which decoheres the filings the instant the transmitter stops. The adjustment of the coherer has to be very delicate, since the metal plugs have to be arranged until the filings are correctly packed. If they are tightly packed, the coherer will not operate, and if the filings are too loose, the action is again spoiled. While the results obtained with the ordinary bell are satisfactory, much greater distances can be obtained by using a sensitive relay in place of the bell. Marconi soon adopted a high resistance and sensitive relay which was connected across the coherer in series with the battery. The bell was then substituted with a delicate electromagnetic hammer which had

accurate adjustments in order to touch the tube with the correct shaking necessary. The coherer was then changed to another type (fig. 5) where the whole tube was sealed with the wires coming through both ends, the interior of the tube having been exhausted of its air. The metal plugs were beveled across the entire surfaces, so that by tilting the tube the filings would be either tighter or looser, depending how the tube was turned. Fig. 6 illustrates the wiring of the earlier receiving sets.

Marconi soon discovered that by using elevated wires or surfaces, and grounded connections on both the receiver and the transmitter, it was possible to increase the range considerably, and consequently adopted these connections in his later experiments. By connecting a Morse tape register across the point marked C in

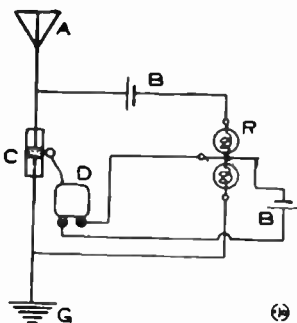

Fig. 6

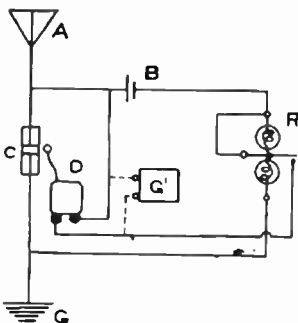

Fig. 7

fig. 7, a permanent record of the signals could be kept. By means of a plain knife switch it was possible to throw on either the sending or receiving apparatus to the aerial in order to transmit or receive, as shown in fig. 8.

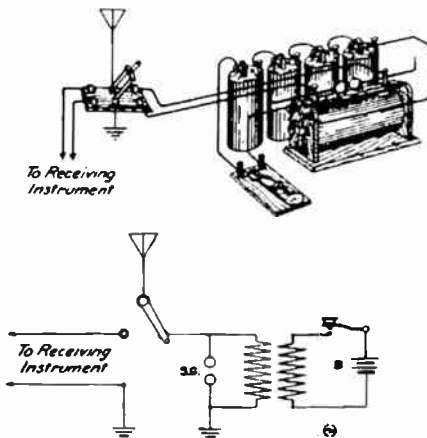

Fig. 8

However, all the systems thus far have been simply discussed in view of the fact that they will receive and send when operated, but the subject of wave length has not been mentioned. Electro-magnetic waves are similar to those of sound and we will therefore make the following analogy. If two instrument strings are stretched at opposite ends of a table, and one of these strings is caused to vibrate, the other string will remain motionless. However, if the silent string be carefully tuned until it is in harmony with the other string, it will begin to vibrate, this action being due to the sound waves in the air caused by the vibrating string. In wireless telegraphy the electro-magnetic waves emitted by a transmitter also have a definite pitch or "tune" as it is named. It is also referred to as "wave-length." This wave-length is caused by the capacity and inductance in the circuit of either the trans-

mitter or the receiver. In the instance of the Hertz oscillator and resonator, the small metal squares or rods at each end of the spark gap are adjusted so as to be in tune with the resonator, or the little squares or wire ends of the resonator may be adjusted so as to be in tune with the oscillator waves. Thus, in all instances, two methods for tuning the both stations may be employed, either tuning the transmitter to the receiver, or the receiver to the transmitter. The latter is, in commercial practice, generally used, as it is more practical than the tuning of the transmitter.

The fact that electro-magnetic waves have a definite wave value, has rendered syntonistic or selective wireless telegraphy possible. The simplest method employed and applied to the early Marconi sets, is illustrated in fig. 9, where there are two sets with aerial and ground connections. At the transmitting station, a coil containing a number of turns of heavy wire and with an adjustable contact to make connection

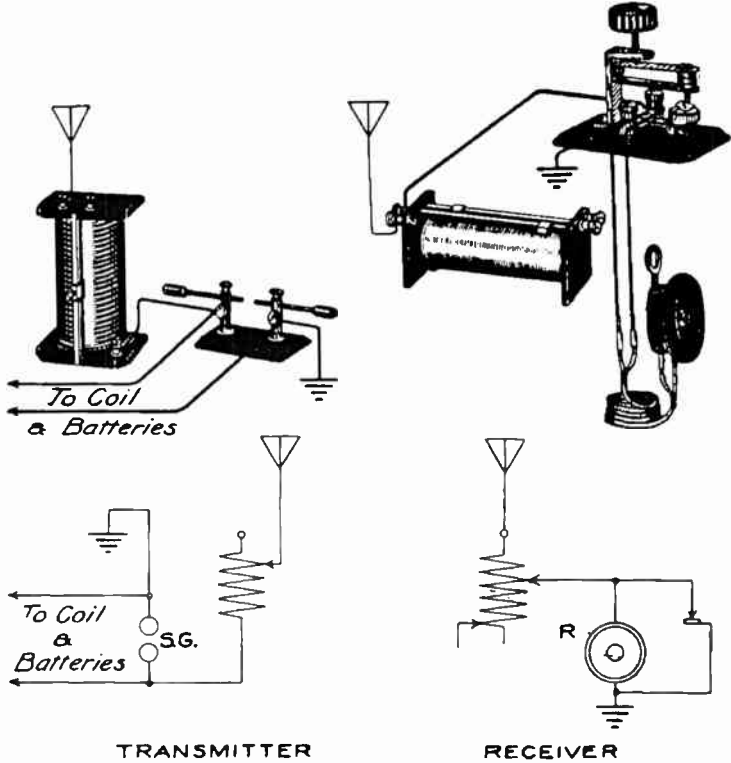
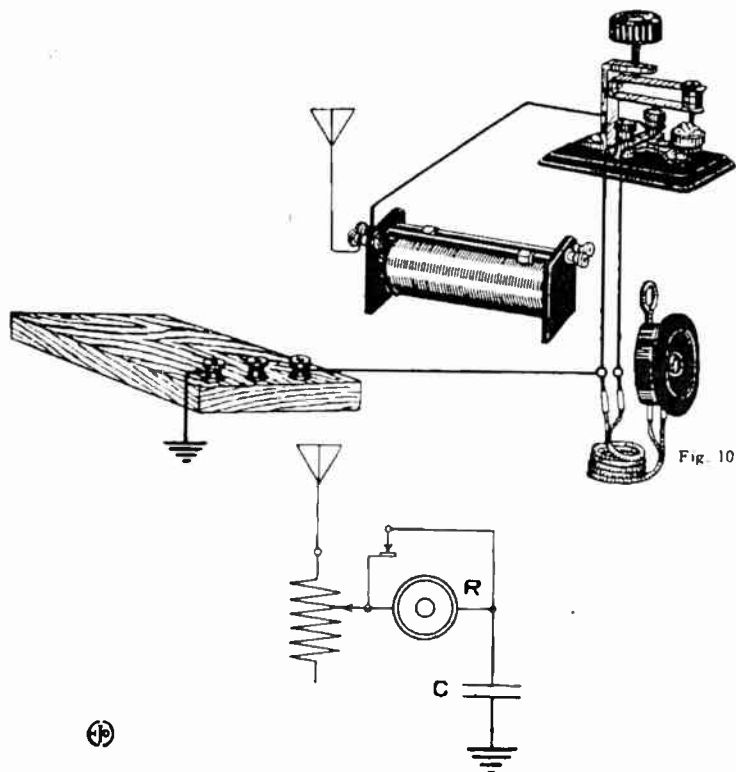

Fig. 9

for any number of turns, is employed in the aerial circuit. This coil is known as the "helix" and will be described in detail in a later lesson. By adding more or less turns, the inductance of the aerial is varied and the wave-length altered. The more inductance placed in the circuit, the greater the resultant wave-length.

At the receiving end, inductance is likewise added in the aerial circuit, thus giving the receiving circuit a greater wave-length in order to be in tune with the transmitter. In this instance, unlike the coil in the transmitter, many turns of fine wire are used, with a sliding contact to make connections with any turn desired. This coil is known as the "tuner" or "tuning coil," and will be described at length in a future lesson, also.

Wave-length is quoted in meters, which is determined by means of a calibrated instrument known as the "wave-meter." In the instance just described, it has been learned that wave-length may be increased by adding more inductance in the aerial circuit. It has also been stated that capacity likewise determines wave-length. In some instances, it so happens that the wave-length of the transmitter is shorter than that of the receiver, even with no inductance turns in the receiving aerial. In this instance, the following method is employed in the receiving circuit. A condenser is placed in the ground circuit as illustrated in the diagram of fig. 10, and thereby reduces the wave-length of the circuit, through the fact that capacity in series decreases the total capacity of a circuit. With the circuit illustrated in fig. 10, it will be possible to tune in long wave-lengths, and also short wave-lengths, by varying the inductance, or varying the capacity in the ground circuit. In the transmitting circuit, the same procedure is employed, the condenser being of the leyden jar type. Only in rare instances, however, is such a method employed, since the transmitting energy is greatly reduced through the introduction of the ground capacity in series.



The various circuits outlined thus far are known as the open circuit type; but not possessing the high degree of selectivity and efficiency as is possible to obtain in closed circuits, Marconi abandoned the open types and began the study of closed types for both receivers and transmitters. These are used to-day for all commercial work. The main objection of the open type of circuit is due to the fact that it contains but slight capacity, and hence the resultant waves are highly damped. By damped is meant that the individual sparks of the transmitter produces but a single train of waves, which rapidly diminishes in value, while an undamped wave is one in which the individual sparks produce a train of waves where the fluctuations are more persistent and deteriorate very slowly in value. This may be illustrated by a simple mechanical experiment. If a string of sufficient length is attached to a

heavy weight at its lower end, and allowed to swing back and forth, it will swing slowly but for a long period. The length of the string represents the capacity in the wireless circuit. Now, if this same string be suddenly shortened, the weight will swing much faster, but the swings will rapidly subside and the swinging cease. This illustrates a wireless circuit with slight capacity as encountered in the open circuits. The former instance with the long string is known as a slightly damped circuit in the corresponding electrical action, and the latter is known as a highly damped circuit in the electrical equivalent. Thus it will be seen that a great advantage exists in employing a closed circuit so as to obtain the longer and

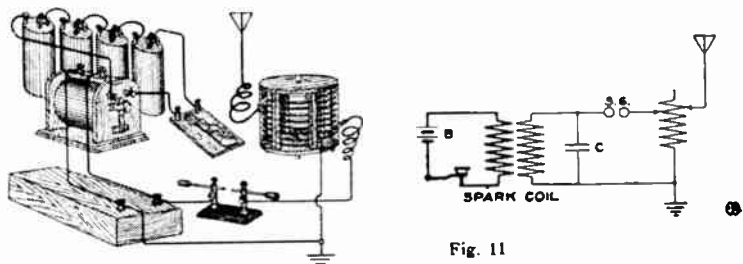

Fig. 11

slightly damped waves, which create greater effects on distant receivers. The comparative efficiency of tuned closed circuits over open circuits; may be noticed by the experiments of Marconi, in which it was experienced that a tuned transmitter operated a tuned receiver 30 miles away, while the same transmitter did not effect a non-tuned receiver only 160 feet away.

A great improvement in the transmitting apparatus was secured through the use of the closed circuit and using condensers, which heretofore had not been used with the open circuit transmitters. This permitted the full capacity effect to add to the lengthening of the waves, so that they would be damped to a minimum. Fig. 11 illustrates a tuned transmitter in which it will be noted that a condenser has been placed across the induction coil, while the spark gap has been arranged in series with the inductance which is interposed between the ground and the aerial. The spark gap may also be arranged across the induction coil, and the condenser in series with the inductance, either method of connection being satisfactory. The action of this circuit, is the charging of the condenser to its utmost capacity, which then discharges across the gap, and the gap being connected in series with the inductance coil, it causes the energy to surge through the closed circuit and to be radiated into the aerial and the ground. It will be noted that the connections of the aerial may be altered on the inductance, so that the proper relation of wave-length may be obtained in reference to the receiver. The closed circuit, which is termed the "closed oscillating circuit," is also variable, the maximum results being obtained when both the aerial and closed oscillating circuits are in perfect tune, which is accomplished by adding or lessening the number of turns of either circuit.

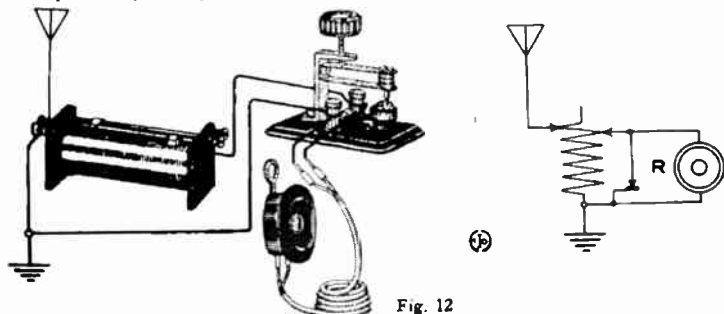

Fig. 12

The closed circuit receiving apparatus likewise consists of a condenser and an inductance. This method enables the apparatus to receive the full advantage of the intercepted waves, and operates by the difference of potential across the inductance coil, the connections being illustrated in fig. 12. It will be noted, that as in the transmitter, the two circuits are separately tuned, so that perfect tune or resonance may exist between the aerial and closed circuit.

Both the transmitting and receiving circuits above described are known as closed direct coupled circuits. Another form of closed circuit, is known as the inductive coupled type, and in which the aerial circuit is connected to the ground through a coil, while another coil placed near the first coil, is connected to the transmitter or receiver, the principle being that of a transformer. By the adoption of these inductive circuits (fig. 13), a considerable advancement over the preceding systems, as regarding selectivity and efficiency, has been made possible, though at the present time the inductive coupled transmitter is not used as extensively as the direct coupled type. However, in receiving, the inductive coupled method is much superior to the direct coupled; the two spools being suitably mounted so that one coil may be drawn away from the other coil, and a greater or less degree of coupling attained. Such an instrument containing these two coils is known as a "loose-coupler" or "inductive-tuner."

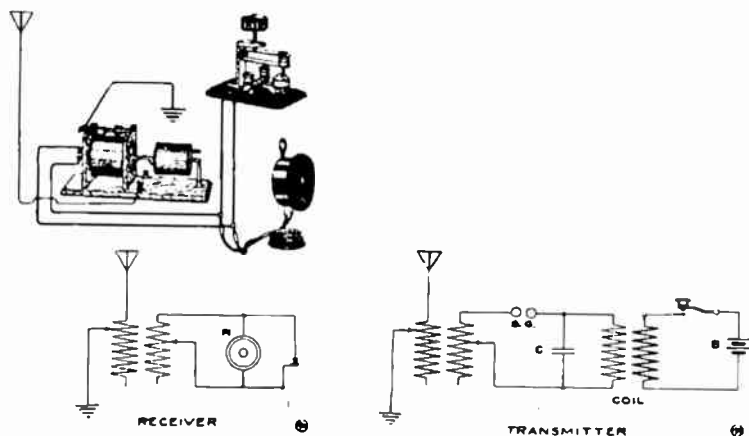

Fig. 13

The action of the inductance coils in both the transmitter and the receiver produce other effects besides the advantage of variable tuning. If an induction coil be connected as shown in fig. 13 to several leyden jars and a spark gap, as well as a few turns of heavy wire surrounding a cylinder wound with many turns of finer wire, we have what is known as the "Tesla Coil," or air core transformer, originally introduced by Nikola Tesla, during 1890. These two coils constitute an open core, (air) transformer, which produces tremendous high frequency and high voltage currents at the secondary terminals. If a single coil be used, containing many turns of wire, and the same induction coil and accessories be connected across a few turns, it will be found that from the two extreme ends of this coil, high frequency current may also be obtained, but the results are not as readily controlled as when an entirely separate coil is used for each circuit. When a single coil is used, the name of "auto-transformer" is applied to the coil, but usually it is known as a helix in regular practice. Thus a helix and a tuning coil are auto-transformers, while loose-couplers and inductive transmitters, are really Tesla transformers. For the preceding reasons, it may be noted that the inductively coupled circuits are preferable, due to their greater range of adjustment.

In the receiving circuits, the loose-coupler not only performs the mission of tuning the apparatus, but also converts the intercepted high frequency waves which flow down the aerial wire, into the high frequency currents of any desired potential, which acts upon the receiving apparatus. In a later lesson different types of wave detecting devices will be described and which are known as "detectors" or cymscopes. Different detectors operate better on different currents.

Short wave-lengths are more readily absorbed by obstacles than longer wave-lengths. For most commercial work, the standard wave-length of 425 or 450 meters has been adopted. For long distance transmission, longer wave-lengths are used sometimes as high as 5,000 meters. Over-land transmission is not practical with short wave-lengths, and usually a wave-length of 3,000 or more is used to obtain better results. For the average station of limited power, it is impossible to use long wave-lengths, for the transmitter is incapable of giving fair results with this huge-wave-length. Most amateurs operate their transmitters between 50 and 300 meters.

Lesson Number Five.

THE AMATEUR TRANSMITTING SETS AND APPARATA.

HAVING learned the principles of wireless telegraphy, naturally the next step in the subject is the thorough mastering of the transmitting and receiving sets. Accordingly, the present lesson has been devoted to the simple transmitting sets mostly used by amateurs at the present time, while the two following lessons will treat on the more complicated commercial transmitters, as well as the latest advances made in this direction.

The student has learned that the simplest set for producing electro-magnetic waves consists of a spark coil with the Hertz Oscillator, and connections made to an aerial and a ground wire. This is the type of transmitter originally used by Marconi in his earlier commercial apparatus. In consequence, the simplest apparatus at the command of the amateur wireless student, will be based on this principle and is illustrated in fig. 1. Here, the coil is shown with two large binding posts into which two rods can slide so as to vary the gap between the two brass balls. A telegraph key has been interposed at K, so that the circuit may be made and broken to form the dots and dashes for the forming of the code signals. At B, a number of cells have been arranged to furnish current to the spark coil. The aerial and ground wires are connected to both rods of the spark balls.

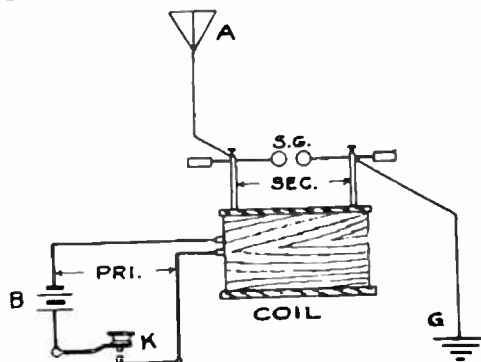

(10)

Fig. 1.

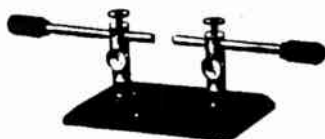

Fig. 2

The brass balls from the spark gap have been abandoned at the present time for metal rods. These brass balls are satisfactory where a small spark coil is employed, but when using greater current in the spark gap, they prove inadequate to serve the purpose. The brass becomes heavily oxidized where the spark forms, and thus presents a poor surface and consequently a rough spark after short use. Many metals have been tried, and zinc has been found to be the most practical. In sets of small power, two zinc rods fitted with insulated handles are used for a spark gap and illustrated in fig. 2. The spark gap should be adjusted so that the spark is smooth and fills the entire gap with a solid discharge. By drawing the gap too large, the discharge becomes broken up and each spark weak and stringy; the oscillations produced in the aerial being likewise broken up and not readable at the receiving end. With the type of set mentioned previously and illustrated in fig. 1, the spark should be no longer than $1/8$ th of an inch, using a 1-inch coil with a suitable aerial, and if a 2-inch coil is employed, this length may perhaps be as great as $3/16$ ths or $1/4$ of an inch. The main object to be kept in mind, is that the spark should be smooth, and jump between every portion of the surfaces, instead

$\frac{1}{4}$ "	use 2 storage cells	or 3 primary cells,	or 3 dry cells.
$\frac{1}{2}$ "	" 2 "	" or 4 "	" or 4 "
1 "	" 3 "	" or 5 "	" or 6 "
$1\frac{1}{2}$ "	" 4 "	" or 6 "	" or 7 "
2 "	" 4 "	" or 7 "	" or 12 "
3 "	" 4 "	" or 8 "	" or 24 "

In multiple.

Fig. 3 represents one of the most practical type of spark coils placed on the market to meet the needs of the amateur and sold at a moderate price. It is known as the "Bull-Dog" type of spark coil, the insulation and other construction features being of the very best. The vibrator on this coil, as in many other standard spark coils, consists of a steel and phosphor-bronze strip firmly held on a brass block to the side of the coil. The iron core of the coil is just in back of this spring which is known as the "vibrator spring," and as previously described in a past lesson, the core attracts the vibrator, but on being attracted, this vibrator breaks the contact between two platinum points, one being on the spring itself, while the other is at the end of a thumb-screw mounted on the brass bridge in front of the vibrator. The adjustment of the coil's vibrator is highly important, since the size of the spark and its smoothness depend to a large degree on the action of the vibrator. The vibrator should be adjusted by connecting the batteries and then turning the thumb-screw in one direction or another until the spark is at its best. If the spark ceases, the cause is that the vibrator screw has been turned too far in either direction. The vibrator spring should be sufficiently free from the contact screw to be able to move readily, yet the speed should be quite high and steady.

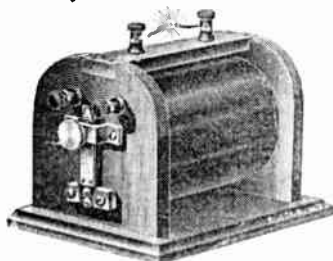

Fig. 3

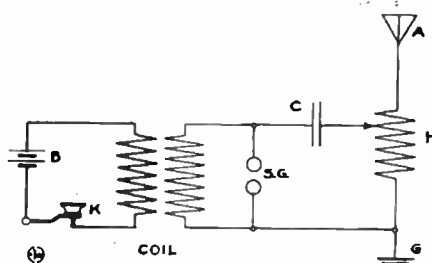

Fig. 4

In the first set described in this lesson, the system is known as the "plain aerial system," since no closed oscillating circuit is employed, but the aerial and ground act as direct capacities to the spark gap. Open circuit transmitters, as in open circuit receivers, are not efficient, and hence little used. The reason is best explained by quoting the following extract from the excellent work of the authority, George W. Pierce, entitled "Principles of Wireless Telegraphy."

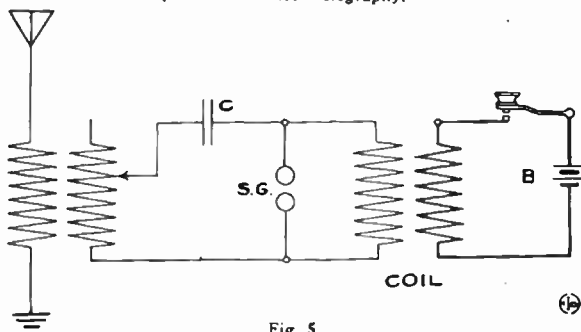

Fig. 5

"A closed condenser circuit is not a good radiator of electrical energy, hence an antenna is employed for the purpose of radiating the energy. But on account of the comparatively small capacity of the antenna, we cannot easily apply large amounts of power directly to the antenna so as to get the necessary high potential.

Now, the use of a long spark gap carries with it disadvantages; it does not produce good oscillations.

"To avoid this disadvantage, the high potential in the antenna is obtained, not by the use of a long spark gap, but by the inductive action of a discharge occurring in a condenser circuit connected with the antenna and put into resonant relation with it, (as shown in figs. 4 and 5). The larger amount of power in the condenser circuit is attained by the largeness of the capacity, instead of by the length of the spark gap. By the use of a suitably large capacity in the condenser circuit, we can obtain tremendous current in the circuit, which will induce very large potential in the antenna, if the antenna is in resonance with the condenser circuit. Thus we get a large amount of radiation."

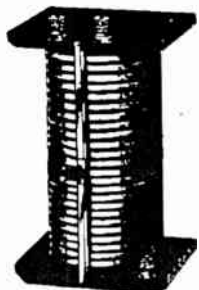

Fig. 6

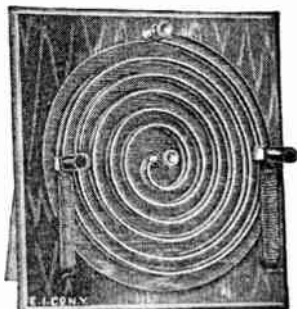

Fig. 7

The reader will accordingly note from the foregoing explanation, that, as in the instance of the receiving sets described in the previous lesson, it is necessary to have a closed circuit transmitting set to obtain the maximum results. If a plain aerial connection is used, the spark gap must by necessity, be of a great length, therefore producing a great difference of potential between the aerial and the earth. This is a very undesirable feature; on shipboard or where dampness exists, in particular; and everywhere in general, since such an aerial and apparatus cannot be insulated without great difficulty. For small sets, intended to communicate from a fraction of a mile to about 15 miles, this system may be used, but the closed circuit transmitter must be resorted to for greater distances.

In order to change the plain aerial set into a closed circuit transmitter, a few turns of heavy wire in the form of a helix, and interposed between the aerial and ground connections, are used. A condenser must also be added. Fig. 4 illustrates the connections used for the closed oscillating type of transmitter. (C-Condenser, H-Helix.)

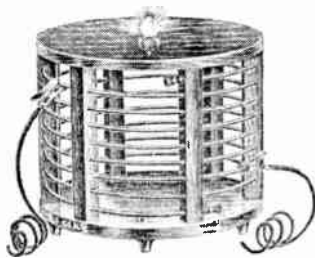

Fig. 8

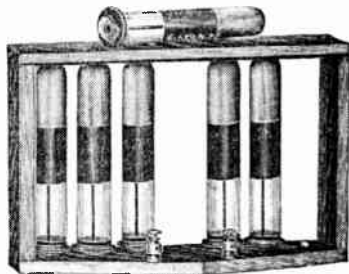

Fig. 9

The few turns of wire are mounted on a suitable framework, and clips or other contacts are used to vary the number of turns across which the condenser and spark gap are placed. Fig. 6 illustrates a very popular type which may be used for coils up to 6 inches with ease, and consists of a number of turns of brass strip wound spirally on an insulated drum. The sliding contact mounted on the brass rod enables the turns to be varied in the oscillation circuit, while the aerial and ground wires are connected to the two end binding posts of the entire turns. Thus in this type of helix the aerial turns remain fixed, but the oscillation circuit turns

are variable so as to obtain the resonance effect between the two circuits. Fig. 7 illustrates another type which is very popular with the amateurs using small coils of from a fraction of an inch to 2 inches. Again, in this type, the turns are of flat brass strip and held in place by grooves and notches in the wooden back board. The turns are wound concentrically, so that the entire helix is flat and occupies the minimum of space. Two small clips attached to flexible cords enable the oscillation circuit to be varied as well as the aerial circuit, shown in a diagram which will be given later. By varying both the aerial and closed condenser circuits, the maximum resonance effects are obtained. This type of flat helix is commonly known as the "pan-cake" type. Fig. 8 represents the universally mounted standard type, used in commercial practice as well as with the better equipped amateur stations. The turns of wire are passed through holes in the wooden uprights, while special clips enable connections to be made at any part of the turns. A small lamp has also been added at the upper end of the helix so that the degree of resonance between the two circuits may be gauged by the brilliancy of the light. This lamp is commonly known as the "pilot lamp."

As for the condenser, any type employing glass for the dielectric will prove satisfactory, providing that it is of the correct capacity, and will not break down. A very neat arrangement for small sets employing coils not larger than 2 inches, can be seen in fig. 9. A number of tubular leyden jars are noticed mounted in a special wooden framework. The leyden jars are held in place by spring devices, so that they can be instantly slipped in or out of the rack, thus varying the capacity until the proper amount of condenser is obtained. The capacity should be adjusted until the spark fills the gap with a solid crashing flame, but if too much capacity is used, there will be little if any spark, since the coil will have to take a much longer time to charge the condenser to a point where it can break down and discharge over the gap. This condenser is patented by H. Gernsback.

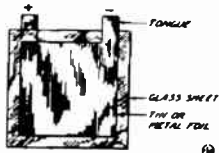

Fig. 10

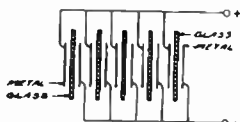

Fig. 11

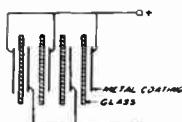
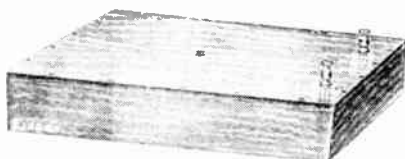

Fig. 12

If larger coils than 2-inch spark length are employed, it is necessary to use a glass plate or leyden jar condenser of great dimensions. A glass plate condenser consists of many plates of glass coated on both sides with metal sheets. The usual type employs heavy tinfoil, which is fastened securely on the glass by thinned orange shellac, banana oil, or other adhesive. The entire plates are well shellacked around the edges of the tinfoil coating, so that the "brush discharges" are reduced to a minimum. Fig. 10 illustrates the arrangement of the metal coating on the glass plate, and it will be noticed that the tin foil used in this instance is cut so that a portion or "tongue" protrudes past the glass plate. This tongue is to make connections with the other apparatus, and all the tongues on one side are connected together, thus forming a parallel condenser. Both sides of this glass sheet are alike, and the tongue from the tin foil coating on the reverse side will be noticed protruding past the glass. The plates are mounted on a small wooden framework arranged with suitable notches or blocks in order to space the plates at least an inch apart. The wiring connections are shown in fig. 11. Another method, which is also used to a great extent, differs from the foregoing by the placing of the metal coatings between each two pieces of glass, so that alternately there will be a metal surface, then glass, then metal, then glass, then metal, etc. This enables the plates to be placed touching each other, thus making the condenser very compact. The one great disadvantage, however, is in the fact that if one plate should break down, it will necessitate the entire deranging of the plates to locate and remove the affected plate, whereas in the previous system, where the plates were separated, the broken plate can be immediately found and removed without disturbing the other plates. However, if the condenser is properly made, breakdowns are rare. When the plates have been completely coated and placed together, they are bound with heavy cord, and then placed in a neat wooden case. Molten paraffine is then poured into the box, and upon cooling, it hardens, thus forming a solid insulating mass around the condenser. Fig. 12 illustrates how the plates should be connected before the condenser is placed in the box. In this type of condenser, thin aluminum or copper sheeting are highly recommended, for the coating is naturally held in place by the tight binding of the plates with the cord, and no adhesive need be used.

The following table gives the proper dimensions of glass plate condensers for standard spark coils:

Kind of Glass	Capacity	Labels	Grid No.	Grid No.	Size of Glass Plates	Thickness	Size of Metal Foil Leaves	Microseconds of C.T.C. per 1000
1	18	12 in. x 14 in.	8 in. x 10 in.	.0048				
2	34	12 in. x 14 in.	8 in. x 10 in.	.0095				
3	40	10 in. x 14 in.	10 in. x 13 in.	.0119				
4	80	16 in. x 19 in.	10 in. x 13 in.	.0237				
5	120	16 in. x 19 in.	10 in. x 13 in.	.0356				
6	160	16 in. x 19 in.	10 in. x 13 in.	.0474				
7	200	16 in. x 19 in.	10 in. x 13 in.	.0593				



"Electro" High Tension Condenser.

When condensers are used on coils which are slightly too large for the capacity of the condenser, a series of small purple sparks giving as a whole the appearance of a purple fringe of light, will appear around the edges of the tin or metal foil. This is known as the "brush" or "brush discharge." It is then that a peculiar and strong odor is noticed, and which is known as ozone, this gas being formed by the silent discharges. Brush discharges indicate a loss of power, and should be reduced to a minimum. When there is too much brush discharge, more condenser should be added, or the edges of the foil and uncovered glass margin should be shellacked or coated with black asphaltum paint, if it has not been thus treated already. A margin of at least 1 inch should always be left between the foil and the edge of the glass. If the coil is too powerful entirely for the condenser, the glass often is pierced by the electric discharges, and shatters completely. It is for this reason that the spark gap in the set should never be left beyond the point where the discharge from the condenser can pass without difficulty while in the circuit.

Fig. 13 illustrates the exact connections used, and it will be noticed that the condenser is placed across the spark coil, while the spark gap is placed in series with the few turns in the helix. The two clips are so arranged as to vary either the aerial circuit or the oscillating circuit, in order to obtain the maximum resonance. In a later lesson, the tuning of the two circuits to secure resonance is described at length as well as the special wave meters by which the wave-length of the transmitter can be determined.

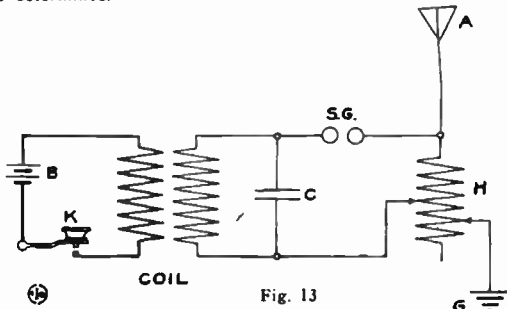

Fig. 13

As yet, only sets employing batteries to operate the coils have been discussed. However, in order to cover greater distances, it is necessary to resort to greater power and larger coils, so that batteries must be abandoned in favor of current from power circuits. In using open core transformers or spark coils of small dimensions, a special interrupter must be employed if either direct or alternating current is being used. This corresponds to the vibrator attached to the smaller spark coil, and serves the same purpose. There are various forms of these interrupters, the most popular types being: the electrolytic; the magnetic; and the motor driven interrupter.

The electrolytic interrupter operates on the principle that when electric current passes through acidulated water, gases are formed at the electrodes. These gases are poor conductors, the current is practically stopped, but in so doing, the heavy and high voltage induced current in the primary winding of the induction coil rushes to the point where the gas has been formed and breaks down the insulation of the bubble of gas, thus permitting the current to again pass and the foregoing action to be repeated. Of course, the reader must appreciate that this takes place almost instantaneously, the interruptions being between 100 and 2,000 per second, depending on the inductance of the circuit and the voltage used. Electrolytic inter-

WIRELESS COURSE—LESSON NO. 5

rupters will not operate on lower voltages than 40 volts, and operate either on direct or alternating current, but with greater efficiency on the former. The positive pole of the direct current power supply, if direct current is used, should always be connected to the electrode where the gas must form, in the Wehnelt type being the platinum or metal rod protruding through the insulating tube, and in the Caldwell type this being the rod contained in the inner jar.

The electrolytic interrupter of the most successful type is the Wehnelt interrupter, which consists of a metal (usually platinum, which gives the best results)

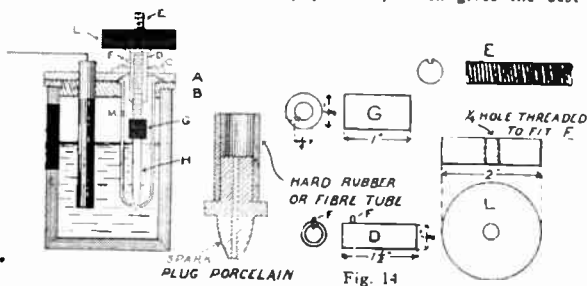

Fig. 14

(Courtesy "Modern Electrics.")

rod protruding through a porcelain or glass tube, which is immersed in the acidulated water. A large lead rod or plate is used as the other electrode for the passage of the current through the liquid. The current flows from the metal point to the lead plate. The solution consists of 4 parts of pure water to 1 part of sulphuric acid. The Wehnelt interrupter illustrated in fig. 14 is an excellent and simple type which may be readily made by the reader. The positive pole of the direct current supply is connected to the brass part C, while the negative pole is attached to the lead rod. L is a fibre handle; E is a threaded rod, which is constructed to fit the threaded handle, but slotted so as to engage the pin F and prevent it from turning; H is a copper rod, though platinum is far more suitable; D is a brass tube as shown; M is the overflow hole in the fibre tube, into the lower end of which a portion of an old spark plug porcelain part has been driven; finally, C is a small brass block as shown. This is the adjustable type of Wehnelt interrupter, since the fibre handle can be operated to allow more or less surface to be exposed to the acidulated water.

Another type of electrolytic interrupter is represented at C in fig. 15. In this instance, a platinum wire, (about No. 6 B & S will give excellent results for coils up to 6 inches) has been placed in the end of a glass tube while the glass was in a molten condition, thus making a perfect joint at the end where the platinum is

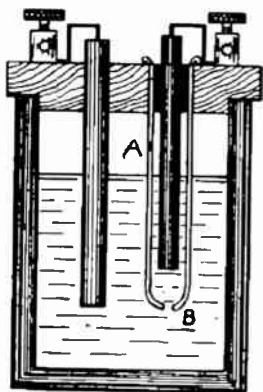

Fig. 15

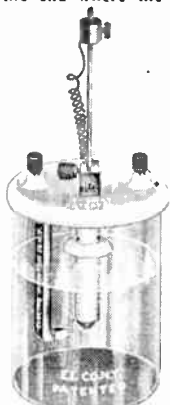

Fig. 16

exposed. Mercury is placed in the bottom of the tube so that it touches the mercury and enables contact to be made with a wire which is inserted through the top of the tube and dips into the mercury. This is a fixed type of Wehnelt interrupter, since the point is non-adjustable.

Still another type, known as the Caldwell type, uses two electrodes which are separated by one of these being placed in a jar which has a small hole, and operates upon the same principle as the Wehnelt, the gas in this instance forming at the opening of the inner jar. Though this type, illustrated in fig. 15, is very simple to construct, it is not as popular as the Wehnelt type.

A great advancement in electrolytic interrupters was marked by the introduction of a perfected interrupter, illustrated in fig. 16, and known as the Gernsback type. Notwithstanding the fact that it is sold at a popular price, within the reach of all experimenters, it will give results which can favorably compare with the more expensive types, in many instances even surpassing these expensive interrupters in efficiency. The Gernsback interrupter is composed essentially of a porcelain cover and a detachable tube into which a metal rod passes and fits into a small aperture in the bottom of this tube. A small sliding weight fits over the top of the rod and serves the combined purposes of conveying the current to the rod, and to feed the rod downwards into the small hole as it wears down. If desired the rod may be slightly lifted into the tube and held in place by the adjustment screw on the aluminum bridge, and will then operate as a Caldwell interrupter. A lead strip dips into the regular solution, which has already been mentioned, and from time to time may be cleaned with a knife and sand-paper to remove the brown or black coating which forms on it. A large tablespoonful of household ammonia added to the solution will also add to the results. This interrupter may be used on all induction coils from $\frac{1}{2}$ -inch to 12-inch, no resistance being necessary with circuits of about 110 volts. If ordinary spark coils are being used, the vibrator contact screw should be turned so that it is firmly pressed on the vibrator spring to prevent it from moving. Better still, a small piece of wire can be placed between the brass bridge and the brass block holding the vibrator spring.

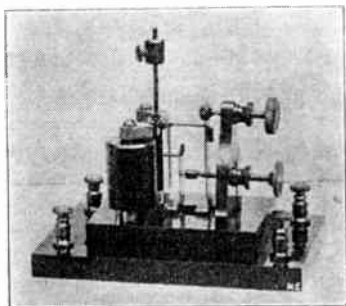

Fig. 17

(Courtesy "Modern Electrics.")

The magnetic type of interrupter (fig. 17) operates on the same principle as the vibrator on the spark coils. It consists of a pair of electro-magnets which attract an iron armature which carries the contacts. Against these contacts are others, located

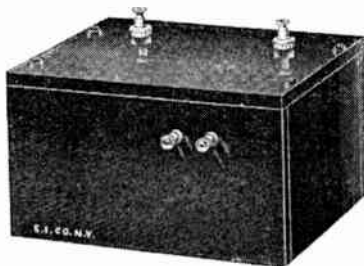

Fig. 19

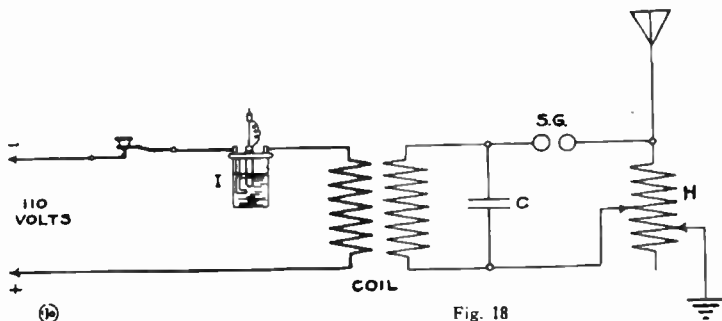

Fig. 18

on posts and adjustable by suitable screws. Many adjustments are used so that the mechanical features may be varied until the best results are obtained. The interruptions with this device are very slow, producing low frequency sparks, which

are not desirable in all instances. In consequence of this low speed, it can only be used in connection with a few storage batteries or on 110 volts if a suitable resistance is inserted to reduce the voltage.

The motor-driven interrupter consists of a small power motor driving rotating contacts which dip in mercury. There are many types, varying widely in mechanical details, the most successful type being that in which the motor operates a small turbine pump which throws a steady stream of mercury against a rapidly revolving toothed wheel, consequently making and breaking the circuit. The great advantage in these motor-driven interrupters lies in the fact that the interruptions may readily be changed by merely varying the speed of the motor. Owing to the high speed of the interruptions, it may be used directly on 110 volts with coils of 6 inches or larger, but with smaller coils it is advisable to employ a resistance in series with the current supply.

Fig. 18 represents a transmitting set arranged for using 110 volts with an electrolytic interrupter, but any other type of interrupter as described in the foregoing may be substituted if the resistance is also inserted in the circuit. This represents the best possible installation for an amateur station employing a spark coil or open core transformer.

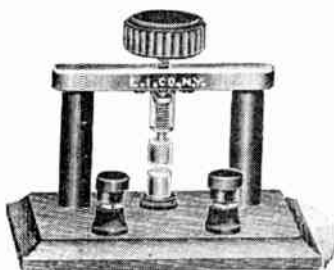

Fig. 20



Fig. 21

As the student has learned in the study of the principles of electricity, he will remember that open core transformers are not to be compared with the efficiency of closed core transformers. If the amateur wishes to have a still better station, and one capable of covering distances up to 100 and even 200 miles, as against 25 miles, which could be covered with the open core transformers and spark coils, he must resort to a closed core transformer of high power, and alternating current. Fig. 19 illustrates a closed core transformer.

With the use of a transformer, the entire accessory apparatus must be of heavier and more substantial nature than when using ordinary small spark coils. Fig. 20 illustrates the extra large spark gap employed, which has two parallel surfaces of zinc, which may be separated further by turning the hard rubber knob. The gap is mounted on rubber pillars to increase the insulation. When using spark gaps on large transformers, they are sometimes placed in boxes so as to reduce the noise caused by the spark. Then the gap is known as "muffled." Fig. 21 illustrates the heavy key equipped with special platinum contacts of large dimensions to handle the heavier current. These contacts are embedded in mica, which can withstand the intense heat. A condenser composed of many sheets of tin foil and paraffined paper is often placed in parallel across these contact points to reduce the excessive sparking if found necessary. The helix should likewise be of heavy construction, and whereas No. 8 wire was suitable for the smaller coils, in this instance it must be much larger in proportion. For a $\frac{1}{4}$ K. W. transformer, the wire should be no smaller than No. 6, for $\frac{1}{2}$ K. W. no smaller than No. 4, and for 1 K. W. no smaller than No. 0. The larger transformers should be equipped with helices of still larger wire.

In the descriptions of complete stations, the student will learn that special switches are used for connecting the aerial and ground either to the sending or receiving sets as well as to disconnect the power circuit from the transformer. This is known as an antenna or aerial switch.

(To be continued next lesson)

Lesson Number Six.

TRANSMITTING SETS (Continued).

THE student has learned from the previous lesson that a special switch known as the Aerial Switch, is employed for connecting the transmitter or receiver respectively to the aerial and ground, for the purpose of communicating to and from a station.

The simplest type of aerial switch is shown in fig 1, and is an ordinary double pole, double throw, porcelain base switch. The base may be of other material, but either hard rubber or porcelain serve the purpose best. Instead of running the connections directly to the ground and aerial, as illustrated in the diagrams heretofore, the leads from the transmitter are connected to the two jaw posts on one end, and the leads from the receiving set are connected to the two jaw posts on the opposite end, while the aerial and ground connections are made at the center hinge posts. Fig. 2 illustrates the connections as described.

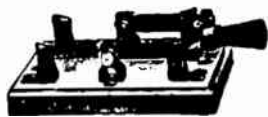

Fig. 1.

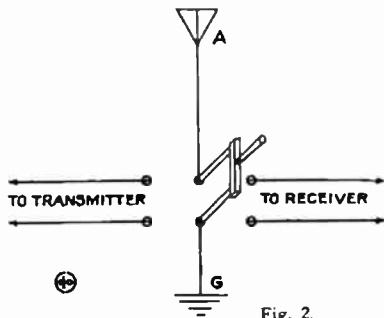

Fig. 2.

Though this simple switch will serve the purpose for small sets operating with coils of smaller sizes than 2 inches, with larger coils and transformers, more elaborate and superior switches must be used. The great disadvantage of this simple switch, even when used on small power, is the fact that the movement of the blades when either set is to be connected, is great and requires more effort than if the throw was less distanced, which would be possible by various methods, as will be presently discussed. Instead of causing the complete throw to swing through an angle of 180 degrees, the blades might so be arranged that only 90 degrees or even 45 degrees completes the throw, thus saving time and effort. Another marked disadvantage lies in the fact that the transmitting primary current is still connected to the key and coil even when the switch has been thrown to the receiving set. Should the key be pressed accidentally while the receiver is connected to the aerial and ground, the sensitive apparatus of the receiving set will temporarily lose its adjustment and ability to receive messages. Dangerous shocks to the operator might also result from the lack of disconnecting the primary current. It is therefore evident that this aerial switch must also include another contact to disconnect the primary circuit of the transmitter when same is disconnected from the aerial circuit.



Fig. 3.

A very simple yet effective aerial switch in which both these foregoing disadvantages have been eliminated, is the "Electro" Aerial Switch illustrated in fig. 3. This switch has three blades, and on one end there are three jaw posts, but on the opposite end there are but two jaw posts to engage the two outside blades of the switch. The center blade is connected in series with the primary of the trans-

mitter, as illustrated in fig. 4, while the receiving and transmitting leads are connected to their respective jaw posts. Aside from the additional blade, the switch is the same relative to the wiring as in the simple switch previously described. However, another improvement is found in the extended and bent blades, which enable the switch to be thrown from one set of jaw posts to the other set with the minimum movement and effort.

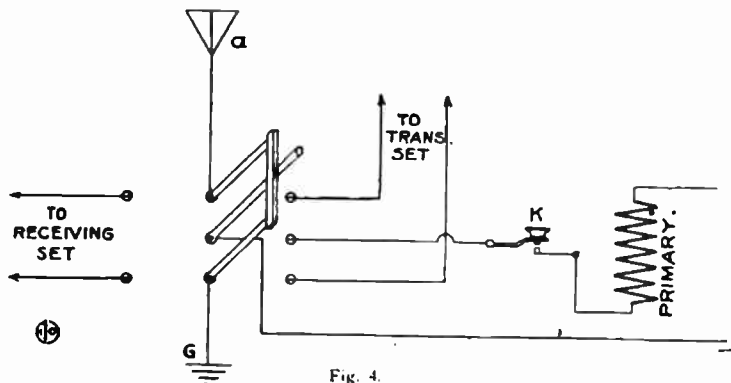

Fig. 4.

In commercial stations the aerial switches are far more complicated, and operate a number of circuits by a simple throw. These switches are made in a variety of forms, in some the rotating blades are mounted on an insulated drum, while in others the contacts are mounted on a long arm. Every system has its particular design of aerial switch, and inasmuch as the operation is identical in each instance, further description is useless. One important point that the student will discover is this; that in order to make a number of connections with a moderately simple switch, only the aerial can be disconnected from the two sets, so that the ground is permanently connected to both the transmitting and receiving instruments. This necessitates the use of a small spark gap in the aerial for the transmitter; this gap being known as the "Anchor Gap." This usually consists of two pointed brass rods spaced a fraction of an inch apart. In other types three brass rods are used, where a special type of aerial known as the "loop" aerial is employed. In fig. 5 will be

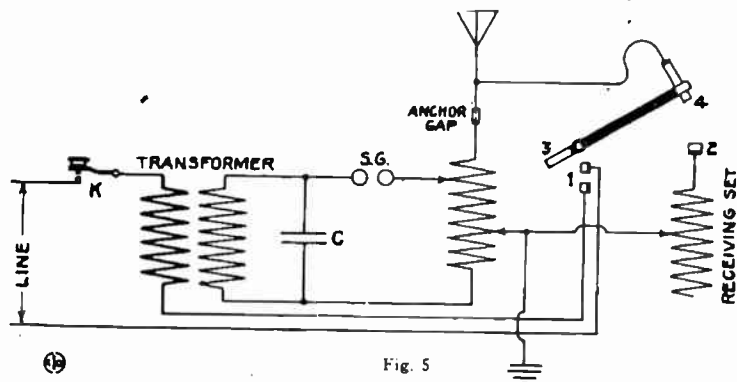

Fig. 5

seen a diagram illustrating the reason for employing an anchor gap in commercial installations. It will be noted that the anchor gap enables the transmitter to be continuously connected to the aerial and ground, inasmuch as the high voltage current from the transmitter easily travels across the small gap. The gap is therefore employed so that the current from the aerial to the receiving set will not be grounded through the transmitting helix. A hard rubber handle is illustrated for an aerial switch, on one end having the contact 4 connected to the aerial lead above the aerial gap, and making connections with the receiving apparatus when pushed

down and touching contact 2. In so doing, the contacts at 1, which are connected in series with the primary circuit of the transmitting apparatus, are no longer bridged by the metal extension 3, so that the receiving set is connected to the aerial with no danger of current from the transmitter effecting it. The rubber handle is then thrown up when the operator desires to send, and in so doing, the metal part J bridges the two contacts 1, closing the primary circuit of the transmitter, and on pressing the key the transmitter operates. In throwing up the switch it also disconnects the receiver at 2, thus avoiding all danger. By mounting additional contact surfaces on the rubber arm, any circuits in the receiving set may be opened or closed. It will thus be seen that the purpose of the anchor gap is to simplify the switching from transmitter to receiver. An anchor gap consumes considerable energy, reducing the range. In sets of 1 K. W. and larger, this loss is negligible, but in smaller sets an anchor gap is discouraged, and it is better to use more complicated switches and avoid the loss of power. All commercial systems of any importance have adopted the anchor gap, and various types of simple switches for this operation.

Commercial installations of reasonable size do not employ spark coils as a rule, though a few exceptions will be found that do. Most stations of reasonable size and range use an open or closed core transformer operated on alternating current. Another complication soon arises that renders the commercial station a veritable power house as compared to the modest amateur station. In order to obtain the alternating current for the transformer, a special motor-generator set is employed, with a direct current motor of suitable voltage driving a direct-connected generator supplying alternating current. Two standard frequencies are usually resorted to, either 60 or 120 cycles. By means of rheostats in the field of the motor, the speed may be varied and accordingly the frequency also, thus allowing a little diversion from the rated frequency of the generator. The voltage may also be raised or lowered by the adjusting of a rheostat in the field winding of the alternator. Adjustable choke coils (inductance coils) made of heavy laminated iron cores wound with windings of insulated wire in series with the transformer, are sometimes used in order that the transformer works to the best advantage with the generator, or as it is called, "placed in resonance with each other."

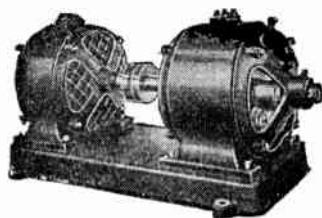

Fig. 6.

Fig. 6 illustrates a motor-generator set of the standard type. In some instances this set is mounted under the operating table, while in other installations, the motor-generator set is placed in another room of the wireless station so that noise will be far removed from the operator. In land stations where electric current is not available from power houses, a dynamo, driven by a gasoline or steam engine is placed in a separate building. The most practical method in such stations, is to have the dynamo furnishing direct current to storage batteries, which in turn supply current to a motor-generator set. In this manner, the engine is only operated a few hours a day in order to charge the batteries, and the motor-generator set may be started only when a message is to be sent.

The student will remember that in a previous lesson it was demonstrated how motors are started by means of a variable resistance, known as a starting box. In some instances a regular hand starting box is employed, and is placed near to the operator so that he may operate it without leaving his seat. In other instances, the motor is started by means of an automatic starter. The automatic starter consists of a modified hand starter, but instead of the lever being operated by hand, it is moved by a powerful electro-magnet. A dash pot consisting of a metal cylinder fitting within another metal cylinder with oil between both, is attached to the lever so that the electro-magnet will not be able to pull the lever up with a jerk, but allows the lever to move slowly over the contacts. The automatic starter is operated by the closing of a circuit, which is usually accomplished by means of a push button switch, conveniently located near the operator or on a switchboard.

The motor-generator set is never operated except when a message is actually being sent. If the operator is going to send at successive intervals and only desires to receive an O. K. or other short message in between, the motor-generator is allowed to run continuously, even when the operator is receiving. The motor-generator may be started in a fraction of a minute, and for this reason, it is advisable to keep it idle in most cases, except when it is to be used as above mentioned.

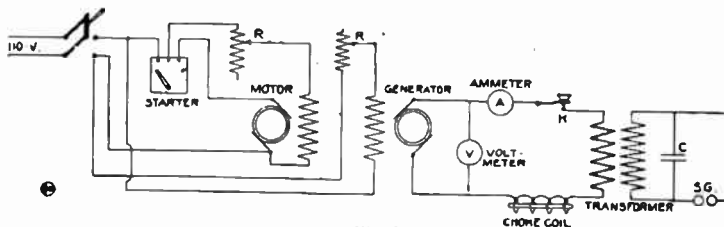

Fig. 7

Rheostats are used in the motor and generator circuits to give flexibility to the set. In the motor held circuit, a rheostat is inserted so as to enable the operator to vary the speed and consequently the frequency of the alternating current. In the generator held circuit, which is excited from the direct current source which operates the motor, another rheostat is inserted so as to raise the voltage of the alternating current. Such adjustments are found necessary under the varying conditions of commercial service. Fig. 7 gives a complete wiring diagram of a standard wireless station.

The main difference between a commercial wireless station and that of the average amateur station lies in the small details which are highly perfected in the commercial station. It stands to reason that the apparatus in the commercial station must represent the highest development, and it is constructed with a view of obtaining the best results with cost as a secondary consideration. Commercial apparatus is accordingly better constructed with better attention paid to the merest details. In order to handle the heavy currents employed, the apparatus must be of heavier construction than that used in amateur stations. We will therefore discuss the different instruments which go to make a commercial station transmitter, from a general standpoint; since each system has slight variations in designs of the various instruments.

The first marked difference in construction between the commercial station and that of the amateur, is the primary key. For the modest purposes of most amateurs employing but a small spark coil, the average telegraph key is found excellent. However, in commercial practice, the heat of the current passing between the contacts would instantly fuse the platinum contact points together. Then again, the rubber in which these platinum contact points are embedded, would melt or burn.



Fig. 8

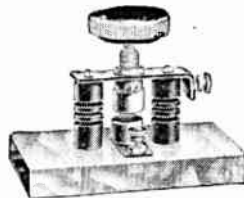

Fig. 9

Fig. 8 illustrates a standard type of key, which can readily handle current up to 3 K. W. The heavy platinum contacts are of a suitable diameter to withstand the heat. The lower one of these is imbedded in mica, which withstands the heat without damage. If heavier currents are to be handled, a paper condenser containing many sheets of tin foil may be shunted across the key contacts, and it will then be possible to operate this key on currents of even greater power. A bank of lamps may also be employed across the key contacts to lessen the sparking.

In some wireless stations a long arm is attached on the key lever, and passes through a slot which is cut in the table. The bottom of this lever has a contact of large diameter which touches another contact, both of these being placed in a tank of oil, so that the sparking is reduced to a minimum. Other systems employ a relay which has very heavy contacts, the relay being operated by an ordinary

telegraph key. Such relays are sluggish in operation, and the signals are not as sharp as those which may be had from directly operated key contacts.

The transformer presents another item which, though the same in operation as the amateur's transformer, is developed to a finer point. Most stations employ a suitable type of open core transformer, though the student will remember that the closed core is far more efficient. In most instances these transformers are insulated with paraffine, though in certain land stations the transformers are placed in oil. In the open core transformers, the primary winding is arranged so that it may be taken out of the coil with the iron core, and rewound with more turns if desired. By winding more or less turns on the core, a condition is arrived at where the inductance of the generator armature and that of the transformer's primary winding are balanced, so that a very slight spark occurs at the key contacts. This is known as perfect resonance. Closed core transformers are arranged quite often with adjustable core parts, so that the magnetic field may be varied. A switch with a number of contacts also enables the winding of the primary to be varied.

The spark gap, as in the key, contains numerous points of superior design and construction over that used in amateur stations. Fig. 9 illustrates the "electro" spark gap which is capable of withstanding discharges up to 3 K. W. The large rubber handle enables the operator to adjust the gap while the spark is passing between the large zinc surfaces. In most gaps the zinc rods are equipped with radiating flanges, so that more cooling surface is added. In commercial stations of large size, the gap is placed in a box so that it is muffled. Compressed air is often furnished through the zinc rods so as to cool the gap.

There is a marked tendency which has been gaining favor since the last few years, to use a gap which contains many zinc points rapidly revolving so as to break the discharges into a number of smaller ones. Fig. 10 illustrates a popular type. In this gap a rotary disc of fibre is mounted on the shaft of a small motor, which may be either run on 110 volts or batteries as desired. A number of zinc rods are mounted on this fibre disc, which revolves past two stationary rods mounted on the marble base. The advantages which are obtained with a rotary gap are numerous, but the most important one is; that the emitted signals have a high and clear pitch which may be distinguished above the ordinary signals, and above the rumbling sound caused by atmospheric disturbances, or commonly known as "static." Various types of rotary gaps have been designed, but the main feature common to all is the rotating member carrying the zinc rods.

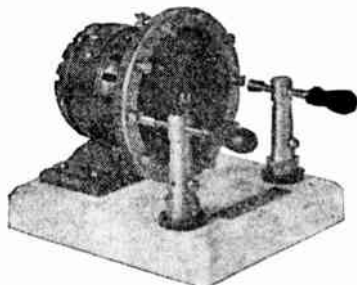

Fig. 10

The condenser is one of the most important items and upon which the success of the station depends to a great extent. As in the other details, the many systems have varying designs for the condenser. Some use plates, while others favor the leyden jar type.

The plate condenser is one of the most efficient types, for it is compact and gives satisfactory results, especially if the plates are imbedded in paraffine. It is compact, and with intelligent use will not break down under heavy currents. One of the most successful systems has the condensers made of suitable units imbedded in insulating material and furnished with terminals, so that any number of separate units may be used as found necessary for the power employed. Plate condensers are often arranged with the plates held in a wooden rack, so that if one should accidentally break down under excessive current, it might be removed without much trouble and a new plate substituted.

The leyden jar type of condenser, as shown in fig. 11, has found more adherents than the plate glass type, and is used in all of the larger commercial stations. Leyden jars of a suitable size are used, which are coated on both the inside and outside with tin foil. By a novel process of having silver melted into the glass, it is possible to have copper plating placed on glass, and which will firmly hold. In fact, copper plated jars, such as are used to-day, will withstand the scraping of a knife on the copper surface without more damage than a slight scratch. Copper

plated jars are somewhat expensive, but as the student has been informed, expense is not an item in commercial stations. These copper plated jars have great advantages over tin foil jars, the latter being subjected to many evils while in actual use. For instance, if a large current is applied to a tin foil coated jar, the tin foil will blister, and as soon as the coating separates itself from the jar, it causes a

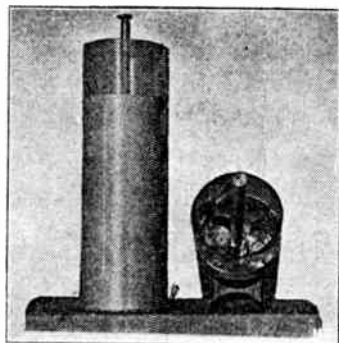
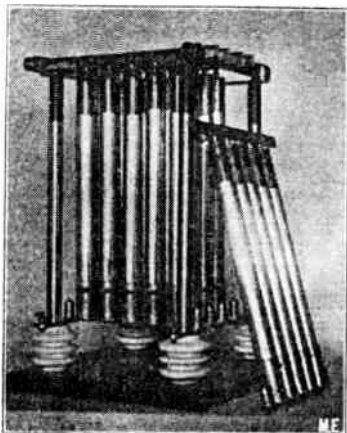

(Courtesy "Modern Electrics.")

Fig. 11

(Courtesy "Modern Electrics.")

small spark to jump to the glass. As this spark continues, the glass becomes weaker until it is finally pierced and the leyden jar rendered useless. Copper plated jars cannot blister, and provided the glass is of the best grade for this purpose, the jars may be used for an endless period.

In the earlier types of leyden jars, such as were used for demonstrating electrical principles in schools, a simple chain was placed on the rod containing the brass ball, to make the inner connection to the foil. This crude method could not be used in commercial practice, so that better means of making connections have been adopted. The inner connection usually consists of making connections which are forced together while being placed into the jar, but expand again making connections with the foil when released. The outer connections consist of brass bands which wrap around the foil making a positive contact. A battery of leyden jars are placed in a metal or wooden rack of suitable design, and in some systems may be contained in a glass cabinet.

The helix in the commercial station varies but little from that employed in the amateur station. Often these commercial helices will be found to have a hard rubber framework, which is a great expense. Notches are cut into the hard rubber parts so that the heavy copper wire can fit into them. At both ends of the wire coil, small metal blocks are screwed on, which in turn are screwed on to the framework. The wire for the average 2 K. W. station is usually about number 0 or 00 of the B. & S. gauge. Fibre frames are best.

In other types of helices, hollow tubing is employed in place of solid wire, since the fact is well known that the high frequency currents travel on the surface of wires, and not through the center portion. Accordingly, a copper or brass tube is far more desirable. Instead of wooden or hard rubber frames, a type sometimes seen employs porcelain insulators mounted on rods so that the turns may be wound around this framework. Small metal clamps hold the turns in place, and are themselves held on to the insulators.

The clips for the helix are of many designs, but the most serviceable types are those in which a jaw may be opened and closed with either a pressure of the hand, or by unscrewing a handle. The requirements for a satisfactory helix clip are: that it should make a good contact, and that it should be rapidly adjusted. Usually the helix clips are supplied with insulating handles, though these are not necessary, since the helix need not be regulated while the current is passing through it. Flexible conducting cord is attached to the helix clips so that the necessary connections may be made. In other systems, the helix clips will be found attached to copper strips, which can be placed at any point of a turn on the helix. Other helices are made in a different fashion, and the turns are flat, or "pan-cake." The connection is then made by an arm carrying a movable contact, so that by moving the arm the contact will slide to any point on the wire which is desired.

Loose-coupled helices are little used, though they may be seen at times. These consist of two individual helices, each having individual clips and conducting cords. One of these helices is stationary, while the other is mounted on rods so that it may slide further away or nearer to the fixed helix.

After having described the differences between commercial instruments and amateur instruments in as brief a manner as is permissible in the limited space, the complete description of a commercial station is interesting.

All the connections in the secondary circuit are made with heavy stranded wire or copper bar. The best installations are completely wired with heavy copper bar, so that the high frequency currents will have plenty of surface. Special precautions are taken to have all the connections thoroughly insulated with porcelain or "Electrose" insulators, for the high tension currents are apt to spark great distances.

Fig. 12 gives the complete wiring for a commercial station, and the connections for the primary circuits are already shown in fig. 7. Four clips are used on the helix so that the greatest variation possible is obtainable in the tuning of the aerial and closed oscillation circuits. A hot wire ammeter is placed in the aerial circuit to denote when the greatest amount of current is radiated into the aerial. In some instances the hot wire ammeter is placed in the ground instead of the aerial lead, but the results are equal and it is a matter of choice. The clips are moved on the helix until the hot wire ammeter indicates the greatest amount of current, which usually proves that both circuits are in perfect resonance. Hot wire ammeters such as are extensively used in wireless work to ascertain the strength of the radiated aerial current, have a short section of platinum or other wire arranged to react on an indicating needle so that whenever a certain current strength passes through it, it will be more or less heated and consequently elongated causing the needle to defect over the graduated scale.

The lead to the aerial from the aerial switch is passed through a heavy porcelain tube or electrose insulator, known as the "lead-in." The lead should be of heavy copper stranded cable, and insulated with a heavy coating of rubber. On the outside of the lead-in, the leads to the aerial are connected. Thus the set is completed.

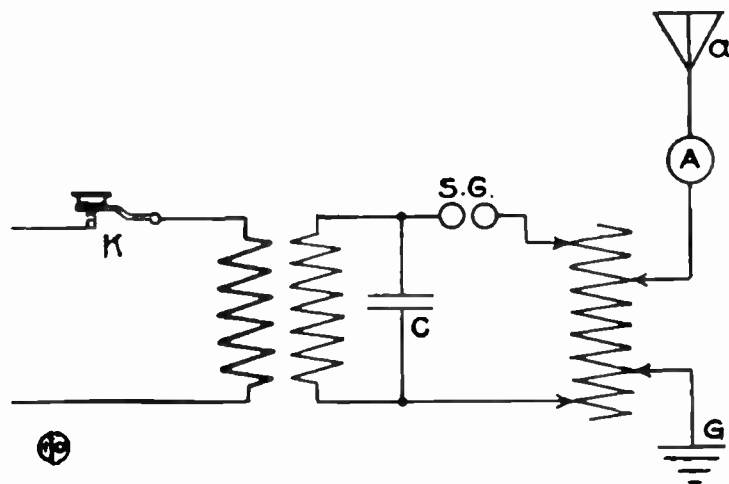

Fig. 12

During thunder storms, it is advisable to ground the aerial, so that no damage will be caused by the heavy lightning. This is accomplished by the use of a single pole, double throw switch as illustrated in fig. 13. It will be noted that the center hinge post of the switch is connected to the aerial lead, while the top post is connected to the transmitting set, and the other post to the ground. By throwing the switch lever to the ground, the station is safe from lightning damages. Commercial stations often have this switch placed on the outside of the building, near the lead-in, which is the most logical place to have it, since the lightning discharge would not pass around the curves of the wire, and instead would leak off the wires and cause great damage.

Fig. 14 illustrates a typical wireless station. The student will note the location and arrangement of the various instruments which have been described. Within the last four years, new wireless systems operating upon new principles

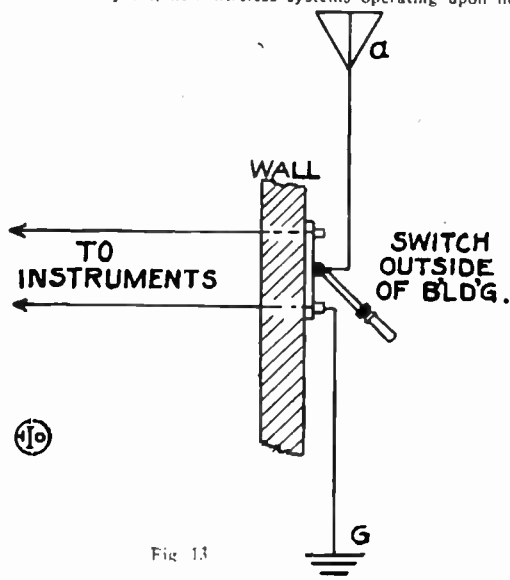

Fig. 13

have become common, and in fact are threatening the continued use of the regular spark systems. These new systems possess many distinct advantages which could not be had with the older systems. In the following lesson, the student will be

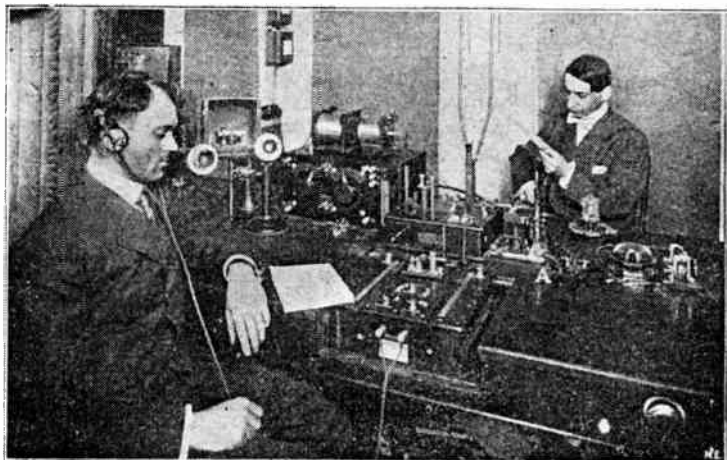

Fig. 14 (Courtesy "Modern Electrics")

given a brief description of the Telefunken, Von Lepel, and the Poulson systems, which represent a novel departure from the standard Marconi spark system, so well known to all.

Lesson Number Seven

NEW TRANSMITTING SYSTEMS.

WITHIN the last few years new systems have been introduced for producing electrical oscillations for wireless transmission. These systems have proven superior to the older spark system which is universally employed to-day, and in fact, it is probably a matter of a short time when all the stations will be employing the more efficient newer systems.

Aside from the regular Marconi spark system, there are two other methods of producing oscillations for wireless purposes used at present in commercial work: **The Quenched spark system, and the Arc system.** Under the former heading, the Telefunken and Von Lepel systems operate; while under the latter system we find the famous Poulsen system, which is also used for wireless telephony.

The **Telefunken system**, which has been introduced by the Telefunken Company in Germany, has been the beginning of a new era in wireless telegraphy, and has awakened the public to the greater possibilities which may be expected of wireless transmission in the future. With this quenched spark system it is possible to send wireless messages at three times the range procurable with an equal amount of power using the older systems. The spark produced is of a perfect musical pitch, and can be distinguished above the rumbling of static electricity in the air, and above the interference of other stations. In fact, it is the only system aside from the Poulsen, Fessenden, and the Von Lepel systems in which tuning can be accomplished to a degree of satisfaction under the trying conditions of commercial service.

The novel feature in the Telefunken quenched spark system is in the spark gap, which is entirely original in design. This gap causes the oscillating circuit and the aerial circuit to react upon each other in such a manner as to produce the greatest effect, the action being explained in the following extract taken from "Modern Electrics," page 775, of Volume No. 4:

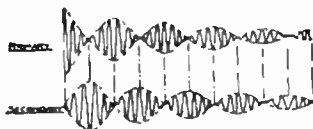

Fig. 1

(Courtesy "Modern Electrics")



Fig. 2

"Most operators have, no doubt, noticed that stations using the ordinary spark gap can be heard in two places on their tuners, in other words, these stations seem to have two different wave lengths at the same time. In reality there are two wave lengths present, even when the aerial and condenser circuits are tuned to the same wave length, and neither wave is that to which the two circuits are tuned. This double wave results from an interchange of energy between the condenser and aerial circuits. Following the initial discharge of the condenser, the primary (condenser) circuit starts oscillating, the oscillations increasing to a maximum value, at which point the secondary (aerial) circuit begins to oscillate and gradually increases to a maximum. Meanwhile the primary oscillations are decreasing in value and become zero at the time the secondary oscillations reach their maximum. The primary then begins oscillating again, as before, but the energy necessary is not supplied by the power transformer but is taken from the aerial circuit, which causes the secondary oscillations to die down to zero at the time the primary oscillations reach their second maximum, which, however, is lower than the first. This is illustrated in fig. 1.

"This interchange of energy continues until the oscillations of both circuits decrease to a point where the current in the primary circuit is no longer able to jump the spark gap. Then the oscillations in the secondary circuit slowly die out but are too feeble to radiate much energy from the aerial. The result of this is that the aerial circuit, instead of radiating a strong train of waves for each discharge of the condenser, radiates a number of short wave trains whose aggregate value is much below that of a single peaked long, slightly damped wave train that would result if the oscillations in the primary circuit be stopped just as soon as the secondary oscillations reach their maximum value, as shown in fig. 2.

"In order to radiate the most energy from the aerial, it is essential that the primary remain active long enough to build up the secondary oscillations to a maximum. If, at this point, the spark gap can be made to lose its conductivity, the

energy in the secondary will not be lost in setting the primary circuit oscillating again, but will be radiated from the aerial.

"There are several forms of spark gap which possess this desirable property of promptly damping out the primary oscillations. The most widely known is probably the rotary gap (which has been explained in the previous lesson), and which was introduced originally by Marconi, and then there are the quenched gaps of Von Lepel, Peukert, the Telefunken Company, and others, which operate on the principles first made known by Professor Max Wein in 1906, and the Mercury Vapor discharger of Cooper-Hewitt."

The student will be given a thorough explanation of the quenched spark system used at present by the Telefunken Company in such manner as the limited space allows.

The Telefunken quenched spark gap consists of a series of copper plates which are so arranged that their center faces are raised, as shown in fig. 3. This is accomplished by having the ridges turned out near the edges of the plates, and by placing mica rings of slight thickness between the two ridges of adjacent plates, a very small gap, (0.01 inch), is introduced. In fig. 3 the student will note the mica rings and the very slight gap which is formed between the plates. Usually 1,200 volts are allowed to each gap, and as many are placed in series as necessary. In the standard Telefunken sets, the gap is composed of a number of copper discs clamped together in a special framework, and each gap is provided with a metal spring piece which is inserted between the gaps which are to be short-circuited. If a nearby station is to be called, the operator lowers the voltage of his generator, and short-circuits a few gaps, leaving only one or two. In this manner the signals are reduced to such a point as to reach the neighboring station without disturbing the other stations within the usual range. The center raised portion of the Telefunken copper discs is made of silver which has been welded on the copper.

In all of the larger sets, the copper plates are single faced, the raised portion being on only one side, while the other side of the plate is perfectly flat. The plate is then placed into the countersunk portion of a large bronze plate which serves the purpose of adding more cooling surface to the plate. These extra cooling plates are necessary, since the sparks can be quenched with better efficiency while the gap remains reasonably cool. The gap is shown in fig. 4.

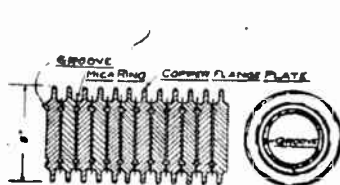

Fig 3

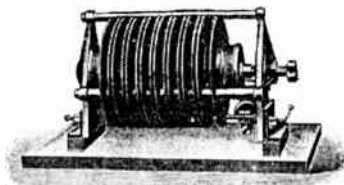

Fig 4

(Courtesy "Modern Electrics.")

While the gap is in operation the sound of the sparks does not resemble the loud crashing sound of the regular spark sets, but instead a faint sound like escaping steam may be barely heard at a distance of less than 10 feet from the gap. On shipboard this system is particularly desirable, since the signals cannot be read from sound by an unauthorized person located near the wireless room.

After describing the gap which forms the vital feature of the Telefunken system, a description of the other parts of this system is naturally of interest. The power is supplied to the gap at a voltage of about 6,000 volts, and is furnished by a closed-core transformer of very small dimensions. The efficiency of this transformer is extremely high, and but a very slight percentage of power is lost in the transformation of the voltage. A 500 cycle generator supplies current at 110 or 220 volts to this transformer through a simple telegraph key. This generator is another feature of the set which is extremely novel, for the obtaining of such high frequency current from a small size generator is a problem requiring much experimenting and designing. This generator has the two windings, both field and armature, mounted on pole pieces which are attached to the iron frame. Between the poles on which these windings are placed, a mass of laminated iron with many teeth, revolves, driven by either a directly coupled electric motor or an engine. In instances where a motor is used, the motor is supplied with a field rheostat of a special type so that the speed of the motor may be carefully varied. This rheostat is similar to a tuning coil, being wound on a cylinder about 10 inches long, and fitted with a sliding contact mounted on a rod. By moving the slider a slight distance one turn or more can be interposed into the field circuit, with the resulting slight difference in speed of the motor. By moving this rheostat handle, the pitch of the spark is changed, and likewise the emitted signal. This is a very valuable characteristic, especially so in war

operations, inasmuch as a station can change its spark and disguise its identity. A coil of wire mounted on a handle and connected across a pair of telephone receivers and detector is used by the operator for determining the pitch of the signals being transmitted by the station.

The condenser used in connection with the transformer and spark gap is also a novelty, since it uses heavy paraffined paper for the dielectric, in place of the glass plates usually employed. The voltage being only 6,000 volts as against the 25,000 volts used in the regular spark systems, enables heavy paraffined paper to be sufficiently strong electrically, to withstand the voltage. The condenser made of these paraffined paper sheets is mounted in a neat wooden case and placed in the framework holding the spark gap and tuning instruments. In larger sets the Leyden jars are used but for sets of 2 K. W. or smaller the paper condensers are satisfactory.

In fig. 5 will be seen a wiring diagram of the Telefunken system, and it will be immediately noticed that no helix arrangement is used for the connecting of the oscillation and aerial circuits. Instead, the aerial and oscillation circuits are separately tuned by independent inductance producers known as "Variometers." These variometers operate on the well known and previously described principle of self induction. The student has learned that a wire produces in itself a certain amount of self induction and that this induction may be increased by forming the wire around

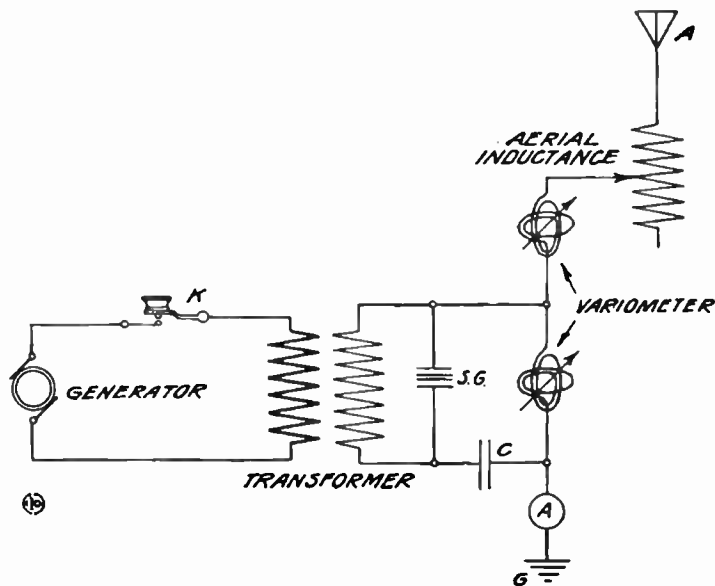

Fig. 5

into a coil. See cut of variometer, fig. 6. The variometer, which is used mostly in receiving instruments, consists of generally two coils connected in series, and so arranged that the inductance between the coils may be increased or decreased by having the coils opposing each other or arranged so as to aid each other, and thus increase the self inductance. In the Telefunken variometers as used for transmitting, four coils are arranged, two in an upper frame, and two in a lower frame. These frames are round in shape, and mounted so that the upper one rotates on its axis, while the lower one is stationary. The edge of the rotating upper disc is marked in degrees of a circle, so that by turning in one direction, the inductance will be at the maximum when the pointer indicates 180 degrees. However, by revolving the disc in the opposite direction, the inductance is decreased, and consequently the wave-length. By a special switch, a certain combination of the windings can be obtained so as to secure different inductance effects. Two of these variometers are fitted to the apparatus, one in the oscillating circuit, and the other in the aerial circuit. Besides the inductance furnished in the aerial circuit by the one variometer, a series of coils are mounted on a framework and arranged with a flexible coil and plug contact, so that these coils may be added in the aerial circuit to increase

the wave-length up to 2,000 meters if desired. In the ground connection, a hot wire ammeter is mounted, so that the two variometers may be turned until the hot wire ammeter indicates the greatest deflection. In a 2 K. W. set this deflection will be about 18 amperes.

The transmitter may be tuned with a wave-meter, by moving the variometer in the oscillation circuit until the circuit is tuned to a desired wave-length. The variometer in the aerial circuit is then turned until the hot-wire ammeter indicates the greatest deflection, the set then emitting the wave-length desired. The flexibility of the set is without equal, for any wave-length may be obtained in an instant with the adjusting of the variometers.

Approximately three times the range may be obtained with the Telefunken quenched spark system over that obtained with the regular spark system. The receiving instruments are likewise vastly superior to those employed with ordinary spark systems.

By means of the mono-tone telephone receiver, signals may be received that are absolutely non-interferable, even if a spark station be located in the immediate neighborhood of the receiving station. The mono-tone telephone receiver consists of a strip of steel which is tuned to vibrate for a certain electrical frequency. When

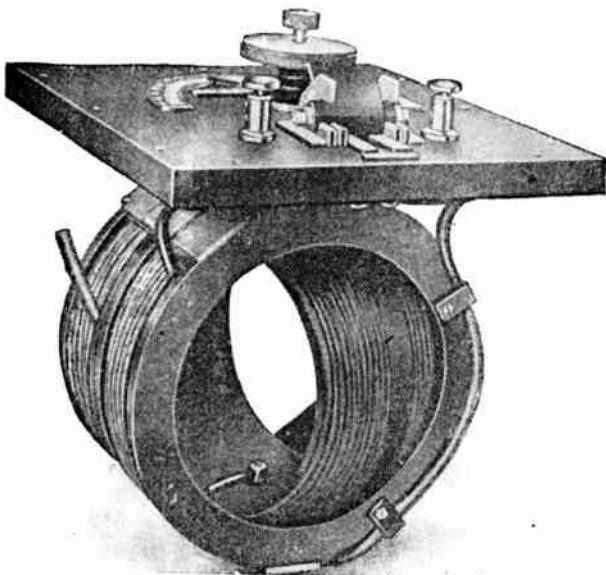

Fig. 6

(Courtesy "Modern Electrics.")

a spark is emitted by the transmitter, if it be of the same frequency as the strip in the telephone receiver, it will operate same. All quenched sparks having a lower or higher pitch will not effect the receiver. Spark sets of the regular type will not operate the receiver at all. Thus, absolute selectivity may be obtained, except if another quenched spark station would seek to interfere intentionally. An instrument known as a resonance relay enables the operator to receive signals on a standard recorder, so that the signals will be printed on a paper tape. A small bell can also be caused to ring so that the operator is informed that he is being called. These possibilities were not found in the older sets, although a bell and tape recorder could be used for very slight distances. In the quenched spark system these instruments may be worked at ranges of several hundred miles, and in fact as far as the transmitter can operate the ordinary telephone receivers usually employed. By means of a specially arranged clock-work, the bell will only respond when a predetermined number of dots or dashes are sent by a quenched spark transmitter tuned both in pitch and in wave-length to the calling apparatus in the receiving station.

The Von Lepel system varies but little from the Telefunken system, the principle of operation being the same, though the execution of the idea is slightly different.

In 1907, the Von Lepel system of producing wireless waves was introduced by Baron Von Lepel of Germany, and during 1908 and 1909, a continuous controversy was engaged in between the Von Lepel interests and the Telefunken Company as to the originality of the rival systems. These debates were printed in the English "Electrician" and were followed by all those interested in wireless telegraphy, though the final results as to which system had the priority in the quenched spark application to wireless telegraphy apparatus, could not be definitely decided. Both the Telefunken Company and the Von Lepel interests have many patents in Germany on presumably similar inventions.

The new and important feature of the Von Lepel system consists of its quenched spark gap. This gap is made of two copper discs which are separated by a piece of ordinary paper, or perhaps two sheets may be used if desired. A small hole has been made in the center of the paper. The copper discs are then tightly clamped together so that no air can enter. An arc or spark forms between the two copper discs where the paper is removed, and as the arc continues to operate for two or three hours, the paper finally becomes entirely consumed and must be replaced. The burning of the paper furnishes additional advantages for the arc. The space between the copper discs is said to be .002 inch, while the plates are 3 inches in diameter.

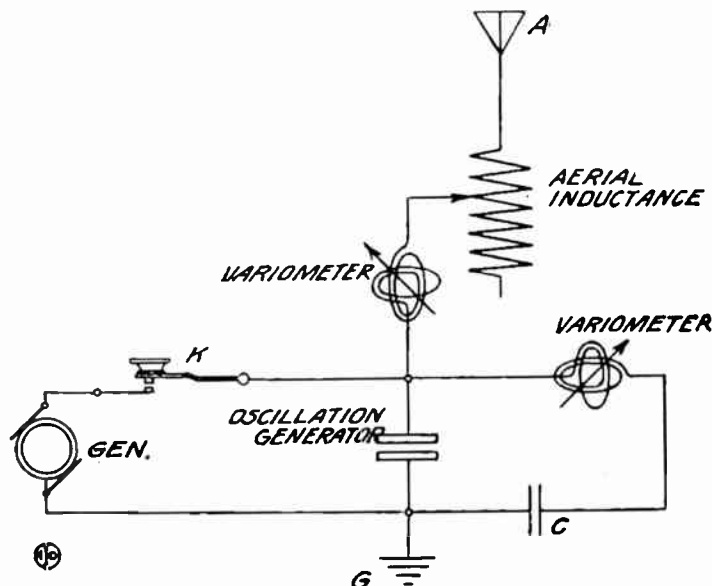

Fig. 7

In the larger forms of the Von Lepel spark gap, the copper discs are water cooled. The arc or spark gap may operate on very low direct current voltages, since the gap is separated by such a small distance. Whether the discharge takes place in the form of an arc or in the form of sparks is a question which is still discussed with uncertainty. It is probably safe to presume that the discharge is an arc, and that the burning paper furnishes hydrogen to this arc, thus steadying it in constancy of operation. It has been claimed that with the Von Lepel system it is possible to cover ranges of 300 miles with less than $\frac{1}{2}$ K. W. of primary power. Should this be correct, there is but little doubt that it is the most efficient system in use at the present time, including the Telefunken quenched spark system.

The arc operates on currents as low as 300 to 500 volts, a transformer being unnecessary if a motor-generator set is employed to raise the current. Direct current is employed at a consumption of 1 to 2 amperes. Owing to the extreme simplicity of the Von Lepel instruments, it is admirably adapted for portable purposes. As in the Telefunken system, the condenser is made of mica or paraffined paper, but is only 4 cubic inches in dimensions.

The wiring diagram of the Von Lepel system shown in fig 7 illustrates the connections. It will be noted that as in the Telefunken system, the oscillation circuit is separately tuned by its own inductance while the aerial also is separately tuned and has an additional aerial inductance for long wave-lengths.

The Poulsen system introduced by Valdemar Poulsen, a Dane, in 1903, is based on the arc principle of producing electrical oscillations, and is used to-day with much success. It possesses many advantages in common with the Telefunken quenched spark system.

The Poulsen system is based on the experiments performed by Duddell in 1900, in which an arc was made to produce electrical oscillations and give out a musical note when shunted with an inductance and condenser. It has since been called the singing arc. Fig. 8 illustrates the Duddell singing arc hook-up, in which it will be noted that a choke coil is used to prevent the oscillations from backing through the generator, and instead are made to charge the condenser and then discharge through the inductance and arc. The following explanation illustrates the reason why electrical oscillations are formed when an arc is shunted by a capacity and inductance.

It is known that with an increase of current through an arc the voltage between the arc terminals decreases. For this reason, when the arc is connected in series with a source of voltage and the current turned on into the arc, this current tends to increase to a very large value, and for this reason, resistances are usually interposed in the power leads of arc lamps. If the capacity and inductance are now shunted around the arc, the condenser begins to charge. This takes current from the arc and in consequence the voltage between the arc terminals increases, and causes more current to flow into the condenser, since it is barred by the increasing voltage difference between the terminals of the arc. Finally the condenser becomes charged to an equal potential to that of the arc, but owing to the inductance in the circuit, the charging of the condenser continues for a time after this period. The result is that the condenser has a higher potential difference than the arc, which causes the current to cease flowing into the condenser. The condenser then begins to discharge through the arc, causing a drop in the arc voltage, and a further

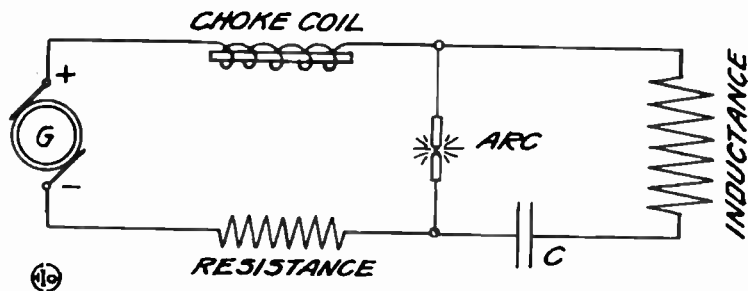

Fig. 8

discharge of the condenser. While the condenser is discharging, the inductance in series with the condenser tends to preserve the discharging current, so that the condenser potential finally falls below that of the arc. After a minimum potential in the condenser has been reached by this discharging, the process is reversed and the action begins anew. The arc and the condenser circuit are thus in an unstable condition and the condenser continues to charge and discharge, thus impoverishing and replenishing the arc as to current. Whatever energy is expended in this oscillation circuit is drawn from the direct current source. It is well to mention here that alternating current cannot be used on the arc for wireless purposes.

In the Duddell arc the period of the oscillations was not sufficiently rapid to enable their use in wireless telegraphy. The improvements of Poulsen made the application possible, and to-day this system ranks among the foremost for efficiency and advantages.

The main difference between the Poulsen and the plain Duddell arc, is that the former is so arranged that the arc takes place between a solid carbon electrode, and a hollow copper vessel in which a continuous current of cold water is caused to flow. This keeps the arc cooled, and the arc is staided by being enclosed in a chamber to which hydrogen gas is supplied. In some types the carbon electrode is slowly rotated by a motor, and two powerful electro-magnet poles cause the frequency of the oscillations to be greatly increased. The arc no longer emits a musical note, since the rapidity of the oscillations has increased to beyond the range of the human ear, and are, therefore, inaudible.

Fig. 9 illustrates the principle of connections employed in the Poulsen system. The oscillation circuit is connected to the aerial circuit by a loose-coupled transformer. The condenser consists of a number of brass plates mounted on a rotary shaft so that these plates may be turned in order to intersect other plates, the whole being immersed in oil. The current is furnished at low voltage (under 110 volts), but in some of the Poulsen arcs a voltage of 550 volts has been employed.

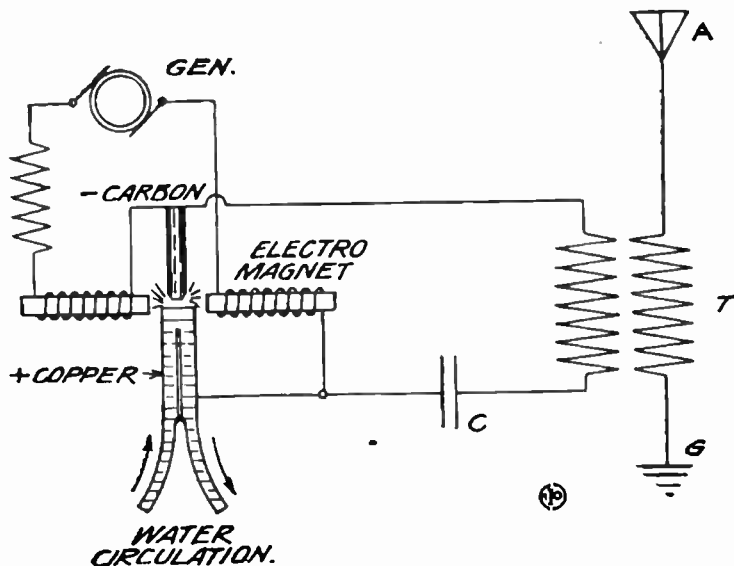
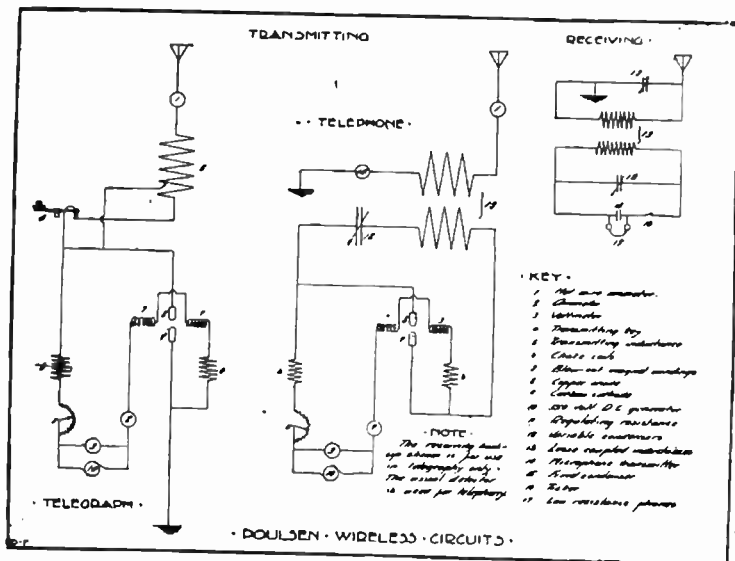

Fig. 9

The oscillations produced by the arc system are exceedingly sharp and require accurate tuning at the receiving end. Inasmuch as the signals produced are beyond the range of audibility, some means must be employed to transform these received oscillations to a lower period so that they may be heard. This is accomplished by a clever arrangement known as the "ticker." The ticker consists of a clever little automatic switch device which causes the current sent through the detector to be interrupted so that it may charge a condenser, and this condenser in turn discharges through the detector, and being that the discharges are of a much lower frequency than the original oscillations, the signals can be heard in the telephone receivers on the operator's head. All other spark stations cannot be heard, even if they are located in the immediate neighborhood.

By supplanting the key with a telephone transmitter, the set is capable of being used for wireless telephony. In the De Forest system, which operates a wireless telephone on the same principle, a clever method is used to break up the oscillations so that they may be received by ordinary stations. This consists of a buzzer having heavy contacts mounted on the vibrating armature. The buzzer operates with a few dry cells and a simple key, while the aerial is connected in series with the heavy contacts. The results are that the oscillations are broken up so that they may be heard by any station equipped with ordinary receiving apparatus. This is known as the "chopper set." In this manner the operator may call up with the wireless telephone or telegraph using the same set.

The Poulsen system is used largely in Europe and gives excellent results. However, it is a matter of doubt whether it can compare to the Telefunken system, which is more stable, since it does not require rotary parts in the gap, nor gases and adjustments. The Poulsen system offers remarkable tuning advantages, which have never been duplicated.



(Courtesy "Modern Electrics.")

The Poulsen apparatus, as used by the Federal Telegraph Co., works practically as follows: The arc is formed in an atmosphere of coal gas or other hydrocarbon gas in an air tight chamber, between the poles of a strong electro-magnet. The magnet coils may also be used as choke coils to prevent oscillations passing back into the generator, or additional choke coils may be inserted. The voltage used is about 500 volts, D. C., the copper electrode and arc chamber being cooled by water circulation.

The oscillation circuit is formed by connecting one electrode direct to the earth connection, and connecting the other pole to the antenna through a large inductance. The condenser, in this case, is the capacity of the antenna and earth.

The Morse key is arranged to cut in a few more turns of inductance when depressed, thus giving out a longer wave. This accounts for the unreadable signals heard by many amateurs, who cannot tune to the longer, or working wave, and only hear the shorter, or compensating wave, when the key is up. The working wave is generally 2,000 to 3,000 meters long.

The receiving apparatus differs from the ordinary, in that it has no detector. As the frequency used, is of course, so high as to be practically inaudible to the ear, it must be broken up to be audible. This is accomplished by a device called a "ticker," as aforementioned, which is merely an interrupter capable of special adjustments, placed in series with a small condenser, around which is shunted a pair of low resistance phones. Across the ticker and small condenser is shunted a variable condenser. The received oscillations charge the variable condenser when the ticker is open. Upon its closing, the variable condenser discharges into the small condenser. When the ticker again opens, the small condenser discharges into the phones, causing the signals to be heard. The ordinary low frequency spark cannot, of course, be heard on this arrangement, but the quenched spark, or so-called "sparkless" system can be.

Great advantages are claimed for the Poulsen system, such as its noiselessness, the ease of handling high-powered sets, the absence of high voltages, etc. It is claimed, also, that greater distances may be covered overland with this system, and the work being done by the Federal Company shows this to be true, as they constantly work from 500 to 900 miles overland in daylight. (See lesson 18.)

As we stated at the beginning of this lesson, it is only a matter of time when the later systems described in this lesson will supersede the ordinary spark system. These later systems have only given us an idea as to what may be expected in the future, when even electrical energy may be transmitted wirelessly without loss of power to any considerable degree. To the student and experimenter, it demonstrates clearly the remarkable field opened for research in this branch of science.

Lesson Number Eight

RECEIVING APPARATA. PART ONE.

THE various instruments or apparatus brought into play, in the receiving of wireless messages, has been much improved upon since **Commandore William Marconi** sent his immortal three dots, representing the Morse code letter "S," across the broad Atlantic in 1901.

It will probably be the best plan, to first explain the function and actions of a simple receiving outfit, such as that employed in the smallest amateur or experimental station. In fig. 1, is shown such a layout, including the aerial wire, a detector D, telephone receiver R, and ground connection G. This forms the very simplest receptor for wireless signals possible.

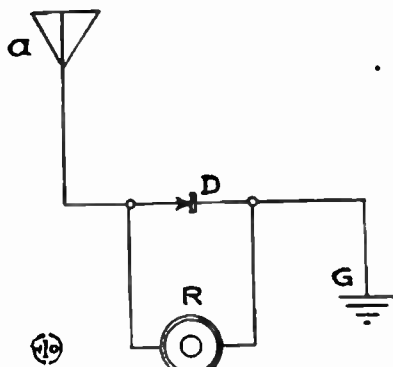

Fig. 1.

The incoming oscillations induced in the aerial wire, pass through the detector or *cymoscope*, as Prof. J. A. Fleming has termed them, and on down to earth. The detector, which in these discussions will be considered one of the modern crystal rectifying type, such as the silicon or perikon, tends to act as an electrolytic valve, and permits the currents coming in one direction to traverse it many times better than currents from the opposite direction, or polarity, and the clipping off of the half waves or oscillations due to this phenomena, causes the telephone receiver to have a pulsating rectified or direct current (practically) impressed upon its windings, and consequently a varying or constantly changing magnetic pull is exerted upon the iron diaphragm, giving rise to the buzzes heard by the ear, whenever a wave impinges upon the aerial circuit. The high self-inductance of the receiver coils prevent the oscillations from passing through it, instead of the detector.

Such a receiving set as just described, is not capable of being tuned to any desired wave-length, and consequently, except for certain wave-lengths or short distance work, its sphere of usefulness is quite limited.

The first method applied to tune the receiving apparatus to any desired wave-length, employed a simple cylindrical coil of insulated wire, made up of several hundred turns or convolutions, each turn being insulated from its neighbor, and a sliding contact arranged to make connection with any desired number of turns. The connection of such a tuning coil is depicted in fig. 2, at T, which is the coil of wire above mentioned. More or less of the wire can thus be readily inserted in series with the aerial, thereby changing its wave-length to a high or low value.

This method is not, however, very efficient for reasons to be subsequently explained, and is not used any more, except for the purpose of an extra tuning inductance, or "loading coil" in the aerial lead, where long wave-lengths beyond the range of the regular instruments are to be received.

The next method utilized for tuning the receiving apparatus, was that where the free end of the tuning coil is grounded or connected to earth, as shown in fig. 3. This scheme at once rendered the tuning coil something more than a mere dead

*See book on "Detectors" of this Course.

resistance coil in the aerial lead, or in other words, it now became a transformer of the type commercially used and known as an "auto-transformer" or mono-coil transformer, meaning one whose primary and secondary coils were combined into one coil, instead of the two separate windings employed in most transformers.

This tuning coil transformer action is a very important one now, in receiving sets, and is made good use of in administering the proper voltage and current to certain classes of detectors, some of which require a stronger voltage than others, for their proper operation. These are usually referred to as current actuated and voltage actuated detectors, respectively.

The manner of varying this impressed detector voltage, in virtue of the transforming action occurring in the three-lead tuning coil, is due to the following reasons:—

When the oscillations set up on the aerial wire pass through the tuning inductance coil T, it causes this coil to become surrounded by an electro-magnetic field of force, which embraces all the turns of wire thereon. Now, if the section of the coil represented by P in fig. 3, is taken as the primary winding of the auto-transformer,

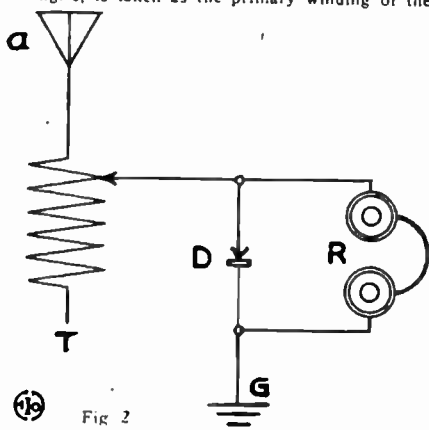

Fig. 2

and the turns or section at S, at the secondary winding, then the voltage of the secondary leads to the detector will be, as the ratio existing between the number of primary and secondary turns, i. e., if the primary were connected across 100 turns

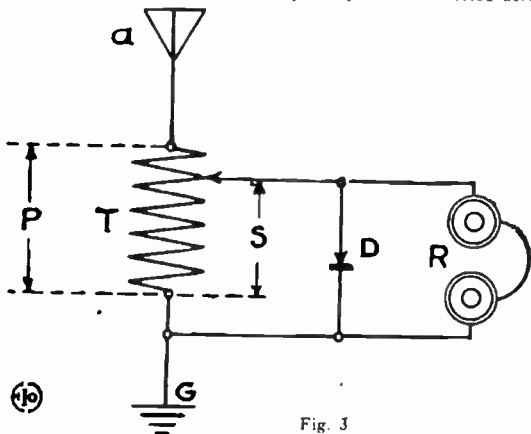

Fig. 3

of the coil, and the secondary leads across only 70 turns, then, supposing that one volt passed through the primary section, only seven-tenths of a volt would be taken off through the secondary leads.

Here the transforming action is step-down, but it can also be made step-up, by simply reversing the ratios and connections of the primary and secondary sections, as depicted at fig. 4, in which case it is at once perceived that the aerial slider is below the detector slider, and consequently there are more turns of the coil embraced in the secondary section S, than in the primary section P. Hence the secondary voltage impressed upon the detector, would be greater than the primary voltage, or if the primary potential was one volt passing through fifty turns of wire, and the secondary section took in one hundred turns of the same coil, then the latter voltage would be stepped-up in the same proportion, or two to one, or the secondary potential would be twice one volt or two volts. Of course, in wireless work, the potentials obtaining in the tuning coil circuits are usually very small, except when a high powered station is in close proximity to the station receiving.

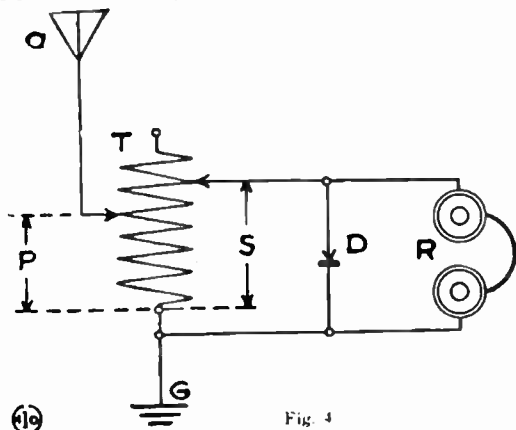

Fig. 4

This type of auto-transformer is used in heavy commercial electric work to step-down the voltage applied to the windings of induction motors in alternating current circuits. The one-coil transformer is also often employed to step-up A. C. voltages for various purposes, being very simple and more efficient than two-coil transformers for certain classes of work. Auto-transformers have been built to step-up five hundred volts to two thousand or more.

Thus the first tuning coil was found to be more perfectly tuned, as regards the open, and detector or closed oscillating circuits, when provided with two movable contacts or sliders.

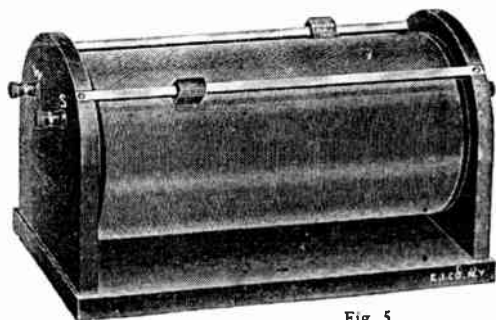

Fig. 5

A cut of a well designed double slide tuning coil or auto-transformer is illustrated by fig. 5, this particular coil having a tuning wave-length capacity of 700 meters, or 2,310 feet about. This coil then would give a station having an aerial wave-length of 50 meters, a total wave-length of 750 meters. The wave-length of the tuning coil is found by multiplying the total length of wire on it in meters by the factor four.

The receiving station employing any form of a single coil tuning inductance is called a "close-coupled" set. In the past few years, due to certain peculiarities occurring in radio-communication, such as static and interference currents, the two-coil or regular type of transformer has been widely adopted, which seems to give the greatest clearness and sharpness in tuning, as it is possible to place the secondary coil in any relative position to the primary or aerial coil.

This type of receiving set, involving the use of a two-coil transformer, is termed professionally a "loose-coupled" set, as there is no metallic electrical connection existing between the primary and secondary circuits, in other words, the coupling is therefore loose. A standard form of a receiving "loose-coupler" or transformer is illustrated in fig. 6, the instrument shown being one of the well known line, built by the Electro Importing Company, of New York City. It has a wave-length capacity of eight hundred meters, and makes possible the very finest and closest tuning, the accuracy being within one per cent. or less.

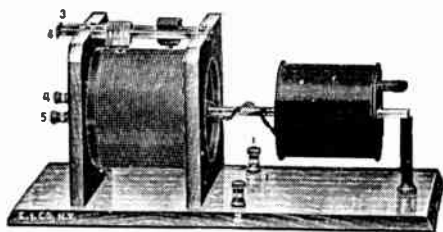

Fig. 6.

Receiving transformers are generally made with a primary or outer aerial winding of a comparatively few turns of large copper wire, about No. 18 to 20 B. & S. gauge, and an inner sliding secondary coil having many turns of fine copper wire, about No. 28 gauge, the idea of this arrangement being to give a good step-up ratio between the primary and secondary windings, and consequently in their voltages, although this ratio can be varied considerably by the position of the primary or secondary sliders and of the secondary coil itself.

It has been found, that to be the most efficient for wireless work, which involves the use of high frequency currents, the copper wire used on tuning coils or tuning transformers should have the lowest possible inherent capacity. Enamelled wire, which has a very high inherent capacity, is thus unsuited for these purposes, and the best wire is bare copper, with the individual convolutions or turns spaced a

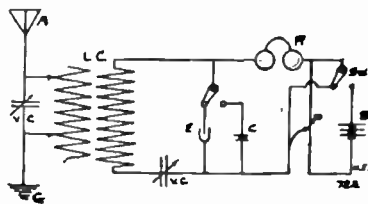

Fig. 7

(Courtesy "Modern Electrics")

slight distance apart, so that they do not touch and short-circuit themselves. All of the tuning coils and tuning transformers built by the Electro Importing Company, exhibit this feature, which is important where any long distance work is to be attempted. The covering on the wire acts as part of a condenser, with the wire as the charging electrode and the higher the inductivity of the covering, the more pronounced the capacity or condenser effect, which tends to choke back the oscillations. This effect is also very noticeable in all long distance electric lines, whether under the water or soil or in the air.

The connections of a receiving station, employing a loose-coupler, is shown by fig. 7. In this diagram are also depicted a variable condenser, a fixed condenser, and a potentiometer and battery for an electrolytic detector or other cyroscope requiring battery current to actuate it.

The action of the loose-coupler or transformer is as follows.—Referring to fig. 8, the incoming oscillations or currents surge along the aerial, into the primary winding of the transformer L. C. and cause an electro-magnetic field of force to be set up around it, whose lines of force naturally embrace the adjacent secondary coil of many turns of fine wire, and induce in it an electro-motive force which passes out into the detector circuit.

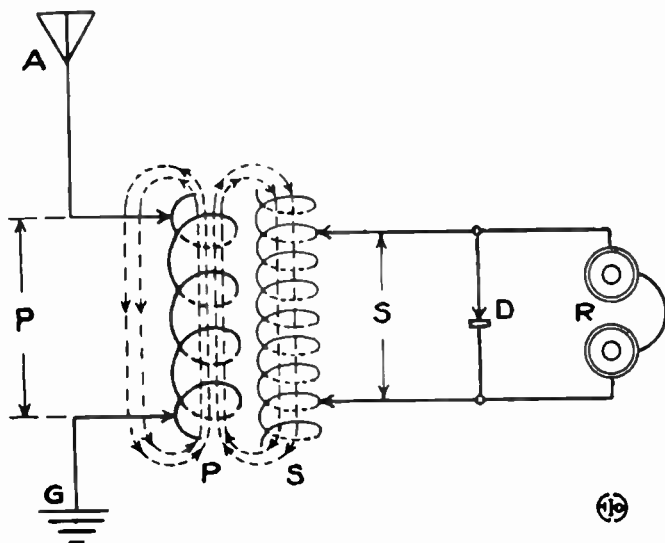

Fig. 8.

The electro-motive force induced in the secondary winding of the loose-coupler is dependent upon the ratio existing between the number of primary turns and number of secondary turns, i. e. if the sliders of the primary coil are set to include 20 turns of wire, and the secondary turns in use amount to 100, then the "ratio of transformation," existing between the two coils is as 100:20 or 5 to 1, and the secondary voltage would be equivalent to five times the primary voltage, the current, however, being decreased accordingly, as the total energy cannot be increased, only changed in its form. So if one-tenth of an ampere at one volt pressure was the primary energy passing, and the ratio of transformation equalled to 5 to 1, then the secondary energy would be in the form of 5 volts, and but one-fifth of the current or one-fifth of one-tenth ampere, which is one-fiftieth of an ampere. This supposes that the efficiency of transformation is 100 per cent., but for an air-core transformer of this type, the efficiency would be very much below this figure, probably not above 5 per cent. Thus the secondary voltage is equal to the calculated value as stated above, but due to the losses in transformation the current strength is about 5 per cent. of the computed value, or 5 per cent. of 1.50 ampere, which is 1-1,000 ampere. These figures are taken merely to help explain the action taking place, and are of course much smaller in actual wireless work, the current strength being about 40 micro-amperes or 40 millionths of an ampere, when good readable signals are received with a crystal rectifying detector, such as the Perikon.

The reason why this class of apparatus, whether one or two-coil type, realizes such a poor efficiency is because the electro-magnetic lines of force must be carried through the air, instead of iron, which has an electro-magnetic conducting power varying from 100 or more, times that of air, resultant in only a fraction of the magnetic flux of the primary coil reaching the secondary coil.

Recently, electrical scientists, have bestowed themselves with the idea of placing a properly designed iron core in wireless oscillation transformers, and by no less an authority than Dr. Charles I. Steinmetz, Chief Electrical Engineer for the General Electric Company, of America.* The use of iron for such high frequency currents as encountered in wireless apparatus, varying from a few hundred thousand cycles up to a million or more per second, would bring out some new and unknown results undoubtedly, tending to the more efficient operation of such apparatus quite likely.

Up to this time, no iron has been utilized in oscillation transformers, either transmitting or receiving, owing to the excessive time lag incurred by the iron mass in having to so rapidly change its magnetic polarity, the molecules of which it is composed being obliged to turn over, end for end, according to the theory now held, and the friction occurring between the millions of molecules, whenever the magnetism reverses, is quickly manifested, as soon as the frequency of reversal exceeds 20 to 30 cycles per second.

If iron is introduced for this purpose, it will undoubtedly have to be a specially prepared grade, and extremely soft and homogenous, besides being divided up into very fine sections.

Besides the familiar tuning coil and loose-coupler for receiving purposes, there is another instrument known as a "variometer," which is employed extensively by the Telefunken Wireless Company. This instrument is nothing more than two helices of wire, one within the other, the inner helix being adjustable as regards its position in relation to the other helix.

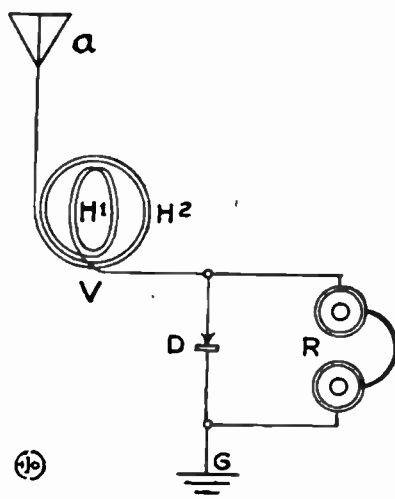

Fig. 9

In fig. 9, is shown the idea of the variometer, H 2 being the outer helix, and H 1 the inner rotative helix. Change in wave-length is accomplished in this instrument, by rotating the movable inner coil or helix, to have a certain position in respect to the stationary helix, this position determining the value of the self-inductance and mutual inductance of the two coils. Usually it is utilized in conjunction with a variable capacity or condenser, as then it becomes possible to tune quite sharply. The variable capacity is generally shunted across one of the variometer coils.

Before taking up the next section on receiving apparatus, a few paragraphs will be devoted to a remarkable receiving instrument devised and perfected by Hugo Gernsback, of New York City.

It is patented by Hugo Gernsback and is very well adapted to the requirements of all portable wireless stations, such as those in mule pack sets, aeroplane and airship sets, and in a hundred other places, where light weight and great compactness are prime requisites.

*See Dec., 1911, Proceedings American Institute of Electrical Engineers.

A view of the instrument, which is called by its inventor a "Detectorium," is shown at fig. 10. The Detectorium combines a tuning coil, of the double slide type, and a crystal rectifying detector, such as the silicon, in one compact instrument, which weighs but 18 ounces, or with a pair of head receivers and some aluminum aerial wire, the whole outfit will not weigh more than 2½ pounds.

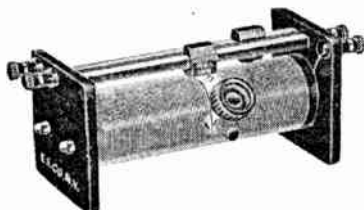

Fig. 10

The unique part of the instrument lies in the detector arrangement, which makes use of a piece of silicon or other crystal, fastened onto a spring protruding from one of the tuner sliders, and by using this crystal as a contact point against the bared convolutions of the coil, the inventor makes it possible to actually tune with a detector. The instrument was thoroughly tried out and proved very sensitive and positive in its action.

In the drawing fig. 11, are shown the best methods of connecting up the instrument, the arrangement at C, having been found to be about the best, especially where there is much static or interference to cut out.

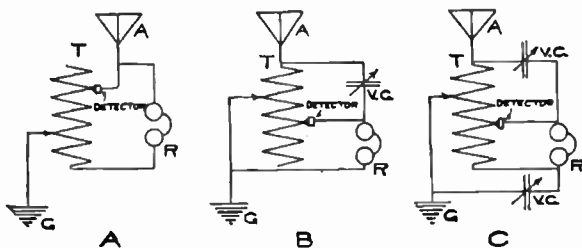

Fig. 11

(Courtesy "Modern Electrics.")

A portable receiving set comprising a high antenna, 1,200-meter tuning coil, silicon detector, variable condenser, receiver, testing buzzer, battery and ground connection, is shown below, and was fully described in "Modern Electrics."

The antenna for this outfit consists of a single No. 28 wire which is elevated by means of a four-foot "tailless" kite, being either dropped down perpendicularly from the kite or run parallel with the kite string. A spring clip on the end of a flexible cord makes connection with the antenna wire. The wire is made very light and covered with cloth. It is rendered portable by making the curved cross stick removable. As this set is used in all kinds of weather, three different weights of string (seine-twine) are used.

A magneto telephone box with inside dimensions of 7x4¼x4 inches, contains the detector, condenser, tuning coil, buzzer and its battery.

The tuner has a 2¼ inch core 7 inches long wound with 75 meters of No. 28 bare wire. In with this is a loading coil containing 225 meters of No. 32 wire which is "tapped" at intervals of 75 meters, taps leading to a four-point switch. This method of using a loading coil is the only way by which so long a wave length may be obtained within such a limited space. To our definite knowledge this plan has never been used before, at least has not come to our notice.

WIRELESS COURSE—LESSON NO. 8

The detector is held inside the box by a spring fastener when not in use, and when in use is connected to binding posts on the outside of box. The silicon detector is chosen as being least liable to injury or getting out of adjustment, besides ranking close to the electrolytic in sensitivity.

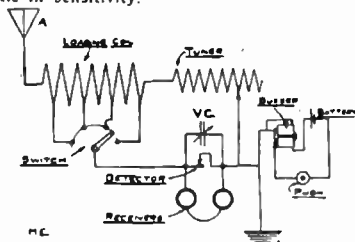

Fig. 12 (Courtesy "Modern Electric")

The variable condenser is capable of fairly close regulation and may be made of any convenient size. The condenser is rolled up into a cylinder and fastened to the inside of the box cover with the condenser switch on the outside of the box.

The testing buzzer, which is almost indispensable, is a very small one, and is connected through a flush type push button to a small flash light battery, fastened also, on the inside of the cover.

The ground consists of an iron rod about 18 inches long, with a ring in the end to facilitate pushing in, and especially pulling out of ground.

The ground and antenna are connected through flexible cords to binding posts on the outside of box.

Double head receivers are almost a necessity, as little can be heard without them on account of wind, etc.



Fig. 13 (Courtesy "Modern Electric.")

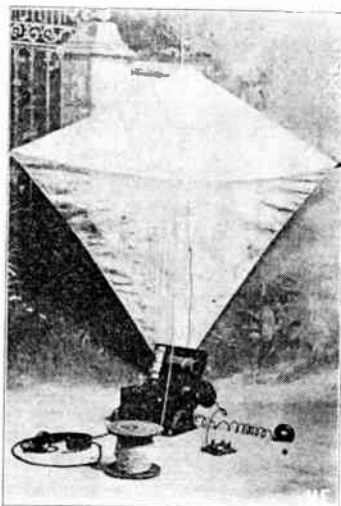

Fig. 14

Fig. 12 shows the connections used, while figs. 13 and 14 are photos of the outfit packed and unpacked.

This set has actually been unpacked, set up, and receiving messages inside of five minutes. It is capable of fine tuning and excellent results have been obtained with it.

In case of damage to the kite, or when there is no wind, fairly good results may be obtained by attaching a stone to the wire and throwing it over a high tree or barn.

(To be continued Next Lesson)

Lesson Number Nine

RECEIVING APPARATUS, CONCLUSION.

PART TWO.

THE commonest type of receiving set and an explanation of the tuning transformers employed were covered in the preceding book. In the present paper, the function of the condensers, head receivers and potentiometers will be discussed, the detectors receiving exhaustive treatment in a special book.

To begin with, a diagram for the connecting up of the above named instruments is referred to at fig. 1, wherein A is the aerial, T the loose-coupler, V C a variable condenser or capacity, D an electrolytic detector requiring battery current to actuate it, R head telephone receivers, P adjustable resistance or a potentiometer shunted across the battery terminals.

The variable condenser may be used in a number of different ways, a small one sometimes being connected across the secondary coil of the loose-coupler. For further diagrams of proper connections of the various apparatus, the student is referred to the lesson on "Hooks-Ups and Connections," where every standard sending and receiving connecting scheme is given in full.

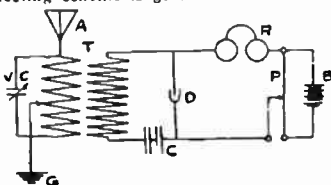

Fig. 1 (Courtesy "Modern Electrics.")

The variable capacity in the primary circuit makes it possible to vary the wave-length, as this is dependent upon the oscillation constant, which is the square root of the product of the inductance and the capacity. Hence, sharper tuning and better elimination of stray currents incurred by static and interference is possible. For long wave-lengths, the variable condenser should shunt the inductance or primary coil as shown in fig. 1, but for tuning in short wave-lengths the capacity must be connected in series with the ground wire, or between the primary winding and the ground connection.

Variable condensers are constructed in several ways, the standard commercial pattern having two sets of semicircular metal plates, with a small air space separating each of the plates from its neighbor. One of the sets is made stationary while the other set is mounted upon a movable spindle, permitting the rotating of it and the attached plates, so that more or less of their surface may be inserted between the stationary plates, with a consequent increase in the capacity, or vice versa.

The maximum capacity is obtained when the moving plates are totally within the stationary plate air spaces, and the minimum capacity, when the moving plates are entirely removed from the stationary plate air spaces. This form of condenser was originally devised by Kordia, and so it is called the Kordia air condenser.

In some condensers of this type, the precision of adjustment has been so close that, only 1-100 inch separated the moving plates and stationary ones. If the plates touch at any point, the condenser would at once be rendered useless, or in other words, it would be short-circuited and cut out of circuit.

At fig. 2, is shown the construction of a rotary plate condenser, for receiving circuits.

A cut of a sliding plate variable condenser, built by the Electro Importing Company, is illustrated at fig. 3. This condenser admits of varying the capacity from zero to maximum, by simply pushing the moving plates in between the fixed ones, and from maximum to zero, by withdrawing them from the fixed plates. This type of condenser originated by H. Gernsback in 1907.

The condenser illustrated here, has 17 plates of aluminum in all, 9 of them being fixed or stationary and 8 of them moving, the individual plates being separated by a minute air-gap. This condenser has a maximum capacity with the moving plates all the way in, of .0016 microfarad, which is sufficiently high for most any requirements. Ordinary rotary plate air condensers have about .001 microfarad capacity.

The capacity of an air dielectric (insulated) condenser such as these, is directly dependent upon the total active area of air, which is surrounded by condenser plates of opposite polarity; the thickness of the air space between the plates; the inductivity factor, which for air at ordinary pressure is 1.

This being so, it becomes a simple matter to compute the capacity of a certain condenser, if the total area of active air space, between the plates is known, and also the specific capacity per one unit of area.

For example, the specific capacity in microfarads for one square inch of air at ordinary pressure (14.7 pounds per square inch, or atmospheric pressure) and 1-16 of an inch thick, is .000003596 M. F. For a similar area, only 1-32 of an inch thick, the capacity would be double that given for the 1-16 inch air gap. In other words, the closer the condenser plates of opposite polarity are brought, the greater the capacity obtained, other things being equal, but the plates must not approach so close to each other, that the potential can break down the condenser, by jumping between them.

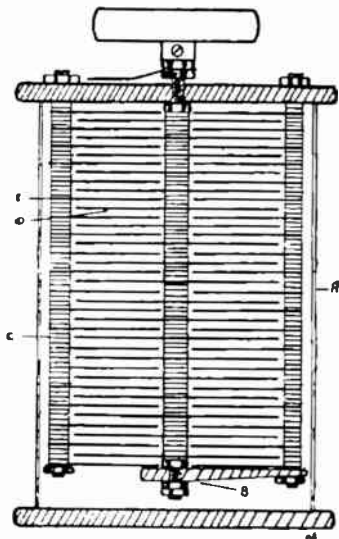

Fig. 2

- A- Glass Casing
 B- Insulating Support
 C- Copper burls
 D- Rotating Plates.
 E- Stationary Plates.

(Courtesy "Modern Electrics.")

Knowing the capacity per square inch of active dielectric, then it is only necessary to multiply the total number of square inches of active air in the whole condenser by it, and the result will be the maximum capacity in microfarads.

As an example: suppose a rotary air condenser has 21 stationary semi-circular plates, and 20 moving plates of similar shape, the diameter of the plates being 6 inches. The air space between the stationary and moving plates is 1-16 inch. First, it is necessary to ascertain the area of one moving plate, which is that of half a circle, with a diameter equal to that of the plate. The area in square inches is found by the formula:—

$$A = \frac{\pi \times r^2}{2} \text{ or } \frac{\pi \times d^2}{8}$$

Where: A is the area in sq. in. of one-half a circle.

π is 3.1416 (a constant).

r is the radius in inches (one-half the diameter).

d is the diameter in inches.

Hence, applying this rule to the above problem, it is ascertained that the area of one moving plate is 14.1372 sq. in. Now, each moving plate is surrounded on both sides by a stationary charging plate, so that the total active air space exposed to charge, is twice the number of moving plates or 20 times 2, or 40 air spaces, and the total active air area in sq. in. must be 40 times 14.1372 sq. in. or 565.488 sq. in. The maximum capacity is then, 565.888 times the capacity per one sq. in. of air 1-16 inch thick (.000003596 M. F.), or .002033 + M. F.

Some types of variable condensers employ other dielectric than air, which greatly increases the resultant capacity, as the charging plates or surfaces can be brought very much closer together.

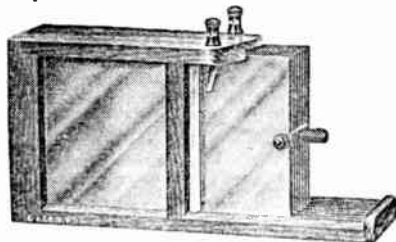

Fig. 3

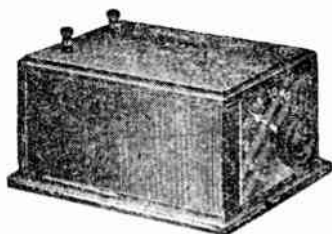

Fig. 4

An entirely new style of Variable Condenser giving an enormous capacity in a comparatively small space is known as the "Gernsback" Rotary Variable Condenser, after its inventor, and is the first condenser using this principle.

From the illustrations, it will be seen that a central roll operating much the same like a roller shade winds and unwinds flexible insulating sheets between thin metallic sheets.

There are three rolls altogether and the actual condenser is wound on the central roll. Thus a very high capacity is obtained simply by moving the central knob back and forward. The capacity is .01 Microfarad, an astonishing capacity for so small a condenser.

The adjustment of the capacity from zero to maximum is easily accomplished by turning the knob on the end of the cabinet. One very agreeable feature possessed by this condenser over other variable condensers, is that it can be used laying flat on the table, enabling the operator to adjust it, without having to raise his arm and hand, a foot or so in the air to reach the knob, as is the case with vertical types. Also there is no possibility of the opposite charging leaves becoming short-circuited, as often occurs in the regular inter-leaving plate types. The charging surfaces are separated by a special dielectric, only one thousandths inch thick, which gives, of course, a remarkable capacity to the condenser, and amply sufficient for any needs arising in the reception of wireless messages.

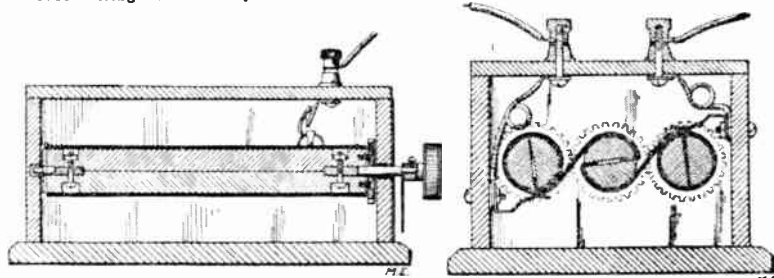

INTERIOR OF GERNSBACK VARIABLE CONDENSER.

(Courtesy "Modern Electrics.")

There are and have been a number of different types of variable condensers used, besides those so far mentioned, but this subject will end with a mention of the "Tubular" type, which is much in favor with the Marconi Company.

The tubular variable capacity, consists of two or more metal tubes, usually brass, having walls about 1-16 inch thick, arranged so that one of the tubes, or a set of them, can be pushed within the other tube, or set of tubes, leaving a small air space between them. Sometimes the inner tube has a piece of insulating material, such as hard rubber or oiled linen (Empire cloth), secured around it, permitting the tubes to be quite close to each other, yet not touching. This makes a very good condenser, the capacity of which depends upon the diameter, length of the tubes, and their number; and also upon the thickness of the air space left between them.

In the realm of receiving condensers, the other form much used in wireless work, is the fixed or stationary type, whose capacity is not adjustable, except in steps in some makes. The fixed condenser is employed in practically all wireless receiving sets to-day, for the purpose of intensifying the effect of the high frequency

oscillations upon the detector, by virtue of its constant charging and discharging. It is sometimes found that, if the telephone receivers are connected across the fixed condenser, where crystal rectifying detectors are employed, the received signals are louder and stronger, than if they are connected across the detector, but this depends upon the capacity of the condenser and several other factors.

The fixed condenser is sometimes shunted around the detector, i. e., connected across its terminals.

A typical fixed condenser of the series-parallel form, is shown in fig. 5. This and the small fixed condenser of the multiple type at fig. 6, are manufactured by the Electro Importing Company.

The condenser depicted by fig. 5, is composed of two distinct units connected to three terminal posts, so that it is possible to connect either one of the units into circuit: both of them on parallel or both in series, the latter connection having been found to give the best results generally, as the discharge voltage of the two units in series is the highest of any combination, and very desirable where voltage operated detectors are utilized. This condenser is constructed of alternate sheets of metal foil, interleaved between slightly larger sheets of extra thin dielectric, resulting in a very high capacity.

The smaller fixed condenser, illustrated at fig. 6, is of very neat and efficient construction, and has a capacity of .0165 microfarad.

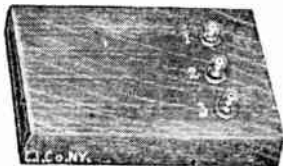

Fig. 5



Fig. 6

For a number of cymscopes or detectors, it is necessary to have a means of applying a critical electro-motive force or voltage to them, the energy usually being supplied by dry or storage cells. The applied voltage must be susceptible of being varied very gradually from weak to strong and vice versa. Besides this feature, the method of controlling the voltage and current must be such, that, any desired fraction of the voltage can be used on the detector, without simultaneously changing the current value, which occurs where ordinary resistance is inserted in series with the source of energy and the device taking the current.

This principle, known as the potentiometer or bridge method, is shown better by the diagram at fig. 7. Here a battery B, of say 6 volts potential, passes a current through the potentiometer or shunt resistance P, made up of 100 turns of resistance

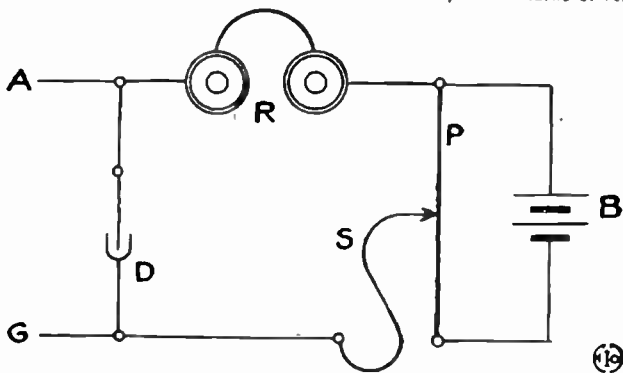

Fig. 7

wire. Connected to one side of the potentiometer resistance is the telephone receivers R, and detector D, and the other lead from the detector terminating in a slider or movable contact, at S, which permits of the detector being shunted across any number of turns of resistance wire.

The action is as follows:—If 6 volts is passing through the 100 turns of resistance wire, then the voltage impressed upon the detector circuit, is directly proportionate to the number of turns embraced by its slider S, and other fixed connection. If the slider is set to embrace all the turns of wire, the voltage applied to the detector circuit, will equal that of the battery, viz., 6 volts; but if the slider is set at say 50 turns, from the end of the coil, then only 50-100ths or one-half of the battery potential, 3 volts, will operate on the detector circuit.

At one time, potentiometers of the resistance coil type, were widely used, but it soon became evident that they could not be effectively used for this purpose, as the inductive kick due to the self-inductance of the coil of wire, caused noises in the telephone receivers, which greatly interfered with the reception of messages, so the only remedy for this state of affairs, was to utilize a non-inductive potentiometer, and to-day this is a cardinal feature of all potentiometers intended for wireless work.

One of the first and best non-inductive potentiometers introduced on the market, was that making use of a carbon or graphite rod of high resistance, mounted on an insulating base, and having a rolling wheel or ball contact traveling along its length, by which means it was possible to cut in any desired amount of resistance, within the limits of the instrument. The total resistance of the carbon rod is 300 ohms. This instrument, which has been extensively adopted in all wireless receiving stations is illustrated at fig. 8.

In a later type of this potentiometer, the adjustment of the resistance has been perfected, so that it is accomplished by a turn of a rotary knob, with a pointer or index attached, to indicate the degree of resistance in circuit. This instrument appears at fig. 9. It is also non-inductive, and very easy of adjustment, taking up premium. Both these instruments originated with H. Gernsback and are patented by him.



Fig. 8



Fig. 9

The most important instrument, aside from the detector itself, is the telephone receiver, serving to make intelligible to the human ear, the various changes going on in the detector circuit, whenever an incoming oscillation representing a signal impinges upon it. The changes occurring in the detector circuit, due to the action of the detector under the influence of an oscillatory high frequency current, are infinitesimally small and minute, and naturally an instrument which is capable of detecting and interpreting them, must of necessity be extremely sensitive.

For the purpose of receiving signals over very short distances, it is possible to use a common low resistance telephone receiver, having a small number of turns of wire upon its bobbins, but for serious work over a greater distance than 10 miles, it is necessary to employ special wireless receivers, wound with many hundred turns of fine copper wire, and equipped with good strong permanent magnets of the best grade of steel, such as Tungsten or Swedish steel, coupled with a thin soft iron diaphragm of proper thickness, the air gap left between the magnet pole-faces and it, being very short and correctly adjusted.

A cut of a pair of head receivers widely adopted by commercial and experimental stations, is shown at fig. 10. These receivers are supplied by the Electro Importing Company, and they guarantee them to respond to the following wonderful test—If the nickel cord tips are slightly moistened and then touched by the fingers, the receivers will respond by emitting a noise, very minute of course, but showing that an electric current has been set up and passed through the receiver magnet coils, which although in the magnitude of one one-hundred-thousandth of

a volt, and one one-millionth of an ampere, has been made audible to the ear by a click of the diaphragm. Surely a remarkable demonstration of the sensitiveness of the receivers, in fact there is possibly, not at the present time, a more susceptible electrical device obtainable than a high resistance wireless receiver, such as these.

The sensitiveness of a wireless receiver depends upon the correct proportioning of its various parts; the proper strength of its permanent magnets, and the number



Fig. 10

of turns of copper wire wound upon its magnet spools, not upon how many megohms of resistance that can be crowded into it. If this were the case, German silver or other high resistance wire might as well be used on the bobbins.

The idea is, to get the greatest possible number of ampere turns active on the receiver magnet spools, which determines the effect of a certain current strength upon the diaphragm. By ampere-turns is inferred the product of the amperes passing through a coil and the number of turns of wire thereon, this determining directly the amount of magnetic flux, in lines of force per square unit of cross-section, which will be set up to react upon the diaphragm.

The best receivers now, are wound with No. 50 B. & S. gauge or finer silk covered wire, of the very best annealed copper. The resistance in ohms of the best



Fig. 11

types does not exceed 1,600 to 2,000 ohms per receiver of 3,200 to 4,000 for a pair. Formerly there were some receivers made having a resistance per set of 6,000 ohms and more, but this is higher than is usually necessary.

A cut of a pair of extra fine professional type receivers are illustrated by fig. 11. These are the Electro Importing Company's very best make, and are hand made, in the laboratory.

Although not generally known, it is essential for the best results, that the two receivers of a set shall have the same tone, as it is called, and the best receivers, such as those shown above, are mated up into pairs in this manner. The usual custom is to connect the two receivers of a set in series, and it may be said in this connection, that it has been found very unsatisfactory to connect a pair of receivers having different resistances, such as 1,000 and 75 ohms, together.



Fig. 12.

At fig. 12, is shown a cut of a 75 ohm receiver, suitable for experimental work, and short distance wireless reception of signals. This receiver is of good construction and quite light in weight.

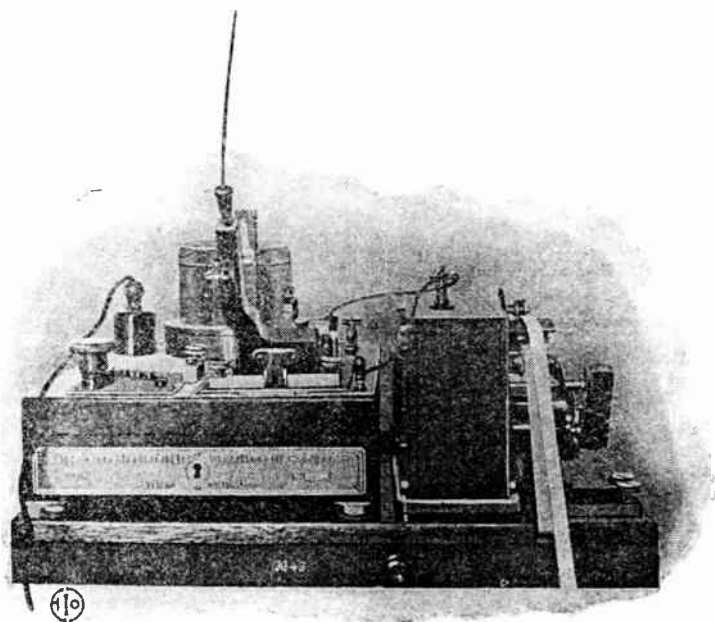

Fig. 13

Fig. 13, shows a receiving set built by the A. E. G. Berlin, and extensively used in large commercial stations, including the U. S. Navy. This set employs a coherer and tape recorder, so that a record of the messages can be taken automatically.

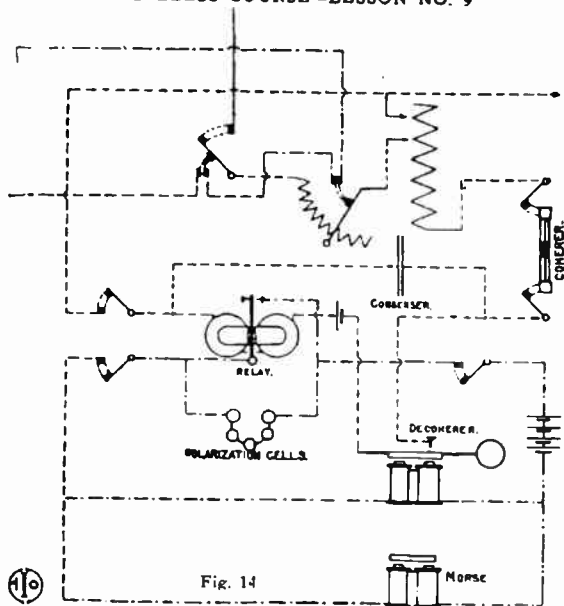
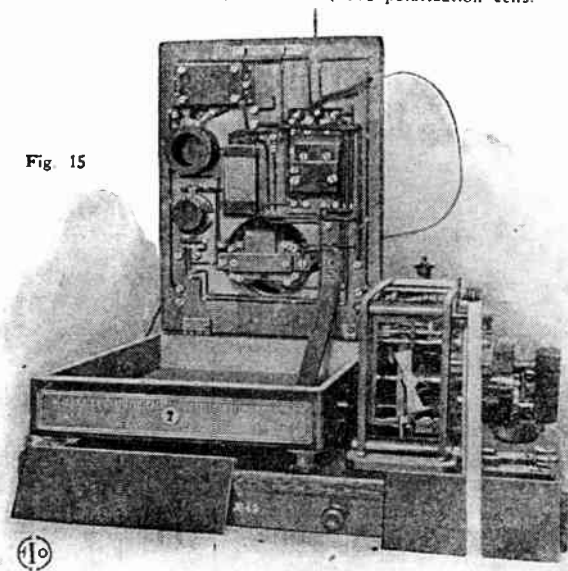

Fig. 14 illustrates the diagram of the connections for this receiving set, including the relay, coherer and decoherer, condensers, and polarization cells.



In Fig. 15. is depicted the same set, with lid raised to show the wiring and connection of the various apparatus.

Lesson Number Ten.

THE DETECTORS.

THE most vital instrument in the receiving set is the detector, though this instrument is largely dependent on the efficiency of the telephone receiver for the results.

The student will recall that we have stated in previous lessons the fact that energy radiated from wireless transmitting instruments is in the form of alternating current of extremely high frequency. Now, the student will logically suppose that an instrument could be inserted in the aerial circuit between the aerial and the ground, and that the current would operate this instrument so that an indication of passing current could be obtained. But, a galvanometer cannot be made to indicate such high frequency current since the pointer would have to move with the same rapidity as the periodic changes in the oscillations, and the results would be that the moving parts in the galvanometer would remain stationary, being unable to follow the rapid motion. The same results apply to the telephone receiver, since the diaphragm cannot follow the rapid alternations of the received energy. Furthermore, in the case of a telephone receiver, on account of the large self-induction of the instrument, the high frequency voltage generated by the waves would produce in a circuit containing a telephone receiver only extremely weak currents. It is therefore obvious that an instrument must be resorted to, in order to transform this high frequency current so as to make it operative on the telephone receiver.

Such an instrument is known as a detector, and the various types of these detectors operating on a different principle are classified as follows:—

Cocherers; Magnetic; Thermal; Crystal Rectifiers; Electrolytic; and Vacuum detectors.

We will first consider the coherer type, which has already been described in an earlier lesson. The coherer exists in various forms, the most widely known form being the filings coherer, originally employed by Marconi. Such a coherer is no longer employed commercially, and is only used to demonstrate the principles of wireless telegraphy to an audience. This detector is extremely unreliable, and must be continuously adjusted. If a loud signal is suddenly received by the coherer, it will cause it to "jam," by which is meant that the fine filings will become burnt and permanently connected together, so that the coherer no longer is operative to signals, and must be replaced by a new one. Then again, the speed at which the coherer will receive messages, is not above fifteen words per minute, which is rather inconvenient, considering that forty words per minute are transmitted with the modern systems and received without difficulty with other detectors. The coherer having such a multitude of disadvantages, was quickly abandoned for the detectors offering better characteristics. The coherer possessed one great advantage, and that was the fact that it could operate a relay which in turn could be made to close electrical circuits, operate a Morse recorder, ring a bell, or do other duties which the modern detectors do not accomplish.

Another type of coherer which does not employ the filings, is the Branly-Popoff detector, which consists of three oxidized-steel pointed rods in the form of a tripod, resting on a steel plate. The connections are similar to those of the coherer, the detector being connected in series to a relay through a dry cell. The signals cause the small steel rods to cohere more firmly to the steel plate, in such a manner that the resistance of the oxide is broken down and allows the current from the battery to flow through the relay magnets. The relay operates a magnetic device which tilts the tripod arrangement of the small rods, and restores the originally high resistance.



SLABY-ARCO VACUUM COHERER

Fig. 1

A relay for electrical purposes consists usually of a pair of electro-magnets arranged with an armature or moving contact bar in front of their pole pieces, this contact bar being normally held away from the magnet poles by a spiral spring and whenever a current passes through the electro-magnet coils, the armature bar is attracted and its contact closes an electrical circuit by coming in contact with the

stationary electrode. As soon as the current ceases to flow through the magnet windings, the armature bar is released and the contact broken.

Still another form of coherer exists in the detector of the former Lodge-Muirhead system, which consists of a steel rotating wheel dipping near but not quite touching a pool of mercury. A contact is made between the pool of mercury and the steel wheel when the signals are received, but upon the interruption of the signals, the mercury ceases to make contact with the steel wheel. This is known as the self-restoring, or automatic coherer, since the decohering is accomplished without any additional apparatus. The mercury coherer is connected to the relay as in the other preceding coherers, and operates on the same principle. It is far more reliable than the Marconi filings coherer, and has been found to be very efficient, though it is not employed at the present time.

Another form of coherer is known as the auto-coherer, and was used in the simpler "Electro" wireless receiving sets. The auto-coherer consists of a small glass tube filled with carbon grains. On both sides of the grains, plugs of brass which have been silver-plated to increase the conductivity are inserted. In some instances, iron or carbon plugs are used, though it is largely a matter of choice. Fig. 1 illustrates the auto-coherer, and it might be interesting to add that this was the type of detector employed by Marconi when he received the first signals transmitted across the Atlantic Ocean at St. John in 1903. The auto-coherer, contrary to the types of coherers described thus far, does not operate a relay, inasmuch as the drop in resistance is too slight, but it is used in connection with one dry cell connected to a low resistance telephone receiver of but 75 ohms. High resistance telephones are of little value in connection with this detector, since the drop in voltage of the detector is sufficient to operate a low resistance receiver. The signals are exceedingly loud, though the disadvantage exists that the detector is microphonic in action, and all sounds in the room or on the operating table will be plainly heard in the telephone receiver. Fig. 2 illustrates the connections to employ for the telephone circuit of this detector, and it will be noted that a resistance has been added in order to allow a better adjustment of the voltage, though this may be dispensed with if desired. The auto-coherer is but little used except by amateurs who have just begun to experiment in wireless telegraphy.

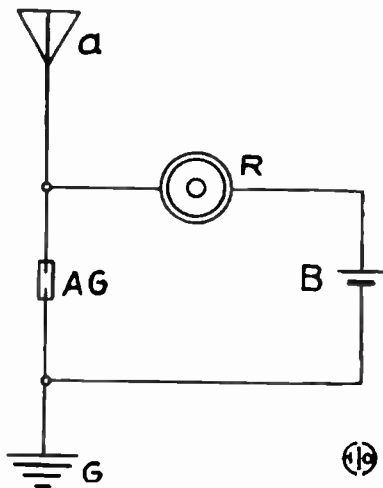

Fig. 2

Under the crystal rectifier type we find the many different detectors employed in present day systems. The term "crystal rectifier" was suggested by Dr. George W. Pierce of Harvard University, in place of the cognomen formerly employed to signify certain detectors possessing the electrolytic valve or rectifying action, these having been known at one time as "thermo electric" detectors due to their action not being fully understood.

The crystal rectifying detector, which may consist of a proper crystal or set of crystals of mineral formation, when placed in a wireless receptive circuit possesses the phenomenon of passing a current in one direction many times better than in the other. Hence, when an oscillating or alternating current such as that which surges on an aerial circuit passes through the detector, the rectifying action is set up and results in the produced pulsating direct current acting on the telephone

receivers. These pulsations of current flowing in the telephone receivers cause the diaphragms to be alternately attracted and released giving rise to the familiar buzzing sound by which the signals are read. It will thus be noticed by the student that the alternating current of the high frequency waves flowing through the receiving circuit, is rectified so that all the same polarity impulses are caused to flow through the telephones, while the other polarity impulses flow through to the ground. In this manner the telephone receivers operate on direct current of a pulsating nature, resulting in the aforesaid buzzing sound. The property of these crystals to allow current to flow through in one direction often is as marked as 400 to 1, i. e., negative or positive impulses, as the case may be, will flow through 400 times easier in one direction than in the other, thus allowing the telephone receivers to operate practically on direct current.

The silicon detector is the most popular type of crystal rectifier used to-day. It employs a piece of the artificial product known as fused silicon, which is manufactured in the electrical furnaces at Niagara Falls. Silicon is a black or sometimes grayish material, very hard and brittle, and resembles coal. It has a bright silver lustre, especially after being broken and exposing a fresh surface.

Silicon is usually placed in a metal cup or special clamp. If used in the former, a solder or other metal alloy melting at a low temperature is employed to hold the crystal in place and to make contact with same. Woods Metal, which can be purchased at any chemical supply house, is the most popular material, since it melts at an exceedingly low temperature. Another material, Hugonium, which has been employed with great success, is the new substance introduced by the Electro Importing Company. This substance is a metal alloy which is very plastic until compressed around the crystal, and after a few hours it sets firmly holding the crystal in place. The use of this material greatly improves the sensitiveness of the crystal, since the heating which would be applied to the solder if same were used to hold the crystal, is eliminated. Solder should not be used if possible, for it causes the crystal to lose its sensitiveness to a great extent.

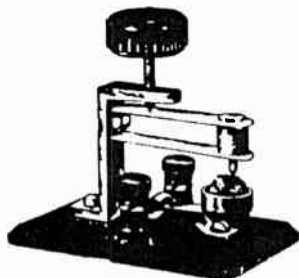

Fig. 3

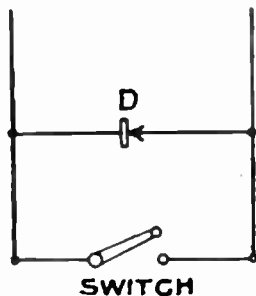

Fig. 4

A very popular mineral detector is shown in the illustration of fig. 3, in which the material is held in the metal cup. As will be noted from the following descriptions, other crystals may be used, and such a detector is therefore known as a "universal" detector. The cup is itself held on a metal spring so that a light tension can be produced between the crystal member and the upper pointed contact. This contact is also arranged on two springs which may be varied by the hard rubber handle adjustment screw, allowing the tension at the contact point to be varied at will. By turning the cup, a new contact surface on the crystal can be obtained. For the utilizing of this universal detector for other crystals which do not require pointed contacts, a flat metal disc which can be screwed on the pointed contact, is supplied. Thus the detector can be used for any type of crystal which requires either form of contact. This detector, which is supplied by the Electro Importing Company, uses the Hugonium compound for holding the crystal, as described above.

In the foregoing example the student has been introduced to the most popular type of mineral detector, but there are more expensive professional types in which the relative position of the crystal and the contact point may be very accurately and positively adjusted. The contact point in the ordinary detector is generally of brass, but it has been ascertained recently, after much research, that generally the

best results are obtainable when the metallic contact resting on the silicon is of gold. For this purpose, the student may employ a gold stick pin, which will be found to give excellent results. Steel needles are also found to give good results, and fine copper wire, resting gently on the crystal, is also very effective.

Telephone receivers used with silicon should be of high resistance. For the best results, telephone receivers of at least 2,000 ohms per pair should be used, and slightly higher resistance windings are in some instances found to be even better.

Silicon detectors, as in the other crystal types, are subject to disadvantages, the most important of which is the fact that if a nearby station is sending when the detector is being used, the sensitiveness will be destroyed. This is probably caused by the fact that the heat of the oscillations passing through the detector causes an oxidizing effect, which interferes with the proper action. All crystal detectors aside from the pyron detector, which will be shortly described, and the carborundum type, are subject to this disadvantage on the passing of heavy high frequency current such as that of the home station or nearby transmitters. If the detector is short-circuited, as shown in the fig. 4, or better still, arranged with a pole-changing switch so that the leads may be completely disconnected and the detector itself short-circuited, as illustrated in fig. 5, the sensitiveness can be preserved while transmitting. No battery is necessary with silicon detectors, but is sometimes used, the negative pole connecting to the silicon.

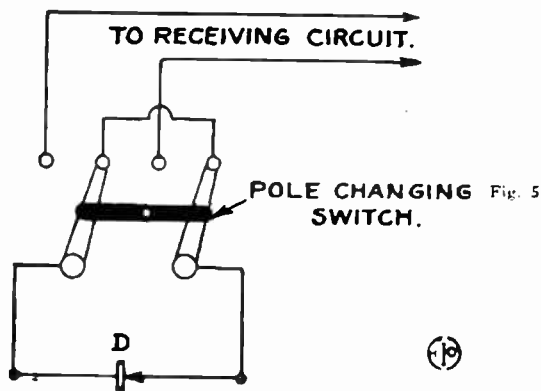

The Pyron detector, which was developed by G. W. Pickard of Amesbury, Mass., and patented by him, is somewhat similar to the silicon type in form excepting that the upper tension spring carrying the pointed contact is wide and massive, its adjusting screw being of a very fine thread. The pyron crystal is iron pyrites, the former name being the trade name under which the detector is known. Its upper face is highly polished and the detector, while combining high sensitiveness with other numerous features, has the very important merit of withstanding heavy nearby discharges without being knocked out of adjustment, and for this reason is much in use in the United States Navy, on battleships.

Another type of crystal detector which has been developed by G. W. Pickard and is strongly covered with patent rights, is the Perikon detector. This detector consists of two crystals, copper pyrites and zincite, held in firm contact against each other. The mounting of these two crystals is exceedingly clever, the copper pyrite crystal being mounted in a cup on a rod which is so arranged that it can be swung in all directions and contact with any portion of the crystals can be obtained. The zincite crystals are in turn mounted in a large cup; usually a number of these being used. The two crystal surfaces are brought into a firm contact by means of a spring which can also be varied. The Perikon detector is probably the most sensitive of the crystal rectifying types, though this is largely a matter of opinion. The authors, after extensive experiments, have found that Galena, if used according to the method advocated by them and explained in a later description, is probably the most sensitive of the crystal detectors, and more so than the Perikon. The Perikon detector is illustrated in fig. 6, and is largely used in the Navy and Army wireless stations as well as in the better commercial stations. Its ease of adjustment makes this detector one of the most popular, and it produces a sharp clear sound in the telephone receivers. The nearby stations also effect its adjustment as in the instance of the silicon detector. To overcome the effect of the strong oscillations, the Perikon detector has lately been placed in a small pool of oil, so that oxidization of the elements, either by the natural action

of the atmosphere, or the more rapid effect of strong signals, are reduced to a minimum. It is well to state that galena and silicon are also used in the same manner, and in fact the covering of these detectors with dust-proof covers has also been suggested lately. Such precautions prevent the oxidization of the crystals to a great extent, and the absence of the dust renders the sensitiveness much greater. No battery current is employed with Perikon detectors usually, and the wiring diagram is illustrated in fig. 7, the same wiring scheme being used for all the other crystal detectors. Battery current is sometimes used, the voltage being very low and regulated by a potentiometer. The polarity of this current must be such that the positive line is connected to the copper pyrites.

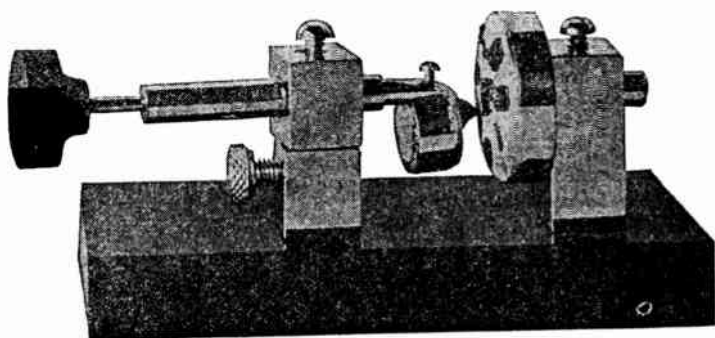

Fig. 6

Galena is a mineral crystal of lead, and is obtained from mines practically all over the world. The crystals resemble a bluish or grayish colored substance, which when broken forms into straight surfaces or cubes. These surfaces have a bright mirror finish. Galena, more so than silicon or the other crystals, has the great disadvantage of being difficult to obtain for use in wireless telegraphy, inasmuch as some pieces may be very sensitive, while other pieces will be of little use. In fact, pieces taken from the same large piece, will be entirely different, one probably very sensitive, and the other of no use at all. However, by buying either selected crystals, or large single pieces which can be broken into a number of smaller ones, it is possible to obtain several good specimens.

The authors have performed numerous experiments and researches on galena, and have stated that it is the most sensitive of the crystal detectors if correctly used. Galena cannot be employed between two flat discs, for the broad surface contact in this case does not allow the rectifying valve effect to be marked. For this reason, fine contact of little surface should be used.

In the experiments the contact materials of various types were tried. German silver has been found to have remarkable advantages, and was used with success for long distance receiving. Steel needles do not give such good results. The sensitiveness of galena was found to be entirely destroyed by the heating of the solder in which it was placed, and for this reason the solder was entirely abandoned. Clips to hold the crystal have been advocated and the method of using is illustrated in fig. 8. The most satisfactory arrangement was found to be a fine wire of about No. 30 B. & S., bare copper, resting lightly on the surface of the galena crystal. The illustration of the detector enables the student to make a galena detector which will give excellent results. With such a detector, signals were received from a S. K. W. station over a distance of 2,500 miles using a foreign grade of galena and a pair of standard 3,200 ohm receivers.

Another point of much importance discovered by the authors in connection with their researches on galena has been to impregnate the crystals in oil. If galena crystals are laid on clean white paper and allowed to remain for any length of time, it will be noticed that the paper is oil marked. This naturally would indicate that a certain amount of oil is present in the galena. It was learned that if the crystals were placed in ordinary lubricating oil of a thin grade and allowed to remain for over a day and then removed, the signals were found to be considerably louder and longer distances could be covered. Following these experiments, many others have lately advocated the impregnation of crystals in oil, owing to the increased efficiency. The Radion detector, used by the Radio Company, works on the principle of galena, using a fine copper wire. In the April, 1911, issue of "Modern Electrics," the student will find a few points on the use of galena.

Molybdenite is another mineral which consists of many layers compressed together. These layers can be taken apart and resemble lead foil. Molybdenite is usually employed between flat contact surfaces. It can also be used with a point, but owing to its softness, a point is not convenient. The great characteristic of Molybdenite is that it can withstand the passage of powerful electrical oscillations without being materially effected in adjustment. It is, however, little used, inasmuch as the sensitiveness is very low.

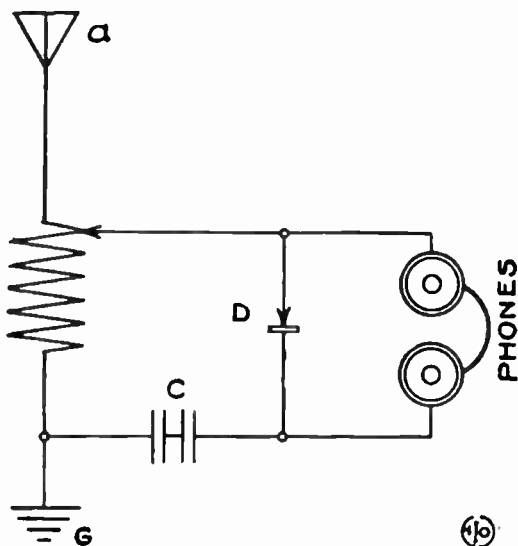

Fig. 7

One of the most popular types which has become universally used in commercial stations through the fact that it can withstand powerful oscillating currents, is the Carborundum detector. This detector is employed with battery current regulated by an adjustable resistance, the voltage being from 1 to 1.2 volts as found by G. W. Pickard. Carborundum is a product of the electrical furnace, created at a temperature of 7,000 degrees F. and is a combination of salt, sand, sawdust, and coke. It is an exceedingly hard crystal, and when employed in a detector, the student will discover that the results will be better if the lengthwise section of the crystals is used. The blue colored crystals will be found to be the best, though green colored crystals are claimed to be superior to any. The poorest quality are those varying from a black to a gray color. This detector may be used in the same wiring diagram as that of the electrolytic detector shown later.

Aside from crystal detectors, the next class is found under the thermo-electric detectors. These operate on the well known principle of thermo-electric couples in which heat applied or developed at the junction of certain different metals establishes an electro-motive force. Incoming oscillations disturb this current and produce variations thereof which are perceptible in the telephone receivers.

The magnetic detector has been extensively adopted by the Marconi Wireless Company and depends for its action on the phenomenon of magnetic hysteresis, a common type being that employing a continuous moving iron wire band which passes by the poles of two adjacent permanent magnets. The variation in the hysteresis action is caused by the incoming oscillations and manifested in the telephone receivers which may be about 80 ohms each. The wiring of the magnetic detector is shown in fig 9.

The electrolytic type of detector, which was largely used before the simpler crystal types were introduced, is illustrated in fig. 10, in which the working parts may be clearly seen. The detector consists of a small carbon cup which is filled with a solution of five parts of pure water to one part of nitric acid. Into this solution dips a fine platinum wire, which can be more or less immersed into the solution by means of the adjusting handle. The action of the electrolytic type of detector is dependent upon the formation of gas at the platinum wire surface, which insulates the wire so that the current from the battery cannot flow through the solution. On the reception of the oscillations, the fine film of gas is punctured by the high frequency current for an instant, and the gas immediately forms again to return the detector to its normal condition. Thus the battery current is allowed to flow periodically when the resistance of the detector is lessened by the oscillations, and this lowering of the resistance is heard in the telephone receivers as a buzzing sound. The electrolytic detector should be used with battery current, and the positive lead should be connected to the platinum wire in all instances, for otherwise no results of any importance can be obtained. A potentiometer is employed to regulate the current.

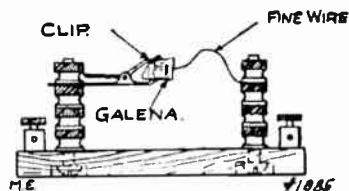

Fig. 8

(Courtesy "Modern Electrics.")

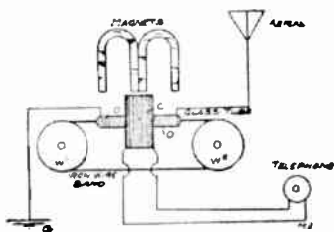

Fig. 9

Another type of electrolytic detector which varies mechanically from the foregoing inasmuch as no liquid is employed, is the Peroxide of Lead detector, similar

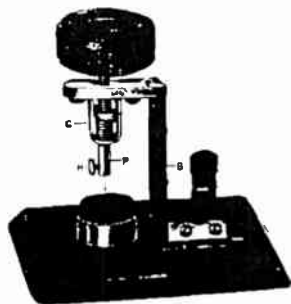

Fig. 10

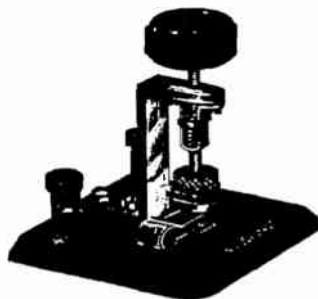

Fig. 11

to that shown in fig. 11, which was developed by Hoosier & Brown. An improved type is handled by the Electro Importing Company, as shown in the foregoing illustration, where a special compressed pellet of lead peroxide is placed between a lower electrode of lead and an upper electrode platinized. This detector operates on a similar principle of electrolytic action as in the foregoing type, and is connected in the same style of circuit as the liquid electrolytic detector, the wiring of which is shown in fig. 12.

A very important and growing class of detectors are those commonly called vacuum or **Fleming valve detectors**. The usual form of the vacuum detector follows that used by Fleming, and one commercial form of it is illustrated in fig. 13. This type is the result of the extensive experiments on the part of the Electro Importing Company and is very efficient. The Electro audion or valve detector consists of a glass vacuum bulb containing two tantalum filaments connected in series with a lead taken off at the connecting point of both filaments. One filament is used at a time

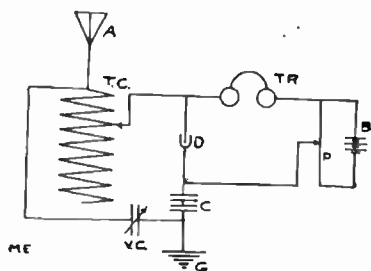

Fig. 12

(Courtesy "Modern Electrics.")

and if it should become exhausted, the other one may be resorted to. The wiring diagram is shown in fig. 14, and it will be noted that the telephonic receiver is connected in series with a battery of 30 volts or more. The filaments are connected in series with a rheostat and a battery of four volts. One small wire is used in the shape of a zig-zag winding and is called the grid, while the other electrode is the nickel or platinum foil. When the filament is raised to incandescence by the battery current passing through it, negative electrons are sent off from it and render the space between the filament and the foil electrode conductive for an electric current, provided the E. M. F. producing this current is directed from the foil to the hot filament. When the oscillating currents from the aerial traverse the detector the action is to allow more current to flow through it in one direction than in the other.



Fig. 13

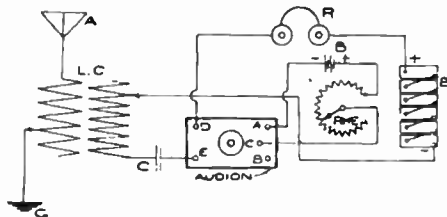

Fig. 14

In all detectors of the crystal type, the best resistance of telephonic receivers is from 2,000 to 3,000 ohms, either for one single receiver, or for the combined resistance of a pair. For the electrolytic detector, the resistance of the receivers should be the same. For the auto-coherer detector, the resistance need not be higher than 75 ohms, since the drop in resistance of this detector is very pronounced. In the magnetic detector, the resistance of the telephonic receiver need not be greater than 80 ohms each. The vacuum valve detector can be used with 2,000 or 3,000 ohm receivers.

Lesson Number Eleven

AERIALS.

THE WIRES OF THE WIRELESS.

THIS section is devoted to aerials, and naturally there have been many different types of them evolved in the development of the wireless art. The word "antenna," meaning a feeler, or to reach out and feel, was formerly applied to the network of wires suspended in the air to catch the wireless signals, but became improper when applied to a sending aerial, as the wire was an "antenna" only so long as it was "feeling," so to speak, for the wireless waves in the ether. Hence the term "aerial" has been universally adopted to represent the wires erected to intercept the waves.

Although some very good work has been accomplished without the use of an aerial wire system, over short distances of 30 to 50 miles, all radio-telegraphic and radio-telephonic stations of any size to-day, employ a more or less elaborate aerial. As in many other branches of science, the simplest device is the best generally, and this is the case with the aerial.

Primarily, the most important factors are to have the aerial wires, run as straight as possible, of some good continuous conductor, such as copper, phosphor bronze, aluminum, antonium, etc., and to have as perfect insulation between the aerial and the ground as can be obtained. For any serious work, all joints in wires must be thoroughly soldered, especially on aluminum wires, "aluminite" solder being very efficacious for this purpose.

For standard aerial construction, stranded phosphor bronze cable has been adopted, as the stranded wires present a greater surface for a given weight of wire, than one solid wire, and the high frequency wireless currents travel only a short depth below the surface of the conductors. Iron wire alone for aerial conductors should be avoided, as the iron will cause an electro-magnetic reaction on the oscillating currents in the wire, tending to choke them and diminishing their strength; but copper clad iron wire has been tested at the College of the City of New York, and found satisfactory for the purpose, due to the skin effect cited above.

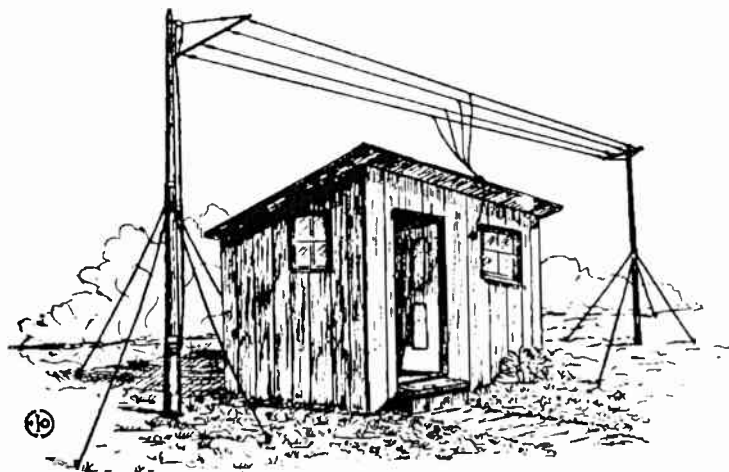

Fig. 1

As aforementioned, many elaborate types of aerials have been advocated and employed from time to time, but one of the best and simplest to construct is that known as the flat top, or T aerial, as seen in illustration fig. 1. This aerial will of course have different dimensions, according to the work to which it is to be adapted to. For ordinary small stations up to $\frac{1}{4}$ K. W. capacity, the two poles at the ends may be about 50 feet high, and 50 to 75 feet apart. Two spars or "spreaders," 3 to 4 feet long, and sufficiently stout, are secured at each pole top by a rope and pulley to

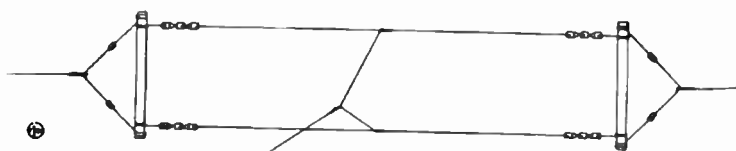

Fig. 2

permit of lowering the aerial for repairs, etc. Bamboo is excellent for spreaders, being very light and strong. Insulators should be placed at points indicated in sketch fig. 2 and between spreaders and aerial wires also, to prevent leakage of the aerial currents to ground. Some typical aerial insulators are portrayed at fig. 3.

Most aerial masts are of wood, and hence no trouble is experienced by dissipation of currents set up in them, as is the case when iron masts are employed. To reduce this loss to a minimum, when utilizing iron masts or poles, they are generally insulated at the base, even such large ones as the 420 foot steel tower of Fessenden's, at Brant Rock, which sets upon a pillar of glass.



Fig. 3

All guy wires on any type of mast, either wood or iron, must be broken up into sections not exceeding 20 feet preferably, by the interposition of strain insulators at these distances apart. This is to prevent any undue surges or dissipations of wireless currents being set up in them unnecessarily, and thus causing a loss in the aerial's efficiency.

As stated above, the majority of aerial masts are wooden staffs, of one piece or several joined together as in regular flag-staff work. Many stations, especially experimental ones, make use of an iron pipe aerial, as shown at Fig. 4, which



Fig. 4

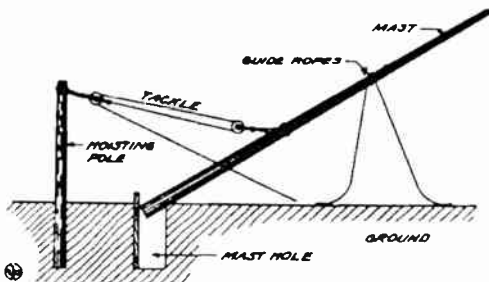

Fig. 5

consists of several lengths of decreasing sizes of pipe joined end to end by means of reducing bushings, and the whole well guyed in position.

A simple way of raising aerial masts of any considerable height, is to plant another short staff about 1-3 the length of the mast, quite close to the base of it, and raise by means of a tackle, as illustrated in fig. 5. Guy ropes should be slung from the mast about 2/3 the way up, to permit of guiding it while it rises.

It is usual to make the aerial of more than two spans of wire, so that a greater conducting surface will be presented. For stations up to 1 K. W. size, an aerial should have at least 6 wires spaced not less than 2 feet apart or greater than 3 feet.

It has been found that nothing is gained by placing the separate spans closer together than 2 feet, and for fairly large aerials, 3 feet is very good spacing.

In general, other things being equal, the greater the height of the aerial the greater its range, either transmitting or receiving, but the range is also largely influenced by the number of strands in the aerials, and where the height is limited, the aerial may be extended so that it covers a considerable area.

It must be kept in mind, that as more wires are connected on parallel to the aerial, to give it greater activity, the capacity inherent in it is also directly increased, and the aerial must not be made too large for the transmitting transformer to charge, or there will be a decrease in the range instead of an increase.

It is often desirable to have a large aerial for receiving and a smaller one of the proper capacity for transmitting, and this is easily and readily accomplished by switching in say half, of the total aerial system for transmitting and all of it for receiving.

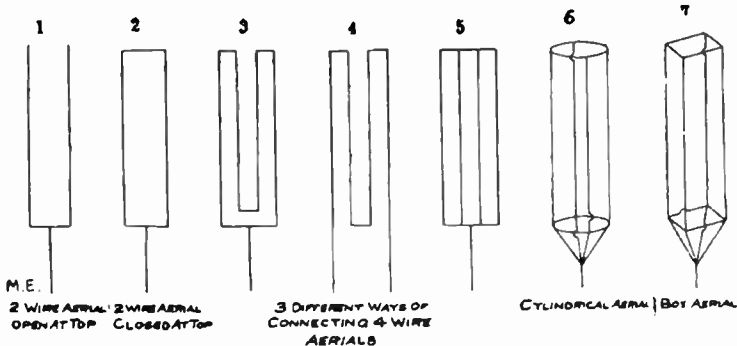

Fig. 6

(Courtesy "Modern Electrics.")

Several varieties of aerials are depicted by the diagram fig. 6, type 5 being the most commonly utilized. Types 3 and 4 are not of very good electrical design, and seldom used any more. Types 1, 2, 3, 5, 6 and 7 are known as straightaway aerials for the reason that all the wires lead straight away from the leading-in wire or "rat-tail." Type 4 is a looped aerial, and this scheme of bringing down two leads from the same aerial has been widely used.

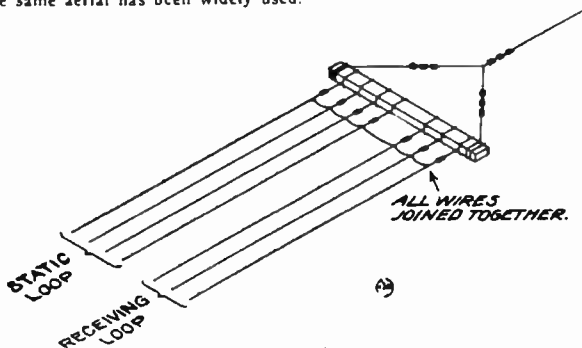
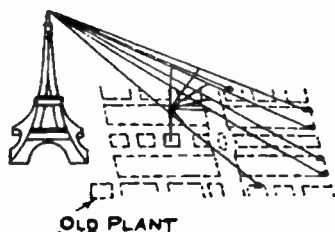

Fig. 7

The great advantage of looped aerials, which by the way, are generally hooked up straight away for transmitting, is that interference and static currents can be eliminated from the receiving instruments quite successfully. A common commercial type of looped aerial is shown at fig. 7, part of the aerial being used as a static loop, and the other part as the receiving loop. The static loop is usually grounded through an adjustable inductance (as a tuning coil), in series with a variable condenser.

A diagram of the immense aerial suspended from the Eiffel Tower, 1,000 feet high, at Paris, is portrayed by sketch 8. The separate strands are left open at top and bottom; the lead-in being taken off as shown, somewhere about the centre.

The length of the aerial, has a direct relation with respect to wave-length emitted from it, and for untuned simple transmitters, such as a spark coil, with no helix or condenser, the approximate wave-length in meters is the length of the aerial wire from the spark gap to end of aerial, multiplied by four, as a factor. For tuned systems, the relation for wave-length is different and more complex, taking into account the inductance and capacity in the closed oscillating circuit, shunting the spark gap, and will be treated on in a later book.



M.E.

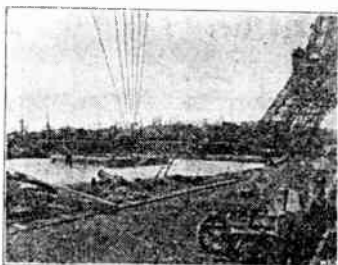

Fig. 8 (Courtesy "Modern Electrics.")

For common tuning coils, consisting of a layer of insulated wire, wound on a circular tube, with a moving contact passing over its various turns, the relation may be assumed, that only one-quarter the actual wave-length desired, is necessary on the coil or the length of wire on the coil, in meters*, times four, equals the wave-length capacity of the coil. This does not hold, however, for loose-coupled tuning coils.

The so-called umbrella form of aerial has been experimented with considerably, the aerial taking its name from the fact that it resembles the ribs of an umbrella in form.

During some recent elaborate tests carried out by the U. S. Naval Wireless Laboratory, under the direction of Dr. L. W. Austin, between the Brant Rock, Mass., station of Fessenden, and the scout cruisers Salem and Birmingham, it was found that the umbrella aerial at Brant Rock, 420 feet high, was equivalent only to a flat top type 170 feet high, for sending purposes, while for receiving purposes the reverse was the case, the umbrella type proving much superior to the flat top. Hence an umbrella aerial is a better receiver than a radiator.

It might be well to give a few dimensions on the Brant Rock aerial, as it is one of the largest in use, being employed for wave-lengths up to 4,000 meters.

The support for the aerial wires is composed of a steel tower, 420 feet high and 3 feet in diameter, resting on a well insulated base, to prevent ground leakage. Four arms, 50 feet in length, extend from the top of the tower, and from each of these, two 300 cylindrical cages are drawn out by means of guys at an angle of about 45 degrees. This forms a system of eight conductors placed symmetrically about the tower to form an umbrella.

The cages are about 4 feet in diameter, consisting of four wires each, kept apart by a series of hoops or separators. The cages are insulated from one another at the bottom and electrically connected to the steel tower at its top.

The inductance of the complete aerial system is .055 milliHenry, and the inherent capacity .0073 microfarads.

All the guy wires are thoroughly insulated by large strain insulators interposed every 40 to 50 feet.

A typical commercial aerial for long distance work is illustrated by the cut fig. 9. This aerial formerly served on top of the Waldorf-Astoria Hotel, New York City, and had a span between towers of 236 feet. The steel towers are each 84 feet high, and the height of the aerial above the ground was 300 feet. This aerial was used in conjunction with a 5 K. W. transmitting set.

One very important point about aerials, is that they tend to gather static charges from the atmosphere, especially during thunder storm weather. The best expedient to follow under these conditions is to ground the aerial to a good earth (a water pipe is best), by connecting through a knife switch and a length of No. 4 R. & S. copper wire, run on porcelain knobs, in as straight a line as possible, avoiding any sharp bends or curvatures. Lightning and static currents are highly oscillatory in nature and do not like sharp bends in their path, preferring to leap to some other nearby conductor before following such paths. Lightning switches are best

*1 meter equals 39.37 inches.

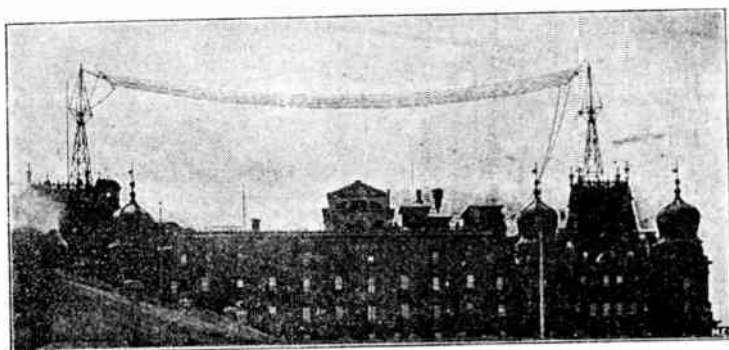

Fig. 9 (Courtesy "Modern Electrics")

placed outside the building, and should have a capacity of 100 amperes, with fireproof base.

Having a well set-up aerial, thoroughly insulated and correctly designed, its operating efficiency depends in great part upon the method of bringing in the lead wires to the instrument room. There are a number of commercial lead-in insulators on the market, one of which is shown at fig. 10, this particular one being composed of two fibre tubes, one sliding within the other, adapting it to walls of varying thicknesses.



Fig. 10

A lead-in insulator for high voltages should have its length divided up into several corrugated or projecting ribs, so as to give a longer path along it, for leakage of the currents. Some of this type are made of electrose composition.

At fig. 11 is a view of a typical umbrella aerial, of simple construction, this particular one being famous as the first one transmitting a wireless message (not dots), 90 miles over land and water, when charged by a 1-inch spark coil, excited from a 6 volt storage battery, using the regular coil vibrator. This record is official.

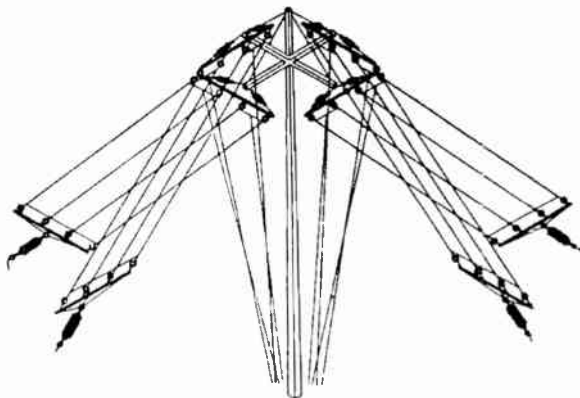

Fig. 11 (Courtesy "Modern Electrics.")

WIRELESS COURSE—LESSON NO. 11

and is all the more remarkable, in that no helix or condenser were employed, the self-inductance and capacity of the aerial and ground being sufficient.

The aerial shown, comprises 4 separate, 4 wire aerials spaced 90 degrees apart. The wire was No. 14 B. & S. copper, with each strand spaced 4 feet from the next one. The aerial was stretched from a tank on top of a seven-story building, and the total amount of wire in the aerial was 7,000 feet.

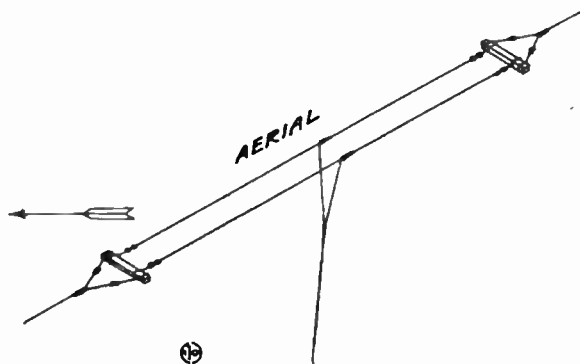

Fig. 12

The secret of charging this immense spread of wire lies in the fact, that all four aerials were connected on multiple to the coil spark gap. Each 4 wire aerial comprised a loop aerial, in the way the lead-in wires were attached, and for receiving, any combination of looped aerial could be utilized.

There have been numerous attempts made to concentrate the direction of the wireless waves emitted from the aerial, and there is quite some difference apparent in the case of oblique or inclined aerials. When an aerial is slanting, in the direction shown at fig. 12, the direction of the greatest activity, is that taken by

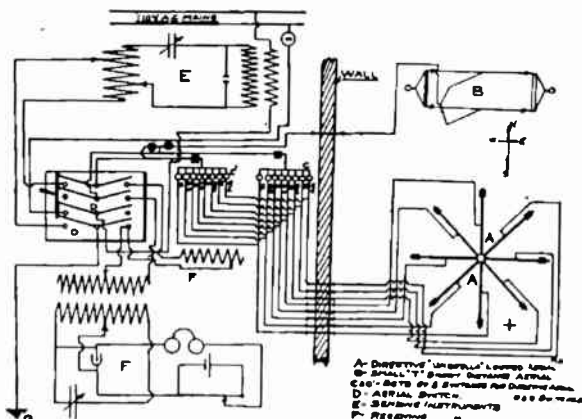

Fig. 13

(Courtesy "Modern Electrics.")

the arrow. On this assumption, there are in use a few directive aerials which give good satisfaction, and a readily adjustable form of directive aerial is depicted by diagram 13, which has a lead from each separate leg of the umbrella aerial, brought to a switch point, so that any one or more of them can be quickly thrown into circuit.

Probably the most efficient method devised so far to direct the waves toward a certain point by means of the aerial, is that evolved by two Italian scientists, Bellini

and Tosi. Diagram 14 will serve to explain the action of their system. In connection with their particular aerial arrangement, they used a "radio-goniometer," a view of which appears at fig. 15. The radio-goniometer consists of three separate coils of wire, one being movable within the other two. The aerial takes on a triangular form, as shown in diagram at E and F, where G is the mast. Two sets of triangular aeriels are utilized, each aerial being connected to one of the radio-goniometer coils, while the usual sending apparatus is connected to the inner moving coil S.

The action of the individual mast systems (A1, B1 and AB) is as follows:—When waves are set up in the system AB, the waves are given off in a general front and back direction from the plane AB, and not from the sides, seeing that at the sides the effects of the two nearly vertical wires are neutralized.

In the same way the second system, A1, B1, emits waves at right angles to the former set. If now, the two systems are excited simultaneously, the resultant effect will be, that waves are emitted in a certain direction only, depending upon the relative value of each circuit. Thus if AB is excited separately, the waves will naturally be in the horizontal direction, and A1 and B1 would emit waves in the vertical sense; with both systems excited equally, the waves will proceed at an angle of 45 degrees, and so on.

To excite the aerial circuits, use is made of the middle coil S, on the radio-goniometer. When the coil S is placed parallel to the coil M, it has an inductive effect upon this coil, and no effect upon the second coil; therefore the aerial system AB, is excited separately and the waves are horizontal or east-west. Placed parallel to coil N, the result is that the waves are vertical or north-south. When at 45 degrees, it has an equal effect upon the two coils and the waves are now at 45 degrees, or northeast-southwest. Turning through any other angle, the wave direction follows this angle and all around the horizon.

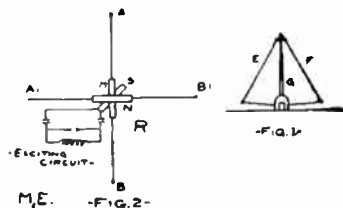

Fig. 14

(Courtesy "Modern Electrics.")

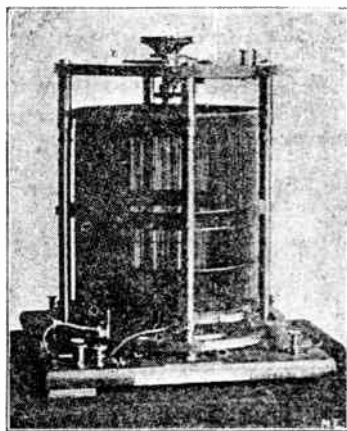

Fig. 15

However, the waves still follow two directions, (north-south), and it is desired to cut off the waves in one direction, so that we only have the north-directed waves, for instance. When this is accomplished, a truly directive aerial system is the result. Bellini and Tosi have done this by using a simple vertical aerial at G, in the centre of the crossing triangular aeriels. This straight aerial wire acts to cut off all the waves proceeding toward the rear, and only allows the front waves, so to speak, to be sent out into the ether, thus making it possible to direct the messages to a predetermined point anywhere on the horizon.

In practice, the single aerial is first employed, and when a message comes in, the combined system is placed into circuit, and the radio-goniometer turned until the position where the signals come in loudest and clearest is reached. A duplicate instrument is used for sending messages, and when its indicator is on the same point as the receiving radio-goniometer, messages can be transmitted to that particular station alone.

With the Bellini-Tosi directive aerial, the position of a distant station can be found to within one degree.

At fig. 16, is given a sketch for a good serviceable aerial of the straightway type, suitable for all around work, both transmitting and receiving.

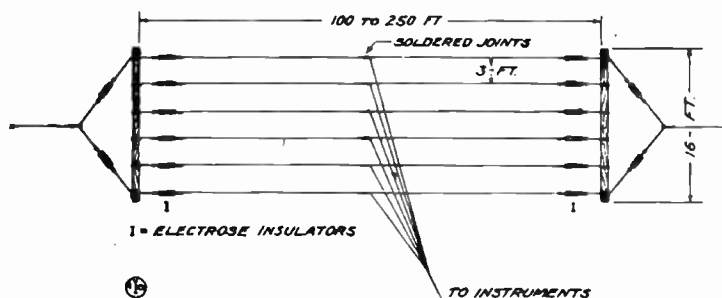

Fig. 16

The aerial may be as large as possible, but not larger than 200 to 250 feet preferably, except for heavy commercial work, where long wave-lengths are most always used. Amateur stations cannot use over 200 meters wave-length.

The aerial wire may be No. 12 B. & S. solid copper, antonium, or stranded phosphor bronze wire, and these are easily soldered. Each strand should be separated from the spars by a good sized insulator, of sufficient strength to hold the discharge from the transmitting set, without leakage. Additional insulators may be placed in the spar ropes as shown, if desired, but are not necessary, if the insulators on the aerial spans are of sufficient size.

The lead-ins are taken off at the centre of the spans, soldering the joints thoroughly, and joining them all together before they enter the wireless room, or every three leads may be joined together, and the two leads thus formed brought down, making a loop aerial.

The spars are generally of hard wood, such as spruce, oak, etc., and bamboo or iron pipe may be substituted. All the ropes for this work should be tarred or waxed, to give them greater serviceability and stability. Fig. 17, shows a simple and effective method of arranging the aerial in connection with a counterbalance weight, *W*, at the end of the rope supporting the aerial. This automatically takes up the stretching and shortening of the rope due to climatic conditions. Some aerials are erected with spiral springs in the supporting ropes, which also compensate for ordinary changes in the rope, etc.

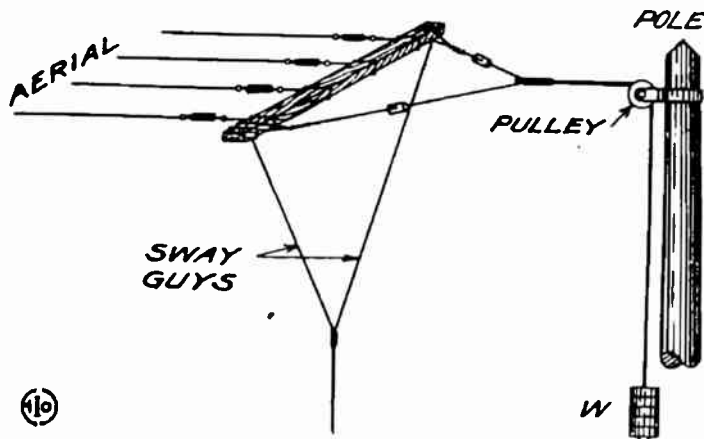

Fig. 17

In general, the height of the aerial determines the range of a wireless station, transmitting and receiving, but of course a large part of this is dependent upon the apparatus used.

Lesson Number Twelve

THE HOOK-UPS AND CONNECTIONS.

A GREAT part of the success in wireless telegraph or telephone work, devolves upon the correct connection of the various instruments to each other, and to the aerial and ground.

We will take up the proper connections of the Transmitting Circuits first, but before starting, a foreword on the reading of diagrams may be helpful. To those

STUDY OF THE DIAGRAMS.

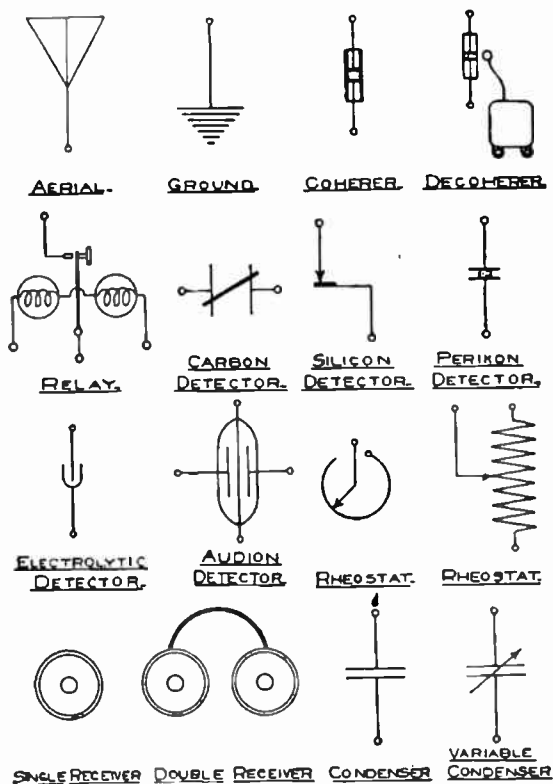

Wireless Telegraph Symbols.

(Courtesy "Modern Electrics.")

unfamiliar with wiring diagrams a first glance is more or less confusing, generally, due to the fact that a clear working idea of the different distinct circuits, is not seen in the mind. To read diagrams quickly, necessitates a well memorized knowledge of the various individual circuits and when several circuits appear together in one sketch, the correct way of reading it, is to search out each individual circuit

Copyright 1912 by E. L. Co.

STUDY OF THE DIAGRAMS.—(Continued.)

correctly first, and then the next, and so on. To illustrate; let the diagram, fig. 1, be taken for an example. This is a simple hook-up for a spark coil, battery, key, spark gap, condenser, aerial and ground.

First, it is known that the spark coil has two windings on it, a primary or battery coil P, and a high voltage secondary coil S. Hence, it is a simple matter to trace out, first, the primary circuit, from primary coil P, to key K, battery B, and thence back to primary coil P, completing the circuit.

Glancing at the secondary circuit, it is best to notice first that the secondary coil S terminals, are connected to the aerial A, and ground G, and then, that the

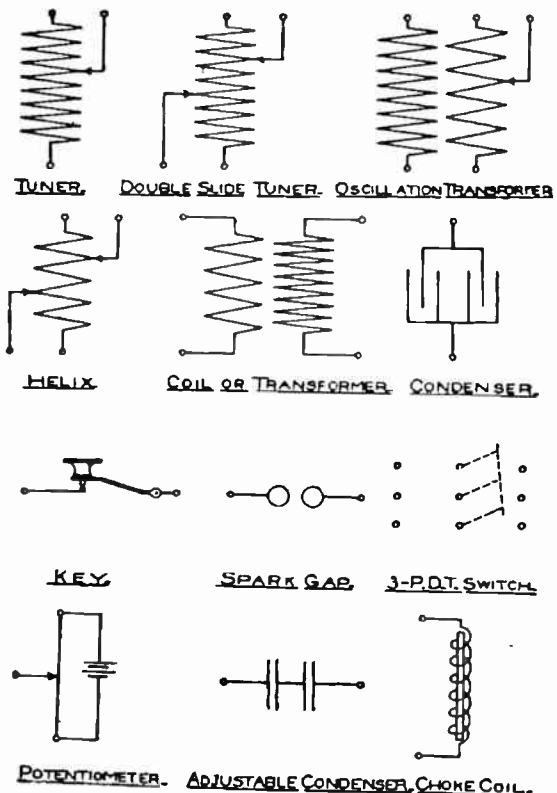

Wireless Telegraph Symbols.

(Courtesy "Modern Electrician.")

condenser C, is shunted across the spark gap S G, which checks off the whole diagram. Of course, a good store of working knowledge regarding the exact action and inter-action of the separate apparatus is absolutely essential before attempting to read any fairly complicated diagrams. A list of symbols, used in wireless diagrams appear on the first and second page.

In fig. 1, is depicted the simplest transmitting hook-up used for sending wireless messages, excepting the condenser, which has been added here. Most all wireless stations, of any size from a 1 inch spark coil up, employ a helix and condenser in the secondary circuit to permit of tuning the apparatus or, in other words, per-

mitting of varying the length of the emitted wave, which is not possible with the simple hook-up just cited, except if a different length of aerial wire was used for different wave-lengths.

The commonest tuned transmitting arrangement is shown in fig. 2, where H is a helix of several turns of large wire, forming a tuning coil or variable inductance, allowing more or less of the turns to be put in series with the aerial, which causes a change in the wave-length sent out. The system here given, conforms to the type known as "close-coupled," owing to the fact that but one transformer coil or helix is utilized. Sometimes it is called a "tight" coupling.

The circuit around the helix winding, condenser and spark gap, constitutes the closed oscillating circuit through which the high frequency surges, set up by the rapid charging and discharging of the condenser pass. This excites the helix, the same as a transformer, but the one winding has to serve the dual purposes of primary and secondary coils here; the helix secondary current flowing out through the aerial and to the ground, charging them both.

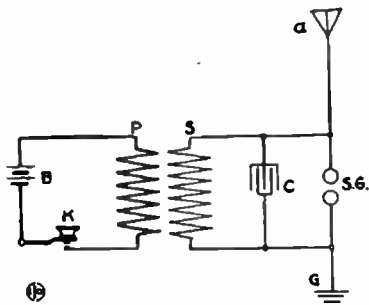

Fig. 1

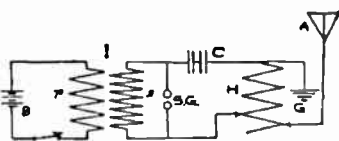

Fig. 2

(Courtesy "Modern Electrics")

A similar transmitting set to that mentioned in fig. 2, is illustrated by fig. 3, only a transformer operating directly on alternating current here takes the place of the spark coil and battery. The transformer is indicated by T, and an adjustable choke coil to limit the value of the current used, C C; K being the key, of substantial construction to stand the heavy current.

At fig. 4 is given a layout, for the connecting up of an electrolytic Interrupter, I; choke coil, C C; and spark coil, with same secondary connection as before. This type of circuit is much used in amateur stations, with more or less modifications.

A diagram for a transmitter employing a loose-coupled tuning coil or helix instead of the single coil helix, is outlined at fig. 5. The primary circuit is A C, feeding the primary of the transformer T, this circuit including also a voltmeter, and an ammeter for noting the amount of current and voltage passing into the transformer.

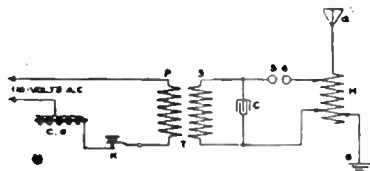

Fig. 3

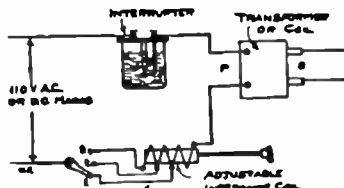

Fig. 4

(Courtesy "Modern Electrics")

The closed oscillating circuit here comprises the condenser, spark gap, and primary coil P, of the sending loose-coupler, or transformer. The oscillating high frequency currents surging through the loose-coupler primary, which is in close proximity to the secondary coil S, sets up another current of higher voltage and similar fre-

quency in it. This excites the aerial and ground, the aerial current passing through a hot-wire ammeter and loading coil A L, the meter denoting when the maximum current is being radiated.

A complete wiring plan appears at fig. 6, for a fairly complete transmitting plant. The apparatus included here is as follows: Regular wireless transformer T, small key K and condenser C, operating a magnetic key R, choke coil R C, Voltmeter V M, Ammeter A M, direct reading Wattmeter W M.

The secondary circuit comprises: the oscillation transformer O T, condenser L, spark gap S G and hot-wire ammeter.

The wiring diagram for a sending station such as used on shipboard for commercial purposes is illustrated by fig. 7.

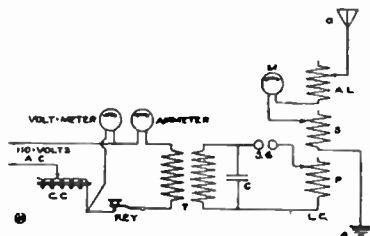

Fig. 5

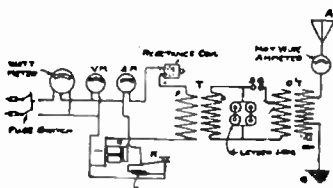

Fig. 6

This set makes use of a motor-generator, the motor being direct current, and the generator alternating current. The motor takes its current from the D C mains through a starting resistance C B, and field rheostat or regulating resistance M F R. The alternator, driven by direct shaft-coupling with the motor, delivers a suitable alternating current from the slip rings S R to transformer T, with the voltmeter V M, ammeter A M, wattmeter W M, frequency meter F M and adjustable choke coil C C interposed in its primary circuit. Regulation of the primary transformer current can thus be governed or varied by adjusting the motor field resistance M F R; the alternator field rheostat A F R; or the choke coil C C; K is the key, which is sometimes a magnetic one.

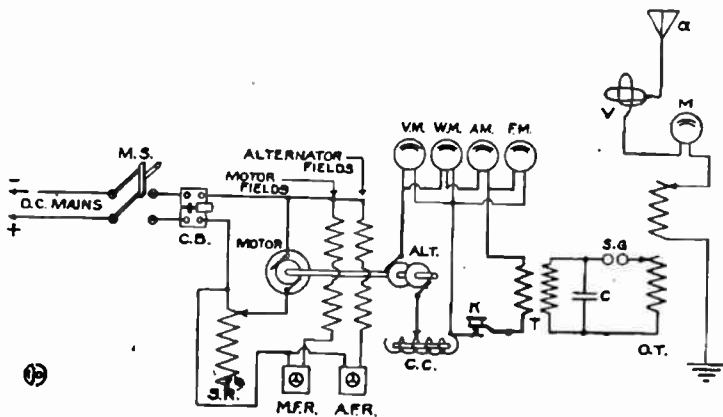

Fig 7

The secondary or high voltage circuit, is the same as previously shown, with the exception that a variometer is inserted in place of the loading coil, which serves the same purpose, in the aerial lead.

The Fessenden High Frequency or Singing spark system, has been quite exten-

sively used in the U. S. Navy, and a diagram of the general layout for the transmitting circuits is depicted by fig. 8.

Referring to fig. 8, the D C mains supply a motor driving the 500 cycle alternator A L T, and on the same shaft with these two machines, is mounted the synchronous rotary spark gap S Y N rotating in step with the alternations of current, causing the sparks to occur in the two gaps S G 1 and S G 2 at periods of maximum activity in each alternation.

A common key K, operates the transformer through the medium of a special magnetic key M K; C 1 and C 2 are compressed air condensers, having safety spark gaps S F 1 and S F 2 connected across them to prevent puncture under severe strains. G 2 is the discharge ground ball for the safety gaps.

The helix is a loose-coupled affair, in three sections, allowing any combination of coupling to be readily effected. P is the primary, S 1 and S 2 the secondaries.

The secondary circuit leads through a hot-wire ammeter M to the aerial, which is of net-like construction, there being a number of cross connecting wires attached to the regular spans, the idea being to imitate a solid radiating surface as near as possible; G' is the ground for the open oscillating circuit.

The connection of a "Telefunken" quenched spark gap or series gap, into a common transmitting set is shown at fig. 9. For tuning, a variometer is depicted but a helix may be utilized. To realize the high efficiency of the Telefunken

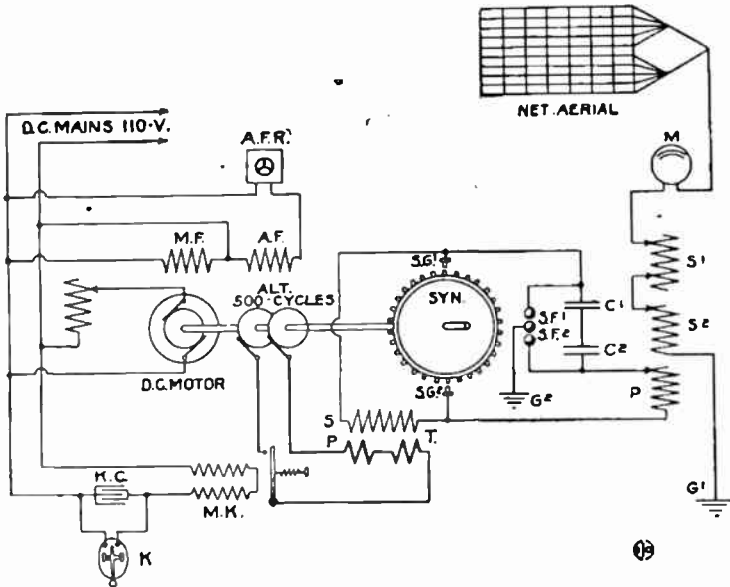

Fig. 8

system, 500 cycle primary current must be used for the transformer, which gives the singing note so penetrating in cases of bad static or interference.

Attention will now be turned to the receiving apparatus and the best methods of connecting it for efficient results.

The very simplest receiving diagram, is that shown at fig. 10, the functions involved being the antenna, a microphone or carbon detector D, battery B, telephone receiver R, and ground connection G, the latter of which, for short distances may be unemployed.

Practically all wireless stations at the present time employ a type of detector which necessitates the use of telephone receivers to read the signals, but the first Marconi apparatus used a coherer or filings tube detector, and a wiring scheme for a good working coherer set, is illustrated in diagram fig. 11, where C is the coherer; D the tapper or de-coherer; T tuning coil; V C variable condenser; F C fixed con-

denser; R high resistance relay (preferably polarized); rheostat R 2; battery B, and choke coils A, C.

A hook-up for a simple tuned receiving set comprising single slide tuning coil T, microphone detector D, telephone receivers R, battery, aerial and ground, is represented at fig. 12.

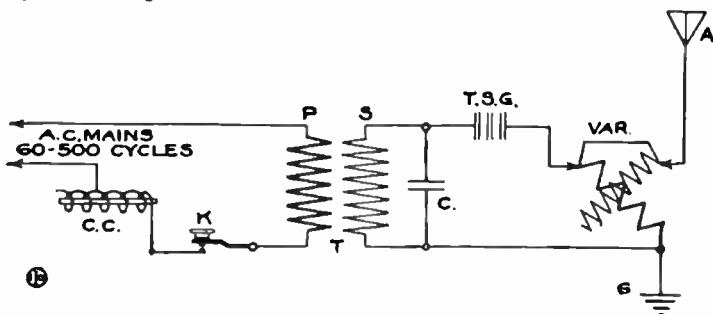

Fig. 9

The principal detector used now is the crystal Silicon or Perikon, a diagram for which appears in fig. 13, while figs. 14-17 depict other connections for "close-coupled" receiving circuits with potentiometer for varying the amount of current supplied to the detectors.

Fig. 18 shows the proper connections for an electrolytic detector and a testing buzzer for ascertaining the sensibility and adjustment of the detector. C is a separate fixed condenser.

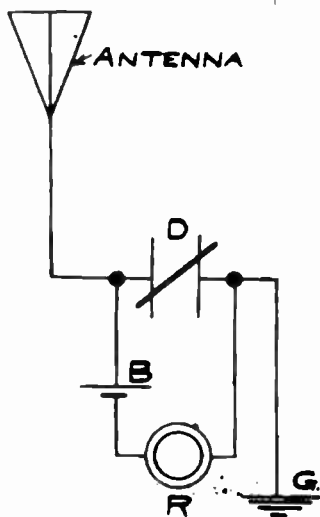

Fig. 10

(Courtesy "Modern Electrics.")

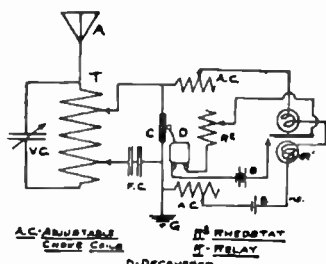

Fig. 11

While "close-coupled" tuning coils or auto-transformers have been largely used, the "loose-coupled" or two-coil transformer has been widely adopted because of its wider range of selectivity, and other possibilities.

A circuit for a loose-coupler L. C., Silicon detector D; fixed condenser F C; telephone receiver R; and variable condenser V C is given in fig. 19.

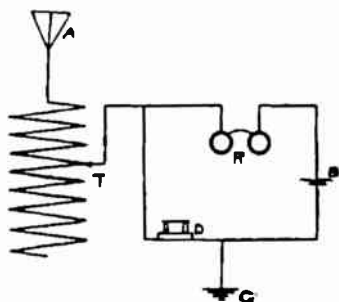

Fig. 12
(Courtesy "Modern Electrics.")

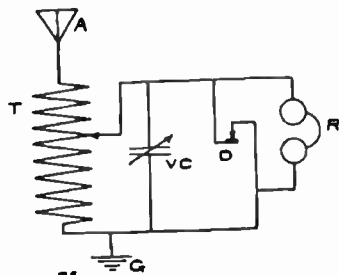

Fig. 13

It may be noted here that the variable condenser is inserted in the ground connection, and whether it is put here or on parallel with the tuning coil, makes a great deal of difference, in the receipt of certain wave-lengths. For receiving wave-

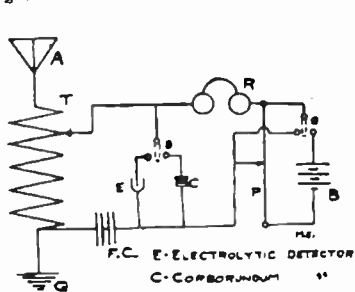

Fig. 14

(Courtesy "Modern Electrics.")

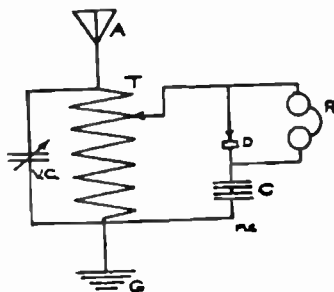

Fig. 15

lengths shorter than that of the natural period of the receiving aerial, the variable condenser is inserted in the ground lead, but to get long wave-lengths the capacity must be shunted across the tuning inductance. It is a very good idea to have the

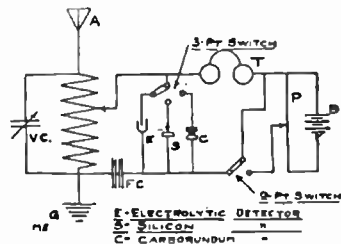

Fig. 16

(Courtesy "Modern Electrics.")

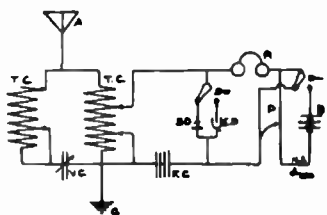

Fig. 17

variable capacity connected to a throw-over switch, as in fig. 20, so that it can be quickly changed when desired from one connection to the other. In this cut, is also shown a variometer in the aerial lead, to give additional wave-length capacity to the receiving set.

WIRELESS COURSE—LESSON NO. 12

A very good receiving set is shown by the arrangement at fig. 21, where the secondary of the loose-coupler is divided up into several steps, and both a loading coil and variometer are used in series with the aerial. The tuning coil T C and

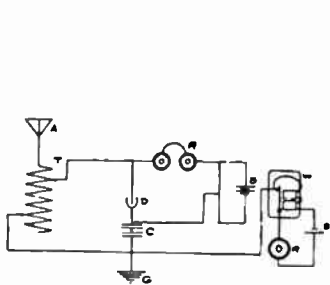

Fig. 18

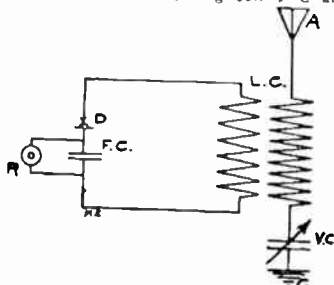

Fig. 19

variable condenser, are used to cut out static, etc. It is advisable to have a short-circuiting switch around the variable condenser in series with the tuner, to cut it out when not wanted, such as when receiving long wave-lengths.

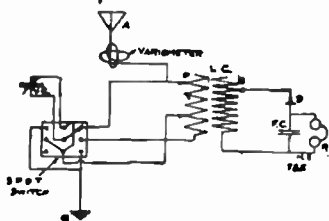

Fig. 20

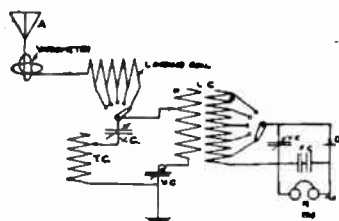

Fig. 21

(Courtesy "Modern Electrics.")

In sketch 22, is illustrated diagrammatically, the Marconi selective receiving set, or "X" stopper as it is called. All the tuning inductances are single coil transformers.

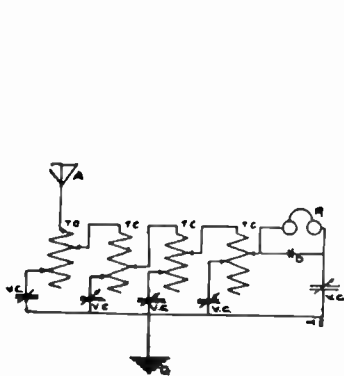

Fig. 22

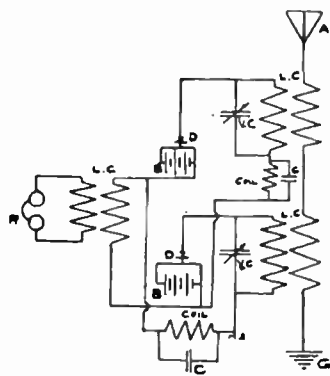

Fig. 23

Marconi's "Interference Preventer" is diagrammed at fig. 23, and employs three loose-couplers, one being in the local detector circuit. The static coil and condenser is also shown.

(To be continued Lesson Thirteen)

Lesson Number Thirteen.

THE HOOK-UPS AND CONNECTIONS.—(Continued) USEFUL INFORMATION.

A receiving set much used by the U S Navy, makes use of a loose-coupler with adjustable primary and secondary inductances, and aerial loading coil. The diagram of connections for this set are at fig 24, where A L is the aerial loading

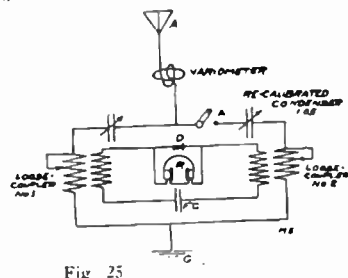
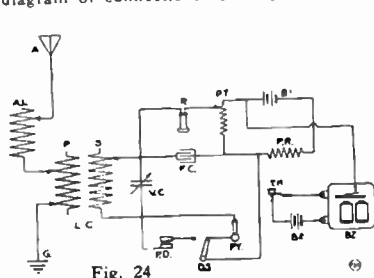

inductance, L C loose-coupler, V C a .002 M. F variable condenser, R telephone receivers of high resistance, F C a fixed condenser. P T potentiometer and auxiliary

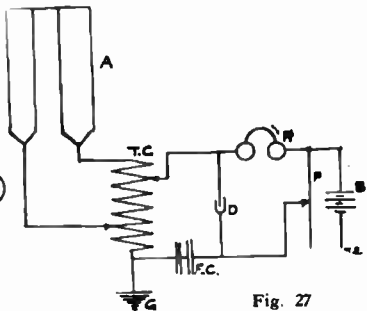
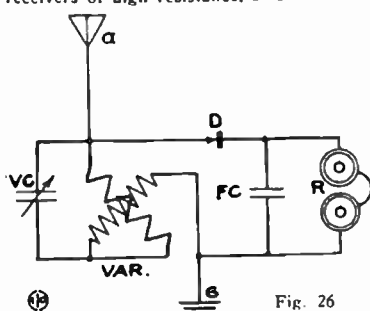

resistance P R of 1,800 ohms. Perikon detector P D and Pyron detector P Y connected separately, by means of the detector switch D S. A testing buzzer is

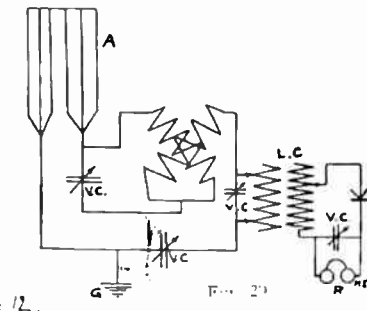
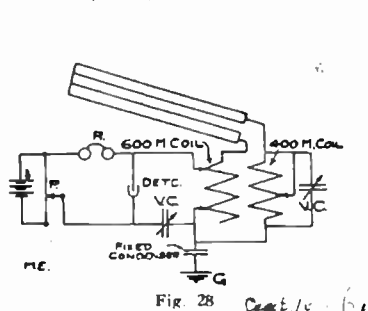

indicated by B Z, with push button T K and battery B 2. The detector battery is at B 1. One of the most efficient receiving devices for the elimination of static and
Copyright 1912 by E. I. Co.

severe interferences from various sources is the Fessenden "interference preventer," which is shown by the diagram fig. 25.

The Fessenden Interference Preventer, involves the use of two loose-couplers, arranged to move together, as regards the adjustments, with one variable condenser calibrated to read .05 higher on each scale division than on the other variable condenser. The variometer is used to tune with in connection with the loose-coupler.

The switch A, is closed to cut out static currents, and the variometer adjusted until it disappears.

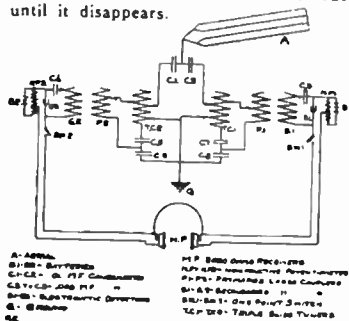

Fig. 30

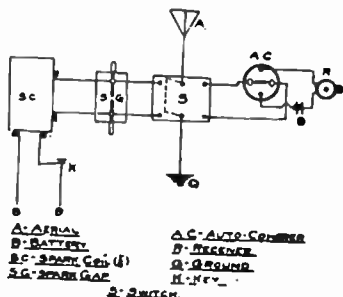

Fig. 31

A diagram of the "Telefunken" receiving set, with variometer, variable condenser, galena-graphite detector, fixed condenser, and head telephones is shown in cut 26. The "looped" aerial or divided aerial is a decided advantage for sharp clear tuning of wireless signals, a common method of utilizing it being shown at fig. 27, in connection with a double slide tuning coil.

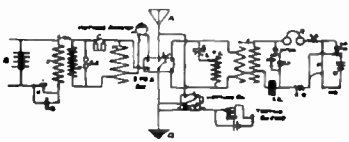

Fig. 32

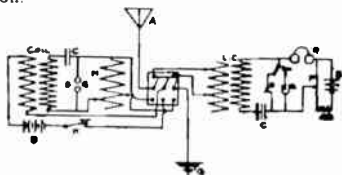

Fig. 33

A looped aerial scheme much in use by commercial stations is that in fig. 28. The 400 meter coil and variable condenser V C constitute the static loop, as it is called, and are used to weed out static or "X."

A diagram for a receiving set, including looped aerial, four variable condensers, variometer, and loose-coupler, is shown by fig. 29.

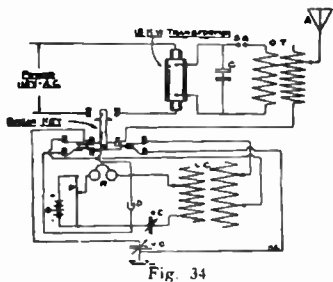

Fig. 34

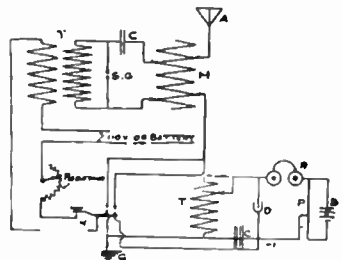

Fig. 35

A duplex receiving set, enabling the operator to receive two distinct messages from the same aerial is illustrated by cut fig. 30. It is best used with two separate pairs of receivers, so that two persons may listen in at the same time.

A few diagrams will now be given attention for the complete wireless station,

i. e., including transmitting and receiving instruments with throw-over switches Fig. 31, shows the simplest complete transmitting and receiving set with a double-pole, double-throw, knife switch for changing from one to the other.

Fig. 32, portrays the station circuits for tuned sending and receiving apparatus with lightning grounding switch, and testing buzzer. The transmitting instruments are close-coupled and the receiving loose-coupled in this instance.

The use of a three-pole aerial switch, on the pattern of the De Forest type, in combination with a set of tuned apparatus is depicted by diagram fig. 33.

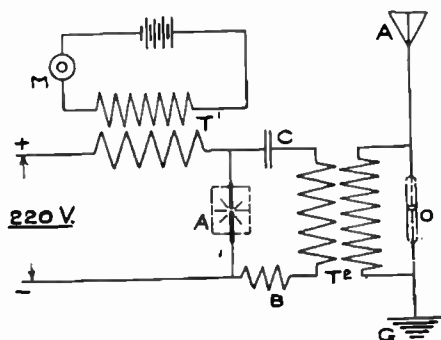

(Courtesy "Modern Electrics.")

Fig. 36

The practice of late, has become common to eliminate the cumbersome aerial switch for changing over from sending to receiving, by the substitution of an automatic "break-key" scheme, or a system whereby the transmitting key connects the receiving instruments after the sending is finished.

One method of accomplishing this idea is exemplified by the drawing, fig. 34, and still another way by fig. 35.

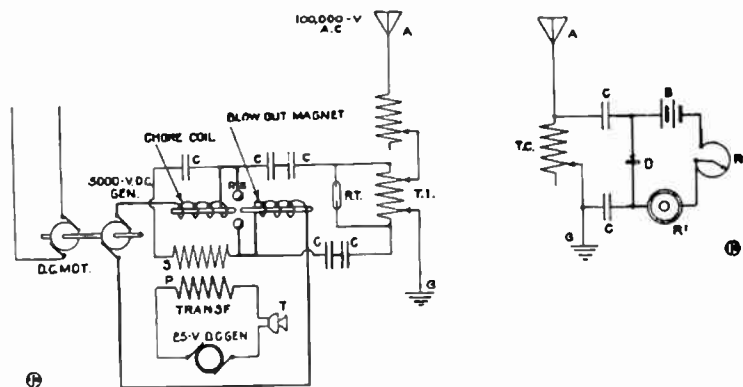

Fig. 37

In wireless telephony or radiophony, an arc of some form is generally utilized to generate the high frequency undamped oscillation or waves, the original Poulsen system being shown in fig. 36, while at fig. 37, is exhibited the working connections of the radiophone system developed by A. Frederick Collins.

In the Collins system, the arc takes place between a pair of rotating electrodes R E with blowout magnets as shown. The arc current is 5,000 volts D. C. The variation in the frequency of the arc current is accomplished by the transmitter T, transformer coil, and 25 volts D. C.; R T is a resonance tube, to ascertain when the instruments are properly tuned. T I is a tuning inductance.

On the receiving side, use is made of a tuning coil T C, Condensers C, battery B, Rheostat R, telephone receiver R, and a special thermo-electric detector D.

The "Audion" detector, developed by Dr. Lee De Forest, the radiophonist, is a very good detector for radiotelegraphic or radiophonic work, and is connected up in the manner outlined in fig. 38.

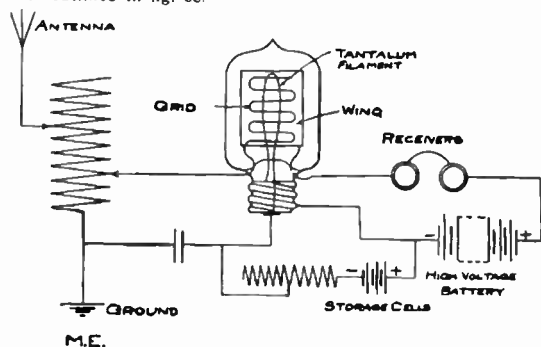

(Courtesy "Modern Electrics.")

Fig. 38

USEFUL INFORMATION.

DIELECTRIC STRENGTHS OF VARIOUS INSULATORS.

Kilovolts per centimetre required to break down the insulator.

MATERIAL.	
Micanite	4000
Mica	2000
American Linen Paper, Paraffined..	540
Ebonite	538
Indiarubber	492
Linseed Oil	83
Cotton Seed Oil	67
Lubricating Oil	48
Air Film, 2 mm. thick	57
Air Film, 106 mm. thick	27

NOTES ON ROPES.

Hemp Rope.—To calculate the working strain of rope, square the circumference in inches, and divide by 8 for the allowable strain in tons.

To find the least size of rope to lift a given weight, multiply the weight in tons by 8 and extract the square root. The number found is the circumference in inches.

Wire Rope.—To find the safe strain for wire rope, multiply the square of the circumference in inches by .3 for iron, and .8 for steel wire. The breaking load is about three times the safe load.

Weight in lbs. per fathom is equal to the square of the circumference in inches. Thus 4-inch wire rope would weigh $4 \times 4 = 16$ lbs. per fathom.

HORSEPOWER.

Horsepower is the amount of mechanical force required to raise 33,000 pounds one foot high, per minute.

How to Find Horsepower of an Engine

Area of piston in inches, multiplied by pressure per square inch, multiplied by speed of piston in feet per minute, and that product divided by 33,000 = 1 Horsepower

The pressure per square inch should be the mean effective pressure throughout the stroke exerted on the piston, which can be found by attaching an indicator to the engine. The result will then be what engineers term indicated Horsepower.

The Horsepower of boilers is best defined by the heating surface of a boiler and is different according to their construction. A Tubular Boiler will give about one horsepower to every 15 square feet of heating surface; a Flue Boiler every 12 square feet, and a Cylinder Boiler 10 square feet gives one horsepower. There is no standard law governing the horsepower of Steam Boilers, but this rule is adopted by most experts as a fair rating.

One cubic foot of water evaporated per hour = 1 nominal horsepower.

$7\frac{1}{2}$ pounds of coal consumed per hour will evaporate 1 cubic foot of water = 1 horsepower.

One square foot of grate will consume an average of 12 pounds of coal per hour = 1 6-10 horsepower.

A theoretically perfect steam engine consumes 66-100 pounds of coal per hour per horsepower.

Marine condensing engines consume 2 to 6 pounds of coal per horsepower.

TABLE OF EQUIVALENTS.

Length.

- 1 in.=25.40010 mm.
- 1 ft.=0.30480 Meter
- 1 yd.=0.91440 Meter
- 1 mile=1.60935 Km.
- 1 Nautical Mile=1853.25 Meters
- 1 fathom=1.829 Meters
- 1 Meter=39.37043 In.
- 1 Meter=3.28083 Ft.
- 1 Meter=1.09361 Yds.
- 1 Km.=0.62137 Mile

Area.

- 1 Sq. In.=6.452 Sq. cm.
- 1 sq. ft.=9.290 Sq. dm.
- 1 Sq. Yd.=0.836 Sq. M.
- 1 Sq. Mile=259,008 Hectares
- 1 Sq. cm.=0.1550 Sq. In.
- 1 Sq. M.=10.764 Sq. Ft.
- 1 Sq. M.=1.196 Sq. Yd.

Weight.

- 1 grain=64.7989 mg.
- 1 oz. Av.=28.3495 Gm.
- 1 oz. Troy=31.10348 Gm.
- 1 lb. Av.=453.5924 Gm.
- 1 lb. Troy=0.37324 Kilo.
- 1 lb. Av.=0.45359 Kilo.
- 1 mg.=0.01543 grain.
- 1 Gm.=15.43236 grains.
- 1 Kilo=33 1/4 lb. av. oz.
- 1 Kilo=2.20462 lb. Av.
- 1 Kilo=2.67924 lb. Troy.
- 1 Kilo=35.274 oz. Av.
- 1 Kilo=32.1507 oz. Trby.
- 1 Millier or Tonne=2204.62 lb. Av.
- 1 Quintal=220.462 lb. Av.

Volume.

- 1 minim (water)=0.06161 c.c.
- 1 flu. dr.=3.70 c.c.
- 1 flu. oz.=29.5737 c.c.
- 1 Apoth. oz. (water)=31.10348 c.c.
- 1 quart=0.94636 Liter
- 1 U. S. gal=3.78543 Liters
- 1 bushel=0.35239 Hectol
- 1 c.c.=16.23 minims (water)
- 1 c.c.=0.2702 flu. dr.
- 1 Centiliter=0.338 flu. oz.
- 1 Liter=1.0567 qt.
- 1 Liter=0.26417 gal
- 1 Decaliter=2.6417 gal.
- 1 Hectoliter=2.8377 bushels
- 1 cu. in.=16.387 c.c.
- 1 cu. ft.=0.02832 c. M.
- 1 cu. yd.=0.765 c. M.
- 1 c.c.=0.03102 cu. in.
- 1 c. dm.=61023 cu. in.
- 1 c. M.=35.314 cu. ft.
- 1 c. M.=1.308 cu. yd.

Force.

- 1 Poundal=13,825 dynes.

TABLE OF EQUIVALENTS (Continued.)

- 1 Pound=4.45×10⁸ dynes
- 1 Grain=63.6 dynes
- 1 Gram=981 dynes.

Energy.

- 1 foot-pound=13,823 gram-centimeters
1.3560×10⁷ ergs
- 1 foot-poundal=4.214×10⁸ ergs
- 1 foot-ton=3.096×10⁷ gram-centimeters
3.0374×10¹⁰ ergs
- 1 joule=10⁷ ergs

Power, Energy Rate, or Activity.

- 1 horse-power=746 watts
- 1 horse-power=7.604×10⁹ gm. cm. per second
7.46×10⁹ ergs per second
- 1 metric horse-power=7.5×10⁹ gm. cm. per second
7.36×10⁹ ergs per second
- 1 kilowatt=10¹⁰ ergs per second
- 1 watt=10⁷ ergs per second

Doubling the diameter of a pipe increases its capacity four times.

Double riveting is from 16 to 20 per cent. stronger than single.

One cubic foot of anthracite coal weighs 53 pounds.

One cubic foot of bituminous coal weighs from 47 to 50 pounds.

One ton of coal is equivalent to two cords of wood for steam purposes.

A gallon of water (U. S. Standard) weighs 8 1/3 pounds and contains 231 cubic inches.

There are nine square feet of heating surface to each square foot of grate surface.

A cubic foot of water contains 7 1/2 gallons, 1728 cubic inches, and weighs 62.425 pounds, at 39.1° F. or 59.76 lb. at 212° F.

Each nominal horsepower of a boiler requires 30 to 35 pounds of water per hour.

Following is a table showing the safe carrying capacity of interior wires:

Size of wire. B. & S.	Area in Circular Mils.	Current in amperes	Rubber Ins.
No. 14	4,107		12
12	6,530		17
10	10,380		24
8	16,510		33
6	26,250		46
5	33,100		54
4	41,740		65
3	52,630		76
2	66,370		90
1	83,690		107
0	105,500		127
00	133,100		150
000	167,800		177

CONNECTING AND SOLDERING WIRES.

Where any joints between span wires and lead-in wires, or other connections are to be made, it is of the utmost importance that the surface of the conductor at the point of joining, shall be thoroughly cleaned, which can be readily accomplished by scraping with a knife or better yet, by sand-papering with sand or emery paper, until the wire is bright and shiny.

This thorough cleaning of the wire is necessitated by the oxidation or corrosive coating forming on its surface, due to certain oxidizing elements in the air, and if not done, the joint even though soldered is seldom what it should be, notwithstanding it may have a good appearance.

As aforementioned, "Aluminite" solder is very excellent for use in soldering aluminum wires or conductors, as is also the formula given below:—Take an alloy composed of 6 parts aluminum, 2 parts zinc and 4 parts of phosphor tin. For a flux, stearic acid is employed, and the sluggish solder is pushed along the seams or joints by means of an iron wire.

For soldering wires composed of copper, phosphor bronze or brass, any standard flux may be used, such as the "Allen" soldering stick, "No-Korode" paste, rosin, etc., or the following mixture recommended by the Fire Underwriters:—

Saturated solution of zinc chloride.....	5 parts.
Alcohol	4 parts.
Glycerine	1 part.

IMPROVED TINNING ACID.

Muriatic acid 1 pound; put into it all the zinc it will dissolve, and 1 ounce of sal ammoniac, then it is ready for use.

COMPOSITION OF SOLDERS.

Fine Solder is an alloy of two parts of block tin, and one part of lead. Glazing solder is equal parts of block tin and lead. Plumbing solder, one part block tin; two parts lead.

Muriatic acid should not be used for soldering any electrical connections whatever, as it causes the joint to corrode in a short time.

To accomplish the soldering of a good joint, does not require any great amount of skill, providing the joint is well heated by means of a blow torch or soldering copper, the flux applied, and the solder fed into the joint until the whole juncture is thoroughly permeated with molten solder and it starts to run.

If any difficulty is experienced in tinning the end of the soldering copper, or iron as it is called, it may be quickly cleaned and tinned while hot, by rubbing it in sal-ammoniac and then smearing solder on it. If the copper becomes roughened or burned on its face, it should be ground or filed smooth.

To give an idea to the uninitiated, as to the method pursued in forming a wire joint, the following drawings (figs. 39 to 42) will serve. They explain themselves, and

FLUXES FOR SOLDERING OR WELDING.

Copper and Brass	Sal-Ammoniac
Iron	Borax
Lead	Tallow or Resin
Lead and Tin Pipes	Resin and Sweet Oil

Tinned Iron

Zinc

Steel: Pulverize together 1 part sal-ammoniac and 10 parts of borax and fuse until clear. When solidified, pulverize to powder.

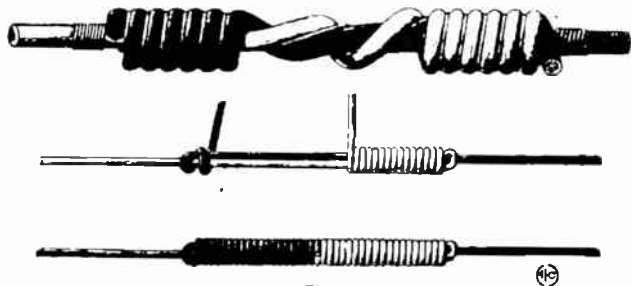

Fig. 39

it may be said, that all such joints are supposed to be mechanically and electrically perfect, before soldering. This is done to preserve the conductivity of the joint, otherwise oxidation soon sets in, and in a short while, the resistance of the joint is several times its original value, which proves too much of an obstacle for the feeble aerial currents to surmount, giving rise to the supposed deterioration of the instruments, which is seldom the case.

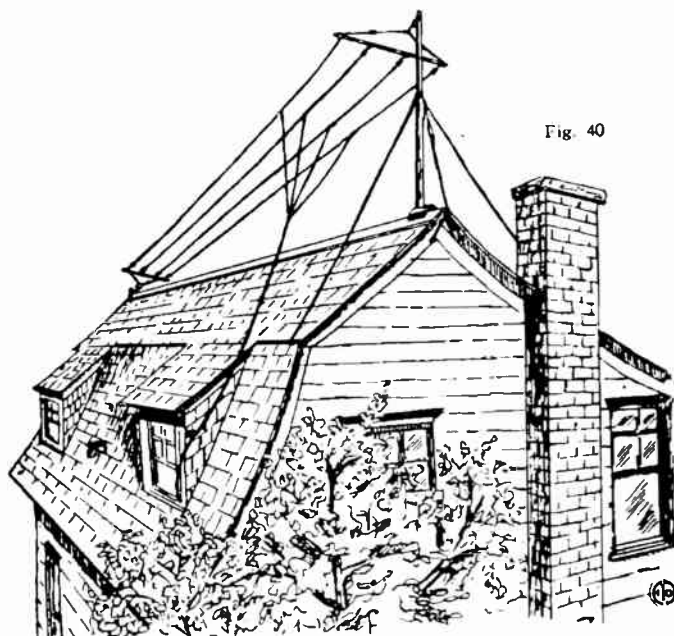

Fig. 40

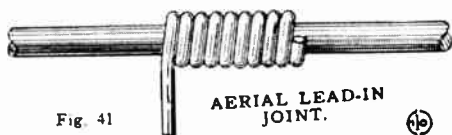

Fig. 41

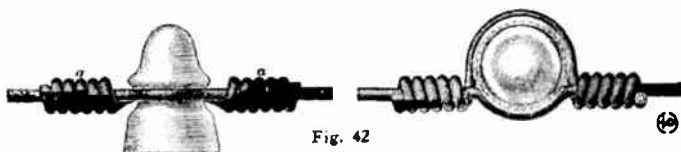
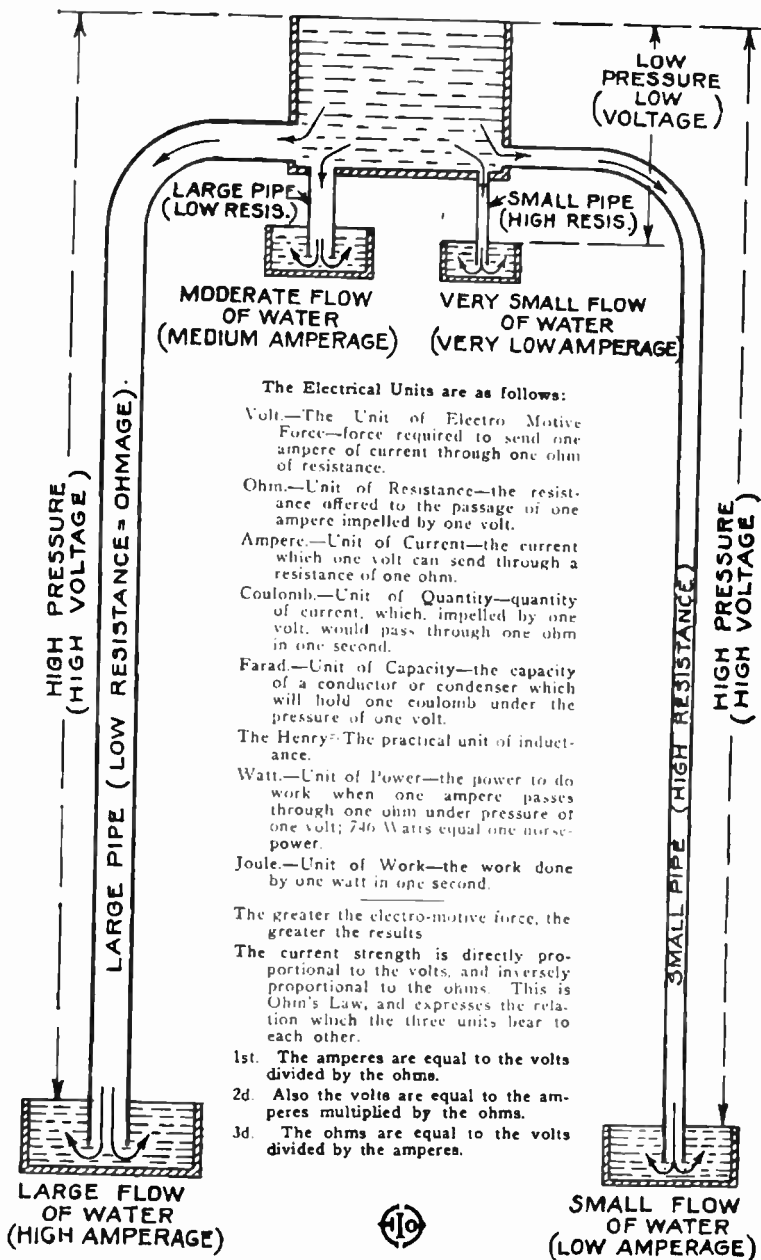

Fig. 42



Lesson Number Fourteen.

OPERATION OF THE INSTRUMENTS—WIRELESS REGULATIONS.

THE operation and tuning of the instruments in wireless circuits is more or less complicated, the adjustment of one having a certain effect on the others, etc. In untuned wireless telegraph circuits, the operation is of course quite simple, and may be readily understood from the diagram fig. 1, which shows the connections of a spark coil, battery, key and spark gap at the transmitting station; and an auto-coherer detector, battery and telephone receiver at the receiving end.

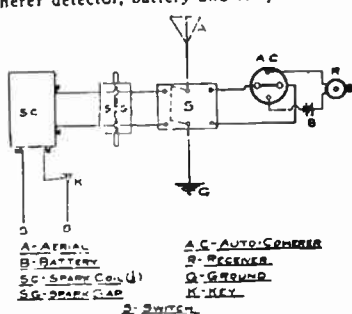

Fig. 1 (Courtesy "Modern Electrics")

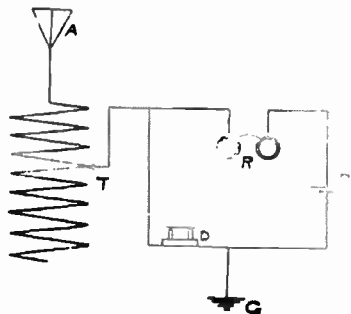

Fig. 2

The action of the apparatus is as follows: when the sending key K, is pressed or closed, the battery current is circulated through the low potential winding on the spark coil. This coil, by means of its high voltage or secondary winding, steps up the voltage to a sufficient value to leap an air space in the spark gap, S G, which results in the aerial wires A, and ground G, becoming charged. These charged arms of the open oscillating circuit, as it is termed, set up electro-magnetic waves in the ether, the length of the radiated wave being approximately 4 (or nearer 4.5) times the length of the aerial wire, from its outer end to the spark gap.

The waves thus set up in the ether, at the transmitting station, travel at the marvelous velocity of 186,500 miles per second, and in the course of their travels, impinge on the receiving aerial A, and manifest their presence, by the setting up of high frequency oscillations or currents in the aerial wire. These pass down through the detector, A C, to the ground G, the action on the detector being noted by means of the telephone receiver and battery shunted around it. Every time a spark jumps the gap, S G, a buzzing sound is heard in the telephone receiver, providing the detector is correctly adjusted. The receiving set and aerial here shown, will respond to any wave-length, if sufficiently close to the sending station, but will respond best to a wave-length approximating the value of the natural period of the aerial, when distant from the sending station.

From the foregoing discussion, it will probably now be evident, that: if the receiving station above cited, was to receive from a distant sending station radiating a wave whose length did not correspond with its own, it would be necessary to so alter the receiving aerial's length, that it would have a natural wave-length equivalent to the sending station.

It would be quite cumbersome and awkward to be changing the length of the aerial wire to correspond with every wave-length which it was desired to tune in or receive, and so the tuning coil, as the simplest wave length variator is termed, is brought into service, in the manner depicted by diagram fig 2, where the tuning coil or inductance is represented by T, the detector D, telephone receivers R, battery B, aerial A, and ground G.

It is easy to comprehend that if the sliding contact on the tuning coil is moved downward, as shown here, it will artificially lengthen the aerial, and vice versa, by adding more or less meters of wire to it, and so, within the capacity of the tuning coil and aerial, any desired wave-length may be adjusted for, and the open oscillating circuit through aerial, tuning coil and ground, made to oscillate or vibrate in tune or resonance with the waves impressed upon it. When this has been accomplished the maximum effect will be exercised on the detector, and consequently on the telephone receivers.

Having gone over the elementary principles of tuning, the tuning of transmitting or sending stations will now be taken up in detail.

The commonest type of tuned sending circuit is that shown at fig. 3, which includes a single coil of wire or helix H, for changing the length of the aerial wire and consequently the wave emitted. C is the condenser, S G, the spark gap, with a hot wire ammeter added to facilitate the tuning.

To begin with, it will be assumed that, it is desired to radiate a fairly long wave or at least one considerably longer than that emitted by the aerial alone. To do this the aerial slide should be set to include a good portion of the helix turns in series with the aerial or the aerial slider must be pushed upward. Having done this, the next function to be attended to, is that of placing the condenser circuit, or closed oscillating circuit, H C, S G, in tune or resonance, with the open oscillating or aerial circuit, A, H, G.

This is done by changing the position of the movable condenser lead on the helix H, and also the capacity of the condenser C, until a loud blue-white spark crashes in the gap S G, and the hot wire ammeter registers a maximum radiation current in the aerial. The tuning may be perfected roughly by noting the quality of the spark in the gap, but this requires experience and a common method of ascertaining the degree of resonance attained, is to insert a Geissler tube or other exhausted tube in the aerial lead, where the hot-wire meter is shown in the diagram fig. 3. When resonance is established the Geissler tube will glow the brightest and vice versa. An anchor gap is also useful in place of the Geissler tube.

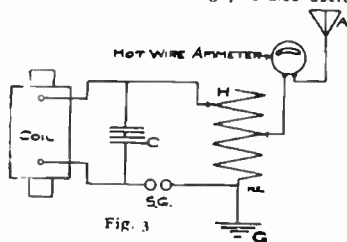

Fig. 3

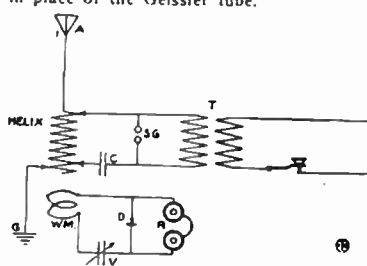

Fig. 4

(Courtesy "Modern Electrics.")

In the receiving tuning coil, it may be taken that about four times the length of wire in use on it, is the increase in wave-length due to its use, but for the transmitting helix no such simple rule holds forth.

There is no simple method of determining the wave-length radiated from the aerial of a tuned sending set, except by the use of a wave-meter, which will be treated later.

For tuned sending circuits, the wave-length radiated can be calculated mathematically when the capacity and inductance of the condensers and helix are definitely known.

This method of finding the wave-length is given below; W representing the wave-length in meters; $\Pi = 3.1416$ (a constant); V, the velocity of the waves in the ether or 300,000,000 meters per second; L, is the inductance of those turns of the helix included in the closed oscillating circuit, in Henries; C, is the capacity in Farads, of the condenser used to attain resonance.

$$W = \Pi \ 2 \ V \ \sqrt{LC};$$

The inductance of the helix turns in use, can be deduced from the formula due to L. Cohen, as given in the U S Bureau of Standards Report, which is as follows:—

$$L \ 1 = 39.4787 \times N^2 \left[\frac{2 \times a^4 + a^3 \times l^2}{1.4 \times a^2 + l^2} - \frac{8 \times a^3}{9.4248} \right];$$

The inductance L 1, being given in C. G. S. units,* which may be transformed into practical units or Henries, by dividing the inductance L 1, by the factor 1,000,000,000. This formula is accurate to within one-half of one per cent. for any helix whose length is at least 4 or 5 times the diameter. The nomenclature involved follows:— a, is the mean radius of the helix in centimeters, l, is the length of the helix in use, in centimeters, and N, is the number of turns of wire per centimeter of length.

The capacity of the condenser may be calculated from the equation below:—

$$C = \frac{2,248 \times K \times a}{t \times 10,000,000,000} + 1,000,000;$$

C, being the capacity in Farads; K the inductivity of dielectric factor, which is about six, for common glass and one for ordinary air; a, is the active area in square

*Inductance in Centimeters.

inches of glass or dielectric coated on both sides with charging plates and connected on multiple; and t , is the thickness in inches of the dielectric or insulating medium.

Owing to the varying form of differently constructed condensers and the brushing consequent on heavy charges thereon, the wave-length as calculated is a little different from that actually radiated. Brushing from the condensers can be largely overcome by immersing the plates in oil; boiled out linseed oil being extensively used for this purpose.

So much for the calculation of the radiated wave-length. We will now consider the more practical method utilized in commercial wireless work, viz., that of using a wave-meter which gives the value of the radiated wave at once, the manner of using it being as follows:—

In fig. 4, is outlined the sending circuit for a common close-coupled wireless station, and a short distance from the end of the helix is shown the exciting loop, or coil of the wave-meter W M; the wave-meter consisting of the inductance mentioned, a variable condenser, a detector (usually carborundum), and a pair of high resistance telephone receivers, shunted around the detector.

When the transmitting set has been properly tuned into resonance as previously explained, the wave-length is determined by placing the wave-meter coil 4 to 6 inches, or more, according to the size of the set, away from the end of the helix, or alongside it, as in fig. 5, which is advocated by many.

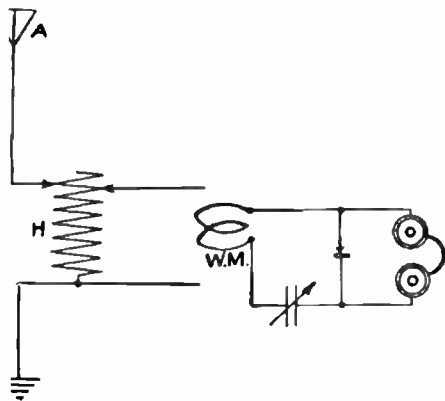

Fig. 5

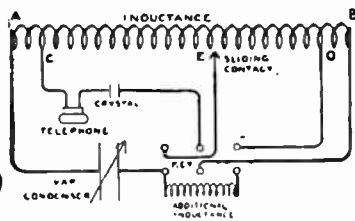

Fig. 6

(Courtesy "Modern Electrics.")

In most wave-meters, the inductance is fixed in value, and the only adjustment necessary is to vary the capacity of the condenser, until the signals are heard the loudest in the receivers, when the wave-length corresponding to this state of resonance in the wave-meter circuit is read directly from calibrated curves or tables supplied with the meter. This is the principle of all wave-meters, the method of attaining the results being accomplished a little different in some.

The Pierce wave-meter, for instance, employs a similar hook-up to that shown but has no detector, using instead, a special high frequency wireless telephone receiver, which indicates when the maximum energy traverses the circuit. The Marconi wave-meter is a very good one, and utilizes a carborundum detector, placed on a shunt circuit to the main oscillating circuit, as can be seen from the diagram fig. 6, which arrangement insures a high accuracy in all of the readings made by it. The Marconi wave-meter complete is depicted at fig. 7.

In diagram 8, the arrangement for measuring the wave-length in loose-coupled transmitting circuits is brought out, the wave-meter coil being placed near the secondary coil of the oscillation transformer, which is, of course, at the same time in close proximity to the primary, but this makes no difference as they are in tune.

To transmit a certain definite wave-length in connection with a wave-meter, the meter should be set for the desired wave, by checking off from the table accompanying it, and then the sending condenser and inductance adjusted until the maximum amount of energy passes through the wave-meter circuit, made apparent by the loudness of the signals in the telephone receivers. Of course, the open and closed oscillating circuits must be tuned to resonance by noting the spark, and the reading of the hot-wire meter or the glow in a resonance tube.

The tuning of the receiving apparatus was explained partially at the beginning of this lesson, i. e., the philosophy of adding additional inductance to the aerial to get the open oscillating circuit in tune with the incoming wave, and this is one of the fundamental factors in the tuning of the receiving circuit.

The most important detail in the receiving circuit, is the detector, and a number of different ones are and have been used. So-called crystal detectors, or more correctly, solid rectifying detectors, are mostly in use now, although the "Audion," a form of gas detector, similar to the Fleming oscillation valve, has been adopted in many stations. The Marconi company uses the Fleming valve, and find it very satisfactory, especially in cases of severe static or interference.

The detector, whatever its ilk or type, should be very carefully treated and adjusted, to realize good efficient service from it. First, it should be mounted upon some shock absorbing mat, such as thick felt, so that any outside jars or vibrations do not reach it. Secondly, the detector, except in the case of the valve or other sealed types, is best placed under an airtight cover of metal or glass to prevent the oxidizing agents in the air, especially ozone, from attacking the crystals, materially lessening their efficiency and life. Under the cover placed over the detector,

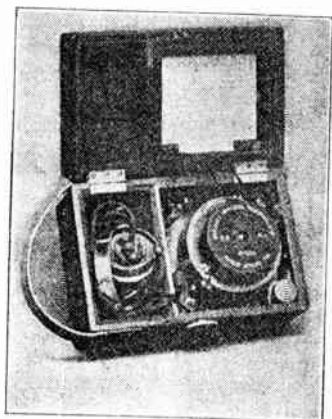

Fig. 7

(Courtesy "Modern Electrics.")

should also be placed, a small quantity of dry calcium chloride, as an air drier. A metal cover over the detector is preferable, as it tends to protect the instrument from the powerful currents set up by the sending apparatus in the home station.

The detector is generally adjusted to its highest sensitiveness by means of a test huzzer, as they are called, the connections for it being given in diagram fig. 9, which also shows a wire leading from the contact screw on the buzzer or bell.

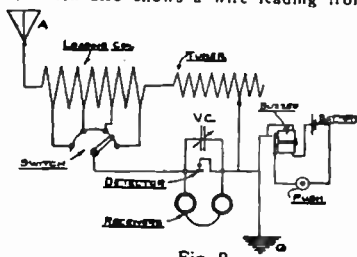

Fig. 9

(Courtesy "Modern Electrics.")

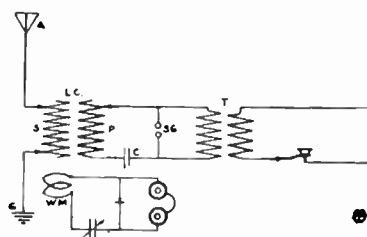

Fig. 8

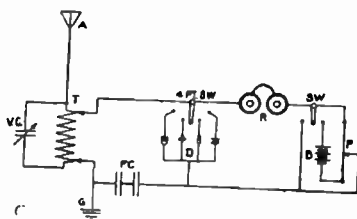

Fig. 10

to the ground lead, with a push button and battery for operating the buzzer itself. The buzzer should be put in some place away from the receiving instruments, so that only the sound in the receiver is heard.

The detector is adjusted to the proper degree, by varying the amount of current fed to it in some types, employing a battery, or by varying the tension existing

between the active elements, such as the crystals, pushing the test buzzer button at intervals, to imitate dots and dashes, and when the maximum sensibility has been reached, the buzzing in the telephone receivers will be loudest, and the detector is then in a state to receive incoming wireless signals.

Where the detector is located in a sending and receiving station, it should be guarded from the powerful waves set up while sending, by shunting it with a switch connected across it, the switch being manually operated, or better automatically from the sending key, by having it arranged to work an extra contact or a relay for this purpose.

Referring to fig. 10, a tuned receiving set is illustrated diagrammatically, with a close-coupled tuning coil, a variable condenser or capacity, a fixed condenser, four different detectors, a potentiometer and battery for the detectors requiring battery current, and the necessary controlling switches.

Here, the variable condenser is shown connected across the whole winding on the tuning coil, but it makes a considerable difference, if it is inserted in the ground lead, the first arrangement adapting the set to receive the longest wave-lengths within its power, while when put in series with the ground, it renders the set tunable for the shortest wave-lengths within its range. There are several ways of connecting up the variable condenser, but the two mentioned here are the most common, where but one variable condenser is utilized.

The fixed condenser, by its charging and discharging action tends to raise to a maximum, the effects of the oscillations impressed upon the detector, and generally is found best if of the series type.

The battery switch, a two point type, permits of placing the receivers in circuit with the crystal detectors alone or in circuit with the potentiometer, whose duty is that of regulating precisely the amount of voltage and current supplied to the detectors. A non-inductive form of potentiometer is always preferable to an inductive one, as the inductive kicks of the coil, forming the inductive type, tends to make false noises and signals in the receivers. The graphite rod type, is quite excellent and widely used, having a very high, constant resistance, easily adjusted, besides being positively non-inductive.

Having adjusted the detector to its maximum sensitiveness, the receivers should be held to the ears, and the open oscillating circuit wave-length varied by moving the position of the ground slider or contact shown in fig. 10, to include more or less turns of the inductance, the more turns left in circuit, the greater the equivalent wave-length capacity. When the signals are heard in the receivers best, after having tuned roughly by moving the ground slider, the tuning may be perfected by manipulating the variable condenser and the detector slider. Adjusting the potentiometer will often make some difference in the strength of the received signals. The variable capacity and the ground slider, should be adjusted simultaneously or nearly so for the quickest tuning.

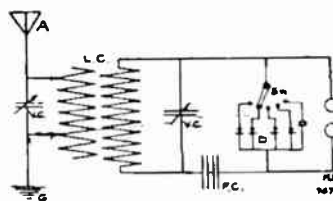
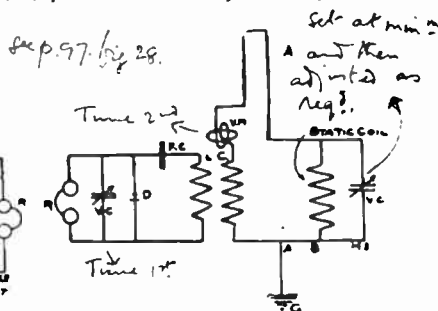

Fig. 11

Fig. 12
(Courtesy "Modern Electrics.")

The process of tuning is essentially the same, for all close-coupled receiving systems, and but little different for the loose-coupled circuits, which are tuned as follows:

In the case of loose-coupled receiving transformers, as per diagram fig. 11, it is common to make use of a variable condenser in the ground wire, or across the primary winding as shown, and also of a smaller variable capacity shunted across the secondary coil, the latter winding being preferably adjustable as well as the primary. The cut given here, shows several crystal detectors connected to a multi-point switch, allowing any one to be used individually.

In tuning such a set, the secondary coil of the loose-coupler is moved in and out of the primary coil, which surrounds it, with about one-half their inductances cut in. When a signal is heard, but not very loud, it is necessary to adjust the capacities and the inductances, as well as the position of the secondary coil, until the loudest signals are obtained.

Such a system as just described, is capable of eliminating ordinary static or interference, but for severe static or power line disturbances, it is best to adopt a looped aerial in connection with a static coil and variable capacity as depicted at fig. 12.

This diagram also provides an extra wave-length capacity, in the form of a variometer, which is nothing but two coils of wire, one turning about its axis within the other. The static loop of the aerial leads down through the static inductance and condenser.

In tuning this circuit, the variable capacity in the loose-coupler secondary circuit, and the position of the secondary coil may be about half cut in, and then the variometer adjusted until signals are heard loudest, when tuning may be finished by adjusting the loose-coupler and variable condenser.

If now, any static or interference occurs, it can generally be eliminated by the proper regulating of the static coil and the variable condenser connected with it.

For severe and unmanageable cases of static or interference, use should be made of the "Fessenden" or "Marconi" interference preventers, both of which were diagrammed in the section on "Hook-Ups."

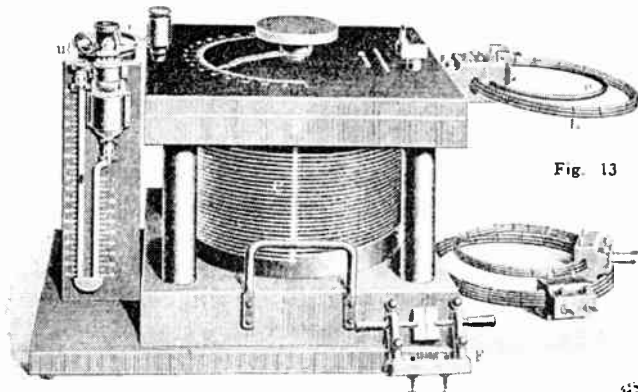

Fig. 13

In general, the operator will find it necessary to learn the best manner in which to tune in a certain set of apparatus by actual experience and trying out.

In cut No. 13, is shown the Doenitz Wave-meter. The condenser is composed of 48 plates, with a radius of 100 millimeters, and a thickness of one millimeter. The plates are semi-circular, and 24 of them are arranged 2 to 3 millimeters apart in a verti-

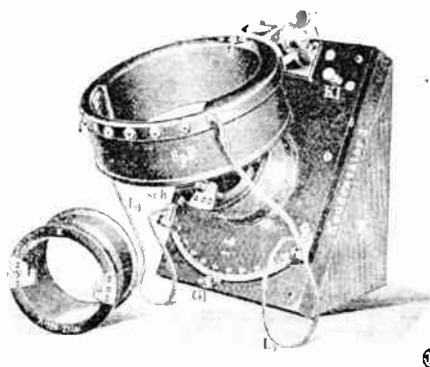

Fig. 14

cal plane; the other 24 plates having the same spacing and attached to a shaft or spindle, provided with an adjusting rotary knob. By turning the knob, the moving plates are interposed between the stationary plates, to increase or decrease the capacity as desired. The whole condenser is placed in a receptacle containing oil.

The apparatus is provided with a self-inductance spiral. In using the wave-meter, it is placed in close proximity to the transmitting set, whose wave-length is to be ascertained, in such a manner that the self-inductance spiral is parallel to the sending helix turns.

In cut No. 14, is depicted a tuner, having a variable condenser in the base K.

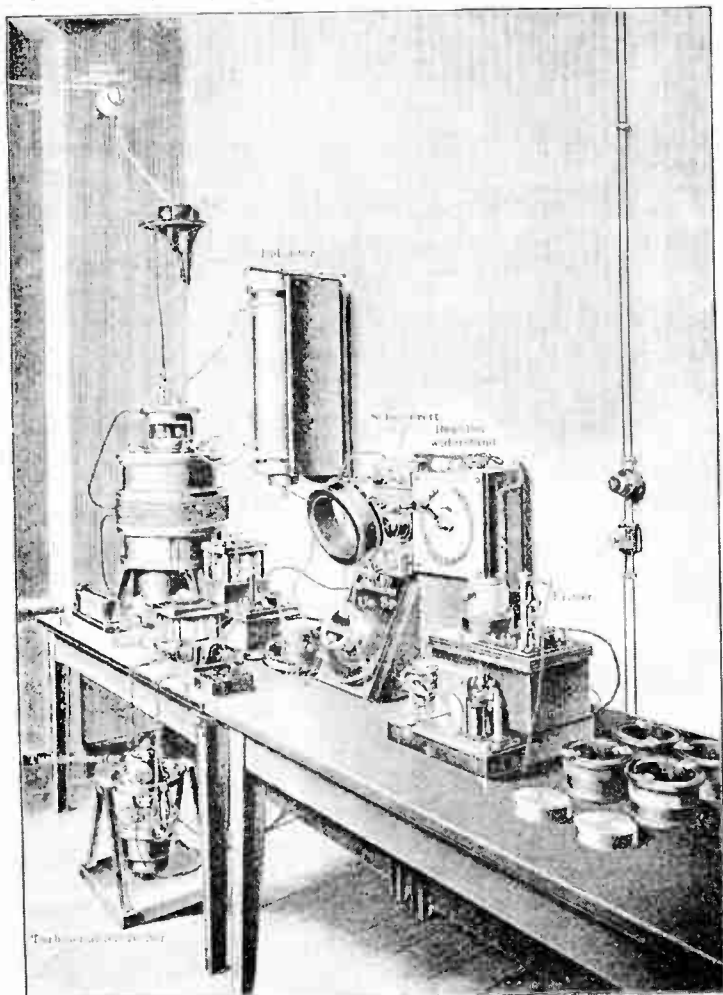

Fig. 15

The coil S P P, is the primary, while coil S P S, is the secondary. Variation of the tuning condenser is effected by moving the arm G L. An auxiliary secondary coil is shown at left of figure.

At fig. 15, is illustrated a complete Telefunken station, with one sending and two receiving sets of instruments. One receiving set is composed of an electrolytic detector and telephone receiver, while the other comprises the coherer and a Morse tape-register. In the sending set, is utilized a mercury interrupter and open core transformer, with tuning inductance.

WIRELESS REGULATIONS.*

NORMAL WAVE LENGTH.

First. Every station shall be required to designate a certain definite wave length as the normal sending and receiving wave length of the station. This wave length shall not exceed six hundred meters or it shall exceed one thousand six hundred meters. Every coastal station open to general public service shall at all times be ready to receive messages of such wave lengths as are required by the Berlin convention. Every ship station, except as hereinafter provided, and every coast station open to general public service shall be prepared to use two sending wave lengths, one of three hundred meters and one of six hundred meters, as required by the international convention in force: Provided, That the Secretary of Commerce and Labor may, in his discretion, change the limit of wave length reservation made by regulations first and second to accord with any international agreement to which the United States is a party.

OTHER WAVE LENGTHS.

Second. In addition to the normal sending wave length all stations, except as provided hereinafter in these regulations, may use other sending wave lengths: Provided, That they do not exceed six hundred meters or that they do exceed one thousand six hundred meters: Provided further, That the character of the waves emitted conforms to the requirements of regulations third and fourth following.

USE OF A "PURE WAVE."

Third. At all stations if the sending apparatus, to be referred to hereinafter as the "transmitter," is of such a character that the energy is radiated in two or more wave lengths, more or less sharply defined, as indicated by a sensitive wave meter, the energy in no one of the lesser waves shall exceed ten per centum of that in the greatest.

USE OF A "SHARP WAVE."

Fourth. At all stations the logarithmic decrement per complete oscillation in the wave trains emitted by the transmitter shall not exceed two-tenths, except when sending distress signals or signals and messages relating thereto.

USE OF "STANDARD DISTRESS WAVE."

Fifth. Every station on shipboard shall be prepared to send distress calls on the normal wave length designated by the international convention in force, except on vessels of small tonnage unable to have plants insuring that wave length.

SIGNAL OF DISTRESS.

Sixth. The distress call used shall be the international signal of distress . . .

USE OF "BROAD INTERFERING WAVE" FOR DISTRESS SIGNALS.

Seventh. When sending distress signals, the transmitter of a station on shipboard may be tuned in such a manner as to create a maximum of interference with a maximum of radiation.

DISTANCE REQUIREMENT FOR DISTRESS SIGNALS.

Eighth. Every station on shipboard, wherever practicable, shall be prepared to send distress signals of the character specified in regulations fifth and sixth with sufficient power to enable them to be received by day over sea a distance of one hundred nautical miles by a shipboard station equipped with apparatus for both sending and receiving equal in all essential particulars to that of the station first mentioned.

"RIGHT OF WAY" FOR DISTRESS SIGNALS.

Ninth. All stations are required to give absolute priority to signals and radiograms relating to ships in distress: to cease all sending on hearing a distress signal, and, except when engaged in answering or aiding the ship in distress, to refrain from sending until all signals and radiograms relating thereto are completed.

REDUCED POWER FOR SHIPS NEAR A GOVERNMENT STATION.

Tenth. No station on shipboard, when within fifteen nautical miles of a naval or military station, shall use a transformer input exceeding one kilowatt, nor, when within five nautical miles of such a station, a transformer not exceeding one-half kilowatt, except for sending signals of distress or signals or radiograms relating thereto.

INTERCOMMUNICATION.

Eleventh. Each shore station open to general public service between the coast and vessels at sea shall be bound to exchange radiograms with any similar shore station and with any ship station without distinction of the radio systems adopted by such stations, respectively, and each station on shipboard shall be bound to exchange radiograms with any other station on shipboard without distinction of the radio systems adopted by each station, respectively.

It shall be the duty of each such shore station, during the hours it is in operation, to listen in at intervals of not less than fifteen minutes and for a period not less than two minutes, with the receiver tuned to receive messages of three hundred meter wave lengths.

See Wireless Law, Lesson No. 15.

*Principal Regulations as given in new Wireless Law, effective since Dec. 13, 1912. 3-6412.

Lesson Number Fifteen.

LEARNING TO OPERATE.—THE CODES.—THE WIRELESS LAW.

IN the wireless telegraph, contrary to the wireless telephone which transmits speech wirelessly, it is necessary to learn the code of signals employed in transmitting and receiving messages.

The code is a series of dots and dashes, as they are called, composed of short and long sparks as liberated at the sending station, a certain combination of short and long sparks forming a code letter or figure. As an example, suppose it is desired to transmit the letter A, in the Morse code of signals. This requires that the sending key be closed or depressed for an instant; released, and again depressed for a period slightly longer, the signals sent thus, being known as, Dot-Space-Dash; or a short spark, no spark, long spark. Electro-magnetic waves corresponding to the short and long sparks set up at the sending station, are propagated through the ether, to the receiving station, where they manifest their presence, by short and long buzzes in the receivers, the various combinations being interpreted by the receiving operator.

There are three codes in general use now, for wireless communication, viz.: the Morse, Continental and Navy codes; the equivalent dots and dashes for letters and figures in each code appearing on next page.

There are several different ways of learning the codes so as to operate properly by them, and in general, two classes of beginners in wireless undertake the work, namely, former wire operators, whom are used to sounder Morse, with its back-kick; and the novice who cannot send a dot.

It seems to be the common experience, that a wire operator taking up wireless, has but little difficulty in grasping the rudiments of the newer art and quickly becoming an expert at the wireless key; on the other hand, many otherwise well grounded students of wireless, who think they can operate, succeed in charging the ether with a nondescript series of spasmodic signals intended for the code, which are enough to make good old S. F. B. Morse himself turn over in anguish.

The first thing an operator must or should learn, is the correct manner of holding the key in transmitting, this being very important, when any long messages or a batch of them are to be sent in succession.

A form of grasping the key adopted by the majority of fast commercial operators, is to rest the first and second fingers on the top of the key button and close to the edge of it, with the thumb placed against the edge of the button, see fig. 1. Then the first and second fingers are curved to form a quadrant of a circle, avoiding any undue straightness or rigidity of these fingers and the thumb. The third and fourth fingers are partly closed, and the elbow allowed to rest easily upon the table, permitting the wrist to be perfectly limber. A moderately firm grasp should be taken on the key, but not a rigid one. If the key button is grasped too tightly, the hand will soon become tired or fatigued, resulting in what is known as "telegrapher's cramp." A little practice, on the key, with careful attention to the codes, will soon break in the amateur operator, and do more for him than a dozen pages of reading on the subject.

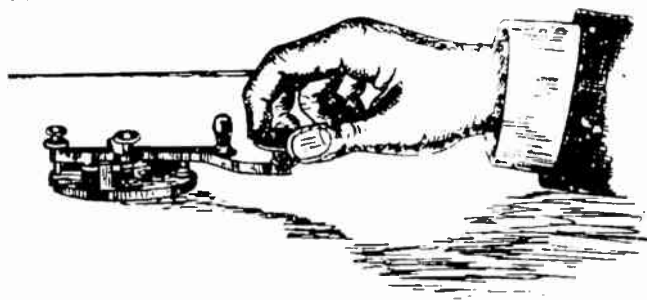

Fig. 1

In this connection it might be mentioned that there are on the market, several automatic instruments which send dots and dashes of regular length, irrespective of the operator's characteristics, two of them being the "Mecograph" and the "Vihroplex." These instruments are satisfactory for wireless work, but generally have to be utilized in connection with a relay, as they are not capable of handling heavy currents, such as occur in a wireless station of any size. These patent keys are operated by a sidewise motion, and are claimed to prevent "telegrapher's cramp," but they

WIRELESS CODES

LETTERS	MORSE	CONTINENTAL	NAVY
A	• —	• —	— — —
B	— • • •	— — • •	— — • • —
C	— • — •	— — — •	• — — •
D	— • — •	— • — •	— — — •
E	•	•	• —
F	• — • •	• — — •	— — — • •
G	— • — •	— — — •	— — — • •
H	• — • •	• — • •	• — — • •
I	• •	• •	• — —
J	• — • — •	• — — — •	• — — — •
K	— • — •	— • — •	• — — •
L	— • — •	— • — •	— — — •
M	— —	— —	• — — •
N	• — •	• — •	• — —
O	• • — •	• — — •	• — —
P	• — • • •	• — — • •	• — — — •
Q	• — • — •	• — — • —	• — — • •
R	• — • • •	• — — • •	• — — • •
S	• — •	• — •	— — — •
T	— • —	— • —	— — —
U	• • —	• • —	• — —
V	• • — •	• • — •	• — — •
W	• — • —	• — • —	• — — •
X	• — • — •	• — — — •	• — — • •
Y	• — • — •	• — — — •	• — — • •
Z	• — • — •	• — — — •	• — — • •
1	• — — •	• — — — •	• • • •
2	• • — • •	• • — — •	• • — —
3	• • — • —	• • — — •	• • — —
4	• • — • —	• • — — •	• • — —
5	• • — • —	• • — — •	• • — —
6	• • — • —	• • — — •	• • — —
7	• • — • —	• • — — •	• • — —
8	• • — • —	• • — — •	• • — —
9	• • — • —	• • — — •	• • — —
0	• • — • —	• • — — •	• • — —
.	• • — — • •	• • • • •	
:	• • — — • •	• • • • •	
;	• • — — • •	• • • • •	
?	• • — — • •	• • • • •	

ABBREVIATED NUMERALS USED BY CONTINENTAL OPERATORS.

1 • — 2 • • — 3 • • • — 4 • • • • — 5 — —
 6 — • • • • 7 — • • • • 8 — • • • • 9 — • • • • 10 — — — —

WIRELESS ABBREVIATIONS.

G. E. - GOOD EVENING
 G. N. - " NIGHT
 G. M. - " MORNING
 G. A. - GO AHEAD
 O. S. - SHIP REPORT
 D. H. - FREE MESSAGE
 M. S. C. - MESSAGE
 O. P. R. - OPERATOR

4 - PLEASE START ME, WHEN
 13 - UNDERSTAND
 25 - AM BUSY NOW
 30 - NO MORE
 73 - BEST REGARDS
 77 - MESSAGE FOR YOU
 92 - DELIVERED
 99 - KEEP OUT

-DISTRESS SIGNALS-

S. O. S. MORSE

C. Q. D. CONTINENTAL

nevertheless require as many movements of the hand as a common Morse key, in sending, excepting dot letters. Sending machines or keys must also be kept in the very best condition, and carefully watched, or they become irregular in the closing of the contacting parts, owing to collections of oil and dirt or burnt surfaces.

The Morse code in its present form was arranged by Mr. Alfred Vail, of Morristown, N. J., and due respect has been given to the most frequently occurring letters, so that they may be the shortest:

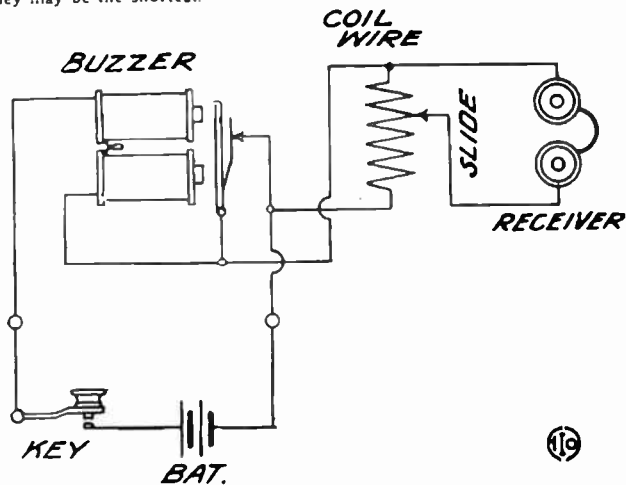
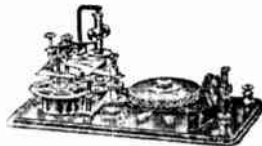
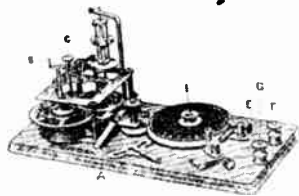

Fig. 2

The great fundamental building block of a good code sender, is the correct time spacing of the various signals employed, and composing the alphabet. To begin with, the time unit upon which the code is built, is the dot, the shortest signal used, and whatever its time duration, the spaces and dashes must be made of proportionate length. This is quite clearly remembered, if it is known that the ordinary space is of the same time duration as a dot, and the ordinary dash twice the length of a dot. In the Morse code, the letter L, is a dash of four times the duration of a dot, while for the figure 0, the signal is an extra long dash, equivalent to the duration of five dots. Between words, the space interval should be two ordinary spaces, and between sentences, the equivalent of three spaces.

If the operator aspirant desires to be thoroughly proficient in his chosen profession, he must pay the strictest attention to the proper time spacing of the various letters and figures of the code. A good plan for the beginner, is to have a friend a short distance from his place, who will send arbitrary signals to him, and he will undoubtedly learn to receive quicker in this manner than in any other, unless he can attend a school for the purpose.

Failing these facilities, for mastering the code, a very good scheme for isolated students is to employ a buzzer set, which includes a key and battery as shown in fig. 2, placing the buzzer quite a distance from the receivers, so that its armature noise



OMNIGRAPHS.

cannot be heard. From across the armature and contact screw as illustrated, two leads are taken to a coil of wire (6 turns are sufficient), and the shunting of different lengths of this coil will faithfully imitate nearby and distant wireless signals, the tone of the buzz heard in the receivers depending upon the thinness of the buzzer armature and also upon its speed of vibration. A "skeeter" spark, as it is often termed

in the profession, meaning a "singing" or high pitched spark note, may be closely imitated by altering the buzzer construction somewhat, as shown at fig. 3, and placing a thin iron strip across the magnet poles, slightly above them, varying its tension by a thumb nut attached to one end of it. This arrangement gives an exceedingly high note in the receivers.

The buzzer set described above can be operated manually by hand, but for beginners who find it hard to properly space the signals, it is better to control it from some sort of automatic sending device, such as the "Omnigraph," which costs from \$2.00 up, according to how elaborate an instrument is desired. It works on the principle, that a circular metal disc with projecting teeth around its periphery, and rotating by means of a spring mechanism, opens and closes an electrical circuit, at definite intervals, by means of a spring contact pressing against certain teeth while rotating. Different discs, for various combinations of words and phrases can be obtained for it, and where the learner has access to no other teacher, this automatic sender, capable of transmitting at any speed, should be a boon.

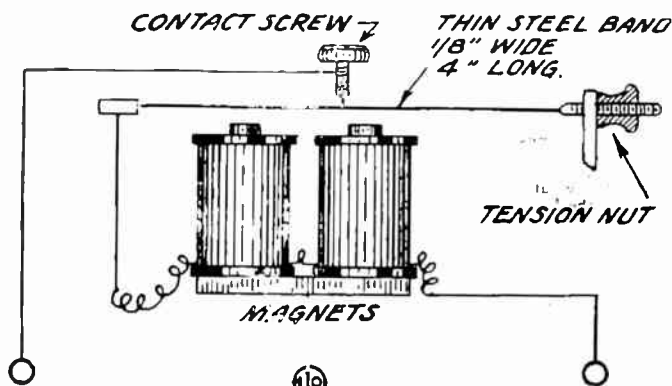

Fig. 3

On regular wire telegraph land systems, a speed of 40 to 50 words per minute is usual in sending, except in bad weather it may be reduced to 25 or 30 or less. The speed of transmission for wireless work, is often as high as 40 or more words per minute under good conditions, but the United States Examiners, before whom all commercial ship operators must appear, require a sending and receiving speed of not less than 15 words a minute, American Morse, or twelve words in the Continental code, as the operator may elect.

The Continental code, although recognized at the Berlin convention for International wireless arrangements, has not been used to any great extent commercially, although the United States Navy employs it. The advantage of the Continental code over the regular Morse code, is that there are no spaced letters, as the letters O and R, in Morse; the Continental signals being composed of straight combinations of dots and dashes.

The disadvantage of the Continental code, when compared to the Morse, is that the figure symbols in the former, are unduly long and require too much time to send. In the letter section of the codes, there are but few differences.

It is advisable for the beginner to practice certain exercises involving the repetition of letters of the same make-up, as dot letters and dash letters, etc.

An exercise in dot letters for the Morse code is:—Ship, she, his, hips, sips, pies, sheep, pipe.

Some practice words, containing dot and dash letters are:—Spanish, spite, shipshape, dishevel, dapple, hissing.

Some dash letters for practice are —Met, till, time, metal, pellmell, mammal, tittle, timid, skilled, multiple, multitude, mallet, emit.

Dot before dash letters:—Awe, awful, law, valve, Eva, vault, lava, pawl, squaw.

Dash before dot letters:—Bend, bidden, ban, dunned, dabble, nab, dined.

Combination of the last two:—Julep, jungle, quaff, quake, exit, exquisite, exhaust.

An exercise in spaced letters is:—Err, errant, corner, ecceitad, corollary, co-operate, coon, circus, buzzard, correlate, corrupt, cohesion, road, dory, there is no royal road to learning.

In learning the beginner should try to send at an even regular speed, going slow at first and gradually increasing the speed to the necessary degree. One of the most common defects in a beginner is his choppy or irregular speed in transmitting, which makes it very difficult for even a good operator to receive.

A large amount of sending is easily and readily taken care of by the steady sender, who makes few mistakes, with consequent few repeats, although in long dispatches the question sign should be given after every 20 words, which will save repeating a whole message. A steady, well trained sender, can operate for 10 hours at a stretch, if need be, but a poor sender, who has not learned to handle the key properly, would succumb to a cramp in a few hours.

A beginner, or "ham" operator as they are termed in popular parlance, is generally known by his style of sending, a very frequent fault of his being, the string of 8 or 10 dots he sends out like so many shots from a gatling gun, and intended for the poor little letter P. It is interesting to note in this connection, that there are professional operators, who cannot for the life of them, send those five dots representing the letter P, correctly at high speed. It seems to be a freak of human nature. Another string of rapid-fire dots often come hurtling through space intended for the six dots, representing the figure 6. The only remedy for these freaks, is to thoroughly practice over and over again, those particular balky symbols, slowly at first, then faster until normal speed is attained.

In the Morse code, a common mistake is that of prolonging the T dash, and shortening the L dash. Another tendency is to lengthen the first and last dots of a letter; running the spaced dots together; dropping dots out of some letters; running letters of different words together; making unintelligible combinations of different half-words and a multitude of others.

When the student has learned how to handle the key properly, so that dots and dashes of the proper length are sent out, his duties will concern the proper handling of dispatches and messages as sent in regular commercial work.

Before a message can be sent, it is necessary to send out the call of the station desired to communicate with, and at the proper wave-length, as the call might be sent out at the wrong wave-length, and never be acknowledged. A book published by the U. S. Government Printing office, at Washington, D. C., gives all the calls for registered ships and shore stations, exclusive of private stations, which are listed in a special blue book published each year by the Modern Publishing Co., N. Y. City, including registry of station, at 25 cents.

For instance, suppose the station wanted is rated in the blue book as, call B N G, wave-length 428 meters. In this case, the call should be repeated at intervals of about fifteen seconds, followed by the call letters of the station calling, allowing time for acknowledgment of call. It is not always possible to send out the call at the wave-length of the called station, in which event it is necessary to send it out at the regular transmitting wave-length and take a chance on the operator of the desired station stumbling over it, while "listening in," at various wave-lengths or tunes.

After the called station acknowledges the call, and gives the "go ahead sign," abbreviated to G A, the following arrangement is a standard one for sending the message: Send the sign "H R" or "M S G," meaning message; then give the number of message; the station's call; operator's sign; number of words, excluding address and signature; date; route of message; address; body of message; and signature.

Regarding the charges on board ship, land wire charges, or both, they can be given after the "number of words." For messages to be forwarded by a certain land line, the directions can be indicated after "Route of message," by the letter "W. U." for Western Union, "P. T." for Postal Telegraph, etc.

All messages are not transmitted in regular form or as they are written, the services of a cipher code, special codes, and various abbreviations being widely used to increase the speed of transmission, decrease the cost of transmitting, and thirdly, to preserve secrecy in some cases.

In wireless work at present a fair list of standard abbreviations have been generally adapted, some of them being given below.

ABBREVIATIONS.

G. A.:	Go ahead.	Min:	Minute.
M. S. G.:	or H. R.; Message for you; or message.	Msgr:	Messenger.
D. H.:	Dead head or free message.	Msk:	Mistake.
O. S.:	Ship Report.	No:	Number.
O. P. R.:	Operator.	Ntg:	Nothing.
G. M.:	Good morning.	N. M.:	No more.
G. E.:	Good evening.	O. K.:	All right.
G. N.:	Good night.	Of's:	Office.
M. D.:	Midday.	Sig:	Signature.
M. N.:	Midnight.	Pd:	Paid.
S. O. S.:	Distress signal (International).	Q. K.:	Quick.
99:	XXXX; or B. K.; Interference; break; Get out.	G. B. A.:	Get better address
W. U.:	Western Union.	Bn:	Been.
P. T.:	Postal Telegraph.	Bat:	Battery.
B. T.:	Bell Telephone.	Bbl:	Barrel.
P. R. B.:	(International). Express the desire to communicate by means of the international signal code by wireless. (Continental Code.)	Col:	Collect.
		Ck:	Check.
		R. R.:	Repeat.

In times of accident at sea, the wireless man is the most important, except the captain possibly, and on his cool head and resourcefulness depends the saving of the ship and its people, in a great measure.

In many cases of distress at sea there may be only a minor accident with no immediate danger, such as a broken down engine, or propeller, in which case the operator is usually told to signal aid, as soon as possible. When a collision or smash-up has occurred, and the engine and dynamo room is flooded, the operator must resort to his storage batteries, which are generally installed on all large ships, and should be in every ship wireless station, for emergency uses.

In event of immediate danger of sinking, the operator should send out the International distress signal, "S. O. S." at 15 second intervals, allowing a little time to elapse between signals, for acknowledgment, by those who may happen to catch the signal; upon receipt of acknowledgment, the location of the ship, trouble, her name, captain's name, number of people on board, and any further particulars necessary, should be sent. This form is adaptable only for large size stations, with suitable reserve power in their batteries. For small equipments not capable of sending over 100 miles, it is the best plan when starting to send the distress signal, to intersperse the location of the ship, and possibly her name call, as it has occurred where a small wireless set on a ship calling for help, got gradually weaker and weaker, and by the time an acknowledgment came in answer to the "S O S" signal, the ship in trouble could not give her location or anything else, reserve power failing, at the critical moment. In such event, the vessels which might have helped are powerless to do anything, but generally in these cases the seas are scoured pretty well, after knowing that a ship somewhere out of sight is in distress.

The ideal wireless ship station as regards life-saving efficiency, would be one having an oil engine driving a dynamo, in a watertight room, on the upper deck, with a good supply of engine fuel in the operating room, or alongside of it. Any wireless set, especially those without a reserve storage battery, are as good as none, in event of the engine and boiler room becoming flooded or damaged. Some important rules formulated by the U. S. Navy Dept., regarding the handling of commercial wireless messages by naval stations ashore and afloat, are given here, as they contain some valuable information as to the proper procedure in such business.

All naval wireless telegraph stations, with the following exceptions, viz.: those at the navy yards at Boston, New York, Philadelphia, Norfolk, Puget Sound and Mare Island, and the naval stations at New Orleans and Yerba Buena, San Francisco, will handle commercial messages under the following conditions:

- (1) That no commercial station is able to do the work.
- (2) That no expense is incurred by the Government thereby.
- (3) That no money or account, in connection with this business is handled by any person in the employ of the Navy Department.
- (4) That the handling of the commercial messages, shall not interfere with Government business.

The Government handles all commercial wireless messages without charge, but assumes no financial responsibility whatever for errors, delays, or non-delivery. Every effort will be made, however, to forward all messages accepted accurately and expeditiously by the best means available. Confirmation copies of commercial messages sent through naval wireless stations will be sent only when request is made in advance, or within thirty days after messages are forwarded.

Messages of all kinds received from ships at sea will ordinarily be forwarded by a land wire, the land wire charges to be collected at destination.

In case of isolated stations, such as stations on Alaskan Islands and in emergencies these messages will be relayed to other wireless stations for further transmission if necessary.

Position reports will be forwarded to owners or agents by a land wire when request is made.

Messages received by land wire at a naval wireless station for a ship at sea will be forwarded by wireless, when the ship comes within range. For this reason ships should ordinarily communicate with wireless stations while passing along the coast, giving their positions.

Messages received by a wireless station for a ship which cannot be delivered for any reasons will be returned to the land wire company from which it was received.

The personnel of naval wireless stations are required to keep the strictest secrecy in regard to the contents of messages passing through their stations, and they are not permitted to communicate the fact that a message on any particular subject has been received.

All messages are kept on file, and senders and addressees may obtain copies of all messages as sent upon request.

A vessel wishing to communicate with a naval coast station should commence calling when about 100 miles from the station, having first "listened in," to ascertain that she is not interfering with messages being exchanged within her range. The power and range of many stations, however, are being rapidly increased, and vessels should note at what distances they hear certain stations working with merchant ships in order that communication may be held over the maximum distance if necessary.

Calls should not be prolonged beyond fifteen seconds, and should be followed by

the letters of the station calling. If, after making the call, a ship hears the signal "B K" or "XXXX" made, she should take it to mean that one station communicating with another is being interfered with by her calls, and that she should wait.

After the station called acknowledges the call, the vessel should report her position. The following manner of reporting position, etc., is preferred:

- a. Distance of the vessel from the coast station in nautical miles.
- b. Her true bearing from coast station in degrees, counted from 0 to 360.
- c. Her true course in degrees, counted from 0 to 360.
- d. Her speed in nautical miles per hour.
- e. The number of messages she desires to transmit.

This will enable the coast station receiving a number of calls from various vessels, to determine which one will pass out of range first, in order that that vessel may be permitted to finish her business. When a coast station acknowledges, she may state whether or not she has messages for the ship, and if she cannot communicate further with the ship at that time, the ship will be informed of the length of the time it will be necessary to wait.

On receiving word to "go ahead" the vessel should send a message as follows:

- a. "H R" or "M S G."
- b. Number of message.
- c. Ship's call letters.
- d. Operator's sign.
- e. Number of words, excluding address and signature.
- f. Original station and number, for relayed messages only.
- g. Original date, for relayed messages only.
- h. Route of message.
- i. Address.
- j. Message (body).
- k. Signature.

In case of long messages, the sending ship should get acknowledgment after every twenty words or thereabouts, before proceeding.

Communication may be interrupted at any time, and the right of way given to a Government station or vessel, if necessary, or to any vessel in distress, or to send broadcast any important information.

All stations may be expected to be familiar with the methods of communication adopted by the International Wireless Conference of Berlin, of 1906, with special regard to the international signal of distress, "S O S," and the signal "P R B," expressing the desire to communicate by means of the international signal code by wireless. Ships are requested not to use the letters "O S" preceding a position report, as the letters "O S" made rapidly and continuously might be mistaken for the signal of distress, "S O S."

Shore stations in designating the order in which messages will be received from the vessels within range, will be guided exclusively by the necessity of permitting each station concerned to exchange the greatest possible number of wireless telegrams. At all times business may be expected to be handled in the following order:

- a. Government business, viz., telegrams from any Government Department to its agent aboard ship.
- b. Business concerning the vessel with which communication has been established, viz., telegrams from owner to master.
- c. Urgent private dispatches, limited.
- d. Press dispatches.
- e. Other dispatches.

—APPENDIX—

NAVIGATION SERVICE FORM 751.

Operator's Certificate of Skill in Radio-Communication.

This is to certify that, under the provisions of the Act of June 24, 1910,.....
..... has been examined in radio-communication and has passed in:

a. The adjustment of apparatus, correction of faults, and change from one wave-length to another;

b. Transmission and sound reading at a speed of not less than fifteen words a minute, American Morse, twelve words Continental, five letters counting as one word.

The candidate's practical knowledge of adjustment was tested on a
set of apparatus. His knowledge of other systems and of international radio-telegraphic regulations and American naval wireless regulations is shown below:

(Signature of examining officer)

Place Date 191.....

By direction of the Secretary of Commerce and Labor.

Commissioner of Navigation, Washington, D. C.

I,, do solemnly swear that I will faithfully preserve the secrecy of all messages coming to my knowledge through my employment under this certificate; that this obligation is taken freely, without mental reservation or purpose

of evasion; and that I will well and faithfully discharge the duties of the office: So help me God.

(Signature of holder).....
 Date of birth,
 Place of birth,
 Sworn to and subscribed before me this day of, A. D., 191....
 (Seal).....
 Notary Public.

The certificate as issued is valid for a period of two years.

The following is an excerpt from a "Treatise on Wireless Telegraphy," by H. Gernsback, regarding the New Wireless law effective since Dec. 13, 1912, affecting private Radio stations.

THE WIRELESS ACT.

"Be it enacted by the Senate and House of Representatives of the United States of America, in Congress assembled; That a person, company, or corporation within the jurisdiction of the United States shall not use or operate any apparatus for radio communication* as a means of commercial intercourse among the several States, or with foreign nations, or upon any vessel of the United States engaged in Interstate or foreign commerce, or for the transmission of radiograms or signals the effect of which extends beyond the jurisdiction of the State or Territory in which the same are made, or where interference would be caused thereby, with the receipt of messages or signals from beyond the jurisdiction of the said State or Territory, except under and in accordance with a license, revocable for cause, in that behalf granted by the Secretary of Commerce and Labor upon application therefor; but nothing in this Act shall be construed to apply to the transmission and exchange of radiograms or signals between points situated in the same State; Provided, That the effect thereof shall not extend beyond the jurisdiction of the said State or interfere with the reception of radiograms or signals from beyond said jurisdiction."

*Wireless Telegraph or Telephone sending stations included.

GENERAL RESTRICTIONS ON PRIVATE STATIONS.

"Fifteenth. No private or commercial station not engaged in the transaction of bona fide commercial business by radio communication or in experimentation in connection with the development and manufacture of radio apparatus for commercial purposes shall use a transmitting wave length exceeding two hundred meters or a transformer input exceeding one kilowatt except by special authority of the Secretary of Commerce and Labor contained in the license of the station; Provided, That the owner or operator of a station of the character mentioned in this regulation shall not be liable for a violation of the requirements of the third or fourth regulations to the penalties of one hundred dollars or twenty-five dollars, respectively, provided in this section unless the person maintaining or operating such station shall have been notified in writing that the said transmitter has been found upon tests conducted by the Government, to be so adjusted as to violate the said third and fourth regulations, and opportunity has been given to said owner or operator to adjust said transmitter in conformity with said regulations.

SPECIAL RESTRICTIONS IN THE VICINITIES OF GOVERNMENT STATIONS.

"Sixteenth. No station of the character mentioned in regulation fifteenth situated within five nautical miles of a naval or military station shall use a transmitting wave length exceeding two hundred meters or a transformer input exceeding one-half kilowatt."

The license is free, it costs not a penny. All that is required of you is that you are familiar with the law and that you can transmit messages at a fair degree of speed.

The law does not require that you take an examination in person if you are located too far from the nearest radio inspector. All you have to do is to take an oath before a notary public that you are conversant with the law and that you can transmit a wireless message. If you wish to be licensed—and we urge all amateurs to do so, as it is a great honor to own a license—write your nearest Radio Inspector (see below), and he will forward the necessary papers to you to be signed.

Radio inspectors are located at the following points: (Address him at the Customs House):

Boston, Mass., New York, N. Y., Baltimore, Md., Savannah, Ga., New Orleans, La.; San Francisco, Cal., Seattle, Wash., Cleveland, Ohio, and Chicago, Ill. Also the Commissioner of Navigation, Department of Commerce and Labor, Washington, D. C.

SECRECY OF MESSAGES.

"Nineteenth. No person or persons engaged in or having knowledge of the operation of any station or stations, shall divulge or publish the contents of any messages transmitted or received by such station, except to the person or persons to whom the same may be directed, or their authorized agent, or to another station employed to forward such message to its destination, unless legally required to do so by the court of competent jurisdiction or other competent authority. Any person guilty of divulging or publishing any message, except as herein provided, shall, on conviction thereof, be punishable by a fine of not more than two hundred and fifty dollars or imprisonment for a period of not exceeding three months, or both fine and imprisonment in the discretion of the court."

Lesson Number Sixteen.

COMMERCIAL SHIP AND LAND WIRELESS STATIONS.

WHEN wireless telegraphy was first developed into a commercial possibility, by Marconi, a few years ago, the principal long distance tests were carried on from land stations, and so it is logical to open this paper with a description of the various characteristics connected with them, in contradistinction to the floating stations on board ship.

To begin with, radio-telegraphic stations on land always have the decided advantage over ship stations, in that they have unlimited space over which to spread their aerial wire systems, which are quite frequently of massive proportions, as for instance the one erected at the Marconi Trans-Atlantic station, located at Glace Bay, Nova Scotia.

This aerial is built in the form of a huge inverted pyramid, about 400 feet in height, and 250 feet long on each of its four sides.

The transmitting apparatus consists of suitable step-up high voltage transformers and an alternating current generator of 150 kilowatts capacity. The sending apparatus includes all the necessary condensers, oscillation transformers, etc. The discharging apparatus is mounted in a special and separate room. The operators have to use cotton in their ears while sending, owing to the terrible crash of the spark, which is audible for several miles. The sending operator sits in a chair mounted upon a glass platform, to prevent getting severely shocked, while he handles the key which puts the "thunder factory" into life, this being the term once conferred upon it, owing to the enormous noise and pyrotechnical display occurring when this nastodon of wireless plants gets into operation.

A lofty wire fence surrounds the entire plant and aerial, so that no one can accidentally get near enough to the highly charged portions to get shocked, and probably killed. The aerial emits a large brush discharge, which is very pretty to watch at night, and resembles a million golden threads reaching out into the darkness.

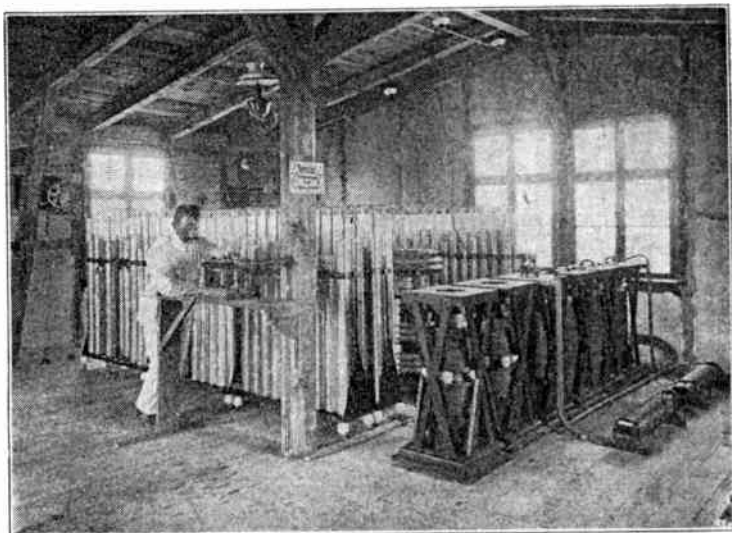

(Courtesy "Modern Electrics")

Fig. 1

A view of the condenser room of one of the highest powered wireless stations in Europe, that situated at Nauen, Germany, is illustrated by fig. 1. The capacity of the transmitting plant is 25 kilowatts, with 50,000 volt alternating current, used to supply the large step-up transformers.

A special transmitting relay for controlling the extremely heavy primary current is always used in these large stations. Instead of opening the primary circuit of the transformers at the Nauen station, the transformer primary coils are short-circuited to discharge the condenser jars, of which there are 360. To again charge the jars, the "short" across the primary winding of the transformer is opened by means of the relay. This scheme was found expeditious to the best handling of the extra heavy currents involved.

The lofty aerial structure, of steel lattice-work and resting on a base pillar of glass, is arranged so that the insulated metal tower can be employed as a part of the aerial system, the aerial wires being spread out to form a large umbrella, with a total spread of about 70,000 square yards. The height of the aerial mast or tower is 330 feet. The steel guys, steadying the tower, are well insulated at frequent intervals.

The aerial and its tower are depicted in fig. 2. The charging current applied to the aerial and ground represents a spark over 3 feet in length and very fat.

It is interesting to note the way in which the ground for such a large station as this is made. Water was found but six feet below the surface of the earth, which assured a damp earth connection. The ground was composed of a set of spreading iron wires, to the number of 108, radiating under ground in all directions, and these were further augmented by branching off at certain distances, so as to make a grand total of 324 wires for the earth. The total area covered by the ground wires amounted to approximately 150,000 square yards, or considerably more than that covered by the aerial. From the centre of the radiating ground wires, one heavy main cable leads into the station.



Fig. 2 (Courtesy "Modern Electrics.")

A view of the aerial and also the operating room of the United Wireless Company's station at No. 42 Broadway, New York City,* is illustrated by the cuts figs. 3 and 4. The transmitting set shown here is of 2 kilowatts capacity, but has been increased to 5 K. W. at the present time. A loose-coupled oscillation transformer is also used now, instead of a helix. The spark gap is a special one, of the ventilated muffed type.

In small size land stations, the ground connection where convenient and permissible is made to the water pipe, or main. Where this is impracticable, the ground must be made separately, either by sinking a standard type of ground plate, such as the Lord Electric Company's design, in moist earth, or a net-work of radiating wires may be buried in damp earth, or placed just above it, this acting as a counterpoise, and is much employed in military portable sets used by the U. S. Signal Corps.

The main ground lead must not be smaller than No. 4 B. & S. gauge copper wire, or the equivalent in conductivity, and preferably of stranded form, this size of conductor being required by the Fire Underwriters Rules. The branch wires, where a counterpoise ground net is used, can be of a smaller size than the main ground wire, as these will be called upon to carry only a part of the total radiation current.

In all stations, the wiring of the primary circuits must conform to the Under-

*Now owned by The Marconi Wireless Telegraph Co.

writers Rules, and the aerial system is required to be provided with satisfactory grounding switches to serve in case of storms of the electrical variety.

Land wireless stations, i. e., stationary ones, usually derive their transformer current from a motor-generator set, the motor taking its quota of current from

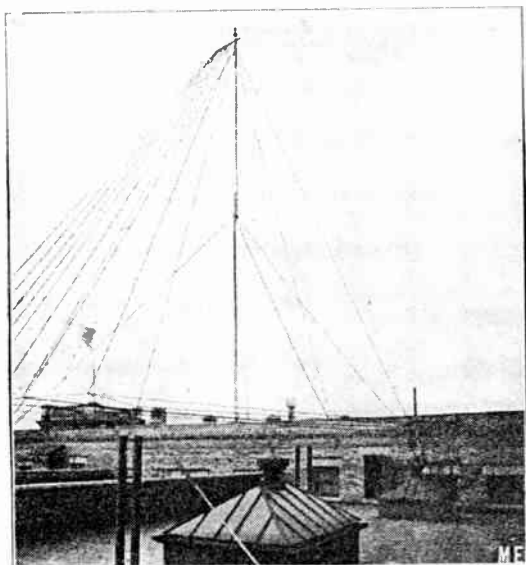

(Courtesy "Modern Electrics.")

Fig. 3

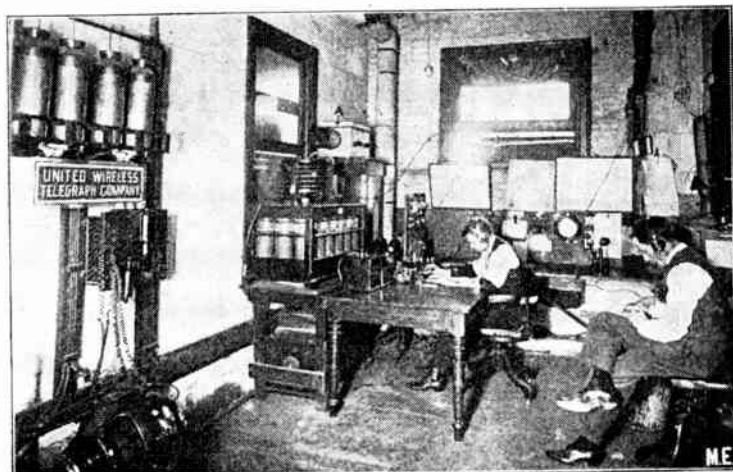

(Courtesy "Modern Electrics.")

Fig. 4

the building mains, or wires, and the generator it drives, supplying an alternating current with a frequency of from 60 to 500 cycles per second. The higher frequency is being extensively adopted all over now, as it makes possible a very high spark

frequency, which carries a great deal further than the ordinary low frequency spark, which is particularly good for penetrating through bad static or interference.

Where stations are isolated, or do not have available the necessary current to drive a motor, a gasoline or kerosene oil engine is pressed into service, and made to drive an alternating current dynamo, steam engines also being used.

In the important land stations, operators are on duty all the time, each operator doing a turn of from 8 to 10 hours generally.

The shore and inland stations maintained by the Marconi Wireless Telegraph Company, which is the principal commercial company operating at this time, vary in size from 2 to 10 kilowatts, sending capacity, although there are a few installations at certain important points, with a sending power of 25 kilowatts.

The sending speed in most of these stations often reaches forty or more words per minute, under good conditions.

In changing from transmitting to receiving instruments, a number of the stations have abolished the aerial switch, which is usually large and clumsy to manipulate, especially when a large number of messages are to be sent and received. The system known as the "break-key" change over, is much in use for this purpose, being very quick and efficient if properly applied to the particular apparatus of which it is made a part of.

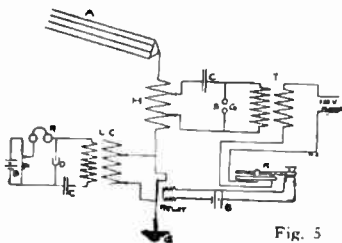

Fig. 5

In diagram fig. 5, is illustrated the connections of a simple break-key circuit. As can be readily seen, the key, when closed to excite the transmitting apparatus, also closes an auxiliary contact through a relay and battery shown. The relay operates to cut-out the receiving instruments by short-circuiting them, and it has been necessary in most cases to also arrange the relay to short-circuit the detector, or it becomes disturbed in its adjustment, whenever the sending instruments are excited.

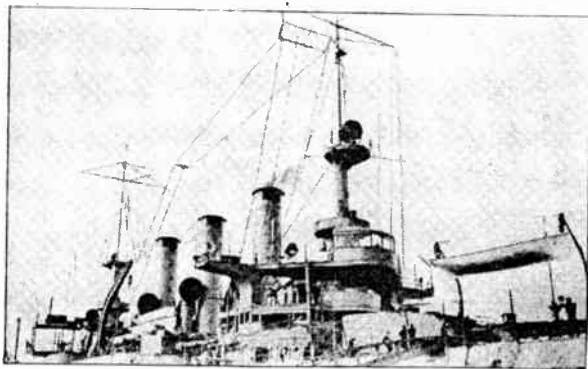

Fig. 6

(Courtesy "Modern Electrics.")

In the break-key system here described, the operator listens-in and receives through the transmitting helix, but this makes practically no difference, as it has a low inductance value.

Having reviewed the salient features of the land wireless stations, attention can now be turned to those aboard a ship, and here things are a little different in some ways, due to natural conditions obtaining in consequence of limited space, and other peculiarities.

Probably the most noticeable difference between land and ship stations, is in the layout of the aerial. Only a limited space is allowable for this part of the wireless

equipment, and the best possible design of aerial for a certain height and length must be put up.

Ship aeriels are generally of the inverted L, or T type either straight-away or looped, according to the instruments employed. Stranded phosphor bronze cable is most always utilized, the number of spans varying from two to six or more; depending upon the size of the ship and the wireless set.

The aerial is stretched between the mast-heads, on the majority of vessels, somewhat after the fashion depicted at fig. 6, the lead-in wires from it, coming down to the wireless cabin in as straight a line as possible.



Fig. 7
(Courtesy "Modern Electrics.")

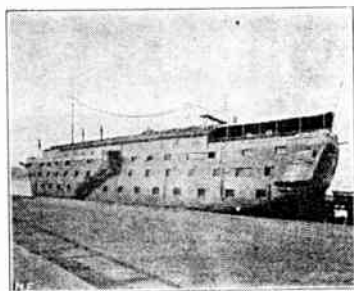

Fig. 7a

The ground for the wireless set on ship board is of course ready at hand in the steel hull of most vessels, and the ground wire is soldered or otherwise secured to a brass plug, threaded into a hole in the steel framework, as near the water plates as possible. This must be done for the reason that sometimes, a very good electrical connection is not present between the joints in the steel work, owing to the red lead upon and between the surface.

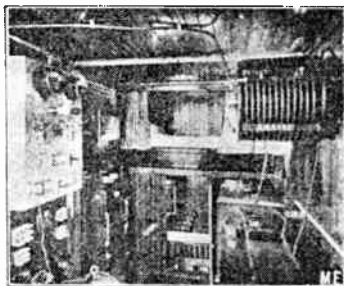

Fig 8

(Courtesy "Modern Electrics.")

On wooden vessels, the ground connection has to be taken care of in another way, but may in some cases be secured to the copper bottom, which covers most wooden hulls. The ground lead wire is run up the side of the ship in this case, in as short a line as possible to the instruments.

Failing this facility for establishing a ground, it becomes necessary to improvise one, by securing a metal plate, preferably of copper, to the outside of the hull, and below the water line. From this a wire is run over the side of the vessel on insulators, to the instruments. A plate of 1-16 inch thick copper, about 3 by 10 feet, forms a very good ground for stations up to 1½ kilowatts capacity.

A glimpse of the operating room on a ship, is given by the cuts, figs. 7 and 7a, which

depicts an equipment supplied for special service during the Hudson-Fulton Celebration, at New York City, by the Electro Importing Company, also of New York. The aerial leads can be seen entering the wireless room, through the side of the cabin. This set was rated at $\frac{1}{2}$ K. W. and the transformer coil, operated from 110 volts D. C. through the medium of a Gernsback electrolytic interrupter.

In fig. 8, is shown the arrangement of the apparatus in a 5 K. W. set on the Steamship "Korea," which broke a world's record for its size, by transmitting 4,700 miles at night and 675 miles in broad daylight, with sun shining.

On board ship, the operator usually has his bunk in the wireless room, excepting on large vessels and men-o-war, where more than one operator is on the staff, in which event separate sleeping and living quarters are provided. An operator on a commercial ship is obliged to sign the ship's articles or papers and is qualified as a non-commissioned officer, being under the direct supervision of the captain in command.



Fig. 9

(Courtesy "Modern Electrics.")

The salary of ship operators varies from 50 to 75 dollars per month, with meals and berth free, also medical attendance when required. The life of a wireless operator at sea is an interesting, congenial and broadening one, serving to educate a man as no other one thing, for there is no better educator than travel.

Returning to the ship's wireless apparatus again, it may be said that, at present the usual equipment comprises a 2 to 5 kilowatt set, made up of a motor-generator, for the transmitting current source, the motor deriving its current from the ship's electric plant in the main engine room. The motor drives an alternating current generator, which supplies A. C. at 110 volts or more pressure, with a frequency of 60 or more cycles per second. The sending transformer is of either the open or closed core type, the open core predominating.

The primary transformer current is generally broken up into dots and dashes, by means of an ordinary Morse key of extra heavy construction, but some sets are equipped with an oil break-key, or a relay operated by a common key.

On commercial vessels, the wireless room is frequently located on one of the upper decks, which facilitates the leading in of the aerial wires to the instruments, and also keeps the cabin more free from being flooded in times of storm or a heavy sea. A speaking tube or telephone connects the wireless cabin with the captain's cabin, pilot-house, and other vital parts of the ship.

On battleships the wireless room is in virtue of its extreme importance, placed in as safe and invulnerable a part of the ship as possible. On the U. S. Battleship Iowa, it is located just back of the rear gun turret, in a well armored cabin. The aerial is supported from the new style shot-proof skeleton mast, ensuring the operation of the station as long as the vessel floats practically, unless a chance shot happened to hit the aerial supporting cables.

The Bellin-Tosi system, employing a special directive form of aerial, which makes it possible to concentrate the direction of the waves radiated, was applied to a commercial ship, with considerable success. A cut of the aerial, which is of triangular form, on the steamship "La Provence," is shown at fig. 9. It is supported from a

wire cable strung between the masts. This system of a directive aerial is thoroughly discussed in the lesson on aeriols.

The apparatus in ship stations, is made as simple and strong as possible, as it is not an easy matter to get or to fit new parts, when the vessel is on the high seas. Duplicate parts of such instruments as glass condenser jars, detector supplies and one or two spare detectors, a spare set of head receivers, an extra sending key, and other things, are or should be carried at all times.

Most of the commercial ship stations employ an oscillation transformer, for tuning the aerial circuit. The condensers are of the glass jar or tube type, with their metallic coatings plated securely onto the glass, to reduce blistering to a minimum.

The transformers or induction coils for ship sets are invariably impregnated in a solid insulation, such as wax, as oil immersed types would cause more or less trouble by the oil leaking out. However, in some larger sets, having extra high secondary voltages, the transformer windings are immersed in oil.

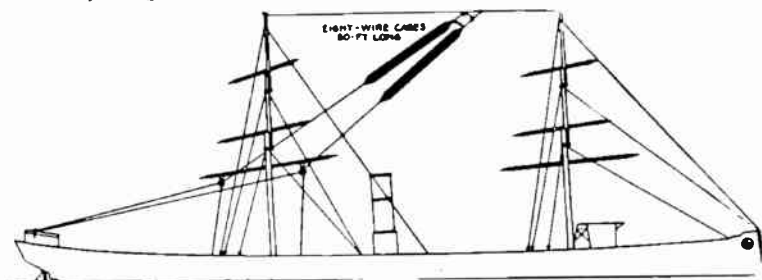

Fig. 10

The receiver sets for this class of service comprise a loose-coupler or receiving transformer, variable condensers, Pyron or Perikon detectors, and sometimes a Fleming valve or Marconi Hysteresis cynoscope. The head telephones, for the Perikon or other crystal rectifying detectors, is of good make and of not greater resistance than 3,200 ohms. Low resistance phones (80 ohms each) are used with the Marconi Hysteresis detector.

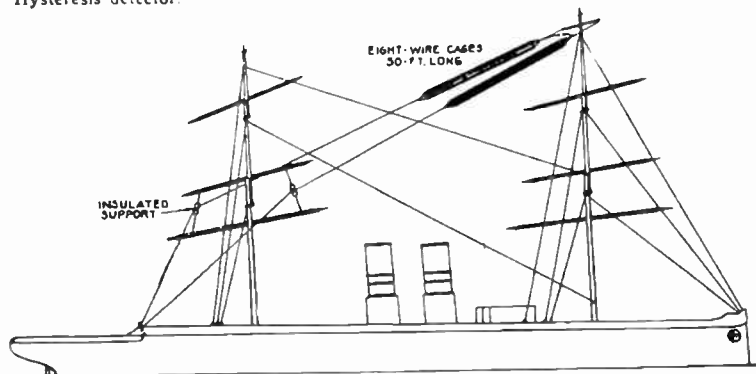

Fig. 11

The following is a copy of the United States law regarding the compulsory wireless equipment of sea-going vessels.

"Be it enacted by the Senate and House of Representatives of the United States of America in Congress assembled: That from and after the first day of July, nineteen hundred and eleven, it shall be unlawful for any ocean-going steamer of the United States, or of any foreign country, carrying passengers, or fifty or more persons, including passengers and crew, to leave or attempt to leave any port of the United States, unless such steamer shall be equipped with an efficient apparatus for radio-communication, in good working order, in charge of a person skilled in the use of such apparatus; which apparatus shall be capable of transmitting and receiving

messages over a distance of at least one hundred miles, night or day: Provided, That the provisions of this Act shall not apply to steamers plying only between ports less than two hundred miles apart."

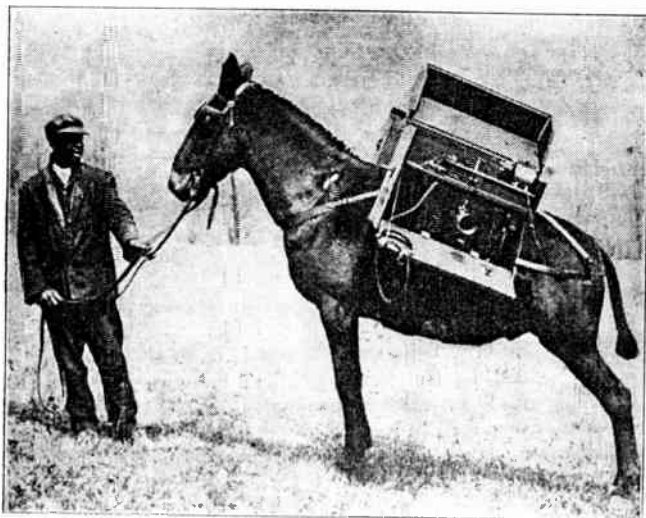

Fig. 12 (Courtesy "Modern Electrics.")

In cuts No. 10 and 11 are shown two typical aerials for ships. At fig. 12 is illustrated a Portable Pack Set carried by a Mule.

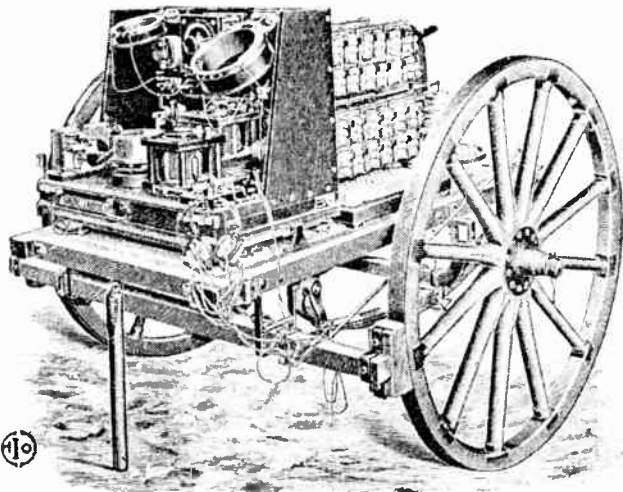

Fig. 13

A Telefunken portable wagon set, for army purposes is seen at fig. 13.

Lesson Number Seventeen.

HIGH FREQUENCY CURRENTS.

A HIGH frequency current is generally understood to mean an oscillating or alternating current, whose speed or frequency of reversal in direction occurs at a much higher rate than that obtaining in commercial lighting circuits, where the frequency does not exceed 120 cycles or 240 alternations per second.

It will be easier to understand just what is meant here probably, in speaking of high frequency currents, by glancing at the curves shown in fig. 1. In the curve representing a 60 cycle alternating current at A, is seen that each alternation requires one-half of 1-60 second or 1-120 second, to take place in: two alternations

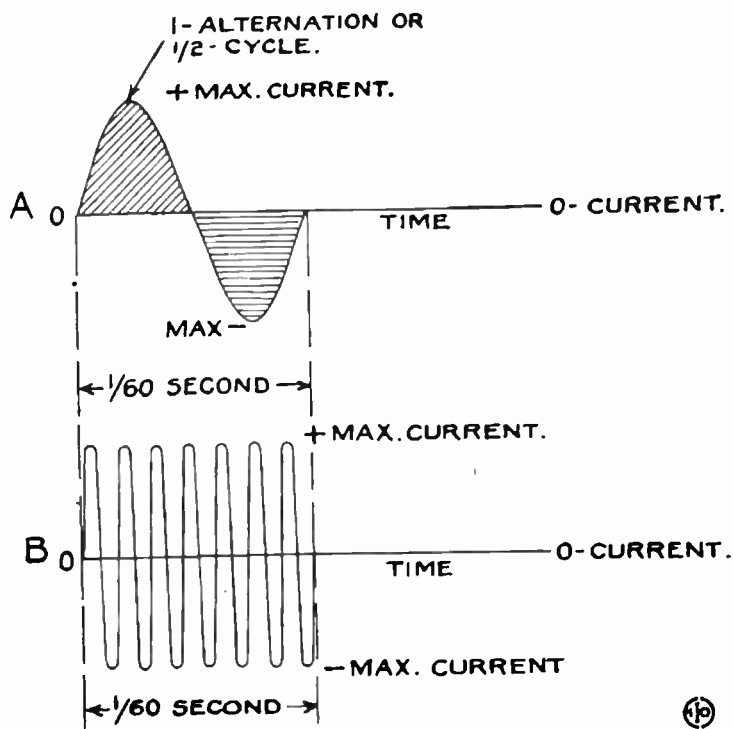

Fig. 1

making a complete cycle and requiring 1-60 of a second, or there will be 60 cycles per second, or also 3,600 per minute, which is that commonly used for electric light and motor circuits.

Looking now at the curve B, it is evident that where formerly, as at curve A, only one cycle of the current occurred in each 1-60 of a second, there is now seven times that number occurring in the same space of time, or the frequency in cycles per second would be, 7 times 60 or 420 cycles per second.

In the usually accepted meaning of the term, high frequency, however, the number of cycles occurring per second is not any such low figure as that just mentioned, but in the order of 100,000 to 1,000,000 cycles per second.

When such high frequency currents as these are employed, many wonderful and unlooked for phenomena take place; among other things, the currents of such a frequency can be handled with impunity, and even passed through the body, notwithstanding that the voltage may be several million, and the amperage several amperes ($\frac{1}{2}$ ampere through the body at 2,000 volts D. C., or low frequency, A. C., means death).

High frequency currents of this order no longer obey the rules governing the ordinary low frequency oscillating currents. For one thing, they travel only on the surface of conductors, not through them, penetrating only a few thousandths of an inch below the surface, this phenomena being known in electrical parlance as the "skin effect," which accounts for the reason that these currents do not hurt the body when handled, i. e., they possibly do not reach far enough below the skin of the body, to shock or destroy the nerves and muscles. This is the theory in general acceptance to-day.

A great part of our knowledge of these high frequency currents is due to the untiring and exhaustive researches of Nikola Tesla, a well known Electrical Engineer and Scientist, after whom the Tesla coil, which is used to produce high frequency currents with, is named. To the student interested in this little known field of electrical science, it is recommended that he procure a copy of Mr. Tesla's book, "Experiments with Currents of High Potential and High Frequency."

High frequency alternating currents may be produced by a special dynamo, such as Prof. Fessenden's, or by a regular high frequency disruptive discharge set, employing a step-up transformer excited by another high voltage transformer or induction coil, coupled with a spark gap and condenser in the exciting circuit, after the manner depicted in fig. 2, which is the commonest arrangement.

In the diagram shown, I is the induction coil of not less than 2 inch spark capacity. T is the air core, Tesla or high frequency transformer, serving to step-up the voltage delivered by the induction coil secondary to many times its original value. C is a condenser composed of glass plates, coated with tin foil on both sides, or regular leyden jars. S G is the spark gap, in which the disruptive discharge of the condenser takes place. G is the discharge gap of the Tesla coil secondary winding, across which the high frequency oscillations surge.

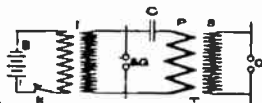

(Courtesy "Modern Electrics.")

Fig. 2

The action of the apparatus is as follows:—The induction coil or transformer I, is excited from the battery shown at B or the regular line wires, and its secondary current at 10,000 volts pressure or more, is caused to charge the condenser C, which immediately discharges itself through the primary coil of the Tesla transformer P, and the spark gap S G; and due to the conditions imposed by such a circuit, the condenser discharge becomes not a single oscillation for each cycle of induction coil current, but many thousand, so that with certain proportions to the circuits as regards their inductance and capacity, the frequency of the current passing through the Tesla coil primary, may reach a million or more cycles per second, rendering the current harmless owing to the "skin effect" already mentioned. The currents thus produced are of course highly damped; i. e., the series of oscillations corresponding to each cycle of primary transformer current, dies down to zero before the next series of oscillations start.

Tesla, in his early experiments employed a high potential transformer of small dimensions immersed in boiled-out linseed oil, to keep it from breaking down, as the strain between separate turns and individual windings is enormous. However, most of the large high frequency sets built to-day, utilize a Tesla coil with air insulation, taking care to sufficiently space the different turns and windings, so that they cannot break down. There is, however, a considerable loss in efficiency incurred by using

these coils, as the permeability of the air for magnetic induction is very inferior, and the greater the distance separating the windings of such a coil, the lower the efficiency, as the air gap to be bridged by electro-magnetic lines of force is also longer. Hence, if this space between windings can be kept down to a low figure, the resultant activity of the secondary coil of the Tesla transformer will be vastly greater, and so the oil immersed coil originally used by Tesla was the most powerful and efficient for a given consumption of watts.

The most efficient Tesla coil, is then, for a certain size, made by keeping the primary and secondary windings as close together as possible, which is best done by covering the secondary winding, usually the inner one, with a stout insulating tube of hard rubber, glass or mica, having a fairly thick wall and over-lapping the ends of the secondary coil a short distance. The primary coil can be wound on the outside of this insulating tube, keeping its turns pretty well in the centre of the tube, and several inches from the ends. Then the whole transformer should be immersed in an oiltight wooden case and filled with transformer oil or double-boiled linseed oil.*

All tuned wireless transmitting sets, develop high frequency oscillations of great periodicity. This will be apparent upon examination of the diagram fig. 3, which shows a close-coupled sending set, having an inductance H, a condenser C, a spark gap S P, and an exciting source in the wireless transformer.

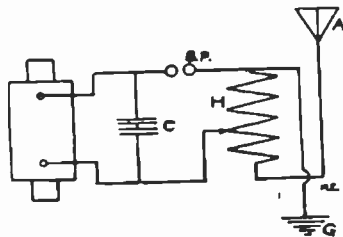

(Courtesy "Modern Electrics.")

Fig. 3

In this case, the stepping up of the voltage by means of the helix is accomplished by making the one coil serve as a primary coil, charged by the oscillatory or condenser circuit, including the spark gap; and also as a secondary coil simultaneously, to charge the aerial wire and ground. If the aerial-ground oscillating circuit is connected to embrace more turns of the helix inductance than the closed or condenser oscillating circuit, then the voltage impressed upon the aerial and ground is greater than that in the closed circuit, by that ratio representing the difference in the number of turns in each circuit. It should be remembered that the helix or loose-coupler, if it be one, does not change the frequency of the current in itself, but only voltage or potential. When the amount of turns included in the condenser or closed circuit is varied, of course, the frequency will then also vary, as it depends upon the value of the condenser capacity and helix inductance in circuit.

It is possible to compute the frequency of the oscillations in a Tesla coil circuit, or tuned wireless sending circuit, without going into higher mathematics. To begin with, what is called the "oscillation constant," is first determined, being the square root of the product of the helix inductance in centimeters, and the condenser capacity in micro-farads. Expressed in algebraic form it is:—

$$O = \sqrt{C \times L};$$

To ascertain the inductance in centimeters of that part of the helix included in the condenser circuit, the following formula may be applied:—

$$L = 1 (\pi D N)^2$$

*For particulars on the construction of Tesla coils, etc., see "Construction of Induction Coils and Transformers" by H. W. Sizer, The Electro Supply Co., N. Y. City. 25 Cents.

Where L is the inductance in centimeters,
is 31416 or π .

D is the diameter of the helix in centimeters.

N is the number of turns per centimeter of helix length.

l is length of helix in centimeters.

The condenser capacity in micro-farads, or C , is found from tests, or by a standard formula as given in the lesson on "Mathematics of Wireless Telegraphy."

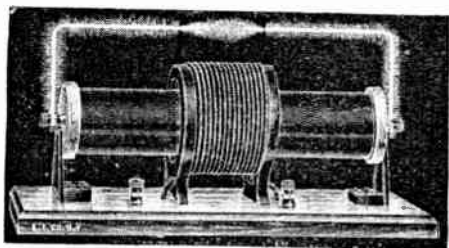

Fig. 4

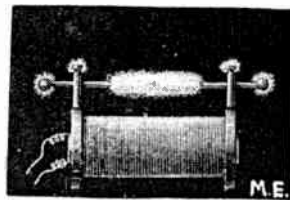
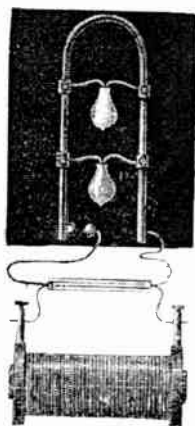
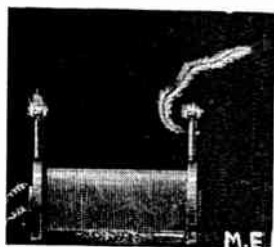
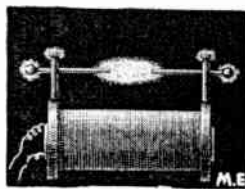
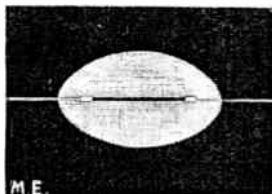
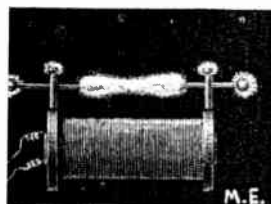

Fig. 5

Fig. 6

(Courtesy "Modern Electrics.")

When the oscillation constant has been determined, the frequency can be derived from the equation below:—

$$F = \frac{5,033,000}{L \times C}$$

Where, F represents the frequency in cycles per second, and $\sqrt{L C}$, is the oscillation constant.

The frequency in wireless stations varies from a hundred thousand or less up to a million and more per second, depending upon the wave-length employed.

A very neat and efficient Tesla transformer designed especially for experimental research, is built by the Electro Importing Company, of New York City.

A cut showing their instrument in full activity is portrayed at fig. 4, which shows the wonderful display it gives when excited from a two inch spark coil run on batteries. A larger exciting spark coil, will of course increase the activity of the Tesla coil considerably. The same company also build large size Tesla transformers, complete with condensers, rotary spark gaps, and exciting transformers, upon request, from six to thirty-six inch Tesla spark. In fig. 5, is shown the wiring connections from the Tesla transformer mentioned above. The transformer itself sells for an extremely low price and should certainly commend itself to experimenters, school laboratories, and demonstrators.

Some of the marvelous and mysterious experiments that can be performed with this Tesla coil are reproduced in the cuts figs. 5 and 6. These experiments and numerous others, together with the manner of making them are fully explained in a brochure supplied with the Tesla coil.

This size of high frequency coil, which is capable of delivering three to four inch sparks at its secondary terminals when excited by a two inch spark coil, employs a simple fixed spark gap, fitted with ball or pointed electrodes, flat faced one having not been found suitable in the small sets. This Tesla high frequency set, will produce an oscillatory high potential current of several hundred thousand volts, at a periodicity of half a million cycles per second or more.

In large high frequency outfits, there are several parts of the apparatus which require a little change in design, as compared with the set previously described, owing to the heavier currents involved.

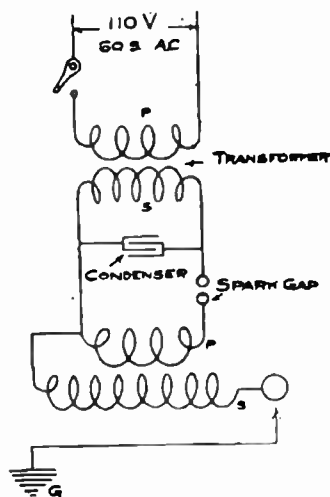
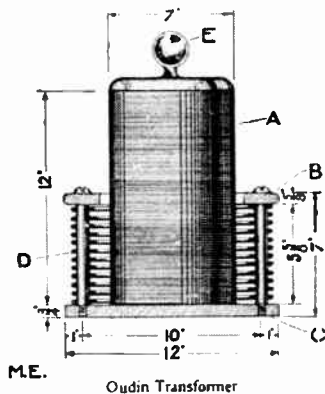

Fig. 7



Oudin Transformer

(Courtesy "Modern Electric.")

One of the important points to be altered is the spark gap connected into the exciting transformer secondary circuit. This has a tendency to arc and so destroy any chance of the condenser discharge in the gap being quickly or disruptively wiped out. This is due to the heating of the air in the gap, owing to the heavy currents traversing it in large sets. One way of reducing the arcing and heating of the disruptive spark gap, is to place several ball gaps in series, the number depending upon the size of the set, but about 4 to 6 being sufficient for transformers of less than one kilowatt capacity.

The series gap, is not the best solution of the problem, however, and the rotating or rotary spark gap has finally been found the best, this type consisting of a disc of hard rubber about 8 or 10 inches in diameter, mounted upon the shaft of a small 1-16 H P alternating or direct current motor, capable of running at a speed of 1,500 revolutions or more per minute. The disc has a number of projecting zinc

or brass plugs mounted on one flat face, the plugs being spaced about one inch apart, and all connected together electrically. The spark takes place between two diametrically opposite plugs and two stationary electrodes.

The advantages due to this gap construction are at once apparent. A fresh supply of cool air is kept constantly passing through the gaps, and the rotating disc also acts as a fan cooling the electrodes mounted upon it. In some forms of the rotary gap, only one spark gap is utilized, one of the wires connecting to the rotating plugs through a spring contact or brush.

The condensers used for large Tesla sets, are generally of the glass plate type, as this form possesses many advantages over leyden jars, one of them being the more flexible adjusting of the circuit, as the capacity is divided up into a number of sections, any of which may be used as required.

The transformers utilized to charge the condensers, in high powered sets of this character, are either wax impregnated or oil immersed. The primary windings are made for any voltage from 110 to 550 A. C. 60 or 120 cycles, ordinarily. The secondary windings are sometimes arranged, so that anywhere from 10,000 to 20,000 volts, can be obtained, according to the connection of the various sections composing it. The variation of the secondary voltage is also made, by arranging the primary winding or coil in several steps or sections, the usual method being to bring out taps from succeeding turns or layers, to the number of six or more.

The Tesla or Oudin coils, employed for large sets, to step up the voltage of the circuit, are invariably of the air insulated type. An Oudin coil is not very different from a Tesla coil, except that the primary and secondary coils are connected in another way. This is illustrated by the diagram fig. 7, which shows how the bottom of the primary winding is joined to the bottom of the secondary coil, the high frequency sparks being taken from the ball at the top of the secondary. In the construction of the Oudin coil, which is used principally for lecture and Electro-therapeutical requirements, the primary coil is placed at one end of the secondary coil, and not in the centre, as in the regular Tesla coil.

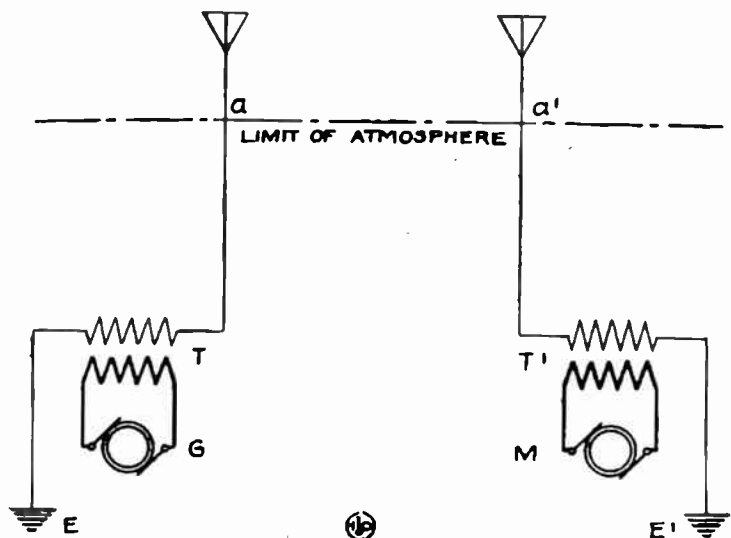

Fig. 8

The high frequency coils, whether Tesla or Oudin, are made with a primary winding of a few turns, says 10 to 15 turns, of large stranded or solid copper conductor, spacing the turns quite a distance apart. The secondary windings are composed of 800 to 1,000 turns of fine copper wire, with a small space equal to the thickness of the wire between turns, to prevent the enormous induced potentials in it from breaking down the coil.

Tesla, in some of his researches a few years ago, had high frequency discharges developed to such a degree that, in one test he was able to make the current leap a gap, twenty-five feet long, the sparks being two to three feet in diameter, and accompanied by a roar, which could be heard ten to twelve miles away. The voltage of this discharge was up in the billions, and the amperage 800.*

The object of all these experiments by Nikola Tesla, was along his line of work regarding the wireless transmission of electrical energy, for useful purposes. It may seem like a dream to-day, but then it is only a little over fourteen years ago that man only dreamed about the wireless telegraph, and at the end of this short space of time, there are laws passed which compel its use on all ships that travel the high sea.

Tesla, in his first book, published over twenty years ago, advocated the cause of the wireless transmission of energy, for the lighting of lamps and running of motors, and at that time, in a lecture before the Institute of Electrical Engineers, at London, England, he demonstrated wireless lights and a "no-wire" motor operating over short distances.



Fig. 9

The motor was operated by connecting one of its coil terminals to earth, and the other terminals to an insulated metal plate suspended in the air. This was Tesla's theory on a small scale, for the wireless transmission of energy to any distance.

The form of the energy was to be in high frequency oscillations stepped up to many million volts, and radiated from extra high aerial wires, extending into the upper strata of rarefied air, through which the high voltage currents travel easily.

The aerial wire would of necessity be quite high, probably more than 50 miles, so as to reach above the atmospheric envelope surrounding the earth, which is variously estimated at from 30 to 50 miles thick.

*See "Wireless Telegraphy," by Sewall.

The scheme for this plan of distributing and utilizing electrical energy is shown by fig. 8, where the aerial wires are represented at A and A1, step-up transformer at distributing station T, excited from the high frequency generator G, the ground being made at E.

The receiving apparatus comprises the aerial wire A 1, for gathering the required energy out of the ether, the step-down transformer T 1, from whose low voltage primary coil is run the special motor M, or lights and other devices as desired. The receiving terminal ground is established at E 1.

Patents covering this scheme, were issued to Tesla many years ago, but for several reasons, financial, industrial and others, the practicability of it has never been tried out, but however this may be, it does not mean that the scheme is impossible.

In fig. 9, is illustrated the laboratory and tower of Tesla's wireless plant on Long Island. The high frequency discharge with the Tesla apparatus, aformentioned, is seen in cut No. 10.

From the foregoing it is easy to understand that there is probably no more interesting or remunerative field of electrical research than that of high voltage and high frequency. Its wonders are unending, and very little of practical value is known about it to-day.

Electrical engineers have been too busy developing and applying the ordinary forms of alternating and direct current for useful purposes. But they are now beginning to realize that the Tesla currents possess some hitherto unknown qualities, and that they are to play an important role in the realm of electrical activities in the years to come.

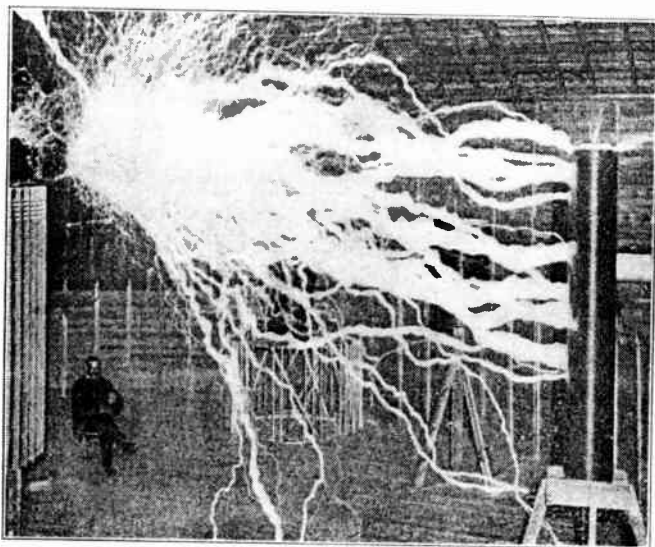

Fig 10

Amateurs and experimenters along wireless and scientific lines have wonderful opportunities open before them, if they could but realize it. Upon the shoulders of the present day youthful electrical student in his attic laboratory will rest the work of developing the future electrical inventions and problems. So if they are alert, as many of them are, they will build up their early education well, for the electrical field is no longer a habitat for the unknowing mind. Brains, and plenty of it, coupled to practical research in field and laboratory are the potent factors in the dawning electrical era.

Be not satisfied to simply punch the wireless key or throw in a switch but make it your personal business to ascertain the why and the wherefore of each action and phenomenon. Experiment and study, and the world is yours.

Lesson Number Eighteen

THE WIRELESS TELEPHONE.

THE wireless telephone, unlike its twin brother, the radio-telegraph, does not require the mastery of any codes to become of value to mankind, and so naturally would be the ideal system of communicating without wires.

However this may be, it has not kept pace with the wireless telegraph, in the distance signalled over, the telegraph having successfully covered 3,000 to 4,000 miles frequently, and Marconi claims to have received a message 5,600 miles. The maximum distance to which radiophone speech has been carried does not exceed a few hundred miles, and this only at certain rare intervals, during experimental tests. There are hundreds of wireless telegraph stations in daily commercial operation now, while there is not one radiophone station in commercial service.

To be able to pick up an ordinary telephone transmitter, talk into it, and propagate the spoken word a distance of a thousand miles or more; that has been the dream and ambition of many learned men in all ages, ancient as well as modern. But how to do it was another story, and still remains so.

It was thought, when wireless telegraphy became prominent a few years ago, that it would be a comparatively easy matter to talk or telephone over the same distances that the telegraph signals covered so readily, and undoubtedly, when the proper method of propagating the speech through the ether is found, the same distances can be covered.

Like every other branch of science, the original investigators are few and far between. The general trend of radiophone researches thus far, have shown this in no small degree. If one experimenter employs an arc lamp to generate the necessary undamped oscillations with, then all the rest must putter around with a similar

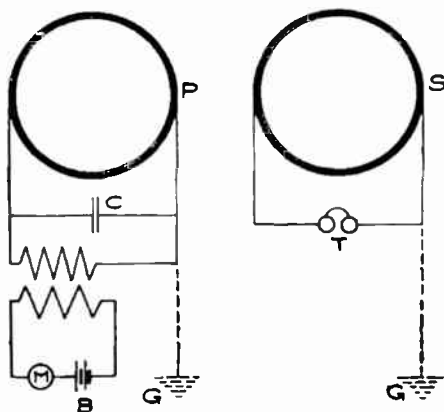

Fig. 1 (Courtesy "Modern Electrics.")

device, in the meanwhile unloading a few million dollars worth of "WIRELESS TELEPHONE" stock on an unsuspecting public. This was the course followed by the Radio Telephone Company, which is now extinct, as are also the Collins Wireless Telephone Company, and a number of others who sprung up over night. Both of these loudly heralded systems used an electric arc to talk with, but they only talked when the arc felt so inclined, and not very far at that. From the very

nature of an electric arc, which is unstable and constantly changing, it is evident that it is not the proper device for commercial radiophony.

The simplest form of a wireless system for transmitting articulate speech, but only good for distances not exceeding 50 feet, is depicted by the drawing of fig. 1, where P and S are coils of insulated wire, about six feet in diameter, with 40 to 50 turns of No. 18 B. & S. gauge wire on the transmitting coil, and 80 to 100 turns of No. 28 gauge wire on the receiving coil S.

At H, is connected a small induction coil, such as used in medical sets, with a paper and tin foil condenser at C, telephone transmitter M, and a battery of 8 to 10 dry cells or a storage battery.

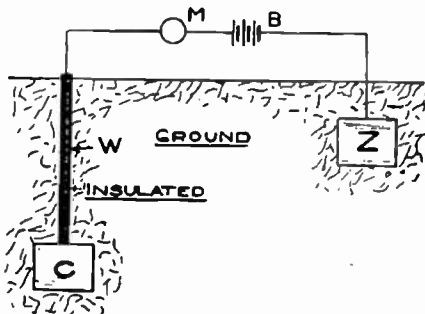

(Courtesy "Modern Electrics") Fig. 2

The receiving coil S, is connected to a telephone receiver, the more sensitive the better. The ground connections, indicated by the dotted lines, are said to improve the results.

The operation of this inductive wireless telephone set, is on the same order as that existing between the primary and secondary coils of an induction coil or trans-

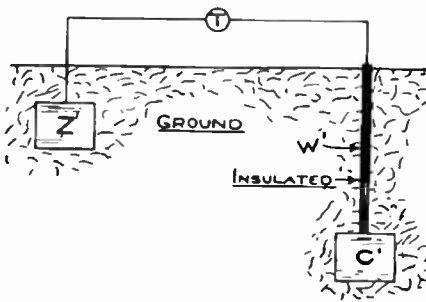

(Courtesy "Modern Electrics") Fig. 2a

former, or purely electro-magnetic induction, and consequently quite feeble in its sphere of usefulness. It makes a good demonstration set for talking through stone walls and the like, having actually been used by the Collins Company to sell stock with at the Philadelphia Electric Show in 1908.

Another very simple wireless telephone, working on the conduction theory instead of the induction theory, is shown by the diagrams figs. 2 and 3.* The transmitting station is represented at fig. 2, and comprises a microphone transmitter M, a battery of several cells B, a zinc plate Z, and a copper plate C; the zinc plate being buried about 3 feet below the surface of the earth, and the plate C about 15 feet deep in the earth.

*See "The Wireless Telephone," by H. Gerstbach, page 25. (E. I. Co., 25 cents.)

The receiving station has the same construction, only the copper plate C 1, is buried 15 feet deep, and opposite the zinc plate C, of the transmitter. Insulated wires lead up from the buried plates to the instruments. Around the ground plates was placed some saturated solution of chloride of zinc, to keep the earth moist, and also to set up an electrolytic action between the plates.

Hugo Gernsback says this scheme worked very well, up to three miles between the stations, when the plates at each station were separated 300 yards.

Such systems as these are, of course, limited in their field of action, as regards practicability, and so several schemes for propagating speech over long distances have been evolved.

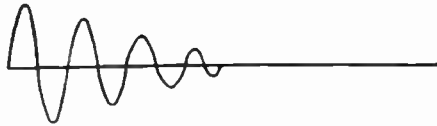

Fig. 3 (Courtesy "Modern Electrics.")

The first principle involved in long distance radiophony by means of electromagnetic waves set up in the ether, is that the waves set up for this purpose, must be those due to undamped oscillations of great frequency. The oscillations generated in an ordinary wireless telegraph transmitter, are highly damped and follow a curve similar to that in fig. 3, while an idea of an undamped oscillation appears at fig. 4.



Fig. 4 (Courtesy "Modern Electrics.")

It has been found that for good radiophony, the oscillations generated must be undamped or of constant amplitude, and also that they must have a frequency or periodicity of not less than 40,000 cycles per second, otherwise the speech will be broken or harsh, due to the ear perceiving the alternations of the talking circuit.

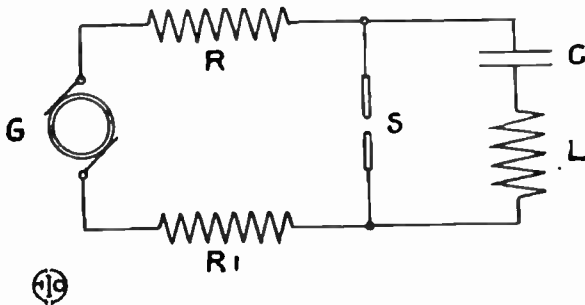

Fig. 5

There are two methods in general use now, for the production of undamped alternating currents with a frequency of at least 35,000 cycles per second, one being that involving the use of an electric arc, and the other, the direct generation of such a current by means of an alternating current dynamo, rotated at tremendous speeds, which sometimes reach 30,000 R. P. M.

The arc method will be described first, as it was the first to be employed for wireless telephony.

The arc scheme of producing undamped high frequency oscillations dates back to the discovery of the musical arc by Dudell, in 1900. Dudell's arrangement is given at fig. 5, where S is an ordinary solid carbon arc, C a condenser of about 3 micro-

farads, and the inductance of helix L is of 5 milli-Heeries. The arc was fed by a direct current dynamo, G , delivering 42 volts pressure, R and R_1 are inductive resistances.

The action of the capacity and inductance shunted across the arc has been described as follows:—

With a steadily burning arc S , shunted by a capacity C , and inductance L , the capacity will instantly take upon itself a charge, and the current through the arc is simultaneously diminished or made smaller; the potential difference across the arc therefore increases, and this tends further to charge the condenser. This now reacts on the arc, still further augmenting its current, which in turn, lowers the potential difference.

As it discharges through an inductance L , it not only fully discharges, but becomes charged in the opposite direction, just as a pendulum, when pulled to one side and released, will not only go back to its original position, but far beyond it in the opposite direction.

When in this condition, it is ready to repeat the operation with more vigor than before, and so persistent and undamped oscillations are set up by the condenser charging and discharging. To have the arc emit a musical note, it is positively essential that the inductance and capacity be properly adjusted to each other, otherwise the oscillations produced will be feeble and weak.

After the discovery of the Dudell musical arc, a Danish scientist, Mr. Valdemar Poulsen, developed a special arc for radiophonic purposes, which employed one solid carbon electrode and one metallic water cooled electrode.

With this arrangement, Poulsen was able to produce powerful undamped high frequency oscillations, with a periodicity of from 500,000 to 1,000,000 cycles per second, which, of course, were highly suitable for wireless telephony. This arc was burned in a chamber filled with hydrogen vapor, formed by admitting alcohol drop by drop, and allowing it to become vaporized by the heat of the arc itself. In the perfected Poulsen radiophone arc apparatus, the carbon electrode is rotated by a motor and a very strong magnetic field is concentrated upon the arc proper.

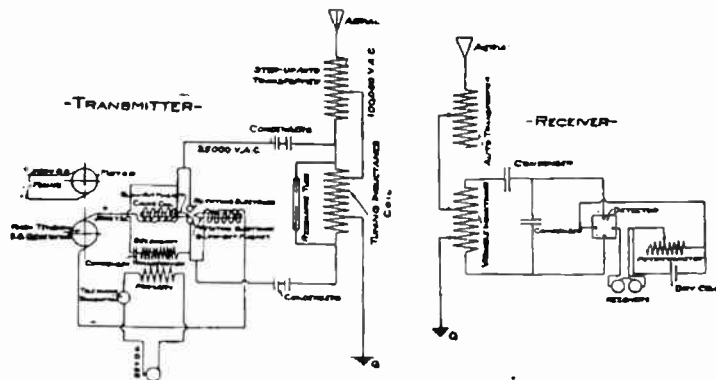

(Courtesy "Modern Electrics.")

Fig. 6

In the wireless telephone system developed by A. Frederick Collins, of Newark, N. J., a rotating arc was the medium by which the undamped high frequency oscillations were produced. The Collins Company claimed to have talked from Newark to Philadelphia, an air-line distance of about 90 miles with their system.

The Collins oscillating arc is quite an ingenious device, and instead of employing carbon or metal rods, there are used two constantly rotating discs of carbon-graphite, which are capable of being moved toward or away from each other. This, it will be seen, provides a constant uniform electrode face, and an arc of great constancy can be maintained between the two disc edges, besides being very well cooled and ventilated.

The arrangement of the complete sending and receiving apparatus used in the Collins radiophone system, is illustrated by the diagram fig. 6. The various parts are clearly shown, and require but little explanation.

The rotating arc, is burned between two large blow-out electro-magnets, and the arc current is 5000 volts D. C. supplied by a high tension D. C. dynamo. The variations in the arc oscillations are made by a microphone transmitter, connected up with 25 volts D. C. in the primary circuit of the induction coil shown. Its secondary winding induced currents, follow the variations of the primary current, and are superimposed across the arc, through the condenser shown, which prevents the arc D. C. from shunting back through the induction coil secondary and burning it out.

To ascertain when the maximum activity occurs in the arc's production of undamped oscillations, the vacuum or resonance tube is utilized, both electrodes in it glowing brightly and evenly when the proper amount of capacity and inductance are shunted around the arc.

The undamped oscillations set up by the arc, are stepped-up to a very high potential, by means of the auto-transformers or helices shown in diagram.

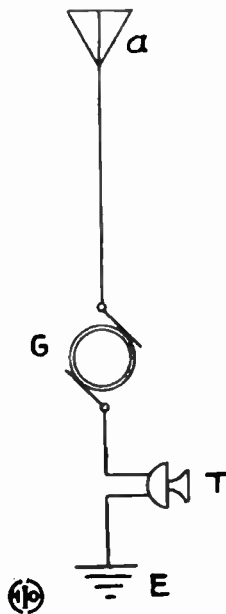

Fig. 7

The Collins receiving set, includes a special thermo-electric detector of two fine crossed wires, high resistance telephone receivers, variable condensers, tuning inductances, aerial and ground. The ordinary wireless telegraph receiving station is often used for receiving radiophone talk, a good detector to use being the peroxide of lead, Perikon or the Audion, which is the best of all.

The other method of producing undamped oscillations for radiophony is the electro-dynamic way, as followed by Prof. Fessenden, formerly special wireless scientist for the U. S. Government. The special high frequency, 25 to 30 volt, alternator used by him, rotates at terrific speed and develops a constant alternating current of over 30,000 cycles per second, so that no interruptions in the transmitted speech is heard whatever.

The commonest manner in which this alternator is connected to the aerial is depicted in fig. 7, where A is the aerial, G the alternator, T the transmitter, and E earth. In other words, the alternator and transmitter are in series.

The transmitter, when spoken into, serves to vary the current strength in the circuit, owing to its change in resistance, and this causes a corresponding variation in the strength of the ether waves set up, and when these varying etheric waves impinge upon the receiving aerial, they are transformed into high frequency oscillatory currents surging through the aerial system, and are interpreted by proper receiving instruments.



Fig. 8 (Courtesy "Modern Electrics.")

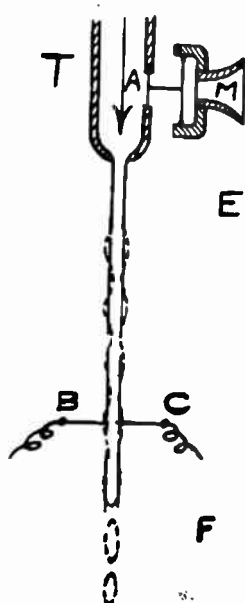

Fig. 9

The Fessenden receiver recently perfected, and termed by him the Heterodyne, is a type of polarized receiver.

Having once devised a method of producing the necessary radiophone transmitting current, the problem that remained and does remain in great part yet, was the manner of controlling the strength of the current, when the transmitter was spoken into.

The ordinary carbon grain microphone transmitter soon heats up, when anything over a fraction of an ampere is put through it. So it became necessary to invent another type, capable of handling several amperes if need be.

One of the most ingenious of these and at the same time most efficient, is that evolved by Prof. Majorana, an Italian inventor. A view of this transmitter, of the "hydraulic microphone" type, is shown at figs. 8 and 9.

At T, in the drawings is a tube containing water or other liquids, which tends to flow downward through the constricted portion G, in a fine stream, but after flowing thus for a short distance, it breaks up into drops. Now, if the tube T, receives a sudden shock, the breaking up of the liquid stream is greatly facilitated, shortening the stream proper, according to the force of the shock.

This shocking of the tube was found to be suitable, when due to different sounds, as of the voice, inside the tube, and thus it was that Prof. Majorana succeeded in making the water column act in unison with the air vibrations set up by the spoken voice.

His arrangement for the working transmitter, is depicted at fig. 9, in which B and C, are two fine wires, inserted into the stream of liquid, and the variation in the resistance, due to the changing of the stream's shape, when acted upon by the transmitter diaphragm A, causing the transmitting current to vary simultaneously and proportionately.

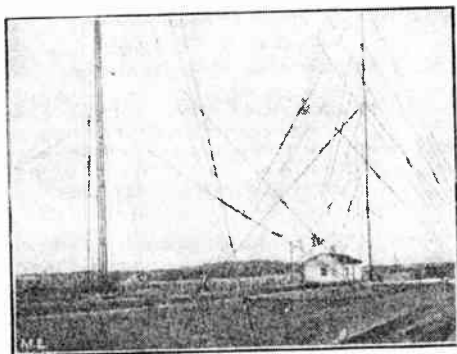

Fig. 10

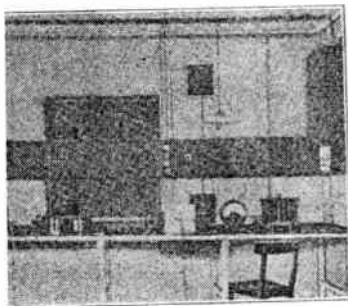

Fig. 11

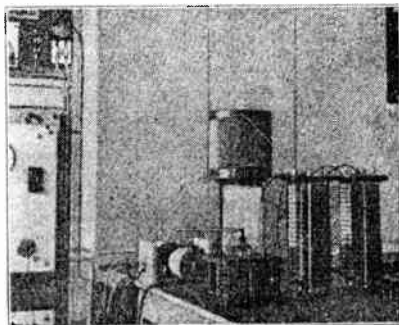

Fig. 12 (Courtesy "Modern Electrics.")

Another part of the scheme in this transmitter is that the conductivity of the liquid stream may be varied by making it of some different solution, such as salt water, mercury, etc.

Thus, the wireless telephone, which seemed to promise so much at first, has not, up to the present time, come into its own, owing principally to the fraudulent corporations promoting it, or rather who claimed to be promoting it. However, the future is full of promise for it, and it is bound to come some time, and quite possibly will be a strong rival of the regular wire companies.

Mr. Poulsen's new wireless station near Lyngby, not far from Copenhagen, has been completely remodeled lately. (See also Lesson No. 7.)

This station is the more interesting because nearly all recent inventions of Mr. Poulsen, in Wireless Telephony, have been made here.

The aerial net is now 70 meters (1m. = 39.37 inches) high against 37 meters original height.

Two masts about 90 meters apart, fig. 10, carry the aerials downward. The electrical counterweight is a wire net which is stretched horizontally over the ground, a few feet away from it.

A gasoline engine of 20 H. P. drives the dynamo, which supplies the arc-generator. The output of the dynamo is 10 K W at 500 volts.

As will be known the Poulsen system uses undamped oscillations (similar to the De Forest system) produced by means of an electric arc operated in hydrogen gas. No spark coil or oscillator balls, etc., as in the common wireless stations are found here, and what strikes one most is the absence of complicated, elaborate apparatus, and instruments.

The generator comprises only one arc which in addition is actuated upon by a strong magnetic field.

The positive electrode of the arc is of copper, the negative of carbon. If more than 6 K. W. arc used the copper anode is constantly cooled by means of water circulation through the interior of the electrode.

The new station has not yet been tested for its maximum distance, but has kept up communication with other stations as far as 2,500 kilometers (1,560 miles) away. Mr. Poulsen is quite confident that his station can reach 3,000 kilometers easily. The wave length in long distance tests was usually 1,200 meters. A 30 K. W. Poulsen arc has sent telegraphic signals 6,000 miles, from the Arlington, W. Va., station, to Honolulu, T. H.

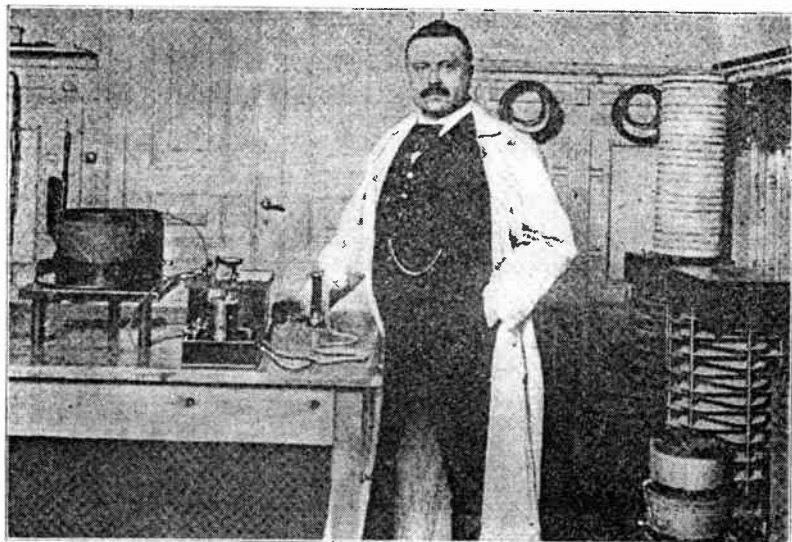

POULSEN IN HIS WIRELESS STATION.

(Courtesy "Modern Electric.")

The undamped oscillations also have another big advantage. It is now possible to receive from 2-4 messages on the same antenna and good operators can work with less than 1% difference of the wave length.

Fig. 11 shows the interior of the station. Of interest is the hard rubber window with lightning arrester, through which the aerial is led. This is seen on the right-hand side of the picture, near the ceiling of the room. Another similar window (close to the top of the table) carries the wire to the electrical counterweight.

The receiver is shown at the left-hand side.

Fig. 12 gives a good view of the generator, and also shows the peculiar high tension discharge on the resonator.

A new idea has lately been incorporated in the generator. Instead of complicated apparatus for the production of the hydrogen, alcohol is used which is introduced by letting it drop slowly in the arc chamber. One to two drops per second are sufficient for a load of 1 K. W.

It is, of course, understood that if desired this station can be used for wireless telephony, by merely throwing over a switch.

Lesson Number Nineteen.

THE MATHEMATICS OF WIRELESS TELEGRAPHY.

THE art of wireless involves the use of some of the finest developments in the realm of mathematics, for some of the calculations, but only the more important practical formulæ will be treated on here, as they will most likely meet the needs of the student or operator.

CALCULATION OF WAVE-LENGTH.

The calculation of wave-length, i. e. the length of the ether wave emitted from the aerial wire in transmitting, is frequently desired to be known. The best way is to employ a wave-meter, correctly calibrated.

For untuned sending circuits, with straight vertical aerials, the wave-length has been ascertained to be very close to 4.5 times the length of the aerial wire from spark gap to its outer end when the spark gap is close to the ground.

In tuned sending sets, the wave-length emitted from the transmitting circuit is given by the equation below:

$$W = \pi 2 V \sqrt{LC};$$

$$\text{Or } W = 1,884,960,000 \sqrt{LC};$$

Where:— W = Wave-length in meters.

π = 3.1416 (a constant).

2 = a constant.

V = Velocity of ether waves or 300,000,000 meters per second.

L is the Inductance in Henries of the helix turns.

C is the capacity in Farads of the condenser.

In calculating the wave-length it must be noted that the inductance of the helix in the above equation, does not mean the total inductance of it, but only those turns in use in the condenser or closed oscillating circuit, when the set is in tune.

WAVE FREQUENCY.

The wave frequency, or the number of waves occurring per second can be readily computed from the other constants when they are known. Wave frequency equals:

$$F = \frac{5,033,000}{\sqrt{LC}};$$

Where: F is the wave frequency in cycles per second.

L is the inductance of helix turns in use in condenser circuit, in centimeters.

C is the capacity of the condenser in tuned sending circuits, in microfarads.

$$\text{Also } F = \frac{300,000,000}{\text{Wave length in meters.}};$$

The term: $\frac{1}{\sqrt{LC}}$, is called the oscillation constant.

INDUCTANCE CALCULATION.

The inductance of a single layer coil or helix of wire, is calculated in centimeters, by the following formula:

$$L = 1 (\pi D N)^2$$

Copyright 1912 by E. I. Co.

In which:—L is the inductance of helix in centimeters.

l is the length of helix in centimeters.

$$\pi = 3.1416$$

D is diameter of helix in centimeters.

N is the number of turns per centimeter ^{W.D.A.} length of helix.

This formula however, is subject to quite a large error for short fat helices, but being correct to within 3 per cent, if the helix is 50 times its diameter in length.

A pretty accurate equation for the helix inductance in C. G. S. units, evolved by Louis Cohen,* is given below. This formula is suitable for short fat helices as well as long thin ones, the result being accurate to within 1/2 of 1 per cent, and closer for long ones.

$$L = \frac{39.48}{39.4786} N^2 \left[\frac{2a^4 + a^2 l^2}{\sqrt{4a^2 + l^2}} - \frac{.85}{9.4248} a^2 \right];$$

In which:—L_a is the inductance in absolute or C. G. S. units. (centimeters).

N is the number of turns per centimeter of helix length.

a is the mean radius of helix in centimeters.

l is the length of the helix in centimeters.

The value of the inductance in Henries, is found by dividing L_a by 1,000,000,000; or (10⁹)

For helix lengths of not less than 15 to 20 times the diameter in value, the following formula holds good:

$$L, \text{ in Henries} = \frac{10.028 \times r^2 \times N^2}{1 \times 100,000,000,000};$$

Where: r is the radius of helix in inches.

N is the total number of turns on helix.

l is the length of helix in inches.

CAPACITY CALCULATIONS.

The capacity of condensers may be found approximately by the equation:

$$C = \left(\frac{2,248 \times K \times a}{t \times 10,000,000,000} \right) + 1,000,000;$$

Where: C is the capacity in Farads.

K is the inductivity of the dielectric. (see appendix).

a is the total active area of dielectric in sq. in.

t is the thickness of dielectric in inches.

To ascertain the capacity in micro-farads, solve only that portion of the equation enclosed in parenthesis.

To find the joint or total capacity of several condensers connected on parallel, add their individual capacities, thus:

$$\text{Total } C = C_1 + C_2 + C_3 \text{ etc.}$$

For the total capacity of a number of condensers connected in series, take the reciprocal of the sum of their reciprocals, thus:

$$\text{Total } C = \frac{1}{\frac{1}{C_1} + \frac{1}{C_2} + \frac{1}{C_3} \text{ etc.}};$$

*See U. S. Bureau of Standard Records.

The required condenser capacity in micro-farads for a wireless transformer of certain size is:

$$C = \frac{\text{Kilowatts} \times 10^6}{f \times V^2};$$

Wherein: f is the frequency of transformer current in cycles per second.

V is transformer secondary volts.

In allowing for the secondary voltage, Prof. G. W. Pierce, of Harvard University, recommends that the figure of 37,500 volts per one inch of spark be figured on, due to the heating of the spark gap, etc.

The formula below will give the area in square centimeters of active condenser dielectric required for a certain capacity:

$$\text{Area in Sq. Cm.} = \frac{36 \pi D C 10^6}{K};$$

In which: $\pi = 3.1416$

D is the thickness of dielectric in centimeters.

C is capacity required in micro-farads.

K the inductivity factor. (See appendix).

10^6 equals 1,000,000

Ohm's Law For Alternating Current Circuits.

Ohm's law as applied to direct current circuits no longer holds good on alternating current circuits, due to the reactive effects incurred by the inductance and capacity of the wires.

With resistance, inductance and capacity in series, the equation for current in amperes is:

$$I \text{ in amperes} = \frac{E}{\sqrt{R^2 + \left(2 \pi f L - \frac{1}{2 \pi f C} \right)^2}}$$

Where: E is the effective volts.

R is resistance in ohms.

f is the frequency in cycles per second.

L is the inductance in Henries.

C the capacity in Farads.

π equals 3.1416 (a constant, representing the ratio between the diameter and circumference of a circle.)

Following the same nomenclature, this formula gives the volts required to produce a certain current under like conditions:

$$\text{Volts} = I \sqrt{R^2 + \left(2 \pi f L - \frac{1}{2 \pi f C} \right)^2};$$

Condenser Charging Current On A. C. Circuits.

When a capacity, in the form of a condenser or the inherent capacity of a conductor, is connected to an A. C. circuit, a certain current will be required to charge it. The equation below gives the value of this charging current in amperes:

Where: I is current in amperes.

$$I = \frac{E C 2 \pi f}{1,000,000};$$

E effective voltage.

C capacity in microfarads.

f frequency of charging current.

Primary Circuit Calculations.

In the primary circuit of the sending transformer, the amount of power utilized cannot be measured by a voltmeter and ammeter, as in direct current circuits. For incandescent lamp loads only, this may be nearly so, but not for any inductive load such as motors or transformers.

The energy in watts is the product of the volts and amperes, in a direct current or non-inductive A. C. circuit, but with inductive load on A. C. circuits, the energy in watts is:

$$W = E I P;$$

Where;—E is the effective volts; I amperes; and P the power factor; but W is the actual or true watts consumed, not the apparent watts as indicated by a voltmeter and ammeter. Actual watts may be read directly from a compensated direct reading watt-meter, such as the Weston. The power factor for induction motors is about 80 per cent; for motors and lamps mixed, 90 per cent; and for transformers 60 to 80 per cent; lamps alone 100 per cent. The power factor is the ratio, (expressed as a per cent), between the true watts, as given by a direct reading watt-meter, and the apparent watts, or the product of the volts and amperes. In other words, the power factor is equivalent to:

$$\text{Power factor} = \frac{\text{True watts}}{\text{Apparent watts}}$$

Also it equals the cosine of the angle of lag between the electromotive force and the current.

The actual watts represent the energy paid for by a consumer; not the apparent watts. The difference between the apparent watts and the true watts, constitutes the quantity known as "wattless current" or the "wattless component of the circuit," and although it has the same heating effect in the circuit and generator and motor windings as direct current, it adds very little to the load on the generator.

Range Of Stations.

The working range of radio-telegraphic stations depends upon the height of the aerial wires, the radiation current in amperes, the wave-length used, the time of operation; being approximately twice the normal day range at night; and several other factors, such as the topography of the land, the particular section of the earth signalled over, etc. In general it is about twice as difficult to send signals in hot tropical regions, as in temperate climates.

The actual working or communicating range of any station varies greatly and cannot be wholly depended upon, but as long as a conservative range is taken as a criterion of a certain station, based upon exhaustive tests and observations, it can be pretty well relied upon.

A few years ago, during 1909 and 1910, to be exact, some very elaborate and exhaustive tests on long distance radio-communication were carried on between the Brant Rock station of Prof. R. A. Fessenden, leased for the purpose by the U. S. Government, and the U. S. scout cruisers, Salem and Birmingham, the maximum distances covered reaching 2,700 miles.

The tests were under the able supervision of Dr. L. W. Austin, Ph. D. of the U. S. Naval Wireless Telegraphic Laboratory.

Dr. Austin evolved an equation representing the relation existing between received aerial currents, aerial altitudes, transmitting current strength, wave-length employed, and a term known as the absorption factor, which allows for the day absorption caused by the sun's rays ionizing the upper strata of the atmosphere apparently.

Quantitative measurements and numerous observations carried on during the tests, served to establish the validity of this equation for all distances up to 1000 nautical miles, over salt sea water, in broad daylight with sun shining; for all sending currents from 7 to 30 amperes; aerial elevations of from 37 to 130 feet; and all wave-lengths of from 300 to 3,750 meters.

His equation is as follows:

$$I = 4.25 \frac{I_s \frac{h_1}{\lambda} \frac{h_2}{d}}{e^{0.0015 d}} ;$$

Where: I is received aerial current in amperes.

4.25 a constant.

I_s the sending current in amperes.

λ the wave-length in kilometers.

D the distance between the stations in kilometers.

h_1 elevation of transmitting aerial in kilometers.

h_2 elevation of receiving aerial in kilometers.

e is the base of the Naperian logarithms, or 2.718281828.

0.0015 the absorption factor.

Handwritten notes and calculations:

$$d^2 + \frac{0.0015 d}{\lambda} = \frac{[R \cdot 100] R_{R.T.}}{\lambda}$$

$$d^2 + 0.027 d \sqrt{\lambda} = \frac{[R \cdot 100] R_{R.T.}}{\lambda}$$

The conditions under which this rule or formula was tested out were: The transmitting transformers were excited from 500 cycle alternating current generators, and this is very important as a 500 cycle set will send a signal two or three times as far as a low frequency set employing 60 or 120 cycle primary current. The resistance from the top of the receiving aerial, through receiving tuning inductance, and down to the ground was 25 ohms. Ordinary high resistance, Navy type, telephone head receivers and crystal rectifying detectors were employed on the long distance tests.

It was found that when the received aerial current did not decrease below 40 micro-amperes, (40 millionths of an ampere), the communication was good and also regular. At a strength of 10 micro-amperes, the signals were just audible. Hence a regular communication strength of current at the receiving aerial may be taken at 40 to 50 micro-amperes.

This rule, good up to 1000 nautical miles, over salt water in daytime, is the only one of any practical use at the present time. Aside from this, transmitting sets of ordinary low frequency type, will radiate messages at about the following distances, in daytime over land, in temperate zones, and a great deal further over water or at night.

1" spark coil, untuned,.....	1 to 3 miles
1" " " tuned,.....	8 to 15 "
6" " " "	40 to 50 "
10" to 12" spark coil, tuned,.....	80 to 100 "
¼ K. W. Transformer, tuned,.....	25 to 30 "
½ " " "	40 to 60 "
1 " " "	80 to 100 "
2 " " "	150 to 225 "
5 " " "	1000 to 1500 "

All the transformer sets used with tuned circuits. The distances cited are compiled from data on the performance of a number of good stations, some of them in cities, where the absorption loss due to ground leakage to roofs and wires are at a maximum, and the aeriels were of good size, and well insulated. Thus, these figures will be modified by the height of the aerial, and the kind of country or water signalled over. The figures above are alright for transmission over water or flat dry land, but where mountains intervene between the sending and receiving stations, a decrease of possibly 50 per cent, may occur in the signalling range. Tropical climates are also detrimental to satisfactory operation of wireless stations, and depreciate the normal activity of a station very considerably, even as much as 60 per cent, in some cases, in which event it is necessary to employ extra high aeriels and long wave-lengths, coupled to powerful transmitters.

No fixed rule can be laid down for the height of aerial to be utilized for a certain station, the size and height usually being governed by natural conditions and the size of the set. Probably a good average elevation for aerials in use with sets of from 1 to 5 K. W. is about 150 feet. See section on aerials for further data.

Summary:

General wireless transmission of intelligence is strongly on the increase commercially, and it is only a matter of time, and a short time at that, when its sphere of activity will be vastly greater and broader, both on land and sea.

At present, it is in the phase of development which every new art must pass through, and presents a golden opportunity to the scientists and experimenter, who are bent upon discovering the secrets it holds. This is particularly true in regard to the wireless telephone, which through apparent abandonment, is left to lie idly by, whereas it is of the most tremendous importance, in virtue of the fact, that it appeals to every person, young or old, savage or savant. Everyone can talk over a telephone instrument, but few there are, who can or care to bother with a telegraph and its codes.

A few remarks will be devoted here to the present practices in the art of radio-communication, as regards the instruments employed, etc.,

It has come to be recognized after several years of experimental research, that for transmitting messages by wireless telegraphy, the high frequency spark or whistling spark, is the most efficient in cases of severe interference from other stations and bad static particularly. The principal systems employing a high frequency spark and at present being commercially applied, are the; Fessenden. Telefunken; and Marconi.

The spark employed by the now defunct Radio Telephone Co., was a very shrill high pitched one, but was obtained by means of a quenched spark gap, the same as the Telefunken Co's spark. For radiophone work the Radio Co., utilized an arc of special construction burned in hydrogen or other gas.

In the science of radiophony, Prof. R. A. Fessenden, claims to have talked about 400 miles from Brant Rock over sea. The Fessenden system has many commendable features about it, both transmitting and receiving, but possibly the most meritorious part of all, is the absolute and unfailing source of high frequency undamped oscillatory current so essential in radiophony. This current is supplied by a very high speed alternator, usually driven by a steam turbine, such as the DeLaval, in which speeds of 25,000 to 30,000 revolutions per minute are common. This means of producing high frequency undamped oscillations is much superior to the arc or quenched spark gap method, as these are very sensitive and do not deliver a current of constant amplitude, as the arc or spark is constantly changing. The capacity and inductance in arc or quenched spark generators has to be very carefully adjusted, or else the frequency and strength of the undamped oscillations produced will be quite inferior and weak.

The Fessenden system makes use of high frequency alternators as aforementioned, and the frequency of some of them is 40,000 cycles, but at present they are building several with a frequency of 200,000 cycles per second. Anything above 35,000 to 40,000 cycles per second is suitable for radiophony.

In the modern receiving stations, high resistance telephone receivers, (not exceeding 4,000 ohms generally), and crystal rectifying detectors, such as the Perikon, Pyron or Silicon, are in wide use. The Marconi Co., are using a Fleming valve, similar to the De Forest Audion, which is especially adapted to radiotelegraphic and radiophonic communication, due to several inherent characteristics it possesses, which enhance its value greatly where much static and interference have to be worked through. Its receiving range seems to compare favorably with that of any other detector at present employed, and its smooth operation has gained it many friends, especially for experimental research.

The tuning of the transmitting and receiving instruments with the aerial is now done practically altogether, with two-coil oscillation transformers or loose-couplers, as the tuning in this way is much sharper and better defined, than with a close-coupled or auto-transformer, with which it is difficult to radiate a single peak wave, which carries the greatest distance and is the most selective in tuning.

An Appendix of useful tables of wire data, Etc., are added below for the benefit of the student.—

APPENDIX.

Inductivity Values for Different Dielectrics.

Dielectric	Inductivity Value, "K"
Air at Ordinary Pressure, Standard	1.0000
Manila Paper	1.50
Paraffine, Clear	1.68 to 2.32
Beeswax	1.86
Paraffine Wax	1.9936 to 2.32
Paraffined Paper	3.65
Resin	1.77 to 2.55
Petroleum	2.03 to 2.42
Hard Rubber (Ebonite)	2.05 to 3.15
Turpentine	2.15 to 2.43
India Rubber, Pure	2.22 to 2.497
Sulphur	2.24 to 3.84
Gutta Percha	2.46 to 4.20
Shellac	2.74 to 3.60
Olive and Neats-Foot Oils	3.00 to 3.16
Sperm Oil	3.02 to 3.09
Glass (Common)	3.013 to 3.25R
Mica Sheet, Pure	4.00 to 8.00
Porcelain	4.38
Quartz	4.50
Flint Glass, Very Light	6.57
" " Light	6.85
" " Very Dense	7.40
" " Double Extra Dense	10.10

TABLE OF DEFLECTIONS AND TENSIONS FOR ALUMINUM WIRE.

D=deflection in inches at center of span; F=factor, which multiply by weight of foot of wire to obtain tension; maximum load=15,000 pounds per square inch. T=temperature at which wire is strung.

Span	T=-20°		-10°		0°		10°		20°		30°	
	F	D	F	D	F	D	F	D	F	D	F	D
80	12940	¾	1660	5¾	1176	8¼	961	10	833	11¼	781	12¾
100	12940	1¼	2083	7¼	1470	10¾	1202	12¾	1042	14¾	933	16
120	12940	1¾	2500	8¾	1768	12¼	1400	15¾	1251	17¼	1120	19¼
150	12940	2¾	3038	11¾	2540	14¾	1788	18¾	1552	21¾	1390	24
175	12940	3¾	3643	12¾	2576	17¾	2104	21¾	1822	25¾	1630	28¾
200	12940	4¾	4206	14¾	2947	20¼	2403	24¾	2084	28¾	1930	31¼
Span	T=40°		50°		60°		70°		80°		90°	
	F	D	F	D	F	D	F	D	F	D	F	D
80	680	14¾	630	15¾	589	16¾	555	17¼	527	18¼	502	19¾
100	869	17¾	768	19	735	20¾	695	21¾	658	22¾	628	23¾
120	1022	21¾	946	22¾	885	24¾	835	25¾	792	27¼	755	28¾
150	1265	26¾	1177	28¾	1060	30¾	1039	32¾	987	34¼	941	35¾
175	1488	30¾	1377	33¾	1279	35¾	1215	37¾	1152	39¾	1099	41¾
200	1672	35¾	1574	38¾	1473	40¾	1393	43	1316	45¾	1256	47¾

COIL WINDING FORMULAE.

The wave length capacity of any tuning coil is given by the following formula:

$$W. L. = \frac{3.1416 \times d \times t \times l \times 4}{3.3}$$

Where:—W. L.=Wave length in meters.
 d=Diameter of coil in feet.
 t=No. of turns of wire per inch.
 l=Length of coil in inches.

The No. of turns of wire per inch, may be taken from the wire table.

To find the gauge No. of enameled wire with which to wind an electro-magnet, having given the dimensions of the magnet and the resistance of the winding.

For example: Let the outside diameter of the coil in inches be represented by D (for this case 2"); the inside diameter of the coil by Dⁱ (here 1") and the length of shell by L (here 2"); Resistance of winding by R (here say 200 ohms). R_c=Resistance per cubic inch winding; see wire table. The formula is:

$$R = \frac{R_c \times \pi \times L \times (D^2 - D_i^2)}{4}$$

$$\text{Then } 200 = \frac{R_c \times \pi \times 2 \times (4-1)}{4} = 4.7124 \times R_c; \text{ and } R_c = \frac{200}{4.7124} = 42.44$$

$$\pi = 3.1416 \text{ (a constant)}$$

Looking at the enameled wire table the nearest value is found to be 44.9 for R_c and opposite this is No. 29 wire, the size to be used on the magnet.

TABLE OF SPARKING DISTANCES

In Air for Various Voltages Between Needle Points.

Volts	Distance		Volts	Distance	
	Inches.	Centimeter		Inches.	Centimeter
5000	.225	.57	60000	4.65	11.8
10000	.470	1.19	70000	5.85	14.9
15000	.725	1.84	80000	7.10	18.0
20000	1.000	2.54	90000	8.35	21.2
25000	1.300	3.30	100000	9.60	24.4
30000	1.625	4.10	110000	10.75	27.3
35000	2.000	5.10	120000	11.85	30.1
40000	2.450	6.20	130000	12.95	32.9
45000	2.95	7.50	140000	13.95	35.4
50000	3.55	9.00	150000	15.00	38.1

TUNING COIL DATA.

No. of WIRE B & S Gauge	Diameter of WIRE CORE	Feet of Wire per 1 in. of Winding	Wave length in meters per 1 in. of Winding	Turns of Wire per 1 in. of Winding	No. of Wire on Loose Coupler Secondary	Length of Primary and Secondary	Wave length in Meters of Loose Coupler
No. 26	2"	30	37	58
No. 28	2"	38	46	73
No. 24	3"	36	44	46
*No. 26	3"	46	56	58	36	4"	700
*No. 24	4"	48	59	46	32	5"	800
*No. 22	5"	49	60	37	32	6"	1000
*No. 22	6"	58	70	37	32	6"	1200
No. 20	7"	55	67	30
No. 20	8"	63	77	30

NOTES.—To find meters wave length of any tuning coil, multiply its length in inches by wave length in meters per inch of winding.

The data in this table was compiled for WINDINGS OF ENAMELED WIRE ONLY.

*Indicates windings suitable for loose coupler primaries.

Wave length in meters in above table equals length of wire on coil in meters multiplied by 4.

Lesson Number Twenty

The History of The Development of Wireless Telegraphy.

WIRELESS telegraphy is but twelve years old in its commercial and practical development, yet it is surprising to learn that the idea of electrical signaling without wires dates back to the birth of wire telegraphy.

In 1838, Steinheil of Munich, Germany, following the suggestion given by Gauss, demonstrated that the earth could be used for the return circuit of a telegraph line, thus marking the first step and birth of wireless signaling by electricity. It is alleged that he anticipated at the time that eventually the two wires used in telegraphy would be entirely eliminated, thereby leaving no metallic conductor between the two stations.

Following the experiments of Steinheil, a number of experimenters continued in the same path of study, but it was not until the latter part of the nineteenth century that actual progress was made towards the much-sought goal. The following methods then appeared to offer the means of solving the wireless transmission of electricity:—

(1) The conduction of the electric current through moist earth. This method was worked upon principally by Morse, the inventor of telegraphy in this country.

(2) Electromagnetic induction between two parallel metallic conductors, a method suggested and largely experimented upon by Preece, Trowbridge, Stevenson and Lodge.

(3) A combination of the two foregoing principles, which was developed into the first practical wireless system by Sir William Preece, aided by the British Postal Telegraph engineers.

(4) Electrostatic Induction between metallic conductors, separated by a greater or less distance. This idea was developed to a working success by Edison, Gilliland, Phelps and W. Smith, as a means of communication between moving trains.

Of the above mentioned principles of wireless signaling, the only one which promised the possible solution of the problem was that used by Preece, consisting of the two parallel conductors, with the earth return. Even this system was disappointing, from the many difficulties which it presented. In the first place, the two conductors had to be as long as the distance which was to be signaled across. For instance, if a distance of two miles separated the two stations, the wires had to stretch for two miles parallel to each other.



HEINRICH RUDOLF HERTZ.

In 1888, Heinrich Rudolph Hertz, a young German scientist, who at the present time is recognized by all as the real founder of present-day wireless telegraphy, started the world by his experiments with ether waves produced by the discharge of high tension currents. These waves have since been named "Hertzian waves." He proved to a great extent the theories of Maxwell, an eminent scientist who formed profound speculations and mathematical theories relative to electromagnetic waves and light waves, in 1865. Hertz demonstrated the wonderful characteristics of these waves, the most striking being the similarity between them and light waves. The premature death of Hertz in January, 1894, robbed the world of a student who might have become a still more important factor in the development of wireless transmission.

The experiments of Hertz set a number of experimenters to work in the different countries between the years 1888 and 1895, all striving to solve a suitable application for these waves.

Nikola Tesla in 1892 captured the attention of the world with a brilliant series of demonstrations in the application of Hertzian waves to wireless signalling. Sir

William Crookes who was present at these demonstrations was favorably impressed with the possibilities which this method offered, and wrote an article entitled "On some possibilities of electricity" in the *Fortnightly Review* for February, 1892, setting forth a vivid prophecy which has been realized to a great extent to-day.

In 1899, Professor D. E. Hughes, the inventor of the Hughes microphone, gave a precise description of the experiments he had performed with an imperfect contact between iron and carbon for detecting Hertzian waves. This statement was recognized by several other eminent electrical authorities whom he had spoken to at the time of his first experiments. In 1879, he succeeded with the imperfect contact detector in hearing signals in a telephone receiver sent out by the spark of an induction coil. To the scientists who witnessed his experiments at the time he suggested the publishing of his discovery, but was discouraged by them, for they termed the results as induction effect and not the detecting of Hertzian waves. It will therefore be noted that Professor Hughes was perhaps the first discoverer of the telephonic means of receiving wireless signals, and which is to-day universally employed.

On Friday, June 1, 1894, Sir Oliver Lodge delivered a memorial lecture to the deceased Hertz, in the Royal Institution in London. The lecture was remarkable in many ways, setting forth new facts in the experiments made with Hertzian waves. He employed a glass tube filled with filings of metal, for the detection of the waves. Another detector consisted of two pieces of metal clamped together by an adjustable pressure. To these devices he gave the name of "coherers." Upon the reception of the waves, the plates or filings came together, and in all instances were decohered by hand. The refraction, reflection, depolarization, and other properties of the waves were demonstrated, as well as the sending of waves through a stone wall. This lecture served to excite interest setting once more a score of inventors on the problem, but using the correct principle for the purpose of signaling without wires.



SIR OLIVER JOSEPH LODGE.



PROF. BRANLY.

One of these scientists, Professor S. S. Popoff, professor in the Imperial Torpedo School at Cronstadt, Russia, developed an interesting device for detecting the approach of thunder storms by recording the lightning. Upon a lightning rod mast, erected on top of a building, he connected a wire which ran to the laboratory. The other connection was taken from the water pipe. The apparatus consisted of an electromagnet, the armature of which was attached to a Richard Pen writing on a Richard recording Cylinder, making one revolution per week. It was possible to make marks on the cylinder at each flash of lightning at considerable distances, and the apparatus was so sensitive, that an electrical bell rung in the same room as the wireless set caused the pen to register on the cylinder. Popoff stated at the time of these experiments that if a means of forming electric waves similar to those caused by lightning were employed, wireless signalling would be an accomplished fact. To Popoff we owe two points in the development of the wireless art, one of which is that he was the first experimenter to use an aerial, which is indispensable for practical work even to-day, and that he recognized the possibility of applying wireless telegraphy to these experiments.

It was not until the appearance of Guglielmo Marconi, a young Italian born at Bologna in 1874, who was working on the commercial possibilities of wireless telegraphy, that the actual progress in the art began.

Marconi had studied in the Leghorn Technical School under Professor Rosa, and had keenly interested himself in all that had been done by the earlier experimenters in wireless signaling. At his father's estate at the Villa Griffone, near Bologna, he began experimenting in June, 1895, with the Hertzian waves. Before long he abandoned the Hertzian form of radiator, and instead connected a wire to a metal plate laid on the ground, and the other wire to a plate held on the summit of a pole. This method had been used by Popoff but without the knowledge of Marconi. During the latter part of 1895, Marconi was able to transmit signals a distance of about $1\frac{1}{2}$ miles using poles about 25 feet high and with tin sheets suspended on the poles. Before this time he had succeeded in improving the Branly coherer, and making it more sensitive. He had also produced an electric tapping arrangement for decohering the coherer.

The apparatus in all consisted of a coherer, a decoherer, a relay, and a Morse printing instrument, all worked with battery cells. Choke coils were interposed between the coherer and the relay, which greatly increased the efficiency of the receiving set. Across the relay and other contacts, he placed shunts, thereby reducing the sparking to a minimum so that it would have little, if any, effect on the sensitive filings. All the adjustments were carefully made, and he was thus able to cover ranges far in excess of the other workers, who had failed to consider the slight details of the individual parts. The transmitting apparatus consisted of a spark gap of huge proportions as compared with the present type, on to which the aerial and ground wires were connected. An induction coil working on batteries was employed for furnishing the high tension current to form the spark. His first spark gap con-

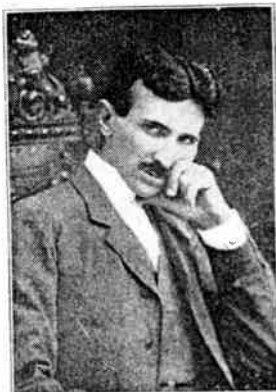

NIKOLA TESLA.

sisted of the ball discharger used by Professor Rhigi, composed of four solid brass balls, the two center ones being separated by a small space filled with vaseline oil, the spark jumping from the two end balls to the center ones which again broke the spark in the vaseline mass, producing a high frequency spark. By pressing the key at the transmitting end, a short or long dash was recorded on the paper tape. In 1896, Marconi came to England, and began to draw the attention of the scientific world towards his apparatus.

In July, 1896, he introduced his invention to Sir William Preece, on which Marconi had already applied for a British patent during the preceding June. Preece was very favorably struck with Marconi's apparatus, and in a subsequent lecture praised it highly. By 1897 Marconi had succeeded in covering nearly 9 miles between Penarth and Brean Down, across the Bristol Channel. On the Salisbury Plain he covered four miles over land. A 6" coil was employed in these tests for distances up to 4 miles, but a 20" spark coil had been used for distances of greater length. Kites were employed to raise the aerial wires, and though reflecting screens were used these were found to play but little part in the results. Up till the present time Marconi had not invented any new apparatus, but had simply made improvements and had arranged the apparatus in a new manner. In July, 1897, Marconi undertook demonstrations for the Italian Government at Spezia, in Italy, and covered a distance of 12 miles between war ships. In April, 1898, Marconi was transmitting messages over 14 miles using a 10' coil between Alum Bay, in the Isle of Wight, and Bournemouth, England, the distance being over the sea. A 10' coil was employed, and spark gap consisted of four brass balls separated a slight distance apart in an ebonite frame. One of the outer balls was connected by a wire to an insulated strip of wire netting about 120 feet long, supported to the top of a mast 120 feet high. The spark gaps were $\frac{1}{4}$ " apart. With this apparatus a speed of 15 words per minute could be maintained without difficulty. Numerous installations followed, some being for light-houses and lightships.

In July, 1898, the Marconi system was installed on the steamer "Flying Huntress" to report the results of the yacht races at the Kingston Regatta for the Dublin *Empress* newspaper. The aerial conductor of the land station was but 40 feet high, yet messages were exchanged at distances varying from 5 to 20 miles, without difficulty. His Majesty, King Edward VII., then the Prince of Wales, had injured his knee and was confined on board the Royal yacht "Osborne" in Cowes Bay. Marconi, at the request of the Prince, fitted the yacht with wireless apparatus and also at the Osborne House, Isle of Wight, and communication was established between these stations for over three weeks. The shore mast was 105 feet high and the aerial aboard the yacht

about 83 feet high. The distances were small, but at times trees, hills and other obstacles were interposed between the two stations which did not detract from the results as had been expected. The successes of these tests led many other stations to be built permanently for the Corporation of Trinity House to be used in connection with the lighthouses and lightships.



GUGLIELMO MARCONI.

(Courtesy Co-Operative Press.)

After many further improvements in his apparatus, Marconi succeeded in transmitting messages across the English Channel from Wimereux, near Boulogne in France to the South Foreland Lighthouse near Dover in England, on March 27, 1899. The aerial wires were single stranded copper wires 150 feet long, insulated with india rubber, and upheld at the top by ebonite rods as insulators. Many scientific men were present at the tests, among which Professor Slaby of Germany obtained his first inception of what has since developed into the Slaby-Arco system of wireless telegraphy.

The first application of wireless telegraphy in saving human lives occurred when the "R. F. Matthews" on April 28, 1899, during a dense fog ran into the East Goodwin Lightship and inflicted serious damage. The lightship being provided with Marconi apparatus was able to communicate at once with the station at South Foreland Lighthouse, and tugs and a lifeboat were sent out immediately from Ramsgate to the assistance of the lightship. If it had not been for the speedy aid of the ships, it is probable that a serious loss of life would have resulted.

Many installations and demonstrations continued, proving to the public that wireless telegraphy was an accomplished fact, and was rapidly progressing. A distance of 85 miles was covered between Wimereux in France and Chelmsford in England, partly over land and sea. A very important demonstration took place when the "New York Herald" employed Marconi apparatus for reporting the results of the

International Cup race between England and the United States. Over 4,000 words were sent in 5 hours' time, covering a number of days. Another test was in the equipment of the two cruisers "Juno" and "Europa" of the British navy, which were able to communicate 85 miles without difficulty. From that time onwards, the installations on land and sea became so numerous that it became an established necessity for navigation.

From 1898 till 1901, Marconi devoted himself to the perfection of tuned wireless transmission, which he succeeded in developing to a working success within that time. His next attentions were turned to transatlantic wireless communication.

Until this time the power used in transmitting had never been over $\frac{1}{2}$ kilowatt, and usually between 200 and 300 watts, the transformers being 10 or 20 inch spark coils. The condensers had been ordinary leyden jars, and likewise the telegraph key was of the standard type to break the low amperage current. With the consideration of greater ranges, many improvements had to be made to handle the much more powerful current.

A site was selected at Poldhu, on the coast of Cornwall and the necessary building erected. 20 masts each 200 feet high were arranged in a circle upon which the aerial wires were supported, being all hunched together at the lower end and entering into the station. In November, 1901, Marconi left England for Newfoundland with his assistants and apparatus. Arriving at St. Johns in Newfoundland on December 5th, he prepared the apparatus for the reception of the signals. On December 9th, he cabled to the Poldhu assistants to begin sending the signal letter "S" from 3 p. m. to 6 p. m. each day. After some difficulty in raising the balloons and kites, he succeeded in receiving the signals on December 12, 1901, marking the first bridging of the Atlantic Ocean by means of wireless telegraphy. The actual power employed at Poldhu for transmitting during these tests did not exceed 10 to 12 kilowatts. The distance covered was approximately 2,200 miles. At the receiving end an auto coherer consisting of carbon-mercury-iron in a glass tube had been employed in connection with a telephone receiver and battery. No tuning device was employed, and it is remarkable that the distance should have been covered with this crude apparatus.

From that time many improvements continued to be made by Marconi until today the majority of transatlantic liners employ his apparatus, and transatlantic wireless telegraphy is firmly established and being used for both commercial work and press messages.

While Marconi may be justly considered the foremost wireless inventor, many others have helped in the lesser details to make the art a commercial success.

Sir Oliver Lodge who had performed experiments and researches in Hertzian waves before Marconi entered the field, continued his work, and after Marconi's successful application of Hertzian waves to commercial purposes, Lodge united with Dr. A. Muirhead to develop a new system. Following the ideas of Marconi, they developed a very successful system, employing an aerial and ground capacity for both sending and receiving. The sending apparatus consisted of the standard spark gap furnished with high tension current from an induction coil. The receiving apparatus consisted of a mercury coherer, an entirely new departure from the Marconi filings coherer. This detector consisted of a small steel wheel dipping into a drop of mercury held in a rubber cup. The contact between the wheel and the mercury was normally separated by the film of oil spread over the mercury, but under the influence of the Hertzian waves the two conductors came together, bridging the circuit for a relay, which in turn closed the writing register. The Lodge-Muirhead system became one of the best, and to-day is still recognized as an improvement over many.

Dr. Adolf Slaby, one of the engineering professors in the Technical High Schools at Charlottenburg—Berlin, had been industriously working on the problem of wireless telegraphy prior to Marconi's success. His attention was called to the experiments of Marconi, and he visited the young inventor to witness the cross-channel tests. Slaby being a deep scientist thoroughly studied Marconi's apparatus, and noted the many improvements which he afterwards incorporated in his system. He joined forces with a young student and electrical engineer, Count Von Arco, who developed the Slaby-Arco system which remained standard until recently, being replaced by the more modern systems. The Slaby-Arco apparatus utilized the same principles as Marconi, employing an induction coil working on lightning current with a mercury interrupter, and the standard spark gap and leyden jars. The receiving set consisted of the silver filings coherer, and the relay with the Morse register.

Professor Ferdinand Braun of the University of Strassburg, also contributed largely to the advancement of wireless telegraphy, though is not as well known as other less capable investigators and inventors. As early as 1895, the German patent office granted patent rights to Braun on closed oscillating systems with an inductive coupled antenna. This system was advocated by Braun as possessing remarkable efficiency over directly coupled systems employed by other rival systems. Braun became associated with the firm of Siemens & Halske, so that his apparatus might be manufactured and placed for sale. His final and commercial sets consisted of a large coil worked with an electrolytic interrupter, a set of leyden jars, enclosed spark-gap, oscillation transformer wound with insulated wire placed in oil, and for the receiving set the standard type of coherer, relay, and Morse register. The coherer consisted of a glass tube containing polished steel plugs with steel filings between

them. An aerial connection was utilized, but instead of using a ground, the capacity method was employed. This consisted of two metal tubes, one fitting within the other, so that it might be drawn out, making more or less capacity with the earth. A number of these "balancing capacities" could be used in accordance with the requirements of the station. In the summers of 1899 and 1900, Braun established communication between Cuxhaven and Heligoland, a distance of 40 miles, using aerial wires 90 feet high, and the inductive coupled antenna connection for transmitting contrary to the other systems at the time.

In the summer of 1903, the inventions and interests of Slaby, Von Arco, Braun, and Siemens, were combined and a single company formed bearing the name of "Gesellschaft für Drahtlose Telegraphie" and operating a system known as the "Telefunken" system. This system has been rapidly developed, and presents to-day perhaps the acme of wireless telegraphy perfection, a description of which will be found under the heading of "Quenched sparks" in a previous lesson.

Professor J. A. Fleming has made many valuable contributions to the steady advance in wireless telegraphy. Among his most important inventions is the Fleming wave-meter, which was among the first to be introduced in the art. The audion, which is also known as the "Fleming Oscillation Valve" is likewise an invention of Fleming, though Edison and other workers had noticed and suggested upon the possibilities of the peculiar phenomena of a heated vacuum in other directions. Many other inventions are credited to Fleming, and while of considerable importance, our space does not permit a full account of these.

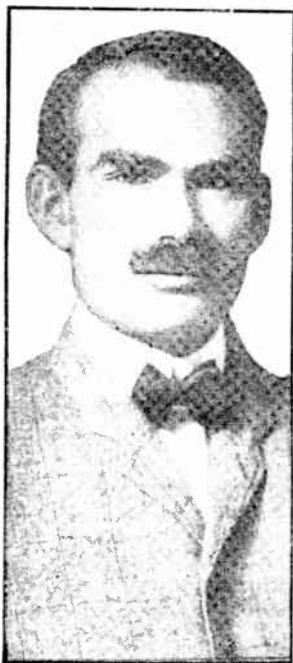

LEE DE FOREST.

(Courtesy Co-Operative Press.)

Dr. Lee de Forest is another American worker in the wireless field, who has invented numberless improvements in the art. He founded the De Forest Wireless Company which was later taken over by the United Wireless Company,* which till recently remained the largest company in America, and operated over a greater field than any company with the exception of the Marconi interests. Dr. De Forest has turned his attention to Wireless telephony in the last few years, and has accomplished some results in that direction, and is now connected with the Federal Telegraph Co.

*The U. W. T. Co., is now owned by the Marconi Wireless Telegraph Co.

In America, Prof. R. A. Fessenden began experimenting in 1899 while in the employ of the United States Weather Bureau at Washington. Among Fessenden's numerous inventions are: the Compressed air condenser, the hot-wire barretter, which consisted of a minute piece of platinum sealed in a vacuum bulb. Fessenden is given credit for having invented the electrolytic detector, which was for a number of years the standard of detectors. By constant application to experimenting and study he has perfected a system which is largely employed and found to be exceedingly powerful for long distance ranges.

Dr. John Stone, and H. Shoemaker are other prominent American inventors, both of whom have developed successful commercial systems bearing their names. At the present time both of these workers have retired from the active wireless enterprises, though their systems are largely employed on various ships and in land stations.

In Europe we must not forget to remember other eminent workers but of less renown. Blondel in France made many suggestions and improvements in selective signaling which are being used to-day, as well as other discoveries. Schloemilch and Ferrie, of Germany and France respectively, both discovered the electrolytic detector independently, which was afterwards patented by Fessenden in the United States. Both of these workers have perfected other valuable apparatus which are being used to-day.

Wein and Goldschmidt of Germany have produced valuable inventions. The former is the originator of the "Quenched Spark" method of wireless signaling which is an entirely new departure from the Marconi spark system that had been used for years and still to-day is the most universally employed. The latter has perfected a high frequency alternator which has a sufficient output and efficiency to make it a success when used in connection with wireless telegraphy and telephony. Perhaps the future contains many surprises through the correct application of this high frequency alternator.



HUGO GERNSBACK.

Valdemar Poulsen of Denmark, has spent many years in the study of the electric arc method of transmitting, and his system is being successfully exploited in the United States to-day by the Federal Telegraph Co. It possesses wonderful tuning merits, and long ranges with the minimum power consumption. Von Lepel, a German scientist, has likewise perfected a system employing a new principle, of two metal conductors separated by a thin piece of paper which has a hole cut through its center. This system has been found to work advantageously for military purposes, for it also possesses an unusual degree of selectivity which cannot be obtained with most other systems.

Through the amalgamation of the ideas and experiments of the many eminent scientists and others of less note, the present wireless industry of to-day has been evolved, covering a period of about 12 years in actual advancement from its first practical demonstration. To-day every vessel of a reasonable size carrying a certain number of passengers is required to possess wireless equipment. The industry employs numberless men who are especially trained for the positions and pass a Government examination before being entitled to positions.

Amateur wireless telegraphy has advanced rapidly in the United States. In 1905 there were possibly a handful of experimenters, and whom could receive a signal or two on a crude coherer device which was home made. Expensive apparatus could be bought, but at prices far beyond the reach of the greater number of enthusiasts. These expensive sets at the most were impractical, and only serviceable for a demonstration in the lecture room. In 1904 Hugo Gernsback founded the **Electro Importing Company**, which had for its main object the supplying of amateur wants. He began the designing of a coherer set with a 1 inch coil which could be used for ranges up to one mile. This apparatus was followed by a tuning coil, then by a different type of detector, and by thus adding a new instrument from time to time to the ever increasing stock, the Electro Importing Company offers to the experimenters at the present time a complete wireless equipment equal to the best of commercial sets within the reach of all. Gernsback has developed his apparatus with great difficulty, having many obstacles to overcome. It would have been an easy task to design apparatus which could be sold at a prohibitive price, but to manufacture and sell wireless apparatus at a low cost has proven a difficult problem, which fortunately to young America, has been met by Gernsback. He also has founded the Wireless Association of America, which has been formed to protect the interests of the amateurs against unfair legislation which threatened the development and liberty of the youthful experimenters. In 1908 Gernsback founded the now well known periodical **Modern Electrics**, which to-day is considered an authority on wireless. This periodical has helped perhaps more than anything else to make American amateur "Wireless" what it is at present.

It is doubtful whether the young experimenters of America appreciate the work which has been done for them by Gernsback, the originator of experimental wireless supply houses in the United States.

CONTENTS.

Lesson No. 1	The Principles of Electricity.
" "	2	The Principles of Magnetism.
" "	3	Dynamos, Motors, Generators and Wiring.
" "	4	The Principles of Wireless Telegraphy.
" "	5	The Amateur Transmitting Sets and Apparata (Part One).
" "	6	Transmitting Sets (Continued).
" "	7	New Transmitting Systems.
" "	8	Receiving Apparata (Part One).
" "	9	Receiving Apparata (Continued).
" "	10	The Detectors.
" "	11	Aerials, The Wires of the Wireless.
" "	12	The Hook-Ups and Connections (Part One).
" "	13	The Hook-Ups and Connections (Continued).
" "	14	Operation of the Instruments. Wireless Regulations.
" "	15	Learning to Operate.—The Codes. Wireless Law.
" "	16	Commercial Ship and Land Wireless Stations.
" "	17	High Frequency Currents.
" "	18	The Wireless Telephone.
" "	19	The Mathematics of Wireless Telegraphy.
" "	20	The History of the Development of Wireless Telegraphy