

HIGH FIDELITY

Simplified

by

HAROLD D. WEILER

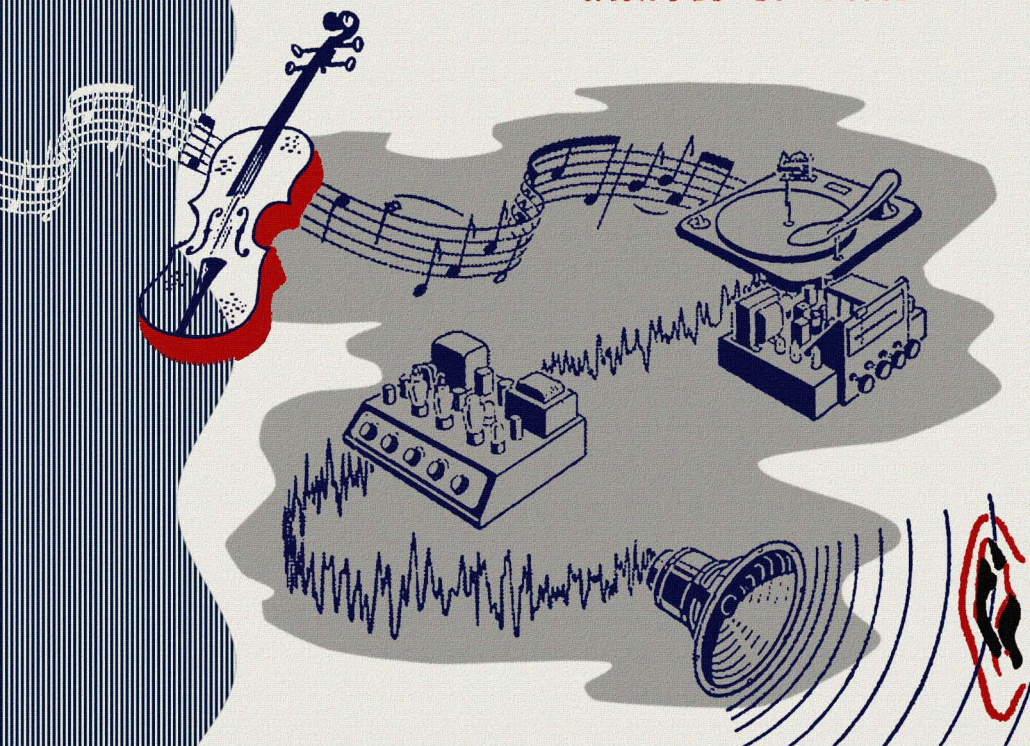

A RIDER PUBLICATION

\$250

HIGH FIDELITY

Simplified

by

HAROLD D. WEILER



JOHN F. RIDER PUBLISHER, INC.
480 Canal St. • New York 13, N. Y.

Copyright 1952

JOHN F. RIDER PUBLISHER, INC.

*All rights reserved. No portion of this book
may be published in any form or language
without written permission of the publisher.*

FIRST EDITION

Printed in the United States of America

To
Marie and Carrie

P R E F A C E

Not so long ago the term "high fidelity" was known only to a handful of engineers; now, it is almost a household word. High fidelity means different things to different people. To the engineer, it means a wide range of frequencies. To the layman, it means superior sound reproduction.

When developing the Long Playing record, I strove for a source of music which would satisfy the majority of people; namely, those whose interpretation of high fidelity falls into the second category. I interpreted their conception of superior music rendition as something which approaches the original as closely as possible. Thus, the expression "high fidelity" is probably misleading to the average person, and what people really seek could be called realism.

This realism has to be preserved first, throughout the production of the record, and so this applies to the record maker; and second, in reproducing the record in the home. There, preservation of realism becomes the task of the reader of *High Fidelity Simplified*.

As for the record, the chief technical ingredients which contribute to this better quality music (and which represents the foundation of the Long Playing record) are low distortion, extended frequency range, low surface noise, and last, but not least, uninterrupted playing of pieces which were meant to be played that way. The need for some of these appears to be quite obvious, but not as obvious as one might think. Let us take, for example, low surface noise. There is no surface noise at all in a concert hall and those listening in their homes to shellac records prior to the LP record became immune to the disturbing sounds. They listened *through* them to the music they desired to hear. Yet we all know that every room, every hall, or even the outdoors has its own acoustical characteristics, echoes and reverberations, without which music cannot

be realistically rendered. Unfortunately, these room tones are subtle enough to be masked easily by surface noise, which then results in unrealistic rendition.

Naturally, recording techniques in the studio, such as placement and types of microphones, locations of the artists, the orchestra, and so on, are all factors which can be made to contribute to the illusion of reality. But, in order for these to become effective in the final reproduction, the medium has to meet certain technical requirements such as those just outlined.

One we have a record which carries in its tracks superior musical quality, the responsibility rests with the reproducing equipment to convey the sound, as originally intended, to the ears of the listener.

Some high-fidelity fans concentrate on equipment designed to handle a frequency range far beyond the capabilities of the record, thus reproducing all its defects with amazing clarity and loudness. Music reproduced through this type of equipment which, incidentally, is expensive, offers little pleasure to the average listener. It is not generally known that to reproduce music with realism in the average home takes surprisingly little investment and space.

High Fidelity Simplified presents in an extremely lucid and easy form what layman, or even the technically initiated, need to know in order to understand and enjoy the reproduction of superior music in their living rooms. It is quite important to keep in mind not to go overboard on any single item. For example, most records do not contain a great deal of usable information below 50 cycles or above 10,000 cycles. Yet reproducing equipment with excessive response below 50 cycles can produce annoying rumble, while exaggerated response above 10,000 cycles will create annoying surface noise. Those 7½ octaves of sound contained on the average Long Playing record, when reproduced the right way, can create a great deal of enjoyment.

There are other effects, such as distortion and inter-modulation, which one should avoid introducing after the difficult task of extracting the music from the record has been overcome. Fortunately, the human ear is reasonably insensitive to these defects. Yet many

amplifiers for high-fidelity installations belong in the expensive class mainly because inter-modulation and distortion have been kept far below the acceptable levels.

In many high-fidelity installations, the emphasis has been placed on the loudspeaker and its enclosure as a device for reproducing the widest range of frequencies at uniform intensities with the greatest possible clarity, while other important factors are overlooked. Such loudspeaker installations do not necessarily give the most realistic rendition of the original music recorded. Yet there are ways and means whereby inexpensive and relatively uncomplicated speaker systems can be devised to obtain realistic sound rendition.

I am confident that much of the splendid advice and explanations presented in *High Fidelity Simplified* will guide the reader in creating a system in his home which will give him the most satisfaction at the least expense.

Peter C. Goldmark

*Research and Development
Vice President in Charge
CBS Laboratories*

October, 1952

INTRODUCTION

While production figures on AM radio receivers show that most sets are getting cheaper and cheaper, and that their audio performance is now hardly above minimum intelligibility, more and more high-fidelity radio-phonograph installations are being made in American homes, comprised of audio equipment in which the quality of reproduction is the controlling factor virtually without regard to price.

Well-informed "guesstimates" put the sales of hi-fi equipment and classical LP records at about one-half billion dollars for 1952. Where is this business coming from? How did it get under way? Where is it going from here?

Because of the tremendous interest in high-fidelity by all segments of our population, it is worth-while to check on these questions and analyze the answers so that we may discover just what they mean.

It isn't exactly clear why the American public is becoming conscious of and interested in good music. Increasing attendance at recitals and concerts all over the country indicate the fact, without explaining it. The comment has been made that this is only a passing fad, but those who study people and their interests are definite in their opinions that the love of music is a heritage of the human race, limited in expression only by the opportunity to enjoy it. And it is generally held that, in this respect, we are only now catching up with European countries, where the appreciation of music is so highly developed as to be an established, long-ingrained characteristic of the people.

In years past, musicians came from the Continent to make brief tours here because it was profitable, but otherwise unrewarding to artistic temperaments. During the last decade, however, many of the most renowned Europeans have found in the United States such a favorable climate for the expression of their talents that they have come to make their homes here on a permanent basis.

In short, all significant factors offer reliable assurance that the demand for finer music in public performances and for more re-

alistic reproduction in our homes it not a passing fad, but a new phase in the cultural progress of the American people.

The demand for fine music from FM, records, and tape has far outgrown the original group of hi-fi enthusiasts who initiated the improvement of audio equipment and records and the development of tape recorders. Those men were chiefly engineers, interested principally in the art of faithful reproduction. They were not so much concerned with listening to musical compositions as in playing spectacular passages which could not be reproduced by conventional equipment. But today sales are being made to people who are discovering that, through the medium of fine audio equipment, FM radio, LP records, and 15,000-cycle tape, they can have musical entertainment in their homes that is virtually equivalent to the original performance.

The mechanical phonograph flourished because it had great appeal as a novelty, but it faded out because it had no permanent status as a means of realistic reproduction.

AM radio rose to popularity as a scientific marvel of universal appeal, but it settled down to the status of an essential home appliance, important mostly because it furnishes listen-while-you-work soap operas, makes it possible to hear crime stories instead of reading them, and provides communication in the form of news and weather reports.

Then, in succession, came FM radio, LP records, and magnetic tape. Each is capable of development as a source of musical entertainment that provides the illusion of bringing the artists and musicians into our homes.

Of these media, LP records are the most popular, and present live-talent programs that are almost perfect as to tonal fidelity and dynamic range. It is also possible to make tape recordings of completely realistic quality, but such tapes are not yet available commercially and must be made at home.

Meanwhile, an increasing number of people are installing high-fidelity equipment capable of getting the best possible reproduction from one or more of these sources of music. As the number continues to grow, the demand will increase for FM programs using live talent or 15,000-cycle tape, as well as for LP records of uni-

formly higher fidelity, and for prerecorded tape of 15,000-cycle quality.

Full-range reproduction adds as much entertainment value to a hill-billy band as to a philharmonic orchestra.

Those who abhor barber-shop quartets discover that the presence *effect* resulting from full audio range and dynamic range gives a totally new and very engaging quality. Truly, something has been added. Similarly, people to whom orchestra compositions seemed tiresome and confusing find new and interesting qualities in such music when they hear it without background noise and distortion, and with full bass and treble response.

In step with the growing volume of hi-fi equipment sales, the number of dealers specializing in this field is gradually increasing. So far, most of them are in the parts-jobber category. Many have been doing a substantial retail business in tuners, amplifiers, and speakers. Now they are installing audio demonstration rooms in increasing numbers.

Until lately, radio stores handling factory-built audio and television sets have not had sufficient understanding of hi-fi customers or equipment to get into that business.

However, public interest is already at such a level that any city of 100,000 population can support a store specializing in hi-fi equipment sales and installation work. Because practically all the present hi-fi dealers started as parts jobbers, they have shied away from handling records. Very few salesmen who know the equipment have any knowledge of music. Yet equipment and records can and should be sold together, and will be, no doubt, as time goes on.

From the foregoing notes on hi-fi activities, it is safe to conclude that an entirely new kind of market for FM receivers and audio equipment has been established. It will grow as rapidly as the American public is given the opportunity to hear and compare high-fidelity reproduction with the limited quality of AM radio on conventional sets, and of records and tape used with the kind of equipment that we are now coming to consider old-fashioned.

Milton B. Sleeper
Publisher, High-Fidelity Magazine

October, 1952

CONTENTS

Chapter 1	How, What, Why and Where	1
Chapter 2	Sound!	16
Chapter 3	Acoustics, Electronics and Music	30
Chapter 4	The Simple Loudspeaker	43
Chapter 5	The High-Fidelity Loudspeaker	57
Chapter 6	Loudspeaker Enclosures	75
Chapter 7	The Basic Amplifier	97
Chapter 8	The Amplifier, Part 2	111
Chapter 9	The Record Player, Part 1	133
Chapter 10	The Record Player, Part 2	143
Chapter 11	The Tuner	165
Chapter 12	Use of the Home Music System	173
Chapter 13	Tape Recorders	186
Index		205
High Fidelity Component Manufacturers		207

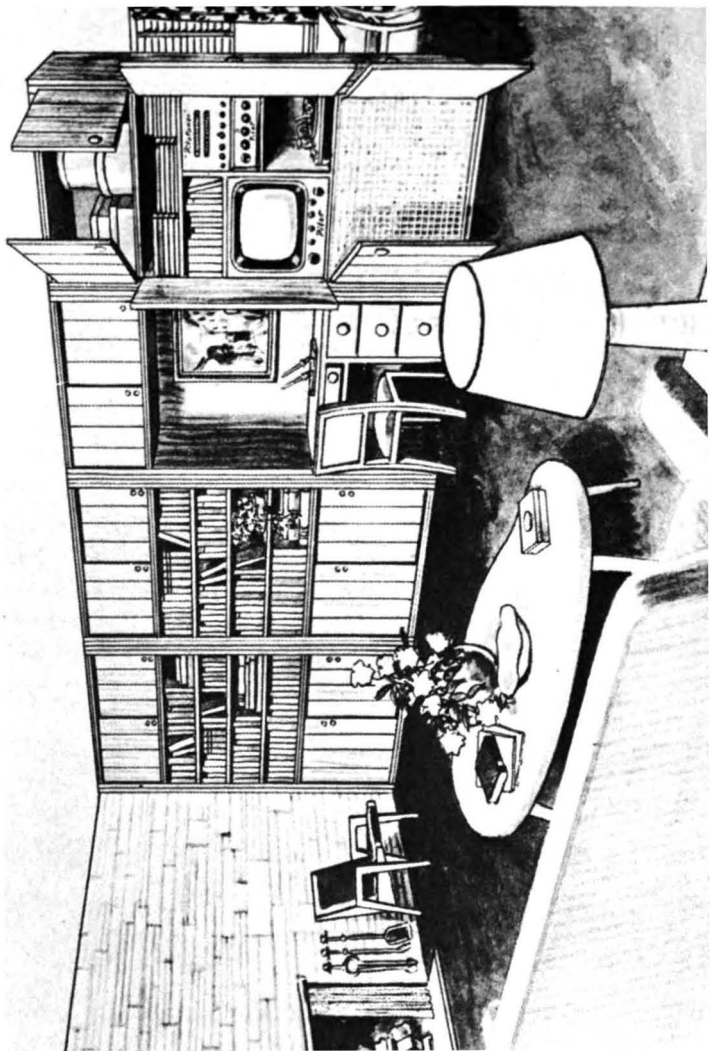

Courtesy Nova Sales Co.

A MODERN HOME MUSIC ROOM

CHAPTER I

HOW, WHAT, WHY AND WHERE

What is high-fidelity reproduction? How does it differ from reproduction available through a commercial radio-phonograph? Can the difference be heard? How? What constitutes a high-fidelity system? How can such a system be obtained? Where? Are period cabinets available? Can a system be installed in existing cabinets? Can high-fidelity components be used with built-in furniture?

This book is addressed to you as one of that growing multitude of people who love and appreciate good music of any kind. For various reasons, geographic and otherwise, many of you cannot manage frequent attendance at live performances of the music you like. Others of you can, but would like to augment this attendance. All of you are concerned with an alternative: the full enjoyment of this medium in your own homes.

The best you have been able to obtain, up through the recent past, could hardly be called music for full enjoyment. You will be the first to acknowledge this. In the years during and before the war, you had little choice. You had to be content with commercial radio-phonographs which gave you, at best, insipid, unsatisfactory reproduction — the shadow rather than the substance of music. The emo-

tional and spiritual impact of inspired expression had vanished; the substitute could not match the soul-satisfying experience of a live concert. Before the end of World War II it was virtually impossible to obtain, in the home, even a reasonably good reproduction of the original music.

The years following the war have brought forth many improvements in both the recording and transmission of sound. The first of these was FM broadcasting, which allows transmission of a tonal range covering the entire span of audibility, and a loudness range very nearly equal to that of a full symphony orchestra. In addition, modern phonograph records are far superior both in range and in respect to reduction of objectionable needle scratch. Even the AM broadcast of today has been greatly improved insofar as tone quality is concerned. These advances set off a chain reaction. They encouraged the engineers and manufacturers of sound reproducing equipment to make corresponding improvements in their products. This is the manner in which "High Fidelity," as we know it today, was born.

High-fidelity reproduction differs from ordinary reproduction as much as a color photograph differs from an ordinary snapshot. One of the important differences is that high fidelity reproduces all of the tones and overtones necessary to distinguish one instrument from another. When we realize that the composer and conductor use the different instruments to create variations of mood and other effects, we can readily understand the tremendous importance of this factor alone. We see that, without it, we cannot hope to reproduce the full artistry and beauty in music.

Yet this is only one of many factors which create the startling difference between high fidelity and ordinary reproduction. As we continue you will discover many more advantages made possible by the new, advanced reproduction techniques for the home.

There are a number of methods which can be used to illustrate the difference between ordinary and high-fidelity reproduction. The simplest of these is to listen to your present equipment — and to listen selectively.

Do you hear cymbals as a crashing sound followed by a sustained shimmering? Do you hear the triangle as a clear ringing

sound? Can you actually feel the vibrations of the tom-tom, the bass drum, or the lowest notes of the organ? A staccato passage in a piano solo should be crisp and clear, each note standing out by itself. Do you hear it that way? Does your system sound well at low volume or is it necessary to increase the level before the reproduction is fairly good? Although they are near opposite ends of the range of strings, can you always differentiate between the violin and the violoncello? Can you tell the difference between string bass and brass bass?

The answer to all these questions should be in the affirmative. Should the answer be negative to any of them, you are not enjoying the results made possible today.

High-fidelity reproduction will then be a revelation to you; it will open the door to a new concept of music at home.

What, then, constitutes a high-fidelity system? It consists of four basic components, all of equal importance as we shall soon discover.

The first component is a tuner, which is used to receive radio broadcasts. There are three types of these. The first is the AM tuner, which is similar to the front end of your radio receiver and is used for standard AM broadcast reception.

AM reception is limited in its ability to reproduce the wide tonal range necessary for high-fidelity reproduction. This is due in part to the method used in allocating the wavelengths on which these stations transmit. These stations were assigned wavelengths so close to each other that their broadcasts are restricted to only a portion of the audible spectrum. Should they attempt to improve their transmission in this respect, interference with stations adjacent on the dial would result.

The FM tuner is the second type. The quality of FM broadcasts is far superior to that of AM transmissions for many reasons. One of the most important to us at the moment is that a similar limitation of tonal range does not exist. The FM method of transmission is also superior to AM in that the background noise has been reduced to a negligible factor, and in that FM has the ability to handle a greater loudness range.

The third type of tuner is a combination of the AM and FM tuners in a single unit. The selection of one of these three types

depends entirely upon such elements as geographic location with respect to transmitters and personal preferences for the programs offered. The AM stations in the more heavily populated areas usually duplicate their programs on FM; in this event a tuner of the latter type should be sufficient. Then again there may be no FM transmission in your vicinity at the present time, and you may wish to purchase only an AM tuner. The FM-AM combination may be desirable when you find that some of your favorite programs are broadcast on AM alone while others are on FM.

We might do well to point out that the AM tuner and AM section of the combination tuner, while limited, are usually capable of much better reception than their equivalents in commercial receivers. The reasons for this fact, and more detailed descriptions of these tuners, will be given in subsequent chapters.

The second component in the high-fidelity system is a record player. This unit is one of our two program sources and, in areas in which there are no FM stations as yet, it becomes the best source for high-fidelity listening.

Many people who use the record player as a program source do not acquire tuners at all, since the music played is of their own choosing and, naturally, is not interrupted by advertising. There are two types of record players available, the manually operated unit and the automatic record changer. The latter will provide hours of music without requiring attention. As you no doubt realize, there are today three types of records available. Needless to say, regardless of which type of player is purchased it should play all three. A complete chapter is devoted to explaining record players in detail later in this volume.

The third component is the amplifier. The function of the amplifier is to increase the minute amounts of electrical energy from the two program sources, the tuner and the record player, to a point where they will actuate the loudspeaker. The amplifier must reproduce with equal fidelity the entire range of audibility without introducing any distortion of its own. This, incidentally, is the point in our high-fidelity system at which volume and tone are controlled.

The fourth component is the loudspeaker. It converts the amplified electrical energy into sound energy. The loudspeaker has a

second function, which is to propagate the sound waves so that they may be heard equally well throughout the room. There is still one other component which, acoustically speaking, is part of the loud-speaker. This is the speaker housing which will be discussed later, together with the cabinets and methods of housing your high-fidelity system.

Lest our brief description of the various components which constitute a high-fidelity system seem complex, it might be well to point out that thousands of non-technical people have assembled and own such systems. These people have learned from friends that one can obtain enormously better sound quality for a given sum of money when the system is acquired in separate units, as previously described.

These high-fidelity systems were originally available only as separate units. Then some enterprising dealers discovered that the equipment was more convenient for the layman to handle when they furnished interconnecting plugs and cables. These plugs and cables permit the connections from one unit to another to be accomplished without tools or soldering. The furnishing of plugs and cables for a slight additional charge has become almost universal today. An installation by the average person is now quite simple. All that need be done is to insert the proper plugs into their sockets according to the simple directions furnished.

These directions, together with the information contained in this volume, should enable you to select and assemble your system as simply as buying or changing a tire on your automobile. For those people who do not care to "change a tire," the local radio service technician will be happy to perform this service at a comparatively low cost, and even advise you on the choice of components.

"Where and how can a high-fidelity system be obtained?" may be your next question. There are two answers to this question: one for the city dweller and another for the man who lives in the country.

High-fidelity equipment is, at the present time, mainly sold by dealers located in large cities, but this condition is being rectified at an amazing rate: the serviceman and the dealer in smaller cities are discovering the huge and growing market. There are not many

in the smaller cities as yet, but your local classified directory will tell you if there is one in your vicinity.

Should you be unable to find one, purchase the two magazines which specialize in this field, *High-Fidelity* and *Audio-Engineering* magazines. The leading dealers advertise in these magazines, the majority of them sell by mail.

The author, who is associated with one such firm, handles hundreds of inquiries each week from people throughout the world who are interested in high-fidelity equipment. These people purchase by mail and obtain complete satisfaction.

For the city and country dweller alike, the first step toward the purchase of a high-fidelity system is some familiarity with the subject. The second step is to either visit or write, depending on your location, the nearest dealer who handles this equipment. If you can pay a direct visit, you will usually find a sound studio in which you will be able to listen to many different combinations of equipment. By that time you will have read this volume and possibly one or two catalogs. You will consequently have an idea of your requirements. The personnel in the sound studio will be happy to demonstrate anything you wish to hear.

The problem of the country dweller is slightly more complicated, but buying by mail is simple when you supply the following information in your first letter:

The distance from your home of the various AM and FM stations which are in your area; whether or not you would like a combination AM and FM tuner; whether you plan on obtaining most of your music from records; how you plan on housing the equipment or whether you would like suggestions. Should the latter be the case: Do you have period or modern furniture? What woods do you prefer? This cabinet or housing information will help determine the type of controls on the amplifier, remote or otherwise. Another important bit of information is the approximate amount of money you wish to spend on an installation. Also does this amount include cabinets and enclosures?

The organization to which you write should reply within a few days recommending a system or giving you quotations on the sys-

tem about which you inquired. They will include their catalog and an order blank. That's how simple it is!

We all know there are few radio cabinets available which are also fine furniture, and fewer still which are examples of fine period furniture. The reason is that radio cabinets must be designed to please the greatest number of people. This cabinet situation, which has plagued the discriminating buyer for years, is no problem in high-fidelity installations.



Courtesy Harrison Associates

Fig. 1-1 Chippendale and Chinese Modern Cabinets

The subject of cabinets and loudspeaker enclosures will be dealt with in detail in a subsequent chapter but, in order to acquaint you with the wide variety available, we will now touch upon the subject briefly.

Commercial cabinets designed expressly for high-fidelity systems run the gamut from Early American to Chippendale. Almost any period can be obtained. Figures 1-1 and 1-2 illustrate a few.

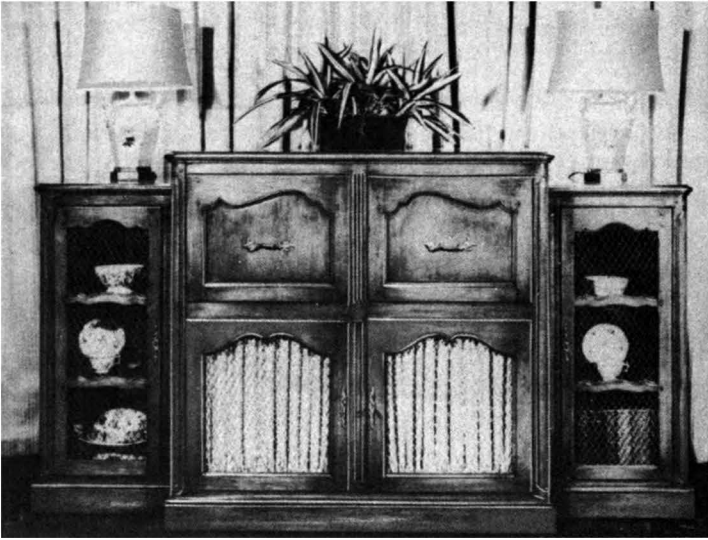

Courtesy Harrison Associates



Courtesy G & H Wood Products Co.

Fig. 1-2 French Provincial and Early American

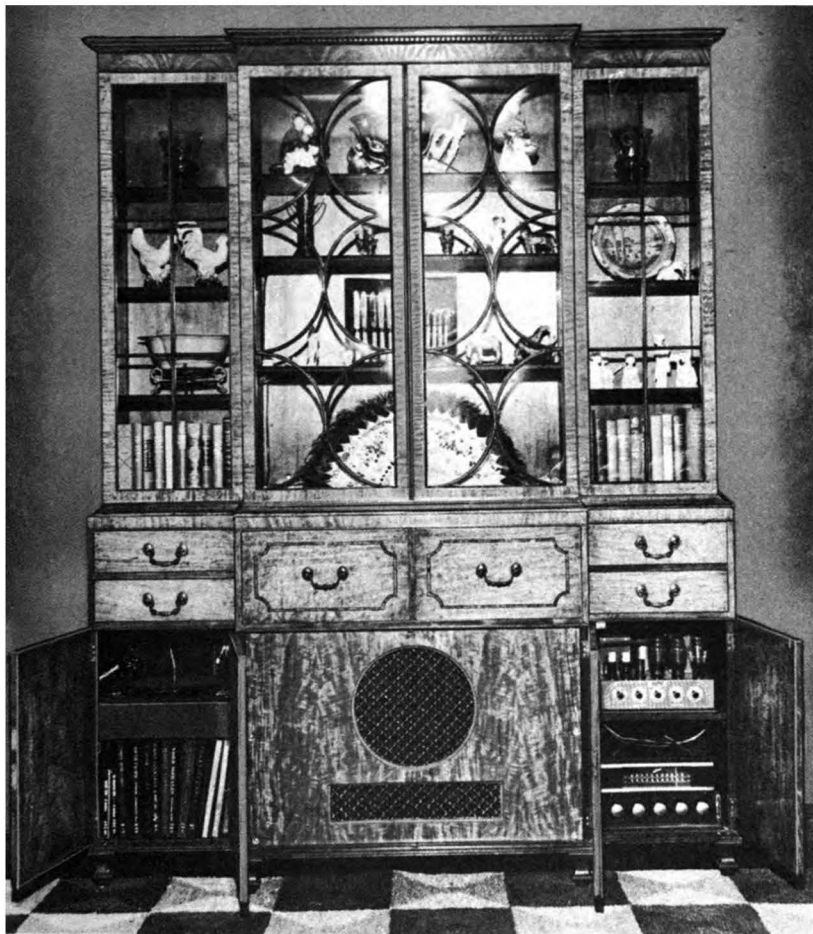

*Courtesy High-Fidelity Magazine
and Bluff City Distributing Co.*

Fig. 1-3 Antique Credenza

One of the many advantages in purchasing a system using separate components is that it can be fitted into almost any space available. This is quite important since many people own cherished period pieces which they would like to put to practical use. These can easily be converted. (See Figure 1-3.) The majority of the companies handling high-fidelity equipment will be happy to help you in making these conversions by suggesting equipment which will fit in the space available; in fact, many of them will even furnish templates for the units you purchase. These are invaluable in making conversions.

The commercial cabinets which can be obtained and the possibility of conversion of older cabinets illustrate the great flexibility with respect to housings.

The current trend toward smaller houses and apartments has resulted in the wide use of space-saving furniture and built-ins. The high-fidelity system lends itself perfectly to this type of furniture. The entire music system can be built into a storage wall. An example is shown in Figure 1-4. Two bookcase arrangements are shown in Figures 1-5 and 1-6.

The cabinets illustrated in this volume may very well suggest variations applicable to your own home. The possibilities are unlimited.

If you were ready at this point to go directly to a dealer or send him an order by mail, the rest of this volume would not be necessary. However, you have begun to form some notions as to what you want in terms of what is possible and how to get it. It will interest you to know that much additional literature is available on the subject both in book form and from manufacturers of high-fidelity equipment. Unfortunately, most of it assumes a previous knowledge on the part of the reader. This book will help you approach much of this data intelligently.

It will also help you to know that other people like you have been banding together for their mutual benefit in approaching their mutual interests. You may wish to affiliate yourself with them.

Enthusiasm for high-fidelity reproduction is so great among those who have heard it, that a number of small groups have

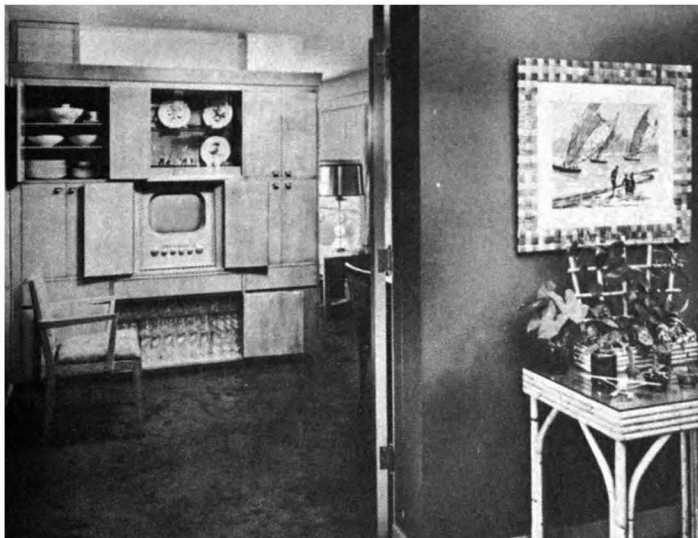

Courtesy Voice and Vision, Inc.

Fig. 1-4 Room Divider Cabinets (ceiling to floor)

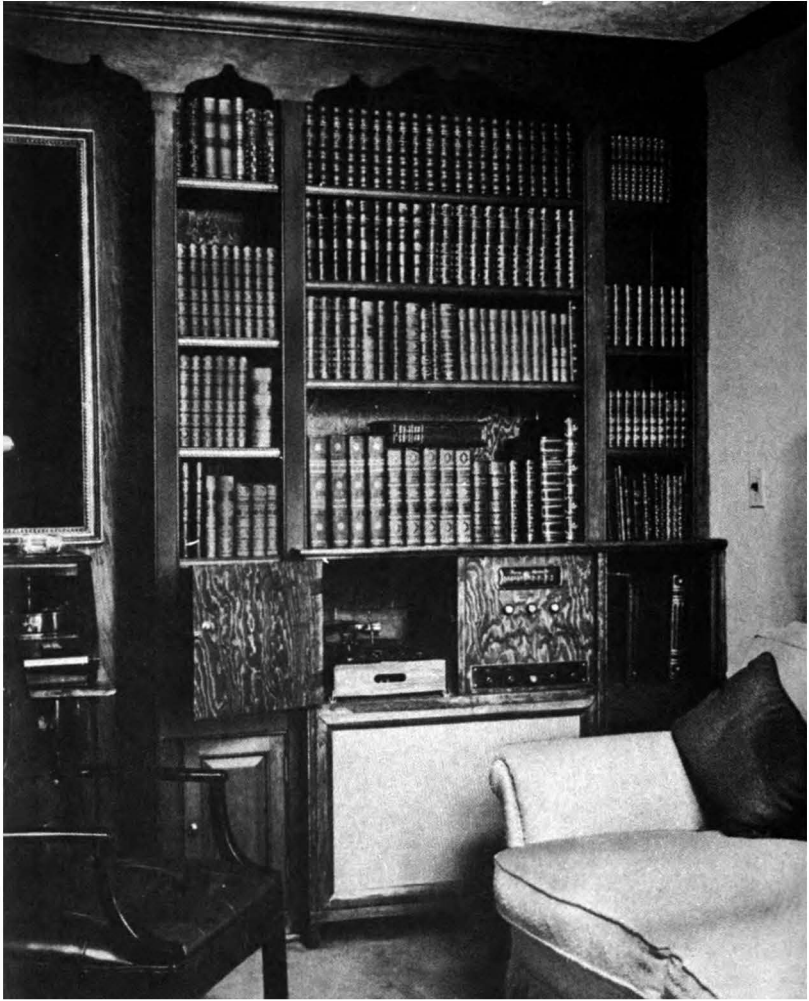

Courtesy Audio Engineering Magazine

Fig. 1-5 Bookcase Installation



Courtesy Voice and Vision, Inc.

Fig. 1-6 Bookcase Installation

already been formed throughout this country and Canada to discuss and compare notes on recorded music and home music systems. The members of these groups are people with a serious interest in music and a keen desire to obtain, in this manner, the music they enjoy.

The spontaneous formation of these widely separated groups is indicative of the tremendous interest in this new aspect of music. This, in turn, has interested a group of serious minded individuals in forming an organization which, from all indications thus far, promises to become an international group soon.

The Society of Music Enthusiasts, for this is its name, states five basic aims, any one of which would be sufficient reason for its being. For interested readers, we reproduce Article II of their Constitution.

Article II of The Constitution

- Section I: Stimulate interest in the subject of music, in all its forms and aspects, for the benefit of all persons everywhere, whether members of The Society of Music Enthusiasts or not.
- Section II: Encourage a better understanding of the creation, interpretation, rendition and reproduction of music through a program of planned education and related activities, within the means of The Society of Music Enthusiasts and its participating member chapters.
- Section III: Provide for the exchange and development of knowledge and information pertinent to the aim and intent of The Society of Music Enthusiasts among its members.
- Section IV: Provide members of The Society of Music Enthusiasts guidance in the technical means of obtaining and attaining "high-fidelity" reproduction of music.

These excerpts point up some of the needs felt by the growing community of home listeners. To meet these needs, this volume will attempt to describe in simple language the various components

which constitute a high-fidelity system, their advantages and disadvantages, in short, how and what to buy in order to obtain complete satisfaction.

As with anything you buy, the more informed you become the greater the possibility of satisfaction. We intend to cover the subject from the manner in which sound is created to the finished high-fidelity system.

CHAPTER II

SOUND!

How sound is created. How it travels. The human ear and how we hear. Measuring sound and the decibel. Common sounds and musical instruments. Pitch, tone and frequency. The piano. Overtones and harmonics. Sound intensity, the ear, and frequency response.

Since our reproducing equipment deals with sound, we must learn something of this medium. Since our ear acquaints us with sound, we should also know something of the human ear and how it functions. We need not delve too deeply into the technicalities involved. We need only a general idea of the operation of this mechanism and its response to stimulation.

Sound is said to travel in waves. A simple analogy for this is the action of the water wave. Everyone has seen a body of water when a stone is dropped into it. From the point where the stone enters the water, a series of continuously expanding ripples move outward in all directions, as shown in Figure 2-1. Sound waves act in the same manner, when the source is non-directional. When the source is directional, the water or sound waves move out in the direction which is not obstructed. An example of this is shown in Figure 2-2, where we drop the stone at the bank of a pond. The ripples

Fig. 2-1
Motion of Sound
and Water Waves

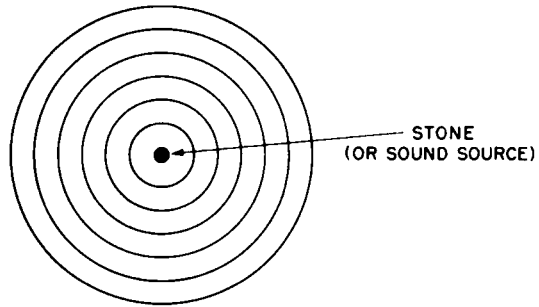

cannot extend on shore and are, therefore, all confined to an off-shore direction.

Other similarities exist between sound and water waves. Dropping a pebble into water creates ripples of relatively small force; dropping a large stone into the water creates ripples of larger force. Sound acts exactly in the same manner; the greater the force that generates it, the louder it will be.

The human ear intercepts this sound energy and converts it into electrical energy; that is to say, it converts sound pressure waves in the air into electrical impulses for the nervous system. The ear is far from being a perfect converting device, as we shall see.

The human ear is divided into three sections: the outer, middle, and inner ear. The outer ear is the collector of the sound pressure waves or energy. The middle ear is separated from the outer ear by the eardrum. This middle ear transmits the sound pressure waves or energy to the inner ear in the following manner: The eardrum vibrates in unison with the sound pressure waves collected by the

Fig. 2-2
Motion of Unidirectional
Sound Waves

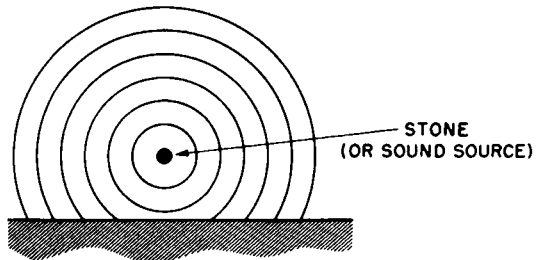

outer ear and actuates three small bones in the middle ear. One of these bones rotates as the ear moves inward. When a part of this bone, which is uneven in shape, rotates, it pushes inward against the fluid in the inner ear and causes the displacement of a membrane. This actuates the inner ear mechanism, in which lies the actual sound converting apparatus. The inner ear converts the sound pressure or mechanical energy into electrical impulses or nervous energy. This, of course, is a greatly simplified description, but is sufficient for our purpose.

Changes in sound intensity affect the ear in the following manner: A loud sound has a greater pressure or intensity than a softer sound and, therefore, causes the eardrum to move a larger distance to create a greater electrical impulse in the nervous system. We can now understand how a sound can be so low that it will not actuate the eardrum. As a result, no electrical impulse is created in the nervous system, and no sound is heard.

We have now arrived at our first technical terms. The first term, *Threshold of Audibility*, refers to a sound pressure or intensity which hardly moves the eardrum and so is barely audible to the average person. The second term, "*Threshold of Feeling*," is a sound pressure or intensity at which the eardrum is displaced to the extent that a painful or tingling sensation is felt.

We will be more concerned with the threshold of audibility. This threshold will be our future *Zero Loudness Level*. This is our third technical phrase.

Since we now have zero level, we must have an exact means of expressing variations from this zero level, or the ratio between two levels; for example, the zero-level sound pressure or intensity and a higher-level sound pressure or intensity which is a certain multiple of it. By having a means of expressing a given variation from the base or zero level we can compare two different loudness levels to each other, or in relation to the zero level.

The means of expressing this variation brings us to more technical terminology and to the most technical portion of this work. An excursion into the science and mathematics of sound is justified, in this case, by the importance of the terms we wish to understand. The *decibel*, for example, is fundamental to most evalu-

ations we will have to make relative to sound equipment. In any event, only enough technical material will be included to make this expression, so important to any discussion of high fidelity, understandable and useful.

We have already said that changes in the intensity or sound pressure of a given sound result in changes of loudness in the ear. However, because of the way in which the ear responds to such changes, the statement must be qualified. First we must recognize that the sound engineer, working in the manner of all objective scientists, has set up exact means of measuring intensity without regard to peculiarities in the ear. The unit in which he expresses these measurements is the microwatt per square centimeter, a microwatt being a millionth of a watt. He has found, for example, that a tone whose frequency is 1,000 cycles per second must have a minimum intensity of .0000000001 microwatt per second when it reaches the ear in order for it to stimulate that organ at all. This is his way of describing zero level or the threshold of hearing, which has already been explained in a somewhat different way.

Dealing with sound intensity in such abstract terms, the sound scientist has discovered interesting facts about the ear. He has, for example, increased the intensity of this sound to twice what it was at the threshold, advancing from .0000000001 to .0000000002 microwatt. One would then expect it to sound twice as loud. This does not happen. If the ear notes any difference at all, it is barely perceptible. Actually, to make the sound seem *twice* as loud to a human being, it must be increased in intensity to *ten times* more than the threshold. It must go from .0000000001 to .000000001 microwatt.

This phenomenon is attributed to a certain stubbornness in the eardrum, which shows an unwillingness to respond to stimulation. When this membrane is excited, it vibrates in sympathy with the exciting sound, but this to-and-fro movement takes place over a prescribed distance. Let us say that a sound whose intensity is .1 microwatt can vibrate the eardrum over a distance of 10 millionths of an inch. These figures are not anatomically correct, but they will serve best for illustration. We know that we must increase the intensity ten times, to 1 microwatt, to make the eardrum move over a distance of 20 millionths of an inch. Table II-1 carries forward this idea to some other sample figures.

TABLE II — 1

Sound Pressure in Microwatts	Motion of Eardrum in Millionths of an Inch
.1	10
1.0	20
10.0	30
100.0	40

Note that, by increasing intensity 1,000 times (from .1 to 100 microwatts), we only increase eardrum motion four times (from 10 to 40 millionths of an inch). That is the same as saying the apparent loudness has only gone up four times. We may now come to certain conclusions. While a change in intensity does result in a change in loudness, the two quantities do not change together in perfect harmony. A relatively large change in sound pressure is required to effect a small change in loudness. For the mathematically inclined, the relationship is approximately logarithmic. In fact the decibel, which is the quantity we use to measure loudness, may be calculated from intensity by means of a logarithmic equation.

For our purpose, knowledge of the equation is not important. We are more concerned with applying the decibel than we are with calculating it. Accordingly, we say that zero decibels, or zero DB, coincides with the threshold of audibility.

We have already mentioned that the relationship between intensity and loudness is only approximately logarithmic. As a result, when one sound is twice as loud as another, it is actually 3 DB higher, or louder. When it is four times as loud, it is approximately 6 DB higher; when it is eight times as loud it is about 9 DB higher. When it is ten times as loud, it also happens to be 10 DB higher.

It is also worthy of note that the smallest change in loudness perceptible by the ear is considered to be a change of one decibel.

Figure 2-3 illustrates our zero level and a scale marked in DB. The horizontal lines of this graph represent the noise levels of typical sounds. The extreme right scale shows intensity of sound pressure. The left-hand scale states the level in DB.

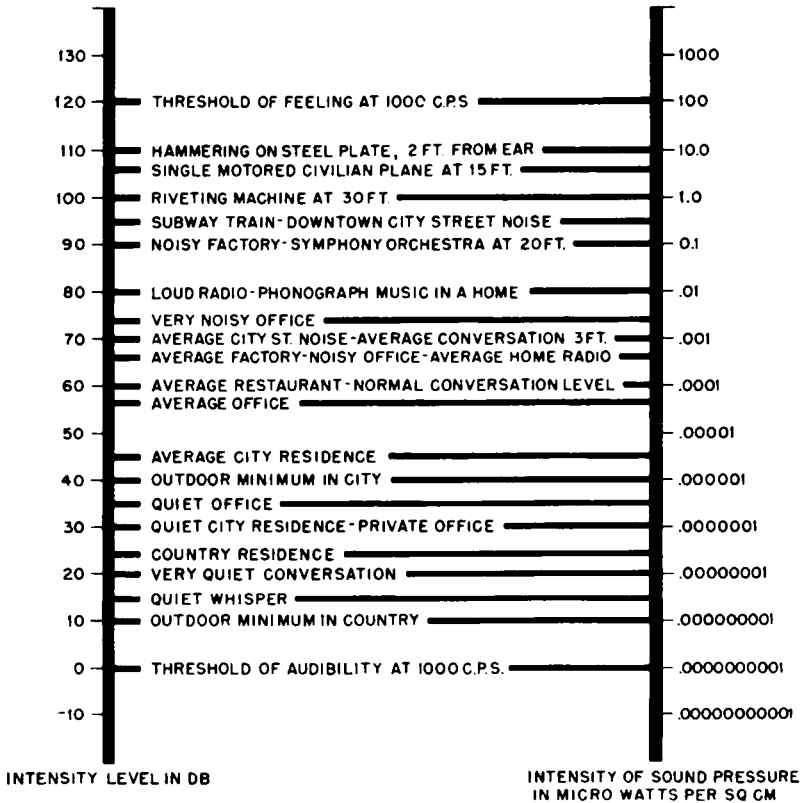

Fig. 2-3 Familiar Sounds and Their Loudness Levels

From Figure 2-3 we can learn a number of interesting facts about the effects of sound pressure or intensity on the human ear.

First, we see why a home in the suburbs is so restful. The average suburban home has a noise level of about 24 DB. A quiet city home has a noise level of 30 DB. This is 6 DB higher and represents four times the amount of noise. We can readily understand why it feels so restful and soothing to get home after a day at a noisy office, even to a city home, as the noise level of a busy office is approximately 56 DB while that of even a noisy residence is 45 DB, or only about one tenth as noisy. This difference is more

pronounced when a subway train is used in traveling home, as its noise level averages 95 DB.

While on the subject of subway noise it becomes obvious why it is so difficult to carry on a conversation in one. We see from our chart that, while the noise level in the subway is 95 DB, our average conversation level is 70 DB at three feet. The subway noise, which is louder, tends to override conversation. This blanketing of one sound by another is called *masking*.

Masking is a tendency of the ear, when listening to a loud sound, to suppress a second or lower sound. In general, any loud sound tends to mask one of less loudness. The person speaking in the subway would, then, have to shout in order to overcome the noise level. Research and experience have taught us that this masking can be eliminated by keeping the desired signal, or wanted sound, at a level of 40 DB above the noise level. This would be almost impossible in our analogy, hence the difficulty of carrying on a conversation in a subway train.

From Figure 2-3, we can also see why the average radio or phonograph in the home is operated at a sound level of about 66 to 75 DB. Since the noise level in the average city home is between 30 to 35 DB, we add our 40-DB figure to overcome masking and arrive at a sound level of 75 DB.

Thus far, we have confined ourselves to only one phase of sound, its loudness level, intensity, or sound pressure. We can now proceed to a second aspect: pitch, tone, or frequency of vibration. For the purpose of discussion we will use these phrases rather loosely at first. *Frequency* refers to the number of vibrations per second of a sound.

The source of any sound is a vibration. For example, a tuning fork that has been struck will sound. We see the edges of the prongs appear blurred because of their rapid to-and-fro motion. Holding a finger lightly against the prongs will enable you to feel the vibration. Looking inside a piano at the strings while striking a key will enable you to see the strings vibrate, touch the string lightly and you will feel the vibrations. If you stop the vibration with your finger, the sound disappears.

Vocal sounds are also produced by vibration, by a blast of air passing through a narrow slit between two membranes in the larynx which are called vocal cords. These cords are set in vibration and, in turn, set the air within the mouth and throat into vibration. These vibrations spread out in waves and are picked up by the ear.

Frequency refers to the number of vibrations, or to-and-fro motions, that the tuning fork, piano string, or vocal cords make in one second. When the piano string, for example, makes 440 complete vibrations per second, it is said to have a frequency of 440 cycles per second. Using the piano as an example, we find that each string makes a different number of vibrations per second, and so each note has a different frequency and sound.

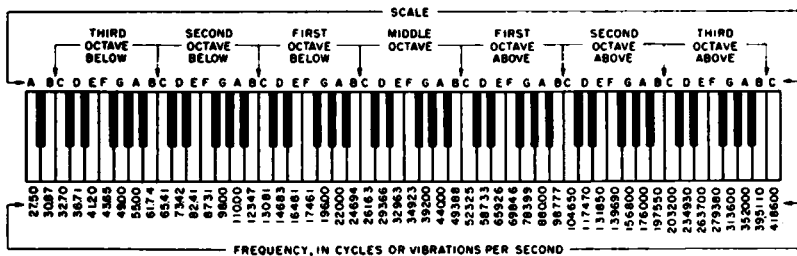

FREQUENCY AS RELATED TO A PIANO KEYBOARD (MIDDLE A=440CPS)

Fig. 2-4 Piano Keyboard vs. Frequency

The difference in frequency of each piano note is due to the fact that the strings vary in length, tension and thickness. How this affects the pitch or frequency can be easily demonstrated by attaching a rubber band to some object, then stretching it a bit and plucking it. A tone will be heard. Stretching it still further and plucking it again will produce another tone. By stretching the rubber band we have reduced its thickness and increased its length and tension.

Figure 2-4 illustrates this fact with respect to the piano. Each key controls a string of different length, tension and thickness. This keyboard is based on the American concert pitch of 440 cycles per second, or CPS, for A above middle C. The European concert pitch is standardized at 439 CPS. In this and the previous paragraph,

we used the words pitch and frequency synonymously. In order to understand their proper usage it may be well to define them.

Pitch may be specified in two ways. To the musician, pitch is that characteristic of a musical tone which enables him to place it in its proper position in the musical scale. The sound engineer, on the other hand, uses a term which describes this characteristic in a physical manner. The number of vibrations per second which cause the sound wave (its frequency) are used to describe it. Since we are at the moment interested in the physical aspect of a sound, we will use the word frequency. At this point it may be well to add that, though pitch is primarily dependent on frequency, it is not determined by frequency alone. Pitch also, but to a lesser degree, is dependent on both the intensity and the complexity of the sound wave. These other influences on pitch will be discussed in a later paragraph.

The average human ear will respond to frequencies or vibrations of from 16 to 20,000 CPS. Individual hearing may vary considerably from the above mentioned figures. The lower limit varies from 15 to 25 CPS, and the upper limit from 15,000 to 30,000 CPS. These limits also vary with the age of the individual. This fact will be discussed in a later chapter.

Knowing of this variation, we now understand why some people can hear a bat squeak when most of us cannot. We can also understand why some television viewers are annoyed by a high-pitched whistle while the set is on, while others cannot hear it at all. This tone originates in a portion of every television receiver which operates at a frequency of 15,750 CPS.

We find the frequency range of any instrument by taking the highest note it will produce and the lowest note. These two frequencies, when stated together, give the frequency range. We can see that this range in the piano is from 27 CPS to 4,186 CPS, for its fundamental tones. (See Figure 2-4.) A fundamental tone is produced by the piano string vibrating as a whole. This string, however, also vibrates in segments, producing harmonics or overtones which are exact multiples of the fundamental frequency. The distribution and intensity of these harmonics determine the quality or timbre of the sound. These harmonics also contribute to the complexity of the sound, as mentioned in the paragraph on pitch.

Figure 2-5 shows the frequency ranges of various musical instruments and sounds. The upper portion has a series of numbers, reading from left to right, from 10 to 30,000. This is the frequency range in CPS. Near the bottom, we illustrate graphically the extended frequency range of the human ear. You will notice this line extends from 15 to 30,000 CPS. We have included the extended range of hearing beyond 20,000 CPS by means of the dashed line.

The line just above this divides the range into smaller sections: the low frequencies, which give us our bass tones; the middle frequencies, which constitute our middle register; the high frequencies, which include the treble tones and some overtones; and the ultra-highs, in which lie most of the harmonics and overtones that contribute so much to the quality and timbre of music.

The solid lines in Figure 2-5 show the fundamental tones. The harmonics and overtones are continued as dashed lines. We can

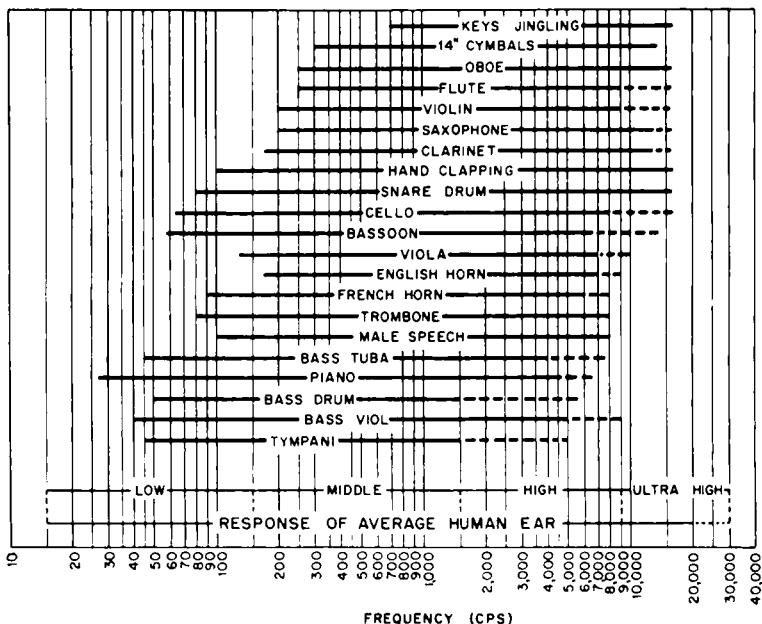

Fig. 2-5 The Frequency Ranges of Familiar Sounds and Instruments

easily see which instruments contribute most to the low or bass tones. The piano, bass viol, bass tuba and tympani are the most important contributors, and their fundamental tones do not go higher in frequency than a general average for the group of 3,700 CPS.

The middle-register instruments, as can be seen, include the trombone, french horn, cello and viola.

Since we can now understand the importance of the harmonics or overtones, which we have already mentioned, we shall attempt to learn what a harmonic or overtone is and does.

A complex tone consists of a fundamental frequency and its harmonics, which are its exact multiples. When the fundamental frequency of a sound is 440 CPS, its first multiple, or overtone, is called the *second harmonic*, and is 880 CPS. The second multiple or overtone, called the *third harmonic*, will be 1,320 CPS. The fundamental tone itself is considered to be the first harmonic.

Returning to the piano in Figure 2-4, we will strike *A* above middle *C*. This is what occurs: The *A* string vibrates at a frequency of 440 CPS. In addition, portions or segments of the string also vibrate at different frequencies due to the reflected waves from the fixed ends of the string.

These vibrating portions or segments of the string cause the harmonics, which combine with the fundamental frequency to produce the complex tone.

We should now be able to understand how a piano with a fundamental tone range of from 27 to 4,186 CPS can produce tones up to 6,500 CPS as shown by the dotted line for the piano in Figure 2-5.

We have already noted that sounds or vibrations are picked up and transmitted within the ear to the membrane actuating the sound-converting apparatus. This membrane is more complicated than the simplified description implied, for it has thousands of little cells. Each group of these cells responds to sounds of a certain frequency. Were these little groups of cells all equally sensitive, our discussion would be greatly simplified. But they are not. Thus

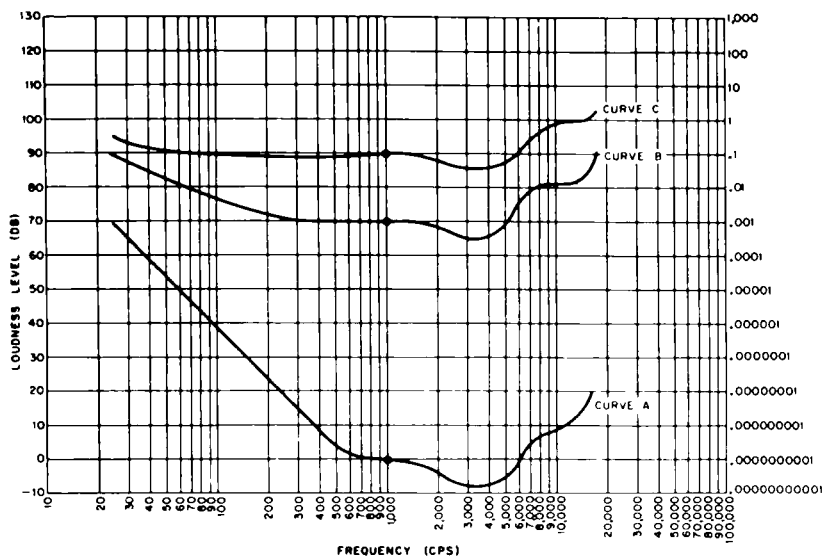

Fig. 2-6 Response of the Human Ear at Various Intensity Levels

we find the human ear more sensitive to some frequencies than to others. This fact will be discussed in connection with Figure 2-6.

Before utilizing this graph, it may be well to explain that it is merely a combination of Figures 2-3 and 2-5. We use both the DB and intensity scales of Figure 2-3 on the vertical axis. The frequency range scale on the horizontal axis at the top of the graph is exactly the same as that used in Figure 2-5. The essential difference is in plotting our frequency response against sound level.

Curve A is based on the threshold of audibility (zero DB) at 1,000 CPS, as was the graph in Figure 2-3. In the latter figure, however, we varied the intensity (and loudness) of the same 1,000-CPS tone. In this case, although we start at the same point (represented by the intersection of zero DB, on one axis, with 1,000 CPS, on the other axis), we are changing frequency.

If the ear's loudness response changes with frequency, then the threshold of audibility must also change. The lowest curve in Figure 2-6, then, traces this threshold at different frequencies. Follow the curve to the left, for example, until you reach 500 cycles. Then

move along the horizontal line at which the curve intersects the 500-CPS line. You will find the sound intensity necessary to create an audible sound has increased 5 DB above that amount necessary to create an audible sound at 1,000 CPS.

Follow the curve upward to 300 CPS and you will find that we require 10 DB more intensity than at 1,000 CPS to make the sound perceptible. This effect continues until, at 30 CPS, we need an intensity 65 DB greater than was needed at 1,000 CPS in order to obtain a sound which is barely audible to the human ear. This also holds true of the higher frequencies, but to a lesser extent.

This change in the ear's response with a change in frequency is very important to our understanding of sound. It is further complicated by the fact that the sensitivity of the ear is *also affected by each change of intensity or sound level.*

As an example, we shall raise our intensity level from the threshold of audibility to 70 DB, which is the level of average conversation at three feet. Again, we start the curve at 1,000 CPS. This is Curve B in Figure 2-6. The starting point is circled, as it was in Curve A.

We can notice the decided flattening of the response curve at this increased level. Let us follow the curve to 500 CPS. We find that the ear's response is the same as at 1,000 CPS. Moving on, as before, to 300 CPS, we find that we only require $\frac{1}{4}$ DB more intensity, instead of 10 DB, as was the case in Curve A. Moving to 30 CPS, we find we only need 18 DB more intensity, instead of the 65 DB previously required. The human ear, as can be seen, has a more uniform response to different frequencies at 70 DB than it has at zero level. The same statement applies to the higher frequencies (those above 1,000 CPS).

When we raise our intensity to 90 DB above zero level, as we do in Curve C, we notice a still greater flattening of response. The sensitivity of the human ear is almost equal at all frequencies here; that is to say, it is as uniform as we can hope for at listenable levels.

As we raise the intensity still more, the response of the ear becomes still flatter; but the level becomes uncomfortable for listening.

The 90-DB level is approximately the average level at which we hear a symphony orchestra 20 feet away in a concert hall, as can be seen by referring back to Figure 2-3.

When we reduce the intensity level to the point at which the average home radio-phonograph is used (66 DB), the response of the ear is no longer equal at all frequencies. The high- and low-frequency response is reduced disproportionately, and we no longer hear the balanced full-range response that sounded so rich in the concert hall. This will be an important consideration when we try to duplicate orchestral sound in the home.

We now know something of how sound is created, travels, and is received by the human ear; how it is changed from mechanical energy into electrical or nervous energy.

We have found the basic level from which sound is measured and a unit of measurement. The prevailing sound levels in familiar places and of familiar sounds.

We have also studied the frequencies of sounds and their effect on the ear; the frequency ranges of the ear, common sounds and musical instruments; the meaning of harmonics and overtones, what they are, how they are created, and their influence on pitch. Last, but far from least, we have observed how intensity affects the frequency response of the human ear. This and our next chapter should give us enough understanding of acoustics to enable us to know what we require in order to obtain high fidelity reproduction.

CHAPTER III

ACOUSTICS, ELECTRONICS AND MUSIC

Reproducing a symphony orchestra at home. Frequency range and program sources. Radio and records. An acoustic facsimile. The listening room and reverberation. The listening room and noise. Dynamic range. Intensity variations and frequency response. The tuner, the record player, the amplifier and the loudspeaker.

We now have a basic knowledge of acoustics and the human ear. We know, for example, what frequency range and at what intensity level we must reproduce a symphony orchestra in order that each instrument should sound exactly as did the original in the concert hall.

We can definitely say that, in order to obtain the required result, we must be able to reproduce faithfully a frequency range of from 16 to 20,000 CPS at an intensity level of about 110 DB, at the maximum.

We say maximum because this sound level is only reached part of the time, in crescendo or peak passages. The average level of a symphony orchestra is about 90 DB, as has been noted.

This range of variation of level is referred to as the "dynamic range." The meaning and effect of this phrase will be given in a later paragraph.

We will again return to the phrase "high-fidelity reproduction" and the instrument which will supply it.

The word instrument is used correctly since, to our minds, such a system is a musical instrument, one that reproduces faithfully what is put into it.

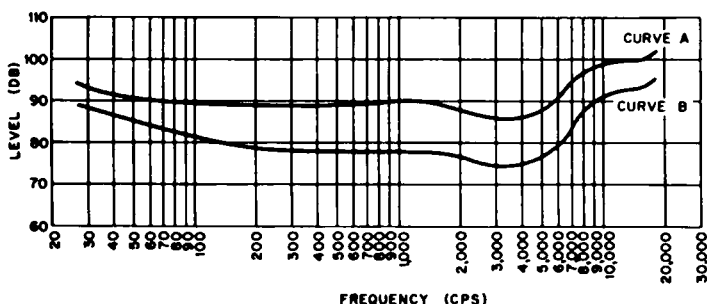

Fig. 3-1 Response of the Ear at Suggested Listening Levels

Curve A in Figure 3-1 illustrates graphically the frequency response of the ear at the average intensity necessary to reproduce a symphony orchestra perfectly.

A symphony orchestra was chosen for our example as, when we reproduce it faithfully, all other sounds which interest us will also be faithfully reproduced.

Although the level at Curve A was discussed as being our theoretically perfect requirement, we find that, in practice, we cannot hope to reproduce at this level in a private home. The intensity of sound which was normal in a concert hall would be much too high, since the home living room, even a large one, does not approach a concert hall in size. This is not to mention what the neighbors would say!

The highest possible level which would afford comfortable listening would be in the order of 78 DB or roughly 10 times the

level at which the average home radio-phonograph is used. This level would by no means be a background for social conversation. It is rather the level for concentrated listening.

Curve A in Figure 3-1 graphically illustrates the ear's response at 90 DB; Curve B is the ear's response at 78 DB and is the more practical level for the home. Note that both curves belong to the same group shown in Figure 2-6. We notice that the ear's response is not as good at the lower level, but we must compromise for the moment. A previous paragraph closed with the remark that our instrument should reproduce faithfully what was put into it. We may require more later.

We have two program sources available. The first source is radio and the second is the phonograph recording.

Figure 3-2 shows at A the transmission range in CPS of a high-quality FM broadcast. This is a live broadcast from a nearby studio. When recordings are broadcast the transmitted frequency range is, of course, limited by that of the record.

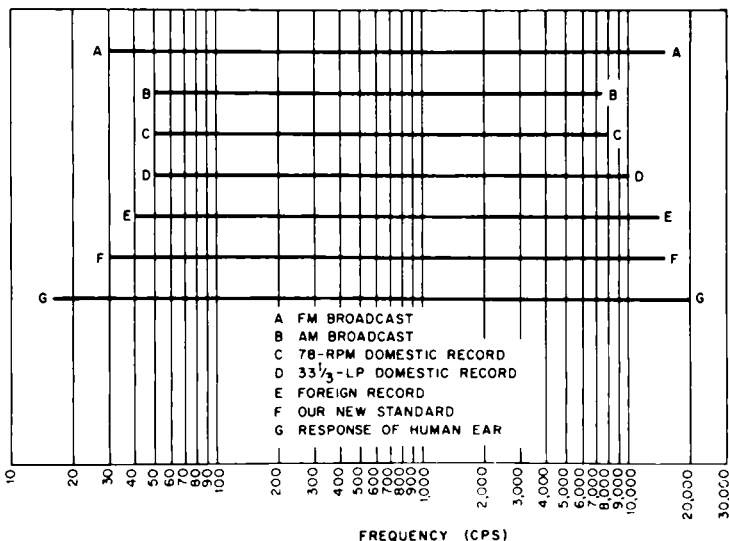

Fig. 3-2 The Frequency Ranges of Our Program Sources

The AM signal broadcast by high-quality commercial stations seldom exceeds 7,500 CPS. In fact, this is the exception rather than the rule; most do not broadcast so wide a range. This range is illustrated as *B* in Figure 3-2.

Our second program source is the phonograph record. The 78 RPM record with which we are all familiar usually has a frequency range of from 50 to 8,000 CPS. The finest made in this country seldom go beyond this limit. This is shown graphically at *C* in our chart.

The 33½ LP's have a frequency range of from 50 to 10,000 CPS, sometimes higher. This is shown at *D*.

The British are making records of from 40 to 14,000 CPS; some companies claim 40 to 20,000 CPS. We will use the first as shown at *E* in Figure 3-2.

A previous paragraph mentioned "an instrument that reproduces faithfully what is put into it." From Figure 3-2 we can easily see that we are not likely to "put into" our instrument a lower frequency than 30 CPS nor a higher one than 15,000 CPS, at least with the program sources available to us at the present time.

Therefore, we have arrived at a new standard for reproduction, shown at *F* in Figure 3-2. We should reproduce 30 to 15,000 CPS at an average intensity level of 78 DB.

We must now return for a moment to Figure 2-5 in Chapter II. What exactly have we lost? The area from 15,000 to 20,000 CPS has no important sounds, unless keys jingling, footsteps, and hand-clapping are important. We have lost a few of the higher harmonics or overtones of instruments such as the snare drum, oboe, and triangle. The narrowing of the lower end from 16 to 30 CPS has resulted in the loss of the lowest pipe organ tones and the lowest piano notes.

We have retained, by far, the most important part of our audible range. There are a great many technical reasons for relinquishing so easily what, at first glance, we seemed to be striving for most, an acoustic facsimile. Though this facsimile is possible, the cost and space required are prohibitive. We must also bear in mind that, between our original symphony orchestra and our record or

radio broadcast, we have placed a complete broadcast station or recording studio. Each has its attendant limitations. Preparing to reproduce more than they can give us is fruitless.

In the acoustic aspect of high-fidelity reproduction, the first consideration is the room in which we listen. We, of course, cannot tear down walls or rebuild the house in order to create an acoustically perfect room, but there are a number of things we can do.

By far the most important of these is to reduce the noise to the lowest possible level. This is not as difficult as it sounds. We are not advocating a complete sound-proofing as is done in broadcast or recording studios. Wall-to-wall carpeting and ceiling-to-floor drapes are almost universal in this day and age of decorating, and we will use these means at hand to best advantage. Drapes and carpeting serve two important functions: they reduce the noise level of the room by absorbing outside sounds and they also absorb the sounds created in the room. Wherever possible it helps considerably to have the drapes lined and a thick cushion under the rug. The drapes, when placed close to the walls or windows which they cover, have a tendency to absorb more sound at the high frequencies. We can obtain increased low-frequency absorption, and therefore better balanced absorption, by hanging the drapes from 8 to 10 inches away from the wall or window.

When drapes are already lined, we can obtain additional absorption by using an inner lining.

The listening room is actually part of our reproducing instrument. Therefore, any of the aforementioned suggestions which we can manage to follow will be of appreciable help in achieving our goal.

Lined drapes and rug cushions also help in reducing reverberation time. *Reverberation* is a characteristic of sound in an enclosed space such as a room or concert hall. The initial sound sent out by the source is reflected by the walls, ceiling, and windows many times before it is ultimately absorbed or dissipated. The length of time required for this dissipation of the original sound is called *reverberation time*. Reverberation time has been defined as the time required for a sound to decrease 60 DB in level, or to one-millionth

of its original intensity. The effect of excessive reverberation time on speech is to reduce its intelligibility. In music it prolongs the individual notes and reduces the crispness. A good example of this effect can be heard when a person speaks in a room devoid of furniture or drapes. The annoying echoes are the sign of excessive reverberation.

We already mentioned that the drapes and rug cushion also absorb sounds created in the room. This function permits us to operate at a higher sound level, since we are absorbing some of the sound which normally filters out of the room and reaches the neighbors. Remembering the response of the ear at various intensity levels will illustrate just why it is advantageous to keep the level high.

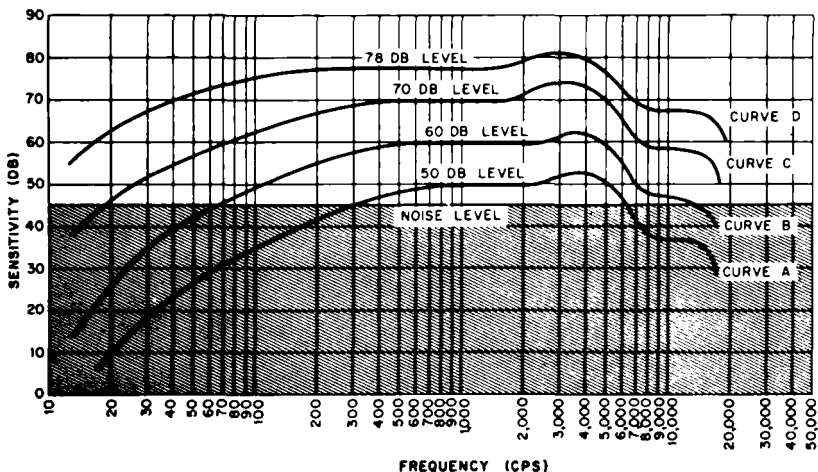

Fig. 3-3 Room Noise Level vs. Frequency Response

The noise level in a listening room also affects the frequency range we hear. We can see this from Figure 3-3. The curves shown in this graph belong to the same family as those shown in Figures 2-6 and 3-1. Since they trace the sensitivity of the ear itself rather than the loudness required by the ear, they are inverted with respect to the earlier curves. We have drawn a line across at an intensity level of 45 DB, which represents the noise level of an average city

residence. This is the level shown earlier in our sound intensity chart in Figure 2-3.

When a radio-phonograph is operated at an average loudness level of 50 DB in a room with a noise level of 45 DB, as in Curve A, all sounds lower in intensity than the noise level are masked. How this affects the perceived frequency range can easily be observed. We can see that all frequencies below 300 CPS and above 6,200 CPS fall below our room noise level, and consequently are masked and lost. When we raise our reproduction level to 60 DB (Curve B), we can see how our perceived range widens down to 65 CPS and up to 14,000 CPS. At the 78-DB level, we can see that no portion of our perceived response lies below the masking level, and we enjoy the full range. This was another of our reasons for establishing the recommended reproduction level at 78 DB. The third reason we promised to explain and now will.

The phrase *dynamic range* is frequently used but not as frequently understood. Dynamic range is the difference in intensity between the loudest sound and the lowest sound of any program or piece of music. The dynamic range of a symphony orchestra is in the order of 98 to 100 DB. This is apparent only when the listener is sitting in front of the brass section. The dynamic range heard by the average listener in a concert hall is about 86 DB. A good FM broadcast of a live concert reduces this range to 76 DB. The LP record reduces the range still further to an average of 65 DB. This is deliberately done for the following reasons: very large intensities are reduced in order to avoid overloading; very low intensities are increased in order to override the record's noise level. We can easily see that, when we increase the intensity of the soft passages and decrease the intensity of the loud passages, we are reducing the difference between the lowest and loudest sounds and, therefore, decreasing the dynamic range.

This reduction has a definite effect on our acoustic facsimile. This compression of the dynamic range in our program sources can be noticed by listening first to an instrument solo and then to a symphony orchestra. The difference in apparent realism is quite noticeable, and is due in part to the fact that little or no compression was necessary on the solo, as its dynamic range was not as large as that of a symphony orchestra.

The dynamic range which has been reduced by compression can be increased by a system known as volume expansion. The amounts of volume expansion, in order to be effective, should be the exact opposite of the amount of the previous compression. It should not introduce any distortion, and it should act instantaneously. Thus far, these requirements have not been met. We must accept the reduction of dynamic range as a necessary evil and be content, for the time being, with the other advantages we can obtain.

This is our third compromise but we must bear in mind that, thus far, we are not attempting to achieve perfection. We will be satisfied with less but, in order to determine how much less, we must first be able to understand the limitations of our medium. From our previous discussion, we know how the noise level in our listening room affects the perceivable dynamic range. Let us assume for a moment that we are listening to a symphony orchestra whose sound intensity varies from 20 DB for the softest sound to 96 DB for the loudest passage. This gives us a dynamic range of 76 DB. When this is reproduced in our listening room, all sounds below the room noise level of 45 DB are masked and therefore lost, leaving us a fully perceivable range of from 45 to 96 DB, or an effective dynamic range of 51 DB. Reduce the room noise level and we have extended our dynamic range by the same amount. The room noise level is quite important, as we have seen. We can add much to our faithful reproduction by paying more attention to this much neglected detail.

Thus far we have mentioned frequency range or response, intensity level, and dynamic range as being the factors which influence the quality and character of reproduction. There is another and very important factor which we shall now discuss.

We have illustrated most of our discussions on frequency range or response with a line drawn from one frequency to another. This actually meant that all frequencies between the two extremes were being reproduced at the same intensity or loudness level. This is the most desirable response; no one portion or frequency is emphasized over another. This type of response is our goal and not an actuality. The previous curves were drawn in this manner in order to simplify our explanations.

An idea of our meaning can be developed by referring again to the curves in Figure 3-3, which illustrate the variation in response of the human ear at different frequencies. For example, when using the 70-DB response curve (Curve C), the sensation level at 220 CPS is 68 DB. The sensation level drops 2 DB at 160 CPS. We can therefore see that the ear's response varies 2 DB between 160 CPS and 220 CPS or, as it is often expressed, "the ears response from 160 to 220 CPS is with 2 DB." We shall give another example, still using the 70-DB curve. The ear's sensation level at 100 CPS is 63 DB. At 30 CPS, it is 52 DB, a difference of 11 DB or, correctly expressed, "the ear's response from 30 to 100 CPS is within 11 DB."

Non-uniform reproduction results in unnatural reproduction, as the sounds of various frequencies no longer have the original balance. Few human ears can detect an intensity change in speech or music of less than 2 DB. For this reason, we can safely permit a response variation of that amount in our perfect reproduction system. In practice we will find a much greater variation, but this figure of 2 DB is our goal.

When our high-fidelity reproduction is extended to 15,000 CPS, there is one more characteristic of sound with which we must become familiar. That is the directional characteristic of our reproducer or loudspeaker.

Figure 3-4 shows the radiation pattern of an average 12-inch speaker at various frequencies. A radiation pattern of this sort illustrates the intensity of sound distributed by the speaker at various angles from it. When we face the speaker directly from the front (at point A) we say that we are on its axis. The speaker itself, in such a graph, is assumed to be located at the center of the bottom line of the graph and facing up toward the top of the figure. The angles off the axis of the speaker, at which we might sit while listening, are marked off in degrees.

The loudspeaker does not radiate all tones in all directions with the same force. We find in Figure 3-4 five curves, each one marked with a specific frequency. The various degrees of intensity are shown as percentages along the axis. Intensity of 100% is that which occurs along the axis, which is the direction of maximum radiation. This graph is read as follows: The point at which any of

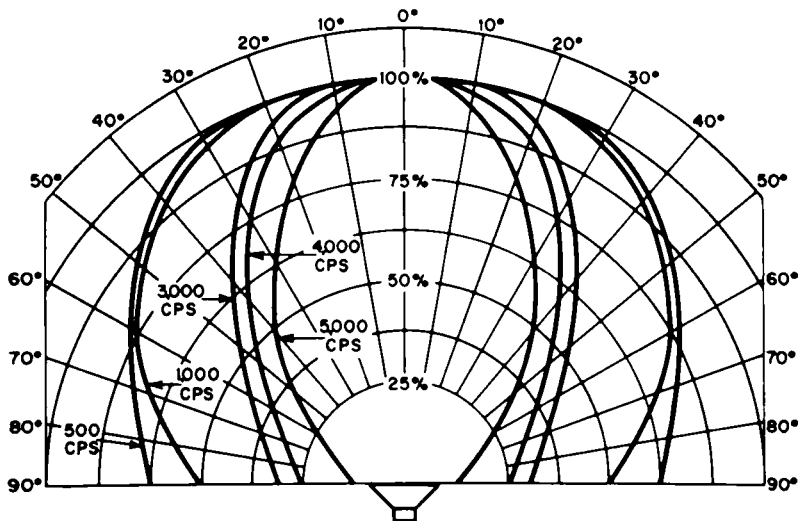

Fig. 3-4 A Loudspeaker's Directional Characteristics

our curves intercept the angle of interest shows the intensity of the sound at that angle. For example, listening at position *B*, we find the 500-CPS tone is almost equal to its intensity at the axis. The 4,000-CPS tone, however, has dropped to 75% of the intensity on the axis. The 5,000-CPS tone is only 62½% of its intensity at the axis. We can see that, as the frequency of the tone is increased, its intensity drops at angles away from the speaker. In other words, when we listen to a loudspeaker at any angle off the axis, the intensity of the sound decreases as the frequency is increased. This is very important to us in reproducing the higher frequencies, as we cannot all sit in line with the speaker. When we look at the 5,000-CPS curve, we can easily see that it is beginning to resemble a beam. Only within six degrees of the axis does it retain full intensity.

Need we go further to prove how directional high-frequency sound waves are? This is a factor which will affect high-fidelity reproduction to a great extent. The solution to the problem it poses will be discussed at greater length in the chapter in high-fidelity loudspeakers.

Thus far in our discussions we have used three phrases synonymously, acoustic facsimile, perfect reproduction, and high-fidelity

reproduction. We have found that we cannot achieve an acoustic facsimile or perfect reproduction in the home for a number of reasons. Therefore in future discussions we will reserve the phrase acoustic facsimile for the description of our much desired but, at present, impossible goal.

The phrase high-fidelity reproduction will become our secondary goal. The closer it comes to our primary goal, the more natural will be the result.

We are now in the position of the farmboy who returned from the wars. We know too much to be satisfied with what we have, but not enough to get what we want. However, we hope to resolve the dilemma by the end of this book.

At least by now we have a fundamental picture of the final system and also of its components: a quality tuner for one of our two major program sources, a good record-playing device for our second source, an amplifier to build up the minute amounts of electrical energy delivered by either source to a useful level, and a loudspeaker to convert this electrical energy back into sound energy.

Reproduction in general, it must be noted, will be no better than any individual component will allow. An excellent tuner and a superlative amplifier, for instance, will be wasted if their combined effort is butchered by a poor speaker. The high-fidelity chain is never stronger than its weakest link. Extreme care, therefore, must be exercised with the choice of each basic element.

We have reached a point at which we can do some stock-taking. When we now set down our requirements for a high-fidelity system, we should know what they mean.

These specifications will provide a system through which we will be able to reproduce a symphony orchestra and hear every instrument. We should be able to pick each one out cleanly by its individual quality, accurately reproduced. We should hear every note of every instrument from the lows of the bass tuba to the highs of the flute. The overtones of each instrument should be perfectly reproduced. The illusion of live music should be given.

The frequency range of each component, limited by our program sources, should be from 30 to 15,000 CPS within 2 DB. The components should allow an average loudness level of 78 DB and introduce no extraneous noises of their own. We may find it difficult to meet our rigorous specifications but, when we do, we will obtain a result which is far above any reproduction of sound heretofore possible.

In doing this, we are not attempting to lay down a rigid formula. For example, when a response curve shows that a speaker is excellent, it need not be so to all men. The speaker may be superb, and yet not sound well to you. Hearing is not perfect in all humans. We have already pointed out that human hearing changes and is different in each person. This fact does not make one person wrong or impossible to satisfy. This subject will receive more attention in our chapters on loudspeakers. Let it suffice to say here that, with the proper choice of components, we can satisfy any ear except a totally deaf one.

This chapter has taught us some of the reasons for not being able to achieve an acoustic facsimile in the home. We have found a highly acceptable substitute: high-fidelity reproduction. We have found the specifications that our instrument must meet in order to obtain this high-fidelity reproduction. We have considered the sources of our programs and analyzed their limitations. We have discovered our own limitations. We have become aware of the acoustics of our listening room and their effects on sound reproduction. The phrases "reverberation time" and "dynamic range" and their effects have been explained. The effect of variations in intensity at different frequencies has been demonstrated. We have discovered the directional characteristics of the higher frequencies and their effect.

We have acquired an elementary knowledge of a field in which art and engineering are so closely linked that they at times overlap. We are actually pioneers in the new art of high-quality music reproduction in the home. Never before has such superb reproduction of music been possible. Vast strides are being made each day toward the ultimate goal of an acoustic facsimile.

Before closing this chapter, it might be well to add that there has been much interest shown in extending the ranges of our two

program sources by both the broadcasters and recording companies. Both feel that, since there is now available equipment which will reproduce their present standards, it is again time for them to move forward.

For this reason, whenever it is possible, we suggest exceeding our specifications in order that we may take advantage of any future advances in our art.

CHAPTER IV

THE SIMPLE LOUDSPEAKER

The simple loudspeaker and how it operates. The frequency response of a loudspeaker. The loudspeaker cone. Tonal balance. The voice coil. Harmonics and efficiency. The forms of distortion in a loudspeaker. Transient distortion. Amplitude distortion. Harmonic distortion. Inter-modulation distortion.

The choice of subject matter for this chapter was not simple. Should we enter our high-fidelity system as does the music, through the tuner or record player then on through the amplifier and to the loudspeaker? Or should we, since the loudspeaker propels the sound directly to us, start with it and work in reverse order? Since the acoustic knowledge of the last chapter should still be fresh, we have decided on the latter course.

The loudspeaker comes very close to being the most important component in our high-fidelity system. This single device must reproduce acoustically the sounds created by many musical instruments. These instruments are so varied in construction and materials that it is truly astounding to find one device that will reproduce them all faithfully. This device becomes even more wonderful when we realize that it not only must mimic the sounds of many instruments,

but also must duplicate their sounds simultaneously, as when reproducing an orchestra. The importance of the loudspeaker can be judged by the fact that three chapters have been devoted to it and its enclosures, which are, acoustically speaking, a part of it.

We will examine a simple loudspeaker and each of its component parts, showing how each of these functions and its individual effect on reproduction. This knowledge will help us understand the kind of speaker we want in our system.

Having already defined a loudspeaker as a device which converts electrical energy into mechanical or sound energy, we will now consider the manner in which this is accomplished. Though there is a great deal to be said on this point, we will confine ourselves to the acoustic aspects of this conversion and to the most important parts of the speaker only.

Figure 4-1 is a cross-sectional view of a simple loudspeaker. The amplified electrical energy or currents are fed into a coil, A.

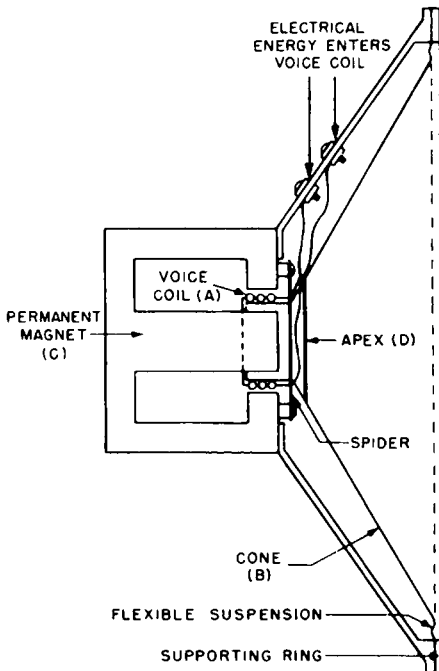

Fig. 4-1 A Loudspeaker

This coil is attached to a cone or diaphragm, shown as *B*. The varying currents being fed into the coil set up a correspondingly variable magnetic field around this coil, or *voice coil*, as it is properly called. This variable magnetic field reacts with the permanent field created by the permanent magnet, *C*; through alternate attraction and repulsion between these fields the voice coil is made to move back and forth on its axis. Since this coil is fastened to the cone and thus controls it, the cone must move in unison with it. This vibrating to-and-fro motion agitates the air and, as we explained in an earlier chapter, a sound is created, just as it may be by any object vibrating in air.

We will give a concrete example of this process by showing how middle *A* on the piano is reproduced. We already know from Figure 2-4 that, in order to create middle *A*, the string vibrates at 400 CPS. Reproducing this note causes the voice coil in our loudspeaker to move to and fro 440 times per second. In other words, it vibrates at exactly the same frequency as the original piano string.

As an additional example, let us reproduce the lowest note on the piano. We find that our voice coil, and the cone with it, moves at a rate of $27\frac{1}{2}$ complete cycles per second. This is exactly the frequency at which the original string vibrated. This is how a loudspeaker reproduces various frequencies. There is yet another operation which must be and is performed simultaneously.

Sound, in addition to constantly varying in frequency, also varies in intensity. We must also duplicate the latter type of variation. For a simple explanation, we call once more on the water analogy of Chapter II.

When we dropped a larger stone into the water, we displaced more water and, in this manner, created larger and more powerful waves. We use exactly the same method in our loudspeaker. We create larger and more powerful waves by making the cone move back and forth over a greater distance, thus displacing more air. This is accomplished by increasing the amount of electrical energy in the voice coil.

The loudspeaker which we have just analyzed is the simplest of many types available. There is a wide variety, each designed for a specific application. These variations will be dealt with in a future

chapter, but let us say here that whether they use a cone or a diaphragm and whether they are large or small, the principle on which they operate is essentially the same.

As a basic instrument we have a device which will convert electrical energy into sound energy. Since we wish to reproduce music it will be necessary to determine the frequency response of our simple loudspeaker. The response of a loudspeaker such as was discussed would be roughly from 100 to 6,000 CPS. We have learned that in order to reproduce music faithfully we require a much wider range. Therefore, our first step will be to extend the range of our simple loudspeaker. Incidentally the range given above is the approximate frequency response of an average commercial radio-phonograph loudspeaker.

We find that we can extend our bass range by increasing the cone size, but we also discover that this results in a decrease in the range at the higher frequencies. We then move in the opposite direction and find that by decreasing the size we can extend our high-frequency range, but at the expense of the low frequencies. Apparently this is not the solution to our problem at the moment. Therefore we must continue our experiments. We should, at this point, mention that this effect of speaker size on frequency response has definite advantages in the specialized loudspeakers which will be discussed at length in the next chapter. The extremes in size are shown by the two loudspeakers in Figure 4-2.

Before continuing our attempts to extend the range, we will have to understand more of the operation and construction of a loudspeaker.

The first component we will discuss will be the speaker cone. The choice of the pulp material used in the construction of a cone is extremely important in controlling its frequency response. Speaker cone manufacturers are quite proficient in compounding different pulps, such as kapok, wool, paper, and combinations of these materials, to provide the various degrees of stiffness or flexibility for the different weight ranges used in modern loudspeaker manufacture.

The proper choice of pulp material and weight goes far in determining the compromise between high- and low-frequency

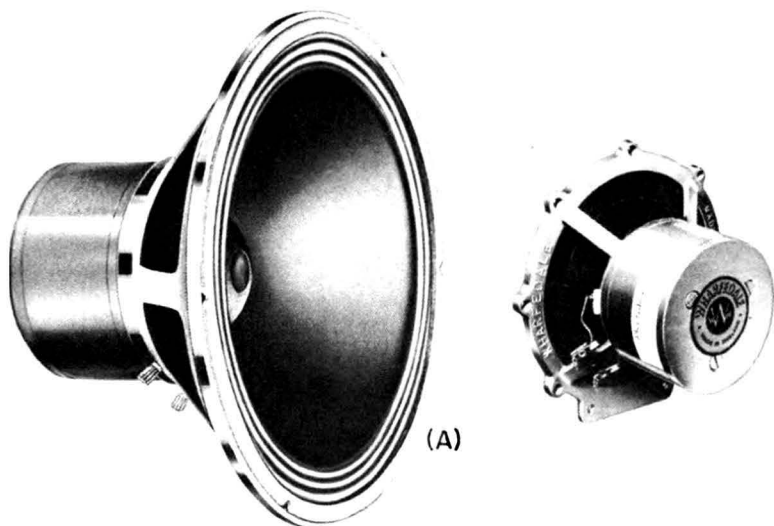

Courtesy Electro-Voice Inc. and British Ind. Corp.

Fig. 4-2 A Woofer and a Tweeter

response. Just as important as pulp material and weight are the shape of the cone, the rim compliance structure, the apex treatment, and the decoupling agents. We will, within the scope of this book, attempt to explain each of these factors as they arise.

A loudspeaker cone of the type we are discussing operates in the following manner: the cone at the lower frequencies operates as a piston; that is to say, the entire cone structure moves as a single unit from apex (shown at *D* in Figure 4-1) to rim. At the higher frequencies, say 3,000 CPS, the cone no longer acts as a piston; instead it vibrates in sections. The higher the frequency the more the vibrations tend to confine themselves to the apex area. The apex area is often treated to enhance this decoupling effect, as it is called, and to allow the "small cone" to operate more efficiently. We use the phrase "small cone" to indicate the fact that only this small portion of the complete cone is effectively functioning at the higher frequencies.

We can, by the careful choice of decoupling agents and apex treatments, increase the decoupling effect just mentioned and, in

this manner, improve high-frequency response. Careful selection of the pulp material and weight of the cone will assist in achieving this end.

By these measures we can achieve a definite improvement in our frequency range. But there is still another factor which must be considered when discussing the behavior of a loudspeaker, or an entire sound system for that matter, and that is tonal balance.

The tonal balance of a loudspeaker is determined by the proportioning of the high and low frequencies reproduced. When the proportion is incorrect the reproduced sounds are either thin and strident because of insufficient low-frequency response, or muddy and indistinct because of insufficient high-frequency response. The ability to produce a balanced response is as important for a good loudspeaker as its ability to cover a wide range.

Much research has been done on this subject, and the famous acoustic authority, Fletcher, suggested a limited range of from 60 to 8,000 CPS as being balanced. This was the basis of the writer's experimentation on listeners who unknowingly contributed to our store of knowledge.

While demonstrating high-fidelity systems, the writer has introduced varying degrees of imbalance in the reproduction and discovered that by using 700 CPS as a center frequency, and reproducing an equal number of octaves or parts of octaves above and below it, the great majority of listeners felt that reproduction was adequate. This despite the fact that the frequency response of the system was reduced, in some cases, to a range as limited as 60 to 8,000 CPS. However when the response was purposely unbalanced, and the writer attempted to reduce the range, even small reductions were very quickly noticed. This reaction illustrated perfectly just how important total balance is in reproduced sound.

A graph depicting the extended response of the human ear and the response curves of the loudspeakers under discussion is shown in Figure 4-3. Curve *A* is the extended response of the human ear and is divided into octaves below and above 1,000 CPS by broken lines. The solid vertical line at 700 CPS is our center of

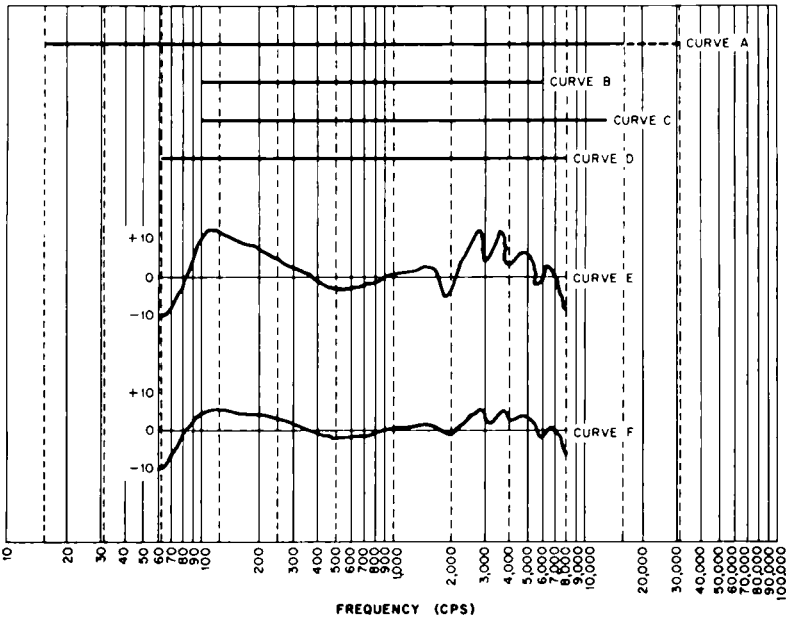

Fig. 4-3 Response of the Ear and of the Loudspeaker

balance. By measuring with a ruler it will be found that this line is almost in the exact center of the limits of human hearing.

Chapter II explained that human hearing varied considerably, just as some people see well and others poorly. Sit in a subway train or street car and watch your fellow passengers. Some will be affected by the high-frequency screech created by the wheels on the tracks when turning a sharp bend; others will not even notice this noise. Watch even more closely and you will find some people clasp their hands to their ears in an attempt to shut out the sound. This will illustrate how much human hearing varies. We also pointed out in Chapter II that some people can hear a bat squeak, whereas most of us cannot.

Human hearing, it was also pointed out in Chapter II, varied approximately between 15 and 25 CPS at the low-frequency end and between 15,000 and 30,000 CPS at the high-frequency end. Of course the extreme limits are exceptional but, for the purpose of

illustration, we have included this portion of the audible spectrum. By eliminating one octave at each end of the spectrum, as shown in Figure 4-3, we come closer to normal adult hearing.

Curve *B* is the response of the simple loudspeaker, which we wish to extend. Curve *C* is the response of a simple speaker with its range extended at the high end but, as we can see, it is now unbalanced.

We can, by increasing the mass of the cone, extend our bass response, although this extension is at the expense of the high-frequency end. When we do extend our bass response to 60 CPS, for example, we find we have reduced our high-frequency response to 8,000 CPS. However, we also have achieved tonal balance, as can be seen in Curve *D*.

There is another important factor to consider. The frequency response must be uniform; in other words, each frequency should be reproduced at the same intensity as any other. We pointed out earlier that non-uniform response results in unnatural reproduction.

The actual response curve of our simple loudspeaker is shown at Curve *E*. Note that the intensity at different frequencies varies as much as 22 DB. Remember that a variation in intensity of more than 2 DB is noticeable to the average ear. Since this response is obviously unsatisfactory, we must continue our experiments. The factors which cause non-uniformity of frequency response in our simple loudspeaker are legion, but we will analyze, at this time, only the most important.

Any vibrating mass has one frequency at which it will vibrate most easily; this is said to be its resonant point, resonant peak, or fundamental frequency.

The resonant peak in our loudspeaker has the following effect on our reproduction: the resonant peak in this speaker occurs at 110 CPS, as can be seen in Figure 4-3, Curve *E*. A signal fed into the speaker at this frequency would result in a sound output 13 DB higher in level than a signal of equal intensity fed into the speaker at 400 CPS.

This variation in intensity has the following result: a piano reproduction would result in Low *A* having a loudness level of

15 DB more than the level produced by Middle A. This is obviously unnatural, and therefore not an exact reproduction of the piano, which is what we are attempting to achieve.

A similar phenomenon causes other peaks. In an earlier discussion of harmonics, we found that any vibrating object, in addition to vibrating at its fundamental (or resonant) frequency, also vibrates at multiples (or harmonics) of this frequency. These harmonic peaks have exactly the same effect on our reproduction as did the peak at the resonant point. This subject will be dealt with more completely in the next chapter.

Fortunately, we can reduce these peaks in our response curve by subduing the resonances at both the fundamental and harmonic frequencies. Increasing the rigidity of the cone, properly selecting the cone pulp material, or altering the cone shape may accomplish this. Curve F of Figure 4-3 illustrates the effect of such measures.

The single low-frequency resonant peak and the four peaks at the high-frequency end are still present, but are no longer as steep. This results in more uniform, or linear, reproduction.

At this point it may be well to stop and review the changes in our loudspeaker characteristics which we have been able to obtain by manipulation of just one component.

We have been able to vary the broadness frequency range, its position in the audible spectrum, and the linearity or uniformity of response. We are now in a position where, within reasonable limits, we can emphasize or de-emphasize any segment of the audible spectrum.

There are other characteristics of loudspeakers which affect our reproduction. These are the various forms of distortion introduced in converting electrical energy into mechanical or sound energy. There are four forms of distortion: transient, harmonic, intermodulation and amplitude distortion. Before we particularize, we ought to understand what distortion is in general, with reference to a loudspeaker. It is the modification or generation of sounds not originally supplied to our loudspeaker.

One important type is *transient distortion*. This results from the inability of the speaker to respond quickly enough to sudden

changes applied to it. Most of our equipment is entirely electronic in operation. However the speaker, like the record player, is also a mechanical device. As such it is subject to a certain amount of inertia. This characteristic takes two forms: there is some delay in action when the speaker is suddenly activated by certain sounds; there is also a delay in cessation of movement when the electrical stimulation is withdrawn. In the latter case, the cone continues to vibrate after the activating electrical energy has ceased. Something is thus added to the original sound in that it is prolonged. This effect is known as *acoustic hangover*.

A reference to our discussion of reverberation will help us understand this time-delay characteristic. These two phenomena are similar in that the initial impulse, in each case, starts a continuing but gradually diminishing sound.

This phenomenon is illustrated in Figure 4-4. Each of the three curves depicted is for a different loudspeaker; each speaker has a different cone and suspension system. Speaker *A* has the longest hangover, since the reproduced sound takes longer to fade than it does in the other two. Speaker *B* is better in this respect; it has less transient distortion than *A* but is not as good as *C*. Speaker *C*, which comes to rest (straight-line position) most quickly, is best in this respect.

When we reproduce music, this acoustic hangover mars the next note played, since the cone is still in a state of vibration from the previous note. This action causes muddy reproduction. As the transient distortion is reduced the sound becomes cleaner and more crisp. This form of distortion is most conspicuous in the mid-frequencies, particularly on a piano reproduction of a staccato passage.

Generally speaking, a loudspeaker which has a rough, uneven frequency response, as does the one in Figure 4-2, Curve *E*, will also have poor transient response. The speaker illustrated in Figure 4-2, Curve *F*, will have less transient distortion and a better transient response.

As a rule, any factor which increases the mechanical resistance to motion of the loudspeaker cone will result in lower transient distortion. The increased mechanical resistance usually is obtained by slight cone compensation, thick outer compliance rolls, and the use

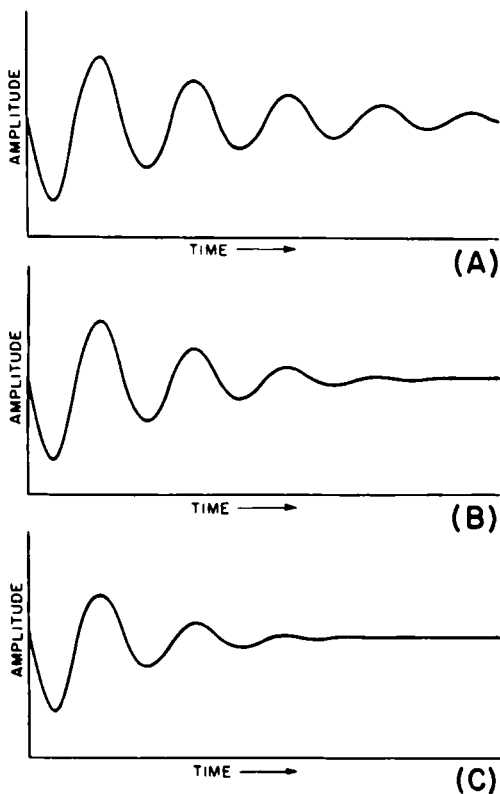

Fig. 4-4 Transient Distortion

of large permanent magnets. The last two are new factors in our loudspeaker and will be discussed at length in a later paragraph.

The next form of distortion is called *amplitude distortion*. It is caused by non-linear response of the loudspeaker cone. A similar effect was discussed in our second chapter with respect to the non-linear characteristic of the human ear. A non-linear characteristic is one in which the effect is not proportional to the cause. In other words, when we apply 1 volt to the loudspeaker the cone moves .1 of an inch; when we apply 2 volts we would expect the cone to be deflected .2 of an inch. When amplitude distortion is present, the cone does not move .2 of an inch but, perhaps, .15 of an inch. Figure 4-5 illustrates this. The response movement of the cone, as indicated by the solid line, is not proportional to the electrical

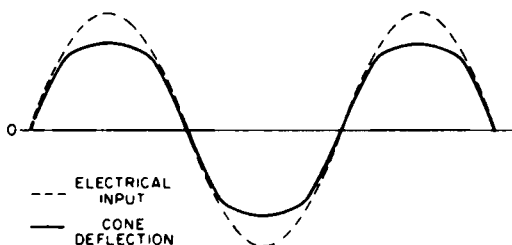

Fig. 4-5
Amplitude Distortion

input, as indicated by the dotted line. The amplitude, or the extent of the swing, is not proportional to the amplitude of the voltage causing it. Therefore, the sound being reproduced is distorted.

Amplitude distortion is greatest at the low-frequency end of the audible spectrum, since it is in this low-frequency area that the cone moves with the greatest displacement.

There is another form of distortion which is related to the type just discussed in that it stems from the same source. It is perhaps the most irritating form we can encounter in a loudspeaker. It only occurs when there is non-linearity at one or more frequencies in the speaker's response frequency.

Figure 4-6B illustrates an acoustic pattern without *inter-modulation distortion*. It shows the combination of a 60-CPS tone with a 1,900-CPS tone. The closely spaced lines within the larger curved lines represent the 1,900-CPS tone; the larger curves represent the 60-CPS tone. We can see from this illustration that the lower and upper contours are replicas. This shows that there is no inter-modulation distortion present in the illustration.

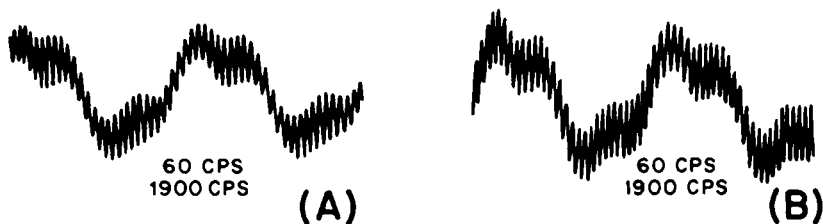

Courtesy *High-Fidelity Magazine*, Spring, 1952; Article by G. A. Briggs

Fig. 4-6 Inter-modulation Distortion

Figure 4-6A illustrates the feeding of both frequencies into one loudspeaker; amplitude distortion results. Note that the top and bottom contours are different. This difference results in the creation of sounds of new frequencies, not present in the original, which are reproduced as harshness to the ear.

Inter-modulation distortion is created in the following manner: when the frequency which has amplitude distortion is reproduced together with another, usually higher, frequency, the former in effect controls the latter, modifying and distorting it in such a manner that the spurious sounds of another frequency are produced.

The fourth form of distortion which was mentioned is *harmonic distortion*. This form is simple for us to understand since, in two previous chapters, we have discussed harmonics. Reviewing the subject briefly, we find that any vibrating object in addition to vibrating at its fundamental frequency also vibrates at multiples or harmonics of this frequency. This is the phenomenon which causes harmonic distortion in our loudspeaker.

This form of distortion can be reduced by the same method which helped us in improving the linearity of response, a properly designed cone. There is another method which will be discussed in detail in the next chapter.

At the beginning of this chapter we mentioned a permanent magnet which was depicted as C in Figure 4-1. This magnet plays a very important part in our loudspeaker. As was previously mentioned, the amplified currents of electrical energy are fed into the voice coil. Here these currents set up a correspondingly variable magnetic field around the coil itself. This variable magnetic field reacts with the fixed permanent field around the permanent magnet. As a general rule, the stronger the magnet or the more efficiently it is used, the more sensitive or efficient is the loudspeaker. In addition to increasing efficiency, the magnet increases the damping on the voice coil. Any factor which increases the damping on the voice coil, and consequently the cone, also results in improved transient response.

The efficiency of a loudspeaker is dependent upon the amount of electrical energy required at its input in order that a stipulated amount of acoustical or sound energy be supplied at the output.

For example, while one speaker will supply an acoustic output of 70 DB with a specified electrical input, another speaker will require twice that electrical input to obtain an acoustic output of 70 DB. The second speaker is obviously only 50% as efficient as the first.

There is one remaining speaker component which is important to us; this is the inner suspension. The inner suspension serves two prime purposes: it keeps the voice coil in the center of the small gap in which it vibrates, and it protects the gap against the entry of foreign particles of dust and grime.

The inner suspension is usually a molded, corrugated disc with its center attached to the voice coil and its outside edges attached to the loudspeaker frame. A perfect inner suspension prevents all sideward or lateral motion of the voice coil without introducing any other effect.

We now know enough about the simple loudspeaker to understand how it converts electrical energy into mechanical or sound energy. We have also learned how it responds to different frequencies and intensities and how its sensitivity and frequency response are varied.

We have considered the meaning and importance of tonal balance and the four forms of distortion which can occur in a loudspeaker. We are now in a position to delve more deeply into the subject of modern high-fidelity loudspeakers, which is the subject of our next chapter.

CHAPTER V

THE HIGH-FIDELITY LOUDSPEAKER

The use of two loudspeakers. The high-frequency loudspeaker or tweeter. The crossover network. The modern co-axial loudspeaker. The low-frequency loudspeaker or woofer. Multiple loudspeaker systems. The advantages of multiple loudspeaker systems. The tri-axial loudspeaker. How to choose a loudspeaker system.

It is almost impossible, at the present time, to obtain from an ordinary single-cone loudspeaker the type of response required for high-fidelity reproduction. At best, single-cone or mono-range speakers, as they are also called, are engineering compromises. No speaker of this type is alone capable of achieving the wide range we require.

There is another type, expressly designed for high-frequency response only, which is called a tweeter. One such is illustrated in Figure 5-1A. The tweeter usually covers a frequency range of from 2,000 to 18,000 CPS. Both the low- and high-frequency cut-offs (limits) vary with different manufacturers for reasons which will be discussed. For the purpose of illustration, our low-frequency cut-off will be set at 2,500 CPS for the tweeter; in other words, our original speaker need no longer reproduce any frequency above 2,500 CPS when used in conjunction with this tweeter.

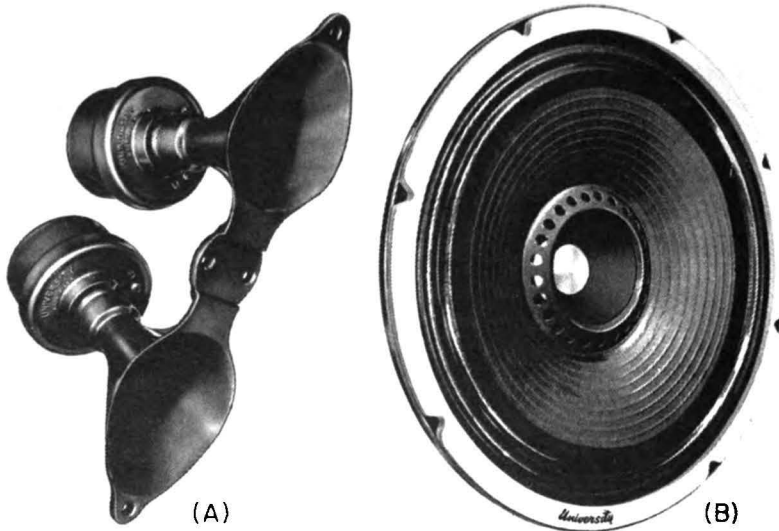

Courtesy University Loudspeakers, Inc.

Fig. 5-1 (A) A Tweeter, (B) A Diffusicone Speaker

Curve *A* in Figure 5-2 depicts the response of the simple speaker described in the previous chapter. Curve *B* illustrates the response of the tweeter. Curve *C* illustrates the response of the combination. For the latter, the improvement in frequency range over a single speaker is quite evident. This obvious increase in frequency range is only one of the many advantages we have gained by using two speakers as a combination. Before becoming involved in the discussion on tweeters, it might be well to explain briefly some of the other advantages we are able to obtain through our decision to divide the audible spectrum between two loudspeakers.

Single-element, mono-range speakers always retain one particular characteristic which is detrimental to true high-fidelity listening. The middle and high frequencies propagate in air almost like a beam of light, as we discovered in Figure 3-4 of Chapter III. These higher frequencies have a tendency to disperse in concentration along the axis of the loudspeaker from its apex. Thus, the dispersion of a good portion of the audio spectrum being produced by even the finest mono-range speakers is actually confined to a comparatively narrow angle. The lows bend rather easily and,

therefore, spread throughout the average room with little difficulty. It is reasonable to assume that something like 60-75% of the total probable listening area of a room will be off the speaker axis; therefore, the response as heard from these positions will be rather limited.

A number of manufacturers, in attempts to remedy this condition, have developed various methods of improving both the high-frequency response and distribution in space, or polar behavior, of a mono-range speaker without resorting to unduly expensive additions. The loudspeaker illustrated in Figure 5-1B is representative of this type and is called a diffusicone. Some knowledge of its operation will be useful to us.

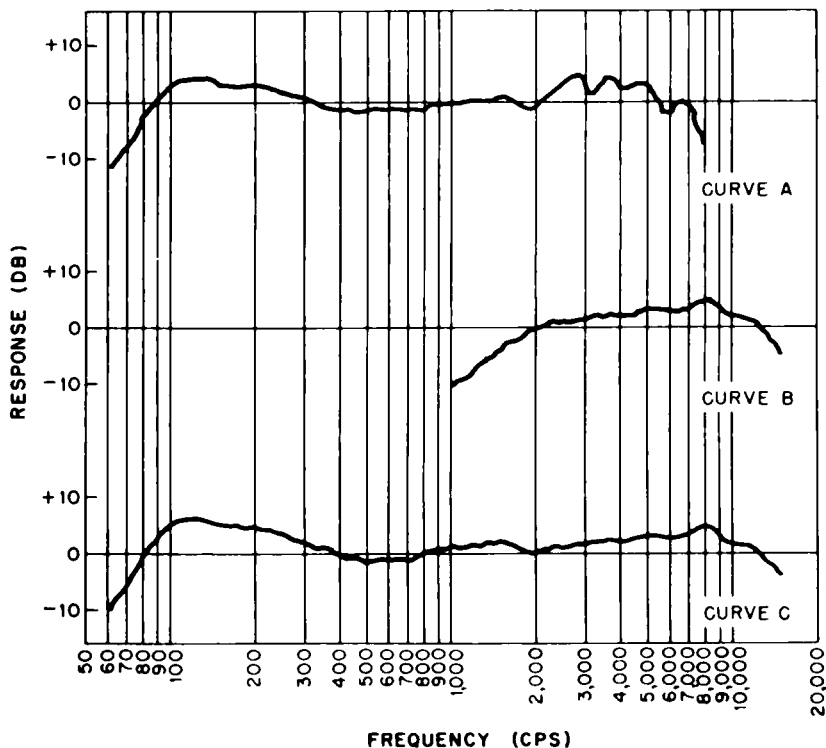
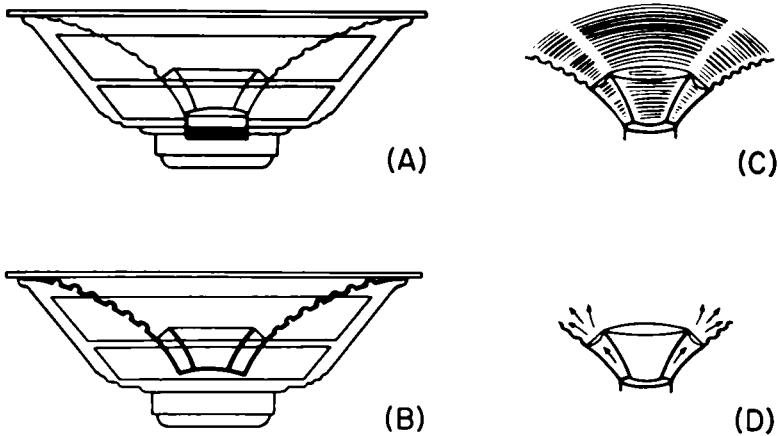

Fig. 5-2 Response Curves of (A) A Mono-Range Speaker, (B) A Tweeter, (C) A Combination of Both



Courtesy University Loudspeakers, Inc.

Fig. 5-3 High-Frequency Dispersion in a Diffusicone Type Speaker

The higher frequencies in any single-element speaker are generated mostly by the apex portion of the cone. The diffusicone type utilizes this energy more completely by placing a dural dome directly over the voice coil. This dome, shown at *A* in Figure 5-3, acts as a piston, pushing the air in front of it. At *B* is shown the specially flared diaphragm which is affixed to the center portion of the dome. The energy appearing across the face of the dome divides into two concentric horns: the horn which operates at the center of the dome and the horn which is formed by the outer surface of the inner horn and the speaker cone. This effect is depicted in heavy lines. The directional characteristics of the higher frequencies are partially overcome by this division of energy into two paths. The outer horn is actually a radial projector which sends the sound waves off on extreme angles from the speaker axis, as in *C* of Figure 5-3. Diffraction of the very high frequencies is accomplished by passing these waves through the apertures in the radial projector, as in *D*. This diffuses the higher frequencies more uniformly in space.

While a special design of this type affords a decided improvement, the use of a tweeter provides better distribution than any compromise and solves other problems besides.

Figure 5-4 illustrates the spatial distribution of a mono-range speaker at 5,000 and 10,000 CPS. These curves, similar to those shown and described in Chapter III, are given as solid lines. The dotted line depicts the spatial distribution of a tweeter. We can see from these curves that the tweeter affords more even distribution of the higher frequencies at the various points off the axis and, in this manner, affects a considerable improvement in listening at different points in a room.

The most important advantage of the tweeter can be seen by comparing Curve B of Figure 5-2, illustrating the frequency response of the tweeter, with Curve A in the same graph, which depicts the response of our simple speaker. The higher frequencies above 2,500 CPS are reproduced much more smoothly by the tweeter. The reason for this, as given in Chapter III, is that the designing of a speaker for a specific range or purpose results in a much better reproducer, because the number of design compromises required decrease with the reduction in the frequency response it is necessary to repro-

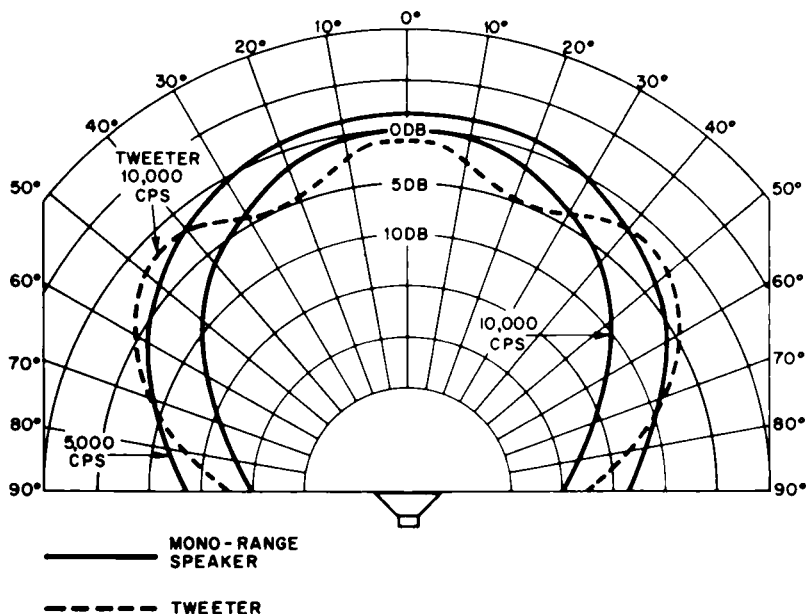

Fig. 5-4 Dispersion Curves for a Mono-Range Speaker, and for a Tweeter

duce. By adding a tweeter to our mono-range speaker, incidentally, we have created another problem. Fortunately, it is quite simple to solve.

Figure 5-2 illustrates the problem we have created by using two loudspeakers in combination. We mentioned in an earlier paragraph that our high-frequency cut-off was 2,500 CPS. As can be seen from Curve B, our tweeter still reproduces frequencies below this figure, though at a reduced level. In addition, the cone speaker reproduces frequencies above this cut-off point. Thus a specific band of frequencies is being reproduced by both loudspeakers simultaneously. This "overlap" in reproduction results in a response in the overlap area which displays a series of peaks and dips and, in consequence, makes for a rough sound.

The foregoing paragraphs make obvious the fact that, when two or more speakers are used in combination, it is essential that each individual speaker be allocated only the specific band of frequencies which it will be called upon to reproduce. For example, the cone speaker in our case should receive for reproduction only those frequencies up to 2,500 CPS. The high-frequency speaker should receive only frequencies down to 2,500 CPS. In this manner, neither speaker will reproduce any frequency being reproduced by the other.

The device by which this frequency-channeling is accomplished is called a *crossover network*, since it determines the frequency at which the crossover of reproduction from one speaker to another takes place. Returning to Figure 5-2, Curve C, we find that inserting the crossover network which channels the audible spectrum into the proper loudspeakers has practically eliminated the roughness and distortion in the crossover area. Figure 5-5 illustrates a typical commercial crossover network.

The choice of a crossover point or points, as in a multiple speaker system, is not a haphazard affair. It is usually the result of a careful analysis of the various characteristics of the loudspeakers involved. The following are some of the most important factors which lead toward the determination of this point or points, as the case may be.

The first consideration in the choice of a crossover frequency is the point at which the response of the low-frequency loudspeaker



Courtesy University Loudspeakers, Inc.

Fig. 5-5 A Crossover Network

starts to become rough or non-linear; in our case approximately 2,500 CPS. The second factor is dependent upon the spatial distribution or polar behavior of the low-frequency speaker as it becomes narrower than that of the tweeter. It is obviously advantageous for the tweeter to handle the reproduction from this frequency upwards. There are other factors which influence the selection of the crossover point, but we reserve these for later discussion.

The many advantages we can obtain through the use of a second loudspeaker should now be obvious. We have two choices: the first may be a combination of a good 12" or 15" speaker and a tweeter, such as was described, perhaps by adding the tweeter to an existing installation. The second choice is use of a loudspeaker which, mechanically, combines a low-frequency speaker and a tweeter in one unit.

Figure 5-6A illustrates a commercial version of a combined tweeter and low-frequency loudspeaker. The low notes up to 2,000 CPS are produced by the large-cone speaker, while the tweeter,

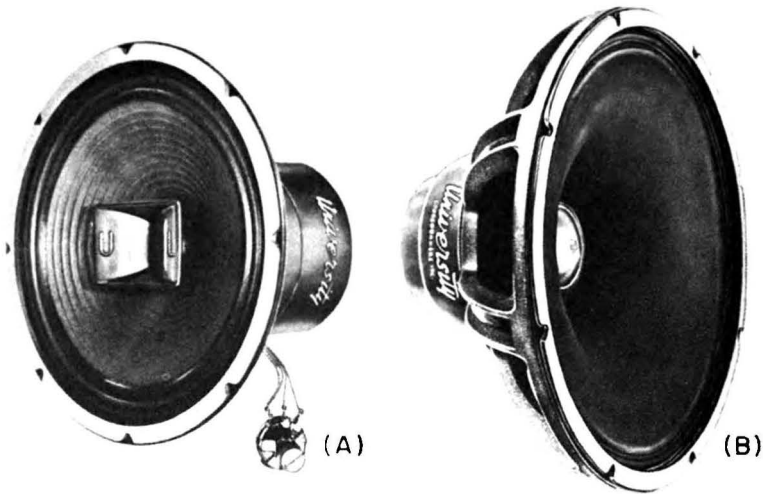

Courtesy University Loudspeakers, Inc.

Fig. 5-6 (A) A Co-Axial Loudspeaker, (B) A Woofer

mounted inside the large cone, takes over the rest of the spectrum up to 15,000 CPS. Division of the signal being reproduced is accomplished by a crossover network which is built into the speaker frame. The particular loudspeaker shown includes a high-frequency control, the purpose of which will be described later in this chapter. It appears below and to the right of the speaker.

At this point, it may be well to dispel the popular misconception that any mono-range speaker automatically becomes a low-frequency reproducer or woofer, as it is called, when the frequencies fed into it are restricted to the lower register. This concept is erroneous since the mono-range speaker does not reproduce the lower register any more efficiently just because it is then confined to only a portion of the spectrum. This is all that actually occurs; the higher frequencies usually reproduced by the mono-range speaker are then more efficiently reproduced by the tweeter.

A true woofer is a loudspeaker which has been expressly designed to reproduce a limited range of frequencies in the lower

register and cannot or should not be used by itself. One of this type has been illustrated in Figure 4-2. Another is shown in Figure 5-6B.

Our next step is quite logical. Since we have obtained such a tremendous improvement by using two loudspeakers instead of one, why not use three instead of two? The idea is an excellent one. In fact, in addition to providing smoother response over a wider range, this arrangement affords another advantage that a two-speaker system cannot give us.

To appreciate this added feature, we will have to reopen our investigation of response curves for loudspeakers. We must explain, in this connection, that the speaker response curves we have been showing are integrated or averaged curves as distinguished from true or machine-run curves.

Figure 5-7, Curve A, shows what the response of one particular speaker looks like as it was recorded by automatic measuring devices. Curve B illustrates how such a curve is sometimes represented in manufacturers' literature. It is a smoothed-out curve representing the over-all picture of the speaker's response.

The reader must not, at this point, construe this explanation as meaning that the manufacturer intends subterfuge. Curve B is an honest and practical representation of the loudspeaker's performance in most respects. The numerous dips and peaks evident in Curve A are, of course, severe, but the space or spread each one occupies on the spectrum is generally narrow enough to be beyond detection by the human ear. Hence, when these characteristics are averaged, the curve that results is closely representative of what the listener actually hears. In discussing this subject with a number of loudspeaker manufacturers, the author found that many would prefer to print "true curves." But he also feels that, for the present, knowledge and true understanding of the art have not reached the point among the great fraternity of music lovers and hi-fi enthusiasts where such curves will be properly interpreted.

Lest the reader be entirely misled, however, the lack of true curves does hide performance deficiencies which show up in even the most expensive equipment. Look at Curve C. This is a true speaker response curve which not only displays the usual dips and peaks but shows certain of these fluctuations to occupy a space of

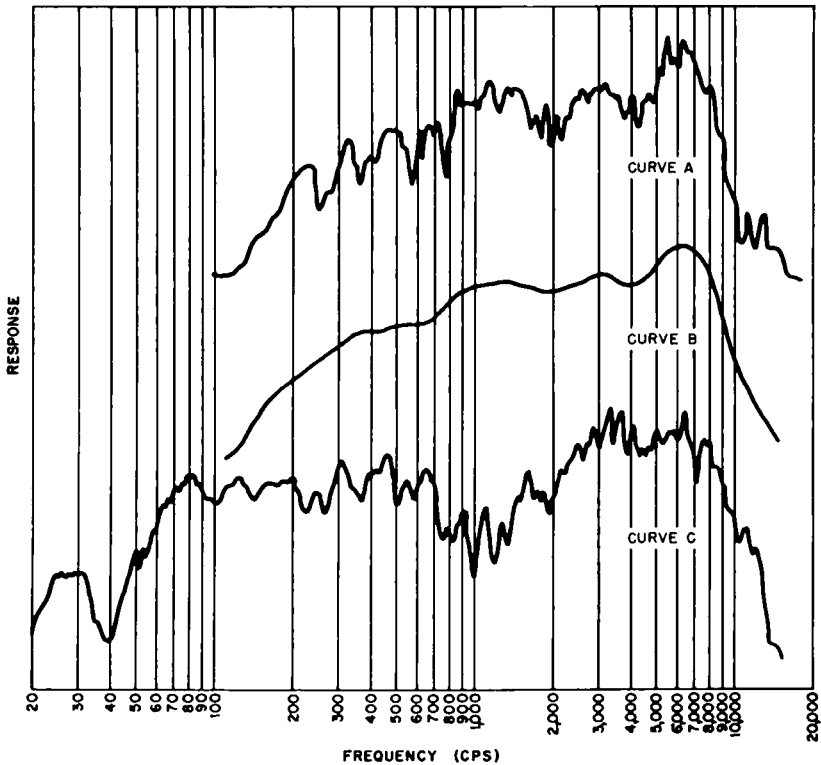

Fig. 5-7 Machine-Run Loudspeaker Curves

some hundreds or thousands of cycles. When such a condition exists, the response of the speaker is said to have "holes." If the spread is great enough, a "valley" exists. Another glance at the chart in Chapter II, showing what frequencies are produced by various musical instruments (Figure 2-5), will give you some idea of what to expect from a speaker with these characteristics. As previously mentioned, the tonal quality of musical instruments which gives them their distinguishing characteristics is determined to a large degree by the relationship of harmonics to the fundamental frequency produced by the instrument in both amplitude and number. Thus the loudspeaker, or any other component for that matter, should it disturb the original relationship, apparently changes the quality of the original sound.

In the case of the speaker producing Curve C, it is clear that, in some cases, the fundamentals of high-pitched instruments and the important second and third harmonics of lower-pitched instruments will be produced at acoustic levels differing from the original. Since the great bulk of acoustic reproduction lies in the mid-range, as we can also see from Figure 2-5, it is obvious that such a condition is detrimental to true high-fidelity reproduction.

As a matter of fact, speakers with nasty holes in the mid-range will often sound as though they have extremely good high- and low-frequency response. But when they are compared with a speaker with good middles, giving full-bodied response, will then be exposed as the inadequate reproducers they are.

The big dips and peaks with which we were concerned are for the most part, as previously explained, the products of cone and suspension design. As we have discovered, even the wood pulp from which the paper cone is made has a direct bearing upon the final performance. Excessive irregularities in the frequency response of these assemblies impose additional hardship on the magnet assembly in coping with transient response, and often dictate the need for great quantities of magnet to keep transients under control. Thus, as we have previously found, a speaker which is unable to follow sudden changes in the amplitude of a complex audio signal without sluggishness and hangover has either an improperly designed cone assembly, an inadequate magnet, or both.

It can be seen, therefore, that a loudspeaker should not always be judged by its weight or the weight of its magnet. In some cases large magnets may be required to overcome inherent design defects, the price of such speakers naturally includes the extra costs involved; therefore, price or weight do not always indicate superior performance. We should also bear in mind that several different types of magnet assemblies and different grades of magnetic material exist, and that similar efficiencies can be achieved by all, though at greatly varying costs, weights, and over-all dimensions.

From our foregoing paragraphs, it should become obvious that no portion of the audible spectrum is subordinate to the others; all must be reproduced with equal faithfulness if we are to enjoy true high-fidelity reproduction. We should, as far as the loudspeaker

is concerned, divide the audible spectrum into at least two and preferably three sections if we wish to obtain that intangible effect generally known as presence. This term is used to indicate the feeling on the part of the listener that he is in the presence of the original orchestra, singer, or speaker.

One company is today manufacturing a loudspeaker which will serve to analyze the importance of three divisions. This unit consists of three separate and distinct loudspeakers combined in one mechanical assembly. It is the Jensen G-610, illustrated in Figure 5-8.

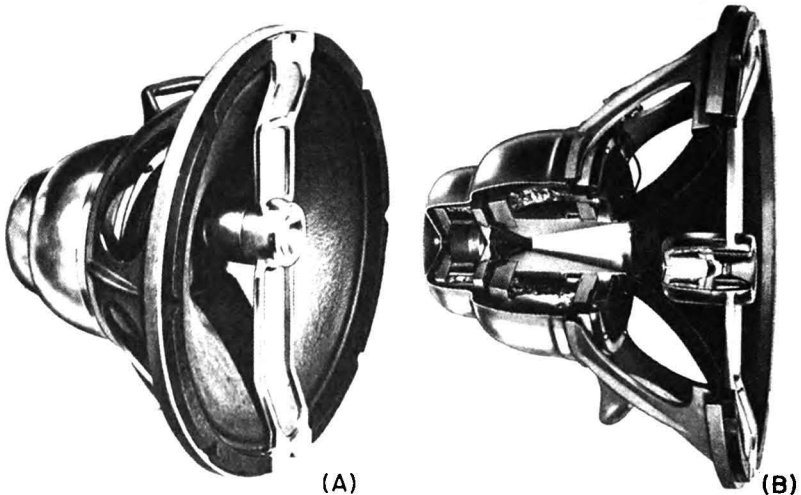

Courtesy Jensen Mfg. Co.

Fig. 5-8 The Jensen Tri-Axial Speaker

This tri-axial unit consists of three independently driven loudspeakers, each of which covers a specific portion of the audible spectrum. The low-frequency speaker covers the range up to 600 CPS. At this point one crossover network channels the signal from 600 to 4,000 CPS into the mid-range speaker. The frequencies above 4,000 CPS are channeled into the high-frequency unit.

The low-frequency section of this loudspeaker is a true woofer, a term which we will now explain, as promised. A woofer is a

loudspeaker which is expressly designed to reproduce only the low-frequencies up to a point ranging from 200 CPS to 800 CPS. When the frequency range which a particular loudspeaker must reproduce is purposely restricted, as in a woofer, the result is a unit with negligible transient distortion and greatly improved linearity. As previously mentioned, a true woofer cannot and should not be used by itself.

The low-frequency speaker or woofer of the Jensen G-610 is designed to operate in the range up to 600 CPS. In this range its behavior is essentially piston-like. The radiating system is a 15" curved-surface cone driven by means of a 3" voice coil in a magnetic field of very high energy. This produces excellent transient response as well as high efficiency. An exceptionally large inner suspension permits large peak excursions while maintaining linearity. Figure 5-8B illustrates the mechanical arrangement of the three separate units.

The mid-frequency speaker, which handles the range from 600 to 4,000 CPS, consists of a driver unit located at the rear of the assembly. It feeds a horn, the initial section of which passes through the core of the low-frequency speaker; the flared cone of the low-frequency loudspeaker is designed to act as the final section of the mid-range horn. The large horn-mouth size provided by the low-frequency cone provides good loading, which results in smooth response and high efficiency down to and below the mid-frequency crossover point of 600 CPS. This horn arrangement permits good diffusion up to the crossover point at which the tweeter takes over, 4,000 CPS.

The range above 4,000 cycles is reproduced by a new special-compression driver and small-horn combination at the front of the entire assembly. Its placement is dictated by diffraction considerations, which become very important at such high frequencies. Streamlining and minimizing of obstacle effects have been carried out in a highly satisfactory manner so that smoothness of response is maintained throughout the high as well as the mid-frequency regions.

The reader, if our efforts have been successful, should by now be aware of the fact that a multiple-speaker system is essential if we are to obtain the finest in reproduction.

There are still a number of other factors which should be considered when choosing a loudspeaker or a speaker system. We should also consider the characteristics of the individual ear, room condition, individual preferences, and even the age of the listener. Figure 5-9 is a reproduction of part of an advertisement by Bell Telephone Laboratories which will serve to illustrate the wide variation in the hearing of individuals. Some means of compensating for this variation would be advantageous. Compensation should also be provided to allow for the reduction of response in the ear at the higher frequencies.

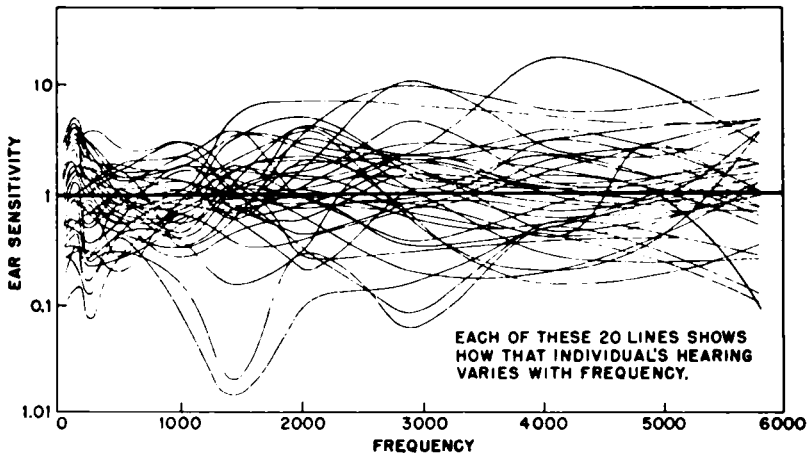

Courtesy Bell Telephone Laboratories

Fig. 5-9 Individual Variations in Human Hearing

The author has watched with great interest customers visiting different sound studios and listening to various systems in one and then comparing them to other systems in a different studio. Aural tests in a sound studio, if one is fortunate enough to be located in or near a large city where such facilities are available, are not wholly dependable. First, the room acoustics are different from those of the room in which the speaker will be finally used. This can make a discernable difference in apparent tonal quality. Second, the other factors previously mentioned vary. Third, it is probable that the selection of loudspeakers available are judged in

cabinets other than those in which they will eventually be used by the purchaser. The level at which various speakers are operated, as well as the program material used, are other misleading factors. The subject of the level at which demonstrations are made will be treated in more detail in a later chapter. The effect of various listening levels on the ear was already discussed.

The simplest solution to the problems just posed would be a three-speaker system *with an individual level control for each speaker*. In this manner we obtain complete level control of each of the three portions of the audible spectrum. The advantages of such a system should be manifest.

Limiting the range which each loudspeaker handles makes it possible for the manufacturer to provide a finer reproducer. The inclusion of a variable level control for each speaker, as part of the crossover network, becomes the first step toward the flexibility required by the variation in the ear characteristics of different individuals and the differences in room acoustics. For example, a person growing on in years will normally be somewhat insensitive to the higher range of frequencies. The control provided can be adjusted to boost the output level of the entire band being handled by the tweeter, thereby making up for that deficiency. On the other hand, should another person's hearing be hypersensitive to the highs, the control is set to some satisfactory position wherein the tweeter output has been reduced, or *attenuated*, to the level required. A certain intermediate position of the control produces "flat" or linear response of the over-all frequency range of the high-frequency loudspeaker. The characteristics of the program material itself can be altered to suit personal taste, scratch noises from an old or worn record can be reduced without reducing the range; or an incoming radio program lacking adequate treble can be boosted in that general range. All of these advantages are accomplished as a result of the far greater energy possible from a tweeter of the horn-loaded driver-unit type as compared to even the best cone-type loudspeaker. Respective efficiencies run from about 30-40% for such tweeters but only 8-10% for the very best cone speakers; thus we literally have energy to burn. The tweeter control changes the level of the entire band being handled by the reproducer.

It should be pointed out that these separate speaker controls do not function in the same way as ordinary tone controls for the bass and treble ranges, and therefore cannot be directly replaced by them. For example, the treble controls included in most amplifiers are generally more selective, operating at a given rate per octave. Therefore, the two types of controls are not necessarily conflicting, but actually complementary. They can be employed together to obtain exactly the results we require.

In our case, a woofer-type loudspeaker is employed to handle the frequencies up to 600 cycles, a mono-range reproducer is used to reproduce the middle range from 600 cycles to about 4,000 cycles, and a tweeter is then used to take over for the home-stretch to 18,000 cycles.

Using three variable controls, one for each loudspeaker, provides us with tremendous flexibility. For example, the middle-range control can be temporarily employed as a *loudness control*. As we have seen previously from the Fletcher-Munson curves (those showing changes in the ear's response at different levels), reducing the over-all level of listening also reduces the sensitivity to low- and high-frequency response. Thus, by attenuating the middles, we can increase the apparent loudness of the highs and lows, thereby partially restoring the balance which our hearing demands for more enjoyable listening at lower volume levels. This helps solve a serious problem we left unanswered in an earlier chapter.

Thus far, we have confined our activities to the search for perfection in reproduction. We have not thought of the almighty, but highly inflated, dollar. We will now attempt to offer a method by which our goal can be achieved without a tremendous initial outlay of money. We know what we should have in order to achieve the result we require but, unfortunately, we do not all have unlimited funds with which to obtain the equipment required. We can, with this method, gradually improve our equipment without discarding any previous purchase and, while on the way toward perfection, we can still have fine reproduction.

The loudspeaker we would choose, if confined to a single reproducer for financial reasons, would be of the type previously described as a mono-range speaker with provision for increased

response and dispersion of the higher frequencies. The response curve of such a loudspeaker is illustrated in Curve A of Figure 5-10. The response, as you will notice, falls short of our goal but, since we have introduced the economic aspect, we must make a temporary compromise. The compromise is not alone in frequency response, as we have learned, but also includes other factors with which we should now be familiar. The low-frequency response can be superior to that shown, but this is the subject of our next chapter.

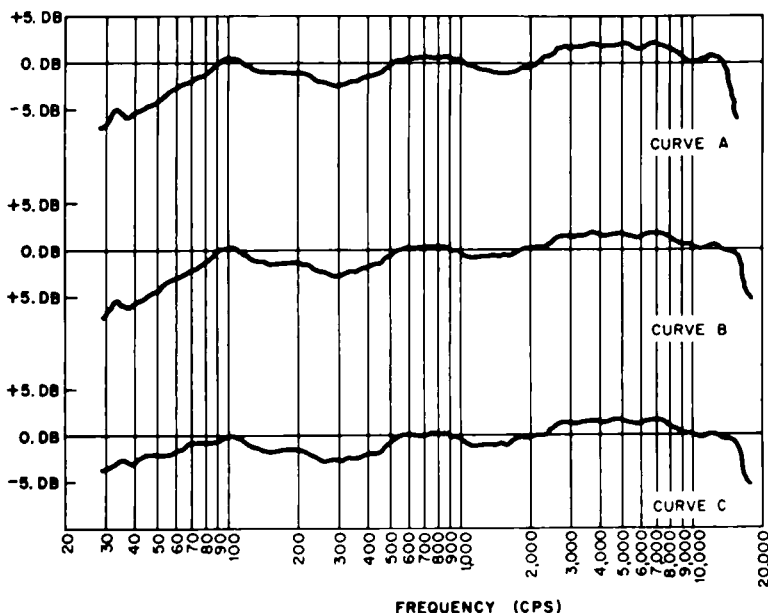

Fig. 5-10 Response of a Quality Speaker, with and without a Woofer and a Tweeter

The diffusicone type of loudspeaker we have chosen, when housed in the proper enclosure, will be far superior to those commonly encountered in even the finest commercial radio-phonographs; in short, reproduction may be considered superior judged even by our high standards.

Later on we can add a high-frequency speaker with a crossover network. We may even be able to start with a co-axial speaker

incorporating a built-in network. We can thus, at the outset, increase our frequency range to an appreciable degree and make a vast improvement in spatial distribution, besides obtaining substantial reduction in both intermodulation and harmonic distortion. By the addition of the tweeter, we can obtain a loudspeaker system which is so far above the average so called high-quality commercial radiophonograph as to be almost beyond comparison. The improvement, which will be quite obvious to the ear, is illustrated graphically in Figure 5-10, Curve B. Curve C partially illustrates our next possible improvement, which is obtained by the addition of a woofer to our existing system. The result of this addition will be even more dramatic aurally than is shown pictorially. By the addition of a good woofer, we can add the sense of *feeling* to reproduction, for you can actually *feel* good bass reproduction in addition to hearing it.

The importance of a good loudspeaker system being what it is, our next chapter, on enclosures, will show us how the reproduction of the important lower register can be even further improved.

Briefly, we have in this chapter discovered the importance of a good loudspeaker system and the fact that, for best results, we must divide the audible spectrum into more than one part, at least as far as the loudspeaker is concerned. The subject of our next chapter is quite as important as the subject of this one, for the loudspeaker enclosure is just as much a part of our loudspeaker system as the speakers themselves. The three-way speaker system just mentioned will also be discussed more completely.

CHAPTER VI

LOUDSPEAKER ENCLOSURES

The purpose of a loudspeaker enclosure. The various types of enclosures. Flat baffles. Open-backed enclosures. Cabinet resonance. Infinite baffles. Bass-reflex enclosures. The acoustic labyrinth. Horn-loaded enclosures. Enclosure for the Weiler Progressive Loudspeaker System. The Electrovoice *Patrician*. The *R-J* enclosure.

In the past few years we have seen much research directed toward the extension of the high-frequency response in home music systems. The results obtained by this research have been very satisfactory, almost too satisfactory, but the research and development continued. "Better and better high-frequency response" was the slogan. These improvements and advances finally resulted in what amounted to an unbalanced condition. The importance of tonal balance in reproduction, discussed in detail in Chapter IV, should require no repetition. The results obtained through this increased high-frequency response were definitely not high-fidelity reproduction as we know it today. The resulting unbalanced condition caused this so called high-fidelity to be shunned by many as being shrill and unnatural. The early critics were correct; the unbalanced condition was unnatural.

From our previous discussions we have discovered that when a tweeter is used in a loudspeaker system some method of controlling its sound output must be included. Without some means of reducing the tweeter output, the sound level at the higher frequencies will be much greater than at the low or middle frequencies, resulting in the unbalanced reproduction we are discussing.

Manufacturers and their engineers apparently realize that they have reached the point of diminishing returns and now are turning for further improvements to the low-frequency end of the spectrum. This is a most important step toward our ultimate goal of an acoustic facsimile.

The two most important components in a loudspeaker system, insofar as low-frequency response is concerned, are the woofer and the loudspeaker enclosure. We will, therefore, analyze the various types available in order to determine their advantages and disadvantages.

When a loudspeaker is in operation, the sound waves, which were mentioned in the previous chapter as coming from the front surface of the cone, are also duplicated by the rear surface of the cone. We actually have two sets of waves, one set radiating from the front of the speaker and one set from the back. These frontal waves and rear waves are produced simultaneously. The waves produced by the rear surface of the cone are the exact opposite of those produced by the front surface. They are said to be 180 degrees out of phase because they are opposite in direction. When these two out-of-phase sets of waves meet, cancellation of the frontal waves by the rear waves occurs, or vice versa. The shorter the air path, as compared to the wavelength of the sound between the two sets of waves, the more complete is the cancellation.

This cancellation effect is one of the reasons for the loss of low-frequencies in the smaller commercial radio sets. When the sound path is of sufficient length to eliminate or reduce this cancellation effect, as in large console radios, the low frequencies are reproduced to a greater extent.

The obvious solution to our problem is therefore to increase the length of the air path. This is best accomplished by means of a flat

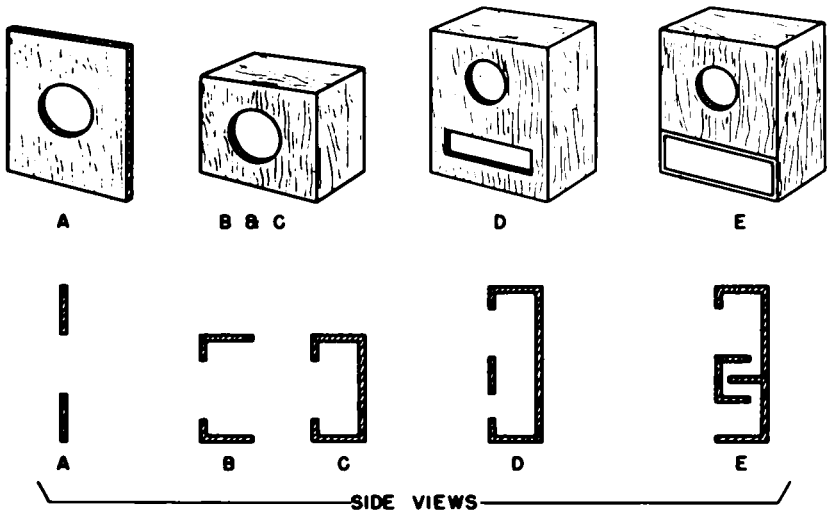

Fig. 6-1 (A) A Flat Baffle, (B) An Open-Backed Enclosure, (C) The Infinite Baffle, (D) The Bass-Reflex Enclosure, (E) The Acoustic Labyrinth

baffle, as depicted in Figure 6-1A. Due to the large physical size required of this type baffle to reduce the cancellation effect at low frequencies, a number of different methods have been devised in an attempt to reduce the size while retaining the same path length.

The simplest method of increasing the path length and simultaneously reducing the physical size is simply to fold back the four edges of the flat baffle. The result is an open-ended box, as illustrated in Figure 6-1B. This box baffle is similar to the type generally used as a speaker housing in a commercial radio-phonograph. The prime difference is that the enclosure in a commercial radio-phonograph is smaller; consequently it produces less bass.

The open-back box, while it has permitted a substantial reduction in physical size, has introduced a new problem: *cabinet resonance*. This so called cabinet resonance results in a sharp peak in the response curve in the area of 100-200 CPS. This peak has an effect similar to the loudspeaker resonance discussed in detail in Chapter IV, and is equally detrimental to high-fidelity reproduction. The effect on the human ear is a boominess often characterized as "one-note bass."

Such cabinet resonance can be eliminated simply by closing the rear opening of the box, thus completely enclosing the loudspeaker. This changes the type of baffle to one which is commonly termed an *infinite baffle*. The complete enclosure of the speaker results in the suppression of the rear waves, consequently eliminating the cancellation effect. This type is illustrated in Figure 6-1C. This enclosure would be ideal were it not for the fact that it has a tendency to raise the resonant frequency, and the fact that the response falls off rather rapidly below this frequency. The response above the resonant frequency, however, is very smooth. This enclosure method has other advantages which will be noted later.

Figure 6-1D illustrates an enclosure which is the most popular today. The bass-reflex enclosure, as it is called, is essentially an infinite baffle with a *port* or opening. It is this port which is responsible for many of the advantages of the baffle. Such an enclosure utilizes the sound energy created by the back wave of the loudspeaker at low frequencies to augment the energy created by the front wave of the cone. The low-frequency output is 3 DB higher than, or double that of, an infinite baffle or any baffle which eliminates either the front or back wave instead of using both.

The bass-reflex enclosure, when properly designed for the speaker or speakers with which it is to be used, is superior to any previously discussed. This point must be emphasized: to function properly the enclosure must be designed for the speaker, or vice versa. Unfortunately, the loudspeaker manufacturer cannot demand that a specific enclosure be used with his speaker; nor can an enclosure manufacturer say, "This enclosure is designed for this specific brand and model of loudspeaker." There is a way of adopting this enclosure to a particular speaker, called "tuning the port." This operation, however, is beyond the skill and equipment possessed by any but our most technically minded readers.

To continue, the bass-reflex enclosure also utilizes the resonant frequency of the enclosure itself to advantage in the following manner: when the resonant frequency of the enclosure is designed to be lower than the resonance of the loudspeaker it houses, the response characteristic of the system, consisting of the speaker and the enclosure, is extended and becomes more uniform throughout the extended range. When properly designed, this enclosure reduces

the amplitude of the loudspeaker's resonant peak. This also results in smoother low-frequency response.

The loudspeaker's resonant frequency determines, to a large extent, the low-frequency characteristics of this system. The physical size of the enclosure should be increased as the speaker resonant frequency is lowered, for otherwise it is almost impossible to match properly the two resonant frequencies to obtain the desired effect.

There is one disadvantage in this type of enclosure when it is used with a mono-range speaker; the mid-frequencies show a tendency to be somewhat rough and non-linear, due to the difference in phase relationship between the waves emitted through the port and those emitted through the cone. A cure for this effect is the judicious use of sound-absorbing material. Again, manufacturers' instructions should be followed closely, since this material also has an effect on cabinet resonance to the extent that it may become impossible to match it to the speaker being used. The sound-absorbing material is utilized to absorb the middle and high frequencies at which the interference between the frontal and port-emitted waves occur.

The bass-reflex enclosure, in short, is the finest enclosure for over-all response thus far discussed. But again, unless the loudspeaker manufacturer's instruction are followed in detail, all of the advantages of this type can be completely nullified.

There is another type of enclosure which is similar to the bass-reflex in that it utilizes the back wave of the loudspeaker to augment the front wave at low frequencies. This type is called an acoustic labyrinth* and is illustrated in Figure 6-1E. This enclosure is not in general use today, primarily because it is more expensive and difficult to construct, but it is superior to the enclosures previously discussed in that it absorbs the high and middle frequencies of the back wave and also lowers the loudspeaker's resonant peak by almost half an octave, thereby extending the speaker's low-frequency response by that amount.

When one is limited to a single loudspeaker of the mono-range type or a co-axial loudspeaker, this enclosure is, without doubt, superior to any thus far described.

* "Acoustical Labyrinth" is a registered trade-mark of Stromberg-Carlson Co.

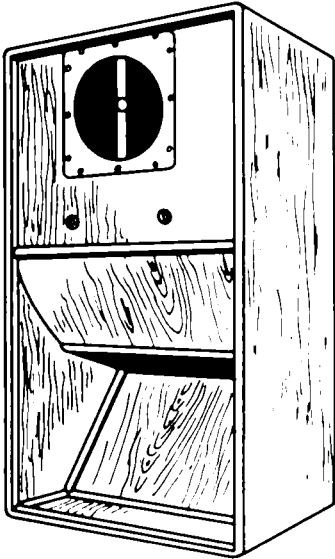
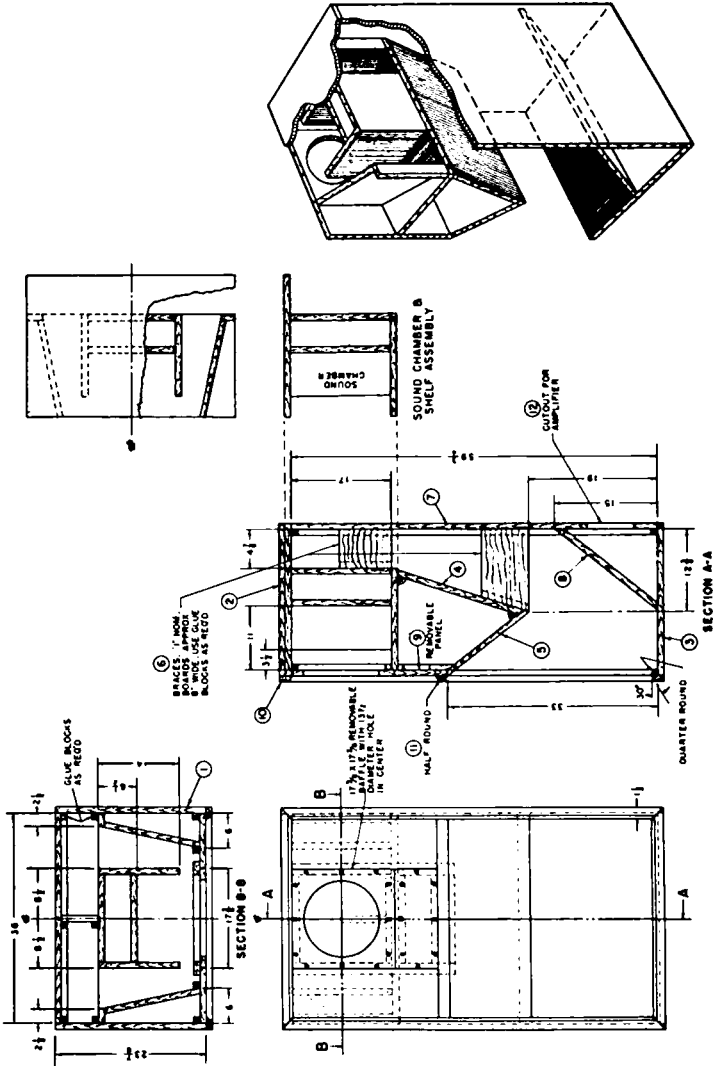

Fig. 6-2 The Jensen Back-Loading
Folded Horn

Courtesy Jensen Mfg. Co.

While discussing previous types of loudspeaker enclosures, the limiting factor was reasonable size; and yet, when we return to acoustics and musical instruments, we find that the physical size of the instruments creating the original sounds are, in most cases, large for those producing the bass tones and small for those producing the higher frequencies. For example the tuba, which produces low frequencies, consists of eighteen feet of tubing with a mouth almost three feet in diameter; on the other hand a flute, producing high frequencies, is only a foot long. We expect our loudspeaker system to reproduce both instruments and yet insist upon limiting the physical size necessary to do so. The primary reason for the large size of the instruments producing the bass tones is the fact that they must cause more air to move than the instruments producing the higher frequencies. When we wish to reproduce the sound of a tuba accurately, the speaker should displace as much air as does a tuba.

The vibration or sound created by the reed in a tuba is fed into the tubing previously mentioned. This tubing terminates in a horn about three feet in diameter. When we do the same with a loudspeaker, substituting the cone for the reed, we can load the cone



Courtesy Jensen Mfg. Co.

Fig. 6-3 Construction Details, Jensen Folded Horn

just as the reed was loaded with the same result, and this result is astounding. An enclosure using this principle is called a *horn-loaded enclosure*. There are several types among them. Some load or utilize the frontal radiation of the cone; others load or utilize the rear wave. The type shown in Figure 6-2 is a rear-loaded type. Proper horn loading of a woofer can increase the low-frequency output from 2 to 4 DB over the conventional enclosure. Such an increase in output in the low-frequency region is an extremely important contribution to the tonal balance we are attempting to achieve. This particular enclosure was designed expressly for the Jensen G-610 tri-axial speaker discussed in the previous chapter. The bulky, ungainly appearance can be disguised, as shown in Chapter XII. This is still a very large enclosure, but then so is the grand piano whose sounds we expect to reproduce. Complete con-

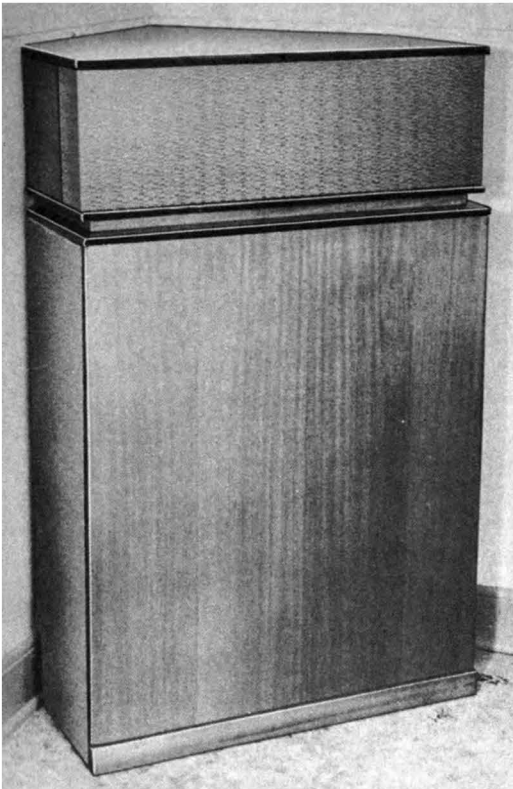

Fig. 6-4
The Klipschorn

Courtesy
Klipsch & Assoc.

struction details of the Jensen G-610 are shown in Figure 6-3. The methods of construction for this, and subsequent enclosures on which dimensions are supplied, will be given in detail in Chapter XII.

To return to the tuba, it too is a large instrument. It would be still larger and more unwieldy if it were not for the fact that the 18 feet of tubing is folded back on itself into a much smaller space.

There is another type illustrated in Figure 6-4. This enclosure was developed by Paul Klipsch and, while it still retains the horn-loading feature, the physical size has been still further reduced by cleverly utilizing the corner walls of a room as the final section of the horn. We can see from the enclosure in Figure 6-2 that a large percentage of the space required is utilized for the horn area. In the Klipschorn type, the space required is reduced considerably. As previously mentioned, the corner of the room is used as an extension of the horn within the cabinet.

Figures 6-5A and 6-5B illustrate the "Aristocrat" and "Regency" enclosures, manufactured by Electrovoice under Klipsch license. Figures 6-6 and 6-7 supply complete construction details on the "Aristocrat" and "Royal" which are two of the smaller horn-loaded enclosures. The "Aristocrat" is designed for a 12" woofer, the "Royal" for a 15" woofer. The horn-loaded enclosure, when compared size for size to any previously analyzed, is a superior type. While on the subject of size, it might be well to add that a large enclosure of a specific type will always provide better bass response than a smaller enclosure of the same type. Large physical size is almost imperative if we are to obtain the extended bass reproduction necessary for high-fidelity results.

During our previous discussions on the merits and limitations of the various types of enclosures, we discovered that the infinite baffle is excellent for the reproduction of frequencies lying above the loudspeaker resonance. This enclosure was rejected from further consideration at the time since it had a tendency to raise the resonant frequency while causing response to fall off sharply below this increased frequency, thus reducing our range. This precluded its use at the time, but were we to limit the response of the loudspeaker, enclosed in a baffle of this type, to say a range of from 600 to 3,000 CPS, the response would be excellent. The rise in

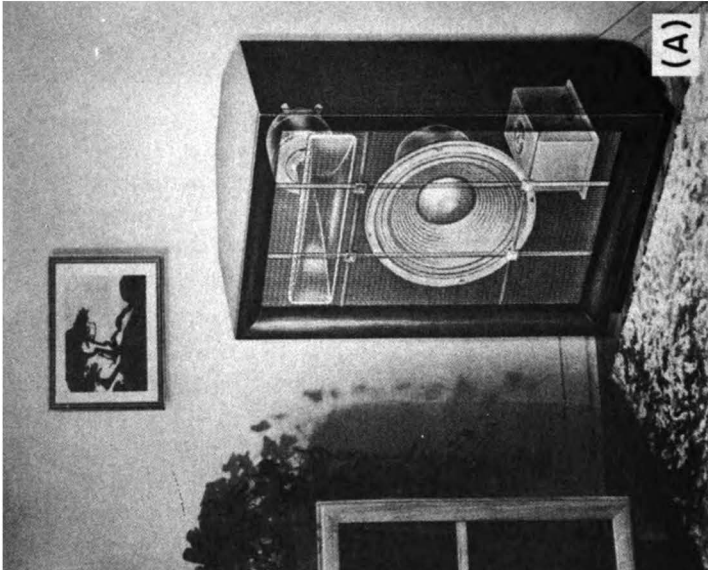
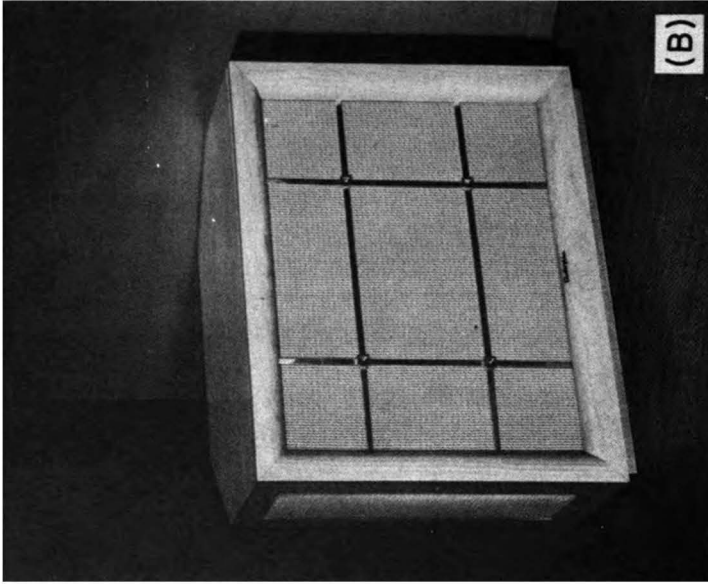

Courtesy Electro-Voice, Inc.

Fig. 6-5 (A) The Electro-Voice Aristocrat Enclosure, (B) The Electro-Voice Regency Enclosure

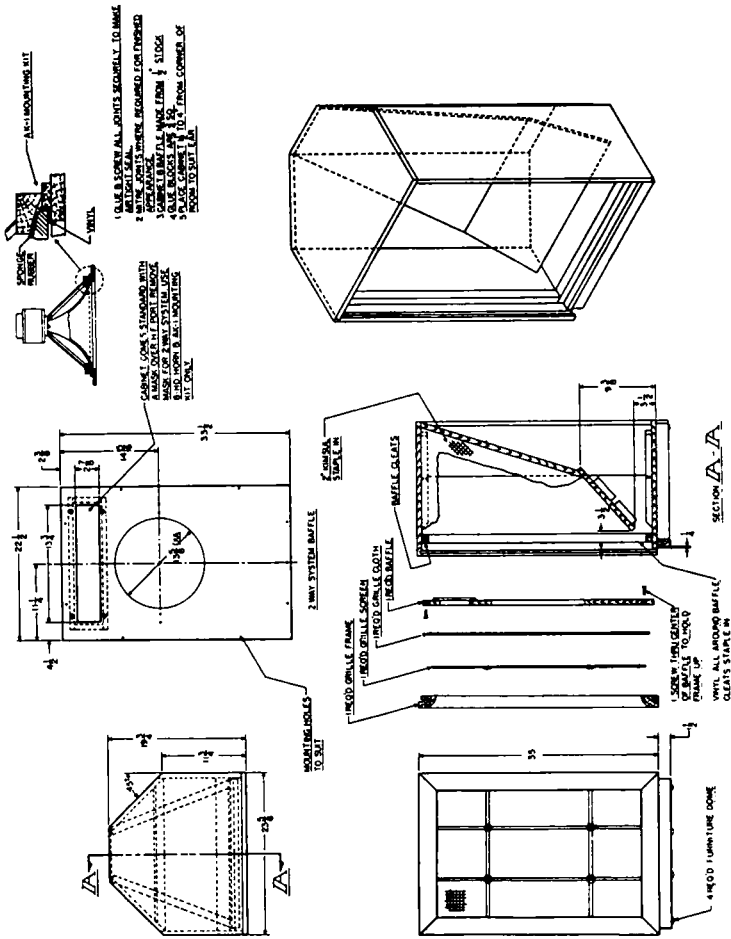

Courtesy Electro-Voice, Inc.

Fig. 6-7 Construction Details, The Royal

resonant frequency would lie well below 600 CPS and consequently have no adverse effect.

We also discovered that the bass-reflex enclosure improved our bass response by lowering the resonant frequency of the system below that of the speaker itself. Using a woofer with a low resonant frequency greatly improved the response, but required a larger enclosure to enable us to match the resonance required for proper operation. The increased size provided a longer air column for this purpose. We can provide a longer air column in another manner, by simply inserting a reflector between the loudspeaker and the port, as shown in Figure 6-8. Increasing the air column in this fashion enables us to reduce the system's resonant frequency and still retain the same physical size. We now have a bass-reflex baffle which gives us excellent reproduction of the frequencies from slightly below the loudspeaker resonance of say 35 CPS to 600 CPS. Any roughness which may occur in the mid-range above 600 CPS is inconsequential, since the woofer does not reproduce any frequency above this figure. The best reproduction of frequencies above 3,000 CPS, as we have found, can be obtained by a tweeter, to which this range will be assigned.

Fig. 6-8
Bass-Reflex with Reflector

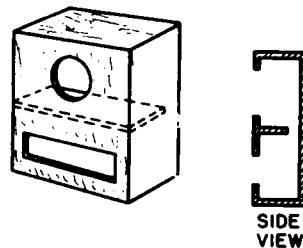

In our previous chapter, we discussed the use of three loudspeakers, each covering a portion of the audible spectrum. We also have three baffles or enclosures, if we may be permitted to call the tweeter horn an enclosure. By combining these three types of enclosures we can obtain one compact unit. This unit will include three distinct enclosures, each of which was specifically chosen for its efficiency and over-all performance over the range for which it is used. This enclosure is illustrated in exterior view and construction detail in Figure 6-9. The loudspeakers and crossover networks

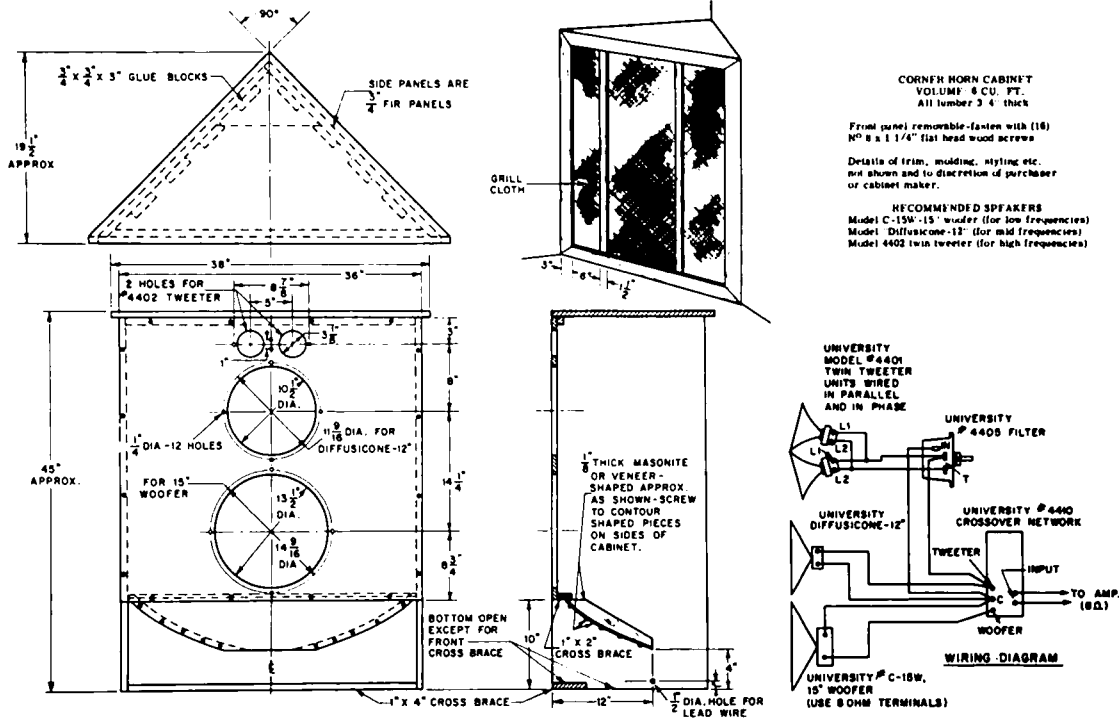

Fig. 6-9 Construction Details of Enclosure for the Weiler Progressive Loudspeaker System

Courtesy University Loudspeakers, Inc.

recommended in the figure are those for which the enclosure was designed, but other similar types may be substituted.

The upper section of this enclosure is only a convenient physical means of mounting a tweeter and has no effect on the high-frequency response. The use of a horn-loaded tweeter completely eliminates the high-frequency back waves and thus precludes the possibility of any interference to other speakers within our enclosure from these frequencies.

The rear of the mid-range loudspeaker is also completely enclosed for this and one other reason. The small enclosure is essentially an infinite baffle, which was chosen for its contribution to smooth response at the frequencies which the loudspeaker it encloses will reproduce.

The lower section is essentially a bass-reflex enclosure similar to the one illustrated in Figure 6-1D, but with three essential differences. First, we have added a reflector, as shown in Figure 6-8, which permits a reduction in physical size while maintaining essentially the same air-column length. Second, we have moved the loudspeaker opening closer to the port opening, at least insofar as the sound waves emitted from both are concerned. Third, we have changed the shape of the reflector. These differences, slight though they may seem, have quite an important bearing on our final result, as we shall soon discover.

Moving the loudspeaker closer toward the port opening has resulted in both openings functioning together more closely in actuating the air immediately in front of the enclosure. The result is essentially the same as having one loudspeaker the combined size of both openings. This, we have discovered through our tuba analogy, is advantageous in reproducing the low frequencies.

The simple expedient of changing the shape and dimensions of the reflector within the enclosure has enabled us to participate in the advantage obtained through horn-loading. The underside of the reflector is, as can be seen, the top of the horn. The bottom and two sides of the horn consist of the room floor and the two side walls of the cabinet. We have, through this simple change, obtained a bass-reflex cabinet in which the rear wave is horn-loaded. The method which we have utilized to horn-load the back wave of the

low-frequency loudspeaker while, at the same time obtaining the advantages of a bass-reflex enclosure, was developed by University Loudspeakers, Inc.

We have, by our simple changes and additions to existing types of enclosures, been able to obtain what actually amounts to a new type. An enclosure which, just as the loudspeakers it houses, is sectionally designed, each section handling its allotted portion of the audible spectrum with unusually high efficiency. When these sections are combined there is no back-wave interference between sections, since the back waves from each loudspeaker are isolated.

We have not called this enclosure new, because we have combined the most efficient existing enclosures for each segment of



Courtesy Electro-Voice, Inc.

Fig. 6-10 The Electro-Voice Patrician

the audible spectrum. A larger horn-loaded enclosure would have been better for the bass. Horn-loading the mid-range would have improved mid-frequency efficiency. However, we have not forgotten the promise made in our last chapter to "offer a method by which the goal of high-fidelity reproduction can be achieved without a tremendous initial outlay of money." For those who can afford it, the Electrovoice "Patrician," illustrated in Figure 6-10, can be obtained as a complete unit. This loudspeaker system divides the audible spectrum into four parts, instead of the three we are discussing. From the phantom view we can see just how the spectrum is divided. Construction details are shown in Figure 6-11, along with the speakers used by Electrovoice in this design.

Since, in our previous chapter, we assumed a start with one loudspeaker, "the improved mono-range type," we will first use our cabinet with this type alone. The box which will later be utilized to enclose the rear of this speaker will not be used for the moment. We can absorb the interfering mid- and high-frequency rear waves, to a great extent, by the judicious use of sound-absorbent material. In this manner we utilize only the back wave of the low frequencies for transmission through the port. The middle and high frequencies are obtained through frontal radiation alone. The important low frequencies are reinforced by the horn-loaded back wave through the port. We could use a co-axial speaker in this position with obviously wider range, better spatial distribution, and less inter-modulation distortion. This, of course, is entirely dependent upon the reader's purse at the moment of purchase.

Assuming we use only the mono-range speaker at first, the addition of the tweeter will provide the results mentioned in our preceding paragraph on the co-axial speaker.

Later on, the woofer and its crossover network are added with the box enclosing the rear of the mid-range speaker. When this enclosure is used in conjunction with high-quality loudspeakers the results leave little to be desired, particularly when we consider the comparatively small size, low cost and great convenience.

The trend in loudspeaker enclosures, as can be seen, is toward "bigger and better," both literally and figuratively. Unfortunately, a large enclosure is essential when we attempt to achieve the ultimate in reproduction. But fortunately, an acceptable compromise is

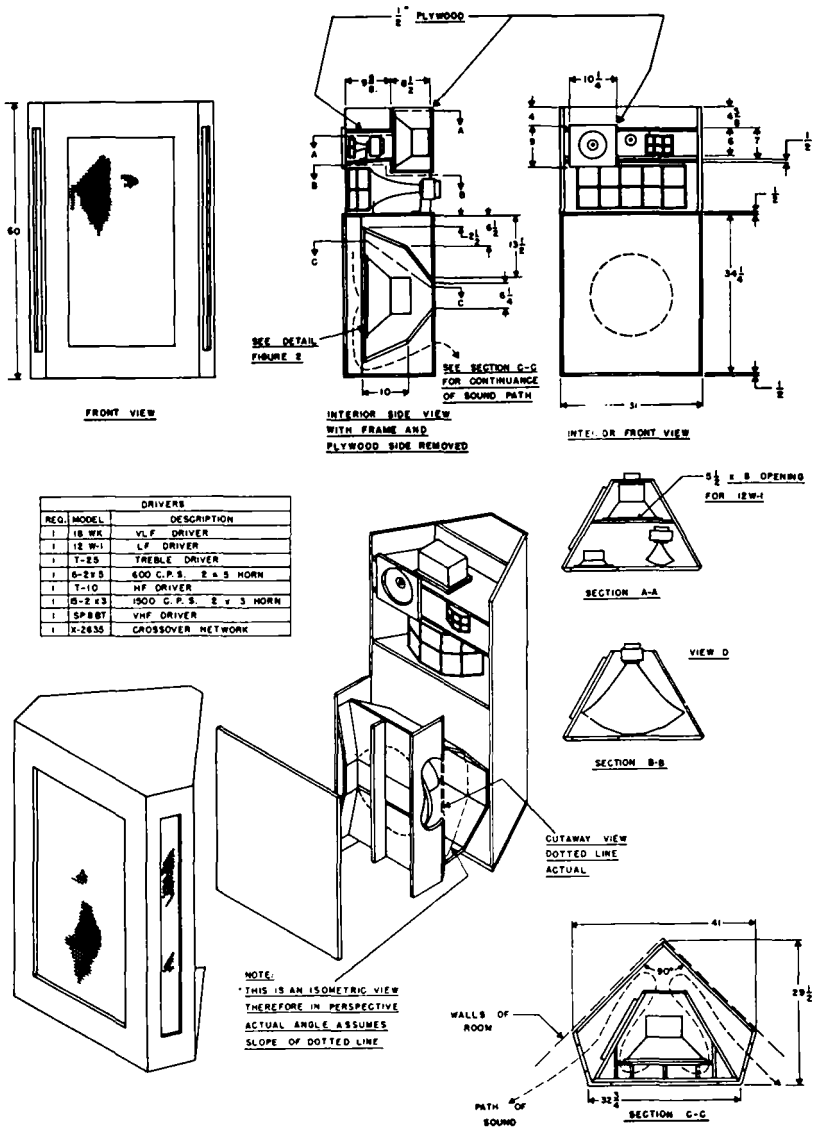
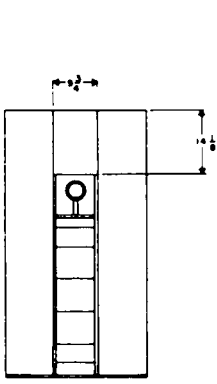

Fig. 6-11 Construction Details,



INTERIOR BACK VIEW

GENERAL INSTRUCTIONS

1. ALL JOINTS MUST BE AIR TIGHT.
2. GLUE AND SCREW FIRMLY TOGETHER.
3. SAND ALL MATING SURFACES FOR TIGHT GLUE SEAL.
4. USE PLYWOOD FOR STRENGTH AND NON-WARP.
5. LAYOUT ALL DIMENSIONS ON CARDBOARD FULL SCALE AND PAPER TAPE TOGETHER FOR USE AS A PATTERN BEFORE CUTTING WOOD.
6. INTERIOR SECTIONS MUST BE CAREFULLY HAND FITTED BECAUSE OF COMPOUND ANGLES. USE GREAT CARE.
7. 3/4" PLYWOOD UNLESS OTHERWISE SPECIFIED.

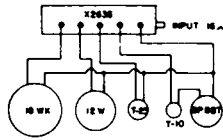
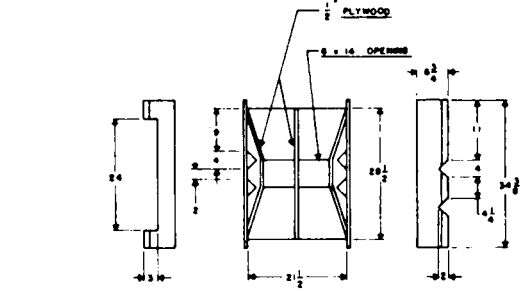

WIRING DIAGRAM

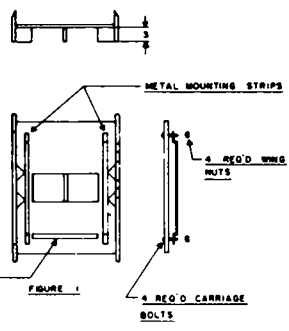
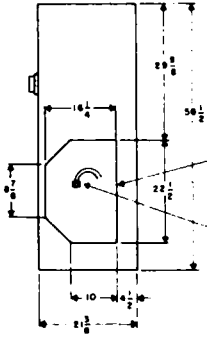

FIGURE 1

TEST PROCEDURE FOR AIR-TIGHTNESS

1. FILL TUBE WITH WATER TO LEVEL "Y".
2. PUMP AIR INTO ENCLOSURE THROUGH POINT "S", UNTIL WATER REACHES LEVEL "Z". SEAL POINT "X".
3. LEVEL "Z" WATER LINE MUST REMAIN FOR A FIVE SECOND PERIOD.
4. MAKE SOLID 15WK MOUNTING BOARD AND USE FOR TEST WITHOUT SPEAKER.



VIEW D

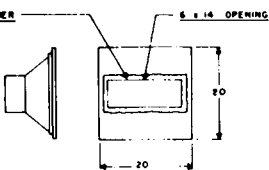

FIGURE 2

MOUNTING BOARD WITH 15WK SPEAKER MOUNTED IS PLACED THROUGH DOOR IN VIEW "D" AND CLAMPED BEHIND METAL MOUNTING STRIPS IN FIGURE 1

Courtesy Electro-Voice, Inc.

now available for those who, for one reason or another, cannot obtain the ultimate. There are many people who want the finest but simply do not have available the amount of space required. When the enclosure employed is a bass-reflex, infinite baffle, folded-horn or flat baffle, we require an absolute minimum of six cubic feet. Upwards of ten cubic feet are necessary when the finest results are to be obtained.

The next enclosure we will discuss, while it makes no pretense of being the equal of some of the larger horn-loaded enclosures mentioned, is a definite contribution toward better reproduction where the available space is limited. Recommending large enclosures is all very well, but there are still a great number of one- and two-room apartments in these United States. A vast number of people have only a limited amount of space to devote to high-fidelity installations; in some instances, the choice lies between a bed and a loudspeaker enclosure.

A new type of enclosure has recently appeared which has been specifically developed to meet this pressing problem. It is called the *R-J* enclosure. The *R-J* enclosure is barely larger than the

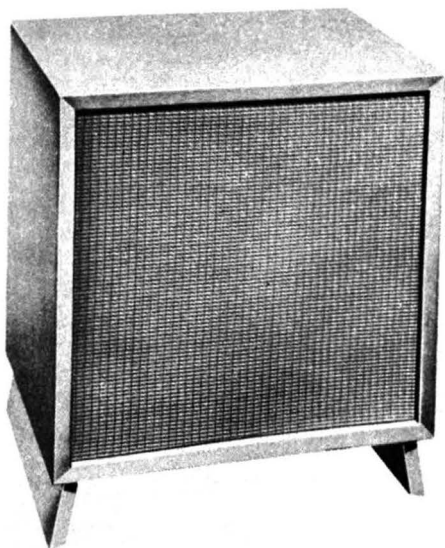
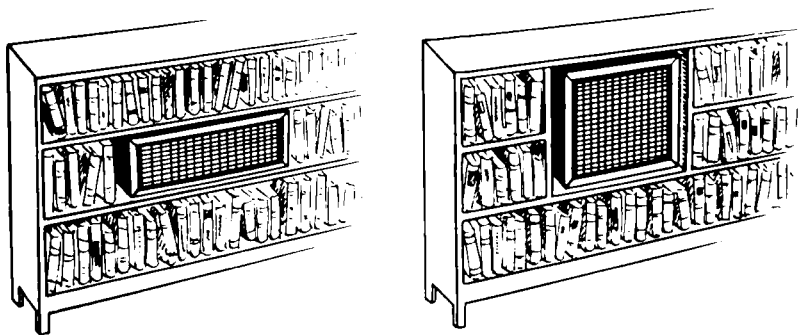

Fig. 6-12 The *R-J* Enclosure

speaker it houses. A fifteen-inch speaker may be enclosed in a cabinet approximately eighteen inches per side. This is very good news to those who simply cannot devote large room areas to a speaker housing.

The construction of the R-J enclosure may be described briefly as follows: the back and sides are completely closed, only one opening in the front being used through which the speaker emits sound. The speaker reproduces through a frontal loading chamber, designed to balance the loading of the front and rear waves and also to provide sufficient damping for optimum transient response. The design is carried out so that the volume employed is proportioned to the size and shape of the front opening, in order to produce a desired low-frequency air resonance in accordance with Helmholtz resonator principles. The extension of bass range is achieved without boominess. Single co-axial speakers may be used, or the unit may be used as a woofer in conjunction with a small tweeter.

Owing to the small size of the enclosure, many applications are opened beyond conventional placement in a corner, against a wall, or in a console arrangement. Relatively flat units have been constructed which will fit into a bookcase; other models, with suitable legs and proportions, may be used as end tables, coffee tables, lamp tables or television tables. A floor enclosure of this type is shown in Figure 6-12. Two bookshelf variations are shown in Figure 6-13.



Courtesy R-J Audio Prods., Inc.

Fig. 6-13 Two Variations of the R-J Enclosure

We have in this chapter discovered the importance of loud-speaker enclosures in obtaining better low-frequency response, increased efficiency and better tonal balance. We have discovered that an enclosure is not merely a housing but is as important in obtaining high-fidelity reproduction as the woofer itself. The decorative aspect of enclosures will be treated more completely in Chapter XII.

CHAPTER VII

THE BASIC AMPLIFIER

The high-fidelity amplifier. What it does. The basic amplifier. The frequency range. Linearity of response. Distortion in amplifiers. Acoustic power requirements. Power output. Noise and hum in amplifiers. The minimum requirements for high-fidelity amplifiers.

The problem of selecting an amplifier is a most confusing one to the layman. This single component has more variables and possible features than all other elements combined.

The prospective purchaser is confronted with such terms as phono equalization, loudness control, volume expansion, noise suppression, bass and treble boost, and a multitude of others. These features are not just advertising claims to be ignored; for each one has a definite place in the amplifier and performs a definite function of greater or lesser importance, depending upon the user's requirements. For example, in a system which reproduces radio programs exclusively, we would have no need for record-noise suppression and phono equalization.

This chapter and the following one will attempt to explain the functions of these features in such a manner that the reader will

be able to make his own choice. In this chapter we will describe a basic amplifier and lay down its basic requirements.

An amplifier is required in any system that reproduces sound because the amount of electrical energy or voltage output of our program sources, the tuner and the record player, is very small. This small amount of energy generated by the program sources must be amplified a million-fold to the point where it is sufficient to actuate the loudspeaker system so that it can produce a facsimile of the original sound.

The average high-fidelity amplifier may be divided into three sections: the pre-amplifier, the power amplifier and the voltage supply. These three sections each perform different functions. The primary function of the pre-amplifier is to increase the minute signal voltages from the program sources, without introducing extraneous noises into the signal which is to be amplified. This pre-amplifier section will be discussed in detail in our next chapter.

The second, or power-amplifier section, is that portion of the amplifier which supplies as much power as is required by the loudspeaker to perform its function properly.

The third section is the voltage supply which, as the name implies, furnishes the voltages necessary for the proper operation of the pre-amplifier and the power amplifier. Amplifiers are usually manufactured on either one or two chassis. The smaller and less expensive ones are more likely to be on one chassis. This type is illustrated in Figure 7-1A. The larger amplifiers are usually mounted on two chassis, the pre-amplifier on one and the power amplifier and voltage supply on another. This type is illustrated in Figure 7-1B. There are also other two-chassis arrangements.

In this chapter we propose to lay down the specifications for a basic amplifier consisting, as mentioned, of the power amplifier and voltage supply on one chassis, and attempt to explain the reasons for these requirements. Amplifiers of this type are illustrated in Figure 7-2.

The first specification we will discuss is frequency range or response. The frequency range or response is specified by figures giving both its upper and lower limits, in cycles per second, which can be amplified properly.



(A)

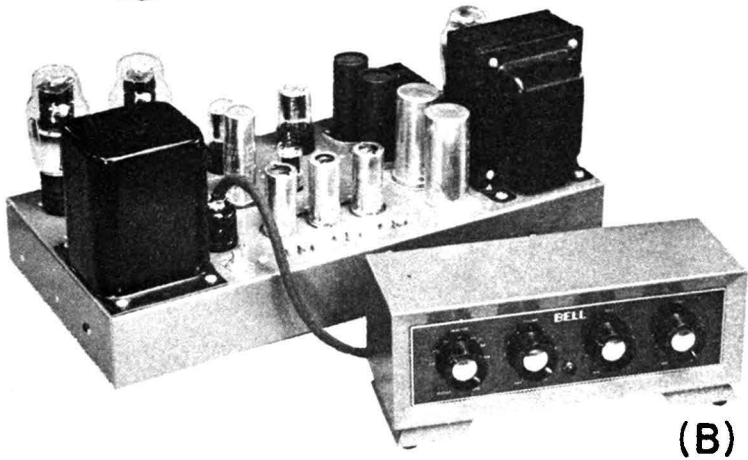

(B)

Courtesy Bell Telephone Laboratories

Fig. 7-1 (A) Bell 2122B Amplifier, (B) Bell 2145 Amplifier

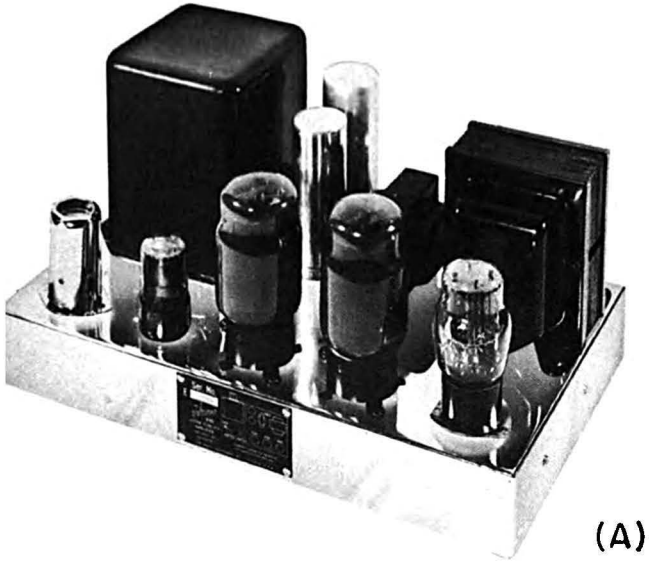

(A)

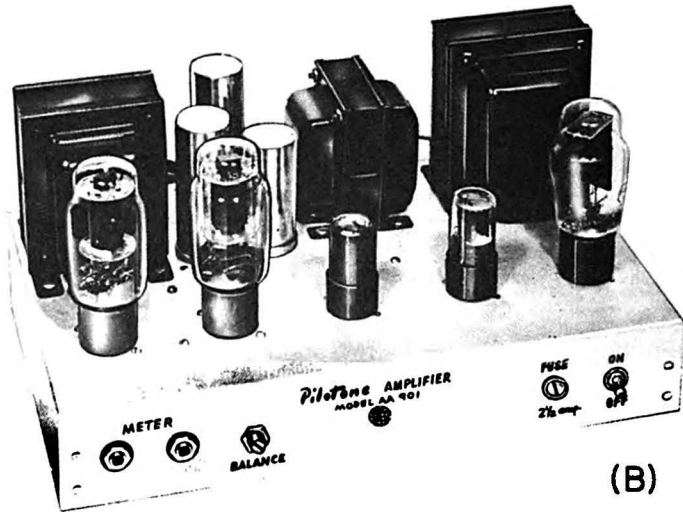

(B)

Courtesy Radio Craftsman, Inc. and Pilot Radio Corp.

Fig. 7-2 (A) The Radio Craftsmen C-500 Amplifier, (B) The Pilot AA-901 Amplifier

From our earlier discussion of program sources, we discovered that the maximum frequency range we could expect from the sources available to us was 30-15,000 CPS. This range, at the present writing, is only available on live FM broadcasts and on a few records. For the moment, we will use the limits imposed on us by our program sources and consider 30-15,000 CPS as our minimum required frequency response.

The frequency range figures alone, however, are almost meaningless unless, as we have learned, we specify in addition any variations in level within this range. That is to say, we must reproduce all of the frequencies in the specified range with equal or almost equal intensity. We have also learned that the reproduction of all frequencies within our required range should not vary more than 2 DB, since any greater variation in level is likely to be noticed by the human ear.

At this point the thought may occur to some of our readers that we have discussed other components which do not fall within the requirements we are specifying for the amplifier. This may cause them to wonder why we do not allow as great a variation of response in the amplifier as there is, for example, in the loudspeaker system. The answer is that when we use a loudspeaker with a 6 DB peak at 4,000 CPS, for example, in conjunction with an amplifier that has a 6 DB peak at 4,000 CPS, our resultant peak is no longer 6 DB, but 12 DB. This is approximately *sixteen times the original level*. In other words, the 4,000 CPS tone is reproduced sixteen times as loud as the other frequencies; consequently the reproduction sounds unnatural, as we discovered in Chapter V. For this reason it is obviously advantageous to reduce the variation in frequency response in our amplifier to an absolute minimum, even beyond the 2-DB variation which we have considered acceptable up to this point. Amplifiers are available today with a variation as little as .1 DB over the entire frequency range.

There is yet another factor which determines the quality of our basic amplifier. This involves our third specification. It is the amount of distortion caused by the amplifier itself in performing its function. Distortion is simply the generation or modification of frequencies within an amplifier, and the resultant change in the facsimile with respect to the original music or speech. There are

two types of distortion introduced by an amplifier which will concern us at the moment: they are harmonic distortion and inter-modulation distortion.

Harmonic distortion is created in the amplifier by the generation of harmonics or overtones which are not present in the original speech or music. These harmonics or overtones modify the tone quality in such a manner that it is no longer a duplicate of the original which is being amplified. This is caused by non-linearity of response, similar to that described in our loudspeaker chapter. The same non-linearity which can produce harmonic distortion from a single frequency can also produce inter-modulation distortion from more than one frequency.

Inter-modulation distortion is created by the modulation or control of one frequency by another and, when non-linearity is present in the response, results in the modification of one (usually the higher) frequency by another. We can easily understand how both types of distortion can occur at the same time. Both types of distortion, when stated for an amplifier, are rated as a percentage of a specified power output. For example, distortion may be stated as being 1% at 5 watts.

There has been much discussion in recent years on methods of distortion measurement. It appears that the inter-modulation method supplies a better indication of the audible result. The foregoing should not be construed to mean that a figure given for inter-modulation distortion alone is sufficient to determine the quality of an amplifier, despite the fact that both forms of distortion are inter-related. Given sufficient information on one, the other may be calculated. These calculations, however, are far beyond the scope of the layman. Consequently, when distortion figures are to be used in determining the quality of an amplifier, both harmonic and inter-modulation figures should be used. Should there be any difficulty in obtaining both figures, so that one must be used alone, the inter-modulation percentage figure is the more indicative of the aural performance.

Figure 7-3 is a graph depicting the percentages of both harmonic and inter-modulation distortion plotted against the power output. This graph illustrates the distortion characteristics of the amplifier shown in Figure 7-2B.

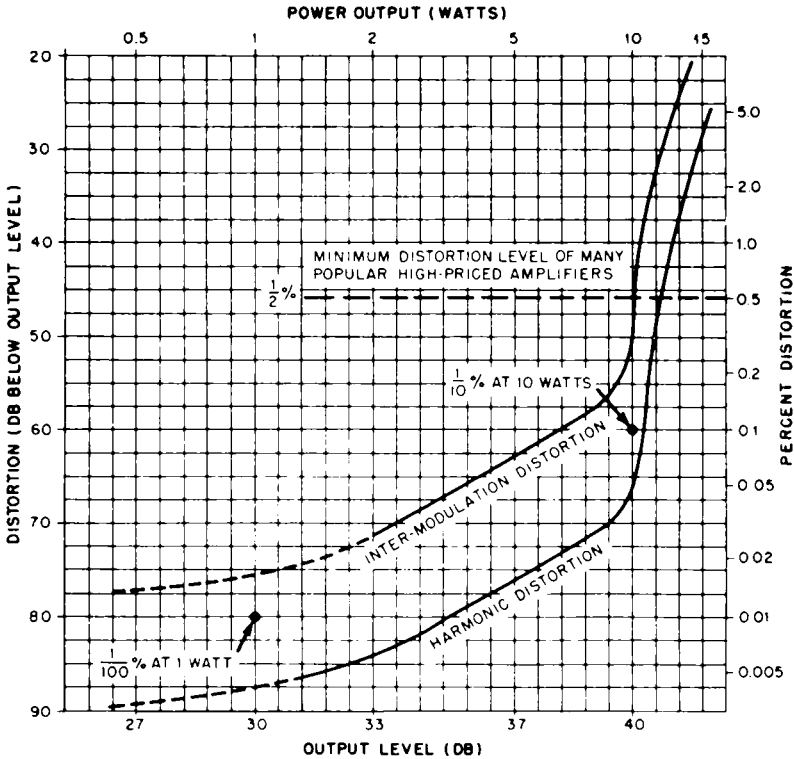

Fig. 7-3 Distortion Characteristics

The lack of complete technical information from the manufacturer is one of the main reasons that our contemporaries say, "a listening test should be the final criterion in choosing an amplifier." The author quite agrees when a manufacturer, under the heading of a distortion specification, supplies the following information: "Distortion: less than 2% total harmonic distortion at rated power."

This specification gives us absolutely no indication of how the unit will sound.

A number of manufacturers supply a single-frequency harmonic-distortion rating. This figure alone is insufficient to help us determine the quality of an amplifier intelligently. Both inter-modulation and harmonic distortion figures should be used. The following tables are

a rough indication of the distortion percentages which should be expected in the various classes of amplifiers available today:

Harmonic Distortion At 1,000 CPS, 10 Watts Output

Low-price class	3%
Medium-price class	1%
High-price class	.1%

*Inter-Modulation Distortion At 40-7,000 CPS, 10 Watts Output
(using 4 to 1 ratio)*

Low-price class	10%
Medium-price class	4%
High-price class	.5%

As can be seen from Figure 7-3, the distortion percentages drop as the power level is reduced to normal listening levels, which are well below maximum power output.

The results of tests made on many individuals show that perceptible distortion percentages for both speech and music are one percent for harmonic distortion and five percent for inter-modulation distortion. From these figures and an analysis of Figure 7-3, we find that, at normal listening levels, the performance of the amplifier depicted is excellent, since the harmonic distortion at one watt is less than .01% and the inter-modulation distortion is less than .02%.

The above paragraphs have mentioned normal listening levels a number of times. In order to understand fully what is meant by this phrase it will be necessary to discuss our fourth specification: power output.

The power-output rating of an amplifier is a measure of the maximum power it can deliver before distortion becomes objectionable. In order to explain power output in a simple way, we should understand something of the power requirements necessary for high-fidelity reproduction of speech and music in the home. When we consider power requirements it becomes necessary to consider minimum acceptable distortion limits at the same time. These limits, for our present purposes, are 1% harmonic and 4% inter-modulation distortion.

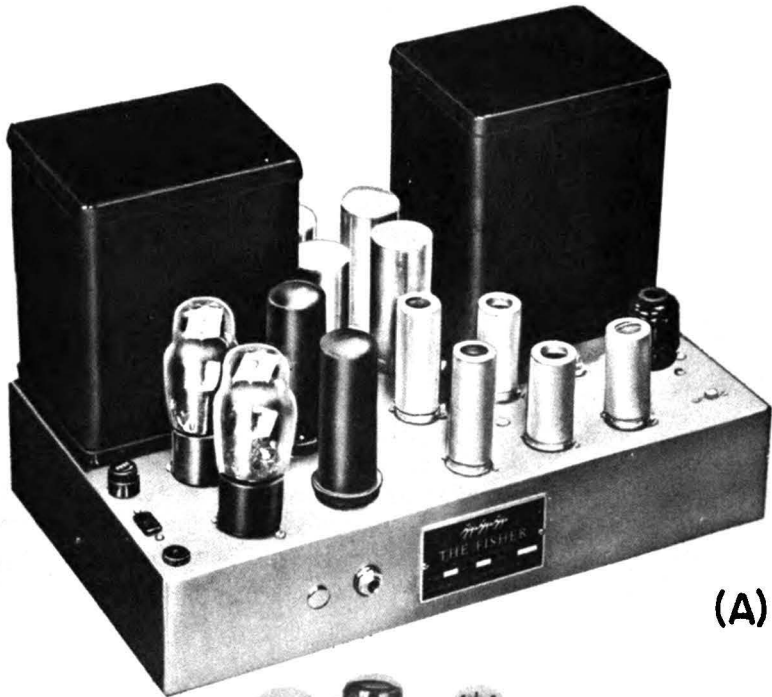

(A)



(B)

Courtesy Fisher Radio Corp. and H. H. Scott, Inc.

Fig. 7-4 (A) The Fisher 4D-A Amplifier, (B) The Scott 220-A Amplifier

Our first requirement is that the amplifier be able to furnish enough power to reproduce the loudness level of the original program as closely as possible in the home. The second requirement is that we have the reserve power necessary to reproduce the musical peaks which occur. Both the normal and peak levels must be reproduced without the distortion content exceeding our specifications.

When sufficient power is available to reproduce the peak passages with negligible distortion, any additional power is superfluous. A power requirement of more than 10 watts is very rare for the home. There is, however, a legitimate reason for having large amplifiers, such as are illustrated in Figure 7-4. The reason is not more power but the fact that larger amplifiers have superior characteristics at the normal listening and peak levels we wish to reproduce.

We would like to explain our previous statements by giving an example of the power required to reproduce a symphony orchestra in the home. We choose a symphony orchestra as an example since it generates more acoustic power than any speech or other music we will be required to reproduce.

The average loudness level of a symphony orchestra is 90 DB. The peaks in symphonic music, such as the clash of cymbals, create a loudness level of 110 DB for brief intervals. Reproducing a loudness level of 110 DB in the average large living room (3,500 cubic feet) requires approximately 5 watts of acoustical power. The average loudness level of 90 DB is, as we discovered in Chapter III, too high, since in practice we cannot hope to reproduce at this level in a private home. The highest possible level which would afford comfortable listening would be in the order of 80 DB. When we add the 20 DB for musical peaks, we arrive at a peak level of 100 DB. From Figure 7-5 we find that, in order to reproduce a peak level of 100 DB in a living room of 3,500 cubic feet, we require an acoustical power of .5 watt from the loudspeaker. Actually, the amplifier must supply the speaker with more than .5 watt of electrical power, since there are losses in the speaker.

The average high-fidelity loudspeaker has an efficiency of 5%, though some top-quality high-fidelity loudspeakers have efficiencies

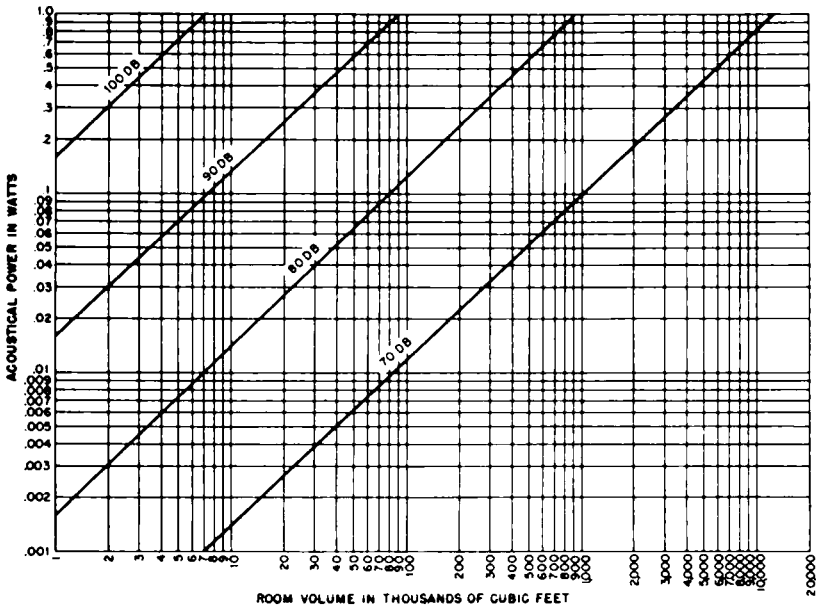

Fig. 7-5 Acoustic Power Requirements

as high as 10%. The larger horn-loaded enclosures, when used in conjunction with high-quality loudspeakers, have efficiencies as high as 50%. However, we will use the lower figure, since the use of these enclosures and loudspeakers are comparatively recent. With this information, we can calculate the amount of electrical power required to reproduce the musical peaks. When we use a loudspeaker with 5% efficiency, we require 10 watts of electrical power in order to obtain .5 watt of acoustical power. With a loudspeaker having 10% efficiency, we only require 5 watts of electrical power in order to produce .5 watt of acoustical power.

While on the subject of larger amplifiers we must in all fairness state that there are advantages in using them, aside from gaining additional power as such. Figure 7-6 illustrates the distortion-versus-power characteristics of two amplifiers. One has a rated power output of 20 watts, the other a rated power output of 10 watts.

Let us examine the inter-modulation curves of both at the point which we decided was our maximum power requirement, 10 watts.

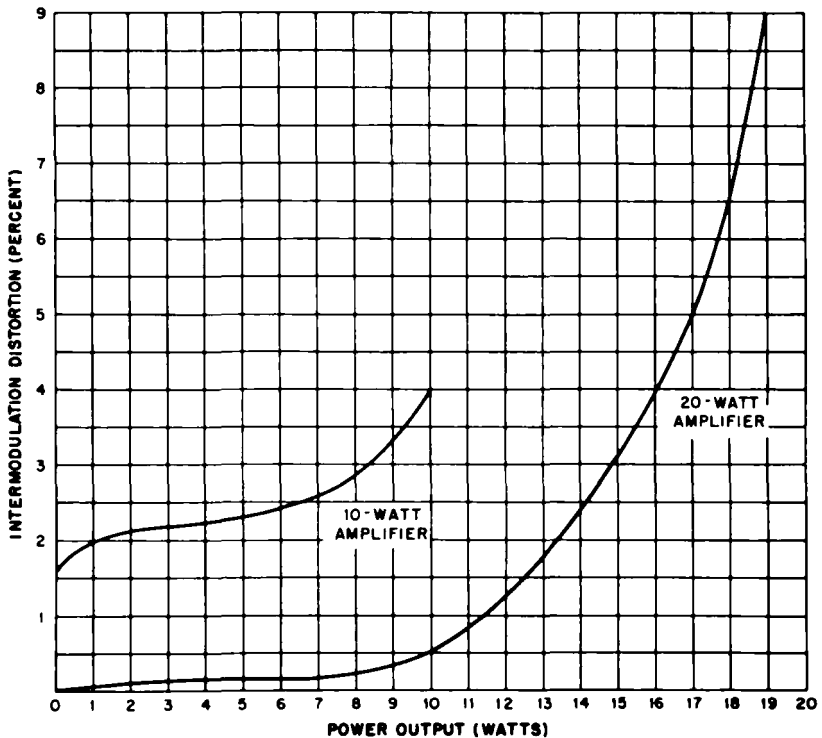

Fig. 7-6 Distortion vs. Power Output

We can readily see that at this point the distortion content of the 20-watt amplifier is $\frac{1}{2}\%$; the 10 watt amplifier shows a distortion content of 4%.

When we go further down the power scale to normal listening level (one watt), we find a similar relationship. The superiority of the high-power amplifier becomes evident; but whether this small reduction in distortion content alone is worth any price difference may seem questionable. Fortunately for the manufacturers of higher-power amplifiers, there are a number of other factors in their favor. These factors, if individually analyzed, do not manifest themselves as tremendous individual improvements; but when they are combined to give an over-all result their superiority becomes evident to the ear. We trust we have made clear the fact that a 20-watt

amplifier is not superior to a 10-watt amplifier merely because its power output is higher. The superiority lies mainly in the fact that distortion of all types is usually lower at *all* levels in the larger amplifier.

Our fifth specification is noise level. By noise we mean all sounds coming from our loudspeaker system apart from the desired music or speech being reproduced. These noises may be divided into two categories: those emanating from our two program sources ("static" and needle noise) and those which are generated within the amplifier itself. The noises originating within the amplifier, which concern us at the moment, can further be subdivided into two categories: noise generated by the various components of the amplifier itself, and hum. Our future discussions will combine both noise and hum under one heading, "noise level," since both are equally annoying.

Numerous tests have shown that the noise level becomes objectionable when it can be detected by the ear more than two feet from the loudspeaker system. When a high-fidelity system is used primarily to reproduce classical rather than dance or military music, this factor becomes of extreme importance because in classical music there are more periods of comparative silence, as during a pause or a solo. It is during these periods that the noise in an amplifier becomes apparent and often unpleasant.

When we measured the amount of noise which was found objectionable by aural tests, it varied from 45 to 65 DB below our maximum output of 10 watts. This variation in objectionable noise level stems from the fact that the tests we conducted were in homes ranging from the author's tenth floor apartment, in a fairly noisy city location, to quiet suburban residences. The varying residual noise levels encountered masked the amplifier noise to a certain extent. The masking effect of noisy listening rooms on speech or music was discussed in Chapter III. This room noise level also tends to mask amplifier noise level in the same manner.

From our tests, which took into consideration varying residual noise levels in listening rooms, we can definitely state that the maximum permissible noise level in an amplifier should be at least 60 DB below maximum output. Even this noise level should only

be tolerated in an amplifier which has low cost as its primary consideration. With our previous knowledge and standards, a noise level of 70 DB would be closer to our specifications. An amplifier in the higher price brackets should have a noise level of at least 78 DB below maximum output.

Voltage gain, the ability of the amplifier to multiply or magnify the minute amounts of energy from our program sources, will be explained in the next chapter, since it is primarily a function of the pre-amplifier.

We have now reached a point at which we can specify just what our amplifier should be capable of doing. An amplifier, in order to meet our requirements, should provide a minimum of 10 watts output with a harmonic distortion content not exceeding 1% at 1,000 CPS at the full output of 10 watts. The inter-modulation distortion content, taken at 40-7,000 CPS and using a 4 to 1 ratio, should not exceed 4% at 10 watts. The frequency response should be from 20-20,000 CPS \pm 1 DB (plus or minus 1 DB) in order that the power response be at least from 30-15,000 CPS within 2 DB at 10 watts. The noise level in our amplifier should be a minimum of 70 DB below maximum output, in our case 10 watts.

We have now arrived at a set of specifications for the power or basic amplifier which is the heart of our high-fidelity system. These specifications are the absolute minimum with which we can hope to maintain the high standards we have set.

In this chapter we have laid down minimum specifications for the amplifier. Further reduction in distortion, noise level and frequency-response variation will of course result in a still finer system. But since these improvements are costly, we must leave the choice to the reader with the comforting note that, if these specifications are used as a minimum, they will leave little to be desired.

CHAPTER VIII

THE AMPLIFIER, PART 2

The magnetic pickup and its requirements. The pre-amplifier; its functions. Noise and hum level. The phonograph record and modern recording. The turnover point. Surface noise. The pre-amplifier and bass boost. The record compensator and how it works. The human ear and the loudness control. Bass and treble control. Commercial audio input systems. Motor rumble and surface noise filters. Dynamic noise suppression.

Our previous chapter described what we called a basic amplifier. This unit provided sufficient amplification for a radio tuner and the type of pickup used in most commercial radio-phonographs, a type called a crystal pickup. Were we to confine ourselves to these two program sources, additional amplification would be unnecessary since the energy delivered by either the tuner or crystal is approximately one volt, or enough to drive the basic amplifier to its full output.

The improvements in recording technique and the introduction of the vinylite LP records with increased frequency ranges necessitated corresponding improvements in phonograph pickups. There was, at last, a justification for increasing frequency response and

reducing distortion in phonograph pickups. The new pickups which were developed had both wider response and produced less distortion but, unfortunately, their energy output was lower. The output of the new magnetic types was one hundredth of the crystal pickup's output; consequently additional amplification had to be provided. In short, the new magnetic pickups required *pre-amplification* before they would drive a basic amplifier to full output. Figure 8-1 illustrates two commercial pre-amplifiers which have been developed to meet these requirements. Since the pre-amplifier is functionally a part of our amplifier, though it may be physically separate, great care should also be used in its selection.

The primary function of a pre-amplifier is, as we have found, to provide additional amplification; however this is more easily said than done. The signal level in the pre-amplifier section is the lowest in our entire system; consequently such tremendous amplification is required that we amplify, in addition to the wanted signal, any unwanted noises created within the pre-amplifier.

Noise, as we discovered in our previous chapter, stems from two sources: hum and actual noise from components. We decided to combine the two under the general heading of noise. For the benefit of our more technically minded readers, we will give some of the reasons for noise in amplifiers and pre-amplifiers.

Noise is introduced in a number of ways. The first type is called thermal noise and usually is developed in resistors, volume controls, and tone controls; it is caused by the random motion of free electrons. This motion causes minute voltages to be developed in a particular resistor or control. These small voltages, called thermal voltages, act in the same manner as the signal voltages and thus are reproduced with them, but as random noise.

The second source of noise in resistors is due to the fluctuations in contact resistance between adjacent carbon granules, caused by temperature and humidity changes. (The element of a resistor is usually carbon.) These changes in resistance result in minute voltage changes which are also amplified with the wanted signal voltage. These two sources of noise have been greatly reduced in modern pre-amplifiers by the use of wire-wound resistors at critical points.

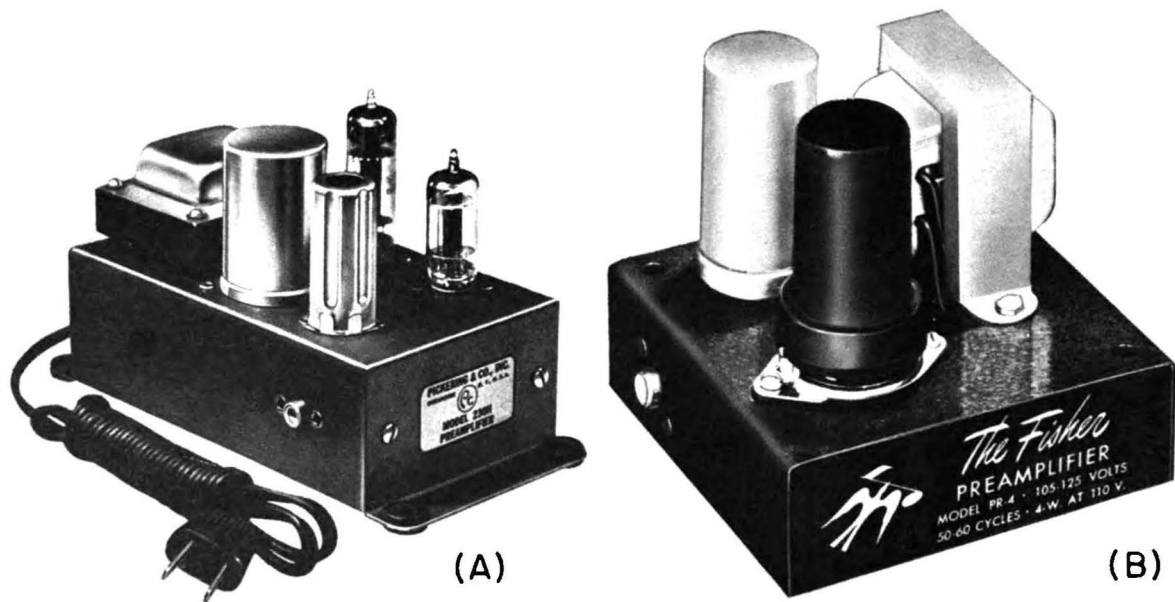

Courtesy Pickering & Co., Inc. and Fisher Radio Corp.

Fig. 8-1 (A) The Pickering Pre-Amplifier, (B) The Fisher Pre-Amplifier

The third source of noise is generated within the vacuum tube itself and is due to the fact that the current passing through it is not a uniform stream, but is emitted as a large number of discrete electron charges. The variations in current caused by this effect result in fluctuations in the tube current similar to those caused by the signal voltages, and are also amplified and reproduced as noise. Keeping noise to an absolute minimum in pre-amplifiers is important, as we have learned. Incidentally, noise reduction is one of the basic reasons for the cost differential in pre-amplifiers.

The pre-amplifier, in addition to its primary function, performs another job. In order to understand this second function it will be necessary to discuss briefly one of our program sources, the phonograph record, and to explain how it is cut.

A record is a flat disc containing wavy spiral grooves, each about the width of a human hair. These grooves are originally engraved into the master recording by a cutting stylus. Figure 8-2 depicts three greatly magnified views of a section of a commercial recording. A is a view from a position almost directly above the

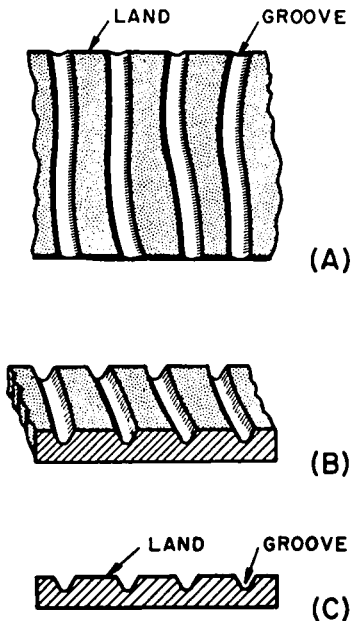

Fig. 8-2 An Enlarged View of Record Grooves

record and illustrates both the groove in which the stylus travels and also the separations between the grooves, called *land*. *B* is a view from a 45-degree angle. *C* is a side view of this same section, cut through the record. There are about 100 of these grooves per inch on the standard 78 RPM record and 325 to the inch on microgroove 33½ RPM records.

The cutting head, during recording, is acted upon by electrical energy in a way similar to the action that takes place in a loud-speaker. Instead of mechanical action of the speaker's cone, the result in this case is a mechanical side-to-side motion of the cutting needle or stylus. The cutting stylus is thus forced to engrave impressions into the rotating disc, which represent the sound. The shape of these impressions is determined by the frequency and intensity of the signal being recorded.

When reproducing a record, the playback stylus or needle is forced to move from side to side by the impressions engraved on the walls of the groove; the playback pickup transforms this lateral or side-to-side motion into electrical impulses. This is the reverse of the cutting procedure.

The action of the modern cutter is such that it always moves the stylus at the same velocity, regardless of the frequency being recorded. To maintain this *constant velocity*, it swings in a much wider arc (side-to-side motion) when cutting a sound signal of lower frequency than when engraving at high frequencies. This effect is shown in Figure 8-3A. The width of the groove and the maximum side-to-side swing allowable during cutting are also indicated. Note that, at lower frequencies (100 CPS, 250 CPS), there is a tendency to overcut the groove limit. When we cut past our maximum allowable width, we may break through the land into the next groove; consequently we must have a means of decreasing the amplitude of the swing below 500 CPS, or some other low frequency. By maintaining constant amplitude, or side-to-side motion, below 500 CPS we can eliminate this problem.

In order to eliminate this breakthrough, recording companies have adopted the *constant-amplitude* method of recording. With this type of recording the amplitude, or degree of side-to-side motion, remains constant regardless of frequency, below 500 CPS. This is

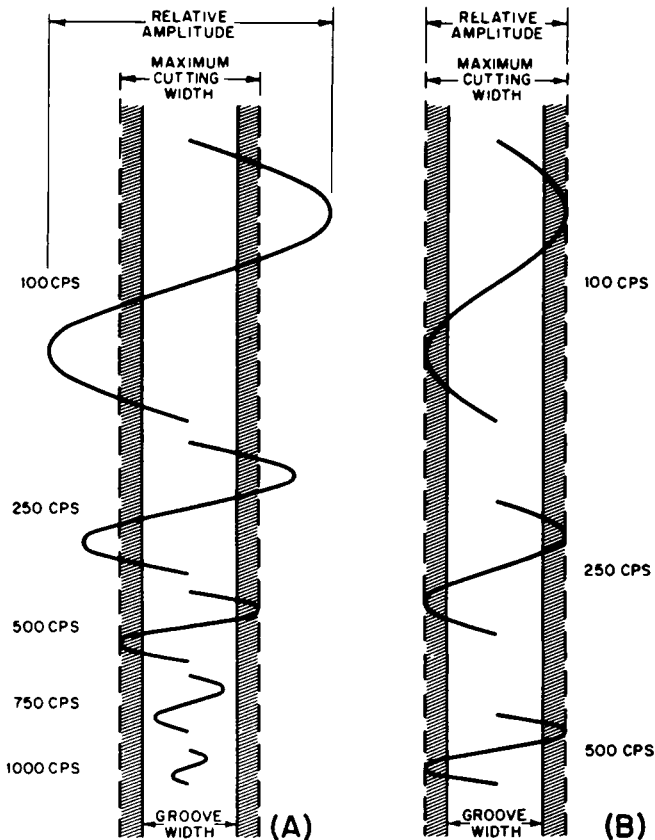

Fig. 8-3 (A) Constant Velocity and (B) Constant Amplitude in Recording

achieved by reducing the amplitude of the signal impulses fed into the recording head in proportion to the decrease in frequency. Usually the electrical input into a cutting head is reduced at a rate of 6 DB each time the frequency recorded is halved or reduced one octave below 500 CPS.

This method of recording results in impressions on the walls of the groove such as are shown in Figure 8-3B. We can see that the constant-amplitude method of recording eliminates the possibility of breakthrough. However, this method of recording also results in a record which, when played, is deficient in bass response,

as can be seen from the dotted line in Figure 8-4. This response curve shows us that some method of increasing the bass output must be used if we are to obtain the uniform or flat response which is necessary for high-fidelity reproduction. We must compensate for the uneven response on the record. This is the second function of the pre-amplifier.

The pre-amplifier boosts the bass response at a rate which is exactly opposite to the recorded characteristic, 6 DB per octave in this case, shown by the dashed line in Figure 8-4. This produces an output which is flat, as shown by the solid horizontal line. We have compensated for the bass droop in the record.

We now have a device which permits us to utilize the magnetic cartridges available, since the pre-amplifier provides the additional amplification they require and, in addition, compensates for one of the limitations of recordings, the bass droop inherent in all modern records.

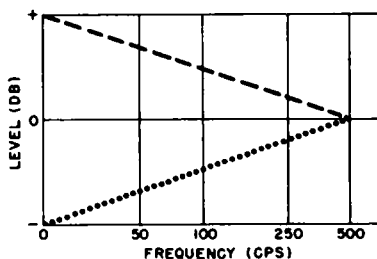

Fig. 8-4 Recorded Bass Roll-Off

However, only one problem is solved; for there is another recording characteristic for which we must compensate. This characteristic is called pre-emphasis, and is used to overcome what is commonly called needle scratch.

Needle scratch is not entirely due to the needle or stylus, as the phrase implies, but partly to the record. For many years recording companies used the method of recording illustrated in Figure 8-3A, the constant-velocity method. The first improvement was the change to the constant-amplitude method below 500 CPS, which was previously discussed.

With the advent of high-fidelity equipment, the "needle scratch" or surface noise, as it is more correctly called, became more ob-

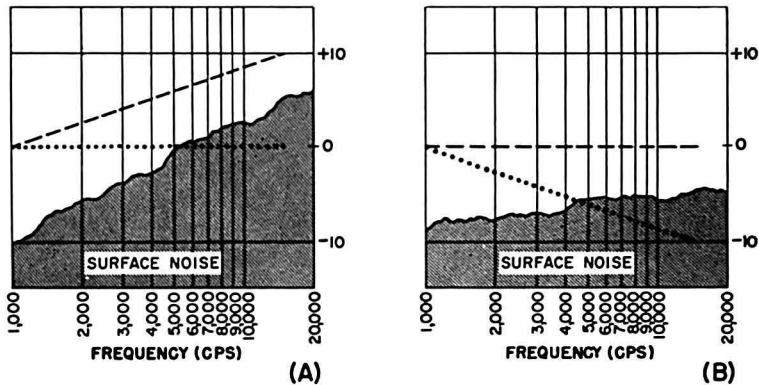

Fig. 8-5 Recorded Treble Pre-Emphasis

noxious. This happened because high-fidelity equipment, through better reproduction of the high frequencies, also reproduced the surface noise to a greater extent. In the constant-velocity method of recording, we remember that the amplitude of the impression decreases with frequency. Obviously, when we record high frequencies, we arrive at a point at which the noise amplitude and that of the recorded signal become equal. As we record still higher frequencies, the noise becomes greater than the signal. This, incidentally, was one of the greatest problems of the early high-fidelity enthusiast.

The hiss or surface noise on a record is due to the granular structure of the material used. When material such as shellac, which has a large granular structure, is employed, the noise is greater than with the vinylite material used in the new LP records. The vinylite records reduced surface noise to a great extent, but it remained for the method of recording known as pre-emphasis to reduce it to a negligible factor.

Figure 8-5A will help explain how this is accomplished. The noise level remains fairly constant throughout the lower range, gradually increasing at the higher frequencies. The dotted line indicates uniform response recorded without pre-emphasis. We find that, above a certain frequency (5,000 CPS), the noise level becomes higher than the signal level. The high frequencies are thus masked by noise. However, when we increase the recorded signal level

as the frequency is increased, we have a response as shown by the dashed line, which is always higher in level than the noise. Unfortunately, though this method of recording solves our surface noise problem, it gives rise to another. If we were to reproduce a recording of this type on high-fidelity equipment, the result would be unbalanced and seem thin due to the preponderance of high frequencies. We must once more make correction for the recorded characteristics; but this time, instead of boost, we require droop. We must reduce the output of the record by exactly the same amount as it was increased, as illustrated by the dotted line in Figure 8-5B.

This compensation results in the flat output we require, as shown by the dashed line. By reducing the high-frequency output

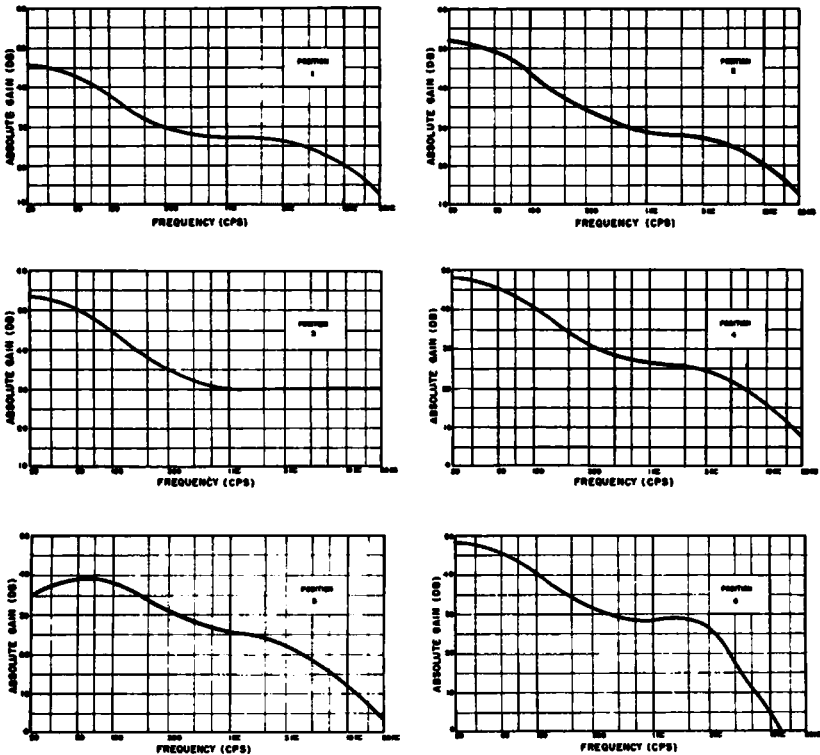

Courtesy Pickering & Co., Inc.

Fig. 8-6 Compensating Curves

we have reduced the record noise level. Thus, by proper compensation, we can obtain from commercial recordings the flat frequency characteristic we require for high-fidelity reproduction. However, we must go one step further. Compensation provided should be variable, since each record manufacturer has his own ideas regarding the amount of pre-emphasis to be used, and the point at which bass droop begins, also called the turnover or crossover frequency.

Figure 8-6 illustrates the type and amount of compensation required by the most popular records available in order for us to obtain the flat frequency characteristic we require in the final output. Figure 8-7 illustrates a compensator which provides the proper correction for these recorded characteristics.

We are now in a position to take full advantage of the high-quality magnetic pickups available, and, through the use of compensation, we are able to obtain from commercial recordings music which is startling in its realism.

While on the subject of compensation we should discuss a type which, to the author's mind, is the most important single contribution to high-fidelity reproduction for the home in recent years. Among other subjects, our second chapter discussed the vagaries of human hearing. We then explained that the human ear is not equally



Fig. 8-7 The Pickering Record Compensator

Courtesy
Pickering & Co., Inc.

sensitive at all frequencies and that, in addition, ear sensitivity varies with the intensity of sound. We also explained in a later chapter that even if all of the components comprising a high-fidelity system were perfectly linear in response, and we reproduced a symphony orchestra over this system at lower, more comfortable listening levels, the result would not be an acoustic facsimile for a number of reasons. One of these is the non-linearity of response of the human ear at lower intensity levels. From Figure 8-8 we can see how the ear's sensitivity to low-frequencies and, to a lesser degree, to the high-frequencies, is reduced as sound level is reduced.

When we listen to a symphony orchestra in a concert hall, the sound level is about 90 DB but, as we explained, this level would

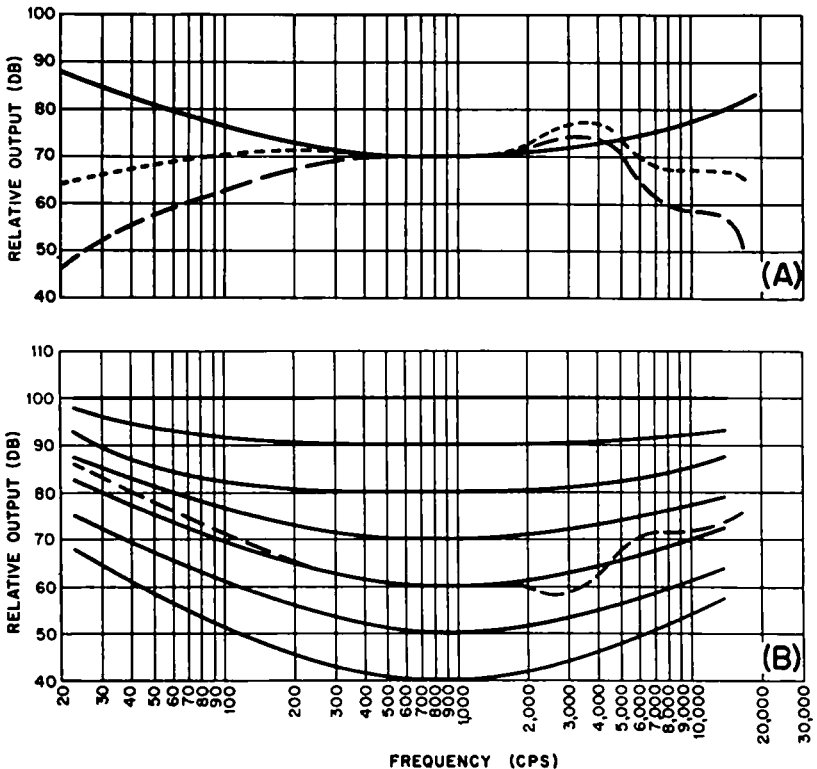

Fig. 8-8 (A) Frequency Response vs. Level and (B) Action of the Loudness Control

be much too high in a small home. We therefore compromised at a level of 78 DB, which is quite loud in a small living room but which is the lowest level at which the ear's response is even reasonably good. We can, of course, compensate to a slight degree by boosting the bass response and, to a lesser degree, the treble response as the reproduced sound level is reduced. This, however, is not an accurate method of compensating for this hearing characteristic.

A device has been developed which does compensate accurately for this hearing characteristic. The device is called a *loudness control*; one is shown in Figure 8-9.

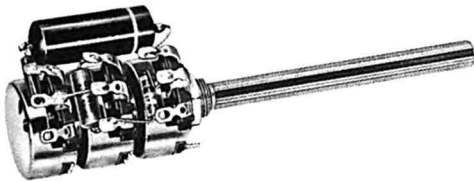

Fig. 8-9 A Loudness Control

Courtesy
International Resist. Corp.

A loudness control automatically provides the correct amount of bass and treble boost required to compensate for the non-linear response of the human ear at low loudness levels. Figure 8-8A illustrates how the response of the ear drops off as the intensity level of sound is reduced. Figure 8-8B depicts the response of the loudness control at various settings.

We notice in Figure 8-8A a solid line that illustrates the amount of correction provided by a loudness control at an intensity level of 70 DB. We can readily see how this control, by providing the proper amount of bass and treble boost, automatically compensates for the ear's response at this level. The resultant response, as heard by the ear, is illustrated by the dotted line. As can easily be seen, the use of a loudness control affords a vast improvement over the uncompensated response.

By utilizing a loudness control we can operate our home music system at a lower and more comfortable listening level than 78 DB, which we have previously recommended. We can now operate at lower levels without sacrificing the bass and treble response which we have worked so hard to obtain. The aural effect of this

control, at the lower listening level, is astounding. When a system using a loudness control is switched back to ordinary volume control, the resultant reproduction is thin, insipid, and lifeless by comparison. The source of the sound seems to recede into the distance, it is like listening to a symphony concert from the lobby.

Thus far in this volume, we have emphasized the importance of linearity or smoothness of frequency response in all of our components. The first mention of response other than linear was in our discussion of the record compensator, which introduced non-linearity — to be exact, introduced controlled non-linearity. Through this controlled non-linearity, we were able to compensate for conditions which existed outside of our high-fidelity system, the characteristics inherent in commercial recordings. The second mention of non-linearity was in our discussion of loudness control. Again in this case, by controlled non-linearity, we were able to compensate for the human hearing characteristic which was also outside our system.

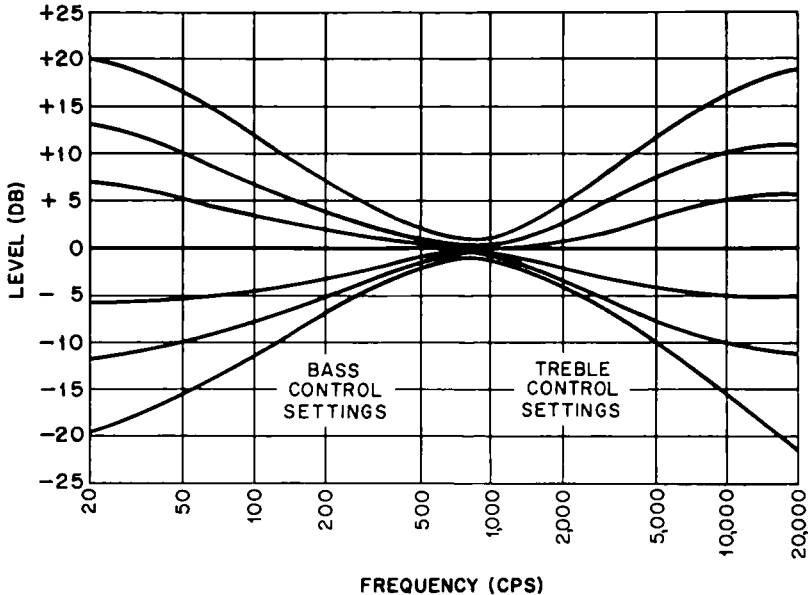

Fig. 8-10 Curves for Bass and Treble Tone Controls

The set of controls we are about to discuss has similar effect and also varies the linearity, but the purpose this time is to compensate for the many variables encountered. For example, the high-frequency absorption of rugs and drapes in the listening room, discussed in an earlier chapter, is such a variable. These *tone controls*, as they are called, may also act to compensate for the minute variations for record to record, in both the crossover point and the amount of pre-emphasis compensation; also for the variations encountered in human hearing (in this manner augmenting the level controls is our loudspeaker system).

Figure 8-10 graphically illustrates the effect on frequency response of the bass and treble controls of the amplifier shown in Figure 8-11B. The bass control permits a range of continuous variation over 32 DB at 50 CPS (from -16 DB to flat; then up to $+16$ DB). The treble control permits the same wide variation (from -16 DB to flat; then to $+16$ DB at 10,000 CPS). This wide latitude in the response of an amplifier system permits compensation for almost any condition that we are apt to encounter.

Lest our readers, at this point, visualize a multitude of controls and gadgets strung together by hundreds of colored wires, we hasten to add that all of the controls and accessories we have mentioned in this chapter are available today in one single unit. Practically all of the basic amplifier manufacturers also have available these *audio input systems*, as they are called. For example, the Pickering Co., the manufacturer of the pre-amplifier illustrated in Figure 8-1A and of the record compensator illustrated in Figure 8-7, also manufactures a complete unit, illustrated in Figure 8-11A, that includes a record compensator, a pre-amplifier, and both the bass and treble controls previously mentioned. This unit also includes three AC outlets at the rear of the chassis, all controlled by the master switch on the front panel, permitting the record player, the tuner, and the amplifier to be shut on or off by means of this one switch. Another switch is provided that permits the instantaneous selection of radio, television, or record player as a program source.

These audio input systems, or pre-amplifier equalizers as they are also called, are available in two primary forms. One of them supplies its own operating power, and a second type, such as is



(A)



(B)

Courtesy Pickering & Co., Inc. and Radio Craftsmen, Inc.

Fig. 8-11 (A) Pickering 410 Pre-Amplifier, (B) Craftsmen 300 Pre-Amplifier

illustrated in Figure 8-12B, obtains its power from the basic amplifier. In the latter type both the pre-amplifier and its associated power source, the basic amplifier, are usually available from the same manufacturer. The second type is always less expensive, though not necessarily less efficient.

The pre-amplifiers shown in Figures 8-12A and 8-13 will serve to illustrate the effort which has been expended by the amplifier manufacturers to make available, in compact units, audio control systems which permit the great degree of flexibility required to compensate for the many variables we have discussed. Since the amplifier has been termed by many as the heart of a high-fidelity system,

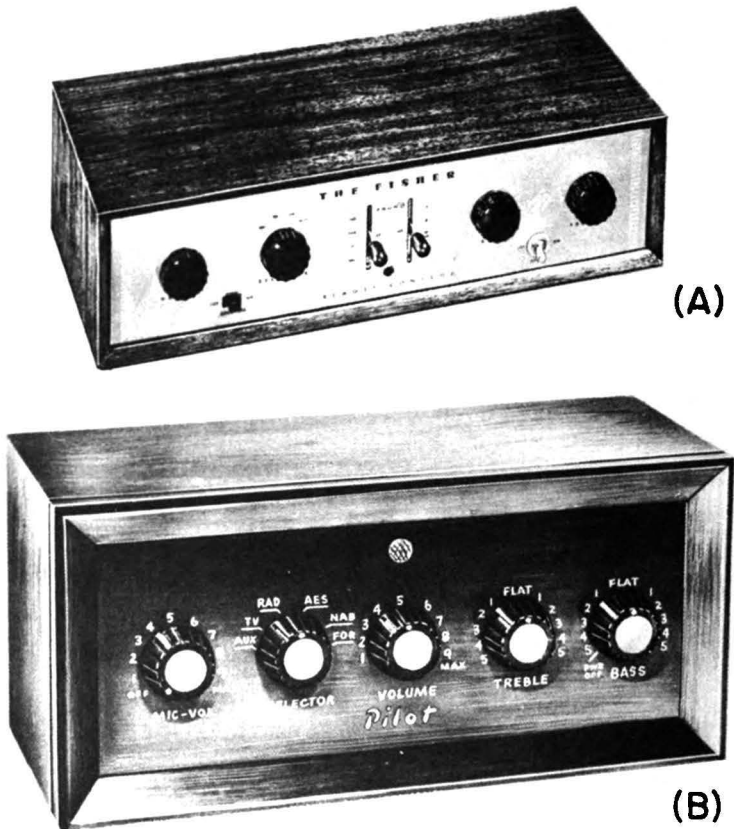

Courtesy Fisher Radio Corp. and Pilot Radio Corp.

Fig. 8-12 (A) Fisher 50-C Audio Control, (B) Pilot PA-911 Pre-Amplifier

we take equal license and say that the modern pre-amplifier and equalizer, with its control upon the system, can be called the brain.

An audio control system should incorporate a switch which permits instantaneous selection of radio, phonograph, or television programs. This same switch will often have additional positions for varying the frequency response characteristics of the pre-amplifier. To compensate for the various record characteristics

encountered, some of the deluxe units also incorporate separate, individual input level controls. These controls are usually mounted on the rear of the pre-amplifier chassis and are used to compensate for the differences in the output level from the various program sources. The output level of an AM-FM tuner, for example, is higher than the output of a magnetic pickup. Consequently, when switching from one program source to another, the level would vary to an annoying degree. The level controls are set in such a manner that the outputs of all program sources are equal or almost equal, in this manner, eliminating the possibility of annoyance from this source. Of course the levels can be set at the individual program source, but the method mentioned is more convenient.

The second control is usually a volume or loudness control, the purpose of which has been discussed. Naturally the unit using a loudness control is more expensive, but the author believes such a control to be essential for fullest enjoyment of a home music system at the levels normally used. When a loudness control is incorporated, it is still more essential that all program sources fed into the pre-amplifier be at a common level; consequently the individual input level controls previously mentioned must also be incorporated.



Courtesy H. H. Scott, Inc.

Fig. 8-13 Scott 120-A Pre-Amplifier

The third and fourth controls are usually the bass and treble controls previously analyzed. Obviously, the wider the control range (from minus DB to plus DB), the more flexible is the pre-amplifier in this respect.

Pre-amplifier equalizers also may incorporate filters of various types to eliminate noises such as turntable rumble, hum, noise from old and worn records, etc. These filters operate by eliminating or cutting off all frequencies at which these noises occur. Unfortunately, in doing so, they also eliminate any music above or below, as the case may be, the frequency of cut-off.

Figure 8-14 graphically illustrates the action of the filters incorporated in the Craftsmen 300 Pre-amplifier. For example, should we set the low-frequency filter to 120 CPS and the high-frequency filter to 6,000 CPS, we should obtain no reproduction below 120 CPS or above 6,000 CPS. The response of the pre-amplifier, and consequently of the entire system, is determined by the adjustment of these filter controls. Actually every effort should be made to eliminate noise and hum at the source, rather than by filters which reduce the frequency range.

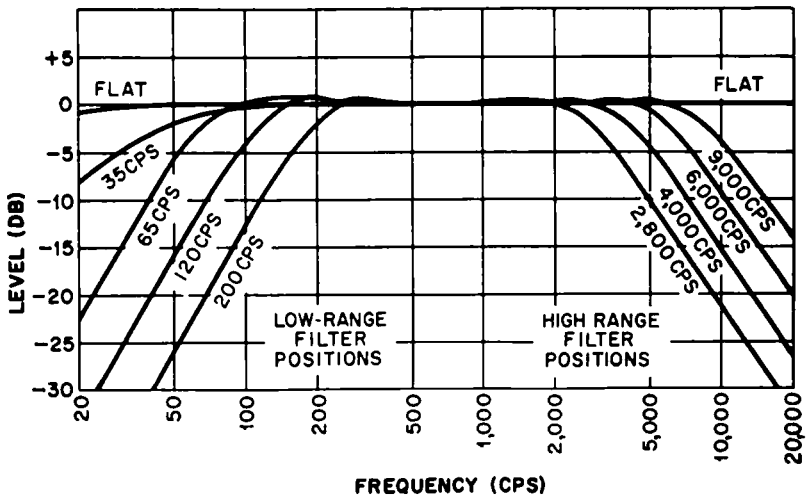

Courtesy the Radio Craftsmen, Inc.

Fig. 8-14 The Effect of Noise Filters

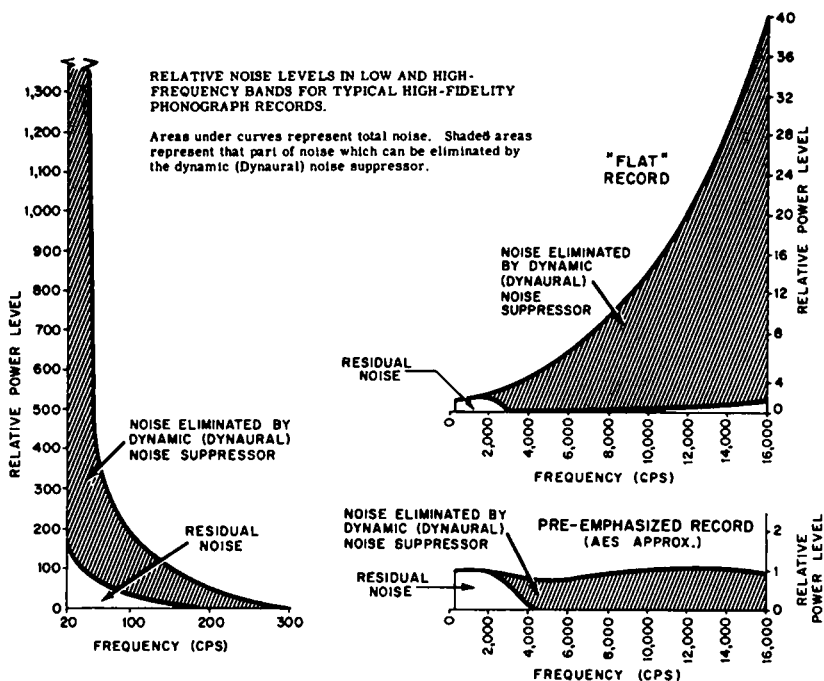

Fig. 8-15 Noise and Noise-Suppression in Records

We have noted that all solid substances have a certain grain or molecular structure which varies in characteristics from material to material but which is never absent entirely. Furthermore in records, which are subject to friction or mechanical wear during usage, the grooves become roughened or scratched. This aging tends to increase the noise level. The process is hastened by the presence of dirt in the grooves or the use of inferior reproducing equipment, such as a worn phonograph stylus.

Most noise resulting from the recording tends to be distributed over the entire frequency spectrum. It may approach *white noise*, wherein each band of, say, 100 cycles contains an equal amount of noise power. In the case of unpre-emphasized or flat recordings it may increase tremendously with frequency, as shown in Figure 8-15. Since the range from 9,000 to 10,000 CPS is 10 times as great in terms of bandwidth as that from 900 to 1,000 cycles, for instance,

even white noise has most of its actual energy in the high-frequency regions.

Figure 8-15 shows typical noise spectra for flat and pre-emphasized recordings in terms of noise per unit bandwidth. Since a linear frequency scale is used, the areas are proportional to the actual noise. In the worst case, when reproducing wide-range flat phonograph records, the noise in a given high-frequency band, for example at 10,000 cycles, may easily be 13 DB above the over-all white noise level. This represents a further power ratio of 20 to 1.

Depending upon the type of recording, therefore, the total of actual noise between 9,000 and 10,000 cycles may typically be between 10 and 200 times the noise occurring from 900 and 1,000 cycles, although these two bands, being of constant percentage, will appear to have the same width on a conventional frequency-response curve. This illustrates dramatically how noise increases as bandwidth or frequency range — and consequently fidelity — increases.

For years it has been accepted engineering practice to keep the bandwidth of any transmission system as narrow as possible to limit the noise. Such a principle is, however, contrary to the fundamentals of high-fidelity reproduction, in which the object is to reproduce the entire audible spectrum accurately.

A novel method of reconciling these opposed factors was first made public by H. H. Scott in 1946. Mr. Scott, who was also a record collector, found that regardless of the frequency response and freedom from distortion in a reproducing system, his friends were disturbed by the background noise. He therefore set out to produce a system which would reproduce the wide-range required, but without the noise.

The Dynamic Noise Suppressor which he developed is the only device of its type to have thus far received general acceptance by both music lovers and engineers. It is shown in Figure 8-16.

The system is fundamentally simple. Noise is spread over the entire range of reproducing frequencies, generally being greatest in the high-frequency region, as we have explained. Noise, therefore, can be reduced by restricting the bandwidth to cut off the high

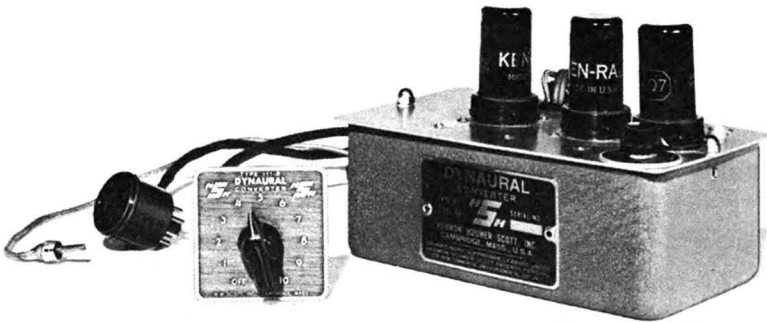

Courtesy H. H. Scott, Inc.

Fig. 8-16 Scott 111-B Noise Suppressor

frequencies, as already shown in Figure 8-14. However, fixed attenuation of these high frequencies, as we have learned, reduces the frequency response of our system.

Music above a certain level, however, masks the noise completely. At lower levels the noise may also be masked depending upon the characteristics of the music and of the noise. Fixed restriction of the high-frequency range is therefore unnecessary to eliminate most of the noise, since at all except the very lowest sound levels, the noise is obscured.

Dynamic noise suppression, therefore, is simply an automatic dynamic band-pass system in which the actual pass band (that is the range of frequencies we are permitting to pass through our system) is continuously controlled by the signal. When high frequencies are not present in the signal or when the level of the signal is so low that the noise would be noticed, the range of the system is reduced automatically. Higher signal levels or the presence of high-frequency musical fundamentals cause the range of the system to expand to maximum, thus permitting reproduction of the entire audible spectrum, including all overtones. This dynamic system operates with such rapidity that it can function between the notes of a rapid piano run.

The same system of dynamic operation can be applied to low-frequency noise. These noises, as we know, generally result from turntable rumble or other mechanical sounds which are exaggerated

by the bass boost required in reproducing phonograph records. The Dynamic Noise Suppressor, therefore, is a true dynamic band-pass system, operating on both high frequencies and low frequencies and providing a maximum of quality with a minimum of noise. Actually, since the ear is extremely sensitive at very high and very low frequencies, this action increases the effectiveness of the Dynamic Noise Suppressor at very low levels by making distortion quite unobtrusive.

Such a system does not oppose the action of loudness controls. If the Dynamic Noise Suppressor is properly adjusted for operation at high levels, the loudness control merely maintains the same apparent frequency response with all levels scaled to lower values. The Dynamic Noise Suppressor changes constantly with the requirements of the music and the ear, while the loudness control merely provides a fixed equalization for any particular setting of its over-all level. Actually, since the loudness control tends to increase the noise level (by boosting the highs), a noise suppressor is even more important when this control is used.

While the Dynamic Noise Suppressor was originally developed to cope with old-style shellac records, its fundamental advantages have become even more apparent with the advent of long-playing records. Such records are made more carefully than the older ones and are pressed upon a smoother material. However, many still have a residual high-frequency noise which becomes annoying when the full frequency range of the disc is reproduced. Wear and dirt also tend to increase this noise level. Furthermore, such discs are recorded at a considerably lower level than are the older type records; thus the signal is reduced in relation to the noise and rumble, which then become more evident.

A prime requisite for any true high-fidelity system is that it must be able to reproduce all types of program material. Therefore, in addition to record compensation, loudness compensation, and flexible tone controls, such a system should include dynamic noise suppression when the ultimate in record reproduction is required.

CHAPTER IX

THE RECORD PLAYER, PART I

Types of record players. The record changer. Record speeds. Record diameters. Types of spindles. The spider. The knockout spider. The changing mechanism. The pusher platform. The automatic stop. The turntable. The tone arm. The motor. The muting switch.

For many people the record player is the primary source of musical enjoyment. Often it is the only high-fidelity source available. A record player enables us to choose the music we enjoy, to hear all of it or parts of it at our own whim. FM and AM radio provide much musical enjoyment, but the programs from a record player have the distinct advantage of being the personal choice of the listener.

There are two types of playback equipment, the manually operated record player and the automatic player, called a record changer. In simple terms a record changer is nothing more than a motor which operates a turntable and a tone-arm, plus a mechanism which permits the entire unit to change records automatically. It is the latter feature which distinguishes the record changer from the manual player. There are a number of makes and models designed to sell at competitive prices. There are a number of variations in

the mechanisms that should be understood. We will not attempt an exhaustive study of each changer on the market; models change regularly, just as they do with automobiles. We can, however, point to certain sections of the record changer which should be examined when purchasing this type of equipment.

Today's changer must be an extremely versatile mechanism. It must play three record speeds: 33 $\frac{1}{3}$ RPM, or revolutions per minute (long playing), 45 RPM, and 78 RPM (the old "standard" speed). The three speeds are essential, since records are manufactured in each of these speeds and a specific recording you wish to own may be available at only one speed.

The record changer should have a simple lever providing immediate and accurate adjustment to any of the three speeds. Garrard, Webster, V-M and other manufacturers of record changers all provide this type of simple speed setting.

Just as it must provide three speeds, so must the changer also accommodate three record diameters: 12", 10" and 7". The setting for the record diameters should be easy to reach and as simple in construction as possible. Some record changers offer semi-automatic record diameter adjustment features, a form of *intermix* mechanism. That is, they will play a load of records of more than one diameter, or intermixed in size, but all at the same speed. The one difficulty here is that records must be individually adjusted at the other two speeds; hence any advantage is questionable. A single, positive adjustment to accommodate the three diameters available is quite satisfactory for most high-fidelity systems.

The changer should also provide a convenient spindle arrangement suitable for each of the two center hole diameters found in today's recordings. Most records are still produced with the standard size 5/16" center hole familiar to the reader. However, 45 RPM records are manufactured with 1 $\frac{1}{2}$ " center holes, a feature which, except on the RCA type (45 RPM only) record changer, has caused considerable inconvenience to users.

The spindle is the center post of the changer on which all records must be placed so that they are centered on the turntable. Naturally a single spindle cannot, by itself, accommodate two entirely different center-hole diameters.

In most three-speed record changers, this problem is solved by the use of inserts called *spiders*. A spider is a device which reduces the large 45 RPM center hole to a standard size hole by fitting into it so that the record can be placed on the standard, single spindle provided with the record changer. This method is sometimes inconvenient, as the record buyer must have a supply of spiders on hand and insert them carefully, one into each 45 RPM record, before it can be played. If it does not fit perfectly, this spider may tend to cause slippage in the wafer-thin 45 RPM records. A solution to this problem has been offered by one of the larger record manufacturers; this is the "knockout" spider, but until it is universally adapted the problem still remains. In these records, a spider is part of the disc. It may be left in place if needed, or punched out by hand to leave a large center hole if the record is to be played on a large-spindle player.

The Garrard record changer provides another logical solution to the record-diameter problem. This changer is equipped with two interchangeable spindles, one for standard-hole discs, the other for large-hole records, making it possible to dispense with spiders. These spindles are illustrated in Figure 9-1A.

The record-changer spindle actually serves two purposes. The first is to center the records on the turntable, as was previously mentioned. In addition, the spindle serves as part of the record changing (or dropping) mechanism and, in this process, is a partner of the platform, the device which holds the outer edge of the record.

There are a number of variations in the design of spindles and platforms for standard-hole records. In all record changers the records are stacked on the spindle, usually with a platform holding the outer edge of the record. The record is then dropped by a simultaneous action of the platform and the spindle. In some record changers a small eccentric cam in the spindle rotates out of the way, at the proper moment, just long enough to permit one record at a time to drop to the turntable. This type of spindle is often recognized by its "broken" vertical design, the break occurring at the point where the cam rotates. This design places a moving part in the center hole of the record, and has a tendency to wear and enlarge this hole. Eventually this may affect the performance of the record by causing it to turn unevenly on the turntable.

In some other record changers the record is steadied and partly supported on a vertical spindle, but its outer edge rests on a platform incorporating a gate-like or scissor-like mechanism. At the proper moment the gate turns or the scissors close and the record drops. Unfortunately, if the record changer is not functioning correctly, the action of the gates may either split the record or nick the edges.

Far more satisfactory than either of the two above mentioned methods is the pusher-type platform combined with a bent spindle design. This mechanism first appeared some years ago on the Garrard record changer and has since been adopted by Webster and others. It is the only method which, in the opinion of the author, gives positive, gentle operation for records with standard center holes. With this type of mechanism, records are stacked at an angle on the upper or bent part of the spindle, being prevented from falling to the turntable by a notch or step in the spindle. The record's outer edge rests on the platform. At the proper moment the sliding part of the platform gently pushes the lowest record in the stack, and as the center hole clears the step in the spindle the record drops to the turntable. There is a minimum of noise and virtually no danger of damage to the record. Record changers made with this pusher-type platform mechanism are the Webster-Chicago HF Models and the Garrard. These are illustrated in Figure 9-1B.

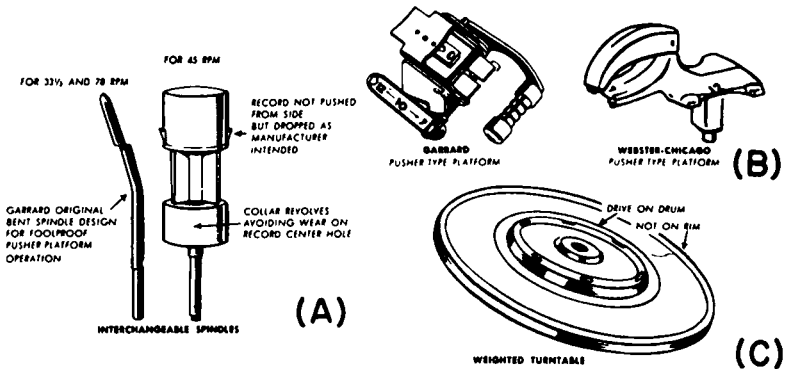

Fig. 9-1 (A) Spindles, (B) Pusher Platforms, (C) A Weighted Turntable

RCA Victor, the original manufacturer of the large-hole 45 RPM record, designed an extremely capable, rapid and simple device for dropping these records. It incorporates a thick (1½" diameter) spindle. The records are stacked on the upper part of this spindle, sitting on the horizontal edges of the two prongs which extend out from it. At the proper time the two prongs retract into the spindle, just long enough to permit a single record to drop to the turntable. This is a quick, practical method, eminently suitable for lightweight records of 7" diameter.

Unfortunately, the RCA-type spindle is available on only one three-speed record changer, the Garrard. In all other record changers, a record with a large center hole must be plugged with a spider, as previously mentioned. The Garrard interchangeable wide spindle incorporates another feature not found on the original RCA design. It is made with a collar at the bottom which revolves with the record, thus preventing wear on the center hole of the record due to friction. The interchangeable spindles were shown in Figure 9-1A.

All record changers on the market have simple, practical controls for starting, stopping and rejecting records at the discretion of the listener. Check the location of this control; it should be away from the tone arm to avoid possible damage to the pickup or tone arm when the control itself is used. Details such as this are quite important when expensive styli are used.

There are also variations in the arrangements for playing records manually, and for stopping the mechanism automatically at the end of the last record. Music students, teachers, and others who of necessity must repeat parts of records will find a manual-playing feature extremely valuable, especially at the 78 RPM speed. Since it is not desirable to set the stylus down in the middle of a long-playing vinylite recording, where the microgrooves may be easily scratched or damaged, many engineers do not consider the manual feature very important. However, this is a matter of the purchaser's preference. The automatic-stop feature (in which the changer shuts off by itself at the end of the last record, returning the tone arm to the "rest" position) is found on Garrard, Webster, V-M and various other machines. It is important. Ordinarily when a record changer does not offer this feature, it will play the last record

over and over until the listener goes to the machine. This may seem comparatively unimportant, but it can become quite a nuisance, as it may be inconvenient to be at the record changer when it reaches the end of each stack of records.

Every record changer is, of course, literally and figuratively built around its turntable. From the top all turntables appear similar, but there the resemblance may end. There is much more to the turntable than the felt or "flock" covering which serves as a cushion for the records.

When buying a record changer, ask the demonstrator to remove the turntable and examine it on both sides, weighing it in your hand as you do so. First note its weight and balance; on a well-built record changer the turntable will be heavy and precision-built for perfect balance. Weight and balance are quite important because they impart flywheel action. In other words, the turntable will tend to revolve smoothly and, because it is weighted, overcome any slight variations in speed that may be present in the driving mechanism.

Second, check the part of the turntable which is driven by the motor and driveshaft. At the bottom of the turntable you will see a rim (at the perimeter) and a drum (near the center). There is less chance of rumble and speed variation if the turntable is drum-driven than there is if it is driven along the rim. A turntable of the former type is illustrated in Figure 9-1C.

Third, it is important that the turntable is so constructed at its center that it sits perfectly level on the record changer; for good reproduction it is essential that the turntable revolve on a level. This helps prevent distortion, uneven sound, and poor tracking of the stylus. Particularly when long-playing records are used, a turntable that weaves up and down as it turns tends to produce these undesired effects. It takes very little unevenness to throw the stylus out of a microgroove and cause it to jump or scratch across the record.

From a reproduction standpoint, the turntable is one of the critical parts of the record changer. A poorly weighted, unbalanced, uneven turntable can cause noticeable rumble or vibration in reproduction. A turntable is not the only source of these ills, but it must be well-built if they are to be avoided.

From a mechanical standpoint, the drive shaft and the linkage which connects the turntable to the motor are of obvious importance. What may not be so obvious, however, is the very close relationship between these mechanical devices and good record reproduction. Actually, a variation of as little as a fraction of one revolution per minute in a long-playing record causes a discernible variation in the pitch of the music. It is essential that the turntable always be driven at precisely the correct record speed, without regard to variations in the weight of the records on the turntable. Because of the three speeds at which they must operate, most record changers employ small belts that are driven by a shaft from the motor. These, in turn, move individual drive shafts and cause a drivewheel to turn. The greater the diameter of the driveshaft, especially for 33½ and 45 RPM, the more traction the belt exerts upon them and the more consistent the motion they impart to the drivewheel. The drivewheel or idler wheel moves the turntable. The rim of the idler wheel is made of rubber or a similar substance. When the record changer is not operating it is essential that this soft rim substance is not in contact with the turntable or driveshafts, in order to avoid flattening. It is obvious that a flattened idler wheel will cause uneven speed in the turntable, just as flat spots in an automobile tread will cause thumping on the road. For this reason, it is wise to insist upon a record changer with a "pullaway" idler wheel featured in the driving mechanism. Changers of good quality, like Garrard and the Webster-Chicago, offer this feature. These changers are illustrated in Figure 9-2.

From the standpoint of record protection and music reproduction, the tone arm of the record changer is all-important. Actually there are two parts to the tone arm, the arm itself and the playing end of the arm, which generally takes the form of a shell to accommodate a pickup cartridge and a needle.

The tone arm itself is not the simple appendage one might assume. In a fine record changer it is scientifically shaped and mounted so as to describe an arc which places the stylus, at all times, on the tangent edge of the record groove. True tangent tracking not only protects the groove walls, thus prolonging the life of the record, but also helps to avoid distortion in musical reproduction. A scientifically designed tone arm should also main-



(A)



(B)

Courtesy Webster-Chicago Corp. and Garrard Sales Corp.

Fig. 9-2 (A) The Webster-Chicago HF Series, (B) The Garrard "Triumph"

tain the needle or stylus in the record groove at the correct angle. Poor stylus angle can cause uneven and excessive wear in the grooves, as well as faulty reproduction. In order to offer this protection, a tone arm must be rigidly mounted so that it cannot roll from side to side; yet it must be free to move along its proper horizontal arc.

When buying a record changer, it is wise to check the tone arm for rigid mounting construction, for parallel lift, and for gentle setting down of the stylus upon the record. You need not have mechanical training to recognize a good tone arm mounting when you see one. Just investigate the manner in which the arm is attached to the mechanism which activates it. One glance will show you whether it look engineered or just makeshift.

Of course, the tone arm itself is not the reproducing part of the record changer. At the end of the tone arm is a shell designed to hold the pickup cartridge. This holds the stylus that picks up the sound in the record grooves. Pickups vary considerably in the quality of the sound they feed into the amplifier. There are two main types now in use, the crystal and the magnetic. In turn, there are a number of variations and popular makes of each type.

The discriminating listener soon chooses his favorite cartridge and has his own ideas about whether to use diamond, sapphire, or osmium styli with it; whether to use the same type of stylus material for microgroove as well as standard records, and so on. Any preconceived ideas along these lines may be changed after reading our next chapter. Therefore, it is important that the record changer tone arm be equipped with a universal type pickup shell to accommodate the user's choice of the various cartridges available for standard and microgroove reproduction, including the popular Astatic, Pickering, Audak and G.E. models. Some record changers furnish plug-in shells for this purpose; others are equipped with a specific cartridge and are not as flexible in their long-range application to the high-fidelity user's requirements.

Although the motor of the record changer is obviously its most important single component, we have deliberately withheld discussion of it up to this point, since the record changer is essentially a musical instrument. The motor should be considered not only as an electro-mechanical device, but also in relation to the effect it

may have on musical reproduction. In a quality record changer the motor should be of heavy-duty construction. Since accuracy with respect to revolutions per minute will be reflected in record pitch, it is important that constantly correct speed be maintained, regardless of small variations in the electric-line voltage or the number of records on the turntable. Nor should there be any noticeable speed variation when operating the record changer "cold" with a full load of records or "hot" with a single record, regardless of weight, thickness or diameter of the record.

Essentially any electric motor consists of an armature revolving in an electro-magnetic field. A four-pole motor will turn more smoothly and evenly than one with two poles. Indeed, a smooth, even-turning, four-pole motor is one of the keys to flawless record reproduction. It tends to reduce rumble and unevenness in pitch (sometimes called *wow*). Many of the ills of poorly built record changers may be traced to two-pole motors of light construction. Both Garrard and Webster-Chicago have, in their high-fidelity models, four-pole motors. In addition, the Garrard armature is scientifically balanced by an ingenious process which adds lead weights to the vanes of the armature (rotor) causing it to balance and operate more smoothly, in much the same manner as weights are added to the front wheels of an automobile for better balance.

The muting switch is in a refinement offered by Webster-Chicago, Garrard and VM whereby there is no sound while the record changer operates on run-in or run-off grooves. This feature eliminates unnecessary noise while records are being changed.

It is not our intention to go into detail concerning the many variations in the underside construction of changers. Suffice it to say that considerable differences do exist, and it is interesting for the purchaser of a record changer to look at the underside mechanism. Look particularly for an over-abundance of springs. If too many are used, they may indicate compensation for a lack of precision engineering; they can also be affected considerably by heat, cold, continued use, and jarring of the mechanism. As in any quality machine, the preferred construction for record changers should be that of a simple, heavy-duty, well-machined instrument, dependent mostly upon precision-ground gears for linkage.

CHAPTER X

THE RECORD PLAYER, PART 2

Records and styli. Osmium, sapphire, and diamond styli. The effect of worn styli upon records. The effect of worn styli on reproduction. Replacement of worn styli. Microscopes. The pickup cartridge, crystal or magnetic. Motors and turntable assemblies. Wow, rumble, and flutter. Pickup arms. Tracking and tangency. Dynamic and FM cartridges.

In connection with recorded music we have discussed the record itself, modern recording techniques, pre-amplifiers, equalizers, and the automatic record changer. Only briefly, in passing, have we mentioned the pickup cartridge and its needle or stylus. These two components, particularly the stylus, have been taken for granted until recently. This is rather strange, particularly since both are extremely important.

Chapter VIII explained that a record was a flat disc containing wavy spiral grooves, each about the width of a human hair, which were originally engraved into the master disc by a cutting stylus. Figure 8-1 illustrated an enlarged segment of a record showing these grooves and the *land* between them. Figure 10-1 is a photomicrograph of these same grooves, showing a record

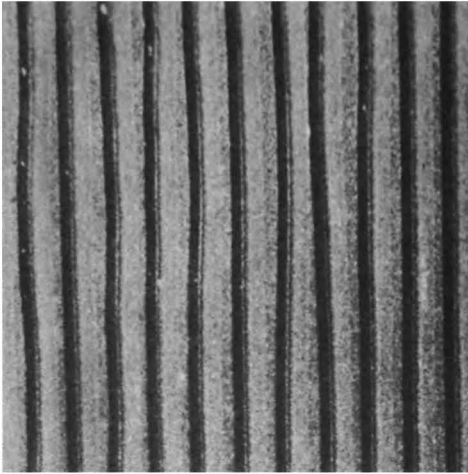

Fig. 10-1
Grooves on a New Record

Courtesy Tetrad Corp.

which has never been used. A standard 78 RPM record has about 100 of these grooves per inch, and a $33\frac{1}{3}$ RPM microgroove record has about 325 grooves per inch, each about half the width of a human hair. This difference in groove width is the reason for two different size styli. A standard stylus for 78 RPM records has a radius at the tip of 2.5 mils (two and a half thousandths of an inch). The microgroove stylus has a radius of 1 mil (one thousandth of an inch).

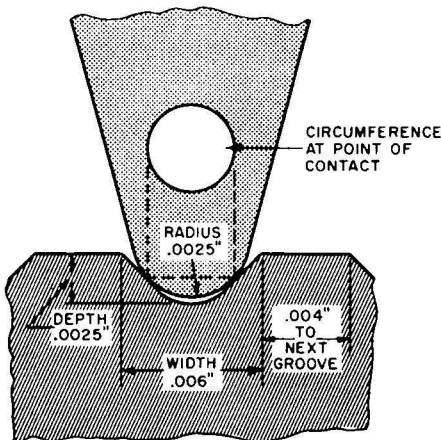

Fig. 10-2
The Stylus in the Groove

Courtesy Service Magazine, June, 1952

Figure 10-2 is a greatly enlarged view of a 78 RPM stylus tip, showing how it fits into the groove. This illustration is from *Sound Reproduction* by G. A. Briggs and is based on original work by C. E. Watts. From Figure 10-2, it can be seen that the stylus touches the walls of the groove at only two microscopically small points. Consequently the entire weight of the tone arm, including the cartridge, and the lateral pressure exerted by the record grooves are concentrated at these points on the stylus. Although the pickup arm and cartridge seem light to the hand, this concentration results in a total pressure, at the contact area, of 26 tons per square inch! The walls of the record grooves are, of course, subject to the same tremendous pressure, but only for the small fraction of a second required for a particular section to move past the tip as the record rotates.

When we stop to consider that we are contending with pressures up to 26 tons per square inch and, in addition, realize that the stylus must travel over one half mile of surface each time a 12" microgroove record is played, it is not surprising to find that any but a stylus of the hardest material wears rather rapidly.

As can be seen from Figure 10-2, a modern stylus is not a sharp, pointed object, but is conical in shape, with a smooth, hemispherical tip. The maintenance of this smooth, hemispherical shape is essential for high-fidelity reproduction and reduced record wear.

Our interest in stylus wear is threefold. The first reason is the effect of a worn stylus on reproduction. The second is the effect of

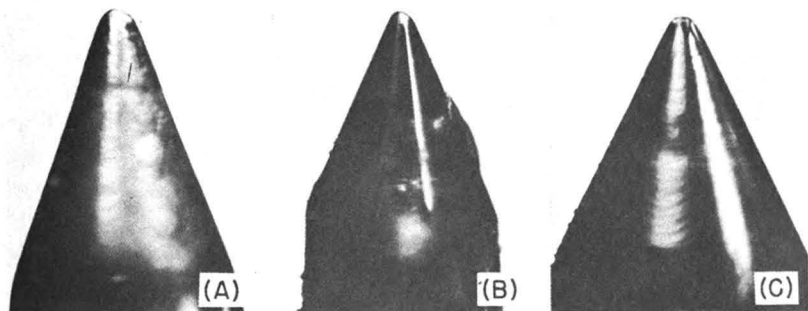

Courtesy Tetrax Corp.

Fig. 10-3 Stylus Wear, 48 Plays on New Records:
(A) Osmium, (B) Sapphire, (C) Diamond

stylus wear on our records. The last consideration, but not the least, is the effect of stylus wear on our pocketbooks. Record styli are today made from three different materials: osmium, sapphire, and diamond. It is our intention, through actual tests, to show which of the three materials is best suited for our purpose.

Figure 10-3 illustrates three different stylus tips. *A* is an osmium tip, *B* is a sapphire tip, and *C* is a diamond tip. Each of these was photographed after being played 48 times on new record surfaces. At no time did any of these tips touch a groove played more than two times.

The records used in this and succeeding tests were all 12" vinylite microgroove records of various manufacture, and were all played on a Webster 3-speed changer with a pickup arm weight of exactly 8 grams. At the end of 48 playings both the sapphire and the osmium have, as can be seen, *flats* worn on the sides of the tips. The diamond tip shows no signs of wear. This test, it is important to note, was conducted on brand new records—an ideal situation not likely to occur in actual practice. The test was made to show the difference in wear even under ideal conditions.

Another series of tests was run, this time under conditions which more closely approximated normal use. All factors were the same except that the records were slightly used. A photomicrograph

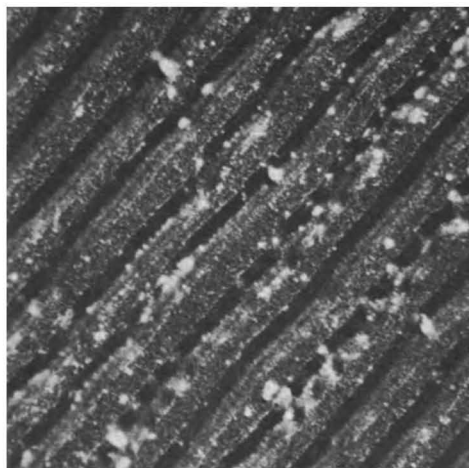
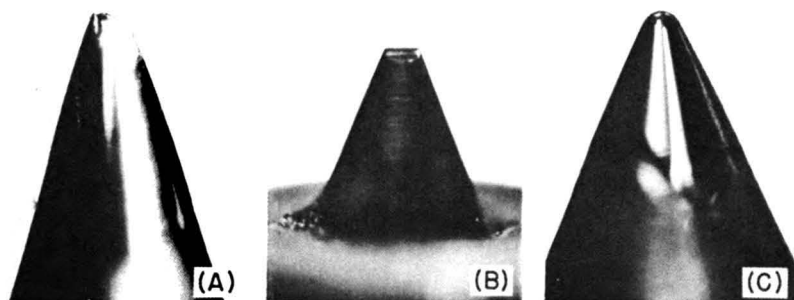

Fig. 10-4 Grooves on a Slightly Used Record

of one of these records is shown in Figure 10-4. Compare these grooves with the ones shown in Figure 10-1: the reasons for the additional abrasive action of used records then becomes obvious.

The results of the second test, after 48 playings, showed marked wear, completely beveled edges and a chisel shape to the osmium and sapphire tips, but still no discernible wear on the diamond.

From these and other tests, we can safely state that on micro-groove records osmium styli should not be used for more than 35 plays, and sapphire should not be used for more than 75 plays—preferably less if we are to obtain the utmost in high-fidelity reproduction. The diamond can be used for more than 1,000 plays.



Courtesy Tetrad Corp.

Fig. 10-5 Stylus Wear Caused by Used Records:
(A) Osmium, (B) Sapphire, (C) Diamond

With standard-groove records the wear on the stylus is less. The average, on the usual home type of equipment, is approximately 100 plays for osmium, 250 plays for sapphire, and over 2,000 plays for diamond. Diamond styli, though higher in initial cost, are actually the least expensive when the cost per playing is compared. Not only is the diamond stylus more economical per playing, but the reduction in record wear, as a result of its use, also contributes to the economy of this type. Our next group of photomicrographs will illustrate this fact.

Figure 10-5 illustrates the results of our third test. Brand new styli of osmium, sapphire, and diamond were played 48 times each

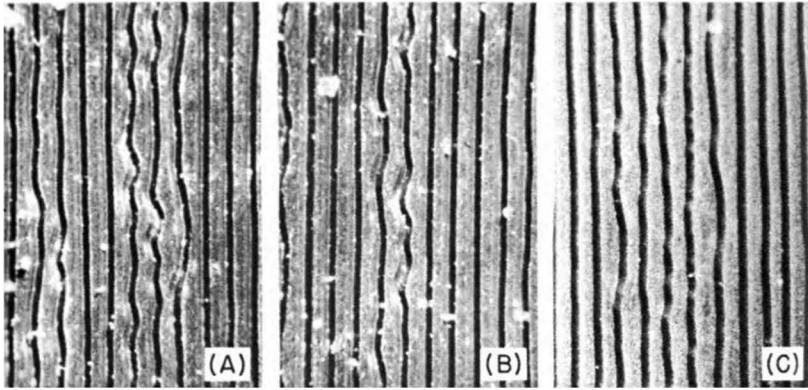

Courtesy Tetrad Corp.

Fig. 10-6 Record Wear Caused by Styli made of:
(A) Osmium, (B) Sapphire, (C) Diamond

on slightly used records. The diamond stylus was then continued in use until 1,000 plays were completed. All styli were then photographed, as shown in Part A for the osmium, Part B for the sapphire, and Part C for the diamond. From Part A we can see the large flats and sharp edges. Part B shows the chisel shape previously mentioned. Part C shows the smooth contours maintained even after 1,000 plays.

The same styli, after being photographed, were then used on three brand new records. Each record was played 50 times with one of the styli. Then the photomicrographs shown in Figure 10-6 were made of sections of the grooves of each record. Part A is a section of the record played by the osmium stylus, shown in Figure 10-5A. Part B is a section of the record played by the sapphire stylus, shown in Figure 10-5B. Part C is a section of the record played by the diamond stylus, shown in Figure 10-5C.

The difference in the condition of the grooves of the three brand new records after 50 playings is obvious. We can easily see that the diamond stylus imposed less wear on the record grooves by comparing each of these photographs to Figure 10-1, depicting a brand new record.

Since we have discovered the damage to records that can be caused by worn styli, it may be interesting to our readers to find

out just how this damage is caused. From Figure 10-2 we discovered that the contact between a new stylus and the record walls occurred at two microscopically small points, one on each side of the tip. When we discovered that these points travel over one half mile of surface with each playing of a 12" microgroove record, at pressures up to 26 tons per inch, it was not at all surprising that these small contact surfaces started to wear and flatten out. It is these flats, as illustrated in Figures 10-5 and 10-7, which are responsible for practically all of the damage to the record grooves.

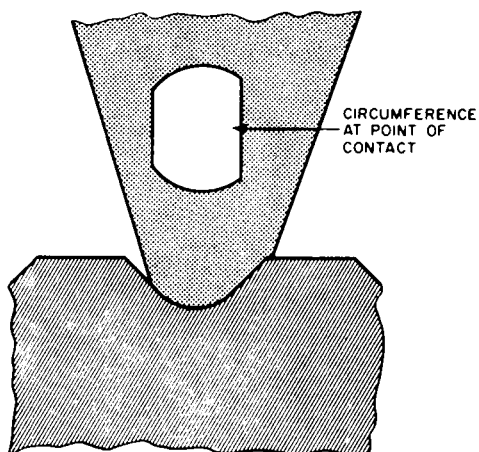

Fig. 10-7 A Worn Stylus in a Record Groove

*Courtesy Service Magazine,
June, 1952*

As the flats on the stylus grow larger with wear, the edges become progressively sharper. When the flats on each side of the stylus eventually meet, the tip starts to resemble a miniature chisel. A stylus tip worn to this condition is illustrated in Figure 10-5B. This chisel tip, when swinging from side to side in the groove, cuts and actually chisels into the groove walls, gouging out minute particles as it travels. These particles cut from the walls of the groove, combined with the particles worn from the stylus itself, remain in the groove, as shown in Figure 10-4, and in turn help grind the flats on the stylus to a still sharper edge.

Thus far we have confined our discussions to the economical aspect of wear, both on the stylus itself and on the record. Despite the fact that these are both important, there is another equally

important factor: the effect of stylus wear on high-fidelity reproduction. In our succeeding paragraphs we will attempt to explain just how worn styli affect reproduction.

Chapter VIII explained how the cutting head, when recording, transformed electrical impulses into mechanical side-to-side or lateral motion, thus forcing the cutting stylus to engrave minute impressions into the walls of the record groove. These impressions are in proportion to the frequency and intensity of the signal being recorded.

We also explained that a sound wave with a frequency of 10,000 CPS caused the cutting stylus to vibrate 10,000 times per second. When the playback stylus transmitted this recorded sound the impressions engraved upon the walls of the groove forced it to vibrate at 10,000 times per second.

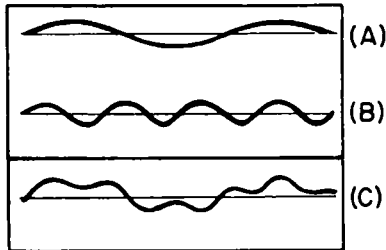

Fig. 10-8 Low-Frequency, High-Frequency, and Complex Recorded Waveforms

Courtesy Service Magazine, June, 1952

The length of a recorded wave on a groove is dependent upon the frequency and amplitude of the sound, upon the diameter of the record and the speed of the recording. A low-frequency note will cause the formation of a wave such as shown in Figure 10-8A, with a comparatively long distance between crests. A high-frequency note will reproduce waves like those shown in Figure 10-8B, with a short distance between crests. A recorded combination of a high and a low frequency will produce a complex wave, as shown in Figure 10-8C.

Since the record speed is constant on a single record, the length of a recorded wave of a specific frequency decreases with the diameter of the groove in use. For example, a 10,000 CPS note has a length in the groove of .002" at the starting grooves of a 12" microgroove record; the same frequency, recorded 6" from the

record center, has a length of .001". At a point 3" from the center, the length decreases to .0005". From these figures we can easily see why a stylus cannot have a flat greater than .0005" if we are to reproduce a frequency of 10,000 CPS. When the flat is greater the stylus will bridge the crests of the recorded wave, consequently it will not reproduce this frequency. As the flat becomes larger, the lower becomes the frequency that the stylus can reproduce properly.

From the foregoing paragraphs, it becomes obvious that the smallest and seemingly the least important component in our high-fidelity system can completely nullify many of the advantages we have thus far obtained. This is readily understandable when we consider that the stylus tip receives more mechanical wear than all of our other components combined.

We have also discovered that even a diamond stylus is not permanent. When should it be replaced? Unfortunately, there is no simple, direct answer to this question. When wear has progressed to a point where there is a clearly defined flat on either side of the tip as shown by a microscope, it is then time to replace the stylus. Unfortunately, the proper checking of a stylus by this method requires the use of a good 150-200 power microscope. Obviously most individuals do not possess such instruments and, therefore, this answer is unsatisfactory.

However, a rapidly increasing number of reputable music dealers are installing microscopes of this type in order to provide this essential service for their record customers. Therefore we would suggest you call on your local dealer first. The best possible suggestion we can offer is to be sure to present for examination under a microscope any diamond stylus that has been used for

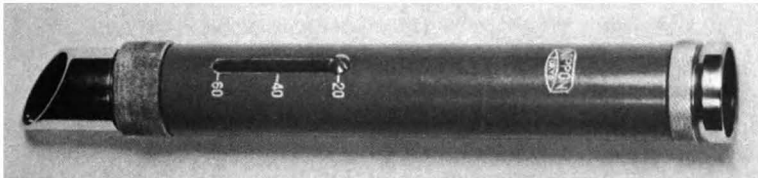

Courtesy Sonofax

Fig. 10-9 Sonofax 60-Power Imported Microscope

1,000 plays or more. For those who insist on making preliminary checks themselves, the Sonofax 60-power microscope shown in Figure 10-9 will be useful.

Many record collectors seem to have the erroneous impression that the time to replace a stylus is when it has deteriorated to a point where the difference can be heard during record reproduction. This is a rather dangerous and expensive misconception, because a stylus that sounds bad has already been damaging records for quite some time.

When a cartridge with a built-in stylus, such as the Pickering, Fairchild, or Weathers cartridge, is used and returned to the manufacturer for stylus replacement, the customer can always be certain of a high-quality replacement. When a cartridge with a replaceable stylus, such as G.E. or Audak is used, styli of equally high quality are available from these manufacturers or from your local music dealer.

The opening of this chapter mentioned two components, one of which has already been discussed. The next will be the pickup cartridge. Pickups can be divided into four general classifications: the crystal, the magnetic, the dynamic, and the FM cartridge. There are a number of variations of each; however, we will discuss only the basic types in each classification.

The first, the crystal cartridge, has one characteristic which precludes its use in high-fidelity systems: it has a limited frequency range.



Fig. 10-10
Audax Cartridge and Arm



Courtesy Garrard Sales Corp.
and Audak Co., Inc.

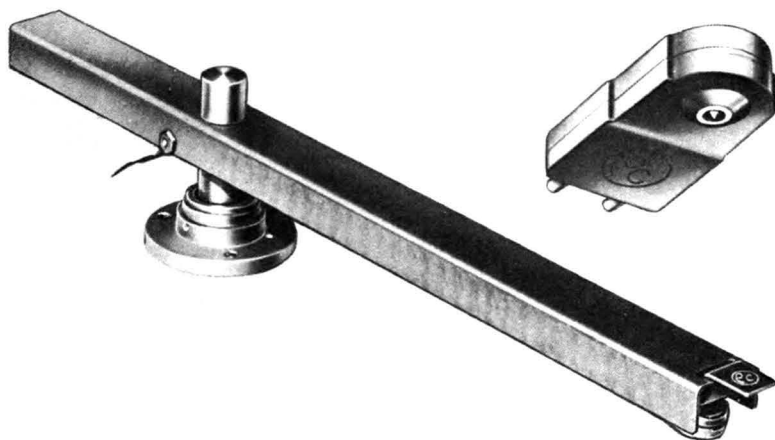

Courtesy Pickering Co., Inc.

Fig. 10-11 Pickering Cartridge and Arm

The second, the magnetic cartridge, is today the most popular for high-fidelity use. In its various forms it has excellent frequency response and is adaptable to both record changers and manual players, which will be discussed later in this chapter.

Two magnetic cartridges and pickup arms with which they are used are shown in Figures 10-10 and 10-11. Another cartridge, the G.E., is shown in two versions in Figure 10-12. Part A shows the

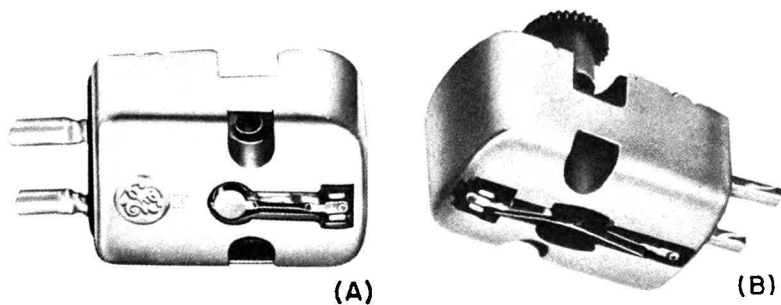

Courtesy G. E.

Fig. 10-12 G.E. Cartridges

cartridge as designed to hold a single, fixed stylus for one type of record only. Part *B* shows the twin-stylus or "twist" version of the cartridge. Depressing and rotating the knob at the top causes one of two stylus tips to come into position. The stylus tips are placed at either extreme of the long arm.

The third and fourth types are highly specialized instruments, more often used on professional record players in broadcast stations and recording studios. Both the dynamic and FM cartridges are usually designed for use with a specific arm, and are characterized by extremely low output. This makes necessary the use of a pre-amplifier with a very high voltage gain.

Until a few years ago, record and stylus wear were thought to be only the result of the high point pressures used. Engineers concentrated on this factor until this pressure was lowered to its present weight of only a few grams. Unfortunately, both record and stylus wear continued despite the large reduction in weight. Further investigation showed that the mass of the moving stylus and the ability of the stylus to move freely in both a vertical and lateral direction were also important factors in wear.

From our previous paragraphs we have discovered how a stylus and a record wear. Returning, for just a moment, to these paragraphs, we find that the stylus is forced to move from side to side by the varying impressions upon the walls of the groove. Should we be able to reduce the pressure required to move the stylus laterally, we would create less friction between the groove walls and the stylus. Less friction would obviously result in less wear on both. *Compliance* is the word used to describe the ability of the stylus to move freely, either vertically or horizontally. *Low compliance* characterizes a stiff stylus assembly; it results in greater wear. *High compliance* is the desirable characteristic; it refers to a freely moving stylus assembly.

The stylus mass is also important, and for similar reasons. In every moving body there is a resistance to motion called inertia, the inertia of a body increases in proportion to its mass. The pressure required to overcome the inertia of a larger mass is obviously greater than that required for a smaller mass. The pressure, in our case, is obtained from the groove walls; consequently, when we reduce the mass of the stylus assembly, we also reduce the pres-

sure required to move it. In this manner we further reduce the friction between the groove walls and the stylus. Reducing the friction results in a further reduction of wear.

The importance of reducing the stylus mass and increasing the compliance becomes more evident when we stop to consider that, at the comparatively low frequency of 500 CPS, the vibrating stylus must make 1,000 reversals of direction per second in order to reproduce this frequency. To reproduce a frequency of 10,000 CPS, the stylus must make 20,000 reversals per second. However, before the stylus can reverse itself, it must come to a complete stop and be restarted in the opposite direction by the groove wall. Inertia is a small factor for a single cycle but, when we multiply this small factor by 20,000 times (in the case of 10,000 CPS), we can see how the amount of pressure required to move the stylus assembly becomes extremely important.

From the foregoing, we can readily understand that the ideal cartridge would have zero or close to zero vibrating mass and infinite or nearly infinite compliance. Since our readers, in all probability, have no means of checking either the stylus mass or the compliance, we make the following suggestion.

Listen to a cartridge in an arm, playing on a record with the amplifier off. As the turntable revolves, you will hear from the vicinity of the stylus what is commonly called *needle chatter* or *needle noise*. This noise is caused by the action of the vibrating stylus. It is developed in conjunction with the record, which acts like a diaphragm, and reproduces acoustically the sound on the record. The degree of needle noise is generally indicative of both the amount of vibrating mass and the compliance. The louder the chatter, the larger the stylus mass and/or the lower the compliance. The better cartridges reduce this noise to a point where it is barely audible, even with the ear close to the record. This needle chatter is most obvious in loud passages.

When the stylus mass is small and the compliance is high, the point pressure is also reduced, as the groove is able to control the stylus more easily. Reduction of point pressure also reduces friction and wear. The point pressure, incidentally, cannot be reduced too far or the pickup will jump or skip grooves when the

turntable is subjected to mechanical vibration, such as caused by a person walking across the floor.

Throughout this chapter we have repeatedly discussed record and stylus wear. Aside from the economic factor this wear is of great importance, because it also affects our reproduction. A previous paragraph explained how a worn stylus affected high-frequency response. A worn, dirty record also affects high-frequency response in a number of ways. Important among these ways is the following: when the record groove is loaded with stylus chips, record particles and atmospheric dust, the vibrating stylus cannot follow the recorded impressions, as this dust can easily plug up the space between the crests of the recorded sound waves, particularly at high frequencies, where the distance between these crests are as small as .0004 inch. The importance of both stylus and record wear should, by now, be quite evident. We have also seen how attention to small details aids us in achieving our goal.

We have mentioned the record player a number of times. It performs essentially the same function as the record changer. The primary differences are that the player is manually operated rather than automatic, and that greater attention is paid to the small details which, as we have discovered, aid us in obtaining high-fidelity reproduction.

The first noticeable difference is in the motor and turntable assembly. The primary requirements of a motor and turntable assembly are that the speed of rotation remain absolutely constant and that the noises, inherent in every moving mechanical device, be reduced to a point at which they cannot be detected by the pick-up and amplified with the wanted signal. This noise can never be eliminated completely, since moving parts such as motors, idler wheels, and shafts set up vibrations. As we have discovered, all vibrations create sound.

The construction of a quality motor and turntable, like the unit shown in Figure 10-13, requires the same care in machining and assembly as a fine watch. Before analyzing the various components which comprise a motor and turntable assembly, we will explain the terms used to describe the various noises and effects which we will encounter.

The first term, *rumble*, is used to describe the low-pitched noises transmitted to the reproducing turntable and superimposed on the reproduction. Its source, as we have discovered, is in the motor and drive mechanism when these are not perfectly machined and aligned.

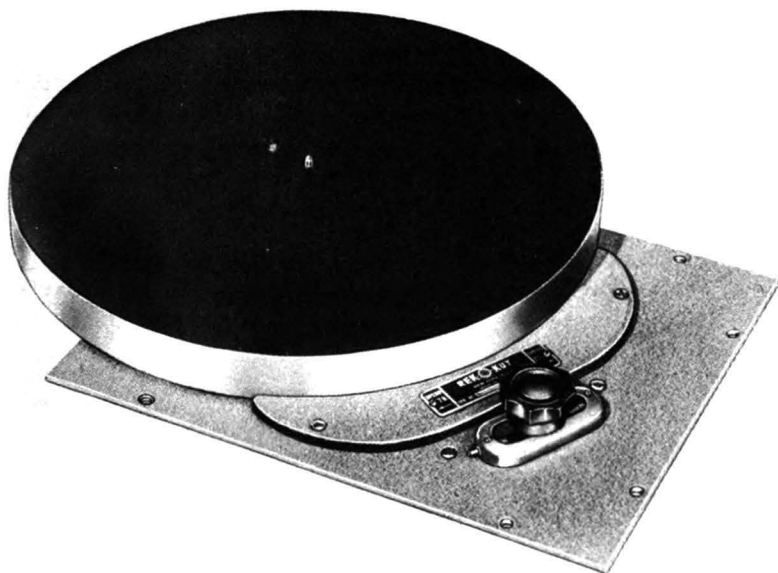

Courtesy Rek-O-Kut Co.

Fig. 10-13 The Rek-O-Kut Turntable Assembly

The second term, *wow*, is used to describe the variations of the reproduced frequency caused by irregular motion of the turntable or record, due to non-uniform speed, off-center hole in the record, variation in record height due to warpage, or unevenness in the turntable itself. This term refers to deviations at a relatively low rate. This same phenomenon is described as *flutter* when it occurs at a higher rate of speed, for example, 10 times per second. Whereas either of these variations recurs in a regular pattern, another variation, known as *drift*, refers to random variations close to $\frac{1}{2}$ cycle per second.

A simple method of testing the speed constancy, wow, flutter, or drift is to play a recorded violin solo with long sustained notes. Since the human ear is extremely sensitive to changes in pitch during a sustained tone, any variation will be very noticeable.

A high-quality motor and turntable assembly will now be broken down into its individual components and each described, together with its effect on reproduction.

The chassis is the foundation of the machine. It must be rigid to avoid twist and bending under operation. Twists and bends will cause the idlers and motor to "run out" in relation to one another; resulting in wow and rumble.

A good turntable is made of an aluminum casting which is machined in a lathe. The rim of the casting is made heavy to impart to the turntable a flywheel action which helps maintain smooth, even motion. The turntable must run absolutely true. This can be checked by watching the lower part of the rim as it revolves. There should be absolutely no discernible up-and-down motion.

Concentricity in the turntable is most important in avoiding wows. This is best explained by showing one circle inside another. The distance from one circle to the other, at any point, should be the same. In the turntable then, the shaft center would always be the same distance from the rim. This always insures that the record revolves in a perfect circle as it rotates.

The same close machining tolerances are required for the idler wheels. These are usually made of special neoprene rubber to permit maximum traction without slippage, long wear, and resistance to oil. Each wheel should be ground individually to give it perfect concentricity. The bearing and shaft should be fitted very closely to eliminate any wobble which would cause wow. Friction also causes wow and rumble. It is reduced to a minimum on a good turntable by the use of hardened and ground shafts and carefully finished bearings.

The hysteresis synchronous motor features a cobalt rotor which is generally a solid casting. The effect of a rotor of this type is to give exceptionally smooth power as compared to the laminated type rotors used in the standard synchronous motors.

The bearings and shafts of the rotor should be held to exceptionally close tolerances. If the diameter of the bearings are larger than specified, the rumble level will increase as much as 10 DB.

The conception that rumble comes only from the idlers and turntable is erroneous. The rotor of the motor is more responsible for this condition than any other component. The dynamic balance of the rotor must be very accurate to bring the motor in tolerance to meet our rigid standards. These factors are prime requisites. To build them into a motor requires a great deal of skill and labor, both in assembly and production. This accounts for the considerable difference in cost between the unit using a hysteresis synchronous and one with an induction motor. The synchronous motor will main-

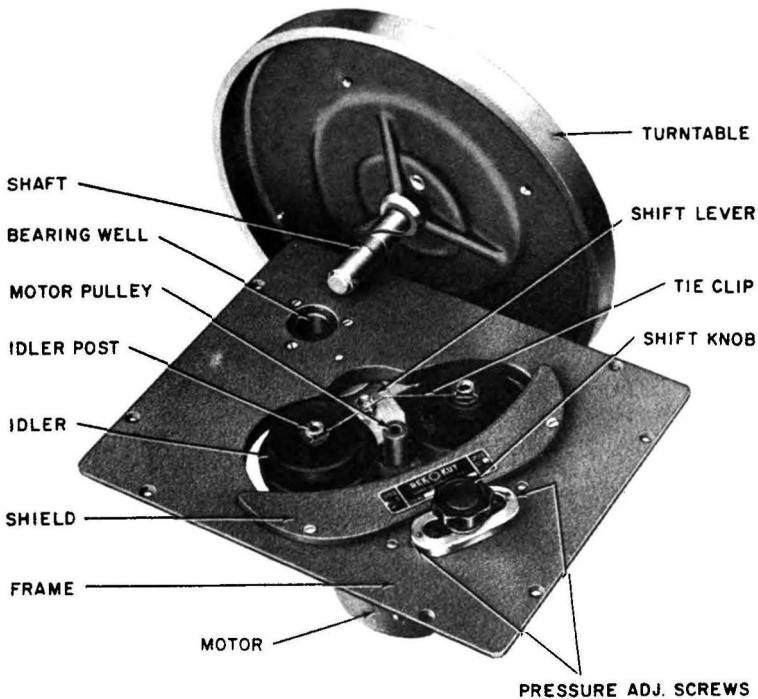

Courtesy Rek-O-Kut Co.

Fig. 10-14 The Rek-O-Kut Player, Turntable Removed

tain a constant speed of 1,800 RPM under load, and will not vary with the fluctuation of the line current. An induction motor drops in speed under load or line fluctuation.

The motor pulley is a component that is overlooked by most manufacturers. It is just as important as the rotor, indeed it becomes part of the rotor when it is attached. Most manufacturers slip the pulley over the shaft and tighten it with a set screw. This method of installation causes eccentricity, which results in a ripple that is reproduced as rumble. The better motor and turntable assemblies have this pulley installed by pressing it firmly on the shaft and then machining it while the motor is operating under its own power. The pulley thereupon becomes one with the rotor, having the same balance and concentricity. The ripple is thereby eliminated and rumble reduced to the inaudible stage. This is the method utilized by the Rek-O-Kut Company, whose motor is illustrated in Figure 10-14. The assembled turntable was previously shown in Figure 10-13.

Another important difference between a changer and a manual record player lies in the length of the pickup arm or tone arm. When a record is made the cutting head travels across the record from groove to groove in a straight line. This is shown in Figure 10-15A. This is accomplished by mounting the cutting head on a feed screw instead of a tone arm. The feed screw is mounted directly over the record and moves the head slowly inward along a straight line, toward the center of the record, as the screw itself slowly rotates. The ideal method of holding the reproducer head

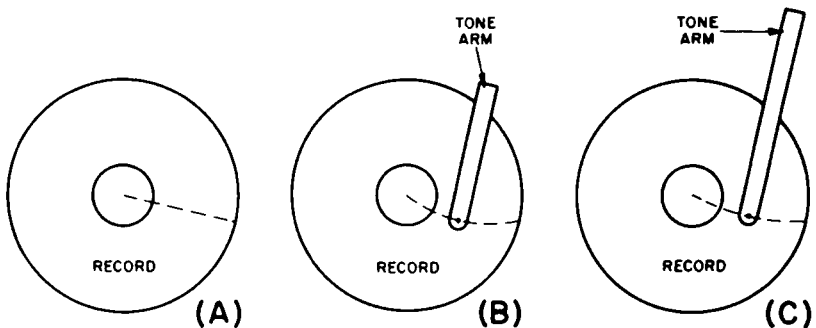

Fig. 10-15 Tracking Error

would be the same overhead feed screw. The pickup would then travel in the same straight line that the recording head did. Unfortunately, this method is both inconvenient and expensive, therefore an arm on a pivot is used. This method introduces a certain amount of distortion and stylus wear due to the fact that it is impossible to keep the pickup tangent to the record grooves at different radii from the center of the record. This *tracking error* constitutes a problem which can, at the present writing, be only partially solved.

Figure 10-15B depicts the arc described across the record by a relatively short tone arm, such as might be used on an automatic record changer. This arc deviates considerably from the ideal straight line and indicates that the arm will not always be tangent to the groove, as it should be. It is this deviation from true tangency which we have called tracking error. It should be kept to a minimum. The effect of a longer pickup arm, as generally used with a good manual player, is shown in Figure 10-14C. The arc now approaches a straight line and the deviation from tangency is not great.



Courtesy Fairchild Recording Equip. Co.

Fig. 10-16 Fairchild Pickup and Arm

Many attempts have been made to design a pickup arm which would keep a pickup tangent to the record grooves at the different radii along the record. The best of these use either a curved arm, as shown in Figure 10-16B, or a straight arm with an offset head, as shown earlier in Figure 10-10 and again in Figure 10-17. There is little choice between them. The greater the length of the arm,

the less tracking error will be encountered. The curved arm or offset head is also usually used on record changers.

The finest test we have yet seen to check the tracking efficiency of a pickup and arm is the *McProud Test*, devised by the editor of *Audio Engineering Magazine*, and illustrated in Figure 10-17. A record with a large center hole is placed on the turntable so that it rotates eccentrically. This permits a $1\frac{1}{4}$ " swing of the pickup arm for every revolution of the record. Under these conditions, it is easy to test for tracking error due to poor tangency and also for poor compliance.



Courtesy Audak Co., Inc.

Fig. 10-17 Arrangement for McProud Tracking Test

In the past few paragraphs we have discovered that the primary differences between a record changer and a record player are that, in the latter, the rumble, wow, and flutter are reduced to an absolute minimum. Oddly enough, the better a home music system, the more noticeable these faults become, because superior equipment reproduces the low frequencies better. It is at these frequencies that such faults manifest themselves. The reduction in tracking error is also important.

Earlier in this chapter we mentioned two other pickups, the dynamic and the FM cartridges. We will discuss briefly the dynamic pickup shown earlier in Figure 10-16 as representative of this type. This particular unit was designed expressly for use in broadcast and recording studios, but is becoming popular in record players for the finer home music systems.

A turret-type cartridge receptacle is used. It holds up to three cartridges and also changes the point pressure automatically as the cartridges are changed. The cartridges are of the dynamic moving-coil type which provide excellent frequency response with extremely low hum and noise level. This cartridge cannot be readily interchanged with the magnetic type, since its output is considerably lower. It should be used with an amplifier having extremely high gain or with a step-up transformer. When using a transformer, hum pickup can become a serious problem unless extreme care is used in its installation and placement. Despite some of its seeming disadvantages, the Fairchild Dynamic Pickup is used in installations where exceptional fidelity is required.

The FM pickup, in essence, is an extremely light device which takes the sound signal from the record groove and imposes it on an oscillator operating at a high radio frequency. This procedure may be likened to what takes place in high-fidelity FM broadcasting, with the oscillator acting as a miniature transmitter.

The Weathers Cartridge, a new device employing this principle, features a miniature record brush just ahead of the stylus. In addition to cleaning the groove before the needle contacts it, this brush absorbs some of the weight of the cartridge and arm. Stylus life is thus increased considerably and record wear is considerably reduced.

Some people believe that this device may revolutionize pickup cartridges. However, certain disadvantages will have to be overcome first. In the first place, the oscillator section which must be inserted between the pickup and the amplifier involves added cost. In the second place, when high radio-transmission frequencies are involved, there is always the possibility of unstable oscillator operation, called *drift*. This has always been a problem with earlier attempts to develop successful pickups of this type. However, time has worked on the side of the designer with respect to this point. FM and television transmitters and receivers also deal with high frequencies and, consequently, also present the problem of drift. Many techniques for insuring stability have been successfully developed in these instruments which can be applied to FM cartridges.

In conclusion, the author states his belief that the best pickups available today for high-fidelity use are the magnetic and dynamic cartridges, with a slight edge going to the former when an automatic changer is to be used. When used with a high-quality tone arm, any of these fine pickups leaves little to be desired.

CHAPTER XI

THE TUNER

The radio tuner. The FM tuner. The FM-AM tuner. Sensitivity. Quieting. Selectivity. Automatic frequency control. Audio response. Tone controls and pre-amplification. Duplication of controls.

At an earlier point, we explained the use of the tuner in receiving radio broadcasts and mentioned the three types of tuners from which we may choose. The first is the AM tuner, which is similar to a portion of your radio receiver in that it picks up standard AM broadcasts. Here the similarity ends.

We also found that AM reception was limited in its ability to reproduce the wide frequency response required for high-fidelity reproduction. This is primarily due to the method originally used in allocating the wavelengths on which AM stations transmit. They were assigned wavelengths so close to each other that their broadcasts must, of necessity, be restricted to only a portion of the audible spectrum. Should they attempt to improve their transmission, interference with adjacent channels would result.

The second type of tuner is the FM tuner, which utilizes broadcasts from the comparatively new FM stations. The quality of an

FM broadcast is far superior to that of an AM broadcast, for many reasons. One of the most important, insofar as high fidelity reproduction is concerned, is that the problem of tonal range does not exist in FM as it does in AM.

The FM method of reception is also superior to AM in that the background "static" has been reduced to a negligible factor, and FM also has the ability to handle a greater dynamic range.

The third type of tuner is a combination of the AM and FM tuners in one unit. The selection of one of these three types depends largely upon the reader's geographical location with respect to the relative availability of AM and FM broadcasts.

The AM stations in the more populated areas usually duplicate their programs on FM. This is a tremendous advantage to those who live in areas which are prone to electrical storms. For example, while in the South, on many an evening when AM reception was almost impossible the author was able to enjoy FM reception. Unfortunately there are still areas without FM broadcasts, consequently the reader may only require AM reception. To these readers, rather than advise the purchase of an AM tuner alone, we would suggest a good FM-AM tuner in which only the AM portion would be used temporarily. We say "temporarily" since the number of FM stations is increasing.

The FM-AM combination tuner is also desirable if you discover that, in your area, some of your favorite programs are broadcast on AM alone. Regardless of whether they are of the AM, FM, or AM-FM variety, separate tuners are usually far superior in performance to their conventional commercial radio counterparts.

Basically, a tuner is used to intercept radio waves and convert them into audio signals of sufficient power to drive an amplifier. The ideal tuner would perform this function without introducing any variations in the signal it picks up; the audio output signal would be an exact facsimile of the signal which is transmitted by the broadcast stations.

There are, of course, many factors which tend to prevent recreation of the exact facsimile we desire. Our intention in this chapter is to explain these factors and the solutions to the problems they present. The FM tuner will be the first subject of discussion.

The first important consideration in the selection of an FM tuner is its *sensitivity*. This word refers to the ability of the tuner to pick up signals. Fundamentally, the sensitivity of a tuner is determined by how weak a broadcast signal can be received and reconstructed properly enough to provide sufficient power to drive the amplifier. Greater sensitivity permits reception of weaker signals, and/or signals from a greater distance.

One method of specifying sensitivity is to indicate the amount of signal required from the antenna in order that the output for the tuner be sufficient. In most cases $\frac{1}{2}$ to 1 volt is required from the tuner. The use of the sensitivity requirement alone as a measure of quality is insufficient, because this does not indicate the amount of extraneous noise which will be mixed with the signal. Some method of indicating this amount of noise is important, as we shall soon discover.

Chapter III explained the masking effect of room noise level. We discovered just how the amount of noise in the listening room affected reproduction. The effect of noise on signal level is similar, consequently some indication of the amount of noise mixed with the signal is required to evaluate the performance properly.

Specifying the sensitivity in relation to the noise is accomplished by indicating the loudness of the noise output in proportion to the loudness of the signal output: thus, "5 microvolts required for 30 quieting." When translated into simple terms this means that a signal of 5 millionths of a volt is required at the antenna terminals of the tuner in order to keep the noise level 30 DB below the signal level. Just what effect a 20 to 30 DB difference between noise and signal level has can be ascertained by returning to Figure 2-3. We can see that 20 DB, for example, represents the difference in noise level between a quiet residence in the suburbs and an average city residence. As we have discovered, the difference in noise level between the two is considerable.

From the foregoing we can readily see why, when specifying the sensitivity of an FM tuner, it is also necessary to specify the degree of quieting. A rating combining the two is an excellent indication of the performance of the tuner. Sensitivity is stated as the minimum signal strength, in microvolts, required by the tuner to develop an

acceptable signal to be fed to the amplifier. Thus, the lower the sensitivity rating in microvolts, the more sensitive will be the tuner. The higher the quieting in DB, the less noise present in the output signal.

High sensitivity is equally important in fringe and urban areas. In fringe areas high sensitivity is of paramount importance in its own right. In urban areas the important factor is the improvement in quieting which results from greater sensitivity.

The term *selectivity*, when used in reference to a tuner, indicates its ability to select a specific broadcast station while rejecting all others. The degree to which a tuner is able to reject stations other than the one desired is dependent upon its selectivity. This is an important consideration. Were the tuner to have a low degree of selectivity, the unwanted stations on adjacent channels would intrude upon the station and program selected.

Figure 11-1 illustrates a section of the dial on an FM tuner. We will select a station at, say, 100 megacycles. This frequency is known as the *carrier frequency*. A broadcast signal carrying speech

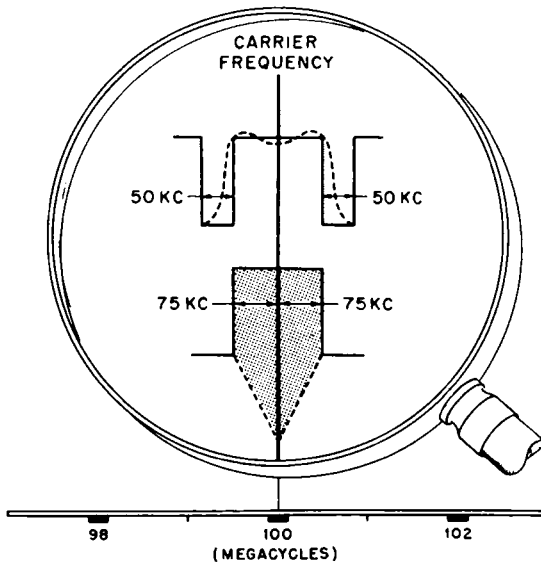

Fig. 11-1 An FM Dial

and music is not confined to this single frequency, however, but is spread over a band of frequencies centered about the carrier. This fact is also illustrated in Figure 11-1, in the magnified view of the same section of the FM tuner dial shown just above the dial itself, with the tuner set for 100 megacycles (100 MC).

We can see from the magnified view that each channel consists of the carrier frequency and a band 75 kilocycles wide on each side of the carrier, each station is separated from the next station by an unused area 50 kilocycles (or 50 KC) wide. This unused band reduces the possible interference between stations that are assigned to adjacent channels.

The straight-line curve represents the ideal selectivity for such a tuner. A tuner with such a curve would, as can be seen, respond equally well to any frequency within the selected channel, but reject all other channels.

A selectivity curve such as this is impossible to achieve at the present time. The best we can obtain is shown by the broken line; the curve shown is a compromise between high selectivity and good frequency response.

When set to a particular frequency the ideal tuner should not vary in its response, but should remain tuned to this frequency regardless of any possible variation within the tuner. This is an ideal situation, however, and not easily attained. To obtain this degree of perfection it becomes necessary to utilize a system called *automatic frequency control*, simply called AFC. AFC automatically makes the proper correction for *drift* or variation in frequency, which is primarily due to physical expansion of components, changes upon molecular structure due to temperature, and the like. The higher quality tuners provide compensation, as far as possible, in the use of zero-temperature-coefficient components, but AFC is still a must. AFC automatically compensates for these variations and another almost as important.

Proper tuning of an FM tuner or receiver is slightly more difficult than of an AM tuner or receiver. There is one and only one correct point on the dial at which reception is perfect. When the station is not properly tuned in, distortion or noise, or both may result. The tuner should incorporate a visual tuning indicator or

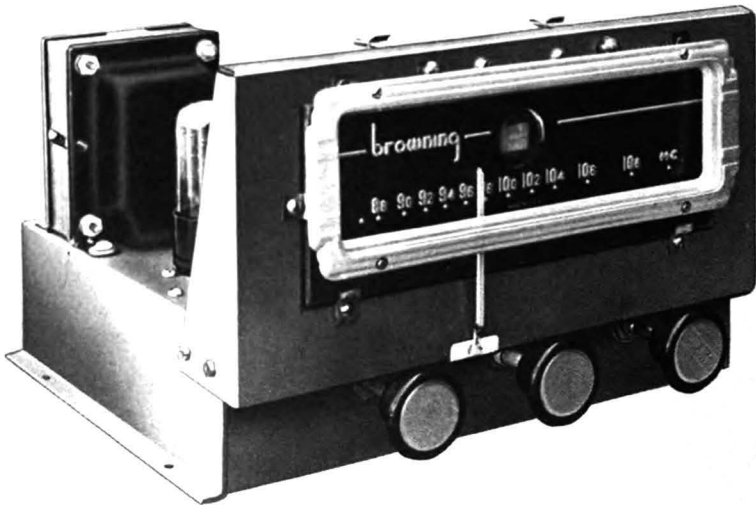

Courtesy Browning Laboratories, Inc.

Fig. 11-2 A Browning Tuner

AFC, preferably the latter, to allow for this. Automatic frequency control functions also as an automatic tuning vernier, thereby compensating for slight errors in manual tuning.

There is one disadvantage in the use of AFC. Fortunately, this is simple to eliminate. When automatic frequency control is used there is a tendency on the part of the tuner to prefer a stronger station to a weaker station on an adjacent channel, despite the fact that the tuner may be tuned to the frequency of the weaker signal. This can be eliminated by cutting out the AFC with a switch on the front panel. Doing this, however, brings us back to the problem of tuning. The better tuners incorporate, in addition to AFC, a tuning indicator which is used when the automatic frequency control is cut out. This feature, though it may seem unimportant, greatly adds to the ease of tuning and to many people is worth its additional cost.

The opening of this chapter mentioned two types of tuners and a combination of both. Tuners may be otherwise subdivided into two categories. Some have, on the front panel, only the tuning

control and a level control — and, in the case of the combination FM-AM tuner, a switch by means of which either FM or AM reception is selected. This type is exemplified by the Browning RV 31, illustrated in Figure 11-2.

The second type is similar to the Pilot and Craftmen tuners, shown in Figures 11-3 and 11-4, and incorporates bass and treble tone controls, a pre-amplifier for magnetic pickups, equalization for phonograph records, and a selector switch similar to the one described in the previous paragraph.

The type chosen is entirely dependent upon the associated equipment. A separate pre-amplifier control unit is more desirable from the standpoint of versatility and the range of its controls; however, a number of the more desirable tuners incorporate these features and, when they are purchased, the controls go along. The problem is not as great as it might be, providing there is a point on the tone controls of the tuner at which the response is flat and that this point is clearly marked. When a separate pre-amplifier is used in conjunction with a tuner of this type, the tuner

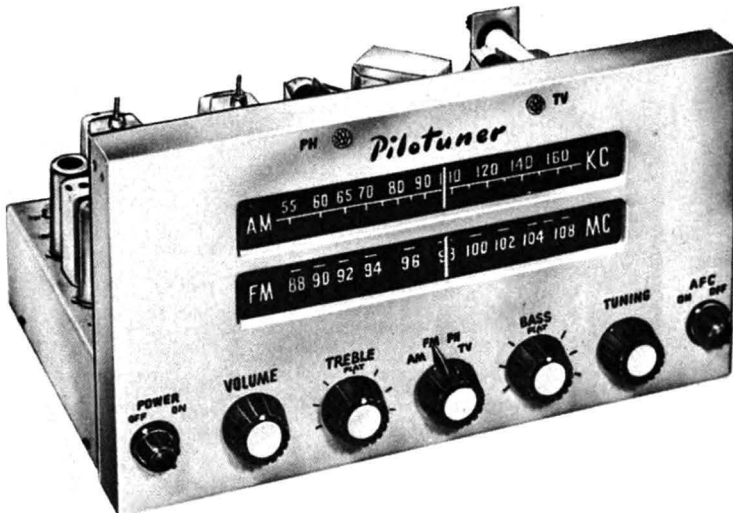

Courtesy Pilot Radio Corp.

Fig. 11-3 Pilot FM-AM Tuner

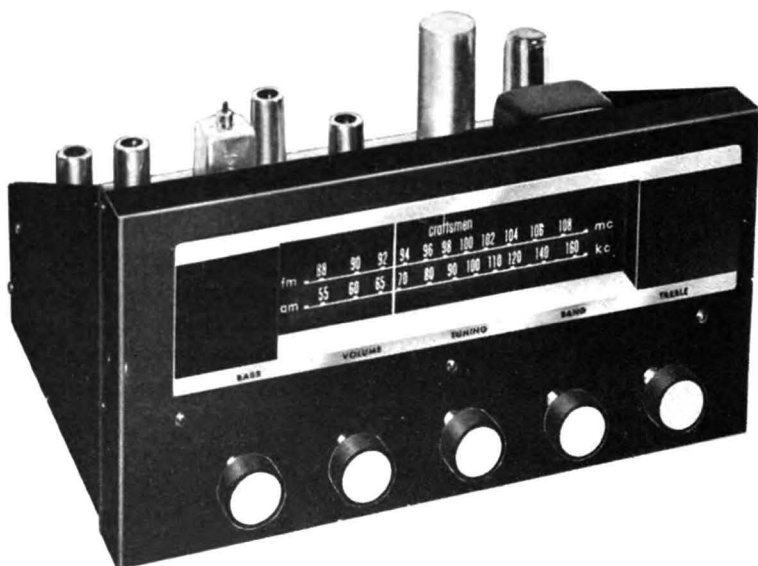

Courtesy the Radio Craftsmen, Inc.

Fig. 11-4 Radio Craftsmen C-800

controls should be left in the flat position and the pre-amplifier controls used exclusively.

When the purchaser plans to build his system progressively, there is a definite advantage in acquiring a tuner with a built-in pre-amplifier and controls. The built-in units provide the latest expensive method of acquiring a pre-amplifier, record compensator and bass and treble controls. A separate unit for this purpose may be added later at the discretion of the user.

We have barely mentioned the AM tuner or the AM section of a combination tuner. There is a definite reason for this apparent oversight: when the specifications must meet the standards used on FM broadcasting, AM broadcast stations are not capable of transmitting high-fidelity programs. This is not to be construed as a criticism of either the tuners or the broadcast stations, but rather a comment on present limitations in AM. To insure high-fidelity reproduction from radio broadcasts, wherever possible, confine your listening to FM stations.

CHAPTER XII

USE OF THE HOME MUSIC SYSTEM

Program sources. Record care. Stylus alignment. The record player. The tuner. The antenna. The pre-amplifier and amplifier. The loudspeaker enclosure. Decoration and high-fidelity cabinets. Room divider and wall-to-wall installations.

Having broken down the high-fidelity system into its component parts, the task now remains to bring them together again or, at least, to consider the unit as a whole. This will give us the opportunity to take stock and also to add pointers that, if given earlier, might have been lost or have served only to bewilder the reader with too much to absorb in a single dose.

We have said that a high-fidelity system was an instrument which would faithfully reproduce the sound material fed into it. We have since discovered that a high-fidelity system consists of a chain of components, a chain which is no stronger than its weakest link. We will briefly review each component in relation to the complete system.

The record is the first of our program sources. The effect of dust, dirt, and wear on high-fidelity reproduction was explained and illustrated in Chapter X, but no method of reducing or elimi-

nating these effects was discussed. We will, in the next few paragraphs, describe such a method.

The proper care of records is a highly controversial subject. However, the finest and most complete explanation we have seen was included in an "Editor's Report," in the August, 1952 issue of *Audio Engineering Magazine*. This was written by C. G. McProud, the editor, who is recognized as an authority in his field. We present this report in the next few paragraphs. We also remind the reader that the method is for vinylite discs, those made of shellac do not present the same problems.

"From this observer's viewpoint and experience records are most effectively cleaned if given the same sort of treatment as that given a photographic plate. The conditions are similar, although the plate is never permitted to accumulate the dirt and grit that gets on the surface of a record. The main similarity is in the fragility of the surface, which should be protected at all costs. We do not feel that it is necessary to clean a record each time it is played, but when it does become necessary we favor the following process:

Wash the record thoroughly, using lukewarm water and a mild soap or detergent. Rinse under running water until all soap is flowed off the surface, and dip in a pan containing warm water and a teaspoonful of wetting agent (such as Photo-Flo, obtainable from photographic suppliers) and stand upright in one of those dust-collecting record racks, allowing the record to dry in air. Needless to say, the records should be placed in a location where there is little dust during the drying process.

There are some static-reducing agents available which do not leave a greasy or waxy scum, others which do. A medium of the former type may be used to neutralize static in those locations where trouble is encountered with it, thus reducing the natural propensity of the record to attract dust and lint. Once the record is so treated, the surfaces can be wiped free of dust with a dry, lintless cloth until such time as another washing is deemed necessary. A minimum of contact with the record surface with anything but the stylus is preferred, and it may be possible to blow any accumulated dust from the surface, once the record is treated so as to be static-free. A trial of this method will be the best proof of its effectiveness."

The next link in the chain is the stylus. The effects of worn styli were considered in Chapter X. This particular subject can be summarized with a few words. The first word is "diamond," the other few are contained in the advertising slogan used by Squibb for many years, "The priceless ingredient in any product is the integrity of the maker." These words could have been expressly written for a manufacturer of styli.

The ingredients required to manufacture a stylus assembly are few: the jewel itself, the shank and the aforementioned integrity. Basically the latter is most important, since the jewel and shank are relatively inexpensive when compared to the precision labor and testing required in all phases of manufacture.

Should any phase of the precision assembly and testing be neglected the quality of the stylus suffers. One manufacturer, Sonafax, recognizing these facts, provides three final inspections to insure perfect styli. Each stylus is inspected electronically with an oscilloscope for waveform, mechanically with a Shadowgraph for precision alignment, and sonically by ear for quality. This manufacturer, realizing that the stylus is an electro-mechanical device, tests it as such. The cost of this product is higher but so is the quality.

We might add a few words about one of the greatest causes of stylus and record wear, stylus misalignment. The stylus in a pickup, when viewed from directly in front, should be at an exact right angle to the record. It should not lean to the right or left against either wall of the groove.

The alignment may be difficult to check. A simple method of doing this was devised which exaggerates the misalignment for viewing purposes. A small mirror, of the type usually found in a woman's purse, is placed on the turntable under the stylus. Viewed from the front, the stylus tip resting on the mirror is compared with its reflection. This comparison causes the angle of misalignment to appear twice as great as it actually is, making it much simpler to see.

The stylus alignment should be checked periodically, especially after a new stylus is installed. Another common cause of stylus

and record wear is a turntable which is not level. This can easily be checked with a small level.

The choice of the type of record player selected must remain with the reader, since his individual requirements dictate the purchase. There is no question of the superiority of a manual player using a so-called transcription arm, insofar as reduced record and stylus wear, improved tracking, and lower distortion are concerned. But there are other factors which must be considered, such as the space required, the cost, and the convenience of automatic record changing. Sufficient information has been supplied in previous chapters to enable the reader to make his own choice.

The second input source, the radio tuner, both FM and AM or the combination, was described in Chapter XI. The important features such as a selectivity, sensitivity, audio fidelity, and automatic frequency control were explained and, with the information supplied, the prospective purchaser should have no difficulty in choosing a tuner to suit his location and particular requirements.

The antenna used in conjunction with an FM tuner is extremely important, since an increase of a few microvolts fed into the tuner will often produce an additional 10 DB of quieting, greatly reducing the noise output. The antenna is not important in rural or suburban areas only, for it will greatly increase signal pickup and reduce noise in metropolitan areas. Wherever possible one should be used; the inconvenience and additional cost will be repayed by better performance. This matter can be made quite simple for people who already own television receivers. Antennas used for FM reception are always similar to and usually identical with those used for television sets. It is a simple matter to install a switch that will feed the television antenna, when desired, to the FM tuner. An improvement should be noted in nearly every case.

The pre-amplifier and amplifier, since they are often combined in a single unit, will be considered together. The H.H. Scott 214-A is an excellent example of such a combination assembly. Its controls provide for all the flexibility we considered to be necessary or desirable. However, as noted, there are many instances where a pre-amplifier or control unit can be added later to a basic amplifier so as to provide all the needed facilities. Many companies that

make both types of units design them so that they may be integrated with each other simply and successfully. The Pilot AA-901 amplifier and PA-911 pre-amplifier represent such a combination. Others can be worked out from the information in Chapters VII and VIII.

The next component is the loudspeaker or loudspeaker system. Our previous chapters have explained the advantages of a multiple unit. Some of our readers may prefer to build such a system progressively, starting out with one loudspeaker, then adding a tweeter and its crossover network. At some later date, a woofer and its crossover network may be added. This is a simple method of obtaining a quality loudspeaker system without a large initial outlay.

For the basic loudspeaker, we prefer the acoustic lens or difusicone type to give good dispersion of the high frequencies while it is used alone. One of this type will provide many pleasurable hours of listening when it is housed in a good enclosure. While an arrangement of this nature falls short of our goal, the reproduction will still be far superior to that provided by the usual commercial radio-phonograph.

The eventual addition of a tweeter to this basic system will increase the high-frequency response and result in an improvement in high-frequency dispersion. It will also provide a reduction of both harmonic and inter-modulation distortion. The tweeter should be carefully selected for maximum horizontal distribution and be provided with a means of controlling its output, as explained in Chapter V.

We can arrive at this point sooner but with a larger initial outlay by using a horn-loaded co-axial assembly as the basic speaker. The co-axial loudspeaker should have two separate driving units to obtain the results we require.

Regardless of which loudspeaker is used, the next basic improvement would be the addition of a woofer. When the system is completed, all speakers should have separate controls for the reasons explained in Chapter V.

When the progressive method of acquiring a loudspeaker system is used, the type of enclosure selected is extremely important,

because not all commercial enclosures allow the same latitude in progressive building. This is one of the primary reasons for the development of the Progressive Loudspeaker System recommended by the author and described in Chapter VI.

The wiring of the system is illustrated in Figure 12-1. Part A is the basic system wiring, illustrating a single loudspeaker. Part B

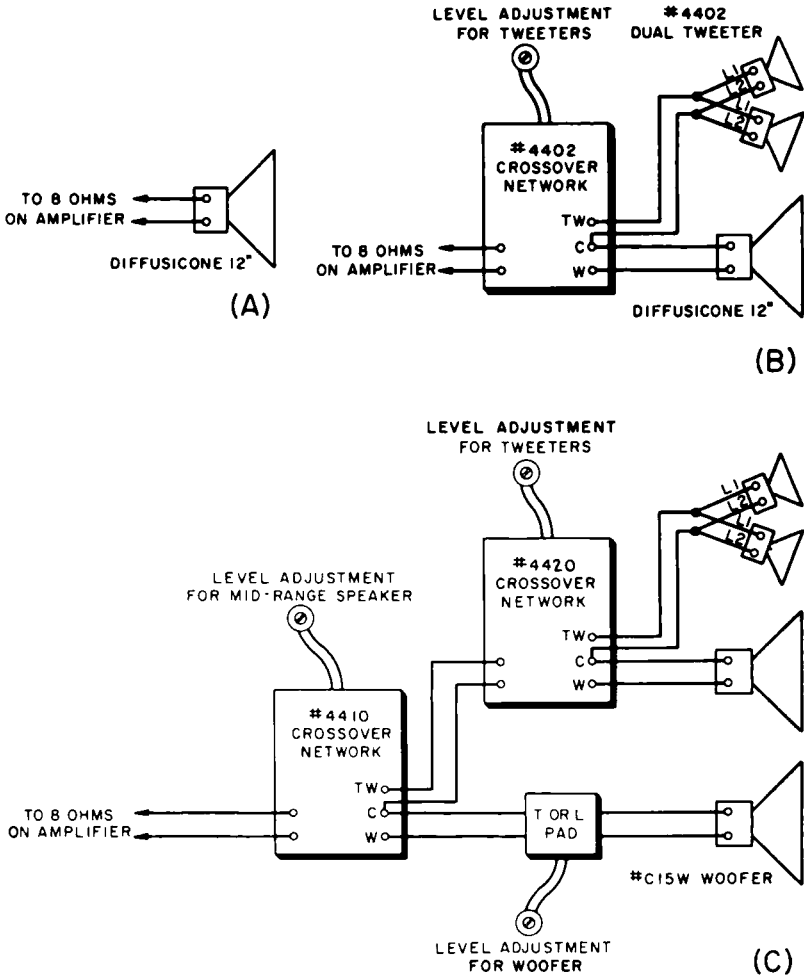

Fig. 12-1 Development of the Progressive Loudspeaker System

shows the wiring when the tweeter and its crossover network are added. Part C is the wiring diagram of the completed system.

The recommended components are:

Woofer	University 15", C-15W
Mid-Range	University Diffusicone 12"
Tweeter	University, 4402
Crossover Network, Low-frequency	University, 4410
Crossover Network, High-frequency	University, 4420

The most important component of a high-fidelity music system, to the woman of the house, is the cabinet or method of enclosure used. This member of the family can be counted on to have a horror of unsightly, unconcealed pieces of equipment strewn about her castle. Our first chapter recognized this fact and promised to provide ways and means of disguising the multitude of components



Courtesy Fisher Radio Corp., Inc.

Fig. 12-2 A Custom Wall Installation

required. As we explained, the use of high-fidelity equipment allowed for a much wider choice of cabinets and enclosures than is ordinarily available in commercial radio-phonographs.

Figures 12-2 and 12-3 illustrate some of the possibilities. Another example is illustrated in Figure 12-4. This end-table cabinet will provide space for a record-changer, amplifier, pre-amplifier, and tuner. When closed it gives no indication of its primary function. The loudspeaker enclosure can be of the type illustrated earlier in Figures 6-5 or 6-12. Another beautiful cabinet combination is illustrated in Figure 12-5, the Peerage and Aristocrat cabinets by Electro-Voice, Inc., shown here, are available in a blonde or mahogany finish.

The endless variety of enclosures and cabinets which can be obtained are a decorator's dream. However, the group that is shown

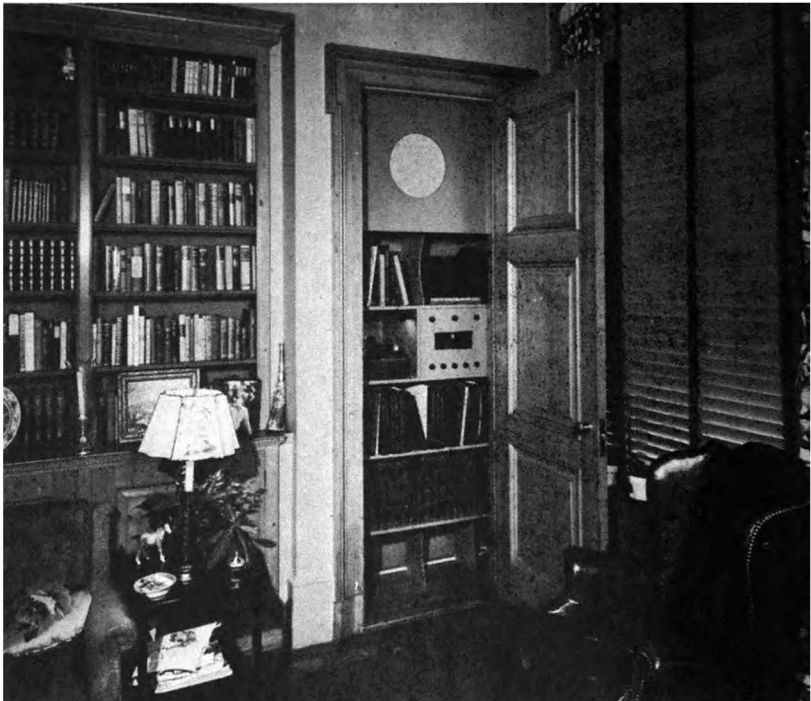

Courtesy Fisher Radio Corp.

Fig. 12-3 Installation in a Converted Closet

in the frontispiece and in Figure 12-6 are, in the opinion of the author, worthy of special mention.

During the past few years various home and high-fidelity magazines have described and illustrated a great number of room-divider and wall-to-wall music installations. These built-in installations are beautiful, practical and, in addition, offer an endless variety of space-saving interiors.

Unfortunately, there are two problems which have restricted the widespread use of this type of installation. First, they have

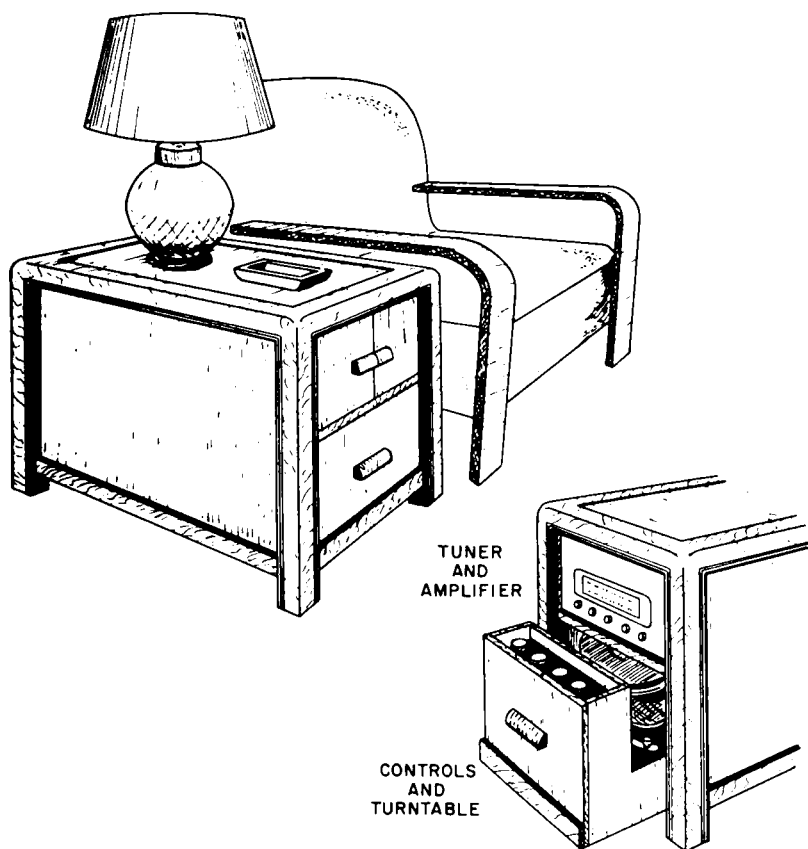

Courtesy Harrison Associates

Fig. 12-4 End-Table Installation

all been of the custom variety and consequently very expensive. Second, these installations have invariably been designed for a specific location or room. Very rarely is it possible to move them once they have been installed.

Both of these important problems have been solved by the units illustrated in Figure 12-6. They are relatively inexpensive and can be assembled easily; they can also be removed and re-assembled in another location in the same room, in another room, or in an entirely different setting. These features, for the first time, permit the economical use of this type of installation in apartments and rented homes, while still maintaining the smooth appearance of a custom installation.

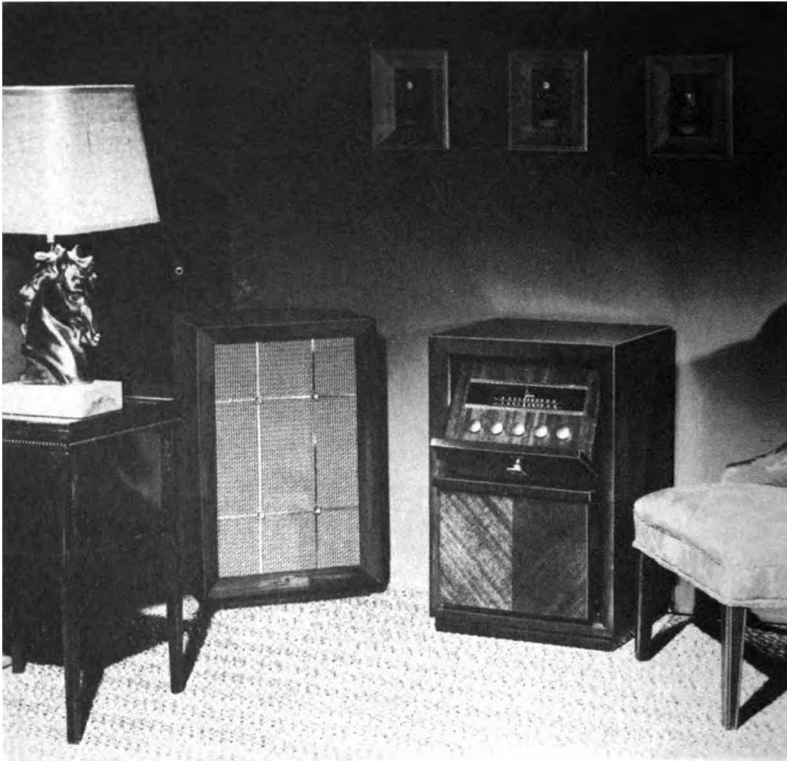

Courtesy Electro-Voice Inc.

Fig. 12-5 The Peerage and Aristocrat Enclosures

The Nova Units are available in many forms, all matching as to size and finish. They may be used individually or in combination. For example, the music unit may be used alone or in combination with a bookcase unit, a desk unit, or where additional storage space is required, a wardrobe unit. Many combinations will suggest themselves.

The fronts and sides are obtainable in a wide variety of woods: for example, selected gum, novelty fir, knotty pine, ash, birch, etchwood, oak, dark walnut, and dark and bleached mahogany. The finishes are: prime coat, paint finish, satin finish, and furniture finish. The wide variety of models, possible combinations, and woods and finishes available make these cabinets the most versatile means of housing a music system that we have seen.

The music unit with which we are primarily concerned is in itself designed to provide the utmost in flexibility. It will house a

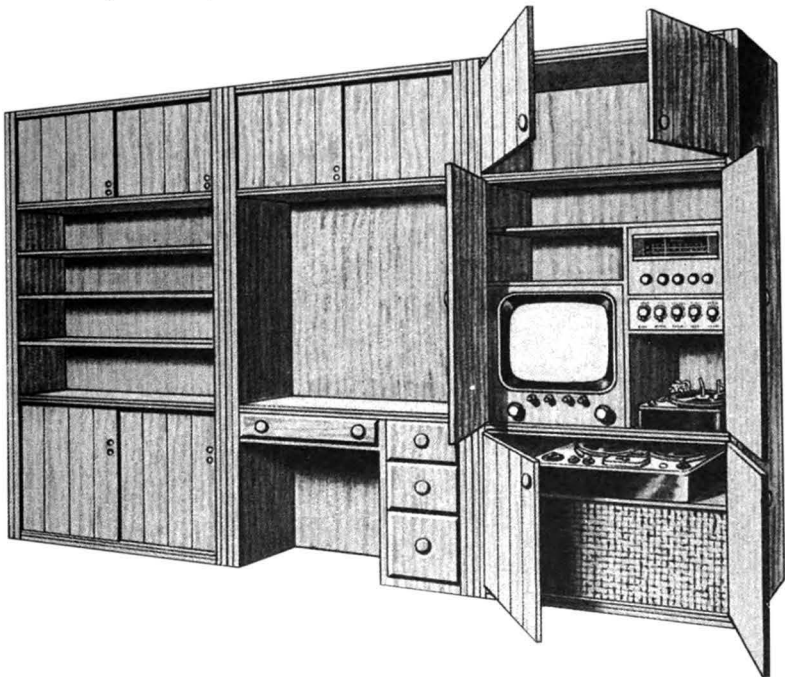

Courtesy Nova Sales Co.

Fig. 12-6 Nova Wall Units

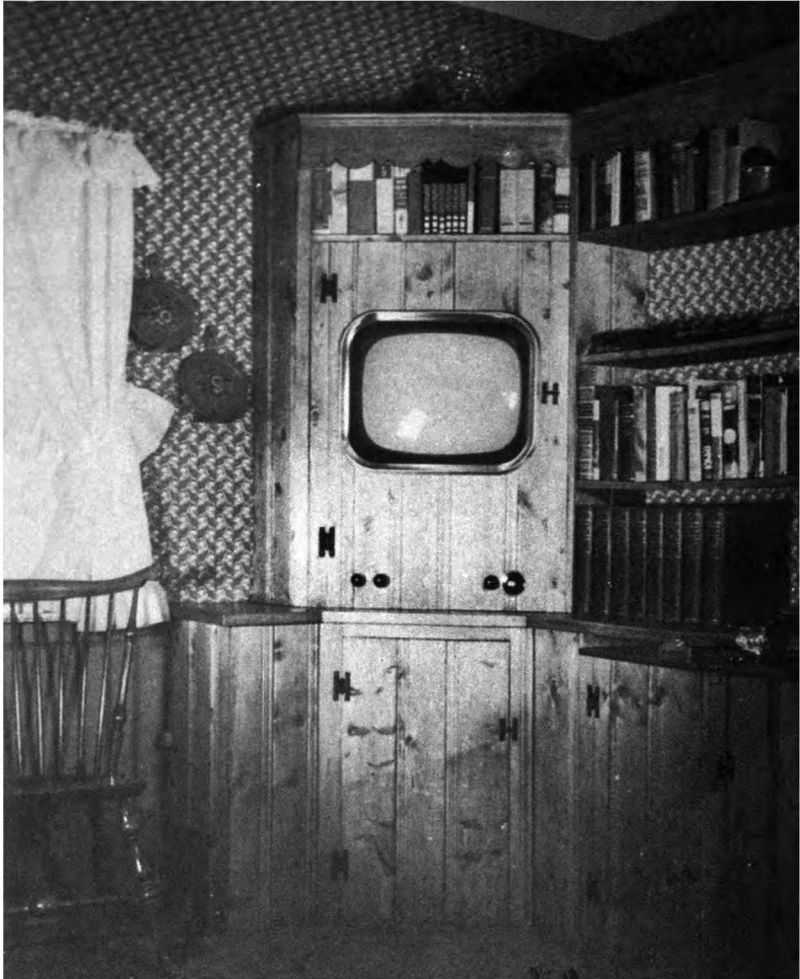

Courtesy Charles Sandak

Fig. 12-7 Knotty Pine Built-in Arrangement

television receiver or tuner, FM-AM broadcast tuner, pre-amplifier control unit, automatic record changer, amplifier, and even a tape recorder. When a recorder is used, there is still approximately 10 cubic feet of enclosed space for the loudspeaker system. The space available for the loudspeaker system is almost 15 cubic feet when the recorder is not installed. In addition, there is also storage space available for records and other accessories. For convenience in handling and shipping these units are furnished in knockdown form, and can be assembled by anyone in a very short time with the simple, detailed instructions furnished. The only tools required are a screwdriver and a hammer.

These units are ideal for semi-custom installations, since the space made available for the various components used in a high-fidelity home music system was determined by allowing for the largest of the popular brands in each category. The tallest tuner, for example, is the Browning; the tuner with the greatest depth is the Bogen. The highest record changer is the Markel. Sufficient space has been allotted to accommodate all popular brands of all of the components. For those who wish to build these units themselves or have them built, complete construction details may be obtained by writing to the Nova Sales Company. Another interesting unit is depicted in Figure 12-7.

For all the components we have discussed in this book, and for others as well, the various manufacturers will be pleased to supply complete literature on request. The author understands that a high-fidelity guide will soon be released containing complete specifications and photographs of all popular components on the market.

One of these components is the tape recorder, about which a discreet silence has been maintained until now. The only reason for silence concerning this excellent type of device is that many enthusiasts will consider it an optional piece of equipment. In any case, we meet it in our next and last chapter.

CHAPTER XIII

TAPE RECORDERS

Home recording and its advantages. Recording heads. Record, erase and playback heads. Tape speed. Frequency response. Distortion. Single and dual track recording. Signal to noise ratio. Selecting a tape recorder. Splicing of tape.

The past three years have seen the popularity of tape recording increase by leaps and bounds. The primary reason for this trend is the simplicity with which superior recordings can be made at home.

Tape recording has made it possible for the music lover to create his own library of music; recording from the air, from other records, and from live performances, ranging from soloists in living rooms to great community choirs and orchestras. Live performances from a good FM station may be recorded easily with a quality unequalled by any but the finest commercial records. Many selections recorded in this manner are unique in that they are not otherwise available.

Records may be transcribed to tape before they become scratched and noisy through continuous wear. The tape itself may be played over and over with all of the original quality of the

performance retained. A tape recording does not deteriorate with repeated playings. When a recording is made on tape and properly stored, it can be retained as a permanent record, or the recording can be erased and the tape re-used as many times as is necessary.

A great deal of literature on tape recording is available, most of it highly technical. We therefore will attempt to present, in a simple manner, the fundamental aspects and a general picture of tape recording for the home user.

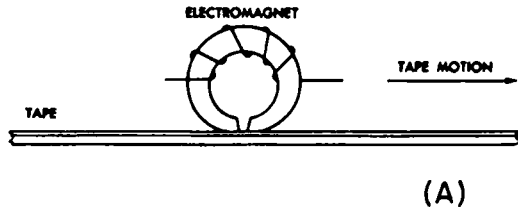
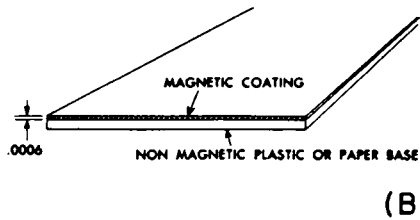

Fig. 13-1 Diagram of
(A) a Magnetic Recording
Head, (B) of Magnetic Tape



Courtesy Audio Devices, Inc.

The technique of tape recording is simple to understand. The signal currents that are to be recorded are fed into a magnet coil which is wound on an iron core, such as is illustrated in Figure 13-1A. This assembly is called the recording head. The magnetic tape, a section of which is illustrated in Figure 13-1B, is drawn past the poles of the magnet. The constantly changing signal currents are recorded as varying degrees of magnetization. The magnetic tape itself consists of a thin deposit of iron oxide in a binder which is applied to one side of the tape. The tape is usually 1/4" wide.

There are two methods of magnetization, transverse and longitudinal. The latter has become the preferred method and is the one discussed in this chapter.

Reproduction of the recording is obtained by passing the tape over the poles of a magnet assembly similar to the one described for recording. The previously recorded magnetic impulses generate a varying voltage in the magnet coil; the minute signal voltages from this coil are then fed into a pre-amplifier to increase them, in much the same manner as the output of a magnetic cartridge in a record player is increased.

Erasure of the recording on the tape is equally simple. The tape is passed through a magnetic field so powerful that it completely obliterates all traces of the magnetic variations previously recorded.

This description of the technique of tape recording is, of course, greatly simplified in order to give the reader a general picture. The following analysis, though more technical, will serve to explain the requirements, both electrical and mechanical, for high-fidelity recording at home.

The differences between the various types of recorders available are explained in order that the reader may be capable of choosing a recorder for his own requirements.

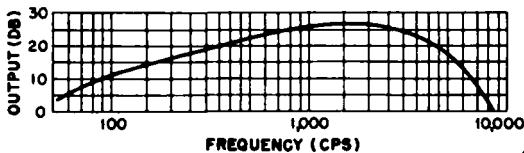

Fig. 13-2
Response Curve of
Magnetic Tape

Courtesy Audio Devices, Inc.

Tape recorders are available with two or three heads; all recorders have an erase head. Recorders with two heads use the second head alternately for recording and reproduction. The Concertone Model 1401, a cutaway view of which is shown in Figure 13-2, utilizes three heads: one for erase, one for recording, and one for playback or reproduction.

The requirements for optimum performance in recording and reproduction are not alike; consequently a double-duty head is, at best, a compromise. Better quality is obtained when three heads are used, as each can then be designed for best performance in a specific application. When a separate playback head is used, the

tape may be checked by listening, or *monitored*, at the time of recording, thus insuring the best possible results. When a tape machine with only two heads is used the program cannot be heard until the recording is completed.

We will consider the erase head first. Its function is to remove the previously recorded program material, during recording the tape is always passed through it before it goes to the record head. This insures the removal of any extraneous signal from the tape before the actual moment of recording. Thus the new signal is always impressed upon "clean" tape. The process of erasure can be accomplished in a number of ways: by demagnetizing the tape with a direct current, with a permanent magnet, an alternating current, or a supersonic signal.

Erasure on less expensive recorders is accomplished with a permanent magnet, but this leaves the tape particles magnetically oriented in one direction. This method is known as DC erase and leaves a characteristic hissing noise on the tape, which reduces its value for high-fidelity recording.

Some of the better low-cost recorders use a modified DC erase that is claimed to produce the same effect as AC erase. In these the tape is magnetized to saturation in one direction, then magnetized very lightly in the other direction. When the tape leaves the erase head the magnetism is supposed to have dropped to zero. This method of erase is, insofar as we are concerned, a cost-cutting expedient for use primarily in the home-type instrument category.

The supersonic method uses a very high frequency current. This sets up a rapidly changing magnetic field that carries the magnetic polarization of each particle past its saturation point, eliminating any signal recorded upon it. The field is designed to diminish as the tape leaves the erase head and, if the head is properly designed, leaves the tape particles magnetized in a random pattern, which may be considered as neutral or silent. The supersonic-signal method is considered the best since it provides maximum erasure with minimum background noise.

The second head in the direction of tape travel is the recording head. At this point the audio signal to be recorded is "mixed"

with a supersonic signal similar to the one used in erasure. This signal is known as *bias*. The bias shakes up the magnetic orientation of the tape particles, and is in turn varied by the audio current. The edge of the field of a recording head is sharp instead of gradual, as in the case of an erase head, and leaves a permanent magnetic charge on the tape which is proportional to the strength of the audio current. The change of direction of this permanent field is physically proportional to the frequency changes of the signal. This varying magnetization, in step with audio-signal variations, can be seen by dipping a recorded tape in a solution of iron carbonyl particles suspended in a liquid such as heptane. The magnetic field recorded on the tape will attract the iron carbonyl particles, and the pattern thus formed will show how the magnetized particles of the tape have formed a series of magnets representing the recorded sound.

The third head is the playback head. The permanent magnetic field on the tape excites the magnetic core of the head, setting up a flux in the core. This flux affects the magnet coil and, in this manner, creates a proportional voltage which is then fed into the amplifier.

Since we are now familiar with the operation of the various heads used in a tape recorder, we can proceed to our first specification, frequency response. Frequency-response standards for the type of recorder we require for high-fidelity reproduction have been set up by the National Association of Radio and Television Broadcasters. We will use these same standards as our minimum.

The standards adopted by the N.A.R.T.B. call for a response of ± 1 DB between 100 and 7,500 CPS. Beyond this range the standards may exceed this deviation at the rate of 3 DB per octave. In our required range of 50 to 15,000 CPS, the variation can be ± 4 DB. However, we will be more critical and use a range of 50-15,000 CPS ± 2 DB.

The frequency range of a tape recorder is determined largely by the tape speed. Roughly speaking, the frequency response is 1,000 times the tape speed in inches per second. In this manner, a tape speed of 15 inches per second (15 IPS) will permit an upper

limit of 15,000 CPS; a speed of $7\frac{1}{2}$ IPS will permit an upper limit of approximately 8,000 CPS.

The deviation from linear response (plus or minus DB) of a tape recorder is determined largely by the degree of equalization or compensation incorporated in the recording amplifier and playback amplifier of the recorder. These are similar to the compensation and equalization discussed previously in connection with records and pre-amplifiers for magnetic pickups. Figure 13-2 depicts the response curve of magnetic tape measured with constant current through the recording head and no compensation in the reproducing circuit. Curve A of Figure 13-3 illustrates the output of the Concertone 1401 recorder, with proper compensation, at a tape speed of 15 IPS. Curve B illustrates the response of the Concertone at $7\frac{1}{2}$ IPS. The result of the difference in tape speed is quite obvious, as is the result of the compensation previously mentioned.

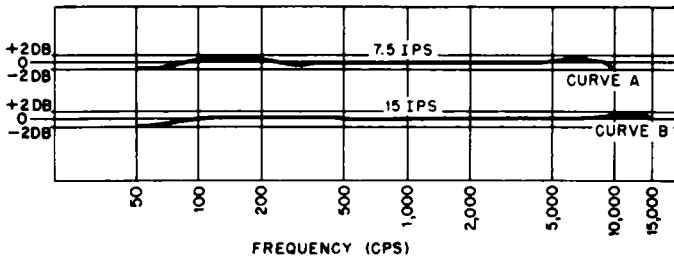

Courtesy Berlant Associates

Fig. 13-3 Tape Response of 1401 at (A) 15 IPS, (B) $7\frac{1}{2}$ IPS

The approved practice of the N.A.R.T.B. is to provide for equalization of the high frequencies while recording, and equalization of the low frequencies during playback.

Our first specification is a frequency response of from 50-15,000 CPS \pm 2 DB at a tape speed of 15 IPS.

Distortion specifications are also given by the N.A.R.T.B. They are 3% at minimum recording level and less than 1% at 10 DB below maximum recording level. The Concertone 1401 has a total harmonic distortion of less than 2% at maximum signal level and, since this particular recorder produces excellent results, we will

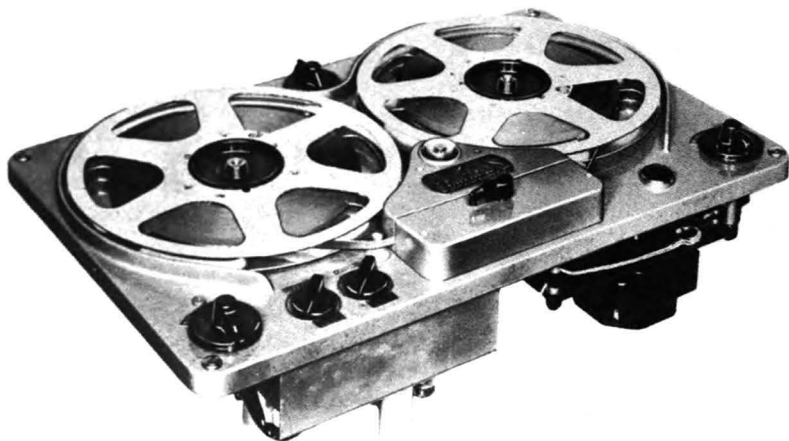

Courtesy Berlant Associates

Fig. 13-4 The Concertone 1401

use this as our standard for distortion. Two views of this unit are shown in Figures 13-4 and 13-5.

The electronic information supplied in the preceding paragraphs, when combined with the mechanical information supplied in the succeeding paragraphs, should enable the reader to select a proper tape recorder for his particular purpose, in our case high-fidelity reproduction.

From Figure 13-3, we can readily see the effect of the difference of tape speed upon the frequency response. The other effects of tape speed are equally important, and are manifest in increased distortion of various kinds. The slower speeds contribute irregularities in mechanical motion that are greater than at 15 IPS.

One of the most important requirements of any tape recorder is consistency of speed. As previously mentioned in the case of disc recordings, any variation in speed causes distortion in the form of wow, flutter, or drift. N.A.R.T.B. specifications require that flutter and wow combined be less than .2% RMS at 15 IPS.

The reasons for our insistence upon a recording speed of 15 IPS should be quite apparent at this point. There is only one dis-

advantage to the higher speed, and this is economic. Table XIII-1 shows that the amount of recording time for a reel of tape at 7½ IPS is double that which can be obtained at 15 IPS. We have not listed the lower speeds because they are unsatisfactory for high-fidelity reproduction. Doubling the recording time on a specific length of tape obviously cuts the cost of the recording by half. The reader should by this time be aware of the results of reducing the recording speed and consequently the decision can be left to him.

TABLE XIII-1

Reel Size	No. of Feet on Reel	Total Time at 15 IPS		Total Time at 7½ IPS	
		Single Track	Dual Track	Single Track	Dual Track
5"	600	7½ min.	15 min.	15 min.	30 min.
7"	1,200	15 min.	30 min.	30 min.	60 min.
10½"	2,400	30 min.	60 min.	60 min.	120 min.

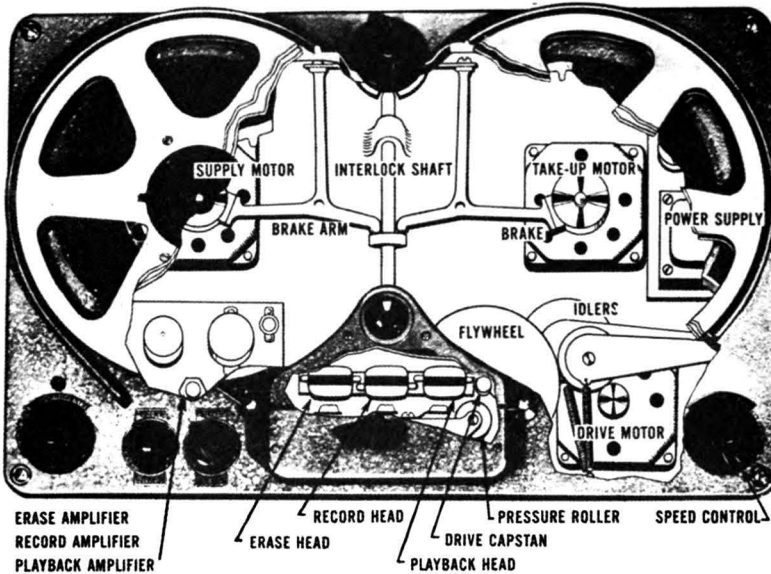

Courtesy Berlant Associates

Fig. 13-5 Cutaway View of the Concertone 1401

There is another method of reducing the cost of a tape recording which, in the author's opinion, is preferable to use of the lower speeds. This is dual-track recording. Most of the better recorders can be obtained with dual-track heads, or have available interchangeable heads. When making a dual-track recording only one half of the width, but the entire length, of the tape is used. After recording the full length of the tape that was put on the recorder, one half of a dual-track recording has been completed. Pick up the tape from the take-up side without rewinding, turn it over, replace it on the supply-reel side, and thread the tape as in the beginning. After rethreading the tape, the same length of recording time may be placed on the unused half of the tape.

One disadvantage with dual-track recording is the difficulty of editing. When editing becomes necessary with dual-track equipment, use of only one of the tracks will work out satisfactorily. Otherwise, editing of one track destroys the other. Another solution is the quick-change pre-aligned head assembly, available with some recorders. To change from one type of head to the other in the recorder illustrated, the operator simply removes two screws and the terminal-pin connectors behind the heads, lifts one assembly out, puts in the other, tightens the two screws, replaces the terminal-pin connectors and the job is done. No complicated head aligning equipment is necessary with the pre-aligned head assembly because this is done at the factory, making the quick change possible for those who desire it.

The question arises, at this point, as to whether a dual-track or a single-track recorder will furnish the most desirable high-fidelity recording. The frequency response of a dual-track system is equal to that of a single-track system. The only advantage is perhaps a 2 DB higher signal-to-noise ratio in favor of the single-track system.

The signal-to-noise ratio is the difference in loudness level between the desired signal and the residual noise level; this noise level is similar in effect to the surface noise on a record. The difference is expressed in decibels. The higher the signal-to-noise ratio, the quieter will be the recording in terms of noise. The recommended signal-to-noise ratio is 50 DB or higher.

The choice of a dual-track or single-track recorder depends entirely upon the individual application. If the recordings are going to be exchanged with recordings made on broadcast recording equipment, or if frequent editing of the tape is necessary, single-track equipment is desirable. Twice the recording time on the tape is possible with dual-track equipment.

We promised to provide, in addition to the electronic specifications, the mechanical information required to choose a good tape recorder. To provide this information it will be necessary to return to the tape itself. The tape is only a few thousandths of an inch thick. The problems of transporting this limp medium past the heads with a minimum of disturbance are complex.

One of the primary requirements of a good tape recorder is similar to that of a good phonograph motor: the speed must be absolutely constant. The *capstan*, *flywheel* and *capstan motor* comprise the actual driving mechanism in a tape recorder. These move the tape over and past the recording and playback heads. The *supply* and *take-up reels* and their motors, however, assist the capstan in maintaining the even tension required to prevent tape stretching. Excessive stretching of the tape results in distortion by physically changing the length of the magnetized areas.

Chapter X explained the methods used in obtaining constant speed in a phonograph motor. These same methods are also used in tape recorders but, since there is no turntable to act as the flywheel, a separate flywheel must be provided to maintain the constant, smooth motion required to reduce wow and flutter to a minimum.

When a recording is to be made, the recorder is loaded with tape, turned on, and set to the *Record* position. The recording level is usually set by either a vacuum-tube eye or meter level indicator. Magnetic recording, incidentally, has a gentler overload characteristic than occurs in disc recording; it is therefore much easier for an inexperienced operator to handle successfully. There are no problems with cutter angles, cutting depth, chips, shavings, and the like. Merely setting the level for maximum signal enables the entire program to be recorded without further adjustment. A recorder using three heads permits a playback of the recording 1/10 of a

second after it is recorded. Any error or defect in recording can, therefore, be detected at once and corrected without losing the balance of the recording; this is quite an important advantage.

When making a recording with a recorder such as was illustrated, several different sized reels may be used. The standard R.M.A. 5" or 7" reels are used by placing them on the spindles on the recorder. By using "hub adapters" over these spindles, the large "professional" 10½" N.A.R.T.B. reels may also be used to provide longer recording and playback time. While on the subject of reels, the better recorders make provision to spool or wind the large 10½" N.A.R.T.B. reels in either direction in approximately 100 seconds when desired. This is accomplished without excessive stretching of the tape when the brakes are applied. The results of tape stretching were mentioned previously and their importance should not be overlooked. The fast rewind feature, though it may seem trivial to the inexperienced recordist, is extremely important to anyone who has used a tape recorder for any length of time.

Having selected the desired length of tape, it becomes necessary to load it on the recorder and thread it. Straight slot-type threading, as done on the machine in the illustration, is the most convenient and least complicated for the user to handle. Pull some tape from the left-hand supply reel in front of the left-hand guide post through the slot in front of the right-hand guide post, and fasten to the take-up reel on the right. After taking up any slack left in the tape between the supply reel and take-up reel, the recorder is ready for operation.

The next step is to select the desired speed on the speed-selector control, which also serves to correct equalization. Turn the mechanical function control on. The tape is now moving from the left past the erase head, which will erase anything previously on the tape; the record head, which will record the input source on the tape; and the reproduce or playback head, which will play back what the record head has put on the tape. With record and playback gain controls turned off, switch to *Record*, turning the record gain control up slowly and reading the input signal modulations on the eye-tube or meter recording indicator. Care should be taken in the final record level adjustment that the eye of the tube barely closes

during the loudest passages of the input signal. This will eliminate possible overmodulation resulting in playback distortion. The playback gain control can be turned up now, and the recording being made can be heard directly from the tape. In professional circles this is known as monitoring a recording from the tape.

It is sometimes desirable to cut out commercials during the recording of FM or TV programs without changing the mechanical motion of the recorder. This is possible on the recorder shown in the illustration by switching from *Record* to *Standby* on the *Record-Standby-Playback* switch. With this by-pass feature, the program continues through the rest of the sound system, but it is not being recorded. When continuing with the recording, switch back to the record position.

When the recording has been completed, it can be played back at once. Since the input source is no longer needed, switch to *Playback* and rewind the tape to the place in the recording which is to be played back. Turn the playback gain control to the desired listening level and you will then be listening to what was recorded on the tape. The sound heard should be the same as if the program were heard directly.

Transporting 2,400 feet of tape from one end to the other in a *fast-forward* or *rewind* position within a 100-second period of time is desirable on a high-fidelity tape recorder. This feature enables quick location of the recorded portions of the tape that the operator wishes to play back. Another purpose is the quick clearance of the tape for storage, or for reloading of the machine with fresh tape.

An interlock system between the *Fast forward-Rewind* control and the mechanical function control is desirable to eliminate any possibility of tape spillage or breakage. In other words, when recording or playing back the tape, an interlock prevents the operation of the *Fast forward-Rewind* control and vice versa. With the better tape recorders, an excellent recording is that simple to achieve!

Thus far we have only mentioned two types of program sources: the record player, for making copies of records, and the FM tuner, for copies of broadcasts. The third input or program source is a microphone for picking up live programs of interest to the recordist.

The microphone should be carefully chosen for the purpose for which it will be used. An excellent article on microphones for recording purposes, by Alan C. Macy, can be found in Volume I, No. 3, Winter, 1951 issue of *High-Fidelity Magazine*.

After a high-fidelity recorder has been put into operation, several things can be done to maintain best results:

1. Clean the heads regularly by folding a pipe cleaner double, dipping it in carbon tetrachloride, and passing it back and forth in the tape slot across the heads. This cleans out accumulated dirt and residue.

2. Demagnetize the heads after each eight hours of recording time (approximately) by running a suitable demagnetizer over them. If the heads are in a magnetized condition, tape noise and loss of high frequencies will occur. Keep all permanent magnets away from the head assembly.

3. Avoid use of warped reels, as they cause audible flutter and irregular motion. They may also cause tape to break.

4. Have the recorder checked annually and replace all rubber idlers and drive wheels.

5. Lubricate your recorder according to the manufacturer's specifications.

6. Always disengage mechanical function controls when the recorder is not in use. This eliminates the possibility of flat spots on the rubber idlers and drive wheels which would cause flutter.

7. Provide adequate ventilation during operation to avoid excessive temperature.

8. Run new rolls of tape through the tape recorder at least once, in fast forward, making certain the tape is not sticking together any place before making a recording. This also applies when playing back tapes that have been in storage.

9. Care of the tape should be the same as that of any high-quality disc in that it should be stored in suitable containers and kept in moderately cool temperatures.

10. Be certain that good connections have been made from the rest of the sound system to the recorder.

For those who will wish to edit tape, many excellent articles have appeared on the subject. Learning to edit, however, resembles

learning to typewrite or play the piano in one important respect: all the literature written on the subject will not help as much as a few hours of practice. Experimentation with a reel of tape containing recorded material no longer wanted will teach the recordist when cutting can be done, at what point the cut should be made, and how this point is to be located. Most tape editors, after the approximate point of the cut is found, prefer to shut off the motors and to rock the reels slowly back and forth so that the tape passes slowly back and forth over the playback head. In this way the exact spot for the cut can be pinpointed by careful listening.

Whether the recordist elects to do editing or not, he should learn how to splice tape properly. There will be times, as when tape snaps during use, when this easily learned skill will be called upon. Only a few simple steps are required.

1. The two ends of tape that are to be spliced together must be placed on a clean, flat surface *with the glossy side up*, in the case of plastic-backed tape, or *with the paper side up*, in the case of paper-backed tape. In other words, the side of the tape that has the magnetic coating is *always face down*.

2. The two ends of the tape are brought together so that they overlap slightly. At this point both lengths of tape *must lie in the same straight line*. A straight edge of some kind is recommended as a guide. An inexpensive splicing block will perform this function, as well as that of holding the tape securely during cutting. If this rule is not observed there may be a slight angle formed by the two lengths at the point of splice. This bend may cause the tape to foul on the recorder as it passes through the tape transport mechanism.

3. The actual cut is now made. A pair of scissors may be used, as shown in Figure 13-6. If an editing board or similar surface is used, a razor blade mounted in a holder or some similar device may be preferred. With a razor blade, the tape is held firmly against the board so that there is little danger that the two ends will fall out of alignment with each other. The cut is made *in the area where the tape ends overlap*. Thus the remaining ends of tape match perfectly; the cut should be made *at an angle of 45 degrees*. An entirely perpendicular cut may cause a click or "burble" to be heard at the point of splice as the tape passes over the head

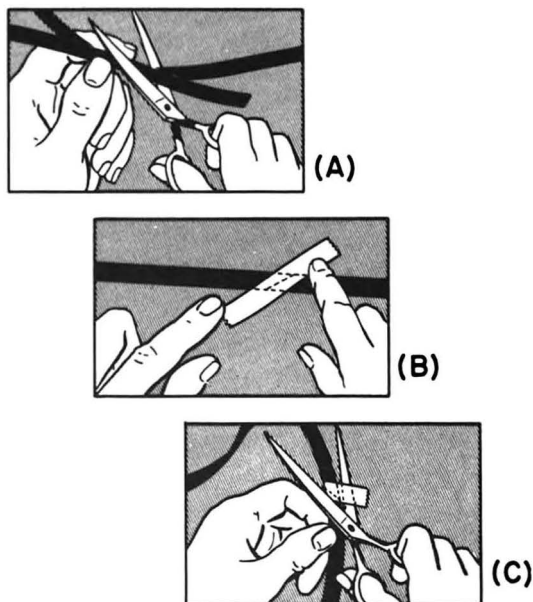

Courtesy Audio Devices, Inc.

Fig. 13-6 Splicing Tape

during playback. If a very close splice is to be made a smaller angle may be cut, but an entirely perpendicular cut should be avoided.

4. After the cut is made the small edges which were snipped off are brushed or blown out of the way, while the matching edges of tape are still held firmly with one hand (or by the splicing block) to keep them aligned. Then a square of cellophane tape large enough to cover the splice is placed over the cut and pressed down. Remember that this gummed tape always goes on the glossy, or paper, side. If it is placed on the side with the magnetic coating, it will obliterate whatever has been recorded at this portion. While ordinary cellophane tape may be used for this operation, a special but inexpensive pressure-sealing tape has been devised. It may be purchased anywhere that recording tape is sold.

5. Now that the splice has been substantially made the tape need no longer be held in position. It is freed and the excess gummed tape is trimmed away with scissors. This is done so that

no gummed area is left exposed. If this precaution is not observed, the tape becomes sticky as it winds and jams in the tape transport mechanism as it is being played.

When tape is edited properly the ear cannot tell a splice as it passes over the playback head. This is an advantage impossible with disc recording. In addition, a reel of tape that contains several splices, if they are properly made, can be erased and re-used as though it were uncut tape.

INDEX

- Acoustic equalization, 121-122
- Acoustic facsimile, 33, 39-40
- Acoustics, 30
 - room, 34-35
- AM broadcasting, 2-4
- AM tuners, 165
- Amplifiers,
 - audio input systems, 124
 - compensation, 119-123
 - distortion rating, 101-104
 - harmonic distortion, 102-104
 - high-power, 107-109
 - inter-modulation distortion, 102-105, 107
 - noise, 109
 - power, 98
 - power output rating, 104-107
 - pre-amplifiers, *see* Pre-amplifiers
 - purpose of, 98
 - size, 107
 - thermal noise, 112
 - two-chassis arrangements, 99-100
 - voltage gain, 110
 - voltage supply, 98
- Amplitude distortion, 51-53, 55
- Apex, 58-60
- Automatic frequency control, 167-170
 - carrier, 168
 - drift, 169
 - noise, 167
 - quieting, 167
 - selectivity, 168-169
 - sensitivity, 167-168
 - tuning indicators, 169-170
- Cabinets, 6-15
 - antique, 8
 - bookcase, 10-13
 - Chinese modern, 7
 - Chippendale, 7
 - complex tone, 26
 - controls, 111-132
 - early American, 7-8
 - end table, 180
 - French provincial, 8
 - loudspeaker, 75-96, 82-83
 - modern, 6
 - period, 6-7, 10
 - room divider, 11, 181-183
- Decibel, 18, 20-22
- Distortion, 101
- Dynamic range, 31, 36-37, 41
- FM-AM tuners, 166
- FM radio, 2, 33, 133
- FM tuners, 167
- Frequency, 23, 27
- Frequency range, 24-26, 30, 46, 58, 61, 98, 101, 110-111
- Fundamental tone, 24-26
 - harmonic distortion of, 102-105
- Harmonics, 24
- High fidelity
 - birth of, 2
 - clubs, 13-14
 - components, 10
 - purchase of, 6
- Home music system, 173-185
- Horn loaded speaker enclosures, 82-83
- Hum, 112
- Human ear, 16, 17-19, 21-24, 26-28, 30-32, 35, 38, 48
- Intermodulation distortion, 102-105, 107
 - see* Loudspeakers
- Loudness control, 121-122
- Loudness level, 18-22
- Loudspeaker, 4, 38-39, 41-44
 - co-axial, 73
 - cone, 45-47, 50, 57
 - crossover networks, 62
 - efficiency, 55-71
 - enclosures, 44
 - harmonic distortion, 51-55, 74
 - intermodulation distortion, 51-54, 74
 - level control, 71
 - mono-range, 58-64
 - peaks, 50-51
 - permanent magnet, 55
 - progressive system, 178-179
 - purpose of, 44
 - response curves of, 65
 - spatial distribution, 61
 - transient distortion, 51

- tweeter, 57-61, 63-71, 74-76, 89-91
 voice coil, 45-55
 woofer, 64-72, 74-87
- Loudspeaker cabinets, 75-96, 82-83
 see Cabinets
- Loudspeaker enclosures
 acoustic labyrinth, 79
 bass-reflex, 78-79, 87
 cabinet resonance, 77
 horn loaded, see Horn loaded speaker enclosures
 infinite baffle, 78, 83
 Klipschorn, 83
 the R-J, 94
- Masking, 22
- Motor
 flutter, 157
 hysteresis synchronous, 159
 induction, 159
 rumble, 157
 wow, 157
- Noise, 112-114
 Noise level, 34-35, 109-112
 Noise suppressor, 129-132
- Overtones, 2, 24-26, 29, 33, 40
- Pickup cartridges
 crystal, 111, 152
 dynamic, 154, 163
 FM, 163
 magnetic, 111-120, 127, 152-153
- Pitch, 24
- Plugs, 5
- Pre-amplifiers, 112, 117, 124-126, 143
 purpose of, 98
- Record
 care, 174
 compensation, 119-120
 grooves, 114, 143-144
 LP, 111
 scratch, 117
 speeds, 134
 spider, 135
- Record players
 automatic, 4, 133-142
 automatic stop, 137
 motor, 133, 141-142, 156
 muting switch, 142
 speeds, 134
 spindle, 134
 tone arm, 133-139, 161
 tracking error, 161
 turntable, 136-156
- Recording, 115
 constant amplitude, 115-116
 constant velocity, 115-116
 pre-emphasis, 117-118
- Reverberation, 34
- Sound
 creation, 22-29
 measurement, 18-21
 travel, 16
- Stylus, 141, 144-145, 149, 175
 alignment, 175
 diamond, 146-148, 151
 microscopes for inspection of, 151-152
 osmium, 146-148
 sapphire, 146-148
 wear, 145
- Tape, 186-201
 Tape recording, 186-201
 uses of, 186-187
- Threshold of audibility, 18-20, 27
- Threshold of feeling, 18
- Tone controls, 124
- Tuning fork, 22-23
- Tweeter, 57-61, 63-71, 74-76, 89-91
 see Loudspeaker
- Volume control, 123
- Volume expansion, 37
- Woofer, 64-72, 74-87
 see Loudspeaker

HIGH FIDELITY COMPONENT MANUFACTURERS

AMPLIFIERS

- Altec-Lansing, 9356 Santa Monica Blvd., Beverly Hills, Calif.
Bell Sound Systems, Inc., 555-57 Marion Rd., Columbus 7, Ohio.
Brociner Electronic Labs., 1546 Second Ave., New York 28, N. Y.
Brook Electronics, 34 De Hart Pl., Elizabeth, N. J.
David Bogen Co., Inc., 663 Broadway, New York, N. Y.
Fisher Radio Corp., 41 East 47th Street, New York, N. Y.
General Electric Co., Electronics Park, Syracuse, N. Y.
Leak (British Industries Corp.), 164 Duane St., New York 13, N. Y.
Masco, 32-38 49th St., Long Island City, N. Y.
McIntosh Laboratory Inc., 326 Water St., Binghamton, N. Y.
Meissner Manufacturing Co., Mt. Carmel, Ill.
Newcomb Audio Products Co., 6824 Lexington Ave., Hollywood, Calif.
Pickering and Co., Inc., Oceanside, N. Y.
Pilot Radio Corp., 37-06 36th St., Long Island City 1, N. Y.
The Radio Craftsmen, Inc., 4401 North Ravenswood Ave., Chicago 40, Ill.
H. H. Scott, Inc., 385 Putnam Ave., Cambridge 39, Mass.
Stromberg Carlson, 1222 Clifford Ave., Rochester 3, N. Y.
Thardarson, Mt. Carmel, Ill.
Waveforms Inc., 333 Sixth Ave., New York 14, N. Y.
Williamson (British Radio Electronics Ltd.), #1 Thomas Circle,
Washington 5, D. C.

208 HIGH FIDELITY COMPONENT MANUFACTURERS

LOUDSPEAKERS AND ENCLOSURES

Altec-Lansing, 9356 Santa Monica Blvd., Beverly Hills, Calif.
Bell Sound Systems, Inc., 555-57 Marion Rd., Columbus 7, Ohio.
Brociner Electronic Labs., 1546 Second Ave., New York 28, N. Y.
Electro-Voice Inc., Buchanan, Mich.
General Electric Co., Electronics Park, Syracuse, N. Y.
Jensen Manufacturing Co., 6601 South Laramie Ave., Chicago 38, Ill.
Klipsch and Associates, Hope, Ark.
J. B. Lansing Sound Inc., 2439 Fletcher Drive, Los Angeles, Calif.
Oxford Electric, 3911 South Michigan Ave., Chicago, Ill.
Permoflux Corp., 4900 West Grand Ave., Chicago 39, Ill.
Racon, 52 East 19th St., New York, N. Y.
Radio Corporation of America, Camden, N. J.
Stevens Manufacturing, 8538 Warner Drive, Culver City, Calif.
University Loudspeakers, Inc., 80 South Kensico Ave., White Plains, N. Y.
Wharfedale Wireless, 164 Duane St., New York 13, N. Y.

RECORD CHANGERS

Garrard, 164 Duane St., New York 13, N. Y.
General Industries, 3637 Taylor St., Elyria, Ohio.
Markel Electric Products, 145 Seneca St., Buffalo, N. Y.
Milwaukee Stamping, 800 South 72nd St., Milwaukee, Wis.
V-M Corporation, Benton Harbor, Mich.
Webster-Chicago Corp., 5610 West Bloomingdale Ave., Chicago 39, Ill.

TUNERS

Altec-Lansing, 9356 Santa Monica Blvd., Beverly Hills, Calif.
Browning Laboratories, Inc., 750 Main St., Winchester, Mass.
David Bogen Co., Inc., 633 Broadway, New York, N. Y.
Espey Manufacturing Co., Inc., 528 East 72nd St., New York 21, N. Y.
The Hallicrafters Co., Fifth and Kostner Aves., Chicago 24, Ill.
Meissner Manufacturing Co., Mt. Carmel, Ill.
Pilot Radio Corp., 37-06 36th St., Long Island City, N. Y.
The Radio Craftsmen, Inc., 4401 North Ravenswood Ave., Chicago 40, Ill.
Sargeant-Rayment, 1401 Middle Harbor Rd., Oakland, Calif.
Stromberg Carlson, 1222 Clifford Ave., Rochester 3, N. Y.