

RADIO NOISES

and their cure



101 SOURCES

Street Cars
Oil Burners
Home Appliances
Traffic Control Apparatus
Rotary Converters
Electro-Medical Apparatus
Interference Ordinances

PRICE 50 CENTS

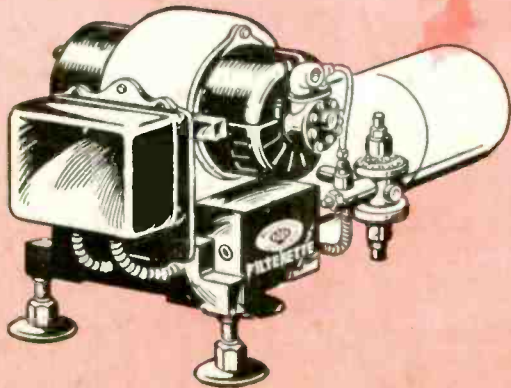
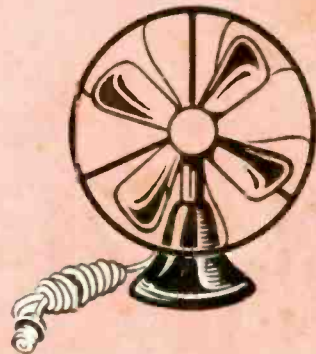
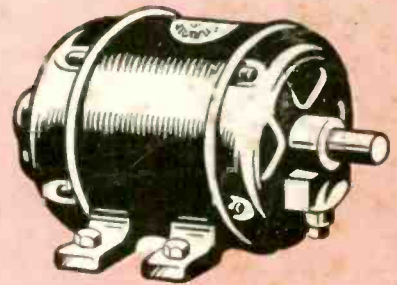

RADIO NOISES AND THEIR CURE

THE RADIO INTERFERENCE PROBLEM
AND ITS SOLUTION

TOBE DEUTSCHMANN CORPORATION
FILTERETTE DIVISION
CANTON, MASS.

Copyright, 1932
TOBE DEUTSCHMANN CORPORATION

Fourth Edition

PRINTED IN U. S. A.

Index

Adding Machine	6, 19	High Tension Lines	7, 62
Addressing Machine	6, 19	Household Appliances	16
Air Purifier	7, 53	Humidifier	6, 53
Annunciator	7	Incubator	7, 37
Autocall System	42	Interference Locator	64
Automobile Electrical System	67	Interference Ordinances	69
Bakery Oven	46	Light Switches	48
Barbers' Clipper	6, 18	Line Filters	6, 54
Billing Machine	6, 19	Mailing Machine	19
Bookkeeping Machine	19	Malted Milk Machine	20
Buzzer	7	Massage Machine	6
Carbonator	20, 21	Milk Shake Machine	20
Cash Register	6, 18, 19	Motor	6
Clock	47	Motor-Generator	6, 22-31
Compressor	20, 21	Neon Sign	38
Converter, Small	22-31	Office Appliances	19
Converter, Street Railway	30, 32	Oil Burner	7, 10-15
Converter, Westinghouse	23, 29, 74	Ordinance Enforcement	72
Counting Machine	19	Ozonator	7, 53
Defective Apparatus	7, 8-10	Portable Tools	46
Defective Wiring	7, 8-10	Posting Machine	19
Dental Engine	21, 22	Power Line	7, 62
Dental Lathe	7, 22	Precipitator	7
Dial Telephone	7, 18	Printing Press	6
Diathermy	7, 49	Radio Club	68
Dictating Machine	19	Receiver Trouble	5
Dishwasher	6, 16, 20	Refrigerator	6, 15, 20
Doctor Paging System	42	Sewing Machine	6, 16
Dough Mixer	6	Shielded Lead-In	55
Drink Mixer	6, 16, 19	Sign Flasher	7, 38
Egg Beater	16	Soda Fountain Equipment	19
Elevator	6, 34	Static	5, 6
Fan	6, 16	Stoker	43
Farm Lighting Plant	6, 43	Street Cars	7, 31
Filterette Analyzer	66	Survey	58
Filterette Characteristics	74, 75	Switch Clicks	48
Filterette Service Stations	72	Tag for Interfering Apparatus	72
Fish Diverter	53	Thermostat	7, 37
Flasher	7, 38	Traffic Signal	7, 40
Floor Polisher	6	Transformer	62
Flour Bleacher	7, 35, 37	Tuning Effect in Wiring	48
Fruit Juice Extractor	16, 20	Vacuum Cleaner	6, 10, 16
Generator	6	Valve Grinder	6, 46
Hair Dryer	6, 17	Vibrator	6
Heater, Automobile	68	Violet Ray	7, 49
Heater, Home	53	Voltage Regulator	35, 37
Heating Pad	7	Washing Machine	6, 16
High Frequency Apparatus	7, 47		

Permission to use copyrighted material on any of the above subjects may be obtained by writing
Tobe Deutschmann Corporation, Canton, Massachusetts.

Introduction

It is indeed gratifying to know that the subject of radio interference which, at one time received but passing reference, is now assuming great proportions. Radio Interference, "Man-made static" is now not only a national problem, but an international one. At the second meeting of the International Technical Consulting Committee on Radio Communication held at Copenhagen last June and attended by representatives of thirty-eight governments, a study of the question of the reduction of radio interference which is broadcast by electrical apparatus was discussed. Out of fourteen questions brought up at this meeting, three pertained to Radio Interference. The administration of Denmark has been requested to submit the results of special studies which will be considered at the third meeting to be held at Lisbon, Portugal in the very near future. Considerable activity is on foot to get organized action on this problem, and there is no doubt that at the great Madrid Conference next year, a definite program of anti-static action will be discussed by radio men from all parts of the world.

In the United States, a committee known as the "Joint Co-ordination Committee on Radio Reception of National Electric Light Association, National Electrical Manufacturers Association and Radio Manufacturers Association, has been appointed and has been holding meetings regularly at both the National Electric Light Association and National Electrical Manufacturers Association quarters in New York.

Responsible electrical manufacturers realize the problem and are earnestly adopting ways and means to reduce the radio interference qualities of their respective apparatus and equipment, thereby reducing the noise level which must not be allowed to rise and should be lowered to keep pace with the technical improvement in broadcasting and reception.

The public, however, is still ignorant of the general problem and can hardly connect a vacuum cleaner, sewing machine and other similar electrical appliances with radio interference. Proposed educational plans, particularly the type of instructive talks broadcast over Station KFI of Los Angeles, will do much to inform the general public of the meaning of "Man-made static." Manufacturers of electrical apparatus and electrical equipment without exception have offered to co-operate and take steps to filterize their respective equipment. Our Filterette Laboratories are constantly receiving new equipment for Filterette designing and we are confident that the time is not far distant when the better type electrical manufacturers will sell non-radio interfering electrical apparatus — Filterized.

It is true that some forms of equipment are operating in remote districts and manufacturers need not go to the expense of filterizing such equipment as standard production, but in such cases, if the manufacturer will designate with the proper label whether the apparatus will or will not create radio interference, the purchaser can be guided in his choice of apparatus.

We have been checking interference and tabulating our findings for many years. We continue to find listeners suffering from needless interference, some of it being created in their own homes. We have found neighborhoods where the most friendly relations exist and where it would be unthinkable to knowingly disturb the peace of another neighbor, and yet, through the operation of a sewing machine, a fan, a vacuum sweeper or some other household appliance, the entire community must discontinue the use of their receivers until the appliance is turned off.

Such conditions have led to the passing of many ordinances now on record. I personally am not in favor of the ordinance idea, for the ordinance without local organization will be of no avail. Education in my opinion will be more practical.

It has been a much debated question in the minds of the public utilities as to their share of the responsibility regarding the general interference problem. It has been said that the total revenue derived by the utilities from Radio is in the neighborhood of \$135,000,000 to \$150,000,000 per year. This is based upon the average individual rate of about \$9.00 per year for current for radio. In addition to the direct revenue, radio without question is responsible for further increased lighting revenue. To estimate the total revenue, it would be about \$15.00 per year, per consumer.

We believe that the Utilities have been very unfairly criticized because of radio interference from electrical appliances attached to the power line. This interference feeds back into the line and the layman, unfamiliar with the problem as he is, will, nine times out of ten, criticize the Utilities. Power companies can increase their revenue by further assisting in the elimination of radio interference in so far as attempting to locate a disturbance which is primarily out of their control. We earnestly hope that Utilities will continue their good work and instruct the buyers of electrical apparatus and equipment regarding the ever present possibility of apparatus creating radio disturbance and that they will offer the public the opportunity of purchasing equipment which can be guaranteed to create no radio interference.

There still remains a possible 40% market for radio. The public is becoming more familiar with various improvements and the Utilities must contend with the problem. They can further build into the good will of the public, and money and effort applied to radio interference work will become a profitable investment for the local power company.

We are prepared to be of more service to the individual, dealer, jobber and appliance manufacturer and the services of our Engineering Department are available to all.



Radio Noises and Their Cure

- What causes noises in radio sets?
 How can I tell what causes the noises I am getting?
 Is there any way to stop them?
 How much would it cost to get rid of the noises?

Questions like these are on everyone's lips today. You will find the answer in the pages of this book.

Q. Every time I turn on my radio set I hear noises, crackling, snapping, roaring or growling: What causes this?

- A. One of three things is to blame:
1. Natural Static.
 2. Man-made static or Interference.
 3. A broken or defective part in the set.

Q. What is natural static?

A. Natural static is a series of electrical discharges caused by disturbances in the atmosphere such as thunderstorms, northern lights, heat lightning, dust storms, etc.

Q. What is Man-made static or Interference?

A. "Man-made static" or Interference is an electrical disturbance caused by the operation of certain types of electrical apparatus or appliances. Electrical apparatus having a make and break contact (the brushes and commutator of a motor, for example), contains the essentials of a spark transmitter, such as is used to send out wireless messages. Even a loose or dirty connection is sufficient to cause trouble. The electric disturbances thus sent out may travel to the set through the air or along wires such as the wiring in your house. Usually they reach the set in both of these ways.

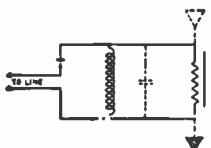

FIG. 1. Diagram showing similarity of electric circuit to a spark transmitter.

Q. What is meant by a broken or defective part in the set?

A. A radio set is like a chain: break or weaken one of the links and the chain is only as good as that link. One poor tube in the most expensive set can and will completely ruin the tone quality of the set no matter what its cost. A single loose connection, a broken wire, or any defective part is sufficient to drown out the program completely or even make the set absolutely silent.

Q. How can I tell which of these three causes is responsible for the noise in my own set?

A. If possible, listen to the same station on some neighbor's set which is as good as or better than your own. (If your set is better, it may get noises which

your neighbor's set is not sensitive enough to receive.) If your neighbor's set is as good as or better than your own, and it does not get the noises at all, it would be well to have your set looked over by a competent service man.

Q. How can I tell whether the noise I am getting is due to natural static?

A. You are most likely to get natural static when electrical disturbances such as thunderstorms, heat lightning or dust storms are in the air. If you get the noise only on such occasions, while on fine days you are not bothered, it is probably due to natural static.

Q. Why is it that I sometimes get a lot of noise when I am listening to a station which is far off, and do not notice it on nearby, or local stations?

A. The signal from a distant city must travel hundreds of miles. During this journey various factors operate to absorb its signal energy and strength and, as a result, by the time it reaches your set, it is not so strong as the local signal. There is always a certain amount of electrical disturbance present in the air, and this causes what is known as the noise-level. The strong local signal is naturally much more powerful in relation to the noise level than the weaker signal from the distant station. We can hear the local station so clearly that we can keep our volume control much lower than we do when listening to the distant station. This, of course, means that we are making the set less sensitive, and so in this way it amplifies less signal and less noise. But when we want to bring in the distant station loud enough to listen comfortably, we have to make the set so sensitive (by turning up the volume control) in order to bring in this distant signal that it brings in more noise at the same time. If you listen to stations farther and farther away, the noise finally becomes so great in proportion, that it drowns out the program completely.

Q. How can I make sure whether my set is to blame for the noises?

A. Shut off the set. Remove the antenna and ground wires. Take a small piece of wire, or a nail, connect the antenna and ground posts with it, and turn on the set again. The antenna system has now been removed, and any noises you hear are due either to radio interference coming in over the electric light lines or to a defective part in your set. If it is a battery set, using no eliminators, and you still get the noise, it is undoubtedly due to a defective part in the set. If it is an electric set, the noise may be due either to interference or to a defect in the set.

Q. If my set is electric or uses eliminators how can I tell whether the noise is due to interference or to a defective part?

A. Having connected antenna and ground posts together, plug a good line filter (Tobe Filterette No. 110 P. L. is excellent for this purpose) into the wall socket, and plug your set into the line filter. Now turn on the set. If the noise has stopped, it was caused by radio interference coming in over the power lines, and the line filter is now keeping it from getting into the set.

Q. If the line filter has not stopped the noise with the antenna and ground systems disconnected, what is causing the noise?

A. If the line filter has not stopped the noise with the antenna and ground systems disconnected, have your set looked over for a defective part.

Q. If the line filter has stopped the noise should it be left on the set permanently?

A. Yes, or the noises will be heard as before.

Q. How can I stop noises caused by natural static?

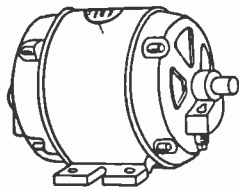

FIG. 2. Small motors often cause radio interference.

A. There is no way to stop noises caused by natural static. It is important for the reader to remember this. There are hundreds of devices on the market which promise to get rid of "Static," but stop and think: the biggest radio manufacturers in the world, the

companies who sell you your radio set, do not put these devices on their sets when they sell them to you. Why? Because they know that they cannot be depended upon to work.

The first thing anyone thinks of when he hears about static or interference for the first time is "something to go on the radio set." He doesn't know that the biggest companies in the world have been seeking for years to find such a device. When it is found, if it ever is found, you will read the news of it on the front page of every newspaper in the country.

Don't waste your money trying "static" eliminators. If you are really interested, study up on the subject in the library, but save your money.

Q. How can I tell whether the noises I am getting are due to man-made static?

A. If you have made the tests described above for natural static, and for defective parts in your set, and get the same noises as before, not just on stormy days but every day or night, then the chances are that man-made static is the cause of your trouble.

Q. What are some of the things that cause man-made static and how are these recognized by their sounds in the speaker?

A. Most types of radio interference have a characteristic sound. Listen carefully to the noise you are getting and see which of the following classes it comes under. Opposite each class of noise is a list of the kinds of electrical apparatus which are most likely to cause such a noise. You can then go hunting for a similar electrical apparatus somewhere in the neighborhood of your radio set.

Whirring, Crackling, Buzzing, Humming, Droning, Whining

Sounds like these generally indicate radio interference which is being caused by an electric motor. Sometimes when the motor starts and stops, the sound will start low and rise in pitch until the motor reaches its full speed when the whine will remain at a certain steady pitch, usually rather high. This is especially true of commutator type motors. Repulsion starting induction running motors may have a sputtering, whirring, crackling, buzzing or humming sound. When such sounds are heard hunt for one of the following:

- | | |
|------------------------------|--------------------------|
| Adding Machines | Floor Polishers |
| Automatic Towels | Generators |
| Barbers' Clippers | Hair Dryers |
| Beauty Parlor Devices | Humidifiers |
| Billing Machines | Massage Machines |
| Cash Registers | Motor Brushes |
| Dental Engines | Motor Generator Sets |
| Dishwashers | Portable Electric Drills |
| Dough Mixers | Printing Presses |
| Drink Mixers | Sewing Machines |
| Electric Addressing Machines | Shoe Dryers |
| Electric Computers | Small Blowers |
| Electric Elevators | Telephone Magnetos |
| Electric Refrigerators | Toy Electric Trains |
| Electric Vibrators | Vacuum Cleaners |
| Fans | Valve Grinders |
| Farm Lighting Plants | Washing Machines |

Whistles and Squeals

Sounds of this sort generally indicate radio interference which is being caused by oscillation. Often the whistle or squeal starts high, dips to a low note and mounts again to a high-pitched squeal which may vanish entirely or remain at a steady, high-pitched whistle. Heterodyning broadcast stations have a sort of bubbling whistle, and can be recognized by the fact that they usually occur at the same spot on the dial. You can only write to the Radio Commission about this: the listener himself is powerless to act. Old-fashioned radio sets which tune by the "squeal" of the wave, usually cause the squealing sound to be heard by all radio sets in the vicinity. The addition of a stage of radio-frequency amplification will stop this. Or, if you are not familiar with radio, we can explain it best by saying that if you add one more tube, you will not only stop your neighbors from being disturbed by the noise, but will make your set get many more stations, and play them much louder than at present. Look for:

RADIO NOISES AND THEIR CURE

Defective or incorrect value of filter condenser in superheterodyne.

Grid and plate leads so paralleled that there is an inductive pick-up between them.

Grid-leak too high.

Heterodyning broadcast stations — two stations of almost the same wave length operating at the same time so that the waves combine to form a "beat."

Inductive pick-up of a loop.

Intermediate stages of a superheterodyne in oscillation.

Regenerative sets improperly tuned.

Set picking up the squeal from a set in the neighborhood.

Some r. f. stages not neutralized.

Too much regeneration.

Rattles, Buzzes, Machine-Gun Fire

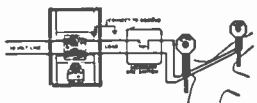

FIG. 3. Line Filterette applied to traffic beacon flasher.

Sounds of this sort generally indicate radio interference which is being caused by telephone dialing, buzzers, or doorbells. It is not generally steady, but stops and starts. Short rattling sounds like machine-gun fire, varying slightly in

length, indicate telephone dialing. Look for:

Annunciators	Doorbells
Automobile Ignition Systems	Elevator Controls
Buzzers	Sewing Machines
Dental Laboratory Motors	Switchboards
Dial Telephones	Vibrating Rectifiers

Violent Heavy Buzzing or Rushing Sound

Sounds of this sort generally indicate radio interference which is being caused by high-frequency apparatus. Such noises will usually be heard over a large area, a whole town, even, and often are so loud that they drown out the radio program completely. Look for:

Air Purifiers
Battery Chargers
Diathermy Machines
Doctors' Apparatus
Dust Precipitators
Flour Bleaching Machinery
High-Frequency Apparatus
Insulation Testers in Cable Plants
Ozone Devices
Rotary Spark Gap of Transmitting Station
Steady Oil-burner Spark Ignition
Violet Ray
X-Ray

Crackling, Sputtering, Snapping, Short Buzzes or Scraping

Sounds of this sort generally indicate radio interference which is being caused by one or more loose connections. Sometimes the sounds are especially

noticeable when the room is jarred or shaken by footsteps, street cars or traffic. Look for:

Bad connections
Burrs on plates of variable condensers
Corroded or loose connections in radio sets
Defective light-sockets
Elevator control
High tension lines
Loose connections in floor lamps, appliance cords, broken heating elements, etc.
Power lines grounded on branches
Street cars
Trickle charger
Wet insulators

Clicking

Sounds of this sort generally indicate radio interference which is being caused by some sort of make-and-break connection, such as a thermostat, especially if it comes at fairly regular intervals. Look for:

Defective Resistors in Eliminator	Ovens
Elevator Control	Percolators
Flashing Signs	Shaving Mug Heaters
Heaters	Sign Flashers
Heating Pads	Soldering Irons
Incubators	Telegraph Relays
Irons	Traffic Signals
Mercury Arc Rectifiers	Typewriters, Electric

Heavy Violent Buzzing, Usually Short

Sounds of this sort generally indicate radio interference which is being caused by arcing across a gap. This may occur as a short noise or a steady one. Look for:

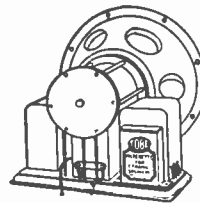

FIG. 4. Filterette DA used to suppress hum in dynamic speaker field.

Arc Light
Automobile Ignition
Breaks in Third Rails
Electric Car Switches
Electric Cigar Lighters
Electric Elevators
Moving Picture Machines
Pole Changers (Telephone Interrupter)
Street Car Switches
Street Lights
Toy Electric Trains

Steady Humming

Sounds of this sort generally indicate radio interference which is being caused by improperly filtered alternating current. Such humming is often the fault of your set or eliminator. Look for:

Dynamic speakers improperly filtered
Faulty construction of set or eliminator
Filter condenser blown or shorted
Ground on set poor
Improper wiring
Poor tubes
Wiring parallel with power line

Improper Wiring Causes Interference

Q. How does building wiring affect radio receivers?

A. The condition of wiring circuits in any building has considerable bearing on the results obtained from radio receiving equipment used in the building. Loose connections in wiring circuits, partial or intermittent grounds and high resistance, swinging short circuits may cause serious interference.

Q. Why do wiring defects such as loose connections cause interference?

A. There are two possible ways to consider the effect of loose wiring connections. Considering the way antenna systems are commonly installed, it is obvious that building wiring is a part of the antenna system. When a short indoor antenna is used, the energy received by the receiver is the result not only of pick-up by the short antenna, but of pick-up by all of the building wiring and by every metallic object in the building. The energy thus collected may be transferred either inductively or capacitively to the short antenna actually connected to the receiver. Thus the effect of a much longer antenna is obtained.

If greater signal pick-up were the only result of this coupling between the indoor antenna and the building wiring, there could be little said except in its favor. Unfortunately, the additional antenna system thus coupled to the receiver contains many potential loose connections conducive to noisy receiver operation. Every light switch, dial telephone, or home appliance containing a thermostat or commutator may cause a break in the antenna circuit. To appreciate the effect of such a break, it is necessary only to disconnect the antenna from the receiver and attach it intermittently to the antenna binding post. The resulting sound in the speaker shows very clearly the effect of loose connections in the antenna system. It is, therefore, evident when noisy reception is found and when the trouble cannot be traced to any defect in the receiver, that conditions within the building in which the receiver is operated may be responsible to a considerable extent for the noisy reception.

Q. What is the first step to be taken in locating possible defects in building wiring?

A. The first step to be taken in assuring clear reception is a careful inspection of all wiring and appliances in the building. This inspection should start at the power service entrance to the building.

The points to be covered at the service entrance are as follows:

1. Be sure that the service wires from the transformer to the building are not grounded to tree branches.
2. Be sure the service conduit is grounded.
3. Be sure the building wiring is grounded in accordance with the National Electric Code, and the regulations of the local power company.
4. Be sure the contacts of the service switch or switches are sufficiently firm to prevent arcing.

5. Be sure all fuses are firmly in place. This applies to branch circuits as well as mains.
6. Be sure the construction of the fuses is such that there is an uninterrupted flow of current through them. Some fuses have been found in which the connection between the link and the shell was not firm, with the result that arcing, causing radio interference, took place in the fuse.
7. Be sure that all wiring connections to branch cut-outs and mains are firmly made.
8. Be sure all lamps are screwed firmly into their sockets. Tap each lamp on the side to locate possible loose connections within the lamp. If such loose connections are found, the lamp should be discarded.
9. Examine all attachment plugs of floor or desk lamps and appliances, making sure that the prongs make firm contact with the receptacles, and that the terminal screws are holding the cord conductors firmly.
10. Examine all lamp and appliance cords, making sure that they are not worn excessively and that there are no possible strands from one conductor making a high resistance contact with the opposite conductor.

NOTE: It is particularly important that lamp cords or other portable cords be maintained in the best possible electrical and mechanical condition as defects in such cords may create a serious fire hazard as well as considerable radio interference. Figure 5 shows a condition often found when unapproved lamp cords have been in use for long periods of time.

When all of the building wiring and home appliances have been inspected, and the necessary corrections made, a material decrease in noise level is likely to

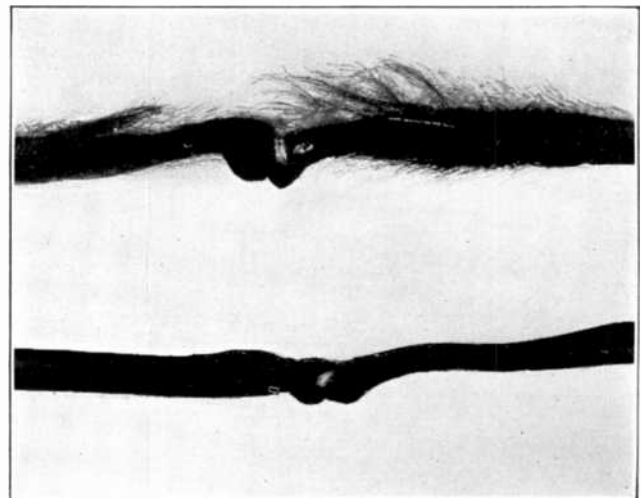

FIG. 5. Badly worn lamp cords are fire hazards as well as sources of interference. Be sure lamps and appliances have approved cords.

result, the reason being that many of the possible loose connections in the antenna system have been eliminated.

Q. Besides the "loose antenna connection effect" just described, what other form of interference may be created by defective building wiring?

A. The second way of looking at this local interference problem is by consideration of the two fundamental sources of radio interference. In the final analysis, it may be shown that interference is the result of an interruption to the flow of current along a conductor, or to the discharge of potentials accumulated on a conductor. These phenomena may occur in the building in which the receiver is located and may thus be coincident with, and indistinguishable from the disturbance due to the loose antenna connections previously discussed. In other cases, however, they will occur in neighboring buildings or at such distance from the receiver that they cannot be considered as loose antenna connections. Under these circumstances the way interference is distributed must be taken into consideration in deciding upon the best method of obtaining relief from this interference.

Interference due either to the making or breaking of an electrical circuit or to the discharge of a potential from one conductor to ground or to another conductor may be carried along any of the conductors in which

the effect takes place and may be radiated from them. This radiated interference may be transferred either inductively or capacitively to other wiring circuits and the interference may thus be spread over a wide area. If any of the circuits on which this interference is traveling enter a building in which a receiver having a short indoor antenna is located, it is then evident that the antenna system of the receiver in addition to accumulating broadcast energy, is carrying undesired electrical disturbances which

are likely to interfere seriously with the reception of the desired signal.

Q. How may interference traveling on, or radiated from building wiring be overcome?

A. When radiated interference is considered, the first thought is usually to provide shielding for the apparatus thus confining the radiant energy as closely as possible to its point of origin. While with some types of interference this shielding is not only theoretically advisable but is a practical necessity, it is obviously impossible to shield all wiring on which interference may be carried. Under these circumstances, it appears to be necessary to locate the source of interference and there to take such steps as may be necessary to prevent the distribution of interference along wiring systems.

If the interference is due to the discharge of a potential from one conductor to ground or to another

conductor, there are two possible methods of overcoming this interference, both of them involving the prevention of the discharge. The first is by providing suitable insulation between the two conductors, and the second is by bonding them together. Two concrete examples of interference due to such a potential discharge as has just been described are as follows:

A broadcast listener found that whenever a certain hot water faucet was used radio reception was impossible. Examination disclosed the fact that a section of armored cable in the wall containing the hot water pipe feeding this faucet was not properly grounded. This cable was so located with relation to the hot water pipe that the slight vibration caused by the flow of water caused an intermittent contact between cable and pipe, allowing the discharge of a low potential from the armor of the cable to the water pipe. Grounding the cable sheath provided relief from the interference.

In another instance it was found that radio reception was out of the question when an electric refrigerator was being used. Examination of the refrigerator showed that the motor and thermostat were in perfect condition, so that interference should not have been caused by this installation. In checking, it was found that the interference continued after the refrigerator had been entirely disconnected from the power line, and that this interference was noticeable as long as the compressor motor continued to rotate. Further examination of the refrigerator installation disclosed the fact that although the armored cable connected to the refrigerator was properly grounded, the refrigerator frame was not grounded. The result was that as long as the compressor motor rotated, the spring supports on which the compressor assembly was mounted allowed the mechanism to vibrate and make intermittent contact with the sheath of the armored cable. Bonding the cable to the compressor assembly removed all trace of interference.

It is, therefore, obvious that if freedom from interference is to be obtained, all metal objects likely to accumulate electrical charges should be grounded or should be so installed that there is no possibility of a potential discharge. Of the two methods, grounding is preferred. The broadcast listener or radio dealer may, by examination of the building in which the receiver is located, make sure that the potential discharges just described are not likely to occur.

Q. After defects in building wiring have been located and removed, what further procedure is required in the home?

A. There then remains the necessity for preventing the distribution of interference caused by interruptions to the flow of current along a conductor. This is accomplished by the application of suitable Filterettes to the pieces of electrical apparatus in which these current interruptions occur. The application of a properly designed Filterette will not only prevent the distribution of interference along the wiring to which the appliance is connected, but will also reduce, to a great



FIG. 6. Small fans, employing series-wound motors, cause much interference. Larger fans, using induction motors, seldom cause interference.

RADIO NOISES AND THEIR CURE

extent, the loose antenna connection effect of the appliance operation.

With the exception of the electric refrigerator and the oil burner, a large majority of the household appliances in common use are operated by series wound or universal motors. Among the household appliances operated by this type of motor are the vacuum cleaner, electric egg beater, humidifier, drink mixer, and fruit juice extractor. By operating each of these appliances while the radio receiver is in use, the effect of the disturbance they create may be clearly observed. This disturbance is generally due to the two effects already described; the first that of a loose antenna connection, and the second the generating of a radio frequency impulse by the household appliance.

Since the radio frequency energy thus developed may be radiated from all wiring to which the appliance is connected, it is obvious that the Filterette which is to prevent this disturbance from reaching the receiver must be installed as close as possible to the point at which the interference originates. In the case of a series motor, the interruptions to current flow occur at each brush. The Filterette must, therefore, be connected as close as possible to the motor brushes. If the Filterette is located at the end of a long attachment cord, it is evident that a considerable length of lead

between interference source and Filterette may allow the radiation of much interference. This might be suppressed by shielding the attachment cord, but since this procedure would decrease the flexibility of the attachment cord as well as increasing its cost, it is not to be recommended. A more satisfactory result will be obtained if the Filterette is connected in the attachment cord within a few inches of the point where this cord connects to the motor. Many appliances, particularly vacuum cleaners, are provided

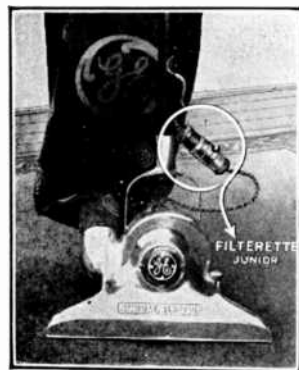

Fig. 7. Application of Filterette Junior to a vacuum cleaner. Note the return wire from the Filterette binding post to the motor frame.

with a separable connector at the point where the attachment cord connects to the motor. This renders the application of a Filterette a simple matter. Figure 7 shows the simplest possible Filterette correctly installed at the motor of a vacuum cleaner. In order to prevent the interference from traveling beyond the Filterette and being distributed along the building wiring, a return connection is provided to allow the return of the interference to the point at which it originates. In effect, the use of a Filterette in connection with a household appliance provides a low impedance path for the return of the radio frequency current to the frame of the appliance, thus keeping the interference out of the building wiring. The loose

antenna connection effect is largely overcome by the bypassing of high frequency currents by the Filterette.

By filterizing all of the electrical apparatus in the home, and by following the procedure recommended for the care of electric wiring and appliances, the individual broadcast listener can not only be more certain of satisfactory radio reception, but can effectively reduce the noise level in his community. And if the old saying about the beginning of charity is true, the individual should take every possible precaution to prevent the production of radio interference by wiring defects in his own home, and to suppress such interference as may be due to the normal operation of household appliances.

Statistics indicate that more than half of all interference arises in the home. It therefore behooves every broadcast listener to clear interference from his own home in order that appeals to others in behalf of improved radio reception may be given the attention they deserve.

Oil Burners

Q. What parts of an oil burner may cause radio interference?

A. Interference may be caused by the pump or blower motor, by the ignition system, or by a portion of the temperature control apparatus.

Q. How may motor interference be traced?

A. The interference due to the motor is usually in the form of a crackling or a siren-like whining noise, which remains at a steady intensity during the entire period that the oil burner is in operation. This type of interference is particularly likely to occur when the motor is operated from direct current. If the motor is operated from alternating current, the interference from the motor should not be continuous.

Q. How does the heat control apparatus create interference?

A. The only type of heat regulating apparatus which consistently causes objectionable radio interference is that which employs a small motor. This is usually of the series-wound type, and generally causes an interference which is heard as a loud roaring noise, usually lasting from 20 to 100 seconds.

Q. How may interference from this apparatus be suppressed?

A. A capacitive type Filterette such as Tobe Filterette No. 11 is usually satisfactory for suppressing the interference from this type of apparatus, although in extreme cases, a Filterette of the inductive capacitive type such as Tobe Filterette No. 110 is required. In

either case the Filterette should be connected directly at the power input to the motor, and its return lead should be connected to a carefully cleaned part of the motor frame.

Q. Do thermostatic heat controls cause interference?

A. Sometimes. It may be that the contacts open slowly so that an arc is produced, causing interference.

Q. How may this interference be suppressed?

A. This condition may usually be overcome by an adjustment of the apparatus. It is not advisable to cover up an inherently wrong condition such as this by use of a Filterette.

Q. In what way is interference from electrical ignition systems indicated?

A. This interference is usually heard as a loud roaring noise, which may continue from 15 to 60 seconds, or during the entire period during which the oil burner is in operation. The duration of the interference from the ignition system will be dependent upon the type of electric ignition employed.

Q. Must a separate Filterette be used for suppressing the interference from each part of the oil burner installation?

A. No. A Single No. 110 Filterette so connected that it is carrying the entire load of the oil burner should satisfactorily suppress the interference from all parts of the burner. When a single Filterette is used, its return wire should be connected to the frame of each motor, and to the metal case of the ignition transformer.

Q. Is a separate ground connection required for a Filterette?

A. No. In fact it is not advisable to make such a connection. The loose wire provided in the Filterette is correctly termed a return lead, and should be connected to the frame of the interference-creating apparatus at a point as close as possible to that at which the interference is arising. In some cases it has been found that the use of a separate ground connection or a

long return connection to the Filterette would cause an apparent increase in interference.

One of the cardinal rules for successfully eliminating radio interference is that which states that all leads between the Filterette and the apparatus to which it is being applied should be kept as short as possible and the return connection to the Filterette should be run in the most direct manner possible to a carefully cleaned part of the frame of the interference-creating apparatus.

Q. How may the exact source of the interference from an oil burner installation be determined?

A. Any of the parts of the burner may be operated independently, and the amount of interference during this independent operation may be observed. Care should, of course, be taken that the fuel supply is shut off before this experimental work is done, otherwise, a dangerous situation may arise.

Q. If, after following the instructions given, the interference still exists, what further steps should be taken?

A. Particular care should be given the arrangement of all leads between the Filterette and the oil burner in order that there may be no coupling between input and output leads or between input leads and the return wire. Special attention should be given the manner in which the return wire is connected to the frames of the various devices in the burner. The leads from the temperature control apparatus should be so arranged that they do not couple with any of the leads which may be carrying interference currents. When the temperature control relays are energized from a small step-down transformer the primary of this transformer should be connected at the line side of the Filterette. In extreme cases it may be necessary to connect a capacitive type Filterette across the thermostat leads. This condition, however, rarely exists and should it be encountered, full details should be sent to Tobe Deutschmann Corporation of Canton, Mass., who will make special recommendations.

Q. In practical Filterette installations, what are the important differences between various types of domestic oil burners?

A. The principles involved in the elimination of interference created by oil burners apply, with a few minor variations, to all of the burners now on the market. The following outline of the sources of interference in any burner may be taken as a guide to the procedure necessary for solving any oil burner interference problems.

Interference from an oil burner may be due to the operation of the blower, the temperature-control system, or the ignition system. The amount of interference from each of these sources will depend upon the construction of the burner and the type of blower, temperature-control, and ignition system used. The blower motor, in most cases, creates interference only for a few seconds or for a fraction of a second at the instant of starting. The reason for this is that the motor commonly used for operation of the blower is generally so constructed

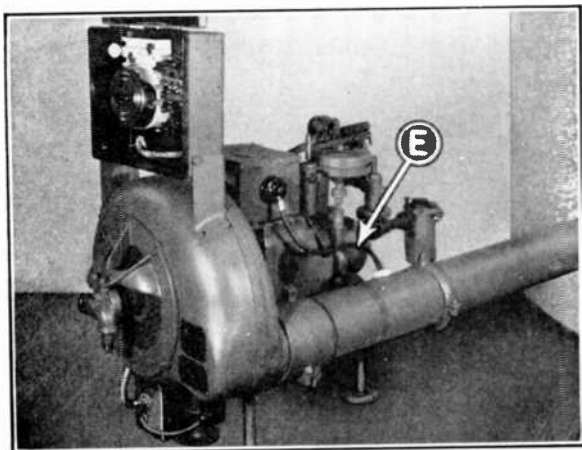

FIG. 8. Oil burner using grounded electrode type of electric ignition. Note length of high tension cable "E".

that the starting brushes lift clear of the commutator as soon as the motor reaches its normal speed. Some motors do not use a brush-lifting mechanism, but contain a centrifugal switch which opens the brush circuit as soon as normal running speed has been reached.

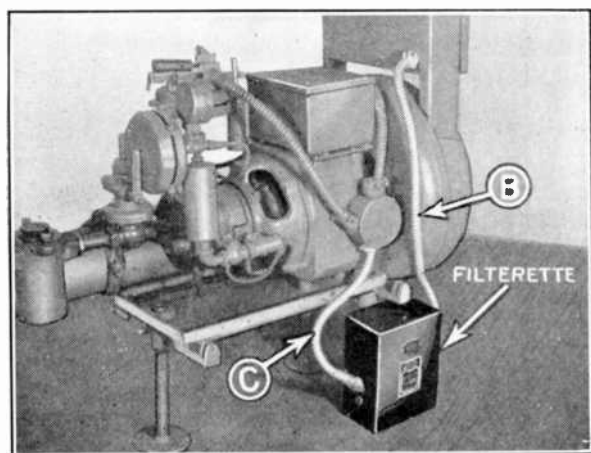

FIG. 9. Application of Filterette OB-110 to the oil burner shown in Figure 8. BX must be used in the installation of this Filterette.

Motors of this type are likely to cause interference during their entire period of operation. In order to prevent the feed-back of interference from the motor into the power line, from which it may be radiated, a Tobe Filterette No. 110 should be connected directly in series with the input leads to the motor. If a direct current motor is used, interference will probably be in evidence whenever the motor is running. In this case the same type of Filterette as is used for the A. C. motor will be required. Care must be taken in the choice of the Filterette used that its current-carrying capacity is sufficient to handle the normal running current of the motor.

The temperature-control system seldom creates interference other than a single click at the time of starting or stopping the burner. Some burners, however, employ a motor-driven temperature control which may cause considerable interference. The motor used for the operation of this control is usually a small series-wound unit of approximately 1/20 H. P. A Filterette No. 110 will be required for suppressing the interference from this motor. The connection most commonly used with this type of installation places the Filterette in series with the main feed line to the burner so that the current to both blower and heat control motor will pass through the Filterette.

Ignition System

Ignition systems may be broadly classified as gas pilot or electric. Gas pilot ignition creates no interference. Electric ignition may be further divided into constant spark and intermittent spark, grounded electrode and ungrounded electrode. As the principles governing the elimination of interference caused by the

various types of electric ignition do not differ materially the procedure outlined below may be followed in the treatment of all cases of ignition interference. Ignition interference presents a two-fold radiation problem, since all wiring connected to the ignition system carries interference. The first step to be taken in suppressing this interference is the application of a suitable Filterette to prevent its conductive impression on the power line and thermostat wiring. A Filterette No. OB-110, connected directly in series with the power input leads to the transformer will accomplish this result.

To be effective Filterette OB-110 must be mounted as close as possible to the ignition transformer. The wiring which connects the Filterette to the transformer must be carried in conduit or BX. The metal housing of the Filterette must be bonded to the conduit or BX sheath and also to the metal case of the ignition transformer. To complete the Filterette installation both return wires must be connected from the Filterette to the same point on the transformer case. If a grounded lug is provided, the Filterette return wires should be soldered to this lug; otherwise, a lug should be soldered to the end of each return wire and both lugs should be fastened under one of the mounting screws of the transformer. Before fastening the lugs in place, all of the finish must be removed from the point on the transformer case at which contact is to be made. Be sure to use a lock washer to prevent loosening of the contact.

Importance of Return Connection

At this point it should be clearly understood that the question of circuit resistance has a decided bearing on the treatment of filtering problems. The frequencies which are responsible for radio interference have entirely different characteristics from the frequencies (25-60 cycle) generally used for power transmission. Resistance, so slight as to be negligible at power line frequen-

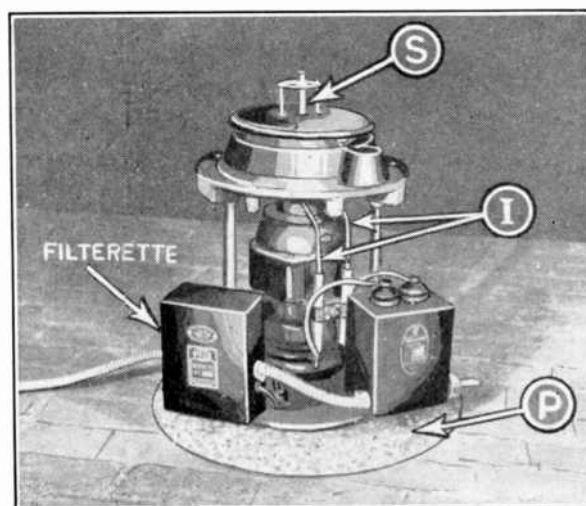

FIG. 10. Installation of Sunflower type oil burner with Filterette and shielding base plate. Galvanized iron screening may be substituted for the metal plate shown at "P".

RADIO NOISES AND THEIR CURE

cies, cannot be tolerated in the return circuit of a Filterette. Minimum contact resistance and length of return wire are, therefore, of extreme importance in order that a satisfactory shunt path may be provided for the localizing of interference frequencies.

Satisfactory grounding of power circuits does not mean that disturbing impulses will be carried to ground thru this circuit. Grounding the return wire of a Filterette does not constitute a satisfactory filtering circuit, as it is necessary to provide a path of low resistance for the return of interference to its source.

Whatever interference remains after the Filterette has been correctly installed will be due to radiation from the higher potential circuit, including the transformer terminals, firing points, and connecting leads. As it is not advisable to connect filters in this circuit, shielding must be used to confine the interference fields to the immediate vicinity of the burner. The amount and type of shielding to be used will depend upon the manner in which the ignition system is installed and upon numerous local conditions which will vary with every installation.

Shielding of High Tension Wiring

In order to be sure that no possibility of interference radiation exists, the entire high potential side of the ignition system should be completely enclosed in metal. The high tension leads are often carried partly within the fuel tube so that some shielding is obtained. The ignition leads not contained within the fuel tube or within a metal housing should be carried in separate flexible metal conduits extending from the transformer terminals to the point at which the high tension leads enter the tube. These conduits should be bonded together and to the burner frame at several points and should be so spaced from the transformer terminals and high tension conductors that there is no possibility of spark discharge from the high potential system to the shielding. The spacing between the conductor and the

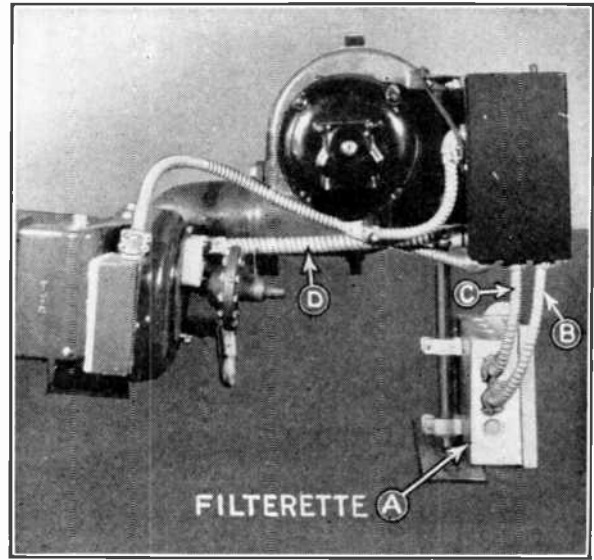

Fig. 11. Filterette OB-110 applied to an Electrol Model TJ oil burner. Removable mounting brackets are shown at "A". Flexible metal conduit shielding high tension cable is shown at "D".

shield is best accomplished by the use of rubber tubing placed over the high tension lead. The minimum size of flexible conduit recommended for shielding is $\frac{3}{4}$ ".

Some burners (Petro) employ a high tension ignition cable having a metallic braid covering which is terminated about two inches from the ignition transformer, at one end, and the same distance from the point at which the cable enters the fuel tube, at the other end. This braid is of little value in preventing the radiation of interference because of the length of unshielded cable which remains. If satisfactory suppression of radiated interference is to be obtained, this type of high tension cable should be shielded exactly as described in the preceding paragraph.

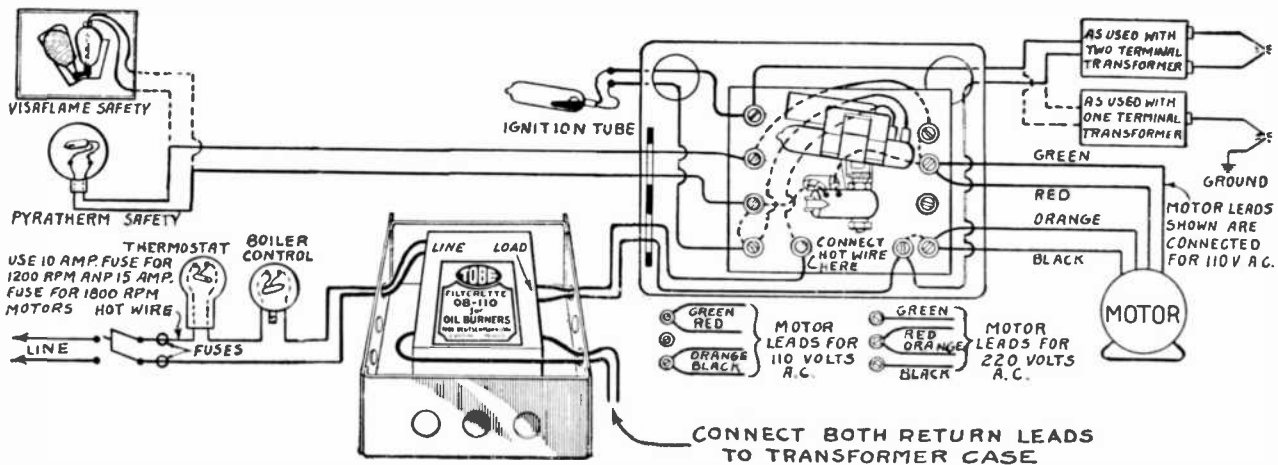

Fig. 12. Wiring diagram showing the location of Filterette OB-110 in the electrical circuit of a Williams Oil-O-Matic Model J or a Model JR burner, equipped with a Visafame combustion or Mercoid Type M-1 Pyrratherm stack safety.

RADIO NOISES AND THEIR CURE

In some cases it will be found that enough interference may be radiated from the high potential terminals of the ignition transformer to nullify the effect of the Filterette and of the shielding applied. When such a case is encountered, a metal housing completely enclosing the high potential terminal and bonded to the transformer case and to the shielding of the high potential leads will be required. When such a housing is employed it must be spaced at least 1½" from the high potential terminals.

Occasionally, it will be found that the furnace wall tends to act as a radiating surface for interference. It is, therefore, advisable to bond the furnace wall to the burner frame. The question of the use of a ground will depend largely upon local conditions. If a good ground is available close to the burner it may be advisable to ground the entire installation. If the ground is located at a considerable distance from the burner, grounding may intensify the interference due to possible radiation from the long ground lead used. When this condition exists, it may be necessary to drive a ground beside the burner, if satisfactory interference elimination is to be obtained.

In commercial practice, it has been found that in most cases interference from A. C. operated burners is due entirely to the ignition system and that the possibility of interference from blower motor or temperature control equipment may be ignored.

Williams Oil-O-Matic Burner

The Williams Oil-O-Matic Burner shown in Figure 8, is an excellent example of a modern oil burner, the interference from which is caused by the ignition system only. In the case of this burner, the interference is fed back into the power supply line and also into the leads from the burner to the room thermostats and is radiated from these lines. The use of Tobe Filterette No. OB-110, connected in the wiring circuits, as shown in Figure 9, and Figure 12, effectively prevents the feedback of interference to power line or thermostat wiring. There then remains the possibility of direct radiation of interference from the high voltage side of the ignition system, the high potential lead of which is shown at "E" in Figure 8. If the burner were left as shown in this figure, it would be necessary to shield the high tension lead and transformer terminal as previously described. Fortun-

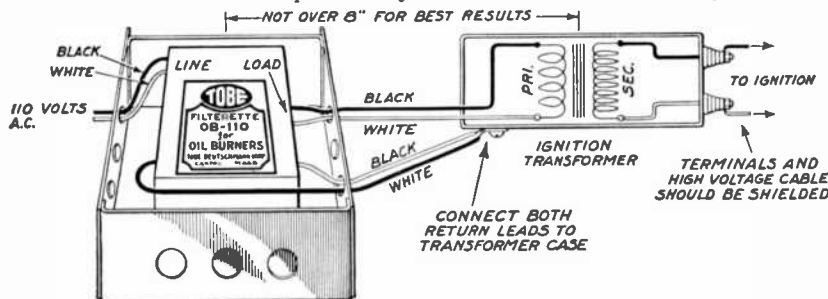

FIG. 13. Standard connection diagram for Filterette OB-110. For maximum satisfaction, BX must be used throughout.

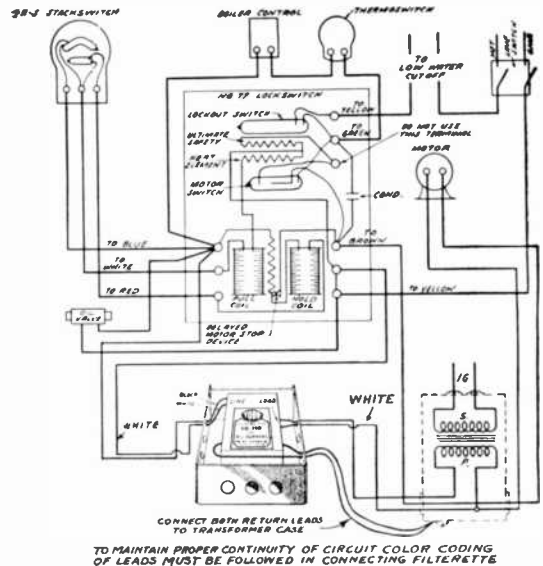

FIG. 14. Wiring diagram showing the location of Filterette OB-110 in the electrical circuit of a Super Oil Heater. Filterette leads are color coded to ensure proper continuity of circuit.

ately, however, the construction of this burner is such that direct radiation of interference is prevented by a metal housing. This housing, which is bonded to the burner frame, completely encloses all high tension leads and provides adequate shielding to prevent direct radiation of interference. Figure 9 shows the changes to be made in the BX wiring of the burner when Filterette No. OB-110 is connected at the power input to the ignition transformer.

When the Filterette is installed in accordance with these instructions, and when the metal housing is in place, there should be no trace of interference from this burner. If any interference remains after the procedure recommended has been followed, one of two further precautions should be taken. The first is the bonding of the neutral input lead of the ignition transformer to the burner frame. The other is the grounding of the entire burner installation. If maximum satisfaction is to be obtained, it will be necessary that this ground be independent of all building wiring and water systems.

Electrol Oil Burner

The Electrol Model T.J Oil Burner, shown in Figure 11, is an excellent example of a burner employing the ungrounded double electrode type of electric ignition. In order to prevent the radiation of interference from the high potential leads of the ignition system of this burner, the leads should be carried in separate pieces of flexible metal conduit not smaller than ¾" in diameter. These conduits should

extend from the transformer terminals to the point at which the leads enter the fuel tube. They should be bonded together at both ends and in the middle, and should also be bonded to the burner frame. In applying the shielding, care must be taken that the

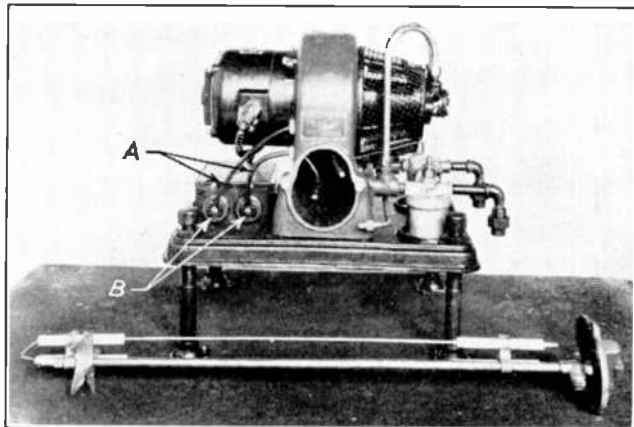

Fig. 15. Oil burner using double electrode type ignition system. Transformer terminals "B" and high tension cables "A" must be shielded to prevent radiation of interference.

spacing provided by the manufacturer between the burner frame and all live portions of the high voltage system is maintained. The location of this shielding is shown at "D" in Figure 11. In order to prevent the feedback of interference into power lines and thermostat wiring, Filterette No. OB-110 should be connected directly in series with the power input leads to the ignition transformer. The simplest method of making this connection is shown in Figure 11, "A" being the Filterette, and "B" and "C" two short pieces of two-wire BX connected to knockouts in the bottom of the terminal block housing. The return wire from the Filterette must be connected to a carefully cleaned part of the transformer case if the Filterette is to be effective.

In the case of this burner it is essential that the neutral lead of the ignition transformer primary be connected to the burner frame. Before making this connection a test should be made to determine whether or not the neutral is grounded. If it proves to be ungrounded, the connection previously described should be made through a 1 microfarad condenser having a D. C. working voltage of not less than 400 volts.

Super Oil Heater

The Super Oil Heater is representative of the third type of burner likely to be encountered. This burner, shown in Figure 10, is wholly contained within the furnace. The ignition system of this burner consists of the high tension transformer; two stationary electrodes, "I" and a rotating disc "S"; the spark discharge occurring from either electrode to the disc. Since none of the wiring of this burner is carried outside the furnace, the only shielding required is a metal plate, "P", covering the entire bottom of the furnace, and bonded to the

furnace wall and burner frame. If it is difficult to install a plate of sheet metal, galvanized iron screening may be used. Tobe Filterette No. OB-110 connected directly in series with the power input leads to the ignition transformer, as shown in Figure 14, completes the interference elimination from this burner. The Gulf Oil Burner also comes under this classification.

General Precautions

The burners described in this bulletin include all types of oil burner construction likely to be encountered, and the service man should have no difficulty in solving any oil burner interference problem by comparing the characteristics of the burner in question with those of the burners described in this bulletin.

The important features to remember are the three possible interference sources in an oil burner installation, and the fact that interference may be carried on any part of the wiring circuit associated with the interference source. The most common source of interference from an oil burner is the ignition system. This interference may be suppressed by use of Filterette No. 110 at the power input leads to the ignition transformer in conjunction with suitable shielding of the high tension circuit. If, in addition to ignition interference, motor interference is present, it will probably be necessary to apply an additional Filterette to the motor. This Filterette should also be of the inductive-capacitive type and may be Tobe Filterette No. 110 or No. 221, depending upon whether the motor is operating from a 110 volt or 220 volt line.

Electric Refrigerators

Q. Do electric refrigerators cause radio interference?

A. When A. C. operated electric refrigerators are in perfect electrical and mechanical condition, they do not cause radio interference except during a period of a few seconds only when the motor is starting, that is, while the motor is attaining its running speed. The motor used with an electric refrigerator is commonly the repulsion-starting, induction-running type employing a centrifugal switch which cuts out the starting mechanism when the motor has attained its normal speed. However, when the motor has been in operation for some time, it is likely to become a creator of radio interference. This condition may be remedied by a thorough overhauling of the motor. However, due to the location of the motor, it is exposed to dirt and moisture and consequently, such overhauling would have to be done frequently. For this reason it is expedient to apply an external device for the elimination of radio interference. Refrigerators operated from direct current are likely to cause continuous interference.

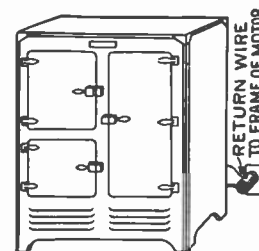

Fig. 16. Tobe Filterette Senior applied to an apartment house refrigerator.

RADIO NOISES AND THEIR CURE

Q. How may the interference from this type of refrigerator be eliminated?

A. Provided the refrigerator is operated from a 110 volt line, Filterette No. 110, which is of the inductive-capacitive type may be applied to suppress the radio interference. If the refrigerator is operated from a 220 volt line, Filterette No. 221 is the correct type.

Before applying a Filterette, however, a careful check should be made to determine the current and voltage requirements of the machine in order that the Filterette installed may not be overloaded.

Q. How should the Filterette be installed?

A. The Filterette should be mounted as close as possible to the motor and its return wire should be connected to a carefully cleaned part of the motor frame.

If the refrigerator is of the type which is connected to the power supply by means of a cord and plug, Filterette No. 110 P. O. may be used. If this is done, the Filterette should be plugged into the receptacle from which the refrigerator was supplied with power, and the attachment plug of the refrigerator should be inserted in the receptacle provided on the Filterette.

A wire should also be run from the binding post on the Filterette to a carefully cleaned part of the motor frame.

Care should be taken that no coupling exists between the input and output leads to the Filterette and that all leads between the Filterette and the interference-creating apparatus are kept as short as possible.

Q. If interference is in evidence after the Filterette has been applied, what steps should be taken?

A. If, after the recommended Filterette has been carefully installed, some interference exists, it is likely that this interference is not being created by the motor.

Certain types of refrigerator employ a spring suspension for the mounting of the motor. In some cases a weakening of one or more of the springs will cause a periodic contact between the motor frame and the refrigerator frame. The result of this contact will be a fairly steady interference, which may appear to be caused by the motor, due to the fact that it is noticeable only when the motor is in operation. This interference, of course, may not be suppressed by use of a Filterette but will require mechanical adjustment of the apparatus.

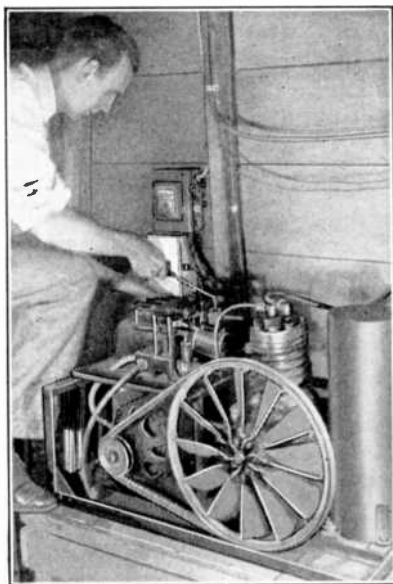

FIG. 17. Application of Tobe Filterette No. 110 to a commercial refrigerator unit.

To overcome this interference the two parts of the installation which are making intermittent contact should be bonded together so that they will be kept at the same radio-frequency potential at all times.

Home Appliances

Q. What apparatus in the home besides the oil burner and refrigerator may be responsible for radio interference?

A. The dial telephone, vacuum cleaner, sewing machine, dish washer or clothes washer, electric mixer or beater, fruit-juice extractor, hair dryer, heating pad, small fan and all appliances employing small motors are likely to create considerable radio interference.

Q. How may the interference from this apparatus be suppressed?

A. In practically all cases a Filterette Junior connected at the power receptacle from which the device is supplied with current, and having its return connection made to the frame of the apparatus, will provide complete elimination of the interference.

Q. If, after the application of the Filterette Junior, some interference remains, what procedure should be followed?

A. The Filterette should be installed so that the connecting lead between the Filterette binding post and the frame of the machine is not over six inches in length. This, of course, may be done experimentally by coiling the attachment cord of the machine into the smallest possible space.

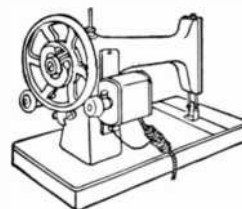

FIG. 18. Filterette Junior applied to a sewing machine.

If this procedure is found effective, the cord should then be cut close to the motor and the Filterette inserted in the cord. If it is desirable to avoid cutting the cord, Filterette JA may be mounted on the frame of the appliance. The application of Filterette JA to a small mixer is shown in Figure 20.

If the interference persists, a Filterette of the inductive-capacitive type will be required. The Filterette Senior is the correct type for this purpose.

For most household apparatus a Filterette Senior

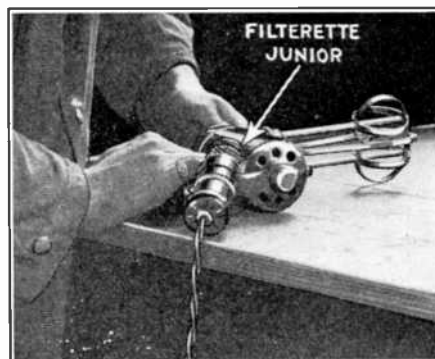

FIG. 19. Filterette Junior applied to an electric egg beater.

connected in the same manner as the Filterette Junior will handle the most stubborn case of interference.

Q. What will govern the choice of a Filterette for application to household appliances?

A. As a rule, the smaller household appliances employing series-wound or universal motors may be effectively silenced by means of the Filterette Junior. Larger appliances, employing repulsion-induction motors, will require the use of inductive-capacitive type Filterettes. In many cases the Filterette Senior will be suitable for application to these devices. However, before applying this Filterette, careful note should be made of the voltage and current requirements of the apparatus for which the Filterette is required, in order that a Filterette having sufficient current carrying capacity may be used.

Q. Why not apply a Filterette to the receiver rather than to each of the appliances in the house?

A. Although the interference from household appliances is fed back into the power line, it is seldom impressed on the receiver through its connection to power line. This may be proved by disconnecting the antenna and ground from the receiver and short-circuiting the antenna and ground posts of the set.

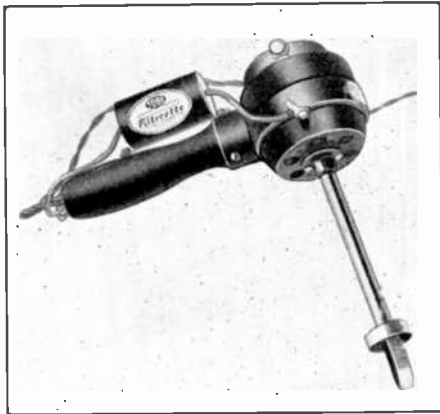

FIG. 20. Filterette JA mounted on the handle of a small mixer.

When this is done, no signal, either broadcast or interference, should be heard.

This indicates that the interference is being introduced into the receiver through the antenna and ground system rather than through the power supply. It is, therefore, obvious that the interference must be prevented from being fed back into the power line from which it may be radiated to the antenna system of the receiver. In cases where radio interference enters the receiving set through the outside antenna and the interference source cannot be located the use of Tobe Filterette No. 110 P. L. in conjunction with a shielded lead-in frequently provides a considerable reduction in interference. Full details are contained on pages 54-56.

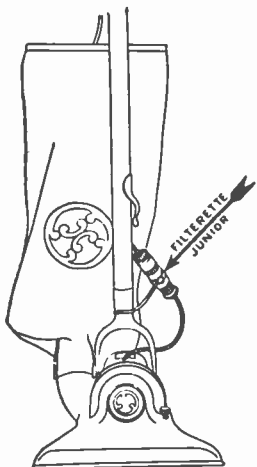

FIG. 21. Filterette Junior inserted in the attachment cord of a vacuum cleaner.

Hair Dryers

Q. How may the interference created by an electric hair dryer be identified?

A. A heavy rushing sound of varying pitch and intensity usually indicates that an electric hair dryer is being operated.

Q. What causes the variation in the sound of the interference?

A. This change is due to the operation of the motor at different speeds and changing loads.

Q. How is the interference from a hair dryer distributed?

A. This interference, which is due to the operation of the blower motor, is fed back into the building wiring, and is also impressed on the heating element and heater wiring from which it is radiated.

Q. How may the interference be suppressed?

A. In the case of a small portable dryer such as may be used in the home, a Filterette Senior connected in series with the attachment cord of the dryer and located as close as possible to the dryer should provide satisfactory reduction of interference. In the case of larger dryers, such as are used in beauty parlors, it is necessary to use a special type Filterette.

Q. How is this Filterette installed?

A. This Filterette is mounted within the base of the dryer and is connected in the electrical circuit as shown in Figure 23. The construction of this Filterette is such that it prevents the feed back of interference from the motor to the power line as well as to the heating element and heater wire. Due to the peculiar intensity of the interference created by a hair dryer, it is necessary to use an inductive-capacitive type Filterette. If this Filterette were installed in the main line to the

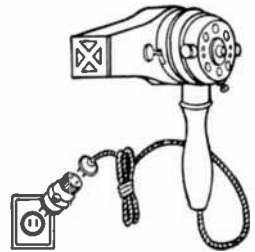

Fig. 22. Small hair dryer filterized by Filterette Junior.

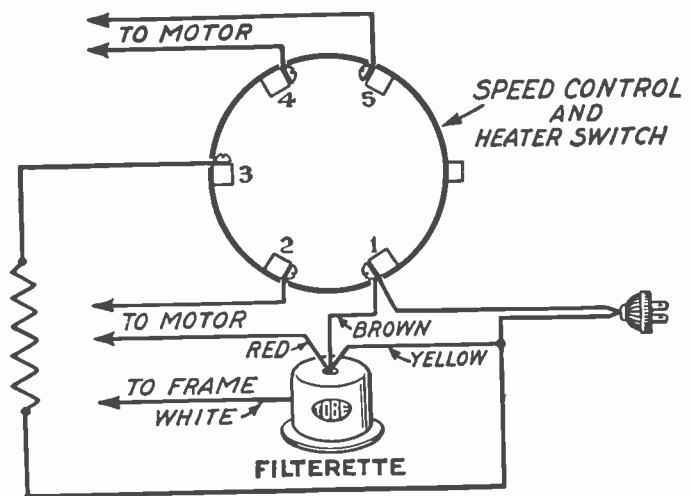

FIG. 23. Application of Filterette S-2 to a variable speed hair dryer.

dryer, it would be required to handle the heavy current drawn by the heating element. Filterette S-2 shown in Figure 23 is so installed that it handles only the current to the motor, thus making it possible to obtain effective filtering in the limited space available.

Barbers' Clippers

Q. How may interference from barbers' clippers be suppressed?

A. In practically all cases a Filterette Junior installed as close as possible to the motor which operates the clipper will provide satisfactory elimination of the interference. In some cases, however, a Filterette of the inductive-capacitive type, such as the Filterette Senior is required. This Filterette should be installed in the same manner as the Filterette Junior.

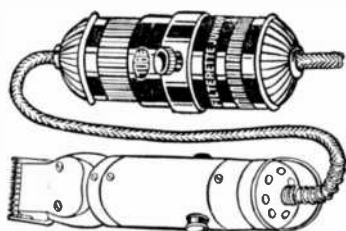

FIG. 24. Filterette Junior applied to barber's clipper.

Q. What governs the choice of the Filterette?

A. There is no hard and fast rule by which you may determine whether to use the Filterette Junior or Filterette Senior. In general, however, it may be said that if any sparking is visible

when the clipper is in operation, a Filterette Senior will be required for suppressing the interference from this apparatus.

Q. Where should the Filterette be installed?

A. In some cases the Filterette may be installed at the end of the attachment cord of the apparatus, but it is usually advisable to cut the attachment cord at the motor and insert the Filterette at this point. If desired, Filterette JA may be mounted directly on the frame of the clipper.



FIG. 25. Installation of Tobe Dial Filterette in the base of a dial telephone.

Q. Must the Filterette be grounded?

A. No. In many cases the return wire may be omitted. When it is used it should be connected to the motor frame rather than to ground.

Automatic Dial Telephones

Q. Does the dialing operation of a dial telephone cause radio interference?

A. Yes.

Q. How may this interference be identified?

A. This interference is heard as a series of clicks, corresponding to the number being called.

Q. How may this interference be suppressed?

A. By the installation of Tobe Dial Filterette.

Q. How may this special Filterette be installed?

- A. 1. Remove the three screws from the telephone stand base as shown in Figure 26 and remove the base of the instrument.
2. Remove the screw marked "C" in Figure 27. Insert this screw into the metal tab of the Filterette, replace the screw and set it up tight holding the Filterette in place as shown.
3. Loosen the screw "B". (Fig. 27) remove the yellow striped wire, and fasten it under the binding post "D" on the Tobe Filterette.
4. Take the "Red" lead of the Tobe Filterette and fasten it under the head of the screw "B".
5. Take the "Black" lead of the Tobe Filterette and fasten it under the head of screw "A". Do not remove the wire lead which is already connected to screw "A".
6. Replace the base cover with the three screws.

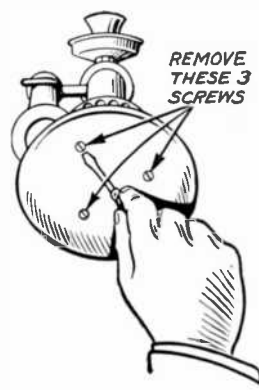

FIG. 26. How to remove base of dial telephone.

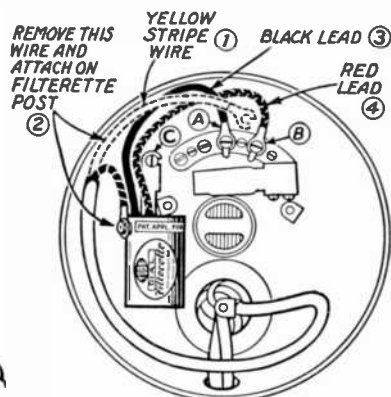

FIG. 27. Wiring of Tobe Dial Filterette.

This Filterette, when installed as outlined above, will not interfere in any way with the operation of your telephone or with the transmission of speech frequencies.

Cash Registers

Q. Why does a cash register cause interference?

A. Radio interference from a cash register is caused by the motor used for its operation.

Q. How may this interference be eliminated?

A. In practically all cases this interference may be suppressed by use of a Filterette Junior.

Q. How should this Filterette be applied?

A. The Filterette should be plugged into the power receptacle to which the cash register is connected. The attachment plug from the cash register should then be plugged into the Filterette Junior. A wire should be run from the binding post on the Filterette Junior to the frame of the operating motor. In some cases the motor is inaccessible. In such cases, the Filterette return wire may be connected to the metal frame of the register.

Care must be taken that the return connection is made to a portion of the register frame which is in contact with the motor frame.

RADIO NOISES AND THEIR CURE

Q. Suppose the use of a Filterette Junior at the power receptacle does not completely eliminate the interference?

A. Should this condition exist, it may be due to the radiation of interference from the attachment cord. This condition may be remedied by cutting the cord at a point close to the machine and inserting the Filterette Junior at this point. The return connection from the Filterette should be made in the manner previously described.

Q. If, after this has been done, the interference persists, what is the next step?

A. In cases where the register is equipped with an automatic speed control motor, we recommend that a Tobe Filterette No. 110-NC be installed. This will also apply to other cash registers on which the Filterette Junior does not eliminate the interference completely.

Q. Is the return connection from the Filterette always necessary?

A. No, but in most cases its use will be found to provide more satisfactory elimination of the radio interference.

Q. Will the Filterette be harmed if the return connection is not used?

A. No. If the interference is eliminated without the use of the return connection, this connection may be omitted with complete safety.

Q. May one Filterette be used for suppressing the interference from several pieces of apparatus?

A. In some cases a single Filterette may be used for suppressing the interference from several devices, although its use is not likely to be as satisfactory as though a single Filterette were used for each machine.



FIG. 28. Filterette NC-110 applied to a cash register.

Q. What other store or office appliances may create interference?

A. Most of the electrically operated apparatus used in an office is likely to create radio interference. Adding machines, billing machines, dictaphones, addressing machines, bookkeeping machines, posting machines, counting machines and mailing machines are all likely to be responsible for some radio interference. The application of a Filterette Junior to a dictaphone is shown in Figure 29.

Q. How may interference from this apparatus be suppressed?

A. In most cases the procedure described for suppressing radio interference from an electrically-operated cash register may be used with complete satisfaction for suppressing

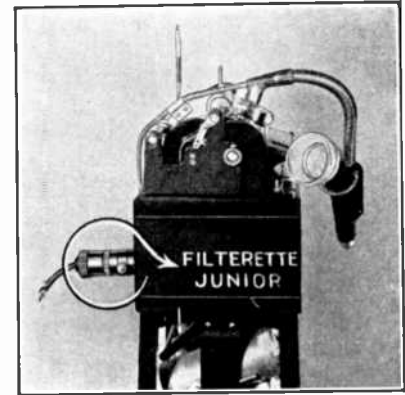

FIG. 29. Filterette Junior applied to a dictating machine.

interference from other store or office equipment. In some cases, however, it may be found that a more effective type of Filterette than either of the two previously recommended may be required. Should this be the case, Filterette No. 110 P. O. is recommended, and, doubtless, will provide complete elimination of the interference.

Soda Fountain Equipment

Q. How important is the interference created by soda fountain equipment?

A. The importance of filterizing the electrical apparatus associated with soda fountains may easily be appreciated when it is known that 11.42% of all interference located by Tobe interference engineers, in the surveys conducted in thirty cities was caused by this type of equipment. The interference due to soda fountain and lunch room appliances, exclusive of sign flashers, comprised 18.37% of all interference from electrical apparatus in stores, offices, factories and garages.

Realizing that every neighborhood contains one or several places where drink mixers may be used, and that the radio interference from each of these appliances may affect many radio receivers, it is evident that the 11.42% of all interference may be disturbing twenty or thirty per cent of the present or potential broadcast listeners in a community.

Q. How may soda fountain equipment be classified?

A. The electrical apparatus in most common use may be divided into two classes:

In the first class are the appliances operated by small universal motors, and in the second class are appliances driven by repulsion-starting, induction-running motors.

RADIO NOISES AND THEIR CURE

First Class:—

Milk Shake Machines
Malted Milk Mixers
Fruit Juice Extractors
Small Fans
Cash Registers

Second Class:—

Dish Washers
Compressors
Electric Refrigerating Equipment
Carbonators

In communities supplied with alternating current, the appliances in class one are likely to be responsible for more interference than those in class two. In direct current districts the interference created by both classes



Fig. 30. Filterette Junior applied to a drink mixer.

of equipment is likely to be serious. Moreover, in direct current districts there will commonly be found motor-generator sets or inverted synchronous converters used to obtain alternating current for the operation of ice machines.

Q. What procedure is recommended for the filterizing of soda fountain apparatus?

A. In filterizing a soda fountain, the first appliances to be considered are those in class one. In practically all cases, a simple type of Filterette, the Junior, will be found satisfactory for suppressing this interference. Figure 30 shows the application of this Filterette to a drink mixer. It will be noticed that the Filterette is located within 8 inches of the point at which the attachment cord is connected to the drink mixer, and that a short wire is connected from the Filterette binding post to the frame of the motor. In order to locate the Filterette as close as possible to the motor, the attachment cord of the appliance is cut and a standard separable connector is installed. It is always advisable to locate the Filterette as close as possible to the point at which the appliance connecting cord enters the appliance frame in order that there may be a minimum of cord from which interference may be radiated.

Q. Is it possible to simplify this procedure and to use one Filterette for overcoming the interference from a number of appliances?

A. If a battery of from two to five drink mixers is installed on a fountain, it is possible to make a Filterette installation of improved appearance by using a single No. 110-PO Filterette in series with the power input leads to all of the mixers. Figure 31 shows this Filterette being used with two mixers. When making an installation of this type, the Filterette should be so located that the connecting leads from the various appliances to the Filterette are of approximately the same length. The appliance attachment cords should be cut to the minimum length satisfactory for connection to the Filterette and the various appliances should be connected to the output receptacle of the Filterette by means of a standard three-way connector. A short wire should be run from the frame of each appliance to the Filterette binding post. This procedure should result in satisfactory suppression of interference from several milk shake machines or malted milk mixers.

Q. What type of Filterette is required for suppressing the interference due to a fruit juice extractor?

A. The one appliance which may require a somewhat more effective type of Filterette than the Junior is the fruit juice extractor. Although the Filterette Junior is often found satisfactory for suppressing the interference from this appliance, there are occasions when Filterette No. 110-PO must be used. This Filterette is connected in series with the power input leads to the fruit juice extractor in exactly the same manner as the Filterette Junior. Regardless of the type of Filterette used, a short return connection from the Filterette binding post to the appliance frame is essential.

Q. What other apparatus may require filterizing?

A. The one remaining appliance in class one is the small universal motored fan, which is becoming increasingly popular. The Filterette Junior installed close to the fan by means of a separable cord connector, as previously described, is suitable for suppressing the interference from an appliance of this type. NOTE: If in any case it is desired to install the Filterette without cutting the appliance cord, the cord may be coiled into the smallest possible space, and its radiating length may thus be effectively reduced.



Fig. 31. Battery of drink mixers silenced by Filterette 110-PO.

Q. How may the interference from dish washers, refrigerator equipment, compressors and carbonators be suppressed?

A. The apparatus in class two, when installed in communities supplied with alternating current, seldom causes serious radio interference, the interference usually being confined to a click on starting and to an interference lasting only until the starting mechanism of the motor throws out. As long as the alternating current motors operating appliances in class two are in good electrical and mechanical condition, they should create only the interference just described. If they appear to be causing continuous interference, it is advisable first to inspect the starting mechanism, and second to check the grounding of the motor and its connecting wiring.

If the starting mechanism is not functioning properly, the motor may cause radio interference during its entire period of operation. Adjusting the starting mechanism or installing a suitable Filterette will suppress the interference. Figure 17 shows the application of a No. 110 Filterette to a commercial ice machine having a motor drawing 4.6 amperes, at 110 volts. It will be noticed that all connecting wires between the Filterette and the motor are carried in BX. A further possible source of interference from apparatus in class two is an intermittent contact between two metal parts of the apparatus. The compressor unit of an electric refrigerator or of a carbonator is generally suspended on springs in order to minimize the transmission of mechanical vibration. If any part of the apparatus which is mounted on the spring suspension is allowed to make intermittent contact with other metal parts of the apparatus, radio interference will result. It is, therefore, necessary to bond together all metal parts of a refrigerator or carbonator installation in order that they may be kept at the same radio frequency potential and in order that the interference due to discharges from one ungrounded conductor to another may be prevented.

Q. What special care is required in the filterizing of a soda fountain located in a direct current district?

A. In direct current districts there is likely to be, in addition to the interference possibilities just described, a possibility of interference due to rotary converter or motor-generator equipment used to supply alternating current to apparatus in class two. In addition to the Filterettes normally applied to the compressor or carbonator motors, it will be necessary to install a Filterette in series with the D. C. input leads to the converter. This Filterette should be capable of handling the maximum continuous operating current of the converter and should be designed to operate at the voltage of the D. C. line. Converters of this type are most commonly connected to a 220-volt D. C. line, and Filterette No. 221 is the Filterette generally required.*

* For a complete description of the filterizing at converters and motor-generators see pages 23-30.

SUMMARY

Summarizing the types of Filterette required for application to soda fountain equipment, it may be said that plug-in types of Filterette such as the Junior and No. 110-PO may be applied to all of the apparatus listed in class one, and that Filterettes designed for installation in building wiring circuits are generally required for application to the electrical equipment in class two. The Filterettes most commonly required for this application are as follows:

Filterette	Working Voltage	Working Current
	A. C. or D. C.	Amperes
No. 110	110	5
No. 131	110	10
No. 221	220	5

These Filterettes are contained in standard metal cabinets and are suitably fused to protect both the Filterette and the apparatus to which it is applied.

Ritter Dental Motors

Q. What type of interference is created by a dental engine?

A. The interference from this source is in the form of a high-pitched whine varying in pitch with the variation of speed of the dental engine.

Q. How may this interference be suppressed?

A. A Tobe Ritter Filterette applied to the drive shaft end of the dental engine should suppress this interference.



FIG. 32. A modern dentist's office contains many potential interference sources.

Q. How is this Filterette installed?

A. Remove the attachment plug from the power receptacle. Turn off the two cap nuts as shown in Fig. 33 and remove the two covers. Remove the drive shaft and turn off the cap nut or pulley. Place the

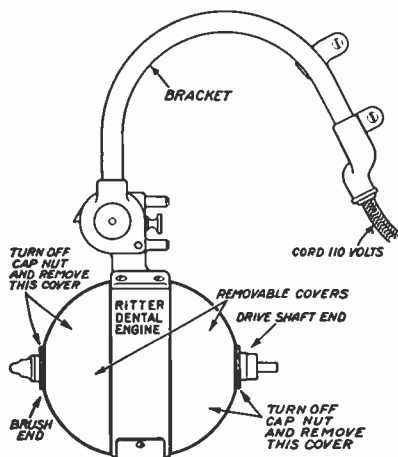

FIG. 33. Typical dental engine mounting.

Tobe Ritter Filterette over the drive shaft end of the motor as shown in Figure 34. Push the two wires from the Filterette, leads No. 1 and No. 2 through to the other end of the engine keeping the wire behind the field coils as illustrated. Connect these same two wires to the brush holder terminals as shown in Figure 35. Do not remove any of the other wires

now on the terminals. Replace the covers and turn on the cap nuts as before. Reconnect the flexible drive shaft or replace the pulley. Occasionally an auxiliary Filterette is required, in which case Filterette No. 110 P. O. should be installed as follows:

Insert the attachment plug of Filterette No. 110 P. O. in the wall receptacle. Insert the attachment plug of the dental engine in the receptacle provided on the Filterette. Connect a wire from the binding post on the Filterette to a carefully cleaned part of the dental engine frame. Coil the attachment cord of the dental engine into the smallest possible space, in order that the likelihood of interference radiation from this cord may be minimized.

Q. What other dental apparatus may cause interference?

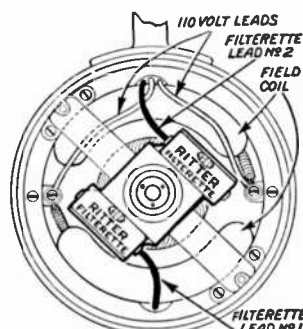

FIG. 34. Location of Tobe Ritter Dental Filterette inside motor shell.

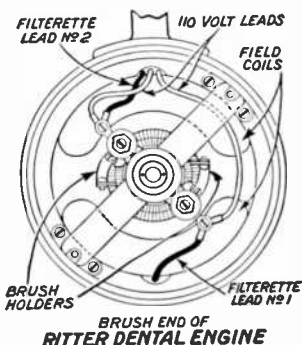

FIG. 35. Connection of Tobe Ritter Dental Filterette leads to motor brushes.

A. The high speed laboratory motor may be an offender as also may the motor used for elevating the chair.

Q. How may interference from this source be identified?

A. This interference is usually in the form of a steady clicking, and is due to the operation of the centrifugal governor used for maintaining the motor at a constant speed.

Q. How may interference from this type of apparatus be suppressed?

A. A Filterette No. 110 PO installed in the same manner as previously described should provide complete elimination of the interference from this source. If satisfaction is to be obtained, however, the lead between the Filterette and the motor should not be over 4" long, and the Filterette should be so located that it is not affected by the field of the motor.

Should the application of Tobe Filterette No. 110 PO fail to provide elimination from a motor of this type, the position of the Filterette with relation to the motor should be varied, since this relation usually has a material bearing on the benefit obtained from the Filterette.

The Tobe Dental Filterette, which is specially designed for application to the Ritter Dental Engine may be obtained from the Ritter Dental Manufacturing Company, Rochester, New York.

Motor Generator Sets and Rotary Converters

Q. What type of interference is created by a motor-generator set?

A. The interference created by a motor-generator set is usually heard as a high pitched crackling, varying slightly in intensity from time to time. This interference originates at the D. C. end of the machine when it is used for converting direct current to alternating current, and may originate at either the D. C. or A. C. end when the machine is used in changing alternating current to direct current.

Usually, however, A. C. to D. C. converters employ 3-phase motors, which are not likely to create radio interference.

Q. How may interference from a machine of this type be suppressed?

A. The procedure necessary for suppressing interference from a motor-generator set will vary with the type of apparatus used and the location and manner in which it is installed. As a rule, it is necessary that a Filterette of the inductive-capacitive type be applied at both the D. C. and A. C. ends of the machine, although in some cases a capacitive type Filterette at one or both ends may prove satisfactory.

Q. How may the type of Filterette or Filterettes for application to a motor-generator set be determined?

A. This determination must be made experimentally. For suppressing the interference due to small D. C. to A. C. Converters such as are commonly used for the

RADIO NOISES AND THEIR CURE

operation of radio receivers, electric phonographs, neon signs, and certain types of electric refrigerators, it is practically always necessary that Filterettes of the inductive-capacitive type be used.

Since the majority of these machines are rated at 500 watts or less, Filterette No. 110 is the type most commonly used. One of these Filterettes should be connected directly in series with the input leads to the machine and should be so located that the connecting leads between the Filterette and the motor are not over 8" in length.

The return wire from the Filterette should be connected in the most direct manner possible to a carefully cleaned part of the motor frame.

Another No. 110 Filterette should be connected directly in series with the output leads from the generator and installed in the manner previously described.

The use of these two Filterettes should effectively prevent the radiation of any radio interference from this apparatus.

Q. Why, if the interference is created at the D. C. end of the machine, must a Filterette be used at the A. C. end?

A. Although the interference is created at the D. C. end of the machine, and is fed back into the D. C. power lines from which it may be radiated, it may also be carried by the A. C. power lines, due to the coupling between the A. C. and D. C. ends of the machine. This, of course, means that if complete suppression of the interference is to be obtained, a Filterette must be applied at the A. C. and as well as the D. C. end of the machine.

In view of the fact that the interference may be transferred from one circuit to another, it is obviously necessary that all long leads to the machine be filtered. In some cases a rheostat for obtaining voltage control may be located at some distance from the machine. It is likely that interference will be carried by the leads to the rheostat and radiated from them to such an extent that objectionable interference will be present even though Filterettes are applied at both D. C. and A. C. ends of the machine.

This condition is remedied by locating the rheostat directly at the machine or by filtering the rheostat leads by means of Tobe Filterette No. 110.

Q. Are two Filterettes required for suppressing interference from a machine for converting alternating current to direct current?

A. In some cases, yes. However, since the interference created by a direct current generator is usually less than that created by a direct current motor, we sometimes find that the application of capacitive type Filterettes to machines of this type is entirely satisfactory.

Assuming, for example, that the machine in question is a 1.0 K.W., 110 volt generator, driven by a three-phase, 220 volt motor, a No. 10 Filterette connected at the D. C. end, and a No. 23 Filterette connected at the A. C. end, should be satisfactory for suppressing whatever interference may be created by this apparatus.

If this procedure does not provide complete elimination of the interference, an inductive-capacitive type Filterette (No. 131) at the D. C. end of the machine will probably complete the elimination of the interference.

It is important that the Filterette used conform with the voltage and amperage rating of the apparatus to which it is to be applied. It is important that the load side of the Filterette be connected to the apparatus causing the interference. When connected to a rotary converter both the A. C. and D. C. ends of the converter are considered the apparatus causing the interference. In other words the converter is connected between the two load sides of the two Filterettes being used.

Q. Where are motor generators or synchronous converters causing interference likely to be found?

A. The most frequently found application for this type of apparatus is to provide alternating current for the operation of A. C. powered radio receivers in locations where only direct current is normally available. These locations include the business districts of many large cities, the whole of some smaller cities, mining communities, farms and camps having individual lighting plants, as well as large vessels, yachts, and power boats. Railroad cars, also, are normally supplied with direct current.

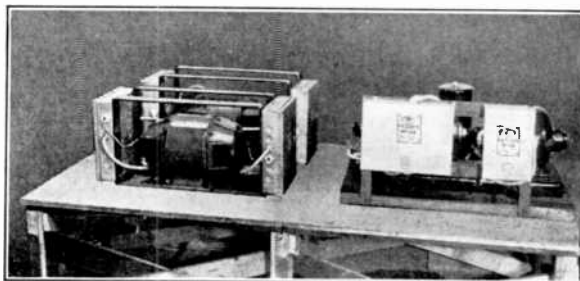

FIG. 36. A workman-like installation of Filterettes 131 and 221, applied to Westinghouse converters used for supplying alternating current to radio receivers in a department store.

If it is desired to operate a modern radio receiver or electric phonograph in any of these places, some source of alternating current must be provided. This A. C. source may be a motor-generator set or an inverted synchronous converter. The latter is often referred to simply as a rotary converter.

A motor-generator set is a unit comprising a motor and a generator, mounted on a common base and having their rotors mounted on a common shaft or coupled together. For the applications just described, a direct current motor and a single phase alternator are used. Figure 37 is a diagram of a motor-generator set of this description. A three-point starting box is shown in the motor circuit. "M" is the motor field and "G" is the alternator field, normally connected across the D. C. line as shown.

Origin of M-G Interference

In an installation of this type, interference originates at the brushes and commutator of the motor. This interference, which is due to the making and breaking of the electrical circuit is impressed on the direct current lines supplying the motor, is distributed along these lines, and being radiated from them, may be picked up by the antenna system of the receiver. It is, therefore, evident that if the receiver being used in conjunction with a motor-generator set is to be independent of the interference created by the D. C. motor, some means of preventing the feed-back of this interference to the D. C. lines must be provided.

The application of a Tobe No. 110 Filterette to the D. C. motor to prevent this feed-back is shown in Figure 38. The Filterette, which is of the inductive-capacitive type is connected in series with the armature leads "A" and "L". If these leads are not accessible, the Filterette may be connected in series with the two line leads ahead of the starting box. This connection is not to be recommended because it generally results in the carrying of long connecting leads between the Filterette and the motor.

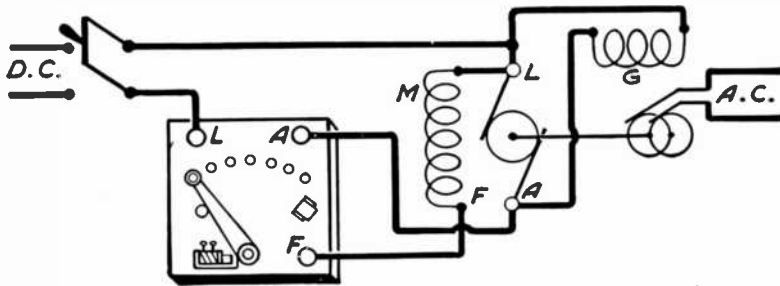

FIG. 37. Motor-Generator of the type generally used for supplying A. C. to operate radio apparatus.

Keep Filterette Leads Short

In applying any Filterette, and particularly in the case of filtering motor-generator or converter equipment, all wiring between the Filterette and the interference source must be kept as short as possible. This connecting wiring should preferably be carried in metallic conduit, either solid or flexible, and must be so carried if the Filterette is more than eight inches from the interference source. The conduit carrying this wiring must be bonded to the motor frame. If any appreciable length of open wiring exists between the motor and the Filterette, interference radiated from this wiring is likely to lessen the benefit obtained from the application of the Filterette. By keeping all connecting leads short, and by carrying them in metal conduit, a minimum of interference radiation is assured.

To complete the Filterette installation, a return connection must be made from the Filterette to the motor frame. This connection should be short and direct. The spot at which the Filterette return wire is connected to the motor frame must be clean, and firm contact between the motor frame and return wire must

be maintained. If the motor frame is provided with a grounding lug, the return wire may be connected to this lug. Otherwise, a lug should be soldered to the end of the Filterette return lead, and should be fastened with a screw to the motor frame. Before fastening the lug in place, all of the finish at the point where connection is to be made to the motor frame should be carefully removed so that the terminal lug of the return wire will be in direct contact with the metal of the motor frame.

Importance of Return Connection

At this point it should be clearly understood that the question of circuit resistance has a decided bearing on the treatment of filtering problems. The frequencies which are responsible for radio interference have entirely different characteristics from the frequencies (25-60 cycle) generally used for power transmission. Resistance, so slight as to be negligible at power line frequencies, cannot be tolerated in the return circuit of a Filterette. Minimum contact resistance and length of return wire are, therefore, of extreme importance in order that a satisfactory shunt path may be provided for the localizing of interference frequencies.

Satisfactory grounding of power circuits does not mean that disturbing impulses will be carried to ground thru this circuit. Grounding the return wire of a Filterette does not constitute a satisfactory filtering circuit, as it is necessary to provide a path of low impedance for the return of interference to its source.

No Interference from Alternator

In view of the fact that alternators in good condition do not normally create radio interference, since there are no making and breaking contacts, it might be assumed that the application of a Filterette at the D. C. end of a motor-generator set, as just described, would provide satisfactory reduction of interference. Further consideration of the manner in which interference is distributed will show why this is not the case.

Radio interference may travel along the wiring system on which it originates; it may be transferred inductively to other wiring systems; it may be transferred capacitively to wiring or conductors such as piping systems, metal lath, and even stoves or bathtubs; it may be picked up by the antenna system of a radio receiver; or it may enter the receiver thru the power connection.

By referring to Figure 37 it will be seen that, since the alternator field is connected in multiple with the D. C. motor, the interference created by motor is carried directly into the alternator field. It is then inductively transferred to the rotor and thus carried out on the A. C. lines to the receiver.

Furthermore, due to the capacitive coupling, as

shown in Figure 39, between the motor and alternator, the motor interference is transferred from the D. C. to the A. C. side of the set. The interference thus inductively and capacitively impressed on the A. C. output of the motor-generator will be distributed along the wiring to which the receiver is connected, and being radiated from this wiring will enter the receiver thru its antenna system as well as thru its power connection.

Filterette Required in A. C. Circuit

It will, therefore, be seen that, in addition to the filterizing of the D. C. motor, Filterettes must be installed in the A. C. circuit as well if it is to be possible to obtain satisfactory radio reception from a radio receiver supplied with alternating current from a motor-generator set.

The correct method of connecting a Filterette in the A. C. circuit is shown in Figure 38. The Filterette shown is the Tobe No. 110, an inductive-capacitive unit. It is connected in series with the output leads of the alternator in the manner already recommended for the application of a similar Filterette to the D. C. motor. All of the precautions given as regards short leads, conduit wiring and firm return connections must be observed when applying the Filterette to the generator.

There is one essential difference in the method of connecting Filterettes at the D. C. and A. C. ends of a motor-generator set. At the motor, the Filterette terminals marked "Load" are connected to the motor input leads, and the Filterette terminals marked "Line" are connected to the incoming line. At the generator, the Filterette terminals marked "Load" are connected to the generator output leads, and the Filterette terminals marked "Line" are connected to the wiring from which the receiver is supplied current.

When the two Filterettes are installed in the manner just described, and when all of the precautions given have been carefully observed, it should be possible to operate a sensitive radio receiver being supplied with alternating current from a motor-generator set, with complete freedom from the radio interference which, under ordinary circumstances, would make it extremely difficult if not impossible to obtain satisfactory radio reception.

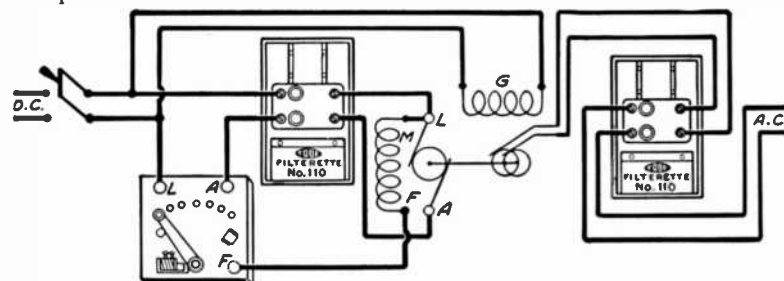

FIG. 38. Motor-generator used for supplying alternating current to a radio receiver. Note that there is no direct wire connection between the A. C. and D. C. circuits; therefore interference caused by the motor can reach the A. C. circuit only by inductive or capacitive coupling.

Additional Precautions

There is one more step which may be taken to decrease further the possibility that the interference created by the motor may be transferred to the alternator. As has already been noted (Figure 37), the alternator field is directly connected to the interference source, i. e., the D. C. motor. It, therefore, appears that a means of keeping the interference out of the alternator field would minimize the inductive transfer of interference to the A. C. output of the set.

Some motor-generators are so constructed that the motor and generator field and armature leads are easily accessible. When this is the case, the alternator field leads may be connected at the "Line" side of the Filterette applied to the motor, as shown in Figure 38. In this way, the alternator is supplied with field current directly from the D. C. line, and the Filterette in the motor circuit prevents the entrance of motor interference to the alternator field.

Altho a field rheostat for controlling the voltage of the alternator is not normally required, in some instances such a rheostat may be used. If this rheostat is located at some distance from the motor-generator, interference coupled either inductively or capacitively to the alternator field will be carried along the leads to the rheostat, and being radiated from them, is likely to be picked up by the antenna system of the receiver. If this condition is found to exist, an additional Filterette (Tobe No. 110 or No. 221) should be connected in series with the rheostat leads at the point where they connect to the alternator. When this Filterette is installed its "Load" terminals should be toward the field. When the alternator field is connected at the "Line" side of the Filterette in the motor circuit, as shown in Figure 38, there is little likelihood that interference will be carried on the rheostat leads.

Choice of Filterettes

In choosing Filterettes for application to a motor-generator set, the following data must be determined:

1. The voltage of the D. C. line.
2. The number of amperes drawn by the motor.
3. The voltage output of the alternator.
4. The number of amperes delivered by the alternator.

With this information available, Filterettes capable of being operated continuously at the voltage of the motor and generator, and capable of carrying the maximum current flowing in the motor and generator circuits may be chosen.

The Filterettes most commonly used for filterizing small motor generator sets supplying a single radio receiver are No. 110, No. 131, No. 221, No. 110-PO and No. 110-PL. The various combinations in general use are listed in the chart on page 75.

When the motor and generator are wired to the building circuits, whether BX, conduit or open (knob and tube) wiring is used, the

Filterettes should be mounted in cut-out cabinets so that their installation may conform to the requirements of the National Electric Code. They should also be fused for protection from overload.

Filterizing Portable M-G Sets

Some of the smaller and portable motor-generator sets are connected to the building wiring by means of attachment cords and plugs. Provided these machines do not carry more than five amperes at 110 volts, plug-in type Filterettes may be used to suppress the interference. Filterette No. 110-PO is the correct type for use at the D. C. end of the machine, and Filterette No. 110-PL should be used at the A. C. end.

To apply Filterette No. 110-PO to the D. C. motor, the motor attachment cord must be cut a few inches from the motor, and an attachment cap connected to the short lead which remains. The prongs of this cap may then be inserted in the Filterette receptacle, after which a short wire must be connected from the Filterette binding post to the motor frame. It is important that a clean spot on the motor frame be provided for connecting the return wire.

In applying Filterette No. 110-PL to the generator, the attachment cord connected to the generator should be cut as short as possible, and the female end of a separable connector should be attached to this cord. The prongs of the attachment cap of the Filterette should then be inserted in the receptacle just described, and a short wire must be connected from the Filterette binding post to the generator frame.

To ensure a minimum length of lead from which interference may be radiated, the attachment cord of the Filterette No. 110-PL should be cut off short, or should be coiled into the smallest possible space and fastened in place.

Since field rheostats are not normally used with small motor-generator sets, it is seldom necessary to take further precautions in the filterizing of this apparatus.

Synchronous Converters

The filterizing of small inverted synchronous converters used to obtain alternating current for the operation of A. C. powered radio receivers in D. C. districts is a somewhat different problem from that of filterizing motor-generator equipment used for radio purposes. Consideration of the operating principles involved with both motor-generator and converter equipment will show why this is the case.

A synchronous converter is an electrical machine having one field and one armature, the armature being connected both to slip rings and commutator bars. The machine is designed to be operated at synchronous speed. If it is driven by a prime mover, both direct current and alternating current may be obtained from the armature; if it is operated at synchronous speed,

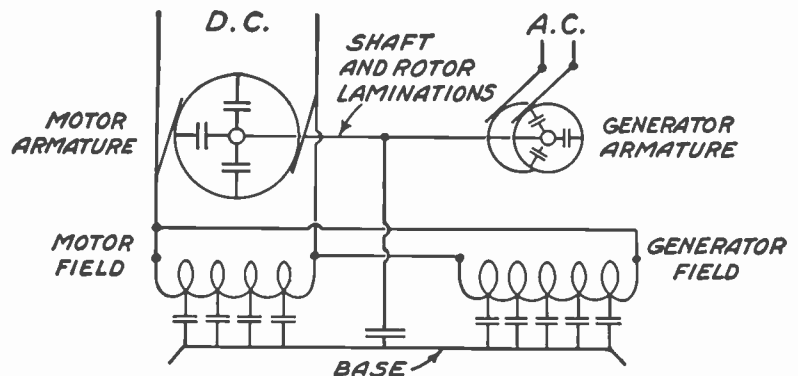

FIG. 39. Diagram showing capacitive coupling which may allow the transfer of interference from the D. C. to A. C. side of a motor-generator.

as an A. C. motor, direct current may be obtained at the commutator; if it is operated as a D. C. motor, alternating current may be obtained at the slip rings. It is the last named operation that is of primary interest to radio dealers and service men, since the inverted synchronous converter is extensively used, not only for changing direct current to alternating current for operating radio receivers and electric phonographs, but also for other purposes not directly associated with radio, but nevertheless likely to be encountered by the radio dealer.

Difference Between Motor-Generator and Synchronous Converter

There are a number of essential differences between a motor-generator and a synchronous converter, particularly as these machines are applied to radio work. These differences are indicated in the wiring diagrams Figure 37 and Figure 40. As Figure 37 shows, the A. C. and D. C. circuits of a motor-generator are largely independent of each other. The motor and generator have individual armatures, as well as separate fields. Thus the radio interference which originates in the D. C. motor circuit may enter the A. C. circuit only by induction, or by capacitive coupling.

Such is not the case, however, with the inverted synchronous converter. The radio interference originating in the D. C. circuit of this type of equipment is connected by direct wire, to the A. C. circuit, since the converter is so constructed that alternating current and direct current flow in the same armature windings. Consequently there is usually superimposed on the A. C. out-put of a D. C. to A. C. converter, more or less radio interference due to the normal operation of the D. C. side of the machine.

Distribution of Interference

Consider the manner in which the interference is created and the way it reaches the receiver. When an inverted synchronous converter, supplying alternating current to a radio receiver is in good electrical and mechanical condition, interference should originate only

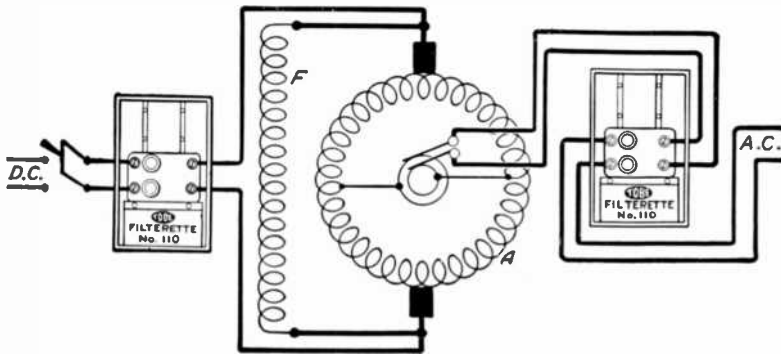

FIG. 40. Inverted synchronous converter used to supply alternating current to a radio receiver. Note that the D. C. and A. C. circuits are common; therefore, interference originating in the D. C. circuit is carried by direct wire to the receiver.

in the D. C. circuit. This interference, due to the making and breaking of electrical circuits, is conductively impressed on the D. C. supply lines and may travel along these lines for a considerable distance. Being radiated from the D. C. lines, the interference may be picked up by the antenna system of the receiver connected to the converter, and may also affect other receivers whose antenna systems are in any way associated with the D. C. circuit supplying the converter.

Since the A. C. output of the converter is directly connected to the D. C. circuit in which the interference originates, it is obvious that the alternating current wiring system supplied by the converter will carry interference as does the direct current wiring system which supplies power to the converter. The receiver, being directly connected to the interference-distributing A. C. lines, will not only be affected by the radiation of interference from these lines, but may also be affected by electrical disturbances which enter it through the power supply unit.

D. C. and A.C. Circuits Must Be Filterized

Thus it is evident that, if satisfactory radio reception is to be obtained from a receiver used with an inverted synchronous converter, both the direct current and the alternating current circuits must be filterized. Figure 40 shows the correct method of connecting two inductive-capacitive Filterettes in a converter circuit. In this diagram the converter is a one-quarter kilowatt unit having a D. C. input of 3.2 amperes at 115 volts and an A. C. output of 2.3 amperes at 110 volts.

For a machine of this rating Tobe Filterette number 110 rated at 110 volts 5 amperes A. C. or D. C. is the correct inductive capacitive type Filterette to use. One of these Filterettes should be connected in series with both D. C. input leads to the converter and the other should be connected in series with both A. C. output leads as indicated in Figure 40.

Installing Filterette in D. C. Circuit

In applying a Filterette at the D. C. side of the converter, the two D. C. input leads of the converter

should be connected to the Filterette terminals marked "Load." If a double-pole line switch is used, the two leads from the switch blades should then be connected to the Filterette terminals marked "Line." If a single-pole switch is used one lead from the switch should be connected to one of the "Line" terminals of the Filterette and the remaining Filterette "Line" terminal should be connected to the opposite side of the D. C. line.

All connecting leads must be carried in conduit, either flexible or rigid, if satisfactory results are to be obtained from the Filterette installation. (Note: BX may be classified as flexible conduit.) The conduit must be bonded to the Filterette cabinet as well as to the converter frame, and the connection to the

converter should be so made that none of the wiring is exposed. Under certain conditions enough interference to minimize the effect of Filterettes may be radiated from as little as two inches of exposed wiring. Too much stress cannot, therefore, be laid on the importance of carrying, in conduit, all wires on which interference may be travelling. For best results the distance between the Filterette and the converter should not exceed eight inches.

If for any reason it is impossible to use conduit or BX when installing the Filterette, care must be taken that the input and output leads of the Filterette are kept separate. If these leads are allowed to parallel each other, interference will be inductively bypassed around the Filterette, thus nullifying its effects.

To complete the installation of the Filterette at the D. C. side of the converter, the return lead (not shown in the wiring diagrams) must be connected to a carefully cleaned part of the converter frame. This return lead must not be connected to a water pipe or other ground and should not be thought of as a ground wire. It is to be kept as short as possible as it carries interference which may be radiated. To insure firm contact, a copper terminal should be soldered to the end of the return wire and fastened under a screw in the converter frame. Before fastening the terminal in place, all of the finish must be removed from the converter frame, at the point of contact. The use of a lock washer is recommended, in order that firm contact between the Filterette return wire and the converter frame may be maintained.

Installing Filterettes

The Filterette used at the A. C. side of the converter should be installed close to the output leads from the machine, and the procedure already outlined for the use of conduit should be followed. In connecting the Filterette, the converter output leads should be connected to the Filterette terminals marked "Load" and the supply lines to the receiver, or receivers, should be connected to the Filterette terminals marked "Line." A terminal should be soldered to the end of the Filterette return wire as previously described, and this terminal should be fastened under the same screw as that to

RADIO NOISES AND THEIR CURE

which the return lead from the Filterette at the D. C. side of the converter is connected.

Since a rheostat for voltage control is seldom used with a converter, the installation of these two Filterettes usually provides all the filtering necessary to allow the operation of a receiver from the converter.

The entire installation must be made in strict accordance with the requirements of the National Electric Code. Figure 36 is a photograph of a workman-like Filterette installation. The converters shown are one kilowatt units operating from a 220 volt D. C. line and delivering 110 volts A. C.

Suggestions for Mounting Filterettes

In making this installation there is constructed a strap iron frame of suitable dimensions to provide a base for the converter, as well as mounting for the two Filterettes. A number 231 Filterette, rated at 220 volts, 10 amperes, is mounted on the frame at the D. C. side of the converter, and is connected to the machine with a short piece of BX. In the same way a number 131 Filterette, rated at 110 volts, 10 amperes, is mounted on the frame at the A. C. side of the converter. When this construction is used, the converter and Filterettes may be handled as a single unit, and, if need be, may readily be moved to various locations where alternating current may be required in the building.

There is one precaution which must be observed when a Filterette installation of this type is made, that is that the metal framework is welded together; or if it is bolted, that lock nuts are provided to preclude any possibility of loose joints. The reason is that such loose contacts, even though they are not in the electrical circuit of the converter, are likely to cause radio interference which will be difficult to locate. The BX used to connect the Filterettes and the converter must be so installed that its sheath makes contact with the metal parts of the associated apparatus only where fittings are provided. In other words, no slack is allowable in the BX. If slack is unavoidable the BX sheath should be bonded to any metal with which it might come in contact. It is not enough to assume that all metal parts of the installation are normally bonded together. The bonding must be provided at the actual point of contact. In this way all parts of the installation which might be of different radio frequency potentials are connected together.

Choice of Filterettes

To determine the correct Filterettes to be used in the Filterizing of an inverted synchronous converter it is necessary to know certain of the electrical characteristics of the machine. These are:

1. The voltage of the D. C. line from which the converter is operated.
2. The number of amperes which the converter draws from the D. C. line.
3. The A. C. output voltage delivered by the converter.

4. The maximum number of amperes delivered by the A. C. side of the converter.

When this data has been obtained Filterettes may be chosen for operation at the voltages and currents of both the input and output circuits of the converter.

Note: If the converter is to be used in a store or other location where it may be overloaded, the Filterettes should be fused at their exact rating or less in order that both the Filterettes and the converter may be protected from damage due to overload. The use of small fuses will also tend to protect the equipment in case insufficient lubrication causes the converter to draw

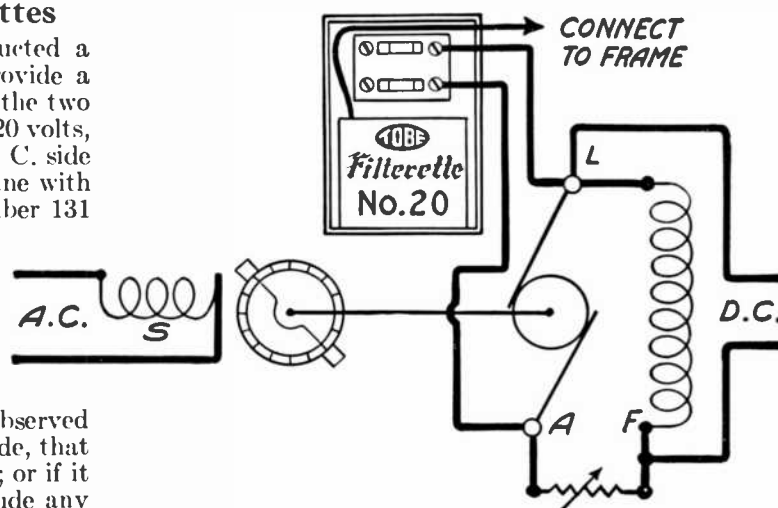

FIG. 41. Motor-generator used for charging storage batteries. Single phase motor coupled to D. C. generator. Interference due to generator only. Filterette No. 20 across generator armature suppresses interference.

excessive current. If interference is still present after Filterettes have been installed in exact accordance with the information contained in this article, it is probable that there is some defect in the wiring or in the converter. In such a case the defect should be found and remedied. Filterettes are designed to suppress only the interference created by the normal operation of electrical apparatus in good electrical and mechanical condition. They should not be used to compensate for defective or overloaded apparatus.

When the converter is directly connected to open wiring (knob and tube) BX, or conduit, the Filterettes used should be mounted in metal cabinets. In the case of small converter units, usually not over one quarter kilowatt, it is common practice to use standard attachment plugs and cords for connecting both to the D. C. line and to the radio receiver. In this case, plug-in type Filterettes may be used provided the current does not exceed 5 amperes at 110 volts.

Use of Plug-in Filterettes

The Filterettes for this application are number 110-PO and number 110-PL. To prevent the feed-back of interference into the D. C. line, Filterette 110-PO must

be connected in series with the input leads to the converter. To install this Filterette, first cut off the attachment cord at the D. C. side of the converter and apply an attachment plug. Insert this plug in the Filterette receptacle and connect a wire, not over eight inches long, from the Filterette binding post to a carefully cleaned part of the converter frame.

To install the Filterette No. 110-PL at the A. C. side of the converter, first cut the Filterette attachment

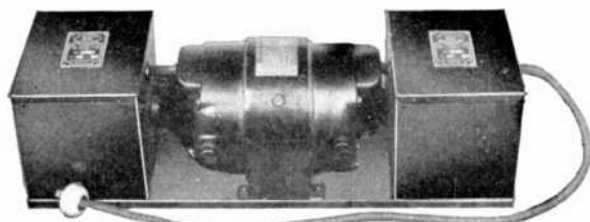

FIG. 42. Westinghouse inverted synchronous converter with special Filterette installed. See table on page 74 for specifications of Westinghouse Converter Filterettes.

cord to a length of six inches or less. Then strip the conductors of the cord and connect them to the A. C. output terminals of the converter. If the converter is provided with a cord and receptacle, cut the cord close to the converter and connect the Filterette either by means of a separable connector or by splicing the leads. Connect a short wire from the Filterette binding post to the converter frame. Note: The wires from both Filterette binding posts must be connected to the same carefully cleaned spot on the converter frame.

Suppressing Interference Created by Motor-Generators and Converters not Used for Radio

Although the radio interference created by a motor-generator or a synchronous converter is usually most objectionable when the receiver affected is being supplied with alternating current from the converter or motor-generator, a great deal of interference may be created by this type of electrical apparatus when it is used for purposes wholly unrelated to radio. This interference is generally radiated from the D. C. and A. C. circuits connected to the converter, and in some cases it is carried along the circuit to which the radio receiver is connected and may enter the receiver thru its power connection.

Electric Refrigerators in D. C. Districts

This condition is most often encountered in D. C. districts when a direct current operated receiver is used in the same building with an electric refrigerator of the type employing a small D. C. to A. C. converter to supply alternating current to the motor which drives the compressor. In this case the interference originating in the D. C. circuit of the converter travels back along the building wiring to the radio receiver, entering the receiver thru its power connection as well as thru the antenna system.

As in the case with a converter used to supply alternating current to a radio receiver, the interference may be transferred both inductively and capacitively from the D. C. to the A. C. side of the converter. However, since the external A. C. circuit is usually limited to the refrigerator motor and a few feet of connecting cable and since the converter, the motor and the connecting cable are usually contained in the metal housing of the refrigerator, there is little probability that interference will be radiated from the A. C. circuit. Consequently a single Filterette, installed at the D. C. side of the converter, is usually sufficient to overcome the interference.

For this application an inductive-capacitive type Filterette is required. This Filterette may be Tobe Number 110, 221, or 131, the size of the Filterette being governed by the voltage and current requirements of the D. C. side of the converter. In direct current districts the converter may be operated at 220 volts D. C., in which case Filterette number 221 will probably be the correct type to use. If the converter is operated at 110 volts D. C. Filterette number 110 will probably be required. If the direct current source is a small farm lighting plant the converter will probably be operated at 32 volts D. C. in which case Filterette number 131 will normally be used. The voltage and amperage of the converter, given on its name plate, should be taken as a guide to the size of Filterette to be used.

Installation of Filterette

To be effective the Filterette must be connected in series with the power input leads to the converter, and the Filterette return wire must be connected to a carefully cleaned part of the converter frame. All wiring should be carried in conduit which should be bonded to the Filterette case, the converter frame, and the metal frame of the refrigerator. If BX is used its sheath must be bonded to all metal parts of the installation with which it may come in contact. If this precaution is not taken considerable interference may result from the intermittent discharge of charges accumulated on the BX sheath.

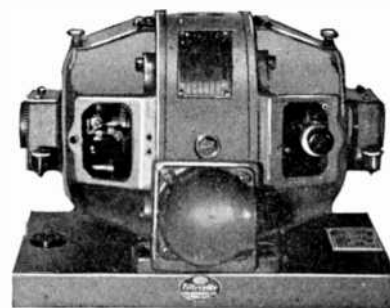

FIG. 43. Special Filterette contained in mounting base for Westinghouse inverted synchronous converter. See page 74 for specifications of the Filterette.

Electric Refrigerators in Radio Demonstration Rooms

Another instance in which the converter used in conjunction with electric refrigerators may cause radio interference affecting a radio dealer is found when such a dealer, having his display and demonstration rooms

in a D. C. district, is located in the same building with a refrigerator dealer, or is, himself, selling electric refrigerators. In this case the converter supplying alternating current for the operation of the refrigerators is likely to be located at some distance from the refrigerator. Consequently there will be a considerable length of A. C. wiring in addition to the D. C. wiring from which interference may be radiated. The Filterette requirements of such a converter will therefore be an inductive-capacitive Filterette at the D. C. side, another at the A. C. side, and, if a voltage control rheostat is located in the demonstration room, a third Filterette in series with the rheostat leads at the converter. The Filterettes should be located as close as possible to the converter and should be connected in series with the D. C. and A. C. leads. All connecting leads should be carried in conduit, and both Filterette return leads should be connected to the same carefully cleaned spot on the converter frame.

Interference from Converter Used with Neon Sign

Radio dealers, having demonstration rooms in D. C. districts are likely to encounter radio interference created by the converters used to supply alternating current for the operation of Neon signs on their own or nearby buildings. As is the case with a converter supplying current for refrigerator demonstration, the converter used with a Neon sign is generally located at some distance from the load being supplied. Therefore the interference is radiated from both D. C. and A. C. leads and the Filterette requirements given in the preceding paragraph apply to converters used with Neon or other gas tube signs.

Neon signs have often been held responsible for radio interference when, if the truth were known, the disturbance was created by the motor-generator or converter equipment used to supply alternating current to the sign transformer. A Neon sign in good condition should create no radio interference. If interference is reported the tubing and bushings should be carefully inspected and cleaned, and a check should be made to determine whether or not the sign transformer is connected to a converter which is responsible for the interference.

All of the preceding uses for converters or motor-generators affect only radio dealers or broadcast listeners in districts normally supplied with direct current. There are, however, other uses for converters or motor-generators, which may affect radio reception in towns and cities using alternating current.

Filterizing Motor-Generators Used for Charging Batteries

Motor-generators used for charging storage batteries are often responsible for considerable radio interference. In this case, the change is from alternating current to direct current rather than from direct current to alternating current as in the case of a motor-generator or converter used for operating a radio receiver in direct current districts. Due to the fact that the radio receiver is seldom in close proximity to the motor generator set, and is but indirectly connected electrically to its circuit, it is generally a simple matter to suppress the interference due to the charging generator.

A motor-generator set used for battery charging may employ either a single phase or a three-phase motor. In either case the motor should not cause radio interference. The generator is responsible for the interference which will be radiated from the leads connecting the generator and the batteries and may also be radiated from the leads between the generator and its field rheostat. Some interference may be transferred capacitively from the D. C. circuit to the A. C. lines but the amount of interference thus transferred is usually so slight as to be negligible.

The type and number of Filterettes required for suppressing the interference will depend upon the manner in which the charging equipment is installed, and upon the proximity of the receiver to this equipment. In many cases the use of a Filterette number 20 connected directly across the armature terminals

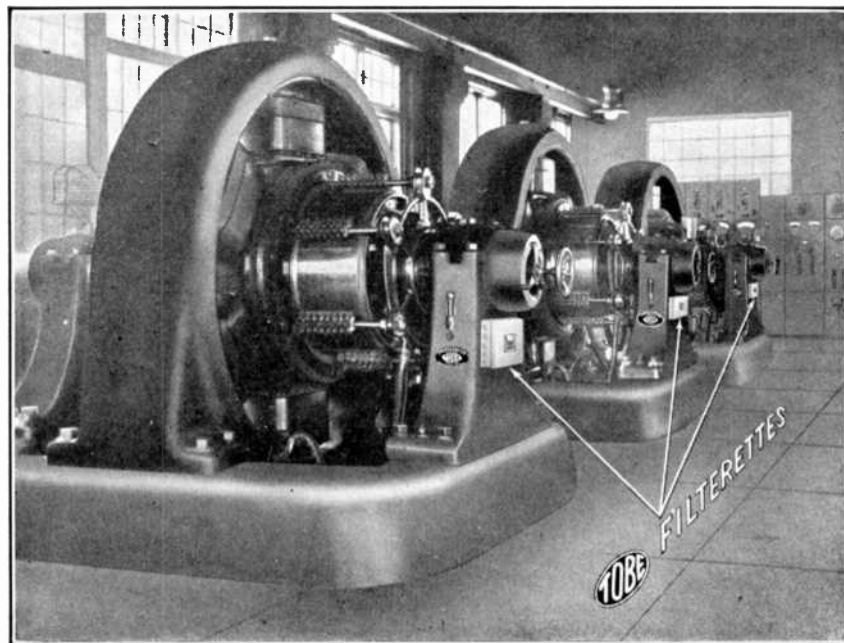

FIG. 44. Street railway converters filterized by application of Filterette No. 60. The converters shown are 500 K. W. machines.

of the generator and having its return wire connected to a carefully cleaned part of the generator frame provides satisfactory reduction of the interference created by the generator (Figure 41). Usually there are three flexible leads brought out of the generator frame. These leads are marked "field", "armature" and "common" or "line." The Filterette should be connected across the armature and line leads and the connection should be made with the shortest possible leads. If the field rheostat is located at any appreciable distance from the generator it may be necessary to connect an additional number 20 Filterette from the generator terminal marked "field" to the terminal marked "armature." In other words, this Filterette is connected across the leads to the field rheostat. In rare instances it may be necessary to use an inductive capacitive type Filterette (Tobe Filterette number 221) in series with the generator output leads, and to apply a Filterette to the A. C. motor to suppress whatever interference might be capacitively coupled to the A. C. line. These instances, however, are so rare that they need not be considered at this time.

Motor-generators used for battery charging are generally found in police or fire alarm telegraph stations, in telephone offices, in garages and in railway signal offices. The generator used for charging police telegraph or fire alarm system batteries usually delivers between 150 and 250 volts. Filterette number 20 is the correct type for application to this generator. The generator used for charging telephone or automobile batteries usually delivers from 6 to 100 volts. Filterette number 10 is the correct type for application to this generator. The generator used for charging railway signal system batteries usually delivers about 500 volts. Filterette number 60 should be applied to this generator.

Theatre Converters

There is one other piece of electrical apparatus used for obtaining direct current in alternating current districts which has been found to be responsible for considerable radio interference. This is the synchronous converter used in many motion picture houses. Since the direct current and alternating current are flowing in the rotor of this machine, the interference originating at the D. C. end is conductively transferred to the A. C. wiring of the building. It is, therefore, necessary to apply a Filterette at the A. C. end of this machine as well as at the D. C. end in order that the

interference may be kept out of both the A. C. and the D. C. circuits. This Filterette may generally be a Tobe number 23, designed for application to three-phase apparatus, since the converter in most common use is operated from a three-phase, 220 volt line. The Filterette for use at the D. C. end of this machine is number 10, since the D. C. out-put is usually between 50 and 100 volts. On some occasions it may be necessary to use an inductive capacitive type at the D. C. end of the machine, in which case Filterette number 135, which is capable of handling 50 amperes, is recommended.

When motor-generator sets are used for obtaining direct current to operate motion picture equipment, it is generally sufficient to filterize the D. C. generator, since the capacitive transfer of interference to the A. C. lines is generally so slight as to be negligible.

Summary

1. Any motor-generator or rotary converter may create interference.
2. This interference originates in the D. C. circuit of the apparatus, whether motor or generator.
3. The interference travels along all wiring circuits to which the converter or motor-generator are connected and, being radiated from them, may enter the receiver through the antenna system as well as through the power unit.
4. If satisfactory radio reception is to be obtained the interference must be kept from getting out on the wiring circuits. To accomplish this Filterettes must be applied to the motor-generator or converter.
5. D. C. to A. C. machines are generally more difficult to filterize than are A. C. to D. C. machines.
6. Filterettes must be chosen with due consideration of the characteristics of the apparatus to be filterized.

The Tobe Deutschmann Corporation will gladly

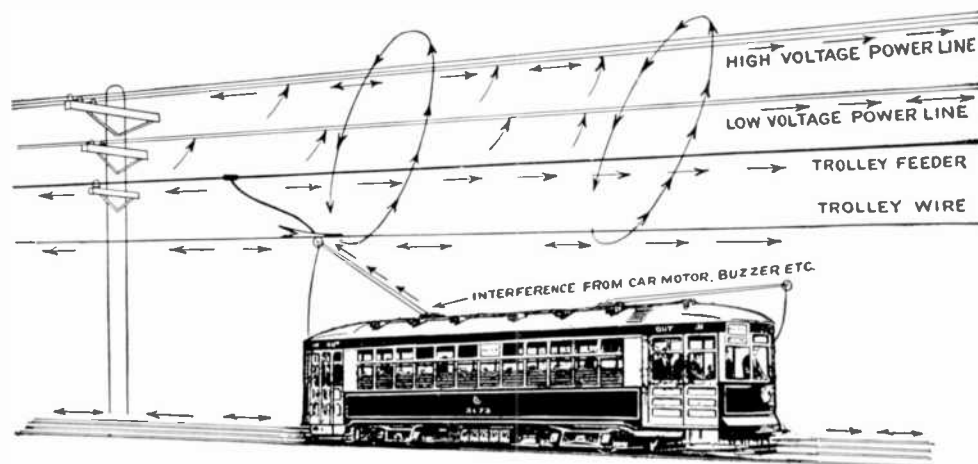

FIG. 45. Diagram showing inductive transfer of interference from a street car to the feeder and primary and secondary distribution network.

recommend Filterettes for application to any motor-generator or synchronous converter. When requesting information be sure to specify the purpose for which the apparatus is being used, and also to copy and forward with your letter all of the information on the name plate of the machine.

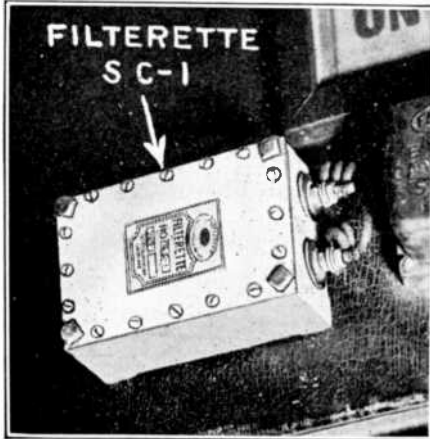

FIG. 46. Filterette SC-1 applied to call buzzer.

Street Railway Interference

Q. How may the interference created by a large rotary converter, such as is used in street railway work, be overcome?

A. A number 60 Filterette installed as shown in Figure 44 usually provides a satisfactory reduction of interference from a rotary converter of this type. In this installation the Filterette is connected across the D. C. output terminals of the machine.

Q. Is this type of Filterette installation adapted to all street railway converters?

A. Usually, altho if the converter frame is well grounded, and if the negative bus is also grounded it will be preferable to connect a capacitive Filterette section type SC-1 from each positive brush to the converter frame. When this type of filtering is used all leads must be kept as short as possible.

Q. Are inductances ever required in filtering a street railway rotary?

A. In addition to the capacitive type Filterettes described above, inductances, connected in the D. C. output leads from the machine are sometimes required, especially if the converter is of an old type.

Q. How should these inductances be installed?

A. These inductances should be mounted as close as possible to the D. C. output terminals of the converter. The distance between the inductances and the converter should not exceed 2 feet. One inductance

should be connected in series with each of the D. C. output leads from the machine.

NOTE: Tests have shown that the location of these choke coils at the bus bars is usually not satisfactory, since the length of feeder between the converter and the bus bars is likely to be sufficient to allow the radiation of considerable interference.

Q. What parts of a street car create radio interference?

A. The first and most obvious source of interference in the car itself is found in the driving motors. Since these motors are in operation practically all the time that the car is moving, the interference which they create constitutes a serious impediment to radio reception, and any remedy for street car interference must give primary recognition to the driving motors.

The next source of interference in the car is the motor which drives the air compressor. This motor is operated intermittently, but as its operation frequently overlaps periods during which the car is not in motion, it tends to keep the interference in evidence at all times.

The call buzzers used for signalling the operator of the car also create considerable interference. On one street railway system it was found that the interference due to call buzzers was audible as far as 12 blocks from the car line, while the interference from the various motors was audible within only one block of the trolley line and feeder.

In addition to the motors and call buzzers there are numerous other making and breaking contacts in the car which may cause radio interference. Most of these contacts, however, occur at such infrequent intervals that the interference they cause is not a source of great annoyance to broadcast listeners. Light switches,

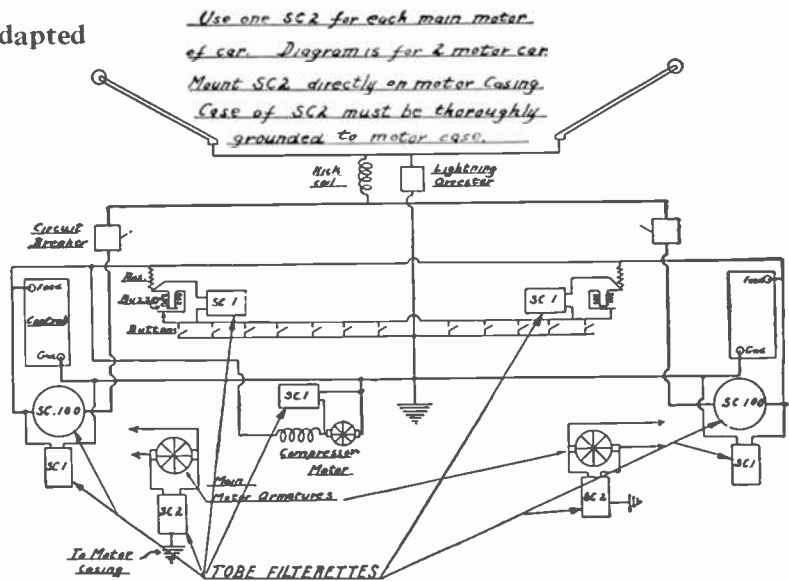

FIG. 47. Simplified wiring diagram showing the filterizing of a two-motored street car.

heater switches, and door switches are among the possible sources of slight interference.

Another source of interference is the controller. Since the operation of this part of the car equipment occupies a considerable part of the time that the car is in motion, the interference from this source is also objectionable.

One further source of interference, which will be in evidence only when the car is in motion, is the rolling contact between the trolley wheel and the trolley wire and between car wheels and rails. This interference, which is heard when the car is coasting under no power as well as when power is being used to drive the car, must be overcome if satisfactory radio reception along street railway systems is to be made possible.

Q. How should the filterizing of a street car be undertaken?

A. In filterizing a street car it has been found necessary to consider the entire car rather than the various components which are individually responsible for the interference. Figure 47 is an abridged wiring diagram of a street car circuit. This diagram shows the sources of interference in a two-motored car.

Q. How is street car interference distributed?

A. The interference created by the various parts of the street car is carried along the power, lighting, heating, and signal circuits of the car, many of which are cabled together or parallel each other, thus making for ease of inductive or capacitive transfer of interference from the circuit on which it originates to the other circuits in the car. From any of these circuits interference may be conductively impressed upon the trolley and trolley wire or it may be radiated from the car wiring and picked up by the trolley wire. The interference which reaches the trolley wire either by direct connection or by inductive coupling may be distributed along the entire trolley line and may also be carried over to the feeder and distributed along the feeder system.

In view of the fact that the greater part of the interference is distributed along the trolley wire and feeder, it is evident that the first step to be taken in suppressing street car interference is the provision of some means whereby interference will be prevented from reaching the trolley wire and feeder. This is best accomplished by use of suitable Filterettes connected in the main lead from the trolley to the controllers and other sources of interference in the car.

Q. What Filterette is required for preventing the transmission of interference to the trolley wire?

A. The correct Filterettes for this application are the Type SC-100 and SC-1. As shown in Figure 47, Filterette SC-100 is connected in series with the lead from the trolley to the controller and is bypassed by Filterette SC-1.

Filterette SC-100 carries the entire current

load of the car and must be firmly mounted as close as possible to the controller. The location of Filterette SC-100 in the electrical circuit of a two-motored car is shown in Figure 47, and the installation of this Filterette on such a car is shown in Figure 48. As this photograph shows, the Type SC-100 Filterette is mounted under the car directly beneath the controller. If possible the lead connecting the Filterette to the trolley should not be cabled with other wiring but should be, as far as possible, separated from all wiring. With the car shown in Figure 47, this is a relatively simple matter since the two down leads to the controllers are carried on opposite ends of the car. In some cases a single down lead is used near the center of one side of the car, in which case some rearrangement of wiring may be necessary to avoid the possibility of coupling between the main controller lead and the motor wiring of the car.

Q. How does Filterette SC-100 affect motor and buzzer interference?

A. When the Filterette is correctly installed it is not only effective in overcoming controller interference but it also aids in preventing the distribution of interference created by motors, buzzers and other contactors in the car. The Type SC-1 section used in conjunction with the Type SC-100 section is connected directly across the input and output terminals of the controller, as shown in Figure 47. To obtain satisfactory reduction of controller interference one combination SC-100 and SC-1 Filterette must be applied to each controller. The use of the Type SC-100 and SC-1 combination effectively suppresses whatever interference may be caused by the operation of the controller.

Q. How are the driving motors filterized?

A. After suitable Filterettes have been applied to the controller, the next step to be taken is the filterizing of the driving motors. The interference which these motors create results from the making and breaking of contact between motor brush and commutator, and is

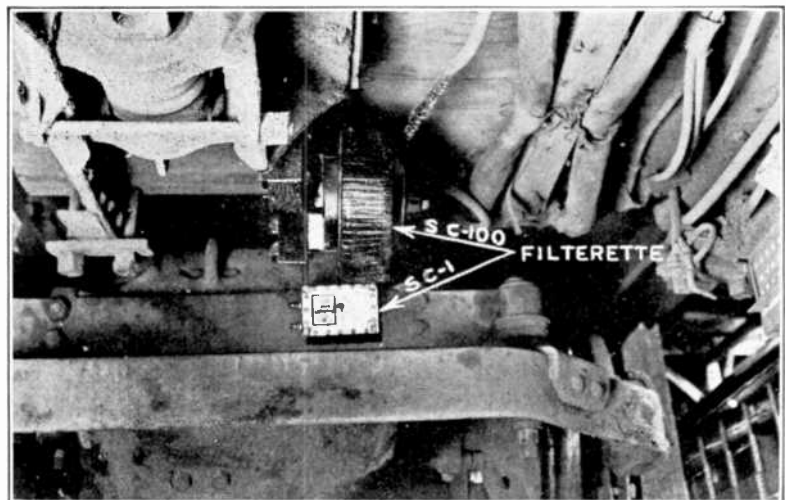

Fig. 48. Filterettes SC-100 and SC-1 in the controller circuit.

generally as pronounced in the case of motors in good condition, as when defective or improperly maintained motors are found. It is, therefore, seldom possible to eliminate driving motor interference by adjusting brushes, turning down commutators, or otherwise servicing motors, although whatever reconditioning of

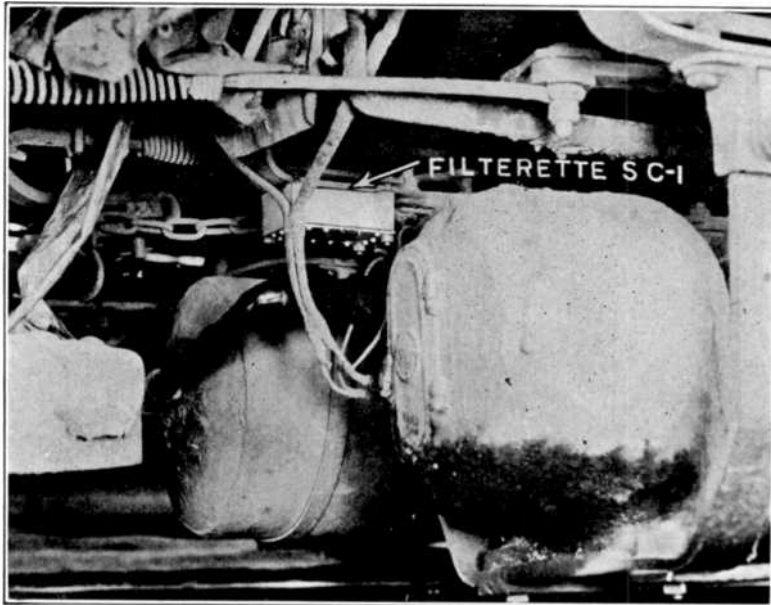

FIG. 49. Filterette SC-1 applied to compressor motor.

equipment may be required should be accomplished before other steps are taken toward the elimination of interference.

NOTE: All apparatus must be placed in the best possible electrical and mechanical condition before Filterettes are applied, as they are intended to be used only for overcoming the interference created by the normal operation of electrical apparatus in good condition.

Filterette SC-2 has been developed for application to driving motors. Filterette SC-2 is contained in a cast iron housing and has two screw terminals from which 2 No. 14 wires, suitably insulated, are connected to the positive and negative brush holders of the driving motor. The Filterette leads should enter the motor housing through a porcelain bushing and should be provided with drip loops to prevent accumulated moisture from following the leads to the terminals and causing flash-over on the Filterette terminals.

NOTE: In the photographs the Filterettes are shown without covers. In actual practice Filterettes are provided with external housings which enclose the terminals, protecting them from moisture.

Filterette SC-2 is designed to be mounted on the housing of the driving motor, or it may be mounted on the frame of the truck. If the Filterette is not mounted on the motor frame it may be necessary to bond the Filterette case to the driving motor frame. One Filterette SC-2 is required for each driving motor.

Q. What Filterette is required for application to the compressor motor?

A. After the driving motors have been filterized, the air compressor motor should receive next consideration. The interference created by the compressor motor is similar in character to that created by the driving motors, but due to the manner in which the motor is connected in the wiring circuit of the car a somewhat different procedure is followed in suppressing the interference.

The Filterette required for application to the compressor motor is the type SC-1 connected, as shown in Figure 47, directly across the brush holders of the motor. This Filterette also is contained in a cast iron housing with screw terminals to facilitate its connection in the motor circuit. Number 14 wire, suitably insulated, should be used for connecting this Filterette, and drip loops, as previously described should be provided. Filterette SC-1 may be either grounded or ungrounded, whichever is more convenient. Figure 49 is a photograph showing the application of this Filterette to a compressor motor.

Q. How is call buzzer interference overcome?

A. A further application of Filterette SC-1 is for suppressing the interference created by the call buzzers. As will be seen from the diagram, Figure 47, the buzzers break a highly inductive circuit with the result that interference is impressed on a number of wiring circuits extending throughout the car. In order to obtain satisfactory reduction of buzzer interference, a type SC-1 Filterette must be connected directly across the buzzer terminals, using the shortest possible connecting leads. Figure 46 shows a Filterette SC-1 applied to a call buzzer. In this application it is not necessary to ground the Filterette case, although this may be done if it is desired.

NOTE: Although the Filterette applied to the call buzzer is not exposed to moisture, it is advisable to provide a cover for the Filterette terminals, since in many cases the Filterette will be installed where it will not be advisable to leave the terminals exposed.

Q. After the car has been filterized, what interference possibilities remain?

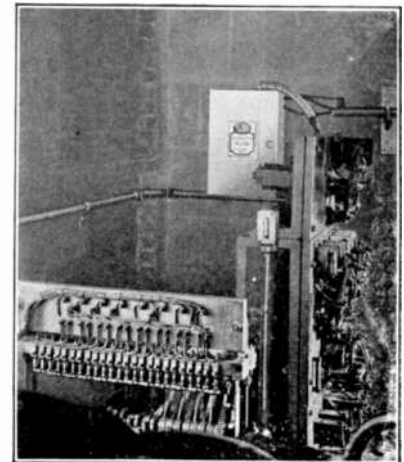

FIG. 50. Application of Filterette 235 to an automatic D. C. elevator.

RADIO NOISES AND THEIR CURE

A. After Filterettes have been correctly applied to the controllers, driving motors, buzzers and compressor motor, there remains the possibility of interference from trolley contact and rail contact. Rail contact is not normally a source of interference, except when the

A. In practically all cases it has been found that the installation of Filterettes at the sources of interference in the car provides satisfactory reduction of interference from the trolley contact as well as from the apparatus within the car. In rare instances, however, the trolley interference may persist, in which case it will be necessary to provide some other means of eliminating trolley contact interference.

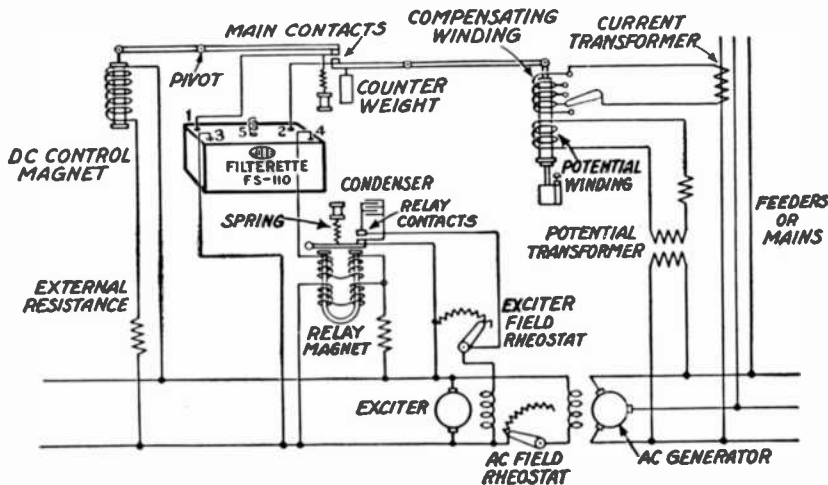

FIG. 51. Filterette FS-110 used for suppressing the interference created by the main contacts of a type TA voltage regulator.

track is laid on an unpaved street so that dirt on the rails causes an increase in contact resistance as well as some sparking. The only remedy for this interference is the provision of a brush to clear dirt from the rails ahead of the driving wheels.

Although the interference due to the rolling contact between rails and car wheels is generally negligible, that due to the varying contact between trolley wheel and trolley wire is highly objectionable. In order to determine what must be done to overcome this interference it is necessary to understand the cause of the interference.

Q. What causes trolley contact interference?

A. Trolley contact interference is caused by rapid changes in the resistance of contact between trolley wheel and trolley wire. These changes cause fluctuations in the flow of current to the car so that, even tho there may be no measurable interruption to the flow of current an electrical disturbance which will cause radio interference is likely to result.

This interference may be in evidence when the car is coasting under no power as well as when power is being used to drive the car. In this case there is no change in the flow of current to the car, but the interference is due to the varying discharge of potentials accumulated on trolley wires and feeders.

Q. How may trolley contact interference be overcome?

Changes in the suspension of the trolley wire and differences in the length of span also cause variation of pressure with consequent differences in contact resistance.

These changes in contact resistance cause wide variation in the amount of heat developed at the point of contact, and as a result the wearing of both wheel and wire is highly irregular.

Since the trolley contact interference becomes intensified as contact irregularities produce pitting of trolley wheel and trolley wire, it is obvious that any

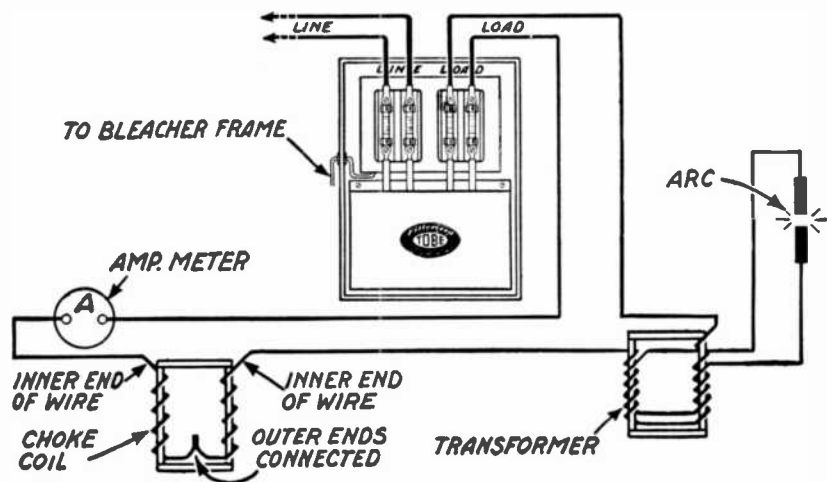

FIG. 52. Flour bleacher interference feeds back into the line, requiring the use of Filterette 231.

procedure which will tend to maintain even pressure of wheel on wire will help to overcome this condition. Experience has shown that the provision of a comparatively long contact surface tends to provide a uniformly decreased contact resistance and thus to minimize pitting of the trolley member. A sliding shoe has been used with considerable success for providing increased contact area with consequent decreased contact resistance. The use of a shoe, however, is not a cure-all since with this greater contact area there is naturally a greater amount of friction on the trolley wire, resulting in increased wearing which shortens the life of the wire. In order to overcome this situation, it is necessary to lubricate the trolley wire for the purpose of decreasing friction. The lubricant used must be of such consistency that it need be applied to the trolley wire approximately once a month, and will remain on the wire under all weather conditions.

The substitution of a sliding shoe for a trolley wheel requires that the overhead system be changed to accommodate the shoe. Consequently it is possible to use shoe-equipped cars only on lines which have had the overhead changed to allow for shoe operation. Moreover, the use of the shoe eliminates contact interference only, and has no effect on controller, motor or buzzer. It is, therefore, advisable to filterize all of the apparatus in the car before making any mechanical changes. This is particularly true in view of the fact that in many cases the application of Filterettes is found to eliminate trolley contact interference.

Q. What other parts of a street railway system may be responsible for radio interference?

A. After the rolling stock has been properly equipped to prevent the distribution of radio interference, consideration must be given to other parts of the railway system. One of the first things to be considered in a study of the remainder of the system is the bonding of rails, since improper rail bonding is responsible for a great deal of radio interference. It should not be necessary to emphasize the need for satisfactory bonding of rails, since poor bonding is also responsible for harmful electrolysis, which has been the cause of costly litigation between street railway and water and gas companies. Proper rail bonding is essential in preventing street railway interference.

Another point at which interference may arise is at each of the section gaps. The passage of a car under power over a section gap results in the creation of considerable interference. The interference is due to the interruption of current flow. On a heavily traveled line this interference may be decidedly objectionable. To overcome the interference it is necessary to bridge the section gaps with Type SC-2 Filterettes connecting them to the rail also under some circumstances.

Signal systems may also cause some interference. This interference, however, is usually so intermittent that it is not objectionable. If signal interference appears to be objectionable, specially designed Filterettes may be applied to the various contactors which energize the signal circuits.

Elevators

Q. What part of an elevator installation may cause radio interference?

A. Interference may be caused by the driving motor, if it is D. C. operated, and by the various contacts in the control circuit. These contacts are located on the main control panel and at the different floors.

Q. How may the motor interference be identified?

A. This interference usually causes a heavy roaring noise in the loud speaker. The progress of the car from floor to floor may easily be traced by the indication in the loud speaker.

Q. How may the interference due to control contacts be identified?

A. If the motor interference is interspersed with loud clicks it is probable that the contacts in the control circuit are causing interference.

Q. How may the motor interference be suppressed?

A. In most cases a capacitive type Filterette No. 23, connected directly across the motor terminals, and having the return wire connected to a carefully cleaned part of the motor frame, provides satisfactory reduction of interference. With D. C. motors it is often necessary to use an inductive-capacitive type Filterette. (See Chart of Inductive Capacitive Types.)

Q. How may control contact interference be suppressed?

A. It has been found that the use of a suitable inductive-capacitive type Filterette connected directly in series with the main supply line to the elevator installation generally provides satisfactory reduction of the interference from both the control panel contacts and the motor. Figure 50 shows a type 235 Filterette applied to a fully automatic D. C. elevator. In some cases it will be found that in addition to the use of the Filterette in series with the supply line to the installation, a capacitive Filterette must be connected across the motor terminals. Filterette No. 20 is the correct Filterette for this application when the motor is operated at 220 volts D. C.

In some cases a motor generator is used in connection with an elevator installation. When this is the case, the motor generator may create interference, which should be suppressed by application of Filterettes as described on pages 22-31.

Q. What other parts of an elevator system may require filterizing?

A. The call buzzer may cause radio interference, which may be suppressed by connecting a type 301-T Tobe Condenser across the buzzer terminals.

Q. May shielding be used in any part of an elevator installation?

A. It has often been found that the construction of a screen, of 16 mesh copper or galvanized iron, enclosing the control panel provided a material reduction in interference. This procedure is experimental and the results cannot be forecast.

Voltage Regulators

Q. How may interference from voltage regulators, as used in power stations, be identified?

A. A rapid clicking may indicate interference from an automatic line voltage regulator.

Q. What part of this apparatus creates interference?

A. Interference may be due to the operation of the main contacts or of the relay contacts.

Q. How may this interference be suppressed?

A. An inductive capacitive type Filterette connected in series with both main contact leads as shown in Figure 51 should eliminate the interference from this source. For use in circuits not over 5 amperes, at 110 volts, Filterette FS-110 is recommended.

Flour Bleachers

Q. What type of interference is created by a flour bleacher of the type commonly termed "continuous arc electrifier?"

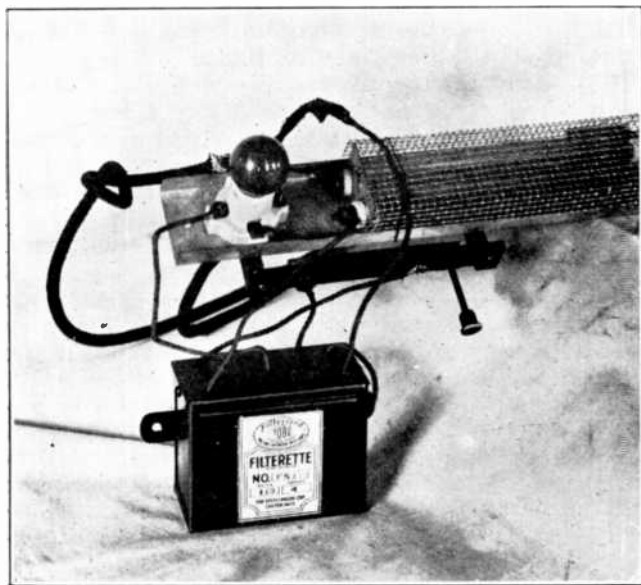

FIG. 59. Filterette FS-110 applied to the thermostatic control of an electric incubator.

A. The interference created by a flour bleacher of this type is similar to that created by the electric ignition system of an oil burner, and is heard as a steady roaring.

Q. How may this interference be suppressed?

A. A Filterette of the inductive-capacitive type, such as Tobe Filterette No. 231, should be connected directly in series with the power input to such a machine to prevent the feed back of interference into the power line. This Filterette should be connected at the load side of the switch controlling the bleacher. Its return wire should be connected to a carefully cleaned part of the bleacher frame.

Q. What shielding of the high tension side of the apparatus is required?

A. Since most flour bleachers are so constructed that the entire high tension system is enclosed within the metal housing of the machine, additional shielding is seldom required.

Q. What governs the choice of the Filterette used with a flour bleacher?

A. The Filterette, which must be of the inductive-capacitive type, should be designed to carry the maximum current required by the bleacher, and should bear the same voltage rating as the bleacher. See table on Page 75 for Filterette ratings.

Electric Incubators

Q. How may the interference which is created by an electric incubator be identified?

A. This interference is heard in the receiver as an intermittent clicking or as an irregular, fairly low-pitched roaring which varies in intensity and in duration.

Q. Where does this interference originate?

A. This interference originates at the contacts of the thermostat which controls the heating elements of the incubator.

Q. How is this interference distributed?

A. The interference which originates at the thermostat contacts is distributed along the wiring from the thermostat to the heating element, or elements and is also fed back on the power line which supplies the incubator.

Q. How may interference created by the thermostat contacts be suppressed?

A. In order to prevent the distribution of this interference, it is necessary to connect a Filterette in series with each side of the thermostat contacts.

Q. What is the correct Filterette for this application?

A. The exact type of Filterette to be used depends upon the voltage at which the heating element is operated and the number of amperes handled by the thermostat contacts. Figure 59 shows a small thermostat and heating element operated at 110 volts and drawing a current of approximately 3 amperes. As this photograph shows Filterette FS-110 is connected in series with the thermostat contact leads, and the Filterette return wire is connected to the metal frame of the heating element and thermostat assembly. The use of this Filterette prevents the distribution of interference along the incubator wiring or the power supply line. If the thermostat breaks a current in excess of 5 amperes, standard inductive capacitive type Filterettes such as No. 131, 231, etc., will be required. When a Filterette of this type is used to suppress thermostat interference, it should be installed as close as possible to the thermostat and all connecting leads should be carried in BX or conduit. To install this Filterette it is necessary to disconnect the two leads which are connected to the thermostat contacts and to connect these two leads to the Filterette terminals marked "load". Short leads, preferably not over 6" in length, should

then be connected from the thermostat contacts to the Filterette terminals marked "line". The Filterette return wire should be connected to the metal frame or housing of the thermostat.

Q. If the heating elements are indirectly controlled, that is, controlled by a relay, which is itself controlled by a thermostat, what procedure will be required to overcome the interference?

A. In an installation of this type, the relay contacts will cause a single click on opening or closing and, unless they are so adjusted that they may chatter, this interference will probably not be objectionable. It will, therefore, be necessary only to install a Filterette FS-110 in the thermostat circuit. If relay-contact interference is found to be objectionable, Filterettes as previously recommended for application to the thermostat contacts should be applied to the relay contacts. Filterettes No. 131-235, as described on page 75 of this book, are the correct type to be used.

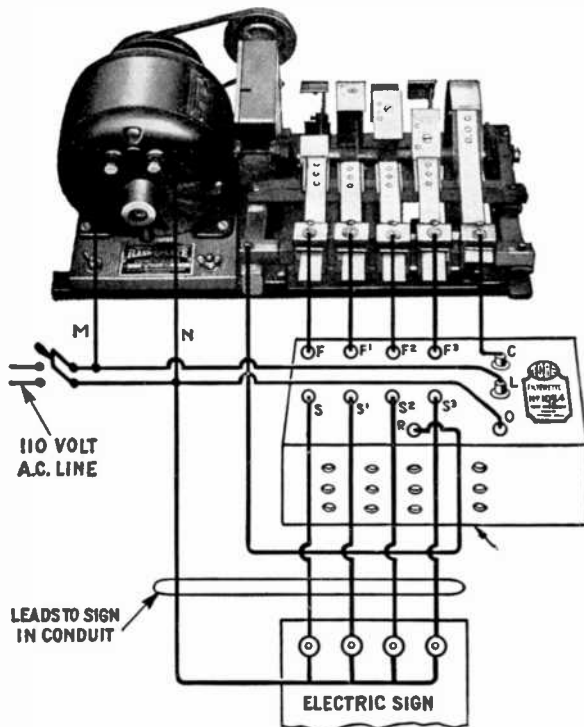

Fig. 60. Filterette NYL-4 applied to a four-circuit flasher of the type used for controlling running borders.

Neon Signs

Q. Do Neon signs cause interference?

A. A steady burning Neon sign in good condition should cause no radio interference. If a sign of this type appears to be causing interference, it should be carefully inspected for broken bushings or other defects. In many cases an accumulation of dirt on the glass tubing of the sign will result in the passage of minute currents causing radio interference. A thorough over-

hauling of the sign should be all that is required to eliminate the interference. A neon sign which consists of glass tubing alone, with no metal backing will sometimes affect nearby receivers. A mass of metal near the tubing usually tends to absorb the interference. If interference is being caused by the flashing on and off of the sign, the same treatment as required for any flashing sign should be followed. In the choice of Filterettes for application to neon signs, the measured primary current of the sign transformer or transformers must be known.

Sign Flashers

Q. What types of sign flasher create radio interference?

A. Practically all types.

Q. How is this interference distributed?

A. This interference may be conductively imposed on the power lines to the flasher mechanism or on the leads between the flasher and the sign, and may be distributed along and radiated from either the power line or the load leads.

Q. How may the interference from the various types of sign flasher be suppressed?

A. The simplest type of sign flasher is the thermostatic button designed to be placed under a lamp in a receptacle. It is not advisable to attempt to eliminate the interference from a flasher of this type, since a Filterette for this purpose would be considerably more expensive than the flasher. However, certain types of small illuminated display employ several thermostatic flashers controlling a total load of approximately 500 watts. These flashers are usually installed in the same housing with the load which they control, and may usually be quieted by use of a single Filterette of the inductive capacitive type, such as Tobe Filterette No. 110, connected directly at the power input to the display.

The suppression of interference from small mercury switches is described in considerable detail under the heading "Traffic Control Apparatus." For controlling sign loads heavier than may be controlled by a thermostatic switch, flashers of the mercury switch or rotating drum type are in common use. When the flasher is so located that the load leads are relatively short, it is often possible to eliminate whatever interference is created by use of a Filterette, of the inductive capacitive type, connected directly at the power input to the flasher mechanism.

Such an installation is usually most effective when the flasher mechanism is insulated from the ground, and the return wire from the Filterette is connected to the frame of the flasher mechanism. This procedure will often result in complete elimination of interference, even when the leads between the flasher mechanism and the sign are of considerable length. Usually, however, a great deal of interference is radiated from these load leads so that a different type of Filterette installation is required. The installation of such a Filterette must be such that the interference is not only kept out

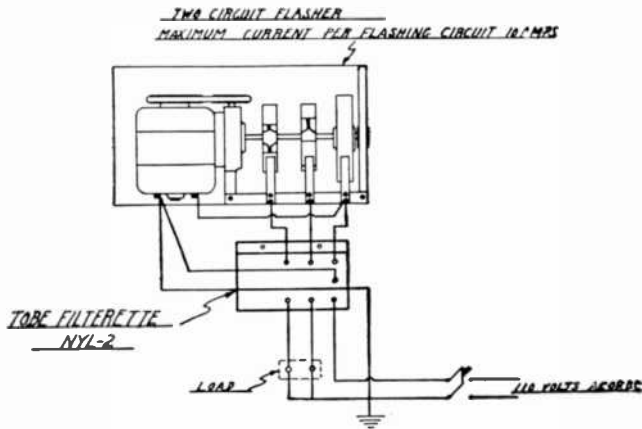

Fig. 61. Application of Filterette NYL-2 to a two-circuit flasher.

of the supply line but is also prevented from reaching the load leads.

Q. How may the correct type of Filterette for application to a sign flasher be determined?

A. In choosing a Filterette for application to a sign flasher it is necessary to know:

1. The voltage at which the flasher is operated.
2. The number of flashing circuits.
3. The number of amperes flowing in each flashing circuit.

Q. What are the requirements of the most common types of sign flasher?

A. Probably the most common type of flasher is the four-circuit unit shown in Figure 60. This flasher is widely used for obtaining running border and other motion effects and is commonly supplied to handle 40 amperes in the feeder circuit and 10 amperes in each flashing circuit.

Another common flasher combination is a two circuit unit handling 20 amperes in the feeder and 10 amperes in each flashing circuit. This type of flasher is commonly used for flashing opposite sides of a double faced sign or as a speller for two names. NOTE: Although Figure 61 shows a mechanical flasher, mercury switch flashers also require filterizing.

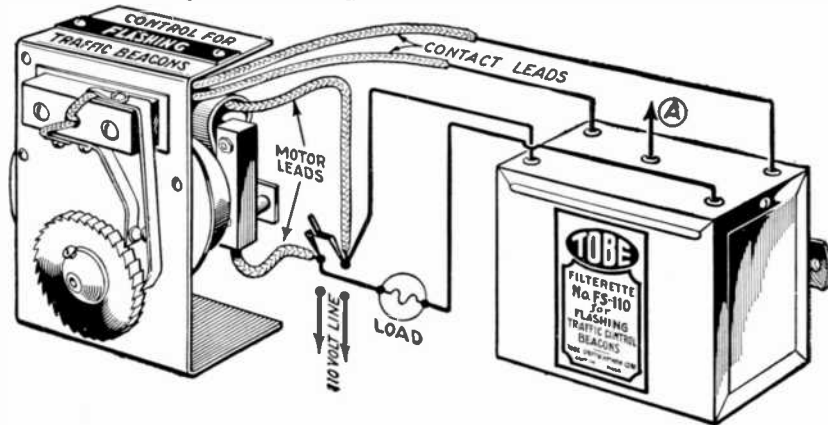

Fig. 62. Single circuit mechanical contactor used for controlling flashing traffic beacon.

Q. What Filterettes may be used for suppressing sign flasher interference?

A. Filterette NYL-2 has been developed for application to two-circuit flashers, and Filterette NYL-4 for application to four-circuit flashers or "chasers".

Q. How are these Filterettes installed?

A. The installation of Filterette NYL-2 is shown in Figure 61 and that of Filterette NYL-4 is shown in Figure 60.

The following procedure should be followed in installation of either of these Filterettes:

The Filterette must be mounted as close as possible to the flasher mechanism and its case must be carefully grounded, preferably by bolting to the metal cabinet containing the flasher mechanism. The flexible leads coming from the outlets marked "F" must be connected to the terminals of the flasher mechanism. The lead from opening "C" connects to the common terminal of the flasher mechanism. The leads from the opening marked "S" are connected to the line wire which would normally be connected to the common terminal of the flasher mechanism. The lead from opening "R" must be connected to a carefully cleaned part of the flasher frame, and that from opening "O" must be connected to the opposite side of the line from that to which "L" was connected. For best results motor lead "N" and the return leads from the sign should be made neutral. When this Filterette is installed in accordance with these instructions, complete elimination of interference due to the feed back into the line or the radiation from the load leads should result.

Q. Does the motor used for operating a sign flasher create interference?

A. No. In practically all cases, this motor creates no interference. However, should it be found that interference is being created by the motor, lead "M"

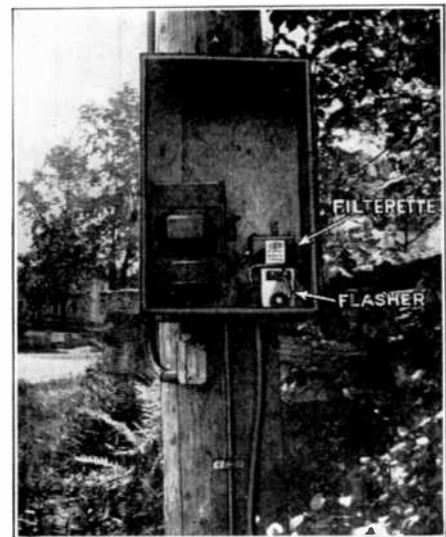

Fig. 63. Photograph showing installation of Filterette FS-110 in a typical traffic flasher control box.

should be connected to the lead coming from "C" instead of being connected as shown.

Q. How may the interference from a flasher having more than four contacts be suppressed?

A. Standard practice provides for the construction of four contact units. This means that if a flasher is required for operating more than four circuits, several four circuit flashers may be combined. When this is done, a Filterette of the NYL-4 type should be applied to each four-circuit section. A condition frequently encountered is the use of three-wire 110-220 volt wiring systems. When applying Filterettes to a flasher installed on such a system, the lead "O" should be connected to the neutral wire of the system.

Traffic Control Apparatus

Q. What types of traffic control apparatus cause radio interference?

A. Both the flashing beacon used as a warning signal at dangerous crossings and the synchronized or progressive form of traffic control apparatus may cause radio interference when operated electrically.

Some flashing traffic beacons are gas operated, and they, of course, do not cause radio interference.

Q. How may interference from a flashing traffic beacon be identified?

A. Interference from a device of this type will be in the form of a steady clicking corresponding to the flashing of the signal. This clicking may occur from 50 to 80 times per minute.

Q. Over how great an area may this disturbance be noticed?

A. This depends on the manner in which the flashing beacon is installed and on the manner in which the power and telephone wiring is carried. If all wiring is exposed, and particularly if the leads between the flasher mechanism and the load are long, the interference may be in evidence at a distance as great as one mile from its origin. However, it is usually noticeable only within a few blocks of the beacon.

Q. How may this interference be suppressed?

A. The exact procedure to be followed in suppressing radio interference created by the single circuit contactor normally used to control a flashing traffic beacon depends to some extent upon the type of flasher being used. There are a number of common types of mechanism used for controlling flashing traffic beacons. One of the most common types is shown in Figure 62. This control consists of a synchronous motor of the telechron type which drives a toothed wheel of an insulating material. Contact points, mounted on springs, are placed in such relation to the toothed wheel and to each other that the rotation of the wheel alternately closes and opens the load circuit. With this type of flasher the motor is connected to the line during the entire period of operation of the flasher, the contacts being used to break the load circuit only.

Another type of contact actuating mechanism used for operating flashing beacons consists of a disc type induction motor geared to a shaft on which a cam is mounted in such relation to the contacts that the rotation of the cam opens and closes the load circuit.

Flashers of the two types just described are normally mounted in wood or metal housings near the beacon or beacons which they control. (See Figure 63.) In this case, Filterette FS-110 may be mounted in the flasher cabinet and connected in the contact circuit as shown in Figure 62.

NOTE: Since the interference is due entirely to the making and breaking of the load circuit, the Filterette is not connected in the motor circuit.

Q. Are Filterettes required in flashing circuits controlled by mercury switches?

A. Yes. Tests have shown that as far as radio interference is concerned there is practically no difference between mercury switches and mechanical contactors.

Q. What types of flasher mechanism employ mercury switches and how may Filterettes be applied to these mechanisms?

A. There are three common types of flasher mechanism employing mercury tube contactors. The first of these consists of a telechron type motor driving a disc which has a pin projecting from its face near the rim, and a yoke pivoted above the disc which is placed over the pin so that as the disc rotates, the yoke moves from side to side imparting a rocking motion to a mercury tube mounted on a cross member at the head of the yoke.

Another type of mercury tube flasher employs a disc type induction motor in place of the telechron motor with a cam movement for rocking the tube. A third type of flasher switch employs a disc type induction motor driving a disc on which is mounted a ring of glass tubing

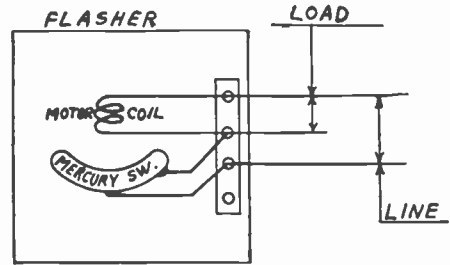

FIG. 64. Diagram of mercury switch flasher in which the switch breaks both the load and motor circuits.



FIG. 65. Checking interference from a traffic flasher.

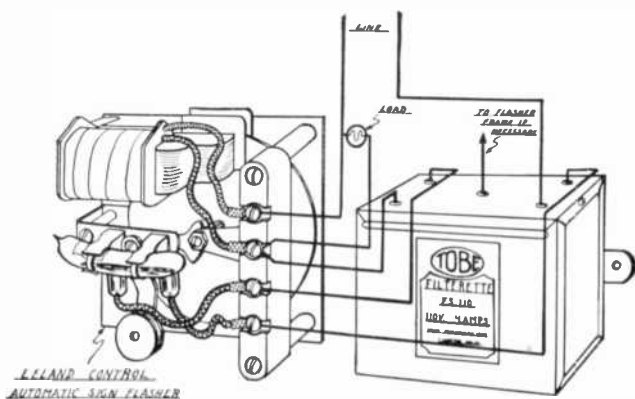

FIG. 66. Application of Filterette FS-110 to the flasher shown in Figure 64.

into which electrodes are sealed. The ring contains mercury in such quantity that when the ring is rotating the mercury, which tends to remain in the lowest section of the ring, closes the circuit between the electrodes as they pass through the mercury.

The operation of these three types of mercury switch is similar to that of the mechanical flashers previously described in that the motor is connected to the line during the entire operating period of the flasher. Being of a type which contains no making or breaking contacts, the motor causes no interference.

These flashers also are normally mounted in wood or metal housings in which ample space is available to allow the installation of Filterette FS-110. This Filterette is connected in the flasher circuit only, in the same manner as is shown in Figure 62.

There is another type of mercury tube flasher which operates on a slightly different principle from the flashers previously described. A schematic diagram is shown in Figure 64. As will be seen from the diagram, the mercury switch used with this flasher is connected in series with one side of the line and the load is connected in parallel with the motor coil. The cycle of this flasher is as follows:

1. The mercury switch makes contact, allowing current to flow through the load and the motor coil.
2. The motor coil attracts an armature or causes

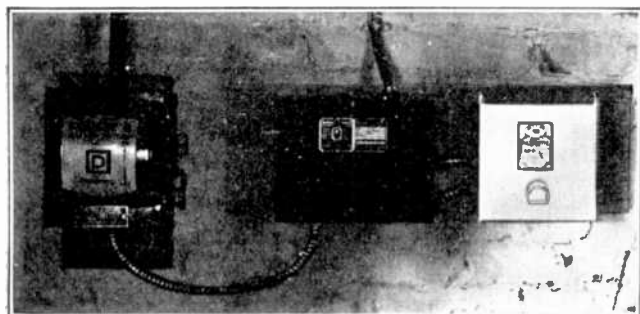

FIG. 67. A typical indoor installation of a single circuit flasher and an OB-110 Filterette.

torque to be developed in a disc. Either of these actions causes sufficient motion of the mercury tube to open the circuit to both load and motor coil.

3. The torque being removed, a spring or counterweight causes the mercury tube to assume its original position, thus completing the cycle

In the design of a Filterette for application to this type of flasher, consideration must be given to the amount of current drawn by the motor coil as well as to the amount of load current.

The motor current, however, is usually relatively small so that it does not necessitate any great increase in the size of the Filterette. With this type of flasher, the Filterette is connected directly in series with the leads to the mercury switch, as shown in Figure 66. Here again Filterette FS-110 is recommended.

Q. If there is not sufficient space available in the flasher housing to allow the installation of a Filterette FS-110, what procedure may be followed?

A. In this case, a Filterette, mounted in a cutout cabinet, should be located as close as possible to the cabinet in which the flasher mechanism is contained. Figure 68 shows the method of connecting Filterette No. OB-110 under these circumstances. In this type of installation the two Filterette terminals marked "line" must be connected to the switch contacts, and the two Filterette terminals marked "load" must be connected to the line and load wires as indicated in the diagram. Figure 67 shows a workman-like installation of Filterette OB-110 used in conjunction with a flasher of this type.

Q. How is interference from synchronized traffic control apparatus indicated?

A. This interference usually consists of a steady clicking, usually at such frequency as to constitute an almost continuous roar, punctuated by heavier clicks as the various indicating circuits are switched on and off.

Q. Over how great an area may this interference be noted?

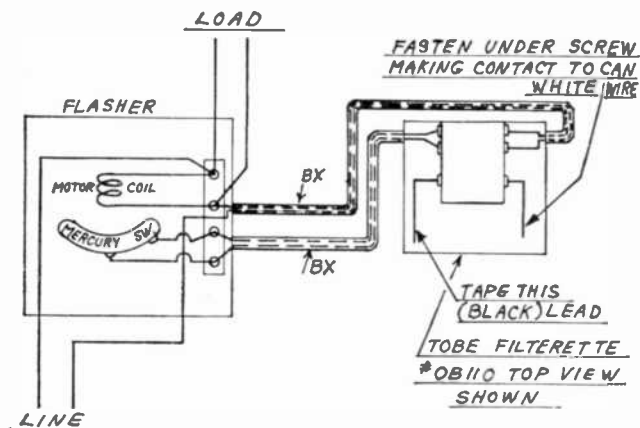

FIG. 68. Wiring diagram of installation shown in Figure 67.

A. Since a synchronized traffic control system may extend for several miles, the interference will probably be noted over the entire area in which the traffic control system is in operation.

Q. How may this interference be suppressed?

A. The treatment of this problem requires specialized knowledge and instruction as to the installation of Filterettes which are designed for application to specific types of apparatus.

The Filterettes may be supplied on receipt of the manufacturer's name, and model number of the traffic control apparatus, and complete information as to the manner in which the apparatus is installed, the number of relay circuits, the load on each of the switching circuits, and the voltages at which the apparatus is operated.

Autocall Systems

Q. What parts of an Autocall System may be responsible for radio interference?

A. Radio interference may be created by the small motor at the "central" station, by the primary contacts in the "central" station, or by the relay contacts.

Q. How may the interference from these sources be identified?

A. The interference created by the operating motor will be heard as a high pitched whine starting a few seconds before the signal is heard and continuing during the entire period of operation of the signal. The interference created by the primary contacts is heard simultaneously with that created by the various relays, and may be definitely identified only by operating the "central" station with the signal circuits of the relays disconnected. The interference created by the relays

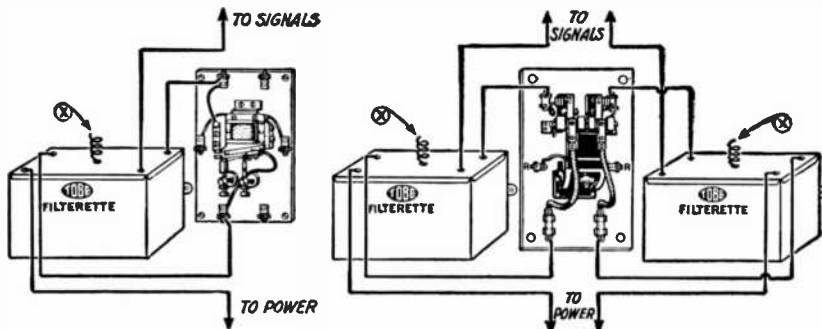

FIG. 69. FS-110 Filterettes are required for filterizing Autocall relays.

originates in the load circuits of the various relays and is heard as a series of clicks corresponding to the station being called.

Q. How is it possible to determine what parts of an Autocall System are causing radio interference?

A. The interference created by the "central" station motor is easily identified and may be checked simply by placing the system in operation. The interference created by the various relays may be checked by operating these relays by hand. If the relays cause interference, the interference will be as much in evidence when

the relays are operated by hand as when they are energized from the central station.

Since the interference from the primary contacts in the "central" station will also appear as a clicking coincident with that due to the relay contacts, it will be necessary to disconnect the load circuits of the various relays and operate the "central" station with the relays blocked to determine just how much of the interference is due to the primary contacts.

Q. How may interference created by the relays be overcome?

A. In order to overcome relay interference it is necessary to apply one Filterette to each relay contact. The Filterette required is Type FS-110 for use in 110 volt circuits, and Filterette No. 221 for use in 220 volt circuits. Figure 69 shows the application of Filterette No. FS-110 to a single circuit Type GPA relay and also shows the application of two Type No. FS-110 Filterettes to a double circuit Type GS-2 relay.

For overcoming the interference created by a Type GS-1 relay a single Filterette No. FS-110 connected in series with both sides of the relay contact is required.

Q. How may the interference created by the central station motor be suppressed?

A. In order to suppress this interference, which is due to the operation of the small series-wound motor, a Type JA Filterette should be connected directly across the power input leads to the motor.

Q. How may the interference due to the primary contacts in the central station be suppressed?

A. In practically all cases it is found that no interference results from the operation of the primary contacts of the central station. If it is found that interference is resulting from the operation of these contacts, a special Filterette, designed to be connected in series with each contact bar and the rotating arm, will be required.

Q. What information is necessary to determine the correct type of Filterette for application to relay contacts?

A. The voltage of the signal circuit and the number of amperes being handled by each contact must be known and the Filterette must be designed to operate at this voltage and current.

Q. What other types of call system are found to create radio interference?

A. The doctor paging system, commonly used in hospitals to signal members of the staff, is a source of considerable radio interference. A typical system of this type is shown in Figure 70.

Q. What is the operating principle of this type of call system?

A. This system consists of a group of contacts connected to a keyboard by means of which various combinations of numbers may be set up. The rotation of a set of cams closes the keyboard circuits intermittently,

thus energizing relays which close secondary circuit lamps in annunciators. The rotation of the cams causes the number being called to flash. Interference from this type of system is due primarily to the relay contacts and may be suppressed by application of specially designed Filterettes in the various relay contact circuits. The primary contacts in this type of call system seldom cause radio interference, since they are energized from a low voltage circuit which is wholly contained within the metal cabinet of the call system.

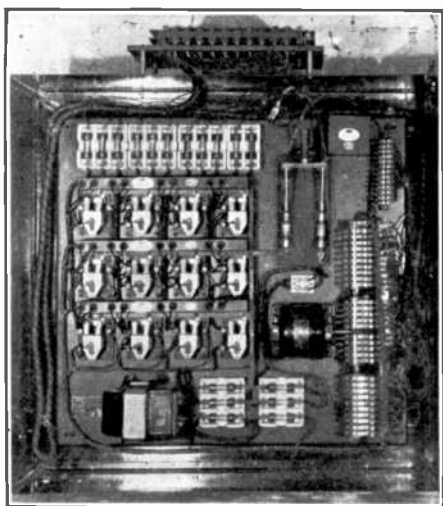

FIG. 70. Special Filterettes applied to a hospital call system.

Automatic Stokers

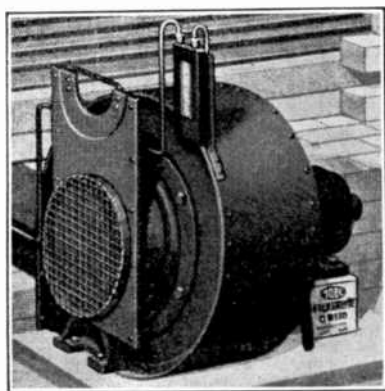

FIG. 71. Filterette OB-110 applied to the blower motor of an automatic stoker.

Q. What parts of an automatic stoker installation may cause radio interference?

A. Interference from an installation of this type may be due to the fuel feed motor or to the blower motor.

Q. How is this interference distributed?

A. The interference from either the blower motor or

the fuel feed motor is fed back into the building wiring from which it is radiated and enters the receiver through the antenna and ground connection.

Q. How may this interference be suppressed?

A. In order to suppress this interference it is necessary to apply a Filterette to each motor.

Q. What type of Filterette is required?

A. The Filterette used should be contained in a metal cut-out cabinet so that it may be installed in conduit or BX wiring. Filterette No. OB-110 is the correct type for application to automatic stokers operated from

110 volt supply lines. The application of this Filterette to the fuel feed motor is shown in Figure 72, and to the blower motor is shown in Figure 71. Some makes of automatic stoker employ 220 volt motors, in which case Filterette No. 221 is the correct type to be used.

Farm Lighting Plants

Q. What causes interference from a farm lighting plant?

A. The interference from a farm lighting plant is due partly to the ignition system of the gas engine employed as prime-mover for the generator and partly to the D. C. Generator.

Q. How is this interference distributed?

A. The distribution of interference depends on the construction of the plant. If the plant is of the type having the generator connected to the building wiring at all times, the interference will be impressed on the building wiring and will be in evidence whenever the plant is in operation. If the plant is of the type employing a floating battery which supplies the load part of the time, the interference will be carried along both the building wiring and the leads to the battery, and will be in evidence only when the generator is in operation.

Q. How may the interference from the fully automatic, or non-battery charging type of plant be overcome?

A. In order to overcome the interference from this type of plant, it is necessary only to prevent its distri-



FIG. 76. Typical installation of Filterette DM-32.

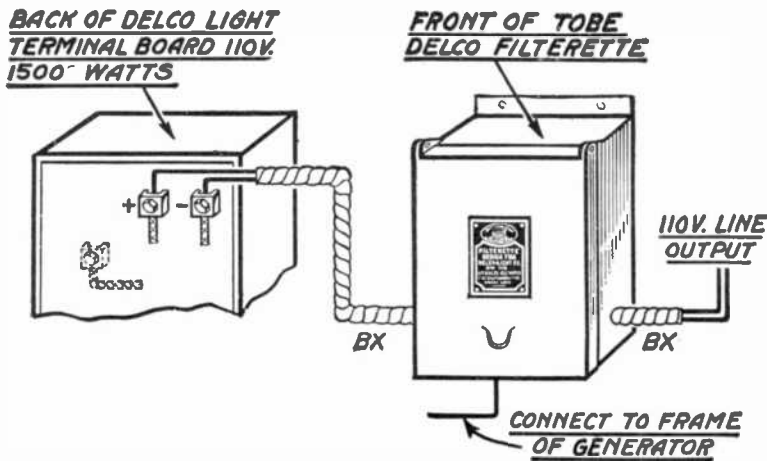

Fig. 73. Application of Filterette DM-110 to a Deleco light plant.

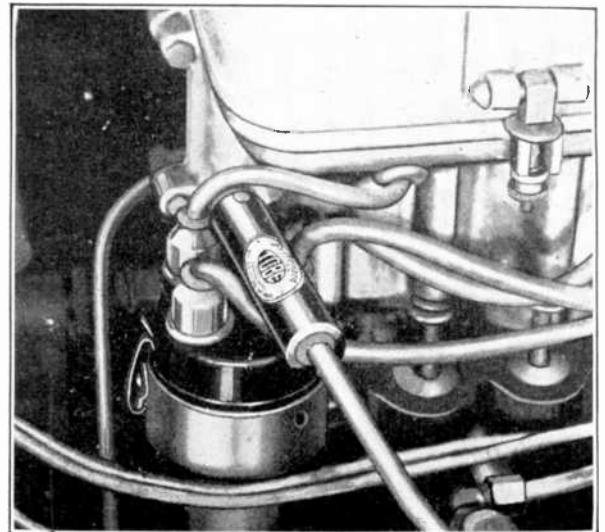

Fig. 75. Installation of ignition unit of Filterette DM-110.

bution along the load wiring connected to the generator. This is best accomplished by use of an inductive-capacitive Filterette installed at the generator.

Q. What are the governing factors in the choice of a Filterette for application to a non-battery charging farm lighting plant?

A. In order to determine the correct type of Filterette it is necessary to know the voltage and current output of the generator. Non-charging plants may employ either 110 volt or 32 volt D. C. generators, and are commonly rated at from 15 to 50 amperes.

Q. What are some of the common types of non-charging plants?

A. Most Kohler plants do not employ a floating, or standby battery. These plants are mostly rated at 110 volts, 800 watts, 1500 watts or 2000 watts. Deleco Light plants Models 8A3, 8M3, 750, 1275 15FA1 and 15H1 are also operated without a standby battery. The ratings of these plants and the correct type of Filterette to be used are shown in the chart Figure 74.

Q. How should the Filterette be applied to this type of plant?

A. The Filterette should be mounted on or as near as possible to the generator and should be connected in series with the generator output leads. When a standard Filterette is applied to a farm lighting plant the Filterette terminals marked "Load" should be connected to the generator terminals and the Filterette terminals marked "Line" should be connected to the wiring system being supplied by the plant. The Filterette return wire must be connected to a carefully cleaned part of the generator frame. When the Filterette is installed in this manner it should effectively prevent the

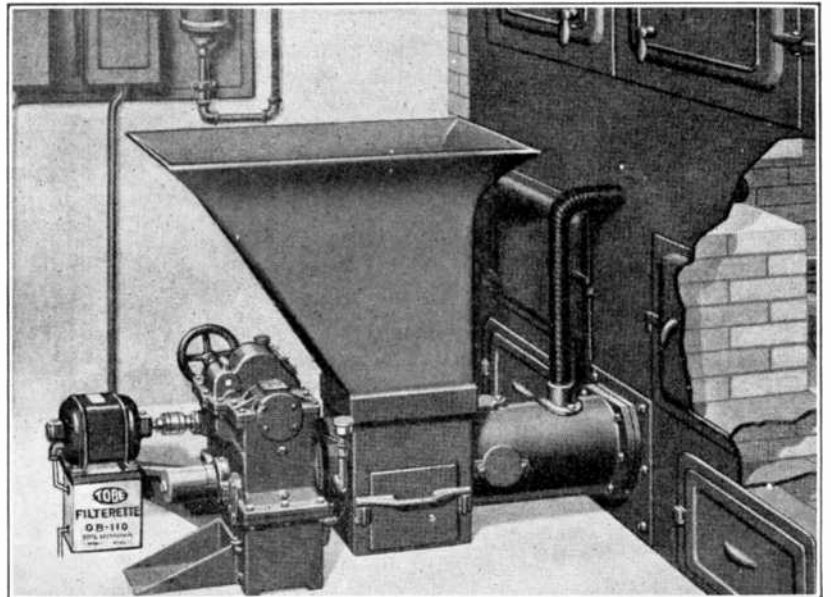

Fig. 72. The fuel feed motor of an automatic stoker generally requires Filterette OB-110.

distribution of interference along building wiring connected to the plant.

Q. If interference is in evidence after the Filterette has been correctly installed, what may be responsible?

A. In such a case it is probable that interference is being carried along wiring connected to a remote starting switch. To overcome this interference a No. 10 Filterette should be connected across the switch leads, at the point where they are connected to the plant.

There is also a possibility that interference may be radiated from the wiring of the ignition system of the gasoline engine employed as a prime mover for the

RADIO NOISES AND THEIR CURE

Make	Model No.	Volts	Watts	Filterette
Delco	8A3	32	800	133
Delco	8M3	32	800	133
Delco	15-FA-1	110	1500	DM-110
Delco	15-H-1	110	1500	DM-110
Delco	1275	110	1200	DM-110
Delco	750	32	750	133
Kohler	S, T	110	800	110
Kohler	D, E	110	1500	DM-110
Kohler	K, L	110	2000	132
Kohler	5A1, 5M1	110	5000	135

Fig. 74. Chart showing Filterettes required for application to non-charging farm lighting plants.

generator. If this proves to be the case, it will be necessary to shield the ignition wiring. The shielding used should enclose the spark plugs, the distributor, and all connecting wiring.

Q. How does the procedure required for filterizing a battery-charging plant differ from that required for a non-battery plant?

A. In the case of a plant employing a standby battery it is necessary to prevent the distribution of interference along the leads from the generator to the battery as well as along the building wiring. This is accomplished by connecting an additional Filterette in series with the charging circuit. A special Filterette, Type DM-32, is available for application to Delco Light Models 751, 752, 8B3, 8C3, and 850. This Filterette contains sections for connection in both charging and load circuits. For other battery-charging plants, such as Delco Models 15C1, 15C3, 1278, 1250 and 1271 it is necessary to use two standard Filterettes, one in series with the leads from the generator to the battery, and the other in series with the leads from the generator to the building wiring. The correct type of Filterette for application to various plants is shown in the chart Figure 78.

Q. How may the interference from an Onan Lighting Plant be suppressed?

A. The interference due to the D. C. Generator is suppressed by use of a special inductive-capacitive type Filterette connected in series with the output terminals of the generator and having its return wire

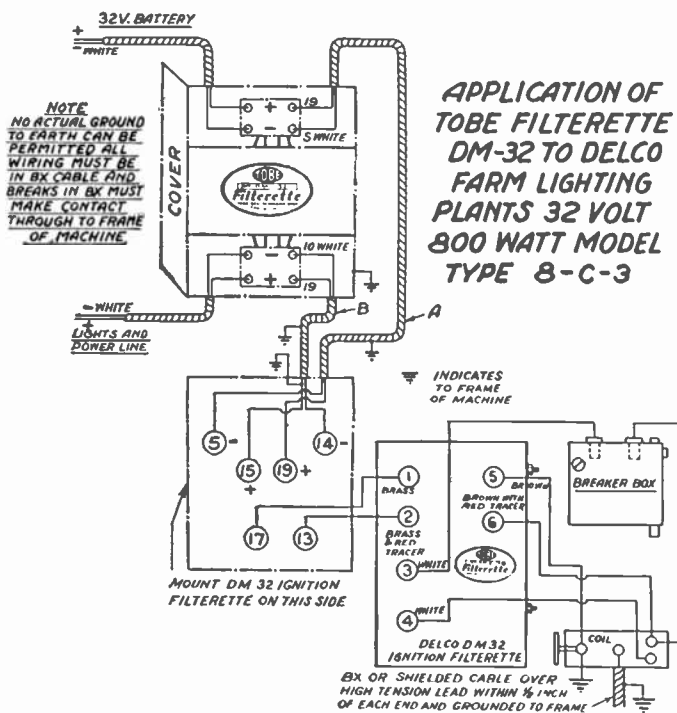

Fig. 77. Application of Filterette DM-32 to Delco light plants 8-C-3 and 752.

APPLICATION OF TOBE FILTERETTE DM-32 TO DELCO FARM LIGHTING PLANTS 32 VOLT 800 WATT MODEL TYPE 8-B-3

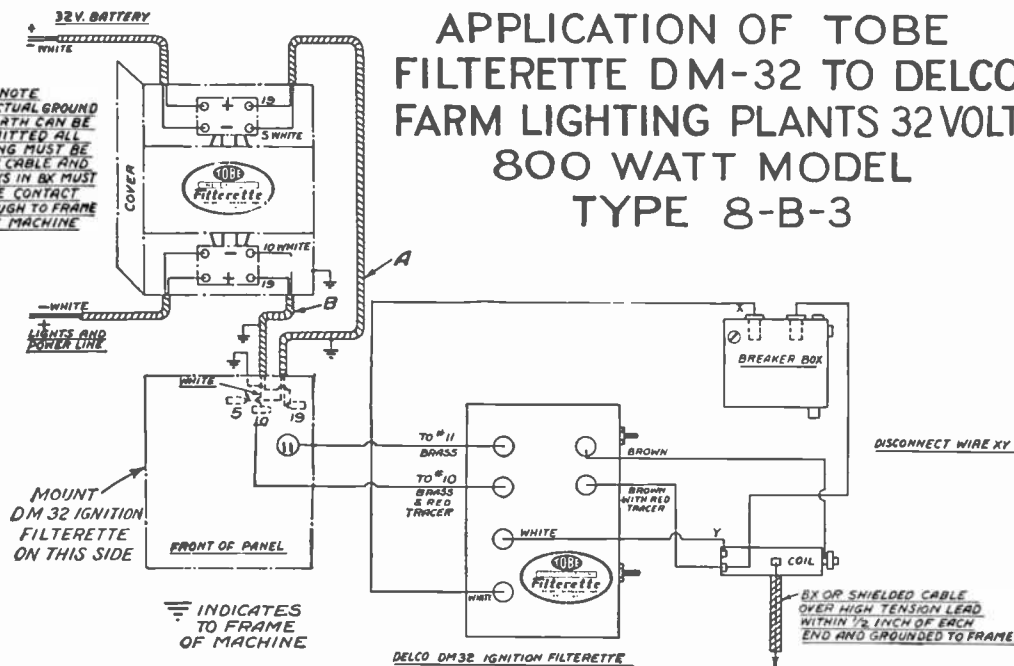

Fig. 79. Application of Filterette DM-32 to Delco light plants 8-B-3 and 751.

connected to a carefully cleaned part of the generator frame. Installation of Filterette is shown in Figure 80.

Q. How is the ignition interference from the prime mover of this plant suppressed?

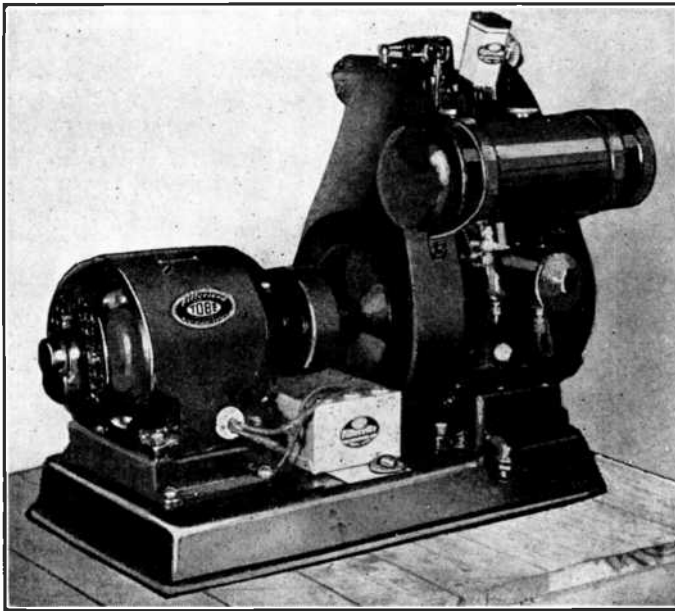

FIG. 80. Special Filterette and ignition shielding applied to Onan lighting plant.

Make	Model	Volts	Watts	Filterettes	
				Load Circuit	Charging Circuit
Deleo	751	32	800	DM-32	
	8B3			DM-32	
Deleo	752	32	800	DM-32	
	8C3			DM-32	
Deleo	15B1	110	1500	DM-110	131
	15C1			DM-110	131
Deleo	15C3	32	1500	135	131
Deleo	1278	32	1200	134	131
	1250			134	131
Deleo	1271	110	1200	DM-110	131
Deleo	850	32	850	DM-32	

FIG. 78. Chart showing Filterettes required in load and charging circuits of farm lighting plants employing standby batteries.

A. This interference, which is radiated from the high tension leads of the ignition system, is suppressed by complete shielding of this wiring. A special shield shown above the fuel tank in Figure 80 is mounted over the spark plug, and the lead to the coil is carried in flexible metal conduit. The shield and conduit must be bonded to the frame of the plant. The special Filterette and shielding required for this plant may be obtained from the D. W. Onan and Sons Company, Minneapolis, Minn.

Bakery Ovens

Q. What part of a large bakery oven installation may cause interference?

A. The electric spark ignition system.

Q. When is this ignition system in operation?

A. Whenever the oven is being used.

Q. How may this interference be suppressed?

A. By a combination of filtering and shielding applied according to the principles outlined in the "Oil Burner" section of this book.

Q. What type of Filterette is required?

A. An inductive-capacitive Filterette.

Q. Where should this Filterette be installed?

A. This Filterette should be connected directly in series with the power input leads to the transformer bank.

Q. What governs the size of the Filterette used?

A. The Filterette must be designed to carry the maximum current, in amperes, drawn by the transformer bank, and must operate at the voltage of the line from which the transformers are supplied. The table on page 75 may be taken as a guide in the choice of Filterettes. Usually this equipment operates from a 220 volt line and requires from 20 to 40 amperes.

Q. How is the current carried from the transformer bank to the spark plugs?

A. Thru a special type of conductor known as Curtistrip.

Q. Does this conductor provide sufficient shielding?

A. Sometimes. However, at the point where the ignition cable leaves the conduit to enter the oven there may be several inches of unshielded cable which must be carried in flexible metal conduit, bonded to all metal parts of the oven.

Q. Should the oven be grounded?

A. An oven installation is usually grounded. Benefit is often obtained, however, by providing driven grounds for the entire installation.

Q. Does the transformer always supply current directly to the spark plugs?

A. Not always. Spark coils are sometimes operated from a step-down transformer.

Q. Will the Filterette installed at the primary of the step-down transformer suppress the interference?

A. With this type of ignition system an inductive-capacitive type Filterette is required in the primary circuit of each spark coil. To determine the proper Filterette, measure the current in the primary circuit and refer to the table on page 75.

Portable Electric Tools

Q. How may the interference from a portable electric drill, screw driver or grinder be identified?

A. A high pitched whine or a slightly lower pitched and coarser rushing sound indicates that interference is being caused by a high speed electric tool. The heavier sound usually indicates that the tool is being operated at its full capacity.

Q. How is the interference from electric tools distributed?

A. This interference is radiated from the long flexible cord commonly used to supply power to the tool.

Q. How may interference from portable electric tools be suppressed?

RADIO NOISES AND THEIR CURE

A. An inductive-capacitive type Filterette connected in series with the power input leads to the tool and having its return wire connected to a carefully cleaned part of the frame of the operating motor should suppress the interference from this source.

Q. May the Filterette be located at the power outlet to which the tool is connected?

A. No. In this case sufficient interference might be radiated from the long attachment cord of the tool to nullify any benefits obtained from the use of the Filterette.

Q. What is the procedure recommended for the installation of a Filterette?

A. Remove whatever part of the tool housing is necessary to reach the attachment cord terminals. If a two-wire cord is used, disconnect both conductors and attach to them the female end of a separable connector. Connect a two-wire cord to the terminals from which the original conductor was removed. This cord should not be over four inches long and should be provided with an attachment plug to be inserted in the receptacle provided on the Filterette. Connect a wire, not over six inches in length, from the Filterette binding post to the metal housing of the motor. Insert the attachment plug of the Filterette in the connector at the end of the power supply cord. Provided the motor does not require more than five amperes at 110 volts, the Filterette Senior is the proper type for use with a portable electric tool.

When using this Filterette it may be necessary to reverse the position of the Filterette attachment plug in the power receptacle in order that the inductance may be located in the hot side of the line. If the tool is connected to an ungrounded line, it will probably be necessary to use Filterette No. 110-PO. If a third conductor is provided in the attachment cord of the tool to allow for grounding of the tool housing, the continuity of this conductor must be maintained.

Electric Clock Systems

Q. How may the interference created by an electric clock system be identified?

A. This interference is generally heard as an intermittent clicking, the number and frequency of occurrence of the clicks being dependent upon the type of clock system which is causing interference.

Q. What parts of an electric clock system may cause radio interference?

A. Since any making or breaking circuit causes interference, it is obvious that the various contactors and

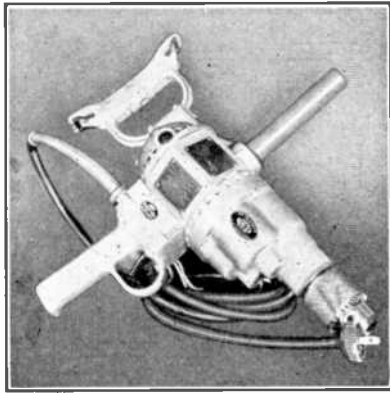

FIG. 81. Portable electric tools of this type cause much interference.

relays in a clock system are likely to be sources of interference. This is particularly true in the case of modern systems which are connected to 110 volt A. C. supply lines.

Q. How is the interference which originates in various clock circuits distributed?

A. This interference, some of which originates in the master clock, and some of which originates at the relays on the distribution panel, is impressed on the wiring connecting the master clock to the distribution panel and upon the wiring connecting the various secondary clocks to the distribution panel.

Q. How may the interference from an electric clock system be suppressed?

A. To suppress this interference it is necessary to apply a Filterette section to each breaking contact in the master clock and on the distribution panel. Figure 82 shows a special Filterette applied to the contacts in the master clock of an electric clock system. In addition to this special Filterette mounted in the master clock, it is also necessary to apply a Filterette section to each relay on the control panel and on the distribution panel. Special Filterettes have been developed for application to these relays and complete information regarding their use may be obtained from the Tobe Deutschmann Corporation, Canton, Mass.

When requesting information regarding the filterizing of an electric clock system, please specify the type and number of relays used in the entire system, the maker's name and model number of the system, the number of secondary clocks per relay, the number of signal bells controlled by relays, whether or not a program mechanism is used, and whether or not the clock uses a synchronous motored movement. A sketch or

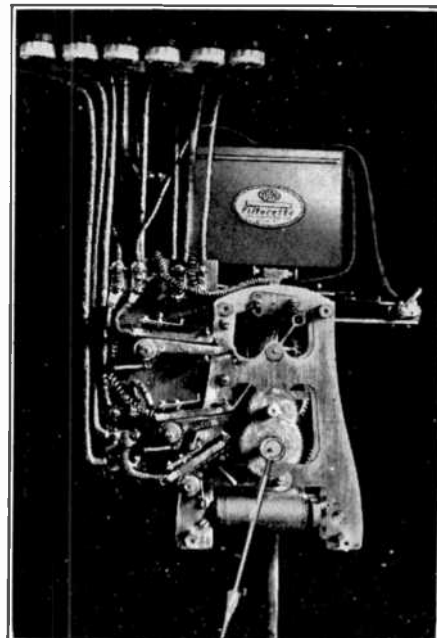

FIG. 82. Application of special Filterette to contacts in the master clock of an electric clock system.

blueprint showing the size of distribution panel and location of relays will also be of value.

Q. Do small, synchronous motored clocks such as are commonly used in the home, cause radio interference?

A. If these clocks are in good condition they should create no radio interference. It is sometimes found, however, that when a synchronous motored clock is placed on a radio cabinet, the magnetic field of the motor induces a hum in the audio amplifier of the receiver. In such a case the audio amplifier should be shielded or the clock should be placed farther from the receiver.

Switch Clicks

Q. How may the clicks heard, when electric light switches are operated, be eliminated?

A. The most satisfactory way is by application of a suitable filter to each switch. This, is seldom practicable.

Q. Why are these clicks more noticeable in some buildings than in others?

A. This may be due to the type of receiver used, to the manner in which it is installed, or to the type of building wiring.

Q. How does the building wiring affect this interference?

A. In modern wiring practice all wires are carried in metal conduit which must be grounded. Such construction tends to prevent the radiation of interference which may be impressed on the wiring. In older buildings, having "open" wiring, interference may be radiated from all conductors.

Q. Will a filter at the power input to the receiver eliminate switch clicks?

A. If the filter is used in conjunction with a shielded lead-in as shown in Figure 84, and if the operation of the switch does not affect the line voltage to the receiver, a number 110-PL Filterette should be effective.

Q. What other steps may be taken to eliminate these clicks?

A. In many cases it has been found that grounding the metal switch plate would eliminate the click.

Tuning of Radio Receivers by Lighting Circuits

Q. Why is it that the volume of signal output from a radio receiver is sometimes increased or decreased when lights are turned on or off in the building in which the receiver is installed?

A. This is apparently a tuning effect of the lighting circuits, although it may be due also to changes in line voltage.

Q. What possible relations are there between volume of receiver output and changes in circuit conditions?

1. Volume decreases when lighting or power circuits are turned on.
2. Volume increases when lighting or power circuits are turned on.
3. Volume decreases when lighting or power circuits are turned off.
4. Volume increases when lighting or power circuits are turned off.

Q. What is the probable cause of the condition described in "1" and "4"?

A. If the only change in volume is a decrease when lighting or power circuits are energized and an increase when they are cut off, the possibility is that the volume change is due to changing line voltage. This line voltage change is due to varying load on the building wiring or on the distribution transformer. If the distribution transformer is being operated at full capacity, or at a slight overload, or if the building wiring is overloaded, any change in the load on the building wiring or distribution transformer will cause a change in the voltage applied to the radio receiver. In either case the remedy is to provide building wiring capable of handling the required load without undue voltage drop, and to install a distribution transformer of sufficient capacity to carry the load. The use of main and branch circuits wired with conductors too small to handle the maximum load current required is a too common mistake in building construction and should be corrected whenever it is found.

Q. What may be the reason for the conditions described under "2" and "3"?

A. If wiring conditions are as described in the preceding paragraph, it is possible that increased line voltage might cause a decrease in the volume of signal delivered by the receiver because of overloading of the detector or audio amplifier tubes. This condition, however, is seldom encountered. It is usually found that volume changes, as described in "2" and "3" are due to a tuning effect in the building wiring. This is particularly likely when the receiver is used with an indoor antenna or a long unshielded lead-in and when the building wiring is not carried in conduit or BX.

Q. How is it possible to determine whether the volume changes are due to variation of line voltage or to tuning of the building wiring?

A. One way to obtain this information is to note the effect of energizing light circuits, at various points in the broadcast band. If the change in volume is consistently the same, over the entire broadcast band, it is reasonable to assume that changing line voltage is responsible. If, however, it is found that the energizing of a certain electrical circuit causes an increase in volume when the receiver is tuned to one of the high frequency stations, and a decrease when the receiver is tuned to a low frequency station, or vice versa, it is safe to assume that changing line voltage is not responsible for volume change. Under these circumstances it is probable that the building wiring is being tuned in such a manner that it acts as a wave trap accepting or rejecting signals of the frequency to which the receiver is tuned, thus causing an increase or decrease in volume as the case may be.

Q. How may this tuning effect be overcome?

A. Tobe Filterette No. 110-PL should be connected at the power input leads to the receiver, and the Filterette binding post should be connected to the same ground as is used for the receiver. When this is done, the receiver is isolated from a power line as far as radio frequencies are concerned and the tuning effect is overcome.

Electro-Medical Apparatus

Q. What effect does the operation of high frequency electro-medical apparatus have on radio reception?

A. High frequency apparatus such as is used in the medical profession, has long been one of the most prolific sources of radio interference. Unlike the majority of electrical devices which create interference in their immediate locality only, certain types of high frequency apparatus set up interference which destroys reception over a large area. In fact, in some cases where the supply lines to the apparatus parallel the primary supply or telephone circuits, the disturbance may be spread over a considerable distance and even carried into cities several miles away.

Q. Why does electro-medical apparatus cause interference?

A. In order to understand the reason for the somewhat complicated procedure which must be followed in overcoming Diathermy interference, it will be well to consider the principles underlying the operation of high frequency electro-medical apparatus. A Diather-

my machine is a device for the production of high frequency currents to be used in the treatment of certain diseases. The frequencies used in the earlier models were from 900 to 1400 K. C., or practically the whole of the broadcast band. In some of the newer models an attempt is made to keep the frequencies used outside the broadcast band, but this is difficult due to the tendency of this apparatus to propagate a broadly tuned wave.

The circuit used for obtaining these frequencies is essentially the same as that used in early spark transmitters whose operation is now forbidden by federal law. In the Diathermy machine a transformer, condenser, and adjustable spark gaps are used to produce high frequency currents. These currents are carried along flexible leads to metal electrodes applied to the body of the patient. The similarity to a spark transmitter is obvious. The high frequency generator is the Diathermy machine. The antenna consists of the electrode leads and the body of the patient. In the case of some types of treatment the body of the operator is also a part of the antenna system. The counterpoise is the power line.

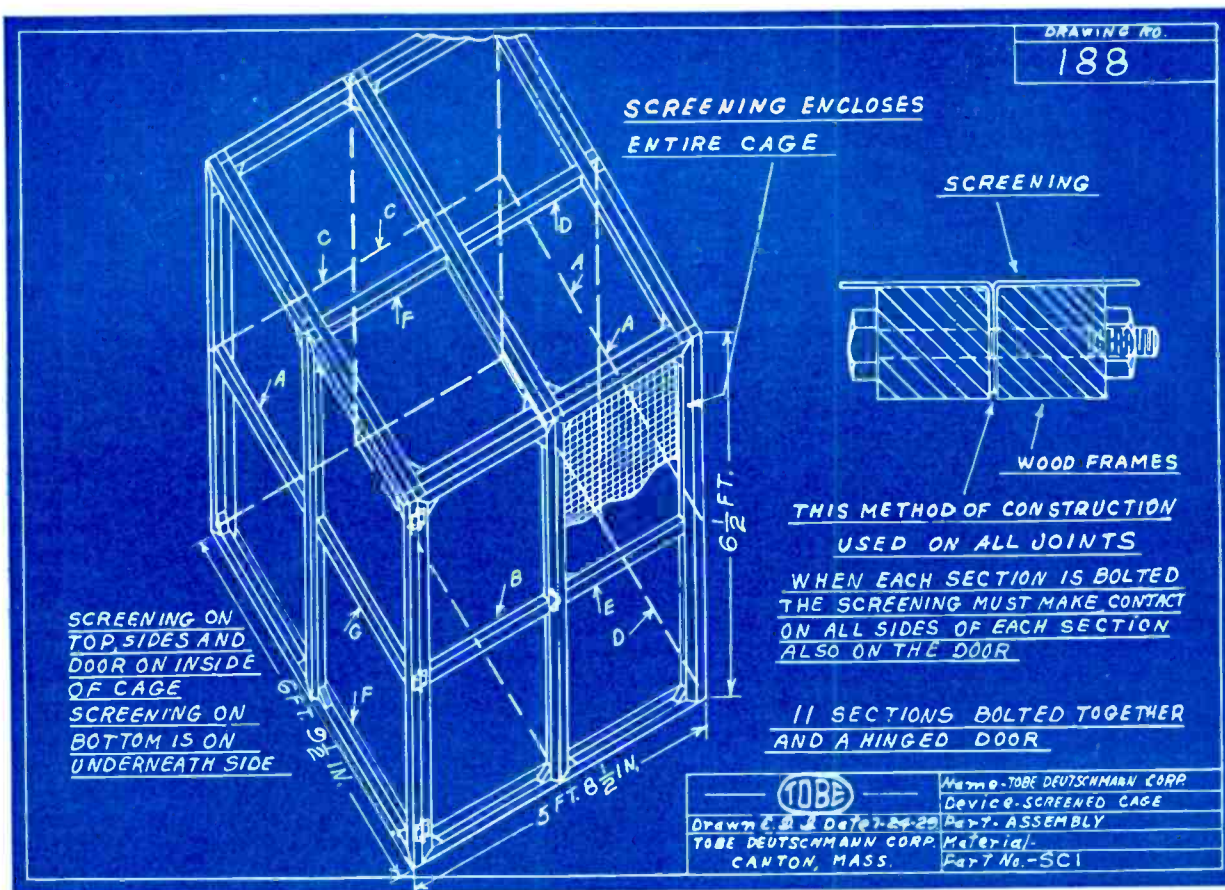

FIG. 53. Assembly of Diathermy screen.

RADIO NOISES AND THEIR CURE

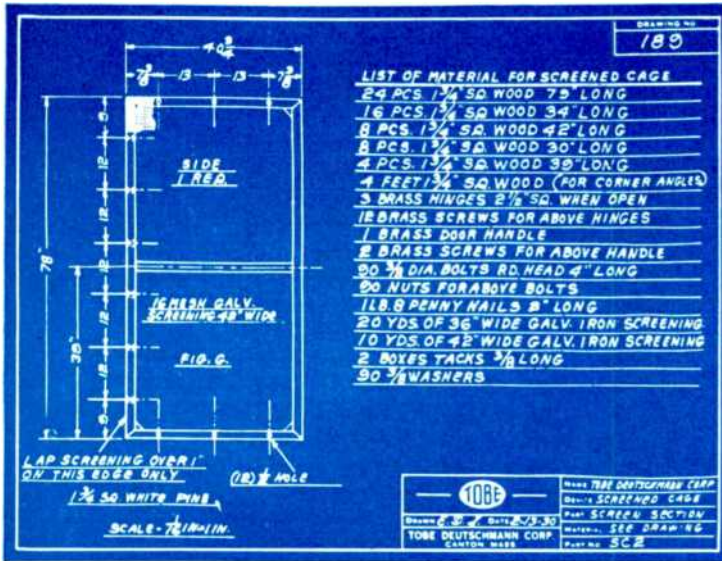

Fig. 54. Panel detail.

The maximum high frequency current used in Diathermy treatments is usually 4000 milliamperes or four amperes. When it is understood that a radio transmitter with an antenna current of 4 amperes may have a working range of several thousand miles, it is obvious that a Diathermy machine can do considerable damage to broadcast reception. Fortunately, the "antenna system" of the Diathermy apparatus is not designed for maximum radiation at the frequencies used, consequently, the area affected by the direct radiation from the electrode leads and the body of the patient is relatively small. This directly radiated interference seldom affects receivers more than 200 feet from the Diathermy apparatus.

Q. How is Diathermy interference distributed?

A. The greater part of the Diathermy interference which affects receivers located at a greater distance than 200 feet from the apparatus is carried along wiring circuits in a manner similar to the transmission of "wired wireless" or more correctly speaking, carrier telephony. This disturbance is impressed upon the various wiring circuits in two ways. The first of these is by feed-back from the Diathermy machine to the power line to which it is connected. The high frequency currents flowing in the electrode circuit of the Diathermy machine cause voltages of the same frequency to be induced in the primary of the transformer used and thus to be superimposed on the power supply line. The high frequency currents flowing as a result of this induced voltage may travel back along the secondary distribution network for many miles, unless a suitable Filterette is installed in the power supply line to the Diathermy machine. This Filterette must be of the special type designed by the Tobe Filterette

Laboratories after a thorough study of the Diathermy interference problem.

Q. What are the governing factors in the choice of a Filterette for preventing feed back of Diathermy interference?

A. In the choice of a line Filterette for application to a Diathermy machine, three factors must be considered. They are:

1. The voltage of the line to which the Diathermy machine is connected.
2. The number of amperes flowing in the primary circuit of the Diathermy machine.
3. The frequency of the power supply.

NOTE: 60 cycles is the frequency most widely used in this country, but 50 cycles, 40 cycles, 30 cycles and 25 cycles may also be encountered.

In the development of line Filterettes for application to Diathermy machines it was found that the single section inductive-capacitive type Filterette, widely used for other applications, was not satisfactory for suppressing Diathermy interference. In order to prevent the feed back of Diathermy interference into the power line it was necessary to construct a three-section inductive-capacitive type Filterette. This was, of course, not commercially practicable because of the high voltage drop in the Filterette, the large size of the Filterette, and its excessive cost. If this construction were to be used, the first difficulty, that of excessive voltage drop, might be eliminated only by a procedure which would further increase the cost of the Filterette. It was, therefore, necessary to develop a Filterette which would combine with high efficiency, the desired characteristics of compactness and low cost. This was successfully accomplished in the Tobe Diathermy Filterette.

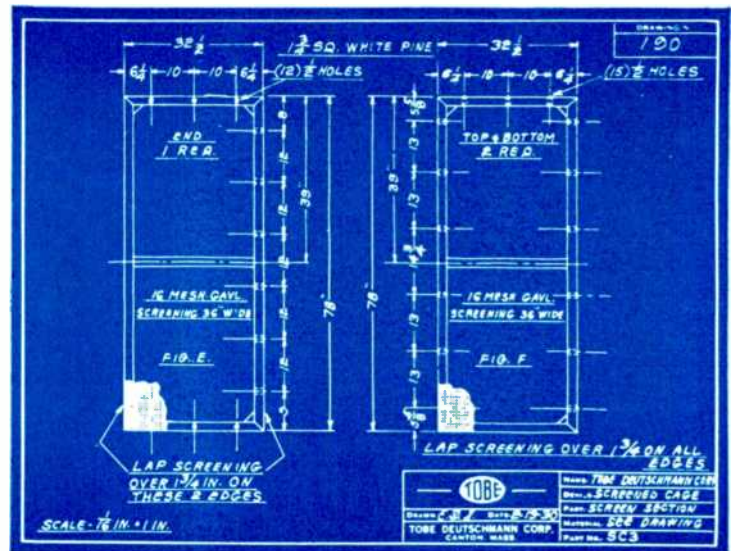

Fig. 55. Panel detail.

RADIO NOISES AND THEIR CURE

Q. What special Filterettes have been developed for suppressing Diathermy interference?

A. There are three standard models of Diathermy Filterette. These are types 1-HFO, 1-HF-2 and 1-HF-3, rated at 6, 15, and 25 amperes respectively.

Q. What additional precautions may be required to ensure complete elimination of Diathermy interference?

A. Although the use of the Filterette alone will prevent the feed back of interference from the Diathermy machine to the power supply line, it will not of itself entirely prevent the distribution of interference. Unless steps are taken to prevent the radiation of interference from the electrode leads and the body of the patient being treated, this interference will be picked up by the various wiring circuits in the building, such as the lighting or telephone circuit, and may thus be carried out into the neighborhood even though the correct Filterette is installed at the power input to the apparatus. It is, therefore, obvious that if the interference from a Diathermy machine is to be successfully eliminated, steps must be taken to prevent the radiation of interference from the secondary side of the apparatus.

Q. May a Filterette be installed in the high frequency output circuit of a Diathermy machine?

A. It is not advisable to install Filterettes in the output circuit of the Diathermy machine since, if these Filterettes were effective in suppressing the interference, they would also prevent the passage of high frequency currents to the body of the patient, and would thus render the apparatus ineffectual in the treatment of disease. It is, therefore, evident that the only remaining possibility is shielding, and that this shielding must enclose the Diathermy machine, the patient being treated, and the operator of the machine.

Q. To what extent is shielding required?

A. The following quotation from the laboratory

report covering the experimental work undertaken in the development of this screen describes the necessary screening:

"A screen cage sufficiently large to contain both the apparatus and the patient was constructed. This cage

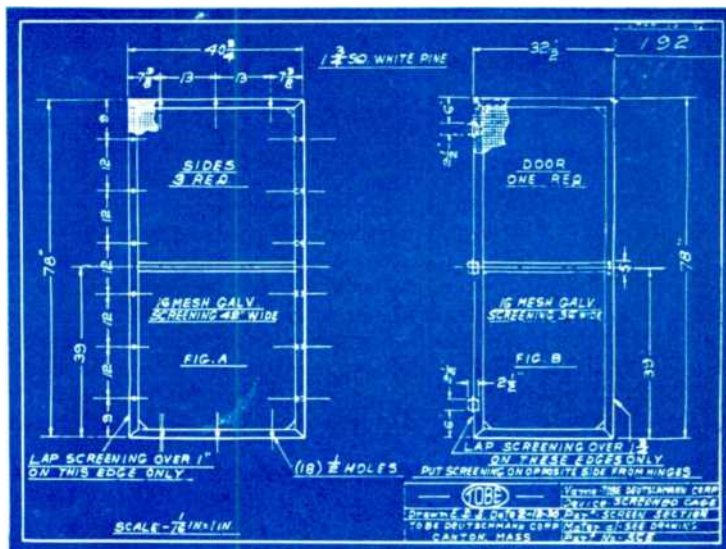

Fig. 57. Door detail

was constructed of copper screening bolted to an angle iron framework, and to all appearances should have been entirely satisfactory. However, upon further experimentation, it was found necessary to solder screening across all the joints in the angle iron framework in order to prevent radiation. As this construction was quite complicated, a third shield was constructed.

"In the construction of the third shield, copper screening was again used. A wood frame, however, was substituted for the iron, and the screening was so arranged that firm metallic contact was maintained between screen sections. This shield proved entirely satisfactory.

"A fourth screen was then constructed on the same principle as that previously employed, with the exception that galvanized iron screening was used in place of copper screening. This screen was, if anything, more satisfactory than the copper screen."

The blue prints show the constructional details of the screen finally adopted as standard for preventing the radiation of interference from a Diathermy machine. The important feature in the construction of this shield is the continuity of the screening. The exact size of the screen cage is not important. Slight variations from the suggested construction are not likely to affect the results obtained from the use of the screen. It must be remembered, however, that the screen alone will not provide satisfactory suppression of Diathermy interference, since the interference which is fed back into the power line is sufficient to minimize the benefit obtained from the use of shielding.

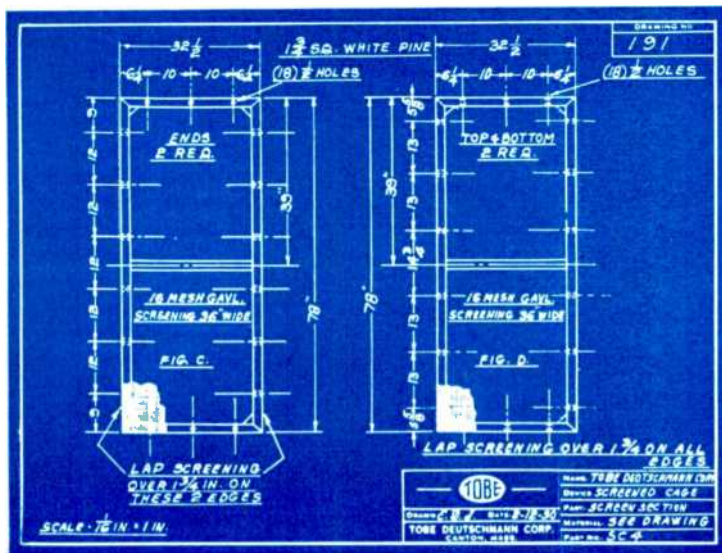

Fig. 56. Panel detail.

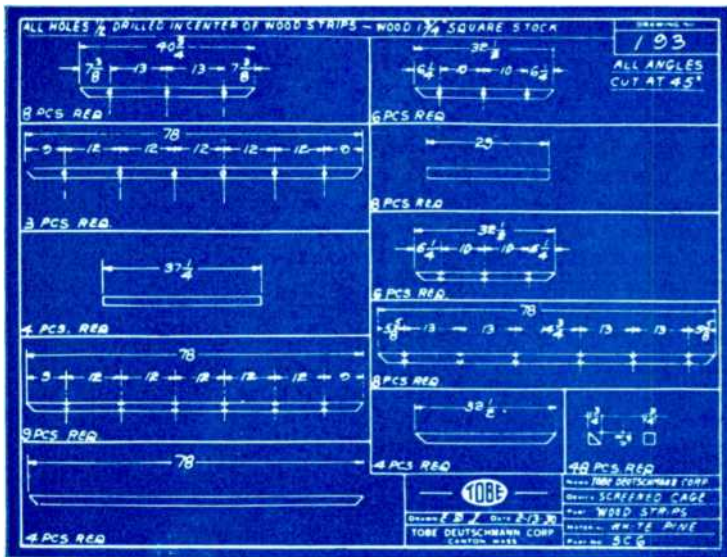

FIG. 58. Wood strip details.

Q. Would the construction of a metal housing surrounding the Diathermy machine and embodying the line filter provide a satisfactory reduction of interference?

A. No. The shielding must enclose both the machine and the patient taking the treatment, since the application of the electrodes to the body of the patient causes the patient to act as a broadcast antenna so that if complete elimination of interference is to result, the patient also must be enclosed within the shielding.

Q. How should Tobe High Frequency Filterettes be installed in a screen booth?

A. Figure 59-A shows the correct method of installing Filterette No. 1-HF-3 in the screen booth. As this picture shows, the Filterette is contained in a metal housing and a short piece of BX, bonded to the Filterette housing, is provided to facilitate connection to the 110 volt line.

A receptacle is provided in the Filterette so that the Diathermy machine may be connected to the supply line by means of its attachment cord and plug. The Filterette may be located at any point within the Diathermy screen, although for best results it should not be located further from the screen than the distance allowed by the length of BX lead supplied with the Filterette.

In making the Filterette installation, standard wiring practices, as recommended in the National Electric Code should be followed. A shallow flush switch box (such as G. E. catalog No. SP6976) is mounted in any one of the sections of the screen, being held in place by a wood frame of 1 3/4" material extending over the top and one side of the box. The bottom and other side of the box are supported by the vertical member and the cross member of the wood frame of the screen section in which the box is to be mounted. When the

box is mounted in this manner, its back will be flush with the screening of the section. A small hole should be made in the screening at the point where the BX is to enter the switch box and a BX connector, fastened to the end of the short piece of BX supplied with the Filterette should be used to hold the BX in place.

It is suggested that a washer be placed over the BX connector in such a manner that the metal screening will be held in firm contact with the switch box when the BX connector has been fastened into the switch box. It is important that the BX sheath, the switch box and the metal screening be bonded together for most satisfactory results. To complete the Filterette installation, a short wire must be connected from the Filterette binding post to the metal screening. An excellent method of making this connection is to wrap the return wire around the BX connector so that it will be held between the screening and the washer which has been recommended.

Q. How should the power connection be made to a Diathermy Filterette?

A. The following method is recommended. Mount on the front of the switch box a flush plate having an outlet for a telephone cord. A composition plate (such as G. E. catalog No. GE-2349) is recommended. Carry through this plate a type PO cord of sufficient length to reach the nearest baseboard outlet or wall receptacle.

NOTE: Do not connect the apparatus to a lighting fixture, as the wiring of fixtures is not designed to handle the current required by Diathermy apparatus.

Whenever the Diathermy apparatus is not in use, the attachment plug of the entire installation should be removed from the baseboard or wall receptacle.

In installing Filterette No. 1-HF-3, a separate branch circuit of No. 10 wire should be run from the service entrance of the building to the Diathermy screen and an indicating switch opening the ungrounded conductor should be mounted on the outside of the screen booth. The Filterette should be mounted just inside the booth opposite this switch, and a short piece of flexible metal conduit should be connected from the switch box to the input side of the Filterette.

Terminals, protected by a metal housing, are provided at the output side of the Filterette to facilitate connection of the Diathermy machine to the Filterette. Be sure to protect the connecting cord by means of a porcelain bushing where it enters this housing. A switch is also provided in this Filterette to compensate for the line drop when the Diathermy apparatus is used at its full capacity.

Q. May lighting fixtures or telephones be located within the screen booth?

A. It is important to note that any wiring which enters the screen booth must pass through the Filterette, otherwise, interference will be picked up on this wiring and carried out of the booth, thus reducing the value of the shielding.

Electric Heaters

Q. Does an electric heater normally cause radio interference?

A. This depends upon the operating principle of the heater. There are two common types of electric heater, the older type consisting of a heating element located in front of a reflector and a more recent type consisting of a heating element having a fan in the housing with the heating element.

Q. What may cause interference from a reflector type heater?

A. If a heater of this type appears to be causing radio interference, it is probable that the heating element is loose in its socket or that the element or attachment cord is defective.

Q. What is likely to be responsible for interference from the blower type heater?

A. Interference from this type of heater will be due to the small motor which drives the fan.

Q. How may this interference be overcome?

A. To overcome this interference a Filterette JA should be connected directly across the motor terminals, and its return wire should be connected to a carefully cleaned part of the motor frame.

NOTE: In applying a Filterette to this type of heater, it is essential that the Filterette be separated as far as possible from the heating element.

Humidifiers

Q. How may the interference created by a humidifier be identified?

A. This interference may be heard as a steady, high-pitched whine or as a fairly heavy rushing sound.

Q. Where does this interference originate?

A. The interference created by a humidifier is due to the small motor on which the operation of this device depends.

Q. How is this interference distributed?

A. This interference is fed back through the attachment cord of the humidifier into the building wiring from which it may be radiated to enter the radio receiver through its antenna system.

Q. How may interference from the humidifier be suppressed?

A. In order to overcome this interference it is necessary to apply a Filterette to the operating motor, locating this Filterette as close as possible to the motor.

Q. What is the correct Filterette for this application?

A. Filterette JA or Filterette Junior may be used. If Filterette Junior is to be used, the attachment cord of the humidifier should be cut as close as possible to

the point at which it enters the humidifier and a separable connector should be installed at the point where the cord is cut. A Filterette Junior may then be connected between the two sections of the separable connector, and a short return wire may be connected from the Filterette binding post to a carefully cleaned part of the humidifier frame. If Filterette JA is used, it may be mounted within the housing of the humidifier being connected directly across the motor terminals and having its return wire connected to a carefully cleaned part of the motor frame.

Ozonators

Q. How is the interference due to the operation of the so-called "ozonator" or air purifier identified?

A. This interference is heard as a steady rushing noise which may be loud enough to drown the broadcast signal.

Q. How may this interference be suppressed?

A. A capacitive type Filterette (Tobe Filterette Junior or JA) connected directly across the input terminals of the transformer used in the air purifier should suppress the interference from this source.

Q. How is this Filterette installed?

A. The success of this Filterette installation depends upon the proximity of the Filterette to the transformer. If maximum satisfaction is to be obtained, the Filterette must be connected directly across the transformer terminals, and its return wire must be connected to a carefully cleaned part of the transformer case. This means that the installation of the Filterette at the end of the ozonator attachment cord is not likely to be satisfactory. The Filterette should be installed by cutting the attachment cord of the appliance and using a separable connector as described under the heading "Humidifiers."

Electric Fish Diverter

Q. How may the interference from an electric fish diverter be identified?

A. This interference is usually indicated by a low-pitched roaring sound.

Q. How may the interference from this equipment be suppressed?

A. An inductive-capacitive type Filterette (No. 132) connected in series with the power input leads to the commutator portion of the diverter should prevent the feed-back of interference into the power line.

Q. Is there any secondary radiation from this equipment?

A. Due to the extremely low frequency at which this apparatus operates, there is no radiation of interference from the secondary circuit.

Effect of Filterette Applied to Receiver

Q. Can interference which comes in over the power lines and is not caused by apparatus on the owner's premises be eliminated?

A. While it is still possible for the owner of a radio receiver to call his dealer and say that his receiver is noisy, or to call the power company and complain of trouble on the lines, and while either of these complaints may be justified, if the listener is in earnest in his desire to obtain improved radio reception, there are many ways in which he can help himself.

Q. How does this interference enter the radio set?

A. Before outlining these methods, consideration should be given to the manner in which interference is distributed and to the manner in which it enters the receiver. Radio interference, or "man-made static," is caused by interruption to the flow of electric current and also by the discharge of potentials accumulated on conductors. Whenever such current interruption or potential discharge occurs, the resulting high-frequency voltage causes a current to flow along the conductor in which the effect takes place. This current may be carried for considerable distances along the conductor and may enter the receiver through its connection to the power line.

A high-frequency voltage may be induced in other conductors, whether power lines, telephone lines, or antenna systems. In this way, the interference may be carried to receivers at a considerable distance from the interference source. The interference may also be radiated from any conductor on which it is traveling and may enter the receiver through the aerial or ground connection.

It will, therefore, be seen that there are three ways in which interference may enter the receiver; first, by conductive coupling, or direct connection to the power line; second, by inductive or capacitive coupling to the aerial, and third, by conductive, inductive, or capacitive coupling to the ground lead. Consequently, numerous methods may be used by the broadcast listener in preventing the entrance of interference to his receiver.

Q. What are these methods?

A. The first of these is by providing the best possible antenna system to carry broadcast signals to the receiver. Since the introduction of the A. C. operated receiver, using the latest developments in amplifier tubes, there has been a tendency to neglect this important part of a radio installation. The fact that the more sensitive, modern receiver will operate more or less satisfactorily with almost any sort of antenna has caused many set owners to depend on an improperly erected antenna, or upon the use of a so-called "Ground" connection to the antenna post of the receiver. Either of these practices is likely to detract materially from the efficiency of the receiver, as well as to increase the pick-up of radio disturbances.

The modern radio receiver is a scientifically-designed, carefully-constructed, thoroughly-tested instrument, and as such it deserves the best possible installation and auxiliary equipment. It is just as important that the signal energy supplied the receiver be drawn from the purest available source, and that the signal, once collected on the antenna, be carried to the receiver without contamination from outside agencies, as it is that drinking water be drawn from unpolluted mountain lakes and springs, and carried to the user in pipes sealed against all other water sources.

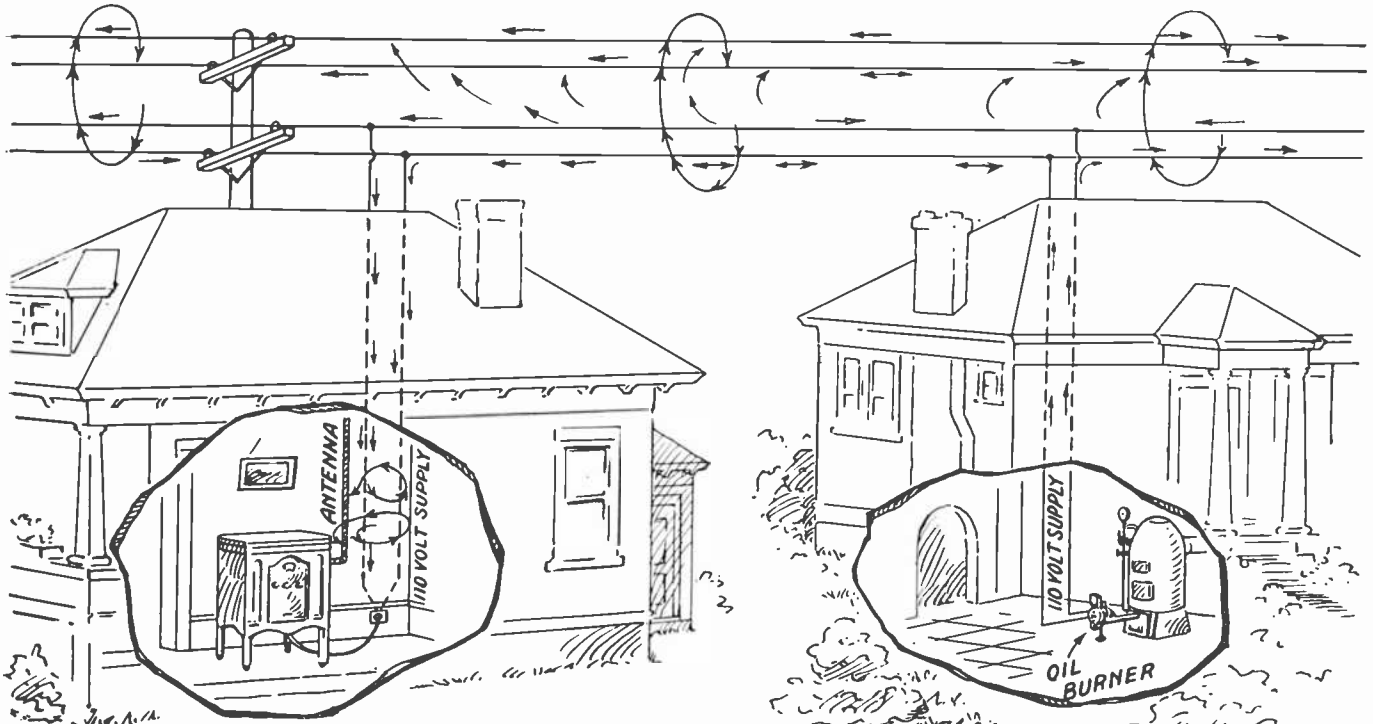

FIG. 83. Diagram showing inductive transfer of interference from the input wiring of an oil burner to the antenna system of a receiver in a neighboring building.

RADIO NOISES AND THEIR CURE

To carry on with this analogy, the pure water source is the air high above the building which houses the receiver, and the sources of impurity are the various wires, pipes, and metal surfaces in the building.

Q. Why are these conductors sources of impurity or interference?

A. One of the fundamental laws of electricity provides the answer to this question. It is an accepted fact that when any conductor, by which is meant any metallic object, is placed within an electrostatic or electromagnetic field, a voltage is induced along the conductor. Every metal object, therefore, may act as a collector of electrical or radio-frequency energy. It is for this reason that many receivers appear to operate satisfactorily from short inside aeri-als. Actually, the receiver is collecting energy from every wire, pipe, or ungrounded metal surface near which the antenna or lead-in passes. The result is that the actual antenna system comprises a short piece of wire, perhaps placed around a room behind picture molding, with a ten foot lead to the receiver, plus every electric light wire, telephone wire, gas pipe, radiator, steam pipe, and even the stove, bath tub, bed spring, or piano.

While such an antenna system may provide tremendous pick-up of broadcast signal, it also introduces many undesired signals. In the first place, this antenna system contains many loose connections. Every switch, pull chain, dial telephone, push button, or thermostat is, in effect, a loose antenna connection. Every electrical appliance which depends upon commutation, or moving contacts for its operation is a source of loose antenna connections.

To determine the importance of firm antenna connections, remove the lead-in wire from its connection to the antenna binding post of the receiver. Now rub the wire back and forth over a metal part of this post. The resulting sound from the loud speaker indicates clearly the effect of a loose antenna connection. Multiplying these loose connections many times, as is the case when an improperly installed antenna is used, will obviously introduce much undesired noise to the receiver.

Q. What is the best antenna location?

A. It is evident then, that, if clear broadcast signals, undisturbed by interference from within the building, are to be received, the antenna must be located away from all conductors and the lead-in must be so installed that it is not affected by the great number of antenna systems in the house.

Numerous tests have shown that the field of radio interference, by which is meant all high-frequency energy except that radiated from the broadcast station, seldom extends more than forty or fifty feet from the conductor on which it may be carried. Consequently,

an aerial separated forty or fifty feet from all power or telephone wiring, and from all other antennae, should be relatively free from local interference.

When the receiver is not located in an apartment building, the installation of such an antenna is a relatively simple matter. In the case of the apartment house dweller, however, considerable difficulty is likely to be encountered in securing a satisfactory location for the antenna. Since coupling to other antenna systems may result in the introduction of interference

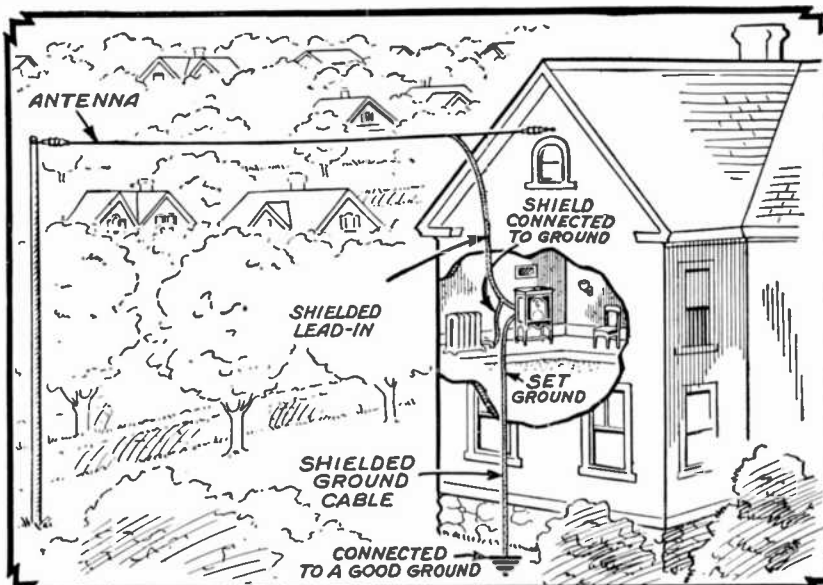

Fig. 84. Typical antenna installation, with shielded lead-in and ground cable.

to the receiver, it is essential that the antenna be separated as much as possible from other antennae on the same roof and from all guy wires, metal drain pipes, flashings, and other metallic objects.

Q. What is the best type of lead-in to carry the signals to the receiver?

A. After a satisfactory antenna location has been found, there remains the problem of conducting the signal from the antenna to the receiver. It is apparent that, if the lead-in is exposed to the fields of the various conductors within the building, the isolation of the antenna from interference sources will be of little value. The connection between antenna and receiver should, therefore, be so arranged that local interference will not affect it. This result may be accomplished by physical separation of lead-in from all conductors and metal objects, by use of a transposition aerial, or by carrying the lead-in through a suitable hollow metal conductor, which when grounded, will act as a shield between lead-in and interference fields.

The first of these methods requires no explanation. The second, the transposition aerial, involves the erection of a special antenna and lead-in system. The antenna should consist of two parallel wires, approximately 100 feet in length, insulated from each other and

separated a minimum distance of 10 feet. Connection from the aerial system to the receiver should be made by means of a piece of twisted pair, each conductor of which is connected to one of the parallel wires. When this system is used, no ground connection is made to the receiver, one of the lead-in conductors being connected to the antenna terminal of the receiver, and the other to the ground terminal. In many cases the use of this type of aerial installation will provide a material decrease in intensity of local interference.

The third method of overcoming interference by special antenna installation requires the use of specially constructed lead-in wire. This wire, consists of a stranded No. 14 conductor, rubber insulated, and having a metal braid outside the insulation. When this wire is used, a long, high antenna, approximately three times the length of the lead-in, should be erected and the lead-in carried in one piece from antenna to receiver. The metal sheath should be stripped back a distance of two inches from each end of the lead-in, and should be connected to a ground. This ground should, whenever possible, be independent of that used for power and telephone wiring, since the use of a common ground may result in the introduction of interference to the receiver by coupling between the shielding and conductor of the lead-in.

The use of the transposition aerial or shielded lead-in alone can seldom be depended upon to provide a maximum of satisfaction, since a considerable amount of interference may enter the receiver through the ground connection, and since the sensitivity of the receiver to local interference is usually increased by its connection to the power line. Consideration of the characteristics of various connections commonly used for grounding will lead to a clearer understanding of the importance of a good ground connection.

Q. How may a good ground be constructed?

A. Next to the antenna, the ground is the most neglected portion of a radio installation. The modern radio receiver will, in many cases, provide a reasonable degree of satisfaction if no actual connection is made to the ground terminal provided by the manufacturer. Furthermore, it sometimes happens that the sensitivity of the receiver is apparently increased by the use of a wire from a water pipe or gas pipe to the antenna post of the receiver. Consequently many persons operate receivers under conditions which were not intended in the design of the receiver.

If clear, interference-free radio reception is to be enjoyed, the receiver must be installed according to the best accepted standards. Just because it is possible to obtain some sort of reception without adhering to accepted standards for antenna and ground installation, the broadcast listener should not assume that his reception is "good enough." The modern broadcast receiver was designed to operate in conjunction with a carefully erected antenna system and a good ground.

Considerable misapprehension exists as to the requirements for a good ground. The following are the recommendations of the United States Bureau of Standards as regards grounding:

"Dig a hole in the ground, one foot deep, and one foot away from all buried pipes. Place in that hole five pounds of rock salt. Pour water in the hole until the salt dissolves. Drive an eight foot rod or section of half inch pipe through the center of the hole. In sections where there is little moisture in the earth use four of these, six feet apart, all connected together."

The fact that a gas pipe eventually enters the ground, or that a steam pipe is connected to the water system, does not necessarily mean that a connection to either of these pipes will provide a satisfactory ground connection for the receiver. This is particularly true if the building is located on dry or rocky terrain. The distance between the point at which connection is made to the pipe and the point at which this pipe is thoroughly grounded may be so great that the pipe will act as an antenna and will pick up radio interference which will enter the receiver through the so-called "Ground" connection.

Even water pipes are not always satisfactory for grounding, since the water system of a building is commonly used as a ground for the power wiring as well as for the telephone system. The fact that the water system may provide a relatively high resistance ground results in the introduction to the receiver of interference carried on power and telephone wiring, if the receiver is grounded to a system common to these lines.

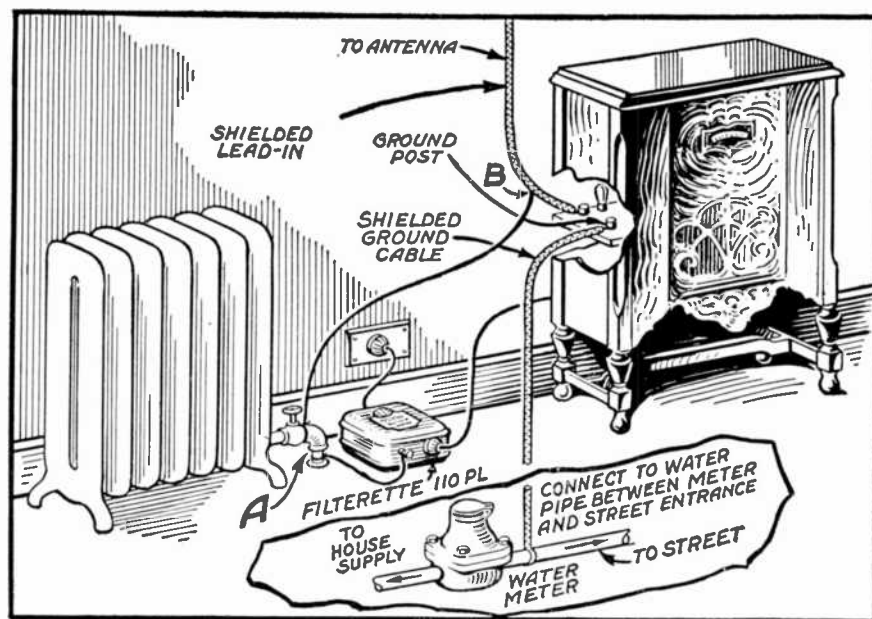

Fig. 85. Use of Filterette 110-PL at the receiver.

RADIO NOISES AND THEIR CURE

This is due to the fact that the ground connection from a receiver is a part of the signal collecting system and may rightly be considered a continuation of the antenna system in that it completes the circuit between the air and earth waves, which is necessary for satisfactory signal reception. It is, therefore, obvious that the ground lead should be shielded from possible inductive or capacitive coupling to interference, as carefully as is the antenna lead-in, and that it must not be common to the ground system of power or telephone lines.

It is recommended that a driven ground be provided for the ground connection of the receiver. In order to prevent the introduction of interference to the receiver by induction between ground wire and other conductors in the building, or due to the connection of the receiver to the same ground system as is used for power and telephone, shielded conductor similar to that used for the lead-in should be connected between the ground terminal of the receiver and the driven ground. The sheath of the ground wire should be connected to the sheath of the lead-in and to the driven ground, although in some cases it may be found that satisfactory results are obtained when the cable sheath is connected at the street side of the water service entrance, as shown in Figure 85.

Q. Is a Filterette also necessary?

A. Yes, it is recommended that a Tobe Filterette No. 110-PL be used with all shielded lead-in installations as illustrated in Figure 85.

Q. How is the Tobe Filterette 110-PL installed for best results?

A. Although the use of shielded lead-in and ground connections, as described, may provide some reduction of interference, full benefit will not be obtained unless a correctly designed filter is used at the power input to the receiver. There are two reasons for this. The first is that interference carried on the power lines may be fed into the receiver through the power supply, and the other is that the coupling to ground, which is provided by the power connection, may result in the introduction of interference through the ground connection in the same manner as when the receiver is grounded to the power and telephone ground.

The filter recommended for use at the power input to the receiver is Tobe Filterette No. 110-PL. This Filterette is installed in conjunction with suitable shielded lead-in and ground wires as shown in Figure 85. A ground terminal is provided on the Filterette for connection to the sheath of the shielded lead-in and ground. It will sometimes be found, however, that more satisfactory results may be obtained if this connection is not used. The Filterette should never be grounded to the same point as the receiver.

The following experimental procedure is recommended for the installation of shielded lead-in and line filter. First determine the amount of background noise when the volume control of the receiver is in the "full on" position and neither antenna nor ground are connected to the receiver. Then install Filterette No. 110-PL

and note the decrease in noise level. Next erect the shielded lead-in to the point at which the aerial is to be located. Do not connect the aerial! Note the increase in noise level. Ground the shielding of the lead-in, changing the location and number of ground connections until the background noise is reduced to its original level. Next connect the shielded ground wire in the same manner. The aerial may then be connected and any interference remaining will be due to pick-up on the aerial.

In view of the fact that a great deal of interference obviously enters the receiver through the antenna and ground connections, it will be appreciated that the use of the Filterette without the shielded lead-in and ground wires and careful installation of the antenna away from possible interference sources will not be likely to prove satisfactory. Since the results to be obtained from the procedure outlined will depend upon the care with which instructions are followed as well as upon local conditions, it should not be expected that 100% elimination of interference will be obtained in all cases.

This procedure is most likely to be found satisfactory when the receiver is located in a single house so that a reasonable separation of antenna from power lines or other antenna systems is obtained. If the receiver is located in an apartment building, satisfactory results may be obtained only when the aerial is located approximately fifty feet above the roof, all power lines, telephone lines, guy wires, or other antenna systems. This system of interference elimination cannot be expected to overcome the interference radiated directly from electrical equipment such as diathermy machines, oil burners, and other sources of intense interference. This interference must be suppressed at its source.

Since a considerable amount of interference undoubtedly enters the receiver through the antenna connection, it is recommended that, as far as possible, electrical appliances located within the home be equipped with suitable Filterettes to suppress whatever interference they may be creating. The oil burner, vacuum cleaner, electric mixer, refrigerator and all appliances which are motor operated or contain thermostats may be sources of interference. It is further recommended that a periodic check of all wiring connections be made in order that loose connections may be eliminated and local interference kept at a low point. At least once a month all bulbs should be tightened in the sockets, all fuses inspected, and the attachment plugs of all appliances checked for firmness of contact. By taking these precautions, the broadcast listener can do much to ensure himself of satisfactory radio reception.

There, of course, remains the possibility that considerable interference originating outside the home will affect the receiver. A survey of the city or town conducted by experienced interference engineers, authorized to recommend or make whatever adjustments or filter applications may be required, has often been found to be productive of great benefit to the broadcast listeners of an entire community. Such a survey

is usually made under the auspices of a Chamber of Commerce, Broadcast Listeners' Association, or other organization interested in civic improvement.

Interference Surveys by Tobe Engineers

Many progressive communities, in various parts of the United States, having decided that radio interference can no longer be tolerated, have instituted vigorous campaigns to rid themselves of this enemy to radio pleasure and profit. Although such campaigns might seem at first to be for the benefit of the radio dealer, investigation has shown that the individual broadcast listener and the community as a whole have benefited sufficiently from interference elimination projects to render them highly worth while. To the credit of many of the communities who have undertaken to combat radio interference, it may be reported that the Chamber of Commerce or the city government has been the moving power in obtaining, for the community, relief from radio interference.

The following report of a typical interference campaign, in which engineers from the Tobe Deutschmann

Filterette Laboratories cooperated with city officials, may be taken as a guide in planning such campaigns.

The first step in planning this campaign was the organization of a committee to consider ways and means. This committee included city officials, radio dealers, members of the Chamber of Commerce, Rotary Club, Kiwanis Club, and Lions Club, representatives

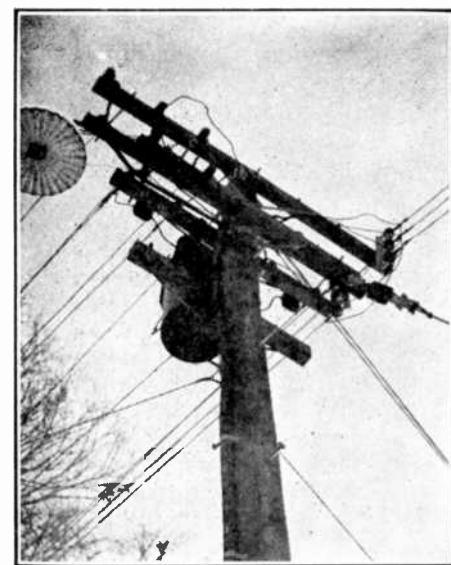

FIG. 86. Lack of spacing between high and low tension circuits at this location caused much interference.

of the Public Utilities and the press. At the first meeting of this committee it became evident that only by the wholehearted cooperation of all the organizations represented as well as by all the citizens of the community, could any lasting results be obtained. It was, therefore, decided to place all findings of the committee before the public and to enlist the aid of all citizens to the fullest extent possible. In order to accomplish this, a questionnaire similar to that shown in Figure 88 was run in the various newspapers for several days.

All persons having definite complaints of radio interference were urged through the press and through local broadcast stations to make complete reports on the printed forms and mail them to the City Clerk. These forms were separated into groups representing various sections of the city, particular care being taken that all reports appearing to relate to the same interference were kept together. When the majority of reports had been classified, the Tobe Deutschmann Interference Engineer was notified, and the reports were given him. From an analysis of these reports he was able to determine the approximate source of some of the major interferences and by use of the interference locator he checked the conclusions drawn from this analysis. Figure 86 shows one of the locations of a major interference. On this pole were carried three 2300 volt circuits and three fire alarm circuits. These were being brought from an underground conduit in a single section of non-metallic flexible conduit. Some of the wiring was grounded to metal cross arm braces causing an interference which was distributed over the area in which the power, lighting and fire alarm circuits were carried.

After checking the major interference sources and recommending the procedure to be followed in overcoming the interference, the interference engineer next visited the various districts of the city which were affected by lesser interference. By use of the Model 230 Interference Locator the engineer was able to identify many of these interference sources while driving along the city streets. In this way, many other interference sources were located and charted on a map of the city. It was next necessary to visit some buildings known to be housing special equipment and to locate definitely the apparatus responsible for the interference. After this had been done, a comprehensive report of the interference sources and the procedure necessary to overcome the interference either by repairs, adjustments, or filterizing was presented to the City Council.

This report showed that approximately 58% of the interference was due to the operation of comparatively small electric appliances which created interference even though they were in good electrical and mechanical condition. The correct type of Filterette for application to each appliance was included in the report. Approximately 14% of the interference was found to be originating on power lines, much of it being due to tree grounds. The responsibility for this condition was divided between the power company and the City Park Commission. In the case pictured in Figure 91, the fault was obviously that of the power company which had allowed its lines to come in contact with a tree until the insulation was worn from the wire and the conductor was making direct contact with the tree.

In the transformer installation pictured in Figure 87, much interference might have been avoided had the City Park Commission allowed the trimming of trees to allow clear space for power lines and street light circuits. Approximately 12% of the interference was found to be caused by Diathermy apparatus. As will be seen from the partial survey map shown in Figure

89, Diathermy interference covers the widest area of any interference. The remainder of the interference was divided among telephone equipment, telegraph equipment, fire alarm equipment and traffic control apparatus.

The following is a condensed interference survey report with a map of the particular section. The Tobe Deutschmann Corporation will be glad to enter into correspondence with municipalities regarding all phases of radio interference. Inquiries will be treated personally and we will make every effort to furnish accurate information irrespective of whether the correspondent proposed to engage our engineers or not.

ENGINEERING REPORT COVERING INTERFERENCE SURVEY

Heavy General Interference

Area — Section bounded by River, North Main, Center and Niagara Streets.

Source — Corona discharge on high tension line coming in on Washington Avenue and Bridge Street. Various electric motors and sign flashers.

Heavy Individual Interference

1. Area — North Main and East Center Streets, with center of disturbance on Third Avenue at Newport Avenue.

Source — Large Diathermy machine in Dr. Brigg's office. This interference blankets the entire area preventing reception of even local stations. Also X-Ray machine.

2. Area — East Center to South Main Streets with center of disturbance along Walter Avenue to East Center.

Source — Various tree grounds on 2300 volt primary feeders and one broken insulator on cross arm.

3. Area — Vicinity of Walter Avenue and South Boulevard. Interference very strong but not carried far.

Source — Boulevard flashing amber warning beacon, and ground leak underground street lighting 2300 volt line.

NOTE: Other traffic lights checked up. Some found O.K., and others while creating some disturbance, were not bad but may become worse at some later date.

Other Individual Interference

1. Area — All Sections.

Source — Oil Burners, Sewing Machines, Commercial Motors and Sign Flashers (business blocks), Fire Alarm Generator, Western Union Telegraph office, and Automatic Dial Telephones.

Interference Cleared

Power Lines —

With aid of Power Company Line Crew all sources of line trouble such as tree grounds, broken insulators, loose cutouts, ground leaks, (defective insulation under-



FIG. 87. Careful trimming of trees is required to avoid tree grounds and consequent interference.

ground) and other small defects found were cleared up. Interference carried on power lines from other sources cannot be immediately cleared up. All interfering appliances will require the application of the proper Filterette to silence the interference caused by their operation.

RADIO INTERFERENCE QUESTIONNAIRE

Name.....
 Address..... Telephone No.....
 Make of Radio..... All Electric..... Battery.....
 What Electrical Appliances have you for home use?.....

Interference Characteristics

Constant..... Intermittent..... What Hours.....
 Does it increase or reduce after Six P. M.?.....
 Describe as near as possible what noises sound like.....

What, in your opinion, is the cause of this interference?....
 If your residence is on or near Street Cars, can you tell when cars are approaching by listening in on Radio?.....

Please fill out accurately and mail or bring to City Clerk as soon as possible.

Do Not Write Below This Line

Interference Checked by Tobe Engineer:—
 A.....
 B.....
 C.....

FIG. 88. Interference questionnaire.

High Tension Line 33,000 Volts —

Relief from this source of trouble may be secured by either moving the line away from other parallel 2300

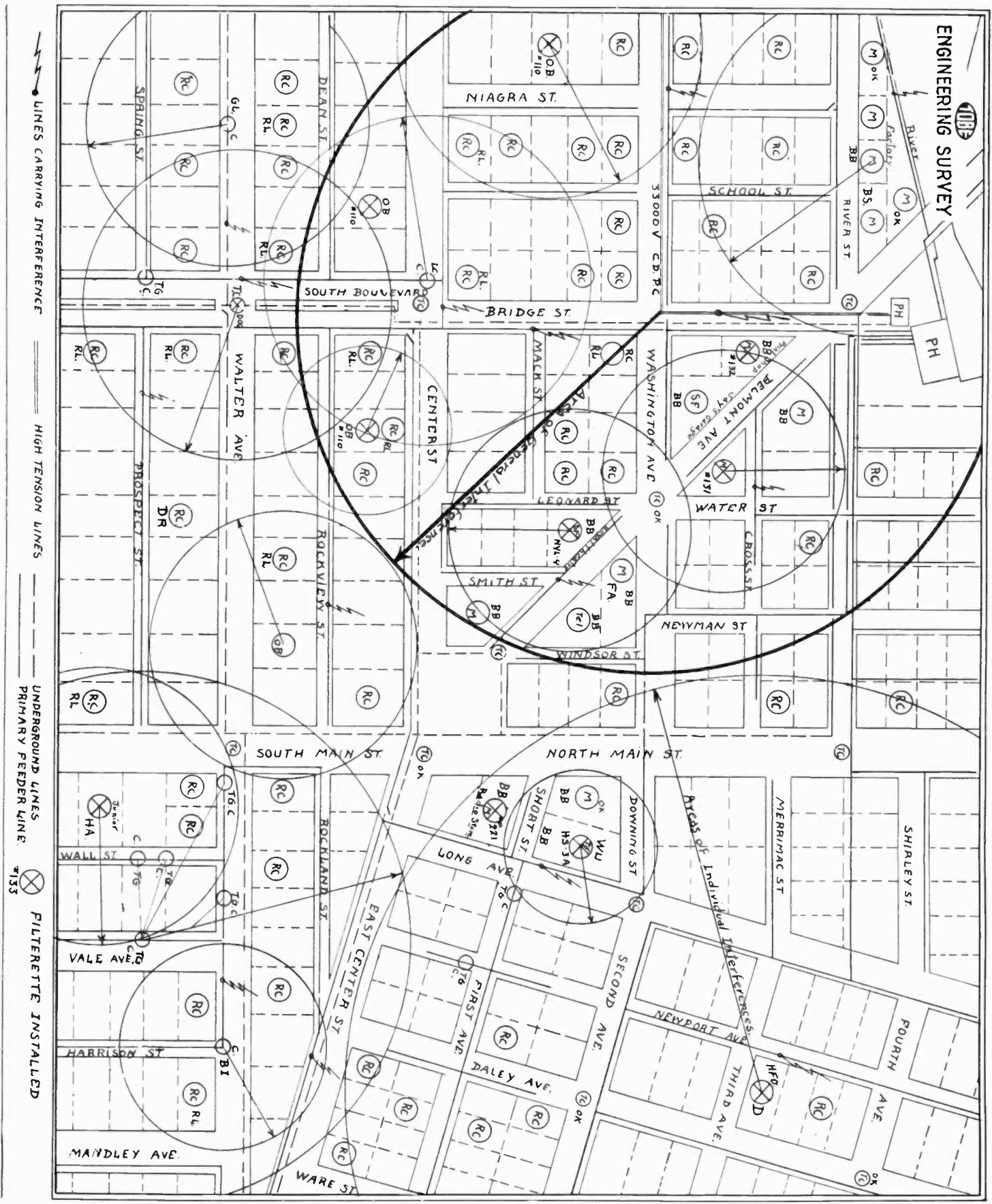

FIG. 89. Interference survey map. See Figure 90 for key.

RADIO NOISES AND THEIR CURE

volt feeders or by use of "no static" insulators and wood cross arms. (Present construction is wood poles, steel "wishbone" cross arms and porcelain pin type insulators.) 2300 volt feeder is carried on same poles and picks up interference of 33,000 volt line.

Interference from the following commercial and household appliances has been silenced by the application of the proper Filterettes.

1. McCarthy's home, South Main St.
1 Junior Filterette on sewing machine.
2. Flashing amber beacon, South Boulevard
FS-110 Filterette.
3. Waldman, Center St.
No. 110 Filterette and shielding on Oil Burner.
4. Smith, Niagara St.
No. 110 Filterette, Oil Burner.
5. Wilkinson, Center St.
No. 110 Filterette Oil Burner.
6. Print Shop, Belmont Ave.
No. 132 Filterette on variable speed motor.
7. Royal Theatre
No. NYL-4 on Sign Flasher.
8. Dr. Briggs, Third and Foley Ave.
1 HFO Filterette and High Frequency Screen on Diathermy Machine. Due to high cost of necessary Filterette devices and the fact that X-Ray interference lasted only a few seconds, it was not deemed advisable to make any Filterette installation on X-Ray.
9. Western Union, Downing St.
FS-110 Filterette on local key circuit.

10. Radio Service Co., Short St.
2 No. 221 Filterettes on Rotary Converter.
11. Meat Market, Belmont Ave.
No. 131 Filterette on Ice Machine.
12. MacKenzie, Walter Ave.
Defective Radio Set Repaired.

Recommended Installation

1. Factory, No. 326 River St.
No. 131 on Battery Charger Generator. Bad Interference.
2. Factory, No. 324 River St.
Several Filterettes on various small motors, etc., 3 Juniors, 2 No. 110 Filterettes and 2 Seniors.
3. Garage, No. 328 River St.
2 Seniors on Electric drill and grinder.
4. Jay's Garage, Belmont Ave.
1 No. 132 plus condenser on Sign Flasher.
5. Newspaper Office, Belmont Ave.
No. 110 on each charging generator.
6. Telephone Office
Cleaning up of ringing machines and installation of Western Electric Filter.
7. Carpenter Shop, Downey St.
No. 221 on motor of rotary saw.
8. Winship on Rockview St.
No. 110 on Oil Burner.
9. Hotel Grand, Belmont Ave.
No. 22 on Ventilator Fan.
10. Filterette for Dial Telephone on all Automatic Dial Units.

General Recommendations

1. Application of Filterettes to all new installations of interfering appliances.
2. Use, by Power Company, of Interference Locator, to check their lines and other interference.
3. Periodic trimming out of tree branches to prevent tree grounds.
4. Use of latest type porcelain cutout boxes.
5. Bringing in of High Tension lines down upper Belmont Ave., instead of through Washington Avenue.

NOTE: This would require changing about six miles of line.
6. Reporting of interference to Authorized Filterette Service Station which is to handle all complaints and interference work.

BB Business block	LL Loose lamp
BI Broken insulator	M Motor
BS Belt static	OB Oil burner
C Interference cleared	PC Power line construction
CD Corona discharge	PH Power house
D Diathermy	RC Regular complaint
DR Defective receiver	RL Radio complaint cleared
FA Fire alarm generator	SF Sign flasher
HA Household appliance	TC Traffic control
LC Loose cutout	TG Tree ground
LJ Loose joint	TS Telegraph
Tel Telephone ringer	
<p>Large circles indicate areas of high noise level due to the combination of several interferences. Smaller circles indicate area blanketed by individual interference sources.</p>	

FIG. 90. Key to survey map shown in Figure 89.

Power Line Interference

Q. What proportion of radio interference is due to power line equipment?

A. It is impossible to answer this question definitely, since the amount and extent of interference from power lines is so largely dependent upon local conditions. In the surveys conducted by Tobe field engineers, interference actually arising on power lines was found in less than 7% of the interference complaints checked by field engineers. Reports of Radio Coordination Departments of Public Utilities show power line interference to be responsible for varying percentages between 5% and 30% of all interference complaints received.

Q. What is a "leaky" transformer?

A. A "leaky" transformer is a myth which has been repeated so often that it is generally believed to be true. A "leaky" transformer could not be a continuing source of radio interference because any leak in a transformer, of sufficient magnitude to cause radio interference, would cause early breakdown of the transformer and its immediate removal from service.

Q. What interference may be caused by a transformer?

A. Practically all of the interference apparently caused by distribution transformers has been found to be due to arcing at the contacts of the plug type primary cut-outs. After primary cut-outs have been in service for a considerable length of time the contact springs tend to lose their tension, with the result that arcing takes place, causing radio interference, which is likely to be distributed along both the primary and secondary distribution networks. The installation of a new cut-out will remedy this interference.



FIG. 91. Tree grounds are an easily avoidable source of interference.

Q. If it is possible to hear a hum within the transformer, does not this indicate that interference is being created?

A. No. This hum may be due to vibration of core laminations and it will not be responsible for radio interference.

Q. Aside from the primary cut-outs, what sources of interference

may be associated with a distribution transformer?

A. Improper spacing of strain insulator bolts and metal cross arm braces may be a source of considerable radio interference. Figure 92 shows a transformer installation in which metal cross arm braces were so close to primary insulator pins that infinitesimal discharges of high frequency voltage caused considerable interference.

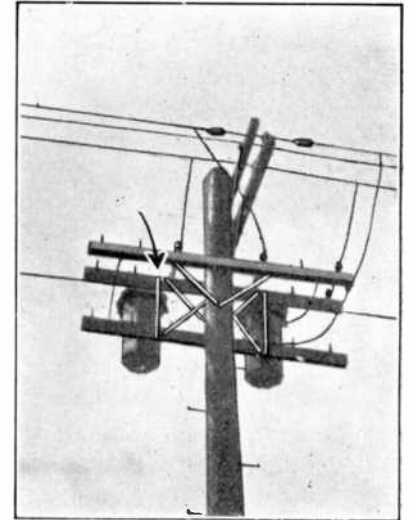

FIG. 92. Interference traced to this pole was due to lack of spacing between insulator pins and metal cross-arm braces.

Q. Why should there be any flow of current between insulator bolts when these bolts are not in contact with wiring circuits?

A. A study of Figure 93 will show the similarity, to a condenser, of a power line, a strain insulator and an insulator bolt. The two plates of the condenser are the power line and the insulator bolt, while the dielectric of the condenser is the insulator. Since the power line bears a continually varying charge, it is obvious that the insulator bolt which is the opposite plate of the condenser, will also bear a continually varying charge. While the quantity of this charge may be extremely small, the radio frequency energy developed when the charge leaks off to ground or to a metal object having a different charge such as another insulator bolt, a metal cross arm brace, a cross arm bolt, etc., is impressed on the high tension line and also on the low tension line by this same condenser action, and is thus distributed along the wiring system.

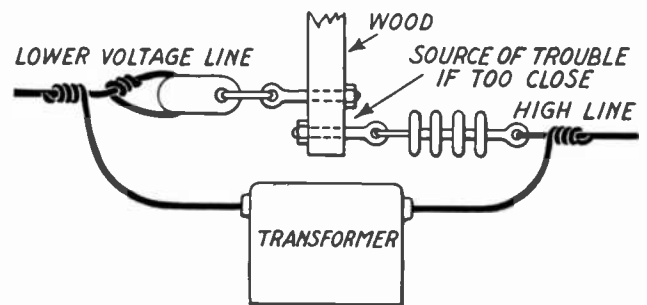

FIG. 93. Interference, thought to be caused by a transformer, is often due to proximity of insulator bolts.

RADIO NOISES AND THEIR CURE

Q. How may interference resulting from the flow of high frequency currents between strain insulator bolts be overcome?

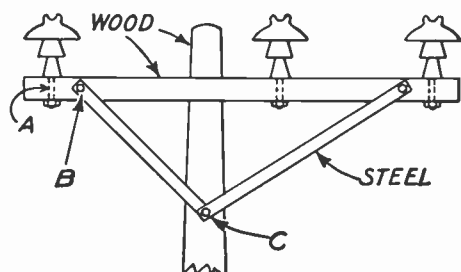

FIG. 94. A loose joint at "C", or lack of spacing between "A" and "B" may cause considerable interference.

A. These bolts should be separated a sufficient distance to prevent discharge of high frequency voltages from one bolt to the other.

Q. Does the discharge of accumulated potentials on other metal parts of a power line cause radio interference?

A. In many cases it does. Figure 94 shows a type of construction which has been found to be particularly productive of radio interference. As will be seen from this diagram, a wood pole and cross arm are used while steel cross arm braces, steel insulator pins and steel cross arm brace bolts are used. Due to the condenser action previously described, charges are accumulated on the insulator pins, and to some extent upon the steel cross arm braces. Other potentials are accumulated on the cross arm braces due to their location within the electro-magnetic field surrounding the conductors of the transmission line. The reaction between the charges on the cross arm braces and those on insulator pins results in considerable radio interference.

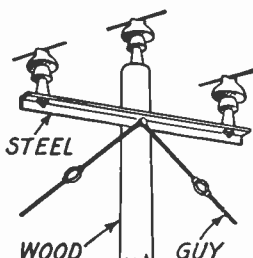

FIG. 95. Loose insulator pins are a source of interference with this type of construction.

Tests have indicated that the amount of interference created by a transmission line using this construction is practically directly proportional to the proximity of point "B" to point "A". A further source of inter-

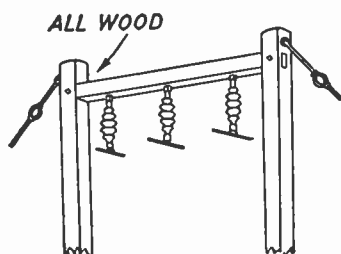

FIG. 97. Wood poles, wood cross-arms and suspension insulators combine to give minimum interference.

ence on a line using this construction may be found at point "C", if this brace bolt becomes loose and allows discharges between the cross arm braces and the bolt or each other.

Another type of line construction which may be productive of considerable interference is shown in Figures 95 and 96. As

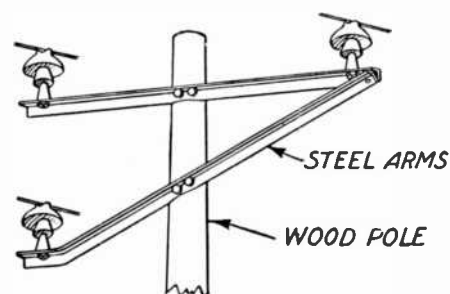

FIG. 96. Interference often arises at the point where the two steel cross-arms are joined.

these figures show steel cross arms are mounted on wood poles. Varying charges induced in the steel cross arms may be discharged to ground, to other wires or to other line hardware. Any

loose connection whether it be a loose cross arm bolt, a loose guy wire or a loose insulator tie wire, will cause an intermittent discharge which will be responsible for a great deal of radio interference.

Q. Is there any type of line construction which is normally reasonably free from interference?

A. All of the types previously described may be kept free from interference if proper spacing is maintained between metal parts, and if loose joints are not allowed to develop. Figure 97 shows a somewhat different type of line construction which has been found to be highly satisfactory from an interference standpoint. As this figure shows, two wood poles joined by a wood cross arm are used. From this wood cross arm, suspension insulators are hung. Guy wires are fastened to the poles in such a manner that there is no probability that charges induced in guy wires will discharge to other metal parts of the installation. A test of a line using this construction as compared to a line using the construction indicated in Figure 95 showed that there was approximately 60% more interference on the line shown in Figure 95 than that shown in Figure 97.

Q. What other conditions on power lines may cause radio interference?

A. Some of the most common sources of line interference are:—

- Loose line connections.
- Tree grounds, slight or otherwise (voltage about 1000). (See Figure 91).
- Arcing fuse contacts.
- Arcing contacts in cutouts.
- Loose fuse or cutout contacts.
- Defective lightning arrestor.
- Defective insulators.
- Loose street lamps.
- Partial on solid grounds on circuits.
- Poor or loose grounds on neutrals.
- Defective or broken transformer bushings.
- Loose transformer cores (not always).
- Guy wires across lines (not necessarily grounded).



FIG. 99. Installation of Interference Locator in the trouble car of the Public Service Company of New Hampshire.

An interesting case of transmission line interference was encountered some time ago. It was found that an 11,000 volt line which passed within a short distance of a cement mill was apparently extremely noisy. Investigation disclosed the fact that the noise was due to leakage across insulators, the leakage being caused by a deposit of cement dust on the insulators. In order to keep this line free from noise it is now the practice to wash the insulators periodically to remove the coating of cement dust which causes the leakage and consequent interference.

One further source of interference found on transmission lines is the corona discharge which takes place when long ends are left on insulator tie wires. This interference may travel for a considerable distance along the transmission line. To overcome this interference it is necessary to cut short any loose ends of tie wires so that there will be no discharge from them.

Q. May interference on one section of a transmission line be kept from reaching other sections of the line by application of filtering devices in the line?

A. Up to the present time there has not been sufficient experimental work conducted to determine the effect of such devices. Considerable benefit has been reported from the use of inductances in transmission lines. In other cases reports have indicated that little benefit was obtained from the use of such inductances.

Q. What progress is being made toward the elimination of transmission line interference?

A. Extensive research is being carried on by power companies, universities and the National Electric Light Association and many independent engineers. At the present time a complete outline of transmission

line interference is not available. With attention being focused on this problem, however, there is little doubt that a satisfactory solution will be reached at an early date.

Apparatus Required for Locating Interference

Q. What apparatus is required for use in locating radio interference?

A. The principal equipment required by an interference locating engineer is an efficient portable instrument which will respond to the same impulses which interfere with radio reception.

Q. What are the characteristics of this instrument?

A. To be satisfactory for use in locating radio interference, an interference locator must be light enough so that it may easily be carried by one man. It must be entirely self contained and it must be sufficiently sensitive to receive any interfering impulse which is affecting an A. C. operated receiver. This sensitivity must be obtained without sacrifice of selectivity and without the use of a ground or any connection to the power line. The instrument must be rugged enough to withstand comparatively rough treatment, and must be provided with meters so that the intensity of interference may be measured.

Q. How does the Tobe Model 230 Interference Locator meet these requirements?

A. The Tobe Model 230 Interference Locator is a highly sensitive portable instrument. A specially designed, four-stage, tuned radio frequency amplifier is used to obtain the extreme sensitivity necessary in an instrument of this type. In sensitivity and selectivity this instrument is equal to the modern A. C. operated broadcast receiver. The input circuit is so designed that it may be tuned to various types of antenna, thus providing a maximum of sensitivity under all conditions. The tubes used in the radio frequency amplifier of this instrument are type 232 screen grid amplifiers having their filaments supplied from two standard No. 6 $1\frac{1}{2}$ volt dry cells. A type 230 tube is used as a detector working into a two-stage, transformer-coupled audio amplifier also employing type 230 tubes. The filament control knob operates a rheostat

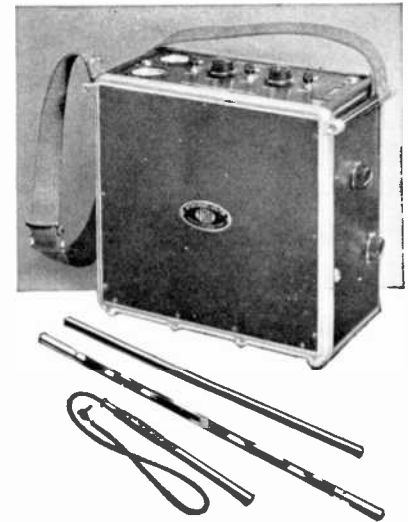

FIG. 98. Model 230 Interference Locator.

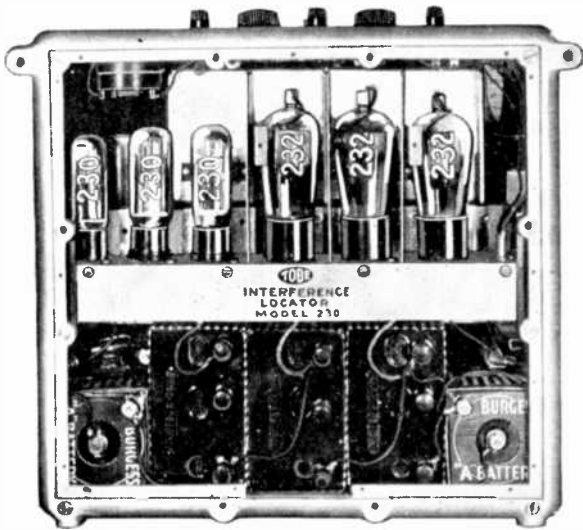

FIG. 100. Model 230 Interference Locator with side panel removed.

governing the voltage applied to all tube filaments. A meter connected in the filament circuit indicates the voltage being applied to the tube filaments. By depressing the button at the top of this meter the plate battery voltage may be read.

The output circuit of the audio amplifier includes a transformer and intensity meter, the meter being connected across the output terminals of an oxide rectifier in the secondary circuit of the output transformer. By means of the meter switch on the control panel, the meter may be cut in or out of the circuit. A meter shunt, controlled by a switch on the top panel, is provided to increase the operating range of the intensity meter. In order to protect the meter it is advisable to keep the meter shunt switch in the "on" position. A jack is provided for the connection of head-phones or speaker. When the meter is in circuit, a decrease in the audible signal will be noticed.

Q. What is the purpose of the intensity meter?

A. The ear alone is a poor indicator of noise intensity, being comparatively easily overloaded so that, after a certain noise level has been reached, the ear does not respond to further increases in noise. The intensity meter, however, is not subject to these limitations, and will continue to record increases of interference intensity after the ear has been overloaded. A further value of the intensity meter is the ability to compare interference intensities by setting the sensitivity control of the instrument at a pre-determined position and comparing meter deflections under varying interference conditions.

Q. What provision is made for varying the frequency setting of the Tobe Model 230 Interference Locator?

A. A frequency selector or tuning dial is provided at the extreme right side of the control panel. This dial is of the drum type graduated from "0" to "100" and

may be easily read at all times. It is operated by a knob at the right-hand side of the instrument case.

In order to allow the detection of electrical disturbances in the audio frequency range a jack, marked "Audio" is provided on the top panel. When the plug of the audio coupling unit is inserted in this jack the signal is impressed on the primary of the first audio frequency transformer, consequently there is no possibility of a radio frequency impulse being indicated by the output meter when the audio jack is being used.

To allow the use of external battery equipment two jacks are provided, one in each of the end panels. The jack in the right or tuning end panel is for the connection of an auxiliary filament battery, and that in the left end panel for the connection of auxiliary plate batteries. Inserting a plug in the auxiliary "A" jack disconnects the internal filament battery. Inserting a plug in the auxiliary "B" jack disconnects the radio and audio frequency plate circuits from the internal plate battery. Screen grid and detector plate voltages are at all times supplied by the internal "B" batteries.

The Model 230 Tobe Interference Locator is constructed with cast aluminum frames and polished bakelite panels. The instruments, switches, volume control, jacks and tuning dial are mounted in the top panel so that they are clearly visible and easily accessible at all times. This panel is so engraved that the controls are readily identified. A carrying strap of 1/8" x 2" webbing, having a nicked buckle and end tip, is provided. A space is provided within the Locator to contain the batteries. The cabinet is 7 1/4" wide, 13 1/2" long, and 12 1/2" high. When fully equipped with tubes and batteries the instrument weighs 35 pounds.

Q. What battery equipment is used with this instrument?

A. The Model 230 Tobe Interference Locator is wholly dry cell powered, the following batteries being required: For filament power two No. 6 dry cells; for plate supply, three small size 45 volt batteries

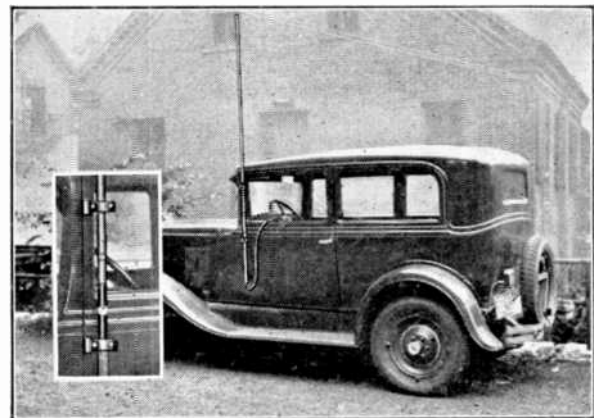

FIG. 101. Mounting bracket for resonance pole used with Model 230 Interference Locator.

(Burgess No. 5308); for grid bias, one 4½ volt battery (Burgess No. 432), and one 3 volt battery (Burgess No. 422).

Q. What type of pick-up units are used with this instrument?

A. For most interference locating, the resonance coil will be used. This coil is encased in black bakelite tubing having ¼" wall. The case of the resonance coil provides sufficient insulation to withstand 2300 volts A. C.; care must be taken that the bakelite housing is not subjected to excessive mechanical stresses. The split bamboo section provides an extension in length of resonance pole of 2' 5½". The third, or handle section, is of hardwood finished in black lacquer. The three sections are joined by means of nickel plated brass ferrules. The total length of resonance pole when assembled is 7' 1". If greater length of pole is desired, additional bamboo sections may be obtained.

The audio coupling coil consists of a multiple wound coil, contained in an insulated housing, capable of withstanding 600 volts A. C. The coil is used for checking individual appliances for interference, where space is limited, and for audio pick-up.

Q. How may this instrument be installed in an automobile?

A. Figure 99 and Figure 101 show suggested methods of installing the instrument in an automobile. In Figure 99 is shown the mounting of the instrument in the automobile. As will be seen from this photograph, the folding seat is removed from the car, and the instrument is placed in a felt-lined box, where it is accessible to the operator of the car, and can easily be used while the car is in motion. Figure 101 shows a method of mounting the resonance pole on the car. When mounting the pole on a steel bodied automobile, it is essential that the bakelite housed top section of the pole be kept well above the metal body of the car.

Q. What auxiliary equipment may be used with this instrument?

A. To provide maximum portability, the batteries used in the Locator are necessarily of small size. In order to reduce the drain on these small batteries, provision has been made for the connection of external filament and plate batteries when the Locator is operated in an automobile. The filament battery may be a two-volt, storage cell or one of the new Eveready air cells. It is connected to the Locator by means of a cord and phone plug. The positive battery terminal connects to the tip of the plug and the negative terminal to the sleeve. Inserting the plug in the jack in the right or tuning end panel of the instrument disconnects the internal Locator battery, and allows the external battery to be controlled by the switch and rheostats on the Locator.

An external plate battery, which should consist of three heavy duty 45 volt batteries, connects to the Locator through a jack in the left end panel. The negative battery terminal should be connected to the negative terminal of the external filament battery, and a single wire from the positive battery terminal should be connected to the tip of a standard phone plug. When



FIG. 102. Tobe Filterette Analyzer.

this plug is inserted in the jack, the radio and audio frequency plate circuits are disconnected from the internal "B" batteries. The batteries within the Locator at all times supply screen grid and detector plate voltages.

The Tobe Filterette Analyzer

Q. What is the Tobe Filterette Analyzer?

A. The Tobe Filterette Analyzer is an instrument containing fundamental Filterette circuits which may be connected or disconnected by means of the switches on the control panel.

Q. What is the purpose of the Tobe Filterette Analyzer?

A. This instrument is designed for use by Authorized Filterette Service Stations. By means of this instrument it is possible to analyze the interference being created by any electrical appliance which is connected to the power supply lines by means of an attachment cord and plug. This interference analysis makes it possible to prescribe the correct plug-in type Filterette without following the cut and try method of applying Filterettes of various types until the desired reduction is obtained.

Q. How is the Tobe Filterette Analyzer used?

A. The use of the Filterette Analyzer is indicated in Figure 103.

As will be seen from this photograph, the attachment plug of the interfering appliance is inserted in the re-

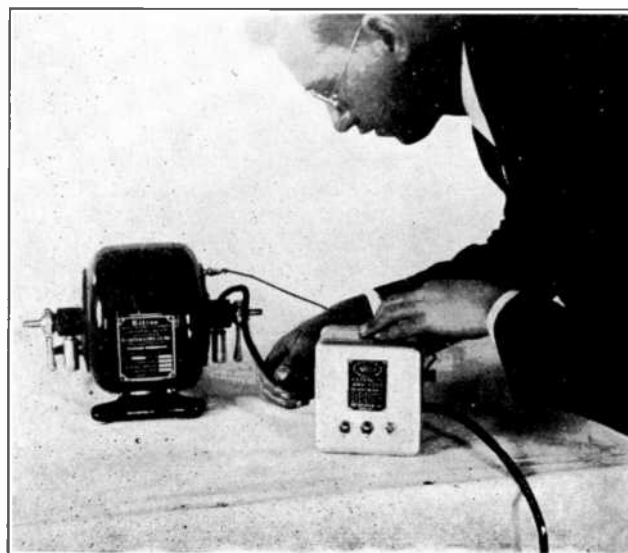

FIG. 103. Use of Analyzer to determine correct Filterette for application to a dental lathe motor.

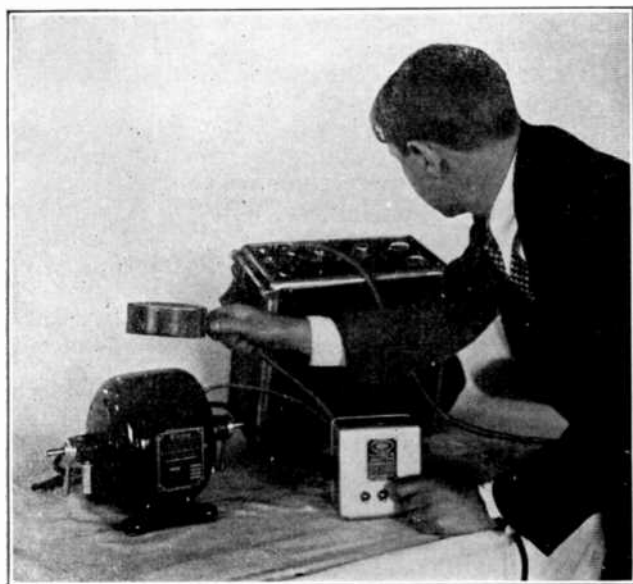

FIG. 104. Measuring interference at different settings of Filterette Analyzer. Intensity meter of Tobe Interference Locator gives comparative readings.

ceptacle of the Analyzer. When this test is being made, the attachment cord of the appliance should be coiled into the smallest possible space in order that there may be no radiation of interference from the attachment cord. A short wire, preferably not more than 6" long, should be connected from the binding post on the side of the Analyzer to a carefully cleaned part of the metal frame of the interfering appliance. For most satisfactory results this connection should be made to the frame of the motor which operates the appliance. The attachment plug of the Filterette Analyzer should then be inserted in the wall or floor receptacle to which the appliance was originally connected. When the appliance has been connected to the Analyzer in the manner previously described, the various Filterette combinations, as indicated on the name plate, should be set up. After the combination, which provides satisfactory reduction of interference, has been set up, the standard Filterette, which will accomplish the same result, will be determined by reference to the name plate of the Analyzer.

Q. What are the most common types of Filterette indicated by the Analyzer?

A. Filterette Junior, Filterette Senior, and Filterette No. 110-PO are generally indicated by the Filterette Analyzer. When the indicated Filterette has been installed, satisfactory reduction of the interference is bound to result.

Interference from Electrical Systems of Automobiles

Q. What parts of the electrical system of an automobile may cause radio interference?

A. The ignition system, the generator, the starter

and the small motor used in connection with the heater, normally cause interference. Other interference may be due to poor contacts in various parts of the car wiring. In some cases interference has been found to be caused by the rubbing together of two metal parts of the car, such as the radiator shell and the sheath of the headlight cable.

Q. For what percentage of the interference are the various parts of the electrical system responsible?

A. This depends upon the type of receiver used, the manner in which it is installed, and the condition of the electrical system of the car.

Q. What is the first step to be taken in overcoming interference in an automobile?

A. The first step should be a careful inspection of all wiring, cleaning of all contacts, replacement of insulating bushings which have been lost, cleaning of generator commutator, replacement of brushes if necessary, and a careful check of all receiver connections, particularly those in the antenna circuit.

Q. How may the interference created by the generator be overcome?

A. To overcome this interference it is necessary to connect a type AG-15 Filterette in the generator circuit. The Filterette is connected in series with the ungrounded terminal of the generator. To be effective, this Filterette must be located within four inches of the generator. In a great many cases the application of Filterette AG-15 to the generator eliminates enough interference to allow satisfactory radio reception while the automobile is in operation.

Q. If, after the generator has been filterized, interference which may be identified as due to the ignition system is in evidence, what procedure should be followed?

A. If objectionable ignition interference is present, the antenna system of the receiver should be separated as much as possible from all ignition wiring before applying any filtering devices to the ignition system. If, after this has been done, the interference persists, changes may be made in the ignition system.

Q. Where does ignition interference originate?

A. This interference originates at every point in the circuit where there is a spark discharge or an interruption to the flow of current. In other words, interference originates at each spark plug, at the distributor and at the breaker.

Q. How is ignition interference distributed?

A. This interference is impressed on the wiring from the spark plugs to the distributor, from the distributor to the coil, and from the coil to the ignition switch. Since all of this wiring is in series with or coupled to the spark gaps, it constitutes a part of an oscillating circuit similar to that used in the old type spark transmitters, and thus acts as a broadcasting antenna for the interference.

Q. How may the effect of these oscillations be overcome?

A. Connecting a resistance in series with each gap

provides sufficient damping of the high frequency disturbance to minimize the interference. The value of this resistance must be carefully adjusted as excessive resistance in the ignition circuit is likely to interfere with the operation of the ignition system. The maximum total resistance which may safely be inserted in an ignition system is from 30,000 to 40,000 ohms. Tests show that little if any benefit is to be obtained from higher values of resistance, while considerable detriment to the operation of the ignition system results from the use of higher resistance values. There has recently been announced a new type of spark plug into which the correct resistance value has been built. This spark plug is shown in Figure 106. The resistance which is built into the spark plug is located as close as possible to the point at which spark plug interference originates, and it is thus most effective. This resistance also is protected against breakage and possible changes of value which would result if the resistance were exposed to the air. A further benefit from the use of the built-in resistor is the elimination of external connections which may become loosened and thus increase rather than decrease the interference. In addition to the use of these resistances at each spark plug, it is necessary to connect a resistance unit in series with the common lead to the distributor.

Q. What adjustment of spark plug gaps is recommended for satisfactory motor performance with a minimum of radio interference?

A. The spark plug gaps should be kept at the lowest possible value consistent with satisfactory motor operation. A gap of from .020 to .025 is usually satisfactory. The gap in the distributor between the rotary arm and the stationary terminal should also be kept as small as possible. In some cases it may be necessary to peen the tongue of the distributor arm to obtain the small gap required. A suggested method of accomplishing this peening is as follows: Remove the distributor head and apply a thick layer of chalk to the end of the distributor arm. Replace the distributor head and, with the ignition switch turned off, turn the motor over slowly by hand, then remove the distributor head and note whether the contacts show markings of chalk. If all of the contacts are chalk marked, the gap should be satisfactory. If some of the contacts are marked and others show no marking, the contacts which are marked should be scraped down until even spacing between contacts and distributor arm is obtained. If no chalk mark shows on any of the contacts, the tongue of the distributor arm should be placed on a flat steel block and hammered until it is lengthened slightly. It should then be chalked once more and the procedure already described should be followed once more. Be sure that the rotor does not make actual contact with any of the stationary points. The recommended distributor gap is from .002 to .004.

Q. What further procedure may be required to prevent the distribution of ignition interference?

A. It may be necessary to connect a Filterette in

series with the primary leads to the ignition coil. Filterette FS-110 is the correct type for this application.

Q. Of what value is shielding in the elimination of ignition interference?

A. In some cases it may be found necessary to provide shielding for the high tension circuit of the ignition system. Shielded wire is not recommended for this purpose, but it is recommended that a metal housing which will enclose the spark plugs, the distributor and all connecting wiring be provided. Whenever shielding is applied to an ignition system, suitable spacing should be maintained between the shielding and the ignition wiring to prevent any possibility of excessive damping of the spark.



FIG. 106. Cut-away view of an A. C. spark plug showing filtering spark suppressor.

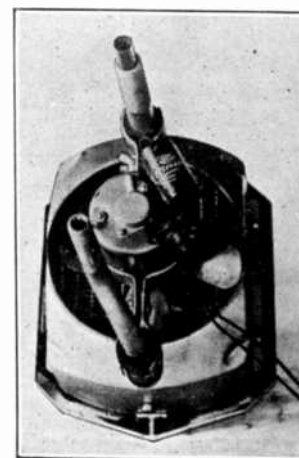

FIG. 107. Application of Filterette JA to the fan motor of an automobile heater.

Q. How may the interference from the small motor used in connection with hot water and hot air automobile heaters be eliminated?

A. This interference will be heard as a high-pitched whine varying in pitch when the speed of the fan is changed.

Q. How may this interference be suppressed?

A. To suppress this interference a type J. A. Filterette should be mounted on the heater frame and its leads should be connected across the brushes of the motor. The Filterette return lead should be connected to the frame of the fan motor. When applying a Filterette to any heating device, be sure to provide ample ventilation space for the Filterette.

How Communities May Attack the Problem of Minimizing Radio Interference

The first step to be taken to improve radio receiving conditions in any city is to discover what is causing the interference. In view of the misconceptions which exist about the causes of radio noises, it is best not to act on supposition, but to have the town surveyed by a competent interference expert with an instrument de-

signed to hunt down strays or radio noises. Almost any town has several radio amateurs who are competent to assist in this work. While the services of an expert are, of course, to be preferred, it may still be possible to locate a large proportion of the trouble by enlisting the aid of local radio dealers and amateurs whose interests are directly affected. Any work which these men do will, of course, be of immediate value. Causes of radio interference can be verified by shutting off the apparatus under suspicion. If the noises stop when the apparatus is turned off, and are heard only when the apparatus is on, it is reasonable to suppose that you have found the cause of your trouble.

One of the first steps for those interested is to form a radio listeners' club. The small sum collected for dues helps to pay the expenses of locating interference.

The next thing to do is to enlist public support. This may be done through circulating petitions, through newspaper advertisements, and through radio broadcasting. Most radio broadcasting stations are only too glad to co-operate in any movement which will help their own listeners to get better reception. Mr. James H. Weir in Pittsburg has done excellent work with a club of this sort which works in conjunction with scheduled broadcasts from a station. Great progress is being made in providing Chicago broadcast listeners with clearer radio reception through the efforts of the Chicago Daily News Interference Club, under the direction of K. A. Hathaway.

You will need money, of course, because filterizing costs money, and unless you succeed in passing ordinances against radio interference the listeners, in many cases, must themselves install the Filterettes; although as a rule the owners of industrial establishments do not wish to antagonize the public by letting it be known that they are refusing to do anything to help stop noises from their apparatus which are ruining the reception of their neighbors.

In smaller communities money can be raised by public subscription, by fairs, dances, or by other means which will readily suggest themselves.

Best of all, perhaps, after your club has attained large proportions, is to submit to the legislative body of your community, a petition, preferably through a selectman, councillor, senator, congressman, alderman, etc., requesting the passing of an ordinance against needlessly disturbing radio reception.

The more names you can get to sign the petition, of course, the greater weight it will carry.

Q. By whom should the expense of Filterette installation be borne?

A. The answer to this question is usually determined by local conditions, the best solution generally being obtained by co-operation between the owners of the offending apparatus and the broadcast listeners whose reception is being affected by the apparatus. In view of the fact that benefits are being received by the broadcast listener, he should be willing to contribute his share toward the Filterette installation.

However, the owner of the interference-creating

apparatus has, of course, some responsibility toward his community, and should, therefore, be willing to contribute his share toward making his own apparatus interference free.

The following quotation from the government bulletin, "State and Municipal Regulation of Radio Communication," recently issued by the Legal Division of the Federal Radio Commission, illustrates the attitude shown by many owners of interference-creating apparatus:

"There are also industrial activities which cause interference with radio reception. For example, 'Precipitator' devices, which are designed to control smoke and noxious fumes by the creation of an intense electrical field within the stack, are, in effect, radio transmitters. Interference is also caused by arc welders, portable drills, motors and generators, bell ringers, thermostats and starting contacts.

"Practically all these devices can be cured of their interference effects by repair or the addition of filtering attachments. In this connection, each industry is greatly concerned with the maintenance of public goodwill as well as efficiency in its own processes. The occasion when a manufacturer refuses to correct an abuse once it is called to his attention is so rare that certainly mere local legislation is not the most effective weapon. Instances are known to every radio trades association where manufacturers have gone to expense aggregating thousands of dollars purely for the purpose of eliminating radio interference. Surely, it would not be expected that merely because of the passing of an ordinance by a community, an industry should go to prohibitive expense".

Q. In the event that the owner of the offending apparatus refuses to co-operate, how may legal steps be taken to compel him to apply interference eliminating devices?

A. In many cases local ordinances may be drawn to compel owners of disturbing machinery to suspend its operation, or to adjust it so that no interference will be created.

Q. How drastic may these ordinances be?

A. These ordinances must be so drawn that they will not conflict with any Federal laws and should be so phrased as to be inapplicable to persons who are not guilty of willful or negligent disregard of the radio reception rights of the community.

Another quotation from the previously mentioned bulletin of the Federal Radio Commission illustrates this point:

"The spark and the arc, together with their accompanying radio interference, are found in hundreds of appliances in common use. In some such appliances the disturbance is a necessary part of the apparatus. Examples of this are X-ray, violet ray, and diathermic machines.

"In these cases radio interference is cured or prevented by the insertion of attachments which prevent the flow of the radio-frequency impulses back into the power lines for general dissemination. In other devices,

RADIO NOISES AND THEIR CURE

the interference is not necessarily produced by the operation of the device and is due only to improper design or to a defect which has developed. Devices of this character are heating pads, vibratory battery chargers, electric sign "flashers," and motors and controls such as those used in vacuum cleaners, electric refrigerators, washing machines, elevators, and innumerable other devices.

"The holding of the householder to a criminal or penal responsibility because of the mere ownership or operation of a device within this classification is certainly unjust.

"In many cities, however, ordinances of general application have been enacted where the real purpose has been to reach individual offenders who knowingly and persistently operate interference-producing devices of wide effect, refusing to attach corrective apparatus or to make repairs.

"As to such persons, ordinances are valid if reasonable. In such applications the ordinances are in nowise burdens on interstate commerce but are rather in aid thereof. They come with the power of the State to prevent and abate nuisances."

Q. Can electrical apparatus be purchased which will not interfere with radio reception?

A. Another quotation from the previously mentioned bulletin of the Federal Radio Commission illustrates this point:

"Whether the device causes interference through lack of "choke" or "filter" attachments or through improper design, the cure for the interference lies in the education of the manufacturer. Many brands of devices have become specifically known as interference producers and this reputation is compelling manufacturers to improve their construction. Already a large number of such appliances carry the guarantee of the maker that they will not produce interference with radio reception. The importance of the work along this line of trades associations has been tremendous and the time will soon arrive when this type of interference will not longer exist."

Q. What ordinances are recognized as enforceable?

A. The following model ordinances drawn by the Legal Department of Federal Radio Commission are designed to provide a maximum of benefit to the broadcast listener with a minimum of hardship to the individual owner of electrical apparatus and to harmonize with Federal laws.

AN ORDINANCE PROHIBITING ELECTRICAL INTERFERENCE WITH RADIO RECEPTION, AND PROVIDING FOR PUNISHMENT FOR THE VIOLATION THEREOF.

Be it ordained by.....

Section 1. That it shall be unlawful for any person, firm, copartnership, association, or corporation knowingly or wantonly to operate or cause to be operated, any machine, device, apparatus, or instrument of any kind whatsoever within the corporate limits of the

city of.....between the hours ofo'clock,m., and 12 o'clock midnight, the operation of which shall cause reasonably preventable electrical interference with radio reception, within said municipal limits; Provided, however, that X-Ray pictures, examinations, or treatments may be made at any time if the machines or apparatus used therefor are properly equipped to avoid all unnecessary or reasonably preventable interference with radio reception and are not negligently operated.

Section 2. That this ordinance shall not be held or construed to embrace or cover the regulation of any transmitting, broadcasting or receiving instrument, apparatus, or device used or useful in interstate commerce or the operation of which instrument, apparatus, or device is licensed or authorized by or under the provisions of any act of the Congress of the United States.

Section 3. That every person, copartnership, association, firm or corporation violating any of the provisions of this ordinance shall, upon conviction, be punished by fine of not less than.....dollars nor more thandollars, or by imprisonment in the city jail for not less than.....days nor more than.....days or by both such fine and imprisonment. Each day during which such violation continues shall constitute a separate offense.

Section 4. That this ordinance shall take effect, etc., (here follow requirements of State Laws).

AN ORDINANCE PROHIBITING THE OPERATION OF MECHANICAL DEVICES, MACHINES, APPARATUS, or INSTRUMENTS TO INTENSIFY OR AMPLIFY THE HUMAN VOICE OR ANY SOUND OR NOISE BY WHICH THE PEACE OR GOOD ORDER OF THE NEIGHBORHOOD IS DISTURBED OR PERSONS OWNING, USING, OR OCCUPYING PROPERTY IN THE NEIGHBORHOOD ARE DISTURBED OR ANNOYED.

Be it ordained by.....

Section 1. That it shall be unlawful for any person, copartnership, association, firm, or corporation knowingly or wantonly to use or operate, or to cause to be used or operated, any mechanical device, machine, apparatus, or instrument for intensification or amplification of the human voice or any sound or noise in any public or private place in such manner that the peace and good order of the neighborhood is disturbed or that persons owning, using, or occupying property in the neighborhood are disturbed or annoyed.

Section 2. That every person, copartnership, association, firm, or corporation violating any of the provisions of this ordinance shall, upon conviction, be punished by fine of not less than.....dollars nor more thandollars, or by imprisonment in the city jail for not less thandays nor more than.....days, or by both such fine and imprisonment. Each day during which such violation continues shall constitute a separate offense.

RADIO NOISES AND THEIR CURE

Section 3. That this ordinance shall take effect, etc. (here follow requirements of state laws).

For those who are desirous of examining a specimen ordinance now actually in force in an American city, we have reproduced below an ordinance now in effect in Los Angeles, Cal.

"BE IT ORDAINED by the City Council of the City of Los Angeles, California

An Ordinance Regulating the use of devices or apparatus which interfere with radio broadcasting reception.

THE PEOPLE OF THE CITY OF LOS ANGELES, CALIFORNIA DO ORDAIN AS FOLLOWS:

Section 1. It shall be unlawful for any person, firm or corporation to operate in the City of Los Angeles any apparatus generating or causing high frequency oscillations which interfere with radio broadcast receiving apparatus or wireless receiving apparatus between the hours of 6 o'clock P. M. and 11 o'clock P. M. except that a person duly licensed to practice medicine, osteopathy, chiropractic or dentistry by the State of California, in a case of absolute emergency arising in the course of practice of his profession and which case demands immediate treatment between the afore-mentioned hours may operate or cause to be operated under his direct supervision any machine necessary to give emergency treatment in such case.

Section 2. Any device or apparatus such as Violet Ray machines, machines using the Tesla Coil or principal, X-Ray machines and Diathermy machines which interfere with the intelligibility of reception under all the following conditions shall be considered as coming within the terms of this ordinance:

(a). Such device or apparatus must be situated one hundred (100) feet or more from the radio receiving equipment with which it interferes.

(b). The radio receiving equipment interfered with shall be operated at a volume comparable to a person speaking in a normal tone of voice.

(c). The broadcasting station whose program is being received when the interference occurs must have a power output of at least one (1) kilowatt and must be located not more than twenty-five (25) miles distant from the receiving set.

It is expressly understood and provided, however, that this ordinance shall not apply to radio stations either broadcast, commercial or amateur, licensed by the Federal Government and/or which are engaged in interstate communication or to public utilities under the supervision of the State Railway Commission.

Section 3. The Chief of the Electrical Division of the Department of Building and Safety or his duly authorized Deputies, shall have the right to enter upon any premises at all reasonable hours for the purpose of inspecting the installation and working of all apparatus coming within the terms of this ordinance, and it shall be unlawful for any person, firm or corporation to interfere with the Chief of the Electrical Division of the Department of Building and Safety or his duly

authorized Deputies, in making said inspection or to refuse to permit the said Chief or his Deputies to enter the premises for such purposes.

Section 4. When an inspection and test shall have been made by the Chief of the Electrical Division of the Department of Building and Safety or his duly authorized Deputies and it is found that equipment or apparatus coming within the terms of this ordinance is being operated in violation of this ordinance the person or persons responsible for the operation of such equipment shall be notified in writing to discontinue the use of such machine or to make additions, repairs or modifications thereof in order that the same may be operated in a manner which complies with the provisions of this ordinance. The mailing of a registered letter addressed to the owner or operator of the machine at the premises where the machine is located shall constitute a sufficient notice for the purpose of this ordinance. In the event that the owner or operator of such machine or apparatus does not, within forty-eight (48) hours after receipt of notice to repair or discontinue the use of such machine, either entirely discontinue the use of such machine during the hours the use of such machine is prohibited by this ordinance, or repair the same so that it complies with the provisions of this ordinance, such owner shall be deemed to be operating such machine or apparatus in violation of the provisions of this ordinance and such persons shall be subject to the penalties hereafter provided for such violation.

Section 5. Any person violating any of the provisions of this ordinance shall be deemed guilty of a misdemeanor and upon conviction thereof shall be punishable by a fine of not more than five hundred (\$500.00) dollars or by imprisonment in the City Jail for a period of not more than six (6) months, or by both such fine and imprisonment.

Q. What municipalities or states now have legislation affecting the operation of apparatus likely to create radio interference?

A. The following is a partial list of municipalities now having interference ordinances against needless disturbance of radio reception:

Brattleboro, Vt.
Grand Rapids, Mich.
Sault Ste. Marie, Mich.
Bay City, Mich.
Two Harbors, Mich.
Chesaning, Mich.
Beverly, Mass.
State of Maine
Hagerstown, Md.
Cole Camp, Mo.
Sedalia, Mo.
Boonville, N. Y.
Millville, N. Y.
Miles City, Montana
Portland, Ore.
St. Paul, Minn.
Dumbright, Okla.
Kimball, S. D.
Sioux Falls, S. D.
Brazil, Ind.

Clinton, Iowa
Fairfield, Iowa
Wausau, Wis.
Stevens Point, Wis.
Los Angeles, Cal.
Inglewood, Cal.
Pasadena, Cal.
South Pasadena, Cal.
Santa Ana, Cal.
Stockton, Cal.
Alhambra, Cal.
Riverside, Cal.
San Buenaventura, Cal.
San Diego, Cal.
Valentine, Neb.
Mt. Pleasant, Mich.
Marinette, Wis.
State of Vermont
Sturgis, South Dakota
Manchester, N. H.

Tag System Used in Enforcement of Interference Ordinance

In order that full benefit may be obtained from radio ordinances it is necessary that a definite means of enforcement be provided. The enforcement of an interference ordinance cannot be left to the usual police authorities, as they do not have the equipment necessary to determine when the ordinance should be applied.

The enforcement of interference ordinances is normally a function of the City Building Inspection Department, or if a separate department exists for the supervision of electric wiring and installation, the enforcement of an interference ordinance will be delegated to this department. Building and wiring inspectors normally have police authority and are, therefore, familiar with the procedure to be followed in the treatment of building code violations as well as violations of electrical wiring and interference ordinances.

In one city the Building Inspection Department has adopted a system followed by the Traffic Department in the treatment of violators of the traffic code. A three section tag which is reproduced on this page (Figure 108) is used to notify owners of interfering appliances that the apparatus has been checked and found to be operating in violation of the local interference ordinance. This tag is returnable within 48 hours and its use has proved to be highly effective in the enforcement of the radio interference ordinance.

In order to locate electrical apparatus which is being operated in violation of a radio interference ordinance, a duly authorized official, usually a member of the Electric Wiring Inspection Department covers the city in a cruising car equipped with interference locating and measuring equipment. (The Tobe Model 230 Interference Locator has been adopted by many municipalities as the standard instrument for locating and checking radio interference ordinance violations.) The interference inspector also investigates all interference complaints and notifies owners of offending electrical apparatus that said apparatus must be so adjusted that its operation will not interfere with radio reception, or that its use must be discontinued during the hours specified in the ordinance.

Although the municipal interference inspector often works in close co-operation with the radio co-ordination department of the local power company, he is independent of all power company officials, radio dealers, trade associations or other outside influences. He does not repair defective electrical apparatus or radio receivers, although he may, at his discretion, advise the owner of offending apparatus what adjustment, repairs or additions will be required to make the apparatus comply with the terms of the interference ordinance.

The enforcement of a radio interference ordinance is often simplified by public education. Radio broadcasts, talks before luncheon clubs or schools, and demonstrations of common interference sources are among the devices used by the interference inspector for creating public understanding of his work.

Authorized Filterette Service

In the installation of all Filterettes, certain fundamental rules must be followed. The most important of these are as follows:

1. Be sure that the Filterette chosen is designed for operation at the maximum voltage rating of the apparatus which creates interference.
2. Be sure that the Filterette chosen is designed for continuous operation at the maximum current drawn by the apparatus which is causing interference.

No 1015

The equipment described below has been checked in accordance with the provisions of City Ordinance No. and found to be operating in violation of the terms thereof.

Description

Make

Type

No 1015

The equipment covered by this notification has been made non-radio interfering and is ready for inspection.

Process

Firm Name

Address

Date

No 1015

Receipt of this notification is hereby acknowledged.
 I will discontinue.
 I will repair.
 I will filter.

Signature

Address

Phone

Date

Description

Make

Type

FIG. 108. Tag used to signify infringement of radio interference ordinance.

NOTE: If there is any question as to the current drawn or delivered by the apparatus, the current should be measured. Do not attempt to calculate the current from the wattage or H. P. rating of the machine.

3. Be sure that all circuits in which interference is originating or on which interference may be carried are adequately filtered.
4. Be sure that the Filterette is located as close as possible to the point at which the interference is originating.

RADIO NOISES AND THEIR CURE

5. Be sure that any high tension wiring from which interference may be radiated is shielded so that radiated interference will be kept from reaching building wiring circuits.
6. Be sure that the Filterette applied is designed for application to the apparatus which is creating the interference. Do not attempt to economize by using a Filterette at voltages or currents in excess of its rating or by using a plug-in type Filterette with electrical apparatus which should be wired to the power distribution circuit.
7. Do not depend upon unqualified persons for Filterette service. There is an Authorized Filterette Service Station near you. Look for the insignia shown in Figure 109.

All Authorized Filterette Service Stations display this insignia on their letterheads, advertising and display material, and store windows. This insignia is issued only to radio and electrical service men who have received special training in the handling of interference problems and who are thoroughly familiar with the application of Filterettes to interference-creating electrical apparatus of the type shown in Figure 111, as well as other types described in this book. Every accredited employee of an Authorized Filterette Service Station carries an identification card bearing the insignia shown in Figure 109, and in addition is provided with an identification badge, as shown in Figure 110. To be sure of satisfactory service, insist that your apparatus be filterized by trained interference experts associated with Authorized Service Stations.



FIG. 109. This insignia on a store window or letterhead indicates that special training in interference elimination has been given the individual or concern displaying the insignia.



FIG. 110. Identification badge for interference inspectors associated with Authorized Filterette Service Stations.

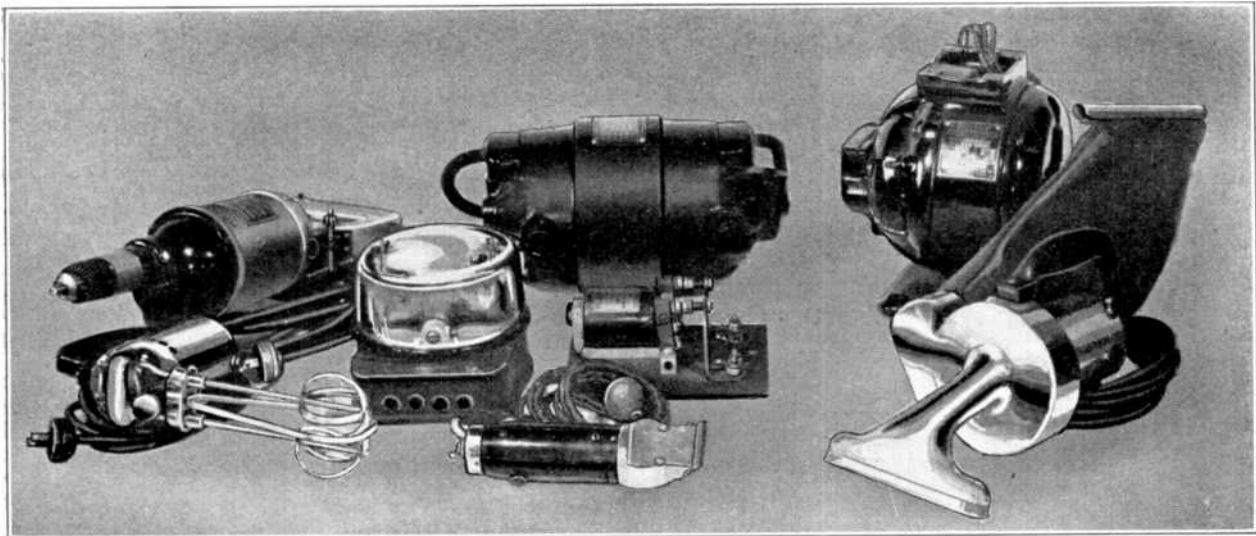

FIG. 111. Appliances of the type shown above are responsible for a large percentage of the radio interference in every city.

RADIO NOISES AND THEIR CURE

REPRESENTATIVE TOBE FILTERETTES



FIG. 112. Tobe Filterette Junior. This Filterette is recommended for application to appliances employing series-wound or universal motors.



FIG. 116. Tobe Filterette FS-110. When a Filterette is required for use in limited space, Filterette 110 is recommended. This Filterette is particularly suited to use with flashing traffic beacons, switches, call relays and other types of switch mechanism operated at 110 volts.

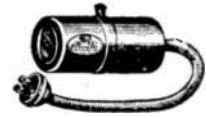

FIG. 113. Tobe Filterette Senior. Portable electric appliances creating a more intense type of interference than may be suppressed by Tobe Filterette Junior or JA require the Filterette Senior.



FIG. 112A. Tobe Filterette JA. This Filterette should be used when permanent installation is required or when the Filterette is to be located within the appliance housing.

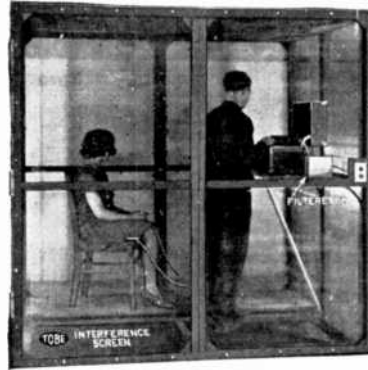

FIG. 59A. High frequency screen used in conjunction with Tobe Diathermy Filterettes. The use of this screen prevents distribution of interference by radiation from the electrode leads and the body of the patient.

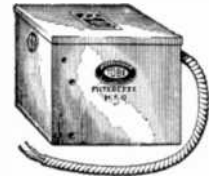

FIG. 117. Tobe Filterette 1-HFO. This Filterette, installed as shown in Figure 59-A will prevent the distribution of interference from Diathermy and other high frequency electro-medical apparatus.



FIG. 114. Tobe Filterette 110-PO. This Filterette is suitable for application to electric refrigerators, fruit juice extractors, adding machines and practically all office appliances.

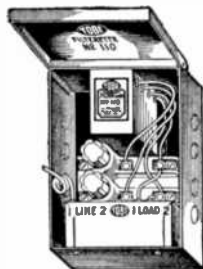

FIG. 115. Tobe Filterette 110. This Filterette is approved by Underwriters Laboratories for installation in any 110-volt circuit carrying 5 amperes or less.

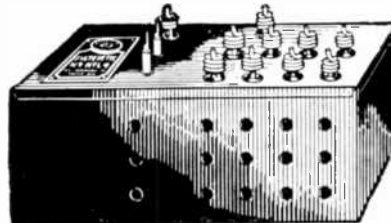

FIG. 116A. Tobe Filterette NYL-4. Sign flashers of the four-circuit type such as are commonly used for obtaining motion effects in incandescent lamp signs may be filtered by application of this Filterette.

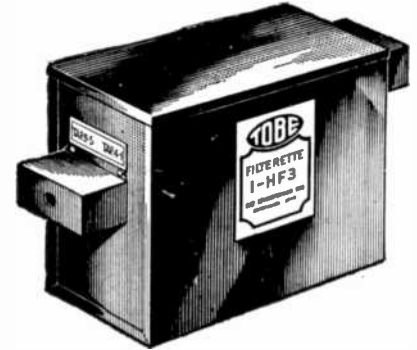

FIG. 117A. Tobe Filterette 1-HF-3. For application to electro-medical apparatus requiring current up to 25 amperes at 110 volts, this Filterette is recommended. To be most effective, it should be used in conjunction with suitable screening.

Filterettes for Application to Westinghouse Converters

KVA	Converter Type	Volts		Amperes		Dimensions	Price
		D.C.	A.C.	D.C.	A.C.		
.25	578137	115	110	3.2	2.3	2 sec. each 5 1/2" x 6 1/4" x 6 3/4"	\$20.00
.50	578138-B	115	110	6.3	4.55	1 sec. 13 3/4" x 8 1/2" x 2 1/8"	25.00
.75	578139-A	115	110	9.	6.8	1 sec. 13 3/4" x 8 1/2" x 2 1/8"	35.00
1.00	578140-B	115	110	11.	9.1	1 sec. 15 1/4" x 10" x 2 3/8"	37.50
.25	578142-B	230	110	2.	2.3	1 sec. 13 3/4" x 8 1/2" x 2 1/8"	38.00
1.50	578058-B	115	110	15.	13.6	1 sec. 16 1/4" x 10" x 2 5/8"	45.00
.25	675607	32	21	15.	12.	2 sec. each 5 1/2" x 6 1/4" x 6 3/4"	45.00*
.10	675608	32	21	6.5	4.75	2 sec. each 5 1/2" x 6 1/4" x 6 3/4"	38.00*

*This price includes a 21 to 110 volt transformer.

RADIO NOISES AND THEIR CURE

SPECIFICATIONS and PRICES OF ALL TOBE FILTERETTES

Model No.	Rating		Housing	Connections	Dimensions	Price
	Volts	Amperes				
Junior	110	..	Bakelite Cylinder	Plug-In	1½" diam. x 2½"	\$3.50
J-A	110	..	Bakelite Tube	Flexible Leads	1⅝" diam. x 2"	3.50
Senior	110	5	Metal Cylinder	Cord and Plug	2" diam. x 4"	7.50
110-PO	110	5	Metal Case	Cord and Plug	5½" x 3½" x 4½"	12.50
110-PL	110	5	Metal Case	Cord and Plug	5½" x 3½" x 4½"	12.50
110	110	5	Cutout Box	Screw Terminals	10" x 6⅜" x 3⅜"	15.00
OB-110	110	4	Cutout Box	Flexible Leads	7" x 6⅜" x 3⅜"	15.00
FS-110	110	4	Metal Case	Flexible Leads	4" x 3¼" x 2¼"	15.00
131	110	10	Cutout Box	Screw Terminals	13" x 9⅝" x 3⅜"	20.00
132	110	20	Cutout Box	Screw Terminals	16" x 10⅝" x 4⅛"	30.00
133	110	30	Cutout Box	Screw Terminals	19" x 12⅝" x 6⅛"	42.50
134	110	40	Cutout Box	Screw Terminals	19" x 12⅝" x 6⅛"	57.50
135	110	50	Cutout Box	Screw Terminals	19" x 12⅝" x 6⅛"	75.00
221	220	5	Cutout Box	Screw Terminals	13" x 6⅜" x 3⅜"	20.00
231	220	10	Cutout Box	Screw Terminals	13" x 9⅝" x 3⅜"	30.00
232	220	20	Cutout Box	Screw Terminals	16" x 10⅝" x 4⅛"	40.00
233	220	30	Cutout Box	Screw Terminals	19" x 12⅝" x 6⅛"	52.50
234	220	40	Cutout Box	Screw Terminals	19" x 12⅝" x 6⅛"	67.50
235	220	50	Cutout Box	Screw Terminals	19" x 12⅝" x 6⅛"	85.00
10*	110	..	Cutout Box	Screw Terminals	7" x 6⅜" x 3⅜"	10.00
11**	110	..	Cutout Box	Screw Terminals	7" x 6⅜" x 3⅜"	10.00
20*	220	..	Cutout Box	Screw Terminals	10" x 6⅜" x 3⅜"	15.00
22**	220	..	Cutout Box	Screw Terminals	10" x 6⅜" x 3⅜"	15.00
23	220	..	Cutout Box	Screw Terminals	13" x 6⅜" x 3⅜"	20.00
	3 phase					
55	550	..	Cutout Box	Screw Terminals	13" x 12⅝" x 4⅛"	25.00
56	550	..	Cutout Box	Screw Terminals	13" x 12⅝" x 4⅛"	35.00
	3 phase					
60*	600	..	Cutout Box	Screw Terminals	13" x 12⅝" x 4⅛"	25.00
1 HFO***	110	6	Metal Case	BX-in Plug-Out	7⅝" x 6¾" x 5½"	35.00
1 HF-2***	110	15	Metal Case	BX-in Plug-Out	7" x 11⅝" x 9"	75.00
1 HF-3***	110	25	Metal Case	Screw Terminals	8" x 16" x 13"	125.00
Dial	Bakelite Tube	Flexible Leads	1" diam. x 1½"	3.50
NYL-4	110	10 per branch	Metal Case	Flexible Leads	13" x 6" x 5"	38.00
NYL-4	220	10 per branch	Metal Case	Flexible Leads	13" x 6" x 5"	50.00
NYL-2	110	10 per branch	Metal Case	Flexible Leads	4" x 2¼" x 3¼"	20.00
DM-32	32	25	Cutout Box	Screw Terminals	11" x 15½" x 4¼"	45.00
DM-110	110	15	Cutout Box	Screw Terminals	6¼" x 10½" x 4⅝"	38.00

Ritter Dental Filterette obtainable thru Ritter Dental Mfg. Co. Rochester N. Y.

*For use in D. C. circuits only.

**For use in A. C. circuits only.

***For use in 50-60 cycle circuits only.



TO HELP YOU . . . FIND WHAT YOU NEED - QUICKLY

In preparing the new Tobe Catalog, we have incorporated many radical ideas in catalog construction with the object of making it easy for you to find just what you want. If you know the capacity of the condenser you wish to use, turn to the chart on page 9 where you will find listed all Tobe Electrolytic Condensers arranged in groups according to capacity rating. Each group is sub-divided according to voltage rating, type of container, method of connection, physical size and price. This chart also lists the number of the page on which you will find more detailed information about the type of condenser you wish to use.

On the catalog pages containing detailed descriptions of the condensers, you will find these units grouped according to voltage so that you may more easily find the condensers you wish to use.

Paper condensers are charted on page 10 in the same manner as electrolytic condensers so that if you know the capacity you wish to use, you will have at your finger tips all the information you need to place your order.

A chart to aid you in choosing Filterettes for application to any

source of man-made static will be found on page 14. On this page are listed all of the known sources of radio interference with the correct Filterette for application to each. This information has never before been published in this form and should be of untold assistance to dealers and servicemen who encounter radio interference problems.

If you have any questions about Condensers, Filterettes, Aerial Filterizer Kits or service instruments that does not appear to be answered in this catalog, please feel entirely free to submit it to our Engineering Department as we are anxious to cooperate closely with every dealer and serviceman so that he may secure maximum benefit and profit from the Tobe line.

GUARANTEE

We guarantee that every product listed in this catalog is manufactured in its entirety in the United States of America under working conditions carefully controlled to insure the highest product quality. The skill and precision for which Yankee artisans are famous are employed in the manufacture of all Tobe products and give com-

plete assurance of satisfaction.

Any Tobe product which fails to give satisfactory service when used within its voltage or current rating, under the conditions for which it is designed, and which our tests show to have been defective in manufacture, will be repaired or replaced at our option if it is returned to us, transportation prepaid, within 90 days after its purchase. In the event that material is to be returned under this guarantee, a letter should be sent us outlining the conditions under which the material was used and specifying the date of purchase and the name of the dealer or distributor from whom it was purchased.

The prices quoted in this catalog are list prices, subject to dealer and jobber discounts. Discount schedules will be submitted immediately on receipt of information clearly identifying the inquirer as either a jobber, a dealer, or a serviceman. In the event that local distribution is not adequate to meet your requirements, arrangements will be made to ship material direct from our factory until such time as local stocks are available. C.O.D. shipments have been found to cause unnecessary expense and inconvenience to all concerned and, for this reason, orders from dealers are accepted only when accompanied by a check or money-order covering the complete cost of the shipment.



TOBE DEUTSCHMANN CORPORATION
OF CANTON, MASSACHUSETTS



TOBE TUBIDON

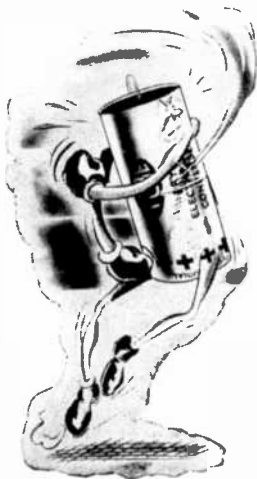

In this corner we have the new light-weight contender for the championship of the radio service field — TOBE TUBIDON. Tough as they come, he takes the hardest punishment that can be handed out by torrid temperature, tropical humidity, arctic fridity and surging over-voltage — and all without flinching or failure. So compact that he fits in the smallest spaces available in modern midget chassis, Tobe TUBIDON is the easiest condenser to use for universal replacement service. When one or more sections of an ordinary electrolytic condenser fail, Tobe

TUBIDON enables you to make the needed repair and get the receiver perking again quickly — without needless expense or waste. *Modern service demands modern materials.* Line up with Tobe TUBIDON and get the benefit of tomorrow's condenser TODAY.

TECHNICAL DETAILS THAT PROVE THE ADVANTAGES OF TOBE TUBIDON

Here is the inside story of why Tobe TUBIDON is the logical condenser for use in every chassis repair:

1. — The unique foil formation process, which is used exclusively by Tobe in place of less effective chemical processes, provides increased active foil area thus ensuring greatest capacity in least space and providing high efficiency for radio and audio frequency by-passing service.

2. — Precision control of processing consistently produces a dielectric film of sapphire hardness as a result of which condenser stability and shelf life are materially increased.

3. — The tubular form of the condenser guarantees freedom from pressure faults that are almost inevitable in ordinary electrolytic construction.

4. — The TRI-DERM body seal, consisting of three asphalt-impregnated layers of close grain paper, spiral wound in a single tube in which the condenser is inserted, prevents absorption of breakdown-producing moisture.

5. — The riveted and soldered connection of the lead wire to the condenser foil keeps contact resistance at a minimum and avoids noisy connections.

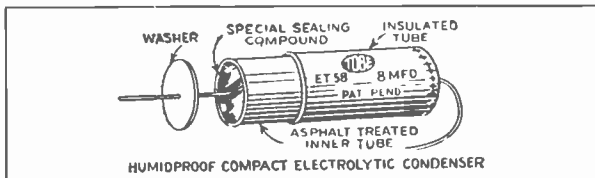

6. — The CAN'T CORRODE terminal seal in which a vulcanized fibre washer is interposed between the electrolytic winding and the lead wire absolutely prevents corrosive action between the electrolyte and the connecting lead. This corrosive action, which takes place in ordinary electrolytic condensers, is responsible for open circuits that develop after the condenser has been in service for a short time.



7. — The HUMID-PROOF wax plug end seal of a non-hygroscopic compound positively prevents entrance of moisture through the ends of the condenser and at the same time serves as an anchor holding the terminal lead firmly in place.

8. — The final super seal, whereby the TRI-DERM unit is placed in an outer paper tube after which the entire assembly is vacuum impregnated, provides additional assurance of protection against moisture — public enemy No. 1 of satisfactory condenser life and performance.

The technical and manufacturing advantages outlined above are characteristics only of the Tobe TUBIDON and make it the most amazing condenser value ever offered in the radio service field. Tobe TUBIDON is available in every essential capacity and voltage rating at prices you cannot afford to overlook.

A WORD ABOUT PRICES

The list prices of Tobe TUBIDON are based only upon our actual manufacturing costs without introduction of artificial factors to maintain high list prices. Tobe TUBIDON prices are materially lower than the prices of other types of electrolytic condensers but this does not mean that the TUBIDON is less valuable. On the contrary, Tobe TUBIDON gives you more for your money because efficient production methods and automatic machinery create savings which are passed along to the user of condensers. The Tobe TUBIDON affords you a real opportunity to standardize on low priced, high quality electrolytic condensers for every radio service application. With a minimum assortment of Tobe TUBIDONS, you can duplicate every necessary voltage and capacity and thus can be sure of handling every repair job with the speed and economy that build your reputation and profits.

TOBE TUBIDONS

Volts Working	Mfd.	Length Inches	Diameter Inches	Type No.	List Price
35	5	2 1/4	3/8	T-305	\$0.40
	10	2 1/4	3/8	T-3010	.40
	25	2 1/4	3/8	T-3025	.50
	50	2 1/4	1	T-3050	.80
	5-5	2 1/4	3/8	T-325	.65
	10-10	2 1/4	3/8	T-3210	.70
50	5	2 1/4	3/8	T-505	.45
	10	2 1/4	3/8	T-5010	.65
	25	2 1/4	3/8	T-5025	.70
	50	2 1/4	1	T-5050	.95
	5-5	2 1/4	3/8	T-525	.70
	10-10	2 1/4	3/8	T-5210	.75
200	2	2 1/4	3/8	ET-22	.45
	4	2 1/4	3/8	ET-24	.50
	8	2 1/4	3/8	ET-28	.55
	12	2 1/4	3/8	ET-212	.65
	16	2 1/4	1	ET-216	.75
475 (Peak 525)	1	2 3/8	3/8	ET-51	.50
	2	2 3/8	3/8	ET-52	.55
	4	2 3/8	3/8	ET-54	.60
	8	2 3/8	1	ET-58	.75
600 (Peak)	4	2 3/4	1	ET-64	.90
	8	2 3/4	1 1/4	ET-68	1.05



TOBE FLEXIDON

In this corner we have another aspirant for championship honors in the electrolytic condenser field — TOBE FLEXIDON. Favored by many servicemen because of his familiar rectangular form, Tobe FLEXIDON now shows new features of superiority rendering him more than ever before the logical choice of conservative radio service organizations.

Tobe FLEXIDON is more than just an electrolytic condenser assembly, he is two, three, or four condensers in one

outer container, having each section entirely independent of the others so that in case of breakdown from over-voltage the shorted section may be replaced without necessity for discarding the remaining good sections. When conventional condenser shapes and sizes are required, insist on Tobe FLEXIDON and be sure of giving your customers the superior service it renders.

TECHNICAL FEATURES OF FLEXIDON CONSTRUCTION

These are the reasons for Tobe FLEXIDON'S dependability and desirability for reliable performance under every operating condition:

1. — Years of manufacturing experience backed by extensive research and development have perfected production methods so that every section of a Tobe FLEXIDON meets the high standards that have been established for Tobe products.

2. — The assembly of multiple capacity blocks with unit sections (Unidons) entirely insulated from each other, so that damage to one section will not affect the others, is in marked contrast to the siamese-twin construction of ordinary electrolytic condensers which, because of their concentric winding, must be entirely replaced if only one section fails.

3. — The utilization of modern foil formation methods ensures uniformity of capacitance and physical size and, by reducing the cubic content of Unidons, makes possible the production of extremely compact sections.

4. — The use of an asphalt-lined, calendered-paper, rectangular container for Unidon sections renders them impervious to moisture.

5. — The wax plug end seal is provided for each individual section thus sealing the condenser ends against moisture and at the same time holding the insulated connecting leads firmly in place.

6. — Separation of the condenser winding from the point at which the connecting wire is attached eliminates danger of galvanic action with its eventual corrosion of the terminal and open-circuiting of the condenser.



7. — The grouping of individual sections in popular FLEXIDON assemblies provides a complete filter or by-pass block requiring only one mounting in the chassis.

8. — Mounting tabs closed with tinned eyelets may be used for holding the FLEXIDON in place or as soldering terminals.

Only Tobe FLEXIDON offers these outstanding advantages. Tobe FLEXIDON is available in all popular single and multiple section arrangements in both standard and midget sizes. Despite the many advantages it offers, its price is no greater than that of ordinary electrolytic condensers. Consequently, it is recognized as the standard of discriminating radio servicemen and engineers.

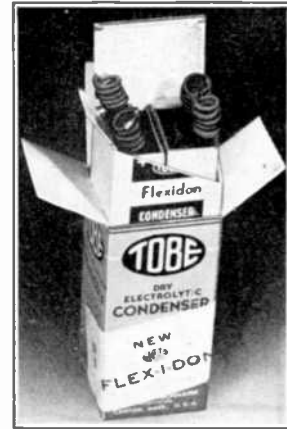

TOBE STANDARD FLEXIDONS

Volts Working	Mfd.	Dimensions Inches	Type No.	List Price
	1	2 1/8 x 1 x 1	511	\$0.55
475 (Peak 525)	2	2 1/8 x 1 x 1	512	.65
	4	3 1/4 x 1 1/8 x 5/8	514	.75
	8	3 1/4 x 1 1/8 x 3/8	518	.95
	4-4	3 1/4 x 1 1/8 x 1 1/8	524	1.20
	4-8	3 1/4 x 1 1/8 x 1 1/8	5048	1.35
	8-8	3 1/4 x 1 1/8 x 1 1/8	528	1.50
	4-4-4	3 1/4 x 1 1/8 x 1 1/8	534	1.80
	8-8-8	3 1/4 x 2 1/8 x 1 1/8	538	2.20

TOBE COMPACT FLEXIDONS

Volts Working	Mfd.	Dimensions Inches	Type No.	List Price
200	4-4	2 1/8 x 1 1/8 x 3/8	ET-244	\$0.90
	8-8	2 1/8 x 1 1/8 x 1	ET-288	1.20
	8-16	2 1/8 x 1 1/8 x 1	ET-2816	1.35
475 (Peak 525)	4	2 1/8 x 1 1/8 x 1/8	EC-54	.75
	8	2 1/8 x 1 x 3/8	EC-58	.95
	4-4	2 1/8 x 1 x 3/8	EC-544	1.20
	8-8	2 1/8 x 1 1/8 x 1	EC-588	1.50
	4-4-4	2 1/8 x 1 1/8 x 1	EC-534	2.00
600 (Peak)	8	2 1/8 x 1 1/8 x 1	EC-68	1.35

NEW COMPACT UNIDONS

Build Your Own New Compact Unidons

Here's something new in the "roll your own" idea. Designed for AC-DC replacement block assembly. Save time and money by making your own filter and by-pass blocks with these compact UNIDONS. These UNIDONS, inner sections of the famous Flexidon condensers, are small and compact and will serve as the answer to the complicated exact duplicate replacement problem. Listed below are the individual sections comprising all the values employed in such blocks. With a small stock of these UNIDONS, you can handle any midget repair.



Volts Working	Mfd.	Dimensions Inches	Type No.	List Price
150 (Peak 200)	16	1/8 x 1 x 2 1/4	ER-2016	\$0.70
	12	1/8 x 3/8 x 2 1/4	ER-2012	.60
	8	1/8 x 3/8 x 2 1/4	ER-218	.50
25 (Peak 35)	10-10	3/8 x 3/8 x 2 1/4	ER-3210	.65
	10	3/8 x 3/8 x 2 1/4	ER-3010	.40
	5	3/8 x 3/8 x 2 1/4	ER-3005	.40

LEAKAGE—LESS THAN 0.1 M. A. PER MICROFARAD

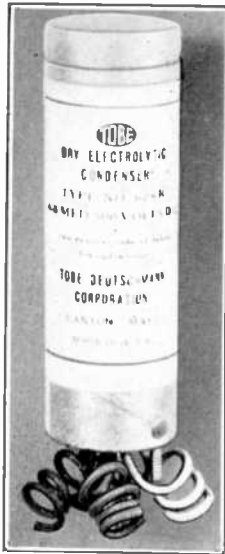

SPECIAL ELECTROLYTICS FOR AC-DC RECEIVERS

Single and multiple section tubular electrolytics contained in aluminized paper tubes. Especially designed for replacement in popular Midget and AC-DC chassis. Provided with 6" insulated flexible leads for connection and threaded mounting lugs for fastening the condenser in place. Each of these units is contained in a heavy cardboard tube 4 1/4" high and 1 7/8" in diameter. The mounting lugs are on 1 5/8" centers.

Volts Working	Mfd.	Type No.	List Price
475	16	6016-B	\$1.40
	4-4	624-B	1.25
	4-8	6048-B	1.35
	8-8	628-B	1.60
200	8-8-8	238-B	1.75
	8-16	20816-B	1.45
200	8-16		
35	10-10	23320-B	2.25

LOW VOLTAGE HIGH CAPACITY ELECTROLYTIC CONDENSERS

Newly designed for ease of installation and convenient use, the original TOBE high capacity long life filter condensers assume a new position of importance in the radio and industrial fields. These dependable condensers are now available in cylindrical aluminum housings with threaded stud for single hole mounting in any chassis or with any type of bracket assembly.

Among the unique features of the new Tobe high capacity condenser are

1. Low power factor
2. Low inductance
3. Constant capacity
4. No local battery action
5. 90% filtering efficiency
6. Less than .002 milliamperes per microfarad leakage.



So great is the capacitance of these condensers that they act practically as a short circuit on alternating current and thus effectively eliminate rectifier ripple in speaker field coil circuits; induced hum in exciter lamp circuits; hum or ripple in telephone or interphone power supplies, relay control circuits, amplifiers and transmitter bias supplies, microphone power supplies, and other circuits in which an exceptionally high degree of filtering efficiency is required.

Mfd.	Volts	Diam.	Length	Type No.	List Price
500	50	1 1/2"	4 1/2"	HC-5	\$5.25
1500	15	1 1/2"	4 1/2"	HC-15	5.00

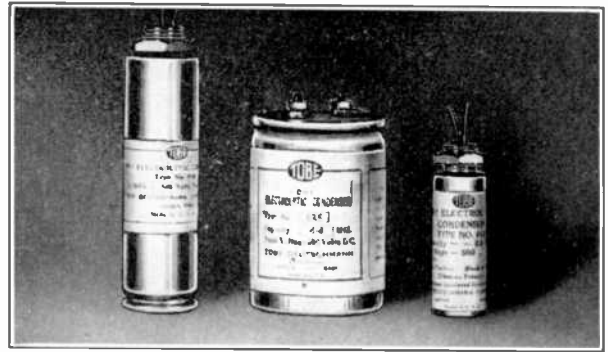

TOBE DRY ELECTROLYTIC CONDENSERS IN METAL CONTAINERS

A complete line of aluminum-cased dry-electrolytic condensers for use in filter circuits in which peak voltages do not exceed 525 volts. The experience of many service men proves metal cased electrolytics to be superior in performance to all other types. Tobe metal cased electrolytics are available in all popular sizes and groups and will replace both wet and dry electrolytics in many receiver chassis. Individual sections embodying the unique double-jacketed construction contribute to the superior performance of these condensers.

The single sections are provided with a threaded stud and nut for inverted mounting and a single threaded hole for a 6-32 screw for upright mounting. Single sections are provided with 6" insulated flexible leads and are completely insulated from the metal container. Multiple sections are provided with threaded studs, double nuts, and soldering lugs for positive connection and have the common negative terminal soldered to the metal case. An exception to this rule is Condenser 628-A which contains two entirely separate eight microfarad sections insulated from each other and from the metal case.

TOBE METAL CAN ELECTROLYTICS

Mfd.	Diam. Inches	Hght. Inches	Type No	Price Each
4	1	3 1/4	614	\$0.85
8	1 1/8	4 1/2	618	1.05
8	1	3 3/4	618-C	1.05
5-15	2 1/2	3 3/4	6515	2.30
8-16	2 1/2	3 3/4	6816	2.85
8-8	2 1/2	3 3/4	628	1.80
8-8	1 1/2	4 1/2	628-A	1.60
8-8-8	3	3 3/4	638	2.70
8-8-8-8	3	3 3/4	648	3.60
9-9-18	3	3 3/4	9918	3.75
9-9-18-18	3 1/4	3 3/4	991818	5.25
			600 Volt Peak	
8	1 1/8	4 1/2	P-618	1.50



EXACT DUPLICATE LABEL CONTAINS COMPLETE VOLTAGE and COLOR CODE DATA

TOBE EXACT DUPLICATE ELECTROLYTIC REPLACEMENT CONDENSERS

On this page you will find listed the condensers which are most frequently required for replacement in receiver chassis. In capacity, color code, length of leads, physical size and mounting arrangement, these condensers are exact duplicates of those originally supplied by the manufacturer. Utilization of the exclusive Tobe mechanical etching process of foil treatment enables us to provide in the same space condensers having higher peak voltage ratings so that Tobe exact duplicate replacement condensers may be depended upon to render superior service.

Each condenser is plainly labeled with complete data showing manufacturer's name, part number, model numbers, color coding and terminal arrangement.

TOBE

APEX
Model 5. Part #6201
4-4-12 Mfd., 175 Volts
1 1/2 x 1 1/2 x 2 3/4" Card. Box
AP-2—List. \$2.10

ATWATER-KENT
Model 155. Part #24602
8-8-8 Mfd., 150 Volts
3 1/2 x 1 1/2 x 1" Cardb'd Box
AK—List. \$1.50

Model 155. Part #24955
8-8-8 Mfd., 150 Volts
3 1/2 x 1 1/2 x 1" Cardb'd Box
AK-3—List. \$1.50

Model 275-825.
Part #26158
8-14-8 Mfd., 150 Volts
3 1/2 x 1 1/2 x 1" Card. Box
AK-4—List. \$2.00

ALL STAR JUNIOR
4-4-4 Mfd., 450 Volts
1 1/2 x 1 1/2 x 1" Cardb'd Box
534N—List. \$1.80

BALKEIT
Model 41-A.
4-8-12 Mfd., 150 Volts
4 1/2 x 1 1/2" Dia. Card. Tube
BA-2—List. \$1.80

BOSCH
Model 117 and 127.
4-8-450 V., 20 Mfd., 50 V.
4 1/2 x 1 1/2" Dia., Metal Can
BS-2—List. \$2.10

CROSLY
Model Travette.
Part #W25857B
8 Mfd., 25 V.; 8 Mfd.,
200 V.,
2 1/2 x 1 x 1" Cardb'd Box
C-2—List. \$1.00

Model Flyer 187.
Part #W27488
8 Mfd., 25 V.; 6 Mfd.,
300 V.,
2 1/2 x 1 x 1" Cardb'd Box
C-3—List. \$1.95

Model Dual Travette.
Part #26870A
6 Mfd., 25 Volts.
2 1/2 x 1 1/2 x 1" Cardb'd Box
C-4—List. \$1.80

Model 146. Part #26896A
6 Mfd., 25 V.; 12 Mfd.,
300 V.,
3 1/2 x 1 1/2 x 1" Cardb'd Box
C-5—List. \$1.75

Model Travette 99.
Part #W28068
12 Mfd., 200 Volts
2 1/2 x 1 x 1" Cardb'd Box
C-6—List. \$1.95

Model 130. Part #W26119
4 Mfd., 300 V.; 8 Mfd.,
150 V.,
2 1/2 x 1 x 1" Cardb'd Box
C-7—List. \$1.40

Model 160. Part #28488
8 Mfd., 350 V.; 12 Mfd.,
475 V.,
4 1/2 x 1 1/2" Dia., Metal Can
C-8—List. \$1.90

Models 164, 170.
Part #W29097
8-8-8 Mfd., 250-350-450 V.,
4 1/2 x 1 1/2" Dia., Metal Can
C-9—List. \$2.20

Model 189. Part #W29150
8-7-6 Mfd., 25-450-400 V.,
4 1/2 x 1 1/2" Dia., Metal Can
C-10—List. \$1.90

TOBE

Model 173. Part #W30124
8-16 Mfd., 125 V.; 16
Mfd., 100 V.,
3 1/2 x 1 1/2" Dia., Metal Can
C-11—List. \$2.10

Models 166, 172.
Part #W29264
16-16-8 Mfd., 125-100-10
3 1/2 x 1 1/2" Dia., Metal Can
C-12—List. \$2.00

DETROLA
Model Aberne.
4-8-17 Mfd., 150 Volts
3 1/2 x 1 1/2 x 1" Cardb'd Box
DE-2—List. \$1.80

EMERSON
Models 20A, 25, 25A.
Part #HC-32
5-5 Mfd., 35 Volts
1 1/2 x 1 1/2 x 1" Cardb'd Box
EM-2—List. \$1.75

Models 20A, 25, 25A.
Part #HC-31
4-4 Mfd., 200 Volts
2 1/2 x 1 x 1" Cardb'd Box
EM-3—List. \$1.00

Model 250. Part #KC-56
8-8 Mfd., 200 Volts
3 1/2 x 1 1/2 x 1" Cardb'd Box
EM-4—List. \$1.25

Model 250AW.
Part #KC-68
4-8-16 Mfd., 175 Volts
4 1/2 x 1 1/2 x 1" Cardb'd Box
EM-5—List. \$1.80

Model 965.
6-10 Mfd., 400 Volts
3 1/2 x 1 1/2 x 1" Cardb'd Box
EM-6—List. \$1.40

Model 36. Part #TTC-159
6-8 Mfd., 450 V.; 12
Mfd., 25 V.,
4 1/2 x 1 1/2" Dia., Metal Can
EM-7—List. \$2.10

**GENERAL ELECTRIC
RCA-VICTOR**
Models K40A, 27, 17M,
18W. Part #3538
4-4 Mfd., 140 Volts
2 1/2 x 1 1/2" Dia., Card. Tube
GE-2—List. \$1.00

Models K40A, 27, 17M,
18W. Part #3536
5-5 Mfd., 35 Volts
2 1/2 x 1 1/2" Dia., Card. Tube
GE-3—List. \$1.75

Models L50, L51, 22S,
22W. Part #6518
8-8 Mfd., 150-250 V.,
3 1/2 x 1 1/2 x 1" Cardb'd Box
GE-4—List. \$1.55

Models L50, L51, 22S,
22W. Part #6511
4-8 Mfd., 250 V.; 10
Mfd., 35 V.,
3 1/2 x 1 1/2 x 1" Cardb'd Box
GE-5—List. \$1.60

Models K63, 120, 220, 37,
38. Part #6487
4-4-10-4 Mfd., 350-350-
150-25 V.,
3 1/2 x 1 1/2 x 1 1/2" Card. Box
*GE-6—List. \$3.10

Models K63, 120, 220, 37,
38. Part #6487
4-4-10-4 Mfd., 350-350-
150-25 V.,
3 1/2 x 1 1/2 x 1 1/2" Card. Box
*GE-6A—List. \$2.00

Models K52, K53, K58,
110, 115. Part #27589
4-4 Mfd., 150-450 V.,
3 1/2 x 1 1/2 x 1" Cardb'd Box
*GE-7—List. \$1.75

Models K52, K53, K58,
110, 115. Part #27589
4-4 Mfd., 150-300 V.,
3 1/2 x 1 1/2 x 1" Cardb'd Box
GE-7A—List. \$1.95

TOBE

Models L50, L51, 22S,
22W. Part #6510
8 Mfd., 200 Volts
2 1/2 x 1 1/2" Cardb'd Tube
GE-8—List. \$1.75

Models K40A, 27, 17M,
18W. Part #6535
4-3 Mfd., 150-300 V.,
3 1/2 x 1 1/2" Dia., Card. Tube
GE-9—List. \$1.25

Models K66, 220, 222.
Part #6691
8-4-4-4 Mfd., 350-300-
150-25 V.,
3 1/2 x 1 1/2 x 1 1/2" Card. Box
GE-10—List. \$2.20

Models M65, 221.
Part #6703
8-4-4 Mfd., 350-280-
150 V.,
3 1/2 x 1 1/2 x 1 1/2" Card. Box
GE-11—List. \$1.95

Models K64, M65, 121,
122. Part #6703
3 1/2 x 1 1/2 x 1 1/2"
8-4-4 Mfd., 350-150-
300 V. Card. Box
GE-12—List. \$1.95

Models K78, 330, 331.
Part #6555
10-4 Mfd., 350-150 V.,
3 1/2 x 1 1/2 x 1" Card. Box
GE-13—List. \$1.45

GRUNOW
Models 501, 550.
Part #27151
4-8-20 Mfd., 150 V.; 4
Mfd., 35 V.,
2 1/2 x 1 1/2 x 1 1/2" Card. Box
GR-2—List. \$2.25

Model 6D.
Part #TH30091-1
8-8-8-12-12 Mfd., 475-
450-450-25-25 V.,
2 1/2 x 1 1/2 x 2 1/2" Card. Box
GR-3—List. \$3.25

INTERN'L KADETTE
Model Standard.
Part #A407
4-4 Mfd., 175 Volts
3 1/2 x 1 1/2 x 1" Card. Box
K-2—List. \$1.00

Model Standard.
Part #A408
5-5 Mfd., 35 Volts
1 1/2 x 1 1/2 x 1" Card. Box
K-3—List. \$0.75

Models A and B.
Part #A424
4-10-10 Mfd., 175 Volts
3 1/2 x 1 1/2 x 1" Cardb'd Box
K-4—List. \$2.10

Model F Jr. Part #A426
2-7 Mfd., 150 Volts
2 1/2 x 1 1/2 x 1" Card. Box
K-5—List. \$1.90

Model F Jr. Part #A427
3.5 3.5-3.5 Mfd., 150-
150-35 V.,
2 1/2 x 1 1/2 x 1" Card. Box
K-6—List. \$1.20

MAJESTIC
Models 310, 320, 330
Part #7489-1
16 Mfd., 500 Volts
3 1/2 x 1 1/2 x 1" Cardb'd Box
MJ-2—List. \$1.45

Models 380, 381.
Part #8755
4-8 Mfd., 500 Volts
3 1/2 x 1 1/2 x 1 1/2" Card. Box
MJ-3—List. \$1.35

Models 15, 25, 150.
Part #4713-D (Dual Unit)
8-8 Mfd., 500 Volts
3 1/2 x 1 1/2 x 1 1/2" Card. Box
MJ-4—List. \$1.75

Models 300, 302, 304.
Part #2728
7-10 Mfd., 300-50 V.,
2 1/2 x 1 1/2 x 1 1/2" Card. Box
M1-5—List. \$1.25

TOBE

Models 400A, 411A, 413A.
Part #9661
5-16 Mfd., 175 V.; 10
Mfd., 35 V.,
3 1/2 x 1 1/2 x 1 1/2" Card. Box
MJ-6—List. \$2.25

Models 440, 500.
Part #10538
6-4-10 Mfd., 350-300-
25 V.,
3 1/2 x 1 1/2 x 1" Cardb'd Box
MJ-7—List. \$1.85

Models 55, 59, 75.
Part #10827
8-8 Mfd., 350 V.; 10
Mfd., 25 V.,
5 1/2 x 1 1/2 x 1 1/2" Cardb'd Box
MJ-8—List. \$1.95

MOTOROLA
Models 44, 68, 77A.
Part #8220
4-8 Mfd., 300 Volts
2 1/2 x 1 1/2 x 1 1/2" Card. Box
MO-2—List. \$1.15

Models 44 (T60 Pack).
Part #8123
8-12 Mfd., 200 Volts
2 1/2 x 1 1/2 x 1 1/2" Card. Box
MO-3—List. \$1.40

SIMPLEX
Model 5.
4-20 Mfd., 175 Volts
4 1/2 x 1 1/2" Cardb'd Box
SM-2—List. \$1.40

SPARTON
Models 61, 62.
Part #A9550
5-5-25 Mfd., 175 Volts
2 1/2 x 1 1/2 x 1 1/2" Card. Box
Type SP-2—List. \$2.10

Models 410, 589, 600, etc.
Part #B2327
5-15 Mfd., 500 Volts
3 1/2 x 2 1/2" Dia., Metal Can
#6515—List. \$2.30

Model 15. Part #B2748A
8-16 Mfd., 500 Volts
3 1/2 x 2 1/2" Dia., Metal Can
#6616—List. \$2.35

STEWART-WARNER
Models R11, R115.
Part #81959S
4-5-9 Mfd., 150 V.,
3 1/2 x 1 1/2 x 1 1/2" Card. Box
ST-2—List. \$1.40

Models R11, R115.
Part #81959
4-13-7 Mfd., 150 Volts
3 1/2 x 1 1/2 x 1 1/2" Card. Box
ST-3—List. \$1.95

SUPERTONE
This condenser used in
many fancy named re-
ceivers.
10-10 Mfd., 150 V.; 10-
10 Mfd., 50 V.,
3 1/2 x 1 1/2" Dia., Card.
Tube
SU-2—List. \$1.75

UNITED MOTORS
Model 4037. Part #26508B
8-8 Mfd., 350 V.; 4-4
Mfd., 25 V.,
2 1/2 x 1 1/2 x 1 1/2" Card. Box
UM-2—List. \$2.20

U. S. RADIO
(See Apex)

WELLS-GARDNER
(Montgomery-Ward
Airlines)
Models 05A, 05B, etc.,
62-98, 62-98.
Part #80944C
4-12-16 Mfd., 150 Volts
2 1/2 x 1 1/2 x 1 1/2" Card. Box
WE-2—List. \$2.00

Condensers marked (*) have voltage ratings higher than originals.

TOBE PAPER-DIELECTRIC SURGPROOF CONDENSERS

Since the introduction of the original Tobe service type paper-dielectric condenser, the name *Surgproof* has been a guarantee of satisfactory condenser performance. It is not by chance that this reputation has been built and maintained but by close adherence to the highest principles of design, engineering and production. The components used in the manufacture of *Surgproof* condensers must pass rigid inspection before being accepted for our use. We are proud of the fact that we have always secured the paper dielectric material from one supplier — The Smith Paper Company of Lee, Massachusetts, a long established New England manufacturer famous for many years for the superlative quality of its product. Smith papers are recognized throughout the electrical industry as the finest that may be secured for condenser construction, and their use is typical of the effort we make to employ only the best materials.

The metal foils which we use for condenser plates are of a high degree of purity thus insuring minimum specific resistivity and power factor. This is an important feature contributing to superiority of performance in radio frequency by-pass circuits.

NON-INDUCTIVE TUBULARS

Recognized as the standard for radio frequency and audio frequency by-pass service, Tobe Tubular Paper-Dielectric Condensers incorporate every desirable feature. They are truly non-inductive and thus provide maximum effective capacitance at the highest frequencies in commercial use. Only the purest of tin-foil is employed for the plates of Tobe Non-inductive Tubular Condensers. As a result, series contact resistance which in other types of construction seriously affects efficiency is kept at an irreducible minimum. The foil edges are mechanically joined so as to short-circuit each turn in the condenser winding and this mechanical joint is made permanent by careful soldering. The $2\frac{1}{2}$ " bare tinned copper leads are so formed that they maintain a firmly soldered contact of large area with each foil end. A metal plate is connected to each terminal at the condenser ends so as to increase the speed with which heat is radiated while a soldered connection is being made to the condenser. This important feature of Tobe Tubulars prevents loosening of the internal lead connection during the soldering operation and thus avoids open circuits.

The dielectric material employed in Tobe Tubular by-pass condensers is specially selected for freedom from impurities likely to decrease insulation resistance. Each condenser is processed by vacuum impregnation in a moisture resisting wax, by cooling in oil, by enclosure in a paper tube, and by secondary vacuum impregnation of the entire assembly in a moisture-proof compound. Tobe tubular by-pass condensers are conservatively rated and may be depended upon to provide trouble-free service under extremes of temperature and humidity. Each condenser is flash tested at five times rated voltage.

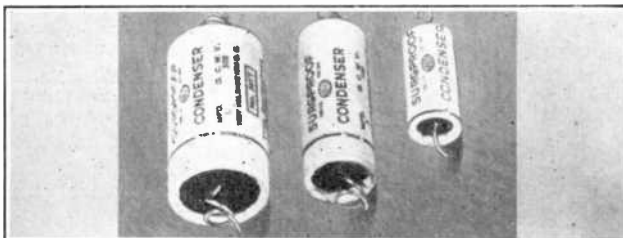

TOBE SURGPROOF REPAIR CONDENSERS

Embodying the original moisture-proof seal developed by our Engineering Department, these condensers are guaranteed moisture-proof and are recommended for use in any circuit or location where they may be subjected to high transient voltages or may be exposed to extremes of temperature and humidity which cause early failure of ordinary paper condensers. So effectively are these condensers sealed against moisture that they may be immersed in salt water for 48 hours or more without being damaged. Consequently, they are especially well suited to use in marine radio installations and in tropical climates.

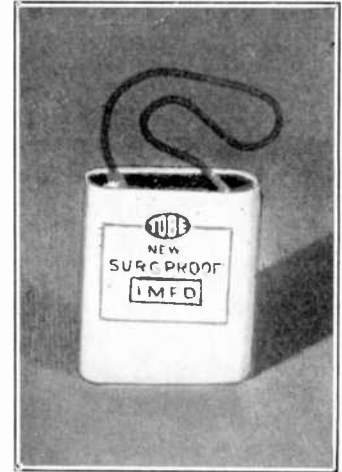

In addition to the customary vacuum impregnation, Tobe Surgproof condensers are dipped in a moisture resisting compound which effectively seals them against humidity. Each condenser is then placed in a specially treated paper wrap and the ends are sealed with a non-hygroscopic compound which, fusing with the wax dip, assures permanent exclusion of moisture. Our patented loop construction allowing the serviceman to secure any desired combination of lead lengths is employed for the insulated flexible leads of Tobe Surgproof condensers. Providing maximum capacity and safety factor in minimum space and guaranteed to withstand transient voltages having peak values of five times their rated working voltage, Tobe Surgproof Repair condensers are the choice of careful buyers.

TOBE SURGPROOF TUBULAR CONDENSERS

Volts Working	Mfd.	Dimensions Inches	Type No.	List Price
300	1.0	1 $\frac{1}{2}$ x 1	301-T	\$0.70
	0.5	1 $\frac{1}{2}$ x $\frac{3}{4}$	350-T	.45
	0.25	1 $\frac{1}{2}$ x $\frac{1}{2}$	325-T	.30
	0.1	1 $\frac{1}{2}$ x $\frac{1}{4}$	310-T	.22
	0.5	1 $\frac{1}{2}$ x 1	450-T	.50
400	0.25	1 $\frac{1}{2}$ x $\frac{3}{4}$	425-T	.35
	0.1	1 $\frac{1}{2}$ x $\frac{1}{2}$	410-T	.25
	.06	1 $\frac{1}{2}$ x $\frac{1}{4}$	M-60	.24
	.05	1 $\frac{1}{2}$ x $\frac{1}{4}$	M-50	.22
	.04	1 $\frac{1}{2}$ x $\frac{1}{4}$	M-40	.22
	.25	1 $\frac{1}{2}$ x 1	625-T	.45
	.1	1 $\frac{1}{2}$ x $\frac{3}{4}$	610-T	.35
	.03	1 $\frac{1}{2}$ x $\frac{1}{2}$	M-30	.20
	.02	1 $\frac{1}{2}$ x $\frac{1}{4}$	M-20	.20
	.01	1 $\frac{1}{2}$ x $\frac{1}{4}$	M-10	.18
600	.008	1 $\frac{1}{2}$ x $\frac{1}{4}$	M-8	.18
	.006	$\frac{1}{2}$ x $\frac{1}{4}$	M-6	.18
	.005	$\frac{1}{2}$ x $\frac{1}{4}$	M-5	.18
	.004	$\frac{1}{2}$ x $\frac{1}{4}$	M-4	.18
	.003	$\frac{1}{2}$ x $\frac{1}{4}$	M-3	.18
	.002	$\frac{1}{2}$ x $\frac{1}{4}$	M-2	.18
	.001	$\frac{1}{2}$ x $\frac{1}{4}$	M-1	.18

TOBE SURGPROOF REPAIR CONDENSERS

Volts Working	Mfd.	Dimensions Inches	Type No.	List Price
400	0.1	1 $\frac{1}{2}$ x $\frac{3}{4}$ x $\frac{3}{4}$	4010	\$0.35
	0.25	1 $\frac{1}{2}$ x $\frac{1}{2}$ x $\frac{3}{4}$	4025	.45
	0.5	2 $\frac{1}{2}$ x 1 $\frac{1}{2}$ x $\frac{1}{2}$	4050	.55
	1.0	2 $\frac{1}{2}$ x 1 $\frac{1}{2}$ x $\frac{3}{4}$	441	.75
	2.0	2 $\frac{1}{2}$ x 2 x $\frac{3}{4}$	442	1.15
600	0.1	2 $\frac{1}{2}$ x $\frac{3}{4}$ x $\frac{3}{4}$	6010	.45
	0.25	2 x 1 $\frac{1}{2}$ x $\frac{3}{4}$	6025	.55
	0.5	2 $\frac{1}{2}$ x 1 $\frac{1}{2}$ x $\frac{3}{4}$	6050	.65
	1.0	2 $\frac{1}{2}$ x 1 $\frac{1}{2}$ x $\frac{3}{4}$	661	.90
	2.0	3 $\frac{1}{2}$ x 2 $\frac{1}{2}$ x $\frac{3}{4}$	662	1.35
800	1.0	4 x 2 $\frac{1}{2}$ x $\frac{3}{4}$	881	1.20
	2.0	4 x 2 $\frac{1}{2}$ x 1 $\frac{1}{4}$	882	1.90
1000	1.0	4 x 2 $\frac{1}{2}$ x $\frac{3}{4}$	1101	1.50

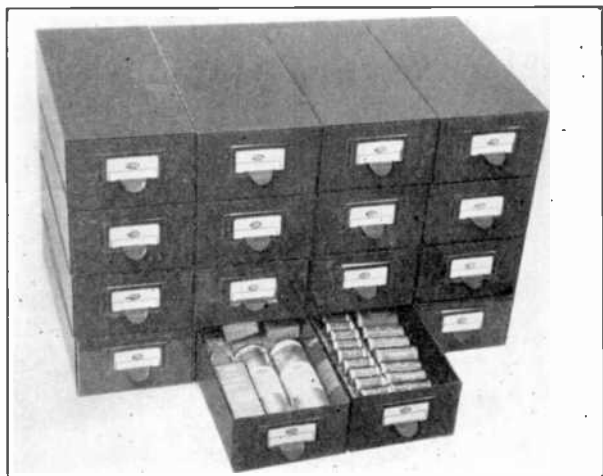

TOBE CONDENSER KITS IN ADD-A-UNIT CABINETS

Convenient and economical condenser kits containing assortments of the capacities and types most used in servicing. In addition to the condensers you receive free of charge a handy metal cabinet with easy sliding drawer having definite re-use value.

Each condenser assortment is contained in one of these attractive olive green steel cabinets, measuring $9\frac{3}{8} \times 4\frac{1}{2} \times 2\frac{5}{8}$ inches. Handy for filing, other small parts, etc. The cabinets are so designed that they may be instantly fastened together into an extended cabinet as additional kits are purchased.

KIT No. 1

Consists of the following Tobe Tubular Condensers in a steel cabinet: 600 volt types: 3 — .001; 2 — .002; 3 — .005; 5 — .01; 5 — .02. 400 volt types: 5 — .05; 5 — .1; 3 — .25; 3 — .5 mfd. *With Free Cabinet.* List \$8.24

KIT No. 2

Consists of the following Dry Electrolytic Condensers in a steel cabinet, 500 volts: 2 — 8 mfd. in metal containers; 5 — 8 mfd. and 2 — 4 mfd. units in cardboard containers. *With Free Cabinet.* List \$8.35

KIT No. 3

Consists of the following Tobe Tubidons: 5 — 8 mfd. 525 volt sections; 5 — 8 mfd. 200 volt sections; 2 — 16 mfd. 200 volt sections. List \$7.75

This condenser assortment will enable you to service any receiver that requires condenser replacement and should be maintained by purchase of new *Tubidons* whenever any of them are removed from the Kit for installation in receivers.

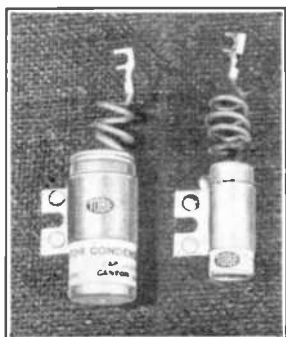

GENERATOR CONDENSERS



VIBRATOR CONDENSERS

NEW BLUE RIBBON MICRANOL (Oil Process) TRANSMITTING CONDENSER

*Unconditionally guaranteed
for 1 year*

The Micranol condenser which won such ready acceptance among the amateurs and broadcasters last season has now been further improved and its shape altered to provide increased ease of installation.

Contained in a rectangular metal case, with terminals supported on rugged insulators of wet process

porcelain, the Blue-Ribbon Micranol condenser is especially suited to assembly in power packs requiring composite groupings of capacitance.

Built to withstand peak surges many times greater than their rating, Tobe Blue-Ribbon Micranol condensers are priced so low that economy demands their use in every amplifier or transmitter.



Working Volts — 2000 D.C. Tested at 5000 Volts

Mfd.	Dimensions	Type No.	List Price
1	$3\frac{1}{4} \times 5 \times 2\frac{1}{8}$ "	TR-1	\$2.85
2	$3\frac{1}{4} \times 5 \times 2\frac{1}{8}$ "	TR-1	4.20

Mounting centers $3\frac{3}{4} \times 1\frac{3}{8}$ "

TOBE AUTOMOBILE VIBRATOR CONDENSERS

Super-safe oil impregnated high voltage condensers for universal vibrator replacement. Designed for safe operation at 1600 volts D.C., these condensers will successfully withstand the peak voltages and transients developed in vibrator circuits.

Volts Working	Mfd.	Dimensions Inches	Type No.	List Price
1600	.01	$2\frac{3}{8} \times \frac{5}{8} \times \frac{5}{8}$	MO-4	\$0.60
	.01	$1\frac{3}{4} \times \frac{5}{8}$	MO-5	.30
	.02	$1\frac{7}{8} \times \frac{5}{8}$	MO-6	.40
	.05	$1\frac{7}{8} \times \frac{5}{8}$	MO-7	.50

GENERATOR CONDENSERS

Especially designed to provide maximum attenuation of radio interference created by automobile generators, these units are non-inductively wound and effectively sealed against the moisture which is bound to be encountered in automotive service. Tobe Automobile Generator condensers are provided with 6" insulated flexible leads soldered directly to the condenser coils and having spade terminals for ease of connection. Contained in a drawn zinc housing, each condenser has a slotted steel mounting band riveted and soldered to the case so as to provide low resistance contact and insure freedom from loose connections. For maximum efficiency, we recommend that wherever possible condenser AP-100 be used with a 2" connecting lead.

TOBE AUTOMOBILE GENERATOR CONDENSERS

Mfd.	Dimensions Inches	Type No.	List Price
.50	$1\frac{3}{4} \times \frac{5}{8}$	AP-50	\$0.60
1.0	$2\frac{1}{4} \times 1$	AP-100	.80

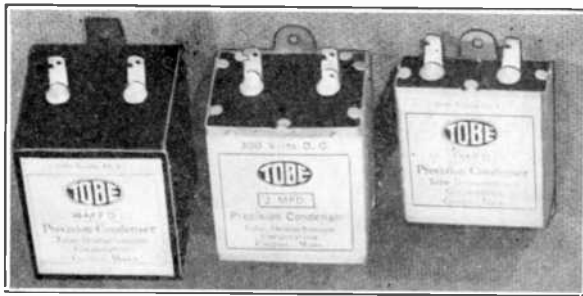

TOBE 300, 400 and 600 LINE FILTER CONDENSERS

These condensers in their compact rectangular metal cases have been famous for 15 years as the standard precision by-pass and filter condensers. Convenient soldering terminals are mounted on the bakelite panel of each condenser.

300 LINE FILTER CONDENSERS

Volts Working	Mfd.	Dimensions Inches	Type No.	List Price
300	0.1	2 x 1 $\frac{1}{4}$ x $\frac{3}{8}$	310	\$0.60
	0.25	2 x 1 $\frac{1}{4}$ x $\frac{3}{8}$	325	.65
	0.5	2 x 1 $\frac{1}{4}$ x $\frac{3}{8}$	350	.75
	1.0	2 x 1 $\frac{1}{4}$ x $\frac{3}{8}$	301	1.00
	2.0	2 x 1 $\frac{1}{4}$ x 1 $\frac{1}{8}$	302	1.50
	4.0	2 x 1 $\frac{1}{4}$ x 2 $\frac{1}{8}$	304	2.75

400 AND 600 LINE FILTER CONDENSERS

Volts Working	Mfd.	Dimensions Inches	Type No.	List Price
400	1	4 $\frac{1}{2}$ x 2 x 1 $\frac{1}{8}$	401	\$1.90
	2	4 $\frac{1}{2}$ x 2 x 1 $\frac{1}{8}$	402	2.30
	4	4 $\frac{1}{2}$ x 2 x 1 $\frac{1}{8}$	404	4.50
600	0.5	4 $\frac{1}{2}$ x 2 x 1 $\frac{1}{8}$	650	1.50
	1	4 $\frac{1}{2}$ x 2 x 1 $\frac{1}{8}$	601	2.35
	2	5 x 4 $\frac{1}{2}$ x 1 $\frac{1}{8}$	602	3.05
	4	5 x 4 $\frac{1}{2}$ x 1 $\frac{1}{8}$	604	4.85

TOBE PAPER DIELECTRIC REPLACEMENT CONDENSERS

These condensers are interchangeable with the units originally supplied by the receiver manufacturer and may be depended upon to provide wholly satisfactory service.

TOBE REPLACEMENT CONDENSERS

Mfd.	Type No.	List Price
.50	AK-350	\$0.75
.25-.25-.25	AK3325	1.35
.25	TS-425	.65
.50	TS-450	.75
1.0	TS-401	1.00

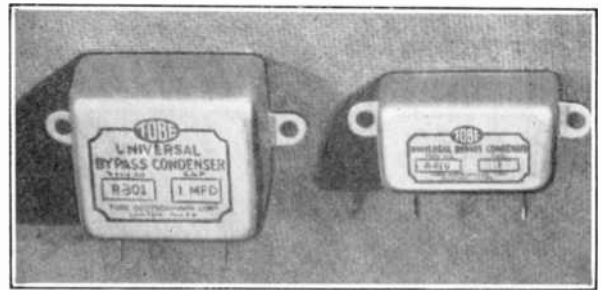

TOBE SURGPROOF METAL CASED CONDENSERS

A wide variety of paper dielectric Surgproof condensers contained in metal cases and provided with soldering terminals for connection. These condensers have in the past been widely used for radio frequency and audio frequency by-pass service and are also useful in the assembly of equipment requiring precision condensers.

TOBE SURGPROOF CASED CONDENSERS

Volts Working	Mfd.	Dimensions Inches	Type No.	List Price
300	0.1	1 $\frac{3}{4}$ x 1 x $\frac{3}{8}$	R-310	\$0.50
	0.25	1 $\frac{3}{4}$ x 1 x $\frac{3}{8}$	R-325	.60
	0.5	1 $\frac{3}{4}$ x 1 x $\frac{3}{8}$	R-350	.75
	1.0	2 x 1 $\frac{1}{4}$ x $\frac{3}{8}$	R-301	.95
	.1-.1	1 $\frac{3}{4}$ x 1 x $\frac{3}{8}$	R-321	.65
400	0.1	1 $\frac{3}{4}$ x 1 x $\frac{3}{8}$	R-410	.55
	0.25	1 $\frac{3}{4}$ x 1 x $\frac{3}{8}$	R-425	.65
	0.5	2 x 1 $\frac{1}{4}$ x $\frac{3}{8}$	R-450	.80
	1.0	2 x 1 $\frac{1}{4}$ x $\frac{3}{8}$	R-401	1.00
	.1-.1	2 x 1 $\frac{1}{4}$ x $\frac{3}{8}$	R-421	.70
	.25-.25	2 x 1 $\frac{1}{4}$ x $\frac{3}{8}$	R-4225	.85
	.5-.5	2 x 2 $\frac{1}{4}$ x 1	R-4250	1.05
300	.1-.1-.1	2 x 1 $\frac{1}{4}$ x $\frac{3}{8}$	R-431	.90
	.25-.25-.25	2 x 1 $\frac{1}{4}$ x $\frac{3}{8}$	R-3325	1.10
400	.25-.25-.25	2 x 1 $\frac{1}{4}$ x $\frac{3}{8}$	R-4325	1.15

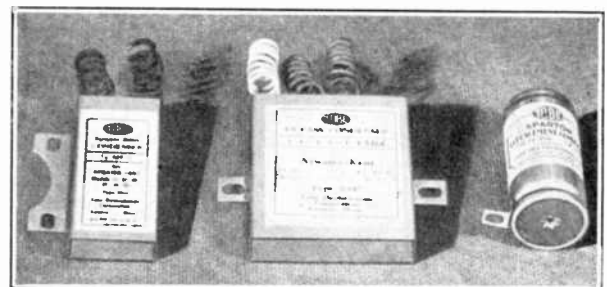



TOBE ELECTROLYTIC CONDENSERS

This chart includes the most popular single and multiple sections electrolytic condensers and enables you to choose at a glance the correct condenser for any application. The type of container and provision for making connections are indicated by the following code letters:

CF — Compact Flexidon Page 3 IT — Inverted Paper Tube Page 4 TD — Tubidon Page 2
 CM — Cylindrical Metal Case Page 4 SF — Standard Flexidon Page 3 UC — Compact Replacement Unidon Page 3
 US — Standard Replacement Unidon Page 3

BS — Bare Tinned Solid Wire Leads IF — Insulated Flexible Leads ST — Threaded Studs

Capacity Mfd.	Working Voltage D.C.	Construction	Connections	Dimensions Inches	Type No.	List Price	
1	475	TD	BS	2 1/4 x 5/8	ET-51	\$0.50	
2	475	SF	IF	2 3/8 x 1 x 1	511	.55	
		TD	BS	2 1/4 x 7/8	ET-52	.55	
4	200	SF	IF	2 3/8 x 1 x 1	512	.65	
	600 (Peak)	TD	BS	2 1/4 x 5/8	ET-22	.45	
4	475	TD	BS	2 3/4 x 1	ET-64	.90	
		TD	BS	2 1/4 x 7/8	ET-54	.60	
5	200	CF	IF	2 1/2 x 3/8 x 1 1/2	EC-54	.75	
		SF	IF	3 1/4 x 1 1/8 x 3/8	514	.75	
	450	UC	IF	2 1/4 x 3/8 x 5/8	UC-514	.65	
		US	IF	3 x 1 1/4 x 3/8	US-4	.65	
	200	CM	IF	3 1/4 x 1	614	.85	
		TD	BS	2 1/4 x 5/8	ET-24	.50	
	5	35	UC	IF	2 x 3/8 x 3/4	UC-214	.45
			TD	BS	2 1/4 x 5/8	T-505	.45
	8	600 (Peak)	TD	BS	2 1/4 x 5/8	T-305	.40
			TD	BS	1 1/4 x 2 3/4	ET-68	1.05
8	475	CF	IF	2 1/2 x 1 1/2 x 1	EC-68	1.35	
		CM	IF	1 5/8 x 4 1/2	618-P	1.50	
		TD	BS	2 1/4 x 1	ET-58	.75	
	450	CF	IF	2 1/2 x 1 x 7/8	EC-58	.95	
		SF	IF	3 1/4 x 1 1/8 x 3/8	518	.95	
	200	UC	IF	2 1/4 x 3/8 x 5/8	UC-518	.85	
		US	IF	3 x 1 1/4 x 3/8	US-8	.85	
	450	CM	IF	4 1/2 x 1 3/4	618	1.05	
		CM	IF	1 x 3 3/4	C-618	1.05	
	10	50	TD	BS	2 1/4 x 3/8	ET-28	.55
UC			IF	2 x 3/8 x 3/8	UC-218	.60	
12	200	TD	BS	2 1/4 x 5/8	T-5010	.65	
		TD	BS	2 1/4 x 5/8	T-3010	.40	
16	475	TD	BS	2 1/4 x 3/8	ET-212	.65	
		IT	IF	4 1/4 x 1 1/8	6016-B	1.40	
25	50	TD	BS	2 1/4 x 1	ET-216	.75	
		UC	IF	2 3/8 x 5/8	UC-2016	.95	
50	35	TD	BS	2 1/4 x 3/8	T-5025	.70	
		TD	BS	2 1/4 x 3/8	T-3025	.50	
500	15	TD	BS	2 1/4 x 1	T-5050	.95	
		TD	BS	2 1/4 x 1	T-3050	.80	
1500	50	CM	IF	1 1/2 x 4 1/2	HC-5	5.25	
	15	CM	IF	1 1/2 x 4 1/2	HC-15	5.00	

MULTIPLE SECTION ELECTROLYTICS

4-4	475	CF	IF	2 1/2 x 1 x 3/8	EC-544	1.20
		SF	IF	3 1/4 x 1 1/8 x 1 1/8	524	1.20
		IT	IF	4 1/4 x 1 1/8	624-B	1.25
4-8	200	CF	IF	2 1/2 x 3/8 x 3/8	ET-244	.90
		IT	IF	4 1/4 x 1 1/8	6048-B	1.35
4-8	475	SF	IF	3 1/4 x 1 1/4 x 1 1/8	5048	1.35
		CF	IF	2 1/2 x 1 1/2 x 1	EC-534	2.00
4-4-4	475	SF	IF	3 1/4 x 1 1/8 x 1 1/8	534	1.80
		TD	BS	2 1/4 x 5/8	T 525	.70
5-5	50	TD	BS	2 1/4 x 5/8	T 325	.65
		CM	ST	3 5/8 x 2 1/2	6515	2.30
5-15	450	CF	IF	3 1/4 x 1 1/2 x 1 1/8	528	1.50
		CF	IF	2 1/2 x 1 1/2 x 1	EC-588	1.50
		IT	IF	4 1/4 x 1 1/8	628-B	1.60
8-8	475	CM	ST	3 5/8 x 2 1/2	628	1.80
		CM	IF	4 1/2 x 1 1/2	628-A	1.60
8-16	200	CF	IF	2 1/2 x 3/8 x 1	ET-288	1.20
		CM	ST	3 5/8 x 2 1/2	6816	2.85
8-16	450	IT	IF	4 1/4 x 1 1/8	20816-B	1.45
		CF	IF	2 3/8 x 1 1/4 x 1	ET-2816	1.35
8-8-8	475	SF	IF	3 1/4 x 2 5/8 x 1 1/8	538	2.20
		CM	ST	3 5/8 x 3	638	2.70
		IT	IF	4 1/4 x 1 1/8	238-B	1.75
8-8-8-8	450	CM	ST	3 5/8 x 3	648	3.60
		CM	ST	3 5/8 x 3	9918	3.75
		CM	ST	3 5/8 x 3 1/4	991818	5.25
10-10	50	TD	BS	2 1/4 x 5/8	T-5210	.75
		TD	BS	2 1/4 x 5/8	T-3210	.70



Capacity Mfd.	Working Voltage D.C.	Type of Case	Connection	Dimensions Inches	Type No.	List Price	
.001	600	paper tube	bare wire	$\frac{7}{8} \times \frac{9}{16}$	M-1	\$0.18	
.002				$\frac{7}{8} \times \frac{9}{16}$	M-2	.18	
.003				$\frac{7}{8} \times \frac{9}{16}$	M-3	.18	
.004				$\frac{7}{8} \times \frac{9}{16}$	M-4	.18	
.005				$\frac{7}{8} \times \frac{9}{16}$	M-5	.18	
.006				$\frac{7}{8} \times \frac{9}{16}$	M-6	.18	
.008				$\frac{7}{8} \times \frac{9}{16}$	M-8	.18	
.01				$\frac{7}{8} \times \frac{9}{16}$	M-10	.18	
.02				$1 \frac{1}{8} \times \frac{3}{8}$	M-20	.20	
.03				$1 \frac{1}{8} \times \frac{3}{8}$	M-30	.20	
.04	400	paper tube	bare wire	$1 \frac{1}{8} \times \frac{3}{8}$	M-40	.22	
.05				$1 \frac{1}{8} \times \frac{3}{8}$	M-50	.22	
.06				$1 \frac{1}{8} \times \frac{3}{8}$	M-60	.24	
	300	paper tube	bare wire	$1 \frac{1}{4} \times \frac{3}{8}$	310-T	.22	
		metal	soldering lugs	$1 \frac{3}{4} \times 2 \times \frac{9}{16}$	310	.60	
		metal	soldering lugs	$1 \frac{3}{4} \times 1 \times \frac{3}{4}$	R-310	.50	
.1	400	paper tube	bare wire	$1 \frac{3}{4} \times \frac{9}{16}$	410-T	.25	
		paper wrap	insulated flexible wire	$1 \frac{3}{4} \times 2 \frac{1}{4} \times \frac{7}{16}$	4010	.35	
		metal	soldering lugs	$1 \frac{3}{4} \times 1 \times \frac{3}{4}$	R-410	.55	
	600	paper tube	bare wire	$1 \frac{3}{8} \times \frac{3}{4}$	610-T	.35	
		paper wrap	insulated flexible wire	$2 \frac{3}{8} \times \frac{3}{4} \times \frac{7}{16}$	6010	.45	
.1-.1	300	metal	soldering lugs	$1 \frac{3}{8} \times 1 \times \frac{3}{4}$	R-321	.65	
	400	metal	soldering lugs	$2 \times 1 \frac{3}{4} \times \frac{7}{8}$	R-421	.70	
.1-.1-.1	400	metal	soldering lugs	$2 \times 1 \frac{3}{4} \times \frac{7}{8}$	R-431	.90	
	300	paper tube	bare wire	$1 \frac{3}{4} \times \frac{3}{8}$	325-T	.30	
		metal	soldering lugs	$1 \frac{3}{4} \times 2 \times \frac{3}{8}$	325	.65	
		metal	soldering lugs	$1 \frac{3}{4} \times 1 \times \frac{3}{4}$	R-325	.60	
.25	400	paper tube	bare wire	$1 \frac{3}{8} \times \frac{3}{4}$	425-T	.35	
		paper wrap	insulated flexible wire	$1 \frac{3}{8} \times 1 \frac{1}{8} \times \frac{7}{16}$	4025	.45	
		metal	soldering lugs	$1 \frac{3}{8} \times 1 \times \frac{3}{4}$	R-425	.65	
	600	paper tube	bare wire	$1 \frac{3}{8} \times 1$	625-T	.45	
		paper wrap	insulated flexible leads	$2 \times 1 \frac{1}{2} \times \frac{7}{16}$	6025	.55	
.25-.25	400	metal	soldering lugs	$2 \times 1 \frac{3}{4} \times \frac{7}{8}$	R-4225	.85	
	300	metal	soldering lugs	$2 \times 1 \frac{3}{4} \times \frac{7}{8}$	R-3325	1.10	
.25-.25-.25	400	metal	soldering lugs	$2 \times 1 \frac{3}{4} \times \frac{7}{8}$	R-4325	1.15	
	300	paper tube	bare wire	$1 \frac{3}{8} \times \frac{3}{4}$	350-T	.45	
		metal	soldering lugs	$1 \frac{3}{8} \times 2 \times \frac{9}{16}$	350	.75	
		metal	soldering lugs	$1 \frac{3}{8} \times 1 \times \frac{3}{4}$	R-350	.75	
.5	400	paper tube	bare wire	$1 \frac{3}{8} \times 1$	450-T	.50	
		paper wrap	insulated flexible wire	$2 \frac{3}{8} \times 1 \frac{1}{8} \times \frac{1}{2}$	4050	.55	
		metal	soldering lugs	$2 \times 1 \frac{3}{4} \times \frac{7}{8}$	R-450	.80	
	600	paper wrap	insulated flexible wire	$2 \frac{3}{8} \times 1 \frac{1}{8} \times \frac{3}{4}$	6050	.65	
		metal	soldering lugs	$4 \frac{1}{2} \times 2 \times 1 \frac{1}{8}$	650	1.50	
.5-.5	400	metal	soldering lugs	$2 \times 2 \frac{1}{4} \times 1$	R-4250	1.05	
	300	paper tube	bare wire	$1 \frac{3}{8} \times 1$	301-T	.70	
		metal	soldering lugs	$1 \frac{3}{4} \times 2 \times \frac{9}{16}$	301	1.00	
		metal	soldering lugs	$2 \times 1 \frac{3}{4} \times \frac{7}{8}$	R-301	.95	
1.0	400	paper wrap	insulated flexible wire	$2 \frac{3}{8} \times 1 \frac{7}{8} \times \frac{5}{8}$	441	.75	
		metal	soldering lugs	$2 \times 1 \frac{3}{4} \times \frac{7}{8}$	R-401	1.00	
		metal	soldering lugs	$4 \frac{1}{2} \times 2 \times 1 \frac{1}{8}$	401	1.90	
	600	paper wrap	insulated flexible wire	$2 \frac{7}{8} \times 1 \frac{1}{8} \times \frac{3}{4}$	661	.90	
		metal	soldering lugs	$4 \frac{1}{2} \times 2 \times 1 \frac{1}{8}$	601	2.35	
	800	paper wrap	insulated flexible wire	$4 \times 2 \frac{1}{2} \times \frac{3}{4}$	881	1.20	
1000	paper wrap	insulated flexible wire	$4 \times 2 \frac{1}{2} \times \frac{7}{8}$	1101	1.50		
300	metal	soldering lugs	$1 \frac{3}{4} \times 2 \times 1 \frac{1}{8}$	302	1.50		
400	paper wrap	metal	insulated flexible wire	442	1.15		
						soldering lugs	402
600	paper wrap	metal	insulated flexible wire	662	1.35		
						soldering lugs	602
800	paper wrap	insulated flexible wire	$3 \frac{1}{2} \times 2 \frac{1}{2} \times \frac{7}{8}$	882	1.90		
						soldering lugs	5 x 4 $\frac{1}{2}$ x 1 $\frac{1}{2}$
300	metal	soldering lugs	$1 \frac{3}{4} \times 2 \times 2 \frac{1}{4}$	404	4.50		
						400	metal
600	metal	soldering lugs	$5 \times 4 \frac{1}{2} \times 1 \frac{7}{8}$				



TOBE BRIDGE-ANALYZER FOR RESISTORS AND CONDENSERS

Combining in a single low-priced instrument the necessary equipment for making every essential test on condensers and resistors, the *Tobe Bridge-Analyzer* supplies a want that has long been felt in the ranks of better service men.

By means of this accurate instrument, you may determine resistance values between 1 ohm and 1,000,000 ohms, as well as values of capacitance between 10 mmf. and 100 mfd., and the resistance, power factor, leakage, and general condition of any electrolytic, mica, or paper condenser.

The *Tobe Bridge-Analyzer*, as its name implies, is a combination RC bridge and condenser analyzer. Its bridge circuits are specially designed for ease and accuracy of operation and enable the operator to speed his testing of resistors and condensers. Its condenser analyzer circuits embody the latest features of construction, including a positive means of indicating swinging opens in condensers.

All Dials are Direct Reading so that you need not refer to charts, calibration curves, or slide rule calculations to secure exactly the information you need. The accuracy of all readings is kept uniform by provision of the *Decade Range Switch* an exclusive *Tobe* feature.

The determination of null points indicating when the bridge is in balance is facilitated by the use of a built-in amplifier ahead of the electric eye. Experience shows that this visual indicating is superior to the conventional method employing head phones.

The *Direct Reading Power Factor Dial* indicates the power factor of the condensers to the surprising accuracy of approximately two-tenths of one percent. This is the greatest accuracy ever provided in a low priced bridge.

The condenser analyzer portion of the instrument enables the operator to check leakage resistances of paper or mica condensers as high as 1500 megohms. It is also arranged to allow leakage tests at the rated operating voltage of the

condenser. A further advantage of this instrument is its direct reading leakage indication for electrolytic condensers. Leakages of one, three, or five milliamperes at rated operating voltage are shown by the *Tobe Bridge-Analyzer*.

The instrument is complete with built-in power supply for any 110 volt 60 cycle circuit, electric eye with pre-amplifier, neon tube for conventional analyzer service, and detailed operating instructions. The possession and intelligent operation of the *Tobe Bridge-Analyzer* stamps the service man as a technician — not a tinkerer. Order one today and avoid call-backs because of component failures not shown by ordinary test equipment.

Contained in rugged steel case, with sloping panel on which all controls are conveniently grouped.

Tobe Bridge-Analyzer. Complete with 1 — 6G6, 1 — 6C6, 1 — 01A, and 1 neon tube. Net price . . . \$28.50

TOBE CONDENSER ANALYZER, NEW IMPROVED! SHOWS ALL TROUBLES!

Tests all types of condensers — mica — paper — oil — electrolytic. Fast — accurate — simple to operate. A new and improved condenser testing instrument that greatly simplifies radio service and eliminates guess work.

All tests made under operating voltage conditions. Makes accurate tests for opens — intermittents — shorts — and high resistance leaks. Latest feature makes positive check for intermittent opens and intermittent shorts.

Contains a built-in power supply delivering voltages up to 700 volts D.C. Uses rugged but sensitive Neon glow indicator and 01-A tube as rectifier. Housed in sturdy metal case $3\frac{3}{4}$ " x $4\frac{1}{2}$ " x $7\frac{1}{2}$ ". Shipping weight 5 lbs. Comes complete with instructions and valuable handbook on condenser testing, Neon lamp, 6 ft. cord and plug, test leads and clips, but less 01-A tube. Used only where power supply is alternating current. 110 volt — 25 cycle model, net price \$15.00. 110 volt 60 cycle model. Net price, \$11.40

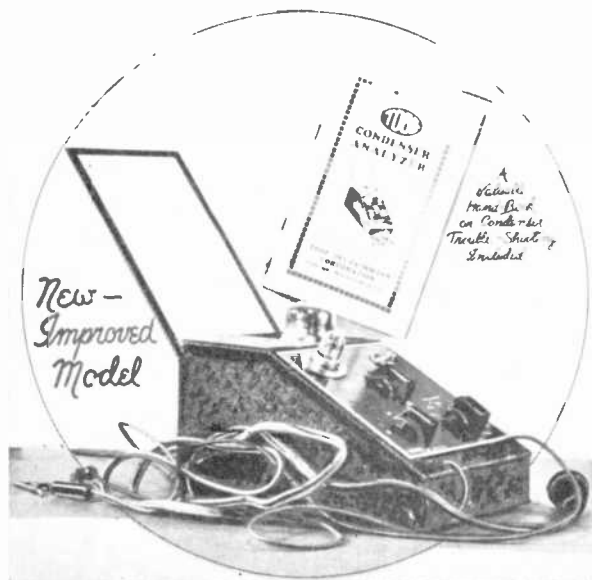

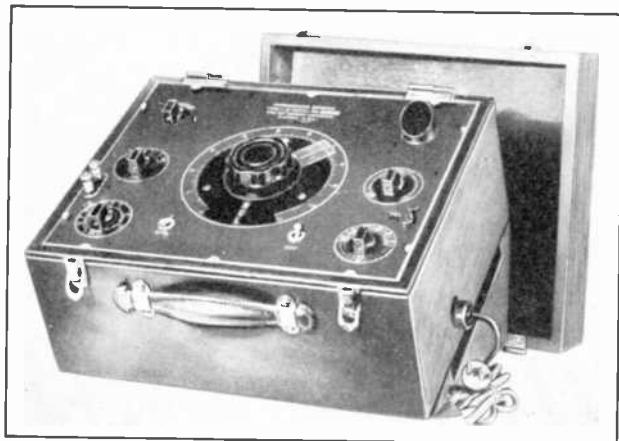

TOBE LABORATORY RCL IMPEDANCE BRIDGE

For Research, Experimental and Service Laboratories

The Tobe Impedance Bridge is a precision instrument for use by the advanced experimenter, engineer, laboratory technician, and the progressive serviceman. Through its use an accurate determination may be made of inductance, capacitance, resistance, coil efficiency, and condenser power factor. This modern instrument removes all uncertainty from the A.C. measurements which are essential to successful design and servicing.

In addition to the three bridge circuits that allow measurement of capacitance, inductance, and resistance, the Tobe RCL Bridge contains a built-in oscillator delivering either 60 or 1200 cycles for convenient A.C. measurement. It also contains an amplifier through which balance indicating voltages are applied to a cathode ray type (electric eye) tube for visual null indication. The entire equipment is provided with a built-in power supply so that the instrument may be operated from any 110 volt 60 cycle line without need for batteries or other auxiliary power supply.

Although the Tobe RCL Bridge is so versatile an instrument, its operation is extremely simple. By following the detailed instructions supplied with each instrument, rapid and accurate measurements may be made by one having no previous experience in bridge operation. It is recommended to the modern serviceman for direct measurement of capacity and power factor of all types of condensers. It will also be found valuable for determining resistance and inductance and for checking the standards employed in every-day service equipment.

The operating ranges and accuracy of the Tobe RCL Bridge are:

1. For Capacitance

Range — 10 mmf. (.00001 mfd.) to 100 mfd.
Accuracy — below 100 mmf. — 5%
 100 mmf. to 10 mfd. — 2%
 above 10 mfd. — 3%

2. For Inductance

Range — 10 microhenries to 100 henries
Accuracy — below 1 milhenry — 2% or 5 micro-
 henries
 1 milhenry to 1 henry — 2%
 above 1 henry — 3%

3. For Resistance

Range — 1 ohm to 1,000,000 ohms
Accuracy — below 100 ohms — 2% or 0.1 ohms
 100 to 100,000 ohms — 2%
 above 100,000 ohms — 3%

For high precision measurements, this instrument may be operated with a Wagner ground.

The Tobe RCL Bridge is supplied ready for operation, complete with one each of the following tubes: 84, 6E5, 6J7, and 6C5. It is contained in a handsome hand-rubbed walnut carrying case $14\frac{1}{2} \times 11\frac{1}{2} \times 8\frac{1}{2}$ inches, with Tilt-table support to hold the instrument at an angle most convenient for operation.

Tobe RCL Bridge, complete. Net price . . . \$95.00
F.O.B. Canton, Mass.

TOBE ELECTRONIC EYE BRIDGE BALANCE

For all a-c bridges — resistance, capacity, inductance. More sensitive, more accurate and more convenient than the telephone receivers which it replaces. Adjustable sensitivity facilitates the determination of approximate null points and contributes a new precision to the final balance. Frequency range up to 5000 cycles provides extreme flexibility. Hooded "eye" is mounted in swivel socket so that it can be swung to face the operator.

HIGH SENSITIVITY

Built-in amplifier provides sufficient amplification for all bridges. Provision made for 'phones in exceptional cases where desired. An instrument that should be in every modern service laboratory. Self-contained power supply operating from 110 volts 60 cycles. Uses 1 — 79, 1 — 84, and 1 — 6E5 tube. Mounted in crackle finish cast aluminum cabinet, $5\frac{1}{2} \times 7\frac{3}{4}$ inches base. Over-all height, one foot. Complete with tubes.

Net Price \$24.00

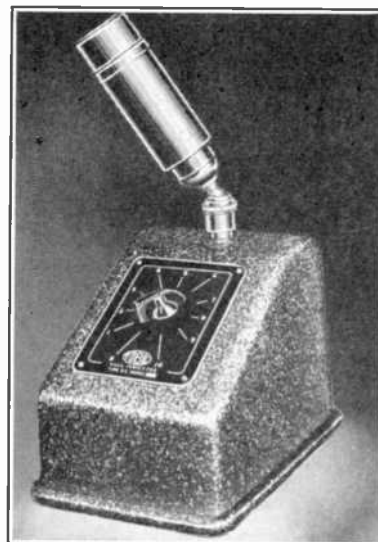

WHAT IS BACK OF TOBE FILTERETTES

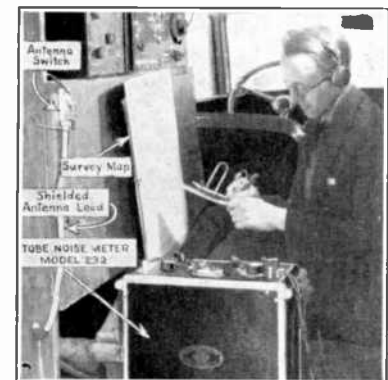
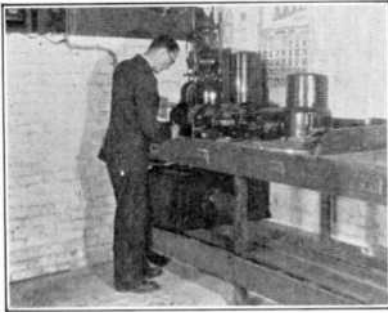

Tobe Filterettes are the product of a competent engineering staff fully versed in all the ramifications of the radio interference problem. For many years, our engineers have been studying the factors relating to the production of radio noise and have been developing methods of combating this scourge of the air-lanes. Not only in our well equipped laboratory, but in field survey cars in all parts of the United States, Tobe interference engineers are constantly serving the radio, electrical, and central station industries by making known the most effective means of finding just where noise originates and by devising means of quelling every known type of man-made static.

This is not a new field for us. The photographs of our interference laboratory reproduced on this page originally appeared in our 1929 publications, and indicate the many types of electrical apparatus that, even then had been submitted to us by manufacturers desirous of knowing how to render their products non-interfering. With the passing years, both the personnel and equipment of the Tobe Interference Laboratory have been greatly augmented to meet the increasing need for authentic information about radio interference. Not boastfully, but with a confidence born of many years' experience, we state that we can cope with any radio noise problem and can supply effective Filterettes for any special application — regardless of size.

The Tobe Deutschmann Corporation maintains the only laboratory and research staff devoted exclusively to radio interference engineering. Our Filterette Engineering Department is recognized by the leading radio and electrical engineers and manufacturers as the final authority on radio interference questions. A list of organizations having utilized our services would be a roster of American industry. Others may imitate Tobe products but they cannot duplicate the years of experience and the exact knowledge which have established the position of Tobe Filterettes as

The Accepted Remedy for Radio Interference

If you find it necessary to eliminate interference from apparatus that does not appear to be described in this catalog or if you require Filterettes having special voltage, current, or frequency ratings, we shall be glad to submit our quotations on specially designed and constructed Filterettes. Simply address

TOBE DEUTSCHMANN CORPORATION

Filterette Division

CANTON, MASSACHUSETTS



TOBE FILTERETTES

WHAT THEY ARE

Tobe Filterettes are electrical apparatus for use in overcoming, at its source, the unwanted radio frequency disturbances that accompany the operation of many types of electrical equipment. They comprise, either singly or in combination, carefully balanced capacitances, inductances, and resistances, so designed that maximum interference attenuation is secured over any desired range of frequencies without hampering in any way the operation of the apparatus to which they are applied. Filterettes are supplied in a wide variety of styles, voltage, current, and frequency ratings to meet every installation requirement. Unless otherwise specified, the Filterettes listed in this catalog are designed to stop noise over the range of frequencies covered by modern broadcast and short-wave receivers.

Successful interference elimination demands the use of correctly engineered equipment incorporating the design and construction features that have been proved by field and laboratory research to be effective. The chart on this page lists such equipment with its correct application to every known source of radio noise. Use it to solve your customers' noise problems.

HOW TO CHOOSE THEM

It will be noted that for some apparatus a Filtertype is printed in italics. This means that this Filterette will provide reasonable interference reduction but cannot be depended upon for complete noise elimination, and, therefore, should be used only when low price or ease of installation is a major consideration. Whenever possible, the Filterette listed at the right side of the column should be used.

It will also be noted that several choices are provided for some types of electrical equipment. To determine exactly what Filterette should be used, it is necessary to examine the equipment which is producing radio interference so as to determine the following facts:

1. — Is it connected to the power distribution system by means of a standard attachment cord and plug or is it permanently connected with BX, conduit or knob and tube wiring?

2. — At what voltage is it operated?

3. — If the interference is being produced by a motor or is originating at the high tension side of a transformer (as for example in an oil burner ignition system) how many amperes are drawn by the motor or transformer?

4. — If the interference is being produced by a D.C. generator, how many amperes are delivered by the generator when it is fully loaded?

5. — If the interference is produced by a sign flasher, a thermostat or any other contact making device, how many contact circuits are employed, how many amperes are handled by each set of contacts, and at what voltage is the apparatus operated?

After these facts have been determined, reference to the following pages will enable you to choose exactly the right Filterette to overcome the interference. In case of uncertainty, send us the answers to the questions above and our engineering department will gladly supply detailed instructions for handling any type of interference.

Most A.C. Motors Do Not Cause Radio Noise

The construction of alternating current motors used for operating refrigerators, washing machines, and oil burners is such that they should not cause radio interference when they are operating properly. If a motor associated with one of these three appliances appears to cause radio interference call your motor service man and have him make an inspection as it is probable that the motor is out of adjustment. Interference from one of these A.C. motors should be eliminated by repairing the motor rather than by installation of the Filterette.

List of interference sources showing correct Filterette for application to each

Adding machine	(Senior)	110-PO
Addressing machine	(Senior)	110-PO
Aerator	(Junior)	JA
Air purifier	(Junior)	JA
Autocall system		110
Barbers clipper	(Junior)	JA
Battery charger		
Mercury arc rectifier		2-No. 22
Rotary type		No. 10
Tungar type — BX connected		No. 11
Tungar type — Cord connected		Junior
Vibrator type		Junior
Beer pump	(Senior)	110-PO
Billing machine	(Senior)	110-PO
Bookkeeping machine	(Senior)	110-PO
Calculating machine	(Senior)	110-PO
Calorimeter		FS-110
Carbonator — Cord Connected		110-PO
Carbonator — BX connected, 110 volt		No. 110
Carbonator — BX connected, 220 volt		No. 221
Cash register	(Junior)	JA
Cellar pump	(Junior)	JA
Compressor — See Chart — Page 17		
Converter — See Chart — Page 17		
Counting Machine	(Senior)	110-PO
Cream tester	(Junior)	JA
Dehydrator		231
Dental engine		110-PO
Dental lathe		110-PO
Dial telephone — call phone company		
Diathermy apparatus — See Chart — Page 19		
Dictation machine		Junior
Dishwasher	(Senior)	110-PO
Dough mixer	(Senior)	110-PO
Drill (portable electric)		JA
Drink mixer	(Junior)	JA
Egg beater	(Junior)	JA
Electro-medical apparatus — See Chart — Page 19		
Elevator motor — See Chart — Page 17		
Elevator control contacts (Shield control panel)		
Exciter		10
Fan	(Junior)	JA
Farm lighting plant — See Chart — Page 18		
Flasher — See Chart — Page 18		
Floor polisher	(Junior)	JA
Flour bleacher — See Chart — Page 17		
Food Mixer	(Junior)	JA
Fruit juice extractor	(Senior)	110-PO
Generator — See charts — Pages 16 and 17		
Hair dryer	(Junior)	JA
Heating pad	(Junior)	Senior
Humidifier	(Junior)	JA
Incubator — See Thermostat		
Ironing machine (motor only)		110-PO
Mailing machine	(Senior)	110-PO
Malted milk machine	(Junior)	JA
Massage machine	(Junior)	JA
Mercury arc rectifier — See Battery Charger		
Milk shake machine	(Junior)	JA
Motors		
Capacity type		None
Repulsion — See Chart — Page 17		
Series — See Chart — Page 17		
Universal	(Junior)	JA
Motor generator — See Converters		
Neon sign — Repair sign		
Oil burner		OB-110
Ozonator	(Junior)	JA
Pipe threader		110
Portable electric tool	(Junior)	JA
Posting machine		110-PO
Printing press — See Chart — Page 17		
Razor		
Refrigerator (domestic)		110-PO
Rotary converter — See Chart — Page 17		
Sewing machine	(Junior)	JA
Sign flashers		
Four circuit		NYL-4
Two circuit		NYL-2
Single circuit		FS-110
Soda fountain equipment	(Junior)	JA
Stoker		221
Street cars (Write for special bulletin)		
Thermostat		FS-110
Traffic signal		FS-110
Vacuum cleaner	(Junior)	JA
Valve grinder		JA
Violet ray	(With shielding)	110-PO
Voltage regulator		FS-110
Washing machine		Senior
X-Ray		(Special. Write for recommendations)

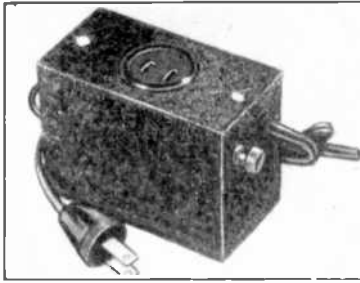

LINE FILTERETTE, RF-2



ELECTRIC RAZOR FILTERETTE



FILTERETTE JUNIOR

FILTERETTES FOR APPLICATION TO PORTABLE OR CORD CONNECTED ELECTRICAL APPLIANCES

Approximately 75% of the radio interference heard in the average receiver may be eliminated by application of the four Filterettes in this group. Consequently, the dealer who intends to keep his customers satisfied with their receivers should become thoroughly familiar with these Filterettes and their use because a simple Filterette installation has often been found to save the sale of an expensive receiver.

FILTERETTE JUNIOR

This unit is the simplest of all Filterettes and may be instantly installed without special tools or electrical experience. It is listed by Underwriters' Laboratories for use on any 110 volt circuit at currents up to 15 amperes. It may be used on either direct or alternating current and at any power frequency. To install the Filterette, simply plug it into the wall socket or baseboard outlet, plug the appliance into the Filterette receptacle and connect a short wire from the Filterette binding post to the appliance frame. Filterette Junior normally provides at least 40 DB attenuation at frequencies between 500 and 3500 kilocycles when it is correctly used with such universal motored appliances as vacuum cleaners, cash registers, hair dryers, dictating machines, drink mixers, floor polishers, and sewing machines.

Filterette Junior, List price \$2.25. Shipping weight 6 ounces.

FILTERETTE JA

Filterette JA is an extremely compact, light-weight unit for connection in series with the attachment cord of any portable appliance. Contained in a bakelite case only 3" long and 1 1/2" in diameter, it does not add objectionable weight to the appliance, yet because of its close proximity to the interference source it provides more satisfactory noise reduction than may be secured through the use of a Filterette installed at the end of the cord. This Filterette is particularly recommended for application to vacuum cleaners, hair dryers, drink mixers, floor polishers, barber clippers and portable electrical tools, to which it is attached by cutting the attachment cord two inches from the point at which it is brought out of the instrument frame and connecting the cord conductors to the screw terminals of the Filterette.

Filterette JA, List price \$2.75. Shipping weight, 6 ounces.

FILTERETTE SENIOR

Tobe Filterette Senior is an inductive-capacitive unit designed for use with appliances requiring a more effective noise reducing circuit than is provided by the Junior or JA Filterette. Filterette Senior contains a filter circuit comprising the basic units of the Junior Filterette plus a group of specially designed inductances so connected that a high

radio frequency impedance is inserted in one side of the power supply line. This unit is frequently extremely effective when used with appliances receiving their power from a circuit having one side grounded. Designed for use on any 110 volt D.C. or A.C. circuit. Filterette Senior will carry a current of five amperes and is thus suitable for use with any of the common small motored appliances.

Filterette Senior, List price \$5.50. Shipping weight, 1 lb. 1 ounce.

FILTERETTE 110-PO

This is the most effective of the plug-in Filterettes and may be depended upon to provide maximum attenuation of interference resulting from the operation of any D.C. or A.C. appliance drawing not more than five amperes at 110 volts A.C. or D.C. Filterette 110-PO contains heavy duty inductances in series with both sides of the line so that interference cannot be fed back to the power supply circuit. If the power service is not grounded or if the appliance causing interference is located more than 25 feet from the service ground, Filterette 110-PO should be used in place of Filterette Senior. Among the appliances frequently requiring the use of Filterette 110-PO are adding machines, fruit juice extractors, electric refrigerators, washing machines and dental engines.

Filterette 110-PO, List price \$10.50. Shipping weight, 3 lbs. 6 ounces.

TOBE POWER LINE FILTERETTE

For Use With Radio Sets

Tobe Power Line Filterette RF-2 embodies a modern all-wave filtering circuit which, when interposed between a radio receiver and the power supply line, effectively prevents entrance of line noise to the receiver. Do not confuse Filterette RF-2 with ordinary so-called line filters which contain only condensers. This guaranteed Filterette contains specially designed high-frequency inductances in both sides of the power supply line and may thus be depended upon to provide maximum efficiency with modern all-wave receivers. Power Line RF-2 is contained in a steel housing which effectively shields it from stray fields. It is provided with a four foot attachment cord, an output receptacle, and a binding post to be used in making the ground connection.

Line Filterette RF-2, \$4.95. Shipping weight, 1 lb. 8 ounces.

ELECTRIC RAZOR FILTERETTE

A special unit for application to electric razors that spoil early morning radio programs. Installed at the end of the cord where it is completely out of the way, this unit reduces the interference to a negligible value under practically all conditions.

Tobe Electric Razor Filterette, List price \$1.00.

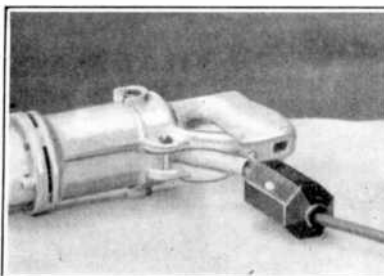

FEED-THRU FILTERETTE JA

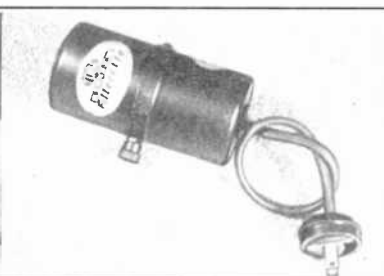

FILTERETTE SENIOR



FILTERETTE 110-PO

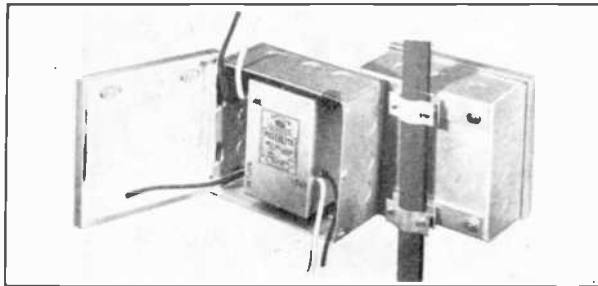

FILTERETTE OB-110 SHOWING PIPE CLAMP

TOBE OIL BURNER FILTERETTE

Embodying structural advantages resulting from many years experience in the design and production of Filterettes which are used as standard by leading oil burner manufacturers, Tobe Filterette OB-110 may be depended upon to provide satisfactory elimination of the radio interference produced by the electric ignition system of any oil burner. This unit comprises a carefully balanced combination of inductance and capacitance insuring satisfactory attenuation of interference over the range of frequencies employed for popular broadcast and short-wave transmission. The Filterette assembly is carefully sealed against moisture, is placed in a protecting shield of heavy gage steel, and the combination is welded into a standard cut-out cabinet 6" x 6" x 3". An important feature contributing to ease of installation is the provision of detachable mounting brackets by means of which the Filterette may be mounted on one of the pipe standards used for supporting an oil burner. The Filterette is connected to the oil burner transformer and to the remainder of the burner wiring by means of color-coded, insulated, flexible leads. Since the unit is designed to carry only the current drawn by the oil burner transformer it is rated at 2½ amperes 110 volts. Complete instructions

are supplied with the Filterette so that any electrician or oil burner serviceman may install it without difficulty on any make of oil burner. Listed by Underwriters' Laboratories. Filterette OB-110, List price, \$9.50. Shipping weight 6 lbs

TOBE CAPACITIVE TYPE FILTERETTES

Designed to provide as high a degree of filtering efficiency as may be secured without resort to choke coils, Tobe capacitive Filterettes are found to provide worthwhile reduction of radio interference from D.C. motors, mercury arc rectifiers, Tungar type chargers, welding generators, series motors, and exciters employed for supplying field current to alternators. They are contained in standard steel cut-out cabinets for installation in BX, conduit, or knob and tube wiring. Tobe capacitive Filterettes are guaranteed moisture-proof and are thus well suited to installation on sea going vessels, in the tropics, or wherever they may be exposed to extremes of temperature and humidity. Since capacitive Filterettes are not required to carry current, they do not bear current ratings but may be used with any machine regardless of its rating. As a rule, however, capacitive Filterettes are not recommended for 32 volt service or for use with 110 or 220 volt machines rated at more than three horsepower. They may, however, be successfully used with 600 volt machines rated at 100 kilowatts or more. Tobe capacitive Filterettes are provided with flexible leads for connection to the interference creating apparatus as indicated by the wiring diagram below.

CAPACITIVE FILTERETTES

Volts	Model Number	List Price
110 D.C.	10	\$10.00
110 A.C.	11	10.00
220 D.C.	20	15.00
220 A.C.	22	15.00
220 — 3 phase	23	20.00
550 A.C.	55	25.00
550 — 3 phase	56	35.00
600 D.C.	60	25.00

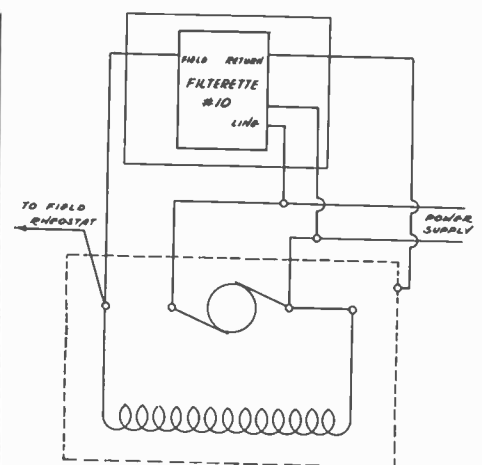
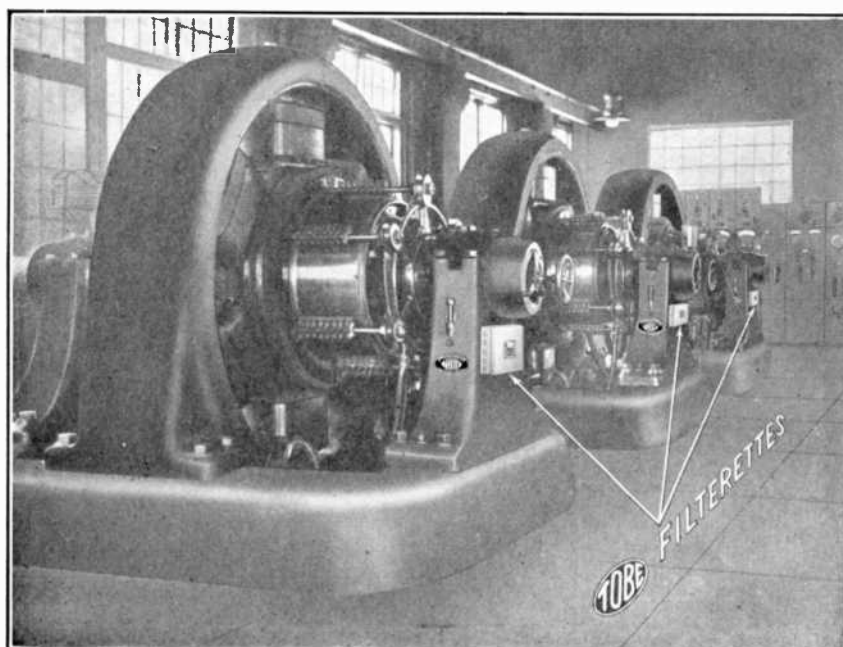

CAPACITIVE FILTERETTE USED WITH D.C. MOTOR

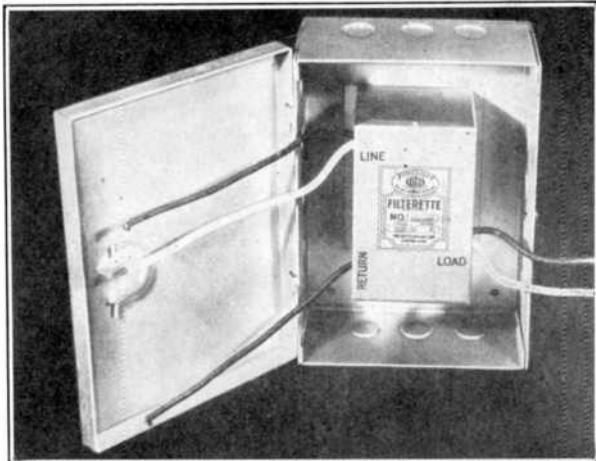

TOBE INDUCTIVE-CAPACITIVE TYPE FILTERETTES

The Filterettes in this group embody the latest developments in design and construction and provide the ultimate in radio noise eliminating efficiency. Besides including capacitances of the correct value and construction to function properly over the frequency range covered by modern all-wave receivers and to operate continuously at full voltage rating, each of these Filterettes contains inductances of the correct value to provide maximum interference attenuation.

An important feature of Tobe inductive-capacitive Filterettes is the fact that the conductor employed for construction of the inductances is of ample size to insure freedom from objectionable temperature rise and voltage drop. The size of conductor employed in Tobe Filterettes is from two to three times that normally specified as safe for the current to be carried. This insures absolute freedom from failure in operation. Stock models cover current ranges of from five to fifty amperes in both 110 and 220 volt ratings. Special units having higher current or voltage ratings will be constructed to order. Figure A shows the size of a 200 ampere inductive-capacitive Filterette as contrasted with the Junior Filterette.

Inductive-capacitive Filterettes of the types shown in the chart below are required for use with farm lighting plants, D.C. generators, elevator motors, compressors, flour bleachers, repulsion motors, autocal systems, pump motors, printing press motors, heavy duty single circuit sign flashers, etc. They are also required for application to rotary converters installed in D.C. districts to operate A.C. radio receivers, neon signs, refrigerators, and oil burners. Two Filterettes are needed for each rotary converter, one connected in series with the D.C. side and the other in series with the A.C. side. To choose Filterettes, check name-plate rating of each machine and refer to chart below.

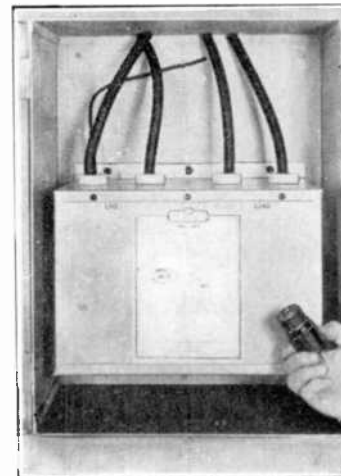

FIGURE A — 200 AMPERE FILTERETTE

INDUCTIVE CAPACITIVE FILTERETTES

Volts	Amperes	Volts Drop At Full Load	Model No.	List Price
110	5	1.25	110	\$12.50
110	10	1.55	131	20.00
110	20	.58	132	30.00
110	30	.92	133	42.50
110	40	1.92	134	57.50
110	50	1.6	135	75.00
220	5	1.25	221	20.00
220	10	1.55	231	30.00
220	20	.58	232	40.00
220	30	.92	233	52.50
220	40	1.92	234	67.50
220	50	1.6	235	85.00

TOBE POWER LINE FILTERETTE

With Free Structural Specifications for a Modern Shielded Test Room

In order to service modern all-wave radio receivers, the signal generators and test oscillators employed for alignment must be operated within a shielded room so that undesirable induction from broadcasting stations and power supply lines will not interfere with accuracy of receiver adjustment. A complete set of detail drawings showing the construction of a shielded service room 6' x 6' x 6' has been prepared for distribution to dealers and servicemen. This set of plans accompanies every Tobe service booth line Filterette regardless of its rating.

TOBE SERVICE BOOTH POWER LINE FILTERETTES

which are available in three standard ratings must be installed at the point at which the power supply line enters the test booth to keep unwanted signals and extraneous noises from entering the booth by way of the power line. This power line Filterette incorporates an exceptionally efficient combination of inductance and capacitance providing maximum interference attenuation without objectionable voltage drop. Its value has been proved by field and laboratory test and it is now being used by many outstanding industrial laboratories. It is recommended that illumination of the test booth be secured from lights above the booth so that the Filterette used may be required to handle only the power drawn by the receivers, soldering iron, and service instruments. Filterette SB-5 rated at 110 volts 5 amperes is ample for most service requirements but for large shops Filterettes are available in 10 ampere and 15 ampere sizes as shown in the chart below.

SERVICE BOOTH POWER LINE FILTERETTES

Amperes	Volts	Volts Drop At Full Load	Model No.	List Price
5	110	1.5	SB-5	\$16.50
10	110	1.5	SB-10	22.50
15	110	1.5	SB-15	27.50

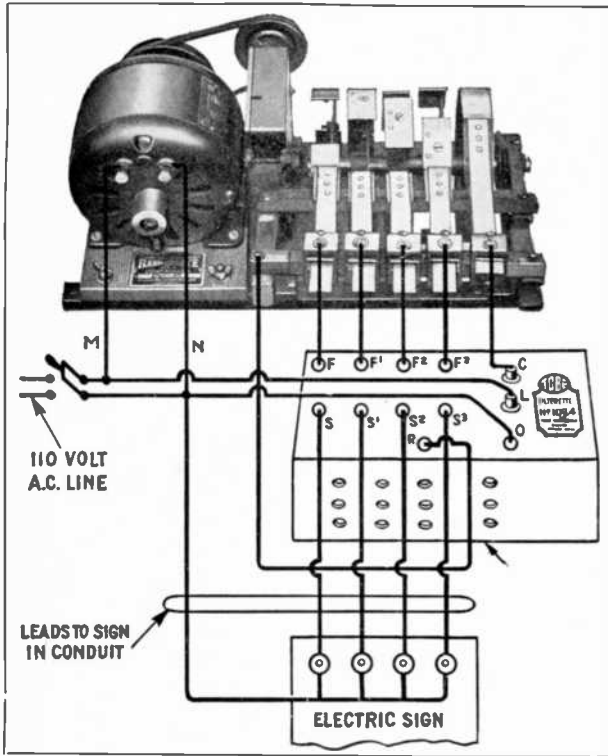

TOBE SIGN FLASHER FILTERETTES

These units are inductive-capacitive Filterettes for special types of service and incorporate in their construction features of convenience rendering them particularly well suited to installation with sign flashers. The simplest Filterette in this group is the Model FS-110 which is designed for application to flashing traffic beacons of the type commonly employed to control warning signals at danger spots along the highway. Another application for this Filterette is in connection with single circuit flashers used for turning a Neon or incandescent lamp sign on and off. Filterette FS-110 has been adopted as standard by the Massachusetts Department of Public Works for use with flashing traffic beacons throughout the state.

Filterette NYL-2 is designed for use with double circuit

sign flashers such as are commonly employed for controlling signs having alternate faces illuminated. It is suitable for use in either 110 or 220 volt circuits. Filterette NYL-4 is designed for application to four-circuit sign flashers such as are commonly used for controlling running border signs and chaser effects. This unit is recommended by leading sign flasher manufacturers.

Filterettes NYL-2 and NYL-4 are rated at 10 amperes per circuit and contain heavy duty inductances for connection in series with the common feed as well as each circuit contact so that they effectively prevent the distribution of interference in any direction from the flasher. The usual Tobe safety factor is provided in the inductances of these sign flasher Filterettes. This means that each circuit inductance is safe for continuous operation at 10 amperes so that the Filterette will not be damaged if for any reason the driving mechanism ceases to function. Standard sign flasher Filterettes are shown in the chart below and special combinations will be constructed to order.

SIGN FLASHER FILTERETTES

No. of Flashing Circuits	Volts	Amperes Per Circuit	Model No.	List Price
1	110	4	FS-110	\$12.50
2	110	10	NYL-2	20.00
4	110	10	NYL-4	38.00
4	220	10	NYL-4A	50.00

FARM LIGHTING PLANT FILTERETTES

These Filterettes are especially designed for use with Delco and Kohler light plants. They are constructed so as to keep radio noise, caused by the D.C. generator, from being carried along the load wiring. For battery charging plants, an auxiliary Filterette is sometimes required in the circuit to the battery. This is provided in Filterette DM-32. For Delco 800 watt, 32 volt, battery-charging type plants, Filterette DM-32 is used. For Delco or Kohler 1500 watt, 110 volt, non-charging plants, Filterette DM-110 is required. Kohler 2000 watt, 110 volt plants use Filterette No. 132.

Watts	Volts	Type	List Price
850	32	DM-32	\$45.00
1500	110	DM-110	38.00
2000	110	132	30.00
5000	110	135	75.00

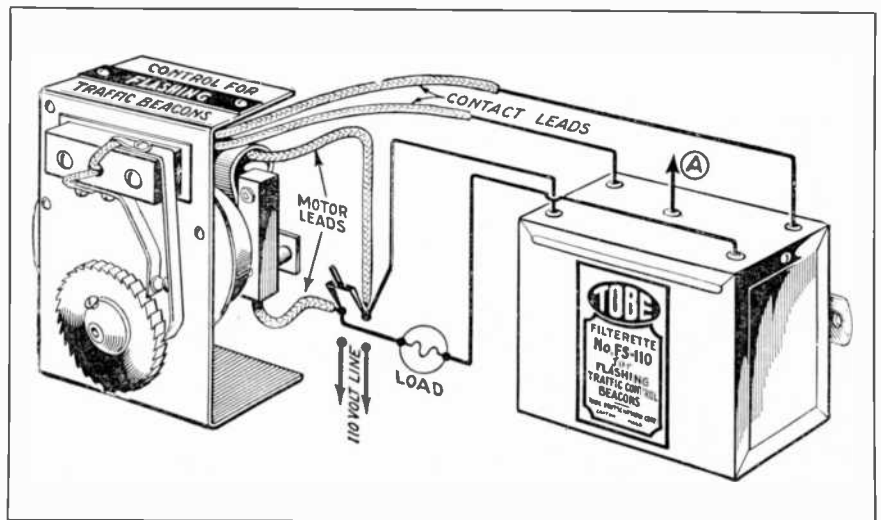
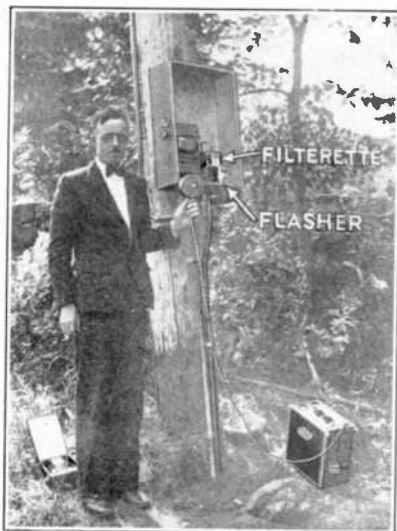

FILTERETTE FS-110 AS USED BY THE MASSACHUSETTS HIGHWAY DEPARTMENT

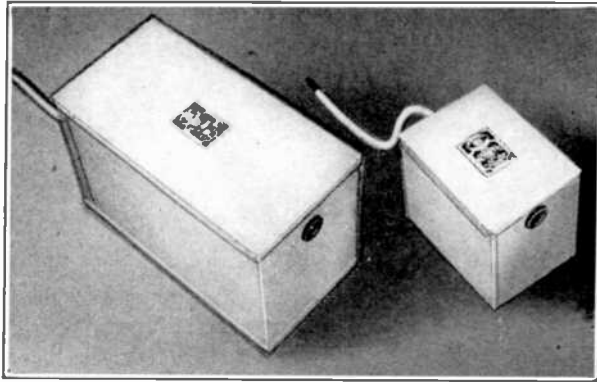

TOBE FILTERETTES FOR ELECTRO-MEDICAL APPARATUS

Diathermy, X-Ray and Violet-Ray

Because of the extreme intensity of interference created by electro-medical apparatus, its elimination is of vital importance to every community. A single diathermy machine may create so much interference that from 100 to 1500 listeners will be unable to secure satisfactory reception even from powerful local broadcasting stations. The efficacy of Tobe Filterettes in eliminating this type of interference has been proved in all parts of the world and we do not hesitate to guarantee that the installation of the correct Filterette in the manner specified in the instruction bulletin accompanying it will so reduce the interference as to allow radio reception within 15 feet of the apparatus without objectionable background noise. The use of Tobe High Frequency Filterettes as recommended and approved by Acme-International, American, Engeln, Fischer, General Electric X-Ray, Hogan, McIntosh and Victor is described in detail in a four page bulletin which will be sent free to any dealer or serviceman who is required to cope with this most serious of all radio interference problems. The three stock Filterettes available for use with electro-medical apparatus are listed in the chart below, and special units having other voltage and current ratings will be constructed to order.

DIATHERMY FILTERETTES
Dimensions

Volts	Amperes	Inches	Model No.	List Price
110	6	7 5/8 x 6 3/4 x 5 1/2	1HF-0	\$35.00
110	15	7 x 11 1/2 x 9	1HF-2	75.00
110	25	8 x 16 x 13	1HF-3	125.00

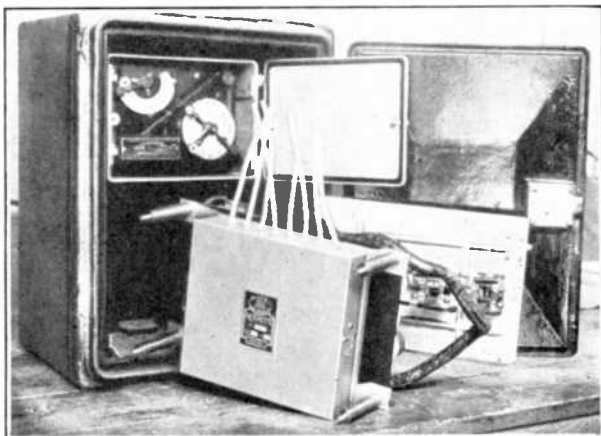

SPECIAL FILTERETTE FOR G. E. TRAFFIC TIMER

THE OFFICIAL RADIO NOISE MANUAL

This book, "Radio Noises and Their Cure," is the standard reference work for guidance of dealers, servicemen, engineers and manufacturers who wish to secure accurate information about radio noise elimination. The data it contains are based upon many years of field and laboratory research, and the results obtainable through the use of the procedures recommended in the book have been verified by field experience.



In the seventy-six 8 1/2" x 11" pages of this most interesting handbook are contained 28 wiring diagrams, 61 photographs of Filterette installations, 24 drawings showing interference distribution and suppression and a typical interference survey map.

A complete interference survey report, a model interference ordinance, and data on the organization of an interference club are also contained in this book.

This comprehensive treatise is endorsed and recommended by all the leading radio manufacturers. We can do no better than to quote from General Bulletin No. 15 issued by the Sales Engineering Department of the Transformer Corporation of America, "The book completely covers the subject of radio interference — and we wouldn't be without it." Philco Service Bulletin No. 124 states, "This book covers the subject very thoroughly and will prove of great value."

List price, 50 cents. Shipping weight, 9 ounces.

TOBE FILTERETTE ENGINEERING SERVICE

Manufacturers, electric power companies and service organizations are invited to utilize the services of our engineering staff in the solution of their radio interference problems. In our pioneering experience extending over many years, we have encountered every known type of radio interference and are thus in a position to render an immediate report on the engineering and economic aspects of any radio noise problem. Regardless of the size or type of equipment found to create radio interference, we can recommend a means of mitigating or entirely eliminating the disturbance. The photograph at the left shows a special Filterette developed for installation behind the control panel of a General Electric traffic control timer to eliminate the interfering click heard whenever the lights change. In most cases an effective Filterette may be installed without any serious alteration of the equipment to be Filterized. The cost depends entirely upon the quantity of Filterettes purchased and upon the amount of hand work required in their construction. In any case the expense involved in overcoming interference is so slight in contrast to the benefit secured that it is needless for man-made static to continue destroying radio reception. For complete information about the construction of special Filterettes, write our Filterette Engineering Department.

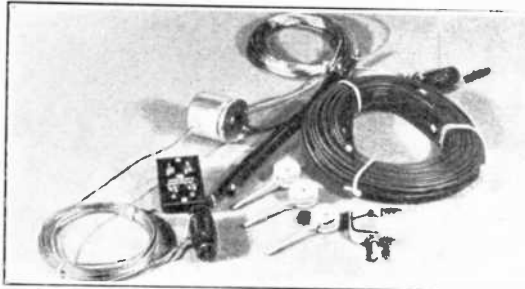

REDI-WIRED ALL-WAVE AERIAL



POWER LINE FILTER



SHIELDED LEAD-IN KIT

TOBE AERIAL FILTERIZER KITS

For Use With Every Receiver to Increase Over-all Efficiency of Reception and to Provide Relief from Local Man-made Static

Designed and produced by the pioneers in the field of radio interference elimination, Tobe Aerial Filterizers are demanded by discriminating dealers who must keep sets sold. For quick and easy installation with all-wave receivers, we have developed

The New Redi-Wired Model 39 All-Wave Aerial Filterizer Kit

comprising a completely assembled doublet antenna with 70 foot span, terminating insulators, connection shield, 72 foot balanced transmission line, three supporting insulators, twin lead-in strip and receiver coupling unit. This is a fully automatic all-wave kit requiring no manual adjustment. Since it employs a single wire doublet the Model 39 Redi-Wired Aerial Filterizer may be installed in a few minutes by one man working alone.

Redi-Wired Model 39 Automatic Aerial Filterizer, List price \$4.50. Shipping weight, 3½ lbs.

SHIELDED LEAD-IN KIT FOR BROADCAST SERVICE

The old reliable Model 33 Aerial Filterizer Kit originally designed for use in the 500 to 1500 kilocycle band is still the most effective noise reducing aerial system ever developed. Despite claims for modern all-wave receivers, analysis of listening habits reveals the fact that, more than 90% of the time, receivers are tuned to the North American broadcasting band and that noise-free reception in this band is the primary interest of most listeners. The Model 33 Aerial Filterizer Kit, with its shielded lead-in and impedance matching transformers for aerial and receiver, effectively isolates the receiver from interference fields which might otherwise cause the introduction of extraneous noise by way of the lead-in. Thus it enables you to provide dependable, noise-free reception under all conditions.

Model 33 Shielded Lead-in Kit. List price, \$5.45. Shipping weight, 2 lbs. Same Kit with Power Line Filterette RF-2, List price \$9.95.

POWER LINE FILTER No. 7

A simple and inexpensive plug type filter for use in locations where line interference is not of extreme intensity. To install this unit, simply plug it into the power outlet and insert the attachment cap of the radio cord in the line filter receptacle.

Power Line Filter No. 7, List price \$1.00. Shipping weight 6 ounces.

NEW TOBE AUTO POLE

This modern automobile aerial whose value was conclusively proved last season has now been improved so that it is even more efficient. The use of tempered heat-treated steel makes the rod especially rigid yet leaves it sufficiently flexible to withstand accidental contact with solid objects. The lower section is finished in black enamel and the upper sections are cadmium-plated for complete protection against the elements. The top of each section is firmly banded to ensure permanent low resistance contact between sections. Quick and easy mounting on the bumper support is assured by the use of a rigid steel bracket having insulated hook clamps which firmly grasp the low loss, pure gum rubber insulator at the base of the pole. A soldering lug permanently attached to the Auto Pole facilitates connection of whatever type of lead-in is to be used. Being adjustable, the Auto Pole is well suited to amateur work as well as to use with broadcast receivers.

Model B5 — Auto Pole List Price \$2.95

HINGE MOUNTING AUTO POLE

Especially designed to provide an inconspicuous yet highly effective auto radio antenna. Hinge pin holds cadmium plated steel bracket firmly in place on any door hinge. Moulded low loss rubber insulator supports 40" rod of tempered, heat-treated steel. Special square tapered construction ensures minimum whip. Black baked enamel finish harmonizes with any car. Supplied complete with 37" lowloss lead-in preconnected to antenna and protected with rubber tubing.

Model H7 — Auto Pole
List Price \$2.95

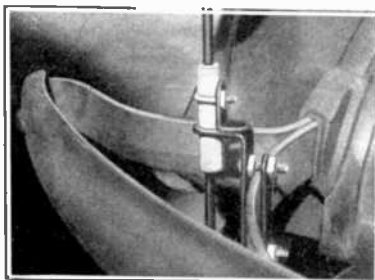

MOUNTING OF TOBE AUTO POLE

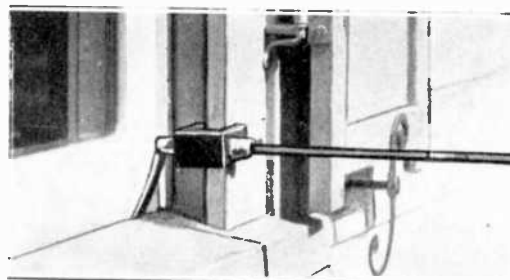

TOBE WINDOW POLE AERIAL — HORIZONTAL MOUNTING

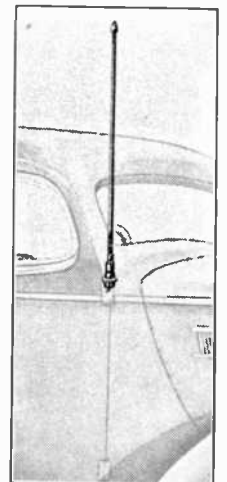

HINGE POLE

