

QST

september, 1946

25 cents

35c In Canada

devoted entirely to
**amateur
radio**

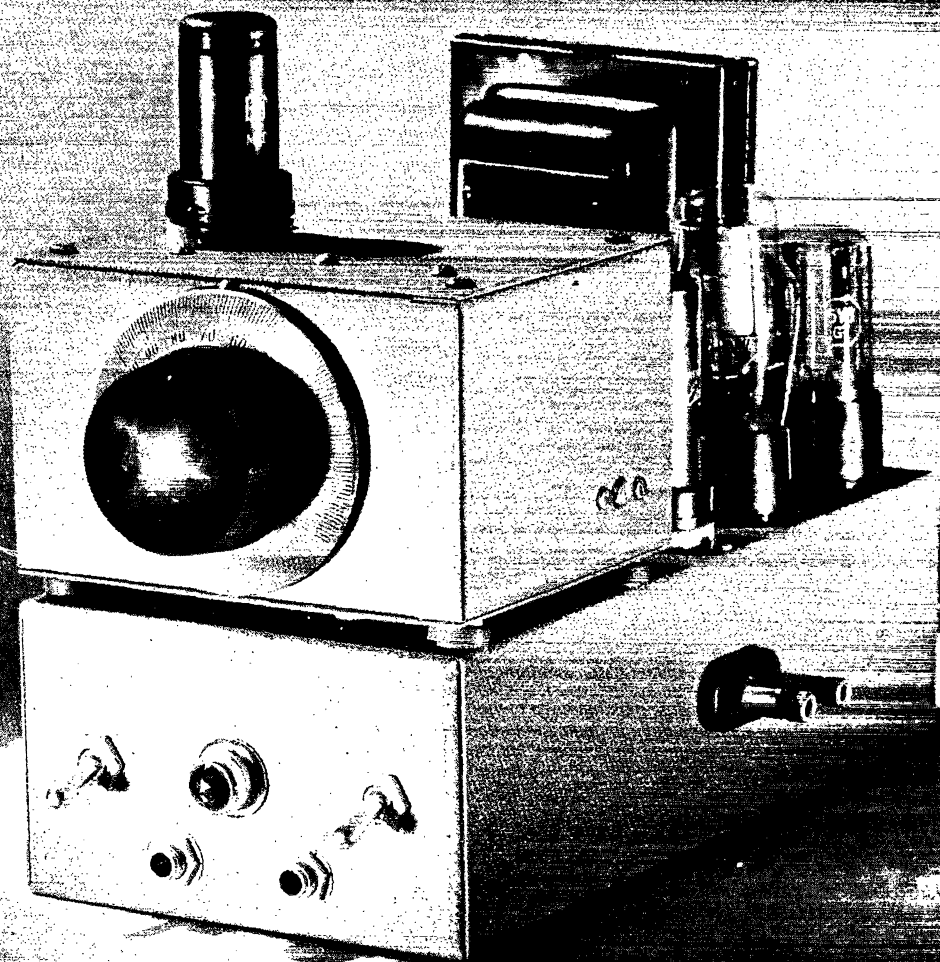

...SIMPLE VFO CRYSTAL SUBSTITUTE



VARITRAN

(VARIABLE VOLTAGE TRANSFORMER)

EXCELLENT REGULATION
 HIGH EFFICIENCY
 SMOOTH CONTROL
 LOW TEMPERATURE RISE
 NO DISTORTION
 RUGGED DESIGN

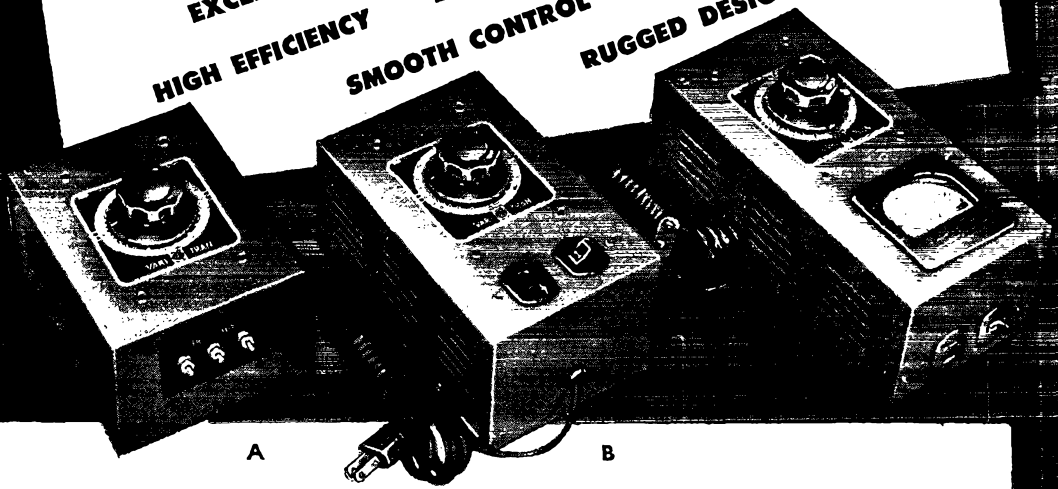

The UTC Varitran is a simple autotransformer whose turns are arranged on one layer with the insulation removed so that every exposed turn may be used as a tap of the winding. A special non-fusing contact, having resistance to minimize circulating currents, is mechanically arranged so that it can be moved to any position on the winding, permitting the exact voltage desired to be obtained.

STANDARD VARITRANS

Standard Varitrans are designed for 115 or 230 volt service. The respective output voltages are 0-130 and 0-260 volts.

Type	Input Voltage	Output Voltage	Watts	Maximum Amps.	Figure	Net Price July 15, 1946
V-O	115 volts	0-130	230	2	A	\$10.10
V-O-B	230 volts	0-260	230	1	A	12.45
V-1	115 volts	0-130	570	5	B	14.25
V-1-M	115 volts	0-130	570	5	C	23.80
V-2	115 volts	0-130	570	5	A	11.90
V-2-B	230 volts	0-260	570	2.5	A	14.85
V-3	115 volts	0-130	850	7.5	A	17.85
V-3-B	230 volts	0-260	850	3.75	A	23.80
V-4	115 volts	0-130	1,250	11	A	26.15
V-4-B	230 volts	0-260	1,250	5.5	A	33.30

UNIVERSAL VARITRANS

Universal Varitrans have two 110 volt Primary windings (110 or 220V connection) and a 28 volt variable secondary winding. This winding can be used as a 0-28 volt low voltage source. It can also be used in autotransformer connection with the primaries to effect . . . 115 in/87 to 143 out, 220 in/192 to 248 out, 220 in/82 to 138 out, 115 in/202 to 258 out.

Type	Max. Amps. Output	Approx. Dimensions	Approx. Weight, Lbs.	Figure	Net Price July 15, 1946
VL-O	1.5	4 1/2 x 6 1/2 x 2 1/2	5	A	\$ 8.30
VL-1	3.5	4 1/2 x 6 1/2 x 3	7	A	9.50
VL-2	6	4 1/2 x 6 1/2 x 4	10	A	11.90
VL-3	11	5 x 7 x 5	15	A	19.00

PRICES ARE SUBJECT TO CHANGE

United Transformer Corp.

150 VARICK STREET NEW YORK 13, N. Y.
 EXPORT DIVISION: 13 EAST 40TH STREET, NEW YORK 16, N. Y. CABLES: "ARLAB"

FOR YOUR FINAL AMPLIFIER STAGE

A
Quality TUBE
 WHERE *Quality*
 COUNTS MOST!



BBETTER made for better results—that's what General Electric's Type GL-813 means to you! This tube is a standout in its intelligent G-E design and painstaking G-E manufacture. Consider these features:

- ★ Special development work has been done to provide highest-quality insulation for supporting the tube elements. This greatly increases overall efficiency.
- ★ Superior internal shielding makes possible:
- ★ Unusually low grid-plate capacitance, which in turn means . . .
- ★ Neutralization is required less frequently. (*None*, if your circuit is properly shielded.)
- ★ Top-quality molybdenum wire forms the control and screen-grid structures. Result—the control-grid to screen-grid relationship, so important in beam power tubes, is maintained during the tube's life!
- ★ No tube gets more complete and rigid G-E tests, at every stage of manufacture. These thorough tests are vital with beam power tubes, because of complex structure.

Total up the above, and your sum is General Electric's great GL-813—a topnotch high-power frequency multiplier, also the ideal final-stage power amplifier where quick band change without neutralizing adjustments is your aim.

Your G-E tube distributor will be glad to receive your request for further information. Or write to *Electronics Department, General Electric Company, Schenectady 5, N. Y.*

The May-June issue of G.E.'s "Ham News" carried full details of a high-efficiency 10-meter final, using a pair of GL-813's.

**TYPE GL-813
 BEAM POWER
 TETRODE**

ELECTRICAL CHARACTERISTICS

Filament voltage	10 v
Filament current	5 amp
Max plate ratings:	
voltage	2,000 v
current	180 ma
input	360 w
dissipation	100 w
Frequency at max ratings	30 mc
GM	3,750 mhos

RATINGS FOR TYPICAL OPERATION

(push-pull Class C power amplifier, plate-modulated, 2 tubes)

Plate voltage	1,600 v
Plate current	300 ma
Grid current	12 ma
Plate power output (approx)	350 w
Driving power (approx)	2.4 w

ELECTRONIC TUBES OF ALL TYPES FOR THE RADIO AMATEUR

GENERAL  ELECTRIC

161-E16-8880

RADIO SET DESIGNERS!

Federal's New MINIATURE Selenium Rectifier

Replaces 117Z6, 117Z3, 0Y4 and most other rectifier-type tubes in AC—DC—Battery Portable Radio Receivers

Assures . . .

- **REDUCED COSTS**
- **SPACE SAVINGS**
- **INSTANT STARTING**
- **LESS HEATING**

Reduced costs, because this rectifier unit costs less than the parts it replaces. Only two soldered connections—minimum mounting hardware required.

Space savings, because this unit, only $1\frac{1}{4} \times 1\frac{1}{4} \times 11/16''$, can be used in place of a rectifier tube, socket, and associated parts.

Instant starting, because power supply operates instantaneously with selenium rectifier. Eliminates warm-up time.

Less heating, because heat-producing filament of rectifier tube is eliminated. Gives longer battery life.

This compact 5-plate unit has all the refinements of design and sturdy construction which have made Federal Selenium Rectifiers the standard of quality throughout the industry. Of all metal construction, with no fragile parts—it will last many times longer than the average tube.

Now in full-scale production . . . orders can be filled almost immediately. Write for details.

RATINGS: Federal 5-plate Rectifier-type 403D-2625
 Peak inverse voltage 380 volts
 Current carrying capacity 100ma DC

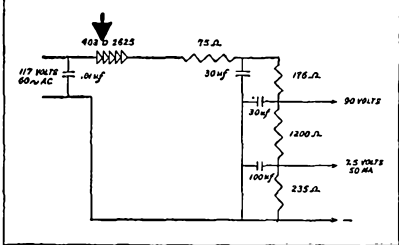
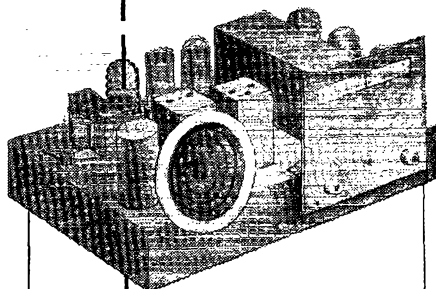
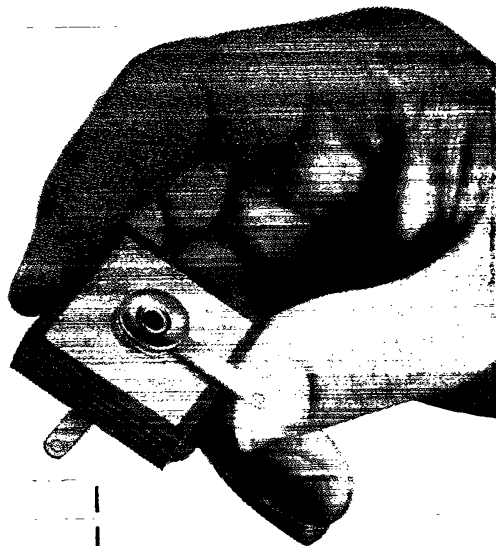

Circuit diagram of power supply for AC/DC—Battery portable radio receiver, using a 5-plate Federal rectifier unit in place of the conventional tube circuit.

Federal Telephone and Radio Corporation

In Canada:—Federal Electric Manufacturing Company, Ltd., Montreal
 Export Distributor:—International Standard Electric Corporation



Newark 1,
 New Jersey

SEPTEMBER 1946

VOLUME XXX

NUMBER 9



STAFF

Editorial

KENNETH B. WARNER, W1EH
(Managing Secretary, ARRL)
Editor

HAROLD M. MCKEAN, W1CQG
Assistant to the Editor

GEORGE GRAMMER, W1DF
(Technical Director, ARRL)
Technical Editor

DONALD H. MIX, W1TS
BYRON GOODMAN, W1JPE
Assistant Technical Editors

EDWARD P. TILTON, W1HDQ
V.H.F. Editor

RICHARD M. SMITH, W1PTX
C. VERNON CHAMBERS, W1JQC
Technical Assistants

WALTER E. BRADLEY, W1FWH
Technical Information Service

Production

RALPH T. BEAUDIN, W1BAW
Superintendent

ELBIE C. HOCHMEISTER
Assistant

Advertising

F. CHEYNEY BEEKLEY, W1GS
Advertising Manager

Circulation

DAVID H. HOUGHTON
Circulation Manager

RALPH T. BEAUDIN, W1BAW
Assistant Circulation Manager



OFFICES

38 La. Salle Road,
West Hartford 7, Connecticut

Subscription rate in United States and Possessions, \$2.50 per year, postpaid; all other countries, \$3.00 per year, postpaid. Single copies, 25 cents. Foreign remittances should be by international postal or express money order or bank draft negotiable in the U. S. and for an equivalent amount in U. S. funds.

Entered as second-class matter May 29, 1919, at the post office at Hartford, Connecticut, under the Act of March 3, 1879. Acceptance for mailing at special rate of postage provided for in section 1103, Act of October 3, 1917, authorized September 9, 1922. Additional entry at Concord, N. H., authorized February 21, 1929, under the Act of February 28, 1925.

Copyright 1946 by the American Radio Relay League, Inc. Title registered at U. S. Patent Office

QST

devoted entirely to

AMATEUR RADIO

PUBLISHED, MONTHLY, AS ITS OFFICIAL ORGAN, BY THE AMERICAN RADIO RELAY LEAGUE, INC., AT WEST HARTFORD, CONN., U. S. A. OFFICIAL ORGAN OF THE INTERNATIONAL AMATEUR RADIO UNION



CONTENTS

"It Seems to Us . . ."	11
A Simple VFO Crystal Substitute . . . Donald Mix, W1TS	13
West Gulf Division Convention	16
A Deluxe Electronic Key . . . Wilbur R. DeHart, W9DED	17
How to Catchum DXCC J. P. Jessup, W2GVZ	24
Solving Feeder Problems Graphically Robert E. Kelley, W1IEB	25
Mobile Receiving Equipment for Two, Six and Ten Meters Edward P. Tilton, W1HDQ	28
Happenings of the Month	36
In QST 25 Years Ago This Month	41
Revamping the BC-342	42
Crystal Control on 144 Mc. . . Wendell W. King, W3NBV	46
ARRL Get-Acquainted Party	51
Foreign Notes	52
Technical Topics	
Simplified Transmitter Frequency Changing	53
BCI	54
Silent Keys	55
Color "Sourdough"	56
How's DX?	58
A Combination Test Meter . . . Robert H. Dellar, WA1CC	61
The World Above 50 Mc.	63
Hints and Kinks	69
Correspondence from Members	71
A New Approach to F.M. Reception	73
Operating News	74
Station Activities	84
WWV	108
ARRL QSL Bureau	110

FIRST OF A LONG LINE...



Model S-38

Four tuning bands, 540 kc to 32 Mc, CW pitch control adjustable from front panel, automatic noise limiter, self contained PM dynamic speaker, "Airodized" steel grille are some of the attractive features... **\$39.50**

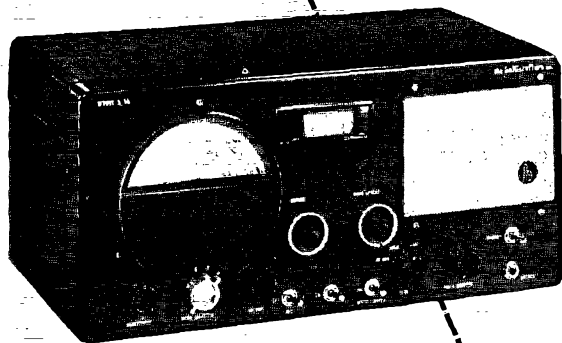

Model S-40

Finest performance ever presented in the popular price field. 540 kc to 43 Mc, RF section uses permeability adjusted "micro-set" inductances. A. N. L., temperature compensated RF oscillator, beat frequency oscillator, separate RF and AF gain controls..... **\$79.50**

WORTH WAITING

Due to industry-wide circumstances Hallicrafters production and distribution of new models is necessarily running far behind the demand.

Radio components are difficult to obtain. Production has been especially slow on components of the high quality and precise design needed for completing Hallicrafters high frequency circuits.

Models S-38 and S-40 are only the beginning. When parts become available Hallicrafters will have many more bigger and better sets. The S-38 and the S-40 are still not available in quantity but production on these beginning models is improving. Just as soon as humanly possible, Hallicrafters will have ready for you the equipment you want at the price you want to pay.

**NEW OFFICIAL SERVICE
CENTERS FOR
hallicrafters
EQUIPMENT**

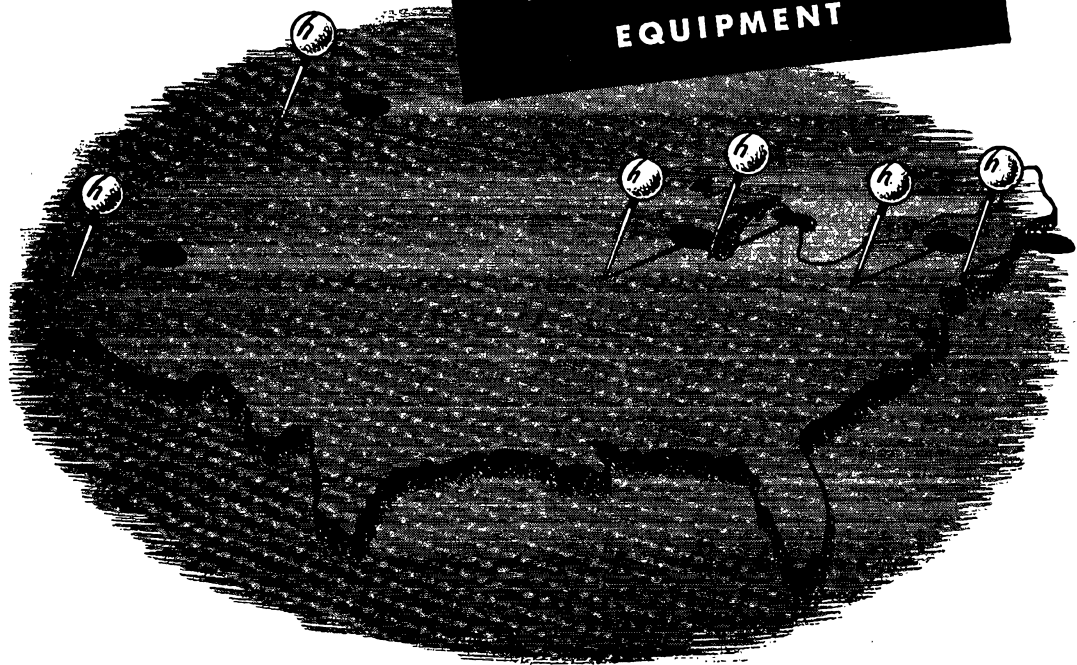

hallicrafters establishes national network of strategically located SERVICE CENTERS

The Hallicrafters Co., Chicago, announces the beginning of a new national network of official service centers to specialize in repair and servicing of all Hallicrafters communications equipment: marine and aviation radio, ham transmitters and receivers. Service centers have already been established at New York, Pittsburgh, Kansas City, Mo., Los Angeles and Seattle. Service at these locations will be equal in every way to that offered by the Chicago factory.

As production and distribution can be increased, more such centers will be established so that Hallicrafters users everywhere will be given the fastest, most efficient service possible.

See your local Hallicrafters distributor to learn how and where you can benefit from this new service system. Your high precision Hallicrafters equipment deserves the finest care . . . put your repair and service problems in the hands of specialists: Hallicrafters official service centers.

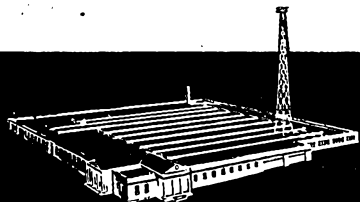

hallicrafters RADIO

THE HALLICRAFTERS CO., MANUFACTURERS OF RADIO
AND ELECTRONIC EQUIPMENT, CHICAGO 16, U. S. A.

Section Communications Managers of the ARRL Communications Department

Reports Invited. All amateurs, especially League members, are invited to report station activities on the first of each month (or preceding month) direct to the SCM, the administrative ARRL official elected by members in each Section. Radio Club reports are also desired by SCMs for inclusion in QST. All ARRL Field Organization appointments are now available to League members. These include ORS, OES, OPS, OO, and OBS. Also, where vacancies exist SCMs desire applications for SEC, EC, RM, and PAM.

ATLANTIC DIVISION			
Eastern Pennsylvania Maryland-Delaware-District of Columbia Southern New Jersey Western New York Western Pennsylvania	W3BES W3CIZ W2GCU W2UPH W3NCJ	Jerry Mathis Hermann E. Hobbs Ray Tomlinson Charles I. Otero R. R. Rosenberg	623 Crescent Ave. 9701 Monroe St. Silver Springs P. O. 623 E. Brown St. 4158 Ridge Road, West 927 East 23rd St.
Illinois Indiana Kentucky Michigan Ohio Wisconsin	W9NUN W9SWH W5IEZ/4 W8DFE W8MFP W9RH	David E. Blake, II Ted K. Clifton Joseph P. Colvin Harold C. Bird Carl F. Wiehe Emil Felber, jr.	4501 N. Malden St. 550 Eben St. 1653 Beechwood Ave. R.F.D. 2, Box 228 122 St. Albert St. 1625 N. 18th St.
North Dakota South Dakota Northern Minnesota Southern Minnesota	W0EVP W0QVY W9FUZ W9OMC	Raymond V. Barnett P. H. Schultz Armond D. Brattland Vernon G. Pribyl	406-17th St. 118 N. Yankton Ave. Birchmont Drive 15 Glen St., South
Arkansas Louisiana Mississippi Tennessee	W5JTC W5DWW W5HAV W4SP	Marshall Riggs W. J. Wilkinson, jr. P. W. Clement James B. Witt	4405 Howell Ave. Room 313, Jefferson Hotel 524 Santini St. R.F.D. 6, Shady Dell Trail
Eastern New York N. Y. C. & Long Island Northern New Jersey*	W2HZL W2IDC W2IIN	Ernest E. George Charles Ham, jr. John J. Vitale	2044 Lexington Parkway 151-06 84th Drive 57 Sayre St.
Iowa Kansas Missouri Nebraska	W0FJR W0AWP W0QUD W0FQB	Leslie B. Vennard Alvin E. Urruh Mrs. Letha A. Dangerfield Arthur R. Gaeth	2712 Washington St. 82 N. Terrace Drive 411 Moffett Ave. 6105 N. 37 St.
Connecticut Maine Eastern Massachusetts Western Massachusetts New Hampshire Rhode Island Vermont	W1KOY W1AQI W1ALP W1JAH W1ARC W1HRC W1NDL	Edmund R. Fraser G. C. Brown Frank L. Baker, jr. William J. Barrett John H. Stoughton Clayton C. Gordon Gerald Benedict	48 Willow St. 379 No. Main St. 21 Atlantic St. 239 Columbia St. RFD 2 70 Columbia Ave., Gaspee 23 Foster St.
Alaska Idaho Montana Oregon Washington	K7CBF W7IWU W7EQM W7BEE W7FWD	August G. Hiebert Alan K. Ross Albert Beck Cliff Tice O. U. Tatro	c/o K FAR 1017 East Jefferson St. 18 Laird St. McKay Dam 513 N. Central
Hawaii* Nevada Santa Clara Valley East Bay San Francisco Sacramento Valley Philippines San Joaquin Valley	K6PHD W7CX W6BPT W6TI W6CVP W6MGC KA1GR W6PSQ	John Souza N. Arthur Sowle Roy E. Pinkham Horace R. Greer Samuel C. Van Liew John R. Kinney George L. Rickard James F. Wakefield	Box 2025 1061 Fremont St. 414 Fairmount Ave. 215 Knowles Ave. 5240 Jay St. Box 849 1548 L St.
North Carolina South Carolina Virginia West Virginia	W4CYB W4BOE/ANG W3KQL W8JM	W. J. Wortman Ted Ferguson Walter R. Bullington Donald B. Morris	c/o Duke Power Co. 3422 Rosewood Drive 1203 E. Brookland Pk. Blvd. 303 Home St.
Colorado Utah-Wyoming	W0QYT W6LLH	Glen Bond Victor Drabble	2550 Kendall 1024 Oak St.
Alabama Eastern Florida Western Florida Georgia West Indies (Cuba) (Puerto Rico-Virgin Islands)*	W4GBV W4HP W4MS W4HYW K4KD	Lawrence J. Smyth Robert B. Murphy Lt. Comdr. Edward J. Collins Thomas M. Moss Everett Mayer	808 Winona Ave. 3302 S.W. Grapeland Blvd. 1215 N. 12th Ave. 570 Oak Drive P. O. Box 1061
Los Angeles Arizona San Diego	W6QWZ W6MLL W6CHV	Ben W. Onstenk Gladden C. Elliott Ralph H. Culbertson	9631 3rd Ave. 1408 West Fresno St. 7172 Eads St.
Northern Texas Oklahoma Southern Texas New Mexico	W5ALA W5AYL W5IC W5HJF	Jack T. Moore Ed Oldfield James B. Rives J. G. Hancock	4529 Fairway Ave. 2141 N.W. 35th St. 1721 Kentucky Ave. 110 S. E. Nevada St.
Maritime	VE1DQ	A. M. Crowell	69 Dublin St.
Ontario	VE3DU	David S. Hutchinson	827 Lovett St.
Quebec	VE2CO	L. G. Morris	4114 Hingston Ave.
Alberta British Columbia	VE6LO VE7WS	W. W. Butchart W. W. Storey	10740-107 St. 3915 W. 32nd Ave.
Manitoba Saskatchewan	VE1AM VE5SY	A. W. Morley Arthur Chesworth	26 Lennox St. 1084 Redland Ave.
			Glenside Gardens Linden, Maryland Trenton 10 Spencerport Erie Chicago 40 New Haven Louisville 4 Pontiac 2 St. Bernard 17 Milwaukee 5 Bismarck Pierre Bemidji Hutchinson Fort Smith Shreveport Biloxi Knoxville Schenectady 8 Jamaica, L. I., 2 Elizabeth 3 Burlington Wichita Joplin Omaha 11 West Haven 16 Brewer North Quincy 71 Adams Claremont Plateau, Providence 5 Montpelier Fairbanks Boise Ramsay Pendleton Olympia Wailuku, Maui Reno Santa Clara Oakland 11 Daly City Sacramento 16 Manila Fresno Charlotte 1 Columbia 25 Richmond 22 Fairmont Denver 14 Ogden, Utah Montgomery Miami 33 Pensacola Hapeville San Juan 5, P. R. Inglewood Tucson La Jolla Dallas 4 Oklahoma City 6 San Antonio 1 Portales Halifax, N. S. London, Ont. Montreal 28, Que. Edmonton, Alta. Vancouver St. Vital Moose Jaw

*Officials appointed to act temporarily in the absence of a regular official.

BETTER

FM Reception

AMPHENOL DIPOLE ANTENNAS

Amphenol Dipole Antennas and Dipole Antennas with Reflectors are engineered to provide excellent reception of FM even in zones of low signal strength.

The directional array virtually eliminates reflected signals, while building up required signal strength. The swivel feature on the mounting bracket and the mast head of the reflector types allows for tilting of the antenna plane to the optimum angle. An exclusive feature of all Amphenol FM Antennas is the Amphenol Twin-Lead low-loss transmission line from antenna to receiver.

TWIN-LEAD TRANSMISSION LINE

A recent Amphenol innovation—a perfect parallel-line lead-in wire extruded with polyethylene dielectric. This low-loss transmission line is highly efficient, inexpensive and completely moisture-proof, and remains flexible at temperatures well below zero. Twin-Lead is manufactured in three impedances that cover requirements for all Broadcast, FM and Television reception.

300 OHM provides best impedance match for FM and Television.
150 OHM is for experimental work and other special applications.
75 OHM is best suited to match a $\frac{1}{2}$ wave element and should be used where receiver input impedance is 75 ohms.

AMPHENOL

COAXIAL CABLES AND CONNECTORS • INDUSTRIAL CONNECTORS, FITTINGS AND

AMERICAN PHENOLIC CORPORATION
CHICAGO 30, ILLINOIS
In Canada • Amphenol Limited • Toronto

COND IT • ANTENNAS • RADIO COMPONENTS • PLASTICS FOR ELECTRONICS



CENTRALAB

takes the "Mystery" out of **CERAMICS**

CENTRALAB controls porosity in ceramics. • Centralab controls heat-shock characteristics. Centralab controls physical strength. • Centralab holds tolerances of $\pm .001$ " where grinding is feasible. Centralab is prepared to supply you with ceramics harder than the hardest quartz ($7\frac{1}{2}$ on Moh Scale). If you need a versatile ceramic for specialized or standard applications, invoke the magic name of Centralab.

Send for Bulletin No. 720

Centralab

Division of GLOBE-UNION INC., Milwaukee

PRODUCERS OF



Silver Mica Capacitors
Bulletin 630



Ceramics
Bulletin 720



Ceramic Trimmers
Bulletin 630



Ceramic High Voltage Capacitors
Bulletin 630



Radiohms
Bulletin 697



Tubular Ceramic
Capacitors
Bulletin 630

Ceramic Plate Capacitors
Bulletin 630



Selector Switches
Bulletin 722



THE COUNTERSIGN OF DEPENDABILITY IN ANY ELECTRONIC EQUIPMENT

**1/2 Kilowatt on CW
with the Collins
30K Transmitter**

Using a single Eimac 4-125A tetrode in the power amplifier and a pair of Eimac 75TL's in the modulator, this transmitter is designed for 1/2 Kw input on CW, 375 watts input on phone. Vfo-controlled, it features 6-band operation, push-to-talk and band-switching, break-in operation, speech-clipper, clean sharp keying, and is fully metered.

Be sure to investigate the Collins 30K transmitter; and remember—Eimac is first choice of leading electronics engineers throughout the world.

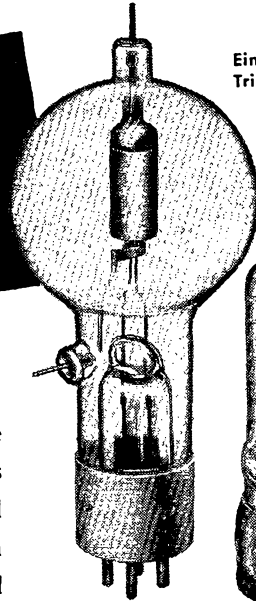

Eimac 75TL
Triode

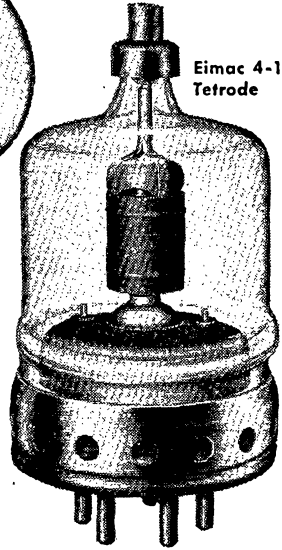

Eimac 4-125A
Tetrode

Follow the Leaders to



NATURALLY COLLINS CHOOSES EIMAC TUBES

Eimac's long-lasting 4-125A tetrode brings you maximum performance in *any* rig, with a minimum of worry about such bugaboos as neutralization, shielding, or driving power. For example, at 70 Mc, the 4-125A develops 375 watts with a driving power of less than 3 watts.

The pair of Eimac 75TL's used in the modulator provide high audio output at low plate voltage, and require a minimum of audio driving power.

Get specifications on these tubes direct from Eimac!

**EITEL-McCULLOUGH, INC., 1291M San Mateo Avenue
San Bruno, California**

Export Agents: **Frazier and Hansen**
301 Clay Street, San Francisco 11, California, U. S. A.

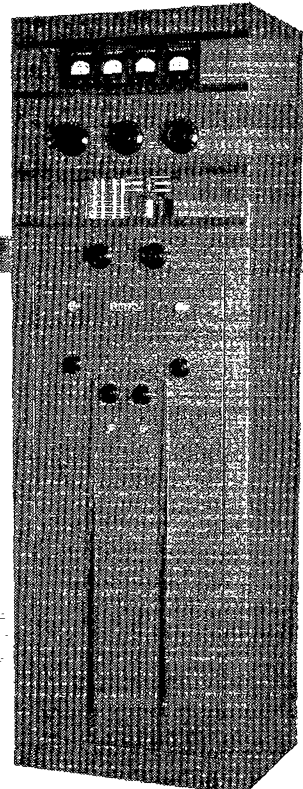

THE AMERICAN RADIO RELAY LEAGUE, INC.,

is a noncommercial association of radio amateurs, bonded for the promotion of interest in amateur radio communication and experimentation, for the relaying of messages by radio, for the advancement of the radio art and of the public welfare, for the representation of the radio amateur in legislative matters, and for the maintenance of fraternalism and a high standard of conduct.

It is an incorporated association without capital stock, chartered under the laws of Connecticut. Its affairs are governed by a Board of Directors, elected every two years by the general membership. The officers are elected or appointed by the Directors. The League is noncommercial and no one commercially engaged in the manufacture, sale or rental of radio apparatus is eligible to membership on its board.

"Of, by and for the amateur," it numbers within its ranks practically every worth-while amateur in the nation and has a history of glorious achievement as the standard-bearer in amateur affairs.

Inquiries regarding membership are solicited. A bona fide interest in amateur radio is the only essential qualification; ownership of a transmitting station and knowledge of the code are not prerequisite, although full voting membership is granted only to licensed amateurs.

All general correspondence should be addressed to the Secretary at the administrative headquarters at West Hartford, Connecticut.



Past Presidents

HIRAM PERCY MAXIM, W1AW, 1914-1936
EUGENE C. WOODRUFF, W8CMP, 1936-1940

Officers

President GEORGE W. BAILEY, W1KH
Washington, D. C.
Vice-President J. LINCOLN MCCARGAR, W6EY
Oakland, California
Secretary KENNETH B. WARNER, W1EH
West Hartford, Connecticut
Communications Manager F. E. HANDY, W1BDI
West Hartford, Connecticut
Treasurer DAVID H. HOUGHTON
West Hartford, Connecticut

General Counsel PAUL M. SEGAL
1026 Woodward Building, Washington 5, D. C.

Directors

President
GEORGE W. BAILEY W1KH
1530 F St., N.W., Washington 25, D. C.

Vice-President
J. LINCOLN MCCARGAR W6EY
66 Hamilton Place, Oakland 12, Calif.

Canadian General Manager
ALEX REID VE2BE
240 Logan Ave., St. Lambert, P. Q.
Alternate: Leonard W. Mitchell VE3AZ
78 Raglan Ave., Toronto, Ont.

Atlantic Division
EDWARD G. RASER W2ZI
315 Beechwood Ave., Trenton 8, N. J.
Alternate: J. Victor Brotherson W8BHN
1743 Ottawa Drive, Erie, Pa.

Central Division
JOHN A. KIENER W8AVH
3462 Edison Rd., Cleveland Heights,
Cleveland 21, Ohio
Alternate: Earl S. Nelson W8DS
22,551 Hadden Rd., Euclid 17, Ohio

Dakota Division
TOM E. DAVIS W9VVA
915 W. Becker Ave., Willmar, Minn.
Alternate: Harold B. Love W9ZRT
Box 426, Mandan, N. D.

Delta Division
GEORGE S. ACTON W6BMM
Palm Dealing, La.
Alternate: Eugene H. Treadway W5DKR
P. O. Box 44, La Place, La.

Hudson Division
ROBERT AKERIDGE KIRKMAN W2DSY
1910 Oak Drive, West Belmar, N. J.
Alternate: George Ruffis, Jr. W2CJY
38 Brookwood Drive, Manhasset, L. I., N. Y.

Midwest Division
FLOYD E. NORWINE, JR. W0EFC
7405 Elawatha Ave., Richmond Heights 17, Mo.
Alternate: C. A. Colvin W9VHR
% Omaha & Council Bluffs St. Railway Co.,
Omaha 2, Nebr.

New England Division
PERCY C. NOBLE W1BVR
37 Broad St., Westfield, Mass.
Alternate: Clayton C. Gordon W1HRC
70 Columbia Ave., Warwick, R. I.

Northwestern Division
KARL W. WEINGARTEN W7BG
3219 N. 24th St., Tacoma 7, Wash.
Alternate: R. Rex Roberts W7CPY
110 W. Brennan St., Glendive, Mont.

Pacific Division
J. L. MCCARGAR W6EY
66 Hamilton Pl., Oakland 12, Calif.
Alternate: Elbert J. Amarantes W6FBW
1675 Dale Ave., San Jose, Calif.

Roanoke Division
H. L. CAVENESS W4DW
2607 Vanderbilt Ave., Raleigh, N. C.
Alternate: J. Frank Key W3ZA
Box 707, Buena Vista, Va.

Rocky Mountain Division
Acting Director:
HOWARD R. MARKWELL W9TFF
355 Monroe St., Denver 6, Colo.

Southeastern Division
WILLIAM C. SEELTON W4ASR
527 Revilo Blvd., Daytona Beach, Fla.
Alternate: William P. Sides W4AUP
Fleming Road, Montgomery, Ala.

Southwestern Division
JOHN E. BICKEL W6BKY
1834 E. Whittier Blvd., Whittier, Calif.
Alternate: Eldridge E. Wyatt, Jr. W6ARW
P. O. Box 3597, Long Beach 3, Calif.

West Gulf Division
WAYLAND M. GROVES W5NW
% Humble Pipe Line Co., Odessa, Texas
Alternate: Jennings R. Poston W5AJ
P. O. Box 848, Curundu, Panama Canal Zone

"It Seems to Us..."

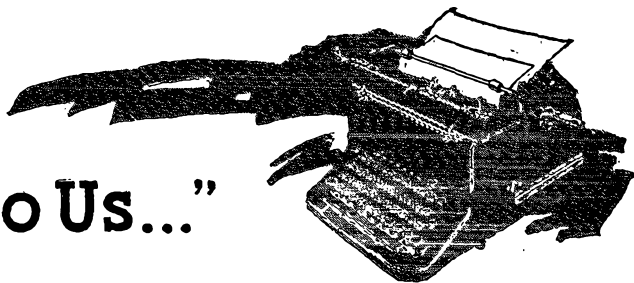

A LOOK BEHIND & AHEAD

It is the first anniversary of V-J Day, a packed and momentous year of recovery for us amateurs. After War I it took us nearly eleven months of fighting to recover the right to operate our 200-meter spark stations, and even longer before we got our new licenses and were actually operating again. Our League and *QST* had folded during the war and had to be rebuilt. We were a weak and pitiful little organization, picking our way, so we got off to quite a slow start. It has been very different this time. We held our League intact during the war. In a few days after V-J Day, FCC had us back on the air on the only amateur band at its disposal, 2½ meters. It didn't require new licenses; it reactivated our old ones. Successive bands and parts of bands were fed back to us the very moment the military services released them, FCC often engaging in special actions to give us immediate restoration. Thus well within the year we have regained, if not all our frequencies, the major portion of them, and we are "sitting pretty" for the remainder. Our routine regulations have been sensibly overhauled, our licensing and renewing proceeds with great vigor, we have many new microwave bands, our call areas have been revised to make more calls available, our organized operating activity has been resumed, and our signals cover the world. All this has happened in the short year since V-J Day. It is a testimony to the esteem in which the amateur institution is held, to its record of service during the war, to its understanding friends in high places, and, incidentally, to some hard work on the part of the directors and officers of the League.

Much, of course, remains to be done. We have yet to get back the second halves of the 7- and 14-Mc. bands, to get the 3.5 band released in the Pacific area, to get back any part of our 1.75 band, and to secure possession of the remaining two-thirds of our 420-450 Mc. band. There is going to be another world conference soon, the first since 1938, and we shall have to defend ourselves through another dangerous period of world reallocations —

offering, at the same time, the prospect of gaining a new band at 21 Mc. We have yet to find thoroughly satisfying formulas for the postwar interior subdivision of our bands. Our networks and trunklines have yet to be rebuilt. Satisfactory progress is being made on all these matters, yet it is apparent that we have some hard work ahead of us and that it is imperative for us to pull together.

During this year there were many sudden changes in amateur rules, frequencies, privileges. Considering how complex the radio structure is, it is no wonder that many amateurs were confused, listened to rumors and sometimes went astray. Since our restoration is still incomplete and there are certain to be more such changes, it is worth reemphasizing that there is a way by which each amateur can avoid this uncertainty. It is W1AW. That is why we have the station, and that is why FCC has given W1AW special temporary authority not given other amateur stations — so that it may bring you the authentic news rapidly. For instance, when the first halves of 7 and 14 were suddenly restored, 1AW carried the news every thirty minutes, simultaneously on five bands at a kilowatt each on c.w., repeating on voice on each band. There wasn't a spot in the country where an amateur couldn't have had firsthand news almost immediately. Yet we heard many amateurs, including oldtimers who should know better, speculating on the rumors and making mistakes on what frequencies were open, at the very moment that AW was broadcasting the McCoy.

If you've listened-in regularly since the war ended you've heard also an appalling lack of comprehension of some of the fundamentals behind the amateur picture. There has been a lot of grousing going on, some of it understandable but much of it not. It started right after V-J Day, at first taking the form of resentment over the slowness of the military services in returning our frequencies, suspicions that all was not well here and there, dislike for changes in the regulations, and so on. Naturally, with as many new hands coming into the game as there were, and with all of us as rusty and out of touch as we have been, we have known that

it would take us some time to shake down into a cohesive and thoroughly-informed outfit. But, even so, it was pretty discouraging to hear the lack of realization of the large number of people who worked so hard and successfully to preserve amateur privileges during a difficult touch-and-go period, the lack of appreciation for the high-ranking people in the armed forces who defended us, helped to line things up for us; for the very special consideration and protection that FCC gave us at every turn; for the way the military services stood up for our frequency assignments; for the long war years of difficult representation and negotiation by ARRL officers, in hearings and allocation proceedings, in the maintenance of the amateur position. It was disheartening to hear the rumors and distortions being passed on, the suspicions and the fears of being short-changed — instead of asking an ARRL director or writing Headquarters or listening to WIAW. More recently there has been talk about the League itself that indicates that the talkers have small comprehension of how ARRL is organized and how it divides its functions.

Let's go into that last item a bit. It is an old, old story that we have many times recounted in *QST*'s pages but it seems to require another retelling. Our League is a nonstock membership corporation. It is controlled by a Board of Directors, with one director selected by the members in each territorial area or division from among their own number. The directors appoint the headquarters officers and give them instructions. The headquarters office is a service center, centralizing the League's work, writing and publishing the ARRL publications, looking after the rights of amateurs, rendering service to members. Confronted with a new problem in its own sphere, it can make a fair stab at finding a solution. But if a subject has been decided by the Board, that decision becomes ARRL policy and the subject is no longer left to the discretion of the headquarters staff: the headquarters is instructed and bound. The members of the Board have the usual responsibilities of corporation directors. They also have the duty, under our by-laws, of keeping themselves informed on the needs and desires of the members of their respective divisions. They do this by travel to clubs and conventions, and by correspondence with both individuals and clubs, particularly receiving vast quantities of letters shortly before their annual meeting. They have various continuing committees, made up exclusively of division directors, which investigate and study various assigned problems during the year, reporting with recommendations shortly before the annual meetings. Thus the Board, reflecting membership desires, formulates League policies and decides precisely what the League

position shall be on all questions that come before it.

We mentioned above that there is still work to be done in finding the most satisfactory postwar subdivision of our bands — as between c.w. and 'phone. This is one subject that in ARRL affairs is always handled and decided exclusively by the Board of Directors. It will also interest you to know that it is perennial and that it receives more of the Board's time and attention than any other subject — almost more, we might say, than all other subjects combined. Essentially insoluble, so far as satisfying everybody is concerned, it gets decided one year only to require redoing the next year — because of our growth and changing conditions and operating preferences in the intervening year. The present arrangement of the amateur assignments has been made by FCC in response to requests and recommendations from the ARRL Board. That arrangement is the best that could be conceived, after long and thoughtful examination, for an initial postwar disposition, in reconciliation of the many diverse sectional opinions of various parts of the country. It is doubtful whether anybody is thoroughly satisfied with the arrangements that stand today, and that includes the Board itself. Yet it has done the most intelligent job that it could, guided by the aim of the greatest good to the greatest number. It will do for a postwar starter, until our postwar occupancy pattern manifests itself. Unquestionably these problems will be before the Board again next Spring, with rearrangements to be decided in the light of our year's experience with the present rules.

Now when there is some feature of the present rules that you dislike and think dumb, consider these facts: (1) Other parts of the c.w.-'phone assignments which you particularly cherish and approve are just as heartily disliked by some fellows in some other part of the country. (2) There is no single part of the assignments for which it wouldn't be possible to marshal a considerable body of objectors, yet, to the best of the available evidence, every provision of the rules enjoys an overwhelming majority approval, taking the country as a whole — as we must. (3) So long as some of us prefer one type of emission to another, or one band to another, differences of opinion on what is desirable are inevitable; and any decisions by a central source, such as the Board, however intelligently and honestly arrived at in the aim to be of the greatest overall benefit, are bound to be unpopular somewhere. Yet angelscandonomore, and the only question — the perpetual one — is whether the nationwide gang agrees that a certain current disposition does provide the greatest

(Continued on page 130)

A Simple VFO Crystal Substitute

Variable Frequency with Good Stability

BY DONALD MIX,* WITS

• The VFO unit, shown in the photographs here and on our cover, was designed to replace a crystal. It delivers sufficient power to drive the conventional crystal-oscillator tube used as an amplifier. While three tubes are used, there is only one tuned circuit to adjust. Tests have shown that the frequency stability is excellent.

IN considering the various factors involved in the design of a VFO for transmitter frequency control, it is, of course, recognized as basic that any change in the capacitance across the frequency-determining tank circuit will result in a change in frequency. If the inductance and capacitance could be held constant the frequency would remain constant. Unfortunately the tube must be connected across the tank circuit and its interelectrode capacitance becomes part of the frequency-determining circuit. This would not be of importance if the tube capacitances — par-

ticularly the grid-cathode capacitance — could be held constant, but there are several factors difficult to control which affect this capacitance. A change in plate or screen voltage will act to change it. If the circuit is of the ECO type, tuning of the plate circuit will cause a change in input capacitance. If the VFO is followed by an amplifier stage, tuning of the amplifier plate circuit or a change in its plate voltage may cause a change in its own input capacitance which, in turn, may change the tuning of the oscillator plate circuit, eventually resulting in a change in capacitance across the frequency-determining circuit. A less serious effect is the change in tube input capacitance with a change in temperature, which combines with changes in the constants of the tuned circuit from the same cause, to produce frequency drift.

The effects of all of these influencing factors can be reduced to a certain degree by making the tank capacitance so large that changes in tube input capacitance constitute only a small percentage of the total circuit capacitance. The use of well-screened tubes in an ECO and in succeeding isolating stages also will help to reduce these effects along the line. The effects of changes in

* Assistant Technical Editor, *QST*.

The complete VFO unit. The oscillator is housed in a separate compartment which is shock-mounted on rubber grommets. The oscillator tube is on top of the compartment. To the rear are the two 6F6 amplifier tubes, the VR tube, the rectifier, and the power transformer. In front are the stand-by switch, power switch, pilot lamp, and the two keying jacks. The output terminals are to the right.

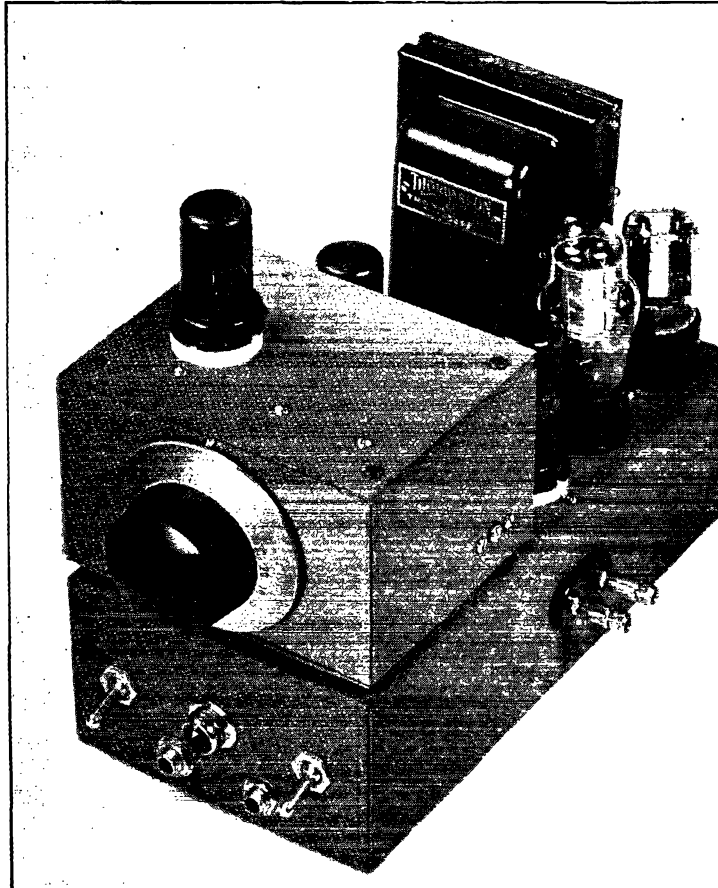

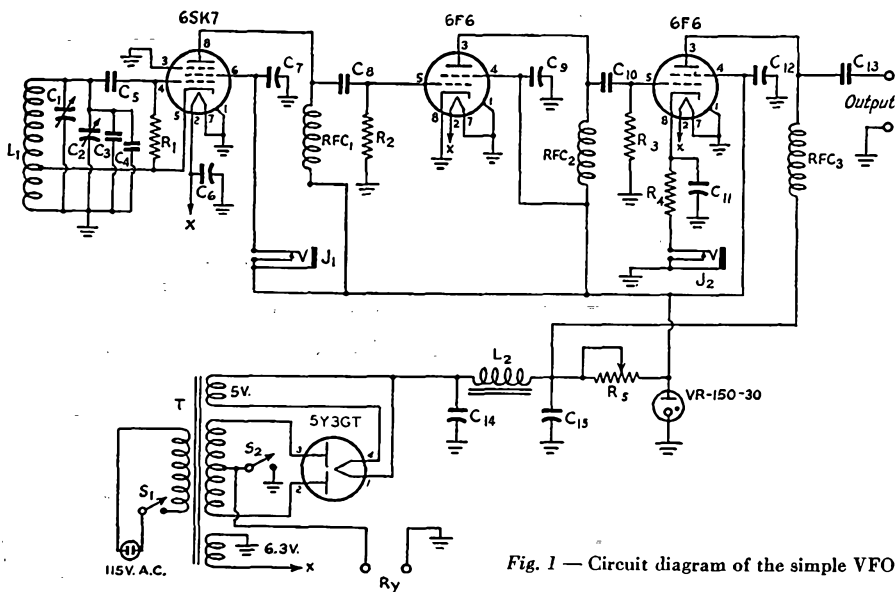

Fig. 1 — Circuit diagram of the simple VFO.

- C₁ — 100- μ fd. variable (Hammarlund MC100S).
- C₂ — 50- μ fd. variable (Hammarlund APC50).
- C₃ — 200- μ fd. zero-temp.-coef. mica.
- C₄ — 68- μ fd. zero-temp.-coef. mica.
- C₆, C₇, C₉, C₁₁, C₁₂ — 0.01- μ fd. paper.
- C₈, C₁₀, C₁₃ — 100- μ fd. mica.
- C₁₄, C₁₅ — 8- μ fd. 450-volt electrolytic.
- R₁, R₂ — 47,000 ohms, $\frac{1}{2}$ watt.
- R₃ — 0.1 megohm, $\frac{1}{2}$ watt.

- R₄ — 220 ohms, 1 watt.
- R₅ — 5000 ohms, 25 watts.
- L₁ — 17 turns No. 20 enam., $1\frac{1}{2}$ inches long, 1 inch diam.
- L₂ — 30 h., 50 ma. (Stancor C-1003).
- RFC₁, RFC₃ — 2.5-mh. r.f. choke.
- RFC₂ — 175 t. No. 30 d.s.c. $\frac{1}{2}$ -inch diam.
- S₁, S₂ — S.p.s.t. toggle switch.
- J₁, J₂ — Closed-circuit jack.
- T — 680 volts c.t., 55 ma.; 5 v., 2 a.; 6.3 v., $1\frac{1}{2}$ a.

plate voltage can be compensated for by holding the supply voltage constant by such means as the use of VR tubes. Most of the frequency variation which occurs when the plate circuit of an ECO and succeeding amplifiers are tuned takes place when these circuits are near resonance at the oscillator frequency. This would indicate that it is desirable to use nonresonant plate circuits in amplifiers whose primary purpose is to provide isolation between the oscillator and the remainder of the transmitter. By observing these rather simple rules, it is not difficult to build a VFO unit which will perform in an entirely satisfactory manner.

A Practical Circuit

In the circuit shown in Fig. 1, a 6SK7 ECO drives a pair of 6F6 isolation stages. The oscillator covers a fixed frequency range of 3500 to 4000 kc. and the power output is sufficient to drive the average crystal-oscillator tube. The 6SK7 was chosen as the oscillator because its screening is superior to that of any of the transmitting types, and because it does not require a heat-confining tube shield, its metal shell, in contrast, providing good heat radiation. A higher-power tube is not needed nor desirable in any event because the power input to the oscillator is kept low to reduce drift, and the small tubes usually are better from the microphonic standpoint. R.f. chokes

instead of tuned circuits in the two following 6F6 stages provide sufficient isolation so that the output terminals of the unit may be short-circuited with negligible effect upon the frequency. The third tube was added primarily to boost the output power of the unit, but it does provide a measurable improvement in isolation.

The use of untuned stages has the added advantage that controls are kept at a minimum — no ganging is required. Also, it solves certain difficulties which might be otherwise encountered in feeding the common types of crystal-oscillator circuits. A tuned output circuit would make it impossible to use the crystal oscillator as a straight amplifier in most cases, because the ex-crystal tube would "take off" as a t.p.t.g. amplifier. Beam tubes, such as the 6V6 or 6L6, are not suitable in this type of amplifier circuit, since their screening is insufficient to prevent low-frequency parasitic oscillation in the amplifier caused by the use of r.f. chokes in both plate and grid circuits. The use of tubes with even better screening than that of the 6F6 would constitute an improvement, but types with sufficient dissipation ratings are not available in the popular-price class. Type 6SK7 tubes may be used at some slight sacrifice of output.

Oscillator Keying

Keying of either a crystal oscillator or VFO is a problem which is difficult to solve with complete satisfaction. Most oscillators can be made to key quite well if care is taken to keep the keying-circuit lag at a minimum. This, however, works against the elimination of key clicks since the shaping of the keyed wave to reduce clicks requires lag circuits which build up the plate voltage slowly at the beginning of the character and keep it from dropping abruptly at the end of the character. Since the oscillator frequency changes with plate voltage, and since the plate voltage must increase from zero to maximum and back again as the oscillator is keyed, it follows that the frequency will change with keying — the signal will chirp. If, however, the time taken for the voltage to build up from zero to maximum is short enough, the chirp will not be noticeable to the ear. Key-click-filter lag circuits spread out the time of voltage build-up and decay and thus the chirp becomes audible. About the only thing which can be done, at the present time at least, is to try to strike some happy medium with the use of a minimum of lag in the key filter which will reduce clicks to a satisfactory level. The unit shown in the photographs was not intended primarily for oscillator keying because of these recognized effects, in the belief that keying a crystal oscillator or VFO is to be avoided if possible. However, tests showed that the oscillator did key quite well in the screen lead and therefore a second keying jack was provided for break-in work on 80 and 40. Because the key is 150 volts above ground, a relay should be used with this system of keying. The screen current is only 3 ma. which may account for the fact that clicks are not bad with no more filter than a pair of r.f. chokes connected at the key terminals.

Bottom view of the oscillator compartment. The tuning condenser and the coil are fastened to the rear wall of the box, while the air trimmer is mounted on the lower end as shown in the photograph. The small cone insulator supports the coupling lead to the first amplifier stage.

The power supply is a standard arrangement for condenser input except for the tube connected across the output to hold the voltage constant. All circuits except the plate of the output tube are operated at 150 volts tapped off the regulator tube.

Construction

The oscillator portion is constructed as a separate unit in a standard $3 \times 4 \times 5$ -inch steel box. The tuning condenser, C_1 , and the coil form for L_1 are fastened to the rear wall of the box. C_1 is coupled to the National Type AM dial by a short extension shaft and a flexible coupling. The air trimmer, C_2 , is mounted against the right side of the box near the lower rear corner where it can be adjusted from the outside with a screwdriver to set the beginning of the tuning range. The tube is mounted externally on top of the box where it will be well ventilated and where its heat will have minimum effect upon the tuned circuit. The coupling lead between the plate of the oscillator tube and the grid of the first 6F6 is made with flexible wire passed through grommets in the bottom of the oscillator compartment and the top of the supporting chassis. The power and keying leads are brought out in the same manner through another pair of holes. The oscillator box is shock-mounted by means of long machine screws at each corner of the bottom plate which pass through grommet-lined holes in the top of the chassis.

The base chassis is $5 \times 10 \times 3$ inches. The two 6F6s are mounted on either side of the chassis immediately behind the oscillator compartment. The power transformer occupies the left rear corner of the chassis with the VR and rectifier tubes alongside. Underneath, the filter choke is fastened against the side of the chassis in the left rear

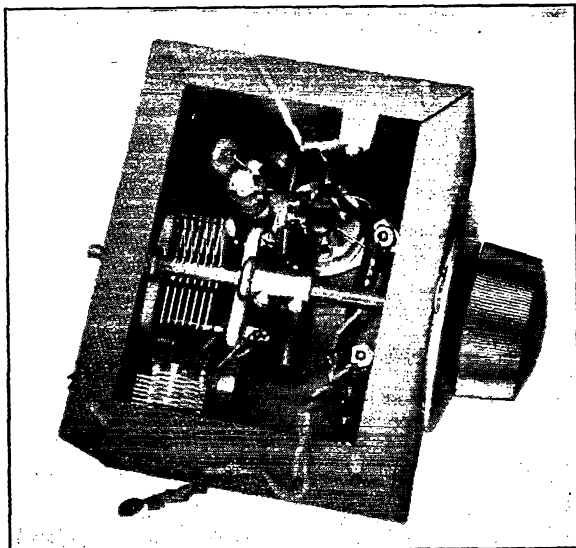

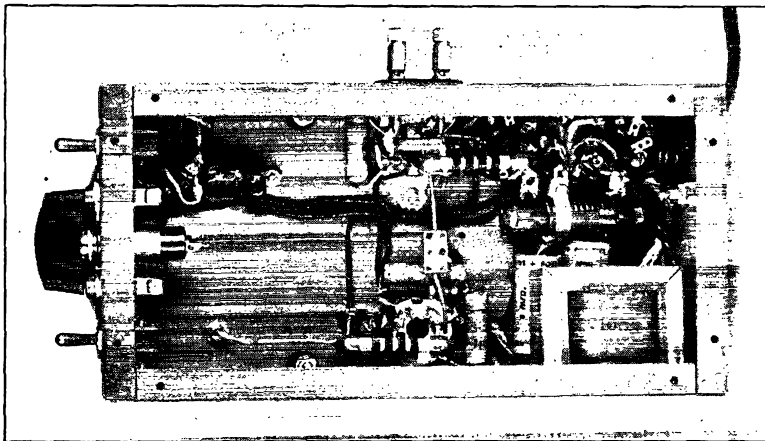

Bottom view of the VFO unit showing the filter choke and condensers and the various r.f. chokes and by-pass condensers associated with the amplifiers.

corner with the two filter condensers, C_{14} and C_{15} , above it. The two plate r.f. chokes, RFC_2 and RFC_3 , are mounted near their associated tube sockets. On the front edge are the control switches: S_1 , the power switch, and S_2 , which is the standby switch cutting off plate voltage to the oscillator. A pair of terminals connected in parallel with S_2 are mounted in the rear edge of the chassis to provide connections for a send-receive relay if this is found desirable. The output terminals are set in the right-hand side.

Adjustment & Coupling

Very few adjustments are required in setting the VFO unit in operation. The resistance of R_5 should be adjusted so that the VR tube is ignited with the key closed. If the glow disappears when the key is closed, the resistance of R_5 should be reduced. The setting of the slider on the resistor should not be done, of course, with the power turned on. With the dial set for maximum capacitance of C_1 , C_2 should be adjusted with a screwdriver to set the frequency at 3500 kc. C_1 should then cover the range to 4 Mc.

Coupling to the crystal oscillator in most transmitters is simply a matter of running a wire from the "hot" output terminal (the terminal connected to the plate of the output tube through C_{13}) to the grid of the oscillator tube, and from the other output terminal to the chassis of the transmitter. The grid connection usually can be made at one of the crystal-socket terminals. In Tri-tet and grid-plate oscillator circuits, the cathode tank circuit should be short-circuited.

In coupling to triode or tetrode crystal-oscillator circuits using parallel feed in the plate circuit, some trouble may be encountered with low-frequency parasitic oscillations when the VFO unit is connected because of the chokes in both plate and grid circuits which may act as tuned low-frequency circuits. In this case, the substitution of a tube with better screening, in the oscillator socket, or a shift to series feed in the

plate circuit are about the only remedies to suggest.

The Pierce oscillator can be expected to give similar trouble, because it always has an r.f. choke in its plate circuit and the normal grid-plate capacitance is augmented by the capacitance of the crystal socket. In most transmitters, sufficient excitation may be obtained by connecting the "hot" output terminal of the VFO to the grid of the tube following the Pierce oscillator, thus eliminating the crystal-oscillator tube. This connection to the grid may be made at the plate terminal of the oscillator tube socket.

The oscillator draws 8 ma. in the plate circuit and 3 ma. in the screen circuit. The plate current of the first amplifier should run about 15 ma. with the oscillator key closed and 32 ma. when excitation is removed; and the output stage plate current should be 17 or 18 ma. with excitation and 24 or 25 ma. without excitation.

West Gulf Division Convention

Oklahoma City, September 21st-22nd

The Oklahoma City gang is playing host to the West Gulf Division this year, with convention headquarters at the Hotel Skirvin. Enough said! W5HXI, Bert Weidner, Crescent, Okla., is handling early registrations, which are \$7.50. The extra prize drawing will be made on registrations received before September 10th. Hotel reservations may be handled through W5AYL, Ed Oldfield, 2141 Northwest 35th St., Oklahoma City. See you there, OM!

Strays

The Kaw Valley Radio Club is sponsoring the Midwest Division Convention at the Hotel Jayhawk, Topeka, Kans., October 5th and 6th. For information write E. N. Johnston, WØICV, 624 Roosevelt, Topeka.

A Deluxe Electronic Key

Built-in Monitor and Tube Keyer in the Electronic Bug

BY WILBUR R. DE HART,* W9DED

• This electronic "bug" is truly a deluxe job, combining, as it does, many of the best features of past keys and a few new ones. If you don't care to include the built-in keying monitor, the inclusion of a tube keyer that eliminates the usual relay is well worth your study.

A NUMBER of articles have been written expounding the merits of electronic automatic keys which produce dashes as well as dots. But always the relay, with all of its headaches — contacts, adjustment, insulation and upkeap — was shoved into the circuit at the last moment to make the necessary connection to the transmitter or other keyed device. Other articles have been confined to the advantages of vacuum-tube keying, pointing out how easy key-click filters are to construct and adjust and how trouble with relays, contacts, and high key voltages are avoided. Put the two together and you really have something!

The electronic key to be described combines the advantages of automatic dots and dashes with vacuum-tube keying, and the results have been very gratifying. Further improvement and refinement of the circuit along with the addition of a number of "gadgets" makes it worthy of the

term "deluxe." At the flip of a switch there is 10, 15, 20 . . . up to 40 words per minute, already set and calibrated, and other speeds can be added easily. There are keyer tubes built in, and key-click filters can be made to suit the taste. All of this with a monitoring oscillator, loud-speaker and power supply thrown in for good measure.

The complete equipment consists of two separate units. Unit 1 consists of a key similar to an ordinary "bug" and a multivibrator which generates the dots and dashes, and Unit 2 contains the keying amplifiers, keying tubes, monitoring oscillator, loudspeaker and power supply.

The Circuit

In Fig. 1 is shown the circuit diagram of Unit 1, a 6SN7 multivibrator adjusted to make dots and dashes in the form of negative pulses appearing on Terminal 2. William L. Gardner used a circuit almost identical to this for his electronic key described in *QST* for March, 1944. The essential features of his design have been retained in this deluxe model, but the performance has been improved slightly by the substitution of a selector switch in the grid circuit for the dual potentiometer used by Gardner, and the addition of the condenser C_4 as suggested by him in obtaining a control voltage for the keyer tube.

With the cathode resistor R_4 shorted out by closing either Contact Q or R, the circuit operates like a conventional multivibrator. It will be re-

* 66 Franklin St., Somerville, Mass.

◆
A deluxe electronic key built in two units. The small unit is the key proper and contains the key and multivibrator circuit. The large unit contains power supply, keying monitor, loudspeaker and keyer tube.
◆

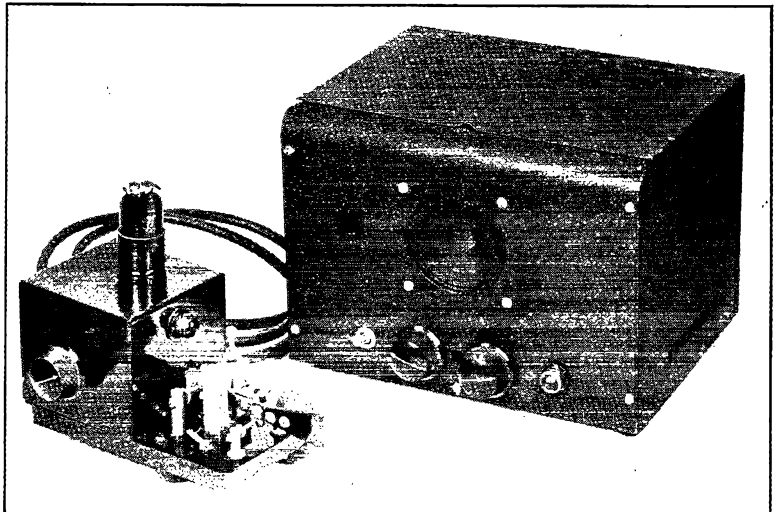

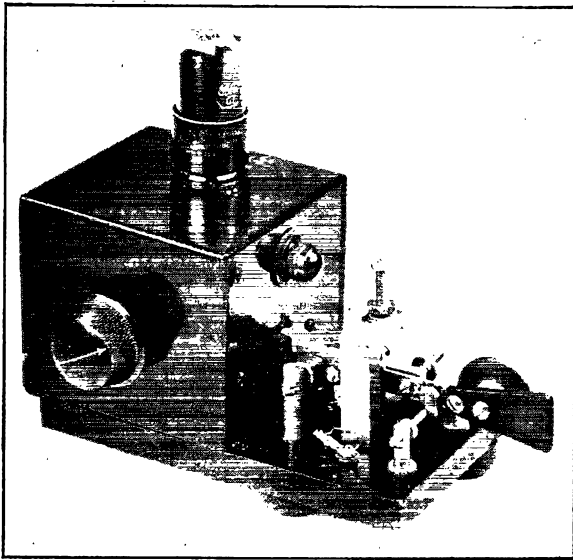

A view of the key proper. The knob controls the speed-selector switch.

called that in a multivibrator circuit first one tube conducts and then the other. The change from one to the other occurs when the appropriate coupling condenser has discharged sufficiently to place less-than-cut-off bias on the nonconducting tube. In other words, the time for which the left-hand triode conducts depends mainly upon the time constant of the condenser C_1 and the grid resistance of the right-hand triode, and for the right-hand triode the time constant of C_2 (plus C_3 for dashes) and the grid resistance of the left-hand triode. Equal conducting periods for the two triodes require equal time constants, while unequal conducting periods require unequal time constants.

In an automatic key, two conditions, aside from neutral, must be set up, one for producing dots and spaces and another for producing dashes and spaces. For dots and spaces, equal conducting periods are required, but for dashes and spaces, one period must be three times the other. Once these conditions have been produced, keying a transmitter or other device is simply a matter of impressing the impulses forming the dots and dashes on the grid of a keying tube. These requirements may be satisfied in the multivibrator circuit by making the grid resistances equal and the condensers C_1 and C_2 equal, and by providing a condenser C_3 (capacitance twice that of C_1) which may be paralleled with C_2 when dashes are desired. It is important to note that the condenser C_3 is kept connected in parallel with C_2 except when the circuit is actually switched for the production of dots. This is necessary in order to keep it charged to the correct potential for making the first dash the correct length.

The selector switch, S_2 , and the associated grid resistors, $R_A, R_B, R_C, R_D, R_E, R_F, R_G$, are used to

provide preset code rates which may be selected at will. This modification of the original circuit of Gardner's was made when it was found that the sections of most dual 2-megohm potentiometers were not properly matched. Several of these pots were carefully measured, and in the majority of cases the resistance of the two sections differed by more than 20 per cent in at least one portion of the total range. This large variation results in an appreciable difference in the dot and space length and was considered undesirable for an electronic key. In addition, the utility of the preset code rates was very appealing.

As was previously stated, the coupling condenser C_4 in Fig. 1 provides a negative pulse at Terminal 2 for the duration of a dot or dash. This can be verified by examining the circuit

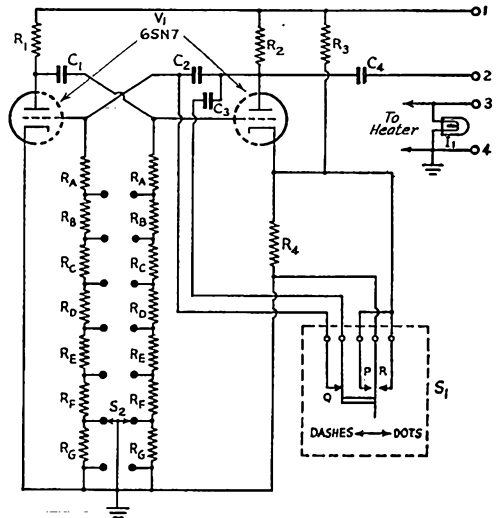

Fig. 1 — Circuit of Unit 1, the key proper.

- C_1, C_2 — 0.01- μ fd. mica (see text).
- C_3 — 0.02- μ fd. mica (see text).
- C_4 — 0.1- μ fd. paper, 400 volts.
- R_A — R_G , inc. — (see text).
- R_1, R_2 — 68,000 ohms, 1 watt.
- R_3 — 0.22 megohm, 1 watt.
- R_4 — 68,000 ohms, $\frac{1}{2}$ watt.
- S_1 — Key mechanism (see text and Figs. 3 and 4).
- S_2 — 2-pole 7-position rotary switch.

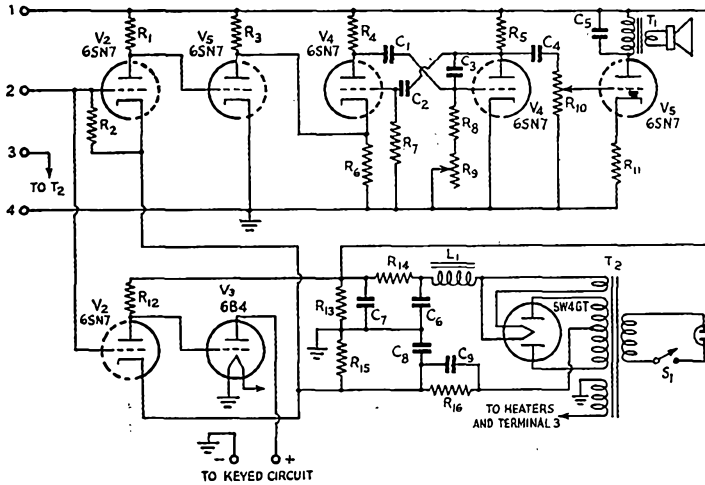
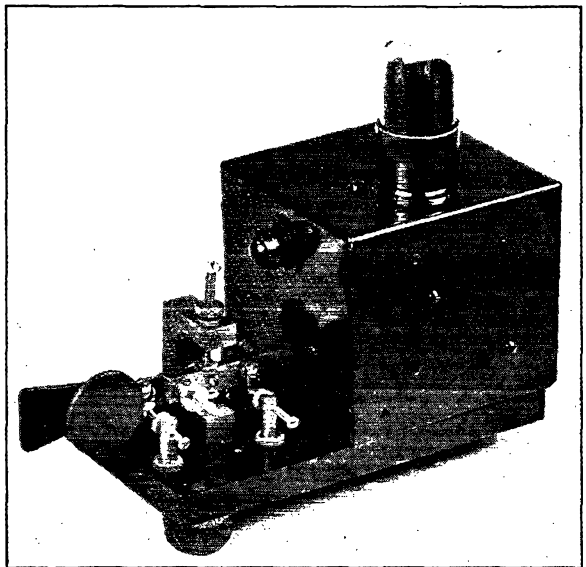

Fig. 2 — Wiring diagram of Unit 2, the amplifier and tube key.

- | | |
|---|---|
| C_1, C_2, C_3, C_4 — 0.1- μ fd. paper, 400 volts. | R_{11} — 3300 ohms, $\frac{1}{2}$ watt. |
| C_5 — 0.01- μ fd. paper, 200 volts. | R_{12} — 82,000 ohms, $\frac{1}{2}$ watt. |
| C_6, C_7 — 40- μ fd. electrolytic, 450 volts. | R_{13} — 40,000 ohms, 20 watts. |
| C_8, C_9 — 12- μ fd. electrolytic, 150 volts. | R_{14} — 1000 ohms, 1 watt. |
| R_1 — 0.15 megohm, $\frac{1}{2}$ watt. | R_{15} — 56,000 ohms, 2 watts. |
| R_2 — 1.5 megohm, $\frac{1}{4}$ watt. | R_{16} — 33,000 ohms, 2 watts. |
| R_3 — 0.82 megohm, 1 watt. | L_1 — Filter choke, 15 henries, 40 ma. |
| R_4, R_5 — 82,000 ohms, 1 watt. | S_1 — S.p.s.t. toggle switch. |
| R_6 — 12,000 ohms, $\frac{1}{2}$ watt. | T_1 — Output transformer, 10,000 ohms to voice coil. |
| R_7 — 10,000 ohms, $\frac{1}{2}$ watt. | T_2 — Power transformer, 300-0-300 v. at 70 ma., 6.3 v. at 3 amp., 5 v. at 2 amp. |
| R_8 — 27,000 ohms, $\frac{1}{2}$ watt. | |
| R_9 — 25,000-ohm potentiometer. | |
| R_{10} — 0.5-megohm potentiometer. | |

when connected for producing dashes. For the key in neutral position, the right-hand triode is biased beyond cut-off by the voltage divider R_2R_4 , and thus the plate end of R_2 is at approximately the supply voltage. When the key is pushed to the left, shorting out the resistor R_4 and connecting the circuit for making dashes, the plate voltage of the right-hand triode immediately drops to about 40 volts, where it stays for the duration of the dash. The multivibrator switching action then occurs and this voltage rises abruptly to that of the supply voltage for the duration of a space (same length of time as for a dot). At the end of the space, the right-hand triode plate potential again drops to about 40 volts for the second dash, and so on. The circuit

Another view of the key.



will continue to produce dashes until the short is removed from R_4 . By connecting the plate of the right-hand triode to Terminal 2 through the coupling condenser C_4 , a negative potential is produced at the terminal for the duration of the dash. For making dots, the key is pushed to the right which disconnects the condenser C_3 and again shorts out the biasing resistor R_4 .

Thus there comes from Unit 1 either dots or dashes in the form of negative pulses separated by intervals exactly equal in length to the dots. These pulses are introduced into the circuit of Unit 2. This circuit diagram is shown in Fig. 2 and is made up of two keying amplifiers, V_2 ; two keys, V_3 and one triode section of V_5 ; a monitoring oscillator, V_4 ; audio amplifier, the other half of V_5 ; and the power supply.

The negative pulse generated by Unit 1 is impressed on the grids of the keying amplifier tubes, each section of V_2 . Under normal "key open" conditions, the amplifier tubes are conducting. If

sufficient negative bias is used, the plate voltage on the amplifier tubes will be beyond the cut-off voltage of the keyer tubes. In this condition the keyer tubes will not conduct. When a dot or dash is being made, the negative voltage from Unit 1 is applied to the grids of the amplifier tubes. This voltage is sufficient to drive the amplifier grids beyond cut-off for the duration of the longest dash produced by the multivibrator. The amplifier tubes cease to conduct and this throws a slight positive voltage (with respect to cathode) on the grids of the keyer tubes. The keyer tubes then are conducting and will successfully key an appropriate circuit. It should be noted that the positive voltage impressed on the grids of the keyer tubes makes the static plate impedance much lower than if the grids were merely at cathode potential. This lower plate impedance improves the keying properties of the tubes by permitting more keyed current per tube for a given voltage drop.

If the values shown in the circuit diagram of Fig. 2 are used, one 6B4 (2A3 if the filament voltage is available) is capable of handling a cathode current of about 20 milliamperes at a drop of less than 20 volts or 50 milliamperes at a drop of less than 60 volts. Two or more tubes may be used in parallel with a corresponding increase in the current at a given voltage drop. However, a slight decrease in the value of R_{12} followed by a reapportionment of R_{15} and R_{16} may be necessary for best performance. If desired, other keying amplifiers with the associated keying tubes may be used to key two or more stages in the same transmitter.

Delving further into the circuit of Fig. 2, it will be seen that the first half of V_5 is used to key the monitoring oscillator, V_4 . This oscillator has been modified slightly from a multivibrator by

the addition of C_3 . This condenser has the effect of reducing the harmonic content of the oscillator output and makes the tone more pleasing to the ear. Any type of oscillator may be used that can be keyed easily with a small triode, but the basic multivibrator circuit was used because it is easy to construct and adjust, and is also free from chirps.

The output of the oscillator is fed to the grid of the second section of V_5 , which in turn drives the small 3-inch speaker. Volume from the unit is more than sufficient for monitoring purposes and is entirely adequate for a small code-practice group.

The power supply is straightforward in every respect. No attempt was made to provide voltage regulation as it is not required. One of the nicest things about the multivibrator circuit of Unit 1 is that its frequency is virtually independent of the supply voltage. Varying this voltage from 200 to 300 changes the code rate less than two words per minute at 40 words per minute!

Construction

The key mechanism of Unit 1 was made from scraps of brass and steel by following the form of the ordinary "bug" to a great extent. The actual mechanism used occupies the front three inches of the steel base, and the drawing of Fig. 3 shows an exploded view of the essential parts of this mechanism. The paddle and knob of the key, as well as the contacts, have been purposely omitted from this drawing for the sake of simplicity. Fig. 4 shows a plan view of the complete assembly. From this view it can be seen that if the key is pushed to the left, Spring L is compressed and Contact P is grounded. The rear arm does not move and Contact Q remains closed. Reference to Fig. 1 will reveal that this is the condition

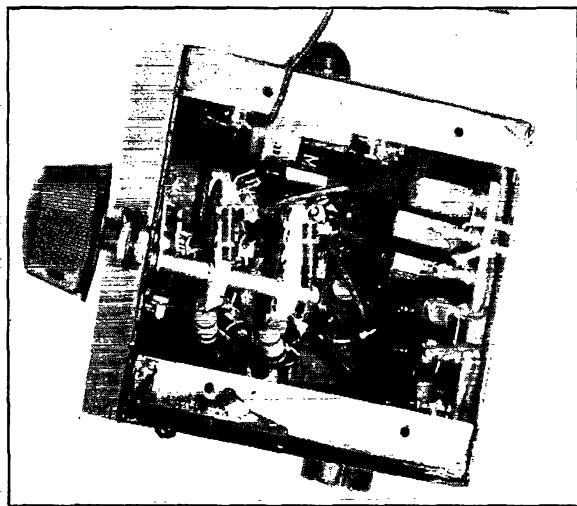

Removing the housing from the key shows how the speed-selector switch and other components are mounted.

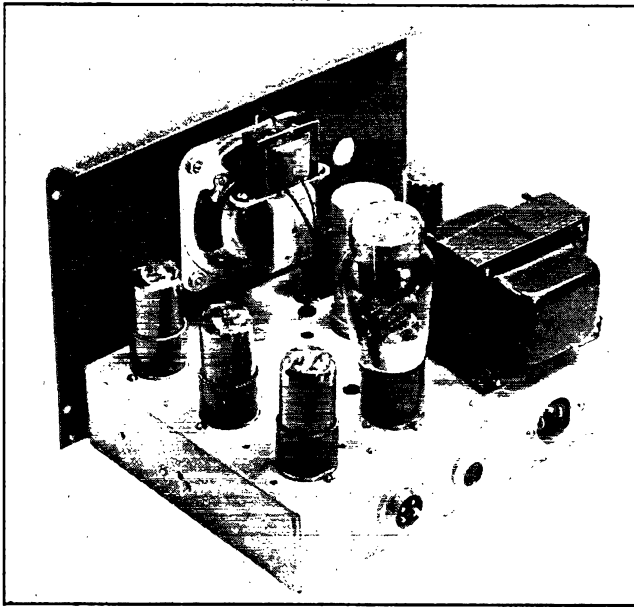

The "works" inside the power supply and monitor cabinet.

ers is measured, several pairs of equal or near-equal (within the accuracy of the measuring equipment) capacitance will be found. Then it remains only to find two other condensers which, in parallel, would have twice the capacitance of one of the pairs. The individual capacitances of these two condensers need not necessarily be the same. Usually a group of about 10 condensers of the ordinary 10-per-cent variety contains one such set of four condensers. The measurements need not be carried beyond the second significant figure for this application because other circuit parameters will introduce errors of this magnitude.

The resistors for the grid circuit of the multi-

vibrator ($R_A, R_B, R_C, R_D, R_E, R_F$ and R_G) must be selected with the circuit in operation. Resistor R_A must be selected first to give the highest code rate desired, then the others may be selected in turn to give the other code rates. The corresponding resistors should be compared on a suitable ohmmeter and those used which have as near the same resistance as possible. From five ordinary 10-per-cent resistors of the same marked value, one, and sometimes two, matched pairs may be obtained. The exact resistance is relatively unimportant and depends mainly upon the exact capacitance of the condensers C_1, C_2 and C_3 . The condensers used by the author were $C_1 - 0.011 \mu\text{fd.}$, $C_2 - 0.011 \mu\text{fd.}$, and $C_3 - 0.022 \mu\text{fd.}$ With these condensers, the resistor values used and the code rates obtained were as shown in the following table:

R_A — 1.2 meg.	40 w.p.m.	16.7 c.p.s.
R_B — 0.15 meg.	35 w.p.m.	14.6 c.p.s.
R_C — 0.22 meg.	30 w.p.m.	12.5 c.p.s.
R_D — 0.33 meg.	25 w.p.m.	10.4 c.p.s.
R_E — 0.47 meg.	20 w.p.m.	8.33 c.p.s.
R_F — 0.82 meg.	15 w.p.m.	6.25 c.p.s.
R_G — 2.2 meg.	10 w.p.m.	4.16 c.p.s.

The frequency which appears after each code rate indicates the fundamental frequency of the square wave producing dots, and is based on a standard of 50 code units per word. Other code rates may be set up, of course, but these were considered to be the most useful ones at the time Unit 1 was built. However, experience since that time suggests that the addition of 13 w.p.m. and 18 w.p.m. would probably be quite useful to the average amateur.

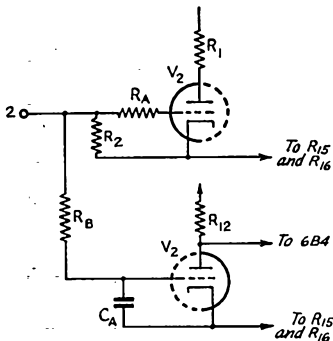

Fig. 5 — Modified circuit of Fig. 2 to shape keying characteristic for reduced clicks.

C_A — 0.005- to 0.01- $\mu\text{fd.}$ mica (see text).

R_A — 0.22 megohm, $\frac{1}{2}$ watt.

R_B — 0.32 megohm, $\frac{1}{2}$ watt.

Other components are the same as in Fig. 2.

If the values indicated in the table are used the code rates should be approximately correct. The exact rate can be calculated from the formula

$$R = 0.080D$$

where R is the rate in words per minute and D is the number of dashes heard when the key is closed for 1 minute.¹ A cathode-ray oscilloscope and a low-frequency oscillator are very useful for setting up the higher code rates. However, by counting the dashes in groups of four, rates as high as 30 w.p.m. may be adjusted with ease.

In order to obtain the best results from the keyer tubes in various circuits, a slight adjustment of the resistors R_{12} , R_{15} and R_{16} may be necessary. The procedure is as follows: With the 6B4 connected to the circuit to be keyed, remove the amplifier tube from its socket and then adjust the resistance of R_{12} until the 6B4 is passing the desired "key-down" current. Then replace the amplifier tube and, without closing the key contacts, adjust the values of R_{15} and R_{16} so that the circuit does not key, making sure to keep the total resistance of R_{15} and R_{16} approximately constant. If frequent adjustments are anticipated, R_{16} may be replaced with a potentiometer.

The keying characteristic of V_3 can be modified by introducing a few additional components, as shown in Fig. 5. The rectangular waves normally applied to the grids of V_2 are modified by these resistances and capacitor in such a fashion that increasing the values of C_A and R_B will increase the "make" time and making R_A larger will increase the "break" time. Actually the optimum adjustment for one code rate will not be optimum for some other speed, but a good compromise can be obtained by using the values shown in Fig. 5. It is suggested that the value of C_A be $0.005 \mu\text{fd.}$ if the code rate is to be above 25 w.p.m., but it

may be increased to $0.01 \mu\text{fd.}$ if the code speed is kept below this value. Using these values the character length will be increased less than 10 per cent at the highest permissible code rate.

Operation

The operation of an electronic key of this type is enough different from that of the ordinary "bug" that an entirely new "feel" of the key must be developed. The first difference the seasoned bug operator will notice is in the production of dashes. They are automatic — not manual! After a little concentrated practice, however, this feeling disappears and another takes its place. It will be found that the characters cannot be made just a little on the "sloppy" side, because they are either almost perfect or terrible. There is no "in-between"! The cure for terrible characters is a good firm grip on the key and a determination to make each contact positive and of long enough duration to complete the dot or dash, because the instant the contact is broken the key returns to a space. Anyone who masters the technique of using the electronic key is destined to "send like a tape"!

BIBLIOGRAPHY

Gardner, "An Improved Electronic Key," *QST*, March, 1944, page 15.

Savage, "An Improved Switching Arrangement for Simplified Electronic Key," *QST*, March, 1942, page 36.

Grammer, "An Inexpensive Electronic Key," *QST* May, 1940, page 12.

Beecher, "Electronic Keying," *QST*, April, 1940, page 9.

¹ This is based on 50 keying units per word. The international standard is 24 bauds per word (48 keying units) and, for this standard, the formula would become $R = .083D$. The difference is, of course, negligible for all practical purposes. — *Ed.*

Below the chassis of Unit 2. The two panel controls are for monitor pitch and volume.

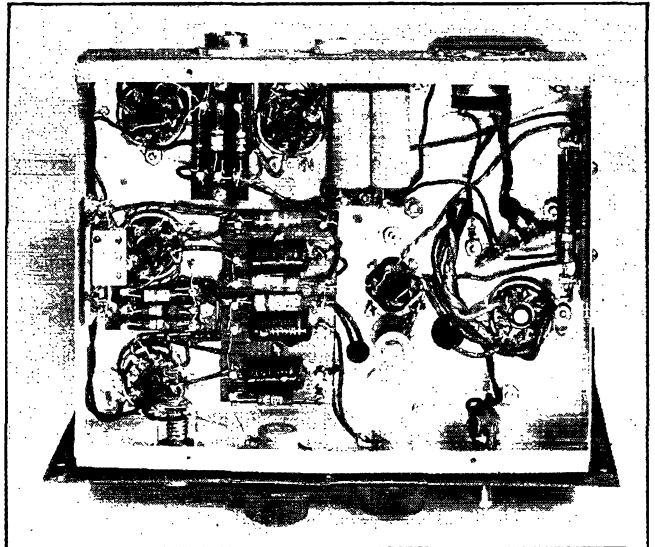

How to Catchum DXCC

The Confessions of a Reformed DX-Snatcher

BY J. P. JESSUP,* W2GVZ

PICK a poor neighborhood where folks can't afford electric razors. If you must live next to a rheumatic guy complete with diathermy, pick one who gets his pains when the band is dead.

START with a vertical, change to a two-element beam and end up with a dual ten-twenty, preferably not just before a global war. (Pick your time carefully between wars to avoid creeping frustration.)

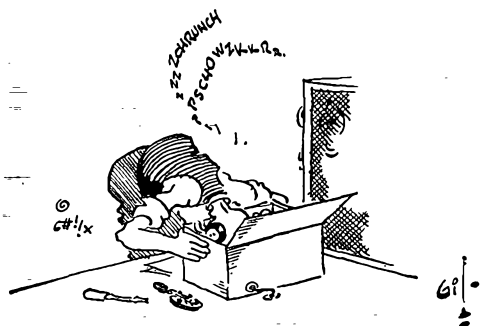

REFRAIN FROM RECEIVER FAILURES JUST AFTER YOU CALL THE PRIZE DX OF THE YEAR

HAVE a separate 14-Mc. rig all fired up and ready to go so that when your pal calls up and says a new one is coming through, you can duck out of the traffic net and hop right down there without band-changing. (OPERATING NOTE — Despite your rush, turn on the rig before starting to call — the results will definitely be better.)

CALIBRATE your receiver with that of your DX pal. A buzz on the air or landline gets you both right on the frequency, regardless of which finds him first. Four ears are better than two for finding the new ones.

MAKE prearranged skeds with new countries, either direct or via an intermediate station, but don't lay any bets. The band is sure to stink when the sked time arrives.

CREATE new countries if they don't exist. Could be a guy could cross a border with a portable.

WORK everything you hear, no matter how goofy the call. Even though "How's DX?" says the guy is a phoney, this may be someone else who is legit. But when your beam says he's in the wrong direction and he doesn't fade but should, you can slack up a bit.

TIP OFF your pals when a rare one rolls

*337 Hamilton Avenue, Glen Rock, N. J.

through. Preferably try to catch them off guard like up in a tree working on the skywire, or taking a shower. Anyway, make it look like you tried.

SPEND your vacation during the DX Contest, but don't work the old stuff for fear of missing a brand new one.

LEARN to eat with one hand while steadily twirling the receiver dial with the other. (Chew quietly or you won't hear that weak one.)

KEEP two blankets to wrap around your knees at 5 A.M. on a winter morning. No use hearing them if you shiver too much to call them. You will even things up, dripping sweat on your log book, come August.

ALWAYS work two stations in each country. The mental strain is reduced by half while waiting for a card — maybe one of them won't be illiterate or perverse.

NEVER enjoy a rag-chew with a strong DX station. Five-to-one you miss a new one if you do.

REFRAIN from having receiver failures just after you call the prize DX of the year.

GET a 'phone-c.w. pal to hook you up with the fone-only DX. (For use only where c.w. is non-existent in a given country.)

NEVER try to break in on a QSO or to hog a new station when the rest of the band is drooling. Reciprocity is sure to set in later.

GO OFF to one side when the VFOs pile up. The injured party usually gets sore and tunes farther out.

DON'T ERECT UR ANTENNA JUST BEFORE A GLOBAL WAR IF YOU WOULD AVOID CREEPING FRUSTRATION



KEEP out from under 'phone carriers in the c.w. band, but sneak a look every now and then in the 'phone band for rare c.w. sigs.

STUDY the habits of the evasive one and lay for him. Have enough patience to try many

(Concluded on page 134)

Solving Feeder Problems Graphically

An Introduction to the Transmission-Line Circle Diagram

BY ROBERT E. KELLEY,* WIIB

THE behavior of r.f. transmission lines is frequently a mystery to the uninitiated amateur, with the result that, when confronted with a particular problem, his only recourse is to cut-and-try. This method sometimes gets him to the proper solution and sometimes doesn't — and in any event it usually involves a waste of time that could have been saved if a more knowledgeable method of approach had been used. On the other hand, solving even the simplified transmission line formulas is a rather formidable task for those who have only a nodding acquaintance with trig tables and the "j" operator.

Fortunately, the solution of transmission-line problems can be carried out rather simply by graphical methods using the impedance or admittance "circle diagram." From the circle diagram, shown in Fig. 1, the input impedance looking into a line of any length, having known characteristic impedance and velocity factor, and terminated in a load of known impedance, can be found by a few simple operations. The impedance is found in terms of its resistive and reactive components, from which it becomes possible to determine the proper measures to take, for example, to couple the line to a transmitter. The only assumption involved in the construction of the circle diagram is that the line has no losses. For the lengths of lines used by amateurs this is near enough to the truth so that the error is inappreciable.

Inspection of Fig. 1 will show that the chart consists of two sets of intersecting circles. The circles of one group, which for convenience of reference we will call the "t" group, have their centers progressively farther to the right along the x or horizontal axis as the diameters of the circles become larger; every circle in this group encloses the point 1, 0 ($x = 1, y = 0$) on the graph. The second group, which we will call the "v" group, really is a set of arcs of circles rather than complete circles; the centers of the v circles are all on the y or vertical axis and every circle passes through the point 1, 0. The v circles are marked in degrees; the t circles need no identification aside from that provided by the points where they pass through the x axis to the right of the point 1, 0.

To make it universally applicable, the circle diagram is constructed on a "unit" basis; that is, resistance and reactance values are "normalized" or referred to a hypothetical transmis-

• Enough of us have become exposed to such technicalities as reactance and impedance during recent years to have no particular fears when the terms appear in an article. Here's how to put them to work on such practical problems as coupling a transmitter to a feed line — by a method that involves no pencil work beyond substitution in simple formulas. A few minutes spent in learning how to use the circle diagram may save plenty of time in getting the antenna to load.

sion line having a characteristic impedance of 1 ohm. It is therefore necessary to divide the actual resistance and reactance values of the load by the characteristic impedance of the line to be used, before making use of the chart. After arriving at the solution, the values as given by the chart must then be multiplied by the line characteristic impedance to obtain the actual values.

How to Use the Diagram

Using the chart is easy once you get the hang of it. Learning by example is the best way, so let us assume that a load having 100-ohms resistance and 20-ohms capacitive reactance is to be fed at a frequency of 29.0 Mc. through a 70-ohm solid-flexible coaxial cable, 8 feet 3 inches long. The question is to determine the resistance and reactance looking into the sending end of the line.

The physical length of the line must first be translated into degrees of electrical length. There are 360 electrical degrees in each wavelength of line, so the length of the line in wavelengths must be found. A wavelength on the line is determined by the frequency and the velocity of propagation. A convenient formula to use for length in electrical degrees is

$$\text{Degrees} = \frac{0.366lt.f\text{Mc.}}{A}$$

where l is the length in feet, f is the frequency in megacycles, and A is the velocity factor of the line. Velocity factors for common types of transmission lines are given in Table I. For the solid coaxial line the velocity factor is 0.66.

Substituting the values in the formula above gives

$$\frac{0.366 \times 8.25 \times 29.0}{0.66} = 133 \text{ degrees}$$

Next, "normalize" the load impedance by

* 5743 W. Ohio St., Chicago 44, Ill.

dividing the resistance and reactance by the line characteristic impedance:

$$\frac{R}{Z_0} = \frac{100}{70} = 1.43$$

$$\frac{X}{Z_0} = \frac{-20}{70} = -0.286$$

Now, referring to Figs. 1 and 2, locate the point (P in Fig. 2) on the chart whose coordinates are the normalized values of R and X . Move in the clockwise direction along the l circle on which this point is located for a distance of 133 degrees (the line length) as measured by the v circles, arriving at the point Q in Fig. 2. The

Fig. 1 — Transmission-line circle diagram. By using this diagram it is possible to find the input impedance of a transmission line whose characteristic impedance is known, and which is terminated in a load of known resistance and reactance. X = reactive component of impedance, R = resistive component of impedance, Z_0 = characteristic impedance of transmission line.

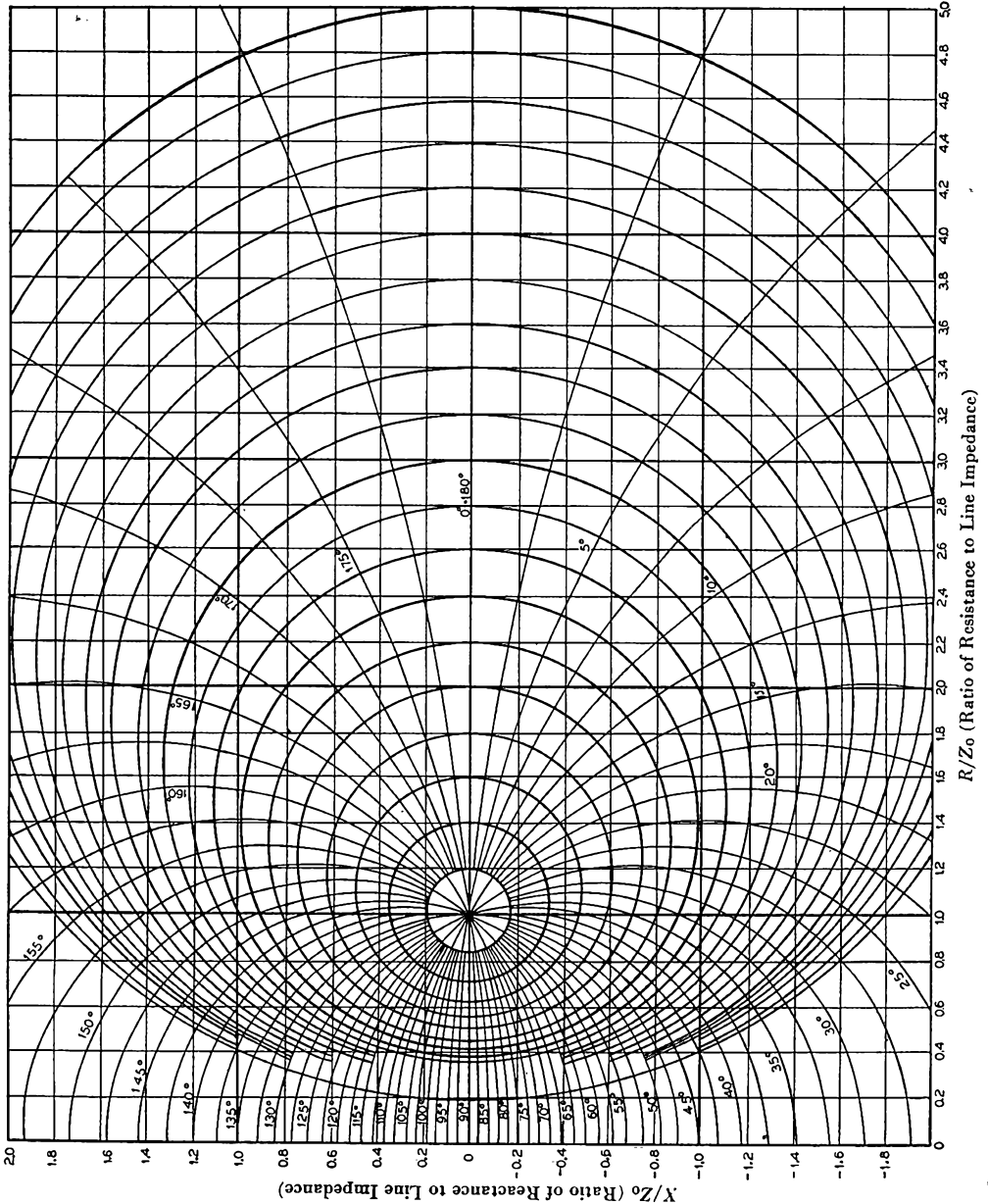

Type of Line	Velocity Factor
Parallel open-wire line	0.975
Parallel tubing	0.95
Air-insulated coaxial line with bead spacers	0.85
Solid coaxial cable (polyethylene insulation)	0.66
Twin-Lead 300-ohm line	0.82
Twisted pair, rubber insulation	0.56-0.65
Twin-Lead 150-ohm line	0.77
Twin-Lead 75-ohm line	0.69

coordinates of Q , $R/Z_0 = 1.12$ and $X/Z_0 = 0.435$, are the normalized values of the resistance and reactance looking into the sending end of the line. To "denormalize" them we multiply by the line impedance:

$$R = 1.12Z_0 = 1.12 \times 70 = 78.4 \text{ ohms}$$

$$X = 0.435Z_0 = 0.435 \times 70 = 30.5 \text{ ohms}$$

Note that the reactance is positive, indicating that the line looks like an inductance in combination with a resistance.

To deliver maximum power to the line, the coupling to the transmitter should be adjusted to work into a resistance load of 78.4 ohms and the inductive reactance should be canceled by inserting a capacitive reactance of 30.5 ohms in series with the line, preferably in series with the center conductor because the outer conductor usually is grounded. The value of capacitance required can be found from the formula:

$$C_{\mu\text{fd.}} = \frac{10^6}{2\pi f_{\text{Mc.}} X} = \frac{10^6}{6.28 \times 29.0 \times 30.5} = 180 \mu\text{fd.}$$

With this value of capacitance in series, the input impedance of the line will be a pure resistance of 78.4 ohms.

In the case of a transmitter with link-coupled output suitable for working into an impedance of this order, the inductive reactance of the link adds to that of the line. Thus a larger value of capacitive reactance is required to cancel all the inductive reactances present. This means that a smaller value of capacitance must be used. The inductances of links ordinarily used at the frequency under consideration probably would be in the vicinity of 0.2 to 0.5 microhenry; using 0.3 microhenry as a representative value, the reactance at 29.0 Mc. would be about 55 ohms. Thus the total inductive reactance would be approximately 85 ohms, and the capacitance required for this value of reactance would be 65 $\mu\text{fd.}$ In adjusting the circuit, the transmitter first should be tuned to resonance with the line disconnected; then, with the line connected to the link, the series condenser should be adjusted to bring the plate current to minimum without

readjustment of the plate tank condenser. The load on the transmitter then can be adjusted by varying the coupling between the tank and link coils, if the variable-link type of assembly is used.

Another Example

A second example is perhaps more representative of the type of problem likely to confront the practical amateur. Assume that we have a half-wave antenna that has been cut to be resonant at 14,200 kc. and that it is to be fed at the center by a 75-foot length of 300-ohm Twin-Lead. What is the impedance looking into the sending end of the line?

Since the antenna is resonant, the impedance at the center can be assumed to be approximately 70 ohms (if the antenna is well above the ground) and to be purely resistive. Normalizing the load impedance by dividing by the line impedance, we have

$$\frac{R}{Z_0} = \frac{70}{300} = 0.233$$

$$\frac{X}{Z_0} = \frac{0}{300} = 0$$

From Table I, the velocity factor of the line is 0.82, and substituting in the formula for length in electrical degrees gives

$$\frac{0.366 \times 75 \times 14.2}{0.82} = 475 \text{ degrees}$$

Since this is greater than 180 degrees, we subtract the largest multiple of 180 degrees contained

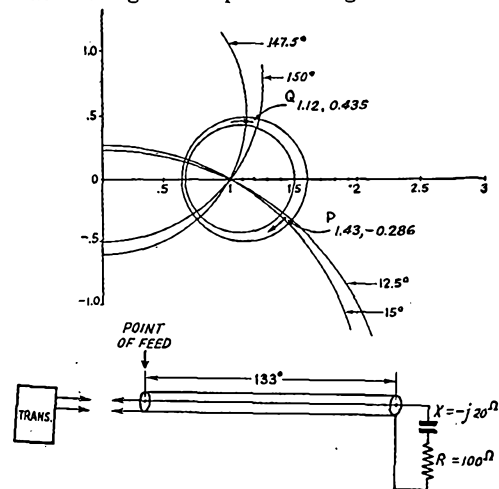

Fig. 2 — Illustrating the use of the chart in solving an example discussed in the text.

in the number (conditions repeat along the line at 180-degree or half-wave intervals). In this case the largest multiple is 360, which when subtracted from 475 leaves 115 degrees as a re-

(Continued on page 138)

Mobile Receiving Equipment for Two, Six and Ten Meters

Two Converters and a Common I.F.-Audio System Provide Coverage for All Our Popular Mobile Frequencies

BY EDWARD P. TILTON, * WIHQ

THE mobile transmitter for 50 and 28 Mc., described in June *QST*, called for a companion receiver, so we began surveying the possible solutions to the mobile receiver problem even before the installation of the transmitter was completed. As we intended to use 2-meter gear in the car, as well as the 6- and 10-meter rig, we started with the idea of using a superregenerative detector to provide reception on all three bands.

As a temporary expedient, we pressed into service an old glove-compartment superregen which had been designed originally for 112-Mc. use. This little two-tube was quite satisfactory for actual mobile operation, where one works with local stations and at high signal levels. Its sensitivity was adequate for this work, and the a.v.c. and noise-rejection which are characteristic of the s.r. detector were very helpful, but in stationary operation at high-altitude locations the superregen was a dismal failure. On any of the bands it was unable to handle strong signals much less than a megacycle apart, and its sensitivity was too low to permit really satisfactory reception of weak signals.

The use of a converter working into the car radio, a common procedure in reception of the stable signals on 6 and 10 meters, was out in our case, as the selectivity of such an arrangement was too great for 144-Mc. work. The converter

idea was interesting, however, as it presented the possibility of experimenting with different types of i.f. systems. It also made steering-post mounting of the tuning units feasible, an important factor in operating under mobile conditions. As it is well-nigh impossible to cover 144 and 28 Mc. with one r.f. section, it was decided to use two converters; one covering 6, 10 and 11 meters, and the other designed for the 2-meter band.

What I.F.?

Choice of the intermediate frequency was dictated by several considerations. We wanted, if possible, to cover two ranges, 27 to 30 Mc., and 50 to 54 Mc., using a common oscillator coil and changing only the r.f. and mixer coils in changing bands. This is accomplished by using an intermediate frequency of 11 Mc. and running the oscillator 11 Mc. lower than the signal frequency when the converter is on the 50-Mc. band, and on the high side for 28-Mc. reception. The 11-Mc. i.f. has other advantages. It is close to the frequency used in several commercial converter units, making possible the use of this i.f. unit with these converters. The frequency lends itself to the use of superregenerative second detectors (the approach exploited herein) or a second mixer-oscillator may be used, converting from 11 Mc. to 455 kc. followed by one or more stages of conventional i.f., with all the customary communications receiver features. Still another possibility is

the use of a second mixer-oscillator converting to about

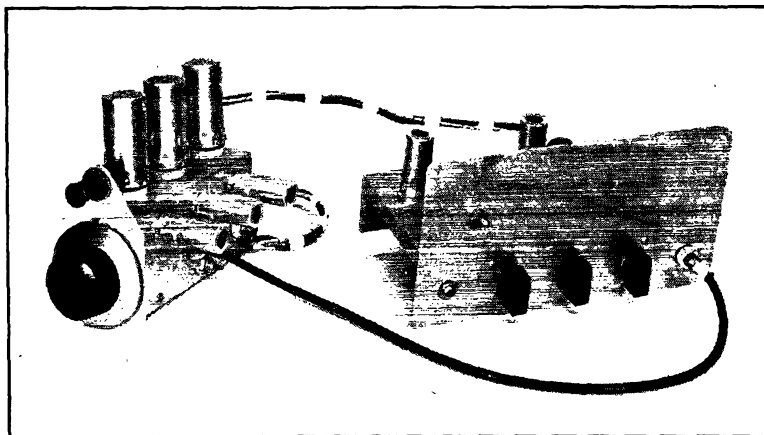

◆
The three-tube converter for 6 and 10 meters connected to the 11-Mc. i.f. amplifier and audio system. The converter is mounted on the steering post, while the i.f. unit is designed for glove-compartment mounting. The object above the converter dial is an adjustable-beam dial light.
◆

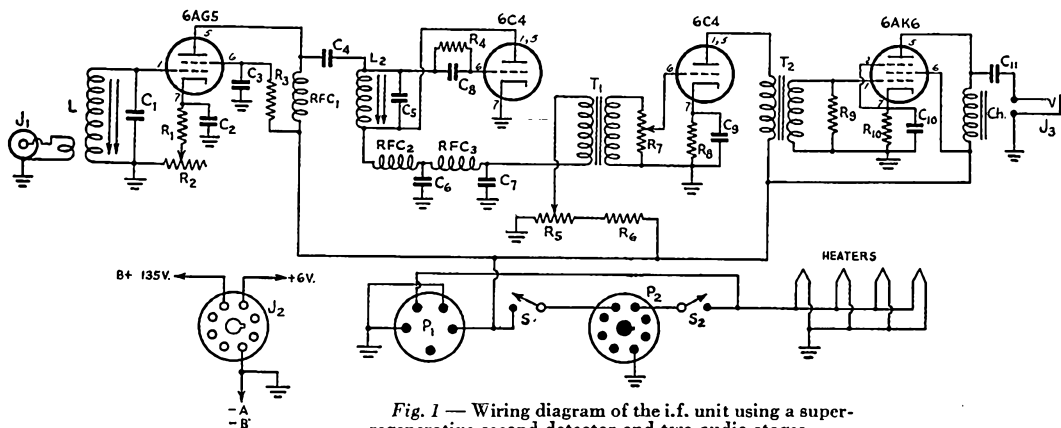

Fig. 1 — Wiring diagram of the i.f. unit using a super-regenerative second detector and two audio stages.

- C₁, C₆ — 50- μ fd. ceramic.
 C₂, C₃ — 470- μ fd. midget mica.
 C₄, C₅ — 100- μ fd. midget mica.
 C₆, C₇ — 0.006- μ fd. mica.
 C₉, C₁₀ — 25- μ fd. 50-volt electrolytic.
 C₁₁ — 0.1- μ fd. 600-volt tubular.
 R₁ — 270 ohms, carbon.
 R₂ — 10,000-ohm potentiometer.
 R₃ — 1000 ohms.
 R₄ — 4.7 megohms.
 R₅ — 50,000-ohm potentiometer.
 R₆ — 50,000 ohms, 1 watt.
 R₇ — 0.25-megohm potentiometer.
 R₈ — 2000 ohms.
 R₉ — 0.25 megohm.
 R₁₀ — 600 ohms.

All resistors $\frac{1}{2}$ -watt type unless otherwise indicated.

L, L₂ — 22 turns No. 22 enam., closewound on National XR-50 form. Primary: 3 turns No. 22 enam. closewound on layer Scotch Tape over ground end of L.

Ch. — Midget filter or audio choke.

J₁ — Coaxial socket (Jones S-201).

J₂ — Octal socket on power cable.

J₃ — Speaker or headphone jack.

P₁ — 5-prong plug for converter power, mounted on back of chassis.

P₂ — Octal plug, mounted on back of chassis.

RFC₁ — 2.5 mh. r.f. choke (National R-100).

RFC₂ — One "pie" from National R-100, mounted on 1-watt resistor.

RFC₃ — 80-mh. r.f. choke.

S — S.p.s.t. toggle switch, bat handle type.

S₂ — S.p.s.t. switch, mounted on R₇.

T₁, T₂ — Midget interstage transformers.

200 kc., followed by a resistance-coupled i.f. amplifier of the type described elsewhere in this issue.

The superregenerative detector has much to recommend it. Its chief weaknesses, broadness of tuning and radiation of an interfering signal, are overcome in this arrangement where the detector operates at a low frequency, with a stage of tuned i.f. amplification ahead of it. Some workers dislike the superregenerative detector because of its hiss, but if the receiver is properly designed the hiss level can be quite low, and the smooth hiss of a low-frequency superregen is certainly much easier on the ears than the barrage of ignition and other noises which results when other systems are used. It is safe to say that in no other system can so large a measure of noise reduction, sensitivity, a.v.c. action, and selectivity be obtained with only two tubes as is provided by this 11-Mc. i.f. amplifier and superregenerative detector.

The size and shape of the space available in different makes of cars will dictate the form which any mobile installation will take. In our case it was decided to fit the i.f. amplifier and audio system into a dash compartment directly in front of the steering wheel, and mount our converters on the steering post.

The i.f.-audio unit consists of a 6AG5 tuned i.f. stage, a 6C4 superregenerative detector, a 6C4 first-audio stage, and a 6AK6 second-audio

stage. The schematic diagram is shown in Fig. 1. Several factors contribute to the smooth operation of the 6C4 detector: the isolation provided by the i.f. stage makes it possible to operate the regeneration control at one setting regardless of converter tuning; "B" batteries are used for plate supply, guaranteeing a steady noise-free source of power; and transformer coupling is used in both audio stages, as experience has shown that removal of the quench voltage from the audio is easier than when resistance coupling is used. The transformer coupling is also helpful in noise reduction, as the transformers have a peak in the speech range which tends to reject ignition and hiss noise components which are outside this frequency range. The detector operates at low hiss level and its output is devoid of the high-pitched whistles and howling which are so often characteristic of superregenerative detectors operated in the v.h.f. range.

The selectivity of the i.f. system is quite different from that of a v.h.f. superregen, and its sensitivity is somewhat better. Checking with a signal generator at 11 Mc., it was found that a signal as low as 0.4 microvolt was audible. There was a perceptible dent in the background hiss at 1.0 microvolt — a level at which many superregens do not even start to respond. At 1.0 microvolt the signal can be heard over a 100-kc. spread, and this increases to only 270 kc. at 100 microvolts.

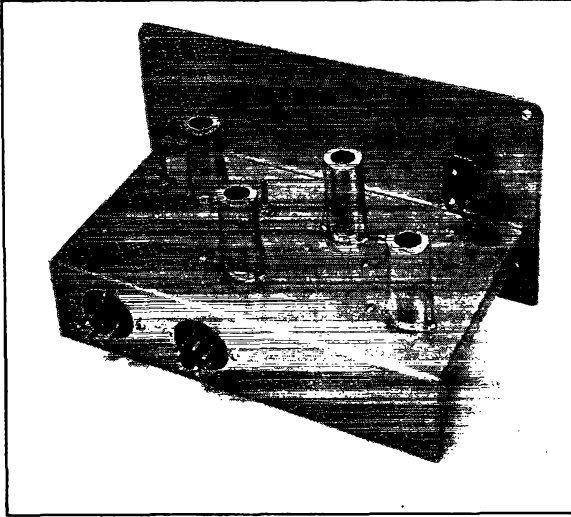

Rear view of the 11-Mc. i.f.-audio unit. The tubes nearest the panel are the i.f. amplifier, left, and the superregenerative detector. The octal plug on the back of the chassis is for the power cable, while the 5-prong plug connects through another cable to the converter. The toggle switch is the B+ stand-by switch.

At 1000 microvolts the signal is audible over less than 450 kc. Compare this with the average superregen, which shows a bandwidth of a megacycle or more on a 100-microvolt signal. When used with a converter the selectivity is even better, especially at high signal levels. The superregen detector is inherently broad enough for all but the worst modulated oscillators on 144 Mc., yet, because of its steep-sided response curve, the converter-i.f. combination provides quite satisfactory station separation on the 6- and 10-

meter bands. The sensitivity on all bands is such that we hear many stations we cannot work with the 15-watt transmitters used.

Little needs to be said about the constructional details of the i.f. unit, as there are few critical factors. The 11-Mc. amplifier stage should be well shielded, in order to prevent oscillation, and also to reduce pick-up on 11 Mc. from transmitters operating in that range. With the unit installed in a car this pick-up is reduced to below the point where any interference is experienced,

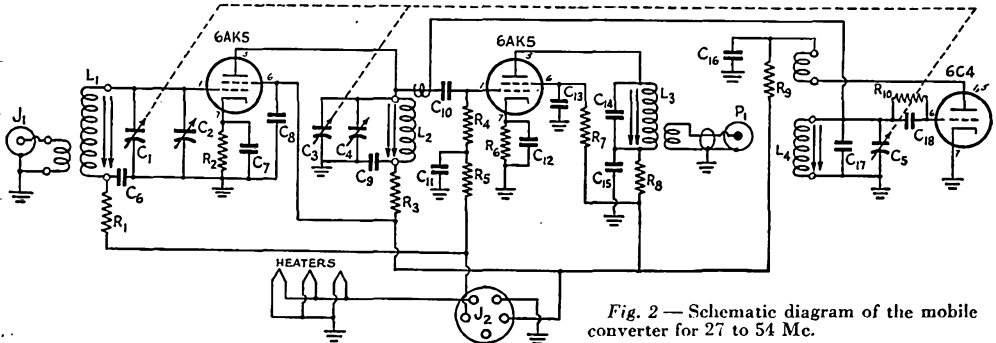

Fig. 2 — Schematic diagram of the mobile converter for 27 to 54 Mc.

- C₁, C₃ — R.f. and mixer tuning condensers (National UM-15 reduced to 2 stator and 2 rotor plates).
- C₂, C₄ — 3-30- μ fd. mica trimmer.
- C₅ — Oscillator tuning condenser (National UM-35 reduced to 4 stator and 4 rotor plates).
- C₆, C₇, C₈, C₉, C₁₁, C₁₂, C₁₃, C₁₅, C₁₆ — 470- μ fd. midget mica.
- C₁₀, C₁₈ — 100- μ fd. mica.
- C₁₄ — 50- μ fd. ceramic.
- C₁₇ — 47- μ fd. ceramic (20 μ fd. and 27 μ fd. in parallel).
- R₁, R₅ — 0.25 megohm.
- R₂, R₃, R₈, R₉ — 270 ohms, carbon.
- R₄, R₇ — 1.0 megohm.
- R₆ — 6800 ohms.
- R₁₀ — 4.7 megohms. (All resistors $\frac{1}{2}$ -watt rating.)

- L₁ — R.f. coil. 28 Mc.: 10 turns No. 22 enam., $\frac{3}{4}$ -inch long. Primary: 2 turns No. 28 d.s.c. interwound in cold end of L₁. 50 Mc.: 5 turns No. 22 enam., $\frac{3}{8}$ -inch long. Primary similar to 28-Mc. coil.
- L₂ — Mixer coil. 28 Mc.: 2 turns No. 22 enam., $\frac{3}{4}$ -inch long. 50 Mc.: 4 turns No. 22 enam., $\frac{3}{8}$ -inch long.
- L₃ — I.f. output transformer. 22 turns No. 22 enam., closewound on National XR-50 form. Coupling winding: 2 turns No. 20 "push-back," wound at cold end of L₃.
- L₄ — Oscillator coil. 2 $\frac{1}{4}$ turns No. 22 enam., $\frac{3}{16}$ -inch long. Feed-back winding: 2 turns No. 28 d.s.c. interwound between turns of L₄.
- J₁ — Coaxial socket (Jones S-201).
- J₂ — 5-prong socket on power cable.
- P₁ — Coaxial plug (Jones P-201).

but with it operating on a table at our home station we found that 11-Mc. QRM was quite heavy during the evening hours. If such a receiving system is destined for home-station use, the 11-Mc. stages should be completely enclosed in shielding.

The tuned circuits used in the 11-Mc. amplifier, the superregenerative detector, and as output coupling units in the two converters, are all similar. The coils are wound of No. 22 enameled wire on National XR-50 core-tuned forms, the secondary winding occupying the entire winding space. A simple way of securing the primary is to wrap a layer of Scotch Tape, sticky side *out*, around the ground end of the secondary. The primary winding will then stick as it is wound on, and holding it in place will be no problem. A small tab of tape, or household cement, will suffice.

The Converter for 6 & 10

The converter for the two lower-frequency bands employs three tubes, a 6AK5 tuned r.f. stage, a 6AK5 mixer, and a 6C4 oscillator. Plug-in coils are used for all three stages, but only the mixer and r.f. coils are changed in going from 6 to 10 meters. To fit the limited space available in the writer's car, some sacrifices were made for the sake of compactness. As we found out when some components had to be changed during the experimental phase of the unit's construction, such compact arrangement has its disadvantages; however, by planning the construction carefully, the builder should experience no difficulty in assembling or adjusting the converter. The arrangement of the parts may be seen in the detail photo, and the schematic diagram is shown in Fig. 2.

The parts are mounted on an L-shaped aluminum chassis, with a cover of the same general shape, making a case which is 2 inches wide, 3

inches high, and 6½ inches long. Octal sockets for the plug-in coils (Millen 74001 shielded core-tuned forms) are mounted along the top edge, with the corresponding tube sockets projecting from the right side. The oscillator compartment is at the front, nearest the dial — a "must" when flexible couplings are used for ganging. The middle compartment houses the mixer-stage components, including the core-tuned i.f. output coupling transformer. Coupling between the oscillator and mixer is obtained by means of a piece of "push-back" wire which is soldered to the oscillator tuned circuit and then wrapped around the r.f. plate or mixer grid lead. The coupling should be set at the lowest value which will provide maximum signal strength. At the back is the r.f. section, which is provided with a coaxial input jack for antenna connection.

As this converter may be used with conventional i.f. systems, provision was made for incorporating a.v.c. Instead of grounding the grid returns from the r.f. and mixer tubes, these returns are brought out, through resistors R_1 and R_5 , to a separate pin on the power-cable socket. The corresponding pin in the i.f. unit is connected to ground.

The oscillator circuit is high- C , for maximum stability, the capacity other than that of the variable condenser being supplied by a fixed ceramic padder, consisting of 20- $\mu\text{mfd.}$ and 27- $\mu\text{mfd.}$ units in parallel with the tuning condenser. Adjustable padders are used on the mixer and r.f. circuits to facilitate tracking. These are mica trimmers, to which some may raise the objection of instability, but the coil inductance is adjusted so that the trimmers tune nearly wide open, so that small changes in plate spacing have a negligible effect on the capacity.

Tracking is made easy by the adjustable-

Bottom view of the i.f.-audio unit, showing arrangement of parts. At the upper right, in a partially-shielded compartment, are the parts comprising the i.f.-amplifier input circuit. In the center are the detector socket and associated parts. At the left and rear are the audio components.

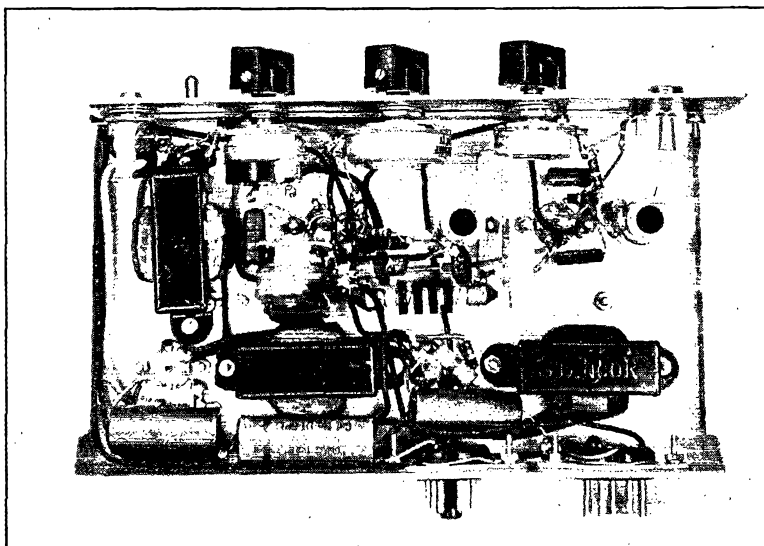

inductance feature of the coil forms used. We cut off most of the core stud, leaving only enough to permit moving the core up about $\frac{1}{2}$ inch from its lowest position. In putting the converter into operation we started by establishing the tuning range of the oscillator. This may be checked with a wavemeter, or monitored by a receiver having a calibrated dial. We wanted the receiver to tune in a station or two at the high end of the old f.m. band, so we made our oscillator tune to about 37 Mc. at the zero end of the dial. At 100 the oscillator frequency is 43 Mc., giving a spread of about 70 divisions for the 50-Mc. band and 50 divisions for 27 to 30 Mc. With the smooth-running vernier dial (it is a new National Type AM, the old familiar Type A with a metal dial scale) and the somewhat broad i.f. used, no difficulty is experienced in tuning in stations; though owners of communications receivers which employ flywheel tuning and yards of bandspread may feel a bit cramped at first. If more spread is desired for 28-Mc. work a separate oscillator coil may be made for that band, and additional capacity built into the mixer and r.f. coils for 28 Mc.

Once the oscillator is tuning the desired range, the mixer should be put into operation. For test purposes, a temporary primary may be wound on the mixer coil, using two of the spare pins on the coil and socket for bringing out the leads thereto. From here on, a signal generator which tunes the desired frequency ranges is a big help, but it is not absolutely necessary. A signal from a VFO, or the harmonics of several crystals, can be made to do the trick. The signal from the oscillator in a communications receiver can be

made to do in a pinch. The signal source should be fed into the converter, by direct connection to the temporary primary, or by means of a pick-up antenna, and the output of the converter fed into a communications receiver tuned to 11 Mc. If the converter is working there will be an appreciable increase in receiver noise as the plate voltage is applied to the mixer, and this will increase as the mixer grid and plate circuits are resonated.

Tracking is accomplished in the usual way, but it is easier than it used to be, as no squeezing of turns is required for inductance adjustment. With a signal near the high end of the band, adjust the trimmer, C_4 , for maximum signal or noise. Tune to near the low end, and recheck the setting of C_4 . If the trimmer capacity has to be increased, the coil inductance is low; if the capacity has to be decreased the inductance is too high. Adjust the coil inductance by moving the core (moving the core into the coil increases the inductance) and repeat the trimmer setting process until the band can be tuned without any readjustment of C_4 . When the mixer is functioning properly the same procedure should be followed with the r.f. coil. It is well to note the performance of the mixer alone, as this will serve to determine whether the r.f. stage is performing as it should. There should be a noticeable increase in sensitivity when the r.f. stage is added, but if the mixer is functioning correctly it should be possible to get quite good performance with the mixer alone.

In this connection it is well to note that the screen voltage and grid bias have a considerable effect on the performance of the 6AK5 as a mixer.

When we started out with this unit, the mixer stage was very noisy. We were running the same

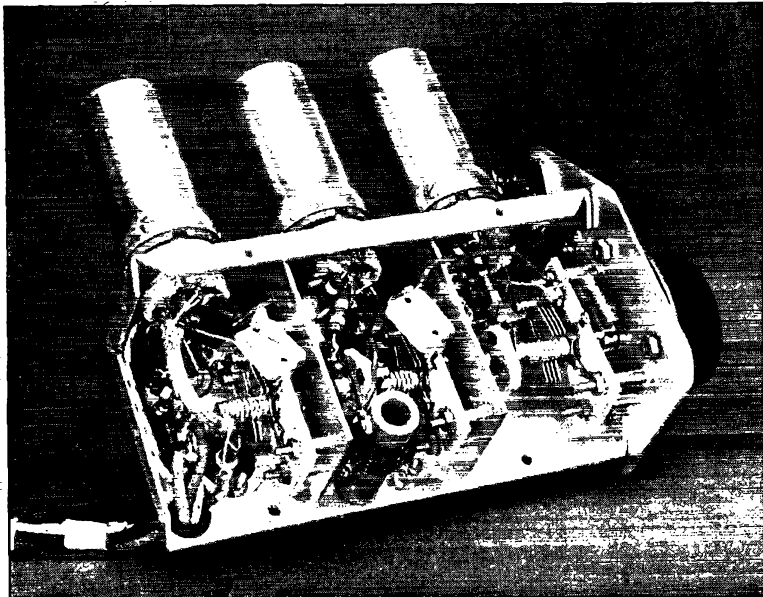

Interior view of the 28- and 50-Mc. converter, with cover removed. The mica trimmers are adjusted through small holes in the chassis cover. The oscillator compartment is at the front (right), the mixer in the middle, and the r.f. amplifier at the left.

voltage (135 volts) on both plate and screen, and using a low value of cathode resistor, so that the mixer was drawing 3 or 4 ma. plate current. The "plate noise" of the mixer ran the S-meter on the receiver (an NC-200) up to S5, even with the mixer grid circuit shorted to ground! Adding the screen dropping resistor, R_7 , and changing the cathode bias resistor to 6800 ohms dropped the plate noise so low that it did not show on the S-meter. Needless to say this made a tremendous difference in the performance of the converter at low signal levels. After this change it was possible to align the mixer and r.f. circuits by the increase in noise; whereas before this, pick-up in noise at resonance had been completely masked by the needless plate noise of the mixer stage.

It is well to make all converter adjustments in conjunction with a communications receiver serving as an i.f. system. It is extremely difficult to adjust the converters while listening to the output of the 11-Mc. superregenerative i.f. system, as its response at low levels is almost impossible to measure, the hiss tending to mask the signal on any measuring device we have employed. The i.f. system should be adjusted with 11-Mc. input, and then the converter connected to it for a test of the combination. The over-all performance will be somewhat lower than that of the converter-receiver combination, but it should be possible to copy any signal which is solidly readable when a communications receiver is used. The useful sensitivity goes down to about 1.5 microvolts — and anyone you hear at that level is certainly not going to hear you if you are using a low-powered mobile rig! Well-modulated signals can be copied well below that level, if you don't mind digging into the noise for them. The weak-signal reception of the converter-i.f. combination will compare favorably with all but the best communications receivers, and its signal-to-noise ratio under mobile conditions will be better than most, especially on 50 Mc.

The 144-Mc. Converter

Judging by the performance of the 6-and-10 converter, we felt that 144-Mc. performance considerably above that of the better superregens could be realized with a converter, even without the use of a tuned r.f. stage, so the simple 2-tube job shown herewith was tried. It uses a 6AK5 as a mixer and a 955 oscillator. The acorn tube was

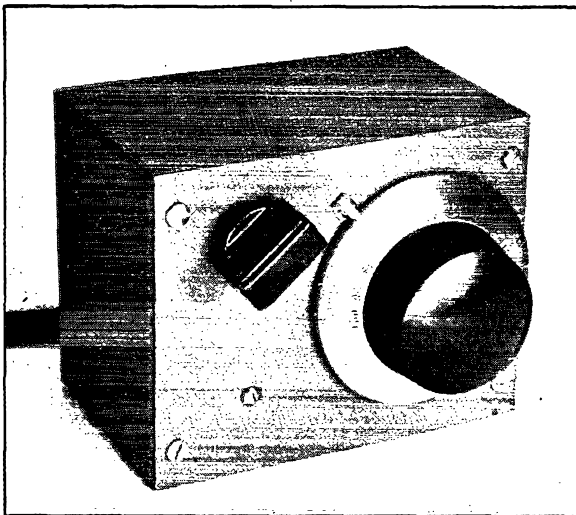

Front view of the 144-Mc. converter. The entire unit is contained in a standard 3×4×5-inch case.

chosen because it fitted readily into the layout we had in mind, and is very easy to handle at this frequency. Because the mixer tuning is fairly broad, no attempt was made to gang the tuned circuits, and only the oscillator is tuned by the vernier dial. The mixer tuning is provided with a front-panel knob, but once set for maximum signal at 146 Mc., it can be left in the same position for both ends of the band with a negligible sacrifice in sensitivity.



The mixer and oscillator sections of the 2-meter converter are mounted on separate brackets of folded aluminum. At the right is the mixer assembly, with the output coupling transformer at the front of the photograph. The antenna coupling coil and the series-tuning condenser are at the rear. The coaxial connection for the antenna extends through a hole in the back of the case.

From the schematic diagram, shown in Fig. 3, it may be seen that the circuits of the converters are somewhat similar except for the elimination of the r.f. stage, and the use of a cathode-tapped coil in the oscillator circuit of the 2-meter unit. The converter was originally laid out using a 6J6 push-push mixer, but due to the difficulty of obtaining satisfactory performance with this arrangement, it was changed to the 6AK5. The "butterfly" tuning condenser used is a hangover from the 6J6 set-up — an ordinary Trimaire, with its stator sawed in half, would do.

All the parts are mounted on the front panel, so that the complete unit can be removed from the case intact. Sections of the folded-over edge of the case were sawed out at several points to provide space for easy removal. The oscillator and mixer assemblies are mounted on individual subpanels of folded aluminum, and most of the wiring can be done before these assemblies are fastened to the front panel. The coaxial socket for the antenna connection is mounted on a separate bracket, and projects through a hole in the back of the case.

Injection of oscillator voltage is accomplished in a manner similar to that used in the other converter, except that a smaller capacity must be used, otherwise the oscillator will "pull out" when the mixer circuit is tuned to resonance. A 5- μ fd. ceramic condenser is connected to the hot end of the oscillator tuned circuit, and the coupling lead is run from this condenser to the mixer grid lead. By a slightly different arrangement of the parts, bringing the two tuned circuits closer together, it would be unnecessary to provide any coupling other than that between the two coils.

The oscillator tuning condensers, C_3 and C_4 ,

are similar mechanically, except that one has a shaft to which is affixed the vernier dial, and the other a screwdriver adjustment. It is important that two similar condensers be used in this arrangement, where the two are mounted at right angles, in order that the stators and rotors line up for direct connection without leads. With the condensers and coil used here, the 144-Mc. band covers about 50 divisions on the dial, permitting coverage up to 150 Mc. This is useful, as commercial signals are available in this range in many locations, and they are quite helpful in making receiver adjustments and in judging the condition of the band. A signal which is on continuously is a fair substitute for a signal generator, and is much more satisfactory for receiver tests than amateur signals, which have an annoying way of going on and off at the wrong times!

Performance

All the units described above have been in use in the writer's car for some time, and we have had plenty of opportunity to compare their performance with other receiving systems for these frequencies. We have made no special effort to attain noiseless reception under mobile conditions, as our main interest lies in operating from stationary positions at elevated points. In this work we have been able consistently to hear more than we can raise, a desirable condition at any time. It doesn't take long for the experienced worker to judge the effectiveness of a receiver, even without the aid of a signal generator, and this receiving combination shows up well by either method, in comparison with other receiving arrangements of comparable simplicity.

To do a completely effective job of mobile

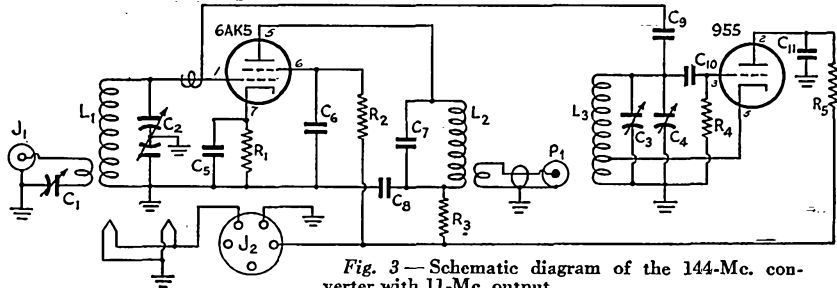
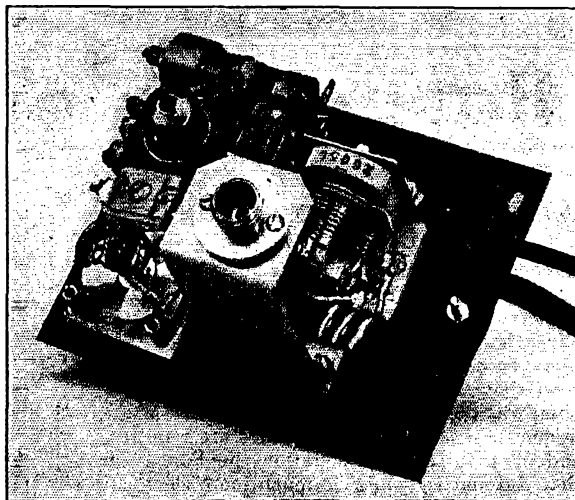

Fig. 3 — Schematic diagram of the 144-Mc. converter with 11-Mc. output.

- C_1 — 3-30- μ fd. mica trimmer.
- C_2 — Cardwell "butterfly" condenser, 1 rotor plate with 1 stator plate on each side. See text.
- C_3 — 25- μ fd. trimmer with screwdriver adjustment (Millen 26025).
- C_4 — Oscillator tuning condenser (Millen 20015 reduced to 1 stator and 1 rotor plate).
- C_5, C_6, C_8, C_{11} — 470- μ fd. mica midget.
- C_7 — 50- μ fd. ceramic.
- C_9 — 5- μ fd. ceramic.
- C_{10} — 100- μ fd. mica midget.
- R_1 — 10,000 ohms.
- R_2 — 1.0 megohm.
- R_3 — 270 ohms.

- R_4 — 22,000 ohms.
 - R_5 — 10,000 ohms.
- All resistors $\frac{1}{2}$ -watt carbon.
- L_1 — 3 turns No. 12 tinned, 3/8-inch long, 3/8-inch inside diameter. Primary: 2 turns No. 20 "push-back" interwound at cold end of L_1 .
 - L_2 — 22 turns No. 22 enam., closewound on National XR-50 form. Coupling winding: 3 turns No. 22 enamel wound on layer of Scotch Tape over cold end of L_2 .
 - L_3 — 3 turns No. 12 tinned, 1/2-inch long, 1/4-inch inside diameter, tapped 1 turn from cold end.
 - J_1 — Coaxial socket (Jones S-201).
 - J_2 — 5-prong socket on power cable.
 - P_1 — Coaxial plug (Jones P-201).

◆
Two similar condensers mounted at right angles comprise the tuning assembly for the oscillator in the 2-meter converter.
◆



operation requires considerable attention to noise reduction. With this sort of receiver, the worst interference comes, not from the car's ignition system, but from the generator. The super-regenerative detector provides effective silencing for noise pulses of short duration, such as ignition interference, but its inherent a.v.c. characteristics make it respond to a continuous noise such as the whine of the generator, to the exclusion of any weaker signal. It is for this reason that we recommend the use of "B" batteries for the receiver plate supply — there is almost certain to be enough interference from any vibrator or generator power supply to mask the weaker signals. How well this receiving arrangement combats ignition interference may be judged from the fact that we have on several occasions, operated from "high spots" where there was a steady stream of passing traffic, without experiencing any serious difficulty with ignition noise on even the weakest signals.

The increased selectivity of the two-meter converter is particularly helpful. Occupancy of the 2-meter band in many areas has long since passed the point where the sensitivity of the receiver is a limiting factor, when superregenerative receivers are used. With strong signals occupying a megacycle or more, it is obvious that an operator working from Mt. Wachuset, where literally hundreds of stations are within line-of-sight, is not going to hear or work much DX using a superregen! There are many points around New England where there is QRM, even on this converter, but stations which appear to be on the same frequency, when the conventional superregen is used, are often received without mutual interference on the converter. The low-frequency superregenerative detector also results in fair f.m. reception. Stations using f.m. can operate with narrow deviation and still be quite

readable; in fact, tests indicate that a deviation which produces the effect of "almost no modulation" on the ordinary superregen is just about right for this receiver. A deviation of much more than 100 kc. begins to produce severe distortion, which makes it a bit rough on many of the modulated-oscillator rigs, but if these boys will go light on the gain control they can be made to sound readable, at least. Crystal-controlled stations, and the more stable MOPA rigs, come through with excellent quality, and high-C oscillators are quite readable.

Several types of reception are possible through variation in the setting of the regeneration control. With the plate voltage on the detector near maximum, the loudest "shush" and widest bandwidth are obtained. This is the setting normally used for 144-Mc. reception. Backing off the regeneration control reduces the hiss level and sharpens the response, and best all-around reception on 28 or 50 Mc. is usually obtained in this position. Further reduction of the plate voltage results in a whistle being heard as carriers are tuned in, and quite satisfactory c.w. reception is possible at this setting. From here down, the detector is operating in a condition in between superregeneration and straight regeneration for a considerable variation in the plate voltage. It goes into straight oscillation and then out of oscillation entirely as the voltage is reduced nearly to zero. Reception of modulated signals is possible when the detector is operated in a manner similar to that used with regenerative detectors, and "hiss-less" reception is possible at this point. Sensitivity is considerably lower, however, giving striking proof of the value of superregeneration as a means of attaining high performance with a few tubes.

Happenings of the Month



CLASS D PROPOSAL WITHDRAWN

The ARRL Board of Directors in early July amended the proposal it had pending before FCC for the creation of a Class D operator license, to request that such licenses be valid for operation on authorized amateur frequencies above 1215 Mc. The original proposal was to make Class D good above 200 Mc. but the purpose of the proposal was purely to encourage occupancy in the frequencies where new techniques are required, and upon further consideration the Board felt that the matter would be much more clean-cut if the 200- and 400-Mc. ranges were eliminated from the picture.

Thereafter the matter continued under study by the Board, the feeling gradually crystallizing that the best interests of amateur radio would be served by abandoning the whole proposal. Accordingly, in late July the Board withdrew its pending request of FCC in its entirety. The subject is now dead.

ALLOCATION PROPOSALS

With the outlook improving for the opening of a world telecommunications conference well within the next year, FCC and IRAC in July completed another survey of proposed frequency allocations below 25 Mc. and sent it to the Department of State with the recommendation that it be the basis for the United States proposals.

This preparatory work is still not complete in the lower portion of the spectrum, below 3 or 4 Mc., and further revisions of that part of the table are probably still to be expected. It is consequently not surprising to find that there are no changes of import from the proposals of a year ago as concern our 160-meter band. There are still no provisions for amateurs; 1800-2000 kc. is still put down for navigation aids; the frequencies at both the high and low ends of our old band are still earmarked to be portions of fixed and mobile bands. The only change of concern to us is that it has been decided that the frequencies for disaster communication will be established between 1750 and 1800 kc., thereby putting them within reach of amateur 160-meter apparatus, as we requested. The League has again asked FCC's consideration of its pending request for a sharing arrangement with loran and for the earmarking of the old amateur frequencies 1750-2000 kc. as jointly amateur and other services, in the world table, so that they will be domestically available to us "if and when."

The table of proposed frequencies then repeats our present 3.5-, 7- and 14-Mc. bands without change and again proposes a new band for us from 21 to 21.5 Mc. It is significant and highly gratifying that the United States, reviewing its proposals for world-wide frequencies after another year's study, proposes to continue all our bands in their entirety and to continue in its endeavor to establish a new 21-Mc. band for us. In its comments, FCC stated that the provisions for the fixed and maritime-mobile services were inadequate but that it was imperative to provide more space for the expanding aeronautical-mobile service and at the same time not reduce the limited space available for high-frequency broadcasting and for the amateur service. The largest reduction is therefore imposed on the fixed services — the Commission, however, observing that they are in the best position to take advantage of technical advances.

MICROWAVE CHANGES

The amateur band in the 5-kMc. range is in process of being changed by dividing it into two relocated sections. Instead of 5250-5650 Mc., it is to consist of two smaller bands: 3300-3500 Mc. and 5650-5850 Mc. The changes are not yet in effect at this writing but will be reported over WIAW when they actually go into effect.

The alteration resulted from the need to provide a new band for marine radar in the vicinity of 5 kMc., FCC says, one subject neither to the lack of definition inherent in 3-kMc. radar nor to the blackout experienced by 9-kMc. radar during rain squalls and snow storms. Rearrangement of several microwave assignments necessarily followed. For us, the change gives the benefit of a new assignment in the 3-kMc. range, where both apparatus and techniques reached a high state of development during the war in the production of S-band radar. Much of this gear is immediately adaptable to the new amateur band, making it possibly the easiest to operate on of all the amateur microwaves.

These changes were incorporated in the FCC announcement, in middle July, of a revised table of allocations above 25 Mc. One purpose in putting it forward at this time was to stipulate the international allocations which FCC recommends to the Department of State as the United States proposals for the coming world conference. Containing both the proposed international allocation column and the contemplated U. S. domestic use, amateurs will be interested in know-

DX QSLs

• "Claim your old QSL cards now or never," says page 31 of July QST, because all prewar cards not applied for by next January 1st will be disposed of at that time, by order of the ARRL Board of Directors.

If you did any hamming prewar, some of these DX cards may be for you! Look up the July article and submit the required self-addressed stamped envelope to your QSL Manager now.

ing that every one of the ham bands above 25 Mc. appears as exclusively amateur in both columns — with the single exception of the temporary sharing of 420–450 Mc. with navigation aids.

A further change of interest to us concerns the 11-meter band, 27.185–27.455 Mc., which in previous allocation tables has appeared as assigned primarily to scientific, industrial and medical apparatus, with a footnote permitting amateurs to make such use of it as is possible. Now, for international purposes, it is observed that scientific, industrial and medical apparatus do not constitute a communications service which can properly be the recipient of a service allocation, and consequently the United States now proposes that the official allocation for this band, both internationally and domestically, be amateur, with provision that we recognize that interference to our operations may result from the QRM devices.

WHAT BANDS AVAILABLE?

Below is a summary of the U. S. amateur bands on which operation is permitted as of August 1st. Future changes will be announced by W1AW broadcasts. Figures are megacycles. A \emptyset means an unmodulated carrier, A1 means c.w. telegraphy, A2 is m.c.w., A3 is a.m. 'phone, A4 is facsimile, A5 is television; FM means frequency modulation, both 'phone and telegraphy.

3.500–	4.0	— A1	
3.850–	4.0	— A3, Class A only	
7.150–	7.3	— A1	
14.100–	14.3	— A1	
14.200–	14.3	— A3, Class A only	
27.185–	27.455	— A \emptyset , A1, A2, A3, A4, FM	
28.0	29.7	— A1	
28.5	29.7	— A3	
29.0	29.7	— FM	
50.0	54.0	— A1, A2, A3, A4	
52.5	54.0	— FM	[band is only
144.0	148.0	— A \emptyset , A1, A2, A3, A4, FM; except	
144.0	146.5	within 50 mi. of Washington, Seattle and Honolulu.	
235	240	— A \emptyset , A1, A2, A3, A4, FM	
420*	430*	— A \emptyset , A1, A2, A3, A4, A5, FM	
1,215	1,295	} A \emptyset , A1, A2, A3, A4, A5, FM, Pulse	
2,300	2,450		
5,250	5,650		
10,000	10,500		
21,000	22,000		
All above 30,000			

* Peak antenna power must not exceed 50 watts.

THE LONG ZERO

There has been some sentiment in the W \emptyset call area that amateurs ought to have the right to form the zero by means of one long dash instead of five regular dashes. Normally FCC would not make this permissible in a matter as important as a call, since only the five dashes are recognized

Hands Across the Sea

• Do you hear many PAs these days? There are a few, of course, but for every one heard there are dozens unable to be on the air because of lack of equipment, or the money to buy it. When war broke out over there, government authorities took all amateur equipment into custody, storing it in warehouses for eventual return — but such gear was either destroyed by enemy bombardment or confiscated by occupation troops. Now there is little or nothing, and of course first radio imports and manufactures must go to commercial and government services until the national communications system is rebuilt.

The Netherlands society has come to us for help. These fellows could make good use of odd bits of gear — not junk — that may be lying around in your spare-parts box: tubes, condensers, coils, resistors, sockets — anything for receivers and modest-powered transmitters. These fellows want to come back on the air, and many need our help. Would you like to "adopt" a Dutch ham and enable him to put another PA signal on the hambands?

If so, and we hope you will, simply send a postcard to ARRL Hq. saying you would like to help. In reply you'll receive the name, call and address of a Dutch ham as submitted by the Netherlands amateur society, to whom you can extend the Good Neighbor policy. We'll include basic shipping information and data on what types of gear are most wanted. From then on, things will be strictly between you two — you can write him, find out what his immediate needs are, and then see what you can do to get him started. Wouldn't you get a kick out of making — and completing — a schedule with your PA buddy, knowing it was you who helped him get back on, and that it was your lil' ole 807, or plate tank condenser or whatever, that did the trick?

We have several hundred names for "adoption." If you'd like to help, just drop a note to Hq.

in the International Radiotelegraph Regulations; and we ourselves have feared that it would add confusion in reading calls, which is frequently hard enough. However, arrangements have now been made for a three months' test: During the months of August, September and October the numeral 8 may be made by one long dash in signing and answering calls. The authorization is permissive, not compulsory. This is an experiment, to see how it works, whether monitoring is impeded, how we like it ourselves. At the end of the test period FCC will decide whether the permission is withdrawn or continued, so watch for further announcement in late October. If you do decide to use it, make that long dash plenty long and take extra pains to keep the whole call clear. For our money, the five dashes are still preferable.

MORE ON PORTABLE INDICATORS

Relief was given a considerable segment of the amateur body on July 11th when FCC adopted its Order 132-A, which so modified previous requirements as to relieve the operators of fixed stations which have changed address but which still operate in the original call area from the need to give the indication of portable operation while awaiting modification. As this is undoubtedly the most numerous category of stations under the obligation of signing a portable designation, there is a considerable shortening of calls and a saving of QRM. Even if a ham has simply moved into the house next door, and even though he has registered the change of address as required by the original Order 132, up to July 11th he had to sign the portable indicator. But since its purpose is to indicate the call area in which operation is occurring, and since in such cases the call itself properly reveals the call area, that particular requirement could be eliminated.

The old rule still applies when a station has been moved to a call area other than that specified in the call itself. If the change to a new location has been to a point that was formerly in the same call area but which is no longer in that area since the boundaries were changed, the portable indication must still be given. And we again call attention to the need to advise the FCC engineers-in-charge of any changes in location from the license address of the station. The FCC requirements in the new order now read as follows:

1. The provision in §12.92 of the Commission's Rules exempting amateur radio station licensees who operate portable stations on frequencies above 25 Mc. from the requirements of prior notice to the inspector of the district where operation is intended is suspended until further order of the Commission. On and after the date of this order, the operation of portable stations on frequencies above 25 Mc. shall be subject to the same requirements of prior notice as are specified for the operation of portable stations on frequencies below 25 Mc. in §12.92.

2. The provisions of §12.93(a) of the Commission's Rules regarding the operation of non-portable stations

ARE YOU LICENSED?

• When joining the League or renewing your membership, it is important that you show whether you have an amateur license, either station or operator. Please state your call and/or the class of operator license held, that we may verify your classification.

which have been moved from one permanent location to another not specified in the station license, are suspended until further order of the Commission.

3. The licensee of an amateur radio station may, on and after the date of this order, commence operation at a permanent location other than that specified in the station license if advance written notice is given to the inspector in charge of the district for which the station license was issued, and to the inspector in charge of the district in which the operation (on frequencies below or above 25 Mc.) is intended of the following particulars: the station call, the name of the licensee, and the proposed station location.

4. The operator of an amateur station located at a permanent location in a call area other than that specified in the station license shall follow the calling procedure referred to in §12.93(c).

NEW LICENSING PLAN

With the big job ahead of renewing all our licenses in the coming year, and with amateur radio growing, FCC has evolved a simplified plan for the mechanical handling of amateur licenses that will result in much greater output. The new system is expected to be in operation by middle September and it is estimated it will at least triple the rate of amateur issuances.

Our present card license is one of eight cards that have to be typewritten on both sides to provide the file records for Washington and the field offices. The new "quantity-production" licenses will be of paper, rather than card, on special forms in rolls on mandrels, so that all the necessary copies may be made by a single electric-typewriting operation. The text and size remain substantially the same but the operator and station halves will be joined top to bottom, rather than being on opposite sides of a card.

As part of this system there is a new and simpler amateur application form — which indeed will probably go into use even before the rest of the mechanism is working. It is only one page long and eliminates many of the questions that have been found unnecessary. It is a combined station-and-operator form, that being the usual amateur case, and under the new system an applicant will automatically be given a station license and assigned a call whenever he applies, provided he qualifies. It will no longer be necessary for an applicant actually to possess transmitting apparatus before being issued a station call — he may qualify when ready and acquire the apparatus later.

This is only one of many log-jams that FCC is having to break up with its growing tasks. We look forward with some satisfaction to the opera-

tion of the new system, believing that it should solve most of the problems of faster action in amateur cases.

HANDPRINTING CODE

In view of the large number of men trained in the armed services to copy code in block letters, FCC has instructed its examining staff to permit the handprinting of the code test in capital letters. Either pencil or pen may be used. The previous requirement was for longhand script.

GEORGES

George P. Adair, a former W5, is chief of the Engineering Department of FCC. One of the several assistant chief engineers is George E. Sterling, W3DF, in charge of the Field & Research Branch. The latter includes a Laboratory Division located at the Laurel monitoring station, under Charles Ellert, W3LO (soon to be succeeded by Edward Chapin), and the very large Field Engineering & Monitoring Division, headed by George S. Turner, once a W9 who was the ARRL SCM for Missouri. The latter George has quite a show now, not only the Washington staff which he heads but the entire field monitoring and inspection establishment of FCC.

On July 1st the Radio Intelligence Division of FCC was merged into normal field establishment and the whole comprehensively reorganized. Of the wartime RID monitoring stations still in commission, those equipped with Adcocks were commissioned as secondary monitoring stations, while those without were attached to district inspection offices as investigative units. As part of a general reorganization, the old title of district inspector-in-charge was changed to engineer-in-charge — which is also now the title of the officers in charge of monitoring stations. The old title of RI has finally disappeared; they are now known as radio engineers. The main administrative change has been to divide the country into nine regions, each consisting of several FCC inspection districts and the monitoring stations therein, with each region in charge of a seasoned inspector occupying the new post of regional manager. The managers having been chosen from the senior inspectors, there have been numerous promotions in the service, particularly resulting in numerous new engineers-in-charge. Following is the new arrangement:

The North Atlantic Region, with headquarters in New York City, has Charles C. Kolster as its regional manager and consists of the old districts whose headquarters are at Boston, New York, Philadelphia, Baltimore and Norfolk. It contains the primary monitoring stations at Millis, Mass., and Laurel, Md., and the secondary monitoring stations at Searsport, Maine, and Scituate, R. I.

The South Atlantic Region, under Paul H. Herndon, jr., at Atlanta, includes the Atlanta, Miami and San Juan districts, the primary monitoring station at Powder Springs, Ga., and the secondaries at South Miami and Hato Rey, P. R.

The Gulf States Region has headquarters at Houston under Joe H. McKinney and embraces the New Orleans, Houston and Dallas districts, the primary at Kingsville and secondaries at New Orleans and Oklahoma City.

Kenneth G. Clark heads the South Pacific Region from San Francisco, his area including the Los Angeles, San Francisco and Denver districts and the primary monitoring stations at Santa Ana and San Leandro, Calif.

The North Pacific Region, with headquarters at Seattle, is under George V. Wiltse, and covers the Portland and Seattle districts, including the primary monitoring station at Portland and the secondaries at Spokane and Twin Falls, Idaho.

L. C. Herndon from Chicago will manage the Central States Region, the districts headed at St. Paul, Kansas City and Chicago, including the original primary monitoring station at Grand Island and the secondary at St. Paul.

The Great Lakes Region is managed from Detroit by Emery H. Lee and embraces the Detroit and Buffalo areas, including the primary at Allegan and secondaries at Lexington, Ky., and Canandaigua, N. Y.

District 21, the Hawaiian Islands, now has added to it the Pacific Islands of the United States to form a Hawaiian Region under the regional management of Lee R. Dawson at Honolulu, including also the primary monitor at Punch Bowl, Honolulu.

The Alaskan Region, including the old Alaskan district, is headed by Victor G. Rowe, at Anchorage, and includes secondary monitoring stations at Juneau as well as Anchorage.

All the monitoring stations operate 24 hours a day, 7 days a week, and are connected by teletype and h.f. radio. Whenever any one of them picks up a suspicious signal it immediately alerts others, so that they can take bearings, the data being coordinated in an intelligence center. When necessary, all the stations in the service are alerted for a nation-wide hunt and they get action in a remarkably short while. There are many skillful amateurs in this service. The deliberate lawbreaker has small chance of getting away with anything these days.

ARMY SIGNAL ASSOCIATION

The recently-formed Army Signal Association invites applications for membership from any interested persons, especially former service men. For many years most of the branches of the Army have had the aid of such associations, having for their ultimate purpose the improvement of our national defense. The Army Signal Association has been formed in the expectation that it will be able to assist the War Department in providing better military signal communications should we ever again become involved in war. Its purposes also include the fostering of a spirit of fellowship among present, former and future members of the Signal Corps — commissioned, enlisted and civilian. It hopes also to maintain the liaison and cooperation that existed between the Army and the operating and manufacturing companies serving in the field of electronics and communications. Membership is open to any American citizen, with dues of \$4 annually. Those interested are invited to communicate with the Executive Secretary at 631 Pennsylvania Ave., N. W., Washington 4, D. C.

ELECTION NOTICE

To All Full Members of the American Radio Relay League residing in the Central (including prospective new Great Lakes Division), Hudson, New England, Northwestern, Roanoke, Rocky Mountain, Southwestern and West Gulf Divisions.

You are hereby notified that, in accordance with the constitution, an election is about to be held in each of the above-mentioned divisions to elect both a member of the ARRL Board of Directors and an alternate thereto for the 1947-1948 term. Your attention is invited to §1 of Article IV of the constitution, providing for the government of ARRL by a board of directors; §2 of Article IV, and By-Law 12, defining their eligibility; and By-Laws 13 to 24, providing for the nomination and election of division directors and their alternates. Copy of the Constitution & By-Laws will be mailed to any member upon request.

The new Great Lakes Division comes into existence January 1, 1947. For the purposes of these elections, Full Members residing in the states of Kentucky, Michigan and Ohio will nominate and elect a director and an alternate from their number to serve for a one-year term during the year 1947, to be followed next year by a two-year election. Similarly, for the purposes of these elections, the Central Division is to be considered as consisting only of the states of Illinois, Indiana and Wisconsin, and Full Members residing therein will nominate and elect a director and an alternate from their number to serve for the usual two-year term, 1947-1948.

All steps in the election process now occur one month earlier than heretofore. Voting will take place between October 1 and November 20, 1946, on ballots that will be mailed from the headquarters office during the first week of October. The ballots for each election will list, in one column, the names of all eligible candidates nominated for the office of director by Full Members of ARRL residing in that division; and, in another column, all those similarly named for the office of alternate. Each Full Member will indicate his choice for each office.

Nomination is by petition. Nominating petitions are hereby solicited. Ten or more Full Members of the League residing in any one of the above-named divisions may join in nominating any eligible Full Member residing in that division as a candidate for director therefrom, or as a candidate for alternate director therefrom. No person may simultaneously be a candidate for both offices. Inasmuch as all the powers of the director are transferred to the alternate in the event of the director's death or inability to perform his duties, *it is of as great importance to name a candidate for alternate as it is for director.* The following form for nomination is suggested (ex-

cept that in the case of the Great Lakes Division it should read "for the 1947 term"):

Executive Committee

*The American Radio Relay League
West Hartford 7, Conn.*

We, the undersigned Full Members of the ARRL residing in the Division, hereby nominate of as a candidate for director; and we also nominate of as a candidate for alternate director; from this division for the 1947-1948 term.

(Signatures and addresses)

The signers must be Full Members in good standing. The nominee must be a Full Member and must have been both a member of the League and a licensed radio amateur operator for a continuous term of at least four years immediately preceding receipt by the Secretary of his petition of nomination, except that a lapse of not to exceed ninety days in the renewal of the operator's license and a lapse of not to exceed thirty days in the renewal of membership in the League, at any expiration of either during the four-year period, will not disqualify the candidate; provided that if a candidate's membership has been interrupted by reason of service in the Armed Forces of the United States, he shall not be deemed to be disqualified so far as concerns continuity of membership if he has, since May 7, 1943, renewed his ARRL membership within ninety days of discharge from the military service. He must be without commercial radio connections: he may not be commercially engaged in the manufacture, selling or renting of radio apparatus normally capable of being used in radio communication or experimentation, nor commercially engaged in the publication of radio literature intended, in whole or part, for consumption by licensed radio amateurs. Further details concerning eligibility are given in By-Law 12. His complete name and address should be stated. The same requirements obtain for alternate as for director. All such petitions must be filed at the headquarters office of the League in West Hartford, Conn., by noon EDST of the 20th day of September, 1946. There is no limit to the number of petitions that may be filed on behalf of a given candidate but no member shall append his signature to more than one petition for the office of director and one petition for the office of alternate. To be valid, a petition must have the signature of at least ten Full Members in good standing; that is to say, ten or more Full Members must join in executing a single document; a candidate is not nominated by one petition bearing six valid signatures and another bearing four.

Petitioners are urged to have an ample number of signatures, since nominators are frequently found not to be Full Members in good standing. It

is not necessary that a petition name candidates both for director and for alternate but members are urged to interest themselves equally in the two offices.

League members are classified as Full Members and Associate Members. Only those possessing Full Membership may nominate candidates or stand as candidates; members holding Associate Membership are not eligible to either function.

Present directors and alternates for these divisions are as follows: Central Division (presently including the states that for the purposes of this election comprise the Great Lakes Division): director, John A. Kiener, W8AVH; alternate, Earl S. Nelson, W8DS. Hudson Division: director, Robert Akeridge Kirkman, W2DSY; alternate, George Rulfs, jr., W2CJY. New England Division: Percy C. Noble, W1BVR; alternate, Clayton C. Gordon, W1HRC. Northwestern Division: Karl W. Weingarten, W7BG; alternate, R. Rex Roberts, W7CPY. Roanoke Division: Hugh L. Caveness, W4DW; alternate, J. Frank Key, W3ZA. Rocky Mountain Division: acting director, Howard R. Markwell, W9TFP; alternate, none. Southwestern Division: director, John E. Bickel, W6BKY; alternate, Eldridge E. Wyatt, jr., W6ARW. West Gulf Division: director, Wayland M. Groves, W5NW; alternate, Jennings R. Poston, W5AJ.

These elections constitute an important part of the machinery of self-government of ARRL. They provide the constitutional opportunity for members to put the direction of their association in the hands of representatives of their own choosing. Full Members are urged to take the initiative and to file nomination petitions immediately.

For the Board of Directors:

K. B. WARNER,
Secretary

July 1, 1946

NOTICE TO MEMBERS DISCHARGED FROM THE MILITARY SERVICES

The requirement of continuous membership in the League for eligibility to ARRL offices has been waived for members serving in the uniform of the United States or Canada. See particulars on page 27 of *QST* for July last. Those desirous of taking advantage of this arrangement are required to claim the right when renewing membership, stating the beginning and ending dates of their military service.

**SWITCH
TO SAFETY!**



CLYDE DARR, 8ZZ, has created a striking cover for our September, 1921, *QST*. Saluting the First National ARRL Convention & Radio Show, now in progress, it pictures a bird's-eye view of the United States and Canada, with airplanes, blimps and balloons from every district converging on Chicago. We haven't had any reports on doings as yet, but Clyde has drawn convention hall silhouetted against an emblazoning array of fireworks.

Paul F. Godley discusses "Simplified vs. Three-Circuit Regenerative Receivers," taking up the cudgels for the latter in the issue's main technical article. He states that c.w. reception requires the added sensitivity, selectivity, and freedom from antenna effect that result from complete and stabilized grid-control of the signal, as afforded only by a three-circuit tuner. Godley reminds the advocates of simplification of the complexities of the new speedy gas-driven cars we are now buying in preference to the simpler more-sluggish electric models. *QST*'s editor agrees with Godley's reasoning, but for an every-day working model he's sold on John L. Reinartz's new simplified tuner (*QST*, June, 1921). The editor solicits reports from the fraternity on the performance of IQP's receiver.

"Portable Wave Meters for Short Wave Radio," by R. T. Cox and S. Kruse of the Bureau of Standards, brings us a wealth of information on the construction and calibration of these units. They report that some commercial models tested at the Bureau had errors as great as 100 meters at 300 meters!

ARRL Traffic Manager Schnell, 1MO, is winner of the c.w.-transmitter building contest staged by The Radio Club of Hartford. His entry uses a Radiotron 5-watter and the 1DH circuit. Efficiency, 18.82 per cent; total cost, \$34. J. C. Randall, 1ANQ, is runner-up. Following the new trend, both rigs employ transformers for a.c. filament voltage.

Power-supply needs for our new c.w. and modulated transmitters are covered by a number of fine articles in this *QST*: "A New Rectifier Scheme" describes 3IL's voltage-doubling circuit using chemical rectifiers; Roy Atkinson presents practical hints in "Operating Notes on Chemical Rectifiers"; "Three-Phase C.W." features a 3-tube self-rectifying oscillator circuit; Robert E. Goll details "A Method of Obtaining High Plate Voltage," a commutator method for conversion and rectification. Harold F. Hastings recommends the use of battery bias on detectors for c.w. reception, and Wm. Leyh, 2WM, reports near

(Continued on page 142)

Revamping the BC-342

ONE ITEM that has decidedly not been a drug on the surplus market is the a.c. model of the standard Signal Corps short-wave receiver, the BC-342. The most popular version, bearing the suffix "N" (but basically the same as those having lower letters in the alphabet) has been snapped up by hams — particularly a few months ago when regular amateur communication receivers were as scarce as hen's teeth. From any angle it's a lot of receiver packed — literally — into a small case; two r.f. stages, crystal filter with two i.f. stages, six bands with switching, a.c. power supply, and a collection of gadgets ordinarily not found on receivers but presumably part of a complete communication set-up with a companion transmitter.

As it stands, the 342 makes a fair ham receiver. It's built like a battleship and is just about as stable, mechanically. Evidently a lot of thought has been given to electrical stabilization of the high-frequency oscillator, too, because the drift is low and the direct-reading dial calibration is quite accurately maintained. Both fast and slow tuning are provided, with the slow or "vernier" tuning geared down so that the tuning on amateur bands is comparable in ease to that on good communication receivers — for example, $9\frac{1}{2}$ complete rotations of the vernier knob are required to cover the 3500-4000-cc. band.

However, some of the 342's characteristics, presumably dictated by military requirements, leave a good deal to be desired in amateur communication. The operating voltages on the r.f. tubes are such that the gain is held down, with the result that the signal-to-noise ratio is not what it might be. We understand that the crystal filter was omitted on some later models of the receiver because nobody ever used it, and after listening to a dozen or so 342s it's not hard to understand why. For one thing, there is a big drop in output when the filter is switched in; second, the receiver has no selectivity control and normal i.f. alignment results in the crystal's working at the very maximum selectivity at all times. The frequency range of the set is from 1500 to 18,000 kc., so that only three ham bands are covered. There is a bad a.c. hum in headphone reception. There is noticeable backlash in the tuning mechanism (said to have been introduced intentionally), varying in different receivers but amounting to as much as 5 divisions on the vernier dial in some. There are only two ways the set can be shut off during transmission: by turning the gain control to minimum, or by opening the a.c. switch and letting the tube heaters get cold.

Most of these things can be fixed up. Changing the tuning range would be a major operation, but

that problem can be dodged by building a converter for the frequencies higher than 18 Mc.; in fact, the set is rather nicely arranged for working with a converter because the shielding is excellent and the antenna input is designed for coax cable, both factors contributing to interference-free converter reception.

The electrical changes to improve the performance are fundamentally simple. Taking the various points in turn:

R.F. End

The two r.f. stages are operated with more than the rated grid bias and with less than the rated screen voltage. This does things to the signal-to-noise ratio, as evidenced by the fact that, with the r.f. gain at maximum and no antenna on the set, tuning the trimmer on the first r.f. stage through resonance (particularly on the higher-frequency bands) produces no change in noise level. In other words, the thermal noise in the first tuned circuit is unable to override the tube noise — as it must if a good signal-to-noise ratio is to be obtained. As further evidence, weak signals disappear into the noise when the r.f. gain is reduced in m.v.c. reception, instead of both noise and signal decreasing at the same rate.

Boosting the gain in the r.f. stages — and particularly in the first stage — materially improves the situation. As the set is wired, the cathode resistors of the first and second stages — R_1 and R_7 , respectively — are 500 ohms; these should be reduced to 250 ohms each. The screen resistors, R_3 in the first stage and R_9 in the second, should be reduced from the design value of 40,000 ohms to 20,000 ohms. These changes raise the screen voltage to 130, approximately, and reduce the grid bias at maximum gain to about 3 volts. It is also advisable to remove the first tube from the manual r.f. gain control so that this tube always runs wide open in c.w. reception with m.v.c.; this keeps the signal-to-noise ratio high when the r.f. gain is reduced to give a comfortable signal level.

To make the changes it is necessary to remove the shield plate at the rear of the chassis behind the r.f. and mixer tubes. This can be done by taking out the four screws on top and lifting off the plate. The screen resistors are on the mounting strip underneath the plate and are identified by the nearby circuit symbols. The easiest way to make the change in value is to shunt R_3 and R_9 with 40,000-ohm $\frac{1}{2}$ -watt resistors, rather than by substituting 20,000-ohm units directly, the original resistors being wired in such a way that it is a real problem to get them out.

The cathode resistors for the two r.f. stages are mounted alongside the tube sockets, and are in-

accessible until the mounting plate for the tubes is removed from the chassis. This plate is held by the two threaded studs at the extreme ends at the rear and by two screws at the front. Take out the screws and remove the grid caps from the tubes; the plate can then be pulled out to the limit of the grid leads, making the socket wiring easy to get at. The cathode resistors are mounted between the cathode pin on the socket and an insulated tie-point alongside; clipping the leads is the simplest way to get them out. The 250-ohm $\frac{1}{2}$ -watt substitute for R_1 should be soldered between the cathode pin and a convenient ground point such as the shell pin on the socket, but the replacement for R_7 should be connected to the same points as the original resistor. After these changes have been made the mounting plate and shield should be reassembled.

Raising the gain by this method should make the trimmer on the first r.f. stage show a definite peak on noise with the antenna disconnected.

Crystal Filter

The principal trouble with the crystal filter is that the capacitance of the phasing condenser is too large. This condenser (C_{51} in the circuit diagram) has a maximum of $50 \mu\text{fd.}$ and has a switch blade on its rear shaft extension to short-circuit the crystal when the condenser is turned to maximum capacitance. In the "crystal out" position, therefore, the $50\text{-}\mu\text{fd.}$ phasing condenser is connected directly across the secondary of the i.f. transformer. With the crystal in, the phasing condenser ordinarily is set at about one-fifth of maximum, or somewhere in the vicinity of 10 to 15 $\mu\text{fd.}$ As this capacitance is in series with the crystal-holder capacitance under these condi-

tions, the shunting capacitance across the transformer secondary is less than $10 \mu\text{fd.}$ Thus simply switching the crystal in and out causes a capacitance change of $40 \mu\text{fd.}$ or more. The result is that if the transformer is lined up without the crystal it is badly out of alignment when the crystal is switched in, and vice versa.

The cure is quite simple: the crystal switch should be arranged to close when the phasing condenser is at *minimum* capacitance. Unfortunately, the switch blade is pinned to the condenser shaft — in a spot where it is practically impossible to get the pin out without wrecking the condenser and the surrounding parts. However, a small stud used as a stop to prevent continuous rotation of the condenser is mounted in the bakelite plate, and this stud can be used as a switch contact instead of the one normally provided. It is only necessary to solder a wire from the stud to the regular fixed contact and the job is done. Be sure to clean off any soldering flux so the edge of the switch blade will make good contact with the stud. The switch and stud are accessible from the rear when the filter-assembly cover, held by four screws at the top corners, is lifted off.

As an alternative method, the switch blade can be forced around 180 degrees on its collar, since it is only crimped to the latter. It may break in the process, but if it does it can be soldered to the collar. This will permit using the old fixed switch contact.

The trimmer in the i.f. transformer secondary (on top of the "first detector" transformer) has to be adjusted after making this change. It may be lined up on noise with the crystal switched out. Thereafter the signal strength, when the signal is peaked on the crystal, should be the same with

By taking out a few screws, the plate holding the r.f. tubes in the BC-342 can be pulled out, exposing the socket wiring. The parts in the crystal-filter unit also are more accessible when the r.f. tubes are out of the way. The arrow points to the stud mentioned in the text.

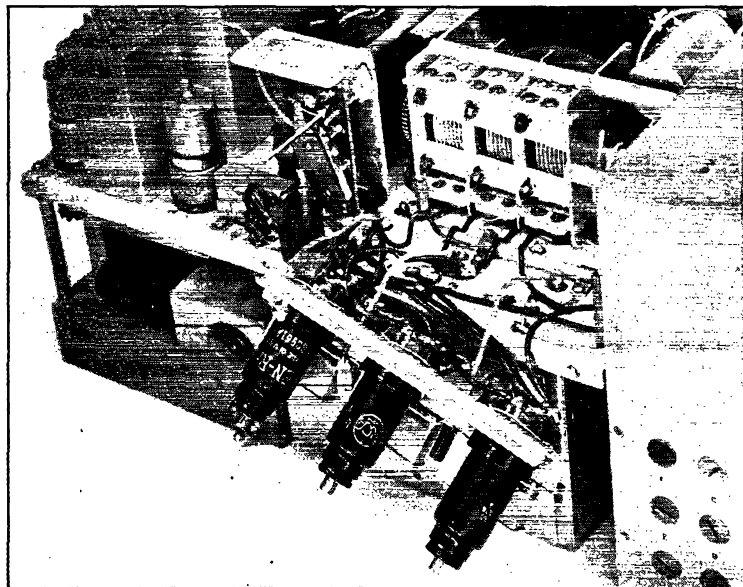

the crystal as without it. The crystal selectivity is not too great — just about optimum for ordinary operating.

As a refinement which makes the phasing control somewhat easier to operate, plates can be taken from the condenser stator to reduce the maximum capacitance. Removing four of the seven fixed plates still leaves plenty of phasing range and makes adjustment less critical. The plates can be broken from the solder holding them to the support rods and then fished out. It is not necessary to remove the filter assembly from the chassis, provided the r.f.-tube section is dismantled as previously described.

A. C. Hum

Although early 342s had a headphone jack in the first audio stage, most of those now extant seem to have both jacks in the second stage. With so much audio amplification the signal strength is ear-splitting if the r.f. gain control is near maximum. But at a setting that gives a comfortable signal level the a.c. hum is extremely annoying. Apparently the hum is the result of a combination of insufficient power-supply filtering and high audio gain, the latter being at maximum when the set is on m.v.c.

Some reduction in hum can be effected by adding capacitance to the filter, and it is possible to find room underneath the chassis for a couple of midget 8- μ fd. electrolytics. However, the real cure is to shift the 'phones to the first audio stage. Either or both 'phone jacks can be used for this purpose. The lowermost one is the easiest to get at; simply clip the wire running to the jack spring and solder a lead from the spring to the grid prong on the 6F6 socket. With this change the headphone volume will be less, of course, but the hum disappears. The 6F6 socket can be reached by taking out the pin in the inner power-supply hinge, removing the two screws holding the power supply unit to the top of the chassis, and swinging the power unit out of the way on the outer hinge.

If more headphone volume is wanted, it can be obtained by substituting a 6Q7 for the 6R7 second-detector first-audio tube. The cathode bias resistance should be changed, since the 6Q7 is a high- μ tube. Soldering a 300-ohm $\frac{1}{2}$ -watt unit across R_{23} will suffice; this resistor is on the mounting board at the edge of the chassis. A further increase in volume will result if a 50,000-ohm resistor is similarly shunted across R_{49} , the filter resistor in the diode circuit, the design value of this resistor being 0.5 megohm.

This method of connecting the headphones in the first audio stage makes no provision for silencing the loudspeaker when the 'phones are plugged in. More serious, however, is the fact that if no speaker is used, or its plug is pulled out when the 'phones are in use, the 6F6 output tube is left without a load. Strong signals or bursts of

noise cause quite high voltages to build up across the primary of the output transformer — high enough to cause sparking inside the tube. The same thing happens, incidentally, when high-impedance 'phones are used in the second-audio jack; in one case we know of the voltage was high enough to break down the insulation in the shielded lead that runs from the transformer to the plate of the 6F6. The remedy for this is to replace the speaker jack with a standard jack of the shorting type wired so that the hot lead from the output-transformer secondary is shorted to ground when there is no plug in the jack.

Send-Receive Switch

The send-receive switch on the 342 does not shut off the receiver "B" supply as is customary in communication receivers, but if regular send-receive switching is wanted it can be incorporated by a simple change in the wiring. Remove the leads from the switch and tape the exposed ends. Ground one switch terminal. Take the bottom plate off the power unit and disconnect the high-voltage center-tap lead from the negative terminal of the filter condenser. This lead has a plain brown covering. It is long enough to reach to the switch terminal, so may be pushed through the grommet with the other power leads and soldered directly to the switch. The switch then breaks the negative high voltage before the filter, and so turns the "B" voltage on and off without the clicks that accompany switching in the positive output lead.

Backlash

The backlash problem is a sticker. We haven't found a satisfactory solution to it, although from all indications it is wholly in the worm-gear combination that drives the condenser shaft and not in the gears connected to the tuning knobs. More intimate contact between the worm and the toothed gear might be the answer, but there seems to be no way to get it without taking the whole assembly off the chassis; there appears to be a possibility of adjustment but the condenser frame is pinned to the gear-assembly casting. The pins, as usual, are inaccessible without a major disassembly job.

In some cases an improvement can be effected by tightening the spring tension on the worm shaft, which can be done by loosening the set-screw in the collar, pressing the collar tightly against the spring, and retightening the setscrew. This will prevent any thrust in the shaft and thus keep the worm from moving back and forth. In a couple of cases doing this reduced the backlash by about one division on the vernier dial.

Odds and Ends

A number of other changes can be made in the receiver to make it more adaptable to ham work, although they have nothing to do with its elec-

◆

A large-size tuning knob in place of the vernier control makes the BC-342 easier to tune in amateur work. This photograph also shows the octal socket installed in the cable outlet in place of the special connector supplied with the set. The socket takes an ordinary octal plug and provides a convenient outlet for filament and plate voltages for a converter, among other possibilities. Note that the cap (an item with high nuisance value) has been removed from the jack that has been switched over to the first audio stage.

◆

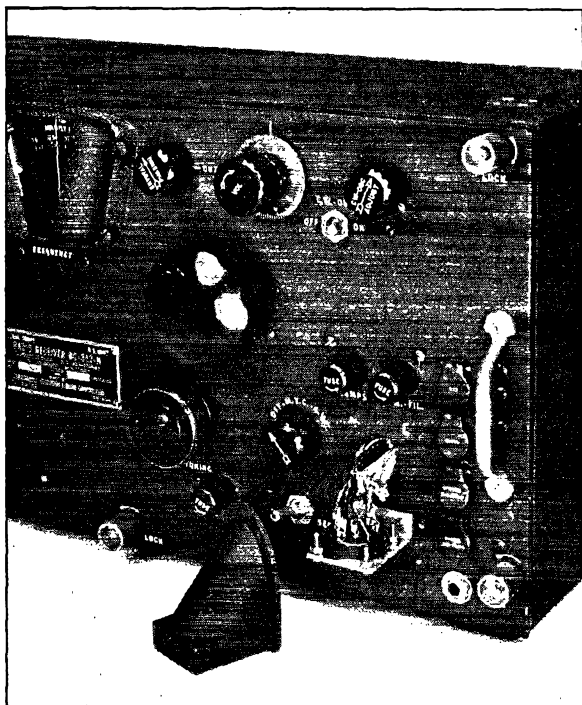

trical performance. One simple thing that makes tuning a lot easier is to substitute a big knob for the miniature job on the vernier control; the shaft is $\frac{1}{4}$ inch so any standard knob will fit. A large knob will cover up the vernier scale, which may be a disadvantage if the scale is used for logging purposes. However, it is probably preferable to log directly from the frequency scale.

Rubber grommets in the holes in the slide fasteners on the bottom will keep the receiver from scratching the operating table and make it practically impossible for the set to slide, even with a hefty push.

The cable outlet is practically useless unless a special plug is obtained to fit. However, an Amphcnol MIP octal socket fits perfectly in place of the original connector insert, even to the mounting holes. The socket mounting plate extends a little beyond the edge of the receptacle, in

one or two spots, but can easily be filed off so the cover can be replaced. Installing such a socket provides an easy means for bringing out filament and plate voltages for operating a converter, for example, and leaves extra contacts for external "B" switching (a lead in parallel with the hot lead to the send-receive switch) and for introducing a keying-monitor tone (a lead to the secondary — already brought out in the cable — of the interstage audio transformer). The unused wires originally running to the connector can simply be clipped off.

A tone control can be installed for cutting down high-frequency noise; a simple one is a 0.02- μ fd. condenser connected between the grid of the 6F6 and ground. It can be cut in and out of the circuit by a toggle switch which may be mounted in the hole now occupied by the spare-fuse holder.

— G.G.

Strays

Have you heard the suggestion for a new ARRL award, WOS, exclusively for those trying to crash the 75-meter 'phone band? Yep, you guessed it — Worked One Station.

— . . . —

W2MDE writes that he uses a pair of Erie "Ceramicons" (3-12- μ fd. ceramic trimmers) as neutralizing condensers in his 28-Mc. PP HK24G rig!

Vectolite, the first nonmetallic and nonconducting permanent-magnet material ever made, has been announced by G-E. It is a hardened drosslike combination of iron rust and cobalt oxide mixed when still in powder form. Permanent magnets of Vectolite are light in weight, prevent electrical losses due to current conduction and are highly resistant to demagnetizing forces.

Crystal Control on 144 Mc.

Three Crystal-Controlled 2-Meter Transmitters

BY WENDELL W. KING,* W3NBV

NO ONE can deny the advantages of a stabilized signal in the v.h.f. bands, but many amateurs are reluctant to undertake the design and construction of a crystal-controlled rig for the 144-Mc. band because they believe it cannot end up with anything that won't need several rooms to house it and several incomes to pay for it. To prove that such a high order of complexity is not necessary, three transmitters of 5-, 20-, and 60-watts output respectively will be described. They are all being used on the air, and distances of over 100 miles have been worked with the 20-watt job.

The design of the transmitters is based on the use of harmonic or "overtone" crystals.¹ This involves the use of AT-cut plates which are specifically processed for harmonic operation and have temperature coefficients of less than 2 cycles/Mc./°C. Such crystals are not to be confused with the harmonic-type "C"- or "E"-cut crystals² of prewar vintage which had coefficients of 20 and 43 cycles/Mc./°C respectively.

All well-known crystal-oscillator circuits except the Pierce can be used with the harmonic

• Most amateurs recognize the advantages of a stable v.h.f. signal but often hesitate to incorporate crystal control because they believe it will involve a large number of multiplier stages and the attendant disadvantages of bulkiness, high total current drain and higher cost. The three transmitters described in this story demonstrate that 144-Mc. crystal-controlled transmitters can be built with few tubes and a minimum of complexity.

"A" cut. The Pierce circuit oscillates at the crystal fundamental frequency unless provision is made to tune the plate reactance so that it is inductive at the fundamental frequency and capacitive at the harmonic frequency.

In the transmitters to be described, the circuits used with the high-harmonic oscillators are conventional except for small details. Such circuits include the tuned-plate, the tuned-plate with a multiplier tank in the plate circuit, and the Tri-tet. The choice of tubes used in the oscillator circuits is by no means limited to those that will be mentioned, but may be any of similar type and power that are recommended by tube manufacturers for the frequencies involved.

Five-Watts Output

The wiring diagram of a simple transmitter capable of delivering 5-watts output at 144 Mc. is shown in Fig. 1. A 7C5 Tri-tet oscillator uses a

*Bliley Electric Company, Union Station Building, Erie, Pa.

¹ Since "harmonic"-type crystals do not operate on the exact integral multiple of the crystal fundamental frequency, the term "overtone" more properly describes this type of operation. Such crystals are usually calibrated at the overtone or harmonic frequency rather than at the fundamental.

² J. M. Wolfskill, "56-Mc. Crystal-Control with 28-Mc. Crystals," *QST*, January, 1938.

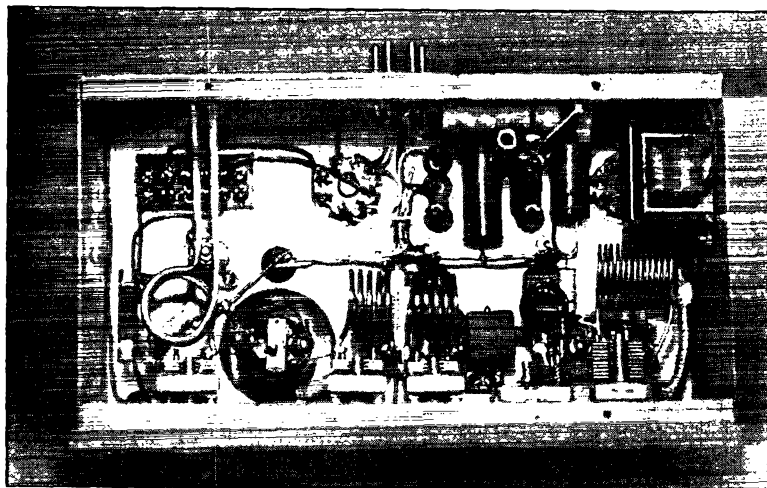

◆
Tank coils are mounted directly on their associated tuning condensers in the 5-watt transmitter. The HY-75 output tube is mounted upside down, and the grid and plate leads project down through the chassis, resulting in very short leads.
◆

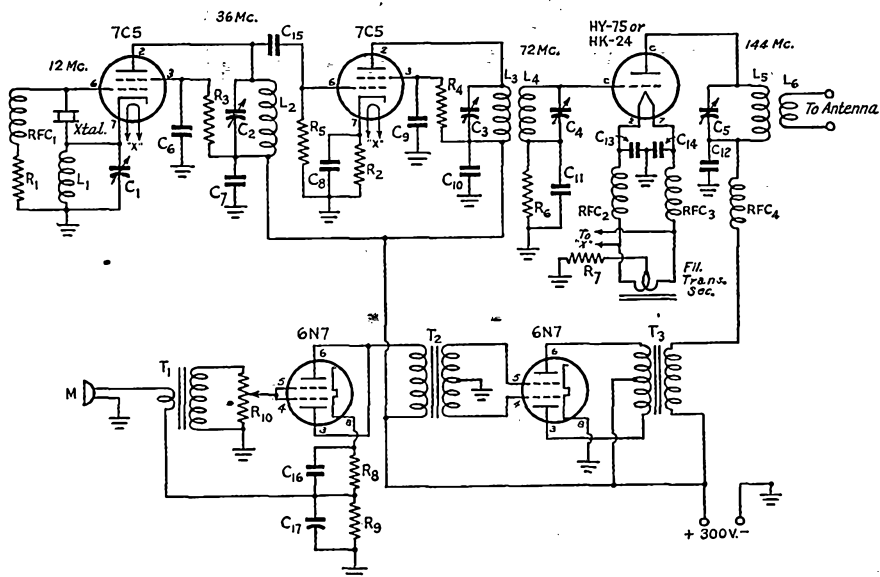

Fig. 1 — Wiring diagram of the simple 5-watt 144-Mc. transmitter.

- C₁ — 75- μ fd. variable (Hammarlund APC).
 C₂, C₃, C₄, C₅ — 35- μ fd. variable (Hammarlund APC).
 C₆, C₇, C₈, C₉, C₁₀, C₁₁ — .002- μ fd. silver mica.
 C₁₂ — 450- μ fd. ceramic (Erie).
 C₁₃, C₁₄, C₁₅ — 100- μ fd. mica.
 C₁₆, C₁₇ — 25- μ fd. 25-volt electrolytic.
 R₁ — 30,000 ohms, 1 watt.
 R₂ — 500 ohms (may be omitted).
 R₃, R₄ — 20,000 ohms, 2 watts.
 R₅ — 20,000 ohms, 1 watt.
 R₆ — 15,000 ohms, 2 watts.
 R₇ — 750 ohms, 10 watts.
 R₈, R₉ — 500 ohms, 10 watts.
 R₁₀ — 0.5-megohm potentiometer.
 L₁ — 10 turns No. 14, $\frac{5}{8}$ -inch dia., spaced 1 turn.

- L₂ — 7 turns No. 14, $\frac{5}{8}$ -inch dia., spaced 1 turn.
 L₃ — 4 turns No. 10, $\frac{3}{4}$ -inch dia., spaced 1 turn.
 L₄ — 5 turns No. 10, $\frac{3}{4}$ -inch dia., spaced 1 turn.
 L₅ — 1 turn No. 10.
 L₆ — 2 turns No. 10, $1\frac{3}{8}$ -inch dia., spaced 1 turn.
 Coupling adjusted for maximum output to 70-ohm coaxial line.
 RFC₁ — 2.1-mh. r.f. choke (Hammarlund).
 RFC₂, RFC₃ — 15 turns No. 18 enameled, $\frac{1}{2}$ -inch dia., closewound.
 RFC₄ — V.h.f. r.f. choke (Ohmite Z1).
 T₁ — S.b. carbon-microphone input transformer (Stancor A4706).
 T₂ — Interstage input-to-p.p.-grids transformer (Stancor A4721 or Thordarson T67D47).
 T₃ — Modulation transformer (UTC VM-0).

A rear view of the 5-watt job shows the modulator equipment at the back of the chassis, and the coaxial output fitting, power connector, and microphone jack on the rear side of the chassis. Note the top of the bracket supporting the output r.f.-tube socket.



12.1-Mc. crystal, with the cathode circuit tuned to the crystal frequency and the plate circuit tripling to 36.3 Mc. This drives a 7C5 doubler stage to 72.6 Mc. which delivers power sufficient to drive an HY-75 output doubler at 145.2 Mc. A simple modulator using two 6N7s is adequate to modulate the HY-75.

The construction of the unit is quite simple, as can be seen from the photographs. The entire transmitter and modulator is built on a single $10 \times 5\frac{1}{2} \times 3$ -inch chassis. The HY-75 is held in an inverted position by mounting the socket on a U-shaped bracket, a method of mounting that permits short leads in the grid- and plate-tank circuits. Tuning adjustments are made with an insulated screwdriver through suitable holes in the panel.

The tuning of this transmitter is not difficult, and the only possible bugaboo, that of tuning to the wrong harmonic in one or more of the tank

circuits, can be avoided by using a small wavemeter that covers the range. The tuning of the Tri-tet oscillator is much the same as when fundamental crystals are used. Best circuit design calls for a cathode tank with a low LC ratio for maximum output and low crystal current. The plate tank must be operated at a higher frequency than the cathode tank or self-oscillation may result, but this is the condition when one is frequency multiplying in the plate circuit. In this transmitter the cathode tank is tuned to the crystal frequency by starting at maximum condenser capacity and decreasing it until a dip in plate current indicates that the crystal is oscillating. Further reduction in capacity too far beyond this point will result in an increase in plate current to a point where a second dip in plate current occurs, indicating self-oscillation. Obviously the mistuning of this second condition is to be avoided.

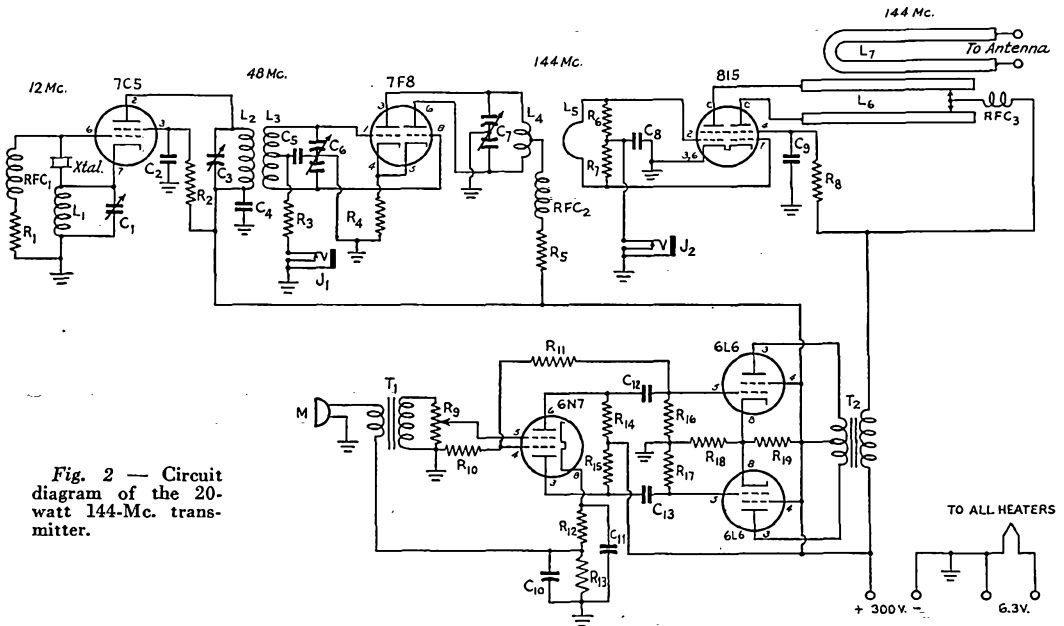
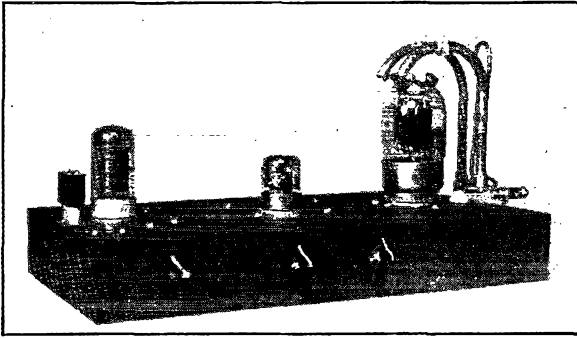

Fig. 2 — Circuit diagram of the 20-watt 144-Mc. transmitter.

- C₁, C₃ — 50- μ fd. variable (Hammarlund APC).
- C₂ — .01- μ fd. mica.
- C₄, C₅ — .001- μ fd. mica.
- C₆, C₇ — 15- μ fd. split-stator variable.
- C₈, C₉ — .0005- μ fd. mica.
- C₁₀, C₁₁ — 50- μ fd. 25-v. electrolytic.
- C₁₂, C₁₃ — 0.1- μ fd. 600-v. paper.
- R₁, R₁₄, R₁₅ — 0.1 megohm, 1 watt.
- R₂ — 15,000 ohms, 1 watt.
- R₃ — 30,000 ohms, 1 watt.
- R₄ — 500 ohms, 2 watts.
- R₅ — 7500 ohms, 10 watts.
- R₆, R₇ — 7500 ohms, 1 watt.
- R₈ — 10,000 ohms, 10 watts.
- R₉ — 0.5-megohm potentiometer.
- R₁₀ — 25,000 ohms, 1 watt.
- R₁₁ — 0.5 megohm, 1 watt.
- R₁₂, R₁₈ — 250 ohms, 10 watts.
- R₁₃ — 750 ohms, 10 watts.

- R₁₆, R₁₇ — 0.2 megohm, 1 watt.
- R₁₉ — 15,000 ohms, 10 watts.
- L₁ — 10 turns No. 14, $\frac{1}{8}$ -inch dia., spaced wire dia.
- L₂ — 5 turns No. 14, $\frac{1}{8}$ -inch dia., spaced wire dia.
- L₃ — 8 turns No. 14, $\frac{1}{8}$ -inch dia., spaced, center-tapped.
- L₄ — 2 turns $\frac{1}{8}$ -inch copper tubing, $1\frac{1}{4}$ -inch dia., center-tapped.
- L₅ — 1 turn $\frac{1}{8}$ -inch copper tubing, $1\frac{1}{4}$ -inch dia., center-tapped.
- L₆ — $\frac{5}{16}$ -inch copper tubing, 8-in.-long sections, spaced 1 inch.
- L₇ — $\frac{1}{8}$ -inch copper tubing, U-shaped, $5\frac{1}{2}$ inches long, spaced 1 inch.
- RFC₁ — 2.1-mh. r.f. choke (Hammarlund).
- RFC₂, RFC₃ — V.h.f. choke (Ohmite Z1).
- T₁ — S.b. microphone transformer (Stancor A4706).
- T₂ — 30-watt Class B output transformer (UTC VM-1).



The simplicity in appearance of this transmitter belies its performance, since it puts out 20 watts of crystal-controlled 144-Mc. power. The output plate lines are tuned by a shorting bar, and the antenna coupling is varied by moving the coupling loop with respect to the plate lines.

Following the correct cathode adjustment, the plate tank is tuned to the third harmonic of the cathode-tank frequency. With the 12.1-Mc. crystal used, the frequency in the plate tank will be 36.3 Mc. This frequency should be checked to avoid mistuning to the second or fourth harmonic. The multipliers are tuned in the conventional manner and offer no special problems. Coils L_3 and L_4 require a slight coupling adjustment for maximum grid drive in the HY-75. A half-inch separation was used in this transmitter. The coil L_6 is a two-turn loop coupled for maximum output to a 70-ohm coaxial cable and delivers a good 5 watts to the antenna.

20-Watts Output

The circuit for a transmitter of 20-watts output is shown in Fig. 2. Here a 7C5 Tri-tet oscillator, using a crystal frequency between 12.0 and 12.3 Mc., quadruples in its plate circuit to 48 Mc. This drives a Sylvania 7F8G twin triode (6C4s in p.p. could be substituted) as a push-pull tripler to 144 Mc. feeding an 815 working as a straight amplifier. Incidentally, the 7F8G should

³ The value given for the grid leak (R_6 and R_7 in parallel) may appear low for the 815, but it should be noted that this is for 300-volt operation. — Ed.

not be operated with more than 275 volts on the plate, if reasonably long life is to be expected. No neutralization of the 815 is required, since good isolation of the grid and plate tanks is provided, and the grid circuit is loaded by R_6 and R_7 . The grid tank of the 815 is adjusted by changing the shape of the coil which, of course, changes the inductance. The grid resistors, R_6 and R_7 , serve in parallel as grid leaks.³ The modulator uses a 6N7 phase inverter to drive two 6L6s in Class AB. Microphone voltage is obtained from the cathode circuit of the 6N7.

The transmitter is built on a $13 \times 7 \times 2$ -inch chassis, and the modulator is built on another chassis of the same size. The photographs show the placement and mounting of the components.

No difficulty should be experienced in putting this transmitter into operation — the Tri-tet adjustments are the same as for the 5-watt set just described, with the exception that the plate tank circuit, L_2C_3 , is tuned to the fourth harmonic of the crystal frequency. This should be checked with a wavemeter to make certain that it is 48 Mc. and not the third harmonic, 36 Mc. The 7F8G tripler is tuned to 144 Mc., and the coupling between L_4 and L_5 , although not critical, should be adjusted for optimum drive to the 815. With

The two split-stator condensers, C_6 and C_7 , are mounted on either side of the 7F8G socket. The Tri-tet plate condenser, C_3 , is mounted on a small metal bracket close to the 7C5 socket.

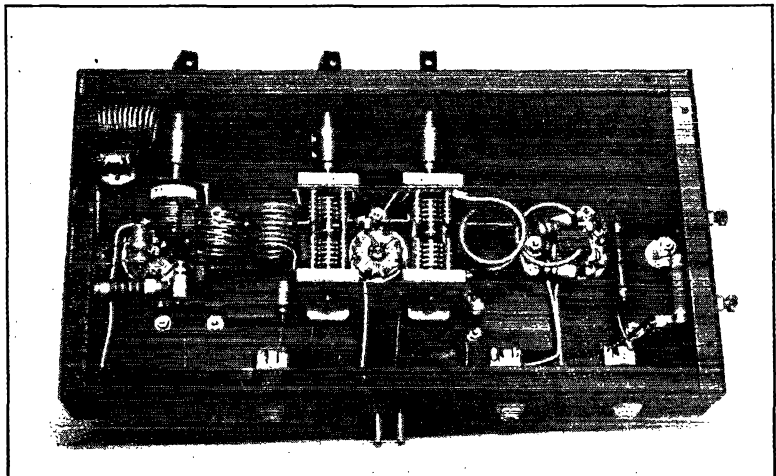

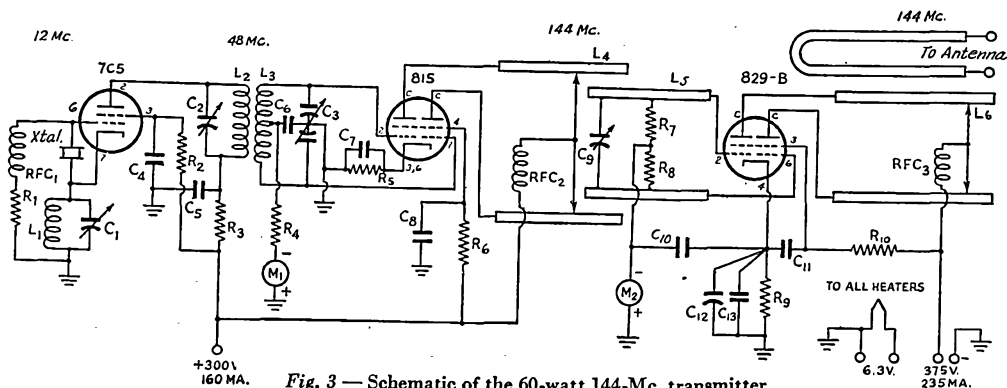

Fig. 3 — Schematic of the 60-watt 144-Mc. transmitter.

- C₁ — 50- μ fd. variable (Hammarlund APC).
- C₂ — 25- μ fd. variable (Hammarlund APC).
- C₃ — 15- μ fd. split-stator (Bud 1666).
- C₄ — .01- μ fd. mica.
- C₅, C₆ — .001- μ fd. mica.
- C₇, C₈, C₁₃ — 500- μ fd. mica.
- C₉ — 25- μ fd. variable (Cardwell).
- C₁₀, C₁₁ — 500- μ fd. mica.
- C₁₂ — 25- μ fd. 200-v. electrolytic.
- R₁ — 0.1 megohm, 1 watt.
- R₂ — 12,000 ohms, 1 watt.
- R₃ — 10 ohms, 1 watt.
- R₄ — 15,000 ohms, 1 watt.
- R₅ — 300 ohms, 10 watts.
- R₆ — 10,000 ohms, 10 watts.

- R₇, R₈ — 7500 ohms, 1 watt.
 - R₉ — 60 ohms, 10 watts.
 - R₁₀ — 6400 ohms, 10 watts.
 - L₁ — 10 turns No. 14, 1-inch dia., double spaced.
 - L₂ — 5 turns No. 14, 1-inch dia., double spaced.
 - L₃ — 8 turns No. 14, 1-inch dia., double spaced.
 - L₄ — $\frac{1}{4}$ -inch copper tubing, 8 inches long, spaced $\frac{7}{8}$ inch.
 - L₅, L₆ — $\frac{1}{16}$ -inch copper tubing, 10-inch-long sections, spaced $\frac{7}{8}$ inch.
 - RFC₁ — 2.1 mh. r.f. choke (Hammarlund).
 - RFC₂, RFC₃ — V.h.f. choke (Ohmite Z0).
- RCA UT-107 (Stock No. 9935) socket recommended for 829-B.

the plate and screen voltages disconnected from the 815, the 815 grid current should run between 3 and 4.5 ma., with 275 volts on the plates of the 7F8G.

When first tuning the final amplifier, it is well to reduce the plate voltage of the 815 to approximately 250 volts. The final output tank is then tuned to resonance by sliding the shorting bar to the correct position, as indicated by a dip to minimum of the 815 plate current.

Coupling to an antenna or to a transmission line is made through a loop paralleling the plate tank lines and terminating at antenna binding posts. Adjustment for maximum output to the antenna system is made by increasing or decreasing the spacing between the loop and the transmitter output tank.

60-Watts Output

An output of 60 watts can be obtained from a transmitter using an 829-B in the final-amplifier stage, and the circuit for such a rig is shown in Fig. 3. It follows the same frequency-multiplication steps as the transmitter just described, but an 815 tripler is substituted for the 7F8G because of the increased grid-drive requirements of the 829-B. It can be built on a 13 X 7 X 2-inch chassis, and the tuning and adjustment procedure follows the pattern for the 20-watt rig. A modulator delivering 60 watts of audio is required, and the transmitter puts out a real signal!

All of these transmitters have given excellent results in coverage and dependability. Nothing

stands in the way of their use as basic exciter units for higher-power transmitters or as drivers for the multipliers to much higher frequencies. It is believed that once the amateur is familiar with the use of harmonic "A"-cut crystals and their possibilities there will be no hesitation in using them. The crystal frequency used for the transmitters in this article does not mean that the oscillator is limited to this particular frequency, as crystals of any frequency which can be multiplied to 144 Mc. may be used provided the necessary circuit modifications are made. However, Tri-tet plate-tank multiplications should not exceed quadrupling, or the multipliers carried beyond tripling. With the generous allotment of QRM-free bands assigned to amateurs on v.h.f and u.h.f., wonderful opportunities are open to newcomers as well as the more experienced amateurs to do some fascinating pioneer work on these bands.

Strays

VE4AJT lives in Hamton, Sask.

First to use "pulsing" techniques successfully, the *Electrophorus electricus* of the *Electrophoridae* family — an electric eel to you and us, OM — in certain species has $\frac{1}{5}$ of its weight devoted to vital organs, the remaining $\frac{4}{5}$ of this underwater denizen consisting of power supplies for his charge.

MST b bty pwr d . . like a sub.

ARRL Get-Acquainted Party

*A Welcome to Postwar Amateurs — Older Licensees to Greet Newcomers —
For All Amateurs in the League's 71 Sections*

September 21st-23rd

THE HAND of good fellowship will be extended to all LSPH station operators in the ARRL Get-Acquainted Party. All contacts will be between those who held prewar station licenses and those whose first station license was issued postwar. A scoring system is included to add zest to the affair, but *rag-chewing* will be the order of the day.

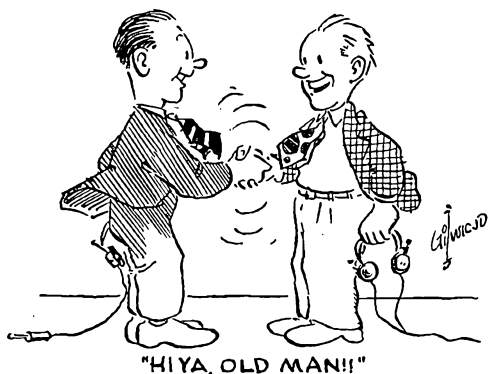

Designed to give the new brothers a rip-roaring welcome to amateur radio, and to enable the older gang to get acquainted with the new blood in our grand hobby, the G-A-P should appeal to old-timer and newcomer alike!

Any or all amateur bands may be used. Contacts may be by either voice or telegraph, or both. Plan your operation as you like it.

Dates & Times

For scoring credit, contacts may be made during any *twenty hours* in the following thirty-two-hour period:

Starting: Saturday, September 21st —
4:00 P.M. PST; 5:00 P.M. MST; 6:00 P.M. CST; 7:00 P.M. EST (2400 GCT).
Ending: Monday, September 23rd —
12:01 A.M. PST; 1:01 A.M. MST; 2:01 A.M. CST; 3:01 A.M. EST (0801 GCT).

¹ The personal "sine" (or sign) consists of the initials of the operator, the first and last letters of his name, an abbreviation for his name, or other identifying designation. In some cases the nickname is used as a personal "sine." It's fraternal in amateur work, and the mark of a real and experienced operator as well, to have a personal sine and use it. In commercial work, operators are often assigned personal identification to use in putting handling data on messages, avoiding confusion between two operators of the same name.

General Calls

The following general calls will be used:

By C.W.: Postwar Licensees will call **CQ O** (indicating that they desire contact with older licensees).

Prewar Licensees will call **CQ N** (indicating that they desire contact with newer licensees).

By Voice: Postwar Licensees will transmit, "calling any contest station."
Prewar Licensees will transmit, "calling any LSPH amateur."

For purposes of the Get-Acquainted Party, "Postwar Licensee" means an amateur whose first station license is dated after Pearl Harbor. "Prewar Licensee" is an operator who at any time prior to P.H. was holder of an amateur station license.

Nature of Contacts

Since the aim of the party is to "get acquainted," contacts should be not of the "hello-and-goodbye" variety. A special factor is included in the scoring system to avoid this type of QSO. Rag-chewers should find the affair particularly inviting. Members of the Rag Chewers' Club should pass up no opportunity to initiate a recruit. The following facts should be exchanged by participants in each contact:

- Signal report
- Operator's name or personal "sine"¹
- Operator's age
- Month and year first amateur station license is dated
- ARRL Section in which located (see page 6 for list)

No special order is required in transmitting the above information, but the facts outlined should be exchanged during each QSO. In the case of YL and XYL participants, transmission of "age" is optional!

Scoring System

Each station may be worked only once for credit. Prewar licensees will work only postwar licensees, and vice versa. Each contact counts one point. Total contact points will be multiplied by the number of different ARRL Sections worked (71 possible; see page 6). The sum of all contacts

(Concluded on page 146)



Foreign Notes



JUNE CALENDAR

The June issue of the IARU Calendar, second since the war, reports that sufficient member-societies have been found active so that the Union may be considered able to transact normal business. The Headquarters has been forced to name eight societies as "nonexistent," they being the amateur organizations in Estonia, Germany, Hungary, Japan, Lithuania, Manchukuo, Poland and Spain. Of the remaining 31 societies, 25 have shown postwar activity.

In international regulatory matters the Calendar sounds an alert, though not a call to arms, in announcing the imminence of a world conference. The Headquarters contemplates that a special Calendar will be issued as plans for the meeting take more definite form.

S.R.A.L. SILVER ANNIVERSARY

The *Suomen Radioamatööriliitto r.y.* can look back with pleasure and satisfaction to its accomplishments during the twenty-five years since its inception on April 14, 1921. Old-timers recall that in the middle 1910s "amateur" experimenters and enthusiasts operated under the highest secrecy, since the government openly discouraged such private research work. There was no law, of course — national or international. When an experimenter was caught, his equipment was

confiscated and he was subjected to severe questioning.

Late in that decade, as it became clear that individual efforts were unavailing, a group of enthusiasts formed a radio subsection of a "young people's society," in an attempt to gain official recognition. The young people's group, devoted to the arts and sciences, obtained government approval and its radio section became the fore-runner of S.R.A.L. For its part, the government expected contributions to the art, and the construction of radio stations for broadcasting purposes in various parts of the country.

In early 1921, the league prepared a full list of members for whom transmitting and receiving licenses were desired; the request was granted by the government on August 21, 1921. Regulations issued by the "Radiotroops" stated, among other things, that only Finnish and Swedish languages could be used, and all codes, ciphers, and abbreviations (even Q-code) were prohibited. The regulations were, however, received with acclaim by "amateurs," since they were quite liberal as compared to those of some other European countries still uneasy from the effects of World War I.

Thenceforth, the record parallels the history of amateur radio in most other countries. In 1924, the annual report of the society stated that "no real ham is any longer using a wave above 100 meters." Results and records were being broken almost weekly. The trend downward culminated in the exploitation of 10 meters in 1929. The society was admitted to membership in IARU in 1932, during which year the first number of *Radio-OH* appeared, still going strong.

Finnish hams are not now on the air, probably because of the peculiar position of their country during the recent war years, but the society finds governmental authorities encouraging and hopes that amateur operation will be permitted again soon.

HK CONTEST

In a one-year contest begun August 1st, Colombian amateurs are competing in communication and experimentation on bands of 7 megacycles and higher, in the categories of (1) best DX record, and (2) success in technical experiments of national scope. Each amateur may enter in only one of the various band-categories.

R.S.G.B. REPRESENTATION REVISED

At its May meeting, the British *Society's* Council adopted changes to broaden its provincial

(Concluded on page 146)



K. S. Sainio, OH2NM, a recent visitor to IARU Hq., is chief engineer of Finland's broadcasting system, and was president of S.R.A.L. from 1928 to 1941. To quote his colleagues, "A full-blooded ham, his personal authority and energy started a program to raise the standards of amateur activity to the highest level."

● Technical Topics —

Simplified Transmitter Frequency Changing

APPARENTLY there are two schools of thought on amateur radio transmitter operation. Students of the conservative school, relaxed and easy going, are quite content to operate on a fixed frequency within a band and, in the rare occasions when the frequency is shifted to another part of the band or even to another band, they are not particularly concerned about putting the rig on the new frequency in 0.1 milliseconds. Our respect for these operators is very high, since they serve as solid pillars upon which to build any amateur band, but this story is not for them. This article is pointed for those frenzied wild-eyed operators whose prime requisite is mobility within a band, with a minimum of elapsed time between frequency changes. They are of the school that is interested in crystal switching, variable-frequency oscillators, gang-tuned transmitters, band-pass exciters, and all of the other dodges designed to accomplish that one ideal — a transmitter that handles like a receiver.

The problems encountered in high-powered, gang-tuned or broad-banded transmitters are all too familiar to those who have tried them, and so much special equipment and careful design is required that, thus far at least, the operating advantages seldom seem to justify the considerable work involved. Certainly a multistage v.f.o. can be ganged, and a low-powered exciter can be broad-banded, but above the minimum power level the problems get out of proportion to the final result. However, we would like to propose something that can be applied to practically any transmitter, past or present, and it will cut down the "swishing" time to a bare minimum. It is so obvious and simple that we hate to mention it, but here goes.

Dials for Transmitters

Yes, it's as simple as that. *Dials* for transmitters. Not the 100-division dials that some transmitters now use for "dress-up" purposes only, but an honest-to-goodness utilitarian dial designed for use on a transmitter. The reason the present dials are no good is obvious — any amateur band except 80 meters usually covers only a few divisions on any of the available dials, and to

A homemade transmitter dial made by reworking a National Type A dial. The transparent pointer is connected to the knob and is used for indicating frequency on the outer scales, when the white index mark is set to the corresponding arc on the inner scale. The bands are marked in the familiar wavelength designations instead of frequency mainly for traditional reasons.

use them for accurate reset would require a pocket microscope or excellent vernier and a calibration chart. No one wants to build bandspread into each stage of his transmitter because of the complexity, but it can be built into the dial. The only trouble is that no such dial is available at present. Further, the dial should have no printed scale but should be designed so that it can be calibrated directly in megacycles after installation in the rig.

To be sure, there have been transmitters built with calibration charts provided for the dial settings, and we are certain that with such a system it takes no longer to set up a transmitter on a new frequency than it does to open the vault at the Last National Bank, the principle being exactly the same. It seems likely that if one were deliberately to set out to devise a method for slowing up the retuning time of a transmitter, he would end up with the present dials, the chart, and a very loose neck, unless he were a memory expert or other mental marvel. On the other hand, if the dials were all calibrated directly in frequency, and they were easy to read, he could set his oscillator on the new frequency, set each dial as close to this frequency as his jitters and urgency would allow and, presto! his transmitter is in tune. Even if he missed the frequency by 25 or 50 kc., almost any transmitter stage will operate with this amount of mistuning without too much trouble. And, blessing of blessings, he didn't turn on the final stage during the tuning process and QRM his fellow hams except, of course, for the initial calibration of the dial. This latter we will forgive, provided it was done when we weren't on the air.

Naturally there are problems in applying transmitter dials to some rigs. The transmitter stages

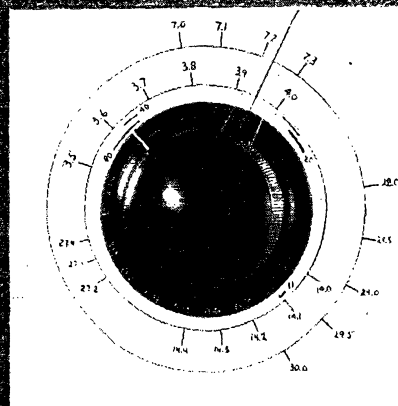

must have good reset accuracy in themselves, which means that the coils must be constructed so that they do not change inductance when they are handled during band-changing operations. Stages with swinging links may require that the link setting be marked for each band if the calibration of the tuning condensers is not to be disturbed, but capacity-coupled stages should give no trouble. Antenna tuning devices are probably the most difficult to hold in calibration because of changes in tuning with variations in the weather, and this is particularly true of tuned lines working into low-impedance loads.

A Suggested Dial

As we see it, this transmitter dial is just about the exact opposite of a receiver dial. Reduced drive to the condenser shaft is not important, but a magnification of the shaft movement is essential because of the small angular change over any one amateur band. Further, the scales must be capable of duplicating the same condenser setting, in the rather improbable event that three or four bands all tune at the same capacity setting of the condenser. It would seem that the dial must have two parts, an index and a scale. The index is connected directly to the shaft and serves to put the condenser in the general vicinity of the desired tuning range. The scale, which is inked in by the builder of the transmitter, has a pointer which may make from three to six revolutions to the shaft's one, thus magnifying the shaft rotation in that proportion. With normal *L-to-C* ratios, our biggest bands, on a percentage basis, will not occupy more than about 20 per cent of the total spread of a condenser.

One way such a dial can be made is by modifying the familiar Type A dial of the National Company, and it is shown in the accompanying

photograph. The normal dial, which is tied to the condenser shaft was turned down to a diameter just covering the mechanism of the dial, the numbers were scratched out, and a single radial index line scribed. A narrow pointer of Plexiglass was molded in hot cooking fat to conform to the curvature of the revamped dial and then fastened to the knob, and the lines were scribed on both sides and filled in with ink. Scribing the lines on both sides is a cheap way to avoid parallax and is a point worth remembering. The entire unit mounts on a paper scale which takes the calibrations. Two lines for calibration are required, and this will handle four bands even if they all fall at the same capacity setting! This is possible because most condensers without stops duplicate capacity at two settings — the butterfly types duplicate at four — and we can use both of these settings and the two lines to give four ranges. However, care must be exercised with a dial of this sort, because we understand that on rare occasions the knob can slip with respect to the dial if the load on the shaft is too great.

Other types of dials will occur to designers. One possibility is a small index directly coupled to the shaft, with the shaft driven through strings or gears by a larger dial alongside. The large dial would be self-calibrated and the drive to the shaft would be through a reduction mechanism.

The particular homespun dial described has one disadvantage that we can see; it takes up a little too much room and might not work into a crowded multistage exciter too well. However, we sincerely hope that some manufacturer will overcome this difficulty and give us what we need — a dial designed for transmitters! And if it is in two sizes, small for exciters and large for spacious amplifiers, so much the better.

— B. G.

BCI

THE OLD problem of interference with broadcast reception is very much in our laps again. All the familiar forms are in evidence, but recently the most prevalent kind has been the type that comes in "all over the dial" and is almost wholly caused by transmitters working at 28 Mc. and higher frequencies. As usual, it is a case of inadequacies in the b.c. receiver and not the fault of the transmitter.

This particular trouble occurs only in receivers located quite close to the transmitter or transmitting antenna — close enough to be in a fairly-strong r.f. field. The prewar 56-Mc. gang found out long ago that it was simply a case of r.f. getting on the grid of an audio tube (usually the first), then being rectified and amplified in much the same way as it would in an unselective 'phone monitor. The prime offenders are midget

a.c.-d.c. sets, where little or no shielding is the rule rather than the exception.

Knowing the cause, the remedy can be devised with some confidence. A very simple one, shown in Fig. 1, has been used with success in a number of cases by Bob Morris, W2LV. The 75,000-ohm

Fig. 1 — A resistor right at the grid of the first audio stage will act in conjunction with the tube capacitance to filter out r.f. picked up on the grid lead.

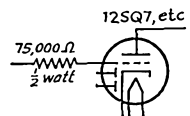

resistor is connected between the grid of the first audio tube, which is usually a duplex-diode high- μ triode, and all other connections to the grid. The resistor should be right at the grid terminal. In conjunction with the grid-cathode capacitance of the tube the resistor

forms a low-pass filter which prevents any appreciable r.f. potential from appearing on the grid. The resistor does not affect the operation of the tube as a normal a.f. amplifier.

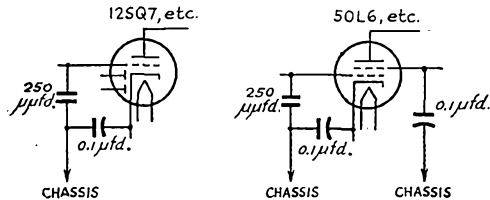

Fig. 2 — By-passing in the audio stages of a.c.-d.c. receivers to cure v.h.f. interference to b.c. reception. Ordinary cases of BCI can be cured by treating the first audio only, but if further reduction of r.f. pick-up is necessary the same treatment can be applied to the power output tube.

Another cure, contributed by Clyde J. Schoenfeld, jr., W6KNH, is shown in Fig. 2. It is based on the same principle of preventing r.f. from reaching the grid, but does it by by-passing. The connection to the chassis should be made as close as possible to the tube socket. None of the regular set connections are disturbed. W6KNH writes, "In the average case only the 12SQ7 (or similar) stage need be treated, but in very stubborn cases by-passing the power tube will at least reduce the interference to the point where it is only audible with the gain control of the receiver all the way off; when the arm of the potentiometer is moved a fraction of a turn away from the grounded end the b.c. signal comes in and the interference goes out. Smaller condensers may be used, but these values have been found to do the most complete job. In some cases, the cathode of the 12SQ7 stage is tied directly to the chassis; I found then that all that could be done was to add the other parts shown. If the receiver has a metal cabinet, the case must be bonded to the chassis and actual ground well by-passed to the chassis at all critical spots in the audio system."

These are cures, but the fundamental difficulty is in the receivers themselves. Turned out in mass production, with a few pennies in cost making a difference in competitive position, it isn't the easiest thing in the world to convince manufacturers that those extra pennies would be well spent — until the consumer himself realizes what is happening and demands something better. When you have BCI that's plainly the fault of the receiver, not your transmitter, give the owner of the set the straight dope — and have him go after the dealer that sold it to him. When the complaints become vigorous enough, manufacturers will listen.

In the meantime, fresh attempts have been made to get somewhere from the other end. The first step has been taken in the form of a resolution in the newly-formed Amateur Committee in

RMA addressed to the Engineering Division, calling attention to the situation and recommending that b.c. receivers be designed with amateur interference in mind. It's the first gun of a probably long war, a war in which every ham can help by letting it be known on every possible occasion where the real root of the trouble lies.

— G. G.

Silent Keys

IT IS with deep regret that we record the passing of these amateurs:

- W1KDV, Major Gerald H. Hoffman, Brattleboro, Vt.
- W2LCX, Lawrence E. Suhadolink, Freeport, L. I., N. Y.
- W3AA, Donald L. Primrose, Baltimore, Md.
- W3AFG, Richard W. Bogert, Allentown, Penna.
- W3BVY, Godfrey F. Hundertmark, Langhorne Manor, Penna.
- W4EYA, T. H. Weaver, Rutherfordton, N. C.
- W4KB, James T. Long, Niceville, Fla.
- W6JFO, Robert O. Carlson, Phoenix, Ariz.
- W6OAV, Ray S. Rosasco, Stockton, Calif.
- W6UQE, ex-W9YCL, Scott L. Bloomfield, Bell, Calif.
- W8IEJ, Edwin Bryan, Port Huron, Mich.
- W8QIH, Sgt. Richard J. Sloane, AAF, Cincinnati, Ohio
- W9MUB, Lee Stann, Chicago, Ill.
- W9NVX, CRM Laurel D. Holdridge, USNR, Waterloo, Iowa

Strays

Excellent high-voltage feed-through grommets can easily be made by cutting wafer-shaped cross-sections of the vinylite dielectric used in coaxial cables. — W6EFH

Brown areas on the screens of cathode-ray tubes employing electromagnetic deflection and electrostatic focusing are eliminated by the use of an iontrap gun, now being incorporated in tubes such as the DuMont 10BP4.

Ions, which are much heavier than electrons, are also emitted by the tube's cathode. They are practically immune to deflection by magnetic fields of the intensity generally used, and consequently bombard the center area of a cathode-ray tube's screen, causing its disintegration. The ion trap is mounted around the neck of the tube, before the focus coil, and it separates the ions from the electron stream by means of combined magnetic and electric fields.

Color

BY "SOURDOUGH"

MARTHA SEES to it that I go to church purty regular. Ain't really any need for it when we got our regular preacher, fer he talks right good common sense and keeps it down to jest the right length. Anyhow, 'sides bein' a preacher he's a man and the best feller with a fly-rod in these hills.

Howsomever, last Sunday we had a temporary fill-in feller. Mind ye, he done his best but he run on, better part of an hour. What with spring outside and him not interesting me much, I got thinking about ham radio. Guess maybe the inside of a church — 'specially our little one, 'cause we built it ourselves — turns a man's mind to something besides circuits and such. Maybe it was the sun streaming through the stained-glass window (that's the only thing we here didn't make) that got me thinking about color.

Now I like dogs fine. I sure admire a good black cold wet nose on the front end of a dog, fer it means he's in swell condition — but I'm hanged if I see why my gear should look like the end of a dog's nose, only dry. Black crackle is right professional stuff and looks efficient, but it sure don't dress up a room any. Like Martha sez, a rack-and-panel job that's all dull black looks bigger and uglier than it really is and don't fit in with nothing — 'cept maybe an undertaker's parlors.

Maybe we took to using black panels when we graduated from the hard-rubber ones, kinda carrying on the habit of having black around. Say, do some of you real old-timers remember them slanting panels we had, with wiper switches all over, and how if you let 'em set in the sun the hard rubber turned a sad sorta greenish-brown and either you had to live with it or else take all the junk off, wipe her down with steel wool, and then oil to get the black back? — yeah, and also how the tarnation things usta warp a little and throw the switches outa line? Waal, just before the war they wuz beginning to use a quiet sorta grey color and even a light blue for big switchboards. Wuz restful to the eyes and looked neat.

Right here I kinda come out of it. Martha has a right sharp little elbow and if I get glassy-eyed during the sermon she rams it into my old ribs about a foot, and somehow she manages so's the neighbors don't see. So I sneaks a quick sidelong peek at her but she's way off with her own thoughts somewheres. OK, I kin go back to mine, too.

Remember seeing in some magazines some fur-rin-made gear with white panels, black knobs, and that kinda dark silvery finish on the dials — sure looked crisp. Why, shucks, I remember when a feller was supposed to wear only a black hat — or

maybe sometimes a brown derby when he went up to the city — and lookit what fellers wear nowadays! Going over it real judicious-like, I come to the conclusion that we stick to our funeral-lookin' stuff mainly outta force of habit.

'Bout then come to with a jolt and stood up just in time to join in the hymn. After the service we wuz drivin' home not sayin' much. Specially on a spring morning, the quiet clop-clop of a horse's hooves makes a sorta background against which talk seems not needful. Never did believe there was much in telepthy but sure is true that every now'n'then me and Martha is thinkin' about the same thing. She opens up after a bit and wonders why, now that I'm all busy rebuilding, I don't try to make the shack look a leetle cheerfuller.

So now we been sketchin' and schemin' and Martha got out her paintbox that she ain't used since she give up schoolteaching to marry me. By gurry, a little drop of color in a nice clean line here and there sure looks swell on paper! Got an idee, too, that when the grey days of winter roll around

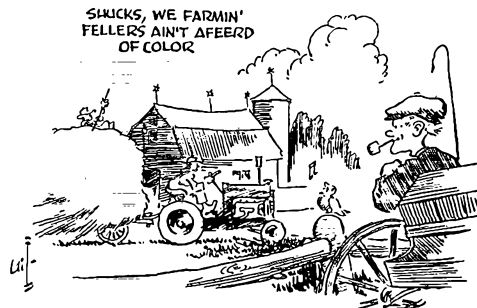

agin it'll be real nice to have a coupla boards starin' at me that don't look colder'n what I see through the window. Shucks, we farmin' fellers ain't afecd of color. Ever see how some fellers paint their wagons and tractors, or the color of some barns (see one or two farmers with noses that war pretty bright, too; course not around here, fer we drink applejack and not corn squeezin's) or the colors the manufacturers put on harvesters and such? Come to look into it, it don't all have to be the paintpot. You take this here plastic edging fer linoleum and such. Comes in all kinda colors, don't cost much, it's light and easy as you like to work. Guess I'm gonna see a lot of that there stuff fer other reasons than color: y' see, I never can quite get the edge of a bit of masonite or plywood to come out straight and nice — plane as keerful as I can, it always looks like the mice been at it. But with this here plastic

edging you just saw the panel off pretty good and then finish off the edge with a nice bright smooth dead-straight length of plastic. The store that has the plastic edging can dish out some special sticky goop, and once that's set you need to blast

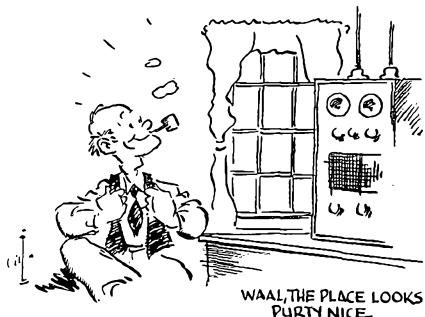

to get it loose. Most of you fellers also know about the chromium-trim strips, look like dollars and costs cents as fer as appearance is concerned.

Masonite takes paint fine. Don't laugh too hearty when I tell you that I put mine on with an ordinary "Flit" gun. If the panel ain't too big it sprays good as a paint shop. Three or four coats of good enamel and she shines like a new-groomed filly — but set it to dry where there ain't no dust, no drafts and no bugs to sit on it and get stuck. Easy even to stick a bank of electric lights on a bent piece of tin and make a homemade infra-red drier — no trick at all.

So I got a new transmitter going up. The panels will be jest a shade more gray than white. Around the edges there will be a bright red plastic trim (OK, laugh, dang ye! — fer you ain't seen it and dunno). Same around the meter-panel cover glass (only it ain't glass, it's lucite) but narrower. The knobs will be black as usual but the dials will be a toned-down silver. There'll be a space between the upper and lower panels so's I kin see how the plates are doin'. The edges will be trimmed with chromium strip and there'll be two-three chromium bars so's the odd visitor don't touch the pretty bottles — and 3500 volts to boot.

Havin' started this bust, I reckon to fix up the shack some. Even put some Celotex panels (second hand) on the ceilin'. Martha she's taken over the beat-up old operating table. Scraped off what was left of the varnish, she did, and painted it up a nice peaceful grey. The top wuz all scarred (bet yours is, too) so over that she put a piece of light-green linoleum or summat like that. Idea is that green don't tire the eyes so much.

Waal, the place looks purty nice. Seems about twice as big as before, and much more peaceful-like — and there ain't nothin' pansy about it. Truth to tell, when we wuz comin' along with the job I wuz right fearful about what the boys would think and maybe send me a hair-ribbon or something. It's OK — all the gang have seen it now and no cracks from them. Martha (you know

women), she showed it to all these fellers' wives, so now I gotta hunch that some more shacks is going to get brightened up — all save one bachelor-fellow, and anyhow Martha sez he don't have a shack, he has a shanty.

Pity *QST* don't run color plates, otherwise Mr. Warner might publish a pitcher (— then again he might not!). As is, you fellers will just hafta imagineer as best you can — and I never see a ham who wasn't past master at *that* — and draw yer own conclusions. Ain't no use writing snooty letters to me, 'cause I like it and ain't gonna change it.

Say! — been on 28 Mc.! (Who hasn't from the sound of the band?) Sure is swell to hear them fellers in the various armies of occupation clearing stuff. QRM ain't so swell but, having an affection for that band, I gotta hunch that a whale of a lot of fellers will move off onto the other bands when they come on to the book and will swear that they'll never touch 28 Mc. again. And, if they stick to it, that's OK by this old feller.

Strays ¹⁹⁴⁴

"When Sgt. Gus Bellavit, W8TVA, a loyal non-resident member of Hamfesters, received his discharge from AACs after pounding brass in Brazil for 2½ years, he stopped in Chicago on his way home and looked up Rudy Barber, W9EZF, an old pal on 80-meter c.w. Rudy promptly invited Gus to visit him at his home and arranged to meet him at the Service Men's Center on South Michigan Avenue, but since neither had ever seen the other, the problem of identification arose. This was promptly solved by having Rudy bring along a copy of *QST* which he carried under his arm!"

— Hamfesters' Ham Gab



"Free Ad" Department: Corner signpost in Brunswick, Ga., spotted and photographed by C. D. Justis, W1JVS.

Sign of inflation noted on the 28-Mc. 'phone band: "W-1-money-means-nothing [W1MMN] to W9OPA."



How's DX?



How:

Well, how does it taste? From the sound of things, many of the lads lopped off a lot of stuff the first month of being back on 20, much of it very savory indeed. There are enough countries on that were impossibly rare before the war to make things very interesting — CR9, ZD8, VS9, EP, AC3, and a bunch of islands we don't know how to count yet — and enough other stuff to keep almost everyone happy. We even have WØs and VE7s and 8s, so no one is left completely out in the cold, except possibly that fellow who is waiting for spark to come back. In fact, things are so nearly normal, what with the old familiar edge-crowding, VFO-climbing and QSL-begging, that we fully expect someone will show up shortly who has worked both AC4YN and AC3SS and is worried for fear we won't count them as two countries! [But it won't be WIJPE, will it? — *Jeeves*]

The way things are right now, the jam calling DX on 14,100 gets a little bad once in a while, and a few Ws for whom we have an indescribable admiration allow themselves to get shoved outside yet. If the DX stations find this jam difficult to copy through, we suggest they change their listening practices and reply to calls from farther down in the bands. As we've said before, a lot of the QRM is caused by listening habits, and it can be alleviated to a slight degree by better operating practices. The old HM, MH and ML are very handy signals to have and use to show how one is tuning.

We are pleased to report that, as a result of our excellent technical suggestion last month, one W9 bought a switch for his final power supply, for use while shifting frequency. He explained his rash act by, "Aw, I never use the thing." We believe him, and it's little incidents like this that go a long way toward making it all seem worth while.

What:

Good old 80 and 40 won't receive much attention this month, but in passing it should be mentioned that W9DXL worked WIDTS/CT2 on 80, and W5EWZ on 40 got himself some XEs, ZLs, VKs and KL7s, with 20 watts to a 6L6 crystal oscillator.

Ten meters was dropped like a hot 6L6 by the DX gang and is now back in the possession of the Indians. However, we will welcome 28-Mc. DX reports at any time, if there exists a soul hardy enough to desert 20 for a few 10-meter contacts.

Let's not kid ourselves, though. Right now 20 is the pay-off band, and there aren't too many guys yet who have worked everything they've heard. W6LER starts the story with CR9AG (14,085), EZ4X (14,090), ZE1JI (14,120), HK4AF (14,050), HR1BD (14,175 T7), "wotta signal" WIDTS/CT2 (14,110) and VK9AZ (14,070), all worked on a vertical folded doublet W6PBV then picks up the ball with ON4GU (14,070), OZ2LX (14,075), F8BS (14,080), HB9CE (14,100), HB9AW (14,060), D4ALS (14,090), I1AY (14,100), ZS1W (14,180), XAPQ (14,080), SM3ZF (14,075) and lots of Gs worked, and TF3AZ (14,100), FM8AD (14,085), EI9N (14,095), WØNVF/KG6 (14,205), ON4AU (14,075), I1KN (14,080), OQ5LL (14,190), PAØNG (14,090) and SM5LK (14,080) in the "heard" column W7EYS has four half-waves in phase on Europe, and it helped him raise ON4GW (14,060), D4ADN (14,120), ON4SW (14,055), SM5ON (14,070), and F8PQ (14,080), and to hear AC3SS (14,305 f), SV1KE (14,090), OZ7F (14,070), EI6G (14,040), UA3KBC (14,065) and CE1AR (14,075 f) W8ROX got EL4A (14,120), W9HJW/Saipan (14,145), PZ1RM (14,120) and VP4TR (14,035), and W3BKZ scared up the very peachy EQ4DC (14,140) W4BRB grabbed off ZB2A (14,095), VS9AN (14,140), C3YW (14,095), VO1G (14,030) and VP1HN (14,140 T6) W6KIP has some choice stuff, ranging from an 80-meter QSO with W8QEN/CT2 and the tip that W6GRL worked AC4YN (14,160) to meaty items like VK4OS (14,195) in Papua, VS4RM (14,120), CR9AN (14,110), PK5LK (14,155), VU2LR (14,110), VU2BG (14,090), XZ2GS (14,055), PK1RI (14,095) and ZD8A (14,070) worked, with unfinished business VS1QB (14,070), VS1BU (14,150) and XACP VE1EP managed to sneak in UA3DA (14,075) and EL3A (14,045) before his vacation; and spotted KA1AE (14,125), LB3ZA (14,095), OQ5BR (14,125), OI2KB (14,095) in Upper Slobovia, no doubt; W2AMH/J9 (14,200), LZ1XX (14,095), VS4JH (14,100) and YI2BA, (14,085). How can anyone go on a vacation with those guys coming through? W1KMY knocked off IILA (14,125), VO2RM (14,210), VO6F (14,180), ZS6GO (14,100), OZ4H (14,110) and ON4SG (14,100), and W9ERU heard HP3L (14,045), YI5AL (14,030), and CT1JS (14,060), who sometimes forgets the "CT" in his call W2ATJ, ex-W3ATJ, worked PZ1FM (14,130 T6), VE8MM (14,065) at Baffin Island and F1F in France, and W2LSN got OQ5-

JF (14,180) ····· W6TND/4 in Virginia is ready to start the old "the-East-is-better-than-the-West-for-DX" argument, and as proof submits PAØUN (14,110), VP9D (14,030), YR5C (14,075), TA1DB (14,050) and FA8RA (14,050) in the "worked" column and ZC1AR (14,040), YN1LB (14,015), HH3L (14,080), UA3AW (14,090), VP5AR (14,025), and LA7R (14,100) in the "heard" department.

The 'phone contingent is well represented by several old reliables. For instance, W9NDA with OX1AA (14,330), EP1C (14,320), EA1D (14,325), LX1SI (14,075), W3IYC/J2 (14,315), CN8MA (14,305), YS1EO (14,120), CT2FR (14,305) and KA2SD (14,160), and W2MPA with VK6KW (14,140), HK3CS (14,005), YR5RW (14,390), I1MT (14,070), YV5AN (14,030), VP2MY (14,330), OA4M (14,300), SU1KE (14,300), PAØJQ (14,360), W2JE/J9 (14,260) on Okinawa, CX2AX (14,020), OX2MJ (14,160), KA1ABD (14,270), F8YI (14,160) and many others ····· That man with the push-pull rhombics, W6ITH, is right in there all the time, and came up with VS2BA/VS1 (14,205), C1MG (14,305), VS1BD (14,125), VS1BQ (14,175), J9ABF (14,245), J9AAG (14,260), C1PL (14,100), W6OCA/J3 (14,125), ST1EA (14,170), OA4F (14,325), CP5EA (14,030), LX1S (14,075), ON4RIL (14,075) and HC1JW (14,035), to mention a few.

Where:

G8KP had 42 countries in a few days on 14 Mc., and passes along several mailing addresses: ZD8A, Pieter Renard, Georgetown, Ascension Island; UAØKAA, QSL via Box Nr. 88, Moscow; VS9AN, QSL via R.S.G.B. The UAØ is at Dicsen Island, 73° N., 80° E ····· If you don't have a card from EK1IND or FA8AB for your 28-Mc. contacts early this year, try a card to W2IND in Hillburn, N. Y. ····· Cards for PZ1FM can go via W4FVI, W. T. Reid, jr., 843 S. W. 13th Avenue, Apt. 5, Miami, Fla., or direct to Box 118, Paramaribo, Surinam ····· W8PQQ says ZB1E is on 10 'phone and c.w. and can be reached thus: R. F. Galea, 20 Collegiate Street, B-Kara, Malta ····· And W1COI adds ZP8CN (14,340 f), John Recalde, 381 Alberdi Street, Asuncion, Paraguay, and PZ1A (14,320), Box 679, Paramaribo, Surinam ····· Cards for VP1HN should go via G3HN, according to W3BKZ ····· Beg poddon, but cards for EZ4X should go to HB9CX, not HB9J as suggested recently.

Operating:

A suggestion just came in from a well-meaning 10-meter man that deserves some discussion. He suggests that ". . . foreign stations might devote 15 minutes to a half hour to a period where they would announce that they are tuning from 28,500 to 28,600 for a 2 to 3 minute period look-

ing for stations calling them, and that the stations calling should call once or twice and sign once or twice repeatedly for that period." The DX station would then come back, reel off a list of calls and the corresponding signal strengths, and repeat the process for stations calling him between 28.6 and 28.7 Mc. and so on. As a matter of fact, TG9PB has already been doing just that.



While it might seem like a good practice at first glance, it could very easily make DX-working a meaningless sort of thing. In the first place, does one exchange QSL cards for a contact like that? If they do it isn't anything more than a "heard" card, because no two-way communication took place. And it wouldn't be too difficult to get a card from a foreign station without ever hearing him, just by calling when the band opens up on him, so QSL cards would be meaningless. It certainly behooves every DX man who wants to protect his own achievements to report and discourage any such type of operation, even though it may appeal to a few mass-production-minded fellows. This shouldn't be confused with the type of operation of some fellows who come back to a string of fellows and work them one after the other. This is two-way stuff, and is quite OK for the mass-production gang. But unless you guys want your legitimate confirmed DX to be put to shame by these pseudo contacts, you'd better bust up any of these alleged short-cuts before they get started.

In the case of the suggestion that started all this, if TG9PB or anyone else wants to use a system like the one outlined, let him come back to one station, the loudest, or the weakest (if he's in a big-hearted mood). When working that station he can report the others he heard calling him, and if they're interested they can eaves-

drop. They'll know they've been heard, but they won't try to take credit for a contact they didn't make.

Who:

A swell letter came in from CR9AG who, as many of you know, is old VS6AG of Hongkong and he needs no further introduction. John says that he and CR9AN, ex-VS6AN, are the only two on Macao and, along with VS6AF are all that is left in the East of the old VS6 gang. However, licenses in VS6 should be along soon for the several new applicants. 9AG has a 150-watt rig and an NC-100A, and already has 56 countries and a 28-Mc. WAC, since March. And, best of all, he expects to be in Macao for some time, so everybody should get a chance at him. Remembering his operating from VS6AG, we know he can handle the eagerest of beavers If some F7 calls start showing up, they will be GIs allowed to operate in France, according to W8PHZ W6TI says VS4JH can be QSLed via R.S.G.B., but we carried his Borneo address in the column a few months ago, so you should be able to reach him by mail. He has mailed 250 out of 1000 cards so far ZD4AD is now in Nigeria and doesn't have a call there yet, but he will SU1US (14,140) has a walloping signal but has been giving the lads some concern with his "QTH-Fingers" routine. He is in Cairo and his name is Fingerman and his — no, I won't use that horrible expression! — he is called "Fingers" by his friends Don't miss that letter by W9STU in "Correspondence from Members" this month, if you are at all interested in the Pitcairn story Mac at W8LZK/NY4, Guantanamo Bay, has been having himself a time. Being the pursued instead of the pursuer now, he finds that the Ws are perfectly willing to cooperate with him so long as he will work Ws. But let him call some DX, preferably an Asian, and he finds the Ws sliding and slurping up to the DX for a shout at poor Mac. He doesn't care for himself, but his wife is urging his giving up ham radio because his language lately is not fit for the children to hear! From W6HG we learn that W9SMA/Christmas Island is being dismantled, but one of the ops is moving to Palmyra and will use his own call, W7ITW/KP6, just to keep that part of the Pacific active A note from G2PL to let us know that Pete is back on the air, with 53 countries accounted for via p.p. 807s. And the 'phone bug finally got him, for a total of 10 via the chin route W4BPD is back with a bang and a fistful of DX, including CN8L (14,190 T7), EZ4F (14,090), UA3AJ (14,090 T4), and PK6TC (14,120) worked, and CP5EL (14,045, 14,090), J9ANB (14,130) and W4DNY/KA (14,115) heard. Gus is curious to know where W6CUH, W6QD, W8CRA, and some of the other DX hounds are. We don't know for sure, but we expect CRA will

show up presently with 100-odd countries worked postwar, W6CUH is working on Long Island and isn't on the air, and W6QD, when last heard, was working on a W5 for a card from New Mexico. There is no truth in the rumor that Herb is pretty confused about the new WØs. When asked about it, he replied, "It's OK with me, although it does make the W9s a little harder to find." And W2OAA/J8 has raised his total to 55 with stuff like ET3Y (14,150), Box 1191, Addis Ababa; CN8ZZ (14,120) and FK8OSL (14,160), in New Caledonia. Harry heard HZ3FI, QSL via R.S.G.B., SV2R (14,100), and ZA2A (14,090). He is still due home shortly W6PBI is leaving two HT-4s at XU1YO for a radio club, so the call will remain active on 10 and 20. He worked about 70 countries from the location, so it can't be too bad. Included in his list were AC4YN, VQ6MI, VQ3TOM, HS2F, FC8Q, VS7CX and VQ4MNS W8HGW had 69 last time we talked to him, but it's lots more now, no doubt. He got 61 of them on 10. He says DX competition is getting so tough out his way that the 'phone boys turn in each other to the RI for overmodulation. Ah, the old sporting touch! The latest at KF6SJJ/W1 includes YI5AL, YR5X (14,075), ZD8A and UAØKAA. Bob says he now has lots more time to operate — he got his W1KFV call back. Oh, well, there goes some of the Europeans' best DX.

— W1JPE

Strays

Casimer "Socky" Sroka, W8FPC, has been awarded the President's Medal by the National Safety Council, in recognition of his action in saving the life of a fellow employee at the testing division of the General Electric Co., Schenectady, N. Y. The employee, who was rendered unconscious from contact with a 2800-volt circuit, was revived by W8FPC's prompt application of artificial respiration.

**SWITCH
TO SAFETY!**



Don't despair, OM, if the XYL's hollerin' 'bout the light bill and you can't get 90 per cent efficiency in the final. Wait'll you take up television! A modern tv. station like WABD, New York, requires upward of 200 kw. just for lighting a studio. Transmitter output? A mere 4 kw. for video and 1 kw. for audio.

A Combination Test Meter

A Versatile Device for Transmitter Checking

BY ROBERT H. DELLAR,* W4ICC

SECTIONS 12.133, 12.134, and 12.135 of the Rules Governing the Amateur Radio Service specifically require that amateur transmitters shall be free of spurious emissions, shall not, in the case of A3 operation, be modulated more than 100 per cent, and shall be provided with means to check operation and to assure that the operating frequency is within the amateur band used.

In view of these regulations it is indeed surprising that only a comparatively small number of amateurs have provided themselves with means to insure proper operation, most depending only on a neon lamp, a receiver, or reports provided by contacts with other amateur stations. It is true that many of us cannot afford expensive test equipment or cathode-ray devices, but such simple gadgets as 'phone monitors and calibrated wavemeters can and should be a part of every amateur station. It is hoped that the instrument to be described will have sufficient appeal to the average amateur to promote his interest in determining the operation of his transmitter and thus perhaps save himself considerable correspondence with the FCC.

The recent appearance of the 1N34 crystal-diode rectifier has made possible a simple and extremely-sensitive device, requiring no batteries, no tubes, nothing to turn on or off, and having no cathode contact potential. As shown in Fig. 1, it is essentially a wavemeter or field-strength indicator with a crystal diode, the output circuit being arranged so that the indicating instrument, a 0-1 d.c. milliammeter, reads either the rectified carrier or rectified audio. The audio signal is rectified by a copper-oxide unit for the a.f. measurements. By means of a calibrating resistor, R_1 , the carrier and modulation voltages can be proportioned so that the milliammeter will indicate percentage of modulation. A 'phone jack, J_1 , is included to make provision for aural monitoring.

With the d.p.d.t. switch, S_1 , connected to position No. 1 the device becomes a sensitive wavemeter, field-strength meter, carrier-shift indicator, neutralizing device, and 'phone monitor. With the switch in the No. 2 position the instrument may be used as a volume-level or modulation-percentage indicator. In addition, it may be used as an output meter when the pin jacks are connected to the loudspeaker terminals of a receiver.

*P.O. Box 347, South Miami, Fla.

The entire unit is housed in a six-inch cube-shaped box with removable front and rear panels. With the exception of the tuning condenser, coil socket, and antenna feed-through insulator, all parts are mounted around the 0-1 milliammeter, so practically all the wiring can be completed before the panel is mounted on the box. After assembly only one last connection need be made; namely, connecting the plus end of the 1N34 diode to the condenser stator plates. A two-foot length of $\frac{1}{4}$ -inch brass rod, threaded at one end to fit the feed-through insulator, completes the job.

Using the Meter

In field-strength work it has been found that the meter will give a good indication, using the two-foot antenna, at a distance of more than 50 yards from a 28-Mc. antenna radiating about 50 watts. A good signal can be heard in the 'phones at a distance of more than a block from the antenna and beyond the range of meter indication. If greater sensitivity is desired a longer antenna or one cut to the operating frequency may be used. However, for general antenna-adjust-

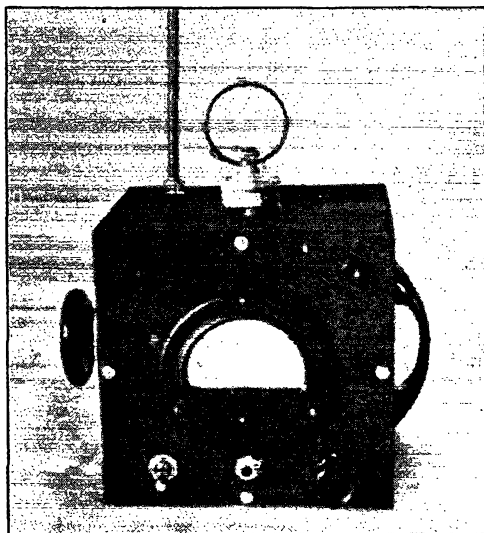

The combination meter in its 6 × 6 × 6-inch box. The tuning control is on the left-hand wall of the cabinet; all other controls and terminals are on the same panel on which the meter is mounted. The tuned-circuit coil and pick-up rod antenna are on top.

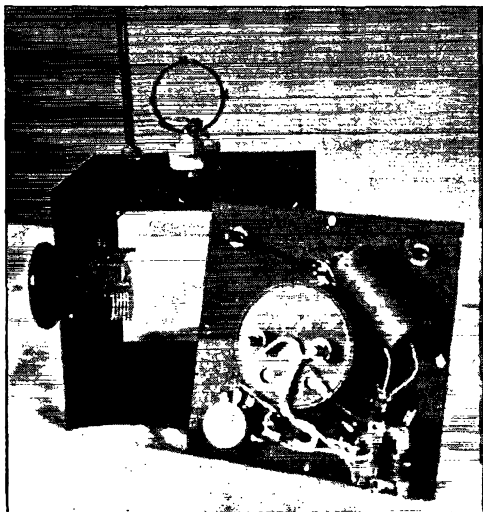

With the exception of one connection, all wiring can be finished before the meter panel is fastened in place on the box.

ment work the two-foot rod is satisfactory. Calibration of the instrument as a wavemeter may be easily done by following any of the methods described in *The Radio Amateur's Handbook* in the chapter, "Measurements and Measuring Equipment."

With the switch S_1 in position No. 2 the percentage of modulation or hum can be determined. However, before this can be done, it will be necessary to calibrate the instrument so that a carrier tone-modulated 100 per cent will be indicated by a full-scale deflection of the meter. This may be accomplished by the following method: With a tone-modulated carrier, indicated at 100 per cent by some accurate means such as a cathode-ray oscilloscope, the meter, with switch S_1 at position No. 2, is brought within the field of the antenna or transmitter until the meter reads full scale or one milliamper. Resistor R_1 is now set to its

About the Author

• Robert H. Dellar, W4ICC, at the present time is officer-in-charge of the FCC monitoring station, South Miami, Florida. He knows our problems and his article should provide enlightenment on many points. The author's first call, W7BAK, was received in 1928. His main interests nowadays (when not listening for our misdoings and signing pink tickets) are traffic handling and experimenting. Before becoming associated with the FCC in 1940, W4ICC was in charge of KGHS, the Spokane, Wash., police radio system. He is a member of the Dade Radio Club, Miami.

maximum value to prevent damage to the meter and the switch S_1 is thrown to position No. 1. Next, adjust R_1 until the meter again reads full scale. This value of resistance or the position of the control knob should now be marked so that the resistor may be set at any time to this value for meter calibration. Now all that is necessary to read percentage of modulation is to set R_1 to the marked value, place switch S_1 in position No. 1, tune C_1 to resonance, and bring the meter within the r.f. field until it reads full scale. With the switch thrown to the No. 2 position the meter will read full scale when the carrier is 100 per cent modulated with a steady-tone signal. On speech, however, an average deflection of 0.6 or 0.7 ma. will be sufficient for a fully-modulated carrier.

Hum level can also be measured by noting the meter reading, if any, when no sound is permitted

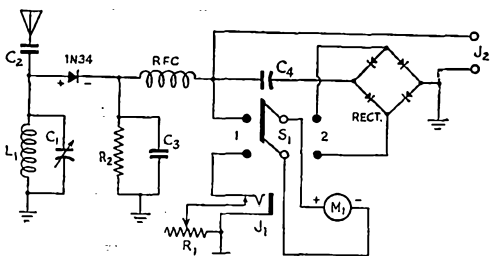

Fig. 1 — Circuit diagram of the test meter.

- C_1 — 100- μ fd. variable.
- C_2 — 0.001- μ fd. mica.
- C_3 — 100- μ fd. mica.
- C_4 — 0.5- μ fd. paper, 200 volts.
- R_1 — 25,000-ohm potentiometer.
- R_2 — 25,000 ohms, $\frac{1}{2}$ watt.
- L_1 — 28 Mc.: 3 turns No. 18, diameter $1\frac{1}{2}$ inches, length $\frac{1}{2}$ inch. 3.5 Mc.: 35 turns No. 26, diameter $1\frac{1}{2}$ inches, length $\frac{3}{4}$ inch. Note: Any set of standard coils may be used to cover the various amateur bands.
- J_1 — Closed-circuit jack.
- J_2 — Pin jacks.
- M_1 — 0-1 d.c. milliammeter.
- Rect. — Type-A4 5-ma. copper-oxide rectifier.
- RFC — 2.5-mh. r.f. choke.
- S_1 — D.p.d.t. toggle switch.

to actuate the microphone, the gain control in the speech amplifier being at its normal setting. A deflection of 0.05 ma. or less will indicate a practically hum-free carrier.

It has been found that the calibration resistance will hold for transmitters of any power on any frequency. To establish this fact checks were made against a 1-kw. broadcast transmitter on 1370 kc., a 200-watt transmitter on 75 meters, and a 70-watt transmitter on 10 meters. In each case the required value of calibrating resistance at R_1 was the same.

Because the instrument depends for its opera-

(Concluded on page 152)



The World Above 50 Mc.

CONDUCTED BY E. P. TILTON,* WIHQD

IN all the years since v.h.f. DX was first worked, July has come to be regarded as the peak month for work beyond 2000 miles. July, 1946, was no exception. The whole spring DX season, in fact, followed familiar lines. The early openings in May were erratic and of very short duration, the thrill of the first postwar DX making up, in a large measure, for the fly-by-night nature of most of the contacts made. June was better. Signals were in for hours at a stretch on several occasions, and the 50-Mc. band was open for DX work somewhere in the country practically every day. During July, the number of openings declined, but on at least four occasions there were opportunities for work beyond 2000 miles, the climax coming, as in years past, on July 27th. At this writing, we have reports of skip work for 16 days in July.

July 1st was a good day over most of the country. No double-hop work has been reported for that date, but W1CGY, Athol, Mass., heard W7QAP, Tucson, Arizona, for a period of nearly an hour around 3 P.M. EDST, when Keller was in contact with stations in Washington and Oregon, and had his beam aimed north! On July 5th, the existing record of 2500 miles was equaled, when W6NAW, Los Angeles, worked W1LLL, Hartford, Conn., at 6:15 P.M. EDST. This QSO was solid, and was followed by a fragmentary contact with W8CIR/1, Boston, during which time W6NAW was heard by several other W1s.

The evening of July 14th was excellent all over the country, and contacts were made for the first time between several call areas, notably W4-W6 and W4-W7. Here are a few highlights from the bale of reports: W1NWE/4, Orlando, Fla., worked 16 states and Canada, in a total of 30 different stations. W8OMY, Pittsburgh, worked W6s AOR, QUK, QG, FMH, NAW, ANN, and OZV, all over 2000 miles distant. W4CYW, Richmond, Va., worked W5JGV/7, Douglas, Ariz., and had a partial contact with W6ANN. W4HVV, Raleigh, N. C., worked 13 states and 7 call areas, his 19 contacts including W6s NAW QG, ANN, and W5JGV/7. W2PWP (ex-W3HDJ), Delanco, N. J., and W2AMJ, Bergenfield, N. J., worked W5JGV/7 and heard W7QAP. W2BYM, Lakehurst, N. J., heard W5JGV/7 and W6ANN. W2BQK, Bergenfield, was heard by W6RVL

RECORDS

Two-way Work

- 50 Mc.: W6OVK-W2BYM
2500 Miles — June 14, 1946
- 144 Mc.: W3HWN-W1KOE
310 Miles — July 5, 1946
- 420 Mc.: W6VQB/6-W6URA/6
96 Miles — July 5, 1946
- 2300 Mc.: W1JSM/1-W1LLS/1
1.6 Miles — June 23, 1946
- 5250 Mc.: W2LGF/2-W7FOF/2
31 Miles — December 2, 1945
- 10,000 Mc.: W4HPJ/3-W6IFE/3
7.65 Miles — July 11, 1946
- 21,000 Mc.: W1NVL/2-W9SAD/2
800 feet — May 18, 1946

and W7ERA. An interesting feature of this opening is the fact that although the W6s and W7s were heard and worked by stations along the Atlantic Seaboard from North Carolina to the New York area, they were not heard by any W1s, nor have there been any reports of W1s being heard out there on that evening. The opening was very widespread, and real QRM showed up on the low end of 50 Mc. for the first time.

New England got another chance on July 27th, when the signals of W7QAP and W5JGV/7 appeared in the midst of a welter of W9s and W8s. W5JGV/7 was over S9 for the better part of an hour, during which he worked most of the W1s and W2s who were on at the time. Numerous W9s were in steadily for several hours, their signals holding well over S9 practically all the time. They were heard over wide areas simultaneously, in contrast to many other openings when stations separated by only a few miles were unable to hear and work the same signals.

The rising curve of signal strength on 144 Mc. continued in July, and the distances being covered expanded accordingly. The recognized record for 144-Mc. DX was recaptured by W3HWN, Mechanicsburg, Pa., when he contacted W1KOE, Wakefield, R. I., on July 5th. The distance is 310 miles! With the keen competition between the East and West Coasts for the 144-Mc. record, this one is not expected to stand too long when the news gets around in California!

* V.H.F. Editor, QST.

WHO'S WHERE ON 6?

W1DIC	Worcester, Mass.	52.3 Mc.
W1HPV	Attleboro, Mass.	50.15
W1IXP	New London, Conn.	51.7
W1JTB	Shrewsbury, Mass.	50.16, 50.88
W1KQF	Mansfield, Mass.	50.32
W1NDM	Lakewood, R. I.	51.6
W2IDZ	Succasunna, N. J.	50.24
W2KS	Hanover, N. J.	50.2
W3AC/2	(Mobile)	51.8
W3AXU	Trenton, N. J.	50.2
W3CGV	Wilmington, Del.	51.4
W3FMD	Grenlocke, N. J.	51.8
W3FMP	West Berlin, N. J.	53.7
W3GOI	Camden, N. J.	51.0
W3GQO	Camden, N. J.	50.2
W3HEU	Clementon, N. J.	51.8
W3OR	Essington, Pa.	50.4
W4QN	Orlando, Fla.	50.9
W4HVV	Raleigh, N. C.	50.2
W5JGV/7	Douglas, Ariz.	50.3
W6JUM	San Diego, Calif.	50.67
W7OWX	Tucson, Ariz.	51.4
W8OAC	Akron, Ohio	50.83
W8SLU	Auburn Hts., Mich.	50.2
W8TDJ	Morgantown, W. Va.	50.2 — 50.5
W8DAL	Dayton, Ohio	50.7
W8JTF	Troy, Ohio	51.0
W8NPE	Dayton, Ohio	52.8
W8TFG	(Mobile)	52.0
W8WHI	Dayton, Ohio	50.1
W9QIQ	Marshall, Minn.	50.2
W9LMX	Elkhart, Ind.	50.01
W9QCY	Ft. Wayne, Ind.	50.005
W9PHV	Newcastle, Ind.	51.0
W9ACU	Browning, Ill.	50.45
W9YLV	Morton Grove, Ill.	50.46
VE3AXT	Toronto, Ontario	51.6

First 50-Mc. WACA

It took all the years until the summer of 1939 for the first operator to work all call areas on 56 Mc., W9ZJB, now W0ZJB, completing the grand slam in August of that year. The same feat (with it made a bit harder by the addition of the W0 area) took just two months on 50 Mc., the first to make it being Cliff Simpson, W0YUQ, Manhattan, Kansas, who completed the circuit with a contact with W1NWE/4, Orlando, Florida, on June 30th. W0ZJB was not far behind, but the W9 was a stumbling block for Vince, most W9s being in that in-between distance, 250 to 500 miles, which is probably the toughest distance of all to cover on 50 Mc. Vince got W9QCY, Ft. Wayne, Ind., during the big opening of July 14th. W9ZHB, Zearing, Ill., made it in July, by working W8CVQ, Kalamazoo, Mich. Note that these fellows had their greatest difficulty in working someone relatively nearby!

No one outside of W5, W8, and W9 ever worked them all on 56 Mc., though there were many fellows on the East Coast who lacked only one. Competition has been keen among the DX hounds of the Atlantic Seaboard to see who would be the first to make it on 50 Mc. For weeks, W8CLS/1, W2BYM, and your conductor have had only one to go, with many others close on our heels. The 27th did it — and W2BYM has them all — the first operator east of Pittsburgh to work all call areas on any v.h.f. band! Mel worked W5JGV/7 for his WACA, having had the even-

more-difficult W6 since June 14th.

Quite a few of us are just one away. W8CLS/1 and your conductor need W6; W1LLL lacks only W5 (Brownie has his log filled with "CQ W5" to no avail!); W2PWP (ex-W3HDJ) needs W6, as does W2AMJ; W5JGV/7 lacked only W3 at last report, and probably has it, by now; W4HVV is close, and may be "in."

Next — 50-Mc. WAS?

That these and many others in all parts of the United States have worked all but one or two call areas points up the fact that there is no place in the country where 50-Mc. work is impossible — yet there are eighteen states where no resident activity has ever been reported! These include Maine, Vermont, South Carolina, Kentucky, Tennessee, Mississippi, Louisiana, Arkansas, North Dakota, Nebraska, Oklahoma, Colorado, New Mexico, Wyoming, Montana, Idaho, Utah and Nevada. Several other states have only one or two representatives on 50 Mc., yet our WAS records show several operators with 20 or more states worked on 6.

Remember, we have a WAS contest for 50 Mc. in progress. Announced in May *QST*, page 58, it began with the opening of the 50-Mc. band, March 1st, and will continue until someone makes the grade. Contestants in the Marathon are automatically included, but if you are not reporting in the Marathon, be sure to send in your states-worked list each month. Participation is practically painless — simply send in a card listing at least one station worked for each state claimed, and then drop us a card each month bringing the record up to date.

A few states have representation on 6 where no activity was reported in prewar days. In Raleigh, N. C., W4HVV and W9WMI/4 have been doing an outstanding job, and through their efforts their state has been written into 50-Mc. logs all over the country. In addition to working 7 call areas on the 14th, W4HVV was heard by W7ERA, Milwaukie, Oregon, and heard W7AVV at Portland. The rig at W4HVV has an 815 in the final, at 50 to 70 watts input. The antenna is a 3-element horizontal rotary, and the receiver a Super-Pro with a home-built converter.

We miss the old gang who used to hold forth from South Florida on 5, but W1NWE/4 at Orlando has done very well at keeping Florida on the v.h.f. map. Grid's success has enticed two other Orlando stations into giving 6 a whirl. W4GIY has already had a number of DX contacts, and W4QN is just getting started as this is being written. These fellows would like more stations within local range, to keep things interesting when there is no DX. The Florida climate should be productive of very interesting v.h.f. propagation effects, and this part of the country will be one of the most favorable spots when the maximum usable frequency for F_2 work begins to

climb this fall. Skip-DX is possible almost every day during the summer months, judging by the log of W1NWE/4, who made skip contacts on 14 different days between June 23rd and July 20th.

As far as we know, there never was a 5- or 6-meter station in South Carolina, but this condition is about to be remedied by W2JUW/4 at North Charleston. He has been hearing plenty of DX, and promises to have a rig on the air shortly.

With W1MEP no longer holding forth from Glastonbury Mountain, Vermont contacts have been impossible on 6. To relieve this situation, your conductor took his mobile rig to Hogback Mountain, Marlboro, Vt., on the week-end of July 13th and 14th, and Vermont contacts for W1s AEP, LLL, HDQ (home station, operated by W1HDF), W8CIR/1, W2JCR/1, W2AMJ, and W1NWE/4 resulted. W1MEP came over to renew old acquaintances. He will be on from his home in Bennington before too long.

Maine is a tough nut to crack, but contacts with that state are being provided by W8CIR/1, and W1LAS/1, with their portable set-ups. The latter is operating from his summer place at Islesboro, on a small island in Penobscot Bay, and at intervals from the summit of Mt. Cadillac. He will be on through the month of August.

When in Doubt, Aim North!

The general swing to high-gain horizontal antennas is paying big dividends in extended coverage on 50 Mc., but you don't get something for nothing, and the price in this case is having to turn the antenna, and having it seemingly always in the wrong direction! The right direction is not necessarily toward the station you are interested in working, especially in DX work. Aurora effect is present more often than most operators realize, and sharp-angle rebounds, with the beam aimed north, are accounting for an increasing number of DX contacts. W7QAP, Tucson, Ariz., reports that on several occasions he has worked W6s in Southern California when he has been gunning for W7s in Oregon and Washington. Bud worked W6s IWS, QUK, OLO, and QG on July 7th, and they came in only with his beam aimed NNW, at the Northwest W7s. One of the W6s who was using a beam reported a similar condition.

The brilliant aurora display on the night of July 26th produced a few instances of signals reflected from the north. W1LLL (that guy is *always* in there!) worked W1KM/3, Washington, D.C., on c.w. by aiming northwest. Signals from more than a few miles away all had that peculiar aurora rumble that night, and they were loudest

with the beam aimed north, northeast, or northwest, depending on the position of the stations involved. At W1HDQ we took readings on the signal of W2AMJ who is always audible at our location. Frank had his beam aimed north, and his signal peaked at our location with our beam aimed NNW. W2AMJ is a little more than 100 miles *southeast* of W1HDQ.

Did you see that sunspot? When the weather began to clear here, about July 25th, after several days of heavy rain, a big sunspot was visible to the naked eye, while the sun was still veiled with a heavy haze. The following day the "smoked-glass astronomers" at Headquarters were all watching its progress. Conditions were cockeyed on the lower frequencies for several days, so we were well primed for big doings on 6. The bright aurora of the 26th was no surprise, but like other aurora displays of the postwar period it produced very little DX on 50 Mc. From folks who know their sunspots, we learn that during the peak of a sunspot cycle, sunspot activity is spread well over the sun's surface; whereas, during a minimum period, such as we were experiencing just before the outbreak of the war, the sunspot activity is concentrated in the region near the solar equator. Thus, in postwar displays, the aurora effect appears all over our sky, instead of being concentrated as a vertical curtain in the north. The net effect, as far as v.h.f. propagation is concerned, is that arrays tend to have less directivity during current aurora displays than they did during those of the prewar period. Signals still peak with the beam aimed north, but it might be well to be able to tilt the antenna upward, too, for the signal may be coming from almost directly overhead, at times! This condition presents a challenge to the ingenuity of our mechanically-minded brethren.

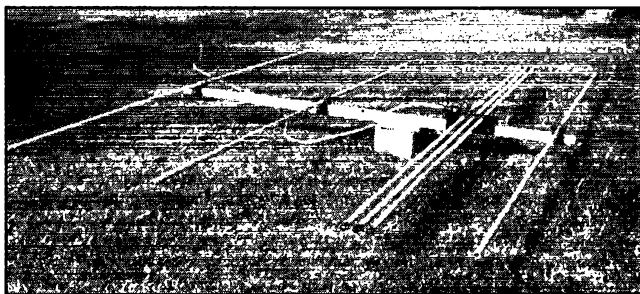

This "vest-pocket" 4-element array was built by W8CLS/1 to check the performance of a very-close-spaced system. Directors are 0.1-wave spaced and the reflector 0.05. Element lengths, determined experimentally for 50.04 Mc.: radiator — 110", reflector — 116", director nearest radiator — 109", second director — 105". The driven element is a 3-section dipole with the $\frac{3}{4}$ -inch elements spaced $1\frac{1}{4}$ inches center to center. The feeder is 50-ohm coaxial line.

Performance data: front-to-back ratio — 17 db.; forward gain — 10 db. Frequency response was very sharp (bad for receiving away from cut frequency), dropping off markedly 500 kc. above the operating frequency.

A good compromise for the fellow who wants high gain in a small space. Total weight: 7 lbs.

This effect may account, in part, for the peculiar results obtained with simple antennas during some DX openings. There have been several instances of improved reception of DX signals when simple dipole antennas were used, particularly verticals. W6NAW, the only W6 to be heard in New England on July 5th, was using a simple ground-plane antenna, and less than 100-watts input. W6RVL has worked quite a bit of DX with only 3.5 watts input, and a ground-plane antenna. The W6OVK-W2BYM contact was made when W2BYM had just finished working a local and was using his vertical dipole. W5AJG has had a number of instances where horizontally-polarized DX stations have come in better when a vertical antenna was used for reception. We think this is tied in with propagation at abnormal angles, as most skip DX is observed to be vastly stronger when the low-angle horizontal beams are used. The vertical dipole is *still* a handy antenna to have around.

The presence of an aurora is usually accompanied by an increase in noise level, with the noise peaking when a directional receiving antenna is turned north. During the period around the end of July, this rush noise was particularly pronounced. W1EYM, Fairfield, Conn., kept track of it by monitoring the voltage developed at the limiter grid of his f.m. receiver, this voltage sometimes running as high as 25 volts, which is the equivalent of a reasonably-strong signal. Other operators reported S-meter readings as high as S9 at times, but, peculiarly enough, these peaks did not seem to occur at times when either 28 or 50 Mc. was open for sporadic-E skip.

International Notes

Interest in 50 Mc. is increasing in Canada, judging by the list of more than thirty VE3s now active on 6, supplied by VE3ANY, Lakeview, Ontario. These boys make plenty of noise, not much of it intelligible, for WØZJB, Gashland, Mo., who is just about the right distance from the Toronto area to receive strong skip signals from there. More of the Canadians are coming on with crystal-control, which will certainly help international relations in the six-meter band! Several of the VEs, including ANY, ATB, AVW, and KM, have worked W1NWE/4. The list of VE3s worked by WØZJB includes AZV, ANY, BFF, AXT, and also VE4AP. VE5AU and VE5MW are plugging away on 6, and quite a number of VE7s are reported to be on the band.

The weekly schedules of G5BY have yet to produce any transatlantic results which can be verified, though there has been quite a bit of European work by a number of Gs. G6FO writes that numerous contacts have been made with French, Italian, Swiss, and North African stations. He says that there are upward of 100 stations now active on 5 in England, and 200-mile contacts are being made quite regularly. On June

16th G5BY worked I1FA and I1DA. On June 24th F3JB, I1SS, I1HV and I1AY were contacted in rapid succession, starting at 1920 GCT. Then the band seemed to go dead, in that no signals could be heard, but still sounded alive "like 28 or 14 Mc. after the East Coast fades out and before the W6s start to come in," and at 2015 FA8B was worked, for the first North African QSO from England. FA8B was worked again the following night, at about the same time. G5BY has had 87 QSOs with other Gs at distances exceeding 150 miles, and has maintained daily contact with G6LK, 156 miles. Stations in Europe and Africa have accounted for 13 contacts since April. The automatic transmission schedule (see July *QST*) will be continued through the fall, in order to take advantage of the F_2 skip which is expected in the fall months.

Local Activity Needed!

Just about this time every year the number of stations working on 5 used to begin to drop, as the best of the skip-DX was past. This is bad at any time, because much of the real satisfaction to be derived from v.h.f. work comes from working with local or semilocal stations. We have, in 50 Mc., what is probably the best band now at the disposal of amateurs for working over distances up to 150 miles and more — and in addition we have the prospect of some world-wide DX in the fall. By maintaining regular schedules with stations within a 200-mile radius, our gear can be developed to maximum efficiency, and what is equally important, there will be some signals on the band when the right conditions break to permit DX work.

Promoting regular activity on any v.h.f. band requires cooperation. It simply isn't accomplished by waiting for some other fellow to get started, and it isn't maintained by just listening occasionally. It requires consistent effort and good equipment, but the results are more than worth the cost. Remember — no one ever yet worked anyone else by listening to see who's on!

Work up to 200 miles or more is not half as difficult as many believe, and the flat country of our Middle West is ideal for this sort of stuff. Yet WØYUQ, Manhattan, Kansas, and WØZJB, Gashland, Mo., working on their nightly schedule seldom find another station to talk to. Vince and Cliff are 110 miles apart, yet the signals often run well over S9, and no trouble is ever experienced in maintaining contact. Surely, in all that great territory there must be many other hams who would enjoy contacts like these!

W4CYW, Richmond, Va., is all alone, his nearest 50-Mc. neighbors being in the vicinity of Washington, D. C., 90 miles distant. Jim hears W3CGV, Wilmington, Del., occasionally, and now and then other stations at distances up to nearly 200 miles.

Some nice work is being done by W8s and W9s

in the vicinity of the Great Lakes. W8SLU, Auburn Heights, Mich., works W8CVQ in Kalamazoo, 125 miles away, with a signal like a local. W9LMX, Elkhart, and W9QCY, Ft. Wayne, Ind., are worked frequently, at 160-175 miles, and W8VIB, Three Rivers, Mich., 135 miles away is good. W8OMY, Pittsburgh, Pa., more than 200 miles distant is contacted now and then.

Contacts between New Jersey stations and those in the vicinity of Boston are made almost nightly, yet at either end of the path the band often sounds dead. Here, again, is evidence of the need for more than listening — "You gotta make calls . . . !" And if you have a directive antenna, you've got to swing it around, and call plenty. The beam, alone, will never make any contacts!

144 Mc. Riding High

There is no dearth of activity on 144 Mc. these nights. In fact the trouble here is just the opposite — so many stations are heard on the 2-meter band on good nights that only the loudest can be worked. With literally hundreds of stations operating in New England, New York, and New Jersey, it is amazing that anyone ever works any distance, but selective receivers, highly-directive antennas, and stable transmitters are turning the trick. The record-breaking contact between W3HWN and W1KOE, already mentioned, would hardly have been possible without such gear, and the population of the band has reached such proportions that improvement in technique is just a moral obligation. With QRM reaching the proportions it has, there is little excuse for the use of high-powered oscillator rigs, radiating receivers, and low-C oscillators which jump frequency a megacycle or more when modulated! Such archaic gear has no place in the scheme of things where there is any appreciable activity on the band. Listen to 2 meters from any New England hilltop on a summer evening, and be convinced!

So many reports have come in regarding work beyond 150 miles that it is impossible to list them all, but here are a few outstanding ones. At 12:30 a.m., July 3rd, W2LXO, West Orange, N. J., worked W1MNF at East Orleans on Cape Cod, a distance of 235 miles. W2LXO reported that when W1MNF called CQ the band was full of New Jersey stations answering him. MNF was heard in New Jersey frequently during July. On the night he contacted W1KOE, W3HWN, Mechanicsburg, Pa., also worked W3ABS/2, Somerville, N. J., W3HOH, Bernardsville, N. J., W2DFV, Perth Amboy, N. J., W2NLE, Union City, N. J., and W2JWO, Patchogue, L. I., the last being a distance of 235 miles. W1BJE, Westport Harbor, Mass., was heard, and a partial contact was made. Each heard the other, but fading set in before an exchange of reports could be made. This would have been still another record —

V.H.F. MARATHON

Call	Contacts Through June		Score	States Worked	
	50 Mc. 144 Mc.	235 Mc.		50 Mc. 144 Mc.	
W1AEP	47		395	14	
W1BDI/1*		14	36		2
W1BCT*		76	354		4
W1CGY	33		257	12	
W1FJN	33		235	11	
W1HDQ ¹	60	69	947	17	6
W1JNX*	7	83	298	1	1
W1KLR		41	186		2
W1LLL	50		431	13	
W1LMU		93	298		1
W1MBS*		98	298		2
W8CLS/1	64		464	16	
W2AMJ	41		275	9	
W2AUF		82	220		3
W2BQK	34		229	9	
W2BYM	73		546	18	
W2DZA		97	353		2
W2LXO		141	555		4
W2OQI*		30	136		2
W2PWP	55		355	13	
W3BTP*		33	151		1
W3CGV	17	31	246	6	4
W3GEJ		4	18		1
W3GKP*		52	317		4
W3HOH		138	497		3
W3HWN*		57	414		5
W3KIE		45	206		3
W3LNL*		88	370		4
W4CDG/3*	4	61	306		4
W5VV	2		22	2	
W6SLO/5	17		181	11	
W6ANN	47		244	5	
W6IBS/6*		36	374		1
W6NJJ*		173	612		1
W6OVK	7	7	168	5	1
W6RVL*	39	68	225	1	1
W6TGY*		19	45		1
W9LLM/6	10		56	3	
W7QAP	16		269	8	
W5JGV/7	29		390	11	
W8NKJ	14	6	79	6	1
W8NOR	4	22	140	2	1
W8RUE	23	6	89	4	1
W8WKE		7	30		1
W9AB	7		24	3	
W9NCS	9		31	2	
W9PK	33		277	11	
W0YUQ	34		372	13	
W0ZJB*	67		717	19	

* Includes portable or mobile operation.

¹ Not eligible for award.

² W0ZJB winner for June with 706 points.

about 325 miles!

The number of stations, and the congestion on the band, is just about as great out in California, and interest in bringing back the DX record is high. The development of portable and mobile equipment has reached a high state out there, and crystal-controlled mobile jobs are common. Even in California's mountainous terrain, some fine work is being done from home locations, too. The contacts between W6OVK, Redwood City, and W6BVK, Sacramento, are continuing on regular schedule, at night three times weekly and at 10 a.m. Sundays. Jim also worked W6NJJ/6 at Clear Lake, a hop of more than 140 miles over mountainous country.

Many of us have thought of trying balloon-supported antennas, but W9IPT, Washington, Ill., has been giving the idea a workout. The balloons used were the anti-aircraft target type, now available as surplus. Page bought his on the street in New York City! They are inflated to a circumference of 7 to 8 feet, measured with a tape measure. They can be clustered, and two of them were used to lift a 200-foot wire, which was worked against ground. A second try was made using the 200-foot wire as a single-wire feeder to a horizontal half wave, supported at the balloons by a balsa bow. Tests with W9FST at Bloomington, 30 miles away, showed a strong signal with either antenna system, and the polarization was horizontal at the receiving end when the single-wire feeder was used, indicating that the system was really putting power into the half wave, rather than working as a vertical long wire.

W9IPT has a crystal-controlled rig, with a pair of 24s in the final, on 145.3 Mc. He runs automatic transmission, with a square-corner reflector aimed at Joliet and Chicago, and is waiting for the "heard" reports to start rolling in. W9FST also has a crystal rig, with an 832 in the final, on 144.06. Both boys use superhet receivers.

The Chicago area is alive with 2-meter stations. W9IPO sends in a list of 50 stations active within a radius of 20 miles of the Windy City. Numerous stations in Indiana, at distances up to 50 miles, are worked regularly, as are others along the lake shore in Milwaukee, Racine, and Kenosha, Wisconsin, up to 80 miles or so. The old polarization battle is being fought out on this new front, and the battle lines are familiar. The Chicago area is predominantly vertical, with W9ZHB, W9HAQ, and others of the old horizontal gang trying to convince them of the merits of taking their antennas lying down. The horizontal boys have results as their best argument — the W9ZHB-W9HAQ circuit is solid day and night, over the 65-mile path between Davenport, Iowa, and Zearing, Illinois, and W9HAQ has been heard by W9IOD in Elmhurst, a Chicago suburb, a distance of 145 miles.

Superhet receivers are becoming more popular, and more necessary, as the activity increases, and beams are going up in many locations. The Chicago gang wonders if there is any activity in Michigan, as no contacts have been made across the lake.

Not all the 2-meter DX is being worked with high power, by any means. On the evening of July 5th, W1MJS, Cape Elizabeth, Maine, worked W1MOH/1 at Dennis, on Cape Cod, a distance of about 150 miles. The rig at W1MJS is a 6J5, running 5-watts input, and the antenna is a 4-element horizontal array. W1MOH/1 was running 7.5 watts. Another nice low-power DX contact — W1JTB, Shrewsbury, Mass — worked W2PZB, Rocky Point, L. I., with an input of

3 watts. The antenna at W1JTB is the 6-element double-Q array described in this department in April QST.

DX on 420 Mc.!

We reported briefly last month on the new record of 96 miles for 420 Mc. set by W6VQB/6 at South Butte, near Meridian, Calif., and W6URA/6 at Mt. Diablo. The rig at W6VQB/6 was a 2C43 "lighthouse" tube running 7-watts input, feeding a 6-element Yagi array. The receiver was a 446A, also a "lighthouse," as a super-regenerative detector. W6URA/6 used a 446A as a transceiver, with a 4-element Yagi antenna. The distance set by W6VQB/6 might have been 126 miles, but for modulator trouble, as W9OAW/6 at Mt. Hamilton was heard S6, but could not be called because of failure of the modulator unit. A haywire repair, permitting the use of A2 emission, was made, but W9OAW/6 had given up by this time!

Southern California is the scene of considerable 420-Mc. activity, according to W6TZX of Compton, who lists W6s BOB, SXN, VIX, RJS, SHD, and VED and VMW as recent participants. Contacts up to 22 miles have been made with flea-power rigs, and in several instances good signals have been exchanged over nonvisual paths, where signal levels on 144 Mc. have been none too good. W6BOB uses a pair of 6C4s and a 4-element beam. W6TZX has a pair of 955s and a 4-element array. A 12-element (6 above 6, in phase) system has been used very effectively at W6TZX.

For some time, W1BBM, North Harwich, Cape Cod, Mass., has been hearing an unidentified signal on about 440 Mc. It came from the East, and was quite loud at times. Tone signals and high-speed telegraphy were heard, and finally the call, WDK, was made out. Having no 420-Mc. stations to work, Bates spent his time experimenting with his acorn receiver and with various antennas, including the latest, a 9-foot parabola. This big dish brought the signal up to S9. Inquiry of RCA disclosed that the station is located at Hauppauge, L. I., more than 170 miles distant! It is a control circuit for low-frequency transmitters, and is on 438 Mc., running a power output of 10 watts! What's holding us back on 420?

Development of activity on 420 or 235 is chiefly a matter of cooperation, as there is considerable interest in a number of places. To help the gang to get started, W1LAS/2 will operate on both bands from his 825-foot elevation at Bedford, New York, during the month of September. He will be on each Wednesday evening, at 8 P.M. on 235 Mc. and at 9 P.M. on 420.

New Record for 10,000 Mc.

When the amateur assignments in the microwave range were first announced, many of us

(Continued on page 158)



Hints and Kinks

For the Experimenter



FILAMENT TRANSFORMERS AS PLATE TRANSFORMERS IN BIAS SUPPLIES

IT WAS desired to provide fixed bias on the 35T used in the final in the rig at W3FDJ, so that the plate current could be cut off during periods of no excitation while in c.w. operation. The transformerless bias supply in the *Handbook* looked good at first, but since the rig here con-

verts) to about 5 or 10 ma. The rectifier section of a 117N7 was used in the bias supply, that type being on hand (we're still trying to figure out a use for the amplifier section). A 12- μ fd. condenser seems to provide enough filtering. All parts are mounted on the r.f. chassis and bias voltage is available as soon as filament voltage is applied.

Using different combinations of filament voltage and windings of transformers, various output voltages in the neighborhood of 50 to 150 volts may be obtained. Naturally, the transformer supplying the source voltage must have a rating slightly in excess of the filament current taken by the r.f. tubes. — *William Hoos, W3FDJ*

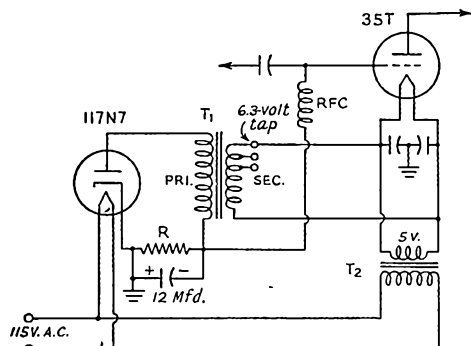

Fig. 1—A filament transformer is connected to supply grid-bias voltage through half-wave rectification. T_1 is a filament transformer with multiple taps on the secondary. T_2 is the 5-volt filament-heating transformer for the 35T. R, the 35T grid resistor, and a 12- μ fd. condenser supply the filter action for the grid bias.

nects to the a.c. line with the garden variety of plug, we were afraid of blowing the fuses too often because of getting the plug in the socket the wrong way, since one side of the a.c. goes directly to ground with this type supply.

To avoid this we looked for a transformer having a secondary of about 100 volts, but being unable to find one, the thought came to use a filament transformer backward; that is, to connect its low-voltage winding as a primary across an existing filament voltage to the 35T, and to use the normal primary for plate supply to a half-wave rectifier.

Worked into the circuit as shown, T_1 , a Thor-darson T61F85 (which has a secondary tapped for 2.5, 5, and 6.3 volts at 2.5 amps.) has the secondary connected across the 5-volt supply of the 35T filament. The 6.3-volt tap is used to produce a secondary voltage of $5/6.3$ times 115, or 91 volts; after half-wave rectification, this giving an output voltage across the grid resistor of about 50 to 60 volts. This was sufficient to reduce the plate current of the 35T (at 1300

A CATHODE-COUPLED OSCILLATOR

THE CIRCUIT shown in Fig. 2 is that of a two-terminal oscillator, known as a "cathode-coupled" oscillator, "first cousin" of the cathode-coupled multivibrator. It is easy to construct, simple to adjust, and the circuit (except for the LC tank) will oscillate from 20 cycles to 80 megacycles, by attaching the proper LC circuit at points A and B. The top limit of one test set-up (a 6J6 without r.f. chokes in the heater) was approximately 208 Mc. Bandswitching may be accomplished easily, as only one "hot" lead need be switched.

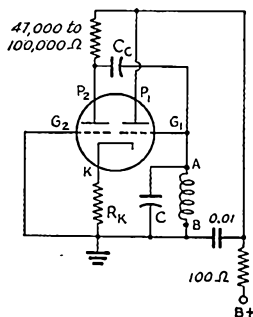

Fig. 2—A cathode-coupled oscillator. The cathode resistor, R_k , should be between 1000 and 3000 ohms. Suitable LC combinations are connected between Grid 1 and ground to produce oscillations ranging from 20 cycles to 80 megacycles. Twin triodes, such as the 6J6, are useful in this circuit.

The only critical value is R_k which should be between 1000 and 3000 ohms. Less than 1000 ohms will result in a poor waveform (observed at

50 kc.). A value greater than 3000 ohms will cause reduced output, but with an improved waveform when used with low- Q tank circuits. The tuned circuit looks into a cathode-follower which results in light loading. The cathode waveform consists of pulses and is high in harmonic content.

This oscillator can be grid modulated by injecting an audio voltage on Grid 2 using a transformer by-passed for r.f. Distortion sets in with over 30 per cent modulation and attempts to modulate 100 per cent resulted in pulsed output.

A quartz crystal can not be successfully tied in at A-B to give crystal results. The circuit will oscillate or multivibrate at the natural frequency of the resistor or r.f. choke used as a grid return. For crystal control, the crystal must be added at C_c , or separate cathodes may be connected together by a crystal. This is satisfactory for low-frequency crystals where the unit may be operated as a stabilized multivibrator. In either case, the LC circuit or RC time constant must be near the crystal frequency. If the LC circuit is placed in the amplifier plate, Miller-effect frequency modulation obtains by modulating Grid 2.

Oscillation is persistent. Keying is good at 10 Mc. using a 6J6 with 4 volts on the heater and only three volts on the plate.

Stability measurements were made at 50 kc. where good observations could be made on my scope. Changes in plate voltage from 150 to 50 (on a 6SN7GT) caused a frequency change of only 0.1 per cent.

Original references to this circuit were obtained from an article by F. Butler presented in the November, 1944, issue of *Wireless Engineer*. — Lt. (jg) Frank C. Alexander, jr., USNR, W8MSS

.....

TWO V.H.F. ADJUSTMENT HINTS

THE idea shown in Fig. 3-A is useful in getting parallel-line oscillators to work. After building such an oscillator it is usually found that the r.f. voltage gradient along the two sides of the line is not symmetrical. This lack of symmetry is caused by the difference in tube and other stray capacitances to ground at the two hot ends of the line. A small tab, C (placed with the horizontal part clearing the chassis about a sixteenth of an inch), will balance the line and improve oscillator performance. This will also reduce the tendency toward "squegging."

Another important kink concerns the adjustment of the grid excitation in u.h.f. and v.h.f. oscillators. Condensers have been shown in equipment but their function is often overlooked. In the usual "grid-separation" circuit, the excitation is determined by the ratio of plate-cathode to grid-cathode capacitance. Normally the grid excitation is too large. This causes downward loading of the oscillator and the no-load plate current is too high.

Reducing the grid-cathode r.f. voltage by

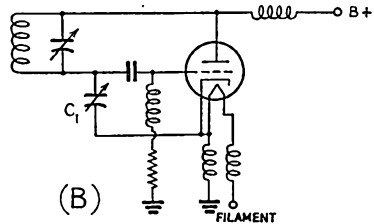
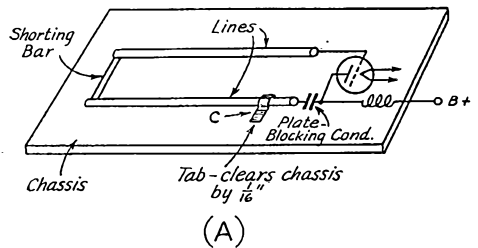

Fig. 3—V.h.f. equipment adjustment ideas by W3HQP. The small tab added to the plate line, as shown in A, helps restore symmetry and improves operation.

The excitation control, C_1 , shown in B, is often overlooked in u.h.f. and v.h.f. oscillators. Downward loading and abnormal plate current of the oscillator will be prevented if the grid-cathode r.f. voltage is reduced by proper adjustment of this condenser.

adding a 5-15- μ fd. condenser, C_1 in Fig. 3-B, from grid to cathode, will reduce the no-load plate current and the grid current and will make the oscillator load upward as it should.

— Lawrence Fleming, W3HQP

.....

HAM-MADE CABLE-LEAD MARKERS

TWO different methods that may be used to mark leads fanned out from a multiwire cable are shown in Fig. 4. In A, a small paper marker is protected by a piece of Scotch Tape that encircles the lead and is pinched together on both sides of the identifying marker.

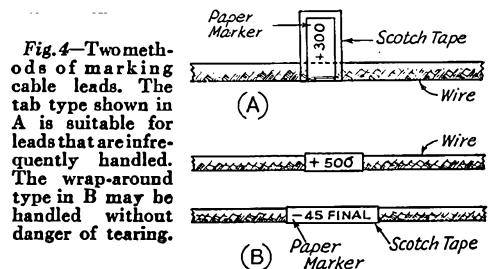

Fig. 4—Two methods of marking cable leads. The tab type shown in A is suitable for leads that are infrequently handled. The wrap-around type in B may be handled without danger of tearing.

In B, the marker is wrapped around the lead and then a piece of Scotch Tape is wound around the lead over the marker, thus protecting it from being defaced or torn off. — Jack Nelson, W8FU



Correspondence From Members -

The Publishers of *QST* assume no responsibility for statements made herein by correspondents.

FREQUENCIES

1321 So. Governor St., Evansville, Ind.

Editor, *QST*:

Congratulations on getting most of our bands back for us. Glad to see the ten-meter band back like it used to be. Now a person can work DX on ten meters without QRM from all of the Ws. Keep up the good work, and hope to see the rest of the bands back in the near future.

— Clifford C. McGuyer, W9DGA

U.S. Naval Auxiliary Air Station,
Saufley Field, Pensacola, Florida

Editor, *QST*:

... Ham radio is strictly a hobby with 99 per cent of us and we want it to stay that way. We want the unbiased (I used this word purposely) right to choose our frequencies, from 160 up and not v.h.f. up! Some of the fellows want v.h.f. — give it to hamdom for those who want to use it, but just because of those few don't force too much of it on us and don't take the lower frequencies away from the vast majority who used them and want to keep them. . . .

By the way, from the looks of things in the past few months, pretty soon FCC will be telling us when we will turn our rigs on and off, who to work, at what hours, what to say, how to say it and what type of emission and gear to use.

In closing I say it is high time quite a few people on the *QST* staff woke up — and stayed awake.

— C. R. Mangum, W4HYB/4, ARM3c

Molly Pitcher Hotel, Red Bank, N. J.

Editor, *QST*:

I have found that hams and would-be hams both overseas and in the good old U.S.A. are very appreciative of the efforts the League is exerting to obtain suitable frequency assignments for amateur use. In particular, they are well pleased with the briefs used to present our case. . . .

— Capt. Harry H. Bowers, W5EWZ

Box 218, Talco, Texas

Editor, *QST*:

I was very interested in your July editorial. I think the policy of the League is exactly correct on the subject of the 160-meter band. The use of these frequencies by Ioran in peacetime is not justified, but others may not be so easily convinced. Its value in the war effort was not so great as some people believe, as the operator factor involved caused much error. If it is not perfected, it is unfit to risk passengers' lives on its operation. Keep up the good work of trying to get our band back. Keep squawking about it! I can't use the band myself, but many of my friends are lost without it.

— Guy G. Ryan, W5IMQ

2211 Calif. Ave., Ft. Wayne, Ind.

Editor, *QST*:

... Unfortunately, many fellows who operated on the higher frequency bands consider 160 of little value and I think that this was the feeling of those who were in a position to save it. I know for what purpose 160 is being used, but I think that slightly higher frequencies could have been used. Now that we have lost it, what happens to the Class B and C hams? Even if 75 were open to them, low power would be useless in the resultant QRM.

— Bob Blaney, W1LIP

REPORT ON SPAIN

Calle 9a. 2232, Apartado 273, Chihuahua, Chih., Mex.

Editor, *QST*:

I was EAR-73 until 1932, when I became EA3AN, operating in Barcelona, Spain. In the same year, my brother became PX1A, operating in Andorra (free republic between France and Spain).

During the Spanish war, I served on the Republican side, as a Signal Corps captain, radio research laboratory. At the end of the war I went to France and then to Mexico, but my brother could not leave Spain because he was wounded and in a hospital. He was taken prisoner by Franco and having been found guilty of being a member of the Spanish masonic lodge, condemned to four years in jail.

Now he is free and we two are happy to have letters avoiding Spanish censorship. He writes to me saying that he wishes to be a ham again. I have sent him an amateur radio receiver, but now he asks for parts for building a c.w. transmitter. As Franco has no radiogoniometers for 20 and 10 meters, he is going to operate c.w. only, on those bands. . . .

Permit me to send my best wishes to all old hams, my friends W2GIZ, W4FT, and hundreds more, but I do not remember their calls now.

— Enrique Ricart, ex-EA3AN

'PHONE-C.W.

927 E. 23rd St., Erie, Pa.

Editor, *QST*:

I desire to express my sincere thanks to the League officials for the commendable work that has already been done in securing the return of practically all of the prewar low-frequency amateur bands. While I personally do not favor some of the Board's proposals, particularly in regard to 'phone-c.w. subdivisions, I believe that the inevitable trend in this direction must be recognized.

Anyone can talk into a microphone; it requires absolutely no skill, technically or otherwise. The real thrill in amateur radio, I believe, comes from working break-in with another skilled telegraph operator. To me this is real pleasure, and no 'phone QSO could possibly equal it for sheer enjoyment. Most 'phone operators who express dislike for c.w., I find, really never stuck long enough to telegraphy to really know the code so as to enjoy it. Yes, it is really enjoyable, once you learn it well. Perhaps it is too much to hope for in this "fast moving" age, for anyone to be expected to take the time to sit down to really learn the code, so that it becomes a pleasure, and not just another obstacle standing in way of securing an amateur license, and the quicker forgotten, the better, after the amateur ticket has been received.

Eventually, telegraphy must yield to 'phone, in the very same manner that spark yielded to c.w. This is progress, but please let's give all the encouragement possible to the c.w. operator, in order that his existence may be prolonged as much as possible.

— R. R. Rosenberg, W3NCJ

THE XYL'S SIDE

21 Maplewood St., Watertown, Mass.

Editor, *QST*:

... For about 10 years now I've been hanging around radio hams, prospective hams, ham enthusiasts, etc., and have found that in general they're a pretty friendly lot. I am very grateful to the many 2-meter hams who have made things so pleasant for myself and husband.

After spending 4½ years in the Army, including almost 3 years overseas, Joe finally was discharged. We were particularly lucky finding a job in New York (our home town) and finally getting an apartment of sorts in Mt. Vernon. Everything was settled, things were working out swell, when bingo! — the company transferred the entire department to Massachusetts. It was most discouraging to me personally since I certainly didn't feel like pulling stakes, but where you earn your bread and butter is where you live.

Everything was topsy-turvy and I was getting more and more lonesome up here by myself. I was beginning to feel like a hermit but thanks to the 2-meter band and Joe's magic 6x6x6 box, we started to meet hams and a few XYs. Now about once a week or so, two or three hams come up here, have coffee and cake, work the rig, chew the rag and think up ways of improving their rigs and things. It's just like back home — usually I get lost in their long discussions about this antenna, that receiver, or some tube, but it still is fun.

Of course some XYs don't share my enthusiasm, but believe me, I sincerely am very grateful to the many hams we've met on the air, and those that we've met personally have been swell. It's made all the difference in the world to me. I might add that I wish more XYs would quit being mike-shy and say hello on the rig once in a while. If you're living in a strange community and don't know a soul, just get the OM to get his 'phone (not c.w. — we'll leave that for the hams exclusively) rig working. You'll meet some nice folks that way, unless of course you enjoy living by yourself, feeling sorry and complaining about the lack of friends. With that I'll QRT and go do some shopping.

— Anna M. Santangelo

TRAINING

Steamboat Bay (Noyes Island), Alaska

Editor, *QST*:

Congratulations to Harry O. Brunn, jr., W8MXT, for getting up and telling the truth in his letter on pages 146-148 of May, 1946, *QST*.

I also taught in GI schools during the war, and heartily agree with Mr. Brunn's conclusions. In general, I found that because of the war-necessitated loosening of radio operator licensing regulations, the caliber of radio work declined badly. If anything, what's needed now is emphasis on quality, not quantity. So far as a "vast store" of amateur radio operators is concerned, a future emergency would be much better served by a moderate-sized group of individuals of eminently superior ability. My contact with the typical GI way of doing things is that it often means a bunch of people milling around, none of whom knows what he's doing, and each one getting in the way of everyone else.

I operated a commercial station for several years in Alaska; during the war it was handled by some of these individuals out of this "vast store" of operators; in six weeks, the entire station had been reduced to inoperativeness and required attention on the part of a prewar-quality operator to bring it back. Later it again fell victim to "victory quality" technical ability, whereupon the equipment was replaced out of government stock and in a short time this equipment, too, became inoperative due to taking apart and tampering. Strangely enough, these "vast store" boys were very quick at taking apart, but very poor at putting back together.

Neighbor, for my money, what ham radio needs is a raising of the qualifications and a stiffening of the examination requirements; then we can keep out of the automobile-crazy-adolescent type of thing, and encourage the people of real ability to get into the game.

— Evert Rodenhouse, W7TQ

PITCAIRN

1009 6th Ave., Sault Ste. Marie, Mich.

Editor, *QST*:

In Brisbane last May I bought the February issue of *QST* and noted therein someone's curiosity about Pitcairn Island. On the voyage back I gathered the following info, straight from the horse's mouth.

About 1938 a number of manufacturers donated equipment for a ham station on Pitcairn. Andrew Young, a fifth-generation descendant of one of the mutineers on the *Bounty*, had an amateur license but little or no equipment. His call was VR6AY. Along with the gear from the States came two American hams to set it up. This transmitter, a combination job designed to handle the 500-kc. ship frequency as well as the 20-meter ham band and working frequencies in the 24-meter band, lasted until sometime in 1939 when a fixed condenser failed and the whole transmitter was shipped to Panama for repair. It has never been on the air since that time. In 1940 an American pleasure yacht brought the repaired transmitter back to Pitcairn and it is stored in the village there now, still in working order.

In December, 1939, the present chief operator, Nelson Byatt, ZL2FR, arrived in Pitcairn from New Zealand with a complete station, which was set up and operated for the New Zealand Navy, under VR6AY's call. Byatt was one of New Zealand's leading hams since he first started in 1932. He was the third or fourth ham in New Zealand to qualify for the 20-meter 'phone permit.

In 1943 the U. S. Government requested the New Zealand authorities to provide a station on Pitcairn for the benefit of passing ships. In November of that year a Liberty Ship started out from New Zealand with a large station and 30 men to set it up. The propeller fell off that ship and the attempt to build a station was not successful until January, 1944, when the ship finally anchored in Bounty Bay. She was there nine days while all the gear was ferried ashore in small boats and hoisted 874 feet to the top of the plateau. In May, 1944, the station, ZKG, was completed and served until November, 1945, when it was sold to the administration having charge of the islanders' affairs, to be used primarily for their benefit. During the war period, Byatt and Young performed all the functions of a coast station for the use of shipping in that area, besides keeping regular skeds with New Zealand, providing valuable weather service for the home islands. They also made regular measurements of conditions in the ionosphere and they say they know those layers as well as if they lived up there.

As soon as ZL2FR, a rabid ham, heard about the releasing of the 10-meter band he went right out and plugged in a soldering iron and emerged with a c.w. and fone transmitter for that band, and for any others that might follow. Last March he applied to the high commission in New Zealand for authority to operate, but up to now that application and two follow-up telegrams have been ignored. His opinions on the subject are pretty strong. Asked about the prospects of VR6AY's coming back on the air, he estimated it as a 50-50 chance.

He expects to return to his home in New Zealand, to "convention and tax collectors," about the end of the year, if any ships stop by. Meanwhile he is continuing the h.f. skeds with Wellington. The government-owned h.f. transmitter is only a 100-watt job and the skeds were none too reliable until he built his ham xmitter and started using that. He claims he hasn't missed a sked since, except once when a lizard got into the power supply.

A fair number of ships stopped at Pitcairn during the war, including a U. S. cruiser and a couple of subs. Since the end of hostilities, however, there hasn't been a visitor on the island. The mail service is pretty bad, too. The schedules call for mail from Panama and New Zealand once a month, but that is more a dream than a reality. Ships don't like to stop in bad weather and if they do the small boats may not be able to get out to them. ZL2FR went out in one of them once to a ship and spent 20 hours getting back. He says he didn't expect to make it. . . .

ZL2FR's other hobby is amateur archeology. Along about the 13th century people of the Polynesian race stopped over at Pitcairn on their way to Easter Island and South America. They made and dropped vast numbers of stone tools and Byatt goes around picking and digging them up. The Auckland Museum has a large collection credited to him.

It just shows what ham radio is likely to lead to.

— Carlton G. Rich, W9STU

(Continued on page 154)

A New Approach to F.M. Reception

An Old Idea Given a New Twist Simplifies the F.M. I.F.-Channel

FOR YEARS amateurs have recognized the potential value of f.m. as a medium for v.h.f. communication. The arguments for f.m. are well known, and it is safe to say that, if it were not for the complexity of the receiver required, the acceptance of f.m. by amateurs would have been well advanced before now. Thus, any new development which offers hope for simplification of f.m. receiving technique is of more than passing interest.

conventional design, the output of which is on 10 Mc., followed by a stage of i.f. amplification and a second mixer-oscillator whose output is on 200 kc. So far the layout is simply that of a double-conversion receiver, and the novelty lies in the stages to follow.

Anyone who worked with resistance-coupled superhets on 5 meters back in the early '30s will recognize the function of the i.f. unit shown in detail in the schematic diagram, Fig. 2. A 6AC7

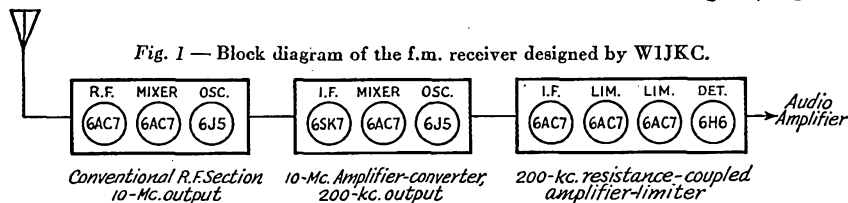

The receiving system described herewith is certainly not new in concept, but the experimental receiver incorporating it, which we have had the opportunity of testing at ARRL Headquarters, is the first we've heard about that used the principle involved for f.m. reception. It was developed by W. W. Moe, W1JKC, of Stratford, Conn.

is used as a 200-kc. amplifier stage, followed by two more resistance-coupled 6AC7s which operate as amplitude limiters, feeding a 6H6 operating as a cycle-counting f. m. detector.¹

It may be seen that this arrangement effects no economy in the total number of tubes used, in comparison with the conventional systems, but the principal difficulty with f.m. receivers, the

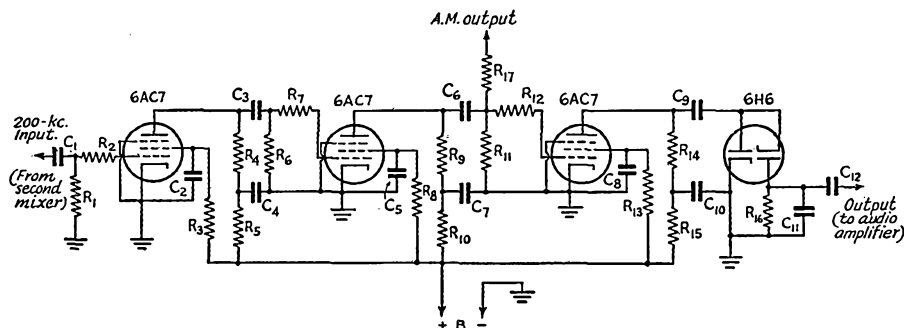

Fig. 2 — Schematic diagram of the resistance-coupled i.f. channel.

C₁ — 50- μ fd. mica.
C₂, C₅ — 0.003- μ fd. mica.
C₃, C₆ — 40- μ fd. mica.
C₄, C₇ — 0.01- μ fd. tubular.
C₈, C₁₂ — 0.1- μ fd. tubular
C₉ — 25- μ fd. mica.
C₁₀ — 1.0- μ fd. tubular.
C₁₁ — 0.001- μ fd. mica.
R₁, R₃, R₈, R₁₃, R₁₇ — 0.1 megohm.
R₂, R₄, R₇, R₉ — 12,000 ohms.

R₅, R₁₀ — 2200 ohms.
R₆ — 33,000 ohms.
R₁₁ — 22,000 ohms.
R₁₂, R₁₄ — 10,000 ohms.
R₁₅ — 25,000 ohms.
R₁₆ — 47,000 ohms.

Low-frequency response will be governed to a certain extent by the values used for C₁₀. The value shown provides good low-frequency response for use in f.m. broadcast reception.

The receiver line-up is shown in block form in Fig. 1. Basically, it consists of a converter of

difficulty-to-align broad-band i.f. system, is eliminated. The i.f. unit is literally a collection of resistors and condensers, and no adjustments of

¹ U.S. Patent No. 2,137,859, W. W. Moe, assigned to the General Electric Co., Schenectady, N. Y.

(Concluded on page 148)



Operating News



F. E. HANDY, WIBDI, Communications Mgr.
E. L. BATTEY, WIUE, Asst. Comm. Mgr.

J. A. MOSKEY, WIJMY, Communications Asst.
LILLIAN M. SALTER, Communications Asst.

A Year of Progress. Amateur operation has come a long way. Just a year has passed since the end of the war's fighting. Aug. 14th was the anniversary of VJ-Day. It was on Aug. 21st that FCC announced that amateur operators in good standing as of Pearl Harbor might use 112-115.5 Mc. Here we are, less than a year later, using our full 3.5 Mc. allocation and with a large part of our frequencies in the 7- and 14-Mc. bands in daily amateur use! New records are being made monthly on v.h.f. The first postwar expedition to depend on Amateur Radio for handling all its traffic has been worked successfully. ORS/OPS are reactivated and are reporting on Activity No. 1. A good old-fashioned ARRL Field Day has been held with all the trimmings. The popular Code-Proficiency Program is bringing in hundreds of copies on each qualifying run!

By contrast, in August 1919, *nearly a year after* the ending of World War I, not a wheel was turning in the matter of amateur operating activities. The government announced *postponement* of the reopening of amateur radio at that time! On Sept. 26, 1919, the Department of Commerce was permitted to take over control from the Navy but licenses had expired and it was November (a whole year lost then) before amateur radio began coming back. During World War II ARRL representation had arranged the technical "suspension" of licensing, paving the way to the series of FCC Orders that have reactivated so much of our frequency territory.

Emergency Preparedness and the Public Interest. It must be recorded that a top reason for quickly reopening amateur facilities one week after the close of World War II, was to permit us to reactivate the ARRL Emergency Corps, that amateurs might assume traditional emergency-radio rôles, if required by circumstance. Immediate use of 2½ meters for any necessary emergency radio-communication problem was called for. In the months that have passed a foundation for sound amateur emergency organization has been laid. Responsibility for assessing and promoting Section progress in emergency-radio plans is assigned to SECs. Coördinators in our postwar organization now have full responsibility for getting groups organized. They issue AEC cards locally, see to it that actual drills, interesting radio activities, and tests are held at intervals,

and the work linked with the appropriate officials and agencies so our facilities will be used and accredited in any emergency!

Your ARRL has presented testimony to the FCC from time to time to prove that amateurs are a group "in the public interest, convenience and necessity." The testimony has stressed the emergency-readiness of the amateur, his support of the military reserves, and the self-training and public-service values and other contributions of the amateur to the nation. A few amateurs have been challenged by legal process from time to time to prove such facts in behalf of their own operations. The position of the fraternity, in the final analysis, rests on the values established by *all* the individual members. (It is an interesting exercise for each amateur to review his own work and aims from this standpoint, not only to note his contribution to the whole, but to note how he might support his own plea for a license in the public interest, should such ever be necessary.)

Our organized readiness is in proportion to your individual support, as an amateur, of the Emergency Corps. This is to cordially invite you to join the Corps, if indeed this is not already one of your activities. In addition to sure fun, profit and recognition from the group radio plans, your work will also fall definitely into the "public interest" category. *All* ARRL activities are dedicated in some way to benefiting the radio amateurs who participate. They add fun and objective to our operating. In addition, they are directed at placing the fraternity in the strongest position, and creating organized facilities to serve the public and each other to best advantage. But among all our activities deserving your approbation (and local participation) the Emergency Corps should, in our opinion, stand first.

Support the Emergency Corps. Here at the beginning of a brand new radio season we renew our invitation to all W/VE amateurs to join the ARRL Emergency Corps. Your local Emergency Coördinator should be contacted, if you know him, but haven't yet a certification or local Emergency Corps card. If you don't know him, drop a card to ARRL Hq. for the necessary form to send to your EC, SEC or SCM to get lined up for the activities of this group in the coming months.

(Continued on page 76)

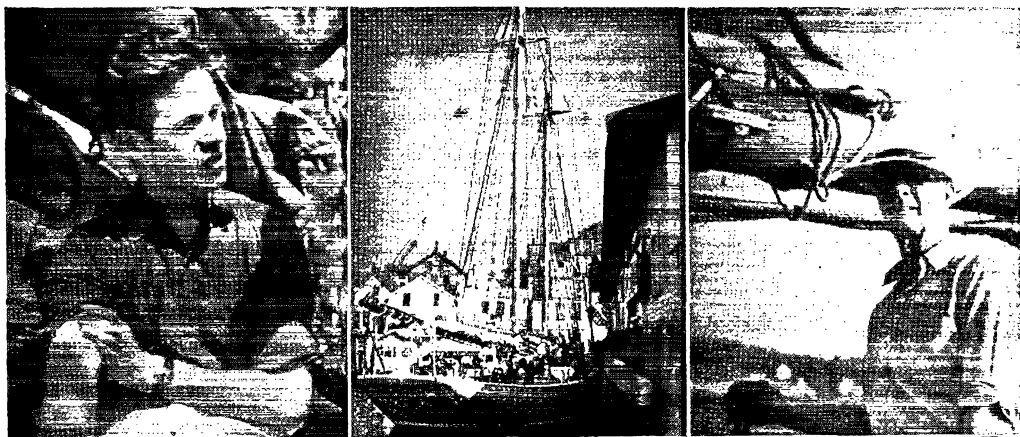

KLPO, MacMILLAN
ARCTIC EXPEDITION, 1946

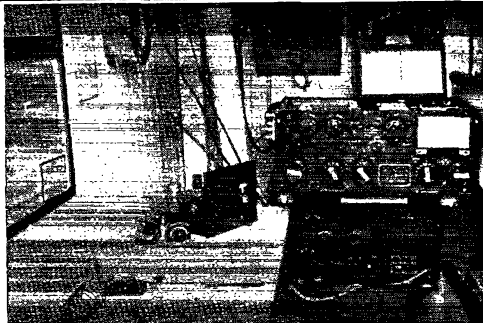

The first postwar expedition licensed by FCC for two-way work with radio amateurs carries a top-notch ARRL radio operator and a Zenith-engineered installation for all the important communication requirements of the voyage.

Commander Donald B. MacMillan's (upper right) *Bowdoin* sailed on schedule June 29th from Boothbay Harbor, Maine, locale of the above photos. This 24th expedition to the North is undertaken under the auspices of the Colorado Museum of Natural History. The 88-foot oak-reinforced schooner *Bowdoin* (upper center) is a veteran of 18 such voyages and was especially built for Arctic exploration. The *Bowdoin* will reach Frobisher Bay, Baffinland, after touching en route at Sydney, N. S., Battle Harbor, Nain, Labrador and other points. (At this writing in mid-July, the expedition is off the North Labrador coast, still pressing northward with massive icebergs constantly in view.)

Two former Navy officers serve as mates, while the ship's company of 16 include noted scientists, naturalists and professional men. On this expedition supplies are carried for the Eskimo children of Northern Labrador. Studies of Arctic currents and soundings are being made for the hydrographic office.

Of top interest to all radio amateurs — Bill Matchett, WIKKS, of Manchester, Conn. (upper left) accompanied the expedition as operator of KLPO. The 25-foot antenna is 70 feet above the *Bowdoin's* deck. The towering mast and rigging may give a small idea of the installation problem! The 5-foot-high "shack" is amidships, sleeps two, and provides rather cramped operating quarters. In spite of this Bill has had no trouble in clearing as many as 30 messages at a sitting with the amateurs scheduled and worked in the course of general contact.

Equipment and radio room: The Zenith-built ATC1/ART13 transmitter (813 in final) is similar to those made for the AAF during the war. Powered from a 28-volt section of the ship's batteries, ten auto-tune channels are available. Frequencies of 12,480-8250-4150 kc. are chiefly used for contacts with amateurs working 14-, 7- and 3.5-Mc. bands. Zenith Engineer Bell found external antenna loading necessary, in view of antenna limitations. The SCR211 frequency meter is mounted at right, above the transmitter, with the dynamotor, control unit and extra loading coils at the left. The BC348Q receiver is below the transmitter. Note on the operating shelf a converter (from 1940 ARRL *Handbook*) which Bill took along, with his bug for traffic, to permit WIKKS-mobile operation on 28,014 kc. Bill's commercial licenses and amateur ticket are posted beside the Commander's restricted radiotelephone operator permit. Ham signals have been copied at sea before by Bill when in the Mediterranean or Pacific, but he says both sides of the DX are more readily copyable from points up near the Arctic Circle.

Bill will have a complete record of expedition contacts on return (about the time you read this report). W1MLP and W1NIJ at Boothbay have worked and visited KLPO. Schedules are kept with W1AW, W1BDI, W1CJD, W1KNP, VE1AL, and others for clearing traffic. At Sydney, VE1AL, VE1CE, VE1CR, VE1GO and VE1YT visited the ship. VE1OD was worked. VO4F learned about the expedition from W1AW bulletins and works KLPO without difficulty. The expedition places chief reliance on radio amateurs and ARRL for handling its 1946 message traffic as on many prewar occasions.

FLASH! As we go to press information has just been received from KLPO via W1AW that a polar ice pack has blocked passage across Hudson Strait, making it impossible for the expedition to reach Frobisher Bay. The schooner has turned about and started return trip to the home port. At Nain, Labrador, supplies were unloaded for the Moravian Mission and for the MacMillan School located there. Also visited was the Masquapu Indian Village in Davis Inlet, where the Indians were encamped in preparation for seal hunting. Latest estimate indicates arrival at Cape Breton Island on July 28th.

(Continued from page 74)

Simulated Emergency, Oct. 12th-13th! An ARRL Emergency Corps test is on the agenda for October 12th and 13th. Emergency Coördinators themselves will develop local aspects of their test and will have special information for all amateurs who become AEC members before those dates. There will be no "second" Field Day before next June. However, there *will* be things doing for every emergency group with imagination, stamina, fixed and portable stations, and the qualities that have made amateur radio the respected service that it is today, and justified its early reactivation! In addition to any other amateur work you like, get in the AEC without delay. Stick with the Emergency Corps and promote its doings! Take steps *now* to be in on the fun Oct. 12th-13th!

The operating conditions that result from an unknown emergency (simulated) in your community will "develop" on those dates from hour to hour. Your Coördinator will have a set of "facts," and plans for coping with them too, but may have to change the disposition of his forces to meet the changing situation. He will be able to hold a post-mortem and "score" his community and himself on how the season's first official drill turned out. The test will aim at developing what all amateur stations and operators can do. It will point out our deficiencies and local needs. It also will be a fascinating unfolding story, and we expect a radio drama in which each of us can play a radio or organizing part. It will be just like a real emergency when radio is called in to help. Get lined up for this interesting test today. The SCM will be glad to have you represent your community, as an individual or as Temporary Coördinator and organizer, if you are the first or only AEC member in the area. (SCMs/SECs will receive late this month extra sets of the operational plan for the dates of the test, to send such TCs on request.) This advance notice is to enable every reader *not* already an Emergency Corps member to request the form (7A) from ARRL. This is so that SCMs and ECs may get you signed in and on the list to get the "inside news" on the "developing emergency"!

Radiotelephone Band Limits. Several members have written ARRL and FCC to inquire about voice operation near the edges of the 'phone bands. ARRL Official Observers will also be interested in this subject, since they endeavor to help all amateurs avoid FCC advisory notices and citations by reaching them by postcard or radio *ahead* of FCC. Here is the way FCC interprets the amateur regulations on this subject:

... amateur radio stations, utilizing A-3 emission within the portion of the band assigned for A-3 emission, should operate in such a manner as to confine all such emissions within the portion of the band so designated. Operation should be conducted in a manner which will avoid the possibility of side bands falling within any portion of any amateur band within which A-3 emission is not authorized.

Official Observers Needed. Did you read (page 73, July *QST*) what FCC had to say on the excellent accomplishments of ARRL Official Observers? Commendation from Asst. Chief Engineer Sterling (W3DF), with the suggestion more ARRL Observers be appointed, is praise indeed! We're willing to expand the OO system. Attention is therefore invited to the plans established by the League for Observers and covered in detail in the July item. Each SCM may appoint up to a quota of three additional Official Observers per section in each of the categories in which applicants can qualify. We will regard the expense of their cooperative notices and administrative costs as well justified in the interest of doing a bigger job for amateur radio. Review what was said in July *QST*. If you can assist in the cooperative ARRL monitoring program, get your request in to us at once for the proper application form for becoming an Official Observer, before your SCM's quota is oversubscribed.

Get-Acquainted Party a "Fraternal" Contest. Perhaps it shouldn't be called a contest at all, but there is a fascination to keeping track of the ham stations contacted. We added a "point" scheme only because we knew it would be three times as good and popular an activity that way. The basic idea is that of a fraternal get-together between our Licensed-Since-Pearl-Harbor amateurs, and those back on the air who were prewar "actives." See the write-up elsewhere in this issue for all details. Don't forget the dates — September 21st and 22nd.

The data to be exchanged during contacts are what everybody wants to know about everybody else anyway. Voice and/or c.w. can be used, as you like. Choose *any* bands, too. If using c.w., a word recommending moderate operating speeds may be in order. True fraternalism in extending the hand of fellowship requires courtesy and patience. Sending speed should conform to that of the brother amateur with whom one is working. Remember when *you* were new on the air, too? There will be some with new and shiny transmitters, and at least as many operators with five to twenty-or-more years amateur experience giving this a whirl. The activity may prove again what so many old and new operators in the Services learned during the war: that a "steady" 12 w.p.m. is worth more from the useful-speed standpoint than a faster 16-to-20 pace with abortive repeats. To new-timers and old-timers alike our best wishes for some pleasant and successful operating hours. See you on the air September 21st-22nd.

— F. E. H.

Who is the youngest active ham? Anyone below 'teen age? And who is the oldest active ham?

"... with W9XYZ in the Hole"

Did you ever get tangled up in a 'phone round-table? We have heard some lads not only get tangled up but completely tied in a knot trying to keep the calls straight and the order of rotation correct. Here's how it goes more often than not: "So, Johnny, you take it; no, I guess it's Pop's turn now; Pop, you turn it over to Bill and he will pass it to Johnny. This is W9ZZZ listening, with W9QRZ, W9QTH, and W9XYZ in the hole, turning it over to W9QSO. Go ahead, W9QSO, W9ZZZ over."

There must be some simpler way! Here is a suggestion. First off, all members of the round-table must know who are the other stations in the circle. If a chap comes in late, it is a simple matter to name quickly the stations already in and assign him his place. Most round-tables build up from a two-station QSO, anyhow.

Let's consider a typical example. W1CC works W1EE. Later on W1AA breaks in; up to that point there has been no "order of rotation," but now with a third station we need it. So we make the order W1CC, W1EE, W1AA. Then in comes W1FF, and he drops into fourth position, after W1AA . . . and so on down the line, each new arrival being told who's who as he arrives. Everyone drops into place in the order of his joining.

Now let's assume we have W1CC, W1EE, W1AA, W1FF, and W1BB, in that order. Each operator knows who is in the group, so why repeat all those calls each time we turn it over to the next station? Why not simply pass it along to the next station in line? Thus, for example, W1EE would say simply, "W1AA from W1EE, over (or go ahead)." And W1AA would say, after he had finished his transmission, "W1FF from W1AA, over," and so on.

A variant method is successfully employed in the Pajama Club, a spot-frequency net of old-timers on 75 'phone. There W1EE, knowing that he passes on to W1AA, could commonly say, "W1AA and the gang, this is W1EE, go ahead." And the latter in acknowledging would commonly say, "W1EE and the gang, this is W1AA, OK." Thus again each station mentions only the call of the station from which he "received it" and the one to which he is "passing it."

Each station should keep on any convenient sheet of paper a list of stations in the order of rotation. Appropriate "doodling" alongside each call would enable us to remember various points we wanted to comment on when our turn came up, and the usual brain-twisting at each sign-over would be eliminated. But best of all, we would get those poor guys out of the "hole" for all time! It's a deplorable expression, anyway, and "rumble-seat" is even worse, to our ear. What do you think, gang?

Logkeeping for a net is a bit of a trial. The frequent practice of just adding more calls on the

same line in the log, as other stations join, fails to meet the FCC requirement for the beginning and ending times of QSO — as concerns all but the first two stations. The best method we have seen adds a new line in the log as each new station joins the net, showing the beginning time. Then, as fellows drop out of the net, one by one, the ending time for each can be entered. When you drop out yourself you note your leaving time on all the remaining lines, and bracket all the lines together with a notation that it was a round-table.

BRIEFS

W7CX, Nevada SCM, and W6QJH, his XYL, announce arrival of a 6-lb. YL on May 8th. W9EID was the doctor; W5ITD performed the delivery. A radio babe if ever there was one!

Among the newer licensees is C. W. Oldham, W3KJU, of Roaring Spring, Pa. Wonder if he is on 'phone?

Official Experimental Station appointments are available to members operating good stations regularly on frequencies above 50 Mc. Have you your appointment in this group interested in v.h.f.-u.h.f.-s.h.f. transmission phenomena and development of new amateur communication systems? See page 66, March *QST*, or the booklet *Operating an Amateur Radio Station* for details. Application form for OES appointment on request.



Three Well-Known Californians

Left to right: Elvin Feige, W6TT, Oakland, ORS-OPS-OBS, DXCC, second-high W scorer in BW Party; Horace R. Greer, W6TI, Oakland, SCM East Bay Section, ORS, W6 QSL Manager; Clayton Bane, W6WB, former SCM S.F. Section, third-high W scorer in BW.

MEET THE SCMs

David Stanley Hutchinson, VE3DU, one of several of our newly-elected Canadian SCMs, was born June 5, 1904, in Hove, Sussex, England.

He is presently employed by the Post Office Department in the capacity of letter carrier. Previously he was engaged in installation work for the Bell Telephone Company.

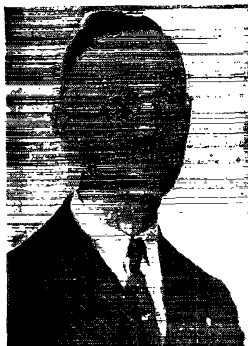

VE3DU started in amateur radio in 1920 with a crystal receiver, then advanced to a honey-comb-coil set with Audiotron tubes and a Ford spark-coil transmitter. The following several years he listened only, although he has maintained his license continuously since 1922. He came on with a c.w. rig in

1931 with p.p. 45s and an SW-3 receiver, put the 45s on 28 Mc. in 1935, then graduated to a bi-push exciter in 1938.

A 6A6 oscillator, 6A6 buffer, p.p. RK-49s final on 3.5-, 7-, 14-, and 28-Mc. c.w.; SW-3 and SX-25 receivers; and a half-wave 3.5-Mc. Marconi antenna constitute his present equipment, which is situated on the main floor of the house.

3DU took an active part in prewar RM-Nites, ORS Parties, and Sweepstakes, and holds postwar ORS and RM appointments. He is a member of the Intercity Amateur Radio Association, of which he is past-president, and the Canadian Amateur Radio Operators' Association.

Stamp-collecting ranks second to amateur radio as a hobby; for recreation he indulges in fishing and 5-pin bowling when the opportunity presents itself.

Dave's past activities prove that he will be a conscientious and thoroughly competent SCM.

BRIEFS

From Greece we hear of the formation of the 4th British Division Ham Club. Organized on March 26th, the club operates a 10-watt 'phone station under the call XACW. The express object of the association is to encourage amateur radio work in the 4 British Divisional Signals. The club president is XABY and another member has the call XACV, both in Salonika. Immediate projects for XACW include a 100-watt amplifier to follow the present rig and construction of a 3-element rotary beam. 50-Mc. experiments are planned for a later date.

W5BMI says he has had more than 27,000 QSOs since licensed in February, 1930!

OPTIONAL CODE CHARACTERS?

The FCC is making a three-month test (Aug., Sept., Oct.) of the optional use of one *long* dash in place of ———— for the zero of the "zeroth" area, in signing or answering calls.

Let's take a look at this matter of the proposed long dash. Is this good operating? *How* long is the long dash? We warrant it will be sent in lengths varying from "T" to a dash as long or even longer than *all five* standard dashes! The idea is then not capable of *useful* savings of time. Strangely enough the Army, Navy, and Air Force got on well enough with the winning of the war without abandoning standard Continental in spelling out the intelligence exchanged.

We have nothing against use of hybrid abbreviations, and such shortenings of characters in complete *numeral* groups where developed and used by understanding operators. Basically there should be maintained an official definition of characters for the Continental Code letters and numerals, however. To abandon or tinker with that standard is plain notional thinking. Under conditions of an *announced* test of optional use the conditions are most favorable to reducing confusion to a minimum. It is an idea that will be tried for "novelty" by some in that period. The idea should be dealt with on its fundamental unsoundness and discrimination. What about our 9s and 1s, *only two dots* shorter than ————? Of course this idea may not prove universally popular. A good many hams will just for pure cussedness call back the guys who sign "a drawn-out dash" by sending good old ————. Hi!

An option permitting official sanction for several methods of sending Continental Code characters is not really in the best interest of anybody.

BRIEFS

The Navy has issued orders regulating the licensing and operating of amateur stations in the Canal Zone on Naval reservations. The regulations are patterned after FCC's and apparently contemplate the same frequencies. Only c.w. will be permitted. The Navy calls in the NY series will be abandoned and both Navy and Army amateur stations there will be assigned calls in the KZ5 series by Headquarters, Panama Canal Department.

Add Scores, Band-Warning Party: W6CW, Nevada, 2725 points, 63 contacts and multiplier of 25, in 14 hours operating on 28-Mc. 'phone.

The ARRL Board of Directors recommends to members that they refrain from using c.w. telegraphy in the portions of amateur bands available for telephony.

HIGH CLAIMED-SCORES — 1946 FIELD DAY

As this issue goes to press, Field Day logs have been received from 104 club groups, 53 nonclub groups and individuals, and 45 home stations.

We are passing along the highest claimed-scores so far reported. These are subject to checking, and should not be considered a final tally.

CLUB GROUPS

(Listing shows club name, call used in FD, claimed-score, and number of simultaneously-operated transmitters.)

Jersey Shore Amateur Association	W2FC/2	9621-8
Frankford Radio Club	W3BES/3	8568-7
Tri-County Radio Association	W2KHK/2	6921-8
Northwest Amateur Radio Club	W9IT/9	6363-5
Monmouth County Amateur Radio Association	W3AC/2	6237-7
Motor City Radio Club	W8ONK/8	4500-3
St. Paul Radio Club	W9KYC/8	4338-6
Greater Cincinnati Amateur Radio Assn.	W8JIN/8	4320-2
Four Lakes Amateur Radio Club	W9RNX/9	4239-3
Somerset Hills Radio Club	W3ZD/2	3978-5
York Road Radio Club	W3IU/3	3879-5
Steel City Amateur Radio Club	W8TUD/3	3870-5
Palomar Radio Club	W6BKZ/6	3756-6
Mountaineer Amateur Radio Association	W8BOK/8	3555-6
Mon Yough Amateur Transmitters Association	W8OC/8	3267-2
Amateur Transmitters Assn. of Western Pa.	W8BSO/3	3249-4
Wisconsin Valley Radio Association	W9RQM/9	3060-2
Narragansett Assn. of Amateur Radio Oprs.	W1LWA/1	3051-1
Minneapolis Radio Club	W9OBM/8	2961-3
Northern Nassau Wireless Association	W2FJV/2	2907-5
Tulsa Amateur Radio Club	W5IAS/5	2875-4
Kalamazoo Amateur Radio Club	W8DM/8	2817-3
Beacon Radio Amateurs	W3ATR/3	2707-2
Lancaster Radio Transmitting Society	W3LN/3	2664-1
Delaware Valley Radio Association	W3AQ/2	2538-3
Milwaukee Radio Amateur Club	W9SYT/9	2538-3
Cuyahoga Radio Association	W8GW/8	2529-2
York Radio Club	W9GY/9	2502-3
Bridgeport Amateur Radio Club	W1MWN/1	2457-3
Cahokia Amateur Radio Club	W9TCK/9	2427-3
So. Lyme Beer, Chowder and Propagation Soc.	W1EH/1	2371-1
North Newark Amateur Radio Club	W2PY/2	2322-3
Greater Cincinnati Amateur Radio Assn.	W8SLO/8	2313-1
Racine Megacycle Club	W9PWJ/9	2214-3
Joliet Amateur Radio Society	W9HVZ/9	2181-3
Fort Worth Kilocycle Club	W5AA/5	2142-2
New Haven Amateur Radio Association	W1GB/1	2106-4
South Hills Brass Pounders and Modulators	W8BK/3	2061-2
Toledo Radio Club	W8ARF/8	2061-3
Iowa City Radio Club	W9IFB/8	2040-3

NONCLUB GROUPS & INDIVIDUALS

(Listing shows call used by each group, number of operators, claimed score, and number of simultaneously-operated transmitters.)

W9ERU/9	10-2574-3	W1BDI/1	5-1428-1
W9RCQ/1	1-2115-1	W7RT/7	1-1424-1
W6PNU/6	4-1978-2	W8KYW/3	9-1368-2
W6STA/6	3-1876-2	W9VPD/9	4-1233-2
W2FBA/2	2-1827-1	W8UPS/4	5-1170-2
W9PEK/9	11-1512-2	W8VMF/3	4-1134-1
W8FBC/8	3-1467-1	W1GKJ/1	4-1118-1
W9AVE/9	7-1431-3	W1JWG/1	2-1057-1
WILLX/1	2-1428-1		

ATTENTION, 28-MC. OPERATORS

ARRL is resuming its program of "on-the-air" Code Practice for beginners. In previous years this has been conducted on the 1.75-Mc. band. With our present assignments, 28 Mc. appears the best range in which to carry forward the program.

Learning the code is the most difficult hurdle for many lads who are working towards a ham ticket. Will you give them a helping hand? Practice schedules may be arranged to suit your convenience. Hints on how to conduct code lessons by radio will be sent to all volunteers. When you are ready to start transmissions, your schedules will be printed in *QST*. In addition, schedules of ARRL Code Practice Stations are mailed to each would-be amateur requesting same — and hundreds of these requests are filled yearly.

Drop us a postal at once signifying your willingness to cooperate and we will send further data. It is expected that the program will get under way in early October.

BRIEFS

Ex-W3DNU, former ORS, is now **W2ORS!** Yes, he has applied for reappointment!

The operation of amateur stations in Japan was authorized on April 24th by an Eighth Army directive. Applications made by U. S. military and shore-based Naval personnel must include the exact location of the radio station, the name and address of a responsible officer, and a block diagram of the transmitter-circuit layout or a designation by Signal Corps type number.

CALENDAR OF A.R.R.L. ACTIVITIES

- Sept. 18th: W1AW CP Qualifying Run
- Sept. 21st-22nd: Get-Acquainted Party (Prewar amateurs to rag-chew with LSPH operators.)
- Oct. 12th-13th: Emergency Corps Test
- Oct. 17th: W1AW CP Qualifying Run
- Oct. 26th-27th: ORS/OPS QSO Parties
- Nov. 16th: W1AW CP Qualifying Run
- Nov. 15th-17th and 22nd-24th: Sweepstakes Contest
- Dec. 15th: W1AW CP Qualifying Run
- Jan. 11th-12th: ARRL Member Party
- Jan. 14th: W1AW CP Qualifying Run

- May 1st-Dec. 31st: 1946 V.H.F. Marathon (complete details in May *QST*)
- Mar. 1st-Dec. 31st: WAS Competition Above 50 Mc. (see page 80, May *QST*)
- Started Mar. 1st: Competition for First WAS on 50-Mc. Band (see page 58, May *QST*)

OPERATING PROCEDURE IN AN A.E.C. NETWORK

By Preston C. Yeomans, W2OHE, ARRL EC

ARRL Emergency Coördinators are confronted with development of standard operating procedure within their local AEC networks. We in the Kings County Network have evolved a procedure that has worked very well for us. We use 144 Mc. entirely and each drill period sees more efficient results. The following procedure is passed along for the information and possible assistance of ECs in planning their tests and drills.

The Net Control Station opens and closes the net, makes general announcements, and directs order of the drill for the test period. The Control may appoint a station to assume partial control for a definite period in order to permit various drills and to distribute experience in control operations.

There are three Alternate Control Stations, who take over control on a time basis. If the regular NCS does not come on the air at a definite time, the first Alternate takes over. If neither NCS nor first Alternate comes on by another predetermined time, the second Alternate takes over, and similarly the third Alternate would take over in the absence of the others. If none of the main Control Stations opens the net, the Section Controls (Red, White and Blue Nets) take over, and after the Section roll calls a station is appointed to act as NCS.

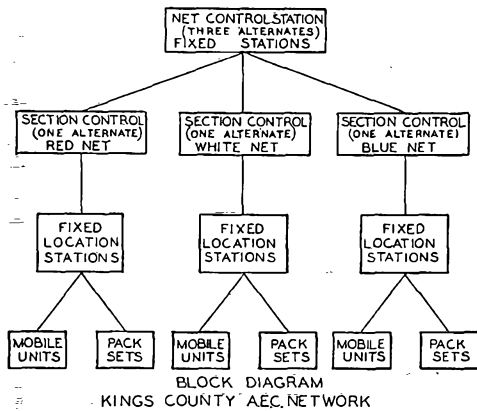

After the network is opened, the Section Controls, representing the Red, White, and Blue Nets, are called by the NCS. In the absence of a Section Control, his Alternate is called and takes charge. If the Alternate is not on, the NCS appoints a station in the Section to act as Control for the test. After all Sections have been checked in, the NCS makes announcements for the evening and clears general network traffic. After this, the NCS directs the Section Controls

to call the roll in their nets and to be on the lookout for new stations desiring to join the AEC. During roll-call time, the NCS monitors the three frequencies of the three Section Controls, for roll-call results must be reported to the NCS.

When roll calls are completed and reports in, explanation of the tests and drills for the evening are transmitted to the Section Controls. In the event that tests are to be handled by any other than the Control Station, contact is made with the appropriate station through his Section Control, or directly, and control is turned over to him until the tests have been completed.

Mobile units check in to whatever stations it is possible for them to contact from their locations, but preferably to their Section Control. Pack sets do likewise, but whenever possible it is our desire to have pack sets work with a mobile station. This makes for "on-the-scene communications" and the mobile unit makes a fine relay station to the Section Control.

We discourage individual interstation operation during net periods (except during tests and for relay purposes) because this causes much confusion. The Control Station to which any station normally reports (excepting mobile and pack sets) is the Control Station through which each network member must operate. This keeps down interference and maintains a high order of discipline.

BRIEFS

Justice Park Gardens, Chicago (Archer Avenue near 79th Street), will be the scene of the Hamfesters Radio Club's 1946 Picnic & Ham Fair on Sunday, September 1st. Features will include games, races, refreshments, music, and an exhibition of the newest in radio gear. First prize is a high-power transmitter and the additional prizes are too numerous to mention—over \$1,000 worth! Hamfesters Picnics are a popular activity, if the attendance of over 3,000 at each of the last two prewar affairs is any indication.

The Greater Cincinnati Amateur Radio Association will hold its first postwar Annual Stag Hamfest at Ash Grove, on Sunday, September 8th. Ash Grove is midway between Green Hills and North Bend Road, on Winton Road. Use Green Hills bus service from downtown Cincinnati to the Grove. Dinner and supper will be served. Plenty of activity, including raffles, ball game, contests, and hours of rag-chewing. Many worthwhile prizes. Gates open 9:30 A.M.

The Central Iowa Picnic and Hamfest will be held Sunday, September 29th, at the Log Cabin, City Park, Slater, Iowa. Ted Hunter, WØNTI, will conduct transmitter and receiver demonstrations. Refreshments will be served. Prizes, of course! No admission charge. Everyone welcome.

(Continued on page 82)

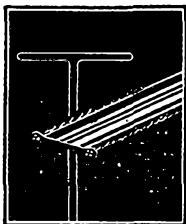

ON THIS PAGE in the July *QST* we told about using ribbon-type feeder to make a folded doublet antenna. Among other things we said that "A length of ribbon equal to about 82% of a half wave length is shorted at each end." This is incorrect; it should be over 90%. The mistake was caught but unfortunately too late to be corrected before publication.

According to some experiments we made, the figure should be about 92%. Roland Danner, W9BYC, wrote to *QST* on the same subject and his figure is slightly less than 94%.

If you look up feeders in manufacturers' catalogues you will find that they give figures showing the ratio of feeder length to wave length as a percentage. This will vary with the type of feeder. It is 82% for the 300 ohm feeder described in July *QST*. It is 77% for a 150 ohm feeder of the same type. However, when these same materials are used for *antennas*, these factors do not apply and regular antenna formulae should be used.

At frequencies of 56 Mc. and higher, the ARRL Handbook gives the length of a half wave antenna in inches as 5540 divided by the frequency in megacycles. Danner in his letter says that one of his colleagues made very careful tests and found that the figure should be 5500 divided by frequency. These two figures are so nearly alike that we will not try to choose between them. Most ham antennas are intended for use over an entire amateur band, in which case the tuning must be only approximate of necessity.

We do not wish to become involved in discussion of the exact correct length for a folded dipole. The main point we wish to make is that an antenna is an antenna and not a feeder, and it should be figured accordingly.

Our page in July *QST* also mentioned that a $\frac{1}{4}$ wave length section of 150 ohm feeder could be used to match a 300 ohm receiver to a 75 ohm antenna. This is correct. By " $\frac{1}{4}$ wave length section" we meant an electrical wave length, of course. The actual length of the section is 77% of a $\frac{1}{4}$ wave length in free space when 150 ohm ribbon feeder is used.

This $\frac{1}{4}$ wave section provides a handy way of connecting a 300 ohm receiver to a 75 ohm antenna. However, if the feeders are long, you may find it convenient to do the same thing in a slightly different way. You can put the $\frac{1}{4}$ wave section at the antenna instead of at the receiver. This will match the antenna to a 300 ohm feeder which in turn matches the receiver. This has the advantage that 300 ohm feeder (which has lower losses than 75 ohm feeder) can be used and this may be desirable when long feeders are required. Other than this, either arrangement works equally well.

We are sorry about the mistake on antenna length and hope you have not cut the ribbon to length yet.

JACK IVERS



(Continued from page 80)

WIAW OPERATING SCHEDULE

Operating-Visiting Hours:

Monday through Friday, 2:00 P.M.—Midnight
Saturday and Sunday, 9:00 A.M.—3:00 P.M.

Official ARRL Bulletins containing latest FCC information relating to amateur operation and reactivation, and other bulletins on matters of general amateur interest are transmitted on regular schedules, as follows:

Frequencies: 3555, 7145, 14,150, 29,150, and 52,000 kc.

Times: 8:00 and 11:30 P.M. EDST, Monday through Friday. (0000 and 0330 GCT, Tuesday through Saturday.)

Starting at the times indicated, bulletins are transmitted by telegraph simultaneously on all frequencies. Bulletins are sent at 25 w.p.m. and repeated at 15 w.p.m. to facilitate code practice. Telegraph bulletins are followed in turn, by voice transmissions, except that 3950 is substituted for 3555 kc., and 14,280 is substituted for 14,150 kc. Changes from this schedule will be announced by the operator.

Code-Proficiency Program: Practice transmissions at five speeds, 15 through 35 w.p.m., are made Monday through Friday on the above-listed frequencies, starting at 10:00 P.M. EDST (0200 GCT, Tuesday through Saturday). Approximately ten-minutes practice is given at each speed. Next certificate-qualification run is scheduled for Wednesday, September 18th.

General Operation: WIAW engages in two-way work with amateurs, dividing time between 3825, 7250, 14,150, 28,060, and (on voice) 3950, 14,280, 29,150, and 52,000 kc.

BOO, HOO -
THOSE BIG BOYS
ARE KICKING ME
AROUND SOME-
THING TERRIBLE

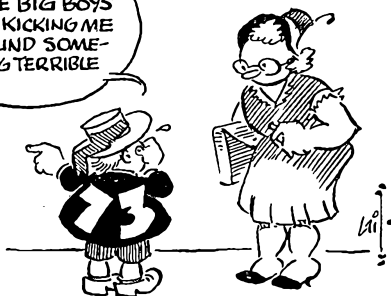

Yes, little ol' 73 is really getting kicked around! This familiar abbreviation and cheery ending to QSOs stands for "best regards." *All by itself*, and without embellishment, "73" means "best regards." Yet, probably fifty per cent of all hams insist on sending "73s" or "best 73s" or some other distortion of the simple snappy "73." You wouldn't say "best regardses" would you? Then why put a superfluous "s" on 73? And "best best regardses" (ouch!) is what you say, if you use "best 73s." It's a sign of a good operator to use procedure and abbreviations correctly. Let's all drop our "esses." Make it plain 73 from now on!

CHECK YOUR RECEIVING ABILITY

WIAW conducts practice transmissions nightly Monday through Friday, 10:00 P.M. EDST, at speeds of 15, 20, 25, 30, and 35 w.p.m. Once each month a special transmission is made to enable you to qualify for a Code Proficiency certificate or endorsement sticker indicating progress above your first certified speed. See WIAW schedule for details on frequencies.

The next qualifying run will be on September 18th. The text transmitted on that date, received successfully by ear at the highest speed you can copy, should be sent to ARRL for checking. To avoid errors in recopying, send your original copy. *Attach a statement certifying over your signature that the copy submitted is direct copy, made from reception of WIAW by ear, without any kind of assistance, personal or mechanical.* If you qualify, you will receive your certificate, or appropriate endorsement sticker for certificate you already hold. Those who qualified in the past should submit copy only if speed is higher than indicated on certificate or endorsement sticker.

QST lists in advance the text to be used on several of the CP schedules. This makes it possible to check your own copy. It also provides a means of obtaining sending practice since it permits direct comparison of one's fist and tape sending. To get sending help hook up your own key and buzzer and attempt to send right in step with the tape transmissions. Adjust your spacing in the manner indicated as necessary for self-improvement.

Date

Subject of Practice Text from July QST.

- Sept. 2nd: *Audio-Modulated Detection*, p. 13
- Sept. 4th: *A Beginner's Two-Stage Transmitter*, p. 18
- Sept. 10th: *"CQ 2400 Megacycles,"* p. 32
- Sept. 12th: *Converting Your Converter*, p. 47
- Sept. 17th: *The World Above 50 Mc.*, p. 50
- Sept. 18th: *Qualifying Run, 10:00 P.M. EDST*
- Sept. 20th: *A Conservative Kilowatt*, p. 54
- Sept. 23rd: *More Stations per Megacycle at Two Meters*, p. 61
- Sept. 26th: *Hints and Kinks*, p. 67

BRIEFS

W1CTI, Norwalk, Conn., lends a helping hand to budding hams in his city. The beginners copy WIAW's 15 w.p.m. transmissions for code practice. CTI also makes a copy of the transmitted material and distributes it among the neophytes so that they may check their copy. Here is a simple, yet effective way to give the code student positive help and encouragement.

Commander Brad Martin, XU1YV, has left China and should be on the air from his home station, W3QV, when you read this. "Brad" turned over the XU1YV layout to Captain Jeffcoat, USMC, ex-XU8FN, who will sign XU1YL.

Let's talk figures

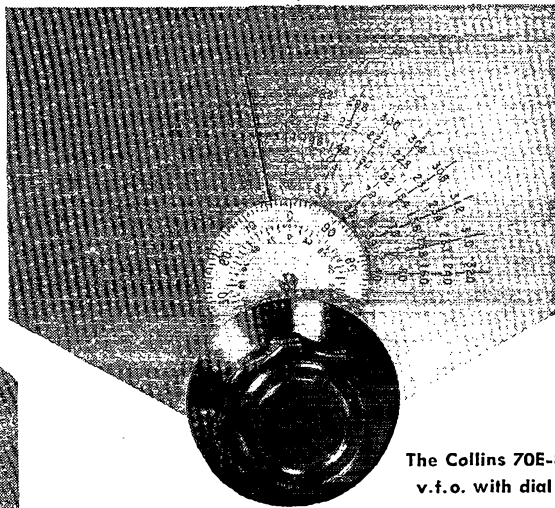
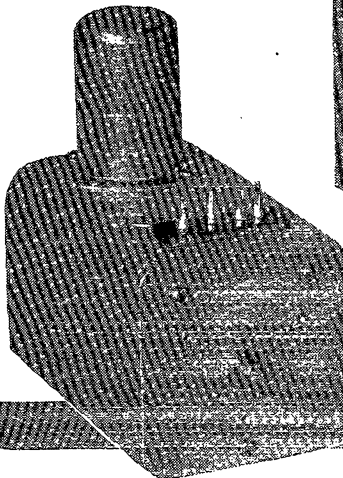

The Collins 70E-8
v.f.o. with dial

When used with the Collins dial illustrated above, the 70E-8 v.f.o. is calibrated directly in frequency. It's compact and reliable—uses only Navy approved components. And most important of all, it's highly stable and extremely accurate.

The total frequency deviation, resulting from all normal fluctuations in operating conditions, is less than .015% of the transmitted frequency. That means that the total error is not more than 150 cycles per megacycle. At 3.5 mc, the 70E-8 is within *515 cycles per second* of absolute accuracy!

Use the 70E-8 in your exciter, and

work the edge of the band with confidence. Or QSY to the frequency of the station you're calling. It's easy with this v.f.o. In fact, the 70E-8 is the heart of the new Collins 32V-1 amateur transmitter to be announced shortly.

This oscillator is excellent for application in test equipment, too. Use it as an r-f signal generator, and in your heterodyne frequency meter. For smooth operation, with twice the precision of a micrometer, get a Collins 70E-8.

FOR RESULTS IN AMATEUR RADIO, IT'S . . .

COLLINS RADIO COMPANY, CEDAR RAPIDS, IOWA
11 West 42nd Street
New York 18, N. Y.

458 South Spring Street
Los Angeles 13, California

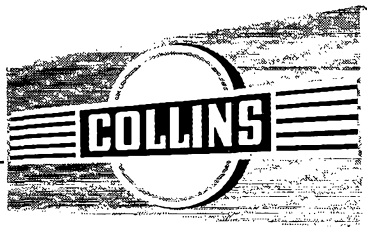

• All operating amateurs are invited to report to the SCM on the first of each month, covering station activities for the preceding month. Radio Club news is also desired by SCMs for inclusion in these columns. The addresses of all SCMs will be found on page 6.

ATLANTIC DIVISION

EASTERN PENNSYLVANIA — SCM, Jerry Mathis, W3BES — 3AQN reports that York County AEC is lined up with the Red Cross and has regular tests on 144 Mc. Prospective members of the Eastern Pennsylvania Traffic Net, please contact 3AQN. 3ADE is going to try to put over his idea of a traffic calling frequency at 3600 kc. before it is occupied by some net. 8EU now schedules 3ADE, AVK, and BQ. He sat out Field Day and logged forty-one Field Day stations. 3BXE is building a new rig using an 809 final. 3DGM and 3JBC have increased power. 3QP wants to know if we have any other vitamin salesmen in the Eastern Pennsylvania gang. Jack schedules OA4U. Most of June's activity consisted of preparation for and participation in the Field Day test. The local clubs turned out in force, and from all reports either the York Road Radio Club or Frankford ran up the highest score around here. These clubs report working out into the Midwest on 50-Mc. 'phone. 3ATR/3, of Beacon Radio Amateurs, made a fine score. 3EVH/3 and 3ITZ/3, of the West Philadelphia Amateur Radio Assn., went out for their first time and got mostly experience. 3FLH is back on the air with an 807 running 50 watts. Traffic: W3QP 10, BXE 4, ADE 3, BES 3, 8EU 1.

MARYLAND-DELAWARE-DISTRICT OF COLUMBIA — Hermann E. Hobbs, W3CIZ — While the U. S. A. T. *Victory* was en route to Europe, ECP worked 2MRL each night until the ship was 2700 miles out of New York City. They handled traffic both ways for the passengers, with 24-hour answer service. The Washington Radio Club is holding summer meetings on the fourth Saturday of each month through August. The meetings are at the usual place, CREI, 16th and Park Road, N. W. Among the Field Day participants were: 8UPS, 4ERG, 4GPW and XYL, 4IPS, 6PXU, G2JK, 9GBA, 9TBB, 5EKN, EYX, AKB, BWT, GKP, KBE, EIS, and AFY. 8MSK, a high man in BW Contest but not a member, went along with the gang. Stations were set up as follows: 8UPS/4, 9GBA/4, EYX/4, EIS. There were probably thirty or more Field Day attendants. WUPS reported a Field Day score of 1170. GKP did a nice job of rebuilding a motor-generator in the field. CDQ operated KBE at home while Wayne went afield. G2JK has left for his home in London, England. The club gang held a farewell get-together at the home of 4GPW, the club president. VE1QZ has gone to Halifax, N. S. He left behind a pair of 805s for the first Washington Club member working all VE1 on 28 Mc. The Washington Radio Club furnished radio facilities to National Capital Model Airplane Meet in June with one fixed station at airport, two mobile units, and one airborne unit, all on 144 Mc. The Washington Club inaugurated a good custom recently. (Good for the SCM!) A large sheet of paper is passed around at every meeting. Each member writes down at least one news item concerning himself or his station. The sheet is sent to the SCM. Other clubs may find this a good idea for news-gathering. 4GPW and his XYL toured New England and part of Canada in July. The entire 1945-46 code class of the Washington Club has passed its ham exams. CIZ was neglected SCM. The news sheet, *D. C. Notes*, is QRX for the summer.

SOUTHERN NEW JERSEY — SCM, W. Ray Tomlinson, W2GCU — Section EC: BAQ; ECs: ABS and JNZ. Delaware Valley Radio Association made 2500 points, over

200 contacts in FD. Trenton Radio Society made some 300 contacts. Hamilton Township Radio Club made a swell showing with only three active operators. Tri-County Radio Association, 2KHK/2, made over 500 contacts. BAQ has been working portable from Penn State Forest on 3700 kc. with alternate frequencies of 3895-kc. c.w. and 3906-kc. 'phone, 200 watts. IDY is on 3.9-Mc. 'phone, 6.9 watts. JNZ and ITR have nice 3.9 signals. JAG works 3.5 Mc. between runs. 2IJC is new Trenton ham. ISZ and BEK have Millen 51 rig. At July DVRA meeting, Jack Shure, of Shure Antenna, gave a demonstration on use of u.h.f. antennas. IAS and AEJ have resumed chess games over the air. JNZ has new beam working. AQM is on with BC-610 and new RME-45. Others lucky enough to own BC-610s are HKY, HEO, and 2PFT. JAV is working 28 Mc. since his return to civvies. 2OTI and 3IIH have new 28-Mc. beams. 2PAZ is grinding 'em out on 3.5 Mc. ZX is on 28 Mc. at Medford Lakes. New members of SJRA: 2OSD, 9CTG, 2PLF, 3EKK. FCQ received Class A recently, along with new call, 2PJK. RNEV and 2IOZ/2 are new hams in Succasunna. CWG is running 1 kw. to 250THs on 3.9 and 28 Mc. and sports a three-element close-spaced rotary. HPX is doing extensive experimenting with 144 Mc. HOH made over 120 contacts in two months of operating 144 Mc. IFT is on 3.5 Mc., 100 watts. INS works some nice DX on 28-Mc. 'phone. 2EKL is on 3.9-Mc. 'phone, 400 watts. JQL has self-constructed v.f.o. on 3.5 Mc. GLZ is runner-up with INS and HEO on 28-Mc. 'phone in Pitman. 8JSU/2 has 12 watts on 3.5 Mc. AWW runs 50 watts to 809 on 28-Mc. 'phone. GMY is working DX on 144 Mc. JAU is also on 144 Mc. INF is working 3.5 Mc. using 211 final, 130 watts, with half-wave end-fed antenna and old RCA 136 receiver. GWW, HRJ, FXV, and JPH are on 3.5 Mc. DOK hit 14 Mc. with the opening. The new State Forestry Emergency Net has several Peterson pot oscillators in m.o.p.a. jobs built by UK, and has very few superregens left as they have been replaced with BC-1068A superhets. Added to their present list of 144-Mc. stations are FWP, FCR, 2FJQ, AAE, and HOH. New calls to date: INF now 2PCF; ASQ now 2ASQ; CFS now 2CFS; ZI now 2ZI; IXH now 2IXH, ZX now 2ZX; BGP now 2BGP; ASG, changed to 2ORH, now 2ASG; GCU now 2GCU. The Somerset Hills Radio Club holds meetings the first and third Thursdays of each month in the Bassett Building, Summit. Officers are: 2BCC, pres.; 2IZP, vice-pres.; GIZ, treas.; HPX, secy. Please get your ORS and OPS certificates for endorsement or appointment applications in to your SCM. Traffic: W2OXX 5, 2ZI 2, Ray.

WESTERN NEW YORK — SCM, Charles I. Otero, W2UPH — One of RTX's transmitters was knocked out by lightning after having been entirely and completely disconnected. FEJ is heard consistently on 3.9- and 28-Mc. 'phone. HJM is on 28-Mc. 'phone with nearly all new gear. PRX also is on 28-Mc. 'phone with 500 watts, as well as UBC, Ken and Marge. WPS is on 3.5-Mc. c.w. MBW is on 3.9 Mc. CBK is on 3.9, 28, and 27 Mc. with PHQ and these two are working on 50-54-Mc. gear. OXP is working 3.5-Mc. c.w. with low power. ADM is active on 3.9- and 144-Mc. 'phone. IY is on 3.9 or 144 Mc. QJT is active with a new HT-4 on 3.9 Mc. and also has gear on 144 Mc. DST is on 28 Mc. and has some 144-Mc. gear going. TVO is working 'phone on 3.9 and 28 Mc. MZZ was speaker at the last RAWNY meeting. BLO is hot on 144 Mc. WHK worked 3GQM, portable-mobile, who was on his way to the Coast. BAG, a real old-timer, is back in the game. FMF now has a BC-610. LPZ has a new 28-Mc. beam. KWS is consistently putting out a swell signal on 3.9 Mc. OVP sports a new harmonic. NNP and PCN were on 3.5-Mc. c.w. Field Day through the cooperation of RRL, who loaned them his kw. gas-generator. SSC and SJV were on with a gas-generator loaned by UHI. LHI/2, the Niagara Radio Club, participated in the ARRL Field Day contest, operating from Niagara University Stadium with five completely portable stations running under 30 watts input. On 3.9 and 3.5 Mc. two center-fed doublets and one long wire antenna

(Continued on page 86)

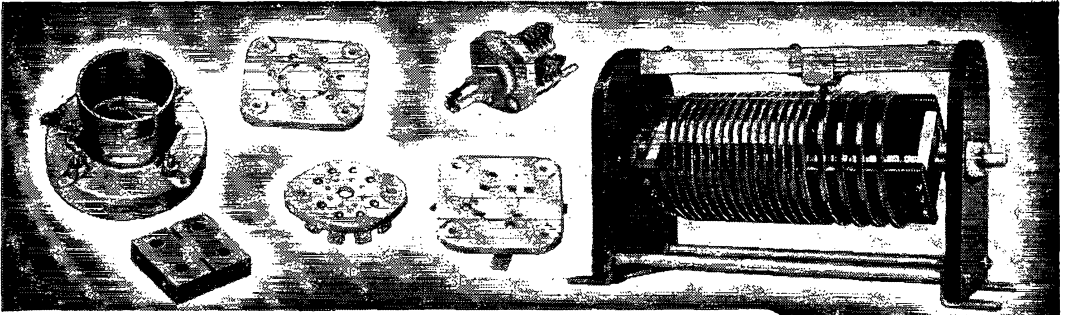

JOHNSON components are widely used and have proven their dependability through outstanding performance in industrial electronic, commercial transmitting and amateur radio applications.

CAPACITORS--Variable and fixed, Air and Pressurized Gas dielectrics. From thimble size miniatures to man-size cast plate models.

INDUCTORS--Wire wound, edgewise-wound copper strip, copper ribbon and copper tubing, plated to meet requirements. Fixed, tapped, continuously variable and variable pitch types.

TUBE SOCKETS--Bayonet, Wafer, Miniature, Acorn and Special Types. Designed to meet the rigid requirements of present day electronic circuits.

INSULATORS--Stand-Off, Thru-Panel, Cone and Antenna. Engineered for maximum mechanical strength and breakdown voltages.

CONNECTORS--Spring Sleeve and Banana Spring type Plugs and Jacks, Tip Plugs and Jacks, Multi-Wire Cable Connectors, Inductor Clips, Soldering Terminals and Tube Cap Connectors.

SHAFT COUPLINGS, R. F. CHOKES, PANEL and PILOT LIGHTS and machined **GLASS BONDED MICA PARTS** are among the other outstanding **JOHNSON** components engineered for flexible, trouble-free service.

JOHNSON standard components, only a few of which are shown here, are highly adaptable to special applications. The result to **JOHNSON** customers is time and money saved!

All standard products stocked by leading radio-electronic parts jobbers.

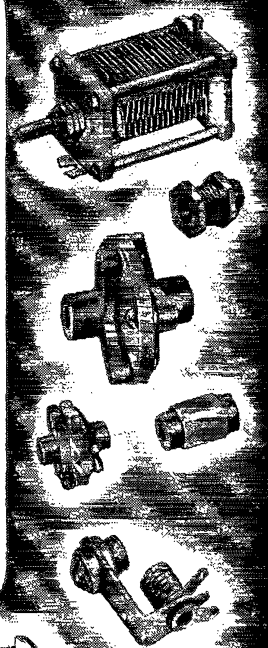

JOHNSON 
a famous name in Radio

E. F. JOHNSON CO. • WASECA • MINNESOTA

(Continued from page 84)

were used. On 28 Mc. a rotary folded dipole of 300-ohm transmission line, and on 144 Mc. a vertical dipole and vertical coaxial antenna were used. About 130 contacts were logged. Participating amateurs were: BAG, FMF, OVP, OWQ, SEF, 3JGU, HNN, IGI, IPZ, KHO, KWS, PDD, PNA, RYA, VJ, VJO, WOE, WOH, TJP, VE3BKL, and VE3TI. SJV lost a good mike Field Day. NOR worked his first W9 on 50 Mc. All former ECs, please contact SJV, the SEC, for endorsement. Write to the SEC, 81 King Street, Tonawanda, for AEC application blanks. On the KBT Radio Club Hamfest committee were PDJ, NNP, IIE, OZT, PRS, MQX, NVJ, IKV, LQC, NVO, and OWE. CV was M.C. UPH, the SCM, and W1UE, from Headquarters, attended. Speakers were 8QKT of Biley, 60JK of G.E., and NAB of Panoramic. LEZ was the speaker at the June 28th meeting of KBT. VDS now is 2PJF. New officers of the RARA are: 6MUA, pres.; MHW, vice-pres.; KFV, secy.; NES, treas. Executive Committee: PDF, VUY, OGC, PHT, and Ray DeWitt. 73. *Charlie.*

WESTERN PENNSYLVANIA — SCM, R. R. Rosenberg, W3NCJ — Section EC: AVY. RMs: TOJ, AOE, KWA. Stations active on Western Pa. ORS net are TOJ (NCS), AOE (Alternate NCS), AXD, CKO, HKU, KQD, TXQ. EYY has new call, 3KQD; GHM now is 3KUI. The following participated in Field Day outing of Warren County AEC group, KYW/3: BOZ, JSQ, PMY, PHC, KYW, RMM, HKU, NTJ, and AXD. SGJ reports that the Beaver Valley Amateur Radio Assn. has been reorganized with the following officers: HXZ, pres.; VRZ, vice-pres.; SGJ, secy.-treas. Present at initial meeting were: BCS, CGF, FJM, FYP, GMH, GUY, HXZ, KMF, RGD, RWI, SGJ, TTQ, TUA, TUN and VRZ. AXD reports that twenty-one members attended the June meeting of the McKean County Radio Club. KOB has rotary beam antenna with 300-ohm amphenol twin line feeders. VNE has pair of 812s on 28 Mc. with 300 watts input. The following operators participated in Field Day tests of Mercer County Radio Assn., OAJ/8: TXS, CBQ, VI, KCV, CJF, VUJ, IYQ, SFG, OAJ, KIL, QHS, QCN, AOE, GEG, VUR, BVP, KQA. Trailer for the outing was furnished by TXS and power was supplied from new 1½ h.p. gas-driven generator. SFG and OAJ/8 are operating on 50-Mc. 'phone. GEG blew up h.v. transformer. TTD/8 is moving to Wyoming. TXS and CJB are running kw. input. AOE worked PY2RG and 8QEN/CT2 on 3.5 Mc. and now has total of seventeen countries worked. The Radio Assn. of Erie has supplied all active members of the AEC with Abbott TR-4 transceivers, and the following stations are active on 144 Mc.: QJ, AAQ, AQY, JWZ, KKK, KKT, KQP, NMP, NBV, NCJ, RHK. During Field Day tests QJ/3, KLD/3, NMP/3, and NCJ/3 operated portable/mobile from cars. AAQ is Erie County EC. TFX and RWF are located in Erie. KVB is Erie's latest amateur to receive call. PDP has new transmitter on 3.9-Mc. 'phone with p.p. 813s final. HKU reports that UAJ was seriously injured in auto accident. KWA finds time for occasional QSO on 3.5 Mc. First OES appointee in this section is QCN/3. Amateurs interested in v.h.f. and u.h.f. experimenting are invited to write the SCM for OES application forms. We also request all amateurs to send in their traffic reports each month. Traffic: W8TOJ 40, KHU 20, 3KQD 19, 3RAT 6. *Ray.*

CENTRAL DIVISION

INDIANA — SCM, Ted K. Clifton, W9SWH — BKJ is new OPS; CLF and JDW are OBS. ECH and AB are on 50 Mc. HTH is new Mishawaka station on 3.5 Mc. NB is at Glenview, Ill. HKP is married now. CYC is on 3.5 Mc. with 50 watts in the woods at Pierson, Mich. EGQ is on 3.5 Mc. with an 80-meter doublet. The Gary CQ Club used the call JZA on Field Day. PBS has two-section 8JK on 28 Mc.; he also has new HQ-129-X. DLI is on 3.5 and 144 Mc. UKT is working both coasts on 3.5-Mc. c.w., using a Russian tank transmitter with 13 watts input. JMS, new station at Clay City, started with 20 watts to RK49 on 3.5 Mc., and uses HK24s with 95 watts on 28-Mc. 'phone. DGA is using e.c.o. with 6K6-6L6-807. EHU took off for vacation in Michigan. VIA worked Massachusetts on 50 Mc. Look for QLL on 3.5-Mc. c.w. IOH is a new station at Madison and is in the same business as ABB was when last heard from. AB and ZYK had rig in the field on Field Day and talked to MVZ in the field with the gang. SAG is holding down the key at YB; also he is trying to get 20 watts on 14 Mc. ENH worked KZ5 on 3.5 Mc. while looking for Vermont and Nevada.

CLF has unique plan for getting W1AW rebroadcast. JLT, his son, copies the message from W1AW using the transmitting antenna at the same time that CLF is transmitting, both using same antenna. The following is the schedule of Indiana OBS: CLF, at Fort Wayne, on 3932 kc., 7:00 p.m. CST, Wednesdays and Fridays. JDW, at Muncie, on 3050 kc. at 8:30 p.m., CST, Mondays and Fridays. Please report your reception of these stations to your SCM. All who are planning to take part in net operation this fall, please write and indicate best time for net operation in your case. Traffic: W9UKT 9, SAG 5, DHJ 2, 73.

MICHIGAN — SCM, Harold C. Bird, W8DPE — 8IFT sends us a card from Sweden and sends best regards to the gang. 8FX is doing a nice job as secretary for the DARA and finds time to get on QMN now and then. 8UGR has cancelled his order for an HQ-129-X to help combat inflation. 8RJC and NIT send in nice traffic reports. 8TZD is bucking for ORS endorsement. 8ONK reports a score of 4500 points during Field Day using call 8ONK/8. 9YX is doing a fine job handling traffic for the college. 8WET reports that Port Austin is well represented in QMN net now. 8KNP has arrived back in the States and will be with us on QMN again. 8ABH now is regular reporter on QMN with traffic. 8IHR still handles traffic. 8SCW, our NCS on Monday and Friday, sure does a fine job handling QMN net. 8SAY is out for ORS again. 8TBP/8 had a swell rag-chew with CB recently and talked about the old days in radio. 8MGQ is doing a nice job for DARA and tried hard to get a good score on Field Day. 8DAQ is running schedules with all parts of the country. 8QJK apologizes for not having a large traffic score; he has moved into new house. 8NQ gets on QMN now and then. He has his final pushed up to 250 watts now. 8YIT is new call in Marquette. 9VJO and 9YLS are getting things going on 50 Mc. 9EVI installed a new noise limiter in receiver. 9CSI is waiting for new 28-Mc. coils for receiver. 9VJJ heard Louis and Conn fight down in iron mine with midget receiver. 8UUV is moving to Tuscaloosa, Ala.; his QTH there will be 7 Druid Court. 8AHV sends the following information: 8WYD is new call. 8VDC is working lots of DX. 8EFW, from Cleveland, passed through with mobile rig on 28 Mc. and worked PUK, VDC, SDB, WYD, and AHV. 9EXT visited Paul while down from the North. 8LR has an HT-46 Hallierafters transmitter on 28 Mc. 8AW has OPS certificate now and sends in report to indicate activity. 8UCG, busy with club picnics and club doings, reports YAD on 28-Mc. mobile soon. Your reports are appreciated, but let's have some activity reports on Field Day; also news of any special work you have been doing of late. Traffic: W8SAY/8 108, 9YX 68, 8DAQ 62, TDBP/8 26, DPE 16, IHR 16, MGQ 16, RJC 13, SCW 12, QJK 11, ABH/8 10, NIT 9, WET 6, ONK 5, TZD 5, 73. *Hal.*

WISCONSIN — SCM, Emil Felber, jr., W9RH — Lester R. Reinmund, PTE, has accepted the position of Section Emergency Coordinator. Organize local emergency units and send your nomination of local Emergency Coordinator to him at 1120 South 76th Street, Milwaukee 14. Lester will also be looking for you fellows on 3.9-Mc. 'phone and will answer all questions over the air or by mail. DRN, at Twin Lakes, has a pair of HK24s TNT on 144 Mc. with a three-element beam. He has contacted HPS at Lake Geneva with an 89 report and would like a schedule with Milwaukee stations. The Northern Wisconsin Radio Club has been meeting regularly the last Tuesday of each month and at the last meeting the club held its regular business meeting including the election of officers for the next season. The new officers will take office the first meeting, which will be held the last Tuesday in September. The following were elected: HMX, pres.; ZRZ, vice-pres.; GIT, treas.; OSF, secy.; ASQ, act. mgr. MUM, at Eau Claire, is looking for traffic. DIR is on the north end of the Kentucky State Network and willing to handle all traffic. The Milwaukee Radio Amateurs' Club operated USA from July 11th through August 12th at the Cities lake front where a mile of lake front parkway shows were held day and night to salute down the years, to commemorate its first 100 years. Special Centurama W9USA QSL cards are being sent to all stations worked. Yours truly finds it necessary to resign as SCM. Thanks for your fine cooperation, fellows, and until the election of a new SCM please forward your monthly reports to C. C. Richelieu, ARE, 4901 South 30th Street, Milwaukee 14, who will serve as Acting SCM. 73 and good luck. *Emil.*

(Continued on page 88)

When your sked comes up... be *Johnny on YOUR SPOT!*

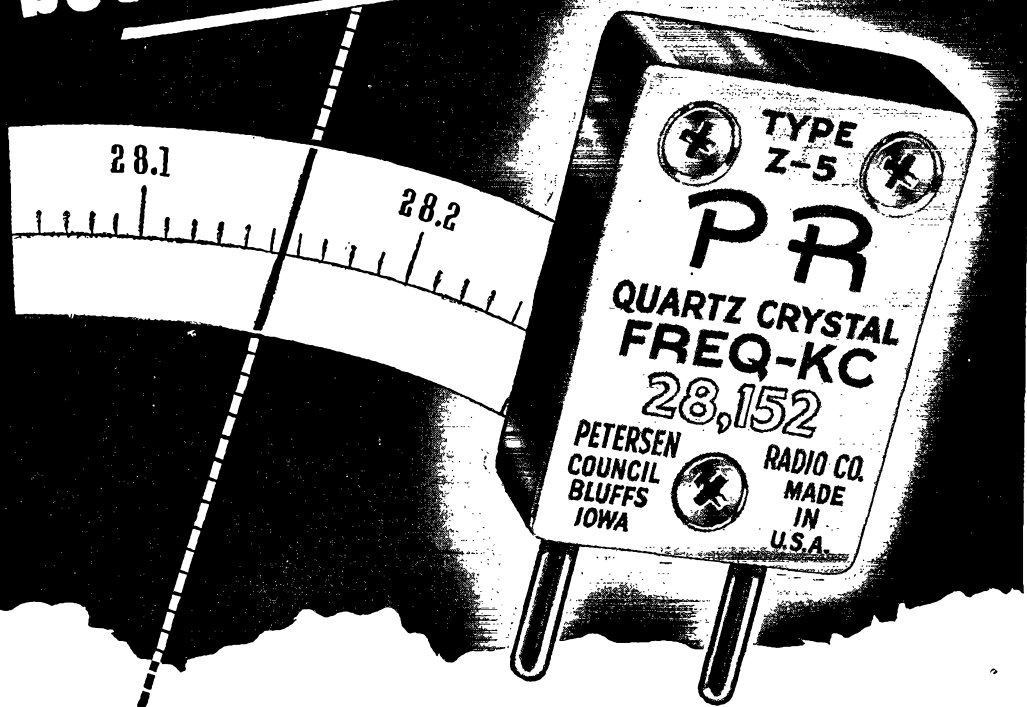

"Your Spot" on the bands you work is something precious . . . it gives you identity and personality . . . it builds radio friendships . . . makes amateur radio something more than a series of QSOs. So pick your spots and be sure you're there EVERY TIME with PR Precision Crystals . . . world famous for low drift, high output, rugged and long-lasting service, even at the highest frequencies. PRs are built for

you, for your operating conditions. They're unconditionally guaranteed . . . moisture and contamination proof . . . low drift . . . high in activity . . . accurate within .01 per cent . . . made from select quartz, X-ray oriented . . . one PR in your rig will show you the difference. Available for ALL BANDS. Get them from your jobber. Petersen Radio Company, 2800 West Broadway, Council Bluffs, Iowa. (Telephone 2760)



SINCE 1934

PR Precision CRYSTALS

10 METERS
PR Type Z-5.

Temp. coefficient less than 2 cycles per MC per degree centigrade. High activity. Heavy drive without crystal damage. \$5.00

20 METERS
PR Type Z-3.

Temp. coefficient less than 2 cycles per MC per degree centigrade. High power output. High activity . . . \$3.50

40 & 80 METERS
PR Type Z-2.

Rugged. Low Drift (less than 2 cycles per MC per degree centigrade). High keying activity. High power output. Accurate calibration . . . \$2.65

(Continued from page 88)

DAKOTA DIVISION

NORTH DAKOTA — SCM, Raymond V. Barnett, WØEVP — GZD is OBS for Grand Forks. He reports VAZ and OCI back in the Forx and working 3.5-Mc. c.w. RGT has souped his rig up to a half-kw. with a pair of HK54s. LHB is still using windcharger to furnish power but expects a.c. line. DM and HSR are putting up new antennas. MYD is putting finishing touches to a new 100-watt 'phone-c.w. rig. VSK, MKB, CYN, KOY, and ZTL are staying on 28 Mc. to avoid the heavy summer QRN. PDN is having grief with both his new HT4 (BC-610) rig and the new RME-45 receiver. PJT is waiting for the return of his new HQ-129-X. EOZ is on the air at Jamestown. OVP/β now is 7JLD at Billings, Mont. GJJ and EVP are QRL installing a new 5-kw. air-cooled rig at KFYR. Your SCM is minus all teeth so will be stuck on c.w. until new store grinders restore voice and confidence. Traffic: WØKZL 2. 73. Ray.

SOUTH DAKOTA — SCM, P. H. Schultz, WØQVY — EKT, of Sioux Falls, visited the Pierre gang recently. GZU is out of the Army and has returned to his job with Materials Testing Lab of State Hiway. EOJ and WKI have moved to their antenna farm at Madison. Arne says there's a bungalow included in the purchase. GLA furnished Sound Truck for Pierre "Days of '81" celebration and took the SCM over the coals for saying that the Rapid City Club had reorganized. They want it to be known that they kept up meetings all during the war. How about some news from gang out there and from all over the state? GLK and BLK have new SX-25s. FJR meets all trains waiting for his. WUU reports that he still is at Alcester. BJV received his old call letters back when he got his β call. 73. Phil.

NORTHERN MINNESOTA — SCM, Armond D. Bratland, W9FUZ — 9WUQ received his new call and it is WØLID, really! Several ORS applications have been received and activity in the northern section is picking up since all the bands are open again. FUZ is looking around for someone to volunteer to take over as SCM of Northern Minnesota as he expects to continue going to sea for several more years. Please send on your suggestions and also your activity reports to Birchmont Drive, Bemidji. TU and 73. Army.

SOUTHERN MINNESOTA — SCM, Vernon G. Pribyl, W9OMC — RHT is announcer at WDGY and is active on 3.9-Mc. 'phone. FGP put in his bid for being oldest man ever to get a ticket; he is 58! RJF is new ORS and will be OO shortly. YXO is considering ORS appointment. The St. Paul Radio Club station worked five stations on the East Coast on 50 Mc. during Field Day operation. Amateurs reported active on the new band are QIN, DWU, and NCS, Minneapolis; TOZ, St. Paul; DZM, Anoka; JHS, Champlain; SV, St. Cloud. NCS has a pair of VT227As for a kw. final and has ordered an HRO-5TA. MLN is on 3.9-Mc. 'phone from Pipestone. NBW operated portable from Chester Park on 3.9-Mc. 'phone with 7 watts to a 7C5 and had good results. DRG is rebuilding using T55s as a low-frequency final and a VT127A as a high-frequency final. LOI is going to a kw. with an 833 final. LSX is new amateur at Butterfield and is active with push-pull 807s in the final on 3.5-Mc. c.w. The Jackson County Amateur Radio Club elected new officers. They are: UYZ, pres.; FAJ, vice-pres.; GBZ, secy.-treas.; JSS, activities manager. The club participated in Field Day at Clear Lake. BHY completed his 900-watt transmitter and reports good luck on 3.9 Mc. and now is heading for 14-Mc. DX. JIE needs one continent for WAC. He uses a "J" antenna on 14 Mc. and really gets out well. OMC is active on 3.9-Mc. 'phone. 73. Vern.

DELTA DIVISION

ARKANSAS — SCM, Marshall Riggs, W5JIC — Thanks, boys, for giving me the honor of holding the office of SCM for the next two years. I will try to fill the post to the best of my ability, and trust that it will be good enough for everyone concerned. I would like the co-operation of everyone in the State. 9WXE visited JIC recently. JSR, Fordyce, is on 3.5 Mc. KVV/KNI is on in Camden. QI and JBU are on 3.5 and 3.9 Mc. from Cullendale. 9JOX/5 is on 3.5 Mc. in the City of Alma. Visitors in town: 9LFW, 9IST, and HNR. HOT has moved to town from Paris. HGC visited ICS several days. IYW is busy constructing 150-watt all-band rig with bandswitching. HER is on 3.9-Mc. 'phone. EA also is on 3.9-Mc. 'phone.

ICS and HGC visited at Hot Springs recently with EA and 8MIH/5 and had a very enjoyable time. The local boys had a nice Field Day trip to nearby Mt. Vista. JIC is dressing up the 812 rig in a new rack and panel. How about you boys pitching in and passing the dope along? Send anything that you think will be of interest. 73. Marshall.

LOUISIANA — SCM, W. J. Wilkinson, jr., W5DWW — LAE and KXP have completed new beams. JYK is back in New Orleans. HTU is enthusiastic about new antenna. 9JWB/5 has XYL more interested in ham radio than he. Reorganization of the Baton Rouge and Shreveport clubs has begun. KHC visited the SCM while in Shreveport. LDH has received new equipment. EVR has beam in attic but can't rotate it. GDU and GJO report good results on 3.9-Mc. 'phone. Visitors are invited to attend the meetings of the Delta Radio Club of New Orleans. EC is all set for forthcoming ORS Parties. AEH reports Delgado Radio Club now 100 per cent ARRL Club transmitter is under construction. LDL is ex-4DTV. LEL is ex-2NKB. KOU has portable-mobile rig on 28 Mc. GXO has 200-watt on 28 Mc. HHT is showing he can pound brass. IKV plans 'phone rig. GST and GJO operate together. UK, ABS, KTB, GXO, KXU, 3FPA, and 6MYR attended beam erection party of EVR. JSM has gone to sea. IMT plans 1 kw. LAY is new-comer to hamdom. 144-Mc. rigs are being built by HTE, ABS, and AEH. HHT and HRD will try 50 Mc. LAB is active in Delta Club. Ex-HSH now is 6VWF. HKU has a pair of 250THs. HGT has new three-element beam. DRX says he will copy 16 w.p.m. if they "don't send it too fast." QH is working lots of DX since erecting new beam. CEW is PAM and wants QSO with 'phone men about state net. IOP will handle your traffic. DWW is ready for action. KZM is getting 400-watt rig build for all bands. Traffic: W5KZM 3. 73. Dub.

MISSISSIPPI — SCM, P. W. Clement, W5HAV — GG has Class A license now and has increased power to 300 watts. EGE, HGL, HTL, IGW, DNS, 8PFP/5, and DEJ are active on 3.5-Mc. c.w. EGE, IGW, HTL, and DNS are member stations of "Rebel" traffic net. Welcome to two new Mississippi hams: LAK and LEC, both active on 3.5-Mc. c.w. 4HLJ/5 now has his old call, HFQ, back. BDQ, CQJ, VJ, BJO, HAV, HFQ, and GG are active on 3.9-Mc. 'phone. IGW is looking for old cronies, and BK is DXing on 3.5-Mc. c.w. with FB signal. HTE is on 28-Mc. 'phone with 100 watts and an excellent "twin three" beam. ANP is quite active on 3.9-Mc. 'phone. DLA, with new rig on 28-Mc. 'phone, is getting his share of DX. IBO has deserted 'phone for his first love, 7-Mc. c.w. JHS and JSH now have Class A licenses and are active on 14-Mc. 'phone. HRW is on 28-Mc. 'phone. IOK is on 3.5-Mc. c.w. with a good signal.

HUDSON DIVISION

EASTERN NEW YORK — SCM, Ernest E. George, W2HZL — Westchester Field Day was held at Whip-poorwill Country Club in Chappaqua. Schenectady Field Day was held at Bevis Hill Reservoir, highest point in the County. One thousand feet of antenna wire used in three antennas 40 ft. high helped the Schenectady gang to get out. BWS, aided by GMM and KKE, guided Westchester; and HZL, aided by KLM, headed up operations at Schenectady. 1LAS/2 worked Mt. Everett, Mass., from Chappaqua on 144 Mc. AKJ, with old call, is back on in Bronxville. Westchester Amateur Radio Association now meets at the Little Theatre at the County Center. AQK has enlarged his Sterba array to sixteen elements. DRH has made up a three-element beam from gutter pipe and is working out fine. DOM is moving to Long Island. AAD is active on 28 Mc. OXD is working on 500-watt. LSD requests that any ham gear donated for Norwegian hams be sent him in Yonkers. GYV hears 1AW on 50 Mc. superhet regularly in Schenectady. IXK reports interest and construction on 2 and 1 in the Poughkeepsie area. Numerous contacts are being made between the G.E. Co. radio department hams now in Syracuse and those still in Schenectady. DC and CBO are keeping this route hot.

NEW YORK CITY—LONG ISLAND — SCM, Charles Ham, jr., W2KDC — New ECs are sought for Queens Manhattan, and Bronx. The EC picnic at Bethpage, June 16th, was small but successful with BKZ, LFY, OIE, BSP, KWO, RZ, CET, KNA, DOB, FQW, AES, JND, OHE, NZB, and BGO, plus numerous ex-YLs and YLettes, in,

(Continued on page 90)

At Last!

A low-cost, easy-to-use modulation meter



Now you can monitor your modulation percentage and speech quality with the new Sylvania Model X-7018 Modulation Meter.

Compactly styled to fit the most cramped operating tables, this new instrument offers you these features:

1. Elimination of battery or A. C. power supply, with consequent freedom from hum or distortion. These advantages result from the use of the **Sylvania 1N34 Germanium Crystal Diode** to replace the vacuum tubes used in conventional monitor circuits.

2. Direct, accurate readings of modulation percentage with carrier frequencies up to 54 mc. Convenient switch permits checking positive or negative peaks and carrier shifts.

3. Phone jack provided to allow amateur

to hear his modulation with complete clarity.

4. Hermetically-sealed meter with easily-read, three-color scale indicating from 0 to 120% modulation.

5. Completely shielded, crackle-gray metal case with etched aluminum nameplate. Terminal strip in rear for external link.

You'll find the Sylvania X-7018 of great assistance in complying with FCC regulations on overmodulation. Equally important, it will help you keep your average percentage up in the effective region between 60% and 90%.

With its rugged, compact construction, the Sylvania X-7018 is also ideally suited for police, fire, marine and forestry radio stations.

Now available at distributors!



SYLVANIA ELECTRIC

Electronics Division . . . 500 Fifth Avenue, New York 18, N. Y.

MAKERS OF ELECTRONIC DEVICES; RADIO TUBES; CATHODE RAY TUBES; FLUORESCENT LAMPS, FIXTURES, WIRING DEVICES; ELECTRIC LIGHT BULBS

(Continued from page 88)

attendance. DOG reports from Suffolk County successful affiliation with three Red Cross Chapters and others pending. All active 144-Mc. stations operated on three bands during Field Day using portable power. A new call in Suffolk is PTQ, on 144 Mc. JFP is back in the Maritime Service for a short hitch. OQI recently became South Shore police officer. Heard unfailingly each night on 144 Mc. are ADW, EBT, FCH, OQI, PTQ, and DOG. Nassau now shows forty-five stations heard quite regularly on the 144-Mc. EC net with PCV, BWC, WD, HFM, BGF, GP, MFI, and 3JHG/2 recently added. 4HQW/2 mobile uses three-element beam as does GZ who, with JND, worked Pennsylvania, New Jersey, and Connecticut on 144-Mc. mobile recently. JIH has new super mobile rig. ASW has new RME-45 while MHH traded HRO for NC-240C. KZ uses a BC-342 receiver. OHE, Brooklyn EC, has been tied up with jury duty and before that was QRT because of illness. Several clubs have sent tentative reports covering Field Day activities, including the Sunrise Radio Club, which used a portable generator at Commack, Long Island, and operated continuously on 144-, 28-, 3.9-Mc. 'phone and 3.5-Mc. c.w. The radio club of the Sperry Gyroscope Company operated from tents on a large plot near Albertson, also using a 5-kw. generator. The Northern Nassau Wireless Association also was active. KDC, during a Cornell reunion at Ithaca, New York, was not believed by local hams when he stated that "hundreds" of signals were heard nightly on the 28-Mc. band in New York City. The 8:17 out of Little Neck could be called the "radio special"; CJY takes a set of seats and holds them for CNJ, LKC, and PYY at a later station. GHK, from Staten Island, reports that he and AMO, CF, FQS, HIY, LVS, NPH, ORB, JNZ, JLC, and MSB are active on 28 Mc.; HIY and 1HWQ/2 are on 3.9-Mc. 'phone. On 144 Mc., GQH uses a TR-4, KOC is a new ham, and AMO sees possibilities in the band. 27 Mc. is fairly popular with many of the 28-Mc. boys. HIY is the proud builder of new superhet. The YLRL reports through PMA, secretary, that OWL, PBI, PCU, and PZA are recent additions to the club. Its first annual luncheon was a great success, the committee being headed by IXY with NAZ, OLB, OWL, and others assisting. They resume operation Sept. 20th. AYJ is using 75 watts on 28 and 3.5 Mc. and also is active in the Northern Nassau Wireless Association, of which DUA is president. They meet every other Wednesday. OEI and PBH are trying for long rag-chew records, they talked three hours twenty-one minutes on 144 Mc. using about 3 watts each. MQB is using low power on 3.5-Mc. c.w. in Easthampton. After four years of inactivity the Queens Radio Amateurs recently reorganized at LUX's home. Present were KXG, LPJ, GXC, GGN, CKQ, AOD, and LEA. The club is interested in contacting past or potential members. LEA is secretary. 1MJK/2 now lives in Rego Park and expects new W2 call. HXT is putting up two 30-foot masts on apartment house. The Federation of Long Island Radio Clubs has definitely scheduled a hamfest at the Commercial House, Queens Village, for October 18th; admission limited to 450. New officers of the Amateur UHF Club, which meets the second Tuesday of each month at the Jamaica YMCA, are DGJ, OTZ, BDV/2, and NAX, in the usual order. IOP worked 8LZK/NY4 on 3.5 Mc. for only DX of the month. GRB, at 815 Quincy Street, Brooklyn, has 350-foot-long feeders to an 80-meter Hertz using 25 watts to a 6L6. Traffic W2EC 14, IOP 10, KDC 4, BO 4, DUA 3.

NORTHERN NEW JERSEY — SCM, John J. Vitale, W2IIN — DZA, NLJ, and MLX are on 235 Mc. and are inviting others to work on this band. DCL will soon join them. CZS/7 is back in town. LIQ, IIN, IZC, AU, and HZK have Collins Autotune 13A transmitters. PUW, PIX, PIY, LXO, FJQ, JLR, IIN, and BLC are on 144 Mc. BLC is building high-power rig for 144 Mc. LTJ, 75 meters, blew out a fire when the celluloid strips on the antenna coil started to burn from flash-over, caused by the damp weather detuning his antenna system. The Somerset Hills Radio Club used 3GQT's 28-Mc. beam and mast on field location for Field Day. MLW, LDI, LSR, ATK, and MHK are selling ham gear at same place. IIN, MUP, NKD, and EUI broadcast over WAAT representing UCARA on the Coffee Club Program. MUP, MLW, IIN, FOA, IZC, NKD, BRC, LTP, EUI, PIX, PIY, LIQ, PMD, BTZ, HVE, ECP, PBD, CIU, HGI, LI, CQD, DVF, LWY, KOJ, and 3BGL were up to Mountain Top, at Watchung on UCARA (W2GSX) Field Day. EUI worked eleven states on 50 Mc. from his home on Field Day. BTZ invited the UCARA

boys on his boat at Great Kills, S. I., for one Sunday in August. AOI had a close call when overcome by fumes from a gas heater. He was able to take the receiver off the hook, and alert the telephone operator, who dispatched radio police to investigate. AZB is living in Virginia, DX is at Countryside; the two 56-Mc. pals have separated. IZP, 3ZD, and HXW are on 144 Mc.; also MYH with 125 watts. PBH is vacationing in New Jersey on 144 Mc. HFP is working "duplex," he paints the ether with a key, and the house with a brush. The Ham Shack Club meets Mondays at 10 P.M. at their Rendezvous. MDZ, Cornell student, is building a 100-watt transmitter and a 6-ft. rack. MDP is mobile on 144 Mc. with 8 watts. MUP is vacationing in Maine. PIY is mobiling to Vermont CQing 144 Mc. NAB has arranged a lecture and demonstration on visual panoramic reception principles. Clubs should write him, if interested. NKD had a four-hour QSO with NQC, a YL MUP, LKN, LXO, FJQ, and JLR are working W1s on 144 Mc. CHQ has gone in for boating. The State Law has been amended regarding the installation of short-wave radio receivers in automobiles, making way for radiotelephone service soon. Station activity reports were received from CJX, GVZ, NIY, JKH, NWA, BRC, MIG, and CGG. Attention is called to fact that maybe you or your buddy, your club or local group, could have been mentioned in this write-up. Why not drop me a card or note regularly. The success of this column depends on what you send in. Northern New Jersey has plenty of activities and amateurs, but has been very weak in reporting. With a little cooperation on your part I shall try to make this column of interest to all of you. **CUL. 73. John.**

MIDWEST DIVISION

IOWA — SCM, Leslie B. Vennard, W9PJR — Only two reports were received for last month's write-up and AHP's was delayed. Therefore, no report. ØYDX is working on 144-Mc. rig. AHP is trying to get the Emergency Corps organized around Tri Cities and hopes to get a good net going in Iowa and Illinois. QUV and HAQ are active on 144 and 50 Mc. ACL and CGY are on 3.5 Mc. AED is vacationing in Minnesota. DIB visited in Davenport. QYW, DVN, and IGL are on 28 Mc. ØAHX's first CQ on 14 Mc. raised OA4R with only 60 watts. WNL, NYU, and QVA were the principal operators at Burlington's Field Day. TMY's rig came through again FB. AEP, IFI, and BBU met at AHP's for the first time in twenty years. AHP/QUV works BBU on 28-Mc. ground wave — 140 miles. Let's get those EC rigs lined up, fellows. Didn't hear many of the Iowa gang on Field Day. Let's get ready for the failure before it hits. Traffic: WØAHP 17, WNL 2, QVA 1. 73. Lea.

KANSAS — SCM, Alvin B. Unruh, WØAWP — KCS was discharged in April from the Navy, and returned to Kansas for a short time. He now is 4IYT in Miami, Fla., and will look for Kansas contacts. PAH writes from Manhattan, where he is instructing. The college station, QQQ, will be reactivated. YUQ has worked all districts on 50 Mc. using 350 watts. OTV is active on 28 Mc. PAH and OUI send OPS certificates for endorsement. AWP has new QTH, one block north of UUS and one block south of OKD. WARC gave the club emergency power supply its annual workout during the Field Day tests. The call UUS was used, with QEF's HT-9 transmitter and DJL's battery-operated equipment. KUU has new QTH at edge of the city, and reports the 8JK beam working out better than the vertical "J." ZKA and his YF returned from vacation to Pacific Northwest. VE7BJ was Wichita visitor. He is active on 3850 kc. and 14-Mc. 'phone. Send in the dope on your equipment, fellers. 73. Abie.

MISSOURI — SCM, Letha A. Dangerfield, WØOD — KPM, back from the Pacific, has 20 watts on 3.5 Mc. 6UTU/9, ex-KIC, back ditto, is spending much time in the hospital, but has changed his 2/5 rig to 144 Mc. with the help of DDX and has erected vertical "J" fed with coax. KEI sends in traffic report and says he is moving to Kansas. QXO renewed ORS and RM appointments and can be found on 3755 kc. from 6 to 7 A.M. and 6:30 to 7 P.M. daily; he has traffic schedule with 5SI and plans one with 4PL. GCL renewed ORS appointment, has three new 3.5-Mc. crystals, and has finished quarter-wave vertical for that band made from 104 Phillips 66 quart cans soldered together. ZJB, who is the only Missouri OES so far, has worked twenty states on 50 Mc. and is doing much FB work with v.h.f. VEE has transferred his ORS from Illinois to Mia-

(Continued on page 88)

NEW Electro-Voice CARDYNE

Now You Get More Features Than Ever Before... in a Single-Head Cardioid Dynamic Microphone

New E-V developments bring you true cardioid unidirectionality... smooth, wide-range response... high output... and other desirable advantages in a rugged single-head dynamic.

Through the exclusive new E-V *Mechanophase** principle, the CARDYNE substantially reduces background noise and reverberation. Increases effective working distance from microphone. Stops feedback. Permits increased loudspeaker volume. Can be used with back close to wall. Gives extremely accurate pick-up and reproduction of speech or music... indoors and outdoors. Highly suitable for the most exacting sound pick-up work... in broadcasting, recording, public address, and communications.

Trim, modern, functional design, finished in rich satin chromium. Smooth, firm tilting action. "On-Off" switch. Available in 50, 250, 500 ohms impedance, or Hi-Z (direct-to-grid, 25,000 ohms). Low impedances balanced to ground. Also available without "On-Off" switch.

CARDYNE II. Model 731. List Price... \$75.00
Frequency response, substantially flat, 30-12,000 c.p.s.

CARDYNE I. Model 726. List Price... \$55.00
Frequency response, substantially flat, 40-10,000 c.p.s.

*Patents Pending

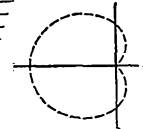
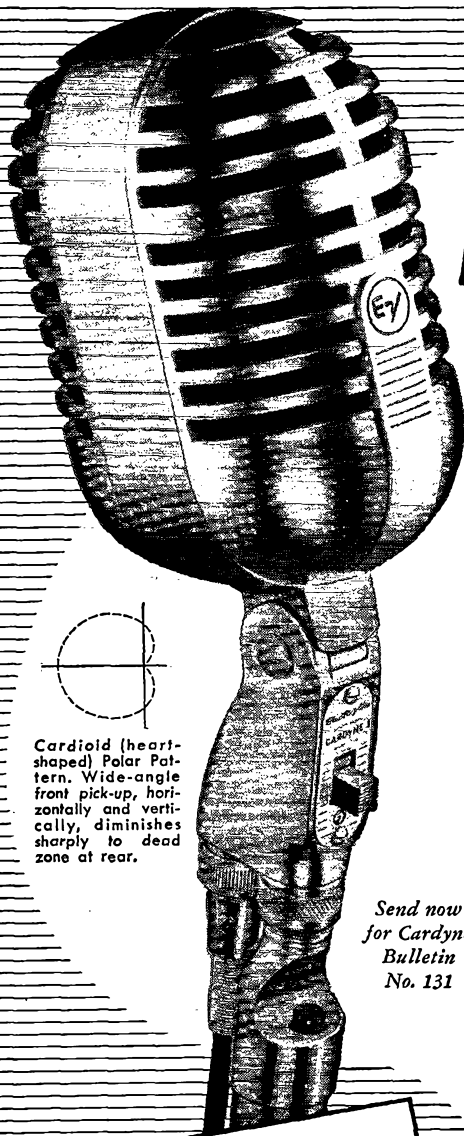

Cardioid (heart-shaped) Polar Pattern. Wide-angle front pick-up, horizontally and vertically, diminishes sharply to dead zone at rear.

Send now
for Cardyne
Bulletin
No. 131

**Only the CARDYNE
Gives You All This!**

- New E-V Mechanophase* Principle
- True Cardioid Unidirectionality
- Reduces Background Noise and Reverberation
- Stops Feedback—Permits Greater Volume
- Relatively High Output
- New E-V Acoustalloy Diaphragm
- Substantially Flat Response

No finer choice than
Electro-Voice
MICROPHONES

ELECTRO-VOICE, INC.
1241-A South Bend Ave., South Bend 24, Ind.
Export Division: 13 E. 40th St., New York 16, N.Y., U.S.A.
Cables: Arlab

Designed to the Highest Standards

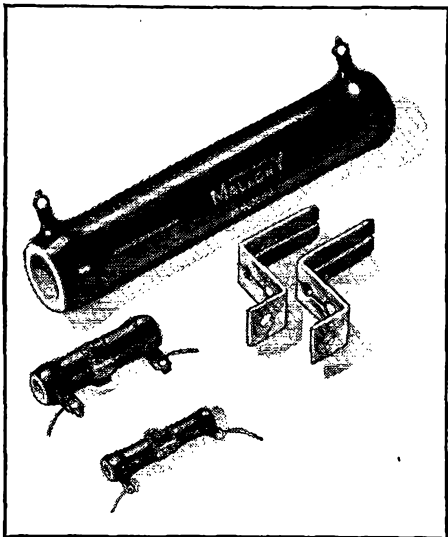

Improved by war-born developments, better in appearance, more reliable in performance, Mallory resistors are serving today in thousands of applications where quality is a "must." This at no increase in price!

You can depend on them to dissipate heat rapidly... to withstand atmospheric conditions... to remain free from burnouts and failures... to stay accurate... to save you time and trouble always.

Available in fixed and variable types, Mallory resistors cover every power range from 10 watts to 200 watts, are stocked in a wide variety of sizes, types and resistance values. See your nearest Mallory distributor—or write direct.

P. R. MALLORY & CO., Inc.
INDIANAPOLIS 6 INDIANA

P. R. MALLORY & CO. Inc.
MALLORY

(Continued from page 80)

squi. OUD hopes the new monitor will make her sending more readable. BMS is winding 40-meter coils from relics of 160-meter coils. That is all we have, gang. If you want to read it—send in some in exchange. Traffic: WØKEI 8, 9QXO 6. 73.

NEBRASKA—SCM, Arthur R. Gaeth, WØFQB—TQD reports hearing RGK on 28 Mc. short skip, and that HLX has a small rig, and DPE is active in Cozad; DMY is experimenting with antennas on 28 Mc.; TJV has a new SX-28A and HT-4; EDI has new e.c.o. on 3.5 Mc.; FBK paid TQD a visit; PDH is active on 3.9-Mc. 'phone; TQD is using new end-fed, half-wave antenna on 3.5 Mc. which is 60 feet up, and received OBS appointment. RQK reports that on June fifth a hamfest was held at GPX's with the following in attendance: UBN, CVC, BIW, EXP, DNW, RQK, Bruner (LSPH), TMK, Pitzer, and Tierney. A door prize, consisting of two Raytheon 866A tubes, was won by Bruner. UBN demonstrated a radio range station and explained its operation. UBN is on 3.5-Mc. c.w. with a pair of 805s; EXP has a pair of sixty-five foot sticks on which to hang 3.9-Mc. antenna; DNW had his NC-200 overhauled and loaned it to RQK while on vacation. RQK finally received his new HQ-129-X. BIW swapped his old RME-45 for the latest model. COU is looking for the old prewar round table gang. 7FFW/Ø has a "gallon of bait" and is looking for the big ones in Nebraska. IJF has three-element beam for 28 Mc. completed. Special Agent ØØ reports EXP giving 28-Mc. beam away when 14 Mc. opened. RQS is sporting new XH array. FQB has 10P on 7 Mc. OO appointments are waiting for those who can qualify, and we need you. CU Midwest Convention. Traffic: W9TQD 6, 9FQB 2. 73. Art.

NEW ENGLAND DIVISION

CONNECTICUT—SCM, Edmund R. Fraser, W1KQY—Have you made application for AEC membership yet? Contact your EC listed below. If none listed for your area, write Raymond W. Woodward, W1EAO, 41 Middlefield Drive, West Hartford, Section EC. ECs as follows: Branford, W1BW; Danielson, W1ED; East Haven, W1NGQ; Guilford, W1KAT; Hartford, W1KDK; Hamden, W1JAK; Manchester, W1FSH; Middletown, W1DBM; Milford, W1DGG; New Haven, W1FMV and Red Cross, W1IGT; Waterford and Niantic, W1NEK; Norwalk, W1CTI; Norwich, W1ALW; Putnam, W1ON; Stratford, W1OGQ; Taftville, W1NPE; Torrington, W1BIH; Waterbury, W1EEM; West Haven, W1TD; West Hartford, W1MBK; Westport, W1MRP; Willimantic, W1KYQ. TD worked 8QEN/CT2 for first 3.5-Mc. DX and is now Class A. BDI was operated on Field Day by UE, JMY, AOK, JTD, and ex-AFB. AW keeps 7 p.m. schedule Monday through Friday with schooner *Bowdoin*, KLPO, of MacMillan Expedition. Operator is KKS. ADW reports officers of Danbury CARA as follows: 2MSG/1, pres.; KYF, vice-pres.; 2GZT/1, secy.; and MHT, treas. Bob Frank, president of the Yale Radio Club, YU, reports the station is active with 400 watts 'phone and c.w. on 3.5 Mc. LIG, secy. of BRAC, reports 132 hams and guests attended ham get-together June 3rd. Field Day activities were held at Bethel with MHH in charge. New 1½-kw. a.c. generator, courtesy of Electric Maintenance Service, provided emergency power. Code and theory classes have started. SARC news: License applied for by ASO. OGQ is holding emergency drills. AZP and HYF are on 3.9-Mc. 'phone. KBZ now is Class A amateur. Ex-AJF now is EYM and holds 58-Mc. two-way communication to West Coast record. FSH reports the MRC had successful Field Day operating under DJC/1. JEC reports NARA news: MGF has SCR-288 and 3A0H has new BC-610 and super-pro both on 3.5 Mc. LJV is on 3.9-Mc. 'phone. JEC is using 4 watts on 3.5 Mc. ACV reports BARA news: JHT operated on Field Day at Easton with 2.5-kw. Homelite generator. IYB knocked off 25 countries on 28 Mc. while in Florida. Club meetings are held at 284 Inwood Rd., Stratfield, until permanent quarters can be found. ATH reports NHARA news: GB made 137 contacts on Field Day at Orange. Hal Graves, 2PPD, has joined the staff of WKNB, New Britain, as announcer and publicity director. This new Connecticut commercial outlet now boasts three hams, 2PPD, 2PKR, and 2HDN. Tentative arrangements are being made to make WKNB headquarters for local disaster relief organization of the Red Cross, employing WERS equipment now idle. Local hams are invited to aid in the organization

(Continued on page 84)

SUPER PRO

Series 400



Less QRM---Phone or CW

When the bands are active it only takes one minute to find that you need Hammarlund's patented variable crystal filter to have a successful QSO—either, phone or CW.

Look to the future! When the number of Hams doubles or trebles you will need the crystal filter that weeds-out the QRM . . . If you can't hear 'em, you can't work 'em!

Price (SP-400-X)

\$342.00

Including Speaker



HAMMARLUND

THE HAMMARLUND MFG. CO., INC., 460 W. 34TH ST., NEW YORK 1, N. Y.
MANUFACTURERS OF PRECISION COMMUNICATIONS EQUIPMENT



A LOT
FOR A
CENTRE



MOUNTED LOW DRIFT
3.5 M.C. AND 7.0 M.C.
CRYSTALS

Only
\$1.50
Postpaid
in U.S.A.

...your frequency adv...
...and 7.0 M.C. bands...
...has stainless steel...
...resistant phe...
...basket gal...
...MONEY ORDER

COMMERCIAL
EQUIPMENT COMPANY

Our Engineering Department
is available
for consultation
on any
commercial crystal problem.
Write us!

(Continued from page 82)

of an emergency net. The Connecticut National Guard has openings at high technical ratings for men who have had radio or radar experience. Interesting activities are planned in Fighter Control, Intercept, etc. Radar intercept, ground control plotting, radioteletype, and much additional modern equipment will be set up at Bradley Field (Windsor Locks) Niantic, and Hartford. Attendance at only four meetings per month is required, with regular pay in rate. The increased Army pay scale applies. For complete details communicate with Mr. Robert Lydon, W1KOY, 23 Hollister St., East Hartford (telephone 8-6189). Traffic: W1KQY 38, AW 32, BDI 28, CTI 20, JMY 9, GB 7, BIH 5, TD 1. 73. Ed.

MAINE — SCM, G. C. Brown, W1AQL — A committee from the Eastern Maine Amateur Radio Club met on June 30th at DPJ's store and lined up a program for the Hamfest and Field Day to be held July 28th at Isle Hurst Park, just across the Trenton Bridge on the Bar Harbor Road. Received a fine letter from VE2IL, who has spent many of his vacations in Bangor and Brewer. LOA reports that OHY, ODA, and ODP are new hams in Portland; he also states that PP, CPL, KOU, EFR, BAV, FBJ, AWT, and FXA are on 144 Mc. in and around Portland. BFA reports a two-hour QSO with VO8AR on 3.5 Mc. from a Coast Guard station in Battle Harbour, Labrador. He also worked a couple of W6s, a W7, and a VE7. IRG, from Massachusetts, is a radio operator with the CAA in Millinocket. LKP says that MGP was a visitor to his shack recently. Your SCM called on AWN and ANU this month. BOK, from Dexter, and JSY, from Fort Fairfield, were visitors to the last EMARC meeting. BGQ is back with WLBZ after several months in the armed forces. Your SCM has just received an Official Notice that there are many amateurs outside of the 14-Mc. authorization at the low end of the band. Don't let this happen to any of the Maine gang. Let's play the game fair and stay on the beam. CHECK YOUR FREQUENCY. Traffic: W1LOA 4, BFA 2. 73. "GC."

EASTERN MASSACHUSETTS — SCM, Frank L. Baker, jr., W1ALP — New ECs: MSF for Maynard, DDC for Ayer, IPZ for Shirley, JSM for Arlington. LQQ sent in his OPS certificate for reinstatement. How about the rest of you prewar ORS/OPS? HXX is OBS, ORS, and OPS. DJ's XYL got her call, OIR. Clarence Clapp is now OKB. IIN/3 writes from Baltimore, Md., that he is on 3.5-Mc. c.w. until DX bands open up, and is an OBS. OIW is on 144 Mc. Jack Burfitt is OIZ. George A. Wilson, jr., secretary of the South Shore Amateur Radio Club, is OLP and is on 144 Mc. OHR and OCV are on 28 Mc. ODQ is on 144 Mc. OMI is on 28 Mc. NZN will be on 28 Mc. soon. SX, of Amphenol Corp., gave a talk at the final meeting of the Eastern Mass. ARA. CKW, chairman of the Brockton Amateur Radio Club Outing and Hamfest held on June 16th, reports that hams were present from all parts of the section. NXY, ex-2MGG, is on 144 Mc. and 3.5 Mc. and has three schedules a week with 2LRP in N. Y. C. LLX, ex-6BHV, is interested in ORS work. OAE is active on 28 Mc. The South Shore Amateur Radio Club held its annual banquet on June 11th at the Fore River Club in Quincy, with about 150 present. New officers were installed and the outgoing officers were presented with certificates in recognition of their services. The committee in charge consisted of: AKY, IYU, FJN, and EAU. The last meeting of the 56 Mc. Minutemen until fall was held at HUV's QTH. LKT is on the air. LQQ is operating port in Boston on 3.5 Mc. with 500 watts, and has worked W6 and KP4AE, who is on 3775 kc. The T9 Radio Club went to North Andover on Field Day, June 23rd, held a meeting at Hum Kennedy's shack in Danvers on July 5th, and had annual boat ride on July 13th. 7GIL, the new secretary of the M. I. T. Radio Society, MX, sends in news on election of officers: 4IKQ, pres.; Jules Levin (LSPH), treas.; 2NKP, station manager; 8WGF and 4IDV, executive committee members. Other members for the summer term are: 3JTL, 4IUH, NGU, 9VJS, 8JKN, 9PCN, 2NTX, 9FMS, and OLP. Meetings are held once a month on Tuesdays, a new code machine donated by M. I. T. will be used for evening code classes, and rigs are being built for 7 and 14 Mc. with 100-watt on 28 Mc. at present. OLC is on 28 Mc. The latest call in Cambridge is ONJ, who is on 144 Mc. LMP is back on 28 Mc. with DM-36 ahead of Super Pro. BDU is keeping some schedules. LQQ and MCC also have Super Pros. JNK is on 28 Mc. OFY is new ham in Marblehead.

(Continued on page 88)

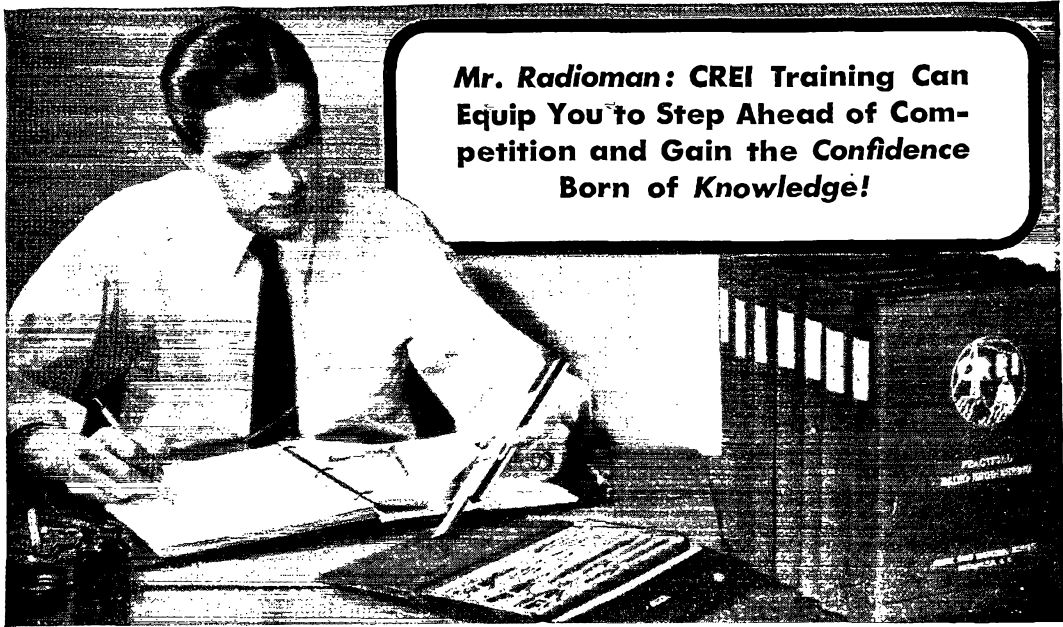

Mr. Radioman: CREI Training Can Equip You to Step Ahead of Competition and Gain the Confidence Born of Knowledge!

WILL YOU BE READY? CREI Can Prepare You Now for a Better Job and a Secure Future in RADIO-ELECTRONICS

CREI home study training prepares you for the secure radio jobs that pay good money for technical ability.

You can be ready to enjoy the security of an important technical position and take advantage of new career opportunities . . . if you prepare yourself *now*.

Join the ambitious radiomen who are assuring themselves of secure good-paying jobs with a planned program of advancement made possible by CREI home study training in Practical Radio-Electronics Engineering.

You can study at home — in your spare time — develop your technical ability — increase your knowledge to keep pace with the many new, important developments now taking place in the industry.

CREI home study courses are constantly being revised and kept up-to-date with these rapid developments. You will have the benefit of individual guidance and supervision of a trained instructor on each step of your work. U. H. F. as well as all other basic principles of

modern, practical radio-electronics engineering are covered in CREI home study courses.

All indications point to a continually growing demand for highly trained radio engineers and technicians. CREI can help you join this select group.

You are now in an era that will see the "survival of the fittest". Make sure that you will not be left behind. Get ready now, for a better job and more money in the new world of Electronics! (CREI training for veterans is approved under the G.I. Bill.)

WRITE FOR FREE 36-PAGE BOOKLET

If you have had professional or amateur radio experience and want to make more money—let us prove to you we have something you need to qualify for a better radio job. To help us intelligently answer your inquiry—please state briefly your background of experience, education and present position.



CAPITOL RADIO ENGINEERING INSTITUTE

E. H. REITZKE, *President*

Dept. Q-9, 16th and Park Road, N. W., Washington 10, D. C.

Branch Offices:

New York City (7), N. Y.
170 Broadway

Chicago (2), Ill.
30 N. LaSalle St.

San Francisco (2), Calif.
760 Market St.

San Diego (1), Calif.
316 C Street

MEMBER: NATIONAL HOME STUDY COUNCIL • NATIONAL COUNCIL OF TECHNICAL SCHOOLS

Why

this team is a leader in VHF

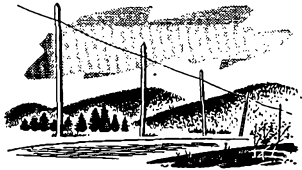

1. First voice circuits were single iron wires with ground return. Frequency limitations, noise and high losses soon ruled them out.

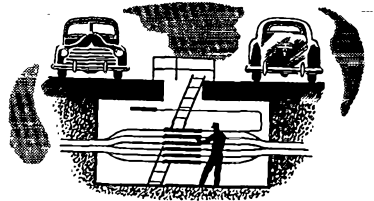

3. Lead covered cable compressed many wire circuits into small space—took wires off city streets. But losses are prohibitive at very high frequencies.

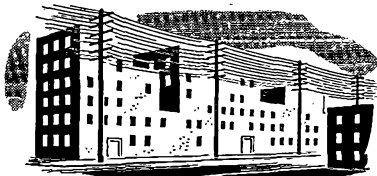

2. Big improvement was the all wire circuit—a pair of wires to a message. Later came carrier which stepped up frequency and permitted several messages per circuit.

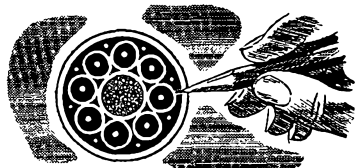

4. Coaxial cable—a single wire strung in a pencil size tube—extended the usable frequency band up to millions of cycles per second and today carries hundreds of messages per circuit, or the wide bands needed for television.

transmission



5. Wave guides, fundamentally different in transmission principle, channel energy as radio waves through pipes; vary in size from several inches to under 1 cm.; become smaller as frequency rises.

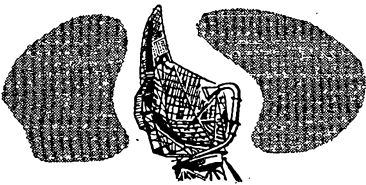

6. Late model radar wave guides, similar to that used to feed the antenna above, can carry $3\frac{1}{2}$ cm. waves at more than eight billion cps. Experimental guides for still shorter waves are being tested.

Back in 1933, Bell scientists established an historic first when they transmitted very high frequency radio waves for hundreds of feet along hollow pipes called wave guides. For them it was another forward step in their long research to make communication circuits carry higher frequencies, broader bands and more messages per circuit.

Continuing Research showed the way

From the days of the single open wire line—through all-metallic circuits, phantoming, cable, carrier systems and coaxials—up to today's wave guides, every improvement has been the result of continuous fundamental study.

When Bell Laboratories started work on wave guides, there was no immediate application for the microwaves they guided. But the scientists foresaw that *some day* wave guides would be needed—so they kept on working until they had developed the wave guide into a practical device.

With the war came radar—and the problem of conducting microwave frequencies. Bell Laboratories had the answer—wave guides—without which radar at the higher frequencies would have been impractical.

What this means to YOU

Year after year, Bell Laboratories have continued to develop methods for handling higher and higher frequencies. Year after year Western Electric has provided equipment putting these scientific advances to work. This team has become the natural leader in the field.

When your requirement dictates the use of VHF—in mobile communications, broadcasting, or point-to-point radio telephony—depend on Western Electric to supply the latest and best equipment for your needs.



BELL TELEPHONE LABORATORIES

World's largest organization devoted exclusively to research and development in all phases of electrical communications.

Western Electric

Manufacturing unit of the Bell System and the nation's largest producer of communications equipment.

Get back on the AIR with . . . SHURE STRATOLINER MICROPHONE

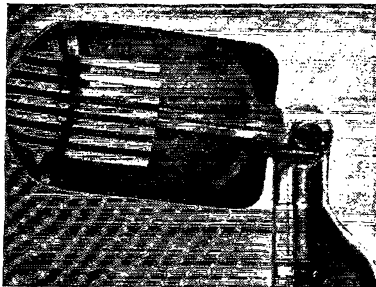

This expensive-looking, low-cost Microphone reproduces your voice clearly and fully. High output level with sharp speech response. Designed especially for Communications, Recording and Public Address. Has all the features of more expensive Microphones such as swivel-head, built-in cable connector. Genuine Bimorph Crystal. Model 708A.

List Price \$21.35

SHURE 707A CRYSTAL MICROPHONE

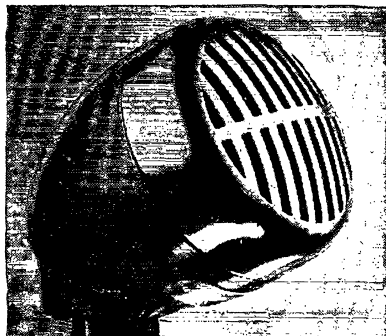

A quality Microphone at low-cost—has long been a favorite among HAMS for dependable service and clear speech reproduction. High output. Attractive modern die-cast case in Iridescent Gray finish with highly-polished plating on front grille. Model 707A.

List Price \$13.50

Available at Shure Distributors
everywhere

Licensed under the Patents of the
Brush Development Company.



SHURE BROTHERS, Inc.

Microphones and Acoustic Devices
225 W. Huron St., Chicago 10, Illinois
Cable Address: SHUREMICRO

(Continued from page 94)

NBV is working lots of DX. NBV is building sixteen-element beam for his car. OKB bought NEX's all band transmitter. ALZ is building transceiver for his bike. ARN is building 144-Mc. mobile transmitter. FWK is putting up a "V" beam in Scituate. HRK is rebuilding. NBV and DEY are working marine mobile in HXK's boat. LMU says he has worked 93 stations in the U. H. F. Marathon, has been on a flight to Dawson Creek, B. C. The Mugford twins, Bob and Russ, who were members of the South Shore Amateur Radio Club, now are in the Army and write from Fort Knox, Ky. The joint committee of the South Shore ARC and EMARA soon will start work on the Boston Hamfest which probably will be held in October. Traffic: WIBDU 24, IQQ 4, NXY 4.

WESTERN MASSACHUSETTS—SCM, William J. Barrett, W1JAH—BIV finally located driver transformer so he can try 3.9-Mc. 'phone. FOI reports a visit from NLL, who just completed his first year at Union College. Hank would like to see more organized 3.5-Mc. activity around Springfield. While on this subject, how about a section traffic net on 3.5 Mc.? The old Western Massachusetts AARS gang might serve as a nucleus, with our old frequency of 3760 kc. for a starter. If interested, drop me a line or give me a buzz on 3.5 Mc. NKN is getting out nicely on 7176 kc. EOB completed new rig with 802 e.c.o. 807 and RK47, with provision for second RK47 for higher power. Vic worked 8WEN/CT2, but still is trying for West Coast on 3.5 Mc. JAH missed Field Day for first time, due to vacation. Visited AJ, and Ralph sends his best to old gang. How about some news, fellows? Traffic: WIBVR 2, NKN 1, 73. Bill.

NEW HAMPSHIRE—SCM, John H. Stoughton, W1AXL—Well here we are again, trying to get the news to you on activities around the state. As usual, we received a report from one or two of the gang and that's all. Maybe you guys and gals in the New Hampshire section don't care about a report each month for QST. If you do want one, please send us the news on the first of each month. If more news isn't sent in, the activities report will be among the missing each month. We are in need of ORS, OPS, OBS, and RMs. How about sending in your certificates for endorsement? ATJ is back on the air after being inactive for about ten years. NQH was on 14-Mc. 'phone the opening day. AXL is trying 7 and 14 Mc. after being off those bands for about twelve years. MLO was graduated from West Point in June. CMB is back from his honeymoon. BBH and family were recent visitors at BFT/FTJ shack. HFO took unto himself a YF recently. MXL recently was married. JEH is hospitalized at this writing. LUK, the Manchester Radio Club, is getting on with postwar plans. TA is working portable on Cape Cod this summer.

RHODE ISLAND—SCM, Clayton C. Gordon, W1HRC—The NAARO is sponsoring a Rhode Island QSO Party Friday, Sept. 20th, 6 p.m., through Sunday, Sept. 22nd, at 6 p.m., on all bands. There will be a separate listing and prize for V.H.F. ONLY work; both 'phone and c.w. prize for high scorer, for high 'phone scorer, and high c.w. scorer. Scoring: 10 points for each contact. Stations worked on different bands may be counted—add 150 points for message originated to Narragansett Association of Amateur Radio Operators (LWA, KYK, KOG, LCH, MJL, or MQF must receipt). Multiply this sum by number of counties worked. To this figure add number of different stations worked. Scores must be postmarked before October 5th. Mail to LWA. Members of NAARO are not eligible for prizes. The NAARO gang made 199 contacts for a score of 3051 on Field Day. LCH worked DTS/CT2 and KZ5AD on 3.5 Mc. with RK47 at 150 watts. LQL and NCH are having nightly checker gangs on 28 Mc. KYK worked KZ5AA, 4IEN/CO, and 8IKV/NY4 on 3.5 Mc. KOG has 811 on 3.5 Mc. MJL is working on an 813 final. MQF is working with RK65s. LWA has had his ORS certificate endorsed. QR has finally got on 3640 kc. DWO and his XYL attended Brockton hamfest and brought home an HY75 and Bud chassis. EPE and his XYL brought home a power transformer. HRC finished a panoramic adapter and rebuilt the oscillator-buffer stage to include band-switching.

VERMONT—SCM, Gerald Benedict, W1NDL—New hams in Vermont are OKH, Essex Center, 50 watts on 3.5 Mc.; OKM, Essex Jct., XYL of OHB; OCD, Rutland. OHB and OKH are building e.c.o.s. GKA's new QTH is Burlington. MMU now is in Randolph. The Burlington

(Continued on page 100)

when your
Rig-Bank
 squeals
 for mercy

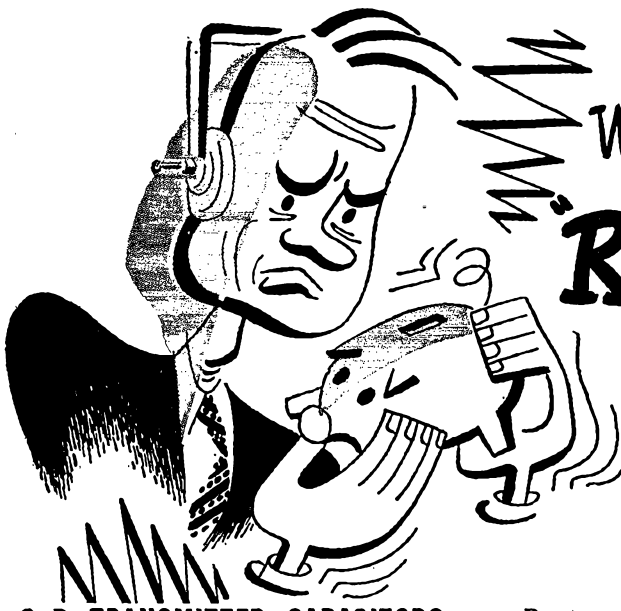

C-D TRANSMITTER CAPACITORS

Perfectly engineered for a wide variety of R.F. applications. Ideal for grid, plate, coupling and by-pass functions.

TYPE 9 MOULDED MICA CAPACITORS

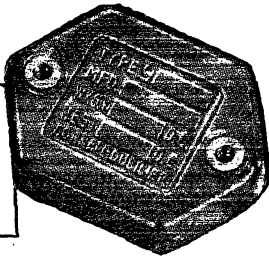
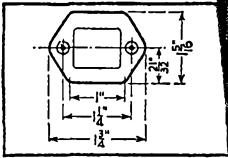

Because every nickel spent on a rig must buy the most dependability, wisened-up hams always specify C-D Capacitors for their two-way savings. C-Ds cost you no more when you buy them — and pay off with extra service in the long run. Regardless of price. Each C-D Capacitor has the finest components and built-in stamina your money can buy. Write for our catalog #195 listing the complete C-D line of quality capacitors. Cornell-Dubilier Electric Corporation, South Plainfield, N. J.

TYPE 4 MOULDED MICA CAPACITOR

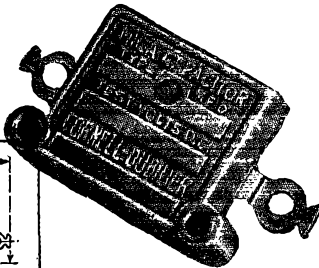
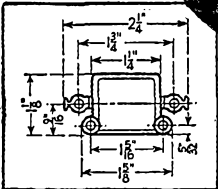

TYPE 30B MOULDED CASE MICA CAPACITOR

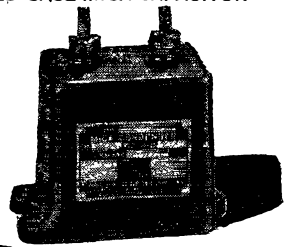
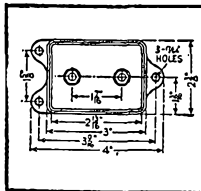

CORNELL-DUBILIER
 MICA
 DYKANOL
 PAPER
 ELECTROLYTIC
CAPACITORS



WORLD'S LARGEST
 MANUFACTURER OF
 CAPACITORS



ANNOUNCES—

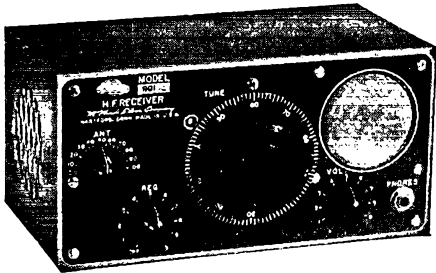

MODEL 800 • 144-148 and 235-240 mcs. U. H.F. receiver. E. P. Tilton's Feb. 1946 QST design modified by Byron Goodman's inductive r.f. tuning, built-in PM speaker, 88" band-spread, all in new "ATOM-X" construction. Factory built or kit for easy home construction, compact.

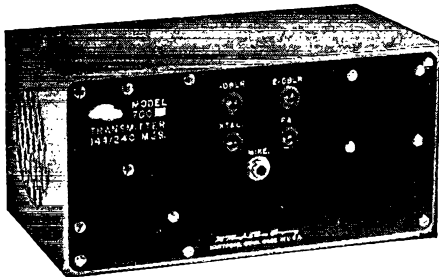

MODEL 700 xtal controlled transmitter. 144-148 and 235-240 mcs. 6AQ5 Tritet drives 6C4 doubler, 6C4 doubler/tripler, 832 long-line push-pull final. Built-in 14 watt 6AQ5 push-pull voice modulator. New "ATOM-X" construction, size only 5" x 10" x 3 1/4". Matches MODEL 800. Makes serious home-station or mobile rig. Factory built or kit.

• • •

Illustrated and high spotted above are but two of many fresh, post-war receivers, transmitters, factory built or kits and parts designed by and for serious amateurs. Prices are as low as quality is high. A penny post-card will bring you catalog of what's new . . . your favorite jobber will have them soon.

OVER 35 YEARS OF RADIO ENGINEERING ACHIEVEMENT

McMurdo Silver Company

1249 MAIN ST., HARTFORD 3, CONNECTICUT
In Canada—McMurdo Silver Division, General Radlonics Ltd.
463 Church Street, Toronto, Ontario

(Continued from page 98)

Club had rigs on Mt. Philo on Field Day. EKV had 30-33 4 1/2-watt rig on. NLO, on vacation, visited BD, CGV, FRT, MLJ, MMV, NDB, and NDL. NLO has 10-watt 'phone rig on 3.9 Mc. Several VEs visited Montpelier-Barre gang. AVP works 28588, 3918, and 3865 kc. on Saturdays and Sundays. Call him for signal checks. Wanted, more EC, OO, OES, OPS, and ORS applications. Drop your SCM a line about it. Traffic: W1AVP 7, NDB 5. 73. *Jerry.*

NORTHWESTERN DIVISION

ALASKA—SCM, August G. Hiebert, K7CBF—The Arctic Amateur Radio Club, of Fairbanks, held its bi-yearly election and voted in 7HXV as president (the old Mayor of Kelly Butte, Oregon!), KL7BK as vice-president, and XYL Patty Brazil as secretary-treasurer. Patty is waiting patiently for her new KL call. A picnic celebration was held at the KFAR transmitter with the XYLs and YLs supervising the food situation. 28-Mc. activity is nil during summer months in the North, 3.5 Mc. has been spotty. DXers should watch for KL7s on 28 Mc. come September. Let's have more reports via the grapevine, fellows! 73. *Augie.*

MONTANA—SCM, Albert Beck, W7EQM—Section EC: BWH. The Montana hams thank CPY for an FB job as SCM. The Butte Amateur Radio Club sponsored a successful combination Field Day and hamfest, June 22nd and 23rd, at Mormon Gulch Camp, near Basin. Fifty hams and friends from different parts of Montana registered, although weather conditions were adverse. 9DSP/6, Whitefish, came from farthest away. Emergency equipment demonstrations were FB. The club scored 600 points. JFR now has Class A license. IBG has private pilot's license besides commercial and amateur tickets.

OREGON—Acting SCM, Cliff Tice, W7BEE—Inclement weather crossed up the plans for the Pendleton and Walla Walla gangs to get together at Langdon Lake. Instead we went to Sacajawea Park, about four miles from Pasco, Wash., and were joined by some of the Pasco hams, including BIW and his XYL. HAZ reports from Baker that AOL is there working for the phone company; GVX has a daughter, born June 15th; and the XYL of HAZ now is JFM. From Bend we learn that ARZ has quit KBND and moved to Salem; SY now has been joined by his family; and JOP has acquired an RME from GNJ and is gathering parts for a transmitter. HAL is being transferred from Swift in Portland to the same in Chicago and is hoping to work the gang from the Windy City. MQ, in Pendleton, now has the new transmitter all steamed up and going places on all the bands open. A former member of the PARC, ENS, now is in San Francisco as 6QJR. GWH, formerly of Walla Walla and Reedsport, is operating portable from San Diego. With short skip on 28 Me., BEE is tickled to death that he has finally been able to get a new receiver. After believing all the ads in regard to receivers he found that deliveries will not begin until the first of August, or later. An SX-28A was finally procured to replace the one now on its way to Japan in the custody of his son. Please, Oregon, send in some news to supplement the few reports I am able to dig up. 73. *Cliff.*

WASHINGTON—SCM, O. U. Tatro, W7FWD—Field Day brought us to realize that this section is not yet ready to furnish radio communication to its public by our own equipment in time of emergency. Reports from ECs are almost wholly lacking but from those we have we find there was one club that owns a portable transmitter and a power generating plant in the field with a borrowed commercial generator and with no filter and taking twenty hours to start a message to Headquarters. We also find another club in the field with a borrowed Army high-powered plant and an Army crew to run it. We noted a dozen refusals by other stations to QSP for Headquarters because "it took too much time." Contacts were what was wanted. So the very purpose for which Field Day was organized (to test and operate individual or group-owned emergency equipment) was thoughtlessly defeated. This condition can be corrected by active, interested ECs and I will consider applications for such appointments. CWN has been endorsed for ORS. Centralia: BDD reports the formation of the Lewis County Radio Club with these officers: BDD, pres.; Frank Ames, vice-pres.; ISC, secy.-treas. Meetings are held the 2nd and 4th Fridays at the high school. BDD, now with KELA, is building for 3.5-Mc. 'phone and c.w. Tacoma: IBM, EC,

(Continued on page 104)

Almost Unbelievable!

Only 8-Watts Drive-
 for 1/2 K.W. Phone-Input
 with NEW UNITED
 GRAPHITE ANODES

Highest Ratings On Record for Graphite Anode Tubes Made Possible by New Getter Trap

A great development in graphite anode tubes ... the *United Isolated Getter Trap* ... has resulted in new, clear glass tubes free from the familiar dark metallic deposit on the bulbs, and utilizing for the first time all the superior advantages of graphite.

The net result of this United achievement in the two types illustrated is a very low cost replacement for lower rated tubes of the 40 or 55 watt plate dissipation class as well as original tubes for new equipment with minimum driver construction cost.

Choice of two types, V-70-D and 812-H bridge many replacement needs with little or no circuit changes. A pair of either type will take 1/2 K. W. phone input at 30Mc -- up to 60Mc with reduced input. Available now at all leading Radio Parts Distributors.

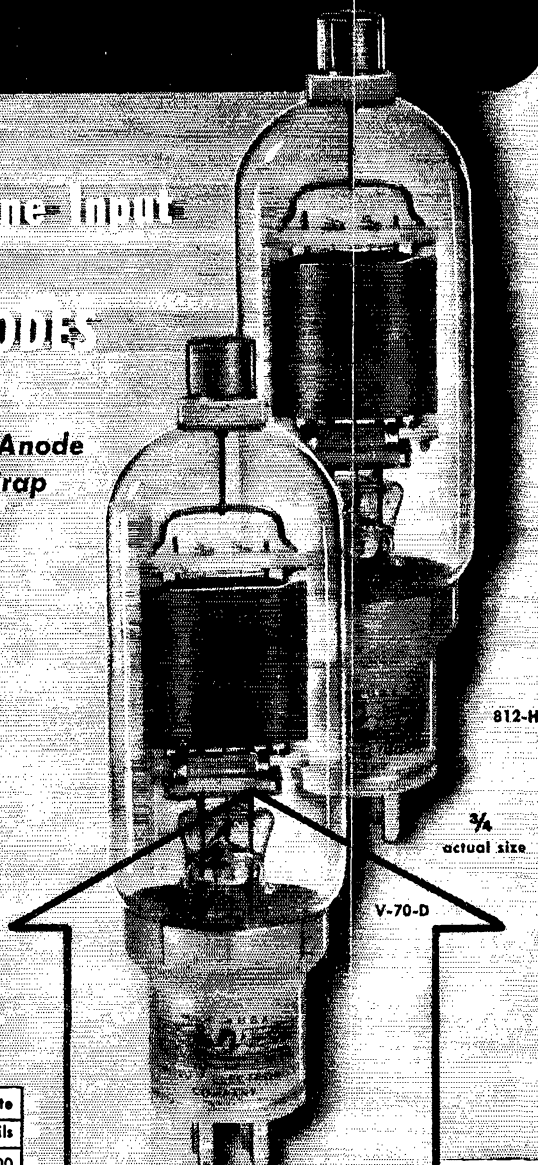

Type	Filament		Max. Plate Dissipation	Capacitances uuf			Max. input per tube	Max. Plate	
	Volts	Amps		cgp	cgf	cpf		Volts	Mils
V-70-D	7.5	3.25	85 Watts	4.5	4.5	1.7	300 Watts	1750	200
812-H	6.3	4.0	85 Watts	5.3	5.3	0.8	300 Watts	1750	200

LOOK FOR THIS
GETTER TRAP
 in all UNITED TUBES

\$6.90
 ea.



UNITED ELECTRONICS COMPANY

AMATEUR RADIO DEPARTMENT

42 SPRING ST. • NEWARK 2, N. J.

Transmitting Tubes EXCLUSIVELY Since 1934

CONFIRMED

Newark **ELECTRIC** Company Inc.
CHICAGO

323 West Madison Street
Chicago 4, Illinois
Deafblind 0921

312 Fuller Street
New York 7, N. Y.
BROAD 9-4725

ADDRESS ONLY TO
115-17 West 45th Street
New York 19, New York
BRYANT 9-4725

July 24, 1946

TRANSMITTER EQUIPMENT MFG. CO.,
345 Hudson Street
New York, New York

Attention: Morton B. Kahn; Free.

Dear Mr. Kahn:

Ever since the first specification pages and display card about the 75 GA were received, great interest was shown by many of our customers. As more and more information appeared in Tencos ads this interest gained momentum.

When the first of these versatile 75 watt CW and Phone Transmitters arrived there was no longer any doubt about the merits of this fine rig. Plans are pretty stored when it comes to appraising the value and quality of radio gear and that is why the 75 GA scored an instant success when it was put on display. Response to date is overwhelming.

The usual Tencos high standards of workmanship and design are evident throughout every inch of the unit and we wish to take this opportunity to congratulate you on a job well done.

With best wishes for your continued success, I am

Sincerely yours,

NEWARK ELECTRIC COMPANY, Inc.

Adolph L. Gross
Adolph L. Gross

Dependable Service is the Foundation of our Business

George W. Korper, Jr.

July 2nd, 1946

Transmitter Equipment Mfg. Co.
345 Hudson Street
New York, N. Y.

Attention: Morton Kahn

Dear Sir:

Just a line to tell you that the 75GA is working along without any fuss or trouble and is doing a real job on 75, 20 and 10 meters.

Most reports especially stress the extremely good quality of the signal. In fact the majority of the boys say it is outstanding.

In over twenty five years of ham radio it is the sweetest little package of transmitter that I have operated since I sold the old penrod rotary gap and hardock coffin transformer.

We'll be looking forward to talking to you on 75 and I imagine how the band is in some livable shape the signal will be bothered even less by QRM.

I am enclosing a check for the stand for also. John is taking the dynamic back with him. We tested over the air and he too, feels the crystal (822K) is better for us.

Sincerely,

George W. Korper, Jr.
GEORGE W. KORPER, JR. (W1MEX)

GWK:rb
encl:ck

Reports from Amateurs and Dealers Acclaiming

"Congratulations on the 75 GA. Wonderful performance."

Art A. Johnson. (W9HGQ)

Art. A. Johnson Sales and Service
Rockford, Ill.

"In over twenty-five years of ham radio it is the sweetest little package of transmitter that I have ever operated."

George W. Korper, Jr. (W1MKK)
Pawtucket, Rhode Island

"75 GA scored an instant success—Response to date is overwhelming."

Adolph L. Gross
Newark Electric Company, Inc.

Charge to the account of

DATE	AMOUNT	BALANCE

WESTERN UNION

Send the following message, subject to the terms on back hereof, which are hereby agreed to

11163 DL PD - ROCKFORD ILL 1 7371)

MORTON B KAHN -
9 SURREY LANE -

1946 JUL 1 AM 9 31

CONGRATULATIONS ON THE 75 GA JUST HEARD YOU AT 805 AM IN OUR STORE IN DOWNTOWN ROCKFORD ANTENNA 300 OHM LINE CEDAR AND FOLDED DUBLET 12 FOOT ABOVE ROOF ONE STORY WONDERFUL PERFORMANCE MORT -

ART A JOHNSON.

75 GA 805 AM 300 OHM 12 MORT

Everything at your fingertips and everything in one cabinet

PERFORMANCE

Excellence of the New Temco GA Transmitters

Day-after-day, as more of the new Temco 75 GA's reach eager amateurs and dealers, glowing reports acclaiming their high performance capabilities continue to pour in.

Made with the perfectionists's greater investment of time and skill, the 75 GA and 500 GA embody all the know-how of Temco's 10 years of specialized experience in building superior quality communication equipment.

To appreciate the superlative engineering design and craftsmanship of these units you must see them. Ask your dealer for a demonstration and read previous Temco advertisements in this publication for complete description of both transmitters, or write for Bulletin T-5.

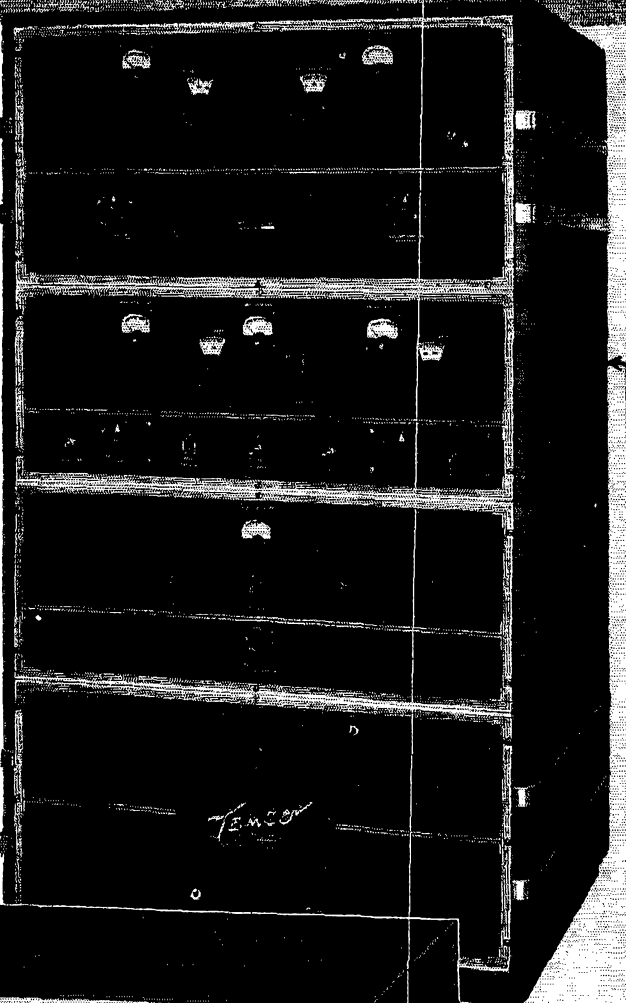

500 GA



75 GA

The 75 GA functions as the exciter unit in the 500 GA



TRANSMITTER EQUIPMENT
MANUFACTURING CO., INC.
345 HUDSON STREET • NEW YORK 14, N. Y.



RIGHT FOR YOUR RIG—

IRC "Precisions"!

See for yourself how IRC Precision Wire Wound Resistors meet your rig requirements. Look into these six specific IRC advantages:

1. Wide selection of ranges and types
2. Standard tolerance $\pm 1\%$
3. Non inductive
4. Extra humidity protection
5. Low noise level
6. Positive terminal connections

These are typical reasons why IRC has long maintained leadership in the manufacture of Precision Wire Wound Resistors.



IRC Catalog 50 lists a resistance unit for every ham-rig requirement. It's available at your local IRC Distributor.



INTERNATIONAL RESISTANCE CO.

401 North Broad St., Phila. 8, Pa.

In Canada: International Resistance Co., Ltd., Toronto, licensee

(Continued from page 100)

reports fourteen operators taking part in the club's Field Day and making 91 contacts. GRQ and GDW set up their bed over a bumblebees' nest. EHQ borrowed a 10-kw. power plant from the Army for Field Day use. AEA did well with 20-watt 'phone. DKN has a cruiser lined up for a TRC outing. FYO is operating 28-Mc. portable-mobile; CGL, EOP, and CXR had a Field Day of their own on a dock at Zenith and ran up a good score. IMB still is trying to work up an Emergency Corps group. Those interested, please contact him. Everett: IOQ is working on the formation of a ham club. Spokane: IOC is on 3.5 Mc. Colfax: DP reports that DRD has a new all-wave transmitter and is working 7 and 14 Mc. EQN sold his 14-Mc. rig to DP. CSN is using a pair of 6L6s on 3.5 Mc. ERH is rebuilding. ERO is building $\frac{1}{2}$ -kw. with 211s class B, also v.f.o. DP completed cathode modulation rig, then bought EQN's 14-Mc. class B which forced aside the cathode job. Olympia: It's a baby girl for 6SBV/7, who has left for California to live and worked 144 Mc. en route. 3ITY is trying to get his old call, 7EWW, back and is on 3.5 Mc. CWY got a new receiver for Father's Day and will be on 3.5 Mc. 73. *Tate.*

PACIFIC DIVISION

NEVADA — SCM, N. Arthur Sowle, W7CX — Assistant SCM, Carroll Short, jr., W6BVZ. RM: 7PST. ECs: 6MRT, 7TJY. 6GYX now is 7JOS. 6UO is active on 3660 kc. 6QKV is home from the Navy. 6TJI is on 28 Mc. low power. 7TJY has new tower and beam on 14 Mc. 1ENU now is 7JPI. 6HHY has 25 watts on 28 Mc. at McGill. 6PEC/7, on 3.9 Mc., is operator at Keno, Las Vegas. 7JLN, new operator, is active at Boulder City. 6PZY has T55 on 3.5, 7 and 14 Mc. 6BVZ reports FB results on 7 and 14 Mc. 6GSB is on 28-Mc. mobile, 3.9- and 14-Mc. fixed. 6TKV, on the shores of lake, reports FB DX with his tank transmitter. 6HDC and 6HJZ are home from the services and will be on soon. 6RPU is knocking 'em out on 7 and 14 Mc. EC 6MRT reports that test runs of the AEC southern unit proved encouraging with the tank rigs they have. 6OPP is assistant EC for that section. 73. *Art.*

SANTA CLARA VALLEY — SCM, Roy E. Pinkham, W6BPT — Assistant SCM, Geoffrey Almy, W6TBK. PAM: QLP. At the June dinner meeting of SCCARA Mr. Bhearsford gave a very interesting account of his work as censor of communication during the war. TBK now has 400 watts into a pair of 100THs. 20FK/6 is using a three-element beam on 28 Mc. NIM can be heard on 28-Mc. 'phone. AHZ took down his 14-Mc. beam while he was in town. FBW is tuning up on 3.5-Mc. c.w. DBK is cooking nuts on 100 Mc. at EI's lab. LXA is sporting a new HRO. JSB is using BC-610 transmitter. 1JCA/6 now is located at Pacific Grove. OVK/6 has worked five districts and five states on 50 Mc. Jim worked 2BYM for the first transcontinental hop on 50 Mc. He is working BVK in Sacramento on 144 Mc. regularly. PBV, EPS, DCR, VWF, BAA, and VEN are working on 144 Mc. QUC is proud papa of a boy. He built the 144-Mc. gear with which RBQ made the 144 Mc. record. VEN is making motor trip to the East and has installed a 28-Mc. mobile unit in his car. DZE was first local on 14 Mc. in San Jose. RVL called while visiting QLP and reports following activity in Los Angeles on 50 Mc. Nets are operating nightly between 7 and 9 p.m. on the following frequencies: 51, 51.6, 51.84, 52.3, and 52.7 Mc. He also reports that 7AVV, 7ERA, 7DNB, and 7DDG are working on 50.4 Mc. in the Portland area nightly. NVO is QRL in Los Angeles. SYW is getting on 50 Mc. 1WV/6 is having pole-raising bee. Traffic: W6DZE 14, PBV 12, TBK 3. 73. *Pinky.*

EAST BAY — SCM, Horace R. Greer, W6TI — Section EC: EE, RM: ZM. EC: QDE. EC v.h.f.: FKQ. Asst. EC v.h.f.: OJU. OO v.h.f.: ZM. OO: ITH. OBS: TT, IDY, ZM, ITH, RMM, UZX. RMM reports he has 1 kw. on c.w. and 'phone on all bands. UZX has pair 100THs in final with 500 watts input on all bands c.w. and 'phone and has worked twenty-five states and twelve countries in three months. SLX reports that QBC on 28-Mc. 'phone and DHE on 3.5-Mc. c.w. are the only ones active around Eureka. JUH has charge of radar for United at field near Arcata. KMH just returned home from Navy radar teaching. ITH sends in FB list of real DX on 14-Mc. 'phone. TT and TI are knocking off rare DX on 14-Mc. c.w. DUB is on 14- and 3.5-Mc. c.w. and 14- and 3.9-Mc. 'phone. VBJ has left 28-Mc. 'phone for 14- and 3.9-Mc. 'phone. CDA has 300

(Continued on page 106)

For VERSATILITY..
 (ENTIRELY SUITABLE FOR FM INSTALLATIONS)
For PERFORMANCE..

The GATES "5M" SYSTEM

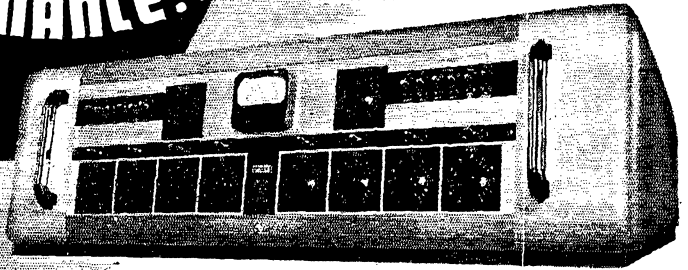

The **5M** CONTROL CONSOLE

The latest contribution by GATES engineers to Station versatility and high performance in speech input procedure, is the New GATES "5M" System, here shown for the first time.

Consisting of the redesigned 5M Control Console for split-second adaptability and newly streamlined for eye appeal, and two Gates engineered Equipment Racks as shown, the 5M System is the ONE adaptable equipment to install for Station technique and showmanship.

NEW SPEECH INPUT EQUIPMENT..

THE **5M** EQUIPMENT RACKS

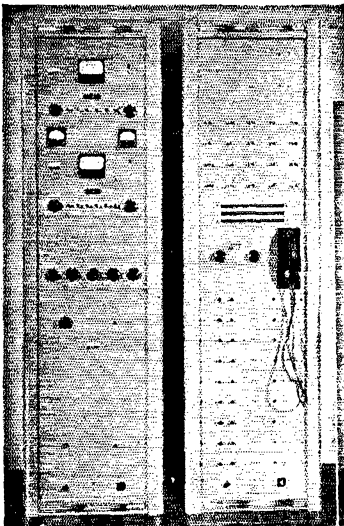

(FRONT VIEW)

(REAR VIEW)

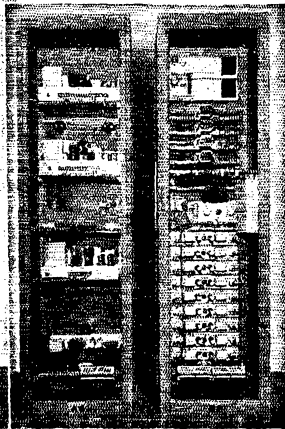

FOR THE MEDIUM AND LARGE SIZE STATION

The GATES 5M System fits the requirements of the medium and large sized broadcasting station:

The overall frequency response for either the program or monitoring circuits is entirely suitable for FM installations, as the response is essentially flat from 30 to 15,000 Cycles. Many combinations of circuits may be set up by means of the switches and the patch panel on the Equipment Racks, and are then controlled by the mixers and switches on the front of the Control Console. The equipment, as shown here, provides 2 program amplifiers, a loud speaker control Panel, monitoring amplifier, switch provision for selecting 25 remote lines, talkback to any of the remote lines, 9 pre-amplifiers, power supply for preamplifiers, and switch and fuse panels for controlling power to each Rack. Terminations at the bottom rear of each Cabinet may be connected to provide practically any permanent arrangement necessary.

GATES

**RADIO CO.
QUINCY, ILL.**

Write for detailed specifications

SOLD IN CANADA by:

Canadian
Marconi Co., Ltd.
Montreal

NEW YORK OFFICE:
9th Floor
40 Exchange Place

EXCLUSIVE MANUFACTURERS OF RADIO TRANSMITTING EQUIPMENT... SINCE 1922

STATION TESTED*

*an added
proof of Quality!*



*Pres. W. A. Kuehl is shown of his amateur radio station W9EZN. With the war over, Walt is again pursuing his favorite hobby.

DRAKE RADIO SOLDERING IRONS

Yes, Drake irons are right for radio. And these sturdy irons have proved their dependability and worth in use on countless other jobs, too, for over 25 years. That's why we say — whatever your needs, you are certain to find a Drake Iron that fills the bill. exactly!



600-10—the Drake No. 600-10 is ideal for those all important connections when rewiring your rig. Get back on the air fast. Make good dependable connections with this 100 watt $\frac{3}{8}$ " tip.



400—the Drake No. 400 is the perfect iron for work in small places. Only 9 inches long, it is especially designed for tight corners and delicate connections. 60 watt, $\frac{1}{8}$ " tip.



Ask your nearest supplier or write for the name of the distributor nearest you . . . and give yourself the advantages of these superior irons.

DRAKE ELECTRIC WORKS, INC.

1656 LINCOLN AVE.

CHICAGO 13, ILL.

(Continued from page 104)

watts on 28-Mc. 'phone. KFK is using British-Russian tank transmitter on 28-Mc. c.w. and 'phone. EJA is going to town on 14- and 7-Mc. c.w. LMZ is on 28 Mc. knocking over the VKs with his 807. MJF has VT127s in final. The Richmond Radio Club elected the following new officers: VOS, pres.; OJU, vice-pres.; QDE, secy-treas.; CTI, sergeant at arms. The SARO gang really knocked them over on Field Day and made a large score. BUY, while on vacation at Lake Tahoe during July, made plenty of contacts with his portable 3.5-Mc. c.w. rig; he also worked the Bay Area on 28-Mc. 'phone with 2 watts. ZA is playing around with electron-coupled exciters. OZC holds club 144-Mc. record for about 190 miles. The SARO boys are going to town with two-watt Army rigs working better than 200 miles regularly, and the Army says they will work for 5. Who said vacation time? Just take a listen on 14 and 7 Mc. Boy, are these bands being used! Truly it seems good to all of us to be on these better ham bands again. Your SCM has never heard any better Pacific DX than there is on 14 Mc. at present. OAV was killed in an auto accident in late June. Have you been down to the Oakland Radio Club yet? Better join up now. Traffic: W6ITH 71, RMM 12, UZX 7, TI 5. Best of luck and 73. "TT."

SAN FRANCISCO—SCM, Samuel C. Van Liew, W6CVP—Phone Juniper 7-6457. Assistant SCM, Joe Horvath, W6GPB. RM: RBQ. ECs: DOT, KZP. OO: NJW. OBS: FVK, KNH, DJI. ORS: RFF, BIP, ATY, RBQ, CVP. OPS: OZC, NYQ. VPJ is on 3.5-Mc. c.w. DZQ is building new rig and calling CQ from KWBR. Between 144-Mc. QSOs ERS is raising and lowering the Third St. Bridge. AHH is building a 28-Mc. rotary beam for his high-power 807. RSL is hammering away on 28-Mc. 'phone. LMK is doing fine with his 28-Mc. mobile rig. TLQ has bugs in his relays. EYY finally balanced his HK54s and is putting out good signal on 3.5-Mc. c.w. ENM should be on the air soon. The San Francisco Radio Club held its monthly meeting June 28th. The speaker was Fran Wells; the subject, Two-Meter Converters, covering the latest circuits of merit and highlighting (1) the means of eliminating unwanted oscillation, (2) means of noise reduction, and (3) coupling methods to communication receivers. Jeff Allen, TBK, now living in Menlo Park, was a welcome visitor. A new DX record for 144 Mc. was established by our good friends, RBQ and 4TZ/6. RBQ, accompanied by ex-JKN, was at Grant National Park, Lookout Station, while 4TZ/6 was at Goat Mt., a distance of 280 miles. The day was June 9th at 9:07 A.M. Solid contact for over an hour was made with both 'phone and c.w., signal strength was R5-7 both ways. 4TZ/6 was running 12-watt crystal-control and a superhet receiver. RBQ had 50-watt crystal-control and superhet receiver. Contacts also were made with MIV on the Grapevine Road, below Bakersfield, a distance of 125 miles. MIV was running 1 $\frac{1}{2}$ -watt input, and CIS was located at Mt. Pino Blanco, a distance of 100 miles. PTS and OCZ, both at Mt. Diablo, a distance of 180 miles, were running about 20 watts. NJJ and VVC were at Mt. St. Helena, a distance of 240 miles. 4TZ/6 also held up one end of the new record established on 420 Mc., of 52 miles from Mt. Hamilton to Twin Peaks in San Francisco. Field Day saw many portable rigs in action, both groups and individuals. CIS and ATY were on Mt. Davidson. The SARO was out in full strength on the Devenshire Hills with transmitters on all assigned frequencies, both 'phone and c.w.; also i.m. on 28 Mc. All transmitters were under 30-watt input. Power was furnished from a centrally-controlled generator unit. Continual operation was maintained by a group of about fifty members. The San Francisco Radio Club withdrew at the last minute because of lack of power supplies. Col. ZF is returning soon to San Francisco, having received his discharge from the air service. CAN is vacationing on Mt. Lassen with a 144-Mc. rig. One of RBQ's sons presented Bill with his first grandchild, Patricia. All are doing nicely, including grandpappy. Correction of error made last month: CIS visited Los Angeles, not moved there. Be sure and vote in director of Pacific Division election early in September. Traffic: (May) W6RBQ 81, NYQ 43, BIP 15; (June) RBQ 56. Sam.

SACRAMENTO VALLEY—SCM, John R. Kinney, W6MGC—Eighty-four members attended the July meeting of the Sacramento Amateur Radio Club, Inc. GZY, president, presided. ZF was the guest speaker and gave a demonstration of Japanese transmitting and receiving equipment. He was in charge of U. S. Air Force Communications

(Continued on page 108)

ONE INSTRUMENT. .. FILLS THESE FOUR NEEDS

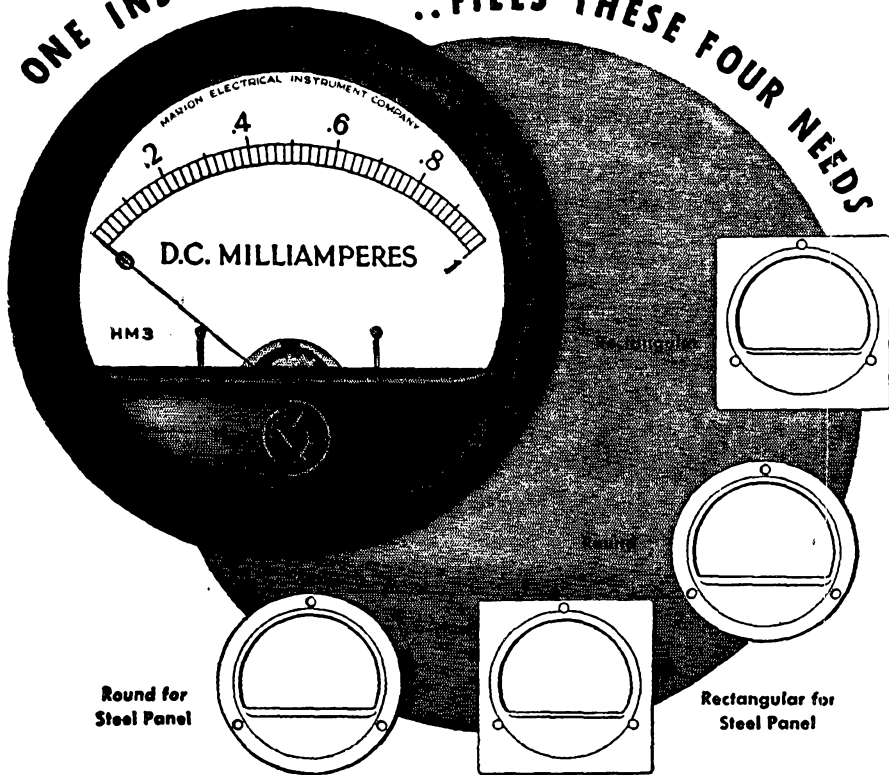

Round for Steel Panel

Rectangular for Steel Panel

THE "4 FOR 1" APPLICATION ADVANTAGE OF Marion Glass-to-Metal Truly Hermetically Sealed 2½" and 3½" Electrical Indicating Instruments

Marion "hermetics" offer new flexibility in application, stocking and sales. Just one instrument, with its appropriate flanges, fills four different requirements . . . the only thing that's necessary is to fit the flange to the need in question. In addition to being truly hermetically sealed, these instruments are magnetically and electrostatically shielded. And are supplied with

Interchangeable Round and Square Colored Flanges

. . . which are the key to the "4 for 1" Advantage. With these, it is possible to order a minimum number of instruments in the most popular ranges, and apply either the round or square flange according to usage. This feature simplifies ordering and inventory procedures for the manufacturer . . .

and stocking and selling for the jobber. Besides black, the flanges are available in 12 iridescent colors — including red, blue, green, gold and silver. The use of color has been found to add to the eye-appeal and, consequently, to the sales-value of otherwise drab equipment.

100% GUARANTEED

for six months — after that, regardless of condition and provided the seal has not been broken, we will replace any 2½" or 3½" type from 200 microamperes upward for \$1.50; any 2½" and 3½" type with sensitivity greater than 200 microamperes for \$2.50.



MARION ELECTRICAL INSTRUMENT CO.

MANCHESTER, NEW HAMPSHIRE

EXPORT DIVISION • 458 BROADWAY • NEW YORK 11, N. Y. U. S. A. • CABLES, MORHANEET

IN CANADA: THE ASTRAL ELECTRIC COMPANY, SCARBORO BLUFFS, ONTARIO

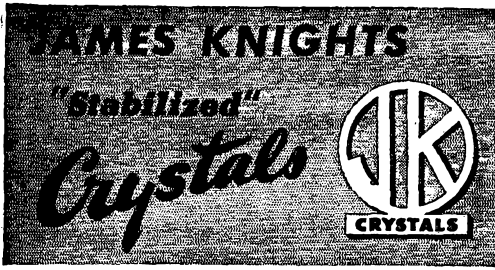

GOOD QSO'S AT BAND ENDS

BAND end operation often results in better QSO's but it also places critical reliance on your crystal. JK "Stabilized" Crystals are especially processed to prevent drift due to aging in service or on the shelf. Their low temperature-drift characteristics (usually less than 1 P.P.M. per degree centigrade) plus their vibration, moisture and dust proof mountings, make band edges as safe as center-of-the-band operation. Listed below are three of the most popular types of JK "Stabilized" Crystals.



H43 — Any frequency between 2000 KC and 30000 KC. Dimensions: 1.4" x 1.2" x .5". Pin spacing: 3/4". Pin diameter: 3/16".



H23 — Any frequency between 2000 KC and 9000 KC. Dimensions: 1.3" x .7". Pin spacing: 3/4". Pin diameter: 3/16".



H73 — Any frequency between 2000 KC and 30000 KC. Dimensions: 1.8" x .5" x .8". Pin spacing: 3/4". Pin diameter: .093".

BUY JK "STABILIZED" CRYSTALS FROM YOUR JOBBER. ANY AMATEUR FREQUENCY BELOW 18,500 KC = 10 KC — \$2.80

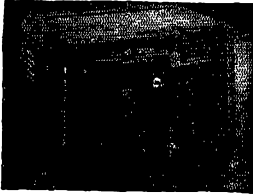

HOW OFTEN HAVE YOU NEEDED A FREQUENCY STANDARD?

To check band edges, transmitter frequency, received signal frequency, signal generator for aligning receiver? With a frequency range from 100 KC to 500 MC in convenient steps, the JK FS-344 covers the whole range of generally useful bands. Continuous frequency stability is maintained with two JK "Stabilized" Crystals. The FS-344 will become one of the most used pieces of equipment in your shack. Price \$79.50 complete with tubes and JK "Stabilized" Crystals.



JAMES KNIGHTS
"A Radio Researcher
Since the Early Days"

The men of the James Knights Company have grown up with Ham Radio. Because of their work with piezo quartz since it first came into use as a frequency control, they know what is expected of a good Ham Crystal. You can depend on JK "Stabilized" Crystals.



LEON A. FABER
W9DAX — "An Active Ham Since 1913"

The JAMES KNIGHTS Co.

SANDWICH, ILLINOIS

Write for New Illustrated Folder



(Continued from page 106)

in Japan. TI and DUB, from Oakland, brought an Eimac 4-250A, which was won by DLB in the membership raffle. OLV won an Eicor dynamotor plate supply which was donated by the Sacramento Electric Supply. New members of the SARC: SYJO, 9MIJQ/6, ZF, and KNX. Associate members: J. D. Bridges, W. R. Arcas, D. D. Davies, R. S. Blake, and W. J. Van Den Berg. On 144 Mc.: QKJ has an 852 with 200 watts input and an antenna of six half-waves in phase. BVK, MIW, QDT, and QKJ worked IBS operating portable on the Donner Summit. BVK keeps a regular schedule with ORK in Redwood City. BIV is building a crystal rig. On 14 Mc.: GDJ worked HB9AW in Switzerland with a pair of 35Ts with 300 watts. AP has a daily schedule with D44DN in Germany and reports the following DX worked consistently: PK6T6, XU1YO, W2IEV/XV1, W8CJR/XV, W5HHO/J2, XU1RP, W7AFG/KLT, KA1AE, J2VW, G8VH, VK2NB, VK2AV, VK3ABW, VK5WR, VK6KZ, and ZL3AB. MGC would appreciate it if more of the gang would send in news for these reports. Traffic: W6AP 18, 73, Jack.

SAN JOAQUIN VALLEY — SCM, James F. Wakefield, W6PSQ — PCS worked WAC three times in twenty-four hours. Jerry is using a 250TH running 900 watts into half-wave doublet. KUT is on with 50 watts into 800 into long wire antenna on 14-Mc. c.w. QEU is back after eight months operating in Singapore on 14 and 28 Mc. Pete worked thirty-five countries from there. VSJ, in Stockton, is on 3.5 Mc. with a Millen Exciter. SJYRC was on for the Field Day at Bass Lake running two rigs, one on 3.9 and one on 3.5 Mc. They made 121 contacts for a total score of 1273 points. GJO, in Stockton, is first appointee for the section. He is OBS for the Stockton area. Any of you fellows that desire appointments, drop me a line. 5JOF/6 has 700 watts on 14- and 3.9-Mc. phone into a pair of VT127s. PTF has 616 on 3.5-Mc. c.w. QON is chief engineer at KERO, the new station in Bakersfield. JCB has added 829 fml to his 832 on 144 Mc. and wants schedules on 144 Mc. GCF has 80 watts into 829 on all bands 3.5 to 50 Mc. 9UDX/6 has returned to his QTH in Iowa. LTO is running a kw. into 30FTL on all bands. EFS, in Armona, is on 3.9 and 3.5 Mc. DYL and PPK, in Bakersfield, are on 3.9 Mc. COQ, in Bishop, was worked by the Field Day station. 73 for now, and remember, all appointments are open. Jimmie.

ROANOKE DIVISION

NORTH CAROLINA — SCM, W. J. Wortman, W4CYB — It is desired to acknowledge reports from the following: GIV, Wilmington; EG, Raleigh; DCQ, Clinton; BBS, Pittsboro; BHR, Norlina; DCG, Tarboro; FXU, Kinston; DSO, Morganton; DGU, Lattimore; MR, Greensboro; and DSU, Hawaii. Congratulations to the Raleigh gang for the swell postwar hamfest. The gang sure had a good time getting together once more. The most recent addition to the affiliated club roll is The Electron Club at Clinton. Let us hear from you fellows. New appointments are EYF as EC for Charlotte, ANU and DSY as OPS, and FXU as ORS. DSU is operating KA1ABR in Hawaii on 28400 kc. with plenty of power and asks that the fellows listen for him. Is anyone interested in an appointment as OO? There is also available for someone interested in v.h.f. an appointment as OES if qualifications are up to standards. Club activity seems to be picking up in some sections. It is known that Raleigh, Greensboro, Charlotte, and Clinton are active. How about some dope from Asheville, Winston, Gastonia, and other places? Clubs are invited to make recommendations for an EC for their area. If you are interested let us have a card. Information is requested on anyone who is interested in traffic network operation. Some of the gang have asked for such information. Well, now that we have parts of the good old 7- and 14-Mc. band back we can look to some semblance of a prewar operating status. Let us hear from you, gang.

SOUTH CAROLINA — SCM, Ted Ferguson, W4BQE/ANG — HOY is building a new 29-Mc. rig. HDR is building new shack to house his kw. rig. 5KQR/4 and BEN are having a lot of fun with narrow band f.m. ITJ, a new ham, is working 3.5-Mc. c.w. The Greenville Amateur Radio Club had a nice outing for Field Day using KZ/4. IZQ is a new ham in Columbia on 28-Mc. phone. The Palmetto Amateur Radio Club, Inc. of Columbia had a very successful Field Day with the following taking part: DNR, HMG,

(Continued on page 110)

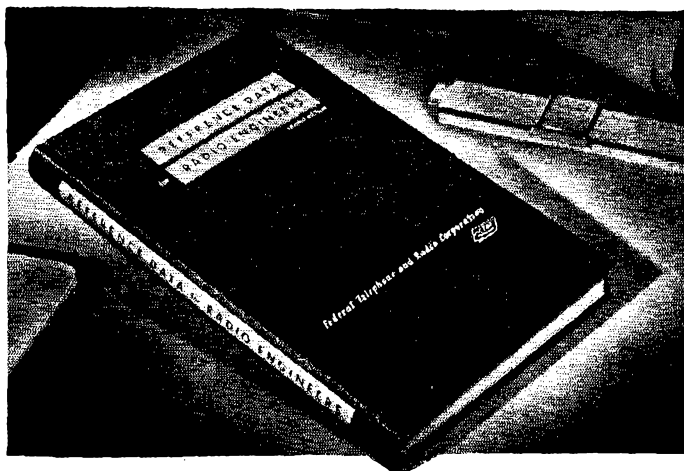

NOW READY— new and enlarged edition "REFERENCE DATA for RADIO ENGINEERS"

Compiled for Radio Engineers, Students of Engineering,
Educators, Electronic Technicians, Radio Amateurs, Inventors

The second edition of this widely accepted pocket-size handbook . . . revised and enlarged . . . now includes important radio technical data developed during the war.

Compiled jointly by the physicists and electronic specialists of the Federal Telecommunication Laboratories and the International Telephone and Telegraph Corporation, the material in this new book has behind it the technical authority of an organization with international leadership in radio, communications and television.

Enlarged from 200 to 336 pages with over 400 charts and diagrams, it makes available quickly the answers to problems that normally arise in practical radio work. This ready reference feature is one reason why *Reference Data for Radio Engineers*, in its earlier edition, received such an enthusiastic welcome by electronic specialists. Orders totaled more than 50,000 copies. With the wealth of new material now included, the second edition can be of even greater aid to the practicing radio engineer.

Commenting on the first edition, Walter J. Seeley, Chairman, Department of Electrical Engineering, Duke University, wrote enthusiastically: "It is so chock full of useful data that I am urging all students to purchase their own personal copies."

The new, second edition of *Reference Data for Radio Engineers*, in green cloth binding, revised and enlarged to include much new data, is ready now. To order, merely fill in the convenient coupon.

PRICE **\$2** (In lots of 12 or more, \$1.60 each)

Federal Telephone and Radio Corporation



Publication Dept., 67 Broad Street, New York 4, N. Y.

PARTIAL OUTLINE OF CONTENTS

General Information. Conversion Factors, Greek Alphabet, Electromotive Force—Series of the Elements, Position of Metals in the Galvanic Series, Relative Humidity, Weather Data, Power Supplies in Foreign Countries, World Time Chart, Radio Frequency Charts, Frequency Band Widths Occupied by Emissions, Tolerances for the Intensity of Harmonics of Fixed, Land, and Broadcasting Stations, Classifications of Emissions, Decibels.

Engineering and Material Data. Wire Tables, Insulating Materials, Plastics: Trade Names, Wind Velocities and Pressure, Temperature Chart of Heated Metals, Physical Constants of Various Alloys and Metals, Thermocouples, Melting Points of Solder, Spark Gap Voltages, Head of Water in Feet, Approximate Discharge Rate, Materials and Finishes for Tropical, Marine Use, Torque and Horsepower.

Audio and Radio Design. Resistor and Capacitor—color codes, Inductance of Single-Layer Solenoids, Magnet Wire Data, Reactance Charts, Impedance Formulas, Skin Effect, Network Theorems, Circuits, Attenuators, Filters.

Rectifiers and Filters. Typical Rectifier Circuit Data, Rectifier Filter Design.

Iron-Core Transformers and Reactors. Major Types, Temperature, Humidity, Pressure Effects, General Limitations, Design of Power-Supply Transformers.

Vacuum Tubes. Formulas, Performance Limitations, Electrode Dissipation Data, Filament Characteristics, Ultra-High-Frequency Tubes, Cathode-Ray Tubes, Preferred Radio Electron Tubes.

Vacuum Tube Amplifiers. Graphical Design Methods, Classification of Amplifier Circuits, Cathode Follower Data, Resistance-Coupled Audio Amplifier Design, Negative Feedback, Distortion.

Room Acoustics. Good Room Acoustics, Optimum Reverberation Time, Computation of Reverberation Time, Electrical Power Levels Required for Public Address Requirements.

Wire Transmission. Telephone Transmission Line Data, Frequency Allocation Charts, Noise Measurement—Wire Telegraphy, Telegraph Data.

Radio-Frequency Transmission Lines. Attenuation Due to Mismatch on Transmission Lines, Impedance Matching with Shorted Stub, Open Stub, and coupled sections, Army-Navy List of R-F Cables, Attenuation of Standard R-F Cables, Resistance of Transmission Lines at Ultra-High Frequencies.

Also Wave Guides and Resonators, Radio Propagation and Noise, Antennas, Non-Sinusoidal Wave Forms.

*Use This Coupon
Order Your Copy Now!*

Federal Telephone and Radio Corp.
Publication Dept. A6, 67 Broad Street
New York 4, N. Y.

() I enclose _____ dollars,
for which send me _____ copies,
at \$2.00 per copy.*

NAME _____

ADDRESS _____

CITY _____

ZONE _____ STATE _____

*For 12 or more copies, sent to a single address, the price per copy is \$1.60

Your Equipment
Deserves the Best ...

C.T.C. CRYSTALS

Your sending and receiving apparatus represents a considerable investment in time and money. It makes good sense, then, to insist on the finest when considering Crystals.

C.T.C. Crystals are tops in quality and performance. Mathematical dimensioning, X-ray orientation, mechanical lapping, etching to final frequency are among 21 vital checks and tests that assure high activity and low drift in every C.T.C. Crystal.

You'll find C.T.C. Crystals for amateur frequencies in the 20, 40 and 80 meter band. Kilocycle spreads include 14,000-14,750 kc. in the 20 meter band; 7000-7300 in the 40; 3500-4000 kc. in the 80. "C" holders to fit octal sockets, HPB holders for 5- or 6-prong sockets.

For complete information on C.T.C. Crystals write for free Crystal Bulletin.



CAMBRIDGE THERMIONIC CORP.

451 Concord Avenue
Cambridge 38, Massachusetts

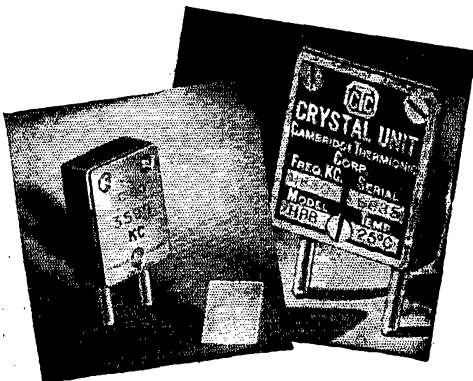

(Continued from page 108)

ITJ, FMZ, HOY, BEN, HEV, IZQ, and Sgt. Joe Alderman and his corps of operators from Ft. Jackson. The club used the call CO/4 and worked fifty-five stations on 3.5-Mc. c.w. and fifty on 28-Mc. 'phone. EZF can be heard on 3.5-Mc. c.w. HMG is starting big drive for emergency net in South Carolina. ITY, the Ft. Jackson gang, is doing FB on 3.5-Mc. c.w. GCW puts in an FB signal on 3.5-Mc. c.w. AFQ and FNS are new RMs and are looking for applications for ORS appointment. BQE is overwhelmed by the generosity of his XYL and the new HRO. The Field Day gang from Columbia had the moral support of HMG's XYL. Make plans now to attend the fest in Charleston Sept. 1st and bring a piece of u.h.f. gear. 73. Ted.

WEST VIRGINIA — SCM, Donald B. Morris, W8JM — The Fayette Radio Club has been reorganized and is off to a good start with AHZ as president. VIY is the proud papa of a new jr. operator. AKH and UFT are located at Portsmouth, Va. HUK has new HT-4 transmitter. For W. Va. WAS contact try LXF on 3550 kc. at 5 A.M. each day. MOP, with new 610, has renewed OPS appointment. TDJ/8, active on 50 Mc., worked Kansas City. LII runs 150 watts on 3.5-Mc. c.w. and wants Trunk Line work. DFC has new 813 final. RJG has renewed OPS appointment. CSF needs 7000-volt variable tank condenser. YCK, new amateur at Ashley, has 300-watt c.w. rig but needs receiver. New hams: YBQ, at Clarksburg, and YGK, Charleston. VFO has a new 800-watt 'phone rig on 3.9 Mc. and plans portable operation in the West Virginia contest with low-power rig. FMU, recently licensed, received the same call he held several years ago. 200S, formerly of Grafton, as CVX visited the gang while home on vacation. The MARA received excellent publicity in local newspapers on their Field Day activities. I would like to have an EC in each county in West Virginia to organize the emergency program. May I have your applications? Traffic: W8CSF 3, DFC 2, GBF 2, BOK 1. 73. Don.

ROCKY MOUNTAIN DIVISION

COLORADO — SCM, Glen Bond, W0QYT — The biggest news in this part of the country is the ARRL Convention to be held at the Shirley Hotel Sept. 14th, being put on by The Electron Club, of Denver. The prize committee says there will be some real prizes and lots of them; also some swell entertainment. There won't be a dull moment so let's all be there. And don't forget the big dinner that goes with it. Everybody is happy about 14 and 7 Mc. opening up. Please send in reports of DX on either band, fellows. We need your activity report, both 'phone and c.w. on all bands. YTY has been doing real well with mobile on 28 Mc. Look for the others who are getting mobile gear together soon. Even QYT has an 807 for mobile on 28 Mc. We are looking for some nice reports on 50 Mc. this summer with all the short skip that has been on. Don't forget to send them in. We wonder how many YLS hold tickets in Colorado. Why don't you send me a postal with your call and station line-up? 14-Mc. 'phone has sure busted up our 28-Mc. local round table rag-chews, but hope you fellows will come back as soon as the new wears off. Will be seeing you at the ARRL Convention Sept. 14th. 73. Glen.

UTAH-WYOMING — SCM, Victor Drabble, W6LLH — 6MQL, now 7MQL, would like the boys of the East Bay region of California to listen for him on the air. 4GFC gets on 3.5, 7, and 14 Mc. with 75 watts to an 807 and is really going places. 4IHV, now 7NPU, is running about 75 watts to a pair of 807s. 6SID, the Section EC, would like EC reports from the gang. 9NFX has been appointed OO and will do his part to keep the gang on the straight and narrow. 6TMK, the college station, is OBS and is on with the ARRL bulletins at 1800 p.m. on Thursdays and Sundays. 6SID has new rig and new QTH. He is using a pair of 809s and running about 200 watts. The Logan Club did not do as well as expected on Field Day but all had a good time anyway. The Salt Lake Club reports one of the best hamfests ever held by that club. Each of these clubs is gunning for the Ogden Club, which ran up a nice score, and vows it will beat the Ogden boys next year. 6DLR uses an HY-615 in a transceiver 144-Mc. mobile rig and is getting the Ogden hams organized in the AEC. He requests that application forms be sent in to put Ogden on top. 7IPQ gets on the air with a new Hallierafters BC-610 transmitter with 500 watts on 3.9 Mc. Traffic: 4GFC 7. 73. Vic.

(Continued on page 112)



RME Owners Say!

W6PGB, 2137 32 Ave.
San Francisco 16, Calif.
18 June, 1946

Radio Mfg. Engineers
Peoria 6, Illinois

Attention: Mr. L. A. Morrow

Dear Mr. Morrow:

I have used the new RME45 for a long enough time now so that I feel well qualified to compare it to other receivers used here in the past and alongside of it for tests. Dollar for dollar I don't believe that there is a receiver on the market at the present time that can even approach it.

There are other receivers that cost quite a lot more than the 45 but . . .

Yours very truly,
Rex A. Reinhart W6PGB

RME Mfg. Engineers, Inc.
300-306 First Ave.
Peoria 6
Illinois

April 29, 1946

Dear Sirs:

Enclosed please find registration card for RME 45 -- serial # EG4 purchased from Kenyon Radio Supply Co., 2214 - 14th Street N.W., Washington, D. C. April 2nd, 1946.

Vy FB and have heard many DX stations and most stable revr ever owned. With vernier knob, can overcome 98% local QRM. Even on 10 meters with auto QRM 1/4 block away noise level is about nil. Hope to have one of your preselectors before vy long.

Such a receiver as the RME 45 deserves all the credit it has earned. A true example of excellent workmanship, planning and electronic achievement.

Very truly yours,
John C. Page W4INA
1313 21st St. S.
Arlington, Va.



FINE COMMUNICATIONS EQUIPMENT
RADIO MFG. ENGINEERS, INC.
Peoria 6, Illinois U. S. A.

REGULATION



§12.136. LOGS. Each licensee of an amateur station shall keep an accurate log of station operation, including the following:

(a) The date and time of each transmission. (The date need only be entered once for each day's operation. The expression "time of each transmission" means the time of making a call and need not be repeated during the sequence of communication which immediately follows; however, an entry shall be made in the log when signing off so as to show the period during which communication was carried on.)

(b) The signature of each licensed operator who manipulates the key of a radiotelegraph transmitter or the signature of each licensed operator who operates a transmitter of any other type and the name of any person not holding an amateur operator license who transmits by voice over a radiotelephone transmitter. The signature of the operator need only be entered once in the log, in those cases when all transmissions are made by or under the supervision of the signatory operator, provided a statement to that effect also is entered. The signature of any other operator who operated the station shall be entered in the proper space for that operator's transmission.

(c) Call of the station called. (This entry need not be repeated for calls made to the same station during any sequence of communication, provided the time of signing off is given.)

(d) The input power to the oscillator, or to the final amplifier stage where an oscillator-amplifier transmitter is employed. (This need be entered only once, provided the input power is not changed.)

(e) The frequency band used. (This information need be entered only once in the log for all transmission until there is a change in frequency to another amateur band.)

(f) The type of emission used. (This need be entered only once until there is a change in the type of emission.)

(g) The location of the station (or the approximate geographical location of a mobile station) at the time of each transmission. (This need be entered only once provided the location of the station is not changed. However, suitable entry shall be made in the log upon changing the location. Where operating at other than a fixed location, the type and identity of the vehicle or other mobile unit in which the station is operated shall be shown.)

(h) The message traffic handled. (If record communications are handled in regular message form, a copy of each message sent and received shall be entered in the log or retained on file at the station for at least 1 year.)

Convenient ————— Complete

THE ARRL LOG BOOKS

Regular Log, 8 1/2 x 11
35¢ each, 3 for \$1.00

Mini-Log, 4 x 6 1/4
25¢ each

American

RADIO RELAY LEAGUE
WEST HARTFORD, CONN., U.S.A.

SOUTHEASTERN DIVISION

ALABAMA — SCM, Lawrence J. Smyth, W4GBV — The Anniston Radio Club had a Field Day Fest at Cheaha State Park, the highest point in Alabama (2460 ft.). Three club stations and three out-of-town guest stations, all self-powered, were used. Club members present were: GBP, BHY, IRX, GVP, GKM, GYD, HLA, HZT, and BCU and family. Out-of-town guests present were: AUP and family, GBV, EW and family, GPX and family, ANM/4, all of Montgomery; EAY and family, of Birmingham; FVT and wife, of Selma; GSS and wife, of Centerville; GBR of Fort Payne; BIW and wife of Atlanta, Ga.; and IGR and wife of Dalton, Ga. Yours truly learned that a ham's wife and family are the truest and most faithful on earth. When a YL's name was drawn for a prize she had a choice of the radio gear or a pair of nylon hose. Believe it or not, the sweet things (bless their hearts) took the radio gear every time. BHY is on 3.9-Mc. 'phone with 813 mod. with 811s. IRX is on 3.5 Mc. with 807. GVP still is calling CQ on 28-Mc. 'phone with p.p. T40s and getting results. GYD is on 3.5 Mc. with 807. HZT is on 3.5 Mc. with 807. BCU is on 3.9-Mc. 'phone. AUP, on vacation in Florida, took his portable. HLA has new jr. operator, 73 John, W4BCU.

EASTERN FLORIDA — SCM, Robert B. Murphy, W4IP — Your SCM is looking for Official Observer applications. AYV has made application for appointment as OO and ORS. BYF is president of the Dade Radio Club. DQW has asked for ORS appointment on a c.w. net and OPS later. While in Ohio IPW worked back to ICC from 8UKA on 28 Mc.; ITE also worked him. 2ETD spent a few days in Miami and visited the local club. 6IRS/4 reports the following: IWM has worked twelve states in three weeks on 3.5-Mc. c.w.; EFH is now in Key West permanently. 7HIM/4 finally cleared with the Comdt. 7th Navdist and is operating; ERE is working 28-Mc. 'phone; IRS tried for a Class A license and is looking for a new W4 call. ES threatens to get on soon; he is a 25-year man in ham radio and needs a little needling. EYI, my very good correspondent in St. Pete, writes that he is on 28 Mc.; APY has a four-element beam on 28 Mc.; DHD has opened up a radio store in Gulfport; 2DFM is new ham in St. Pete; IK is now on the air with a BC-610E. HLV has been transferred to Balboa with PAA as a radio mechanic; he says WIAW puts in a good signal on 3.5, 7, and 14 Mc. VV puts in a very strong signal to the Canal Zone and almost every other place in the old world. GVC, the old reliable Section EC, is doing a nice job and it looks as though we may be well prepared for the Hurricane Net. All of you fellows interested in this sort of emergency set-up, get in touch with him. QN has accepted appointment as EC of Orange County. ASR is planning to take over the EC job for Volusia County. All these jobs are simple assignments that you are doing every day, so why not join the gang. We definitely need OO, ORS, EC, assistant EC appointees. Let me hear from some of you fellows so we can get lined up in this before there is an emergency. GVC, QN, and BCJ make up the Red Cross Emergency Communications Board for Orange County. Traffic: W4BYF 32, 73. Merf.

WESTERN FLORIDA — SCM, Lt. Comdr. Edward J. Collins, W4MS — JBJ and JBI are our newest hams. DAO is enjoying 7 and 14 Mc. HJA is getting out swell with BC-610. 5IAO/4 has rig ready to perk. HIZ has his new rig on. EGN is going big guns on 14 Mc. with an attic antenna. VR is on with buffer of big rig. JV really gets out on 14 Mc. 3IHC/4 was seen buying 14-Mc. parts. 1DBT/4 is now at a new QTH and planning beams. EQR wants T125s and a kw. DZX has the HRO back. The club, "Hams, Inc.," threw a party at the local hotel. BKQ is really working hard on the big rig. QK is on 7 Mc. Ex-BFD took the exam again. FHQ is happy over the return of 7 Mc. ECT, FJR, and AXP are welcoming 7 Mc. back. ACB is on 7 Mc. JT works all bands in fine style. AXF is happy over 14-Mc. 'phone band opening. UW is busy with Police Radio. MS is trying to get big rig ready for 14-Mc. 'phone. EPT gets on with Signal Shifter. CDE works DX now and then.

GEORGIA — SCM, Thomas M. Moss, W4HYW — ERS is out of the Navy, and is our new EC for Ware. New AEC members are: ISS, ALW, IRT, and 2DGM. HWS renewed ORS appointment. GFJ has returned from Coast Guard. 5GRP is in business at Hannon, Ala. AAO is in KP4. IVH is at Ft. Monmouth. GZU is a midshipman at

(Continued on page 114)

Save Weight! Save Space!

- IN THE SHACK
- WORKING PORTABLE
- WORKING MOBILE

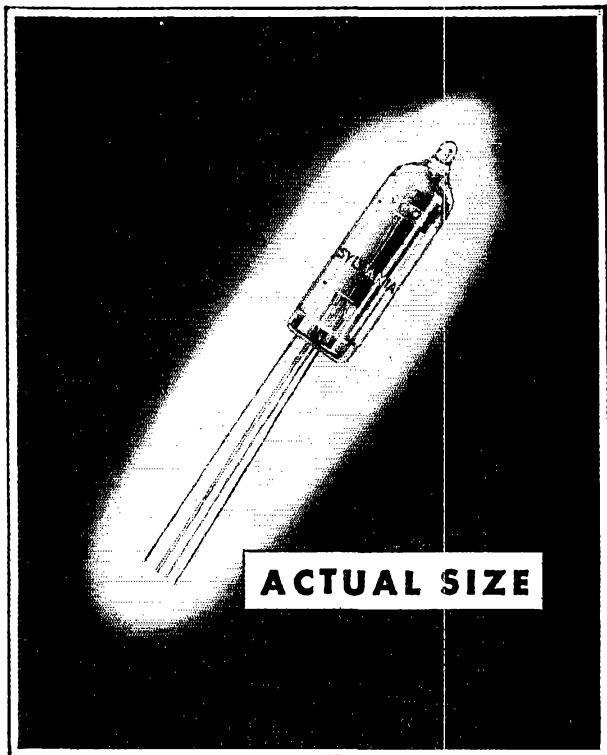

New T-3 tube ideal for high frequency operation

You remember the tiny tube that became the heart of the famous proximity fuze—the complete radio transceiver capable of being fired from a gun!

Well, the commercial version of this Sylvania achievement is now being produced. It has a life of hundreds of hours and is ideally suited for high frequency operation. Its extremely small size will directly contribute to the compactness and lightness of your rig.

Write Sylvania Electric Products Inc., Emporium, Pa., for details.



SYLVANIA ELECTRIC

Emporium, Pa.

MAKERS OF RADIO TUBES; CATHODE RAY TUBES; ELECTRONIC DEVICES; FLUORESCENT LAMPS, FIXTURES, WIRING DEVICES; ELECTRIC LIGHT BULBS

AMATEURS! Leo W9GFQ Offers

Immediate Delivery

On His New, Exclusive, Low Priced

**WRL GLOBE TROTTER
TRANSMITTER KIT**

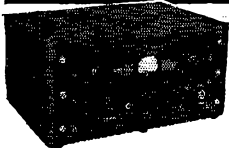

**Users Acclaim
Its Superior
Performance!**

Actual field reports of amateurs using the Globe Trotter testify to its excellent performance. It's the hottest ham equipment on the market today. The WRL Globe Trotter is capable of 40 watts input on C.W. and 25 watts input on phone on all bands from 1500 KC through 28 Mcgacycles. Incorporates the Tritet Oscillator using a 40 meter X-tal; Heising choke modulation; three bands, all pretuned; 10, 20, and 80 meters; two power supplies, one for 807 final and modulator tubes, one for speech amplifier and oscillator stage.

40 WATT INPUT
Cat. No. 70-300..... **\$59.95**

Complete including all parts, chassis panel, streamlined cabinet, less tubes, coils, and meter.
No. 70-312 same as above, wired by our engineers.....\$75.00
All Necessary Accessories.....\$13.85 Extra

*** Receivers - Immediate Delivery**

- * Hallicrafters S-38.....\$39.50
 - * BC 348Q Surplus Receiver (110-115 Volt) \$85.00
 - * National HRO-5TA-1 or 5RA-1.....\$274.35
(Less speaker and power supply)
 - Power Supply for above, Cat. No. 30-283.....\$20.38
 - MCS Speaker for above, Cat. No. 30-285.....\$12.00
 - RFSH Speaker for above, Cat. No. 30-287.....\$21.70
- For Fast Delivery order your receiver now from World Radio. Here are a few more:
- RME 45.....\$186.50
 - RME 84.....\$98.70
 - Hammerlund HQ129X.....\$173.25
 - Hammerlund SPC-400-SX.....\$323.25

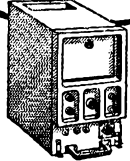

AUDIO AMPLIFIER

Cat. No. 0-73
less power supply... **\$3.45**

Output rated at 8 watts; freq. response, 200 to 1800 cycles; 2 mike input; low impedance and carbon mic.; output impedance 2000 to 5000 ohms; 2 powerful 1619 tubes

FREE! OUR LATEST FLYER

Packed with real buys in radio, electronic, and general merchandise.

- Giant Radio Map (Size 31 ft. x 41 ft.).....15c
- Nandy Tube-Base Calculator.....25c
- Tube and Circuit Book.....10c



Formerly Wholesale Radio Laboratories
Address Dept. QST-9 Council Bluffs, Iowa.

(Continued from page 118)

Annapolis. HGA works as serviceman in KU's shop. RM is installing f.m. station at Columbus. 3DLH now is IPE. FMS is with Atlanta wholesale house. IRL and FZE are students at Ga. Tech. We officially welcome to the section: 2DGM, 5HUV, 8LXS, 9KAZ, 9HFA, 9RQD, and 9KMR. The Eastern Air Lines gang in Atlanta includes: GXU, HQI, ABI, OK, EJN, GTX, IVU, EMM, HXW, HAJ, GTX, EN, CUP, 8LXS, 9HFA, FIN, EZJ, and DSI. BPT and BIW are with Southern Airways in Atlanta. IJA and IYG have joined the mobile gang in Atlanta. KL, ZD, BOC, IYQ, IWZ, CWE, RZ, and 5HUV are with Atlanta Police Radio, WPDY, AEC, UO and EDE are at WSB. GMP and FBH are invading 50 and 144 Mc. 8UEB is at Ft. McPherson. FKN is doing OK on 50 Mc. Now that 7 Mc. is open, our prewar ORS are urged to renew appointment so that we can start our nets on 7 and 14 Mc. New applications are also invited. Vacancies also exist for OPS. The grapevine news is running out, so let's have your reports. Best of luck on 7 and 14 Mc. 73. Tom.

WEST INDIES — Acting SCM, Everett Mayer, K4KD/KP4 — On June 23rd KP4AZ worked all continents in a little over six hours. He has a new three-element plumber's delight working out FB. KP4AM reports DX cards from G and W7 coming in. He has a brand-new NC-2-4C receiver. K4HEB still is planning his new big rig (p.p. 813a). KP4AU still gets bugs in his 475 watts. W4DYX/KP4 is busy constructing v.f.o. antennas. W4BZA/KP4 tried 14-Mc. 'phone but wound up on 7- and 14-Mc. c.w. K4KD/KP4 has 3- and 7-Mc. v.f.o.s, but is sticking tight on 14- and 28-Mc. c.w. KP4AE is planning 14-Mc. beam. KP4JA is installing new antenna and plans three-element beam. K4HEB/KP4 and K4KD/KP4 worked their first postwar Russian (?), UA3KAO on 14 Mc., and both added FM8 to their lists. KP4AW, a new-comer, will be on soon aided by KP4AQ. K4ENT now is KP4BG. Ex-4GJM now is KP4BC. Mrs. W3JOD presented her OM, W3JLH, with a jr. operator. 73. Ev.

SOUTHWESTERN DIVISION

LOS ANGELES — SCM, Ben W. Onstenk, W6QWZ — The Los Angeles Section Field Day will be October 12th and 13th. All clubs and AEC groups will participate. Let's all get in on it. See your club activities manager, the local EC, or the SEC, UXN. The Inglewood AEC net, under MSO, continues to hold regular weekly drills and incidents each Monday evening on 146.5 Mc. The San Fernando AEC group, under KEI, is planning incident drills. The sheriff's communications reserve, under GVT, is being re-activated. EBK is organizing AEC in Baldwin Park and vicinity. Official Broadcast Stations are: ON, VOZ (ex-K4HTU), ANN, EKM, GZZ, OGM, ASW, QL, IWE, SMK, and 20IQ/6. OPS are IWU, BUK, AM, and OGM. ORS are AM, IFW, VOZ, CMN, UYP, and EBK. RMs are IFW and BOZ. Official Observers are ON, GZZ, and GM. Emergency Coördinators are 4EJQ/6, EBK, NGK, GVT, KEI, PTR, MSO, RO, and MVZ. The Los Angeles Section Council of Clubs, consisting of two delegates from each club, is being formed and will hold monthly meetings to consolidate activities in the section. OGM is on the u.h.f. looking for contacts. IWU operated at a Boy Scout camp during vacation. AM is using his dream shack, now eight rhombics and two "V" beams. UYP has p.p. 807s on 7 Mc. VOZ is starting net on 3810 kc. IFW is starting net on 3830 kc. CMN has p.p. 813s on 3.5 Mc. MEP is using 500-foot antenna on 28 Mc. BOB, EBK, VDE, VIX, SJF, USK, VES, DJW, and EKW are active on 420 Mc. NAW, ANN, AQJ, NSC, TBS, IF, FMH, and RIU are breaking records on 50 Mc. QWZ finally got his MBF going on 50 Mc. The M.K. net on 51840 kc. now is an Official Section Net, TBS and PTR controls. For a good band try 50 Mc. Crystal-controlled on 144 Mc. are JXZ, MJU, EBK, UXN, PTN, LFC, HHU, and NAW. Plenty of room on 144 Mc. for crystal-control rigs. Traffic: W6VOZ 17, AM 12, IWU 10, CMN 9, OGM 2, 73. Ben.

ARIZONA — SCM, Gladden C. Elliott, W6MLL — PKZ was top man for Arizona in the Band Warming Contest. TJG put on a big barbecue for the Phoenix gang and ninety-two showed up for the steaks and French fries. It was a great QSO party for all with many out-of-town visitors. OAS won the door prize, which was Bob Carlson's transmitter. TNJ has a new rig on the air. NVS has a new 8-40. New calls are 7KMM, 7JMS, 7JJY, 7JGW, and

(Continued on page 118)

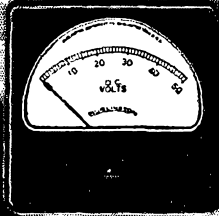
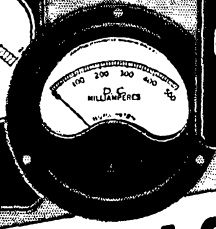
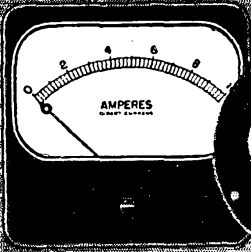

PRECISION

★ BASIC WITH



Burlington INSTRUMENTS

1. Magnets of Alnico, the most stable magnetic material available, are used in all DC instruments.

2. Large Clearances, between core, moving coil, and magnet pole pieces assure freedom of movement by eliminating sticking due to moving element rubbing on adjacent parts.

3. Jewel Supports are machined and assembled with aid of precision gauging fixtures to maintain perfect alignment.

4. Control Springs are fabricated from the

highest quality phosphor bronze.

5. Ceramic Pointer Stops are used to prevent damage to the pointer due to accidental application of sudden overloads.

6. Balance Weights of helical type phosphor

bronze are used to balance the moving element, so formed as to eliminate slipping or shifting.

7. Magnetic Shunt is standard equipment on each DC instrument, insuring uniform damping characteristics.

All ranges AC and DC are available in 2 1/2", 3 1/2", 4 1/2" sizes, both rectangular and round case styles. Inquiries for complete information and engineering service are solicited

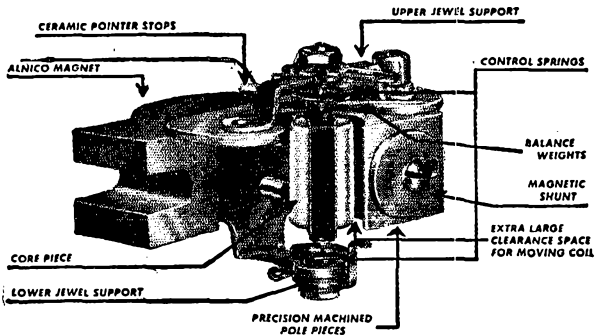

BURLINGTON INSTRUMENT COMPANY
 809 Fourth Street • BURLINGTON, IOWA

FIRST

FOR THE
GREATEST NAMES
IN
HAM RADIO



Here they are—the newest Post-War "Ham" Receivers with all the latest improvements in technique and design.

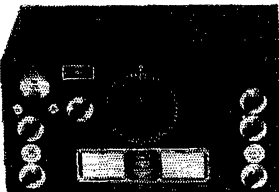

NATIONAL HRO-5TA-1 • Net \$274.35
697 Power Unit \$20.36 • MCS Speaker \$12

A Receiver, designed for the Amateur, to provide dependable communications, under most severe conditions. New Noise Limiter incorporated. Band spread on all "Ham" Bands—Coverage 1.7 to 30 Mc.

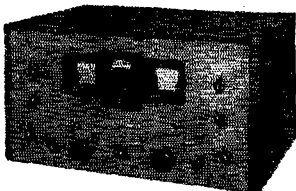

HAMMARLUND HQ-129-X • NET \$173.25
Price Includes Cabinet Speaker

A "Ham" Receiver with the professional touch, providing flexibility of operation. Six bands for easy location of stations. Has all "Ham" features with sensitive and stable performance.

HALLICRAFTER S-40 • Net \$79.50
With Built In Speaker

Performance and beauty are combined in this outstanding Receiver value. Many circuit refinements never before available at this price. Electrical Bandspeed Dial—Coverage 540 KC to 43 MC.

HAM RADIO SUPPLIERS SINCE 1919

CAMERADIO CO.

963 LIBERTY AVE. • PITTSBURGH 22, PA.

(Continued from page 114)

7JFT, SDU, QON, and RFE are on the air again. 3DMV/7 is working Js and VKs on 28 Mc. like locals. He says a four-element beam with an artificial ground of chicken wire under the beam does the work. The first Sunday p.m. of every month will be V.H.F. Day in Arizona. RNB has a new HT-4 and plans to cover all bands. One of his first contacts was on 14-Mc. 'phone to La. at 11 p.m. Lots of short skip on bands in Arizona. SQN reports hearing Tucson and Biebee 28-Mc. 'phones in the Verde Valley. QAP is going great guns on 50 Mc. making many contacts with 6s and 7s. UPF has an 813 on 3.5, 7, and 14 Mc. and is working c.w. 7JIV has a new rig on the air. 6PGQ was back in Arizona from El Paso for a few days. OZM had a big dinner for his staff. Get on 3.5 Mc. Sundays and meet the gang. 73. GC.

SAN DIEGO—SCM, Ralph H. Culbertson, W6CHV—MKW reports that BWO, CIG, DHP, HWJ, MQF, RKL, RPI, and MKW are on 3.9-Mc. 'phone. ALO has 28-Mc. rig going. QG is on 50 Mc. with QRP job but is building high-power layout with pair of 24Gs. HAA is uncrating a new BC-610 transmitter. TIK has moved to Orange. BAM has new HRO, MQF an HQ-129-X, BWO and MKW a couple of RME-45s. UPP is on 28 Mc. and VAD is on 3.9 Mc. at Orange. VEK and VNN are new calls in Orange County. NIK is on 3.5-Mc. c.w. MRP is holding down 3.9-Mc. 'phone at Garden Grove. 9QZX/6 is reported on 3.5-Mc. c.w. at Laguna Beach. LDJ, NGN, NGO, PGM, and QLA attended the last meeting of the Orange County Radio Club. The Club was active on Field Day under the call of PNU and operated from Lemon Heights reporting conditions on both 3.5 and 28 Mc. New calls in San Diego are VTA, VVA, VBA, VBT, VOP, VTS, and VTV. JUM reports lots of activity on 50 Mc. with R9 reports from FPV, ANN, 7ERA, 7HEA, 7DNB, and 7AMX. JUM is operating with about 22 watts and four-element beam. He would like reports from any stations hearing him. The San Diego Radio Club is in full swing with fifty-two charter members with the following officers: DBV, pres.; RTX, vice-pres.; MLB, secy. MLB has 500 watts on 28-Mc. 'phone. QNM and OUG both have their pilot licenses and have installed mobile 28-Mc. rigs in their planes. BEY and PJW are on 3.9-Mc. 'phone at El Centro and both are with KXO. The Palomar Radio Club was also active on Field Day at Del Mar with about twenty-four operators participating. Fifteen forty-foot poles were erected for supporting the sky wires. 3.5-Mc. c.w. was handled by BKZ, JOY, LYF, SKZ, 8VLZ. 3.9-Mc. 'phone: MHL, RPJ, CHV. 28-Mc. c.w.: SIG, RMN, BTB. 28-Mc. 'phone: LKC, MMO, VJA. 50 Mc. and 144 Mc.: OFT, NWL, 9WSC. EPM and BOS held down the power plant and CLT did a fine job with the cook shack. 73. Ralph.

WEST GULF DIVISION

NORTHERN TEXAS—SCM, Jack T. Moore, W5ALA—JBD attended the 500-mile race at Indianapolis on Memorial Day. GSZ reports that JQU has moved to San Antonio. KBP has an HT-4, according to JOT. ICT is signing portable 8 from Cleveland, Ohio. ESC is working in the maintenance department of Braniff Airways at Dallas. EVN now is K4AU, according to JBD. IBE is on the air with a 500-watt rig from the Fifth Air Force Hospital at Kyushu, Japan. LGM, of Ft. Worth, really started off with a power house, as he is using a BC-610 transmitter and an SX-28 receiver. KXY is getting out much better now that he is using a folded dipole that he can rotate. Ex-LXV now is KP4AJ. DAS reports that BSY is aboard a tanker sailing between Gulf ports and the East Coast. Travis is on 28800 kc. when at sea and on 3.5-Mc. c.w. when in port. IXM/J9 is back home from Kwajalein and requests that anyone who contacted him between April 23 and May 10, 1946, who has not received a QSL please write him at 3543 Haynie, Dallas. JIZ is out of the Navy and has returned home. The SCM had an FB visit from 4IPA (ex-K6RUA), who was on his way to new QTH at San Diego. See you at the West Gulf Division Convention at Oklahoma City September 21st. Traffic: W5ALA 3. 73. Jack.

OKLAHOMA—SCM, Ed Oldfield, W5AYL—WEST GULF DIVISION CONVENTION—Sept. 21-22, Hotel Skirvin, Oklahoma City. Pre-registration prize a big one. Send registrations to HXI, Crescent, Okla. For hotel reservations wire or write AYL. The OCARC will show you

(Continued on page 118)

BUILT TO CARDWELL STANDARDS

The Cardwell Fifty-Four

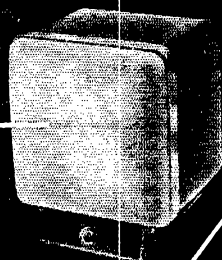
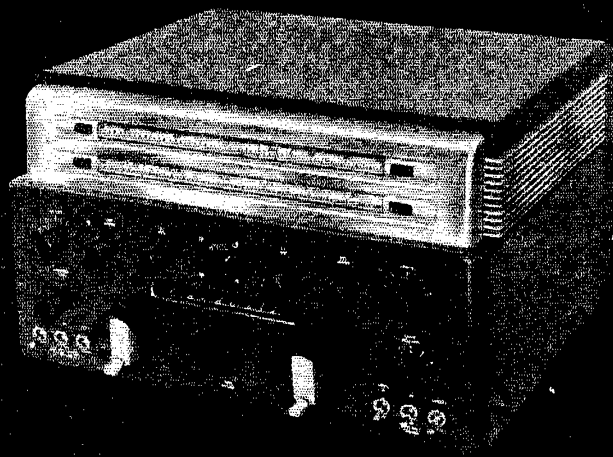

truly a postwar communications receiver

It is gratifying to note how many orders followed the recent announcement of the Cardwell Fifty-Four . . . gratifying, because these orders were placed regardless of price . . . indicating unmistakable recognition of Cardwell quality. This completely new communications receiver will be ready for delivery this fall. Check the following outstanding features:

- 1. Full Turret Type R. F. Section.**
(Sturdy cast aluminum construction.)
- 2. Wide Frequency Coverage.**
(Range .54 to 54.0 mcs. Basic turret covers .54 through 40 mcs. in six bands. Extra coil strip supplied with set extends range to 54 mcs.)
- 3. Secondary Frequency Standard.**
(Unique type crystal calibrator provides check points of either 100 or 1000 kcs.)
- 4. Variable Selectivity Crystal Filter.**
(Choice of 5 degrees of selectivity—three with crystal, two without.)
- 5. Exceptional Signal to Noise Ratio**
(Receiver noise less than 6 db above thermal)

6. New Type Noise Limiter.

(A really effective aid in reducing local ignition interference and similar noises.)

7. Electrical Band Spread.

(Band spread scales calibrated directly. Arbitrary scale 0-100 also visible on each setting.)

8. Direct Reading Precision Dials.

(Excellent visibility—pointer travel better than 10½ inches—velvet smooth dial action.)

9. Temperature Compensated Oscillator.

(Stability is better than 25 parts per million per degree centigrade. V.R. tube maintains maximum frequency stability against line voltage fluctuations.)

10. Mechanical Coupling Provisions.

(Control shafts are brought out at rear

for linkage to other units such as a transmitter exciter.)

11. All Aluminum Unit Construction.

(Receiver and power supply combined in one sturdy, lightweight unit 18¼" wide x 16" deep x 11" high. Weight approximately 70 lbs.)

12. Heavy Duty Speaker.

(Compact tilting unit 9¼" wide x 8¼" deep x 11" high for wall or table mounting.)

13. Eight Watts Audio Output.

(Push-pull class AB—with four output impedances. Connections provided for phono-pickup or microphone input.)

14. 18 Tubes—All Miniature.

15. Threshold Squelch.

16. Panoramic Adaptor Jack.

WRITE FOR COMPLETE TECHNICAL BULLETIN

THE ALLEN D. CARDWELL MANUFACTURING CORP.

MAIN OFFICE
& FACTORY:



97 WHITING STREET
PLAINVILLE, CONN.

Brand New!

Army Air Force Transmitter

(BC-375-E)

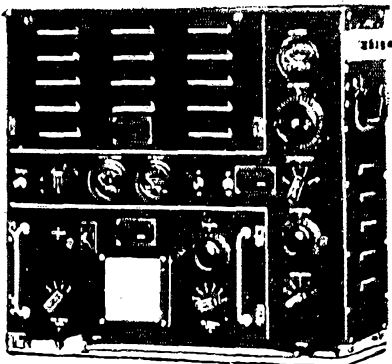

Mounting ET-151-A

Transmitter Tuning Unit

All tubes including 1 type 10 tube and 4 type 211 tubes. Not shown are dynamotor, antenna tuning unit, 7 tuning units and cases for same for 28 volt D.C. operation. Comes with complete instructions for converting to 110 V A.C. operation.

45⁰⁰
F.O.B. Phila.

Army Signal Corps Receiver

(BC-224-E)

Brand New!



Has two R.F. stages, one I.F. stage, crystal filter, 8 tubes with dynamotor for 12 volt D.C. operation. With instructions for easily change to 110 volt A.C. 6 bands—200 to 500 K.C. and 1500 to 18,000 K.C.

59⁹⁵
F.O.B. Phila.

SAVE ON ARMY SURPLUS!

HANDSETS

H 22 A U—Like new type telephone handset. Standard single button carbon microphone 1000 ohm D.C. resistance receiver (hi-impedance). With 5-ft. rubber cord ending in PL 55 and PL 68 phone plugs . . .

4⁹⁵

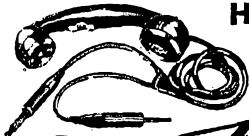

Radio Electric

SERVICE CO. OF PENNA., INC.

7TH AND ARCH STREETS, PHILA. 6, PENNA.

Branches in Wilmington, Del., Easton, Penna., Allentown, Penna.

(Continued from page 116)

a good time. AQE/5 reports the Oh-Pe-Kah Club is again active with new officers elected on June 6th: EST, pres.; GTU, vice-pres.; AQE/5, secy-treas. Code will be taught to Class C boys. BBM, HBB, EST, and BMK, all prewar members, were present at first meeting with one newcomer, IKC, a YL. Field Day was an enormous success for the Oh-Pe-Kah Club. A dozen members installed a rig, 125 watts HK54 final on 3.5-Mc. c.w. and 175 watts (2) 812s final on 28 Mc. Plenty of power supplied from a 2 3/4 kw. and 600-watt units. Wind, thirty miles per hour, hampered erection of the tent shelter. They made seventy-five contacts on 3.5 Mc., thirty-two on 28 Mc. XYLs and offspring were in attendance and a good time was enjoyed. OCARA has the convention problems in hand, and the ball rolling. The OC boys had one 28-Mc. rig on and made twenty-five contacts on Field Day. CXE officiated. Regards. Ed.

SOUTHERN TEXAS — SCM, James B. Rives, W5JC — HIF reports the Corpus Christi Club Field Day was a big success with plenty of portable and mobile gear on hand. Power was furnished by a gas-driven 7-kw. plant and antennas supported by everything from trees to a box kite. GMT is conducting code classes at each club meeting. Former SCM, MN, advises he has a new shack and HRO receiver and requests ORS appointment so he can get back in the groove with traffic handling. KMV reports for the gang at Laredo. He has an 807 on 3.5 Mc. HSV has 150 watts on 3.5- and 7-Mc. c.w. EAE received his new ticket and old call letters and is ready for action. BFT is teaching radio at the Laredo High School and has plenty of potential hams in the making. DPI has returned from Austria and is moving to Washington, D. C. JMP is with KMAC in San Antonio. HHO is on regularly in Tokyo at 7 A.M. CST and desires contacts with Southern Texas hams. GKX has moved to Iceland and is employed by one of the Airways there. LBG, LDU, KTL, KYJ, LFM, LGG, LEK, and LEM are all new calls just issued in San Antonio. FNA is working some choice DX on 14 Mc. with a new rig he has just completed. KTL requests OBS appointment. BUV had his old ORS certificate endorsed and is active on 3.5-Mc. c.w. 73. Jim.

NEW MEXICO — SCM, J. G. Hancock, W5HJF — 4DWB/5 is on 3.5-, 7-, and 14-Mc. c.w. with 75 watts to an 829B from Los Alamos. 3JSD has his old original call, 5GGX, back. 9NGL is sporting a new Millen 90800 50-watt exciter unit with which he plans to drive a pair of TZ40s. GSD is on 3.5-Mc. c.w. from Washington, D. C., and expects to be discharged soon. Traffic: W4DWB/5 16. 73. Jake.

CANADA

MARITIME DIVISION

MARITIME — SCM, A. M. Crowell, VE1DQ — IMPORTANT REMINDER — Send in your reservations for our Maritime Division ARRL Convention NOW. By so doing you qualify for the big door and registration prizes. The place — Nova Scotian Hotel, Halifax. The time — August 31, September 1 and 2. The price — \$3.00 for OMs, \$2.00 for YLs, YFs, and OWs. Write EK, c/o Mannings, Halifax. The HARC Field Day crew, under HJ and DB ably assisted by EK, with KB using the club station call, FO, piled up a nice score of 900 points. Outfit was powered by gas-driven "chore horse" and used a half-wave Zepp on 3.5 Mc. and three-element beam on 28 Mc. Fifty-one contacts were made, twenty-four being Field Day stations. DQ, DB, and ET already have 14-Mc. sky wires up. DQ finally got the long-looked-for HRO. KY now is quite active on 3.8-Mc. 'phone. CW sends in nice dope from P. E. I. Wylie is on 3.5-Mc. c.w. and is building portable for 50 Mc. CO is going on 3.5-Mc. c.w. BD is going strong on 28 Mc. RG, ex-AF, is on 3.5-Mc. c.w. HJ schedules RB on Sable Island. EP is going after the DX; he is on 14 Mc. DB and QZ, both using folded dipoles with 10 imp. twin cable, work out FB on 14 Mc. TA is on 28-Mc. 'phone, and QT is on 3.8 Mc. Traffic: VE1HJ 15. 73. Art.

ONTARIO DIVISION

ONTARIO — SCM, David S. Hutchinson, VE3DU — Greetings from your new SCM, and I hope that you fellows will give me your support by sending in your reports the first of each month. All ORS, OPS, OBS, EC, RM, etc., appointees of prewar days are requested to mail certificates

(Continued on page 120)

*For Outstanding
Performance!*

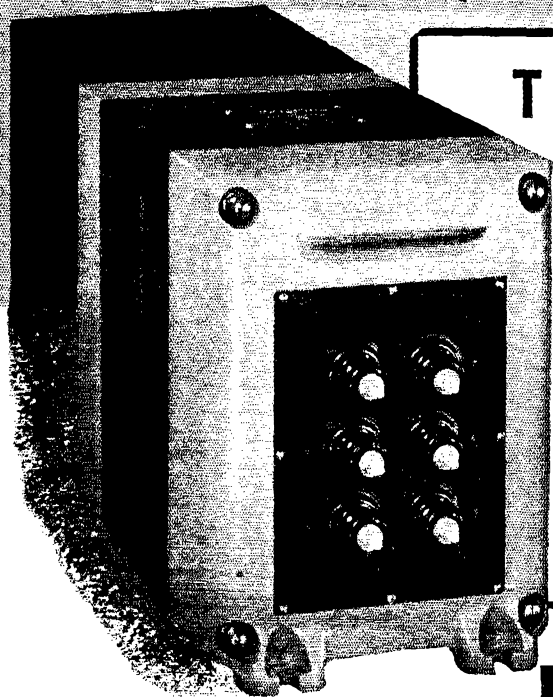

THORDARSON

Transformers

Ham rigs "Powered by Thordarson" have been creating and breaking DX records since radio began. Designs now available to match the newest tubes. Power your new rig with Thordarson...visit your Thordarson jobber today!

MEISSNER

SIGNAL SHIFTER

The Number One requirement for the "complete" ham shack. Covers all the new bands. Completely new. Ask your jobber for full information.

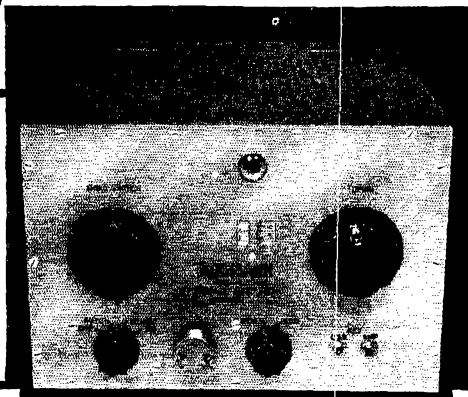

**ELECTRONIC DISTRIBUTOR AND INDUSTRIAL SALES
DEPARTMENT, MAGUIRE INDUSTRIES, INCORPORATED
936 NORTH MICHIGAN AVENUE, CHICAGO 11, ILLINOIS**

**AARON LIPPMAN OFFERS
SPECIAL VALUES**

in
TRANSMITTER PARTS

**All in perfect condition — removed
from U. S. Gov't Radar equipment.**

G.R. 200 CU Variac.....	\$14.50
Kenyon Trans. 115 V Pri. 3200 V Sec. at 150 MA.....	12.50
1 MFD 1000 V G.E. cond.....	1.75
2 MFD 1000 V G.E. cond.....	2.25
2 MFD 4000 V G.E. cond.....	10.95
5 Volt 30 amp. trans.....	5.25
2.5 Volt 10 amp. trans. Kenyon T389.....	3.85
American Trans. L218 choke...	3.50
Thordarson T74C29.....	2.75
Thordarson T13C27.....	.55
Thordarson T92R21.....	4.95
8-8-600 V Paper Cond.....	2.50
Weston 301 0-1 MA with 4 KV Scale.....	5.00
Socket for 304TL tube.....	1.25
Eimac 304TL Brand new in carton.....	10.00
Dunco D.P.D.T. Relay with 10 amp contacts, 115 V AC coil...	2.00
Dunco Interlock Relay.....	3.00
GR 433 Pot 100 M 25 watts....	5.00
IRC type HA 100 M 100 watt....	1.00
IRC type HA 50 M 100 watt....	1.00
IRC type HA 3 M 100 watt.....	.50

We are Radio Parts Jobbers of all stand-
ard nationally known brands of mer-
chandise especially adapted to "Hams"
and Shortwave listeners. We welcome
your mail order trade.

PUT YOUR NAME ON OUR MAILING LIST

*Send your name and address on post card and
receive all our announcements of special bar-
gains and available new items from time to time.*

**AARON LIPPMAN
and COMPANY**

246 Central Ave. Newark 4, N. J.
Mitchell 2-3065-6-7

(Continued from page 118)

to me for endorsement. After receipt of two monthly reports they will be endorsed. It is necessary that all appointees do this promptly so that we can get our traffic nets working by early fall. Applications are solicited for CD appointments so get them in to your SCM at 827 Lovett Street, London, or in care of Post Office, London. KM reports the HARC had a successful Field Day June 22/23 working 3.5- and 28-Mc. c.w., 3.5-, 28-, and 144-Mc. 'phone. KM contacted Buffalo on 144-Mc. 'phone using 12 watts to HY75 with six-element beam. At Model Airplane Meet in Hamilton on June 29th, KM used 50-Mc. portable and fixed battery rigs and handled over 200 messages in six hours with four rigs, two fixed and two portable. The Frontier Radio Club is putting out a mimeo sheet, *MIM*. The first copy was received in time for the June report. CP, ADN, AEP, MY, ZO, FP, and LA are executive officers. AHL worked F8 on 3.5 Mc. with 2A3 final and in recent tornado lost his home, radio gear, in fact everything. HK is on 3.9 Mc. with 807. BLE is newcomer in Leamington. AKR and FU are recent additions to 3.9-Mc. 'phone. XG has emergency gear. London: AJE, BJI, BLD, CM, and DU are on 3.5-Mc. c.w. GV, ADC, AVS, and HI are on 3.9-Mc. 'phone. BEV, FD, AJQ, and GB are on 28-Mc. 'phone. Watch your frequencies on 7- and 14-Mc. bands, boys — 7150-7300 kc. and 14150-14300 kc., with 'phone operation on 14200-14300 only. HZ, GC, and FD, using portable 3.5-Mc. 'phone job at Rondeau with 8.5 watts input, made forty-two QSOs over May 24th week-end. Best DX was Montreal. Is anyone on in Toronto? Traffic: (May) VE3OI 8.

QUEBEC DIVISION

QUEBEC — Acting SCM, W. Stephen, VE2LC — Three Qgroups took part in the Field Day contest: WC with RD in Westmount; RE with UT, UV, and UW in Ste. Cecile; CO with GE, SU, IE, and PW, assisted by SM, WW, H, Hulse, and F. Basserman, in Cedar Park. DY, JT, GT, NR, XX and KC are active in the Lakeshore district. DU reports attending a Quebec Radio Club meeting. Visitors to Montreal include 4AO, 4VM, 1BE, 3AFS, PY1GR, G2CMU, GW2FUD, and W8ADX. UO is a new ham in Sherbrooke, using a suppressor grid-modulated RK20. BK has an HQ-129-X, UU is newly-licensed in Naudville. OE and DV are busy in the Chicoutimi area, the latter assisting three SWLs to get their tickets. II, with LU as alternate, schedules 1EX, 3BDX, W3JQN, W1NKW, and W1BVR. DD lost four fingers in an accident on a punch press in his shop at Grand'mere. Condolences to ex-JZ, now 3BCJ, on the loss of his father. BF finally decided that two can live as cheap as one. HZ is new call issued to ex-3PI, while ex-3ACN is now DG. QY and TJ are active in Quebec City. MP works out of Farnham with 12 watts on 3.5 Mc. LT is on with c.w. and 'phone from Rock Island and reports frequent visits from W1GXP. TW, UG, and UI are new tickets in Montreal. SD is a newcomer in Hull. EX and OS have rotary beams on 28 Mc. IG puts out a fine signal from Drummondville on 3.9 Mc. QS is a member of the Montreal Philharmonic. AF, a student at Dawson, works c.w. on 3.5 Mc. AS has completed a superbet and is on the air from Sherbrooke. Traffic: VE2CO 1.

VANALTA DIVISION

ALBERTA — SCM, W. W. Butchart, VE6LQ — Ex-4ANS now signs 6LF. HZ, of Chancellor, visited the Edmonton gang. IJ has separate 3.5- and 28-Mc. rigs. He has been transferred to Whitehorse, Y. T., and awaits his VE8 call. HM gets FB 28-Mc. c.w. contacts, and is trying to get line-up on an HRO. LG, EA, AE, and BZ have 144-Mc. rigs ready for Calgary Hamfest Field Day. Tests have been highly satisfactory. GA bought an HQ-129-X and has rig practically completed. MJ put up FB pair of new sticks, and is QRL gardening. EA and CE are designing new battery-power rig for CE's QTH at Rexborough. LQ sports new HQ-129-X. BW's rebuilt rig gives perfect satisfaction. AO has received discharge from RCAF. He will be new RM for Alberta. ZL puts his rig at AO's disposal for keeping traffic schedules. EY got his rig cranked up on 3.9 Mc. and says the v.f.o. is worth its weight in gold! LL moved up to Grimshaw for two weeks. He says it's an FB location for ham radio. UP has gone to U. S. A. for instructional course. Frank Gue gets on 3.5-Mc. c.w. with QRP rig, using call

(Continued on page 122)

TERMINAL OFFERS YOU MORE IN QUALITY — VALUE — SERVICE

Once you try Terminal, you'll agree that Terminal is your best bet for the best in radio equipment! Whether it's a new communications receiver or a bargain surplus part, you can be sure the quality has been ascertained by our own discriminating ham purchasing men!

**HEADQUARTERS
FOR THE BEST
AMATEUR RADIO
EQUIPMENT**

KENYON UNIVERSAL MODULATION TRANSFORMERS

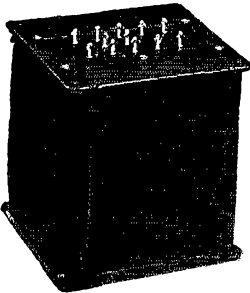

Type No.	Audio Watts	Net Price
T-489	15	\$ 4.03
T-493	40	5.88
T-494	75	8.82
T-495	125	19.46
T-496	300	29.55

Will match any Class B tube or tubes to any Class C load!

HALLCRAFTERS RECEIVERS

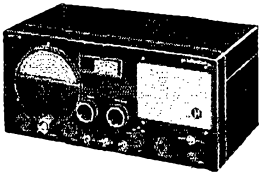

S-40..... \$79.50
S-38..... 39.50

PANADAPTOR... \$99.75

MICA TRANSMITTING CONDENSERS

5000 volts test, 2500 volts working. Made by a top-notch capacitor manufacturer.

.001 and .002 MFD **65¢**
5 FOR \$3.00 EACH

ALUMINUM RACK PANELS

LIGHT—STRONG—EASY TO DRILL
Black or Grey Wrinkle Finish. 19" wide, slotted for rack mounting.

5 1/4" — \$1.74 8 3/4" — \$2.49
7 " — 2.04 10 1/2" — 3.18

TRANSMITTING CRYSTALS

Bliley 20 meter band..... \$3.95
Bliley 40 and 80 meter bands 2.80
Petersen 10 meter band..... 5.00
Petersen 20 meter band..... 3.50
Petersen 40 and 80 meter bands..... 2.65

WIRE WOUND PRECISION RESISTORS

IRC AND SHALLCROSS

Now you can make your own high voltage meters with any 1 mill movement! 1% tolerance.

.5 meg 75¢ 3 for \$2.00
1.0 meg 95¢ 3 for \$2.50

Order now—while they last!

HIGH VOLTAGE CONDENSERS

Oil impregnated and filled. Built to last! With mounting brackets.

G.E. 2 mfd.—4000 Volts... \$5.75
G.E. 4 mfd.—4000 Volts... 9.75
Aerovox 1 mfd.—5000 Volts 4.95

TRANSMITTING TUBE SPECIALS!

G.E. VT 154/814 beam power..... \$5.95
JAN 829B..... 4.95
829B stealite socket assembly..... .75



MILLEN'S NEW COIL FORM ASSEMBLY

Shielded plug-in type, permeability tuned. 1/2" form, suitable up to 35 mc.

No. 74001. Net \$1.85

We carry all Millen products

BARKER & WILLIAMSON TRANSMITTING COILS

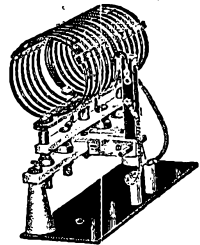

TYPE BVL—150 W. Input

Band	Type	Net
5	5BVL	\$1.93
10	10BVL	1.93
15	15BVL	2.00
20	20BVL	2.00
40	40BVL	2.28
80	80BVL	2.61

Base Assembly and Swinging Link for BVL Inductors.

Net..... \$3.44

TYPE TVL—500 W. Input

Band	Type	Net
10	10TVL	\$2.20
15	15TVL	2.28
20	20TVL	2.28
40	40TVL	2.61
80	80TVL	2.96

Base Assembly and Swinging Link for TVL Inductors.

Net..... \$5.50

TYPE HDVL—1000 W. In.

Band	Type	Net
10	10HDVL	\$4.48
15	15HDVL	5.16
20	20HDVL	5.16
40	40HDVL	5.50
80	80HDVL	6.19

Base Assembly and Swinging Link for HDVL Inductors.

Net..... \$6.88

All B & W Inductors and Tank Condensers in stock! Write for complete B & W catalog!

TERMINAL RADIO CORP.

85 CORTLANDT STREET, NEW YORK 7, N. Y.

PHONE WORTH 2-4415

QST

YEARLY BINDERS



Are We Right?

You should have at least two of them — one for your complete 1945 file of copies, and one for each 1946 issue as published.

With each Binder is furnished a sheet of gold and black gummed labels for years 1927 through 1947. The proper one can be cut from the sheet and pasted in the space provided for it on the back of the binder.

Price **\$2.00** postpaid

Available only in United States and Possessions

THE AMERICAN RADIO RELAY LEAGUE
West Hartford, Conn.

(Continued from page 120)

6BH. AL is QRL and on barnstorming tour with light plane. PP's modulator went haywire for want of TZ20s. OT, of Watts, is on 3.9-Mc. phone with generator-powered rig. Traffic: VE6AO 39, LQ 17.

PRAIRIE DIVISION

MANITOBA — SCM, A. W. Morley, VE4AM — The only report to reach me this month was the news of DX work on 56 Mc. DG worked a W0, some 1100 miles away. Doug is Manitoba's only OES and has the knack of working the DX when the band opens. I have heard remarks that to be eligible for appointment as ORS, OPS, OBS, etc. you must work on 3.5 Mc. This is entirely wrong. All appointments are open to League members regardless of the band you work on. This section is particularly poorly represented in that we have no CD appointments other than DG's OES. Full details on any appointment will be sent to anyone requesting same. By the time this appears in print fall will be here, 7 and 14 Mc. open, and winter activity just about all planned. Include one of the CD appointments in your plans. This is your section and it cannot be built up without your help. Please drop me a line and let me know your plans. 73. *Arl*

SASKATCHEWAN — SCM, Arthur Chesworth, VE5SY — 5MW is the first OES in this district. He was visited by 4YW and 5AU over the week end. The Moose Jaw Club was all ready for the Field Day but transportation difficulties at the last moment forced a cancellation of all plans. 5SY has been trying out a 6L6 regenerative oscillator but is going back to the old tri-tet. 5HW expects to be on the air in new shack shortly. 5YR has been accepted as the new QSL Manager. Please don't forget to send your envelopes to him for those expected DX cards. 5HB has been heard on phone. 5JV rebuilt his final and is pleased with its performance. 5OM is very busy chasing sleeping car space. 5EP promised a report on 3.5-Mc. phone. 5OP has his 813 working. No reports of activity have been received from outside points in this district. What's the trouble, boys? Don't you want anyone to know what you are doing? If you wish to see a Saskatchewan report in *QST*, please get busy and let me have the news. 73.

~~Strays~~ Strays

During the recent tragic La Salle Hotel fire in Chicago, W9IUF, Dr. Ralph W. Taraba, served as a volunteer physician at the scene, working for hours in the care of the injured and dying. W9IUF survived the ordeal without ill effect until he was leaving the scene, when he was injured in a fall on a fire-weakened marble staircase.

When we were in Washington recently we learned that the FCC's monitoring people, by various means, have succeeded in identifying many of the operators who jumped the gun on the opening of the 3.5-Mc. band; all are getting letters of warning which become part of their "records" at Washington.

According to RCA's *Relay*, the Chinese went to a lot of bother in overcoming their paper shortage. For example, after running receiving "slip" through an inking recorder, they turned it around, top for bottom, and ran it through again, using a different color of ink. Two more runs could be made after it was turned over on the other side. Then they rewound it and ran it through a perforator and into a transmitter head. Five runs for one piece of tape! That's really saving paper.

SPECIAL!!!

Brand New 150 Watt Xmtros

COMPLETE WITH  **Meissner SIGNAL SHIFTER**

at an amazingly low price . . . far below government cost

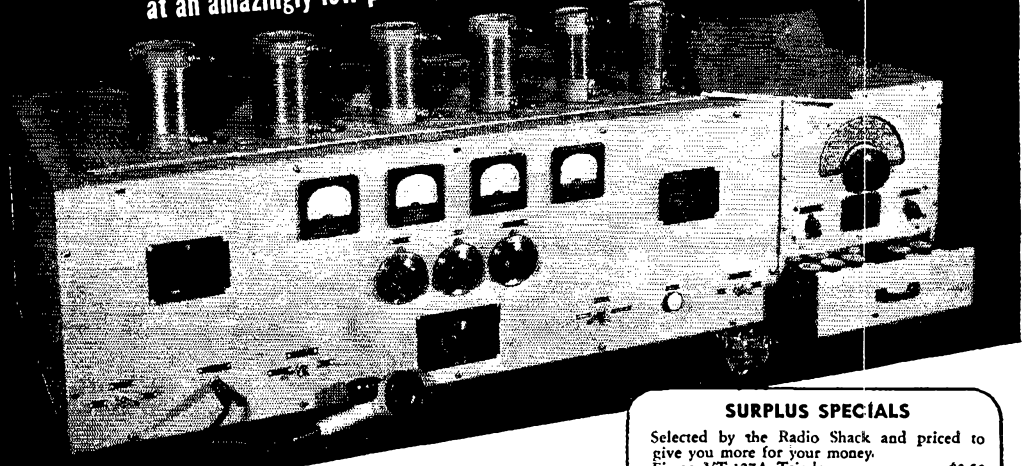

Ready for Use

JUST PLUG IN 110 VOLT A-C LINE, HOOK ON ANTENNA, AND GO RIGHT ON AIR

Modern styling that will delight your eye — PLUS the superb performance demanded when this Meissner 150-B Xmtros was built for the Signal Corps — PLUS accessories, extras, spare parts, and instruction manuals — all add up to a bargain that surpasses anything we've ever been able to offer.

JUST LOOK AT THESE PLUS VALUES!

- 150 watt output on all bands
- High-level plate modulation
- Time delay relays on modulator and Class "C" stages
- Fused primary circuits
- Safety interlocks
- Built-in antenna coupler
- Grid current meter, modulator current meter, plate current meter, antenna current meter
- Hand microphone
- Key
- Cables, cords, and plugs

Complete set of plug-in coils for 80-40-20 meters, in storage cabinet (for full 20-meter coverage, short one turn on 20-meter tank) readily adapted to 10-meter use

77-page operating and service manual with diagrams, parts lists, etc.

And a full set of spare parts you'll probably never need to use

Order today for immediate shipment by Railway Express

only \$225.00 Complete
WITH TUBES AND SIGNAL SHIFTER

HERE'S THE TUBE LINEUP!

- For the Transmitter**
- 813 CL "C" RF amp.
 - 811 CL "B" modulators
 - 811
- 6V6GT** Audio drivers
- 6V6GT** Modulator supply
- 866A** rectifiers
- 866A** Audio amplifier
- 866A** RF amplifier
- 866A** Supply rectifiers
- 5U4G** Speech amp. sup. rect.
- For the Exciter**
- 6L6G 2nd doubler
 - VR-150 Voltage regulators
 - VR-105
 - 6F6G Osc. & 1st doubler
 - 5U4G Rectifier

SURPLUS SPECIALS

Selected by the Radio Shack and priced to give you more for your money.

- Eimac VT-127A Triode \$3.50
- G. E. Type 211 Tube 4.95
- G. E. Pyranol Capacitor 4.95
- 4000 volts 2 MFD
- Signal Corps Communications Receivers — 1.5-18 m c. complete with tubes and pwr supply
- BC - 324-N 110 v a-c 64.50
- BC - 312-HX 24 v d-c 59.50
- BC - 406 H. F. Superhet — with tubes 22.50
- BC - 223-A 80 mtr 25 w xmtros, with tubes 37.50

And all these Standard Receivers!

- NATIONAL
 - NC-2-40-C \$225.00
 - NC-1-10 56.10
 - HRO-5TA-1 274.35
 - HAMMARLUND
 - HQ-129-X complete 173.25
 - New Super-Pro's
 - SPC-400-SX 310.05
 - SPR-400-SX (Rack Model) 320.55
 - SPR-400-X 334.05
 - SPR-400-X (Rack Model) 344.55
 - Speaker, in Cabinet 18.45
 - R. M. E.
 - RME-45 complete 186.00
 - HALLICRAFTERS
 - S-22R Skyriider Marine 74.50
 - S-36A VHF FM-AM 307.00
 - S-38 39.50
 - S-39 Sky Ranger 110.00
 - S-40 Complete 79.50
 - S-41G Complete 33.50
 - SX-25 Super Defiant 109.50
 - SX-28A Super Skyriider 238.00
- All prices net FOB Boston



REGISTER NOW FOR NEW CATALOG 49-B AND WRITE ALSO FOR SURPLUS BULLETIN 9-S

AMATEUR GEAR

8 CONNECTICUT AND MASSACHUSETTS HAM STORES

Quick as you can say "Ham," you'll find the first-choice makes, the elect in electronics, at Hatry & Young. Eight conveniently located stores... dozens of lines... and the best names, such as...

Amphenol • Bud • Cardwell • G.E. Hallcrafters • Hammarlund • Mal-lory • Millen • National • Ohmite Panoramic • Par-Metal • Petersen RCA • R.M.E. • Silver • Shure • Stan-cor • Taylor • Turner • Valpey and many others

CONNECTICUT:

Hartford, New Haven, Bridgeport, New London, Stamford, Waterbury. MASSACHUSETTS: Boston and Lawrence

HATRY & YOUNG

The Elect in Electronics



RECEIVING SENDING
CODE *Speed* *without strain*

CHAMPIONS ENDORSE CANDLER WAY

Get skill, accuracy, speed with the highly endorsed Candler System. Learn to send and receive by telegraph or radio code. Government service and commerce need thousands of better trained operators. Air commerce, mail, freight, etc., demand expert, reliable operators. Good pay. Get the Candler System, the maker of champions. It teaches you the "knack" of sound sense, alertness, speedy sending and receiving without strain. Adventure—good pay. Learn at home or wherever you are. Rush name today for free book.

FREE!

CANDLER SYSTEM CO.
Dept. 4-K, Box 928, Denver 1, Colorado, U.S.A.
and at 121 Kingsway, London, W.C. 2, England

WWV Schedules

STANDARD-FREQUENCY transmissions are made available as a public service by the National Bureau of Standards over its standard-frequency station, WWV, on the following schedules and frequencies:

- 2.5 Mc. — 7 P.M. to 9 A.M. EST (0000 to 1400 GCT).
- 5.0 Mc. — Continuously, day and night.
- 10.0 Mc. — Continuously, day and night.
- 15.0 Mc. — Continuously, day and night.

The 10- and 15-Mc. radio frequencies are modulated simultaneously at accurate audio frequencies of 440 and 4000 cycles. 5 Mc. carries both audio frequencies during the daytime but only 440 cycles from 7:00 P.M. to 7:00 A.M., EST, while 2.5 Mc. carries only the 440-cycle modulation. A 0.005-second pulse may be heard as a faint tick every second, except the 59th second of each minute. These pulses may be used for accurate time signals, and their one-second spacing provides an accurate time interval for physical measurements.

The audio frequencies are interrupted precisely on the hour and each five minutes thereafter, resuming after an interval of precisely one minute. This one-minute interval is provided to give Eastern Standard Time in telegraphic code and to afford an interval for the checking of radio-frequency measurements free from the presence of the audio frequencies. Ionospheric disturbance warnings applicable to the North Atlantic path are given at 20 and 50 minutes past each hour. If a disturbance is in progress or is anticipated within 24 hours, the time announcement is followed by 6 Ws; if conditions are quiet or normal, the time announcement is followed by 8 Ns. The announcement of the station's services and of the station's call (WWV) is given by voice at the hour and half hour.

The accuracy of all the frequencies, radio and audio, as transmitted, is better than a part in 10,000,000. Transmission effects in the medium may result in slight fluctuations in the audio frequencies as received at a particular place; the average frequency received, however, is as accurate as that transmitted. The time interval marked by the pulse every second is accurate to 0.00001 second. The 1-minute, 4-minute and 5-minute intervals, synchronized with the second pulses and marked by the beginning and ending of the periods when the audio frequencies are off, are accurate to a part in 10,000,000. The beginnings of the periods when the audio frequencies are off are so synchronized with the basic time service of the U. S. Naval Observatory that they mark accurately the hour and the successive 5-minute periods.

Of the frequencies mentioned above, the lowest provides service to short distances and the highest to great distances. In general, reliable reception is possible at all times throughout the United States and the North Atlantic Ocean, and fair reception over most of the world.

The easy sure-fire way

1 1/4
METERS

2
METERS

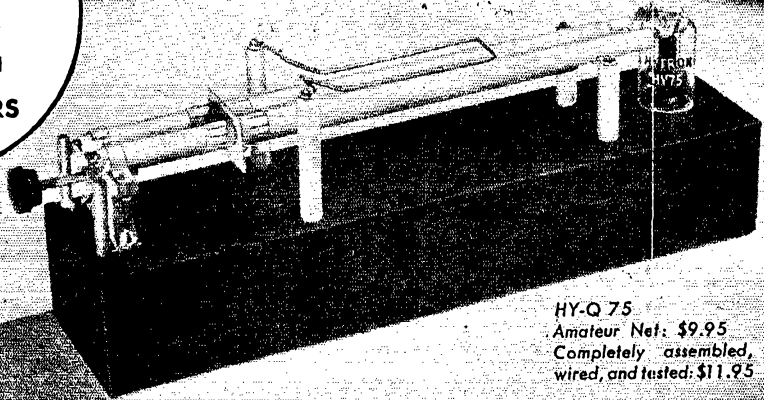

HY-Q 75
Amateur Net: \$9.95
Completely assembled,
wired, and tested: \$11.95

ASSEMBLE THIS EFFICIENT HY-Q 75 KIT IN AN HOUR

Like most amateurs you may prefer to "roll your own." If your leisure time is limited, however, you will welcome the HY-Q 75. Long hours of engineering have ironed out the "bugs"—have assured easily reproducible maximum efficiency on 1 1/4 and 2 meters with the popular HY75. Fancy "plumbing" and tricky parts are prefabricated. With screwdriver, pliers, and soldering iron, you can quickly put this efficient linear oscillator on the air. Check the many features. Ask your jobber to let you see the HY-Q 75.

HY-Q 75 KIT HAS MANY FEATURES

CAREFULLY ENGINEERED to make it easy for you to duplicate results on 1 1/4 and 2 meters.

NO CUT AND TRY—chart assures quick location of amateur bands.

MICROMETRIC TUNING (135 mc to 250 mc) by finely adjustable lead screw.

SILVER-PLATED TANK CIRCUIT means permanently low r-f losses.

PRECISION-MACHINED SHORTING BAR with multi-fingered silver-plated contacts for low resistance.

LOW-LOSS INSULATORS with extremely long leakage paths.

SPECIAL R-F CHOKES—filament, plate, grid—assure peak operation of HY75 at vhf.

NON-INDUCTIVE PLATE BLOCKING CONDENSER is concentric with the plate line.

QUICK BAND CHANGING from 1 1/4 to 2 meters by adjusting the positions of shorting bar and coupling loop.

ADJUSTABLE ANTENNA COUPLING LOOP matches efficiently either concentric or parallel line feeders.

BETTER FREQUENCY STABILITY is obtained from the rugged parallel-line construction.

COMPLETE VHF TRANSMITTER—a-c or d-c, fixed or mobile. Add only tube, power supply, and a-f unit.

LABORATORY POWER OSCILLATOR for special measurements and classroom vhf demonstrations.

USEFUL POWER TO LOAD at 144 mc (less at 225 mc) is 14 w on c-w; 11 w on phone.*

PEAK PERFORMANCE OF HY75—but readily adaptable to other vhf tubes.

PICTORIAL WIRING DIAGRAM and easy-to-understand instruction manual.

**Useful power output equals total power output minus radiation losses, circuit losses, and grid drive.*

SPECIALISTS IN RADIO RECEIVING TUBES SINCE 1921.



HYTRON
RADIO AND ELECTRONICS CORP.



MAIN OFFICE: SALEM, MASSACHUSETTS

T.A.C. ANNOUNCES THE NEW CODE PRACTICE OSCILLATOR WITH ADJUSTABLE RESONATOR

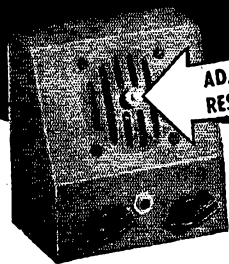

for Greater Volume
Better Tone

ADJUSTABLE
RESONATOR

MS 710, less resonator and less built-in key. Amateur net price, \$9.00

MS 710R, with resonator but less built-in key. Amateur net price, \$10.50

MS 710P, with built-in key but less resonator. Amateur net price, \$11.50

MS 710PR, DeLuxe Master Oscillator with resonator and built-in key. Amateur net price, \$13.00

Adjustable Resonator (optional) increases volume five times. Tone frequency variable from 600 to 1500 cycles. Volume control from 0 to FULL ON. "PM" DYNAMIC speaker may be disconnected during headphone operation. Up to 300 headphones may be used. Has phone jack for headphones. Optional built-in key. 110 V. AC or DC. Uses a 117N7GT tube. Gray crackle finish.

NOW IN STOCK AT ALL LEADING RADIO DISTRIBUTORS

TELEGRAPH
Apparatus Co.
412 SOUTH GREEN ST. CHICAGO 7, ILLINOIS

CLEAN ACCURATE HOLES



cut in radio chassis

Greenlee Punches make this tough job easy. No reaming, filing or tedious drilling. Tool has three parts: *punch* cuts through chassis, *die* supports metal to prevent distortion, *cap screw* is turned with wrench to cut holes. Sizes for holes $\frac{3}{4}$ " to $3\frac{1}{2}$ ". Ask your radio supply or electrical jobber or write for folder and prices. Greenlee Tool Co., 1869 Columbia Ave., Rockford, Illinois.

WRITE FOR FREE FOLDER

REGISTERED TOOLS
GREENLEE
FOR THE CRAFTSMAN

A.R.R.L. QSL BUREAU

FOR THE convenience of American and Canadian amateurs, the League maintains a QSL-card distributing system which operates through volunteer "District QSL Managers" in each call area. To secure such foreign cards as may be received for you, send your district manager a standard No. 10 stamped self-addressed envelope. If you have reason to expect a considerable number of cards, put on an extra stamp so that it has a total of six cents postage. Your own name and address go in the customary place on the face, and your station call should be printed prominently in the upper left-hand corner. If you have held other calls in previous years, submit an envelope for each such call to the proper manager—there are many thousands of un-called-for cards in the files. All incoming cards are routed by Hq. to the *home district* of the call shown in the address. Therefore, cards for portable operation in other districts should be obtained from the home-district manager.

W1—Jules T. Steiger, W1BGY, 231 Meadow St., Wilimansett, Mass.

W2—Henry W. Yahnel, W2SN, Lake Ave., Helmetta, N. J.

W3—Maurice W. Downs, W3WU, 1311 Sheridan St., N. W., Washington 11, D. C.

W4—Edward J. Collins, W4MS, 1215 North 12th Ave., Pensacola, Fla.

W5—L. W. May, jr., W5AJG, 9428 Hobart St., Dallas 18, Texas.

W6—Horace R. Greer, W6TI, 414 Fairmount Ave., Oakland, Calif.

W7—Frank E. Pratt, W7DXZ, 5023 S. Ferry St., Tacoma, Wash.

W8—Fred W. Allen, W8GER, 1959 Riverside Drive, Dayton 5, Ohio.

W9—F. Claude Moore, W9HLF, 1024 Henrietta St., Pekin, Ill.

W0—Alva A. Smith, W9DMA, 238 East Main St., Caledonia, Minn.

VE1—VE1FQ will resume service soon.

VE2—C. W. Skarstedt, VE2DR, 3821 Girouard Ave., Montreal 28, P. Q.

VE3—W. Bert Knowles, VE3QB, Lanark, Ont.

VE4—c/o A.R.R.L.

VE5—J. A. Bettin, VE5YR, P. O. Box 55, Togo, Sask.

VE6—W. R. Savage, VE6EO, 329 15th St. North, Lethbridge, Alta.

VE7—H. R. Hough, VE7HR, 1785 Emerson St., Victoria, B. C.

VE8—Yukon A. R. C., P. O. Box 268, Whitehorse, Y. T.
K4, KP4—E. W. Mayer, KP4KD, P. O. Box 1061, San Juan, P. R.

K5, KZ5—Signal Officer, KZ5AA, Quarry Heights, Canal Zone.

K7, KL7—J. W. McKinley, K7GSC, Box 1533, Juneau, Alaska.

LOS ANGELES HAMFEST

Big Ham Fiesta and Barbecue at Verdugo Park, Glendale, Sunday, September 8th. Communications Manager Handy coming from West Hartford as one of the speakers. Over 2,000 expected. If you want to meet your fellow-ham and have a good time, Tickets from W6BXR. BE THERE!

PLASTICON* ASG Silicone-Filled GLASSMIKES

1-3/8 x 3-1/2



FOR HIGHER VOLTAGES

*Extreme Temperature Range
from Minus 60° C to Plus 125° C*

From 600 Volts to over 30,000

Modern functionally designed capacitors.

• Metal ferrules are soldered to silver bands fused to each end of heavy-walled glass tubes.

• This vacuum tight assembly is fungus-proof and passes Signal Corp, Air Corp, and Navy thermal cycle and immersion tests. Ample flashover spacing is provided between silver bands for sea level operation. Submit specifications for high altitude applications.

* PLASTICONS: Plastic-Film Dielectric Capacitors

Order from your jobber: If he cannot supply you, order direct

Applications

Television and Oscilloscope Circuits
Vibrator Buffer and Arc Elimination
AF and RF Coupling and Bypass uses
Geiger Counter and Instrument
Capacitors
High Temperature AC and DC
Applications
Capacitance tolerance plus or
minus 10%

CP **Condenser Products Company**

1375 NORTH BRANCH STREET • CHICAGO 22, ILLINOIS

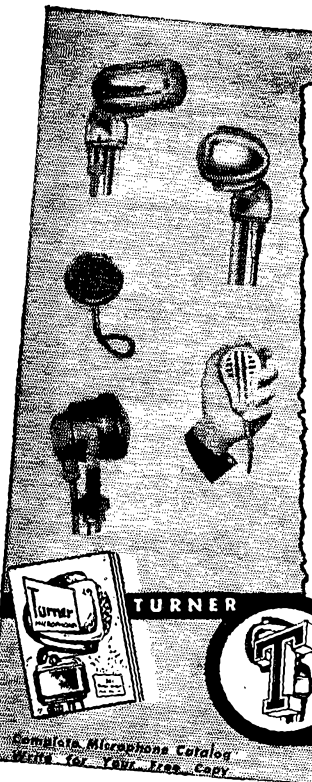

TURNER VT-73 Desk Microphone

A WORLD WIDE FAVORITE WITH PROMINENT AMATEURS FOR QUALITY REPORTS

Here's a dependable, precision unit for clear, crisp results. The Turner VT-73 increases your effective intelligibility at voice frequencies without over-modulation. Engineered especially for Quality speech recording, public address and amateur use with *rising curvature of response between 500-4000 cycles*. Has high quality moisture proofed crystal. Output -52DB. Range 50-7000 cycles. Finished in rich black crinkle and chrome. Complete with ball swivel head, stand and 7 ft. cable.

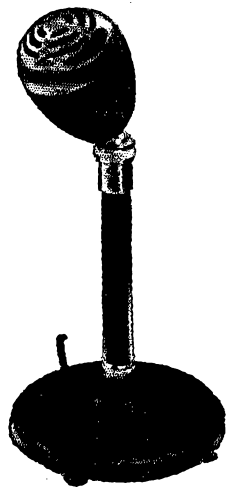

ASK YOUR DEALER OR WRITE

Turner microphones licensed under U. S. Patents of The American Telephone and Telegraph Company, and Western Electric Company, Inc.



TURNER

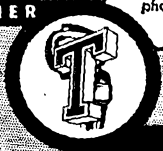

TURNER

THE TURNER COMPANY
917 17th Street N.E.
CEDAR RAPIDS, IOWA

Pioneers in the communications field

Microphones

Crystals licensed under patents of the Brush Development Co.

Complete Microphone Catalog
Write for Your Free Copy

A Buy-word for Excellence

40

YEARS

DEPENDABILITY

1906

BRACH

1946

PUR-A-TONE
Reg. Trade Mark

ANTENNAS

ALL TYPES FOR

**AUTOS
HOMES
MARINE**

A.M. - F.M. -
TELEVISION

Special-purpose transmitting antennas designed for volume production to your own specifications. Collapsible—sectional—direction finding—radar and coaxial type. All sizes, lengths and materials. Consult us on your needs.

L. S. BRACH MFG. CORP.

200 CENTRAL AVENUE NEWARK, N. J.



WORLD'S OLDEST AND LARGEST MANUFACTURERS OF RADIO ANTENNAS AND ACCESSORIES.

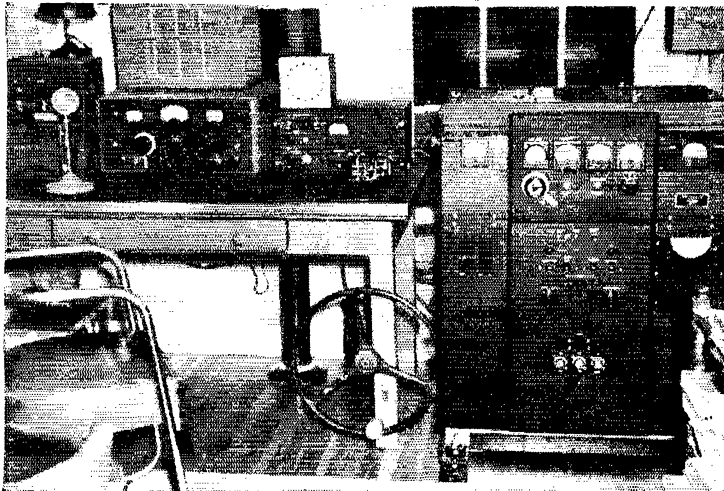

W5DZ
On the Air Again!
 Post-war W5DZ—an outstanding modern Ham station. Listen for him on 20 and 75 meter phone.

Communications Equipment
 for earliest delivery order from **ALLIED**
 Time Payments Available
 Trade-Ins Accepted

Hallcrafters S-38 \$39.50	RME DB-20 Preselector \$ 59.30
Hallcrafters S-40 79.50	Hammarlund HQ-129X 168.00
National NC-48 97.50	RME-45 188.00
NC-48 Speaker 9.90	National HRO 274.35
RME-84 98.70	National NC-240D 225.00
RME VHF-152 Converter 86.60	Hammarlund SPC-400X 342.00

Net F.O.B. Chicago. Prices subject to possible change.

ALLIED HAM "SCOOPS"!

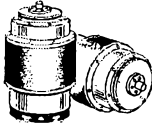
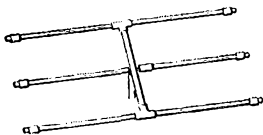

6 METER 3 ELEMENT ROTARY BEAM ANTENNA

SPECIAL!

SERIES 5 SELSYN MOTORS Brand New!

LIMITED QUANTITY

No. X97-420 **1750**

1250 PER PAIR

ALLIED RADIO
Everything for the HAM

Writes Colonel W. P. Clarke, W5DZ, Waco, Texas: "I may mention that I sold all my pre-war equipment to the Signal Corps, and upon my return from the Far Eastern Theater, I had to start from 'scratch.' I have been an active amateur since March 4, 1920."

Welcome back, brother ham! We at ALLIED are happy to have had the opportunity to re-equip W5DZ. We're busy helping hundreds of other old-timers to "start from scratch," or to get back on the air again with rebuilt rigs.

Whether you're "starting from scratch," rebuilding, or newly licensed, you can count on ALLIED for all the help you need—for earliest delivery of the latest available gear, for guaranteed quality at the lowest prevailing prices, for preferred personal service from ALLIED'S staff of licensed hams, each of whom shares your interest in amateur radio.

Send for Allied's 1946 Radio Catalog

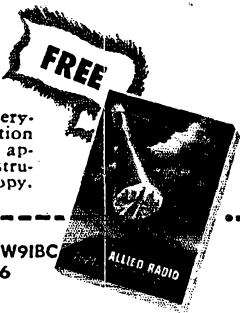

Here's the Buying Guide that lists everything for the Ham . . . communication receivers, xmitters, Ham gear, code apparatus, parts, kits, tubes, test instruments, etc. Send for your FREE copy.

ALLIED RADIO CORP., D. L. Warner, W91BC
 833 W. Jackson Blvd., Dept. 27-JJ-6
 Chicago 7, Illinois

- Enter order for Model
- Enclosed \$ Full Payment Part Payment
 (Balance C.O.D.)
- Send Literature on Receivers and Time Payment Plan.
- Send FREE 1946 Catalog.

Name
 Address
 City Zone State

Quality PRODUCTS
Since 1923



CERAMIC—
PORCELAIN & STEATITE
INSULATORS

for every
purpose

BIRNBACH RADIO CO., Inc.

145 HUDSON ST. NEW YORK, 13. N. Y.



ARMY-NAVY
Official
HEAD PHONES

\$249



EXTRA
SPECIAL
VALUE

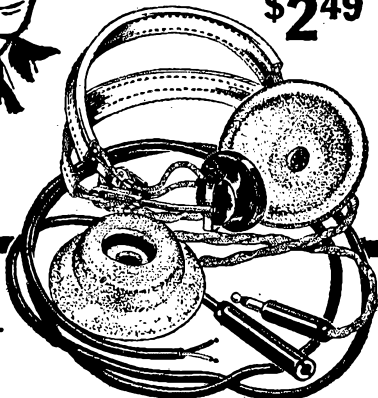

Limited quantity of these head phones. Highly sensitive, 8000 ohms impedance. Bi-polar magnets, bakelite shell and cap. Adjustable head band. Cord connects from one side out of the way. One of our many special features. Write today for complete catalog.

BURSTEIN-APPLEBEE CO.
1012T McGee, Kansas City 6, Mo.

"It Seems to Us . . ."

(Continued from page 12)

over-all benefit or whether changing conditions and operating habits make some other solution preferable. So keep it in your mind that the problem will always be with us, that the apparently-best solution will change frequently, that we can never hope to have everybody happy about it, and that the best we can aspire to are scientifically-sound arrangements that reflect majority amateur opinion. And that last, OMs, is something that the ARRL mechanism does provide.

A parting thought, as we all go mulling over these problems until next Spring: It would be very grand if we could whack up the DX bands by international agreement so that there'd be a segment of a band, for example, where you could find Australasian 'phones any time you wanted them and with no QRM from anybody else. Yet, because all such schemes involve our agreeing not to transmit on some of our authorized frequencies, American amateur radio has never been willing to agree to them. Gradually an alternative philosophy has developed: we'll have our ARRL 'phone assignments working down from the high-frequency end of each band, and the lower limit will be adjustable from time to time in terms of changing patterns of occupancy or mass preferences. Suppose, for example, that it became our custom to think that a certain DX band ought to be divided 50/50 between c.w. and 'phone because that is the way we

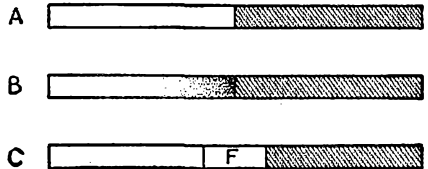

divide our operating time in that band. Like A in the figure. Simple problem, simple solution, eh? Well, right there it is necessary for us to stop and realize that we influence only the regulations of the United States or, at most, those of the U.S. and Canada, the operating territory of the League. Foreign 'phones, traditionally having the right to operate anywhere in the band, will not willingly operate within our 'phone assignment and put up with the QRM. Do we know what they'll do if they want to work us? Yes, we do: they'll put themselves in what we fondly believed was our exclusively-c.w. space, close to our 'phone band but out from under. Like the dots in B in the figure, thickest close to the "border," and running down to some indeterminate figure that will vary with how crowded a night it is. And now where have we got ourselves? Have we divided the band 50/50 between our c.w. and our 'phone, as we thought? Not by several

(Concluded on page 132)

EXPERIENCE PROVES

Invariably

It's VALPEY

Years of performance in war and peace prove that VALPEY CRYSTALS meet all tests for quality and precision.

For the latest information on amateur, police, commercial, aircraft, marine, VHF, and supersonic crystals from VALPEY consult your dealer.

VALPEY CRYSTAL CORP.
Craftsmanship in Crystals Since 1931
HOLLISTON, MASSACHUSETTS

WIATP WIBZJ
WIHVP WILQI
W8HMJ

Valpey
CRYSTALS

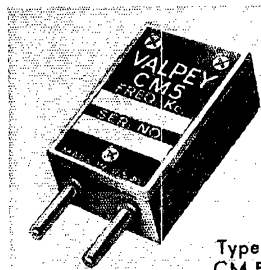

Type CM 5

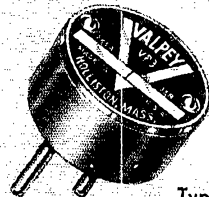

Type VP 3

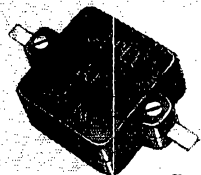

Type A 1

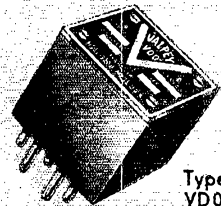

Type VD0

Albany, N. Y. Taylor, E. E.
 Atlanta, Ga. Specialty Distributing Co.
 Asheville, N. C., Freck Radio & Supply Co.
 Auburn, N. Y. Dare's Radio
 Binghamton, N. Y.
 Broome Distributing Co.
 Boston, Mass. DeMambo Radio Supply
 Boston, Mass. Hatry & Young
 Boston, Mass. A. W. Mayer
 Boston, Mass. Radio Shack
 Boston, Mass. Sager Electric Supply Co.
 Bridgeport, Conn. Hatry & Young
 Brockton, Mass. Ware Radio Supply Co.
 Buffalo, N. Y. Buffalo Radio Supply Co.
 Burbank, Calif.
 Valley Electronic Supply Co.
 Charlotte, N. C. Dick, Henry V.
 Charlotte, N. C. Shaw Distributing Co.
 Chattanooga, Tenn.
 Specialty Distributing Co.
 Cincinnati, O. Mytronic Co.
 Cincinnati, O. United Radio, Inc.
 Denver, Colo. Radio Product Sales Co.
 Evansville, Ind. Wesco Radio Parts
 Fort Wayne, Ind. Warren Radio
 Gary, Ind. Cosmopolitan Radio
 Hammond, Ind. Stanton Radio Co.
 Hartford, Conn. Hatry & Young
 Hartford, Conn. Scell, R. G. & Co.
 Holyoke, Mass. Springfield Radio Co.
 Indianapolis, Ind. Kiefer-Stewart Co.
 Indianapolis, Ind. Radio Distributing Co.
 Jacksonville, Fla.
 Kinkade Radio Supply Co.
 Jersey City, N. J. Nidisco

Kingsport, Tenn.
 Radio Electric Supply Co.
 Knoxville, Tenn. Bomar's
 Knoxville, Tenn. Chemcity Radio
 Lawrence, Mass. Hatry & Young
 Los Angeles, Calif.
 Universal Radio Supply Co.
 Macon, Ga. Specialty Distributing Co.
 Manchester, N. H. Radio Service Labs
 Memphis, Tenn.
 Bluff City Distributing Co.
 Memphis, Tenn. McGregor's
 Memphis, Tenn.
 Radio Electronics Sales Co.
 Memphis, Tenn.
 Radio & Electronics Supply
 Mobile, Ala. Nelson Radio & Supply Co.
 Mobile, Ala. Radio Labs
 Montgomery, Ala. Nolin-McInnes
 Montreal, Canada. Payette & Co.
 Mt. Vernon, N. Y., Davis Radio & Dist. Co.
 Nashville, Tenn. Braid Electric Co.
 New Bedford, Mass. Beckman, C. E.
 New Haven, Conn. Hatry & Young
 New London, Conn. Hatry & Young
 New Orleans, La. Radio Parts Inc.
 New York, N. Y.
 Federated Purchasers Inc.
 New York, N. Y. Grand Central Radio
 New York, N. Y. Leeds Radio
 New York, N. Y. Terminal Radio Corp.
 Newark, N. J. Lippman, Aaron & Co.
 Norwich, Conn. Grover's Radio
 Ottawa, Canada. Electronic Supply

Pawtucket, R. I., DeMambo Radio Supply
 Pensacola, Fla., Gulf Electric Supply Co.
 Philadelphia, Pa. Almo Radio
 Portland, Me. Radio Service Labs.
 Pottsville, Pa. Jones Radio
 Providence, R. I. Edwards, W. H.
 Providence, R. I. Kraus & Co.
 Quebec, Canada Corteau, J. Romeo
 Reno, Nevada, Savier's Electrical Products
 Rochester, N. Y. Masline Radio
 Rochester, N. Y.
 Radio Parts & Equipment Co.
 Salt Lake City, Utah, Standard Supply Co.
 Savannah, Ga. Specialty Distributing Co.
 Schenectady, N. Y. Schwartz, M. & Son
 Scranton, Pa. Broome Distributing Co.
 Scranton, Pa.
 Scranton Radio & Television Co.
 Springfield, Mass. Springfield Radio Co.
 Springfield, Mass. Springfield Sound Co.
 Stamford, Conn. Hatry & Young
 Syracuse, N. Y. Broome Distributing Co.
 Syracuse, N. Y.
 Syracuse Radio Supply Co.
 Tampa, Fla. Kinkade Radio Supply Co.
 Terre Haute, Ind. Terre Haute, Radio
 Toronto, Canada Alpha Aracon
 Toronto, Can., Wholesale Radio Co. Ltd.
 Victoria, B. C., Queale, Ellison Supply Co.
 Washington, D. C. Sun Radio Co.
 Waterbury, Conn. Hatry & Young
 Worcester, Mass.
 DeMambo Radio Supply
 Radio Electronics Sales Co.



Time For

Walter Ashe
SPECIALS!

What We Advertise We Deliver!

Instant Delivery On

Xtal Adapters for using new type holder in old sockets.....**35¢**
Ballentine Phono Motor and turntable, a quality motor...**\$4.44**

AMERTRAN PRIMARY CONTROLS—to adjust your input voltage.

Primary from 95 to 130 V. @ 9½ Amps. Type 32415 at.....**\$14.95**
Primary from 102 to 128 V. at 16 Amps. Type 31970 at.....**\$17.95**

4 mfd. 2500 V. GE. Pyranol Condensers, fresh, new stock, **\$3.75**
Pocketscope—compact oscilloscope with bu'll-in sweep amplifier, complete with all tubes, including 2" Cathode tube...**\$53.00**

CHOKES—Thordarson made originally for U. S. Navy. Very conservatively rated. Smoothing Choke, 12 Hy. @ 200 M.A. 110 Ohms DC resistance.....**\$2.98**
Swinging Choke, 5-25 Hy. @ 200 M.A., 110 Ohms DC resistance.....**\$2.98**

Talkie Crystal Kits to grind your own 40 meter crystals.....**98¢**
Amertran Plate Transformers, rated at 2 KVA. Primary 104/110/115, 60 cycle. Secondary 6200 V. ct. Freight prepaid anywhere in Continental U. S. A.....**\$39.95**

RECEIVERS—Instant Delivery!

RME 45 with Cal-O-Matic Dial and Speaker.....**\$186.00**
National HRO 5TA, 1.7 MC to 30 MC with Band Spreader and Noise Limiter, less Speaker and Power Supply.....**\$274.35**
Speaker, type MCS.....**\$12.00**
Power Supply, type 697.....**\$20.36**
National NC 240-D, newest model, complete.....**\$241.44**
RME DB20 Preselector.....**\$59.30**
National NC 46, less speaker.....**\$97.50**
Speaker.....**\$9.90**

Write Us For A Real Trade-In Offer!

Immediate to 30-Day Delivery On

Hammarlund HQ 129-X with Speaker.....**\$173.25**
New Hammarlund Super-Pro SPC-400X (540 kc. to 30 mc.).....**\$334.05**
Hallcrafters S40.....**\$79.50**
Hallcrafters S38.....**\$39.50**

GET YOUR NAME ON OUR MAIL LIST

W0LDO W0QDF W0ZIP W0IYD W0ULH W0GTF

WALTER ASHE RADIO CO.
1125 PINE STREET ST. LOUIS 1, MO

(Continued from page 130)

jugfuls. Considering that splatter makes 'phone practically self-exclusive, we have considerably more than half of the band devoted to 'phone, considerably less than half available for c.w. The point we want to make is that it is necessary for us to take account of foreign 'phones in our thinking, make an allowance for them in our planning. Like C' in the figure, for instance. We can only estimate how much of the band we think is going to be taken up in this way, but some allowance we must make for it before we start whacking up the rest of the band, half for our c.w. and half for our 'phone (or whatever other ratio is in mind). Or else our arithmetic will turn out very sour.

It's something, we think, to keep in mind as we turn over ideas for the future.

Walter Ashe

Strays

The Marin Radio Amateurs (Calif.) will hold their first postwar hamfest at McNear's Beach on Sunday, September 15th. There will be lots of prizes, games and special events. YLs and XYLs are specially invited and there will be prizes for them also. Further details available from H. W. Weddell, Secy.-Treas., Box 204, Corte Madera, Calif.

George W. Bailey, W1KH, president of ARRL and executive secretary of IRE, is the new secretary of the Radio Technical Planning Board for the year beginning October 1st.

The Coast Guard appropriation bill, recently approved by the House, provides \$2,600,000 for relocating and expanding eight stations of the loran system, which will replace eleven wartime loran installations and perform the same functions. The stations are being increased in power and relocated to improve service in certain sectors. The bill provides \$121,250 per station, which will be used to buy new transmitters with narrower bandwidths having a considerably improved energy distribution in the spectrum, and there is \$1,720,000 for the construction of permanent buildings for housing installations and personnel. Investigations are actively under way to determine the feasibility of filters in the output of present transmitters to further reduce side-band width.

Golden Wedding Day congratulations are in order for "Gramp" (W9GP) and "Ma" Kerr, Little Sioux, Iowa, who will have been OM and XYL for fifty years on September 29th. Mr. Kerr is an ex-director of ARRL, representing the Midwest Division in 1931-36.

The Editor would be grateful to anyone who can advise him of the present address of Dr. Curt Lamm.

HARVEY has everything for the amateur station

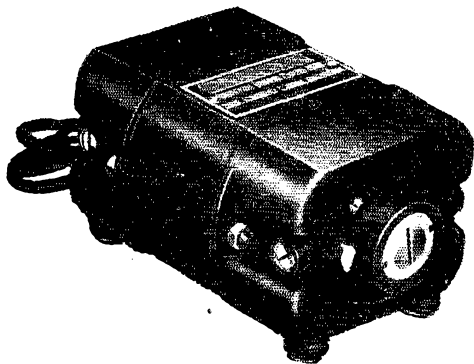

CARTER GENEMOTOR FOR PORTABLE OPERATION

This power supply is a natural for portable operation on 2½, 5 and 10 meters. 6 volts input; 350 volts, 150 ma DC output. Genemotor may be purchased alone or on steel chassis with two-4 mfd. oil-filled condensers, 20 henry filter choke, self-contained relay for push-to-talk operation and screw terminal strip for easy connection.

Genemotor only, Harvey Special Price.....\$14.95
 6 volt power supply with filter, Harvey Special Price.....\$29.50

Quantities Limited — Order NOW!

HARVEY'S HIT OF THE MONTH

Shure Single-Button Hand Mike — Signal Corps Type 17B, with push-to-talk switch, about 7 feet of cable and 3-contact plug.....\$1.95

HARVEY'S HAMFESTIVAL OF VALUES

General Electric Pyranol Capacitor — 4 mfd., 3000 working volts DC. Brand new and guaranteed. Measures 4½" x 3¾" x 4½", 8" over terminals. Complete with mounting brackets.....\$5.95

General Electric Pyranol Capacitor — 1 mfd. at 15000 working volts D.C. Brand new. Harvey Special Price.....\$24.50

Cornell-Dubilier TJ-20040 — 4 mfd., 2000 working volts DC. Dykanol filled; ceramic insulated standoff terminals; factory installed mounting bracket... not to be confused with "surplus" filter condensers. Brand new. Harvey Special Price. \$3.75

Cardwell V.H.F. Oscillator — uses 6F4 tube; complete with coils for 141-151 Mc., 215-230 Mc., 415-455 Mc.....\$10.80
 6F4 tube, extra..... 5.55

Harvey has a complete line of books on radio and electronics, as well as engineering handbooks. Send us a list of your needs.

Newly redesigned Abbott TR-4 Model B — uses 955 as detector. It has new construction features including new condensers, additional polystyrene supports, etc.....\$52.00
 Kit of tubes including HY75, 6L6, 7F7 and 955.....\$ 9.39

Mallory Vibropack — 12 volt DC input; 300 volt, 100 ma output. Complete with vibrator, less filter.....\$8.50

Harvey has a complete line of Johnson sockets to take care of any and all tubes — 304TL, 100TH, 813, 211, etc.; 829 socket.....\$1.05

Special! 5 Mc. precision crystal, mounted in dustproof holder with neoprene gasket.....\$1.95

40 and 80 meter crystals, in holders. Specify frequency. Harvey Special Price.....\$1.00

Telephone:  Longacre 3-1800

Panadaotor — for use with any receiver having a 455 kc. I.F.; for 10 volt, 60 cycle operation. Complete with tubes... \$99.75

HARVEY
RADIO COMPANY, INC.
 103 West 43rd St., New York 18, N. Y.

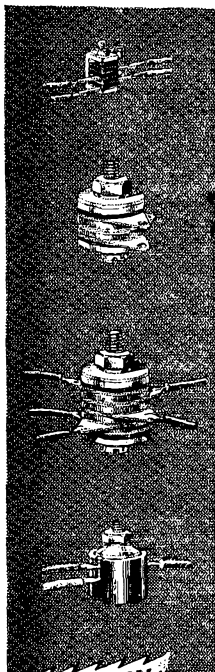

ELECTROX LOW CAPACITY RECTIFIERS

➤ Full and half wave low-capacity copper-oxide rectifiers, for test sets, instruments, and other electronic applications. Made by one of the oldest manufacturers of dry disc rectifiers.

At your parts supplier or write for Circular 446

**ELECTROX
DIVISION**

SCHAUER MACHINE CO.

2049 Reading Rd. • Cincinnati 2, Ohio

RADIO COURSES

SERVICING
BROADCAST ENGINEERING
COMMERCIAL OPERATING
FM — TELEVISION
SHOP MATH
HOME APPLIANCE REPAIRING

October Classes Now Forming

Baltimore Technical Institute

1425 EUTAW PLACE • Dept. S
BALTIMORE 17, MARYLAND

Veterans Accepted Under G.I. Bill
Resident Courses Only

ELECTRICITY

FOR RADIO AND ELECTRONIC APPLICATIONS

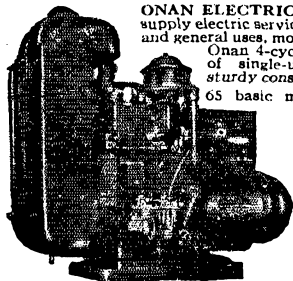

ONAN ELECTRIC GENERATING PLANTS supply electric service for electronics applications and general uses, mobile or stationary. Driven by Onan 4-cycle gasoline engines, they are of single-unit, compact design and sturdy construction.

65 basic models ranging in capacity from 300 to 35,000 watts. Standard A.C. models, 115-volt, 60-cycle, single-phase. Standard D.C. models, 32 to 115 volts. Special voltages to 600 A.C., and 6 to 4,000 volts D.C. 5 KW to 35 KW units available in 3-phase. High frequencies to 800 cycles. Combination A.C.-D.C. types. Write for detailed literature or engineering assistance.

D. W. ONAN & SONS 2640 Royalton Ave. Minneapolis 5, Minn.

134

Catchum DXCC

(Continued from page 24)

successive times. What if it did take hours or weeks, you got him, didn't you?

NEVER go to a movie or play bridge away from home. The best DX I ever missed came through when I was a pallbearer at a funeral.

ALWAYS use c.w., so that when you curse and curse the DX's tin ear, it won't go out over the air.

KEEP an alphabetical list of all reported DX and their frequencies. It minimizes the game of "where the heck is the button."

USE break-in and you won't always be Tail-End Charlie.

PRACTISE short calls and the DX won't get bored.

DON'T stop at 100. Human nature isn't that perfect. You need a safety margin to garner the needed 100 pasteboards.

So You Worked 'Em. How Do You Get The Proof? It Helps to:

INCLUDE a picture of the rig and a stamp or international return coupon. (It is not necessary to wrap the stamp in a five-dollar bill.)

ALWAYS forward cards by registered mail to ARRL Headquarters for checking. Greater grief hath no man than a lost QSL.

NEVER give up. If an expedition fails to come through, run down every trace and hound them.

WHEN a pal visits the foreign country, get him to bang on the guy's door.

KEEP a running file of cards not answered and send duplicates and triplicates.

KEEP a card record of each DX station worked and dumbfound him with your memory on the next QSO.

That's the way it's done. As to your other qualifications, all you need is a less-than-average mentality and a straight key (and heaven help me now!).

Strays

N. K. Maxwell, W5FOH/Ø, relates this hair-raising experience of his infantry company while located on the Sauer River, just before the Battle of the Ardennes. Writes FOH, ". . . all indications were that Jerry was up to something special. An excited guard woke the company commander and whispered hoarsely, 'Someone is talking German on our company 'phone lines!' A cold hand gripped the captain's thumping heart. They were surrounded — cut off! He crawled out of his hole to the 'phone. The sentry was right. Teutonic growls and wheezes were unmistakably loud and clear! With a feeling of dismay, the captain started to check the battalion 'phone line to see if it were cut. But first he picked up the sound-powered 'phone again to be sure. This time his amazed ears heard 100-per-cent-American boogie-woogie! A few minutes further listening revealed that the Psychological Warfare Division's powerful voice, Radio Luxembourg, located 30 miles away, was being received on our 'phone lines!'"

Here's DC POWER for WAR SURPLUS ARMY-NAVY RADIO EQUIPMENT!

**Get 6-12-24-28 Volts DC with
a FEDERAL Power Supply**

(FROM 115 AC 60 CYCLE — FOR USE WITHOUT BATTERIES)

**... BUILT WITH SELENIUM RECTIFIERS
FOR LONG LIFE, HIGH EFFICIENCY**

Now you can take full advantage of the fine equipment becoming available as-war surplus. Without the inconvenience of batteries, without any wiring changes, Federal's power supplies give you the required DC voltages from any 115 volt, 60 cycle, AC source . . . *assuring the utmost in performance from the equipment!* And they're available now!

Powered by Federal "Center Contact" Selenium Rectifiers, they have practically unlimited life, operate noiselessly. They provide the heavy current, low voltage outputs required by mobile and airborne transmitters and receivers, ground station units, rotary equipment.

It will pay you to plan your power supply *first* when considering war surplus radio gear, motors, relays, inverters. Consult the chart below for ratings, and let us send you full information.

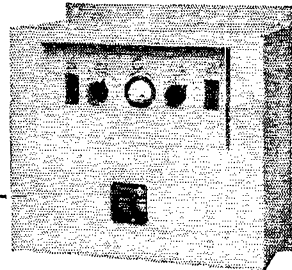

FTR 3106-S — Low ripple DC power supply. Highly flexible unit provides DC at 5 to 80 volts—12 amperes. Sturdily constructed, requires no maintenance.

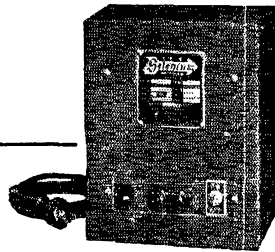

FTR 3093-S — 12 volt battery eliminator. Supplies 3 amperes, continuous operation. Compact unit; weighs only 15 pounds. Larger models supply 5 and 7.5 amperes.

RATINGS: 6-12-24-28 VOLT POWER SUPPLIES

Model Number	AC Volts Single Phase 60 Cycles	DC Volts	DC Amperes	Filter
FTR-3246-AS	115	6	10	NO
FTR-3008-BS	115	5/10	24/12	NO
FTR-3093-S	115	12	3	YES
FTR-3138-S	115	12	5	YES
FTR-3185-S	115	12	7.5	YES
FTR-3133-BS	115	6-24	2-18	NO
FTR-3341-AS	115	28	5	NO
FTR-3182-S	220/3 phase	14/28	200/100	YES
FTR-3128-S	115	22-30	10	(Regulated & Filtered)
FTR-3300-AS	115	2-32	45	NO
FTR-3106-S	115	5-80	12	Choke Only

CLIP AND MAIL IN TODAY

Federal Telephone and Radio Corporation
200 Mount Pleasant Avenue
Newark 1, New Jersey

Please send full information on the following FTR power supplies (listed by model number):

NAME _____

ADDRESS _____

Federal Telephone and Radio Corporation

In Canada:—Federal Electric Manufacturing Company, Ltd., Montreal
Export Distribution:—International Standard Electric Corporation, 67 Broad St., N. Y. C.



Newark 1,
New Jersey



World's Largest DISTRIBUTOR OF SHORT WAVE RECEIVERS

Do business with the biggest and one of the best in the field. Enter your orders for the following:

Hallicrafters S38 complete.....	\$39.50
Hallicrafters S40 complete.....	79.50
Hallicrafters S36A.....	307.50
Hammarlund HQ-129X complete.....	173.25
SP-400-2 Super Pro complete.....	318.00
SP-400-2 Super Pro complete.....	342.00
National NC-46 complete.....	107.40
HRO Sr. noise silencer, 4 bandspread coils.....	274.35
National NC-2-40D complete.....	240.00
National 1-10A.....	56.10
RME-45 complete.....	186.00
RME-84 complete.....	98.70
Pierson KP-81 complete.....	318.00
BC-348Q 110 V AC model NEW.....	85.00
SCR-211 NEW.....	86.50
Tamco 75GA transmitter.....	495.00
Panoramic PCA-2 panadaptors.....	99.75

Prices subject to change.

Other receivers, transmitters, etc., as available

Delivery of receivers is much better. Many models I can ship at once from stock. By dealing with the world's largest distributor of short wave receivers you are assured of the fastest delivery and the best service.

Send your orders now. Trade-ins solicited. You can buy on my 6% terms. I have a large stock of test equipment, amateur transmitters and parts, government surplus bargains, etc. Write for lists. Let me know your needs. I will try to give you better service and help. Your inquiries and orders invited. Write, fone, wire or visit either of my stores.

W0ARA

BUTLER, MISSOURI

HENRY RADIO SHOPS

LOS ANGELES 25, CALIF.

"WORLD'S LARGEST DISTRIBUTOR OF SHORT WAVE RECEIVERS"

Have You a Copy?

"A COURSE IN RADIO FUNDAMENTALS" ^{By} GEORGE GRAMMER

In Book Form

THE MATERIAL in this volume was prepared in response to the demand for a course of study emphasizing the fundamentals upon which practical radio communication is built. It originally appeared serially in QST and so great was the enthusiasm with which it was received that it is now published under one cover. The course is equally as valuable for those studying at home as for the teaching profession, many members of which have found themselves in the (to them) new field of radio technician training without the benefit of a planned course, nor the time to put in to thorough preparation.

It has been said by the planners of military and pre-service training for radio technicians and mechanics that their objective is to provide, as nearly as possible, the practical experience possessed by the radio amateur with a background of basic fundamentals. The objective in preparing this course, therefore, was to accent those principles most frequently applied in actual radio communication. "A Course in Radio Fundamentals" is a study guide, examination book and laboratory manual. Its text is based on the "Radio Amateur's Handbook" of 1942 or subsequent editions. Either the special edition for war training purposes or the Standard Edition may

be used. References contained in the "Course" are identical in both editions.

The material is divided into thirty-six study assignments. With each assignment there is a series of questions designed to bring out the most significant points in the text. When problems of a mathematical nature are included, the answers are given at the end of the book. In cases where more than routine methods are required, the complete solution is given. Where feasible, experiments accompany each assignment to best illustrate the principles being studied. Anyone undertaking the course may be assured that, if he follows its precepts literally and exactly, performs the experiments and examines himself honestly with the test questions, he cannot fail to learn the principles of radio and will be well equipped to undertake specialized and advanced training in any branch of radio communications or electronics. Instructors using this material may be confident that their students will receive thorough training in the essential fundamentals of radio.

PRICE 50 CENTS POSTPAID (No Stamps, Please)

AMERICAN RADIO RELAY LEAGUE, WEST HARTFORD, CONNECTICUT

FOR GRAND PERFORMANCE

Astatic **Dynamic Microphones**

*Newly Designed
and Engineered*

● Incorporating advanced ideas in operation and design, Astatic DN-Series Dynamic Microphones are highly recommended for a wide variety of communications and public address applications, especially where temperatures vary and high relative humidity is encountered. Four models, of different output impedances, are available: DN-50, DN-200, DN-500 and DN-HZ. All models are available with the Type G, Grip-to-Talk Desk Stand. Only the high impedance model, DN-HZ, however, is supplied with Type S On-Off Switch. Astatic Dynamic Microphones are sturdy and dependable, relatively low in cost, smartly streamlined, attractively finished in opalescent gray with bright chrome grille, and sure to give long and highly satisfactory service.

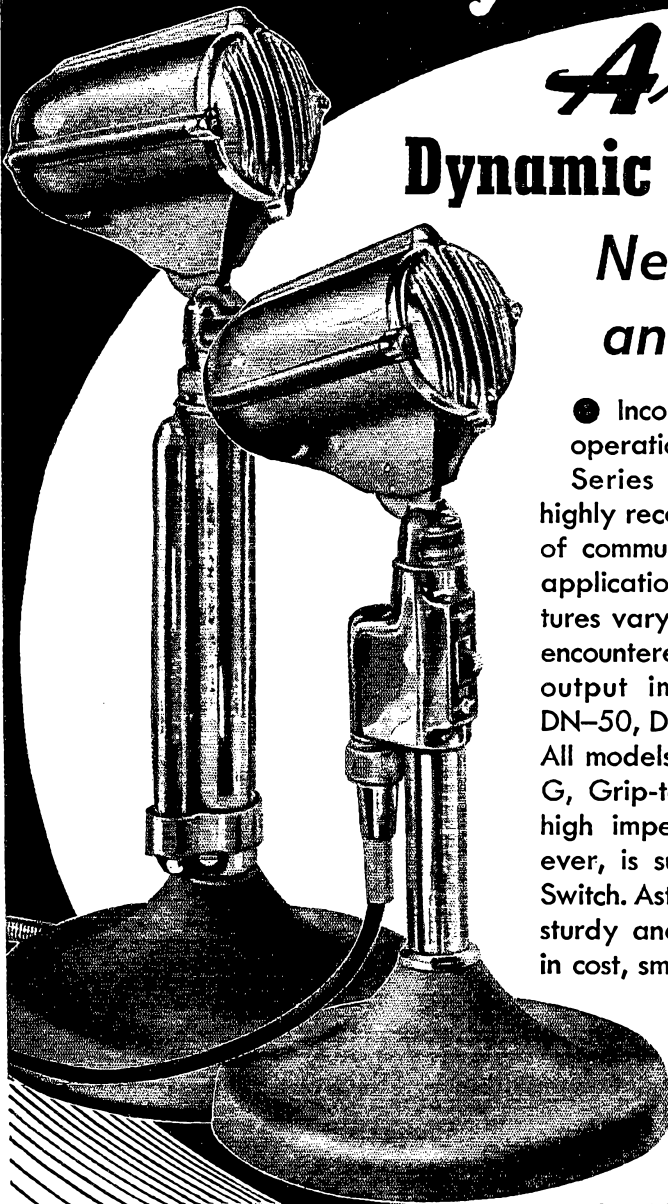

THE *Astatic* CORPORATION
ASTATIC CONNEAUT, OHIO

IN CANADA: CANADIAN ASTATIC LTD., TORONTO, ONTARIO

Shur ANTENNA MOUNT

Perfect for
AMATEURS

Fits Anywhere
ANY ROOF TOP

ANY SLOPING SIDE

ANY HOUSE SIDE

SIMPLE STURDY
VERSATILE

Fits 1/4" Uprights

Pat. Pending



SHUR-ANTENNA-MOUNT INC.

Eastern Division
SEA CLIFF, N. Y.

Western Division
PORTER BLDG., KANSAS CITY, MO.

Now—a really
high-powered



RADIO ENGINEERING LIBRARY

- especially selected by radio specialists of McGraw-Hill publications
- to give most complete, dependable coverage of facts needed by all whose fields are grounded on radio fundamentals
- available at a special price and terms

THESE books cover circuit phenomena, tube theory, networks, measurements, and other subjects—give specialized treatments of all fields of practical design and application. They are books of recognized position in the literature—books you will refer to and be referred to often. If you are a practical designer, researcher or engineer in any field based on radio, you want these books for the help they give in hundreds of problems throughout the whole field of radio engineering.

Free Examination • Special Low Price • Easy Terms

McGraw-Hill Book Co., 330 W. 42nd St., New York 18
Send me Radio Engineering Library, 5 vols., for 10 days' examination on approval. In 10 days I will send \$2.50, plus few cents postage, and \$4.00 monthly till \$26.50 is paid, or return books postpaid. (We pay postage on orders accompanied by remittance of first instalment.)

Name.....
Address..... Company.....
City and State..... Position..... QST 9-46

Solving Feeder Problems

(Continued from page 28)

mainder. The input impedance of the 75-foot or 475-degree line is therefore the same as the input impedance of a 115-degree line, the remaining half-wave sections in the length serving only to reproduce the conditions existing at the 115-degree point.

We now locate the point 0.233, 0, which lies on the x axis since the reactive component is zero. In this instance, following the t circle through 115 degrees as marked off by the v circles would be difficult because the larger t circles go off the chart at the top and bottom. However, it will be observed that one complete travel around a t circle carries us through 180 degrees. Consequently, if we move through $180-115=65$ degrees in the counterclockwise direction we will arrive at the same point that we would reach by traveling 115 degrees in the clockwise direction. Following the t circle through 65 degrees (to the 25-degree v circle) in this fashion brings us to the point $R/Z_0 = 1.05$, $X/Z_0 = -1.62$, so that the actual values of resistance and reactance are

$$R = 1.05Z_0 = 1.05 \times 300 = 315 \text{ ohms}$$

$$X = -1.62Z_0 = -1.62 \times 300 = -486 \text{ ohms}$$

The impedance looking into the sending end of the line is therefore equivalent to a resistance of 315 ohms in series with a capacitive reactance of 486 ohms.

To cancel the line reactance we would need an inductive reactance of 486 ohms. The required inductance can be found from the formula

$$L_{uh} = \frac{X}{2\pi fMc}$$

Substituting gives

$$L_{uh} = \frac{486}{6.28 \times 14.2} = 5.45 \text{ microhenrys}$$

Since the line is balanced, the inductance preferably should be divided between two coils of 2.72 microhenrys each, one being connected in series with each side of the line.

Canceling the line reactance leaves the line looking like a pure resistance of 315 ohms at the sending end. Matching a load of this magnitude to the transmitter presents no particular difficulties, although the resistance may be too high to permit maximum power transfer through a one- or two-turn link. Should it be impossible to load the transmitter to the desired input with the tightest possible coupling between the link and the final tank coil, the number of turns in the link can be increased to provide the proper turns ratio between the tank and the link coil. An alternative method is to tap the line on the tank, adjusting the spread between the taps to give proper loading, or—preferably—to tap on a separate antenna-tuner tank link-coupled to the transmitter. Whatever the method used for matching the load to the transmitter, the criterion for correct cancellation of line reactance is that

(Continued on page 140)

THE MOST EXCITING HAM NEWS IN YEARS!

THE MOST SPECTACULAR HAM CONTEST IN HISTORY!

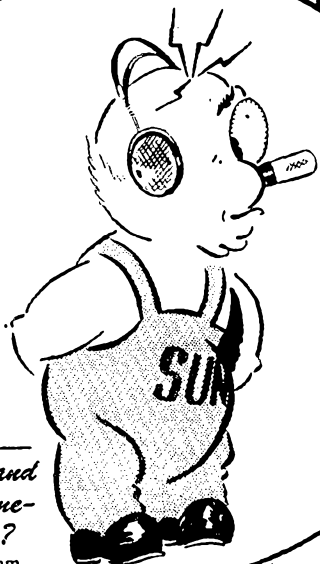

Give me a name and WIN a New Hammarlund

"SUPER-PRO"

(Selling nationally for \$342.00)

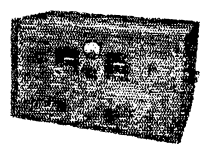

FREE!

FREE!

Who, what, and why is this nameless character?

He's the best pal a ham ever had. He's going to appear in all future advertisements of Sun Radio, always bringing you specials, bargains, exclusives, and the latest gear. He'll save you money. He'll save you time. He'll keep your rig efficient and modern. In short, he's your new good luck charm. Look for him every month.

SUN RADIO is giving away—absolutely free—this brand new Hammarlund "Super-Pro" (SP-400-X) receiver, complete with speaker and power supply. This set is currently selling all over the country for \$342.00 (if you can get it).

You can WIN it! It's easy. Just make up a winning name for the little pixy whose picture appears above. Your name can be clever, humorous, descriptive, or what-have-you. It can be long or short. It can be one name or more. It can be anything, as long as it follows these general hints:

- originality
- humor
- "ham-iness"
- appropriateness to Sun Radio
- appropriateness to appearance of character

THERE'S NOTHING TO PAY, NOTHING TO LOSE. The idea that wins the "Super-Pro" may come to you during work, at dinner, or even while you're QSOing. Exchange ideas on the air. But don't delay. Start working on it *now*. The contest ends midnight, October 15.

Remember, your call letters MUST be sent in with your entry. This contest is being run exclusively for licensed operators.

PLEASE READ THESE IMPORTANT RULES

- 1. This contest is for licensed operators only. All entries must be accompanied by the contestant's call letters. Entries received without the contestant's call letters will be discarded. We're keeping this a contest for real hams only.
- 2. A contestant may NOT submit more than ONE suggestion. If you have several ideas, choose the best one and send it in.
- 3. The contest is open to all American and foreign hams, except employees of Sun Radio and their families.
- 4. Send entries to Contest Dept., Sun Radio & Electronics Co., Inc., 122-124 Duane Street, New York City 7, N. Y.
- 5. All names will be judged primarily for originality and aptness. The decision of the judges is final.
- 6. In the event of a tie, duplicate prizes will be awarded.
- 7. All entries must be postmarked before midnight, October 15, 1946.
- 8. The winning entry and the winning contestant's name, call, and picture will be published on Sun Radio's page in the December issue of QST.

The well known judges of the contest will be announced next month. Watch for them.

SUN RADIO
 & ELECTRONICS CO., Inc.
 ESTABLISHED 1922
 122-124 DUANE ST. • NEW YORK 7, N. Y. • BARclay 7-1840

IT'S NEW . . .

send for your copy of catalog

(Continued from page 138)

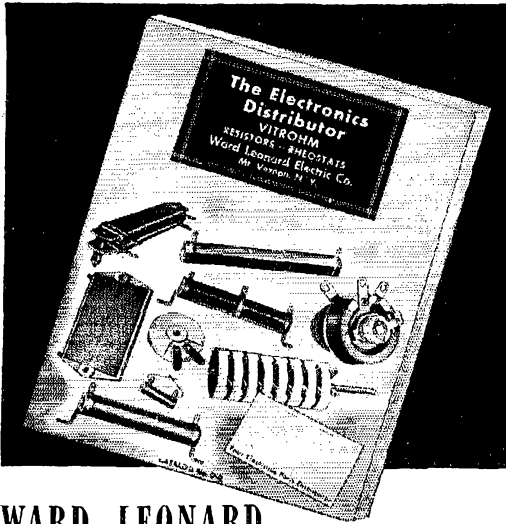

WARD LEONARD

RELAYS • RESISTORS • RHEOSTATS Electric Control Devices Since 1892

WARD LEONARD ELECTRIC COMPANY

Radio and Electronic Distributor Division

53B WEST JACKSON BLVD., CHICAGO, ILL.

LEARN RADIO CODE WITH THIS . . .

BASIC RADIO CODE KIT

\$35.00 Complete • Prepared by U.S. Army Signal Corps to teach radio code (up to 10 words per minute). Kit consists of 17 twelve-inch standard phonograph records with manual and self-scoring practice sheets. Can be used with your own phonograph. No other equipment needed.

NOBLE & NOBLE, Publishers, Inc.
72 Fifth Avenue, N. Y. 11, N. Y.

CUT SENDING EFFORT IN HALF

WITH
THE GENUINE
EASY-WORKING

VIBROPLEX

Reg. Trade Mark: Vibroplex, Lightning Bug, Bug

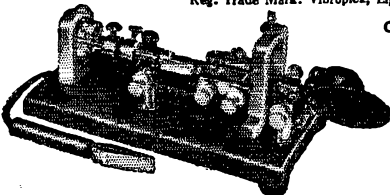

Original Deluxe
Model

WITH
PATENTED
JEWEL
MOVEMENT

\$19.50

For downright easy sending — there's nothing to equal this "ORIGINAL" Del-Luxe Vibroplex key.



The "BUG" Trade Mark identifies the Genuine Vibroplex. Accept No Substitute

Famous the world over for its feather-touch action, superior signals and ease of operation. Equipped with the sensational and exclusive PATENTED JEWEL MOVEMENT this key develops the highest degree of sending skill attainable, prevents "glass" arm and cuts sending effort in half. Chromium finished base. Bright machined parts. Colorful red switch knob, finger and thumb piece. 3/16th contacts. Circuit closer, cord and wedge. Del-Luxe finish also available in "BLUE RACER" and "LIGHTNING BUG" models. Act wisely! Order yours to-day! Money order or registered mail. FREE catalog.

THE VIBROPLEX CO., Inc.

833 Broadway New York 3, N. Y.

the tank tuning remains unchanged whether or not the line is connected.

It should be realized that in practice some departure from calculated values is to be expected, since not all the factors can be accurately known. Consequently, some adjustment of the compensating reactance in series with the line ordinarily will be required. However, the calculated values provide a badly-needed starting point and eliminate much working in the dark.

In using the chart for problems of the type illustrated above, the following points should be kept in mind:

1) The impedance components (resistance and reactance) obtained from the diagram form an equivalent series circuit that, with lumped constants assumed, duplicates the conditions that would be observed when looking into the line, at the point considered, *toward* the load end.

2) When traveling along the line from the load end toward the sending end, move *clockwise* along the *t* circles.

3) When traveling along the line from the sending end toward the load end, move *counter-clockwise* along the *t* circles.

4) Inductive reactance has a *positive* sign.

5) Capacitive reactance has a *negative* sign.

The examples worked out above represent only one type of problem that may be solved by the use of the chart. To do justice to its versatility would require a great many examples, understanding some of which would necessitate more technical knowledge than the ordinary amateur is expected to have. But in addition to the practical uses of the circle diagram, working out a few typical problems will enable one to get a "feeling" for the operation of transmission lines that it is impossible to get simply from inspection of the impedance formula.

About the Author

• Robert E. Kelley, W1EB, an equipment engineer for the Western Electric Co., has spent the years since 1933, when he was first licensed, as a DXer, v.h.f. enthusiast, and general experimenter. During the war he served as a Navy lieutenant in both the Atlantic and Pacific theaters as a radar repair officer. While stationed at the Naval Training Station, Norfolk, he received commendation from the commanding officer and endorsement from Coctlant for original development work on an artificial training device used to simulate radar echoes on actual radar screens. W1EB was also active in the promotion of the Navy's fire-control radar training program. Mr. Kelley is a graduate of the University of Maine, class of '42, with a B.S. degree in E.E., and while there, served as president of the U. of M. Radio Club.

**NEWARK
HAS IT NOW!**

**QUICK DELIVERY ON
ALL YOUR RADIO NEEDS**

Write, phone or wire the store nearest you. Orders shipped the same day they are received. Prompt and complete answers given to all inquiries.

TEMCO 75 GA
Telephone and Telegraph
75/100 Watt Output
TRANSMITTER



This delivers 75 Watts output on phone - 100 Watts output on CW. Multi-frequency VFO with crystal-like stability. Five band operation covering 3.5 - 7 - 14 - 21 - 28 megacycles. Crystal control with front-of-panel selection for two crystals. One dial operation when on crystal frequency control. All controls adjacent to meters. Switch-con-

\$495.00

trolled, built-in antenna relay for Standby-Transmit. Metering of grid and plate currents of the final amplifier and plate current of the modulator. A hot rig! Available now.

RME-45

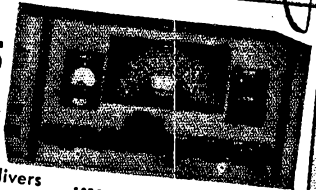

Features Cal-O-Matic two speed tuning, calibrated bandspread. Delivers peak performance from 550 Kc. to 33,000 Kc. Has DB signal level meter, five position Xtal filter, automatic noise suppression also stable, variable pitch beat os-

IMMEDIATE DELIVERY \$186

illator, and many other new features. A prime favorite with phone as well as CW operators.

MORE THAN EVER

FOR YOUR MONEY

U. S. SIGNAL CORPS BC-312 RECEIVERS

Don't miss getting one of these brand new, smooth operating Signal Corps Communications Receivers. Built to operate consistently under any and all conditions. Continuous coverage 1500 to 18,000 Kc. in 6 bands; frequency calibrated dial; antenna compensator; crystal filter and phasing control; send-receive relay; 250 and 4000 ohm output; built-in

24 volt D.C. dynamotor. Can easily be converted to A.C. by building power supply—diagram on request. Act fast — send your order in now. All new in original carton. There may not be enough to go around at

This Sensational
Low Price

\$44.50

YOU CAN GET ALL THE THINGS YOU NEED AT NEWARK

- Hallcrafters S-38.....\$39.50
 - Hallcrafters S-40.....79.50
 - SM-40 "S" Meter.....15.00
 - RME-84.....98.70
 - Panadapter PCA-2.....99.75
 - RME DB-20.....68.20
 - RME VHF-152 Converter.....86.60
 - National NC-46.....97.50
 - Speaker for NC-46.....9.90
 - Hammarlund HQ-129X, with speaker.....173.25
 - RME-45.....186.00
 - National HRO.....197.70
 - National NC-2-40D, with speaker.....240.00
 - Hallcrafters S-36A.....307.50
 - Hammarlund 400X, with speaker.....342.00
 - Hallcrafters S-37.....591.75
 - HT-9 Transmitter.....250.00
- and other models.

NEWARK'S OUTSTANDING VALUES IN SURPLUS SPECIALS...

MOBILE 40 & 80 METER XMTR - RCVR SET
Famous Mark II

Own one of these complete 40 and 80 meter rigs for this ridiculously low price. Two sets in one. Phone and CW on 2 to 8 Mc (Right Smack in the 40 and 80 meter bands!) 6 tube Super Receiver, 6 tube MOPA Xmtr. Also, a complete 235 Mc transceiver. Included in this wonderful buy is: 1 pair headphones, 1 key, 1 "A" set antenna with variometer, 1 "B" set antenna, 1 control box, 1 microphone, 1 Dynamotor power supply kit, plus all the plugs, cable connectors, etc., that are needed for operation. Made originally for tanks, it will last for years. For 12 volt operation. **A REMARKABLE VALUE.ONLY \$34.50**

DYNAMOTOR P-103-A

Brand new, in original Signal Corps cartons. Supplies 500 volts at 160 mils D.C. from any 6 volt or 12 volt battery source. AN UNUSUAL OPPORTUNITY.**\$14.95**

EICOR DYNAMOTOR

Ideal for mobile rigs. Brand new and fully guaranteed. Two windings deliver following voltages: 12 volt in- (500 volts at 50 mils put delivers) 275 volts at 110 mils Compact, sturdy, used by U. S. Army. **A TERRIFIC BUY AT \$4.95**

NEW YORK

115-17 W. 45th St.
New York 19, N. Y.

NEWARK CHICAGO
ELECTRIC COMPANY, INC.

323 W. Madison St.
Chicago 6, Ill.

For more details see our advertisement on Page 137 of August issue of QST.

Branch: 212 Fulton St., New York 7, N. Y.

Send for bargain bulletins of hot buys we can get for you after QST goes to press.

New COLLINS ART-13's • \$198.00

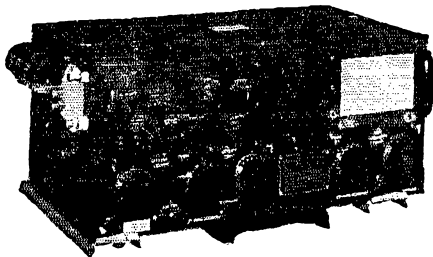

811's Modulate 813, 160 w.

This fine commercial transmitter which is standard equipment on heavy airliners is being offered at surplus bargain prices. Range 2 to 18 MC. Can easily be converted to 10 Meters and 110-v. operation.

PRICE NOW: \$198.00 with tubes, ess power supply. Rush \$20.00 deposit, balance C.O.D., only a few left.

TEMCO Model 1250GSC • \$1129.00

Only 2 available, 300-watt phone 2 to 16 MC. A high grade commercial job complete in 66" rack cabinet with tubes, control box and 220-v. AC power supply. New, packed for overseas shipment.

NAVY TBY-8 Walkie-Talkie • \$39.00

28 to 80 MC. Receiver-Transmitter. Now **\$39.00** with accessories less battery. Rechargeable battery pack for TBY-8, **\$30.00**

VAN SICKLE RADIO SUPPLY CO.

Indianapolis 6, Indiana

RADIO INSTRUCTORS ●

Receiver servicing experience. College degree preferred. \$3600 a year to start. \$4200 after four months. Work in the heart of the Radio Industry. We will teach you practical television. Write Raleigh G. Dougherty, 158 Market Street, Newark 2, New Jersey, c/o New York Technical Institute of New Jersey. America's foremost Television school.

COMPLETE RADIO TRAINING!

Prepare now to accept a responsible position in Commercial Radio. New developments will demand technicians with thorough basic training, plus a knowledge of new techniques discovered during the war. Training open to high school graduates or those with high school equivalency. Courses 6 to 18 months' duration in RADIO AND ELECTRONICS. Approved Veteran training in Radio. Write for Particulars.

VALPARAISO TECHNICAL INSTITUTE
Dept. TN Valparaiso, Ind.

Here's a New POWER CUTTER KIT

with a cutting range of 5/8" to 2 1/2"



Only
\$7.85
Complete

Two Bruno Adjustable Hole Cutters in one convenient kit. High speed steel blades cut clean, fast holes in metal, wood, plastics. Quickly adjustable and easily sharpened. Designed by tool engineers to operate efficiently in bench drill, drill press or portable drill. Ask your jobber, or write Dept. Q-9

MODEL	SHANK SIZE	EXPANSION	PRICE
100	1/4" straight shank	5/8" - 1 1/2"	\$3.00
101	3/8" straight shank	1" - 2 1/2" 5/8" - 2 1/2"	\$5.00 \$8.00*

*Fair Trade Minimum \$7.85

BRUNO

TOOLS

9330 Santa Monica Blvd.
Beverly Hills, Calif.

25 Years Ago

(Continued from page 41)

static-free reception of signals on his Grebe CR-3 when operated down cellar.

Things are all haywire at T.O.M.'s house, with the OW taking up radio and the baby playing with the batteries, according to the month's fiction, "Overheard By The Old Man's Son." The author, R. K. B., is Mrs. Arthur A. Hebert, wife of our treasurer.

The widely-heralded Static Puncturing Contest was washed out, unfortunately, by terrific country-wide electric storms on the contest date. C.w. seemed to have an edge on spark, according to the few reports received. . . . Mid-May's aurora blanked DX throughout the country. . . . A second transatlantic sending test is announced for December. . . . The Smith Cup award committee invites individual as well as station candidacy for the award.

Last month's traffic champ was a West Coaster, 7ZJ, the Mumford brothers, with 324 total. Vermilya's (1ZE) traffic has suffered again, attributable no doubt to his taking time out to write "As The Reporters See Us," for this issue. Eunice Randall (1XE) passed her first-grade examination with marks of "100 per cent" and "excellent." First-districters are proud of their OW. Incidentally, three-letter "1" calls are all being changed to conform to rectify an error in sequence made by the Radio Inspector.

Stations described are 8DE, Akron, 5ZJ, State College, N. M., 9EQ, St. Louis, and 3HX, Philadelphia. F. L. Pullen, 5ZAB, and J. K. Hewitt, 2RK, are introduced in "Who's Who in Amateur Wireless."

The Dempsey-Carpentier fight was broadcast on 1600 meters, with ARRL's ex-director, J. O. Smith, doing the announcing, according to "Strays." Other items tell us that members of the Columbus (Ohio) Radio Club had their car raided by the police on suspicion of bootlegging while they were testing a receiver installation in the car. . . . Youngest licensed amateur operator to date is believed to be 7-year-old Robert Garcia of Los Angeles.

COMING CONVENTIONS

Maritime Division, Halifax, N. S.,
August 31st, September 1st-2nd.

Rocky Mountain Division, Denver,
September 14th-15th.

West Gulf Division, Oklahoma City,
September 21st-22nd.

Midwest Division, Topeka, October
5th.

Vermont State, Burlington, October
5th.

**WOUND WITH
CERAMIC
INSULATED
WIRE**

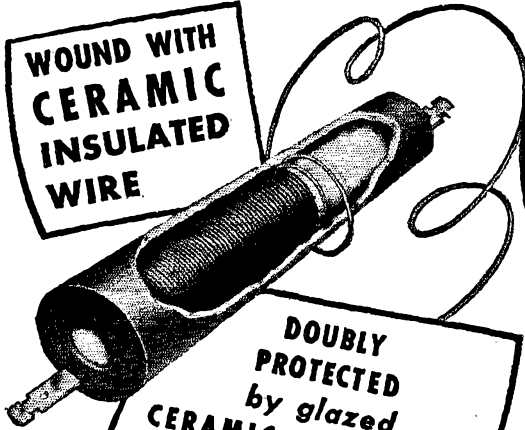

**DOUBLY
PROTECTED
by glazed
CERAMIC SHELLS and
MOISTURE-PROOF END SEALS**



**MOUNT 'EM
ANY WAY...
ANYWHERE!**

Sprague KOOLOHM
Wire-Wound Resistor Con-
struction allows units to be mounted
directly to metal or grounded parts
—even in high-voltage circuits.

SAFE! COMPLETELY INSULATED!

"TOPS" FOR HIGH-VOLTAGE USES!

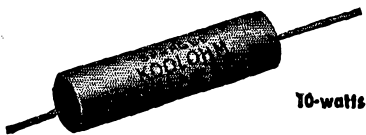

10-watts



5-watts

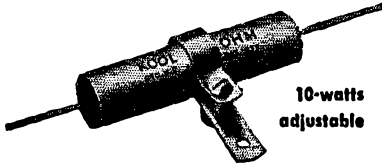

10-watts
adjustable

... Use 'em at Full Wattage Ratings!

For safety on high voltages, use Sprague Koolohms! The wire itself is insulated with 1000° C. heat-proof ceramic—then doubly protected by a glazed outer ceramic shell. Insulation resistance from the outer surface of the shell to the resistance element is 10,000 volts or better!

And don't forget that Koolohm wattage ratings mean what they say. No need to buy a larger unit than you actually need. Use Koolohms at full wattage ratings—even in enclosed spaces.

Moreover, standard Koolohms have the same high degree of humidity protection formerly obtainable only on special order to meet the most exacting military specifications.

Write for Catalog C-306 of Sprague Capacitors and Koolohm Resistors for all amateur, radio service and experimental uses.

SPRAGUE PRODUCTS CO., North Adams, Mass.

SPRAGUE KOOLOHMS

TRADEMARK REGISTERED U.S. PAT. OFF.

The Greatest Wire-Wound Resistor Development in 20 Years

Crystalab CRYSTALS

TRADE MARK REG. U. S. PAT. OFF.

HANG RIGHT THERE . . . HIGH OUTPUT

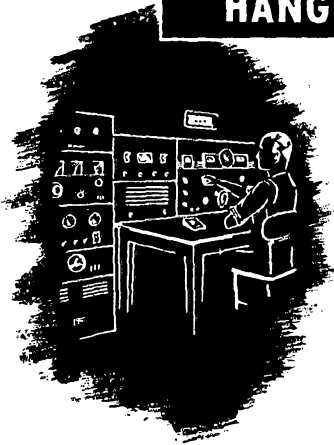

CRYSTALAB puts the same top engineering skill into CRL-16 "Ham" crystals as they do into their unexcelled, precision crystals for **INDUSTRY** (supersonic crystals for scanning devices), **AIRLINE** (radio beacon navigational aids), **POLICE** (HF FM transmission and reception), and the **ARMED FORCES** (Pack and Mobile). Ham crystals are available for any band from 2 to 80 meters with fundamental frequencies from 3.5 MC to 9.83 MC. **\$2.80 NET PRICE**

GRIND your own crystals Crystalab Crystal Kit #3 has all the components for grinding your own, plus simplified instruction book. **\$5.00 NET PRICE**

Crystalab Crystal Blanks for Crystal Kit #3 come 5 to a card, each card covers one band. **\$5.00 NET PRICE**

See Your Favorite Dealer



CRYSTAL RESEARCH

LABORATORIES INC.

29 ALLYN ST., HARTFORD, 3, CONN., PHONE 7-3215

RG-8/U FLEXIBLE COAXIAL CABLE

at a War-Surplus Price



U. S. Signal Corps excess inventories of RG-8/U flexible coaxial cable have been released for civilian sale at a new low price. This is your opportunity to acquire a stock of coaxial cable at rock bottom cost.

RG-8/U is the most completely practical cable for feeding receiving and transmitting antennae for all frequencies up to 250 mc, and also can be used up to 3,000 mc and down to dc. Easily installed because of its flexibility, it is excellent for high-fidelity telephone transmission lines and unsurpassed for feeding PM speakers at long distances from the amplifier and at low impedance levels.

Its shielding, if used as a ground lead, prevents electrical noise pickup, and its low attenuation results in maximum power transmission. The Armed Forces used RG-8/U Coaxial Cable for all-weather outdoor and indoor transmission lines, test cables, and antenna phasing lines.

The solid polyethylene dielectric is absolutely impervious to moisture. Lines do not have to be

pressureized, as in the case of beaded-dielectric cables. The solid dielectric and absolute uniformity of construction eliminates reflections caused by discontinuity of dielectric, and enables engineers to figure on lumped constants.

Nominal impedance is 52 ohms. Nominal capacity per foot is 29 mmf. Maximum attenuation is .027 db per foot at 100 mc and .25 db at 3,000 mc. Maximum operating voltage is 4,000 volts rms. Average power rating is 480 watts at 200 mc and 90 watts at 3,000 mc.

Your local dealer has RG-8/U coaxial cable in stock or can get prompt delivery from

BELMONT RADIO CORPORATION

3633 S. RACINE AVE. • CHICAGO 9, ILLINOIS

AGENTS FOR THE WAR ASSETS ADMINISTRATION
UNDER CONTRACT SIA-3-5



R. C. (Dick) Hall
W5EIB

R. C. & L. F. HALL, INC.

"THE HAM SHACK"

HOUSTON: 1015-17 Caroline Street
Telephone C-9731

DALLAS: 2123 Cedar Springs Avenue
Telephone Central 6632

GALVESTON: 1803 Tremont (23rd) Street
Telephone 24807

In addition to our Dallas and Houston stores, we have now opened a store at 1803 Tremont (23rd) Street in Galveston, Texas, for the convenience of our many friends. Mr. George A. Freeman, Jr., an amateur of many years standing, is in charge of our Galveston store and Mr. H. M. Tomlin, W5BVH, is in charge of our Dallas store. Drop in to see us at any of our stores.



L. F. (Lillian) Hall
W5EUG

RECEIVERS

HALLICRAFTERS

SX-42 — 540 KC to 110 MC.....	\$250.00
SX-43 — 540 KC to 108 MC.....	* 150.00
SX-46 — 540 KC to 43 MC.....	* 115.00
S-38.....	39.50
S-40.....	79.50
HT-9 — Transmitter (1500 KC to 30 MC).....	250.00
S-37 — FM/AM/CW (130 MC to 210 MC).....	591.75
S-36A — FM/AM/CW (27.8 to 143 MC).....	307.50
S-47 — AM/FM (535 KC to 108 MC).....	135.00

* Speakers not included (\$15.00 Up)

HAMMARLUND

HQ-129-X — with speaker.....	\$173.25
Super Pro — SP-400-X, with speaker.....	342.00

SPECIAL

UHF Aircraft transmitter, T-67/ARC-3, 8 channel crystal control, less crystals, 100-156 MC.....	\$47.50
---	---------

NATIONAL

NC-2-40-D — (Speaker — \$16.44 extra).....	\$225.00
HRO-5TA-1 — (1700 KC to 30 MC).....	274.35
Speaker — \$12.00 — Power Supply.....	20.36
HRO-5RA-1 — (Rack Model).....	274.35
Speaker — \$21.70 — Power Supply.....	37.95
NC-46 — (Speaker — \$9.90).....	97.50

RME

RME-45 with crystal, meter and speaker.....	\$186.00
RME-84.....	98.70
DB-20 Preselector.....	59.30
VHF-152 (2, 6, and 10 Meter Converter).....	86.60

MECK TRANSMITTER

Model T-60-1, efficient performance on any Amateur Band, 10 to 80 meters. Phone or C.W. 60 watts.	\$150.00
---	----------

Wire, write or phone your order. We will ship C.O.D. with a \$5.00 deposit. We also offer easy terms and trade-in allowances for used equipment. State Tax not included in above figures.

TEST EQUIPMENT IN STOCK

Monitor Crystallizer, Signal Generator.....	\$57.50
Silver Vomax, V.T.M. and V.O.M.....	59.85
Silver Model 904, Capacitance-Resistance Bridge.....	49.90
Silver Model 905, "SPARX," Signal Tracer.....	39.90
Silver Model 906, FM/AM, Signal Generator.....	89.90

Ask for complete Silver catalogue showing radically new receivers, transmitters and components.

Ask for other brands and models, since Test Equipment is arriving in larger shipments.

PUBLICATIONS — NOW IN STOCK

Radio Amateur Handbook — 1946 Edition.....	\$1.00
Radio Amateur Call Book.....	1.50
The Radio Handbook — 10th Edition.....	2.00
Fundamentals of Radio — Compilation.....	5.00
How to Become a Radio Amateur.....	.25
License Manual — Postwar Edition.....	.25
Learning the Radiotelegraph Code.....	.25
Log Books.....	.35

(Add \$.10 for postage)

CRYSTALS

BLILEY

80 & 40 Meter.....	\$2.80
--------------------	--------

PETERSEN

80 & 40 Meter.....	\$2.65
20 Meter.....	3.50
10 Meter.....	5.00

SHUR ANTENNAS

Dipole, 144 MC-Horizontal.....	\$4.05
Interceptor, 2 Element Beam — Horizontal or Vertical.....	\$5.70
Dipole, 6 Meters — Polished — Horizontal.....	5.40
Mounts — Fits any surface.....	5.25

NEW CATALOGUE IS READY

Our complete catalogue for 1946 is just off the press and a postal card addressed to Dept. Q will place you on our mailing list.

"ACROSS THE OPERATING TABLE"

Our latest amateur bulletin is now off the press and a postal card addressed to Dept. Q will place you on our mailing list.

A FEW OF THE MANUFACTURERS WHOSE PRODUCTS WE DISTRIBUTE

Aerovox	Clarostat	GE	Kaar	Meissner	Pioneer	Setchell-Carlson	Trimmm
Amphenol	Drake	Hallcrafters	Kainer	Millen	Precision	Silver	Triplet
Astac	Dumont	Hammarlund	Kelnor	Mueller	Premax	Simpson	Turner
B&W	Echophone	Hytron	Kwikheat	National	Radel	Speed-X	Vaco
Belden	Elmac	Instructograph	Leach	Newcomb	Raytheon	Stancor	Vibroplex
Billiey	Electronics Lab.	Insuline	Lectrohmm	Ohmite	RCA	Supreme	Walsco
Bud	Erie	Jensen	Les Logan	Panoramic	Robson-Burgess	Taylor	Ward
Centralab	Gammatron	JFD	Littelfuse	Peerless	RME	Thermador	Weller
Cinaudagraph	General Cement	Johnson	John Meck	Petersen	Sangamo	Thordarson	Weston

PREMAX

You Need This New Catalog

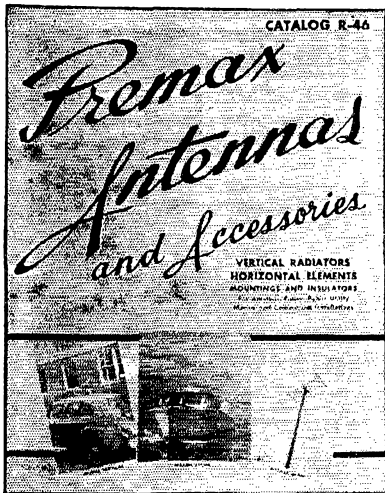

Get It From Your Jobber

Premax Products

Division Chisholm-Ryder Co., Inc.

4615 Highland Avenue

Niagara Falls, N. Y.

RADIO COURSES

- RADIO OPERATING
- RADIO SERVICING
- REFRIGERATION SERVICING
- CODE
- ELECTRONICS

Personal Counselling Services for Veterans
Write for Latest Trade & Technical Catalog

Y. M. C. A. TRADE & TECHNICAL SCHOOLS
4 W. 64th Street New York City

CONNECTICUT

HAM HEADQUARTERS

Complete stocks of nationally known
amateur gear — radio electronic parts
— tubes — sets and equipment.

Wholesale Only

R. G. SCELLI & CO.

Pete De Pasquale, W1GUC Roger Amundsen, W1HYF
George Lappe, W1LWW Roy Watkins, W1MHH
Porter Noe, W1LWZ Ernie Johnson, W1F5Y
Art Lundeen, W9PZ1 John Yacovelli, W1IKB

317 Asylum St.
Hartford 3, Conn.
Tel. 2-1144

84 Elm St.
Bridgeport 3, Conn.
Tel. 6-1811

ASK FOR OUR BARGAIN BULLETIN

Get Acquainted Party

(Continued from page 51)

of fifteen-minutes-or-longer duration will constitute a second or final multiplier.

Thus, final score equals total contact-points times number of ARRL Sections worked times number of fifteen-minute-or-longer contacts.

Prewar licensees will be competing only with other prewar amateurs, postwar licensees will compete only with other postwar operators.

Reporting

All logs should be mailed to ARRL Communications Department, 38 La Salle Road, West Hartford, Conn., and must be *postmarked no later than October 3, 1946*. Mimeographed reporting forms will be furnished upon request to Hq. in advance of the party, but are not required. Send postal or radiogram for your copy of the convenient form.

Reports should list stations in the order worked, with date, time, and frequency band indicated for each contact. In the case of fifteen-minute-or-longer QSOs, *ending time* of the contact must be given also. Alongside the call of each station worked, record the following information received from each operator: (a) signal report, (b) operator's name or personal "sine," (c) operator's age, (d) month and year first amateur station license was received, (e) ARRL Section in which located.

Sections claimed in the score should be numbered consecutively as worked. Each reporting participant shall include once in his log the facts called for in (b) through (e) regarding himself. It will not be required that you list the signal reports you gave to the stations worked.

A time record must be included with report, showing each operating session, with "on" and "off" times listed consecutively, and total hours shown.

Foreign Notes

(Continued from page 52)

organization, announcing that the Isles will be apportioned into 15 regions, each under the general direction of a Regional Representative. First seats will be filled by Council appointment from former "district representatives," but it is expected that soon provisions will be made for nomination and election by the regional membership. This new arrangement will exist not only for self-governing purposes but also to provide channels of organization from which membership activity reports can be handled for eventual inclusion in the *Bulletin*.

NORWAY

At a general meeting of the *Norsk Radio Relae Liga* on May 25th, a board of directors was chosen who selected the following officers for the coming term: O. G. Larsson, LA1V, president; O. Johannesen, LA9K, vice-president; C. Amundsen, LA7Y, secretary; S. Tomter, LA8K, treasurer; and L. R. Heyerdahl, LA6A, editor.

5 CRYSTALS

FOR
\$4.75

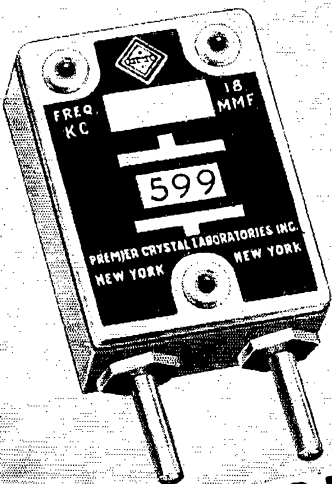

599
NEED
WE SAY
MORE?

SPECIAL INTRODUCTORY OFFER!

Compare!

Check these quality features of the Premier 599:

- CRYSTAL PLATE—**
- Precision machine lapped
 - X-ray oriented and checked
 - Low temperature coefficient
 - Etched to high output
- HOLDER—**
- Hermetically sealed
 - Standard 1/2" spacing between pins
 - Molded of low-loss mica-filled phenolic plastic
 - Stainless steel electrodes, pins and contact plates

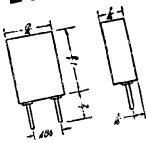

Each crystal complete in holder as shown above

Here's your chance to get a complete set of FIVE crystals — at an amazingly low price! For only \$4.75, and 25¢ to cover handling and postage, we will send you, post-paid, FIVE new, individually calibrated crystals in the 3500-4000 KC and 7000-7300 KC ranges. Each crystal is backed by Premier Crystal Laboratories, Inc., for many years one of the country's pioneers in making unexcelled crystals for the most discriminating professional and military users.

Act now! This offer expires Oct. 15, 1946. It is being made only to acquaint you with the new Premier 599 Crystal. Check its features—then fill out and mail the coupon today. Just enclose check or money order. Be sure to specify frequencies desired. We will fill orders from stock to within ± 5 KC. Crystal units are calibrated in a factory standard oscillator (18 mmf.) to the nearest integral kilocycle and may be relied upon within ± 500 cycles of the nameplate frequency.



PREMIER CRYSTAL LABORATORIES, INC.

53-63 PARK ROW (PULITZER BLDG.) • NEW YORK 7, N. Y.

Premier Crystal Laboratories, Inc.
53-63 Park Row
New York 7, N. Y.

Gentlemen:
Enclosed please find \$5.00 (\$4.75 plus 25¢ for mailing and handling) for FIVE new Premier 599 precision quartz crystals. I am specifying the five frequencies desired, in the 3500-4000 KC and 7000-7300 KC ranges, and understand you will supply crystals from stock to within ± 5 KC.

Frequency _____ KC Send to: _____ QST-1

Frequency _____ KC Name _____

Frequency _____ KC Address _____

Frequency _____ KC City & Zone _____

Frequency _____ KC State _____



HOW TO PASS Commercial Radio Operators' FCC LICENSE EXAMINATIONS...

How To Pass
FCC
LICENSE
EXAMINATIONS

CLEVELAND INSTITUTE
OF
RADIO ELECTRONICS
Terminal Tower - Cleveland, Ohio

Don't Delay—
Write Today!

FREE BOOKLET

Tells you the Government Requirements for all classes of commercial licenses. Tells where to apply for and take the examinations, examining offices, scope of knowledge required, extracts from FCC Rules and Regulations, extracts from FCC Study Guide and Reference Material, approved way to prepare for FCC

examinations, positive method of checking your knowledge before taking the examinations.

CLEVELAND INSTITUTE of RADIO ELECTRONICS

QT-9, TERMINAL TOWER CLEVELAND 13, OHIO

Approved for Veteran Training under GI Bill of Rights

MAIL THIS COUPON

Cleveland Institute of Radio Electronics
QT-9 Terminal Tower, Cleveland 13, Ohio

Gentlemen: Please send your FREE Booklet, "How to Pass FCC License Examinations." (NOTE: This booklet does not cover examinations for Amateur Licenses.)

Name.....Address.....

City.....State.....

Check here, if a veteran

COMMERCIAL RADIO INSTITUTE

A RADIO TRAINING CENTER FOR 26 YEARS

Resident Courses Only • Broadcast, Service, Aeronautical, Television, W.H.F., Freq. Modulation and Marine telegraphy classes now forming for fall term Oct. 1.

Literature upon request. Veteran training

Dept. B, 38 West Biddle Street, Baltimore 1, Maryland



Founded in 1909

RADIO TELEPHONY RADIO TELEGRAPHY

Courses ranging in length from 7 to 12 months. Dormitory accommodations on campus. Advanced students eligible for practical training at KPAC, 1 KW broadcast station owned and operated by Port Arthur College. New students accepted monthly. If interested in radio training necessary to pass F.C.C. examinations for first-class telephone and second-class telegraph licenses, write for details.

PORT ARTHUR COLLEGE PORT ARTHUR TEXAS

Approved for G.I. training

F. M. Reception

(Continued from page 73)

any kind are required to put it into operation — no tuned i.f. transformers to align, and no discriminator transformer to balance.

Users of the resistance-coupled i.f. system will recall that one of its defects was "two-spot tuning." This is eliminated in this receiver through the use of a conventional mixer and oscillator in the second converter unit, instead of the autodyne type of detector used in the resistance-coupled supers of bygone days.

Just a word about performance. This experimental receiver was built for use in the old f.m. band, 42 to 50 Mc. We have heard it work in conjunction with a high-fidelity amplifier, and can find nothing lacking in its quality.² We have also run sensitivity and selectivity tests here in the lab, and find that its performance in both these respects compares favorably with the better commercial units built for that frequency. Sensitivity is excellent. The leakage of the signal generator (something under 0.1 microvolt) can be heard, and 1.0-microvolt input provides appreciable quieting of the f.m. noise.

The selectivity curve is essentially straight-sided, and is about 100 kc. wide at 30 microvolts, increasing to only 200 kc. at 1000 microvolts. This degree of selectivity is just about right for 2-meter amateur work, indicating that the substitution of a 144-Mc. r.f. section for the 42-Mc. r.f. end would make the receiver a very hot item for 2-meter operation.

For f.m. work on 6 or 10 meters a somewhat narrower response would be desirable. This could be obtained by using a lower frequency than 10 Mc. in the second converter.

— E.P.T.

² Measurements made by the designer show less than 1% f.m. distortion with ≈ 75 -kc. swing.

About the Designer

• W. W. Moe, who was responsible for the design of the receiver described herewith, has been active in amateur radio since 1926, when he was first licensed as 9BVE. He also held 9GGT and 9GGN.

He received his B.S. in E.E. from the University of Colorado in 1934, and was employed by the General Electric Co., Bridgeport, Conn., as a radio receiver engineer, from 1935 to the end of 1945. In 1939 he did the design work on the well-known JFM-90 f.m. translator. During the war he worked on naval radar equipment, and after VJ Day on television receiver design.

As W1JKC, Stratford, Conn., he is interested chiefly in v.h.f. experimental work and in high-fidelity sound engineering. He is now working as an industrial electronics consultant.

FIRST AGAIN!

THE NEW 10-11 METER

GON-SET CONVERTER

For Fixed — Mobile Use. Built In Pre-Selection

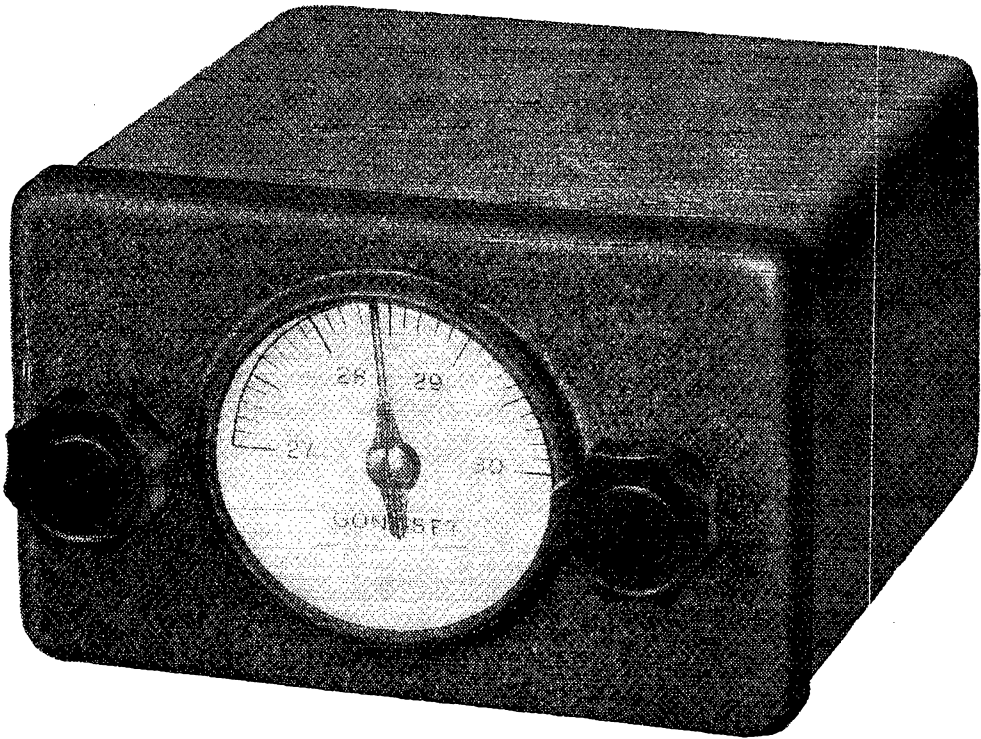

Actual size is slightly larger— $3\frac{1}{2}''$ x $5\frac{1}{2}''$ x $5\frac{1}{2}''$.

The new Gon-set 10-11 meter converter, complete with built-in pre-selection is designed for use with either broadcast, auto, or communication receivers. Attaching the converter to your present radio provides unexcelled mobile or fixed reception.

Gon-set converters have been manufactured since 1938 and are used world wide. Long experience, together with precision design and construction assures a superior product. Ideal for surplus receivers.

- ★ Tubes: 6AK5 R.F.—6AK5 Mixer—6C4 OSC. OB2 Voltage Regulator
- ★ Complete Bandspread 27-30 MC.
- ★ Output: 1500-2000 KC.

- ★ 8-1 Vernier
- ★ Illuminated Dial
- ★ Connecting cables included
- ★ Weight: 2 lbs.
- ★ Single Dial Control
- ★ On-off Switch Provided
- ★ Completely wired and tested, not a kit

• IMMEDIATE DELIVERY •

Price Complete.....\$39.95
Special Noise Silencer..... 8.25
High Frequency Antenna Lead Cable..... .08 foot
OPA Approved **W6VR**

WATERPROOF ELECTRIC COMPANY

70 East Verdugo Avenue

Burbank, California

HAM

HEADQUARTERS FOR Equipment and Information

SPECIALS

Aladdin—5.3 MC IF Transformer input—output Diode.....	\$1.15
Colonial Radio Corp. TBY Whip Antenna.....	1.95
BC-312 6-Band RF coils with switch Pyrex glass insulator with four MTG screws.....	.39
3 Mfd.—2000-Volt G.E.....	3.50
3 x 3 Mfd. 600-Volt Oil Filled.....	.99
Tubes—3C24/24G.....	1.90
Aero Running Time Meter. 60 Cycle AC.....	3.50

MAIL ORDERS PROMPTLY FILLED

Amateurs to Serve You
(20% Must Accompany All C. O. D. Orders)

Write to Dept. QST

W6SCQ • W6UXN • W6NAT • W6SSU

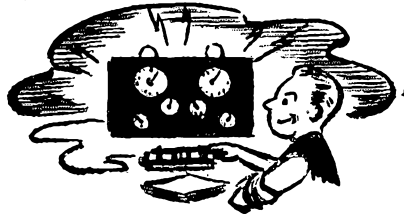

FOR YOUR NEW RIG
We Have a Good Stock
of All Standard Lines

SUPER DELUXE SPECIAL

5-Tube 24 Watt Code Practice Osc. \$29.50
A few minor changes the amplifier can be converted to speech or P.A. Audio Amplifier, complete with tubes and dust cover.

Radio Product Sales Company

238 WEST 15TH STREET
LOS ANGELES 15, CALIFORNIA PRespect 7471

LINE SPACER

- LOW LOSS
- EASILY ATTACHED
- NOISELESS

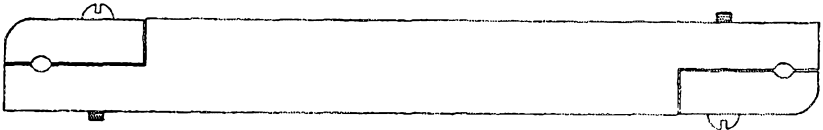

PATENT APPLIED FOR

Type LX-2 (2 in.)	.35 list	.21 net
Type LX-4 (4 in.)	.45 list	.27 net
Type LX-6 (6 in.)	.60 list	.36 net

Amateur's net price at your jobber — or direct if he does not stock them

● **LOW LOSS.** Fabricated from Amphenol 912-B (a crystal clear, hard, tough acrylic thermoplastic, light in weight, strong and durable) possessing excellent electrical characteristics at high frequencies — low power factor — low loss factor.

● **LOW MOISTURE ABSORPTION.** Possesses excellent water and weather resistance. Will not discolor from sunlight or outdoor exposure.

● **EASILY ATTACHED.** A feature of the Type LX Line Spacer is that it is easily attached to line without threading wires through holes.

● **NOISELESS.** There is no metal contact between line wire and spacer to cause noise or changes in line characteristic. The use of tie-wires or set screws in direct contact with line wires is a contributing cause of unsuspected high noise level.

SEE THEM AT YOUR DISTRIBUTORS!

FREE — Write for pamphlet "HOW TO FEED YOUR ANTENNA DIRECTLY WITH A 500-OHM LINE," by A. L. Munzig, W6BY.

MR. JOBBER: If you do not stock this fast moving item write or wire for samples and discounts.

The **ARTHUR L. MUNZIG MANUFACTURING CO.,** Redlands, California
Factory: Laurelwood and Tippecanoe Ave., Loma Linda, California

Munzig COMMUNICATIONS EQUIPMENT



**ANNOUNCING A
NEW LINE OF AMATEUR**

ANTENNA EQUIPMENT

The Workshop has developed an entirely new line of antennas and accessory mast equipment for the 2-, 6-, and 10-meter bands. Designed by the staff of an organization which manufactured the finest and most precise airborne antennas for the Navy and Army Air Forces, these new antennas offer the maximum in performance. The elements are made of aluminum alloy tubing, sealed on the ends with spherical tips. They are securely mounted in a heavy molded plastic head which gives the whole assembly ample ruggedness to withstand winds of high velocity. Another design feature is the interchangeability of parts, which permits easy conversion from one band to another by merely changing elements and a few accessories.

As companion equipment the Workshop mast provides a complete antenna installation designed to operate as a unit. The mast is assembled from 4-foot units with telescoping joints, readily adaptable to any desired height. Hand rotation is standard equipment, easily adapted to Selsyn or electric motor drive. (New Workshop remote rotating device for above mast equipment to be announced soon.) Workshop antenna equipment is available through the better amateur dealers everywhere.

1. 2-Meter Beam Antenna Model #146AB. A high-gain, directional, 6-element array with two driven elements. Price.....\$19.00.
2. 6-Meter Beam Antenna Model #52AB. A high-gain, directional, 3-element antenna to be used with Workshop rotating mast equipment. Price.....\$8.00.
3. 10-Meter Dipole Antenna Model #29AD. This bi-directional antenna is designed to cover the spectrum from 27 mc. to 30 mc. Telescoping elements adjustable to any length between 130 and 214 inches cover the new 11-meter band as well.
4. Antenna Mast Kit Model #AM. Two sections of 4-foot mast complete with adjustable mounting brackets, nuts, bolts, etc. A stationary mast to be used with all Workshop antennas. Price.....\$7.25.
5. Model #AM1. Extra 4-foot sections to lengthen the above mast. Price.....\$1.30.
6. Rotating Accessory Kit Model #AM2, to convert Model #AM mast to a manually rotated mast, complete with instructions. Price.....\$4.25.

The above are the amateur net prices—slightly higher in the far West.

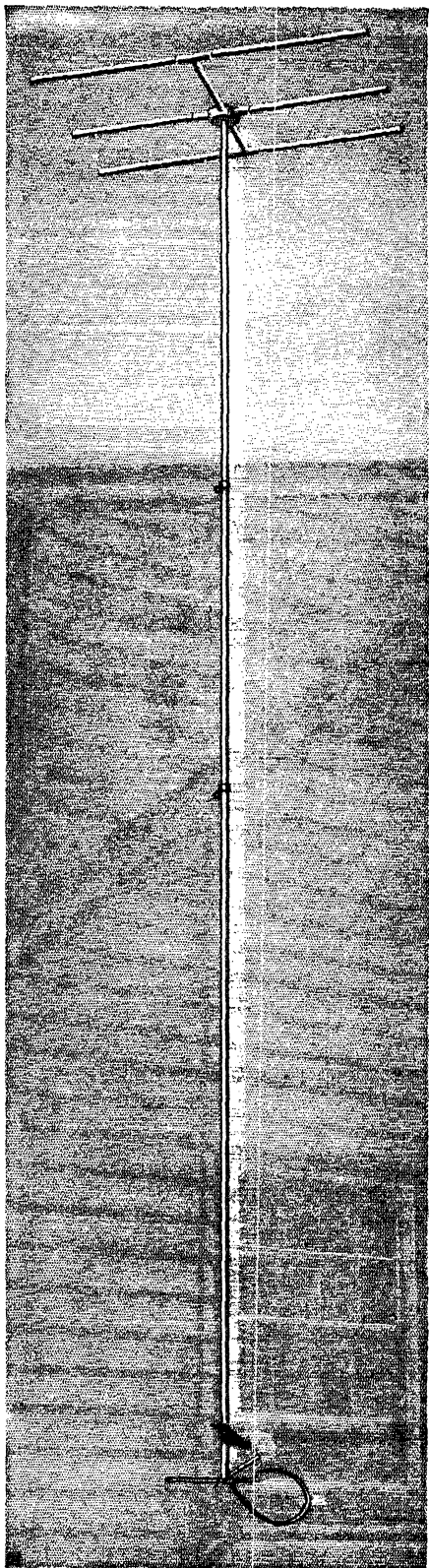

The WORKSHOP ASSOCIATES
Specialists in High-Frequency Antennas



66 NEEDHAM STREET, NEWTON HIGHLANDS 61, MASSACHUSETTS

"SURPLUS"

Filter Condensers

8 mfd. @ 1000V • \$3.25 Net

Dual 8 mfd. @ 1000V • \$5.95 Net

These are made by a well-known condenser manufacturer and are really a buy for the money.

* * *

National R-154 R.F.C. • \$1.39 Net

* * *

Johnson 250F20 — 250 mf. .045"

Spacing • \$2.50 Net

* * *

Jennings 50 mf. 32,000V Vacuum
Condenser • \$7.50 Net

* * *

ALL ABOVE SUBJECT TO PRIOR SALE

W. D. BRILL CO.

198 TENTH ST. • OAKLAND 7, CALIFORNIA

W6KLO

W6SSN

W6FJX

RADIO

RADIO Technician and Radio Communications courses.
Register now for new classes starting first Monday of each
month. Day and Evening Classes.

AMERICAN RADIO INSTITUTE

101 West 63d St.

New York 23, N. Y.

Approved under GI Bill of Rights

ELECTRONIC INSTRUCTORS

WANTED

Practical experience with industrial control circuits. Thyatron and ignitron experience. Phase-shift control experience. Timing circuits. Photoelectric circuits. High-frequency heating. Can also use men with radio experience. \$250 per month to start. Salary increases when you have proved your ability.

An old, established school with
30 years experience teaching
electricity and electronics.

LEE WILCOXON

2150 Lawrence Avenue

Chicago 25, Illinois

Combination Test Meter

(Continued from page 62)

tion entirely on the r.f. output of the transmitter, a great deal of reliance can be placed on the information indicated by the meter. Thus, a remotely-controlled transmitter in the attic may be checked from an operating position in the living room with complete assurance that everything is as it should be. Any change in frequency, carrier strength, or modulation would be instantly noted on the meter, permitting the transmitter to be made inoperative before serious damage could be done to the equipment.

The only precaution that need be observed in constructing the device is in soldering the 1N34 crystal diode and the copper-oxide rectifier. Both of these units can be damaged by excessive heat, so considerable care should be exercised during the soldering operation. The units should be held by a pair of long-nose pliers close to the joint being soldered so that most of the heat will be dissipated into the pliers.

World Above 50 Mc.

(Continued from page 63)

gued that it would be years before there would be any amateur interest therein. But not only has there been amateur activity in every one of the microwave bands except the 1145-Mc. band, there also has been some competition to see who can work the farthest in some of them. Who would have guessed, a few years back, that 1946 would see amateurs working on 10,000 and 21,000 Mc.?

Latest news in this field is from D. L. Thompson, W6IFE/3, and W. F. Kennedy, W4HPJ/3, both now of Washington, D. C., who have stretched the distance for amateur work on 10,000 Mc. to 7.65 miles. Assisted by W. C. Mock, W3AMQ, these fellows were using 723A/B oscillators on 10,010 and 10,040 Mc. Note the 30-Mc. difference frequency, which is taken off at each end through an i.f. and audio system in the usual manner. Parabolic reflectors 30 inches in diameter were used, with a dipole in one set-up and an electromagnetic horn in the other. Preliminary tests were made at 300 feet and 2 miles, but the final test at 7.65 miles showed very little reduction in signal level.

The boys suggest that anyone wishing to try 10,000 Mc. first head for the nearest surplus dealer, for if you can locate an old radar receiver with a 723A/B local oscillator, you're practically in business! It is merely necessary to modulate the repeller voltage with a carbon mike. Care should be exercised in moving the oscillator into the amateur band, as the tube must be run with maximum rated cavity potential, and the cavity must be warped more than it was originally designed for. It was found necessary to file off the spot weld on the nuts on the fixed strut and run the nuts up approximately two turns.

PANORAMIC RECEPTION

attends the opening of the 20 and 40 meter bands

When the 20 and 40 meter bands reopened for amateur communication with all the excitement and ceremony that usually accompanies a "first night," a Panadaptor sat in on the fun. Below is an account, with illustrations, of the activity that took place before, during and after that long-awaited ham occasion.

(As Viewed by W2LNP)

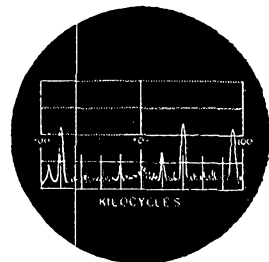
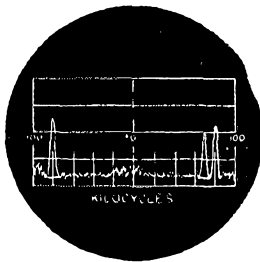
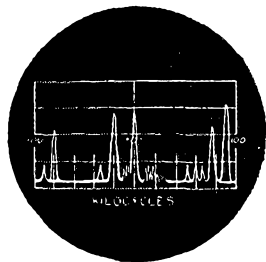

THE STAGE WAS SET! At approximately 11:30 P.M. the British Broadcasting Company and a Spanish station were still to be seen and heard on the 40 meter band. Their signals occupied the center of the screen. On the edge of the screen, but outside of the band, were a few cw and phone stations.

12 MIDNIGHT! All activity within the band ceased. The stations on the outside fringe remained on.

2:00-2:30 A.M.! Signals appeared on the band. Patterns of deflections showed that these were only carriers, and not actual communications.

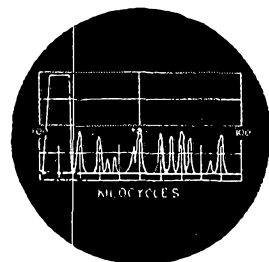
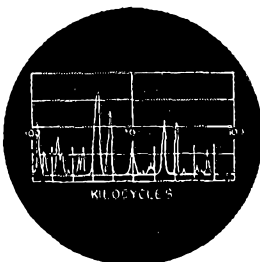
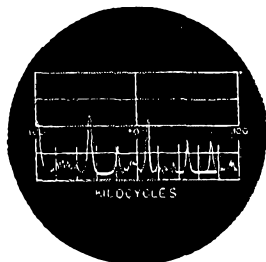

4 A.M.! And the official message from the official station of ARRL, W1AW, announced to all amateurs that the 20 and 40 meter bands were again their property.

4:05-4:30 A.M.! Within a few minutes of the announcement, about fifteen stations were on the air... early birds! W2LNP, the station to which the Panadaptor was rigged, exchanged greetings with W6SET in Fontana, California, a station whose signal appeared on the screen.

4:45 A.M.! The number of stations on the air was growing. And activity on the 40 meter band appeared to be normal for the first time in many years. About the same time, a large signal suddenly sprang up... which appeared to be a local station. This was found to come from KZ5AA in Panama, C.Z.

Only with Panoramic Reception was it possible to see a Panoramic picture of what was happening and where. Panoramic Reception permits you to do the same every day of the year! With it, you can see a continuous visible picture of band activity that enables you to spot signals . . . and to identify them. It adds to the efficiency . . . ease of operation . . . fun . . . of amateur radio. See it at your radio parts jobber now.

Get what you're missing

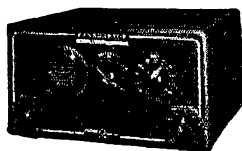

. . . with PANADAPTOR

The PANADAPTOR, Model PCA-2, is a 10 tube electronically tuned superheterodyne with a self-contained scope, complete for 115V, 50-60 cycle operation, at ONLY \$99.75 net. GUARANTEED FOR ONE YEAR.

PANORAMIC

SOLE AGENTS
PANORAMIC NEW YORK



RADIO CORPORATION

242-250 WEST 55TH ST. New York 19, N.Y.

Exclusive Canadian Representative: Canadian Marconi, Ltd.

Easy Terms Trade-ins

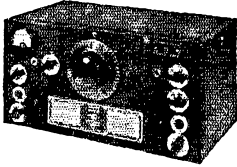

NATIONAL HRO-5-TA1

Latest model of this famous receiver, incorporating new type noise limiter, four continuous coverage and band spread coils supplied, covering frequency range of 1.7 to 30 MC.

Receiver, with tubes.....net \$274.35
Power Supply, 115 volts AC.....net 20.36
Speakernet 12.00

NATIONAL NC 46 RECEIVER

Operates from 120 volts AC or DC, 10 tubes, frequency range from 540 KC to 30 MC covered in four bands.

Receiver, with tubes.....net \$97.50
Speakernet 9.90

Standard
RADIO & ELECTRONIC
PRODUCTS COMPANY

135 E. SECOND STREET • DAYTON 2, OHIO

Mass. Radio School

271 Huntington Ave., Boston 15, Mass.

For over 27 years the educational radio center of New England. Prepares for all U. S. Government Radio Operators' Licenses. Also gives Radio Technician Training. Approved courses for Veteran Training under G.I. Bill.

Licensed by Commonwealth of Mass.,
Department of Education

High Forward Gain, Wide-Spaced, 4-Element,
All-Aluminum

10 METER BEAM

and High Forward Gain, Wide-Spaced,
3-Element, All-Aluminum

20 METER BEAM

These end-fire arrays are wide-spaced and so have much greater gain than the old-fashioned close spaced variety. Check with articles in late issues of various magazines. They are made entirely of hard alu. and do not use any wood, brackets, cradles, etc., as the elements pass directly through the central boom and are fastened there. Very strong and very light.

No tuning or adjustments of any kind are necessary.

Up to ten times power gain over ¼ wave ant. Greatly reduces QRM, ignition noise, feedback, BCI (except out front in line of fire). Shipped in wood boxes, express prepaid within 1000 miles, 10 meter beam \$50, 20 meter beam \$100. Only needs screw-driver and pliers to assemble. Send for literature.

U.H.F. RESONATOR CO.

W. F. Hoisington, WILAS/2

GUION ROAD, RYE, N. Y. Telephone Rye 2030

Correspondence

(Continued from page 72)

144 MC.

10, 110 Pierce Dr., Woodmoor, Silver Spring, Md.
Editor, QST:

... In my opinion the 144-Mc. band is in pretty sad shape. It is being loused up by rotten operating and bum receivers. Regarding the operating techniques, many stations sign hurriedly and never use phonetic symbols for their call letters. After calling CQ or finishing a QSO they seem to come back to the first station they hear or the loudest station on the band. Many then proceed to work some "DX" station 40 miles distant when they are being received 100 or 200 miles away. And then they complain about "conditions being bad tonight"! I think these fellows must be fugitives from 75 meters, where a kw. is required to blast thru the QRM, a 4-tube a.c./d.c. performs almost as well as a good receiver (on account of heterodynes), and there is no such thing as a signal fading in and out of the tube noise and consequently being half readable. . . .

I don't know what can be done with these fellows. Somebody, preferably someone in whom they have confidence, should seek them out one by one and give them the word, but if I ask you to publish this blast I will be blackballed, except possibly for one or two who would get decent receivers, correct their operating techniques and thank me for the advice.

Can't they learn that v.h.f. DX requires a really good receiver? If I go from 30 watts to 1 kw. that's 15 db. and several hundred bucks, but a surplus radar receiver costs only \$20 or \$30 and might mean 20 or 30 db. improvement over some of the receivers in use.

— William L. Smith, W3GKP

THE ENDLESS QUESTION

6715a Crest, University City 14, Mo.

Editor, QST:

... I believe that amateurs should be limited in power to 100-watts input to the final because with the influx of new amateurs the QRM will be terrific; Australians are limited to 50 watts and certainly do a swell job; the average ham cannot afford over 100 watts; it will limit BCL trouble to a great extent; it will make hams perfect their equipment and hence make better qualified operators. . . .

I was in a position to see what amateur radio did for the war effort. Without ham operators, communications and radar would have never succeeded. In my estimation ham radio did a tremendous job. It must go on, it must have every man it can get, it is the training ground the Army and the Navy need, the experimental ground the broadcasters need and must not be cluttered up with a lot of high power just so some lux can sit back and be sure he won't have to exert himself and repeat a word. . . .

— Wells R. Chapin, W9DIJ

Strays

Amateurs who are fraternal Masons, particularly those with QTHs in the Chicago area, are asked to contact M. Warren Clark, W9YDV, 2916 N. Albany Ave., Chicago 18, Ill.



RCA INSTITUTES, INC.

Offer thorough training courses
in all technical phases of

RADIO and TELEVISION

WEEKLY RATES

DAYS—EVENINGS

VETERANS: RCA Institutes is approved
under G. I. Bill of Rights
For Free Catalog write Dept. ST-46

RCA INSTITUTES, INC.

A Service of Radio Corporation of America
75 Varick Street, New York 13, N. Y.

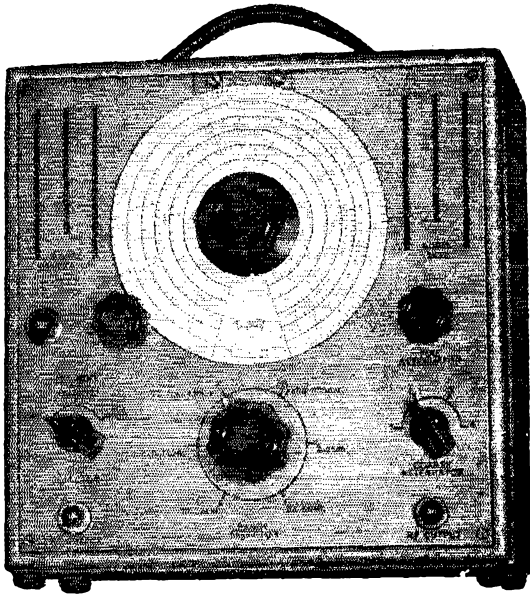

For the Man Who Takes Pride in His Work

**FM and Television Band Coverage on
Strong Harmonics. Strong Fundamentals to 50 MC:**

Another member of the Triplet Square Line of unmatched units this signal generator has features normally found only in "custom priced" laboratory models. **FREQUENCY COVERAGE** — Continuous and overlapping 75 KC to 50 MC. Six bands. All Fundamentals. **TURRETTYPE COIL ASSEMBLY** — Six-position turret type coil switching with complete shielding. Coil assembly rotates inside a copper-plated steel shield. **ATTENUATION** — Individually shielded and adjustable, by fine and coarse controls, to zero for all practical purposes. **STABILITY** — Greatly increased by use of air trimmer capacitors, electron coupled oscillator circuit and permeability adjusted coils. **INTERNAL MODULATION** — Approximately 30% at 400 cycles. **POWER SUPPLY** — 115 volts, 50-60 cycles A.C. Voltage regulated for increased oscillator stability. **CASE** — Heavy metal with tan and brown hammered enamel finish.



**MODEL 2432
SIGNAL GENERATOR**

Triplet

ELECTRICAL INSTRUMENT CO., BLUFFTON, OHIO

**A MUST IN EVERY LAB . . .
ON EVERY SERVICEMAN'S BENCH . . .
IN EVERY SERVICE KIT . . .**

A pocket-size

OSCILLOSCOPE

The **POCKETSCOPE**

- So **SMALL** in size (4" x 6 $\frac{3}{8}$ " x 10") • So **LIGHT** in weight (5 $\frac{3}{4}$ lbs.) • So **COMPLETE** in performance
- So **INEXPENSIVE** in price • Plus **WIDE-ANGLE VISION**: on shelf, on floor, on bench • Plus **RETRACTABLE LIGHT SHIELD**: for increased visibility.

A 2" "pocket-size" scope incorporating the cathode ray tube, vertical and horizontal amplifiers, linear time base oscillator, synchronization means and self-contained power supply.

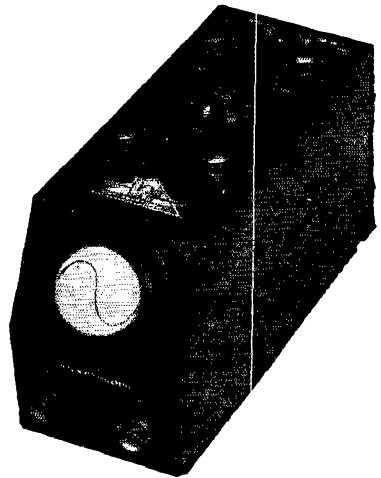

FOR DELIVERY :

Contact your nearest jobber. If he doesn't have the POCKETSCOPE available, contact us direct.

WATERMAN PRODUCTS CO.
INCORPORATED

PHILADELPHIA 25, PENNSYLVANIA



HAM-ADS

(1) Advertising shall pertain to radio and shall be of nature of interest to radio amateurs or experimenters in their pursuit of the art.

(2) No display of any character will be accepted, nor can any special typographical arrangement, such as all or part capital letters be used which would tend to make one advertisement stand out from the others.

(3) The Ham-Ad rate is 30c per word, except as noted in paragraph (6) below.

(4) Remittance in full must accompany copy. No cash or contract discount or agency commission will be allowed.

(5) Closing date for Ham-Ads is the 25th of the second month preceding publication date.

(6) A special rate of 7c per word will apply to advertising which, in our judgment, is obviously non-commercial in nature and is placed and signed by a member of the American Radio Relay League. Thus, advertising of bona fide surplus equipment owned, used and for sale by an individual or apparatus offered for exchange or advertising inquiring for special equipment, if by a member of the American Radio Relay League takes the 7c rate. An attempt to deal in apparatus in quantity for profit, even if by an individual, is commercial and all advertising by him takes the 30c rate. Provisions of paragraphs (1), (2), (4) and (5), apply to all advertising in this column regardless of which rate may apply.

(7) Because error is more easily avoided, it is requested signature and address be printed plainly.

Having made no investigation of the advertisers in the classified columns, the publishers of QST are unable to vouch for their integrity or for the grade or character of the products or services advertised.

QUARTZ—Direct importers from Brazil of best quality pure quartz suitable for making piezo-electric crystals. Diamond Drill Carbon Co., 719 World Bldg., New York City.

AMATEUR radio licenses. Complete code or theory preparation for passing amateur radio examinations. Home study and resident courses. American Radio Institute, 101 West 63rd Street, New York City.

WRL Transmitting kits—15, 35, 70, and 150-watt units—low priced. All makes of receivers, both new and reconditioned. Leo offers best trade-in deal, and easy time payment plan. One of the country's largest parts supply houses. Write today for free catalog, special radio map offer, tube-base calculator offer, and other items. Leo, at World Radio Labs, Dept. HA, Council Bluffs, Iowa.

RADIO tubes, parts, condensers, free bargain lists. Potter, 1314 McGee, Kansas City 6, Mo.

YOUR station call plate beautifully cast in aluminum, size 2" x 5 1/4". Two styles, Type P, with tapped bosses for panel mounting. Type D for desk use. Price either type, \$1.50. Duplicates of same type, 75c each. Print your call plainly. P & H Sales Co., 619 Jasper Street, Kalamazoo 31, Mich.

QSLs samples. H. L. Carter, Jr., W8JOT, 749 S. Plymouth, Rochester 8, N. Y.

QSLs. Samples. Glenn Print, 1042 Pine Heights Ave., Baltimore 29, Md.

COMMERCIAL radio operators examination questions-and-answers. One dollar per element. G. C. Waller, W5ATV, 6540 E. Washington Blvd., Tulsa 15, Okla.

OLD amateur, commercial radio sets, parts, catalogs, wanted. Will trade new gear or pay cash. McMirdo Silver, Simsbury, Conn.

ELECTRICAL Instrument Service, 15 Howard Avenue, Vallejo, Calif. Send us your meters and instruments for fast and reasonable repair, calibration and conversion. Write for estimates.

WALKIE-Talkie wanted, or small transceiver. Hulse, 1547 Cole St., Baltimore 23, Md.

HEADQUARTERS in the Pike's Peak region for amateur gear. Write for catalog and free IRC Resistor-Guide. Mail orders given special attention. Large stock Hammarlund, RME, Taylor, Eimac, etc. Complete stock Peterson Crystals, Don (W0HDDU) at Murray Radio Co., 502 West Colorado Ave., Colorado Springs, Colo.

CRYSTALS: Precision low drift units, Type 100A in 80, 40, and 20 meter bands. Two units plus in one octal socket. One dollar each. Rex Bassett, Inc., Ft. Lauderdale, Fla.

EIMAC 100 TS VT-127 triode h.f. tubes, 5-volt filament 500-watt input, \$4.50. Petersen crystals, 10-meter, \$5; 20-meter, \$3.50; 40 meter and 80-meter, \$2.80. Hallicrafters transmitter, complete ready to go on 10, 20, 40 and 80 meters, \$35. Many surplus items available. Radio & Electronics Supply, P. O. Box 1171, Laredo, Texas.

W2PTS is former W8CJJ.

FOR SALE: transmitter receiver combination, mobile type, for 10, 40 and 80-meter bands, \$125. To buy: we pay best prices for National, Hammarlund, Western Electric, Collins a/c, and Hallicrafters transmitters and receivers. GI Radio Exchange, Box 431, Coral Gables, Florida.

WE have the machinery, skill and the desire to do an excellent job on that new equipment you are planning or building. We cut any size round or oblong holes for meters, speakers, dials, and transformers. We build special cabinets, parts for dial mechanisms, rotary beams, etc. We engrave or letter panels, dials, and meters. We duplicate most equipment in Handbook and QST. Write for information and prices. S & G Instrument Co., Box 1461, Tulsa 1, Okla.

QSLs, samples free. Radio Headquarters, 1704 Hale Avenue, Ft. Wayne 6, Indiana.

HAM Crystals: \$2.25 (2 for \$3.75) mounted FT243 type holder, 3 Mc to 9 Mc. within 10 Kc. of requested frequency. Kipp, 277 B'way, NYC 7.

HAVE some heavy duty chokes, meters and ham equipment. No lists. Write your requirements. Leitch, 34 Park Drive, West Orange, N. J.

FOR Sale: RCA 500-watt phone xmitter. Make offer. ABC Radio, Danville, Ky.

FOR Sale: meters, condensers, transformers. Send for list. Richard Baker, W8DRG, 513 North Main St., Orrville, Ohio.

WANTED: 1500 or 2000 VDC power supply or just transformer and chokes. Will trade new 813s or pay cash. Hal Willes, W3KIM, 3909 Gwynns Falls Pkway, Baltimore 16, Md.

WAR Surplus radio parts: condensers, Sprague 1 μ f, 600 volt, oil-filled, metal encased tubulars, 10 for \$1.85. Micamolds 0.01 μ f 400 volt, molded in bakelite, 10 for 95c; Sprague 1 μ f 1500 DCMV, oil-filled, filter condensers, \$1.09. 1N21 Sylvania silicon crystal, 98c. Free circular for outstanding bargains. Erie Supply, 88 Exchange St., Rochester, N. Y.

SELL RME-45 complete, new condition, \$150. T. R. Chatten, 329 West 60th St., Los Angeles, Calif.

CRYSTAL blanks, precision, low drift, within ham bands 3.5 to 18.5 Mc. Specify range; 2 for \$1. Breon Laboratories, Williamsport, Pa.

FOR Sale or trade: two 50-watt transmitters, complete with mike, tubes, coils, crystals; 806J9, 809, 807; transformers and other transmitter parts. Write for list. Newton Amateur Radio Association, 137 East 12th St. South, Newton, Iowa.

FOR Sale: composite receiver, transmitter, audio equipment, parts, tubes. Gordon L. Schmehl, W9USP, Durango, Colo.

WANTED: Old style 6N7Gs with large glass envelope. RK20 transmitting tubes. October 1936 and April 1937 QST. SW3 coils, Nos. 18 and 19. W1BB

QST: 1920-1935, some years complete. 133 copies total. Make offer. E. Bouton, 8903 Eager Road, St. Louis 17, Mo.

WANTED: SW3, using 58 tubes with or without coils and power pack. Please quote price either way. K. S. Jackson, W1HB, 14 Chew Street, West Haven, Conn.

QSLs. The way you want them. Dossett, W9BHV, 857 Burlington, Frankfort, Indiana.

IN STOCK: War surplus. Cost government \$1,000. Special: \$78.50. B-19 consists of 25-watt 2 to 8 Mc. transmitter and receiver and 235 Mc/cycles transceiver, 5 mikes, phones, tubes, antennas complete with 12-volt d.c. dynamotor. Johnson 10-O, \$5.19 net. U. S. Army BC-610 used transmitter. The old reliable for "ham" rcvrs, xmitters, parts. We'll trade. Freck Radio & Supply Co., Asheville, N. C.

COLLINS broadcast amplifier 7R-9. See July Ham-ad Original carton, never used. Best offer takes it. Complete with tubes. Grey rack panel mounting. W0CVU, P. O. Box 224, Cedar Rapids, Iowa.

ROTARY beam antenna indicators. Use 2 Bendix selsyns as automatic antenna direction indicators. Will operate satisfactorily on 60-cycle supply. Price \$7.50 per pair. Instructions included. General Developments, 521 Fifth Ave., NYC.

EXCESS equipment: I Speco Signal Tracer; 1 Aerovox L-C checker. First \$45 money order takes both. Herbert O. Pueschner, Stetsonville, Wis.

SELL: new IRC 2500 ohm, 200-watt resistor, \$1.50; Cardwell smtng condenser 220 μ f, \$3.50; New Mallory T2-387, 1 μ f, 1500 volt filter condenser, \$3.50; new Solar X-23, 2 μ f 2000 volt filter cond., \$5; two new Pyrex, 7 1/2" long, 1/4 KIV antenna insulators, \$1.60; Pyrex 7 1/2" stand-off insulator, \$1.50; Hoyt 0-150, DC milli-ammeter, 2" dia., \$3; used Dunco 115 volts, AC keying relay, \$1. Sangamo 0.002 μ f, 2500 VDC mica condenser, \$1.10. New Vibroplex "Champion" key, \$8.50. All for \$29. T. B. Winstead, Elm City, N. C.

RADIOTELEPHONE first class sample tests, \$10. We correct. New correspondence course. Box 1298, Hollywood, Calif.

SELLING: new power supply, 115 input, 275-500 output. Army earphones with microphones. Also transceiver with accessories. Harry H. Wason, 57 Dartmouth Ave., Dedham, Mass.

RECEIVERS: New RME-45, RME-84, VHF-152, DB-20, NC-240D, HRO HQ-129X, Super-Pro, Hallicrafters, Panadaptors, Tenco transmitters, Roro-beams, Conklin Radio, Bethesda 14, Md.

QSLs? SWLs? America's finest! 10¢ for samples. Billey Crystals? RME-45? Sakers, W8ED, Holland, Mich. (Veteran).

NATIONAL NTE-B RF exciter speech amplifier, A-1 condition: \$150 or swap. W8CUT, 1449 Eggert Road, Buffalo, 21, N. Y.

XU6AZ-VS6AZ returning to China soon needs BC-779 or standard Super-Pro. All offers answered. Y. K. Luk, 6000 No. Sheridan, Chicago, Ill.

WANTED: Mim's 10-meter signal quarter beam. Will pay top price for beam in good condition. J. Michaels, 1000 Dean St., Brooklyn 16, N. Y.

SELLING my spare tubes: new HK-254s, \$11; 838s, \$7; 807s, \$1.50; 813, \$7; 830B, \$3; slightly used 813, \$4; 211s, \$4; 872-Aa, \$3; T2-40, \$1. W8OPB, Dalton, Ohio.

WANTED: Hallicrafters S20-R. Sell: New S41-G; Superior 450 tube tester, \$27.50 (f.o.b.). Gordon Wilkinson, Tulalake, Calif.

QSLs. Free samples. Dave Thompson, W9JIP, 737 W. 44th St., Indianapolis, Ind.

SURPLUS modulation and driver transformers, 20-watt, pr. \$2.95. HRH Electronic Supply, 2511 Burrmont, Rockford, Ill.

SELL new Signal Corps receiver, BC-348-R, two r.f. and three i.f. stages. Covers all ham bands except 10-meter, with 115-volt a.c. supply, \$70; also S-20R Sky Champion, perfect condition: \$45. Write Alan Stein, 552 Parkside Ave., Brooklyn 26, N. Y.

SELL six Westinghouse KU627 grid controlled rectifiers, \$4 each; also Radio City Products electronic multimeter, Model #661, \$25. WBLCI, 4750 Baptist Rd., Pittsburgh, Pa.

PROTECT that ham ticket with a Plex-O-View holder. Mounts on transmitter or wall. One dollar postpaid. De Los, W6QKI, 245 Los Alamos Dr., San Diego 2, Calif.

SELL 1000 new 6SL7 tubes at 65¢ in any lots desired. James Botsford, W2PYM, 704 Baronne St., New Orleans, La.

CODE keyer, Gardiner type "A," induction a.c. motor, adjustable speed, ten bases, like new: \$17.50. WSDTJ, 535 Astor Street, San Antonio 3, Texas.

SELL three tube receiver, #14, with power supply, \$19. Norman, 2432 Burt, Omaha, Nebr.

SELVSN motors, new G-E, for beam direction indicators, operate on 2 to 25 volts, 60-cycle, A.C. \$5 pair. George Toma, W8QPH, 835 Starkweather Ave., Cleveland, Ohio.

SELL or trade: 2 field strength meters, Simpson 50 microamp movements, three band, 2, 6, and 10. W9FNP, 687 W. Lexington Ave., Elkhart, Ind.

PANEL engraving. Any free-machining material. Professional service, fair prices, single pieces welcome. W. E. Gilpin, Box 638R4, Mt. Clemens, Mich.

SWAP RME-45 for RME-43 and \$94, RME-41 and \$112, or RME-99 and \$75. W41PS, Box 236, Vienna, Virginia.

6 or 12 volt dynamo power supply 500 VDC, 160 Ma. complete with cables and circuit breakers, relays, and filters, Govt. cost \$300, our price \$9.95 in perfect condition used. 0.002 3000 WVC mica, 89c, 6 for \$4.50; 955-9004 tubes, 75¢ ea; 6 for \$4; 1 µd oil cond. 1000 WVC, 75¢ ea; 6 for \$4; 75000 ohm 200-watt resistors 49¢ ea. 6 for \$2.75. Hershel, 5249 Grand River, Detroit 8, Mich.

SWAP: slightly used 804s, 805s, 838s, 204-A, for BC-221 frequency meter. Leland Wheeler, W1DIZ, Shelburne, Mass.

CATHODE ray tubes 5CP1As, brand new, \$7.95 (plus 6 lbs shipping; socket with tube, 45¢, otherwise 90¢; 5CP1 steel shields, 85¢ (3-lbs). Brand new 954, 956 acorn tubes, original cartons, 89¢ ea, postpaid. Free electronic bargain list, Ohmeyer Engineering, Dept. A, Fairview Blvd., Hempstead, N. Y.

NEW 240s, \$2.50 each, postpaid. Send card for list of other stuff. W6GDS, 1656 W. 59th St., Los Angeles 44, Calif.

SELL: 400-watt 807, T240, p.p., c.w. rig, made of best parts money can buy. All Weston meters. In compact case, 10 20, 40-80-160 coils. \$10.60/WJ, 1147 No. Howard Blvd., Tucson, Ariz.

10-meter converters, 2 tubes, \$26.95. Globe Radio, 2911 Elm, Dallas, Texas.

WANT OS7s to replace my copies which were lost at sea. Especially want volumes 1-9. Will pay any price within reason, or will trade Contx 2, brand new condition, with sonnar F/2.5 cm. Eveready case, filters, for complete file in good condition. George Meek, 440 Georgetown Ave., San Mateo, Calif.

KELVIN Electronics has items priced for hams only. Request list. 74 Cortland St., New York 7, N. Y.

HALLICRAFTERS S-36A. Slightly used, perfect condition. Will sacrifice to any reasonable bid. J. M. Junkins, W0CJS, Bryant, S. Dak.

WANTED: 100 Kc. frequency standard, Hallcrafters H & 7, Tetrad, or other similar unit. James Buck, W0ZDS, 1224 Orchard Drive, Ames, Iowa

FOR Sale: New tubes: four 832As @ 3.50; two 832s @ 4.50; four 6L21s @ 4.50; two 6L6s @ 5.00; ten 6J7s @ 3.50; six 6J5s @ 2.50; eight 6AK5s @ 90¢; five 6F8s @ 35¢; four 9001As @ 70¢; four 9002s @ 50¢; seven 9003As @ 50¢; two 9V150/30 @ 50¢; ten 6V6GTs @ 35¢ five 6SN7GTs @ 35¢; five 6X5GTs @ 25¢; 1 Philco battery signal generator @ \$8; 1 pocket volt-ohm-milliammeter @ \$7. Will sell singly, You pay postage. William B. Johnson, 15616 Leadwell St., Van Nuys, Calif.

SELL Instructograph-Electric. Best condition. \$22. Paul Buckley, 5511 Litch, Chicago, Ill.

TELEVISION magnetic deflection yokes for new 50" tubes and all other types \$14.75 each. Blocking oscillator transformers, \$3.50 per pair. Yoke matching transformers also available. Fully guaranteed. Teletron, 1988 East 59th St., Cleveland 3, Ohio.

LABORATORY galvanometer and microammeter, ideal for use as basic meter. Westinghouse type CAV, rugged dual movement, each independent with separate printed scale furnished: 100-1000 ua and 0-200 ua. \$6.50. Drilled metal cabinet available, as illustrated in December Radio News. Write for circular, form c.o.d., enclose \$1. Radiolab, 652 Montgomery St., Brooklyn 25, N. Y.

SALE: National SW-3, National 1-10. Write for details. W2PXZ, B. L. Norcross, 42 Laurel Ave., Linwood, N. J.
3 Acme 600 mil 30 henry chokes, 3 UV204-a. Make offer. W0BZV, Box 551, Akron, Colorado.

SELL, trade new 8001, HK54, WE316A (door knob), 2C43, 554 (light house), 931A (multigrad FM), 807, 815, 832, 829B, 717A (SHF), 6AK5, 954 to 958, 866, 614, 6C4, Westinghouse 0-100MA, 0-150MA. Dual crystal 130-1300 Kc., 1750 Kc., 5BP1 (television), also slightly used Weston RF thermal galvanometer, 200 assorted tubes, hi-voltage mica condensers, new 300 ft. 50 Ohm Co-ax; Corona No. 3 portable typewriter, Excel. model 16 mm. projector, 600 ft. film, comed with 3 ft. screen; Electronic. Electronics mag dating back 1940 present date, recently purchased S20 R. tuning eye, new germanium crystal limiter, circuit added. M.O. \$65 buying HRO. Cash for used commercial transmitter about 100 watts. Irvin Gordon, W3JYZ, 2, 182 Hegeman Avenue, Brooklyn 12, N. Y.

ONE slightly used Harvey UHX10, model 38 xmtr and power pack. Also hand mike, extra set of tubes, set of coils for 160-m, 10-m, and 5-m. Also 100-watt mounted xtal. Seven L21 type ranging from 1775-S to 2043-S and three WLD5 type from 7061 to 7246. (One new RCA 810 tube and socket. Make me an offer on the works. Write to Dr. Arthur C. Whitaker, Jr., 97 E. Commerce, Bridgeton, N. J.)

SELL QSTs, 1930-1946 complete. Offer? W801G.

CRYSTAL processing kit, as advertised April QST. 4 crystal blanks, AT & BT cuts, covering all popular amateur bands including 10-meter, high activity guaranteed if you follow processing instructions. All equipment necessary to process your own crystals accurately and change frequency of your rig, quickly, easily, economically. Free: 1000 Kc. var surplus crystal without holder with each lot. Limited time only. Special price, \$8.75 f.o.b. General Electronics B, 116 West 5th St., Kansas City 6, Mo.

BC348 110-w. operation, good condition, highest cash offer. W5BUV, 202 Dickson, San Antonio 4, Texas.

TOWERS: for your rotary beams. Full lattice-work spruce construction. Priced for amateur. Write for Bulletin T-101. Sky-Lane Products, Ironwood, Michigan.

FOR SALE: 2-meter transceiver, all bands 35-w phone, cw, xmtr. Pair new 807s. Stamp for details. Ernest Austin, 1445 Ogden, NW, Washington, D. C.

FOR Sale: HQ-120-X. Excellent condition. Price \$100. George Britting, 12 Lincoln St., Middletown, N. Y.

SELLING W6CM transmitter with spare 100TH. Separate choke input power supply, six triodes, Shure 700 microphones, 6F5, 6C5, 6F6, push-pull 6A3s, push-pull T240s with V M 4 varimatch. Also complete Mims ten and twenty signal squirter. J. G. Harrington, Hagerstown, Ind.

WANT to buy a Hallcrafters SX-17 receiver in good condition. Will pay reasonable price. Write W5CC, Box 669, Denton, Texas.

AMATEURS, experiments, industrials and export accounts write for TAB catalog 300 and monthly bulletins. Buy the "TAB" way and save. IAB, Dept. Z, Six Church St., New York 6, N. Y.

BRAND new Cornell-Dubilier 0.5 mic 3000 v.d.c. condensers type TJH, 30005 or TJU 30005 @ 85¢ postpaid anywhere in U. S., \$9.75 per dozen. (Only postal note, money order or cash accepted. R. E. Bruce, 1032 Warwick Place, Dayton 9, Ohio.

WANTED: one Thordarson T-19H-64 plate transformer. State condition and price. W5LBR, W. A. Hensaring, Jr., Uvalde, Texas.

SELL: new condition: Thordarson plate transformer 560, 615, 670, 725 volts each side. CT 500 mls. \$7.50; Kenyon cathode-drive modulation transformer, T473, \$4. Will ship c.o.d. all f.o.b. W31CZ.

RECORDING playback unit: G.I. single-speed, complete with amplifier, xtal mic, speaker, portable. \$85. or would like SX-25 receiver. A. Vandervoort, W2DGG, 51 Chambers St., New York 7, N. Y.

WANTED: modulation transformer Thordarson 1M77 or equivalent. J. P. Gehegan, W2ODQ, 740 East 243rd St., Bronx 66, N. Y.

SELL: National FB7 with 20 and 40 meter coils. Homemade power supply. \$25. W. L. Mraz, Bernardville, New Jersey.

SUPER-PRO for sale, complete with power supply, bought new, surplus. Frequency range: 100-400 Kc., 2 1/2, 20, 200. Used few hours. W2EDF, Box Q, East Northport, Long Island, N. Y.

SELL or swap Supreme model 563 heat frequency audio generator, two 1µd 15,000 V.V. and two 2µd 4000 V.V. G.E. Pyronal condensers, and BC 406 15 tube radar receiver. Want communications receiver. K. Matzinger, Box 409, Red Bank, N. J.

SELL slightly used NC-240-C. \$230. J. G. Dittmer, 2116 S. Frazier St., Philadelphia, Penna.

COAXIAL Cable RG8U, 7c per ft. RG59/U, 9c per ft. See QST, April 1946, p. 51 for detailed description. Coaxial Cable Co., Box 19, Woodside, N. Y.

SIGNAL shifter coils. Information on request. Rodgers & Harris, Mt. Carmel, Ill.

SELL National NC-100 ASD receiver, \$110, also Hallcrafters S-39 Sky Traveler, \$90. R. S. Weiss, 1910 South Taylor Rd., Cleveland Heights, 18, Ohio.

ARC5 xmtr J-4MC GF12 xmtr, 2-9MC, ea. \$80 and perfect. W6VNO, 2035 Broadway, San Diego, Calif.

SELVSN motors: 115-v. 60-cycle, heavy duty, \$15 pair, less in quantity; 400-cycle units, 10 pair lots \$25. W2EDW, 201 W. 10th St., New York 11.

YOUR station call on bookmatches, 50 for \$1.45 postpaid. No c.o.d. Arlington Radio Shack, Jennings, W1VIX, 951A Massachusetts Avenue, Arlington, Mass.

FOR Sale: SX-28 A radio receiver, \$200. C. M. Giggey, 2539 River Drive, Denver 11, Colorado.

KENTUCKY values! GE Pyranols, 4 µd 1500 v., \$3.25; 15 µd 1500 v., \$6.50; Aerovox 2 µd 600 v., \$1.00; 4 µd 600 v., \$1.50; 16 µd 1500 v., \$9.75; 2 µd 4000 v., \$5.00. Waterman Pocketscopes \$55.00. Transformers, 4520 v. CT 700 Ma. \$4.95; 900 v. CT 250 Ma. \$4.25; 750 CT 250 Ma. 5v. 3a. \$4.75. Mallory 551 Vibropack \$8.00. Choke 15 hy 250 Ma. \$4.75. Taylor tubes, B & W coils, \$8.00. X 14 v. 21. \$1.32. 6L6 driver transformer \$2.75. Many other uses. Write for catalog. Write for circular, form c.o.d., enclose \$1. Kentucky Radio Supply Co., 519 Georgetown Street, Lexington, 25, Ky.

METERS: Westinghouse 4 1/2" round bakelite case D.C., calibrated for 1/10" sterl panel. 200 microamps full scale. \$5.95, 150 volts full scale, \$5.45. Used by in A-1 condition. Jaeger, 45 Sprague Road, Scarsdale, New York.

SELLING out: Meissner signal shifter, Meissner "signal spotter," Meissner "signal booster," prescaler; Meissner 5 and 10 meter converter; Meissner Model 150-B transmitter, 225 watts input, converted to work on all ham bands. All in A-1 condition. Make offer. Charles Rodgers, W9KMI, 727 Main St., Mt. Carmel.

INCREASE DX, 10 to 20-meter prescaler; two meter super-regenerative, new tuning circuit; free details. Constant Electric, 112 Cornelia St., Brooklyn, 21, N. Y.

SELL new, perfect Hallcrafters HT-9, coils and crystals all bands. Bought bigger rig. Two and one-half bills. W2WD.

SELL Hallcrafters SX-25 receiver with speaker, Millen exciter transmitter with coils, 2 bands and tubes, two power supplies of 250 and 500 volts, superregenerative 54.2, 4-tube exciter for opex, Bug, Turner VT73 xtal mike, 9 quartz crystals on three bands, miscellaneous parts. All new or in good condition. Offer for all? Ross Webster, W6CZP, 26 Pine St., Los Gatos, Calif.

FOR Sale: SW3 coils, 75-600 power supply, \$15.00. RK20A, new, with special screened mounted socket, chokes and bypass condensers attached, \$7.00. 500 w. Variac, \$6.00. Good SB carbon mike switch in handle and cord, \$2.00. New 210 (2) 250s, \$1 each, 7 1/2 v. filament transformer for RK20A, \$2. Ship collect first com. Dr. C. R. Crosby, 203 Union Ave., Framingham, Mass.

IMMEDIATE delivery National NC-240-C in original packing. Fine receiver. Very little use. Just re-checked by National. Delivery in USA prepaid. Regular price, W8ROM/9, Taylorville, Illinois.

TRANSMITTER for sale, 90-watt, final 6L6s in parallel, complete coils, relay rack and gray panels, tubes, crystal and meter. Change-over relay. Transmitter in excellent condition, 6 mos. old, ready to go on 80. Any offer over \$90 considered. Don McNamara, W9MZO, Anamosa, Iowa.

FOR SALE: Rotary beam antenna drive mechanisms, AC operation solenoid indicator, reversible, inertial control, precision built, rugged, weatherproof. Quantity limited. Price \$159.50 delivered. Write for details. Fred M. Myers, 4147 Virginia Ave., Kansas City, Mo.

Designed for

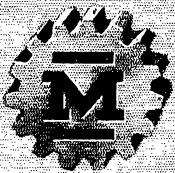

Application

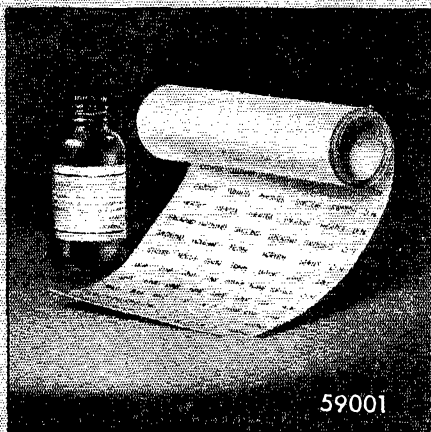

59001

**The No. 59001
PANEL MARKING
TRANSFERS**

The panel marking transfers have 1/8" white block letters. Special solution furnished. Must not be used with water. Equally satisfactory on smooth or wrinkle finished panels or chassis. Ample supply of every conceivable word or marking required for amateur or commercial equipment.

**JAMES MILLEN
MFG. CO., INC.**

MAIN OFFICE AND FACTORY
**MALDEN
MASSACHUSETTS**



Index to Advertisers

	Page
Allied Radio Corporation	129
American Phenolic Corp.	7
American Radio Institute	152
Ashe Radio Company, Walter	152
Astatic Corporation, The	137
Baltimore Technical Institute	134
Belmont Radio Corp.	144
Birnback Radio Co.	130
Brach Manufacturing Co.	128
Brill Co., W. D.	152
Bruno Tools	142
Burlington Instrument Co.	115
Burstein-Applebee Co.	130
Cambridge Thermionic Co.	110
Cameradio Co.	116
Candler System Co.	124
Capitol Radio Eng. Institute	95
Cardwell Mfg. Co., Allen D.	117
Centralab	8
Cleveland Inst. of Radio Electronics	148
Collins Radio Co.	83
Commercial Equipment Co.	94
Commercial Radio Institute	148
Condenser Products Co.	127
Cornell-Dubilier Electric Corp.	99
Crystal Research Labs.	144
Drake Electric Co.	106
Eitel-McCullough, Inc.	9
Electro-Voice Corp.	91
Federal Telephone & Radio Corporation	2, 109, 135
Gates Radio Company	105
General Electric Co.	1
Greenlee Tool Co.	126
Hall, R. C. & L. Co.	145
Hallcrafters Co., The	4, 5
Hammarlund Mfg. Co.	93
Harvey Radio Company	133
Hatry & Young	124
Henry Radio Shop	136
Hytron Radio & Electronic Corp.	125
Industrial Training Institute	152
International Resistance Co.	104
Johnson Co., E. F.	85
Knights Co., James	108
Lippman & Co., Aaron	120
Maguire Industries	119
Mallory & Co., P. R.	92
Marion Elec. Instrument Co.	107
Mass. Radio & Television School	154
McGraw-Hill Book Co.	138
Millen Mfg. Co., The Jas.	138
Munzig Mfg. Co., A. L.	150
National Co., Inc.	81, Cov. III
Newark Electric Co.	141
New York Technical Institute	142
New York YMCA Trade & Tech. School	146
Noble & Noble	140
Onan & Sons, D. W.	134
Panoramic Radio Corporation	153
Petersen Radio Co.	87
Port Arthur College	148
Premax Products Co.	146
Premier Crystal Labs.	147
Radio Elec. Service Co. of Penna.	118
Radio Mfg. Engineers	111, 159
Radio Prod. Sales	150
Radio Shack, The	123
RCA Institutes, Inc.	154
RCA Mfg. Co.	Cov. IV
Seeli & Co., R. G.	146
Schauer Machine Co.	134
Shur-Antenna Mount	138
Shure Brothers	98
Silver Co., McMurdo	100
Solar Capacitor Sales Co.	160
Sprague Products Co.	143
Standard Radio & Elec. Products Co.	154
Sun Radio & Electronics Co., Inc.	139
Sylvania Elec. Products Co.	89, 113
Telegraph Apparatus Co.	126
Terminal Radio Co.	121
Transmitter Equip. Mfg. Co.	102, 103
Triplet Elec. Instrument Co.	155
Turner Co., The	128
U. H. F. Resonator Co.	154
United Electronics	101
United Transformer Corp.	Cov. II
Valparaiso Technical Inst.	142
Valpey Crystal Co.	131
Van Sickle Radio Supply Co.	142
Vibroplex Company	140
Ward Leonard Electric Co.	140
Waterman Products Co.	155
Waterproof Electric Co.	149
Western Electric Co.	96, 97
Workshop Associates	114
World Radio Labs.	114

GET THE MOST

OUT OF YOUR RECEIVER

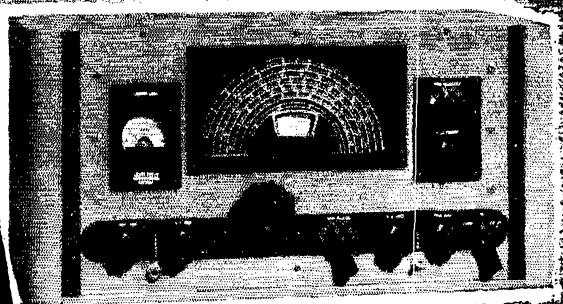
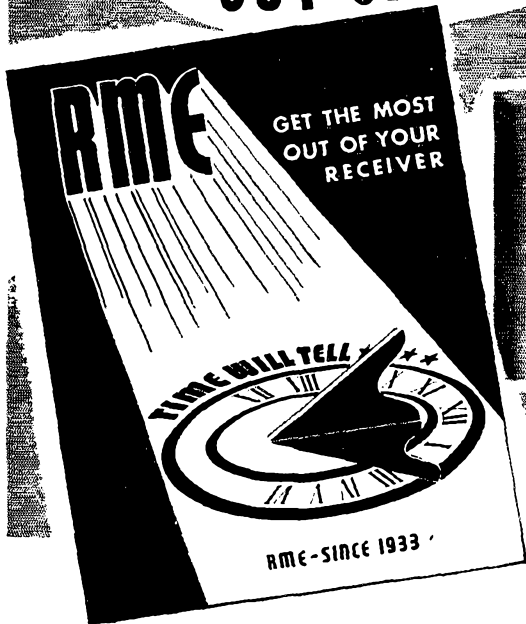

THE RME 45

Have you ever felt that you were not getting the most out of your receiver? If you have, you'll want to read RME's pamphlet on this important subject. Although it's sent to each owner of an RME 45 on receipt of his registration card, it's yours for the asking—regardless of the communications instrument you happen to own. If you are troubled with QRM, doubtless you'll find the material on adjustments for single signal reception especially beneficial. The pamphlet is one more example of RME service!

Simply address your request to Radio Mfg. Engineers, Inc., First Avenue, Peoria, Ill., and ask for your copy of **GET THE MOST OUT OF YOUR RECEIVER.**

You'll also find that the RME 45 provides many pleasant surprises—surprises that spell the difference between RME performance as against service from just another receiver. You'll like Two Speed Tuning which results in smooth, effortless, single dial control and calibration on five amateur bands with plenty of spread and real efficiency. Then there's voltage regulation that reduces drift to an absolute minimum, and an improved noise limiter that goes after all types of interference with a vengeance!

Make your own comparison—and you'll find the 45 gives you **MORE** for **LESS!**

Descriptive Folder
of RME 45 Also
Available.



RME

FINE COMMUNICATIONS EQUIPMENT

RADIO MFG. ENGINEERS, INC.

Peoria 6, Illinois U. S. A.



Have You Seen The Solar System?

FREE



It's a bi-monthly magazine of authoritative information on new developments in the capacitor field. Simply fill in the coupon below if you'd like to receive this easy-to-read technical publication regularly at your home or at your office.

Solar Manufacturing Corporation
285 Madison Avenue, New York 17, N. Y.

QST

Gentlemen: Please send me the SOLAR SYSTEM regularly, starting with the current issue.

Name.....

Address.....

City..... Zone No..... State.....



NC-46

Clean modern styling combines with advanced electrical design to make the NC-46 an outstanding choice for the amateur. Workmanship is of traditional National quality in spite of moderate price. Features of the NC-46 include a series valve noise limiter with automatic threshold control, CW oscillator, separate RF and AF gain controls, and amplified and delayed AVC. Four coil ranges cover from 550 Kc. to 30 Mc. A straight-line-frequency condenser is used in combination with a separate bandspread condenser. Look over an NC-46 at your dealer's, study it inside and out. It's a lot of receiver for your money.



NATIONAL COMPANY, INC.,



MALDEN, MASSACHUSETTS

Why the RCA-8005 is called "THE POWERHOUSE"

Ceramic washer minimizes corona discharge—provides superior bond to glass and plate cap, eliminating strain.

Heavy ribbon leads between cap and anode improve conductivity and reduce RF resistance.

Nonex hard-glass envelope will not crack, buckle or puncture under high operating temperatures.

Oversized 50-watt filament—the same as used in much larger tubes—has enormous reserve of emission.

Drawn-tungsten seal rods have smoother surfaces—hence, provide superior seals against air leakage.

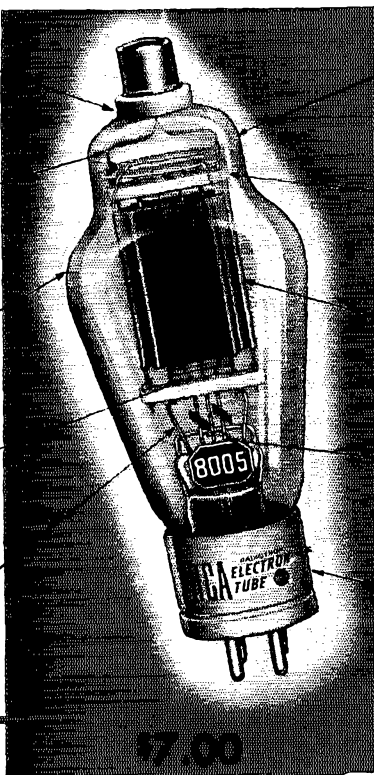

Dome construction insures rigid support of elements at top of tube—reinforces mount structure.

RCA alumina insulating separators are dimensionally uniform and chemically pure—hence, free of gas.

Zirconium-coated molybdenum anode provides unusually rapid heat dissipation and permits greater power input.

Guarded getter is flashed low on envelope, but fully exposed, so as to be quick and positive in action.

Sturdy metal base and low-loss ceramic insert combine strength with high heat and insulation resistance.

RCA-8005 has extra features for the final of that crystal-controlled "all-band" transmitter

The points of superiority built into the RCA-8005 transmitting triode combine to provide it with remarkable power handling ability and long life for a tube only 6-11/16" high and 2-7/16" in diameter. It is readily capable of taking 300 watts input (ICAS) at 1500 volts in Class C telegraphy, or 240 watts input (ICAS) at 1250 volts in Class C telephony.

The unusual heat-dissipating characteristics of zirconium-coated molybdenum permit the use of a smaller anode with a consequent reduction in the inter-electrode capacitances. This is one reason why the RCA-8005 may be operated at full ratings as high as 60 Mc. An 807 doubler will drive a pair of 8005's at 60 Mc. with power to spare.

Because of its power capabilities, wide operating range and low drive requirements, the RCA-8005 has received preference as a final amplifier for crystal-controlled transmitters covering the amateur bands from 75 to 6 meters. It is the answer to adequate power in all bands at low cost.

For further details, see your local RCA Tube Distributor or write RCA, Commercial Engineering, Section A-211, Harrison, N. J.

Have you seen HAM TIPS? Your RCA Tube Distributor has a free copy waiting for you.

**THE FOUNTAINHEAD OF MODERN
TUBE DEVELOPMENT IS RCA**



TUBE DEPARTMENT

RADIO CORPORATION of AMERICA
HARRISON, N. J.