

# selezione di tecnica radio-tv

# 2 a

numero speciale dedicato  
alle parti staccate G.B.C.

1961

SELEZIONE DI TECNICA RADIO - TV, SUPPLEMENTO AL N. 2 - 1961

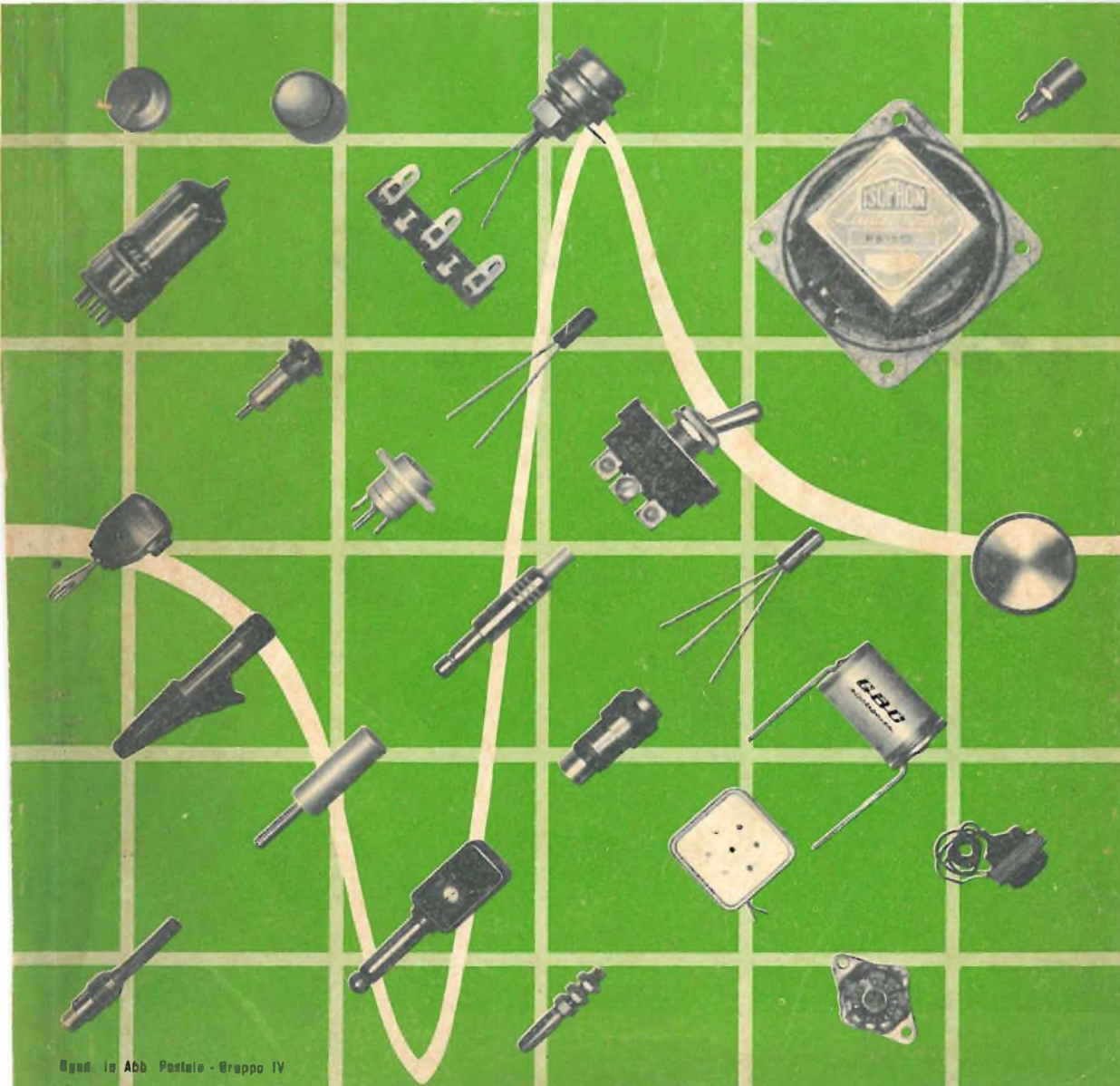



**Riservato ai:**

**TECNICI  
RIVENDITORI  
NEGOZIANTI**

**CONDIZIONI DI VENDITA**

I prezzi si intendono franco Milano, le spedizioni effettuate **contro assegno**. Imballo porto e bolli a carico del cliente. Si dà la precedenza alle ordinazioni accompagnate da importi anticipati. Le spedizioni vengono eseguite tenute presente la disponibilità di magazzino. **I prezzi segnati sul presente listino non sono impegnativi**. Variazioni impreviste dovute ad eventuali oscillazioni dei cambi, provvedimenti doganali, dazi, od altre cause impreviste, porteranno per conseguenza la variazione dei prezzi del presente Listino **senza alcun obbligo di preventivo avviso**. Non si riceve merce di ritorno. La merce viaggia a rischio e pericolo del committente. Per ogni contestazione il Foro competente è quello di Milano o della città Sede dell'Agenzia che ha effettuato la vendita. Si declina ogni responsabilità relativa a spese accessorie per merci commissionate e non ritirate.

**Il presente listino annulla i precedenti ed è riservato ai soli negozianti, rivenditori e tecnici.**

Per le rimesse, preghiamo prendere nota del nostro numero di Conto Corrente Postale: 3/23395.

**GLI ARTICOLI NON RIPORTATI SUL PRESENTE LISTINO, S'INTENDONO ESAURITI.**







Prezzo listino

Articolo

**Condensatori ceramici a perlina « Philips »**

Tensione di lavoro: 500 Vcc

Tensione di prova: 1500 Vcc

Resist. isolamento:

50.000 MΩ da 1,8 a 18 pF

10.000 MΩ da 18 a 2200 pF

Tolleranza:

da 1,8 a 2,2 pF:  $\pm 0,5$  pF

da 2,7 a 5,7 pF:  $\pm 1$  pF

da 6,8 a 150 pF:  $\pm 20$  %

da 180 a 2200 pF:  $-20 + 50$  %

Coefficiente di temperatura:

da 3,3 a 18 pF  $-330 \pm 500 \times 10^{-6}/^{\circ}\text{C}$

da 22 a 150 pF  $< 25$  %

da 180 a 2200 pF  $< 50$  %

Temperatura ammissibile:

$-40^{\circ}\text{C} \div +85^{\circ}\text{C}$

Capacità pF	L mm	Capacità pF	L mm
3,3	5	82	8
3,9	5,5	100	9
4,7	6	120	6
5,6	6,5	150	6,5
6,8	7	180	6,5
8,2	5,5	220	7,5
10	6	270	8,5
12	7	330	8,5
15	8	390	6,5
18	9	470	7
22	5,5	680	9
27	6,5	820	10
33	7	1000	7
39	7,5	1200	7,5
47	8,5	1500	9
56	6,5	1800	10
68	7	2200	11,5



**34**

**Condensatori** da 3,3 a 470 pF

**B/11**

**38**

**Condensatori** da 680 a 2200 pF

**B/12**



Articolo

Prezzo listino

**Condensatori ceramici**

a tubetto « Philips »

Tensione di lavoro: 500 Vcc

Tensione di prova: 1500 Vcc

Resist. isolamento:  $\geq 50.000 \text{ M}\Omega$

a 20° C

Tolleranza:

da 1,8 a 2,2 pF:  $\pm 0,25 \text{ pF}$

da 2,7 a 10 pF:  $\pm 0,5 \text{ pF}$

da 12 a 470 pF:  $\pm 5 \%$

Coefficiente di temperatura:

da 1,8 a 18 pF  $-120 \pm 250 \times 10^{-6}/^{\circ}\text{C}$

da 22 a 470 pF  $-750 \pm 120 \times 10^{-6}/^{\circ}\text{C}$

Temperatura ammissibile:

$-40^{\circ}\text{C} \div +85^{\circ}\text{C}$

Capacità pF	L mm	Capacità pF	L mm
1,8	12	47	12
2,2	12	56	12
2,7	12	68	12
3,3	12	82	12
3,9	12	100	12
4,7	12	120	14
5,6	12	150	16
6,8	12	180	18
8,2	12	220	20
10	12	270	22
12	12	330	26
15	12	470	34
18	12		
22	12		
27	12		
33	12		
39	12		

**B/15**

**Condensatori da 1,8 a 470 pF**

**36**

**Condensatori ceramici**

a tubetto « Philips »

Tensione di lavoro: 500 Vcc

Tensione di prova: 1500 Vcc

Resist. isolamento:  $\geq 10.000 \text{ M}\Omega$

a 20° C

Tolleranza:  $-20 \pm 50 \%$

Temperatura ammissibile:

$-40^{\circ}\text{C} \div +85^{\circ}\text{C}$

Capacità pF	$\phi \times L$ mm	Capacità pF	$\phi \times L$ mm
680	3,2x14	3.900	3,2x16
820	3,2x12	4.700	3,2x18
1.000	3,2x14	5.600	3,2x20
1.200	3,2x14	6.800	3,2x22
1.500	3,2x14	8.200	4,4x20
1.800	3,2x14	10.000	4,4x22
2.200	3,2x12	12.000	4,4x26
2.700	3,2x14	15.000	4,4x28
3.300	3,2x14	18.000	4,4x34
		22.000	4,4x40

**B/16**



**Condensatori da 680 a 4700 pF**

**38**

**B/17**

**Condensatori da 5600 a 22.000 pF**

**56**

Prezzo listino		Articolo	
108	<p><b>Condensatori</b> ceramici a disco con <b>coefficiente di temperatura controllato</b>            Tensione di lavoro: 3500 Vcc            Tensione di prova: 7500 Vcc            Resistenza isolamento: <math>\geq 7500 \text{ M}\Omega</math>            Temperatura di lavoro: <math>-55 + 85 \text{ }^\circ\text{C}</math>            Coefficiente di temperatura:  <math>-750 \pm 120 \times 10^{-6} \text{ }^\circ\text{C}</math>            Valore pF 120 e 150            Dimensioni: <math>\varnothing 15 \times 4 \text{ mm}</math></p>	B/21	
42	<p><b>Condensatori</b> ceramici a disco con <b>coefficiente di temperatura controllato</b>            Tensione di lavoro: 600 Vcc            Resist. isolamento: <math>\geq 7500 \text{ M}\Omega</math>            Temperatura di lavoro: <math>-55 + 85 \text{ }^\circ\text{C}</math>            Coefficiente di temperatura:  <math>\text{NPO} \pm 30 \times 10^{-6} / ^\circ\text{C}</math>            Tolleranza: 10 %</p> <p>Capacità <span style="float: right;"><math>\varnothing</math></span>            pF <span style="float: right;">mm</span></p>	6,4	B/21-1
42	15	9,5	B/21-2
42	22	9,5	B/21-3
56	33	15	B/21-4
56	47	15	B/21-5
66	68	19	B/21-6
66	100	19	B/21-7
260	<p><b>Condensatori</b> ceramici a disco            Tensione di lavoro: 6.000 Vcc            Tensione di prova: 12.000 Vcc            Resist. isolamento: <math>\geq 10.000 \text{ M}\Omega</math>            Coefficiente di temperatura:  <math>-750 \pm 15 \% \times 10^{-6} / ^\circ\text{C}</math>            Tolleranza: 10 %            Valore: 82 pF            Dimensioni: <math>\varnothing 22 \times 4 \text{ mm}</math></p>	B/22	

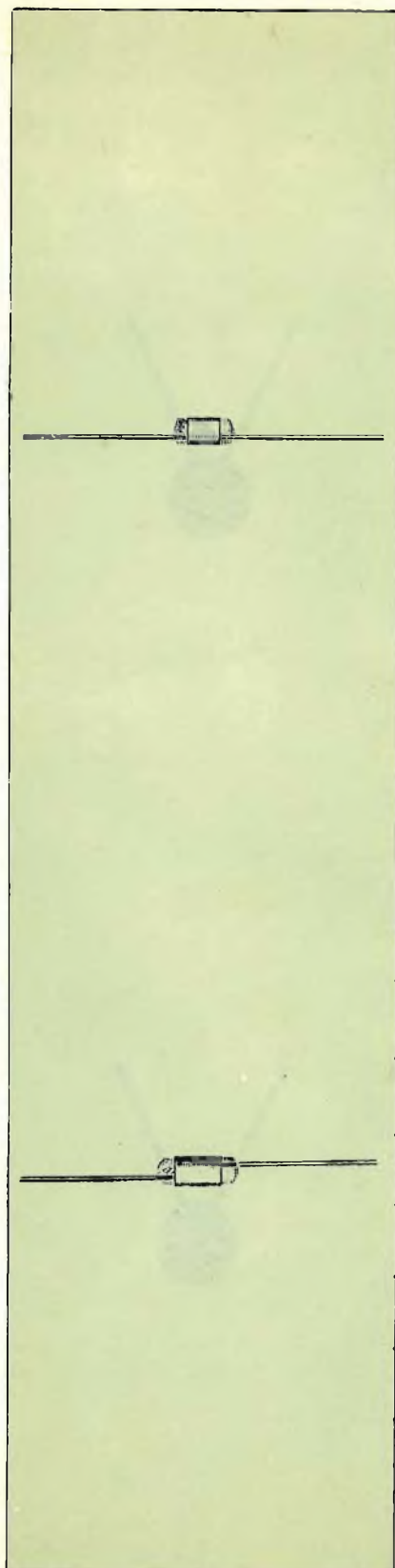

	Articolo	<p><b>Condensatori</b> in polistirolo  Tensione di lavoro: 125 Vcc  Resist. isolamento a 100 Vcc  + 20 °C, 80 % UR: <math>\geq 5 \cdot 10^{-5} \text{ M}\Omega</math>  Coefficiente di temperatura:  — <math>150 \cdot 10^{-6}/^{\circ}\text{C}</math> <math>\pm 50 \cdot 10^{-6}/^{\circ}\text{C}</math>  Frequenza di misura della capacit�:  <math>\leq 1000 \text{ pF}</math>: 100 KHz  <math>&gt; 1000 \text{ pF}</math>: 100 Hz  Tolleranza: 5 %</p> <table border="1" data-bbox="609 403 1016 743"> <thead> <tr> <th colspan="2">Capacit� pF</th> <th colspan="2">Capacit� pF</th> </tr> </thead> <tbody> <tr> <td>20</td> <td>150</td> <td>860</td> <td>3.000</td> </tr> <tr> <td>33</td> <td>300</td> <td>1.000</td> <td>5.000</td> </tr> <tr> <td>47</td> <td>500</td> <td>1.500</td> <td>10.000</td> </tr> <tr> <td>100</td> <td>680</td> <td>1.600</td> <td>15.000</td> </tr> <tr> <td>115</td> <td>750</td> <td>2.000</td> <td>20.000</td> </tr> <tr> <td></td> <td></td> <td></td> <td>25.000</td> </tr> </tbody> </table> <p><b>Dimensioni:</b>  da 20 a 500 pF lungh.: mm <math>7 \pm 2</math>  <math>\varnothing</math> mm <math>3 \div 5,5</math>  da 680 a 1.000 pF lungh.: mm <math>10 \pm 2</math>  <math>\varnothing</math> mm <math>4,5 \div 5,5</math>  da 1500 a 5.000 pF lungh.: mm <math>15 \pm 2</math>  <math>\varnothing</math> mm <math>5 \div 8</math>  da 10.000 a 15.000 pF  lungh.: mm <math>15 \pm 2</math> - <math>\varnothing</math> mm <math>7,5 \div 12,5</math>  da 20.000 a 25.000 pF  lungh.: mm <math>30 \pm 2</math> - <math>\varnothing</math> mm <math>10 \div 13,5</math></p>	Capacit� pF		Capacit� pF		20	150	860	3.000	33	300	1.000	5.000	47	500	1.500	10.000	100	680	1.600	15.000	115	750	2.000	20.000				25.000	Prezzo listino
	Capacit� pF		Capacit� pF																												
20	150	860	3.000																												
33	300	1.000	5.000																												
47	500	1.500	10.000																												
100	680	1.600	15.000																												
115	750	2.000	20.000																												
			25.000																												
	<b>B/25</b>	<b>Condensatori</b> da 20 a 47 pF	<b>34</b>																												
	<b>B/26</b>	<b>Condensatori</b> da 100 a 500 pF	<b>30</b>																												
	<b>B/27</b>	<b>Condensatori</b> da 680 a 1000 pF	<b>36</b>																												
	<b>B/28</b>	<b>Condensatori</b> da 1500 a 3000 pF	<b>44</b>																												
	<b>B/29</b>	<b>Condensatori</b> da 5.000 pF	<b>50</b>																												
	<b>B/30</b>	<b>Condensatori</b> da 10.000 pF	<b>54</b>																												
	<b>B/31</b>	<b>Condensatori</b> da 15.000 pF	<b>66</b>																												
	<b>B/32</b>	<b>Condensatori</b> da 20.000 pF	<b>76</b>																												
	<b>B/33</b>	<b>Condensatori</b> da 25.000 pF	<b>80</b>																												

Prezzo listino	<b>Condensatori</b> in polistirolo Tensione di lavoro: 250 Vcc Tolleranza: 5 %				Articolo
	Capacità pF		Capacità pF		
	100	500	1.500	10.000	
	115	680	1.600	15.000	
	150	750	2.000	20.000	
	200	860	3.000	25.000	
	300	1.000	5.000		
	<b>Dimensioni:</b> da 100 a 300 pF ungh.: mm 10±2 Ø mm 4÷5,5 da 500 a 5.000 pF ungh.: mm 15±2 Ø mm 4÷9,5 da 10.000 pF ungh.: mm 20±2 Ø mm 8÷12,5 da 15.000 pF a 25.000 pF ungh.: mm 30±2 Ø mm 9,5÷14,5				
<b>30</b>	<b>Condensatori</b> da 100 a 500 pF			<b>B/26-1</b>	
<b>36</b>	<b>Condensatori</b> da 680 a 1000 pF			<b>B/27-1</b>	
<b>44</b>	<b>Condensatori</b> da 1500 a 3000 pF			<b>B/28-1</b>	
<b>50</b>	<b>Condensatori</b> da 5.000 pF			<b>B/29-1</b>	
<b>54</b>	<b>Condensatori</b> da 10.000 pF			<b>B/30-1</b>	
<b>66</b>	<b>Condensatori</b> da 15.000 pF			<b>B/31-1</b>	
<b>76</b>	<b>Condensatori</b> da 20.000 pF			<b>B/32-1</b>	
<b>80</b>	<b>Condensatori</b> da 25.000 pF			<b>B/33-1</b>	

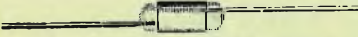
          	Articolo	<p><b>Condensatori</b> in polistirolo Tensione di lavoro: 500 Vcc Tolleranza: 5 %</p> <table border="1"> <thead> <tr> <th colspan="2">Capacità pF</th> <th colspan="2">Capacità pF</th> </tr> </thead> <tbody> <tr> <td>20</td> <td>150</td> <td>860</td> <td>3.000</td> </tr> <tr> <td>33</td> <td>300</td> <td>1.000</td> <td>5.000</td> </tr> <tr> <td>47</td> <td>500</td> <td>1.500</td> <td>10.000</td> </tr> <tr> <td>100</td> <td>680</td> <td>1.600</td> <td>15.000</td> </tr> <tr> <td>115</td> <td>750</td> <td>2.000</td> <td>20.000</td> </tr> <tr> <td></td> <td></td> <td></td> <td>25.000</td> </tr> </tbody> </table> <p><b>Dimensioni:</b> da 20 a 150 pF lungh.: mm 10±2 Ø mm 4÷7 da 300 a 3.000 pF lungh.: mm 15±2 Ø mm 5÷10,5 da 5.000 a 10.000 pF lungh.: mm 20±2 - Ø mm 8,5÷13,5 da 15.000 a 25.000 pF lungh.: mm 30±2 - Ø mm 11÷16</p>		Capacità pF		Capacità pF		20	150	860	3.000	33	300	1.000	5.000	47	500	1.500	10.000	100	680	1.600	15.000	115	750	2.000	20.000				25.000	Prezzo listino
	Capacità pF		Capacità pF																													
	20	150	860	3.000																												
	33	300	1.000	5.000																												
	47	500	1.500	10.000																												
	100	680	1.600	15.000																												
	115	750	2.000	20.000																												
				25.000																												
	<b>B/25-2</b>	<b>Condensatori da 20 a 47 pF</b>	<b>34</b>																													
	<b>B/26-2</b>	<b>Condensatori da 100 a 500 pF</b>	<b>30</b>																													
<b>B/27-2</b>	<b>Condensatori da 680 a 1000 pF</b>	<b>36</b>																														
<b>B/28-2</b>	<b>Condensatori da 1500 a 3000 pF</b>	<b>44</b>																														
<b>B/29-2</b>	<b>Condensatori da 5.000 pF</b>	<b>50</b>																														
<b>B/30-2</b>	<b>Condensatori da 10.000 pF</b>	<b>54</b>																														
<b>B/31-2</b>	<b>Condensatori da 15.000 pF</b>	<b>66</b>																														
<b>B/32-2</b>	<b>Condensatori da 20.000 pF</b>	<b>76</b>																														
<b>B/33-2</b>	<b>Condensatori da 25.000 pF</b>	<b>80</b>																														



Prezzo listino	Condensatori in polistirolo adatti per il montaggio su circuiti stampati Resist. isolamento a 100 Vcc + 20 °C, 80 % U.R.: $\geq 5 \cdot 10^{-5} \text{ M}\Omega$ Coefficiente di temperatura: — $150 \cdot 10^{-6}/^{\circ}\text{C} \pm 50 \cdot 10^{-6}/^{\circ}\text{C}$ Temperatura di lavoro — 10 °C + 70 °C Tolleranza: 5 %			Articolo
	Capacità pF	Vn c.c.	$\varnothing$ x L circa mm	
<b>44</b>	3.000	125	6 x 15	<b>B/33-4</b>
<b>50</b>	5.000	125	8,5 x 17	<b>B/33-5</b>
<b>54</b>	10.000	125	9 x 22	<b>B/33-6</b>
<b>64</b>	15.000	125	11 x 22	<b>B/33-7</b>
<b>76</b>	20.000	125	10,5 x 33	<b>B/33-8</b>
<b>80</b>	25.000	125	11 x 33,5	<b>B/33-9</b>
<b>44</b>	2.000	250	6 x 15,5	<b>B/34</b>
<b>44</b>	3.000	250	7 x 16	<b>B/34-1</b>
<b>50</b>	5.000	250	9 x 16	<b>B/34-2</b>
<b>54</b>	10.000	250	10 x 22,5	<b>B/34-3</b>
<b>64</b>	15.000	250	10 x 32,5	<b>B/34-5</b>
<b>76</b>	20.000	250	11 x 32	<b>B/34-6</b>
<b>80</b>	25.000	250	13,5 x 33,5	<b>B/34-7</b>
<b>34</b>	1.000	500	6 x 16	<b>B/34-8</b>
<b>44</b>	1.500	500	7 x 17	<b>B/34-9</b>
<b>44</b>	2.000	500	8 x 17	<b>B/34-11</b>
<b>44</b>	3.000	500	9 x 17	<b>B/34-12</b>
<b>50</b>	5.000	500	9 x 17	<b>B/34-13</b>
<b>54</b>	10.000	500	12,5 x 24	<b>B/34-14</b>
<b>64</b>	15.000	500	13 x 34	<b>B/34-15</b>
<b>76</b>	20.000	500	13 x 34	<b>B/34-16</b>
<b>80</b>	25.000	500	15 x 34	<b>B/34-17</b>



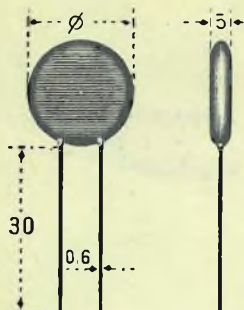

Articolo	<b>Condensatori</b> ceramici a dischetto Serie Bassa Tensione Tensione nominale 500 Vcc Tensione di prova 1500 Vcc Resist. isolamento $\geq 10000$ Mohm Toll. sulla capacit� $-20\% +100\%$ Finitura in rivestimento fenolico		Prezzo listino
	Capacit� pF	$\varnothing$ mm	
<b>B/35</b>	470	6	<b>34</b>
<b>B/35-1</b>	680	6	<b>34</b>
<b>B/35-2</b>	1000	8	<b>34</b>
<b>B/35-3</b>	1500	8	<b>36</b>
<b>B/35-4</b>	2200	11	<b>38</b>
<b>B/35-5</b>	3300	11	<b>38</b>
<b>B/35-6</b>	4700	11	<b>40</b>
<b>B/35-7</b>	6800	15	<b>44</b>
<b>B/35-8</b>	10000	15	<b>46</b>

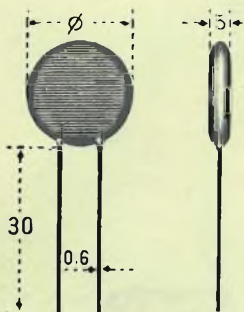

Articolo	<b>Condensatori</b> ceramici a dischetto Serie Media Tensione Tensione nominale 1000 Vcc Tensione di prova 4000 Vcc Tensione di prova a 50 Hz 1500 Veff Toll. sulla capacit� $-20\% +100\%$ Questo condensatore pu� sopportare picchi istantanei di 1500 V		Prezzo listino
	Capacit� pF	$\varnothing$ mm	
<b>B/36</b>	470	8	<b>42</b>
<b>B/36-1</b>	680	8	<b>42</b>
<b>B/36-2</b>	1000	11	<b>46</b>
<b>B/36-3</b>	1500	11	<b>52</b>
<b>B/36-4</b>	2200	15	<b>58</b>
<b>B/36-5</b>	3300	15	<b>62</b>
<b>B/36-6</b>	4700	15	<b>62</b>
<b>B/36-7</b>	6800	19	<b>72</b>
<b>B/36-8</b>	10000	19	<b>72</b>

Prezzo listino			Articolo
	<b>Condensatori</b> ceramici a dischetto con <b>coefficiente di temperatura controllato</b> Impiego: correzione di deriva termica nei ricevitori radio e TV. Tensione nominale 500 Vcc Tensione di prova 1500 Vcc Resistenze isolamento >10000 Mohm Tolleranza sulla capacità $C < 10 \text{ pF} \pm 0,5 \text{ pF}$ $C > 10 \text{ pF} \pm 20 \%$ Coefficiente di temperatura $-750 \pm 250 \text{ in } 10^{-6}/^{\circ}\text{C}$		
	Capacità pF	$\varnothing$ mm	
<b>36</b>	4,7	6	<b>B/37</b>
<b>36</b>	5,6	6	<b>B/37-1</b>
<b>36</b>	6,8	6	<b>B/37-2</b>
<b>36</b>	8,2	6	<b>B/37-3</b>
<b>36</b>	10	6	<b>B/37-4</b>
<b>36</b>	15	8	<b>B/37-5</b>
<b>36</b>	22	8	<b>B/37-6</b>
<b>36</b>	33	8	<b>B/37-8</b>
<b>40</b>	39	11	<b>B/37-9</b>
<b>40</b>	47	11	<b>B/38</b>
<b>40</b>	56	11	<b>B/38-1</b>
<b>40</b>	68	11	<b>B/38-2</b>
<b>50</b>	82	15	<b>B/38-3</b>
<b>50</b>	100	15	<b>B/38-4</b>
<b>50</b>	120	15	<b>B/38-5</b>
<b>68</b>	150	19	<b>B/38-6</b>
<b>68</b>	180	19	<b>B/38-7</b>
<b>68</b>	220	19	<b>B/38-8</b>

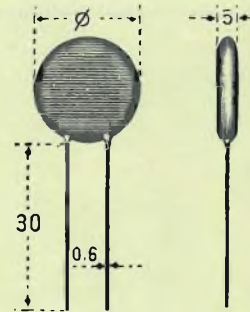



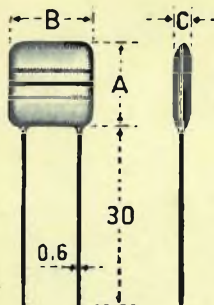

Articolo	Condensatori ceramici a piastrina bassa tensione			Prezzo listino	
	Tensione nominale	30 Vcc			
	Tensione di prova	90 Vcc			
	Angolo di perdita	$\leq 400 \cdot 10^{-4}$			
	Resist. isolamento	$\geq 5000 \text{ Mohm}$			
	Tolleranza sulla capacit�	+ 80 — 20%			
	Capacit�	Dimensioni in mm			
	pF	A	B	C	
<b>B/39-1</b>	4.700	6	6	3	<b>68</b>
<b>B/39-3</b>	10.000	10	10	3	<b>72</b>
<b>B/39-5</b>	25.000	10	10	3	<b>74</b>
<b>B/39-7</b>	50.000	12	12	3	<b>84</b>
<b>B/39-9</b>	100.000	15	15	3	<b>114</b>



Articolo	Condensatori a carta metallizzata in custodia di plastica.			Prezzo listino
	Tolleranza sulla capacit�	$\pm 20 \%$		
	Resistenza d'isolamento	200 Mohm x $\mu\text{F}$ a 20 °C		
	Angolo di perdita	$100 \cdot 10^{-4}$ a 20 °C a 1 kc		
	<b>Serie ultraminiatura</b>			
	Capacit�	Vn cc	$\varnothing \times L$	
	pF		mm	
<b>B/40</b>	4.000	150 V	4,5 x 11	<b>36</b>
<b>B/40-1</b>	5.000	150 V	4,5 x 11	<b>36</b>
<b>B/40-2</b>	10.000	150 V	4,5 x 11	<b>36</b>
<b>B/40-3</b>	20.000	150 V	6,3 x 14	<b>42</b>
<b>B/40-4</b>	30.000	150 V	6,3 x 14	<b>48</b>
<b>B/40-5</b>	40.000	150 V	6,4 x 14	<b>48</b>
<b>B/41</b>	1.000	400 V	4,5 x 11	<b>36</b>
<b>B/41-1</b>	2.000	400 V	4,5 x 11	<b>36</b>
<b>B/41-2</b>	3.000	400 V	4,5 x 11	<b>36</b>
<b>B/41-3</b>	5.000	400 V	6,3 x 14	<b>46</b>
<b>B/41-4</b>	10.000	400 V	6,3 x 14	<b>46</b>

Prezzo listino	Condensatori a carta metallizzata in custodia di plastica.			Articolo
	Serie miniatura			
	Capacità pF	Vn cc	∅ x L mm	
<b>72</b>	100.000	150 V	9,5 x 22	<b>B/42</b>
<b>94</b>	250.000	150 V	12,5 x 22	<b>B/42-1</b>
<b>114</b>	500.000	150 V	12,5 x 35	<b>B/42-2</b>
<b>188</b>	1 μF	150 V	16 x 35	<b>B/42-3</b>
<b>292</b>	2 μF	150 V	17,5 x 47	<b>B/42-4</b>
<b>72</b>	25.000	350 V	9,5 x 22	<b>B/43</b>
<b>94</b>	50.000	350 V	12,5 x 22	<b>B/43-1</b>
<b>104</b>	100.000	350 V	12,5 x 35	<b>B/43-2</b>
<b>156</b>	250.000	350 V	16 x 35	<b>B/43-3</b>

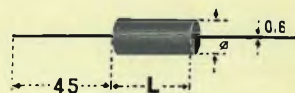

PREGHIAMO CORTESEMENTE CHIUNQUE INTERESSATO ALLA PRESENTE PUBBLICAZIONE DI VOLERSI ASTENERE DALL'IMITARLA NELLA SUA VESTE, NELLE SUE ILLUSTRAZIONI E NEI SUOI DATI, ANCHE PARZIALMENTE.





Prezzo listino	Condensatori a mica metallizzata Serie 402 con protezione in cera Tensione di lavoro: 500 Vcc Tensione di prova: 1000 Vcc Resist. isolamento a 100 V + 20/°C 80 % di U.R. $\geq 7500 M\Omega$ Coefficiente di temperatura: $\pm 100.10^{-6}/^{\circ}C$ Tolleranza: 5 %						Articolo
	Capacità		Dimensioni in mm				
	pF		A	B	C	D	
<b>40</b>	31 ÷	155	17	10	2,5	0,8	<b>B/81</b>
<b>48</b>	156 ÷	250	17	10	2,5	0,8	<b>B/82</b>
<b>58</b>	251 ÷	300	17	10	2,5	0,8	<b>B/83</b>
<b>58</b>	301 ÷	400	17	10	2,5	0,8	<b>B/83-1</b>
<b>62</b>	401 ÷	500	17	10	2,5	0,8	<b>B/84</b>
<b>76</b>	501 ÷	600	17	10	2,5	0,8	<b>B/85</b>
<b>76</b>	601 ÷	700	17	10	2,5	0,8	<b>B/85-1</b>
<b>80</b>	701 ÷	800	17	10	2,5	0,8	<b>B/85-2</b>
<b>80</b>	801 ÷	900	17	10	2,5	0,8	<b>B/85-3</b>
<b>90</b>	901 ÷	1000	17	10	2,5	0,8	<b>B/85-4</b>
<b>110</b>	1001 ÷	1500	25	10	2,5	0,8	<b>B/86</b>
<b>120</b>	1501 ÷	2000	25	10	2,5	0,8	<b>B/87</b>
<b>150</b>	2001 ÷	3000	37	17	3,5	1,5	<b>B/88</b>
<b>180</b>	3001 ÷	4000	37	17	3,5	1,5	<b>B/89</b>
<b>210</b>	4001 ÷	5000	37	17	3,5	1,5	<b>B/90</b>
<b>260</b>	5001 ÷	6000	37	17	3,5	1,5	<b>B/91</b>
<b>290</b>	6001 ÷	7000	37	17	3,5	1,5	<b>B/92</b>
<b>330</b>	7001 ÷	8000	37	17	3,5	1,5	<b>B/93</b>
<b>360</b>	8001 ÷	9000	37	17	3,5	1,5	<b>B/94</b>
<b>390</b>	9001 ÷	10000	37	17	3,5	1,5	<b>B/95</b>

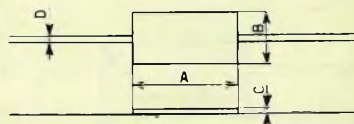

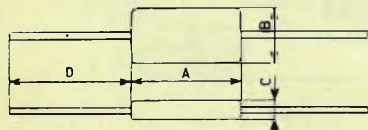

Articolo	Condensatori a mica metallizzata Serie « 420 » in custodia stampata Tensione di lavoro: 500 Vcc Tensione di prova: 1000 Vcc Tolleranza: 5 %						Prezzo listino
	Capacità		Dimensioni in mm				
	pF		A	B	C	D	
<b>B/125</b>	5 ÷	200	19,8	11,8	5,4	29	<b>80</b>
<b>B/126</b>	201 ÷	400	19,8	11,8	5,4	29	<b>90</b>
<b>B/127</b>	401 ÷	600	19,8	11,8	5,4	29	<b>100</b>
<b>B/128</b>	601 ÷	800	19,8	11,8	5,4	29	<b>120</b>
<b>B/128-1</b>	801 ÷	1000	19,8	11,8	5,4	29	<b>130</b>
<b>B/129</b>	1001 ÷	1500	20,5	20,5	6,8	29	<b>200</b>
<b>B/129-1</b>	1501 ÷	2000	20,5	20,5	6,8	29	<b>220</b>
<b>B/130</b>	2001 ÷	2500	20,5	20,5	6,8	29	<b>260</b>
<b>B/130-1</b>	2501 ÷	3000	20,5	20,5	6,8	29	<b>270</b>
<b>B/131</b>	3001 ÷	3500	20,5	20,5	6,8	29	<b>390</b>
<b>B/131-1</b>	3501 ÷	4000	20,5	20,5	8,5	29	<b>390</b>
<b>B/131-2</b>	4001 ÷	4500	20,5	20,5	8,5	29	<b>420</b>
<b>B/131-3</b>	4501 ÷	5000	20,5	20,5	6,8	29	<b>440</b>
<b>B/132</b>	5001 ÷	5500	20,5	20,5	6,8	29	<b>590</b>
<b>B/132-1</b>	5501 ÷	6000	20,5	20,5	6,8	29	<b>620</b>
<b>B/132-2</b>	6001 ÷	6500	20,5	20,5	6,8	29	<b>640</b>
<b>B/132-3</b>	6501 ÷	7000	20,5	20,5	6,8	29	<b>660</b>
<b>B/133</b>	7001 ÷	7500	20,5	20,5	6,8	29	<b>680</b>
<b>B/133-1</b>	7501 ÷	8000	20,5	20,5	6,8	29	<b>690</b>
<b>B/133-2</b>	8001 ÷	8500	20,5	20,5	6,8	29	<b>720</b>
<b>B/134</b>	8501 ÷	9000	20,5	20,5	6,8	29	<b>740</b>
<b>B/134-1</b>	9001 ÷	9500	20,5	20,5	6,8	29	<b>760</b>
<b>B/134-2</b>	9501 ÷	10000	20,5	20,5	6,8	29	<b>780</b>

Prezzo listino	Condensatori a mica metallizzata Serie « 422 » in custodia stampata Tensione di lavoro: 500 Vcc Tensione di prova: 1000 Vcc Resist. isolamento a 100 Vcc + 20 °C, 80 % di U.R. $\geq 10.000 M\Omega$ Tolleranza: 5%				Articolo	
	Capacità pF	Dimensioni in mm A B C D				
<b>30</b>	31 ÷ 45	13,6	7,2	3,2	30	<b>B/141</b>
<b>34</b>	46 ÷ 80	13,6	7,2	3,2	30	<b>B/141-1</b>
<b>36</b>	81 ÷ 120	13,6	7,2	3,2	30	<b>B/141-2</b>
<b>40</b>	121 ÷ 155	13,6	7,2	3,2	30	<b>B/141-3</b>
<b>40</b>	156 ÷ 185	13,6	7,2	3,2	30	<b>B/142</b>
<b>46</b>	186 ÷ 215	13,6	7,2	3,2	30	<b>B/142-1</b>
<b>48</b>	216 ÷ 250	13,6	7,2	3,2	30	<b>B/142-2</b>
<b>54</b>	251 ÷ 300	19,8	11,8	4	30	<b>B/143</b>
<b>60</b>	301 ÷ 400	19,8	11,8	4	30	<b>B/143-1</b>
<b>68</b>	401 ÷ 500	19,8	11,8	4	30	<b>B/143-2</b>
	Condensatori al mylar « Copo » in poliesteri antiinduttivi con speciale isolamento in materiale plastico Resist. isolamento: 20/°C 100 Vcc > 100.000 M $\Omega$ Temperatura ammissibile: — 25 ÷ 85°C Tolleranza: 20 %					
	Capacità pF	Vn c.c	$\varnothing \times L$ mm			
<b>40</b>	1.000	600	7 x 19		<b>B/160</b>	
<b>40</b>	1.500	600	7 x 19		<b>B/161</b>	
<b>40</b>	2.200	600	7 x 19		<b>B/162</b>	
<b>40</b>	3.300	400	7 x 19		<b>B/165</b>	
<b>40</b>	4.700	400	7 x 19		<b>B/166</b>	
<b>40</b>	6.800	400	7 x 19		<b>B/167</b>	
<b>40</b>	10.000	400	8 x 19		<b>B/168</b>	
<b>40</b>	15.000	400	9 x 19		<b>B/169</b>	
<b>48</b>	22.000	400	9 x 21		<b>B/170</b>	
<b>54</b>	33.000	400	10 x 21		<b>B/171</b>	
<b>60</b>	47.000	400	11 x 21		<b>B/172</b>	
<b>68</b>	68.000	400	10 x 28		<b>B/173</b>	
<b>76</b>	100.000	400	11 x 28		<b>B/174</b>	

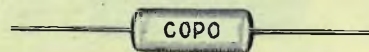
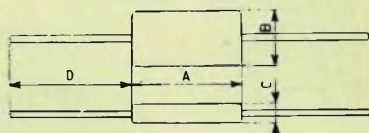



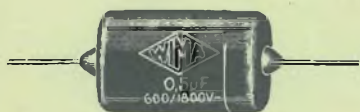

Articolo	Condensatori a carta « Wima - Tropydur » Resist. isolamento: 20.000 MΩ < 0,05 μF Tolleranza: sino a 100 kpF ± 20 % da 0,22 a 470.000 pF ± 10 %			Prezzo listino
	Capacità pF	Vn cc	Ø x L mm	
<b>B/181</b>	1.000	400	6,5 x 9	<b>62</b>
<b>B/182</b>	2.200	400	7,5 x 10,5	<b>62</b>
<b>B/183</b>	3.300	400	7,5 x 11,5	<b>62</b>
<b>B/183-1</b>	4.700	400	8 x 12	<b>62</b>
<b>B/184</b>	10.000	400	8 x 13	<b>70</b>
<b>B/185</b>	15.000	400	7,5 x 12,5	<b>78</b>
<b>B/186</b>	22.000	400	10 x 14	<b>84</b>
<b>B/187</b>	33.000	400	10 x 15	<b>88</b>
<b>B/188</b>	47.000	400	11,5 x 16,5	<b>98</b>
<b>B/189</b>	100.000	400	13 x 18	<b>130</b>
<b>B/190</b>	220.000	400	17 x 23	<b>170</b>
<b>B/191</b>	470.000	400	19 x 27	<b>230</b>

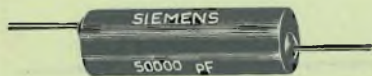



Articolo	Condensatori a carta « Siemens » in custodia di vetro Temperatura di lavoro — 25 ÷ + 60°C Resistenza isolamento: ≥ 10.000 MΩ per C ≤ 0,047 μF ≥ 600 MΩ per C ≥ 0,047 μF Tolleranza: ± 20 %			Prezzo listino
	Capacità pF	Vn cc	Ø x L mm	
<b>B/201</b>	1.000	400	7 x 25	<b>38</b>
<b>B/201-1</b>	2.200	400	7 x 25	<b>38</b>
<b>B/201-2</b>	3.300	400	7 x 25	<b>38</b>
<b>B/202</b>	4.700	400	7 x 25	<b>38</b>
<b>B/202-1</b>	10.000	400	7 x 31	<b>38</b>
<b>B/203</b>	15.000	400	8 x 31	<b>46</b>
<b>B/203-1</b>	22.000	400	9 x 31	<b>56</b>
<b>B/204</b>	33.000	400	11 x 31	<b>64</b>
<b>B/204-1</b>	47.000	400	11 x 35	<b>66</b>
<b>B/205</b>	100.000	400	12 x 45	<b>76</b>
<b>B/206</b>	220.000	400	17 x 45	<b>100</b>
<b>B/207-1</b>	330.000	400	17 x 52	<b>168</b>
<b>B/208</b>	470.000	400	21 x 52	<b>178</b>

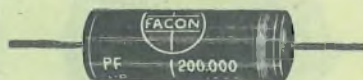
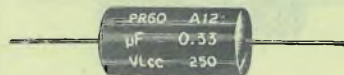

Prezzo listino				Articolo
	<b>Condensatori a carta « Icar »</b> custodia isolante iniettata in polixite rossa Resist. isolamento: a 25°C: $\geq 10.000 \text{ M}\Omega$ Temperatura di lavoro: — 30 + 85 °C Tolleranza: $\pm 20 \%$			
	Capacità pF	Vn cc	$\varnothing \times L$ mm	
<b>250</b>	4.700	1000	6,5 x 16	<b>B/227</b>
<b>260</b>	10.000	1000	10,5 x 21	<b>B/228</b>
<b>270</b>	22.000	1000	12,5 x 26	<b>B/229</b>
<b>296</b>	47.000	1000	14,5 x 31	<b>B/230</b>
<b>340</b>	100.000	1000	18 x 42	<b>B/231</b>
<b>518</b>	150.000	1000	20,5 x 47	<b>B/232</b>
<b>586</b>	220.000	1000	25,5 x 49	<b>B/233</b>
	<b>Condensatori a carta « Facon »</b> in tubetto di vetro Avvolgimento anti-induttivo Temperatura di lavoro: — 20 + 70° C			
	Capacità pF	Vn cc	$\varnothing \times L$ mm	
<b>50</b>	1.000	630	8 x 23	<b>B/241</b>
<b>50</b>	2.200	630	8,5 x 31	<b>B/242</b>
<b>50</b>	3.300	630	8,5 x 31	<b>B/243</b>
<b>50</b>	4.700	630	8,5 x 31	<b>B/244</b>
<b>56</b>	10.000	630	10,5 x 39	<b>B/245</b>
<b>82</b>	22.000	630	10,5 x 39	<b>B/246</b>
<b>100</b>	33.000	630	10,5 x 39	<b>B/246-1</b>
<b>106</b>	47.000	630	13,5 x 39	<b>B/247</b>
<b>166</b>	100.000	630	16 x 50	<b>B/248</b>



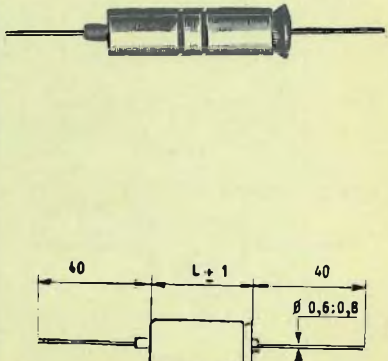

Prezzo listino				Articolo	
	<b>Condensatori elettrolitici miniaturizzati</b>				
	Capacità µF	Vn cc	∅ x L mm		
<b>240</b>	10	3	5 x 14	<b>B/285</b>	
<b>240</b>	30	3	6 x 17	<b>B/286</b>	
<b>240</b>	5	6	5 x 14	<b>B/287</b>	
<b>240</b>	100	6	6 x 17	<b>B/288</b>	
<b>320</b>	3 x 20	10	10 x 14	<b>B/289</b>	
<b>240</b>	10	10	6 x 17	<b>B/291</b>	
	<b>Condensatori elettrolitici miniatura « Philips »</b>				
	Capacità µF	Vn cc	∅ x L mm		
<b>150</b>	64	10	6,4 x 18	<b>B/295</b>	
<b>150</b>	16	10	4,5 x 10	<b>B/296</b>	
<b>160</b>	6,4	25	4,5 x 10	<b>B/297</b>	
	<b>Condensatori elettrolitici miniatura per circuiti a transistor</b> Temperatura di lavoro da -20 °C ÷ +70 °C Tolleranza di capacità: da -20 % ÷ +50 %				
	Capacità µF	Vn cc	∅ x L mm		
<b>130</b>	2	3	4,5 x 10	<b>B/321</b>	
<b>130</b>	5	3	4,5 x 10	<b>B/322</b>	
<b>130</b>	10	3	4,5 x 10	<b>B/323</b>	
<b>130</b>	25	3	4,5 x 10	<b>B/324</b>	
<b>138</b>	50	3	4,5 x 14	<b>B/325</b>	
<b>106</b>	100	3	6,5 x 19	<b>B/326</b>	
<b>120</b>	200	3	6,5 x 25	<b>B/327</b>	





Prezzo listino	Condensatori elettrolitici catodici « GBC » custodia in tubetto di alluminio			Articolo
	Capacità μF	Vn cc	∅ x L mm	
<b>82</b>	10	25	11 x 22	<b>B/361</b>
<b>98</b>	25	25	11 x 22	<b>B/362</b>
<b>116</b>	50	25	14 x 22	<b>B/363</b>
<b>176</b>	100	25	14 x 32	<b>B/364</b>
<b>250</b>	200	25	14 x 44	<b>B/365</b>
<b>90</b>	5	50	11 x 22	<b>B/371</b>
<b>98</b>	10	50	11 x 22	<b>B/372</b>
<b>116</b>	25	50	14 x 22	<b>B/373</b>
<b>176</b>	50	50	14 x 32	<b>B/374</b>
<b>250</b>	100	50	20 x 36	<b>B/375</b>
<b>278</b>	50	5 c.a.	20 x 34	<b>B/376</b>
	Condensatori elettrolitici catodici con custodia cilindrica di alluminio Temperatura di lavoro da - 20 °C ÷ + 70 °C Tolleranza di capacità: da - 20 % a + 50 %			
	Capacità μF	Vn cc	∅ x L mm	
<b>112</b>	10	25	12 x 19	<b>B/380</b>
<b>124</b>	25	25	12 x 19	<b>B/381</b>
<b>150</b>	50	25	12 x 19	<b>B/381-1</b>
<b>172</b>	100	25	12 x 29	<b>B/382</b>
<b>230</b>	200	25	14 x 35	<b>B/383</b>
<b>390</b>	500	25	16 x 50	<b>B/384</b>
<b>128</b>	10	50	12 x 19	<b>B/385</b>
<b>140</b>	25	50	12 x 19	<b>B/386</b>
<b>170</b>	50	50	14 x 25	<b>B/387</b>
<b>240</b>	100	50	16 x 30	<b>B/388</b>
<b>320</b>	250	50	16 x 50	<b>B/389</b>
<b>570</b>	500	50	25 x 64	<b>B/390</b>





Prezzo listino	Condensatori elettrolitici tubolari Tolleranza sulla capacità: — 10 % ÷ + 50 % Temperatura di lavoro: — 20 °C + 55 °C			Articolo
	Capacità $\mu\text{F}$	Vn cc	$\varnothing \times L$ mm	
<b>168</b>	8	500	18 x 37	<b>B/461</b>
<b>280</b>	16	500	20 x 50	<b>B/462</b>
<b>460</b>	32	500	29 x 50	<b>B/463</b>
<b>300</b>	8 + 8	500	25 x 37	<b>B/464</b>
<b>510</b>	16 + 16	500	29 x 50	<b>B/465</b>
<b>830</b>	25 + 25	500	32 x 64	<b>B/466</b>
<b>166</b>	8	350	16 x 37	<b>B/467</b>
<b>230</b>	16	350	20 x 37	<b>B/468</b>
<b>350</b>	32	350	22 x 50	<b>B/469</b>
<b>470</b>	50	350	25 x 50	<b>B/470</b>
<b>280</b>	8 + 8	350	22 x 37	<b>B/471</b>
<b>395</b>	16 + 16	350	25 x 37	<b>B/472</b>
<b>578</b>	32 + 32	350	25 x 50	<b>B/473</b>
<b>720</b>	40 + 40	350	29 x 50	<b>B/474</b>
<b>790</b>	50 + 50	350	29 x 62	<b>B/475</b>
<b>240</b>	32	250	20 x 52	<b>B/476</b>
<b>390</b>	50	250	20 x 50	<b>B/477</b>
<b>590</b>	100	250	25 x 50	<b>B/478</b>
<b>430</b>	32 + 32	250	25 x 37	<b>B/479</b>
<b>520</b>	40 + 40	250	25 x 50	<b>B/480</b>
<b>580</b>	50 + 50	250	25 x 50	<b>B/481</b>

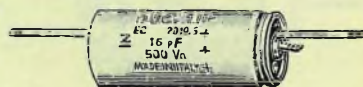

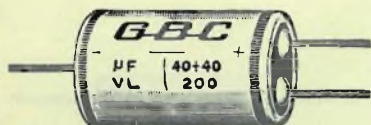

Articolo	Condensatori elettrolitici « GBC » in custodia tubolare di alluminio			Prezzo listino
	Capacità $\mu\text{F}$	Vn cc	$\varnothing \times L$ mm	
<b>B/501</b>	8	500	20 x 36	<b>148</b>
<b>B/502</b>	8 + 8	500	25 x 45	<b>326</b>
<b>B/502-1</b>	16 + 16	500	35 x 45	<b>530</b>
<b>B/503</b>	16	500	25 x 45	<b>290</b>
<b>B/503-1</b>	32	500	30 x 45	<b>476</b>
<b>B/503-2</b>	40	500	30 x 45	<b>500</b>
<b>B/504</b>	80	500	34 x 82	<b>890</b>
<b>B/505</b>	100	450	34 x 82	<b>960</b>
<b>B/505-1</b>	8	350	20 x 36	<b>150</b>
<b>B/506</b>	8 + 8	350	26 x 36	<b>250</b>
<b>B/507</b>	16	350	26 x 36	<b>226</b>
<b>B/508</b>	20	350	26 x 36	<b>288</b>
<b>B/509</b>	16 + 16	350	26 x 45	<b>370</b>
<b>B/510</b>	32	350	26 x 45	<b>350</b>
<b>B/511</b>	40	350	30 x 45	<b>400</b>
<b>B/512</b>	50	350	30 x 45	<b>460</b>
<b>B/513</b>	32 + 32	350	30 x 45	<b>570</b>
<b>B/514</b>	40 + 40	350	34 x 60	<b>650</b>
<b>B/514-1</b>	50 + 50	350	34 x 60	<b>810</b>
<b>B/514-2</b>	100	350	34 x 60	<b>790</b>
<b>B/515</b>	65 + 65	350	34 x 60	<b>890</b>
<b>B/515-1</b>	80 + 200	350	45 x 99	<b>1050</b>
<b>B/516</b>	100 + 50	350	34 x 80	<b>1050</b>
<b>B/516-1</b>	8	250	14 x 32	<b>130</b>
<b>B/516-2</b>	16	250	20 x 36	<b>210</b>
<b>B/517</b>	32	250	20 x 45	<b>250</b>
<b>B/518</b>	32 + 32	250	26 x 45	<b>390</b>
<b>B/518-1</b>	40 + 40	250	26 x 45	<b>420</b>
<b>B/518-2</b>	50 + 50	250	30 x 45	<b>530</b>
<b>B/518-3</b>	100	250	30 x 45	<b>510</b>
<b>B/518-4</b>	90 + 90	250	30 x 60	<b>880</b>
<b>B/518-6</b>	150 duplic.	200	30 x 45	<b>590</b>
<b>B/522</b>	20	200	26 x 34	<b>220</b>
<b>B/519</b>	50	200	20 x 45	<b>290</b>
<b>B/520</b>	32 + 32	200	26 x 45	<b>290</b>
<b>B/521</b>	40 + 40	200	26 x 34	<b>290</b>



Prezzo listino	Condensatori elettrolitici « <b>Facon</b> » in custodia tubolare di alluminio			Articolo
	Capacità $\mu$ F	Vn cc	$\varnothing$ x L mm	
<b>148</b>	8	500	20 x 34	<b>B/551</b>
<b>326</b>	8 + 8	500	26 x 46	<b>B/552</b>
<b>310</b>	16	500	24 x 46	<b>B/553</b>
<b>390</b>	25	500	26 x 46	<b>B/554</b>
<b>550</b>	16 + 16	500	30 x 46	<b>B/555</b>
<b>530</b>	32	500	30 x 46	<b>B/556</b>
<b>850</b>	32 + 32	500	34 x 60	<b>B/556-1</b>
<b>990</b>	40 + 40	500	34 x 80	<b>B/556-2</b>
<b>150</b>	8	350	20 x 34	<b>B/557</b>
<b>298</b>	8 + 8	350	26 x 34	<b>B/558</b>
<b>240</b>	16	350	26 x 34	<b>B/559</b>
<b>370</b>	16 + 16	350	26 x 46	<b>B/560</b>
<b>350</b>	32	350	26 x 46	<b>B/561</b>
<b>490</b>	50	350	30 x 46	<b>B/562</b>
<b>650</b>	32 + 32	350	30 x 46	<b>B/563</b>
<b>890</b>	50 + 50	350	34 x 60	<b>B/564</b>
<b>870</b>	100	350	34 x 60	<b>B/565</b>
<b>210</b>	16	250	20 x 34	<b>B/566</b>
<b>250</b>	25	250	20 x 34	<b>B/567</b>
<b>270</b>	32	250	20 x 46	<b>B/568</b>
<b>390</b>	32 + 32	250	26 x 34	<b>B/569</b>
<b>420</b>	40 + 40	250	26 x 34	<b>B/570</b>
<b>650</b>	50 + 50	250	30 x 46	<b>B/571</b>
<b>630</b>	100	250	30 x 46	<b>B/572</b>
<b>290</b>	32 + 32	200	26 x 26	<b>B/573</b>
<b>290</b>	40 + 40	200	26 x 46	<b>B/574</b>
<b>550</b>	150	200	30 x 46	<b>B/575</b>
<b>600</b>	150 duplic.	200	30 x 46	<b>B/575-1</b>
<b>230</b>	100	50	20 x 34	<b>B/576</b>
<b>390</b>	200	50	26 x 46	<b>B/577</b>

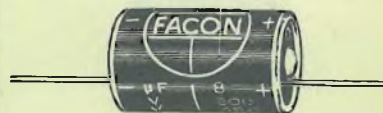



Articolo

**Condensatori** elettrolitici a pacchetto  
« G.B.C. » in custodia di  
bachelite ricoperta in cartoncino  
Tolleranza sulla capacità:  
— 10 ÷ + 50 %  
Temperatura di lavoro:  
— 10 + 70 °C

Prezzo  
listino

**B/601**

Capacità  $\mu\text{F}$       Vn cc      Dimens. mm

8      500      28 x 14 x 50

**156**

**B/602**

16      500      31 x 24 x 50

**290**



**Condensatori** elettrolitici a pacchetto  
« Facon » in custodia di  
bachelite ricoperta in cartoncino  
Tolleranza sulla capacità:  
— 10 ÷ + 50 %  
Temperatura di lavoro:  
— 10 + 70 °C

**B/621**

Capacità  $\mu\text{F}$       Vn cc      Dimens. mm

8      500      28 x 14 x 50

**154**

**B/622**

8 + 8      500      28 x 28 x 50

**320**

**B/623**

16      500      31 x 24 x 50

**330**

**B/624**

16      350      28 x 14 x 50

**260**

**B/625**

32      350      31 x 24 x 50

**360**

**B/626**

32      250      28 x 14 x 50

**320**

**B/627**

60 + 20      150      38 x 15 x 50

**540**

**B/628**

80 + 30      130      38 x 15 x 50

**580**

**B/629**

8      750      28 x 28 x 50

**750**

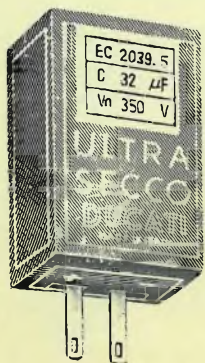

**Condensatori** elettrolitici a pacchetto  
in custodia di bachelite  
ricoperta in cartoncino  
Tolleranza sulla capacità:  
— 10 % ÷ + 50 %

**B/641**

Capacità  $\mu\text{F}$       Vn c.c.      Dimens. mm

8      500      30 x 14 x 47

**164**

**B/642**

16      500      30 x 22 x 47

**280**

**B/643**

16      350      30 x 14 x 47

**260**

**B/644**

32      350      30 x 14 x 47

**370**



Prezzo listino	Condensatori elettrolitici a vitone « Facon » Tolleranza sulla capacità: — 10 ÷ + 50 %			Articolo
	Capacità $\mu\text{F}$	Vn cc	$\varnothing \times L$ mm	
<b>250</b>	8	500	24 x 38	<b>B/661</b>
<b>440</b>	8 + 8	500	24 x 50	<b>B/662</b>
<b>490</b>	8 + 8 + 8	500	37 x 50	<b>B/662-1</b>
<b>440</b>	16	500	24 x 50	<b>B/663</b>
<b>650</b>	16 + 16	500	24 x 88	<b>B/664</b>
<b>630</b>	32	500	24 x 88	<b>B/665</b>
<b>950</b>	32 + 32	500	30 x 88	<b>B/666</b>
<b>1000</b>	40 + 40	500	37 x 88	<b>B/667</b>
<b>1000</b>	80	500	37 x 88	<b>B/668</b>
<b>230</b>	8	350	24 x 38	<b>B/669</b>
<b>350</b>	8 + 8	350	24 x 38	<b>B/670</b>
<b>330</b>	16	350	24 x 38	<b>B/671</b>
<b>510</b>	16 + 16	350	24 x 50	<b>B/672</b>
<b>490</b>	32	350	24 x 50	<b>B/673</b>
<b>500</b>	40	350	24 x 50	<b>B/673-1</b>
<b>750</b>	32 + 32	350	24 x 88	<b>B/674</b>
<b>950</b>	50 + 50	350	30 x 88	<b>B/675</b>
<b>930</b>	100	350	30 x 88	<b>B/676</b>
<b>1130</b>	150 + 50 + 16	350	37 x 88	<b>B/676-1</b>
<b>500</b>	50	250	24 x 50	<b>B/677</b>
<b>580</b>	32 + 32	250	24 x 50	<b>B/678</b>
<b>680</b>	40 + 40	250	24 x 88	<b>B/679</b>
<b>720</b>	50 + 50	250	24 x 88	<b>B/680</b>
<b>590</b>	150 duplic.	200	30 x 50	<b>B/685</b>
	Condensatori elettrolitici « Facon » per telefonia - tipi a vitone Tolleranza sulla capacità: — 10 ÷ + 50 %			
	Capacità $\mu\text{F}$	Vn cc	$\varnothing \times L$ mm	
<b>750</b>	500	15	24 x 50	<b>B/691</b>
<b>950</b>	500 + 500	15	30 x 50	<b>B/692</b>
<b>950</b>	1000	15	30 x 50	<b>B/693</b>
<b>950</b>	500	50	30 x 50	<b>B/694</b>
<b>1250</b>	500 + 500	40	30 x 88	<b>B/695</b>





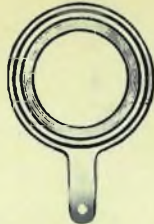

Articolo				Prezzo listino
<b>Condensatori elettrolitici a vitone « G.B.C. »</b> Tolleranza sulla capacità: — 10 % ÷ + 50 % Temperatura di lavoro: —10 + 70° C				
	Capacità µF	Vn c.c.	Ø x L mm	
<b>B/696</b>	8	500	25 x 40	<b>240</b>
<b>B/696-1</b>	8 + 8	500	25 x 50	<b>430</b>
<b>B/697</b>	16 + 16	500	25 x 85	<b>640</b>
<b>B/698</b>	32	500	25 x 85	<b>610</b>
<b>B/698-1</b>	32 + 32	500	30 x 85	<b>900</b>
<b>B/699</b>	40 + 40	500	35 x 85	<b>970</b>
<b>B/701</b>	80	500	35 x 85	<b>970</b>
<b>B/701-1</b>	8 + 8	350	25 x 10	<b>350</b>
<b>B/701-2</b>	16	350	25 x 40	<b>320</b>
<b>B/701-3</b>	16 + 16	350	25 x 50	<b>500</b>
<b>B/701-4</b>	32	350	25 x 50	<b>480</b>
<b>B/701-5</b>	32 + 32	350	25 x 85	<b>720</b>
<b>B/702</b>	50 + 50	350	30 x 85	<b>900</b>
<b>B/702-1</b>	32 + 32	250	25 x 50	<b>560</b>
<b>B/703</b>	50 + 50	250	25 x 85	<b>690</b>



Prezzo listino				Articolo	
	<b>Rondella</b> metallica per condensatori elettrolitici a vite				
<b>10</b>	∅ esterno mm 26 - ∅ interno mm 16			<b>B/711</b>	
<b>10</b>	∅ esterno mm 31 - ∅ interno mm 17			<b>B/712</b>	
	<b>Rondella</b> isolante per condensatori elettrolitici a vite				
<b>10</b>	∅ esterno mm 26 - ∅ interno mm 15,5			<b>B/715</b>	
<b>10</b>	∅ esterno mm 31 - ∅ interno mm 16			<b>B/716</b>	
	<b>Condensatori</b> elettrolitici con fissaggio a vite Tolleranza sulla capacità: — 10 % ÷ + 50 % Temperatura di lavoro: — 20 °C + 55 °C				
<b>330</b>	Capacità µF	Vn cc	∅ x L mm	<b>B/721</b>	
	32	250	20 x 40		
<b>620</b>	40 + 40	250	25 x 62	<b>B/722</b>	
<b>720</b>	50 + 50	250	32 x 69	<b>B/723</b>	
<b>430</b>	32	350	22 x 53	<b>B/724</b>	
<b>650</b>	50	350	25 x 56	<b>B/725</b>	
<b>820</b>	32 + 32	350	25 x 62	<b>B/726</b>	
<b>880</b>	40 + 40	350	29 x 62	<b>B/727</b>	
<b>1040</b>	50 + 50	350	29 x 72	<b>B/728</b>	
<b>250</b>	8	500	20 x 40	<b>B/729</b>	
<b>370</b>	16	500	20 x 53	<b>B/730</b>	
<b>570</b>	32	500	29 x 56	<b>B/731</b>	
<b>950</b>	80	500	36 x 68	<b>B/732</b>	
<b>420</b>	8 + 8	500	25 x 47	<b>B/733</b>	
<b>620</b>	16 + 16	500	29 x 60	<b>B/734</b>	
<b>940</b>	32 + 32	500	29 x 100	<b>B/735</b>	
<b>1150</b>	40 + 40	500	36 x 72	<b>B/736</b>	
<b>1250</b>	50 + 50	500	36 x 100	<b>B/737</b>	

	Articolo	Condensatori elettrolitici a vitone « Philips »			Prezzo listino
		Capacità $\mu\text{F}$	Vn cc	$\varnothing$ x L mm	
	<b>B/751</b>	50 + 50	250	30 x 80	<b>660</b>
	<b>B/751-1</b>	16 + 16	300	30 x 80	<b>590</b>
	<b>B/751-2</b>	25 + 25	300	30 x 80	<b>690</b>
	<b>B/751-3</b>	32 + 32	300	30 x 80	<b>740</b>
	<b>B/751-4</b>	50 + 50	300	30 x 80	<b>850</b>
	<b>B/754</b>	32	350	30 x 80	<b>490</b>
	<b>B/755</b>	50 + 50	350	30 x 80	<b>740</b>
	<b>B/756</b>	16 + 16	350	30 x 80	<b>650</b>
	<b>B/757</b>	25 + 25	350	30 x 80	<b>630</b>
	<b>B/758</b>	32 + 32	350	30 x 80	<b>790</b>
<b>B/759</b>	64 + 64	350	30 x 80	<b>990</b>	
<b>B/752</b>	16	450	30 x 80	<b>490</b>	
<b>B/768</b>	32 + 32	450	30 x 80	<b>850</b>	
	Condensatori elettrolitici fissaggio americano « Philips »				
	Articolo	Capacità $\mu\text{F}$	Vn cc	$\varnothing$ x L mm	Prezzo listino
<b>B/761</b>	100 + 100	250	30 x 80	<b>1050</b>	
<b>B/762</b>	100 + 100 + 50	300	30 x 80	<b>1150</b>	
	Condensatori di livellamento « Facon » in carta ed olio				
	Articolo	Capacità $\mu\text{F}$	Vn cc	$\varnothing$ x L mm	Prezzo listino
	<b>B/771</b>	4	500	45 x 75	<b>1200</b>
<b>B/772</b>	8	500	45 x 120	<b>1750</b>	
<b>B/773</b>	12	500	60 x 120	<b>2700</b>	

Prezzo listino	Condensatori « Facon » in carta ed olio, adatti per rifasamento di lampade fluorescenti e per avviamento di motori monofasi ad induzione Tolleranza sulla capacità, a 20 °C, 50 Hz: — 5 + 10 % Resist. isolamento a 100 Vcc: $\geq 3.000 \text{ M}\Omega \times \mu\text{F}$			Articolo
	Capacità $\mu\text{F}$	Vn ca	$\varnothing \times L$ mm	
<b>750</b>	2	260	40 x 65	<b>B/781</b>
<b>790</b>	4	260	45 x 75	<b>B/782</b>
<b>1150</b>	6	260	50 x 75	<b>B/783</b>
<b>1250</b>	7	260	40 x 120	<b>B/784</b>
<b>1300</b>	8	260	45 x 120	<b>B/785</b>
<b>1850</b>	10	260	45 x 120	<b>B/786</b>
<b>2250</b>	12	260	50 x 120	<b>B/787</b>
<b>2450</b>	16	260	60 x 120	<b>B/788</b>
<b>950</b>	2	400	40 x 65	<b>B/789</b>
<b>1550</b>	4	400	50 x 75	<b>B/790</b>
<b>2100</b>	6	400	45 x 120	<b>B/791</b>
<b>2700</b>	8	400	50 x 120	<b>B/792</b>
<b>2900</b>	10	400	60 x 120	<b>B/793</b>
	Condensatori « Facon » in carta ed olio, adatti per stabilizzatori di tensione			
	Capacità $\mu\text{F}$	Vn ca	$\varnothing \times L$ mm	
<b>1980</b>	4	600	50 x 120	<b>B/801</b>
<b>2480</b>	5	600	50 x 120	<b>B/802</b>
<b>2980</b>	6	600	60 x 120	<b>B/803</b>
<b>3240</b>	7	600	60 x 120	<b>B/804</b>
<b>3500</b>	8	600	60 x 120	<b>B/805</b>
	Condensatori « Facon » elettrolitici in custodia cilindrica			
	Capacità $\mu\text{F}$	Vn cc	$\varnothing \times L$ mm	
<b>900</b>	80	500	37 x 100	<b>B/811</b>
<b>890</b>	100	350	37 x 50	<b>B/812</b>





Articolo				Prezzo listino
	<b>Condensatori a carta e olio</b> per telefonia ed elettronica Tolleranza: $\pm 10\%$ Temperatura di lavoro: da $-55\text{ }^{\circ}\text{C}$ $\div$ $+85\text{ }^{\circ}\text{C}$			
	Capacità $\mu\text{F}$	Vn cc	$\varnothing \times L$ mm	
<b>B/821</b>	1,6	500 V	20 x 35	<b>1150</b>
<b>B/822</b>	2,5	500 V	20 x 53	<b>1350</b>
<b>B/823</b>	0,5	750 V	12 x 53	<b>850</b>
<b>B/824</b>	1	750 V	12 x 53	<b>950</b>
<b>B/825</b>	2	750 V	20 x 53	<b>1150</b>
<b>B/826</b>	0,5	1000 V	12 x 35	<b>950</b>
<b>B/827</b>	1	1000 V	20 x 35	<b>1000</b>
<b>B/828</b>	1,6	1000 V	30 x 53	<b>1200</b>
<b>B/829</b>	0,5	2000 V	20 x 35	<b>1100</b>
<b>B/830</b>	1	2000 V	20 x 53	<b>1300</b>

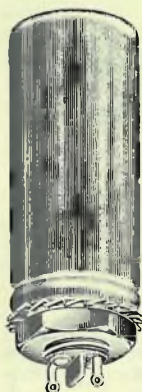

Articolo				Prezzo listino
	<b>Condensatori tubolari in carta e olio</b> per uso universale Tolleranza: $\pm 10\%$ Temperatura di lavoro: da $55\text{ }^{\circ}\text{C}$ $\div$ $+85\text{ }^{\circ}\text{C}$			
	Capacità $\mu\text{F}$	Vn cc	$\varnothing \times L$ mm	
<b>B/861</b>	8	500	40 x 112	<b>2150</b>
<b>B/862</b>	10	500	45 x 112	<b>2550</b>
<b>B/863</b>	16	500	55 x 112	<b>3350</b>
<b>B/864</b>	20	500	60 x 112	<b>3980</b>
<b>B/865</b>	2	1000	36 x 64	<b>1400</b>
<b>B/866</b>	5	1000	40 x 112	<b>2000</b>
<b>B/867</b>	8	1000	55 x 112	<b>2500</b>
<b>B/868</b>	10	1000	60 x 112	<b>3100</b>
<b>B/869</b>	0,5	3000	40 x 64	<b>1350</b>
<b>B/870</b>	1	3000	40 x 112	<b>1650</b>

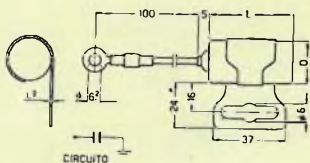
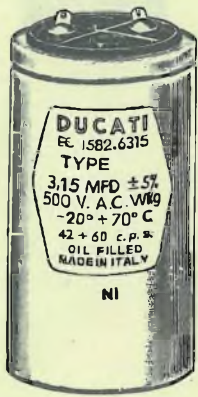

Prezzo listino          <b>590</b>	<p><b>Condensatori « Icar »</b> antidisturbo per auto Tolleranza: <math>\pm 10\%</math> Resist. isolamento: <math>&gt; 5000 \text{ M}\Omega \mu\text{F}</math></p> <p>Capacità: <math>0,5 \mu\text{F}</math> Tensione di lavoro: <math>500 \text{ Vcc}</math> Dimensioni: mm <math>22,5 \times 40</math></p>	Articolo          <b>B/871</b>																																					
<b>740</b>	<p>Capacità: <math>1 \mu\text{F}</math> Tensione di lavoro: <math>500 \text{ Vcc}</math> Dimensioni: mm <math>26 \times 50</math></p>	<b>B/872</b>																																					
	<p><b>Condensatori</b> per applicazioni varie in circuiti a corrente alternata. Serie realizzata per tutte le applicazioni in c.a. ove non si superi la tensione max. permanente di lavoro di <math>560 \text{ V}</math>.</p> <table border="1" data-bbox="206 1039 616 1612"> <thead> <tr> <th>Capacità <math>\mu\text{F}</math></th> <th>VI</th> <th><math>\varnothing \times L</math> mm</th> <th></th> </tr> </thead> <tbody> <tr> <td><b>1250</b></td> <td>3,15</td> <td>600</td> <td><math>45 \times 102</math></td> </tr> <tr> <td><b>1450</b></td> <td>4</td> <td>600</td> <td><math>50 \times 102</math></td> </tr> <tr> <td><b>1750</b></td> <td>5</td> <td>600</td> <td><math>50 \times 120</math></td> </tr> <tr> <td><b>2200</b></td> <td>6,3</td> <td>600</td> <td><math>55 \times 110</math></td> </tr> <tr> <td><b>2300</b></td> <td>7</td> <td>600</td> <td><math>50 \times 112</math></td> </tr> <tr> <td><b>2500</b></td> <td>8</td> <td>600</td> <td><math>60 \times 110</math></td> </tr> <tr> <td><b>3200</b></td> <td>10</td> <td>600</td> <td><math>60 \times 130</math></td> </tr> <tr> <td><b>3700</b></td> <td>12,5</td> <td>600</td> <td><math>65 \times 130</math></td> </tr> </tbody> </table>	Capacità $\mu\text{F}$	VI	$\varnothing \times L$ mm		<b>1250</b>	3,15	600	$45 \times 102$	<b>1450</b>	4	600	$50 \times 102$	<b>1750</b>	5	600	$50 \times 120$	<b>2200</b>	6,3	600	$55 \times 110$	<b>2300</b>	7	600	$50 \times 112$	<b>2500</b>	8	600	$60 \times 110$	<b>3200</b>	10	600	$60 \times 130$	<b>3700</b>	12,5	600	$65 \times 130$	<b>B/880</b>  <b>B/881</b>  <b>B/882</b>  <b>B/883</b>  <b>B/884</b>  <b>B/885</b>  <b>B/886</b>  <b>B/887</b>	
Capacità $\mu\text{F}$	VI	$\varnothing \times L$ mm																																					
<b>1250</b>	3,15	600	$45 \times 102$																																				
<b>1450</b>	4	600	$50 \times 102$																																				
<b>1750</b>	5	600	$50 \times 120$																																				
<b>2200</b>	6,3	600	$55 \times 110$																																				
<b>2300</b>	7	600	$50 \times 112$																																				
<b>2500</b>	8	600	$60 \times 110$																																				
<b>3200</b>	10	600	$60 \times 130$																																				
<b>3700</b>	12,5	600	$65 \times 130$																																				





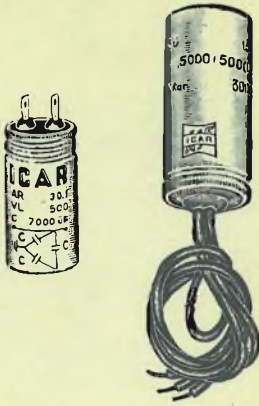
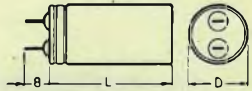
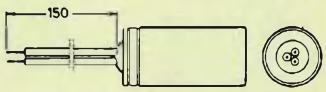
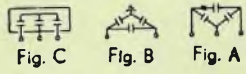
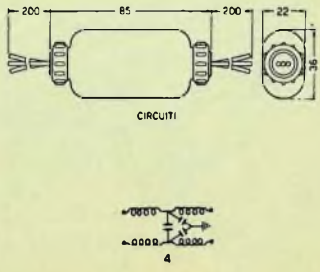













Articolo	Condensatori elettrolitici « Facon » per avviamento di motori monofase ad induzione			Prezzo listino
	Capacità µF	VI ca	Ø x L mm	
<b>B/901</b>	75	125	37 x 60	<b>1500</b>
<b>B/902</b>	100	125	37 x 60	<b>1600</b>
<b>B/903</b>	140	125	37 x 100	<b>1900</b>
<b>B/904</b>	160	125	37 x 100	<b>2200</b>
<b>B/905</b>	200	125	37 x 100	<b>2600</b>
<b>B/906</b>	250	125	45 x 100	<b>2900</b>
<b>B/907</b>	300	125	45 x 100	<b>3600</b>
<b>B/908</b>	75	160	37 x 60	<b>1600</b>
<b>B/909</b>	100	160	37 x 100	<b>1700</b>
<b>B/910</b>	140	160	37 x 100	<b>2200</b>
<b>B/911</b>	160	160	37 x 100	<b>2500</b>
<b>B/912</b>	200	160	45 x 100	<b>2800</b>
<b>B/913</b>	250	160	45 x 100	<b>3500</b>
<b>B/914</b>	315	160	50 x 100	<b>4600</b>
<b>B/915</b>	30	220	37 x 60	<b>1500</b>
<b>B/916</b>	80	220	37 x 100	<b>2200</b>
<b>B/917</b>	100	220	45 x 100	<b>2500</b>
<b>B/918</b>	140	220	45 x 100	<b>3100</b>
<b>B/919</b>	160	220	45 x 100	<b>3500</b>
<b>B/920</b>	200	220	50 x 100	<b>4200</b>
<b>B/921</b>	250	220	50 x 100	<b>4600</b>



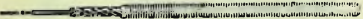
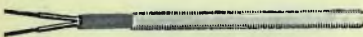

Prezzo listino	<p><b>Condensatori « Icar »</b> di filtro spegni scintilla, silenziamento, dispositivi eliminadisturbi Tolleranza: <math>\pm 10\%</math> Resist. isolamento: <math>\geq 5000\text{ M}\Omega</math> Limite di temperatura: <math>-20 + 85\text{ }^\circ\text{C}</math></p> <p><b>Condensatore</b> triplo Capacità: pF 7000 x 3 Tensione di lavoro: 500 V Dimensioni: mm <math>\varnothing 16 \times 32</math> Circuiti: fig. B</p>	Articolo																					
490	<p><b>Condensatore</b> triplo Capacità: pF 50.000 + 50.000 + 5.000 Tensione di lavoro: 350 V Dimensioni: mm <math>\varnothing 16 \times 32</math> Circuiti: fig. C</p>	B/951																					
1080	<p><b>Condensatore</b> triplo Capacità: pF 5.000 + 5.000 + 50.000 Tensione di lavoro: 350 V Dimensioni: mm <math>\varnothing 16 \times 32</math> Circuiti: fig. A</p>	B/952																					
1080	<p><b>Condensatore</b> triplo Capacità: pF 2.500 + 2.500 + 50.000 Tensione di lavoro: 350 V Dimensioni: mm <math>\varnothing 16 \times 32</math> Circuiti: fig. A</p>	B/953																					
1080	<p><b>Condensatore</b> triplo Capacità: pF 25.000 + 25.000 + 25.000 Tensione di lavoro: 350 V Dimensioni: mm <math>\varnothing 16 \times 32</math> Circuiti: fig. A</p>	B/954	<p style="text-align: center;"><b>Circuiti interni</b></p> 																				
3900	<p><b>Dispositivi anti disturbo « Icar »</b> in custodia di materiale plastico Corrente max: 2 A Tensione: 42 ÷ 60 Hz</p> <table border="0" style="width: 100%;"> <thead> <tr> <th style="width: 60%;"></th> <th style="text-align: center;">Capacità</th> <th style="text-align: center;">Tens.</th> <th style="width: 20%;"></th> </tr> <tr> <th></th> <th style="text-align: center;">pF</th> <th style="text-align: center;">V.</th> <th></th> </tr> </thead> <tbody> <tr> <td style="text-align: right;"><b>3900</b></td> <td style="text-align: center;">5.000 + 5.000 + 50.000</td> <td style="text-align: center;">300</td> <td style="text-align: left;"><b>B/961</b></td> </tr> <tr> <td style="text-align: right;"><b>3900</b></td> <td style="text-align: center;">2.500 + 2.500 + 50.000</td> <td style="text-align: center;">300</td> <td style="text-align: left;"><b>B/962</b></td> </tr> <tr> <td style="text-align: right;"><b>3900</b></td> <td style="text-align: center;">25.000 + 25.000 + 25.000</td> <td style="text-align: center;">300</td> <td style="text-align: left;"><b>B/963</b></td> </tr> </tbody> </table>		Capacità	Tens.			pF	V.		<b>3900</b>	5.000 + 5.000 + 50.000	300	<b>B/961</b>	<b>3900</b>	2.500 + 2.500 + 50.000	300	<b>B/962</b>	<b>3900</b>	25.000 + 25.000 + 25.000	300	<b>B/963</b>		
	Capacità	Tens.																					
	pF	V.																					
<b>3900</b>	5.000 + 5.000 + 50.000	300	<b>B/961</b>																				
<b>3900</b>	2.500 + 2.500 + 50.000	300	<b>B/962</b>																				
<b>3900</b>	25.000 + 25.000 + 25.000	300	<b>B/963</b>																				

	Articolo	<p style="text-align: center;"><b>CAVI COASSIALI SCHERMATI ISOLATI IN POLIETILENE PER DISCESE D'ANTENNA TV</b></p> <p>Tutti i nostri conduttori si distinguono dalla concorrenza per la qualità della materia prima impiegata, direttamente, importata, di cui garantiamo l'assoluta stabilità nel tempo e di isolamento. Le nostre piattine TV sono marcate ogni cm. 60 e quindi non soggette ad essere facilmente contraffatte. I prezzi si intendono per matasse da 100 metri. Per quantitativi inferiori aumento 20 %.</p>	Prezzo listino
	<b>C/3</b>	<b>Cavo</b> coassiale 62 Ohm - schermatura in rame rosso - tipo normale $\varnothing$ esterno mm 6	<b>70</b>
	<b>C/8</b>	<b>Cavo</b> coassiale 75 $\Omega$ tipo C schermatura in rame rosso $\varnothing$ esterno mm 6	<b>64</b>
	<b>C/9</b>	<b>Cavo</b> coassiale 62/75 $\Omega$ tipo CC economico - schermatura in rame rosso $\varnothing$ esterno mm 5	<b>58</b>
	<b>C/10</b>	<b>Cavo</b> coassiale 75 Ohm - schermatura in rame rosso - tipo extra $\varnothing$ esterno mm 6	<b>78</b>
	<b>C/11</b>	<b>Cavo</b> coassiale 75 Ohm - schermatura in rame stagnato - tipo extra $\varnothing$ esterno mm 6	<b>88</b>
	<b>C/12</b>	<b>Cavo</b> coassiale 62 $\Omega$ « Isocel » $\varnothing$ esterno mm 5,5	<b>88</b>
	<b>C/13</b>	<b>Cavo</b> coassiale 75 $\Omega$ « Isocel » $\varnothing$ esterno mm 5,5	<b>82</b>
	<b>C/14</b>	<b>Cavo</b> coassiale 75 $\Omega$ « Isocel » $\varnothing$ esterno mm 5,8	<b>94</b>
	<b>C/16</b>	<b>Cavo</b> coassiale 51 ohm Con forte schermatura, esecuzione speciale a bassa attenuazione per impianti <b>UHF</b> (2° canale) $\varnothing$ mm 8	<b>360</b>
	<b>C/17</b>	<b>Cavo</b> coassiale 75 ohm con forte schermatura e nastro antimigrante - per impianti <b>UHF</b> (2° canale) $\varnothing$ esterno: mm 6,7 Sezione: mmq 1 Formazione: 1 x 11,5/10	<b>140</b>
	<b>C/18</b>	<b>Cavo</b> coassiale schermato 75 ohm per impianti <b>UHF</b> (2° canale) $\varnothing$ esterno: mm 6,30 circa Sezione: mmq 0,80	<b>98</b>

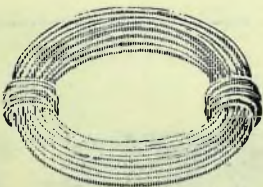

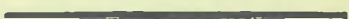

Prezzo listino		Articolo	
	<b>PIATTINE TV</b>		
<b>22</b>	<b>Piattina TV - 300 Ohm</b> isol. rinforzato in polietilene 2 x 0,35	<b>C/51</b>	
<b>28</b>	<b>Piattina TV - 300 Ohm</b> isol. rinforzato in polietilene 2 x 0,35	<b>C/52</b>	
<b>36</b>	<b>Piattina TV - 300 Ohm</b> isol. rinforzato in polietilene 2 x 0,50	<b>C/53</b>	
<b>56</b>	<b>Piattina TV - 300 Ohm</b> isol. super extra in polietilene 2 x 0,50	<b>C/61</b>	
<b>150</b>	<b>Piattina TV - 300 Ohm - Tipo RAI</b> isol. in polietilene per grandi distanze 2 x 1,37	<b>C/71</b>	
<b>38</b>	<b>Piattina TV - 300 Ohm</b> isol. « Antiox » rinforzato 2 x 0,50	<b>C/83</b>	
<b>60</b>	<b>Piattina TV - 300 Ohm</b> isol. « Antiox » super extra 2 x 0,50	<b>C/91</b>	
<b>166</b>	<b>Piattina TV - 300 Ohm</b> isol. « Antiox » - grandi distanze 2 x 1,37	<b>C/95</b>	
<b>170</b>	<b>Piattina bifilare TV - 300 ohm « Isocel »</b> Dimensioni esterne mm. 13 x 8	<b>C/96</b>	
<b>42</b>	<b>Piattina TV - 300 Ohm</b> guaina in cloruro di polivinile colore grigio 2 x 0,35	<b>C/98</b>	
<b>56</b>	<b>Piattina TV - 300 Ohm</b> guaina in cloruro di polivinile colore grigio 2 x 0,50	<b>C/99</b>	

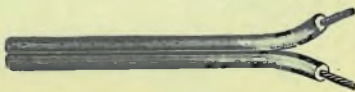

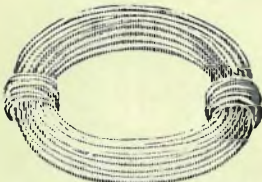

	Articolo		Prezzo Ilistino
	<b>C/101</b>	<b>Cavetto</b> schermato; calza cotone e rame stagnato - Sez.: 1 x 0,35	<b>46</b>
	<b>C/102</b>	<b>Cavetto</b> schermato; elica cellophan e calza rame stagnato - Sez.: 1 x 0,35	<b>56</b>
	<b>C/103</b>	<b>Cavetto</b> per microfono schermato; rivestimento vipla - Sez.: 1 x 0,50	<b>100</b>
	<b>C/104</b>	<b>Cavetto</b> per microfono, schermato rivestimento vipla - Sez.: 2 x 0,50	<b>146</b>
	<b>C/105</b>	<b>Cavetto</b> per microfono, schermato in rame stagnato ricoperto in vipla color avorio - Sez.: mmq 0,125	<b>50</b>
	<b>C/106</b>	<b>Cavetto</b> per microfono, schermato in rame stagnato, ricoperto in vipla color nero - Sez.: mmq 0,125	<b>50</b>
	<b>C/107</b>	<b>Cavetto</b> schermato Spiralatura lamellare - Sez.: 1 x 0,35	<b>84</b>
	<b>C/108</b>	<b>Cavetto</b> schermato unipolare per pick-up e microfono, ricoperto in vipla, color avorio Ø esterno: mm 1,6	<b>160</b>
	<b>C/109</b>	<b>Cavetto</b> schermato bifilare per microfono e pick-up stereofonici, ricoperto in vipla, color avorio Ø esterno: mm 2	<b>86</b>
	<b>C/111</b>	<b>Cavetto</b> isolato in politene a 6000 Volt Sez.: 0,50	<b>46</b>
	<b>C/112</b>	<b>Cavetto</b> isolato in politene a 20000 Volt Sez.: 0,50	<b>58</b>
	<b>C/121</b>	<b>Filo push-back</b> per connessioni, rame stagnato Ø 8/10 isolato con 2 spirali di cotone; nastro carta e calza cotone paraffinato	<b>24</b>
	<b>C/129-1</b>	<b>Busta</b> filo push-back ricoperto in vipla Ø 5/10 da mt 5 Colori assortiti	<b>100</b>
	<b>C/129-2</b>	<b>Busta</b> filo push-back ricoperto in vipla Ø 5/10 da mt 10 Colori assortiti	<b>164</b>
	<b>C/130-1</b>	<b>Busta</b> filo push-back ricoperto in vipla Ø 6/10 da mt 5 Colori assortiti	<b>120</b>
	<b>C/130-2</b>	<b>Busta</b> filo push-back ricoperto in vipla Ø 6/10 da mt 10 Colori assortiti	<b>174</b>

Prezzo listino		Articolo	
14	<b>Filo push-back</b> - rame stagnato, ricoperto in vipla Ø 6/10	<b>C/130</b>	
12	<b>Filo push-back</b> - rame stagnato, ricoperto in vipla Ø 7/10	<b>C/131</b>	
14	<b>Filo push-back</b> - rame stagnato, ricoperto in vipla Ø 8/10	<b>C/132</b>	
28	<b>Filo push-back</b> isolato in Althene Ø 8/10 - monocoloro	<b>C/136</b>	
38	<b>Filo push-back</b> isolato in Althene Ø 8/10 - bicolore	<b>C/136-1</b>	
264	<b>Cavetto</b> unipolare a forte schermatura, ricopertura in plastica. Capacità ca. 200 pF/m Ø ca. 2 mm	<b>C/141</b>	
408	<b>Cavetto</b> unipolare a forte schermatura, ricopertura in plastica. Capacità ca. 60 pF/m - Ø ca. 4 mm	<b>C/142</b>	
418	<b>Cavetto</b> unipolare, forte schermo, con ricopertura in plastica, Capacità ca. 100 pF/m - Ø ca. 2,6 mm	<b>C/143</b>	
506	<b>Cavetto</b> bipolare, forte schermatura ricopertura in plastica Capacità 90 pF/m - Ø ca. 4 mm	<b>C/144</b>	
2400	<b>Filo</b> rame stagnato nudo Ø 7/10 al kg	<b>C/151</b>	
2400	<b>Filo</b> rame stagnato nudo Ø 8/10 al kg	<b>C/152</b>	
2400	<b>Filo</b> rame stagnato nudo Ø 10/10 al kg	<b>C/153</b>	
18	<b>Piattina</b> vipla - Costa stretta Sez. 2 x 0,35	<b>C/171</b>	
26	<b>Piattina</b> vipla - Costa stretta Sez. 2 x 0,50	<b>C/172</b>	
18	<b>Piattina</b> vipla - Costa larga Sez. 2 x 0,35	<b>C/173</b>	
26	<b>Piattina</b> vipla - Costa larga Sez. 2 x 0,50	<b>C/174</b>	
34	<b>Piattina</b> flessibilissima extra-lusso Sez. 2 x 0,35	<b>C/181</b>	
48	<b>Piattina</b> flessibilissima extra-lusso Sez. 2 x 0,50	<b>C/182</b>	







	Articolo		Prezzo listino
	<b>C/191</b>	<b>Trecciola</b> ricoperta in vipla Sez.: mmq 0,12 Ø esterno: mm 1	<b>4</b>
	<b>C/192</b>	<b>Trecciola</b> ricoperta in vipla Sez.: mmq 0,15 Ø esterno: mm 1	<b>6</b>
	<b>C/193</b>	<b>Trecciola</b> ricoperta in vipla Sez.: mmq 0,25 Ø esterno: mm 1,2	<b>8</b>
	<b>C/194</b>	<b>Trecciola</b> ricoperta in vipla Sez.: mmq 0,35 Ø esterno: mm 2	<b>10</b>
	<b>C/195</b>	<b>Trecciola</b> ricoperta in vipla Sez.: mmq 0,50 Ø esterno: mm 2	<b>14</b>
	<b>C/196</b>	<b>Buste</b> di trecciola ricoperta in vipla Sez.: mmq 0,12 - da mt 10 Colori assortiti	<b>144</b>
	<b>C/197</b>	<b>Buste</b> di trecciola ricoperta in vipla Sez.: mmq 0,15 - da mt 10 Colori assortiti	<b>156</b>
	<b>C/198</b>	<b>Buste</b> di trecciola ricoperta in vipla Sez.: mmq 0,25 da mt 10 Colori assortiti	<b>180</b>
	<b>C/199</b>	<b>Buste</b> di trecciola ricoperta in vipla Sez.: mmq 0,35 da mt 10 Colori assortiti	<b>206</b>
	<b>C/200</b>	<b>Buste</b> di trecciola ricoperta in vipla Sez.: mmq 0,50 da mt 10 Colori assortiti	<b>230</b>
	<b>C/201</b>	<b>Cordone</b> in vipla a 2 conduttori Sez.: mmq 0,35	<b>33</b>
	<b>C/202</b>	<b>Cordone</b> in vipla a 3 conduttori Sez.: mmq 0,35	<b>44</b>
	<b>C/203</b>	<b>Cordone</b> in vipla a 4 conduttori Sez.: mmq 0,35	<b>52</b>
	<b>C/204</b>	<b>Cordone</b> in vipla a 5 conduttori Sez.: mmq 0,35	<b>74</b>
	<b>C/205</b>	<b>Cordone</b> in vipla a 6 conduttori Sez.: mmq 0,35	<b>94</b>



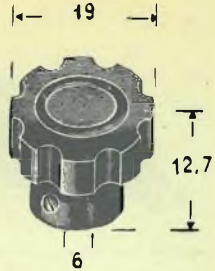
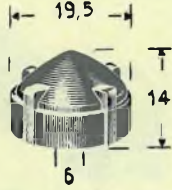
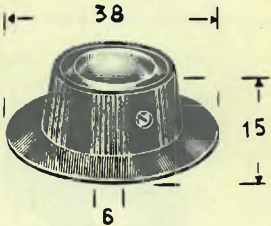
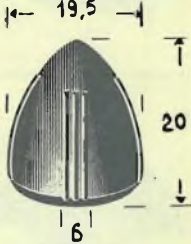

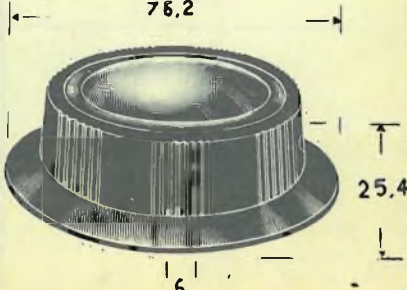
Prezzo listino		Articolo	
	<b>Cordone</b> in vipla completo di spina da 6 Amp. Lunghezza mt. 1,50		
<b>120</b>	Colore avorio - sez. mmq. 0,35	<b>C/221</b>	
<b>120</b>	» marrone - sez. mmq. 0,35	<b>C/222</b>	
<b>120</b>	» nero - sez. mmq. 0,35	<b>C/222-1</b>	
<b>150</b>	» avorio - sez. mmq. 0,50	<b>C/223</b>	
<b>150</b>	» marrone - sez. mmq. 0,50	<b>C/224</b>	
<b>150</b>	» nero - sez. mmq. 0,50	<b>C/225</b>	
	<b>Cordone</b> in vipla completo di spina e presa da 6 Amp. Lunghezza mt. 2		
<b>210</b>	Colore avorio - sez. mmq. 0,35	<b>C/231</b>	
<b>210</b>	» marrone - sez. mmq. 0,35	<b>C/232</b>	
<b>210</b>	» nero - sez. mmq. 0,35	<b>C/232-1</b>	
<b>250</b>	» avorio - sez. mmq. 0,50	<b>C/233</b>	
<b>250</b>	» marrone - sez. mmq. 0,50	<b>C/234</b>	
<b>250</b>	» nero - sez. mmq. 0,50	<b>C/235</b>	
	<b>Cordone</b> in vipla completo di due spine da 6 Amp. Lunghezza mt 2		
<b>210</b>	Colore avorio - sez. mmq. 0,35	<b>C/251</b>	
<b>210</b>	» marrone - sez. mmq. 0,35	<b>C/252</b>	
<b>210</b>	» nero - sez. mmq. 0,35	<b>C/252-1</b>	
<b>250</b>	» avorio - sez. mmq. 0,50	<b>C/253</b>	
<b>250</b>	» marrone - sez. mmq. 0,50	<b>C/254</b>	
<b>250</b>	» nero - sez. mmq. 0,50	<b>C/255</b>	
<b>290</b>	<b>Cordone</b> d'alimentazione color avorio, con presa speciale - fori mm 3 Interasse mm 13 - spina 6 Amp. Sez 2 x 0,75 - lunghezza mt 1,5	<b>C/260</b>	
<b>290</b>	<b>Cordone</b> d'alimentazione color marro- ne, con presa speciale - fori mm 3 Interasse mm 13 - spina 6 Amp. Sez. 2 x 0,75 - lunghezza mt 1,5	<b>C/262</b>	
<b>2950</b>	<b>Riavvolgitore</b> automatico per collegamenti volanti - adatto per rasoi elettrici, accendigas, ecc. - comprende una spina bipolare con dispositivo antistrappo e mt. 2,20 di cavetto m/mq. 2 x 0,75, racchiuso in custodia di plastica avorio Ingombro: mm 145 x 125 x 35	<b>C/281</b>	

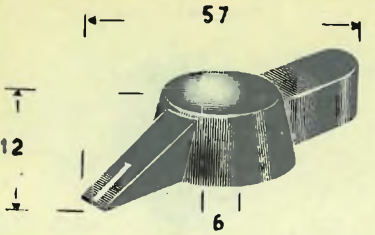
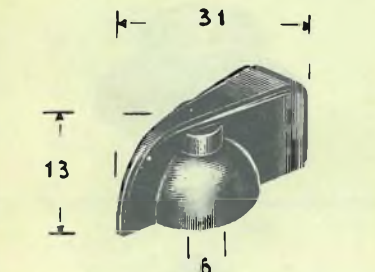
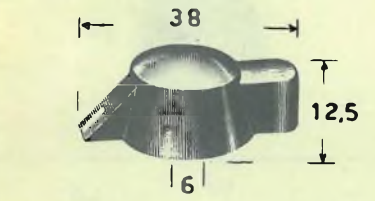
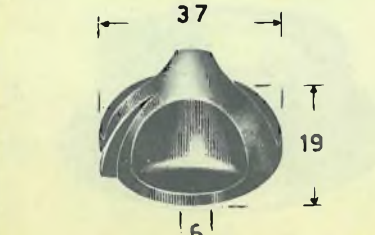
Articolo		Prezzo listino
<b>C/301</b>	<b>Tubetto</b> vipla $\varnothing$ mm 1	<b>8</b>
<b>C/302</b>	<b>Tubetto</b> vipla $\varnothing$ mm 1,5	<b>10</b>
<b>C/303</b>	<b>Tubetto</b> vipla $\varnothing$ mm 2	<b>12</b>
<b>C/304</b>	<b>Tubetto</b> vipla $\varnothing$ mm 2,5	<b>14</b>
<b>C/305</b>	<b>Tubetto</b> vipla $\varnothing$ mm 3	<b>16</b>
<b>C/306</b>	<b>Tubetto</b> vipla $\varnothing$ mm 4	<b>20</b>
<b>C/307</b>	<b>Tubetto</b> vipla $\varnothing$ mm 5	<b>22</b>
<b>C/308</b>	<b>Tubetto</b> vipla $\varnothing$ mm 6	<b>32</b>
<b>C/309</b>	<b>Tubetto</b> vipla $\varnothing$ mm 7	<b>40</b>
<b>C/310</b>	<b>Tubetto</b> vipla $\varnothing$ mm 8	<b>44</b>
<b>C/311</b>	<b>Tubetto</b> vipla $\varnothing$ mm 9	<b>48</b>
<b>C/312</b>	<b>Tubetto</b> vipla $\varnothing$ mm 10	<b>60</b>
<b>C/351</b>	<b>Tubetto</b> sterlingato $\varnothing$ mm 0,5	<b>32</b>
<b>C/352</b>	<b>Tubetto</b> sterlingato $\varnothing$ mm 1	<b>36</b>
<b>C/353</b>	<b>Tubetto</b> sterlingato $\varnothing$ mm 1,5	<b>42</b>
<b>C/354</b>	<b>Tubetto</b> sterlingato $\varnothing$ mm 2	<b>48</b>
<b>C/355</b>	<b>Tubetto</b> sterlingato $\varnothing$ mm 2,5	<b>52</b>
<b>C/356</b>	<b>Tubetto</b> sterlingato $\varnothing$ mm 3	<b>60</b>
<b>C/357</b>	<b>Tubetto</b> sterlingato $\varnothing$ mm 4	<b>70</b>
<b>C/358</b>	<b>Tubetto</b> sterlingato $\varnothing$ mm 5	<b>80</b>
<b>C/358-1</b>	<b>Tubetto</b> sterlingato $\varnothing$ mm 6	<b>94</b>
<b>C/358-2</b>	<b>Tubetto</b> sterlingato $\varnothing$ mm 7	<b>108</b>
<b>C/358-3</b>	<b>Tubetto</b> sterlingato $\varnothing$ mm 8	<b>128</b>
<b>C/358-4</b>	<b>Tubetto</b> sterlingato $\varnothing$ mm 9	<b>144</b>
<b>C/359</b>	<b>Tubetto</b> sterlingato $\varnothing$ mm 10	<b>170</b>
<b>C/360</b>	<b>Tubetto</b> di seta $\varnothing$ mm 0,8	<b>72</b>



<p>Prezzo listino</p> <p><b>150</b></p>	<p><b>Manopola</b> con impugnatura scanalata in bachelite nera K 111</p>	<p>Articolo</p> <p><b>F/1</b></p>	
<p><b>136</b></p>	<p><b>Manopola</b> in bachelite nera K 324</p>	<p><b>F/2</b></p>	
<p><b>230</b></p>	<p><b>Manopola</b> per strumenti in bachelite nera K 360</p>	<p><b>F/4</b></p>	
<p><b>150</b></p>	<p><b>Manopola</b> a « cuore » in bachelite nera K 133</p>	<p><b>F/5</b></p>	
<p><b>380</b></p>	<p><b>Manopola</b> per strumenti in bachelite nera K 361</p>	<p><b>F/6</b></p>	
<p><b>780</b></p>	<p><b>Manopola</b> per strumenti in bachelite nera K 362</p>	<p><b>F/7</b></p>	

	Articolo		Prezzo listino
	F/12	Manopola a indice in bachelite nera K 60	230
	F/13	Manopola a indice in bachelite nera K 390	200
	F/14	Manopola a indice in bachelite nera K 107	140
	F/15	Manopola a indice in bachelite nera K 357	140
	F/16	Manopola a indice in polistirene termoplastico nera K 58	190
	F/17	Manopola a indice in bachelite nera K 344/P	160
	F/18	Manopola a indice in bachelite nera K 345/P	160

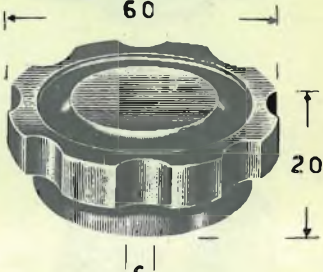
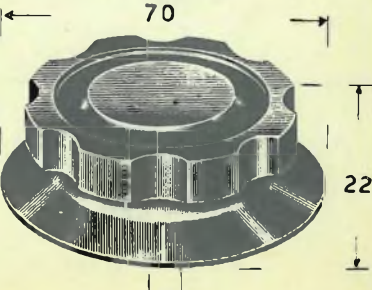

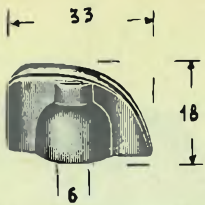
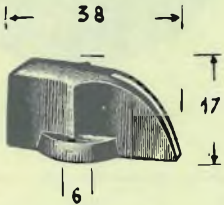
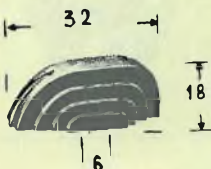
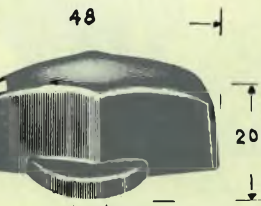
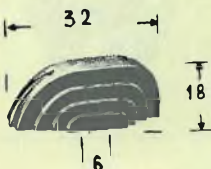
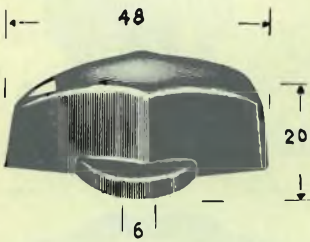
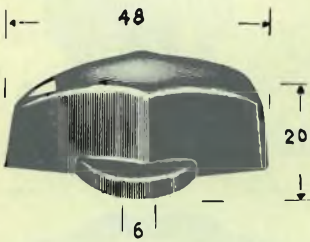
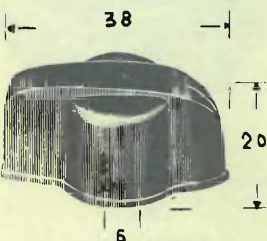
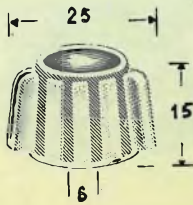
Prezzo listino		Articolo	
240	<b>Manopola</b> a indice per strumenti in bachelite nera lungh. max: mm 36 altezza: mm 15 foro: $\varnothing$ 6 K 370	F/19	
136 240 240 240	<b>Piattelli</b> per manopola F/19 in bachelite nera $\varnothing$ mm 48  <b>Piattello</b> non graduato <b>Piattello</b> graduato 0 ÷ 10 su 250° <b>Piattello</b> graduato 0 ÷ 10 su 180° <b>Piattello</b> graduato 0 ÷ 18 su 360°	F/20 F/21 F/22 F/23	
76	<b>Manopola</b> per strumenti in bachelite nera	F/31	
200	<b>Manopola</b> per strumenti in bachelite nera	F/32	
300	<b>Manopola</b> per strumenti in bachelite nera	F/33	
330	<b>Manopola</b> per strumenti in bachelite nera	F/34	

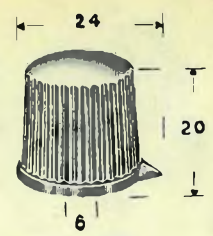

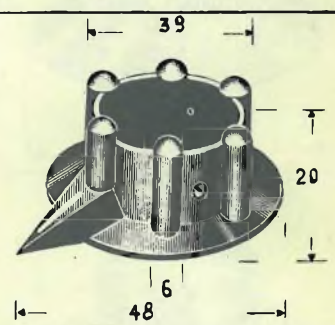
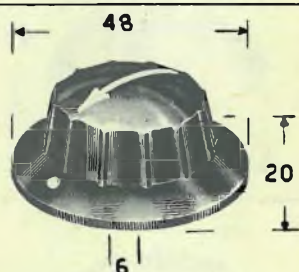
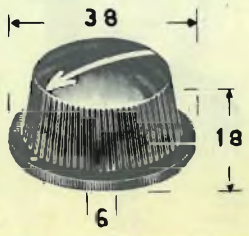
	Articolo		Prezzo listino
	<b>F/35</b>	<b>Manopola</b> a indice in urea color avorio	<b>66</b>
	<b>F/36</b>	<b>Manopola</b> a indice in bachelite nera	<b>60</b>
	<b>F/37</b>	<b>Manopola</b> a indice in urea color avorio	<b>72</b>
	<b>F/38</b>	<b>Manopola</b> a indice in bachelite nera	<b>62</b>
	<b>F/39</b>	<b>Manopola</b> a indice in urea color avorio	<b>90</b>
	<b>F/40</b>	<b>Manopola</b> a indice in bachelite nera	<b>90</b>
	<b>F/43</b>	<b>Manopola</b> a indice in bachelite nera 10534	<b>218</b>
	<b>F/44</b>	<b>Manopola</b> a indice in bachelite nera 20108	<b>184</b>
	<b>F/45</b>	<b>Manopola</b> a indice in bachelite color grigio-disco in metallo color argento - 10742	<b>200</b>

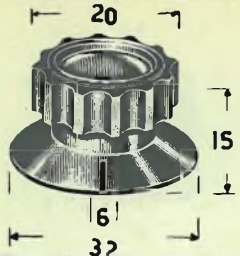
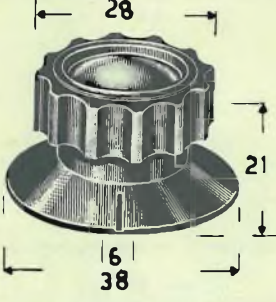
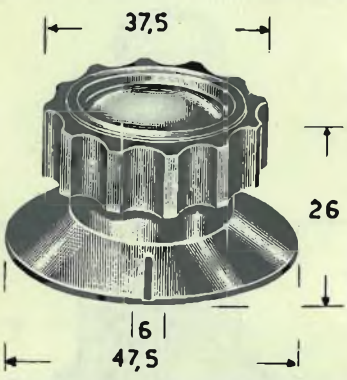
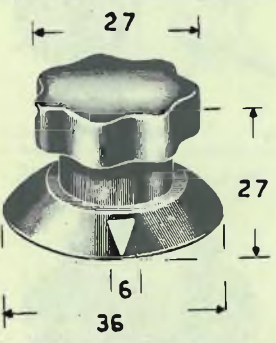
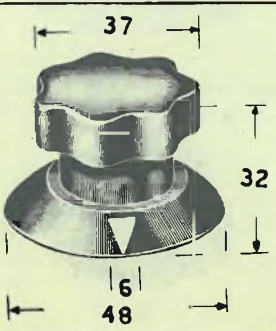
Prezzo listino		Articolo	
130	<b>Manopola</b> a indice in urea color avorio 20109	F/51	
130	<b>Manopola</b> a indice in bachelite nera 20109	F/51-1	
120	<b>Manopola</b> a indice in bachelite nera 10530	F/52	
82	<b>Manopola</b> a indice in urea color avorio, con bussola di metallo annegata 2769/RK	F/53-1	
82	<b>Manopola</b> a indice in bachelite nera con bussola di metallo annegata 2769/RK	F/53-2	
200	<b>Manopola</b> a indice in bachelite nera 2768/RK	F/54	
346	<b>Manopola</b> a indice in bachelite nera 10535	F/55	
130	<b>Manopola</b> a indice in bachelite nera 10532	F/56	

	Articolo		Prezzo listino
	F/56-1	<b>Manopola</b> per strumenti con piattello a indice in bachelite nera	<b>326</b>
	F/56-2	<b>Manopola</b> per strumenti con piattello a indice in bachelite nera	<b>376</b>
	F/56-3	<b>Manopola</b> per strumenti con piattello a indice in bachelite nera	<b>462</b>
	F/57	<b>Manopola</b> per strumenti con piattello a indice in bachelite nera	<b>276</b>
	F/58	<b>Manopola</b> per strumenti con piattello a indice in bachelite nera	<b>400</b>

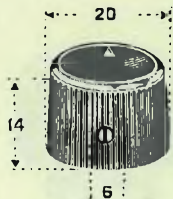
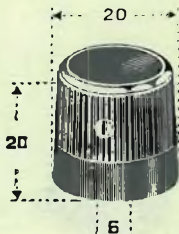
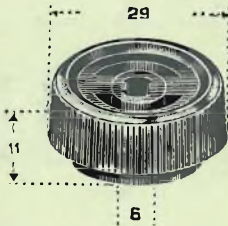

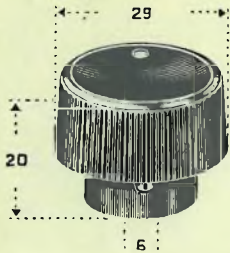
Prezzo listino		Articolo	
90	<b>Manopola</b> a indice in bachelite color grigio-bordatura con anellino nichelato 142	F/58-1	
86	<b>Manopola</b> a indice in urea color avorio bordatura con anellino in metallo color oro 142	F/58-2	
86	<b>Manopola</b> a indice in bachelite color marrone, bordatura con anellino in metallo color oro 142	F/59	
86	<b>Manopola</b> in bachelite color marrone bordatura con anellino in metallo color oro 141	F/59-1	
90	<b>Manopola</b> in bachelite color grigio bordatura con anellino nichelato 141	F/59-2	
86	<b>Manopola</b> in bachelite color nero bordatura con anellino in metallo color oro 141	F/59-3	
86	<b>Manopola</b> in urea color avorio bordatura con anellino in metallo color oro 141	F/59-4	
90	<b>Piattello</b> in bachelite color marrone bordatura con anellino in metallo color oro - da impiegare con manopola F/59 e F/59-1 140	F/59-7	
100	<b>Piattello</b> in bachelite color grigio bordatura con anellino nichelato da impiegare con manopola F/59-2 e F/58-1 140	F/59-8	
90	<b>Piattello</b> in bachelite color nero bordatura con anellino in metallo color oro da impiegare con manopola F/59-3 140	F/59-9	
90	<b>Piattello</b> in urea color avorio bordatura con anellino in metallo color oro - da impiegare con manopola F/58-2 e F/59-4 140	F/60	

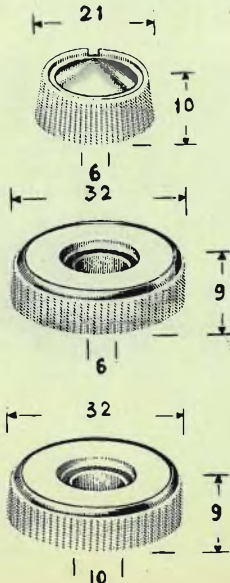
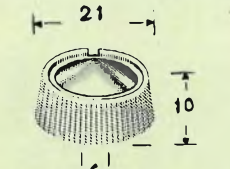
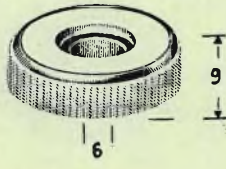
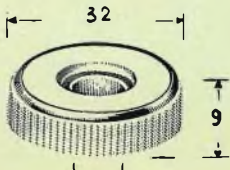
	Articolo		Prezzo listino
	<b>F/60-1</b>	<b>Manopola</b> a indice in bachelite color marrone - bordatura con anellino in metallo color oro 144	<b>100</b>
	<b>F/60-2</b>	<b>Manopola</b> a indice in bachelite color grigio - bordatura con anellino nichelato 144	<b>110</b>
	<b>F/60-3</b>	<b>Manopola</b> a indice in urea color avorio - bordatura con anellino in metallo color oro 144	<b>100</b>
	<b>F/60-4</b>	<b>Manopola</b> a indice in bachelite color marrone disco in metallo color oro 145	<b>76</b>
	<b>F/60-5</b>	<b>Manopola</b> a indice in bachelite color grigio disco in metallo nichelato 145	<b>86</b>
	<b>F/60-6</b>	<b>Manopola</b> a indice in urea color avorio disco in metallo color oro 145	<b>76</b>
	<b>F/61</b>	<b>Manopola</b> in urea color avorio disco in metallo color oro 20056	<b>160</b>
	<b>F/62</b>	<b>Piattello</b> in urea color avorio bordatura con anellino in metallo color oro 20057	<b>184</b>
	<b>F/63</b>	<b>Piattello</b> in urea color avorio bordatura con anellino in metallo color oro 20057	<b>186</b>

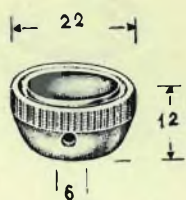
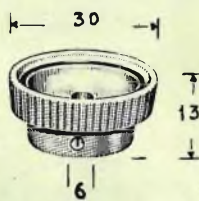
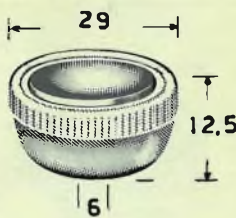
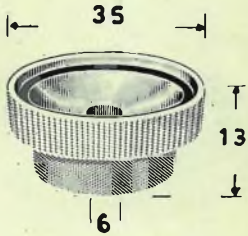
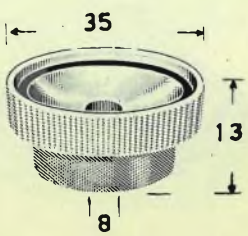
Prezzo listino		Articolo	
50	<b>Manopola</b> in urea color avorio disco in metallo color oro 20026	<b>F/64</b>	
50	<b>Manopola</b> in bachelite color marrone disco in metallo color oro 20026	<b>F/66</b>	
56	<b>Piattello</b> in urea color avorio bordatura con anellino in metallo color oro - da impiegare con manopola F/64 20027	<b>F/65</b>	
56	<b>Piattello</b> in bachelite color marrone bordatura con anellino in metallo color oro - da impiegare con manopola F/66 20027	<b>F/67</b>	
140	<b>Manopola</b> in urea color avorio disco in metallo color oro 20202	<b>F/68</b>	
140	<b>Manopola</b> in bachelite color marrone disco in metallo color oro 20202	<b>F/68-1</b>	
120	<b>Piattello</b> in urea color avorio bordatura con anellino in metallo color oro - da impiegare con manopola F/68 20126	<b>F/69</b>	
120	<b>Piattello</b> in bachelite color marrone bordatura con anellino in metallo color oro - da impiegare con manopola F/68-1 20126	<b>F/69-1</b>	

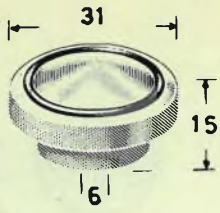
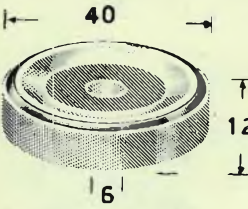
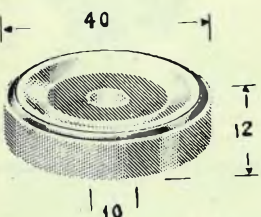
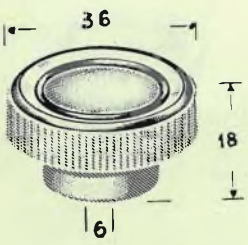
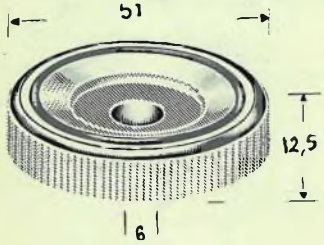
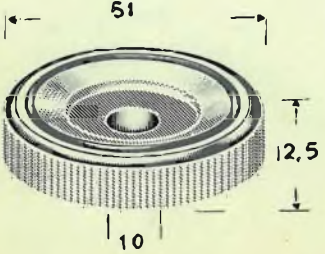
	<p>Articolo</p> <p><b>F/70</b></p>	<p><b>Manopola</b> in urea color avorio bordatura con anellino in metallo color oro 20114</p>	<p>Prezzo listino</p> <p><b>138</b></p>
	<p><b>F/71</b></p>	<p><b>Piattello</b> in urea color avorio bordatura con anellino in metallo color oro 20115</p>	<p><b>154</b></p>
	<p><b>F/72</b></p>	<p><b>Piattello</b> in urea color avorio bordatura con anellino in metallo color oro 20115</p>	<p><b>154</b></p>
	<p><b>F/73</b></p>	<p><b>Manopola</b> in urea color avorio bordatura con due anellini in metallo color oro 10278</p>	<p><b>214</b></p>
	<p><b>F/74</b></p>	<p><b>Piattello</b> in urea color avorio bordatura con due anellini in metallo color oro 10279</p>	<p><b>204</b></p>
	<p><b>F/75</b></p>	<p><b>Piattello</b> in urea color avorio bordatura con due anellini in metallo color oro 10279</p>	<p><b>204</b></p>



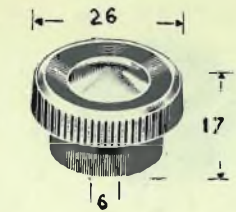
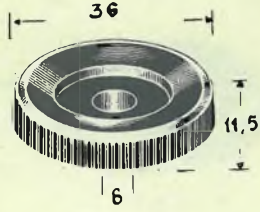
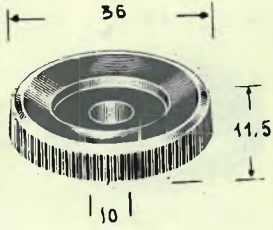
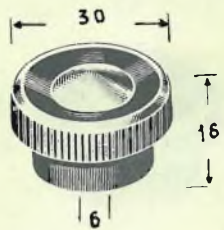
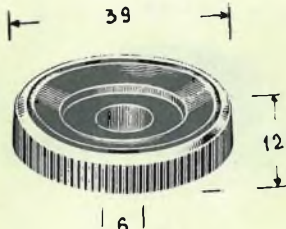
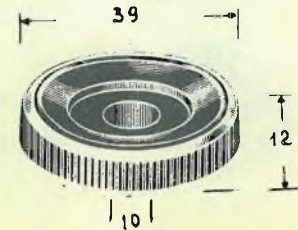

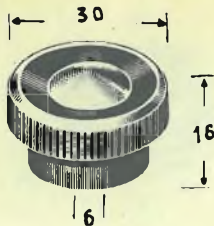
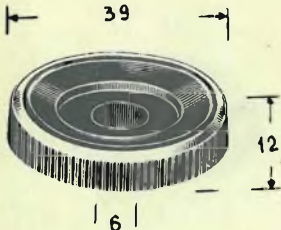
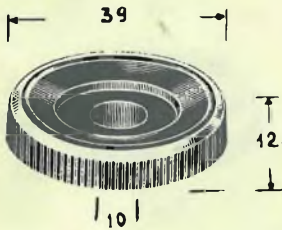
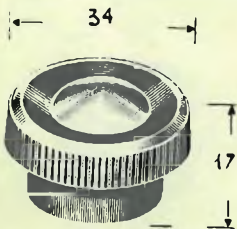
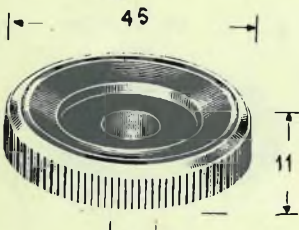
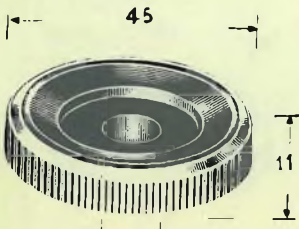
Prezzo listino		Articolo	
96	<b>Manopola</b> in bachelite color marrone disco e anellino in metallo color oro 10394	F/76	
118	<b>Piattello</b> in bachelite color marrone bordatura con anellino in metallo color oro 10395	F/77	
118	<b>Piattello</b> in bachelite color marrone bordatura con anellino in metallo color oro 10395	F/78	
98	<b>Manopola</b> in bachelite color marrone disco e anellino in metallo color oro 10280	F/79	
96	<b>Piattello</b> in bachelite color marrone bordatura con anellino in metallo color oro 10281	F/80	
118	<b>Piattello</b> in bachelite color marrone bordatura con anellino in metallo color oro 10281	F/81	

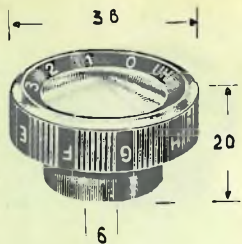
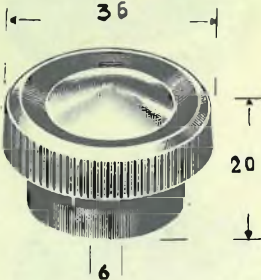
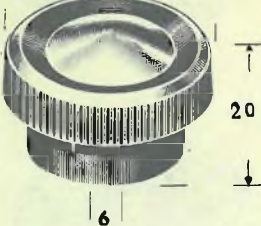
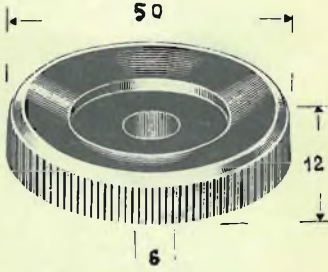
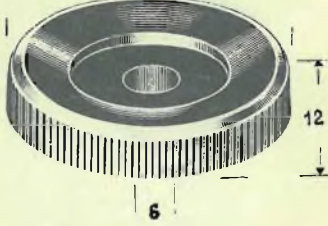
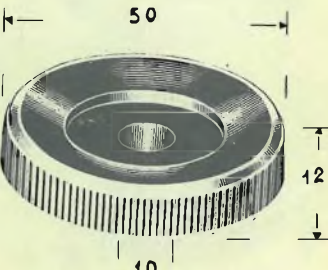
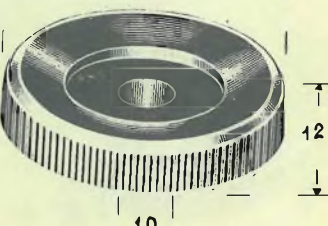

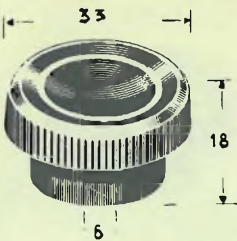
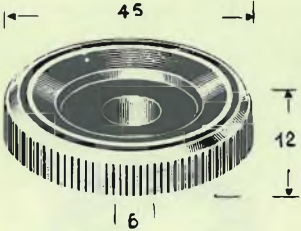
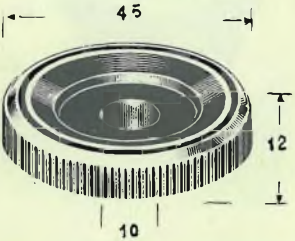
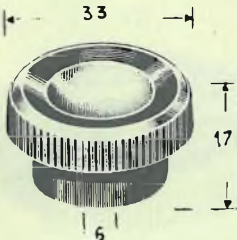
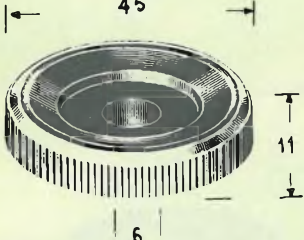
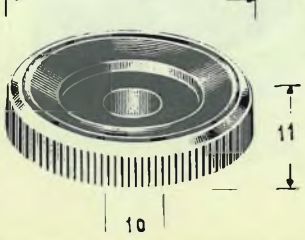
	Articolo		Prezzo listino
	F/82	<b>Manopola</b> in urea color avorio disco e anellino in metallo color oro 10280	180
	F/83	<b>Piattello</b> in urea color avorio bordatura con anellino in metallo color oro 10281	150
	F/84	<b>Piattello</b> in urea color avorio bordatura con anellino in metallo color oro - 10281	150
	F/85	<b>Manopola</b> in bachelite color marrone disco e anellino in metallo color oro - 10290	102
	F/86	<b>Piattello</b> in bachelite color marrone bordatura con anellino in metallo color oro - 10291	96
	F/87	<b>Piattello</b> in bachelite color marrone bordatura con anellino in metallo color oro - 10291	96

Prezzo listino		Articolo	
478	<b>Manopola</b> in bachelite color marrone disco e anellino in metallo color oro con numerazione canali - 10306	F/87-1	
102	<b>Manopola</b> in bachelite color marrone disco e anellino in metallo color oro - 10306	F/88	
200	<b>Manopola</b> in urea color avorio disco e anellino in metallo color oro - 10306	F/88-1	
130	<b>Piattello</b> in bachelite color marrone bordatura con anellino in metallo color oro - da impiegare con manopola F/88 - 10307	F/89	
186	<b>Piattello</b> in urea color avorio bordatura con anellino in metallo color oro - da impiegare con manopola F/88-1 - 10307	F/89-1	
130	<b>Piattello</b> in bachelite color marrone bordatura con anellino in metallo color oro - da impiegare con manopola F/88 - 10307	F/90	
186	<b>Piattello</b> in urea color avorio bordatura con anellino in metallo color oro - da impiegare con manopola F/88-1 - 10307	F/90-1	

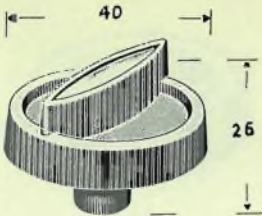
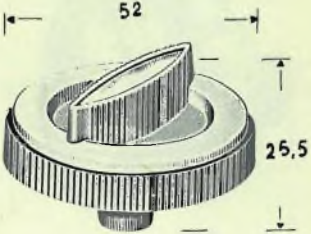
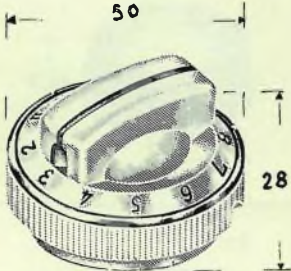

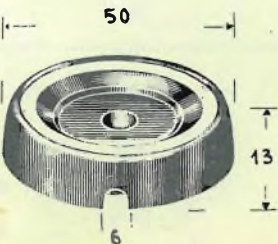
	Articolo		Prezzo listino
	F/91	<b>Manopola</b> in bachelite color marrone bordatura con due anellini in metallo color oro - 10435	<b>122</b>
	F/92	<b>Piattello</b> in bachelite color marrone bordatura con due anellini in metallo color oro - 10436	<b>122</b>
	F/93	<b>Piattello</b> in bachelite color marrone bordatura con due anellini in metallo color oro - 10436	<b>122</b>
	F/94	<b>Manopola</b> in bachelite color marrone disco e anellino in metallo color oro 10378	<b>150</b>
	F/95	<b>Piattello</b> in bachelite color marrone bordatura con anellino in metallo color oro - 10291	<b>96</b>
	F/96	<b>Piattello</b> in bachelite color marrone bordatura con anellino in metallo color oro - 10291	<b>96</b>

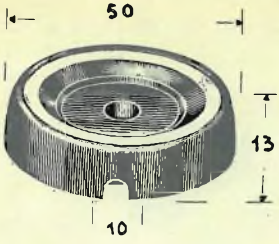
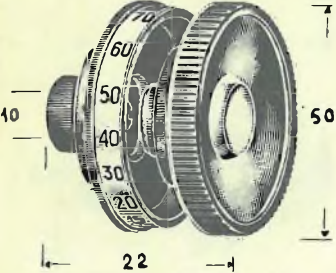
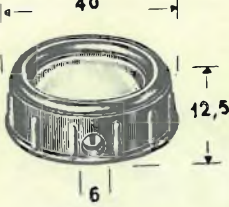

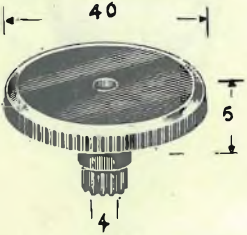
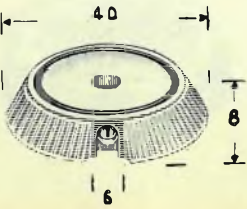

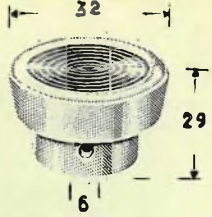
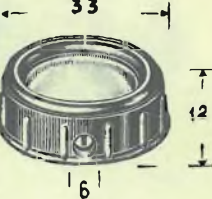
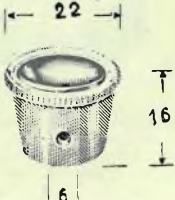
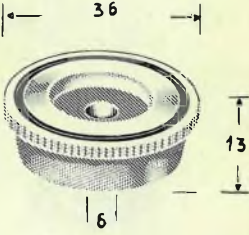
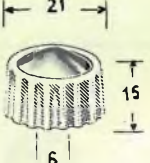
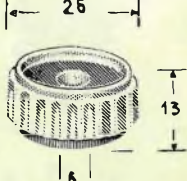
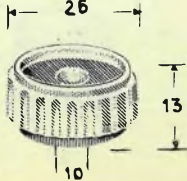

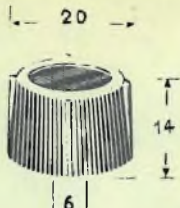
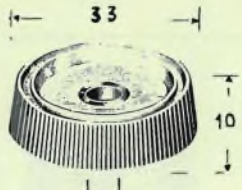
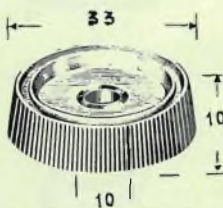
Prezzo listino	Articolo	Immagine
130	<p><b>Manopola</b> in polistirolo color grigio disco in metallo color argento completa di piattelli con innesto a pressione adatta per gruppo UHF</p>	<p>F/96-1</p> 
190	<p><b>Manopola</b> in polistirolo color grigio disco in metallo color argento completa di piattelli con innesto a pressione adatta per gruppo VHF</p>	<p>F/96-2</p> 
610	<p><b>Manopola</b> in urea color avorio - indice a anellino in metallo color oro graduata per dodici posizioni <math>\varnothing</math> foro mm 6 piattello con foro centrale <math>\varnothing</math> mm 10 due fori di fissaggio distanti mm 23 20089 - 10551/6 - 10551/10</p>	<p>F/97</p> 
168	<p><b>Manopola</b> in bachelite color nero disco in metallo color oro - 10521</p>	<p>F/97-1</p> 
168	<p><b>Piattello</b> in bachelite color nero bordatura con anellino in metallo color oro - 20063</p>	<p>F/97-2</p> 

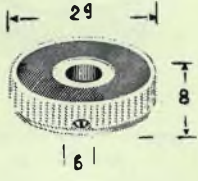
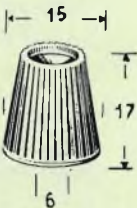
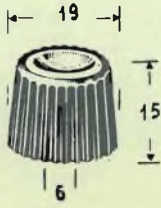

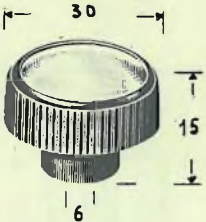
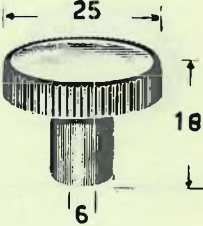

	Articolo		Prezzo listino
	F/97-3	<b>Piattello</b> in bachelite color nero bordatura con anellino in metallo color oro - 20063	168
	F/97-4	<b>Manopola</b> in polistirolo color marrone speciale per UHF (2° canale)	160
	F/99-1	<b>Manopola</b> in bachelite color marrone disco e filettatura in metallo color oro - 10159	130
	F/99-2	<b>Manopola</b> in bachelite color marrone disco e filettatura in metallo color oro - 10161	200
	F/100	<b>Manopola</b> in bachelite color marrone per TV - bordatura con anellino in metallo color oro - 10386	194
	F/100-1	<b>Manopola</b> in urea color avorio bordatura con filetto dorato - 20032	78



Prezzo listino		Articolo	
172	<b>Manopola</b> in urea color avorio disco in metallo color oro - 20074	F/100-2	
118	<b>Manopola</b> in bachelite color marrone disco e filettatura in metallo color oro - 10179	F/100-3	
96	<b>Manopola</b> in urea color avorio disco in metallo color oro - 20035	F/100-4	
82	<b>Piattello</b> in urea color avorio bordatura con filetto in metallo color oro - 20036	F/100-5	
36	<b>Manopola</b> in urea color avorio disco in metallo color oro	F/109	
78	<b>Piattello</b> in urea color avorio	F/110	
86	<b>Piattello</b> in urea color avorio	F/111	

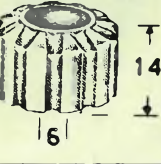

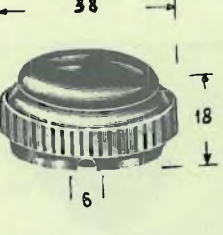
	Articolo		Prezzo listino
	F/112	<b>Manopola</b> in urea color avorio disco in metallo color oro	40
	F/113	<b>Piattello</b> in urea color avorio bordatura con filetto dorato	76
	F/114	<b>Piattello</b> in urea color avorio bordatura con filetto dorato	76
	F/115	<b>Manopola</b> in urea color avorio	98
	F/116	<b>Piattello</b> in urea color avorio	146
	F/117	<b>Manopola</b> in polistirolo color grigio disco in metallo color argento innesto a pressione	66
	F/119	<b>Manopola</b> in polistirolo color marrone disco in metallo color oro	40

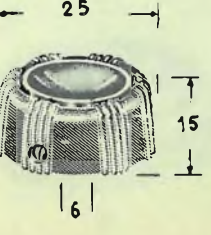

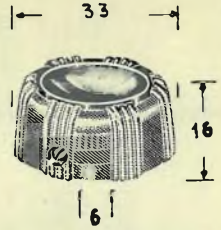
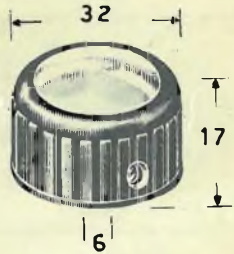
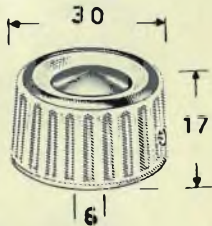
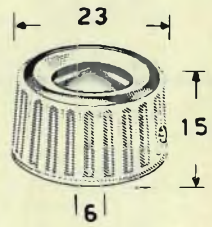
Prezzo listino		Articolo	
62	<b>Manopola</b> in bachelite color marrone centro avorio	F/121	
62	<b>Manopola</b> in urea color avorio centro marrone	F/122	
62	<b>Manopola</b> in urea color avorio disco in metallo color oro	F/123	
76	<b>Manopola</b> in polistirolo color marrone disco in metallo color oro innesto a pressione	F/125	
62	<b>Manopola</b> in bachelite color marrone disco in metallo color oro	F/126	
72	<b>Manopola</b> in bachelite color marrone disco in metallo color oro	F/127	
120	<b>Manopola</b> in bachelite color marrone disco e anellino in metallo color oro	F/128	

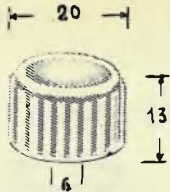
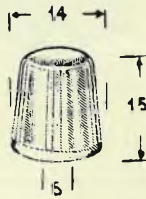
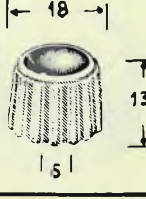

	Articolo		Prezzo listino
	F/130	<b>Manopola</b> in urea color avorio disco in metallo color oro	40
	F/131	<b>Manopola</b> in urea color avorio disco in metallo color oro	46
	F/132	<b>Manopola</b> in urea color avorio bordatura con anellino in metallo color oro	82
	F/133	<b>Manopola</b> in bachelite color marrone bordatura con anellino in metallo color oro	82
	F/134	<b>Manopola</b> in urea color avorio bordatura con anellino in metallo color oro	92
	F/135	<b>Manopola</b> in bachelite color marrone bordatura con anellino in metallo color oro	92
	F/136	<b>Manopola</b> in plexiglas disco in metallo color oro	42
	F/137	<b>Manopola</b> in bachelite color marrone disco in metallo color oro	42
	F/138	<b>Manopola</b> in urea color avorio disco in metallo color oro	42
	F/139	<b>Manopola</b> in urea color avorio disco in metallo color oro	60
	F/140	<b>Manopola</b> in plexiglas disco in metallo color oro	60
	F/141	<b>Manopola</b> in bachelite color marrone disco in metallo color oro	60

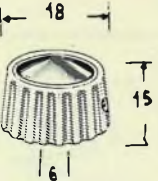
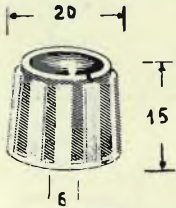
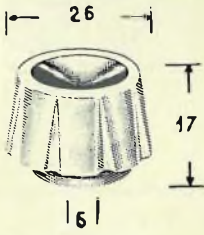
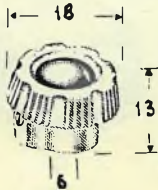

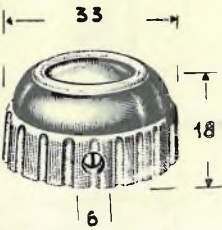
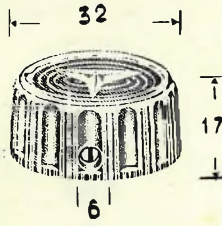
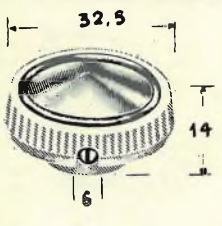
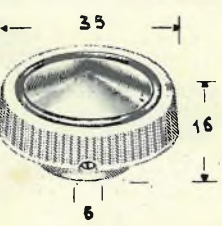
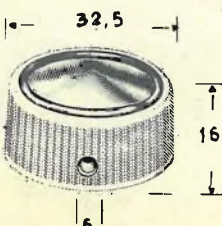

Prezzo listino		Articolo	
72	<b>Manopola</b> in plexiglas disco in metallo color oro	F/142	
72	<b>Manopola</b> in urea color avorio disco in metallo color oro	F/143	
72	<b>Manopola</b> in bachelite color marrone disco in metallo color oro	F/144	
72	<b>Manopola</b> in urea color avorio disco in metallo color oro	F/149	
86	<b>Manopola</b> in urea color avorio disco e anellino in metallo color oro	F/153	
86	<b>Manopola</b> in bachelite color marrone disco e anellino in metallo color oro	F/153-1	
60	<b>Manopola</b> in urea color avorio disco e anellino in metallo color oro	F/154	
60	<b>Manopola</b> in bachelite color marrone disco e anellino in metallo color oro	F/154-1	
166	<b>Manopola</b> in urea color avorio disco in metallo color oro 20058	F/155	
166	<b>Manopola</b> in bachelite color grigio disco in metallo color oro 20058	F/156	

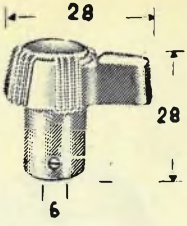
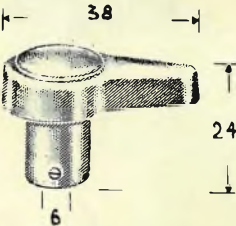
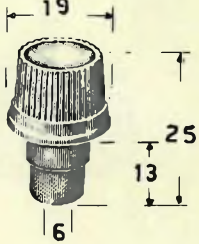
	Articolo		Prezzo listino
	F/162	Manopola in urea color avorio	26
	F/163	Manopola in bachelite color marrone	26
	F/164	Manopola in urea color avorio disco in metallo color oro	36
	F/165	Manopola in urea color avorio disco in metallo color oro	32
	F/167	Manopola in bachelite color grigio disco in metallo color argento - 10760	190
	F/168	Manopola in urea color avorio disco in metallo color oro - 20221	166
	F/171	Manopola in urea color avorio disco in metallo color oro	40

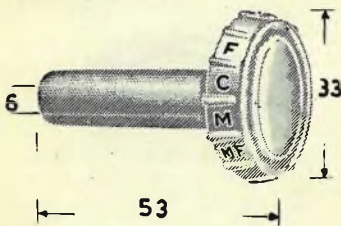
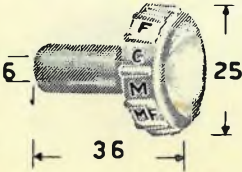

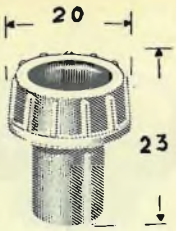
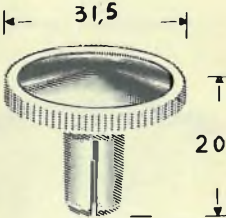
Prezzo listino		Articolo	
88	<b>Manopola</b> in bachelite color marrone disco e anellino in metallo color oro	F/172	
72	<b>Manopola</b> in bachelite color marrone disco in metallo color oro bordatura in avorio	F/173	
72	<b>Manopola</b> in urea color avorio disco in metallo color oro bordatura in amaranto	F/174	
88	<b>Manopola</b> in urea color avorio disco e anellino in metallo color oro	F/175	
82	<b>Manopola</b> in urea color avorio ricoperta in plexiglas disco in metallo color oro	F/176	
78	<b>Manopola</b> in urea color avorio disco in metallo color oro	F/177	
78	<b>Manopola</b> in urea color avorio disco in metallo color oro	F/178	
88	<b>Manopola</b> in urea color avorio disco in metallo color oro	F/179	

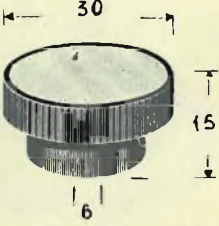
	Articolo		Prezzo listino
	F/181	Manopola a indice in urea color avorio	68
	F/182	Manopola a indice in urea color avorio	68
	F/183	Manopola in bachelite color marrone disco in metallo color oro innesto a pressione	62
	F/184	Manopola in vipla per TV - colori assortiti	16
	F/185	Manopola in urea color avorio per cambio onda per K2/199	56
	F/186	Manopola in urea color avorio per cambio onda per K3/10	38
	F/187	Manopola in urea color avorio per cambio onda per K2/10	40

Prezzo listino		Articolo	
56	<b>Manopola</b> in urea color avorio disco in metallo color oro innesto a pressione per apparecchi FM/2	F/191	
26	<b>Manopola</b> in bachelite color grigio disco in metallo color oro innesto a pressione per apparecchi AR/4 la coppia	F/192	
96	<b>Manopola</b> in bachelite color marrone disco in metallo color oro	F/195	
100	<b>Manopola</b> in bachelite color grigio disco in metallo color argento	F/195-1	
98	<b>Manopola</b> in bachelite color marrone disco in metallo color oro	F/196	
102	<b>Manopola</b> in bachelite color grigio disco in metallo color argento	F/196-1	
102	<b>Manopola</b> in bachelite color marrone disco in metallo color oro	F/197	
110	<b>Manopola</b> in bachelite color grigio disco in metallo color argento	F/197-1	

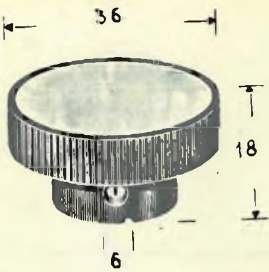
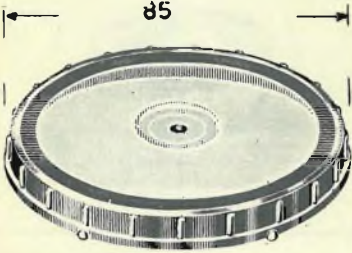
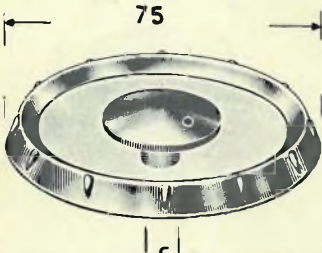
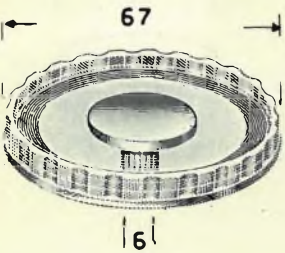
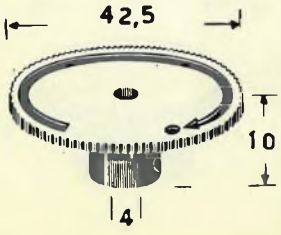
	Articolo		Prezzo listino
	F/198	Manopola in bachelite color marrone disco in metallo color oro	102
	F/198-1	Manopola in bachelite color grigio disco in metallo color argento	110
	F/205	Manopola di sintonia in plexiglas disco in metallo color oro per apparecchi « FM/2 » innesto a pressione	300
	F/207	Manopola di sintonia in plexiglas disco e anellino in metallo color oro adatta per apparecchi « Herman » innesto a pressione	400
	F/213	Manopola di sintonia in plexiglas disco in metallo color oro adatta per apparecchi « AR 20 » e « SM 3350 » innesto a pressione	126
	F/214	Manopola per controllo volume in polistirolo color grigio adatta per apparecchi « AR 20 » e « SM 3350 »	76



**MANOPOLE SPECIALI IN BACHELITE NERA PER STRUMENTI**

Prezzo Listino	Dimensioni in mm			Articolo
	A	B	C	
<b>330</b>	19	12	6	<b>F/250</b>
<b>386</b>	25	15	6	<b>F/252</b>
<b>600</b>	31	19	6	<b>F/254</b>
<b>630</b>	40	19	6	<b>F/256</b>
<b>936</b>	45	27,5	6	<b>F/258</b>
<b>936</b>	45	27,5	8	<b>F/260</b>
<b>1266</b>	58	35	6	<b>F/262</b>
<b>1266</b>	58	35	8	<b>F/264</b>
<b>1266</b>	58	35	10	<b>F/266</b>
<b>1760</b>	75	44	6	<b>F/268</b>
<b>1760</b>	75	44	8	<b>F/270</b>
<b>1760</b>	75	44	10	<b>F/272</b>

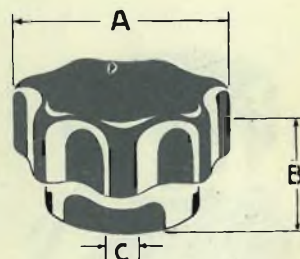

**MANOPOLE SPECIALI IN BACHELITE NERA PER STRUMENTI**

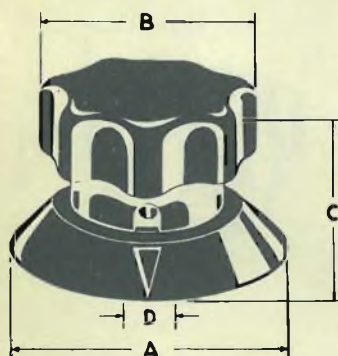

Articolo	Dimensioni in mm				Prezzo Listino
	A	B	C	D	
<b>F/300</b>	21	19	16	6	<b>440</b>
<b>F/302</b>	32	25	22	6	<b>500</b>
<b>F/304</b>	40	31	27	6	<b>680</b>
<b>F/306</b>	40	40	27	6	<b>716</b>
<b>F/308</b>	48	40	27,5	6	<b>770</b>
<b>F/310</b>	58	45	36,5	6	<b>1050</b>
<b>F/312</b>	58	45	36,5	8	<b>1050</b>
<b>F/314</b>	58	45	36,5	10	<b>1050</b>
<b>F/316</b>	75	58	46	6	<b>1430</b>
<b>F/318</b>	75	58	46	8	<b>1430</b>
<b>F/320</b>	75	58	46	10	<b>1430</b>
<b>F/322</b>	90	58	44	6	<b>1540</b>
<b>F/324</b>	90	58	44	8	<b>1540</b>
<b>F/326</b>	90	58	44	10	<b>1540</b>
<b>F/328</b>	90	75	53	6	<b>2420</b>
<b>F/330</b>	90	75	53	8	<b>2420</b>
<b>F/332</b>	90	75	53	10	<b>2420</b>
<b>F/334</b>	110	75	54	10	<b>2420</b>

MANOPOLE SPECIALI PER STRUMENTI CON PIATTELLO AD INDICE E FORO SUPERIORE



Dimensioni in mm

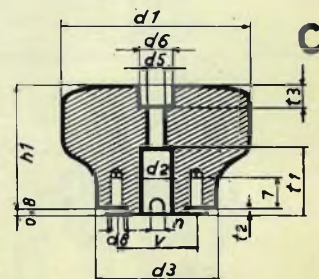
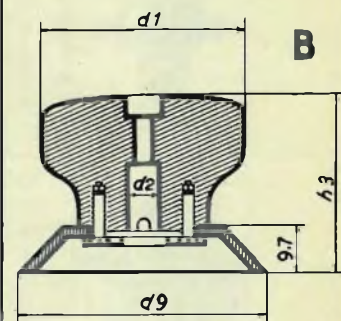
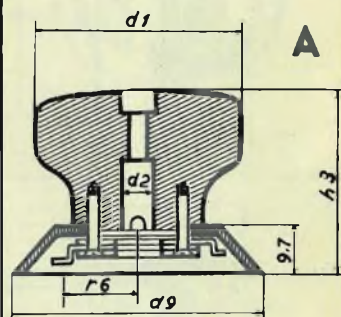

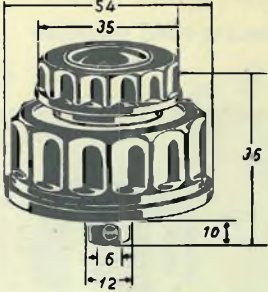
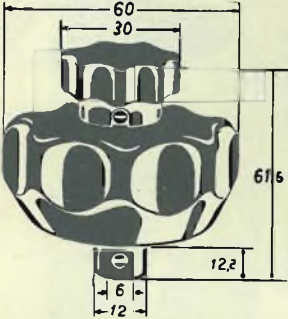
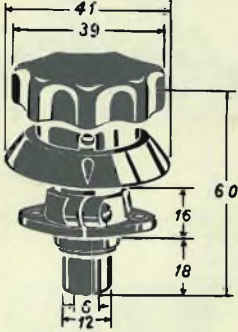
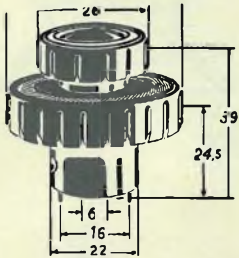
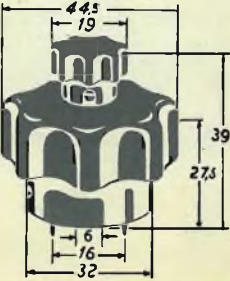

Articolo	F/350	F/352	F/354	F/356	F/358	F/360	F/362	F/364
diseg.	A	A	A	B	B	C	C	C
d 1	40	40	50	40	40	40	40	50
d 2	6	8	8	6	8	6	8	8
d 3	26	26	32	26	26	26	26	32
d 5	3,5	4,5	4,5	3,5	4,5	3,5	4,5	4,5
d 6	7	9	9	7	9	7	9	9
d 8	Fil. 2,6	Fil. 2,6	Fil. 2,6	Fil. 2,6	Fil. 2,6	Fil. 2,6	Fil. 2,6	Fil. 2,6
d 9	48	48	60	48	48	48	48	60
h 1	26	26	32	26	26	26	26	32
h 3	35	35	41	35	35	35	35	41
n	2,2	2,7	2,7	2,2	2,7	2,2	2,7	2,7
r 6	14,5	14,5	17	14,5	14,5	14,5	14,5	17
t 1	14	15	16	14	15	14	15	16
t 2	1,4	1,4	1,4	1,4	1,4	1,4	1,4	1,4
t 3	4	5	5	4	5	4	5	5
V	17	17	17	17	17	17	17	17
Prezzo Listino	1000	946	1150	946	946	630	630	850

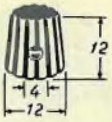
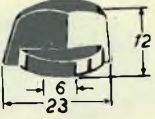
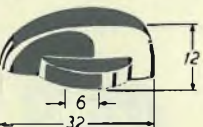

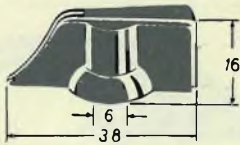
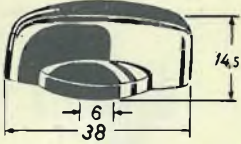
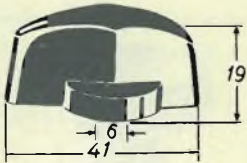
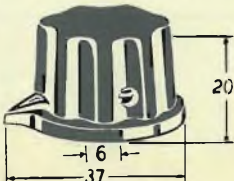
	Articolo		Prezzo listino
	<b>F/370</b>	<b>Manopola</b> doppia con demoltiplica. Possibilità di regolazione diretta e demoltiplicata Bachelite nera Rapporto: 6 : 1 120 - 1	<b>3750</b>
	<b>F/372</b>	<b>Manopola</b> doppia con demoltiplica Bachelite nera Rapporto: 6 : 1 120 - 2	<b>4750</b>
	<b>F/374</b>	<b>Manopola</b> con regolazione demoltiplicata Bachelite nera Piattello con indice Rapporto: 6 : 1 120 - 3	<b>4100</b>
	<b>F/376</b>	<b>Manopola</b> doppia con demoltiplica tipo « Automat » Bachelite nera Rapporto: 6 : 1 125 - 1	<b>2200</b>
	<b>F/378</b>	<b>Manopola</b> doppia con demoltiplica tipo « Automat » Bachelite nera Rapporto: 6 : 1 125 - 2	<b>3026</b>

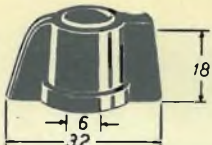
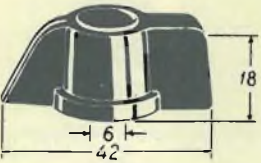

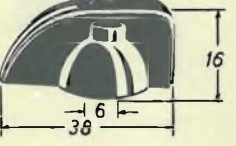
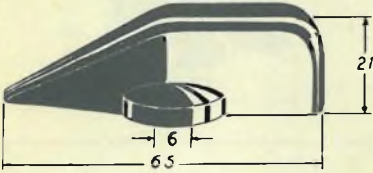
Prezzo listino		Articolo	
150	<b>Manopola</b> in bachelite nera 341 - 41	F/390	
158	<b>Manopola</b> a indice in bachelite nera 390 - 61	F/392	
166	<b>Manopola</b> a indice in bachelite nera 391 - 61	F/396	
216	<b>Manopola</b> a indice in bachelite nera 392 - 611	F/398	
216	<b>Manopola</b> a indice in bachelite nera 393 - 611	F/400	
216	<b>Manopola</b> a indice in bachelite nera 395 - 611	F/402	
220	<b>Manopola</b> a indice in bachelite nera 394 - 611	F/404	
270	<b>Manopola</b> a indice in bachelite nera 396 - 611	F/406	

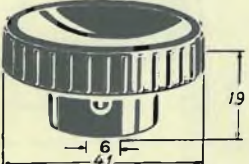
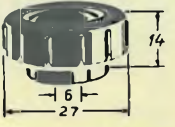
	Articolo		Prezzo listino
	<b>F/408</b>	<b>Manopola</b> a indice in bachelite nera 397 - 611	<b>230</b>
	<b>F/410</b>	<b>Manopola</b> a indice in bachelite nera 398 - 611	<b>260</b>
	<b>F/412</b>	<b>Manopola</b> a indice in bachelite nera 399 - 611	<b>210</b>
	<b>F/414</b>	<b>Manopola</b> a indice in bachelite nera 400 - 611	<b>216</b>
	<b>F/416</b>	<b>Manopola</b> a indice in bachelite nera 401 - 611	<b>350</b>
	<b>F/418</b>	<b>Manopola</b> in bachelite nera 540 - 611	<b>200</b>
	<b>F/420</b>	<b>Manopola</b> in bachelite nera 541 - 611	<b>230</b>
	<b>F/422</b>	<b>Manopola</b> in bachelite nera 542 - 611	<b>156</b>





Prezzo listino		Articolo	
<b>216</b>	<b>Manopola</b> in bachelite nera 543 - 61	<b>F/424</b>	
<b>180</b>	<b>Manopola</b> in bachelite nera 544 - 61	<b>F/426</b>	
<b>240</b>	<b>Manopola</b> in bachelite nera 342 - 61	<b>F/428</b>	
<b>260</b>	<b>Manopola</b> in bachelite nera 545 - 611	<b>F/430</b>	
<b>360</b>	<b>Manopola</b> speciale per strumenti con piattello ad indice Bachelite nera 342 - 611	<b>F/432</b>	
<b>836</b>	<b>Manopola</b> speciale per strumenti con piattello graduato Graduazione di 10° in 10° sino a 360° Bachelite nera 350 - 611	<b>F/434</b>	
<b>870</b>	<b>Manopola</b> speciale per strumenti con piattello graduato Graduazione di 10° in 10° sino a 360° Bachelite nera 351 - 611	<b>F/436</b>	

Figura	Articolo	Giradischi	Cartuccia	Dia- mante	Zaffiro	Norm. 78''	L.P.16/ 33/45	Stereo	Prezzo listino
	<b>R/1501</b>	Lesca	B		▲		▲		<b>210</b>
	<b>R/1501-1</b>	Lesca	B	▲			▲		<b>3750</b>
	<b>R/1502</b>	Lesca	B		▲	▲			<b>210</b>
	<b>R/1511</b>	Lesca	E		▲		▲		<b>240</b>
	<b>R/1511-1</b>	Lesca	E	▲			▲		<b>3750</b>
	<b>R/1512</b>	Lesca	E		▲	▲			<b>240</b>
	<b>R/1521</b>	Lesca Braun Audiofon Collaro GBC Telefunken Garis Lenco Prima fon Perpectuum Faro Fonmusic Webster	D  Ronette DC 284/ov  Duplo Kristall TO 284 PE		▲		▲		<b>240</b>
	<b>R/1521-1</b>	Lesca Braun Audiofon Collaro GBC Telefunken Garis Lenco Prima fon Perpetuum Faro Fonmusic Webster	D  Ronette DC 284/ov  Duplo Kristall TO 284 PE	▲			▲		<b>3750</b>
	<b>R/1522</b>	Lesca Braun Audiofon Collaro GBC Telefunken Garis Lenco Prima fon Perpetuum Faro Fonmusic Webster	D  Ronette DC 284/ov  Duplo Kristall TO 284 PE		▲	▲			<b>240</b>



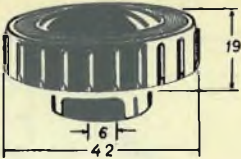
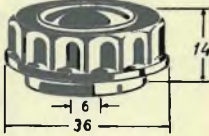
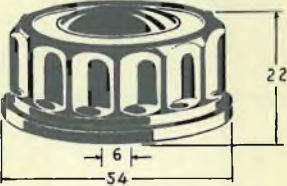
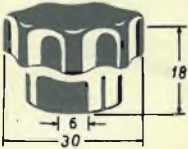
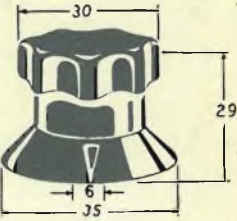
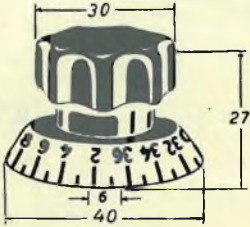
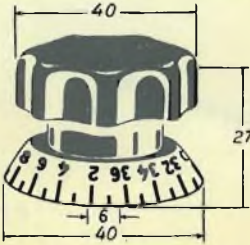











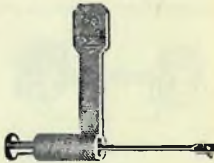

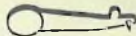
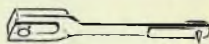

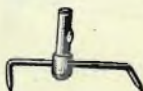

Prezzo listino	Giradischi	Cartuccia	Dia- mante	Zaffiro	Norm. 78''	.P.16/ 33/45	Stereo	Articolo	Figura
<b>300</b>	Lesca Astatic	A T		▲		▲		<b>R/1531</b>	
<b>300</b>	Lesca Astatic	A T		▲	▲			<b>R/1532</b>	
<b>480</b>	Lesca	S		▲			▲	<b>R/1533</b>	
<b>600</b>	Lesca	U		▲	▲	▲	▲	<b>R/1535</b>	
<b>270</b>	Schumann	SK 452		▲		▲		<b>R/1536</b>	
<b>270</b>	Schumann	SK 452		▲	▲			<b>R/1536-1</b>	
<b>420</b>	Schumann	SK 453		▲		▲		<b>R/1537</b>	
<b>420</b>	Schumann	SK 453		▲	▲			<b>R/1537-1</b>	
<b>480</b>	Schumann	Merula STK 490		▲			▲	<b>R/1537-3</b>	
<b>350</b>	Astatic Roc-Ola	G		▲		▲		<b>R/1538</b>	
<b>350</b>	Astatic Roc-Ola	G		▲	▲			<b>R/1538-1</b>	
<b>270</b>	Stare			▲		▲		<b>R/1539</b>	
<b>270</b>	Stare			▲	▲			<b>R/1539-1</b>	
<b>300</b>	SW 59			▲		▲		<b>R/1540</b>	
<b>300</b>	SW 59			▲	▲			<b>R/1540-1</b>	
<b>600</b>	Lenco			▲	▲	▲		<b>R/1541</b>	
<b>300</b>	Ariston GBC Geloso Garrard Columbia Astatic	Q		▲		▲		<b>R/1551</b>	
<b>300</b>	Ariston GBC Geloso Garrard Columbia Astatic	Q		▲	▲			<b>R/1552</b>	

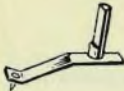
Figura	Articolo	Giradischi	Cartuccia	Dia- mante	Zaffiro	Norm. 78"	L.P.16/ 33/45	Stereo	Prezzo listino
	<b>R/1553</b>	Astatic	K		▲		▲		<b>480</b>
	<b>R/1554</b>	Astatic	K		▲	▲			<b>480</b>
	<b>R/1556</b>	Columbia	SC 1		▲			▲	<b>600</b>
	<b>R/1558</b>	Decca	H		▲		▲		<b>660</b>
	<b>R/1559</b>	Decca	H		▲	▲			<b>660</b>
	<b>R/1561</b>	BSR Plessey Monarch Radiohm Acos	} Acos HGP 59		▲		▲		<b>300</b>
	<b>R/1562</b>	BSR Plessey Monarch Radiohm Acos			▲	▲			<b>300</b>
	<b>R/1565</b>	Garrard Eden 59			▲		▲		<b>600</b>
	<b>R/1566</b>	Garrard Eden 59			▲	▲			<b>600</b>
	<b>R/1567</b>	Eden			▲		▲		<b>240</b>
	<b>R/1568</b>	Eden			▲	▲			<b>240</b>
	<b>R/1569</b>	Eden	Stereo		▲			▲	<b>600</b>
	<b>R/1571</b>	BSR Monarch			▲	▲			<b>300</b>
	<b>R/1572</b>	BSR Monarch			▲		▲		<b>300</b>
	<b>R/1581</b>	BSR Plessey	} Acos HGP 37-1		▲		▲		<b>300</b>
	<b>R/1582</b>	BSR Plessey			▲	▲			<b>300</b>











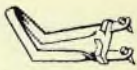

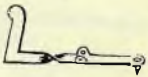



Prezzo listino	Giradischi	Cartuccia	Dia- mante	Zaffiro	Norm. 78"	L.P.16/ 33/45	Stereo	Articolo	Figura
<b>300</b>	BSR	Stereo		▲			▲	<b>R/1585</b>	
<b>600</b>	Philips 2 V	AG 3001 AG 3109		▲	▲	▲		<b>R/1591</b>	
<b>270</b>	Philips	AG 3010 AG 3013		▲		▲		<b>R/1601</b>	
<b>270</b>	Philips	AG 3010 AG 3013		▲	▲			<b>R/1602</b>	
<b>300</b>	Philips 4 V	AG 3016		▲		▲		<b>R/1603</b>	
<b>3750</b>	Philips 4 V	AG 3016	▲			▲		<b>R/1603-1</b>	
<b>300</b>	Philips 4 V	AG 3016		▲	▲			<b>R/1604</b>	
<b>270</b>	Philips	AG 3019		▲		▲		<b>R/1605</b>	
<b>270</b>	Philips	AG 3019		▲	▲			<b>R/1605-1</b>	
<b>3750</b>	Philips	AG 3060	▲				▲	<b>R/1606</b>	
<b>480</b>	Philips	AG 3063		▲			▲	<b>R/1607</b>	
<b>720</b>	Philips	AG 3052 AG 5001		▲	▲	▲		<b>R/1608</b>	
<b>1200</b>	Philips	AG 5012 AG 5013		▲		▲		<b>R/1609</b>	
<b>1200</b>	Philips	AG 5012 AG 5013		▲	▲			<b>R/1609-1</b>	
<b>480</b>	Philips	AG 3301 AG 3304		▲		▲		<b>R/1610</b>	
<b>480</b>	Philips	AG 3301 AG 3304		▲	▲			<b>R/1610-1</b>	

Figura	Articolo	Giradischi	Cartuccia	Dia- mante	Zaffiro	Norm. 78"	L.P.16/ 33/45	Stereo	Prezzo listino
	<b>R/1611-1</b>	Admiral 409 B/19-8			▲		▲		<b>300</b>
	<b>R/1611-2</b>	Admiral 409 B/19-8			▲	▲			<b>300</b>
	<b>R/1612</b>	GBC Teppaz Visseau	R/1357		▲		▲		<b>240</b>
	<b>R/1613</b>	GBC Teppaz Visseau	R/1357		▲	▲			<b>240</b>
	<b>R/1614</b>	Teppaz	Stereo		▲			▲	<b>300</b>
	<b>R/1615</b>	Collaro Braun	SK 451 Schumann		▲		▲		<b>270</b>
	<b>R/1616</b>	Collaro Braun	SK 451 Schumann		▲	▲			<b>270</b>
	<b>R/1617</b>	Magnavox	560133 560170		▲	▲	▲		<b>600</b>
	<b>R/1617-1</b>	Philco Magnavox			▲	▲	▲		<b>540</b>
	<b>R/1618</b>	R.C.A.	72345		▲		▲		<b>510</b>
	<b>R/1618-1</b>	R.C.A.	72345		▲	▲			<b>510</b>
	<b>R/1618-2</b>	R.C.A.	75497		▲		▲		<b>480</b>
	<b>R/1618-3</b>	R.C.A.	75497		▲	▲			<b>480</b>
	<b>R/1619</b>	R.C.A.	74068		▲		▲		<b>480</b>
	<b>R/1619-1</b>	R.C.A.	74068		▲	▲			<b>480</b>
	<b>R/1620</b>	R.C.A.	104		▲	▲	▲	▲	<b>900</b>
	<b>R/1620-1</b>	R.C.A.	106770		▲			▲	<b>360</b>



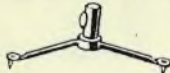



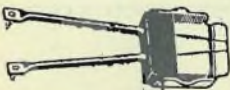
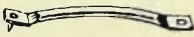







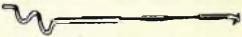

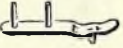
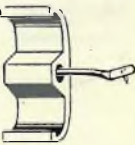

Prezzo listino	Giradischi	Cartuccia	Dia- mante	Zaffiro	Norm. 78"	L.P. 16/ 33/45	Stereo	Articolo	Figura
600	Plessey Dual			▲	▲	▲		R/1621	
510	Luxor	72411		▲	▲	▲		R/1631	
900	Luxor Stereo	72786		▲	▲	▲	▲	R/1632	
600	Luxor Stereo	74916		▲	▲	▲	▲	R/1633	
390	Elac	KST 2		▲		▲		R/1634	
390	Elac	KST 2		▲	▲		R/1634-1		
630	Elac	SM 11		▲		▲		R/1634-2	
630	Elac	SM 11		▲	▲		R/1634-3		
630	Elac	SNM 14		▲	▲	▲		R/1634-4	
630	Elac	SM 21		▲		▲		R/1634-5	
630	Elac	SM 21		▲	▲		R/1634-6		
570	Elac	SM-103		▲			▲	R/1635	
690	Elac	SNM 104 PE 182 US		▲	▲	▲	▲	R/1635-1	
690	Elac	SNM 100 PE 180 US		▲	▲	▲	▲	R/1635-2	

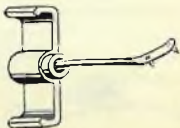
Figura	Articolo	Giradischi	Cartuccia	Dia- mante	Zaffiro	Norm. 78"	L.P. 16/ 33/45	Stereo	Prezzo listino
	<b>R/1635-3</b>	Elac	SM 101		▲			▲	<b>570</b>
	<b>R/1635-4</b>	Elac	SNM 102		▲	▲	▲	▲	<b>690</b>
	<b>R/1635-5</b>	Elac	SNM 106		▲	▲	▲		<b>2100</b>
	<b>R/1635-6</b>	Elac	STS 210		▲		▲		<b>2550</b>
	<b>R/1635-7</b>	Elac	STS 210		▲	▲			<b>2550</b>
	<b>R/1636</b>	Seeburg	R 150		▲		▲		<b>270</b>
	<b>R/1636-1</b>	Seeburg	R 150		▲	▲			<b>270</b>
	<b>R/1637</b>	Fentone	H 51		▲		▲		<b>840</b>
	<b>R/1638</b>	Fentone	H 51		▲	▲			<b>840</b>
	<b>R/1639</b>	Seeburg	Stereo		▲			▲	<b>2700</b>
	<b>R/1640</b>	Seeburg Juke box		▲			▲		<b>3750</b>
	<b>R/1640-1</b>	Seeburg Juke box			▲		▲		<b>1200</b>
	<b>R/1641</b>	Telefunken Braun Grundig			▲	▲	▲		<b>450</b>
	<b>R/1642</b>	Shure	PC 2		▲	▲	▲		<b>810</b>

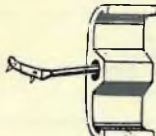



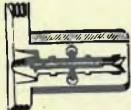

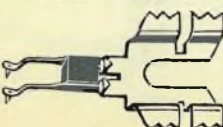



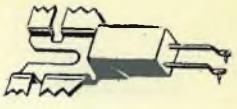
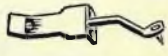
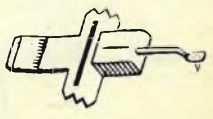



Prezzo listino	Giradischi	Cartuccia	Dia- mante	Zaffiro	Norm. 78"	L.P.16/ 33/45	Stereo	Articolo	Figura
<b>850</b>	Shure	WC 6 PC 6		▲	▲	▲		<b>R/1643</b>	
<b>550</b>	Shure	PC 9 WC 38		▲		▲		<b>R/1644</b>	
<b>550</b>	Shure	PC 9 WC 38		▲	▲			<b>R/1644-1</b>	
<b>680</b>	Shure	WC 20 PC 20		▲		▲		<b>R/1645</b>	
<b>680</b>	Shure	WC 20 PC 20		▲	▲			<b>R/1645-1</b>	
<b>510</b>	Shure	WC 32		▲		▲		<b>R/1646</b>	
<b>510</b>	Shure	WC 32		▲	▲			<b>R/1646-1</b>	
<b>350</b>	Shure	P 73		▲		▲		<b>R/1647</b>	
<b>350</b>	Shure	P 73		▲	▲			<b>R/1647-1</b>	
<b>2850</b>	Shure	M 7 D		▲			▲	<b>R/1648</b>	
<b>600</b>	Dual	CDS/320 CDS/520		▲	▲	▲	▲	<b>R/1650</b>	
<b>390</b>	Dual	CDS 2 CDS 3		▲	▲	▲		<b>R/1651</b>	
<b>3750</b>	Dual	CDS 2 CDS 3	▲		▲	▲		<b>R/1651-1</b>	
<b>390</b>	Dual	CDS 1		▲	▲	▲		<b>R/1652</b>	

Figura	Articolo	Giradischi	Cartuccia	Dia- mante	Zaffiro	Norm. 78''	L.P.16/ 33/45	Stereo	Prezzo listino
	<b>R/1654</b>	Dual 1006/T5	CDS 420		▲		▲	▲	<b>600</b>
	<b>R/1655</b>	Dual 1006/T5	CDS 420	▲			▲	▲	<b>3750</b>
	<b>R/1656</b>	Tonnoy	MK 2		▲		▲		<b>900</b>
	<b>R/1657</b>	Tonnoy	MK 2		▲	▲			<b>900</b>
	<b>R/1658</b>	Telefunken	200		▲	▲	▲		<b>900</b>
	<b>R/1659</b>	Telefunken	A 20/2		▲	▲	▲	▲	<b>1140</b>
	<b>R/1661</b>	Perpetuum Elac	PE 5 SN 12		▲	▲	▲		<b>490</b>
	<b>R/1662</b>	Perpetuum Elac	PE-8/PE-10 SNM 9		▲	▲	▲		<b>490</b>
	<b>R/1663</b>	Perpetuum Elac	PE-8/PE-10 SNM 9	▲		▲	▲		<b>3750</b>
	<b>R/1681</b>	Perpetuum	PE 12		▲	▲	▲		<b>480</b>
	<b>R/1682</b>	Perpetuum	PE 7000		▲		▲		<b>540</b>
	<b>R/1683</b>	Perpetuum	PE 7000		▲	▲			<b>540</b>
	<b>R/1684</b>	Old Models			▲		▲		<b>450</b>
	<b>R/1684-1</b>	Old Models			▲	▲			<b>450</b>

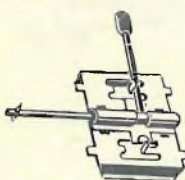











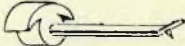

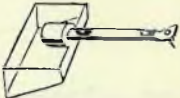





Prezzo listino	Giradischi	Cartuccia	Dia- mante	Zaffiro	Norm. 78''	L.P.16/ 33/45	Stereo	Articolo	Figura
240	Pathé Marconi 51			▲		▲		R/1685	
240	Pathé Marconi 51			▲	▲			R/1685-1	
540	Pathé	RC 7		▲		▲		R/1686	
540	Pathé	RC 7		▲	▲			R/1686-1	
240	Pathé Marconi 53			▲		▲		R/1687	
240	Pathé Marconi 53			▲	▲			R/1687-1	
540	Pathé	stereo		▲			▲	R/1688	
540	Pathé	RC 5/6		▲		▲		R/1689	
540	Pathé	RC 5/6		▲	▲			R/1689-1	
300	Acos	GP 19		▲		▲		R/1691	
300	Acos	GP 19		▲	▲			R/1692	
600	Acos	GP 73/1		▲	▲	▲	▲	R/1697	
300	Acos	GP 29		▲		▲		R/1698	
300	Acos	GP 29		▲	▲			R/1698-1	
400	Acos	GP 33		▲		▲		R/1699	
400	Acos	GP 33		▲	▲			R/1699-1	

Figura	Articolo	Giradischi	Cartuccia	Dia- mante	Zaffiro	Norm. 78"	L.P.16/ 33/45	Stereo	Prezzo listino
	<b>R/1700</b>	Acos	GP 65		▲		▲		<b>330</b>
	<b>R/1700-1</b>	Acos	GP 65		▲	▲			<b>330</b>
	<b>R/1700-5</b>	Acos	GP 71/3		▲			▲	<b>400</b>
	<b>R/1701</b>	Monarch	TC 4		▲		▲		<b>300</b>
	<b>R/1702</b>	Monarch	TC 4		▲	▲			<b>300</b>
	<b>R/1703</b>	Miniature	HMV		▲		▲		<b>240</b>
	<b>R/1704</b>	Miniature	HMV		▲	▲			<b>240</b>
	<b>R/1705</b>	Thorens			▲	▲	▲		<b>480</b>
	<b>R/1706</b>	Garrard	TOM 1		▲	▲	▲		<b>660</b>
	<b>R/1707</b>	Garrard	TOM 2		▲	▲	▲		<b>660</b>
	<b>R/1721</b>	Garrard	GC 2		▲		▲		<b>380</b>
	<b>R/1722</b>	Garrard	GC 2		▲	▲			<b>380</b>
	<b>R/1741</b>	Garrard	Astatic		▲		▲		<b>380</b>
	<b>R/1742</b>	Garrard	Astatic		▲	▲			<b>380</b>
	<b>R/1743</b>	Garrard	GC 8		▲		▲		<b>380</b>
	<b>R/1744</b>	Garrard	GC 8		▲	▲			<b>380</b>













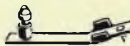
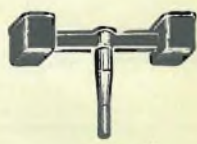

Prezzo listino	Giradischi	Cartuccia	Dia- mante	Zaffiro	Norm. 78''	L.P.16/ 33/45	Stereo	Articolo	Figura
<b>3750</b>	Garrard	GMC 5	▲			▲		<b>R/1745</b>	
<b>600</b>	Garrard	GMC 5		▲	▲			<b>R/1746</b>	
<b>300</b>	Garrard	GCS 10		▲			▲	<b>R/1747</b>	
<b>390</b>	Garrard	GC 12		▲		▲		<b>R/1747-1</b>	
<b>390</b>	Garrard	GC 12		▲	▲			<b>R/1747-2</b>	
<b>660</b>	Decca	XMS		▲		▲		<b>R/1748</b>	
<b>660</b>	Decca	XMS		▲	▲			<b>R/1749</b>	
<b>300</b>	Electrovoice	14-34		▲		▲		<b>R/1752</b>	
<b>300</b>	Electrovoice	14-34		▲	▲			<b>R/1752-1</b>	
<b>480</b>	Electrovoice	16-TT		▲	▲	▲		<b>R/1753</b>	
<b>480</b>	Electrovoice	EV 21		▲			▲	<b>R/1754</b>	
<b>630</b>	Electrovoice	22-TT		▲	▲	▲		<b>R/1755</b>	

Figura	Articolo	Giradischi	Cartuccia	Dia- mante	Zaffro	Norm. 78"	L.P.16/ 33/45	Stereo	Prezzo listino
	<b>R/1756</b>	E.M.I. Multiplay			▲		▲		<b>360</b>
	<b>R/1756-1</b>	E.M.I. Multiplay			▲	▲			<b>360</b>
	<b>R/1757</b>	E.M.I.	RS 3		▲		▲		<b>570</b>
	<b>R/1757-1</b>	E.M.I.	RS 3		▲	▲			<b>570</b>
	<b>R/1758</b>	Audak	R 2/R 6		▲		▲		<b>690</b>
	<b>R/1758-1</b>	Audak	R 2/R 6		▲	▲			<b>690</b>
	<b>R/1759</b>	Vaco			▲			▲	<b>270</b>
	<b>R/1760</b>	Webster	WE 14/15		▲		▲		<b>300</b>
	<b>R/1760-1</b>	Webster	WE 14/15		▲	▲			<b>300</b>
	<b>R/1762</b>	Webster	SC 1		◊		▲		<b>360</b>
	<b>R/1762-1</b>	Webster	SC 1		▲	▲			<b>360</b>
	<b>R/1763</b>	Webster	SC 3 SCT 3		▲	▲	▲	▲	<b>900</b>
	<b>R/1767</b>	Zenith Cobra			▲		▲		<b>4200</b>
	<b>R/1768</b>	Zenith Cobra			▲	▲			<b>4200</b>

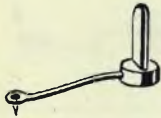



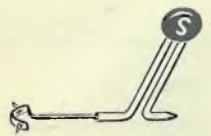









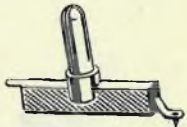







Prezzo listino	Giradischi	Cartuccia	Dia- mante	Zaffiro	Norm. 78"	L.P.16/ 33/45	Stereo	Articolo	Figura
<b>510</b>	Collaro	Ronette TX 88		▲		▲		<b>R/1771</b>	
<b>510</b>	Collaro	Ronette TX 88		▲	▲			<b>R/1772</b>	
<b>376</b>	G.E	RPY RPX		▲		▲		<b>R/1777</b>	
<b>3750</b>	G.E	RPY RPX	▲			▲		<b>R/1779</b>	
<b>376</b>	G.E	RPY RPX		▲	▲			<b>R/1780</b>	
<b>376</b>	G.E	VR II 4G050		▲		▲		<b>R/1781</b>	
<b>3750</b>	G.E	VR II 4G050	▲			▲		<b>R/1782</b>	
<b>376</b>	G.E	VR II 4G050		▲	▲			<b>R/1783</b>	
<b>840</b>	G.E	GC 7		▲			▲	<b>R/1784</b>	
<b>690</b>	G.E	RPX 040		▲		▲		<b>R/1784-3</b>	
<b>690</b>	G.E	RPX 040		▲	▲			<b>R/1784-4</b>	
<b>360</b>	BSR Plessey	} Goldring 200		▲		▲		<b>R/1785</b>	
<b>360</b>	BSR Plessey		} Goldring 200		▲	▲			
<b>450</b>	Collaro Garrard	Goldring 500		▲		▲		<b>R/1788</b>	
<b>450</b>	Collaro Garrard	Goldring 500		▲	▲			<b>R/1789</b>	
<b>330</b>	Collaro	PX		▲		▲		<b>R/1790</b>	
<b>330</b>	Collaro	PX		▲	▲			<b>R/1790-1</b>	

Figura	Articolo	Giradischi	Cartuccia	Dia- mante	Zaffiro	Norm. 78"	L.P.16/ 33/45	Stereo	Prezzo listino
	<b>R/1790-3</b>	Collaro studio	Stereo		▲			▲	<b>500</b>
	<b>R/1791</b>	Garrard Goldring	} Goldring 600-580		▲	▲			<b>1050</b>
	<b>R/1792</b>	Garrard Goldring	} Goldring 600-580		▲		▲		<b>1050</b>
	<b>R/1793</b>	Elac Miratwin			▲		▲		<b>630</b>
	<b>R/1794</b>	Elac Miratwin			▲	▲			<b>630</b>
	<b>R/1795</b>	Garrard Collaro	} Ronette BF 40		▲		▲	▲	<b>300</b>
	<b>R/1795-1</b>	Garrard Collaro	} Ronette BF 40	▲			▲	▲	<b>3750</b>
	<b>R/1796</b>	Garrard Collaro	} Ronette BF 40		▲	▲			<b>300</b>
	<b>R/1797</b>	Sonotone	Stereo		▲			▲	<b>720</b>
	<b>R/1797-1</b>	Sonotone	8 T		▲	▲		▲	<b>570</b>
	<b>R/1797-5</b>	Sonotone	8 TA		▲	▲	▲	▲	<b>600</b>

Prezzo listino	Giradischi	Cartuccia	Dia- mante	Zaffiro	Norm. 78"	L.P.16/ 33/45	Stereo	Articolo	Figura
1200	Sonotone	9 T		▲	▲	▲	▲	R/1797-6	
570	Plessey Sonotone	2 T		▲	▲	▲		R/1798	
570	Plessey Sonotone	3 T		▲	▲	▲		R/1799	
800	Sonotone	10 T		▲		▲		R/1799-3	
800	Sonotone	10 T		▲	▲			R/1799-4	
1200	Sonotone	12 T		▲	▲	▲		R/1799-6	
800	Sonotone	S 63		▲		▲		R/1799-8	
800	Sonotone	S 63		▲	▲			R/1799-9	
300	BSR Monarch	} TC 8 H TC 8		▲		▲		R/1800	
300	BSR Monarch		} TC 8 H TC 8		▲	▲		R/1800-1	

*Al fine di facilitare l'evasione delle ordinazioni, Vi preghiamo di attenerVi scrupolosamente a quanto appresso:*

- I. - Scrivete chiaramente il Vostro indirizzo, possibilmente a macchina o in stampatello.**
- II. - Consultate attentamente il Catalogo illustrato e successivi bollettini prima di compilare gli ordini.**
- III. - Indicare SEMPRE il numero di Catalogo.**
- IV. - Non richiedete materiali speciali non compresi nella nostra gamma di vendita.**
- V. - Non ordinate materiali per importi inferiori a L. 5000.**
- VI. - Accompagnate le ordinazioni con un anticipo.**
- VII. - Indirizzare gli ordini al magazzino competente di zona.**

*Gian Bruto Castelfranchi*

DIREZIONE GENERALE:

Via Petrella, 6 - **MILANO** - Telef. 211.051/5

ORGANIZZAZIONE DI VENDITA:

<b>ANCONA</b>	- Via Vitt. Emanuele, 122	<b>NAPOLI</b>	- Via Cimara, 93/A
<b>AVELLINO</b>	- Via Marconi, 143	<b>VOMERO</b>	
<b>BARI</b>	- Via Dante, 5	<b>NAPOLI</b>	- Via C. Porzio, 10a - 10b
<b>BOLOGNA</b>	- Via R. Reno, 62	<b>NAPOLI</b>	- Via Roma, 28/21
<b>BENEVENTO</b>	- C.so Garibaldi, 12	<b>NOVARA</b>	- C.so F. Cavallotti, 40
<b>CIVITANOVA</b>	- C.so Umberto, 77	<b>PALERMO</b>	- P.zza Casteinuovo, 48
<b>CAGLIARI</b>	- Via Rossini, 44	<b>PADOVA</b>	- Via Beldomandi, 1
<b>FIRENZE</b>	- Viale Belfiore, 8r	<b>ROMA</b>	- Via S. Agostino, 14
<b>GENOVA</b>	- P.zza J. da Varagine - da Caricamento	<b>TORINO</b>	- Via Nizza, 34
		<b>UDINE</b>	- Via Div. Julia, 26



# LISTINO PREZZI

LUGLIO 1961

PAG. N°	ART. N°	PREZZO LISTINO	PREZZO NETTO	PAG. N°	ART. N°	PREZZO LISTINO	PREZZO NETTO
6	A/1	950		18	A/210	1.350	
6	A/2	1.620		18	A/211	1.600	
6	A/3	1.620		—	A/211-1	2.400	
7	A/4	2.750		18	A/212	2.900	
7	A/101	1.200		—	A/212-1	3.800	
7	A/102	1.200		18	A/213	3.000	
8	A/103	1.750		—	A/213-1	4.000	
8	A/104	2.100		19	A/214	2.250	
8	A/105	3.250		—	A/214-1	2.500	
9	A/106	4.350		—	A/214-2	1.800	
9	A/107	5.100		—	A/214-3	2.200	
9	A/108	17.500		—	A/214-4	2.300	
10	A/109	20.000		19	A/215	2.700	
10	A/110	31.000		—	A/215-1	2.000	
11	A/111	2.200		—	A/215-2	2.500	
11	A/112	1.150		19	A/216	13.500	
11	A/113	1.450		20	A/217	11.500	
12	A/114	2.100		20	A/218	14.800	
12	A/115	3.000		20	A/219	23.500	
12	A/116	1.600		21	A/220	11.000	
13	A/117	2.500		—	A/220-2	1.600	
13	A/118	2.850		—	A/220-3	1.900	
13	A/119	3.650		—	A/220-4	2.100	
14	A/120	2.350		21	A/221	12.500	
14	A/121	4.250		—	A/221-1	2.200	
14	A/122	26.000		21	A/222	14.000	
—	A/131	2.200		—	A/222-1	2.300	
—	A/132	3.700		—	A/222-2	2.600	
15	A/201	1.200		22	A/223	9.800	
15	A/202	1.250		—	A/223-1	5.600	
—	A/202-1	1.350		—	A/223-3	2.000	
—	A/202-2	1.500		—	A/223-4	2.100	
—	A/202-3	1.400		22	A/224	9.800	
—	A/202-4	1.500		—	A/224-1	2.300	
—	A/202-5	1.600		—	A/224-2	2.500	
—	A/202-6	1.700		22	A/225	23.000	
—	A/202-7	1.900		—	A/225-1	2.700	
—	A/202-8	2.100		—	A/225-2	2.700	
—	A/202-9	2.250		—	A/225-3	2.500	
15	A/203	2.800		—	A/225-4	2.600	
—	A/206-1	2.400		23	A/226	3.100	
—	A/206-2	2.300		23	A/227	1.800	
—	A/207-1	2.400		23	A/228	1.250	
17	A/209	2.450		—	A/230	11.500	

PAG. N°	ART. N°	PREZZO LISTINO	PREZZO NETTO	PAG. N°	ART. N°	PREZZO LISTINO	PREZZO NETTO
—	A/231	<b>13.000</b>		34	A/435	<b>1.750</b>	
—	A/232	<b>15.500</b>		35	A/436	<b>1.650</b>	
—	A/233	<b>24.500</b>		—	A/436-1	<b>1.680</b>	
—	A/240	<b>14.000</b>		—	A/436-2	<b>1.800</b>	
—	A/241	<b>16.000</b>		35	A/437	<b>1.500</b>	
—	A/242	<b>25.000</b>		35	A/438-1	<b>1.900</b>	
25	A/301	<b>890</b>		36	A/439	<b>2.000</b>	
25	A/302	<b>910</b>		36	A/440	<b>1.900</b>	
25	A/303	<b>1.150</b>		36	A/441	<b>2.400</b>	
26	A/304	<b>1.300</b>		—	A/441-1	<b>2.400</b>	
26	A/305	<b>2.200</b>		37	A/442	<b>3.300</b>	
26	A/306	<b>1.350</b>		37	A/443	<b>3.300</b>	
27	A/307	<b>1.500</b>		—	A/443-1	<b>2.700</b>	
27	A/401	<b>3.600</b>		37	A/444	<b>5.000</b>	
27	A/402	<b>4.350</b>		38	A/451	<b>3.100</b>	
28	A/411	<b>3.300</b>		38	A/452	<b>3.850</b>	
28	A/412	<b>1.650</b>		38	A/453	<b>4.900</b>	
28	A/413	<b>1.950</b>		39	A/454	<b>5.400</b>	
29	A/414	<b>2.060</b>		39	A/455	<b>5.900</b>	
29	A/415	<b>2.000</b>		39	A/456	<b>6.500</b>	
29	A/416	<b>10.500</b>		40	A/457	<b>8.100</b>	
30	A/421	<b>1.200</b>		40	A/458	<b>9.100</b>	
30	A/422	<b>1.500</b>		41	A/460	<b>12.200</b>	
30	A/423	<b>1.650</b>		41	A/461	<b>5.500</b>	
31	A/424	<b>1.800</b>		41	A/462	<b>6.600</b>	
31	A/425	<b>2.300</b>		42	A/463	<b>3.900</b>	
31	A/426	<b>3.300</b>		42	A/464	<b>17.800</b>	
32	A/427	<b>6.000</b>		43	A/465	<b>28.700</b>	
32	A/428	<b>1.400</b>		43	A/466	<b>36.700</b>	
32	A/429	<b>1.650</b>		43	A/467	<b>41.000</b>	
—	A/429-1	<b>1.900</b>		43	A/468	<b>71.500</b>	
—	A/429-2	<b>2.600</b>		44	A/469	<b>9.800</b>	
33	A/430	<b>1.650</b>		44	A/470	<b>44.500</b>	
—	A/430-2	<b>1.300</b>		44	A/471	<b>56.000</b>	
—	A/430-3	<b>1.550</b>		45	A/473	<b>6.000</b>	
—	A/430-4	<b>1.680</b>		45	A/474	<b>15.400</b>	
—	A/430-5	<b>1.800</b>		46	A/475	<b>15.900</b>	
—	A/430-6	<b>2.300</b>		46	A/476	<b>6.200</b>	
—	A/430-7	<b>1.800</b>		46	A/477	<b>8.200</b>	
—	A/430-8	<b>2.300</b>		47	A/478	<b>24.000</b>	
33	A/431	<b>2.000</b>		47	A/479	<b>30.000</b>	
33	A/432	<b>2.500</b>		—	A/479-1	<b>20.200</b>	
34	A/433	<b>3.800</b>		—	A/479-2	<b>20.200</b>	
34	A/434	<b>1.500</b>		—	A/479-3	<b>11.900</b>	

PAG. N°	ART. N°	PREZZO LISTINO	PREZZO NETTO	PAG. N°	ART. N°	PREZZO LISTINO	PREZZO NETTO
48	A/480	<b>69.000</b>		—	A/664	<b>25.000</b>	
48	A/481	<b>89.000</b>		—	A/671	<b>1.750</b>	
48	A/482	<b>32.000</b>		—	A/672	<b>1.750</b>	
—	A/483	<b>44.000</b>		—	A/673	<b>1.750</b>	
49	A/485	<b>38.000</b>					
—	A/485-1	<b>43.000</b>			<b>B</b>		
—	A/494	<b>6.000</b>					
—	A/495	<b>8.200</b>		58	B/1	<b>2.300</b>	
—	A/496	<b>18.200</b>		58	B/2	<b>2.300</b>	
—	A/497	<b>13.200</b>		58	B/3	<b>2.300</b>	
—	A/498	<b>12.300</b>		58	B/4	<b>2.300</b>	
—	A/499	<b>12.900</b>		59	B/11	<b>34</b>	
—	A/500	<b>19.400</b>		59	B/12	<b>38</b>	
52	A/522	<b>1.650</b>		59	B/15	<b>36</b>	
52	A/531	<b>5.700</b>		59	B/16	<b>38</b>	
53	A/561	<b>1.400</b>		59	B/17	<b>56</b>	
53	A/562	<b>2.000</b>		—	B/21	<b>108</b>	
53	A/563	<b>2.500</b>		—	B/21-1	<b>42</b>	
53	A/564	<b>3.000</b>		—	B/21-2	<b>42</b>	
53	A/571	<b>1.000</b>		—	B/21-3	<b>42</b>	
53	A/572	<b>1.400</b>		—	B/21-4	<b>56</b>	
53	A/573	<b>1.600</b>		—	B/21-5	<b>56</b>	
53	A/574	<b>2.150</b>		—	B/21-6	<b>66</b>	
54	A/592	—		—	B/21-7	<b>66</b>	
54	A/593	—		—	B/22	<b>260</b>	
54	A/594	—		—	B/25	<b>34</b>	
54	A/595	—		—	B/25-2	<b>34</b>	
54	A/596	—		—	B/26	<b>30</b>	
54	A/597	—		—	B/26-1	<b>30</b>	
55	A/610	—		—	B/26-2	<b>30</b>	
55	A/611	—		—	B/27	<b>36</b>	
55	A/612	—		—	B/27-1	<b>36</b>	
55	A/613	—		—	B/27-2	<b>36</b>	
55	A/614	—		—	B/28	<b>44</b>	
56	A/620	—		—	B/28-1	<b>44</b>	
56	A/621	—		—	B/28-2	<b>44</b>	
56	A/622	—		—	B/29	<b>50</b>	
—	A/625	<b>15.400</b>		—	B/29-1	<b>50</b>	
—	A/640	<b>14.400</b>		—	B/29-2	<b>50</b>	
—	A/641	<b>25.700</b>		—	B/30	<b>54</b>	
—	A/642	<b>11.700</b>		—	B/30-1	<b>54</b>	
—	A/644	<b>21.200</b>		—	B/30-2	<b>54</b>	
—	A/660	<b>9.250</b>		—	B/31	<b>66</b>	
—	A/662	<b>15.400</b>		—	B/31-1	<b>66</b>	



PAG. N°	ART. N°	PREZZO LISTINO	PREZZO NETTO	PAG. N°	ART. N°	PREZZO LISTINO	PREZZO NETTO
—	B/31-2	<b>66</b>		—	B/36-6	<b>62</b>	
—	B/32	<b>76</b>		—	B/36-7	<b>72</b>	
—	B/32-1	<b>76</b>		—	B/36-8	<b>72</b>	
—	B/32-2	<b>76</b>		—	B/37	<b>36</b>	
—	B/33	<b>80</b>		—	B/37-1	<b>36</b>	
—	B/33-1	<b>80</b>		—	B/37-2	<b>36</b>	
—	B/33-2	<b>80</b>		—	B/37-3	<b>36</b>	
—	B/33-4	<b>44</b>		—	B/37-4	<b>36</b>	
—	B/33-5	<b>50</b>		—	B/37-5	<b>36</b>	
—	B/33-6	<b>54</b>		—	B/37-6	<b>36</b>	
—	B/33-7	<b>64</b>		—	B/37-8	<b>36</b>	
—	B/33-8	<b>76</b>		—	B/37-9	<b>40</b>	
—	B/33-9	<b>80</b>		—	B/38	<b>40</b>	
—	B/34	<b>44</b>		—	B/38-1	<b>40</b>	
—	B/34-1	<b>44</b>		—	B/38-2	<b>40</b>	
—	B/34-2	<b>50</b>		—	B/38-3	<b>50</b>	
—	B/34-3	<b>54</b>		—	B/38-4	<b>50</b>	
—	B/34-5	<b>64</b>		—	B/38-5	<b>50</b>	
—	B/34-6	<b>76</b>		—	B/38-6	<b>68</b>	
—	B/34-7	<b>80</b>		—	B/38-7	<b>68</b>	
—	B/34-8	<b>34</b>		—	B/38-8	<b>68</b>	
—	B/34-9	<b>44</b>		—	B/39-1	<b>68</b>	
—	B/34-11	<b>44</b>		—	B/39-3	<b>72</b>	
—	B/34-12	<b>44</b>		—	B/39-5	<b>74</b>	
—	B/34-13	<b>50</b>		—	B/39-7	<b>84</b>	
—	B/34-14	<b>54</b>		—	B/39-9	<b>114</b>	
—	B/34-15	<b>64</b>		—	B/40	<b>36</b>	
—	B/34-16	<b>76</b>		—	B/40-1	<b>36</b>	
—	B/34-17	<b>80</b>		—	B/40-2	<b>36</b>	
—	B/35	<b>34</b>		—	B/40-3	<b>42</b>	
—	B/35-1	<b>34</b>		—	B/40-4	<b>48</b>	
—	B/35-2	<b>34</b>		—	B/40-5	<b>48</b>	
—	B/35-3	<b>36</b>		—	B/41	<b>36</b>	
—	B/35-4	<b>38</b>		—	B/41-1	<b>36</b>	
—	B/35-5	<b>38</b>		—	B/41-2	<b>36</b>	
—	B/35-6	<b>40</b>		—	B/41-3	<b>46</b>	
—	B/35-7	<b>44</b>		—	B/41-4	<b>46</b>	
—	B/35-8	<b>46</b>		—	B/42	<b>72</b>	
—	B/36	<b>42</b>		—	B/42-1	<b>94</b>	
—	B/36-1	<b>42</b>		—	B/42-2	<b>114</b>	
—	B/36-2	<b>46</b>		—	B/42-3	<b>188</b>	
—	B/36-3	<b>52</b>		—	B/42-4	<b>292</b>	
—	B/36-4	<b>58</b>		—	B/43	<b>72</b>	
—	B/36-5	<b>62</b>		—	B/43-1	<b>94</b>	

PAG. N°	ART. N°	PREZZO LISTINO	PREZZO NETTO	PAG. N°	ART. N°	PREZZO LISTINO	PREZZO NETTO
—	B/43-2	104		60	B/89	180	
—	B/43-3	156		60	B/90	210	
—	B/54	58		60	B/91	260	
—	B/56	90		60	B/92	290	
—	B/76-1	42		60	B/93	330	
—	B/76-2	40		60	B/94	360	
—	B/76-3	40		60	B/95	390	
—	B/76-4	34		60	B/125	80	
—	B/76-5	34		60	B/126	90	
—	B/76-6	30		60	B/127	100	
—	B/76-7	30		60	B/128	120	
59	B/77	30		—	B/128-1	130	
—	B/77-1	30		60	B/129	200	
—	B/77-2	30		—	B/129-1	220	
59	B/78	30		60	B/130	260	
—	B/78-1	30		—	B/130-1	270	
59	B/79	34		60	B/131	390	
—	B/79-1	34		—	B/131-1	390	
—	B/79-2	34		—	B/131-2	420	
—	B/79-3	34		—	B/131-3	440	
—	B/79-4	40		60	B/132	590	
—	B/79-5	40		—	B/132-1	620	
—	B/79-6	40		—	B/132-2	640	
—	B/79-7	50		—	B/132-3	660	
59	B/80	50		60	B/133	680	
—	B/80-1	60		—	B/133-1	690	
—	B/80-2	70		—	B/133-2	720	
—	B/80-3	86		60	B/134	740	
—	B/80-4	140		—	B/134-1	760	
—	B/80-5	162		—	B/134-2	780	
—	B/80-6	212		60	B/141	30	
60	B/81	40		—	B/141-1	34	
60	B/82	48		—	B/141-2	36	
60	B/83	58		—	B/141-3	40	
—	B/83-1	58		60	B/142	40	
60	B/84	62		—	B/142-1	46	
60	B/85	76		—	B/142-2	48	
—	B/85-1	76		60	B/143	54	
—	B/85-2	80		—	B/143-1	60	
—	B/85-3	80		—	B/143-2	68	
—	B/85-4	90		—	B/160	40	
60	B/86	110		—	B/161	40	
60	B/87	120		—	B/162	40	
60	B/88	150		—	B/165	40	

PAG. N°	ART. N°	PREZZO LISTINO	PREZZO NETTO	PAG. N°	ART. N°	PREZZO LISTINO	PREZZO NETTO
—	B/166	40		62	B/244	50	
—	B/167	40		62	B/245	56	
—	B/168	40		62	B/246	82	
—	B/169	40		—	B/246-1	100	
—	B/170	48		62	B/247	106	
—	B/171	54		62	B/248	166	
—	B/172	60		62	B/252	36	
—	B/173	68		62	B/253	36	
—	B/174	76		62	B/254	36	
61	B/181	62		62	B/255	36	
61	B/182	62		62	B/256	38	
61	B/183	62		62	B/257	40	
—	B/183-1	62		62	B/258	44	
61	B/184	70		62	B/260	50	
61	B/185	78		62	B/261	60	
61	B/186	84		62	B/262	70	
61	B/187	88		62	B/263	110	
61	B/188	98		62	B/264	180	
61	B/189	130		62	B/271	170	
61	B/190	170		62	B/272	170	
61	B/191	230		62	B/273	170	
61	B/201	38		62	B/274	170	
—	B/201-1	38		62	B/275	200	
—	B/201-2	38		62	B/276	210	
61	B/202	38		62	B/277	220	
—	B/202-1	38		62	B/278	230	
61	B/203	46		62	B/279	270	
—	B/203-1	56		62	B/280	300	
61	B/204	64		62	B/281	480	
—	B/204-1	66		—	B/285	240	
61	B/205	76		—	B/286	240	
61	B/206	100		—	B/287	240	
—	B/207-1	168		—	B/288	240	
61	B/208	178		—	B/289	320	
61	B/227	250		—	B/291	240	
61	B/228	260		—	B/295	150	
61	B/229	270		—	B/296	150	
61	B/230	296		—	B/297	160	
61	B/231	340		64	B/321	130	
—	B/232	518		64	B/322	130	
—	B/233	586		64	B/323	130	
62	B/241	50		64	B/324	130	
62	B/242	50		64	B/325	138	
62	B/243	50		64	B/326	106	

PAG. N°	ART. N°	PREZZO LISTINO	PREZZO NETTO	PAG. N°	ART. N°	PREZZO LISTINO	PREZZO NETTO
64	B/327	120		65	B/389	320	
64	B/331	130		65	B/390	570	
64	B/331-1	130		65	B/404	148	
64	B/331-2	130		—	B/405-1	850	
64	B/331-3	106		65	B/406	80	
64	B/333	106		65	B/407	120	
64	B/334-1	120		65	B/408	130	
64	B/335	130		65	B/409	190	
64	B/336-1	130		65	B/410	280	
64	B/337-1	130		65	B/412	96	
64	B/337-2	106		65	B/414	180	
64	B/338-1	120		65	B/415	98	
64	B/339-1	130		—	B/417-1	320	
—	B/339-2	150		65	B/418	230	
—	B/339-3	180		66	B/461	168	
—	B/339-4	130		66	B/462	280	
—	B/341-1	138		66	B/463	460	
64	B/343	106		66	B/464	300	
—	B/345	120		66	B/465	510	
—	B/346	126		66	B/466	830	
—	B/347	150		66	B/467	166	
—	B/348	180		66	B/468	230	
65	B/361	82		66	B/469	350	
65	B/362	98		66	B/470	470	
65	B/363	116		66	B/471	280	
65	B/364	176		66	B/472	395	
65	B/365	250		66	B/473	578	
65	B/371	90		66	B/474	720	
65	B/372	98		66	B/475	790	
65	B/373	116		66	B/476	240	
65	B/374	176		66	B/477	390	
65	B/375	250		66	B/478	590	
—	B/376	278		66	B/479	430	
—	B/377	300		66	B/480	520	
—	B/380	112		66	B/481	580	
65	B/381	124		67	B/501	148	
—	B/381-1	150		67	B/502	326	
65	B/382	172		—	B/502-1	530	
65	B/383	230		67	B/503	290	
65	B/384	390		67	B/503-1	476	
65	B/385	128		67	B/503-2	500	
65	B/386	140		67	B/504	890	
65	B/387	170		67	B/505	960	
65	B/388	240		67	B/505-1	150	



PAG. N°	ART. N°	PREZZO LISTINO	PREZZO NETTO	PAG. N°	ART. N°	PREZZO LISTINO	PREZZO NETTO
67	B/506	250		68	B/566	210	
67	B/507	226		68	B/567	250	
67	B/508	288		68	B/568	270	
67	B/509	370		68	B/569	390	
67	B/510	350		68	B/570	420	
67	B/511	400		68	B/571	650	
67	B/512	460		68	B/572	630	
67	B/513	570		68	B/573	290	
67	B/514	650		68	B/574	290	
67	B/514-1	810		68	B/575	550	
67	B/514-2	790		—	B/575-1	600	
67	B/515	890		68	B/576	230	
—	B/515-1	1.050		68	B/577	390	
67	B/516	1.050		69	B/601	156	
67	B/516-1	130		69	B/602	290	
67	B/516-2	210		69	B/621	154	
67	B/517	250		69	B/622	320	
67	B/518	390		69	B/623	330	
67	B/518-1	420		69	B/624	260	
67	B/518-2	530		69	B/625	360	
67	B/518-3	510		69	B/626	320	
67	B/518-4	880		69	B/627	540	
—	B/518-6	590		69	B/628	580	
67	B/519	290		69	B/629	750	
67	B/520	290		69	B/641	164	
67	B/521	290		69	B/642	280	
68	B/522	220		69	B/643	260	
68	B/551	148		69	B/644	370	
68	B/552	326		70	B/661	250	
68	B/553	310		70	B/662	440	
68	B/554	390		—	B/662-1	490	
68	B/555	550		70	B/663	440	
68	B/556	530		70	B/664	650	
68	B/556-1	850		70	B/665	630	
68	B/556-2	990		70	B/666	950	
68	B/557	150		70	B/667	1.000	
68	B/558	298		70	B/668	1.000	
68	B/559	240		70	B/669	230	
68	B/560	370		70	B/670	350	
68	B/561	350		70	B/671	330	
68	B/562	490		70	B/672	510	
68	B/563	650		70	B/673	490	
68	B/564	890		70	B/673-1	500	
68	B/565	870		70	B/674	750	

PAG. N°	ART. N°	PREZZO LISTINO	PREZZO NETTO	PAG. N°	ART. N°	PREZZO LISTINO	PREZZO NETTO
70	B/675	950		71	B/733	420	
70	B/676	930		71	B/734	620	
—	B/676-1	1.130		71	B/735	940	
70	B/677	500		71	B/736	1.150	
70	B/678	580		71	B/737	1.250	
70	B/679	680		71	B/751	660	
70	B/680	720		—	B/751-1	590	
—	B/685	590		—	B/751-2	690	
70	B/691	750		—	B/751-3	740	
70	B/692	950		—	B/751-4	850	
70	B/693	950		71	B/752	490	
70	B/694	950		71	B/754	490	
70	B/695	1.250		71	B/755	740	
—	B/696	240		—	B/756	650	
—	B/696-1	430		—	B/757	630	
—	B/697	640		—	B/758	790	
—	B/698	610		—	B/759	990	
—	B/698-1	900		71	B/761	1.050	
—	B/699	970		71	B/762	1.150	
—	B/701	970		—	B/768	850	
—	B/701-1	350		72	B/771	1.200	
—	B/701-2	320		72	B/772	1.750	
—	B/701-3	500		72	B/773	2.700	
—	B/701-4	480		72	B/781	750	
—	B/701-5	720		72	B/782	790	
—	B/702	900		72	B/783	1.150	
—	B/702-1	560		72	B/784	1.250	
—	B/703	690		72	B/785	1.300	
70	B/711	10		72	B/786	1.850	
70	B/712	10		72	B/787	2.250	
70	B/715	10		72	B/788	2.450	
70	B/716	10		72	B/789	950	
71	B/721	330		72	B/790	1.550	
71	B/722	620		72	B/791	2.100	
71	B/723	720		72	B/792	2.700	
71	B/724	430		72	B/793	2.900	
71	B/725	650		72	B/801	1.980	
71	B/726	820		72	B/802	2.480	
71	B/727	880		72	B/803	2.980	
71	B/728	1.040		72	B/804	3.240	
71	B/729	250		—	B/805	3.500	
71	B/730	370		72	B/811	900	
71	B/731	570		72	B/812	890	
71	B/732	950		73	B/821	1.150	

PAG. N°	ART. N°	PREZZO LISTINO	PREZZO NETTO	PAG. N°	ART. N°	PREZZO LISTINO	PREZZO NETTO
73	B/822	<b>1.350</b>		75	B/916	<b>2.200</b>	
73	B/823	<b>850</b>		75	B/917	<b>2.500</b>	
73	B/824	<b>950</b>		75	B/918	<b>3.100</b>	
73	B/825	<b>1.150</b>		75	B/919	<b>3.500</b>	
73	B/826	<b>950</b>		75	B/920	<b>4.200</b>	
73	B/827	<b>1.000</b>		75	B/921	<b>4.600</b>	
73	B/828	<b>1.200</b>		76	B/951	<b>490</b>	
73	B/829	<b>1.100</b>		76	B/952	<b>640</b>	
73	B/830	<b>1.300</b>		76	B/953	<b>1.080</b>	
74	B/861	<b>2.150</b>		76	B/954	<b>1.080</b>	
74	B/862	<b>2.550</b>		76	B/955	<b>1.080</b>	
74	B/863	<b>3.350</b>		76	B/961	<b>3.900</b>	
74	B/864	<b>3.980</b>		76	B/962	<b>3.900</b>	
74	B/865	<b>1.400</b>		76	B/963	<b>3.900</b>	
74	B/866	<b>2.000</b>					
74	B/867	<b>2.500</b>			<b>C</b>		
74	B/868	<b>3.100</b>					
74	B/869	<b>1.350</b>		78	C/3	<b>70</b>	
74	B/870	<b>1.650</b>		—	C/8	<b>64</b>	
74	B/871	<b>590</b>		—	C/9	<b>58</b>	
74	B/872	<b>740</b>		78	C/10	<b>78</b>	
75	B/880	<b>1.250</b>		78	C/11	<b>88</b>	
75	B/881	<b>1.450</b>		78	C/12	<b>88</b>	
75	B/882	<b>1.750</b>		78	C/13	<b>82</b>	
75	B/883	<b>2.200</b>		78	C/14	<b>94</b>	
75	B/884	<b>2.300</b>		—	C/16	<b>360</b>	
75	B/885	<b>2.500</b>		—	C/17	<b>140</b>	
75	B/886	<b>3.200</b>		—	C/18	<b>98</b>	
75	B/887	<b>3.700</b>		79	C/51	<b>22</b>	
75	B/901	<b>1.500</b>		79	C/52	<b>28</b>	
75	B/902	<b>1.600</b>		79	C/53	<b>36</b>	
75	B/903	<b>1.900</b>		79	C/61	<b>56</b>	
75	B/904	<b>2.200</b>		79	C/71	<b>150</b>	
75	B/905	<b>2.600</b>		79	C/83	<b>38</b>	
75	B/906	<b>2.900</b>		79	C/91	<b>60</b>	
75	B/907	<b>3.600</b>		79	C/95	<b>166</b>	
75	B/908	<b>1.600</b>		79	C/96	<b>170</b>	
75	B/909	<b>1.700</b>		79	C/98	<b>42</b>	
75	B/910	<b>2.200</b>		79	C/99	<b>56</b>	
75	B/911	<b>2.500</b>		80	C/101	<b>46</b>	
75	B/912	<b>2.800</b>		80	C/102	<b>56</b>	
75	B/913	<b>3.500</b>		80	C/103	<b>100</b>	
75	B/914	<b>4.600</b>		80	C/104	<b>146</b>	
75	B/915	<b>1.500</b>		80	C/105	<b>50</b>	

PAG. N°	ART. N°	PREZZO LISTINO	PREZZO NETTO	PAG. N°	ART. N°	PREZZO LISTINO	PREZZO NETTO
80	C/106	50		82	C/221	120	
80	C/107	84		82	C/222	120	
—	C/108	160		82	C/222-1	120	
—	C/109	86		82	C/223	150	
80	C/111	46		82	C/224	150	
80	C/112	58		82	C/225	150	
80	C/121	24		82	C/231	210	
—	C/129-1	100		82	C/232	210	
—	C/129-2	164		82	C/232-1	210	
—	C/130	14		82	C/233	250	
—	C/130-1	120		82	C/234	250	
—	C/130-2	174		82	C/235	250	
80	C/131	12		82	C/251	210	
80	C/132	14		82	C/252	210	
80	C/136	28		82	C/252-1	210	
—	C/136-1	38		82	C/253	250	
80	C/141	264		82	C/254	250	
80	C/142	408		82	C/255	250	
80	C/143	418		—	C/260	290	
80	C/144	506		—	C/262	290	
80	C/151	2.400		83	C/281	2.950	
80	C/152	2.400		84	C/301	8	
80	C/153	2.400		84	C/302	10	
81	C/171	18		84	C/303	12	
81	C/172	26		84	C/304	14	
81	C/173	18		84	C/305	16	
81	C/174	26		84	C/306	20	
81	C/181	34		84	C/307	22	
81	C/182	48		84	C/308	32	
81	C/191	4		84	C/309	40	
81	C/192	6		84	C/310	44	
81	C/193	8		84	C/311	48	
81	C/194	10		84	C/312	60	
81	C/195	14		84	C/351	32	
—	C/196	144		84	C/352	36	
—	C/197	156		84	C/353	42	
—	C/198	180		84	C/354	48	
—	C/199	206		84	C/355	52	
—	C/200	230		84	C/356	60	
81	C/201	33		84	C/357	70	
81	C/202	44		84	C/358	80	
81	C/203	52		—	C/358-1	94	
81	C/204	74		—	C/358-2	108	
81	C/205	94		—	C/358-3	128	



PAG. N°	ART. N°	PREZZO LISTINO	PREZZO NETTO	PAG. N°	ART. N°	PREZZO LISTINO	PREZZO NETTO
—	C/358-4	<b>144</b>		—	D/66-7	<b>66</b>	
84	C/359	<b>170</b>		—	D/67	<b>28</b>	
—	C/360	<b>72</b>		—	D/67-2	<b>32</b>	
	<b>D</b>			—	D/68	<b>30</b>	
86	D/1	<b>1.700</b>		—	D/68-2	<b>34</b>	
86	D/11	<b>2.350</b>		—	D/68-4	<b>56</b>	
87	D/2	<b>1.700</b>		—	D/68-5	<b>66</b>	
86	D/12	<b>5.800</b>		—	D/69	<b>30</b>	
87	D/22	<b>2.350</b>		—	D/69-2	<b>34</b>	
87	D/23	<b>5.800</b>		—	D/69-4	<b>60</b>	
88	D/3	<b>2.000</b>		—	D/69-5	<b>70</b>	
88	D/13	<b>2.250</b>		—	D/70	<b>42</b>	
88	D/4	<b>2.000</b>		—	D/70-2	<b>50</b>	
88	D/14	<b>2.250</b>		91	D/71	<b>38</b>	
89	D/31	<b>60</b>		91	D/72	<b>54</b>	
89	D/32	<b>18</b>		91	D/73	<b>72</b>	
89	D/33	<b>16</b>		91	D/74	<b>88</b>	
90	D/41	<b>100</b>		91	D/75	<b>100</b>	
90	D/42	<b>28</b>		91	D/76	<b>120</b>	
90	D/43	<b>24</b>		91	D/77	<b>130</b>	
90	D/51	<b>200</b>		91	D/78	<b>150</b>	
90	D/52	<b>100</b>		91	D/79	<b>250</b>	
90	D/53	<b>80</b>		—	D/80	<b>440</b>	
—	D/54	<b>250</b>		—	D/85	<b>120</b>	
—	D/54-1	<b>230</b>		—	D/86	<b>150</b>	
—	D/54-2	<b>240</b>		—	D/87	<b>250</b>	
—	D/54-3	<b>270</b>		92	D/91	<b>430</b>	
—	D/54-4	<b>340</b>		92	D/92	<b>510</b>	
91	D/56	<b>310</b>		—	D/92-1	<b>550</b>	
91	D/57	<b>310</b>		92	D/93	<b>570</b>	
91	D/58	<b>1.550</b>		92	D/94	<b>630</b>	
—	D/59	<b>32</b>		92	D/95	<b>850</b>	
—	D/60	<b>270</b>		92	D/96	<b>1.150</b>	
—	D/60-1	<b>810</b>		92	D/97	<b>1.300</b>	
91	D/64	<b>30</b>		92	D/101	<b>750</b>	
—	D/65	<b>60</b>		92	D/102	<b>1.350</b>	
—	D/65-2	<b>74</b>		92	D/103	<b>1.550</b>	
—	D/66	<b>38</b>		92	D/104	<b>1.650</b>	
—	D/66-2	<b>44</b>		92	D/105	<b>2.500</b>	
—	D/66-4	<b>28</b>		—	D/130	<b>650</b>	
—	D/66-5	<b>34</b>		—	D/131	<b>1.400</b>	
—	D/66-6	<b>56</b>		—	D/135	<b>1.400</b>	
				—	D/136	<b>1.400</b>	
				—	D/141	<b>680</b>	

PAG. N°	ART. N°	PREZZO LISTINO	PREZZO NETTO	PAG. N°	ART. N°	PREZZO LISTINO	PREZZO NETTO
—	D/142	<b>680</b>		94	D/223	<b>470</b>	
—	D/143	<b>650</b>		95	D/231	<b>470</b>	
—	D/146	<b>130</b>		95	D/232	<b>470</b>	
—	D/147	<b>130</b>		—	D/232-1	<b>1.000</b>	
—	D/148	<b>130</b>		95	D/233	<b>470</b>	
—	D/149	<b>130</b>		—	D/235	<b>360</b>	
—	D/150	<b>750</b>		—	D/236	<b>360</b>	
93	D/151	<b>190</b>		—	D/237	<b>460</b>	
93	D/161	<b>210</b>		—	D/238	<b>460</b>	
93	D/162	<b>210</b>		—	D/239	<b>510</b>	
93	D/171	<b>220</b>		95	D/241	<b>290</b>	
93	D/172	<b>220</b>		—	D/241-1	<b>330</b>	
93	D/181	<b>230</b>		95	D/242	<b>380</b>	
93	D/182	<b>230</b>		95	D/243	<b>290</b>	
93	D/191	<b>300</b>		—	D/243-1	<b>270</b>	
93	D/192	<b>300</b>		—	D/243-2	<b>330</b>	
—	D/192-5	<b>90</b>		95	D/244	<b>380</b>	
—	D/192-6	<b>320</b>		—	D/244-1	<b>290</b>	
—	D/192-7	<b>320</b>		95	D/251	<b>380</b>	
—	D/192-8	<b>500</b>		95	D/252	<b>500</b>	
—	D/192-9	<b>500</b>		95	D/253	<b>380</b>	
—	D/193	<b>150</b>		95	D/254	<b>500</b>	
—	D/194	<b>160</b>		95	D/255	<b>500</b>	
—	D/194-1	<b>190</b>		95	D/256	<b>500</b>	
—	D/195	<b>190</b>		95	D/257	<b>500</b>	
94	D/196	<b>200</b>		—	D/260	<b>1.150</b>	
—	D/197	<b>250</b>		—	D/261	<b>1.150</b>	
94	D/201	<b>370</b>		96	D/271	<b>880</b>	
94	D/202	<b>370</b>		96	D/272	<b>960</b>	
—	D/203	<b>480</b>		96	D/273	<b>1.030</b>	
—	D/204	<b>480</b>		96	D/274	<b>1.080</b>	
—	D/206	<b>520</b>		97	D/275	<b>1.180</b>	
—	D/207	<b>520</b>		97	D/276	<b>1.230</b>	
94	D/211	<b>250</b>		97	D/281	<b>320</b>	
—	D/211-2	<b>330</b>		97	D/282	<b>320</b>	
—	D/211-4	<b>360</b>		97	D/291	<b>930</b>	
94	D/212	<b>250</b>		97	D/292	<b>1.080</b>	
—	D/212-2	<b>330</b>		—	D/292-1	<b>1.150</b>	
94	D/213	<b>340</b>		98	D/293	<b>830</b>	
94	D/221	<b>380</b>		98	D/294	<b>930</b>	
—	D/221-2	<b>440</b>		98	D/301	<b>750</b>	
—	D/221-4	<b>460</b>		99	D/311	<b>860</b>	
94	D/222	<b>380</b>		99	D/312	<b>860</b>	
—	D/222-1	<b>440</b>		99	D/314	<b>960</b>	

PAG. N°	ART. N°	PREZZO LISTINO	PREZZO NETTO	PAG. N°	ART. N°	PREZZO LISTINO	PREZZO NETTO
99	D/316	<b>1.080</b>		—	D/380-2	<b>4.100</b>	
99	D/317	<b>1.180</b>		—	D/380-3	<b>4.350</b>	
99	D/321	<b>1.080</b>		101	D/381	<b>5.000</b>	
—	D/321-1	<b>1.100</b>		101	D/382	<b>5.100</b>	
99	D/322	<b>1.180</b>		101	D/383	<b>5.600</b>	
—	D/322-1	<b>1.200</b>		101	D/391	<b>6.600</b>	
99	D/323	<b>1.280</b>		101	D/392	<b>6.950</b>	
99	D/331	<b>840</b>		101	D/393	<b>7.300</b>	
99	D/332	<b>840</b>		101	D/394	<b>7.600</b>	
—	D/333	<b>1.080</b>		101	D/396	<b>11.700</b>	
—	D/334	<b>1.100</b>		101	D/397	<b>12.500</b>	
100	D/341	<b>1.250</b>		101	D/398	<b>13.500</b>	
100	D/342	<b>1.350</b>		101	D/399	<b>14.500</b>	
100	D/344	<b>1.450</b>		101	D/400	<b>15.500</b>	
100	D/351	<b>1.550</b>		102	D/411	<b>170</b>	
100	D/352	<b>1.650</b>		102	D/412	<b>200</b>	
100	D/353	<b>1.750</b>		102	D/413	<b>250</b>	
100	D/354	<b>1.850</b>		102	D/414	<b>250</b>	
100	D/355	<b>1.950</b>		102	D/415	<b>250</b>	
100	D/356	<b>2.000</b>		102	D/416	<b>250</b>	
100	D/357	<b>2.350</b>		102	D/417	<b>380</b>	
—	D/358	<b>1.700</b>		102	D/418	<b>250</b>	
—	D/359	<b>1.800</b>		102	D/419	<b>380</b>	
—	D/359-1	<b>1.900</b>					
—	D/359-2	<b>2.000</b>					
—	D/360	<b>2.100</b>			<b>E</b>		
100	D/361	<b>1.950</b>		104	E/1	<b>800</b>	
100	D/362	<b>2.100</b>		104	E/2	<b>710</b>	
100	D/363	<b>2.200</b>		104	E/2-1	<b>1.050</b>	
100	D/364	<b>2.300</b>		104	E/3	<b>1.150</b>	
100	D/365	<b>2.400</b>		104	E/4	<b>970</b>	
100	D/366	<b>2.500</b>		104	E/4-1	<b>1.450</b>	
100	D/367	<b>2.600</b>		104	E/5	<b>1.200</b>	
100	D/371	<b>4.400</b>		104	E/6	<b>1.000</b>	
100	D/372	<b>4.500</b>		104	E/6-1	<b>1.500</b>	
100	D/373	<b>4.700</b>		104	E/7	<b>1.480</b>	
100	D/374	<b>4.800</b>		104	E/8	<b>1.250</b>	
100	D/375	<b>4.900</b>		104	E/8-1	<b>1.880</b>	
—	D/376	<b>4.500</b>		104	E/9	<b>1.590</b>	
—	D/377	<b>4.750</b>		104	E/10	<b>1.330</b>	
—	D/378	<b>4.850</b>		104	E/10-1	<b>1.980</b>	
—	D/379	<b>4.950</b>		105	E/11	<b>2.050</b>	
—	D/380	<b>5.100</b>		105	E/12	<b>1.780</b>	
—	D/380-1	<b>3.800</b>					

PAG. N°	ART. N°	PREZZO LISTINO	PREZZO NETTO	PAG. N°	ART. N°	PREZZO LISTINO	PREZZO NETTO
105	E/12-1	<b>2.650</b>		—	E/81-1	<b>666</b>	
105	E/13	<b>2.180</b>		112	E/82-1	<b>750</b>	
105	E/14	<b>2.850</b>		112	E/83-1	<b>550</b>	
105	E/14-1	<b>2.850</b>		—	E/83-2	<b>660</b>	
105	E/15	<b>2.900</b>		112	E/84	<b>620</b>	
105	E/16	<b>2.490</b>		112	E/86-1	<b>950</b>	
105	E/16-1	<b>3.750</b>		112	E/87	<b>750</b>	
105	E/17	<b>3.100</b>		112	E/88	<b>1.190</b>	
105	E/18	<b>2.650</b>		113	E/89-1	<b>950</b>	
105	E/19	<b>3.900</b>		113	E/90-1	<b>1.250</b>	
107	E/21	<b>580</b>		113	E/91-1	<b>1.350</b>	
107	E/22	<b>670</b>		113	E/92	<b>970</b>	
107	E/23	<b>690</b>		—	E/92-1	<b>1.400</b>	
107	E/24	<b>780</b>		113	E/93	<b>1.080</b>	
108	E/25	<b>870</b>		—	E/93-1	<b>700</b>	
108	E/26	<b>780</b>		—	E/93-2	<b>1.350</b>	
108	E/28	<b>1.000</b>		113	E/94	<b>1.290</b>	
108	E/29	<b>1.250</b>		113	E/95	<b>1.380</b>	
108	E/51	<b>620</b>		—	E/95-1	<b>2.900</b>	
108	E/52	<b>700</b>		113	E/96	<b>1.050</b>	
108	E/53	<b>750</b>		114	E/111-1	<b>1.290</b>	
109	E/54	<b>370</b>		114	E/112-1	<b>1.940</b>	
109	E/55	<b>450</b>		114	E/114-1	<b>1.830</b>	
109	E/56	<b>690</b>		—	E/114-2	<b>2.820</b>	
109	E/57	<b>1.280</b>		114	E/115	<b>1.750</b>	
109	E/58	<b>700</b>		—	E/116	<b>2.600</b>	
109	E/59	<b>820</b>		—	E/117	<b>2.800</b>	
109	E/60	<b>1.280</b>		114	E/122	<b>2.950</b>	
109	E/60-1	<b>2.400</b>		114	E/123	<b>3.000</b>	
—	E/60-2	<b>466</b>		—	E/126	<b>2.600</b>	
110	E/61	<b>470</b>		—	E/127	<b>3.150</b>	
110	E/62	<b>560</b>		—	E/128	<b>3.600</b>	
110	E/62-1	<b>560</b>					
110	E/63	<b>560</b>					
110	E/64	<b>590</b>					
110	E/64-1	<b>610</b>					
110	E/64-2	<b>660</b>					
111	E/64-3	<b>690</b>					
111	E/64-4	<b>760</b>					
111	E/64-5	<b>730</b>					
111	E/65	<b>810</b>					
111	E/66	<b>890</b>					
—	E/70	<b>690</b>					
					<b>F</b>		
				116	F/1	<b>150</b>	
				116	F/2	<b>136</b>	
				116	F/4	<b>230</b>	
				116	F/5	<b>150</b>	
				116	F/6	<b>380</b>	
				116	F/7	<b>780</b>	
				117	F/12	<b>230</b>	
				117	F/13	<b>200</b>	



PAG. N°	ART. N°	PREZZO LISTINO	PREZZO NETTO	PAG. N°	ART. N°	PREZZO LISTINO	PREZZO NETTO
117	F/14	140		—	F/59-7	90	
117	F/15	140		—	F/59-8	100	
117	F/16	190		—	F/59-9	90	
117	F/17	160		—	F/60	90	
117	F/18	160		—	F/60-1	100	
117	F/19	240		—	F/60-2	110	
117	F/20	136		—	F/60-3	100	
117	F/21	240		—	F/60-4	76	
117	F/22	240		—	F/60-5	86	
117	F/23	240		—	F/60-6	76	
118	F/31	76		120	F/61	160	
118	F/32	200		120	F/62	184	
118	F/33	300		120	F/63	186	
118	F/34	330		120	F/64	50	
118	F/35	66		120	F/65	56	
118	F/36	60		120	F/66	50	
118	F/37	72		120	F/67	56	
118	F/38	62		120	F/68	140	
118	F/39	90		—	F/68-1	140	
118	F/40	90		120	F/69	120	
118	F/43	218		—	F/69-1	120	
118	F/44	184		120	F/70	138	
—	F/45	200		120	F/71	154	
119	F/51	130		120	F/72	154	
119	F/51-1	130		120	F/73	214	
119	F/52	120		120	F/74	204	
—	F/53-1	82		120	F/75	204	
—	F/53-2	82		121	F/76	96	
119	F/54	200		121	F/77	118	
119	F/55	346		121	F/78	118	
119	F/56	130		121	F/79	98	
—	F/56-1	326		121	F/80	96	
—	F/56-2	376		121	F/81	118	
—	F/56-3	462		121	F/82	180	
119	F/57	276		121	F/83	150	
119	F/58	400		121	F/84	150	
—	F/58-1	90		121	F/85	102	
—	F/58-2	86		121	F/86	96	
—	F/59	86		121	F/87	96	
—	F/59-1	86		—	F/87-1	478	
—	F/59-2	90		121	F/88	102	
—	F/59-3	86		—	F/88-1	200	
—	F/59-4	86		121	F/89	130	

PAG. N°	ART. N°	PREZZO LISTINO	PREZZO NETTO	PAG. N°	ART. N°	PREZZO LISTINO	PREZZO NETTO
—	F/89-1	<b>186</b>		125	F/131	<b>46</b>	
121	F/90	<b>130</b>		126	F/132	<b>82</b>	
—	F/90-1	<b>186</b>		126	F/133	<b>82</b>	
122	F/91	<b>122</b>		126	F/134	<b>92</b>	
122	F/92	<b>122</b>		126	F/135	<b>92</b>	
122	F/93	<b>122</b>		126	F/136	<b>42</b>	
122	F/94	<b>150</b>		126	F/137	<b>42</b>	
122	F/95	<b>96</b>		126	F/138	<b>42</b>	
122	F/96	<b>96</b>		126	F/139	<b>60</b>	
—	F/96-1	<b>130</b>		126	F/140	<b>60</b>	
—	F/96-2	<b>190</b>		126	F/141	<b>60</b>	
122	F/97	<b>610</b>		126	F/142	<b>72</b>	
122	F/97-1	<b>168</b>		126	F/143	<b>72</b>	
122	F/97-2	<b>168</b>		126	F/144	<b>72</b>	
122	F/97-3	<b>168</b>		126	F/149	<b>72</b>	
—	F/97-4	<b>160</b>		127	F/153	<b>86</b>	
—	F/97-5	<b>180</b>		127	F/153-1	<b>86</b>	
—	F/99-1	<b>130</b>		127	F/154	<b>60</b>	
—	F/99-2	<b>200</b>		127	F/154-1	<b>60</b>	
123	F/100	<b>194</b>		127	F/155	<b>166</b>	
123	F/100-1	<b>78</b>		127	F/156	<b>166</b>	
123	F/100-2	<b>172</b>		127	F/161	<b>42</b>	
123	F/100-3	<b>118</b>		127	F/162	<b>26</b>	
123	F/100-4	<b>96</b>		127	F/163	<b>26</b>	
123	F/100-5	<b>82</b>		128	F/164	<b>36</b>	
124	F/109	<b>36</b>		128	F/165	<b>32</b>	
124	F/110	<b>78</b>		—	F/167	<b>190</b>	
124	F/111	<b>86</b>		—	F/168	<b>166</b>	
124	F/112	<b>40</b>		128	F/171	<b>40</b>	
124	F/113	<b>76</b>		128	F/172	<b>88</b>	
124	F/114	<b>76</b>		128	F/173	<b>72</b>	
125	F/115	<b>98</b>		128	F/174	<b>72</b>	
125	F/116	<b>146</b>		128	F/175	<b>88</b>	
—	F/117	<b>66</b>		128	F/176	<b>82</b>	
125	F/119	<b>40</b>		128	F/177	<b>78</b>	
125	F/121	<b>62</b>		128	F/178	<b>78</b>	
125	F/122	<b>62</b>		129	F/179	<b>88</b>	
125	F/123	<b>62</b>		129	F/181	<b>68</b>	
—	F/125	<b>76</b>		129	F/182	<b>68</b>	
125	F/126	<b>62</b>		—	F/183	<b>62</b>	
125	F/127	<b>72</b>		129	F/184	<b>16</b>	
—	F/128	<b>120</b>		129	F/185	<b>56</b>	
125	F/130	<b>40</b>		129	F/186	<b>38</b>	

PAG. N°	ART. N°	PREZZO LISTINO	PREZZO NETTO	PAG. N°	ART. N°	PREZZO LISTINO	PREZZO NETTO
129	F/187	40		—	F/324	1.540	
—	F/191	56		—	F/326	1.540	
—	F/192	26		—	F/328	2.420	
609	F/195	96		—	F/330	2.420	
—	F/195-1	100		—	F/332	2.420	
609	F/196	98		—	F/334	2.420	
—	F/196-1	102		—	F/350	1.000	
609	F/197	102		—	F/352	946	
—	F/197-1	110		—	F/354	1.150	
609	F/198	102		—	F/356	946	
—	F/198-1	110		—	F/358	946	
—	F/201	300		—	F/360	630	
—	F/205	300		—	F/362	630	
—	F/207	400		—	F/364	850	
—	F/211-1	200		—	F/370	3.750	
—	F/212	428		—	F/372	4.750	
—	F/213	126		—	F/374	4.100	
—	F/214	76		—	F/376	2.200	
—	F/250	330		—	F/378	3.026	
—	F/252	386		—	F/390	150	
—	F/254	600		—	F/392	158	
—	F/256	630		—	F/396	166	
—	F/258	936		—	F/398	216	
—	F/260	936		—	F/400	216	
—	F/262	1.266		—	F/402	216	
—	F/264	1.266		—	F/404	220	
—	F/266	1.266		—	F/406	270	
—	F/268	1.760		—	F/408	230	
—	F/270	1.760		—	F/410	260	
—	F/272	1.760		—	F/412	210	
—	F/300	440		—	F/414	216	
—	F/302	500		—	F/416	350	
—	F/304	680		—	F/418	200	
—	F/306	716		—	F/420	230	
—	F/308	770		—	F/422	156	
—	F/310	1.050		—	F/424	216	
—	F/312	1.050		—	F/426	180	
—	F/314	1.050		—	F/428	240	
—	F/316	1.430		—	F/430	260	
—	F/318	1.430		—	F/432	360	
—	F/320	1.430		—	F/434	836	
—	F/322	1.540		—	F/436	870	

PAG. N°	ART. N°	PREZZO LISTINO	PREZZO NETTO	PAG. N°	ART. N°	PREZZO LISTINO	PREZZO NETTO
	<b>G</b>			132	G/144	<b>8</b>	
				132	G/145	<b>12</b>	
130	G/1	<b>600 %</b>		132	G/146	<b>20</b>	
130	G/11	<b>380 %</b>		132	G/147	<b>32</b>	
130	G/21	<b>150 %</b>		132	G/148	<b>50</b>	
130	G/22	<b>150 %</b>		132	G/161	<b>4</b>	
130	G/23	<b>150 %</b>		132	G/162	<b>6</b>	
130	G/24	<b>150 %</b>		132	G/163	<b>8</b>	
130	G/25	<b>170 %</b>		—	G/165	<b>30</b>	
130	G/26	<b>500 %</b>		132	G/171	<b>8</b>	
130	G/27	<b>600 %</b>		132	G/181	<b>16</b>	
130	G/28	<b>600 %</b>		132	G/191	<b>78</b>	
130	G/29	<b>600 %</b>		132	G/195	<b>110</b>	
—	G/39	<b>250 %</b>		133	G/201	<b>36</b>	
—	G/40	<b>250 %</b>		133	G/202	<b>42</b>	
130	G/41	<b>240 %</b>		133	G/205	<b>20</b>	
130	G/42	<b>240 %</b>		133	G/206	<b>24</b>	
130	G/43	<b>300 %</b>		133	G/207	<b>28</b>	
130	G/44	<b>400 %</b>		133	G/208	<b>38</b>	
130	G/61	<b>400 %</b>		133	G/209	<b>42</b>	
130	G/62	<b>400 %</b>		133	G/211	<b>26</b>	
130	G/63	<b>400 %</b>		133	G/213	<b>24</b>	
130	G/64	<b>400 %</b>		133	G/216	<b>4</b>	
130	G/65	<b>400 %</b>		133	G/217	<b>36</b>	
130	G/66	<b>400 %</b>		133	G/218	<b>24</b>	
130	G/67	<b>400 %</b>		134	G/231	<b>4</b>	
130	G/68	<b>400 %</b>		134	G/232	<b>6</b>	
131	G/101	<b>400 %</b>		134	G/236	<b>4</b>	
131	G/102	<b>80 %</b>		134	G/237	<b>6</b>	
131	G/103	<b>150 %</b>		134	G/261	<b>26</b>	
131	G/104	<b>120 %</b>		134	G/262	<b>30</b>	
131	G/105	<b>150 %</b>		134	G/263	<b>54</b>	
131	G/106	<b>170 %</b>		134	G/271	<b>70</b>	
131	G/107	<b>20</b>		—	G/272	<b>125</b>	
131	G/111	<b>350 %</b>		—	G/272-1	<b>80</b>	
131	G/116	<b>220 %</b>		—	G/273	<b>78</b>	
131	G/117	<b>420 %</b>		—	G/274	<b>80</b>	
131	G/118	<b>600 %</b>		—	G/274-1	<b>66</b>	
131	G/121	<b>300 %</b>		—	G/275	<b>18</b>	
132	G/131	<b>40</b>		—	G/276	<b>10</b>	
132	G/141	<b>6</b>		—	G/278	<b>14</b>	
132	G/142	<b>6</b>		—	G/279	<b>14</b>	
132	G/143	<b>6</b>		—	G/279-5	<b>366</b>	



PAG. N°	ART. N°	PREZZO LISTINO	PREZZO NETTO	PAG. N°	ART. N°	PREZZO LISTINO	PREZZO NETTO
—	G/280	<b>310</b>		137	G/401	<b>48</b>	
—	G/280-1	<b>850</b>		137	G/402	<b>48</b>	
—	G/280-2	<b>1.076</b>		137	G/403	<b>36</b>	
—	G/280-3	<b>1.500</b>		137	G/404	<b>30</b>	
—	G/280-5	<b>826</b>		137	G/405	<b>44</b>	
—	G/280-6	<b>380</b>		137	G/406	<b>64</b>	
134	G/281	<b>70</b>		137	G/411	<b>36</b>	
134	G/282	<b>70</b>		137	G/421	<b>34</b>	
134	G/283	<b>80</b>		137	G/422	<b>58</b>	
134	G/286	<b>300</b>		137	G/423	<b>60</b>	
—	G/287	<b>24</b>		137	G/424	<b>88</b>	
—	G/288	<b>18</b>		137	G/429	<b>250</b>	
135	G/301	<b>2</b>		137	G/430	<b>570</b>	
135	G/302	<b>6</b>		138	G/451	<b>800 %</b>	
135	G/303	<b>10</b>		138	G/452	<b>600 %</b>	
135	G/311	<b>2</b>		138	G/453	<b>600 %</b>	
135	G/312	<b>8</b>		138	G/454	<b>600 %</b>	
135	G/313	<b>12</b>		138	G/455	<b>600 %</b>	
135	G/314	<b>14</b>		138	G/456	<b>800 %</b>	
135	G/321	<b>160</b>		138	G/457	<b>800 %</b>	
135	G/322	<b>170</b>		138	G/458	<b>600 %</b>	
135	G/331	<b>24</b>		138	G/459	<b>600 %</b>	
135	G/341	<b>24</b>		138	G/460	<b>600 %</b>	
135	G/342	<b>24</b>		138	G/461	<b>600 %</b>	
135	G/343	<b>24</b>		138	G/462	<b>600 %</b>	
136	G/351	<b>4</b>		138	G/471	<b>80</b>	
136	G/352	<b>6</b>		138	G/472	<b>80</b>	
136	G/353	<b>6</b>		138	G/473	<b>80</b>	
136	G/354	<b>8</b>		138	G/474	<b>80</b>	
136	G/355	<b>10</b>		139	G/481	<b>20</b>	
136	G/356	<b>14</b>		139	G/482	<b>56</b>	
136	B/711	<b>10</b>		139	G/491	<b>106</b>	
136	B/712	<b>10</b>		139	G/492	<b>86</b>	
136	B/715	<b>10</b>		139	G/493	<b>56</b>	
136	B/716	<b>10</b>		139	G/494	<b>60</b>	
136	G/371	<b>100</b>		139	G/495	<b>58</b>	
136	G/375	<b>80</b>		139	G/496	<b>54</b>	
136	G/376	<b>12</b>		139	G/497	<b>38</b>	
136	G/377	<b>12</b>		139	G/498	<b>36</b>	
136	G/378	<b>8</b>		139	G/499	<b>24</b>	
136	G/379	<b>8</b>		139	G/500	<b>26</b>	
136	G/381	<b>140</b>		139	G/501	<b>34</b>	
136	G/382	<b>140</b>		139	G/502	<b>94</b>	

PAG. N°	ART. N°	PREZZO LISTINO	PREZZO NETTO	PAG. N°	ART. N°	PREZZO LISTINO	PREZZO NETTO
139	G/503	108		142	G/624	48	
139	G/504	64		142	G/625	80	
139	G/505	74		143	G/626	40	
139	G/506	66		143	G/628	48	
139	G/507	46		143	G/629	52	
139	G/508	46		608	G/630	70	
139	G/510	32		—	G/632	110	
139	G/511	36		—	G/634	62	
139	G/516	32		—	G/635	74	
139	G/517	32		143	G/636	48	
139	G/531	36		143	G/641	106	
139	G/541	110		143	G/646	184	
140	G/561	6		143	G/647	950	
140	G/562	6		144	G/651	70	
140	G/563	4		144	G/652	50	
140	G/571	450		144	G/653	50	
140	G/576	700		144	G/654	56	
140	G/577	330		144	G/655	56	
140	G/578	30		144	G/656	110	
140	G/581	70		144	G/657	60	
140	G/583	140		144	G/658	60	
140	G/586	94		144	G/659	110	
140	G/587	64		144	G/660	110	
140	G/588	42		144	G/661	60	
141	G/601	10		144	G/662	54	
141	G/602	68		145	G/671	74	
141	G/603	44		145	G/672	84	
141	G/604	28		145	G/673	140	
141	G/606	50		145	G/674	162	
141	G/607	20		145	G/675	162	
141	G/608	32		145	G/681	48	
141	G/609	42		145	G/682	170	
141	G/610	42		145	G/683	150	
141	G/611	52		145	G/684	420	
141	G/612	62		145	G/685	390	
142	G/614	62		145	G/687	320	
142	G/615	32		145	G/688	420	
142	G/617	20		145	G/689	260	
142	G/619	16		—	G/690	1.000	
142	G/620	14		—	G/690-1	880	
142	G/621	48		—	G/690-2	1.160	
142	G/622	48		—	G/690-3	660	
142	G/623	54		—	G/690-4	1.730	

PAG. N°	ART. N°	PREZZO LISTINO	PREZZO NETTO	PAG. N°	ART. N°	PREZZO LISTINO	PREZZO NETTO
146	G/691	80		149	G/799	18	
146	G/692	80		149	G/800	42	
146	G/693	44		150	G/811	60	
146	G/696	78		150	G/812	120	
146	G/697	84		150	G/813	80	
146	G/698	90		150	G/814	76	
146	G/699	84		150	G/815	90	
—	G/700	90		150	G/816	80	
—	G/700-1	90		150	G/819	200	
—	G/700-2	450		151	G/831	10	
—	G/705	120		151	G/832	12	
147	G/721	60		151	G/833	14	
147	G/722	90		151	G/834	22	
147	G/723	68		151	G/835	28	
147	G/724	68		151	G/836	40	
147	G/725	48		151	G/837	36	
147	G/726	48		151	G/838	150	
147	G/727	52		151	G/839	220	
147	G/728	150		151	G/851	18	
147	G/729	90		151	G/852	18	
148	G/741	90		152	G/853	26	
148	G/742	32		152	G/854	30	
148	G/743	56		152	G/856	42	
148	G/744	16		152	G/857	38	
148	G/745	42		152	G/858	52	
148	G/746	130		—	G/858-1	130	
148	G/747	40		152	G/859	240	
148	G/748	90		152	G/860	300	
148	G/749	130		152	G/861	130	
148	G/750	280		152	G/862	110	
149	G/781	28		152	G/863	110	
149	G/782	32		153	G/864	110	
149	G/783	32		153	G/865	110	
149	G/784	30		153	G/866	130	
149	G/785	30		153	G/867	130	
149	G/791	28		153	G/868	80	
149	G/792	28		153	G/869	110	
149	G/793	30		153	G/870	220	
149	G/794	30		153	G/871	220	
149	G/795	36		153	G/872	110	
149	G/796	18		153	G/873	60	
149	G/797	20		153	G/874	140	
149	G/798	16		153	G/875	240	

PAG. N°	ART. N°	PREZZO LISTINO	PREZZO NETTO	PAG. N°	ART. N°	PREZZO LISTINO	PREZZO NETTO
153	G/876	<b>74</b>		158	G/1017	<b>830</b>	
154	G/901	<b>62</b>		158	G/1018	<b>800</b>	
154	G/902	<b>116</b>		158	G/1019	<b>830</b>	
154	G/903	<b>144</b>		158	G/1020	<b>1.050</b>	
154	G/904	<b>170</b>		158	G/1021	<b>1.080</b>	
154	G/905	<b>130</b>		158	G/1022	<b>1.050</b>	
154	G/906	<b>210</b>		158	G/1023	<b>700</b>	
154	G/907	<b>80</b>		—	G/1026	<b>630</b>	
155	G/908	<b>138</b>		—	G/1030	<b>430</b>	
155	G/909	<b>210</b>		—	G/1031	<b>450</b>	
155	G/911	<b>350</b>		—	G/1032	<b>480</b>	
155	G/912	<b>200</b>		—	G/1033	<b>510</b>	
155	G/914	<b>460</b>		—	G/1034	<b>530</b>	
156	G/915	<b>120</b>		—	G/1035	<b>510</b>	
156	G/916	<b>120</b>		—	G/1036	<b>660</b>	
156	G/917	<b>140</b>		—	G/1037	<b>660</b>	
156	G/918	<b>140</b>		—	G/1038	<b>660</b>	
156	G/919	<b>260</b>		—	G/1039	<b>750</b>	
156	G/920	<b>260</b>		—	G/1040	<b>800</b>	
156	G/921	<b>260</b>		—	G/1041	<b>850</b>	
156	G/922	<b>260</b>		—	G/1042	<b>850</b>	
156	G/923	<b>260</b>		—	G/1043	<b>1.050</b>	
156	G/924	<b>260</b>		—	G/1044	<b>1.050</b>	
157	G/931	<b>220</b>		—	G/1045	<b>1.200</b>	
157	G/932	<b>440</b>		—	G/1046	<b>1.300</b>	
157	G/933	<b>650</b>		—	G/1047	<b>1.350</b>	
157	G/934	<b>820</b>		—	G/1048	<b>1.350</b>	
158	G/1001	<b>420</b>		—	G/1049	<b>1.300</b>	
158	G/1002	<b>430</b>		159	G/1051	<b>1.300</b>	
158	G/1003	<b>420</b>		159	G/1052	<b>1.300</b>	
158	G/1004	<b>420</b>		159	G/1053	<b>1.400</b>	
158	G/1005	<b>450</b>		159	G/1054	<b>1.400</b>	
158	G/1006	<b>440</b>		159	G/1055	<b>1.300</b>	
158	G/1007	<b>420</b>		159	G/1056	<b>1.400</b>	
158	G/1008	<b>630</b>		159	G/1057	<b>1.400</b>	
158	G/1009	<b>630</b>		159	G/1058	<b>1.300</b>	
158	G/1010	<b>650</b>		159	G/1059	<b>1.400</b>	
158	G/1011	<b>800</b>		159	G/1061	<b>2.200</b>	
158	G/1012	<b>630</b>		—	G/1062	<b>1.500</b>	
158	G/1013	<b>620</b>		—	G/1063	<b>2.900</b>	
158	G/1014	<b>830</b>		159	G/1071	<b>950</b>	
158	G/1015	<b>750</b>		159	G/1072	<b>490</b>	
158	G/1016	<b>1.130</b>		159	G/1081	<b>2.200</b>	



PAG. N°	ART. N°	PREZZO LISTINO	PREZZO NETTO	PAG. N°	ART. N°	PREZZO LISTINO	PREZZO NETTO
159	G/1082	<b>1.700</b>		—	G/1159	<b>380</b>	
159	G/1083	<b>1.700</b>		165	G/1161	<b>300</b>	
161	G/1092	<b>250</b>		165	G/1171	<b>46</b>	
161	G/1093	<b>620</b>		165	G/1201	<b>416</b>	
161	G/1094	<b>1.350</b>		165	G/1202	<b>416</b>	
161	G/1095	<b>2.370</b>		165	G/1203	<b>774</b>	
161	G/1096	<b>870</b>		165	G/1204	<b>774</b>	
161	G/1097	<b>1.250</b>		165	G/1205	<b>50</b>	
—	G/1098	<b>620</b>		165	G/1206	<b>468</b>	
162	G/1101	<b>190</b>		165	G/1207	<b>468</b>	
162	G/1101-N	<b>180</b>		165	G/1208	<b>450</b>	
162	G/1101-B	<b>180</b>		165	G/1209	<b>450</b>	
162	G/1102	<b>224</b>		165	G/1210	<b>450</b>	
162	G/1103	<b>344</b>		608	G/1210-1	<b>750</b>	
162	G/1104	<b>364</b>		166	G/1211	<b>110</b>	
162	G/1105	<b>220</b>		166	G/1212	<b>136</b>	
162	G/1106	<b>240</b>		166	G/1213	<b>800</b>	
162	G/1107	<b>410</b>		166	G/1214	<b>800</b>	
162	G/1108	<b>500</b>		166	G/1215	<b>800</b>	
162	G/1109	<b>200</b>		166	G/1215-1	<b>800</b>	
162	G/1110	<b>210</b>		166	G/1216	<b>144</b>	
162	G/1111	<b>400</b>		167	G/1221	<b>300</b>	
162	G/1112	<b>450</b>		167	G/1222	<b>326</b>	
163	G/1113	<b>250</b>		167	G/1223	<b>350</b>	
163	G/1114	<b>310</b>		167	G/1225	<b>420</b>	
163	G/1115	<b>380</b>		168	G/1261	<b>820</b>	
163	G/1116	<b>400</b>		168	G/1262	<b>890</b>	
163	G/1122	<b>360</b>		168	G/1263	<b>740</b>	
163	G/1123	<b>300</b>		168	G/1264	<b>890</b>	
163	G/1125	<b>500</b>		168	G/1265	<b>820</b>	
163	G/1126	<b>800</b>		168	G/1266	<b>890</b>	
163	G/1127	<b>850</b>		168	G/1267	<b>890</b>	
163	G/1128	<b>950</b>		168	G/1268	<b>820</b>	
164	G/1129	<b>380</b>		168	G/1269	<b>890</b>	
164	G/1130	<b>1.120</b>		168	G/1270	<b>820</b>	
164	G/1131	<b>1.250</b>		168	G/1271	<b>740</b>	
164	G/1141	<b>860</b>		168	G/1272	<b>890</b>	
164	G/1142	<b>980</b>		168	G/1273	<b>890</b>	
164	G/1151	<b>390</b>		168	G/1274	<b>890</b>	
164	G/1155	<b>120</b>		168	G/1275	<b>820</b>	
164	G/1156	<b>120</b>		168	G/1276	<b>890</b>	
164	G/1157	<b>130</b>		168	G/1277	<b>890</b>	
164	G/1158	<b>130</b>		168	G/1278	<b>820</b>	

PAG. N°	ART. N°	PREZZO LISTINO	PREZZO NETTO	PAG. N°	ART. N°	PREZZO LISTINO	PREZZO NETTO
168	G/1279	740		169	G/1348	740	
168	G/1280	890		169	G/1349	890	
168	G/1281	890		169	G/1350	740	
168	G/1282	820		169	G/1351	920	
168	G/1283	890		169	G/1352	740	
168	G/1301	580		169	G/1353	890	
168	G/1302	660		169	G/1354	890	
168	G/1303	730		169	G/1355	890	
168	G/1304	660		169	G/1356	890	
168	G/1305	660		169	G/1357	740	
168	G/1306	730		169	G/1358	890	
168	G/1307	880		169	G/1359	1.050	
168	G/1307-1	930		169	G/1360	1.190	
168	G/1308	670		169	G/1361	1.190	
168	G/1309	850		169	G/1362	860	
168	G/1310	730		169	G/1363	670	
168	G/1311	880		169	G/1363-1	740	
168	G/1312	960		169	G/1364	740	
168	G/1313	770		169	G/1365	890	
168	G/1314	1.100		169	G/1366	890	
168	G/1321	630		169	G/1367	670	
168	G/1322	660		169	G/1368	970	
168	G/1323	840		169	G/1369	1.100	
168	G/1324	780		169	G/1370	800	
168	G/1325	700		169	G/1371	970	
169	G/1331	630		169	G/1372	890	
169	G/1332	580		169	G/1373	780	
169	G/1333	580		169	G/1374	980	
169	G/1334	670		169	G/1375	1.100	
169	G/1335	770		169	G/1376	1.200	
169	G/1336	670		170	G/1401	740	
169	G/1337	740		170	G/1402	700	
169	G/1338	630		170	G/1403	700	
169	G/1339	590		170	G/1404	900	
169	G/1340	590		170	G/1405	700	
169	G/1341	770		170	G/1406	980	
169	G/1342	630		170	G/1407	950	
169	G/1343	670		170	G/1408	990	
169	G/1344	740		170	G/1409	850	
169	G/1344-1	890		170	G/1410	780	
169	G/1345	670		170	G/1411	750	
169	G/1346	740		170	G/1412	780	
169	G/1347	750		170	G/1413	950	

PAG. N°	ART. N°	PREZZO LISTINO	PREZZO NETTO	PAG. N°	ART. N°	PREZZO LISTINO	PREZZO NETTO
170	G/1414	<b>1.000</b>		176	G/1471-1	<b>1.220</b>	
607	G/1421	<b>1.900</b>		176	G/1471-2	<b>1.220</b>	
608	G/1422	<b>750</b>		176	G/1471-3	<b>1.220</b>	
170	G/1441	<b>900</b>		176	G/1471-4	<b>1.220</b>	
170	G/1442	<b>900</b>		176	G/1471-5	<b>1.220</b>	
170	G/1443	<b>810</b>		178	G/1471-6	<b>1.300</b>	
170	G/1444	<b>810</b>		178	G/1472	<b>1.300</b>	
170	G/1445	<b>1.100</b>		178	G/1472-1	<b>1.300</b>	
170	G/1446	<b>1.100</b>		178	G/1472-2	<b>1.300</b>	
170	G/1447	<b>1.000</b>		178	G/1472-3	<b>1.300</b>	
170	G/1448	<b>900</b>		178	G/1472-4	<b>1.300</b>	
170	G/1449	<b>1.100</b>		180	G/1472-6	<b>1.500</b>	
170	G/1450	<b>600</b>		180	G/1473	<b>1.500</b>	
170	G/1451	<b>600</b>		180	G/1474	<b>1.500</b>	
—	G/1461	<b>650</b>		180	G/1475	<b>1.500</b>	
170	G/1462	<b>550</b>		180	G/1476	<b>1.500</b>	
170	G/1463	<b>750</b>		180	G/1477	<b>1.800</b>	
170	G/1464	<b>750</b>		180	G/1478	<b>1.800</b>	
170	G/1465	<b>750</b>		180	G/1479	<b>1.800</b>	
170	G/1466	<b>650</b>		182	G/1480	<b>650</b>	
170	G/1467	<b>800</b>		183	G/1480-1	<b>800</b>	
172	G/1467-1	<b>600</b>		183	G/1480-2	<b>600</b>	
172	G/1467-2	<b>100</b>		183	G/1480-3	<b>570</b>	
172	G/1467-3	<b>170</b>		185	G/1481	<b>1.300</b>	
173	G/1468	<b>1.020</b>		185	G/1482	<b>1.300</b>	
173	G/1469	<b>1.020</b>		185	G/1483	<b>1.300</b>	
173	G/1470	<b>1.020</b>		185	G/1485	<b>1.250</b>	
173	G/1470-1	<b>1.020</b>		185	G/1486	<b>1.250</b>	
173	G/1470-2	<b>1.020</b>		185	G/1487	<b>1.250</b>	
173	G/1470-3	<b>1.020</b>		186	G/1488	<b>1.700</b>	
173	G/1470-4	<b>1.020</b>		186	G/1489	<b>1.700</b>	
173	G/1470-5	<b>1.020</b>		186	G/1490	<b>1.700</b>	
173	G/1470-6	<b>1.020</b>		186	G/1491	<b>950</b>	
174	G/1470-10	<b>1.020</b>		186	G/1492	<b>950</b>	
174	G/1470-11	<b>1.020</b>		186	G/1493	<b>950</b>	
174	G/1470-12	<b>1.020</b>		—	G/1495	<b>1.130</b>	
174	G/1470-13	<b>1.020</b>		187	G/1501	<b>220</b>	
174	G/1470-14	<b>1.020</b>		187	G/1502	<b>220</b>	
174	G/1470-15	<b>1.020</b>		187	G/1503	<b>630</b>	
174	G/1470-16	<b>1.020</b>		187	G/1504	<b>490</b>	
174	G/1470-17	<b>1.020</b>		188	G/1511	<b>430</b>	
174	G/1470-18	<b>1.020</b>		188	G/1512	<b>430</b>	
176	G/1471	<b>1.220</b>		188	G/1513	<b>430</b>	



PAG. N°	ART. N°	PREZZO LISTINO	PREZZO NETTO	PAG. N°	ART. N°	PREZZO LISTINO	PREZZO NETTO
188	G/1514	<b>660</b>		192	G/1579	<b>730</b>	
188	G/1515	<b>590</b>		192	G/1580	<b>750</b>	
607	G/1516	<b>650</b>		192	G/1581	<b>750</b>	
188	G/1521	<b>650</b>		192	G/1582	<b>750</b>	
188	G/1522	<b>650</b>		193	G/1601	<b>2.380</b>	
189	G/1531	<b>430</b>		193	G/1602	<b>2.230</b>	
189	G/1532	<b>360</b>		193	G/1603	<b>2.900</b>	
189	G/1533	<b>400</b>		193	G/1604	<b>4.050</b>	
189	G/1534	<b>430</b>		193	G/1605	<b>3.240</b>	
189	G/1535	<b>430</b>		193	G/1611	<b>8.500</b>	
189	G/1536	<b>490</b>		193	G/1612	<b>8.130</b>	
607	G/1537	<b>400</b>		193	G/1613	<b>6.680</b>	
—	G/1537-1	<b>330</b>		193	G/1621	<b>350</b>	
—	G/1538	<b>170</b>		193	G/1622	<b>540</b>	
190	G/1539	<b>140</b>		607	G/1623	<b>1.100</b>	
—	G/1539-1	<b>116</b>		194	G/1701	<b>48</b>	
190	G/1540	<b>120</b>		194	G/1702	<b>48</b>	
—	G/1540-1	<b>106</b>		194	G/1703	<b>48</b>	
—	G/1540-2	<b>280</b>		194	G/1704	<b>48</b>	
190	G/1541	<b>98</b>		194	G/1711	<b>56</b>	
190	G/1542	<b>140</b>		194	G/1712	<b>56</b>	
190	G/1543	<b>310</b>		194	G/1713	<b>56</b>	
190	G/1544	<b>250</b>		194	G/1714	<b>56</b>	
191	G/1551	<b>820</b>		194	G/1715	<b>56</b>	
191	G/1552	<b>900</b>		194	G/1716	<b>116</b>	
191	G/1553	<b>840</b>		194	G/1717	<b>156</b>	
191	G/1554	<b>920</b>		194	G/1721	<b>64</b>	
191	G/1555	<b>920</b>		194	G/1731	<b>58</b>	
191	G/1556	<b>1.150</b>		194	G/1736	<b>100</b>	
191	G/1557	<b>880</b>		194	G/1737	<b>100</b>	
191	G/1558	<b>1.050</b>		195	G/1741	<b>280</b>	
191	G/1559	<b>880</b>		195	G/1742	<b>280</b>	
191	G/1560	<b>1.050</b>		195	G/1744	<b>280</b>	
191	G/1561	<b>1.050</b>		195	G/1745	<b>280</b>	
191	G/1562	<b>1.150</b>		195	G/1746	<b>280</b>	
192	G/1571	<b>460</b>		195	G/1747	<b>280</b>	
192	G/1572	<b>480</b>		195	G/1748	<b>320</b>	
192	G/1573	<b>730</b>		195	G/1749	<b>320</b>	
192	G/1574	<b>730</b>		195	G/1750	<b>320</b>	
192	G/1575	<b>730</b>		195	G/1750-1	<b>320</b>	
192	G/1576	<b>530</b>		195	G/1750-2	<b>320</b>	
192	G/1577	<b>730</b>		195	G/1750-3	<b>320</b>	
192	G/1578	<b>730</b>		196	G/1761	<b>130</b>	



PAG. N°	ART. N°	PREZZO LISTINO	PREZZO NETTO	PAG. N°	ART. N°	PREZZO LISTINO	PREZZO NETTO
196	G/1762	140		200	G/1825-2	470	
196	G/1763	170		200	G/1826	820	
196	G/1771	30		200	G/1827	930	
196	G/1781	130		200	G/1828	470	
196	G/1782	140		200	G/1829	470	
196	G/1783	170		201	G/1830	210	
196	G/1786	130		201	G/1830-1	138	
196	G/1787	140		201	G/1831	560	
196	G/1788	170		201	G/1832	560	
196	G/1791	286		201	G/1834	560	
196	G/1792	286		201	G/1835	560	
196	G/1793	300		201	G/1836	560	
197	G/1801	58		201	G/1837	560	
197	G/1802	58		608	G/1841	420	
197	G/1803	74		608	G/1842	420	
197	G/1803-1	48		608	G/1843	420	
197	G/1804	86		608	G/1844	420	
197	G/1804-1	64		608	G/1845	420	
197	G/1805	110		608	G/1846	420	
197	G/1806	190		—	G/1850	420	
197	G/1806-1	130		—	G/1851	420	
197	G/1806-2	12		—	G/1852	420	
197	G/1806-3	12		—	G/1853	420	
198	G/1807	6		—	G/1854	420	
198	G/1808	20		—	G/1855	420	
198	G/1809	280		—	G/1900	140	
198	G/1810	280		—	G/1900-1	96	
198	G/1812	220		202	G/1901	78	
198	G/1813	220		202	G/1902	34	
198	G/1814	300		202	G/1903	34	
198	G/1815	300		202	G/1904	34	
199	G/1816	400		202	G/1905	76	
199	G/1817	400		202	G/1906	50	
199	G/1818	164		202	G/1907	50	
199	G/1819	140		202	G/1908	50	
199	G/1820	270		202	G/1909	50	
199	G/1821	320		202	G/2001	280	
199	G/1821-1	300		202	G/2002	280	
199	G/1822	290		202	G/2003	280	
200	G/1823	320		202	G/2005	80	
200	G/1824	110		202	G/2011	300	
200	G/1825	110		203	G/2016	230	
200	G/1825-1	470		203	G/2019	170	

PAG. N°	ART. N°	PREZZO LISTINO	PREZZO NETTO	PAG. N°	ART. N°	PREZZO LISTINO	PREZZO NETTO
—	G/2021	<b>170</b>		208	G/2140	<b>16</b>	
203	G/2026	<b>320</b>		208	G/2145	<b>96</b>	
203	G/2031	<b>390</b>		209	G/2201	<b>54</b>	
607	G/2033	<b>250</b>		209	G/2202	<b>54</b>	
203	G/2034	<b>300</b>		209	G/2203	<b>38</b>	
203	G/2035	<b>300</b>		209	G/2204	<b>20</b>	
203	G/2036	<b>700</b>		209	G/2206	<b>36</b>	
203	G/2041	<b>2.700</b>		209	G/2207	<b>30</b>	
203	G/2042	<b>2.700</b>		209	G/2208	<b>34</b>	
203	G/2043	<b>2.700</b>		209	G/2209	<b>34</b>	
204	G/2051	<b>1.250</b>		209	G/2221	<b>60</b>	
204	G/2052	<b>270</b>		—	G/2226	<b>140</b>	
204	G/2052-1	<b>150</b>		209	G/2231	<b>72</b>	
204	G/2053	<b>160</b>		210	G/2251	<b>54</b>	
204	G/2054	<b>240</b>		210	G/2251-1	<b>62</b>	
204	G/2055	<b>350</b>		210	G/2252	<b>70</b>	
205	G/2056	<b>44</b>		210	G/2252-1	<b>76</b>	
205	G/2057	<b>10</b>		210	G/2253	<b>66</b>	
205	G/2058	<b>148</b>		210	G/2261	<b>44</b>	
205	G/2059	<b>42</b>		210	G/2261-1	<b>50</b>	
205	G/2060	<b>86</b>		210	G/2262	<b>44</b>	
205	G/2061	<b>420</b>		210	G/2262-1	<b>50</b>	
206	G/2101	<b>74</b>		210	G/2263	<b>44</b>	
206	G/2101-1	<b>74</b>		210	G/2263-1	<b>50</b>	
206	G/2101-2	<b>74</b>		210	G/2271	<b>32</b>	
206	G/2102	<b>58</b>		211	G/2276	<b>44</b>	
206	G/2103	<b>60</b>		211	G/2277	<b>18</b>	
206	G/2105	<b>64</b>		211	G/2278	<b>20</b>	
206	G/2106	<b>66</b>		211	G/2281	<b>14</b>	
206	G/2107	<b>60</b>		211	G/2282	<b>18</b>	
206	G/2108	<b>70</b>		—	G/2283	<b>22</b>	
207	G/2111	<b>98</b>		211	G/2291	<b>88</b>	
207	G/2112	<b>98</b>		—	G/2291-1	<b>100</b>	
207	G/2113	<b>98</b>		211	G/2301	<b>82</b>	
207	G/2114	<b>98</b>		211	G/2305	<b>50</b>	
207	G/2115	<b>180</b>		211	G/2306	<b>110</b>	
207	G/2116	<b>94</b>		212	G/2307	<b>74</b>	
207	G/2118	<b>280</b>		212	G/2308	<b>74</b>	
208	G/2131	<b>56</b>		212	G/2311	<b>88</b>	
208	G/2132	<b>62</b>		212	G/2312	<b>150</b>	
208	G/2136	<b>62</b>		212	G/2313	<b>54</b>	
208	G/2137	<b>62</b>		212	G/2314	<b>124</b>	
208	G/2138	<b>64</b>		212	G/2315	<b>146</b>	

PAG. N°	ART. N°	PREZZO LISTINO	PREZZO NETTO	PAG. N°	ART. N°	PREZZO LISTINO	PREZZO NETTO
212	G/2316	<b>146</b>		217	G/2375-7	<b>210</b>	
212	G/2319	<b>138</b>		217	G/2375-8	<b>250</b>	
213	G/2321	<b>60</b>		217	G/2375-9	<b>260</b>	
213	G/2322	<b>330</b>		218	G/2375-11	<b>520</b>	
213	G/2323	<b>300</b>		218	G/2375-12	<b>570</b>	
—	G/2330	<b>100</b>		218	G/2375-13	<b>600</b>	
213	G/2335	<b>98</b>		218	G/2375-14	<b>460</b>	
213	G/2336	<b>118</b>		218	G/2375-15	<b>600</b>	
213	G/2341	<b>326</b>		218	G/2375-16	<b>680</b>	
213	G/2342	<b>276</b>		218	G/2375-17	<b>790</b>	
214	G/2345	<b>200</b>		219	G/2376	<b>560</b>	
214	G/2348	<b>230</b>		219	G/2377	<b>670</b>	
214	G/2349	<b>250</b>		219	G/2378	<b>480</b>	
215	G/2350	<b>220</b>		219	G/2379	<b>570</b>	
215	G/2351	<b>220</b>		219	G/2380	<b>290</b>	
215	G/2352	<b>220</b>		219	G/2381	<b>290</b>	
215	G/2353	<b>220</b>		219	G/2382	<b>290</b>	
215	G/2354	<b>170</b>		220	G/2383	<b>290</b>	
215	G/2355	<b>170</b>		220	G/2384	<b>420</b>	
215	G/2356	<b>180</b>		220	G/2395	<b>240</b>	
215	G/2357	<b>290</b>		220	G/2396	<b>270</b>	
215	G/2358	<b>180</b>		220	G/2401	<b>650</b>	
215	G/2359	<b>180</b>		220	G/2402	<b>880</b>	
215	G/2360	<b>190</b>		220	G/2411	<b>730</b>	
215	G/2361	<b>220</b>		220	G/2413	<b>980</b>	
216	G/2362	<b>180</b>		220	G/2415	<b>1.100</b>	
216	G/2363	<b>190</b>		220	G/2416	<b>1.400</b>	
216	G/2364	<b>220</b>		220	G/2421	<b>290</b>	
216	G/2365	<b>220</b>		220	G/2431	<b>64</b>	
216	G/2366	<b>110</b>		220	G/2432	<b>74</b>	
216	G/2367	<b>180</b>		—	G/2433	<b>70</b>	
216	G/2368	<b>110</b>		220	G/2436	<b>150</b>	
216	G/2369	<b>220</b>		220	G/2441	<b>120</b>	
216	G/2370	<b>180</b>		220	G/2442	<b>124</b>	
216	G/2371	<b>180</b>		220	G/2443	<b>130</b>	
216	G/2372	<b>180</b>		220	G/2445	<b>400</b>	
216	G/2373	<b>180</b>		220	G/2451	<b>290</b>	
217	G/2374	<b>180</b>		220	G/2452	<b>150</b>	
217	G/2375	<b>180</b>		222	G/2456	<b>440</b>	
217	G/2375-1	<b>150</b>		222	G /2457	<b>440</b>	
217	G/2375-2	<b>270</b>		222	G/2461	<b>530</b>	
217	G/2375-3	<b>300</b>		222	G/2462	<b>570</b>	
217	G/2375-6	<b>136</b>		222	G/2463	<b>670</b>	

PAG. N°	ART. N°	PREZZO LISTINO	PREZZO NETTO	PAG. N°	ART. N°	PREZZO LISTINO	PREZZO NETTO
222	G/2464	680		228	G/2523	110	
222	G/2465	780		228	G/2524	110	
222	G/2466	780		228	G/2525	206	
222	G/2467	830		228	G/2526	270	
222	G/2468	890		228	G/2527	184	
223	G/2469	830		229	G/2541	150	
223	G/2470	590		229	G/2542	150	
223	G/2471	690		229	G/2543	150	
223	G/2472	750		229	G/2544	150	
223	G/2473	1.150		229	G/2546	184	
223	G/2474	1.250		229	G/2548	216	
223	G/2481	230		230	G/2551	54	
223	G/2482	110		230	G/2555	160	
223	G/2483	96		230	G/2556	160	
223	G/2483-1	126		230	G/2557	126	
224	G/2484	420		230	G/2558	126	
224	G/2485	340		230	G/2559	140	
224	G/2486	350		230	G/2560-1	110	
224	G/2487	530		230	G/2560-2	110	
225	G/2491	680		231	G/2561	98	
225	G/2492	960		231	G/2562	54	
225	G/2498	620		231	G/2563	54	
225	G/2499	620		231	G/2564	54	
226	G/2501	60		231	G/2565	54	
226	G/2502	90		231	G/2568	54	
226	G/2503	90		231	G/2568-1	54	
226	G/2504	110		231	G/2568-2	54	
226	G/2505	150		231	G/2568-3	112	
226	G/2506	150		231	G/2568-6	48	
226	G/2507	150		232	G/2569	76	
226	G/2508	180		232	G/2570	80	
226	G/2509	190		232	G/2571	390	
226	G/2510	240		232	G/2576	52	
226	G/2511	260		232	G/2577	100	
226	G/2512	290		232	G/2577-1	116	
226	G/2513	290		232	G/2578	270	
226	G/2514	370		234	G/2601	74	
227	G/2516	34		234	G/2602	82	
227	G/2517	76		234	G/2603	90	
227	G/2518	54		234	G/2604	100	
227	G/2519	90		234	G/2608	140	
228	G/2521	16		234	G/2611	30	
228	G/2522	20		234	G/2612	30	



PAG. N°	ART. N°	PREZZO LISTINO	PREZZO NETTO	PAG. N°	ART. N°	PREZZO LISTINO	PREZZO NETTO
234	G/2613	30		239	G/2676	200	
234	G/2614	30		239	G/2676-1	250	
234	G/2615	38		240	G/2678	660	
234	G/2616	44		240	G/2679	290	
235	G/2617	58		240	G/2691	48	
235	G/2617-1	56		240	G/2692	44	
235	G/2618	56		240	G/2693	50	
235	G/2619	40		240	G/2694	42	
235	G/2620	96		240	G/2696	130	
235	G/2621	74		240	G/2701	74	
235	G/2622	72		241	G/2702	132	
235	G/2623	86		241	G/2703	40	
236	G/2624	92		241	G/2706	60	
236	G/2624-1	46		241	G/2707	78	
236	G/2625	92		241	G/2708	70	
236	G/2626	92		241	G/2709	46	
236	G/2641	44		242	G/2711	80	
236	G/2642	38		242	G/2712	70	
236	G/2643	48		242	G/2713	10	
237	G/2644	96		242	G/2714	60	
237	G/2644-1	56		242	G/2716	70	
237	G/2645	96		242	G/2717	18	
237	G/2646	96		242	G/2718	44	
237	G/2647	96		242	G/2719	12	
237	G/2648	114		242	G/2720	24	
237	G/2649	82		242	G/2721	150	
237	G/2650	82		243	G/2722	160	
237	G/2651	96		243	G/2723	176	
238	G/2652	40		243	G/2724	100	
238	G/2653	54		243	G/2725	340	
238	G/2653-1	54		243	G/2731	388	
238	G/2654	54		243	G/2732	388	
238	G/2654-1	54		243	G/2736	78	
238	G/2655	70		244	G/2741	140	
238	G/2655-1	70		244	G/2743	160	
238	G/2655-2	66		244	G/2751	1.600	
238	G/2658	50		244	G/2752	800	
239	G/2659	54		244	G/2752-1	900	
239	G/2662	80		244	G/2761	48	
239	G/2663	250		244	G/2762	54	
239	G/2671	20		244	G/2771	150	
239	G/2672	20		245	G/2776	420	
239	G/2675	200		245	G/2777	410	

PAG. N°	ART. N°	PREZZO LISTINO	PREZZO NETTO	PAG. N°	ART. N°	PREZZO LISTINO	PREZZO NETTO
245	G/2781	400		251	G/2860	46	
245	G/2782	400		251	G/2860-1	26	
245	G/2783	300		251	G/2860-2	26	
245	G/2784	250		251	G/2860-5	28	
245	G/2785	700		251	G/2860-6	30	
246	G/2791	360		252	G/2861	230	
246	G/2792	260		252	G/2862	240	
246	G/2792-1	194		252	G/2863	270	
246	G/2792-3	330		252	G/2864	240	
246	G/2793	230		252	G/2865	370	
246	G/2793-1	1.450		252	G/2866	320	
248	G/2793-5	1.000		252	G/2867	340	
248	G/2793-6	2.400		252	G/2867-5	170	
248	G/2794	146		252	G/2867-6	160	
248	G/2795	146		252	G/2873	70	
248	G/2795-1	136		253	G/2901	20	
—	G/2795-5	100		253	G/2902	20	
248	G/2795-6	100		253	G/2903	20	
248	G/2795-7	76		253	G/2904	20	
248	G/2796	100		253	G/2905	20	
248	G/2798	200		253	G/2906	20	
248	G/2799	90		253	G/2907	20	
249	G/2801	50		253	G/2908	20	
249	G/2802	50		253	G/2909	20	
249	G/2803	50		253	G/2910	20	
249	G/2804	50		253	G/2911	20	
249	G/2805	50		253	G/2912	20	
249	G/2811	100		253	G/2913	20	
249	G/2812	114		253	G/2914	20	
249	G/2813	124		253	G/2915	20	
249	G/2814	138		253	G/2916	20	
250	G/2851	52		253	G/2917	20	
250	G/2852	54		253	G/2918	20	
250	G/2853	58		253	G/2920	20	
250	G/2855	20		253	G/2921	20	
250	G/2856	58		253	G/2922	20	
250	G/2857	62		253	G/2923	20	
250	G/2858	24		253	G/2924	20	
250	G/2858-1	54		253	G/2925	20	
250	G/2858-2	60		253	G/2926	20	
250	G/2858-5	20		253	G/2927	20	
250	G/2858-6	20		253	G/2928	20	
251	G/2859	46		253	G/2929	20	

PAG. N°	ART. N°	PREZZO LISTINO	PREZZO NETTO	PAG. N°	ART. N°	PREZZO LISTINO	PREZZO NETTO
253	G/2930	<b>20</b>		257	G/3022-2	<b>550</b>	
254	G/2931	<b>24</b>		257	G/3023	<b>110</b>	
254	G/2932	<b>24</b>		257	G/3031	<b>200</b>	
254	G/2933	<b>24</b>		257	G/3032	<b>400</b>	
254	G/2934	<b>24</b>		257	G/3036	<b>106</b>	
254	G/2936	<b>48</b>		257	G/3037	<b>138</b>	
254	G/2937	<b>48</b>		257	G/3038	<b>190</b>	
254	G/2938	<b>48</b>		257	G/3039	<b>250</b>	
254	G/2939	<b>48</b>					
254	G/2941	<b>480</b>			<b>H</b>		
254	G/2942	<b>1.400</b>					
254	G/2943	<b>1.500</b>					
—	G/2944	<b>2.000</b>		258	H/2	<b>1.350</b>	
—	G/2945	<b>900</b>		258	H/3	<b>1.400</b>	
—	G/2946	<b>2.200</b>		258	H/4	<b>1.400</b>	
—	G/2947	<b>1.650</b>		258	H/11	<b>650</b>	
—	G/2948	<b>880</b>		258	H/12	<b>650</b>	
—	G/2949	<b>350</b>		258	H/13	<b>650</b>	
255	G/2951	<b>22</b>		258	H/14	<b>650</b>	
255	G/2952	<b>38</b>		258	H/15	<b>650</b>	
255	G/2953	<b>52</b>		258	H/16	<b>650</b>	
255	G/2954	<b>14</b>		258	H/17	<b>650</b>	
255	G/2955	<b>26</b>		258	H/18	<b>650</b>	
255	G/2956	<b>4</b>		258	H/19	<b>750</b>	
256	G/2957	<b>26</b>		258	H/20	<b>750</b>	
255	G/3001	<b>200</b>		258	H/21	<b>750</b>	
256	G/3002	<b>150</b>		258	H/22	<b>750</b>	
256	G/3003	<b>1.250</b>		258	H/31	<b>630</b>	
256	G/3004	<b>1.700</b>		258	H/32	<b>630</b>	
256	G/3005	<b>2.200</b>		258	H/33	<b>630</b>	
256	G/3006	<b>3.120</b>		258	H/35	<b>630</b>	
256	G/3007	<b>3.750</b>		258	H/36	<b>630</b>	
256	G/3008	<b>680</b>		258	H/37	<b>630</b>	
256	G/3009	<b>2.000</b>		258	H/38	<b>630</b>	
256	G/3010	<b>260</b>		258	H/39	<b>630</b>	
257	G/3011	<b>140</b>		258	H/40	<b>630</b>	
257	G/3011-1	<b>210</b>		258	H/41	<b>630</b>	
257	G/3011-2	<b>270</b>		259	H/42	<b>750</b>	
257	G/3012	<b>120</b>		259	H/43	<b>750</b>	
257	G/3013	<b>70</b>		259	H/44	<b>750</b>	
257	G/3021	<b>130</b>		259	H/45	<b>750</b>	
257	G/3022	<b>290</b>		259	H/46	<b>750</b>	
257	G/3022-1	<b>390</b>		259	H/47	<b>750</b>	

PAG. N°	ART. N°	PREZZO LISTINO	PREZZO NETTO	PAG. N°	ART. N°	PREZZO LISTINO	PREZZO NETTO
259	H/48	<b>750</b>		260	H/86	<b>580</b>	
259	H/49	<b>750</b>		260	H/87	<b>580</b>	
259	H/50	<b>750</b>		260	H/88	<b>580</b>	
259	H/50-1	<b>950</b>		260	H/89	<b>580</b>	
259	H/50-2	<b>950</b>		261	H/91	<b>550</b>	
259	H/50-3	<b>950</b>		261	H/92	<b>550</b>	
259	H/50-4	<b>950</b>		261	H/93	<b>550</b>	
259	H/50-5	<b>950</b>		261	H/94	<b>550</b>	
259	H/50-6	<b>950</b>		—	H/94-1	<b>550</b>	
259	H/50-11	<b>1.500</b>		—	H/95	<b>1.000</b>	
259	H/50-12	<b>1.500</b>		—	H/96	<b>1.000</b>	
259	H/50-16	<b>1.750</b>		—	H/96-1	<b>1.000</b>	
259	H/50-17	<b>1.750</b>		—	H/97	<b>900</b>	
259	H/50-18	<b>1.750</b>		—	H/97-1	<b>1.250</b>	
260	H/51	<b>1.450</b>		—	H/97-2	<b>1.000</b>	
260	H/52	<b>1.450</b>		—	H/97-3	<b>900</b>	
260	H/53	<b>1.450</b>		—	H/97-4	<b>650</b>	
—	H/54	<b>630</b>		261	H/98	<b>1.800</b>	
—	H/55	<b>630</b>		261	H/99	<b>600</b>	
—	H/56	<b>630</b>		—	H/100	<b>600</b>	
—	H/57	<b>630</b>		—	H/100-1	<b>1.000</b>	
—	H/58	<b>630</b>		—	H/100-2	<b>1.000</b>	
—	H/59	<b>630</b>		—	H/100-3	<b>700</b>	
260	H/61	<b>630</b>		—	H/100-4	<b>900</b>	
260	H/62	<b>630</b>		—	H/100-5	<b>800</b>	
260	H/63	<b>630</b>		—	H/100-6	<b>650</b>	
260	H/64	<b>630</b>		—	H/100-7	<b>400</b>	
260	H/65	<b>630</b>		262	H/101	<b>2.420</b>	
260	H/66	<b>630</b>		262	H/102	<b>2.860</b>	
260	H/67	<b>630</b>		262	H/103	<b>3.740</b>	
260	H/68	<b>630</b>		262	H/104	<b>3.700</b>	
260	H/69	<b>630</b>		262	H/105	<b>4.840</b>	
260	H/70	<b>630</b>		262	H/106	<b>6.500</b>	
260	H/71	<b>630</b>		262	H/107	<b>6.500</b>	
260	H/72	<b>630</b>		262	H/108	<b>13.200</b>	
260	H/73	<b>630</b>		—	H/131	<b>900</b>	
260	H/74	<b>630</b>		263	H/132	<b>1.480</b>	
260	H/75	<b>630</b>		263	H/133	<b>1.280</b>	
260	H/81	<b>580</b>		263	H/134	<b>1.280</b>	
260	H/82	<b>580</b>		—	H/134-1	<b>850</b>	
260	H/83	<b>580</b>		263	H/135	<b>1.700</b>	
260	H/84	<b>580</b>		263	H/136	<b>3.400</b>	
260	H/85	<b>580</b>		—	H/136-1	<b>9.000</b>	



PAG. N°	ART. N°	PREZZO LISTINO	PREZZO NETTO	PAG. N°	ART. N°	PREZZO LISTINO	PREZZO NETTO
—	H/136-2	<b>2.000</b>		266	H/205	<b>1.400</b>	
263	H/137	<b>790</b>		267	H/211	<b>7.000</b>	
263	H/138	<b>900</b>		267	H/212	<b>15.000</b>	
264	H/151	<b>3.600</b>		267	H/213	<b>17.000</b>	
264	H/152	<b>3.600</b>		267	H/214	<b>14.000</b>	
264	H/153	<b>3.600</b>		267	H/215	<b>14.000</b>	
264	H/154	<b>3.600</b>		267	H/221	<b>10.500</b>	
264	H/161	<b>2.500</b>		267	H/222	<b>10.500</b>	
264	H/171	<b>3.200</b>		267	H/223	<b>10.500</b>	
264	H/172	<b>3.200</b>		267	H/224	<b>20.000</b>	
264	H/173	<b>3.200</b>		267	H/225	<b>20.000</b>	
265	H/174	<b>3.200</b>		267	H/226	<b>20.000</b>	
265	H/175	<b>2.900</b>		267	H/227	<b>22.000</b>	
265	H/176	<b>2.900</b>		267	H/228	<b>22.000</b>	
265	H/181	<b>2.700</b>		267	H/229	<b>22.000</b>	
265	H/182	<b>2.700</b>		267	H/230	<b>14.500</b>	
265	H/183	<b>2.700</b>		267	H/231	<b>14.500</b>	
—	H/184	<b>1.800</b>		268	H/240	<b>8.800</b>	
—	H/184-2	<b>2.300</b>		—	H/240-1	<b>8.800</b>	
—	H/184-3	<b>2.300</b>		—	H/240-2	<b>8.800</b>	
—	H/184-4	<b>2.800</b>		—	H/240-3	<b>8.800</b>	
265	H/185	<b>1.300</b>		268	H/241	<b>7.400</b>	
265	H/186	<b>1.600</b>		268	H/242	<b>2.000</b>	
265	H/187	<b>3.800</b>		268	H/243	<b>8.600</b>	
—	H/187-1	<b>2.000</b>		—	H/245	<b>5.000</b>	
—	H/187-2	<b>1.900</b>		269	H/251	—	
—	H/188	<b>1.600</b>		269	H/253	—	
—	H/189	<b>3.450</b>		270	H/254	—	
—	H/190	<b>1.150</b>		270	H/255	—	
—	H/190-1	<b>1.150</b>		271	H/271	<b>12.000</b>	
—	H/190-2	<b>1.150</b>		271	H/281	<b>3.000</b>	
—	H/190-3	<b>1.000</b>		271	H/282	<b>3.800</b>	
—	H/190-4	<b>1.950</b>		271	H/283	<b>4.400</b>	
—	H/190-5	<b>1.000</b>		271	H/284	<b>4.000</b>	
—	H/190-6	<b>2.200</b>		271	H/285	<b>4.400</b>	
—	H/190-7	<b>900</b>		271	H/290	<b>730</b>	
—	H/190-8	<b>900</b>		271	H/291	<b>830</b>	
—	H/190-9	<b>1.250</b>		271	H/295	<b>730</b>	
266	H/191	<b>1.400</b>		271	H/296	<b>870</b>	
266	H/192	<b>1.400</b>		—	H/300	<b>8.500</b>	
266	H/193	<b>1.000</b>		272	H/350	—	
266	H/201	<b>1.500</b>		272	H/351	—	
266	H/203	<b>1.100</b>		272	H/352	—	

PAG. N°	ART. N°	PREZZO LISTINO	PREZZO NETTO	PAG. N°	ART. N°	PREZZO LISTINO	PREZZO NETTO
272	H/353	—		279	I/11	<b>4.600</b>	
272	H/354	—		279	I/12	<b>4.800</b>	
272	H/355	—		279	I/13	<b>4.900</b>	
272	H/356	—		279	I/14	<b>4.800</b>	
272	H/357	—		280	I/21	<b>4.300</b>	
272	H/358	—		280	I/22	<b>4.300</b>	
272	H/359	—		280	I/23	<b>4.300</b>	
272	H/360	—		280	I/24	<b>4.300</b>	
272	H/361	—		280	I/25	<b>5.800</b>	
272	H/381	<b>4.600</b>		280	I/26	<b>5.800</b>	
273	H/401	<b>1.200</b>		280	I/27	<b>5.800</b>	
273	H/402	<b>1.200</b>		280	I/28	<b>5.800</b>	
273	H/406	<b>1.300</b>		280	I/29	<b>6.800</b>	
273	H/407	<b>1.300</b>		280	I/30	<b>6.800</b>	
273	H/411	<b>2.350</b>		280	I/36	<b>4.400</b>	
274	H/455	—		280	I/37	<b>4.400</b>	
274	H/450	—		282	I/41	<b>4.400</b>	
274	H/445	—		282	I/42	<b>4.400</b>	
274	H/446	—		282	I/43	<b>5.800</b>	
275	H/453	—		282	I/44	<b>5.800</b>	
275	H/451	—		282	I/61	<b>6.400</b>	
—	H/453-1	—		282	I/62	<b>560</b>	
—	H/453-2	—		283	I/101	<b>650</b>	
275	H/453-5	—		283	I/102	<b>950</b>	
275	H/457	—		283	I/103	<b>1.150</b>	
276	H/456	—		283	I/104	<b>750</b>	
276	H/454	—		283	I/111	<b>450</b>	
276	H/452	—		283	I/112	<b>750</b>	
276	H/461	—		283	I/113	<b>530</b>	
277	H/471	—		283	I/122	<b>1.950</b>	
—	H/475	<b>27.350</b>		283	I/126	<b>2.900</b>	
—	H/476	<b>31.900</b>		283	G/271	<b>70</b>	
—	H/477	<b>45.600</b>		283	G/281	<b>70</b>	
				283	G/282	<b>70</b>	
				283	G/283	<b>80</b>	
				283	G/286	<b>300</b>	
				284	I/301	—	
279	I/1	<b>3.600</b>		—	I/301-1	—	
279	I/2	<b>3.800</b>		284	I/302	—	
279	I/3	<b>3.900</b>		284	I/303	—	
279	I/4	<b>4.600</b>		284	I/304	—	
279	I/5	<b>4.800</b>		—	I/305	—	
279	I/6	<b>4.900</b>		284	I/305-1	—	

PAG. N°	ART. N°	PREZZO LISTINO	PREZZO NETTO	PAG. N°	ART. N°	PREZZO LISTINO	PREZZO NETTO
284	1/306	—		288	1/431	—	
284	1/307	—		288	1/432	—	
—	1/310	—		288	1/436	—	
285	1/311	—		289	1/441	—	
285	1/312	—		289	1/442	—	
—	1/313	—		289	1/443	—	
—	1/314	—		289	1/444	—	
—	1/316	—		289	1/445	—	
—	1/317	—		289	1/446	—	
285	1/321	—		289	1/447	—	
285	1/322	—		289	1/448	—	
285	1/323	—		289	1/449	—	
285	1/324	—		289	1/450	—	
285	1/325	—		—	1/450-1	—	
285	1/325-1	—		—	1/450-2	—	
—	1/325-2	—		290	1/451	—	
285	1/326	—		290	1/452	—	
285	1/331	—		290	1/452-1	—	
285	1/332	—		290	1/453	—	
285	1/333	—		290	1/454	—	
286	1/401	—		290	1/461	—	
286	1/402	—		290	1/462	—	
286	1/402-1	—		290	1/463	—	
286	1/403	—		290	1/471	—	
—	1/403-1	—		290	1/472	—	
286	1/404	—		290	1/473	—	
286	1/404-1	—		290	1/474	—	
—	1/404-2	—		—	1/517	—	
286	1/405	—		—	1/600	<b>2.100</b>	
286	1/406	—		—	1/601	<b>2.200</b>	
286	1/407	—		—	1/605	<b>2.650</b>	
287	1/411	—		—	1/606	<b>2.650</b>	
287	1/412	—		—	1/700	—	
—	1/413	—		—	1/701	—	
287	1/416	—		—	1/702	—	
287	1/421	—		—	1/703	—	
—	1/421-1	—		—	1/704	—	
287	1/422	—		—	1/705	—	
287	1/422-1	—		—	1/706	—	
287	1/422-2	—		—	1/707	—	
287	1/422-3	—		—	1/708	—	
288	1/423	—		—	1/709	—	
288	1/426	—		—		—	

PAG. N°	ART. N°	PREZZO LISTINO	PREZZO NETTO	PAG. N°	ART. N°	PREZZO LISTINO	PREZZO NETTO
	<b>L</b>			296	L/212	<b>500</b>	
				296	L/213	<b>260</b>	
292	L/1	<b>750</b>		296	L/214	<b>230</b>	
292	L/2	<b>2.000</b>		296	L/215	<b>710</b>	
292	L/6	<b>750</b>		297	L/216	<b>600</b>	
292	L/7	<b>2.000</b>		297	L/217	<b>600</b>	
292	L/11	<b>850</b>		297	L/218	<b>600</b>	
292	L/12	<b>2.000</b>		297	L/219	<b>600</b>	
292	L/16	<b>2.300</b>		297	L/221	<b>600</b>	
292	L/17	<b>2.300</b>		297	L/222	<b>600</b>	
292	L/21	<b>1.500</b>		297	L/223	<b>600</b>	
292	L/22	<b>2.500</b>		297	L/224	<b>600</b>	
292	L/26	<b>2.000</b>		297	L/231	<b>1.300</b>	
292	L/27	<b>2.300</b>		297	L/232	<b>1.300</b>	
293	L/51	<b>330</b>		297	L/233	<b>1.300</b>	
293	L/52	<b>360</b>		297	L/234	<b>1.300</b>	
293	L/53	<b>370</b>		297	L/235	<b>1.300</b>	
293	L/56	<b>450</b>		297	L/236	<b>1.300</b>	
293	L/57	<b>700</b>		297	L/237	<b>1.500</b>	
293	L/61	<b>200</b>		297	L/238	<b>1.750</b>	
293	L/62	<b>370</b>		297	L/239	<b>11.100</b>	
293	L/71	<b>100</b>		297	L/241	<b>740</b>	
293	L/81	<b>600</b>		297	L/242	<b>740</b>	
294	L/91	<b>2.900</b>		297	L/243	<b>500</b>	
294	L/101	<b>2.300</b>		297	L/244	<b>360</b>	
294	L/102	<b>1.600</b>		297	L/251	<b>1.600</b>	
294	L/103	<b>2.600</b>		298	L/252	<b>2.800</b>	
294	L/104	<b>850</b>		298	L/253	<b>3.000</b>	
295	L/121	<b>220</b>		298	L/254	<b>2.500</b>	
295	L/122	<b>276</b>		298	L/255	<b>3.100</b>	
295	L/123	<b>496</b>		298	L/256	<b>2.900</b>	
295	L/124	<b>496</b>		298	L/257	<b>3.100</b>	
296	L/201	<b>600</b>		298	L/258	<b>1.950</b>	
296	L/202	<b>820</b>		298	L/259	<b>2.400</b>	
296	L/203	<b>820</b>		299	L/260	<b>1.600</b>	
296	L/204	<b>540</b>		299	L/261	<b>1.900</b>	
296	L/205	<b>330</b>		299	L/262	<b>1.950</b>	
296	L/206	<b>450</b>		299	L/263	<b>2.400</b>	
296	L/207	<b>280</b>		299	L/264	<b>3.500</b>	
296	L/208	<b>260</b>		299	L/271	<b>6.800</b>	
296	L/209	<b>200</b>		300	L/281	<b>1.850</b>	
296	L/210	<b>200</b>		300	L/282	<b>2.000</b>	
296	L/211	<b>200</b>		300	L/283	<b>1.800</b>	



PAG. N°	ART. N°	PREZZO LISTINO	PREZZO NETTO	PAG. N°	ART. N°	PREZZO LISTINO	PREZZO NETTO
300	L/284	2.050		309	L/396-2	2.800	
300	L/285	1.950		309	L/396-3	2.900	
300	L/286	2.250		309	L/396-4	3.000	
300	L/287	1.450		309	L/396-5	3.000	
300	L/288	1.750		309	L/396-6	250	
301	L/291	9.800		309	L/397	3.100	
301	L/292	13.000		309	L/397-1	3.600	
301	L/294	16.800		309	L/397-2	3.750	
301	L/295	1.200		309	L/397-3	4.300	
302	L/301	2.850		309	L/397-4	6.400	
302	L/301-1	1.500		309	L/397-5	6.600	
302	L/302	5.500		309	L/397-6	7.900	
303	L/303	10.000		309	L/398	5.900	
303	L/304	15.700		310	L/401	4.300	
304	L/305	1.450		310	L/402	4.300	
304	L/306	1.600		310	L/403	4.300	
304	L/307	1.200		310	L/404	4.300	
304	L/308	980		310	L/405	5.700	
305	L/309	35.500		310	L/406	4.300	
306	L/310	24.900		310	L/407	4.300	
307	L/311	15.700		310	L/407-1	4.300	
—	L/312	27.250		310	L/408	5.700	
307	L/337	950		—	L/408-1	5.800	
—	L/338	950		310	L/409	150	
—	L/339	1.150		310	L/421	150	
—	L/340	1.200		310	L/422	150	
—	L/341	1.400		310	L/423	650	
308	L/351	50		310	L/424	250	
308	L/352	430		311	L/451	1.100	
308	L/353	200		311	L/452	1.100	
308	L/354	110		311	L/453	1.100	
308	L/356	170		311	L/454	2.600	
308	L/357	200		311	L/461	280	
308	L/358	140		311	L/462	660	
308	L/359	140		311	L/466	340	
308	L/360	800		311	L/467	430	
308	L/361	800		311	L/471	3.000	
308	L/362	800		311	L/472	3.750	
309	L/391	5.800		311	L/473	3.370	
—	L/392	8.000		311	L/474	4.120	
—	L/393	8.500		311	L/475	3.370	
309	L/396	2.400		311	L/476	4.120	
309	L/396-1	2.700		311	L/477	3.500	

PAG. N°	ART. N°	PREZZO LISTINO	PREZZO NETTO	PAG. N°	ART. N°	PREZZO LISTINO	PREZZO NETTO
311	L/478	<b>4.500</b>		315	L/556	<b>900</b>	
312	L/481	<b>1.120</b>		315	L/557	<b>900</b>	
312	L/482	<b>1.630</b>		315	L/558	<b>900</b>	
312	L/483	<b>1.250</b>		315	L/559	<b>900</b>	
312	L/484	<b>1.870</b>		315	L/560	<b>1.300</b>	
312	L/485	<b>1.250</b>		315	L/561	<b>1.300</b>	
312	L/486	<b>1.870</b>		315	L/562	<b>2.600</b>	
312	L/487	<b>1.250</b>		316	L/566	<b>3.780</b>	
312	L/488	<b>1.870</b>		316	L/567	<b>3.780</b>	
312	L/491	<b>250</b>		316	L/571	<b>3.400</b>	
312	L/492	<b>400</b>		316	L/572	<b>3.400</b>	
312	L/493	<b>450</b>		316	L/573	<b>3.400</b>	
312	L/501	<b>3.850</b>		316	L/574	<b>3.700</b>	
312	L/502	<b>3.850</b>		316	L/575	<b>3.700</b>	
312	L/503	<b>1.300</b>		—	L/575-1	<b>2.600</b>	
606	L/506	<b>5.100</b>		—	L/575-2	<b>2.600</b>	
606	L/507	<b>6.400</b>		—	L/575-3	<b>2.850</b>	
313	L/511	<b>8.300</b>		—	L/575-4	<b>2.850</b>	
313	L/512	<b>8.650</b>		—	L/575-5	<b>3.300</b>	
—	L/513	<b>640</b>		—	L/575-6	<b>3.300</b>	
313	L/518	<b>220</b>		—	L/575-7	<b>3.600</b>	
313	L/519	<b>610</b>		—	L/575-8	<b>3.600</b>	
—	L/520	<b>7.500</b>		—	L/579	<b>1.600</b>	
—	L/521	<b>5.450</b>		317	L/580	<b>2.100</b>	
—	L/522-1	<b>7.000</b>		317	L/581	<b>1.600</b>	
—	L/523-1	<b>2.500</b>		317	L/582	<b>1.700</b>	
—	L/524-1	<b>530</b>		—	L/585	<b>800</b>	
313	L/527	<b>5.650</b>		—	L/586	<b>850</b>	
313	L/528	<b>5.650</b>		—	L/587	<b>1.050</b>	
313	L/529	<b>5.650</b>		—	L/588	<b>1.450</b>	
313	L/530	<b>2.550</b>		—	L/589	<b>450</b>	
313	L/530-1	<b>400</b>		—	L/589-1	<b>450</b>	
314	L/531.	<b>7.600</b>		—	L/589-2	<b>600</b>	
314	L/532	<b>8.850</b>		—	L/589-3	<b>600</b>	
314	L/533	<b>17.000</b>		—	L/589-4	<b>800</b>	
314	L/534	<b>21.500</b>		—	L/589-5	<b>800</b>	
606	L/549	<b>2.550</b>		317	L/590	<b>200</b>	
606	L/550	<b>3.200</b>		317	L/591	<b>350</b>	
315	L/551	<b>900</b>		317	L/592	<b>400</b>	
315	L/552	<b>900</b>		317	L/592-1	<b>200</b>	
—	L/553-1	<b>900</b>		317	L/593	<b>350</b>	
—	L/554-1	<b>900</b>		317	L/594	<b>400</b>	
315	L/555	<b>900</b>		317	L/595	<b>380</b>	



PAG. N°	ART. N°	PREZZO LISTINO	PREZZO NETTO	PAG. N°	ART. N°	PREZZO LISTINO	PREZZO NETTO
330	M/160	<b>4.400</b>		—	M/380-8	<b>450</b>	
330	M/162	<b>4.400</b>		—	M/381	<b>4.600</b>	
331	M/176	<b>5.200</b>		—	M/382	<b>880</b>	
—	M/176-1	<b>5.300</b>		—	M/383	<b>1.780</b>	
331	M/181	<b>94</b>		—	M/384	<b>1.700</b>	
—	M/187	<b>230</b>		—	M/386	<b>19.500</b>	
—	M/188	<b>60</b>		—	M/386-1	<b>11.900</b>	
331	M/191	<b>180</b>		—	M/387	<b>8.500</b>	
331	M/211	<b>1.350</b>		—	M/387-1	<b>5.700</b>	
332	M/221	<b>700</b>		—	M/388	<b>9.500</b>	
332	M/222	<b>300</b>		—	M/388-1	<b>8.000</b>	
332	M/261	<b>400</b>		—	M/389	<b>3.500</b>	
332	M/262	<b>400</b>		—	M/390	<b>11.900</b>	
332	M/271	<b>300</b>		—	M/391	<b>11.900</b>	
332	M/272	<b>300</b>		—	M/392	<b>4.600</b>	
333	M/281	<b>300</b>		—	M/400	<b>380</b>	
333	M/291	<b>1.100</b>		—	M/402	<b>380</b>	
333	M/296	<b>400</b>		335	M/521	<b>5.500</b>	
333	M/301	<b>1.300</b>		335	M/522	<b>4.800</b>	
—	M/311	<b>6.500</b>		335	M/531	<b>1.600</b>	
—	M/321	<b>4.800</b>		335	M/532	<b>1.900</b>	
—	M/322	<b>1.800</b>		335	M/533	<b>1.850</b>	
—	M/323	<b>1.850</b>		336	M/551	<b>17.500</b>	
—	M/331	<b>7.800</b>		336	M/552	<b>12.900</b>	
—	M/332	<b>5.600</b>		337	M/571	<b>9.800</b>	
—	M/333	<b>4.900</b>		337	M/572	<b>10.800</b>	
—	M/334	<b>7.000</b>		338	M/582	<b>4.800</b>	
—	M/336	<b>9.000</b>		339	M/593-1	<b>600</b>	
—	M/340	<b>1.400</b>		339	M/593-2	<b>300</b>	
—	M/341	<b>1.800</b>		339	M/593-3	<b>200</b>	
—	M/345	<b>1.150</b>		339	M/593-5	<b>750</b>	
—	M/346	<b>180</b>		339	M/593-6	<b>330</b>	
—	M/347	<b>400</b>		339	M/593-7	<b>330</b>	
—	M/351	<b>700</b>		—	M/593-8	<b>400</b>	
—	M/360	<b>25.000</b>		341	M/598	<b>1.700</b>	
—	M/380	<b>5.900</b>		—	M/598-1	<b>1.600</b>	
—	M/380-1	<b>600</b>		—	M/598-2	<b>1.600</b>	
—	M/380-2	<b>280</b>		—	M/598-3	<b>1.600</b>	
—	M/380-3	<b>550</b>		—	M/598-4	<b>1.600</b>	
—	M/380-4	<b>300</b>		—	M/598-5	<b>1.600</b>	
—	M/380-5	<b>800</b>		—	M/598-6	<b>1.600</b>	
—	M/380-6	<b>50</b>		—	M/598-7	<b>1.600</b>	
—	M/380-7	<b>950</b>		341	M/599	<b>1.750</b>	



PAG. N°	ART. N°	PREZZO LISTINO	PREZZO NETTO	PAG. N°	ART. N°	PREZZO LISTINO	PREZZO NETTO
341	M/599-1	<b>1.750</b>		—	M/661-2	<b>4.000</b>	
341	M/599-2	<b>1.750</b>		353	M/662	<b>3.600</b>	
341	M/599-3	<b>1.750</b>		353	M/663	<b>4.600</b>	
—	M/599-4	<b>1.800</b>		353	M/664	<b>9.700</b>	
343	M/600	<b>3.600</b>		354	M/665	<b>6.300</b>	
343	M/600-2	<b>3.600</b>		354	M/665-1	<b>4.500</b>	
343	M/601	<b>3.500</b>		355	M/681	<b>3.300</b>	
343	M/601-1	<b>3.500</b>		355	M/701	<b>1.000</b>	
344	M/602	<b>3.500</b>		—	M/706	<b>3.900</b>	
344	M/602-2	<b>3.500</b>		355	M/711	<b>2.100</b>	
344	M/603	<b>3.500</b>		355	M/712	<b>3.600</b>	
345	M/603-3	<b>3.500</b>		356	M/731	<b>3.600</b>	
345	M/604	<b>3.500</b>		356	M/732	<b>4.500</b>	
346	M/604-4	<b>3.500</b>		356	M/733	<b>4.200</b>	
346	M/605	<b>3.500</b>		356	M/741	<b>700</b>	
—	M/605-3	<b>3.500</b>		356	M/742	<b>850</b>	
347	M/605-5	<b>3.500</b>		357	M/771	<b>15.500</b>	
—	M/605-6	<b>3.500</b>					
—	M/605-8	<b>3.500</b>			<b>N</b>		
—	M/606-1	<b>3.620</b>					
—	M/607-1	<b>3.620</b>		358	N/1	<b>66</b>	
—	M/608-1	<b>3.620</b>		358	N/2	<b>90</b>	
348	M/609	<b>4.500</b>		358	N/3	<b>106</b>	
348	M/610	<b>4.500</b>		358	N/4	<b>1.380</b>	
348	M/611	<b>4.500</b>		358	N/5	<b>1.650</b>	
348	M/612	<b>4.500</b>		359	N/21	<b>220</b>	
348	M/613	<b>4.500</b>		359	N/21-1	<b>220</b>	
349	M/633	<b>7.900</b>		359	N/21-2	<b>220</b>	
349	M/634	<b>7.900</b>		359	N/22	<b>220</b>	
350	M/635-1	<b>4.150</b>		359	N/23	<b>180</b>	
350	M/635-2	<b>4.150</b>		359	N/24	<b>390</b>	
350	M/641	<b>5.700</b>		359	N/25	<b>220</b>	
350	M/641-1	<b>4.150</b>		360	N/61	<b>5.250</b>	
350	M/641-2	<b>4.150</b>		360	N/91	<b>3.500</b>	
351	M/642-1	<b>4.150</b>		360	N/101	<b>2.200</b>	
351	M/642-2	<b>4.150</b>		—	N/110	<b>4.840</b>	
351	M/643	<b>9.750</b>		361	N/121	<b>1.000</b>	
—	M/649	<b>6.100</b>		—	N/121-1	<b>850</b>	
—	M/651	<b>4.550</b>		—	N/130	<b>380</b>	
—	M/652	<b>6.900</b>		361	N/131	<b>2.550</b>	
—	M/653	<b>8.800</b>		361	N/131-1	<b>4.300</b>	
—	M/656	<b>4.750</b>		361	N/132	<b>3.900</b>	
352	M/661	<b>7.700</b>		362	N/141	<b>2.600</b>	

PAG. N°	ART. N°	PREZZO LISTINO	PREZZO NETTO	PAG. N°	ART. N°	PREZZO LISTINO	PREZZO NETTO
—	N/142	<b>2.200</b>		365	N/363	<b>3.800</b>	
362	N/145	<b>2.400</b>		365	N/371	<b>5.600</b>	
362	N/151	<b>2.380</b>		365	N/372	<b>4.600</b>	
363	N/161	<b>2.500</b>		365	N/373	<b>3.800</b>	
363	N/162	<b>2.350</b>		365	N/381	<b>2.600</b>	
363	N/164	<b>2.350</b>		365	N/382	<b>2.300</b>	
—	N/165	<b>1.870</b>		365	N/383	<b>2.100</b>	
—	N/166	<b>2.500</b>		365	N/391	<b>3.000</b>	
—	N/167	<b>1.750</b>		365	N/392	<b>2.600</b>	
—	N/168	<b>1.200</b>		365	N/393	<b>2.300</b>	
363	N/171	<b>3.700</b>		365	N/394	<b>2.100</b>	
363	N/172	<b>400</b>		365	N/401	<b>2.600</b>	
364	N/251	<b>3.200</b>		365	N/402	<b>2.300</b>	
364	N/252	<b>3.700</b>		365	N/403	<b>2.100</b>	
364	N/253	<b>4.400</b>		365	N/411	<b>3.000</b>	
364	N/261	<b>3.200</b>		365	N/412	<b>2.600</b>	
364	N/262	<b>3.700</b>		365	N/413	<b>2.300</b>	
364	N/263	<b>4.400</b>		365	N/414	<b>2.100</b>	
364	N/271	<b>3.200</b>		365	N/421	<b>2.600</b>	
364	N/272	<b>3.700</b>		365	N/422	<b>2.300</b>	
364	N/273	<b>4.400</b>		365	N/423	<b>2.100</b>	
364	N/281	<b>2.000</b>		365	N/431	<b>4.200</b>	
364	N/282	<b>2.200</b>		365	N/432	<b>3.500</b>	
364	N/283	<b>2.500</b>		365	N/441	<b>1.300</b>	
364	N/291	<b>2.000</b>		366	N/451	<b>2.800</b>	
364	N/292	<b>2.200</b>		366	N/452	<b>3.200</b>	
364	N/293	<b>2.500</b>		366	N/453	<b>3.600</b>	
364	N/301	<b>2.000</b>		366	N/461	<b>2.800</b>	
364	N/302	<b>2.200</b>		366	N/462	<b>2.800</b>	
364	N/303	<b>2.500</b>		366	N/463	<b>2.800</b>	
364	N/311	<b>2.000</b>		366	N/464	<b>2.800</b>	
364	N/312	<b>2.200</b>		—	N/465	<b>1.600</b>	
364	N/313	<b>2.500</b>		—	N/466	<b>1.600</b>	
364	N/321	<b>2.000</b>		—	N/467	<b>2.000</b>	
364	N/322	<b>2.200</b>		—	N/468	<b>3.500</b>	
364	N/323	<b>2.500</b>		—	N/468-1	<b>3.000</b>	
364	N/331	<b>3.200</b>		—	N/469	<b>17.700</b>	
364	N/332	<b>3.700</b>		—	N/470	<b>3.700</b>	
365	N/351	<b>5.600</b>		367	N/470-1	<b>2.750</b>	
365	N/352	<b>4.600</b>		—	N/470-2	<b>2.950</b>	
365	N/353	<b>3.800</b>		367	N/470-3	<b>3.450</b>	
365	N/361	<b>5.600</b>		367	N/470-4	<b>3.950</b>	
365	N/362	<b>4.600</b>		367	N/471-2	<b>2.700</b>	

PAG. N°	ART. N°	PREZZO LISTINO	PREZZO NETTO	PAG. N°	ART. N°	PREZZO LISTINO	PREZZO NETTO
367	N/471-3	<b>3.200</b>		368	N/485-5	<b>2.600</b>	
367	N/471-4	<b>3.700</b>		368	N/485-6	<b>3.100</b>	
367	N/472-3	<b>2.000</b>		368	N/486-3	<b>2.000</b>	
367	N/472-4	<b>2.200</b>		368	N/486-4	<b>2.200</b>	
367	N/472-5	<b>2.600</b>		368	N/486-5	<b>2.600</b>	
367	N/472-6	<b>3.100</b>		368	N/486-6	<b>3.100</b>	
367	N/473-3	<b>2.000</b>		368	N/487-3	<b>2.000</b>	
367	N/473-4	<b>2.200</b>		368	N/487-4	<b>2.200</b>	
367	N/473-5	<b>2.600</b>		368	N/487-5	<b>2.600</b>	
367	N/473-6	<b>3.100</b>		368	N/487-6	<b>3.100</b>	
367	N/474-3	<b>2.000</b>		368	N/488	<b>1.350</b>	
367	N/474-4	<b>2.200</b>		368	N/489	<b>1.850</b>	
367	N/474-5	<b>2.600</b>		368	N/490	<b>2.350</b>	
367	N/474-6	<b>3.100</b>		369	N/501	<b>19.900</b>	
367	N/475-3	<b>2.000</b>		369	N/502	<b>19.900</b>	
367	N/475-4	<b>2.200</b>		369	N/503	<b>19.900</b>	
367	N/475-5	<b>2.600</b>		369	N/504	<b>19.900</b>	
367	N/475-6	<b>3.100</b>		369	N/505	<b>19.900</b>	
367	N/476-3	<b>2.000</b>		369	N/506	<b>19.900</b>	
367	N/476-4	<b>2.200</b>		369	N/507	<b>19.900</b>	
367	N/476-5	<b>2.600</b>		369	N/508	<b>19.900</b>	
367	N/476-6	<b>3.100</b>		369	N/511	<b>38.500</b>	
367	N/477	<b>1.350</b>		369	N/512	<b>38.500</b>	
367	N/478	<b>1.850</b>		369	N/513	<b>38.500</b>	
367	N/479	<b>2.350</b>		369	N/514	<b>38.500</b>	
—	N/481	<b>1.360</b>		369	N/515	<b>38.500</b>	
—	N/481-1	<b>1.360</b>		369	N/516	<b>38.500</b>	
368	N/481-2	<b>2.950</b>		369	N/517	<b>38.500</b>	
368	N/481-3	<b>3.400</b>		369	N/518	<b>38.500</b>	
368	N/481-4	<b>3.900</b>		370	N/601	<b>480</b>	
368	N/482-2	<b>2.700</b>		370	N/602	<b>570</b>	
368	N/482-3	<b>3.200</b>		370	N/603	<b>480</b>	
368	N/482-4	<b>3.700</b>		370	N/604	<b>750</b>	
368	N/483-3	<b>2.000</b>		370	N/605	<b>64</b>	
368	N/483-4	<b>2.200</b>		—	N/605-1	<b>580</b>	
368	N/483-5	<b>2.600</b>		370	N/606	<b>750</b>	
368	N/483-6	<b>3.100</b>		370	N/606-1	<b>870</b>	
368	N/484-3	<b>2.000</b>		—	N/606-2	<b>1.000</b>	
368	N/484-4	<b>2.200</b>		370	N/607	<b>940</b>	
368	N/484-5	<b>2.600</b>		370	N/607-1	<b>1.100</b>	
368	N/484-6	<b>3.100</b>		—	N/607-2	<b>1.250</b>	
368	N/485-3	<b>2.000</b>		370	N/608	<b>1.120</b>	
368	N/485-4	<b>2.200</b>		370	N/608-1	<b>1.300</b>	

PAG. N°	ART. N°	PREZZO LISTINO	PREZZO NETTO	PAG. N°	ART. N°	PREZZO LISTINO	PREZZO NETTO
—	N/608-2	<b>1.500</b>		375	N/804	<b>60</b>	
370	N/609	<b>100</b>		375	N/812	<b>250</b>	
370	N/610	<b>750</b>		375	N/821	<b>390</b>	
370	N/610-1	<b>950</b>		376	N/834	<b>98</b>	
370	N/611	<b>170</b>		376	N/841	<b>18</b>	
—	N/612	<b>420</b>		376	N/842	<b>34</b>	
—	N/615	<b>720</b>		377	N/851	<b>28</b>	
—	N/616	<b>850</b>		377	N/852	<b>12</b>	
—	N/620	<b>260</b>		377	N/856	<b>12</b>	
370	N/631	<b>198</b>		—	N/857	<b>8</b>	
371	N/641	<b>160</b>		377	N/858	<b>24</b>	
371	N/642	<b>200</b>		377	N/871	<b>58</b>	
—	N/652	<b>176</b>		378	N/891	<b>4</b>	
371	N/656	<b>40</b>		378	N/892	<b>2</b>	
—	N/656-1	<b>56</b>		378	N/893	<b>8</b>	
371	N/661	<b>174</b>		378	N/894	<b>2</b>	
371	N/662	<b>106</b>		378	N/901	<b>4</b>	
371	N/663	<b>156</b>		378	N/911	<b>14</b>	
—	N/669	<b>200</b>		378	N/912	<b>14</b>	
—	N/670	<b>220</b>		378	N/913	<b>18</b>	
371	N/671	<b>870</b>		378	N/921	<b>8</b>	
371	N/672	<b>2.250</b>		378	N/926	<b>8</b>	
371	N/673	<b>1.600</b>		—	N/930	<b>80</b>	
372	N/676	<b>2.150</b>		379	N/931	<b>124</b>	
372	N/677	<b>1.800</b>		379	N/932	<b>74</b>	
372	N/678	<b>500</b>		379	N/933	<b>110</b>	
372	N/679	<b>40</b>		379	N/936	<b>50</b>	
372	N/681	<b>100</b>		379	N/941	<b>64</b>	
—	N/682	<b>90</b>		379	N/946	<b>44</b>	
372	N/701	<b>290</b>		379	N/951	<b>78</b>	
372	N/702	<b>290</b>		380	N/961	<b>4</b>	
372	N/713	<b>98</b>		380	N/962	<b>12</b>	
372	N/730	<b>100</b>		380	N/963	<b>8</b>	
373	N/731	<b>650</b>		380	N/964	<b>8</b>	
373	N/732	<b>750</b>		380	N/965	<b>12</b>	
—	N/733	<b>106</b>		380	N/966	<b>12</b>	
373	N/741	<b>715</b>		380	N/967	<b>12</b>	
374	N/751	<b>44</b>		380	N/968	<b>12</b>	
374	N/761	<b>130</b>		380	N/969	<b>10</b>	
374	N/762	<b>96</b>		380	N/981	<b>44</b>	
—	N/765	<b>64</b>		380	N/982	<b>44</b>	
374	N/772	<b>50</b>		381	N/985	<b>20</b>	
375	N/801	<b>46</b>		381	N/985-1	<b>20</b>	
375	N/803	<b>34</b>		381	N/986	<b>20</b>	



PAG. N°	ART. N°	PREZZO LISTINO	PREZZO NETTO	PAG. N°	ART. N°	PREZZO LISTINO	PREZZO NETTO
381	N/991	76		387	N/1203	470	
381	N/992	76		388	N/1203-1	690	
381	N/1001	68		388	N/1204	470	
381	N/1002	100		388	N/1204-1	790	
381	N/1003	100		388	N/1205	490	
381	N/1004	124		—	N/1207	4.000	
381	N/1006	56		—	N/1207-1	2.000	
—	N/1008	64		—	N/1207-2	2.000	
381	N/1011	134		—	N/1208	7.500	
382	N/1012	78		—	N/1208-1	3.750	
382	N/1013	86		—	N/1208-2	3.750	
383	N/1071	1.650		389	N/1221	4.100	
383	N/1072	1.800		—	N/1225	6.100	
383	N/1073	1.800		389	N/1236	6.100	
383	N/1076	1.800		390	N/1251	3.250	
384	N/1077	550		390	N/1252	3.100	
—	N/1078	680		390	N/1253	2.600	
384	N/1081	1.050		390	N/1261	850	
384	N/1082	200		—	N/1270	2.000	
—	N/1083	312		—	N/1272	1.250	
384	N/1091	1.400		—	N/1274	880	
384	N/1092	1.800		—	N/1276	880	
384	N/1093	1.800		—	N/1278	2.500	
384	N/1094	1.800		—	N/1280	2.930	
384	N/1097	550		—	N/1282	1.000	
—	N/1098	320		—	N/1284	630	
—	N/1099	612		391	N/1399	38	
384	N/1101	1.300		391	N/1400	54	
385	N/1121	1.400		391	N/1401-2	150	
385	N/1122	1.650		391	N/1401-3	170	
385	N/1123	1.650		391	N/1401-4	226	
385	N/1125	1.440		391	N/1401-5	280	
—	N/1145	6.250		392	N/1402	490	
386	N/1151	1.750		392	N/1403	200	
—	N/1152	1.110		392	N/1404	300	
387	N/1161	500		392	N/1405	210	
387	N/1162	270		—	N/1406	500	
387	N/1171	2.700		—	N/1407	340	
—	N/1172	3.400		—	N/1408	276	
—	N/1173	3.400		—	N/1409	170	
387	N/1201	940		392	N/1416	420	
—	N/1201-1	810		392	N/1417	590	
387	N/1202	940		392	N/1418	220	
—	N/1202-1	810		—	N/1419	300	

PAG. N°	ART. N°	PREZZO LISTINO	PREZZO NETTO	PAG. N°	ART. N°	PREZZO LISTINO	PREZZO NETTO
—	N/1420	<b>550</b>		400	N/1602	<b>150</b>	
393	N/1422	<b>730</b>		400	N/1603	<b>180</b>	
393	N/1423	<b>1.030</b>		400	N/1606	<b>240</b>	
393	N/1424	<b>1.030</b>		400	N/1621	<b>380</b>	
393	N/1432	<b>1.050</b>		400	N/1622	<b>380</b>	
393	N/1433	<b>1.190</b>					
393	N/1434	<b>1.190</b>			<b>O</b>		
393	N/1435	<b>1.190</b>					
393	N/1436	<b>1.190</b>		402	O/1	<b>210</b>	
393	N/1443	<b>1.190</b>		402	O/2	<b>210</b>	
394	N/1445	<b>800</b>		402	O/3	<b>210</b>	
394	N/1446	<b>1.150</b>		402	O/11	<b>110</b>	
394	N/1447	<b>1.150</b>		402	O/12	<b>110</b>	
394	N/1452	<b>1.050</b>		402	O/13	<b>130</b>	
394	N/1453	<b>1.150</b>		402	O/14	<b>140</b>	
395	N/1462	<b>1.100</b>		—	O/16	<b>110</b>	
395	N/1463	<b>1.250</b>		—	O/17	<b>120</b>	
395	N/1472	<b>870</b>		402	O/21	<b>50</b>	
395	N/1473	<b>1.100</b>		402	O/31	<b>100</b>	
396	N/1476	<b>250</b>		402	O/41	<b>620</b>	
396	N/1477	<b>280</b>		402	O/42	<b>720</b>	
396	N/1478	<b>690</b>		402	O/43	<b>750</b>	
396	N/1479	<b>690</b>		402	O/44	<b>920</b>	
396	N/1480	<b>1.600</b>		402	O/45	<b>1.440</b>	
396	N/1481	<b>1.770</b>		402	O/46	<b>1.840</b>	
396	N/1482	<b>1.770</b>		403	O/51	<b>700</b>	
397	N/1483	<b>270</b>		403	O/52	<b>700</b>	
397	N/1484	<b>270</b>		403	O/61	<b>770</b>	
397	N/1485	<b>820</b>		403	O/62	<b>700</b>	
397	N/1486	<b>820</b>		403	O/71	<b>700</b>	
397	N/1487	<b>770</b>		403	O/72	<b>700</b>	
397	N/1488	<b>770</b>		403	O/73	<b>900</b>	
397	N/1489	<b>770</b>		403	O/74	<b>900</b>	
397	N/1490	<b>770</b>		403	O/76	<b>800</b>	
—	N/1580	<b>1.150</b>		403	O/77	<b>800</b>	
—	N/1581	<b>750</b>		404	O/82	<b>800</b>	
399	N/1591	<b>1.600</b>		404	O/83	<b>830</b>	
399	N/1592	<b>2.000</b>		404	O/84	<b>930</b>	
399	N/1593	<b>2.250</b>		404	O/86	<b>830</b>	
399	N/1594	<b>2.400</b>		404	O/87	<b>780</b>	
399	N/1595	<b>2.500</b>		405	O/101	<b>1.000</b>	
399	N/1596	<b>2.800</b>		405	O/102	<b>1.000</b>	
400	N/1601	<b>70</b>		405	O/103	<b>1.000</b>	

PAG. N°	ART. N°	PREZZO LISTINO	PREZZO NETTO	PAG. N°	ART. N°	PREZZO LISTINO	PREZZO NETTO
405	O/104	1.000		414	O/256	1.500	
405	O/105	1.000		415	O/301	970	
405	O/106	1.000		415	O/302	1.300	
405	O/107	1.250		416	O/303	1.350	
405	O/108	1.250		416	O/304	2.750	
405	O/109	1.250		—	O/311	2.100	
405	O/110	1.250		—	O/312	1.300	
406	O/121	730		—	O/313	1.150	
406	O/122	730		—	O/314	1.500	
406	O/121-1	1.050		—	O/315	5.100	
406	O/122-2	1.000		417	O/401	1.250	
406	O/122-3	1.100		417	O/402	1.250	
406	O/122-4	1.050		417	O/403	1.250	
406	O/122-5	1.150		417	O/404	1.250	
406	O/122-6	1.100		417	O/421	2.700	
407	O/123	740		419	O/462	1.700	
407	O/124	850		—	O/462-1	1.800	
408	O/126	980		419	O/463	2.650	
408	O/127	1.350		419	O/464	3.400	
409	O/128	1.300		—	O/465	3.800	
409	O/129	1.350		—	O/466	3.460	
410	O/131	750		420	O/481	330	
410	O/131-1	900		420	O/486	330	
410	O/131-2	880		420	O/491	250	
410	O/133	780		420	O/492	250	
411	O/141	1.300		420	O/496	250	
411	O/151	930		420	O/497	330	
411	O/152	1.050		420	O/497-1	1.500	
411	O/152-1	750		420	O/497-2	600	
411	O/153	1.170		420	O/497-3	700	
411	O/161	1.000		420	O/497-4	1.200	
411	O/162	1.200		—	O/498-1	130	
412	O/171	1.650		—	O/498-2	130	
412	O/172	950		—	O/498-3	130	
412	O/173	1.150		—	O/498-4	220	
413	O/201	950		—	O/498-5	330	
413	O/202	470		—	O/498-6	500	
413	O/203	560		—	O/498-7	100	
—	O/207	260		—	O/498-8	100	
414	O/241	980		421	O/502	690	
414	O/242	700		421	O/503	700	
414	O/251	820		421	O/504	780	
414	O/252	820		421	O/505	700	

PAG. N°	ART. N°	PREZZO LISTINO	PREZZO NETTO	PAG. N°	ART. N°	PREZZO LISTINO	PREZZO NETTO
422	O/506	<b>860</b>		426	O/620-2	<b>20</b>	
422	O/507	<b>1.050</b>		426	O/620-3	<b>38</b>	
422	O/508	<b>1.250</b>		426	O/620-4	<b>28</b>	
422	O/509	<b>1.450</b>		426	O/620-5	<b>28</b>	
422	O/510	<b>1.650</b>		426	O/620-6	<b>28</b>	
422	O/511	<b>1.900</b>		426	O/620-7	<b>38</b>	
—	O/517	<b>1.400</b>		426	O/620-8	<b>20</b>	
—	O/521	<b>24</b>		427	O/620-9	<b>38</b>	
—	O/522	<b>24</b>		427	O/620-10	<b>28</b>	
—	O/523	<b>40</b>		427	O/620-11	<b>24</b>	
423	O/601	<b>300</b>		427	O/620-12	<b>30</b>	
423	O/602	<b>180</b>		427	O/621	<b>14</b>	
423	O/603	<b>200</b>		427	O/621-1	<b>30</b>	
—	O/603-1	<b>700</b>		427	O/621-2	<b>30</b>	
424	O/604	<b>42</b>		427	O/621-3	<b>24</b>	
424	O/605	<b>150</b>		427	O/621-4	<b>34</b>	
424	O/606	<b>110</b>		427	O/621-5	<b>48</b>	
424	O/607	<b>64</b>		427	O/621-6	<b>34</b>	
424	O/608	<b>50</b>		427	O/621-7	<b>28</b>	
424	O/609	<b>50</b>		427	O/621-8	<b>30</b>	
424	O/610	<b>66</b>		427	O/621-9	<b>34</b>	
424	O/610-1	<b>180</b>		427	O/621-10	<b>40</b>	
424	O/611-1	<b>44</b>		427	O/621-11	<b>26</b>	
424	O/611-2	<b>46</b>		427	O/621-12	<b>38</b>	
425	O/611-3	<b>44</b>		428	O/621-13	<b>40</b>	
425	O/611-4	<b>44</b>		428	O/622	<b>18</b>	
425	O/611-5	<b>66</b>		428	O/623	<b>20</b>	
425	O/612	<b>30</b>		428	O/623-1	<b>24</b>	
425	O/613	<b>30</b>		428	O/623-2	<b>34</b>	
425	O/613-1	<b>70</b>		428	O/624	<b>22</b>	
425	O/613-2	<b>44</b>		428	O/624-1	<b>20</b>	
425	O/613-3	<b>78</b>		428	O/624-2	<b>40</b>	
425	O/613-4	<b>70</b>		428	O/624-3	<b>40</b>	
425	O/614	<b>36</b>		428	O/624-4	<b>50</b>	
425	O/614-1	<b>80</b>		428	O/625	<b>22</b>	
426	O/614-2	<b>76</b>		428	O/626	<b>30</b>	
426	O/615	<b>30</b>		428	O/626-1	<b>90</b>	
426	O/616	<b>34</b>		428	O/626-2	<b>50</b>	
426	O/617	<b>40</b>		428	O/627	<b>26</b>	
426	O/618	<b>40</b>		428	O/628	<b>40</b>	
426	O/619	<b>30</b>		428	O/629	<b>40</b>	
426	O/620	<b>36</b>		428	O/630	<b>48</b>	
426	O/620-1	<b>34</b>		428	O/631	<b>58</b>	



PAG. N°	ART. N°	PREZZO LISTINO	PREZZO NETTO	PAG. N°	ART. N°	PREZZO LISTINO	PREZZO NETTO
429	O/632	58		434	O/712	50	
429	O/633	150		434	O/713	40	
430	O/634	50		434	O/714	60	
430	O/635	38		434	O/715	50	
430	O/636	40		434	O/716	50	
430	O/638	44		434	O/717	50	
430	O/640	48		434	O/721	80	
430	O/640-1	48		434	O/731	54	
430	O/641	36		434	O/732	54	
430	O/641-1	48		434	O/733	60	
430	O/641-2	70		435	O/802	400	
430	O/642	60		435	O/803	400	
430	O/644	44		435	O/804	400	
431	O/651	4		435	O/805	750	
431	O/652	4		435	O/806	750	
431	O/653	4		435	O/809	400	
431	O/654	4		435	O/810	400	
431	O/661	14		435	O/821	300	
431	O/665	20		436	O/822	300	
431	O/666	20		—	O/823	300	
431	O/667	20		—	O/824	300	
431	O/668	30		—	O/825	300	
431	O/669	20		—	O/826-1	650	
431	O/670	24		436	O/827	850	
432	O/671	30		—	O/830	450	
432	O/672	20		—	O/831	500	
432	O/673	24		—	O/832	330	
432	O/674	24		436	O/835	850	
432	O/675	20		436	O/837	300	
432	O/676	20		436	O/838	850	
432	O/677	20		436	O/839	700	
433	O/681	40		436	O/840	400	
433	O/682	40		436	O/841	550	
433	O/683	36		436	O/842	1.000	
433	O/691	40		436	O/843	550	
433	O/692	40		437	O/905	880	
433	O/693	40		437	O/906	880	
433	O/694	40		437	O/907	620	
433	O/695	30		437	O/908	620	
433	O/701	40		437	O/909	620	
433	O/702	30		437	O/910	300	
433	O/703	40		438	O/931	2.200	
434	O/711	50		438	O/936	2.350	

PAG. N°	ART. N°	PREZZO LISTINO	PREZZO NETTO	PAG. N°	ART. N°	PREZZO LISTINO	PREZZO NETTO
438	O/937	1.500		—	P/10	2.200	
439	O/944	1.700		—	P/10-1	750	
439	O/945	2.350		—	P/10-2	750	
439	O/946	500		—	P/10-3	750	
439	O/947	2.900		—	P/10-4	2.100	
439	O/949	7.900		—	P/10-5	600	
—	O/950	3.000		—	P/10-6	600	
440	O/951	10		—	P/10-7	600	
440	O/952	12		—	P/11	2.200	
440	O/961	10		—	P/11-1	750	
440	O/962	10		—	P/11-2	750	
440	O/963	10		—	P/11-3	750	
440	O/964	14		—	P/15	750	
440	O/991	64		—	P/15-1	550	
441	O/1001	10		—	P/16	1.550	
441	O/1002	10		444	P/101	380	
441	O/1003	10		444	P/102	750	
441	O/1004	10		444	P/103	780	
441	O/1012	160		444	P/104	780	
441	O/1014	120		445	P/106	3.600	
441	O/1018	100		—	P/106-1	850	
441	O/1019	90		—	P/106-2	850	
441	O/1051	50		—	P/106-3	850	
442	O/1061	90		—	P/106-4	380	
—	O/1066-1	40		—	P/106-5	750	
—	O/1070	200		—	P/108	3.350	
442	O/1071	220		—	P/110	320	
442	O/1073	220		—	P/111	320	
442	O/1076	110		—	P/112	320	
442	O/1081	220		—	P/113	150	
443	O/1086	50		—	P/114	350	
443	O/1087	70		—	P/115	1.500	
443	O/1088	120		—	P/117-1	560	
443	O/1089	100		—	P/117-2	560	
443	O/1090	140		—	P/117-3	560	
443	O/1091	140		—	P/118	220	
	<b>P</b>			—	P/119	420	
				446	P/121	3.600	
—	P/2	700		—	P/123	790	
—	P/2-1	500		—	P/130	950	
—	P/3	700		—	P/130-1	750	
—	P/8	700		—	P/131	950	
				—	P/132	750	

PAG. N°	ART. N°	PREZZO LISTINO	PREZZO NETTO	PAG. N°	ART. N°	PREZZO LISTINO	PREZZO NETTO
—	P/134	<b>2.700</b>		451	P/185	<b>620</b>	
—	P/135	<b>1.150</b>		451	P/186	<b>620</b>	
—	P/136	<b>1.250</b>		—	P/211	<b>620</b>	
—	P/137	<b>2.000</b>		—	P/214	<b>900</b>	
446	P/141	<b>750</b>		—	P/215	<b>900</b>	
447	P/142	<b>750</b>		—	P/216	<b>900</b>	
447	P/151	<b>1.000</b>		—	P/217	<b>900</b>	
447	P/152	<b>1.000</b>		—	P/218	<b>900</b>	
447	P/152-2	<b>1.370</b>		—	P/219	<b>900</b>	
—	P/153	<b>570</b>		454	P/221	<b>1.900</b>	
—	P/154	<b>1.200</b>		454	P/222	<b>2.950</b>	
—	P/155	<b>650</b>		454	P/223	<b>3.950</b>	
—	P/156	<b>720</b>		454	P/224	<b>4.850</b>	
447	P/161	<b>1.300</b>		454	P/231	<b>680</b>	
447	P/162	<b>1.600</b>		454	P/236	<b>850</b>	
448	P/162-3	<b>1.600</b>		454	P/237	<b>700</b>	
448	P/162-5	<b>1.600</b>		—	P/237-1	<b>830</b>	
448	P/163	<b>1.600</b>		—	P/238	<b>1.950</b>	
448	P/163-13	<b>1.650</b>		—	P/239	<b>1.700</b>	
448	P/164-5	<b>1.600</b>		—	P/240	<b>2.000</b>	
448	P/165-5	<b>2.450</b>		—	P/242	<b>1.800</b>	
448	P/166	<b>2.450</b>		—	P/243-1	<b>2.250</b>	
—	P/166-1	<b>1.800</b>		—	P/243-2	<b>2.000</b>	
—	P/166-2	<b>1.500</b>		—	P/243-3	<b>2.250</b>	
—	P/166-3	<b>1.800</b>		—	P/243-4	<b>1.950</b>	
—	P/166-4	<b>1.400</b>		455	P/244	<b>1.550</b>	
—	P/166-5	<b>1.800</b>		—	P/245	<b>1.500</b>	
—	P/166-6	<b>1.400</b>		455	P/246	<b>1.780</b>	
—	P/166-7	<b>850</b>		455	P/247	<b>2.000</b>	
—	P/166-8	<b>850</b>		455	P/248	<b>1.900</b>	
448	P/167-5	<b>3.700</b>		455	P/249	<b>2.000</b>	
—	P/167-6	<b>3.700</b>		456	P/251	<b>250</b>	
448	P/168	<b>2.500</b>		456	P/253	<b>250</b>	
—	P/168-1	<b>2.500</b>		456	P/254	<b>250</b>	
—	P/168-2	<b>1.000</b>		—	P/256	<b>420</b>	
—	P/168-3	<b>950</b>		—	P/258	<b>100</b>	
—	P/168-4	<b>950</b>		—	P/261	<b>250</b>	
450	P/171	<b>850</b>		—	P/263	<b>830</b>	
450	P/172	<b>850</b>		—	P/264	<b>580</b>	
—	P/174	<b>850</b>		—	P/265	<b>580</b>	
—	P/175	<b>850</b>		—	P/266	<b>660</b>	
451	P/181	<b>620</b>		—	P/267	<b>500</b>	
451	P/182	<b>620</b>		—	P/268	<b>500</b>	

PAG. N°	ART. N°	PREZZO LISTINO	PREZZO NETTO	PAG. N°	ART. N°	PREZZO LISTINO	PREZZO NETTO
—	P/269	<b>460</b>		464	Q/42	<b>17.600</b>	
456	P/271	<b>500</b>		464	Q/43	<b>20.800</b>	
456	P/272	<b>500</b>		464	Q/44	<b>29.800</b>	
456	P/276	<b>500</b>		464	Q/51	<b>18.700</b>	
456	P/277	<b>500</b>		465	Q/52	<b>6.800</b>	
457	P/281	<b>250</b>		465	Q/53	<b>6.700</b>	
457	P/282	<b>40</b>		465	Q/56	<b>8.100</b>	
457	P/283	<b>60</b>		465	Q/61	<b>10.800</b>	
457	P/292	<b>500</b>		465	Q/66	<b>7.600</b>	
457	P/292-1	<b>500</b>		465	Q/71	<b>21.600</b>	
457	P/293	<b>500</b>		—	Q/92	<b>17.000</b>	
457	P/293-1	<b>500</b>		466	Q/101	<b>38.800</b>	
457	P/294	<b>500</b>		467	Q/111	<b>11.000</b>	
—	P/294-1	<b>500</b>		—	Q/115	<b>5.000</b>	
458	P/311	<b>2.150</b>		467	Q/121	<b>66.000</b>	
458	P/312	<b>2.150</b>		467	Q/131	<b>66.000</b>	
458	P/313	<b>2.150</b>		—	Q/152	<b>2.500</b>	
458	P/314	<b>2.150</b>		468	Q/161	<b>3.200</b>	
	<b>Q</b>			468	Q/171	<b>2.750</b>	
				468	Q/181	<b>3.900</b>	
				469	Q/203	<b>23.800</b>	
460	Q/1	<b>3.200</b>		469	Q/204	<b>23.800</b>	
—	Q/3	<b>7.000</b>		469	Q/211	<b>23.600</b>	
—	Q/5	<b>7.500</b>		469	Q/221	<b>1.200</b>	
460	Q/6	<b>9.200</b>		469	Q/222	<b>1.300</b>	
460	Q/11	<b>1.500</b>		469	Q/226	<b>1.300</b>	
460	Q/12	<b>2.100</b>		469	Q/231	<b>1.750</b>	
461	Q/21	<b>17.700</b>		470	Q/232	<b>3.800</b>	
461	Q/22	<b>16.000</b>		470	Q/233	<b>3.800</b>	
461	Q/23	<b>6.200</b>		470	Q/234	<b>3.800</b>	
461	Q/24	<b>6.700</b>		470	Q/241	<b>3.700</b>	
461	Q/31	<b>9.500</b>		470	Q/242	<b>3.700</b>	
461	Q/32	<b>12.800</b>		470	Q/243	<b>4.300</b>	
462	Q/33	<b>8.800</b>		470	Q/244	<b>4.300</b>	
462	Q/36	<b>14.800</b>		471	Q/251	<b>4.100</b>	
462	Q/37	<b>21.400</b>		471	Q/252	<b>3.400</b>	
462	Q/37-1	<b>19.400</b>		471	Q/261	<b>3.400</b>	
463	Q/38	<b>55.800</b>		471	Q/262	<b>3.400</b>	
463	Q/38-1	<b>44.800</b>		471	Q/263	<b>3.500</b>	
463	Q/38-2	<b>39.000</b>		471	Q/264	<b>3.500</b>	
463	Q/39	<b>56.000</b>		471	Q/271	<b>3.700</b>	
464	Q/41	<b>15.800</b>		472	Q/272	<b>3.400</b>	
				472	Q/273	<b>3.400</b>	



PAG. N°	ART. N°	PREZZO LISTINO	PREZZO NETTO	PAG. N°	ART. N°	PREZZO LISTINO	PREZZO NETTO
472	Q/274	3.300		476	Q/477	8.700	
472	Q/275	3.700		—	Q/477-1	9.800	
472	Q/276	3.400		—	Q/477-2	9.600	
472	Q/277	4.400		476	Q/478	7.600	
472	Q/278	3.800		476	Q/479	4.900	
606	Q/290	9.900		476	Q/480	4.500	
606	Q/291	9.900		476	Q/481	7.850	
606	Q/292	6.750		477	Q/491	3.100	
473	Q/361	7.600		477	Q/492	3.200	
473	Q/366	4.000		477	Q/493	16.800	
473	Q/367	6.700		477	Q/501	1.450	
473	Q/368	3.400		—	Q/508	28.750	
473	Q/369	5.500		—	Q/510	2.850	
473	Q/370	3.700		—	Q/512	8.300	
473	Q/381	3.500		—	Q/514	1.400	
473	Q/382	1.900		478	Q/601	870	
473	Q/391	950		478	Q/602	960	
474	Q/401	2.700		478	Q/603	840	
—	Q/405	1.700		478	Q/604	40	
—	Q/406	1.700		478	Q/611	84	
—	Q/407	1.700		478	Q/612	116	
—	Q/408	1.700		478	Q/613	126	
—	Q/409	1.700		479	Q/614	510	
—	Q/410	1.700		479	Q/615	510	
474	Q/420	1.480		479	Q/616	430	
474	Q/421	4.700		—	Q/618	750	
474	Q/431	1.250		479	Q/619	270	
—	Q/433	500		479	Q/620	470	
—	Q/434	600		479	Q/621	130	
474	Q/436	4.100		479	Q/622	130	
475	Q/440	500		479	Q/623	170	
475	Q/443	1.800		479	Q/624	126	
—	Q/444	1.500		480	Q/631	380	
—	Q/445	2.400		480	Q/632	640	
—	Q/446	2.200		480	Q/633	640	
—	Q/447	7.500		480	Q/635	950	
—	Q/448	8.300		480	Q/636	820	
—	Q/449	9.000		480	Q/651	400	
—	Q/450	7.000		481	Q/652	730	
475	Q/451	12.400		481	Q/653	770	
475	Q/452	11.300		481	Q/654	870	
476	Q/471	7.500		481	Q/655	380	
476	Q/476	6.250		481	Q/656	730	

PAG. N°	ART. N°	PREZZO LISTINO	PREZZO NETTO	PAG. N°	ART. N°	PREZZO LISTINO	PREZZO NETTO
482	Q/661	<b>1.050</b>		—	R/132	—	
482	Q/662	<b>900</b>		—	R/134	<b>2.250</b>	
482	Q/663	<b>1.340</b>		488	R/141	—	
482	Q/664	<b>1.200</b>		488	R/142	—	
482	Q/665	<b>600</b>		489	R/151	—	
482	Q/666	<b>250</b>		489	R/152	—	
482	Q/667	<b>1.500</b>		—	R/222-2	—	
482	Q/668	<b>1.500</b>		—	R/223-2	—	
483	Q/669	<b>1.500</b>		490	R/231	—	
483	Q/670	<b>1.800</b>		490	R/232	—	
483	Q/671	<b>530</b>		490	R/241	—	
483	Q/672	<b>450</b>		490	R/242	—	
—	Q/690	<b>3.000</b>		491	R/246	—	
—	Q/692	<b>3.000</b>		491	R/251	—	
	<b>R</b>			492	R/501	<b>250</b>	
484	R/1-1	—		492	R/502	<b>2.200</b>	
484	R/1-2	—		492	R/505	<b>30</b>	
484	R/1-3	—		492	R/506	<b>30</b>	
484	R/1-4	—		492	R/507	<b>1.200</b>	
485	R/2	—		492	R/508	<b>550</b>	
485	R/2-1	—		492	R/509	<b>30</b>	
485	R/3	—		492	R/510	<b>430</b>	
485	R/6	—		492	R/511	<b>430</b>	
486	R/7	—		492	R/512	<b>430</b>	
486	R/11	<b>4.300</b>		492	R/513	<b>500</b>	
—	R/18	—		492	R/514	<b>130</b>	
486	R/21	—		492	R/515	<b>2.300</b>	
—	R/25	—		492	R/516	<b>2.200</b>	
—	R/26	—		493	R/517	<b>400</b>	
—	R/54	—		493	R/518	<b>1.800</b>	
—	R/57	—		493	R/519	<b>470</b>	
—	R/60	—		493	R/520	<b>150</b>	
—	R/63	—		493	R/522	<b>160</b>	
—	R/65	—		493	R/523	<b>500</b>	
—	R/70	—		494	R/551	<b>2.000</b>	
487	R/81	—		494	R/552	<b>500</b>	
—	R/86	<b>3.900</b>		494	R/553	<b>500</b>	
487	R/101	—		494	R/554	<b>150</b>	
—	R/106-1	—		494	R/555	<b>350</b>	
—	R/109	—		494	R/556	<b>210</b>	
				494	R/557	<b>30</b>	
				494	R/558	<b>390</b>	
				494	R/559	<b>290</b>	

PAG. N°	ART. N°	PREZZO LISTINO	PREZZO NETTO	PAG. N°	ART. N°	PREZZO LISTINO	PREZZO NETTO
494	R/560	140		500	R/704	110	
494	R/561	2.300		500	R/705	40	
494	R/562	2.200		500	R/706	390	
494	R/563	390		500	R/707	520	
494	R/564	26		500	R/708	130	
495	R/601	26		500	R/709	1.500	
495	R/602	2.000		500	R/710	200	
495	R/603	160		500	R/712	130	
495	R/604	500		501	R/713	150	
495	R/606	1.050		501	R/714	150	
495	R/607	1.850		501	R/715	50	
496	R/608	160		501	R/716	150	
496	R/610	2.000		501	R/717	200	
496	R/611	500		501	R/718	50	
496	R/612	2.300		501	R/719	200	
496	R/613	210		501	R/720	160	
496	R/614	20		501	R/721	300	
496	R/615	390		501	R/722	2.200	
496	R/616	290		501	R/723	400	
496	R/618	140		501	R/724	40	
496	R/619	2.200		501	R/725	50	
496	R/620	390		501	R/726	30	
496	R/601	26		501	R/727	60	
498	R/651	470		501	R/728	100	
498	R/652	160		501	R/729	200	
498	R/653	390		501	R/730	1.600	
498	R/655	1.400		501	R/731	600	
498	R/656	570		502	R/801	500	
498	R/657	2.250		502	R/802	220	
498	R/658	26		502	R/803	56	
498	R/659	280		502	R/804	1.500	
498	R/660	130		502	R/805	2.100	
498	R/661	2.200		502	R/806	2.530	
498	R/662	380		502	R/807	2.100	
499	R/663	2.000		502	R/808	56	
499	R/664	150		502	R/809	276	
499	R/665	580		502	R/810	990	
499	R/666	20		502	R/811	2.530	
499	R/668	1.000		502	R/812	440	
499	R/669	2.300		503	R/813	990	
500	R/701	2.200		503	R/814	2.100	
500	R/702	460		503	R/815	1.050	
500	R/703	150		503	R/816	770	

PAG. N°	ART. N°	PREZZO LISTINO	PREZZO NETTO	PAG. N°	ART. N°	PREZZO LISTINO	PREZZO NETTO
503	R/817	<b>300</b>		506	R/914	<b>3.000</b>	
503	R/818-1	<b>3.000</b>		506	R/915	<b>250</b>	
503	R/819	<b>5.400</b>		506	R/917	<b>900</b>	
503	R/820	<b>990</b>		506	R/918	<b>4.800</b>	
503	R/821	<b>390</b>		506	R/919	<b>2.000</b>	
503	R/822	<b>500</b>		507	R/920	<b>220</b>	
503	R/823	<b>110</b>		507	R/921	<b>220</b>	
503	R/824	<b>1.100</b>		507	R/922	<b>1.000</b>	
503	R/825	<b>220</b>		507	R/923	<b>700</b>	
503	R/826	<b>270</b>		507	R/924	<b>150</b>	
503	R/827	<b>110</b>		507	R/925	<b>100</b>	
504	R/851	<b>550</b>		507	R/926	<b>250</b>	
504	R/852	<b>1.300</b>		507	R/928	<b>60</b>	
504	R/853	<b>800</b>		507	R/929	<b>680</b>	
504	R/854	<b>400</b>		507	R/930	<b>2.500</b>	
504	R/855	<b>1.200</b>		507	R/931	<b>280</b>	
504	R/856	<b>1.000</b>		507	R/932	<b>450</b>	
504	R/857	<b>2.400</b>		507	R/933	<b>880</b>	
504	R/858	<b>400</b>		507	R/934	<b>1.200</b>	
504	R/859	<b>680</b>		507	R/935	<b>150</b>	
504	R/860	<b>4.800</b>		—	R/940	<b>2.350</b>	
504	R/861	<b>1.500</b>		—	R/941	<b>3.500</b>	
504	R/862	<b>550</b>		—	R/943	<b>1.500</b>	
504	R/863	<b>1.300</b>		—	R/944	<b>5.500</b>	
505	R/864	<b>500</b>		—	R/945	<b>250</b>	
505	R/865	<b>7.800</b>		—	R/946	<b>200</b>	
505	R/866	<b>680</b>		—	R/947	<b>220</b>	
505	R/867	<b>400</b>		—	R/948	<b>250</b>	
505	R/869	<b>1.000</b>		—	R/960	<b>300</b>	
505	R/870	<b>4.400</b>		—	R/961	<b>600</b>	
505	R/871	<b>120</b>		—	R/965	<b>400</b>	
505	R/872	<b>4.600</b>		—	R/966	<b>400</b>	
506	R/901	<b>30</b>		—	R/967	<b>80</b>	
506	R/902	<b>1.000</b>		—	R/968	<b>500</b>	
506	R/903	<b>950</b>		—	R/1100	<b>1.200</b>	
506	R/904	<b>950</b>		—	R/1150	<b>300</b>	
506	R/905	<b>2.200</b>		509	R/1201	<b>8.300</b>	
506	R/906	<b>950</b>		509	R/1206	<b>2.000</b>	
506	R/907	<b>950</b>		—	R/1206-1	<b>2.000</b>	
506	R/908	<b>680</b>		509	R/1208	<b>2.000</b>	
506	R/910	<b>300</b>		—	R/1208-1	<b>2.100</b>	
506	R/912	<b>30</b>		509	R/1209	<b>2.000</b>	
506	R/913	<b>150</b>		509	R/1210	<b>10.850</b>	



PAG. N°	ART. N°	PREZZO LISTINO	PREZZO NETTO	PAG. N°	ART. N°	PREZZO LISTINO	PREZZO NETTO
509	R/1211	<b>4.200</b>		515	R/1381	<b>7.000</b>	
—	R/1212	<b>4.400</b>		515	R/1382	<b>7.100</b>	
509	R/1213	<b>4.200</b>		515	R/1388	<b>29.000</b>	
—	R/1216	<b>1.000</b>		515	R/1389	<b>7.100</b>	
—	R/1217	<b>1.350</b>		515	R/1390	<b>10.000</b>	
—	R/1218	<b>1.500</b>		516	R/1391	<b>6.200</b>	
509	R/1221	<b>260</b>		516	R/1392	<b>6.200</b>	
—	R/1227	<b>4.230</b>		516	R/1394	<b>30.000</b>	
510	R/1231	<b>390</b>		516	R/1398	<b>7.900</b>	
510	R/1241	<b>36.400</b>		—	R/1400	<b>8.420</b>	
510	R/1243	<b>14.000</b>		516	R/1406	<b>13.000</b>	
510	R/1245	<b>16.500</b>		516	R/1407	<b>44.000</b>	
511	R/1303	<b>6.900</b>		516	R/1408	<b>40.000</b>	
511	R/1304	<b>7.100</b>		516	R/1409	<b>33.800</b>	
512	R/1311	<b>4.500</b>		517	R/1411	<b>3.400</b>	
512	R/1316	<b>3.900</b>		517	R/1412	<b>1.900</b>	
512	R/1317	<b>3.200</b>		—	R/1414	<b>4.500</b>	
512	R/1319	<b>6.300</b>		—	R/1415	<b>4.500</b>	
513	R/1325	<b>7.650</b>		517	R/1421	<b>3.000</b>	
513	R/1327	<b>13.300</b>		517	R/1422	<b>3.000</b>	
513	R/1329	<b>6.300</b>		517	R/1423	<b>6.800</b>	
513	R/1330	<b>10.300</b>		518	R/1425	<b>7.500</b>	
513	R/1331	<b>28.400</b>		518	R/1426	<b>3.500</b>	
513	R/1332	<b>6.300</b>		518	R/1427	<b>11.500</b>	
513	R/1333	<b>10.300</b>		518	R/1428	<b>6.000</b>	
513	R/1334	<b>28.400</b>		518	R/1430	<b>30.400</b>	
514	R/1343	<b>2.800</b>		519	R/1433	<b>26.000</b>	
—	R/1343-1	<b>2.800</b>		519	R/1434	<b>11.000</b>	
—	R/1344	<b>4.200</b>		519	R/1441	<b>1.700</b>	
514	R/1346	<b>2.800</b>		—	R/1442	<b>2.500</b>	
—	R/1347	<b>5.800</b>		520	R/1501	<b>210</b>	
—	R/1348	<b>3.000</b>		—	R/1501-1	<b>3.750</b>	
—	R/1353	<b>10.500</b>		520	R/1502	<b>210</b>	
—	R/1354	<b>16.700</b>		520	R/1511	<b>240</b>	
514	R/1357	<b>1.250</b>		—	R/1511-1	<b>3.750</b>	
514	R/1358	<b>8.250</b>		520	R/1512	<b>240</b>	
515	R/1361	<b>5.830</b>		520	R/1521	<b>240</b>	
515	R/1362	<b>990</b>		—	R/1521-1	<b>3.750</b>	
515	R/1363	<b>4.950</b>		520	R/1522	<b>240</b>	
515	R/1366	<b>7.260</b>		520	R/1531	<b>300</b>	
515	R/1367	<b>10.120</b>		520	R/1532	<b>300</b>	
515	R/1377	<b>4.000</b>		520	R/1533	<b>480</b>	
515	R/1878	<b>8.000</b>		521	R/1535	<b>600</b>	

PAG. N°	ART. N°	PREZZO LISTINO	PREZZO NETTO	PAG. N°	ART. N°	PREZZO LISTINO	PREZZO NETTO
—	R/1536	<b>270</b>		—	R/1609-1	<b>1.200</b>	
—	R/1536-1	<b>270</b>		—	R/1610	<b>480</b>	
—	R/1537	<b>420</b>		—	R/1610-1	<b>480</b>	
—	R/1537-1	<b>420</b>		—	R/1611-1	<b>300</b>	
—	R/1537-3	<b>480</b>		—	R/1611-2	<b>300</b>	
—	R/1538	<b>350</b>		522	R/1612	<b>240</b>	
—	R/1538-1	<b>350</b>		522	R/1613	<b>240</b>	
—	R/1539	<b>270</b>		—	R/1614	<b>300</b>	
—	R/1539-1	<b>270</b>		522	R/1615	<b>270</b>	
—	R/1540	<b>300</b>		522	R/1616	<b>270</b>	
—	R/1540-1	<b>300</b>		—	R/1617	<b>600</b>	
521	R/1541	<b>600</b>		—	R/1617-1	<b>540</b>	
521	R/1551	<b>300</b>		—	R/1618	<b>510</b>	
521	R/1552	<b>300</b>		—	R/1618-1	<b>510</b>	
—	R/1553	<b>480</b>		—	R/1618-2	<b>480</b>	
—	R/1554	<b>480</b>		—	R/1618-3	<b>480</b>	
—	R/1556	<b>600</b>		—	R/1619	<b>480</b>	
—	R/1558	<b>660</b>		—	R/1619-1	<b>480</b>	
—	R/1559	<b>660</b>		—	R/1620	<b>900</b>	
521	R/1561	<b>300</b>		—	R/1620-1	<b>360</b>	
521	R/1562	<b>300</b>		522	R/1621	<b>600</b>	
521	R/1565	<b>600</b>		522	R/1631	<b>510</b>	
521	R/1566	<b>600</b>		—	R/1632	<b>900</b>	
—	R/1567	<b>240</b>		—	R/1633	<b>600</b>	
—	R/1568	<b>240</b>		—	R/1634	<b>390</b>	
—	R/1569	<b>600</b>		—	R/1634-1	<b>390</b>	
521	R/1571	<b>300</b>		—	R/1634-2	<b>630</b>	
521	R/1572	<b>300</b>		—	R/1634-3	<b>630</b>	
522	R/1581	<b>300</b>		—	R/1634-4	<b>630</b>	
522	R/1582	<b>300</b>		—	R/1634-5	<b>630</b>	
—	R/1585	<b>300</b>		—	R/1634-6	<b>630</b>	
522	R/1591	<b>600</b>		—	R/1635	<b>570</b>	
522	R/1601	<b>270</b>		—	R/1635-1	<b>690</b>	
522	R/1602	<b>270</b>		—	R/1635-2	<b>690</b>	
522	R/1603	<b>300</b>		—	R/1635-3	<b>570</b>	
—	R/1603-1	<b>3.750</b>		—	R/1635-4	<b>690</b>	
522	R/1604	<b>300</b>		—	R/1635-5	<b>2.100</b>	
—	R/1605	<b>270</b>		—	R/1635-6	<b>2.550</b>	
—	R/1605-1	<b>270</b>		—	R/1635-7	<b>2.550</b>	
522	R/1606	<b>3.750</b>		—	R/1636	<b>270</b>	
522	R/1607	<b>480</b>		—	R/1636-1	<b>270</b>	
—	R/1608	<b>720</b>		—	R/1637	<b>840</b>	
—	R/1609	<b>1.200</b>		—	R/1638	<b>840</b>	

PAG. N°	ART. N°	PREZZO LISTINO	PREZZO NETTO	PAG. N°	ART. N°	PREZZO LISTINO	PREZZO NETTO
—	R/1639	<b>2.700</b>		523	R/1692	<b>300</b>	
—	R/1640	<b>3.750</b>		523	R/1697	<b>600</b>	
—	R/1640-1	<b>1.200</b>		—	R/1698	<b>300</b>	
523	R/1641	<b>450</b>		—	R/1698-1	<b>300</b>	
—	R/1642	<b>810</b>		—	R/1699	<b>400</b>	
—	R/1643	<b>850</b>		—	R/1699-1	<b>400</b>	
—	R/1644	<b>550</b>		—	R/1700	<b>330</b>	
—	R/1644-1	<b>550</b>		—	R/1700-1	<b>330</b>	
—	R/1645	<b>680</b>		—	R/1700-5	<b>400</b>	
—	R/1645-1	<b>680</b>		524	R/1701	<b>300</b>	
—	R/1646	<b>510</b>		524	R/1702	<b>300</b>	
—	R/1646-1	<b>510</b>		524	R/1703	<b>240</b>	
—	R/1647	<b>350</b>		524	R/1704	<b>240</b>	
—	R/1647-1	<b>350</b>		524	R/1705	<b>480</b>	
—	R/1648	<b>2.850</b>		—	R/1706	<b>660</b>	
523	R/1650	<b>600</b>		—	R/1707	<b>660</b>	
523	R/1651	<b>390</b>		524	R/1721	<b>380</b>	
—	R/1651-1	<b>3.750</b>		524	R/1722	<b>380</b>	
523	R/1652	<b>390</b>		524	R/1741	<b>380</b>	
—	R/1654	<b>600</b>		524	R/1742	<b>380</b>	
—	R/1655	<b>3.750</b>		524	R/1743	<b>380</b>	
—	R/1656	<b>900</b>		524	R/1744	<b>380</b>	
—	R/1657	<b>900</b>		524	R/1745	<b>3.750</b>	
—	R/1658	<b>900</b>		524	R/1746	<b>600</b>	
—	R/1659	<b>1.140</b>		524	R/1747	<b>300</b>	
523	R/1661	<b>490</b>		—	R/1747-1	<b>390</b>	
523	R/1662	<b>490</b>		—	R/1747-2	<b>390</b>	
—	R/1663	<b>3.750</b>		525	R/1748	<b>660</b>	
523	R/1681	<b>480</b>		525	R/1749	<b>660</b>	
523	R/1682	<b>540</b>		—	R/1752	<b>300</b>	
523	R/1683	<b>540</b>		—	R/1752-1	<b>300</b>	
—	R/1684	<b>450</b>		—	R/1753	<b>480</b>	
—	R/1684-1	<b>450</b>		—	R/1754	<b>480</b>	
—	R/1685	<b>240</b>		—	R/1755	<b>630</b>	
—	R/1685-1	<b>240</b>		—	R/1756	<b>360</b>	
—	R/1686	<b>540</b>		—	R/1756-1	<b>360</b>	
—	R/1686-1	<b>540</b>		—	R/1757	<b>570</b>	
—	R/1687	<b>240</b>		—	R/1757-1	<b>570</b>	
—	R/1687-1	<b>240</b>		—	R/1758	<b>690</b>	
—	R/1688	<b>540</b>		—	R/1758-1	<b>690</b>	
—	R/1689	<b>540</b>		—	R/1759	<b>270</b>	
—	R/1689-1	<b>540</b>		—	R/1760	<b>300</b>	
523	R/1691	<b>300</b>		—	R/1760-1	<b>300</b>	

PAG. N°	ART. N°	PREZZO LISTINO	PREZZO NETTO	PAG. N°	ART. N°	PREZZO LISTINO	PREZZO NETTO
—	R/1762	<b>360</b>		527	R/1803	<b>1.600</b> ‰	
—	R/1762-1	<b>360</b>		527	R/1804	<b>2.100</b> ‰	
—	R/1763	<b>900</b>		527	R/1805	<b>2.100</b> ‰	
—	R/1767	<b>4.200</b>		527	R/1841	<b>1.900</b> ‰	
—	R/1768	<b>4.200</b>		527	R/1845	<b>1.500</b> ‰	
525	R/1771	<b>510</b>		528	R/1861	<b>570</b>	
525	R/1772	<b>510</b>		528	R/1862	<b>300</b>	
525	R/1777	<b>376</b>		529	R/1882	<b>1.800</b>	
525	R/1779	<b>3.750</b>		529	R/1883	<b>5.500</b>	
525	R/1780	<b>376</b>		529	R/1902	<b>1.800</b>	
525	R/1781	<b>376</b>		—	R/1903	<b>1.800</b>	
525	R/1782	<b>3.750</b>		529	R/1911	<b>550</b>	
525	R/1783	<b>376</b>		529	R/1921	<b>780</b>	
—	R/1784	<b>840</b>		529	R/1951	<b>500</b>	
—	R/1784-3	<b>690</b>		—	R/1966	<b>4.000</b>	
—	R/1784-4	<b>690</b>		—	R/1980	<b>6.600</b>	
525	R/1785	<b>360</b>		—	R/1981	<b>220</b>	
525	R/1786	<b>360</b>		—	R/1982	<b>480</b>	
526	R/1788	<b>450</b>		530	R/2101	<b>550</b>	
526	R/1789	<b>450</b>		530	R/2103	<b>14</b>	
—	R/1790	<b>330</b>		530	R/2104	<b>14</b>	
—	R/1790-1	<b>330</b>		530	R/2105	<b>2.200</b>	
—	R/1790-3	<b>500</b>		530	R/2106	<b>2.500</b>	
526	R/1791	<b>1.050</b>		530	R/2107	<b>130</b>	
526	R/1792	<b>1.050</b>		530	R/2108	<b>40</b>	
526	R/1793	<b>630</b>		530	R/2109	<b>400</b>	
526	R/1794	<b>630</b>		530	R/2110	<b>440</b>	
526	R/1795	<b>300</b>		530	R/2111	<b>70</b>	
—	R/1795-1	<b>3.750</b>		531	R/2121	<b>3.200</b>	
526	R/1796	<b>300</b>		531	R/2122	<b>4.100</b>	
—	R/1797	<b>720</b>		531	R/2123	<b>4.100</b>	
—	R/1797-1	<b>570</b>		531	R/2124	<b>3.200</b>	
—	R/1797-5	<b>600</b>		—	R/2125	<b>2.500</b>	
—	R/1797-6	<b>1.200</b>		—	R/2126	<b>4.000</b>	
526	R/1798	<b>570</b>		—	R/2127	<b>3.500</b>	
526	R/1799	<b>570</b>		531	R/2151	<b>850</b>	
—	R/1799-3	<b>800</b>		531	R/2152	<b>850</b>	
—	R/1799-4	<b>800</b>		531	R/2153	<b>850</b>	
—	R/1799-6	<b>1.200</b>		531	R/2161	<b>850</b>	
—	R/1799-8	<b>800</b>		531	R/2162	<b>850</b>	
—	R/1799-9	<b>800</b>		531	R/2163	<b>850</b>	
—	R/1800	<b>300</b>		531	R/2171	<b>850</b>	
—	R/1800-1	<b>300</b>		531	R/2172	<b>850</b>	



PAG. N°	ART. N°	PREZZO LISTINO	PREZZO NETTO	PAG. N°	ART. N°	PREZZO LISTINO	PREZZO NETTO
531	R/2173	<b>850</b>		—	S/216	—	
531	R/2181	<b>950</b>		538	S/301	<b>1.500</b>	
531	R/2182	<b>950</b>		538	S/302	<b>1.150</b>	
531	R/2183	<b>950</b>		538	S/303	<b>2.250</b>	
532	R/2201	<b>1.300</b>		538	S/311	<b>5.000</b>	
532	R/2202	<b>1.300</b>		538	S/312	<b>5.000</b>	
532	R/2206	<b>1.300</b>		538	S/313	<b>2.500</b>	
532	R/2207	<b>1.300</b>		538	S/314	<b>5.000</b>	
532	R/2211	<b>1.300</b>		538	S/315	<b>5.000</b>	
532	R/2212	<b>1.300</b>		538	S/316	<b>2.500</b>	
532	R/2221	<b>3.700</b>		539	S/321	<b>9.900</b>	
—	R/2222	<b>3.700</b>		539	S/322	<b>7.500</b>	
—	R/2223	<b>3.750</b>		539	S/331	<b>2.750</b>	
532	R/2231	<b>3.300</b>		539	S/332	<b>1.500</b>	
532	R/2232	<b>3.300</b>		539	S/336	<b>7.600</b>	
532	R/2241	<b>500</b>		—	S/337	<b>3.800</b>	
532	R/2242	<b>500</b>		540	S/340	—	
532	R/2245	<b>2.126</b>		540	S/341	<b>750</b>	
532	R/2271	<b>1.100</b>		540	S/342	<b>750</b>	
532	R/2272	<b>950</b>		541	S/351	<b>6.400</b>	
532	R/2276	<b>1.700</b>		541	S/352	<b>6.400</b>	
532	R/2281	<b>900</b>		541	S/353	<b>6.400</b>	
533	R/2501	<b>120</b>		541	S/354	<b>6.400</b>	
533	R/2502	<b>300</b>		541	S/355	<b>2.500</b>	
533	R/2503	<b>160</b>		541	S/356	<b>2.500</b>	
533	R/2521	<b>150</b>		541	S/357	<b>2.500</b>	
533	R/2531	<b>40</b>		541	S/358	<b>3.800</b>	
533	R/2541	<b>12</b>		542	S/361	<b>5.500</b>	
533	R/2551	<b>30</b>		542	S/362	<b>5.000</b>	
	<b>S</b>			542	S/363	<b>10.500</b>	
534	S/161	—		542	S/371	<b>800</b>	
534	S/171	—		542	S/376	<b>550</b>	
534	S/181	—		—	S/376-1	<b>900</b>	
535	S/182	—		—	S/377-1	<b>900</b>	
535	S/183	—		—	S/378	<b>1.650</b>	
536	S/201	—		—	S/379	<b>1.650</b>	
536	S/202	<b>1.700</b>		542	S/381	<b>1.000</b>	
536	S/203	<b>1.700</b>		542	S/382	<b>2.900</b>	
536	S/204	<b>6.300</b>		—	S/472	<b>4.500</b>	
537	S/211	—		543	S/601	<b>80</b>	
537	S/212	—		543	S/601-1	<b>140</b>	
				543	S/601-2	<b>100</b>	
				543	S/601-3	<b>150</b>	

PAG. N°	ART. N°	PREZZO LISTINO	PREZZO NETTO	PAG. N°	ART. N°	PREZZO LISTINO	PREZZO NETTO
543	S/602	160		546	S/720-1	300	
543	S/603	260		—	S/721	2.800	
—	S/603-1	160		547	S/723	7.800	
543	S/604	280					
543	S/605	700			<b>T</b>		
543	S/606	90					
543	S/607	1.500		548	T/1	626	
543	S/608	250		548	T/2	626	
543	S/609	750		548	T/16	2.000	
543	S/610	400		548	T/21	400	
544	S/625	590		548	T/22	400	
544	S/625-1	660		548	T/23	400	
544	S/625-2	890		—	T/35	200	
544	S/628	1.290		548	T/41	600	
544	S/628-1	1.950		548	T/51	600	
544	S/631	2.550		548	T/61	500	
544	S/626	880		609	T/120	74.000	
544	S/626-1	980		554	T/121	—	
544	S/626-2	1.200		554	T/122	—	
544	S/629	1.650		554	T/123	—	
544	S/629-1	2.450		555	T/131	—	
544	S/632	3.300		555	T/132	—	
544	S/627	2.100		555	T/133	—	
544	S/627-1	2.700		555	T/141	—	
544	S/627-2	3.100		556	T/161	—	
544	S/630	4.800		557	T/181	—	
544	S/630-1	6.800		557	T/191	—	
544	S/633	9.500		557	T/201	—	
545	S/651	720		558	T/211	—	
—	S/651-1	980		558	T/221	—	
545	S/653	1.860		559	T/231	—	
545	S/655	2.880		559	T/232	—	
545	S/657	3.540		559	T/233	—	
545	S/652	1.020		560	T/234	—	
545	S/654	2.340		560	T/235	—	
545	S/656	3.480		561	T/236	—	
545	S/658	4.740		561	T/237	—	
—	S/658-1	3.650		562	T/238	—	
545	S/659	5.550		562	T/239	—	
—	S/717	10.900		562	T/240	—	
546	S/718	12.400		562	T/241	—	
546	S/719	850		562	T/241	—	
546	S/720	1.500		563	T/242	—	

PAG. N°	ART. N°	PREZZO LISTINO	PREZZO NETTO	PAG. N°	ART. N°	PREZZO LISTINO	PREZZO NETTO
563	T/243	—		568	T/375	—	
563	T/244	—		568	T/383	—	
564	T/245	—		568	T/385	—	
564	T/246	—		568	T/404	—	
—	T/247	—		568	T/405	—	
564	T/248	—		568	T/411	—	
565	T/249	—		568	T/413	—	
565	T/250	—		568	T/414	—	
565	T/251	—		568	T/415	—	
—	T/260	—		568	T/421	—	
—	T/261	—		568	T/423	—	
566	T/281	—		568	T/424	—	
—	T/281-1	—		568	T/425	—	
566	T/282	—		568	T/443	—	
—	T/282-1	—		568	T/444	—	
566	T/283	—		568	T/445	—	
567	T/285	—		568	T/453	—	
567	T/286	—		568	T/454	—	
567	T/287	—		568	T/455	—	
567	T/288	—		568	T/463	—	
567	T/289	—		568	T/464	—	
567	T/290	—		568	T/465	—	
568	T/302	—		568	T/483	—	
568	T/312	—		568	T/484	—	
568	T/321	—		568	T/485	—	
568	T/322	—		568	T/491	—	
568	T/323	—		568	T/493	—	
568	T/324	—		568	T/494	—	
568	T/325	—		568	T/495	—	
568	T/331	—		568	T/501	—	
568	T/332	—		568	T/503	—	
568	T/333	—		568	T/504	—	
568	T/334	—		568	T/505	—	
568	T/335	—		568	T/531	—	
568	T/352	—		568	T/532	—	
568	T/354	—		570	T/541	—	
568	T/355	—		570	T/542	—	
568	T/361	—		570	T/544	—	
568	T/363	—		570	T/551	—	
568	T/371	—		570	T/552	—	
568	T/372	—		570	T/553	—	
568	T/373	—		570	T/554	—	
568	T/374	—		—	T/557	—	



PAG. N°	ART. N°	PREZZO LISTINO	PREZZO NETTO	PAG. N°	ART. N°	PREZZO LISTINO	PREZZO NETTO
—	T/560 c.b.	—		575	U/256	<b>450</b>	
—	T/561 c.b.	—		—	U/256-1	<b>150</b>	
—	T/570 c.b.	—		—	U/256-2	<b>150</b>	
—	T/571 c.b.	—		575	U/257	<b>160</b>	
—	T/572 c.b.	—		575	U/258	<b>186</b>	
—	T/573	—		575	U/259	<b>300</b>	
	<b>U</b>			575	U/260	<b>336</b>	
				575	U/261	<b>350</b>	
572	U/1	<b>8.000</b>		576	U/262	<b>260</b>	
572	U/31	<b>3.800</b>		576	U/271	<b>62</b>	
572	U/50	<b>2.600</b>		576	U/272	<b>120</b>	
573	U/52-1	<b>1.700</b>		576	U/281	<b>220</b>	
573	U/53	<b>2.600</b>		576	U/282	<b>290</b>	
573	U/55	<b>2.600</b>		576	U/291	<b>270</b>	
573	U/56	<b>1.900</b>		576	U/292	<b>350</b>	
573	U/67	<b>2.700</b>		576	U/301	<b>300</b>	
573	U/68	<b>1.800</b>		576	U/302	<b>400</b>	
573	U/69	<b>2.100</b>		576	U/311	<b>350</b>	
573	U/70	<b>2.100</b>		576	U/312	<b>450</b>	
—	U/71	<b>1.600</b>		577	U/321	<b>84</b>	
—	U/72	<b>2.200</b>		577	U/322	<b>110</b>	
—	U/73	<b>3.300</b>		577	U/331	<b>84</b>	
—	U/75	<b>2.100</b>		577	U/332	<b>110</b>	
—	U/76	<b>3.300</b>		577	U/341	<b>84</b>	
—	U/78	<b>1.500</b>		577	U/342	<b>110</b>	
—	U/79	<b>2.300</b>		577	U/351	<b>84</b>	
—	U/95	<b>1.600</b>		577	U/352	<b>110</b>	
—	U/96	<b>1.600</b>		577	U/361	<b>50</b>	
—	U/97	<b>1.600</b>		577	U/362	<b>100</b>	
—	U/98	<b>1.600</b>		577	U/371	<b>84</b>	
574	U/209	<b>550</b>		577	U/372	<b>110</b>	
574	U/210	<b>1.000</b>		577	U/381	<b>84</b>	
574	U/211	<b>550</b>		577	U/382	<b>110</b>	
574	U/212	<b>550</b>		578	U/386	<b>900</b>	
574	U/221	<b>160</b>		578	U/387	<b>800</b>	
574	U/222	<b>80</b>		578	U/391	<b>200</b>	
575	U/251	<b>50</b>		578	U/401	<b>1.540</b>	
575	U/252	<b>60</b>		578	U/411	<b>1.760</b>	
575	U/253	<b>90</b>		579	U/422	<b>150</b>	
575	U/254	<b>120</b>		579	U/424	<b>170</b>	
575	U/255	<b>170</b>		580	U/451	<b>2.200</b>	
				580	U/452	<b>1.500</b>	
				580	U/453	<b>2.400</b>	



PAG. N°	ART. N°	PREZZO LISTINO	PREZZO NETTO	PAG. N°	ART. N°	PREZZO LISTINO	PREZZO NETTO
580	U/454	2.100		593	Z/167	—	
580	U/455	2.000		594	Z/182	53.000	
581	U/459	4.900		594	Z/183	103.000	
—	U/461-1	2.100		594	Z/186	18.100	
—	U/462-1	2.150		—	Z/187	16.900	
—	U/463-1	2.150		—	Z/190	39.500	
—	U/464-1	1.900		595	Z/202	12.000	
—	U/465	1.100		595	Z/203	16.500	
—	U/465-2	2.350		595	Z/204	33.500	
—	U/465-3	2.350		595	Z/205	48.800	
583	U/466	650		595	Z/206	41.800	
583	U/467	550		596	Z/207	111.000	
583	U/468	500		596	Z/212	41.800	
583	U/469	500		596	Z/213	23.800	
583	U/471	750		596	Z/214	64.400	
583	U/472	1.000		597	Z/241	—	
583	U/473	870		—	Z/254	30.000	
583	U/477	700		—	Z/256	—	
583	U/478	700		—	Z/260	4.800	
583	U/479	500		599	Z/261	11.800	
583	U/481	7.500		599	Z/262	29.000	
583	U/491	7.200		599	Z/263	10.300	
583	U/501	8.700		599	Z/264	19.000	
	<b>Z</b>			599	Z/265	10.300	
584	Z/81	—		599	Z/266	19.000	
584	Z/91	—		599	Z/267	16.500	
585	Z/101	—		599	Z/268	36.000	
585	Z/111	—		600	Z/269	28.500	
586	Z/116	—		600	Z/270	48.000	
587	Z/121	—		600	Z/276	31.000	
588	Z/131	—		600	Z/277	53.000	
589	Z/141	—		601	Z/278	28.000	
589	Z/151	—		601	Z/279	49.000	
590	Z/153	—		—	Z/281	88.000	
590	Z/154	—		—	Z/300	178.000	
591	Z/156	—		—	Z/301	45.000	
591	Z/157	—		—	Z/302	79.000	
591	Z/158	—		—	Z/303	39.000	
592	Z/161	—		602	Z/390	16.000	
593	Z/166	—		602	Z/391	11.000	
				—	Z/440	—	
				—	Z/450	22.500	
				—	Z/451	43.500	

PAG. N°	ART. N°	PREZZO LISTINO	PREZZO NETTO	PAG. N°	ART. N°	PREZZO LISTINO	PREZZO NETTO
—	Z/1122	<b>10.800</b>					
—	Z/1133	<b>39.000</b>					
—	Z/1134	<b>10.900</b>					
—	Z/5100	—					
—	Z/5101	—					
—	Z/5106	—					
—	Z/5107	—					
—	Z/5110	—					
—	Z/5111	—					
—	Z/5116	—					
—	Z/5117	—					
—	Z/5119	—					
—	Z/5121	—					
—	Z/5122	—					
—	Z/5125	—					
—	Z/5126	—					
—	Z/5128	—					
—	Z/5129	—					

***Tutti i numeri delle pagine***

***si riferiscono al***

***“Catalogo Generale” 1931 - 1959***



# CONDENSATORI CON DIELETTRICO IN POLIESTERE PER RADIO ED APPARECCHIATURE ELETTRONICHE



## POLYESTER CAPACITORS FOR RADIO AND ELECTRONICS EQUIPMENTS

Type Tipo	Capacitance Capacità		D.C. Working voltage V Tensione di lavoro	Dimensions in mm Dimensioni in mm				Catalog No Numero di Catalogo	Prezzo Listino Lit.
				D	L	d	l		
<b>Copo 1000/600</b>	1000 pF	1 nF	600	7	19	0,6	40	B/160	40
» <b>1500/600</b>	1500 pF	1,5 nF	600	7	19	0,6	40	B/161	40
» <b>2200/600</b>	2200 pF	2,2 nF	600	7	19	0,6	40	B/162	40
» <b>3300/400</b>	3300 pF	3,3 nF	400	7	19	0,6	40	B/165	40
» <b>4700/400</b>	4700 pF	4,7 nF	400	7	19	0,6	40	B/166	40
» <b>6800/400</b>	6800 pF	6,8 nF	400	7	19	0,6	40	B/167	40
» <b>0,01/400</b>	0,01 $\mu$ F	10 nF	400	8	19	0,6	40	B/168	40
» <b>0,015/400</b>	15000 pF	15 nF	400	9	19	0,7	40	B/169	40
» <b>0,022/400</b>	22000 pF	22 nF	400	9	21	0,7	40	B/170	48
» <b>0,033/400</b>	33000 pF	33 nF	400	10	21	0,7	40	B/171	54
» <b>0,047/400</b>	47000 pF	47 nF	400	11	21	0,7	40	B/172	60
» <b>0,068/400</b>	68000 pF	68 nF	400	10	28	0,7	40	B/173	68
» <b>0,1/400</b>	100000 pF	100 nF	400	11	28	0,7	40	B/174	76

SUITABLE FOR NORMAL MOUNTING AND FOR PRINTED CIRCUIT  
ADATTI PER MONTAGGIO NORMALE E PER CIRCUITI STAMPATI





# THE **BULGIN** CATALOGUE



## Electronic Components



**A.F. BULGIN & CO. LTD BYE-PASS ROAD, BARKING, ESSEX**

Our 164 page technical catalogue published in MARCH 1960 contains illustrations, full working details and dimensions of over 10,000 ELECTRONIC COMPONENTS and includes all the new lines and developments announced during the past year. Available free on request to all Manufacturers and Electronic Engineers WHO HAVE NOT ALREADY APPLIED.

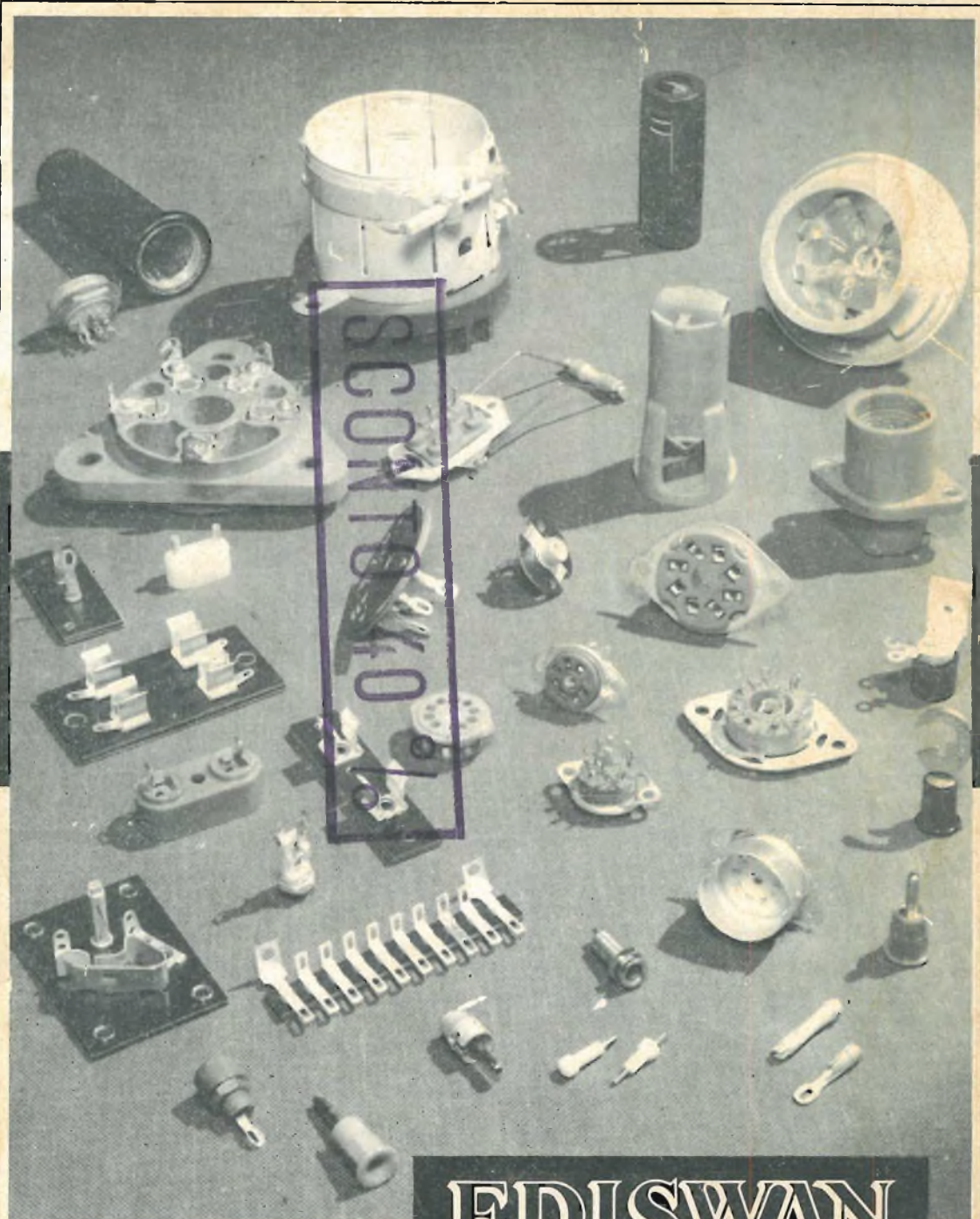

**EDISWAN**

**Parti staccate di qualità**

**EDISWAN - ASSOCIATED ELECTRICAL INDUSTRIES**

155, CHARING CROSS ROAD - LONDON, W.C.2

**"SELEZIONE DI TECNICA RADIO - TV: L. 400**