

RADIO OUT-OF-DOORS

Practical Wireless

3^D 1

Published every Wednesday by
GEORGE NEWNES LTD.

Vol. 4. No. 90.
June 9th, 1934.

Registered at the G.P.O. as a Newspaper.

AND PRACTICAL TELEVISION

EDITED BY F.J. CAMM

More about

The

ATOM

LIGHTWEIGHT PORTABLE

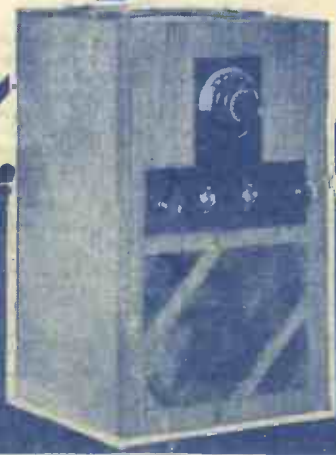

PETO-SCOTT 75/- DISC TELEVISION KIT

ASSEMBLED IN 30 MINUTES

NO SPECIAL TOOLS REQUIRED

PETO-SCOTT, Pioneers in Television since 1927, have, after considerable research, produced this "up-to-the-minute" Disc Television Receiver Kit, of which Efficiency and Economy are the keynotes. Designed to work from almost any 3-valve battery or mains set, the Peto-Scott 75/- Disc Television Receiver is supplied in Kit form, and comprises Peto-Scott Universal Television Motor and Stand; control-

ling resistances; laminated and ready assembled chassis; Stroboscopic 16in. scanning disc; Lens and lensholder; Neon Lamp and holder, together with sundry small parts. It is absolutely complete down to the last screw and piece of wire. Full-size Blueprint with assembly, wiring and operating instructions included with every kit. Cash or C.O.D., Carriage Paid, 75/-, or yours for 15/- and 11 monthly payments of 8/3.

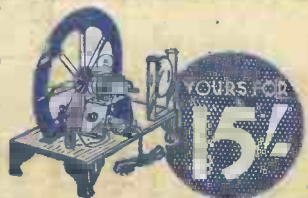

PETO-SCOTT CO. LTD. 77, CITY ROAD, LONDON, E.C.1.

ADVT.

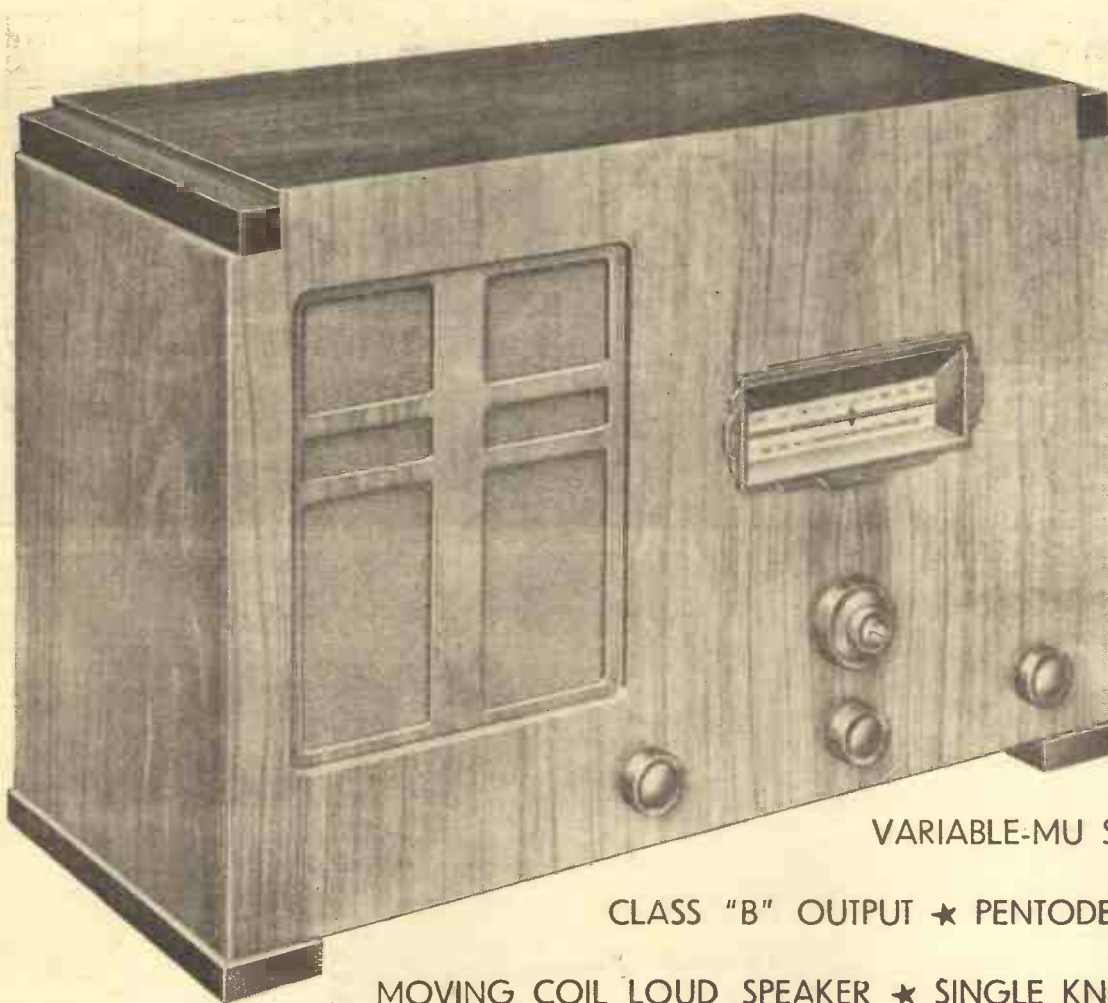

VARIABLE-MU S.G. CIRCUIT

CLASS "B" OUTPUT ★ PENTODE DETECTOR

MOVING COIL LOUD SPEAKER ★ SINGLE KNOB TUNING

SPECIFICATION, MODEL 435B.

Cossor 4-valve Battery-operated Receiver Model 435B with Class "B" Amplification, complete with Cossor Valves as follows: Screened Grid Variable-Mu H.F., H.F. Pentode Detector, Driver and Class "B" Output. Fully screened, super-selective low-loss coils. Single knob moving-pointer tuning with horizontal full-vision scale calibrated in wavelengths. Combination switch for on-off, wavelength change and gramophone pick-up. Selectivity control and volume control. Permanent Magnet Moving Coil Loud Speaker of the latest type. Handsome walnut and brown finish cabinet 20" x 14" x 10", with accommodation for batteries. Terminals for pick-up and sockets for extension loudspeaker.

£8.15s.

Hire purchase terms—16/6 deposit and 11 monthly payments of 16/6 (Exclusive of Batteries).

COSSOR

4-VALVE BATTERY RECEIVER WITH CLASS "B" AMPLIFICATION

Here is something unusual in performance . . . unusual in economy . . . unusual in price. The Cossor Model 435B is a powerful, modern in design, modern in appearance . . . a brilliant example of modern radio at reasonable cost.

A Variable-Mu S.G. Circuit gives exceptional range and wide choice of programmes. Fully screened low-loss coils ensure utmost selectivity, whilst for distortionless detection and great amplification, a Pentode Detector is incorporated.

The final touch of perfection is added with a Class "B" Output Stage which gives "mains" volume and true-to-life tone with low H.T. consumption.

Ask your dealer to demonstrate Model 435B and judge for yourself.

To A. C. COSSOR LTD., Melody Dept., Highbury Grove, London, N.5
Please send me a copy of your Leaflet No. L.115.

Name

Address

PRAG. 9/6/34.

L.115

THE LEADING WIRELESS WEEKLY!



Practical Wireless

EDITOR:
Vol. IV. No. 90. || F. J. CAMM || June 9th, 1934.
Technical Staff:
W. J. Delaney,
H. J. Barton Chapple, Wh.Sch., B.Sc. (Hons.), A.M.I.E.E.,
Frank Preston, F.R.A.

ROUND *the* WORLD of WIRELESS

Television Goes Ahead

WE learn that important extensions to the space allotted at the Crystal Palace to the Baird Company will render some important developments possible in the near future. As our readers know, special ultra-short wave transmissions have been taking place from this well-known public building, and a new contract has just been signed under which a certain amount of additional space in the South Tower has been given over to the Baird Company. None of the public portion of the Tower has been utilized, but the extra space will permit of the installation of some new apparatus which will give greater scope for experimental transmission and research work in connection with the ultra-short-wave transmission of vision.

"Time to Spare" Series

WE are informed that the B.B.C. has now completed the investigation into charges made in the House of Commons. Doubt has been cast on the authenticity of the stories told by unemployed persons as a full and fair picture of their circumstances. The B.B.C. is now able to announce not only that the statements as broadcast were correct, but also that there was no omission that could justify the contention that "had the full facts been declared there was no need whatever for there to be any tragedy at all." Correspondence with the Ministry of Labour makes it clear that statements in the House of Commons by the Parliamentary Secretary to the Ministry of Labour were based on misunderstanding.

P.E.N. Club Conference

ONE of the most interesting Scottish events in 1934 promises to be the P.E.N. Club Conference which goes into session in the third week in June. On June 13th, Marian McNeill, the Scottish writer and an enthusiastic member of P.E.N., will give a talk on this important event. Several hundred distinguished literary men from all parts of the world are expected to attend the conference.

Three Counties Show Discussion

ON June 11th, the eve of the Three Counties Show at Hereford, a round table discussion will be relayed to Midland Regional listeners from the Society's offices

on the showground, with a view to bringing out the significance of the event to the community. Two farmers, a representative of the agricultural implement industry, and the secretary will take part. The first Show at Hereford was held in 1798. Worcestershire and Gloucestershire Societies amalgamated with Herefordshire in 1895 and 1922, respectively, and in spite of heavy loss by the flooding of the show-ground at Worcester several feet deep in 1924, the Three Counties has made great progress.

OUR ATOM LIGHTWEIGHT PORTABLE THREE

IS THE SMALLEST
AND MOST EFFICIENT
OF ITS TYPE!

Start To Make It Now!

See Pages 360 and 361

New South African Broadcasting Stations

FURTHER particulars of the new Marconi broadcasting stations at Grahams-town and Pietermaritzburg, mentioned on this page in last week's issue, are now to hand. In accordance with the practice adopted in a large number of modern wireless stations the new transmitters will be built up in the form of a commercial switchboard, on the face of which indicating meters and controls are mounted, while the valves and wireless circuits are installed at the rear. Safety gates on both sides of the "switchboard" front give access to the transmitting circuits. A control desk in front of the transmitter provides a means of

supervising the transmission and the power plant. Both transmitters will have a power of ten kilowatts in the aerial, the maximum undistorted modulation being 100 per cent. The working wavelengths of the stations will probably be chosen between 480 and 530 metres, while the available wave-range covered by the transmitters is 200-545 metres. "Series modulation," a system which is being used with conspicuous success in all the new broadcasting stations designed by the Marconi Company, will be incorporated in their design.

"Bitter Brevities"

SCOTTISH REGIONAL listeners who were not scared away from the microphone, and indeed enjoyed Halbert Tatlock's "Bitter Brevities" when they were broadcast some weeks ago, will be interested to hear that another edition is to be broadcast on June 15th.

Central Council for School Broadcasting

THE Central Council for School Broadcasting entered recently on its sixth year of office. In the absence of the Chairman, Lord Eustace Percy, Dr. W. W. Vaughan, Vice-chairman, took the chair. Dr. Vaughan drew the attention of the Council to the expansion in the programme of broadcasts to schools. It was ten years since the regular service had been started with five half-hour afternoon periods each week; now, the school programme occupied most of the National wavelength between 14.00 (2.0 p.m.) and 16.00 (4.0 p.m.), and for the coming academic year the B.B.C. had also granted a daily period of broadcasting time in the morning programme. The Council received a report from the Executive Committee containing the programme proposals for September, 1934, to June, 1935. New features in the programme are a course entitled "Some Districts of England," which has been specially designed for the smaller rural school; a course for young children on Music and Movement, which will provide the necessary musical background for rhythmic work; and a course of broadcast talks for older pupils on Peoples of the World, which has been planned in response to a widespread request from senior schools for a course which would provide a basis for training in the geographical aspects of world citizenship.

ROUND the WORLD of WIRELESS (Continued)

"Made in the North" Series

THE two concluding talks in this series, from the North Regional, will deal not with the manufacture, but with the distribution of clothes. Accordingly, on June 8th, Mr. A. Biard, manager of a Manchester commercial house, will describe how he, as a home trader, buys goods, principally gloves, from the manufacturers and sells them again to the shopkeepers.

Arcadian Follies Broadcast

ON June 9th, a show by the Arcadian Follies (under the direction of Ernest Binns) will be relayed from the Arcadian Pavilion, Morecambe. This concert party includes: Jimmie Britton (comedian); Evie Carcroft (soprano soubrette); H. Mitchell-Craig (producer and light comedian) Lan Clifford (pianist-entertainer); Marion Thornton (soubrette and dancer); Jim Fitzpatrick (comedian); Les Marrell (light comedian and instrumentalist); The Lund Sisters and Jeffrey (speciality dancers); and Enrica d'Sala (baritone).

Speedway Test Match Commentary

THE first official speedway test match between England and Australia takes place at the Empire Stadium, Wembley, on June 7th. Mr. Bernard C. Holding will describe the contest to London Regional listeners in a relay from Wembley.

New Air Liner's Marconi Equipment

THE illustration on this page shows the new Marconi installation in the air-liner *Scylla*. The equipment is suitable for telephony and C.W. or I.C.W. telegraphy, covering the wave-band of 500-1,000 metres. The power of the transmitter, which is fitted with an independent valve drive to ensure stability of the transmitted frequency, is 160 watts input to the magnifier valves. The receiver is a three-valve instrument with one screen-grid high-frequency stage, a detector, and pentode output. The bottom section of the installation comprises a wave-switching unit which makes it possible rapidly to select any one of four different wavelengths. Another switching unit fitted to the left of the aerial ammeter on the side of the transmitter connects either a fixed aerial or a trailing aerial let out from the aerial winch, visible in the bottom of the picture, to the wireless installation. The apparatus can be operated from the pilot's seat by remote control or by an operator in the wireless compartment. An operating tube with morse key is on the left of the photograph.

"Rallentando"

THE musical extravaganza *Rallentando* will be heard by Midland Regional listeners on June 14th, and the scenes include a palace, a milk-cart, a Parisian night club, an aeroplane, an orange grove, a sailing ship, and the London Zoo. The plot concerns the adventures of the exiled Royal Family of Rallentando. Harold Clemence plays the King; Dorothy Summers, the Queen; Hugh Morton, the Prince; and Alma Vane, the singer with whom the Prince elopes. Victor Hely-Hutchinson conducts the Midland Theatre

INTERESTING and TOPICAL PARAGRAPHS

Orchestra. Bruno Barnabe and Arthur Goulet are the authors of this amusing musical play.

AN AIR-LINER'S RADIO EQUIPMENT.

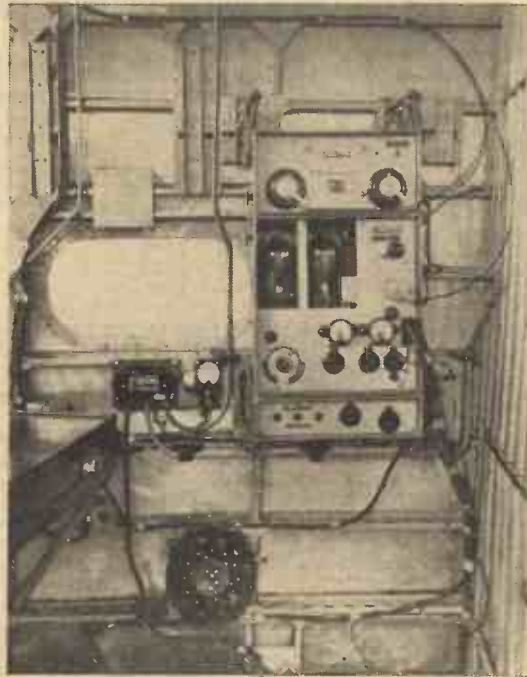

The Marconi combined wireless transmitting and receiving equipment, Type A.D. 41/42 installed in the four-engined Short "Scylla" air-liner.

"The Calendar"

EDGAR WALLACE'S racing comedy, *The Calendar*, will be broadcast to National listeners on June 20th, the microphone adaptation having been made by Barbara Burnham, of the B.B.C.'s drama staff. Producer is Howard Rose.

The action of this play occurs in the period before the alteration of the rules of racing and the rules of Tattersalls affecting disqualifications. *The Calendar* was first produced at Wyndham's Theatre in 1929 and revived at the Lyceum in 1930, with Mr. Wallace as producer. Margaret Bannerman was in the cast. No arrangements have yet been made for the casting of the broadcast version.

Concert from South Devon

A CONCERT from Dartington Hall, South Devon, on June 16th, will be relayed for West Regional listeners. Listeners will hear the Boyd Neel String Orchestra (leader, Louis Willoughby), Marie Korchinska (harp), who will play the *Danse Sacré* and *Danse Profane* for harp and strings by Debussy, and Trude Rittmann (solo pianist). The only amateurs who will take part in the concert are the members of the Dartington Hall Chorus. They are drawn from the Dartington Hall Estate and from the district round, and for the concert they will be approximately a hundred strong. The chorus, accompanied by the orchestra, will sing the choruses from the *Peasant Cantata*, by Bach. The conductor and music director is Ronald Biggs.

Home Life Afloat

AN interesting discussion on the above subject will be broadcast from the Midland Regional on June 13th. Mr. J. M. Anderson, Birmingham manager of one of the leading companies of canal carriers, and Mr. and Mrs. John Cresswell, of the motor-boat *Fox* and the butty boat *Amesbury*, will present a picture of life on canal boats. At sixteen, Mr. Cresswell ran away from home in Birmingham and set out to walk along the canal to London, but near Warwick got a job afloat.

Serenade from Canterbury Cathedral Cloisters

ON the evening of June 12th, London Regional listeners will hear a serenade from the Cloisters at Canterbury Cathedral. For this a B.B.C. Orchestra of forty-two players will be used and Dr. Boulton will be the conductor. The programme consists of Bach (*Brandenburg Concerto No. 4 in G*), Mendelssohn (*Scherzo in G minor*), Vaughan Williams (*The Lark Ascending*), and Schubert (*Symphony No. 5, in B flat*). Marie Wilson is solo violin.

School Choir's Broadcast

A NOTTINGHAMSHIRE school choir, which has won two hundred awards at leading musical festivals, will be heard in the Midland Regional programme from the Victoria Ballroom, Nottingham, on June 14th. This is the High Oakham Central School Choir, founded in 1927 by Harry Smith, music master, who conducts. It has given demonstration concerts by request as far afield as Bolton, Lancashire,

SOLVE THIS!

PROBLEM No. 90.

Jenkins required a fixed condenser of .0002 mfd. capacity for coupling his H.F. and detector stages, but, unfortunately, found that he had not one of this value by him. The shops were closed, and as he wished to try out the circuit he thought of various schemes. He remembered that a coil of wire possesses self-capacity, and after a few moments consideration decided that the required capacity could be obtained by winding a fairly large solenoid with thin wire. This he did, and connected the resultant component in his circuit and switched on. All that happened was that the fuse blew. Why? Three books will be awarded for the first three correct solutions opened. Address your attempts to The Editor, PRACTICAL WIRELESS, Geo. Newnes, Ltd., 8-11, Southampton Street, Strand, London, W.C.2 Envelopes must be marked Problem No. 90, and must be posted to reach here not later than June 11th, 1934.

Solution to Problem No. 89.

When Jarvis wound his coil, although he put on the correct total number of turns, he had connected the wave-change switch too low down on the medium-wave section, and thus had too many turns in circuit when switched over to medium waves. By transferring this tapping point he would have obtained correct results.

The following three readers successfully solved Problem No. 88, and books have accordingly been forwarded to them:—

J. W. Forrest, 7, Hamer Avenue, Blackburn. A. Bloomer, 10, New Street, Baddesley Ensor, Nr. Atherstone. G. F. Warland, 44, Beresford Road, Kingston-on-Thames, Surrey.

WIRES AND WIRELESS

Details are Here Given of the Various Wires Used for Wireless Connections and for Winding Coils.

By W. H. DELLER

THE various wires employed in a wireless receiving system and other apparatus closely linked with it, and for such purposes as carrying current from the mains, are of many different classes. It is, therefore, proposed briefly to describe them within the space of this article and at the same time dispense practical suggestions and hints that may prove helpful when using them.



Fig. 1.—A circular gap-type wire gauge.

What Wire Is

Wire is a product obtained by drawing metal that has been previously rolled to a conveniently small diameter through a series of hardened dies. Each successive die is a shade smaller than the diameter of the preceding one. This difference is equal to the variation between one size of wire and the next smaller size. The drawing process is carried on until the required size is obtained. For small sizes diamond dies are used, the diamond being suitably mounted in a metal holder and a hole of the correct size being drilled through the diamond. As the wire during the operation completely fills the hole in the die the material, within very narrow limits, comes through with a constant cross-sectional area. The difference between one diameter of wire and the next nearest size to it is smaller or larger, as the case may be, by one gauge. This gauge is equal to a certain number, which is governed by the gauging standard employed. Wires in general use in this country are manufactured to correspond to the British Imperial Standard Wire Gauge. For the purpose of this article gauges above No. 16 will not be considered. From No. 16 gauge down to No. 50 gauge there are, including these, thirty-five sizes; they are each designated by a number followed by the letters s.w.g. Thus No. 16 s.w.g. is equal to .064in. diameter or two-thousandths of an inch larger than 1/16in., and No. 50 is .001in. diameter, or one-thousandth of an inch, this being, by the way, finer in diameter than an average human hair.

Wires may be measured conveniently down to No. 26 gauge (.018in. diameter) by means of a gauge of the gap type such as is shown in Fig. 1. To identify a size within the range of the gauge, select a slot which looks near enough to the size of the wire, and enter the wire into that slot. If it goes in, or will not go in, try it in the next size smaller or *vice versa*. The correct gauge size is that indicated against the slot into which the wire passes without forcing. Apart from the difficulties of manufacturing gap gauges accurately below this size, the wires then begin to get too flimsy to handle and also the changes in diameter become very gradual. After No. 30 gauge is reached this change is of the order of tenths-of-thousandths of an inch only, so that measurement must be carried out by means of a micrometer, as in Fig. 2, or by a direct indicating device.

Overleaf is given a table of gauge sizes and corresponding diameters in inches, from No. 16 to No. 50 s.w.g., along with other useful wire data.

Classes of Wire

Wire for electrical purposes falls into one of two broad classes. These are either bare or insulated. The insulation, apart from the composition of the metal, may vary according to the use for which the wire is intended.

Aerial Wire

The generally-accepted standard for this class of wire for an outdoor aerial is that known as 7/22 bare copper and consists of seven strands of No. 22 s.w.g. wire bunched



Fig. 2.—Using a micrometer for measuring fine gauge wire.

together and twisted spirally to form a wire rope, as it were. In an efficient aerial system connection is best made to the lead-in terminal by soldering the end of the wire into a thimble type connector. Bending the end of the wire into a loop for connecting purposes does not provide such a good contact, as the terminal and nut can only engage with the high spots on the wire, allowing water to penetrate between. Corrosion at this point is often a source of crackling noises and should be prevented. By reason of its low resistance value, this wire provides an ideal earth lead.

Bare Copper Wire

This wire is chiefly used for the inter-connecting of units or component parts. When used for this purpose the wire should be obtained in a tinned condition. This is necessary to protect the surface of the wire

and prevent corrosion. The tinning is also an aid where soldered joints are made.

To keep the resistance offered by the wire within reasonably-low limits, a gauge of not lower than No. 18 s.w.g. should be used. On account of the liability of the wire to sag, and as a precautionary measure against inadvertently causing a short circuit, wire of this size must be encased between the terminals in an insulated sleeving.

Heavier gauge wires, such as No. 16 s.w.g., are stiff enough to be self-supporting, and may, with careful spacing and subsequent handling, be fitted in a bare condition. In fact, this method was not so long ago almost universally adopted for wiring up. All joints were soldered with lugs or tags socketed to fit the section of the wire, which was usually 1/16in. square. Crosses or tees were also available, these being made in like manner for use at the junction of a wire or wires with another one.

Insulated Wires for Wiring Up

For this purpose also a wire is manufactured and marketed under the name "Glazite." This is a tinned copper wire encased in a tight-fitting sheathing of hard insulating material. Although hard, the insulation is flexible, and will not crack or peel, even where the wire is sharply bent. The insulation is not fixed to the wire, thus it strips easily for making connections, and will, by marking round with a penknife, taking care not to damage the wire, pull off in the form of a tube. Soldered joints can be made without burning or discolouring the insulation. By using several of the different colours in the range in which this particular wire is made, the various circuits may be easily distinguished.

Where connections are made by forming eyes on the ends of the wire, make the internal diameter of the eye as close to the diameter of the screw thread as possible. The formed end should be put over the terminal screw in such a way that the nut when tightened turns towards the extreme end of the wire. This procedure

(Continued on next page)



Fig. 3.



Fig. 4.



Fig. 5.

Fig. 3.—Flex made up of strands of fine wire.

Figs. 4 and 5.—Showing the single and double-cotton covering as used for instrument wire.

CUTTING OUT NOISES ON THE MAINS

An Interesting Account of Some Experiments Carried Out by the Writer in an Attempt to Eliminate Electrical Interference

By DEREK ARCHER

A PART from noises in the actual receiver, which can be located by various tests which have been outlined in this journal previously, it will be found that the ordinary electrical equipment of the home, such as the lighting and the power circuits, switches, fuses, etc., can be a source of continual trouble.

A mains receiver was installed recently on D.C. mains, and noises were extremely unpleasant and gave considerable trouble until it was decided that equipment outside the receiver was the cause. A first test was made by feeding the receiver direct from the live side of the main fuses, the main switch itself being out; the crackling and hissing entirely disappeared; in fact, the receiver had a perfectly quiet background. The interference returned immediately the switch was put in again. The accompanying diagram shows the entire electrical circuits of the house in question, and the points lettered are dealt with one by one as they occurred in the actual tests. Some of the points seem so minute that it might appear to be unnecessary to deal with them, but it was found that every detail which received attention added its quota towards the reduction of background and other noises. Even the mush, which is generally put down to aerial noise, carrier-wave noise, and valve hiss, was very small, and, in fact, the receiver seemed to have lost its "liveliness," but this was not so as the results proved on test. The decrease in the general background noise was so marked that a number of foreign stations which would normally have been of no entertainment value were really a pleasure to listen to.

The procedure for locating and correcting the faults in the normal electric system of the house were as follows:

Cleaning the Contacts

Having turned off the main switch A and withdrawn the fuses for safety, it was found that the terminals of the main fuses, B, were dirty, corroded, and covered with verdigris. Using an insulated screw-driver where necessary, these were carefully removed from the switchboard, great care being taken to keep the live ends of the cables coming from the meter and the company's fuses, D, separated. (If perfect safety is required, the company's main fuses should be withdrawn, and this usually means a visit from the company's engineer to unseal and reseal the fuse box for you. Using reasonable care, this course can be avoided.) The contacts and the screws of the fuses were so corroded that scraping with a knife or cleaning with emery cloth seemed an endless job, so the violent action of nitric acid was called into use. Feeling that this sort of treatment would be needed on quite a large number of parts, the following equipment was got ready: A stone jam jar with the nitric acid, a pail of very hot water with plenty of soap powder mixed in, a pail of cold water, and an old nail-brush, together with the necessary pieces of rag. The

acid was used outside the house, as the fumes from the acid are obnoxious and corrosive. The fuses, as stated, were unscrewed from the switchboard and all the metal work separated from the porcelain parts. The iron fuse box was given a dust-over, and the grime adhering to the porcelain pieces removed with the hot water and the nail brush, the porcelain then being rinsed off in cold water and dried. The metal parts were attached to a piece of wire and dipped into the acid for about a second, transferred to the hot water, given a good swish round, and then rinsed off in cold water. In most cases the first dipping was enough, but the contact sector plates had to have another dipping. (It is very important when using acid for cleaning to see that all traces of the acid are removed by a really good washing in cold water.) The fuse boxes were again assembled and re-fixed

other parts indicated that the trouble was general. The main switch was therefore pulled out again and the distribution box, E, given attention. It was noticed that the holes in the contact collars, into which the various cables fitted, were of such a diameter that where a thin wire was used, the screw which fitted into the side of the collar failed to grip the wire properly. In such cases the cable end was stripped for a further half inch or so, and the end of the wire doubled back on itself. All the fuses were replaced with new wire and further test made with the receiver. Some improvement was immediately noticed, so the inspection was carried farther.

Earthing to Conduit Pipes

The fuses for each separate circuit were withdrawn one at a time with the receiver switched on to indicate which circuits were giving the trouble and the worst was tackled first. The extra fuses, H, were treated as before, and new fuse wires fitted, but this did not effect a cure. The switch in this circuit was also taken down and

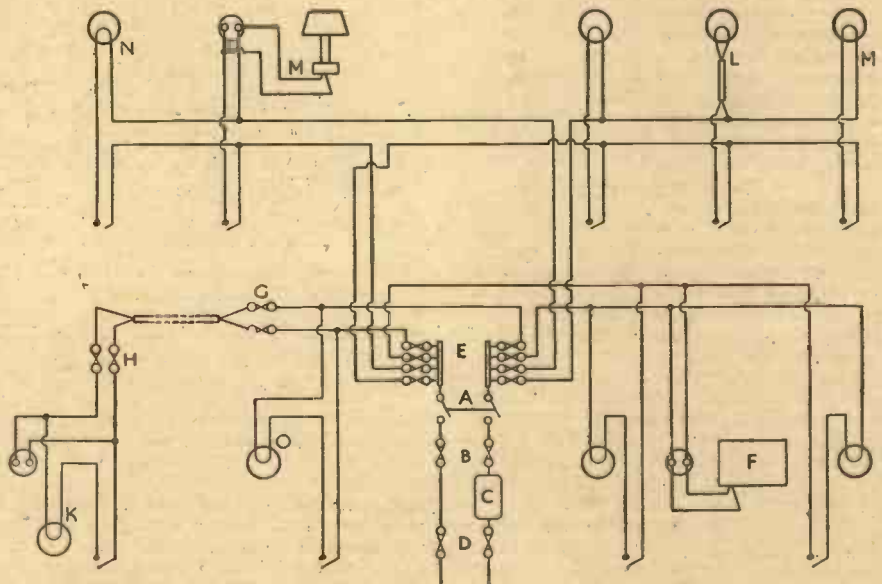

A diagram of the complete mains wiring referred to in the text.

to the switchboard, the actual fuse wires being left out for safety.

The main switch next received similar attention. Excepting that the small springs were not dipped into the acid, the procedure was identical. These springs were washed in paraffin and finally dipped in vaseline. On assembly the switch blades were inspected to see that these made good hard contact with the switch contacts and, where necessary, these were bent until such a condition was obtained. The switch was replaced on the board and the fuses fitted with new wire. A test was made at this stage, but little improvement resulted, and a casual inspection at

properly cleaned, but without much effect. The fault was, after inspection, located in the twin lead-covered lead just at the point where the cable entered the steel tube used for leading the cable under a concrete path and so into the house. Some attempt had been made when the cable was put in to protect the lead covering against the sharp end of the tube, by wrapping adhesive tape round the entrance, but this proved ineffective. The lead covering had worn away by movement, and rain had entered the skin, rotted the tape covering, and perished the rubber. This section of the cable was replaced by a new piece and the junction made well away from the pipe.

THE MASTER MIDGET

The Designer Here Gives Some Further Notes on the Construction and Operation of This Remarkable Little Receiver With Some Suggested Modifications

THERE are several commercial midget receivers of the mains-operated type on the market, but as far as I know, no manufacturer has managed to cater for the battery user. It was left to PRACTICAL WIRELESS to produce the first genuine battery-operated midget set.

I designed the Master Midget with the object of catering for the home constructor who desires an efficient and inexpensive miniature receiver for use where electricity is not available. It is, of course, entirely self-contained, the moving coil speaker, a standard-size H.T. battery, and a generous capacity accumulator being accommodated within a cabinet measuring approximately 5in. by 10in. by 11in.

The constructional details of this little set were given in PRACTICAL WIRELESS of May 12th, but for the benefit of those readers who are about to embark on its construction, I am giving here a few further hints on its assembly and operation.

First of all there are one or two points regarding the wiring. Naturally, with so small a receiver the wiring needs a certain amount of care, but if it is set about in the right manner it is not really difficult or tedious. The whole secret is to leave the joining up of the panel and baseboard, and the erection of the accumulator compartment until after the main part of the wiring is completed. In this way it is much easier to get at the various components to wire them up. When the wiring is completed as far as possible the panel and baseboard are screwed together and the accumulator partitions fixed in place. The few remaining connections between the components on the baseboard and those on the panel can then be carried out.

To make a neat job of the flex leads to the H.T. and G.B. batteries they can be plaited together. Incidentally the best way to make a connection to a terminal with flex is to bare about an inch of the wire, bend this in a loop round the shaft of an awl or the nose of a pair of round-nosed pliers and then, holding the two sides of the loop to twist the awl or pliers round and round. This twists the wires together and leaves a neat round loop when the tool is withdrawn. The loop is then slipped over the terminal.

Connections to the Foil Screen

In connection with the tinfoil shield at the back of the panel, the foil is cut away round the hole for the reaction condenser spindle, that is the hole on the extreme left when looking at the back of the panel, and also round the hole which takes

the wave-change switch spindle—the one at the bottom. The spindle of the tuning condenser is simply pushed straight through the foil and thus makes contact with it. In the case of the filament-switch spindle it does not matter whether this makes contact with the foil or not, since with the particular switch specified the spindle is insulated. Of course, if any other type is employed it is safest to cut the foil away here also, because with many makes the spindle is in direct electrical connection with the switch contacts. In this case, to allow the spindle to touch the foil

the construction of the set you have embodied any other components of different make which you happened to have on hand, you may find the reaction is inclined to be a little "ploppy." A different detector valve or a different transformer, for instance, may produce this effect. In this case a very simple and effective remedy consists in increasing the value of the decoupling resistance. Instead of the 20,000-ohm resistance specified you should use a 30,000-ohm or 40,000-ohm component.

If stations overlap, or the local station can be heard over a large movement of the tuning knob, this can be overcome by unscrewing the knob of the pre-set condenser (inside the receiver beside the tuning coil) a turn or two. Do not screw it out too far, however, or the range of the set will be reduced.

Tone Control

With a midget receiver, you might be led to expect something rather below the average in the matter of quality of reproduction. For instance, you might be quite prepared for the loss of a few notes at either end of the musical scale, combined with the "boxed-in" effect usually associated with small enclosed speakers. On the contrary, however, the reproduction is excellent. There is a very fine response to the higher frequencies, and although the bass does not "boom" out it is certainly not lacking. Speech is particularly well reproduced. Owing

to the careful positioning of the detector valve, which is placed as far from the back of the speaker as possible, there is no tendency towards microphonic noises, while a very rigid panel and baseboard assembly together with a stout cabinet reduces the possibility of unwanted resonances to a minimum.

The over-emphasis of the high notes usually associated with a pentode output valve is compensated for by means of the grid-stopper resistance, R3. The value chosen for this, namely 100,000 ohms, is that which has been calculated to give the most natural tone with the particular valve and speaker specified. However, this particular value is by no means essential and considerable variation in the tone of the receiver can be effected by using other values; thus a 250,000 ohms ($\frac{1}{4}$ megohm) resistance will mean less response to the high notes, so making the general tone appear lower. A lower resistance, on the other hand, will produce greater emphasis of the treble. In this way you can, in a large measure, adjust the tone of the set to suit your own taste. (W. B. RICHARDSON.)

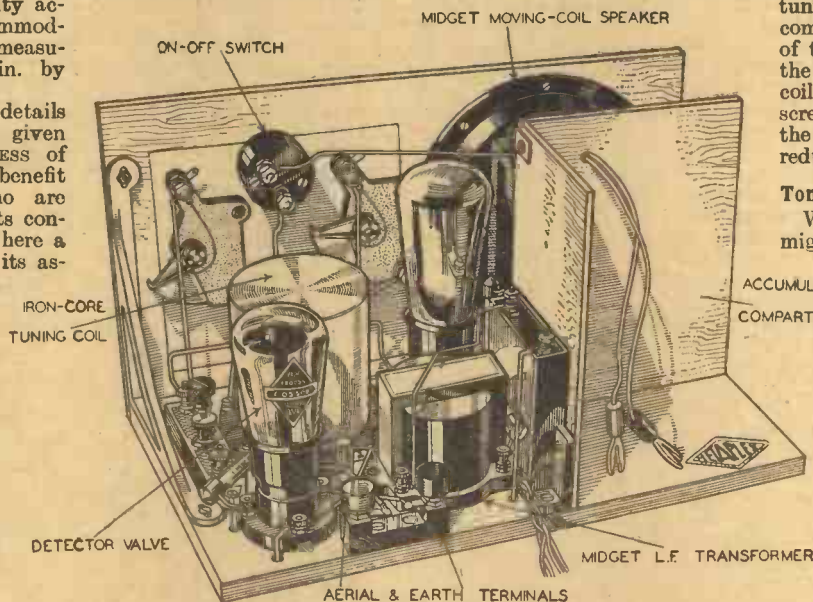

Three-quarter rear view of the receiver, removed from its cabinet, showing the compact layout of the components.

would cause a short-circuit of the L.T. battery.

Tuning Hints

Here are a few final hints on handling your Master Midget after you have switched on for the first time: One of the best ways to search for stations is to turn the tuning knob (the left hand one) slowly through the whole length of its travel, at the same time the reaction control (right hand knob) as far as possible in a clockwise direction without causing the set to oscillate (denoted by whistles and squeaks and distortion of signals). With the reaction knob in this position the set is in its most sensitive condition, and as the tuning knob is slowly turned so the various stations will appear and disappear. The reaction knob should not, however, be left entirely alone while rotating the tuning knob, as it will be found that when tuning-in stations at the top end of the waveband, the reaction knob will need to be turned a little more in a clockwise direction than when tuning to the shorter wave stations at the lower end of the tuning range.

With the original receiver, employing the components specified, the reaction control was particularly smooth, but if in

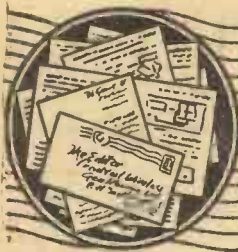

READERS' WRINKLES



A Handy Disc Cutter

ALL that is required for this handy cutter is a length of perforated strip, to one end of which is fastened a short piece of pointed 2BA rod. The other end of the strip is bent to a right angle to which is attached an old safety razor blade, bolted at

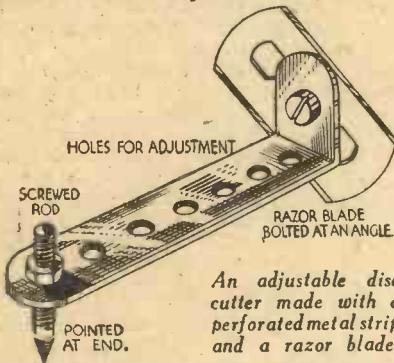

An adjustable disc cutter made with a perforated metal strip and a razor blade.

an angle to allow for cutting, as shown in the sketch. This tool will be found most useful for cutting out loudspeaker cones, television discs, etc., the perforations in the strip allowing discs of various sizes to be cut.—T. D. COULEY (Sunderland).

A Novel Tuning Scale

HERE is a dodge for those who, having built their own receiver, wish to give it the advantage of a professional looking scale, calibrated with names of stations, and transparent for rear illumination. The method described is for use with a pointer and rectangular panel indicator, but it is easily adaptable to others, such as sliding cursor, drum, etc.

A piece of white card is placed in the panel behind the pointer and a station tuned in, a dot is then made behind the pointer, and then the name of the station is cut from any suitable published list of wavelengths and pasted on to the white card at the side of the dot. This procedure is followed in the case of as many stations as it is possible to identify, and by this time it will doubtless be possible to fix points for all stations likely to be received. The next step is to remove the card and have it photographed on to a film of the same size (any photographer will do this for a small fee). The film is then

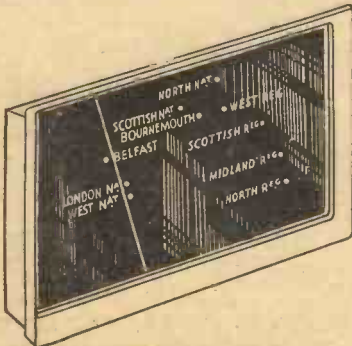

A novel illuminated tuning scale.

THAT DODGE OF YOURS!

Every Reader of "PRACTICAL WIRELESS" must have originated some little dodge which would interest other readers. Why not pass it on to us? We pay £1-10-0 for the best wrinkle submitted, and for every other item published on this page we will pay half-a-guinea. Turn that idea of yours to account by sending it in to us addressed to the Editor, "PRACTICAL WIRELESS," George Newnes, Ltd., 8-11, Southampton Street, Strand, W.C.2. Put your name and address on every item. Please note that every notion sent in must be original. Mark envelopes "Radio Wrinkles." Do NOT enclose Queries with your Wrinkle.

placed on the receiver in the place of the white card and with the pilot lamp behind one sees the names of the stations in neat white letters on a black background. It is, of course, desirable to see that the film is developed for plenty of contrast so as to obtain a good black.—E. GREENWOOD (Stockport).

A Combination Lock for the Receiver

HERE is an idea of my own which might be of interest to other readers. It is a secret radio lock which keeps unauthorized persons away from my radio. As will be seen from the attached drawing, the lock only opens when the dials are set

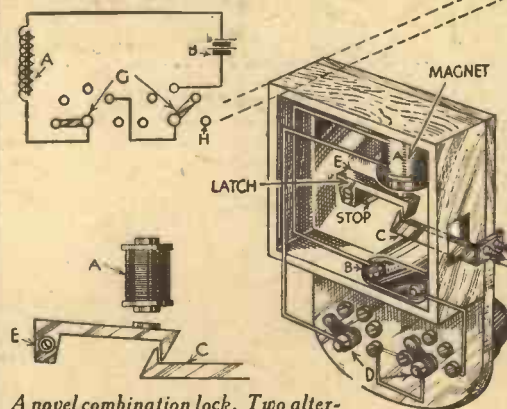

A novel combination lock. Two alternative methods of wiring are given.

at the right combination. Two dry cells B operate the magnet. The two knobs have contact arms fitted and these make connection with a series of studs. Connections can then be arranged so that the complete battery-magnet circuit is made only when the two knobs are in pre-determined positions. All necessary constructional details are given in the accompanying sketch. It might also be added that the electro-magnet may, if desired, be taken from an old bell.—J. YOUNG (Inverness).

An Improved Lead-in

HAVING to take a wire through the roof of my workshop recently, I made up an efficient lead-in from two ceiling rose covers, a length of 2BA screwed rod, some 2BA nuts, and terminal heads. I first drilled a hole about 7/16 in. in the roof. The screwed rod is passed through the hole

and one ceiling rose cover is screwed on the inside, and the other on the outside of the roof, as shown in the sketch. A couple

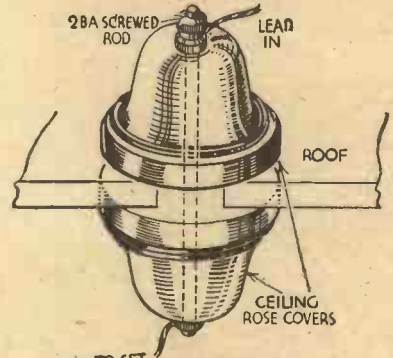

A handy lead-in arrangement.

of terminal heads secure the lead-in, and also the flex to the set.—A. A. JENKINS (Monmouth).

Ganging Two Condensers

THIS idea is more easily applicable to sets having a sub-panel, but it could also be utilised in sets without one by making a cover for the gears. The parts required are two gear wheels, and a short spindle which should exactly fit a discarded push-pull switch frame, and a coil of thin wire round the end of the short spindle so that the knob will fit tightly in place. The accompanying illustration shows the complete assembly quite clearly.—J. C. FIELD (Redditch).

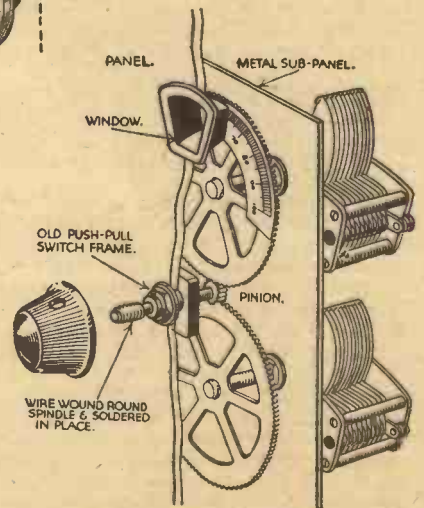

A method of ganging two condensers.

READERS' WRINKLES

(Continued from previous page)

A Baffle-board with Spring Suspension
HAVING had a lot of trouble with my speaker, I made the baffle-board shown in the accompanying sketch, which solved the problem. It is made in the form of a fire-screen and can be moved into any room. The board is a piece of seven-ply, 2ft. 6in. square, with a hole in the centre for speaker. The frame is made of 1in. square wood, with feet cut from a piece of wood 2in. by 9in. by 4in. The baffle is

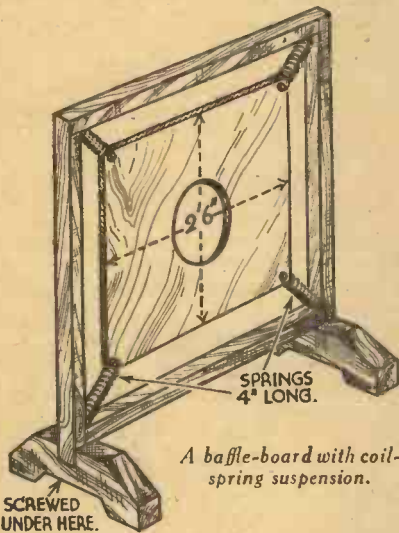

A baffle-board with coil-spring suspension.

held with four small coil springs, with rubber tape over them to prevent any unwanted noises that might be set up.—**H. OLIVER** (Primrose Hill, Co. Durham).

Strip-light Device for Mirror-screw Scanner
HAVING constructed a mirror-screw scanner, a strip of light about 6in. by $\frac{1}{2}$ in. became necessary for its operation, and this is how I overcame the problem. A second-hand motor head-lamp reflector,

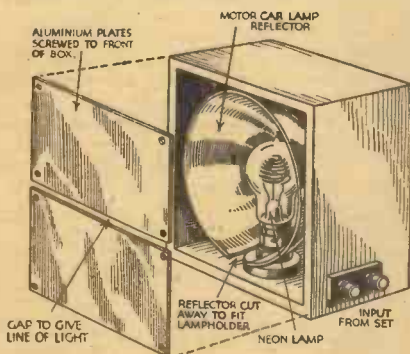

A strip-light device for a mirror-screw scanner.

of the spun-metal type, was obtained, and a portion cut away to allow an ordinary beehive neon lamp to be placed as far in the reflector as possible. Then a box was constructed from $\frac{1}{2}$ in. plywood to house the reflector, as shown in the illustration. The slot is formed by two pieces of sheet aluminium screwed on the front of the box, and separated by a space equal to the width of light line required. The inside of the aluminium is polished, and terminals are provided for connection to the receiver. This light source gives a well-lit picture 2in. wide by 4 $\frac{1}{2}$ in. high. The accompanying illustration shows the complete device.—**G. E. CARDEN** (Folkestone).

An Improved Variable Resistance

A MAKESHIFT graded variable resistance can be made by shunting a potentiometer of the straight-line type by a fixed resistance of about equal value. The maximum resistance of the combina-

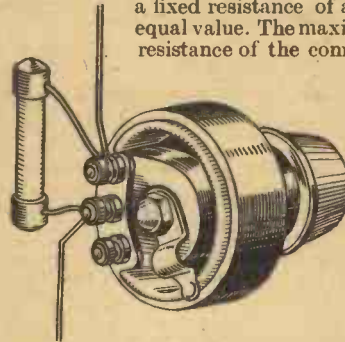

Adapting a potentiometer for use as a variable resistance.

tion is then about half that of each component separately. The variation in resistance is between that given by an ordinary variable resistance and a graded type. The connections are shown in the accompanying illustration.—**A. GOODALE** (Wandsworth).

Another Improved Microphone

WHEN giving a recital of gramophone records, with the radiogram and speaker placed in different rooms, the possession of a microphone is a decided advantage. If a suitable one is not at hand,



A simple improvised pick-up.

a fairly efficient substitute can be improvised from the pick-up and a match-box cover. The latter is simply impaled on the needle of the pick-up, as shown in the sketch, during the intervals in the recital. Announcements are made with the mouth placed close to the match-box cover.—**S. RAINEY** (Wishaw).

Re-centring a Speech Coil

WITH some of the cheaper and lighter makes of moving-coil speakers it is sometimes extremely difficult to re-centre the speech coil by any of the well-known methods. In some cases the magnet and speech coil are not out of centre, but "out of parallel" due to the chassis having been distorted by unequal screw pressure, warped baffle, or other defect of mounting. The following method can then be tried with advantage: The fixing bolts or screws of the magnet plate should be slackened off one at a time, and a small feeler gauge, which can be a small finger

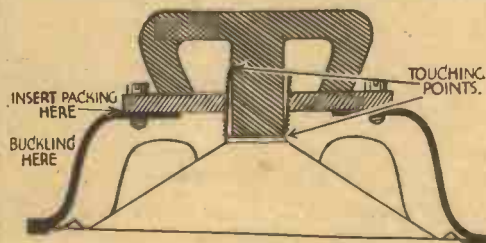

Re-centring a speech coil.

of copper or brass foil, tried between plate and chassis, at the slackened corner. If the feeler can be inserted without pressure then the gap should be packed with foil either in single pieces, or folded as many times as necessary to fill the gap, and as close to the fixing bolt as possible. It may be found necessary to pack under more than one place, but great care should be taken to tighten up each bolt or screw before slackening off the next.—**W. H. GEDDES** (Manston).



SCREW FOR ATTACHING TO BASEBOARD

A novel stand-off insulator.

Novel Stand-off Insulator
THE accompanying illustration shows a novel but efficient stand-off insulator, made from an ordinary glass salt-pourer which can be obtained for twopence at any of the cheap stores. The hole in the base can be drilled with an ordinary twist drill with the aid of turpentine and camphor for lubrication. The hole takes about a minute to drill.—**E. ROBINSON** (Newport).

Repairing a Bakelite Knob

THE bakelite trimmer knob of my two-gang condenser broke owing to the grub screw being tightened too much, the broken part being that which took the strain of the nut on the grub screw. To preserve the appearance of the set it was essential to mend the knob, and the usual glues and cements would not stand the strain. A good repair job was made as follows: A piece of sheet iron was cut with a hacksaw and filed to a cross shape, as shown in the sketch. Holes were drilled in it for the grub screw and the spindle so that when the arms of the cross were bent down round the bakelite centre the grub screw and its nut would fit in under the

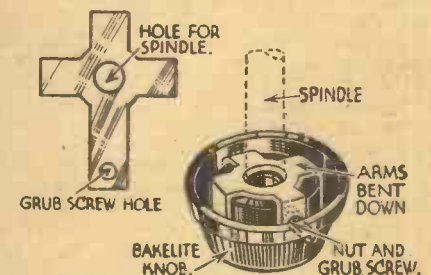

Method of repairing bakelite knob.

long arm. The grub screw hole might with advantage be threaded, though I did not do this. By suitably bending the arms the claw can be made a tight fit over the bakelite centre of the knob, and then the strain is taken evenly by the whole moulding and the broken piece is cemented on with a thin layer of liquid cement.

Although used for a trimmer knob, the idea is applicable in similar circumstances to many other kinds of knobs.—**V. W. HETREED** (Old Windsor).

THE PRACTICAL MOTORIST
 3d. EVERY WEDNESDAY 3d.

RADIO OUT-OF-DOORS

Some Suggestions for Using the Ordinary Receiver in the Open Air

By FRANK PRESTON

WITH the approach of summer weather interest in wireless reception is rather liable to fall off. The reason is that, instead of sitting by the fireside in the evenings, most folk prefer to get out into the open air, spending the time in the garden or on the tennis court. But anyone who is really interested in listening need not forgo his pleasure in this respect simply because most of his time is spent in the open air. It is a perfectly simple matter to extend the speaker leads so that the loud-speaker can be taken into the garden, and even if the distance happens to be fifty feet or more there need be no difficulty if the proper method is adopted.

The proper method is to couple the speaker on the choke-capacity principle if this form of connection is not already employed in the set itself. The usual system to be followed in adding a choke-capacity output filter to an existing receiver is to connect a good low-frequency choke in place of the speaker to the appropriate terminals on the set, a lead then being taken from that speaker terminal which is connected to the anode of the output valve to one side of a large-capacity (1 to 4 mfd.) fixed condenser. The speaker is then connected between the other side of the condenser and earth. Needless to say, the choke should be so chosen that it matches the output valve, and it should therefore have a rated inductance of about 40 or 75 henries

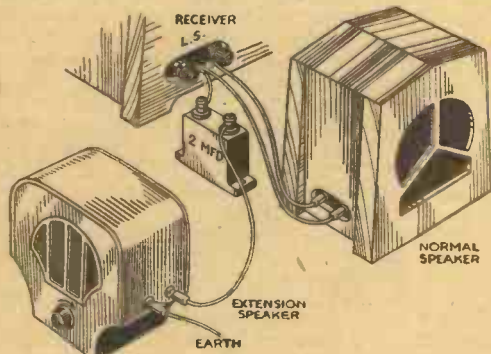

Fig. 1.—This diagram shows how a single extension lead will suffice for the extra loud-speaker.

respectively, for power or pentode valve, when carrying the normal anode current.

A Single-wire Speaker Extension

By following this method of connection it will be seen that it is only necessary to take a single lead from the set to the speaker, because the earth-return connection can be obtained at the speaker "end" by making contact with a short metal spike pushed into the ground (see Fig. 1).

If two speakers are available, or when the normal speaker is a fixture inside the set, the primary winding of one speaker (assuming it to be a moving-coil instrument) can be used in place of the choke previously mentioned. Should it then be desired to put the inside speaker out of action it will be necessary to disconnect one of the leads from the secondary of the coupling transformer to the speech coil. In many cases

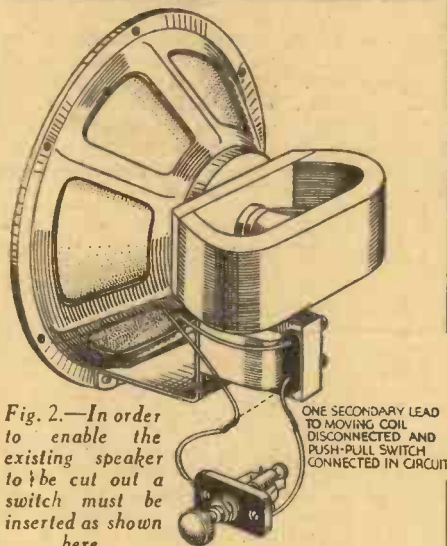

Fig. 2.—In order to enable the existing speaker to be cut out a switch must be inserted as shown here.

this lead will be soldered at both ends so that it will have to be cut as shown in Fig. 2; when that has been done it will be found most convenient to fit an ordinary push-pull switch for connecting or disconnecting the inside speaker when required. The method of arranging this is also shown in Fig. 2, and it should be mentioned that the wire from the speech coil must be left quite slack so that there will be no tension or "pull" on the diaphragm.

Tone and Volume Control

Those who have not previously used a loud-speaker out of doors will probably find that reproduction appears very "thin" and rather high-pitched; this is because the sound reflection that is normally obtained from the walls of the room is absent. The obvious manner in which to overcome this difficulty is to fit some form of tone control or, at least, a high-note filter. Methods of doing this have been previously described, but it might be mentioned that the simplest one is to connect a .01-mfd. condenser in series with a 50,000-ohm

variable resistance between the speaker terminals. These components can most conveniently be mounted in the speaker itself, as shown in Fig. 3.

Some means of varying the volume at the speaker "end" will also be desirable, and it might be pointed out that a few simple methods of doing this were described in an article in the issue of PRACTICAL WIRELESS dated March 10th, 1934. The simplest one of all is to connect a potentiometer between the "supply" leads and the speaker terminals, also fitting a fixed condenser to prevent high-note cut-off at low volume levels. Fig. 4 is an illustration reproduced from the latter article, and this

shows a neat unit for connection between the speaker and the set for obtaining control of both tone and volume without having to touch the controls of the receiver.

Just as when the speaker is used inside the house, it is desirable to see that it is placed in the best position, since slight alterations might affect the tone of reproduction to an appreciable extent. Generally it will be found best to place the speaker in a corner between two walls or fences, or just inside the summer house or pavilion. Where there is a pond the speaker should be as far away from this as possible since the water has a "deadening" effect.

Taking the Set Outside the House

When it is desired to listen out of doors

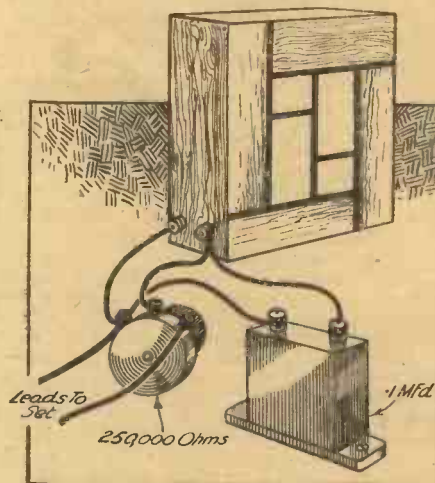

Fig. 3.—A tone-control or high-note filter.

without taking a long lead for the speaker, or if it is found that the extension introduces too great a loss in volume, it is usually a simple enough matter to move the set itself. If it is of the transportable variety with a built-in frame aerial there will be no difficulty at all, but otherwise some kind of temporary aerial should be rigged up. Incidentally, it might be suggested that if the set is to be used, say, in the garden

(Continued on next page)

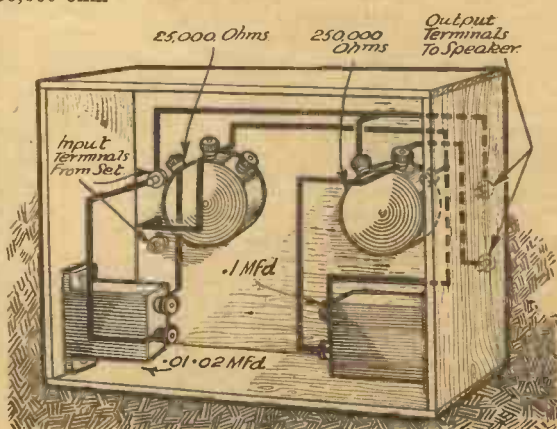

Fig. 4.—A combined tone and volume control unit.

RADIO OUT-OF-DOORS

(Continued from previous page)

fairly regularly it will be worth while to erect a second permanent aerial; this will not make it necessary to take out another licence, as many people believe, provided that both aerials are on the same premises and used by the same household.

There are a number of ideas which can be used for makeshift aerials, the simplest of which is a connection to a wire fence or to an iron railing. Simply scrape a bright place on the metal and tie a piece of wire round it, or even use a large paper clip with a length of wire attached. A very obvious method of "erecting" an aerial is to sling a length of insulated wire, with a small

weight attached, over the bough of a convenient tree.

An earth lead seldom gives rise to any trouble, because it is simple enough to solder a length of wire to a metal spike which can be pushed into a spot of (preferably damp or clay) soil. If there is a stream running nearby an excellent earth connection can be obtained by throwing a length of bare wire into the water. When an aerial cannot very easily be provided a good earth connection, taken to the aerial terminal, will prove to be an excellent substitute. When using this idea the normal earth terminal will be left disconnected.

In The Car

Those readers who travel by car and who

wish to take the standard wireless set with them can do so quite conveniently and, although the set cannot be used whilst the car is in motion (at least, not without fitting special suppressor resistances and so on), it will function very satisfactorily when the car is not in motion. An aerial might be provided by sticking one of the "adhesive tape" type of aerial materials round the outside of the roof, whilst the chassis will provide an excellent counter-poise earth. The earth lead can be bound round the brake pedal rod, or it may be properly attached to any of the chassis bolts, or even to one of the studs which hold the top of the gear box in position.

TO many amateurs, the mains transformer is merely a convenient and economical means whereby one can obtain the power to feed the heaters of their valves and supply them with the necessary high-tension. In actual fact, this important component is a highly specialized product, and a few of the lesser known aspects of transformer design are worthy of serious consideration by the constructor who uses or intends to use A.C. mains for power supply.

The general principles of the transformer are well known; if we wind a primary winding of, say, 1,000 turns and a secondary of 100 turns, the secondary voltage will be one-tenth that of the primary; if the secondary has 2,000 turns, its voltage will be twice that of the primary. The actual number of turns on the primary has to be calculated to conform to a certain ratio of "turns-per-volt"—and then certain corrections have to be made.

Two Forms of "Loss"

The two chief causes of loss in a transformer are "iron loss" and "copper loss." "Iron loss" is the general term given to losses in the iron circuit due to hysteresis and eddy currents and is partly overcome by "laminating" the core into thin sheets insulated from one another in order to reduce, as far as possible, the eddy currents that tend to circulate in the core itself; hysteresis losses are reduced by using a suitable alloy for the laminations. The most common alloy in use to-day is what is known as "silicon-iron" and consists of iron that has had a small percentage of silicon (among other things) introduced into its composition to achieve, as far as possible, the desired magnetic state and, at the same time, increase the D.C. resistance of the material in a further effort to reduce eddy current losses.

"Copper losses" are due entirely to the resistance of the windings. It is an unfortunate fact that when we wind a coil we introduce resistance, and when we pass current through the coil, power is dissipated in the form of heat. In the case of the power transformer, it is obvious that the external load will cause current to pass through the windings, and—if we know the resistance of the winding and the magnitude of the current, it is possible to calculate the "copper loss" according to the well-known equation $\text{Watts} = \text{Current}^2 \times \text{Resistance}$. Another source of loss is that due to leakage of flux. In other words, the lines of force due to the current flowing in the primary do not all travel round the iron circuit, but some of them "stray," as it were, into the air and represent loss—but we shall discuss this later.

Transformer Efficiency

Now let us consider the transformer from the efficiency point of view. It is obvious that the user has to pay for losses in hard

NOTES ON POWER TRANSFORMERS

Some Interesting Details Concerning the Mains Apparatus. By R. S. ROBERTS

cash. With large power transformers the efficiency is usually high and in the region of 99 or 99.5 per cent., which means, of course, that 990 or 995 watts output will be obtained with 1,000 watts input; the small transformers so popular in most modern radio sets and power units generally have a lower efficiency than this and, though the actual figure varies over wide limits according to the actual manufacturers, are usually in the region of 80-95 per cent. At first sight these figures do not appear to be bad, but before we can make use of the efficiency figure for purposes of calculating running costs of the receiver or power unit there is another factor to consider—the rectifier. The rectifier has impedance (another name for its resistance) and, as we pass all the D.C. current through this impedance, we obviously have another source of loss. The effective efficiency of the combination of transformer plus rectifier varies over very wide limits, due to (a) various makes of transformers differing in efficiency, and (b) variations of rectifier impedance due to make or type (i.e., valve or metal). With a transformer of reliable make and a valve of average efficiency, we can expect an overall efficiency in excess of 70 per cent. The use of metal rectifiers gives overall efficiencies that differ widely according to the method of use adopted, i.e., half-wave, voltage doubler, bridge, etc.; some methods are not as efficient as using a valve, but others are more efficient.

For the sake of example let us now consider a typical 3-valve A.C. receiver in the light of the above remarks. Let us suppose that the power unit, when the set is running under normal conditions, delivers 40 m.A at 250 volts; this is 10 watts for our H.T. supply, to which must be added 12 watts for supplying the heaters of the three valves, and 4 watts for the valve rectifier filament, giving a total consumption of 26 watts. We have seen that this represents only about 70 per cent. of the actual power drawn from the main, therefore we have to pay for some 37 watts.

Careful Transformer Design

From the point of view of iron and copper losses it will be obvious that the designer of a power transformer requires considerable experience in order to arrive at an effective compromise between the amount of iron and the quantity of wire required for a given output. If he attempts to reduce copper losses by reducing the amount of wire

(i.e., by making the turns-per-volt figure too low) he will increase the iron loss and produce an excessive "stray" field with a risk of introducing hum into adjacent components by induction; any effort to reduce iron loss by an increase in the amount of wire gives rise to overheating and bad regulation.

"Regulation" is the term given to the drop in voltage produced at the output terminals on the application of a load. Every transformer suffers from regulation—although it varies in degree according to the manufacture and type, and for this reason it is not advisable to under-run a transformer. It is often assumed that if a transformer is rated at, say, 4 volts at 5 amps. it can do no harm to take only 2 amps. from it; this is true as far as the transformer is concerned, but the voltage rise due to regulation may be harmful to the valves. Whilst it can often be taken for granted that half an ampere either way will not upset the voltage to a very great extent, the manufacturers should be consulted whenever it is proposed to run a transformer at outputs other than those specified.

Most transformers are now fitted with a screen over the primary winding and some amateurs are not clear as to what advantages, if any, this offers. A number of power supplies have a large high-frequency content imposed on the usual working frequency (say 50 cycles), which passes through the power unit into the receiver and causes interference or hum that is sometimes difficult to remove. This form of interference is not transferred from the mains by pure transformer action owing to its high frequency, but passes from the primary to secondary by means of the capacity existing between the windings; an earthed screen between the primary and the other windings is a very effective cure.

Fuses

Finally, a word about fuses. All mains equipment should be fitted with fuses to safeguard apparatus in the event of short circuits or similar overloads. Fuses in the primary of a mains transformer cannot be regarded as satisfactory because they have to be large enough to withstand the heavy surge current that sometimes flows at the instant of switching on. Probably the most vulnerable part of the receiver from the point of view of breakdown is the high-tension circuit, and the fuse or fuses should be inserted in this circuit preferably in the H.T.—lead or centre tapping of the H.T. section on the transformer; a condenser breakdown for instance would then cause the fuse to blow and afford complete protection to the rectifier and the transformer. The fuse should be rated to blow at 50-100 per cent. greater than the normal working current.

WIN £1 A WEEK FOR A YEAR
10/- A WEEK FOR A YEAR
£10 CASH - OR ONE OF 25 OTHER VALUABLE PRIZES!

Free! **SIMPLE! EASY-TO-WIN!!**
CASH PRIZE
COMPETITION

OPEN TO ALL

Have you entered yet?

MILLIAMPS

0-6 milliamps.
 0-30 "
 0-120 "

VOLTS

0-6 volts.
 0-120 "
 0-300 "

OHMS

0-10,000 ohms.
 0-60,000 "
 0-1,200,000 "
 0-3 megohms.



40/-

● DEFERRED TERMS IF DESIRED.

This invaluable instrument gives you the getting of better performance. It gives you the testing facilities of an expert with the accuracy that enables the expert always to get best results.

THE AVOMINOR
TRADE MARK
TEN TESTING INSTRUMENTS IN 1

THE AUTOMATIC COIL WINDER & ELECTRICAL EQUIPMENT CO. LTD.

WINDER HOUSE, DOUGLAS STREET, LONDON, S.W.1.

Phone: Victoria 3404-5-6-7.

Life runs all the smoother for some extra cash. You can easily win some, too. Just your natural, usual interest in radio can bring you a welcome windfall in a way that will at the same time give you a greater radio enjoyment.

Simply by utilising your interest in the performance of your set, you can win a valuable prize and more than enjoy the winning of it.

Ask your nearest radio dealer for particulars and free Entry Forms for the novel Avometer competition.

Free and open to all, it gives you a rare chance of tuning in to the spare money that you could do with, or winning one of twenty-five prizes that every radio man needs.

Get an Entry Form to-day. You don't have to be technical or even particularly clever. Here is an easy and exclusively radio way of winning a prize.

POST THIS COUPON FOR FREE ENTRY

If you have any difficulty in obtaining Entry Forms, post this coupon to:

THE AUTOMATIC COIL WINDER & ELECTRICAL EQUIPMENT CO. LIMITED.
 WINDER HOUSE, DOUGLAS STREET, LONDON, S.W.1.

I enclose stamped addressed envelope for Free Entry Form and full particulars of the Avometer competition.

NAME.....

ADDRESS.....

W.W.2.

OPERATING ATOM LIGHTWEIGHT

This Ultra-efficient Receiver is Very Efficient

A Full-size Blueprint was Given



Neatness and small size; compare the size of the receiver with that of the valves.

LAST week you were given all the necessary information for building the "Atom," and no doubt many readers have by now completed the constructional work and are ready to give the set its preliminary trial. The first thing is to fit the midget speaker into the cabinet; this is practically essential, because much of the speaker's efficiency depends upon the correct baffle effect of the containing case. If you fitted long speaker leads to the set it will be a simple matter to connect them to the soldering tags provided on the unit. On the other hand, if the leads fitted were short ones (they need be no more than about 12in. to reach from the set to the speaker when these parts are fitted into the carrier) they should be extended temporarily by twisting a couple of lengths of d.c.c. wire to them. The idea of this is that it will be better in the first place to give the set a trial before finally fixing it into the case.

LIST OF COMPONENTS

Two Wearite Iron-Cored Universal Coils (Type I.C.6).
 One British Radiogram Two-Gang Solid Dielectric Variable Capacitor (C1, C2).
 One Bulgin "Senator" L.F. Transformer (Type L.F.12).
 One Wearite "Junior" H.F. Choke.
 One Polar .00015 mfd. Diff. Reaction Condenser (C6).
 One T.M.C. .01 Tubular Fixed Condenser (C3).
 Two .0002 mfd. Tubular Fixed Condensers (C5, C7).
 One .1 mfd. Tubular Fixed Condenser (C4).
 One 1 mfd. Fixed Condenser (Type 25) (C8).
 One Ferranti 500-ohm Half-watt Resistance (R1).
 One 1,000-ohm Half-watt Resistance (R2).
 One 20,000-ohm Half-watt Resistance (R4).
 One 1 megohm Half-watt Resistance (R3).
 One Bulgin Rotary On-off Switch (Type S91).
 Two Bulgin 3-point Q.M.B. Switches (Type S87).
 One Peto-Scott Aluminium Chassis, 8½ x 5½ x 2½.
 Two British Radiogram Long Component Brackets.
 One British Radiogram 2½in. Component Bracket.
 Two 4-pin Clix Chassis Type Valveholders.
 One 5-pin Clix Chassis Type Valveholder.
 Length of Goltone Double Screening Lead.
 Flex, Wander Plugs (H.T.—, H.T.1, H.T.2, L.T.— and L.T.+).
 One Petrix 90 volts H.T. Battery.
 One 4.5 volt Grid Bias Battery.
 One Exide 2-volt Accumulator (Type PY4).
 One Rothermel Midget P.M. Speaker.
 Three Cossor Valves, 220 S.G. (Met.), 210 Det. (Met.), 220 H.P.T.
 One Peto-Scott Atom Cabinet.

Next, you can insert the valves into their correct holders. Looking at the set from the front, the valve on the left is the 220 S.G., that at the back on the right is the pentode, and the third is, of course, the 210 Det. detector. Connect the screened lead to the anode terminal on top of the S.G. valve, and attach

H.T.+1 going to the screening grid of the first valve, being inserted into the 50-volt socket and H.T.—2 into the 90-volt socket. These voltages have been found to give best results in the original receivers built in our laboratories, but it might prove worth while to experiment with different voltages for the H.T.+1 tapping.

Switch on the set by turning the left-hand rotary switch knob in a clockwise direction, and turn the two centre switches to either their long- or medium-wave positions. The escutcheon plates with which these switches are supplied are marked "Long" and "Short" at the top and bottom respectively, so it will be obvious in which direction the toggles should be moved. Although rather obvious, it should be mentioned that it is absolutely essential that both switches are turned to the same position, because otherwise nothing will be heard.

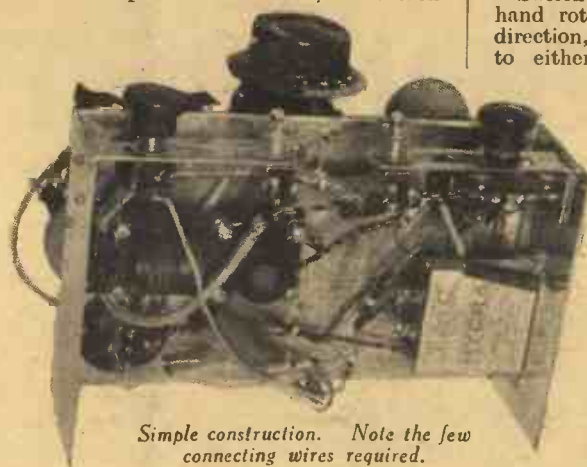

Simple construction. Note the few connecting wires required.

either a proper aerial lead-in or a length of insulated wire to terminal 3 on that coil which is mounted on top of the chassis. It might also be desirable, in the first place, to connect an earth lead, although this is by no means essential. When used, the earth should be joined either to the metal chassis, or to terminal 4 on the top coil; alternatively, it can be connected to the negative accumulator terminal, after the latter has been connected to the appropriate spade terminal.

Simple Tuning

Now turn both tuning-condenser scales to zero (that is, with the condenser plates fully out of mesh) and, if necessary, alter the position of one knob until the 0-180-degree scales coincide with each

Battery Connections

All the battery leads are clearly marked by means of the wander plugs, so no difficulty will be experienced in joining them up to the H.T., L.T., and G.B. batteries. The two L.T. wires should be joined to the positive and negative (red and black) terminals respectively on the accumulator, whilst the G.B. wander plugs should be inserted in the positive and 4½-volts negative sockets of the small grid-bias battery. The H.T. negative wander plug should, of course, be inserted into the negative socket on the high-tension battery, the plug marked



Another view of the "Atom," which shows the clean component lay-out and simplicity of wiring.

ING THE EIGHT PORTABLE

Easy to Build and Just as Simple to Use
 Free with Last Week's Issue



The "Atom" weighs only 18 pounds and can be carried with ease.

other. Turn the right-hand (reaction) knob slowly in a clockwise direction until a faint "pop" indicates that the set is oscillating. After that the two tuning knobs can slowly be rotated together until a whistle is heard. Immediately reduce the reaction setting, and slightly re-tune until the station is heard clearly. At first, the re-tuning can be done by turning both knobs together, but when signals have in that way been brought to their maximum strength the two knobs should separately be moved slightly in each direction. When this has been done it will be found that the two knobs can then be kept in the same relative positions whilst other stations are being searched for. When necessary, an effective trimming effect can be secured by operating the smaller (central) tuning knob by itself; this will only be found necessary when receiving comparatively weak or more distant stations.

Reaction Control

The reaction control will be found very useful, and, although sensitive, its operation is very smooth so that the set goes into and comes out of oscillation very gradually. If this does not appear to be the case when testing the set, it will be desirable to modify the screening-grid voltage by moving the wander plug marked H.T.+1 into higher- and lower-voltage tapping sockets on the H.T. battery.

Once the receiver has been properly tested and found to be functioning satisfactorily it can be fitted into the carrying case. It slides into position along two narrow runners, whilst the accumulator must be stood alongside the speaker unit. Remember to attach the throw-out aerial wire to terminal 3 on the coil before finally fitting the set into its position, and also, if desired, fit an earth terminal. As

explained last week, the latter may simply consist of an ordinary, uninsulated terminal secured in a hole made through the chassis. As an alternative, a short length of flex, similar to that used for the aerial, can be attached to terminal 4 on the coil and brought, along with the aerial wire, through the hole in the back of the cabinet.

Connect up the accumulator, and then fit the plugs into the H.T. battery before inserting this into the case. The battery

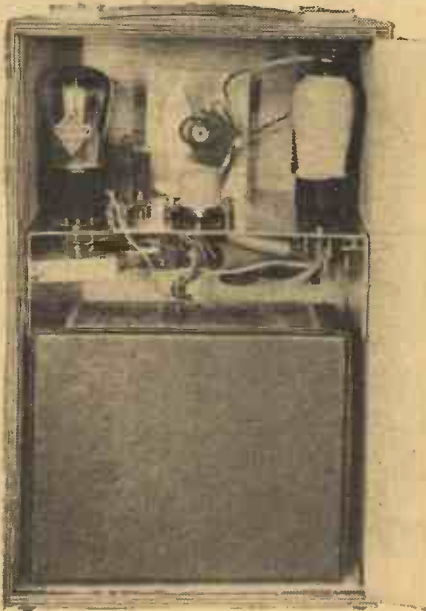

This illustration shows how very little waste space there really is when the "Atom" is fitted into its cabinet.

must be placed with the sockets toward the speaker, since if they face outward the wander plugs will prevent the back of the cabinet from closing. The grid-bias battery is connected last of all, and can be laid either on top of the H.T. battery or between the battery and the speaker in the bottom of the case.

Aerial and Earth

When used with the throw-out aerial wire (a piece of rubber-covered flex from 10ft. to 30ft. long), the method of operation will be exactly the same as that described above, but if the earth connection is dispensed with, as it might well be, reaction control will prove to be somewhat more critical. For this reason alone it is worth while to make use of an earth connection where a convenient earthing point is available. When the set is used out of doors or in the garden, the earth connection can well be dispensed with, and the aerial wire may simply be laid along the ground or slung over the bough of a tree. Instead, it might be laid along the top of a nearby fence. In any case, reception will be slightly better when the aerial wire is elevated to a certain extent, and, just the same as with an orthodox aerial, the greater its height the better will results be.

Should it be found that instability, hand-capacity effects, or fierce reaction operation are experienced, the wiring should be examined, and the positions of the connecting leads compared with those which can be seen in the photographs of the original set. As we pointed out last week, the positions of the wires were carefully chosen and experimented with: consequently, they should be duplicated as nearly as possible. It might also be stressed that it is very important that the screening braid used for some of the connections should be effectively "earthed"—that is, connected to the H.T. negative circuit. Despite what has just been stated, it is most unlikely that any trouble will be experienced, since there is so little that can possibly go wrong. Do not, however, under any circumstances, deviate from any of the components listed, for if you do trouble is almost certain to follow. The parts used and specified were chosen with great care, and having regard not only to their physical, but also to their electrical dimensions and properties.

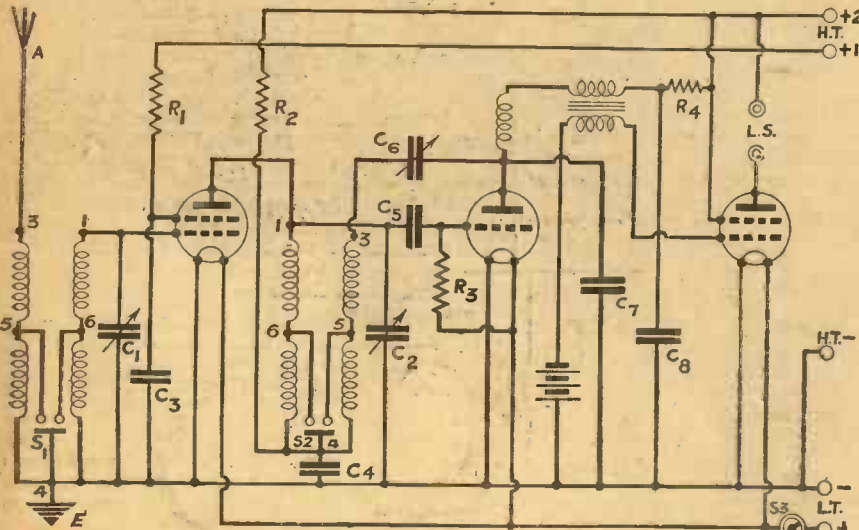

The circuit is also very straightforward, as can be seen from the above drawing.

Practical Television

SUPPLEMENT TO PRACTICAL WIRELESS

JUNE 9th, 1934. Vol. 1. No. 23.

TELEVISION SCANNING WITH CATHODE-RAY TUBES

By H. J. BARTON CHAPPLE, Wh.Sch., B.Sc., A.M.I.E.E.

WHENEVER a cathode-ray tube is to be employed as a television receiver, two essential factors arise. First of all, the cathode-ray or electron beam must be made to scan the fluorescent screen in a manner exactly similar to the exploring spot undergoing its pre-determined path at the transmitting

having a regular and uniform rise in valve up to a certain pre-arranged limit, followed by a sharp fall to the initial value, the cycle being repetitive. They are termed "linear" time bases owing to the linear effects that they produce, and in a cathode-ray tube used for television reception two of these are necessary so that they can be connected to the two pairs of ray-deflectory plates of the tube's electrode system, one giving the line-traverse periodicity, while the other gives the picture periodicity.

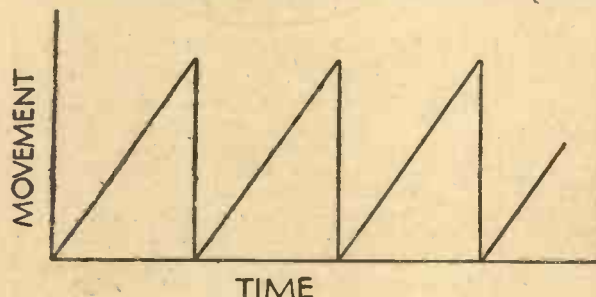

Fig. 1.—The "saw-tooth" movement of the television scanning spot.

end. In the second place, the intensity of the spot fluorescence seen on the screen must, at every instant, vary in exact accordance with the degrees of light and shade produced by the subject being transmitted.

The second factor is a modulation problem concerning which some notes appeared recently in these pages, but with the first item it is necessary to carry out, by wholly electrical methods, a duplication of an original mechanically-produced movement. If the reader recalls the normal scanning process, say of the present thirty-line B.B.C. transmissions, there is a vertical movement of the scanning spot, and when this spot reaches the end of its upward scan there is a "quick return" to the bottom of the "field" where the spot begins its vertical movement all over again in a path similar to that just described. This is called a "saw-tooth" movement owing to the steady and constant-velocity upward movement, coupled with the extremely rapid return stroke (see Fig. 1) and the scanning effect has to be repeated 12½ times per second.

Naturally, there are several ways of producing the line or strip frequency (375 in the case of the B.B.C. television service or 4,500 for the recent demonstrations of 180-line television), and the picture-sequence frequency, but the most common, and incidentally the simplest, is to employ what are termed electrical time bases.

Time Bases

These time bases produce a voltage variation of definite form, the potential

sensibly constant over a reasonably wide range of voltages. This current flows into the condenser C and, since the potential or voltage across a condenser is proportional to the charge in it, and in this case the current flow is constant, the voltage across it rises uniformly with time.

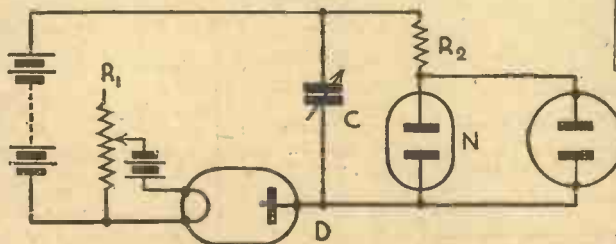

Fig. 2.—A simple form of electrical time base.

This process goes on until a voltage value is reached at which the gas in the neon tube N suddenly ionizes and allows a current to pass.

This current is momentarily so heavy that the condenser is discharged completely down to a value at which the neon lamp discharge extinguishes. The charging process then begins all over again and the slow rise and sudden drop

in potential across the neon lamp between the striking and extinguishing voltages of the neon lamp is maintained periodically as long as the battery lasts.

In order to prevent disintegration of the gas and electrodes in the neon tube a resistance R2 is inserted in series with it, this being done at the expense of lengthening slightly the back-stroke time of the time base. In addition, to vary the periodicity of the cycle action, a filament rheostat R1 and a variable condenser at C are usually employed, although within a specific range either of these controls alone is sufficient to yield a variation in periodicity.

Using a Gas-filled Relay

The pair of deflector plates of the cathode-ray tube which are connected across the neon lamp thus have a uniformly increasing potential applied to them, and this has the required effect of deflecting the cathode ray or electron beam across the screen. When the condenser discharges, the beam returns almost instantaneously to its initial position only to make the journey over again. The time of the traverse of the beam is controlled by the time constants of the condenser diode circuit.

In the time bases used for much of the practical work now being done with cathode-ray tubes, the ordinary neon tube N, shown in Fig. 2, is replaced by a gas-discharge relay or thyatron. This device functions in a manner similar to an ordinary three-electrode valve, except that once the anode has been made sufficiently positive or the bias on the grid has become insufficiently negative, a current between cathode and anode commences to flow, which is stopped by the reduction of the anode voltage to a very low value. A circuit employing a device of this character is shown in Fig. 3, the gas-filled relays normally used being either neon or mercury-vapour filled. They are capable of passing a discharge current of 0.6 ampere peak value without any sensible disintegration of the cathode.

DEFLECTOR PLATES OF CATHODE RAY TUBE.

Teaching by Television

ALTHOUGH it has been suggested and even demonstrated occasionally that television can be applied for teaching purposes, it has been left to America to conduct a long series of experiments in this connection. The work has been undertaken by the State University of Iowa, the transmissions having been effected through the radio station W9XK. Dr. E. B. Kurtz has drawn up an interesting report in which he pointed out that the student was easily able to imagine himself in the classroom with the Professor in front, either writing on the blackboard, talking, or using pictures and models to illustrate lectures.

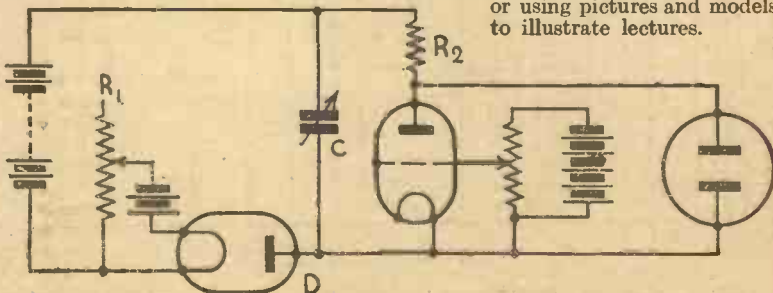

Fig. 3.—Substituting a gas-filled relay for the neon tube in a time base.



THE EASY ROAD TO RADIO

THE BEGINNER'S SUPPLEMENT

ADDING ANOTHER SPEAKER

Although Apparently a Simple Matter, the Addition of a Second Speaker Calls for Some Consideration, and the Points Involved are Discussed in this Article.

It is often a great advantage to be able to run a second loud-speaker from your set—to extend your radio to boudoir, nursery, or kitchen. On the face of it this is simple enough—merely a matter of running a piece of flex from the receiver to the extra speaker. However, on examining the matter closely, you will find that it is not quite so straightforward as all this, and several little problems present themselves. The addition or removal of a second or third speaker is bound to alter the working conditions of the receiver. For instance, if the output stage of the set is carefully matched with a certain speaker the sudden addition of another reproducer, even if of identical type with the first, will inevitably alter the load and upset the original matching. This will result in two things—a reduction in the volume and an alteration in the quality of reproduction.

The Effect on Volume and Tone

The reduction in volume is only what might be expected. After all, you cannot get something for nothing, and obviously the power provided by the set will have to be divided between the two speakers. Fortunately, however, the average modern set is rarely run at full power, so that any reduction in volume due to the increased load of an extra speaker

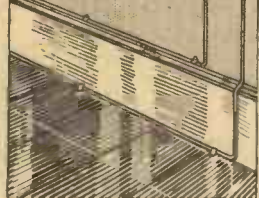

Fig. 2.—How to place speaker leads to avoid self-capacity.

can be compensated for by a turn of the volume control. The only thing to guard against is the use of two speakers of widely differing impedances, which would result in the one being starved at the expense of the other.

The easiest solution of the problem occurs when the two speakers are to be permanently connected to the receiver. If this arrangement is decided upon when building the set, two speakers can

be correctly matched. First of all, note the optimum load required by the output valve, and then order two speakers each with an impedance of twice this figure.

The two speakers are connected in parallel, as in Fig. 1. With this arrange-

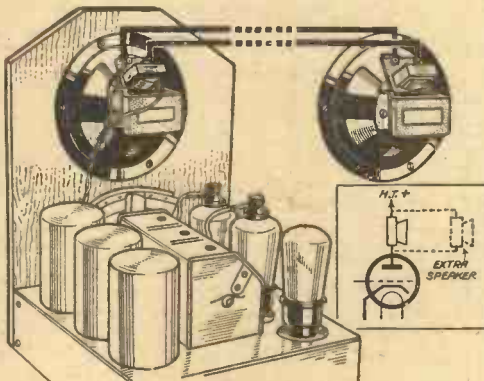

Fig. 1.—An extra speaker of similar type connected in parallel with the one in the receiver.

ment, which, incidentally, is preferable to connecting them in series, the total impedance across the two speakers is half that of one, hence the reason for having them each of twice the normal figure. As an example, suppose the load required by the output valve is 4,000 ohms. In this case two identical speakers of 8,000 ohms would be required. Actually, the matching is not critical, so that two speakers of, say, 10,000 ohms impedance would also be quite suitable.

Overcoming Self-capacity of the Leads

There is only one drawback to this arrangement, which is that if very long leads are used for the extension speaker the self-capacity of the leads may be sufficiently large to cause a weakening of the high notes.

In this case, instead of using the customary twin flex for the extension, separate leads of bell wire or flex spaced apart will overcome the difficulty. Fig. 2 shows how the self-capacity of the leads can be reduced to a negligible amount by running one wire along the top of the skirting and the other along the bottom.

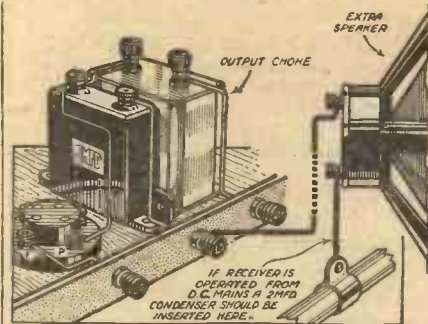

Fig. 4.—A pictorial representation of the circuit in Fig. 3.

High-note loss due to the self-capacity of the leads is entirely ruled out if choke-capacity output is used in place of direct coupling. This method is now quite common, and is illustrated in Figs. 3 and 4. There is just one warning, however: if the set is operated from D.C. mains, the connection from the extra speaker to earth must be made through a good condenser of 1— or 2—mfd. capacity, as shown. Omission of this condenser may lead to the full voltage of the mains being placed across the two speakers.

The methods just described are ideal so long as both speakers are connected up, but it may not always be desirable to have the two switched on. See what happens if one speaker is removed. First of all, it will cause an increase in the output from the remaining one, although the power will not be anything like twice what it was previously. The other effect will be a slight reduction of the high-note response. With receivers fitted with a tone control this can be quite easily corrected, but in any case is not very pronounced.

Adjusting the Load Automatically

The increase in power may prove an annoyance when, say, the speaker which is most remote from the set is working at comfortable loudness and the local speaker is suddenly switched off. To reduce the volume from the distant speaker to its original level obviously necessitates a journey to the receiver to alter the volume control. However, this adjustment can be carried out automatically if the method shown in Fig. 5 is adopted.

A resistance is connected so that the action of removing the local speaker introduces the resistance into the circuit and by-passes the extra power which

(Continued overleaf)

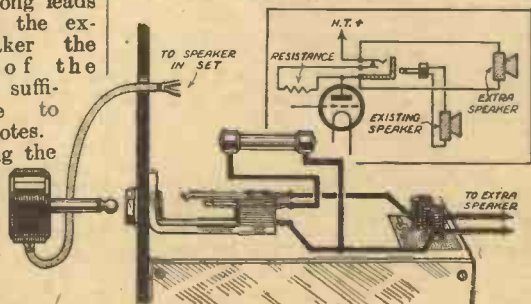

Fig. 5.—Arrangement for automatically adjusting the load when one speaker is switched off.

(Continued from previous page)

would otherwise be fed to the remaining speaker. A simple closed-circuit jack is mounted on the panel or other convenient part of the receiver and connected to the resistance and to the output terminals of the set. The original speaker is disconnected from the output terminals and

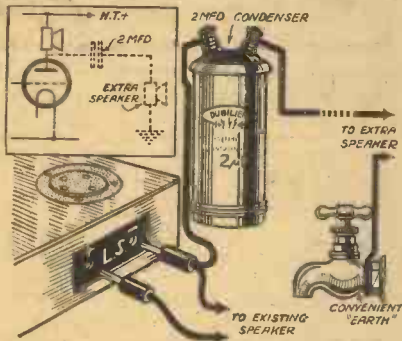

Fig. 6.—Ingenious method of connecting an extra speaker, using the existing speaker as a choke.

joined by a flex lead to the plug. It can then be switched on or off by the insertion or removal of the plug. A suitable value for the resistance is the same as the A.C. resistance (impedance) of the speaker it replaces.

The device just described is quite effective as a means of automatically adjusting the volume when one speaker is removed, but does nothing to correct the slight alteration in tone which occurs when one speaker only is working. In fact, it has a tendency, if anything, to increase the attenuation of the high notes, since the impedance of a speaker rises with increase in frequency. Thus on the higher notes the impedance of the speaker is greater compared with that of the resistance, and so less current flows through the speaker and more through the resistance. On the low notes, however, the impedance of the speaker is less; therefore more current passes through the speaker and less through the resistance. The result is that less power is obtained from the speaker on the high notes than on the low ones.

TOPICAL TECHNICALITIES

TUNING INDICATORS.

WITH the increased employment of automatic volume control circuits it is becoming essential to provide an indication when a receiver is tuned exactly to the frequency of a transmission in order to obtain undistorted signals. The reason is that the A.V.C. arrangement reduces the strength of a signal in order to prevent overloading, and, therefore, as the tuning adjustment is removed from the actual resonant point the H.F. amplification would be increased (through the medium of the A.V.C. device) and consequently the side-bands at that part of the tuning adjustment would receive over-amplification as compared with the side-bands on the other side of the fundamental. To avoid this, a device is usually fitted into the circuit to show when the resonant point is attained. In its simplest form it may consist of a milliammeter arranged in the anode circuit, or in the biasing circuit, to indicate the correct position. Instead of a meter, some form of electrically-operated mechanism may be used, and this may take the form of a small electro-magnet which operates a shutter arranged in front of a lamp; a magnet to move a small mirror and thus cast a varying light area on a small window or panel; a glow from a neon device which varies with the signal, etc. A receiver which is so fitted may be tuned in silence from one station to another, with the certainty that when the exact point is finally obtained, the volume control may be slowly adjusted to bring the volume up to the desired strength without distortion.

By means of a slightly more elaborate arrangement than that shown in Fig. 5, it is possible to introduce tone correction. The idea is to use, in place of the resistance, a choke of similar characteristics to the disconnected speaker; that is, one whose impedance, like that of the speaker, increases with frequency. Experiments with an old loud-speaker unit, the remaining winding of a burnt-out transformer, or a pair of discarded headphones from which the diaphragms have been removed, naturally suggest themselves. A combination of a variable resistance and one of these improvised chokes connected in series can sometimes be made to match the characteristics of the speaker which they replace with a fair degree of accuracy. Thus when the local speaker is disconnected this choke device is introduced, and both the volume and quality from the distant speaker remain appreciably as before.

When fitting an extra speaker to a set which already contains a properly matched speaker, the best thing to do is to buy an extra speaker of the same

impedance as the one in the set, and to connect it in parallel with it. Admittedly, this arrangement is not ideal, since the load will now be only half what it should be, but it is the best possible under the circumstances, and the load will at least be divided equally between the two speakers. Parallel connection is preferable to series connection on the grounds of quality of reproduction, for any defects in the reproduction from one instrument tends to be transmitted to the other when they are joined in series. With direct coupling the method of connection shown in Fig. 1 will be applicable, while with choke-capacity coupling the circuit of Figs. 3 and 4 is suitable.

Another circuit which can be used with direct coupling is shown in Fig. 6. It is quite simple, and combines the advantages of both direct coupling and choke-condenser coupling. The only extra component needed is a fixed condenser of about 1—or 2—mfd. capacity. Although the existing speaker is directly coupled, the extra speaker is choke-capacity coupled.

AERIALS 6—

Various Types of Indoor Aerials and Earths

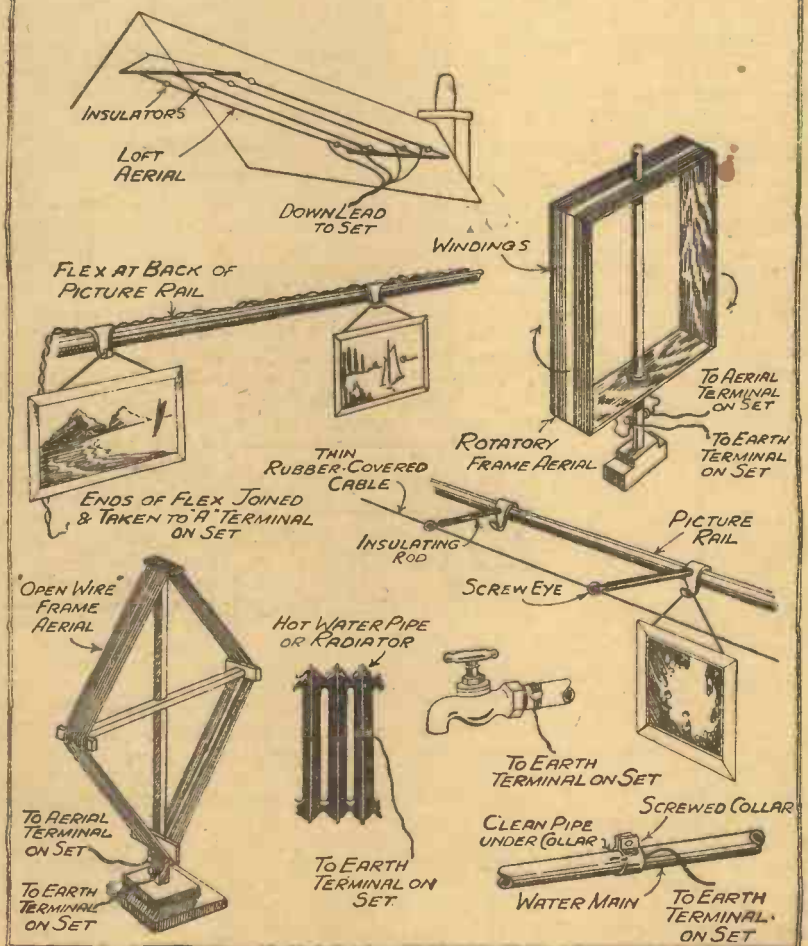



By the Editor.

Exide Goes to Scarborough

THE record number of 750 delegates and guests will attend the fourteenth Annual Exide Battery Convention, held by the Chloride Electrical Storage Co., Ltd., at Scarborough, from June 12th to 14th, among them being representatives from Australia, South Africa, India, Germany, France, Holland, Belgium, and the Netherlands. The headquarters of the Convention will be at the Royal Hotel, where the morning business sessions, devoted to discussions and the reading of papers, will be held, the Convention being opened with an address by Mr. D. P. Dunne, Managing Director of the Company and Chairman of the Convention. On Wednesday, June 13th, his Worship, the Mayor of Scarborough, Councillor G. K. G. Pindar, and other notable guests, will attend the official Reception and Banquet at the Olympia Ballroom, which will be followed by a cabaret entertainment and dancing. The cares of business will be relieved by a number of social and other functions, among them being the Exide Golf Challenge Cup.

Budapest's Combined Mast and Aerial

THE new 1,005ft. mast of the Budapest broadcasting station is now well known, but it is not generally realized that it is both mast and aerial, there being no other aerial than the "mast" itself, which is directly connected to the "Standard" 120kW. transmitter. The masts that support the usual form of aerial become charged and cause a strong wave propagation in the upward directions, which gives rise to fading. The "mast-aerial" at Budapest is claimed to have only small radiation above the horizontal.

Uses of Cathode-ray Tubes

CATHODE-RAY tubes are in general use for testing purposes in modern radio factories. As would be imagined, considerable use is made of C.R.O. tubes in the Cossor factory, where they are used to check frequency curves of superheterodynes, to mention only one of the numerous uses.

Frequency Extremes of the Tympani

WHEN the deep roll of the tympani is heard from the loud-speaker, the happy owner probably never dreams that its true reproduction is dependent on the ability of the set to handle the treble faithfully. The lower tympani requires a range of 65 cycles to some 5,000 cycles for perfect reproduction.

Micro-condenser in Aerial Lead

WHEN the bottom of the short-wave dial is feeble, connect a very small condenser from aerial to grid, about .000025 mf. will do very well; this value can now be bought as standard.

Noise Caused by Rubbing Pipes

A COMMON but obscure source of noise is that caused by two pipes rubbing together, particularly if one of them happens to be connected to the earth terminal of the receiver. The cure is to use a direct earth, and if trouble is still experienced, the only thing to do is to put a piece of leather or other suitable material between the pipes where they touch.

Cossor's New Factory

OWING to the greatly increased demand for their products, Messrs. A. C. Cossor, Ltd., have been compelled to enlarge their production plant by a five-storey factory at Highbury. When the building is finished and the plant installed, work will be available for over 1,000 workers, which is a very worthy reduction, by one firm, in the number of unemployed persons in this country. The new building, which will have 60,000 square feet of floor space available for manufacturing plant, will have the following imposing list of materials used in its construction: 500 tons of British steel girder; 10,700 square feet of glass; 10,000 feet of steel conduit; 28,000 feet of electric cable, and 42,000 hollow blocks for flooring. The illustration on this page shows the steel constructional work of the new building.

NEW COSSOR FACTORY

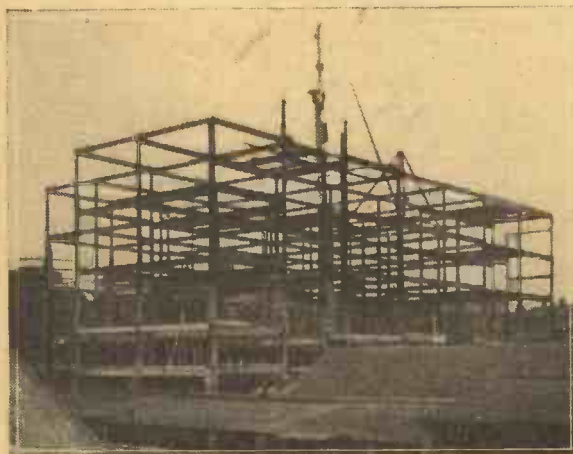

A general view of the steel girder work for the new Cossor Radio Factory.

Mains Rediffusion of Broadcasting

WE are informed by British Insulated Cables, Ltd., that this company, in conjunction with Captain P. P. Eckersley, late Chief Engineer of the British Broadcasting Corporation, have developed a system of electrical mains rediffusion of broadcast matter. The system utilizes the electricity supply wires of a householder's installation, and removes the necessity of attaching the special wires to his house required by existing methods of broadcasting by wire.

PILOT AUTHOR KITS
Exact to Specification

IMPORTANT Miscellaneous Components, Parts, Kits, Finished Receivers or Accessories for Cash, C.O.D. or H.P. on our own system of Easy Payments. Send us a list of your wants. We will quote you by return. C.O.D. orders value over 10/- sent carriage and post charges paid (GREAT BRITAIN ONLY).

ATOM LIGHTWEIGHT PORTABLE KIT "A" or Yours for **5/-**

Author's Kit of first specified parts, including **Peto-Scott READY-DRILLED**, polished and lacquered Aluminium Chassis as specified. Cash or C.O.D. Carriage Paid, **£217s. 6d.**

Deposit 4/- and balance in 11 monthly payments of 5/3

- KIT "B"** as Kit "A" with set of 3 specified valves, but less Cabinet, Speaker and Batteries. Cash or C.O.D. Carriage Paid, **£4 16s. 6d.** or 12 monthly payments of 8s. 0d.
- KIT "C"** as Kit "A" with Valves, Cabinet and Speaker, but less batteries. Cash or C.O.D. Carriage Paid, **£8/15/0**, or 12 monthly payments of 12/6.

KIT "C.B." As Kit "A" but including Valve, Speaker, Cabinet and all batteries. Cash or C.O.D. Carriage Paid, **£7/17/6**, or 15/- Deposit and balance in 11 monthly payments of 14/3.

PETO-SCOTT "ATOM" CHASSIS
Peto-Scott READY-DRILLED, polished and lacquered aluminium chassis, 8 1/2" x 5 1/2" x 2 1/2", as specified. Cash or C.O.D. **7/6**

SPECIAL "ATOM" C.O.D. PARCEL
Comprising: 1 B.R.G. Two Gang Solid Dielectric Variable condenser
1 Peto-Scott Aluminium Chassis 8 1/2" x 5 1/2" x 2 1/2", ready drilled **17/-**
2 B.R.G. Long Component Brackets
1 B.R.G. 2 1/2" Bracket **Post Paid.**

★ For Detailed List of Parts see our announcement in last week's issue. ★

PETO-SCOTT AGAIN CHOSEN



The "ATOM" Lightweight Portable," Cabinet has been specially designed by Peto-Scott for compactness and lightness. Made from finest Walnut faced 5-ply, with contrasting Walnut inlays, beautifully finished in French-polish. **17/6** Carriage and Packing 2/6 extra.

BLUE SPOT "STAR" MOVING-COIL SPEAKER. Send Complete with universal matching transformer. Cash or C.O.D. Carriage Paid, **£3/10/0**, Balance in 11 monthly payments of 6/6. **6/6** only

BLOCK PLATE-LESS ACCUMULATORS, 120 volts. Half the weight and half the size. Finished in coloured bakelite. Cash or C.O.D. Carriage Paid **£3/15/0**. Balance in 11 monthly payments of 7/- **7/-** only

NEW W.B. P.M.4A MICROLODE PERMANENT-MAGNET SPEAKER, complete with switch-controlled multi-ratio input transformer. Cash or C.O.D. Carriage Paid, **£2/2/0**. Balance in 7 monthly payments of 5/9. **5/9** only

NEW ROLA CLASS-B PERMANENT MAGNET MOVING-COIL SPEAKER AND AMPLIFIER. Complete with Valve and Input Transformer. Two models: "A" for PM2B, PD220, and 220B; "B" for 240 Band HP 2 (state which when ordering). Cash or C.O.D. Carriage Paid, **£3/11/0**. Balance only in 11 monthly payments of 6/6. **6/6** only

PETO-SCOTT CO. LTD.
77 (PR.9), CITY ROAD, LONDON, E.C.1
Telephone: Clerkenwell 9406/7.
West End Showrooms: 62, High Holborn, London, W.C.1.
EST. 1919

Do You Know What This Graph Means?

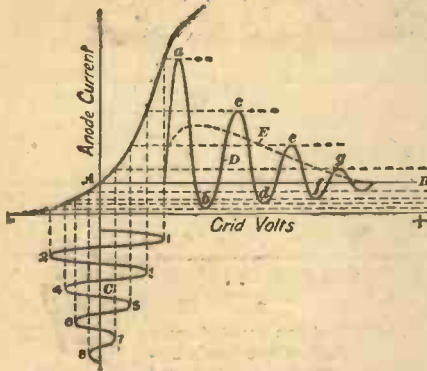

The man who can analyse these curves and understand what they indicate knows his job. But if they do not convey to him perfectly definite information, it would appear that he needs more training than he has had. He is not competent to fill a responsible position in wireless.

Radio has developed so rapidly throughout the last ten years that it has now greatly outgrown the supply of technically qualified men required for the better posts. Moreover, it continues to develop with such speed that only by knowing the basic principles can pace be kept with it.

The I.C.S. Radio Courses cover every phase of radio work. Our instruction includes American broadcasting as well as British wireless practice. It is a modern education, covering every department of the industry.

OUR COURSES

Included in the I.C.S. range are Courses dealing with the Installing of radio sets and, in particular, with their Servicing, which to-day intimately concerns every wireless dealer and his employees. The Operating Course is vital to mastery of operating and transmitting.

There is also a Course for the Wireless Salesman. This, in addition to inculcating the art of salesmanship, provides that knowledge which enables the salesman to hold his own with the most technical of his customers.

We will be pleased to send you details of any or all of these subjects. Just fill in, and post the coupon, or write in any other way, stating which branch of Wireless interests you—the information you require will be forwarded at once.

International Correspondence Schools, Ltd.,
Dept. 94, International Buildings,
Kingsway, London, W.C.2.

Without cost, or obligation, please send me full information about the Courses I have marked X

- COMPLETE RADIO
- RADIO SERVICING
- RADIO EQUIPMENT
- RADIO SERVICING AND SALESMANSHIP
- WIRELESS ENGINEERING
- WIRELESS OPERATORS

Name.....Age.....

Address.....

PRACTICAL LETTERS FROM READERS

The Editor does not necessarily agree with opinions expressed by his correspondents. All letters must be accompanied by the name and address of the sender (not necessarily for publication).

Extremely Handy

SIR,—My Tool Kit to hand safely, and for which I thank you very much. The Kit is everything that other readers have said about it, and which I can only reiterate. It will be extremely handy to anyone who suffers from "thumbs!"—R. M. ROSS (Alness, Ross-shire).

A Really First-class Gift

SIR,—I received one of your PRACTICAL WIRELESS Pocket Tool Kits, and they certainly come up to the high standard of PRACTICAL WIRELESS. I congratulate you on the production of a really first-class gift.—E. MYERS (Johannesburg, S. Africa).

"A Very Handy Book"

SIR,—I have received my copy of "Everyman's Wireless Book" and desire to express my thanks for same. It is certainly a very handy book, and the information contained therein is, I think, very useful and helpful and should be in the hands of every wireless enthusiast.—H. P. SINGLETON (Blackpool).

A South African Reader's Comments

SIR,—I have taken PRACTICAL WIRELESS from No. 1 and find it an excellent paper. The Data Sheets have been extremely useful, especially those dealing with wire gauges and power transformers. The "Constructor's Encyclopaedia" is also an extremely useful book.

I wonder if you are aware of the fact that a British short wave or, better still, a short and medium set is practically unobtainable in South Africa. More than 80 per cent. of the dealers stock American superheterodynes, usually of the cheap variety, that is in construction and performance though not in price, which is exorbitant.

I would like to make the following suggestion re PRACTICAL WIRELESS. Could the Short-wave Section be conducted in the same manner as the Television Section, by including a series of articles on faults.

My present set is a high-class superhet, and out of five hours daily listening I put in four hours to the Daventry transmissions, commencing at 5 o'clock G.M.T., just in time for the news.—B. BURMESTER (Benoni, Transvaal, S. Africa).

Our Encyclopaedia in Iraq

SIR,—Many thanks for the "Encyclopaedia" and Data Sheets safely received; they certainly provide a quick and ready reference and are very well compiled. I find them particularly useful as they provide more up-to-date information than the various text books one has collected from time to time. I have just completed the design for a short-wave all-electric radiogram for particular use in this country, and if it comes up to expectations I will send along results.—A. J. MOORE (Hinaidi, Iraq).

New Chassis System

SIR,—I think you will be interested to know that arrangements have been made

for the supply of a sectionalized uniform chassis system which will be produced by Messrs. Colvern, Ltd. This system should be of value to constructors, as it enables a set to be built which is more comparable with a commercial article. The system includes a number of standard size brackets and plates, and also paxolin strips with eyelet tags, to form sub-assemblies.

The system is by no means a perforated metal scheme, but it utilizes only a few standard parts which are found to be convenient for the construction of most types of modern sets.—P. D. TYERS (Watford).

An Overseas Reader's Appreciation

SIR,—I have been a reader of PRACTICAL WIRELESS since Volume 3, and I find it so interesting that I have ordered my bookseller to get me all the back copies of Volumes 1 and 2. PRACTICAL WIRELESS is worth more than 3d., but to your overseas readers its value will be much more enhanced if you can see your way to increase the Short-wave Section. You have designed the Luxus A.C. superhet, the Leader 3, etc., for the special benefit of your home readers, so what about a special set for overseas constructors, who are mainly interested in short waves. An all-wave set, incorporating the latest improvements, will be very much appreciated by us. It can either be a straight circuit or superhet—A.C., D.C., and battery types. Our voltage supply is 230 volts D.C. or A.C.—T. M. LUCKVUR (Kuala Lumpur, F.M.S.).

CUT THIS OUT EACH WEEK.

Do you know

- THAT a moving-coil loud-speaker should preferably be enclosed in a dust-proof bag to avoid the entry of metallic dust into the gap.
- THAT microphony in a detector valve may be removed by placing anything into contact with the glass bulb.
- THAT although a reaction winding and reaction condenser are inter-related there is a limit to the size of condenser which can usefully be employed.
- THAT ordinary glass is a very efficient insulator and is not difficult to work.
- THAT all insulators require to be kept scrupulously clean to preserve their property.
- THAT where more than one wire is used for aerial or earth leads to make up a thicker combined lead, they should be kept apart or otherwise prevented from coming into contact.
- THAT ordinary cobbler's heel-ball is a splendid material for repairing holes in ebonite panels and components.

The Editor will be pleased to consider articles of a practical nature suitable for publication in PRACTICAL WIRELESS. Such articles should be written on one side of the paper only, and should contain the name and address of the sender. Whilst the Editor does not hold himself responsible for manuscripts, every effort will be made to return them if a stamped and addressed envelope is enclosed. All correspondence intended for the Editor should be addressed: The Editor, PRACTICAL WIRELESS, Geo. Newnes, Ltd., 8-11, Southampton Street, Strand, W.C.2.

Owing to the rapid progress in the design of wireless apparatus and to our efforts to keep our readers in touch with the latest developments, we give no warranty that apparatus described in our columns is not the subject of letters patent.

A Radio Reference Library

THE OUTLINE OF WIRELESS

By RALPH STRANGER

A comprehensive and popular work that has already reached its Third Edition. Specially written for the Man-in-the-Street, it leads him, step by step, to a complete understanding of the theory and practice of modern Wireless.

Contains 816 pages and many illustrations.
Price 8/6. By post 9/3.

THE ELEMENTS OF WIRELESS

By RALPH STRANGER

Indispensable to all who would understand fully the principles and practice of modern Wireless Reception. The whole field is covered. Starting with elementary principles and finishing with a complete survey of a four-valve set, the author makes the whole subject plain from A to Z.

Fully Illustrated. Price 3/6. By post 3/11.

THE MATHEMATICS OF WIRELESS

By RALPH STRANGER.

Probably because it seems such a dull subject, this is a side of Wireless that is too often neglected by amateurs. But, none the less, it is of tremendous importance—and this gifted writer deals with it in such a way that there isn't a dull page in the book!

Fully illustrated. 256 pages. Price 5/-. By post 5/6.

THE WIRELESS CONSTRUCTOR'S ENCYCLOPAEDIA

by F. J. CAMM
(Editor of "Practical Wireless")

The knowledge and practical experience of the most accomplished designers and writers on the practical side of Wireless presented in an attractive and easily accessible form. A veritable Treasury of Wireless Knowledge that should be on the bookshelf of every enthusiast.

Third Edition. Copiously illustrated.
Price 5/-. By post 5/6.

From all Booksellers and Newsagents.

Send a postcard for Complete List of Wireless Publications

GEORGE NEWNES, LTD.,

8-11, Southampton Street, Strand, London, W.C.2.

TWO

Reg. Trade Mark

WEARITE

IRON CORE COILS SPECIFIED for the

ATOM

LIGHTWEIGHT PORTABLE

Here is a mighty little set—a set in which the very last ounce of efficiency must be produced by its every component. That is why the coils are by "Wearite." That is why the "Wearite", H.F.P.J. Junior H.F. Choke is selected—really first class components of minimum physical dimensions. Follow the designer—use "Wearite."

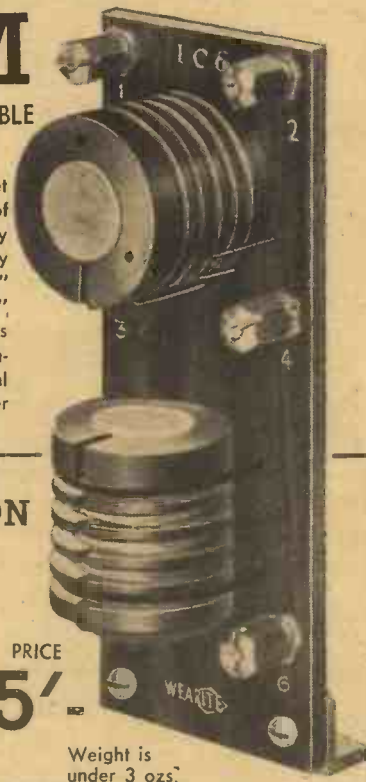

A FULL SIZE ILLUSTRATION of the I.C.6.

A small general purpose iron core coil for standard use in average 2, 3 or 4 valve sets.

RANGE 190-580 and 850 to 1950 metres, using standard .0005 variable condenser. Screened type also available (I.C.S.6.) 7/6 each!

PRICE

5/-

Weight is under 3 ozs.

... ALSO SPECIFIED

The WEARITE H.F.P.J. CHOKE



The famous "UNIVERSAL" tunes 180 - 550 and 750 - 1950 metres.

The secret of the success of the famous "LEADER RECEIVERS."

PRICE

5/- per coil.



Price 2/-

COUPON

TO MESSRS. WRIGHT & WEARE, LTD.,
740, High Road, Tottenham, London, N.17.

Please send me your new booklet GN.2, together with literature on Class "B" Units, details of the NEW Universal Coils, the new "L.P." (Lucerne Plan) Circuits and details of your H.T. Power Packs, with circuits.

NAME.....

ADDRESS.....

PRAC. 9/6/34.....

COMPONENTS FOR UNIVERSAL NEEDS

Varley Mains Transformers are an extensive range. We manufacture Transformers of every kind—but that's not all! Run your eye through our catalogue (if you haven't one yet, send for it now) selecting chokes, coils, resistances of every type, pick-ups, volume controls... But write to-day, our catalogue will come by return, giving full information of the whole range of Varley Components.



Advertisement of Varley (Oliver Pell Control, Ltd.), Bloomfield Road, Woolwich, S.E.18. Telephone: Woolwich 2345.



MICROLOODE OFFERED FOR 7 DAYS TRIAL!

With any Set, the W.B. MICROLOODE model P.M.1a gives amazing tone and volume because by a simple switch you obtain perfect music in line. Send only 2/6 for it on 7 days' trial, if satisfied pay further 2/6 at once, then 8 monthly payments of 5/- (Cash, in 7 days, 42/-).

E. J. HERAUD, Ltd. (Dept. P. 59), NUMBER ONE, EDMONTON, LONDON, N.18.

SEND ONLY

2/6

BALANCE MONTHLY

Many good but none better than **362** and you save 50%

Battery and AC MAINS.

For more volume, purer tone, greater selectivity, and longer life.

ACHL 7/6d., ACPX4 9/-. ACSG4 & ACVS4 12/6d., ACME4 & ACHM4 13/-.
Minimum guarantee on all valves 6 months.
Battery types H.H. & L. 3/6d. LP 4/-. P. 4/6d. SG & VS 7/6d., Class B 9/-. Pentode-Type 10/-.
Post FREE Dept. W. Trade Dept. W.T.
362 RADIO VALVE CO., LTD.,
STONEHAM RD., LONDON E.5.

● H.T. FRESH AS THE DAWN EVERY MORNING—recharges itself overnight! Install a Standard Wet Battery, and H.T. troubles for good. Lasts years. Annual replenishment—that's all! 120-v., 12,500 m.a. —£2 carr. paid. All Standard H.T. spares. Write for details.—WET H.T. BATTERY CO., 26, Lisle Street, London, W.C.2.

RADIO CLUBS AND SOCIETIES

Club Reports should not exceed 200 words in length and should be received First Post each Monday morning for publication in the following week's issue.

SLADE RADIO

A lecture on "Frequency Changers" was given by Mr. G. F. Clarke at the last meeting of this society. In opening his lecture he raised the question of "What are frequency changers and why?" and passed on to the question of why he dealt with amplitude and amplification, superoxide frequencies, early superhets, selectivity, and tone control. The question of how he dealt with frequencies, harmonics, and intermediate frequency selection was also dealt with. The development of superhets followed, in which he described the various types and circuits from 1922 up to the present day. Many of the interesting points were described in detail, including the cause of second channel interference, and how it can be eliminated. —Hon. Sec., 110, Hillaries Road, Gravelly Hill, Birmingham.

ANGLO-AMERICAN RADIO AND TELEVISION SOCIETY

An inter-branch contest has been arranged by the A.-A.R. and T.S. to discover which branch holds the DX championship. Branches which notified their intention of competing are the South Essex Branch, the South Herts Branch, and the West Middlesex and East Buckinghamshire Branch. Other branches should notify H.Q. if they desire to join the contest. At the moment Mr. Leslie W. Orton (W.M. and E.B. Branch) holds the championship.

At the last meeting of the West Middlesex and East Bucks Branch of the above society, arrangements were made for Mr. William Johnston to demonstrate his short-wave receiver at a future meeting. Mr. K. Cawse also challenged him to a test demonstration with his own short-wave receiver. This will take place in about three weeks' time. Mr. Leslie W. Orton and Mr. Johnston also arranged for a contest between themselves to see who received the most medium-wave American stations.

It was suggested that a rally of South England members of the A.-A.R. and T.S. take place near the end of August, Uxbridge being the rallying point. The society will be pleased to hear from members who could join such a rally if it took place upon Sunday, August 26th. Stamps should be enclosed for reply. Letters should be addressed to Mr. Leslie W. Orton, "Kingsthorpe," Willowbank, Uxbridge.

INTERNATIONAL SHORT WAVE CLUB (LONDON)

One of the biggest laboratory demonstrations ever attempted by the G.E.C. was given at the London Chapter on Friday, May 18th, when Mr. Nixon and Mr. A. L. Parsons lectured on and demonstrated the gas-filled relay. Mr. Nixon opened the lecture by describing this gas discharge valve, which consists of a cathode, anode, and grid in a mercury vapour-filled bulb. His lecture was illustrated by lantern slides. The various applications of the gas-filled relay were then demonstrated by Mr. Parsons, and in one of the demonstrations, in which these relays were used to control neon tube lighting, a power of 20,000 volts was used.—A. E. Bear, Sec., 10, St. Mary's Place, Rotherhithe, London, S.E.16.

CATALOGUES RECEIVED

To save readers trouble, we undertake to send on catalogues of any of our advertisers. Merely state, on a postcard, the names of the firms from whom you require catalogues, and address it to "Catalogues," PRACTICAL WIRELESS, Geo. Neumes, Ltd., 8/11, Southampton St., Strand, London, W.C.2. Where advertisers make a charge, or require postage, this should be enclosed with applications for catalogues. No other correspondence whatsoever should be enclosed.

ROLA MOVING-COIL SPEAKERS

ROLA speakers are the outcome of over ten years' acoustical research work, and are made in a well-equipped modern factory. The range of models now available combines brilliance of tone with unrivalled fidelity of reproduction, and the Rola Class "B" amplifier unit is a remarkable instrument comprising a P.M. moving-coil speaker, with which is incorporated a complete properly matched Class "B" amplifier. This assembly when connected to any battery set converts it to Class "B" output. The price of the unit, complete with valve, is £3 11s. 0d., or without valve £2 17s. 0d. Among the other Rola permanent-magnet moving-coil speakers are the new model FR5-P.M., a remarkable little speaker of high performance, and model F7-P.M., a speaker designed for the man who demands radio at its best. For brilliance of tone, this instrument is definitely in a class by itself. These two models are priced at 29s. 6d. and 60s. respectively. Another new Rola speaker is a mains energized model (F5), which is listed at the low price of 27s. 6d. There are also dual balanced pairs of speakers specially compensated so that the inherent frequencies and resonant points balance out, giving an almost perfect reproduction over the whole harmonic range. Further particulars and prices of this useful range of high-class speakers are given in an attractive folder, copies of which can be obtained from the British Rola Co., Ltd., Minerva Road, Park Royal, London, N.W.10, who also supply a useful data sheet in connection with these speakers.

NEW EKCO RADIOGRAM

THE latest addition to the Ekco range, model RG.84, is a five-valve superhet radiogram with a remarkable volume, tone, and sensitivity. A seven-stage circuit is employed comprising first detector, oscillator, I.F. amplifier, second detector, A.V.C. diode, L.F. amplifier, and pentode output. H.T. current is supplied in the A.C. model through an indirectly-heated full-wave rectifier valve. Full automatic volume control, operated by the double-diode circuit of the second detector valve, is arranged to feed a constant signal to the audio-frequency amplifier, the actual output through the mains-energized moving-coil speaker being decided by the setting of the manual volume control. Stations are selected by a single control which moves a shadow pointer to the name of the station desired. The A.C. model is priced at 21 guineas, and the D.C. model at 22 guineas. Further details of these fine instruments, together with hire-purchase terms are given in a neat folder, copies of which can be obtained from E. K. Cole, Ltd., Ekco Works, Southend-on-Sea.

THE AVO-MINOR COMPETITION

IF you have not already done so, you should send off at once for particulars of the grand Competition which is being organized by the Automatic Coil Winder and Electrical Equipment Co., Ltd. See their announcement in this issue.

NOTES, NEWS, AND VIEWS

Cutting Off the Top Notes

EVERY constructor knows that a condenser placed across a transformer or loud-speaker will cut the top notes, but few know that a resistance in series with the condenser will make the attenuation more gradual as it makes a complete cut impossible.

Radio Beacons

IT is interesting to know that our radio beacons are more advanced than those used in America and elsewhere. Ordinary radio beacons are in general use, but we have some that are aided by a sound signal so that a ship can know the exact distance to the beacon by counting the time between the two; radio, of course, travels much faster than sound.

Novel Use for Plastic Wood

THE substance known as plastic wood (obtainable in tubes from most iron-mongers) is very useful to mould knobs when another has to be matched; when dry

it can be cut, sand-papered, stained, or painted just like wood.

A Metallized Valve's Efficiency

IT is strange but nevertheless true that a metallized valve is more efficient than a similar valve with a metal cover or shield; in the former case the capacity between electrodes is lower than in the latter.

"Midsummer Eve"

JOHN DRINKWATER'S play, *Midsummer Eve*, will be produced for West Regional listeners by Peter Creswell on June 13th. This play was first produced by him from London on the eve of Midsummer Day, 1932. It is not an adapted stage play but was written specially for wireless performance. Gerrard Williams, composer of the incidental music, has written a great deal of music for radio drama and he is particularly successful in the "colour" and "mood" he can evoke in his orchestration.

FACTS & FIGURES

Components tested in our Laboratories

HIVAC H.F. PENTODES

TWO new high-frequency pentodes are announced by the High Vacuum Valve Co., Ltd., of 113-117, Farringdon Road, E.C.1. One is of the variable-mu type, reference VP215, and the other is of the "straight" type, reference HP215. As shown by the type numbers, they have 2-volt .15 amp. filaments, and each is designed for a maximum H.T. voltage of 150, with 70 volts for the screening grid. The mutual conductance of the HP215 is 1.2 mA/V and of the

centre-tap may sometimes be rendered ineffective owing to the external wiring which is fitted, and thus the use of a device of this nature will assist greatly in obtaining silent working from A.C. mains. The travel of the arm is a full 300 degrees, and the price is 2s.

FERRANTI NEW GLORIA RECEIVER

THE new Gloria Console which is announced by Messrs. Ferranti includes the refinement of an electric clock on the upper portion, and in accordance with the new B.B.C. twenty-four hour system, this clock is provided with a twenty-four-hour dial. The normal twelve hours are arranged in Roman numerals round the face in the customary manner, and the figures from 13 to 24 are printed in ordinary figures beneath the others. The clock is almost elliptical, and presents a most attractive appearance above the loud-speaker grille. The new Gloria costs 22 guineas.

A NOVEL CHLORIDE RECEIVER

BATTERY-USERS will be very interested in the receiver shown-at the foot of this page. It was designed and built by Mr. S. Brown, of the Engineering Department of Exide Batteries, for their managing director, and is a good example of what can be done in the way of manufacturing a really up-to-date receiver without calling into use the power supply mains. The circuit is of the superhet type, embodying a pre-selector H.F. stage, heptode oscillator, two I.F. stages, and a double-diode-triode second detector. The output consists of two PX4 valves in push-pull fed from a tone-corrector valve, all valves, with the exception of the output stage, being of standard 2-volt type. For high-tension accumulators totalling 200 volts are employed, and these are split up into parallel sections for charging. An ingenious switching device has been incorporated for charging purposes, and this puts all the sections of the H.T. batteries in parallel, together with the L.T. battery. On the reverse movement the sections are connected in series, and the receiver is switched on. The trickle charge current

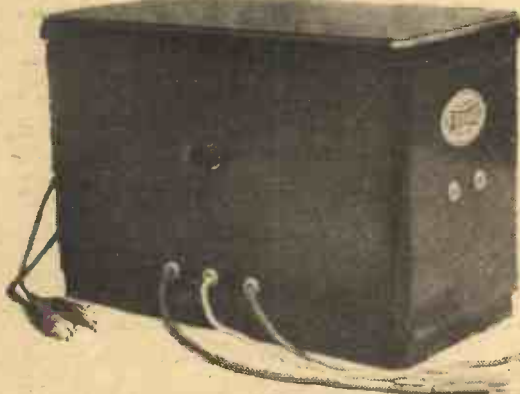

The Ferranti Class B unit which was fully described on this page last week.

VP215 is .005 to 1.25 mA/V. The variable-mu valve is of the short-grid base type, requiring a total bias of 9 volts for complete volume control purposes. This may be supplied by means of a potentiometer and biasing battery or through the medium of the usual resistances in association with an A.V.C. valve or circuit. Standard 7-pin bases are fitted, and the anode is taken to a cap on top of the valve for use with a clip, as distinct from the more customary terminal.

KABI HUM BALANCER

MESSRS. F. W. LECHNER AND CO., LTD., of 61, Spencer Street, Clerkenwell, E.C.1, have produced a neat new component designed especially for the removal of hum from A.C. operated receivers. This has an overall size no larger than a sixpence, and carries a wire-wound element having a total resistance of approximately 50 ohms. A small rotatable arm is fitted in the same manner as a standard potentiometer, and soldering lugs are provided for connection to the ends of the resistance and to the arm. The balancer is intended for connection across the L.T. windings of a mains transformer, with the arm connected to earth, in which condition it is easily possible to rotate the arm and thus find a position where hum is reduced to a minimum. The usual



may be carefully adjusted so that it is insufficient to cause gassing of the plates and consequent loss of water by electrolysis. Sealed-in type cells are used so that loss of water by evaporation is negligible. The Chloride Electrical Storage Co. do not intend to market or build the receivers, but full information will be given concerning the receiver, and the expert knowledge of this firm in battery radio is at the disposal of the trade. Blue prints and charging arrangements are available.

COSSOR FREQUENCY-CHANGER

AMONG the recently-introduced Cossor valves is a frequency changer and a super-power pentode. These are both of the indirectly-heated type, with



Three views of the interesting Chloride receiver which is described on this page.

4-volt heaters, the former requiring a current of 1 amp. and the latter 2 amps. The former valve is designated 41.M.P.G., and it is distinguished by its high value of conversion conductance and inherent freedom from modulator harmonics. The maximum anode voltage is 250 (modulator) and 100 volts for oscillator anode voltage. The Mod. screen voltage is 100 maximum. A standard 7-pin base is fitted, and the top cap is connected to the modulator grid. The new pentode is the 42MPPen., and this also has a 7-pin base, the maximum anode dissipation is 8 watts, and the anode voltage rating is 250 volts at 32 mA, with 5.5 volts grid bias. The optimum load for this valve is 8,000 ohms, and this value must be adhered to if best results are to be obtained. For tone compensation the makers recommend a .01 mfd. condenser and 10,000 ohm resistance in series.

FERRANTI ELECTROLYTIC CONDENSER BLOCK

THE illustration below shows one of the newly-introduced Ferranti components, consisting of two 8 mfd. dry electrolytic condensers in a waxed container, and employing flexible leads for connecting



A neat Ferranti condenser block.

purposes. This is Type CE.100, and costs 7s. 9d. It is designed for a peak working voltage of 500. There are a number of other dry electrolytic condensers in the Ferranti range, and these are contained in Pertinax boxes and cover all the most useful ranges.

TRADE NOTES

MR. FRANK GILL, O.B.E., Chairman of the board of Standard Telephones and Cables, Ltd., and of Creed and Co., Ltd., has been elected Chairman of Kolster Brandes, Ltd., as from May 7th. Mr. S. Wilding Cole, President of the Radio Manufacturers' Association, will retain the office of Deputy Chairman.

Mr. E. J. Long, who has held the position of General Manager of the British Ebonite Company, Ltd., for the past ten years, has now been appointed Managing Director.

NEW BLOCK BATTERY

BLOCK BATTERIES, LTD., announce that they are now putting on the market a further type Block (plateless) L.T. Accumulator, having a capacity of 45 amp. hours at slow intermittent rates. In common with the other products of this company, the battery deviates very considerably from the ordinary type of accumulator, the chief characteristic being that the terminals are at the front, thus making it extremely simple to connect and disconnect, and also adds greatly to the protection from corrosion due to acid creeping.

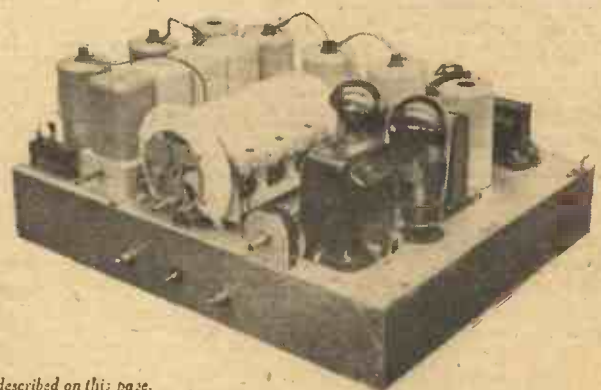

REPLIES TO

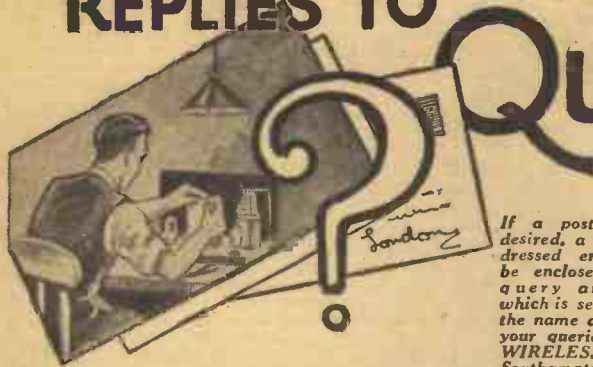

LET OUR TECHNICAL STAFF SOLVE YOUR PROBLEMS

QUERIES and ENQUIRIES by Our Technical Staff

The coupon on Page iii of Cover must be attached to every query

If a postal reply is desired, a stamped addressed envelope must be enclosed. Every query and drawing which is sent must bear the name and address of the sender. Send your queries to the Editor, "PRACTICAL WIRELESS, Geo. Newnes, Ltd., 8-11, Southampton St., Strand, London, W.C.2."

The wiring diagram given on page 906 of PRACTICAL WIRELESS dated January 27th, 1934. Variable-mu H.F. valves would also be found useful in bringing the set up-to-date.

SPECIAL NOTE.

We wish to draw the reader's attention to the fact that the Queries Service is intended only for the solution of problems or difficulties arising from the construction of receivers described in our pages, from articles appearing in our pages, or on general wireless matters. We regret that we cannot, for obvious reasons—

- (1) Supply circuit diagrams of complete multi-valve receivers.
- (2) Suggest alterations or modifications of receivers described in our contemporaries.
- (3) Suggest alterations or modifications of commercial receivers.
- (4) Answer queries over the telephone.

Please note also, that all sketches and drawings which are sent to us, should bear the name and address of the sender.

THE MASTER MIDGET

"In the Midget receiver which you recently described I notice that you do not give the name of the tuning coil. Could you please tell me what it was and whether I could use a screened coil which I have got, in its place? I also have a cabinet on hand, 21in. high by 16 1/2in. wide and 9 1/2in. deep. Could I put the Midget in this?"—E. A. S. (Erith).

The coil which was used in the original model of the Midget was an Igranitor Type H.F. Unfortunately, this coil is not now made, although it may be obtained from many wireless shops. In this particular receiver, the coil is not critical, and any good make may, therefore, be substituted for that which was used in the original design. The connections to the coil will, no doubt, have to be modified to suit the particular component which is used, and the manufacturer's instructions should be followed in this respect. Your cabinet should be quite suitable, although you will have to make your own arrangements regarding the housing of the batteries.

PERFORMANCE, NOT APPEARANCE

"Will you inform me what is the good or the use of the .1 x .1 condensers and the four resistances (1 watt) in the Fury Four? Do they really do anything important? Can they be substituted? Is there any alternative to them, because the set never looks neat with those parts wired up?"—J. H. R. (Hull).

Components are never put into a wireless receiver unless they are required. With regard to the particular resistances and components you refer to these act as decoupling circuits for the anodes and screening grids of the first two valves, and the .1 x .1 condensers incorporate two condensers in one case, thus reducing space and simplifying construction. You cannot remove these parts without incurring the risk of instability.

MODERNIZING THE 1933 FURY

"I have a D.C. Fury Four, but owing to the radical change in the wavelengths, I am getting interference all over the dial. Is there any way of modernizing the set so as to remove this?"—F. J. W. (Stoke Newington).

If you do not wish to completely rebuild the original version of the Fury Four, we would suggest that you fit coils of modern design, such as were employed in the 1934 model. The same coils as we used could be fitted, and the connections may be ascertained from

EARTH RETURN REQUIRED

"I have built the Leader 3, but cannot get any medium-wave stations. I have mounted the wave-change switch on a panel instead of the chassis, and wonder if this is the cause of the trouble."—A. R. G. (Angus).

If you examine the circuit of the Leader you will find that a three-point switch is required for wave-change purposes. Two arms are joined to the two coils, and the third arm is connected to earth, so that in the medium-wave position the tapplings on the coils and the earthed end of the coils are joined together. An ordinary two-point switch was, however, used for this purpose, and third, or earth contact, was obtained through the medium of the arm of the switch and the mounting bracket, which was mounted direct on the metallized chassis. You must, therefore, in your case, obtain a three-point switch and join the third arm to earth in order to enable the switch to function.

DATA SHEET No. 82

Cut this out each week and paste it in a Notebook.

DECOUPLING AND VOLTAGE DROPPING RESISTANCES

Current in mA.	Voltage to be dropped						
	1	2	5	10	20	40	80
1	1,000	2,000	5,000	10,000	20,000	40,000	80,000
2	500	1,000	2,500	5,000	10,000	20,000	40,000
5	200	400	1,000	2,000	4,000	8,000	16,000
10	100	200	500	1,000	2,000	4,000	8,000
15	66	133	333	666	1,333	2,666	5,333
20	50	100	250	500	1,000	2,000	4,000
25	40	80	200	400	800	1,600	3,200
30	33	66	166	333	666	1,333	2,666
35	28	57	142	285	571	1,142	2,275
40	25	50	125	250	500	1,000	2,000
45	22	44	111	222	444	888	1,777
50	20	40	100	200	400	800	1,600

To find the Wattage Rating of the resistances, multiply the current squared by the value of the resistance in ohms.

COMBINED VOLUME CONTROL

"My set is a battery straight three, using two L.F. transformers. The detector is an S.G. valve. How can I fit a pick-up and also a volume control to have effect on both radio and gramophone? I have one with three terminals (! megohm). Would this do?"—J. J. R. (Dublin).

The volume control should be quite suitable if joined across the secondary of the first L.F. transformer. Join the two outside terminals on the control to G. and G.B. terminals, and disconnect the lead at present joined from the grid of the L.F. valve to the G. terminal on transformer. This lead must then be joined to the arm (centre terminal) on the volume control. The pick-up should be joined between the grid and earth line of the detector valve, and the volume control will then function on both radio and gram.

USING A FRAME AERIAL

"Could you give me the general rule for substituting a frame aerial for aerial and earth in a wireless circuit provided with coils for long and medium waves. To

which points, for example, does one join the beginning and end of the frame?"—H. F. (Northwood).

The frame aerial takes the place of the aerial-tuning coil. The latter must therefore be removed from the receiver. One end of the frame is then joined to the grid of the first valve (or to the fixed vanes of the first tuning condenser, if no H.F. stage is incorporated), and the other end of the frame is then joined to the original earth line, or the H.T. — terminal. If the frame is designed to cover medium and long waves, the short-circuited portion should be on the earth side in the same manner as with ordinary coils.

OUTPUT TRANSFORMER DETAILS

"I have acquired an unknown make of M.C. speaker, for which I wish to wind an input transformer. I have the necessary parts and could tap both primary and secondary if necessary. Could you give me an idea of the wire which is necessary, the number of turns required, etc.?"—A. R. W. (York.)

You do not state the size of the stampings, and this will govern the arrangement of the windings, as well as the gauge of wire which you can use. The relation between primary and secondary will depend upon the resistance of the speech coil, and again you give no particulars. The wire should preferably be somewhere between 20 and 24 gauge enamelled, and the primary will probably consist of 3,000 or so turns of wire to give a load of approximately 4,000 ohms. It is not possible to give exact data, however, in view of the lack of essential figures in your query.

H.F. INSTABILITY

"I have just finished building a set employing two H.F. stages, but I get hopeless instability. All types of decoupling have been inserted and I cannot stop the trouble. Is there any way by which I can trace the cause of the trouble so as to enable the set to work satisfactorily?"—Y. T. (York).

As you have fitted various decoupling circuits, it may be that the instability is due to interaction between some wiring or components. To trace this, the simplest way is to take a piece of thin aluminum or copper and enclose it in a thin rubber cover or in a thick paper envelope. Connect it to a long flex wire joined to earth, and then move the metal about on the H.F. side of the receiver in between components and wiring, etc. If you arrive at a position where the instability ceases, you will know that it will be necessary to insert an earthed screen at that point, and a permanent job can then be made.

ANOTHER REASON

"I recently made up a set in which I used two English variable condensers made up from aluminium. I was not very pleased with the results, and I saw some American variables in a junk shop one day, and as they looked rather good, being made from brass, I bought them and put them in my set. I got much louder results and many more stations. Is this due to the fact that brass is a better conductor?"—A. D. R. (Highgate).

Some theories were once advanced concerning the chemical aspects of wireless components, but nothing was proved regarding the differences in performance between aluminium and brass plates. What you will probably find is that the old condensers which you had at first relied for their contact with the moving vanes on a friction disc which had probably got dirty, or had been oiled. The new brass condensers no doubt had soldered pigtails for connection, and thus gave a lower resistance and a much better contact, thus giving better results.

The Queries Coupon Appears on Page iii of Cover

Replies to Broadcast Queries

KEIGHLEY (Yorks): W9EYN, J. Bohrer, 1,220, North Tejon Street, Colorado Springs (Col.); W9IMZ, R. Page, 7,125, Paseo Boulevard, Kansas City (Mo.); W1BNM, E. W. Lincoln, 215, Lincoln Avenue, North Dighton (Mass.); W1BRL/245 (Bristol): PY5AB, write, Liga de Amadores Brasileiros de Radio Emissao, Post Box 280, Sao Paulo, Brazil; HB1FG, cannot trace call; write: Swiss Radio Amateur Association, Postfach, Zurich 22, Switzerland; VE2BG, T. H. Letts, 102, 13th Avenue, Longueuil, Province Quebec. E. H. PAGE (Leeds): Not SU1VH, but SU1CH, E. M. Chorlian, 7, Rue Peake-Bulkeley, Alexandria, Egypt. Addresses of two British amateur call-signs not

published, write: The Radio Society of Great Britain, 53, Victoria Street, S.W.1. F. WALKER (Wisbech): W3NX, E. L. Langford, 1,108, Dukeland Avenue, Baltimore (Md.); WTKI, call incorrect, but if W3KI, Rev. J. Kenny, Northeast Catholic Radio Club, Kensington Avenue, Philadelphia (Pa.). A. W. MANN (Middlesbrough): W2CVA, C. G. Short, 124, Easton Avenue, New Brunswick, New Jersey; W2BRA, Bushwick Radio Amateur Club, 550, Onderdonk

Avenue, Ridgewood, New York; W2GAQ, S. T. LeRoy, 103, 5th Avenue, Watervliet, New York. H. J. WITHERS (Leamington Spa): W20A, C. A. Porter, 116, Sickles Avenue, New Rochelle, New York; W2AKA, J. M. Kiefer, Jr., 32, Hawthorne Avenue, Bloomfield, New Jersey; VE1BV, C. S. Taylor, Stewiacke, Nova Scotia. SHORT WAYER (Greenock): Cannot trace PAOSLB, but if PAOSL, I. Snock, 11, Tulpenstraat, Leyden, Holland; if PAOEMD, E. Drukker, Jacobusstraat, Hilversum, Holland; address of PAOEM not published, write: N.V.I.R., Post Box 400, Rotterdam, Holland; G5SZ, J. W. Riddiough, Trannero Park, Guiseley, Yorks.

Miscellaneous Advertisements

Advertisements are accepted for these columns at the rate of 3d. per word prepaid - minimum charge 3/- per paragraph - and must reach this office not later than Tuesday for the following week's issue. Radio Components advertised at below list price do not carry manufacturers' guarantee. All communications should be addressed to the Advertisement Manager, "Practical Wireless," 8, Southampton Street, Strand, London.

PREMIER SUPPLY STORES

Offer the Following Set Manufacturers' Surplus New Goods at a Fraction of the Original Cost; all goods guaranteed perfect, carriage paid over 5/-, under 5/- carriage forward, I.F.S. and abroad, carriage extra. PLEASE SEND FOR ILLUSTRATED CATALOGUE POST FREE.

STUPENDOUS Purchase of Set Manufacturers' Stock. All electric. 3 Valve (S.G. Det. Pen.) Set in Walnut Cabinet with Magnavox moving coil speaker 200-250 volt 40-60 cycles. Chassis built. 200-2,000 metres with 4 valves, £4/19/6.

ALL Electric Radio Gram. in Walnut Cabinet Fitted with Above Chassis and Speaker and Collaro Gramophone Unit Complete, £9/19/6.

ALL Electric 3-stage Amplifiers, 200-250v., 40-60 cycles, 10 watts, undistorted output, complete with 5 valves, £7/7/-.

Suitable speakers, pickups and microphones can be supplied.

SPECIAL Offer of P.M. and Energised M.C. Speakers

TYPE 10971G, 9in. diameter, 115 ohm field, 120/200 m.a., with power output transformer. Handle 4 watts, 17/6.

TYPE 10971C, 9in. diameter, 2,000 ohm field, 40/70 m.a., Pentode transformer. Handles 4 watts, 17/6.

TYPE 10955F, 9in. diameter, 11,650 ohm field, 20/30 m.a., auditorium type power transformer. Handles 10 watts, 30/-.

TYPE 10955H, 9in. diameter, 115 ohm field, 350/400 m.a., auditorium type Pentode transformer. Handles 10 watts, 30/-.

TYPE 4480B, 9in. diameter, permanent magnet. Handles 4 watts. 7 ohms speech coil, 13/6. Multi-ratio transformer, 4/6 extra.

PREMIER SUPPLY STORES announce the Purchase of the Complete Stock of a World Famous Continental Valve Manufacturer; all the following standard mains types fully guaranteed, 4/6 each, H., H.L., L., power, high magnification screen grid, low magnification screen grid, variable-mu screen grid, directly heated 6-watt Pentode, directly heated 9-watt Pentode, 250v. 60 millamp, full wave rectifier. THE Following Type, 5/6 each; 350v. 120 millamp, full wave rectifier. A.C. Pen, 5/6.

THE Following American Types at 3/6; some of these are listed at 30/-: 250 (5 watts A.C. output), 227, 112, 171, 210, 245, 26, 47, 46, 24, 35, 51, 57, 58, 55.

THE Following Type, 6/6; 500 volt 120 millamp, full wave rectifier.

ELIMINATOR Kits, including transformer, choke, Westinghouse metal rectifier, T.C.C. condensers, resistances and diagram, 120v., 20 m.a., 20/-; trickle charger 8/- extra; 150v., 30 millamps, with 4v., 2-4 amps. C.T., L.T., 25/-; trickle charger 6/6 extra; 250v., 60 millamps with 4v., 3-5 amps. C.T. L.T., 30/-; 300v. 60 m.a. with 4 volts, 3-5 amps. 37/6; other outputs to order at pro rata prices.

PREMIER chokes, 40 millamps, 25 hrs., 4/-; 65 millamps, 30 hrs., 5/6; 150 millamps, 30 hrs., 10/6; 60 millamps, 80 hrs., 2,500 ohms, 5/6; 25 millamps, 20 hrs., 2/6.

ALL Premier Guaranteed Mains Transformers have Engaged Terminal Strips, with terminal connections, input 200-250v., 40-100 cycles, all windings paper interleaved.

PREMIER H.T. 7 Transformer, output 135v. 80 m.a. for voltage doubling, 8/6; 4v. 3-4a., C.T. L.T. 2/- extra; with Westinghouse rectifier giving 200v. 30 m.a., 17/6.

PREMIER H.T. 8 and 9 Transformers, 250v., 60 m.a., and 300v. 60 m.a. rectified, with 4v. 3-5a. and 4v. 1-2a. C.T. L.T. and screened primary, 10/-; with Westinghouse rectifier, 18/6.

PREMIER H.T. 10 Transformer, 200v. 100 m.a., rectified with 4v. 3-5a., and 4v. 1-2a. C.T. L.T., and screened primary, 10/-; with Westinghouse rectifier, 18/6.

PREMIER Mains Transformer, output 250-0-250v. 60 m.a., 4v. 3-5a., 4v. 2-3a., 4v. 1-2a. (all C.T.) with screened primary; 10/-.

PREMIER Mains Transformers, output 350-0-350v. 90 m.a., 4v., 3-5a., 4v. 2-3a., 4v. 1-2a. (all C.T.) with screened primary; 10/-.

PREMIER Auto Transformers, 100-110/200-250v. or vice versa, 100-watt, 10/-.

L.T. Transformers, 4v. 3a. C.T., 6v. 2a. C.T., 9v. 1a., 12v. 1a., 7/6 each; 4v. 3-5a., 22v. 1a., 8/6 each; 10v. 3a., 14v. 4a., 10/- each.

WESTERN ELECTRIC Mains Transformers, 300-0-300v. 65 m.a., 4v. 1-2a. 4v. 2-3a., 8/6; 500-0-500v. 150 m.a., 4v. 3-5a., 4v. 2-3a., 4v. 1a. C.T. 4v. 1a. C.T. 10/6; 1,000-0-1,000v. 250 m.a. 4v. 3a. C.T., 4v. 3a. C.T., 49/6; 2,000-0-2,000 150 millamps, 49/6.

(Continued at top of column three)

MORE BARGAINS

5-VALVE CLASS "B" SUPERHET BATTERY RADIOGRAM

- Class B Output
- Moving-Coil Speaker
- Wavelength Scale
- Metal Chassis
- Screened Condensers
- Single-knob Control
- Long and Medium Waves
- Volume Control
- Screened Coils

BARGAIN RADIOGRAM—5-Valve Class "B" Super-het in handsome full-size Walnut cabinet with contrasting veneered inlays.

READY TO PLAY. Here's an amazing Radiogram at an exceptionally Bargain Price. Honestly worth 15 Gns. Incorporates 5-valve Class "B" Battery Super-het Chassis with Double-Spring Edison Bell motor. 12in. plush-covered-turntable, B.R.G. Tone-arm with Pick-up and Volume control, Automatic Needle-cup. Complete with 5 B.V.A. matched and tested valves and Hellesen and Exide Batteries. **GUARANTEED BRAND NEW and IN PERFECT WORKING ORDER BY P.E.T.O.-SCOTT.** Cash or G.O.D. Carriage Paid £10. 18/-.

Overall Dimensions: 38" high, 22" wide, 15½" deep

BARGAIN No. 2

ATLAS S.G.3 A.C. SET

Model 334. Variable-Mu S.G. Detector and Power Valves. Westinghouse Rectifier. Full-vision illuminated Wavelength Scale. Sockets for Pick-up and extra Speaker. A.C. Mains, 200/250 volts, 40/120 cycles. Complete with Valves, Speaker and Cabinet. Guaranteed BRAND NEW in Manufacturer's Sealed Carton. Ready to play.

or Yours for **11/6**

Balance in 11 monthly Payments of 11/6.

LIST PRICE ~~£9.17.6~~ OUR PRICE **£5.19.6**

PET O-SCOTT CO. LTD.

Bargain Dept:
77, CITY ROAD, LONDON, E.C.1
Telephone: Clerkenwell 9406/7.
West End Showrooms: 62, High Holborn, London, W.C.1
EST. 1919

ELECTRICALLY SOLDER YOUR RADIO CONTACTS

Electric Soldering is **SPEEDY, CLEAN, EFFICIENT, RELIABLE AND ECONOMICAL**

Every Handyman should use a

SOLO N TRADE MARK
ELECTRIC SOLDERING IRON

7/6 for every handy man

VOLTAGE. If unable to obtain, send us the name 200/220, 230/250 of your nearest dealer.

W.T. HENLEY'S TELEGRAPH WORKS COMPANY LTD.
Y.O.18 Dept. - HOLBORN VIADUCT - LONDON - E.C.1

MADE IN ENGLAND

(Continued from foot of column one)

SPECIAL Offer of Mains Transformers, manufactured by Phillips, input 100-120 v. or 200-250v., output 180-0-180 volts 40 m.a., 4v. 1 amp., 4v. 3 amps., 4/6; 200-0-200v., 4v. 1a., 4v. 3a., 4/6.

SPECIAL Offer Manufacturers' Type Transformers 350-0-350 100 m.a., 4v. 1a., 4v. 2a., 4v. 3-5a., 10/-; input 200-250 A.C.; 350-0-350 120 m.a., 4v. 2-3a., 4v. 2-4a., 100-120v. input only, 5/-.

PREMIER L.T. Charger Kits, consisting of Premier transformer and Westinghouse rectifier, input 200-250v. A.C., output 8v. ½ amp., 14/6; 8v. 1 amp., 17/6; 15v. 1 amp., 19/-; 6v. 2 amp., 27/6; 30v. 1 amp., 37/6; 2v. ½ amp., 11/-.

COLLARO Gramo. Unit consisting of A.C. motor, 200-250v. high quality pick-up and volume control, 49/-; without volume control, 46/-.

T.H. Trusped Induction Type (A.C. only) Electric Gramophone Motors, 100-250v.; 30/- complete.

SPECIAL Offer B.T.H. Gramophone Motors, A.C. and D.C., 100/250v., 30/-, listed £3/3/-.

ARRARD Gramophone Motors, 100/250v., A.C. and D.C. list price £5/5/-.

DISON Bell Double Spring Gramophone Motors, complete with turn-table and all fittings, a really sound job; 15/-.

SPECIAL Offer of Wire Wound Resistances, 4 watts, any value up to 10,000 ohms, 1/-; 8 watts, any value up to 15,000 ohms, 1/6; 15 watts, any value up to 50,000 ohms, 2/-; 25 watts, any value up to 50,000 ohms, 2/6.

WIRE Wound Potentiometers, 15,000 ohms, 1/6; 50,000 ohms, 2/-; 500,000 ohms, 3/-; 1,000 ohm wire-wound semi variable resistances, carry 150 m.a.

CENTRALAB Potentiometers, 50,000 250,000, ½ meg. any value, 2/-; 200 ohms, wire wound, 1/-.

POLAR Star, manufacturers' model, 3-gang condensers, fully screened, 7/6; with trimmers.

ORMOND and Polar All-brass .0005 Condensers, with knob dial, 2/-.

AMERICAN Triple Gang 0.0005 Condensers, with trimmers, 4/11; Utility Bakelite 2-gang 0.0005 screened with unknob trimmer, 3/6; Polar Bakelite condensers, complete with knob, 0.00015, 0.00035, 0.0005, 0.0005, 1/-.

ORMOND Condensers, 0.0005 2-gang semi-shielded, 2/6; brass vanes, with trimmers, 3/6.

MAGNAVOX D.C.162, 2,500 ohms, 17/6; D.C.154, 2,500 ohms, 12/6; D.C.152 Magna, 2,500 ohms, 37/6, all complete with humbucking coils; please state whether power or Pentode required; A.C. conversion kit for above types, 10/-; Magnavox P.M. 7in. cone, 18/6.

AMPLION Loud-Speaker Units, 1/0; complete with 12in. cone and chassis, 3/11.

RELIABLE Canned Coils with Circuit, accurately matched, dual range, 3/- per coil; ditto, iron-cored, 3/6.

RELIABLE Intervalve Transformers, 2/-; Cyldon capacitors (double trimmers), 1/-; multi ratio output transformers, 4/6.

HELLESEN 8 mf. Electrolytic Condensers, 435 volts working, 2/3; Mershon ditto, 1/9.

POLAR 2-gang Uniknob Condenser with Trimmers and complete Slow-motion Dial, 6/-.

WESTERN ELECTRIC Condensers, 250v. working, 1 mf., 6d.; 2 mf., 1/6.

T.C.C. Electrolytic Condensers, 550v. working, 650v. peak, 8 mf., 4/-; 4 mf. or 8 mf. 440v. working, 3/-; 15 mf. 50v. working, 1/-; 25v. working, 25 mf., 1/3; 6 mf. 50v. working and 2 mf. 100v. working, 6d.; 16 4 mf. 250v. working, 4/6.

T.C.C. Condensers, 250v. working, 2 mf., 1/9; 2 mf. 1,500v. working, 6/-.

M.V. Condensers, 400v. working, 4x4x1x1x1x5 1x0.1x0.1x0.1x0.1, 6/-; 4x2x1x1x1x0.5 4/6.

DUBILIER Condensers, 2 mfd., 1,200v. working, 4/-; 8 or 4 mfd. dry electrolytic 450v. working, 3/-.

VARLEY Constant Square Peak Coils, band-pass type BP7, brand new in maker's cartons with instructions and diagram, 2/4.

VARLEY H.F. Intervalve Coils, BP8, band pass complete with instructions in original cartons, 2/6.

SCREENED H.F. Chokes by One of the Largest Manufacturers in the Country, 1/9.

PREMIER British made Meters, moving irons, flush mounting, accurate, 0-10, 0-15, 0-100, 0-250 m.a., 0-1, 0-5 amps.; all at 6/-.

LARGE Selection of Pedestal, table and radiogram cabinets, by best manufacturers, at a fraction of original cost, for callers.

THE Following Lines 6d. Each, or 5/- per dozen.—Chassis valve holders, 5-, 6-, or 7-pin, screened screen grid leads; any value 1-watt wire end resistances, wire end condensers, 0.0001 to 0.1 trimming condensers, Bulgin 3-amp. mains switches.

PREMIER SUPPLY STORES
20-22, High St., Clapham, S.W.4. Telephone: Macaulay 2188. Nearest Station, Clapham North Underground.

PEARL & PEARL Bargain List "B" Free. 190, Bishopsgate, London, E.C.2.

YOUNG men trained for all branches of Wireless Profession. Britain's leading College, situated on sea-front. Boarders accepted. Training fee payable after appointment. Prospectus free. The

WIRELESS COLLEGE, COLWYN BAY.

SOUTHERN RADIO'S Bargains.—Manufacturer's guaranteed surplus.

VARIABLE Condensers.—Lotus. All 0.0005. Complete with dials, escutcheons, knobs. Fully screened with trimmers. 3-gang, 12/6; 2-gang, 8/6; single, 4/6. (List 9/6). Irramic 0.0003, 1/6 (list 7/9). Hydra block condenser, 16 mfd. (2+2+8+2+1+1), 1,000v. D.C., 7/-. Dubilier 4 mfd. (2+1+1), 1,000v. D.C., 2/9; 4.5 mfd. (2.25+2.25), 1,000v. for mains noise suppression, 3/-; fixed 4 mfd., 2/3; 2 mfd., 1/6; 1 mfd., 1/-; Utility Midget 2-gang, variable condensers, 0.0005, with concentric trimmers, 3/5.

TC.C. 0.1+0.1 Condensers, 450 working, 1/3 each (list 4/6).

SPEAKERS.—Blue Spot permanent magnet, universal transformer for power, super power, pentode and Class B, 23/- (list 39/6); Celestion Soundex permanent magnet, 15/- (list 27/6).

BLUE Spot, genuine 100U, inductor speaker on B chassis; 13/6 (list 39/6).

ST.400 Kits, all specified proprietary components; £219/6 (list £417/6).

IGRANIC Coils, set of four (1 osc., 2 I.F. with pigtails, 1 I.F. plain), 12/6 (list 50/-).

IGRANIC Band Pass 3 Coils Unit, iron-cored, screened on base, with switch; 14/- (list 33/-).

LISSEN Super-het. 3 Coils Unit, screened, ganged on base with wave-change and filament switches type LN5181 for battery or mains, 12/6 (list 30/-).

VARLEY Constant Square Peak Coils, complete with all accessories, new, boxed; DP5; 2/4 each (list 15/-).

VARLEY H.F. Inter-valve Coils, BP6, 2/3 (list 8/0); Varley power transformers, EP6, 12/- (list, 45/-).

5-VALVE Class B Superhet, Chassis by Plessey, wired ready for use, with 5 Mullard valves, new, in sealed cartons, £317/0; (list £121/2); valves alone are priced £3.

LISSEN Base Revolving Turntables, 1/6 (list 5/-).

SPECIAL Offer of Lewcos Spaghetti Resistances, all sizes, in original sealed boxes, 4/- per dozen, assorted; special price to trade, 36/- per gross.

MAINS Transformers.—Full list of mains transformers and chokes sent free; specials can be supplied in 3 days; transformers and chokes guaranteed 12 months.

MISCELLANEOUS.—Rotorohm and Radiophone volume controls, all values, 3/- switch, 3/3 (list 10/6); Westinghouse metal rectifiers, H.T. 6, 7, 8, 9/3 each; Ferranti chokes, 20 henry 60 m.a., 6/9 each.

ALL Goods Guaranteed and Sent Carriage Paid.

BRANCHES at 271-275, High Rd., Willesden Green, N.W.10, and at 46, Lisle St., W.C.2. Please send all post orders to 323, Euston Rd., N.W.1.

SOUTHERN RADIO, 323, Euston Rd., London, S.W.1 (near Warren St. Tube). Phone: Museum 6324.

WOBURN RADIO offer following new and Bankrupt stock:

UNIVERSAL AC/DC Eliminators, output 150v. 30 m.a., three positive H.T. Tappings, 25/-.

AC. 25/-; D.C., 11/6. Written guarantee 12 months.

WESTINGHOUSE Rectifiers: H.T.7, 8, 9, 9/-; H.T.10, 9/6.

COLUMBIA L.F. Transformers, 3/1, 5/1, 3/-.

Seradex Resistors, 5d. each. Chassis mounting valve holders, 4/5 pin 3d., 7 pin 6d. Baseboard 4/5 pin 4d. Binocular Chokes 1/2. H.F. Chokes 1/-.

Stampings No. 4 2/6 gross. Paxolin formers 1 1/4 in. x 3 in. 3d. Screened sleeving 3d. yd. Class B Driver and Choke 9/-.

DUBILIER Electrolytics, dry, 4 mfd. and 8 mfd., 500v., and 50 mfd. 50v., 3/3. Dubilier 2 mfd., 1,000v. test, 1/6; 500v. test, 1/3. Wego condensers, 750v. test, 1 mfd., 11d.; 2 mfd., 1/2; 4 mfd., 2/3. Tubulars, 0.01, 0.1, 0.05, 0.02, 6d.

KITS. Leader 3, 25/-; Class B3 with iron cored coils, 24/-.

S.T.300, 37/6. S.T.400, 47/6. S.T.500, 55/-.

TRADE enquiries invited. All goods fully guaranteed.

WOBURN RADIO CO., 7, Woburn Buildings, W.C.1.

REPAIRS—REWINDING—OVERHAULS. New cones and centres fitted any make M/c chassis, M/cs rewound. Mains transformers, etc. Receivers converted D.C. to A.C. Write Repair Dept. C.

WEEDON P.L.R. Co., 80, Lonsdale Avenue, London, E.6. (Grangewood 1837).

WANTED, good Modern Wireless Parts, Sets, Eliminators, Meters, Valves, Speakers, etc. Spot Cash waiting. Send or bring. We pay more than any other dealer. Open 9-8.—University Radio, 142, Drummond St., Hampstead Rd., N.W.1.

THE PRACTICAL MOTORIST
3d. every Wednesday.
Published by George Newnes, Ltd.,
8-11, Southampton Street, Strand,
W.C.2.

BULGIN FOR SWITCHES



A type for every purpose, and to fill every requirement. Models for ganging, for rotary operation, for thick panels, for thin panels, for mains sets, for battery sets.

Rotary g.m.b. type, panel-mounting, in black, walnut, or mahogany bakelite, enclosed and dust-proof. For battery or mains circuits, rating 1Amp., 250V. With engraved indicating plate.

LIST No. 585
1/6

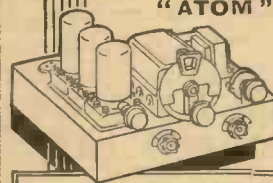

Types Specified for the "ATOM" PORTABLE

List No. 891 1/9 each.
List No. 887 1/9 each.

Our New Enlarged Booklet "Hints to Better Reception" contains 34 diagrams and instructions of interest to all.

Please send Free 16-page Booklet "N.N." "Hints to Better Reception."

NAME.....

ADDRESS.....

A. F. BULGIN & Co., Ltd., Abbey Rd., Barking, Essex.
London Showrooms :
9, 10, 11, Cursitor Street, Chancery Lane, E.C.4.



NUGANG tuning condenser

The Disc Drive is powerful and reliable: the visor has a large aperture: the whole condenser being mounted in a rigid one-piece chassis. Type "A" .0005 mfd. Single Stage .. 10/6 with cover ..

PRECISION INSTRUMENTS

..... for greatest reliability.
J.B. — Britain's most famous makers of condensers and tuning dials—the most efficient in their class—as efficient mechanically as they are electrically. Write NOW for the fully illustrated J.B. catalogue.

Advertisement of Jackson Bros. (London) Ltd., 72 St. Thomas' Street, S.E.1. Telephone: Hop 1837.

THE following unused Set Manufacturers' Surplus; all goods guaranteed perfect; immediate delivery.

FERROCART coils, G1, G2, G3, or G1, G2, G8 with switch, 27/6. G10, G11, G12, G13 with switch, 34/-. Colverlynes (Ferrocart), 7/6.

DUBILIER or Erie resistors, 1 watt type 7d., 2 watt type 1/2, Marconi K19 pick-ups 22/6.

Radiophone I.F. transformers, 110KC or 117.5KC 6/6.

WESTINGHOUSE rectifiers, HT8, 9/6, HT9, HT10, HT4, HT5, 11/-. Resonance transformers for HT8 or HT9 with 4v-4a LT winding, 7/6.

MAINS transformers, 350-0-350v., 60ma., 4v-4a, 4v-2a, 12/6. Eliminators, outputs, 150v, 25ma, S.G. and detector. A.C. type with Westinghouse rectifier, 25/-.

D.C. type, 12/6. Collaro gramophone motor, 100-250v A.C., 34/-.

DUBILIER dry electrolytic condensers, 8mf or 4mf, 500v working, 50v, 50mf, 3/0.

ROTOROHM volume controls with switch, 2/6.

BTH pick-up tone arms, 3/-.

ALL types of brand new American valves in stock, first-class makes, guaranteed. 247, 235, 551, 89, 18, 10, 46, 59, 6A7, 15, 42, 41, 38, 39, 78, 75, 57, 58, 24, 44, 36, 43, 12/-.

UX171A, UX190, UX280, UX245, UX226, UY227, 8/-.

UX250, UX281, UX210, 18/-.

BTH-RK speakers, 6v field, suitable for P.A. work, 27/6.

A.C. type with field rectifier, £27/6.

MAGNAVOX speakers complete with hum-bucking coils, output transformers, etc., 152 (9in. cone), 22/6. 154 (7in. cone), 15/9. Kola F6 (7in. cone), 17/6, all with 2,500 or 6,500 ohm fields. Magnavox PM254, 18/-.

Carriage paid, cash with order or C.O.D.

WARD, 2nd floor, 45, Farringdon Street, London, E.C.4. Telephone, Holborn, 9703.

VAUXHALL Magnavox Permanent Magnets universal, suitable for Class B power or pentode, 5 1/2 in. cone, 15/6, 7in. cone, 17/6, 10in. cone, 23/-.

ENERGISED 2,500 or 6,500, 10in. cone, 23/-, 7in. cone, 15/3. Brand new, with humbucking coils; state cover or pentode.

RADIOPHONE Radiopaks R.F. or Band-pass R superhets, 117-110 k/c, with Lucerne station named, scales and metres, complete with volume controls and switch, 32/6.

RADIOPHONE I.F. transformers, with terminals, 6/-.

Volume controls with switch, 3/6. Radiophone trimming condensers, various values. 1/-.

Tubular fixed condensers, 0.1, 0.005, 8d.; 0.002, 7d.; 0.001, 5d.

Clix valveholders, chassis type, 7-pin, 7d.; 4-5 pin, with terminals, 7d.; V.B. 4-5 pin, 4d.

Scales for Lissen Skyscrapers, with Stations named, and metres; Lucerne wavelengths, 2/6 pair; also for Radiopaks, 1/9 each.

Varley B.P.5 constant, square peak coils, 2/6.

Dubilier or Erie Resistors, 1 watt, all values, 7d. each.

Benjamin, Class B, 1-1, 1 1/2-1, transformers, 6/6.

B.T.H. TruSpeed Induction Type electric gramophone motors, 100-250v., 30/- complete; Collaro gramophone motors, A.C., 110-240v., 32/6 complete.

CASH With Order, post paid over 2/6, or c.o.d.; all goods guaranteed. Valves, etc. Send for Lists.

VAUXHALL UTILITIES, 163a, Strand, W.C.2. Temple Bar 9335.

HA. WIRELESS for everything radio.

SPECIAL Bargain.

CROSLEY 5 Valve A.V.C. Midget Superhet 10 x 8 x 5. AC/DC 100/250v. No aerial. Zebra Wood and Satinwood Cabinet with Chromium Fittings. List 10 guineas. OUR PRICE £5/19/6.

LISSEN Super Transformer 3-1-1, list 19/- 6/-.

LISSEN Output Choke, list 12/6 6/-.

WE supply components, valves or kits for any Practical Wireless set.

SUPPLIED cash with order or C.O.D. Send for Lists.

HA. WIRELESS (Shoreditch), Dept. PW4, 9 & 13, Hackney Rd., Shoreditch, E.2. Telephone Bishopsgate 8169 (PBX).

RICSSON 3/1 L.F. Transformers. List price, 17/6. New and guaranteed. Our price, 2/3, post free U.K.

VARLEY Constant Square Peak Band Pass coils, Type B.P.5. Complete with switch, brand new, in maker's original carton. With full instructions and diagrams. List price, 15/-.

Our price, 3/9, post free U.K.

POLAR 3-gang Star Minor Condenser with trimmer. Brand new. List price 18/9. Our price, 7/6 each, post free U.K.

COLLARO Electric Gramo Motor A/C 200-250, with Pick-up and Vol. Control. Brand new. Listed at £4. Our price, 52/6, carriage paid.

PIONEER RADIO, Coptic Street, London, W.C.1. Museum 9600.

ELIMINATORS, 25 m.a. D.C. 10/-, A.C. 21/-.

Transformers 3-1, 5-1, 1/0. British-Made Valves H.F., L.F. and Dec. 1/9. Power 2/-.

S.G. 5/-.

Carriage Paid Cash with Order.—Radio Electrical Supplies, 237, Camberwell Road, London, S.E.5.

HIGHEST possible allowance made on used wireless sets or parts in exchange for any new set, kit or parts. Peto-Scott kits supplied. Goods bought for cash.—R. Wigfield, Furlong Road, Goldthorpe, Yorks.

AMAZING PORTABLE OFFERS!

Complete Kit Outfits at unprecedented prices.
S.G.—H.F. Pen., 15/6. Class B III, 27/6. Screen Grid IV, 39/-. Cl. B, S.G. IV, 40/-.

HERE IS YOUR OPPORTUNITY to make an up-to-date portable receiver of your choice at an altogether unproportionate price.

SUITS CASE OR TRANSPORTABLE MODELS. Every Kit is available in either form at the same price. Please state which type preferred. Transportable type may be considered preferable if required for use indoors as well as out.

EACH PORTABLE OUTFIT AVAILABLE AS KIT A: A.1; B: C; or KIT D, comprising as follows: KIT A. Complete Kit of components, with all sundries, frame aerial and full diagrams and instructions. KIT B. As Kit A, with set of matched valves. British and fully guaranteed.

KIT C. As Kit B, together with carrying case and speaker. KIT D. As Kit C, with batteries, comprising complete outfit.

SG.—H.F. PEN. 2-VALVE MIDGET PORTABLE KITS, 15/6. A Midget design, giving giant results fairly sums up the merits of this ultra-modern and efficient 2-valve portable, which employs an H.F. Pentode as detector, and an L.F. Pentode in the output stage. Results superior to many four-valvers. PRICES: KIT A, 15/6; KIT A1, 22/6; KIT B, 25/6; KIT C, 32/6; KIT D, 39/6.

CLASS B III PORTABLE KITS, 27/6. Another ultra-efficient design, whose chief merits is large output and high quality of reproduction. KIT A, 27/6; KIT A1, 37/6; KIT B, 42/-; KIT C, 52/-; KIT D, 64/-.

SCREEN-GRID IV PORTABLE KITS, 30/-. An S.G. IV portable, employing midget dual-gang condenser with illuminated disc drive control, and midget iron-cored H.F. coil. A real long-distance portable. KIT A, 30/-; KIT A1, 42/6; KIT B, 45/6; KIT C, 58/6; KIT D, 70/-.

CLASS B S.G. IV PORTABLE KITS, 40/-. This Kit represents the last word in modern portable receiver design. Features dual-gang condensers, iron-cored H.F. inductance and powerful Class B amplification. The portable that combines distance with mains volume and quality of reproduction. KIT A, 40/-; KIT A1, 52/6; KIT B, 58/6; KIT C, 72/-; KIT D, 85/-. If Ormond Midget P.M. Speaker preferred to Bal-Armature Type, add 9/6.

SHORT-WAVE KIT BARGAINS!

Short-Wave Kits at a fraction of usual price.

LISTEN TO THE WORLD with these short-wave Kits, which employ high grade components of the finest manufacture throughout. Slow-motion drives are of the smoothest made; all coils are wound on low-loss ribbed formers and generally every detail has been attended to in producing these highly efficient short-wave sets. All Kits complete with all sundries, and instructions in sealed cartons.

SHORT-WAVE ADAPTOR KITS. For adapting any battery receiver for use on the 15-80 metre waveband.

SUPERHET S.W. ADAPTOR KITS. Employs separate oscillator valve. Will convert any receiver (battery or mains) which employs one or more stages of H.F. amplification into an efficient S.W. Superhet.

SHORT-WAVE 1-VALVE KITS. A simple short-wave receiver giving highly satisfactory results with headphones.

SHORT-WAVE 2-VALVE KITS. An efficient straight two-valve design employing a single stage of L.F. amplification.

SHORT-WAVE 3-VALVE KITS. A straight 3-valve design with ample amplification for speaker reproduction.

SHORT-WAVE S.G. III KITS. A short-wave design of extraordinary sensitivity.

SHORT-WAVE CLASS B S.G. IV KITS WITH A.V.C. The finest short-wave Kit we have to offer. Super sensitivity and mains quality and reproduction characterise this fine set. An anti-fading device is incorporated in the circuit—a tremendous asset in world-wide reception.

ACCESSORIES, VALVES—British and fully guaranteed. A fraction of usual price. H.F.; det.; L.F., each, 2/6; Power, 2/9; Super Power, 3/3; S.G., 4/10; Class B, 7/10. Also all Triotron valves at 25 per cent. off list prices. H.T. BATTERIES, 100 volt, 5/10; Class B Super-Capacity, 9/-; G.B. 9-volt, 7d. ACCUMULATORS, 2-volt, 20 a.h., 2/4; 45 a.h., 4/4.

ELIMINATOR KITS with all sundries and full instructions; 100-120v. or 200-230 volts. A.C. 25 ma., 19/6; D.C. 25 ma, 7/6; Special Class B, 27/6. SPEAKERS: Amplion Super-Cone Units, 27/6; Ormond P.M. Moving-Coil Speakers, 14/11; Headphones, per pair, 5/9.

SHOP SOILED SNIPS!!

For Immediate Disposal, Limited Quantities only
BURNE-JONES DUAL RANGE COILS, per pair (Aerial and H.F.); 1/11; Brownie, dual range, 11d.; Iron-cored, 2/3; Varley Square Peak Coils (list 15/-), 2/11.

LONDON EAST CENTRAL TRADING COMPANY (Dept. M.115), 23, Bartholomew Close, London, E.C.1. (Phone, NATIONAL 7473).

For ALL Surplus Radio, remember—**THE 'GOLD-MINE' STORES**



"We're Fluxite and Solder—the reliable pair; Famous for Soldering—known everywhere!"

"The Music WAS perfect—till something went wrong! We came to the rescue—hence laughter and song!"

See that Fluxite and solder are always by you—in the house—garage—workshop—anywhere where simple, speedy soldering is needed.

ALL MECHANICS WILL HAVE FLUXITE IT SIMPLIFIES ALL SOLDERING

All Ironmongers sell Fluxite in tins: 4d., 8d., 1s. 4d., and 2s. 8d. Ask to see the FLUXITE POCKET SOLDERING KIT—complete with full instructions—7s. 6d. Ask also for our leaflet on HARDENING STEEL with Fluxite.

FLUXITE, LTD. (Dept. W.P.), Dragon Works, Bermondsey Street, S.E.1.

FOR ALL REPAIRS!



"MAINS POWER FOR YOUR RADIO"

If you intend running your radio from the mains, write NOW for the new Heayberd Handbook. This book gives all the information required for building your own mains unit, battery charger, etc. It also contains a special television supplement with blueprints of Kits of parts for television uses. Helpful technical hints and tips that will prove useful to all amateurs, and a complete list of HEAYBERD MAINS APPARATUS.

Cut out this ad. and send with 3d. in stamps for your copy.

F. C. HEAYBERD & CO., 10, FINSBURY STREET, LONDON, E.C.2

Add 50/- WEEKLY to your earnings

by charging accumulators in your spare time. Complete plant incorporating Westinghouse Rectifiers to charge 105 cells weekly. Trade price 4 guineas or 8/- monthly. Models for A.C. and D.C. mains. Also Charger for H.T. accumulators.

M.P.R. Ltd ROMFORD, ESSEX.



ENGINEERS! ARE YOU EARNING LESS THAN £10 PER WEEK?

If so, you cannot afford to carry on without reading our 256-page Handbook. The book explains clearly and definitely many ways of carrying out a successful career. Among other things, it explains the Service of our unique Appointments Department, outlines Home-Study Courses in all branches of Civil, Mechanical, Electrical, Motor, Aero, Wireless, "Talkie," Eng. Building, etc., and gives details of B.Sc., A.M.I.C.E., I.E.E., A.M.I.Mech.E., A.M.I.A.E., G.P.O., MATRIC, and all Exams. We alone Guarantee—NO PASS—NO FEE! Whether you be an old hand or a budding apprentice, get this book to-day—FREE and POST FREE. **BRITISH INSTITUTE OF ENGINEERING TECHNOLOGY**, 393, Shakespeare House, 29/31, Oxford St., London, W.1.



1000 ELECTRADIX BARGAINS

Electradix Radios offer 1000 bargains at sacrifice prices in radio components, meters, dynamos, microphones, switches, chargers, valves, etc. **ELECTRADIX RADIOS** Send for Sale List "N." It will save you pounds. 218, Upper Thames Street, E.C.4. Central 4611.

PATENTS AND TRADE MARKS. KING'S PATENT AGENCY, LTD., 146b, Queen Victoria Street, E.C.4, offer "Advice Handbook" and Consultations free. 49 years' references. Write, call, or 'phone. 'Phone: City 6161. Director, B. T. King, C.I.M.E., Reg. Patent Agent, G.B., U.S.A., and Canada.

SEND NOW FOR OUR FREE HANDBOOK, "RADIO PROGRESS." Fully explaining the R.T.I. Home-Study Training in Radio, Talkies or Television. They are practical and lead to Certificate and a Better Job. A P.O. will do. Write now.—Radio Training Institute of Gr. Brit., 85, New Oxford Street, London, W.C.1.

THE WIRELESS CONSTRUCTOR'S ENCYCLOPAEDIA

(2nd Edition) By **F. J. CAMM** (Editor of "Practical Wireless")

THIS invaluable encyclopaedia is written in plain language by one of the most accomplished designers and writers on wireless construction. Obtainable at all Booksellers, or by post 5/6 from Geo. Newnes, Ltd., 8-11, Southampton Street, Strand, London, W.C.2. **5/-**

FREE ADVICE BUREAU.

COUPON

This coupon is available until June 16th, 1934, and must be attached to all letters containing queries.

PRACTICAL WIRELESS, 9/6/34.

ADVERTISEMENT INDEX

Automatic Coil Winder & Electrical Equipment Co., Ltd.	Page 359
British Institute of Engineering Technology	Inside Back Cover
Bulgin, A. F., & Co.	372
Cosser, A. C., Ltd.	Inside Front Cover
Electradix Radios	Inside Back Cover
Fluxite, Ltd.	Inside Back Cover
Heayberd, F. C., & Co.	Inside Back Cover
Herauld, E. J., Ltd.	368
International Correspondence Schools	366
Jackson Bros. (London), Ltd.	372
King's Patent Agency, Ltd.	Inside Back Cover
Mains Power Agency	Inside Back Cover
Peto Scott, Ltd.	Front Cover Strip, 365, 371
Radio Training Institute of Gr. Brit.	Inside Back Cover
362 Radio Valve Co., Ltd.	368
Varley, Ltd.	368
W. T. Henley's Telegraph Works Co., Ltd.	371
Wet H.T. Battery Co.	368
Wright & Weaire	367

18 Clarendon

GRAND HOLIDAY READING!

The July GRAND is now out and you'll meet its gay green and gold cover everywhere this holiday season. Holiday time is reading time, and, as all good judges of fiction know, the GRAND always contains a splendid selection of the best stories of the month. There are stories for all tastes and every occasion—for the train, for the beach, for the open-air and (though we hope this won't apply in your case) for the "rainy day"!

The journey will seem shorter and the holiday longer and more enjoyable if you have a July GRAND to keep you company.

NOW ON SALE

Get your Copy To-day!



Obtainable at all Newsagents and Bookstalls
SEVENPENCE

Geo. Newnes, Ltd.

In the June STRAND MAGAZINE

A GREAT NEW HUMOROUS STORY

"The Amazing Hat Mystery"

P.G. WODEHOUSE

At all Newsagents and Bookstalls, or by post 1/3 from
George Newnes, Ltd., 8-11, Southampton Street,
Strand, London, W.C.2.

NOW ON SALE - ONE SHILLING

Geo. Newnes, Ltd.

P.W. Gift Stamp No. 23

Printed in Great Britain by NEWNES & PEARSON PRINTING CO., LTD., Exmoor Street, Ladbroke Grove, W.10, and published by GEORGE NEWNES, LTD., 8-11, Southampton Street, Strand, W.C.2. Sole Agents for Australia and New Zealand: GORDON & GOTCH, LTD. South Africa: CENTRAL NEWS AGENCY, LTD. *Practical Wireless* can be sent to any part of the world, post free, for 17/4 per annum; six months, 8/8. Registered at the General Post Office for Transmission by Canadian Magazine Post.