

HOW TO TRICKLE-CHARGE YOUR ACCUMULATOR AT HOME

Amateur Wireless

3^d
Every
Wednesday

and
Radiovision

**SURGERY ON THE
SHORT WAVES**

**STATIC-FREE
RECEPTION**

**ADVENTURES IN
AFRICA**

**LOW-POWER
TRANSMITTERS**

WHAT IS THE BEST..... LOW-FREQUENCY COUPLING?

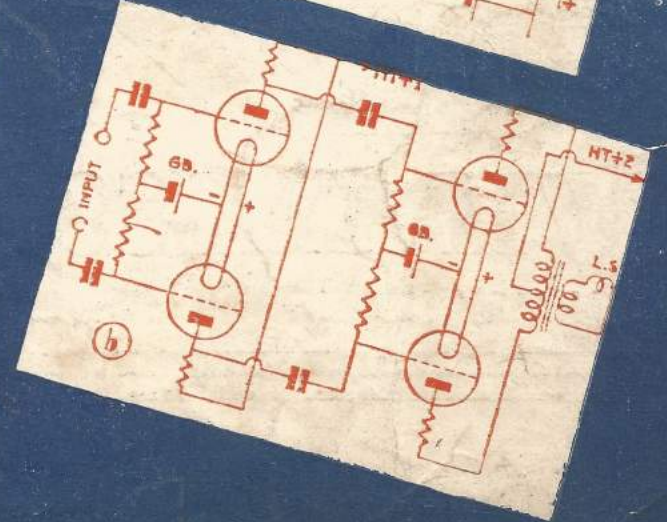
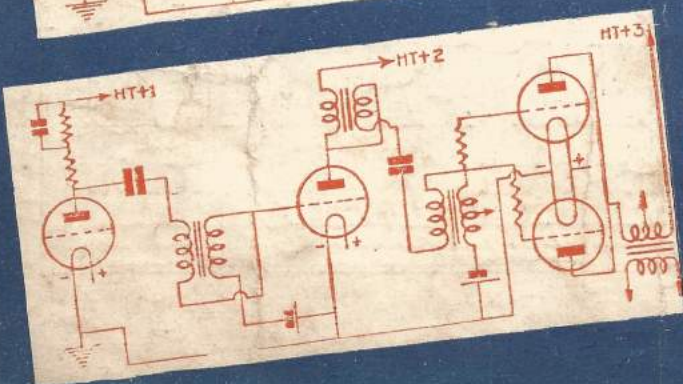
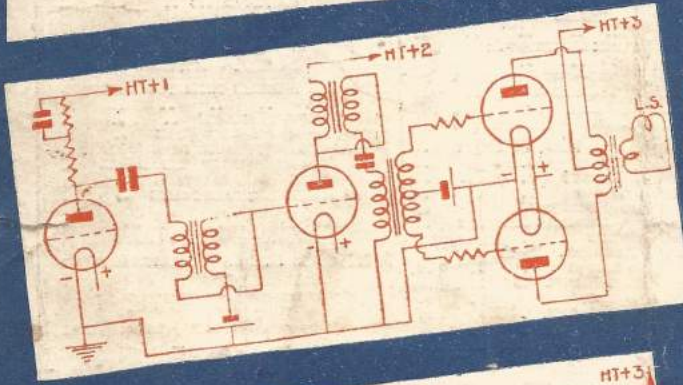
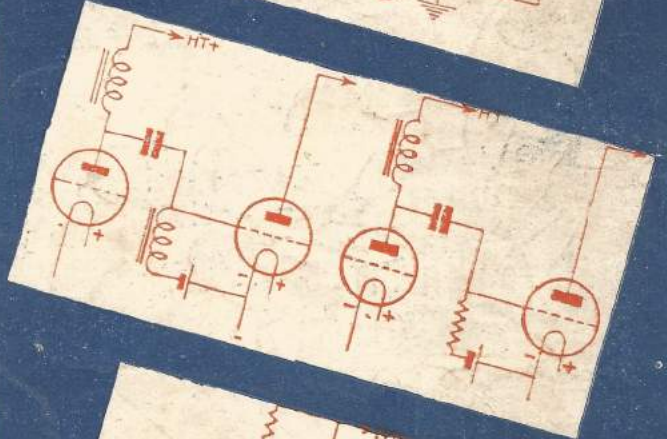
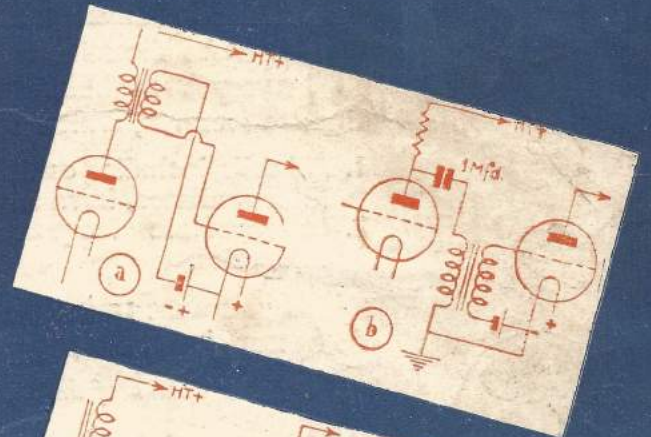

The 1935 Super Five

Designed by the "W.M." Technical Staff



THIS up-to-the-minute battery Super-het receiver is described in the January WIRELESS MAGAZINE. The 1935 Super Five has five distinctive features, which will appeal to all technicians.

- | | |
|--|---|
| 1. All coils, including oscillator and intermediates, have iron cores. | 3. Self-adjusting volume control. |
| 2. Intermediate frequencies—110 kilocycles. | 4. Battery economiser. |
| | 5. Selectivity can be varied between 6 and 12 kilocycles. |

If you want to build a really good set for the New Year you cannot do better than start on the 1935 Super Five.

Below are some of the other contents of this remarkably fine January issue.

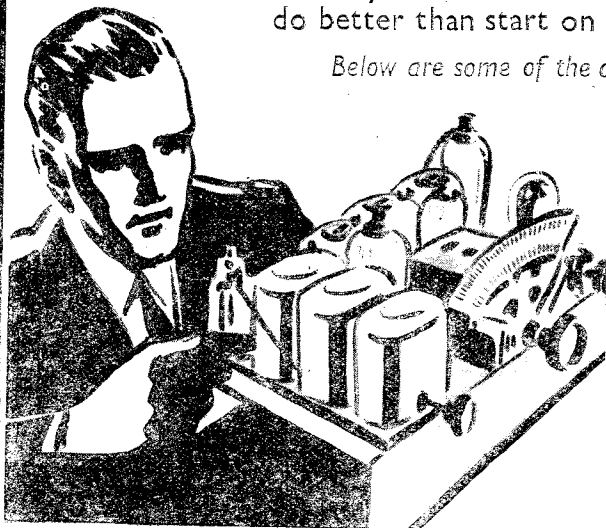

FOR THE CONSTRUCTOR

GRADUATING TO A LOW-FREQUENCY STAGE. By the "W.M." Technical Staff
 THIRTY-THREE STATIONS ON OUR THREE-VALVER
 INDIVIDUAL VOLUME CONTROL FOR SEPARATE LOUD-SPEAKERS
 THE "W.M." LONG-WAVE CONVERTER. By the "W.M." Technical Staff

TECHNICAL FEATURES

MORE ABOUT THE NEW DETECTOR
 THE RADIO AIRWAY
 WHAT IS THIS QUALITY?
 TO-MORROW'S VALVES
 RECTIFIERS AND LINEARITY
 HOW TO GET SMOOTH REACTION
 THE IDEAL RESPONSE
 TESTS OF THE NEW SETS. By the "W.M." Set Selection Bureau
 K.B. UNIVERSAL MODEL 383
 C.S. 350 BATTERY THREE
 E.K.O. SUPER-HET MODEL ADT95
 H.S.S. A.C. THREE-VALVER
 G.L.C. SUPER-HET D.C. FIVE

MORE EXPERIMENTS WITH OUR TEST SET
 NOISELESS PICK-UP SWITCHING
 AERIAL DESIGN
 TESTS OF NEW APPARATUS

GENERAL ARTICLES

WORLDLY BROADCAST WAVELENGTHS
 NEW YEAR MESSAGE FROM THE DIRECTOR-GENERAL
 IS DRIFT WITH A FAILURE?
 EUROPE'S GIANT TUNING FORK
 WHO SHOULD PAY FOR ANTI-STATIC TUNING?
 FILES AND RECORDS OF THE B.B.C.
 NEWS OF THE SHORT WAVES
 RADIO VALVES IN OTHER FIELDS

TELEVISION SECTION

IT IS EASY TO BUILD A TELEVISION RECEIVER

GRAMMO-RADIO FEATURES

THE MANUFACTURE OF GRAMMOPHONE RECORDS

WIRELESS MAGAZINE

JANUARY ISSUE

NOW ON SALE

PRICE 1/-

Editor-in-Chief:
BERNARD E. JONES

Radiovision Editor:
H. CORBISHLEY

Amateur Wireless and Radiovision

Editor:
D. SISSON RELPH

Assistant Editor:
ALAN HUNTER

Published by BERNARD JONES PUBLICATIONS, LTD., 52/61 Fetter Lane, London, E.C.4. Telephone: Central 4341 (four lines). Telegrams: "Beejabee, Fleet, London." Subscription post paid to any part of the world: 3 months, 4s. 6d.; 6 months, 8s. 9d.; 12 months, 17s. 6d. Published on Wednesdays and dated for the following Saturday.

News and Gossip of the Week

This Television

AN enormous amount of non-sense is being written about television at the moment. Particularly in the lay press.

As usual, real television—whatever that may mean—is said to be "here"—which actually is neither here nor there when you know the facts.

B.B.C. Monopoly

WHAT can be said with almost complete certainty is that the B.B.C.—vive the Corp!—will have monopolistic control of television broadcasts.

Secondly, the system to be adopted—if, indeed, any one system as such is adopted—will be British in origin, not a foreign-sponsored system.

Lucky Metropolis

As usual, London will be the lucky centre when television does start up. Experiment and slow progress towards service will be the slogan—certainly not a mushroom growth of ultra-short-wave stations all over the country.

Vision Channels

IT is obvious to the meanest intelligence—is it not?—that this television cannot go into the broadcasting channels now occupied by sound.

The ultra-short waves will take the television of the future. High definition, probably 180 lines, will take the field; but the suggestion that sets can be sold for the modest sum of £12 are very wide of the mark.

Television on a commercial basis cannot be bought so cheaply—not at the beginning, anyway.

Finance

WHERE is the money coming from for this television? It is coming from the Treasury—part of the present licence revenue being appropriated.

Quite right, too. At the moment the B.B.C. takes only 4s. 6d. from the 10s. licence money. A few more shillings would enable a really good television service to be started.

Droitwich Tests

RECORDS are still being feverishly compiled all over the country of the peculiar behaviour of the Droitwich transmitter.

Gone are the pious hopes that the fading and distortion are only

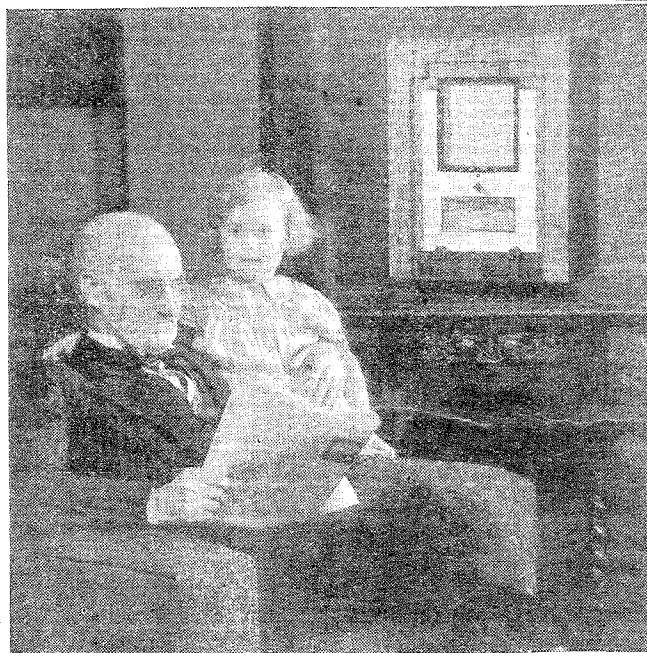

Ferranti photo
Young lady listens to the Arcadia—and so does her grandfather. Radio—especially on a good modern set—appeals to all ages

seasonal. It is now admitted that Droitwich is not living up to expectations.

Experts say that the Heavyside Layer is behaving in an odd way just now, but Mr. Ashbridge refuses to accept that as justification for the shortcomings of Droitwich.

New Aerial

EVERYTHING points to the fact that the aerial at Droitwich is wrongly designed in some way.

Already the B.B.C. is hinting that it would be prepared to spend money on putting the aerial right—anything to get the signal well received, at least up to the 200-mile-radius mark.

At the moment, fading occurs even at 100 miles—which, as Euclid would have said, is absurd.

Listener Test

ENGINEERS spent a great deal of time before Christmas taking records from the short-wave links, and altogether 75 per cent of the material sent out from the B.B.C. during the "Empire Exchange" programme was "incoming," leaving only 25 per cent of home stuff.

The quality of such broadcasting is, of course, inferior to the normal, owing to atmospheric disturbances—surely a test of listener patience and loyalty!

More Talk

EDINBURGH is to have an additional talks studio. Work will be started in the New Year.

It must be remembered that Scottish talks are arranged practically independent of London—the only region where this freedom is allowed.

Scottish Trials

ON the lines of the London series, Scotland is arranging a series of famous trial broadcasts, including one or two murders!

One of these will be "The Murder of Madelaine Smith"—which sounds good enough meat for the most fiery of Scots.

End of "Regionals"

ON January 6 the title "Regional" will be dropped from all except the London station.

After that the programmes will

be known as the Northern, the Midland, the Western, and the Scottish.

London Regional will remain to distinguish it from the National.

Distinctive Sounds

ANOTHER evidence of an increasing tendency to make the centres more "contrasty" is the decision to start individual interval signals for each region.

This is always assuming that suitable sounds can be heard—distinctive enough not only from one another, but from the motley sounds of European stations.

Doctor's Advice

THE General Medical Council is concerned about the medical talks broadcast by the B.B.C.

Listeners are in the habit of writing in apropos the talks; and, of course, the B.B.C. has to say that, as its contributors are anonymous, they cannot possibly deal with queries.

"Question Time"

BUT there is to be an attempt to start a query department at the B.B.C. in another sphere of social welfare. On January 7, R. C. Clements will begin a series called "Question Time—Service and Information," the idea being to deal with problems arising from social legislation.

Problems such as rent restriction and liability of tenants, and so on, will be dealt with by a special Information Service to be set up—a significant departure from pure broadcasting.

To Help "U"

LISTENERS will be invited to send in their letters to the B.B.C., marking the envelope with the letter "U."

These will then be sent to the National Council of Social Service—to be dealt with by experts. It all sounds very imposing, doesn't it!

History Has It!

COMPLAINTS have been received by the B.B.C. anent the reference to the "Bloody Tower" in a Stanley Holloway monologue.

The B.B.C.'s reply is delicious: "The term 'Bloody Tower' is permissible because it has a genuine historical association."

History has a habit of repeating itself, though, particularly in swear words. Oh, Stanley!

Surgery— on the Short Waves!

By KENNETH ULLYETT

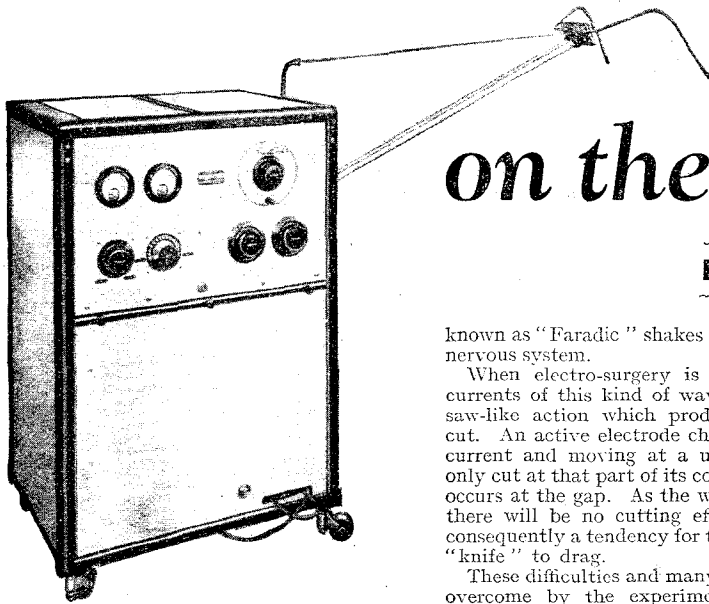

This is the experimental model of the Marconi-Dean apparatus which can be used for surgery or healing by flooding a local area with high-frequency energy

SHORT-WAVE fans, experimenting with ultra high-frequency gear, complained of strange heating effects and irritation of the eyes.

Amateur transmitters working on five to ten metres complained of peculiar burns somewhat akin to those caused by hurtful X-rays.

Hard-boiled technicians were cynical. They said it was impossible for radiations anywhere near this order in the frequency range to cause heating or burning effects on the body.

Fisherman's Yarns

These tales were thought to be just as much "fisherman's yarns" as WJZ on a crystal set! They were wrong.

Five-metre transmissions under certain circumstances can have an amazing effect on the human body.

Take a peep into the operating theatre of a Midland hospital. At the side of the operating table you can see a cabinet looking for all the world like a miniature version of the control desk at Brookmans Park.

White-shrouded figures bend anxiously over the patient on the table.

The surgeon moves swiftly and silently . . . he is operating not with a knife but with an electrode connected to the mysterious-looking control panel.

This is electro-surgery in its latest version: the adaptation of radio to medicine.

Operations can be carried out only with a high-frequency "knife," which enables a surgeon to carry out delicate operations, some of them almost impossible by more conventional medical means.

Curative Purposes

The radio man is curious to know how high-frequency currents can be harnessed in this way, not only for surgical operations but for flooding the human body with high-frequency vibrations for curative purposes.

In the laboratory experiments first produced high-frequency currents for electro-surgery by an arrangement which was similar to that of spark transmitter. This, of course, gives a damped wave. It is not a wave of constant amplitude, and there is a period when the wave has completely died out. Then we get a peak of high amplitude as the spark gap is bridged across. This type of damped wave high-frequency vibration produces what are

known as "Faradic" shakes upon the patient's nervous system.

When electro-surgery is carried out with currents of this kind of wave-form there is a saw-like action which produces an irregular cut. An active electrode charged with such a current and moving at a uniform speed can only cut at that part of its course when a spark occurs at the gap. As the wave-train dies out there will be no cutting effect, and there is consequently a tendency for the high-frequency "knife" to drag.

These difficulties and many others have been overcome by the experiments of a special branch of the Marconi organisation, and the result is the Marconi-Dean valve diathermy apparatus, which is proving a godsend to hospitals.

There are three models, the universal type being used both for therapy and surgery. It meets the needs of the general practitioner and of small hospitals and allows of full diathermy treatment of one patient.

It is a radio transmitter in miniature, the maximum output of high-frequency energy at the patient's terminals being 240 watts!

The frequency is continuously variable by the operator over a range of 90 to 130 metres (3,300,000 to 2,300,000 cycles per second).

Cutting is done by means of the high-frequency charge on a special electrode.

The controls are simple and the control handles are easily removable so that they may be sterilised. The surgeon can control the apparatus himself or with a foot-operated control.

The high-frequency discharge is provided by an ordinary valve oscillatory circuit, a Marconi MT12A valve being used with 2,500 volts on the anode. The filament needs a 12.5 volts supply, and the total current on the filament side is 11 amperes. The complete "broadcaster" only takes 4 amperes from a 250-volt 50-cycle supply.

Look at the broadcaster . . . it is mounted in a cellulosed grey and polished aluminium lined panel just like a B.B.C. transmitter. The high-frequency components are inside with the "sterilisable" controls brought out to the top.

An engraved dial on the black panel enables the operator to pre-select suitable voltages and frequencies for the skin and tissue cut, before commencing the operation.

The surgeon can "tune-in" the patient so that a condition of resonance is established between the person undergoing the treatment and the oscillatory circuit.

While the operation is going on the surgeon handles the high-frequency

"knife" in the ordinary way, and a continuous wave-form supply is used for cutting.

This 240-watt universal model has ample power for all surgical purposes; it rapidly severs fat, muscle, and every tissue—except bone or calcification—according to the set. An expert with whom I have discussed the Marconi-Dean apparatus says that at a correct frequency setting a very simple cut is produced and the continuous-wave high-frequency supply ensures the greatest sedative effect both for surgery and therapy.

I asked this surgeon exactly why electro-surgery is an improvement on the older technique. He said that it has the advantage over the "knife-and-fork" type of operation in that it is not necessary to the surgeon to handle the tissues, and it is much cleaner in consequence of the complete, sterilisation of both malignant and bacterial infection.

Sealing Action

The active electrode, of which various forms are used according to the purpose in hand, when charged with suitable current, completely severs the tissue in its course, and, more important still, it completely seals up the capillaries and lymphatics, thereby arresting haemorrhage. By thus checking haemorrhage and keeping the fingers away from the wound it is possible to continue work deep in the body.

This sealing effect will depend upon the current and the speed at which the electrode is directed through the tissue by the surgeon.

The current and speed must be adjusted so that the coagulation is just sufficiently effective to seal up the capillaries and lymphatics; but for cutting purposes the coagulation must be very light—of film-like depth. With these precautions the healing effect is good. Primary union follows the operation, and an excision will be healed by first intention.

When it is necessary to sever blood vessels larger than about one millimetre diameter, and the current and the speed of cutting the tissue are just sufficient to seal up the capillaries and lymphatics, the larger vessels may not be completely sealed by the electrode in its course; but the vessel can be quickly sealed by taking up the severed end with pointed haemostatic forceps and then applying the operating electrode, still charged

Continued on page 4

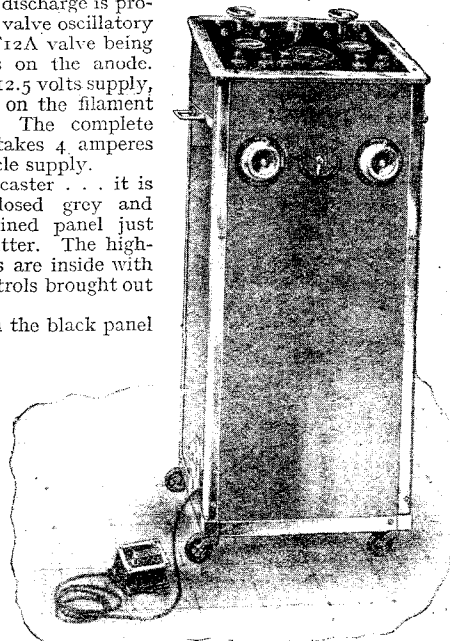

This is the universal model, used in hospitals for operations and therapy. The surgeon uses the foot control shown here while operating with a high-frequency knife

How to Trickle-charge That Accumulator

By the "A.W."
Technical Staff

WHY is it that so many listeners stagger week after week to the distant charging station when they might so easily avoid this unquestionably back-breaking experience?

The answer lies deep in the mystery of human nature. It is not for us to probe into such inscrutable depths. At the same time we pop the question in the hope that it will sting a few back-breakers to reflect upon their inordinate folly.

Rather Baffling

Perhaps one big reason can be found in the fact that the listener has no electric-light supply. Which is rather baffling, when you come to think of it. For, of course, you cannot charge at home unless you have some sort of electric-light supply.

Thousands of people have electric light and don't make any use of it at all. Their existing battery sets are probably too good to throw on the junk heap—which accounts for the use of a battery set when mains have probably been laid on for a year or more.

On the other hand, a sort of half-way house to electrification of the radio can be reached through the trickle charger. It does nothing, of course, to stop the high-tension battery from running down as quickly as ever. All we

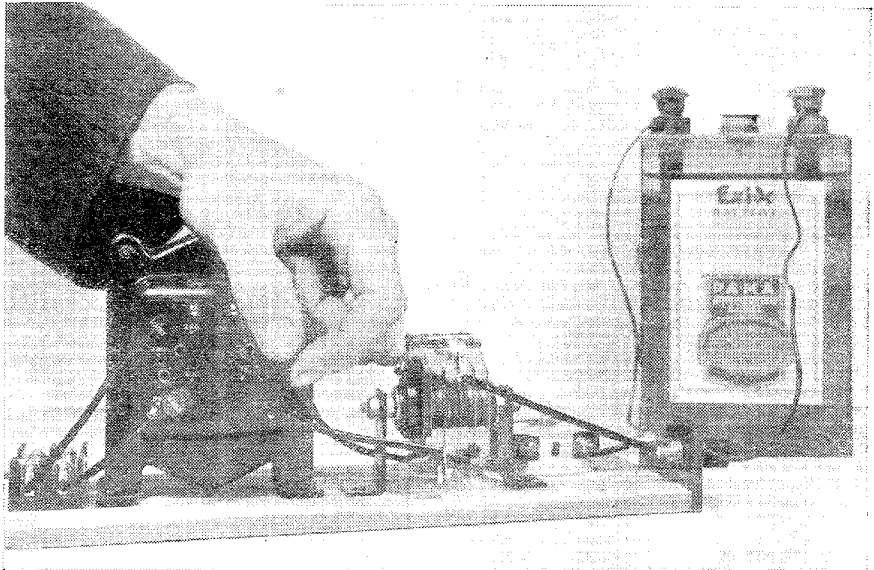

With this trickle-charger you can be sure that your accumulator will be always up to the mark. It works from A.C. mains

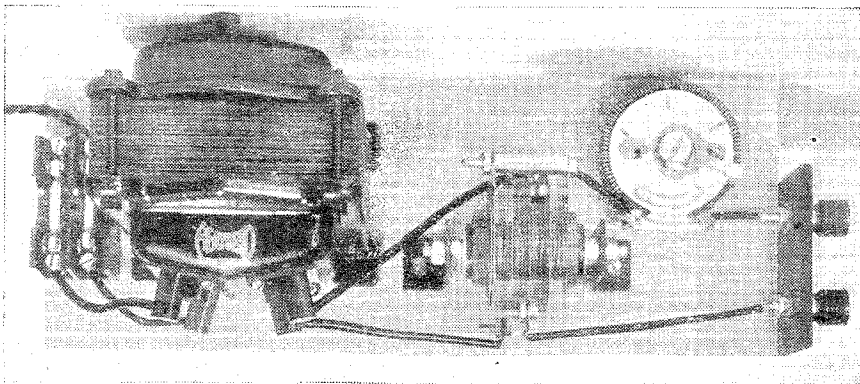

Looking down on the trickle-charger—a view that clearly shows the layout of the transformer, rectifier and rheostat

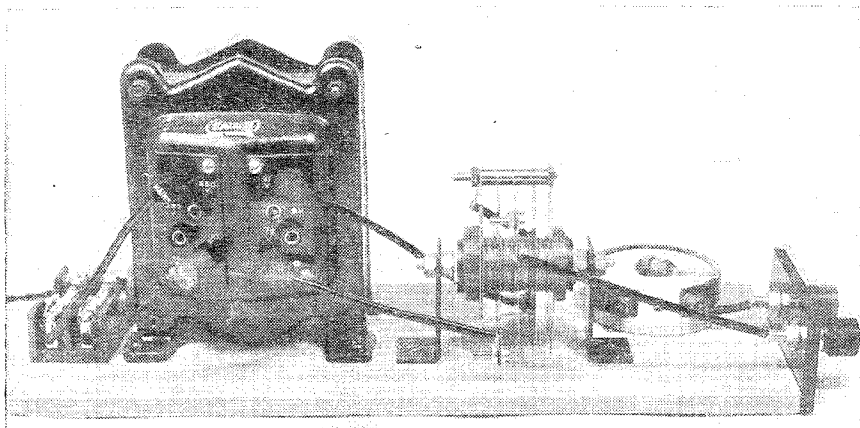

Tappings on the mains transformer enable the charger to be worked from practically every voltage of supply

suggest a trickle-charger can do is, first, save a permanent crick developing in the vertebrae and, secondly, keep the accumulator always on the top of its form.

Perhaps of the two advantages the latter is the more important—although we sympathise with those whose backs seem to be verging on the "every-picture-tells-a-story" posture.

It Gently Recuperates

Trickle-charging is not very different from any other charging. Simply a lower rate of charging—that's all. Whereas your accumulator groans under perhaps a 6- or even 12-ampere charging rate at the garage, frothing at the vents alongside stalwart car batteries and suchlike odd bench fellows, under the soothing influence of a trickle-charger it gently recuperates with a mere .5-ampere of charging current.

If you add up the current consumption of each of the filaments of each of the valves in your set you will find, very probably, that it comes to just about .5 ampere. Maybe a little less, maybe a little more, but that's the average.

So that on the assumption you use the set for six hours a day—don't forget all the time the wife is using it when you are not at home!—it is possible to charge up overnight all you discharge during the day and evening.

Up to Scratch

Or, if you don't use the set as much as that, two or three nights a week on the charger will keep the accumulator right up to scratch. That is really the whole point about these trickle-chargers—they enable you to keep the accumulator practically at the fully charged condition.

Which, if you know anything of the chemistry of accumulators, is a good thing. It happens that an accumulator is peculiarly vulnerable to attack by the dread process of sulphation when it is in a lowly state of discharge. Nothing keeps an accumulator so young and healthy as being always well charged

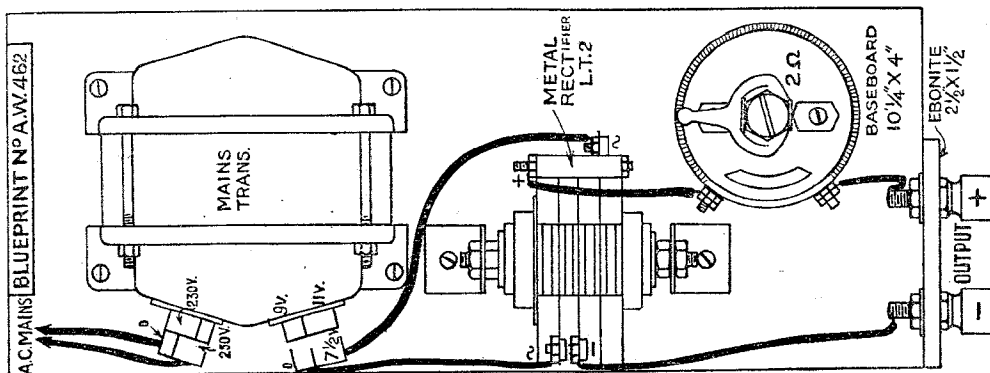

Half-scale reproduction of the full-size blueprint of the charger, which can be obtained, price 6d. post paid from us

Why do you suppose that a car battery, which for momentary periods has to undergo enormous discharges, wears so well? Only because the car's dynamo is always charging up the battery's cells and so keeping them at the fully charged mark.

From many points of view trickle or low-rate charging every night or every other night is a commendable practice. When, too, it is realised how wonderfully cheap the process is we cannot understand why more people do not dash to make or buy a charger.

Making Things Yourself

Making a charger is frankly not cheaper than buying one—there are plenty of good models on the market at ridiculously low prices. But as a reader of this paper you obviously like making things for yourself—and that is why all these illustrations have been made of what is essentially a very simple piece of apparatus.

Assuming that you have A.C. mains, what precisely do you need for a trickle charger? Three gadgets: a transformer, a rectifier and a regulating resistance.

The transformer is needed to step down the A.C.-mains voltage to a suitable charging voltage—to a voltage that will remain more than the voltage of the battery even when it is fully charged.

One-way Current

The rectifier is needed, rather obviously, to change the A.C., which is rushing first one way and then the opposite, into a one-way or direct current that will pour directly into the battery through a process of chemical change.

The resistance is essential to control the degree of charging current. As a matter of fact the charging current can be worked out very nearly well enough by suitably tapping down the secondary of the mains transformer—but although this has been done for the present charger a resistance on the D.C. side of the rectifier is still advisable to prevent disastrous short circuits and inadvertent reversals of the polarity of the connections.

For the charger shown in these pages a transformer with three secondary windings has been used, giving output voltages of approximately 11, 9 and 7 1/2 volts. These are suitable respectively for 6-, 4- and 2-volt

accumulators—the voltage difference between the secondary output and the voltage of the accumulator being largely responsible for the actual charging current.

With .5 ampere as the standard charging current a 2-ohm resistance in series between the rectifier and the output terminals is needed—a variable one being used with the slider pushed round to its maximum.

The input or primary of the transformer also has windings suitable for all mains from 200 to 250 volts. It is of course essential to adjust the input for your particular mains voltage, otherwise there will be an error in the charging currents.

One other component has been included in the pictured charger—a twin fuse holder on the mains side of the transformer. This is always advisable, though not actually essential to the working of the apparatus.

If you study the theoretical circuit diagram

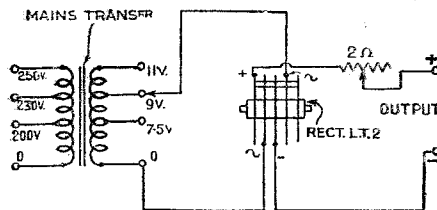

Theoretical circuit diagram of the charger, showing fuses, transformer, metal rectifier and output terminals

Any sort of plug can be used to connect up to the mains—wall socket or bayonet type—depending on where you propose to do the charging, of course. Open up the vent plugs before you turn in for the night, otherwise excessive gassing may cause a spot of bother inside the case.

Home charging is absurdly simple—and the extra drain on the mains meter is not readable. It is fatally easy, all the same, to overlook one of the points that even the charging station sometimes forgets to attend to—the "topping up" of the acid solution.

Remember that this must be done with distilled water.

Surgery—on the Short Waves!
Continued from page 2

with high-frequency current, to the forceps. With the Marconi-Dean machine the surgeon can perform these operations without any risk whatever of burns or shocks.

When it is necessary to destroy large masses of tissue by heavy coagulation the machine will deliver coagulating current up to 3.5 amperes, which will effectively coagulate tissue to a depth of 1.5 millimetres.

The universal model for hospital work is an ordinary high-frequency circuit built around the M12A valve, but there is a special research model with a 180-watts output which is designed specially for the medical research worker.

The maximum output of high-frequency current at the patient terminals is 150 watts. The frequency is continuously variable over a range of from 35,300,000 cycles to 115,380,000 cycles per second (8.5 to 2.6 metres).

The high-frequency oscillatory circuit is adjusted to the required frequency by a variable inductance for coarse tuning, and by a vernier condenser for fine tuning. A coupling control between the primary oscillatory circuit and the feeder enables the amount of energy transferred to the latter circuit to be adjusted according to requirements.

Two controls are provided for valve circuit adjustment, one for adjusting the filament current and the other for adjusting the strength of the magnetic field surrounding the valve filament. Once these controls are adjusted to the correct values they seldom need re-adjustment.

A D.C. voltmeter facilitates adjustment of the filament voltage to the correct value, and a D.C. milliammeter is provided to facilitate adjustment of the valve anode current to the correct working value.

The standard equipment is designed for direct operation from a 200-250-volts 50-cycles alternating current supply.

Tappings on the power transformer enable the apparatus to work off 200, 210, 220, 230, 240, and 250 volts.

The total input energy for the maximum output is approximately 500 watts.

The low-tension A.C. supply is transformed to a higher voltage, and is rectified by a bank of full-wave metal rectifiers, a method which eliminates the cost of maintaining rectifying valves.

Portable Model

There is also a portable model for doctors who want to carry out high-frequency treatment or operations on the spot. The Marconi-Dean portable has an output of 85 watts. A wavelength of 300 metres is used for therapy, and 100 metres for surgery. It works off an alternating current mains supply and takes only 300 watts.

For demonstration purposes metal handles can be fitted to one of these electro-surgery outfits so that a patient can feel the high-frequency currents. Demonstrations are carried out, for the benefit of the layman, by "operations" on raw meat. This is how budding surgeons experiment with electro-surgery, listening-in while they produce callous cuts on prime steaks with a high-frequency knife.

PARTS NEEDED FOR TRICKLE CHARGER

- BASEBOARD**
- 1—Five-ply, 10 1/4 in. by 4 in.
- HOLDER, FUSE**
- 1—Bulgin twin, type F14.
- RECTIFIER**
- 1—Westinghouse, type LT2.
- RESISTANCE, VARIABLE**
- 1—Heayberd 2-ohm, baseboard mounting.
- SUNDRIES**
- 1—Ebonite strip, 2 1/2 in. by 1 1/2 in.
- 2—Clix terminals, marked: L.T.+, L.T.—.
- Connecting wire and sleeving.
- TRANSFORMER, MAINS**
- 1—Heayberd, type W36.

Amateur Adventures in Africa

TO be in a town in the British Isles where there are numerous shops vying with each other in selling radio components is one thing. To be in a village in the same Isles where there is not a single shop that stocks the said components is another thing. But to be in the centre of Africa, where the nearest shop is 350 miles away and where they do not stock radio components, that is quite another thing! This is where we find ourselves. The nearest spot where we can obtain a radio part is nearly a thousand miles away and one must reckon on five weeks before a reply can be obtained by post.

This Outlandish Place

Into this outlandish place we walked with the precious kit of parts, warranted to complete a wonder set called the Melody Ranger. H.T. and bias batteries we had, but no L.T. supply. That precious shop nearly 1,000 miles away hadn't one in, but "Oh, yeees, in a few days we shall dispatch one to you."

Having got settled in a bit, we got to work on the kit of parts and soon had the set completed. It was easy to arrange about the aerial; there was a lovely big tree standing about 100 feet away, and another one was soon cut down and erected near to the window, through which the lead was to be brought. All present and correct except the L.T. supply.

One week—two weeks—three weeks—four weeks, and still no sign of it. In desperation we became daring enough to risk getting something with a pocket lamp battery for L.T. supply. But what a business! We had not the feel of the set and hours and hours of fiddling about with the dials produced nothing. But at long last we got Big Ben half-way through with his chimes and then "This is London—" and what excitement that produced!

But a pocket lamp battery does not promise much and so we conserved its little stock of juice by listening each evening to the news and then switching off. Yet, in spite of all our care, fading became more and more pronounced and of longer duration until at last dead silence reigned. Still that L. T. battery did not turn up!

Determined not to be deprived of the London news, we begged a friend's pocket-lamp battery. Later on we borrowed others, and later still we began to be desperate and daring enough to annex some! But they all, sooner or later, gave up the effort to keep those filaments heated. Then we hit on the idea of wiring them up in parallel and at last we had a row of batteries of various shapes and sizes stretching across the table like a miniature goods train.

The wiring together of these batteries was not a work of art, and if someone nearly touched the table, then the whole performance ended abruptly.

It did so end once, when everybody was standing well away, stretching their necks like giraffes to catch the news from the weak little voice proceeding out of the loud speaker! The only conclusion we could come to was that there must have been a slight technical hitch at the B.B.C.

But hurrah! at long last the L.T. battery has arrived, fully charged but oh, horrors! it has had a rough passage and there is only a tablespoonful of acid left in it! Whatever shall we do now?

At the end of that same 350 miles walk is the nearest supply of acid and distilled water. Yes, but you can use rain water and top up for the time being and so save the plates. Oh yes, but there isn't any rain water about, and there will be no rain for another four months.

Only one thing for it. Fasten down the lid of the old kettle, affix to the spout the rubber tubing off the douche can, coil the said tubing in a pan of cold water, keep the fire going, and watch the precious distilled aqua drop! drop! drop! into the glass jar. Even so, and in due time we topped up.

The steady 2-volt supply of L.T. made all the difference in the world to reception. The Melody Ranger fully justified itself as a ranger, but I am afraid it was somewhat handicapped as to melody by one or two faults in earth and aerial.

For instance, the aerial was 80 feet long and the far end of it was attached to a branch of a lovely tree. The earth was an old B.S.A. rifle barrel!

The aerial stayed as it was for a time, but we fitted a Filtr earth and that made a big difference. Then later on we stumbled on the idea of the equipoise earth and that

dynamo from a scrap motor-car dealer in England.

Not far away from our place here we had observed a fair-sized spring with a few rather awkward falls in it. We made a start at the highest fall and arranged for the river to run out of its natural course for about 100 yards and then we made a respectable fall. This being successful, all we needed was to make a water turbine from boards and odd bits of scrap. Yes, boards we could have easily enough by sending natives out with a pit saw, but where oh where were we to find the scrap?

A Water Turbine

At last this problem was solved; an old worn-out bike was made to yield up the scrap. In due time we had completed a wonderful contraption which we dared call a "water turbine."

We wandered down to see if all was O.K. at the fall, but alas! alack! there was no longer a fall there! The earth had been washed away and there remained a deep channel through which the water rushed. This demanded that we set to and do the job properly, or as near properly as possible under the circumstances. Cement was out of the question and so we worked away with boards and we were successful, though often perilously near failing. There only remained to transport the turbine to the scene of the man-made fall and to fix it in position.

What a day of excitement! Two perspiring niggers staggering along through the bush bearing on their shoulders a pole to which was slung the wonderful contraption. The many black spectators lining the bush route gazed at it in wonder and perplexity. The only conclusion they could come to was that the Baas had made a new-fangled leopard trap!

Arriving at the river, we soon had the turbine in position. The dam was removed from the new water course and soon the water was rushing down and tumbling on to the wheel, which revolved at a rare speed. The shouts of excitement were great, but we now came to remember that our task was not yet finished. The dynamo had to be fixed somewhere! And some sort of a drive would have to be made.

We soon saw how to fix the dynamo, but the drive was a little more difficult to provide

for. When certain other members of the family were not about I looked out all the straps of hold-alls, but alas! there was not one to fit the dynamo pulley. So necessity demanded that "Daddy go a-hunting—To kill a little animal—And get a skin for belting."

He did, and after a couple of days a raw hide belt was to hand. And oh! how can I express my feelings when at last the dynamo was revolving at 3,000 revs per minute and generating a full half volt! Every possible adjustment was tried, but the output never varied.

Worse, it was getting well on into the dry season and the stream was shrinking daily—that was another thing we had not taken into consideration. So what with a dynamo

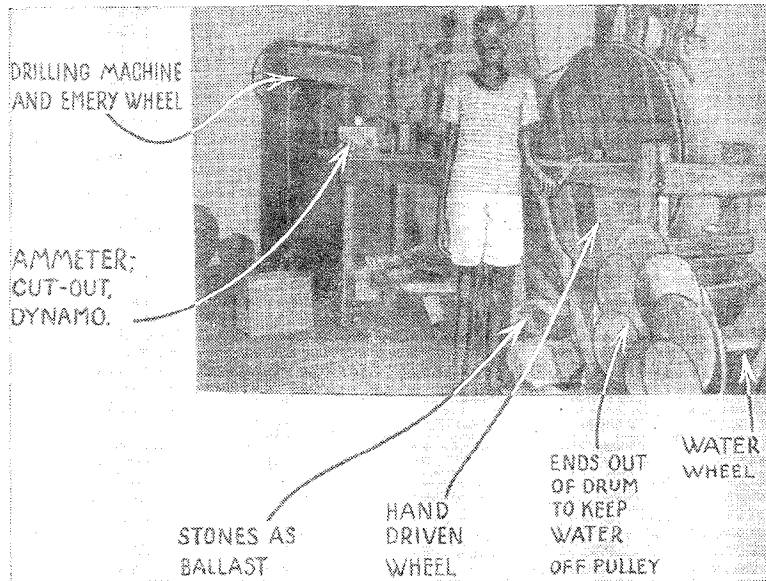

"The Contraption," as our African correspondent describes his weird and wonderful accumulator-charging outfit. With unlimited "boy power" the Melody Ranger's power supply is kept always up to scratch!

seemed to give the Ranger a better chance.

Next we turned our attention to the aerial and began to shorten it 5 feet at a time; each piece chopped off made us come further and further away from that lovely tree, and reception became better and better and interference less and less. We finally left the aerial alone at 17 feet, including the lead-in, at which point the Melody Ranger was giving us both Melody and Range.

But all this time something else had been happening, the precious L.T. battery was getting rather down in the mouth. Of course, we had an idea that this might happen sooner or later and in some measure we had been preparing to counteract it. For a few shillings I had bought an old—I mean an ancient—

refusing to give a proper output, a stream daily cutting down its supply to the turbine, an accumulator more or less full of only distilled water, hope began to die within the human breast.

But we pulled ourselves together. Something *must* be done. The pessimist who says "It *can't* be done" and the optimist who sits down (!) and says: "It *can* be done"—neither was any use in a situation like this. Only a "Peptimist" will get through with it, for he takes off his coat and gets at it!

Well, what about it? What is to be the next move? Why not change the existing contraption into a windmill? There is always plenty of breeze on this spot. We were soon

Next Week

We have been asked by many readers when Noel Bonavia-Hunt is again going to contribute to our pages. Well, he does this week, as you will see by turning to pages 10 and 11.

Next week he will discuss the possibilities of getting real quality from a simple battery three-valver.

well on the way to complete the windmill and it promised to be quite a success—in fact, in a way, it was a success! But I must tell you about it.

Petrol tins were cut up and vanes made which were wired to one of the scrap bike wheels; this with much difficulty was mounted, but the improvised shaft was none too strong. The following day demanded our absence from the place. Imagine our vexation when upon our return we discovered the windmill a wreck, the wheel and vanes lying on the ground!

Certain Niggers Argue

It turned out that certain niggers had been arguing as to whether the windmill would revolve or not. Only untying it would prove it. A strong wind was blowing at the time and the wheel soon gathered speed. The proof-provider having provided the proof put out his hand to stop it and received a nasty gash. The doubters bolted and left him to it. Faster and faster went the wind-mill, and then suddenly the final crash came. There was no further scrap that we could use to repair it, so the wind-mill died a premature death. So what is to be done now? Come along old Peptimist, what about it?

Our eyes alighted upon the drilling machine; you know the kind—they have an emery-wheel fitted which you push into gear when you want to grind. What about fitting that up temporarily, just to get the battery up a bit? We soon had a 14-inch wooden pulley ready and this was fixed in place of the emery-wheel. We got the speed all right—in fact, about 10,000 revs per minute, but that dynamo stubbornly refused to yield more than a half volt! But even if it had yielded a respectable output, it would have taken all the African male population in this district to have kept that emery machine going for a whole day. I did my bit at it during the experimenting and I spent the next couple of days in a state of convalescence!

Semi-final Idea

After seriously considering the problem during the aforesaid convalescence, the more or less semi-final idea presented itself to the somewhat fatigued brain. Two-inch planks were sawn and planed and squared, and with these a solid wheel was made measuring three feet six inches in diameter.

We tried to keep calm while on with all these experiments, but it was not easy when we remembered the dreadful chemical actions which would be taking place in that precious accumulator's inside! I wished many times I

had not looked up in the book the things that *could* happen inside a neglected accumulator.

At last—it seemed years—we got the wonderful bearings (pieces of tubing from the scrap bike) in position and the wheel mounted and then—there goes that wretched gong for afternoon tea! Leaving the carpenter to put in a few more screws here and there, I strolled over to tea and after tea invited all and sundry to come and have a look at the latest success! (Oh, that I hadn't!) It certainly looked a bit queer—this ex-turbine, ex-wind-mill fitted with a wooden wheel and cycle crank, but that didn't matter so long as the present idea was a success, and everybody thought it was.

"Boy! You there! Get hold of that crank and start up that wheel!" Slowly it began to revolve, but oh, horrors, did ever a wheel—could ever a wheel—wobble as this one does? I looked—I stared—I tried to speak—my mouth was dry—my throat parched—oh, that the earth might open and swallow me up out of sight!

All filed out slowly—so did I, and wandered around a bit busying myself doing nothing! But I couldn't keep away and at last found my way back to the scene of baffled wisdom. I found my carpenter had taken matters into his own hands; while one boy turned the crank he had two others doing their best to guide the belt and keep it on the wheel, but would it? Not it—not even for half a turn of the crank.

I went away again and upon my return I found my precious carpenter more aggressive than ever. He was working for dear life to complete a deep groove in the driving wheel. I must confess that hope somewhat revived for, after all, how could the belt run out of a groove like that? But it did—and snap went the belt. I sat and watched him and I learned a lesson in patience.

He tried it over and over again, until at last the belt was nearly all joints and bifurcated rivets. Then he gave it up and sat down on the floor. That carpenter of mine has brains, I will say that for him. Honour where honour is due, you know. His final suggestion seemed to be the only feasible one left. He said: "Why not get two men to hold the block with the dynamo on it, and while one turns the crank, these two can move the block from side to side and in this way compensate for the wobble in the wheel." I did not wait to witness the experiment, I ran out and away where I could be quiet for a time. Having calmed down, I ventured back and peeped in—there was not a soul present.

That night I had horrible dreams of tangled masses of wheels, dynamos, windmills and turbines, but I awoke with another idea coursing through my mind, and long before sun-up I had my precious carpenter working at that wheel. We took it off, made the hole in it larger, and then judiciously packed it with quarter and half sections of steel tubing sawn off the old scrap bike—what would we have done without that bike?

We certainly took a heap of wobble out of that wheel, but oh dear! not enough to make that belt stay put. It was most exasperating. But patient effort and perseverance was about to be rewarded with success, had we but known it. The overtaxed but futile—I mean fertile—mind presented its final scheme.

The fut-fertile mind: "Now, Mr. Peptimist, what about taking your coat off and tackling that eight gallon drum lying there?" "Tackling that drum? But what on earth can I do with that?"

F. M.: "Well, you could cut the ends out of it, split it down the seam, cut 6-inch wide lengths, nail them round the driving wheel so making its width 6 inches instead of two and—Hey Presto! your belt stays put." No sooner said than done and hurrah! it does stay put; victory is ours—but is it? There is still only a full half volt from that dynamo. That dynamo will be the death of me!

I had boys sweating at that crank from morn till night, day in and day out, while I sat above the dynamo trying out every conceivable method of wiring up the cut-out, ammeter and accumulator. At the end of a week I was nearly blind, my mind threatened to give way, and I was about as far away from success as ever.

Begone Dull Care

But begone dull care. I espy two men ascending the slope to our shanty and I recognise them as two old friends, both motor mechanics of many years standing and experience on African bush roads, where there are no garages, no A.A. scouts, no spare depots; all of which means that scores and scores of times they have proved necessity the mother of invention.

I felt sure they would not fail me in my hour of distress. We gave them a warm welcome and found out they had travelled about 250 miles down river in their little motor-boat. Having refreshed them with umpteenth glasses of lemonade and dumpteenth cups of coffee—a dry and thirsty land, this—we ventured to mention our dilemma. Would they help? "Rather!" Being what they were, and after two days and two nights couped up in a motor-boat—why their fingers were just itching for something to fiddle about with.

We adjourned to the scene of glorious achievement and humiliating defeat. The boy starts up the wheel—my friends grab the voltmeter leads—and then follows a solid two hours of changing round the wiring, testing each component separately, touching up the com' with some glass paper and taking out and replacing the brushes, etc., and net result—one half volt! I really enjoyed those two hours. Every change they made and every adjustment and every etc. I knew off by heart and I knew they would fail, I had *hail* some! It had hurt my pride to discover what a fool and a duffer I was in all this business, but as I watched these two experienced men at it—well, I did not feel it quite so keenly.

At last they straightened up and both gazed at the dynamo. I had done that myself, too. So much so it was a wonder my eyes had not dropped out. Then they gave their final verdict with no uncertain voice: "This dynamo is a dud!" I was waiting for that and so I said: "Excuse me, but that dynamo was tested by an expert. I was present at the testing and the dynamo was found to be in perfect order."

Saved By the Gong!

For the fifth time the gong went calling us to lunch and the poor chaps were delivered from further complications and embarrassment. After lunch they had no more time to waste and must needs say good-bye, but they were good fellows and saved the situation after all. Stripping the little dynamo off their motor-boat, they sent it up for me to use until I could get my own fixed up.

We swopped acids—I mean we swopped nearly distilled water for acid, because they would soon be able to get a fresh supply. We soon had the dynamo in position and in a couple of days the accumulator was gassing freely and everything in the garage was lovely.

After a short holiday, the mind being now rested, Old Man Peptimist began to agitate once again. He said: "You had better take your coat off again and get at that old dynamo. Those chaps will expect their dynamo to be sent back sooner or later." So I whipped off my coat and was soon in the thick of it. To this day I cannot tell you what really happened, but as soon as the dynamo was in position and the wheel started up, there was 12 full volts on the voltmeter and 6 amps on the ammeter! And we have had no further trouble with it since!

So ends the story of adventure with a wireless set in central Africa in which necessity the mother of invention played such an important part.

J. H. BROWN.

On Your Wavelength

The Week's Radio Gossip :: By THERMION

Is Droitwich a Failure?

THOUGH I wouldn't go so far as to call the new giant National transmitter a failure, there is, I am afraid, little doubt that its results at present are not up to the expectations of those who planned it. I receive many complaints from listeners, particularly those living in the West Country, that their reception of the National programmes is so bad that they are not worth listening to.

Droitwich actually behaves in a very unusual way for a long-wave station. Its transmissions fade badly in several parts of the country. It used to be thought that fading on the long waves was something which just didn't happen, but you may remember that last year Radio-Paris began to wobble a bit towards the end of the summer.

What's the Reason?

NEVER at any time, though, has Radio-Paris shown such fading as now occurs with Droitwich, and still more curious, though Droitwich fades in the West Country, Radio-Paris, which is rather farther away, does not do so.

The trouble must almost certainly be in the aerial system, and though Droitwich has naturally an aerial of the very latest pattern, it may eventually be found unsuitable for local conditions.

I don't regard the problem of Droitwich as insoluble, and though the B.B.C.'s engineers are naturally disappointed, I fancy that they still have a card or two up their sleeves.

Unfortunately, fading is by no means the only crime of which Droitwich is accused at the moment. The West Regional lies almost exactly in a straight line between Droitwich, a large part of Devon, and the greater part of Cornwall.

West Regional to Be Moved?

HENCE what was originally known as the Luxembourg Effect is manifesting itself in somewhat aggravated form in these two counties, and in some places the unfortunate West Regional is pretty well blotted out.

I don't feel at all sure that the fading of Droitwich in the West Country is not pretty closely bound up with the fact that it and the West Regional are as near as makes no matter in a straight line with a large part of the affected area.

There seems little doubt that the Luxembourg Effect is a two-edged sword: not only can a long-wave station interfere with a medium-waver, but also a medium-waver may cause trouble to the long-wave transmitter.

It may be found necessary to move the West Regional transmitter, and I shouldn't be at all surprised if this were the eventual solution. Its position has always seemed to me none too good, since behind it—that is to say, to the south, south-east, and south-west—there rise the very considerable heights of the Brendon Hills and of Exmoor.

I have often wondered whether

the station would not give a better account of itself if it were moved to higher ground, either in the south of Exmoor or the north of Dartmoor.

Programme Innovation

FOR, I believe, the first time in history, one and the same item was broadcast twice from all the Regional stations on Thursday, December 20.

The item in question was *The Princess of Paraphernalia*, which was described as "a piece of nonsense for all children under a hundred." It was given at four o'clock and again at 7.30 p.m. A jolly good piece of foolery it was, and one could see the reason for its double presentation.

Most children under ten would have been (or should have been) in bed by the time that the evening performance was due, and most children aged between about eighteen and sixty would have been (or should have been) engaged at four o'clock in the afternoon in earning their daily bread.

The idea is quite a sound one, but I feel, somehow, that there might have been a rather better alternative for those, whatever might be their age, who had heard the matinee performance and didn't want to hear it again. The only alternative provided at 7.30 p.m. was a talk from the Nationals on "Leaving School."

This child, who had been able to hear the matinee because, like most writers, he works at queer times, blessed his nice fat superhet which enabled him to make a jolly little trip abroad.

Inadequate H.T.B.s!

LAST year I referred to the folly of many set makers who turned out big sets containing anything from four to six valves and provided them with small high-tension batteries, in some cases of very poor quality.

There is no question that they did themselves incalculable harm by this piece of stupidity, for my correspondence shows that any number of people, who were hard hit by excessive running costs, have become shy of buying sets, however good they may be, by the particular maker who sold them a pup—not a K.B. Pup!—in the past.

Yet this year again one finds sets needing umpteen milliamperes of plate current turned out with silly little H.T.B.s.

New Angle on Battery Sets

IF the makers won't fit large-capacity batteries because they cost a bob or two more, and if the public won't buy them as replacements

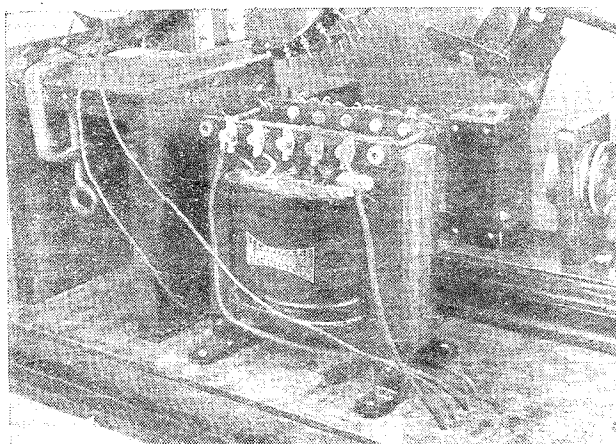

In a mains receiver it is necessary to arrange for the connections to the input of the transformer to be tapped, so that the transformer can be adjusted to the voltage of supply—which may vary from 200 to 250 volts or more

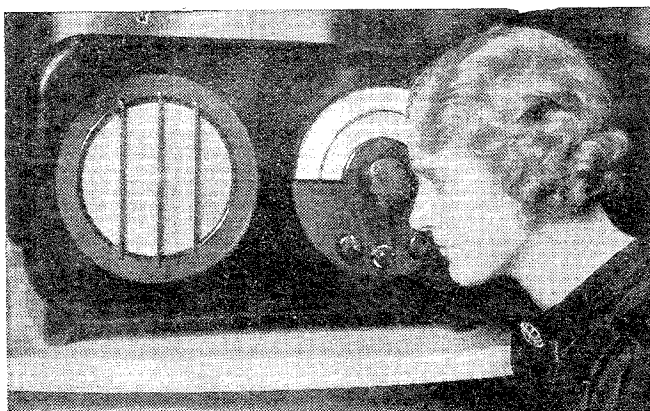

Keo photo

Control of the modern well-designed set is vastly simplified by the provision of a really large tuning scale clearly marked in both wavelengths and stations

for the same reason—even though an extra two or three shillings may mean weeks and weeks of additional service—it seems to me that the problem of the battery set will have to be looked at from an entirely new standpoint.

As matters are at present, the designer is rather in a quandary. He knows that to give you good sensitiveness plus good quality of reproduction, a three-valve set cannot draw much less than 10 milliamperes from the high-tension battery and that the superheterodyne needs about half as much again. No standard-capacity battery can supply economically 10 milliamperes; much less can it supply 15.

Hence, if the designer is told that he has to base his set on a small-capacity H.T.B. he must sacrifice either performance or economy in running costs.

"A. W." Reference Sheet—No. 14.

All About Safety Fuses

MANY constructors do not appreciate the value of fuses and likewise do not take the trouble to embody them in their receivers. Bearing in mind the low cost of these components and the amount of protection they afford, they should be included in every receiver, particularly if one is in the habit of experimenting with the circuit.

If the circuit of an ordinary battery receiver is examined, it will be found that one side of the high tension battery is common with one side of the low-tension supply. In the majority of cases, it is the negative poles which are joined together.

Therefore, as the object of a fuse is to prevent the valve filaments receiving excessive voltage, it is inserted between the junction of these batteries.

In a battery receiver, a single fuse is sufficient and this can be quite easily fitted by separating the high-tension negative wire from the low-tension negative and inserting the fuse between these two points.

A more elaborate system is one where the filaments are also protected from the grid-bias supply, and in this case a double fuse is fitted, the holder being so designed that three connecting points are provided. The connections are then high-tension negative, low-tension negative and grid-bias positive.

With mains receivers it is necessary to insert the fuse in the supply side and it is also advisable to employ those of the double type. Here again it is only a matter of breaking the two supply leads going to the primary of the mains transformer and inserting a fuse in each lead.

It is advisable to fit these after the switch, thus allowing the supply to be switched off, and so rendering the fuses dead.

This will allow them to be replaced without fear of a shock.

The current-carrying capacity of the fuses will depend entirely upon the filament rating and high-tension current flowing.

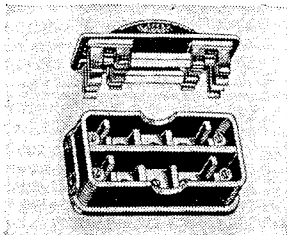

Typical twin fuse, suitable for insertion in the input mains leads to a transformer

The trouble is that modern valves require surprisingly large amounts of high-tension current. This doesn't matter a bit if you are working off the mains, but it matters a whole heap of bits if you are relying on batteries.

To me it seems that valve makers should set themselves the task of turning out efficient valves with low high-tension consumption. After all, the only stage in which we want current from the plate is the output, which has to work the loud-speaker. In every other part of the set volts have to be passed on, and the steady plate current is largely wasted.

Third-party Risks

FAMILIARITY, they say, breeds contempt; but, all the same, I prefer to switch a set off before starting to explore the inside wiring. The other night a friend of mine, who has been long enough at the game to know better, wanted to show me what he called a queer "loose-contact" effect.

As it didn't show up when he wanted it to, he proceeded to open the back of the cabinet and tinker about inside. I was standing by patiently, when he suddenly let out a yelp, said "Gee-whiz"—or words to that effect—and shot his hand out so swiftly that he spilled a glass of beer I happened to be holding.

Of course, a fellow who does a thing like that deserves all he gets, but he certainly has no right to introduce third-party risks.

Safety First

AS a matter of fact, one doesn't run much risk of getting a bad shock from the ordinary type of wireless set; though I wouldn't be so sure about the low-frequency side of some of the high-powered models.

It really depends a lot upon the person concerned, as some folk seem to have a higher skin-resistance than others. For instance, a man who is able to handle ordinary mains voltage with impunity will get quite peevish if a live wire happens to come up against

the inside of his wrist or the back of his hand.

Again, it isn't volts so much as amps which do the damage. Most people can stand up to an induction-coil delivering as much as 100,000 volts, because the discharge current only amounts to a few milliamps. On the other hand, the passage of a quarter of an ampere through the body is definitely dangerous, whilst half an ampere means certain death.

Whistles!

A HIGH-PITCHED whistle, though usually due to heterodyne interference, can be caused by a valve which has exceeded its useful term of life. Owing to falling emission, the effective impedance of a valve starts to rise with increasing age, and the point will come when it sets up interaction between the circuits.

Wire-wound Resistances

THESE wire-wound resistances rated to handle one watt, are extremely useful to the home constructor. Their use greatly simplifies the wiring of any set—no special holders are needed, as their wire ends connect straight into the circuit to terminals on appropriate components.

Owing to their very special construction, these resistances will actually handle much more than the rated one watt of power—in fact, if you have an accidental short circuit, although they will then get very hot, they will return to normal resistance value when cooled. Incidentally, they are unaffected by changes in temperature and are ideal for short-wave sets, especially when used under adverse climatic conditions.

The prices of all values from 50 to 100,000 ohms is only one shilling, which is remarkably good value. This card can be seen hanging in every wireless shop.

The detector valve is the most likely to misbehave in this way, particularly in the type of set where the detector is transformer-coupled to the L.F. amplifier. So if you find that the whistle persists, even when the aerial is disconnected, try the effect of replacing the old valve with a new one.

Wireless in the Air

THE art of direction finding, including the new radio-beacon system of navigating ships and aircraft, is not only one of the most interesting "side-shows" in wireless, but, in my opinion, is likely, before long, to become one of the biggest.

In America, for instance, radio-beam systems for guiding an aeroplane "home" and for enabling the pilot to land the machine safely, in foggy weather, are already in constant use. The equipment is practically fool-proof—so much so that the pilot can glide safely down the "landing beam" whilst seated inside a hooded cockpit, i.e. so that he cannot see anything except the instruments on his dashboard.

This seems just the kind of thing we want over here, where poor visibility—particularly fog—practically puts a stop, for the time being, to all passenger flying. Incidentally it would allow machines to land closer to town than either Craydon, Hendon, or Heston. Wormwood Scrubs, for instance, would make an ideal airport once the danger of a forced landing due to fog is removed.

Direction Finding

WHILST on this subject I must refer to Mr. Barfield's recent paper on direction finding addressed to the Wireless Section of the Institute of Electrical Engineers. Amongst other things he showed how far we have gone towards making direction finding an exact science, as compared with the rather hit-or-miss affair it was when I first ran into it in the later stages of the war.

Most of the uncertainty in those days, we put down, by and large, to a multiplicity of causes, such as night effect, coastal effect, and what not.

Lieutenant Adcock, however, put his finger on the real source of the trouble in 1918, when he pointed out that one couldn't trust wireless waves once they had been reflected from the Heaviside layer, because they were liable to come down "twisted." Obviously you can't get accurate bearings from a twisted wave-front, and so he produced an aerial which responded only to the direct or "earthbound" wave, and took no notice of reflected waves. To my mind this was one of the pioneer inventions which laid the foundation of modern, dependable, direction-finding.

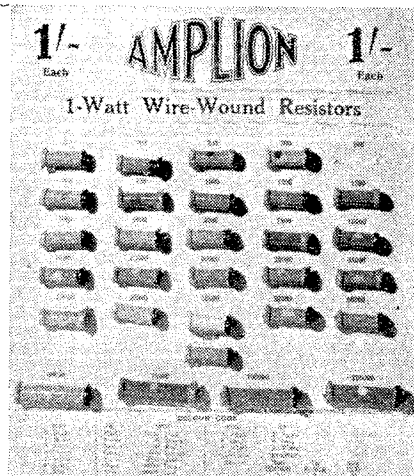

Reducing Short-wave Interference

By J. R. McDOWALL

THE following aeri- als are used especially on wave-lengths below 50 metres, but are as effective as any system for broadcast and even longer commercial wavelengths. As man-made interference is originated generally close to the ground, the collector system should be well up in the air and the lead-in should not act as a collector.

The lead-in should be transposed so that it picks up interference 180 degrees out of phase. The pick-up is partially concealed at the coupling coil in the receiver, and the signal-to-noise ratio is greatly lowered. If possible, all aeri- als should be kept 20 ft. away from the ground or other objects.

The horizontal doublet shown in Fig. 1 is made up of two wires of equal length, each wire being between 35 ft. and 75 ft. in length. The directional characteristics of the aerial are shown in Fig. 3. The transposition blocks can be made

out of old hard rubber or bakelite panels $\frac{1}{4}$ to $\frac{3}{8}$ in. in thickness, cut as in Fig. 6. Dry hardwood boiled in paraffin will do as well as either of the above.

The inverted L aerial may seem unbalanced because the lead-in line *d* is terminated between the insulators, but it is balanced by suitable resistors, R1 and R2.

The coupling coil can be wound on a coil former, which will slip inside the aerial coil of the receiver. A strip of fibre fastened on the coil former of the coupling coil will act as a spring to hold the coil at any desired coupling. The coupling should be changed for best results. The primary of the aerial coil is not then used in the receiver.

If oscillation occurs on A.C. sets when the volume control is turned on full, try reversing the position of the plug going to the regular A.C. lines.

This type of aerial really should be used with shielded receivers for best interference-reduction results.

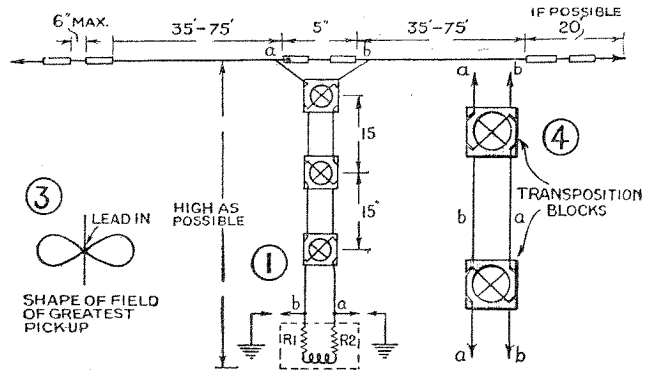

Fig. 1.—Horizontal doublet. Fig. 3.—Shape of field. Fig. 4.— Transposition blocks

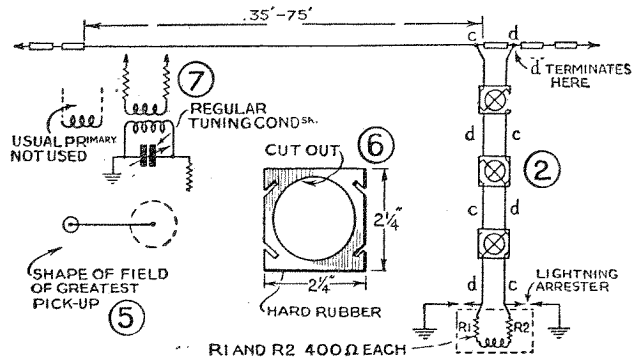

Fig. 2.—Inverted L aerial. Fig. 5.—Shape of field. Fig. 6.— Transposition block. Fig. 7.—Coupling coils

Crusaders Air Their Views

NOW that the Christmas holidays are—for most of us, anyway!—only a dim memory, we must buckle on our armour and think out the final analysis of that next Crusader set.

If we judge only by the letters received from enthusiastic readers of the Crusader Corner, we shall be rather at sea—for there is more and more evidence of conflict as to the exact form the super-het will take.

That a super-het is coming can be said to be certain. The knotty problems still to be solved are many. Shall it be battery- or mains-driven? Medium and long or all-wave? Console or table cabinet? And so on through the gamut of controversial design features.

We shall quote a few more readers' letters before finally letting the cat out of the bag. Believe us, this time it is some cat!

"I am myself for an A.C. super-het," says CC1549. "I have not built the preceding two Crusader sets because I am done with battery operation. I pay only a id. per unit for 'juice,' so I think you'll agree mains are cheapest for me!"

Unconscionable Time

We do. It is a pity that this Grid is taking such an unconscionable time to spread to every home in the land—for then the problem of the wireless set designer would indeed be simplified.

"I have at present the 1932 Super 60, built when it was first introduced to us—it is the best super-het I have had or heard. I also built one for a friend and he is very pleased with it. But I want a change. As you know, it has the grid bias from batteries, and I have tried auto bias but the set doesn't like it.

"So can you give us one with the Super 60 calibre fitted with auto-bias and an outside aerial?"

"I thought perhaps you could get the

boys on to a super-het using the Wearite intermediate-frequency coils—it seems a pity to discard the set of coils—especially as my lot are quite new."

Well, that's an interesting letter, especially the last bit about the coils. It is a very serious problem, this coil sacrifice. We cannot stick to the same coils for set after set because, as most of you quite naturally agree, the coils really are the heart of any high-frequency design, and have to be altered to suit the conditions it is desired to bring about.

At the same time, we fully appreciate that constructors are loath to scrap a perfectly good set of coils. If there is any reader who can offer a really constructive suggestion on this matter we shall be happy to publish his views,

always bearing in mind, those of you who write in, our remarks on the necessity for considering the coils as the key-point in the set's design.

As far as we can see, the question boils down to this: if the coils are good enough to keep in service so is the set in which they are used. That being so, the right thing to do is to keep the set or pass it on to a friend, and completely set yourself up again with the new design.

It is useless to "botch" a new set with coils not really designed for it. That will cause disappointment of the worst kind. To take good coils from an existing set that is giving satisfaction and put them into a new design is to ask for trouble that will surely ensue. The result will be the scrapping of a good set and the building of a bad one.

Problem Still There

At the same time, the problem is there—and we ourselves don't pretend to have solved it any more than any other designers have. We admit it, though, which is a degree of frankness not perhaps as universal as it might be.

That is where the Crusade comes in—to right constructor wrongs, to build up a fellowship of real co-ordination between designers and amateurs.

"I hope your new Crusader set will be a battery-driven, four-valve super-het, using the latest and most up-to-date valves, including the double-diode-triode as second detector, and double-pentode output."

So speaks CC1383. Like many other readers, this Crusader insists on self-adjusting volume control—which as a matter of fact is not too easy to put into a simple super-het with a minimum of high-frequency amplification.

At the same time, it can be done, and will be done if our designers have their way.

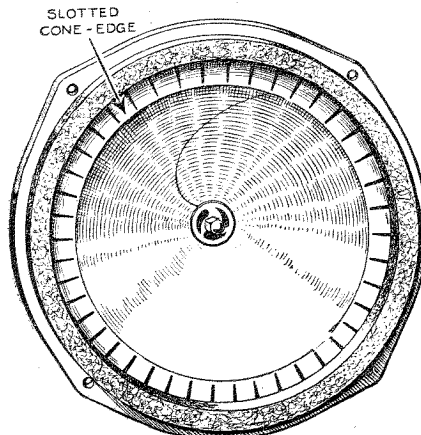

One of the innovations in loud-speaker design is the slotted cone edge as shown above

What Is the Best Form of LOW-FREQUENCY

NOEL BONAVIA-HUNT, M.A., Reviews the Seven

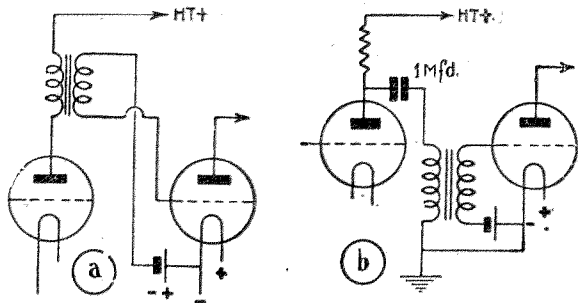

Fig. 1.—Transformer coupling, direct (a) and parallel-fed (b)

THIS is a burning question, and the obvious answer would seem to be that the best method is that which gives the best quality result.

Let us be quite clear about this question of quality. It is always assumed that for the production of high quality it is essential before all things to secure a wide range of frequencies. We are told that an amplifier that cuts off at 4,000 or even 5,000 cycles must in the nature of things be bad. It is often assumed that when the range is extended to 10,000 cycles, quality immediately becomes of a very high order.

What nonsense this is! It may be safely assumed, on the contrary, that a frequency range up to 10,000 cycles is going to destroy what semblance of quality there might have been extracted from an otherwise excellent amplifier.

The whole question of quality reproduction is governed by these two factors:—

1. Instant radiation of sound by the loud-speaker.
2. Accuracy of harmonic network.

The first postulate is outside the subject of this article and therefore cannot be discussed. But the time has come for designers of loud-speakers to concentrate on this little problem. The second postulate intimately concerns us in our quest for the ideal amplifier of the audible frequencies, and it is the object of this article to deal with it.

If the harmonic network of the original sounds is accurately reproduced by radio, the result is a really beautiful performance. It is so beautiful that there is no desire at the moment to exchange the radio version for the real. Unfortunately, the harmonic network is never accurately reproduced; but this is no reason why an attempt should not be made to do so. In reviewing the different low-frequency coupling systems I am chiefly conscious of one thing, and that is the success or failure of a given system to reproduce the harmonic network of the original with reasonable accuracy.

Upper and Lower Ends of Spectrum

Frequency range must, of course, be taken into account, since the attenuation of the upper or lower ends of the spectrum must be avoided. Even so, it will be assumed that the complete range of musical frequencies is not an essential factor in the success of the amplifier. Quality must come even before range.

Of low-frequency methods of coupling there are seven to choose from. Two more can be added to the list, but they

are outside the scope of the amateur. These may, however, be mentioned, if only to satisfy the curiosity of the reader. They are (1) direct and (2) "stereophonic" coupling.

The seven methods open to amateur constructors are as follows:—

1. Transformer coupling.
2. Resistance coupling.
3. Choke coupling.
4. Dual-impedance coupling.
5. Parallel-fed auto-transformer coupling.
6. Push-pull methods of coupling.
7. Auto-transformer-fed auto-transformer coupling.

Each Form of Coupling Illustrated

A goodly list to be sure! Nos. 1, 2, 5 and 6 are the most widely used to-day, while No. 4 was all the rage in 1928. No. 3 appears to be obsolete. To preclude all risk of misunderstanding I am giving an illustration of each form of coupling in Figs. 1 to 7.

In some cases there are two types of the particular class of coupling available, in which circumstance they are shown as a and b. For example, push-pulling can be effected both by transformer and by resistance coupling, and parallel-feeding can be worked by means of either a resistance or a choke in the anode circuit of the valve.

Now the point is, which is the best out of the seven? In order to make a wise choice it is supremely important that the chooser should be in a position to judge between the various claims put forward by advocates of each class of coupling. We must examine these claims. What are the *pros* and *cons* in each case?

1. Transformer Coupling

This is popular because the connections are simple, and the step-up ratio of primary to secondary turns admits of more amplification per stage than can be secured from other systems of coupling. From a quality point of view, there are flaws in this system, due to the presence of the iron core.

It is now definitely established that a transformer creates what is known as harmonic distortion, due to the fact that the operating point occurs at either the top or the bottom of the magnetisation curve. This fault, which is responsible for frequency coupling, can be cured by the introduction of anode bias, a device due to Dr. L. F. E. Johnson.

It is necessary, if this is introduced, to provide a parallel feed for the primary of the transformer, and to insert a large resistance between high-tension positive and the input terminal of the primary winding of the transformer. But while the harmonic distortion above referred to is thus removed, the other faults inherent in transformer coupling still remain.

These are frequency distortion at the extreme ends of the spectrum, and transient signal distortion. There is a definite limit to the number of turns on primary and secondary for practical use in an amplifier, and although a good transformer is able to put up

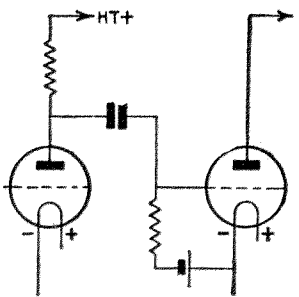

Fig. 2.—Resistance-capacity coupling

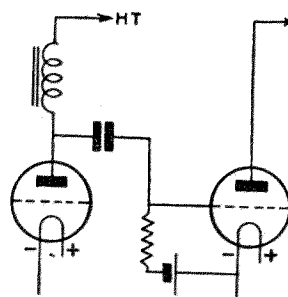

Fig. 3.—Choke-capacity coupling

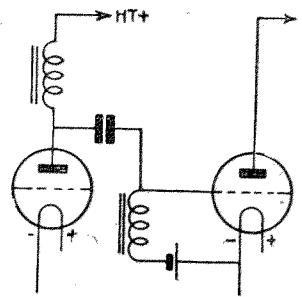

Fig. 4.—Dual-impedance coupling

f FREQUENCY COUPLING ?

Possible Methods from the Quality Point of View

a good performance, far better, in fact, than that obtained from many forms of resistance coupling, the system itself is not perfect by any means.

I have yet to hear real bass and a distinct upper register simultaneously resulting from transformer coupling. No transformer is capable of amplifying the extreme ends of the musical spectrum with sufficient intensity to compensate for losses in loud-speaker combination. The published voltage amplification curves show this deficiency with remarkable clearness.

2. Resistance Coupling

Here the troublesome iron core is at least eliminated, a condenser taking its place. Further, it is well known that

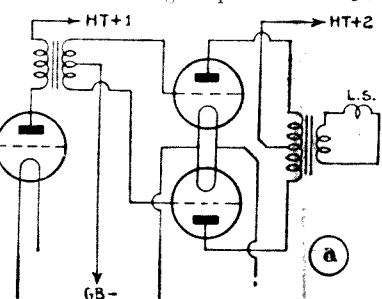

Fig. 6a.—Push-pull transformer coupling

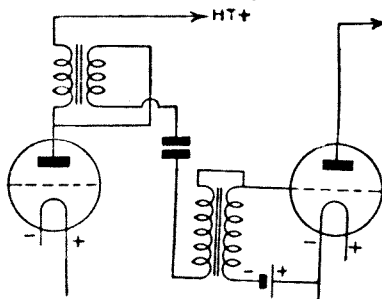

Fig. 7.—Auto-transformer-fed auto-transformer coupling

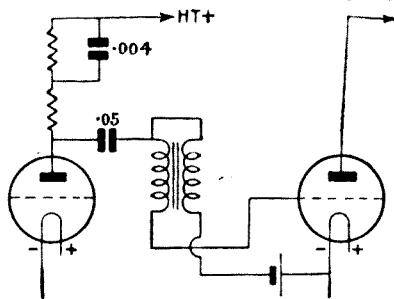

Fig. 8.—Partially-shunted anode resistance parafeeding

a coil winding offers an impedance to a transient signal, while the pure non-inductive resistance offers very little.

Again, a coil winding requires a high inductance to preserve the lower frequencies, while a resistance favours practically all the musical frequencies impartially. Thus, to respond to a 50-cycle note with the same intensity as a 1,000-cycle note, an inductance of at least 900 henries is required; but a 10,000-ohm resistance is capable of doing this just as easily.

What is the Snag ?

What is the snag in resistance coupling, then? If it is complained that the amplification per stage is low compared with that obtained from transformer coupling, the obvious answer is that two stages of resistance coupling can be arranged to replace one stage of transformer coupling. With the application of high anode voltages and the use of suitable valves and resistance values, one may obtain really gratifying results.

This is undoubtedly true up to a degree, but it is not possible to get the upper register right, and without unduly labouring the point, designers of amplifiers who possess a cultivated aural faculty (how many are there?) are bound to endorse this fact, if not in public, then at least privately.

It should be obvious to anyone who has made a study of coupling systems that resistance coupling in the nature of

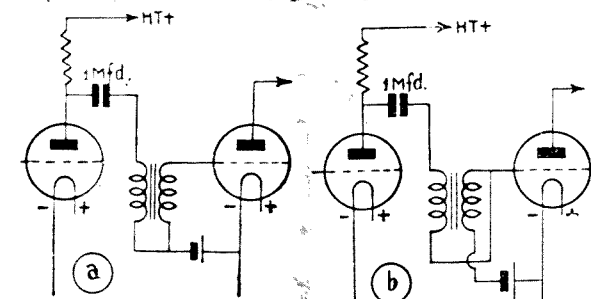

Figs. 5a and b.—Parallel-fed auto-transformer coupling

things is incapable of amplifying the high notes as well as the low notes in proper proportion. Even the frequency-response curves prove this, though such curves can be most misleading as an indication of the capabilities of a circuit.

The best property of resistance coupling is the way in which it handles explosive sounds, but it is not the only method which enables us to tackle this particular problem.

3. Choke Coupling

This has gone out of fashion. In the days when everyone used either dry batteries or accumulators for high-tension supply, a choke coil in the anode circuit of the valve enabled the user to get more volts on the anode with more amplification per stage as compared with resistance coupling.

But the trouble is that a large choke creates high-note loss through the self-capacity of the winding being excessive, while a small choke cuts off the bass. Moreover, it cannot be denied that transient impulses are unsatisfactorily handled.

4. Dual-impedance Coupling

This was introduced by Professor Donle of America, and from 1927 to 1929 enjoyed quite considerable patronage in this country. The theory put forward by Professor Donle was that signal inputs leaked off the grid of the valve far more rapidly through a choke coil than a resistance of several thousands of ohms (that is, the usual grid leak), and that in consequence positive peak current charges on the grid were obviated to all intents and purposes.

This is quite true, but the problem was to find the optimum value of choke winding to substitute for the grid leak. The same old difficulty cropped up once more that designers of choke coupling had had to grapple with, namely the self-capacity of the winding in both anode and grid circuits. This precluded the employment of large inductances, which were essential to the preservation of the low notes.

5. Parallel-fed Auto-transformer Coupling

This only differs from parallel-fed transformer coupling in that the transformer is serialised, so that the primary and secondary windings are connected in the form of a tapped choke coil. The great advantage of this method of connection lies in the fact that the transformer may be used in two different ratios, as shown in Fig. 5 at a and b respectively.

The value of the anode resistance is a highly important factor; if the transformer is connected as at a the resistance should be comparatively low in value, say 20,000 to 30,000 ohms, and the coupling condenser should have a comparatively high capacity, say .5 to 1 microfarad.

In the case of b the resistance should be much larger and the condenser much smaller. The

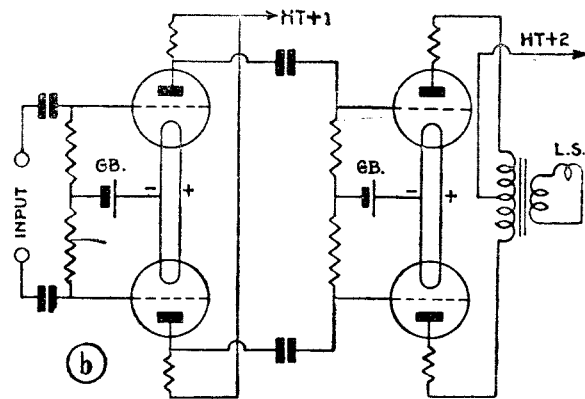

Fig. 6b.—Push-pull resistance coupling

arrangement of b is far preferable from the quality standpoint, and as a coupling system it has much to commend it. Indeed, it is rather difficult to find anything to say against it, always provided that it is not employed for more than one stage of the amplifier.

If the anode resistance is treated so as to have a portion of it shunted by a suitable condenser, as shown in Fig. 8, there can be no possible objection to the coupling.

The choke coupled auto-transformer is not good, because there is bound to be a considerable attenuation of low notes unless the anode choke is so large that bass is gained at the expense of treble. The usual parallel-fed auto-transformer coupling is also bad for the reasons explained under transformer coupling.

6. Push-pull Methods of Coupling

The object of all push-pulling systems is to increase the grid swing of the output valve and the undistorted output at the same time. When the output valves are paralleled instead of push-pulled, the grid swing remains unaltered, that is, it is the same as that of a single output valve, though the undistorted output is theoretically doubled.

Obviously, when two valves are arranged in push-pull the danger of overloading is, in theory at least, considerably lessened; hence, with comparatively low anode voltages push-pulling is regarded as a solution of the problem of obtaining a sufficiently large undistorted output, which in the case of a single output valve or of two in parallel would involve much higher voltages for really satisfactory reproduction.

So much for the theory of the subject. In practice, things do not work out quite so smoothly. It does not matter what type of push-pull is tried, whether mid-point, bottom bend ("quiescent"), or, as an alternative, the push-

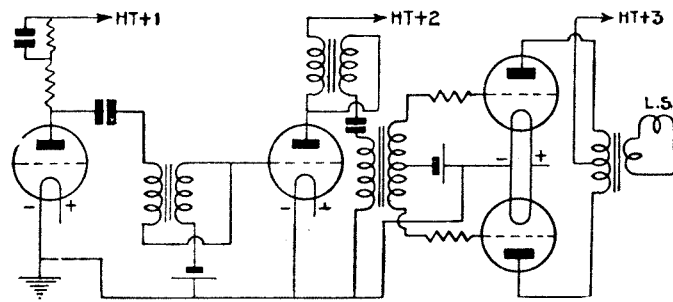

Fig. 9.—Circuit used by the author's friend

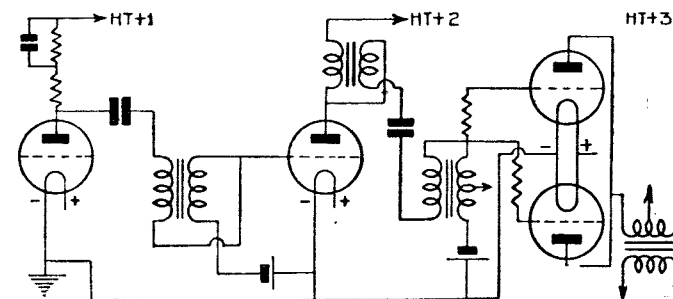

Fig. 10.—Modification suggested by the author

push of class B, whether transformers or resistances are employed, the results are always problematical. Nor is it possible to secure a really satisfactory low-note response from transformer coupling, whether the transformer is parallel-fed or not.

High-note response is equally deficient, unless resistance coupling is resorted to. But resistance coupling does not give satisfactory high-note results; the defectiveness of the system is patent enough to those who have ears to hear.

Transformer Coupling Criticised

To be quite fair, I am bound to criticise transformer coupling (used in push-pull) favourably in respect of its treatment of the harmonic network. The defect inherent in ordinary transformer coupling, namely harmonic distortion, is absent, though other defects inseparable from iron cores remain unchanged. Very beautiful quality is obtainable from push-pull transformer coupling when the valves so treated are correctly matched and biased.

Even so, there are the obvious imperfections of the system which are not readily removed. The frequency range is strictly limited at either end, transients (in the case of transformers) are not so well handled as in resistance coupling, and it is difficult to maintain the necessary conditions for an indefinite period.

Two Output Valves

Most amateurs imagine that with a maximum high-tension voltage available of 150, two output valves in push-pull are a necessity for high quality at reasonable volume in a living-room. Especially is this felt in regard to 2-volt valves, accumulator supplied. The Lissen PX240 gives an output of 800 milliwatts, the highest figure so far attained in the 2-volt class of valve. Two of these in parallel or in push-pull will give an output of 1.6 watts.

In push-pull the grid swing is doubled as well. It is therefore a great temptation to adopt push-pull in such a case.

But what about the matching of the valves? When matched, what guarantee is there that

they will remain matched indefinitely? If battery bias is used, any deterioration in the battery will upset the matching, and therefore the push-pulling characteristic. When valves are paralleled these small changes are immaterial; accurate matching is not essential nor is accurate biasing. I make this latter statement with a full sense of responsibility.

7. Auto-transformer-fed Auto-transformer Coupling

This method is one which I introduced some years ago, and I have always found it work extremely well. It enables one to employ high-inductance windings with reduced self-capacity, so that high notes are reasonably preserved, while there is no doubt at all as to the low-note response. Transient signals are well handled, and the general quality of reproduction is of a high order.

Moreover, the low ratio of step-up reduces the possibility of overloading, while the major amplification is applied to the signals that most need it. No frequency doubling (harmonic distortion) occurs provided the valves are not overloaded, and overloading does not readily take place where a reasonable volume is maintained.

I have an enthusiastic wireless friend who not so long ago was using two super-power output valves of the 2-volt class in push-pull on 150 volts. The first low-frequency valve was coupled to the second by means of resistance capacity in the normal manner, while the second valve was coupled in push-pull to the last valves as above stated.

The quality was excellent and considered so by those who came to hear the set, both on radio and gramophone. It was possible, however, to criticise it adversely, there being an inadequate bass register and a noticeable fall off above 5,000 cycles. There were other points against which adverse criticism could be levelled, though really such criticism would be regarded more as hypercritical by the average radio listener.

However, I was able to compliment him on the results he was getting, which were quite excellent and distinctly above the average

standard. The circuit from the first low-frequency valve to the output is given in Fig. 9. It will be noticed that the input push-pull transformer is auto-transformer-fed, an arrangement adopted by my friend in pursuance of advice which he had formerly obtained from me with the object of increasing his bass response.

I suggested trying out the circuit arrangement of Fig. 10, retaining the components already mounted on the baseboard. The resistance (50,000 ohms) shown in series with the anode auto-transformer was added, and the coupling condenser of 1 microfarad replaced by a smaller capacity.

Auto-Transformer-Feed

This is the auto-transformer-fed auto-transformer coupling advocated by me in previous articles, and is probably by now familiar to my readers. The step-up ratio was originally $3\frac{1}{2}$ to 1 with the push-pull coupling; after the alteration the step-up was reduced to $1\frac{2}{7}$ to 1.

Nevertheless, to the great surprise of the owner of the set, the volume remained substantially the same as before, while the increase of both bass and treble was most noticeable. In addition, transients were greatly improved, and the reproduction was much crisper.

The low notes came through with a *separateness* which lent great distinction to the performance, and the results were equally satisfactory on both radio and gramophone. Exchanging a pair of output valves of a different make and having different characteristics for those in use made very little difference to the quality. The output transformer ratio had, of course, to be altered to another tapping to match the paralleled valves to the loud-speaker, since the impedance of valves operating in push-pull is four times that of the same valves operating in parallel.

I offered, as was only polite and proper, to restore the amplifier to the original circuit, but my friend would not hear of it, and I, for one, do not blame him.

Insulators for the Short Waves

SPECIAL insulators with high insulation properties have very suddenly become popular on the short waves. High-frequency chokes, transposition blocks, coil and condenser bases, and simple aerial insulators are now being made of Steatite, Mycalex, and such substances.

This material is exceptionally hard and cannot be drilled by the amateur. It has the advantage, however, that it is impervious to climatic conditions.

That is primarily why several manufacturers are using it, particularly with large all-wave receivers designed for export.

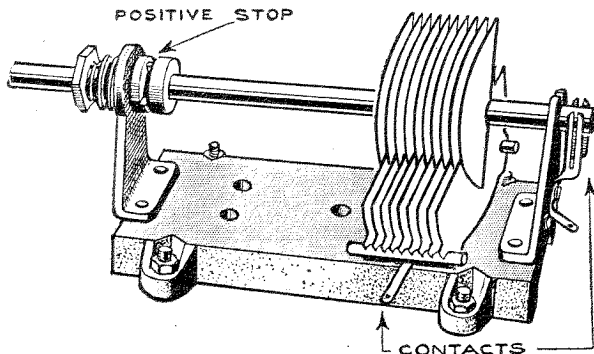

One of the latest types of short-wave tuning condenser built up on a Steatite base

The amateur can obtain Steatite formers on which coils and high-frequency chokes can be made so that these components can be assembled at home.

If you really want to get the best from your short-wave set on the low wavelengths, you will notice a marked improvement by using these special insulators. It is not so noticeable above 30 metres, but that is quite usual with short waves. The losses are always more apparent the lower the wavelength.

In time, no doubt, these insulators will become universal, particularly when television really gets into its stride.

If you are trying to read weak signals from the loud-speaker, it is particularly difficult when the top notes are not there. As a general rule, there is a very bad top-note cut on phone stations. I have found quite an easy way of overcoming this little trouble.

If you use a loud-speaker with a switched input transformer, such as the W.B., by altering the ratio so that the loud-speaker is not correctly matched to the output valve the bass is cut, while the top notes appear to be accentuated. This is not a very

good idea technically, but in practice it has the effect of enabling speech to be read which would otherwise have been too muffled.

It is little points like this that enable amateurs to hear DX stations from New Zealand, for example, when other listeners would be unable to catch the call sign. Of course, pentode output helps to put in top, but remember that on all short-wave sets—no tone correction.

Short-wave enthusiasts should make a note that the 1935 edition of the Eddystone Short-wave Manual is now available. You can buy it from any retailer or W. H. Smith bookstall, price 1s. 6d. In case of difficulty, you can get it straight from Stratton & Co., Ltd., Bromsgrove Street, Birmingham.

Worth Getting

This manual is really worth getting. It gives you all the details you are likely to want when you start your short-wave receiving or transmitting.

Readers appear to have appreciated the article on band-spreading. One reader tells me that W8XK, on the 19-metre band, can be spread 28 degrees when using the band-spread condenser. Compare this with the knife-edge tuning on a standard receiver and you will appreciate the worth of band-spreading.

K. J.

A Real Low-power Station

By G2VV

THIS station is owned and operated by James N. Roc, at 27 Baronsfield Road, St. Margarets-on-Thames, Middlesex, where it has been in operation almost daily for the past year and previously was located at Farnham, Surrey.

The full call sign was issued in 1929, but prior to this an artificial aerial licence, call 2BUW, was issued in 1927. This station is, and always has been, a truly low-power short-wave outfit, inputs of from 2 to 10 watts being the power.

Using Dry Batteries

When located at Farnham all work was carried out using dry batteries, as there was no mains in the building. During the last year at the new address, however, A.C. mains have been employed.

From time to time various types of self-excited circuits have been tried and used, including tuned plate, tuned grid, ultraudion and Hartley. The operator favours the T.P.T.G., and this circuit is at present used on 7 and 14 metres. G2VV is licensed for transmission on the 5-10-20-40-80- and 160-metre amateur bands, and with the exception of 10 metres experiments have been conducted on all of these bands.

A good deal of work has been conducted on 5 metres, using single-valve oscillators and transceivers employing telephony. On the 160- and 40-metre bands C.W. and telephony have been used, employing the grid method for modulating, which, although the modulation percentage was rather low, gave pleasing results in respect to quality.

Whilst mentioning telephony it might be of interest to say that many European countries have been worked on speech and also Egypt with an R6 report when using only three-watts input. Transmissions at the present time are mainly in C.W., but it is hoped that speech will be used again in the near future.

Regarding results obtained on C.W., it should be mentioned that this station holds the W.B.E. and W.A.C. certificates and contacts have been made with Australia, North and South America, Canada, Egypt, Malay, Barbados, and other distant places as well as all European countries. America has been worked on 3 watts and Australia on 5 watts input, and during this year consistent contact with America has been maintained on 20 metres, using 8 to 10 watts input. For some time G2VV was the Manager of the

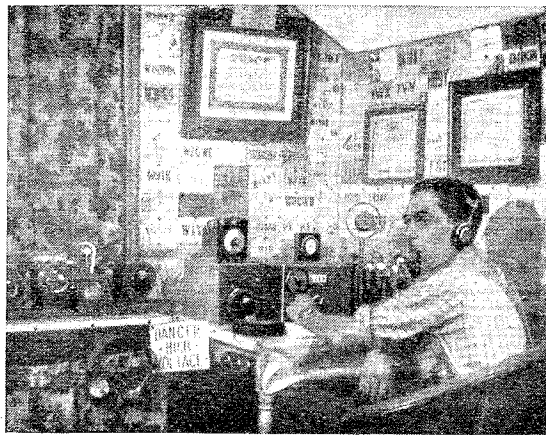

Like all good "hams" the operator of G2VV is a pipe smoker—and, of course, headphones almost grow on his head!



An essentially homely little station is G2VV, with its neatly laid out low power short wave transmitter and receivers

R.S.G.B.'s low-power section of contact bureau, and is now a member of the R.S.G.B. research and experimental section (5-metre group), member of the Thames Valley Amateur Radio and Television Society, and serving on the committee of this Society and late hon. secretary of the West Surrey Amateur Radio Society.

A few details of the station as seen in the accompanying photograph may be of interest, although, as the equipment used is straightforward and simple to operate, there is not much to say. On the extreme left will be seen the transmitter, T.P.T.G., using an LS6A or a T25D valve, and with coils for either 20- or 40-metre operation.

The power supply is not shown, but is housed under the table directly below the transmitter itself. It consists of 400 volts R.A.C.

supplied by metal rectifiers and incorporating the necessary smoothing low-frequency chokes and condensers. As particular attention is given to obtain a good D.C. note a great deal of time has been spent in connection with high-frequency chokes in the supply leads to the transmitter, and with these wound to a quarter of the working wavelength (taking 40 metres as the wavelength in this case) and a good "key click" filter in the key circuit, the result is a steady D.C. note and is often reported as equal to crystal control. It should be mentioned that the transmitter is keyed in the negative high-tension side.

While on the question of the quality of a self-excited note there is one vital point worth mentioning. Many people tap the aerial right at the "hot end" of the plate coil, as this gives a bigger load draw. Although the load admittedly is bigger, the quality of the note suffers as the valve is often working almost ready to go out of oscillation.

By tapping back two or three turns the note should become quite stable, but, naturally, the draw will be a little less and it may seem that the transmitter is not "doing so well," but a slightly weaker signal with better quality will get further than an unsteady signal which is drawing everything to the last ounce.

As an example. At G2VV a 6-turn plate coil is used on 20 metres, and the aerial is tapped direct on at 3 turns, giving a good clear steady note. By tapping one or two turns nearer the hot end the draw is increased, but the note becomes unsteady and chirpy. Of course, the correct point is found by experiment when the aerial becomes exactly resonant with the wavelength that the transmitter is set to. These remarks are not intended to set any definite rules, as adjustments will vary according to the type of apparatus used, etc., but it is thought that they may serve as a rough guide to anyone trying a self-excited transmitter for the first time.

Switch Mounting

Referring to the photograph again, the various switches controlling the mains, high-tension, and low-tension supply can be seen mounted on the second table in the front left-hand corner. The filament supply is derived from a low-tension transformer with several tappings. A 2-microfarad condenser is fitted between each filament lead with a common connection to the centre tap.

On the operating table to the right of the transmitter is the monitor used for checking

Continued on page 16



Some idea of the host of QSL cards gathered from all continents can be seen by this picture of G2VV's den

How to Cut Out That Interference and Get—

Static-free Reception

By G. V. COLLE

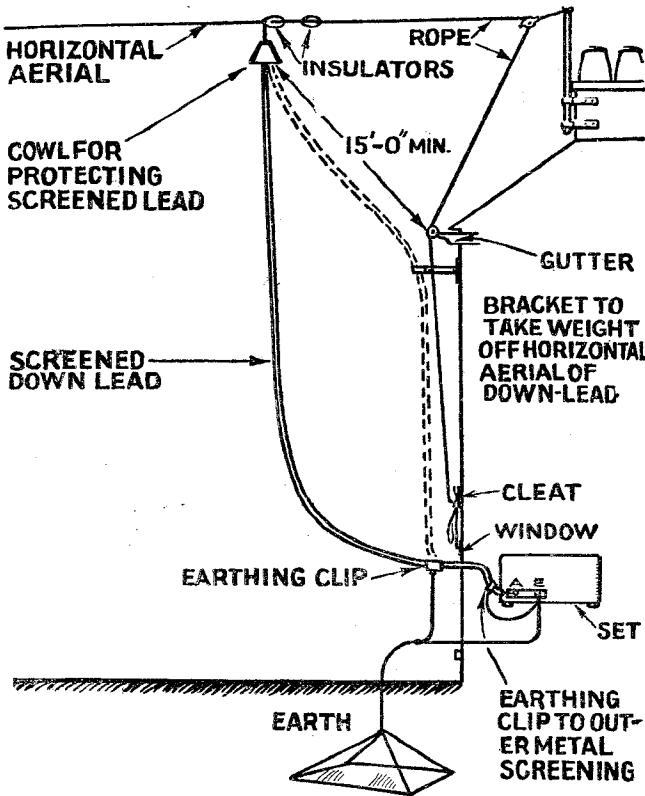

Points to watch in aerial erection. A great deal of interference can be cut out if proper consideration is given to the factors indicated

THE manufacture of increasing numbers of sensitive receivers has forcibly drawn the attention of designers to the fact that before further progress can be made in this direction more perfect means of suppressing man-made static must be devised.

It is a fact that a great number of the receivers now sold (and publication designs) are multi-valve affairs such as super-hets, which have a high degree of sensitivity and better all-round reproduction, particularly in the higher audio-frequency range.

The greater frequency response which these modern receivers provide unfortunately shows up many now familiar aspects of reception, such as heterodyne whistles due to the close spacing of stations.

Eliminating Noises

Whereas these interferences may be suppressed in the receiver by tone-control transformers, heterodyne and second-channel whistle filters, and similar variable frequency-limiting devices, it is not possible to eliminate the usual accompanying noises caused by nearby electrical devices.

These interferences manifest themselves in a variety of forms, such as crackles, hisses, splutters, and spasmodic interruptions. Indeed, it is fairly safe to say that practically all listeners are only too familiar with these annoyances, and it is the writer's experience that the majority accept them as inevitable.

The truth of the matter is that these noises are picked up by the receiver from electrical

machinery within quite a small radius of the receiving point.

An analysis shows that the majority of sufferers own powerful sets, live in congested residential areas, and invariably employ quite inefficient aerial systems. Another factor of interest is that these sets are generally screened, since they are constructed on metal chassis, the coils being "canned," together with the condensers and even to the valves. Bearing these facts in mind it is simple to deduce that electrical interference can only be picked up from two vulnerable sources, namely, the electric mains and the aerial-earth system.

Where battery sets are concerned only the aerial-earth system will provide the accessible point for interference.

Electrical interference in the mains is of high-frequency character, and as such can enter the receiver via the mains leads or by the aerial circuit. Without entering into the technical aspects of this question it will suffice to say that the mains can be isolated from the receiver from the high-frequency point of view.

The application of a static-suppression device at the mains to by-pass these high-frequency interferences to earth will obviously render the receiver immune from mains-borne interference.

Devices of this nature can consist of high-frequency chokes in each mains lead (capable of carrying the current consumed by the receiver) and in conjunction with condensers having a low impedance to high-frequency currents. This latter point is very important and necessitates the use of condensers having low power factors and preferably of a non-inductive type.

The chokes must be of low self-capacity and low D.C. resistance. Where A.C. mains are concerned, an additional precaution can be taken by providing a metal screen in the mains transformer between the primary and secondary, and earthing it.

No account has been taken of residual mains hum, as this is a matter for adequate smoothing devices, short grid leads, screened high-frequency leads where necessary, and similar conditions.

High-frequency filters as described can be fitted at the power point from which current is derived or, better still, in the mains leads near the master fuse-box.

Interference which persists after the application of a mains filter properly applied (and the maker's recommendations must always be

faithfully observed), can then only be due to that which is picked up on the aerial-earth system.

Local interference, such as caused by the operation of electric switches, can be minimised to a considerable extent by providing a short earth lead or alternatively one having a low-resistance path. Where an earth lead is of small-diameter wire and tends to be long, it is feasible for a potential to build up and pass to the receiver.

Earth Difficulties

The difficulty of providing a good earth can be overcome by making use of a flat copper strip, say 1/2 in. by 3/64 in. thick (or 3/8 in. thick), and tacking this to the nearest earthing point.

In no case must the resistance of this wire exceed a minute fraction of an ohm, and it is up to the owner of a receiver to use his ingenuity as to the best means of fulfilling this condition.

One important reason for referring to the aerial as a last point on the subject is that it is useless making recommendations until minor interference elimination schemes are carried into effect.

Unfortunately, high-frequency interferences are normally complex in character and may easily be due to a combination of statics having entry to the receiver at the points mentioned. There are now many well-defined principles to be observed when erecting an outdoor aerial, and especially if it is to provide signal currents free from man-made static.

As High As Possible

The first is that the horizontal section of the aerial (which, incidentally, need only be of the single-wire type) should be as high as possible, and certainly 15 ft. or more above the level of the roof.

Where power and overhead cables are concerned, this section of the aerial must be at right angles to them, and arranged as far away as space will permit. If the user has the choice of erecting the aerial over a roof or between the house and the end of a garden, the latter arrangement is the one to be adopted,

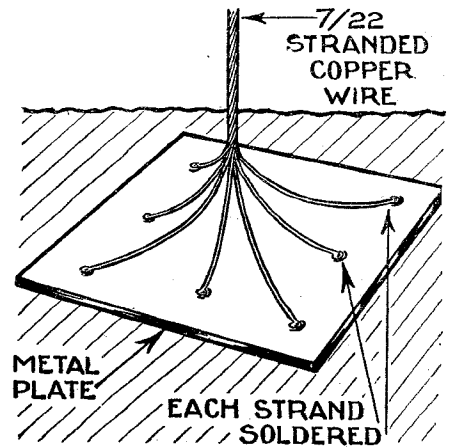

Equally as important as a good aerial is a good earth. Here is an effective type

particularly as the effective height of the aerial is then considerably greater from the point of efficiency.

As the effective height of an aerial can normally be considered as being that which is measurable to objects immediately below it, it can at once be perceived what a vast difference there will be in the pick-up efficiency, the lower capacity to earth and the improbability of induced eddy currents arising from nearby gutters, pipes or metal roofs.

More Complete Effect

To render the effect more complete, the end of the horizontal aerial nearest the house should be 15 to 20 ft. from the nearest wall, the down-lead being taken at an acute angle direct to the window of the room in which the set is installed.

If the aerial system, however, is close to a main thoroughfare with overhead tram cables or power lines, it is practically certain that further precautions will have to be taken in the way of preventing interfering high-frequency waves from impinging on the down-lead.

The user can lose nothing by carrying out the earlier suggestions regarding the aerial and noting the effect. Should the interference persist, replacing the down-lead with a screened lead of low capacity will invariably bring about the desired reduction in interference.

To be effective, though, the screened down-lead must be in one continuous piece, direct from the horizontal section of the aerial to within, say, an inch of the aerial terminal on the receiver. An earth clip can be attached to the outer metal screening of the down-lead, just prior to where it enters the window, and a substantial earth wire attached to it, the other end going to a good earthing point.

Most screened leads, owing to their unavoidable self-capacity, inevitably cause a reduction of signal strength, but this need not be

even noticeable if the tapping or primary winding on the aerial coil is made low, say one-tenth from the earth end. In actual fact the capacity of the down-lead is equal to the square of the tapping on the coil.

Thus with a one-tenth tapping the capacity of the down-lead is one-hundredth of its capacity across the coil. A one-fifth tapping would be one-twenty-fifth of the capacity of the down-lead across the coil, which is striking evidence that the lower the tapping the less noticeable will be the effect of the capacity of the down-lead.

Another way of stating the case is that for, roughly, every 5 per cent. of signal attenuation, a reduction of 20 per cent. of static is effected. A screened down-lead therefore offers great possibilities of real static suppression, provided the earlier recommendations are carried out.

Indoor aerials enter into another category and generally, when used with screened down-leads, the latter will eliminate hum arising from electric cables embedded in the walls and perhaps running parallel to the down-lead.

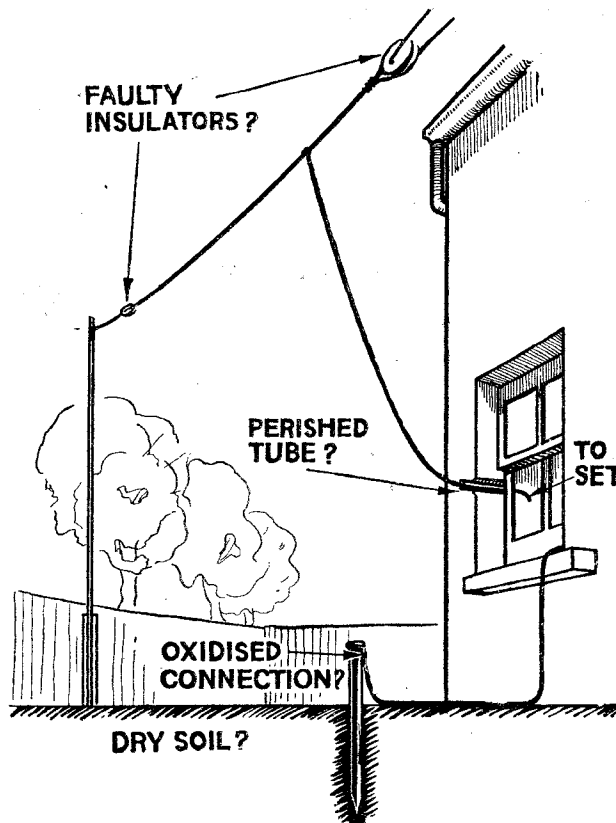

A reminder as to what parts of an aerial system may need periodic attention to keep it up to full efficiency

Rambling Radio Rays

I HAVE just been given a stack of notes, not Treasury, by He Who Must Be Obeyed, and told to write more words than I care to think about on them. That's all very well, but . . . I don't feel like writing notes and, besides . . . who wants to read them when I have written them?

I have a much better idea. (Of course, it is a million to one that He Who Must Be Obeyed won't think so.) I suggest that I use up the space available by having a chatty little chinwag all about our hobby. In case there are any of you who don't agree with this brainwave, I suppose I ought to take a vote on it. Those in favour signify in the usual manner.

That's right, now let me count the show of hands. One . . . two . . . Ah! splendid. Thank you, sir. Well, now that the matter has been carried so unanimously, let us proceed with the scandal.

Swapping.—Have you ever noticed how gardeners, golf enthusiasts, dart throwers and fishing fiends talk when they get together? Well, I have, and in spite of the fact that I could not follow their various languages, I gleaned that they make a habit of swapping experiences and views, thus assisting each other in no small degree. Now, I think the principle is very sound and I would most humbly suggest that we radio hams could do likewise.

Mind, I am not suggesting, for one moment, oh dear no, that our modest yarns are likely to be as tall as the gardeners' wonderful cadidalums, or as long as the fisherman's fish, which calmly took the hook out of its mouth with its tail

Far from it; in fact, I would go so far as to say that radio enthusiasts are not subject to this form of mental aberration. (H—m.—Ed.)

Lend me your ears—sorry, I mean eyes—for one moment and let me explain more fully. During our messing about with the radio—that doesn't sound very nice, but it is what the rest of the family always call it—all of us come across little snags, remedies, new circuits, a different way of doing this or that, together with other useful little discoveries.

Now, this is where my idea comes in. It is highly probable that the remedy, the new circuit, the way to make so-and-so work, which you have found out, is just the thing that would help poor old Brown, who is completely stuck.

The same applies the other way round, so, if we take it unto ourselves to pool our findings and ideas, we should eliminate much of that hopeless feeling we all run up against at times.

Tweeters.—Last week-end my moving-coil loud-speaker went pp the loop and left me high and dry. I was annoyed. The result was a hurried visit to my junk cupboard, wherein I found two reed units, one being of the balanced-armature type. Within an hour I had made a 12-inch cone and mounted one of the units.

The reproduction was not too bad, except that the high notes were simply not there. I know that may sound strange, but it was so. Having nothing better to do, I proceeded to make a 6-in. cone out of thin stiff paper and mounted it with the other unit.

I was very tickled with the results as when I had both units working the reproduction was really amazing for these loud-speakers

Loud-speaker Volume.—How loud do you have your reproduction? I know this question lends itself for someone to say: "Oh! about ninety-nine times as loud as that Pappa!" But, seriously, how do you set the volume?

I know it is usual to adjust it to suit the room the loud-speaker is in, but have you ever tried this method? When a talk is on, get someone to stand alongside the loud-speaker and talk in a perfectly normal manner then, turn the volume control down until the loud-speaker is equal.

It is worth trying if only to see how much louder you have your radio than is necessary.

A Million-to-one Chance.—I was trying out a new set I had just completed and the results were far from satisfactory. The low-frequency portion was all O.K., the trouble being in the high-frequency and/or detector section. I could not get the range or control I expected, and I can tell you I did everything I could think of.

After getting some meters on the aerial side, I went into the garden for the third time and looked at my aerial and lead-in. This time, however, feeling rather peeved, no doubt, I gave the lead-in a hefty pull and, much to my amazement, it stretched about 2 ft.

On closer examination, I found that the wire inside the thick rubber covering had broken about 3 ft. from the spot where it entered the house. I admit it was rather old and, on thinking the matter over, I remember giving the lead-in a little tug to try to make it reach the set.

MORAL: Don't be cruel to your aerial and don't forget that it needs renewing at times.

S. O. L.

Complete Guide to Commercial Radio

By PERCY W. HARRIS, M.Inst. Rad.E.

(who is not feeling very well at the moment)

Acoustics.—The science of spoiling the tone of a good commercial set, to please the managing director.

Aerial.—That part of a set which, when disconnected, improves the selectivity.

Calibrated Dial.—Tuning device which, when set at Scottish Regional, gets Milan.

Double-Diode-Triode.—Thermionic pin-cushion.

Earth.—1924 model iron bath, buried near the dustbin, and separated by at least three inches from a corroded wire leading to the dining-room.

High Frequencies.—Important parts of the musical scale which are rendered conspicuous by their absence.

Low Frequencies.—Effects introduced by manufacturer for the purpose of shaking the cabinet.

Mains Interference.—Absence of any proper soldered connections on a chassis.

Makers' Guarantee.—A document which makes it quite clear that unless the set goes wrong, they will do what is unnecessary at your expense, carriage forward.

Moving-coil Loud-speaker.—Instrument in which a coil is dispersed from moving by means of a stiff cone.

Radiolympia.—A large building in which all the sets work without being turned on, for

the benefit of visitors whose own sets won't work when they are.

Revolutionary Improvement.—Last year's chassis in this year's cabinet.

Sales Manager.—Man who gets the credit when a set is a success.

Service Station.—Shop which sells you a complete new set of valves when your high-tension plug comes out.

Set Designer.—Man who is blamed by Works Manager when set is a "flop."

Super-Heterodyne.—A receiver using more valves than you need, to get more squeaks than you want.

Television Receiver.—Apparatus which produces a picture which looks much better at a distance.

10-kc. Selectivity.—Reception of the local station over only two degrees of the scale, when the volume control is turned right down.

Tone Control.—A knob which cuts off what little "top" remains in a set after it has left the factory.

Undistorted Output.—Any form of reproduction which enables a piano to be distinguished from a violin.

Works Manager.—Man who is blamed by Set Designer when set is a "flop."

A Real Low-power Station

Continued from page 13

the quality of the emitted note. It consists of a battery-driven straight one-valve circuit, employing an 80-metre coil which enables good reception of any harmonic in the Amateur Bands and is a constant check on the transmission. The whole rig is totally enclosed in a metal case.

Standing on top of this monitor is a 5-metre transceiver of which more will be said later.

Next to the monitor is the receiver. It is battery driven with a dual-range coil tuning from 12 to 85 metres with a band-spread condenser in parallel with the main tuning condenser, and enables a quick change to any band up to 80 metres. The circuit is the usual o-v-1 with 2-volt valves. This is also built into a metal case, and there is no evidence of any hand-capacity even when an earth is not used. The transmitting aerial is used for reception as a quick change-over switch is employed.

Headphone Connections

The headphones are connected in common leads to the output of the monitor and receiver so that when changing from one to the other it is only necessary to switch the filament circuits.

To the right of the receiver can be seen a carbon inset microphone which is fairly sensitive when used in conjunction with a "mike" transformer. Against the wall at the side of the microphone is a rack holding spare valves which are always kept handy in the event of a breakdown. QSL cards from various countries can be seen on the wall, together with the W.A.C., W.B.E., and R.S.G.B. membership certificates.

The present aerial system is a voltage-fed Hertz 68 feet long and about 40 feet high. This is tapped direct on to the plate coil and has given very satisfying results. Much time has been devoted in the past to experiments

with different types of aeriels, and after a summary of results obtained the operator favours the present type and the Window which gave good results on 20 metres but was not so successful on the other wavebands.

The dimensions of the Window as used at G2VV are 33 feet long and the feeder tapped at a third of that length. It should be mentioned that the present voltage-fed Hertz gives equally good results on all the Amateur Bands, including 5 metres!

The present situation of G2VV is by no means ideal for radio work as the aerial system is enclosed by buildings, many of which are higher than the aerial itself. The ends of the aerial are north and south, with the down-lead at the south end. As the main road is not far away considerable interference is caused by car-ignition noises, which often cause words to be used that cannot be found in the dictionary. Before concluding it may be of interest to mention a little about the apparatus used for 5-metre work, and to give briefly a few words regarding results obtained on this wavelength.

Most experiments have been conducted at G2VV using the transceiver seen in the photograph, so the remarks here will apply to work carried out using this small and compact transceiver.

The size of it makes portability an accomplished fact, and the whole thing may be used while walking along the road.

Actual measurements are: Front panel, 5 in. wide and 6 in. high; and the baseboard is 5 in. wide and 8 in. long. The whole thing slips into a wooden case for carrying which has a handle at the top. In this same wooden case there is a space under the transceiver itself for the batteries, microphone, and 'phones.

If operation is desired whilst one is walking along, the headphones are, of course, worn and the microphone held in the other hand. Sometimes, for convenience, the transceiver has been slung on a leather belt and worn round the waist. There are two switches on the front

panel, one being an ordinary filament switch and the other a three-pole single-throw switch for "send" and "receive." Two 2-volt valves are used, such as LP2's, PM2A's, or PM2DX's.

For reception one valve is used as a detector and the other as a quencher, and on changing the detector becomes the oscillator and the quencher the modulator. A one-plate tuning condenser is used, and a miniature one-plate condenser is employed to tune the aerial. After considerable experiment a variable aerial coupling coil has been fitted, so that the aerial system can be tuned by a condenser and also varied mechanically. The aerial used consists of two di-poles, each 4 ft. in length and are heavy gauge copper wire. Almost any stout wire will be suitable, and for portable work aluminium tubing is ideal.

Aerial-coupling Coil

These are fixed to terminal connections connecting the aerial-coupling coil, and can be varied to any desired position. When walking along one is kept towards the ground and the other pointing directly upwards. For very local work results are often satisfactory when using no aerial at all.

The batteries consist of a very small 2-volt accumulator about the size of the usual flashlight battery, and the high-tension supply is a small size 60-volt dry battery. The usual consumption from this is 8 to 10 milliampères, and the voltage for the microphone itself is supplied from the low-tension battery.

With an input of half a watt surprising results have been obtained, and readable telephony transmitted about four miles in fairly open country. When the transceiver is used at a fixed station the inputs can, of course, be higher, and at G2VV up to ten watts is used and the high-tension supplied from rectified A.C.

As would be expected, a great deal of the success of longer-distance 5-metre communication lies in the type of locality chosen, or of necessity enforced. Although the common theory accepted regarding communication on 5 metres or thereabouts being almost confined to visual distance, results at G2VV have at times proved to the contrary.

One example can be given when signals emitted along a visual line to the receiver were weaker than when objects were placed in the visual line. Naturally, objects in the field of the transmitter and receiver cause reflection or absorption, and when taking field strength measurements objects a good distance away from the transmitter have definite effects upon the measurements.

Endless Distances

If it were possible to erect reflector system along a given route 5-metre communication could be carried on to endless distances. There is one point of interest to be mentioned before concluding these random remarks on 5-metre work. It has been found on one or two occasions when operating a receiver in an open field that at one spot in the field signals completely cut-off in a small area of three or four feet, but immediately the receiver is removed from this area signals can be received at any position in the field.

It has been proved that the transmitter is not in any way "locking" or "swamping" the receiver, and the only conclusion gathered is that in the "silent area" something is buried, or there is some mineral effect in the ground immediately below the receiver that completely absorbs the incoming signals. This, of course, is only the writer's assumption, but it is one of the many mysteries that remains to be satisfactorily solved to help us discover what these high frequencies may be able to do for us in the future.

In closing, it is hoped that this article will have proved of some interest, and G2VV is always ready to chat to any fellow-amateurs, if they will give him a call when he is heard sending "TEST."

Receive the Continent FREE FROM ELECTRICAL INTERFERENCE

"GOLTONE" AIR SPACED METAL SCREEN DOWN LEAD

Eng. Pat. No. 414,913

Ensures a clear background, elimination of electrical interference and makes reception a pleasure.

REPEAT ORDERS have been received from BRITISH AND DOMINION GOVERNMENTS. BRITISH BROADCASTING CORPORATION AND LEADING CONCERNS.

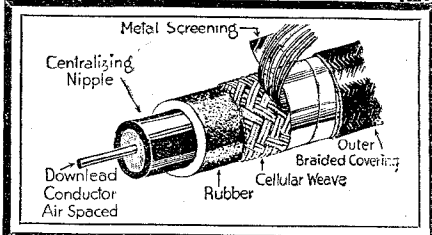

"GOLTONE" COMPONENTS are obtainable from First-Class Radio Stores. Refuse substitutes. If any difficulty write direct.

Let "Goltone" Technical Department solve your Interference Problems. Send postcard for "Interference Elimination" form and descriptive folders.

FREE ON REQUEST. 1935-60 page Radio Catalogue and folders describing Screened Down-leads and other interference suppressing devices.



There was a young fellow named Sid
Always practical in all that he did;
His hobby was Wireless—
At it he was tireless—
And using Fluxite—saved many a quid!



See that FLUXITE is always by you—in the house—garage—workshop—anywhere where simple speedy soldering is needed. Used for 30 years in government works and by the leading engineers and manufacturers. Of all Ironmongers—in tins, 4d., 8d., 1/4 and 2/8. Ask to see the FLUXITE SMALL-SPACE SOLDERING SET—compact but substantial—complete with full instructions—7/6. Ask also for Leaflet on CASE HARDENING STEEL and TEMPERING TOOLS with FLUXITE.

THE FLUXITE GUN

(Registered)

is a handy and economical tool that enables you to put the Fluxite where you want it on the soldering job, and is clean and simple to use. Nothing to remove—no mess—no trouble. Always READY FOR USE.

Also used to project grease into grease cups, bearings, etc.—Just fill the nozzle portion—half fill the cup—put together and press as required. Price 1/6

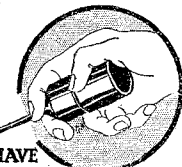

ALL MECHANICS WILL HAVE

FLUXITE

IT SIMPLIFIES ALL SOLDERING

Fluxite Ltd. (Dept. 326), Dragon Works, Bermondsey Street, S.E.1.

Listeners' Letters

"The Experimenters"

To the Editor, AMATEUR WIRELESS.

I AM voicing the opinions of two more "A.W." readers when I say we want "The Experimenters" back again. What's happened to them? Are they fired?

Surely some explanation is due, please. They are the one bright spot in our lives.

THREE "A.W." REGULAR READERS.

Bristol. [1170
["The Experimenters" have again contributed to AMATEUR WIRELESS quite recently. —Ed.]

Value of Band-spreading

THANK you for your article on band-spreading in AMATEUR WIRELESS. You may be interested to know that I added band-spread to my set last night, and was amazed at the difference in tuning.

I tried it out on W8XK, and found that this station was actually spread out over twenty degrees on the dial of the miniature condenser, and, incidentally, hand-capacity seems to have lessened considerably.

The W's were again coming over very well on Sunday last, and those deserving particular mention are W3MD, W2DKU, W2GOQ, W3BPH, and W8GLY, all at R6-7 with slight fading. The last-named, W8GLY, was a splendid signal, and while working with G2PL he actually picked up GSF and relayed part of the programme through his own transmitter. His location is Pittsburg, Pa.

JOHN G. KERR.

P.S.—Above stations are on 20-metre band and were received on phones, a short outside aerial being used.
Glasgow, E.2. [1171

ELECTRADIX

5,000 Western Electric Microphones at 1/- each. We are makers of Home Radio mikes with solid bakelite body, 5/6; Special Table model, 15/-; G.P.O. Pedestal Microphones, with mouthpiece, 7/6; P.A. mikes, 55/-. Illustrated list free.



Dynamos—If you already have an engine and want to light your workshop, etc., say 10 lights, we have the very thing. Shunt wound Dynamo, 12/20 volts, 10/12 amps., with pulley, ball bearings, dust-tight covers, etc. A fully automatic generator. Switchboard on bakelite base with field regr., main switch, ammeter, fuses, etc. The pair, 47/6, with 12 months' guarantee.

As illustrated.

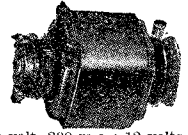

Motors, Electradix—Fractional h.p. and sewing machine motors, 1/40 h.p., 220 volts A.C., 15/-; 1/50 h.p. motor, double-ended shaft, 250 volts, with resistance, A.C. or D.C., 22/6; 220 volt grammo. motor, with turntable, 50/-.

Motor Generators, 220 volt to 500 volt, 200 m.a.; 12 volts to 800 volts, 30/100 m.a.; D.C. 7 1/2 h.p., 400 volts, 12 amps. to 100 volts 66 amps., 1,700 revs., by E.C.C.; D.C. 115 volts, 3 h.p., 23 amps. Motor coupled to 110 volts, 14 amps., 50 cycles, 1 1/2 K.W.A.C. Gen.; 220 d.c. to 310 volt, 300 m.a., and 12 volts, 10 amps.; ditto to 480 volts, 200 m.a., and 18 volts, 20 amps. The best bargains ever offered, 1,000 others in stock.

Magnetic Circuit Breakers—1 amp., 2 amps., 3 amps., or 4 amps., 7/6; 6 amps., 10/-; 10 amps., 14/-; 15 amps., 16/-; 20 amps., 18/6. All with covers, D.C. or A.C. Useful on motors or other hard work.

Selector Switches—8 arms of 25 volts each. Relay solenoid operated for distant control. As used in Tote and Auto 'phone exchange. 7/6 and 10/-. Overload Trip Switches, any amps., 7/6.

Projectors—35-mm. with motor drive and enclosed 10-amp. arc lamp and lantern on floor stand, by Pathe, 25 10s. 15 to 10 amp. Arc Lamps, 30/-. Film Printer with motor drive, 27 by 19 by 10 in. cabinet, sprockets, brackets, asbestos lampshade and filter for movie film printer, 24.

Combination Projector and Camera—Campro 35-mm., suitcase model. Secondhand, 45/-.

Midas Camera-Projector—New. 9-mm. Seven guineas. Ideal gift, unsoiled. Guaranteed, 24.

Electric Heaters—Flat metal frame, 2 by 12 by 12 in., 200/210 volts, 500, 600 or 700 watts, 7/6 each; 1 kw., 9/-; 220 volts, 500 and 800 watts, 8/- each; 1 kw., 11 kw., 10/- each; 230 volts, 1/2 kw., 8/-; 1 1/2 kw., 12/-; 250 volts, 700 watts, 8/-.

Focusing Arc Lamps—5 to 20 amps., 22/6. Automatic Magnet Feed, 35/-; Cinema Arcs, 10 to 60 amps., 23/-; 35-mm. Professional Projectors for small hall, enclosed arc with condenser. Motor drive Projector with iron floor stand, 25 10s.

Govt.—Fine Naval Telescopes, screw focus, 9-mile range, 20-in. gun type, 15/-; Spotting Telescopes, lightweight, 17 in., 25/-.

For 1,000 other bargains, send 1d. stamp for New Illustrated Sale List "A." State your requirements.

ELECTRADIX RADIOS,
218 Upper Thames Street, London, E.C.4

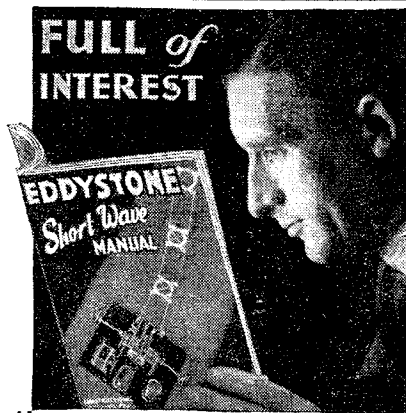

Fully illustrated with constructional details for building Battery and Mains S.W. Receivers—6v. S.W. Super-het with A.V.C.—All Wave Wavemeter—5-metre Receiver—Simple 5-metre Transmitter—Circuit Aerial System—Battery and Mains S.W. Converters—Amateur Bands Receiver—100 watt Transmitter Eliminators, etc. COMPILED BY THE LEADING SHORT WAVE SPECIALISTS. Obtainable from your radio dealer, W. H. Smith, or, in case of difficulty, direct from STRATTON & CO., LTD. (Dept. 23), Bromsgrove Street, Birmingham. London Service Depot—Webb's Radio Stores, 14 Soho St., Oxford St., W.1. Glasgow Service: J. R. Hunter, 138 West Nile St.

1935 EDDYSTONE SHORT WAVE MANUAL

Piano Case CABINETS
65/- Radio-Gram 35/- Cabinet for NO MIDDLE PROFIT
Finest Radio Furniture as Supplied to the B.B.C.
PICKETT'S
Cabinet (M.G.) Works, Beckleyheath, Near London.

ENGINEERS! LOOK WHAT YOU HAVE AT YOUR FINGER TIPS!
Do not let a first-class post slip through your fingers for the sake of a few letters after your name. Whatever your experience, age, or education, you should send to-day for "ENGINEERING OPPORTUNITIES." This free 250-page Handbook shows the easiest way of preparing for the A.M.I.C.E., A.M.I.Mech.E., A.M.I.E.E., A.M.I.A.E., Matric, G.P.O., etc. The book also gives details of all branches of Civil, Mech., Elec., Motor, Aero., Wireless, and "Talkie" Engineering, and explains the unique advantages of our Appointments Department. Send for the valuable Handbook to-day—FREE, and post free. BRITISH INSTITUTE OF ENGINEERING TECHNOLOGY, 409 Shakespeare House, 29/31 Oxford Street, London, W.1.

High Tension for your Radio from the Mains at 1/- PER YEAR
Model A.C.T. 150 volts at 30 milli-amps. or 120 volts at 18 milli-amps. with 8.6. and Detector Transformers, 2 with 1 amp. Trickle charger. Price 47/6.
Send for full particulars.
M.P.R. Ltd. ROMFORD, ESSEX

My Short-wave Log

By J. GODCHAUX ABRAHAMS

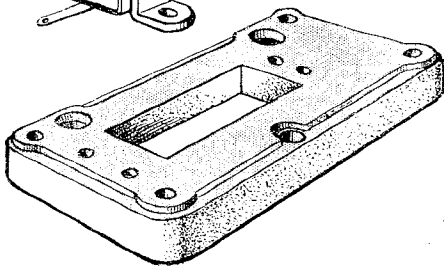
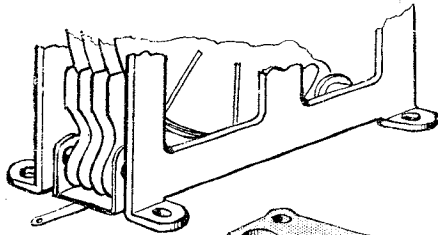

Low-loss Steatite base for short-wave variable condenser

FOR those who prefer fresh fields of exploration may I suggest a search for the following: Havana, COH (Philippine Islands) on 31.81 metres (9,428 kilocycles), which is on the air daily at G.M.T. 1500-1600; 2200-2300, and from 0100-0200.

CM6FX, Santa Clara, Cuba, on 36.5 metres (8,220 kilocycles), which has been heard at 2 a.m. G.M.T. with announcements in Spanish and English in a programme of gramophone records.

Also H1A, Santiago de los Caballeros, Dominican Republic, on 47.78 metres (6,279 kilocycles), calling *La Voz del Yaque*, and transmitting daily between G.M.T. 1240-1840 and again between 0040-0240; HJ2ABA, Tunja (Colombia), *La Voz del Pais* on 48.78 metres (6,150 kilocycles) with a programme every Tuesday, Thursday

and Saturday from G.M.T. 2300-0300.

Finally HC20C, Quito (Ecuador) on 65 metres which I am told has been picked up by French listeners between G.M.T. 0130-0430.

Between 40 and 50 metres there is now a welter of signals, not only from commercial stations but also from new broadcasters; it is without doubt the favourite winter short-wave band.

Taking CT1GO, Parede (Lisbon) on 48.4 metres as a start—it is an easy transmission to pick up—and working up very slowly, you should find without much difficulty HJ2ABA, Tunja (Colombia) on 48.78 metres which, owing to the proximity of YV3RC, Caracas, varies now and again in wavelength. On one night I logged the station definitely between the latter and W8XK, Pittsburgh on 48.86 metres.

HJ2ABA is usually on the air on Tuesdays, Thursdays and Saturdays between G.M.T. 2300 and 0300. I have noted no particular interval signal, but in its call it uses the slogan: "La Voz del Pais." I am informed that in the near future it may use a lower channel, namely, nearer 48.4 metres.

Immediately below W3XAL, Boundbrook (49.18 metres), which is now well heard in the later evening hours, you should log Vienna OER2, as it is transmitting daily from G.M.T. 1400-2200. It has somewhat increased its power, but the promised new transmitter has not yet made its appearance.

A correspondent tells me that he has heard a broadcast from HC2RL, Guayaquil (Ecuador) in which the call given in Spanish (phonetically) "Ah-kee es-ta-see-own atcha say dos air-ell," was repeated in English for the benefit of the United States. The wavelength announced was 45.02 metres (6,659 kilocycles).

In its neighbourhood you may come across HC1FG, Riobamba of the same country, which styles itself Estacion el Prado (45.31 metres). A woman frequently officiates in the studio.

Continental Jottings

By JAY COOTE

BUDAPEST is now offering alternative programmes: the National entertainment is put out on 550.5 metres, the Regional broadcast on 227.9 metres (1,317 kilocycles) with a power of 20 kilowatts. It is good to make a note of this, as you may have heard the Nyiregyhaza relay on 267.4 metres. Budapest 11, at the moment, is only working four hours daily, namely, from about 7 p.m., but shortly it will be on the air all day.

French listeners have been complaining bitterly regarding the inaccuracy of time signals given out by their studios, and that if they wish to set their watches they must tune their receivers to a B.B.C. broadcast. It is a curious fact that whenever I have been listening to a French station when the announcer has asked his hearers to stand by for the time signal, I have found that the pong on the gong, used

for this purpose, seldom corresponded with my watch.

Except for certain periods of the day, when the official Nauen time signal is relayed, the Germans also are verbally informed, but in such cases the minutes and seconds past the hour are correctly given. As in Great Britain, the studios possess electric clocks.

A Paris correspondent informed me recently that he had listened to three of the local stations and as in each case the time differed he struck an average. Most French people, if they wish to set their clocks, ring up the telephone exchange.

Amongst the many excellent programmes which are being broadcast during the holidays by the Continental stations, I find that the Swiss will be well in front with good concerts and operatic relays. Arrangements have been

made with the Scala of Milan for a definite number of transmissions during the next six months.

Three dates have already been fixed, namely, January 1, when the Swiss stations relayed Bellini's opera, *La Sonnambula*; February 3, Mascagni's opera *Neron*, taken by Bero-muenster and Monte Ceneri; and April 24, when Sottens and Monte Ceneri broadcast Verdi's *Aida*.

Work has already been started on the new transmitter at Banska Bystrica (formerly Newsohl) in central Czecho Slovakia, and it will be completed by 1935. The channel allocated by Lucerne is 765 metres.

The authorities have now decided to construct a 100-kilowatt station to give a "crystal" service to the western portion of the country.

Tests are being carried out to find a suitable site; so far, no definite locality has been selected.

New Interval Signal

Contrary to the principle adopted by other Continental stations which have now given up morse interval signals, Brno introduced a new one on January 1. From that date between broadcasts you will hear the name spelt out: — . . . — . . . — . . . — . . .

Although other methods have been tried, the engineers still consider that this is the best way to advertise the presence of radio entertainments on the ether.

The 3-kilowatt station which has been installed at Dornbirn to act as relay of the Vienna programmes in the Vorarlberg district (Western Austria) is now ready and was officially opened on December 18. It works on 231.8 metres (1,294 kilocycles), a wavelength common to Linz and Klagenfurt.

By Christmas it was also hoped to operate the new Salzburg station and higher-powered plant for Innsbruck will be installed in January.

To provide not only a "stand by" transmitter but also an alternative programme, the Ravag is reconstructing the old Stubenberg station.

As soon as the work is finished the Rosenhugel 17-kilowatt transmitter will be transferred to Graz, to act as relay.

If you wish to listen to Lisbon, I find from experience that the best day and time is on Sunday from G.M.T. 2200 (10 p.m.) as by that hour Trondheim on the same wavelength has closed down, leaving the channel perfectly clear. For the guidance of the uninitiated the call is: *Lisboa Emissora Nacional*—no mention of *Radio* or *Hallo*; announcements are made by a man but the news is given out by a woman.

When the average listener desires to hear foreign programmes he does doubtless very much what I do—and should not!—twiddle the condenser dial until he captures some transmission which appeals to him. Almost nightly, I make the round of the European stations and on occasion find something out of the ordinary. But, invariably after having carried out the grand tour of Europe roughly, I settle down to certain sections of the broadcast band.

Lesser-heard Transmissions

It is after 10 p.m. G.M.T. (which represent one, two or three hours later on the Continent) that I make the captures of the lesser-heard transmissions. By that time a number of studios have closed down or are giving their last items and when their carrier waves are switched off, a free field is offered for exploration.

The point is an interesting one inasmuch as where a channel is shared by two stations it will be found that in every instance one studio signs off before the other, thus permitting at different times both to be heard.

Criticisms by WHITAKER-WILSON

My Broadcasting Diary

Economy Week : : Superb Hamlet : : Good "Musicals" Needed
 St. Hilary Nativity Play : : "Poor Old Sam" : : Cheap Melodrama

THIS must be economy week at Broadcasting House. Saving up for the Christmas programmes. More routine type of broadcasting than usual. Still, it is gratifying that the routine work is so good.

Sunday

THE week began with something not routine, and perfectly produced—*Hamlet* was superb.

Strong term, but in this instance deserved. Val Gielgud has never done anything better. Whether he thinks that or not, I am not sure, as I haven't seen him since; but if he is satisfied, nothing shall be said by me to detract from his pleasure at having done a good thing well.

What a cast! Malcolm Keen, Harcourt Williams, Robert Speaight, Charles Mason, Philip Wade, Hilary Fisher-White, and Fay Compton. Others, too—all good. And a word for Barbara Burnham, who adapted it.

Monday

SOMETHING about *A Girl Friend*. No friend of mine, I do assure you. I thought her very unattractive. Hardly worth Denis Freeman's obvious care over presenting her.

Which shows, yet once again, how we need good musical comedy to be written specially for broadcasting. Unless these things are originally thought out for the microphone there is always a risk with them.

Talking about "arrangements," I heard some first-rate ones by Gerrard Williams to-night in the Wireless Military Band programme. Completely successful. An instance of what I mean when I say the B.B.C.'s routine work is often really tip-top. The W.M.B. is one of the best bands in England.

Tuesday

PEOPLE and their orchestras, chiefly. And, of course, the Nativity Play from St. Hilary. Somehow, I cannot see anything attractive in the way that play is written—or spoken.

I imagine it is considered a success by the B.B.C. or we should not get it every year. Which just shows that a critic can't be right every time—or something to that effect.

Wednesday

BITS and pieces to-night. Duty coming before pleasure, I sampled each of the three bands advertised as doing their stuff at half-past seven. I quaglined and accordioned and banjood. At the end I didn't know which I disliked most; but there, again, I suppose these things are popular. Also I am sure they are very good technically. It is simply that I have not risen so high, I suppose.

* * *

I waited patiently until eight o'clock, when a Chopin recital was announced in Polish (and most other earthly languages) from Warsaw.

A very fine relay, too. Very little disturbing noises, and I enjoyed the pianist. I still think there ought to be a Chopin recital once a week—simply because he appeals to so many people.

* * *

Bransby Williams, in "Poor Old Sam," was excellent. A very good little farce it proved to be, smartly produced by Charles Brewer. I see the author is Morton Howard. I suggest the B.B.C. keeps his telephone number and asks him for another quite soon.

* * *

David and Harry are topical entertainers at the piano, according to the programme. I think their songs would appeal to some people, but I must say they disappointed me.

* * *

Then came a thoroughly bad piece of broadcasting. There is one form of art definitely no good for wireless—cheap melodrama. Christine Silver is a first-rate actress with an honoured name. I suggest she never lends that name to broadcast melodrama again. If she could have only *heard* what it sounded like. . . .

* * *

John Watt, selling the best sellers over again, remarked that he noticed all the best were slow tunes. I had also noted it. I think it always has been that way with English people. They like their tunes slow. A very well-produced show, this. Marius Winter's

Band excellent. Also Brian Lawrence, who is one of the best singers we have for this kind of thing.

Thursday

PEOPLE'S bands, quintets, and the like, to-night, but nothing else of account. "Soft Lights and Sweet Music" and all that.

Friday

HENRY HALL in an excellent mood. Well, taken all round, I think his band is as good as any we ever hear. I have heard all sorts of arguments for and against the statement. Still, I keep to my own view. Henry is as good as any of them and a good deal better than most. All right, have it your own way—that's *my* view. And now such a lot of letters will come in saying the writers think it's about time I gave up criticism.

Saturday

THERE has been another Ridgeway Parade.

Ambrose and his Embassy fellers gave a tip-top programme this afternoon. Very distinctive playing. I should recognise that band without actually thinking about it, though far from being an authority on dance bands.

A good "In Town To-night." I enjoyed the tiger tamer's story particularly.

As I happen to know how difficult it is to keep up this feature, I congratulate everyone concerned on the standard of entertainment they have reached.

The vaudeville not too bad. Tommy Handley quite up to form. Also Rupert Hazell and Elsie Day. How well she sings, too! I like to hear *real* singing in a vaudeville.

Well, a dull page for you this week. But, then, on the whole, it has been a dull week of broadcasting. Nobody has said anything really funny the whole week, and I haven't been moved artistically since Sunday. *Hamlet* had to last me all the week from that point of view.

ELEMENTARY WIRELESS FOR THE BEGINNER

"An Elementary Wireless Course for Beginners" has been written particularly for the listener who wants to know how his wireless set works. The Course takes the reader in easy stages right through all the processes of wireless reception. It avoids text-book style, every line is technically accurate.

131 ILLUSTRATIONS!

The unique illustrations, of which there are 131 in all, are a remarkable feature and constitute the finest series of explanatory diagrams ever included in any volume on the subject.

AND OVER 270 PAGES!

The 32 chapters of this book cover nearly 300 pages, at the remarkably low cost of 3s. 6d.

Send for your copy to-day, together with remittance for 3s. 10d. to the publishers

BERNARD JONES PUBLICATIONS LTD.
 58-61 Fetter Lane, London, E.C.4

**HIGHEST in QUALITY
 LOWEST in PRICE**



Absolutely non-microphonic detector types, S.G. types of exceptionally low inter-electrode capacity. Output valve giving larger undistorted output than "luxury" price valves.

362 BATTERY VALVES
 H.H.L. & L., 3/6; Power, 4/-; Super Power, 4/6; S.G. & V.S., 7/6; V.P.2, 9/-; Pentode type, 10/-; B.A. & B.X., 9/-.

362 A.C. MAINS
 ACHL4, 7/6; P625, 8/-; ACPX4, 9/-; ACSG4 & ACVS4, 12/6; ACME4 & ACHM4, 13/-; ACVP4, 13/- Full Wave Rectifiers, RB41, 7/6; RB42, 10/-.

IF UNOBTAINABLE FROM YOUR DEALER—SEND P.O. to DEPT. O
 OF THE 362 RADIO VALVE CO. LTD., SIONHEAM ROAD LONDON, E.5.

**H.L.2.
3/6**

362

**THE VALVE WITH
 THE 6 MONTHS'
 GUARANTEE**

PREPAID ADVERTISEMENTS

Advertisements under this head are charged **THREEPENNY PER WORD**, minimum charge **THREE SHILLINGS. DEPOSIT SYSTEM.**

As the publishers cannot accept responsibility for the bona fides of advertisers in this section, they have introduced a system of deposit which it is recommended should be adopted by readers when dealing with persons with whom they are unacquainted.

The amount of the Deposit and Fee must be remitted by Postal Order or Registered Letter (Cheques cannot be accepted), addressed to

"Amateur Wireless" Advertisement Department,
58-61 Fetter Lane, London, E.C.4.

PATENTS.—Trade Marks, "Advice Handbook" free.—B. T. King, Regd. Patent Agent, 146a Queen Victoria Street, London.

REPAIRS TO MOVING-COIL SPEAKERS.—Cones and Coils fitted or rewound. Eliminator and Transformers quoted for Loud-speakers, L.F. and Speech Transformers, 4/- each, post free. Trade invited. Satisfaction guaranteed. Prompt service.—Loud-speaker Repair Service, 5 Balham Grove, London, S.W.12. Battersea 1321.

A/C ACCUMULATOR CHARGERS. Entirely new improved type, fitted with Westinghouse rectifier and lamp indicator. 2 volt, 1 amp., 19/6. Other sizes up to 12 volts 3 amps. Latest lists free.—Thompsons, 39 London Street, Greenwich, S.E.10.

"WIRELESS MAGAZINE" EMPIRE SHORT-WAVE, complete, valves, best components. Seen by appointment.—32 Basildene Road, Hounslow, Tel.: Hounslow 0400.

BANKRUPT BARGAINS.—List free. Three-valve Kit, 15/-; S.T. 600 Kit, 43. Mains Sets from £4. Regentone 30 M.A. Eliminators, 32/6. Celestion P.M. Speakers, 11/-; Triotron Valves from 3/-. Part exchange. Anything radio supplied. Large stock.—Bullin, 143b Preston Road, Brighton.

PEARL & PEARL

190 Bishopsgate, London, E.C.2. The following eliminator bargains are guaranteed new goods.

ELIMINATORS.—Special purchase of large quantity of Lincoln-Stewart eliminators enables us to offer them at sacrifice prices. All models O.K. for 200-250v. D.C. 25 milliamp output, 9/11; A.C. 30 milliamp output with Westinghouse Rectifier, etc., 24/11, or with half amp. Trickle Charger incorporated, price only 37/6. All fully guaranteed by Pearl & Pearl. Cash or C.O.D., carriage paid.

CABINETS.—2,000 Cromwell Cabinets (for set and speaker combined) just secured on terms which enable us to offer them at the astoundingly low price of only 4/11 each. Horizontal type, 23 in. wide, 8 in. deep, 11 1/2 in. high. Polished Walnut veneer, additional baffle behind speaker grille. Our price 4/11. Supplied for cash with order. Carriage forward.

LARGE RECEIVER CABINETS.—Highly polished, as used for "Cromwell" 8-valve Superhet. Measurements, 22 in. high, 17 in. wide, 11 1/2 in. deep. Finished in contrasting rosewood and walnut veneers. Special additional baffle on speaker fret. Cost over £2 to make. A few only left. Our price 15/- each. Cash with order. Carriage forward.

FREE.—Our latest, fully revised Bargain List AW, now ready. Send P.C. for your copy.

All Mail Orders Direct to

PEARL & PEARL,
190 Bishopsgate, London, E.C.2.
Telephone: Bishopsgate 1212.

INFORMATION BUREAU

Will every querist please observe the following revised rules?

Please write concisely, giving essential particulars. A fee of one shilling, postal order (not stamps), a stamped, addressed envelope and the coupon on this page must accompany all queries.

Not more than two questions should be sent at any time.

The designing of apparatus or receivers cannot be undertaken.

Slight modifications of a straightforward nature only can be made to blueprints. For more serious alterations the minimum charge is 2/6.

Blueprints supplied by us will be charged for in addition, but, of course, readers may send their own blueprints for alteration.

Modifications to proprietary receivers and designs published by contemporary journals cannot be undertaken. Readers' sets and components cannot be tested by us. Queries cannot be answered by telephone or personally. Readers ordering blueprints and requiring technical information in addition should address a separate letter to the Information Bureau and should see that their remittance covers the price of the Blueprint and the amount of the query fee.

We do not answer queries in cases where the fee is omitted.

Queries should be addressed to the Query Dept., "Amateur Wireless," 58/61 Fetter Lane, London, E.C.4.

Postcard Radio Literature

Ever Ready Batteries

SEVERAL new leaflets are now available from the makers of Ever Ready batteries and accumulators. All types of high-tension, low-tension and grid-bias batteries are mentioned and the information covers not only the technical specifications but the sizes and weights are also given. One list, which is very handy for the users of commercial sets, gives the details of the various batteries suitable for most makes. **235**

Wavemaster Condensers

VARIOUS forms of variable condensers are described in detail in the latest folder received from the makers of these components. The usual air-spaced types, with brass and aluminium vanes, are illustrated, together with several solid-dielectric models. For those who like the new style of clock-face dials there is a very neat design priced at 7s. 6d. In place of the more usual degrees or wavelengths the scale is marked off into twenty-four divisions, these being subdivided into ten small sections. The pointer makes one complete revolution, therefore providing a generous space between station settings. The ivory scale is protected by glass and framed with a heavy-gauge nickel-plated escutcheon plate. **236**

Cossor Wireless Book

FOURTY pages of most useful information is between the covers of Cossor's latest publication. It is more like a young textbook than a valve catalogue, and every constructor should make a point of getting hold of it. Several methods of high-frequency coupling are shown and explained, while A.V.C., the superheterodyne, radio definitions, and a tuning chart for all wavelengths help to form interesting reading in this most useful little booklet. **237**

Ferranti Radio

THE latest Ferranti booklet contains full specifications of all their receivers, electric clocks and extension speakers. The various items are illustrated in natural colours and this, together with the comprehensive specifications, enables a very true idea to be obtained of the models. The sets embody a most useful asset in the form of the all-in visible control which shows at a glance everything you wish to know regarding the adjustment of the receiver. **238**

Here "Observer" reviews the latest booklets and folders issued by well-known manufacturers. If you want copies of any or all of them FREE OF CHARGE, just send a postcard giving the index numbers of the catalogues required (shown at the end of each paragraph) to "Postcard Radio Literature," AMATEUR WIRELESS, 58-61 Fetter Lane, E.C.4. "Observer" will see that you get all the literature you desire. Please write your name and address in block letters.

Kabi Products

FOUR illustrated leaflets have been received, dealing with multi-contact switches, midget potentiometers and a very minute hum-balancer. The potentiometers are wire-wound and embody stud contacts. They are available in varying sizes from 2 to 1 watts. Positive contact is obtained, while the operation is smooth and silent. The resistance values range from 73 to 300,000 ohms, and the elements are so arranged that a linear or log-law variation is obtained.

The multi-contact switches employ brass or German silver contacts and the action is such that a self-cleaning contact is secured with a definite click action for each position of the contact arm. These can be supplied in single, double, or triple-gang with contacts varying between 3 and 10. The hum-balancer is very neat, the overall diameter being no greater than that of a sixpence. The standard values are 30 and 50 ohms. **239**

Sunbeam Radio

DETAILS of the latest addition to the Sunbeam range are contained in the leaflet received from Sunbeam Electric, Ltd. The new receiver is known as type 57, and takes the form of a five-valve eight-stage universal mains super-het receiver. Band-pass input is employed, together with a 110-kilocycle intermediate-frequency transformer and 9-kilocycle selectivity.

Full automatic volume control is obtainable, while the undistorted output of 2.5 watts is fed into a Celestion moving-coil loud-speaker having an energised field. Mullard valves are fitted throughout and a self-contained aerial is provided in a handsome walnut cabinet. Those interested in the very efficient receiver at the moderate price of ten guineas, should secure this leaflet without delay. **240**

Trying the Short Waves

To the Editor, "AMATEUR WIRELESS,"

AS a regular reader, I am writing to thank you for your short-wave page. I have been interested in the short waves ever since I started wireless four years ago, but I have never been very successful and for the past year I confined myself to the broadcast wavelengths.

On Saturday I picked up "A.W." and read two articles, which impressed me so much that I decided to take up the short waves again.

On Sunday morning I got up early, dug out my two-valve set and gave it a good clean up. When I connected up at 8 o'clock, there was very little doing, but towards 10 o'clock the 40-metre band began to liven up, so I decided to confine my attentions to it.

By 12 o'clock I had managed to log twelve amateurs, all telephony and all at good phone strength. This bucked me up considerably, because the most I ever managed to log at one sitting before was three or four on any band.

These are the amateurs I logged:—

G2XO of London, calling test.

G5Z1 good strength, but distorted badly.

G5XB calling G6JZ.

G5YG of Glasgow.

G5GB of W. London, working G2QO of Hull.

G5LC of Surrey, a very good signal.

G5MM calling test.

G6RB of Bristol, calling test.

G6JQ, calling test.

G6TO of Bristol, calling test.

ON4AD of Belgium, calling a British amateur.

G5YG was of colossal strength, but had a background like a high-speed morse station, or a generator which blotted out everything for a good distance on each side, spoiling the reception of about six other medium signals.

There were about four others I failed to identify because of bad fading, and one very good signal which I think was G2DL, but which closed down before I could make sure.

The set I am using is a modified form of Eddystone's Empire Two, using a metallised baseboard instead of a chassis. I use a Mazda HL2 for detector, and an Osram LP2 as output, with 120 volts high-tension.

This bag is certainly not a record, but I am very pleased with it and I must thank you again for being the instigator of such a well spent morning.

B. McDougall.

Glasgow, S.I.

[1172

Amateur Wireless
FEE 1/-

INFORMATION BUREAU
COUPON

Available until Saturday,
JANUARY 12, 1935

Printed in Great Britain for the Proprietors and Publishers, BERNARD JONES PUBLICATIONS, LTD., 58-61 Fetter Lane, London, E.C.4, by The Sun Engraving Co., Ltd., London and Watford. Sole Agents for South Africa: CENTRAL NEWS AGENCY, LIMITED. Sole Agents for Australia and New Zealand: GORDON & GOTCH (A'SIA), LIMITED. Saturday, January 5, 1935.