

# electronics today

INTERNATIONAL

1979

up

**3080  
Circuits**

**Amplifier  
Module  
Survey**

**Videograph  
AMBUSH**

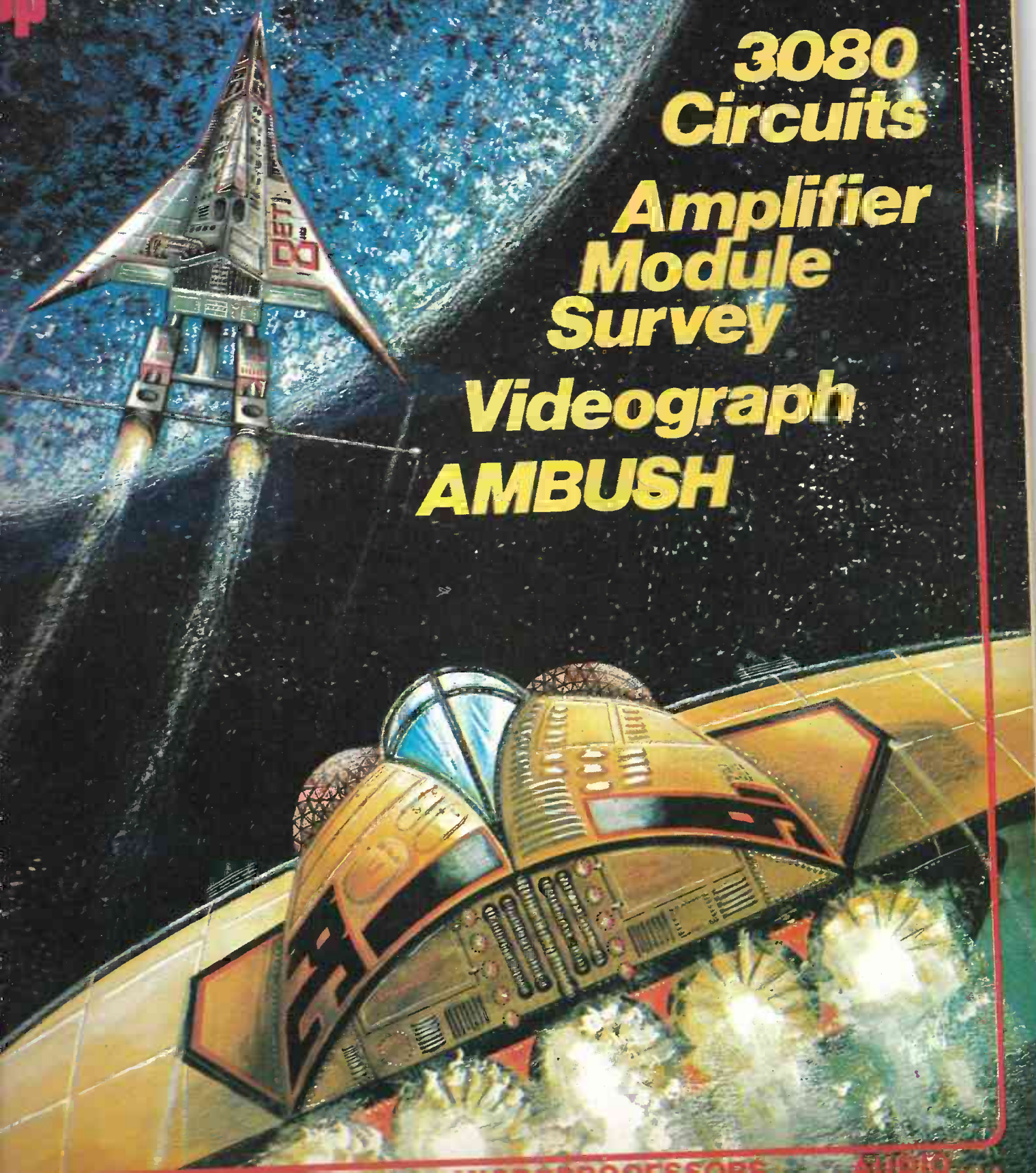

...PROFESSORS

AUDIO



securely in the cavernous bosom of the GPO, and should they ever be disgorged, Audiophile will be more than pleased to follow up and complete the project.

Anyway, only slightly daunted we shall proceed with what we have, and consider the two amplifiers which did arrive (and the one on loan!).

Our source for the listening tests was to be a Sony EL-7 Elcaset machine which gives reel-to-reel quality of reproduction without all the time consuming drawbacks of that medium. When you're trying to compare several pieces of equipment such luxurious convenience is not to be scorned lightly.

I could never understand why Elcaset has not done better for itself. The Sony machines in particular offer a standard of reproduction far above that which any cassette machine achieves

The reference amplifier was a Lecson AP3 II.

### AL-120 BI-PAK

This unit arrives three quarters wrapped in a black heatsink, with connection being made to pads at one end which protrude beyond the edge of said heatsink. The output pair (2N3055s) are bolted to the back of the heatsink and are hard wired into the circuit.

The quality of construction was generally high and in use the AL120s gave us no trouble at all. They drove the required speakers (Celestion/KEF) with no apparent distress and gave a sound technical account of themselves.

### Crimson CE608

There's not really a lot to say about Crimson Elektrik that has not been said already. Their products are well constructed, well thought out and well thought of! The CE608 is no exception.

Crimson supplied us their unit completely assembled within the superb metalwork shown in the photograph, which includes a PSU and stabiliser board to run one of their pre-amp modules.

The metalwork is black, and in style looks not unlike a Quad 405 power amplifier unit.

### ILP HY50

Since these are completely encapsulated we can offer no real comment on constructional finish. A mere five pins protrude from the metalwork, along which travels all communication between the HY50 and the world.

### Three In A Testbed

Once introduced to their proper PSUs all three amplifiers functioned well, and gave no real problems at all. The ILP gave a poorer 'hum' performance than the others, regardless of how we tried to wire it, so the problem must lie within the black box.

Of the three the Crimson gave what must be regarded as the best overall performance. Its sound is very clean and it possesses good attack. However the BI-PAK A2120 was not far behind, and loses out mainly due to a slight lack of transparency when directly compared to the CE608. It has a warmer sound overall too, and one that many people may well prefer.

Alas the ILP HY50 did not produce reproduction of the same quality as the other two. The test modules are about three years old though — our new review samples not having turned up in time — so things may well have improved here. We hope to give a listen to some more

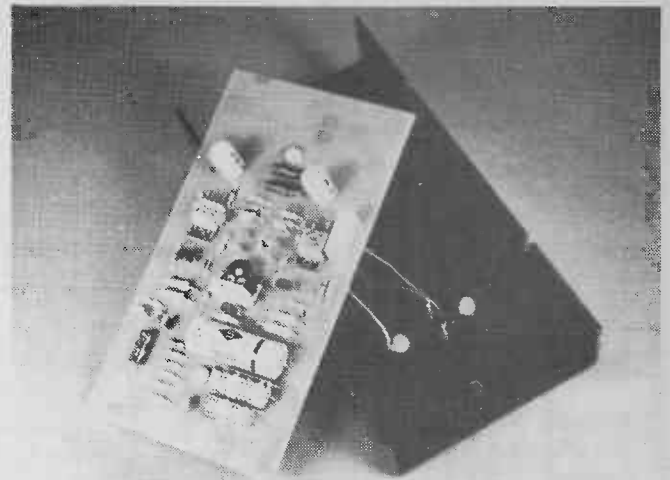

BI-PAKs AL-120 module, removed from its heatsink. The output pair sit centrally on the reverse of the black heatsink.

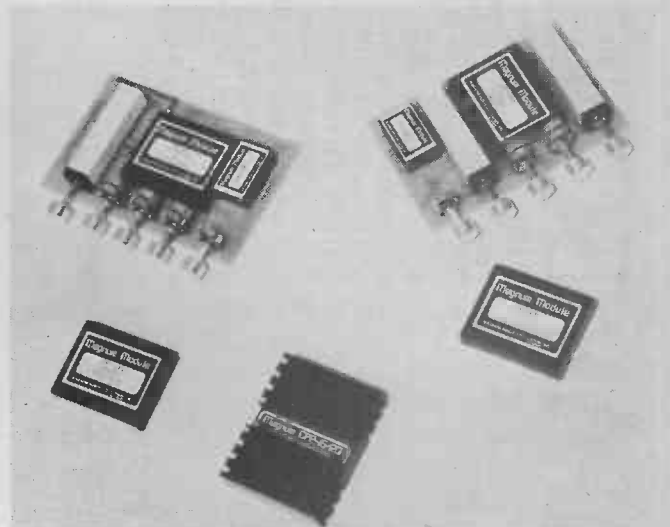

The Magnum Audio range. Their power amp is shown in the centre foreground. Note that this in fact a dual unit, incorporating two amplifier circuits.



The ILP HY50. This is an encapsulated unit, and only five pins are required for connection purposes.

recent samples as soon as possible to confirm or deny this, but as it is the impression is one of a hard "gritty" sound which was immediately distinguished in comparisons.

### Conclusions

Well there it is. Not as complete as might have been, but very interesting (we hope) nonetheless. As for the comparisons we never got, if the manufacturers agree we'll follow those up in the next few issues in Audiophile.

ETI



Left: the Sony EL-7 Elcaset unit which proved the source for the listening tests. Somehow the machine has never received the attention it deserves for its performance.

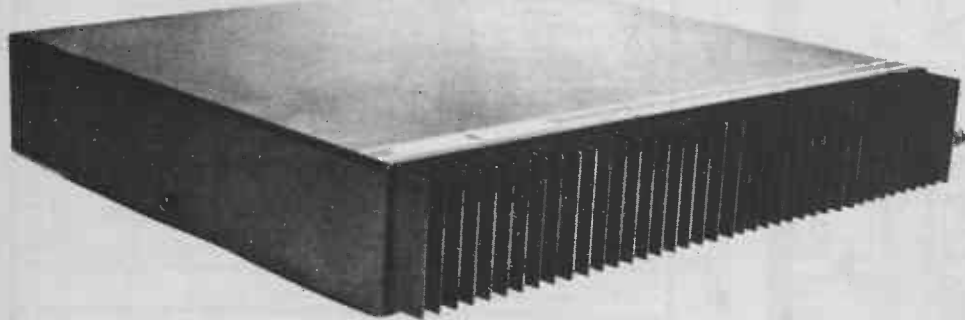

Below: remind you of anything? Looking like a squashed 405 its the Crimson unit all boxed and set to go.

## Suppliers

**Magnum Audio Ltd**  
13 Hazelbury Crescent  
Luton  
Beds  
LU1 1DF

**BI-PAK Semiconductors**  
Dept ETI  
PO Box 6  
Ware  
Herts

**Crimson Elektrik**  
1A Stamford Street  
Leicester  
LE1 6NL

**Stirling Sound**  
37 Vanguard Way  
Shoeburyness  
Essex

**ILP Electronics Ltd**  
Graham Bell House  
Roper Close  
Canterbury  
Kent  
CT2 7EP

**Kingsley TV**  
40/42 Shields Road  
Newcastle upon Tyne  
NE6 1DR

## CHROMASONIC electronics

your soundest connection in the world of components

DEPT. ETI 1, 56 FORTIS GREEN ROAD  
MUSWELL HILL, LONDON N10 3HN  
TELEPHONE: 01-883 3705

### LOW POWER SCHOTTKY and TTL CMOS

### BITS and PIECES

7400	N	.13	.19	7476	N	.30	.29	74170	N	1.85	1.65	4000	.15	4077	.21	Static RAM's	1+	17-63	64+	LM326N	2.60
7401	.13	.19	7478	.29	74173	1.41	.88	74171	1.41	.88	4001	.16	4081	.21	2102A (350ns)	1.05	.95	.88	LM345K	8.10	
7402	.15	.19	7482	.73	74174	1.01	1.05	74175	.81	1.05	4002	.16	4082	.21	2102A-2 (650ns)	1.29	1.15	1.08	LM129/30/31	.85	
7403	.15	.19	7483	1.18	74176	1.01	—	74177	1.01	—	4006	.92	4085	.92	2111A-1 (500ns)	2.46	2.19	2.05	IC's		
7404	.16	.21	7485	1.18	74176	1.01	—	74177	1.01	—	4007	.18	4086	.92	2112A-2 (250ns)	2.14	1.90	1.78	CA3080	.75	
7405	.16	.21	7486	.25	74177	1.01	—	74178	1.01	—	4008	.92	4093	.81	2112A-2 (350ns)	1.07	.96	.86	CA3130E	.90	
7406	.26	—	7489	2.60	74180	1.01	—	74181	1.01	—	4009	.54	4099	1.81	MMS4044	8.10	7.19	6.76	CA3140E	.37	
7407	.26	—	7490	.34	74181	2.21	2.99	74182	.81	—	4010	.54	4502	.92	2114 (450ns)	8.10	7.19	6.76	LM301AN	.30	
7408	.17	.19	7491	.73	74182	.81	—	74183	1.81	—	4011	.18	4508	2.46	8810	3.50	2.97	2.52	LM324AN	.73	
7409	.17	.19	7492	.46	74184	1.81	—	74185	1.81	—	4012	.18	4510	1.07	Dynamic RAM	8251	8251	5.97	LM324N	.73	
7410	.15	.19	7493	.34	74185	1.62	—	74186	2.97	—	4013	.48	4511	.95	8252	12.75	8253	8.10	LM348N	.99	
7411	.25	.19	7495	.54	74188	2.97	—	74189	3.17	2.25	4014	.92	4514	2.70	8255	42.50	8255	5.51	LM380N	.97	
7412	.18	.19	7496	.67	74189	3.17	2.25	74190	1.21	.75	4015	.92	4515	2.70	8080	5.95	8080	8.99	LM381N	1.73	
7413	.27	.40	74107	.27	74190	1.21	.75	74191	1.21	.75	4016	.43	4516	1.07	8800	8.99	8800	42.50	LM382N	1.33	
7414	.27	.40	74107	.27	74191	1.21	.75	74192	1.21	.75	4017	.81	4517	4.10	9900	42.50	9900	42.50	LM3900N	.65	
7415	.25	—	74112	—	74192	1.21	1.85	74193	1.21	1.85	4018	.92	4518	.95	E-Prom's UV	5.75	5.75	5.75	LM3909N	.70	
7416	.25	—	74114	—	74193	1.21	1.85	74194	1.21	—	4019	.56	4521	2.54	1702AQ	7.87	1702AQ	7.87	SN76011N	1.02	
7417	.34	—	74113	—	74194	1.21	—	74195	1.01	1.05	4021	.92	4522	1.89	2708Q	7.87	2708Q	7.87	SN76003N	2.32	
7420	.16	.19	74121	.27	74195	1.01	1.05	74196	1.18	1.05	4022	.92	4522	.92	TriState Buffers	7.87	7.87	7.87	SN76013N	1.55	
7421	—	.19	74122	.50	74196	1.18	1.05	74197	1.18	1.05	4023	.18	4534	7.12	81LS95	.75	81LS95	.75	SN76023N	1.55	
7422	—	.19	74123	.60	74197	1.18	1.05	74198	1.81	—	4024	.65	4536	3.74	81LS96	.75	81LS96	.75	TBA810AS	.90	
7423	.25	—	74124	—	74198	1.81	—	74199	1.81	—	4025	.18	4543	1.62	81LS97	.75	81LS97	.75	TCA940	1.75	
7425	.25	—	74125	.51	74199	1.81	—	74200	1.81	—	4026	1.84	4543	4.53	74365	.75	74365	.75	ZN414	.90	
7426	.25	.19	74126	.51	74201	—	.99	74202	—	.25	4027	.51	4566	1.51	74366	.75	74366	.75	ZN424E	1.35	
7427	.39	.19	74132	.78	74202	—	.25	74203	—	.25	4028	.70	4568	1.02	74367	.75	74367	.75	ZN425E	3.78	
7428	.38	.21	74133	—	74203	—	2.25	74204	—	2.25	4029	1.18	4585	1.07	74368	.75	74368	.75	ZN459CT	3.54	
7430	.16	.19	74136	—	74204	—	2.25	74205	—	2.25	4030	.56	4585	1.07	74368	.75	74368	.75	ZN1034E	2.03	
7432	—	.25	74138	—	74205	—	2.25	74206	—	2.25	4032	1.08	4585	1.07	74368	.75	74368	.75	ZN1040E	8.43	
7433	—	.28	74139	—	74206	—	.95	74207	—	.95	4034	1.89	4585	1.07	74368	.75	74368	.75	ZNA116E	6.75	
7437	.25	.25	74141	.78	74207	—	.95	74208	—	.95	4035	1.06	4585	1.07	74368	.75	74368	.75			
7438	.25	.25	74145	.75	74208	—	.95	74209	—	.95	4036	1.06	4585	1.07	74368	.75	74368	.75			
7440	.17	.19	74147	1.59	74209	—	.95	74210	—	.95	4037	.70	4585	1.07	74368	.75	74368	.75			
7441	.70	—	74149	1.38	74210	—	.95	74211	—	.95	4038	.70	4585	1.07	74368	.75	74368	.75			
7443	.50	.55	74150	1.08	74211	—	.95	74212	—	.95	4039	.70	4585	1.07	74368	.75	74368	.75			
7445	.60	—	74151	.67	74212	—	.95	74213	—	.95	4040	.92	4585	1.07	74368	.75	74368	.75			
7446	.60	—	74153	.67	74213	—	.95	74214	—	.95	4041	.92	4585	1.07	74368	.75	74368	.75			
7447	.60	.87	74154	1.31	74214	—	.95	74215	—	.95	4042	.70	4585	1.07	74368	.75	74368	.75			
7448	.16	.87	74155	.67	74215	—	.95	74216	—	.95	4043	.81	4585	1.07	74368	.75	74368	.75			
7449	—	.87	74156	.67	74216	—	.95	74217	—	.95	4044	.81	4585	1.07	74368	.75	74368	.75			
7450	.16	—	74157	.67	74217	—	.95	74218	—	.95	4045	.81	4585	1.07	74368	.75	74368	.75			
7451	.16	.19	74158	—	74218	—	.95	74219	—	.95	4046	1.06	4585	1.07	74368	.75	74368	.75			
7453	.16	.19	74161	1.21	74219	—	.95	74220	—	.95	4046	1.06	4585	1.07	74368	.75	74368	.75			
7454	—	.19	74162	1.21	74220	—	.95	74221	—	.95	4047	1.06	4585	1.07	74368	.75	74368	.75			
7455	—	.19	74163	1.21	74221	—	.95	74222	—	.95	4048	.43	4585	1.07	74368	.75	74368	.75			
7460	.16	—	74163	1.21	74222	—	.95	74223	—	.95	4049	.43	4585	1.07	74368	.75	74368	.75			
7470	.27	—	74164	1.08	74223	—	.95	74224	—	.95	4050	.43	4585	1.07	74368	.75	74368	.75			
7472	.23	—	74165	—	74224	—	.95	74225	—	.95	4051	.81	4585	1.07	74368	.75	74368	.75			
7473	.28	.29	74166	1.02	74225	—	.95	74226	—	.95	4052	.81	4585	1.07	74368	.75	74368	.75			
7474	.28	.29	74168	—	74226	—	.95	74227	—	.95	4053	.81	4585	1.07	74368	.75	74368	.75			
7475	.44	.43	74169	—	74227	—	.95	74228	—	.95	4054	1.29	4585	1.07	74368	.75	74368	.75			
					74228	—	.95	74229	—	.95	4055	1.46	4585	1.07	74368	.75	74368	.75			
					74229	—	.95	74230	—	.95	4056	1.46	4585	1.07	74368	.75	74368	.75			
					74230	—	.95	74231	—	.95	4057	1.46	4585	1.07	74368	.75	74368	.75			
					74231	—	.95	74232	—	.95	4058	1.46	4585	1.07	74368	.75	74368	.75			
					74232	—	.95	74233	—	.95	4059	1.46	4585	1.07	74368	.75	74368	.75			
					74233	—	.95	74234	—	.95	4060	1.24	4585	1.07	74368	.75	74368	.75			
					74234	—	.95	74235	—	.95	4061	.81	4585	1.07	74368	.75	74368	.75			
					74235	—	.95	74236	—	.95	4062	.81	4585	1.07	74368	.75	74368	.75			
					74236	—	.95	74237	—	.95	4063	.81	4585	1.07	74368	.75	74368	.75			
					74237	—	.95	74238	—	.95	4064	.81	4585	1.07	74368	.75	74368	.75			
					74238	—	.95	74239	—	.95	4065	.81	4585	1.07	74368	.75	74368	.75			
					74239	—	.95	74240	—	.95	4066	.81	4585	1.07	74368	.75	74368	.75			
					74240	—	.95	74241	—	.95	4067	.81	4585	1.07	74368	.75	74368	.75			
					74241	—	.95	74242	—	.95	4068	.81	4585	1.07	74368	.75	74368	.75			
					74242	—	.95	74243	—	.95	4069	.81	4585	1.07	74368	.75	74368	.75			
					74243	—	.95	74244	—	.95											

# VIDEOGRAPH

Turn your colour television into a dual trace oscilloscope with this UHF colour modulator and video display generator.

THE PURCHASE of even the simplest oscilloscope is probably unjustified for most amateur electronics constructors. Other amateurs feel, rightly or wrongly, that their money is better spent on projects which other members of the family can appreciate!

Which ever category you belong to, or even if you are in the scope league already, Videograph will be found to be a fascinating and useful piece of equipment which will give many hours of pleasure.

## Principle Of Operation

The Videograph makes use of the fact that the television screen is scanned from top to bottom every 20 mS. This is used as the effective



oscilloscope timebase, trace modulation being obtained by varying the timing between start of

each line and a fixed-length 'bright-up' pulse.

Two complete circuits are required to produce a twin trace, and these are colour coded blue and orange respectively. These circuits are triggered by a common sync pulse generator, and further components generate an eight-stage background colour change, triggered by peak signals. There is also an internal frame-locked square wave generator which serves as a test waveform for injection into amplifiers and tape-recorders.

Controls are provided for inverting one channel, freezing the background colour and switching a filter to give a relatively "smooth" music display.

Complete kits can be obtained from William Stuart Systems Ltd, who hold the PCB copyright. They also produce a ready drilled cabinet. The heavy gauge anodised facia plate is screen printed to improve finish and the PCBs are silk screened to aid construction.

## Construction

Two printed circuit board assemblies are involved, one consisting of a UHF Colour Modulator and the other the

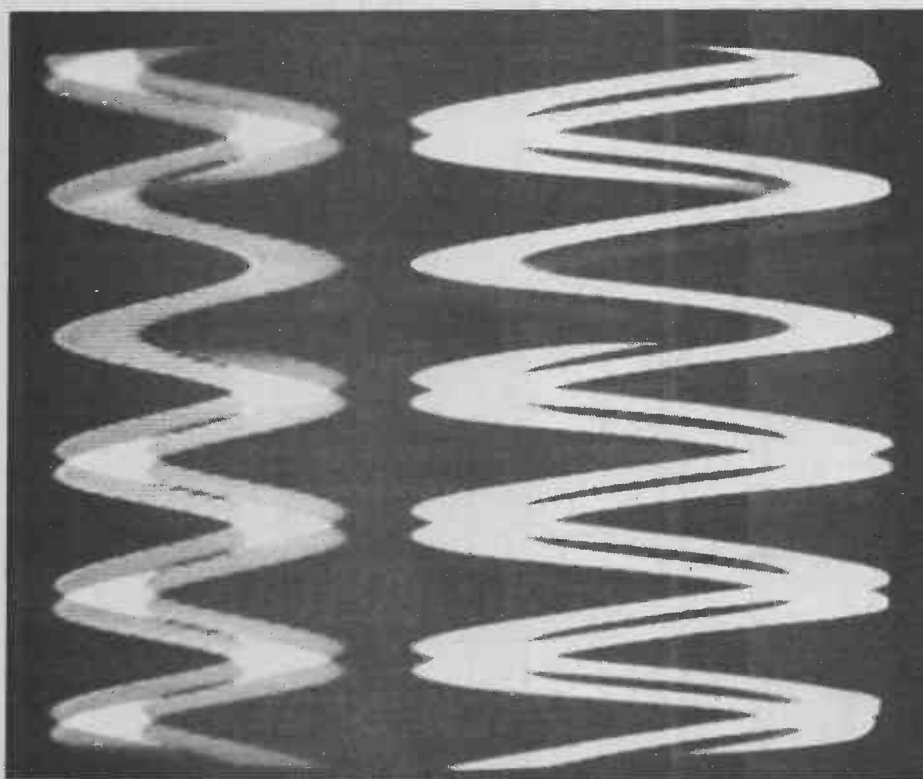

Sinewave generation with Videograph



# HOW IT WORKS ~ MODULATOR

Q3 forms a crystal oscillator, generating the precise 4.433618 MHz subcarrier for colour information. The transformer produces outputs which are suitably phase-shifted by R24, C12, C11 and R23. Diodes D1 and D6 modulate three signals, which are now at +45°, -45° and 180 degrees respectively.

Colour hue is dependent on the subcarrier phase and in the PAL system 180 degrees gives blue while + & - 45 degrees approximate to red and green alternately by the three K's, IC1 being the controller. IC1 generates a squarewave at half line frequency, and this is also used to generate colour bursts via C22 and C21. Q2 amplifies the colour information and feeds it in to join

the black and white composite video signal. The complete signal now modulates Q4, which is a VHF oscillator. Harmonics in the UHF band are extracted via C8 and developed across a short length of printed circuit transmission line which acts as a high pass filter.

C20 and R21 expand the Sync pulse to give via IC2 and IC3 the Field signal. This is a properly blanked "background true" for controlling background illumination. TELI can be forced low if the 'X' input is pulled high. This feature allows objects which are to be displayed (e.g. the Videograph stripes) to cancel the background whenever they are to appear.

main Videograph Display Generator. Both are printed with detailed legends so that components can be inserted direct from the parts list. Note that each board has a separate list!

The ICs should be inserted last of all, and IC7 on the generator board should be left out initially; instead insert a link between pins 3 & 12 as shown. This gives a fixed green background and results in easier setting up and tuning. IC7 can be inserted later on to give the automatic colour change.

The boards are connected to each other by short lengths of wire between the points labelled OV, Field, +ve, Video, B, R, G, X and Sync.

All the controls can be board mounted and the only other wires needed are for connection to the aerial and DIN sockets, and 9 volt power.

The aerial socket can be connected directly to the modulator via two closed loops, one on the board and one on the socket. The loops are simply bent to couple closely with each other. This method

ensures that no "earth loop" can exist between the TV and the hi-fi system, causing undesirable hum on some equipment.

## Setting up

The modulator tuning capacitor is set to 30% of maximum. Generator board presets are set fully anticlockwise. The GAIN controls SHOULD be at minimum and the LOCATE controls at mid position.

Connect a TV set via low-loss coax cable and switch on both TV and Videograph. Tune the TV to obtain a good signal, searching from channel 21 upwards. The picture will be unstable.

Adjust RV9 (Line sync) to give an unbroken background, and adjust RV7 (frame sync) to give vertical stability. Provided that the TV tuning is exact the picture should now be uniformly green. If the top of the picture is red then adjust RV8 (frame pulse width) for best position.

Adjust RV2 and RV5 to give blue and orange vertical stripes; these should appear from the left as the

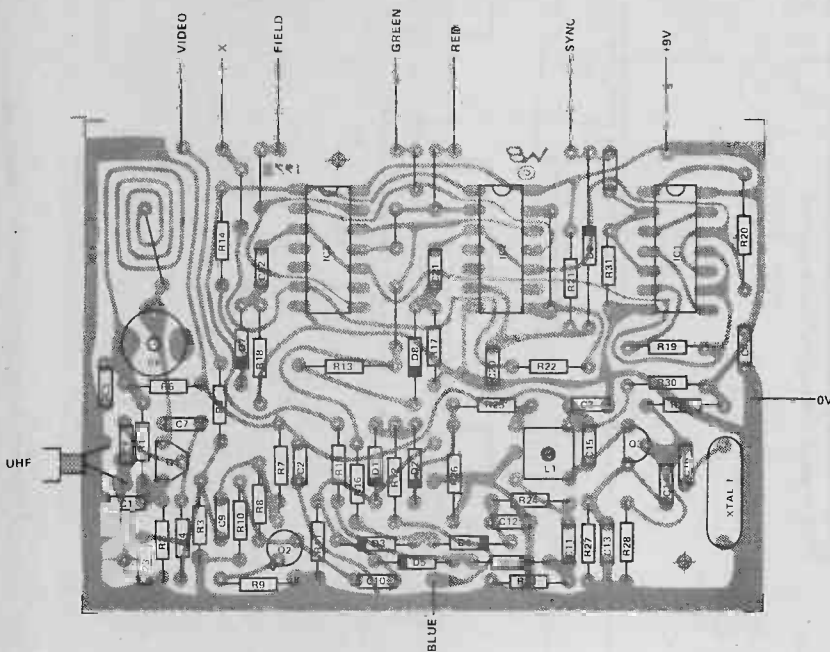
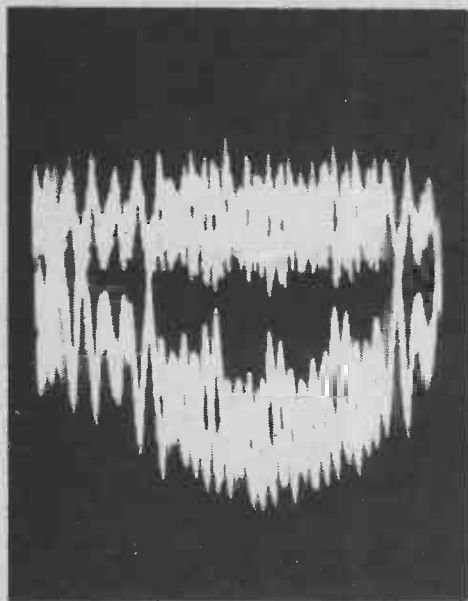

Fig. 2 Colour modulator component overlay.

# PARTS LIST ~ MODULATOR

RESISTORS all 1/4W 5%	C9 19 20 23	120p	SEMICONDUCTORS	MISCELLANEOUS
R1 840	C10	39p ceramic	Q1	Pipe to pattern battery 1pin VHF socket
R2 4.10	C11 17	180p	Q2 3	
R3 150R	C12	680p	Q108	BC457
R5 11 25 27	C14	330p	D1-D9	1N4748
R6 23 24 30	C15	680 ceramic	Note: D1-D3 D3-D4 D5-D6 matched pairs	
R7 12 16 16	C16	22p ceramic	IC1	4007E
R8 13 14 17	C21 22	1n poly-kev	IC2 3	4007B
R9 18 22 28	C17 18	omitted (see text)		
R10 10k				
R19 20				
R21 330k				
R28 31				
CAPACITORS				
C1-5				
C6				
C7				
C8				





A typical Videograph telly picture

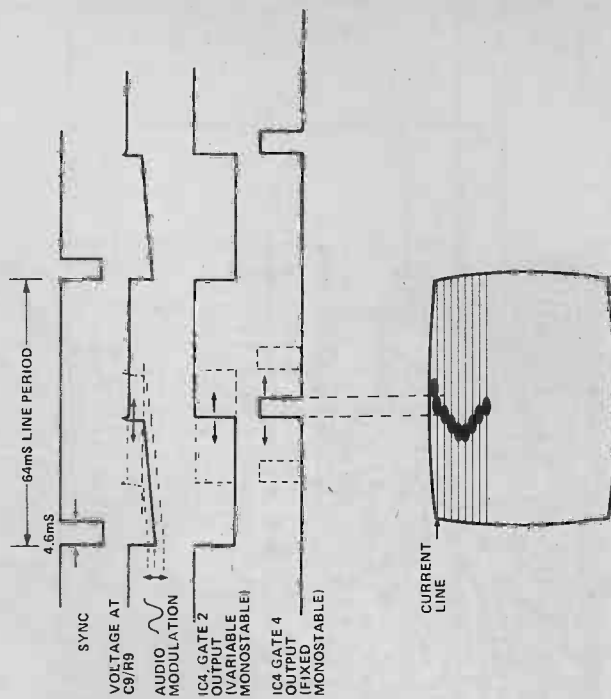

Fig. 5 Generating graphics with the Videograph.

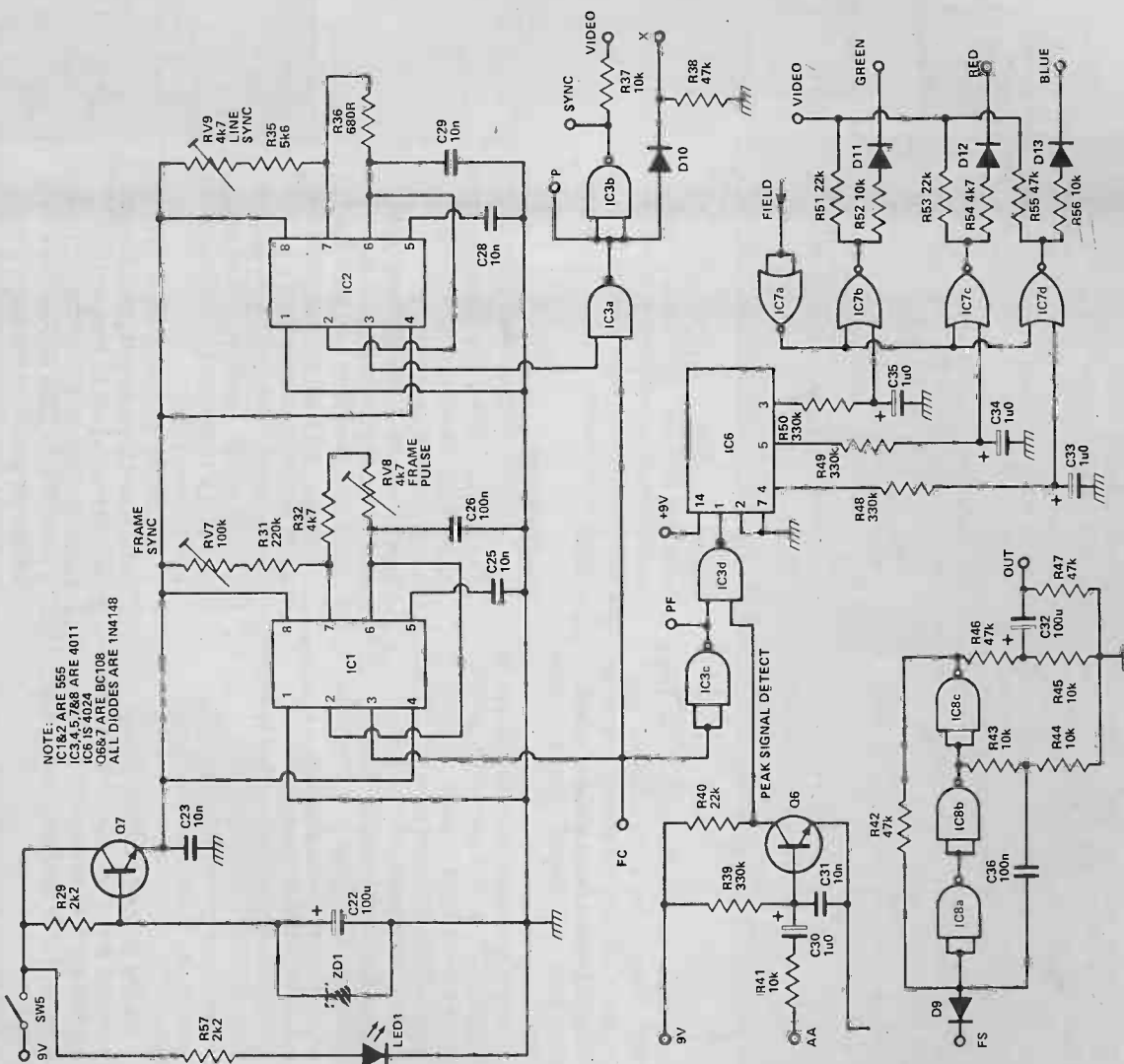

Fig. 3 Videograph generator circuit diagram

# HOW IT WORKS - GENERATOR

IC1 and IC2 are timers which generate frame and line sync respectively. RV3 controls these to form negative S'V.C. and positive sync pulse. The height of the frame sync pulse is adjusted by RV8. This is necessary because in the PAL system there must be an even number of whole line periods in a frame pulse period, otherwise the TV set's raster will be out of step at the start of each picture scan and the top of the screen will tend to be red/green reversed.

Audio input signals, of the right hand channel, are normally fed to Q2 alternatively, if the 'right hand' switch is operated then signal passes first through Q1.

Q2 drives a clamp diode D1, which RV2 (wiper) determines the mean DC voltage while RV3 (LOCATE control) gives a fine adjustment. Gates 3 and 4 of IC4 form a monostable, triggered by positive sync pulse. Thus at the start of each line the output of gate 2 goes low and C5 provides positive feedback to gate 1, but is clamped to an initial value of say 3V by the clamp diode. C5 now charges via R6 through gate 1 switches back at approximately 4V, and the monostable resets itself. Note that the charging is nearly linear over the range to 4V and R6 can be considered as a constant current source. Since the initial clamp voltage is maintained by the

audio signal, the monostable period is also linearly modulated.  
At the end of the above period a second fixed duration monostable formed by gates 3 and 4 is triggered via C11. This produces a positive pulse which defines the oscillation frequency. Q4 is an emitter follower which drives the modulator with Video (brightness) and colour information, and suppresses the background by pulling X' high. Line and field blanking are ensured by R13, C12, R14 and C13, which cancel the line and frame pulses and prevent trace generation when necessary.  
The left hand channel is identical, except

that the input drive is to a different colour, and the inverse stage is absent.

C6 detects peak signals on the right hand channel provided that COLOUR MODE has not been selected. These signals are sampled by the frame sync pulse to produce a 'burst' random clock pulse for counter IC6. IC7 gates free of the counter outputs with the 'true' sync signal and drives the Modulator with bright (res. 1 tone) and colour (R, G, B) signals.

IC8 is connected as the square wave generator, phase-locked to the picture scan by the frame sync pulses.

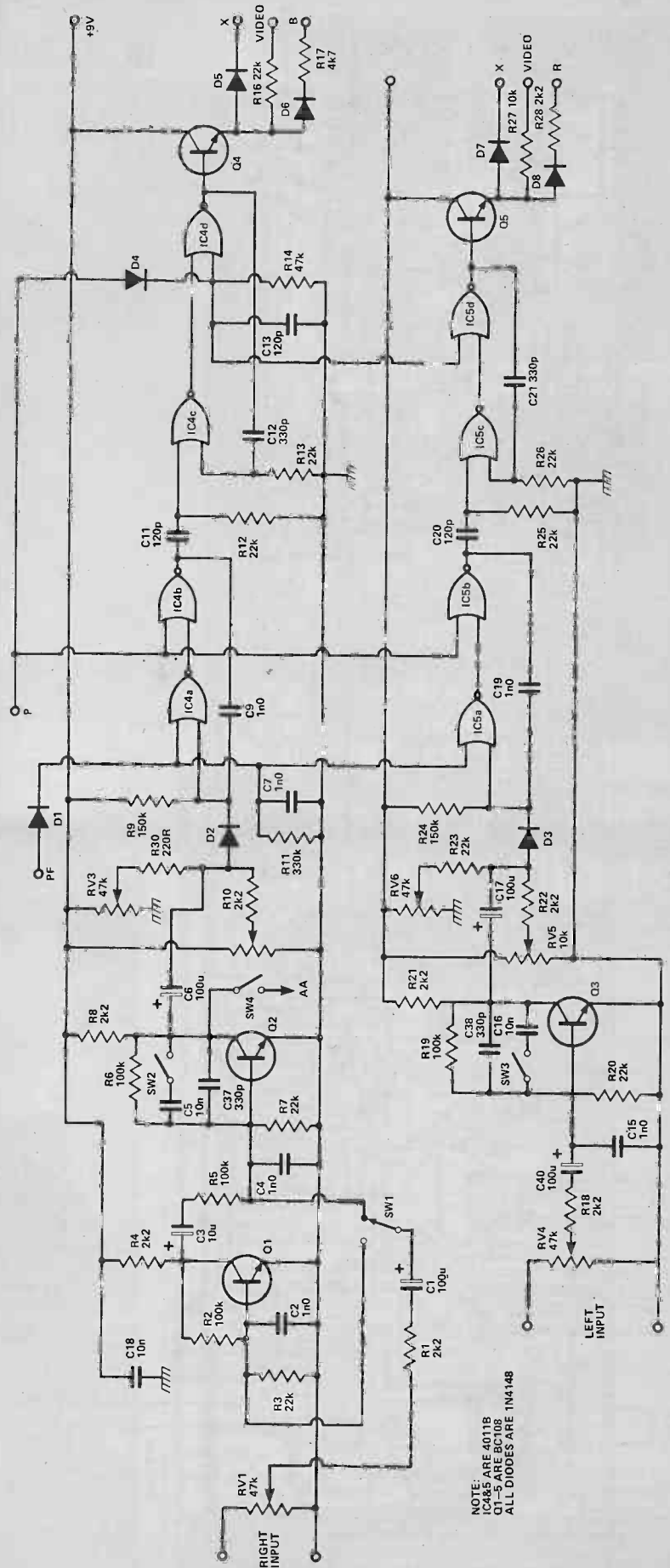



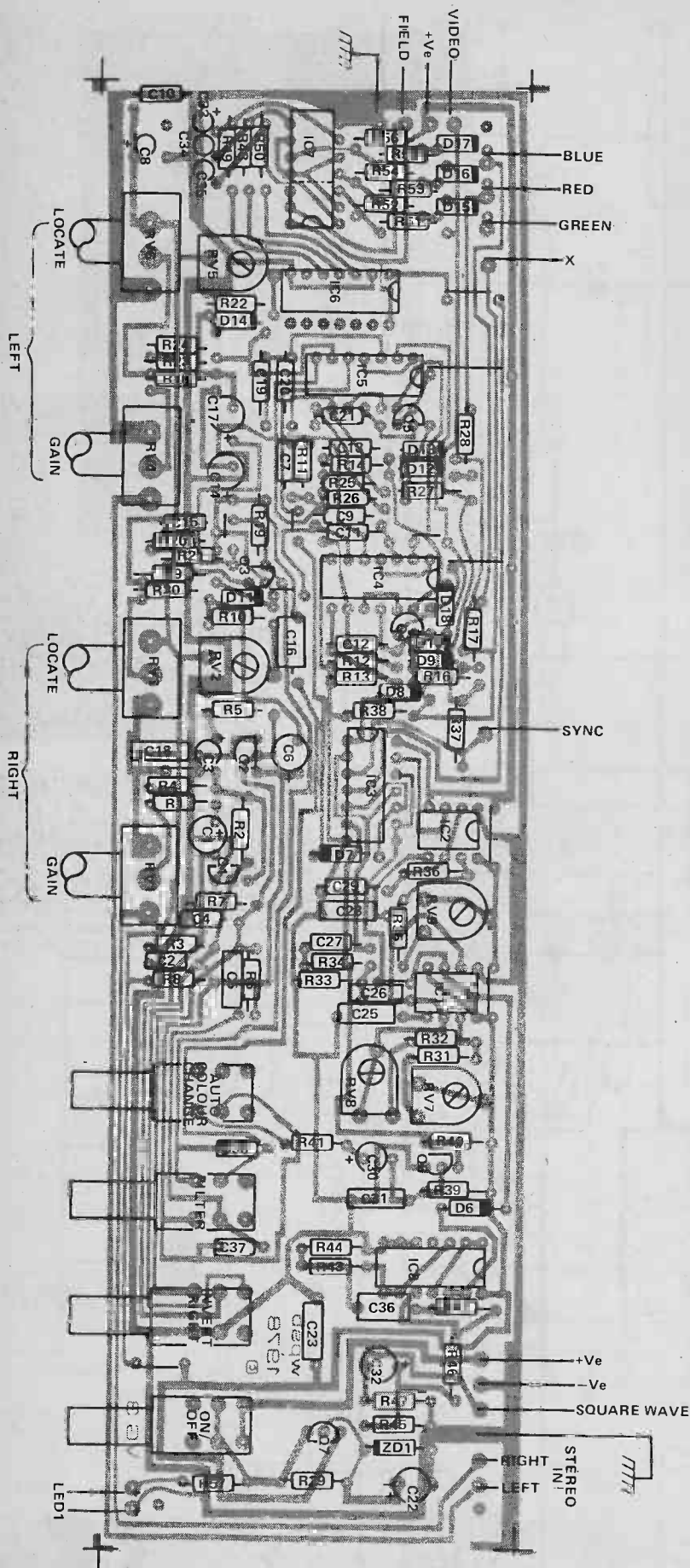
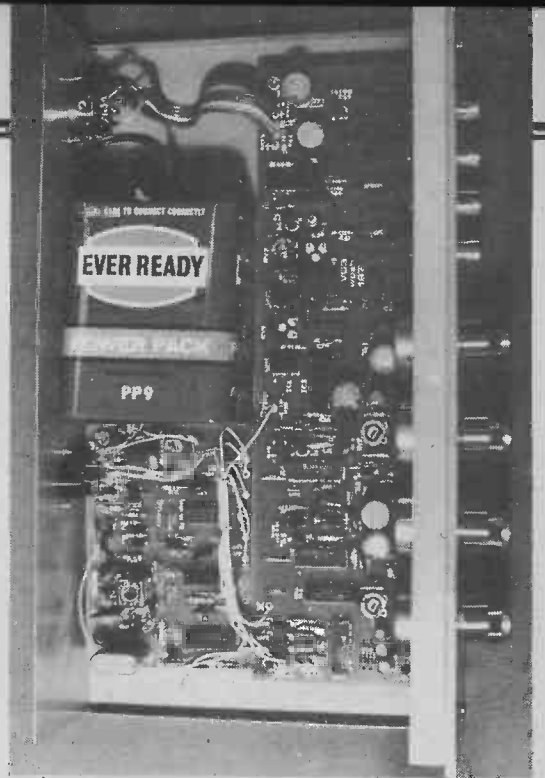
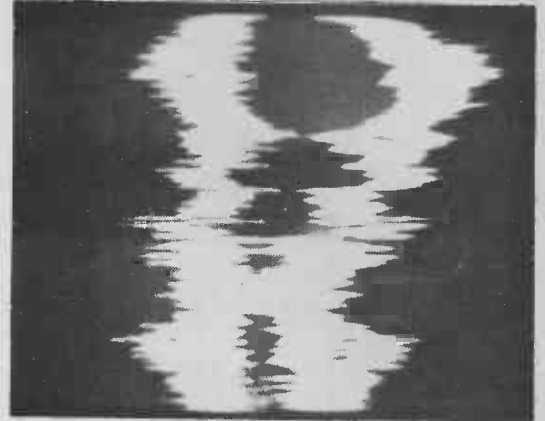

Fig. 6 Videograph generator component overlay



Circuit boards completed and installed in the Videograph chassis



No, it's not something from outer space!

## BUYLINES

A complete kit of parts is available for this project from William Stuart Systems Ltd, Dower House, Herongate, Brentwood, Essex CM13 3SD. The PCBs remain their copyright and will be available only from them. All components are available separately, and the PCBs are normally supplied as a 'mini-kit' along with ICI-3 and ready wound coils. See advert elsewhere in this issue for prices.

pots are turned clockwise. Position both stripes centrally, then separate them using the LOCATE controls. At this stage the line sync (RV9) should be fine-adjusted to give perfect colour registration on the stripes.

IC7 may now be inserted (and the link removed!) to give the background colour change function: the sequence being black, white, cyan, yellow, green, mauve, blue, red.

ETI

## PARTS LIST - GENERATOR

<b>RESISTORS all 1/4W 5%</b>		C2 4 7 9	1n polyester
R1 4,8,10,18		15,19	10µ 25V
21,22,28,29		C3	10µ 25V
.57	242	C6,16,18,23	10n polyester
R2 5,6,19	100k	25,28,31	omitted (see text)
R3 7,12,13		C8,10	120p ceramic
16,20,23,25,		C11 13,20	
26,30,40,51		C12 21,27,37	
53	22k	38	330p ceramic
R9 24	150k	C26,36	100n hi-stability
R11 34	330k	C29	10n hi-stability
R17 32,54	4v7	C30	1µ 25V
R27,37,41,43		C33,35	1µ 25V
44,45,52,56	10k		
R31	220k	<b>SEMICONDUCTORS</b>	
R33	100R	IC1 2	555
R34 38,42,46		IC3 5,7,8	4011 (IC7 must be unbuffered)
47,55,14	47k	IC6	4024
R36	5k6	Q1 7	BC108 or BC452
R36	680R	D1-13	1N4148
R48 49,50	330k	ZD1	8V2 (if supply exceeds 10V)
<b>POTENTIOMETERS</b>		LED1	TIL 209 or similar
PV1,4	47k log	Add if background colours required to fade rather than switch.	
PV2,5	10k preset	<b>MISCELLANEOUS</b>	
PV3,6	47k lin	Case, PCB, PCB mounting switch assembly, mounting hardware	
PV7	100k preset		
PV8,9	4k7 preset		
<b>CAPACITORS</b>			
C1 6,14,17			
22,32,40	100µ 25V		

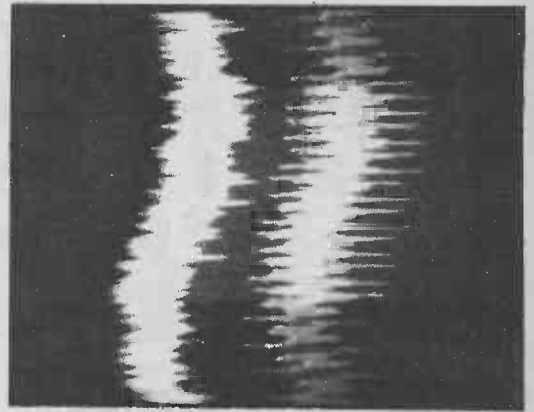

Above and below: Videograph's two colour traces

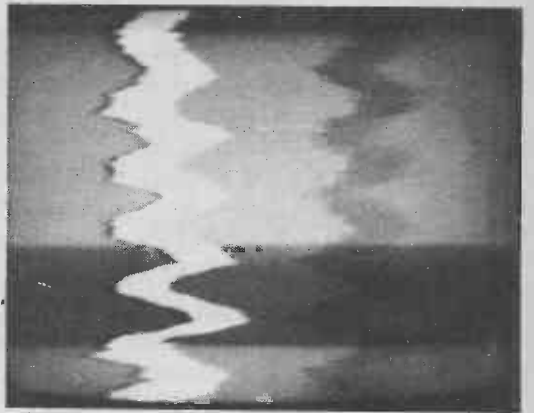

**WHAT'S MISSING?**

An ETI T-Shirt of course!

Our little lady is perfectly intact thank you! We took her T-Shirt away just to show you how lost you'd be without one.

(At least that's what we told her anyway)

After all they are printed back & front on high quality cotton — black logo on red background — and cost a mere £2.00 all inc.

Orders to  
ETISHIRTS  
25,27 OXFORD ST  
LONDON W1 1RF

Please specify size — S, M, or L and allow 14 days for delivery

## Catronics for VALUE & VARIETY in FREQUENCY COUNTERS

In addition to our popular 250MHz and 500MHz counters we have produced a **NEW 200MHz COUNTER KIT** specially for home constructors.

Our new KF200 counter, although small, is a no-compromise design. It offers:

- ★ A full 8 digit LED display.
- ★ A frequency range of 10Hz to 200MHz.
- ★ An accuracy of 10Hz at 30MHz, 50Hz at 150MHz in normal home environments.
- ★ 5/6 volt operation from batteries or mains PSU (not supplied)
- ★ Power consumption of only 1W maximum.
- ★ A crystal oscillator at 5MHz which doesn't need any special setting up equipment.
- ★ Small size 4" x 2" x 1".
- ★ Uses only 4 i.c.s.
- ★ Assembly time of about 2 hours.
- ★ Full illustrated assembly instructions.

The KF200 consists of 2 PCB assemblies, one being the complete input and counter unit. (Suitable for direct driving an 8 digit common cathode display), the other, the display unit. The unit is available in kit or assembled / tested module form. Prices (INCLUDING VAT):

Counter Kit ..... £68.00      Module ..... £85.00

Add 75p for Post & Pkg.

This new Catronics model KF200 complements our DFM5, a 250 MHz, 7 DIGIT MAINS / 12v HIGH QUALITY Frequency Counter, and the DFM 500 — a REAL 500 MHz — try some of the others actually at this frequency.

Both are absolute for money and are available now with better than 1-in-10<sup>7</sup> reference oscillators as / S models.

Special prices, INCLUDING VAT

DFM5 ..... £148.50      DFM5/S ... £191.70  
DFM 500 .... £177.12      DFM500/S . £220.86

Please add £5 for Insurance and Securicor Delivery

Send SAE for **FREE PRICE LIST**  
or 45p + large (A4) 18 1/2p SAE for copy of our **DATA CATALOGUE**

**CATRONICS LTD.** (Dept. 954) COMMUNICATIONS HOUSE  
20 WALLINGTON SQUARE

WALLINGTON, SURREY, SM6 8RG

Phone: 01-669 6700. Mon.-Fri. 9 a.m.-5.30 p.m. Sats. 1 p.m.

# Gm REVISITED

Nothing to do with American car manufacturers Gm is in fact a throw-back from the days of valves, now finding a new lease of life with up-to-date semiconductor devices. K. T. Wilson explains . . . .

MANY A LONG YEAR ago, when transistors were an item which hadn't been dreamt of by science fiction writers, we all used valves, and we all knew the magic letters Gm. Gm stood for a quantity called mutual conductance, and it measured an important feature of the valve from which we could work out how much voltage gain we could get out of a given bottle. Well, the years have passed, and valves are dead for many purposes, but Gm lives and is back working for us.

It's odd that Gm should have gone out of fashion for so long, because the idea of Gm is even more useful in transistor amplifier circuits than it ever was in valve circuits. Still, the idea seems to be coming back in a big way, so let's take a look at it.

Mutual conductance of any electronic device means the ratio of signal current at the output to signal voltage at the input. For a transistor, this is the ratio  $I_c/V_{be}$ .  $I_c$  being the collector current and  $V_{be}$  the voltage between base and emitter, Fig 1. The squiggle above the letters means that it's AC signal voltage and currents we're talking about not the steady bias voltages and currents.

Using Gm therefore allows us to represent a valve or transistor as a generator of signal currents, the amount of signal current being  $G_m \tilde{V}_{in}$ . Now a current generator means a device which will deliver its current into any load, high or low. No valve or semiconductor is really like this, but for most of the uses we make of transistors, the idea of a current generator is not far from the mark.

## Current Generators

If a transistor were a perfect current generator, it would have an infinite resistance at its output. That means just that a signal voltage applied between the collector and the emitter would cause no collector signal current.

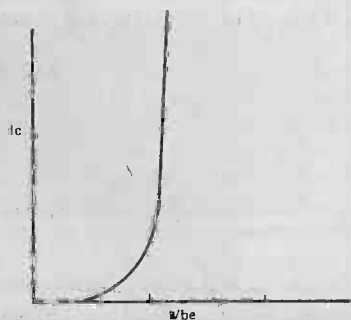

Fig. 1. Mutual conductance,  $I_c/V_{be}$  for a transistor.

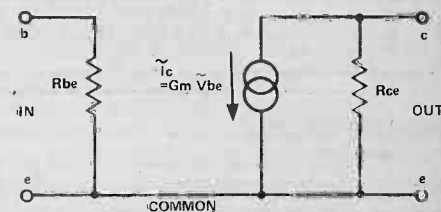

Fig. 2. An equivalent circuit for a transistor.

Once again, it's not quite correct but not far from the truth. A bit of collector signal current does flow, but not very much, about as much as would flow if there were a resistor of around 40k between collector and emitter.

Now the usefulness of all this is that it allows us to draw an equivalent circuit for a transistor. An equivalent circuit is a circuit made of simple components which behaves in just the same sort of way as some device which is, in reality, much more complicated. A simple equivalent circuit for a transistor is, therefore, as shown in Fig 2. It consists of a current generator, which generates a signal current  $G_m V_{be}$ , and a resistor of about 40k in parallel. This simple circuit accounts for the size of the signal current at the output (the collector) and the output resistance between collector and emitter.

How does this help us? Quite a lot if we remember all the time that equivalent circuits are about signal currents, not about bias currents. As far as signal currents are concerned, the positive supply line of an amplifier is just as earthed as the earth line. Why? Because in the power supply there's a smoothing capacitor of several thousand microfarads, connected between the +ve and -ve lines. As far as DC is concerned, this capacitor is an insulator; but for AC signals the capacitor is just a short circuit, shorting the +ve line to the -ve line. When we connect a load resistor between the collector terminal of a transistor and the positive line, then, as far as signals are concerned the load resistor is connected between collector and emitter. Draw this into the equivalent circuit, and the result is Fig. 3. Back in the old days of valves (nostalgia corner, this!), we found the sum of these two resistors in parallel, which was

$$\frac{R_{ce} R_L}{R_{ce} + R_L}$$

and then the voltage signal out was just the current signal times this resistance (Ohm's Law still rules, OK?) giving

$$\frac{G_m R_{ce} R_L}{R_{ce} + R_L}$$





To Boldly Go . . . . . p61

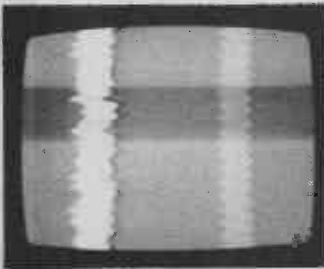

Beats Crossroads . . p27

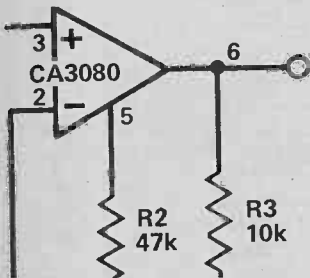

How To Use It! . . . p70

# electronics today

APRIL 1979 VOL. 8 NO 4 INTERNATIONAL

## FEATURES

NEWS DIGEST	<b>9</b>	Did you know . . . . .
POWER AMP SURVEY	<b>19</b>	Power to the people
Gm REVISITED	<b>37</b>	New life for an old idea
DATA SHEET	<b>52</b>	IC survey
READERS DESIGNS	<b>54</b>	Your designs built
TEN 3080 CIRCUITS	<b>70</b>	It does more than you think
MICROFILE	<b>80</b>	A floppy pet
TECH TIPS	<b>103</b>	Circuits from you to you

## PROJECTS

VIDEOGRAPH	<b>27</b>	Sound to light on your telly
CLICK ELIMINATOR	<b>41</b>	Clean up your records
AMBUSH	<b>61</b>	The new space game with sounds
WIND SPEED INDICATOR	<b>85</b>	Get the wind up this unit
GUITAR EFFECTS UNIT	<b>97</b>	We think we've found a new one for you
PCB FOIL PATTERNS	<b>110</b>	All in one place now

## INFORMATION

BOOK SERVICE	<b>25</b>	You name it, we have a book on it
HOBBY ELECTRONICS PREVIEW	<b>35</b>	On its way to you
ETI PRINTS	<b>49</b>	For DIY PCB's
MARKET PLACE	<b>58</b>	Can you beat these prices?
ETI SPECIALS	<b>69</b>	Specially for you
COMPUTING TODAY	<b>83</b>	On its own now
NEXT MONTH IN ETI	<b>90</b>	What we've got for May

### INTERNATIONAL EDITIONS

AUSTRALIA	Collyn Rivers Publisher Les Bell Acting Editor
Holland	Anton Kriegsman Editor-in-Chief
CANADA	Steve Braidwood Editor Graham Wideman Assistant Editor
GERMANY	Udo Wittig Editor



ABC

### EDITORIAL AND ADVERTISEMENT OFFICE

25-27 Oxford Street, London W1R 1RF. Telephone 01-434 1781 / 2. Telex 8811896

Ron Harris, B.Sc.	Editor
Rick Maybury, Ian Graham, B.Sc.	Editorial Assistants
Diego M. Rincon	Art Director
Pete Howells	Production Editor
Paul Edwards, Tony Strakas	Technical Illustrators
Ray Marston	Project Editor
John Fitzgerald	Project Engineer
Steve Ramsahadeo	Project Development
Margaret Hewitt	Administration
Alan Carlton (Manager), Kim Hamlin	Reader Services
Bren Goodwin, Tim Salmon	
Christopher Surgenor (Manager),	Advertising
David Sinfeld, Joy Cheshire, Halina Di-Lallo	
Halvor Moorshead	Editorial Director

PUBLISHED BY Modmags Ltd., 25-27 Oxford Street,  
DISTRIBUTED BY Argus Distribution Ltd. (British Isles)  
Gordon & Gotch Ltd. (Overseas)  
PRINTED BY QB Limited, Colchester

Electronics Today International is normally published on the first Friday of the month prior to the cover date.

COPYRIGHT: All material is subject to world wide Copyright protection. All reasonable care is taken in the preparation of the magazine to ensure accuracy but ETI cannot be held responsible for it legally. Where errors do occur a correction will be published as soon as possible afterwards.

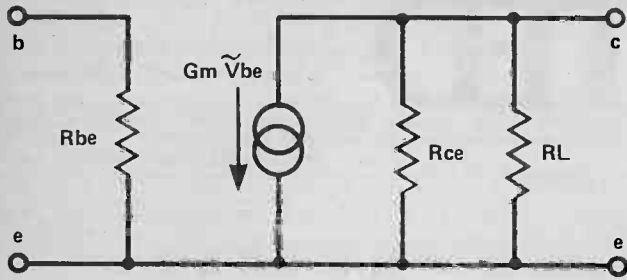

Fig. 3. For AC signals, a load resistor connected between collector and positive supply behaves as if connected between collector and emitter.

$$G_m = \frac{e}{kT} I_c$$

$e$  = CHARGE CARRIED BY AN ELECTRON  
 $k$  = BOLTZMANN'S CONSTANT  
 $T$  = TEMPERATURE IN KELVIN SCALE  
 $I_c$  = STEADY (BIAS) COLLECTOR CURRENT

## Simple Silicon

One of the things that makes life simpler in these days of silicon transistors is that the quantity  $R_{ce}$ , the output resistance of the transistor, is quite a large value compared to most of the load resistors we use. An output resistance (the usual symbol nowadays is  $h_{oe}$ ) of 40k is quite a bit larger than the 3k3 or so we use as a load, so that most of the signal current from the transistor is through this resistor in the equivalent circuit. That simplifies the output voltage to  $G_m R_L$  so that the gain of a transistor amplifier is just  $G_m R_L$ .

If it's as easy as that, why don't we see it in text books? The reasons are historical — we didn't start with silicon transistors, and a transistor, unlike a valve doesn't have a constant value of  $G_m$ . If we plot a graph of collector current against base voltage (as in Fig. 1), the result is not the nice straight line we get when we plot such a graph for a valve, or the not-too-crooked line we get when we plot the graph for an FET, but a very curved line indeed. This indicates that the value of  $G_m$  is not constant, but a value which changes as the current through the transistor changes. This, coupled with the rather low output resistance of the early germanium transistors seemed to seal the fate of  $G_m$  for good.

## Ebers Moll

A few years back, though, the Ebers-Moll equation was noticed. You've never heard of it? You're not alone, very few text books mention it, and some mention it without explaining it. Very briefly, it's an equation which links the collector current with the  $V_{be}$  value for a transistor. In other words, it's the equation for finding  $G_m$ . Now the full equation is a fearsome looking thing, full of mathematical symbols you may never have seen before. It repays close attention, though, because most of the symbols are of quantities that are pretty well constant, and only two of them vary very much. One of them is the steady bias current,  $I_c$ , and the other is temperature. As it happens, temperature, for the purposes of the Ebers-Moll equation, is measured in the Kelvin scale, which starts at the absolute zero of temperature around  $-273^\circ\text{C}$ . Room temperature is therefore around 293K (no degrees sign) in the Kelvin

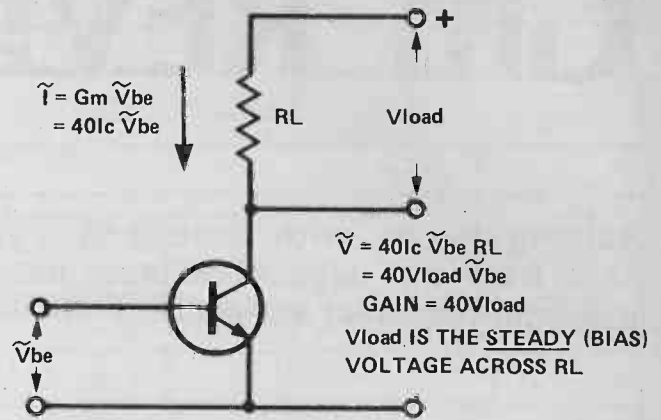

Fig. 4. Transistor circuit with load resistor ( $R_L$ ).  $G_m$  can be replaced by  $40I_c$ .

scale, and a few degrees above or below doesn't make much difference to the equation.

That leaves  $I_c$  as the one thing that really affects  $G_m$ , and the relationship works out at approximately

$$G_m = 40 I_c \quad (I_c \text{ in mA})$$

Put in words, that means we can take a  $G_m$  value of 40 times the steady bias collector current in milliamps. For a bias current of 1 mA, the  $G_m$  value of a transistor is 40 mA/A. Too good to be true? Looks it, but it really does apply to any silicon transistor, apart from a few freak types.

This brings back the  $G_m$  idea in a big way, and we can forget a lot of the old formulae we once used in calculating the design of transistor amplifiers. The fact that  $G_m$  is not constant but varies with the bias current is, oddly enough, a help rather than a hindrance.

## Gain

Going back to our equivalent circuit, and ignoring the large output resistance of the transistor, we can now write  $40 I_c$  in place of  $G_m$  (fig. 4). This makes the gain of a transistor with load resistor  $R_L$  become  $40 I_c R_L$ . But  $I_c$  in this equation is the *steady* bias collector current, and so  $I_c R_L$  must be the steady DC voltage across  $R_L$ , the load resistor. This makes calculating the gain of transistor amplifiers with resistive loads a bit easier than falling off a log. Pick a value of voltage across the load resistor, multiply by 40, and that's your value of gain!

For example, we very often design voltage amplifiers so that about half of the supply voltage is dropped across the load resistor. For a 9 V supply, that's 4.5 V. Do this, and you can expect a voltage gain of  $40 \times 4.5 = 180$  times. Don't believe it? It works all right, and tests on a single transistor amplifier confirm it as a rule of thumb. You don't, of course, expect to get a gain of *exactly* 180 in the case I've illustrated — there are 20% tolerances on load resistors apart from anything else, but you're never far out; that's what a rule of thumb is for.

When you couple a single transistor amplifier to another stage, of course, that's another story. You may have set the gain of the first stage to 180 times, but not all of its output signal ends up usefully at the input of the

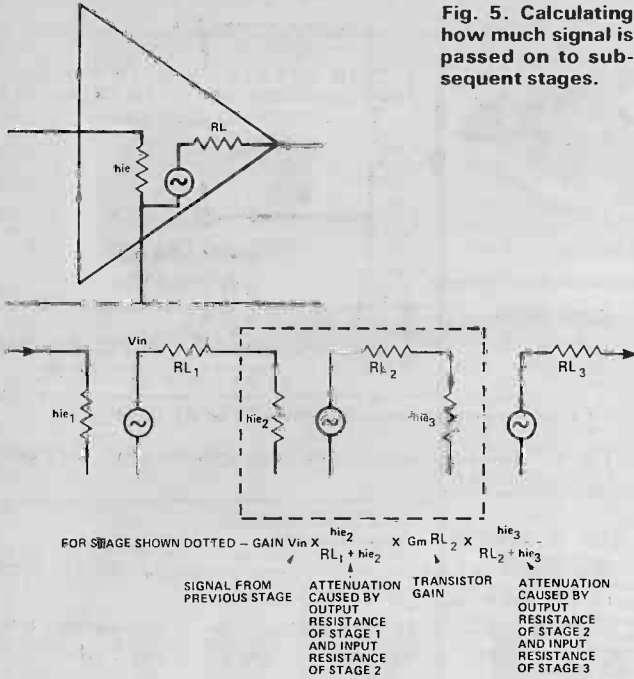

Fig. 5. Calculating how much signal is passed on to subsequent stages.

next stage. Reason? The next stage has a rather low input resistance, and feeding signal from the collector of one transistor into the base of another, even if they are directly connected, is rather like feeding signal through a voltage divider. There are, in fact, two ways of calculating how much of the signal is passed on. One simple way is to imagine a voltage divider (Fig. 5) in which the load resistance of the first stage forms the upper resistor and the input resistance  $h_{ie}$  of the second stage. The quantity  $h_{ie}$  (on k ohms) is equal to  $h_{fe}/G_m$ , where  $h_{fe}$  is the current gain of the transistor, a quantity which *does* vary between one transistor and another. For a transistor with  $h_{fe} = 100$ ,  $G_m$  set to 40 (1 mA collector current)  $h_{ie}$  is  $100/40 = 2k5$ . If we feed this from a transistor with a 4k7 load resistor, the amount of signal reaching the second transistor is

$$\frac{2.5}{2.5 + 4.7} = .35$$

of the signal at the output of the first. This brings the gain of the first transistor stage down to  $180 \times .35 = 63$  which is the sort of value we usually measure for one stage of a multi-stage amplifier.

With all this going for it,  $G_m$  is coming back, folks. As Sam Goldwyn is supposed to have said, "simplify and add lightness". Let's hope we've added a bit of lightness today. **EN**

**MAINS OPERATED ELECTRONIC DIGITAL ALARM CLOCK** IMMEDIATE DELIVERY

**£8.95**  
INCL. V.A.T.  
POST PAID  
**THREE FOR £26.00\***  
POST FREE

**E.T.I. RECOMMEND THIS MODEL**

- Hanimex HC-1100
- Large Bright LED display
- White case with red display on black background
- Adjustable dim/bright control
- Silent operation, all electronic
- Space age technology L.S.I. circuitry
- Alarm and 9 minute snooze repeater
- P.M. indicator
- Hour and minute display
- Size 100mm x 130mm x 60mm high
- Fully guaranteed

**BARCLAY ACCESS**  
Just phone in number

**HENRY'S RADIO**  
404 Edgware Rd. London W2  
PHONE (01)723 1008 ENGLAND

wonderboard

SOLDERLESS CIRCUIT BOARDS  
"One for each circuit"

Build Your Circuits Just Once In Minutes...

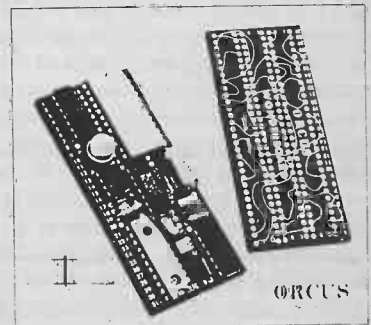

It's crazy to build, unbuild, construct and destruct your circuits on expensive "Breadboards". Now very economically on WONDERBOARD, you plug your components into one side of the board, the wires into the other, and you install the finished circuit in your equipment. They're like PC boards, but no soldering (which is enemy No. 1 of prototypes). Change any wire or component any time without disturbing others. Up to six interconnecting wires and one component lead into one multicontact. WONDERBOARDS accept all IC's from 4 to 60 pins and discrete components too.

Reliable? They conform to applicable sections of USA Military Standard MIL-A-46 146 and are used by the US Navy. You can't ask for better. WONDERBOARDS the universal board for equivalents of single-sided, double sided, plated thro' hole, and multilayer printed circuits.

"Small Wonder"  
12 IC DIL 14 capacity  
(Equiv. No. tie points 1302)

"Big Wonder"  
48 IC DIL 14 capacity  
(Equiv. No. tie-points 5208)

£2.80

£11.20

All prices include VAT and P&P. Send cheque or postal order to:

**CHARCROFT ELECTRONICS LIMITED**  
Charcroft House, Sturmer, Haverhill, Suffolk CB9 7XR  
Telephone Haverhill (0440) 5700 Telex 817574





# CLICK ELIMINATOR

Part two of the Click Eliminator article, presented here, is in fact a redesign of the project leading to better performance and lower cost.

In the January issue of ETI we presented a design for a click eliminator unit. However, between that issue and the time for the February ETI — in which we were to complete the project we found several disturbing inconsistencies which would have rendered the design's repeatability doubtful—to put it mildly.

These problems mainly concerned the area around Q1, IC9 and IC10. The biasing arrangement for Q1, and its function within the circuit means that the adjustments are very very critical indeed. Our prototype operated satisfactorily, especially in its breadboarded form, but was too dependent upon too many variables for us to be happy with the project.

## Taking Aim

The aim then, as now, was to present a design for a unit which would remove the clicks and scratches from damaged LPs, without impairing the music material contained therein.

Operation was to be indicated by an LED, and threshold of operation was to be variable to make the Eliminator flexible in use.

However, as we said, development work has continued since initial publication, and while we felt that there was nothing wrong with the aims of the project, our method of realising them left something to be desired.

## Change Of Track

Accordingly we are presenting here an alternative design, and

recommend our readers to construct this in lieu of the design shown in Part One of the article. A comparison between both circuits will show this version to be greatly simplified, and using components which will make construction cheaper.

For example the 570, has been replaced with a 4016, which is closed to the signal for a short period of time to blank the 'click' signal.

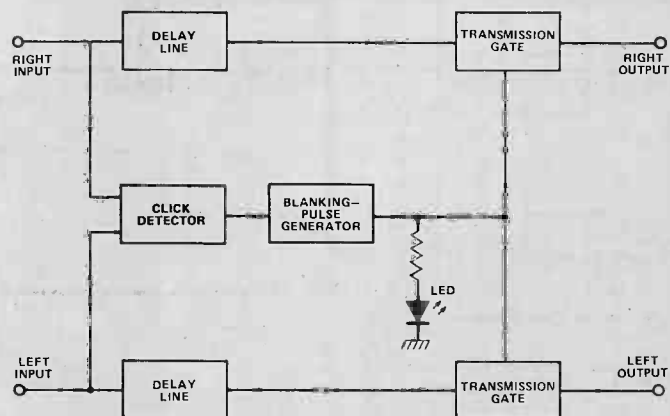

Fig 1. Basic block diagram for Click Eliminator Mk 2.



As the block diagrams of Fig. 1

will show, the basic remains unchanged. The incoming audio is delayed by a TDA 1022, long enough for the circuit to detect the click and generate a pulse which shuts off the transmission gate (4016) as the 'click' arrives.

The waveforms shown in Fig. 8 give an indication of the timing of the circuit, and the manner in which the blank period is made to 'straddle' the click signal.

### Circuits and Components

Figures 2-6 show the schematic for the Click Eliminator. Figure 2 is the audio input and delay line circuit. Figure 5 shows the click detection and blanking pulse generation components. Inputs A and B come from points A and B marked on the left and right audio inputs respectively.

Circuits 5 and 7 are the output blanking (and bypass) and system clock respectively. The latter is referred in the audio circuit simply as Q and Q̄.

### Construction

The unit is assembled onto a single PCB, and so construction is really quite straightforward. Assemble the board carefully, remembering to fit resistors and capacitors first, and ICs last. Sockets are best used for these devices, especially the high cost items. This will facilitate checking and servicing should this be needed.

The easiest place to make a mistake is in fitting the polarised components — electrolytics, diodes, ICs etc so check these carefully. It is best to build up the PSU first and check this before connecting to the rest of the circuit.

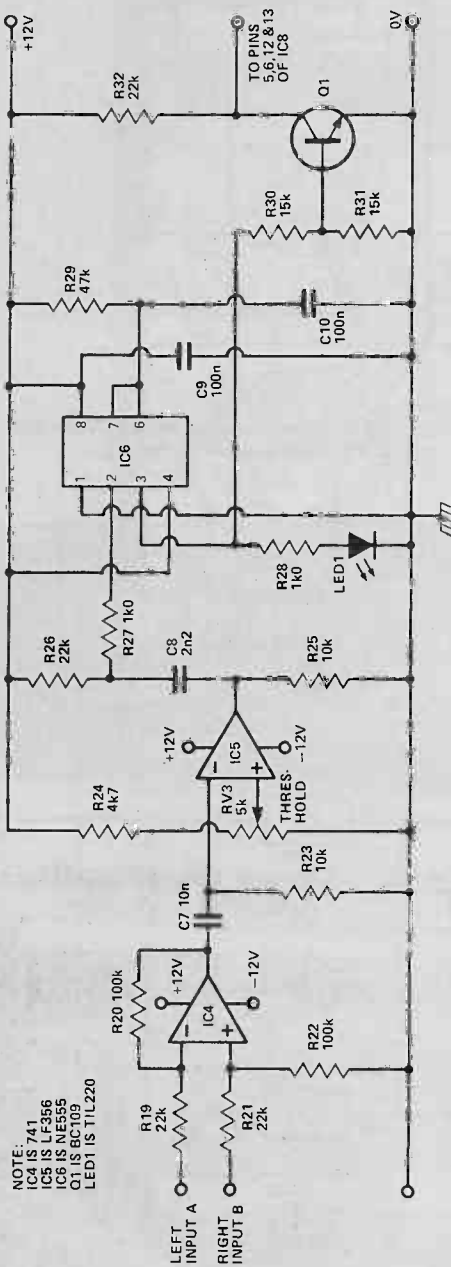

Fig 3. Circuit of the click detector section of the Mk 2 Click Eliminator. The LED flashes to indicate operation.

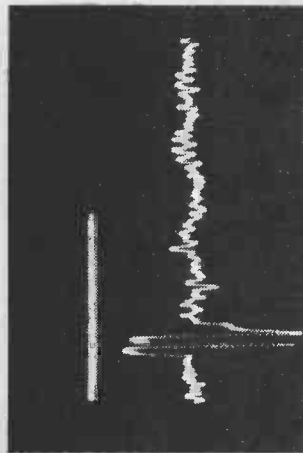
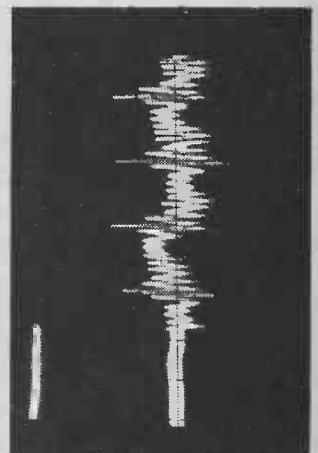

Fig 4 (a). Above: the waveform of the Click Eliminator blanking pulse straddling the click waveform, which includes some ringing. Fig 4(b). Below: the combined waveform showing the blank period inserted into the music.



## HOW IT WORKS

The full circuit diagram of the click detector block, which incorporates a "click identifier," a threshold detector, and a blanking pulse generator, is shown in Figure 3.

A "click" or scratch has a number of unique characteristics. It has fast attack and decay times, and its output is consequently rich in high-frequency components. Also, it appears to a stereo pick-up head as a set of recorded anti-phase signals, since it causes purely vertical displacement of the stylus, whereas normal recorded signals tend to be in phase and cause predominantly horizontal movement of the stylus. The ETI Click Eliminator uses these unique phase characteristics to provide its primary means of click identification.

In the circuit, the amplified pick-up signals are taken from the outputs of the two channel pre-amplifiers (IC1a, Fig 2, and are passed to one or other of the two input terminals of IC4 in Fig 3. IC4 is wired as a differential amplifier or "sub-

tractor," and has a gain of about five on each input. The action of this IC is such that it amplifies the anti-phase "click" signals, but tends to cancel the predominantly in-phase recorded signals, so that the output of the IC consists of an audio signal with greatly emphasised "clicks." This signal is passed to threshold detector IC5, which is wired as an open-loop voltage comparator, with its output normally at positive saturation.

The "threshold" level of IC5 can be adjusted via panel-mounted control RV3, so that the output of the IC is just held high throughout the passage of a "clean" record. Then, each time that a "click" arrives, the output of IC5 switches to negative saturation, to produce a large negative-going pulse. This pulse is used to trigger monostable multi-vibrator IC6, which has a period of about 5 ms, and which drives "click indicator" LED 1 on and drives output transistor Q1 to saturation for the duration of the 5 ms pulse. The output of Q1 appears as a blanking pulse, and is fed to the click blanking circuit of Fig 4.



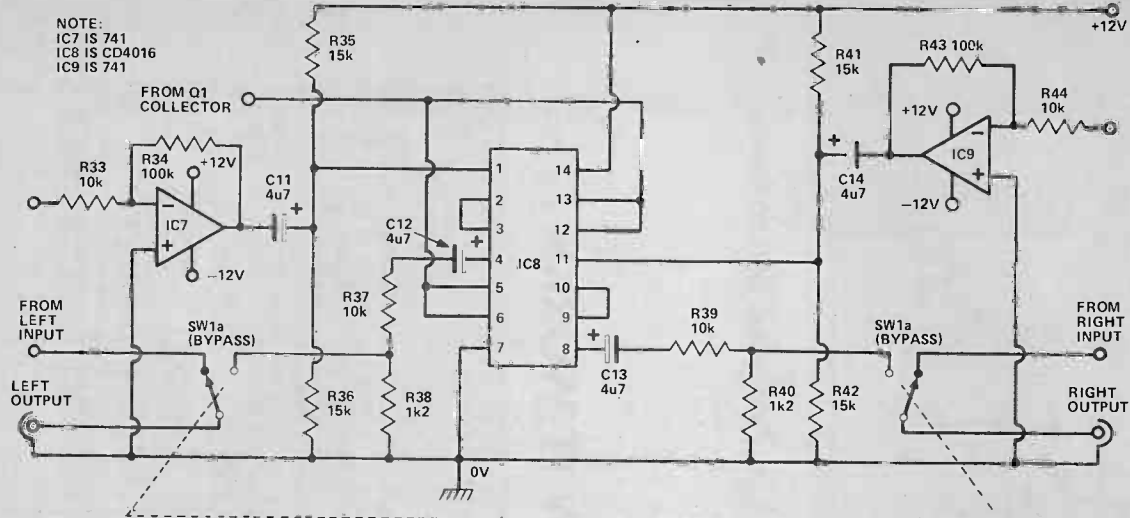

Fig 5. Click blanking circuit. Note that SW1 is the bypass switch.

## HOW IT WORKS

The circuit of the click blanking block is shown in Figure 5. Circuit operation is fairly straightforward. The output of each channel is taken from its volume control (Fig 2) and is fed through a times-ten inverting amplifier (IC7 or IC9), and is then passed to one half of IC8, a 4016 quad bilateral switch. In each channel, two of the internal "switches" of the 4016 are wired in series, and are normally held on by the high control signal from the collector of Q1 (Fig 4), but turn off for 5 mS when a blanking pulse arrives from the click detector circuit. The output of each channel is then passed on to the outside world via a divide-by-ten (approx) attenuator network.

Thus, during "clean" parts of the record the output signal from the delay line is passed through the click blanking circuit of Fig 5 via the two series-connected

switches of IC8 with negligible loss or gain, but in the presence of a "click" the two series-connected switches of IC8 open 1 mS before the arrival of the click and remain open for about 5 mS, thus replacing the click with an imperceptible "blank."

Note in the circuit that the inputs of IC8 are biased at half-supply volts to enable

the IC to pass signals with a minimum of distortion when operated from a single-ended power supply. The 4016 IC suffers from a certain amount of control-signal breakthrough; by using a times-ten amplifier before the input and a divide-by-ten attenuator after the output of the IC, this breakthrough is reduced to insignificant levels relative to those of the basic audio signal.

The power supply is a straightforward design based on a pair of three-terminal IC regulators, which provide plus or minus twelve volt outputs. LED 2 is a panel-mounted component, which indicates the power on state.

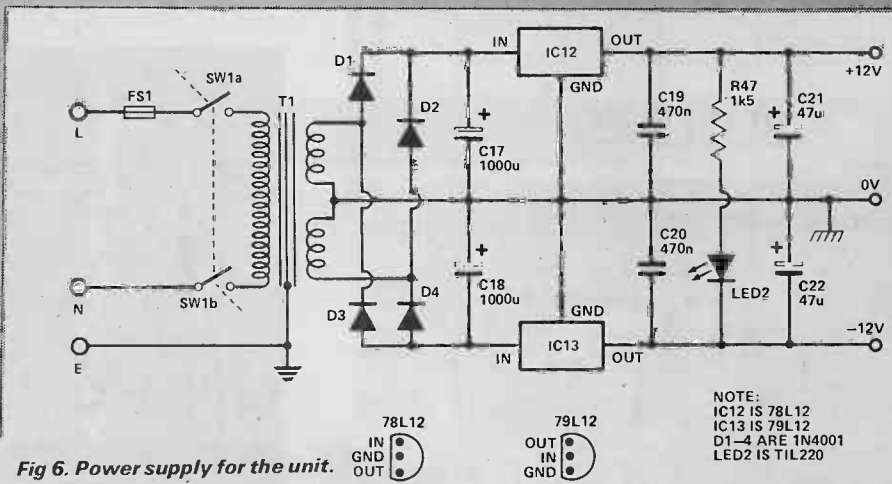

Fig 6. Power supply for the unit.

Next assemble and check the audio circuitry. Make sure a signal is present at the level control RV2a and RV2b. Normally IC8 gates will be 'open' and so an audio output should be present at the phono sockets if all is well.

If no output is present, check the audio through to RV2, and if a signal is present here, the fault probably lies with IC6 and Q1. Disconnecting the base of Q1 will restore output if this is the case.

### Over the Threshold

In use, the unit is connected between the output of a record player pick-up

and the input of a stereo amplifier. Volume control RV2 should be adjusted so that no perceptible difference occurs in audio sound levels when the bypass switch is switched in and out. Pre-sets RV1 and RV101 should be adjusted for minimum distortion on the Right and Left channels respectively. Threshold control RV3 should be adjusted in use so that LED 1 just operates in the presence of a 'click'.

It should be noted that the relative amplitude of a 'click' is proportional to the velocity of the record track past the pick-up head, and decreases as the head moves towards the centre of the disc: the threshold control may

consequently need occasional readjustment as the record progresses through its play.

There is no equalisation circuitry within our design, and so it cannot be used in place of the preamp in your system, it must be used in front of it instead.

When playing damaged LP's simply advance the Threshold control, RV3 from its minimum setting until the click is removed. This is the correct setting.

LED 1 will indicate the unit operation, and if it flashes on musical peaks, chances are you have the threshold control set too high and are removing some of the signal as well.

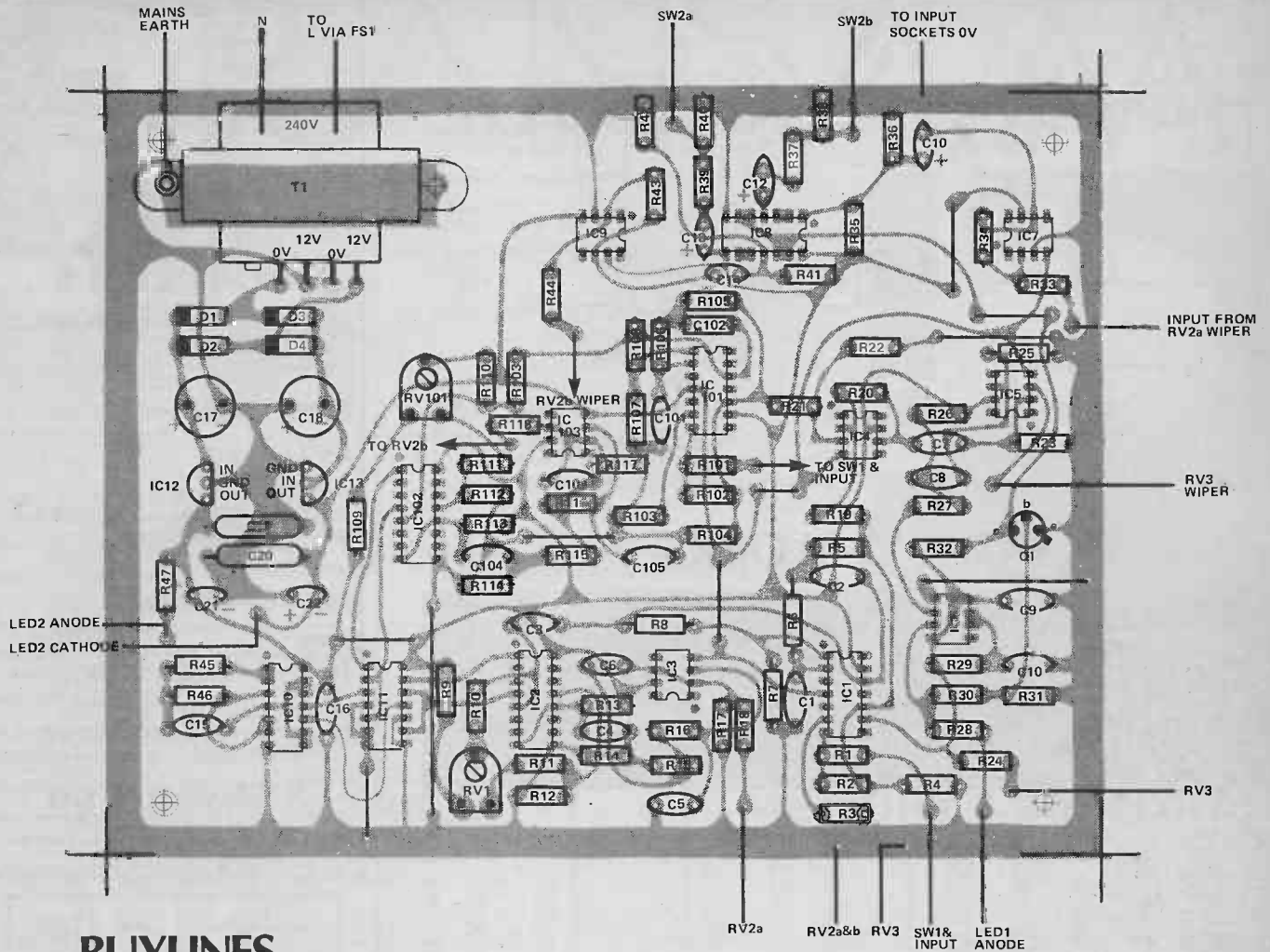

## BUYLINES

Being composed mainly of 'standard' components, the Eliminator should pose most component shops no problems. The LF 356 is available from Watford in case of difficulty.

Fig 7. Component overlay for the Click Eliminator unit. Note that all the components bar the potentiometers mount on this PCB. The operation LED is also best front panel mounted.

## PARTS LIST

### RESISTORS (all 1/4W 5%)

R1, 3, 13,,	47k
29, 45	470k
R2	470k
R4, 17, 23, 25,	10k
33, 37, 39, 44	10k
R5, 6, 30, 31,	15k
35, 36, 41, 42	15k
R7, 10, 14,	100k
15, 16, 20,	56k
22, 23, 34,	2k7
43	6k8
R8	100k
R9	56k
R11	2k7
R12, 27, 28	6k8
R18, 24	1k
R21, 26, 32	4k7
R38, 40	22k
R46	1k2
R47	1k8
R47	1k5
Resistors 101-118 for RH channel identical to R1-18	

### POTENTIOMETERS

RV1	4k7 preset
RV2	100k log twin gang
RV3	5k Lin

### CAPACITORS

C1, 2, 15	330p polystyrene
C3, 4, 9,	100n polyester
10, 16	56p ceramic
C5	100p ceramic
C6	10n polyester
C7	2n2 polyester
C8	4u7 25V electrolytic
C11-14	1000u 25V electrolytic
C17, 18	470n polyester
C19, 20	47u 25V electrolytic
C21, 22	47u 25V electrolytic

### SEMICONDUCTORS

IC1	TL083
IC2	TDA1022
IC3, 5	LF 356
IC4, 7, 9	741
IC6	555
IC8	4016
IC10	4011
IC11	4013
IC12	78L12
IC13	79L12
Q1	BC 109
D1-D4	1N 4001
LED1, 2	TIL 220

### MISCELLANEOUS

240/12-0-12 transformer (100mA), fuse (3A) and holder, case to suit, DPDT mains switch control knobs, PCB

# PROJECT: Click Eliminator

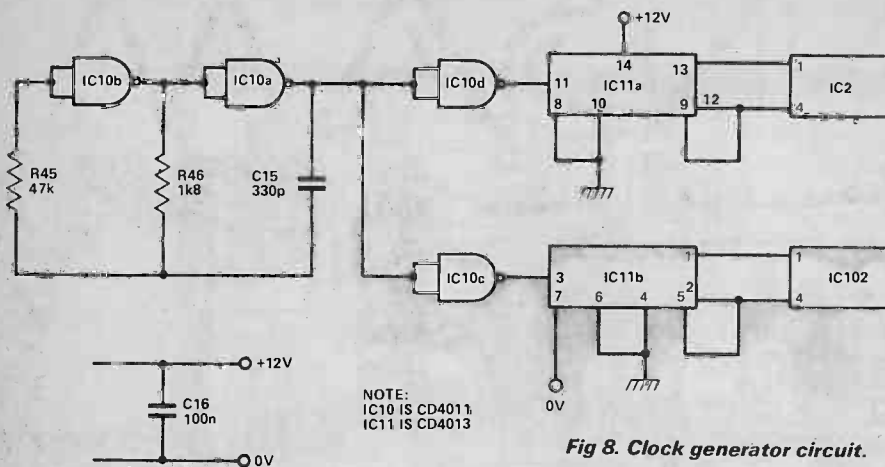

Fig 8. Clock generator circuit.

## HOW IT WORKS

Pins 1 and 4 of the TDA 1022 delay line IC must be presented with symmetrical anti-phase clock signals for correct operation. The basic clock signal of a few hundred kHz is generated by a CMOS astable multivibrator formed by IC10a and IC10b. The clock signal is taken to

each channel via a buffer stage (IC10d or IC10c) and a D-type flip-flop (IC11a or IC11b), which provides the required anti-phase drive signals (from the Q and  $\bar{Q}$  outputs) for the delay line. The clock generator has RF decoupling provided by C16, which is mounted close to the supply pins of IC10 and IC11.

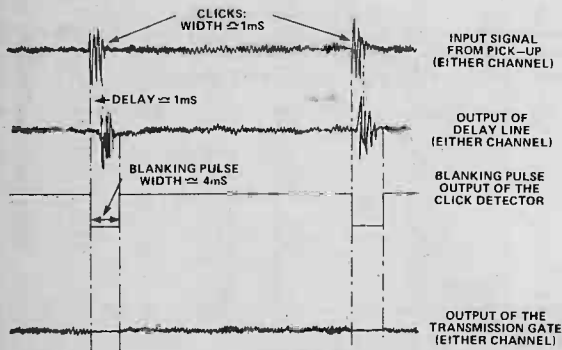
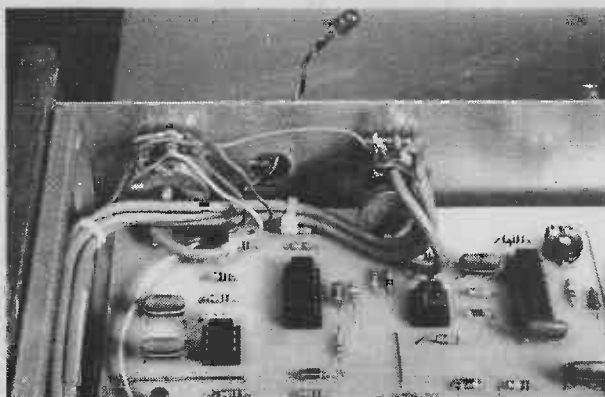

Fig 9. Some typical waveforms which illustrate the timing of the circuitry within the general block of the Click Eliminator. Blanking pulse width is fixed.

Close up of the socket wiring for the Click Eliminator. Keep these as close to the boards as possible, and use screened leads if this is not possible, earthing only one end of the screen.



### THE SINCLAIR PDM35 Digital Multimeter

Now a digital multimeter at an analogue price and look at the spec!

**D.C. VOLTS** 1mV-1000V (1% - 1 count) 10mΩ input.

**A.C. VOLTS** 1V-500V, 40Hz-5kHz (1% + 2 counts).

**D.C. CURRENT** 1 inA-200mA (1% count).

**RESISTANCE** 1Ω-20MΩ (1.5% + 1 count) **£29.82** C.W.O.

or £32.95 company or govt. purchase order. Adaptor £3.20. Padded case £3.20. 30kV probe £18.92.



### THE SINCLAIR MICROVISION

The amazing pocket T.V. that will pick up programs throughout the world, complete with rechargeable batteries. International model. £149.95 inc VAT. UK model £99 inc VAT. Batteries £1.16. Adaptor £6.76. See (for detailed Brochure ex-stock)

### SINCLAIR DM235

Portable 3½ digit 6 function Multimeter. DC volts 1mV to 1000V AC volts 1mV to 750V AC & DC current 1μA to 1A Resistance 1Ω to 20MΩ Diode test 0.1μA to 1mA 10mΩ input, DC acc. 1.0% AC acc 1.5% 30Hz-10kHz

£49.90 inc VAT. Cash with order. Case £8.50. Adaptor £3.75 CWO

### SINCLAIR DM350 & DM450

Resistance range 10mΩ to 20MΩ (100mΩ on DM350) Basic accuracy 0.05% for DM450 0.1% for DM350 Input impedance 10MΩ with 1000MΩ selectable on basic DC voltage range. Automatic polarity selection Push-button range selection

DM450 £99.90  
DM350 £69.90

Send SAE for full details.  
DC Voltage range 10μV to 1200V (100μV on DM350)

## KRAMER & CO

We will match any lower advertised price on a cash with order basis if competitor has goods in stock  
9 October Place, Holders Hill Road, London NW14 1EJ  
Telex 888941 Attn. Kramer K7. Tel. 01-203 2473  
Mail order only. SAE for data sheets. Export enquiries welcome

T.T.L.		LINEAR	TRANSISTORS
7400	.10	74121 .25	LM709 .20
7401	.10	74122 .32	LM741 .17
7402	.10	74123 .38	LM380 .55
7404	.10	74125 .32	LM3900 .45
7405	.13	74126 .32	NE555 .22
7406	.22	74132 .45	NE556 .55
7407	.24	74141 .50	NE556 1.15
7408	.12	74150 .65	NE567 1.20
7409	.12	74151 .45	REG U.L.A.
7410	.12	74153 .45	TOURS
7411	.15	74154 .70	LM340T5 .55
7412	.15	74156 .45	LM340T12 .55
7413	.25	74157 .45	LM340T15 .55
7414	.45	74161 .55	LM340T18 .55
7420	.12	74163 .55	LM340T24 .55
7426	.20	74164 .55	LM340T24 .55
7427	.20	74165 .60	BRIDGES
7430	.12	74166 .75	(1A)
7432	.20	74175 .65	WO1 100V
7437	.20	74176 .50	WO4 400V
7438	.20	74180 .75	
7440	.12	74181 1.25	
7441	.80	74182 .50	
7442	.38	74180 .70	
7443	.60	74191 .70	
7444	.60	74192 .55	
7445	.60	74193 .60	
7446	.50	74194 .55	
7447	.50	74195 .55	
7448	.50	74196 .55	
7450	.14	74197 .55	
7451	.14	74198 1.00	
7453	.14		
7454	.14		
7460	.14		
7470	.25		
7472	.21		
7473	.21		
7474	.21		
7475	.25		
7476	.25		
7480	.40		
7483	.75		
7485	.60		
7486	.25		
7489	1.20		
7490	.25		
7491	.40		
7492	.32		
7493	.28		
7494	.55		
7495	.50		
7496	.50		
74100	.80		
74107	.22		

MICROS etc	
2102	450ns .95
8080A	4.95
8212	1.90
8214	4.90
8224	2.50
8228	3.90
8251	6.50
8255	7.75
AY-5-1013	3.50
AY-5-2376	8.75

OPTOELECTRONICS	
LEDS 125 RED	.09
OL704 3" CC	.95
DL707 3" CA	.95
FND500 5" CC	.92
FND507 5" CA	1.00
FND807 8" CA	1.65

All prices include V.A.T. Please add 25p P&P on orders under £5.00.

### H & S ELECTRONICS

7 The Pavement, Chapel Rd.,  
West Norwood, London SE27 0UN  
Tel: 01-761 3614



# data sheet.....

## IC SURVEY

THERE ARE VERY many IC's available on the market today, and new devices seem to appear daily (probably hourly). This barrage of technology can be rather daunting, particularly to the newcomer to electronics. The following article tries to untangle some of the confusion by surveying IC technology in four groups of devices; Op Amps, audio amplifiers, multipliers, and oscillators.

### Operational Amplifiers (Op Amps)

There are many different types of OP Amp and they are manufactured by several different companies. Most of these companies produce standard Op Amp devices but they put their own part number on them.

In recent years, the trend has been to develop IC's with more than one Op Amp inside. This has resulted in a range of dual and quad Op Amp packages. Texas have brought out a range of Bifet Op Amps. These are pin for pin compatible with standard types, but they are different in that they have FET inputs, giving them a very high input impedance.

Chart 1 shows comparative performance for several standard Op Amp types. The parameters chosen are the most important ones when selecting Op Amps.

### Audio Amplifiers.

Several manufacturers produce monolithic medium power amplifiers for audio use. This makes the design of small audio

amplifier sections relatively easy. There are some pitfalls to watch out for. IC amplifiers can easily destroy themselves if the power rails are high or if insufficient heat sinking is provided. There are now quite a wide range of devices, some of which are shown in Chart 2.

### Multipliers

The range of multiplier IC's has never been very large, but recently a few more have been added to the list partly inspired by the needs of telephone compansion systems. These systems produce a better signal to noise ratio over the line. Another and very common noise reducer (a special multiplier) is the Dolby B chip. This unfortunately is only obtainable under license.

### Oscillators

There are many oscillator IC's that can provide waveforms with periods of several hours to tens of nano seconds. For high frequency work there is the SN74S124 at 85 MHz and the LM375 at 200 MHz. These are TTL devices, they are not linear and are intended for use in feedback circuits. The Teledyne 9400 is a well known linear VCO. Teledyne also make a wide range of VCO modules. The NM5837 and the S2688 are the same device. They are both pseudo random oscillators, that is, they oscillate but the waveform is so complex that the resultant output just sounds like noise. Chart 3 details the most common types.

**CHART 1 OP AMP — ABRIDGED PERFORMANCE** S = Single D = Dual Q = Quad

Op amp type	Input offset voltage mV	Input bias current nA	Type of input structure	Bandwidth MHz	Slew rate V/NS	Voltage gain dB	Maximum supply voltage V	CMRR dB	Qty	Comments
709	2	300	NPN	1	0.25	90	± 18	90	S	Needs frequency compensation
307	2	70	NPN	1	0.25	100	± 18	90	S	Internal frequency compensation
301	2	70	NPN	10	0.5	100	± 18	90	S	Needs frequency compensation
741	2	80	NPN	1	0.5	106	± 18	90	S	Internal frequency compensation
748	1	120	NPN	10	0.5	103	± 22	90	S	A decompensated 741
308	2	1.5	NPN	3	0.5	110	± 18	100	S	Low supply current drain 0.3mA Needs frequency compensation Very low differential input voltage range
318	4	150	NPN	15	50	106	± 20	100	S	Very low differential input voltage range. Sometimes needs frequency compensation
747	2	80	NPN	1	0.5	106	± 18	90	D	Internal frequency compensation
1458	1	80	NPN	1	0.8	103	± 18	90	D	Internal frequency compensation
4136	0.5	40	PNP	3	1.0	110	± 18	100	D	Low noise
3900 3401	Current inputs	30	Current sinks	2.5	0.5 20	70	± 18	—	Q	Current balancing amplifier
324	2	45	PNP	1	0.5	100	+30	70	Q	{ Ground sensing inputs Output voltage can go to ground Low power. 0.8mA drain per IC
3403	2	150	PNP	1	1.2	100	+36	90	Q	{ Ground sensing inputs Class AB output Output voltage can go to ground Low power 3mA drain per IC
348	1	30	NPN	1	0.5	103	± 18	90	Q	{ Low power 2.4mA drain per IC Class AB output

**CHART 2**  
**MONOLITHIC PREAMPLIFIER AND POWER AMPLIFIER SURVEY**

<b>Part Number</b>	
FAIRCHILD	
nA 739	-- Low noise stereo preamplifier
nA 706	-- 5 watt audio amplifier. Low voltage
MOTOROLA	
MC 1306	-- 0.5 watt audio amplifier 12V operation
NATIONAL SEMICONDUCTOR	
LM 370	-- AGC/squelch amplifier
LM 377	-- Dual 2 watt amplifier
LM 378	-- Dual 4 watt amplifier
LM 379	-- Dual 6 watt amplifier
LM 380	-- 2.5 watt mono amplifier
LM 381	-- Dual low noise preamplifier
LM 382	-- Dual low noise preamplifier
LM 384	-- 5 watt mono amplifier
LM 386	
LM 387	-- Low noise dual preamplifier
LM 388	-- 1.5 watt mono amplifier
LM 389	-- 0.35 watt mono amplifier plus npn transistor array
LM 390	-- 1.0 watt low voltage amplifier
LM 1303	-- Stereo preamplifier
RAYTHEON	
RC 4136	-- Quad low noise op amp
RC 4739	-- Low noise stereo preamplifier
SIGNETICS	
NE 540	-- Power drive op amp
NE 542	-- Dual low noise preamp
RCA	
CA 3052	-- Stereo preamp
CA 3134	-- TV sound IF and audio output (3 watts)

**CHART 3**  
**OSCILLATOR SURVEY**

Manufacturer	Part No.	Description	Package	Frequency range	
TEXAS	745124	Dual VCO	16 pin DIL	0.12Hz to 85MHz	
EXAR	XR2209	LIN VCO (low cost)	8 pin DIL	0.01Hz to 1MHz	
Teledyne	9400	LIN VCO	14 pin DIL	1000:1 sweep range	
EXAR	XR2206C	LIN VCO + AM + FSK	16 pin DIL	10Hz to 100kHz	
EXAR	XR2205C	LIN ICO + AM	16 pin DIL	2000:1 sweep range	
EXAR	XR2207C	LIN ICO	14 pin DIL	0.01Hz to 1MHz	
EXAR	XR2209C	LIN VCO	8 pin DIL	1000:1 sweep range	
Raytheon	RC4151	LIN VCO	8 pin DIL	0.01Hz to 1MHz	
Intersil	8038	VCO	14 pin DIL	0-10kHz	
Signetics	NE555	Timer/Oscillator	8 pin DIL	0.01 to 1MHz	
Signetics	NE556	Dual 555	14 pin DIL	Up to 100kHz	
Signetics	NE566	LIN VCO	8 pin DIL	10:1 sweep 1MHz max	
National	LM3909	Led Flasher	8 pin DIL	Up to 1 kHz	
Conductor	LM375	VCO+TTL Buffer	14 Pin DIL	Up to 200MHz	
National	NM5837	Pseudo Random Oscillator	8 pin DIL		
Semi Conductor	S2688	Pseudo Random Oscillator	8 pin DIL		
Motorola	MC14412	FSK Modem	8 pin DIL	Audio	
Motorola	MC14410	2 out of 8 tone ENCODER	16 pin DIL		
Motorola	MC14450	OSC + 2 <sup>16</sup> divider	6 pin	For fixed frequency operation — as in watches	
Motorola	MC14451	OSC+ 2 <sup>11</sup> to 2 <sup>19</sup> dividers			
Motorola	MC1451	Programmable Oscillator	16 pin DIL	Up to 100kHz	

**ABBREVIATIONS:**  
LIN—Linear  
VCO—Voltage Controlled Oscillator  
ICO—Current Controlled Oscillator

AM—Amplitude Modulation  
FSK—Frequency Shift Keying  
DIL—Dual In Line

**CHART 4**  
**OP AMP — ABRIDGED PERFORMANCE**

Op amp type	offset voltage mV	input bias current nA	Type of input structure	Band-width MHz	Slew rate V/uS	Voltage gain dB	Maximum supply voltage V	CMRR dB	Qty / IC	Comments
RC4739	2	40	PNP	3	1	110	± 18	100	D	Raytheon device only Low noise audio amplifier
uA739	1	300	NPN	10	1	86	± 18	90	D	Fairchild device only Low noise audio amplifier Needs frequency compensation
LM381	Not applicable	Not applicable	NPN	15	—	112	± 20	—	D	Low noise amplifier Internally compensated
CA3130	8	0.005	MOSFET	15	10	110	+16	90	S	Ground sensing inputs Very high input impedance Needs frequency compensation
CA3140	8	0.010	MOSFET	4.5	9	100	+36	90	S	Ground sensing inputs Very high input impedance
CA3160	6	0.005	MOSFET	4	10	110	+15	90	S	Ground sensing inputs Very high / input impedance
NE531 RC4531	2	400	NPN	10	35	96	± 22	100	S	Very fast op amp Needs frequency compensation
CA3080	0.4	I <sub>ABC</sub> 100	NPN	2	50	—	± 18	110	S	OTA device Programmable gain Current output
CA3094	0.4	I <sub>ABC</sub> 300	NPN	30	50	—	± 12	110	S	OTA device Programmable power switch/ amplifier
TL080	15	0.4	JFET	3	13	83	± 18	70	S	JFET input op amps, with fast slew rate and wide bandwidth [TEXAS]
TL081	15	0.4	JFET	3	13	83	± 18	70	S	
TL082	15	0.4	JFET	3	13	83	± 18	70	D	
TL083	15	0.4	JFET	3	13	83	± 18	70	D	
TL084	15	0.4	JFET	3	13	83	± 18	70	Q	

**Pin for pin replacement for 748**

741

1458

747

324

# NEWS digest.....



## COME UP AND SEE ME.....

A new model of the familiar pocket bleeper will be keeping athletes on their toes at the Moscow Olympics.

Multitone's new RB151 receiver uses a combination of single digit numerical display, with a choice of eight audible codes to convey more information than any other long-range receiver on the market.

The receiver also has a memory. In a meeting, for instance, where bleeper sound would be intrusive, call information can be stored and recalled after the meeting.

Ten remote control units will be used in Moscow to send out

messages and all information can be displayed on a monitor or printed out.

Each remote controller has a conventional pad of ten keys for entering numerical information and four keys enable one of four call codes to be selected.

Additionally, a deafening alert call can be sent to a group of receivers. Another group of keys allows calls to be transferred automatically to any other designated receiver. There are also battery check and out-of-range warning buttons. Multitone Electric Company Ltd, 10-28 Underwood Street, London N1 7JT.

## GLOW BAR

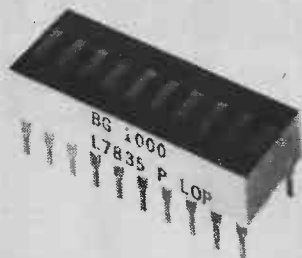

The new RGB-1000 from Litronix is a red, 10 element, linear bar display in a one inch long 20 pin DIL package. Individual addressable anode and cathode and intensity colour-coding for display uniformity are featured. At 20 mA, typical

luminous intensity for display and element are 5 and 0.5 mcd respectively. Suggested applications include solid state meters and positional indicators. Details from Litronix Inc, 23 Churchgate, Hitchin, Herts, SG5 1DN.

## CALL FOR ANALYSIS?



Hewlett Packard's new HP 3779 is a microprocessor-based instrument for checking multiplexed telephone equipment. The 'scope-size unit replaces two large racks of test gear and automatically displays its results in minutes rather than days.

Over forty different measurements from gain to intelligible crosstalk and local alarms can be assembled into a test sequence defined by the user.

The results are displayed in tabular form on the instrument's own CRT. The information can be fed to a computer or printer through an integral IEEE-488 (HP-IB) digital interface.

The analyser is produced in two models — the 3779A for the 3779B Europe and the 3779B for Bell system users. Further details from Hewlett Packard Ltd, King Street Lane, Winnarsh, Workingham, Berkshire RG11 5AR.

## TELETEXT — A LOAD OF RUBBISH...

THE most infuriating aspect of teletext from the viewer's standpoint is trying to decipher the occasional sentence or word on a page that may look like this example. This week premium bond Winner is \* 1 x ! ? / /. The above statement emphasises a need for a device which could eliminate these annoying factors usually raised by multipath reception problems. A new large scale integrated circuit co-developed by Toshiba and NHK has proved successful in attenuating 'ghosts' of up to 27 uS delay by a reduction of up to 30 dB.

The principal method of circuit operation is as follows: The circuit examines the ordinarily stable intervals between equalising pulses in the composite video required, to determine the presence of ghostly images. They would actually appear as smaller trailing pulses. Through multiplexing and analog memory techniques, voltages accurately derived from the amplitude and amount of delay of the ghost pulses are applied to vary the gain on each of the 64 MOSFET weighting circuits fed in paral-

lel with a sample of the video signal. These outputs of the weighting circuits in turn feed 64 CCD delay lines each having a pre-determined delay time. The outputs of the delay lines are added and then applied as negative feedback to the composite video signal in a form having sufficient amplitude and delay to cancel the ghosts.

Do not however expect to see this ghost eliminator available just yet. It is still many months from the full production. GERALD CHEVIN.

## AND ALSO...

An enterprising American TV station has finally decided to write a software package allowing American teletext to link up with British Viewdata.

In what is believed to be the first US attempt to interface the two systems, station KSL-TV (Salt Lake City) hopes to use the combination of the two systems to store and edit incoming US international wire copy in its General Automation 16/440 computer.

# readers designs

## TELEPHONE CALL TIMER — Submitted by Mr A. M. Tucker of Dorchester.

TO CARRY OUT its function, which is to display the cost of individual calls, and also to keep a running total of all metered calls, the circuit must add the amount of the unit charge (at present 3p) to each register when the call commences, and subsequently at the end of each charge period. This period will vary for peak, standard and cheap times, and with distance. Provision should be made for altering the settings of the counting circuits if there is a change in the Post Office charges.

Various circuits were considered, and this was considered to be as cheap to make as any for the facilities provided, as although there is a large number of ICs, the bulk are low priced.

The two sets of figures are circulated in a single shift register, the digits being interlaced; ie, the least significant figure in one register is followed by the least significant figure in the other register, and then by the next figure in the first register, and so on.

In order to be able to adjust the unit charge, and the periods available per unit, the outputs of the dividers are connected to sockets into which leads from the inputs of the resetting gates are plugged. These sockets, plus "parking places" for spare gates, can be made from IC sockets, or soldercon pins in plastic supports. To prevent damage to the pins of sockets when cutting into sections, push into a piece of rigid foam plastic. The wander leads are just lengths of connecting wire. Solid core is suitable: if stranded wire is used, tin the end and check that it is thin enough to insert into the socket.

In the interests of economy, small low consumption displays have been used. If larger displays are required, it will probably be necessary to add segment drivers. The

drivers should then be supplied from the unregulated side of the supply, and S1 made a double-pole switch.

The 9-volt standby battery is essential, as otherwise the "total cost" register would be cleared in the event of a mains failure. In order to reduce consumption during idle time, the counters IC1 and IC2 and their associated gates, the oscillator IC21 and the display buffers and driver IC23-IC26 are switched off by S1. It is unwise to try to include other ICs, as some inputs may be high. In any case, with the oscillator off, power consumption is very low in the remaining circuits.

It may simplify the wiring of a 4001 and a 4011 are substituted for the 4069. One NOR gate can be used instead of IC20a and IC22a, and a choice of ICs is available for the other inverters.

The meter can be adapted for battery power only by including a 4518 to divide the 10 kHz oscillator frequency down to 100 Hz, and doubling the division in IC1 by shifting each flying lead one place to the right. Setting the oscillator frequency exactly can be carried out either by comparing the 100 Hz output with 50 Hz from the mains on an oscilloscope, or by varying the setting until the charges are incremented at 10 second intervals for long distance calls at peak rates.

Decoupling capacitors for pulses in the supply lines may be required. While CMOS is less exacting than TTL in this respect, 10n non-inductive capacitors should be fitted across the supply pins of ICs at the end of supply lines, and across each of the more complex ICs.

A flashing LED is provided as an indication (and reminder!) that the timing circuits are operating.

ETI

## HOW IT WORKS

TO commence timing a call, SW1 is switched on, and SW4 and SW5 set. When the person replies, SW2 is closed. This removes the reset from IC1 and IC2, which start counting 50Hz mains pulses. At the same time IC6a is triggered, producing a 1ms pulse which clears the single call register — the digits being selected by IC21b and IC18b.

At the termination of the pulse, Q goes low and triggers IC6b. The Q output of this IC then goes low for 7ms or until reset by IC7, which is enabled by the high Q output of IC6b, and is clocked through IC20b each time the LSB of the registers are present at Q<sub>0</sub> and Q<sub>1</sub> of IC11, until the output connected to IC22e goes high, when IC6b resets and inhibits IC7.

The output from IC7 is fed through IC8 to the 'carry in' of the adder (IC14) driving the

LSB. Three cycles of the shift registers are required to increment the registers by 3p.

SW4 and SW5 set the time available for one unit. For present Post Office rates, IC1 is preset to divide by 250, giving an output pulse every 5S. IC2a divides by two, three or twelve. IC2b by three or twelve.

A pulse stretcher (R3, C3, D5) is included to ensure IC1 resets.

When the timing pulse reaches IC20j, IC6b is retriggered, clocking up another unit charge. The two sets of figures are stored in four 8 stage shift registers IC12 and IC13 and are circulated through the adder (IC14). The digits are selected for display by the divider IC11.

Clocking of these ICs and IC10 is affected by the 10k oscillator IC21a, b. The exact frequency of this is not important, but must be related to the length of the monostables

IC6a and IC6b.

IC21c is a buffer and the low clocking pulse required by the shift registers is provided by IC21d.

When the call is completed, SW2 is switched to off, and the resets on IC1 and IC2 go high, stopping the count. The cost of the call remains in the register until SW2 is closed for the next call. At the end of a quarter, the 'total cost' register can be cleared by pressing SW3. C4, D4, R6 provide a 'power-on' reset which ensures that the flip-flops are correctly set initially, and that IC7 is not started in the middle of a charge period.

When no more calls are expected to be made for a while SW1 is opened, dropping current consumption to a very low figure so that a battery backup can be used against mains failure.

## PARTS LIST

### RESISTORS all 5% 1/2W

R1, 2, 14-20 1k  
R3 12k  
R4, 5, 10 100k  
R6, 7, 9, 11, 13 1M  
R8 1M5  
R12 3M3  
R21, 22 1k5

### POTENTIOMETERS

RV1 500 k trimmer

### CAPACITORS

C1, 2 470u electrolytic  
C3 47p ceramic

C4 1u electrolytic  
C5, 7 1n polyester  
plus various 10n ceramic decoupling capacitors.  
SEMICONDUCTORS  
D1 4x 1N4001 or 1A bridge  
D2-5 1N914 or equivalent  
IC1 4040  
IC2 4520  
IC3, 5 4082  
IC4 4073  
IC6 4098  
IC7, 11 4022  
IC8, 16, 21 4072

IC9, 20 4071  
IC10 4027  
IC12, 13 4006  
IC14 4008  
IC15 4511  
IC17-19 4081  
IC21 4011  
IC22 4069  
IC23, 24 4050  
IC25, 26 74592  
IC27 LM78L12  
Displays HP5082-7414  
MISCELLANEOUS  
100mA transformer, etc.



This new feature is open to all our readers. It exists as a showcase for projects YOU have designed and built. We pay full ETI page rates for any designs we publish. We must stress that these designs must have been built by you. To further this end, we are giving preference to those which arrive at our offices with photographs, or which can be photographed by us.

Initially a simple draft outlining the idea behind the project and what the unit can do is all that is required. Photographs should be included at this stage.

Write to: 'Readers Design,' ETI Offices, 25-27 Oxford Street, London, W1P 1RF.

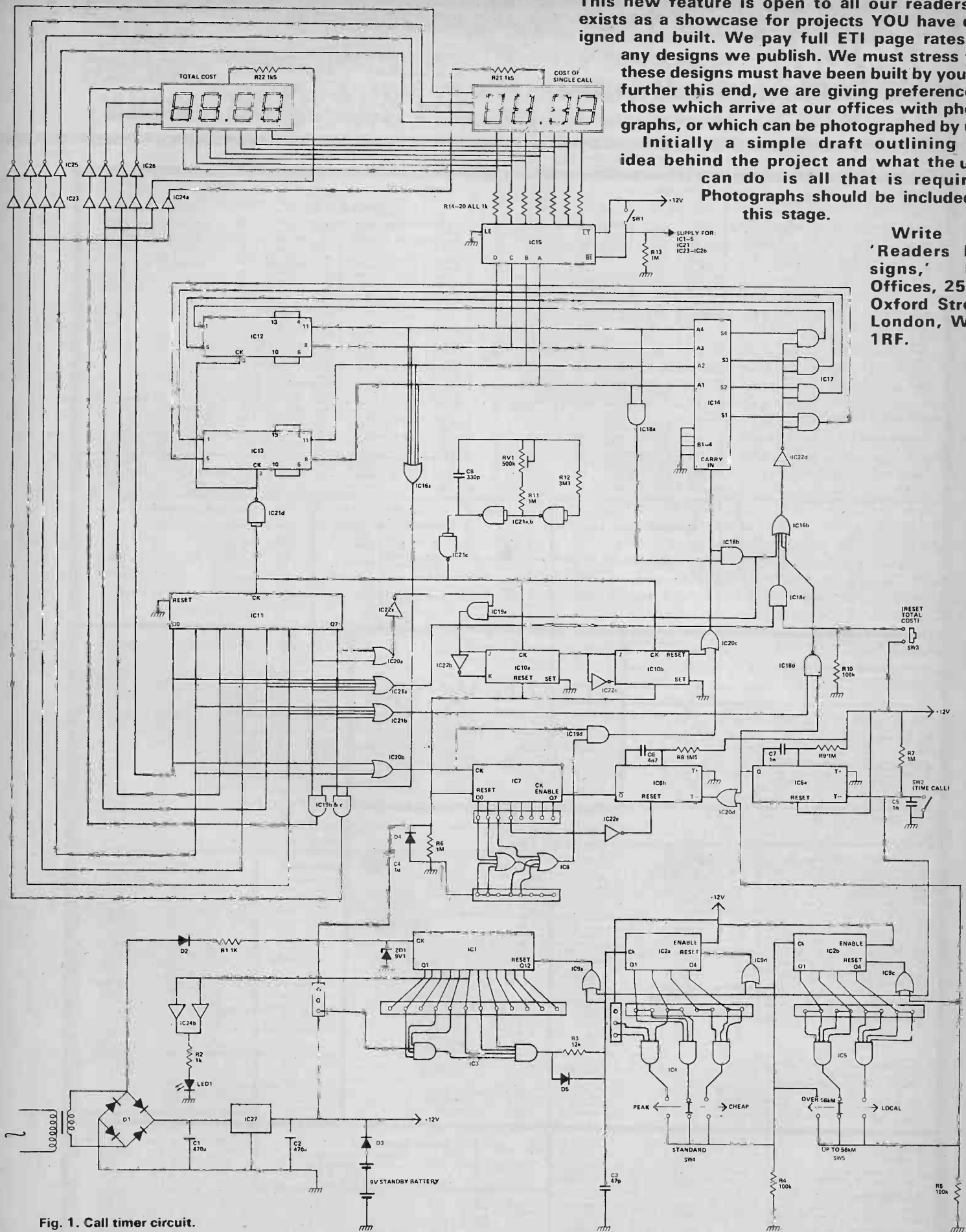
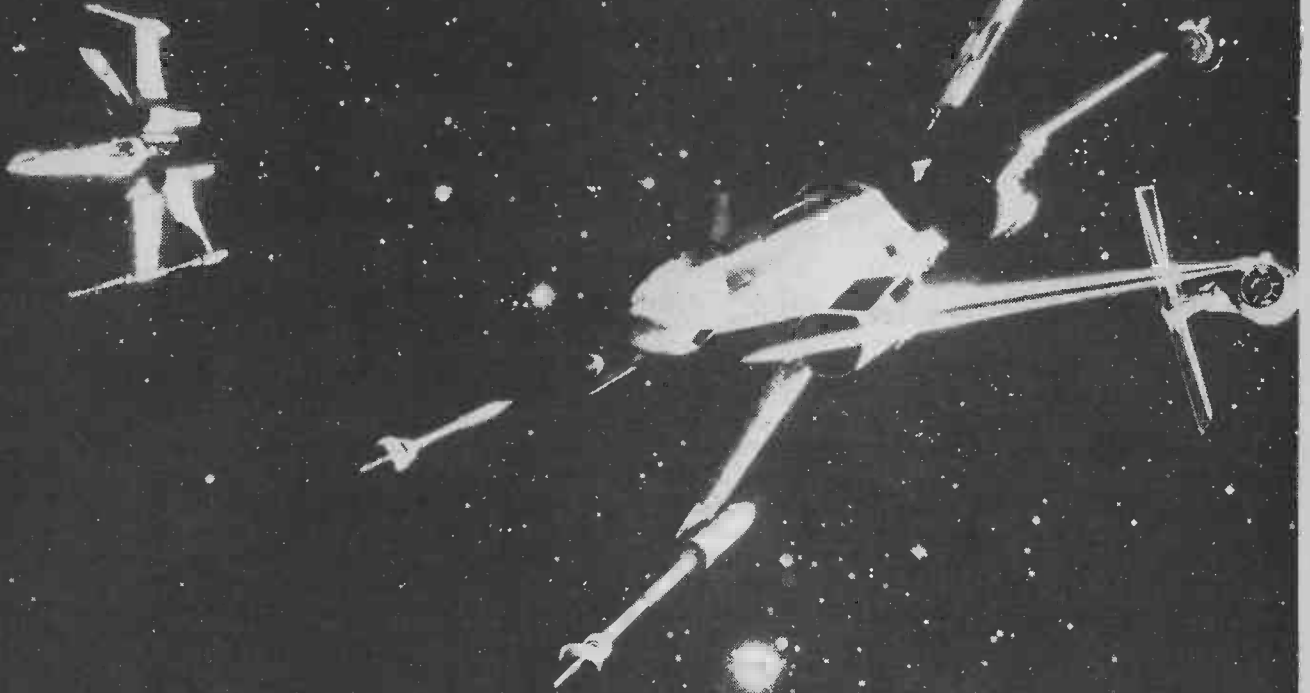

Fig. 1. Call timer circuit.

# AMBUSH



**AMBUSH! is bound to rate as the most fascinating, exciting, and addictive space game of the year. It gives visual and sound effects of a space battle, and is loaded with realism. Impress your friends (and enemies) by building this unique and fascinating game.**

(Photo by courtesy of 20th Century Fox)

AMBUSH! is a space game par excellence. It represents a space ship (yours) that is about to be attacked by a fleet of suicide craft. The craft can attack you on one of four randomly selected quadrants. The attacks come one at a time, at randomly selected intervals that vary between nought and five seconds. Your ship has a limited store of ammunition, and you can defend the vessel with one of four FIRE buttons. You have to hit the correct one of those buttons to stop the attack: if you hit more than one button at a time, you use up ammunition at an excessive rate.

The game continues until all the attacking craft are destroyed, or until you are wiped out. You can be wiped out by being too slow in hitting a FIRE button, by hitting the wrong FIRE button, or by running out of

ammunition through incorrect operation of the FIRE buttons. You can chose to face an attack by either ten (a DEK) or a hundred (a CENT) suicide craft: ammunition storage is automatically selected to suit the type of game chosen. A DEK game typically takes less than one minute to play. A CENT game takes several minutes.

## Sound And Light

The game is loaded with audio and visual effects. On the sound side, there are individual noises to represent an attack, or the operating of FIRE weapons, and to indicate the winning or losing of a game. The level of the ATTACK sound varies with the quadrant of attack; attacks from the forward quadrant are silent, those from port or starboard are at

half volume, and those from aft are at full volume.

The visual effects are also quite impressive. The attacks are shown by an array of LED's, arranged in the form of a cross with arms of varying lengths. The upper arm represents the forward attack quadrant, and comprises five orange LED's. The lower arm represents the aft attack quadrant, and comprises seven green LED's. The port and starboard arms each comprise six yellow LED's. At the centre of the cross is a red LED, representing your own ship.

The game is also provided with an ammunition level indicator, in the form of a three colour column of ten LED's, and with a two digit attack counter with seven-segment LED readouts. There are individual LED's to indicate the GAME WON and GAME LOST states. ▶

## Science Project

Ambush! is a CMOS based design of considerable technical interest, and should make an excellent educational project for schools and colleges. It uses seventeen IC's plus a couple of transistors. The IC types range from simple NAND and NOR gates to complete decade counter-decoder chips, and include flip-flops, data latches, 12-stage ripple counters, and multiplexers.

## Playing The Game

**Game Start.** The game starts as soon as power is applied to its circuits. A game can be restarted by pressing the RESET switch.

### Attacks:

- (1). The game can be set for play against either ten (a DEK) or a hundred (a CENT) attacks.
- (2). Attacks come at random intervals, variable between nought and approximately five seconds.
- (3). The quadrant of each attack is randomly selected, except for the first attack of the game, which always

comes from the aft quadrant.

(4). The speed of attack can be pre-set by the player, to suit skill levels. A 'respectable' attack speed is equal to about 50 mS per LED division on the quadrant attack indicator.

(5). At 'respectable' attack speeds, the player has approximately 250 mS of attack warning on the forward quadrant, 300 mS on the port and

starboard quadrants, and 350 mS on the aft quadrant.

(6). Attacks on the aft quadrant are accompanied by a full volume staccato sound. Port and starboard attacks are at reduced volume, and those from the forward quadrant are silent.

(7). The accumulated number of attacks is registered on a 2-digit display throughout the game.

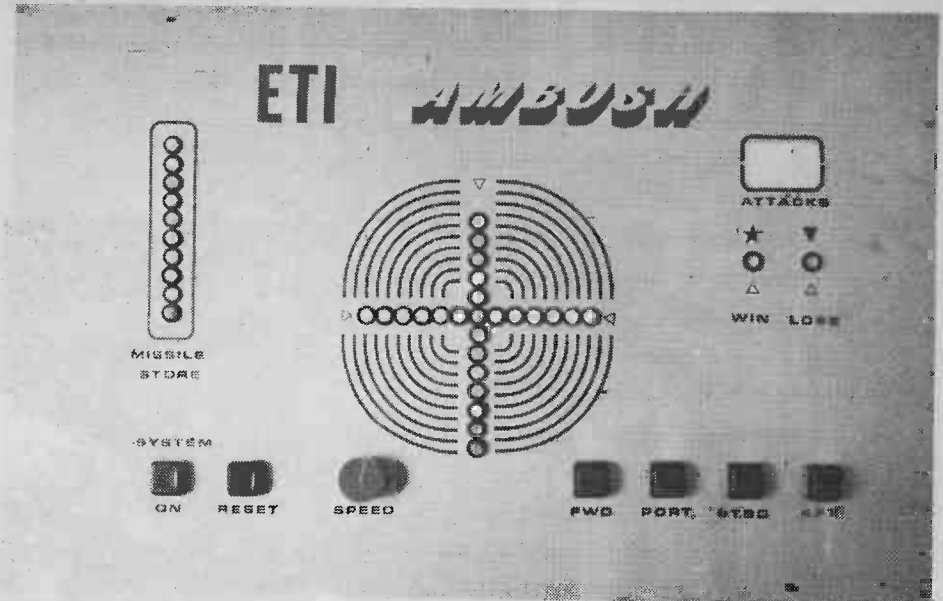

## HOW IT WORKS

### SIMPLIFIED BLOCK DIAGRAM OF THE AMBUSH GAME

The heart of the unit is the 'Display Matrix Driver and Logic' block, which in reality takes the form of a 4017 decade counter with ten decoded outputs. Outputs 1 to 7 of the counter are fed to the LED display matrix, and outputs 6 to 8 are selectively fed via a multiplexer to the GAME LOST indicator block and to the CLOCK DISABLE pin of the 4017. The input of the 4017 is derived from a clock generator via a gate, which in turn is controlled by a simple START-STOP (Reset/Set) bistable.

The operating sequence of the above six blocks is fairly simple. Initially, the bistable is in the STOP mode, the gate is closed, the 4017 is in the RESET state and all LED's in the display matrix are off. At some randomly determined time a START pulse is fed to the bistable, the gate opens, clock pulses start to reach the 4017, and LED's are sequentially switched on in one of the arms of the display matrix. If the gate remains open, one of the selectively chosen 6-7-8 outputs of the IC eventually goes high and operates the GAME LOST indicator and disables the clock input line of the 4017.

Alternatively, the bistable can be set to the STOP mode before the game terminates by operating the appropriate FIRE switch. In this case the bistable closes the clock gate, and the 4017 resets to the zero state. A new sequence of operations starts when another random START pulse is fed

to the input of the bistable. Note that output 1 of the 4017 is fed to the ATTACK COUNTER, so that the counter advances by one count each time the clock genera-

tor gate opens. The game ends shortly after the attack counter reaches its full (at 10 or 100) state, at which point the GAME WON indicator circuits come into operation.

The START signal to the bistable is derived from the random delay generator which is integral with the FIRE switch circuitry. In each attack, the appropriate one of the four FIRE switches is selectively coupled to the STOP side of the

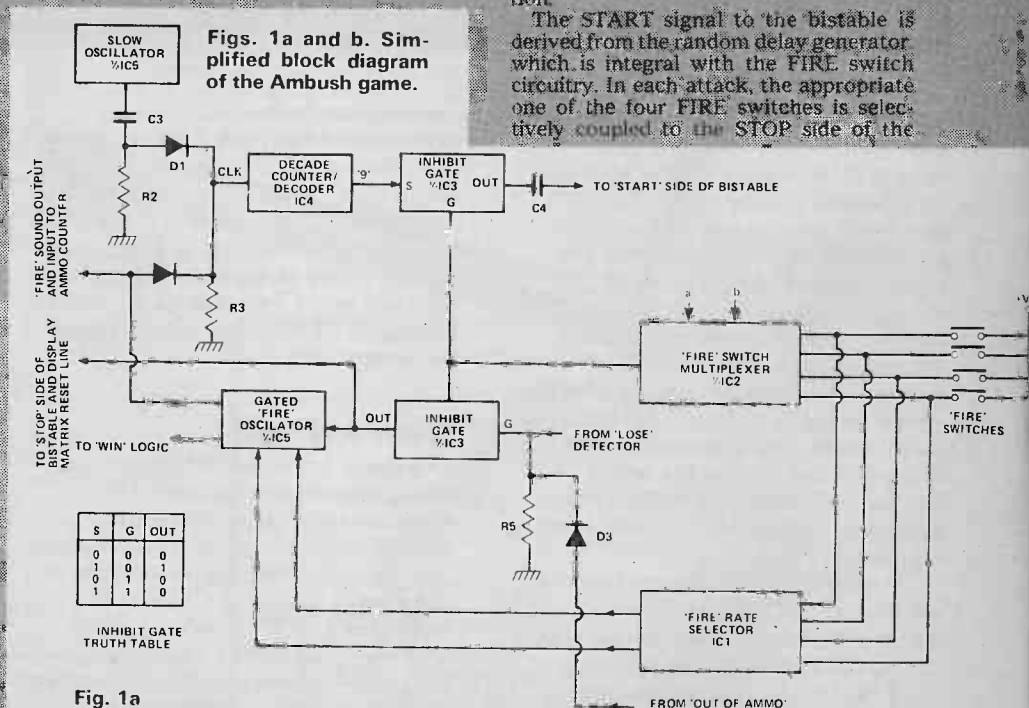

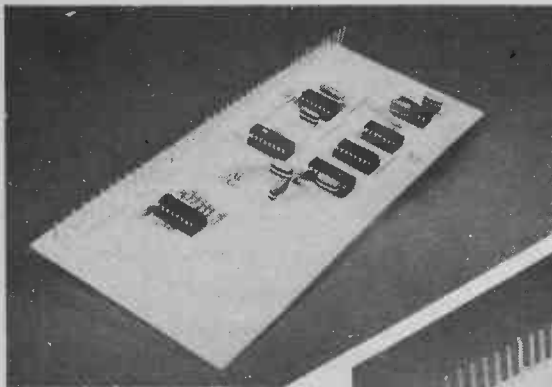

(left) ICs 2 and 6-11 mounted on an Ambush PCB.

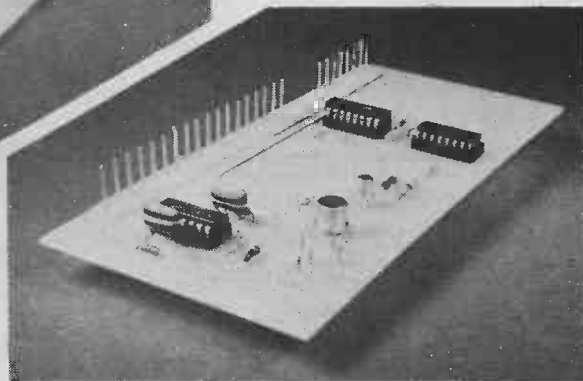

(right) This board carries LED display matrix drivers, multiplexers and logic, plus audio and power connections.

## Defence

(a). The player has four FIRE buttons for defence. The buttons are marked F (forward), P (port), S (starboard), and A (aft). To stop an attack, the player must press the FIRE button appropriate to the prevailing attack quadrant, before the attacking vessel reaches its target (the red LED at the centre of the display). A correct firing is accompanied by a rasping sound.

No sound is produced if the wrong button is pressed.

(b). The ship has sufficient ammunition to fight off attacks only if each FIRE duration is limited to about 100 mS or less. Thus, there is sufficient ammunition for about one second of continuous fire in the DEK game, and ten seconds of fire in the CENT game. The ammunition state is shown on a register throughout the game.

(c). When the correct FIRE button is pressed, the rate of ammunition usage is directly proportional to the total number of FIRE buttons that are pressed at that time. Thus, if all the fire buttons are pressed at once, the ammunition supply will exhaust in 0.25 seconds in the DEK game or 2.5 seconds in the CENT game. The audio frequency of the FIRE sound is proportional to the rate of ammunition usage. When the ammunition store is exhausted, the player has no defence, and loses the game after the next attack.

**Game Lost.** The player loses the game by having his starship hit by an attacking suicide craft. When the game is lost the red LED at the centre of the attack quadrant indicator turns off, and simultaneously a loud droning noise is generated and a red GAME LOST LED flashes on the control panel.

**Game Won.** The player wins the game by defeating all attacks. At GAME WON a green LED illuminates on the control panel, and a coarse beating or throbbing sound is generated.

bistable via a multiplexer, and a simulated fire' sound is generated if the operator activates the correct switch; the frequency of the 'fire' sound is determined by the FIRE RATE SELECTOR circuit, and is proportional to the total number of FIRE switches' pressed at any given moment.

The output of the fire sound generator is used to drive the ammunition register, which counts and gives a visual readout of the total number of cycles generated. The sound is also used to generate a latched random 'select' code for the four multiplexers that are used in the game. These multiplexers are used for FIRE

switch selection, for LED Display Matrix line and line length selection, and to determine the audio levels of the ATTACK sounds.

The ATTACK, FIRE, WIN and LOSE sound signals are all fed to a simple two-transistor audio amplifier, which drives a 10 ohm output speaker.

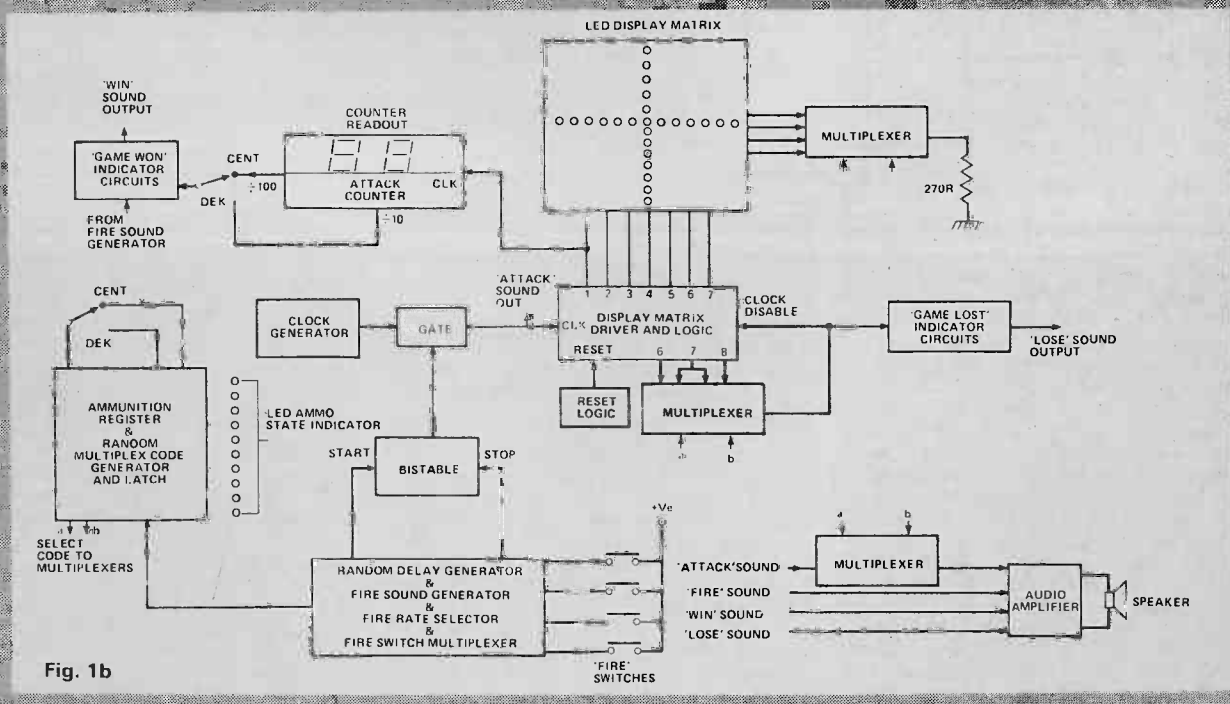

Fig. 1b



# HOW IT WORKS

RANDOM DELAY and 'FIRE' SOUND GENERATOR, plus 'FIRE' RATE SELECTOR and 'FIRE' SWITCH MULTIPLEXER.

THIS IS probably the most complex 'block' in the entire game, because most of its individual sections are interdependent. Fig. 2 shows the circuit diagram of this major 'block'.

## THE 'FIRE' SOUND GENERATOR

Let's deal first with the 'FIRE' SOUND GENERATOR. IC2 is one half of a 4052 dual 4-channel multiplexer. This connects a selected one of its four inputs to its output, depending on the 'a-b' binary code signal that is fed to its 'select' (pins 9 and 10) terminals. Thus, when the appropriate one of the four FIRE switches is pressed, a logic-1 signal appears at output pin-3 of the multiplexer. This signal is 'debounced' by R6-C6 and R7 and is passed to the signal input of the INHIBIT GATE formed by IC3/3 and IC3/4.

It passes signals only when its GATE input is at logic-0; pin-1 is the 'G' terminal of this particular gate, and is tied to ground via R5, but can be driven high by the outputs of the LOSE and OUT OF AMMO detectors. The gate thus passes on the FIRE switch signals, only when the

game is not lost and the ammunition store is not exhausted.

The output of the inhibit gate is used to activate a gated 'FIRE' sound oscillator designed around IC5/3 and IC5/4. The main timing components of this oscillator are C2 and R12 to R15. These timing resistors are connected via IC1, which is a 4016 quad bilateral switch, which has each of its four internal switches activated by one of the four FIRE switches; these internal switches are normally open, and close when their appropriate FIRE switch is closed.

Thus, the complete action of the 'FIRE' sound generator is such that a sound is produced only when the 'correct' FIRE switch is pressed, and only when the game is not lost or the ammunition exhausted. The frequency of the sound is proportional to the total number of FIRE switches pressed and varies from about 800 Hz for one switch, to about 320 Hz for four switches.

The pin-4 output of the 'FIRE' oscillator is low in the normal quiescent state, and its signals are passed to the input of an audio amplifier for sound effects and also to the inputs of the ammunition register and the Random Delay generator. An inverted output (normally high) is also taken from the pin-3 output of the oscillator and is fed to the WIN LOGIC circuitry. Note that the gate input signal of the oscillator is also fed to the STOP

side of the bistable and to the RESET pin of the display matrix driver, so that IC12 is reset each time the correct FIRE switch is pressed.

## THE RANDOM DELAY GENERATOR

The heart of the random delay generator is IC4, a 4017 decade counter with ten decoded outputs (numbered 0 to 9); the '9' output of the counter is coupled to the START side of the bistable via a normally-ON inhibit gate. The clock input to the counter is derived from a slow (about 2 Hz) oscillator (IC5/1 and IC5/2) and from the 'FIRE' oscillator output via an OR gate formed by D1-D2 and R3.

Whenever the correct FIRE button is pressed during an attack a logic-1 signal is fed to the 'G' (pin 13) terminal of the inhibit gate, which turns off and blocks the signals from the 4017 counter. Simultaneously, the clock signals are fed into the counter from the 'FIRE' sound generator. Consequently, when the FIRE switch is released and the inhibit gate returns to the ON state the counter is an unknown or random number of steps from the '9' count (which is the one that provides the START signal to the bistable). Clock signals are then fed to the counter from the slow oscillator, only until, after a delay that is infinitely variable from zero to about five seconds, the counter reaches the '9' state and feeds a START command to the bistable.

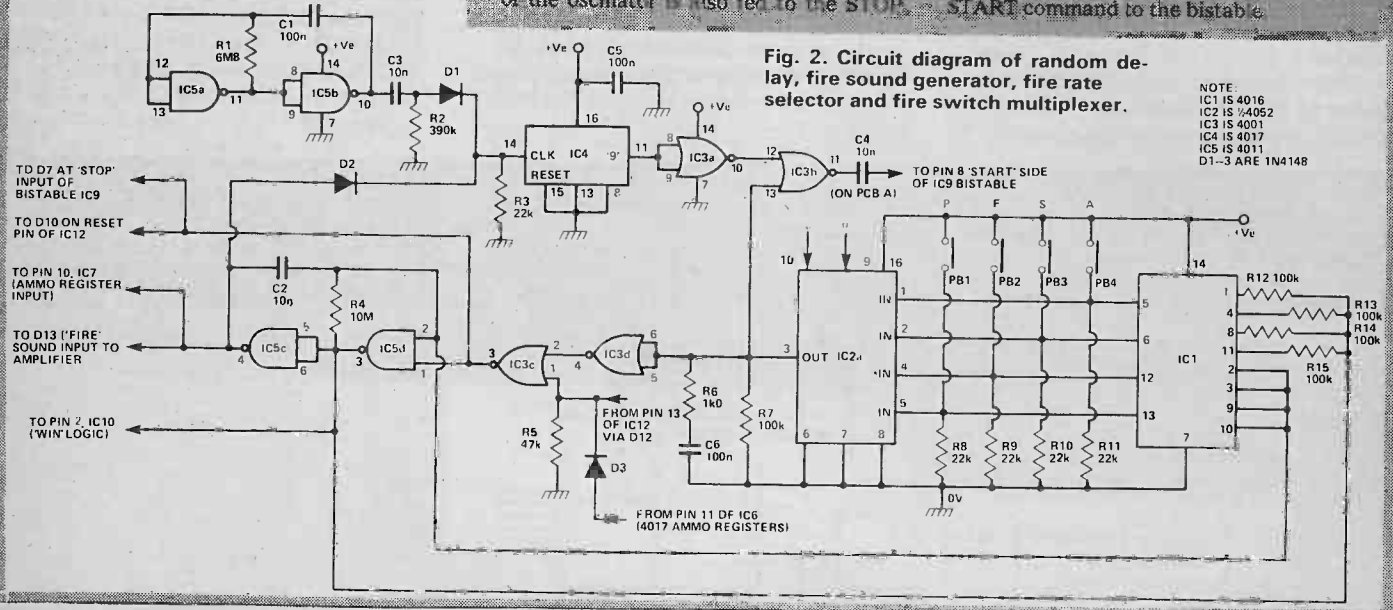

Fig. 2. Circuit diagram of random delay, fire sound generator, fire rate selector and fire switch multiplexer.

NOTE:  
IC1 IS 4016  
IC2 IS 4052  
IC3 IS 4001  
IC4 IS 4017  
IC5 IS 4011  
D1-3 ARE 1N4148

# HOW IT WORKS

THE BISTABLE, CLOCK GENERATOR, 'ATTACK' SOUND MULTIPLEXER, AND 'GAME LOST' INDICATORS

THE BISTABLE is a simple R-S type, made from a pair of NOR gates (IC9/1 and IC9/2). Its 'START' input is derived from the random delay generator via C4, and 'STOP' inputs are obtained from the 'FIRE' logic or the 'GAME LOST' detector circuitry via the D6-D7-R30 diode OR gate. The pin-1 output of the bistable is normally high, but goes low in the 'START' mode, and is fed to one input of the IC10/3 NOR gate, which provides the clock input signal to IC12 (the display matrix counter-driver). The other input of the NOR gate is obtained from the

variable-speed CLOCK GENERATOR (IC10/1 and IC10/2) or from the WIN DETECTOR circuitry via the D4-D5-R28 diode-OR gate.

Thus, input pin-6 of the NOR gate is normally high, and its output is locked low, so it is unable to pass clock signals. When a 'START' signal is fed to the bistable from the random delay generator, input pin-6 of the gate is driven low, and it does pass clock signals. The gate is turned off again when a 'STOP' signal is fed to the bistable from the 'FIRE' logic circuitry. Note that the gate gets locked into the off state if a logic-1 signal is fed to its pin-5 input from the 'WIN' detector (via D4), or if a logic-1 'GAME LOST'

signal is fed to the 'STOP' side of the bistable via D6.

The IC10/1 and IC10/2 clock generator determines the speed of any attack, and its frequency is variable via R-V1. The clock signal appearing at the pin-11 output of the IC10/3 NOR gate provides the basic 'ATTACK' sound of the game. The amplitude of this sound is determined by multiplexer IC2/2 and resistors R31 and R32. Attacks from the aft quadrant are at full volume, those from port or starboard are at reduced volume, and those from the forward quadrant are silent.

The 'GAME LOST' indicators use four NAND and one NOR gates; their basic input signals are obtained from pin-13 of IC12, which is normally low but goes high under the game lost condition. IC9/3 is wired as a simple inverter, and drives the

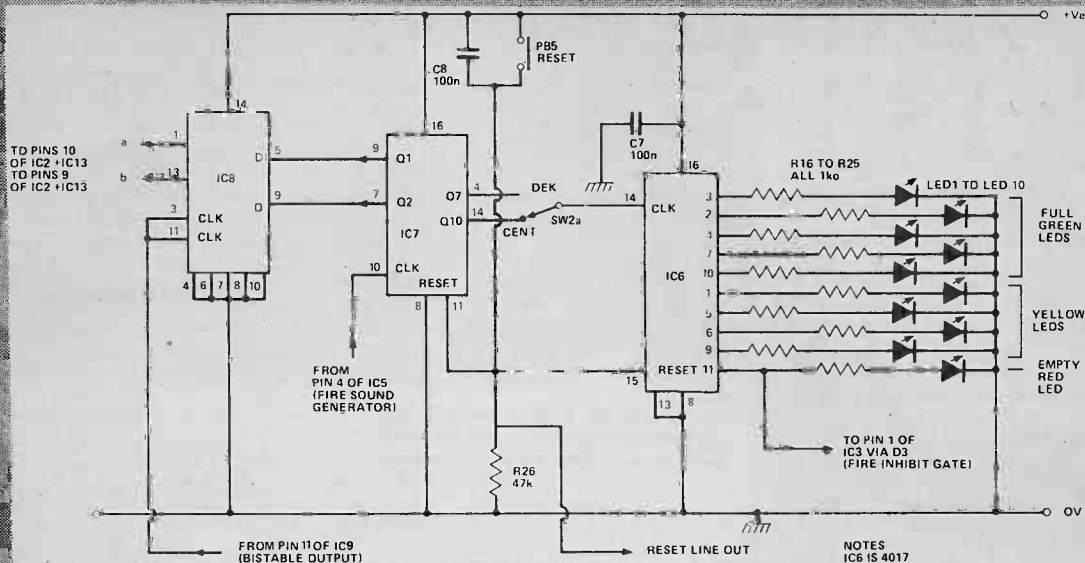

Fig. 3. Circuit diagram of ammo register, random multiplex code generator and latch with the reset line control.

NOTES  
IC6 IS 4017  
IC7 IS 4040  
IC8 IS 4013  
LEDS 1 TO 5 ARE 0.2" GREEN  
LEDS 6 TO 9 ARE 0.2" YELLOW  
LED 10 IS 0.2" RED YELLOW

## HOW IT WORKS

THE AMMO REGISTER, RANDOM MULTIPLEX CODE GENERATOR AND LATCH, AND RESET LINE CONTROL. THIS BLOCK is relatively simple in its theory of operation. IC7 is a 4040 12-stage ripple counter, and takes its clock input from the output of the FIRE sound generator. IC8 is a 4013 dual D flip-flop, which is wired as a dual data latch with its clock signal taken from the output of the bistable and its data taken from the Q1 (+2) and Q2 (+4) outputs of IC7. Thus, whenever a FIRE button is pressed and then released IC7 sets randomly determined states on the data inputs of IC8, the next time that the output of the bistable goes high (as an attack begins, on receipt of the bistable START command) these states are latched into the 4013 and are

pressed on to the games multiplexers as a 2-bit binary code.

IC6 is yet another 4017 decade counter with ten decoded outputs. It has its outputs fed to a vertical line of ten LED's, which act as the ammunition register. The 0' output of the 4017 goes to the top (FULL level) of the line, and the 9' output goes to the bottom (EMPTY level) of the line. The 9' output also goes to the inhibit gate controlling the FIRE oscillator, preventing the oscillator from working under the 'ammo exhausted' condition. At the start of each game the counter is reset to zero, so that the line of LED's indicate the FULL state.

The clock input of the counter is taken from one of the outputs of the IC7 ripple counter via SW2a. When SW2 is set for a

DEK (ten-attack) game the Q7 (+128) output is fed to the clock input of IC6, giving a clock signal of about 6.2 Hz; when a single FIRE button is operated, and thus causing the register to empty in about 1.5 seconds. When SW2 is set for a CENT (hundred attack) game the Q10 (+1024) output is fed to IC6, giving a clock frequency of about 0.8 Hz from a single FIRE button, and causing the register to empty in about 11.2 seconds. Thus, to win a DEK game the average FIRE duration must be limited below 150 mS in each attack, and in the CENT game it must be limited below 112 mS.

The games main reset line is activated automatically at switch on via CA. The line can be operated manually at any time via RESET button PB5.

red LED at the centre of the games main display matrix. This LED is normally on, but goes off when the game is lost.

IC11/1 and IC11/2 are wired as a medium-speed gated astable, which provides the 'GAME LOST' sound output via D9 and R34, and IC11/3 and IC11/4 are

wired as a low-speed gated astable, which drives a red 'GAME LOST' LED. Both astables are normally off, with their outputs low. Under the 'GAME LOST' condition both astables operate, the 'LOSE' sound is generated and the 'LOSE' LED flashes on and off.

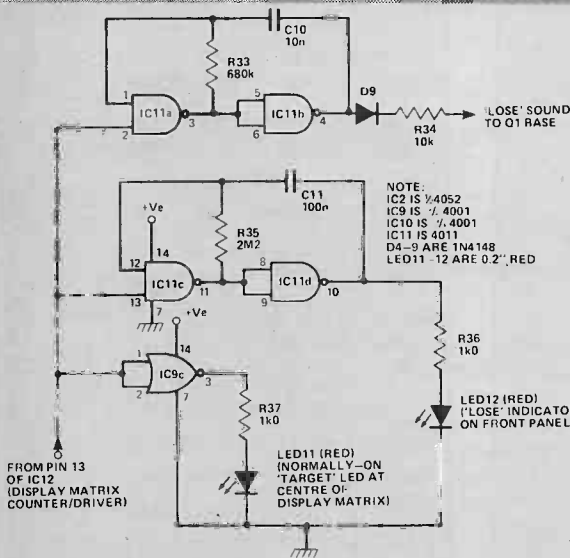

NOTE:  
IC2 IS 4052  
IC9 IS 4001  
IC10 IS 4001  
IC11 IS 4011  
D4-9 ARE 1N4148  
LED11-12 ARE 0.2" RED

Fig. 4 (left) Display matrix counter/driver, target LED and 'LOSE' indicator.

Fig. 5. (right) Bistable, clock gen., 'ATTACK' sound multiplexer and 'GAME LOST' indicators.

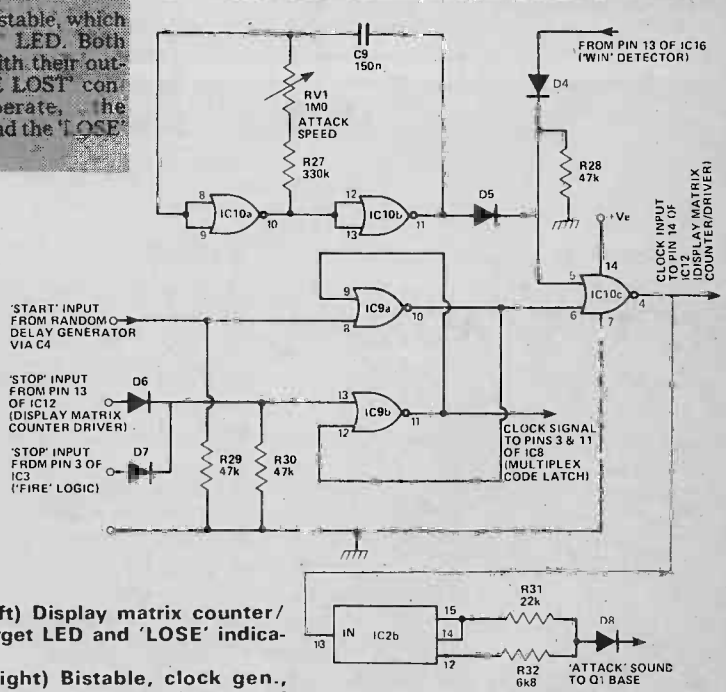

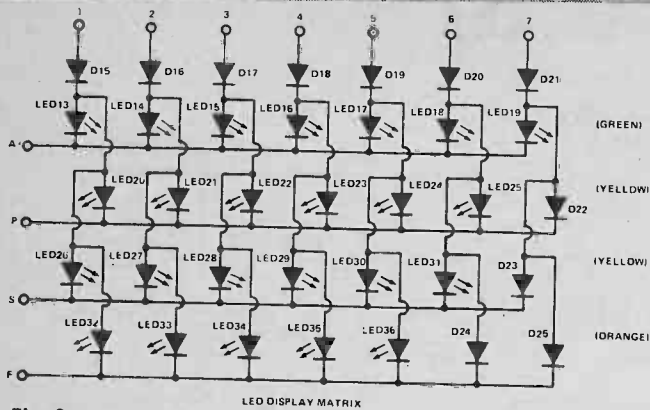

Fig. 6a. LED display matrix.

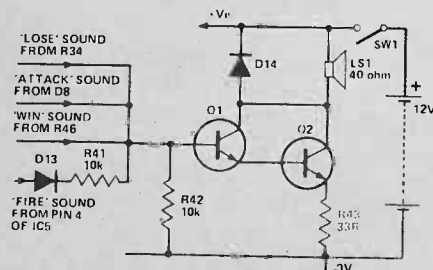

Fig. 6c. Audio amplifier.

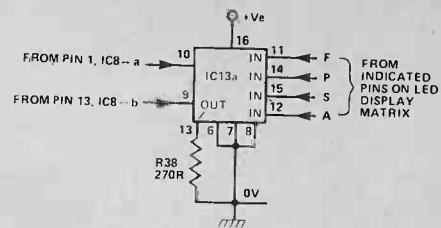

Fig. 6b. Line selection.

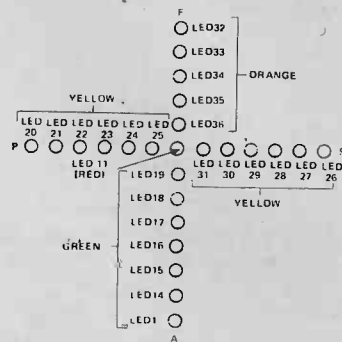

Fig. 6d. Panel LED display.

## HOW IT WORKS

### LED DISPLAY MATRIX DRIVERS, MULTIPLEXERS, AND LOGIC, PLUS AUDIO AMPLIFIER AND POWER SUPPLY CONNECTIONS

THE MAIN PART of the LED display matrix is made up of four lines of LED's, arranged in the form of a cross. The upper (Forward) line is five LED's long, the lower (Aft) line is seven LED's long, and the other two lines are each six LED's long. The individual LED's in each line are selected by IC12, a 4017 decade counter with ten decoded outputs, and the lines are selected by multiplexer IC13/1. Note that diodes D15 to D25 are used to eliminate sneak paths in the matrix, and ensure that only a single selected LED

turns on at any one time. Figure 6b shows the positions of the LED's in the actual display. Note that LED 11, at the centre of the display, is normally on and represents the player's own vessel.

Prior to the start of each attack IC12 is in the RESET state, so all LED's in the matrix (except LED 11) are off. As soon as an attack starts, IC13/1 selects a line of length 'n' in the display matrix, and IC13/2 connects the 'n+1' output of IC12 to its own pin-13 'clock disable' terminal. Thus, when an attack starts the LED's in the selected line turn on sequentially and run towards the centre of the cross; if a RESET signal is fed to pin-15 of IC12 from the 'FIRE' logic circuitry before the 'n+1' state is reached, the attack is defeated; if

the attack is not defeated, pin-13 of IC12 is driven high as the counter reaches the 'n+1' state, and all further clock signals are inhibited and all GAME LOST indicators are activated.

All sound effects signals that are generated in the game are digital in form, and are fed via gate diodes and amplitude-determining resistors to the simple Q1-Q2 audio amplifier stage, which is unbiased. The amplifier directly drives a 40R speaker, which has transient limiting provided by D14.

The game is powered by a 12V battery supply, and typically consumes 50 mA to 150 mA of current, depending on the state of play. Readers can, if they wish, power the game via a simple mains adaptor.

## PARTS LIST

R1	6M8	SEMICONDUCTOR	
R2	390k	IC1	4016
R3, 8, 9, 10, 11, 31, 40, 48	22k	IC2, 13	4052
R4	10M	IC3, 9, 10	4001
R5, 26, 28, 29, 30, 31	47k	IC4, 6, 12	4017
R6, 16-25, 36, 37, 47	1k	IC5, 17, 11	4011
R7, 12, 13, 14, 15	100k	IC7	4040
R27	330k	IC8, 16	4026
R32	6k8	IC14, 15	4013
R33	680k	NOTE: All CMOS devices are B Series.	
R34, 41, 42, 46	10k	Q1	BC109
R35	2M2	Q2	BFY50
R38	270R	D14	1N4001
R43	33R	All other diodes are	1N4148
R44, 45	1M5	LED 1-37 are standard 0.2in dia.	
R49-62	470R	LED 7 segment displays are common	
POTENTIOMETER		cathode 0.3in	
RV1	1M0	MISCELLANEOUS	
CAPACITORS		LS1 2in 40R	
C1, 5, 6, 7, 8, 11, 14, 15	100n	5 off SPST push buttons	
C2, 3, 4, 10, 12, 13	10n	1 off SPST latching push button	
C9	150n	1 off DPDT min. toggle	
		8 off HP11	
		2 off 4 section battery holders	
		case to suit	

## BUYLINES

The case we used for the Ambush project is available from Boss Industries. Full details next month. Since panel layout is not critical, inventive ETI readers may be able to come up with their own hardware designs. All the ICs are common types, available from most component mail order firms.

If you think you are likely to spend every waking hour zapping the starfleet, it's worthwhile investing in a mains adaptor, available from your local Tranny shop.



# HOW IT WORKS

## THE ATTACK COUNTER AND GAME WON DETECTOR AND INDICATORS

THE '1' OUTPUT of IC12 (the display matrix driver) briefly goes high at the start of each attack. This '1' signal provides the clock signal to the IC14-IC15 ATTACK COUNTER. These two IC's are 4026 decade counters with decoded outputs suitable for directly driving common cathode 7-segment LED displays at low power levels. The two counters are cascaded, to give 00 to 99 indications:

leading zero suppression is not used in the counter.

The 'GAME WON' detector is designed around IC16, a 4013 dual D flip-flop, and IC10/4, a NOR gate. IC16/1 is connected as a bistable divider stage, and is clocked via one or other of the attack counter outputs. The action is such that its Q output is normally high, but switches low at the start of the 10th attack in a DEK game or the 100th attack in a CENT game. The Q output is fed to one of the inputs of the IC10/4 NOR gate, which has its other

input provided from the normally-high output of the IC5 'FIRE' sound generator. The output of the NOR gate is fed to the SET (pin-8) terminal of IC16/2, which is wired as an R-S flip-flop. Both bistables are reset at the start of each game.

The action of the complete 'GAME WON' detector is such that 'FIRE' signals are fed to one input of the NOR gate each time a 'FIRE' signal is generated, but are unable to reach IC16/2 until IC16/1 changes state after the start of the 10th (in a DEK game) or 100th (in a CENT game) attack, at which point the Q output of IC16/2 goes low and drives green 'WIN' LED 37 'ON' via IC9/4, and the Q output goes high and activates the 'WIN' sound generator.

The 'WIN' sound generator is designed around IC17, and consists of two virtually identical medium-frequency gated astable multivibrators, which are operated in parallel and have their outputs fed to the audio amplifier via the D26-D27-R46 diode OR gate. Because of inevitable slight differences in timing component values, these two astables oscillate at slightly different frequencies, and produce a coarse 'beating' or 'throbbing' sound when they are activated by the 'WIN' detector.

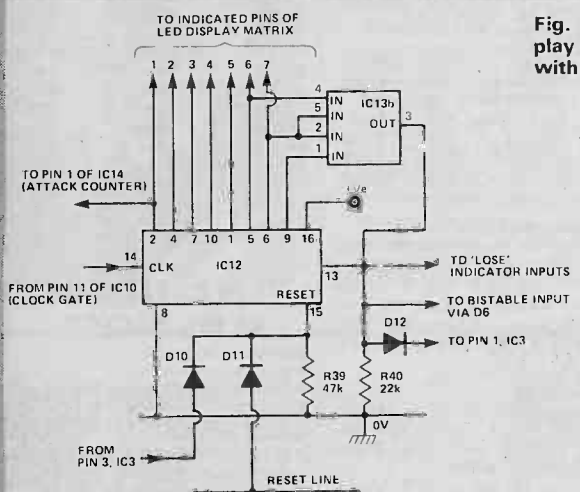
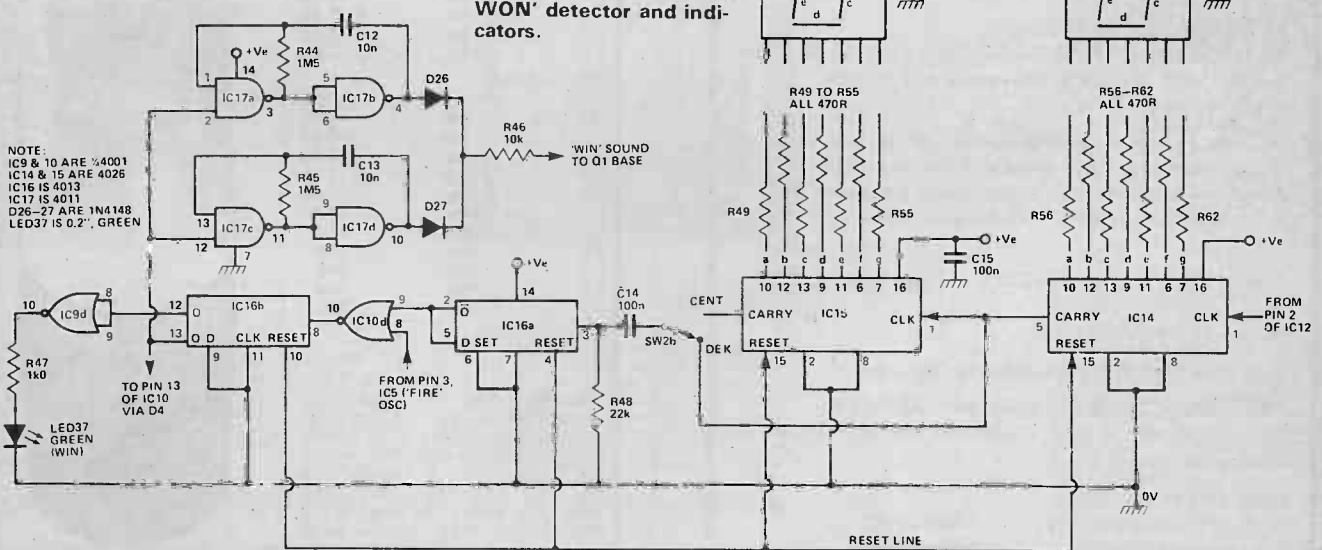

Fig. 7 (left) Circuit diagram of display drivers, multiplexers and logic with audio and power connections.

NOTE:  
IC12 IS 4017  
IC13 IS 4052  
O1 IS BC109  
O2 IS BFY50  
D11-13 ARE 1N4148  
D14 IS 1N4001  
D15-25 ARE 1N4148  
LED13-15 ARE 0.2" GREEN  
LED20-31 ARE 0.2" YELLOW  
LED32-36 ARE 0.2" ORANGE

Fig. 8 (below) Attack counter and 'GAME WON' detector and indicators.



*Next month we conclude the project with full constructional details and component overlays. In addition we'll show you the act of inspired heroism which led to the saving of the starship Eatyeigh and the designing of this project! For those who to get started the Parts List and circuit diagrams given here are complete.*



# 3080 CIRCUITS

The 3080 is not a run of the mill op amp. These ten circuits from Tim Orr show you why.

The CA3080 is known as an operational transconductance amplifier, (OTA). This is a type of op amp, the gain of which can be varied by use of a control current, (I<sub>ABC</sub>). The device has a differential input, a control input known

as the 'Amplifier bias input' and a current output. It differs in many respects from conventional op amps and it is these differences that can be used to realize many useful circuit blocks.

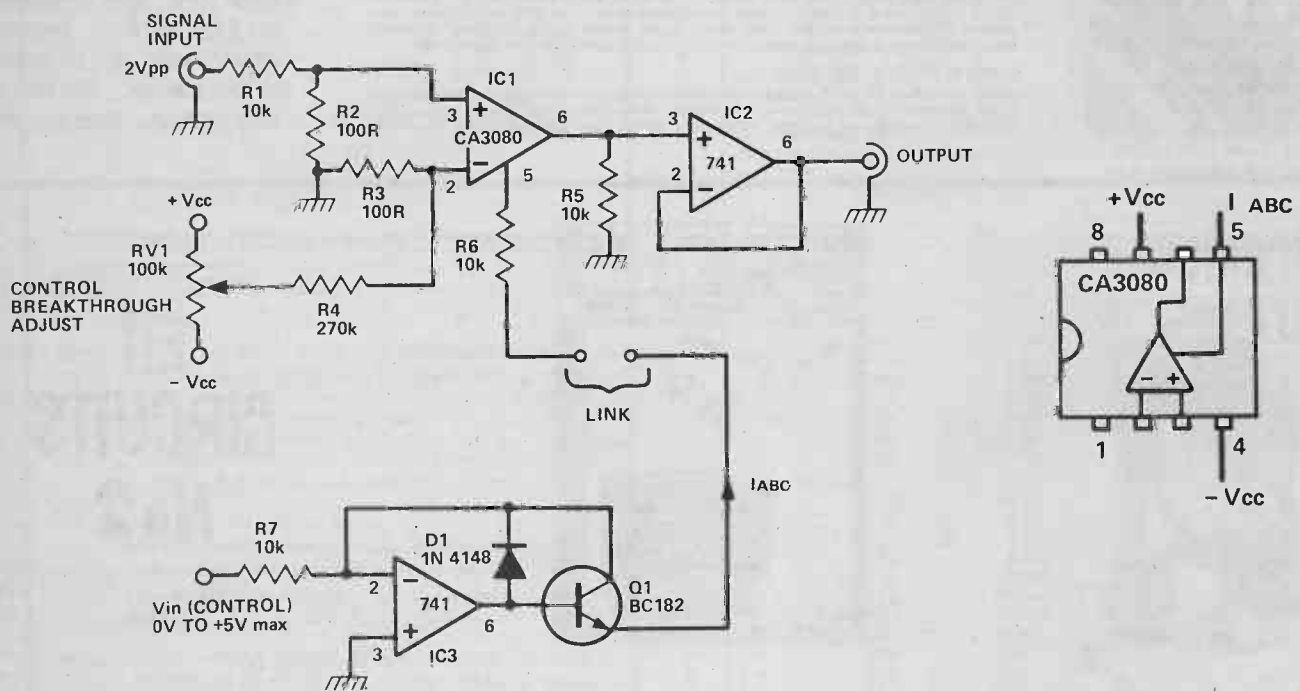

## Voltage Controlled Amplifier

The CA3080 can be used as a gain controlling device. The input signal is attenuated by R1, R2 such that a 20 mVpp signal is applied to the input terminals. If this voltage is much larger, then significant distortion will occur at the output. In fact, this distortion is put to good use in the triangle-to-sinewave converter. The gain of the circuit is controlled by the magnitude of the current I<sub>ABC</sub>. This current flows into the CA3080 at pin 5, which is held at one diode voltage drop above the -V<sub>cc</sub> rail. If you connect pin 5 to 0 V, then this diode will get zapped, (and so will the IC)! The maximum value of I<sub>ABC</sub> permitted is 1 mA and the device is 'linear' over 4 decades of this current. That is, the gain of the CA3080 is 'linearly' proportional to the magnitude of the I<sub>ABC</sub> current over a range of 0.1µA to 1 mA. Thus, by controlling I<sub>ABC</sub>, we can control the signal level at the output. The output is a current output which has to be 'dumped' into a resistive load (R5) to produce a voltage output. The output impedance seen at IC1 pin 6 is 10k (R5), but this is 'unloaded' by the voltage follower (IC2) to produce a low output impedance. The circuit around IC3 is a precision voltage-to-current converter and this can be used to generate I<sub>ABC</sub>. When Vin (control) is positive, it linearly controls the gain of the circuit. When it is negative, I<sub>ABC</sub> is zero and so the gain is zero.

This type of circuit is known by several names. It is a voltage controlled amplifier, (VCA), or an amplitude modulator, or a two

quadrant multiplier.

One problem that occurs with the CA3080 is that of the 'input offset voltage'. This is a small voltage offset between its input terminals. When there is no signal input and the control input is varied a voltage similar to the control input will appear at the output. By adjusting RV1 it is possible to null out most of this control breakthrough.

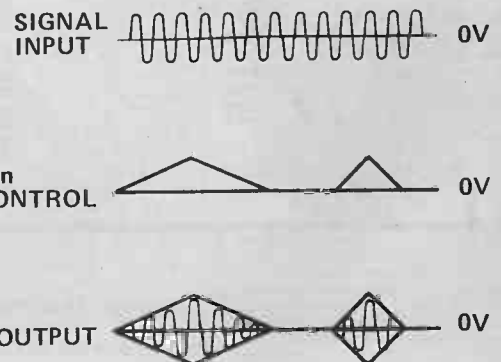

**ILP MODULES 15-240 WATTS**

We are now stockists for these world famous fully guaranteed (2 years guarantee on all modules) Pre amps, Amplifiers & Power Supplies.

- HY5** Preamplifier. Input, magnetic pickup 3mV, ceramic 30mV. Output: Mains 500mV RMS, Distortion 0.1% at 1KHz. Price: **£6.27**
- HY30** Amplifier Kit. 15 Watts into 8Ω, extremely easy to construct. Output 15W RMS, Distortion 0.1% at 15W Freq. 10Hz-16KHz. Supply + 18V. Price: **£6.27**
- HY50** Hi-Fi Amplifier Module. 25 Watts 8Ω. Input Sensitivity 500mV. Output 25W RMS, Distortion 0.04% at 25W. Freq. 10Hz-45KHz. Supply + 25V. Price: **£8.18**
- HY120** Amplifier Module — 60 Watts 8Ω. Input sens. 500mV. Output 60W RMS, Distortion 0.04%. Freq. 10Hz-45KHz. Power Supply + 35V. Price: **£18.98\***
- HY200** Hi-Fi/Disco Amplifier Module — 120 Watts 8Ω. Input sens. 500mV 120W RMS, Freq. 10Hz-45KHz. Power Supply + 45V. Size 114 x 100 x 85mm. Price: **£27.99\***
- HY400** (Big Daddy) Amplifier Module — 240 Watts 4Ω. Ideal for High Power Disco or P.A. Output 240 Watts RMS 4Ω 114 x 100 x 85mm. Distortion 0.1%. Price: **£38.60\***



- POWER SUPPLIES**
- PSU36 — Drives 2 x HY30s **£6.44**
  - PSU50 — Drives 2 x HY50s **£8.18**
  - PSU70 — Drives 2 x H120s **£14.58\***
  - PSU90 one HY200 **£15.10\***
  - PSU180 2 x HY200 or one HY400 **£25.42\***

JACK PLUGS		SOCKETS		SWITCHES*		SLIDE 250V	
Screened chrome	Plastic body	open metal	moulded with break contacts	in line couplers	SPST	1A DPDT	1A DPDT c/over
2.5mm 13p	10p	8p	11p	28p	1A DPDT	13p	13p
3.5mm 15p	10p	8p	12p	34p	4 pole 2-way	24p	24p
MONO 25p	14p	13p	17p	DPDT	<b>PUSH BUTTON</b>		
STEREO 32p	17p	15p	22p	4 pole on/off	Spring loaded		
					SPST on/off	60p	
					SPDT c/over	65p	
					DPDT 6 Tag	85p	
					4 pole 2-way		
					<b>MINIATURE</b>		
					Non Locking		
					Push to Make	15p	
					Push Break	25p	

DIN	PLUGS	SOCKETS	In Line
2 PIN Loudspeaker	10p	7p	20p
3, 4, 5 Audio	15p	10p	20p

C-O-AXIAL (TV)	PLUGS	SOCKETS	In Line
	14p	14p	14p

PHONO	PLUGS	SOCKETS	In Line
assorted colours	10p	5p single	12p
Metal screened	15p	8p double	20p
		15p 4-way	

BANANA	PLUGS	SOCKETS	In Line
4mm	11p	12p	—
2mm	10p	10p	—
1mm	6p	6p	—

WANDER 3mm	PLUGS	SOCKETS	In Line
DC Type	6p	6p	—
AC 2-pin American	15p	20p	—

**TRANSFORMERS\*** (Mains Prim. 220-240V)

6.0-6V, 9.0-9V, 12.0-12V 100mA	95p
8VA: 6V-5A 6V-5A; 9V-4A 9V-4A; 12V-3A 12V-3A; 15V-2.5A 15V-2.5A	195p
12V-4.5V-1.3A 4.5V-1.3A; 6V-1.2A 6V-1.2A; 12V-5A 12V-5A; 15V-4A 15V-4A; 20V-3A 20V-3A 220p (20p p&p)	
24VA: 6V-1.5A 6V-1.5A; 9V-1.3A 9V-1.3A; 12V-1A 12V-1A; 15V-8A 15V-8A; 20V-6A 20V-6A 290p (45p p&p)	
50VA: 6V-4A 6V-4A; 9V-2.5A 9V-2.5A; 12V-2A 12V-2A; 15V-1.5A 15V-1.5A; 20V-1.2A 20V-1.2A; 25V-1A 25V-1A; 30V-8A 30V-8A 350p (50p p&p)	
100VA: 12V-4A 12V-4A; 15V-3A 15V-3A; 20V-2.5A 20V-2.5A; 30V-1.5A 30V-1.5A; 40V-1.25A 40V-1.25A; 50V-1A 50V-1A 650p (60p p&p) (N.B. p&p charge to be added above our normal postal charge)	

**VOLTAGE REGULATORS\***

1A TO3	+ve	-ve	Price
5V 7805	145p	7905	220p
12V 7812	145p	7912	220p
15V 7815	145p	7915	220p
18V 7818	145p	7918	220p

**ETI Projects: Parts available for:**

Click Eliminator	5V 7805	80p	7905	90p
Ambush, Guitar Effect Unit.	12V 7812	80p	7912	90p
Send SAE plus 5p for list.	15V 7815	80p	7915	90p
	18V 7818	85p	7918	90p
	24V 7824	85p	7924	90p

**ULTRASONIC TRANSDUCERS**

LM300H	170p	LM327	270p
LM305H	140p	LM723	43p
LM309K	135p	MVR5	180p
LM317K	350p	MVR12	180p
LM323K	625p	TAA550	50p
LM325N	240p	TBA625B	95p
LM326N	240p	TDA1412	150p

**CMOS\***

4000	15	4032	100	4066	58	4175	99	4513	206
4001	17	4033	145	4067	380	4194	108	4514	265
4002	17	4034	196	4068	22	4408	720	4515	299
4005	105	4035	111	4069	20	4409	720	4516	125
4007	18	4036	325	4070	32	4410	720	4517	382
4008	87	4037	100	4071	21	4412F	1650	4518	102
4009	50	4038	108	4072	21	4412V	1380	4519	55
4010	50	4039	320	4073	21	4415F	795	4520	108
4011	16	4040	105	4075	23	4415V	795	4521	188
4012	18	4041	80	4076	85	4419	280	4522	199
4013	42	4042	75	4077	40	4422	545	4527	152
4014	86	4043	94	4078	21	4423	1095	4528	99
4015	89	4044	88	4081	20	4435	825	4529	165
4016	44	4045	145	4082	21	4440	1275	4530	85
4017	89								

**VDU Chip and MODULE for TV**

Convert your TV into a VDU by using the new Thompson-CSF TV-CRT controller chip SF-F96364. 16 line by 64 characters text refreshment. Cursor management. Cursor management on screen. Line erasing. Compatible with any computing system.

SF-F96364E	£11.75*
AY-3-1015	£5.60*
AY-5-1013UART	£4.50*
71301 ROM	£8.20*
SFS80102 RAM	£2.05*
741S163	£1.18*
SN75450	£1.20*
SN75451	70p*
SN75452	70p*
SN75454	£2.25*
UHF Modulator	£2.50*
Complete Module	£136.50*

(Send 30p stamps for full technical data)

# ..... news digest.....

## BIG SCREEN SCOPE

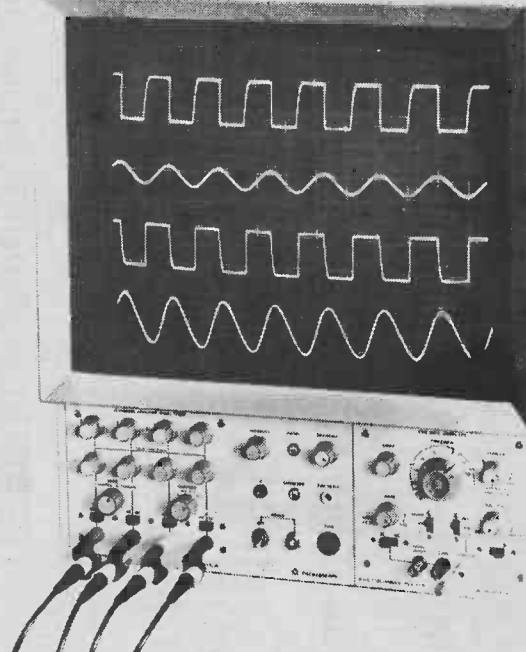

Climaire have introduced what they believe to be the only low cost, large screen (17 inch) oscilloscope in Britain, designated the BWD 1722.

The high sensitivity four channel amplifier can switch up to four traces with alternate or chopped presentation. All inputs are AC or DC coupled with independent gain and shift

controls. Trigger output is taken from channel one. Continuously variable sensitivity, from 35 mV to 5 V per inch is provided. Auto, manual, line and external triggering with a horizontal sensitivity of 100 mV to 50 V per inch are provided. The BWD 1722 sells at £1350 from Climaire Ltd Instruments, Apsley House, Apsley Road, New Malden, Surrey.

## MIGHTY MINI-SWITCH



Digitran's new series of miniature push buttons are built to last. The Series 12000 Minibutton is designed for use in applications where severe environmental conditions are expected.

The switch is designed for a life of one million detent operations. It meets the shock, vibration, moisture-resistance, thermal shock, salt spray, explosion — proofing and sand and dust requirements of MIL-STD-202, a stringent specification. Eight or ten standard dial positions are available. Series 12000 is available from Digitran UK, Melbourn, Royston, Herts.

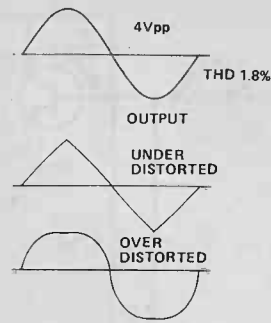
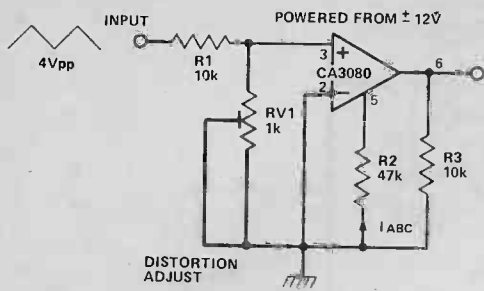

### Triangle To Sinewave Converter

By overloading the input of a CA3080 it is possible to produce a 'sinusoidal' transfer function. That is, if a triangle waveform of the correct magnitude is applied to the CA3080 input, the output will be distorted in such a way as to produce a sinewave approximation. In the circuit shown, RV1 is adjusted so that the output waveform resembles a sinewave. I tested this circuit using an automatic distortion analyser and found the sinewave distortion to be only 1.8%, mostly third harmonic distortion, which, for such a simple arrangement, seems very reasonable indeed. This could be used to produce a sinewave output from a triangle/square wave oscillator.

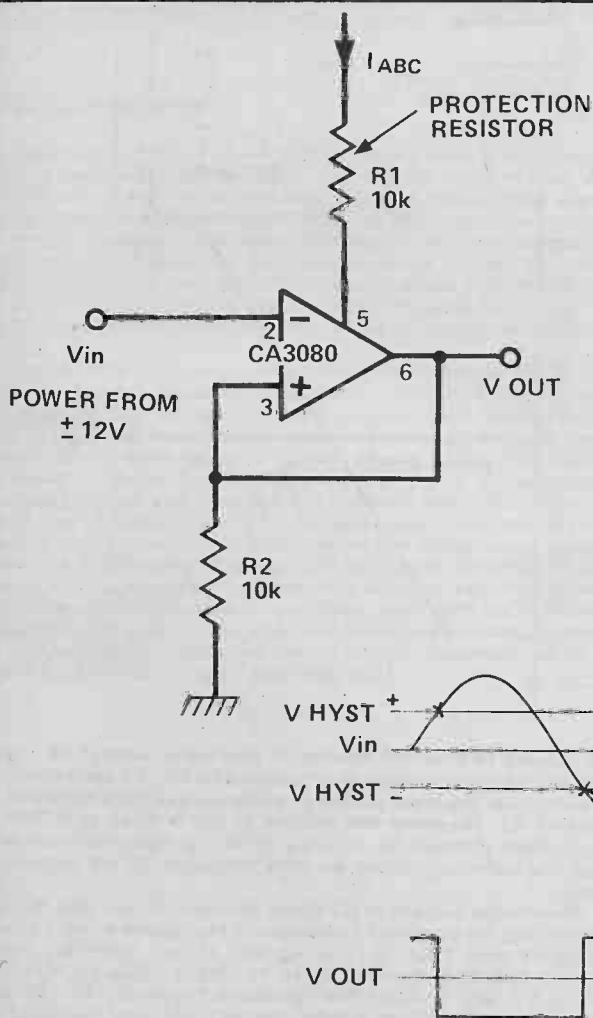
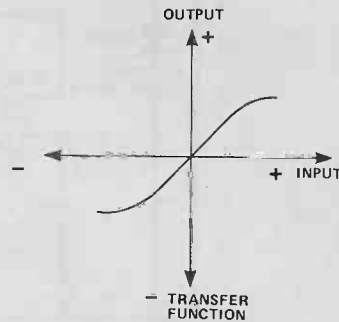

### Schmitt Trigger

Most Schmitt trigger circuits prove to be very complicated when it comes to calculating the hysteresis levels. However, by using the CA 3080 these calculations are rendered trivial plus there is the added bonus of fast operation. The hysteresis levels are calculated from the simple equation,

$$V_{HYST} \approx \pm (I_{ABC} \times R_2)$$

The output squarewave level is in fact equal in magnitude to the hysteresis levels. The circuit operation is as follows.

Imagine the output voltage is high. The output voltage will then be equal to  $(R_2 \times I_{ABC})$  which we will call  $+V_{HYST}$ . If  $V_{IN}$  becomes more positive than  $+V_{HYST}$ , the output will start to move in a negative direction, which will increase the voltage between the input terminals which will further accelerate the speed of the output movement. This is known as regenerative feedback and is responsible for the schmitt trigger action. The output snaps into a negative state, at a voltage equal to  $-(R_2 \times I_{ABC})$  which is designated as  $-V_{HYST}$ . Only when  $V_{IN}$  becomes more negative than  $-V_{HYST}$  will the output change back to the  $+V_{HYST}$  state.

The Schmitt trigger is a very useful building block for detecting two discrete voltage levels and finds many uses in circuit designs.

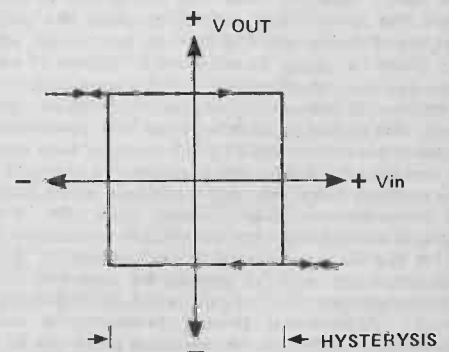
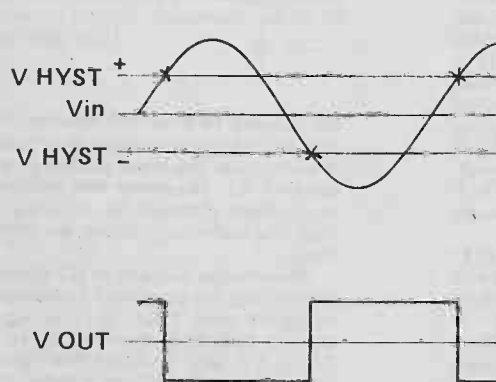

I<sub>ABC</sub> CONTROLS HYSTERESIS LEVELS AND OUTPUT LEVEL

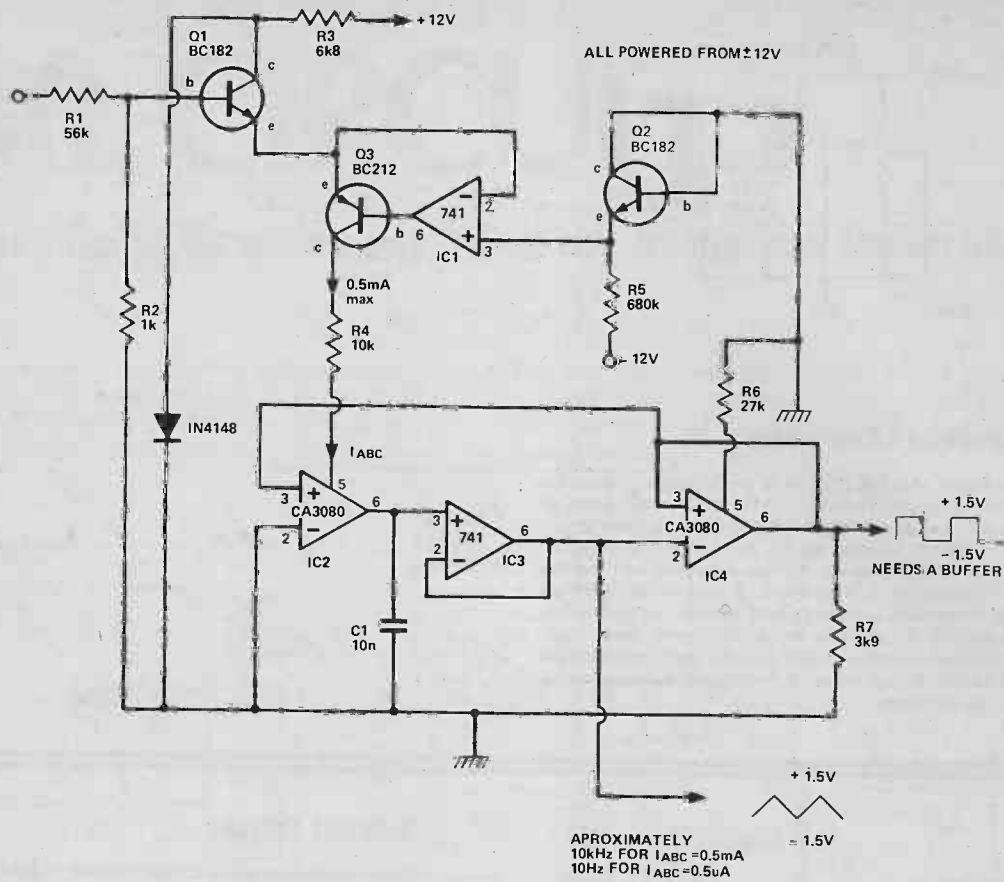

## Voltage Controlled Oscillator

By using two CA3080's and some op amps it is possible to make an oscillator, the frequency of which is voltage controllable. This unit finds many applications in the field of electronic music production and test equipment. The circuit has been given a logarithmic control law, that is, the frequency of operation doubles for every volt increase in the control voltage. This makes it ideal for musical applications where linear control voltages need to be converted into musical intervals (which are logarithmically spaced) and also for audio testing where frequencies are generally measured as logarithmic functions.

IC2 is an integrator. The IABC current that drives this IC is used to either charge or discharge C1. This produces triangular waveforms which are buffered by IC3, which then drives the Schmitt trigger IC4. The hysteresis levels for this device are fixed at  $\pm 1.5V$ , being determined by R6, R7.

The output of the schmitt is fed back in such a way as to control the direction of motion of the integrator's output. If the Schmitt output is high, then the integrator will ramp upwards and vice versa. Imagine that the integrator is ramping upwards. When the integrator's output reaches the positive hysteresis level, the Schmitt will flip into its low state, and the integrator will start to ramp downwards. When it reaches the low hysteresis level the Schmitt will flip back into its high state. Thus the integrator ramps up and down in between the two hysteresis levels. The speed at which it does this, and hence the oscillating frequency is determined by the value of IABC into IC2. The larger the current, the faster the capacitor is charged and discharged. Two outputs are produced, a triangle wave (buffered) from IC3 and a squarewave (unbuffered) from IC4. If the squarewave output is loaded then the oscillation frequency will change.

The log law generator is composed of Q1, 2, 3 and IC1. Transistors Q1 and Q2 should be matched so that their base emitter voltages ( $V_{be}$ ) are the same for the same emitter current, (50uA). Matching these devices to within 5 mV is satisfactory, although unmatched pairs could be used. When matching transistors take care not to touch them with your fingers. This will heat them up and produce erroneous measurements. Transistor Q2 is used to produce a reference voltage of about  $-0V6$  which is connected to IC1 pin 3. This op amp and

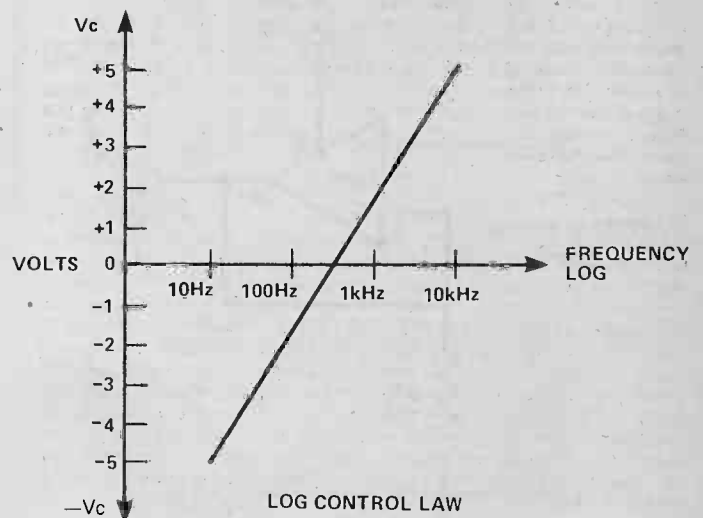

Q3 is used to keep Q1 emitter at this same voltage of  $-0V6$ . The input control voltage is attenuated by R1, R2 such that a +1 V increase at the input produces a change of only +18 mV at the base of Q1. However the emitter of Q1 is fixed at  $-0V6$ , so the current through Q1 doubles. (It is a property of transistors that the collector current doubles for every 18 mV increase in  $V_{be}$ ).

The emitter current of Q1 flows through Q3 and into IC2 thus controlling the oscillator frequency. It is possible to get a control range of over 1000 to 1 using this circuit. With the values shown, operation from 10 Hz to 10 kHz is achieved. Reducing C1 to 1 n will increase the maximum frequency to 100 kHz, although the waveform quality may be somewhat degraded.

Changing C1 to 1uF (non-polarized) will give a minimum frequency of 0.1 Hz.



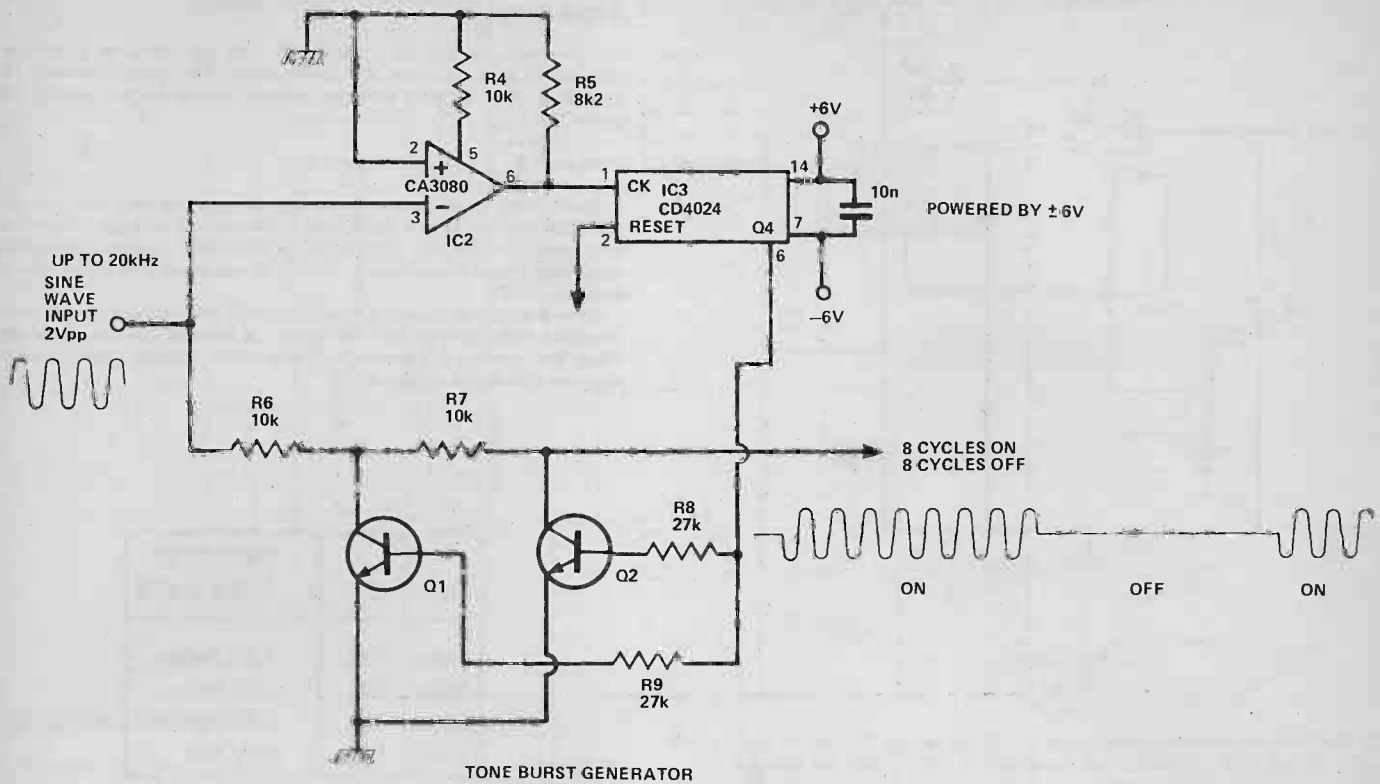

### Fast Comparator

The high slew rate of the CA3080 makes it an excellent fast voltage comparator. When pin 2, IC1 is more positive than  $V_{ref}$  the output of IC1 goes negative and vice versa.  $V_{ref}$  can be moved around so that the point at which the output changes can be varied. As long as the input sinewave level is quite large (1 V say) then the output can be made to move at very fast rates indeed. However, care must be taken to avoid overloading the inputs. If the differential input voltage exceeds 5 V, then the input stage breaks down and may cause an undesired output to occur.

One use of a fast comparator is in a tone burst generator. This device produces bursts of sinewaves, the burst starting and finishing on axis crossings of the sinusoid. The comparator is used to detect these axis crossings and to produce a square wave output which then drives a binary divider (IC3). The divider produces a 'divide by sixteen' output which is high for eight sinewave cycles and then low for the next eight. This signal is then used to gate ON and OFF the sinewave. The gate mechanism is a pair of transistors which short the sinewave to ground when the divider output is high and let it pass when the divider output is low. The resulting output is a toneburst. However, if the comparator is not very fast, then there will be a delay in generating the gate and so the tone burst will not start or finish on axis crossings. Using the circuit shown, operation up to 20 kHz is obtainable.

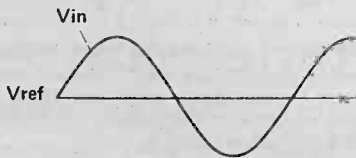
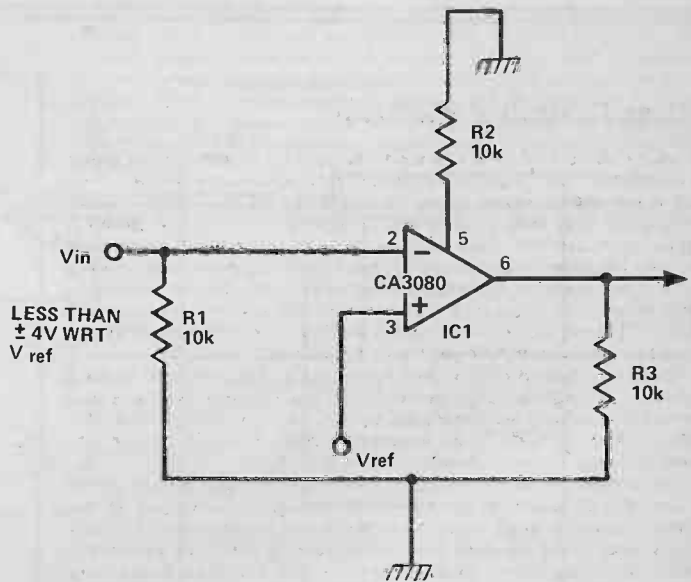

POWERED FROM ± 12V

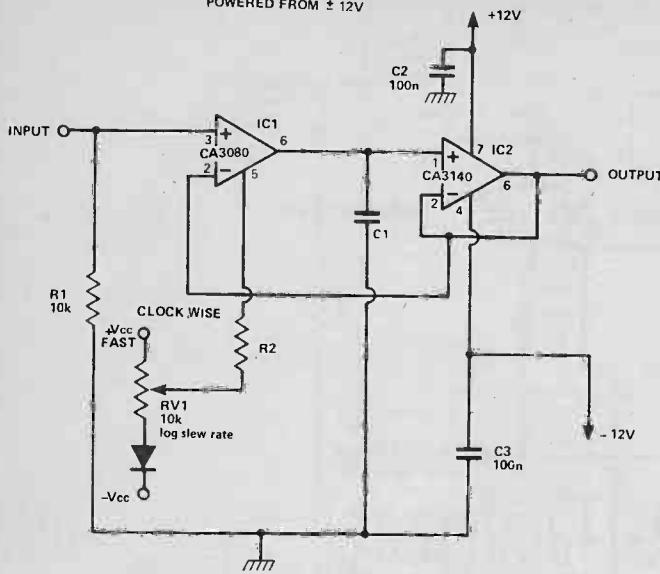

## Slew Limiter

The current output of a CA3080 can be used to produce a controlled slew limiter. By connecting the output current to a capacitor, the output voltage cannot move faster than a rate given by

$$\text{slew rate} = \frac{I_{ABC} \text{ Volts per sec.}}{C1}$$

Note that  $I_{ABC}$  determines the slew rate and as  $I_{ABC}$  is a variable then so is the slew rate. The output voltage is buffered by a voltage follower, IC2. This is a MOSFET op amp which has a very high input impedance, which is necessary to minimise the loading on C1.

When an input signal is applied to IC1 the output tries to move towards this voltage but its speed is limited by the slew rate. Thus the output produces a linear ramp which stops when it reaches the input signal level.

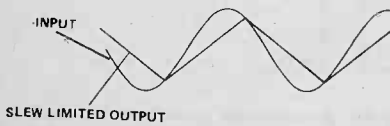

R2	C1	FASTEST SLEW RATE
150k	100n	1.5V/mSec
150k	10n	15V/mSec
150k	1u0	0.15V/mSec
1M5	1u0	15V/Sec

POWERED FROM ± 12V

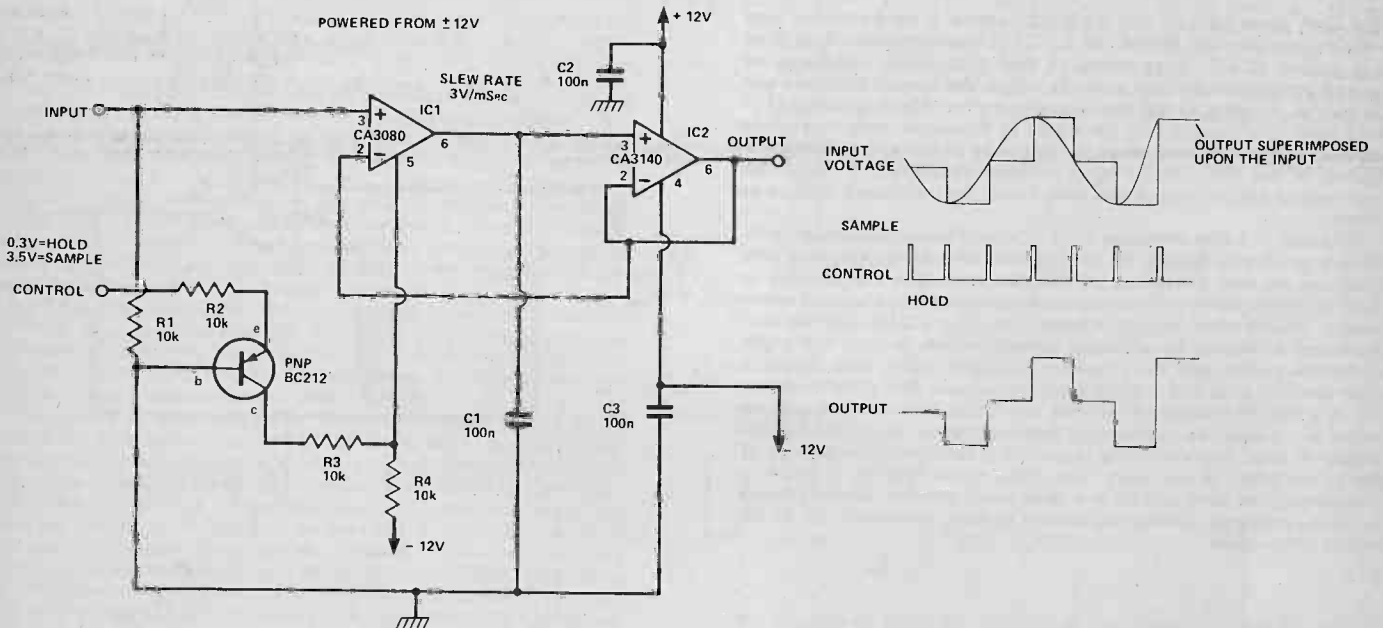

## Sample And Hold

The slew limiter can be modified so that it becomes a sample and hold unit. In this circuit  $I_{ABC}$  is either hard ON (sample) or completely OFF (hold). In the sample mode, the output voltage quickly adjusts itself so that it equals the input voltage. This

enables a short sample period to be used. In the HOLD mode,  $I_{ABC}$  is zero and so the voltage on C1 should remain fixed. The circuit is in fact an analogue memory. It is used in music synthesisers (to remember the pitch), in analogue to digital converters and many other circuits.

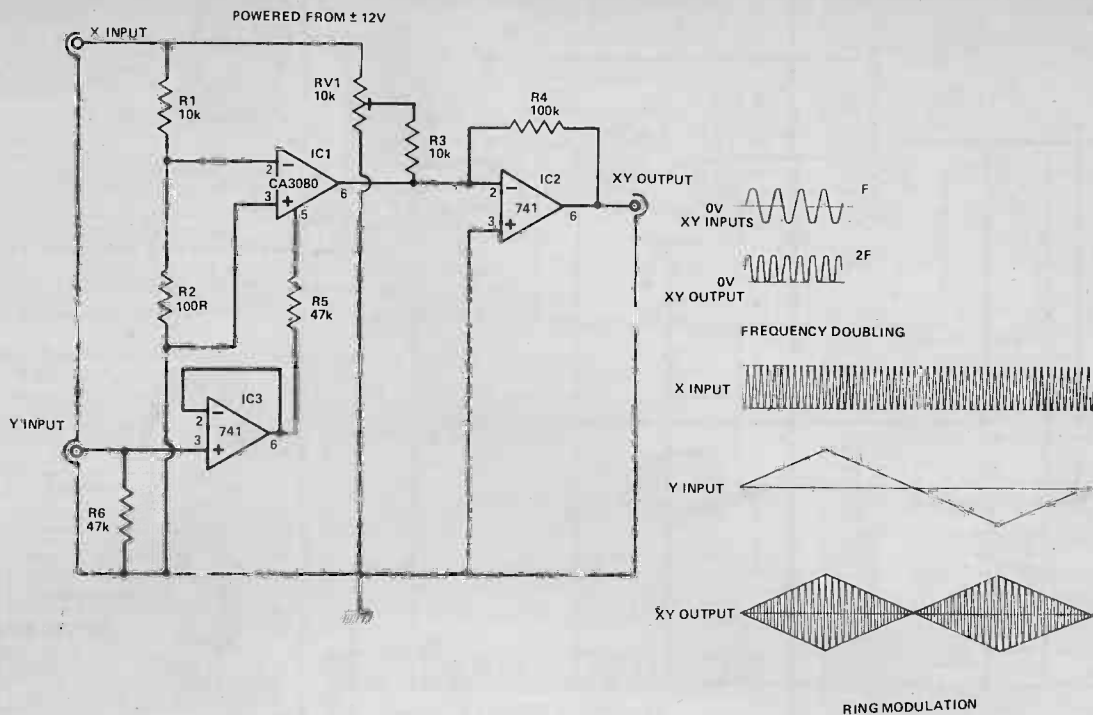

## 4 Quadrant Multiplier

The CA3080 is a two quadrant multiplier but, with the addition of a few extra bits of electronics, it can be made into a four quadrant circuit. A two quadrant multiplier has two inputs, one can accept bipolar signals (the inverting or non inverting input) and one can only accept a unipolar signal, (the IABC current). However, a four quadrant multiplier can accept bipolar signals on both of its inputs which enables it to perform frequency doubling and ring modulation.

The circuit is fairly similar to that of the two quadrant multiplier described earlier except for two differences. IC3 is used to generate IABC in such a way that the Y input can go both positive and negative, thus the Y input is bipolar, when Y is at 0 V

and there is a signal on the X input the desired output ( $X \times Y$ ) should be zero. This is achieved by adjusting RV1 so that the signal via IC1 (this is inverted) is exactly cancelled out by that via R3. Now, when Y is increased positively, a non-inverted value of X is produced at the output and, when Y is increased negatively, an inverted value of X is produced. When Y is zero, so is the output. This is known sometimes as ring modulation. If a speech signal is connected to the X input and a variable frequency oscillator is connected to the Y input the resulting sound is that of a 'dalek'. Also, if a sinewave is connected to both the X and Y inputs, the XY product is a sinewave of twice the frequency. This is known as a frequency doubler, but it will only work with sinewaves.

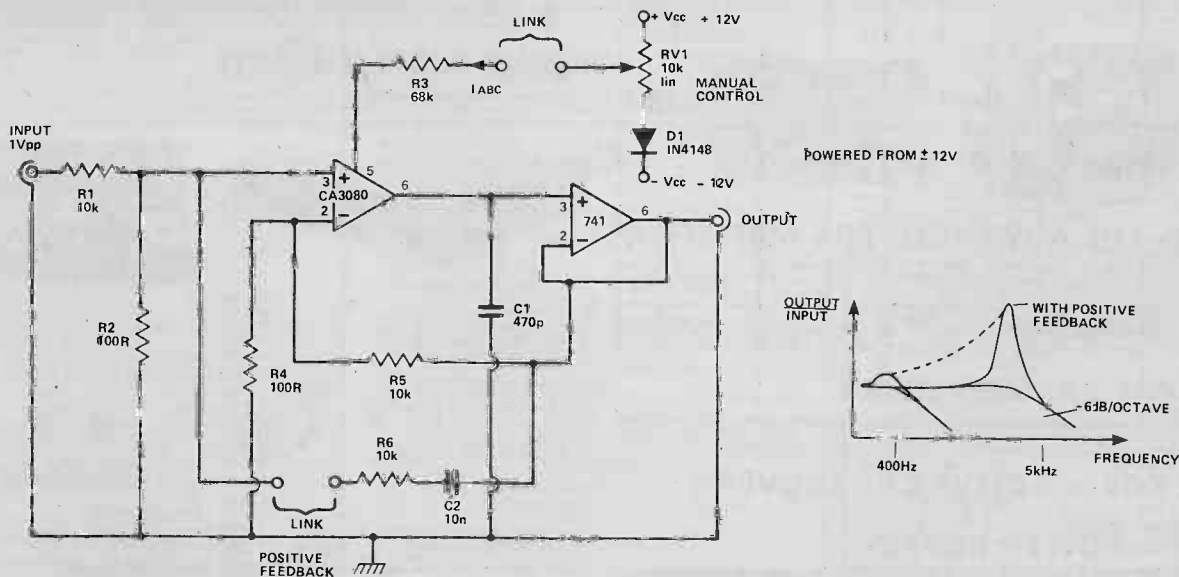

## Single Pole Filter

A singlepole lowpass filter can be constructed using a CA3080 as a current controlled resistor. The filter is, in fact, just a simple RC low pass section where the R, which is controllable, is constructed out of IC1, R4, R5. Varying IABC changes the amount of current drive to C1. This would normally make the circuit a slew limiter, but because the signal level that IC1 (pins 2

and 3) handles is so small, the CA3080 works in its linear mode. This enables it to look like a variable resistor. When this resistor is varied, the break frequency of the filter also varies. By applying some positive feedback around the filter (R6, C2) it is possible to produce a peaky filter response. The peak actually increases with frequency making the circuit useful as a guitar Wah Wah unit.

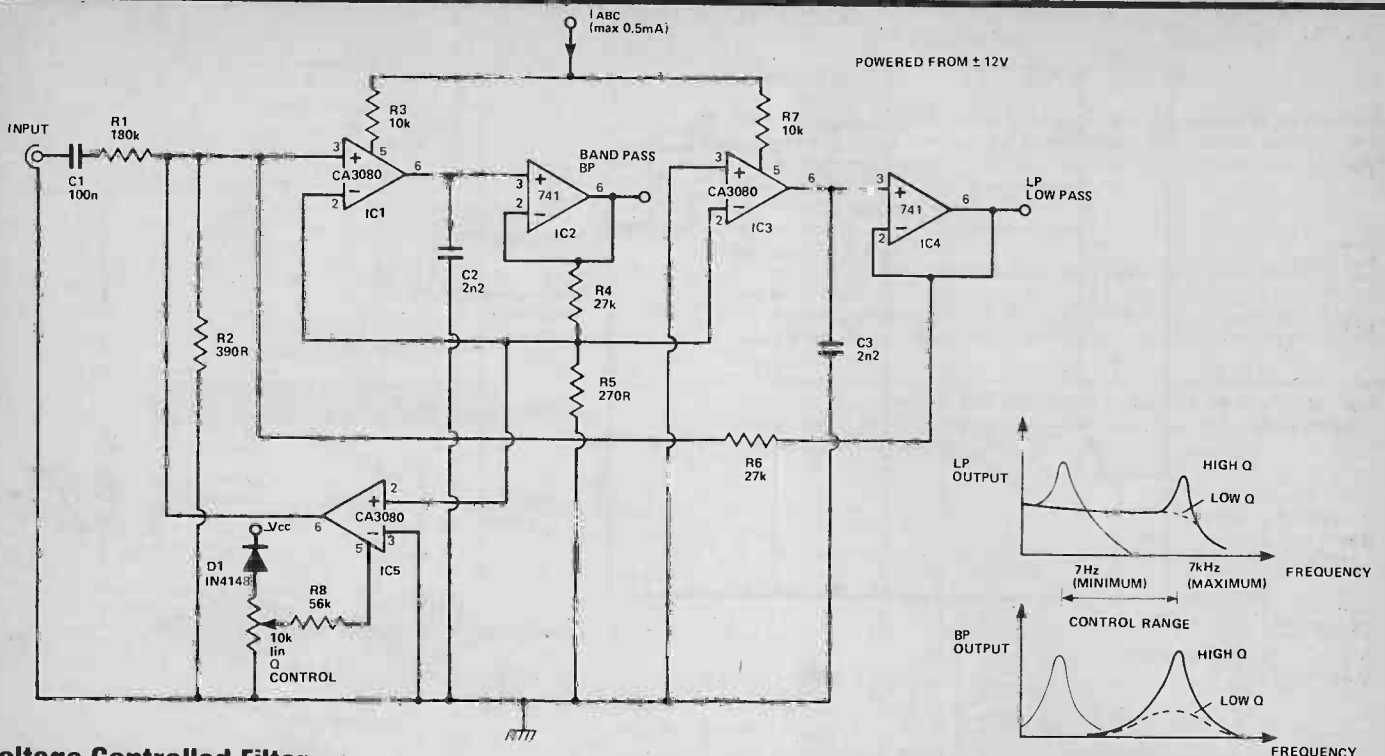

## Voltage Controlled Filter

A standard dual integrator filter can be constructed using a few CA3080's. By varying  $I_{ABC}$  the resonant frequency can be swept over a 1000 to 1 range. IC1, 3 are two current controlled integrators. IC2, 4 are voltage followers which serve to buffer

the high impedance outputs of the integrators. A third CA3080 (IC5) is used to control the Q factor of the filter. Q factors as high as 50 can be obtained. The resonant frequency of the filter is linearly proportional to  $I_{ABC}$  and hence this unit is very useful in electronic music production. There are two outputs produced, a low pass and a band pass response. **ETI**

# TOTAL AMPLIFICATION FROM CRIMSON ELEKTRIK

## WE NOW OFFER THE WIDEST RANGE OF SOUND PRODUCTS

### STEREO PRE-AMPLIFIERS

MC 1

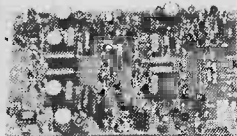
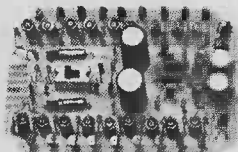

CPR 1

### CPR 1—THE ADVANCED PRE-AMPLIFIER

The best pre-amplifier in the U.K. The superiority of the CPR 1 is probably in the disc stage. The overload margin is a superb 40dB, this together with the high slewing rate ensures clean top, even with high output cartridges 'racking' heavily modulated records. Common-mode distortion is eliminated by an unusual design. R.I.A.A. is accurate to 1dB; signal to noise ratio is 70dB relative to 3.5mV; distortion < .005% at 30dB overload 20kHz. Following this stage is the flat gain/balance stage to bring tape, tuner, etc., up to power amp. signal levels. Signal to noise ratio 86dB; slew-rate 3V/μs; T.H.D. 20Hz — 20kHz < .008% at any level. F.E.T. muting. No controls are fitted. There is no provision for tone controls. CPR 1 size is 138 x 80 x 20mm. Supply to be ± 15 volts.

### MC 1 PRE-AMPLIFIER

Suitable for nearly all moving-coil cartridges. Sensitivity 70/170μV switchable on the p.c.b. This module brings signals from the now popular low output moving-coil cartridges up to 3.5mV (typical signal required by most pre-amp disc inputs). Can be powered from a 9V battery or from our REG 1 regulator board.

### XO2 : XO3 — ACTIVE CROSSOVERS

XO2 — two way XO3 — three way Slope 24dB/octave Crossover points set to order within 10%

### REG 1 — POWER SUPPLY

The regulator module, REG 1 provides 15.0-15v to power the CPR 1 and MC 1. It can be used with any of our power amp supplies or our small transformer TR 6. The power amp kit will accommodate it.

### POWER AMPLIFIERS

It would be pointless to list in so small a space the number of recording studios, educational and government establishments, etc., who have been using CRIMSON amps satisfactorily for quite some time. We have a reputation for the highest quality at the lowest prices. The power amp is available in five types, they all have the same specification. T.H.D. typically .01% any power. 1kHz 8 ohms; T.I.D. insignificant; slew rate limit 25V/μs; signal to noise ratio 110dB; frequency response 10Hz-35kHz, —3dB; stability unconditional; —3dB; protection drives any load safely; sensitivity 775mV (250mV or 100mV on request); size 120 x 80 x 25mm.

### POWER SUPPLIES

We produce suitable power supplies which use our superb TOROIDAL transformers only 50mm high with a 120-240 primary and single bolt fixing (includes capacitors/bridge rectifier).

### POWER AMPLIFIER KIT

The kit includes all metalwork, heatsinks and hardware to house any two of our power amp modules plus a power supply. It is contemporarily styled and its quality is consistent with that of our other products. Comprehensive instructions and full back-up service enables a novice to build it with confidence in a few hours

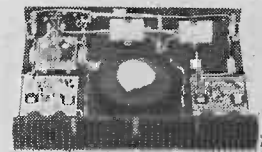
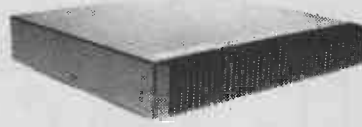

#### POWER AMPLIFIER MODULES

CE 608 60W/8 ohms 35.0-35v	£16.30
CE 1004 100W/4 ohms 35.0-35v	£19.22
CE 1008 100W/8 ohms 45.0-45v	£23.22
CE 1704 170W/4 ohms 45.0-45v	£29.12
CE 1706 170W/8 ohms 60.0-60v	£31.90

#### TOROIDAL POWER SUPPLIES

CPS1 for 2 x CE 608 or 1 x CE 1004	£14.47
CPS2 for 2 x CE 1004 or 2/4 x CE 608	£16.82
CPS3 for 2 x CE 1008 or 1 x CE 1704	£17.66
CPS4 for 1 x CE 1008	£15.31
CPS5 for 1 x CE 1708	£22.68
CPS6 for 2 x CE 1704 or 2 x CE 1708	£23.98

#### HEATSINKS

Light duty, 50mm, 2 C/W	£1.30
Medium power, 100mm, 1.4 C/W	£2.20
Disco/group, 150mm, 1.1 C/W	£2.85
Fan, 80mm, state 120 or 240v	£18.50
Fan mounted on two drilled 100mm heatsinks, 2 x 4 C/W, 65 C max. with two 170W modules	£29.16

#### THERMAL CUT-OUT, 70 C

	£1.38
--	-------

#### Distributor

Minic Teleproduktur  
Box 12035  
S-750 12  
Uppsala 12  
Sweden

## CRIMSON ELEKTRIK

1A STAMFORD STREET, LEICESTER LE1 6NLL. Tel. (0533) 537722

U.K. Please allow up to 21 days for delivery

All prices shown are UK only and include VAT and post. COD 90p extra, £100 limit. Export is no problem, please write for specific quote. Send large SAE or 3 International Reply Coupons for detailed information.

#### ACTIVE CROSSOVERS

XO2	£14.83	XO3	£23.06
-----	--------	-----	--------

#### POWER SUPPLY:

REG1	£6.75	TR6	£1.75
------	-------	-----	-------

#### BRIDGE DRIVER, BDI

Obtain up to 340W using 2 x 170W amps and this module, BDI

	£5.40
--	-------



# microfile.....

## Gary Evans looks at PET add-ons, a Simon that's not simple and has news on superboard II.

WITH THE PLETHORA of new small computer systems appearing on the market, it's nice to see some of the old warhorses beginning to meet this onslaught by supporting the user with a broad base of hardware. Surely one of the oldest warriors (its flowery prose this month) and one which has to date been poorly supported by its manufacturer, is the PET.

A number of companies have stepped into the void caused by lack of Commodore peripherals, everything from RS232 interfaces to PET compatible floppy drives are available but not from Commodore. The latest issue of the PET User's Club newsletter indicates that this situation is about to change.

The most exciting of the PET add-ons from Commodore is their 2040 Dual Drive Floppy Disk. Details are sketchy at present but I'll outline the spec of the 2040 as presented in the newsletter.

The drive will allow 360K bytes of data to be stored on two standard 5¼in Disk drives (Shugart SA390). This is accomplished without resorting to double tracking or double density. This is achieved (we're not told exactly how) by the use of two MPUs — 6504 and 6502 — and fifteen memory ICs within the 2040.

Formatting is by the drive itself and any mini-floppy disk may be used. 35 tracks with a constant density recording on each track provide 171520 bytes for user storage per disk side.

The 2040 requires only one connection to the PET, an interface cord connecting the unit to PET's IEEE port.

Just what we've been waiting for — but you'll have to wait until May and part with £799.20 for the pleasure of fitting this box of tricks next to your PET.

Good news that we don't have to wait for is a price reduction in the PET model 2001-8. The 8K machine that until now has been the only PET computer is down in price to £594.00.

The 8K machine is to be joined by a 4K machine at £496.00 and two models featuring 16K and 32K of memory. The memory used in these larger systems is dynamic, a departure from the static RAM used in the 8K and 4K versions. The 16K and 32K machines will also feature a full typewriter style keyboard in place of the calculator keyboard that was one of the most persistent criticisms of the 8K 2001-8. In order to make room for the larger keyboard the integral cassette deck has been omitted and a separate deck will have to be obtained in order to record programs.

The 4K PET is due in February while the larger versions will be here in May.

The last addition to Commodore's hardware is the 2023 printer. This will replace the ill fated 2020 printer — announced but not seen — and has to quote "a significantly better quality and more reliable print head." The 2023 is due in April.

Well there we are then, a range of well spec'd. PET peripherals. Let's hope that Commodore manage to meet the promised delivery dates as in the past, this is the area in which Commodore have been distinctly lacking in performance.

**If you can't wait for Commodore's floppy disk unit, this product from Compu-think is available now and plugs into a PET that has been fitted with a minimum of 16K additional memory.**

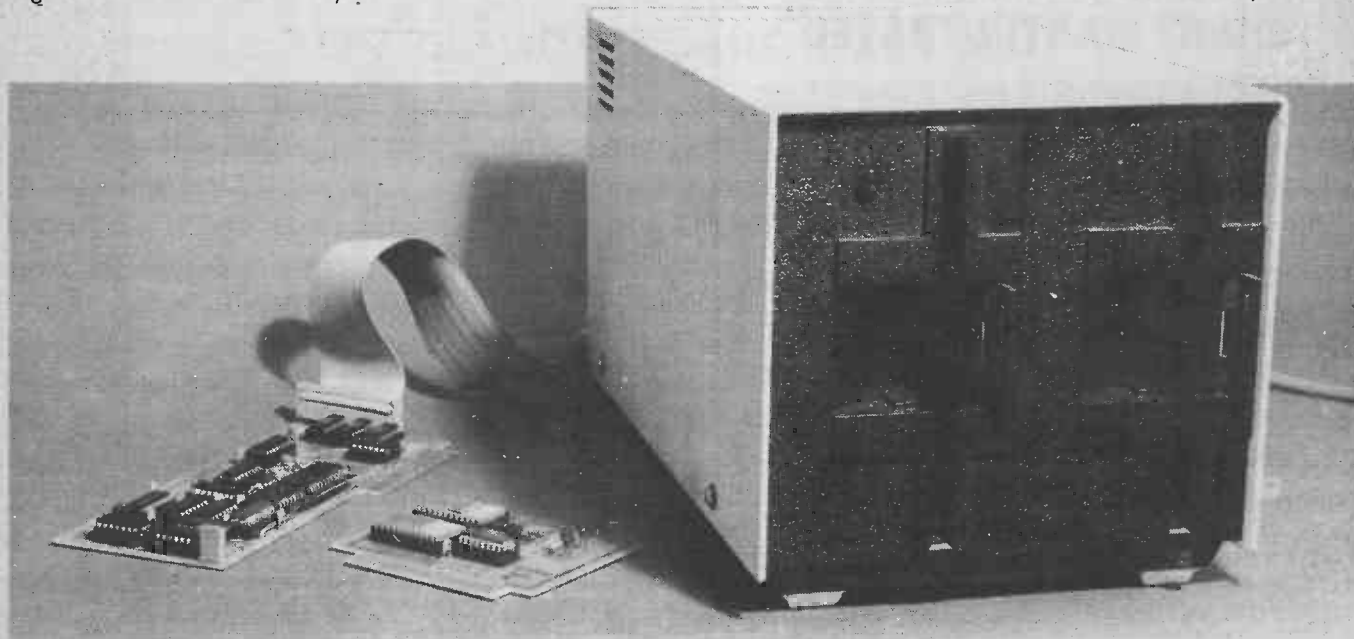

## Toying With MPUs

At last the MPU has found its way into the toy market. Christmas saw a number of electronic games, Invicta's Mastermind being one of the most popular and the new year is seeing many more games added to the shop's shelves.

The current rage in America is a game called Simon. Presented with four buttons of different colours, the player has to remember the sequence in which the machine "calls" them. The sequence starts off with just two colours but rapidly extends this until the player must press the four buttons in a sequence that as it extends will eventually defeat the user.

Not very easy to explain, but its all the rage in the US and will be over here soon — you'll be able to see it for yourself then.

## Super Ohio

I am assured that the long awaited Ohio Scientific's Superboard II will be available "off the shelf" within the next 45 days. Needless to say I am trying very hard to get hold of one of these boards and will report on its performance soon.

ETI

# Back numbers

Not all back issues of ETI are available. Indeed more are not than are! The table below shows which copies can be obtained from our offices. Each copy costs 60p inc p&p and please mark your envelopes "Back Issues".

	1978	1977	1976	1975	1974	1973	1972
Jan			No!	No!	No!	No!	
Feb			No!			No!	
March		No!	No!		No!		
April			No!	No!		No!	No!
May	No!	No!		No!		No!	No!
June	No!		No!	No!			No!
July		No!		No!			No!
Aug	No!	No!		No!		No!	No!
Sept		No!		No!	No!	No!	No!
Oct		No!		No!	No!	No!	No!
Nov		No!	No!	No!	No!	No!	No!
Dec		No!	No!	No!	No!	No!	No!

Photocopies of any article from any one issue are available, and cost 50p regardless of nos. of pages. Copies of series will be charged at article rate per installment. Mark envelope "P".

**ALL INVOICES, ENQUIRIES, ETC., TO  
OUR TEMPORARY ADDRESS OF  
CHILTMEAD LTD  
NORWOOD ROAD  
READING  
TELEPHONE NO. READING 65916**

# WIND METER

Here is the project all you amateur meteorologists have been waiting for. When this meter gets the wind up you'll know how fast and where it's coming from.

TRADITIONALLY, THE FOUR primary elements are fire, earth, water and air. At ETI, we've designed projects concerned with the first three (temperature meters, soil moisture indicators, rain alarms), but not much for the last. The major property of the air, apart from the fact that it is necessary to support life, is the movement of the air — wind. Light winds generally aren't of terribly much significance except to meteorologists, but stronger winds can be useful as a source of power; for traditional milling, for electricity generation or as a means of propulsion for sailing yachts. Stronger winds such as hurricanes, can be destructive, causing damage to life or property.

So for all the private pilots, yachtsmen, amateur meteorologists and general weather watchers who read ETI, here is a device which will tell you the wind's speed and direction, with a remote indication of both quantities. Our design is, we'd like to think, both stylish and unusual, but there are simpler methods of mechanical construction which you can follow if you wish.

## The Head

The drawings along with the photos will give the general design that we used. The actual dimensions have to be left to the individual constructor as components such as the ball races and light bulbs may vary in size.

While we used a single head for both speed and direction, it may be simpler to use separate heads.

The discs we used were 1.5mm thick clear plastic with a piece of photographic film glued onto it. It may be easier to make it out of thin aluminium and cut out the slots. For the speed disc simply drilling holes will suffice.

The most important part of the design, apart from ensuring that the discs rotate with a minimum of friction, is the shielding of the light and preventing light scatter striking a

transistor which should be dark. As can be seen from the photos and diagram the bulbs and transistors are embedded in aluminium blocks with small holes providing a passage for the light beam.

The wiring of the head is shown in fig. 3. Note that the base lead is not used and can be cut off close to the body. Insulate the joints onto the transistors to ensure that they do not short on the aluminium blocks. The bulbs may touch the block with their outer connection but this is the 0 volt line and does no harm. In fact it provides some electrical shielding for the leads. The bulbs we used were 12V but they were bright enough on 6V giving a much longer life.

## Design Features

When we started design on this project it was to have a digital

readout of wind direction with a resolution of either one or two degrees. This would also make it useful in a sailing boat to tell the wind direction relative to the heading.

Difficulties however soon became apparent. The first of these was the sensor head. The only accurate method is a digital head, probably optical. Two methods could have been used, one using a disc with a single optical track of 360 slots and an updown counter and the second using eight or nine tracks in a grey code. The first is simpler in head design but the second is less prone to error. The problem, and the reason for rejecting both, is that with such resolution, the reading would move around so much when the wind is gusty to be unreadable. What is needed is an averaging circuit which unfortunately becomes

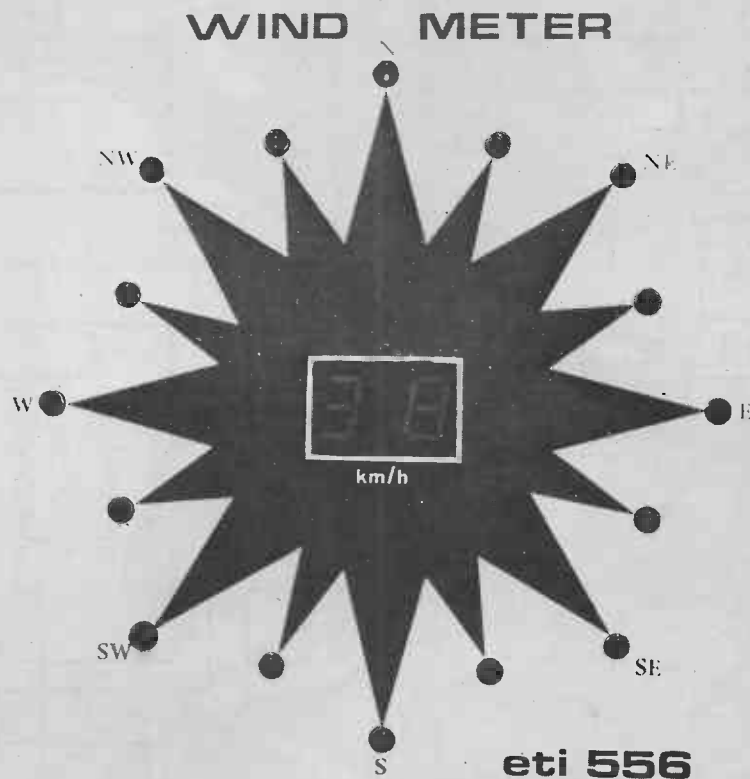

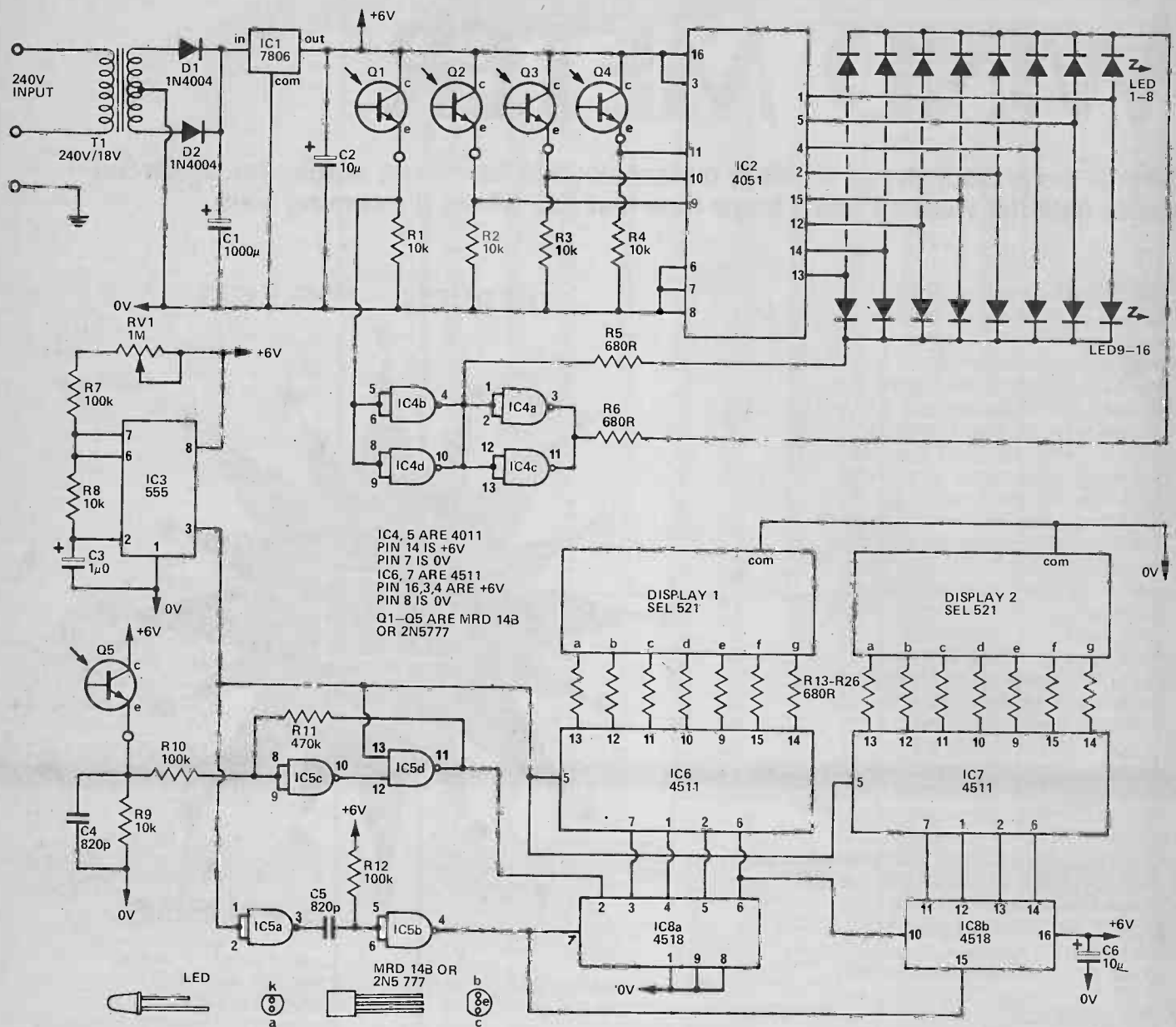

Fig. 1. Complete circuit diagram of the ETI Wind Meter

difficult when the wind is changing from just west of north to just east of north. i.e. 355 to 005. How do you average these (use a microprocessor?)

As this was intended to be a simple project we relaxed our original specification, deleting the use in a boat (we may get back to this problem. A four track 'Grey' scale allows the wind to be given to within 11° of its true heading, without the complexity of a nine track one, and the use of LEDs to give direction solves the problem of averaging as the variations can be seen and averaged by the brain.

### Construction

The electronics is relatively simple provided the PCB described is used. Due to a height limitation C1 should be mounted on the rear of the board. The LEDs should be mounted about 7mm from the board with care being taken not to damage them as the leads have to be bent out slightly. The regulator also has to lie down to give clearance.

We mounted the unit behind an aluminium front panel with the LEDs protruding through holes. If this is to be done it is preferable not to solder the LEDs until after alignment with

the front panel.

The head is more difficult as some mechanical ability is necessary to ensure good results. The requirements are basically simple. A disc is to be allowed to rotate, either continuously with the wind or aligning it to the wind, with a bulb on one side and phototransistors on the other.

The method used by us is shown in fig 4 with the aluminium blocks providing the shielding necessary to give accurate results. As the unit will be exposed to the weather it must be made waterproof otherwise the ball races will corrode. The races used



# MICRO CHIMES

FROM THE INVENTORS  
OF MICROPROCESSOR  
MUSICAL CHIMES

New price for the  
original

## CHROMA- CHIME KIT

24 tune model!

Due to the fantastic  
success of this product right  
across the World we are able to offer it at

only **£9.95** + 75p p&p

Comes complete with:

- \* TMS1000 Micro
- \* Superb cabinet
- \* All R's & C's
- \* Switches & pots
- \* Fully detailed kit manual
- \* Fully prepared PCB
- \* All semiconductors
- \* Loudspeaker
- \* Socket & Hardware

**TMS 1000N** - MP0027A Micro-  
computer chip available separately if  
required. Full 24 tune spec device  
supplied with data sheet and fully  
guaranteed.

New low price only **£4.95** inc. p&p  
(Only present 24 tune repertoire currently available.)

## A COMPLETE KIT FOR THE

## NEW MICRO CHIME

This easy to  
build kit includes:

- \* TMS1000 Custom MPU Chip
- \* Special purpose designed case
- \* Fully drilled and legended PCB
- \* All transistors, Resistors and Capacitors
- \* Full set of mechanical parts
- \* Smart fascia labels
- \* IC Socket and Loudspeaker
- \* Really Low Price!

only **£8.95** + 55p p&p

ALL CHROMATRONICS PRODUCTS  
SUPPLIED WITH MONEY BACK GUARANTEE  
PLEASE ALLOW 7-21 DAYS FOR DELIVERY

Please send me:

TO: CHROMATRONICS, RIVER WAY, HARLOW, ESSEX. UK.

NAME \_\_\_\_\_

ADDRESS \_\_\_\_\_

I enclose cheque/PO value £ \_\_\_\_\_  
or debit my ACCESS/BARCLAYCARD account no. \_\_\_\_\_

Signature \_\_\_\_\_

ETI 1

# CHROMATRONICS

ELECTRONICS TODAY INTERNATIONAL — APRIL 1979

# ..... news digest.....

## DIL SWITCHES

The Series 206 DIL program-  
ming switches from AB  
Controls has been extended to  
include SPST, DPST, SPDT and  
DPDT version. Applications in-  
clude logic functions in com-  
puters and test equipment.  
Switches are available with two  
to ten sections.

Gold-plated wiping contacts  
and terminals ensure long term  
corrosion resistance. Further  
details from AB Electronic Pro-  
ducts Group Ltd, Abercynon,  
Mid Glamorgan CF45 4SF.

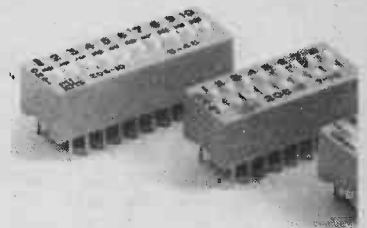

## IN BEZELLED?

This new display bezel from  
Vero Electronics comes with  
your choice of neutral, red or  
clear lens (polarised or unpo-  
larised).

The bezel is positioned in a  
single, rectangular cut-out by  
four removable pegs, and firmly  
secured by two screwed studs,  
which also secure the display  
mounting board on the spacers  
provided. A full range of com-

patible mounting boards for  
LED and LCD displays is avail-  
able.

Prices range from £1.50 for a  
four digit bezel with clear lens,  
to £2.65 for a six digit with  
coloured lens. Further details  
on Display Bezel AB064 from  
Vero Electronics Ltd, Industrial  
Estate, Chandler's Ford, East-  
leigh, Hampshire, SO5 3ZR.



## OOPS AND ALL THAT ...

### Disco Lightshow — Dec 78

Page 46 — C14, 19, 24, 29, 34 are  
shown upside down.  
junctions T1/R33, T2/R43,  
T3/R51, T4/R60, T5/R68 all  
should be shown going to  
-12V.

Page 47 — R71 1k (between  
D18 and ZD5) was not  
shown on the circuit dia-  
gram (it is however shown  
correctly on the overlay)  
Transformer.

Page 47 — ZD6 is 5V6 not 4V7.  
Page 48 — (Parts list) R73 is  
4K7.

Page 49 — Switch 3: the two  
brown wires should be

shown on tag 3 not 4. On the  
output terminal blocks N  
and L are interchanged.

### Stage Dimmer — March 79

We omitted details of the choke  
L1 from the Parts Lists. On our  
prototype this was wound onto a  
one inch square core with a 50  
thou gap. The 10A version is  
wound full of 16 SWG wire, and  
the 20A is wound full of two  
parallel windings of 16 SWG.

T1 can be wound as  
45t primary and 15t secondary  
on Neosid core 4329R/3/F7/  
EC, if available.

## HOW IT WORKS

### Wind Direction

Wind direction is indicated by a series of 16 equally spaced LEDs around a circle. These represent the main points on the compass. These are controlled by IC2 and IC4 which are in turn controlled by the direction sensor head.

The sensor head, which is described in fig 3 consists of a disc which has four optical tracks and four bulbs and phototransistors. The phototransistors sense either a clear disc (logical "1") or a black disc (logical "0") and thus control IC2 and IC4. The code used is special in that only one bit is changed at each location eliminating gross errors which occur with the binary code if the heads are not perfectly aligned. An example of this is going from location 7 (0111) to location 8 (1000). If this is not done simultaneously almost any location can be specified. With the grey code the same change is from 0100 to 1100. Here there can be no ambiguity as only one bit is changed. Remember these bits are not weighted similarly to binary and a lookup table must be used to decide what number (decimal) a particular code is.

The decoder, IC2, is an eight output analogue demultiplexer with the common line joined to the +5V line. When a particular 3 bit code is presented to its control inputs one of the eight outputs will be joined to the +6V line. The fourth output from the sensor head controls IC4 which gives two, inverted, outputs to drive either bank of LEDs. The complete four bit code therefore specifies a particular LED to be lit. By placing the LEDs correctly around the circle the grey code is decoded.

### Wind Speed

This is a simple frequency counter measuring pulses from the sensor head. The head consists of a disc with eight holes which breaks a light beam to its associated phototransistor. The output of this phototransistor is squared up by a schmitt trigger formed by IC5c and IC4d.

The counting is done by IC5a and IC5b (a dual decade counter) with IC6 and IC7 providing the store and LED drivers necessary to drive the seven segment display. Time base is provided by IC3 which gives a 7 mS wide negative pulse about every one second. We say about as it is adjustable by RV1 as individual heads will have different responses and calibration will be necessary.

This negative pulse opens the store to allow the number reached by the counters to be displayed while simultaneously stopping any further counting by disabling the schmitt trigger. On the completion of the 7mS pulse IC5a, and IC5b generate a 50µS wide pulse which resets the counter ICs to recommence the sequence.

### Power Supply

This is simply a full wave rectified supply with IC1 giving a regulated +6V output. This regulation is needed to ensure that the time base (IC3) remain accurate.

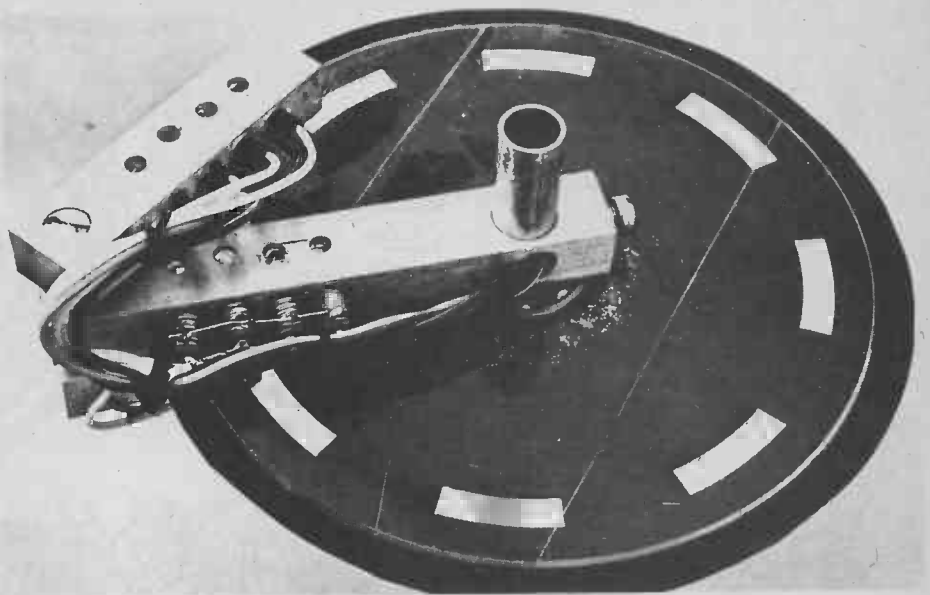

Above and Below: Constructional details of the sensor head

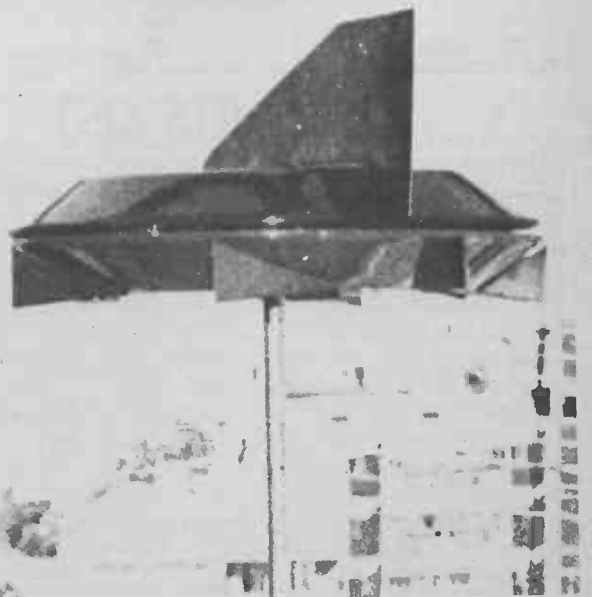
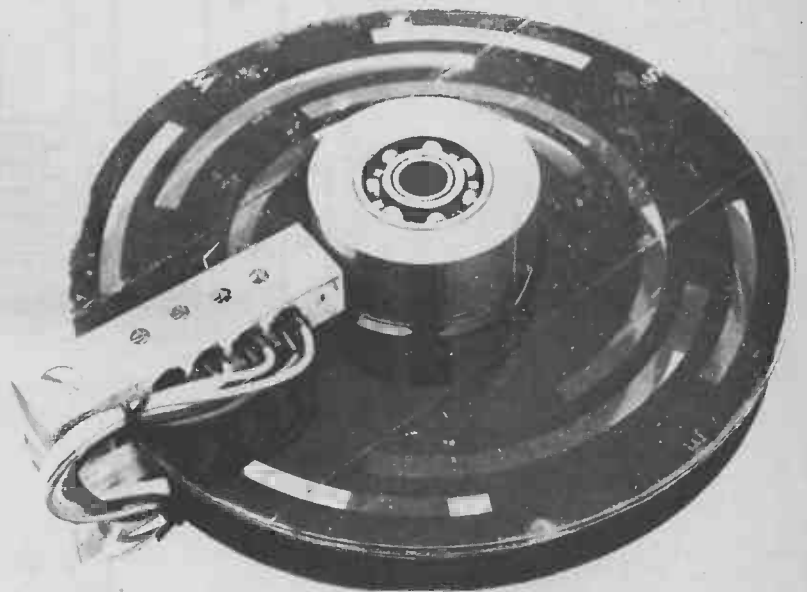

The finished unit in use

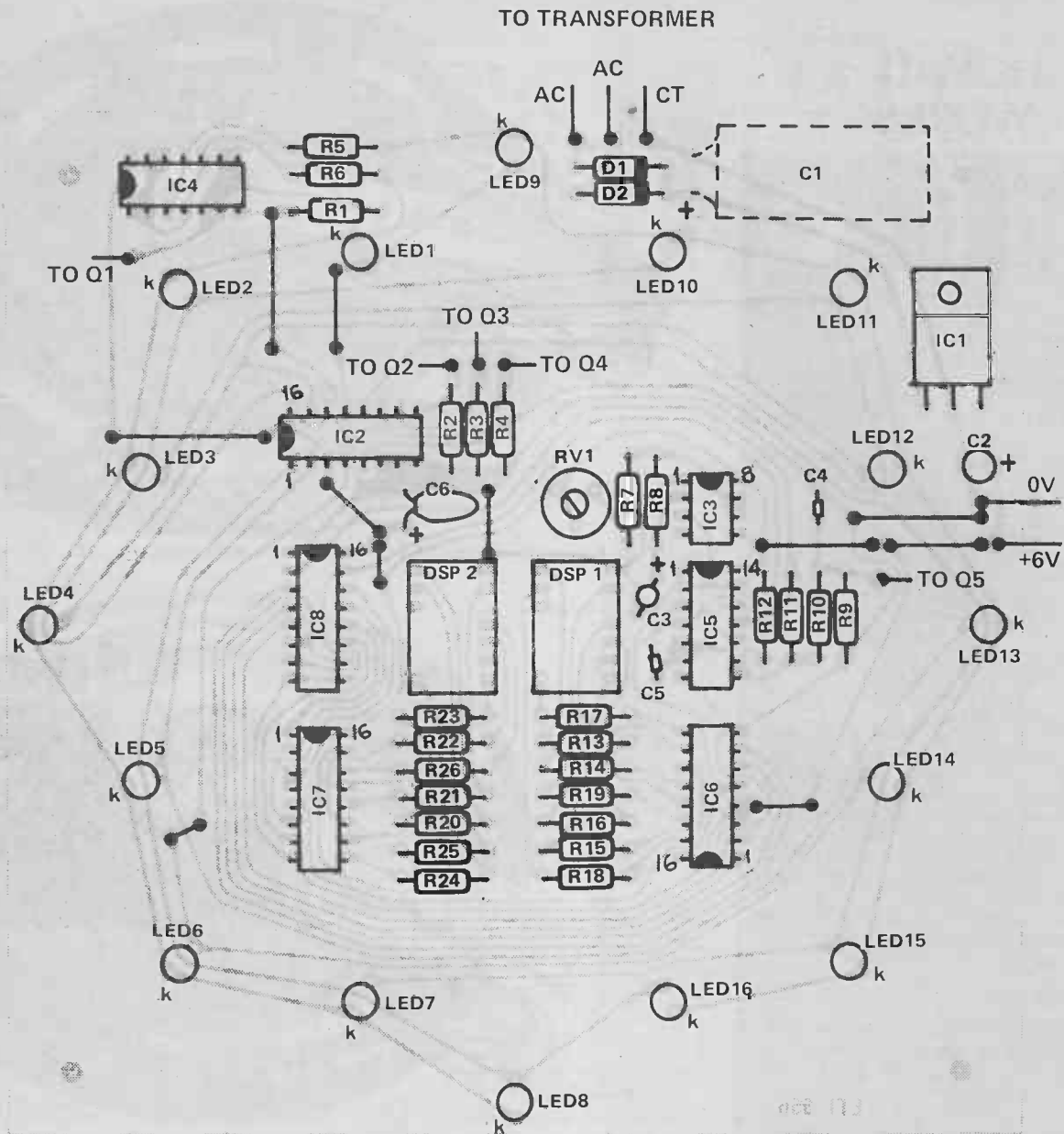

Fig. 2. Component overlay for the Wind Meter

## PARTS LIST

RESISTORS all 1/2W, 5%		SEMICONDUCTORS	
R1-4, 8, 9	10k	IC1	7806
R5, 6, 13, 28	680R	IC2	4051
R7, 10, 12	100k	IC3	555
R11	470k	IC4, 5	4311
POTENTIOMETER		IC6, 7	4511
RV1	1M trimmer	IC8	4518
CAPACITORS		Q1-Q5	2N5777
C1	1000u 16V	D1, 2	1N4004
C2, 6	10u 25V	LED 1-16	TL 209 or similar
C3	1u 25V	DISP 1, 2	Common cathode seven segment (high brightness)
C4, 5	820p ceramic	MISCELLANEOUS	
		Four miniature 12V bulbs, PCB, 240V/18V transformer box, head assembly	

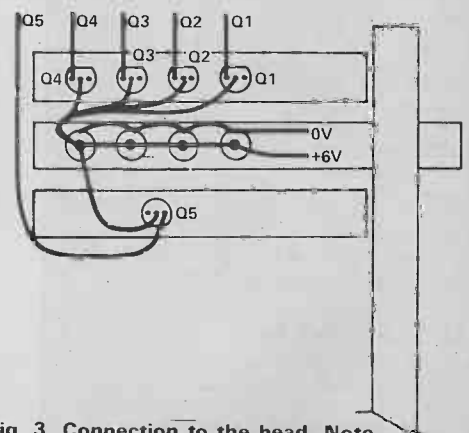
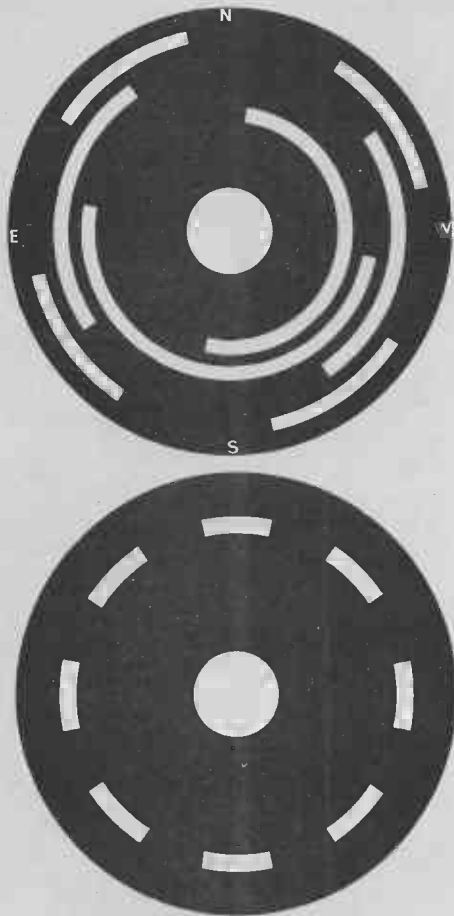

Fig. 3. Connection to the head. Note that transistor bases are not used.



Discs used in the sensor head — 1.5 mm thick, clear plastic with photographic film glued on.

will normally have to be washed out to give low enough friction with a light spray of WD40 or similar to give some protection.

While our housing is a little ornate, it did work but the more usual half ping pong balls may be more suitable.

## Calibration

### Wind Speed.

The easiest method for wind speed calibration is to provide the unit with a DC supply (via the common and one of the AC inputs) and to take a drive in the car with the unit supported above the vehicle. Providing there is no wind the potentiometer should be adjusted until the reading corresponds to the speed.

Direction alignment is simply a matter of aligning the vertical rod so that it gives the correct results.

ETI

## BUYLINES

The metalwork for this project we must leave to our readers, as this will be fabricated to suit individual requirements. The displays can be any type no's really, just observe polarity. Similarly with the LEDs. The photodarlington's can be supplied by Marshall's.

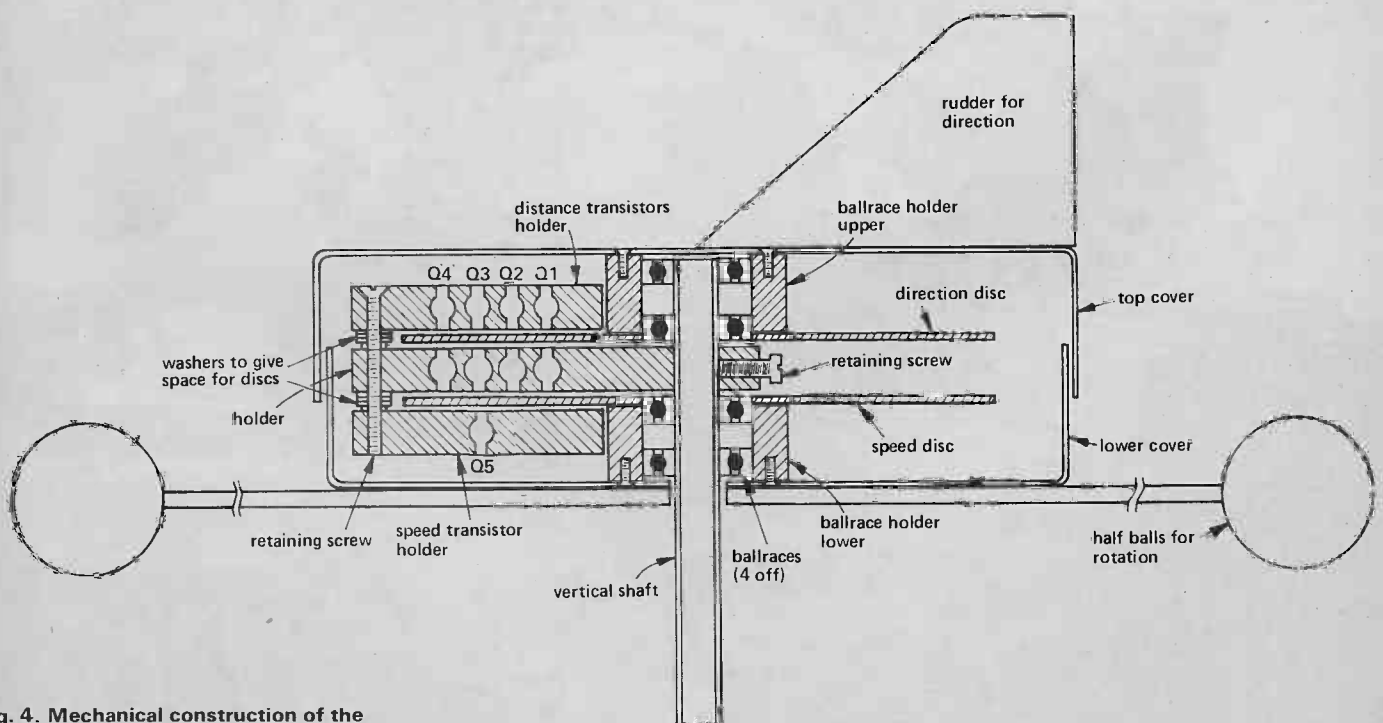

Fig. 4. Mechanical construction of the sensor head.



# GUITAR EFFECTS UNIT



**Our guitar effects unit isn't just a fuzz box. Use it to give you a new sound to play with.**

LIKE US, YOU probably thought that one guitar effects unit was much the same as any other. After fuzz and Wah-Wah, what do you do? Well, we think we have come up with a new one, which we have christened **struzz**.

With this unit you can select either a conventional fuzz effect or our new struzz effect. A depth control allows you to alter the sustain rate of the effect. If the neighbours start banging the wall, you can instantly cut out the crunchy effects with a bypass switch.

## Make-up

Construction should not pose any problems. It's even easier if you use our PCB. Make sure the electrolytic capacitors are put in the correct way round. As always, don't plug in the ICs until you have checked the circuit thoroughly.

Happy fuzzing and struzzing. ▶

## BUYLINES

The only component that may be difficult to find is the LF356 FET op-amp. Watford Electronics can supply this IC.

## Smashing sound

Now you are wondering what struzz sounds like, aren't you. Well, it's a distortion of fuzz. The fundamental frequency of the input is full wave rectified but the numerous harmonics are not. The result sounds rather like an antique piano finally succumbing to the ravages of woodworm, and collapsing. If you play the guitar (we don't) you will, no doubt, find many more musical uses for this effect than we could.

Switching between fuzz and struzz while playing produces an interesting sound. You might like to use a footswitch for this purpose.

Internal view of the effects unit

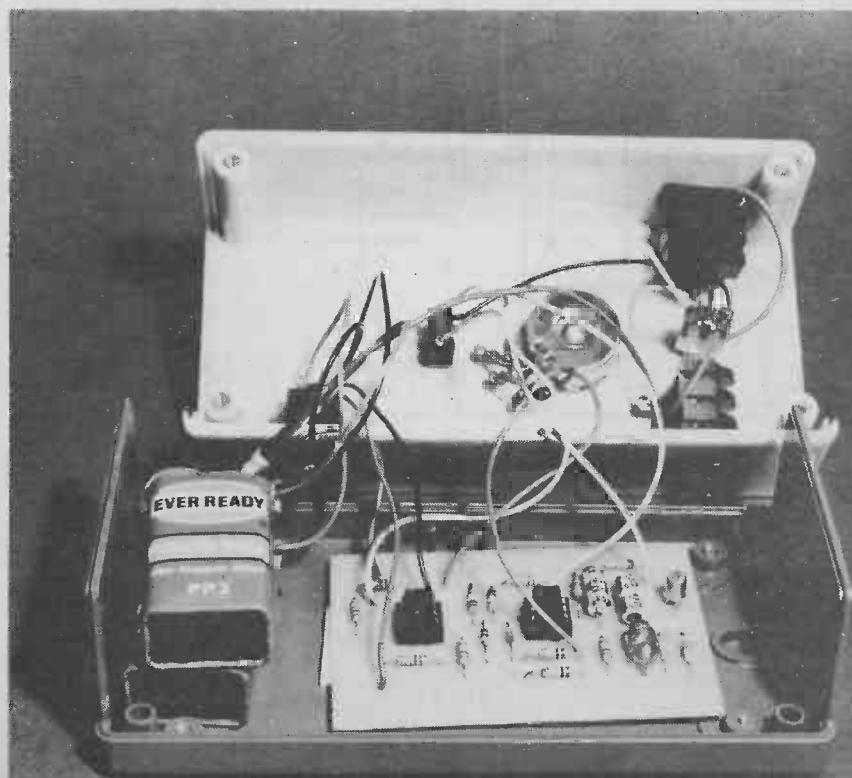

# PARTS LIST

RESISTORS (All 5% 1/4W)	
R1	500k
R2	6k8
R3	270R
R4, 6, 10, 11, 12	10k
R5	3k3
R7	100k
R8	39k
R9	820R
R13, 14	1k

POTENTIOMETERS	
RV1	1M0

CAPACITORS	
C1, 3	1u0 electrolytic
C2	560p polystyrene

SEMICONDUCTORS	
Q1	BC109
IC1	741
IC2	LF356
D1, 2	IN4148

SWITCHES	
SW1	SPDT Footswitch
SW2	SPDT
SW3	DPDT

MISCELLANEOUS	
Two 4-pin mono jack sockets	
PCB	
Verocase to suit	

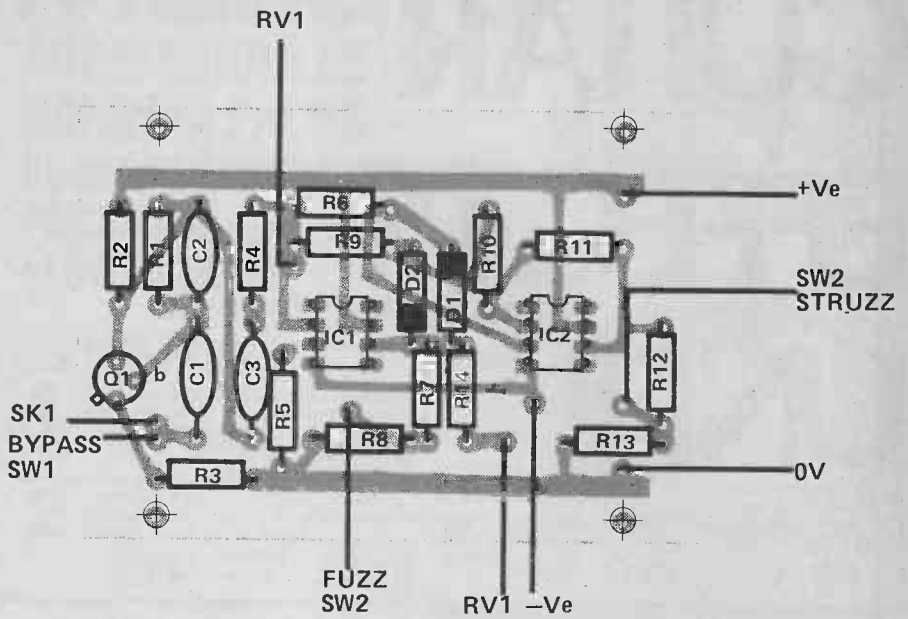
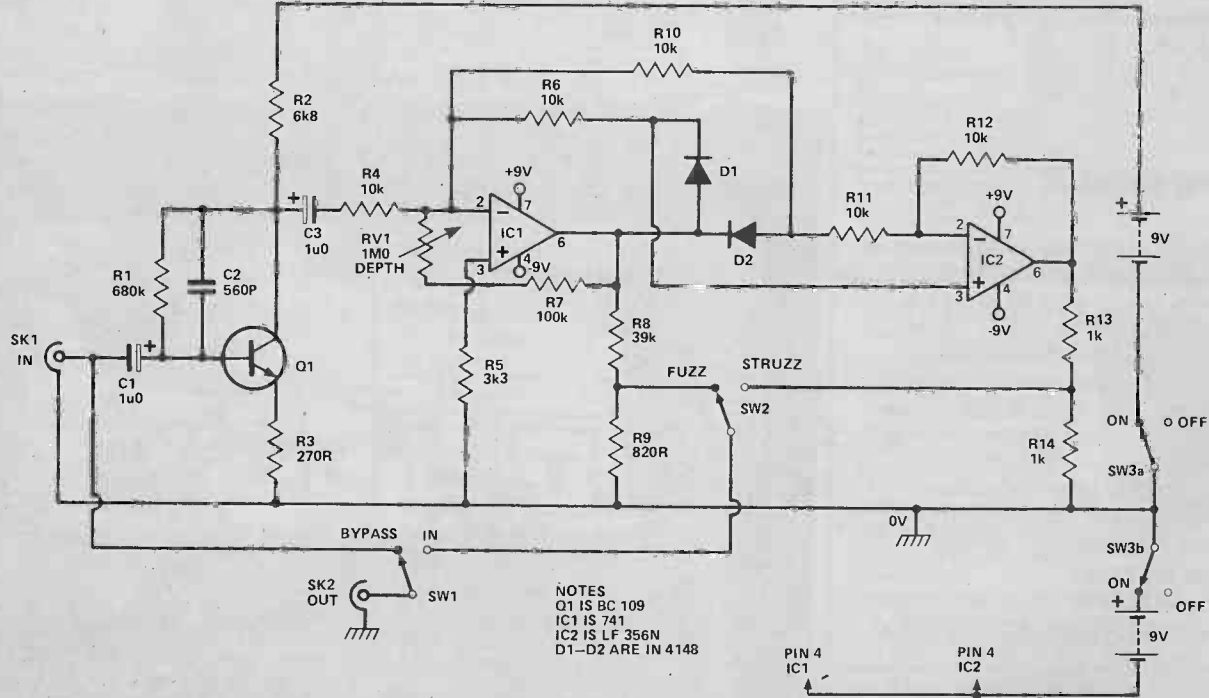
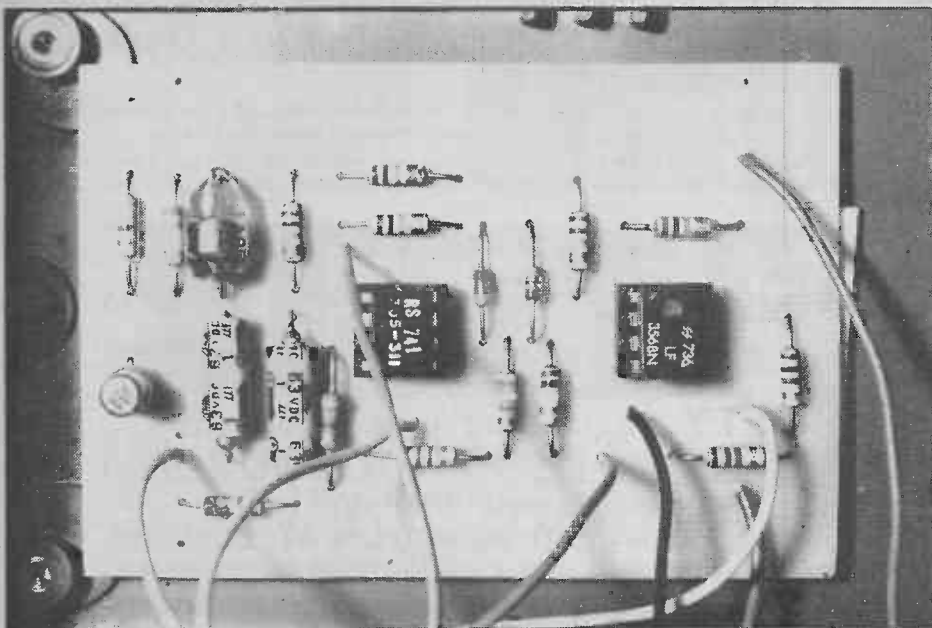

Fig. 1. (above) PCB component overlay

(Above right) Completed PCB

Fig. 2. (Below) Circuit diagram





## HOW IT WORKS

THE SIGNAL from the guitar pick-up is fed to common-emitter amplifier Q1 via blocking capacitor C1. Q1 has a voltage gain of about twenty-five, and brings the guitar signal up to a reasonable level for driving the fuzz and struzz circuitry. The upper frequency response of Q1 is restricted by C2 in the interest of circuit stability.

Operational amplifiers IC1 and IC2 are wired together as a precision full wave rectifier, with its true output signal appearing at pin 6 of FET op-amp IC2. A very heavily clipped version of the input (Q1 collector) signal appears at pin 6 of IC1, and has a peak-to-peak amplitude of about 1.2 volts. RV1 enables the small signal voltage gain of IC1 to be varied from  $\times 10$  to about  $\times 110$ , and controls the depth and 'sustain' characteristics of the sound effect unit. IC1 has a 'large-signal' gain of unity.

The fuzz output of the unit is taken from the output of IC1 via potential

divider R8-R9, and is a perfectly conventional heavily-clipped, fuzz signal, with variable depth and sustain. The struzz output, on the other hand, is very unusual, and is taken from the output of IC2 via potential divider R13-R14. In the struzz mode the original guitar signal is full-wave rectified, so that its fundamental tone (which passes through zero cross-over points in each cycle) has its frequency doubled, but the overtones (which modulate the fundamental and do not pass through zero cross-over points) do not have their frequencies altered. The struzz output signal also has amplitude distortion imparted to it, due to the full-wave rectifier action.

Thus, the fuzz output signal has very heavy amplitude distortion, and the struzz output has both amplitude and frequency distortion. The sound effects unit can be switched in and out via bypass switch SW1, and should be interposed between the guitar and the main amplifier.

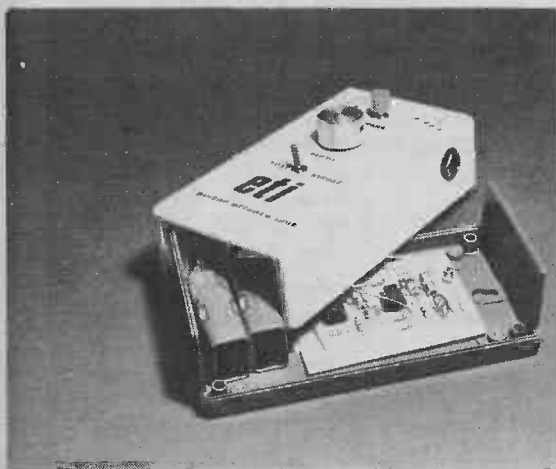

The PCB and batteries, mounted in the verecase, showing one of the jack sockets on the side of the case.

## CALCULATORS

### SCIENTIFIC

**SPECIAL OFFER**  
TEXAS T159 together with PC100B  
(Complete as manufacturer's specifications)  
**£285.00**

- TEXAS/HP Accessories available
- \*TEXAS T159 (New Card prog 960 prog steps of 100 mem) **£156.50**
  - \*TEXAS T158 (New Key prog 480 steps or 60 mem) **£60.00**
  - \*TEXAS PC100B (New updated Printing Unit for T158/T159) **£140.00**
  - \*TEXAS T157 (Key Prog 8 mem. 150 Keystrokes/50 Prog Steps) **£25.00**
  - TEXAS T133 (New — same spec. as T130, but 3 mem) **£13.95**
  - \*TEXAS T145 (New updated version of the Texas T140) **£19.95**
  - \*TEXAS 42MBA (10 Dig Fin/Stat Prog 12 mem 32 keystrokes) **£42.95**
  - \*TEXAS TI PROGRAMMER (Hexadecimal Oct) **£46.50**
  - \*TEXAS T151/iii (New 8 Dig + Exp 10 mem 32 Prog Steps. Cat/Sci) **£26.30**
  - TEXAS : 50 Sci. Stat. 2 Con Memis) **£23.00**

### "SLIM-LINE" Chronograph BARGAIN OFFER

You will not believe the luxury of this "slim line" 12 function Chronograph until you have worn it . . . until you have enjoyed the compliments it generates.

The "Slim-line" Chronograph gives continuous easy to read LCD display of hours, minutes, seconds, AM/PM. At the touch of button you have date — month date — day of week — reverting to normal display time at the release of the button.

Press again for immediate stop watch/lap time facility to 1/100 second. The "Slim-line" even has a powerful back light for easy night use, the casing is chrome finished with matching linked bracelet.

We are so certain you will be delighted and satisfied with this "Slim-line" Chronograph that in addition to the One Year Warranty we are offering a 14-day money back guarantee if you are not entirely satisfied.



**ONLY £20.00 + £1.00 p/p ins.** Send cheque/P.O. or order via Barclay/Access credit card today under our Special 14-day Trial Offer.

- \*TEXAS T158 with Applied Statistics **£80.00**
- \*TEXAS T159 with PC100B and Applied Statistics **£305.00**

### WINTER SALE

TEXAS T159 Calculator (complete as manufacturer's spec. master module, charger, etc.), PLUS statistics module and extra set of 40 Blank Prog Cards with wallet, etc.  
**ONLY £180**

- \*CBM 9190R (as 4190R but with 9 memories) **£27.50**
- \*CBM Pro 100 (72 Step Prog) **£29.50**
- \*HP 19C (Cont Mem key Prog Printer) **£129.00**
- \*HP 29C (as 19C but no Printer) **£93.00**
- \*HP33E (8 mem Pro Sci/Stat) **£64.00**
- \*HP32E (Advanced Sci with Statistics) **£50.00**
- \*HP27 (10 Mem Sci/Fin/Stat) **£73.50**
- \*HP31E (New Sci replace HP21) **£35.00**
- \*HP 67A (C Prog 224 Steps 26 Mem) **£257.75**
- \*HP97A (Fully prog with Printer) **£422.00**
- All HP range avail. inc. new 'E' range.
- CASIO FX360 (New 10 Dig + Exp 7 Mem 8) (St. Div Lin Regr. etc.) **£45.00**
- CASIO AQ-000 (updated AQ1000 Cal. 3-Way Stopwatch, Alarm) **£22.00**
- CASIO FX3100 (LCD Sci. Sid. DP. Rec.) **£22.50**
- CASIO FX8000 (as above + Stop Watch/Alarm) **£27.73**

### THE COMMODORE PET COMPUTER

with 8K bytes RAM 2001-B  
A complete personal computer that operates anywhere by simply plugging into Main supply. Allows communications directly from BASIC to IEEE — 488 standard devices —

Cassette, Video Display Unit and Keyboard built into PET  
Fully guaranteed Warranty by CBM  
complete only **£550**  
**PET 2001-16N £675**

### NOW IT'S YOU AGAINST 'COMPUTERS'

**BORRIS** the most advanced chess computer yet. Borris is ideal for learning and improving your chess game from beginner to master. Borris can play against himself, has Alpha-Numeric prompting to help improve play and by simple switching you have facility to follow Borris's thinking while he analyses position before making a move. Walnut case, wooden chess men, board mains adapter, etc. **£184.00**  
**CHESS CHALLENGER '10'** (10 Levels of beginner to master) **£180.00**

\*FREE — Mains /Charger included\*

GOODS FULLY GUARANTEED. PRICES EXCLUDE VAT (ADD 8%)  
BUT INC. P & P CHEQUE WITH ORDER  
Company/ Hospital and Government orders accepted by phone  
Barclaycard/Access accepted by phone

**Tel. 01-455 9823**

EXPORT ORDERS WELCOMED  
Air Freight/Air Post Delivery  
Quotations on request. Payments via Letter of Credit / Int.  
Money Order / American Express, etc.

**MOUNTAINDENE**  
22 Cowper St., London, EC2.

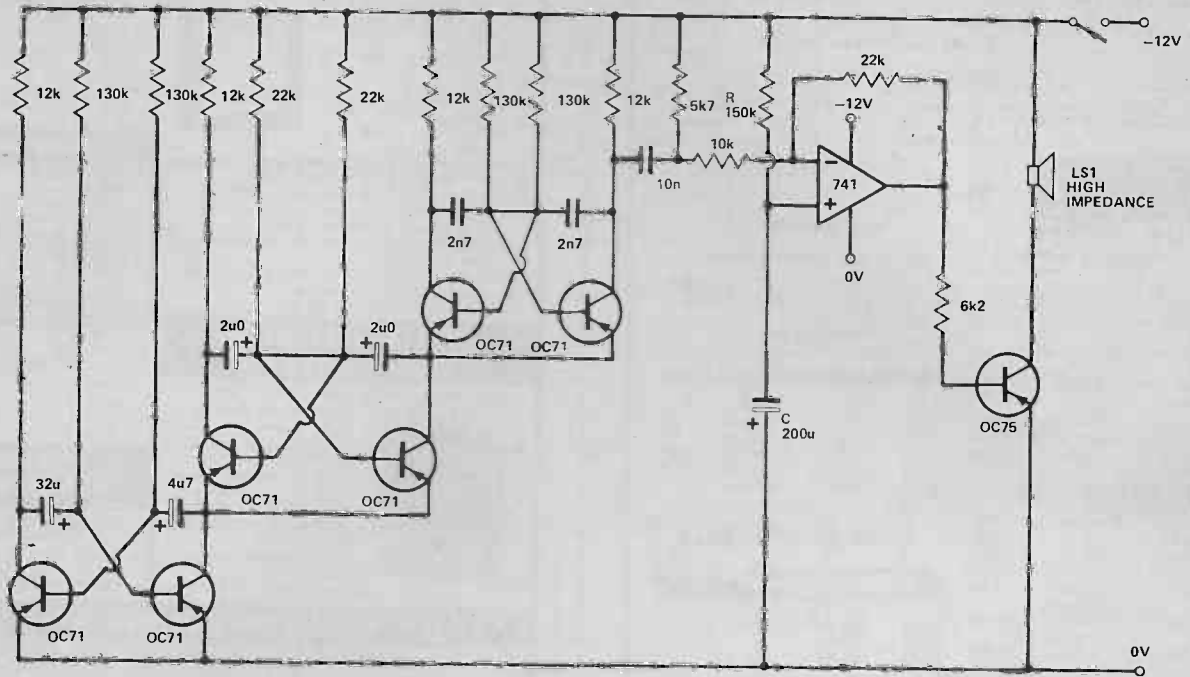

### Gentle Clock Alarm

I. Hill-Smith

RING! RING! BUZZ! This is DLT  
CLANG! PIP PIP PIP!

There are gentler ways to wake up. This circuit provides an alarm which builds up from being inaudible to loud over about one minute. As a result you are always woken by the minimum volume required to wake you; a far more comfortable experience than the usual trauma. The three multivibrators in cascade provide a signal like the sound of a warbler telephone. As C slowly charges through R a larger fraction of the signal is amplified by the op amp producing a louder output.

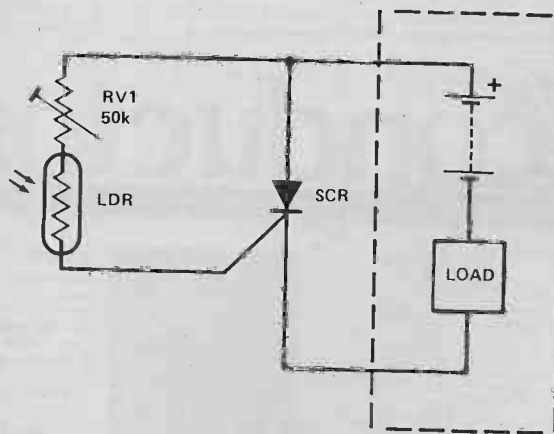

```
X . 00
# 3 01
4 4 02
5 5 03
1 1 04
. A 05
8 8 06
1 1 07
- F 08
+ E 09
# 3 10
1 1 11
= - 12
▼ A 13
gin 1 14
0 0 15
9 9 16
# 3 17
8 8 18
8 8 19
8 8 20
= - 21
stop 0 22
```

### Calculator Radio Alarm

T. Corringham

This very simple circuit, used with a Sinclair Cambridge Programmable calculator, enables a transistor radio to be turned on after a predetermined time, (within the range of a few seconds to five months).

None of the components are critical, but the SCR should have a suf-

ficiently high voltage and current rating for the radio used.

If a transistor radio is used the SCR is connected in series with the battery, but if a cassette recorder/player is used it can be connected to the remote socket.

The LDR is placed above the left hand three digits of the display. RV1 is adjusted so that the circuit is triggered by '888' being displayed, but not by the background light only.

Using the program given, the time

in minutes of the required delay is put in and /RUN/ pressed to start the timing period.

To stop the program prematurely /÷/c/CE/ is pressed.

The calculator should be used with a mains adaptor.

The timing is accurate to within five minutes in eight hours.

If a buzzer or similar alarm is used the same circuit can be used to give an audible indication of the termination of long programs.

Tech-Tips is an ideas forum and is not aimed at the beginner. We regret we cannot answer queries on these items.

ETI is prepared to consider circuits or ideas submitted by readers for this page. All items used will be paid for. Drawings should be as clear as possible and the text should preferably be typed. Circuits must not be subject to copyright. Items for consideration should be sent to ETI TECH-TIPS, Electronics Today International, 25-27 Oxford St., London W1R 1RF.



### Keyboard/display sound converter

K. G. Reid

This circuit can be used in several modes: It can provide quantized feedback (a distinct improvement over the normal single 'bleep') from the key actions made on a calculator-type keyboard. It can be used to give a 'sound' translation of a digital display, or completely replace the display when sound would be a better communication medium.

The keyboard or display information (a maximum of 16 bits with one 16-line 74150 multiplexer) is translated into a series of 16 high or low frequency tone pulses, corresponding to the 'high' or 'low' logic state of the 16 bits.

The circuit illustrated was used in conjunction with a digital multimeter, requiring three 4-bit words for the digits and three additional bits for over-range, negative and decimal point. Thus, 15 lines only were required, the 16th being used for resetting.

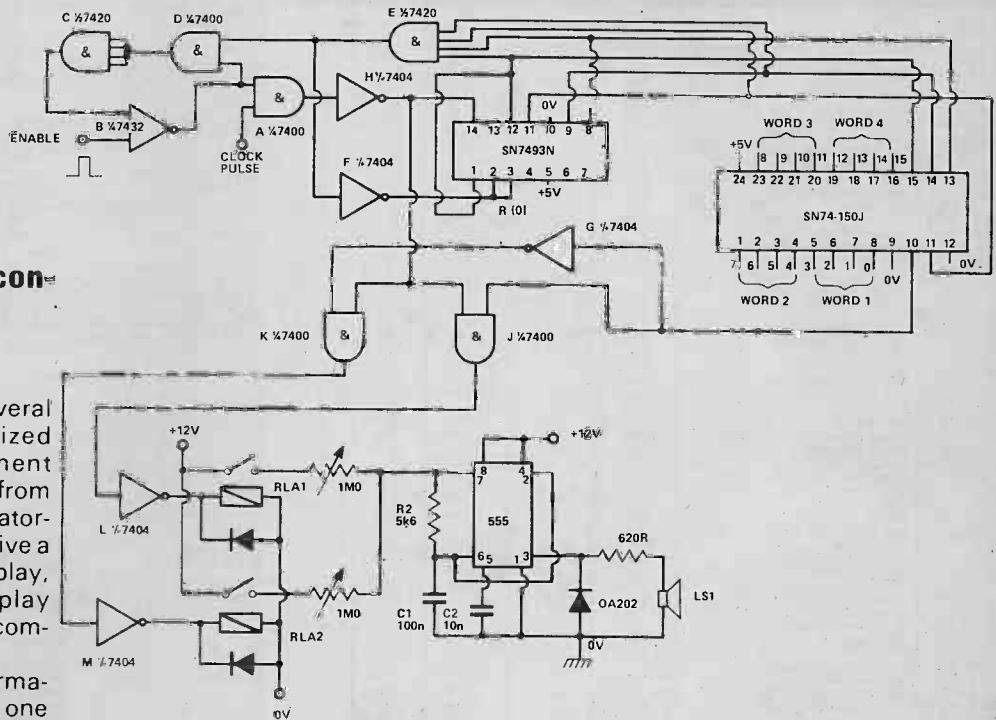

The 15 bits are latched on to the inputs of the 74150 multiplexer. Presentation of the enable pulse results in a logic '1' appearing at the output of gate B, allowing clock pulses to pass via gates A and H to the 7493 counter. Gates B, E, D and C form a latch which remains 'set' until all 15 bits have been sampled. As each bit is sampled, the inverse state appears at the multiplexer output, opening gate

J or K and thus operating one of the two reed relays. As a count of 1111 appears from the counter, the output of F drops low, resetting the latch and counter. The operation of either relay results in a tone appearing at the loudspeaker (or earpiece), the tone frequencies being set (1.2 kHz maximum) by the 1 megohm pots. The tone pulse length is governed by the clock rate.

### Digital Pulse Compressor

N. C. Hall

Whilst constructing a digital frequency meter the author found it necessary to be able to accurately trim the width of a gate pulse. The circuit shown uses only two ICs and can reduce the width of a pulse applied at its input by up to a few milliseconds. The table shows the reduction achieved by using different values of C1.

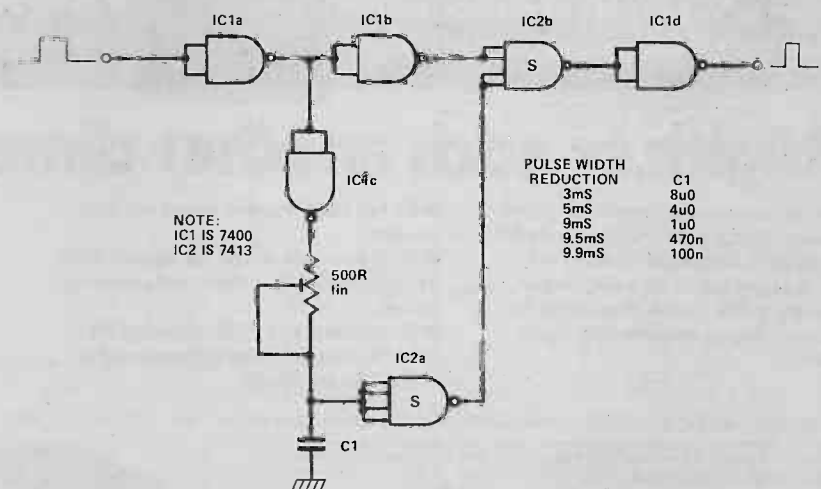

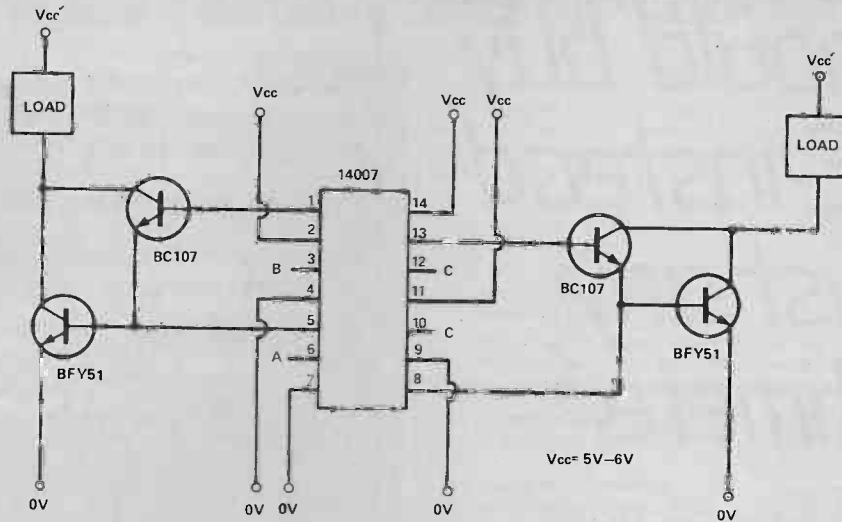

### Darlington Drivers for a few pence

C. J. Ramey

This circuit offers a very efficient way of driving a pair of transistors in Darlington configuration from CMOS. The circuit in Fig 1 shows how two loads of up to 1A may be driven from a single 14007 chip with no external resistors. Using a 2N3055 in place of the BFY51 will enable loads of up to 3A to be driven at voltages limited only by the  $V_{ce0}$  of the transistors ( $V_{cc}$ ).

Fig. 2 shows the internal circuit of one section of the 14007. A high on

pin 6 switches the lower CMOS transistor on, holding Q2 off and sinking the leakage current of Q1. A low on pin 6 drives Q1 and switches the lower CMOS transistor off and the upper CMOS transistor on.

The result is fast switch off at low cost and efficient switch on.

A bonus is the inverter between pins 10 and 12. Note:  $V_{cc}$  should be 5-6V to prevent excessive current being drawn from the CMOS chip.

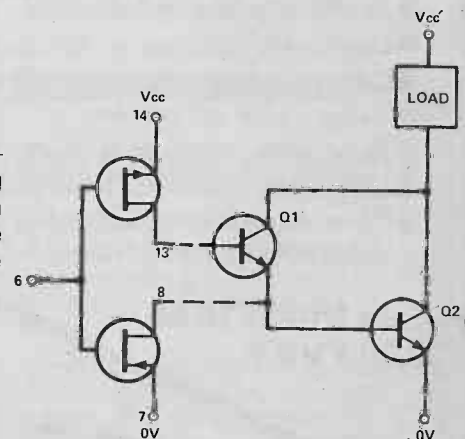

### Precision Rectifying with the LM3900

A. Winsor

The LM3900 is different from most op-amps in that it is current differencing and operates from a single supply rail, which means that the inputs bias at one base-emitter voltage above ground. Hence standard techniques are not applicable as the diode would always be forward-biased. Two feedback paths are therefore provided:— R3 for DC stability, and R4 for the AC signal after C2 and R5 have filtered out the DC bias. When  $R2 = 2 \times R3$  point A will be at  $V_{cc}/2$ , allowing the diode to be reversed at will. For large positive input returned to ground. Input impedance equals R1, and voltage gain equals  $-R4/R1$  since R4 is

made very much smaller than R3. C1 and C3 are DC blocking capacitors and determine the low frequency roll-off. Component values quoted are those used on the prototype and may be altered to suit individual require-

ments.

This circuit has obvious potential, especially in portable equipment where the 4 amps. in one package and single supply rail yield a more compact, more convenient unit.

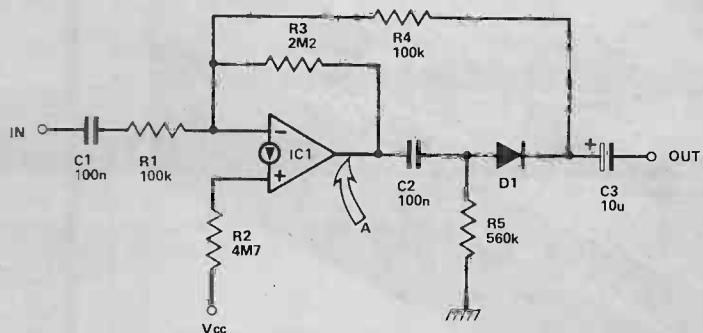

NOTE:  
IC1 IS 1/4 LM3900  
D1 IS ANY GENERAL PURPOSE  
DIODE

# PCB FOIL PATTERNS

GATHERED HERE are all the PCBs for this month's projects. From now on the boards will be grouped together like this in order to facilitate their use by those readers wishing to produce their own PCBs from these patterns.

All are shown foil side up, and full size. Companies wishing to produce these for sale as ready made PCBs should note that where the board carries a copyright

symbol, the designer retains that copyright to himself, so his company, and that particular board may *not* be produced on a commercial basis.

These pages form the basis of our ETIPRINT sheets, which are etch resistant transfers of the foil patterns, designed to simplify one-off PCB production. See the ad on page 49 for further details.

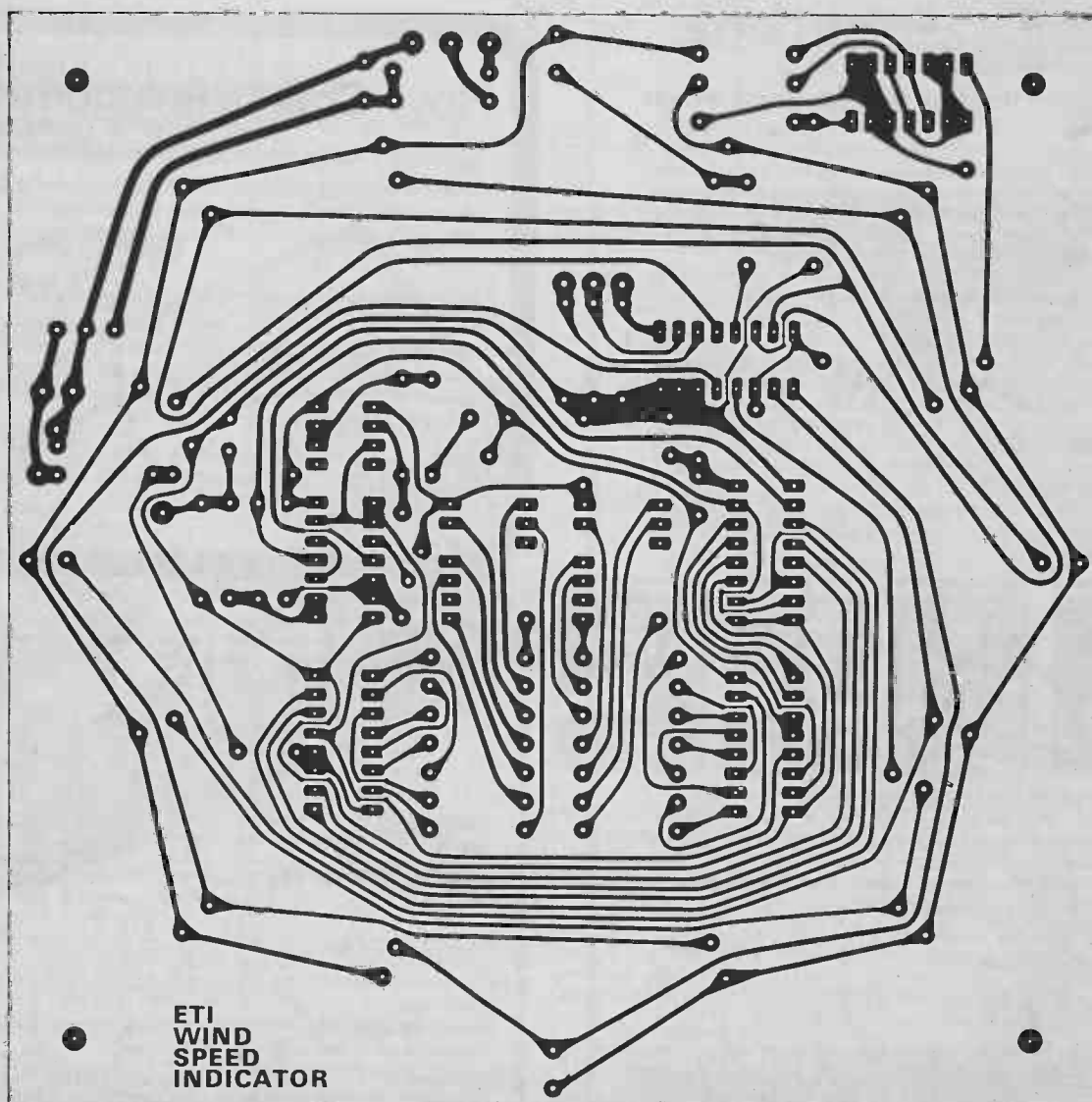

# news digest.....

## INFRARED EYES

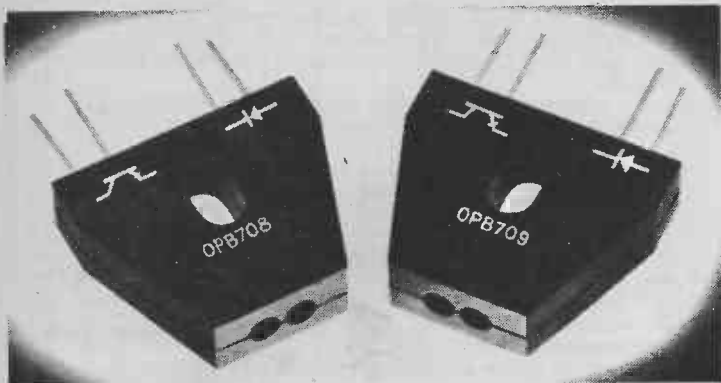

NORBAIN have announced the introduction of two new reflective object sensors. Optron types OPB708 and OPB709 are reflective transducers incorporating a gallium arsenide infrared emitting diode and a planar silicon phototransistor (OPB708) or photodarlington (OPB709).

With a reflective surface of magnetic tape 0.15 inches from the read head, typical values of

photo-current are 65 mA (OPB708) and 8 mA (OPB709). An aluminium foil at the end of a tape produces typical values of 1 mA and 140 mA respectively. With an opaque reflective surface flush to the read head, maximum crosstalk current is 100 nA (OPB708) and 250 nA (OPB709). Further details from Norbain-Optoelectronics Division, Norbain House, Arkwright Road, Reading, Berkshire RG2 0LT.

## THREE FUNCTION TOOL

Cut the copper conductor of a wire free, strip off a length of insulation and wrap several times around a terminal, all in one operation with this bit and sleeve combination from Vero Systems (Electronic) Ltd. The three functions are performed in one rotating operation using any electric or pneumatic tool with normal output and a speed of about 3,000 RPM. Vero's Standard Pneumatic 230 V wrapping tool is suitable.

The bit and sleeve, designed to use a specific gauge of conductor and insulation diameter, are available in the range 22-30 AWG. Low strip-force Mylene wire for use with these bits and sleeves is available in six colours from Vero Systems. Cut, strip and wrap tool AB065 is £98 from Vero Systems (Electronic) Ltd, 362 Spring Road, Sholing, Southampton, Hampshire SO9 5QJ.

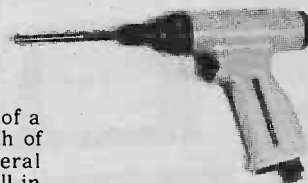

## DOING TIME?

ARE you one of the select few whose calculator is doing six months in Parkhurst? Have you been ordering digital watches from the Lord Chancellor? What ETI reader in his right mind would do that?

It seems that Mountandene's old phone number was similar to that of the Lord Chancellor's Prison Office. Hence the confusion.

If you still have a piece of paper with Mountandene's old number on it, use it to pack convict 4017 back to the Lord Chancellor. If you ask nicely he might give your calculator parole.

### AUDIO MODULES

#### 1 Stereo Cassette Deck N999

Complete with electronics uses: Music centres, disco consols, tape editing, etc. Freq resp 63 Hz-10KHz WOW: 0.15% FLUTTER: 0.18% channel; separation 55dB. Electronic speed control. ALC Mic and line inputs. JAPANESE manufacture — requires 12 VDC. **£23.95.**

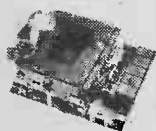

### RF MODULES

#### 6 Surplus RF Board 020

Complete MW/LW/FM/MPX Tuner uses 3-stage FET front end 2 ceramic filters 3089E-1310 Decoder. AM section built around 3132E, 2-stage tuning comes with 4-way switch — ferrite rod aerial. **£9.99.**



#### 2 Preamp Amp — PSU Wimborne 11W per channel.

Four Rotary controls. Vol., Bass, Treble, Bal. 2 x PSUs for RF Board — cassette deck, LM 387 preamp IC driver. TIP 31 — TIP 32 Output Pairs. Special price includes transformer, **£16.95.** (October, 1978, PW).

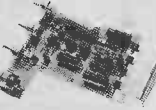

#### 7 RF 030

Improved version of above extra gain stage imposed S/N ratio and 1.5  $\mu$ V sensitivity for 26dB S/N way selector switch AFC stereo/mono switching — two additional inputs. **£19.95.**

3 AMP 041 8 watt RMS per channel amp — preamp supplied with pots. Fully complementary requires 2 $\pm$  VDC. Price complete **£6.99.**



8 RF 040 MW/LW/FM/MPX varicap tuned RF board as per 78 Nov./Dec. PW Dual gate MOSFET front end, 2 x 1F gain stages 3189 Deviation mute, interstation mute, MPX filters. STab PSU 1  $\mu$ V sensitivity and 75dB S/N ratio. AM Section also varicap tuned HA1197, excellent performance. Special price **£28.95.**

4 AMP 020 Stereo power amp 30 W RMS per channel. Class ABI TIP 34A — TIP 33A. 16 Transistor circuit. Fre. resp. 15Hz — 18 KHz — 1dB. **£7.99.**



9 VT01 108-150MHz MOSFET front end 26dB gain. 10.7MHz 1F output. Covers 2 metres. Amateurs. Aircraft, etc. **£7.99.**

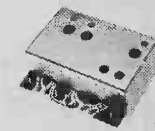

5 Matching Hi-Fi Preamplifier, four rotary controls, Vol., Bal., Treble, Bass, Treble — 14dB Bass-14dB facility for loudness control. **£6.99.**

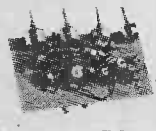

10 IF15 Matching IF Strip double conversion 10.7MHz/470 KHz AM/NB/FM. Excellent performance. **£12.95.**

We have all parts in stock for the Wimborne Music Centre — parts for amps/tuner amps and music centres up to 25 watts per channel. We stock all hardware and trim to give units a professional finish. Front panels, meters, knobs, sockets, etc.

All prices include VAT, P&P £1 per item. Max. £2 postage. All items fully wired. Full data supplied. 3-YEAR guarantee. 7-day delivery.

**ESE** RAILWAY HOUSE, HARDHAM CROSSING, PULBOROUGH, SUSSEX



Below left: Wind Speed Indicator PCB  
Below right: Click Eliminator Mk 2 board  
Right: Struzz effects unit  
All are shown full size and will form the basis of ETIPRINT  
sheet 023 which will be available shortly

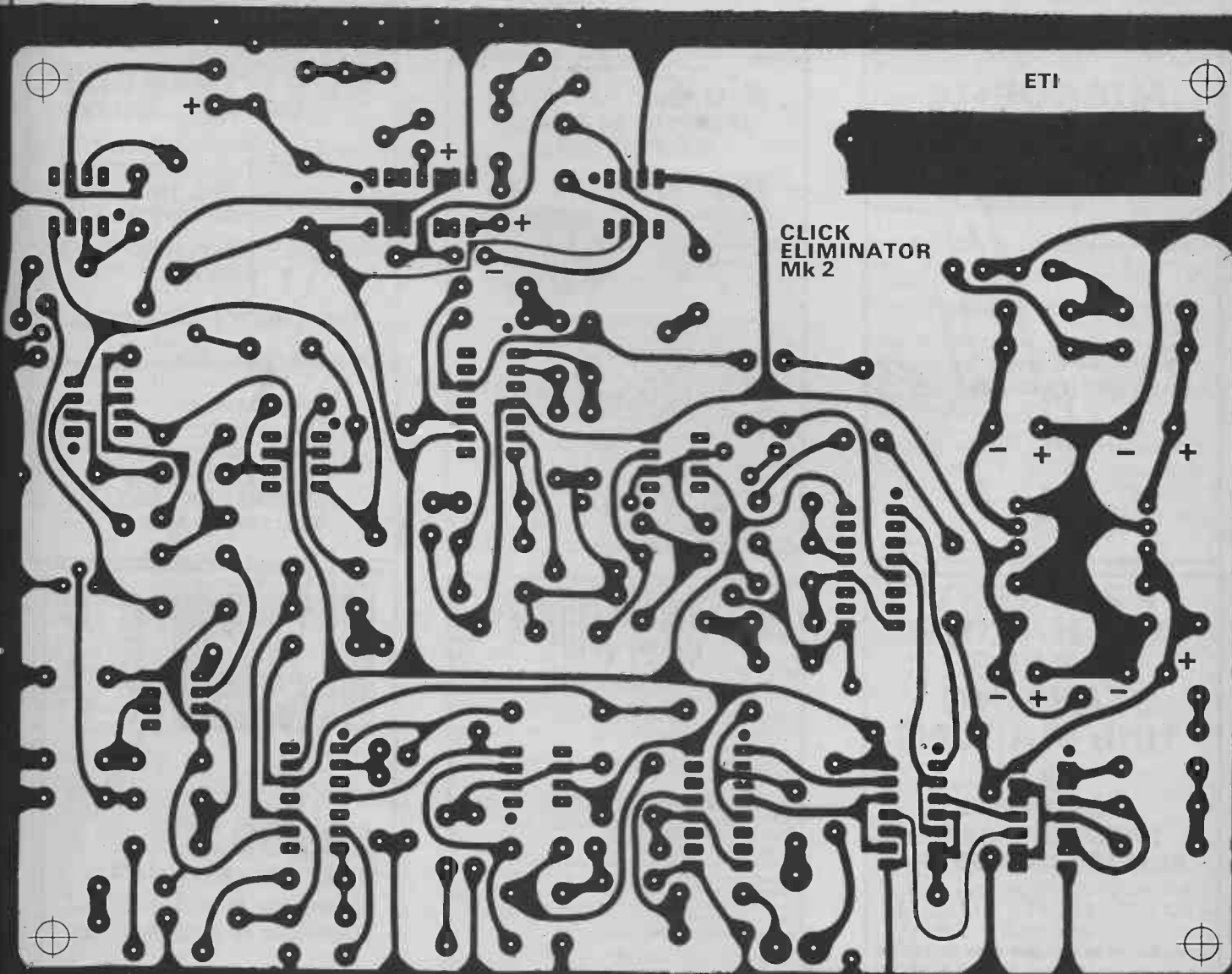
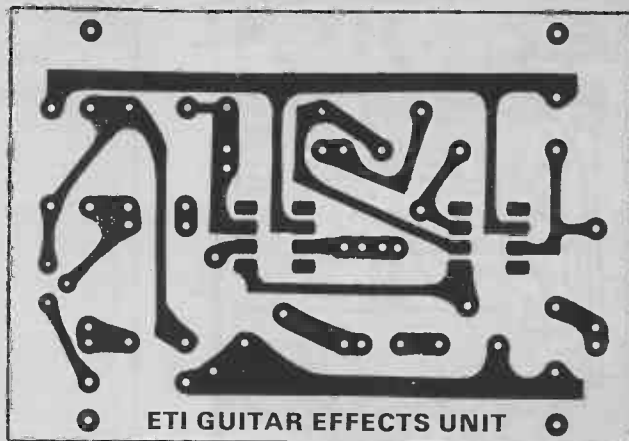

# POWER AMP SURVEY

The Americans would describe it as a 'crowded marketplace'. Power amplifiers appear almost daily and the resulting choice can easily lead to confusion. Ron Harris attempts an overview.

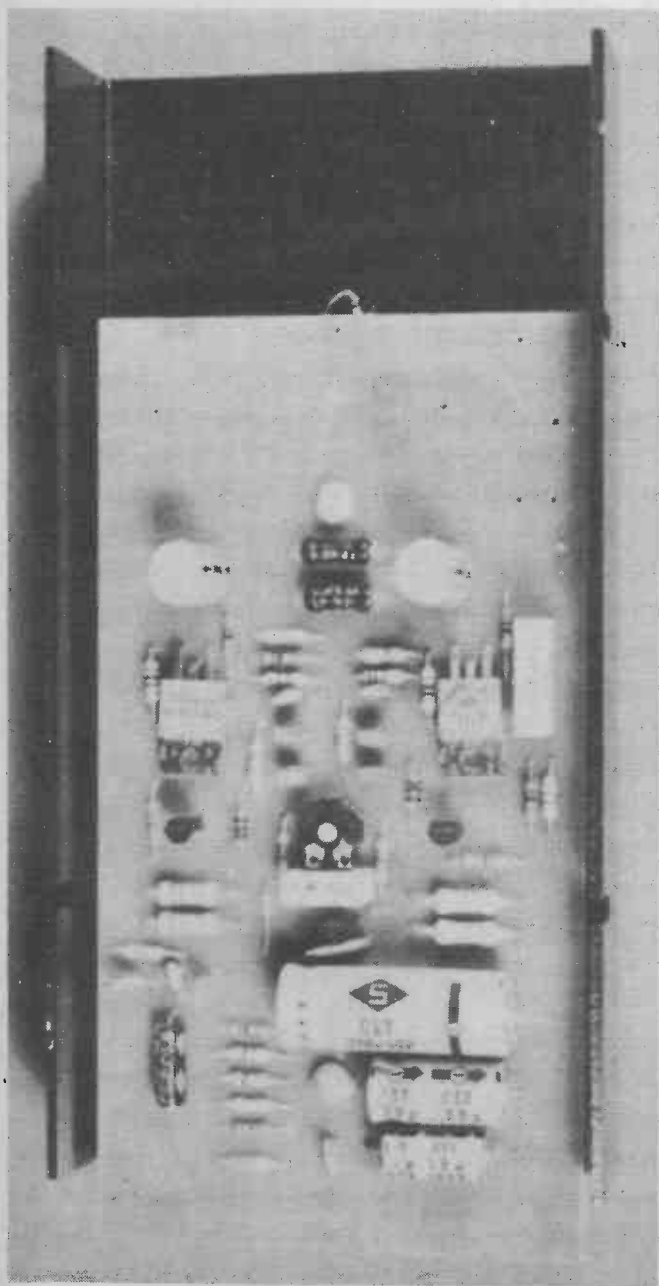

UPGRADING HI-FI is a costly business using commercial units, as 'better' can somehow read 'dearer' once over the threshold into a hi-fi emporium. Once contracted, however, the improving 'bug' is no respecter of price and pocket.

Quite commonly the malady can be caught via the cones of new loudspeakers which are crying out for more watts to drive them. The amplifier just **has** to go!

## The Modular Connection

One method of gaining the extra power — if you're quite content with facilities etc — is to replace output stages of your present equipment with two power amplifier modules. There are certainly enough on the market to choose from.

This will certainly be cheaper, and most of these modules outperform similarly priced commercial units, so performance need not suffer. Since you need not necessarily have to pay for a PSU and case you don't need, it **must** be cheaper. Very often too, the existing case can be utilised to house the new boards, with attendant saving in that most onerous of tasks — metalwork.

Judging by the continuing popularity of the audio projects which appear within these pages, do-it-yourself hi-fi continues to abound, even though building up from scratch is often no cheaper than buying commercial units. Modular construction — with most designs being pre-tested — can make this task easier and more certain.

With kit construction, however, there is obviously more to go wrong, and this tends to mean the results are more dependent (at times!) upon the constructor than the supplying company. We have been told by several reputable kit suppliers that the greatest single reason for non-functioning units is poor soldering!

## Board Decision

With the large number of available kits for power amplifiers in mind, we decided to exclude them from our deliberations, and concentrate on modules alone. This was defined as a unit in which the amplifier is supplied completely pre-assembled; in other words as a PCB, which can then be utilised.

Undoubtedly there are some modules we have missed out in our scan across the adverts — and if you know of any we **have** missed please let us know so that as few injustices as possible are perpetrated! ▶

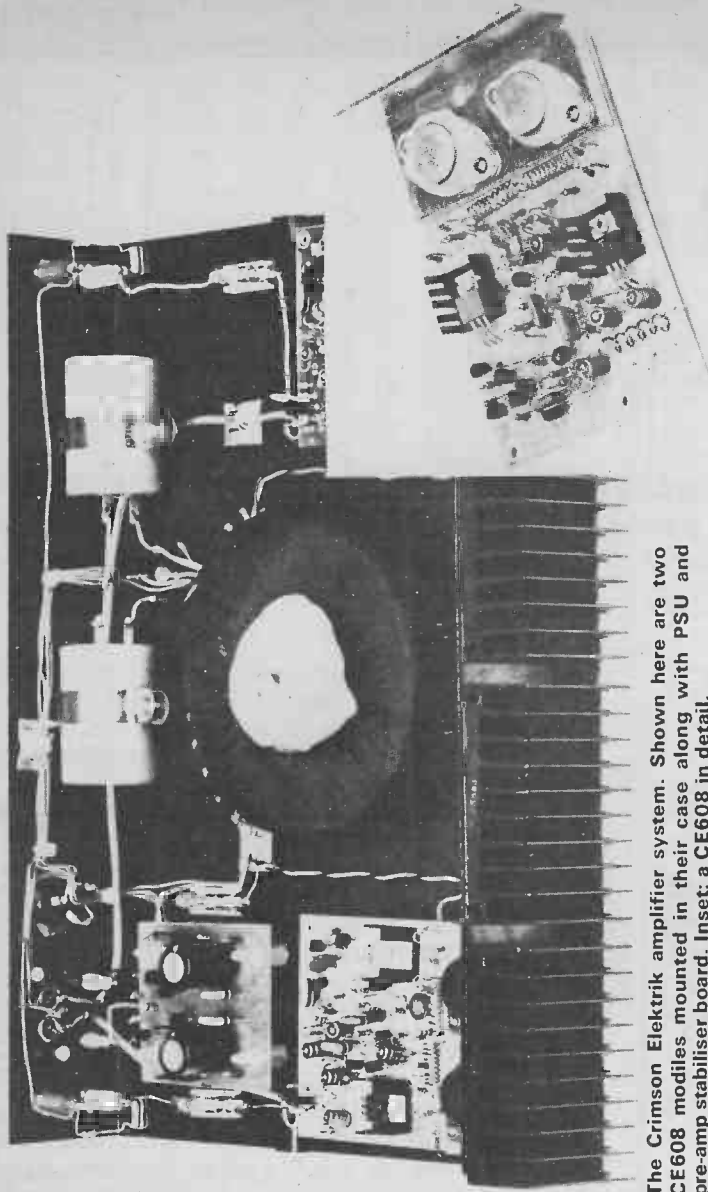

The Crimson Elektrik amplifier system. Shown here are two CE608 modules mounted in their case along with PSU and pre-amp stabiliser board. Inset: a CE608 in detail.

## Advantage Points

Using these units is very straightforward. The manufacturers will have set up the amplifier already — and hopefully tested a few to specification. All that should remain for the purchaser to do is to connect up a PSU, some input and output sockets and a case. Music should then flow forth — suitably amplified.

One hint for wiring up a unit from modules is to keep an eye on the earthing arrangements. Insufficient attention to this can — and will — lead to monumental amplification at 50 Hz alone, i.e. hum. Use a 'spider' earth technique, taking loudspeaker PSU and board earths to a common point. The Reservoir capacitors are a convenient place to work upon.

Connect all the earth tags on the input phono sockets together, and take out a single lead to the PCBs only. Make sure there is only a single path to signal earth, as this will alleviate any 'loop' problems which may otherwise arise.

When laying out the case, keep the transformer as far away from the amplifiers as possible, and always shield it properly. Positioning the PSU board between modules and windings will ensure that some distance is maintained.

## Choosing

If you're using your new vaits to replace an aging or new-underpowered predecessor remember that to obtain a barely perceptible increase in sound volume (3 dB) you will need to DOUBLE power output.

It is no good going from 20 W to 30 W and expecting to rock neighbours out of bed — if they could sleep through your 1812 renderings before, that extra 10 W is not going to add significant 'umph' to your overtures.

It is better to choose too high a power output for your application and be gentle with volume control, than to underpower and regret it later. The correct rating depends upon the volume of the room you intend to play your music in.

Allow 25 W for the first 1000 cu ft, and add 10 W per 1000 cu ft thereafter. This will yield up a minimum figure for normal listening levels with a decent reserve, assuming average efficiency loudspeakers.

If you use transmission line designs, add 15 W to every 25 W of your estimate to allow for the basic inefficiency of this loading method.

## Wot Happened?

One part of this survey which somehow never materialised was the proposed listening tests with one sample from each range. Most manufacturers seemed unable to respond within the time required — approx. two weeks. We were left with BI-PAK, Crimson and two ILP HY50s I borrowed from a neighbour!

The idea had been to select a power output which was common to all ranges — 60W seemed reasonable, and build up a unit from each suppliers modules. This *would* have told us much about the sound quality, reliability and overall standard of the amplifiers. Would have.

## Press On

In fairness to Magnum Audio they came upon the scheme late and were very quick indeed sending us information and a sample of their excellent instruction manuals. The scheme is not however dead and buried yet — it is at least possible that our samples are reposing

## Table A Motion

The table shown here lists some thirty odd modules, ranging in power output from about three watts to well over 150W. A list of manufacturers is given at the end of the article.

All the companies produce their own power supplies to power the amplifiers, and it is at least convenient to employ these where needed. One common failing of these is that the firms tend to 'underpower' the modules, in that not enough reserve is allowed for in the PSU. Quite often the same PSU is recommended for a stereo design as for driving a single module.

At the high power end of the ranges, where cost is pretty high anyway it is well worth powering each module from a separate PSU board. This reduces dynamic crosstalk — where a peak on one channel 'drains' the supply thus distorting the second channel by clipping the signal. If you use a single transformer make sure it is generously rated, at least 50% above the current you expect to draw.

# COMPARISON TABLE

MODEL	POWER OUTPUT	THD (at given load at 1kHz)	FREQUENCY RESPONSE	SIGNAL TO NOISE RATIO	DAMPING FACTOR	SENSITIVITY (for rated output)	SETTLING TIME (8R, 2uF)	OUTPUT PROTECTION REQUIRED	POWER SUPPLY (DC)	SIZE (mm)	PRICE INCL. VAT
<b>BI-PAK</b>											
AL30A	10W (8R)	0.25% (5W)	50Hz-20kHz±3dB	—	—	75 mV	—	NO	15V	74×63×28	£ 4.20
AL60	25W (8R)	0.1% (25W)	20Hz-30kHz±2dB	—	—	280 mV	—	NO	30-50V	103×64×15	£ 5.11
AL80	35W (8R)	0.1% (35W)	20Hz-30kHz±2dB	—	—	280 mV	—	NO	40-60V	103×64×15	£ 7.72
AL120	50W (8R)	0.05% (50W)	25Hz-20kHz±1dB	—	—	500 mV	—	YES	65V	192×89×49	£12.90
AL250	125W (4R)	0.1% (50W)	25Hz-20kHz±2dB	—	—	450 mV	—	YES	50-80V	—	£18.63
<b>CRIMSON</b>											
CE608	55W (8R)	All models	All models	All models	All models	All models	All models	All models	36-0-36V	All models	£16.30
CE1004	81W (4R)	0.01% full	20Hz-20kHz±½dB	110dB	40	775 mV	20 uS	YES	36-0-36V	80×120×25	£19.22
CE1008	92W (8R)	0.0035% 10W	—	unweighted	—	—	—	—	61-0-61V	—	£23.22
CE1704	160W (4R)	—	—	—	—	—	—	—	61-0-61V	—	£29.12
CE1708	145W (8R)	—	—	—	—	—	—	—	61-0-61V	—	£31.90
<b>ILP</b>											
HY30	15W (8R)	0.1% (15W)	10Hz-16kHz±3dB	75dB	—	All models	—	All models	18-0-18V	PCB mounted	£7.05
HY50	25W (8R)	0.04% (25W)	10Hz-45kHz±3dB	75dB	—	500 mV	—	YES	25-0-25V	105×50×20	£9.20
HY120	60W (8R)	0.04% (60W)	10Hz-45kHz±3dB	90dB	—	—	—	—	35-0-35V	114×50×85	£20.53
HY200	120W (8R)	0.05% (120W)	10Hz-45kHz±3dB	96dB	—	—	—	—	45-0-45V	114×100×85	£30.23
HY400	240W (4R)	0.1% (240W)	10Hz-45kHz±3dB	94dB	—	—	—	—	45-0-45V	114×100×85	£41.70
<b>KINGSLEY</b>											
ET1100	100W (4R)	0.1% (100W)	5Hz-50kHz±0dB —3dB	100dB	20	500 mV	—	YES	40-0-40V	—	£18.35
<b>MAGNUM</b>											
CP2/15	2x20W (8R)	0.03% (20W)	20Hz-25kHz±3dB	106dB	—	1000 mV	20 uS	YES	20-0-20V	130×102×32	£14.45
<b>STERLING SOUND</b>											
SS103	3W (8R)	—	—	—	—	100 mV	—	YES	20V	—	£ 2.85
SS105	5W (3R)	0.3% (1W)	—	—	—	30 mV	—	NO	14V	82×50×25	£ 3.95
SS110	10W (4R)	0.3% (5W)	—	—	—	60 mV	—	NO	24V	82×50×25	£ 4.65
SS120	20W (4R)	0.3% (10W)	—	—	—	80 mV	—	NO	34V	82×50×25	£ 5.15
SS125	25W (8R)	0.1% (10W)	—	—	—	140 mV	—	NO	50V	82×50×25	£ 7.25
SS140	40W (4R)	0.05% (20W)	—	70dB	—	300 mV	—	YES	45V	125×80×25	£ 6.50
SS160	64W (8R)	0.1% (30W)	20Hz-20kHz±3dB	70dB	—	350 mV	—	YES	50V	125×80×25	£ 8.50
SS1100	100W (4R)	0.1% (50W)	20Hz-20kHz±3dB	70dB	—	500 mV	—	YES	70V	125×80×25	£10.00