

Easy to build projects for everyone

SEPT. 77

35p

Everyday ELECTRONICS

PROBOPHONE



**ADD ON
CAPACITANCE
UNIT**

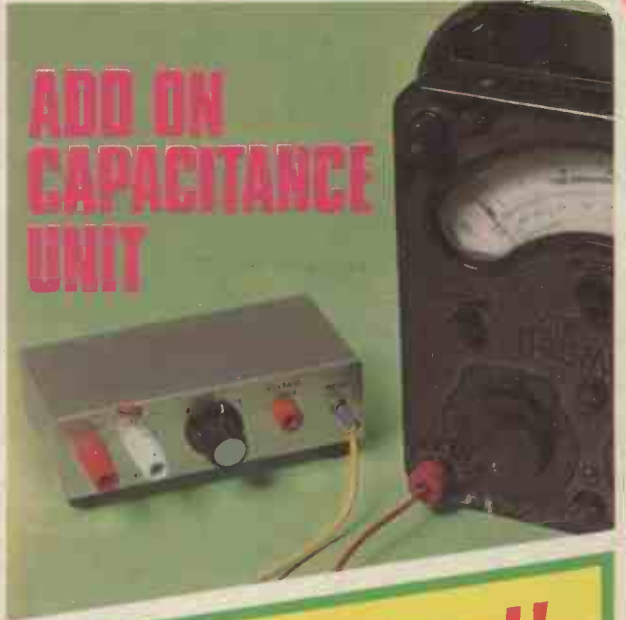

FOUR varied projects of wide appeal!

**DYNAMO
BACK-UP**

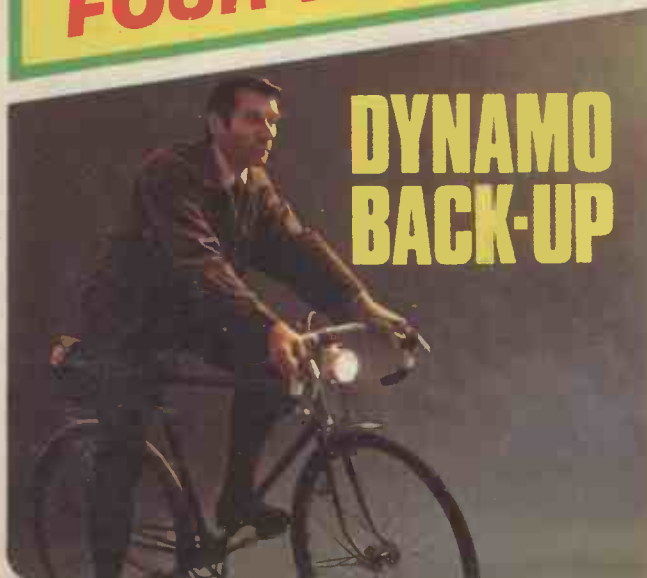

**FLASHER
BLEEPER**

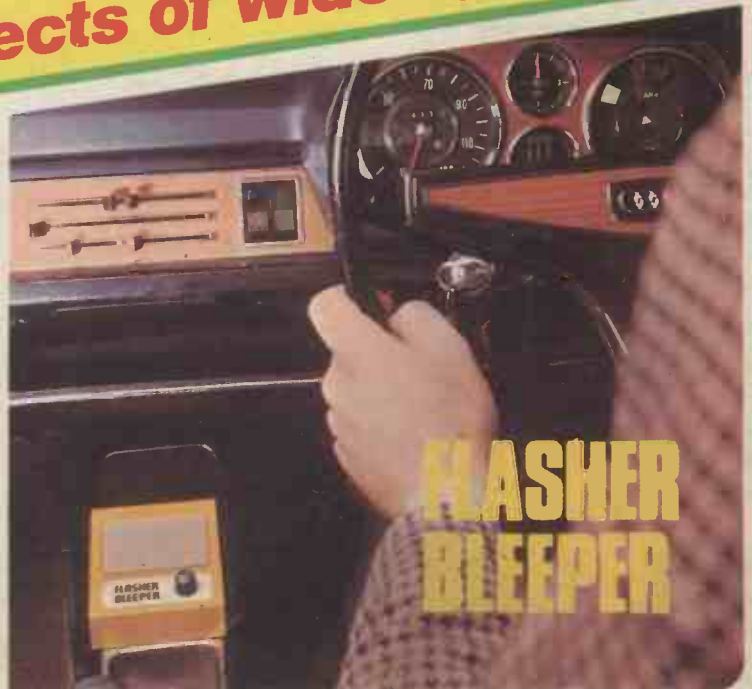



JUBILEE SALE

74 SERIES TTL IC'S

Type	Quantity	Type	Quantity	Type	Quantity
	£ p	£ p	£ p	£ p	£ p
7400	0.09	0.08	7448	0.70	0.68
7401	0.11	0.10	7450	0.12	0.10
7402	0.11	0.10	7451	0.12	0.10
7403	0.11	0.10	7453	0.12	0.10
7404	0.11	0.10	7454	0.12	0.10
7405	0.11	0.10	7460	0.12	0.10
7406	0.28	0.25	7470	0.24	0.23
7407	0.28	0.25	7472	0.20	0.19
7408	0.12	0.11	7473	0.26	0.22
7409	0.12	0.11	7474	0.24	0.23
7410	0.09	0.08	7475	0.44	0.40
7411	0.22	0.20	7476	0.26	0.25
7412	0.22	0.20	7480	0.45	0.42
7413	0.26	0.25	7481	0.90	0.88
7416	0.28	0.25	7482	0.75	0.73
7417	0.26	0.25	7483	0.88	0.82
7420	0.11	0.10	7484	0.85	0.80
7422	0.19	0.18	7485	1.10	1.00
7423	0.21	0.20	7486	0.28	0.26
7425	0.25	0.23	7489	2.70	2.50
7426	0.25	0.23	7490	0.38	0.32
7427	0.25	0.23	7491	0.65	0.62
7428	0.36	0.34	7492	0.43	0.35
7430	0.12	0.10	7493	0.38	0.35
7432	0.20	0.19	7494	0.70	0.68
7433	0.38	0.36	7495	0.60	0.58
7437	0.26	0.25	7496	0.70	0.68
7438	0.26	0.25	74100	0.95	0.90
7440	0.12	0.10	74104	0.40	0.35
7441	0.60	0.57	74105	0.30	0.25
7442	0.80	0.70	74107	0.30	0.25
7443	0.95	0.90	74110	0.48	0.45
7444	0.95	0.90	74111	0.75	0.72
7445	0.80	0.75	74118	0.85	0.82
7446	0.80	0.75	74119	1.30	1.20
7447	0.70	0.68	74121	0.28	0.26
			74122	0.45	0.42
			74123	0.65	0.62
			74141	0.68	0.65
			74145	0.75	0.72
			74150	1.10	1.05
			74151	0.65	0.60
			74153	0.70	0.68
			74154	1.20	1.10
			74155	0.70	0.68
			74156	0.70	0.68
			74157	0.70	0.68
			74160	0.95	0.85
			74161	0.95	0.85
			74162	0.95	0.85
			74163	0.95	0.85
			74164	1.20	1.10
			74165	1.20	1.10
			74166	1.20	1.10
			74174	1.10	1.00
			74175	0.85	0.82
			74176	1.10	1.00
			74177	1.10	1.00
			74180	1.10	1.00
			74181	1.90	1.80
			74182	0.30	0.28
			74184	1.50	1.40
			74190	1.40	1.30
			74191	1.40	1.30
			74192	1.10	1.00
			74193	1.05	1.00
			74194	1.05	1.00
			74195	0.80	0.75
			74196	0.90	0.85
			74197	0.90	0.85
			74198	1.90	1.80
			74199	1.80	1.70

Devices may be mixed to qualify for quantity price. Data is available for the above series of IC's in booklet form Price 35p

CMOS IC'S

CD4000	£0.18	CD4022	£0.80	CD4046	£0.95
CD4001	£0.18	CD4023	£0.18	CD4047	£0.75
CD4002	£0.18	CD4024	£0.64	CD4049	£0.46
CD4006	£0.80	CD4025	£0.18	CD4050	£0.46
CD4007	£0.18	CD4026	£1.85	CD4054	£0.95
CD4008	£0.80	CD4027	£0.48	CD4055	£1.60
CD4009	£0.50	CD4028	£0.80	CD4056	£1.15
CD4010	£0.50	CD4029	£0.95	CD4059	£0.32
CD4011	£0.18	CD4030	£0.46	CD4067	£0.32
CD4012	£0.18	CD4031	£1.80	CD4071	£0.20
CD4013	£0.42	CD4035	£1.40	CD4072	£0.20
CD4015	£0.80	CD4037	£0.78	CD4081	£0.20
CD4016	£0.42	CD4040	£0.78	CD4082	£0.20
CD4017	£0.80	CD4041	£0.68	CD4510	£1.10
CD4018	£0.85	CD4042	£0.68	CD4511	£1.25
CD4019	£0.45	CD4043	£0.78	CD4516	£1.10
CD4020	£0.95	CD4044	£0.78	CD4518	£1.10
CD4021	£0.85	CD4045	£1.15	CD4520	£1.10

ORDERING
PLEASE WORD YOUR ORDERS EXACTLY AS PRINTED
NOT FORGETTING TO INCLUDE OUR "J" NUMBERS
V.A.T.

ADD 12½% TO PRICES MARKED • ADD 8% TO ALL OTHERS

POSTAGE AND PACKING
ADD 25p FOR POSTAGE AND PACKING UNLESS OTHERWISE SHOWN. ADD EXTRA FOR AIRMAIL
MINIMUM ORDER £1.00

TESTED TRANSISTOR PAKS

All devices brand new, tested and coded

J1	3 each AC128/AC176	J16	2 each BFY50/51/52
J2	10 x BC107	J17	6 x OC71
J3	10 x BC108	J18	4 each ZTX108/19 2 x ZTX107*
J4	10 x BC109	J19	2 each ZTX301/2 4 x ZTX300*
J5	3 each BC148/149-2 BC147*	J20	2 each ZTX500/1/2*
J6	3 each BC169/171/172*	J21	4 each 2N706/2N708
J7	2 each BC177/18/9	J22	1 each 2N2218/19/21/22
J8	2 each BC182/3/4*	J23	2 each 2N904/05
J9	2 each BC212/213/214*	J24	3 each 2N2907* 2 x 2N2906
J10	2 x BC327 3 x BC328*	J25	7 x 2N2926 G*
J11	2 x BC337 3 x BC338*	J26	4 x 2N3053
J12	2 each BF115—BF167—BF173	J27	2 x 2N3055
J13	2 each BF194/5/6*	J28	3 each 2N3702/03/04*
J14	2 x BF258	J29	3 each 2N3904/06*
J15	2 x BFX29 3 x BFX84		

PRICE 60p PER PACK

TESTED DIODE PAKS

J30	12 x OA81	J35	20 x IN4001	J39	5 x IN5400
J31	12 x OA91	J36	15 x IN4002	J40	5 x IN5401
J32	12 x OA200	J37	10 x IN4004	J41	4 x IN5404
J33	12 x OA202	J38	8 x IN4007	J42	3 x IN5408
J34	15 x IN4148				

PRICE 60p PER PACK

OPTOELECTRONICS

J43	4 x DL707 + Data	£2.80
J44	5 x 125 Red LED	£0.50
J45	5 x 2 Red LED	£0.50
J46	5 x 2 and 125 LED's mixed colours	£0.50
J47	3 x ORP12 equivalent	£1.20
J48	5 x OCP71	£1.00

THYRISTOR PAKS

J49	2 x 1 amp 1 x 400 1 x 600	£1.00
J50	5amp SCR 1 x 50 2 x 400 1 x 600	£1.50

UNIUNCTION F.E.T. PAKS

J51	6 x T1543/UT46	£1.00
J52	4 x 2N3819	£0.60

P.C.B. PRODUCTS

J53	2x Etch resistant pens	£1.00
J54	2 x etchant paks	£1.00

D.I.Y. PRINTED CIRCUIT KIT

CONTAINS 6 Pieces copper laminate, box of etchant powder and measure, tweezers, marker pen, high quality pump drill, Stanley knife & blades, 6 inch metal rule. FULL Easy to follow instructions.
J59 ONLY £5.50

RESISTOR PAK

J55	240 first quality ¼W resistors—mixed from 100ohm—820k	£1.60*
J56	160 first quality ¼W resistors—mixed from 100ohm—820k	£1.60*

ELECTROLYTIC PAK

J57	54 first quality miniature electrolytics from .47µF—1000µF	£1.20*
-----	--	--------

CERAMIC PAK

J58	93 first quality ceramic capacitors—mixed from 22pF—0.47µF	£1.60*
-----	--	--------

I.C. SOCKET PAKS

J60	11 x 8 pin D.I.L. Sockets	£1.00
J61	10 x 14 pin D.I.L. Sockets	£1.00
J62	9 x 16 pin D.I.L. Sockets	£1.00

ZENER PAKS

J63	20 mixed value 400MW zener diodes 3-10V	£1.00
J64	20 mixed value 400MW zener diodes 11-33V	£1.00

BI-PAK

Dept. E.E.9, P.O. Box 6, Ware, Herts

COMPONENTS SHOP.
18, BALDOCK STREET, WARE, HERTS.

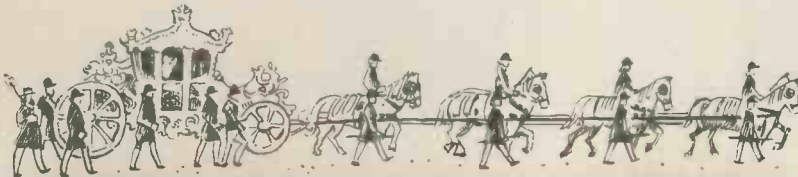

Bring 'scope' to your interest.

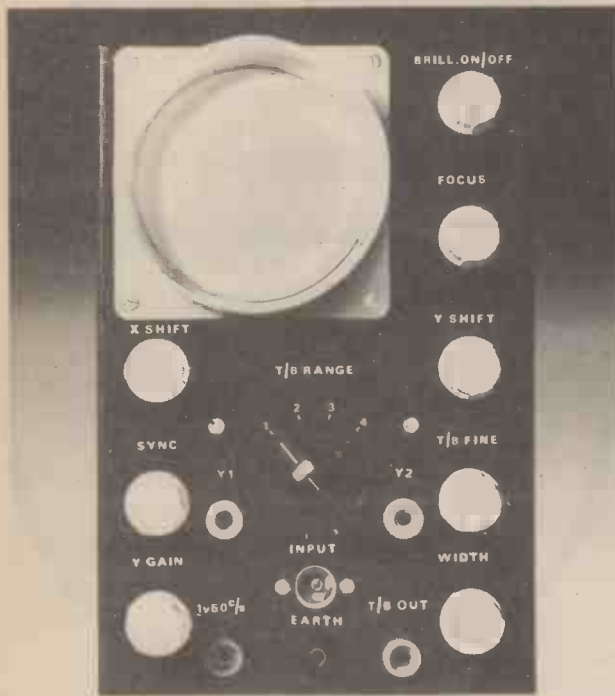

'There's only one way to master electronics... to see what is going on and learn by doing.'

This new style course will enable anyone to have a real understanding of electronics by a modern, practical and visual method. No previous knowledge is required, no maths, and an absolute minimum of theory.

You learn the practical way in easy steps mastering all the essentials of your hobby or to further your career in electronics or as a self-employed electronics engineer.

All the training can be carried out in the comfort of your own home and at your own pace. A tutor is available to whom you can write, at any time, for advice or help during your work. A Certificate is given at the end of every course.

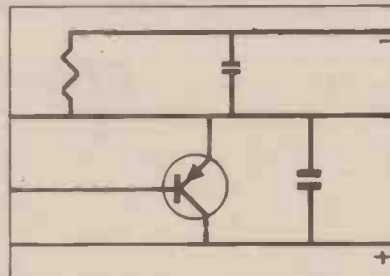
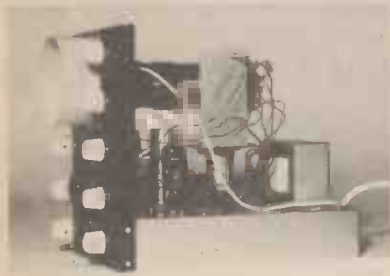

1 Build an oscilloscope.

As the first stage of your training you actually build your own Cathode ray oscilloscope! This is no toy, but a test instrument that you will need not only for the course's practical experiments, but also later if you decide to develop your knowledge and enter the profession. It remains your property and represents a very large saving over buying a similar piece of essential equipment.

2 Read, draw and understand circuit diagrams.

In a short time you will be able to read and draw circuit diagrams, understand the very fundamentals of television, radio, computers and countless other electronic devices and their servicing procedures.

3 Carry out over 40 experiments on basic circuits.

We show you how to conduct experiments on a wide variety of different circuits and turn the information gained into a working knowledge of testing, servicing and maintaining all types of electronic equipment, radio, t.v. etc.

FREE GIFT



All students enrolling in our courses receive a free circuit board originating from a computer and containing many different components that can be used in experiments and provide an excellent example of current electronic practice.

To find out more about how to learn electronics in a new, exciting and absorbing way, just clip the coupon for a free colour brochure and full details of enrolment.

Write to:- British National Radio & Electronics School,
P.O. Box 156, Jersey, Channel Islands.

NAME _____

ADDRESS _____

EEB 97

new book

I. R. Sinclair

Beginner's Guide to Integrated Circuits

There is hardly any item of domestic electronic equipment not incorporating at least one i.c. This book is for the comparative newcomer to electronics, with some knowledge of transistor circuits, wishing to acquire an understanding of i.c.s. The principles and construction of i.c.s. are described, as well as their many different uses. The book is copiously illustrated with many examples of practical i.c. circuits.

CONTENTS: What is an integrated circuit? Production of i.c.s. Simple voltage amplifier i.c.s. Simple digital i.c.s. MOS i.c.s. Domestic uses of i.c.s. Other specialised i.c.s. Practical construction. Index.

192 pages · 190 X 127 mm · 0 408 00278 6 · £2.75

ORDER NOW FROM your local bookseller or



Newnes Technical Books

NEWNES-BUTTERWORTHS

Borough Green, Sevenoaks, Kent TN15 8PH

Other Beginner's Guides include

Beginner's Guide to Audio
I. R. Sinclair

Beginner's Guide to Colour
Television — 2nd Ed.
G. J. King

Beginner's Guide to Electronics — 3rd Ed.
T. L. Squires & C. M. Deason

Beginner's Guide to Radio — 7th Ed.
G. J. King

Beginner's Guide to Television
— 5th Ed.
G. J. King

SOLDERLESS BREADBOARDING—DECS

The famous DEC System of Solderless Breadboarding is ideal for both the young and more mature students of Electronic Engineering as it enables circuits to be tried and tested without the use of soldering and because of the specially designed contacts allows components to be used over and over again. It is also extremely useful for the Circuit Designer who wishes to experiment with and perfect his circuit quickly yet economically.

S-DEC (Model PB11)

This, the most popular Board, is designed solely for the use of discrete components and is particularly useful for basic educational purposes.

(No. of Contacts: 70)

1 off £1.98
5 off £1.76

T-DEC (Model PB21)

This board allows 2 TO5 or 1 DIL IC Station to be used and so is primarily intended for discrete work or for linear IC application where considerable numbers of discrete components may be required.

(No. of Contacts: 208)

1 off £3.62
5 off £3.21

μ-DEC 'A' (Model PB31)

The μ-DEC 'A' is specially designed for ease of use with IC's and allows 2 DIL or 4 TO5 stations to be used but will accommodate discrete components with equal facility.

(No. of Contacts: 208)

1 off £3.97
5 off £3.53

μ-DEC 'B' (Model PB41)

The μ-DEC 'B' is for similar uses as μ-DEC 'A', but has two 16 lead IC sockets as part of the Board.

(No. of Contacts: 208)

1 off £6.97
5 off £6.19

DEC ACCESSORIES

16 DIL adaptor (with socket) PB062	£1.92
10 TO5 adaptor (with socket) PB072	£1.80
Single ended leads (set of ten) PB101	£0.90
Double ended leads (set of ten) PB102	£0.99
1mm plugs (set of ten) PB103	£0.45

All prices include 8% VAT. P. & P. 25p.

Our retail counter is now open, stocking a large variety of audio and electronic parts and accessories, branded and surplus.

We are situated 2 minutes Watford Junction Station

THE COMPONENTS CENTRE

7 LANGLEY ROAD, WATFORD, HERTS., WDI 3PS
Tel.: Watford 45335

CRESCENT RADIO LTD.

164-166 HIGH ROAD LONDON N22 6EJ 888-3206

(also) 13 SOUTH MALL, Edmonton, N.9 803-1685

MAIL ORDER DEPT. 1 St Michaels Terrace Wood Green
London N22 4SJ Phone 888-4474

POWER PACKS

PP1 Switched 3, 4½, 6, 7½, 9 and 12 volt @ 500 ma. with on/off switch and pilot light. Size = 130 mm x 55 mm x 75 mm. ONLY = £5.50 + 8%.

TI MULTI-METER

Ideal tester for everybody interested in electronics. Weighing less than 100 grammes and only 60mm x 24mm x 90mm. Ranges: AC volts: 0-10v, 50v, 250v, 1,000v, D.C. volts: 0-10v, 50v, 250v, 1,000v. DC current: 0-1ma, 0-100ma. Resistance: 0-150K ohm. PRICE £5.50 + VAT 8%

"C100" 100 WATT AMPLIFIER

All built and tested, mounted on a plain aluminium chassis which measures 18" x 9½" x 4" and which you can mount into a cabinet of your choice. Four Controlled Inputs. Master Volume, Treble, Middle and Bass Controls. S/C protected output. 100 watts clean into 8ohm L/S. Ideal for Disco, Music, Groups, PA and Clubs. A Bargain at £48 + £1.50 carr. + 8% VAT.

FERRIC CHLORIDE

Anhydrous ferric chloride in double sealed one pound Poly packs. OUR PRICE—65p + PP + 8% per lb.

ABS PLASTIC BOXES

Handy boxes for construction projects. Moulded extrusion rails for P.C. or chassis panels. Fitted with 1mm front panels.

1005 = 105mm x 73mm x 45mm = 62p
1006 = 150mm x 74mm x 47mm = 80p
1007 = 185mm x 124mm x 60mm = £1.80
1022 = 107mm x 85mm x 45mm = 62p

(sloping front) Plus 8% VAT

PIEZO ELECTRIC HORN UNITS
New High Quality High Power Tweeter. No form of crossover network is required as low frequency voltages simply have no effect on the Tweeter.

Specification:
Frequency Response: 3-8KHz to 28KHz ±3db. (Input 4V rms Pink Noise—Output 105db) Max. continuous RMS Input Voltage: 25V.
Minimum Series Resistor: 10 ohm at 1W.

Weight: 63 gm. (2.25 oz.).
Panel Cut Out: 76mm dia. (3in).
Size: 85mm x 85mm x 75mm.
Rating: Depending on connections up to 100W approx.
Price: £9.00 + 8% VAT.

3 K WATTS PSYCHEDELIC LIGHT CONTROL UNIT

Three Channel Bass, Middle, Treble. Each channel has its own sensitivity control. Just connect the input of this unit to the loudspeaker terminals of an amplifier and connect three 250V up to 1000W lamps to the output terminals of the unit, and you produce a fascinating sound-light display. (All guaranteed).
£18.50 plus £1.25 P. & P. + 8%



MINI LOUDSPEAKERS

2½" 80 ohm 90p	} +12% VAT
2½" 40 ohm 90p	
2½" 8 ohm 90p	} +12% VAT

BARGAIN PROJECT BOX

A plastic box with moulded extrusion rails for PC or Chassis panels with metal front plate fitted with four screws (all supplied). SIZE (internal) 81mm x 51mm x 28mm
OUR PRICE 50p + 8%

U.K. CARR.
50p unless otherwise stated.

All prices are excluding VAT. Please add to each item the VAT rate indicated to all orders
ACCESS AND BARCLAYCARD ACCEPTED

*** Don't miss this important issue with BIGGER PAGES!**

SOUNDS GREAT

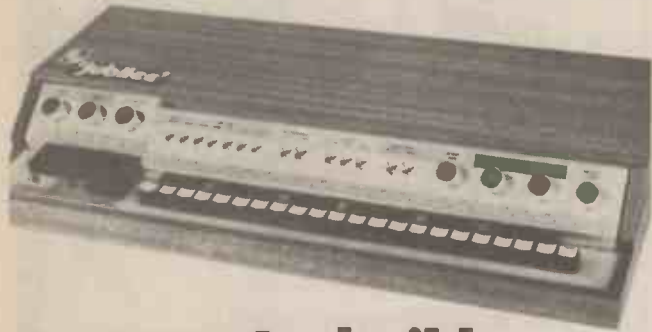

an easy-to-build single-board electronic organ you can play with two fingers!

Mixed rhythms, three melody octaves, percussion, variable vibrato – just some of the features of the fantastic PW "Jubilee"! It's mains powered, has 1 watt output, and the single-board construction makes it really simple to build. Get started now and give it to someone special for Christmas!

STARTING! TWO NEW SERIES TO HELP YOU

- **Design your own projects No. 1**
we'll show you it's easier than you think
- **'So you want to pass the Radio Amateur Examination' Part 1**
we'll coach you to get you through

plus these projects

- **Electronic Car Voltage Regulator**
- **General Purpose SW Receiver**

TUNE IN TO

PRACTICAL WIRELESS

SEPTEMBER ISSUE ON SALE 5th AUGUST 40p

FREE WITH SEPTEMBER'S PRACTICAL ELECTRONICS



Britain's best-selling 64-page electronic kit and component catalogue from Doram with new products, new ideas!

Extra copies of catalogue available (send 20p to cover post and packing) from Doram Electronics Ltd, PO Box TR8, Wellington Road Estate, Wellington Bridge, Leeds LS12 2UF. Tel: 34222 (STD code 0532).

DORAM

SPECIAL OFFER FOR READERS

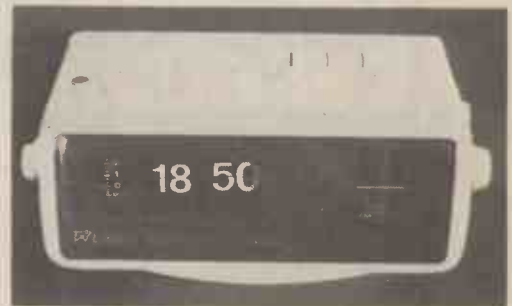

£18.50 inc VAT + £1.45 p. & p. & i.

- AM/FM Radio Alarm Clock (AC 220-240V only)
- 24-Hour Clock
- High quality white abs case
- Push-button mode selection
- Sleep delay control
- Illuminated clock and radio scale
- Alarm with buzzer and/or music
- All chrome control knobs
- Complies with BS415, (1972) safety requirements
- Each unit fully inspected before despatch
- Guaranteed for one year

Please send cheque or postal order to:

D. & D. POWER SUPPLY CO. LTD.
79 LOWFIELD STREET, DARTFORD, KENT

Please allow 10-14 days for delivery
Callers welcome Monday-Friday 9-5, Saturday 9-1.



Become a radio amateur.

Learn how to become a radio-amateur in contact with the whole world. We give skilled preparation for the G.P.O. licence.

WAA
EEK97

Free! Brochure, without obligation to:
BRITISH NATIONAL RADIO & ELECTRONICS SCHOOL,
 P.O.Box 156, Jersey, Channel Islands.

NAME _____

ADDRESS _____ (Block caps please)

PHILIPS



YOU & PHILIPS HI-FI KITS

The top sellers for home assembly in Europe — now available in the U.K.

Now — read all about the Philips range of quality kits for home assembly — mixers, amplifiers, speakers, etc, etc. Send today to
 S.S.T. Distributors (Electronic Components) Ltd.,
 West Road, Tottenham, London N17 0RN

Please send me, quickly, the new colour catalogue. EE91

Name _____

Address _____

Postcode _____

free SEND TODAY!
 S.S.T. Distributors is a member of the Philips Group of Companies.

Everyday Electronics, September 1977

ELECTRONI-KIT

Proclaimed "... educational kits of exceptional quality" in extensive survey by **AUDIO** mag. Also many other first class Press reports.



The Famous DENSHI kits — now even better value

The kits are suitable both for the beginner to gain a wide practical understanding of electronics and for the more experienced to carry out many advanced experiments not available elsewhere.

Illustrated is the SR-4ADX kit—over 150 different actual working projects can be built, dismantled and rebuilt any number of times, plus any circuits of your own design.

Each component is beautifully encapsulated in transparent plastic, engraved with its electronic symbol. No soldering is involved with any kit and yet this fantastic versatility is provided. The kits are complete in every respect, including educational manuals and batteries. **NOTHING ELSE NEEDED.**

This is the most practical and effective way to learn about electronics—the kits are also first-class testing kits for laying-out and testing new circuits quickly. There is no danger whatsoever in the use of these kits.

Add-on kits and spares are available too, to increase the scope of each kit if required.

SR-3A—over 100 experiments—radio receivers, transmitters, amplifiers, microphones, alarms, morse code, electronic birds, cats, sirens, organs, intercoms, metronomes, photoelectric cell, high voltage generator, circuits demonstrating Amps, Ohms, Watts, etc., etc. **£26.45 COMPLETE**

SR-3ADX—over 105 experiments—similar to SR-3A plus sophisticated control panel and solar cell circuits, etc., etc. **£33.45 COMPLETE**

SR-4ADX—over 150 experiments—similar to SR-3ADX plus Relay and Multi-meter circuits—ammeter, voltmeter, resistance meter, water purity —, Ion concentration —, volume —, output —, field intensity meter, illuminometer, etc., etc. **£41.45 COMPLETE**

PRICES INCLUDE VAT, P & P, MANUALS, BATTERIES, etc. NOTHING ELSE TO PAY—FANTASTIC VALUE for MONEY.

Educational and Trade enquiries welcomed.

Personal callers welcome.

CHEQUE/P.O. (or 11p for illustrated literature) to: Dept. EE

**ELECTRONI-KIT LTD., 20 Bride Lane,
 Ludgate Circus, London, EC4Y 8DX
 Tel: 353-6430.**

EDITOR

F. E. BENNETT

TECHNICAL EDITOR

B. W. TERRELL B.Sc.

TECHNICAL SUB-EDITOR

T. J. JOHNSON G8MGS

ART EDITOR

J. D. POUNTNEY

TECHNICAL ILLUSTRATOR

P. A. LOATES

GENERAL ARTIST

K. A. WOODRUFF

EDITORIAL OFFICES

Fleetway House
 Farringdon Street
 London EC4A 4AD
 Phone: 01-634 4452

ADVERTISEMENT MANAGER

D. W. B. TILLEARD
 Phone: 01-634 4504

REPRESENTATIVE

P. J. MEW
 Phone: 01-634 4181

CLASSIFIED MANAGER

C. R. BROWN
 Phone: 01-261 5762

MAKE-UP AND COPY DEPARTMENT

Phone 01-634 4372

ADVERTISEMENT OFFICES

Fleetway House
 Farringdon Street
 London EC4A 4AD

Projects... Theory ... and Popular Features ...

EVERYDAY ELECTRONICS has undergone a change—that will already have been noted by our regular readers even before they opened their copy this month. The larger page size is an immediately obvious change, but there are other innovations also incorporated this month.

Of these, perhaps the most important are the rearrangements within our constructional articles. The text has been laid out to allow the reader direct approach to the practical details, with the full circuit description removed from its more conventional place at the beginning of the article, and presented as a separate section. Those not especially interested in the detailed account of the circuit operation can easily and quickly obtain sufficient general information about the project from the *Introduction* and *How It Works* sections and then pass on without further delay to the actual building instructions.

Another innovation is for the benefit of newcomers. This is the *Square One* feature with its concise, directly-to-the-point facts and explanations about d.i.y. electronics. Each month certain fundamental matters appertaining to the practical and theoretical side of this hobby will be dealt with. The newcomer should quickly feel at home with EE through this helpful feature, and in no time be able to explore the remainder of our contents with understanding and, of course we trust, with a zest to start building our projects.

We hope all our readers like the New Look of EE. In some respects it is perhaps unfortunate that this improvement had to be made this month and not the beginning of next year. However, for those who like to retain all issues of EE for future reference the binder problem has been resolved by commencing the new volume with this month's issue. The current binder will thus contain eight issues only. A new-size binder will be available to accommodate the 16 issues which will make up volume seven (September 1977 to December 1978). Thereafter volumes will run from January to December, as previously.

So far we have been talking about innovations. We now wish to refer to something which is traditional and yet new. This apparent conundrum is easily explained, for we are referring to our *Teach-In* series. The latest edition of this biennial series for beginners commences next month. The name's the same, the purpose is the same, yet each series is different, because a new tutor takes over each time, thus offering yet another fresh and individual approach to the subject.

So please pass the word along to anyone you know who has a hankering to learn about electronics.

Next month's issue has other big attractions as well, so do make certain of your copy well in advance.

Fred Bennett

Our October issue will be published on Friday, September 16. See page 21 for details.

Readers' Enquiries

We cannot undertake to answer readers' letters requesting modifications, designs or information on commercial equipment or subjects not published by us. All letters requiring a personal reply should be accompanied by a stamped self-addressed envelope.

Telephone enquiries should be limited to those requiring only a brief reply. We cannot undertake to engage in discussions on the telephone, technical or otherwise.

Component Supplies

Readers should note that we do not supply electronic components for building the projects featured in EVERYDAY ELECTRONICS, but these requirements can be met by our advertisers.

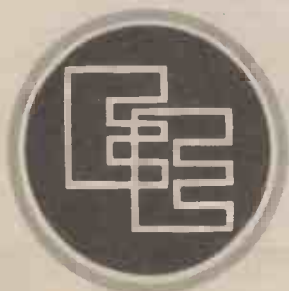

Everyday ELECTRONICS

VOL. 7 NO. 1

SEPTEMBER 1977

CONSTRUCTIONAL PROJECTS

PROBOPHONE <i>Simple to use electronic organ</i> by D. C. Jenkin	8
DYNAMO BACK-UP <i>Useful aid to the cyclist</i> by R. Everson	14
FLASHER BLEEPER <i>Attracts the attention of the forgetful driver</i> by T. R. de Vaux-Balbirnie, B.Sc.	24
ADD-ON CAPACITANCE UNIT <i>Turn your multimeter into a capacitance meter</i> by R. A. Penfold	32

GENERAL FEATURES

EDITORIAL

SHOP TALK <i>New products and components for constructional projects</i> by Brian Terrell	6
THE OSCILLOSCOPE <i>How it works, what it does</i> by John Smith	13
SQUARE ONE <i>Beginners! Start Here!</i>	18
BRIGHT IDEAS <i>Reader's hints and tips</i>	19
BOOK REVIEWS <i>A selection of recent releases</i>	20
PHYSICS IS FUN <i>Shocking coils</i> by Derrick Daines	22
READERS' LETTERS <i>Your news and views</i>	23
RADIO ASTRONOMY AT CAMBRIDGE <i>Looking at the stars with radio</i> by S. McClelland	27
WHAT DO YOU KNOW? <i>Test your knowledge—Power</i>	28
YOUR CAREER IN ELECTRONICS <i>Selling components</i> by Peter Verwig	35
JACK PLUG AND FAMILY <i>Cartoon</i>	36
FOR YOUR ENTERTAINMENT <i>Video cassettes</i> by Adrian Hope	39
PROFESSOR ERNEST EVERSURE <i>The Extraordinary Experiments of.</i> by Anthony J. Bassett	40
DOWN TO EARTH <i>Mains hum and earth</i> by George Hylton	42
PLEASE TAKE NOTE <i>Touch Switch, Fish Attractor, Fuzztone, Soil Moisture Monitor</i>	44

Back Number Service and Binders

Back issues of EVERYDAY ELECTRONICS (June 1977 onwards) are available worldwide at a cost of 60p per copy inclusive of postage and packing. Orders and remittance should be sent to: Post Sales Department, IPC Magazines Ltd., Lavington House, 25 Lavington Street, London SE1 0PF.

Binders for Volumes 1 to 6 (state which) are available from the above address for £2.10 inclusive of postage and packing.

© IPC Magazines Limited 1977. Copyright in all drawings, photographs and articles published in EVERYDAY ELECTRONICS is fully protected, and reproductions or imitations in whole or in part are expressly forbidden.

All reasonable precautions are taken to ensure that the advice and data given to readers are reliable. We cannot however guarantee it, and we cannot accept legal responsibility for it. Prices quoted are those current as we go to press.

SQUARE
Special Page
for BEGINNERS
ONE



PROBOPHONE

By D. JENKIN

INTRODUCTION

Small hand held electronic organs have become very popular in recent years. The following design illustrates how such an instrument can be constructed quite simply using just one integrated circuit, the 556 dual timer.

HOW IT WORKS...

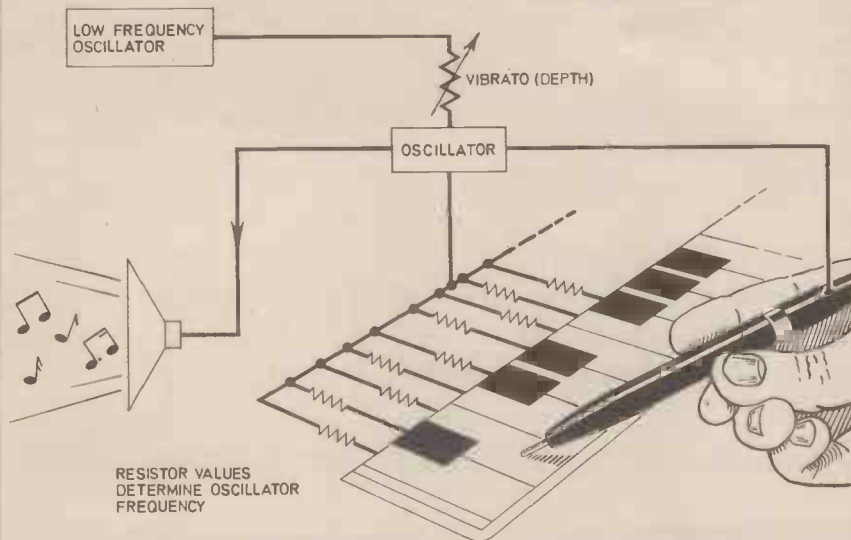

For the main oscillator of the *Probophone* to function, the circuit needs to be completed by the addition of a resistor. This is accomplished by means of a probe (from the circuitry) selecting via a keyboard arrangement, one of a range of resistances connected to the keyboard notes and wired back to the circuit. By touching the probe on one of the "note-pads", a tone is heard in the loudspeaker. The resistances are chosen so that the twenty tones produced are in accordance with a $1\frac{1}{2}$ octave musical scale.

A second oscillator running at a much lower frequency, about 10Hz, is fed to a point in the master oscillator that causes a change in frequency, to-and-fro about that selected by the probe to produce a warbling or vibrato effect.

START HERE FOR CONSTRUCTION

Excluding the 20 presets, most of the circuitry is mounted on a piece of stripboard having 17 strips by 25 holes. The layout of this board is shown in Fig. 2, which also shows the connections required to VR1, the loudspeaker and the keyboard, etc. Alternatively, if the constructor wishes, this part of the circuit may be incorporated on a printed circuit board, Fig. 1.

Referring to Fig. 3, this shows the copper pattern required for the keyboard and presets. To make life easier, use is made of sticky labels to define the area for the "keys". Using this particular method the copper pattern can be drawn more accurately.

Begin by cleaning the copper board thoroughly using either steel wool or a scouring powder. Ensure

PROBOPHONE

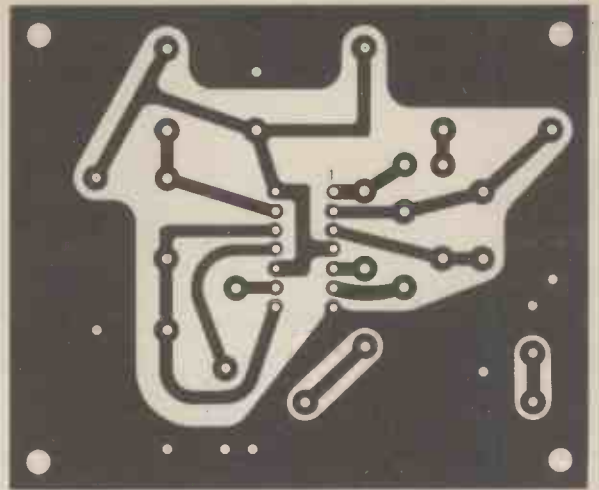
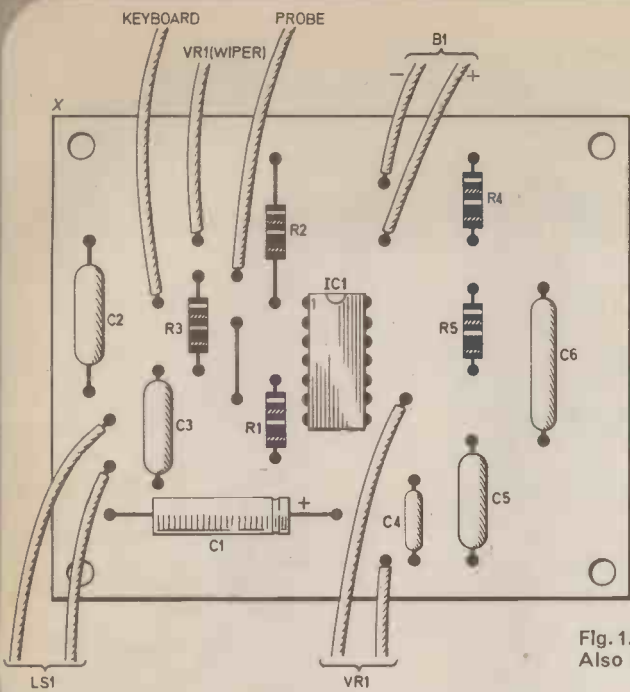
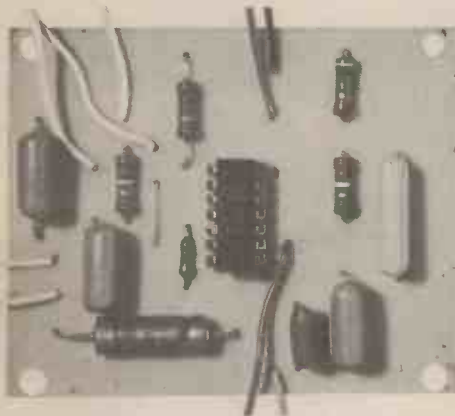
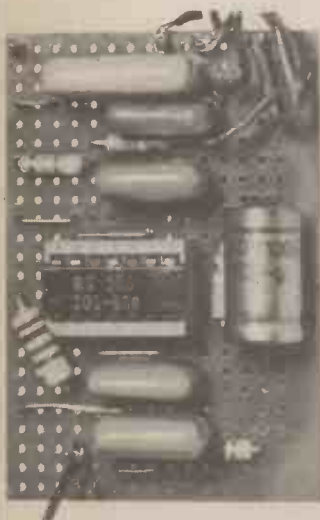

Fig. 1. If the circuit is to be built on a PCB then this is the required copper pattern. Also shown is the component layout on the plain side of the board.



Two views of the PCB version. On the left a topside view showing the components, and on the right the underside showing the copper pattern.



Photograph of the completed stripboard layout.

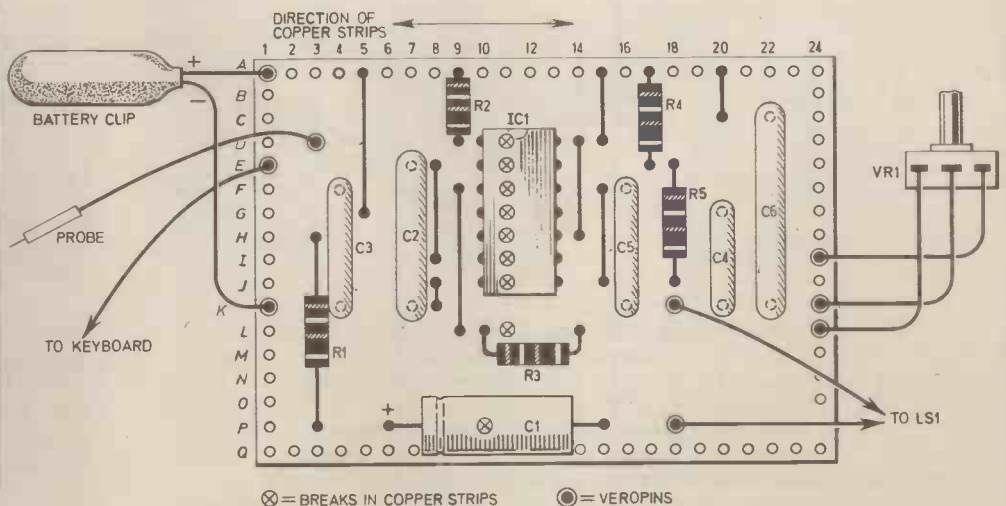

Fig. 2. Stripboard layout also showing the breaks required on the underside. This method of construction is preferred if the constructor is unsure about making a PCB.

CIRCUIT DESCRIPTION

OPERATION OF THE 556 TIMER

Referring to Fig. 5, this shows a block diagram of one of the two timers contained in the i.c. The external components are connected in such a way to produce a continuously running multivibrator. The two resistors RA and RB, and the capacitor C set the frequency of oscillation.

The capacitor C charges up at a rate dependent on the values of RA and RB. As the capacitor charges the voltage across it rises towards the *threshold voltage* in the timer. The comparator, 1, senses this voltage and causes the flip flop to change state, in doing so it turns transistor TR1 on.

This has the effect of putting a short circuit between the junction of the two resistors and earth. As this happens the capacitor begins to discharge through resistor RB. As this happens the capacitor falls the second comparator 2 detects this voltage drop, which is in fact a value similar to the threshold voltage, and causes the flip flop to revert back to its original state. Transistor TR1 is then turned off, which allows the capacitor to charge up once again.

The output appears at pin 5 and is essentially a square wave. This

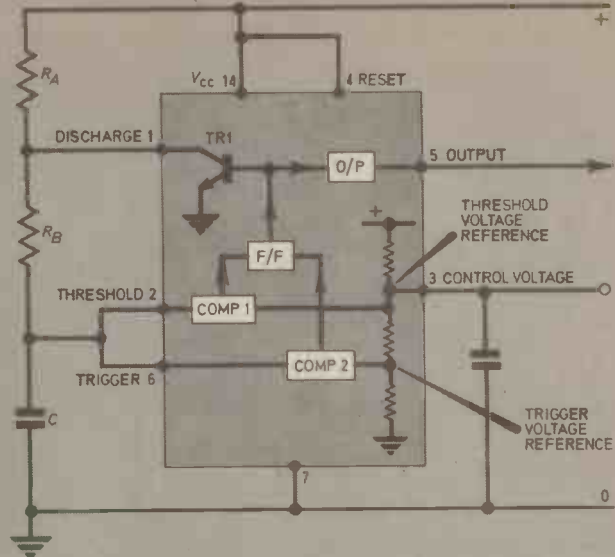

Fig. 5. A block diagram of one of the timers in the 556 timer I.C.

is depicted in Fig. 6. where the "on" time of t1 and the "off" time of t2 is given by the following:

$$t_1 = 0.7 \times (R_A + R_B) \times C$$

$$t_2 = 0.7 \times C$$

The frequency is then given by:
 $f = 1/T$ cycles.



Fig. 6. Wave form appearing at pin 5 of the circuit shown in Fig. 5.

CIRCUIT DESCRIPTION

The dual timer is connected as two separate astable multivibrators; a tone oscillator, the frequency of which depends on the values of the presets, and a vibrato oscillator running at about 10Hz.

The threshold, pin 2 of the tone oscillator is connected to the 20 presets mounted on the keyboard. These presets are in fact the various values of RB already described, which go to make up the musical scale. The vibrato oscillator comprising the second half of IC1 together with R4, R5 and C5 produces a 10Hz square-wave at the output, pin 9.

The ideal vibrato should preferably be a sine wave, in order to approximate this shape, a filter consisting of R3 and C3 is used to filter the high frequencies caused by the sharp edges of the square-wave. The vibrato level, control VR1, passes the resulting wave-form to the *control voltage*, pin 3 of the tone oscillator, thus causing the familiar rhythmic wobble to the sound.

Resistor R1 limits the output of the i.c. to well within its capabilities and also reduces battery consumption. Capacitor C1 blocks direct current to the loudspeaker. The capacitor across the supply prevents instability occurring when the internal resistance of the battery increases with age. If it is not fitted this will cause slight plopping noises to be heard from the loudspeaker.

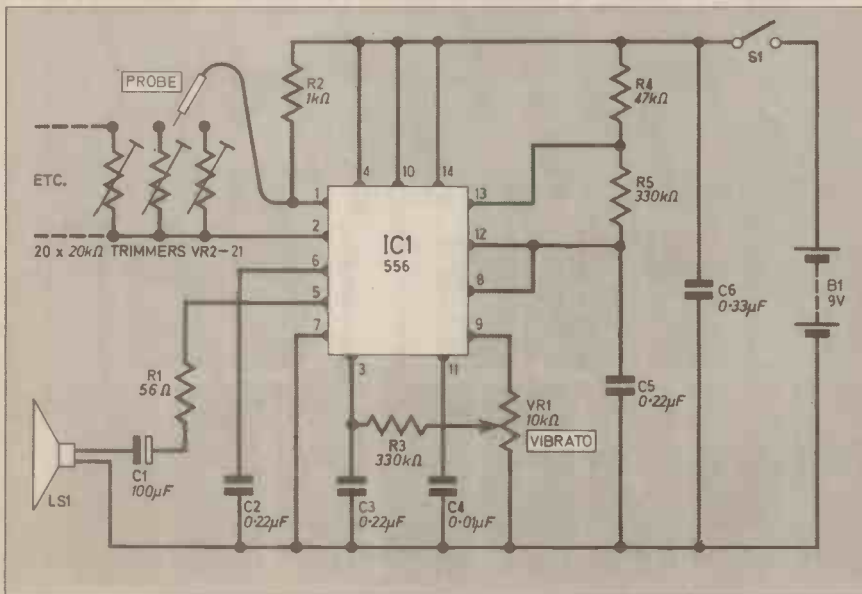
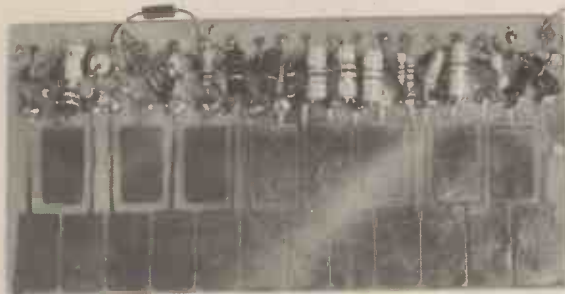
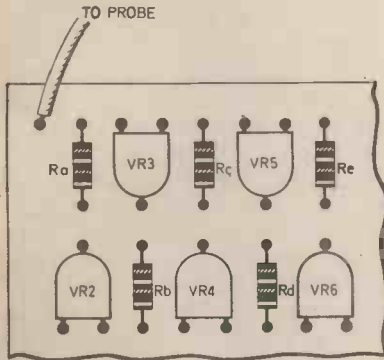
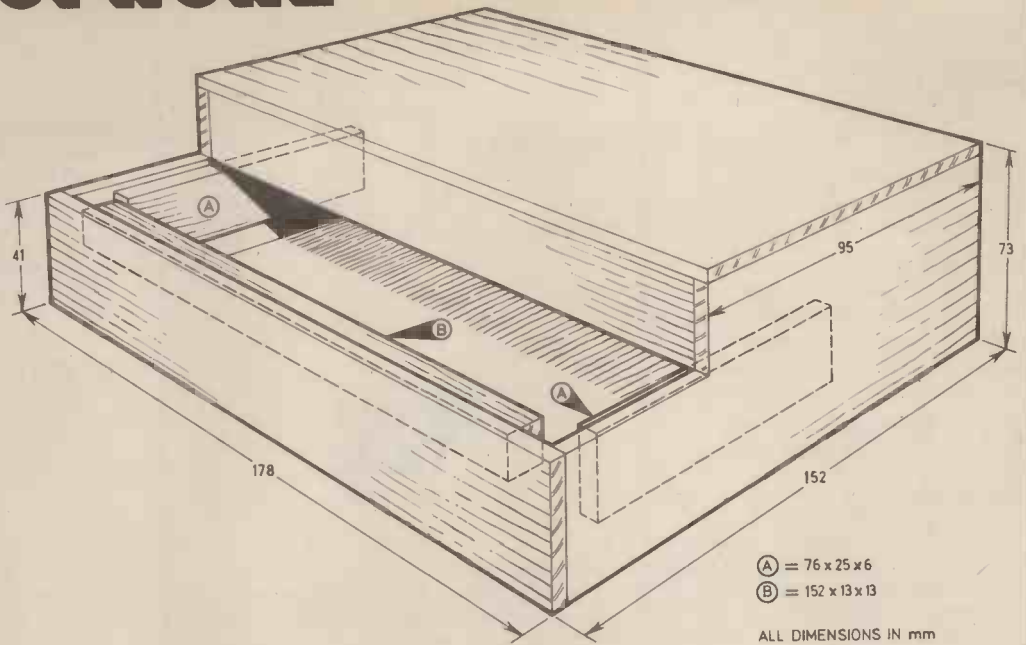

Fig. 7. Complete circuit diagram of the Probophone.

PROBOPHONE

Fig. 4. Dimensions of the case made from 4mm plywood. Depending on the components used, the sizes may have to be altered. Below; layout of the presets on the copper side of the PCB. The resistors are normally replaced with wire links. If it is desired to use fixed values for the tuning, then these are used and the presets replaced with wire links. The resistors selected are then soldered in the positions indicated by Ra, Rb, etc.



In this photograph, fixed value resistors have been used in place of the presets.

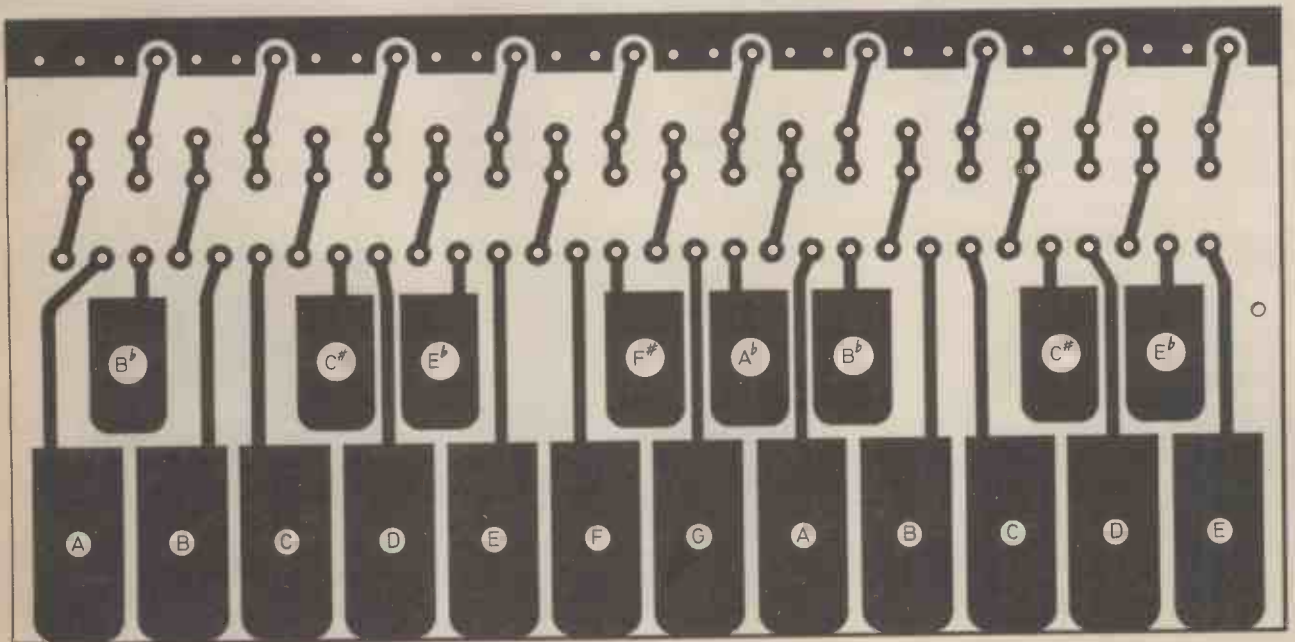

Fig. 3. Copper pattern required for the keyboard. This is drawn full size and may be used as a template.

COMPONENTS

Resistors

R1 1k Ω
 R2 56 Ω
 R3 330k Ω
 R4 47k Ω
 R5 330k Ω
 Ra to Rt (see text) All resistors carbon $\frac{1}{4}$ W \pm 10%

Potentiometers

VR1 10k Ω lin. carbon
 VR2 to 21 22k Ω horizontal sub-miniature presets (20 off)

Capacitors

C1 100 μ F 16V elect.
 C2, C3 0.22 μ F polyester (2 off)
 C4 0.01 μ F polyester
 C5 0.22 μ F polyester
 C6 0.33 μ F polyester

Semiconductor

IC1 NE556 dual timer i.c.

Miscellaneous

B1 9V PP3 battery
 S1 s.p.s.t. toggle switch
 LS1 3 to 5 ohm speaker approx 60mm diameter
 Stripboard 0.1 inch matrix 17 holes \times 25 holes; battery connector; i.c. socket; small knob for VR1; veropins; modified ball point pen for probe; printed circuit board, size as required (see text); materials for case (see text); connecting wire; solder; etc.

See
**Shop
 Talk**
 page 13

that the board is not touched once this has been done. Apply the labels with firm pressure to exclude any air bubbles, and fill in the connections between the keys and the remainder of the circuit with an etch resist pen.

The circuit board can then be etched in a solution of ferric chloride until all the copper has been etched away. *Take care when handling ferric chloride, it is highly corrosive and dangerous to the skin.* Once all the copper has been removed rinse the board in water, applying some scouring powder to remove all traces of the ferric chloride. The mounting holes for the presets can then be drilled using a 1mm diameter drill.

In time the copper becomes dull

and tarnished with use, and unless the printed circuit board is plated it is necessary to give the keys an occasional rub with metal polish to prevent poor contact with the probe.

CASE DETAILS

The prototype Probophone was constructed in a simple plywood case. There is of course no reason why a ready made case of similar dimensions cannot be used.

The general layout of components in the case is shown in the various photographs. The sizes given in Fig. 4 are of course only correct if the recommended

printed board and loudspeaker are used. If alternative components are used then the dimensions need to be altered.

The vibrato control is mounted on the rear panel, although it would be an advantage when constructing the case, provision is made for it to be mounted on the front panel. Once the case has been constructed it can be painted in a colour of the constructor's choice. The lid needs to be removable to gain access to the tuning presets and to replace the battery when required.

TUNING

Once construction has been completed and a check has been made for any wiring errors, the battery can be connected. Touching the probe to one of the "keys" a note should be heard. Set the vibrato control to zero and adjust the appropriate preset for the correct pitch, if possible comparing the note with a piano, pitch pipes or other musical source.

An alternative cheaper method is to select fixed resistors to make up the required values. Each note is initially tuned by inserting a 15 kilohm potentiometer in place of the resistor. The potentiometer is then carefully adjusted and the value measured on an ohm meter. This value is then made up from different combinations of fixed resistors and then soldered in place on the printed circuit board. If this is done carefully the combination should produce the same note as tuned by the potentiometer.

Once all the tuning has been carried out and the constructor is satisfied that the range of notes produced are correct the Probophone is then ready to be played! \square



General view of the completed Probophone, showing the layout used.

FOR GUIDANCE ONLY

ESTIMATED COST
 OF COMPONENTS

£5

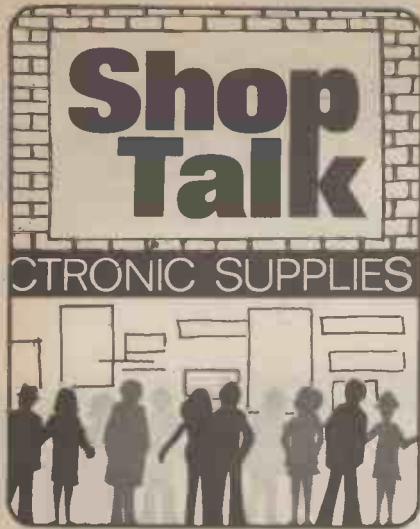

By Brian Terrell

New products and component buying for constructional projects.

Unfortunately the Introduction subject to last months Shop Talk, dealing with getting together a stock of components for project building suffered from lack of space. This is an important topic that has been noted in my diary for future treatment.

New Soldering Iron

We received news and a model (returnable unfortunately) of a soldering iron recently added to the Rawplug range of tools. This mains powered 25 watt iron conforms to BS 3456 and carries the BEAB (British Electrical Appliances Board) mark of approval.

It has been designed for the radio and t.v. engineer and the d.i.y. enthusiast. It is suitable for construction of E.E. projects.

Features include a slide-on iron plated conical bit which encloses the ceramic heating element housed in a stainless steel shaft. Insulation is quoted at 1500 volts a.c.

The fully insulated handle has been designed to prevent rolling if the iron is laid down on the workbench. A hook is fitted to the handle for securing the iron when not in use. Ample three-core mains lead is attached, 1.8 metres long.

The iron is available from most d.i.y. stores and is priced at £3.80 excluding VAT.



The Rawplug 25W soldering iron.

New Marshalls Catalogue

A new 32-page catalogue is now available from Marshall's priced at 25p to callers or 35p post paid. The catalogue takes on a new look having much larger pages (290 x 210mm) and has been set out to make component buying easy. In our opinion a vast improvement on their previous catalogue!

Due to the postal dispute in Cricklewood, customers of Marshall's (components and catalogues) are advised to direct their mail orders to the Bristol or Glasgow branches. Addresses are to be found in the advertisement pages.

Tidy Tubs For Tools and Things

A useful set of small cylindrical storage compartments—six in fact—of varying lengths and diameters bonded together from Tidy Tubs now being marketed by Platignum. Electronics constructors may find these useful for holding and keeping together essential tools on the workbench such as pliers, screwdrivers, files, drills, etc.

You won't find these for sale by electronic component suppliers, but they should be available from all good department stores and stationers at a cost of £1.50. There are six colours to choose from.

Constructors are advised to keep their Tidy Tubs in a safe secure place as other members of the family will find other uses for them in the kitchen, bedroom, bathroom or office.

Electrically Conductive Paint

A product that should interest the amateur electronic constructor has recently been made available to the consumer market by Industrial Science Limited through several outlets (see below). It is electrically conductive paint, named Elecolit 340.

It can be applied by brushing, dipping, silk screen or roller and forms a tough film with good adhesive to ceramics, glass, rubber, plastic and most plastic films.

Typical applications involve r.f. shielding, printed circuit repair, in prototype circuit production and has been used to repair a broken track in a car rear window heater.

A colleague suggested an application for car windscreen wiper control system where the paint was placed on the outside of the front windscreen to be swept by the wipers, in the pattern of interlocking fingers to form a sensor.



Photograph of a Tidy Tub being used to hold various tools.

The control circuitry would be designed to switch the wipers on when moisture bridged the sensor and off when the wipers swept the screen dry (or below a threshold moisture level). Any offers?

We received a 3g bottle of the paint and brushed it onto a break made along a copper track on stripboard. Two thin coats were applied at half an hour interval and left to dry overnight. When measured the next morning with our Avo meter, the resistance reading was just above zero on the divide-by-100 range indicating a virtual short circuit.

The paint is not cheap—understandable when you realise that it contains pure silver—and costs £2.70 for a 3 gram bottle which includes VAT, postage and packing from: Magenta Electronics Ltd., 61 Newton Leys, Burton-on-Trent, Staffs., Xerosa Radio, 305 St. Paul's Road, Highbury Corner, London N1, and Zartonic, 115 Lion Lane, Haslemere, Surrey.

Constructional Projects This Month

All the components required for the four constructional projects featured this month should be readily available from component suppliers advertising in this issue.

Care should be taken when buying components for the *Probophone* project especially with regards the sub-miniature horizontal presets and the C280 type capacitors. The printed circuit board has been designed to accommodate these components and other sizes will not be usable with our board design.

In the *Dynamo Back-Up* unit, the weatherproof case can be a standard rigid case treated with a silicon spray when fully assembled. This is sometimes used to make watertight the distributor housing in a car, and should be available from many garages and car accessory shops. Don't forget to plug the grommet gap with a piece of plasticine or similar. A hose-clip or Terry clip to secure the case to the cycle frame should be available from any ironmongery shop or cycle accessory store.

DYNAMO

BACK-UP

By R. EVERSON

INTRODUCTION

CYCLISTS who use a dynamo to power their lamps are often at risk at slow speeds and when at rest because the dynamo does not generate sufficient power (none if at rest) to light the lamps.

This circuit was designed to keep an amount of light above a certain minimum always emitting from the cycle lamps when the cycle is travelling at slow speeds or is stationary and to conserve battery power when the cycle is in motion.

**START
HERE FOR
CONSTRUCTION**

The voltage of the battery, B1, is chosen by one of two methods: either by reference to the operating voltage normally stamped on the dynamo bulbs, or by spinning the wheel to which the dynamo is connected and measuring the voltage. Remember to use the a.c. voltage range on your multimeter. This will give an approximate guide; the voltage should then be chosen to produce sufficient light from the lamps when the bicycle is stationary.

The battery must obviously be able to supply sufficient current for both lamps which are connected in parallel. The diodes used in the prototype will handle lamps whose maximum wattage sum is 5 watts. Higher rated lamps will require higher current capacity diodes.

In the prototype, the circuitry was built on a piece of 0.1 inch matrix stripboard size 12 strips by 11 holes as shown in Fig. 1. There are no breaks to be made on the underside of the board. Two fixing holes need to be drilled for securing the board to the case. Stand-off spacers need to be employed to raise the board above the base of the case to prevent shorting of the circuitry. A suggested layout and

wiring up details are seen in Fig. 2.

Choose a weatherproof case of size to suit the battery selected and other components and fix in position the switch, component board, terminal block and rubber grommet and wire up as shown in Fig. 2. The connections to the battery are shown soldered but suitable connectors would be better to make battery replacement much easier. Foam rubber/sponge packed around the battery will hold this secure when the case lid is fitted.

There are two wires coming from the dynamo. These should be cut at a convenient distance from the dynamo and connected to the terminal blocks at the positions shown in Fig. 2.

If the front lamp housing is large enough, the component board could

Fig. 1. The layout of the diodes on the top-side of the stripboard. Also shown are connection wires to other components.

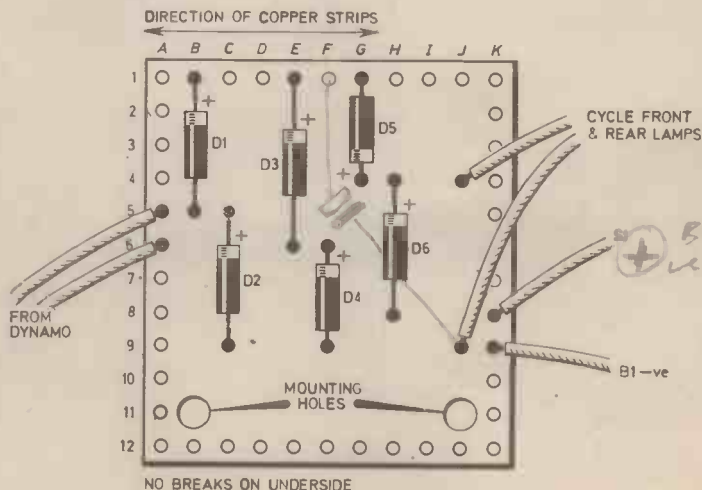

CIRCUIT DESCRIPTION

Consider first when the bicycle is in motion. The a.c. current from the dynamo is full-wave rectified by the diode bridge arrangement (D1 to D4) to produce pulsed d.c. which illuminates the lamps. Providing the voltage at D5 cathode is greater than the battery voltage

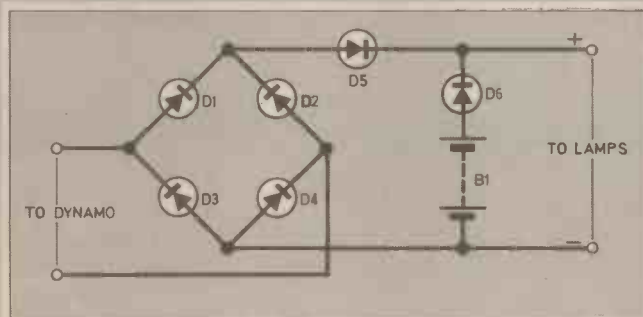

plus the forward voltage drop of D6 (about 0.5 volt) then D6 will be reverse biased and the battery will effectively be switched out of the circuit and so no current flows from the battery.

However, when the bicycle is at rest, or travelling so slow that the

be located there with the battery. However, if a separate case is used, a suitable position must be found for locating it on the bicycle. If the latter is equipped with a saddlebag, this could be the easiest method, otherwise two suitably sized hose-pipe clips can be utilised. The hose-clips can be riveted or bolted to the case and the clip tightened around a circular member of the bicycle frame. □

COMPONENTS

D1 to D6 1N4001 or similar 1A silicon types (6 off)
 B1 See text
 S1 on/off toggle
 Stripboard: 0.1 inch matrix size 12 strips × 11 holes; 4-way 2 amp terminal block; weatherproof case; rubber grommet; battery connectors to suit B1 selected; 4BA fixings—nuts, bolts and shake-proof washers (4 off); 4BA spacing pillars (2 off); hose-clips (2 off); connecting wire.

voltage at junction D5/D6 falls below the threshold level, the lamps will be powered by the battery as D6 becomes forward biased and passes current. Thus a minimum amount of light from the lamps will be maintained at all times.

A switch has been incorporated in the prototype to isolate the battery from the circuit when the lights are not required. However, this may not be required as some dynamo systems incorporate a switch in the front lamp housing and this can be wired as S1.

Fig. 2. Positioning and wiring up details to the board and other components within the case.

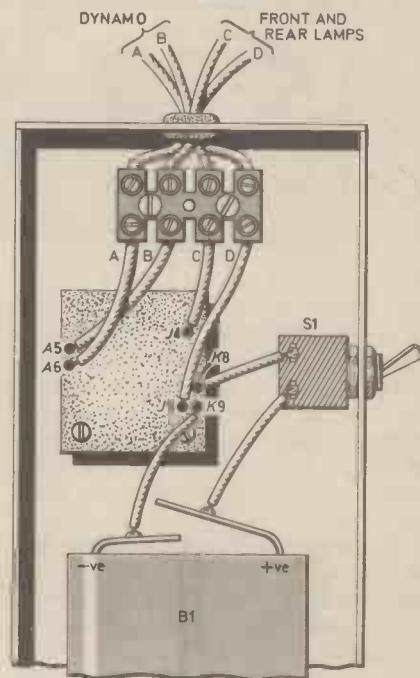

HOW IT WORKS...

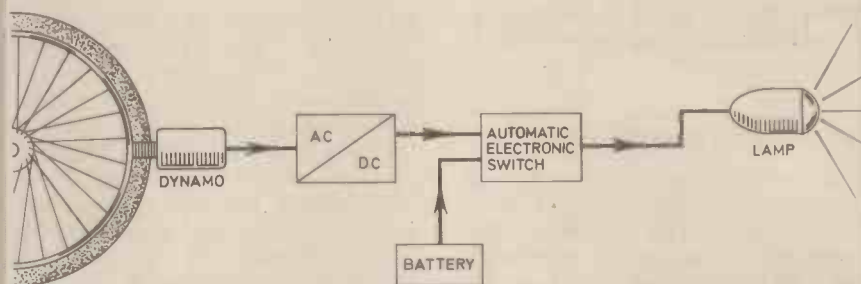

The unit is to be placed between the dynamo and the cycle lamps. When the cycle is travelling and the dynamo is being operated by the wheel, an a.c. voltage is developed which is normally applied direct to the lamps. In this unit, the resulting a.c. voltage is rectified first to produce d.c. and this is then applied to the lamps via an electronic switch. With the dynamo in operation, the battery is out of circuit (disconnected). Now if the dynamo voltage reduces below a threshold level, as a result of the cycle travelling very slowly or stopping, the electronic switch allows the battery to power the lamps. Increasing the dynamo voltage above the threshold causes the battery to return to the switched off mode.

FOR GUIDANCE ONLY

ESTIMATED COST
OF COMPONENTS

£2

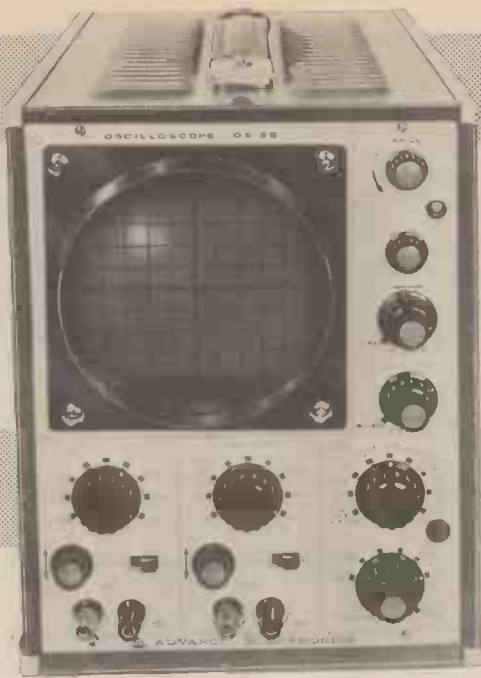

INTRODUCING the OSCILLOSCOPE

By JOHN SMITH

ARTICLES appearing in EVERYDAY ELECTRONICS frequently show diagrams of oscilloscope waveforms. Anyone taking a serious interest in electronics will, sooner or later, find that an oscilloscope is needed. Indeed, the professional engineer can hardly manage without one.

It is very difficult to make use of an oscilloscope without some rudimentary knowledge of how they work. This article sets out to explain how oscilloscopes work, for readers who may have the opportunity to use one.

When the principles of oscilloscopes are understood and one has actually made use of the instrument, articles containing reference to waveforms become much easier to understand.

CRT CONSTRUCTION

An oscilloscope is constructed around the cathode ray tube (CRT), which we will recall is a device for projecting a beam of electrons onto a light emitting phosphor. An oscilloscope CRT uses *electrostatic* deflection as opposed to the *magnetic* deflection employed in the CRT of television receivers.

Electrostatic deflection means quite simply that there are two plates mounted either side of the CRT between which the electron beam passes. If a voltage is applied to these plates an electrostatic field exists between them. This

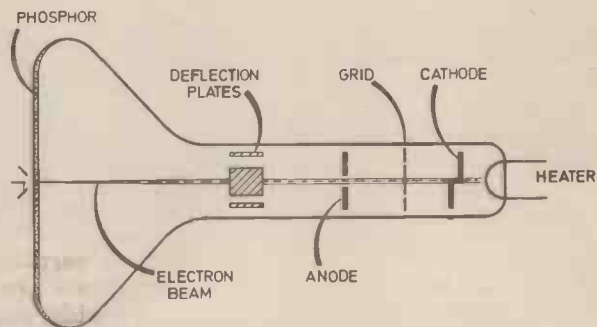

Fig. 1. Electrode arrangement in a cathode ray tube.

field is capable of deflecting the electron beam; Fig. 1 shows the electrode arrangement.

In this tube we have a heater to heat the cathode which gives off electrons. The electrons pass through a grid and are accelerated by the anode, passing between the deflection plates before they hit the screen phosphor. In terms of the spot of light appearing on the CRT screen, the grid voltage controls *brilliance*, the anode voltage controls *focus* and the deflection plates control *position*. As is shown in Fig. 1 the position of the spot can only be moved up and down in a straight line, therefore the CRT is fitted with another two plates to move the spot at right angles to the first pair. The plates which cause the spot to move vertically are called Y-deflection plates, whilst the plates moving the spot horizontally are called the X-deflection plates.

Thus we have a device where a spot of light may be controlled in any vertical position (Y-deflection), any horizontal position (X-deflection), its brilliance (grid voltage) and its focus (anode voltage) are also controlled. Most oscilloscope tubes employ more electrodes than this, but from a user's point of view the only other controllable facility they provide is the *roundness* of the spot (astigmatism). No matter how complex and expensive an oscilloscope, they all have these basic tube controls.

TIMEBASE

A second feature incorporated into every oscilloscope is the time base. This is an internal oscillator which deflects the spot across the horizontal axis. The time base causes the CRT spot to start on the left of the screen and travel at a constant velocity across the screen

to the right hand side. Thus a horizontal line is drawn which can be evenly divided into centimetre divisions representing time.

For example, if a time base of 1 millisecond caused the CRT spot to traverse 10cm across the screen then each centimetre would represent 100 microseconds of time; Fig. 2 shows how this would appear on the oscilloscope screen.

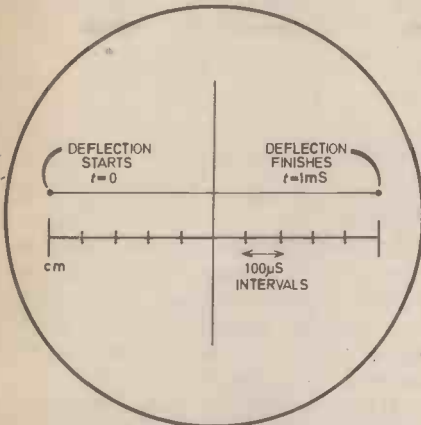

Fig. 2. Typical time scale used on oscilloscopes.

The purpose of this time base is to show any electrical events occurring between the start and the finish of the scan. The spot is suppressed (blanked) when it flies back from the finish to the starting point. Oscilloscopes are provided with a wide range of time bases to examine slow and fast changing signals.

At this juncture it is necessary to examine how the time base starts at $t=0$ and what is $t=0$? This starting point is determined by the user of the oscilloscope with the aid of another feature, always provided, called sync (synchronisation) or trigger.

The user must synchronise or trigger the oscilloscope at the start of the signal he wishes to examine. If one is trying to make a circuit work and it's not known if there are signals present or not, one can be faced with a completely blank screen. For this reason most oscilloscopes provide a "free run" position on the trigger circuits.

Finally, we come to the part of the oscilloscope which is used to examine the circuit waveforms, the Y-amplifier. The Y-amplifier is an amplifier/attenuator which transfers the signals to be examined to the Y-deflection plates. If applied without a time base it would produce a vertical line where displacement represented voltage.



Typical of many oscilloscopes, is the facility to provide two traces. The IO-4510 from Heathkit is a good example.

Y-amplifiers are designed to give so many "volts per centimetre" deflection. The deflection of the beam depends upon the voltage applied to the deflection plates, therefore a voltage applied to the Y set of plates merely shifts the spot up or down.

If a voltage is varying in time the Y trace shows the instantaneous voltage, whilst the X trace plots the time. Now examine Fig. 3 which shows a block diagram of the complete oscilloscope with all the facilities mentioned.

The oscilloscope is really a device for plotting signals, similar

to a pen recorder. In a pen recorder, paper (the time base) is continuously fed out of the machine whilst the pen shows (by deflection on the paper) the voltage applied. The oscilloscope uses the time base generator instead of a roll of paper.

It may be useful to examine how one would plot a signal on graph paper and then proceed to plotting the same signal on an oscilloscope. Consider a signal present in most electronic equipment, a 50Hz sine wave of 10 volts peak amplitude. This is about 7 volt r.m.s.

A 50Hz sinewave means 50 com-

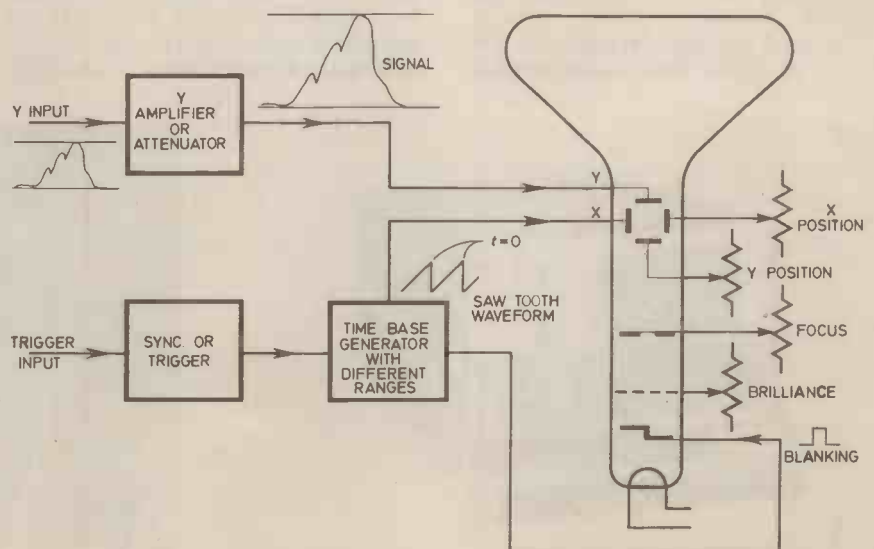

Fig. 3. Block diagram of an oscilloscope.

plete cycles or oscillations per second, therefore one cycle takes $1/50$ second or $1000/50$ milliseconds = 20 milliseconds. This is a complete cycle from 0 to 360 degrees.

The main signal is varying in voltage according to the sine of the angle therefore the instantaneous voltage is given by

$$V = V_p \sin \theta$$

$V_p = 10$ volts

For $\theta = 0$, $\sin 0 = 0 \therefore V = 0$ volts

$= 30$, $\sin 30 = 0.5 \therefore V = 5$ volts

$= 45$, $\sin 45 = 0.707 \therefore V = 7.07$

volts

$= 90$, $\sin 90 = 1 \therefore V = 10$ volts

for angles between 90 and 180 use $V = V_p \sin(180 - \theta)$, and when the signal goes negative we can start again with $V = V_p \sin \theta_1$ where $\theta_1 = \theta - 180$ degrees.

These results are plotted on Fig. 4 and readers are invited to look up a table of $\sin \theta$ to plot the complete waveform.

All the different angles θ occur during a fixed period of time already worked out to 20 milliseconds, therefore each 40 degree interval is given by $\frac{20 \times 40}{360}$

seconds = $20/9 = 2.2$ milliseconds.

If instead of degrees we plotted the X-axis in 10cm divisions, each division would represent 2 milliseconds or 36 degrees, which although inconvenient to plot on a graph is much easier to plot on an oscilloscope. The oscilloscope is no more than an instrument to plot the results just obtained onto the face of a CRT instead of paper.

The waveform is plotted by adjusting the oscilloscope as follows:

1. Connect the sync/trigger to the 10 volt signal and adjust until a

trace appears.

2. Set the time base to 2mS per cm.
3. Set the Y amplifier to 2.5 volts per cm.
4. Connect the 10 volt peak sine-wave to the Y-amplifier.
5. Adjust the sync/trigger controls to obtain a stationary trace.
6. Adjust the brilliance and focus controls to obtain a fine clear trace.

The sinewave will now appear on the CRT face for as long as the signals are present.

With unknown signals, an unknown frequency for example, the procedure is more or less the same except that the time base and Y-amplifier controls are adjusted to give the best display possible and the signal is measured against the oscilloscope calibration.

For example, suppose the time base selected was 100mS and the nearest full sinewave measured 35mS (3.5cm) its frequency would be $1000/35$ or 28.57Hz. In a similar manner its voltage can be determined from the Y-deflection

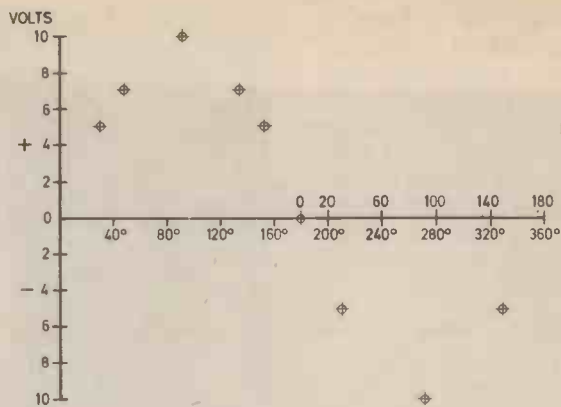

Fig. 4. Plotting a sinewave on graph paper.

and the setting of the Y-amplifier controls.

In practice one seldom looks at sinewaves, signals are usually pulses, square waves, saw tooth and similar waveforms. In each case $t=0$ has to be determined to start the time base.

With practice one becomes skilled at adjusting the instrument and interpreting the signals displayed. It is not possible in the space of a short article to list all the different signals that one can examine with the oscilloscope, except to say in general that any signal can be examined. Unfortunately, any 'scope cannot examine all possible signals as each different model is designed for a range of uses, some extremely specialised.

A glance at advertisements for oscilloscopes will have already informed readers that a wide range of prices are quoted. A higher price in general will mean that the 'scope can handle a wider range of signals, has more facilities and is more accurate. □



The Heathkit IO-4530 single trace oscilloscope.

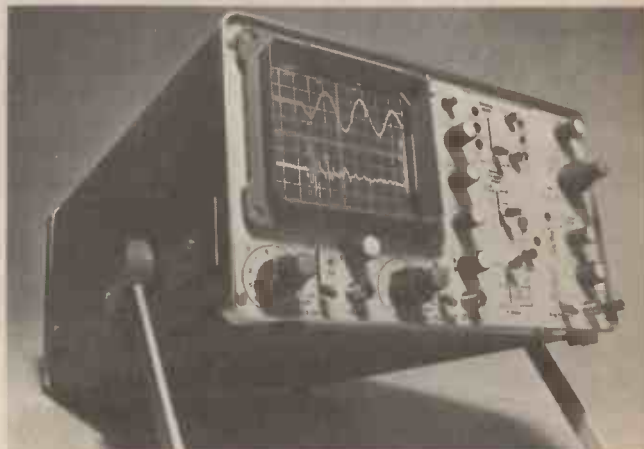

The OS4000 storage oscilloscope from Gould Advance Ltd.

SQUARE

...FOR BEGINNERS

WE ARE HERE TO HELP YOU -

NO MATTER HOW NON-TECHNICAL YOU MAY BE, JUST READ ON!

ONE

Let us lead you into the exciting world of electronics. There are things you can make for yourself that will amaze you and your friends!

It all looks so mysterious. Yet this is largely deceptive. The building part of electronics is really quite simple. True you need a certain knack and ability to handle small parts and to make soldered connections. But these skills are soon acquired with a little practice.

How does one start building? First look at one of the constructional articles in this issue. Read the INTRODUCTION, then the "HOW IT WORKS" section and move on to the CONSTRUCTIONAL instructions. Study these in conjunction with the component layout. Refer to the COMPONENTS list—this tells you exactly what to buy.

All electronic designs are based on

Here is a very simple explanation of this small circuit. The electronic working part is a transistor, labelled TR1. This component is illustrated in Fig. 4. Note the Emitter, Base, and Collector lead-out wires. These are identified in Fig. 1, by e, b and c respectively. This transistor operates as an amplifier, magnifying the electrical signal (input) applied at A sufficiently to "drive" the speech coil of the loudspeaker LS1. Power for the transistor is provided from a 12V battery: the positive side ("H.T. Line") is applied via the loudspeaker coil to the Collector of TR1; the negative side is applied directly to the Emitter of TR1.

If you were brought up on valves, think of the Collector as the anode, and the Emitter as the cathode. The third connection to the transistor is called the Base; this is very similar in function to the grid of a valve.

The input signal applied to the Base controls the current passing through the transistor, and hence, in our case, the current passing through the loudspeaker.

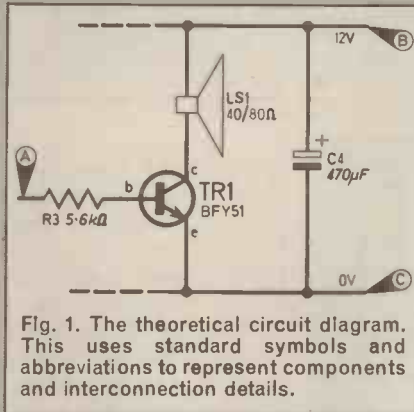

Fig. 1. The theoretical circuit diagram. This uses standard symbols and abbreviations to represent components and interconnection details.

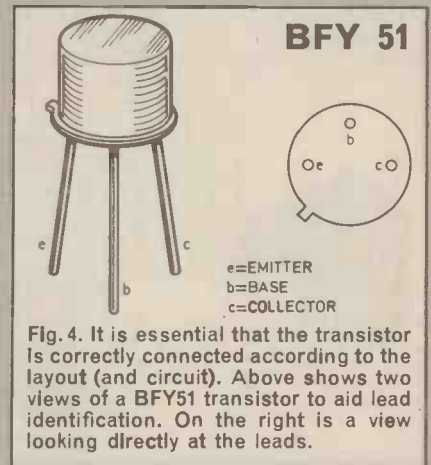

Fig. 4. It is essential that the transistor is correctly connected according to the layout (and circuit). Above shows two views of a BFY51 transistor to aid lead identification. On the right is a view looking directly at the leads.

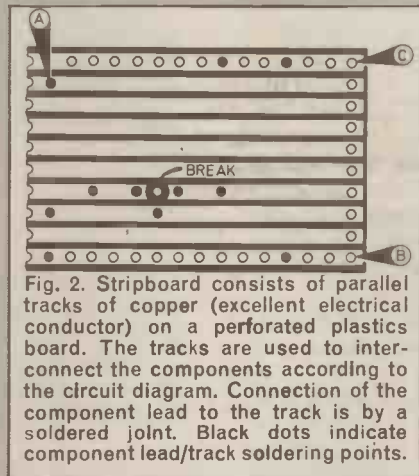

Fig. 2. Stripboard consists of parallel tracks of copper (excellent electrical conductor) on a perforated plastic board. The tracks are used to interconnect the components according to the circuit diagram. Connection of the component lead to the track is by a soldered joint. Black dots indicate component lead/track soldering points.

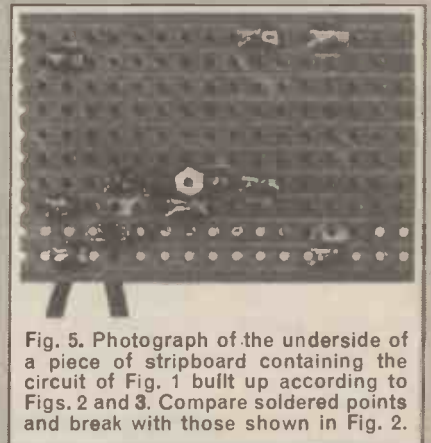

Fig. 5. Photograph of the underside of a piece of stripboard containing the circuit of Fig. 1 built up according to Figs. 2 and 3. Compare soldered points and break with those shown in Fig. 2.

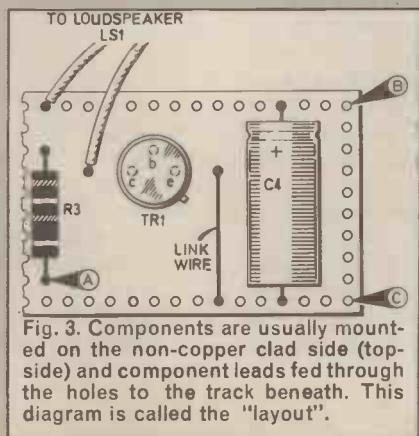

Fig. 3. Components are usually mounted on the non-copper clad side (topside) and component leads fed through the holes to the track beneath. This diagram is called the "layout".

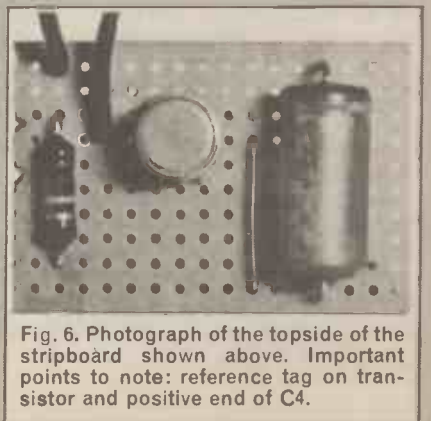

Fig. 6. Photograph of the topside of the stripboard shown above. Important points to note: reference tag on transistor and positive end of C4.

a *Circuit Diagram*, sometimes referred to as a theoretical diagram. Usually the circuit diagram is arranged so that we proceed from cause to effect (from input to output) by reading across from left to right.

At this stage, it is not essential to understand how the circuit works in detail.

Our business is to translate the circuit diagram into a practical form using standard electronic components. (See components list.) The foundation for our building is usually a piece of plastics board. In the example illustrated we are using a small piece of circuit board known as stripboard.

Look at Fig. 1. This is a small section taken from the *Flasher Bleeper*, see page 24. Now look at

Fig. 3. Here we see this section of the circuit translated into a physical form.

Note that Figs. 1, 2 and 3 have input and supply lines annotated A, B and C to aid the constructor in translating from theoretical to physical.

Now to the practical work of building. First we prepare the underside of the stripboard by making the necessary "break" in the copper strip as shown in Fig. 2. A twist drill is suitable for this.

Next turn the board and insert the component leads through holes in the board in accordance with Fig. 3. Use a pair of long-nosed pliers to bend the wires to suit. As each component is fitted, turn the board and then solder

the wires to the copper strip. Cut off the surplus wire. That's all there is to it!

Join us here next month for more basic facts and helpful advice about electronic circuit construction.



PCB AIDS

I have recently been using a method of making printed circuits straight from the circuit diagram.

Take a piece of 0.1 inch plain matrix board large enough to accommodate all the components. Cover one side with white Fablon. On the uncovered side, position the components approximately as they are in the circuit diagram, pushing the leads through the Fablon. The points where the wires come through the board can now be seen, and the "islands" drawn in with a pencil, carefully connecting the proper wires together.

Now remove the components and gently peel off the Fablon and stick it down on the copper side of the board. Cut round the islands and remove the excess. The board can then be etched in the normal way, the Fablon acting as an etch resist.

P. A. Boocock,
Thirsk,
North Yorkshire

When making printed circuit boards I mark on the board the edges of the required copper areas and roughly cover them in nail varnish. When dry it is a simple matter to scrape away the excess with a sharp knife. This, I find is much easier than carefully marking the areas and applying the resist.

L. U. Barker,
Solihull

CASES

One problem which is often encountered is how to attach a finished project to the inside of its box. One very easy way is to attach a piece of expanded polystyrene foam to the inside of the box with glue. The PCB is then placed on top of it and pressed down. The leads of some of the components should be left long to ensure that it remains fixed.

This method ensures to some extent that the board is protected against knocks and bangs, and is also electrically isolated from the case.

G. S. M. Potter,
Wimborne,
Dorset

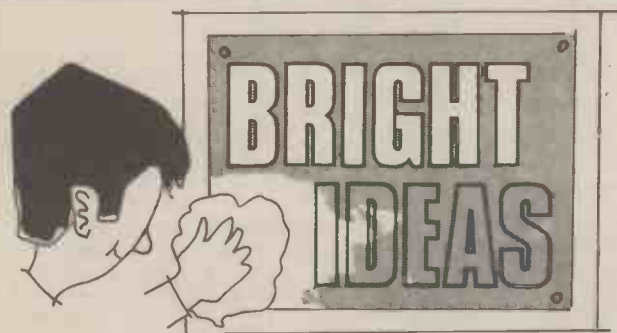

Readers' Bright Ideas; any idea that is published will be awarded payment according to its merit. The ideas have not been proved by us.

HEATSINKS

I have thought of a way of making a heatsink for transistors. You simply take a piece of aluminium cooking foil, about 70mm square and wrap it tightly around the transistor. I find this provides an excellent heatsink, especially when a proper heatsink is not available.

Ensure that the foil does not touch any of the leads on the transistor, otherwise a short will occur and possibly destroy the transistor.

J. Kilmister,
Hartcliffe,
Bristol

DIODE TESTER

Having constructed the *Transistor Lead Out Indicator* as described in the June issue of *EVERYDAY ELECTRONICS*, it occurred to me that it could also be used as a diode tester. To achieve this facility two miniature screw terminals are used instead of the jack socket, these being marked anode and cathode. It is also necessary to insert a good transistor in the socket.

In use a good diode will only give a good tone when correctly connected, a diode which is open circuit gives no response, a shorted diode gives equal response in both directions. I have found this modification most useful for sorting out diodes from the many bargain packs which are sold by firms advertising in *EVERYDAY ELECTRONICS*.

L. K. Noyce,
London

FREE! in Next Months' issue

POCKET DATA CARD

Part 1 of our
New Beginners Series

TEACH-IN '78

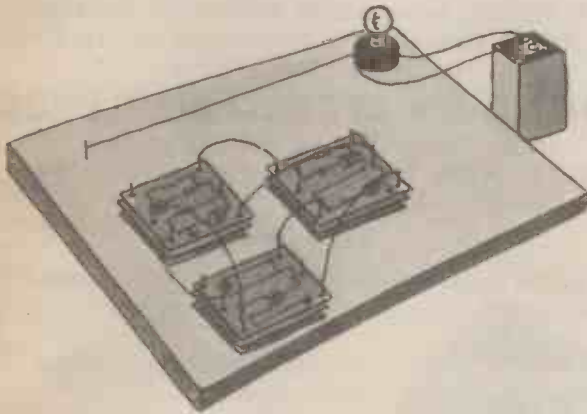
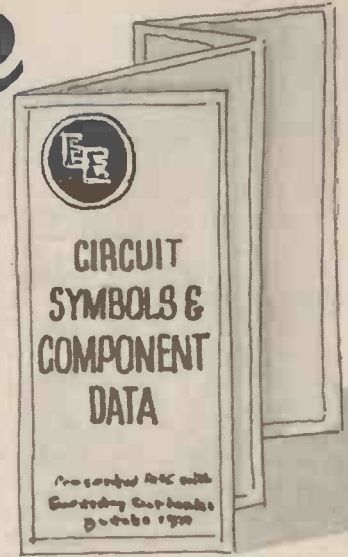

Have you ever asked yourself "what is a transistor? . . . how does an amplifier work? . . ." If so, join us next month for the start of a series that will explain the fundamentals of electronics . . . by theory and experiment.

Also

ENLARGER TIMER · MODEL TRAIN CONTROLLER · TRANSISTOR TESTER

TREASURE LOCATOR

Get on the right trail with this inexpensive easy-to-build unit. Fun for all the family!



Everyday ELECTRONICS

OUR OCTOBER ISSUE
WILL BE ON SALE
FRIDAY, SEPTEMBER 16

BOOK REVIEWS

50 CMOS IC Projects

Author R. A. Penfold

Price 95p

Size 180 × 108mm 102 pages paperback

Publisher Bernard's (Publishers) Ltd

ISBN 0 900162 64 3

ALTHOUGH not entirely new to the amateur market, the wide range of CMOS i.c.s is fast gaining popularity amongst constructors. Due to the fact that CMOS i.c.s can operate between supply voltages of 3 to 15V, and for practical purposes at zero current drain, they are being used in many varied projects.

Divided into four sections; multivibrator projects, amplifiers and oscillators, Schmitt triggers, and special devices, each section contains a multitude of different projects ranging from a metronome, enlarger timer, audio squelch unit and many more.

As with many other books written in a similar style, no detailed information has been given as regards actual construction, this should not however prove to be a disadvantage as the circuits are all fairly easy to build.

It is unfortunate that a few mistakes have been let through this otherwise commendable book. It is advisable to check the pin leadouts of the 4016 and 4017 i.c.s before embarking on any projects using these types.

T.J.J.



Back Numbers

We are pleased to announce that the Back Numbers Service has now been reinstated and will operate from the issue dated June 1977.

This and subsequent issues of EVERYDAY ELECTRONICS will be available at the inclusive price of 60p per copy. This includes inland/overseas postage and packing.

Orders should be addressed to: Post Sales Department, IPC Magazines Ltd., Lavington House, 25 Lavington Street, London SE1 0PF. Cheques and postal orders should be made payable to IPC Magazines Limited.

A limited supply of earlier back issues is also available. Requests with appropriate remittance, should be sent to the above address. In the event of non-availability, remittances will be refunded.

SOUND DESIGN

A PRACTICAL ELECTRONICS PUBLICATION

SECOND EDITION

A SPECIAL SELECTION OF MUSICAL PROJECTS FROM PE

THE MINISONIC MK2 SOUND SYNTHESISER

An up-dated version of the published Mk 1, the Mk 2 has an integral keyboard, two 250 mW monitoring channels and loudspeakers, and facilities for amplitude, frequency and harmonic modulation.

THE JOANNA ELECTRONIC PIANO

has realistic piano effect with touch-sensitive keyboard and additional choice of harpsichord or honky-tonk voicing.

THE ORION STEREO AMPLIFIER

A hi-fi amplifier with output of over 20+20 watts. Compact and complete in one unit, it measures only 14" × 6" × 2".

PLUS

Some great sound effects units for guitars, keyboard instruments and general recording.

Available Now
£1.20

POST PAID

(Please allow at least 2 weeks for delivery)

If you do not wish to mutilate your copy of the magazine, please send your order on a separate sheet.

To: Practical Electronics
IPC Magazines Ltd., Receiving Cashiers Dept.,
King's Reach Tower, Stamford Street, London SE1 9LS

Please send me.....copy(ies) of
"Sound Design". I enclose a Postal Order/Cheque
for £1.20 (post paid) or (state amount for
more than one copy)..... (£2.35 post paid
for 2 copies)

PLEASE WRITE IN BLOCK LETTERS

Name

Address

..... Post code

Remittances with overseas orders must be sufficient to cover despatch by sea or air mail as required. Payable by International Money Order only.

EE.1510

*Company registered in England. Regd. No. 53626.
A subsidiary of Reed International Limited.*

Everyday Electronics, September 1977

... physics is fun!

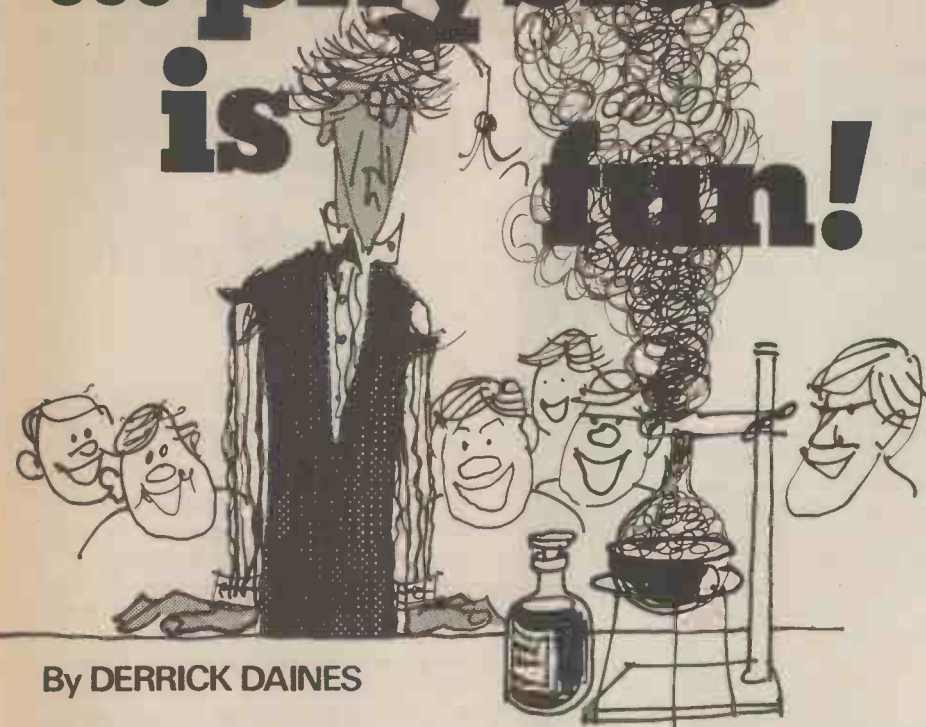

By DERRICK DAINES

OF ALL the gadgets made by youngsters entering the hobby of electronics, the shocking coil is certainly among the top three favourites, so no excuse is needed to introduce the item here. There are several ways of making such a device and one that is probably the easiest to understand is outlined in Fig. 1.

Shocking coils

All shocking coils for amusement have in common the provision of a very high voltage at an extremely low current and as such are perfectly harmless. It must be stressed however that multiplying the supply voltage by, say, a factor of ten also increases the total power even if the current is still very low.

Moreover, it appears that some people are less tolerant towards the effect of shocking coils than others. It is for these reasons that the supply voltage **must not** be increased above that recommended—certainly in no case should it exceed 4.5 volts.

It would be a great pity if at the outset of an interest in electronics we cause the ire of the household authorities with perhaps the subsequent ban on all future experiments!

We therefore utilise small torch batteries for the supply, 1, 2, or 3 will give voltages of 1.5, 3.0 and 4.5 volts respectively. However, a bell transformer will not work with d.c., so some means must be found to produce a.c. or trains of pulses which will be stepped up by the transformer.

One way is to pass the current through a small d.c. motor, thereby chopping-up the d.c. by the spinning of the armature. Another way is to feed a bell movement, as shown in Fig. 1. Notice that the bell transformer is operated in the reverse mode i.e. as a step-up transformer. To this end the chopped-up battery supply is fed into the winding that normally is connected to the bell, while the hand held probes are connected to the winding normally connected to the mains supply.

In use two, three or four people hold hands with the person at each end grasping a probe. All will then feel the high-voltage tingle. If any body protests that it is decidedly unpleasant, reduce the supply voltage by removing one battery cell.

Self Induction

Sooner or later it will occur to the young hobbyist that he is using two coils, one to chop-up his d.c. and the other to transform it to a higher voltage. Is it possible, he will wonder, to make one coil do both jobs? Indeed it is and last month I promised to show how to make a shocking coil using the self-induction principle. The circuit is shown in Fig. 2.

All that is needed is a bell movement, which can be either taken from a discarded bell or made up in the manner shown earlier in this series. Since the heart of the movement is a very efficient electro magnet, it is also good for producing the phenomenon of self-induction. In Fig. 2 I have not shown the connection to one of the hand-held probes. This is because it will work connected to either point A or point B of the circuit.

Connected to one of the points the probe will gather the self-induced current generated when the magnetic flux builds up; connected to the other point it will gather that produced when the magnetic field collapses. Can you determine which is which? If you cannot, try each in turn. Remember that the self-inductance generates more current when the field collapses than when it builds up.

Self-inductance is sometimes referred to as back e.m.f (electromotive force) and when sensitive electronic devices are in a circuit containing a coil it is very frequently necessary to insert a diode expressly to discharge the back e.m.f. Otherwise, the device would be destroyed.

But there—you will be able to feel the power of the back e.m.f for yourself!

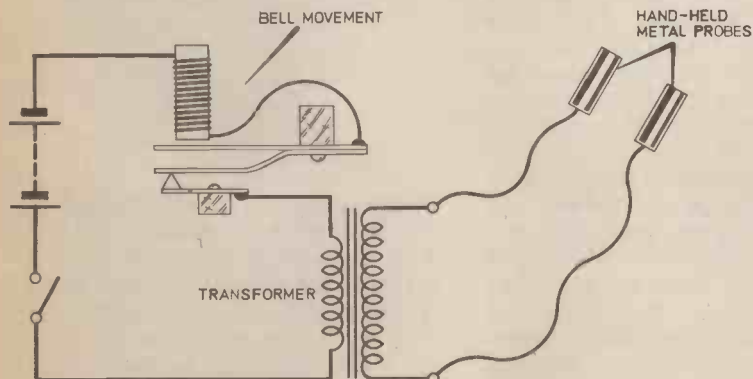

Fig. 1. Utilising a bell transformer a simple (and effective!) shocking coil can be made.

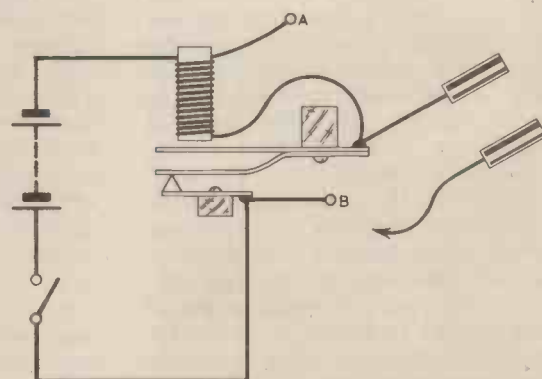
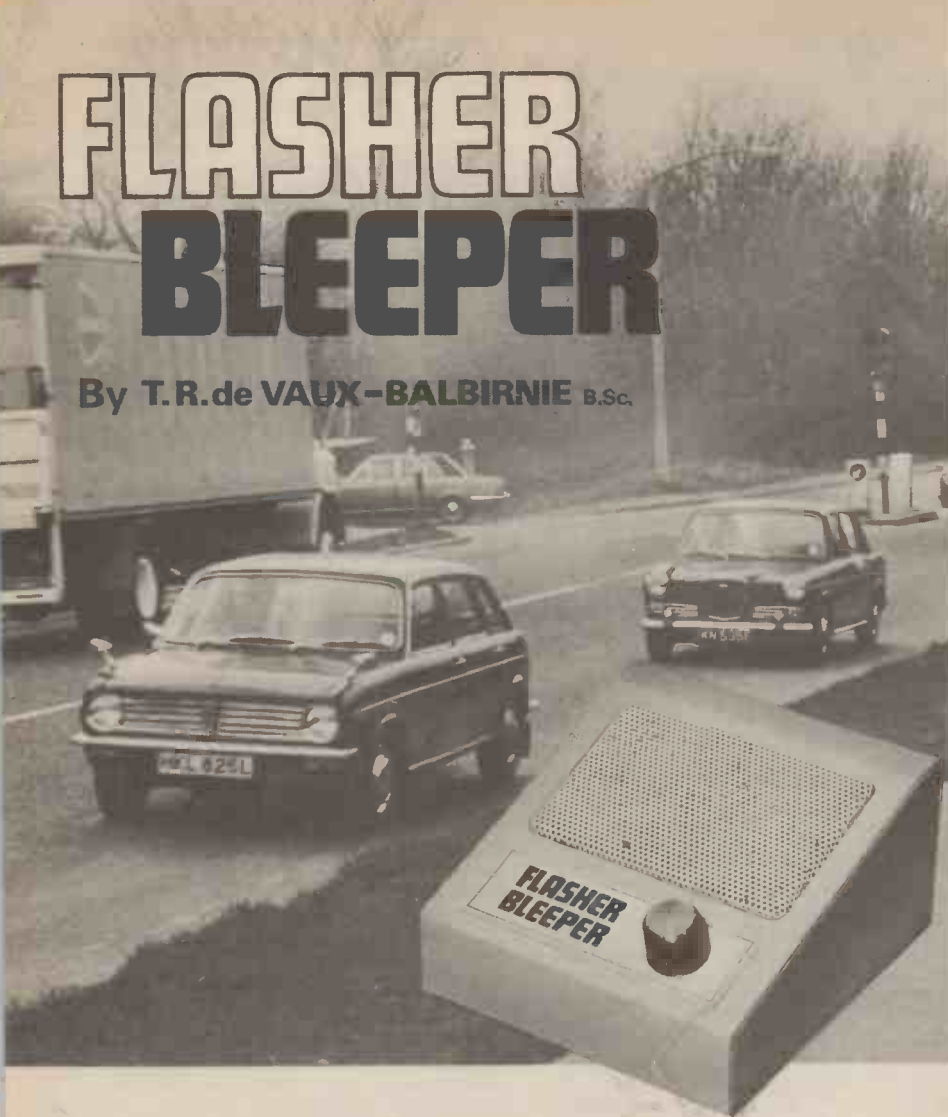

Fig. 2. A similar circuit to Fig. 1 but in this case uses the principle of self-induction.

FLASHER BLEEPER

By T.R.de VAUX-BALBIRNIE B.Sc.



INTRODUCTION

WHEN the author drives the family motor caravan, it has been known for him to drive for mile after mile with the flashing indicators operating. The reason is that they are not self-cancelling and the "tick" from the flasher unit is rather quiet especially when driving at speed. The author's wife has unkindly intimated that he is going a little deaf—a suggestion which the author vehemently denies.

Whatever the reason, it seemed a good idea to devise an electronic circuit which emits a loud warning note in time with the flashing indicators. This project could be found very useful to those in a similar situation, those a little hard of hearing or those who drive old and noisy vehicles. It could be of real benefit to van drivers. The indica-

tor light on the dashboard is often badly positioned so that it is obscured by the steering wheel or is too dim to attract attention in bright light. Similarly, the indicator unit itself may be badly sited so that the "ticks" are too quiet.

When designing the circuit, it was thought necessary to provide two special features. One is a volume control so that the normally loud warning signal can be adjusted to the particular application. It was also thought necessary to fit an on/off switch so that the unit can be completely silenced as required. Sleeping babies or elderly passengers may take exception to electronic bleeps. It must also be remembered that others may drive the vehicle and may not require the device. A preset control is provided on the circuit panel by which the pitch of the warning note may be altered to suit individual taste.

FOR GUIDANCE ONLY



ESTIMATED COST
OF COMPONENTS

£3

The design of the original circuit was made with discrete components but found that it suffered from changing pitch as the voltage varied. This meant that it changed its note abruptly as the engine was revved up or the brake lights were operated. The circuit was effective but this defect was very annoying. To incorporate a stabilizing circuit seemed hardly worthwhile. It was finally decided to use an integrated circuit as a tone generator. The type chosen was the low-cost 555 Timer, an 8 pin d.i.l. device normally used for short period timing circuits. It may, however, be wired as an effective astable multivibrator. The circuit is very tolerant to voltage changes which makes it ideal for this type of application. It hardly changes its tone with quite wide variations in supply voltage.

START
HERE FOR
CONSTRUCTION

The suggested layout is based on 0.1 inch pitch stripboard, see Fig. 1. It is essential to cut the copper strips in the places indicated using a proper tool or with a small twist drill turned by hand. The i.c. may be soldered direct to the circuit panel but the use of an 8 pin socket is advised.

Whether using an i.c. socket or

not, care should be taken not to cause bridging between the pins or any of the copper strips in the circuit panel. The two way connector shown in the illustration is advised as it allows for easy installation and removal in the event of failure.

After constructing the project it will be necessary to find a suitable connection to power it. This is easy if the car is fitted with a single warning light on the dashboard which flashes for both right and left turns. Most cars these days have this sort of arrangement and the prototype is used on one.

The "live" connection will then be taken to the non earth side of the bulb or from the corresponding terminal on the flasher unit.

COMPONENTS

Resistors

- R1 22k Ω
- R2 1.5k Ω
- R3 5.6k Ω All resistors are $\frac{1}{2}$ W carbon $\pm 10\%$

Potentiometers

- VR1 100k Ω horizontal miniature preset
- VR2/S1 10k Ω carbon log. with ganged single pole switch

Capacitors

- C1, C2 0.01 μ F polyester (2 off)
- C3 0.1 μ F polyester
- C4 470 μ F 15V elect.

Semiconductors

- IC1 NE555 timer i.c.
- TR1 BFY51 silicon npn

Miscellaneous

- LS1 miniature loudspeaker 40 to 70 ohm coil impedance
- Stripboard 0.1 inch matrix 12 strips \times 35 holes; 8 pin i.c. socket; small 2 way 5 amp block connector; case to suit; stranded wire; solder.

See
**Shop
Talk**

Page 13

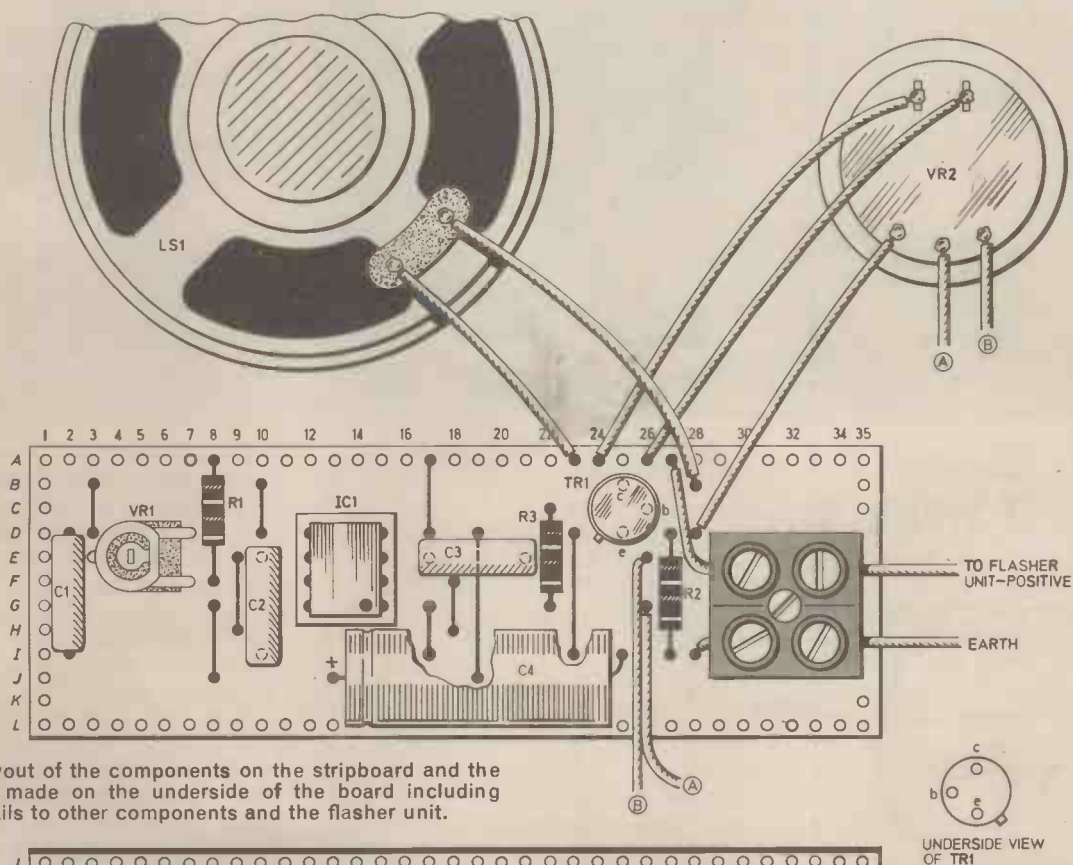

Fig. 1. The layout of the components on the stripboard and the breaks to be made on the underside of the board including wiring up details to other components and the flasher unit.

CIRCUIT DESCRIPTION

The output from the i.c. is fed via a capacitor to the volume control and from there to the base of the output transistor. Resistor R2 deserves mention. Without it, the volume control needs considerable rotation before any signal is heard at all. This means that the adjustment from very quiet to full volume happens over quite a small part of the track. It would be quite possible to fit a preset variable of value 10 kilohms instead of the fixed resistor R2 so that the exact operating characteristics would be adjustable.

The fixed resistor of 1.5 kilohms, however, works very well in the prototype. With the control just turned from the off position the signal is very quiet and adjusts to full volume over the entire rotation.

The transistor chosen for the prototype is a rather "hefty" one and the experimenter may wish to use a different type than that specified. It is likely that a ZTX300 would serve as an alternative. The loudspeaker is a miniature 50mm type with an impedance of 70 ohms or so. It was found possible to build the whole unit into a small

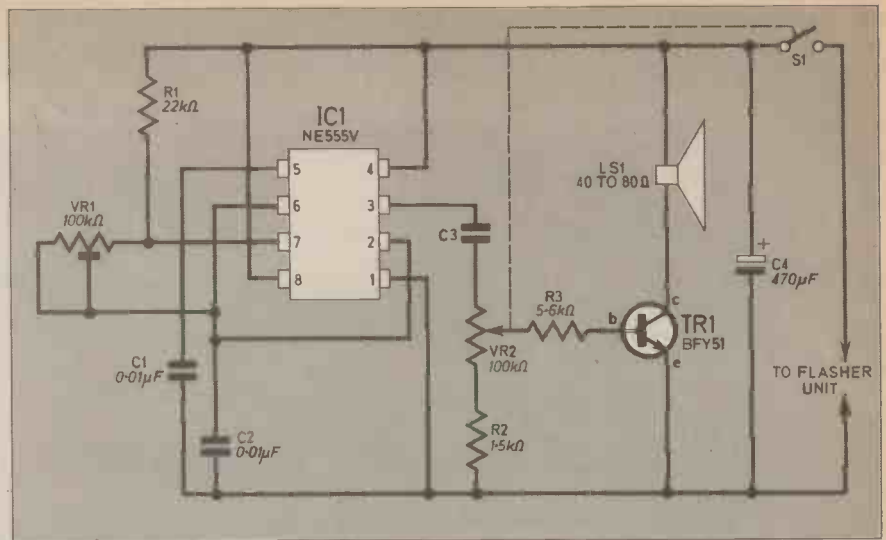

plastic box with small holes for the sound. The method of securing the volume control will depend on the type used.

It will be noted that the unit is equally at home in a positive or negative earth vehicle. The position of the on/off switch is for negative earth vehicles. It would be fitted in the negative lead if the unit were fitted to a positive earth car.

The purpose of capacitor C4 is to suppress clicks. Without it, the loudspeaker is likely to emit annoying clicks each time the flashing indicator unit operates.

This is largely eliminated by including the capacitor, although it adds to the cost, it is worthwhile. The suggested value is 470 microfarads. For those with junk boxes, there is scope for trying different values but that given should behave well. If its value is too small, the clicks will not be properly suppressed. If it is too large in value the bleeps from the loudspeaker will not start and end sharply as they should but will "grow" and "decay" rather slowly giving an unpleasant effect.

The polarity of the electrolytic capacitor must, as always be observed.

HOW IT WORKS...

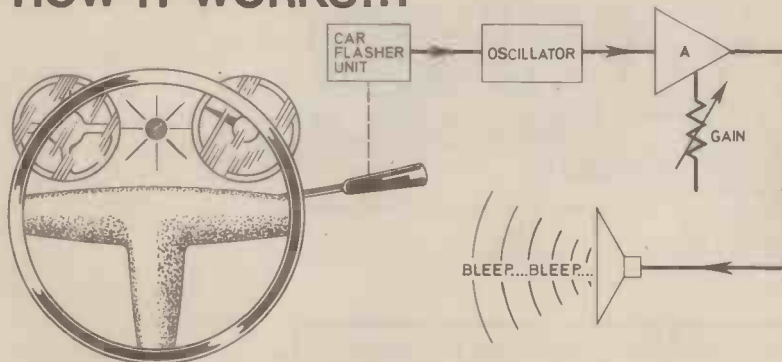

When the car indicator arm is operated to indicate an intended change in car direction, the indicator lamps are made to flash on and off by applying, via the flasher unit, a pulsed 12 volts to the indicator lamps. Now the *Flasher Bleeper* consists of an oscillator whose power supply line is connected to a pulsed 12V point in the indicator system. Therefore each time the lamps flash on, the oscillator is turned on and produces an audible tone in the loudspeaker. The output from the oscillator is fed to an amplifier fitted with volume control to allow for varying ambient noise conditions.

If the car has two indicator lights, one which flashes for the left indicators and one for the right, the constructor must investigate at the flasher unit to find the connection which gives the desired effect. This may be done with a small 12 volt test bulb one connection of which is earthed to a suitable point.

Both the live and earth wires must be of the stranded type, single wires soon fail under vibration. Note that the indicator light itself forms an important part of the circuit in providing a discharge path for the electrolytic capacitor. If the constructor tests projects like these with dry batteries on the table before installing them in the car it will be necessary to fit a small 12 volt bulb across the positive and negative connections to obtain the true effect. Without this, the curious "growth" and "decay" effect referred to in the Circuit Description will occur.

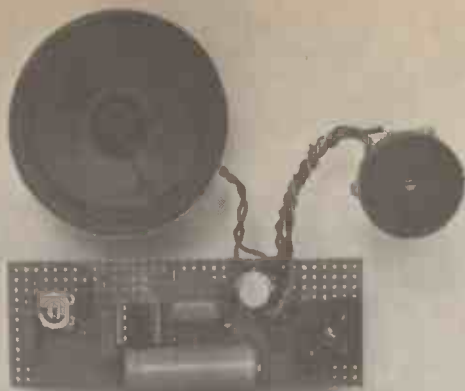

Photograph of the prototype Flasher Bleeper.

Modern flasher units tend to be very current sensitive. This does not matter at all if the unit is powered from the indicator light circuit on a three terminal flasher unit. On a two terminal flasher unit, however, the current consumed by the unit adds itself to the total drawn by the main lights. The current drawn by this project is so small that there will be no upset here—it is only about 100 mA depending on the setting of the volume control.

Flashing indicators left going are a danger to other road users. This project will make sure that you do not offend in this way! □

The frame coils being connected to probes. The sensitivity I obtained was 136mV/cm.

A. Hill,
Chelmsley Wood,
Birmingham.

The idea of using a redundant tv as an oscilloscope is of course well known, a design for one was published recently in one of our companion magazines.

It should be realised that due to the internal circuitry of the tv, the available bandwidth is severely limited. The best you could hope for is in the audio frequency range. A word of warning, the innards of a tv are potentially dangerous, so unless the constructor knows what he is doing, this modification should **not** be tackled by the beginner.

You are quite right in saying i.c.s of the CMOS type are sensitive to static. In this case however the tags referred to are outputs, and therefore need no protection.

It is however a different story when inputs are left open. In very severe cases leaving the inputs open can cause the entire i.c. to oscillate, and in some cases the i.c. may overheat through excessive current drain and destroy itself.

The simple remedy is to connect all unused inputs either to the negative or positive supply line, whichever is appropriate for the logic circuit involved.

Amateur Radio Classes

An amateur radio and theory and morse class is to be run by the Newcastle upon Tyne Education Committee. The classes will be held at the Gosforth Adult Association Classes at the Gosforth High School, commencing in September 1977.

Although specifically for the Radio Amateurs Examination, the course is ideal for anyone wanting to get an insight into radio theory, having just taken up radio or electronics generally as a hobby.

The theory class will be held on Tuesdays of each week from 7pm to 9pm, the morse class will be held on the Thursdays of each week at the same times.

Enquiries should be addressed to; The Principal, Gosforth Adult Association, Gosforth High School, Knightsbridge, Gosforth who will arrange for further details to be sent on application. Alternatively further information can be had from myself by telephoning Newcastle upon Tyne 668439.

D. R. Loveday
(G3FPE)

Can You Help?

I recently bought the July issue of EVERYDAY ELECTRONICS, and I am particularly interested in the *Phone/Door Bell Repeater*

Being deaf I am interested to know if the circuit can be modified to operate a lamp when the phone rings.

W. Westgate,
57, Kelsull Croft,
Chelmsley Wood,
Birmingham.

It is not our standard practice to provide readers with modifications to our published designs. However we feel sure that among our many readers there is someone who could come up with a design suited to your needs. If any reader does so they are asked to write to the above address.

Cmos i.c.'s

In your article, *Electronic Dice*, published in the March issue of EVERYDAY ELECTRONICS the i.c. type CD4017 has three unused tags.

As the device is static-sensitive, should these tags be connected to earth? Hoping you can advise.

A. Goudge,
St. Albans, Herts.

Remember that "Readers Letters" is your page for your news, views and comments. So don't be shy, write to us, we will be pleased to hear from you.



Estimated Cost

My son, aged 13, is very keen on electronics and we have a standing order for your magazine every month.

I know the prices you give are approximate, but I would like to point out that the *Fish Attractor* in the June issue, you give the approximate price cost as £3.00 but up to now it has cost him £7.50 and he still has three components to buy.

I thought you might be interested to know this as he bought the components from Tandy's.

Mrs. B.H. Shilling,
Aspley,
Nottingham.

We sympathize with you and your son for spending such a great deal of money.

All the prices for the constructional projects are taken from advertisers in EVERYDAY ELECTRONICS, not just one but many. In this way the price of each project is kept to a minimum. Certainly our prices in the main are cheap, but in many circumstances constructors have even made the projects for less! The moral therefore is to shop around.

T.V. Oscilloscope

I recently discovered that by using an old u.h.f. television it is possible to construct a fairly sensitive oscilloscope. The method I used was to plug the frame output generator into the line deflector coils.

ANY traveller waiting on the railway platform at Lord's Bridge Station, Cambridgeshire, will be disappointed for no trains will ever call there again, and if that sounds like the end of the story, it isn't. In fact it's the beginning of one.

For the site is now the home of the Mullard Radio Astronomy Observatory (MRAO). Founded with the aid of a generous benefaction from Mullard Ltd, but administered by the Science Research Council, it is indeed the end of a communication link that stretches back much farther than Cambridge or Bedford, but quite literally to the stars.

It shares a unique place in the forefront of international radio astronomy with the only other major British installation, Jodrell Bank in Cheshire.

The two observatories do indeed investigate a common science but they have differed considerably in development. There are no massive steel dish aerials at Cambridge like the very famous Mark IA Jodrell Bank reflector 250 feet in diameter.

Instead we see several groups of much smaller aerials at Lord's Bridge. Just how does this arrangement offer a valuable alternative to the big dish approach?

AERIAL SYNTHESIS

We can well understand the radio astronomer's yearn for bigger and bigger telescopes. With big dishes, he can pick up faint radio sources far away in the universe—more importantly he can resolve the fine detail of the sources he already knows about. So on both counts, the bigger the instruments, the better.

However, radio waves have a very much longer wavelength than light waves. This means that a high resolution optical telescope needs a mirror of only a few feet across but a comparable radio telescope would need a reflector dish several miles in diameter. Building such a dish would be an engineering nightmare and even if it were possible the cost would, quite

literally, be astronomical.

However there is an ingenious way out. In 1946 a research team led by the radio astronomer Sir Martin Ryle realised that such a dish could be broken down in effect into two or more much smaller dishes spaced out. Only one line of these dishes is actually needed because the earth's rotation will swing it round in a circle with respect to a radio source. The result is shown in Fig. 1.

We reform the big dish in outline and can "fill" it in if we combine observations made at different spacings of the small dishes.

This is the basic principle of aperture or aerial synthesis.

LOOKING AROUND

At Lord's Bridge most of the telescopes work on the above principle. Thus the so-called "One Mile Telescope" actually consists of three separate dishes or reflectors: one moveable one on a railway line and two fixed. This

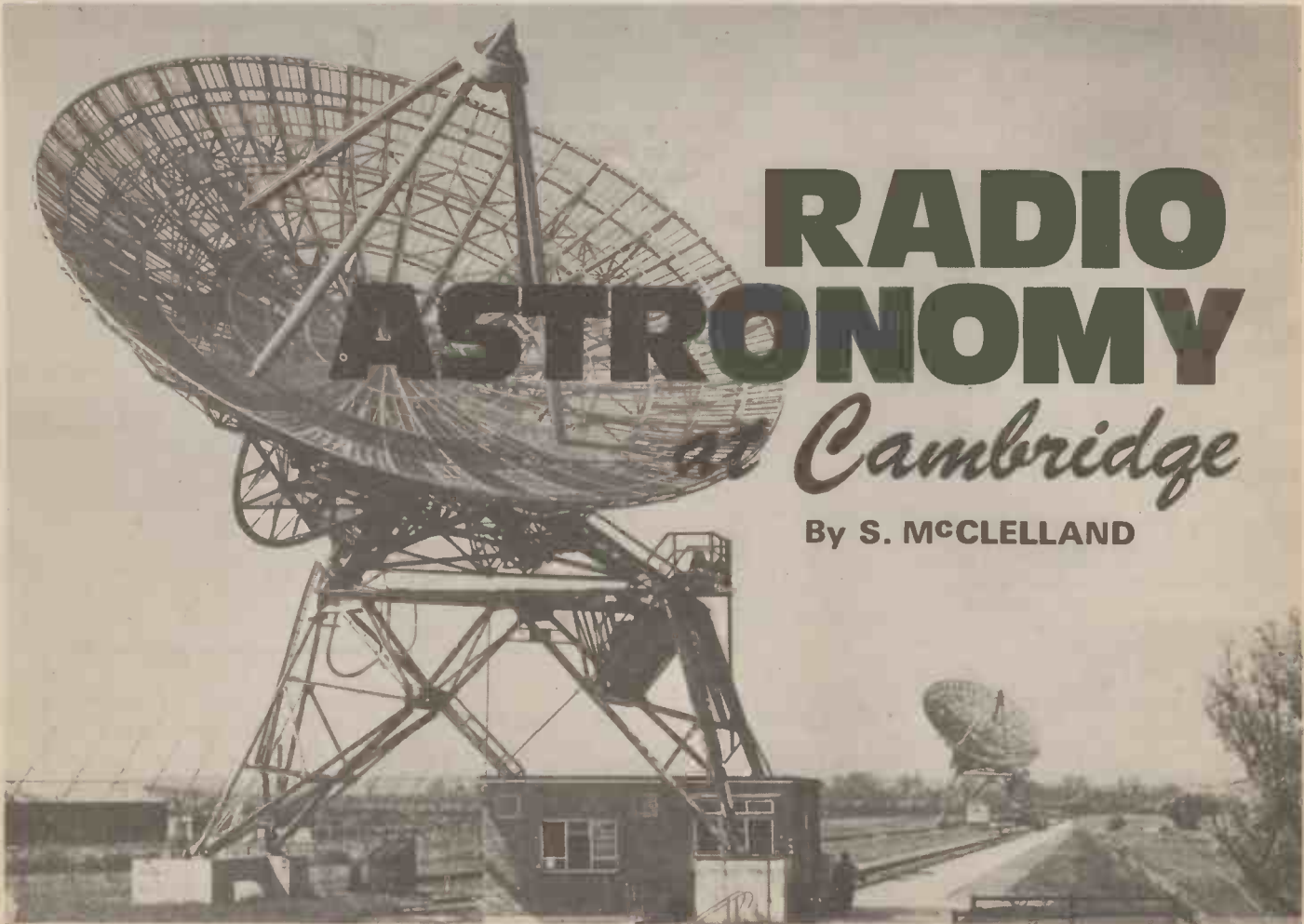

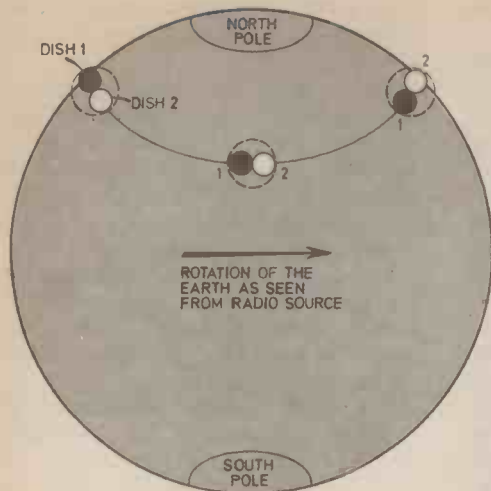

BIG DISH FORMED FROM APPARENT MOTION OF SMALL DISHES

Fig. 1. The principle of Aerial Synthesis. To a radio source far out in space, two small aerials spaced out are combined by the Earth's rotation effectively into one large one.

arrangement can give all dish spacings from zero to half mile and from half to one mile, i.e. this arrangement is equivalent to a big reflector of 1 mile diameter.

The "Half Mile Telescope" associated with it has a group of 4 reflectors, two fixed and two moveable ones and works similarly. However, the technique has reached its highest level of sophistication in the most recent of the Cambridge telescopes—the 5km instrument, completed in 1972. This has 8 dishes—four fixed and four moveable—spread out over a distance of just over 3 miles. It will be described in more detail later.

The point is with each of the above arrays, individual reflector sizes are small, 60 feet, 30 feet, and 42 feet for the One Mile, Half Mile and 5km telescopes respectively. Yet the 5km telescope is quite capable of achieving the resolving power of the world's most advanced optical telescopes.

OUT IN SPACE

However, after all the effort of building a telescope it would not be unreasonable to ask "What's out there to study?"

The simple answer could almost be "More than we could ever find out".

For the stars that the casual observer sees in the night sky are the few and relatively insignificant representatives of the 10,000 million other stars in our galaxy alone. The truth is that there are thousands of other galaxies. Their

distances are so great that they are unimaginable as the quantities of energy they must pour out for us to detect them.

A special category of these powerhouses are the "radio galaxies" which, as their name suggests, are very strong radio emitters. The prima donnas amongst even these are the mysterious quasars—star like objects, which can be over a million times brighter than ordinary stars.

Above all, we realise that the universe is not static but is constantly expanding. Everything is moving away from everything else

and the farther away it is, the faster it moves. Indeed some of the very distant quasars appear to be receding at velocities very near that of light itself.

Enormous distances, huge numbers and intense energies, all are set pieces in the cosmic battleground over our heads. The radio waves which tell us so much about their origins tell us one thing more—about the past. For even light and radio waves travelling at 186,000 miles per second can take an appreciable time to cross the vastness of space. The result is we see the universe not as it is but as it was in the past and the farther we look out into space the more we look back in time.

We see our own sun as it was 8 minutes ago, but the light from its nearest neighbour star took 4 years to reach us. And from the Andromeda nebula—a nearby galaxy—the picture the Cambridge radiotelescopes now receive began its journey two million years ago!

Indeed the most distant objects of all at the very edge of the observable universe can tell us what the universe was like thousands of millions of years ago and perhaps even how it began.

It is for this reason that deep space surveys have been made by the Cambridge radio astronomers and their 3C, 4C and 5C radio source catalogues are used internationally as a source of reference.

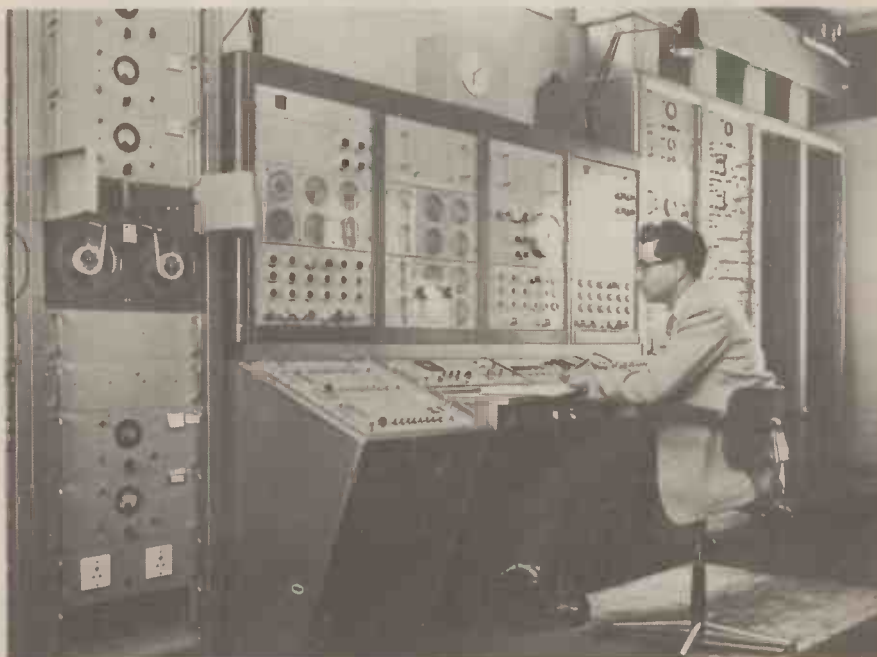

Professor Anthony Hewish, Nobel prizewinner, at the controls of the One-Mile Telescope. BICC photograph

It is found at great distances out in space, radio sources become far more numerous. This seems to indicate that some 13,000 million years ago all the matter in the universe was much more concentrated than it is now, perhaps even in a gigantic fireball which blew apart in a so-called "Big Bang" explosion.

Fascinating enough but perhaps the MRAO's most spectacular discovery came in 1967 when radio astronomers realised that some stars could tick like clocks—the pulsars.

PULSARS AND BLACK HOLES

It is ironic that the first pulsar was discovered by a radio telescope that had no dishes at all.

The "Four Acre Array" at Lord's Bridge instead consists of 2048 dipole aerials at an approximate height of 6 feet strung together like so many clothes lines alongside the One Mile instrument. It was built to investigate small diameter radio sources, but superimposed on the pen-recording output was a series of blips.

These blips were very regular,

their periodicity was at least as good as the most advanced clocks on earth.

After a thorough investigation, the scientists realised with excitement and perhaps some trepidation that those signals were not indeed produced on earth.

Where could they have come from? At first the recordings were dubbed LGM—(Little Green Men) which shows that one possibility had already crossed the minds of the scientists involved.

The truth is probably stranger still. Astrophysicists believe that these signals are produced by dead stars, which have ended their lives in a huge blaze of glory or supernova leaving behind a tiny hulk. This is made of matter so condensed that it's been picturesquely suggested that a teaspoonful of it would weigh 10 million tons!

The radio blips arise because this hulk, a so-called neutron star is spinning and is throwing off electromagnetic radiation in crests as it does so, like an earth-bound lighthouse beacon.

Pulsars are by no means uncommon, their numbers now run into three figures and more are being discovered all the time in

the various "pulsar hunts" being conducted in various radio astronomical observatories around the world.

However, as is often the case in science, theory has outstripped experiment and is waiting for it to catch up. In this case, theory predicts that for some, neutron stars may not be the final resting state.

For these, the gravitational pressures may be strong enough to force them all the way into the bizarre nothingness of those objects seemingly straight from science fiction—the black holes.

We must wait for experimental evidence to confirm the existence of these objects.

NOBEL PRIZE

The pacemaking work of the Cambridge group was given international recognition in 1974 when two of its members were awarded the Nobel Prize for Physics.

The award was made jointly to Professor Sir Martin Ryle the Astronomer Royal, who as head of the radio astronomy group, was largely responsible for its initiation and the development of the aperture synthesis techniques;

Five of the aerials of the 5km telescope: four of these are mounted on rails. *BICC photograph*

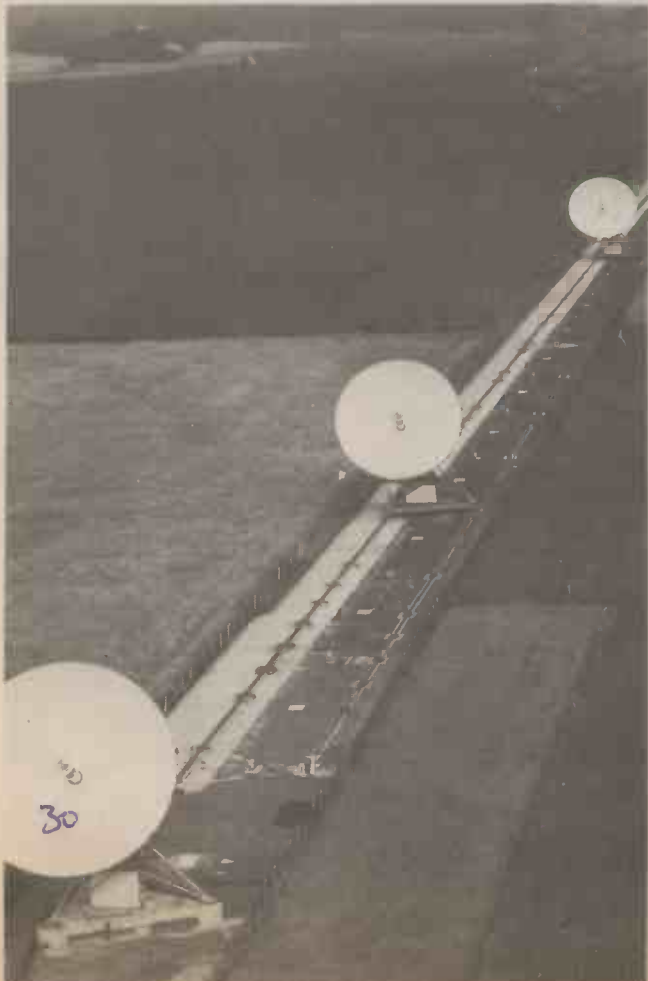

Aerial view of a radio-mounted dish of the 5km telescope. *BICC photograph*

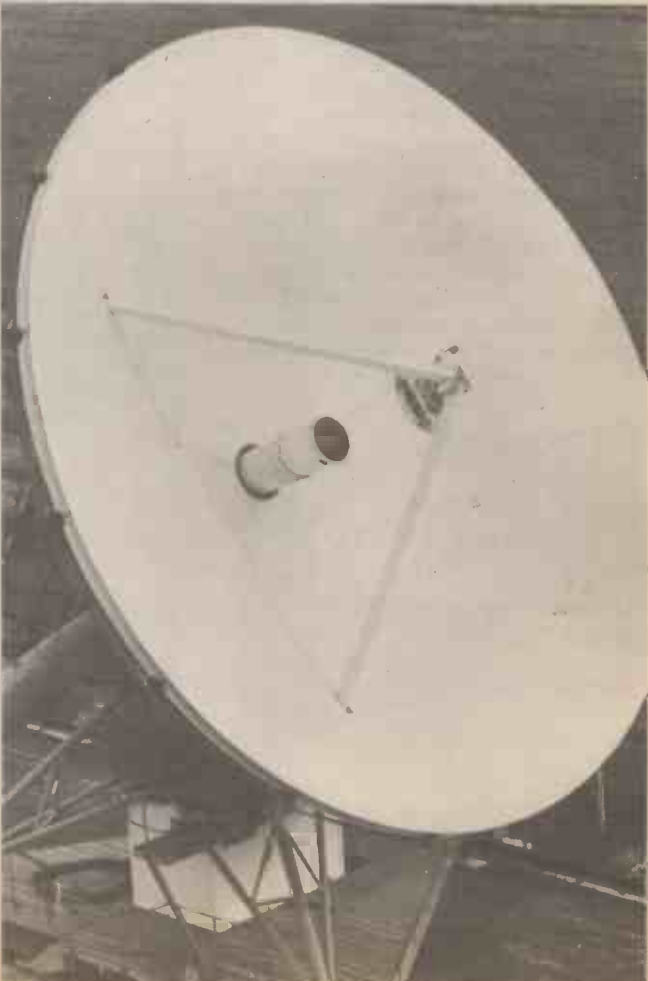

and Professor Anthony Hewish for his contribution to the discovery of pulsars.

THE 5km TELESCOPE

We can now bring the story of Cambridge radioastronomy up to date by discussing the most recent and advanced instrument to be built there, the 5km telescope.

Like the others it is built on the aperture synthesis design and its eight dishes (four fixed and four moveable) are spread out at Lord's Bridge along the site of the old Cambridge to Bedford railway line.

Its designers have gone to great lengths to ensure that it is one of the most accurate instruments available. This accuracy necessitated surveying the site with unprecedented precision, and this was carried out by the Ordnance Survey. They managed to make all measurements with an error of less than 1cm over 5km.

In fact this was still insufficient but by recalibrating the dishes (when the instrument was set up) against known radio sources in the sky the positioning error was brought down to 0.3 millimetres over the same distance! An object lesson indeed in measurement. No less was the accuracy aimed for and achieved in the operation of the telescope, low noise electronic equipment of high stability is in use throughout the telescope system to take advantage of this.

The radio waves received by each dish are focused by the Cassegrainian reflector (positioned on the projecting tripod) and fed into the central receiver.

These receivers are special solid state amplifiers of the parametric type. Signal amplification at the selected frequency is achieved by actually driving the amplifier at twice this frequency. So, for a working wavelength of 6cm i.e. 4995GHz, the amplifier is operated at 9990GHz. After mixing with signals from a local oscillator in the control room the final output frequency is about 45MHz.

CONTROL

The whole network of dishes must be kept "locked on" to the radio source it is studying and this necessitates the use of an on-line control computer which continuously adjusts the position of



The Director of the Mullard Radio-Astronomy Observatory and Nobel laureate, Professor Sir Martin Ryle. *BICC photograph*

each dish to compensate, for example, for the rotation of the earth.

The computer oversees every aspect of the instruments operation. It even keeps the system of telescope dishes electrically "balanced" by automatically inserting cable sections as required, from the 60 miles of cable network that runs between the control room and the eight dishes. This is to ensure that the path to each dish is constant no matter where the dishes themselves may be pointing (necessary for bandwidth reasons).

Aware too of the fact that the radio telescope is sensitive enough to pick up any noise signals generated by the computer itself into a room lined with copper-clad walls.

The second function of the computer is to process the radio signals received by the telescope into meaningful output which can be fed to a graph plotter for example, to display a "picture" of the radio source in terms of contours linking points of equal radio intensity as an ordinary contour links equal heights.

LOOKING TO THE FUTURE

Due to the accuracy which the aperture synthesis technique affords it has been possible to map the structure of many radio sources in much finer detail than previously possible. More information can often be gleaned if radio

source results are compared with optical observations of the same area, but intriguingly many optically bright objects are weak radio sources and the converse may equally be true.

Cygnus A, for example, is a galaxy system and one of the brightest objects in the radio sky. It has two very strong radio sources apparently moving in opposite directions but all that can be seen with an optical telescope is a small, faint central galaxy.

Another strong radio source is Cassiopeia A. Here the radiotelescope shows a distinct circular shell of matter gradually spreading outward: it is another remnant of a supernova explosion.

Just what is going on inside these sources? Scientists can only speculate. Without more information they are uncertain as to whether even the basic laws of physics hold under such extreme conditions.

As always we must look to the future for this information, the pieces needed to complete the tantalising puzzle Nature has set out before us. □

Acknowledgement

The author wishes to acknowledge the co-operation given to him by the radioastronomy group of the Cavendish Laboratory, Cambridge, and the Mullard Radio Astronomy Observatory.

Add-on CAPACITANCE UNIT

By R. A. PENFOLD

INTRODUCTION

There can be little doubt that the single most useful piece of electronic test equipment is the multirange test meter. However, multimeters do have distinct limitations, and one of their primary ones is that very few are equipped to measure capacitance.

This unit has been designed to enable any multimeter that possesses a 0 to 50 microamp

range to measure capacitance in the following three switched ranges; Range 1: 0 to $0.05\mu\text{F}$; Range 2: 0 to $0.5\mu\text{F}$; Range 3: 0 to $5\mu\text{F}$. This covers most of the values that are likely to be encountered in general electronics work, with the exceptions of electrolytic types and very low value components. The former can usually be tested satisfactorily using a multimeter

without any adaptor, and the latter are more rarely encountered, and their measurement is really beyond the scope of a very simple instrument such as that described here.

A minimum of components are used in the circuit which is, in consequence, both simple and inexpensive to construct. The unit should prove to be a very useful addition to one's test gear.

HOW IT WORKS...

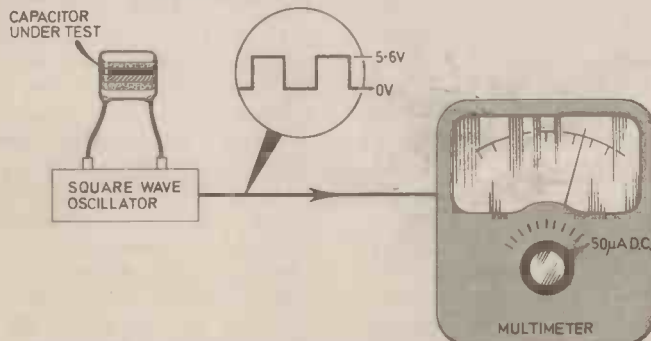

The *Add-On Capacitance Unit* consists of a square wave oscillator with a vital component missing—a capacitor. By inserting the capacitor to be tested into the circuitry, the oscillator is completed and an output results. The output consists of a train of pulses and the value of the capacitor will determine the frequency of oscillation and mark/space ratio.

The signal from the oscillator is fed to a multimeter set at $50\mu\text{A d.c.}$ (or a panel meter of same rating). As the pulses are produced at a rate of hundreds per second, the meter movement responds to the average output voltage rather than to individual pulses and so the result is the same as if the signal was a d.c. one.

START
HERE FOR
CONSTRUCTION

A ready made $133 \times 70 \times 38\text{mm}$ aluminium case is used as the housing for the prototype adaptor. This is about the smallest size that can be used, and it would be advisable for the inexperienced constructor to use a somewhat larger case. Apart from this virtually any case can be used. The symmetrical panel layout used by the author gives an attractive appearance, but the exact layout used is not critical.

All the resistors and semiconductors are wired up on a 0.15inch matrix stripboard panel having 13 copper strips by 15 holes. Details of this, together with details of all the other wiring are shown in Fig. 1.

Start by cutting the board to size using a hacksaw and then drill the two 6BA mounting holes using a 3mm twist drill. Then make the six cuts in the copper strips. A hand-held drill bit (about 6mm dia)

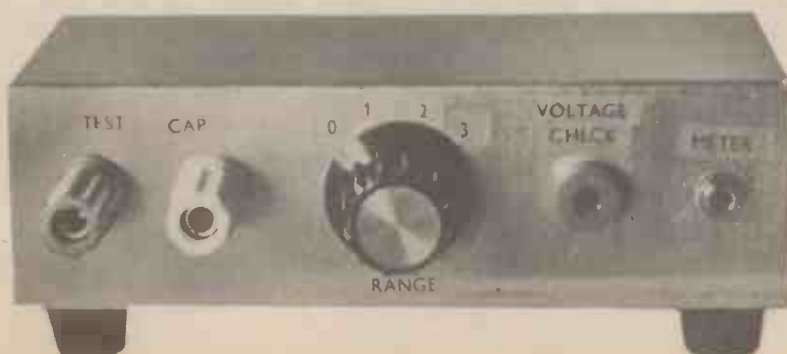

FOR GUIDANCE ONLY

ESTIMATED COST OF COMPONENTS

£3

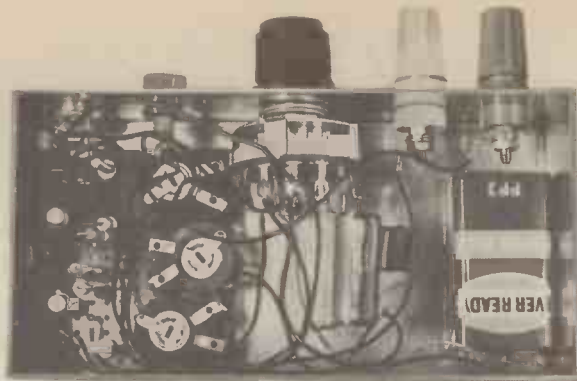

Internal photograph of the completed Add-on Capacitance Unit, showing the layout used.

can be used to do this if the special spot face cutter tool is not available. Next the resistors and then the capacitors are mounted and soldered in. Veropins are used at the points where S1, SK1, etc., will eventually connect to the panel.

Mount the component panel at any convenient place inside the case using short insulated spacers over the mounting bolts in order to hold the panel a little way clear of the bottom of the case. Make sure that the panel is positioned somewhere that permits easy access to the three presets.

Finally, the unit is wired up to conform to Fig. 1 using ordinary insulated connecting wire. Capacitors C1 to C3 are wired up on S1 which is a standard 3-pole 4-way wafer switch.

ADJUSTMENT AND USE

The test prods of the multimeter are connected to the unit by a couple of ordinary insulated leads which are terminated in a 3.5mm jack plug at one end and a couple of crocodile clips at the other. The jack plug is inserted into SK2 and the crocodile clips are connected to the test prods. Make sure that the test prods are connected with the correct polarity (positive prod to the wiper tag of S1b (via SK2)).

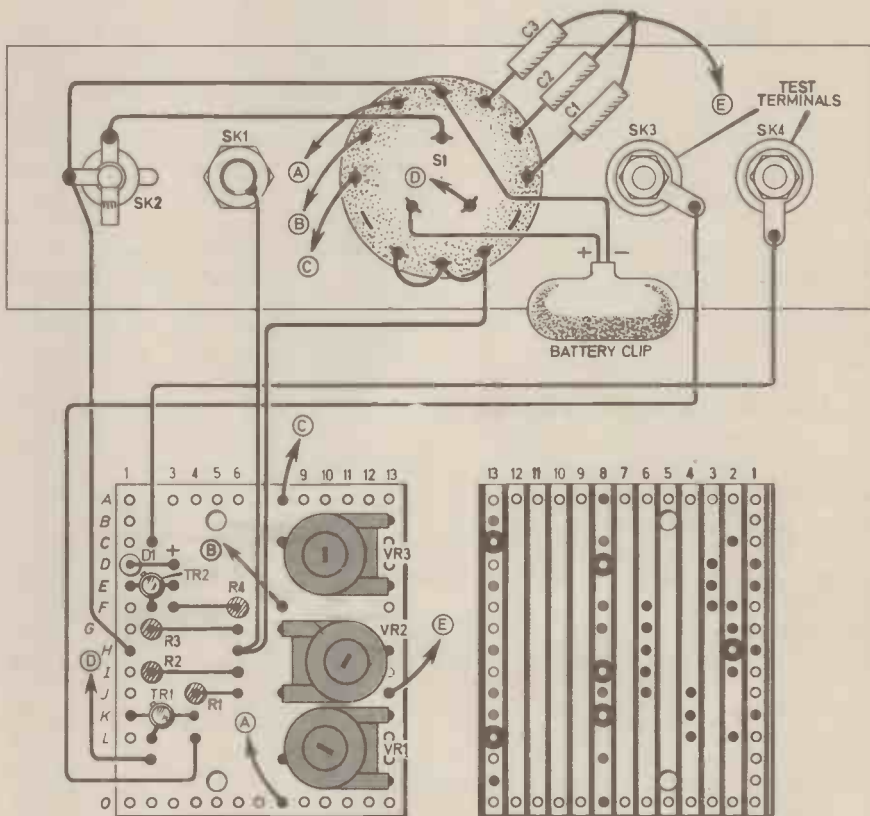
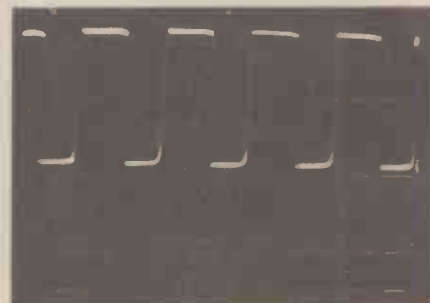

Fig. 1. Stripboard layout showing breaks required, and the various interconnections between the components on the front panel.



Three photographs taken from the screen of an oscilloscope. The waveform shown is that appearing at the output, when different value of capacitors are connected. Note in particular the increase in length of the bottom of the waveform, this corresponds to an increase of capacitance.

CIRCUIT DESCRIPTION

Referring to Fig. 3 this shows the complete circuit diagram of the adaptor, and is based on an astable multivibrator. The operation of an astable circuit is probably most easily explained with the aid of the skeleton circuit shown in Fig. 2.

The circuit consists basically of two single transistor stages. One stage uses TR1 with R1 as its collector load and R2 as its base bias resistor, and the other stage uses TR2 with R3 and R4 in these respective positions. The output of each stage is coupled to the input of the other stage via a d.c. blocking capacitor. These are C1 and C2 of Fig. 2.

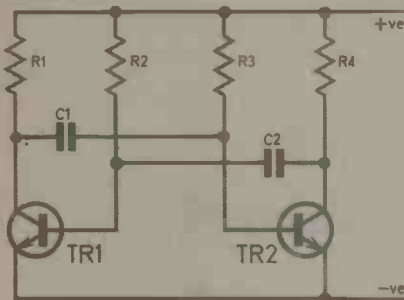

Fig. 2. Basic multivibrator circuit.

When power is initially connected to the circuit both transistors will begin to turn on, as they will both be receiving a base current via the appropriate resistor. Due to component tolerances, one transistor will begin to turn on faster than the other.

For the sake of this explanation we will assume that it is TR1 that turns on the faster. As it does so it will send a negative signal to the base of TR2 via C1. This has the effect of turning TR2 off. TR1 thus turns hard on while TR2 is held in the off state.

When the collector potential of TR1 has fallen to virtually the negative supply rail voltage, obviously no further negative signal voltage can be applied via C1 to TR2 base. Capacitor C1 therefore charges by way of R3 until about 0.65V is present at TR2 base. TR2 then begins to turn on and a negative signal is supplied via C2 to TR1 base. This turns TR1 hard off, and the positive signal produced across R1 is fed by way of C2 to TR2 base, turning TR2 hard on.

Capacitor C2 then begins to charge through R2 and when about 0.65V is present at TR1 base, TR1 begins to turn on. A regenerative action similar to that which just occurred will now take place,

except that it is now TR1 that finishes hard on, and TR2 that finishes hard off.

The similarities between the practical circuit of Fig. 3 and the skeleton circuit of Fig. 2 should be obvious. There are a few additional components in the circuit of Fig. 3, such as zener diode D1. This ensures that the peak output voltage at TR2 collector remains reasonably constant, and is not greatly affected by variations in the supply voltage.

If we consider the unit switched to Range 1 (S1 in position 2 and capacitor C1 in circuit), with a 0.05μF capacitor in circuit, VR1 is adjusted to produce full scale deflection of the meter. If a lower value capacitor is now connected across the test terminals, say 0.01μF, the output pulses (and thus also the average output voltage) will be only one-fifth of their original value. The meter will therefore read one-fifth f.s.d.

Thus with the circuit values shown there is virtually a linear relationship between the value of the test capacitor and the meter

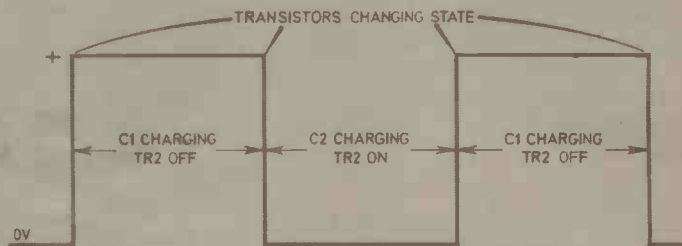

Fig. 4. Typical waveform produced at TR2 collector.

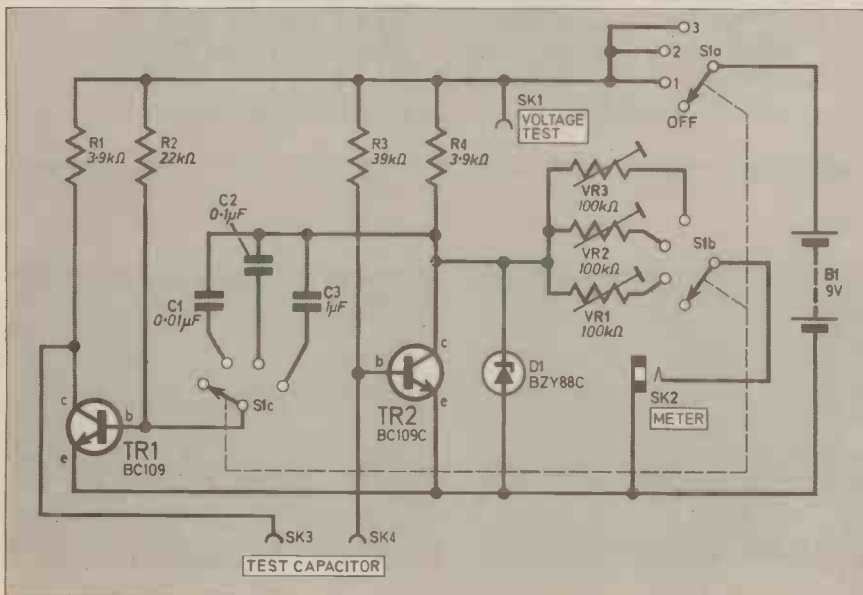

Fig. 3. Complete circuit diagram of the Add-On Capacitance Unit.

reading.

With capacitor C2 switched into circuit ten times the test capacitance is required to produce f.s.d. of the meter. This is because the higher value of C2 in relation to C1 increases the time that the output is low by a factor of ten. Ten times the test capacitance is therefore required to maintain the proportion of high to low output by also increasing the high output by a factor of ten. With C3 in circuit a further increase of ten times the test capacitance is required for f.s.d. of the meter.

With S1 in position 1, S1a disconnects the battery and turns the unit off. S1 is both the on/off and range switch, and is the only control fitted to the device. SK1 connects to the positive supply rail. This enables the loaded battery voltage to be easily measured.

Three close-tolerance capacitors are required for calibration, and these should preferably have values of $0.047\mu\text{F}$, $0.47\mu\text{F}$ and $4.7\mu\text{F}$, as these represent nearly the f.s.d. values of the three ranges covered. The smaller the tolerances of these capacitors the better, and 5 per cent should be regarded as the minimum acceptable.

Start with the three preset resistors set to insert maximum resistance into circuit, turn S1 to Range 1 and connect the $0.047\mu\text{F}$ capacitor across the test terminals. This should produce some deflection of the meter, VR1 is then adjusted to produce a reading of precisely 47 on the meter. The unit is next switched to Range 2 and VR2 is adjusted for a reading of 47 on the meter with the $0.47\mu\text{F}$ capacitor connected to test terminals. Finally, VR3 is similarly adjusted with the unit switched to Range 3 and the $4.7\mu\text{F}$ capacitor connected to the unit.

Other values of test capacitor can be used, with the preset resistors being adjusted for the appropriate meter readings. In the interest of good accuracy one should use a capacitor with a value corresponding to half f.s.d. or more of the range being calibrated.

It sometimes happens that when a perfectly good capacitor is connected across the test terminals the unit fails to oscillate. Either swapping over the leads of the component or momentarily shorting them together will provide the necessary impetus to initiate oscillation. If this fails to produce a suitable reading, the test capacitor is certainly a dud. □

COMPONENTS

Resistors

R1	$3.9\text{k}\Omega$
R2	$22\text{k}\Omega$
R3	$39\text{k}\Omega$
R4	$3.9\text{k}\Omega$ All $\frac{1}{4}\text{W}$ carbon $\pm 10\%$

Potentiometers

VR1, 2, 3 $100\text{k}\Omega$ standard horizontal preset (3 off)

Capacitors

C1	$0.01\mu\text{F}$ polyester
C2	$0.1\mu\text{F}$ polyester
C3	$1\mu\text{F}$ polyester

Semiconductors

TR1	BC109 silicon <i>npn</i>
TR2	BC109C silicon <i>npn</i>
D1	BZY88C5V6 5.6V 400mW Zener diode

Miscellaneous

S1	3 pole 4 way rotary switch
SK1	3mm wander socket
SK2	3.5mm jack socket
SK3, 4	4mm screw terminal (one off red, one off black)
B1	9V PP3 battery
Stripboard 0.15 inch matrix 13 strips \times 15 holes; aluminium case 132mm \times 68mm \times 40mm; battery clip; two crocodile clips; 3.5mm jack plug; small pointer knob, connecting wire; solder, feet for case (4 off)	

See
**Shop
Talk**

Page 13



Illustrating how the Capacitance Unit is connected to a multimeter.

What do you know?

POWER

1. A circuit consumes 150 watts of power. If the supply voltage is 240 volts, what is the current flowing?
2. 2.5 amp flows in a circuit which has a total resistance of 60 ohms. What is the power being developed in the circuit and what is the supply voltage?
3. The resistance of a circuit when using a 240 volt supply is 576 ohms. What is the power in the circuit?

4. A $\frac{1}{4}$ watt resistor is the only size available. If it is to be used in a circuit with a supply voltage of 5 volts, taking a current of 150mA, would the power rating be sufficient?

ANSWERS

1. 625 milliamps.
2. 375 watts and 150 volts.
3. 100 watts.
4. No, a resistor rated at $\frac{3}{4}$ watt or more would be necessary.

A busy sales position at ITT Electronic Services. Note the size of the products catalogue in the foreground and the visual display linked to the firm's computer. Looking on at the proceedings, centre, is Kevin Walker an ex-sales engineer and now sales manager of B & R Relays for which ITT is one of the franchised distributors.

manufacturer is Mullard, employing 12,000 people in nine factories turning out £180 million worth of components a year. Mullard happens to be owned by the giant Philips Group so it will come as no surprise when opening up a Philips TV set or radio to find quite a few Mullard components.

But to Mullard, Philips is just another customer, albeit an important one. If Philips were Mullard's only customer, Mullard would shrink to less than half its present size, the economies of scale would be lost and Philips would find itself paying more for Mullard components than it does today. With Mullard supplying the whole of British industry and exporting components as well, everybody benefits.

COMPETITION

But apart from sheer volume of manufacturing in millions rather than thousands or hundreds of components, the other great check on prices is competition.

The components industry consists of hundreds of firms in the UK and many thousands throughout the rest of the world. No equipment manufacturer likes to be dependent on a single source of supply for components because the firm supplying him may have a strike, or discontinue a particular product line, might even go broke and close down. So we get the strange paradox of a components firm, say a semiconductor manufacturer, bringing out an exciting new device and finding difficulty in selling it until a second firm also starts making it.

As a deliberate policy one firm will allow a second firm to be a second source of supply on a friendly agreement, thus greatly expanding the market for that product. You might think this can't do much good for either firm but in practice both do rather better because the availability of a second source encourages equipment manufacturers to specify it into new equipment.

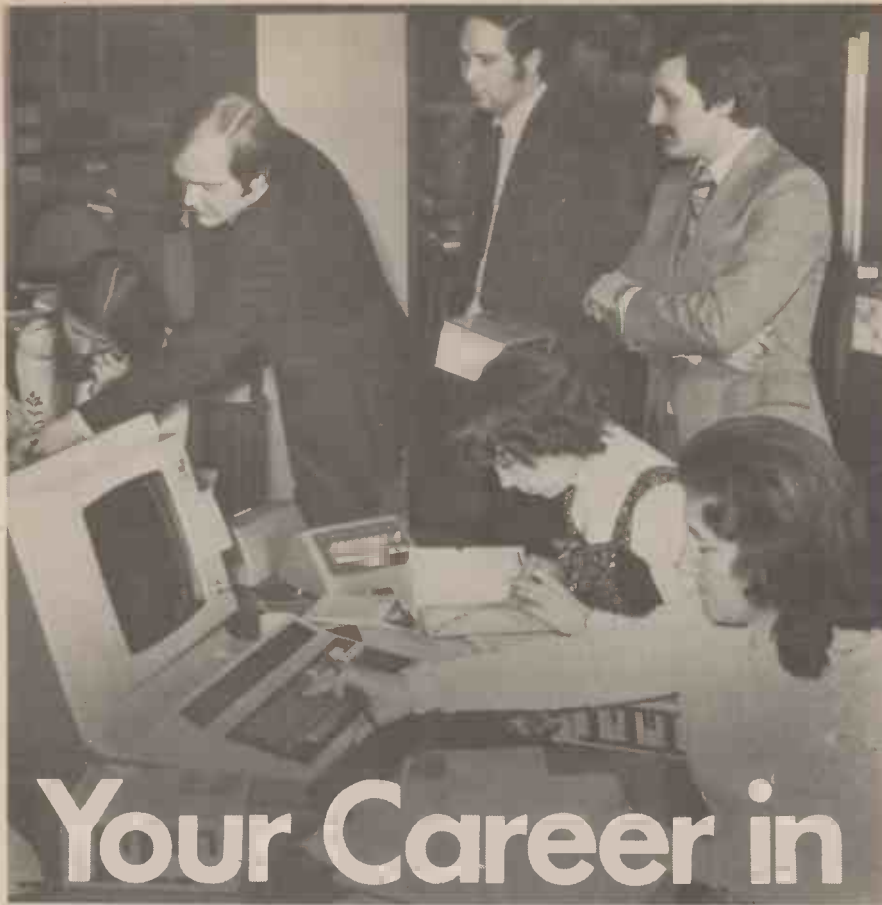

Your Career in Electronics

by Peter Verwig

SELLING COMPONENTS

SELLING electronic components doesn't sound a very exciting occupation. And exceedingly dull it would be if taken at face value. But dig a little deeper and you expose a very large group of people, widely scattered round the electronics industry, calling themselves not components salesmen but sales engineers. Not all deserve the title but most do, and without them the industry would certainly function a lot less efficiently.

Electronic components are the building blocks of electronic equipment. They are broadly classified into active components, nowadays mainly semiconductor devices, and passive components such as resistors and capacitors, wound components, connectors. Another broad classification is electronics hardware which includes racks, panels,

instrument cases, cable harnesses and all the other bits and pieces not directly concerned with electronic circuitry but are necessary to build a functional item of electronic equipment.

Some electronic equipment manufacturers also have components manufacturing divisions or subsidiary companies but no equipment manufacturer, however large, makes all its own components. A very large percentage of requirements is always bought from specialist suppliers manufacturing in such vast quantities that the components cost very much less than if manufactured locally. The reason why semiconductor prices continue to fall while nearly everything else rises in price is because semiconductor production has doubled, trebled and quadrupled through the years aided by vast investment in automation. Prices fall as volume rises.

Britain's biggest component

ECONOMICS

Another odd thing about the components industry is that in many product areas it is global rather than national. Let us look at one example, the Motorola semiconductor plant at East Kilbride, Scotland, which this year won the Queen's Award for export performance.

The East Kilbride plant is the manufacturing centre for mos products for Europe. The devices are designed either at Motorola's global headquarters in Phoenix, Arizona, or at the European headquarters in Geneva. All the processing of the chips is undertaken at East Kilbride and they are then sent all the way to Malaysia for assembly into packages, then shipped all the way back to East Kilbride for final testing before being sold in the market place.

If this sounds crazy maybe its because we all live in a crazy world. But the fact is that it is cheaper to have them assembled in a country with low labour costs, the savings easily outstripping the shipping costs. The high technology part of the production is done in high-cost high-quality labour areas, the less technically demanding work in low-cost areas. It must make sense, otherwise it wouldn't be done that way.

Similarly, with very simple devices like low-grade resistors and capacitors, much of the world's output is now concentrated in third-world countries with whole manufacturing plants leaving developed countries to be re-established in the third-world. In their place the developed countries re-invest in more sophisticated plants

to produce a higher technology product.

In general the third-world, while now establishing an economically viable electronics industry, can never catch up with the developed countries because they are always one technology generation behind in production and because the best of their engineers, many of them brilliant, need to join European, American or Japanese laboratories because these are the only profitable outlets for their talents.

The UK market for electronic components is currently £500 million a year, a little over half being in active devices, the remainder passive devices. The three largest market sectors are electronic computers, colour TV and other consumer products, and telecommunications, the latter increasing fast since the advent of electronic telephone exchanges.

Other important markets are in industrial automation, radio communications and aerospace. The defence industries market is less in volume of components, but piece-for-piece the value of each component is generally higher than the average because of the stringent reliability requirements and tight specifications needed for the military role.

SALES ENGINEER

The interface between the component manufacturers and the component users is the sales engineer. So his or hers is a very important job—far more than superficially just selling components.

In the one direction the sales engineer has to keep his customers

informed of what is available to be designed into new equipment. In the other, he feeds back to the components industry what the end user requires technically, and a forecast of demand so that there is sufficient production capacity available to meet the anticipated demand and at a price the customer can afford.

The sales engineer might work for one of the many component manufacturers or he might work for a components distributor of which there are well over 100 in the UK.

Let us examine the first case, that of working for a components manufacturer. He has a range of products already in production and listed in the catalogue and it is his job to convince customers that he has the best product in specification, in price, in availability or best in all three.

In a big organisation he will possibly be a specialist. In some cases, depending on how the marketing department is structured, he may be responsible for a limited range of products, say resistors and capacitors, sold throughout the whole industry. In other cases he might be responsible for a market sector concentrating, say, on computers or consumer products, and selling all the components made by his company that are appropriate to that market sector.

But either way, his target is to sell in what are called OEM quantities. OEM means original equipment manufacture and this is where the large volume business lies. A colour TV manufacturer, perhaps, is contemplating a new model and already has some idea



Demonstration model for Burroughs self-scan optical displays available through Walmore Electronics.



How components shrink. The Siemens electrolytic capacitor on the left was found to be still working after 15 years submerged in Lake Constance. In the meantime, capacitors have become smaller. The modern version on the right is only half the volume but has the same capacity and working voltage.

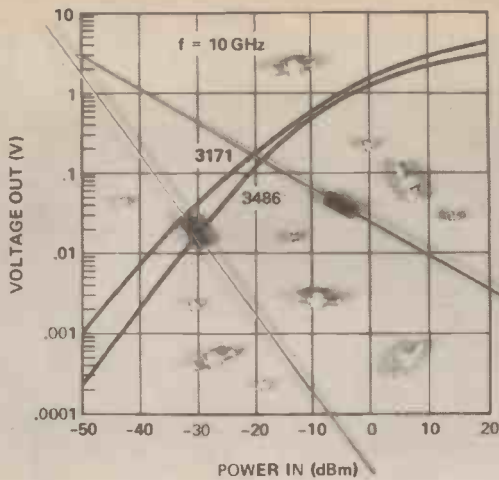

Tiny components but big money. Hewlett-Packard zero-bias HSCH-3000 Series Schottky diodes against a background of output voltage characteristics. Prices range from £8.13 to £17.89 each in quantities of 10-99.

of what performance and price he is aiming at. He obviously wants to get a technical or price edge on existing competitive products. And he might hope with this particular model to capture five percent of the total UK market of 1.8 million sets expected to be sold in 1979 when his new model will be ready. So he hopes to make and sell 90,000 sets in that year and similar quantities in succeeding years. His total production run might eventually extend to half a million sets.

There are hundreds of components in a colour TV set and if the sales engineer can get, say, only ten of his components specified in to the design he then has a potential sale of five million components or, assuming a second source as equal supplier, two and a half million. And this for only one model although, of course, spread over a period of years. Certainly worth spending some time over.

On the other hand, the TV manufacturer is in a very strong position. The buyer of the TV manufacturer might have as many as a dozen people fighting for such a nice order and he can drive a hard bargain. So hard, in fact, that in the end the order may not be worth having.

During the course of such a negotiation the sales engineer will be enlisting the aid of his colleagues. The customer may need a new component developed or wish to use an existing one in a novel way. Either case will necessitate liaison with applications engineers or development

engineers. The sales engineer will also need to discuss the potential order within the framework of his company's marketing and pricing policy and ensure that delivery schedules can be accommodated within the time framework by the production manager.

Production planning people will need information so that raw materials supply can be arranged and any special tooling be designed and built ready for the production process.

The sales engineer may need to do a little fighting within his own organisation to keep his sale intact. With a factory already fully loaded he may have to struggle to get his own customer's products manufactured on time. His whole life is a challenge from the initial discussion of an order to the last piece being delivered.

SMALL ORDERS

Big manufacturers and even a lot of small ones find it totally uneconomic to handle small orders. They like to have a few big OEM customers and rather than have thousands of little customers they pass this business to the component distributor.

The distributor is similar to the high street supermarket except that most of the business is by mail order rather than by personal shopper. Some specialise in supplying components to the electronics hobbyist and can be spotted easily in the advertisement columns of EVERYDAY ELECTRONICS and its sister journal PRACTICAL ELEC-

TRONICS. But there are more than 100 such firms in the UK, some of considerable size, serving the professional electronics industry. Some belong to large electronics companies (ITT Electronic Services for example is an ITT company and SASCO is part of Philips) but many are smallish independently run affairs.

All buy in bulk at manufacturers rates and sell in smaller quantities at a much higher rate, the difference paying their operating costs and providing a profit margin. Some operate purely as "shops" for small customers while others have engineering staff who can offer advice. Quite a few have Ministry Approvals which allows them to supply components released and certificated to Defence or Air Registration Board specifications.

DISTRIBUTORS

Component distributors come in all shapes and sizes. Some are broad-line stocking a large range of components, perhaps as many as 20,000 different types, while others are narrow-line supplying perhaps 2,000 lines from a restricted catalogue. Some also have production tools such as soldering irons, pliers, wire-cutters in their catalogues. There are two, Electroplan and ITT Instrument Services, who specialise entirely in test instruments, being virtually instrument supermarkets.

Their customers are all the non-OEM buyers and a few equipment



Peter Tagg, managing director of distributor RITRO Electronics (UK) Ltd.

manufacturers whose volume is too small to negotiate directly with the large component manufacturers. One fifth of the UK component market is served by distributors who will have a combined turnover this year of £100 million.

As already mentioned, many of the distributors have strong engineering back-up and employ sales engineers to advise customers as well as to make sales. The advent of programmable memories and, more recently, the microprocessor handled by a number of distributors has resulted in an increased demand in the distribution industry for qualified engineers. The great bulk of routine sales is through sales girls who need little or no technical knowledge to get through the day.

The routine is generally for a customer to telephone an order. He is routed to one of the sales points and a sales girl will generally take the enquiry. A number of the larger distributors are fully computerised and in such cases the girl will punch an enquiry into a visual display unit and on the screen will be displayed the stock position. If the product is available she confirms the order, pushes the appropriate buttons to release the stock and the order is processed in the warehouse. Technical enquiries will be generally routed to a sales engineer.

QUALIFICATIONS

What qualifications do you need to be a sales engineer? There is really no substitute for an apprenticeship in manufacture or through the laboratories. You not



Automatic wafer-probing at Motorola's MOS integrated circuit plant in Scotland. Apart from their own sales engineers based on Wembley, Motorola products reach the UK market through six distributors.

only need a technical knowledge of the product itself but also of the way it is used. In addition the sales engineer must be a business man. He needs to know the competitive position in pricing and specification with his rivals. He needs to be alert and have a good personality because he is always dealing with people as well as products.

He needs to be a competent engineer rather than a brilliant one. If he were that brilliant he might be better staying in research and development. As it is, a com-

petent engineer with a genuine liking for dealing with people can make far more financial headway in sales than he can in a laboratory. This may be a sorry state of affairs but it happens to be true.

You will notice that I have perhaps overstressed the masculine role in sales engineering. This merely reflects the present male predominance. There seems no reason why the girls should not do equally as well if they would only come forward. But they don't. How about it, girls?

JACK PLUG & FAMILY...

THE STEADY HAND TESTER PROVES MY HAND IS STEADIER THAN YOURS...



AH, YES, BUT BE FAIR TO YOUR FATHER. HE WAS AT A DISADVANTAGE...



... THAT AFFECTED BOTH HIS HAND AND HIS EYE.

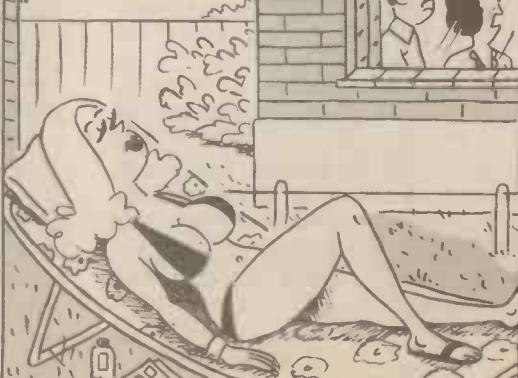

I WON EVERY TIME, DAD.



By ADRIAN HOPE

INTERESTING things are happening on the video front. Various firms are still working on videodisc systems, and several of these are ready for domestic launch. But all are replay-only systems (that is you can't make a recording of your own) and as such I would reckon all to be a dead duck. Well how many times would you want to watch a videodisc of excerpts from *The Tempest* or Mick Jagger singing or the Prime Minister speaking? I'll bet the videodisc only comes into its own when records are issued in video-audio compatible format; that is to say every record sold will produce pictures as well as sound if you have the right equipment, just as quadrasonic discs will play in mono, stereo or quad, depending on what equipment you have available.

But as yet the public is just not ready for video-audio compatible discs.

The immediate future of domestic video must without doubt centre around home recording systems, so that users can tape TV programmes while they are out and watch them later, or build up a library of favourite programmes such as films.

Copyright

Of course all these activities are strictly illegal, as they are breaching copyright, and in the USA Sony is being sued by some of the film studios for allegedly inciting the public to use Sony Betamax video recorders to tape films off-air.

Just before *Gone With The Wind* was shown on American television, for instance, you couldn't buy a blank Sony Betamax cassette for love nor money, because the shops had all sold out. What ever happens over the court action, however, it has already achieved one thing. That is to bring domestic video into the public eye.

For the first time ever the American man in the street knows what video is and what it's all about.

Video Recorders

Domestic video is also catching on in the States because Sony, with the Betamax machine, has made both a technological and price breakthrough. Up till now video has been a pretty expensive business. The cheapest domestic video cassette machine (the Philips range in the UK) costs well over £500, and the original Sony U-matic machines cost around £1,000. Also, the video heads tend to wear out much more quickly than the heads of an audio tape recorder, and cost around £50 to replace.

Most important of all, videotape cassettes have so far cost around £20 an hour running time. This isn't a problem if you use one cassette over and over again, for instance to record while you are out and replay later; but it is a problem once you start keeping what you have taped, to build up a library.

The Sony breakthrough was the development of the Betamax system mentioned above. This doubles the length of playing time by halving the tape's speed. To achieve this the rotating heads are set at an angle, so that where the recorded tracks overlap there is phase cancellation. Philips has now answered the Sony Betamax challenge, by developing a half-speed version of the standard Philips VCR. In fact the new 1700 series of Philips videocassette recorders will soon be in the shops, by the end of this year, and will record 130 minutes on a Philips videocassette that gives only 60 minutes on existing 1500 series machines.

There is also news, albeit somewhat confused and unconfirmed, of an even more dramatic breakthrough from Matsushita in Japan. Apparently joining forces with RCA and the Philips subsidiary Magnavox in the USA, Matsushita will market the VHS videocassette machine. Allegedly this can provide an option of two or four hours recording on a single

cassette. Quite why anyone should want to record four solid hours on a single cassette tape is as yet unsure. So are the electronic means by which this is achieved. It seems likely that the Matsushita machine uses a combination of the slant-head approach adopted by both Sony for Betamax and Philips for 1700 series, along with the so-called skip field system.

Indeed it is believed that Sony is also working with a combination of the two techniques. Skip field is a clever way of squeezing twice as much recording information into the same tape space. All TV pictures are interlaced, the frame being built up first by odd lines (lines 1, 3, 5 and so on of the 625 line structure) and then by even lines (lines 2, 4, 6, 8 and so on). Normally odd and even lines are scanned one after the other. In the skip field recording system only the odd or the even lines are recorded and then doubled up on playback. For instance only the odd lines are recorded, and on playback they are used twice, to build up a complete picture from half the normal amount of video information.

Battle of The Giants

If all this starts to sound like the line-up for a massive and self-defeating standards battle between Sony, Philips, Matsushita (and several other companies working on equally ingenious rival systems), that's true but only partly true. Some people draw parallels with the quadrasonic standards battle, and point to how all the systems lost out because the public became confused and lost interest. The parallel is not really valid, however. With quadrasonic it was a chicken-and-the-egg situation, where people would not buy hardware to play records until there were records to play; so no one produced records because no one had any equipment on which to play them; and so on.

With video-cassette machines, the whole point is to be able to make and replay your own recordings.

So unless you want to swap tapes with someone else, it really doesn't matter what system you use.



"You've just made our £157,000 computer redundant!"

TEACH-IN

'78

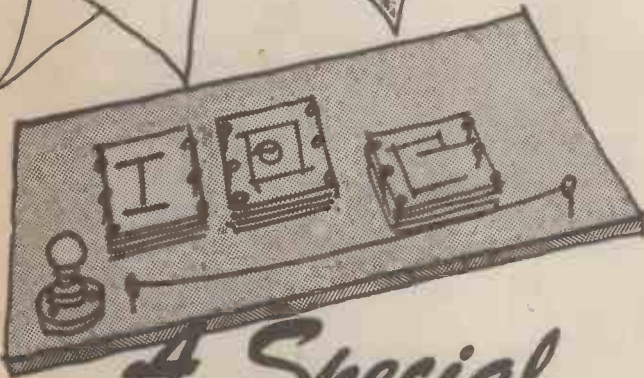

A Special Series for You?

STARTS NEXT MONTH

Everyday Electronics, September 1977

TV GAMES CHIP

AY-3-8500 £6.95. Printed circuit and kit of extra parts.—black and white version £10.95. Colour model £24.95. Colour generator—converts any black and white TV game to colour £17.95. Rifle kit £4.95. Send sae for free data.

NEW COMPONENT SERVICE

Resistors 5%, carbon E12 1Ω to 10M 1/4W 1/4p. 1W 3p. Preset pots subminiature 0-1W 100Ω to 4M7 9p. Potentiometers 1/4W 4K7 to 2M2 log or lin. Single 30p. Dual 95p. Polystyrene capacitors E12 63V 22pf to 8200pf 3/4p. Ceramic capacitors 50V E6 22pf to 47000pf 3p. Polyester capacitors 250V E6 .01 to .1mf 5/4p. .15. .22. .33mf 7p. .47mf 11p. Electrolytics 50V .47, 1, 2mf 5p. 25V 5, 10mf 5p. 16V 22, 33, 47mf 6p. 100mf 7p. 220, 330mf 9p. 470mf 11p. 1000mf 18p. Zener diodes 400mW E24 3V3 to 33V 8/4p.

MAINS TRANSFORMERS

6-0-6V 100mA 94p. 9-0-9V 75mA 94p. 0/12/15/20/24/30V 1A £3.85. 12-0-12V 50mA 94p. 0/12/15/20/24/30V 2A £5.15. 6-3V 1/4A £2.30. 6-0-6V 1/4A £2.75. 9-0-9V 1A £2.39. 12-0-12V 1A £2.69. 15-0-15V 1A £2.89. 30-0-30V 1A £3.59.

PRINTED CIRCUIT KITS ETC.*

Contains etching dish, 100 sq ins of pc board, 1 lb ferric chloride, etch resist pen, drill bit and laminate cutter £3.85. 100 sq ins pc board 80p. 1 lb FeCl £1.05. Etch resist pen 79p.

S-DECS AND T-DECS*

S-DeC £1.94. T-DeC £3.61. u-DeCA £3.97. u-DeCB £6.67. IC carriers with sockets:— 16 dil £1.91. 10T05 £1.79.



SINCLAIR CALCULATORS & POCKET TV

Sinclair pocket TV £165. Cambridge scientific programmable £13.95. Prog. library £4.95. Cambridge scientific £8.45. Oxford scientific £10.60. Mains adaptors £3.20.

BATTERY ELIMINATOR BARGAINS

3-WAY MODELS

With switched output and 4-way multi-jack connector. Type 1:—3/4/6V at 100mA £2.30. Type 2:—6/7/9V 300mA £2.90.

100MA RADIO MODELS

With press-stud connectors. 9V £3.45. 6V £3.45. 9V+9V £5.15. 6V+6V £5.15. 4 1/2V+4 1/2V £5.15.

CASSETTE MAINS UNIT

7 1/2V with 5 pin din plug 150mA £3.65.

FULLY STABILIZED MODEL £6.40

Switched output of 3/6/7 1/2/9V 400mA stabilized.

CAR CONVERTORS 12V INPUT

Output 9V 300mA £1.80. Output 7 1/2V 300mA £1.80.

BATTERY ELIMINATOR KITS

Send sae for free leaflet on range.

100mA radio types with press stud battery terminals.

4 1/2V £2.10. 6V £2.10. 9V £2.10. 4 1/2V+4 1/2V £2.50.

6V+6V £2.50. 9V+9V £2.50.

Cassette type 7 1/2V 100mA with din plug £2.10.

Transistor stabilized 8-way type for low hum.

3/4/6/7 1/2/9/12/15/18V. 100mA £3.20. 1 Amp £6.40.

Heavy duty 13-way types 4 1/2/6/7/8 1/2/11/13/14/17/21/25/28/34/42V. 1 Amp, 2 Amp £7.95.

Car converter kit Input 12V DC. Output 6/7 1/2/9V DC 1A transistor stabilized £1.95.

Stabilized Laboratory power kit Switched 1 to 30V in 0-1V steps. 1 Amp £12.45. 2 Amp £14.95.

SINCLAIR PROJECT 80 AUDIO MODULES

Z40 £5.75.

BI-PAK AUDIO MODULES

S450 tuner £21.95. AL60 £4.86. PA100 £14.95.

MK60 audio kit £36.45. Stereo 30 £17.95. SPM80 £3.75.

BMT80 £4.25. Send sae for free data.

SINCLAIR IC20

IC20 10W+10W stereo integrated circuit amp kit with printed circuit and data £6.95.

PZ20 Power supply kit for above £3.65.

VP20 Volume, tone control and preamp kit £8.95.

Send sae for free leaflet on the whole system.

JC12 AND JC40 AMPLIFIERS

JC12 6W IC audio amp with free data and printed circuit £1.95.

Also new JC40 20W model with pcb £3.95.

Send sae for free leaflet on both models and associated power supply and preamp kits.



FERRANTI ZN414

IC radio chip £1.44. Extra parts and pcb for radio £3.85.

Case £1. Send sae for free data.

SWANLEY ELECTRONICS

DEPT. EE, PO BOX 68, J2 GOLDSSEL ROAD, SWANLEY, KENT

Mail order only. No callers. Send sae for free data on kits. Post and packing 30p. Prices include VAT. Official orders welcome. Overseas customers deduct 7% on items marked * and 11% on others.

The Extraordinary Experiments of Professor Ernest Eversure

by Anthony John Bassett



THE Prof. surveyed the small collection of "irreparable" electret condenser microphones which had been sent to him by a friend who was sceptical of his repairman's verdict. Already the Prof. and his young friend Bob had repaired two of these, and the faults had appeared so trivial, and easily put right, that the "irreparable" label now seemed to be thoroughly ridiculous.

The Prof. selected a third microphone from the collection.

"From my previous quick checks, I suspect that this one may have a faulty f.e.t. pre-amplifier, Bob." Whilst the Prof. carefully dismantled the microphone to reveal the pre-amplifier, again taking particular care not to bend or damage the delicate diaphragm, Bob observed attentively and was very surprised when the Prof. opened a tiny compartment in the microphone. He brought out the pre-amplifier, which consisted of a tiny piece of printed circuit board bearing four components, and connected to the remainder of the microphone by means of four thin flexible wires.

PRE-AMPLIFIER

Bob was flabbergasted! He looked first at the tiny pre-ampli-

fier, then at the circuit diagram which the Prof. had already scribbled out, Fig. 1.

"It hardly seems worth putting in!" he remarked, "If the makers go to all the trouble of putting in a battery and battery compartment, surely it deserves a little more electronics than that! They should either put in a few more transistors", he declared emphatically, "or leave it out completely, and connect the microphone up directly to the main amplifier. The extra gain needed could then be supplied by simply turning up the volume control."

"Okay, Bob", the Prof. replied "I think the idea of having a bit more electronics in these microphones is a good one; who knows, before long, with some of the miniature potentiometers and

other parts becoming available we may soon see a microphone produced with a built-in graphic equaliser. However, I think that in a couple of minutes you will have an opportunity to test your other theory with a practical experiment!"

The Prof. switched the microphone on, and applied the test probes of his multimeter to the battery negative terminal, and to the drain of the f.e.t. The multimeter was set to a low voltage range, and promptly gave a reading of 1.5 volts, showing that the battery was delivering the correct voltage. Now the Prof. transferred the test probes to the source of the f.e.t., and the reading changed to 0.6 volts. He promptly plugged the microphone into an audio amplifier, turned up the volume, and spoke into the microphone. His voice came over clearly for a few moments, then, with a loud crackle, the microphone ceased to work.

The voltage reading at the source had now dropped to zero. By gently touching the f.e.t. with his finger, the Prof. could make the voltage change from zero to the correct reading of about 0.6 volts, and the microphone would then operate correctly for a short while.

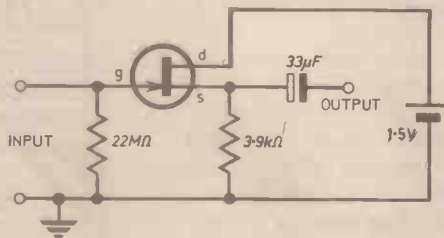

Fig. 1. Typical f.e.t. pre-amplifier as used in electret microphones.

ANONYMOUS FET

He checked that the f.e.t. was soldered in with good soldered joints, but the condition persisted.

"As I suspected" he informed Bob, "a faulty f.e.t." He removed it and showed it to Bob. One of the connecting wires was loose in the plastic moulding and was obviously not making good contact to the interior of the transistor.

Bob examined the f.e.t. with horror. It was an irregularly shaped piece of black plastic with a large, pale pink blob on top. He carefully picked away the blob, using a craft knife, to reveal the black plastic below it.

"There are no markings on this transistor, Prof." he cried in despair, "How could anyone be expected to be able to replace it? No wonder the repairman said that these microphones were irreparable!"

"Ah, well," said the Prof. with a smile, "That gives you your opportunity to try a capacitor microphone connected directly to the main amplifier, and test your theory that the f.e.t. pre-amplifier is not necessary."

So saying that the Prof. disconnected the four wires from the pre-amplifier, after switching off

the battery, and made off with it to another part of the laboratory, leaving Bob with a microphone but no pre-amplifier.

"See what you can do with that, Bob", he suggested, "whilst I investigate possible replacements for this anonymous transistor."

DIRECT CONNECTION

Bob connected the output of the electret unit directly to the screened lead of the microphone cable, and connected the other end of the cable to the high impedance input of one of the Prof's. audio amplifiers. He turned up the volume, and, just as he had expected, the microphone worked, and without the aid of an f.e.t. pre-amplifier Bob's voice could be heard loudly in the laboratory as he tested the microphone. Hearing this the Prof. returned.

"Have you noticed something, Bob?" he enquired.

"Yes, Prof. when I first connected the microphone and tested it I found that there was a lack of treble response. But by adjusting the tone controls of the amplifier, I can now hear plenty of treble frequencies from the loudspeaker."

COMPARISON

"May I suggest, Bob, that we compare this performance with another microphone?"

The Prof. took one of the microphones which they had already repaired, and which still contained an f.e.t. pre-amplifier, and connected it to another input channel of the amplifier. He turned up the volume and adjusted the tone controls of this channel.

"Listen, Bob, and compare the performances of the two microphones."

The Prof. spoke into each microphone in turn, and soon Bob began to twiddle the various controls of the channel which carried the signal from the microphone which lacked the f.e.t. pre-amplifier. Eventually, in despair, he turned to the Prof.

"It does not sound so natural as the one with the f.e.t. pre-amplifier," he complained.

"No matter how I adjust the tone controls, although I can hear every word clearly and there is no obvious distortion, I just cannot seem to set the tone controls quite to my satisfaction. The f.e.t. pre-amplifier makes the response of the microphone sound much more natural. Why is this, Prof?"

To be continued

Careers and Hobbies in Electronics.

Enrol in the BNR & E School and you'll have an entertaining and fascinating hobby. Stick with it and the opportunities and the big money await you, if qualified, in every field of Electronics today. We offer the finest home study training for all subjects in radio, television, etc., especially for the CITY AND GUILDS EXAMS (Technicians' Certificates); the Grad. Brit. I.E.R. Exam; the RADIO AMATEUR'S LICENCE; P.M.G. Certificates; the R.T.E.B. Servicing Certificates; etc. Also courses in Television; Transistors; Radar; Computers; Servo-mechanisms; Mathematics and Practical Transistor Radio course with equipment. We have OVER 20 YEARS' experience in teaching radio subjects and an unbroken record of exam successes. We are the only privately run British home study College specialising in electronics subjects only. Full details will be gladly sent without any obligation.



Become a Radio Amateur.

Learn how to become a radio-amateur in contact with the whole world. We give skilled preparation for the G.P.O. licence.

FREE! Brochure without obligation to: **EEB 97**
BRITISH NATIONAL RADIO &
ELECTRONICS SCHOOL,
P.O. BOX 156, JERSEY, CHANNEL ISLANDS.

NAME _____
ADDRESS _____

BLOCK CAPS PLEASE

GEORGE HYLTON brings it down

Earthing Power Supplies

A READER in Malta, remarks that a Down to Earth he's been reading makes no mention of "earth". He goes on to describe a case where an earth connection was very useful:

"I built a power pack for my 9V transistor radio. The result was much mains hum. I decided to earth the positive lead, before it comes out of the power pack box. The mains hum was completely eliminated."

I don't guarantee to mention earths every month, because the subject isn't always relevant. "Down to earth" has another meaning, to come down to earth is to get to grips with practical problems, which I try to do in this column. In cases of mains hum, a topic which keeps cropping up, earthing is often very relevant.

Mains Hum

There are several ways in which mains hum can be produced in a radio with a mains power supply. Perhaps the most common is direct induction of a mains frequency voltage into the receiver's ferrite aerial coils. This happens when the power pack is put inside the set, with the ferrite rod close to the mains transformer. It is clearly not the cause of the hum in the present case, because our reader's power pack is in a box, and presumably outside the receiver. Moreover, earthing the supply does not cure induced hum.

Leakage

The most probable cause of the hum in the present case is mains leakage. In any mains power pack, there are paths through which tiny mains currents can flow. In a typical case Fig. 1, the major path is via an invisible component, capacitor C1. This is the capacitance between the mains primary and the low voltage secondary winding of the transformer. This is the result of having two conductors (the wire on the windings) close to one another with relatively thin insulation in between. The two sets of wire are the "plates" of the capacitor and the insulator is the dielectric.

The capacitance is usually only a few hundred picofarads. But it has 240V, 50Hz applied to it. The result is that a small mains leakage current flows. Where does it flow to? If the neutral side of the mains is earthed, as in Britain (at a distribution

signals at that point, and produces a loud hum. The total mains leakage is about $8\mu\text{A}$ for every 100pF of inter-winding capacitance.

So a "stray capacitance" of 500pF gives $40\mu\text{A}$, and one-fortieth of this flowing through the audio amplifier input (e.g. the volume control) would produce the sort of hum I'm talking about.

The large smoothing capacitors in the power unit have no effect on this hum. All they do is allow the mains leakage to flow freely between the positive and negative sides of the d.c. output. There may be no hum between positive and negative (because of C2 and C3) but both positive and negative lines are at a certain hum voltage above "earth". Earthing either side of the d.c. output provides an easy path for the leakage and removes the hum. For other reasons, it is best to earth the positive side in a common positive (positive earth)

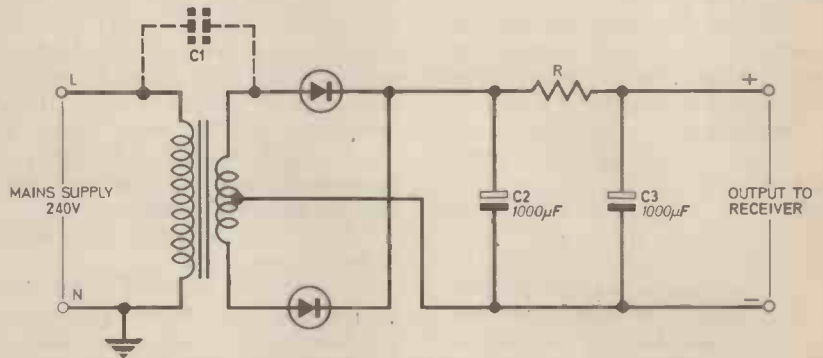

Fig. 1. Circuit diagram of a typical full wave rectified power supply. The capacitor shown dotted is explained fully in the text.

transformer) the path is clear. The leakage must flow to earth, via anything that gets in the way.

What gets in the way, in the present case, is the receiver. If the receiver is not earthed, the leakage flows via many parallel paths, but principally through the capacitance formed by the metal chassis or wiring and the earth itself. Some of this current flows through sensitive parts of the circuitry, for instance the input of the audio amplifier. Even a tiny current here can cause trouble. If the input impedance of the audio amplifier portion of the receiver is 10 kilohms and a mains leakage of $1\mu\text{A}$ flows through this then a mains frequency voltage of 10mV is set up. This is comparable in strength to the audio

receiver and the negative side in common negative equipment.

Safety First

I must stress that this is only one of several kinds of mains hum. It is an important kind, however. But before readers go around connecting earths to equipment to cure hum they should first make sure that the part of the equipment they are earthing is well insulated from the mains. Some cheap power supply units are not. They contain no mains transformers.

Earthing equipment powered by these could be lethal.

to earth

PLEASE TAKE NOTE

Touch Operated Power Switch (July '77)

In Fig. 2 page 328, there are two breaks shown along strip E on the underside of the stripboard. These should not be made. If the unit has been built as shown then the breaks can be bridged with tinned copper wire.

Fuzztone (July '77)

The value of R2 in the component list is incorrect, it should read 470 ohms.

Fish Attractor (June '77)

Capacitor C3 is shown connected the wrong way round in the layout diagram of Fig. 4 on page 261. The circuit diagram is correct.

B. BAMBER ELECTRONICS

Dept. EE, 5 STATION ROAD, LITTLEPORT, CAMBS., CB6 1QE
Telephone: ELY (0353) 860185 (2 lines) Tuesday to Saturday

PLEASE ADD 8% VAT UNLESS OTHERWISE STATED

18V DC RELAYS, 4 pole change-over (double contacts) (will work from 14-24V DC). Brand New, boxed, good quality, made by AEI 40p each.

Slider Switches, 2 pole make and break (or can be used as 1 pole change-over by linking the two centre pins), 4 for 50p.

Smart Min. Rectangular Push to Make Switches, black rectangular surround with white rectangular button, overall size 12 x 17mm, 3 for 50p.

A NEW RANGE OF QUALITY BOXES & INSTRUMENT CASES.

Aluminium Boxes with Lids		
AB10	5 1/2 x 4 x 1 1/2	50p
AB13	6 x 4 x 2	80p
AB14	7 x 5 x 2 1/2	£1-00
AB15	8 x 6 x 3	£1-30
AB16	10 x 7 x 3	£1-50
AB17	10 x 4 1/2 x 3	£1-30
AB25	6 x 4 x 3	£1-00

Vinyl Coated Aluminium Instrument Cases
Light Blue tops and White lower sections. Very smart finish.

WB1	5 x 2 1/2 x 2 1/2	60p
WB2	6 x 4 x 1 1/2	£1-10
WB3	8 x 5 x 2	£1-60
WB4	9 x 5 1/2 x 2 1/2	£1-80
WB5	11 x 6 1/2 x 3	£2-00
WB6	11 x 7 x 3 1/2	£2-25
WB7	12 x 6 1/2 x 5 1/2	£2-60
WB853	8 x 5 1/2 x 3 1/2	£2-00

MAGNETIC DEVICES PROGRAMMERS. Contain 9 fully adjustable cams and 9 change over micro-switches (rated approx. 1A at 240VAC) Needs slow-motion motor to drive (not supplied). Ideal for disc lights, sequence switching, etc. ex equipment £1-50 each.

GARRARD 9V DC MINIATURE MOTORS. Type 318M, 3200 RPM governed, size approx. 1 1/2in dia. x 1 1/2in high, with 2mm spindle. Brand New, 60p each or 2 for £1.

QUARTZ-KTAL CONTROLLED CLOCKS. 9 to 12V DC at approx. 3mA required. Dial size approx. 2", depth of unit approx. 2". Not in cases, unit only, smart modern appearance, black face with white lettering, 12hr. with second hand, and red hour and minute hands (Costs over £40 to produce) £18 each while stocks last, tested before despatch.

RED LEDs (Min. type) 5 for 70p.

VIDICON SCAN COILS (Transistor type, but no data) complete with vidicon base £3-50 each. Brand New.

FULL RANGE OF BERNARDS/BABANI ELECTRONICS BOOKS IN STOCK, S.A.E. FOR LIST.

NEW FOR THE VHF CONSTRUCTOR. A range of tuned circuits on formers with slugs and screening cans. Frequencies quoted are approximate, and range can be greatly extended by using varying capacitors in parallel.

Type S (3in. square, dummy type).
Type SA 20 to 30MHz (when 33pF fitted in parallel).
Type SB 35 to 50MHz (with link winding).
Type SC 70 to 100MHz (with link winding).
Type SD 135 to 175MHz (with link winding).
Type M (Min. 3in. square types).
Type MA 19 to 28MHz (when 33pF fitted in parallel).
Type MB 22 to 32MHz (when 33pF fitted in parallel).
Type MC 25 to 35MHz (when 33pF fitted in parallel).
Type MD 38 to 50MHz (when 33pF fitted in parallel).
Type ME 45 to 60MHz (when 33pF fitted in parallel).
Type MF 100 to 200MHz (without slug) when 0 to 30pF variable fitted in parallel.
All the above coils available in packs of five only (same type) at 50p per pack of 5.

PLASTIC PROJECT BOXES with screw on lids (in black ABS) with brass inserts.
Type NB2 3 1/2in. x 2 1/2in. x 1 1/2in. 50p each.
Type NB3 approx. 4 1/2in. x 3 1/2in. x 1 1/2in. 60p each.

MULLARD 85A2 85V STABILISER VALVES (Brand New) 70p each or 2 for £1-20.

TO3 transistor insulator sets, 10 for 50p

BSX20 (VHF Osc/Mult), 3 for 50p.
BC108 (metal can), 4 for 50p.
PBC108 (plastic BC108), 5 for 50p.
BFY51 Transistors, 4 for 50p.
BCY72 Transistors, 4 for 50p.
PNP audio type TO5 Transistors, 12 for 25p.
BF152 (UHF amp/mixer), 3 for 50p.
2N3819 Fet., 3 for 60p.
BC148 NPN SILICON, 4 for 50p.
BC158 PNP SILICON, 4 for 50p.
BAY31 Signal Diodes, 10 for 35p.
BA121 Varicap Diodes, 4 for 50p.

SMALL MAINS SUPPRESSORS (small chokes. Ideal for radio, Hi-Fi inputs. etc.), approx. 1/2in. x 1 1/2in., 3 for 50p.

PERSEPEX TUNER PANELS (for FM Band 2 tuners) marked 88-108MHz and Channels 0-70, clear numbers, rest blacked out, smart modern appearance, size approx. 8 1/2in x 1 1/2in., 2 for 35p.

PLUGS AND SOCKETS
N-Type Plugs 50 ohm, 60p each, 3 for £1-50.
PL259 Plugs (PTFE), brand new, packed with reducers, 85p or 5 for £3.
SO239 Sockets (PTFE), brand new (4-hole fixing type), 50p each or 5 for £2-25

SOLDER SUCKERS (Pluriger type). Standard Model, £5. Skirted Model £5-50. Spare Nozzles 60p each.

WELLER SOLDERING IRONS
EXPERT. Built-in-spotlight illuminates work. Pistol grip with fingertip trigger. High efficiency copper soldering tip.
EXPERT SOLDER GUN £100 £9-90.
EXPERT SOLDER GUN KIT (spare bits, case, etc.) £12-90.
Spare bits 35p pair.

NEW MARKSMAN RANGE OF SOLDERING IRONS.

S115D 15W 240V £3-80.
S125D 25W 240V £3-80.
S140D 40W 240V £4-20.
S125DK 25W 240V + bits etc., KIT £4-90.
SPECIAL 12V version S125-12 25W 12V £3-80.
BENCH STAND with spring and sponge for Marksmen Irons £2-38.

Spare bits MT9 (for 15W) 50p, MT5 (for 25W) 45p, MT10 (for 40W) 50p.

ALL PRICES + 8% VAT.
TCP2 TEMPERATURE CONTROLLED IRON. Temperature controlled iron and PSU. £30 + VAT (£2-40).

SPARE TIPS
Type CC single flat. Type K double flat fine tip. Type P very fine tip. £1 each + VAT (8p).
MOST SPARES AVAILABLE.

MULTICORE SOLDER
Size 4 Savbit 18 s.w.g. in alloy dispenser, 32p + VAT (3p).
Size C1SAV18 Savbit 18 s.w.g., 56p + VAT (4p).
1 Kg. (1-1lb) 60 x 40, 20 s.w.g. on plastic reel £3 + VAT (24p).

14 DIL REED RELAYS, 5 to 12V DC, 450 ohm coil. Designed to work directly from TTL Logic. Single Pole Change over. Contact ratings 28V 1A 3W. £1-75 each.

A LARGE RANGE OF CAPACITORS AVAILABLE AT BARGAIN PRICES, S.A.E. FOR LIST.

MIXED COMPONENT PACKS, containing resistors, capacitors, pots, etc. All new. Hundreds of items. £2 per pack, while stocks last.

ALU-SOL ALUMINIUM SOLDER (made by Multicore). Solders aluminium to itself or copper, brass, steel, nickel or tinplate. 16s g.w. with multicore flux, with instructions. Approx. 1 metre coil 40p pack. Large reel £2-75.

VARICAP TUNERS Mullard type ELC1043/05. Brand New, £4-40 + 12 1/2% VAT.

BARGAIN PACK OF LOW VOLTAGE ELECTROLYTIC CAPACITORS. Up to 50V working, Seatronc Manufacture. Approx. 100. £1-50 per pack + 12 1/2% VAT.

OSMOR REED RELAY COILS (for reed relays up to 1/2in dia., not supplied) 12V, 500 ohm coil, 2 for 50p.

We now stock Spiralex Tools for the electronic enthusiast. Screwdrivers, Nut spanners, BA and Metric sizes, pop rivet guns, etc. S.A.E. for list.

TWIN I.F. CANS, approx. 1in. x 1/2in. x 1 1/2in. high, around 3-5.5MHz, 2 separate transformers in 1 can, internally screened, 5 for 50p + 12 1/2% VAT.

Duobiler Electrolytics, 50uF, 450V, 2 for 50p.
Duobiler Electrolytics, 100uF, 275V, 2 for 50p.
Duobiler Electrolytics, 470uF, 63V, 3 for 50p.
TCC Electrolytics, 1000uF, 30V, 3 for 50p.
Duobiler Electrolytics, 5000uF, 35V, 50p each.
Duobiler Electrolytics, 5000uF, 50V, 60p each.
ITT Electrolytics, 6800uF, 25V, high grade, screw terminals, with mounting clips, 50p each.

PLEASE ADD 12 1/2% VAT TO ALL CAPACITORS.

TV PLUGS AND SOCKETS
TV Plugs (metal type), 5 for 50p.
TV Sockets (metal type), 4 for 50p.
TV Line Connectors (back-to-back sockets), 4 for 50p.
Please add 12 1/2% VAT.

Terms of Business: CASH WITH ORDER. MINIMUM ORDER £2. ALL PRICES INCLUDE POST & PACKING (UK ONLY). SAE with ALL ENQUIRIES Please. PLEASE ADD VAT AS SHOWN. ALL GOODS IN STOCK DESPATCHED BY RETURN CALLERS WELCOME BY APPOINTMENT ONLY.



I bought this beautiful little milliamp-meter through the special Bargain List that Home Radio sent me when I bought a copy of their famous Components Catalogue. I reckon I saved a good £1-50 on this one item alone—more than the catalogue itself cost. If I'm not mistaken, you got that natty

transformer the same way, so no doubt you're as familiar as I am with the scores of bargains they're offering.

But have you noticed that there are quite a few bargains in the main catalogue itself? That Resistor Pack SP22 for instance—400 preferred value 1/2 watt 5% resistors for only £6, beautifully arranged for easy selection. If that's not a bargain, what is?

For those readers who have not yet caught on to the advantages of dealing with Home Radio let us explain. It's perfectly simple. Purchase a copy of the Home Radio catalogue, £1-40 including postage and packing or £1 over the counter. It has over 200 pages, listing about 5,000 items, nearly 2,000 of them illustrated. It's a marvellous production. With every catalogue Home Radio give you free an up-to-date Bargain List. You're on to a winner, so why wait? Send the coupon with a cheque or postal order for £1-40 to Home Radio Components, 240 London Road, Mitcham, Surrey.

Please write your Name and Address in block capitals

NAME.....

ADDRESS.....

HOME RADIO (Components) LTD., Dept. EE (Regn. No. London 912966)
234-240 London Road, Mitcham, Surrey CR4 3HD



POST THIS COUPON
with cheque or p.o. for
£1-40

HOME RADIO (Components) LTD. Dept. E.E., 234-240 London Road, Mitcham, CR4 3HD. Phone 01-648 8422



SMALL ADS

The prepaid rate for classified advertisements is 14 pence per word (minimum 12 words), box number 40p extra. Semi-display setting £9.00 per single column inch (2.5cm). All cheques, postal orders, etc., to be made payable to Everyday Electronics and crossed "Lloyds Bank Ltd." Treasury notes should always be sent registered post. Advertisements, together with remittance, should be sent to the Classified Advertisement Manager, Everyday Electronics, Room 2337, IPC Magazines Limited, King's Reach Tower, Stamford St., London, SE1 9LS. (Telephone 01-261 5918).

CONDITIONS OF ACCEPTANCE OF CLASSIFIED ADVERTISEMENTS

1. Advertisements are accepted subject to the conditions appearing on our current advertisement rate card and on the express understanding that the Advertiser warrants that the advertisement does not contravene any Act of Parliament nor is it an infringement of the British Code of Advertising Practice.
2. The publishers reserve the right to refuse or withdraw any advertisement.
3. Although every care is taken, the Publishers shall not be liable for clerical or printers' errors or their consequences.

Receivers and Components

ELECTRONIC DEVICES and components. Latest free lists from N.K.M. 32 Seaside, Eastbourne, Sussex. Telephone 32921. (Export welcome.)

71b ASSORTED COMPONENTS £2.95. Small audio amplifiers. 3 transistors equivalent to AC128, OC72, with circuit. 3 for £1. Goods post paid. List 15p. Refunds on purchase. Insurance add 10p. J. W. B. Radio, 2 Barnfield Crescent, Sale, Cheshire M33 1NL.

TIRRO ELECTRONICS the mail order division of RITRO ELECTRONICS UK offers a wide range of components for the amateur enthusiast. Large SAE or 20p brings list. **GRENFELL PLACE, MAIDENHEAD, BERKS. SL6 1HL.**

I.C.s., TTL.C/Mos, Linear, Capacitors, Resistors (E12) SIL/Rectifiers, Diodes, LED, Thyristors, Zenors, Voltage Reg, DIL Sockets, Bridge Rectifiers, Potentiometers, Presets, Triacs, Diac, Plugs, Sockets, Cable, Vero. Carefully selected range, excellent despatch service. Same day turn round. S.A.E. List. Suppliers to A.E.R.E., U.K.A.E.A., Government Depts, Schools, Universities, Manufacturers. Accounts opened for trade and amateur. Join the professionals. Phone by 4 p.m. Goods out 1st class by 5p.m. Try us and prove it!

ORCHARD ELECTRONICS

Flint House, High Street, Wallingford, Oxon. Telephone 0491-35539.

DISCOVER ELECTRONICS. Build twenty easy projects including; Metal Detector; Wireless Transmitter; Breathalyser; Miniature Radios; Stethoscope; Lie Detector; Touch, time switches; Burglar Alarms; etc. Circuits, plans all for £1.29 including circuit board. Mail only. Ridley photo/electronics, Box 62, 111 Rockspark Road, Uckfield, Sussex.

NO LICENCE EXAMS NEEDED

To operate this miniature, solid-state Transmitter-Receiver Kit. Only £9.75 plus 25p P&P.

'Brain-Freeze' 'em with a MINI-STROBE Kit, pocket-sized 'lightning flashes', vari-speed, for discos and parties. A mere £4.30 plus 20p P&P. Experiment with a psychedelic DREAM LAB, or pick up faint speech/sounds with the BIG EAR sound-catcher; ready-made multi-function modules. £5.00 each plus 20p P&P.

LOTS MORE! Send 20p for lists. Prices include VAT. (Mail order U.K. only).

BOFFIN PROJECTS

4 Cunliffe Road, Stoneleigh Ewell, Surrey. (E.E.)

For Sale

FOR SALE—MARCONI CR-100 1944 Naval Receiver good working order £12 ring Ringwood 2848 or 01-455-3740 after 6p.m.

Wanted

SURPLUS?? Turn it into cash. Phone: 0491 35529 (Oxon).

Books and Publications

SIMPLIFIED TV REPAIRS. Full repair instructions individual British sets £4.50, request free circuit diagram. Stamp brings details unique TV publications. Ausee, 76 Church Street, Larkhall, Lanarkshire.

Educational

COURSES—RADIO AMATEURS EXAMINATION. City and Guilds. Pass this important examination and obtain your G3 licence, with an RRC home study course. For details of this, and other courses (GCE, professional examinations, etc.), write or phone: **THE RAPID RESULTS COLLEGE, Dept. JR1, Tuition House, London SW19 4DS.** Tel: 01-947 7272 (Careers Advisory Service), or phone for a prospectus only, ring 01-946 1102 (24hr recording service).

Courses

BE A SUCCESSFUL TV ENGINEER. Join our full-time Two-year College Diploma Course, specially designed to cover the examinations of the City and Guilds Radio, Television and Electronics Technicians' Certificate. Full theoretical and practical instruction on all types of modern receivers including the latest colour sets. Enrolments are now under way for September 1977. Minimum entrance requirements are Senior Cambridge or 'O' level, or equivalent in Mathematics and English. September includes a specialised Colour TV and FM Stereo servicing course, plus a 2nd year Technicians' course. Contact us for free prospectus: **THE PEMBRIDGE COLLEGE OF ELECTRONICS, Dept. EE, 34a Hereford Road, London W2 5AJ.** Tel: 01-229 9117.

Miscellaneous

STYLL, CARTRIDGES & AUDIO LEADS ETC. For the best at keenest prices send SAE for free illustrated list to: **FELSTEAD ELECTRONICS, (EE), Longley Lane, Gatley, Cheadle, Cheshire SK8 4EE.**

BARGAIN BOX for BEGINNERS containing 2 Transistor/component panels, 1 Relay, 1 Rectifier, 1 earphone insert, 1 mike insert, 2 diodes 1 buzzer, 3 core cord, 1 salvaged tool—an ideal collection for experiments: £1.80 inc. VAT and P.P. 5 digit counter, 10 digits/sec., 24-48v. non-reset, brand new GPO type 85p Inc. Also 3, 4, 5, 6 & 9 core cords many other telephone spares at give away prices

Trade enquiries welcome. S.A.E. for lists or orders to:

B. B. SUPPLIES

141, Shalmsford St., Near Canterbury, Kent, CT4 7QZ

ENAMELLED COPPER WIRE

SWG	1 lb	8 oz	4 oz	2 oz
14-19	2.40	1.20	.69	.50
20-29	2.45	1.60	.82	.59
30-34	2.60	1.70	.89	.64
35-40	2.85	1.90	1.04	.75

Inclusive of p&p and VAT.

SAE brings Catalogue of copper and resistance wires in all coverings.

THE SCIENTIFIC WIRE COMPANY
PO Box 30, London E4 9BW
Reg. office 22, Coningsby Gardens.

DOING IT DIGITALLY?? 100 used T.T.L. E4 (90% good). J. BRUERE, 17 Heald Close, Shawclough, Rochdale.

100 RESISTORS 75p
1/2W 5% c/FILM 2.2Ω-2.2M Ω (E12)
10 each of any value

Send stamped envelope for free sample

C60 CASSETTES 30p All Cassettes in Plastic Case with Index and Screwed Assembly.

690 CASSETTES 45p

All prices include VAT. Add Postage 10p in £1

Quantity Discounts **SALOP ELECTRONICS,**
10 Units 5% 23 WYLE COP,
50 Units 7% **SHREWSBURY.**
100 Units 10% Tel. 53206

DIY BURGLAR ALARM EQUIPMENT

COMPLETE INSTALLATION KITS

★ Magnetic switches. Pressure mats. Bells & Bell Housings. Junction Boxes. Control Panels. Foil, etc.

Send s.a.e. for lists:

DACH ELECTRONICS

13 Hamilton Square, Birkenhead, Merseyside, L41 6BP Tel. 051 647 5030

INSTRUMENT CASES, Loudspeaker cabinet kits, Teak sleeves for Amplifiers etc. Post today for free illustrated list to Curtis Furniture, Junction Road, Totton, Hants.

TREASURE TRACER

MK III Metal Locator

- Vericap tuning
- Britain's best selling metal locator kit; 4,000 sold
- Weighs only 22oz. Fitted with Faraday shield
- Speaker and earphone operation
- Knocks down to only 17in
- Prebuilt search coil assembly
- Thoroughly professional finish
- As seen on BBC1 and BBC2 TV
- You only need soldering iron screwdriver, pliers and snips
- Five transistor circuit

Send stamped addressed envelope for leaflet

Complete Kit **£15.95** Built & tested **£20.95**
Post £1.20-£1.37 VAT (8%) Post £1.20-£1.77 VAT (8%)

MINIKITS ELECTRONICS
6b CLEVELAND ROAD,
LONDON, E16 2AN (Mail order only)

Service Sheets

SERVICE SHEETS for Radio, Television, Tape Recorders, Stereo, etc. With free fault-finding guide, from 50p and s.a.e. Catalogue 25p and s.a.e. Hamilton Road, 47 Bohemia Road, St. Leonards, Sussex.

BELL'S TELEVISION SERVICE for service sheets of Radio, TV etc. 75p plus SAE. Colour TV Service Manuals on request. SAE with enquiries to BTS, 190 King's Road, Harrogate, N. Yorkshire. Tel: 0423 558855.



PE

MICROPROCESSOR DEVELOPMENT SYSTEM

the first alternative to commercial ones!

Comprising 3 units (Development System, Programmer and UV Eraser), it has a calculator-based hexadecimal keyboard and display, battery-powered CMOS RAM store, and a programmable input/output array. The microprocessor used is the Intel 4040. For a component outlay of around £200, the home constructor can build this system and develop his own microprocessor based hardware and software.

Other projects in this issue:

FREQUENCY COUNTER TIMER

4 mode settings, counts at up to 25MHz, accurate 5-digit display readout.

LINEAR OHMMETER

Valuable item of test gear for all constructors.
plus

FREE Doram catalogue with every copy

NOTE

PE is NOW BIGGER to accommodate more information on today's expanding technology!

Progress with

PRACTICAL *September issue out now 40p*
ELECTRONICS

Your free start to a rewarding new hobby.



Heathkit make the world's largest range of electronic kits.

Including amateur radio, test equipment, educational and general interest kits.

Every one of which comes to you absolutely complete—right down

to the last nut and bolt.

You'll also get a very easy to understand instruction manual that takes you step by step through the assembly.

So, besides making an attractive, useful piece of equipment, you'll also have the makings of a satisfying, rewarding hobby.

To find out more, post the coupon and we'll send you our latest catalogue. Heath (Gloucester) Ltd., Dept. EE-97, Bristol Rd., Gloucester, GL2 6EE. Tel: Glos (0452) 29451.



HEATHKIT

BETTER BUILT BECAUSE YOU BUILD IT YOURSELF

The new Heathkit catalogue. Out now. FREE.

To: Heath (Gloucester) Ltd., Dept. EE-97, Gloucester, GL2 6EE. Please send me my Heathkit catalogue.

I enclose an 11p stamp for postage.



Name _____
Address _____

Postcode _____

ACCESS AND BARCLAYCARD WELCOMED

Showrooms at 233 Tottenham Court Road, London and Bristol Road, Gloucester.

TECHNICAL TRAINING IN ELECTRONICS AND TELECOMMUNICATIONS

ICS can provide the technical knowledge that is so essential to your success; knowledge that will enable you to take advantage of the many opportunities open to you. Study in your own home, in your own time and at your own pace and if you are studying for an examination ICS guarantee coaching until you are successful.

City and Guilds Certificates:
Telecommunications Technicians
Radio, TV, Electronics Technicians
Technical Communications
Radio Servicing Theory
Radio Amateurs
Electrical Installation Work
MPT Radio Communications Certificate

Diploma Courses:
Colour TV Servicing
Electronic Engineering and Maintenance
Computer Engineering and Programming
Radio, TV, Audio Engineering and Servicing
Electrical Engineering, Installation
and Contracting

POST OR PHONE TODAY FOR FREE BOOKLET

ICS To: International Correspondence
Schools

Dept 710J Intertext House, London
SW8 4UJ or telephone 622 9911

Subject of Interest
Name
Address
Tel:

DENCO (CLACTON) LIMITED

Dept. E.E.

357-8-9 OLD ROAD
CLACTON-ON-SEA
ESSEX CO15 3RH

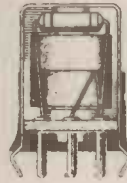

Our components are chosen by technical authors and constructors throughout the world for their performance and reliability, every coil being inspected twice plus a final test and near spot-on alignment. General Catalogue showing full product range 34p. Overseas Customers 70p, Air-Mail Post Paid.

**U.K. & OVERSEAS MANUFACTURERS/STOCKISTS
ENQUIRIES WELCOME**

Australian Readers Please Note—Our Complete Range of Coils are available from Watkin Wynne Pty. Ltd., 32, Falcon Street, CROWS NEST, 2065, AUSTRALIA. P.O. Box 392.

**THIS VOUCHER ENTITLES YOU TO
A DISCOUNT OF**

ONE POUND

IF YOU PURCHASE A RADIO-ALARM-CLOCK at £18.50 incl. VAT + £1.45 P & P & Ins. from—

£1

D. & D. POWER SUPPLY CO. LTD.
79 LOWFIELD STREET
DARTFORD, KENT

OFF

Please see advertisement on page 9 for details
This offer is valid only until 30th SEPTEMBER, 1977

IT'S EASY WHEN YOU KNOW!

To avoid missing your copy of EVERYDAY ELECTRONICS—simply complete this order form and hand it to your newsagent.

ORDER FORM

To: (name of newsagent)

Address

Please reserve/deliver every month one copy of EVERYDAY ELECTRONICS until further notice.

My Name

Address

THE OPEN DOOR TO QUALITY

THE COVER IS BLACK & WHITE



4th ISSUE INCLUDES NEW METERS

This 144 page catalogue—Electrovalue Catalogue No. 8 (Issue 4, up-dated) offers items from advanced opto-electronic components to humble (but essential) washers. Many things listed are very difficult to obtain elsewhere. The Company's own computer is programmed to expedite delivery and maintain customer satisfaction. Attractive discounts continue on many purchases; Access and Barclaycard orders are accepted. **FREE POSTAGE** on all C.W.O. mail orders in U.K. over £2.00 list value (excluding V.A.T.) If under add 15p handling charge.

144 Page

40p

inc. refund
voucher worth
40p

WE CAN SUPPLY ALMOST EVERYTHING TO SPECIFICATION REQUIRED FOR BUILDING "EVERYDAY ELECTRONICS" DESIGNS AND PROJECTS

All communications to Dept. E.E.
28 ST. JUDES RD., ENGLEFIELD GREEN, EGHAM, SURREY
TW20 0HB. Phone Egham 3503. Telex 254475.
NORTHERN BRANCH: 580 Burnage Lane, Burnage, Manchester
M19 1WA. Phone (061) 432 4945.
Shop hours both addresses 9-5.30 p.m.; 1 pm Sats.

ELECTROVALUE LTD

Published approximately the third Friday of each month by IPC Magazine Ltd., Fleetway House, Farringdon St., London EC4 4AD. Printed in England by Index Printers Ltd., Dunstable, Beds. Sole Agents for Australia and New Zealand—Gordon and Gotch (A/S) Ltd. South Africa—Central News Agency Ltd. Everyday Electronics is sold subject to the following conditions namely that it shall not, without the written consent of the Publishers first given, be lent, resold, hired out or otherwise disposed of by way of Trade at more than the recommended selling price shown on cover, excluding Eire where the selling price is subject to V.A.T., and that it shall not be lent, resold, or hired out or otherwise disposed of in a mutilated condition or in any unauthorised cover by way of Trade, or affixed to or as part of any publication or advertising, literary or pictorial matter whatsoever.

Get a great deal from

Marshall's

A. MARSHALL (LONDON) LTD. DEPT. E.E.
LONDON W4 4QZ Cricklewood Broadway, NW2 3ET
Tel. 01-452 0161 Telex 21492
GLASGOW—85 West Regent Street, G2 2QD
Tel. 041-332 4133
BRISTOL—1 Straits Parade, Fishponds Rd. BS16 2LX
Tel. 0272 654201

NEW CATALOGUE 77

2ND EDITION FOR AUTUMN
OVER 8,000 LINE ITEMS
Plenty of New Products and Ideas
35p POST PAD (25p to callers)

TOP 400 SEMICONDUCTORS FROM THE LARGEST RANGE IN THE U.K.

EXPRESS M.O. SERVICE BY RETURN POST—all

orders received despatched same day on stock items

2N696	-35	2N3703	-15	2N6126	-45	BC159	-76	BD116	1-20	BFX84	-35
2N697	-30	2N3704	-15	40361	-50	BC160	-35	BD131	-51	BFX85	-35
2N698	-62	2N3705	-15	40362	-55	BC161	-35	BD132	-54	BFX87	-30
2N699	-55	2N3706	-16	40363	-1-30	BC162	-12	BD133	-37	BFX88	-30
2N706	-28	2N3708	-13	40407	-52	BC167	-12	BD136	-37	BFX89	-1-25
2N708	-28	2N3709	-15	40408	-75	BC169	-12	BD137	-38	BFY50	-25
2N709	-50	2N3710	-16	40409	-75	BC170	-12	BD138	-38	BFY51	-25
2N718	-27	2N3711	-16	40410	-75	BC172	-14	BD139	-40	BFY52	-30
2N718A	-50	2N3712	-20	40411	-2-85	BC177	-20	BD239	-40	BFY90	-1-20
2N720A	-80	2N3713	-20	40594	-80	BC178	-20	BD240	-45	BRV39	-50
2N914	-35	2N3714	-2-45	40595	-90	BC179	-23	BD241	-45	BSX20	-33
2N916	-30	2N3715	-2-55	40673	-75	BC182	-11	BD242	-50	BSX21	-32
2N918	-38	2N3716	-3-00	AC126	-45	BC182L	-14	BD243	-60	CA3050	2-42
2N929	-25	2N3771	-1-45	AC127	-45	BC183	-11	BD244	-65	CA3052	2-20
2N930	-28	2N3772	-2-00	AC128	-45	BC183L	-14	BD245	-65	CA3080	-75
2N1131	-30	2N3773	-2-90	AC151V	-40	BC184	-12	BD246	-66	ME0402	-15
2N1132	-37	2N3789	-2-90	AC152V	-50	BC184L	-14	BD529	-45	ME0412	-20
2N1613	-30	2N3790	-3-00	AC153	-55	BC208	-16	BD530	-50	ME4102	-10
2N1711	-30	2N3791	-3-10	AC153K	-55	BC208	-16	BDY20	1-00	ME4104	-10
2N1932	-38	2N3792	-3-50	AC176	-60	BC217	-14	BF115	-38	MJ481	1-55
2N2102	-98	2N3794	-20	AC176K	-65	BC212L	-17	BF121	-35	MJ490	1-35
2N2218	-37	2N3819	-36	AC187K	-60	BC213	-14	BF122	-35	MJ491	1-85
2N2218A	-37	2N3820	-38	AC188K	-60	BC213L	-16	BF152	-25	MJ2955	1-25
2N2219	-35	2N3823	-80	AD161	1-00	BC214	-16	BF153	-25	MJE340	-58
2N2219A	-36	2N3824	-21	AD162	1-00	BC214L	-17	BF154	-25	MJE370	-58
2N2220	-35	2N3906	-22	AF106	-55	BC237	-14	BF155	-35	MJE371	-58
2N2221	-25	2N4036	-67	AF109	-75	BC238	-12	BF159	-35	MJE520	-45
2N2221A	-25	2N4037	-56	AF124	-65	BC239	-15	BF160	-30	MJE521	-65
2N2222	-25	2N4058	-40	AF125	-65	BC251	-16	BF166	-40	MJE29551	-50
2N2222A	-25	2N4059	-15	AF126	-65	BC253	-22	BF167	-35	MJE3055	-95
2N2358	-25	2N4060	-20	AC139	-35	BC254	-17	BF173	-35	MP1811	-45
2N2359	-25	2N4061	-17	AF185	-50	BC259	-18	BF177	-25	MP1812	-40
2N2369A	-25	2N4062	-18	AF200	-1-20	BC259B	-18	BF178	-25	MP1813	-45
2N2648	-1-45	2N4126	-17	AF230	-65	BC261A	-24	BF179	-30	MPF102	-30
2N1647	1-40	2N4289	-20	AF240	1-14	BC262B	-24	BF180	-35	MPSA05	-25
2N2904	-36	2N4919	-65	AF279	-80	BC263C	-30	BF181	-35	MPSA06	-25
2N2904A	-37	2N4920	-75	AF280	-85	BC264	-30	BF182	-35	MPSA12	-40
2N2905	-37	2N4921	-50	BC107	-15	BC301	-40	BF183	-35	MPSA55	-25
2N2905A	-38	2N4922	-55	BC108	-15	BC303	-50	BF184	-30	MPSA56	-25
2N2906	-28	2N4923	-60	BC109	-15	BC307	-15	BF185	-38	MPSA05	-50
2N2906A	-35	2N4924	-60	BC113	-20	BC308	-15	BF194	-15	MPSU06	-56
2N2907	-25	2N4925	-75	BC115	-20	BC309C	-15	BF195	-15	MPSU55	-60
2N2907A	-25	2N4926	-75	BC116	-19	BC317	-14	BF196	-15	MPSU56	-60
2N2924	-15	2N4927	-30	BC116A	-20	BC318	-13	BF199	-15	TP129A	-45
2N2925	-17	2N4928	-34	BC117	-22	BC327	-20	BF199	-17	TP129C	-60
2N3019	-55	2N4929	-40	BC118	-20	BC328	-19	BF198	-18	TP130A	-49
2N3053	-26	2N4929	-40	BC119	-30	BC337	-19	BF200	-35	TP130C	-65
2N3054	-60	2N4930	-40	BC121	-25	BC337A	-17	BF201	-35	TP131A	-90
2N3055	-70	2N4931	-40	BC132	-30	BC347	-12	BF244	-35	TP131C	-68
2N3056	-20	2N4932	-15	BC134	-30	BC347	-12	BF245	-40	TP132A	-55
2N3057	-20	2N4933	-15	BC135	-30	BC349	-13	BF246	-75	TP132C	-75
2N3058	-20	2N4934	-19	BC136	-19	BCY30	1-00	BF254	-24	TP133A	-80
2N3059	-16	2N4935	-32	BC137	-20	BCY31	1-00	BF257	-37	TP133C	1-10
2N3060	-15	2N4936	-33	BC138	-20	BCY32	1-00	BF258	-24	TP134	-90
2N3061	-20	2N4937	-32	BC141	-40	BCY33	1-00	BF258	-45	TP134C	1-20
2N3062	-59	2N4938	-34	BC142	-30	BCY34	1-00	BF259	-49	TP135A	2-50
2N3063	-64	2N4939	-38	BC143	-30	BCY38	2-00	BF459	-50	TP136A	2-80
2N3064	-81	2N4940	-60	BC147	-12	BCY42	-60	BF459	-28	TP141A	-70
2N3065	-1-35	2N4941	-65	BC148	-12	BCY58	-25	BF521A	2-60	TP141C	90
2N3066	-27	2N4942	-42	BC189	-14	BCY59	-25	BF522	1-38	TP142A	-80
2N3067	-16	2N4943	-50	BC153	-27	BCY70	-25	BF561	-30	TP142C	-1-00
2N3068	-30	2N4944	-58	BC154	-27	BCY71	-26	BF598	-30	TP12955	-65
2N3069	-20	2N4945	-41	BC157	-14	BCY72	-24	BFX29	-35	TP13055	-55
2N3070	-13	2N4946	-43	BC158	-14	BD115	-80	BFX30	-35	TI543	-43

INTEGRATED CIRCUITS

CA3020	2-00	LM748-8	-55	TAA570	2-30
CA3020A	-	LM748N	-55	TAA611B	-
	-	LM1800	-76		1-85
CA3028B	-	LM1801	-92	TAA621	2-15
	-1-29	LM1826	1-75	TAA661A	-
CA3028A	-	LM3308	-85		1-50
	-	LM3308N	-40	TAA661B	-
	-1-08	LM3302N	-40		1-50
CA3030	1-35	LM3401	-70		1-50
CA3030A	-	LM3900	-75	TAA700	3-91
	-2-00	LM3905	-60	TAA930A	-
CA3045	1-40	LM3909	-65		1-30
CA3046	-89	MC1035	-75	TAA930B	-
CA3048	-203	MC1303	1-03		1-30
CA3049	1-80	MC1304	-40	TAD100	1-95
CA3050	2-42	MC1305	-40	TBA120	-75
CA3052	2-20	MC1310	-91	TBA400	2-00
CA3080	-75	MC1327	-54	TBA500	2-21
CA3080A	-	MC1330	1-00	TBA500Q	-
	-1-88	MC1350	-90		2-30
CA3086	-60	MC1351	-20	TBA510	2-21
CA3088	1-70	MC1352	-10	TBA510Q	-
CA3089	-	MC1353	-10		2-30
CA3090	4-00	NE555	-40	TBA520	2-21
CA3130	-98	NE556	1-10	TBA520Q	-
LM301A	-67	NE565	-1-30		2-30
LM301N	-40	NE566	-1-65	TBA530	1-98
LM302N	2-45	NE567	-1-80	TBA530Q	-
LM307N	-65	SAS550	2-50		2-07
LM308C	-82	SAS570	2-50	TBA540	2-21
LM308N	-85	SO42	1-25	TBA540Q	-
LM309K	-85	76001N	1-30		2-30
LM317K	3-00	76003N	2-20	TBA550	3-13
LM328N	-76	76008K	1-50	TBA550Q	-
LM339N	-46	76013N	1-30		3-22
LM3438N	-40	76013ND	1-30		3-22
LM3438N	-40	76018K	1-50		3-22
LM3460N	-75	76023N	1-45	TBA570	1-29
LM370N	-70	76023ND	-26	TBA570Q	-
LM371N	-70	76033N	2-20		1-38
LM372N	1-50	76110N	1-18	TBA641B	-
LM373N	2-00	76115N	-51		2-70
LM374N	3-10	76116N	-66	TBA651	2-20
LM377N	1-75	76131N	-1-26	TBA700	1-52
LM378N	2-25	76229N	1-50	TBA700Q	-
LM379S	3-95	76227N	1-20		1-61
LM380-8	-90	76228N	-41	TBA720Q	-
LM380N	-98	76530N	-75		2-30
LM381A	2-45	76532N	1-40	TBA750	1-97
LM381N	1-60	76533N	1-20		2-08
LM382N	1-25	76544N	1-44	TBA800	1-25
LM384N	-65	76545N	1-65	TBA810	1-25
LM386N	-75	76546N	1-65	TBA820	1-25
LM387N	-05	76550N	-35	TBA820	1-25
LM388N	-90	76552N	-52	TBA920	2-90
LM389N	-100	76570N	-1-65	TBA940	1-62
LM392N	-75	76623N	-90	TCA160C	1-85
LM394N	-65	76650N	-1-60		1-85
LM395N	-60	76666N	-92	TCA160B	-
LM710C	-60	TAA320A	-		1-51
LM710N	-60	TAA320B	-		1-51
LM723C	-85		-		1-00
LM723N	-85		-		1-00
LM733A	-75	TAA350A	-48		1-00
LM741C	-85	TAA521	1-00		1-30
LM741N	-40	TAA522	1-90		1-30
LM747-8	-90	TAA550	-60		1-30
LM747N	-90	TAA560	1-75		3-13

WE STOCK MORE

- CRYSTALS
- VALVES
- CHOKES
- KNOBBS
- CABLES
- CASES
- FUSES
- METERS
- TOOLS
- SPRAYS
- PRESETS
- NEONS
- HEAT SINKS
- INDICATORS

FROM NATIONAL
TELLAS
MULLARD
SIEMENS
MOTOROLA
SIGNETICS
RCA, SCS

NATIONWIDE SERVICE

12 008 CLOCK MODULES DIGITAL

Built and tested—requires only switches and transformer to complete, 12 or 24hr alarm modules.

MA1002F 2hr 5min display	£10-90
MA1002H 24hr 5min display	£10-90
MA1010E 12hr 84in display	£14-50
MA1010G 24hr 84in display	£14-50

CAR CLOCK MODULE
MA1003 Built Tested 12V supply and four-digit module. Crystal controlled 17-00. Data Sheet 5p + SAE.

MAPLIN

ELECTRONIC ORGAN

The only organ you can build in stages and tailor to your requirements as you go along—and at each stage you'll have a fully working instrument! We haven't got the gimmicks (yet—they're coming soon), but we have got the most beautiful sounds—you won't find them on any organ less than twice our price. So get our MES50 series leaflets now! 65p buys the three available so far.



GRAPHIC EQUALISER



This high quality Graphic Equaliser will enhance even the most sophisticated system at a fraction of the cost of a ready-made equaliser of equal quality. You can get all the parts from us (except woodwork) including drilled and printed metalwork. Construction details in our leaflet: 15p.

TOOLS



We stock an excellent range of tools especially for the electronics enthusiast. From miniature wiring tools to multimeters including soldering irons and desoldering tools, screwdrivers, cutters, pliers, strippers, miniature electric drills for p.c.b.'s, transistor tester etc. Full details on catalogue pages 167 to 176.

PEDAL UNIT

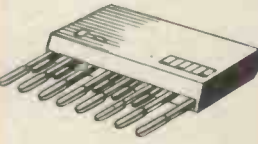

A completely self-contained pedal unit. 13-note, 2-octave range, 4 organ stops. It can be added to any organ! A really unusual extra is the bass guitar stop which uses four envelope shapers to give a real bass guitar sound. A must for the solo guitarist. Full construction details in our catalogue—post the coupon below now!

T.V. GAME



Play fascinating games NOW on your own tv. in your own living room. The kids will think it's magic when the scores pop up on the screen. Lay your bets—anyone could win—with Maplin's prices everyone can win. Complete kit to play four games only £24.50. Add 35p for copy of construction details. See our June newsletter for details of rifle kit.

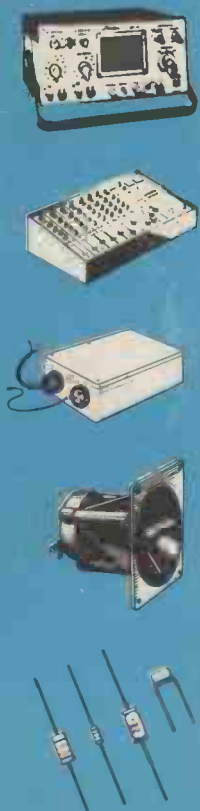
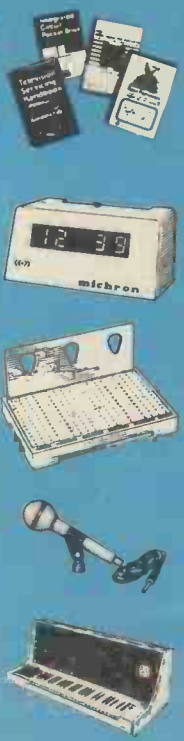

IT'S A FANTASTIC BESTSELLER!

216 big (11" x 8") pages! Over a thousand illustrations! Over 30 pages of complete projects to build! Thousands and thousands of useful components described and illustrated! No wonder it's a bestseller!
DON'T MISS OUT! SEND 60p NOW!

POST THIS COUPON NOW FOR YOUR COPY OF OUR CATALOGUE PRICE 60p

Please rush me a copy of your 216 page catalogue by return of post. I enclose 60p, but understand that if I am not completely satisfied I may return the catalogue to you within 14 days and have my 60p refunded immediately.

NAME _____

ADDRESS _____

EE9



Our bi-monthly newsletter keeps you up to date with latest guaranteed prices — our latest special offers (they save you pounds) — details of new projects and new lines. Send 30p for the next six issues (5p discount voucher with each copy).

MAPLIN ELECTRONIC SUPPLIES
 P.O. BOX 3 RAYLEIGH ESSEX SS6 8LR
 Telephone: Southend (0702) 715155
 Shop: 284, London Road, Westcliff-on-Sea, Essex
 (Closed on Monday) Telephone: Southend (0702) 47379