

THE
**WIRELESS
ENGINEER**
AND
EXPERIMENTAL WIRELESS

NUMBER 117 VOLUME X

JUNE 1933

A JOURNAL OF
RADIO RESEARCH
AND
PROGRESS



PUBLISHED BY
ILIFFE & SONS LTD.
DORSET HOUSE STAMFORD STREET LONDON S.E.1

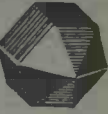

NOW ON SALE

Complete Constructional Details of

The
Wireless
THE PRACTICAL RADIO JOURNAL
World

MONODIAL A.C. SUPER

A SEVEN-VALVE SUPERHETERODYNE RECEIVER OF OUTSTANDING PERFORMANCE

By W. T. COCKING

This booklet contains in a compact form the original articles which appeared in "The Wireless World" some months ago

It describes at length, with full explanations and illustrations, a superheterodyne receiver for A.C. Mains, which is still unchallenged for faithful reproduction and exclusive selectivity.

Since the Monodial A.C. Super was first described, many thousands have been built, and no single instance of failure or disappointment with the performance due to difficulties of construction, has come to light. The Receiver is an ambitious one, but the design is straightforward, and a simplified method of construction has been adopted.

For quality, range and selectivity, the performance is unsurpassed by any known receiver.

Crown 4to. 24 pp. In attractive coloured cover.

PRICE

1/6 net.

By post 1/8

From all booksellers, or direct from the Publishers

WILKINSON & SONS LIMITED, DORSET HOUSE, STAMFORD STREET, LONDON, S.E.1

Kindly mention "The Wireless Engineer" when replying to advertisers.

STANDARD FREQUENCIES

For many years we have specialised in the supply of Precision Apparatus relating to frequency determination, Comparison and Generation.

Our range of Frequency Standardisation Apparatus is an absolutely complete one, ranging from such items as the simple patterns of Wavemeter, or a calibrated Quartz Crystal, to our elaborate "G.R." Class C, 21-H Standard-Frequency Assembly illustrated.

This Assembly will produce any required frequency in the Audio-, Carrier-, Sub-Radio- and Radio-Frequencies, with an accuracy of one part in one million, or better. Indeed, British Laboratories have recently been reporting accuracy as high as one part in five millions, and in one case the deviation was found to be less than one in ten millions over a period of nearly six months.

This Assembly measures 69" x 20" x 3" frame, and occupies a floor-space of only 20" x 15". It is completely AC-Operated and generously "metered." Weight 100 lb. The price is well below your expectations!

Smaller equipments, generating frequencies with a known accuracy of 1:100,000 (or better, with care) are available for the smaller laboratory, at correspondingly lower prices. Send for our new, free 80-page Manual entitled "FREQUENCY MEASUREMENTS AT RADIO FREQUENCIES," mentioning this journal. The Edition is severely limited.

FOR COMPLETE INFORMATION, WRITE:—

CLAUDE LYONS LIMITED

KNOWN FOR PRECISION RADIO LABORATORY GEAR SINCE 1918
40, BUCKINGHAM GATE, WESTMINSTER, LONDON, S.W.1

Kindly mention "The Wireless Engineer" when replying to advertisers.

A

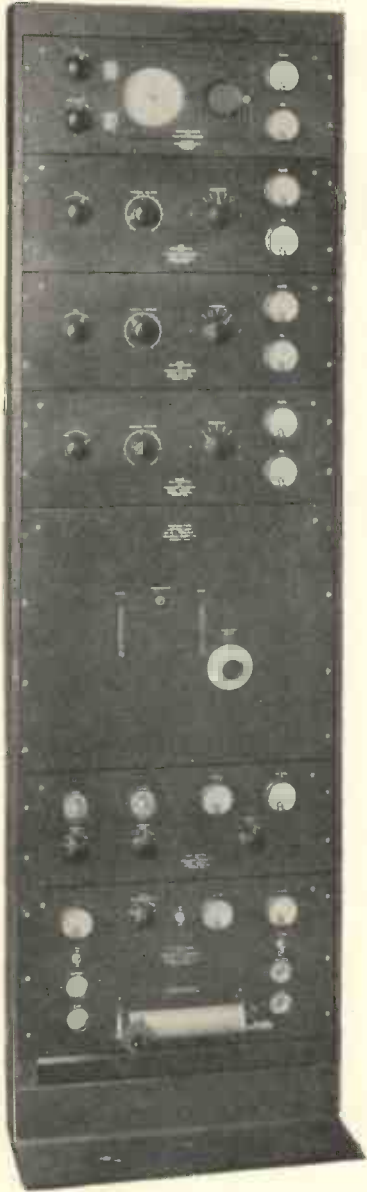

A NEW INEXPENSIVE UNIVERSAL WAVEMETER

Provisional Patent

20—10,000 METRES

Patented Thermal Compensated Coils.

Calibration as
a generator
independent of
valve replacement.

Supplied in
the following forms

Resonant Circuit only - £26

Complete Dynatron
Oscillating Wavemeter - £38

Complete Visual Indicating
Absorption Wavemeter - £38

Combined Dynatron Oscillating
and Visual Indicating
Absorption Wavemeter - £45

All prices include valves.



Dynatron Oscillating and
Absorption without
change of calibration.

Calibration Accuracy 0.1%
Scale Reading Accuracy 0.03%
Frequency Stability .0002%

Accurate simple arithmetic
interpolation ensured by S.L.F. law.

Delivery from stock
calibrated and in a
fully aged condition.

H. W. SULLIVAN, LTD.,
Leo St., London, S.E.15

JOURNAL OF SCIENTIFIC INSTRUMENTS

produced by the Institute of Physics with the co-operation of the National Physical Laboratory. The English journal devoted to scientific instruments, their principles, construction and use. Essential to designers, makers and users.

CONTENTS OF THE MAY NUMBER.

THE INFLUENCE OF MEASUREMENTS ON STEAM PRACTICE. By A. C. Egerton, F.R.S.

AN ANALYSIS OF THE ERRORS OF FLUID-PRESSURE THERMOMETERS AND THEIR METHODS OF CORRECTION. By W. G. Bird, M.A., A.Inst.P.

A VALVE-VOLTMETER FOR MEASUREMENTS OF HYDROGEN-ION CONCENTRATION. By A. S. McFarlane, M.A., B.Sc., M.B.

APPARATUS FOR AUTOMATIC RECORDING OF SETTING TIME OF CEMENT. By N. Davey, B.Sc., A.M.Inst.C.E.

THE BALANCING OF MIRROR DRUMS. By E. E. Wright, B.Sc.

NEW INSTRUMENTS:

A NEW INDUSTRIAL AND RESEARCH SPECTRO-PHOTOMETER. By J. H. Dowell, F.R.P.S.

LABORATORY AND WORKSHOP NOTES:

THE CORRECTION OF DISPLACEMENT ERRORS IN THE CALIBRATION OF SENSITIVE MANOMETERS. By J. Whitmore.

A DRAWING INSTRUMENT FOR LARGE RADIUS ARCS. By E. Simeon.

CORRESPONDENCE, NEW BOOKS, CATALOGUES, NOTES AND COMMENTS, INSTITUTE NOTES.

The subscription rate for a yearly volume is £1 10s. net (post free) payable in advance. Separate parts, 2s. 8d. (post free). Subscriptions should be sent to the publishers.

CAMBRIDGE UNIVERSITY PRESS
Fetter Lane, London, E.C.4 - - - England

FIFTY YEARS of ELECTRICITY

Memories of an Electrical Engineer

By Sir Ambrose FLEMING, M.A.,
D.Sc., F.R.S.

(1921)

The name of Sir Ambrose Fleming gives to this book an authority which those interested in the subject will appreciate. The author has a word to say upon every phase of applied electricity, and besides giving a critical account of the activities of the past fifty years, he indicates the trend of present research and suggests the course of future progress and development. Every student should make a point of obtaining a copy of what may be regarded as a classic of technical literature.

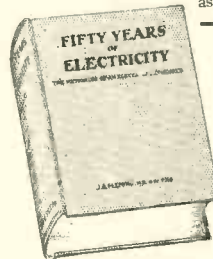

Crown 4to. 371 Pages. 111 Plates.
Cloth Bound.

PRICE 15/- NET

By Post 15/9

From all leading Booksellers or direct
from the Publishers:

ILIFFE & SONS LIMITED,
Dorset House, Stamford St.,
LONDON, S.E.1. W.E.6.

Kindly mention "The Wireless Engineer" when replying to advertisers.

The
WIRELESS ENGINEER
and EXPERIMENTAL WIRELESS

A Journal of Radio Research & Progress

Editor
HUGH S. POCOCK

Technical Editor
Prof. G. W. O. HOWE D.Sc., M.I.E.E.

VOL. X No. 117

JUNE 1933

C	O	N	T	E	N	T	S
EDITORIAL							293
AMPLIFICATION OF TRANSIENTS.	By C. H. SMITH, B.Sc.,						296
	A.M.I.E.E.						
THE SIMPLIFICATION OF ACCURATE MEASUREMENT OF							
RADIO-FREQUENCY (concluded).	By W. H. F. GRIFFITHS,						299
	F.INST.P., A.M.I.E.E.						
DECOUPLING EFFICIENCY.	By the late W. A. BARCLAY, M.A.						307
A VALVE VOLTMETER FOR AUDIO FREQUENCIES							310
CORRESPONDENCE							313
WORLD PHYSICS IN RELATION TO WIRELESS							317
ABSTRACTS AND REFERENCES							318
SOME RECENT PATENTS							345

Published Monthly on the first of each month
SUBSCRIPTIONS Home and Abroad : One Year, 32/-, 6 Months, 16/- Single Copies, 2/8 post free

Editorial, Advertising and Publishing Offices
DORSET HOUSE, STAMFORD STREET, LONDON, S.E. 1
Telegrams : " Experiwyr Watloo London " Telephone : Hop 3333 (50 lines)

Branch Offices

COVENTRY
19 Hertford Street
Telegrams : " Cyellst, Coventry " Telephone : 5210 Coventry

BIRMINGHAM
Guildhall Bldgs., Navigation St., 2
Telegrams : " Autopress, Birmingham " Telephone : Midland 2970 (3 lines)

MANCHESTER
260 Deansgate, 3
Telegrams : " Iliffe, Manchester. " Telephone : " Blackfriars 4412 (4 lines)

GLASGOW
26B Renfield Street, C.2
Telegrams : " Iliffe, Glasgow " Telephone : Central 4857

The Editor invites the submission of articles with a view to publication. Contributions which are not exclusive should be so described when submitted. MSS. should be addressed to the Editor, "The Wireless Engineer and Experimental Wireless," Dorset House, Stamford Street, London, S.E. 1. Especial care should be taken as to the legibility of MSS. including mathematical work.

BUILD WITH

DUBILIER
DRY
ELECTROLYTIC
CONDENSERS

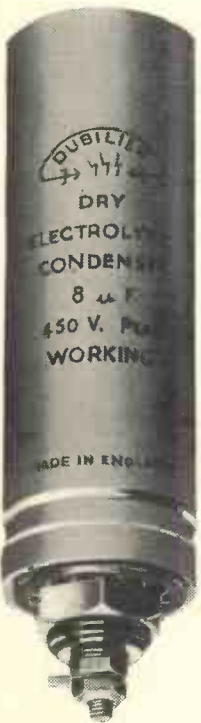

This Dubilier High Voltage Dry Electrolytic Condenser has been proved, by independent authorities, to be far ahead of anything else at present on the market and represents the finest condenser of this type yet offered to the public. Then remember — it is made by Dubilier. And that means that it is as efficient as the finest craftsmanship in the industry can make it. It has already been adopted by leading set makers.

Prices :
 4mfd. - - - - - 4/6
 6mfd. - - - - - 5/-
 8mfd. - - - - - 5/6

VOLTAGE RATING.

● The maximum peak voltage (D.C. and A.C. peak) on these condensers should not exceed 450 volts. The actual A.C. ripple voltage impressed may be as high as 70 volts r.m.s.

OVERLOADS.

● If Dubilier Electrolytic Condensers are subjected to a transient over voltage, they reform on restoration of normal voltage.

LEAKAGE.

● The D.C. leakage current of these condensers is very low. It drops quickly to a fraction of a milliampere after a short period on load. The recovery after a period of rest is also very rapid.

POWER FACTOR.

● The power factor of these condensers is about 8%, which is less than half that of the "wet" types.

TEMPERATURE RANGE.

● The electrolyte in these condensers contains no free water, and since it is not liquid there can be no splashing or creeping of electrolyte from them. It will not freeze and the condensers are undamaged by exposure to any extremes of cold.

DUBILIER CONDENSER Co. (1925), Ltd.
 Ducon Works, Victoria Road,
 North Acton, London, W.3

DAVENSET

AUTO-TRANSFORMERS

with **HIGH OUTPUTS** at **LOW PRICES**



DAVENSET Engineers have produced High Output Transformers at extremely Low Prices. **NO SACRIFICE IN QUALITY HAS HOWEVER BEEN MADE.** DAVENSET add to their comprehensive range of double-wound transformers, a further series of Auto-Transformers, designed with Universal Inputs of 200/250 volts, 40/100 cycles, and with Outputs of 100/110 volts.

List No.	Max. Loading.	Retail Price.
18	35 Watts	17/6
19	75 "	22/6
20	150 "	30/-
21	350 "	50/-

DAVENSET Transformers are manufactured to your own specific requirements, whilst our Technical Department is always at your service to advise and suggest the simplest, yet most practical schemes for overcoming your transformer or rectification problems.

FREE

Write for a copy of "Mains Transformers and Power Smoothing Chokes for Radio and Industrial Purposes."

PARTRIDGE, WILSON & CO.

Specialist manufacturers of Static Rectifiers and Accumulator Charging Plant.

Dept. 32, Davenset Works, Leicester.
 Scottish Branch: 200, St. Vincent Street, Glasgow, C.2.

Kindly mention "The Wireless Engineer" when replying to advertisers.

THE
**WIRELESS
ENGINEER**
AND
EXPERIMENTAL WIRELESS

VOL. X.

JUNE, 1933.

No. 117

Editorial

Iron Core Tuning Coils

IN the January number we discussed the possibilities and limitations of the use of such materials as that to which Hans Vogt has given the name of Ferrocart. We showed that even if the core contained 90 per cent. of the most permeable iron the resulting permeability of the mass could not exceed about 30, but that even this might be well worth while if it were not accompanied by counteracting disadvantages. We mentioned that one German writer had suggested that all the losses could not be ascribed to hysteresis and eddy currents in the iron particles, and that mechanical movement of the particles in the insulating matrix had been suggested as a possible source of loss. In the April number we published an article by A. Schneider giving particulars of the manufacture of Ferrocart and substantiating the conclusions arrived at in the January Editorial; but disagreeing with those who regarded the mechanical movement of the particles as a contributory source of loss. Schneider maintained that although additional losses do occur, and, indeed, represent a considerable share of the total losses in the magnetic core, they are due to a fundamental new discovery on which the Vogt

core is based. This discovery was that dielectric losses occur in the insulating material between the iron particles, and it was claimed that the losses in Vogt cores are extremely low because steps are taken in the manufacture of the core to form high capacitive reactances between the various groups of particles. Now, although such losses must undoubtedly occur, one could not but wonder if they really were as important as Herr Schneider believed. In this issue we publish a letter from Herr Georg Nissen purporting to prove that these dielectric losses are absolutely negligible, and maintaining that the special precautions taken by Vogt, such as the introduction of layers of paper, merely reduce the ordinary eddy currents by improving the insulation between the particles, and that Schneider's capacitive eddy currents are of no account.

With the non-scientific portions of Herr Nissen's letter we are not concerned; our readers will form their own opinions of the claims and statements made. His method of approaching the scientific problem is, however, very ingenious. He does not calculate the dielectric losses in the core, but determines the effective total capacity of all the elementary condensers represented by

the iron particles separated by the dielectric. He then replaces this by an equivalent capacity placed across the coil in parallel with the tuning condenser and shows that it is so small that, however bad its dielectric might be, it could not appreciably affect the damping of the circuit.

As the question is one of some practical importance and scientific interest we have looked into it in a more direct manner by attempting to make an approximate calculation of the actual losses in the dielectric material of the core. No accurate determination is required; the question is whether the dielectric losses are of the same order as the other losses or not.

We assume a circular core of radius r with sector-shaped iron particles arranged as shown. If the frequency be f and the maximum magnetic induction averaged over the whole cross-section, including the insulating material, be B , then the E.M.F. induced in a circle of radius x will have a R.M.S. value

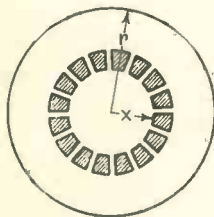

$$E = 4.44(\pi x^2 B) f 10^{-8} \text{ volts.}$$

If a be the linear space factor of the iron, then only $(1 - a)$ of the circular path will be occupied by dielectric, and the electric force induced in the dielectric between the iron particles will be

$$E = \frac{E}{2\pi x} \cdot \frac{1}{1 - a} \text{ volts per cm.}$$

To find the loss in the dielectric we take a unit cube regarded as a plate condenser;

its capacity $C = \frac{A\kappa}{4\pi a} = \frac{\kappa}{4\pi \cdot 9 \cdot 10^{11}}$ farad.

The voltage across it is E . The power dissipated in the unit cube condenser

$$= EI \cos \phi = E \cdot 2\pi f EC \cos \phi = \frac{f E^2 \kappa \cos \phi}{18 \cdot 10^{11}} \text{ watts}$$

where $\cos \phi$ is the power factor of the dielectric, usually a very small fraction. This, then, is the power lost per cm^3 of dielectric in terms of E at any point. Substituting the above value of E it is found that the average value of the loss per cm^3 of dielectric is equal to

$$\frac{1.37}{10^{28}} \frac{f^3 \kappa \cos \phi B^2 r^2}{(1 - a)^2} \text{ watts.}$$

This loss only occurs in the dielectric between the iron particles; that in the rest of the dielectric may be neglected. If the dielectric loss be expressed in terms of the total volume of the core it becomes considerably less, viz. : the above value multiplied by $a^2(1 - a)$, or

$$\frac{1.37}{10^{28}} \cdot f^3 \kappa \cos \phi B^2 r^2 \cdot \frac{a^2}{1 - a} \text{ watts per cm}^3 \text{ of core.}$$

In order to obtain an idea of the magnitude of this loss we may assume $f = 10^6$, $\kappa = 2.5$, $\cos \phi = 0.2$, $r = 0.25$ cm, $a = 0.8$, i.e., a volume space factor of 0.5. A power factor of 0.2 represents a very poor dielectric.

Substituting these values in the formula gives

$$1.37 B^2 10^{-11} \text{ watts per cm}^3.$$

We have assumed a radius of 0.25 cm for the core; if its length were about 5 cm, the volume would be about 1 cm^3 , and the above figure could be taken for the dielectric loss of the whole core. If the linear dimensions were multiplied by 2, the loss per cm^3 would be quadrupled, since the formula contains r^2 , and the volume would be increased 8 times, thus increasing the total losses for the same value of B to 32 times the above figure.

To obtain an idea of the relative importance of this loss one can compare it with the magnetic hysteresis loss in the iron particles by assuming that the latter loss is represented by the formula $0.001 f B_i^2 10^{-7}$ watts per cm^3 of iron. Both the coefficient and the index of B are very uncertain at such low values of B as occur in these cores and the comparison can only be regarded as a very rough approximation, the actual hysteresis loss being probably considerably less than that given by this formula. Using the average B and not that in the iron and allowing for the space factor, the formula for the magnetic hysteresis loss per cm^3

$$\text{of the whole core would be } 0.001 f B^2 10^{-7} \frac{1}{a}$$

Taking $f = 10^6$ and $a = 0.8$ as before, this gives a loss of $1.25 B^2 10^{-4}$ watts per cm^3 , which is 10 million times the calculated dielectric loss.

We can, however, adopt a much more certain basis of comparison by considering the copper losses. We have measured the D.C. resistance of a Ferrocarril coil and obtained about 0.8 ohm for the medium-

wave coil, and 12.4 ohms for the long-wave coil. We shall consider only the former and assume a current of 3 milliamperes. Neglecting any increase of resistance above the D.C. valve this gives an I^2R loss of 7.2×10^{-6} watts. If we assume that the coil has about 70 turns and that the permeability is about 20, the magnetic induction B will be about 1 and the dielectric loss therefore about 1.37×10^{-11} watts, *i.e.*, about two millionths of the D.C. copper loss.

A careful perusal of Herr Schneider's article leaves one in some doubt, however, as to whether his capacitive eddy-current losses occur in the dielectric itself or in the iron particles; he says that the "eddy current, which cannot flow in the usual galvanic way due to the insulating skin, passes as a dielectric displacement current from particle to particle" and therefore presumably as an ordinary conduction current through the particles themselves and, as these have resistance, loss will occur in them. It is a simple matter to show, however, that these losses will be microscopically small compared with even the dielectric losses. The ring of particles shown in the Figure may be regarded as a resistance of iron in series with a condenser. Assuming a length of 1 cm normal to the paper, the resistance of the

iron in the ring is

$$R = \rho \frac{2\pi x}{dx} a \text{ ohms}$$

and the reactance $\frac{1}{\omega C}$ of the condenser, *i.e.*, of all the little condensers in series, is

$$\frac{1}{\omega C} = \frac{4\pi(2\pi x)(1-a)g \times 10^{11}}{2\pi f \kappa dx} \text{ ohms.}$$

If we put ρ for iron = 10×10^{-6} ohms per cm cube, $a = 0.8$, $f = 10^6$ and $\kappa = 2.5$ we get

$$\frac{R}{1/\omega C} = 5.5 \times 10^{-11}$$

This is the ratio of the voltage drops across the iron and dielectric for a given current and shows conclusively that this I^2R loss in the iron is negligible. However one looks at the question one is forced to the conclusion that Herr Nissen's criticism is fully justified and that Herr Schneider's fundamental new discovery has no real existence. We would emphasise, however, that although the theories of Vogt and Schneider may be fallacious in this respect, their Ferrocart coils may do all that is claimed for them. An invention is often much better than the inventor's theory of its operation. G. W. O. H.

A New Idea in Valve Construction

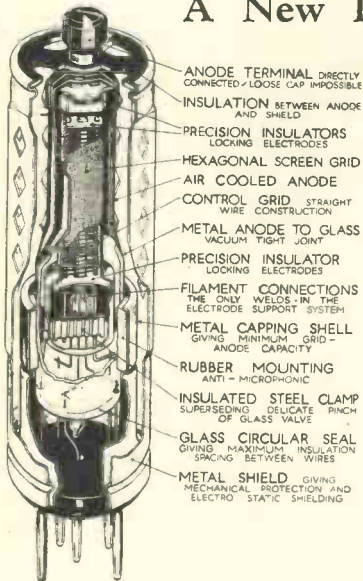

THE Catkin valve, a new Osram and Marconi product, is primarily distinguished from other valves by reason of the fact that metal has largely replaced glass in construction. The anode of copper forms the external envelope and the general construction of the valve is such that it is practically unbreakable. In addition, the dimensions are so small that the Catkin valve boxed occupies one-sixth of the space ordinarily taken by an orthodox valve in its box. The valves are made as equivalents of existing types, so that Catkins can be used as replacements for present valves. Uniformity of characteristics is claimed to be one of the outstanding advantages of the new form of construction.

The illustrations show the valve in section and as it appears in its finished state. Details of the points of special interest in construction are indicated in the lettering of the diagram.



Amplification of Transients*

By C. H. Smith, B.Sc., A.M.I.E.E.

A mathematical analysis which indicates discrepancies between the response of a receiver to steady tones and to transient waves, and suggests possible lines for fruitful experimental investigation.

IT is common practice to estimate the ability of a wireless receiver or low frequency amplifier to reproduce faithfully transmitted speech or music by an inspection of the frequency response curve which indicates the amplification obtainable when the input consists of a pure tone of a given period.

It is well known, of course, that normal transmitted speech or music is at least transient if not aperiodic in character, and several investigations, both theoretical and practical, have been made into the behaviour of amplifiers and loudspeakers when the input signal is aperiodic.† If, however, we are to attempt to discriminate between the behaviour of an amplifier with an input consisting of a pure tone or of transmitted programme, it becomes necessary to place some limits on the manner in which signal amplitude may vary.

The envelope of modulation of a transmitter is rarely sufficiently periodic to permit of the exact application of Fourier's Analysis. There is, however, no necessity to go to the other extreme and make the normal condition one of complete irregularity. A little consideration of the practical side of the production of speech and music will show that since all vibrating sound producers (including the larynx) possess mass, elasticity and friction, the wave trains they emit will consist very largely of exponentially damped sine waves. If, therefore, we make what may be considered as an extension of

Fourier's Theorem and postulate that any transmitted programme may be resolved, at least theoretically, into a finite number of exponentially damped sine waves of fixed frequency, decrement and initial amplitude, we have a concept which is much more general and probably much more accurate in practice than the present one of resolution into pure tones, and which gives a result still capable of mathematical analysis.

In order to investigate the probable response of an amplifier to inputs of this type, it is desirable to consider the results to be obtained with simple forms of valve coupling impedances. If all coupling units are pure resistances the amplification will, of course, be constant not only for all frequencies but for all types of input, periodic or aperiodic. If, however, the coupling unit contains reactances, then the amplification obtained will in general vary not only with the frequency of the input signal, but also with the decrement.

A simple practical case is shown in Fig. 1, in which there exists in the anode circuit of a valve a resistance R and, in addition, in parallel with this resistance a condenser C resulting from the anode-filament capacity of the valve, capacity of the wiring, etc. Let the magnification and resistance of the valve be denoted by μ and ρ ;

then when the input to the grid of the valve consists of a steady tone this circuit will exhibit high-note cut-off giving an amplification represented by the expression

$$M = \frac{\mu R}{\sqrt{(\rho + R)^2 + (2\pi f C \rho R)^2}}$$

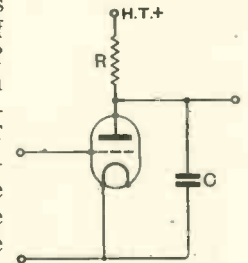

Fig. 1.—Circuit possessing high-note cut-off.

* MS. received by the Editor, July, 1932.

† (1) N. W. McLachlan: "Transients in Loud Speakers and Amplifiers." *Wireless World*, August 7th-14th, 1929.

(2) C. W. Oatley: "The Distortionless Amplification of Transients." *E.W. & W.E.*, May and June, 1931.

(3) T. S. E. Thomas: "Transients and Telephony." *E.W. & W.E.*, September, 1931.

or by $\frac{\mu R}{R + \rho} \cdot \sqrt{\frac{K_1^2}{K_1^2 + p^2}} \dots \dots \dots (1)$

where $K_1 = \frac{\rho + R}{\rho RC}$ and $p = 2\pi f$

If now the input to the grid of the amplifying valve is a damped sine wave of the form $\epsilon^{-at} \sin pt$, the output voltage E_0 can be shown to be given by the expression

$$E_0 = \frac{\mu}{\rho C} \epsilon^{-K_1 t} \int_0^t \epsilon^{(K_1 - a)t} \sin pt \, dt$$

$$= \frac{\mu}{\rho C} \epsilon^{-K_1 t} \left[\frac{\epsilon^{(K_1 - a)t} \sin (pt - \phi)}{\sqrt{(K_1 - a)^2 + p^2}} \right]_0^t$$

where $\tan \phi = \frac{p}{K_1 - a}$

Neglecting the aperiodic part of this expression, we find that

$$E_0 = \frac{\mu}{\rho C} \frac{\epsilon^{-at} \sin (pt - \phi)}{\sqrt{(K_1 - a)^2 + p^2}}$$

We may deduce from this expression that the output signal is similar in form to the input, *i.e.*, the decrement is unchanged, and that the amplification of the circuit to an input of this type is given by the expression

$$\frac{\mu}{\rho C} \cdot \frac{1}{\sqrt{(K_1 - a)^2 + p^2}}$$

$$= \frac{\mu R}{R + \rho} \cdot \sqrt{\frac{K_1^2}{(K_1 - a)^2 + p^2}} \dots \dots (2)$$

An interesting comparison can be made between expressions (1) and (2), for we see that the term "a" occurs in such a manner as to indicate that damped waves should be amplified more efficiently than undamped waves. It should be noted, however, that "a" measures the decrement per second. It is rational to assume that for a given type of sound the decrement per second is more or less proportional to frequency. If this is the case, then "a" will be proportional to "p" and, in general, for low frequencies where the effect of "p" in expressions (1) and (2) is negligible the effect of "a" will also be very small and can be ignored. When, however, high audio frequencies are under consideration, so that an appreciable amount of loss of amplification would be

expected according to expression (1), then the effect of decrement may also become appreciable, and expression (2) indicate that for damped sine waves the frequency characteristic of an amplifier may be appreciably better than the simpler theory indicates. There should be, according to the formula, a value of "a" for which the amplification is a maximum. This is given by the relation $a = K_1$ and any further increase in decrement will result in a reduction in amplification. To produce this condition, however, in any amplifier other than one with an

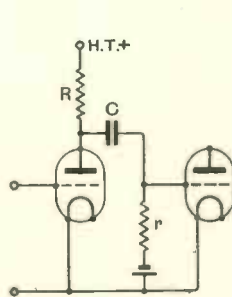

Fig. 2.

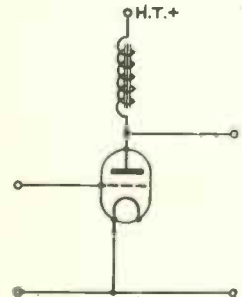

Fig. 3.

Circuits possessing low-note cut-off.

absurdly bad frequency characteristic requires a wave with a very high decrement per cycle. It is a matter to be determined by experiment whether such a condition may occur in practice.

A similar effect to the one described above arises in a circuit such as is shown in Fig. 2, in which the condenser C is sufficiently small to produce low-note cut-off. Let μ and ρ be the magnification and resistance of the amplifying valve, R the anode resistance and r the value of grid resistance of the following valve.

To steady tones the amplification is given by the expression

$$\frac{\mu R r}{R r + R \rho + r \rho} \sqrt{\frac{p^2}{p^2 + K_2^2}} \dots \dots (3)$$

where

$$K_2 = \frac{1}{C \left(r + \frac{R \rho}{R + \rho} \right)}$$

If, however, the input voltage is of the form $E_0 \epsilon^{-at} \sin pt$, the amplification can be shown (by a method similar to that pre-

viously employed) to be given by the expression

$$\frac{\mu R r}{R r + R \rho + r \rho} \cdot \sqrt{\frac{a^2 + p^2}{(K_2 - a)^2 + p^2}} \dots (4)$$

Once again, expression (4) which resolves into expression (3) by putting $a = 0$, indicates that damped sine waves will be amplified more efficiently than undamped waves, and that this increase in amplification will become more pronounced in that region in which the normal frequency characteristic begins to fall. We should therefore once again expect musical reproduction from such an amplifier to be actually better than the frequency characteristic indicates.

The amplifying circuit shown in Fig. 3 using an anode choke gives a similar result.

Writing $K_3 = \frac{\rho}{L}$ where L is the inductance of the choke the output voltage E_0 for any input voltage E_1 is given by the integral

$$\frac{E_0}{\mu} = E_1 - K_3 \int \varepsilon^{-K_3 t} \int \varepsilon^{K_3 t} \cdot E_1 dt.$$

If, in this equation, we substitute for E_1 an expression of the type $\varepsilon^{-at} \sin pt$, we find the magnification of the circuit to be given by the expression

$$\mu \cdot \sqrt{\frac{a^2 + p^2}{(K_3 - a)^2 + p^2}} \dots (5)$$

a result identical in form with the previous expression.

A somewhat more complicated but more practical case is shown in Fig. 4. In this circuit high-note cut-off is produced by the presence of the condenser C_1 between anode and filament, and low-note cut-off exists simultaneously due to the finite size of the grid coupling condenser C_2 . Let R be the value of the anode resistance and r the value of the grid resistance of the next stage. The solution of the differential equation giving the amplification of a damped sine wave by this circuit is somewhat more laborious than the previous cases, but follows roughly on the same lines, and by a judicious choice of constants the result can be made intelligible.

Writing

$$K_4 = \frac{R \rho (C_1 + C_2) + r (R + \rho) C_2}{R r \rho C_1 C_2}$$

$$K_5 = \frac{R + \rho}{R \rho (C_1 + C_2) + r (R + \rho) C_2}$$

and $A = \frac{C_2 R r}{(R \rho) (C_1 + C_2) + R_2 (R_1 + \rho) C_2}$

The amplification obtained when the input consists of a damped sine wave is given by the expression

$$\frac{A}{\sqrt{\left\{ \frac{(K_4 - a)^2 + p^2}{K_4^2} \right\} + \left\{ \frac{(K_5 - a)^2 + p^2}{a^2 + p^2} \right\}}} - 1 + \frac{2K_5}{K_4} - \frac{4p^2 K_5}{K_4 (a^2 + p^2)}$$

This expression has been so written as to make its meaning as obvious as possible. The first term in the denominator has an obvious parallel in expression (2) and indicates that the reduction of amplification at high frequencies due to the presence of the condenser C_1 will be counteracted by the

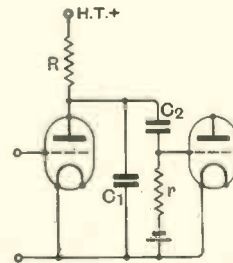

Fig. 4.—Circuit possessing high-note and low-note cut-off.

effect of decrement of the incoming signal. Similarly the second term indicates the same effect as expression (4), *i.e.*, a reduction in the expected low-note cut-off when damped wave trains are being amplified. Of the remaining terms only the last depends on frequency or decrement, and this again shows a tendency to

increased amplification with increased decrement.

Sufficient examples have now been taken to establish the general rule that the response of a low frequency amplifier to exponentially damped sine waves differs from the response to steady tones.

The decrement of the damped sine wave is unchanged, but the amplification obtained is greater for the damped wave train than the undamped, particularly for those frequencies at which, due to the presence of reactances in the coupling units, a reduction in the amplification of steady tones occurs.

The Simplification of Accurate Measurement of Radio-frequency

By *W. H. F. Griffiths, F.Inst.P., A.M.I.E.E.*

(Concluded from page 247 of May issue)

The Effect of the Valve upon Frequency

SINCE it is this adjustment of slope to suit each range coil which governs the $R/2r$ frequency-modifying factors, if this is effected with care the frequency of the wavemeter is almost independent of small changes in the various potentials applied to the valve.

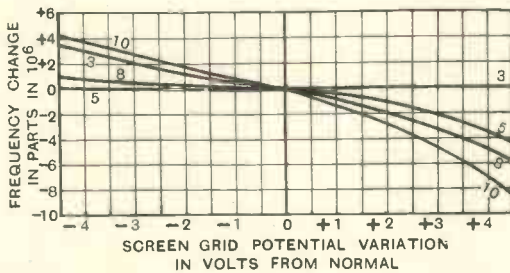

Fig. 13.—Curves showing the observed change of frequency of Sullivan-Griffiths dynatron oscillating wavemeter due to variations in screen-grid potential. The permissible potential fluctuation is ± 1 volt and the greatest inaccuracy introduced by this 1 part in 10^6 (at the lower frequencies).

The change of calibration due to variations of potentials of the various electrodes was carefully ascertained for each range coil of the wavemeter under the worst conditions, i.e., at the high frequency end of each range where the $R/2r$ factor is a maximum. The results are given in the form of curves in Figs. 13, 14, 17, and 18. Fig. 13 shows the effect upon calibration of changes of

TABULATION II.

Coil No.	L.	Frequency at which the stability tests were carried out.
1	10 μ H	2,000 kilohertz
2	18 "	1,600 "
3	32 "	1,200 "
4	80 "	750 "
5	200 "	470 "
6	510 "	300 "
7	1,300 "	190 "
8	3,300 "	120 "
9	8,300 "	75 "
10	21,000 "	45 "

screen grid potential. The voltage can be read and adjusted easily to ± 1 volt, and the greatest inaccuracy from this cause is therefore only 1 part in 10^6 , this occurring at the lowest frequencies. In this and the following curves the various ranges of the wavemeter are given the numbers of their range coils and a tabulation showing the order of their inductance and corresponding frequency has therefore been added.

Fig. 14 shows the calibration inaccuracy introduced by changes in anode potential, and here, again, it will be seen that for quite ordinary voltage adjustment of ± 0.1 volt (the normal anode potential is of the order 10 volts) the inaccuracy is limited to little more than 1 part in 10^6 .

Changes of anode potential would be entirely negligible in their effect upon frequency if the operating points could be fixed on the flat lowest resistance portions of the negative resistance curves of Fig. 15, but this is impossible for the following reason. These curves were taken under the actual conditions of oscillation, i.e., with the applied audio-frequency potential sweeping a portion of the negative resistance characteristic

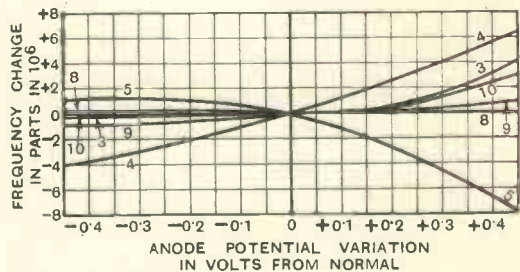

Fig. 14.—Curves showing the observed change of frequency consequent upon variation of anode potential. A potential fluctuation of ± 0.1 volt is permitted—the greatest inaccuracy then being of the order 1 part in 10^6 .

exactly corresponding with the amplitude of oscillation, and they were taken, it must be remembered, at the lowest capacity end of each range in order to correspond to the

stability determinations, which were being effected under the worst conditions. But the operating points on these curves were fixed under different conditions, for, although

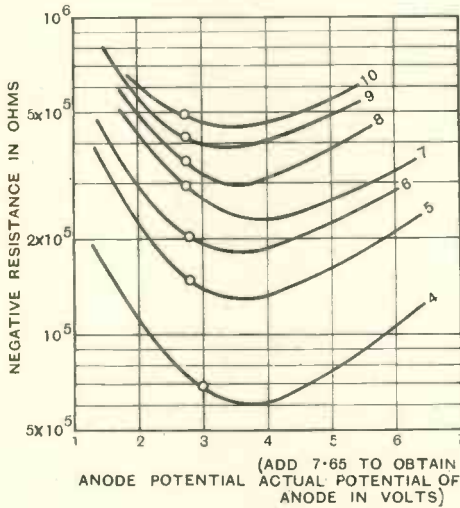

Fig. 15.—Negative resistance curves of some of the ranges of the dynatron wavemeter taken under conditions approximating to those of oscillation.

the potentials of the various electrodes were constant throughout any single range, the amplitude of oscillation at the maximum capacity end of that range was naturally less owing to the smaller value of L/CR . It is at this maximum capacity end of each range that the valve resistance must be adjusted to have just a safely lower value than L/CR , and so the operating anode potential has to be adjusted to give the lowest negative resistance on a curve corresponding with a low amplitude of oscillation such as the 0.35 volt curve of Fig. 16. In this figure it will be seen that the minima are displaced to the left as the amplitude is reduced owing to the characteristic of the valve being of the type indicated in Fig. 9. The curves of Fig. 16 were taken under the actual conditions for range 4 of the wavemeter, the 1.7 volt and 0.35 volt curves corresponding with the highest and lowest (safe) values of L/CR respectively and show clearly why the operating potential is not at the minimum of the former curve since it was fixed under the conditions of the latter.

The importance of adjusting r to the highest safe value is emphasised by the

curves of Fig. 17, which show the change of frequency consequent upon a deliberate 0.05 volt decrease of cathode heater supply; the curves showing these changes are plotted for various values of control grid potential, the lower extremity of each curve indicating the frequency change which occurs with the correctly adjusted value of r used in calibrating the wavemeter. It is seen that from this cause also the inaccuracy cannot exceed 1 part in 10^6 , for cathode heater voltage changes of the order 0.05 volt (in 4.0) can be easily detected and adjusted. The curve for coil 10 shows very clearly that this error could be ten times greater with an ill-chosen value of control grid potential— r being much too low even with nearly 3 volts negative applied to this electrode, a bias which would generally be regarded as ample. The attendant instability of frequency generation would be very marked and this may, therefore, be the reason for the prevalent idea that long wavelength dynatron oscillators are unstable. With -2 volts control grid potential the instability could clearly be fifty to a hundred times greater than that experienced under the correct conditions.

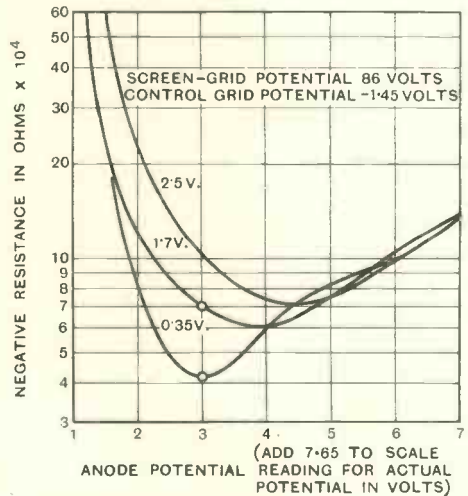

Fig. 16.—Negative resistance curves for various amplitudes associated with the oscillation conditions of range 4 of the dynatron wavemeter.

The curves of Fig. 18 are, however, the most interesting in that they show the real extent of calibration error due to a change of value of valve resistance. They show that the frequency of the wavemeter is much more

dependent upon control grid potential than upon any other valve variation, especially in the case of the lower frequencies. The curves show the increase or decrease of frequency which accompanies a change of control grid potential below or above the values with which the calibration was effected respectively. At these values it will be noted that the curves are steeper for the coils of greater inductance. This is partly due to the fact that the rate of change of negative resistance dr/dv_g becomes greater with the lowering of control grid potential,

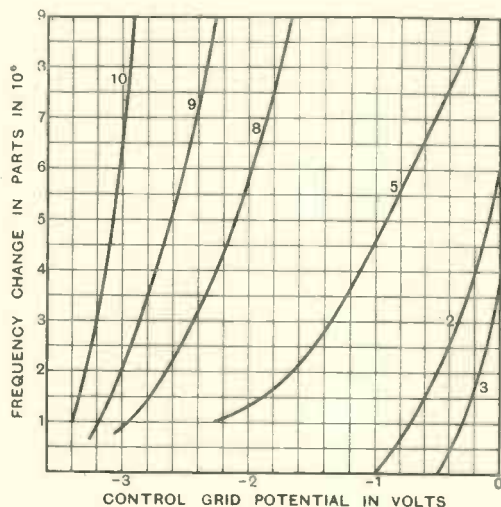

Fig. 17.—Curves showing the observed change of frequency of the Sullivan-Griffiths dynatron oscillating wavemeter due to 0.05 volt decrease of cathode heater voltage. The lower extremities of the curves indicate the frequency changes which occur under the correct calibration condition of control grid potential—the greatest change being 1 part in 10⁶.

and partly to the fact that the decrement of the oscillating circuit became higher as range coils of higher inductance were employed. On the lower ranges also there was a tendency to increased decrement, but this was offset by the much lower value of dr/dv_g at less negative control grid potential. The value of dr/dv_g at the lower control grid potentials is so great that a logarithmic law potential divider would be an advantage. In order to check the shapes of the experimental curves of Fig. 18, those of Fig. 19 have been plotted from a very approximate estimation of the frequency change anticipated for ranges 2 and 8 on the assumption

that the negative resistance of the valve did not vary greatly for widely differing amplitudes. The close agreement will be observed. It ought, perhaps, to be explained that

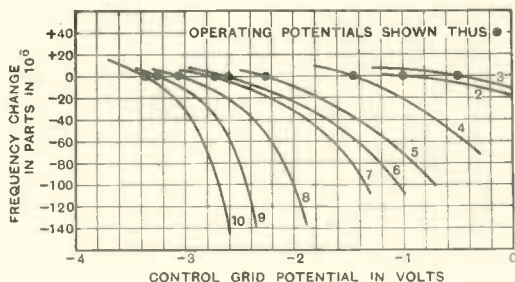

Fig. 18.—Curves showing, for all ranges of the wavemeter, the observed frequency variations which occur with changes of potential of control-grid above and below the correct calibration values which are indicated. (See also Fig. 19 for corresponding theoretical curves).

the upper extremities of the curves of Figs. 18 and 19 indicate the cessation of oscillation, with the wavemeter set, it will be remembered, to its worst position as regards stability (lowest capacity—highest value of L/CR).

It will be seen that the frequency change resulting from a control grid potential change of ± 0.05 volt varies from 1 to 3 parts in 10⁶ over the entire range of the wavemeter. These instability values will be given in detail later in the article.

The Importance of Low Decrement

The curves of Fig. 20 have been plotted to show the necessity for keeping down the decrement of the oscillatory circuit. The

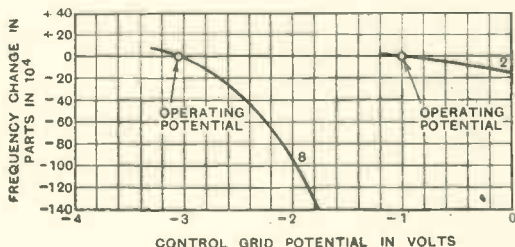

Fig. 19.—Curves of the estimated effect upon frequency of control-grid potential variation. These will be seen to agree approximately with those similarly numbered in Fig. 18.

two curves, which were obtained by actual experiment, show the tremendous increase of frequency instability consequent upon

lowering the resistance, L/CR , of the circuit from $1.1 \times 10^6 \Omega$ to $2.4 \times 10^5 \Omega$ by altering R only.

A reduction of decrement is the chief improvement that can be effected in any attempt to increase the stability of the wavemeter, for, since r , the maximum arithmetic value of negative resistance with which

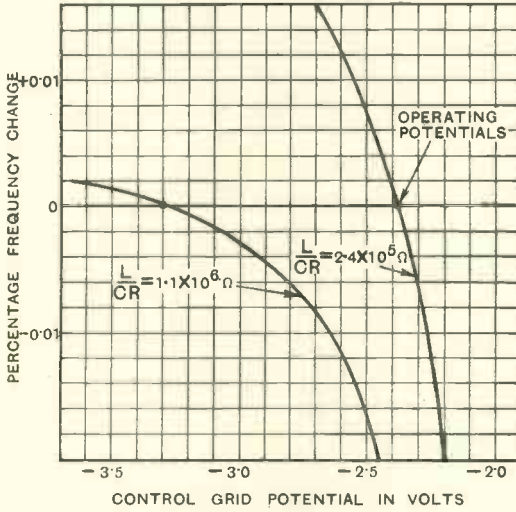

Fig. 20.—Showing the frequency instability introduced by increasing the decrement of the oscillatory circuit of a dynatron generator.

oscillation can be maintained, is proportional to the reciprocal of R^* , the resistance of the resonant circuit, it follows that the frequency modifying factor is

$$R/2r \propto R^2$$

The frequency instability may be expressed as the percentage change of frequency for a given percentage change of valve resistance, or, for oscillation near the critical $r = L/CR$ condition

$$\begin{aligned} \frac{\Delta f}{f} \frac{\Delta r}{r} &= \frac{R}{2r} \\ &= \frac{1}{2\pi^2} \left(\frac{R}{2fL} \right)^2 \\ &= 0.05\delta^2 \end{aligned}$$

where δ is the decrement of the oscillatory circuit.

* Because $r < \frac{L}{CR}$ or, under best conditions, $r = \frac{L}{CR}$

Summary of Frequency Instability Due to Valve Changes

It will be seen from the curves that reasonable changes in the potentials applied to the screen-grid and anode electrodes of the valve and to its cathode heater in each case cause changes of the generated frequency of 1 part in 10^6 or less. Similar changes in control grid potential produce frequency changes considerably greater since changes in valve resistance are, naturally, more directly evidenced by a change of potential of this electrode. Frequency changes of from 1 to 3 parts in 10^6 may arise from this cause.

Frequency changes resulting from the various sources of instability are given in Tabulation III and in the curves of Fig. 21:

TABULATION III

Coil.	Approximate frequency. (Kilohertz).	Frequency changes.			
		due to a 1% reduction of the various applied voltages.			greatest possible due to inaccurately setting all potentials
		L.T.	H.T.	L.T. & H.T.	
1	2,000	0	-1.5	-1.5	± 1.5
2	1,600	0	-1.5	-1.5	± 1.5
3	1,200	0	-1.5	-1.5	± 1.5
4	750	+0.5	-1.6	-1.1	± 4.5
5	470	+1	<0.2	+1.5	± 3.6
6	300	+0.5	<0.2	+0.5	± 2.5
7	190	+0.5	<0.2	+0.6	± 2.5
8	120	+0.7	<0.2	+0.7	± 2.7
9	75	+0.7	<0.2	+1.1	± 3.7
10	45	+1	<0.2	<0.2	± 5.0

All frequency changes are given in parts in 10^6 .

These curves show the frequency changes experienced throughout the entire range of the wavemeter due to the following causes:—

A.—The arithmetic sum of all errors, *i.e.*, the greatest possible case of incorrect adjustment of the potentials of all electrodes and of the cathode heater. This cannot be considered a case of instability, but rather the greatest inaccuracy of calibration reproduction for a given (untouched) condenser setting.

L.T.—The frequency drift due to a 1 per cent. fall in the voltage of the L.T. battery (supplying the cathode heater).

H.T.—The frequency drift due to a 1 per cent. fall in the voltage of the H.T. battery (affecting the potentials of screen-grid, control grid and anode electrodes).

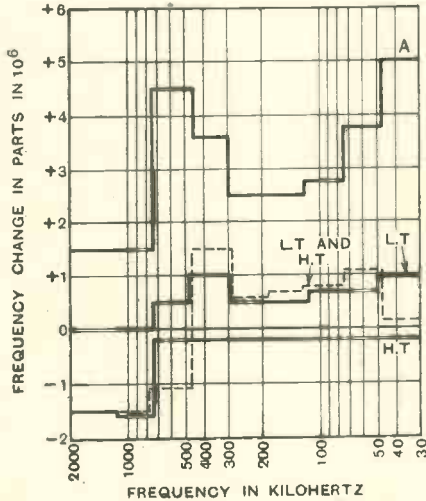

Fig. 21.—Showing the frequency instability throughout the entire range of the wavemeter due to various causes (1 per cent. voltage fall of L.T., H.T., and both L.T. and H.T.). The frequency error due to inaccurately adjusting all potentials is also shown by curve A.

L.T. and H.T.—The frequency drift accompanying a 1 per cent. fall in the voltage of both L.T. and H.T. batteries.

It will be seen that the maximum frequency instability due to fluctuations in battery voltages is less than ± 2 parts in 10^6 . This represents a very high degree of constancy which is only experienced in practice if the temperature of the wavemeter is maintained constant within 0.5 degree Fahrenheit. The temperature coefficient of the wavemeter, low as it is, is the overwhelming source of instability—such is the degree of perfection of the method of generation. Confirmation of this stability throughout considerable periods has, however, been obtained by heterodyne beating two similarly constructed wavemeters and thus eliminating the temperature coefficient component of instability.

Agreement between Observed and Anticipated Frequency Stability due to Valve

In order to obtain some rough confirmation of the frequency change obtained experi-

mentally, it was thought interesting to calculate the approximate frequency modifying term $R/2r$ for each range of the wavemeter, for, from

$$\omega = \frac{1}{\sqrt{LC}} \left(1 - \frac{R}{2r} \right)$$

at a glance it will be seen that the percentage change of frequency corresponding with a small change of r is

$$\frac{\Delta f}{f} \frac{\Delta r}{r} = \frac{R}{2r}$$

When the valve resistance has been adjusted to the critical value L/CR and the smallest possible oscillation amplitude just maintained

$$\frac{\Delta f}{f} \frac{\Delta r}{r} = \frac{R^2 C}{2L}$$

and there is no need to ascertain the value of r (or, conversely, if r is known R may be found as in a well-known method of determination of resistance of resonant circuits).

In the wavemeter, however, an appreciable factor of safety has been allowed even at the minimum L/CR end of each range, so that at the maximum L/CR ends of the ranges (conditions which correspond with those of the curves of Fig. 18, to confirm which this theoretical check was made) a considerable amplitude of oscillation was maintained and a considerable variation of r necessarily occurred throughout a cycle.

Under these conditions it is no longer permissible to allow the resonant circuit constants to give a value for r by using $\frac{R^2 C}{2L}$ as an estimation of frequency stability.

Neither is it true to use $R/2r$ when r is the value of valve resistance measured by the audio frequency method employed by the author, in which a sinusoidal input waveform was employed (even though the R.M.S. value of the input voltage was made equal to the R.M.S. value of the oscillatory voltage generated), for the oscillation waveform was probably far from pure under these conditions where the amplitude was limited only by a considerable change of r . In the absence of more exact knowledge, however, this was the value used.

The decrement of each range was carefully measured in order to obtain correct values for R and the values of valve resistance r under the correct dynamic conditions ob-

tained from the curves of Fig. 15. The results are given in the tabulation IV below, $R/2r$ being expressed directly as a percentage of the natural frequency of the circuit.

The percentage change of valve resistance $\Delta r/r$, due to a 0.05 volt change of control grid potential, under the correct operating condition for each range, was then obtained from the valve characteristics. The product of $R/2r$ and $\Delta r/r$ gives the percentage change of frequency of the wavemeter due to a 0.05 volt change of control grid potential. On most of the ranges good agreement will be seen to exist between estimated and observed frequency changes—the curves of Fig. 22 have been plotted to facilitate comparison and to show the resemblance between curves of instability and square of decrement for which it is proportional. The most efficient ranges (of lowest decrement), at a frequency of about 300 kilohertz, are, as one would expect, least affected by valve changes, while on the lower frequencies the higher circuit decrements bring greater instability. On the higher frequencies the higher decrements are rendered ineffective by the smaller values of dr/dv_g .

It is interesting to note from a glance at Fig. 22 the almost complete similarity between the curve of δ^2 for the various ranges and that of observed frequency change in all but the three highest frequency ranges. These exceptions are, of course, due to the

much reduced values of dr/dv_g at these higher frequencies, where the control grid potential

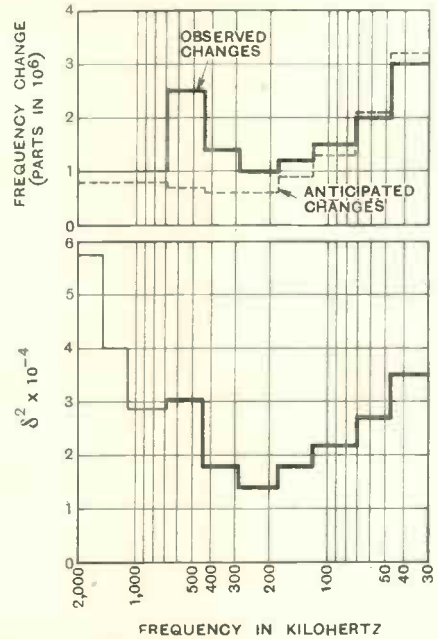

Fig. 22.—Showing, for all ranges of the wavemeter, the frequency changes, both estimated and observed, due to a 0.05 volt change of control-grid potential. Below is plotted, to the same frequency scale, the square of the decrement of the oscillatory circuit for the various ranges.

v_g is not very highly negative. The two curves will only be similar while dr/dv_g is of

TABULATION IV.

Coil.	Frequency (kilohertz).	Decrement of oscillatory circuit.	L/CR (Ω)		$R/2r$ (%)	$\Delta r/r$ for 0.05v. change of Control-grid potential (%)	$\Delta f/f$ Frequency change (parts in 10^6) due to 0.05 v. change of Control-grid potential		Oscillation cessation value of $R/2r = \frac{R^2C}{2L}$ (%)	Maximum possible change of frequency due to valve ageing over "life" period. (%)
			Calculated.	Measured.			Estimated.	Observed.		
1	2,000	0.024	17,500	13,000	0.0036	2.5	0.9	< 1	0.0027	0.0009
2	1,600	0.020	29,000	25,000	0.0022	4	0.9	< 1	0.0018	0.0004
3	1,200	0.017	45,000	37,000	0.0022	4	0.9	< 1	0.0013	0.0009
4	750	0.017	77,000	67,000	0.0014	5	0.7	2.5	0.0012	0.0002
5	470	0.013	150,000	145,000	0.00085	6.5	0.6	1.4	0.0008	0.00005
6	300	0.011	265,000	200,000	0.00087	7	0.6	1.0	0.0007	0.0002
7	190	0.013	380,000	290,000	0.0011	8	0.9	1.2	0.0008	0.0003
8	120	0.015	560,000	345,000	0.0016	9	1.4	1.5	0.0010	0.0006
9	75	0.016	800,000	410,000	0.0023	9	2.1	2.0	0.0012	0.0011
10	45	0.018	1,100,000	480,000	0.0036	9	3.2	3.0	0.0016	0.002

a constant order and this condition is approached throughout the lower frequency ranges of the wavemeter.

The column of values of $R/2r$ is interesting since it shows to a high degree of approximation the influence of the valve circuit upon the natural frequency of the simple resonant circuit. Moreover, from these values can be gauged the effect of changing valve characteristics with age upon the calibration permanence of the wavemeter. Any change in the value of r is likely to be an increase, and, of course, oscillation would cease when the value L/CR was reached. The difference between the normal and "oscillation cessation" values of $R/2r$ or $R^2C/2L$ can be regarded as a criterion* of the possible maximum frequency errors due to valve changes with age as distinct from the probable short period instability given in the curves of Fig. 21. In the last column of tabulation IV these possible frequency errors with time are given. On all but the very lowest frequency the inconstancy will be seen to be less than 0.001 per cent.—four or five times better than the constancy of the LC value of the oscillatory circuit.

The Effect of Valve Replacement upon Calibration

Since the valve circuit of the wavemeter has so little effect upon the natural frequency of its oscillatory circuit it was thought that its calibration could be made independent of valve replacement.

For this purpose, therefore, a very small variable air condenser was incorporated in the design inside the screen of the main variable condenser. Its function is to compensate for the differences between the anode to screen grid capacities of the spare valves and that of the calibrated valve which they are intended to replace. These interelectrode differences were found to be always less than 0.2 $\mu\mu F$, and so it was possible to limit the range of the compensating condenser to an exceedingly low value even after provision had been made for double this variation due to the use, in some cases, of two valves in parallel.

* A rather severe criterion, since oscillation at the lower values of L/CR for each range would have ceased before such an increase in valve resistance had occurred.

Valves could not be chosen having similar interelectrode capacities because the more important negative resistance characteristic selection already mentioned took prior claim.

How nearly the wavemeter was by this selection rendered independent of the valve in use is clearly shown by the tabulation V giving frequency errors introduced by the substitution of spare valves for the one with which the calibration had been effected.

TABULATION V

Approximate frequency (kilohertz).	Frequency errors introduced by the substitution of spare valves.			
	A	B	C	D
	Per cent.	Per cent.	Per cent.	Per cent.
1,000	+0.0008	+0.0017	+0.0015	+0.002
600	+0.0008	+0.0017	-0.0005	0
380	+0.0008	+0.0017	-0.001	-0.001
250	+0.0008	+0.0017	-0.001	-0.001
160	+0.0008	0	-0.0005	-0.0005
100	-0.0008	0	-0.0015	-0.0005
60	-0.0008	-0.0017	-0.0015	-0.001
37	-0.0008	-0.0017	-0.0015	-0.0015

In each case a constant setting of the compensating condenser was made for the whole of the ranges tabulated, but different values of suitable electrode potentials were, of course, determined for each spare valve, independently, prior to calibration in a manner similar to that employed in the case of the calibration valve.

In the actual calibration of the wavemeter the compensating condenser was naturally set to an appropriate value for each independent range, thus eliminating the small range-to-range errors given in the tabulation. Errors of the same order or, in some cases somewhat higher, were, however, experienced throughout each range, but for one predetermined setting of the compensating condenser the frequency error introduced by the substitution of spare valves was always less than 1 part in 20,000 at any capacity setting of any range.

The National Physical Laboratory, in fact, in a report on a wavemeter of this type, states that "Check points were taken with the two pairs of spare valves at about 30° and 120° on the AB ranges and at about 70° on the BC ranges, but no differences were obtained provided that the respective pairs

of valves were operated under the conditions indicated in Tables 3 and 4." This statement covered the full wavelength range of the wavemeter, and the condenser readings of 30°, 120° and 70° correspond with equally spaced capacities throughout each range. The tables mentioned merely give the selected operating potentials of the various electrodes and the settings of the compensating condenser, all of which were constant throughout the ranges associated with any single-range coil.

The importance of this feature will be appreciated by many who have endeavoured in vain to "fit" a spare valve to a calibration (throughout a wide range of frequency) which has been effected with another valve having apparently similar characteristics. It should be clearly understood that the compensating condenser merely compensated for the different anode to screen grid capacities of the valves and that no compensation was provided for their different voltage-current characteristics. This proves that the electrode potentials had been chosen correctly and that the frequency generated must be stable.

Conclusion

In conclusion, the author would like to summarise the results thus.

The wavemeter has a calibration permanence limited only by the permanence of the natural frequency of its oscillatory circuit, which is, for a wide range meter it must be remembered, 0.005 per cent. This high degree of permanence can only, in the author's opinion, be attained by the use of the author's complementary series dielectric gap variable condenser in conjunction with his thermal compensated inductance standards. With a proper selection of valves and their operating conditions, the valve circuit, or even valve replacement, does not contribute to the inaccuracy of the wavemeter, even throughout a considerable period of time, since the inconstancy due to this cause throughout the life of the valve is only of the order 0.001 per cent. Even the short period stability of generated frequency can hardly be said to be governed by the valve, since, for a constant temperature, the fre-

quency instability is only of the order 0.0001 per cent. to 0.0002 per cent., whereas the temperature coefficient of the wavemeter is at least ten times this value per degree Centigrade. This high degree of stability can be attained only by very careful exploration of the negative resistance portions of the valve characteristics by a dynamic method before making a judicious choice of operating conditions. Failure to do this has, in the author's opinion, been responsible for the failure of many workers to produce really stable dynatron oscillators.

It is interesting to note that the stability of the natural frequency of the resonant circuit itself is at least as good as that of the modification of the frequency of that circuit due to the associated valve circuit. The variable condenser, owing to its series gap principle of construction, can, during oscillation, be treated quite roughly, even to the extent of endeavouring to raise it by its spindle, without affecting the generated frequency by even 1 part in 10⁶.

The author recently designed two dynatron oscillators of about 100 kilohertz frequency for use in a beat tone oscillator. The stability of oscillation of these was such that the beat frequency was stable to the order 0.1 or 0.2 cycle per second (1 or 2 parts in 10⁶), considerable temperature changes affecting both oscillators similarly.

Although the wavelength range of the wavemeter described is limited to 150-10,000 metres, the author hopes to describe, in a future article, a method by which this range may be extended down to 30 metres without loss of accuracy or stability.

New Radio Department at the N.P.L.

WE understand that with effect from 1st May a new Radio Department has been formed at the National Physical Laboratory, under the superintendence of Mr. R. A. Watson Watt. The new Radio Department includes the former Wireless Division of the N.P.L. Electricity Department, and also the Radio Research Station at Slough, which will continue in its present work and location as an "out-station" of the Laboratory.

Decoupling Efficiency*

By the late W. A. Barclay, M.A.

THE "efficiency" of any given system of decoupling may be defined as the relative proportion of the total L.F. current which is by-passed through the condenser. This figure may be conveniently expressed as a percentage, and will, of

minimum figure for the efficiency which will be exceeded in the case of every practical working frequency.

The percentage of L.F. current by-passed through the condenser may be expressed by the formula

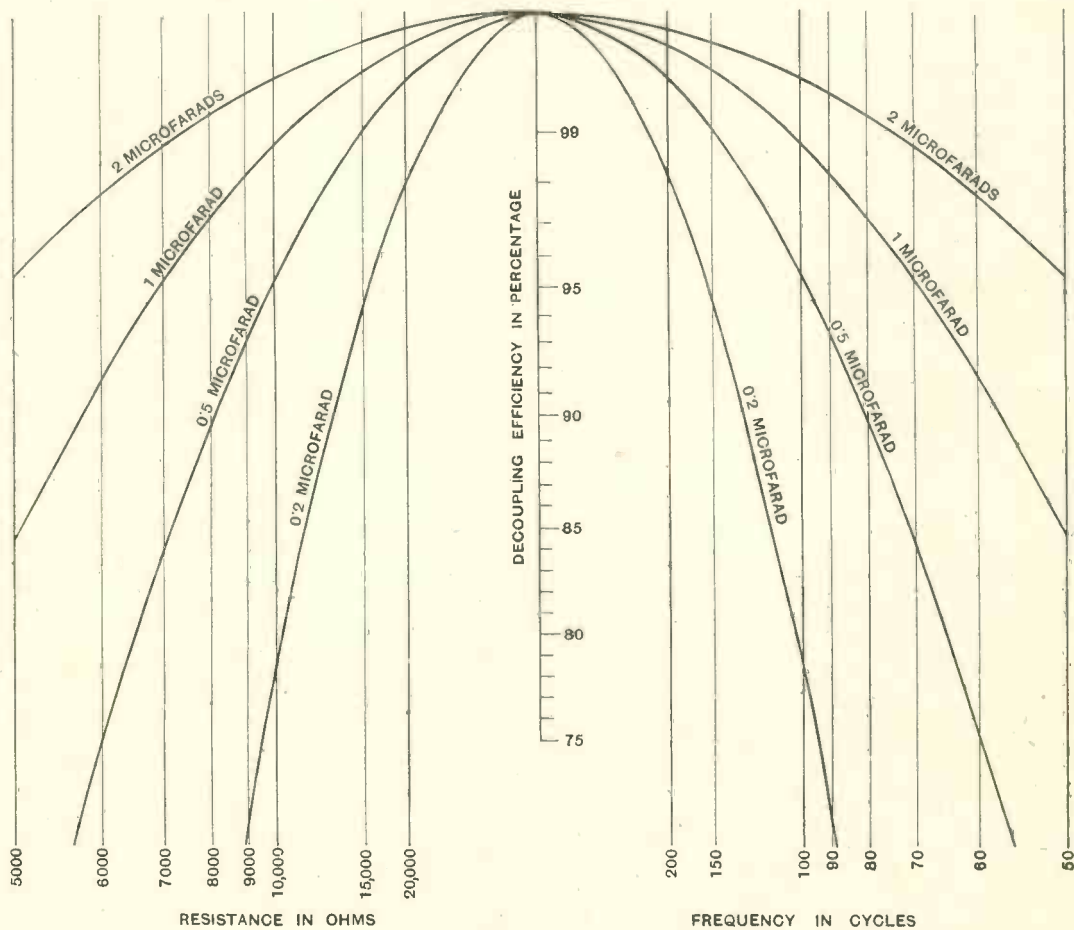

Fig. 1.—Alignment chart for decoupling efficiency.

course, approach 100 per cent. as the frequency is increased. In computing the efficiency of a decoupling system, therefore, it is well to take some standard minimum frequency, say 50 or 100 cycles per second, as the basis of calculation. This will give a

Percentage decoupling efficiency

$$= \frac{R}{\sqrt{R^2 + \frac{1}{\omega^2 C^2}}} \times 100$$

where R denotes the ohmic value of the decoupling resistance. C the condenser capa-

* MS. received by Editor August, 1932.

city in farads, and ω as usual the product $2\pi \times$ frequency in cycles per sec.

This is an awkward formula in which to substitute numerical values, especially when the process has to be repeated several times, as, e.g., when it is desired to compare different combinations of R and C with a view to estimating performance. In order to overcome these arithmetical difficulties the accompanying alignment chart is now presented.

The diagram (Fig. 1) is a "four-variable single-index" chart of a type which has not previously been applied to wireless purposes. It contains two series of numbered vertical lines, those on the left representing resistance values from 5,000 to 20,000 ohms, while those on the right represent values of frequency between 200 and 50 cycles per second. It will be seen that these lines are not spaced evenly, but follow a "reciprocal" law: that is, their distances from the central vertical line are proportional to the reciprocals of their several graduations.

Superimposed upon the two series of verticals are four curves, corresponding respectively to the condenser values 0.2 mfd., 0.5 mfd., 1 mfd. and 2 mfd. These curves are symmetrically disposed about the centre vertical, and all meet in a common vertex.

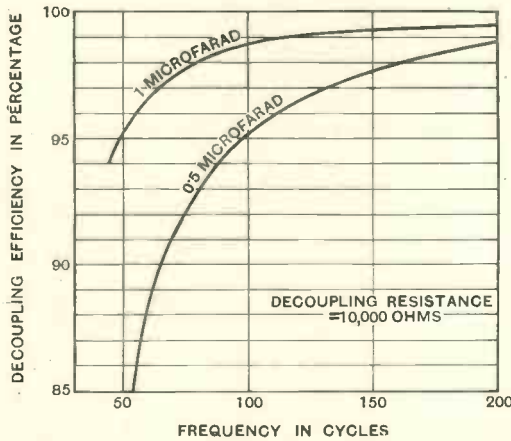

Fig. 2a.—Efficiency graph for fixed decoupling resistance.

Lastly, the central vertical itself bears a scale of values of "decoupling efficiency," expressed as a percentage. Only the more useful values are shown in this scale, ranging

actually from 99 to 75 per cent., though, of course, had it been desired to do so, the diagram could have been extended downwards to include still smaller values of efficiency.

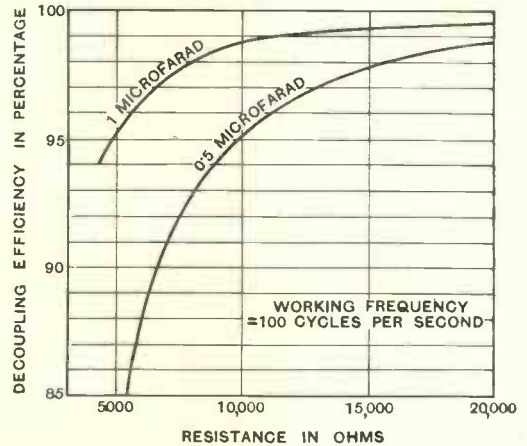

Fig. 2b.—Efficiency graph for fixed working frequency.

It will have been remarked that each condenser curve meets both sets of vertical lines. We have thus two networks, or separate systems of numbered lines and curves. That on the left gives values of condenser and resistance, while that on the right indicates values of condenser and frequency. On each of these networks it is thus possible to find the position of a point which will correspond to given values of these quantities. Naturally, the two points concerned must lie on the same condenser curve in any instance, since the capacity value is the same in both networks. The position of the points on the curve will, however, vary in each network according to the values of resistance and frequency in question.

The method of using the chart is simple. If P be the point on the left-hand network corresponding to a given condenser value and resistance, while Q is the similar point on the right-hand network corresponding to the same condenser and the working frequency, then the index-line between P and Q will meet the central vertical scale in the required value of decoupling efficiency. For example, a decoupling resistance of 10,000 ohms with a condenser of 1 mfd., will be found to have an efficiency at 50 cycles of just over 95 per cent.

The remarkable utility of this chart will

be apparent to the user. By its means the effect of altering the value of any of the variables can be immediately estimated. Thus, in the above example, the effect on the decoupling efficiency of increasing the frequency from 50 to, say, 100 cycles can be studied. Since the condenser and resistance values remain unaltered, the point used for these values on the left-hand network is fixed, and may be used as a pivot on which the index-line is swung. The free end of the index is then made to follow the course of the "right-hand" curve for 1 mfd., pausing at the intersection of each frequency line to note the corresponding value of decoupling efficiency. Other examples could be multiplied.

The two diagrams Figs. 2a and 2b have

been plotted from data taken from this alignment chart. Fig. 2a illustrates the improvement in decoupling efficiency which takes place as the frequency is increased. For this purpose a decoupling resistance of 10,000 ohms was assumed, the two curves corresponding to condensers of the values shown. Fig. 2b, on the other hand, shows the essential dependence of the decoupling efficiency upon the resistance value chosen. The working frequency is here assumed to be constant at 100 cycles per second, and, as before, the results for two condenser values are shown. It will be seen that the curves in the two figures are precisely similar, this being due, of course, to the symmetry of the decoupling formula which has been already noted as a feature of the alignment chart.

Completion of B.B.C. Regional Scheme

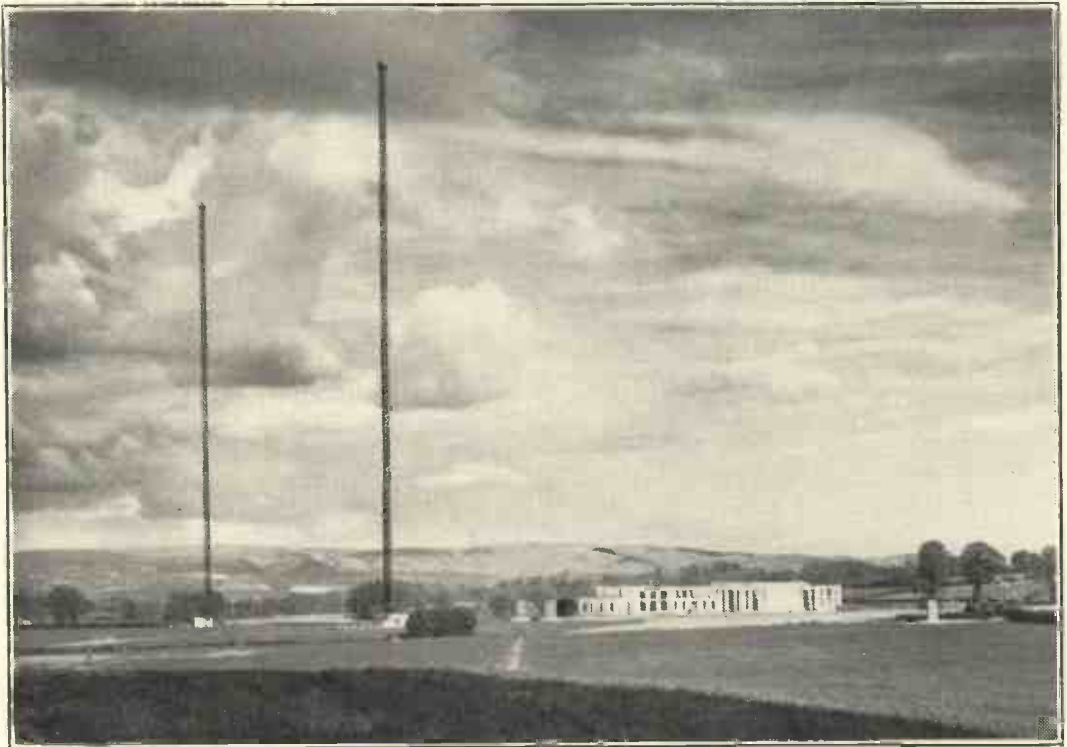

A general view of the B.B.C. West Regional broadcasting station at Washford Cross, near Minehead, Somerset, which has now begun regular transmissions on a wavelength of 309.9 metres. The National transmitter, with which tests will begin shortly, will be synchronised with London National on a wavelength of 261.6 metres. The new station is the last of the B.B.C. twin wave transmitters of the Regional scheme.

A Valve Voltmeter for Audio Frequencies Calibrated by Direct Current

IN a previous article* a description has been given of a particular type of radio-frequency valve voltmeter which could be calibrated to a useful degree of accuracy by comparatively simple direct current measurements. It was pointed out that the same 0-120 microammeter involved and incidentally, the same valve, were equally suitable for incorporation in another type of valve voltmeter of great utility in experimental work on radio receivers, namely, an audio-frequency voltmeter of the type first described in principle by James Taylor.† The characteristics of this voltmeter are: (a) constant calibration for all frequencies in the audible range; (b) calibration independent of the valve characteristic to within one or two per cent., and independent of filament voltage over a wide range of variation of the latter; (c) fairly high input resistance; (d) range easily variable by a change of resistance, the lowest accurate range being about 20 to 30 volts for full scale deflection, making it suitable for measurement of loud-speaker voltages; (e) linear scale; (f) calibration carried out by simple direct current measurements.

The instrument operates by linear rectification of the applied alternating voltages, and before describing it in practical and constructional detail, it will be well to give a brief account of the theory.

Suppose we have a perfect rectifier, *i.e.*, one which has zero conductivity in one direction and constant conductivity in the other. If an alternating voltage be applied to the terminals of such a rectifier in series with a galvanometer or other d.c. indicating instrument, the latter will record the average value of the current, which is clearly half the mean value of half a cycle. Thus, for a sine wave alternating voltage of amplitude or peak value \hat{v} , the recorded current will be $i = \hat{v}/\pi R$, where R is the resistance of the rectifying circuit in the

conducting direction. Conversely, the recorded current i will indicate a voltage having an amplitude $\hat{v} = \pi R i$. Such a rectifier could therefore be used as a voltmeter, having a linear scale proportional to the mean value of half a cycle of the applied voltage, *i.e.*, proportional to the amplitude and therefore to the R.M.S. value in the case of sine wave voltages. The linear scale is, of course, a very desirable feature in this arrangement, but it must be noted that since the indications are proportional to average value, they will depend on wave form in a manner somewhat different from that for a R.M.S. instrument, and their true significance must be borne in mind in any quantitative application. This is not a very serious limitation in practice, as will be shown in more detail later on.

A very close approximation to the postulated type of characteristic can be obtained by the arrangement shown in Fig. 1, which consists of a triode used as a diode (*i.e.*, with grid and anode connected) in series with a high resistance. In the paper referred to above, Taylor gives a mathematical analysis of this circuit, showing that it gives very approximately the characteristics of a perfect rectifier. It really amounts to the fact that the resistance is exceedingly high in one direction, and is practically that of the external resistance, and is therefore constant, in the other.

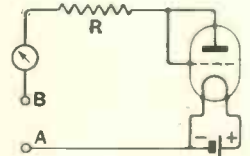

Fig. 1.

If the characteristic of the valve itself is known, the actual behaviour of the valve-resistance combination can be determined in a very simple manner. Suppose, for example, that the valve is a PM252 as used in the radio-frequency voltmeter already referred to. The characteristic of one such valve connected as a diode is shown in Fig. 2. Suppose further that the external resistance is exactly 100,000 ohms. To find the current through the combination corresponding to a given voltage would involve a rather complicated calculation owing to the curvature of the valve characteristic,

* "Valve voltmeter, Designed for Calibration by Direct Current," *Wireless World*, October 14th, 1931.

† "An Application of the Diode to the Measurement of A.C. Voltages," James Taylor, M.Sc., *Journal of Scientific Instruments*, Vol. III, pp. 113-116.

but this difficulty can be evaded by the simple expedient of reversing the process. For a resistance R and an assumed current i the voltage across the valve and resistance in series will be $Ri + v$, where v is the voltage drop in the valve as shown by the characteristic. It is thus a simple matter to

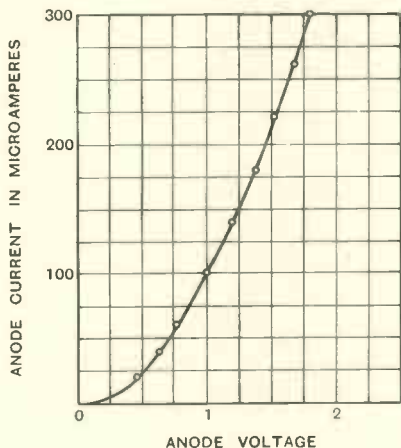

Fig. 2.

calculate the current-voltage characteristic of the combination, and Fig. 3 shows the result obtained for the particular valve in question with an external resistance of 100,000 ohms. It will be seen that it is a straight line passing not quite through the origin. This last fact will be neglected for the moment. From the slope of the line, or, more correctly, the reciprocal of the slope, AB (in volts)/ BC (in amperes), the effective resistance of the combination R_e , can be calculated. In the given case it is 105,000 ohms, of which the 5,000 ohms represents a sort of average contribution of the valve. The calibration of the combination as an a.c. voltmeter will be, as already shown,

$$\hat{v} = \pi R_e i = 3.14 R_e i$$

for peak value, or

$$V = \pi R_e i / \sqrt{2} = 2.22 R_e i$$

for R.M.S. value.

This is one method of d.c. calibration. A more direct method is the actual determination of the current-voltage characteristic of the valve-resistance combination by applying the appropriate known d.c. voltages. In this case it is not necessary to know either the value of the resistance R or the calibration of the indicating instrument. This more direct method is obviously to be

preferred where the necessary d.c. voltmeter of sufficient accuracy is available for the purpose.

We can now consider the correction for the fact that the characteristic line does not pass exactly through the origin. In the case illustrated in Fig. 3 it cuts the voltage axis at 0.5 volts. An input alternating voltage would have to reach this value 0.5 volts before it could produce any current at all in the rectifier circuit. An approximate correction for this small effect can clearly be made by adding 0.5 volts to the apparent measured peak value of the a.c. voltage, or, if the scale is calibrated in R.M.S. values, by adding $0.5/\sqrt{2}$, i.e., 0.4 volts to the reading. The more exact formula for the calibration is therefore

$$V = 2.22 KO + v_0/\sqrt{2}$$

where v_0 is the intercept on the voltage axis. The correction term is small, but since it is a constant it becomes significant at the low end of the scale.

Either of the above methods of calibration is capable of giving a good degree of accuracy. One such instrument designed for a full scale deflection of 55 volts was found to be correct to better than $\frac{1}{3}$ per cent. at full scale when checked by very accurate measurement at 50 cycles.

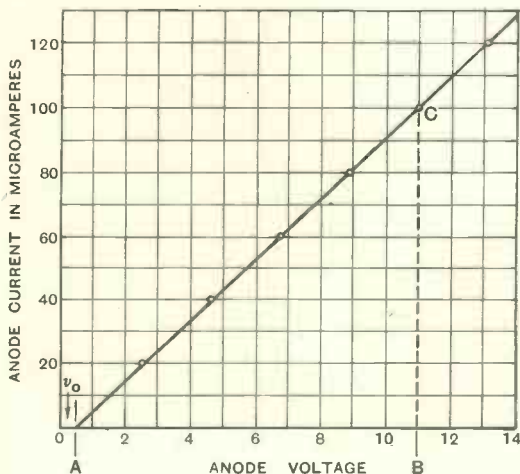

Fig. 3.

The design of the voltmeter can now be discussed in practical detail. The valve used should be one having as low a resistance as possible when connected as a diode. Most of the two volt dull emitter class would be suitable, but the power types will have the

lowest resistance. The PM252 valve used in the radio-frequency voltmeter will therefore do very well. The resistance is required to be constant with respect to frequency, and must therefore be non-inductive. The magnitude of the resistance obviously determines the range, which can be increased up to 100 volts or more by using a sufficiently high value. The lower the resistance, the lower will be the voltage for full scale deflection, but the less accurately will the ideal linear characteristic be obtained. About 100,000 ohms is the lowest value that can be used without appreciable loss of accuracy with the d.c. method of calibration. This will give full scale for about 26 volts using a $120\mu A$ d.c. instrument. The sensitivity ultimately depends on that of the indicating instrument, which should therefore have the highest sensitivity of the pointer type. The $120\mu A$ unipivot microammeter made by the Cambridge Instrument Co., which was suggested for the radio-frequency voltmeter, is very suitable for the present purpose.

As far as assembly and wiring are concerned, the voltmeter circuit is very simple in character and calls for no special pre-

there is no provision for adjustment of filament voltage. Such adjustment is quite unnecessary. It will be found that the deflection is independent of filament voltage to a surprising degree.

Two points in connection with the application of the instrument call for special mention. The first of these is that it cannot be used in its simplest form for the measurement of a.c. voltages having a d.c. component. In such cases it is necessary to balance out the d.c. component so that the instrument reads zero when the pure a.c. voltage is removed. An example is the measurement of the voltage across a loud-speaker connected directly in the anode circuit of a valve. The arrangement shown in Fig. 5 can be used to balance out the d.c. voltage. The necessary potentiometer and switch can be included in the assembly if the instrument has often to be used in this way, but in general the measurement circuit can be so arranged as to carry pure alternating current only.

The other point relates to wave-form. It has already been pointed out that the instrument actually reads the mean value of half cycles, and the R.M.S. calibration will therefore apply accurately only to sine wave voltages. The effect of departure from sine wave form is, however, less than one might imagine. For a sine wave the calibration formula contains the factor 2.22. The following table shows the true value of the factor for other types of wave form.

Wave Form.	Calibration Factor.
Sine	2.22
Semi-circle	2.12
Parabola	2.19
Triangle	2.31
Rectangle	2.00

It will be seen that only in the rather extreme case of a rectangular wave form is the factor more than 5 per cent. different from that for a sine wave. If preferred the calibration can be stated in mean values, and no question of wave form will then arise at all, unless for any purpose it is necessary to convert to R.M.S. values.

F. M. C.

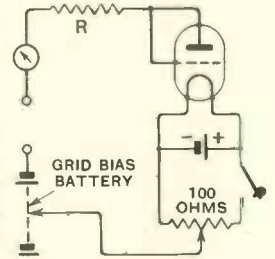

Fig. 5.



Fig. 4.

cautions or instructions beyond proper attention to insulation. No by-pass condensers are required. A model constructed in the laboratory of *The Wireless World* is illustrated in Fig. 4. It will be noted that

Correspondence

Letters of technical interest are always welcome. In publishing such communications the Editors do not necessarily endorse any technical or general statements which they may contain.

Vibrations of a Coil-driven Paper Cone

To the Editor, *The Wireless Engineer*.

SIR,—Referring to Mr. Strafford's article, "Vibrations of a Coil-driven Paper Cone," in the March number of *Wireless Engineer and Experimental Wireless*, describing the observation, in connection with a vibrating loud-speaker diaphragm, of an additional note of a considerably lower tone, I should like to communicate that identical observations were made here in my laboratories about a year ago and led me to arrange a series of investigations with the object of elucidating the occurrence of these sub-harmonics, as I call them.

These comprehensive mathematical and experimental investigations which have led to quite satisfactory explanations of the phenomenon are now completed and a detailed publication is under preparation and will be issued in the course of about two months: P. O. Pedersen; "Sub-harmonics in Forced Oscillations" ("Ingeniorvidenskabelige Skrifter Nr. 35," G. E. C. Gad, Copenhagen). An abridged report of the work has been published in the Danish periodical *Ingenioren*, Nr. 4, 1933, January 28th, of which you will find a copy herein enclosed.

As Mr. Strafford expressed the desirability of someone undertaking a mathematical analysis of the phenomenon it may possibly have sufficient interest to set forth already here a short indication of the results obtained.

If we have a mechanical system with one degree of freedom and the mass m , further, a damping resistance r_0 and a non-linear elastic force $s_0(I + a_1x)x$, and such a system be acted upon by a sinusoidally varying vibro-motoric force $F_0 \sin 2\omega t$ (frequency $f = \frac{2\omega}{2\pi}$) then the resulting motion of the system will be determined by the differential equation

$$m_0 \frac{d^2x}{dt^2} + r_0 \frac{dx}{dt} + s_0(I + a_1x)x = F_0 \sin 2\omega t \dots (1)$$

An exact solution of this equation is not possible, but an approximate one consists, as is well known, of the fundamental frequency ($f = \frac{2\omega}{2\pi}$) and a number of higher harmonics ($2f, 3f, 4f \dots$), the amplitudes of the latter being small compared with the amplitude of the fundamental frequency as long as $|a_1x| \ll |I|$.

It is found, however, that if

$$a_1^2 A^2 > \frac{(1 - \xi^2)^2 + 4p_0^2 \xi^2}{3 - 2\xi^2} \dots (2)$$

where A is the amplitude of the fundamental oscillations of frequency f , and where

$$\xi = \frac{r_0}{\omega_0}, p_0 = \frac{r_0}{2\omega_0 \cdot m_0}, \text{ and } \omega_0 = \sqrt{\frac{s_0}{m_0}}$$

the solution also contains oscillations having the

frequency $\frac{1}{2}f = \frac{\omega}{2\pi}$ and its higher harmonics $3/2f, 5/2f \dots$. The condition (2) only holds good though when $|a_1x| \ll |I|$.

Sub-harmonics may further arise in a system where the acting force besides being a function of the time t is also a function of the displacement X (for example, in the case of a moving coil in an inhomogeneous magnetic field).

The validity of formula (2) has been proved experimentally both for pure mechanical, electro-mechanical and pure electrical oscillating systems. The figure shows the very satisfactory agreement between theory (formula (2)) and experiment for an oscillatory electric system, curve I showing the calculated, curve II the experimentally found relation between the critical $a_1^2 A^2$ -value and the detuning ($\xi^2 - 1$).

This theory can be extended to oscillating systems having more than one degree of freedom (the loud-speaker diaphragm may be considered one of these), and the conditions which give rise to sub-harmonics are here essentially the same as for a simple system, namely, the presence of non-linear terms in the differential equations of the system. It is easily proved that sub-harmonics cannot arise in systems determined by linear differential equations, however complicated the systems may be.

In a system having but one degree of freedom sub-harmonics can only be had of the frequency $\frac{1}{2}f$. In a system having more degrees of freedom it is further possible to have sub-harmonics of the frequencies $\frac{1}{4}f, \frac{3}{4}f$ and so forth. Sub-harmonics of $\frac{1}{4}f$ are thus observed here with one of our loud-speakers, and it would be of interest to learn whether Mr. Strafford has made similar observations.

P. O. PEDERSEN.

Laboratory of Telegraphy and Telephony,
Royal Technical College, Copenhagen.

Iron Cores for High-frequency Coils

To the Editor, *The Wireless Engineer*

SIR,—In your journal (*The Wireless Engineer*, Nr. 115, Vol. X, April, 1933) an article appeared, entitled "Iron Cores for High-frequency Coils," by Alfred Schneider, where the author gives some theoretical considerations about Vogt's iron cores for high-frequency coils. As a subscriber of your journal I am sorry to say that in my opinion the greater part of these considerations is not at all correct. This can be easily shown by an elementary mathematical proceeding and also has been proved by our experiments. Mr. A. Schneider probably would be rather embarrassed if he were asked to give exact figures in order to prove his theories. We will give these figures, and we hope to show in this way better than by any other explaining, why the vague observations of Mr. Schneider are not in accordance with the facts.

Mr. Schneider says that Vogt has discovered a

new source of losses, the "capacitive eddy currents." It is very possible such currents exist. And in this case they must produce dielectric losses in the insulating material. But what is the real value of these losses?

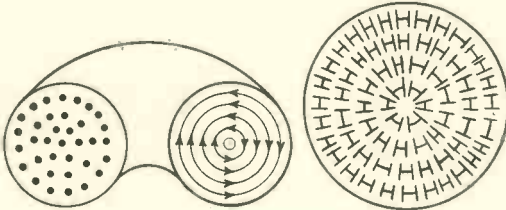

Fig. 1.

Fig. 2.

First, let us consider the capacity of a common core of insulated iron powder, without any intermediate paper layers. Fig. 1 may represent such a core with a round section. The arrows show the direction of the capacitive eddy currents. Each two iron particles separated by the insulating skin form a sort of little condenser. So, in the path of the capacitive eddy currents we have a chain of little condensers (Fig. 2). Supposing the capacity between two magnetic particles to be c , and the number of the particles, forming one chain, to be n , the total capacity of one chain is given by the equation:

$$C = \frac{c}{n} \dots \dots \dots (1)$$

As the number n falls as we approach the centre of the core, the capacity of each chain increases. Instead of imagining all these circuits or chains, each one consisting of n condensers, we may consider circuits with only one condenser, having the same capacity:

$$C = \frac{c}{n}$$

In this case the distance d between two condenser "plates" is represented by the sum of the distances between the iron particles of one chain (Fig. 3). It is evident that this distance is proportional to the radius x of every chain; and its real value can be easily calculated, even without knowing exactly the distances between the iron particles and their number, by the following approximate proceeding.

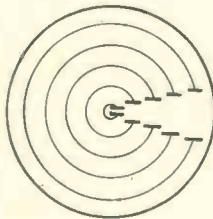

Fig. 3.

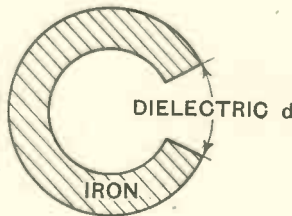

Fig. 4.

We know the permeability μ_r in a magnetic circuit, consisting of an interrupted iron ring

(Fig. 4) is given by the equation

$$\mu_r = \frac{\mu_i}{\frac{d}{2\pi r} (\mu_i - 1) - 1} \dots \dots (2)$$

As the iron used for Ferrocart cores has the very high permeability (μ_i from 2,000 to 20,000) we may write with great approximation:

$$d = \frac{2\pi r}{\mu_r} \dots \dots \dots (3)$$

As the permeability of the Ferrocart material is known to be about 12 to 13, and can be measured at any time, we can get the value of d .

The total surface of the condenser "plates" separated by this imagined distance d is

$$S = l \cdot r \dots \dots \dots (4)$$

and one element of this surface may be

$$dS = l \cdot dx \dots \dots \dots (5)$$

The capacity of this element (Fig. 5) against the same element of the opposite plate in one condenser chain is represented with sufficient approximation by the equation:

$$dC = \frac{dS \cdot \epsilon}{4\pi d} \dots (6)$$

ϵ being the dielectric constant of the insulating mass. Replacing dS and d by their values, we get:

$$dC = \frac{\epsilon \cdot \mu \cdot l \cdot dx}{8\pi^2 x} \dots \dots (7)$$

The electric charge of this condenser is given by:

$$dQ = e \cdot dC \dots \dots (8)$$

e being the electromotive force, induced in the capacitive circuit by the magnetic flux. And for the current, circulating in this circuit, we may write:

$$di = \frac{\partial(dQ)}{\partial t} = \frac{\partial e}{\partial t} \cdot dC \dots \dots (9)$$

Now

$$e = - \frac{\partial \phi_x}{\partial t} \dots \dots (10)$$

ϕ_x being the magnetic flux in a section of the radius x .

$$\frac{\phi_x}{\phi_i} = \frac{x^2}{r^2} \dots \dots (11)$$

when ϕ_i is the total flux in a section of radius r . Eliminating ϕ_x in equation (10) we get:

$$e = - \frac{\partial \phi_i}{\partial t} \cdot \frac{x^2}{r^2} \dots \dots (12)$$

and, replacing e and dC by their values, given by equation (8) and (12) we obtain from equation (9):

$$di = \frac{\partial^2 \phi_i}{\partial t^2} \cdot \frac{\mu \cdot \epsilon \cdot l \cdot x \cdot dx}{16\pi^2 r^2} \dots \dots (13)$$

Integrating this equation from 0 to r , we obtain the total capacitive eddy current in the core:

$$i = \frac{\mu \cdot \epsilon \cdot l}{16\pi^2} \cdot \frac{\partial^2 \phi_i}{\partial t^2} \dots \dots (14)$$

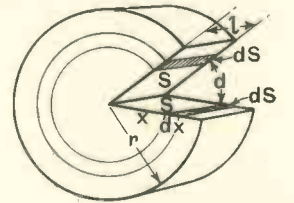

Fig. 5.

By means of equation (9) we have :

$$i = \frac{\partial e}{\partial t} \cdot C \dots \dots \dots (15)$$

And, replacing e by its value given by the equation (10), we get :

$$i = \frac{\partial^2 \phi_m}{\partial t^2} \cdot C \dots \dots \dots (16)$$

Finally, replacing i in the equation (13) by this last value, we obtain the capacity, causing the losses in the dielectric material :

$$C = \frac{\mu \cdot \epsilon \cdot l}{16\pi^2} \dots \dots \dots (17)$$

Putting $\mu_r = 12 \dots 13$, $\epsilon = 2 \dots 3$, depending on the insulating material, the length l of the core (better : of the magnetic circuit) = 5 cm. to 10 cm., varying with the design of the core, we get :

$$0.75 \text{ cm.} < C < 2.25 \text{ cm.} \dots \dots (18)$$

Considering the whole system as a transformer, we can imagine the self capacity of the iron core as a parallel capacity to the tuning coil (Fig. 6). The actual size of this little capacity will then vary with the square of the ratio of this transformer. Thus :

$$C' = C \frac{T_1^2}{T_2^2} \dots \dots \dots (19)$$

As the iron core forms only one turn, as shown above, and the tuning coil for the broadcasting range has about 60 . . . 80 turns, the additional capacity, caused by the capacitive effect of the iron particles, will be :

$$0.00012 \text{ cm.} < C' < 0.0007 \text{ cm.} \dots \dots (20)$$

As the tuning capacity in a resonating circuit, employed in a wireless set varies between 50 and 500 $\mu\mu\text{F.}$, it is obvious that no considerable damage



Fig. 6.

can be obtained by introducing 0.0001 . . . 0.001 $\mu\mu\text{F.}$ more, even with the worst possible dielectric. It has to be remembered that the self-capacity of a tuning coil, which is usually 3 . . . 5 $\mu\mu\text{F.}$, is still enormously high compared with the effect introduced by the capacity of the core.

It can be shown that the introduction of paper layers can reduce the capacity of the core to about a half of the above-mentioned figures. On the other hand, space is wasted and less iron remains in the core, so that the total magnetic flux decreases. The diminution of the magnetic field must be compensated by the number of turns and the additional resistance losses in the wire are several hundred times as great as the capacitive losses in the core.

Beyond all that, if really the losses caused by the capacitive eddy currents should be of any importance, the insulation of the iron mass by paper is a perfectly false proceeding for reducing such losses, as paper is known as one of the worst

dielectrics and, therefore, a diminution of the capacity would not necessarily cause a diminution of losses.

The real reason why Hans Vogt uses the paper layers—and Mr. Schneider does not deny this fact—is because the insulation of the iron particles is not perfect. The paper layers serve only to reduce the common eddy currents (not the capacitive ones) which can cause considerable losses in a semi-conductor like Ferrocart, if no intermediate insulation is applied.

As a matter of fact our laboratory could produce iron cores without paper layers, or any other kind of intermediate insulation, having particles insulated from each other by a special process, whereby the efficiency of coils having exactly the same physical dimensions as Ferrocart coils (coil and core) owing to the increased mass of iron and so of the magnetic flux, have 50 per cent. better performance than Ferrocart at any frequency.

We think that after what we have said it is quite superfluous to criticise further the described manner of producing Ferrocart, as—referring especially to the aligning method, employing a magnetic field—nothing of this kind is either necessary or really possible in practice.

Berlin.

ING. GEORG NISSEN.

The Theory and Practice of Tone Correction

To the Editor, The Wireless Engineer.

SIR,—My attention has been called to an error in Fig. 4 and in Fig. 7 of my article on "The Theory and Practice of Tone Correction," published in your issue for January, 1933. In each case " μH " should read "mH." It is clear from Section 3 of the article that this should be so, but I must apologise to your readers for passing these slips in the proof stage.

F. M. COLEBROOK.

The Principles of Electromagnetism

To the Editor, The Wireless Engineer

SIR,—Your second Editorial and the correspondence on this subject in your April issue compel me again to beg a little of your space.

It is, of course, quite possible to replace a magnet by a current-carrying coil as you suggest, but the laws of the magnetic field have to be established eventually, and it is here that the difficulties arise!

With regard to the distinction between B and H , I will only comment on the remark inserted in your Editorial on the right of Fig. 3 on p. 181. The whole of this discussion turns upon the "phenomenon" here involved. How do we know it exists in air or vacuous space? Because a magnet (or current-carrying coil) is acted upon by an observable mechanical force. How do we know that it exists in other media? Generally because when it is caused to change a quantity of electricity is caused to pass round an encircling coil. But how do we know that this quantity of electricity is related to the phenomenon in question? The answer obviously is that Faraday's Law enables us to calculate the relationship. Certainly! But what is the thing which when caused to change gives rise, according to this law, to the induced

E.M.F.? This is a hard question and there is no answer! All we know is that in air or vacuous space when there is a change throughout the encircling coil of a state measured quantitatively by a product of a field strength (as measured by a mechanical force exerted on a magnet) and an area, then the E.M.F. is induced.

Is there any reason to suppose that the change of state inducing an E.M.F. in a coil in vacuous space differs from the change causing a similar E.M.F., though perhaps of relatively greater magnitude, if the coil surrounds a ferromagnetic medium? If not—and I think no one will wish to claim a difference— B and H must be the same thing unless it is conventionally agreed that under certain circumstances a particular component of B shall be described by another name and indicated by H . But if so, why introduce μ_0 ? It is always a number because it connects two quantities measured in the same way.

No, Sir, with all due deference I would observe that it is not I who claim "to know more of the secrets of nature than have been revealed to the rest." It is the members of those Committees who at Oslo, London and Paris have resolved:—

"(C) That B and H are quantities of different nature."

There is no question in this resolution as to its being convenient to regard them as different. Not at all! They *are* different—whether Nature has really made them different or not!

C. L. FORTESCUE.

To the Editor, *The Wireless Engineer*.

SIR,—I was pleased to read in the April issue of *The Wireless Engineer* that you are inclined to consider H and B as quantities of different natures.

In many text-books on electricity the relation between these two quantities is given by the following expression:

$$\vec{B} = \vec{H} + 4\pi\vec{J}$$

where J represents the intensity of magnetisation. This formula, which seems to indicate that H and B are of the same nature, has no meaning whatever if the involved quantities are expressed in electrostatic units. This is due to the fact that the correct relation between B and H is really given by:

$$\vec{B} = \mu_0\vec{H} + 4\pi\vec{J}$$

where μ_0 is the value of permeability for a vacuous space. If in the electromagnetic system of units μ_0 is numerically equal to 1 (so that B and H may be mistaken for quantities of the same nature), it should not be forgotten that in the electrostatic system of units μ_0 is numerically equal to $1/v^2$ and has the dimensions of this quantity, where v is the velocity of light in vacuum.

This remark, I think, is sufficient to show the danger of considering H and B as quantities of the same nature; they may be sometimes proportional, like stress and strain, cause and effect, but they are surely as much different as any two physical quantities may be.

As a matter of fact, this difficulty would never

have existed if scientists had chosen a more coherent system of electromagnetic units.

Paris.

B. FREUDENBERG.

Book Review

Radio Engineering

By Frederick Emmons Terman, Sc.D. McGraw Hill Publishing Co., Ltd., London. Pp. 668. Price 30s.

A text book with a wide title is reasonably expected to have a wide and comprehensive scope. Such a title as *Radio Engineering* therefore suggests a very comprehensive treatment of the subject, and Dr. F. E. Terman's new book adequately fulfils this expectation.

The book is thoroughly up to date, the author's preface being dated August, 1932. Its modernity is shown by the fact that, in their proper places, are dealt with such modern points as the design of broadcast receivers (including power supplies and filters), short-wave adaptors to precede broadcast sets, pentodes and variable- μ valves, Barkhausen oscillators, short-wave arrays, transmission lines, etc. The modernity is further illustrated by the last chapter on "Sound and Sound Equipment," including accounts of some of the Bell Laboratories' most recent electro-acoustical and allied work.

The mere reading of chapter-headings is sufficient to indicate that the book attempts to cover every branch of modern wireless practice, but more careful reading reveals that it succeeds in doing so not only in the scope of the matter but also in its presentation. The reasoning and explanatory matter are carried out in terms of words as far as possible, but the essential mathematical relations are available for correlation. Throughout the text, also, footnote references to more diffuse treatments of particular subjects—published papers, etc.—are plentifully provided for the reader's guidance through the maze of modern technical literature. In these references, incidentally, one had the impression that English sources were not featured as much as they might have been.

The book serves as an admirable text-book taken either by itself or in conjunction with other studies in electrical or communications engineering. Several sections are particularly noteworthy; the chapter on oscillators appears a particularly good one, giving an excellent analysis of the circuits and of the characteristics of constant-frequency sources.

Considering the excellence of the book, it is, therefore, surprising to find that the section on "Band-pass Filters" deals only with what are more properly described as "band-selectors," of the type now commonly in use for broadcast receiver tuning, and that no account is given of what is more usually described as a filter. Similarly the chapter on propagation of waves fails to deal with the now generally accepted theory of two ionised regions, or with the evidence which has led to the acceptance of the belief.

Despite these criticisms Dr. Terman's book must be welcomed as a worthy newcomer to wireless literature, particularly in the manner in which it brings scattered literature up to date in collected text-book form.

J. F. H.

World Physics in Relation to Wireless

How Wireless Has Advanced Our Knowledge

THE annual Kelvin Lecture of the Institution of Electrical Engineers—delivered this year by Sir Frank Smith, K.C.B., F.R.S., Head of the Department of Scientific and Industrial Research—was devoted to the travel of wireless waves. The lecturer dealt with the subject from the broad view of world physics in relation to the propagation of wireless waves, showing in particular how wireless investigations had added to our knowledge of the atmosphere.

The story of the travel of wireless waves, said the lecturer, is, in the main, a story of the radiotelegraphist surprising himself and others by doing things which he was hardly expected to achieve, of the physicist offering qualitative explanations of these achievements, and of the mathematician bringing up the rear in a constant effort to make his too simple world (of theory) sufficiently complicated to agree with the experimental facts.

Referring to the work of the amateurs in revealing the remarkable carrying properties of short waves, the lecturer then showed how the observed facts of long-distance transmissions demanded that much of the received energy—in many cases all of it—must travel upwards from the transmitter through the air until an electrically conducting layer is reached, by which the energy is deviated with little loss down to earth again at the distant receiving station. A film was then shown of the radiated electric field from the transmitting aerial, illustrating the emission of a field along the surface of the earth and also of loops shot into the air.

Having established the importance of the upper air to the wireless scientist, the lecturer proceeded to outline the general picture of the earth's atmosphere which modern science, including wireless science, could at the moment afford us.

The lower layer of the atmosphere, known to the meteorologist as the troposphere, was of importance in relation to weather. It was also the seat of thunderstorm activity, but—apart from the production of atmospherics—the importance of thunderstorms in relation to the travel of radio waves was likely to be manifested not at the actual place and level of the storm, but at greater heights and spreading to great distances. Next above the troposphere was the stratosphere, with the ozone region immediately above it. Although the ozone region itself plays no part in the propagation of wireless waves, the theoretical explanation of its existence also led to the belief of ionisation or electrical activity at a still higher level. Further

evidence, apart from wireless, was provided by the aurora and by studies of terrestrial magnetism. The first suggestion of the existence of the ionised layer (later to be called the Kennelly-Heaviside layer) arose from the study of terrestrial magnetism and was made as long ago as 1878.

The lecturer then showed how the existence of the upper conducting regions could be used to explain the phenomena met with in the travel of wireless waves. After dealing with the travel of short waves and showing that these were suited to long-distance communication, he dealt with the medium waves of the broadcasting band. "Fading" with these waves was produced by parts of the energy from the transmitting station travelling along the ground and being at one moment augmented and at another wiped out by energy reaching the receiver from the upper atmosphere. (Cf. "Why Signals Fade" in *Wireless World* of 11th and 18th November, 1932.)

In the last part of the lecture, the speaker dealt with the information which the radio investigator had had to supply for himself. Although other sciences had told the radiotelegraphist that his necessary conducting layers were likely to be present, they had really very few definite data to give him concerning their nature. To understand fully how his waves travelled and arrived, it was necessary for the radio worker to obtain numerical information of the heights of the layers and of the number of electrons likely to be present in them at various times of the day and at different seasons of the year. Work in this country under the auspices of the Radio Research Board has accumulated considerable data which put us in the forefront of this branch of knowledge.

The lecturer described the "short pulse" method of investigating the height of the layer, described in *The Wireless World* articles already quoted above, and gave a demonstration of the reflection of waves from a suitable reflecting surface. The demonstration took the form of short pulses of sound acting directly on a microphone and indirectly, after reflection, from a board some distance above the microphone and sound source. The arrival of the impulses was shown to the audience on a cathode-ray oscillograph, the shorter time of echo-arrival being demonstrated by lowering the reflecting layer. A film was also projected showing the oscillograph images in the actual reception of radio pulses, echoes being seen from the Kennelly-Heaviside layer at 90 to 120 kilometres and from the upper or Appleton layer at 230 to 350 kilometres.

Abstracts and References

Compiled by the Radio Research Board and reproduced by arrangement with the Department of Scientific and Industrial Research.

	PAGE		PAGE
Propagation of Waves	318	Directional Wireless	331
Atmospherics and Atmospheric Electricity	322	Acoustics and Audio-Frequencies ..	331
Properties of Circuits	323	Phototelegraphy and Television ..	334
Transmission	324	Measurements and Standards ..	337
Reception	325	Subsidiary Apparatus and Materials	338
Aerials and Aerial Systems ..	327	Stations, Design and Operation ..	342
Valves and Thermionics	328	General Physical Articles	342
		Miscellaneous	343

PROPAGATION OF WAVES

ULTRA-SHORT-WAVE PROPAGATION [with Methods of Measuring Attenuation and Field Strength: Important Action of Regular Reflection and of Diffraction: etc.].—J. C. Schelling, C. R. Burrows and E. B. Ferrell. (*Proc. Inst. Rad. Eng.*, March, 1933, Vol. 21, No. 3, pp. 427-463.)

Authors' summary:—Part I of this paper first describes a method of measuring attenuation and field strength in the ultra-short-wave range. A résumé of some of the quantitative experiments carried out in the range between 17 megacycles (17.65 metres) and 80 megacycles (3.75 m) and with distances up to 100 kilometres is then given. Two cases are included: (1) "Optical" paths over sea water and (2) "Nonoptical" paths over level and hilly country. An outstanding result is that the absolute values of the fields measured were always less than the inverse distance value. Over sea water, the fields decreased as the frequency increased from 34 megacycles (8.8 metres) to 80 megacycles (3.75 metres), while the opposite trend was found over land. As a rule, the signals received were very steady, but some evidence of slow fading was obtained for certain cases when the attenuation was much greater than that for free space.

Part II gives a discussion of reflection, diffraction, and refraction as applied to ultra-short-wave transmission. It is shown (1) that regular reflection is of importance even in the case of fairly rough terrain, (2) that diffraction considerations are of prime importance in the case of nonoptical paths, and (3) that refraction by the lower atmosphere can be taken into account by assuming a fictitious radius of the earth. This radius is ordinarily equal to about four-thirds the actual radius.

The experiments over sea water are found to be consistent with the simple assumption of a direct and a reflected wave except for distances so great that the curvature of the earth requires a more fundamental solution. It is shown that the trend with frequency to be expected in the results for a nonoptical path over land is the same as that actually observed, and that in one specific case, which is particularly amenable to calculation, the absolute values also check reasonably well. It is found both from experiment and from theory that

nonoptical paths do not suffer from so great a disadvantage as has usually been supposed.

Several trends with respect to frequency are pointed out, two of which, the "conductivity" and the "diffraction" trends, give decreased efficiency with increased frequency, and another of which, the "negative reflection" trend, gives increased efficiency with increased frequency under the conditions usually encountered.

The existence of optimum frequencies [both for optical and nonoptical paths] is pointed out, and it is emphasised that they depend on the topography of the particular paths, and that different paths may therefore have widely different optimum frequencies. Thus, among the particular cases mentioned, the lowest optimum values vary from frequencies which are well below the ultra-high-frequency range up to 1200 megacycles (25 centimetres). For other paths the lowest optimum frequency may be still higher.

SOME RESULTS OF A STUDY OF ULTRA-SHORT-WAVE TRANSMISSION PHENOMENA [Effect of Reflection Components: Three Reflection Surfaces even in Hill-to-Hill Transmission: Comparison of Methods of Field Strength Measurement: etc.].—C. R. England, A. B. Crawford and W. W. Mumford. (*Proc. Inst. Rad. Eng.*, March, 1933, Vol. 21, No. 3, pp. 464-492.)

Authors' summary:—The results of a series of transmission experiments made in the range 3.7 to 4.7 metres and over distances up to 125 miles are reported. These observations were chiefly confined to the region reached by the directly transmitted radiation and are found in good agreement with the assumption that such transmission consists mainly of a directly transmitted radiation plus the reflection components which would be expected from the earth's contour. The residual field not thus explained consists of a more or less pronounced diffraction pattern due to the irregularities of the earth's surface. A hill-to-hill transmission has three demonstrable reflection surfaces.

Quantitative checks on hill-to-hill transmission have been obtained and it has been found that a field intensity of 40 microvolts per metre gives very good transmission. Static is ordinarily

entirely absent and no Heaviside layer reflections have been observed.

The almost universal standing wave diffraction patterns have been studied and sample records are given. The methods of measuring field intensity which we have used are described in an appendix. No long range transmissions, such as harmonics of distant (greater than 500 miles) short-wave stations would yield, have been observed.

NOTES ON PROPAGATION OF WAVES BELOW TEN METRES IN LENGTH [Empire State Building and Other Transmissions].—Trevor and Carter. (See under "Phototelegraphy and Television.")

A STUDY OF THE PROPAGATION OF [Ultra-Short] WAVELENGTHS BETWEEN THREE AND EIGHT METRES [and an Empirical Ultra-Short-Wave Propagation Formula].—Jones. (See under "Phototelegraphy and Television.")

ABSORPTION AND RERADIATION OF [Ultra-] SHORT ELECTRIC WAVES.—Fountain. (See under "Aerials and Aerial Systems.")

CHECKING THE BEHAVIOUR OF ULTRA-HIGH-FREQUENCY [2- and 5-Metre] WAVES: INTERESTING TRANSMISSION TESTS USING DIRECTIVE AERIALS.—Jones. (See under "Aerials and Aerial Systems.")

SOME CHARACTERISTICS OF SHORT-WAVE PROPAGATION.—J. Hollingworth. (*Journ. I.E.E.*, March, 1933, Vol. 72, No. 435, pp. 229-251.)

The full paper, summaries of which were dealt with in April Abstracts, p. 206. The latest observations of the distant station (Moscow), taken in November, showed angles of 35° (instead of the normal 30°), and on several occasions of 45° and even 60° . In particular, on 24th November, three rays were present, the angle of the steepest being not less than 60° : on that day the Heaviside layer density had the unusually low mid-day value of 1.05×10^5 . Further comparison on these lines distinctly suggested a connection between the angle of incidence and the density of the Heaviside layer, whereas no such connection was to be seen with the Appleton layer densities. This has suggested the following idea. Taking the usual angle of incidence of 30° and the normal layer density of 2×10^5 , this density is just sufficient to bend the ray horizontal after passing through the Heaviside layer; then, on the assumption that the ionisation remains roughly constant between the two layers, the ray would proceed in a straight line and strike the Appleton layer at nearly grazing incidence. In this way a long span would be obtained even with a low angle of incidence. "This result appears to be so important that its implications require some discussion": the writer points out that his idea fits in with the above-mentioned tendency of large angles of incidence to be associated with low Heaviside layer densities, whereas by the ordinary theory a decrease in average density would result in the ray having to go higher to find enough electrons for refraction, so that smaller angles of incidence

should result. Other points are mentioned in support of the theory. Alternative explanations of the observed results are suggested in the Discussion.

THE PROPAGATION OF WAVES: AN ACCOUNT OF WORK CARRIED OUT AT MADRID [Field Intensities for 1 kw Radiated, Wavelengths 150-2 000 Metres: Limiting Ratio of Fields of Two Stations on Same Wavelength].—(World Radio, 17th Feb., 1933, Vol. 16, No. 395, pp. 229-230.)

A summary of three reports of Van der Pol's Committee. Graphs are given for the field intensities for 1 kw radiated during day and night, over land and over sea, for ranges 50-2 000 km. When asked to extend the range, the Committee found the data too meagre to furnish a precise reply, but estimated that in the band 550-1 500 kc/s about $3 \mu\text{V/m}$ for 4 000 km and $0.8 \mu\text{V/m}$ for 6 000 km could be taken as the order of greatness of maximum night fields for 1 kw radiated. In the band 150-300 kc/s the fields would be somewhat greater—say 3 times. Various factors, including the geographical position of the path (notably in relation to the magnetic poles) would affect the values.

With regard to the second problem (where stations working on different programmes must be understood) it would appear that the stations should be separated by distances of the order of 5 000 or of 4 000 km, according to the quality of service required. But other observations relative to field strengths at distances up to 4 000 km had been communicated by the Soviet delegation and by the U.S.A. Commission, giving values approximately seven times higher. This discrepancy was thought to be due principally to differences in the nearness of the paths to the magnetic poles.

PERIODIC VARIATIONS OF THE FIELD STRENGTHS OF [Broadcasting] RADIO STATIONS [at Short Distances].—Eppen. (See under "Stations, Design and Operation.")

AUSBREITUNG ELEKTROMAGNETISCHER FELDÉR LÄNGS FLUSSLÄUFEN (The Propagation of Electromagnetic Fields along Rivers [Tests along the Danube in Flat and Mountainous Regions]).—V. Fritsch. (*Hochf.tech. u. Elek.akus.*, March, 1933, Vol. 41, No. 3, pp. 100-104.)

From the author's summary:—"The tests showed that long waves [in the "medium" band: Budapest, Vienna, Belgrade, German broadcasting stations, etc.] are more readily absorbed by mountains than short waves [40-metre band]. Further, the guiding effect of watercourses on electric waves was investigated and it was found that short waves were much more strongly influenced by this than long waves. This was particularly well established by observations on a station at a very great distance [a New Zealand short-wave station, which was received R6/7 on board the steam boat, but only R3/4 at the land station, though this had a much better aerial].

"The practical value of these tests lies in the demonstration that for river service a wave in the

40- or 80-metre band is to be recommended, and that the use of long waves is unfavourable. . . . The earlier tests (1932 Abstracts, p. 30, r-h column) were confirmed in 1932.

BEOBACHTUNGEN AN DEN KENNELLY-HEAVISIDE-SCHICHTEN WÄHREND DER SONNENFINSTERNIS AM 31 AUGUST 1932 (Observations on the Kennelly-Heaviside Layers during the Solar Eclipse of 31st August, 1932 [Investigation of "Corpuscular Eclipse" Effects on 60-Metre Wave Reflection].—H. E. Paul. (*Hochf.tech. u. Elek.akus.*, March, 1933, Vol. 41, No. 3, pp. 81-83.)

It was decided that owing to the irregular concentration changes in the K.H. layer any effects of the corpuscular eclipse would be more satisfactorily determined by observations on the more regular Appleton layer, and a wave of 60 m was selected as being nearly the critical wave for the time of the corpuscular eclipse in mid-Europe and as likely, therefore, to bring into evidence apparent height changes resulting from small variations in ionisation. The recording technique of Rukop and Wolf (1932 Abstracts, pp. 275-276: see also Wolf, May Abstracts, p. 263) was employed.

The records of a number of days in the period 4th August-8th September all showed what the writer calls an "evening concentration" in the Appleton layer (*cf.* Wolf, *loc. cit.*): namely a regular and distinct increase of ionisation beginning at sunset and leading to a maximum ionisation an hour or two later, *i.e.*, between 20^h and 22^h (Central European time). This "evening concentration" began between 18^h and 19^h, following on the usual ionisation decrease in the afternoon and its "sunset effect" at about 17^h (actual sunset ranging from 19^h to past 20^h). Possible causes of this phenomenon are discussed; contraction of the upper atmosphere (Störmer, Vegard) and increase of corpuscular rays at sunset are both plausible explanations. The "evening concentration" set in at 19^h on the day of the eclipse; that is, *about one hour later than on the preceding days*, and disappeared about one hour earlier. The height of the layer was appreciably greater than on other days. But a certain amount of doubt as to whether these differences can be attributed definitely to the corpuscular eclipse is raised by the fact that somewhat similar anomalies occurred on subsequent days, *e.g.*, 6th and 8th September.

THE OCCURRENCE OF "EVENING CONCENTRATION" IN THE APPLETON LAYER.—Paul. (*See* above abstract.)

EINE METHODE ZUR SELBSTTÄTIGEN AUFZEICHNUNG DER ECHOS AUS DER IONOSPHERE (A Method of Automatically Recording Echoes from the Ionosphere [using a Cathode-Ray Oscillograph and capable of recording Simultaneous Tests on Several Wavelengths]).—G. Goubau and J. Zenneck. (*Hochf.tech. u. Elek.akus.*, March, 1933, Vol. 41, No. 3, pp. 77-80.)

With the screen in a vertical plane, the spot is given a vertical up and down movement by impulses from a sinusoidal valve oscillator of frequency

76 c/s, kept in synchronism with the pulse frequency ($3 \times 76 = 228$ c/s) of the transmitter through a telephone line joining the transmitting and receiving stations. The synchronising current acts on the grid of the retroaction valve of the oscillator and by the pulling-in effect maintains synchronism. A second valve oscillator, acting on the second pair of plates, produces a horizontal sinusoidal motion of the spot with a frequency which is an odd multiple of the vertical frequency. By means of a special auxiliary valve circuit shunting the oscillating circuit of this second oscillator, and coupled to the circuit of the first (vertical motion) oscillator, it is arranged that the second oscillator is only in action during the *downward* motion of the spot, starting and stopping suddenly as the motion reverses at the two ends of the vertical path. The first and second oscillators are seen at the left and right-hand sides of Fig. 5, with the auxiliary circuit between them. The bottom, *s.g.* valve circuit is the signal circuit, and acts on the same pair of plates as the second oscillator, so that signals also produce a horizontal deflection. Their action on the oscillograph, however, is also controlled by the auxiliary circuit, and can only take effect during that half period of the vertical-motion oscillator when the horizontal-motion oscillator is out of action—*i.e.*, during the *upward* motion of the spot.

The brightness of the spot varies with the recording speed, so that the straight upward trace is comparatively bright, while the sinusoidal downward trace and the horizontal signal deflections are dimmer. The brightest spots of all are the points on the vertical trace where the downward trace intersects it (Fig. 2). If, then, a record is made on a photographic paper strip moving horizontally past a narrow vertical slit, these fixed bright spots form dark horizontal lines ("height index lines"), while the breaks in the bright vertical trace, caused by the horizontal signal deflections, show themselves as white tracks (Figs. 3 and 4, where *P*, *Q*, *R* . . . are the height index lines, *D* represents the ground-wave signal, and *E*₁ and *E*₂ the first and second echoes).

Of the three specimen records shown, Fig. 10 shows tests on three wavelengths, 80, 150 and 250 metres, recorded in recurrent succession on the same strip. When any occurrence of interest is noticed on the screen on one particular wavelength, the automatic recording equipment is switched on to that wavelength: *e.g.*, Fig. 9, where on 150 m the transition from the upper to the lower layer is taking place.

A NEW MODULATOR FOR USE IN KENNELLY-HEAVISIDE LAYER RECORDING.—H. R. Mimno, P. H. Wang and P. B. King. (*Phys. Review*, 15th March, 1933, Series 2, Vol. 43, No. 6, p. 501: abstract only.)

"THOSE SUNSPOTS" [Effect of Sunspot Cycle on Choice of Working Waves for Short-Wave Services: Percentage Change dependent on Nearness of Path to Magnetic Pole].—E. J. Alway. (*World Radio*, 11th Nov., 1932, Vol. 15, No. 381, pp. 1105 and 1108.)

Including curves based on the London to Montreal, New York, and Buenos Ayres services.

Regarding the percentage increase for night transmission, "we do not yet appear to have reached the maximum in the case of the N. American circuits. In fact, it is understood that certain commercial firms . . . are seriously considering the possibilities of 100-metre waves this winter." For "Transradio" results see Mögel, 1932 Abstracts, pp. 515-516.

WIRELESS RECEPTION AND THE WEATHER [Correlation between Barometric Pressure and Strength of WCAU Signals at Paisley, Renfrewshire].—(*World Radio*, 24th Feb., 1933, Vol. 16, No. 396, p. 271.)

EFFECT OF STORMS ON RADIO.—R. C. Colwell and I. O. Myers. (*Science*, 17th March, 1933, Vol. 77, No. 1994, Supp. p. 10.)

At a meeting of the American Physical Society, the authors produced "evidence that moving storm areas of low barometric pressure affect radio signals of wavelengths longer than 100 metres by varying the strength of the lower ionised layer of the earth's atmosphere." It was found that "the E layer is concentrated in the regions of low pressure and is more active in the eastern half of the storm cyclone or whirl of winds."

ABNORMALLY GOOD RECEPTION FROM W3XAL (16.87 m) IN ENGLAND ON EVE OF CALIFORNIAN EARTHQUAKE.—(*World Radio*, 17th and 31st March, 1933, Vol. 16, pp. 365 and 429.)

SYMPOSIUM ON CLIMATIC CYCLES [Tree Ring Records, Periodicity in Solar Variation, the Nature of the Solar Cycle, Correlation of Sedimentary and Climatic Records].—(*Proc. Nat. Acad. Sci.*, March, 1933, Vol. 19, pp. 349-388.)

RADIO-FREQUENCY TRANSMISSION LINES: ELLIPSE DIAGRAM OF A LECHER WIRE SYSTEM: APPLICATION OF CIRCLE DIAGRAM TO TRANSMISSION LINES.—Roder: Hikosaburo: Creedy. (See abstracts under "Aerials and Aerial Systems.")

THEORY OF THE PROPAGATION OF ELECTRICAL ENERGY ALONG TRANSMISSION LINES.—A. Bláha. (*Rev. Gén. de l'Élec.*, 18th Feb., 1933, Vol. 33, No. 7, pp. 205-214.)

DISPERSION DANS LES ONDES COURTES (Short-Wave Dispersion [in Polar Liquids]).—R. Luthi. (*Helvet. Phys. Acta*, Fasc. 2, Vol. 6, 1933, pp. 139-159.)

"We have studied the anomalous dispersion of the dielectric constant of nitrobenzene, butyl alcohol and amyl alcohol, in very dilute solutions in a highly viscous mineral oil, for electrical fields of frequencies between 0 and 1.7×10^9 . We have found two partial dispersions, one around a wavelength of 100 m and the other around 1 m. We attribute the first of these dispersions to [free] polar molecules surrounded by molecules of oil, and the second to polar molecules associated . . . in groups, at the heart of which would prevail properties near to those of the pure polar liquid."

STANDING LIGHT WAVES; REPETITION OF AN EXPERIMENT BY WIENER, USING A PHOTO-ELECTRIC PROBE SURFACE—Ives and Fry. (See under "Phototelegraphy and Television.")

CHARACTERISTICS OF DIFFERENTIAL SYSTEMS, AND THE PROPAGATION OF WAVES.—T. Levi-Civita. (Book Review in *Rev. Gén. de l'Élec.*, 25th March, 1933, Vol. 33, No. 12, p. 370.)

THE SURFACE OF WAVES IN A LIQUID SUBMITTED TO THE ACTION OF A MAGNETIC FIELD.—M. A. Cotton. (*Ann. de Physique*, Jan., 1933, Vol. 19, pp. 47-58.)

From the author's summary:—"Cornu was led to the conclusion that the wave surface characterising the optical properties of a liquid placed in a magnetic field consisted of two spheres of the same radius, slightly displaced with respect to each other. He deduced from this that a luminous ray directed perpendicularly to the lines of force should, in penetrating into the magnetised medium, be bifurcated into two rays circularly polarised. It is here shown that the researches on magnetic birefringence, and also the experimental study (with the Bellevue electromagnet) of the superposition of this phenomenon on that of magnetic polarisation, lead to the abandonment of this conclusion of Cornu's. . . ."

L'ABSORPTION DU SON DANS L'ATMOSPHÈRE: UNE TENTATIVE D'EXPLICATION (The Absorption of Sound in the Atmosphere: a Suggested Explanation [of the Observed Absorption more than Twenty Times as great as the Calculated]).—Y. Roçard. (*Journ. de Phys. et le Rad.*, March, 1933, Vol. 4, Series 7, No. 3, pp. 119-122.)

THE THEORY OF REFRACTION SHOOTING [of Seismic Waves].—M. Muskat. (*Physics*, Jan., 1933, Vol. 4, No. 1, pp. 14-28.)

Author's summary:—"Considerations of geometrical optics indicate that the limiting rays travelling along the interface between two homogeneous elastic media should carry inappreciable amounts of energy. Nevertheless, the "first arrival" waves in refraction shooting processes, which give linear time distance curves, are usually interpreted as being due to such limiting rays travelling along the interface with the velocity of the lower medium. To clear up the situation an analysis of the problem has been made both from the points of view of geometrical optics and wave theory. It is pointed out that although the assumed "refraction" paths are minimal time paths in the sense of Fermat's principle, the applicability of the latter along a surface of discontinuity may be open to question. On the other hand, it is proved that, geometrically, they are necessarily real, since they are the only type of path that can give the observed linear time distance curves. The wave theory treatment of the problem for fluid media, modified slightly from the operator method analysis previously given by Jeffreys, is then presented to show that the wave theory actually gives waves whose geometrical interpretations are exactly those

of the refraction shooting process. Their amplitudes vary inversely as the square of the distance from the source and they give vertical displacements of the same order as those of the directly reflected waves. The analysis is extended to the case of general elastic media and it is shown that four types of "refracted" waves will be produced upon the incidence at the interface of either a longitudinal or transverse wave pulse. Two of the waves will be recorded as longitudinal waves and the other two as transverse. One of each pair effectively travels in the second medium with the longitudinal velocity of the medium and the other two travel with the transverse velocity of the lower medium. The velocities and accelerations produced by these "refracted" waves vary over the pulse thickness exactly as the displacements and velocities in the incident pulse.

ATMOSPHERICS AND ATMOSPHERIC ELECTRICITY

SOME EVIDENCE REGARDING THE NATURE OF COSMIC RAYS.—A. H. Compton. (*Phys. Review*, 1st March, 1933, Series 2, Vol. 43, No. 5, p. 382.)

Abstract only. The methods of "distinguishing between photons and electrons or other charged particles as the primary cosmic rays are discussed" and the conclusion is reached that "cosmic rays are electrified particles, with energies (if electrons) of 10^{10} electron-volts and more."

A GEOGRAPHIC STUDY OF COSMIC RAYS.—A. H. Compton. (*Phys. Review*, 15th March, 1933, Series 2, Vol. 43, No. 6, pp. 387-403.)

The full account of the work, reports and results of which have already been described in previous papers (Abstracts, 1932, pp. 89-90 and 90, 219, 336, 578—two, 635; February and March, 1933, pp. 94 and 152; all by Compton alone or conjointly. Also Bennett and others, and Stearns and others, February, pp. 94 and 95).

NEW TECHNIQUE IN THE COSMIC-RAY FIELD AND SOME OF THE RESULTS OBTAINED WITH IT.—R. A. Millikan and H. V. Neher. (*Phys. Review*, 1st March, 1933, Series 2, Vol. 43, No. 5, pp. 381-382.)

Abstract only; new types of sensitive, self-recording cosmic-ray electroscopes have been developed, which have "thus far failed to reveal any variation in the cosmic ray intensities in any of the localities through which they have been carried over the earth's surface, so long as they have been kept at a uniform depth beneath the top of the atmosphere," with sea-level observations at latitudes between 49° N and 8° N. No direct effect of the sun or of any other celestial objects has been found. "Thus far, then, the new technique has brought no evidence that the incident cosmic-ray photons are mixed in appreciable amount with their secondary corpuscular radiations when they enter the atmosphere." See also May Abstracts, p. 268.

COSMIC RAYS ARE PHOTONS, DR. MILLIKAN DECLARES.—R. M. Langer: Millikan. (*Sci. News Letter*, 17th Dec., 1932, Vol. 22, No. 610, pp. 384-385.)

Summary of a discussion presented by Millikan

at Mt. Wilson Observatory. "Cosmic rays are primarily light rays, or photons, which may be mixed to some extent with secondary charged particles, even when they enter the atmosphere. The rays originate out in interstellar space."

THE AIRPLANE METHOD OF OBTAINING COSMIC-RAY INTENSITY DATA.—L. G. Howell and L. M. Mott-Smith. (*Phys. Review*, 1st March, 1933, Series 2, Vol. 43, No. 5, p. 381: abstract only.) See also below.

AIRPLANE COSMIC-RAY INTENSITY MEASUREMENTS.—L. M. Mott-Smith and L. G. Howell. (*Phys. Review*, 1st March, 1933, Series 2, Vol. 43, No. 5, p. 381.)

See also above. Abstract only: "... the following cosmic-ray measurements have been made: (1) daytime intensity curve from 1000 to 27000 feet, (2) night-time intensity curve up to 27000 feet, (3) absorption in a few cm of lead at various elevations, (4) intensity measurement at 27000 feet during the solar eclipse of Aug. 31st, 1932. Comparison with the earlier high altitude measurements, notably those of Kolhörster, indicates that the present curve is steeper at 27000 feet, so that the marked decrease in the absorption coefficient above 20000 feet is not observed. It is found, however, that the values at the highest altitudes are too small by a factor of about two to fall on Millikan and Cameron's synthetic cosmic-ray curve. No significant decrease in intensity was observed during the night-time observation even at the highest altitudes. In accordance with all previous eclipse measurements, no change in intensity was observed during the solar eclipse."

THE INTERPRETATION OF THE EXPERIMENTAL DETERMINATION OF THE MEAN SPECIFIC IONISATION OF COSMIC RADIATION FROM COMPARATIVE MEASUREMENTS WITH AN IONISATION CHAMBER AND A COUNTER.—W. Kolhörster and L. Tuwim. (*Zeitschr. f. Physik*, 1933, Vol. 81, No. 7/8, pp. 435-439.)

The writers find that their experimental value $h = 135$ ions per cm for the specific ionisation h of cosmic radiation is in accordance with recent results of quantum mechanics. They define the concept "specific ionisation" in agreement with the definition in *Handbuch der Physik*, 1930, Vol. 24, p. 51, as "the total charge set free per unit length of path, whether it is caused directly by the primary rays or by the secondary electrons," and show that their experimental method corresponds to the definition.

ENERGY-LOSS AND SCATTERING OF COSMIC-RAY PARTICLES.—C. D. Anderson. (*Phys. Review*, 1st March, 1933, Series 2, Vol. 43, No. 5, p. 381: abstract only.)

SOME PHOTOGRAPHS OF THE TRACKS OF PENETRATING RADIATION [SHOWING POSITIVE ELECTRONS].—Blackett and Occhialini. (See under "General Physical Articles.")

COSMIC RAY BURSTS.—C. D. Anderson. (*Phys. Review*, 1st March, 1933, Series 2, Vol. 43, No. 5, pp. 368-369.)

A preliminary letter on associated tracks in cloud-chamber experiments on cosmic rays, discussing the nature of the tracks obtained in one case.

MATHEMATICAL THEORY OF THE AVERAGE ACTION OF THE COSMIC RADIATION ON DETECTING INSTRUMENTS, SHIELDED OR NON-SHIELDED.—L. Tuwim. (*Journ. de Phys. et le Rad.*, March, 1933, Vol. 4, Series 7, No. 3, pp. 138-164.)

EXPANSION CHAMBER DATA ON COSMIC-RAY IONISATION.—G. L. Locher. (*Phys. Review*, 1st March, 1933, Series 2, Vol. 43, No. 5, p. 381.)

Abstract only; the writer thinks that "part of the ionisation is produced by characteristic X-radiation generated in the gas by the passage of the particle through it."

WEATHER FORECASTING BY ATMOSPHERICS.—C. W. H. Ashwin. (*British Radio Annual*, 1932, pp. 42-44.)

SUMMER THUNDERSTORMS.—S. M. Bower. (*Nature*, 1st April, 1933, Vol. 131, p. 473.)

A letter asking for thunderstorm observations during the summer of 1933.

THE AUDIBILITY OF THE AURORA.—(*Electrician*, 24th March, 1933, Vol. 110, No. 2860, p. 394.)

Note on an analysis of the observations of inhabitants of Northern Canada; 144 persons reported that they had observed sound effects accompanying the aurora. The majority described them as of a swishing, rustling or crackling nature.

ON THE PATHS OF ELECTRONS IN AN ELECTRIC AND MAGNETIC FIELD WITH AXIAL SYMMETRY [Theoretical Paper].—Störmer. (See under "Subsidiary Apparatus and Materials.")

A STRANGE PHENOMENON [Arcs of Light in Evening Sky in England on Day of Large Sunspot: Apparent Height about 300 Miles].—(*World Radio*, 31st March, 1933, Vol. 16, No. 401, p. 429.)

ÜBER DIE ENTWICKLUNG DER RAUMLADUNG EINER FUNKENSTRECKE BEI STOSSSPANNUNG (On the Development of the Space Charge of a Spark Gap with an Impulsive Voltage [Theoretical Investigation]).—J. J. Sämmer. (*Zeitschr. f. Physik*, 1933, Vol. 81, No. 576, pp. 383-404.)

AN EXTREMELY SIMPLE METHOD OF PERIODOGRAM ANALYSIS [taking One-Third the Time taken by Correlation Periodogram: Calculations made on ordinary Adding Machine].—D. Alter. (*Proc. Nat. Acad. Sci.*, March, 1933, Vol. 19, pp. 335-339.)

PROPERTIES OF CIRCUITS

BEITRAG ZUR THEORIE DER EIGENFREQUENZEN UND DER SELBSTERREGUNG IN ELEKTRISCHEN SCHWINGUNGSKREISEN (Contribution to the Theory of the Natural Frequencies and Self-Excitation in [Coupled] Electrical Oscillatory Circuits).—H. Kaiser. (*E.N.T.*, March, 1933, Vol. 10, No. 3, pp. 123-143.)

Referring to previous treatments of undamped oscillations in coupled circuits, the writer says that the formulae arrived at are so complex that their essential physical meaning is almost completely hidden. He therefore sets himself to elucidate the clear physical grounds for the various processes, without however neglecting quantitative results. "It will be possible to demonstrate a number of known phenomena in a new interconnection, and to point out a few relationships not previously recognised." Thus from the frequency equations he obtains a simple derivation of the critical coupling, and the limits of the multi-wave zone and their dependence on the decrement and detuning of the two circuits. At these limits the second coupling frequency of the system vanishes. The expression for the limiting coupling is seen to be a generalisation of the expression for the critical coupling in de-tuned circuits.

From the energy equations he deduces the difference between "non-oscillatory zones" and "oscillation gaps" (see Fig. 21 and neighbouring text) and the necessary conditions for each; equation 22 gives the relation between the "limiting resistances" of the oscillation-gap field. This and other results are confirmed experimentally at the end of the paper. Three recent papers having some points in common with the present work are referred to: Petržilka and Fehr, Heegner, and Hecht (Abstracts, 1932, p. 636; March, p. 154; and 1932, p. 458).

ÜBER DEN WECHSELSTROMWIDERSTAND VON GERADEN DRÄHTEN MIT KREISFÖRMIGEM QUERSCHNITT, DIE AUS MEHREREN KONZENTRISCHEN SCHICHTEN BESTEHEN (The A.C. Resistance of Straight Wires of Circular Section composed of Several Concentric Layers [e.g., Tinned or Oxidised Copper Wire]).—S. Ekelöf. (*E.N.T.*, March, 1933, Vol. 10, No. 3, pp. 115-122.)

Author's summary:—"Formulae are given enabling the high-frequency resistance of straight, stratified conductors to be determined. The formulae are applicable at all frequencies [they were confirmed experimentally at wavelengths from 50 to 300 m] and, in contrast to earlier formulae of Försterling, do not require that the skin effect should be marked. As examples, tinned and oxidised copper wires, among others, are dealt with." In the derivation of numerically applicable formulae the writer was greatly assisted by Pleijel's series developments of Bessel functions. The first confirmatory tests were made on coppered constantan wire, and an interesting result was that by choosing a suitable thickness for the copper layer the resistance was to a very great extent rendered independent of frequency, even for resistances considerably smaller than those attainable other-

wise with resistances free from skin effect. See also Strutt, May Abstracts, p. 269.

EQUIVALENT CIRCUIT OF A BLOCKING-LAYER PHOTOCCELL.—L. A. Wood. (*Phys. Review*, 1st March, 1933, Series 2, Vol. 43, No. 5; pp. 375-376: abstract only.)

RELATIONS BETWEEN THE PARAMETERS OF COUPLED-CIRCUIT THEORY AND TRANSDUCER THEORY, WITH SOME APPLICATIONS [Determination of Conditions for Resonance in a Chain of Coupled Circuits].—J. G. Brainerd. (*Proc. Inst. Rad. Eng.*, Feb., 1933, Vol. 21, pp. 282-289.)

THE IMPEDANCE OF DEFECTIVE LOADED LINES, PARTICULARLY ONE WITH ABNORMAL WIRE-TO-WIRE CAPACITY IN A LOADING COIL SECTION.—E. Adam and F. Haas. (*E.N.T.*, March, 1933, Vol. 10, No. 3, pp. 109-115.)

Further development of the work referred to in 1932 Abstracts, p. 34, 1-h column.

MUTUAL IMPEDANCE OF LONG GROUNDED WIRES WHEN THE CONDUCTIVITY OF THE EARTH VARIES EXPONENTIALLY WITH DEPTH.—Gray. (See under "Aerials and Aerial Systems.")

IMPÉDANCES ITÉRATIVES (Repeated Impedances [of Dissymmetrical Quadripoles]).—J. B. Pomey. (*Rev. Gén. de l'Élec.*, 11th Feb., 1933, Vol. 33, No. 6, pp. 173-177.)

TRANSMISSION

ELECTRONIC OSCILLATIONS. Also AN INVESTIGATION OF THE MAGNETRON [Ultra-] SHORT-WAVE OSCILLATOR.—E. C. S. Megaw: General Electric Company. (*Journ. I.E.E.*, April, 1933, Vol. 72, No. 436, pp. 313-325: 326-348. Discussion pp. 348-352.)

The full papers, summaries of which are dealt with in May Abstracts, pp. 270-271. See also *Wireless Engineer*, March, 1933, Vol. 10, No. 114, pp. 142-144, for illustrated summaries. In the subsequent Discussion the author's replies to the various participants include the following:—"... I must agree with Mr. Benham that the existence of negative conductance in a diode does apparently involve the space-charge forces. My only objection to his explanation of triode electronic oscillations on the basis of his analysis of the diode case is that the oscillation wavelength calculated on this basis is much smaller than the wavelength observed in typical cases, including that of the flat-electrode triode described by Wundt" [1931 Abstracts, pp. 94-95. Regarding this action of the space charge forces, Fortescue points out among other things that "it is a general experience that the triode oscillations are more easily produced at grid voltages such that thermionic saturation of the cathode has set in, and therefore when space-charge effects are less. More information on this point is very desirable"].

"With regard to the best electrode form for triode electronic oscillators, the results obtained by various workers with special electrode forms (e.g. flat plate,

parallel wire, external cylindrical cathode) suggest that these are not superior to the ordinary cylindrical construction." Replying to E. W. B. Gill, who disagrees with the statement that the electron current to the anode represents a damping loss, "the fundamental reason for considering that the electron current to the anode of a triode electronic oscillator represents a damping loss is that those electrons which reach the anode have obtained the extra energy enabling them to do so from the oscillatory circuit. This energy reappears as heat at the anode." Replying to Tedham and Smith-Rose, concerning the possibility that secondary emission may be of importance in the mechanism of electronic oscillations, "while this possibility has not been overlooked, the experimental results have not so far suggested its importance. . . . It seems probable that the only important result will be to increase the effective closeness of the grid mesh. In the triode electronic oscillator the final velocity of electrons reaching the anode is small, and anode secondary emission is not likely to be important. In the magnetron case, anode secondary emission will increase to some extent the already large space charge in the immediate neighbourhood of the anode." Shearing points out that the author's method of obtaining a concentrated field and of avoiding troubles due to the inter-electrode capacitance of the anode and filament leads is probably the explanation of the excellent results obtained in comparison with those given by the split magnetron, as used by Okabe; discusses local overheating, and suggests that the narrow gap in the split anode is an important factor in the production of large-amplitude oscillations.

A [Split-Anode] MAGNETRON OSCILLATOR FOR ULTRA-SHORT WAVELENGTHS.—E. C. S. Megaw. (*Wireless Engineer*, April, 1933, Vol. 10, No. 115, pp. 197-202.)

Author's summary:—"The paper describes the characteristics and performance of a magnetron oscillator of improved design. The oscillator is primarily intended for operation on wavelengths between 1 metre and 10 metres, but it can be used on both shorter and longer wavelengths. At wavelengths down to about 3 metres an output of 40-50 watts is obtainable with a conversion efficiency of the order of 50%. At shorter wavelengths the output falls off, reaching about 10 watts at 1 metre. In the range mentioned, the performance compares favourably with that of the normal triode oscillator, particularly at the shorter wavelengths." It is quite practicable to operate a mobile transmitter, with an output of the order of 20 watts at a few metres wavelength, from a 12 volt car battery. Magnetron designs for considerably larger output are being investigated. Another application is for longer wavelengths in circuits where a very low internal capacity is of importance; another is as a symmetrical negative resistance for measurements at any frequency in the radio laboratory. See also preceding abstract.

ULTRA-SHORT-WAVE OSCILLATORS AND RADIO-COMMUNICATION ON ULTRA-SHORT WAVES.—C. Gutton. (*Ann. des P.T.T.*, Feb., 1933, Vol. 22, No. 2, pp. 164-180.) See Jan. Abstracts, p. 37.

THE WAVES OF LESS THAN TEN METRES [Ultra-Short Waves: a Survey of Ten Years].—G. A. Beauvais. (*L'Onde Élec.*, Nov.–Dec., 1932 [pub. 28th March, 1933], Vol. 11, Nos. 131–132, pp. 533–540.)

DISCUSSION ON "HISTORICAL REVIEW OF ULTRA-SHORT-WAVE PROGRESS."—H. M. Dowsett: Wenstrom. (*Proc. Inst. Rad. Eng.*, Feb., 1933, Vol. 21, pp. 314–315.)

Discussion on Wenstrom's paper dealt with in 1932 Abstracts, p. 163. Dowsett points out that no mention was made of the Marconi-Franklin work in 1916 and 1917, when a range of over 20 miles was obtained on a wavelength of 3 m, using a reflector at the transmitting end only.

SCREEN-GRID VALVES IN QUARTZ-CONTROLLED TRANSMITTERS [for Short and Ultra-Short Waves].—L. J. Price. (*British Radio Annual*, 1932, pp. 47–48.)

DAMPED WAVES, MUSICAL SPARK TRANSMISSIONS, LONG WAVES, ARCS AND ALTERNATORS [a Survey of Ten Years].—J. Bethenod. (*L'Onde Élec.*, Nov.–Dec., 1932 [pub. 28th March, 1933], Vol. 11, Nos. 131–132, pp. 405–412.)

A POWER TYPE ELECTRON-COUPLED EXCITER UNIT [and the Measurement of Power by Incandescent Lamp and Photronic Cell].—C. J. Houldson. (*QST*, March, 1933, Vol. 17, pp. 11–13 and 86.)

RECEPTION

CONCERNING THE SECOND CONGRESS OF DEFENCE AGAINST RADIOELECTRIC DISTURBANCES (PARIS, 25TH–27TH NOVEMBER, 1932).—M. Adam. (*Rev. Gén. de l'Élec.*, 25th Feb., 1933, Vol. 33, No. 8, pp. 247–257.)

Part I. (1) General. (2) Doljansky's method of dealing with neon signs: the report of the Société Claude-Lumière. (3) High-tension networks: summary of Brailard's address ("a distributing system in proper condition provokes practically no trouble"): good results in Parisian flats from dipole on roof and 35 mm earthed copper tube shielding parallel wire leads: excellent results with a Belgian company's special single-wire shielded down-lead in which the conductor is surrounded in succession by several layers of paper, an earthed coating of lead, an insulating layer, and finally an earthed metallic braiding; the self-capacity is thus reduced to 0.015 μmF per metre. Another down-lead is described in which the bare copper wire is air-insulated, being held centrally in a 1 mm thick rubber tube, of 14 mm diameter, by rubber separators spaced 120° : the rubber tube is wound with strip aluminium, which is earthed: the capacity is about 0.025 μmF per metre. (4) Electric traction: English, Swiss, German and Italian results. (5) Medical apparatus. (6) Multi-plex telegraphs and signalling installations. (7) Lifts. (8) Central-heating oil burners with thermostatic control: Doljansky's silencing circuit, Fig. 3. (9) Disturbances conducted by the low-tension network: mains-fed receivers—Barthélemy's

capacity-free mains transformer—the advantages of frame aerials, especially with the balanced three-point frame connection, Fig. 6, II, Toulon. (10) Anti-interference filters. (11) The identification of interference. (12) Results abroad. Part II deals with the subject from the juridical and administrative standpoints.

SCREENED AERIAL DOWN-LEADS.—Brigham. (*Wireless World*, 7th April, 1933, Vol. 32, pp. 261–262.)

This article is based on a paper recently read before the Radio Club of America by C. E. Brigham, Chief Engineer of Kolster Radio, and deals with the question of electrical interference and measures which may be taken at the receiving end in order to combat it. American engineers have found that a properly screened aerial down-lead is the most efficacious measure to adopt. Losses usually introduced by shielding are avoided to a large extent by fitting impedance-matching transformers. See also next abstract.

[Hints on] REDUCING NOISE INTERFERENCE [including the Limited Usefulness of the Shielded Lead-In].—Engineering Department, Philco Company. (*Radio Engineering*, Jan., 1933, Vol. 13, p. 9.) See also preceding abstract.

SHIELDED CABLE FOR DOWN LEAD [Capacity under 30 cm/m, Weight 160 gm/m].—Telefunken Company. (*Radio, B., F. für Alle*, April, 1933, pp. 165–166.)

THE EFFECT OF THE LEADS TO AN INTERFERENCE-SUPPRESSING CONDENSER.—Kotowski and Kühn. (See abstract under "Subsidiary Apparatus and Materials," p. 340.)

ANTI-INTERFERENCE FILTER FOR ELECTRIC MOTORS, ETC., WHICH DOES NOT RAISE POTENTIAL OF FRAME OF MOTOR. (*Rev. Gén. de l'Élec.*, 25th Feb., 1933, Vol. 33, No. 8, p. 61D: French Pat. No. 734 163, pub. 17th Oct., 1932, Philips' Company.)

ELIMINATING RADIO INTERFERENCE FROM PIN TYPE INSULATORS.—G. W. BAITOW. (*Elec. World*, 10th Dec., 1932, Vol. 100, No. 24, p. 787.)

ELIMINATING SPARK PLUG DISTURBANCE IN AUTOMOBILE RADIO.—J. MARSTEN. (*Rad. Engineering*, Feb., 1933, Vol. 13, p. 20.)

RADIOPHONIE ET TROUBLES DE VOISINAGE (Radio Reception and Interference from Neighbours [from Electrical Apparatus, etc.]).—A. MESTRE. (*Génie Civil*, 8th April, 1933, Vol. 102, No. 14, pp. 332–333.)

Dealing with the legal aspects, the writer concludes that "at the present time, wireless amateurs receive particularly effective legal protection against the troubles arising from the electrical installations of their neighbours."

SOME NOTES ON THE USE OF A DIODE AS A CUMULATIVE GRID RECTIFIER.—E. A. Biedermann. (*Wireless Engineer*, March, 1933, Vol. 10, No. 114, pp. 123-133.)

From the work of Colebrook and of Kirke (Abstracts, 1931, p. 440; 1932, p. 408) it appears that it is possible to obtain practically perfect rectification with any r.f. input voltage exceeding a fraction of a volt. "If, then, by the use of an r.f. filter it can be ensured that only a small fraction of the r.f. voltage applied to the rectifier is passed on to the succeeding l.f. amplifier, the full capacity of the latter is available for amplification of the l.f. voltage." The advantages of this are discussed: thus a given grid swing can be accommodated with a smaller mean anode current. "This is a great advantage when mains voltage is limited, since adequate de-coupling can then be effected irrespective of the method of coupling the amplifier to the succeeding valve. Since the last-mentioned advantage will only be obtained in full measure provided the r.f. voltage passed on to the amplifier is but a small part of that applied to the rectifier, it seems desirable to examine what are the best conditions for ensuring this."

VOLTAGE AMPLIFICATION WITH HIGH SELECTIVITY BY MEANS OF THE DYNATRON CIRCUIT.—D. A. Bell: Colebrook. (*Wireless Engineer*, April, 1933, Vol. 10, No. 115, pp. 204-205.)

A letter prompted by Colebrook's paper dealt with in April Abstracts, p. 212. "The use of audio-frequencies for measurements obscures the practical difficulties which would be experienced in applying such a circuit to selective r.f. amplification." Examples of such difficulties are suggested.

OSCILLATING SPLIT-ANODE MAGNETRON AS DETECTOR FOR ULTRA-SHORT WAVES.—Int. Gen. Elec. Company. (Summary of German Patent in *Hochf. tech. u. Elek. akus.*, Jan., 1933, Vol. 41, No. 1, p. 39.)

TUNED-TRANSFORMER COUPLING CIRCUITS [Low-Loss Air-Core Transformers, as used in I.F. Amplifier of Field Strength Measuring Set].—A. J. Christopher. (*Bell Lab. Record*, March, 1933, Vol. 11, No. 7, pp. 195-199.)

CLASS "B" FERROCART RECEIVER.—W. I. G. Page. (*Wireless World*, 7th April, 1933, Vol. 32, pp. 250-254.)

A four-valve battery-operated receiver for the amateur constructor, using Class B amplification (May Abstracts, pp. 272-273) and special iron-cored tuning coils (Ferrocarts: January Abstracts, p. 39).

SUPPRESSION OF NOISE IN RADIO RECEIVERS: QAVC [Quiet Automatic Volume Control], NSC [Noise Suppression Control], OR SIMPLY "SQUELCH."—E. Messing. (*Rad. Engineering*, Feb., 1933, Vol. 13, pp. 7-9 and 22.)

ACOUSTICALLY COMPENSATED VOLUME CONTROL FOR RADIO AND PHONOGRAPH SETS.—Wolff and Cornell. (See under "Acoustics and Audio-frequencies," p. 332.)

MANUAL VOLUME CONTROLS.—L.E.T. Branch. (*Wireless World*, 21st April, 1933, Vol. 32, pp. 287-288.)

It is generally recognised that when the volume control is turned down, low notes are weakened out of proportion to high notes. In this article the reasons why this happens are explained and practical circuits for overcoming this defect are given.

AN A.V.C. UNIT.—H. F. Smith. (*Wireless World*, 31st March, 1933, Vol. 32, pp. 234-235.)

Constructional details of an automatic volume control unit which can be added to practically any existing receiver.

THE HISTORY OF A.V.C. (*Ibid.*, pp. 236-237.)

SELECTIVITY IN BROADCAST RECEPTION. 1. BAND-PASS FILTERS. 2. TONE CORRECTION.—T. D. Davidson: D. A. Bell. (*British Radio Annual*, 1932, pp. 17-23: 24-29.)

RECEIVERS [a Survey of Ten Years].—P. David. (*L'Onde Elec.*, Nov.-Dec., 1932 [pub. 28th March, 1933], Vol. 11, Nos. 131-132, pp. 517-532.)

PRESENT AND POSSIBLE FUTURE TRENDS IN RADIO.—(*Electronics*, March, 1933, p. 64.)

An article entitled "Prices of components tend to stabilise" includes the following points:—"at least one company has mastered the art of using steel for anodes"; extruded carbon plates are used in power valves and may find their way into receiving valves; "new alloy wires are on the way for grids, etc. Allen-Bradley have developed a carbon enamel for plates to reduce secondary emission."

"Ultimately, perhaps," there will be a two-valve superheterodyne, with a detector-oscillator valve (cf. Wheeler, under "Valves and Thermionics") and a detector-power valve.

RADIO STATISTICS—PRODUCTION AND USE.—(*Electronics*, March, 1933, pp. 60-61.)

AVERAGE SELECTIVITY CURVES OF 1931-32 SUPERHETERODYNE AND TUNED R.F. RECEIVERS.—Horn. (See abstract under "Stations, Design and Operation.")

STRAIGHT SETS versus SUPERHETERODYNES: CORRESPONDENCE.—M. L. Elliott. (*Wireless Engineer*, March, 1933, Vol. 10, No. 114, p. 145.)

Referring to a past editorial under this title, the writer gives his own experience, in particular comparing the *Wireless World* "Modern Straight Five" and "Monodial" 7-valve superheterodyne.

VDE REGULATIONS FOR MAINS-DRIVEN BROADCAST RECEIVERS.—Verband Deutscher Elektrotechniker. (*E.T.Z.*, 30th March, 1933, Vol. 54, No. 13, pp. 314-316 and 318.)

A RADIO DISTRIBUTION SYSTEM FOR APARTMENT BUILDINGS [wired with Special Coaxial Conductor: One Aerial, 3 000 or more Receivers].—C. F. Boeck. (*Bell Lab. Record*, March, 1933, Vol. 11, No. 7, pp. 205-209.)

THE DEVELOPMENT OF POLICE MOTOR-CAR RADIO.—H. E. Thomas. (*Rad. Engineering*, Jan., 1933, Vol. 13, pp. 20-21.)

GETTING THE MOST FROM THE SINGLE-SIGNAL SUPERHET: LINING UP THE FILTER CIRCUIT AND CHECKING ITS PERFORMANCE.—J. J. Lamb. (*QST*, March, 1933, Vol. 17, pp. 33-36.) See January Abstracts, p. 39, l-h column.

SHORT-WAVE TRANSOCEANIC TELEPHONE RECEIVING EQUIPMENT.—F. A. Polkinghorn. (*Rad. Engineering*, Feb., 1933, Vol. 13, pp. 12-17 and 20.)

AERIALS AND AERIAL SYSTEMS

ATTENUATION OF TRANSMISSION LINES [H.F. Feeders, etc.]: SIMPLE METHOD OF MEASURING.—M. J. O. Strutt. (*Wireless Engineer*, March, 1933, Vol. 10, No. 114, pp. 139-140.)

After briefly discussing five known methods, the writer introduces a new procedure which has been successfully applied to cables used for carrier waves and to telephone lines, and which can easily be applied to short-wave feeders, provided they are long enough to contain more than one half-wave-lengths. Voltmeters, with internal impedance very large compared with the line characteristic impedance, are connected to the input and output of the line: the output is otherwise free. The frequency is then varied until the ratio of the input voltage V_1 to the output voltage V_2 is a maximum; then, provided al is not too great compared with unity (a being the attenuation and l the length of the line), a is given by $|V_1/V_2| = \cosh al$. Examples of the use of the method are given.

EINE EINFACHE METHODE ZUR BESTIMMUNG DER DAMPFUNG VON ÜBERTRAGUNGSLEITUNGEN (A Simple Method of Measuring the Attenuation of Transmission Lines [H.F. Feeders, etc.]).—M. J. O. Strutt. (*Hochf.tech. u. Elek. akus.*, March, 1933, Vol. 41, No. 3, pp. 98-100.) See preceding abstract.

GRAPHICAL METHODS FOR PROBLEMS INVOLVING RADIO-FREQUENCY TRANSMISSION LINES.—H. Roder. (*Proc. Inst. Rad. Eng.*, Feb., 1933, Vol. 21, pp. 290-302.)

"The exact theory of transmission lines becomes considerably simplified if applied to radio-frequency transmission. On account of the high frequency, the effects of distributed L and C become predominant to such an extent that in most cases line resistance and leakage conductance can be neglected with respect to inductance and capacitance. The simplicity of the theory can be further emphasised by employing graphical methods for the determination of currents, voltages, and impedances." Such methods are described, and a simplified elliptical diagram is developed for finding current or voltage distribution. The application of circle diagrams is explained, by means of which the line input impedance may be obtained under various conditions.

ELLIPSE DIAGRAM OF A LECHER WIRE SYSTEM [and the Transition from Double to Single Hump of Current Distribution].—A. Hikosaburo: Mohammed and Kantebet: Takagishi. (*Proc. Inst. Rad. Eng.*, Feb., 1933, Vol. 21, pp. 303-311.)

Prompted by the work of Mohammed and Kantebet (1932 Abstracts, p. 175). Author's summary:—"According to theoretical investigation, the current through the end of a Lecher wire system has been found to be inversely proportional to the length of a radius vector drawn from a point to the boundary of an ellipse. Such a diagram is called an "ellipse diagram" of the Lecher wire system, and is analogous to the so-called circle diagram for the induction motor [see next abstract]. The nature of this diagram is explained in detail in this paper. By the aid of this diagram the effect of the length of the wires on the form of the current through the end of the Lecher wire system is investigated." The double-hump phenomenon is a general form of current through the end, and the single-hump, which is usually observed, is its special form. The current through the bridge is slightly different from that through the end, and the ellipse diagram for this current is more complicated: the general features, however, are similar.

A PROOF THAT THE INDUCTION MOTOR CIRCLE DIAGRAM APPLIES TO THE TRANSMISSION LINE.—F. Creedy. (*Journ. I.E.E.*, Vol. 49, 1930, p. 381.)

ABSORPTION AND RERADIATION OF [Ultra-] SHORT ELECTRIC WAVES.—C. R. Fountain. (*Phys. Review*, 1st March, 1933, Series 2, Vol. 43, No. 5, p. 384.)

Abstract only of experiments on the absorption and reradiation of 3.7 metre waves by a resonance rod at various positions in the field. The writer finds that there is "bunching" of energy by the rod.

AN EXPERIMENTAL AND ANALYTICAL INVESTIGATION OF EARTHED RECEIVING AERIALS: CORRECTIONS.—Colebrook. (*Journ. I.E.E.*, March, 1933, Vol. 72, No. 435, p. 268.) See 1932 Abstracts, pp. 526-527.

MUTUAL IMPEDANCE OF LONG GROUNDED WIRES WHEN THE CONDUCTIVITY OF THE EARTH VARIES EXPONENTIALLY WITH DEPTH.—M. C. Gray. (*Physics*, Feb., 1933, Vol. 4, No. 2, pp. 76-80.)

Author's summary:—"This paper presents a formula for the mutual impedance of long grounded wires above the surface of the earth, on the assumption that the conductivity of the earth varies exponentially with depth according to the formula $\gamma = \gamma_0 e^{-bz}$. For $b = 0$ the formula reduces to the known result for a uniformly conducting earth, while if b is allowed to become negatively infinite it reduces to the result for an earth consisting of a conducting layer at the surface only. For small values of b the first terms in the expansion of the impedance in powers of b are obtained, and curves are included of the real and imaginary parts of the coefficient of b .

CHECKING THE BEHAVIOUR OF ULTRA-HIGH-FREQUENCY [2- and 5-Metre] WAVES: INTERESTING TRANSMISSION TESTS USING DIRECTIVE AERIALS [Wave Reflectors and Directors].—F. C. Jones. (*QST*, March, 1933, Vol. 17, pp. 14-17 and 26.)

The correct ratio of transmitting aerial length to wavelength was found to be, for average conditions (of insulators, rod diameter, etc.), 0.475. For the reflectors the best ratio, giving them inductive reactance, was found to be 0.485; for the directors (requiring capacitive reactance) it was 0.435. These values were obtained with 2 m waves, and agreed well with the 4.41 m results in Japan (1928 Abstracts, pp. 103—Uda—and 519—Yagi; 1932, pp. 461—462 and 462—Kikuchi); they were found also to give good results with 5 m waves. With regard to these latter tests, "the resulting signal seems to be quite satisfactory over the whole San Francisco Bay area except in one locality where several small ranges of hills intervene. Possibly a director chain could be placed over the top of each hill to re-direct the radiated waves down into the valleys [cf. Japanese results, March Abstracts, p. 148—Smith-Rose]. Some such idea may be necessary to put ultra-high frequency television signals into dead spots such as valleys in suburban districts."

Polar diagrams of a number of aerial systems are given which illustrate the above results and show the effects of different numbers of reflectors and directors, etc. The article ends with a description of some distance tests on 5 m waves indicating that "either vertical or horizontal antennas could be used for distances of more than a mile or so but with usually better results if both receiving and transmitting antennas were in the same plane. Intervening hills seemed to alter these conditions, especially if the hills were near the transmitter. Similar results were obtained when listening with a super-regenerative receiver to various 56-mc/s 'phone stations. Sometimes a half-wave horizontal antenna would be best, even when the transmitter used a vertical antenna. However, by an average ratio of about 3 to 1, a vertical receiving aerial gave better results regardless of the type of transmitting antenna. The location of the transmitter with regard to hills and large buildings seemed to have an important effect on the degree of vertical or horizontal polarisation at the receiving end. Often the combination of a long, high antenna plus a short vertical (half-wave) one gave the best received signal and is the one most used at this station. The directional antennas also work very well for receiving providing the natural resonant period is not at the wrong end of the amateur band—a director wire for the low-frequency end of the five-metre band becomes nearly a reflector at the other end."

SHORT-WAVE DIRECTIONAL AERIAL SYSTEMS. PART I.—C. C. Whitehead. (*World Radio*, 31st March, 1933, Vol. 16, No. 401, p. 440.)

IMPROVED DIRECTIVE RECEPTION ON A MULTIPLICITY OF AERIALS BY USING REPEATED FREQUENCY MULTIPLICATION BEFORE COMBINING.—J. von Plebanski. (Summary of German Patent in *Hochf.tech. u. Elek.akus.*, Jan., 1933, Vol. 41, No. 1, p. 39.)

VALVES AND THERMIONICS

THE EMISSION VALVE MODULATOR FOR SUPER-HETERODYNES [Four-Grid Detector-Oscillator].—H. A. Wheeler. (*Electronics*, March, 1933, pp. 76-77.)

The following functions were aimed at: (1) combination oscillator-modulator, (2) high conversion gain, and (3) grid-bias volume control. (2) and (3) seem at first incompatible, because (2) requires a sharp-cut-off grid and (3) a gradual-cut-off grid. This problem was solved by putting two grids in the same electron stream, each having the structure best adapted to its function. Each grid has its screen grid, and between the oscillator screen grid and the modulator grid a cloud of retarded electrons is formed which acts as a "virtual cathode" for the outer, modulator section of the electrode system. The "emission valve" mechanism mentioned in the title is as follows:—when the oscillator grid is only slightly negative, or slightly positive, the "virtual cathode" has a plentiful supply of electrons for the modulator section; when it swings considerably negative, the virtual cathode, and hence the modulator plate, are momentarily deprived of their electron supply.

"The performance of the new tube . . . is proving superior to that of a gradual-cut-off modulator coupled to a separate oscillator." For the possibility of a two-valve superheterodyne receiver using this valve, see under "Reception"—"Present and Possible Future Trends."

NEW VACUUM TUBES AND THEIR APPLICATIONS.—A. W. Hull. (*Rad. Engineering*, Jan., 1933, Vol. 13, pp. 17-19). See March Abstracts, pp. 160-161.

DEVELOPMENTS IN THE ELECTRICAL INDUSTRY DURING 1932: ELECTRONIC TUBES [including Improved Plotron for Sensitive Measurements at Low Frequencies, with Cathode between Grid and Anode].—(*Gen. Elec. Review*, Jan., 1933, Vol. 36, pp. 42-43.)

PROGRESS IN TUBES FOR RADIO [RCA Radiotron and Cunningham 25Z5 Rectifier, Power Amplifier Triode 2A3 with Multi-filamentary Cathode, etc.].—(*Rad. Engineering*, Feb., 1933, Vol. 13, pp. 10-11 and 22.)

FILAMENTLESS RADIO TUBES DEMONSTRATED FOR WIDE USE.—A. Hund: Wired Radio, Inc. (*Elec. World*, 14th Jan., 1933, Vol. 101, No. 2, p. 57.)

"These tubes accomplish all the operations normally required of a vacuum tube, in addition to many that are unusual. Some have operated on test continuously for more than 1200 hours." They operate on d.c. and require a single voltage; in operation a purple glow appears. No details are given. Cf. April Abstracts, p. 215.

PUSH-PULL AMPLIFIER GRAPHICS.—C. E. Kilgour. (*Electronics*, March, 1933, p. 73.)

INDIRECTLY HEATED VALVES WITH DOUBLE-WOUND [Non-Inductive] FILAMENTS.—(*Radio, B., F. für Alle*, April, 1933, p. 180.)

"SPRAYED MICA" USED IN VALVES TO PREVENT LEAKAGE.—National Union Radio Corporation. (*Rad. Engineering*, Jan, 1933, Vol. 13, p. 24.)

METHOD OF FIXATION OF EMISSIVE MATERIAL ON CATHODE TUBES HEATED BY INTERNAL FILAMENT [Adherence ensured by covering Nickel Tube with Spiral or Net of Very Fine Nickel Wire, avoiding use of Added Organic Substances]. (*Rev. Gén. de l'Élec.*, 25th Feb., 1933, Vol. 33, No. 8, pp. 61-62D: French Pat. No. 734 709, pub. 27th Oct., 1932, Lévy.)

RADIO TUBES IN NEED OF SIMPLIFICATION.—Bureau of Standards. (*Commercial Standards Monthly*, Feb., 1933, Vol. 9, No. 8, p. 180.)

To-day there are 65 types of valves, with very little interchange possible, compared with 33 types six months ago. A seven pronged tube is the latest to be put on the market. It is expected that set owners will eventually protest on account of replacement difficulties and thus simplification may be brought about.

VALVES [a Survey of Ten Years].—M. Ponte. (*L'Onde Élec.*, Nov.-Dec., 1932 [pub. 28th March, 1933], Vol. 11, Nos. 131-132, pp. 413-426.)

PRESENT AND POSSIBLE FUTURE TRENDS IN RADIO [including Steel for Valve Anodes, etc.]. (See under "Reception.")

THE MAGNETRON ULTRA-SHORT-WAVE OSCILLATOR.—Megaw. (See two abstracts under "Transmission.")

CHARACTERISTICS AND FUNCTIONS OF THYRATONS.—Hull. (See under "Subsidiary Apparatus and Materials.")

GRID AND PLATE CURRENTS IN A GRID-CONTROLLED MERCURY VAPOUR TUBE.—A. C. Seletzky and S. T. Shevki. (*Journ. Franklin Inst.*, March, 1933, Vol. 215, No. 3, pp. 299-326.)

Authors' summary:—An oscillographic and quantitative investigation of the grid and plate currents of a grid-controlled mercury vapour tube, operating in an a.c. circuit, as functions of grid voltage and resistance, plate voltage and phase displacement between grid and plate voltages.

It is shown that the direction of grid current depends not only upon the instantaneous polarity of the grid but also upon the magnitude of the grid voltage and upon the plate current. The grid current wave may consist of positive loops only, of positive and negative loops of varying areas or of equal areas, and of negative loops only. The various factors affecting the form of grid current wave are considered in detail.

Inverse plate current occurs whenever the grid current is concurrent with the negative half-cycle of the plate voltage. The minimum value of inverse plate current occurs when there is no grid current coincident with the negative half-cycle of the plate voltage. It is caused by the lag of de-

ionisation of the mercury vapour furnishing a small amount of ionisation when the plate voltage becomes instantaneously negative. With a constant average grid current the magnitude of the inverse plate current varies approximately sinusoidally with phase displacement between grid and plate voltages.

EMISSION FROM OXIDE-COATED CATHODES.—M. Benjamin and H. P. Rooksby. (*Phil. Mag.*, April, 1933, Series 7, Vol. 15, No. 100, pp. 810-829.)

Authors' summary:—It has been shown by X-ray analysis that the only material present in bulk form in the coating of an active cathode is the monoxide. If the coating consists of a mixture of barium and strontium oxides, these form a solid solution in one another. If the coating is of one oxide only and the emission is destroyed by flashing, the remaining coating may be fully reactivated by repeating the activating process. Recovery of the original activity is not possible after severe flashing of a mixed BaO/SrO coated cathode. This has been shown to be associated with a preferential loss by evaporation of BaO from the coating, and is thus attributable to an altered composition. If the emission of a cathode coated with a single oxide has been poisoned by oxygen, it may always be completely recovered by first flashing at sufficiently high temperature with space current, and then reactivating. In the case of a mixed BaO/SrO coated cathode, it is not always possible to recover the emission in this way, presumably because surface oxygen cannot be "flashed off" without serious evaporation of BaO occurring at the same time. Recovery, however, is possible in this case also, if, instead of flashing, the surface layer is sputtered off by ions of argon or mercury.

DIE ENTAKTIVIERUNG (ZERSTÄUBUNG) VON THORIERTEM WOLFRAM DURCH AUFPRALLENDE POSITIVE IONEN (The Deactivation—Dispersion of the Thorium Layer—of Thoriated Tungsten through Bombardment by Positive Ions [Contradiction of Kingdon and Langmuir's Theory]).—A. Gehrts. (*Zeitschr. f. tech. Phys.*, No. 4, Vol. 14, 1933, pp. 145-152.)

From the author's summary:—If we take into consideration the fact that the thorium atoms are displaceable along the tungsten surface, and further that the ions give up not only their kinetic energy but also their neutralisation energy on rebounding from the cathode, we can show, from the measurements of Kingdon and Langmuir and of Hull, that the setting-in of sputtering in a thoriated tungsten cathode is independent, at least in the first approximation, of the nature of the gas and is dependent only on the energy which the ion delivers to the cathode. The view put forward by Kingdon and Langmuir according to which the thorium dispersion is produced [in two stages, a thorium atom at the surface of the tungsten being first driven into the underlying tungsten layer by the impact of an ion, and then hit by a second ion: this ion is reflected elastically and drives out a neighbouring thorium atom] must be replaced by the conception of the sputtering as the result of a transference of

energy from ion to thorium atom. The theory of cathode sputtering developed by von Hippel, according to which the positive ions so heat a part of the cathode surface that a purely thermal evaporation takes place, is not applicable to thoriated tungsten cathodes. The dispersion of the thorium depends rather on a direct energy transference between ion and surface molecule.

THE DIFFUSION OF THORIUM IN TUNGSTEN [and the Effect of Size of Grain].—G. R. Fonda, A. H. Young and A. Walker. (*Physics*, Jan., 1933, Vol. 4, No. 1, pp. 1-6.)

Authors' summary:—Thoriated tungsten wires have been so heat-treated in gas as to develop variations in grain size, ranging in length from 4μ to 3 cm. These variations produced marked changes in the thermionic emissive characteristics, such as rates of deactivation and of activation and duration of emissive life at normal operating temperature. The heat of diffusion remained unaffected. It was concluded that intergranular diffusion of thorium through tungsten is relatively too rapid to be measured and that the observed phenomenon depends purely on intragranular diffusion. This conception is in accord with the existence of a critical grain size for the realisation of a maximum emissive life. Experiments are also described to demonstrate the spreading of thorium atoms over the surface of a single crystal of tungsten and to manifest the effect of slight strains in the lattice upon activation.

THERMIONIC AND ADSORPTION CHARACTERISTICS OF THORIUM ON TUNGSTEN.—W. H. Brattain and J. A. Becker. (*Phys. Review*, 15th March, 1933, Series 2, Vol. 43, No. 6, pp. 428-450.)

Experimental results are given for the variation of thermionic emission of tungsten with surface density of adsorbed thorium, for the variation of emission from thoriated tungsten with applied field, and for the evaporation and migration of thorium on tungsten surface.

THE QUANTITATIVE DETERMINATION OF THE FREE ALKALI-EARTH METAL IN THE OXIDE CATHODE.—T. B. Berdennikowa. (*Hochf. tech. u. Elek. akus.*, March, 1933, Vol. 41, No. 3, pp. 106-107: summary only.)

In atomic layers the desirable content of free barium is of the order of 10^{-6} gm/cm². The writer describes a purely chemical method of measuring such a quantity (down to 5×10^{-8} gm), depending on the action of water vapour. Whichever of the two possible equations is involved, one gramme-atom of barium always gives one gramme-molecule of hydrogen; this hydrogen is measured with a manometer, after removal of all other gas and excess water vapour. Results of tests by this method, on electrically activated cathodes, are tabulated. With thermal dissociation no free metal was found.

PHENOMENA IN OXIDE CATHODES, AND THEIR TRANSVERSE RESISTANCE.—I. Kroczek. (*Ibid.*, pp. 107-108: summary only.)

THE [Experimental] EFFECT OF HIGH ELECTROSTATIC FIELDS UPON THE VAPORISATION OF MOLYBDENUM [in the form of Heated Wires].—G. B. Estabrook. (*Phys. Review*, 1st March, 1933, Series 2, Vol. 43, No. 5, p. 383: abstract only: see also below.)

ON THE EFFECT OF HIGH ELECTROSTATIC FIELDS ON THE VAPORISATION OF METALS [Theoretical Discussion].—A. G. Worthing. (*Ibid.*, p. 383: abstract only.)

ÜBER DIE DICHTEVERTEILUNG UNIPOLARER IONENSTRÖME (On the Density Distribution of Unipolar Ion Currents [Theoretical Investigation]).—W. Deutsch. (*Ann. der Physik*, 1933, Series 5, Vol. 16, No. 5, pp. 588-612.)

Author's summary:—The equations governing the conduction of unipolar ions may in general be approximately solved for small values of space charge, when changes in direction of field intensities, modified by this space charge, are neglected. The theory is applied to calculate the following examples: (1) Thin emitting wire parallel to a plane; (2) edge of a half plane, emitting towards a plane; (3) point discharge; (4) thin emitting wire between two parallel planes. A certain integral expression, which is easy to interpret and evaluate, is found to play an important part in the solution. The results calculated for the point discharge agree with Warburg's experimental results [*Handbuch der Physik*, Vol. 14, p. 154 (1927).]

THE POSITIVE ION WORK FUNCTION OF TUNGSTEN FOR THE ALKALI METALS.—R. C. Evans. (*Proc. Roy. Soc.*, March, 1933, Vol. 139, No. A 839, pp. 604-617.)

The experiments described in this paper were made "with ions of potassium, rubidium and caesium evaporating from clean tungsten, and give for the work functions the values 2.4₃, 2.1₄ and 1.8₁ volts respectively."

EXPERIMENTS ON THE CONTACT POTENTIAL OF ZINC CRYSTALS.—W. A. Zisman and H. G. Yamins. (*Physics*, Jan., 1933, Vol. 4, No. 1, pp. 7-13.)

"Experiments were made proving for the first time that it is possible to obtain a reproducible contact potential difference on zinc in air at ordinary pressures, provided the cleaved surface of a single crystal is used. It is suggested that the lack of reproducibility of the Volta effect of turned or scraped surfaces of zinc is due to an anisotropy in the zinc crystals with respect to the Volta effect, and not due to condensation phenomena accompanying the roughness of the surface. Confirmatory evidence is found in the reproducibility of the contact potential difference of turned and scraped surfaces of copper. Ende's suggestion that emery embedded in the metals gives rise to false potential differences is demonstrated to be correct. It is found that emery increases the potential difference between zinc and gold by about 0.4 volts, and rouge decreases it by about 0.5 volts."

DIRECTIONAL WIRELESS

AUTOMATIC STEERING CONTROL WITH AUTOMATIC RADIO DRIFT CORRECTION, FOR AIRCRAFT.—(Gen. Elec. Review, Jan., 1933, Vol. 36, pp. 15-17.)

"Up to date, the effective range of this control equipment is about 150 miles, and at present it cannot be considered as being fully developed." The course angle establishes the relative positions of the magneto compass and the radio loop aerial: this relation remains constant and the radio compass controls the rudder. Current from the magneto compass due to deviation to the right or left causes a simultaneous rotation of compass and loop until the poles of the former again point east and west and no more current flows. Then as the plane drifts when a cross wind is encountered, the loop ceases to be normal to the radio waves from the station towards which it is flying, and current flows from the radio compass, acts on the rudder, and brings the aeroplane back to its correct path. This movement, changing as it does the position of the magneto compass poles with reference to their east-west position, brings that compass into action as described above. The aeroplane is now not pointing directly toward the radio station but is headed into the cross wind at an angle which corrects for the drift, and this condition is maintained, any change in wind velocity being automatically compensated.

WIRELESS DIRECTION FINDING [Marconi-Adcock Installations at Pulham and Lympe: another for Dubendorff].—Marconi Company. (Electrician, 21st April, 1933, Vol. 110, No. 2864, p. 513.)

RADIOELECTRICITY IN AVIATION [a Survey of Ten Years].—P. Franck. (L'Onde Élec., Nov.-Dec., 1932 [pub. 28th March, 1933], Vol. 11, Nos. 131-132, pp. 541-552.)

SONIC MARKER BEACON FOR FOG LANDING [Fan-Shaped Beams of 3000 c/s Whistle].—C. W. Rice. (Gen. Elec. Review, Jan. and March, 1933, Vol. 36, pp. 16, 17 and 159.)

ACOUSTICS AND AUDIO-FREQUENCIES

A HIGH-GAIN AUDIO-FREQUENCY AMPLIFIER [using Screen-Grid Valves].—L. C. Verman. (Review Scient. Instr., March, 1933, Vol. 4, pp. 153-156.)

Author's summary:—"The design of a 3-stage high-gain amplifier for laboratory use in audio-frequency investigations is described. Four-electrode tubes are used as screen-grid amplifiers and an amplification of the order of 200 per stage is obtained [cf. McDonald, 1931 Abstracts, p. 148]. The inaccuracy of McDonald's formula for calculation of stage-gain has been pointed out [$A = \mu r / (Rp + r)$, not $A = Mr$]. The gain-frequency characteristics are given for power as well as for voltage amplification. It is shown that extreme care is necessary in the design of shielding to obtain high-voltage amplification of the order of 120 db as obtained in this 3-stage amplifier." Thus in a second model, instead of having a separate steel box for each stage, "one large box was built with two partitions of the same thickness of steel."

When the s.g. voltage was increased gradually in the attempt to increase the amplification, a singing point was reached; the amplification just before this point was reached was found to be less than half that given by the first model.

HARMONIC CONTENT IN AMPLIFIERS: CORRESPONDENCE.—W. E. Benham: Kirke. (Wireless Engineer, March, 1933, Vol. 10, No. 114, p. 147.)

A letter on Kirke's suggestion that the harmonic content should be expressed in decibels below the fundamental (April Abstracts, p. 218.)

ELEKTRO-AKUSTISCHE UNTERSUCHUNGEN AN ELEKTRO-MAGNETISCHEN LAUTSPRECHERN (Electro-Acoustic Investigations on Electro-Magnetic Loud Speakers).—W. Lehmann. (Helvet. Phys. Acta, Fasc. 1, Vol. 6, 1933, pp. 3-41.)

Author's summary:—"In the present work a method is described of investigating the electro-acoustic transformation in loud speakers. The writer designed and constructed, for this purpose: (a) a heterodyne note generator; (b) a special l.f. amplifier for this generator; (c) an a.c. voltmeter with low energy consumption [valve voltmeter found inapplicable, on account of its limited range and difficulty in maintaining constancy over several hours: quadrant electrometer demanded too high an insulation of output condenser: a copper-oxide rectifier with sensitive m.c. galvanometer was finally chosen]; and (d) a sensitive Rayleigh disc [the possible use of a Pitot tube is also discussed].

To show that the electrical energy taken by a loud speaker is dependent on the driving system, the radiator coupled to this, and the radiated acoustical energy, the following tests were made: (a) investigation of a vibrating element (commercial loud speaker drive) without any radiator; (b) tests with the smallest possible sound radiator, with a marked natural frequency (tests with strings); and (c) measurements on the changes of electrical quantities produced by variation of the radiation conditions of the acoustical energy by means of resonators. Finally, a number of commercial types of loud speaker were investigated with this equipment [Blue Spot, Pathé, Telefunken, Loewe, Wufa, and a loud speaker with celluloid diaphragm. For references to previous work by the writer and Zickendraht see January Abstracts, p. 43, 1-h column].

DISCUSSION ON "ON THE AMPLITUDE OF DRIVEN LOUD SPEAKER CONES."—N. W. McLachlan: Strutt. (Proc. Inst. Rad. Eng., Feb., 1933, Vol. 21, pp. 312-314.)

Continuation of the argument referred to in 1932 Abstracts, p. 101. McLachlan maintains that M_e/M , the ratio taken by Strutt as the efficiency, is not a criterion of the acoustic performance of a vibrating diaphragm. Strutt points out that he has already stated that no damping and hence no sound radiation was taken into account in his theoretical interpretation of experimental results: "they could not and still (I am sorry to say) cannot be duly taken into account, as no sufficient theoretical and experimental material on this rather difficult but

very important question is available." With regard to the "central point" of the argument, the values of effective mass, he maintains that the difference between McLachlan's results and his own is that McLachlan says that there is one equivalent mass of any specified cone at any specified frequency, while he himself contends that there are "as many as you like," depending on the driving direction (1932 Abstracts, p. 350).

VIBRATIONS OF A COIL-DRIVEN PAPER CONE [Occurrence of Auxiliary Vibrations of Lower Frequency at Equally Spaced Critical Values of Input Frequency].—F. R. W. Strafford. (*Wireless Engineer*, March, 1933, Vol. 10, No. 114, p. 141.)

The first auxiliary vibration was encountered at an input frequency of 900 c/s: the phenomenon ceased at input frequencies above 2 150 c/s. The "spurious" frequencies were always half the input frequencies producing them. Various obvious explanations are considered and dismissed as inconsistent with the details of the case, and further investigation is suggested.

McLachlan (*ibid.*, April, 1933, p. 204) gives an analysis together with a physical explanation which "probably diagnoses Mr. Strafford's trouble"; owing to variation of the field within the magnet, a "rectification effect" (1932 Abstracts, p. 589, r-h col.) superposes, among a myriad others, a motion of half frequency on the fundamental; this half frequency comes into prominence owing to radial mode resonances. Ways of testing the validity of this explanation are suggested.

SYMMETRICAL LOUD SPEAKER SYSTEM WITH SOFT IRON LAMINATED FIELD MAGNETS AND ARMATURE: ARMATURE FLEXIBLY CONNECTED TO NEUTRAL POINT OF FIELD MAGNET.—F. Noack: Borchardt. (*Electronics*, Feb., 1933, p. 55.)

LOUD SPEAKER WITH COMPOSITE CONE OF TWO OR MORE FLEXIBLY CONNECTED PORTIONS EACH DRIVEN BY ITS OWN MOVING COIL.—AEG. (Summary of German Patent in *Hochf.tech. u. Elek.akis.*, Jan., 1933, Vol. 41, No. 1, pp. 39-40.)

THE ROCHELLE SALT LOUD SPEAKER.—H. Gerwin: Sawyer. (*Radio, B., F. für Alle*, April, 1933, pp. 177-179.)

ACOUSTICALLY COMPENSATED VOLUME CONTROL FOR RADIO AND PHONOGRAPH SETS [and the Frequency Response Curves of the Ear at Different Levels of Loudness].—I. Wolff and J. I. Cornell. (*Electronics*, Feb., 1933, pp. 50-51.)

Circuits are given for providing a volume control which raises the low frequencies in almost an inverse ratio to the relative sensitivity of the ear in going from normal volume to the volume at which the sound is to be heard. A series of loudness contour lines, taken from a paper by Kingsbury in the *Physical Review*, is given.

ESTIMATING LOUDNESS: IS THE EAR AN A.V.C. DEVICE?—R. T. Beatty. (*Wireless World*, 21st April, 1933, Vol. 32, pp. 289-290.)

Recent experiments, in which nearly two hundred

observers took part, show that the ear does not respond proportionately to increases in sound intensity. It appears, for example, that in cases where the loudness of a sound is actually increased eight times according to the decibel scale, mental estimates will assess the final result as being only twice the original volume. See also Jan. Abstracts, p. 43, Ham and Parkinson.

VERTICALLY CUT SOUND RECORDS.—H. A. Frederick and H. C. Harrison. (*Elec. Engineering*, March, 1933, Vol. 52, No. 3, pp. 183-188.)

EINFÜHRUNG IN DIE TONPHOTOGRAPHIE (Introduction to the Photographic Recording of Sound).—J. Eggert and R. Schmidt. (Book Review in *Review Scient. Instr.*, March, 1933, Vol. 4, p. 179.)

SOUND ORNAMENTS [Musical Effects produced by "Ornamental Forms" traced on Sound Film and projected].—Gradenitz: Fischinger. (Summary in *Electronics*, Feb., 1933, p. 55.)

This is referred to as "an article of considerable importance as a step towards the direct production of music from films" (cf. Rosen on Pfenniger's work, April Abstracts, p. 217). A note with its octave, third and fifth, and the "geometrical ornaments which give the timbres of bassoon, flute, xylophone, etc.," are among the results mentioned.

TÖNENDE SCHRIFT (Audible Writing [Synthetic Sound]).—H. Böhm: Pfenniger. (*Die Sendung*, 10th Feb., 1933, Vol. 10, No. 7, pp. 135-136.)

Short article on a broadcast by Böhm on the artificial sound work of Pfenniger (April Abstracts, p. 217—Rosen). One photograph shows Pfenniger smashing a cup with a hammer and watching the oscillogram of the sound so as to be able to reproduce it later.

SUCCESS IN OBTAINING TONAL BALANCE BETWEEN BRASS BAND AND PIANO, VIOLIN, ETC., FOR BROADCASTING.—Taylor Branson: Stokowski. (*Electronics*, Feb., 1933, p. 52.)

ELECTRONIC MUSICAL INSTRUMENTS OF EUROPE AND U.S.—B. F. Miessner. (*Electronics*, March, 1933, pp. 65 and 72.)

SCIENTIFIC PIANO FOR RADIO CITY.—(*Scient. American*, April, 1933, p. 248.)

Note on a new Hammond-Bechstein piano in which the sounding board is "replaced by 18 microphones which amplify the tones and produce the effect of any given instrument in a symphony orchestra."

ÜBER DIE ERSATZQUELLENMETHODE ZUR BESTIMMUNG DER EMPFINDLICHKEIT VON ELEKTRO-AKUSTISCHEN EMPFÄNGERN (The Voltage-Substitution Method of Determining the Sensitivity of Electro-Acoustic Receivers [as in Calibrating a Condenser Microphone for the Absolute Measurement of Sound Pressures]).—H. Lueder and E. Spenke. (*E.N.T.*, March, 1933, Vol. 10, No. 3, pp. 99-105.)

An investigation of the question as to what

exactly is represented as the "primary driving force." It is concluded that there are two alternatives: (1) the driving force may be taken as the "aeromotive force" of the sound field. This leads to the solution of an electro-acoustical quadripole composed of the microphone itself and its "radiation brake" (depending on the surrounding space), and not of the microphone alone. The e.m.f. of this quadripole, measured by the voltage-substitution method, is related to the aeromotive force of the sound field and not to the pressure at the moving diaphragm. The method is suitable for absolute sound-pressure measurements in a free sound field.

(2) The force exerted on the moving diaphragm can be regarded as the driving force, with which the measured e.m.f. is connected. Then the transmission ratio e.m.f./driving force characterises the microphone by itself, and the process is suitable for pressure-chamber calibrations. There is no direct method of measuring this force exerted on the moving diaphragm: this difficulty is evaded by the taking of a series of purely electrical resistance measurements.

DEFLEXIONS AND VIBRATIONS OF A CIRCULAR ELASTIC PLATE UNDER TENSION [Mathematical Investigation for application to Design of Condenser Microphone].—W. G. Bickley. (*Phil. Mag.*, April, 1933, Series 7, Vol. 15, No. 100, pp. 776-797.)

From the author's summary:—In view of the proposed design of a condenser microphone, in which the natural frequencies of vibration of the diaphragm were to be raised by the application of tension in its plane, the investigation of the effects of this tension upon the normal displacement under pressure, and upon the natural frequencies of vibration, was undertaken. The present paper gives the results of this investigation.

EIN NEUES KOMPENSATIONSMICROPHON (A New Compensating Microphone).—W. Geffcken. (*Physik. Zeitschr.*, 15th March, 1933, Vol. 34, No. 6, p. 237.)

A note on some constructional alterations to the microphone referred to in April Abstracts, p. 217, l-h column.

ÜBER DIE GÜNSTIGSTE RAUMDÄMPFUNG (On the Most Favourable Space Absorption [and the Influence of the "Building-Up Period"]).—H. Benecke. (*Ann. der Physik*, Nov., 1932, Series 5, Vol. 15, No. 3, pp. 259-272.)

Introducing the term "building-up period," the period during which the sound reaches approximately two-thirds of its maximum. Optimum damping is given when this period is about 0.06 sec. Musical appreciation depends largely on this period, a fact which accounts for a lack of "true quality" in mechanical and electrical reproduction.

BESTIMMUNG DES SCHALLDRUCKES AN DER GRENZE DER HÖREMPFINDUNG MIT THERMOPHONEN (Determination of the Sound Pressure at the Limit of Audibility by means of Thermophones).—E. Waetzmann and W. Geffcken. (*Physik. Zeitschr.*, 15th March, 1933, Vol. 34, No. 6, pp. 234-235.) See also next abstract.

DAS THERMOPHON UND SEINE VERWENDUNG ALS AKUSTISCHES MESSINSTRUMENT (The Thermophone and its Use as an Acoustic Measuring Instrument).—W. Geffcken and L. Keibs. (*Physik. Zeitschr.*, 15th March, 1933, Vol. 34, No. 6, p. 237.)

See also preceding abstract. A short note on the theory of the thermophone; the complete paper was referred to in May Abstracts, p. 276, r-h column.

THE ABSOLUTE MEASUREMENT OF THE FUNDAMENTAL MAGNITUDES IN ACOUSTICS.—Z. Carrière. (*Review Scient. Instr.*, March, 1933, Vol. 4, pp. 165-166: short summary only of first paper of a series.)

ACOUSTIC RECEIVERS.—J. Perrin. (*Ibid.*, p. 166.)

THE PRODUCTION OF SPECIFIED WAVE FORMS WITH THE PHOTOELECTRIC SIREN.—H. P. Knauss. (*Phys. Review*, 1st March, 1933, Series 2, Vol. 43, No. 5, p. 375.)

Abstract only; a siren disc is used to interrupt a beam of light falling on a photoelectric cell and the amplified output produces a complex tone. The shape of the aperture to produce a desired wave form may be calculated. Cf. Schäffer and Lubszynski, Abstracts, 1931, p. 563 (r-h col.); 1932, p. 352 (l-h col.).

OUTPUT TRANSFORMER DESIGN.—H. B. Dent. (*Wireless World*, 21st April, 1933, Vol. 32, pp. 284-286.)

An article for the amateur constructor. Full details are given for the making of a number of output transformers to meet special requirements.

AKUSTISCHER DEMONSTRATIONSVERSUCH (Acoustic Demonstration Experiment).—E. Waetzmann. (*Physik. Zeitschr.*, 15th March, 1933, Vol. 34, No. 6, pp. 235-236.)

A description of a known arrangement for making acoustic phenomena audible and visible at the same time.

ACTION DES ULTRASONS SUR LES PLAQUES PHOTOGRAPHIQUES (Action of Supersonic Waves on Photographic Plates).—N. Marinenco and J. J. Trillat. (*Comptes Rendus*, 20th March, 1933, Vol. 196, No. 12, pp. 858-860.)

"To sum up, supersonic waves undoubtedly act on plates and papers sensitised with a silver salt, having a latent image, by aiding the blackening during development. . . . We cannot yet affirm the formation of latent images by the h.f. elastic waves."

EINIGE BEOBSACHTUNGEN AM SCHALLFELD VON PIEZOQUARZEN (Some Observation on the Acoustic Field of Piezo-Quartz Crystals).—K. Bücks. (*Physik. Zeitschr.*, 15th March, 1933, Vol. 34, No. 6, p. 237.)

A short preliminary account of a lecture demonstration of the properties of the acoustic field of piezo-quartz.

L'ABSORPTION DU SON DANS L'ATMOSPHERE : UNE TENTATIVE D'EXPLICATION (The Absorption of Sound in the Atmosphere : a Suggested Explanation [of the Observed Absorption more than Twenty Times as great as the Calculated]).—Y. Rocard. (*Journ. de Phys. et le Rad.*, March, 1933, Vol. 4, Series 7, No. 3, pp. 119-122.)

PHOTOTELEGRAPHY AND TELEVISION

SCHROTEFFEKT UND WÄRMEGERÄUSCH IM PHOTOZELLENERSTÄRKER (Shot Effect and Thermal Noise in the Photocell Amplifier).—F. von Orbán. (*Zeitschr. f. tech. Phys.*, No. 4, Vol. 14, 1933, pp. 137-143.)

Continuation of the work dealt with in 1932 Abstracts, p. 649. Author's summary:—"The background noise in photocell amplifiers is seen to be composed of two effects: shot effect in the photocell and thermal noise in the first grid circuit. This allows the resulting background noise to be calculated in advance for vacuum cells (its order of magnitude is a few microvolts of sinusoidal input voltage). The thermal noise is normally smaller than the shot effect. In vacuum cells the shot effect is, at saturation, proportional to the photoelectric current; below saturation voltage it retains—in contrast to the hot-cathode valve—its theoretical value. This is explained by the absence of space charge.

"In gas-filled cells the noise effect increases with increasing anode potential more rapidly than the photoelectric current, and rises to 4 to 50 times the theoretical value, according to the nature of the gas filling. Its frequency spectrum, moreover, shows increasing amplitudes at the lower frequencies. In these circumstances it is more advantageous to employ a vacuum cell with one additional stage of amplification than to use a gas-filled cell to save amplification—always assuming that the mechanical background noise [e.g., film rustle in a sound film] is not predominant." Cf. Kingsbury, 1932 Abstracts, p. 102.

EINE EVAKUIERTE VERSTÄRKERANORDNUNG ZUR MESSUNG KLEINER PHOTOSTRÖME (An Evacuated Amplifier Combination for the Measurement of Small Photoelectric Currents).—J. F. H. Custers. (*Zeitschr. f. tech. Phys.*, No. 4, Vol. 14, 1933, pp. 154-157.)

In order to overcome the difficulties of insufficient grid circuit insulation, the writer encloses his two electrometer valves, liquid resistance of 10^{10} ohms, and photoelectric cell in a strong glass container with a quartz window. This container is continuously evacuated. With a current sensitivity of 1.35×10^{-9} A per mm scale deflection (amplification $10^5 - 10^6$) the average unrest of the galvanometer spot is only a quarter of a millimetre (zero at night, when external disturbances are absent), and it wanders only 1 cm in a quarter of an hour. The arrangement has worked consistently for six months.

A STUDY OF THE PROPAGATION OF [Ultra-Short] WAVELENGTHS BETWEEN THREE AND EIGHT METRES [chiefly from Television Transmissions from Empire State Building].—L. F. Jones. (*Proc. Inst. Rad. Eng.*, March, 1933, Vol. 21, No. 3, pp. 349-386.)

The Empire State Building transmissions (see

also April Abstracts, p. 220, r-h column) were received and measured in an autogiro, a dirigible (data of doubtful value on account of reflection from the metal cabin and excessive ignition interference), a motor car, and indoors. "The absorption of ultra-short waves travelling through or around large buildings is shown to be, in terms of amplitude, about 50% every 500 feet for 7 metres and 50% every 200 feet for 3 metres. A number of reflection phenomena are discussed and the influence of interference patterns on receiving conditions is emphasised. It is shown that any modulation frequency is partly or completely suppressed if propagation to the receiver takes place over two paths differing in length by half of the hypothetical radio wavelength of the modulation frequency. For a good television picture this corresponds to a difference of about 500 feet.

"Various types of interference are mentioned. There are maps of the interference patterns measured in a typical residential room. The manner in which traffic movements cause severe fluctuations in u-s-w field strengths at certain indoor points is shown by recorded field strengths. It is shown that the service range of the Empire State transmitters includes most of the urban and suburban areas of New York, and that the interference range is approximately 100 miles. Variations of field strength with altitude, beyond line of sight, are shown. Observations made at a distance of 280 miles are described.

"An empirical u-s-w propagation formula is proposed. Curves are then calculated showing the relations between wavelength, power, range, attenuation, and antenna height."

NOTES ON PROPAGATION OF WAVES BELOW TEN METRES IN LENGTH [based on Empire State Building and Other Transmissions].—B. Trevor and P. S. Carter. (*Proc. Inst. Rad. Eng.*, March, 1933, Vol. 21, No. 3, pp. 387-426.)

Authors' summary:—"The results of a number of measurements of field strength variation with distance from the transmitter and height above ground for several wavelengths in the range below ten metres are shown. Observations of the two transmitters on the Empire State Building in New York City, on 44 and 61 megacycles, were made in an airplane over Long Island. These tests show the nature of the interference patterns set up by the combination of the direct and reflected rays. With low transmitting and receiving antennas, field strength measurements with distance were taken for both horizontal and vertical polarisations over Long Island sand on 41.4 and 61 megacycles. Similar tests were made over salt water with low antennas on 34.8 and 59.7 megacycles. Another airplane test was made on 34 megacycles with a higher transmitting antenna and increased power up to a distance of 200 kilometres. The intervening territory in this run was partly land and partly salt water.

The experimental data are discussed in comparison with the theoretical curves determined from optical principles. The experimental results are shown to conform in general with the predictions from theoretical considerations.

The derivation of the theoretical formulæ is shown in the appendix.

LICHTELEKTRISCHE EMISSION IM MAGNETFELD (Photoelectric Emission in a Magnetic Field).—R. Schmid. (*Ann. der Physik*, 1933, Series 5, Vol. 16, No. 6, pp. 647-656).

Author's summary:—An increase in the photoelectric emission of an open photocell (at atmospheric pressure) could be effected with a simple experimental arrangement in the presence of a longitudinal magnetic field. The increased final value of the emission was not in general attained simultaneously with that of the field; the photoelectric current showed certain transient phenomena. The magnitude of the effect depended not only on the strength of the photoelectric current and the magnetic field but also on the previous treatment of the electrodes. It might be possible to explain the experimental results by assuming that the longitudinal magnetic field causes a decrease of the work function.

STANDING LIGHT WAVES; REPETITION OF AN EXPERIMENT BY WIENER, USING A PHOTOELECTRIC PROBE SURFACE.—H. E. Ives and T. C. Fry. (*Journ. Opt. Soc. Am.*, March, 1933, Vol. 23, pp. 73-83.)

"The present study was undertaken as part of the experimental support which was sought for our theory of photoelectric action [photoelectric emission from thin alkali films directly correlated with amount of energy absorbed by the films: Ives, and Ives and Briggs, 1932 Abstracts, p. 532], and had for its object the lifting of the sensitive film up to different positions above the reflecting metal surface, to find out whether the photoelectric current followed the very considerable alterations in the energy density which computations indicate." The alkali metal was therefore deposited on a quartz wedge.

"The results give added support to the line on which we are studying the photoelectric effect from thin films of alkali metal. The experiment has in fact carried the investigation of the relation between electric intensity and photoelectric current up away from the metallic base . . . into the space above. Here, according to the theory, quite unusual photoelectric phenomena [pronounced maxima and minima of emission through the visible spectrum, periodic reversals of strength of photoelectric current for the two planes of polarisation; etc.] were to be expected, and have now been observed.

The similarity of the maxima of emission . . . to the maxima produced by subjecting the surface to a hydrogen glow discharge and other processes is so striking as to suggest the futility of theoretical speculation correlating these maxima with atomic, crystalline, or wave mechanical factors until the purely optical factors have been evaluated" [e.g., Suhrmann's results may be interpreted optically instead of chemically]. Thus the present paper may be considered to some extent as preparatory work to the further study of the very efficient caesium-silver-oxide cell, where (as recent tests indicate) the silver oxide acts as a transparent supporting layer similar to the quartz wedge in the above experiment.

PHOTOELECTRIC CELLS USING CAESIUM ON OXIDISED SILVER: OPTICAL EFFECT OF THE SILVER OXIDE.—Ives and Fry. (See end of preceding abstract.)

ZUSAMMENHANG ZWISCHEN EIGENSCHWINGUNG UND SELEKTIVEN ÄUSSEREN LICHELEKTRISCHEN EFFECT. I. VERHALTEN VON TEERFARBSTOFFEN IM SICHTBAREN SPEKTRALBEREICH (Connection between Natural Vibration and Selective External Photoelectric Effect. I. Behaviour of Coal Tar Dyes in the Visible Spectrum).—F. Hlučka. (*Zeitschr. f. Physik*, 1933, Vol. 81, No. 1/2, pp. 66-75.)

The writer uses coal tar dyes as experimental substances and finds that the "selective external photoelectric effect and natural vibration are almost coincident in the spectrum, so that observations of photoelectric selectivity point to the presence of natural vibration periods and *vice versa*." See also next abstracts.

CONNECTION BETWEEN NATURAL VIBRATION AND SELECTIVE EXTERNAL PHOTOELECTRIC EFFECT. II. BEHAVIOUR OF SOME METALS IN THE ULTRAVIOLET. III. BEHAVIOUR OF COAL TAR DYES IN THE ULTRAVIOLET REGION.—F. Hlučka. (*Ibid.*, pp. 76-79 and No. 7/8, pp. 521-527.)

In Part II the writer shows experimentally that Au, Pt, Ni, Zn and Ag show a selective external photoelectric effect at the position in the spectrum where natural vibrations are to be expected from optical data. In Part III he establishes a similar direct connection. See also preceding abstract, and below.

THE PERIODIC PHOTOELECTRIC EFFECT OF THIN LAYERS WITH MONOCHROMATIC ILLUMINATION.—F. Hlučka. (*Ibid.*, No. 7/8, pp. 516-520.)

See also above two abstracts. The writer finds experimentally regular periodic photoelectric curves for very thin layers of semi-conductors, with monochromatic illumination, and gives a theoretical explanation thereof.

PHOTO-ELECTRIC CELLS: THEIR PROPERTIES AND USES.—L. G. Stoodley. (*World Power*, April, 1933, Vol. 19, No. 112, pp. 207-209: first instalment.)

VERSUCHE UND MESSUNGEN MIT SELENSPERRSCHICHTPHOTOZELLEN (Experiments and Measurements with Selenium Barrier-Layer Photocells).—L. Bergmann. (*Physik. Zeitschr.*, 15th March, 1933, Vol. 34, No. 6, pp. 227-228.)

A short account of lecture experiments and demonstrations with selenium barrier-layer photocells; included are descriptions of a small photoelectric motor and two photometers, one of which permits of measurements from 1 to 20 000 lux in three stages to a degree of accuracy of 1% and the other, a pocket instrument, measures from 0 to 5 000 lux, also in three stages. The factors determining the sensitivity of the instruments

and their combination with the human eye are discussed.

DER INNERE PHOTOEFFEKT IN HALBLEITERN UND DER HALLEFFEKT (The Internal Photoelectric Effect in Semi-Conductors, and the Hall Effect).—I. Kikoin and M. Noskov. (*Physik. Zeitschr. der Sowjetunion*, No. 1, Vol. 3, 1933, pp. 97-99.)

"In view of the importance of the rôle which the internal photoelectric effect plays in elucidating the working mechanism of the Cu_2O photoelement and the rectifying processes, etc., in the same, it was determined to investigate this phenomenon afresh and to decide once and for all whether an internal photoelectric effect in cuprous oxide exists or not" [previously it was assumed to exist, but cf. Waibel and Schottky, Abstracts, 1932, p. 649; also Nasledow and Nemenow, May, p. 277].

The method employed was the study of the Hall effect (which is directly dependent on the electron concentration) and of the variation of this effect on illumination, with simultaneous observation of the photo-conductivity. Preliminary results are announced: at room temperature neither the change in conductivity nor the change in Hall effect exceeded 1%. On the other hand, the effect looked for would naturally be most easily found at low temperatures, where the number of free electrons in the sample in the dark would be very small; the tests were therefore repeated at the temperature of liquid air. "Illumination of the sample caused its conductivity to increase about 80 to 100 times [while the heating effect could only account for 2-3% of this increase], whereby the photoelectric current was of the order of 5×10^{-11} A [this accounts for the phenomenon being unobservable at room temperatures, when the 'dark' current alone was of the order of 10^{-4} A]. The 'dark' current was so small that it could not be accurately measured. The applied field was 120 v/cm. . . . No influence of the barrier-layer photoelectric effect was found. As regards the Hall effect, without illumination this could not be observed. . . . On illumination the e.m.f. increased largely so that it could be observed. The polarity of the Hall effect was normal (negative). These tests show that here we have to do with the usual internal photoelectric effect, in which the current found by us is to be regarded as primary current. . . ."

DER PHOTOELEKTRISCHE EFFEKT IN DER SPERRSCHICHT BEI ULTRAVIOLETTER BESTRAHLUNG (The Photoelectric Effect in the [Copper Oxide/Zinc] Barrier Layer on Irradiation by Ultra-Violet Light).—D. N. Nasledow and L. M. Nemenow. (*Physik. Zeitschr. der Sowjetunion*, No. 1, Vol. 3, 1933, pp. 29-34.)

Authors' summary:—"It is shown that under the action of ultra-violet light on the contact $\text{Cu}_2\text{O}/\text{Zn}$ the electrons move in the direction from the Cu_2O to the Zn, although the photoelectric current from the Zn *in vacuo* is much stronger than that from the Cu_2O . This is apparently due to the fact that the great difference in the concentration of the free electrons in the Cu_2O and in the Zn produces also a great difference in the energy-distribution function." Thus the photoelectric effect in

such a case is governed by the fact that an electron gas is involved which has different structures in a semi-conductor and in a metal, and follows different statistical laws.

ZUR FREQUENZABHÄNGIGKEIT DER SPERRSCHICHT-PHOTOZELLEN (The Frequency Variation of the Barrier-Layer Photocell).—P. Gorlich. (*Zeitschr. f. tech. Phys.*, No. 4, Vol. 14, 1933, pp. 144-145.)

Tests with an optical siren on copper-oxide anterior- and posterior-wall cells, and on two selenium barrier-layer cells, are described and discussed. The flattest frequency characteristic was given by the copper-oxide anterior-wall cell. The lag shown by the selenium barrier-layer cell may be the result of modifications due to the passage of current superimposing themselves on the recombination process. "These phenomena imply a kinship between the barrier-layer photoelectric effect and the internal photoelectric effect [cf. Scharf and Weinbaum, using X-rays: May Abstracts, pp. 277-278]. . . . definite conclusions can only be drawn when measurements with monochromatic light are available" [Bergmann announces that such measurements are now in progress in his Institute].

EQUIVALENT CIRCUIT OF A BLOCKING-LAYER PHOTOCCELL.—L. A. Wood. (*Phys. Review*, 1st March, 1933, Series 2, Vol. 43, No. 5, pp. 375-376: abstract only.)

LES PILES PHOTOVOLTAÏQUES ET LEURS APPLICATIONS (Photovoltaic Cells and Their Applications).—A. Boutaric: Audubert. (*Génie Civil*, 25th March, 1933, Vol. 102, No. 12, pp. 278-279.)

A survey based on the work of Audubert, whose book is referred to: see also May Abstracts, p. 278 (l-h col.) and 1932, p. 470.

ELIMINATION OF ECHO EFFECTS IN PHOTOTELEGRAPHY BY AUTOMATIC THRESHOLD REGULATION OF RECEIVER.—Telefunken Company: Schröter and Federmann. (Summary of German Patent in *Hochf. tech. u. Elek. akus.*, Jan., 1933, Vol. 41, No. 1, p. 40.)

TELEVISION EXHIBITION.—(*Electrician*, 14th April, 1933, Vol. 110, No. 2863, pp. 480 and 499.) Short notes on the third annual exhibition of the Television Society.

CATHODE-RAY TELEVISION WITH LINE CHANGE EFFECTED BY RAY ITSELF.—Telefunken Company: Ilberg. (Summary of German Patent in *Hochf. tech. u. Elek. akus.*, Dec., 1932, Vol. 40, No. 6, p. 223.)

SYNCHRONISATION OF D.C. MOTOR BY TUNING FORK DRIVEN BY MAGNET POLES ON SHAFT OF MOTOR ITSELF.—(*Rev. Gén. de l'Élec.*, 25th Feb., 1933, Vol. 33, No. 8, p. 61D: French Pat. No. 733 837, pub. 12th Oct., 1932, Thomson-Houston Company.)

MEASUREMENTS AND STANDARDS

EINE NEUE METHODE ZUR MESSUNG VON KAPAZITÄTEN BEI HOHEN FREQUENZEN (A New Method of Measuring Capacities at High Frequencies).—Th. W. Schmidt. (*Hochf. tech. u. Elek. akus.*, March, 1933, Vol. 41, No. 3, pp. 96-98.)

A simple and convenient technique which renders the constancy of heating-current and anode-supply sources less essential than in other methods. The high frequency (e.g., 1-3 mc/s or more) is provided by a quartz-controlled generator with the crystal in the grid-cathode lead, which also contains a reaction coil; the anode circuit contains a closed oscillatory circuit made up of an inductance and a variable standard condenser with the unknown capacity in parallel with it. A d.c. meter in the battery end of the anode circuit shows the anode current. A grid leak lies across the crystal, and the anode battery is shunted by a condenser.

In such a circuit, as the capacity of the closed oscillatory circuit is gradually increased, a point is reached where the oscillations break off suddenly and the anode current jumps to its high repose value. This very sudden change forms a particularly good indication of the circuit tuning provided it is consistently reproducible: tests are described which show that this is the case, and also that even a 50% change in anode voltage causes an error of only 0.3%. Heating voltage variation has more effect, a change of 10% producing an error of 0.6%; but the use of good accumulators allows the error to be kept down to about 0.2%. By suitable adjustment of the reaction the position of the "jump" can be made the same for a decreasing capacity as for an increasing capacity. It is found that the sudden drop of anode current is more satisfactory to employ as an index than the sudden rise, since in the former case the valve has been fully loaded with its repose current and has attained a stationary state. The use of a similar method, in a Siemens & Halske inductance-measuring instrument, is referred to (Jaumann, 1931 Abstracts, p. 566).

For measuring very small capacities the method may be modified and the change in anode current at the "jump" used as a measure of the capacity, a linear relation existing between capacity and anode current. In this case the circuit of Fig. 5 is preferable, in which the inductive reaction coupling is accurately regulated by the condenser C_n . By this method capacity changes of 10×10^{-6} cm can be measured.

A RADIO-FREQUENCY BRIDGE FOR IMPEDANCE AND POWER-FACTOR MEASUREMENTS.—D. W. Dye and T. Iorwerth Jones. (*Journ. I.E.E.*, Feb., 1933, Vol. 72, No. 434, pp. 169-181.)

"The paper deals with the problems which arose in the adaptation of the Schering bridge network for service at radio frequencies, and describes the final form taken by the arrangement of components, screened h.f. source, and screened detector-amplifier, which has given a satisfactory performance at frequencies as high as 1 million cycles per sec. . . . In its present form it is considered that the bridge arrangement is capable of measuring, to an accu-

racy of 1%, power factors lying between the limits 0.001 and 0.1, and differences in power factor of precision air condensers to an accuracy of 0.0001 at all frequencies up to 1 million cycles per sec."

IMPEDANCE MEASUREMENTS.—R. Walsh: Starr. (*Wireless Engineer*, March, 1933, Vol. 10, No. 114, p. 146.)

A letter prompted by Starr's "Note" (February Abstracts, p. 110), in which Walsh's *Phil. Mag.* paper (1930 Abstracts, p. 580) was referred to.

ATTENUATION OF TRANSMISSION LINES: SIMPLE METHOD OF MEASURING.—Strutt. (See under "Aerials and Aerial Systems.")

THE MEASUREMENT OF THE POWER OF A TRANSMITTER BY INCANDESCENT LAMP AND PHOTONIC CELL.—Houldson. (See reference under "Transmission.") Cf. Groszkowski, 1932 Abstracts, p. 163.

A MULTI-RANGE MAINS-OPERATED VALVE VOLT-METER [0.5 to 150 Volts, suitable for Radio Frequencies].—C. N. Smyth: G.E.C. (*Wireless Engineer*, March, 1933, Vol. 10, No. 114, pp. 134-137.)

Of anode-bend self-biased type, with a shunt capacity of $15 \mu\text{F}$ and an effective shunt resistance of 7 megohms at 1.2 mc/s. "At the worst an 8% variation in mains voltage causes a 1% change in instrument calibration." If desired it may be run off batteries.

A PRACTICAL VACUUM-TUBE CIRCUIT FOR THE MEASUREMENT OF ELECTROMOTIVE FORCE [especially in Systems easily Polarised or of High Resistance: Avoiding the Use of Special Low-Grid-Current Valves].—S. B. Ellis and S. J. Kiehl. (*Review Scient. Instr.*, March, 1933, Vol. 4, pp. 131-137.) With many literature references to past work.

THE UTILISATION OF MULTI-ELECTRODE VACUUM TUBES FOR LABORATORY MEASUREMENTS.—U. Ruelle. (*Review Scient. Instr.*, March, 1933, Vol. 4, p. 175: summary of International Electricity Congress paper.)

ÜBER LEUCHTRESONATOREN ALS HOCHFREQUENZ-NORMALE (Luminous Quartz Resonators as High-Frequency Standards).—E. Giebe and A. Scheibe. (*Hochf. tech. u. Elek. akus.*, March, 1933, Vol. 41, No. 3, pp. 83-96.)

Authors' summary:—(1) Four different types of longitudinally vibrating luminous resonators of the Reichsanstalt are described: they differ in the orientation I and II of the quartz bar with respect to the crystal axes and in their method of mounting. The axis of the bar runs perpendicular to the optical axis and either perpendicular (orientation I) or parallel (orientation II) to the direction of an electrical axis [X axis]. The bars are either held loosely between the electrodes or held tightly at oscillation nodes of the elastic vibration. (2) The resonance breadth within which the resonators show luminosity is, for the loose types, about $10-20 \times 10^{-6}$; for the fixed type about 5×10^{-6} .

With the latter type the accuracy with which a transmitter can be tuned is $0.5-1 \times 10^{-6}$.

(3) Various methods of measuring the resonator frequencies are described. By the most recent and most accurate method [comparison, by harmonic frequency multiplication and reduction, with a particularly constant quartz-controlled valve oscillator whose frequency—60 000 c/s—is known within 1×10^{-7} : Scheibe and Adelsberger, Feb. Abstracts, p. 109] the uncertainty is smaller than 1×10^{-6} .

(4) The temperature coefficient (T.C.) of the resonator frequency depends on the orientation, on the temperature, and largely on the dimensions of the bar. For orientation I the T.C. is negative and increases with increasing frequency, *i.e.* with decreasing length of bar, from some millionths to some tenths. For orientation II the T.C. is smaller than for I, and is negative for long bars and positive for short. The negative T.Cs of type I become larger with increasing temperature, the positive T.Cs of type II become smaller. By suitably choosing the dimensions of type II the T.C. at room temperatures can be made vanishingly small. (5) Frequency constancy over long intervals of time: luminous resonators of the loosely held type are constant within about $\pm 1 \times 10^{-5}$; those in which the bars are fixed at the nodes are constant within a few millionths.

AN X-RAY EXAMINATION OF THE HARMONIC THICKNESS VIBRATION OF PIEZOELECTRIC QUARTZ PLATES [Preliminary Letter].—S. Nishikawa, Y. Sakisaka and I. Sumoto. (*Phys. Review*, 1st March, 1933, Series 2, Vol. 43, No. 5, pp. 363-364.)

Further development of the work referred to in 1932 Abstracts, p. 178, r-h column.

SOME OBSERVATIONS ON THE ACOUSTIC FIELD OF PIEZO-QUARTZ CRYSTALS.—Bücks. (See under "Acoustics and Audio-frequencies.")

THE RESEARCHES OF THE LATE DR. D. W. DYE ON THE VIBRATIONS OF QUARTZ [including his Ring Oscillator].—E. H. Rayner: Dye. (*Wireless Engineer*, April, 1933, Vol. 10, No. 115, p. 205.)

Summary of Rayner's I.E.E. lecture, ending with a demonstration of the ring oscillator as a frequency standard.

ON THE PIEZOELECTRIC PROPERTIES OF TOURMALINE.—G. W. Fox and M. Underwood. (*Physics*, Jan., 1933, Vol. 4, No. 1, pp. 10-13.)

Authors' summary:—"Oscillating piezoelectric plates of different frequencies have been made from Californian and South African Tourmaline. These plates have a frequency response of approximately 3 770 kc per millimetre of thickness. The temperature coefficient for both specimens was found to be negative and is about 35.5 parts per million per degree centigrade for the African specimen and 38.1 parts per million per degree centigrade for the Californian crystal. Comparison of the tourmaline plates with a Y-cut quartz plate of the same size and frequency shows the tourmaline oscillators decidedly inferior on the basis of

power output." Regarding Straubel's use of a tourmaline plate for a 5-metre wave (January Abstracts, p. 37, l-h col., and back references) the writers remark that, from their curve, such a plate would be "thinner than the paper on which this is printed and, as such, would be a very delicate affair indeed. From our experiments it seems doubtful if plates having a fundamental of this high value can be successful practically."

MOUNTING QUARTZ PLATES [and the Simplification of the Frequency/Temperature Curve by Clamping].—F. R. Lack. (*Bell Lab. Record*, March, 1933, Vol. 11, No. 7, pp. 200-204.)

DEFLECTIONS AND VIBRATIONS OF A CIRCULAR ELASTIC PLATE UNDER TENSION.—Bickley. (See under "Acoustics and Audio-frequencies.")

THE STABILISATION OF FREQUENCIES AND THEIR EXACT MEASUREMENT [a Survey of Ten Years].—B. Decaux. (*L'Onde Élec.*, Nov.-Dec., 1932 [pub. 28th March, 1933], Vol. 11, Nos. 131-132, pp. 553-570.)

RADIO CLOCK SYSTEM PATENTED.—C. F. McCann. (*Scient. American*, April, 1933, p. 253.)

It is claimed that radio waves "from a central station having a master control clock can hold all other clocks adequately equipped within its reception range to precision timing." The method should eliminate the time lag present in wire-control systems.

THE STANDARDS OF CAPACITANCE AT THE PHYSIKALISCH - TECHNISCHE REICHSANSTALT.—E. Giebe and G. Zickner. (*Zeitschr. f. Instr.kunde*, Jan., 1933, Vol. 53, pp. 1-11.)

ELECTRIC AND MAGNETIC UNITS. THE BASIS OF A SYSTEM OF DEFINITIONS.—R. T. Glazebrook. (*Journ. I.E.E.*, March, 1933, Vol. 72, No. 435, pp. 265-267.)

SUBSIDIARY APPARATUS AND MATERIALS

A NEW ELECTRONIC RECORDER: NEW SYSTEM OF RECORDING USING ELECTRONIC MEANS.—H. L. Bernade and L. J. Lunas. (*Elec. Engineering*, March, 1933, Vol. 52, No. 3, pp. 168-170.)

The full paper, a summary of which was referred to in April Abstracts, p. 227, l-h column. The action depends on the use of an additional "pilot" coil on the moving element of the measuring instrument. This coil adds no appreciable work for the element to perform; its object is to detect the position of the element with respect to the electro-magnet, and it is connected in series with, and in opposition to, a similar coil of a pilot element mechanically connected to the 2-phase pen-driving motor of the recorder. The amplified output of these coils, which is zero when the coils are in the same relative position with regard to their electro-magnets, controls the phase position of one phase of the high-torque pen-driving motor, so that this turns in one direction or the other till the pilot-coil positions correspond. There is no hunting and the recorder action can be

made as fast as that of the primary element. The pilot elements are standard d'Arsonval-type mechanisms.

SIMULTANAUFZEICHNUNG MEHRERER VORGÄNGE MIT DEM KATHODENSTRAHLOSZILLOGRAPHEN (The Simultaneous Recording of Several Processes with the Cathode-Ray Oscillograph [using an Ordinary Single Tube and a Thyatron or "Grid-Glow Tube" High-Speed Commutating Circuit].)—R. Sewig. (*Zeitschr. f. tech. Phys.*, No. 4, Vol. 14, 1933, pp. 152-153.)

THE TECHNIQUE OF THE HIGH-SPEED CATHODE-RAY OSCILLOGRAPH: DISCUSSION.—Burch and Whelpton. (*Journ. I.E.E.*, April, 1933, Vol. 72, No. 436, pp. 353-357.) See January Abstracts, p. 51.

ÜBER DIE BAHNEN VON ELEKTRONEN IM AXIAL-SYMMETRISCHEN ELEKTRISCHEN UND MAGNETISCHEN FELDE (On the Paths of Electrons in an Electric and Magnetic Field with Axial Symmetry [Theoretical Paper]).—C. Störmer. (*Ann. der Physik*, 1933, Series 5, Vol. 16, No. 6, pp. 685-696.)

This paper gives a résumé of the writer's theoretical investigations on electron paths and compares the results with those of H. Busch.

THE KATHETRON: A CONTROL TUBE WITH EXTERNAL GRID.—P. H. Craig. (*Electronics*, March, 1933, pp. 70-72.)

"The most important use of the kathetron is the control of relatively large power by the expenditure of negligible energy. The external grid consumes little power compared to grids immersed in the ionised vapour of the more usual type of grid-controlled rectifier." As an inverter (H. J. Reich), an a.c. output of the order of 100 w or more can be obtained. "With proper adjustment the tube can be made very sensitive to capacity changes. Such circuits are adapted for detection of changes in dielectric of a condenser when materials are passed through the condenser conductors, or for the detection of foreign bodies or other flaws." Another application is to voltage regulation.

MAGNETIC CONTROL OF MERCURY VAPOUR RECTIFIER TUBES [instead of Grid Control].—H. J. Reich. (*Electronics*, Feb., 1933, p. 48.)

THE RELAXATION INVERTER AND D.C. TRANSFORMER.—H. J. Reich. (*Review Scient. Instr.*, March, 1933, Vol. 4, pp. 147-152.)

The relaxation inverter uses a single thyatron in relaxation oscillation connection (see January Abstracts, p. 53). An internal grid is not essential, as the discharge may be controlled by an external grid (cf. Craig, above) or a magnetic field (cf. Reich, above). In the d.c. transformer, a condenser is charged through a rectifier tube from the high-voltage oscillation condenser of the relaxation inverter, and d.c. is drawn from the former condenser through a filter eliminating voltage fluctuation. With the experimental apparatus no difficulty was experienced in obtaining from 80 to 100 ma at 400 v from the 120 v d.c. supply. With an FG-27 thyatron it was also possible to use a 32 v supply. Improved wave form; increased out-

put, etc., can be obtained by developing the circuits for push-pull.

GRID AND PLATE CURRENTS IN A GRID-CONTROLLED MERCURY VAPOUR TUBE.—Seletzky and Shevki. (See under "Valves and Thermionics.")

A METHOD OF CONTROL FOR GAS FILLED TUBES [by "Repeated Transient" Voltages—Condenser Discharge Method—instead of D.C. or Sinusoidal A.C. Voltages to Control Grid].—C. Stansbury. (*Elec. Engineering*, March, 1933, Vol. 52, No. 3, pp. 190-194.)

CHARACTERISTICS AND FUNCTIONS OF THYATRONS.—A. W. Hull. (*Physics*, Feb., 1933, Vol. 4, No. 2, pp. 66-75.)

Author's summary:—The Thyatron is a tube of very low resistance (arc discharge) which can be started or prevented from starting by a grid. Its qualities are: enormous power-amplification, approximately 10^{11} per tube; efficiency between 95 and 99% at all voltages above 250; unlimited size, as regards current-capacity; high-voltage limit equal to that of the Pliotron; starting time one to six microseconds; deionisation time 10 to 500 microseconds.

Use of Thyatron as switch and for power control:—The controlling element may be a switch, clock, thermostat, or photo-tube; the controlled element a motor, magnet, contactor, or reactor. Typical applications of this kind of use are: turning on lamps at dusk, dispatching products to predetermined stations, cutting hot steel bars to exact length, opening doors at the approach of a person, wrapping packages, sorting beans and other articles, counting people or products, operating line or spot welding machines. By varying the phase of the grid voltage with respect to that of the anode voltage, a smooth variation of average anode current may be obtained. A typical application is the dimming and blending of lights in theatres.

Use of Thyatron as rectifier and as inverter from direct to alternating currents:—Immediate objectives are frequency changing, from 60 to 25 cycles for railway and power purposes, and from 60 to 200 for spinning mills; and commutatorless motors of variable and controllable speed. A more remote but important application is d.c. transmission of power, with inversion to a.c. at the point of utilisation.

Use of Thyatrons in scientific research:—Applications include high-speed stroboscopes, timing devices, synchronous switches, and voltage regulators. Most interesting and promising of all is a device for counting alpha-particles, protons, and neutrons [cf. Wynn-Williams, 1932 Abstracts, p. 535].

METAL-CLAD MERCURY-ARC RECTIFIERS IN BROADCAST STATIONS.—P. R. Sidler. (*Rad. Engineering*, Jan., 1933, Vol. 13, pp. 10-11.)

PREVENTION OF GLOW DISCHARGE AT HOT CATHODE OF GAS-FILLED DISCHARGE TUBE BY USE OF A SUPPRESSOR GRID.—Telefunken Company: Bräuer. (Summary of German Patent in *Hochf. tech. u. Elek. akus.*, Jan., 1933, Vol. 41, No. 1, p. 39.)

- BERECHNUNG DER PERMEABILITÄT UND DER VERLUSTE IN FERROMAGNETISCHEN BLECHEN BEI BELIEBIGER FREQUENZ (Calculation of the Permeability and Losses in Ferromagnetic Sheets at a Given Frequency [with Formulae and Curves]).—W. Arkadiew. (*Physik. Zeitschr. der Sowjetunion*, No. 1, Vol. 3, 1933, pp. 1-28.)
- CURRENT TRANSFORMER OF TOROIDAL TYPE, GIVING LIMITED SECONDARY CURRENT EVEN WITH EXCESSIVE PRIMARY CURRENT [No Coupling between Windings except through Core].—(*Rev. Gén. de l'Élec.*, 25th Feb., 1933, Vol. 33, No. 8, p. 63D: French Pat. No. 734 767, pub. 28th Oct., 1932, Ateliers Delle.)
- A MAGNET FOR ALPHA-RAY SPECTROSCOPY [with 1 cm Annular Air Gap of Diameter 80 cm, Fields up to 18 000 Gauss].—J. D. Cockcroft. (*Journ. Scient. Instr.*, March, 1933, Vol. 10, pp. 71-75.)
- CONTRIBUTIONS TO THE DESIGN CALCULATION OF POT MAGNETS. PART II.—E. Jasse. (*Elektrot. u. Masch.bau*, 1st Jan., 1933, Vol. 51, No. 1, pp. 8-10.)
- ÜBER EINSCHWINGVORGÄNGE BEI TRANSFORMATOR-VERSTÄRKERN (On Transients in Transformer Amplifiers).—W. Nowotny. (*Archiv f. Elektrot.*, 14th Feb., 1933, Vol. 27, No. 2, pp. 144-154.)
- VDE RULES FOR DESIGN AND TESTING OF SMALL AND LOW-VOLTAGE TRANSFORMERS. (*E.T.Z.*, 16th March, 1933, Vol. 54, No. 11, pp. 266-269.)
- INDUKTIVER WIDERSTAND VON WICKELKONDENSATOREN BEI HOCHFREQUENZ (The Inductive Resistance of Roll-Type Condensers at High Frequencies).—P. Kotowski and E. Kühn. (*E.N.T.*, March, 1933, Vol. 10, No. 3, pp. 105-108.)
- The self-inductance of a roll-type condenser is due to the magnetic fields of the current in the connecting leads, of the current in the roll itself, and of the displacement current. To reduce the inductance due to the last two causes, numerous improvements have been made: several metal-strip conductors have been introduced at various points of the winding (simultaneously decreasing the ohmic resistance) or the projecting edges of each winding have been soldered or clamped together. But in any case the bifilar winding renders the inductance due to the roll itself comparatively small, and the contribution made by the displacement current must also be small. Therefore the results found by testing old condensers, in which a $2 \mu\text{F}$ condenser gave a resonance wavelength of 900 m, must be due chiefly to the connecting leads. An investigation of this point is described: it was found that the inductance could be greatly decreased by shortening the leads as much as possible, by twisting them and arranging them to form as little of a loop as possible (see Fig. 5). The arrangement at the right hand side of Fig. 3 gave much lower inductance than the other two (see Fig. 4), and when the condenser is used as an anti-interference condenser this separation of the "cleaned" and "uncleaned" leads should be used: the interfering machine going to the outside pair and the line to be protected to the inside, "measuring leads" pair. The good results of curve III, Fig. 4, were partly produced by the introduction of "potential terminals" (not further described) which almost eliminated the residual effect of the leads.
- INCREASING THE RANGE OF ROTATION OF A VARIABLE CONDENSER BY COMBINATION OF SEVERAL SYSTEMS EACH GRADUALLY REACHING ITS MAXIMUM VALUE AND RETAINING THIS TO END OF RANGE.—Telefunken Company: Hagenhaus and Seng. (Summary of German Patent in *Hochf.tech. u. Elek.akus*, Jan., 1933, Vol. 41, No. 1, p. 39.)
- CAPACITANCE AND POTENTIAL GRADIENTS OF ECCENTRIC CYLINDRICAL CONDENSERS.—C. L. Dawes. (*Physics*, Feb., 1933, Vol. 4, No. 2, pp. 81-85.)
- "Sometimes it becomes desirable to calculate the capacitance and the potential gradient of eccentric cylindrical condensers, for example, with cables and with special condensers. Although methods have been evolved which give the capacitance and potential gradient in such condensers, very little literature giving a complete but compact treatment of the subject is available. Moreover, the different formulas presented here are derived on a somewhat different basis than is ordinarily adopted. Several forms of the same formula together with their analysis are presented. The formulas are derived from the well-known method of inverse points and images. For simplicity, the formulas are derived in statfarads per cm length, with vacuum as the dielectric ($\kappa = 1$). It is a simple matter to apply the necessary coefficients for the desired lengths and for other dielectrics."
- THE DIELECTRIC LOSSES IN IMPREGNATED PAPER.—J. B. Whitehead. (*Elec. Engineering*, Jan., 1933, Vol. 52, pp. 51-52: summary only.)
- HIGH-FREQUENCY CERAMIC MATERIAL [giving Accuracy of Dimension, High Dielectric and Mechanical Strengths].—(*Electronics*, Feb., 1933, p. 48.)
- A German material: no name is given. "The dielectric loss varies with frequency as follows: at 100 kilocycles, 0.21% . . . at 12 000 kilocycles, 0.10%."
- CONTACT PHENOMENA IN DIELECTRICS.—Electrical Research Association: Metropolitan-Vickers Company. (*Journ. I.E.E.*, March, 1933, Vol. 72, No. 435, pp. 252-258.)
- AN EFFICIENT INSULATING DEVICE FOR ELECTROSTATIC WORK [Quartz Insulators with Surface Films eliminated by use of Heaters].—A. V. R. Telang. (*Review Scient. Instr.*, March, 1933, Vol. 4, p. 169: short summary only.)
- THE PROPERTIES OF ELECTROTECHNICAL INSULATING MATERIALS AND THEIR MEASUREMENT.—K. W. Wagner. (*Review Scient. Instr.*, March, 1933, Vol. 4, p. 170: short summary of International Electricity Congress paper.)

- DIE OSZILLOGRAPHISCHE UNTERSUCHUNG DER VORGÄNGE BEIM WÄRMEDURCHSCHLAG (The Oscillographic Investigation of the Breakdown Process due to Overheating [in a Solid Dielectric]).—W. von Philippoff. (*Zeitschr. f. tech. Phys.*, No. 1, Vol. 14, 1933, pp. 21-23.)
Using the piezoelectric oscillograph dealt with in 1932 Abstracts, p. 418. "The tests showed that before breakdown, under certain conditions, a hysteresis process may occur which, if there is sufficient removal of heat, may lead to a stationary condition."
- ZUR MECHANIK DES DURCHSCHLAGS VON TRANSFORMATORENÖL (The Mechanism of the Electrical Breakdown of Transformer Oil).—J. Rebhan. (*E.T.Z.*, 5th Jan., 1933, Vol. 54, No. 1, pp. 4-6.)
- SOME OBSERVATIONS ON RESIDUAL CHARGE IN DIELECTRICS [Theoretical and Experimental Investigation].—D. K. McCleery. (*Phil. Mag.*, Feb., 1933, Series 7, Vol. 15, No. 97, pp. 223-236.)
- A STUDY OF THE ELECTRICAL BREAKDOWN OF LIQUIDS [Paraffin Oil and Xylol] BY MEANS OF THE ELECTRO-OPTICAL SHUTTER.—H. W. Washburn. (*Physics*, Jan., 1933, Vol. 4, No. 1, pp. 29-37.)
- THE A.C. RESISTANCE OF STRAIGHT WIRES OF CIRCULAR SECTION COMPOSED OF SEVERAL CONCENTRIC LAYERS [e.g., Tinned or Oxidised Copper Wire].—Ekelöf. (See under "Properties of Circuits.")
- HEAT-RESISTANT INSULATED WIRE [Vega Chrom-oxide Wire].—(*Electronics*, Feb., 1933, p. 56.)
- DESIGN OF RADIO-FREQUENCY COILS.—S. W. Place. (*Rad. Engineering*, Jan., 1933, Vol. 13, pp. 12-13.)
- TUNED-TRANSFORMER COUPLING CIRCUITS [Low-Loss Air-Core Transformers, as used in I.F. Amplifier of Field Strength Measuring Set].—A. J. Christopher. (*Bell Lab. Record*, March, 1933, Vol. 11, No. 7, pp. 195-199.)
- TWO NEW OSCILLATORS FOR THE RADIO-FREQUENCY RANGE.—C. T. Grant. (*Bell Lab. Record*, April, 1933, Vol. 11, No. 8, pp. 237-240.)
- A SIGNAL GENERATOR FOR THE NEW RECEIVER TESTS.—A. E. Thiessen. (*Rad. Engineering*, Jan., 1933, Vol. 13, pp. 14-16.)
- ELECTRICAL ACCUMULATORS ACCORDING TO RECENT PATENTS.—L. Jumau. (*Rev. Gén. de l'Élec.*, 11th, 25th March and 1st April, 1933, Vol. 33, Nos. 10, 12 and 13, pp. 339-352, 377-391, 413-424.)
- CLASS "B" ELIMINATOR [using special Neon Tube Stabiliser].—W. I. G. Page. (*Wireless World*, 14th April, 1933, Vol. 32, pp. 268-269.)
An article for the amateur constructor. The eliminator is designed to counteract the effect of the widely fluctuating load due to the use of Class B amplification.
- DIODE REGULATORS—A SIMPLE METHOD OF VOLTAGE CONTROL.—(*Elec. Review*, 16th Dec., 1932, Vol. 111, No. 2873, p. 886.)
- CONSTANT DIRECT CURRENT [by use of Grid-Controlled Rectifier: Drop of Main Rectified Current in Iron-Wire Ballast Lamp used as Grid Bias].—W. F. Westendorp. (*Gen. Elec. Review*, March, 1933, Vol. 36, p. 159: paragraph only.)
- SENSITIVE SPEED CONTROL FOR ELECTRIC MOTORS [regulating Speed to within 0.001% at 15 r.p.m.].—E. Giebe. (*Zeitschr. f. Instr.kunde*, August, 1932, No. 8, pp. 345-348.)
A mechanical device, affecting the field circuit, which is in use at the Physikalisch-Technische Reichsanstalt.
- SHOT EFFECT AND THERMAL NOISE IN THE PHOTOCELL AMPLIFIER.—von Orbán. (See under "Phototelegraphy and Television.")
- DETECTION OF CORPUSCULAR RADIATION BY VACUUM TUBE METHODS [Design of High Gain Resistance-Capacity Coupled Amplifiers].—J. R. Dunning. (*Phys. Review*, 1st March, 1933, Series 2, Vol. 43, No. 5, p. 380: abstract only.)
- A SUPERSENSITIVE AMPLIFIER FOR MEASURING SMALL CURRENTS [10^{-17} Ampere D.C., and Resistances up to 10^{13} Ohms: for Research or Routine Testing].—F. J. Moles: General Electric Company. (*Gen. Elec. Review*, March, 1933, Vol. 36, pp. 156-158.)
- A CIRCUIT FOR RECORDING MULTIPLY-COINCIDENT DISCHARGES OF GEIGER-MÜLLER COUNTERS [of Cosmic Radiation].—T. H. Johnson and J. C. Street. (*Journ. Franklin Inst.*, March, 1933, Vol. 215, No. 3, pp. 239-246.)
- DESIGN OF AN APPARATUS FOR CATHODE SPUTTERING.—J. A. Darbyshire. (*Journ. Scient. Instr.*, March, 1933, Vol. 10, pp. 83-85.)
- THE CONSTRUCTION OF THERMOELECTRIC PILES.—A. Cotton: Égal. (*Comptes Rendus*, 27th Feb., 1933, Vol. 196, No. 9, pp. 586-587.)
With reference to one of the methods of construction described by Égal (April Abstracts, p. 227), Cotton mentions previous similar designs of thermoelectric elements using electro-deposition to dispense with soldered joints.
- AN IRIIDIUM-RHODIUM THERMOELEMENT FOR TEMPERATURES UP TO 2000°C.—O. Feussner. (*E.T.Z.*, 16th Feb., 1933, Vol. 54, No. 7, pp. 155-156.)
- SUPPLYING ATMOSPHERES OF KNOWN HUMIDITY.—A. C. Walker. (*Bell Lab. Record*, Feb., 1933, Vol. 11, No. 6, pp. 169-171.)

ENTWURF ZU EINER THEORIE DER TEMPERATUR-REGELTECHNIK (Outline of a Theory of the Technique of Temperature Regulation).—M. Lang. (*Zeitschr. f. tech. Phys.*, No. 3, Vol. 14, 1933, pp. 98-105.)

STATIONS, DESIGN AND OPERATION

ÜBER PERIODISCHE SCHWANKUNGEN DER FELDSTÄRKE VON FUNKSENDERN (Periodic Variations of the Field Strengths of [Broadcasting] Radio Stations).—F. Eppen. (*E.N.T.*, March, 1933, Vol. 10, No. 3, p. 108.)

A preliminary communication on field-strength measurements at two different receiving stations about 35 km from a high-power broadcasting station, both sets of measurements indicating a minimum field strength in July and marked maxima in December and February. The ratio of maximum to minimum was 3 : 1 at the receiving station in open country and only 2 : 1 at the station in a large town. At much greater distances (100 km and more) the differences between summer and winter appeared to be smaller. "The measurements on another station under quite different conditions and in a quite different region similarly gave in various directions in December, 1932, the double to treble field-strength values compared with those measured in January, 1932. To clear up the questions, which are of importance not only for practical broadcasting but also, perhaps, for the explanation of the increased ranges of stations from autumn to the New Year, further investigations are being made which will be communicated later."

BROADCASTING ON 7.85 METRES: EXPERIMENTAL WORK IN AMSTERDAM.—P. J. H. A. Nordlohne: Philips' Company. (*Wireless Engineer*, April, 1933, Vol. 10, No. 115, pp. 186-196.)

English version of the Dutch paper dealt with in April Abstracts, p. 229.

PROPER SITES FOR BROADCAST STATIONS: A RADICAL PROPOSAL TO IMPROVE RECEIVING CONDITIONS [Transference of Stations to Sites near Centre of Territory Served].—C. W. Horn. (*Electronics*, March, 1933, pp. 66-69.)

Under present-day conditions of programme quality and selective and shielded receivers (average selectivity curves are given) the writer considers that distant reception need not be considered and that consequently the present U.S.A. rules as to the distance of a station from a centre of population are not necessary.

THE CLEAR CHANNEL IN AMERICAN BROADCASTING [Is it Still Essential?].—Broadcast Committee, I.R.E. (*Proc. Inst. Rad. Eng.*, March, 1933, Vol. 21, No. 3, pp. 331-335.)

THE PROPAGATION OF WAVES: AN ACCOUNT OF WORK CARRIED OUT AT MADRID [Field Intensities for 1 kw Radiated: Limiting Ratio of Fields of Two Stations on Same Wavelengths].—(See under "Propagation of Waves.")

LONG-DISTANCE SHORT-WAVE SERVICES [a Survey of Ten Years: including Multiplex Working and Its Application to Secret Telephony].—R. Villem. (*L'Onde Élec.*, Nov.-Dec., 1932 [pub. 28th March, 1933], Vol. 11, Nos. 131-132, pp. 427-464.)

THE WORKING OF RADIOELECTRIC SERVICES [a Survey of Ten Years].—E. Picault. (*Ibid.*, pp. 465-484.)

TEN YEARS OF BROADCASTING.—J. Fleury. (*Ibid.*, pp. 485-515.)

DEUTSCHLANDS GROSSRUNDFUNKSENDER (Germany's High-Power Broadcasting Stations).—A. Semm. (*Zeitschr. V.D.I.*, 11th March, 1933, Vol. 77, No. 10, pp. 257-264.)

THE TATSFIELD CHECKING STATION: DEVELOPMENT OF THE B.B.C. LISTENING POST.—(*World Radio*, 7th and 14th April, 1933, Vol. 16, Nos. 402 and 403, pp. 468-469 and 500-501: to be continued.)

THE BOAT RACE: DESCRIPTION OF THE APPARATUS USED ON THE B.B.C. LAUNCH.—(*World Radio*, 31st March, 1933, Vol. 16, No. 401, pp. 434-435.)

THE USE OF A CONTROL FREQUENCY OUTSIDE THE SPEECH BAND FOR CONTROLLING RECEIVER AMPLIFICATION AND SIMULTANEOUSLY FOR TELEGRAPHIC COMMUNICATION.—Telefunken Company: Runge. (Summary of German Patent in *Hochf. tech. u. Elek. akus.*, Jan., 1933, Vol. 41, No. 1, p. 39.) Cf. March Abstracts, p. 156, Jarvis.

A FREQUENCY MONITORING UNIT FOR BROADCAST STATIONS.—R. E. Coram. (*Rad. Engineering*, Feb., 1933, Vol. 13, pp. 18-19.)

GENERAL PHYSICAL ARTICLES

THE LAGRANGIAN IN QUANTUM MECHANICS.—P. A. M. Dirac. (*Physik. Zeitschr. der Sowjetunion*, No. 1, Vol. 3, 1933, pp. 64-72.)

"Now there is an alternative formulation [to the Hamiltonian theory] for classical dynamics, provided by the Lagrangian. This requires one to work in terms of co-ordinates and velocities instead of co-ordinates and momenta. The two formulations are, of course, closely related, but there are reasons for believing that the Lagrangian one is the more fundamental. . . . We must . . . seek our quantum Lagrangian theory in an indirect way. We must try to take over the ideas of the classical Lagrangian theory, not the equations. . . ."

THE ELECTROMAGNETIC FIELD OF A MOVING UNIFORMLY AND RIGIDLY ELECTRIFIED SPHERE AND ITS RADIATIONLESS ORBITS.—G. A. Schott. (*Phil. Mag.*, April, 1933, Series 7, Vol. 15, No. 100, pp. 752-761.)

The writer shows theoretically that "if the centre of a uniformly and rigidly electrified sphere describes a closed orbit of any form with a suitably chosen period, and the sphere rotates with such an

angular velocity that every point of it describes an equal and parallel orbit, then the electromagnetic field due to the sphere at a sufficient distance is a static field, and therefore no energy will be radiated to infinity. The motion of the sphere must be one of pure translation without any spin." The possible application of the theorem to the constitution of the neutron is shortly discussed.

SOME PHOTOGRAPHS OF THE TRACKS OF PENETRATING RADIATION [showing Positive Electrons].—P. M. S. Blackett and G. P. S. Occhialini. (*Proc. Roy. Soc.*, March, 1933, Vol. 139, No. A 839, pp. 699-726.)

From the authors' summary:—A short description is given of a method of making particles of high energy take their own cloud photographs. The most striking features of some 500 photographs taken by this method are described, and the nature of the showers of particles producing the complex tracks is discussed. A consideration of the range, ionisation, curvature and direction of the particles leads to a confirmation of the view put forward by Anderson (*Science*, Vol. 76, 1932, p. 238; see also 1932 Abstracts, p. 634; also Langer, January Abstracts, p. 54) that particles must exist with a positive charge but with a mass comparable with that of an electron rather than with that of a proton. . . . The origin of the positive and negative electrons in the showers is discussed.

GRAVITATION AND ELECTRICITY: PARTS II AND III.—I. E. Viney and G. G. Leybourne; H. F. Willis. (*Phil. Mag.*, Jan., 1933, Series 7, Vol. 15, No. 96, pp. 33-48; 130-143.)

Continuation of a series of papers on investigations (see Viney, January Abstracts, p. 54) on the formulation of "a simple unified field theory, independently of the general discussions of the theory of relativity."

THE VALUE OF e/m .—R. T. Birge. (*Phys. Review*, 1st Dec., 1932, Series 2, Vol. 42, No. 5, p. 736.)

This letter considers four recent direct accurate determinations of e/m for an electron and gives as a conservative estimate $(1.759 \pm 0.001) \times 10^7$ e.m.u. for the present most probable direct evaluation.

DETERMINATION OF e/m FOR AN ELECTRON BY A NEW DEFLECTION METHOD.—F. G. Dunnington. (*Phys. Review*, 1st Dec., 1932, Series 2, Vol. 42, No. 5, pp. 734-736.)

This letter gives a preliminary account of a method for determining e/m for an electron by a magnetic deflection method in which errors due to contact potentials are practically eliminated. The measurements so far made give the result $e/m_0 = (1.7592 \pm 0.0015) \times 10^7$ e.m.u. For a full account see *ibid.*, 15th March, 1933, Series 2, Vol. 43, No. 6, pp. 404-416.

A DETERMINATION OF e/m BY MEANS OF PHOTO-ELECTRONS EXCITED BY X-RAYS.—G. G. Kretschmar. (*Phys. Review*, 15th March, 1932, Series 2, Vol. 43, No. 6, pp. 417-423.)

THE MOST PROBABLE VALUES OF e , e/m AND h .—K. Shiba. (Summary in *Physik. Ber.*, 15th Jan., 1933, Vol. 14, No. 2, pp. 124-125.)

THE MOST PROBABLE VALUES OF THE ATOMIC CONSTANTS e AND h .—R. Ladenburg. (*Ann. der Physik*, Feb., 1933, Series 5, Vol. 16, No. 4, pp. 468-472.)

The values given are $e = (4.770 \pm 0.004) \cdot 10^{-10}$, $h = (6.547 \pm 0.009) \cdot 10^{-27}$.

ELECTRODELESS DISCHARGES IN UNIFORM FIELDS.—G. D. Yarnold. (*Phil. Mag.*, Feb., 1933, Series 7, Vol. 15, No. 97, pp. 294-300.)

IONISATION BY POSITIVE IONS.—J. S. Townsend and F. L. Jones. (*Phil. Mag.*, Feb., 1933, Series 7, Vol. 15, No. 97, pp. 282-294.)

EMISSION OF ELECTRONS FROM METALS UNDER THE ACTION OF MONOCHROMATIC X-RADIATION.—H. Hase. (*Zeitschr. f. Physik*, 1933, Vol. 80, No. 9/10, pp. 670-689.)

SECONDARY ELECTRON EMISSION FROM TANTALUM [on Bombardment by Lithium Ions].—C. L. Utterback and E. A. Williams. (*Phys. Review*, 1st Feb., 1933, Series 2, Vol. 43, No. 3, p. 212; abstract only.)

THE NATURE OF ADSORBED FILMS OF CAESIUM ON TUNGSTEN. PART I. THE SPACE CHARGE SHEATH AND THE IMAGE FORCE.—I. Langmuir. (*Phys. Review*, 15th Feb., 1933, Series 2, Vol. 43, No. 4, pp. 224-251.)

THE ADSORPTION OF CAESIUM ATOMS ON TUNGSTEN.—I. Langmuir. (*Angewandte Chemie*, 25th Feb., 1933, Vol. 46, No. 8, p. 131.)

Report of a paper recently read in Berlin.

THE EQUILIBRIUM OF ATOMS AND IONS ADSORBED ON A METAL SURFACE.—R. C. Evans. (*Proc. Camb. Phil. Soc.*, Jan., 1933, Vol. 29, No. 1, pp. 161-164.)

INTERPRETATION OF PHENOMENA DUE TO ACCOMMODATION COEFFICIENT OF IONS AT CATHODE SURFACES.—K. T. Compton. (Summary in *Science*, 2nd Dec., 1932, Vol. 76, No. 1979, pp. 518-519). See also February Abstracts, p. 115.

ON THE VELOCITY DISTRIBUTION OF SECONDARY ELECTRONS FROM INSULATORS.—G. Kalckhoff. (*Zeitschr. f. Physik*, 1933, Vol. 80, No. 5/6, pp. 305-323.)

MISCELLANEOUS

THE DIFFERENTIAL EQUATIONS OF BALLISTICS.—C. A. Clemmow. (*Phil. Trans. Roy. Soc.*, Vol. 231, No. A701, pp. 263-288.)

An account of the practical solution of some non-linear second order differential equations which arise in internal ballistics.

AN EXTREMELY SIMPLE METHOD OF PERIODOGRAM ANALYSIS [taking One-Third the Time taken by Correlation Periodogram: Calculations made on Ordinary Adding Machine.]—D. Alter. (*Proc. Nat. Acad. Sci.*, March, 1933, Vol. 19, pp. 335-339.)

TEN YEARS OF WIRELESS, 1922-1932. THE FIRST TEN YEARS OF THE "SOCIÉTÉ DES AMIS DE LA T.S.F." AND OF THE JOURNAL "L'ONDE ÉLECTRIQUE."—C. Gutton. (*L'Onde Elec.*, Nov.-Dec., 1932 [pub. 28th March, 1933], Vol. 11, Nos. 131-132, pp. 397-404.)

- THE ATOMS AS A SOURCE OF LIGHT [and the Search for "Cold" Light].—S. Dushman. (*Elec. Engineering*, March, 1933, Vol. 52, No. 3, pp. 173-175.)
- HEATING EFFECTS OF ULTRA-SHORT WAVES.—McLennan. (Summary in *National Research Council, Canada, 14th Annual Report, 1930-1931*, p. 114.)
For previous work see 1931 Abstracts, p. 286; the researches have now been extended to waves below 10 m. "The law of maximum heating was confirmed for a wavelength of 6.5 m. It was found that in this region the dielectric constant of dilute solutions of potassium chloride was the same as that of water. Various pieces of meat were heated in the field of the high-frequency oscillator, and by the use of a paint that changes colour at 35°C the development of heat in the different places was followed by the taking of photographs. Selective effects could be modified by a change of wavelength. The temperatures developed by the oscillations in different parts of a hen's egg have been measured by using a thermocouple made in a hypodermic needle. Experiments on the relative heating of different body substances are in progress."
- GREATLY ENHANCED EFFECTS OF GALVANIC ELECTROTHERAPY BY USE OF HIGH VOLTAGES.—F. Pasteur. (*Comptes Rendus*, 27th Feb., 1933, Vol. 196, No. 9, pp. 649-651.)
- DECREASING THE TRACTIVE FORCE NECESSARY FOR PLOUGHING BY THE USE OF ELECTRIC CURRENTS BETWEEN PLOUGH AND BLADE.—Fr. Weber. (*Zeitschr. V.D.I.*, 25th Feb., 1933, Vol. 77, No. 8, p. 198: summary only.)
- THE OPTICAL ELECTRICAL TRANSFORMATION OF PRINTED MATTER INTO SOUND OR RAISED CHARACTERS FOR THE BLIND, WITH THE HELP OF THE "PRINCIPLE OF OPTICAL CONGRUENCE."—G. Schutkowski. (*Zeitschr. f. tech. Phys.*, No. 4, Vol. 14, 1933, pp. 158-160.)
On the principle described the writer has constructed a machine which uses only a single caesium cell. When the projected image of the letter to be read is "congruent" with the standard letter on which it is superimposed, the photocell is completely in the dark and the anode current, rising sharply, activates a relay.
- THE ROBOT TRANSLATOR [the Caralozzi Translator-phone].—(*World Radio*, 14th April, 1933, Vol. 16, 403, p. 490.)
A letter from Italy: "I hope that you and many of your readers listened to Hilversum, Holland . . . at 7.40 p.m., and heard Sr. M. J. Caralozzi demonstrate his machine translating German into Dutch and vice versa . . . As English is a Germanic language, we hope that he will soon add that to his transláeterphone." The date mentioned for the Hilversum programme is 1st April.
- THE KATHETRON AS A DETECTOR OF SMALL CAPACITY CHANGES [Application to Detection of Foreign Bodies or Flaws].—Craig. (See abstract under "Subsidiary Apparatus and Materials.")
- PORTABLE VIBRATION-VELOCITY METER FOR VELOCITIES FROM 25 TO 2 500 MILS PER SECOND THROUGH FREQUENCY RANGE 25 TO 5 000 CYCLES/SECOND. (*Gen. Elec. Review*, Jan., 1933, Vol. 36, pp. 65-66.)
- AUTOMATIC WEIGHING WITH VACUUM TUBES [for Wind Tunnel Measurements of Aeroplane Stresses, etc.].—F. S. Eastman. (Summary in *Proc. Inst. Rad. Eng.*, Feb., 1933, Vol. 21, pp. 185-186.)
- ELECTRON TUBES IN RADIO CITY THEATRES: LIGHTING-CONTROL, SOUND, AND AIR-CONDITIONING, APPLICATIONS OF TUBES. (*Electronics*, Feb., 1933, pp. 32-34.)
- DEVELOPMENT OF THE HIGH-FREQUENCY METALLURGICAL OVEN.—M. Tama. (*Zeitschr. V.D.I.*, 25th Feb., 1933, Vol. 77, No. 8, pp. 199-202.)
- AN ELECTRONIC PHASE-FAILURE RELAY [for Lifts or Hoists driven by Polyphase Mains].—C. Stanbury and G. C. Brown. (*Electronics*, Feb., 1933, pp. 46-47.)
- OPPOSED PHOTRONIC CELLS RESPONSIVE, INDEPENDENT OF GENERAL ILLUMINATION [except Direct Rays from Sun].—(*Electronics*, Feb., 1933, p. 44.)
- PHOTOELECTRIC CELL APPLICATIONS [Control of Hydrogen Ion Concentration in Various Processes: Handling of Hot Steel Strip in Tube Manufacture].—(*World Power*, Feb., 1933, Vol. 19, No. 110, pp. 72-73.)
- PHOTOELECTRIC CELL EQUIPMENT IN STEEL TUBE WORKS.—(*Gen. Elec. Journal*, Feb., 1933, Vol. 4, No. 1, pp. 40-41.)
- PHOTOELECTRIC CONTROL OF WORKS LIGHTING SAVES 4 000 kwh MONTHLY, REDUCES LAMP REPLACEMENTS 25%, IMPROVES PRODUCTION AND REDUCES ACCIDENTS.—(*Electronics*, Jan., 1933, p. 14.)
- EXPERIMENTS WITH A RECORDING PHOTOELECTRIC PYROMETER [and Its Use as an Automatic Control in Spot Welding, etc.].—G. Müller and H. J. Zetzmann. (*Zeitschr. f. tech. Phys.*, No. 2, Vol. 14, 1933, pp. 90-94.)
- COLOUR MEASUREMENT BY THE THREE-COLOUR METHOD USING A PHOTOCCELL.—L. Bloch. (*Naturwiss.*, 16th/23rd Dec., 1932, Vol. 20, No. 51, pp. 919-921.)
- SEMI-CONDUCTOR PHOTOCELLS AND THEIR APPLICATION IN COLORIMETRY AND PHOTOMETRY.—B. Lange. (*Naturwiss.*, 10th Feb., 1933, Vol. 21, No. 5/6/7, p. 152.)
- PHOTOELECTRIC SCOPOMETER [for Turbidimetric and Colorimetric Measurements].—Bausch and Lomb Company. (*Electronics*, Jan., 1933, p. 25.)
- A PHOTOELECTRIC MOTOR AND TWO PHOTOMETERS, USING BARRIER-LAYER PHOTOCELLS.—Bergmann. (See abstract under "Phototelegraphy and Television.")

Some Recent Patents

The following abstracts are prepared, with the permission of the Controller of H.M. Stationery Office, from Specifications obtainable at the Patent Office, 25, Southampton Buildings, London, W.C.2, price 1/- each.

COLD-CATHODE VALVES

Convention date (Germany), 28th January, 1931.

No. 383807

Relates to valves of the kind in which the usual heated filament is replaced by the glow-discharge set up between a pair of electrodes F, F_1 connected across a battery or other source B . The electron stream through the valve originates in the glow-discharge across the gap F, F_1 , and flows to the anode A via a control grid G . The invention consists in back-coupling a coil L_1 in the "cathode" circuit with a coil L in the circuit of the main anode, so as to generate sustained oscillations in the circuit L, C .

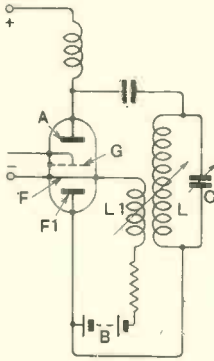

No. 383807

Patent issued to Telefunken Ges. Fur Drahtlose Telegraphie m.b.h.

MODULATING SYSTEMS

Application date, 11th November, 1931. No. 383412

In frequency-modulation there is usually present an undesirable percentage of amplitude-modulation, which is stated to be undesirable because it increases the width of the sidebands. According to the invention a compensating amplitude-modulation of opposite phase is deliberately introduced to offset this effect. As shown, carrier oscillations generated by a back-coupled valve V are frequency-modulated by a condenser-microphone M and are passed to the aerial A through a coupling L . A detector valve V_1 , also coupled to the aerial at L_1 , rectifies any amplitude variations that may be present. The corresponding rectified current is amplified by a valve V_2 , and then passed back through a variable resistance R to a valve V_3 , which applies a corresponding but phase-opposed amplitude-modulation to the C.W. generator V . The correction may be applied in the first instance to a low-frequency oscillation, which is subsequently heterodyned up to carrier-frequency.

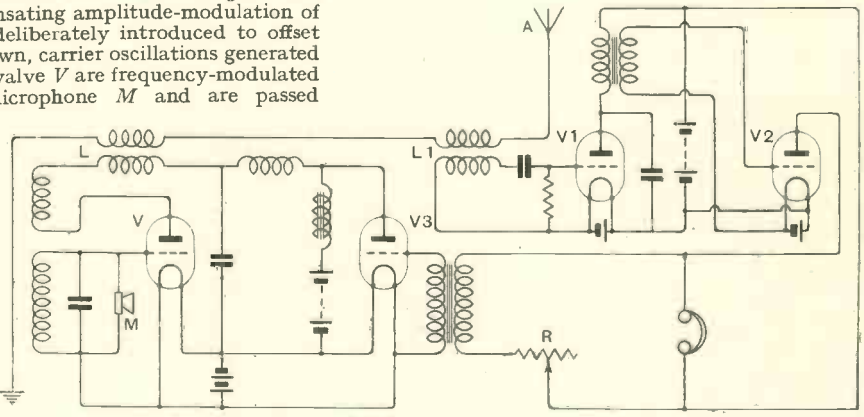

No. 383412

Patent issued to Marconi's Wireless Telegraph Co., Ltd.

TELEVISION APPARATUS

Convention date (Germany), 31st March, 1931.

No. 382206

A mirror-drum, e.g., of the Weiler type, for use in television is provided with milled and finished facets on which the individual mirrors are seated and held in position by spring clips, projecting from the side of the drum and gripping the two sides of each mirror. The construction reduces the weight of the drum and also the risk of unbalanced stresses caused by the use of numerous adjusting-screws. The spring clips for the mirrors also facilitate subsequent "balancing" and similar adjustments of the drum as a whole.

Patent issued to Fernseh Akt.

THERMIONIC VALVES

Convention date (France), 24th March, 1931.

No. 382520

To free the cathode of an indirectly-heated valve from occluded gas, it is usual in the process of manufacture to pass a heavy current through the heating-element. As this frequently damages the cathode the invention provides an alternative method in which the desired effect is secured by electron bombardment. A small deposit of barium azide is attached to the inside of the anode, and is reduced to pure barium in the high-frequency furnace. A positive voltage is then applied to the cathode and the anode is heated until it emits elec-

trons, which bombard the cathode until it is free from occluded gas. The temperature of the anode is subsequently raised to the point where the barium is volatilised and deposited on the cathode to form the usual emissive coating.

Patent issued to N. V. Philips Gloeilampen-Fabrieken.

REMOTE CONTROL

Application date, 2nd May, 1932. No. 383189

Relates to systems for distributing and controlling broadcast programmes through the electric

plate circuit of the valve *V1*. The amplitude of the local oscillations is varied by a condenser *C1* at the distant station, this, in turn, controlling the volume from the loud speaker. The adaptor unit *D* may be fitted with an aerial *A* for direct reception

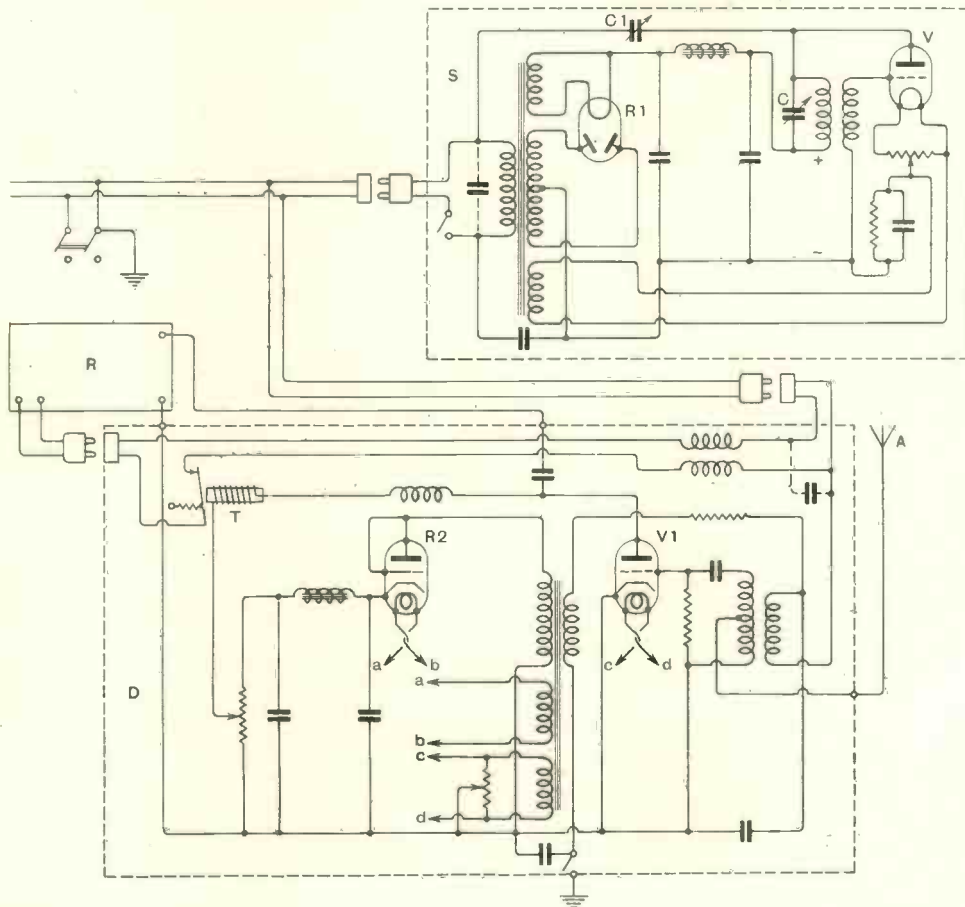

No. 383189

supply mains. The receiving set *R* is switched on and off, and supplied with a selected programme, and controlled in volume, all these operations being performed at a distant point *S* by means of high-frequency currents supplied through the mains. The circuits of the receiver are permanently tuned, programme selecting being effected in much the same way as in a superhet circuit. Local oscillations are generated by a valve *V* at the distant control-station, and are fed to a valve *V1* in an adaptor unit *D* located near the receiving set. This produces an intermediate or beat frequency corresponding to the "fixed" tuning of the set. Different programmes are supplied by varying the frequency of the oscillator valve *V* through a condenser *C*. On the receipt of oscillations, the receiving set is switched on by a relay *T* in the

via the ether. The whole system is energised from the mains through rectifiers *R*, *R2*.

Patent issued to E. C. Axe.

LOUD-SPEAKER CONNECTIONS

Convention date (Germany), 26th February, 1931.

No. 382149

For making the necessary connections both to the mains and the set, for a separately energised moving-coil speaker, a four-pin plug is used, the spacing of the pins being such as to render it impossible for the field voltage to be inadvertently applied to the speech-coil.

Patent issued to Ideal Werke Akt. fur drahtlose Telephonie.

PENTODE VALVES

*Convention date (Germany), 8th April, 1931.
No. 382540*

The auxiliary grid in a pentode prevents any current due to secondary emission from passing between the anode and the screening grid, but does not prevent current flow in the screening-grid circuit due to primary electrons from the cathode. According to the invention this second effect is prevented by mounting the three grids of a pentode so that all the turns, as viewed from the cathode, are arranged directly behind one another in a plane substantially at right angles to the cathode surface.

Patent issued to N. V. Philips Gloeilampen-Fabrieken.

HIGH-FREQUENCY AMPLIFIERS

Application date, 27th July, 1931. No. 382648

For high-frequency working, either in transmission or reception, the batteries or other sources of supply to the amplifying-valves are insulated by being connected to the anode or filament through a pair of concentric or Lecher-wire conductors. These form no part of the main oscillatory circuits, but are substantially one-quarter of a wavelength long so as to present infinite impedance. The conductors are bridged at the end desired to be maintained at zero high-frequency potential by a small shunt impedance, and may conveniently be made telescopic.

Patent issued to Marconi's Wireless Telegraph Co., Ltd., and O. S. Puckle.

REDUCING "MAN-MADE" STATIC

*Convention date (Germany), 30th January, 1931.
No. 382809*

The use of chokes, for preventing the distribution of high-frequency disturbances through the supply mains feeding vacuum-cleaners and similar appliances liable to "spark," is limited by the fact that it is difficult to manufacture a coil which will have a sufficiently high HF impedance and, at the same time, a low impedance to the 50-cycle power-current. According to the invention choke windings are inserted in each of the supply leads, and each winding is divided into two sections which are wound in reverse over the opposite limbs of a closed-circuit iron core. This gives a high ratio of HF and LF impedance at small cost.

Patent issued to N. V. Philips Gloeilampen-Fabrieken.

RECEIVING CIRCUITS

*Convention date (Germany), 16th June, 1931.
No. 382915*

In a transformer-coupled amplifier the tuned circuits of one or more of the transformers are coupled critically and are comparatively-highly damped, whilst the circuits of the other transformers are coupled "hypercritically" and slightly damped. Critical coupling is defined to be that at which the top of the resulting resonance curve is just on the verge of "sagging." A stronger coup-

ling is "hypercritical." High damping corresponds to a decrement of 0.04, and slight damping to half that figure.

Patent issued to N. V. Philips Gloeilampen-Fabrieken.

VALVE-OSCILLATORS

*Convention date (U.S.A.), 22nd April, 1931.
No. 383981*

Oscillations are maintained at constant frequency, in spite of variations in the voltage-supply, by taking advantage of the fact that in the circuit shown any change in voltage on the outer anode *A* is counterbalanced by a corresponding voltage-change on the inner anode *A1*. One gives rise to

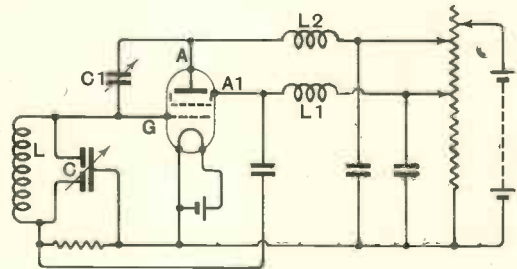

No. 383981

a falling and the other to a rising frequency-response. The main oscillatory circuit *L,C* is provided with a split-stator condenser *C*, whilst inter-electrode capacity between the anode *A* and control-grid *G* is neutralised by a condenser *C1*. The load is coupled either to the tuned circuit *L,C* or to inductive impedances *L1, L2*.

Patent issued to Wired Radio Inc.

THERMIONIC VALVE AMPLIFIERS

*Convention date (U.S.A.), 19th March, 1930.
No. 382945*

An indirectly-heated valve is designed so that the average "transconductance" over one portion of the electron stream between cathode and anode is substantially different from that of another portion of the stream, the effect being to give the grid-volts anode-current characteristic a gradual slope down to the negative cut-off point, thus preventing cross-modulation. A distinction is drawn between this effect and the action of the known variable-mu valve. The desired object is achieved either by omitting one or more of the spiral turns at the centre of the control grid, or by varying their pitch. Or the grid may be made in two parts, each of a different pitch, or the pitch may vary progressively from end to end. Alternatively the grid may be made shorter than the effective length of the cathode, or it may be made conical; or the screening grid or anode may be conical; or more than one of these features may be used in combination.

Patent issued to Boonton Research Corporation.

REDUCING INTERFERENCE

*Convention date (Germany), 5th June, 1930.
No. 383298*

Brush and glow discharges across the insulating-supports used in the suspension of high-tension transmission lines are known to give rise to interference with broadcast reception, particularly during wet weather. The effect is reduced by fitting the insulators with a protecting ring of semi-conducting material, such as a mixture of graphite, synthetic resin, and carborundum, which offers a high resistance to the discharge current and damps both the initial and equalising surges.

Patent issued to Hermsdorf-Schomburg-Isolatoren, G.m.b.h.

GRAMOPHONE AMPLIFIERS

*Convention date (U.S.A.), 23rd August, 1930.
No. 383986*

In order to secure a desired and predetermined sequence of tone and volume control, each record is fitted with a series of slots which coact with control members and automatically adjust the settings of potentiometers P , P_1 , P_2 as the record is placed in position on the turntable. In addition the effective voltages across resistances R , R_1 in the input circuit of the first valve V are automatically

comprising a filter F_1 and detector D_1 . A second branch across the transformer T influences the output from an amplifier V_2 to operate a solenoid S , which adjusts the settings of a pair of condensers in a tone or band-pass filter F_2 inserted in the input circuit to the valve of the main amplifier.

Patent issued to J. H. Hammond, Jr.

BAND-PASS FILTERS

Application date, 18th September, 1931. No. 383352

The tuning-coils of a two-wave band-pass unit, particularly when mounted on a common support, are liable to exceed the optimum coupling-factor on the lower wave-range. According to the invention this difficulty is overcome by locating a partial screen between the coils, so that it is more effective on the low-waves than on the high, thus reducing the mutual inductance on the former setting. The method is applicable to arrangements covering more than two wave-bands.

Patent issued to L. E. T. Branch.

TELEVISION SCANNING-DISCS

*Convention date (Germany), 12th September, 1931.
No. 383946*

To reduce air resistance, and thereby the amount of energy required to apply an effective synchro-

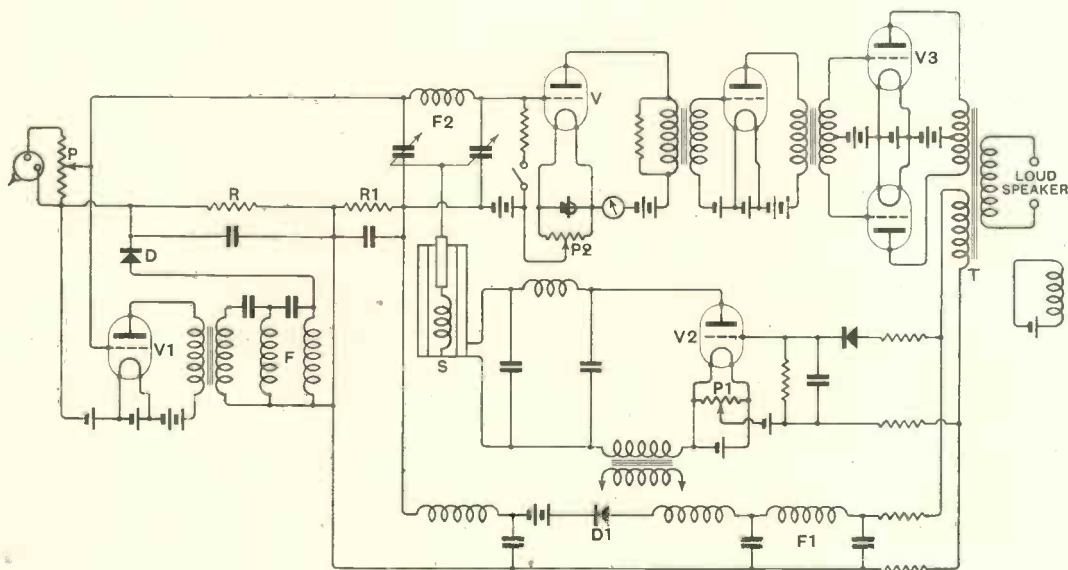

No. 383986

regulated to produce desired effects. For instance, the current through the biasing resistance R is determined by an amplifier V_1 , filter circuit F , and a detector D branched across the output from the pick-up. Similarly the current through the biasing resistance R_1 is regulated automatically in accordance with the output from the main amplifier V_3 through a transformer T , which energises a circuit

nising control, the scanning-disc is enclosed in a stationary casing which is fitted with glass panes in front of the spiral holes to allow the necessary passage of light. The casing is stream-lined to avoid the formation of eddy-currents, and is designed to reduce the total mass of air driven by the rotating disc to a minimum.

Patent issued to Fernseh Akt-ges.

AUTOMATIC VOLUME CONTROL

*Convention date (Germany), 2nd May, 1931.
No. 384178*

To avoid undesirable reaction between the input amplifier *V* and the detector valve *D* producing the "gain control" biasing voltage, the two are electrically separated by a local-oscillator valve *O*, the output of which is fed back to the high-frequency stage *V* through a transformer *T* and a dry-contact

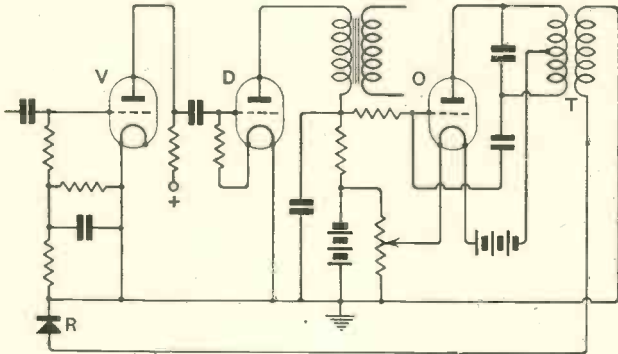

No. 384178.

rectifier *R*. The bias applied by the detector *D* to the oscillator *O* varies in accordance with the average amplitude of the incoming carrier-wave, and the output from the latter is used to vary the sensitivity of the input valve *V*. The action is preferably made intermittent by suitably adjusting the "threshold" bias of the valve *O*.

Patent issued to Siemens & Halske Akt.

VARIABLE RESISTANCES

Application date, 14th November, 1931. No. 383063

For controlling volume, it is frequently desirable to employ a "graded" resistance which gives a large resistance-variation when the contact-arm moves over one part of its surface, and a much smaller variation over another part. According to the invention a resistance strip of carbon-coated paper is coated with a layer of conducting-material, preferably gold, over a portion of the surface. The gold is "sputtered" on to the carbonised strip from the gold-encased electrode of a cathode-ray apparatus operated by an alternating potential of 1500 volts.

Patent issued to The Gramophone Co., Ltd.; F. B. Sargent; and T. C. Fimmimore.

MOVING-COIL SPEAKERS

Application date, 7th August, 1931. No. 383664

The speech coil for a dynamic loud speaker is made of strip or ribbon conductor wound in a flat spiral, the width of the strip being parallel to the axis of the coil. Adjacent coils are insulated from each other by a thin layer of the oxide of the metal forming the strip. The construction allows of a higher ratio of conductor to insulation than is

usual in the magnetic gap, and thereby increases the effective driving-force applied to the coil.

Patent issued to Kolster-Brandes, Ltd.; M. S. Hoban; and F. R. W. Srafford.

Application date, 13th October, 1931. No. 383376

The moving coil, or its sleeve or former, is centred between the magnet pole-pieces by balls of rubber, at least three in number, housed in recesses formed in the pole-pieces. The balls contact lightly with the coil, after the manner of ball-bearings, so as to allow longitudinal movement to occur, with only such degree of friction as puts a desirable elastic restraint on the coil. Patent issued to F. W. Lanchester.

POT-SCREENS

Convention date (Germany), 21st December, 1931. No. 383524

Pot-screens for valves, tuning-coils, etc., are constructed in two parts, one of which is firmly fixed to the baseplate or chassis of the set. The other and larger part is hinged at its lower end to the chassis, so that it can be swung back, away from the other part, to give easy access to the enclosed valve, etc., and to enable the latter to be removed without having to lift the screen bodily over it as usual—thus economising space. The two parts of the pot-screen are normally held together by a flexible clip or clamp.

Patent issued to Ideal Werke Akt fur Drahtlose Telephonie.

DIAPHRAGMS FOR LOUD SPEAKERS

Convention date (Holland), 14th July, 1931. No. 383921

It is desirable that the edge of a diaphragm supported around its circumference should have a certain degree of suppleness. To ensure this the edge is first deformed so as to produce concentric ribs, which are interrupted at intervals by plane portions. It is stated that, during vibration, the plane portions act as if they alone supported the sound-producing or middle part of the diaphragm, particularly if the latter is of conical shape.

Patent issued to N. V. Philips Gloeilampen-Fabrieken.

GRAMOPHONE PICK-UPS

Convention date (Germany), 31st January, 1931. No. 384107

In a pick-up of the kind in which a bar armature, surrounded by a fixed coil, carries the needle at one end and at the other end oscillates past (but not between) the pole-pieces, the faces of the latter are, according to the invention, curved so as to be centred about the pivotal axis of the armature. The armature may also be flattened at its upper end so as to concentrate the whole of the magnetic flux through the armature.

Patent issued to Ideal Werke Akt fur drahtlose Telephonie.

THERMIONIC VALVES

Convention date (Austria), 24th December, 1930.
No. 384099

The cathode of a valve is made emissive by means of an arc-discharge set up between a central heated filament and an associated "cold" electrode, which may be the inner wall of a cylinder, carrying an outer coating of electron-emitter. Or instead of a heated filament one or more "cold" electrodes may alone be used to create the arc-discharge. In all cases the arc-discharge is completely separated from the path of the electron stream through the valve.

Patent issued to J. Kremenetzky.

AIRCRAFT WIRELESS

Convention date (U.S.A.), 21st February, 1931.
No. 384470

Interference from the ignition system of an aeroplane motor M is balanced-out by a compensating voltage induced in an auxiliary aerial A_1 . The usual trailing aerial A is connected through a coil L and condenser C to an "earth" E on the chassis. The auxiliary aerial is connected through a phase-adjusting condenser C_1 to the low-potential end of the tuning coil L . The result is the balanced-bridge arrangement shown in (b), where C_2 re-

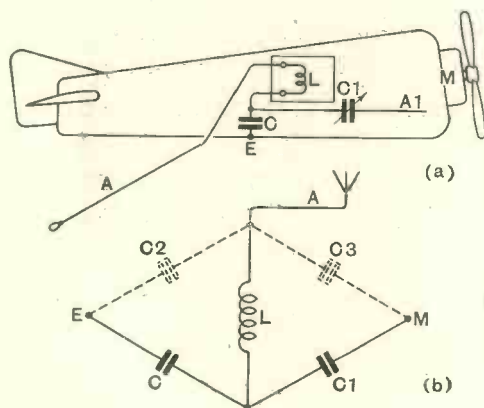

No. 384470

presents the "earth" capacity of the trailing aerial A , and C_3 the capacity between the motor M and the auxiliary aerial A_1 , the other references being the same as in (a).

Patent issued to Marconi's Wireless Telegraph Co., Ltd.

CATHODE-RAY TUBES

Convention date (U.S.A.), 24th December, 1930.
No. 384094

To ensure effective control of the cathode-ray emission by the relatively-low voltage derived directly from a radio receiver, an auxiliary anode is located between the control grid and the anode proper, and carries a voltage considerably lower

than that applied to the latter. The electrode assembly comprises an indirectly-heated cathode surrounded by a cap-like control grid. An auxiliary anode is carried in close proximity to the grid from the glass pinch through insulating beads, the anode proper being supported in turn through a spacing-ring of insulating material. Fine apertures are made at the centre of the grid, the auxiliary anode, and the anode proper, to allow the passage of a concentrated pencil of cathode rays.

Patent issued to Marconi's Wireless Telegraph Co., Ltd.

WIRED WIRELESS SYSTEMS

Convention date (U.S.A.), 25th February, 1931.
No. 384121

In a system for receiving programmes at a central station and relaying them in high-frequency form to a number of "service" points located in the different rooms of an apartment house or hotel, the transmission line is aperiodic and consists of a loaded cable with a central insulated conductor and an outer ground conductor. At each tapping point, series resistance and capacity are connected to the side of the conductor at high radio-frequency potential, so as to prevent undesirable interaction between the various receiving sets.

Patent issued to Marconi's Wireless Telegraph Co., Ltd.

TELEVISION SYSTEMS

Application date, 22nd June, 1931. No. 384346

Alternating-current impulses of triangular or "peaked" form are used for synchronising the local scanning-device with that used at the transmitter. The synchronising impulses are separated from the signal components, and set a back-coupled valve into oscillation at the synchronising frequency. This valve is coupled to a power amplifier, the output of which supplies the field windings of an inductor motor, the rotor and stator poles being specially designed to yield a driving torque of high efficiency from the form of current supplied. The power amplifier also serves to separate the motor electrically from the first valve, in order to prevent any load-variations from affecting the frequency generated by the latter.

Patent issued to W. W. Jacomb and Baird Television, Ltd.

CONSTANT-FREQUENCY GENERATORS

Application date, 23rd November, 1931. No. 384421

One quartz crystal is cut at right angles to the electrical axis so as to have a negative temperature-frequency coefficient, and a second crystal is cut parallel to the same axis so that it has a positive coefficient. The combination gives a constant frequency-response over a definite temperature-range. Each crystal is applied to the grid of a separate valve-oscillator, the anode circuit in each case being tuned to the characteristic frequency. Both outputs are then coupled to the grid of a common modulator valve, the summation frequency being filtered out in the anode of the last-mentioned valve.

Patent issued to E. Blackburn.

VOLTAGE DIVIDING RESISTANCES



*Fully described
in Bulletin
19-A.*

For many purposes where a potentiometer is required or where it is required to divide a potential drop in a known ratio, the Rayleigh form of potentiometer is convenient. This utilises two resistance boxes in series and the total resistance is kept constant. In this Voltage Dividing Resistance the switches have been designed to do this automatically. As resistance is introduced on one side of the dividing point an equal resistance is removed from the other side. In this way a potentiometer is obtained which may have any number of dials.

The Type 1 Voltage Dividing Resistances are made with one, two, three or four dials all of which have a total resistance of 10,000 ohms. The resistance elements are non-reactively wound for use at high frequencies.

by

MUIRHEAD
& CO. LTD.
ELMERS END . . . KENT

Kindly mention "The Wireless Engineer" when replying to advertisers.

UNIFORMITY

Meticulous care is taken to ensure that Erie Resistors meet the most exacting requirements. In every stage of manufacture they are subjected to every conceivable test to make certain of absolute uniformity. By using Erie Resistors you are assured of the very best resistors of fixed resistance value that the market offers.

Informative and interesting pamphlet free on request.

ERIE RESISTOR, LTD.
WATERLOO ROAD, CRICKLEWOOD, LONDON, N.W.2



ERIE RESISTORS



ERIE SPARK PLUG SUPPRESSORS effectively eliminate interference from the Spark Plugs and Distributors. The resistance unit is enclosed in a ceramic tube to protect it from oil, dirt and moisture, also from mechanical breakage.

Publishers

BINDING CASES

in Grey Cloth — for Vol. IX of

THE

WIRELESS ENGINEER

Price 3/-. By post 3/3

Volume IX, Bound Complete, £2. By post £2 : 1 : 0

Earlier Volumes can be supplied. Write for particulars to the Publishers.

ILIFFE & SONS LTD., Dorset House, Stamford Street, London, S.E.1

RICH & BUNDY

EXTRA HEAVY DUTY MAINS TRANSFORMER

MODEL W.211.

For use with Westinghouse Metal Rectifier H.T.11.

Secondaries. 300v. 550 m/a.
4 v.c.t. 2 amps.
4 v.c.t. 6 amps.

Full specification on request.

Price £3 . 10 . 0

Special Models supplied for Cinemas, Broadcast Relay, and Public Address work.

All RICH & BUNDY Mains Transformers for Radio are fitted with Screened Primary.

Every Transformer and choke an individual job. We welcome specialist work.

Full details of Mains Transformers, Output and Filter Chokes, Auto-Transformers and Output Transformers are given in our

NEW ART CATALOGUE "E."
May we send you a copy?

RICH & BUNDY LTD.,
Transformer Manufacturers,
New Road, Ponders End, Middx.

*Phone: Enfield 0777.

Sole distributors J.F.S. KELLY & SHIEL Ltd.,
47, Fleet Street, Dublin, C.4.

TANNOY

HIGH GRADE

**SOUND REPRODUCERS
P.A. LOUD SPEAKERS**

AND

**OTHER EQUIPMENT SUIT-
ABLE FOR HOTELS, DANCE
HALLS, SPORTS MEETINGS,
ETC.**

Full Details or Demonstration

1-7, DALTON ST., W. NORWOOD, S.E.27

Scottish Agents:—Messrs. Spensers (Scotland) Ltd.,
119, George Street, Edinburgh

PATENTS.

The Proprietors of British Patent No. 263,109, relating to "Electric Discharge Devices," are desirous of entering into negotiations with interested parties with a view to the exploitation of the invention either by sale of the Patent Rights or by the granting of Licences on reasonable terms. All enquiries should be addressed to Wm. Brookes & Son, No. 1, Quality Court, Chancery Lane, London, W.C.2.

[0271]

THE INSTITUTE OF WIRELESS TECHNOLOGY

(Incorporated)

1933 EXAMINATIONS

The Associateship and Associate Membership Examinations of the Institute of Wireless Technology will take place on the 29th and 30th June, 1933, in Edinburgh, London, Sheffield and South Africa, and at other centres if necessary.

Candidates taking either examination next year should obtain a copy of the revised regulations operating from the 1st of January, 1934.

Applications on Form E must be sent to the Secretary at 72, Oxford Street, London, W.1.

SITUATIONS WANTED.

Radio Engineer, age 21, experienced in all branches of radio. Well educated, with manufacturing experience. Requires situation. Box 6999, c/o W.E.

[0272]

PATENT AGENTS.

A. Mathisen, B.Sc., (Elect. Eng.), Specialist: Patents covering electrical radio inventions of high technical standard. Preliminary advice free.—First Avenue House, High Holborn, London, W.C.1.

[0268]

BOOKS on WIRELESS

Write for complete list to

ILIFFE & SONS LTD.,

Dorset House, Stamford St.,
London, S.E.1

W.E.17

WIRELESS
DIRECTION FINDING
 and **DIRECTIONAL RECEPTION**

By R. KEEN, B.Eng. (Hons.)

SECOND EDITION: (1927)

This volume deals with the principles of the subject and the constructional details of direction finding installations, and includes some information concerning aircraft installation. It describes the principles of Direction and Position Finding in such a way that the subject may be grasped easily by engineers tackling this field of wireless work for the first time. Numerous photographs and diagrams are included

Price 21/- net

By post 21/9

From leading booksellers or direct from the publishers:

ILIFFE & SONS LIMITED,
DORSET HOUSE, STAMFORD STREET, LONDON, S.E.1.

W.E.s.

RADIO DATA CHARTS

A SERIES OF ABACS

providing most of the essential Data required in Receiver Design.

By R. T. BEATTY, M.A., B.E., D.Sc.

Reprinted from "The Wireless World."
 (1930)

"Radio Data Charts" provide designers of wireless apparatus with a ready and convenient means of solving problems without having recourse to complicated formulæ and mathematics.

By the use of the charts it is possible to tackle all the more familiar problems in radio receiver design; such as, for example, finding the relationship between inductance capacity and frequency, and working out the design of high frequency transformers. All keen experimenters will appreciate this helpful book.

Price 4/6 net.

By post 4/10.

(39 CHARTS and more than 50 Diagrams.)

From all leading booksellers or direct from the Publishers.

Published from the Offices of "THE WIRELESS WORLD."

ILIFFE & SONS LTD., Dorset House, Stamford St., London, S.E.1.

W.E.11

Kindly mention "The Wireless Engineer" when replying to advertisers.

“THE WIRELESS WORLD”

The weekly journal which keeps its readers thoroughly in touch with all that is happening in wireless. It covers every wireless interest and appeals to every wireless amateur.

It is in every sense a wireless newspaper, for it records and reviews prevailing theory and current practice in design, and also gives, week by week, broadcasting and other general news.

Special features are: Theoretical Articles discussing new principles: Detailed Technical Reviews of Commercial Radio Receivers: Designs for Experimental Receivers specially prepared to illustrate the practical application of new principles in valves, components, or circuit arrangements: *The complete weekly programmes of all Foreign Stations.*

The Wireless World

EVERY FRIDAY 4d

Subscriptions:

Home & Canada, 21.1.8, other Countries
Abroad, 21.3.10 per annum, post free.

ILIFFE & SONS LIMITED DORSET HOUSE STAMFORD STREET LONDON S.E.1

W.E.4